

JANUARY

25 CENTS

POPULAR MECHANICS

MAGAZINE

WRITTEN SO YOU CAN UNDERSTAND IT

REG'D. TRADE MARK GREAT BRITAIN No. 410426

REG. U.S. PAT. OFF.



SEE PAGE 11

ATKINS SILVER STEEL SAWS

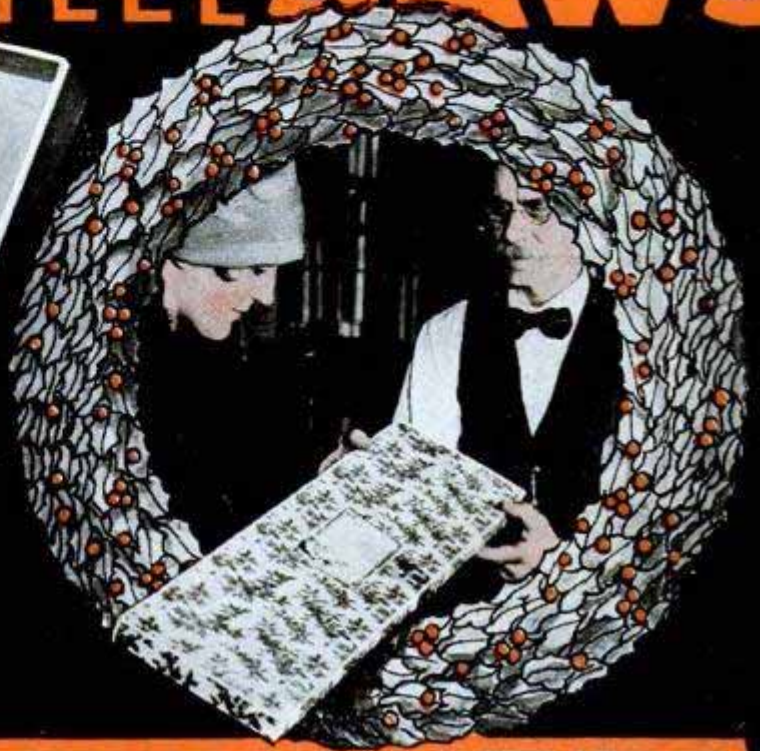
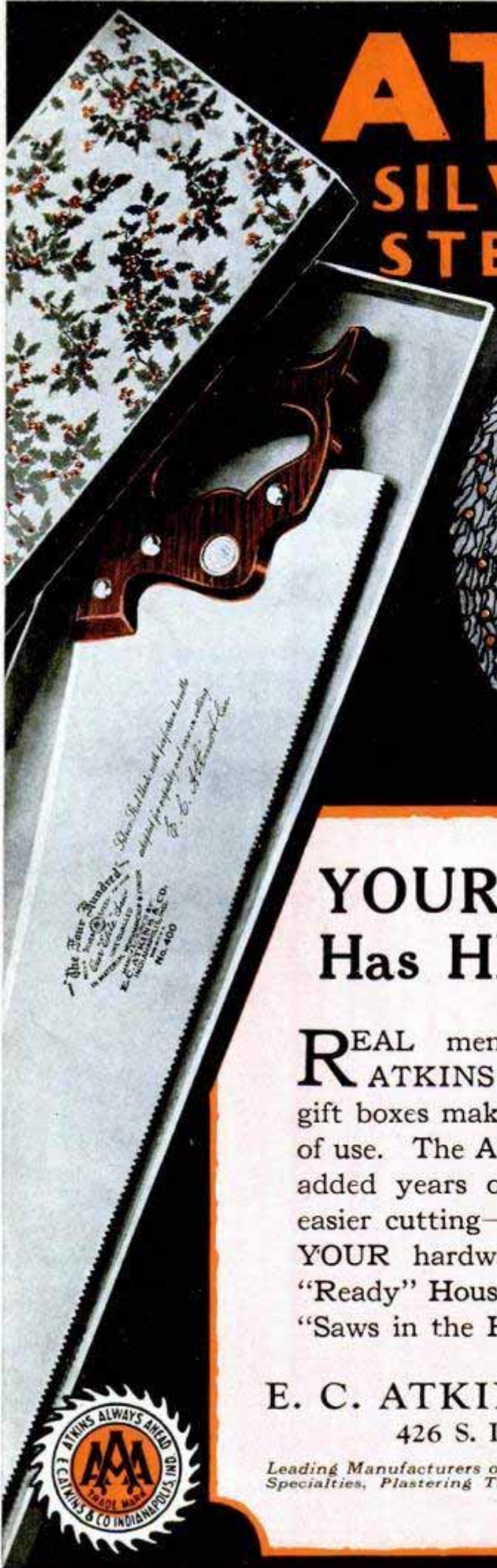

YOUR Hardware Store Has HIS Christmas Gift!

REAL men and boys want good tools. ATKINS "Silver Steel" Saws in holiday gift boxes make practical presents for a lifetime of use. The ATKINS name on the blade means added years of service, as well as faster and easier cutting—the best saw you can buy. Ask YOUR hardware dealer about the ATKINS "Ready" Household Kit, or write for free folder, "Saws in the Home."

E. C. ATKINS & CO. Established 1857
426 S. Illinois St., Indianapolis, Ind.

Leading Manufacturers of Highest Grade Saws for Every Use; Saw Tools, Saw Specialties, Plastering Trowels, Machine Knives, Grinding Wheels and Files.





“No sir-eee!
... we know
our skates”

“**M**AGINE that! He says those old skates are as good as **NESTOR JOHNSONS**.” Bud snickered. Jim and Bill thought it was a good joke, too.

The dealer smiled gently. “Well, boys, since you know so much about skates, tell me the difference between the **NESTOR JOHNSON** and this one.” He pointed at a skate on the counter.

Jim proudly held his skates up. “That’s easy! Look here—see how perfectly balanced my **NESTOR JOHNSONS** are? See how they set on the shoes—just right—and riveted so as not to come loose.” He pointed to the insole. “And look here—this solid leather arch supporting counter comes clear under the instep and holds the foot straight when I skate.”

“My Dad—he had **NESTOR JOHNSONS** when he was a boy. Believe me, he knows steel! He says the reason **NESTOR JOHNSONS** stay sharp longer is because of the high carbon crucible tool steel used in the runners—the same steel

they use in fine knives.” Bud chimed in. “Yeah, Jim’s right. Frank bought a pair of those old skates you have there—and Gosh, they don’t hold an edge at all!”

He turned towards the door. “Come on, fellows—let’s go over to Mack’s. They got real **NESTOR JOHNSONS**—and that’s what I want.” The boys slung their skates over their shoulders, and started out.

“Hey—wait a minute,” the dealer shouted after them. “I’ll have some genuine **JOHNSONS** Monday. Come in, and I’ll fit you out.”

But Jim hollered back: “Can’t wait that long—not while it’s skatin’ weather, and ice is three inches thick!”

Through the frosted window-pane, the dealer watched them cross the street to Mack’s Hardware store. “It beats all how these boys learn so fast,” he mused. “Guess they must learn by experience—anyway, they sure do know their skates.”

.. Yes, they do know Their Skates!

The Boys of today are wise on skates—just as wise as the Boys of 1892. They are the hardest of judges to please—they have tested and tried skates like no expert can. That’s why they have insisted on **NESTOR JOHNSONS**, the original tubular skate, the best for thirty-five years.

Trust the Boys—they do know their skates. Let their choice be your choice this winter. When the snow is glistening and the air has a frosty tang, the ice is mirror-smooth—come join the crowd. Thrill as you have never thrilled—on “Wings of Steel”; skate as you have never skated—on **NESTOR JOHNSONS**. Tubular steel makes the difference. Alive, full of vitality, light in weight,

amazingly durable and strong—it has made champions and won championships for the last 35 years.

JOHNSONS are made for men, women, boys and girls in racer and hockey styles. Hockeys for general skating. Racers for speed skating.

NESTOR JOHNSON NORTH STAR. For those that want the best . . . \$11 and \$12.50 per pair, with Shoes
NESTOR JOHNSON FLYERS. \$8 per pair, with Shoes
JUNIOR JOHNSONS. . . . \$7.00 per pair, with Shoes

If your dealer has no **NESTOR JOHNSONS** left—write us.

JOHNSONS
Trade-mark Reg. U. S. Pat. Off.
WINGS OF STEEL

⌈ Beware of imitations. To be sure of getting the original and genuine **JOHNSON** Skates, look for the full name, **NESTOR JOHNSON**, on the skate. ⌋

NESTOR JOHNSON MFG. CO.
1900 North Springfield Ave., Chicago, Ill.

- Please send me this year’s catalog on Nestor Johnson skates.
 Enclosed is twenty cents in stamps. Please send me a pair of **JOHNSON** Buck woven laces and a skate pin.

Name **This One**

Add

City



OKYF-GQ7-G5H9

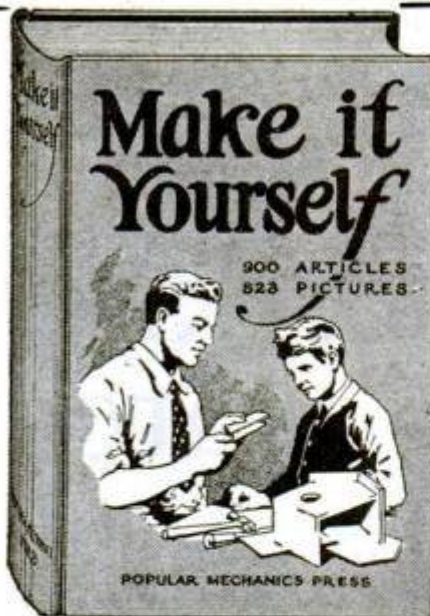

Do You Enjoy Making Things?

If so, you should have a copy of this new book just published by Popular Mechanics entitled

Make It Yourself

The home mechanic, whether young or old, amateur or professional, will take pride and delight in making many of the things described therein.

Both father and son will find fascination and an association of interest in making useful and ornamental articles for mother to admire upon their completion.

900 Articles All Different

There are attractive ship models, a great variety of toys that operate themselves by means of an ingenious application of mechanical principles, novel amusement devices for indoors and outdoors, for both water and land, unique designs in furniture for children, scores of useful appliances for the home, things of beauty and utility for lawn and garden, etc.

Special articles instruct the amateur mechanic in the care and use of tools, special tools for special purposes, how to read and use plans, how to solder, the making of a handy work bench, cuts, joints and methods in woodworking, automobile repairing, installing radio equipment, house wiring, fixture hanging, working in glass, leather, metal, celluloid, lathe work, utilizing parts of old machines to make equipment that would be expensive to buy, etc.

Some of the Articles:

Tools for the Home	Monorail Coaster
Mechanic	Writing Cabinet
Ship Model Maker's Tools	Workbench
Build Your Own Ship Model	Tea Wagon
Ship Model Plans	Radio Apparatus
Water Sprite	Lawn Canopy
Puzzles	Camp Car
Crazy Clown	California Cooler
Walking Wampus	Musical Instruments
Winter Toboggan Slide	Hedge Trimmer
Colonial Bric-a-Brac	Homemade Baseball Game
Merry-Go-Twist	Small Turbine Motor
Wiggling Pup	Tools from Sewing Machines
Black Cat Bench	Small Valves
Christmas Toys	Bench Lathe
Skating Whirligig	Auto Glare Shield
Venetian Swing	Sesaw Merry-Go-Round
Bird Houses	Ferris Wheel

480 Pages—823 Illustrations. Price \$3.00
Size 7x10x1 1/2 in. Cloth Binding

Mailed Postpaid upon receipt of price anywhere in the world. If you reside in U. S., Hawaii, Porto Rico, Alaska or Mexico, we will send the book by mail C. O. D. if you prefer. Simply pay postman when he delivers the package.

POPULAR MECHANICS PRESS (ROOM P-1)
200 East Ontario St. Chicago, Ill.



BOYS

It's Fun to Make Things



Let the other boys wonder how you can make so many interesting things. Make your own automobile. Make your own radio. Make your own kites and gliders. You can learn how to make almost anything that any boy could want by following the pictures and the simple directions in

The Boy Mechanic Library

And just think of it, there are nearly 4,000 separate articles in the four beautiful volumes! Some of the most fascinating subjects are listed below:

How to Make Things

Boats	China painting
Winter sports	Decorative metal work
Camping	Furniture making
Ice boats	Farming
Water sports	Poultry
Toboggans	Models
Tents	Laboratory helps
Skis	Household helps
Indian snowshoes	Wood working
Skating	Electrical devices
Gymnasium	Photography
Wind wagons	Music
Motor sleds	Outdoor games
Radio	Stoves
Magic	Furnaces
Trapping	Wireless
Pets	Tricks
Leather work	Puzzles
Carpentry	Bicycle
Painting	Flowers
Toys	Hunting
Fishing	Kites
Fruit growing	Metal working tools
Entertainments	Secret locks
Automobile	Swings
House decorations	Sleds
Drafting	Power devices

Buy the complete library, including Book 1, Book 2, Book 3 and Book 4 for \$7, thus saving \$1 as single volumes are \$2. If you want individual books at \$2 each order by number 1, 2, 3 or 4.

When the postman delivers the books to your door, pay him the price of the books and the postage. That is all. If outside U. S. remit when ordering and include 28 cents per volume extra for postage.

POPULARMECHANICS PRESS.
200 E. Ontario St.
Room P-1 CHICAGO, ILL.

Popular Mechanics Magazine

200 E. Ontario Street, Chicago, U. S. A.

H. H. WINDSOR, Founder

H. H. WINDSOR, Jr., Editor and Publisher

London: Hachette & Cie.,
16-17 King William Street, Charing Cross, W. C. 2

Paris: Hachette & Cie.,
111 Rue Reaumur

Melbourne: Gordon & Gotch
509-513 Little Collins St.

ISSUED MONTHLY

SUBSCRIPTION:

SINGLE COPY, 25 CENTS

In United States and its possessions, also Canada, Cuba, and Mexico, per year, postpaid - \$2.50

To all other countries in the Postal Union - 3.00

All subscriptions are discontinued at expiration. Please examine the date printed on your wrapper.

Entered as Second Class Matter Sept. 15, 1903, at the Post Office at Chicago, Illinois, under Act of March 3rd, 1879.

Entered as Second Class Matter at the Post Office Department, Canada.

Published monthly by POPULAR MECHANICS CO.

Copyright, 1928, by Popular Mechanics Co.

Copyright in Australia. Copyright in France

Vol. 49

Contents for January, 1928

No. 1

Accidents—traffic, the most dangerous hour	90	Crime—rogues' gallery of movies to help catch crooks	58
Acrobat—Berlin, loops the loop on his head	100	Dance Hall—like monoplane is resort novelty	79
Airplane		Disease	
automatic steering gear increases safety	33	camera shows how eyes reveal	63
brake on propeller to aid in landings	58	menace of fly's footprints revealed by microscope	109
British Schneider cup winners carry ballast	4	weird image health guards abandoned in Korea	120
made more stable with vane controls	54	Doughnuts—cooked at table in electric mold	94
"sea flea" for ocean flight develops high speed	81	Earthquakes—thousands a year	8
to fly straight up	10	Egg Timer—sandglass, rings bell when done	78
Ambergris—wealth from	43	Electric Generator—giant "hoop" for, is marvel of	
Amusement Parks—there's money in it, but—	59	welding	105
Aquarium—used as rural church	71	Electricity—electrical "man" obeys voice on phone	6
Archæology—digging up Bible lands	26	Electric Lights—plug in ceiling socket aids in cleaning	
Architecture—artistic brick buildings show German		lamps	96
skill	87	Electric Power—load fluctuations shown by solid model	112
Army—portable footbridge of pipe aids drills	113	Elephants—royal Indian wear gem-studded robes	41
Army Maneuvers—blanketing the sky with curtain of		Engine—burns oil and water	16
death	95	Eyes—40,000 glass used yearly in U. S.	25
Art		Fair—taxicabs and camels meet at oriental	72
models in glass	15	Fingerprints—duplicated with machine	103
pictures chiseled in brass latest fad	41	Fire Engine—tractor fitted as, for forest service	3
Automobiles		Fire Fighting—spray nozzle on hose to reduce damage	99
gearless car run on turbine principle	63	Fire Prevention—in the home shows good housekeeping	100
springs as long as the car add comfort	54	Fish and Fishing	
striping made easy with pencil painter	81	catching big game fish from small boats	73
Automobiles—Accessories		fish from tropics travel in luxury to zoo	72
baggage carriers like car body	46	the stickleback fans its young to supply oxygen	105
compressed-air jack operated by turn of wrist	7	wrecking of old ships urged to improve fishing	63
disappearing bed adds comfort	17	Floods—caging behind steel and concrete	47
folding luggage trunk serves as trailer	98	Flooring	
heated windshield wiper	57	low-cost parquetry, easily laid	64
map like roller shade	119	maple, beauty shown by stain	42
Automobiles—Driving		Flowers—"sick" revived by artificial sunlight	89
ball in tube tests brakes	39	Football—stop watch to end disputes	115
"game" tests skill	45	Furniture	
limitless-speed highway in Italy	9	is heavier in summer	114
overhead straps warn of crossings	40	toy cardboard, child can build	120
Automobiles—Equipment and Supplies		Garage	
battery filler keeps water at right level	99	electric hands move cars in tall	106
glare shade for mirror aids safer driving	96	in electric liner latest travel aid	119
Automobiles—Lighting—light shines around curves	10	Gas—to be made at coal mines and piped to cities	79
Automobiles—Tires—air-service station eliminates		Gas Mask—efficient as diver's helmet	7
gauge	74	Gold	
Aviation		giant nugget kept by bank as reserve	18
dummy flyers help make air safe	104	that turns black, found in Australia	63
flexible-cable landing light prevents damaging plane	64	Gold Mining—eight-cent digger earns millions	75
flying boat links Hamburg to London	115	Grapes—canning aided by stem remover	89
life raft inflated by gas as parachute drops	86	Grass Seed—"fiddle" that sows helps golf-course keeper	4
to be helped by movies of air currents	64	Guns—trigger guard prevents bruised fingers	93
Awning—adjusted to sun to protect goods	88	Hay Fever—victims aided by pollen collectors	65
Basket Ball—without lacing	16	Hearing—tester of children's	54
Bears—hunting with camera	82	Household Devices	110
Blotters—black, for banks, to defeat forgeries	7	House Plan	176
Boats and Boating—rowing drill in one-man tank	107	Hydroglider—steered by motors, to cross Atlantic	96
Bridge—new \$30,000,000 for New York	57	Ice—chemical used to freeze water pipe	48
Building Material—excelsior blocks for homes	109	Ice Cream—weird architecture helps sell	101
Cactus Apples—raised for jelly and candy	46	Imagination—putting to work	50
Cafe—in form of large shoe recalls nursery rhyme	103	Industry—center of	7
Calculating Machine—solves problems too deep for		Insulation—removed from wire by timesaving tool	72
brain	15	Jewels—that aided Columbus valued at half million	80
Canaries—that sing jazz gain in popularity	115	Kite—shaped like monoplane	119
Church—ancient, built without nails	55	Laundry—uses steel boxes to collect packages	17
Cigaret—that lights itself	9	Life—oldest living things	41
Clock		Light—invisible used at garden fete	40
floral, helps draw trade	87	Locomotives—sixty-five years of progress in	56
sway of high building stops	103	Lumber—skylining our	11
Cookstove—concealed in cabinet, reduces odors	114	Lunch Car—moved on giant casters	48
Cotton—rival seen in ancient plant	25	Mail—air, dropped from plane for forest patrol	85

Roll House Castle

Seaplanes must

[Continued on Page 4]

make 10 papers 49

Mirrors—help deaf children learn to talk	79	Voice—defects in speech recorded to aid speakers	8
Money—air driers speed output of	96	Volcano—model is feature of exhibit	25
Moving Pictures		Washbasin—for industrial plant, pedal saves time and water	57
camera and projector take pictures on paper	89	Washer—has even grip to defeat vibration	53
of birds and insects teach flying secrets	55	Wasps—raised to fight codling moth	42
waves made with boxes	48	Water Pipes—why hot freeze more readily than cold	119
Museum—Philadelphia art, millions spent on curves that fool the eye	32	Weather—insects are prophets	107
Navy—U. S., breaking the world's big gun record	66	Weather Vane—grasshopper, honors business man	64
Occupations—the most dangerous jobs	49	Whales—tagged to aid study of habits	80
Ocean—Monaco, home of its story	97	Wood—walnut trees grafted for beautiful grain	86
Oil—search for, leads to sea on California coast	113	Workers—produce more today despite shorter hours	46
Orchids—grown under glass rival tropic kin	49	Zoo	
Pansy—four-inch blossoms	58	animals' health guarded by special weather	74
Playground Apparatus—fire escape as child's slide	25	sailors' pets form collection	99
Police—models help teach street location	39	sight-seeing bus for small boys	86
Radio—short waves cast shadows	1		
Radio—Aerials—ball antenna kit	124		
Radio—Applications—voice starts and stops train	112		
Radio—Batteries			
five dollars builds A-battery and charger	121		
homemade fuses on cable	124		
snap terminals on leads	130		
testing kink	131		
Radio—B-Eliminator—resistance C-bias for B-eliminator	133		
Radio—Condensers—fixed midget easy to wire	133		
Radio—Installation—efficient radio ground	134		
Radio—Pictorial	125		
Radio—Receivers			
bunched leads for sharp tuning	132		
controlling tone and volume	133		
selectivity feature of aero-dyne six	127		
superheterodyne kink	132		
Radio—Repairs—trouble-shooting kinks	134		
Radio—Tubes			
light-sensitive	136		
new tube is self-neutralized	135		
output impedance for power tube	131		
power tubes used as detectors	132		
Razor—safety, blade moves like mower's	10		
Reindeer—herds of Alaska to supply future meat	102		
Rubber			
longer life for, seen in new treatment	78		
as upholstering substitute for springs	114		
Saws—motor bone, saves work for butcher	120		
Seasickness—gas latest cure	4		
Sewage Gas—as fuel to drive electric generator	94		
Shale—makes concrete light without strength loss	114		
Sharks—ship hunts sea terrors to make shoes	108		
Shaving Accessories—lather bulb replaces brush	33		
Ships and Shipping			
running a seagoing hotel	18		
speed boat to cross Atlantic in four days	8		
when a ship is arrested	65		
Siphon—employs bulb to start and stop	71		
Skin—registers emotions	79		
Skyscrapers—have they reached their limit?	34		
Sled—with roller runners speeds over bare ground	74		
Slippers—paper, given to hotel guests	45		
Smokers' Accessories—pipe cleaning set in holder carried like pen	113		
Smokestack			
kept dark to protect birds	46		
outline hidden with steel framework	57		
Snowflakes—icy jewels of winter storms	116		
Statue—Lincoln shown as lawyer	89		
Steel—better and cheaper, by new process	103		
Sugar			
from wood	99		
used as medicine in early ages	88		
Swimming			
bathers' push wheel adds sport	88		
spinning wheel adds sport	33		
Taxes—aerial maps cut city	17		
Television—fashion designs by radio	42		
Tires—faults revealed by superspeed photos	81		
Tongs—to remove clinkers save coal and dirt	14		
Toothbrush			
rotary, aids dental hygiene	39		
with replaceable head, cleans between teeth	100		
Towels—hotel, are popular souvenirs	120		
Toys			
endless track for train, novel window display	107		
miniature castle doll house	17		
Traffic—street guide, at curve, saves extra police	94		
Trousers—protected from storms by waterproof covers	86		
Tunnel—ten-mile under-sea (Japan)	16		
Typewriting—chart to teach, saves students' time	112		
Umbrella—growing handles	45		
Vacuum Cleaner—hand-size, simplifies housework	99		

AMATEUR MECHANICS

Aquarium—top for	153
Automobiles	
eliminating alcohol odors	152
locking Ford windows	151
Automobiles—Driving—natural gas for starting	142
Automobiles—Repairs—lamp for locating short circuits	141
Baby Chair—non-tipping	141
Bicycle—with auto steering wheel	156
Clock—how to level	156
Clothes Hanger—moth-proof	151
Clothesline—detachable reel	140
Door—silencer for sick room	151
Kitchen—filing cabinet aid in	152
Latches—for outside cellar doors	150
Lath—spraying speeds work	155
Mirror—campers' shaving	152
Paste—to squeeze from tubes	140
Photography—loading box aids field work	153
Rat Trap—simple way of deodorizing	141
Ship Models—"Flying Cloud"	143
Skating—skate-sailing is thrilling sport	137
Sled—barrel stave	151
Snowslides—prevented by wire loops	155
Soap Bubbles—blowing giant	142
Valve Springs—uses for old	155
Wool—how to shrink darning	141

SHOP NOTES

Aluminum	
etching on	175
how to mend with zinc	174
Automobiles	
double wheels conquer soft dirt	158
packing for Ford window glass	163
Automobiles—Repairs—restoring contact of third generator brush	175
Automobiles—Tires—vulcanizing inner tubes	173
Belting—softening hard leather	170
Coal—easily built portable bin	175
Commutator—tool for cleaning	164
Crankcases—machine for lapping	162
Crucible—improvised electric	170
Draftsmen	
accurate perpendiculars with a 2-foot rule	169
a timesaver for	159
reading glass for	163
Drawings—protected from being soiled	161
Drilling—vertical holes without drill press	163
Dumb-Waiter—how to build	171
Eave Trough—combination hanger	164
Fertilizer—continuous for the garden	161
Furnace—easy way to fill water pan	163
Garage—Equipment and Supplies—small crane	173
Gaskets—renovating copper asbestos	173
Handle—to operate two cocks	162
Hay—baled, dolly for handling	169
Iron—drilling chilled cast	169
Lathe—fitting, to do job requiring larger swing	175
Paints—effective tool for stirring	160
Pipe	
unscrewing thin tubing	174
well, removing driven	170
Piston—ring compressor	162
Pliers—have stop for bending wire	161
Potato—better plants	174
Pump—old, making new	165
Sandpaper—using in plane	161
Saw Frame—farm, uses for	160
Saws and Sawing—case for the tool chest	174
Tank—hot-water, insulating	157
Vegetables—handy containers for store	159
Wire—coiled by aid of copper pipe	172

ean with rubber tips 161

an cleaner 159

You &
number of
country.
From them
Popular M
advantage
would ra

DRAKE'S PRACTICAL MECHANICAL BOOKS

THEY WILL RAISE YOUR PAY—

ORDER ON 5-DAY TRIAL

Steel

The books listed below will perfect you in your chosen trade—pave the way to the big positions. Written in non-technical language—easy to read and understand. Every book covers its subject completely. **entire course of instruction condensed into one volume.** Your choice sent postpaid—you **benefit 5 days—money refunded in full if not entirely satisfactory.** Order direct from this page.

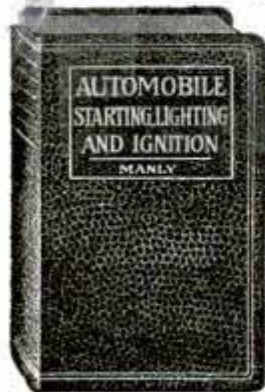

Automobile Books

- Automobile Starting, Lighting and Ignition, by Manly... 700 pp. **\$3.00**
- Brookes' Automobile Handbook... **\$2.00**
- Ford Motor Car, Truck and Tractor, by Manly... Cloth **\$1.50**
- Automobile Battery, Care and Repair, by Manly... Leatherette **\$2.00**
- Motorcycle Handbook, by Manly... **\$1.50**



Shop Practice Books

- Practical Heating Systems, Trouble Jobs and Ventilation... **\$4.00**
- Sheet Metal Workers' Manual... **\$2.00**
- Oxy-Acetylene Welding and Cutting... Cloth **\$1.25**
- Slide Rule and Logarithmic Tables... **\$2.00**
- Handbook for Millwrights... Cloth **\$2.00**
- Machine Shop Practice... Cloth **\$2.00**
- Mechanical Drawing and Machine Design... Cloth **\$2.00**

ORDER DIRECT FROM THIS PAGE—ON OUR MONEY-BACK PLAN

The books listed above are only a few of the many in our catalogue, which you will receive promptly after filling out and mailing us the attached coupon. For quick action order direct from this page—cross name of each book wanted and send in with price quoted. We'll repay postage and send the books on our money-back plan.

FREDERICK J. DRAKE & CO.

Publishers

1008 Michigan Ave. CHICAGO

Drake Books Are For Sale at All Book Stores

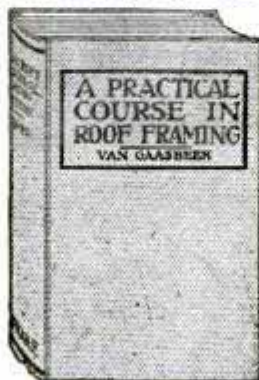

Carpentry Books

Cloth Binding

- Modern Carpentry, 2 vols... **\$3.00**
- The Steel Square, 2 vols... **\$3.00**
- Modern Estimator... **\$1.50**
- Timber Framing... **\$2.00**
- Builders' Architectural Drawing... **\$2.00**
- Concretes... **\$1.50**
- Practical Bungalows... **\$1.00**
- Roof Framing, by Van Gaasbeek... **\$1.50**

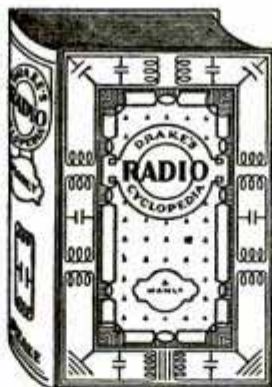

Drake's Radio Cyclopeda

By H. P. Manly

870 Pages, 985 Illustrations, 1700 Subjects, arranged alphabetically. For Service and Repair Men, Dealers, Salesmen, Experimenters and Designers. Bound in Art Buckram. Price... **\$6.00**



Painting and Decorating

- Furniture, Furniture Finishing, Decoration and Patching... **\$5.00**
- Ross Crane Book of Home Furnishing and Decoration... Cloth **\$3.00**
- House Painting Methods with the Brush and Spray Gun, by Vanderwalker... Cloth **\$2.00**
- Interior Wall Decoration, by Vanderwalker... Leatherette **\$4.00**
- The Mixing of Colors and Paints, by Vanderwalker... Cloth **\$2.00**
- Studio Handbook—Letter and Design... **\$3.00**
- A Show at Sho' Cards... Cloth **\$4.00**
- Sign Painting, by Atkinson... Cloth **\$4.00**
- Strong's Book of Designs, Leatherette **\$4.00**
- Modern Painters' Cyclopeda... Cloth **\$2.00**
- Automobile Painting... Cloth **\$1.50**
- New Hardwood Finishing... Cloth **\$1.50**
- Wood Finishing, Plain and Decorative... Cloth **\$2.00**
- Owen's Paint Guide... Cloth **\$1.00**

Steam Engineering

- Swingle's Handbook for Steam Engineers and Electricians... Leatherette **\$4.00**
- Examination Questions and Answers for Marine and Stationary Engineers... Leatherette **\$2.00**
- Steam Boilers... Leatherette **\$2.00**
- Swingle's Catechism of Steam, Gas and Electrical Engineering... Leatherette **\$1.50**

Modern Languages

- By Prof. P. S. Allen, U. of Chicago
- French without a Teacher... Cloth **\$1.25**
- Spanish without a Teacher... Cloth **\$1.25**
- German without a Teacher... Cloth **\$1.25**
- Everyday French... **\$1.25**
- Everyday Spanish... **\$1.25**

FREDERICK J. DRAKE & CO.
1008 Michigan Avenue
Chicago, Ill.

GENTLEMEN:—Please send me free, postage paid, your illustrated catalogue which lists and describes 200 Practical Mechanical Books for Home Study.

My name is

and my address

Mail Coupon For Free Catalogue
Your Guide to Home Study

"Were You Born a Money-Maker?"

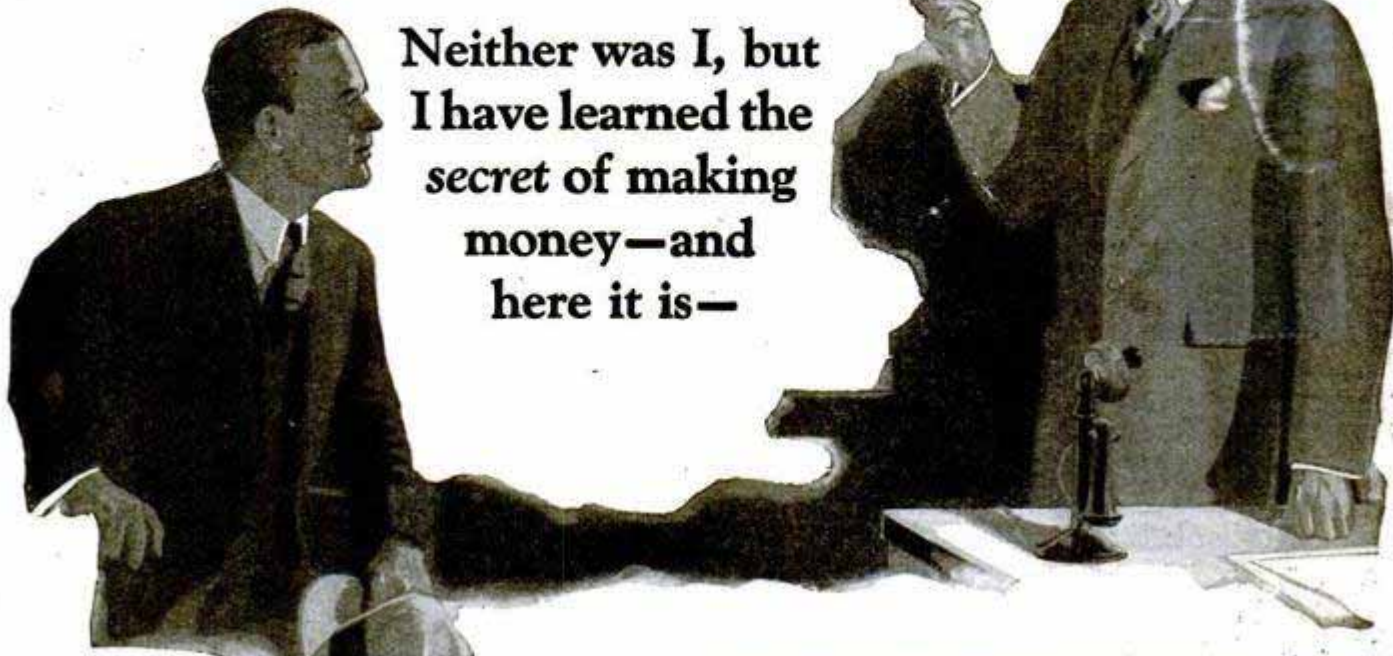

Neither was I, but I have learned the secret of making money—and here it is—

I'M going to let you in on a little secret, Tom. It ought to be worth at least \$5,000 a year to you, and I'm not going to charge you a single penny—

"When I was your age, I was always wondering why the boss never seemed to take much interest in me. Every six months or so I would hit him for a 'raise'—and once in a great while I would get an extra \$5 a week. But the big jobs—the jobs that paid real money—always went to someone else.

"Then something happened that set me thinking—

"Bob Harris, who had started at the same time I did, was promoted to the very job I had picked for myself—salary \$6,500. I knew Bob didn't have any more natural ability than I had—yet the fact remained that he got the place. And I had to admit he was better able to swing it!

"Well, I took myself aside, and for the first time in my life I looked the situation squarely in the face. That night I clipped and mailed a LaSalle coupon.

How He Landed the Big Job

"And now came the big surprise—for me, at least.

"I had always looked upon home-study business training as drudgery. Inside of three weeks, however, I actually got to *looking forward* to those different lesson assignments. You see, instead of reading a lot of heavy, theoretical stuff, I took up case after case that represented *actual business problems*. I was shown the principles that governed them; *then I worked them out for myself*. It fascinated me, because I could actually see myself grow.

"First thing I knew, I received my first real 'raise'—then a better job—and a better one yet—

"I told you I was going to let you in on a little secret. Well—the secret is this: Always give a little more than you're paid for. And—so that you can be *sure to give more, first get more to give!*"

Send for These Free Books—They Tell You How

You want to make more money—as soon as possible—with the least lost effort.

Then there's one thing you should do immediately—you should send to LaSalle Extension University and find out how you can turn that secret into cash.

During only six months' time—as a direct result of putting that secret into practice—as many as 1,248 LaSalle members reported definite salary-increases totalling \$1,399,507—an average increase per man of 89 per cent. *Find out how you can duplicate or even exceed this record.*

To aid you in this purpose, LaSalle has prepared two very interesting and helpful books and will send them to you without cost or obligation. One is a 64-page book outlining the opportunities in the business field that most appeals to you—telling you exactly how you can turn them to your own advantage. The other has marked the turning point for thousands. It is entitled, "Ten Years' Promotion in One."

Face your problem—decide the field in which you want to make a big success—then fill in, clip and mail the coupon NOW.

— — — — Find Yourself Through LaSalle! — — — —

LaSalle Extension University

The World's Largest Business Training Institution

Dept. 164-R Chicago

I would welcome an outline of the LaSalle plan, together with a copy of "Ten Years' Promotion in One," all without obligation.

- Business Management
- Modern Salesmanship
- Higher Accountancy
- Traffic Management
- Railway Station Management
- Law: Degree of LL. B.
- Commercial Law
- Industrial Management
- Modern Business Correspondence
- Credit and Collection Correspondence
- Telegraphy

- Banking and Finance
- Modern Foremanship
- Personnel Management
- Expert Bookkeeping
- Business English
- Commercial Spanish
- Effective Speaking
- C. P. A. Coaching
- Stenotypy—Stenography



Name

Present Position

Address

BUILDERS TRADE GUIDES



4 Vols. \$6

AUDELS CARPENTERS AND BUILDERS GUIDES—4 VOLS. \$6

Inside Information for Carpenters, Builders, Joiners, Building Mechanics—all Woodworkers. **1600 pages; 3700 diagrams; flexible; pocket size.** Short-cut instructions, new methods, ideas, solutions, plans, systems—money saving suggestions. An easy progressive course for the apprentice. A practical daily helper and Quick Reference for the master worker. A Helping Hand to Easier and Better Work and Better Pay. To get this aid for yourself, simply fill in and mail the FREE COUPON below.



How to use steel square; How to file and set saws; How to build furniture; How to use mitre box; How to use chalk line; How to use rules; How to make joints; Carpenters' arithmetic; Mensuration problems; Estimat-

ing strength of timbers; How to set girders and sills; How to frame houses and roofs; How to estimate costs; How to build houses, barns, garages, bungalows, etc.; How to read and draw plans; Drawing up specifications; How

to excavate; How to use settings 12, 13 and 17 on the steel square; How to build hoists and scaffolds—skylights; How to build stairs; How to put on interior trim; How to hang doors; How to lath—lay floors; How to paint.

"Audels Guides worth four times their price—handy too as I carry them in pocket for reference." W. J. Bates, Knoxville, Pa.

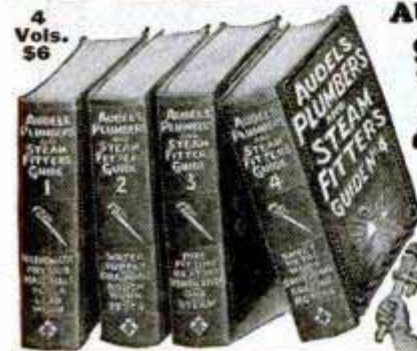

4 Vols. \$6

AUDELS PLUMBERS AND STEAMFITTERS GUIDES—4 VOLS. \$6

A new set—just out! A practical, illustrated, Reference Library and Study-Course for Master Plumbers, Journeymen and Apprentice Steamfitters, Gas Fitters and Helpers, Sheet Metal Workers, Draughtsmen, Master Builders, Engineers and all Building Trade Students. **1670 pages; 3642 diagrams; flexible; pocket size.** Guides explain all the principles, advances and short cuts of the Plumbing and Heating trade. Contains instructions on how to figure and estimate jobs. Use FREE COUPON below to examine, without obligation, this valuable work.



Soldering, tinning. Joint wiping, bending, beating. Pipe—iron—steel, threading. Mathematics, tables, physics. Materials—iron, steel, copper, brass, lead, tin, antimony. Sheet metal—galvanized—plate. Sanita-

tion, syphonage, tanks. Drainage, sewage, purification. Fixtures—bath—kitchen. Pipe fittings, soil pipe, tools. Laying out work. Roughing. Screwed fittings, flanges, joints. Pipe bending, examples. Elbows. Heating, ven-

tilation, refrigeration. Water supply, mains, wells, tanks. Gas-fittings. Underwriters. Sheet metal work, problems, methods, brazing, heating, lead burning. Welding, various welds, methods. Blacksmithing, forges, tools.

"Audels Guides are practical, easy to understand, reliable. Cover the field in plain language." W. F. Arnsinger, Annapolis, Md.

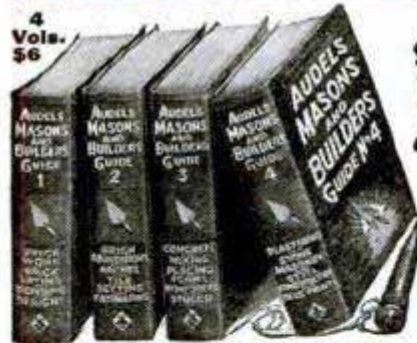

4 Vols. \$6

AUDELS MASONS AND BUILDERS GUIDES—4 VOLS. \$6

A new, complete, illustrated trade reference library, for Bricklayers, Cement Workers, Plasterers, Tile Setters and Stone Masons, including a practical outline of Steel Construction. **1100 pages; 2067 diagrams; flexible; pocket size.** A practical Trade Assistant explaining modern methods of masonry construction. Easy to understand and apply. A reliable and authentic reference work and study-course for Master Journeyman and Young Mechanic. Use FREE COUPON below and find out for yourself, without obligation, whether this set will benefit you.



Bricklaying, tools, materials; Brick designs, patterns, bonds; Setting frames and foundations; Mortars, scaffolds, estimating; Mortars and mortar mixing; Tile setting, mosaic, hollow tile; Straight edge test, trow-

eling; How to figure brick work; Safe loads, piers, chimneys; Boiler settings, anchors, fire stops; Labor tables; Concrete, forms; How to figure concrete work; Stucco—on old and new buildings; Plastering—wood lath—metal;

Plasterers agreement; Plastering on various surfaces; Stonemasonry; Cutting, finishing, estimating stone; Derricks, rigging; Steel construction; Fire proof; How to read blue prints.

"Audels Masons Guides are the best books on the subject. Have laid brick 12 years and am able to judge." H. A. Senneker, Cortice, Pa.

PRACTICAL ELECTRICITY — 1 VOL. \$4

Audels Handy Book of Practical Electricity is a simplified Ready Reference and Study Course in one pocket size, leather bound volume—for Engineers, Professional Electricians and Students. **1040 pages; 2600 diagrams; flexible red leather bound.** A reliable authority and handy helper for every electrical worker. Contains important and valuable wiring diagrams, calculations, machine sketches, helps on maintenance and repair. Use this FREE COUPON today and find out, without obligation, how this handy book will help you in your daily work.



Complete in one handy, red leather bound volume



1040 Pages 2600 Diagrams

INSIDE TRADE INFORMATION ON:

Electro-Therapeutics, X-Rays, Shoeks, Welding, Brazing, Radio Hook-ups, Motion Pictures, Telephone, Telegraph, Cranes, Bells, Elevators, Pumps, Tools, Ship Drive, Railways, Vehicles, Automobile Electric Systems, Ignition, Generation, Lighting, Plant Management, Power Plans, Armature Winding, Repairing, A. C. Motors and Apparatus, D. C. Motors and Apparatus, Alternator Construction, Dynamos, Wiring Diagrams, Sign Flashers, Cable Splicing, Power Wiring, Outside Wiring, Switches, Lighting, Rectifiers, Converters, Transformers, Fuses, Circuit Breakers, Rheostats, Electro Plating, Electrolysis, Storage Batteries, Magnetism, Electrical Energy, Conductors, Insulators, Static, Dynamic, Radio Electricity, Applications. Ready Reference and Index Covering the entire field of Modern Electricity.

Learn More and You Will Earn More!

Know your job and you'll never be without one. The skilled man is always in demand. Knowledge is power. Learn your trade thoroughly by easy reading. This coupon is your opportunity for advancement and better pay. You risk nothing in sending for Audels Guides for free examination. Send it NOW!

FREE EXAMINATION COUPON

THEO. AUDEL & CO.,
65 W. 23 ST., NEW YORK CITY
Please mail me for free examination the books marked (x) below. If I find them satisfactory, I agree to mail \$1 in 7 days, on each set ordered, and to further mail \$1 monthly on each set until I have paid the purchase price.

- 4 CARPENTERS GUIDES \$6
- 4 PLUMBERS GUIDES \$6
- 4 MASONS GUIDES \$6
- 1 ELECTRICIANS HANDY BOOK \$4

NAME

ADDRESS

OCCUPATION

EMPLOYED BY..... 1T3C

Be an AUTO EXPERT

I Train You At HOME

up to EARN \$5000 A YEAR

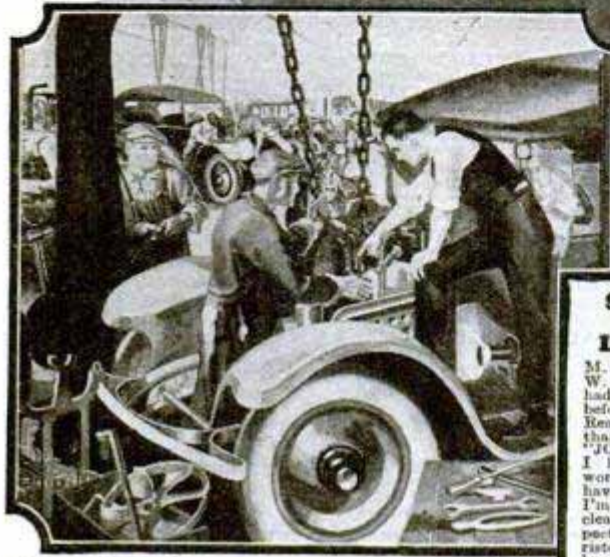

Start to Make Money Quick Like Morrision

M. J. Morrision, Parkersburg, W. Va. (photo at right), never had a day's experience on cars before starting my training. Read what he says when less than half-way through his "JOB-WAY" course. "What I have already learned is worth over \$500 to me. I have gone into business and I'm making over \$50 a week clear, with wonderful prospects." And what Mr. Morrision and hundreds of others have done I will help you to do!



M. J. MORRISON, Parkersburg, W. Va.

Clip this Coupon Now for my Big FREE AUTO BOOK

4 repair & testing OUTFITS INCLUDED

The World's biggest, most fascinating business needs you!

You needn't slave away at small wages another minute—mail coupon and I'll tell you how I train you at home in your spare time for positions paying up to \$150 a week. Unlimited opportunities for trained Electrical and Mechanical Auto Experts. Let me show you how my "JOB-WAY" training has prepared hundreds of men just like yourself for a quick, brilliant success in the Auto business.

No Other "JOB-WAY" Training!

My training includes ALL Electrical work—Ignition, Starting, Lighting—ALL Mechanical end, Welding, Brazing, Vulcanizing—also Business Course—also Monthly Magazine, also 4 Testing and Repair Outfits. Nowhere else I know of, can get you ALL this.

Tools and Test Bench Equipment Included

I supply every Cooke JOB-WAY student with 4 big, complete, costly outfits absolutely free of extra cost! Many students use these outfits to make money shortly after starting my training. Mail coupon for this remarkable offer!

Earn Up to \$150 a Week!

Don't sell your time for low pay! You don't need to when you have my "JOB-WAY" training. As Directing Engineer of this Institution I know what training you need to succeed, AND I GIVE YOU THAT TRAINING right in your own home. MASTER every branch of Auto, Truck and Tractor work. I train you with JOBS—not books. I bring the original "JOB-WAY" training TO YOUR HOME!

Read My Agreement!
Ten agreements in my big free Auto book. No. 1 is "I will refund every cent of your money if after receiving my training you are not absolutely satisfied." This and nine other wonderful agreements make my "JOB-WAY" course the training for you! Be sure to get my book and read all ten agreements.

Experience, Education Not Needed!
I don't care how little schooling you have, I will train you to become an Auto Mechanic or refund your money! Boys and men of all ages have become Garage owners and managers, Superintendents, Foremen, Auto Experts, BIG PAY executives, after completing Cooke "JOB-WAY" training. I prove to you that I will prepare you to take advantage of the many wonderful opportunities of the great auto business!

Get My Big Book Quick!

I will send it to you without one penny of cost. Read all the facts, find out about the demand for trained Auto Experts. Let me tell you how easily and quickly you, too, may become an Auto Expert. Splendid offer right now to ambitious men. Coupon brings complete information. Mail it today!

MAIL THIS COUPON NOW!

Free Auto Book

B. W. COOKE, Directing Engineer, Chicago Motor Training Corp., Dept. 116, 1916 Sunnyside Avenue, Chicago. Send me FREE your Big Auto Book "Auto Facts" and proof that you will train me in spare time at home. Also reserve 4 Outfits without obligating me.

Name.....

Address.....

City.....State.....

Address Me Personally **B. W. COOKE** DIRECTING ENGINEER
CHICAGO MOTOR TRAINING CORPORATION
 1916 Sunnyside Ave., Dept. 116, CHICAGO, ILL.

What Will You Be Doing One Year From Today?

Three hundred and sixty-five days from now—what?

Will you still be struggling along in the same old job at the same old salary—worried about the future—never quite able to make both ends meet—standing still while other men go ahead?

One year from today will you still be putting off your start toward success—thrilled with ambition one moment and then cold the next—delaying, waiting, fiddling away the precious hours that will never come again?

Don't do it, man—don't do it. There is no greater tragedy in the world than that of a man who stays in the rut all his life,

when with just a little effort he could bring large success within his grasp.

Make up your mind today that you're going to train yourself to do some one thing well. Choose the work you like best in the list below, mark an X beside it, mail the coupon to Scranton, and we will send you, without cost or obligation, the full story of what the I. C. S. can do for you.

Right now you can decide where you will be this time next year.

Common sense will tell you that it is far better to send in this Success Coupon today than to wait another precious year and then wish you had!

INTERNATIONAL CORRESPONDENCE SCHOOLS

"The Universal University"

INTERNATIONAL CORRESPONDENCE SCHOOLS, Box 5695-E, Scranton, Pa.

Without cost or obligation, please send me a copy of your booklet, "Who Wins and Why," and full particulars about the subject *before* which I have marked X:

BUSINESS TRAINING COURSES

- | | | | |
|---|--|--|---|
| <input type="checkbox"/> Industrial Management | <input type="checkbox"/> Cost Accounting | <input type="checkbox"/> Business Correspondence | <input type="checkbox"/> Civil Service |
| <input type="checkbox"/> Personnel Organization | <input type="checkbox"/> Bookkeeping | <input type="checkbox"/> Show Card Lettering | <input type="checkbox"/> Railway Mail Clerk |
| <input type="checkbox"/> Traffic Management | <input type="checkbox"/> Secretarial Work | <input type="checkbox"/> Stenography and Typing | <input type="checkbox"/> Common School Subjects |
| <input type="checkbox"/> Business Law | <input type="checkbox"/> Spanish <input type="checkbox"/> French | <input type="checkbox"/> English | <input type="checkbox"/> High School Subjects |
| <input type="checkbox"/> Accounting and C.P.A. Coaching | <input type="checkbox"/> Salesmanship | <input type="checkbox"/> Advertising | <input type="checkbox"/> Illustrating |
| | | | <input type="checkbox"/> Cartooning |

TECHNICAL AND INDUSTRIAL COURSES

- | | | | |
|--|---|--|--|
| <input type="checkbox"/> Electrical Engineer | <input type="checkbox"/> Gas Engine Operating | <input type="checkbox"/> Architect | <input type="checkbox"/> Chemistry |
| <input type="checkbox"/> Electric Lighting | <input type="checkbox"/> Civil Engineer | <input type="checkbox"/> Architects' Blueprints | <input type="checkbox"/> Pharmacy |
| <input type="checkbox"/> Mechanical Engineer | <input type="checkbox"/> Surveying and Mapping | <input type="checkbox"/> Contractor and Builder | <input type="checkbox"/> Automobile Work |
| <input type="checkbox"/> Mechanical Draftsman | <input type="checkbox"/> Metallurgy <input type="checkbox"/> Mining | <input type="checkbox"/> Architectural Draftsman | <input type="checkbox"/> Airplane Engines |
| <input type="checkbox"/> Machine Shop Practice | <input type="checkbox"/> Steam Engineering | <input type="checkbox"/> Concrete Builder | <input type="checkbox"/> Agriculture and Poultry |
| <input type="checkbox"/> Railroad Positions | <input type="checkbox"/> Radio | <input type="checkbox"/> Structural Engineer | <input type="checkbox"/> Mathematics |

Name.....

Street Address..... City.....

State..... Occupation.....

If you reside in Canada, send this coupon to the International Correspondence Schools Canadian, Limited, Montreal

You Daring Young Men Seize Life's Biggest Thrill!



The famous "Spirit of St. Louis" which flew from New York to Paris in the memorable non-stop flight May 20-21. Wide World Photo.

Get into Aviation

WHAT thrill could compare with this—what sport could bring you the tingling, breath-taking adventure of this fascinating, new occupation—the game for men with sporting blood! See life—win applause—thrills—big money—step into a field of excitement and daring—away from the monotony of tame, narrow humdrum everyday life!

Think what Aviation offers you. Thrills such as you never had before! The praise and plaudits of the multitude. And a chance to get in on the ground floor where rewards may be unlimited!

Amazing Opportunities

Aviation is growing so swiftly that one can hardly keep track of all the astonishing new developments. Air mail routes have just been extended to form a vast aerial network over the entire U. S. Airlines and airplane factories are springing up all over the country. Men like Henry Ford are investing millions in the future of commercial Aviation in America! The possibilities are so tremendous that they stagger imagination!

Everything is set for one of the greatest booms in history. Big fortunes came out of the automobile industry and out of motion pictures. Big fortunes will also come out of Aviation. The development of Aviation as an industry is bringing with it a call for trained men. Those who qualify quickly should find themselves on the road to

unusual earnings—success—popularity—and prominence.

Easy to Become an Aviation Expert

Get into this thrilling business at once while the field is new and uncrowded. Now—by a unique new plan—you can quickly secure at home, during spare time, the preliminary training necessary to get a start in the Aviation Industry. Experts will teach you the secrets—give you the inside facts that are essential to your success. And the study of Aviation by our method is almost as fascinating as the actual work itself. Every lesson is chock-full of interest—and so absorbing that you actually forget you are studying. But best of all are the ultimate rewards you are fitting yourself to gain.

Send for FREE Book

Send the coupon for our new, free booklet—*Opportunities in the Airplane Industry*. It is unusually interesting, reads like a romance, and gives vital facts about Aviation you probably never even dreamed of. You owe it to yourself to at least read it. We offer you a free copy now. No obligation. Mail the coupon for yours today.

American School of Aviation

Dept. 1351
3601 Michigan Ave.
Chicago, Illinois

NOW FREE



PICK YOUR JOB!

- Flying
- Airplane Repairman
- Airplane Mechanician
- Airplane Inspector
- Airplane Salesman
- Airplane Assembler
- Airplane Builder
- Airplane Pilot
- Airplane Instructor
- Airplane Contractor
- Airplane Engineer
- Aerial Photography
- Aerial Advertising

American School of Aviation,
Dept. 1351, 3601 Michigan Ave.
Chicago, Ill.

Without any obligation please send me your FREE book, *Opportunities in the Airplane Industry*. Also information about your course in Practical Aviation.

Name.....Age.....

Address.....

City.....State.....

Come To Chicago A Resident School

**28 Years
of
Success**

**Will Teach
You
Practical
ELECTRICITY!**

In 90 Days—No Books—No Lessons!

My new sure method of training will teach you Electricity in 90 days by practical work on actual Electrical machines—right here in the World's Greatest Electrical Center. You learn by actual work. An instructor is constantly by your side. He shows you step by step each minute detail. He carefully explains every move. First thing you know, you can do the same yourself. You will be amazed at the ease with which you learn.

New \$2,000,000 Home

My school is now located in the new \$2,000,000 home. Many thousands of dollars' worth of new equipment has just been installed. You learn on this new equipment—the very latest of its kind in America. You wind real armatures; you build real batteries; you work on real switchboards; you wire real houses—in fact—everything you do is on real equipment. No books! No lessons! Everything is action. You can't keep from learning, so real is everything.

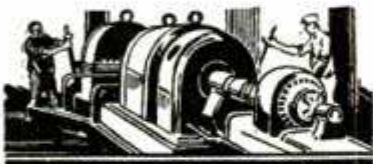

Get My Big Book—FREE!

Now is the time to act. You are ambitious. You want to get ahead. Then fill out the coupon and mail it today. I will rush to you my big 56-page book containing 150 photographs of actual scenes taken in my classrooms. This is your big opportunity. And another thing: You get the benefit of a real Employment Service that is lifetime.

Act NOW — Don't Gamble With The Future!

My Course Includes Training in **Aeroplane Electricity**

COYNE Electrical School

Not a Correspondence School

H. C. LEWIS, Pres., Dept. 18-72
Established 1899

500 South Paulina Street, Chicago

Get a Big Pay Job

I don't care if you have not had an advanced education or how little experience you have had, you can learn Practical Electricity in 12 short weeks and be prepared for the big pay class after Graduation. Constantly throughout the country there is always a demand for Practical Electrical Experts. Many of the World's largest Electrical Organizations endorse the Coyne Electrical School. Coyne men throughout the nation are making \$50.00 a week and up. Others in business for themselves are pulling down \$3,000.00 a year and up. You can't afford to stick in a small \$25.00 a week job and wait for those small raises, a slave to your boss.

Remember—No Books—No Lessons

Absolutely no books or lessons. After you enter my class you will work on real equipment. Fascinating work—preparing yourself for a big position in the World's Greatest Industry. As each day goes by you will feel within yourself the great power of the TRAINED MAN. Then you will step out and join the big pay class with a wonderful future before you.

Mr. H. C. Lewis, Pres.

**COYNE ELECTRICAL SCHOOL, Dept. 18-72
500 S. Paulina St., Chicago, Ill.**

Dear Mr. Lewis: Without obligation send me your big free catalog and all details of Free Employment Service, Radio, Aeroplane and Automotive Courses that are included and how you will help me "earn while learning." I understand I will not be bothered by any salesman.

Name

Address

City State

The Auto Painter



Is "Sitting on Top of the World" Today!

You men, looking for something better—**MORE MONEY!** You can make the most money in Auto Painting. Here is the biggest uncrowded field in the world today. Prove it to yourself by the next 20 cars you see. Yes, sir, 17 out of 20 need painting.

I will have you ready in a few months

Now—how many auto painters do you know? . . . I thought so. Well, who's going to do the work? You are—after you get the right training and you're going to make more money than you ever dreamed of! The world is looking for trained auto painters. Cash in on this big demand!

You Can Own Your Own Business!

Yes you can! With the information I supply you, you can make your dream come true. You can be the head of your own establishment. In auto painting it's no trick to be your own boss—own your own business and be independent!

You don't have to start out with the biggest building

on the busiest corner. You can begin small with little or no capital, but I don't know of another business where you can get big so fast. We show you how to open your own shop.

Now—Make 60 to 90 Dollars a Week!

Why plod? There are jobs that pay real money waiting for men that know what I have to teach you. After you get my training you can get a job anywhere. You can travel and know at your destination there will be a job waiting for you that pays big money. Remember—I don't forget you when you complete the course. I help you get a real job. You also get a life

consultation service without extra charge. 17,000,000 cars need painting. Just imagine! There are t-w-e-n-t-y f-i-v-e m-i-l-l-i-o-n cars in the U. S. alone—and 17 million need priming, surfacing, painting, ducoing, varnishing, striping and the whole works—and take it from me, I teach you the whole works so you can get in on the **BIG MONEY**—or I'll refund every penny of the small price you pay.

I realize that you are up against quite a problem in deciding what field to enter, but on my say-so, and my guarantee to you, just come into auto painting with me and you'll be glad of it all your life. Men like yourself who have taken my advice are now making \$5,000 to \$10,000 a year.

PROOF

Chicago Duco says: "Skilled Duco men are scarce. We can place many at \$1.00 to \$1.25 an hour." Binks, one of the largest auto equipment manufacturers, says: "The big auto manufacturers are insisting that their dealers repaint all used cars." Stockton, Illinois, says: "No shop here. All work must go to Freeport. Believe plenty of work to make paying business." Nash says: "This is a big field and splendid opportunities for your graduates in repainting cars." Many, many more like these.

Send Coupon for

**G. King Franklin, Supt.,
American Auto Painting School,
Dept. 1001, 425 S. Ashland Ave., Chicago.**

Send sample shop-tickets free and information on how I may learn auto painting and Duco at home in spare time.

Name.....
Street No.....
City.....
State.....

FREE BOOK

LEARN at HOME!

And the beauty of my proposition is that you can learn at home in your spare time—evenings—and keep your present job while learning. By my **SHOP-TYPE METHOD** you learn quickly and easily—the greatest advance in home study training assures you success—no car needed—work on wood and metal panels which we furnish you! 13 big outfits of standard tools and materials given without extra charge—
Get information now! Don't wait. Get my big illustrated booklet **FREE**—you will not be obligated—



G. KING FRANKLIN, Supt.

**American Auto Painting School
Dept. 1001, 425 So. Ashland Avenue, CHICAGO**

AUTO

5 AUTO BOOKS SENT FREE!

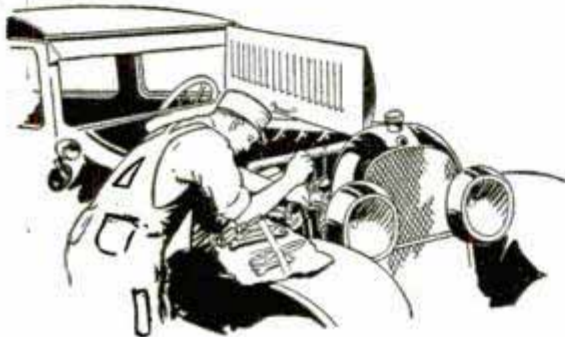

Mail the coupon and we'll send you a set of these remarkable auto books, just off the press. Whether you are mechanic or helper, expert or student, auto owner or driver, if you're interested in autos, by all means take advantage of this opportunity to see the latest and most complete work on autos we have ever published. Built by eighteen of America's greatest automotive engineers. Simple enough for men with little schooling to understand, yet in daily use by hundreds of engineers, service-station superintendents and foremen as an authoritative REFERENCE Cyclopedic. This new edition includes straight-eights, 4-wheel brakes of all types and other features of the 1928 models.

Put the **JIFFY INDEX**

to work for you!

Can You FIX IT?

Can you take out "play" in differential? Can you kill the "Shimmy" in steering? Can you reset TIMING? Can you put your finger on engine trouble without guessing or tinkering? Can you pull the starter off and fix it? Can you adjust and repair transmission, engine, rear axle, bearing?

These Books Tell How!

They bring the answer to any auto problem instantly. And they show the best, quick, professional way to do EVERY repair and replacement job you will ever need. Auto owners say the cost is saved over and over again by showing how to make adjustments and emergency repairs on the road.

5 Big De Luxe Volumes just off the press!

2400 pages, over 2000 illustrations, wiring diagrams, equipment charts, etc. De Luxe edition with gold-stamped flexible binding. Sent FREE for 15 days' use. If not wanted return express collect. If kept, send only \$2 after 15 days, then \$3 a month until special advertising price, \$24.80, is paid.

A Year's Consulting Membership FREE!

Privilege of consulting engineers of million-dollar American Technical Society on any automotive problem for one year without charge, if you mail coupon immediately.

American Technical Society



Dept. A-119, Drexel Ave. & 58th St.,

CHICAGO, ILL.

The billion-dollar auto industry offers rich prizes to men with gumption enough to really learn all branches of automotive mechanics. A better job, bigger pay—a chance to go into business and get a share of the huge profits, are waiting for any man who even half tries to improve his ability to deliver service. And here's the shortest, easiest way: No tedious studying, no memorizing, no lessons or examinations. Just LOOK UP the fact you seek. You'll find the answer to any auto problem literally at your finger-tips, in the famous JIFFY INDEX. No need to "carry it in your head," at all.



"Was garage hand—now have Shop of my own," writes W. Sidle of Toboso, O.

J. H. Geise of Detroit says: "I received \$50 worth of information out of them the first 5 days."

"I got a raise," says P. Ervin of Yarmouth, N. S., shortly after getting his books.

And D. S. Reid of Siluria, Ala., was offered \$4000 for invention worked out with these Auto Books.

Dont Send a Penny!

AMERICAN TECHNICAL SOCIETY,
Dept. A-119, Drexel Ave. and 58th St., Chicago, Ill.

I would like to see the new 5-volume edition of your AUTO BOOKS, but without obligating me to buy them. I will pay the few cents delivery charges only, but if I choose to, I will return them express collect and owe you nothing. If after 15 days' use I prefer to keep them, I will send you \$2 and pay the balance at the rate of only \$3 a month, until \$24.80 is paid. Please include free membership.

Name.....

Address.....

Employed by.....

Address.....

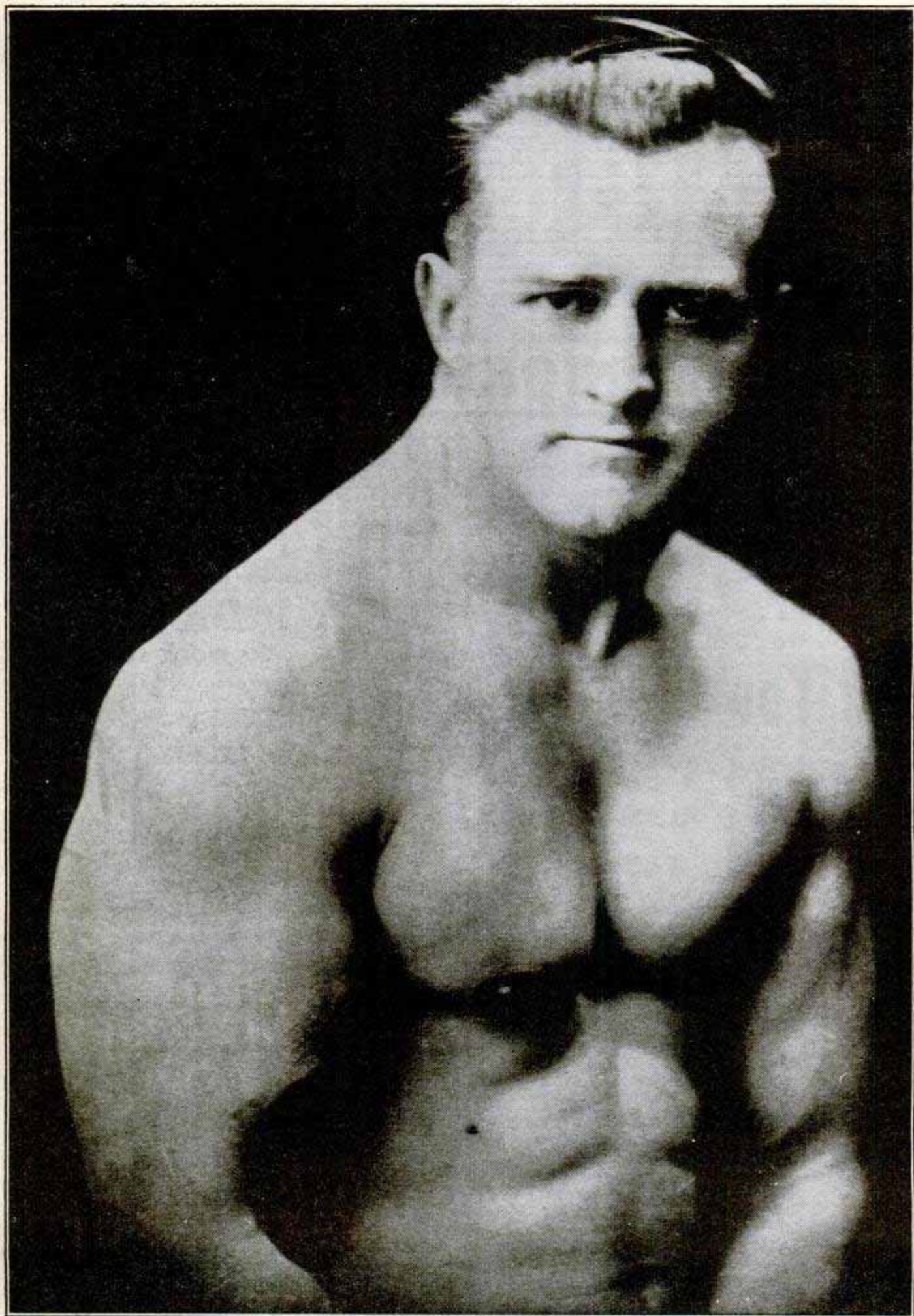

EARLE E. LIEDERMAN, *The Muscle Builder*
Author of "Science of Wrestling," "Muscle Building," "Secrets of Strength," "Here's Health," "Endurance," etc.

MUSCLES!

5¢ a piece!

Wouldn't it be great if we could buy muscles by the bag—take them home and paste them on our shoulders? Then our rich friends with money to buy them sure would be socking us all over the lots.

But they don't come that easy, fellows. If you want muscle you have to work for it. That's the reason why the lazy fellow never can hope to be strong. So if you're lazy and don't want to work—you had better quit right here. This talk was never meant for you.

I Want Live Ones

I've been making big men out of little ones for over fifteen years. I've made pretty near as many strong men as Heinz has made pickles. My system never fails. That's why I guarantee my works to do the trick. That's why they gave me the name of "The Muscle Builder."

I have the surest bet that you ever heard of. Eugen Sandow himself said that my system is the shortest and surest that America ever had to offer.

Follow me closely now and I'll tell you a few things I'm going to do for you.

In just 30 days I'm going to increase your arm one full inch. Yes, and add two inches to your chest in the same length of time. But that's nothing. I've only started: get this—I'm going to put knobs of muscles on your shoulders like baseballs. I'm going to deepen your chest so that you will double your lung capacity. Each breath you take will flood every crevice of your pulmonary cavity with oxygen. This will load your blood with red corpuscles, shooting life and vitality throughout your entire system. I'm going to give you arms and legs like pillars. I'm going to work on every inner muscle as well, toning up your liver, your heart, etc. You'll have a snap to your step and a flash to your eye. You'll feel the real pep shooting up and down your old backbone.

You'll stretch out your big brawny arms and crave for a chance to crush everything before you. You'll just bubble over with vim and animation.

Sounds pretty good, what? You can bet your old ukulele it's good. It's wonderful. And don't forget, fellow—I'm not just promising all this—I guarantee it. Well, let's get busy, I want some action—So do you.

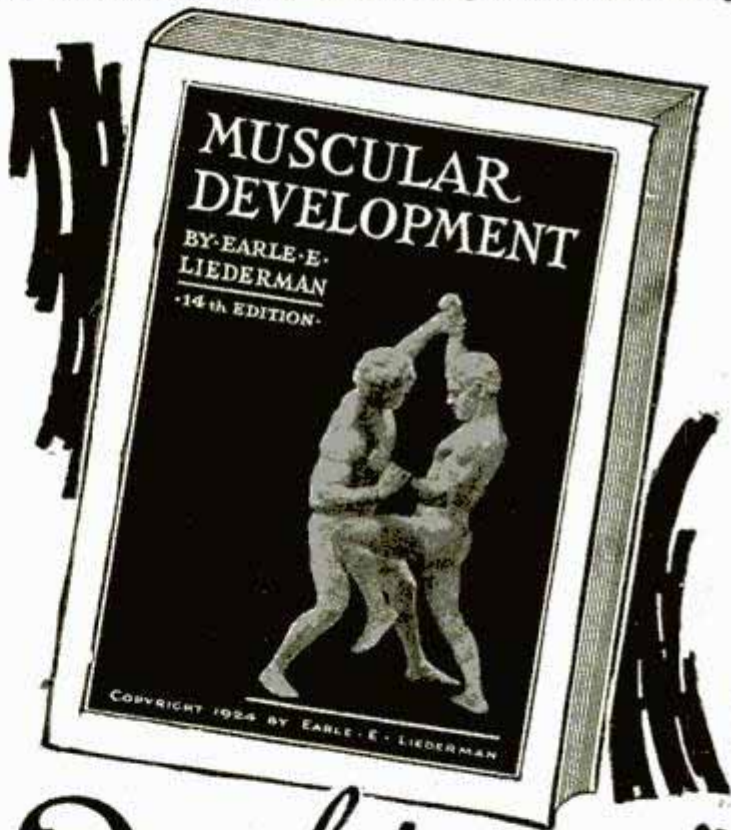

Send For My New
64 Page Book
"Muscular Development"
IT'S FREE

Do you get that? It's free. I don't ask a cent. It's yours with my compliments. Take it and read it. It's the peppiest piece of literature you ever flashed your glimmers on. And 48-full-page photos of myself and some of my numerous prize-winning pupils. This is the finest collection of strong men ever assembled into one book—look them over—doctors, lawyers, merchants, mechanics and every line of trade you can think of, I swear you'll never let this book get out of your hands again. And just think—you're getting it for nothing. Don't hesitate—there's no strings attached to it. Grab it.

Take your pen or pencil and fill out the coupon, or even your name and address on a postal will do—do it now before you turn this page.

EARLE E. LIEDERMAN

Dept. 2001 305 Broadway New York City

EARLE E. LIEDERMAN

Dept. 2001, 305 Broadway, New York City

Dear Sir:—Please send me absolutely free and without any obligation on my part whatever, a copy of your latest book, "Muscular Development." (Please write or print plainly.)

Name

Address

City State

From \$30 a Week Bookkeeper to \$150 A Week as Owner of Dental Laboratory



WILLIAM CLAYTON
McCarrie Graduate

And His Own Dental Laboratory

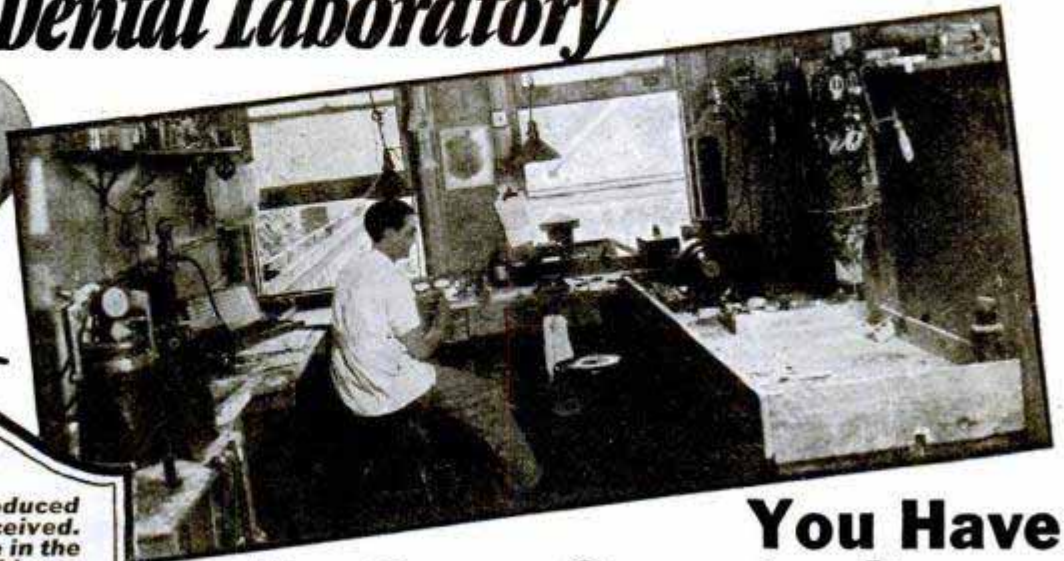

The following is reproduced from a letter we received. The original is on file in the McCarrie School in Chicago

Dear Mr. McCarrie:

I was bookkeeping up until January, 1924, at \$1500 per year, and while having lunch one noon, I picked up a "Popular Mechanics" and ran across your ad, which fascinated me very much. Although making a good living at the time, I was not entirely satisfied, so I wrote for your literature.

Upon receipt of the above, and having read it very thoroughly, I could not help but admit I was quite enthused. Two weeks later I arrived at your school. Completing the course in August, I returned home where I received a position in a laboratory. After a few months' experience, I got connected with Dr. L. with whom I stayed two years, resigning my position to open a laboratory of my own, October 15, 1926. I have ten dentists on my list which net me about \$150.00 of business per week, with business increasing rapidly.

Thanking you hardly expresses my appreciation of your most thorough course. Your promises were more than fulfilled, and in closing I want to state that there is a large field open for your graduates. I remain,

A Successful McCarrie Graduate,

(Signed)
William H. Clayton.

You Have the Same Opportunity— Learn Mechanical Dentistry

Follow in Clayton's footsteps! Read his inspiring letter telling how he jumped from \$30.00 a week to \$150.00 a week! Many McCarrie graduates are doing the same! Larson writes, "Our laboratory has averaged about \$800.00 a month profit since first of year—not bad for two of your boys who have been in business for only a year." Ostrander says, "I earned as high as \$45 profit in a single day." Another McCarrie man sends us this message: "No trick for me to make \$20.00 a day." Our free book tells many more amazing success stories like this—write for it today!

Day or Night Schools—All Personal Instruction —No Books—No Classes—Work Your Way Thru School—We Help You To Spare Time Job

Enter this fascinating profession—assure yourself steady employment the year round—work that is highly congenial and dignified! Associate with a fine class of people! Earn a splendid income! We have hundreds of testimonial letters on file from enthusiastic McCarrie men who have made good.

Will you accept this big opportunity? The dental profession needs you. It has grown so fast that the demand for mechanical dentists far exceeds the supply. Here is specialized training of the finest sort! No mechanical skill necessary—no special educational requirements—and a quick, sure reward!

SEND FOR INTERESTING BOOK

Read absorbing facts about mechanical Dentistry—the laboratory bench work that the dentist turns over to the laboratory worker, the making of plates, crowns, bridges, etc.—why 64,000 dentists need laboratory work—how we train you in a few months, day or night, for this uncrowded, moneymaking field!

McCarrie Schools are located in Chicago, Detroit, Cleveland, Philadelphia and Boston.

MAIL COUPON TODAY

No obligation—no cost! Mail coupon today and get your free copy of this handsomely illustrated, interesting book. Complete details of our special offer—low rates—easy terms. Send coupon today!

McCARRIE SCHOOL OF MECHANICAL DENTISTRY

Dept. 152 1338 S. Michigan Ave. CHICAGO, ILL.



FREE BOOK

McCarrie School of Mechanical Dentistry,
1338 S. Michigan Ave.,
Dept. 152 Chicago, Ill.

Without obligation, please send me your free Book with complete information about how I may become a Mechanical Dentist, how you will help me open a Laboratory, how you will help me find a job while I take my training, etc.

Name.....

St. No. or R. F. D.....

City.....State.....

The Book that is Worth a Year's Pay

Imagine A Book That Holds Between Its Covers A Message So Amazing That Its CASH VALUE Is Considered By Many Equal to 52-Weeks' Pay. See For Yourself Why Business Experts Have Called It "The Most Astonishing Book Ever Printed." Send For Your Copy Which Will Be Mailed You Absolutely Without Charge.



NOW FREE!



OVER \$10,000 A YEAR
 "I owe much of my success to N. S. T. A. training. It has enabled me to learn more, earn more, and BE MORE. I am now President and Treasurer of a national organization and my earnings this year will exceed the 5 figure mark."—C. V. CHAMPTION, Danville, Ill.



\$7,286 LAST YEAR
 "I was working as a clerk earning \$1,000 a year, trying to support a wife and three children when I enrolled with N.S.T.A. After completing the Course, my first year's income tax was more than double the old salary. Last year my income tax showed earnings of \$7,286. My grateful thanks will always be due N.S.T.A. for opening my eyes to the opportunities offered by salesmanship as you teach it."—F. J. WALSH, Box No. 1586, Springfield, Mass.



FROM \$15 A WEEK TO \$7,500 A YEAR
 "Three years ago I was working in a shop for \$15 a week. Today I am making \$7,500 per year. I can only speak words of praise for N. S. T. A. for it raised me from that \$15 a week job in a shop to \$7,500 a year as a salesman!"—C. W. BIRMINGHAM, 1712 W. 1st St., Dayton, Ohio.

At the top of this page you will see a much reduced photograph of a surprising little volume that works wonders for ambitious men. . . . And at the left you will see the photographs of three men who have achieved real success by applying secrets they discovered after reading this book. Yet they are only three out of thousands who have taken this same simple route from poorly-paid, routine jobs into a field where they are now earning \$5,000 to \$10,000 a year and more.

The Secret of Earning Big Money

Stop a minute and study the faces of the three men pictured at the left. Notice that there is nothing extraordinary in the appearance of any one of them. As a matter of fact, they are simply ordinary fellows like dozens you meet every day. Their success (wonderful as it may seem) is due in large part to choosing the type of work which is capable of yielding real money to men who go into it!

Figure it out for yourself. Most kinds of jobs are worth just so much and no more. No matter how hard a man works, he simply can't increase his cash value. The salaries of clerks, mechanics, etc., are definitely limited, and the opportunity offered these workers is practically negligible.

But how different with Salesmanship! Master Salesmen are the very life-blood of any business. Upon their efforts depends the profits which any concern makes. No company can exist without them—and there is almost no limit to the importance which a salesman can achieve in the eyes of a firm employing him. No wonder they are able to enjoy luxuries most other men can only dream of—And no wonder they are called the "Aces" of twentieth century business!

Proof That You Can Become A Master Salesman

Yet despite all the wonderful advantages enjoyed by Master Salesmen, proficiency in this fascinating field is surprisingly easy for a man to achieve—without losing a day or dollar from his present position. During the past twenty years the National Salesmen's Training Association has developed thousands of every-day, ordinary men into Master Salesmen, able to earn money ranging anywhere from \$5,000 to \$10,000

a year and even more. These men were from every walk of life, and yet, by showing them the simple, easy, certain methods used by all successful salesmen they were turned into capable producers—often earning five to ten times as much as they had earned before.

No matter what your occupation is, there is no reason why you cannot make good as a salesman. Salesmanship is governed by rules and laws. There are certain ways of stimulating keen interest, ways to overcome objections, batter down prejudices, outwit competition, and make the prospect act. You can learn these vital secrets quickly and easily.

Information Worth a Year's Pay—FREE

If "Modern Salesmanship" cost several dollars a copy you might hesitate. But it is now FREE. We cannot urge you too strongly to take advantage of this opportunity to get without cost information on how to raise your pay.

It is a simple act to fill in and mail the coupon, but look what it did for the men on this page. It may be worth a year's pay to you; it can easily bring you bigger earnings. Why not send for the book and full details—TODAY.



Dept. A-100, N. S. T. A. BLDG., CHICAGO, ILL.

NATIONAL SALESMEN'S TRAINING ASSOCIATION, Dept. A-100, N. S. T. A. Bldg., Chicago, Ill.

Please mail me FREE your illustrated book, "Modern Salesmanship" and particulars of membership in your Association and its FREE Employment Service.

Name.....

Address.....

City.....State.....

Age.....Occupation.....

Quickly Learn to Play Hawaiian Guitar Play Like This Native

Bring the romantic, enchanting, entrancing and melodious strains of the great instrument of the Hawaiian Islands into your soul. Become popular and successful. This **short cut method** of home instruction enables you to quickly master Hawaiian Guitar so you will **play as well as Native Hawaiians.**

Our staff of Hawaiian instructors have perfected a method of teaching, so **simple**, that without musical knowledge, you quickly learn to play real music from notes. **Simple as learning your A B C's**, and it will not be long before you will play latest Broadway hits.

Only four simple motions to learn. You will then play any music, whether it be popular, dance or classical. Almost from first lesson, you play love songs like Aloha Oe.

To help you get started, we furnish without extra charge when you enroll as a student, a beautiful, full tone, genuine \$18.00 Hawaiian Guitar. Only 1,000 free instruments given away; if you want to get in on this offer, write for particulars at once—you must act quickly!



**New Invention—
Kno-All-Chart
QUICKLY TEACHES
YOU HOW TO PLAY**
The newest invention of our Hawaiian instructor, which is exclusively used by us and which we call the "Kno-All-Chart."

quickly teaches you how to play and read notes. So simple is this device that anyone can understand it and begin to **play immediately.**

Picture Method Easy

**GIVEN
\$18 Hawaiian
Guitar when
you enroll!**

We do not depend upon our printed instructions alone for your success as a student, but we also supply you with many pictures of our professors' playing. This enables you to imitate the pictures. **Isn't this easy?**



Phonograph Records Given

As an additional guide, we also furnish you with **phonograph records** of our Hawaiian instructor's own playing of the piece you are learning. This practically brings our professors from our studio to your own home and enables you to listen to their playing just as if they were actually in front of you.

Genuine \$18.00 Hawaiian Guitar Given

Enroll as a student, and secure a beautiful, full tone, genuine \$18.00 Hawaiian Guitar. We also furnish every bit of equipment so it is never necessary for you to spend an extra penny. When you graduate, you get a **beautifully engraved diploma** and after graduation, we also give you **six months' free service** and consultation. Send for free particulars now

JAZZ

**Your Way to
Popularity and
Success**

No forming class to wait for. Start at once and join band wagon of success and popularity. Do it through Hawaiian Guitar.

Send for free First Lesson and Book. So positive are we you will become one of our students, that if you write at once, we will send you **free**, our first lesson which will enable you to see just what you can expect when you enroll. You will also receive our **big book** of full particulars. Write for your copy and **free lesson** today.

Write at **Hawaiian Studio No. 52018** of New York Academy of Music, 100 Fifth Ave., New York, N. Y.

HAWAIIAN STUDIO No. 52018 of New York Academy of Music, 100 Fifth Avenue, New York, N. Y.

Please rush your book, "How to Learn Hawaiian Guitar," and my first free lesson. Also reserve a Hawaiian Guitar for me without extra charge. This obligates me in no way whatever.

Name.....
Address.....
City..... State.....



Young outdoor men wanted

Interesting, vigorous outdoor work in a growing organization where merit wins advancement. Good starting wages. Permanent positions and a real future for men who make good. Our present field force of Davy Tree Experts cannot meet the increasing demand. So we are selecting now, to enter our employ, a few sturdy, clean young men, thorough Americans, single, between 20 and 30 years old, free to travel, industrious, with good practical education, and able to give good references. Write for qualification blank to serve in place of personal interview. **The Davy Tree Expert Co., Inc.,**

842 Federal Bldg., Kent, Ohio

Learn Advertising at HOME

Send your name and address for free booklet giving interesting information and vital facts about Advertising. Find out how we prepare you at home, in your spare time, for the opportunities open in this fascinating business. Practical work. No text books. Old established school. Successful graduates everywhere. Just the plan you have always wanted. Write today. No obligation. **PAGE-DAVIS SCHOOL OF ADVERTISING** Dept. 1351, 3601 Michigan Ave. Chicago, U. S. A.



TRAVEL for "Uncle Sam"

U. S. GOVERNMENT JOBS \$1140 TO \$3000 YEAR

Men—Boys, 18 Up

Steady Work
Paid Vacations
Common Education
Sufficient

Mail Coupon—Today SURE

FRANKLIN INSTITUTE
Dept. T176, Rochester, N. Y.
Gentlemen: Rush to me without charge 32-page book with list of U. S. Government big paid positions obtainable. Advise me regarding the salaries, hours, duties, vacation and full particulars.

COUPON Name.....
Address.....

1000 Hotel Positions Open!



HOTELS, Restaurants, Clubs, Apartments, Institutions, Schools, Colleges, Hospitals, etc., Everywhere Need Trained Men and Women. Over 70,000 High-Class Positions Paying \$2,500 to \$10,000 a Year Are Open Each Year in the Hotels of the United States. Nearly One and Three Quarter Billions of Dollars' Worth of New Hotels, Clubs and Institutions Built This Year Will Need Over 200,000 Trained Men and Women.

I Absolutely Contract to Teach You

In my home-study course on hotel work what the leading experts know about the business—men earning from \$5,000 to \$50,000 a year—and at any time there are over 1,000 hotel positions open in this industry.

I Put My Students in Touch with Positions

all over the United States. They are eagerly sought by the biggest and best hotels in the country. Hotels start you at salaries up to \$3,500 a year with your living usually included. If you want a steady, permanent position, with big-pay, quick advancement, fine living, with meals and apartment usually included FREE—you can find it in hotel work.

**MAIL
FREE COUPON
NOW!**

Opportunity Coupon 1000 Hotel Positions Open!

Lewis Hotel Training Schools,
Room AP-327, Washington, D. C.

Kindly send me, without obligation, a copy of the free book "Your Big Opportunity," with details of the Free Registration in your National Employment Bureau.

Name

Address

City.....State.....

No Previous Experience Needed

You need no previous experience when you take the Lewis Course. We train you by mail in your spare time at home with the Lewis Simplified Study Plan, and put you in touch with big opportunities. All of your training under the personal supervision of Clifford Lewis, former U. S. Government Hotel and Restaurant Expert, now Managing Consultant for over 225 Hotels. **FREE BOOK GIVES FULL DETAILS**—There are opportunities for you in this big paying hotel industry. Many students have obtained hotel positions paying as high as \$2500 a year, even before they finished the course. My **FREE BOOK "Your Big Opportunity"** shows how you can do as well. The coupon above will bring you by return mail this vitally interesting, illustrated book, which shows how you can become a high-salaried hotel executive; also tells how our students are winning success with Lewis Training and explains how you obtain Free Registration in our National Employment Bureau and our Money-Back Agreement.

LEWIS HOTEL TRAINING SCHOOLS

Clifford Lewis, President

Room AP-327, Washington, D. C.

Charter Member, National Home Study Council

PROOF

Our files are crammed with letters like these which prove that the hotel industry is the field of big opportunity today.

Earnest Crowder: "Your course is wholly responsible for my appointment as Assistant Manager of Hotel English, Indianapolis, Ind."

V. T. Ingram: "Although I never had any previous experience in hotel work, your course enabled me to secure a position as steward in National Park Hotel, Vicksburg, Miss."

D. A. Robinson: "I am Manager of St. Clair Country Club, Tecumseh Shores, Ont., at double the salary I earned before taking the Lewis Course."

See the World FREE!



Taste Romance and Adventure In the Far Lands of the Earth.

How often you've longed to see for yourself the awe of Egypt's pyramids—the beauties of the gorgeous Mediterranean sunset—the squalor of China's ancient cities!

Spend a few years, or the rest of your life, tasting high adventure on the seven seas and in all the world's great ports—roving the earth's highways and byways! You can do it FREE—all your expenses paid—and earn a good salary besides!

Only one profession will carry you around the world at will, traveling like a gentleman, but that's the most interesting and pleasant work there is—Radio Operating! Easily and quickly learned, there's no other profession like it for the man who wants the experiences and pleasures of world-travel. Radio operators are needed—all sea-going ships like the one shown here must carry from one to half a dozen or more.

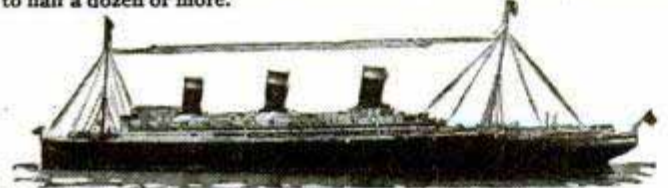

Take a Look Beyond the Skyline Without a Penny's Expense

Radio operators aboard ocean liners live luxuriously—they rank as officers of the ship. Meals, a private cabin, all other living needs are furnished free, and besides the operator draws a good salary. You can learn quickly and easily at home in your spare time to be a Radio operator through our practical training methods. Take a look at the FREE BOOK which tells how—mail coupon below.

This U. S. Government-recognized school has been training successful operators since 1914. Our graduates are all over the world. We maintain an Employment Department to help put you on your own ship. The world-famous NATROMETER, our own patented invention, obtainable only by students of this Institute, is recognized as the best and easiest way to learn the Radio code. A few short months, with the aid of the famous Natrometer and our quick home training, and you too can be a fully qualified Radio operator, sitting in your cabin like the one shown above, bound out for Liverpool or Nagasaki!

Read the Free Book that tells all about this fascinating profession and our practical Government-recognized methods of training you for it. Send coupon TODAY—no obligation. Special tuition offer now on, includes world-famous Natrometer free of extra cost with your course! Act at once.

**NATIONAL RADIO INSTITUTE
WASHINGTON, D. C.**

SPECIAL OFFER COUPON

National Radio Institute,
Dept. 1-HH, Washington, D. C.

Gentlemen: Without obligating me in any way send me your free book and information about your offer of Natrometer with course.



World-Famous
Natrometer

Name

Address



Double Your Pay This Easy Way

SCORES of ambitious fellows earn more than their regular salaries simply by using a few pleasant hours a week of their spare time making show cards for local stores. Every retailer in your neighborhood will pay big money for clever sales-producing display cards. Learn at home through simple professional method. Earn \$25 to \$50 a week spare time—\$50 to \$100 a week in full time. Business of your own. Wonderful future. Earn even while you learn.

Send for new illustrated booklet, "Quick Success in Show Card Making." Also for details on Show Card Outfit given to new students. No obligation. Write now to

WASHINGTON SHOW CARD SCHOOL

Dept. 301F, 1117—15th St., N. W., WASHINGTON, D. C.



For Beginners 4 Big Volumes

Written so you can understand every word, by 18 famous Engineers and Architects. DeLuxe, flexible binding. 1750 pages, 1050 blue prints, charts and diagrams. Prepares you for a good Drafting job in mechanical or architectural lines. Sent for 15 days' free use, if you mail coupon immediately.

DRAFTING

BOOKS SENT FREE!

Only fifteen minutes a day with these WONDER BOOKS will prepare you for a good Drafting job in less than a year! Mechanical and Architectural Drafting from simple straight lines to important, complex plans, a step at a time! Built especially for beginners, for men with only grammar schooling. Drafting room practice plus engineering made easy and clear!

Big Field—Big Demand—Big Pay!

Competent Draftsmen are urgently needed right now in all building and manufacturing lines at \$50 to \$100 a week. That's just the beginning—for draftsmen have the best chance for advancement! Pleasant, fascinating work, easy to learn and do. Learn quick with these books—send coupon for a set FREE, and see for yourself!

A year's Consulting Membership in the American Technical Society now given free to all readers of this famous Cyclopedia of Drafting. Many say that's worth more than cost of books.

American Technical Society
Dept. D-119, 58th & Drexel Ave., Chicago



Modern American Homes FREE!

American Technical Society
Dept. D-119, 58th & Drexel Ave., Chicago

Send for 15 days' free use 4-volume set of DRAFTING. In return for mailing this coupon promptly send absolutely FREE "Modern American Homes," 112 plates, exteriors, interiors and plans. I will pay the few cents delivery charges. If I wish I may return books in 15 days and owe you nothing. But if I prefer to keep them I will send \$1.80 after 15 days, then \$2.00 a month until \$14.80 (special reduced price) is paid.

Name

Address

Employed by

Address

"Watch him make a fool of himself" - *I heard someone whisper*



-then I started to play!

IT was the first big party of the season and the fun was at its height. The room fairly rocked with laughter as Jim finished his side-splitting imitation of a ballet dancer.

Tom, who was giving the party, turned to me and said, "And now our young friend here will give us his well-known imitation of Paderewski!"

Instantly all attention centered upon me. Feigning reluctance, I made as if to beg off, but was forthwith dragged to the piano. Admonitions of "Come on, old timer, do your stuff!"—"Don't be bashful!"—came from all sides.

They expected me to do my usual clowning—but I had a surprise up my sleeve for them. Just as I was about to begin, I heard someone whisper, "Watch him make a fool of himself—why, he can't play a note!"

I Surprised My Friends

They thought I was going to give them my one-finger rendition of chop-sticks. But instead I swung into the opening bars of "The Road to Mandalay"—that rollicking soldier song of Kipling's. You should have seen the look of amazement that spread over their faces. This was not the clowning they had expected! Then Tom began to sing. One by one they joined in, until soon they were all crowding around the piano, singing away at the top of their lungs.

It was almost an hour before they let me get up from the piano. Then a deluge of questions: "How in the world did you ever do it?"—"Where did you study?"—"When did you learn to play?"—"Who was your teacher?"—"How long have you studied?"

"One at a time, please," I begged. "I'll tell you all about it. To begin with, I didn't have any teacher."

"What! Say you don't expect us to believe that, do you?"

"Sure thing. But I don't blame you for not believing it. I wouldn't have myself. As you know, I've never been able to play a note. But I always liked music, and many a time when I was pepping up a party with my clowning I would have given anything in the world to be able to sit down at the piano and really play.

"But it never occurred to me to take lessons. I thought I was too old—and besides, I couldn't see my way clear towards paying an expensive teacher—to say nothing of the long hours I'd have to put in practicing.

How I Learned to Play

"But one day I noticed an advertisement for the U. S. School of Music. This school offered to teach music by a new and wonderfully simplified method which didn't require a teacher, and which cost only a few cents a lesson.

"Well, boys, that certainly sounded good to me, so I filled out the coupon and sent for the Free Demonstration Lesson. When it arrived I found that it seemed even easier than I had hoped.

"I made up my mind to take the course. And believe me that was the luckiest decision of my life! Why, almost before I knew it, I was playing simple tunes! And I studied just whenever I pleased, a few minutes a day in my spare time. Now I can play anything I like—ballads, classical numbers, jazz. Listen to this!"

With that I snapped right into a tantalizing jazz number. All evening I was the center of a laughing, singing, hilarious group. And it's been that way at every party I've attended since. * * * * *

This story is typical. Over half a million men and women have already learned to play musical instruments through the U. S. School of Music system.

First you are told what to do—then a picture shows you what to do—then you do it yourself and hear it. No private teacher could make it clearer.

One of the reasons for the quick results is, that learning music this way is such fun. Instead of waiting a year before playing tunes—you learn by playing tunes. You play simple familiar melodies by note right from the start. You learn twice as fast—three times as fast—as those who study by old-time plodding methods.

Free Book and Demonstration Lesson

Our wonderful illustrated free book and our free demonstration lesson explain all about this remarkable method. They prove just how anyone can learn to play his favorite instrument by note in almost no time and for just a fraction of what old slow methods cost.

If you really want to learn to play—if new friends, good times, social popularity and increased income appeal to you—take this opportunity to make your dreams come true. Sign the coupon and send it before it's too late. Instruments supplied when needed, cash or credit. U. S. School of Music, 71, Brunswick Building, New York City.

U. S. SCHOOL OF MUSIC, 71 Brunswick Building, New York City

Please send me your free book, "Music Lessons in Your Own Home," with introduction by Dr. Frank Crane, Demonstration Lesson and particulars of your offer. I am interested in the following course:

Have You
..... Instr.?
Name.....
Address.....
City..... State.....

Pick Your Course

Piano	Cello
Organ	Harmony and
Violin	Composition
Drums	Sight Singing
and Traps	Ukulele
Mandolin	Guitar
Clarinet	Hawaiian
Flute	Steel Guitar
Saxophone	Harp
Cornet	Piccolo
	Trombone
Voice and Speech	Culture
Automatic Finger	Control
Piano Accordion	
Banjo (Plectrum,	
5-String or Tenor)	



There's the Man Who's Holding You Down

Yes, sir! There's the man. You see him every time you look in the mirror. His name isn't Brown or Smith or Jones but Y-O-U. He's your real boss. He's the man who decides whether your salary will be \$35 a week or \$100 or \$150.

If you want to get ahead there's just one sure way to do it—train yourself to do the day's work better than any other man in the office. Ability is bound to count. Your employer will be glad to pay you more money if you show him you deserve it.

A home-study course with the International Correspondence Schools will prepare YOU for the position you want in the work you like best. All it takes is an hour a day of the spare time that now goes to waste.

At least find out how by marking and mailing the coupon that has meant the difference between Failure and Success to so many other men. It doesn't obligate you in any way to fill in this coupon, yet it may be the means of changing your entire life. Do-it—now!

Write for Free Booklet

INTERNATIONAL CORRESPONDENCE SCHOOLS

"The Universal University"
Box 5700-E, Scranton, Penna.

Without cost or obligation, please send me a copy of your booklet, "Who Wins and Why," and full particulars about the course before which I have marked X in the list below:

BUSINESS TRAINING COURSES

- | | |
|--|---|
| <input type="checkbox"/> Business Management | <input type="checkbox"/> Salesmanship |
| <input type="checkbox"/> Industrial Management | <input type="checkbox"/> Advertising |
| <input type="checkbox"/> Personnel Organization | <input type="checkbox"/> Better Letters |
| <input type="checkbox"/> Traffic Management | <input type="checkbox"/> Show Card Lettering |
| <input type="checkbox"/> Business Law | <input type="checkbox"/> Stenography and Typing |
| <input type="checkbox"/> Banking and Finance Management | <input type="checkbox"/> English |
| <input type="checkbox"/> Accountancy (including C.P.A.) | <input type="checkbox"/> Civil Service |
| <input type="checkbox"/> Nicholson Cost Accounting | <input type="checkbox"/> Railway Mail Clerk |
| <input type="checkbox"/> Bookkeeping | <input type="checkbox"/> Common School Subjects |
| <input type="checkbox"/> Private Secretary | <input type="checkbox"/> High School Subjects |
| <input type="checkbox"/> Spanish <input type="checkbox"/> French | <input type="checkbox"/> Illustrating <input type="checkbox"/> Cartooning |

TECHNICAL AND INDUSTRIAL COURSES

- | | |
|---|--|
| <input type="checkbox"/> Electrical Engineering | <input type="checkbox"/> Architect |
| <input type="checkbox"/> Electric Lighting | <input type="checkbox"/> Architects' Blueprints |
| <input type="checkbox"/> Mechanical Engineer | <input type="checkbox"/> Contractor and Builder |
| <input type="checkbox"/> Mechanical Draftsman | <input type="checkbox"/> Architectural Draftsman |
| <input type="checkbox"/> Machine Shop Practice | <input type="checkbox"/> Concrete Builder |
| <input type="checkbox"/> Railroad Positions | <input type="checkbox"/> Structural Engineer |
| <input type="checkbox"/> Gas Engine Operating | <input type="checkbox"/> Chemistry <input type="checkbox"/> Pharmacy |
| <input type="checkbox"/> Civil Engineer | <input type="checkbox"/> Automobile Work |
| <input type="checkbox"/> Surveying and Mapping | <input type="checkbox"/> Airplane Engines |
| <input type="checkbox"/> Metallurgy <input type="checkbox"/> Mining | <input type="checkbox"/> Agriculture <input type="checkbox"/> Navigation |
| <input type="checkbox"/> Steam Engineering | <input type="checkbox"/> Mathematics <input type="checkbox"/> Radio |

Name.....

Street Address.....

City..... State.....

Occupation.....

Persons residing in Canada should send this coupon to the International Correspondence Schools Canadian, Limited, Montreal, Canada

Become a PHOTOGRAPHER

Attractive money making opportunities in Portrait, Commercial and News Photography, or Get Into Motion Picture Photography. Camera Men Earn \$50 to \$250 a Week. Fascinating Work; in big demand. You can learn at Home or in our N. Y. Studios.



FREE BOOK Tells How—
How to prepare for High Salaried position.

How to start your own business.

How to make money in spare time.

Write for this big illustrated Book and Job Chart today—FREE.

N. Y. INSTITUTE OF PHOTOGRAPHY, Dept. 49
10 West 33rd Street, New York, N. Y.

LEARN WATCH REPAIRING

Be a watchmaker—you can learn this profitable trade by correspondence in a few weeks in your own home by the DeSelms Chart System. After you complete the course you will know a watch from A to Z. You will know just what the matter is and how to repair one. When you graduate you will be a practical watchmaker and repairer and competent to fill any position. Positions for our graduates. Ask for our Free Book. It explains our system and terms.



THE DeSELMS WATCH SCHOOL
LOGANSFORT, INDIANA

PIANO JAZZ

By Note or Ear. With or without music. Short Course. Adult beginners taught by mail. No teacher required. Self-Instruction Course for Advanced Pianists. Learn 259 styles of Bass, 684 Syncopated Effects, Blue Harmony, Oriental, Chime, Movie and Café Jazz, Trick Endings, Clever Breaks, Space Fillers, Sax Slurs, Triple Bass, Wicked Harmony, Blue Obligato, and 247 other Subjects, including Ear Playing. 133 pages of REAL Jazz, 25,000 words. A Postal brings our FREE Special Offer.

Waterman Piano School, 1826 W. Adams St. Los Angeles, Cal.

A GREAT BOOK FREE WITH THIS LIBRARY!

For a short time only we will give every subscriber to the New Library of Machine Shop Practice a copy of French's Engineering Drawing—the greatest book on mechanical drawing ever written. This book makes drawing as plain as day and prepares you to handle any drawing job you will ever have to do. It comes to you absolutely free with

Machine Shop Practice

9 volumes—3065 pages—3608 illustrations
(A combined home-study course and reference library)

The Machine Shop Library was written for practical men. It gives you the best methods for every kind of machine shop work. It explains machine tools and their operation, drawing and design, tool work, gears and grinding, jigs and fixtures, automatic screw machines and their tools and all of the mathematics you will ever need. Plainly written, completely illustrated—the best kind of help to the machine-shop man who wants to advance himself.

Sent

No money down—
only 7c
a day

FREE



FREE EXAMINATION COUPON

McGraw-Hill Book Co., Inc., 370 Seventh Ave., New York
Send me for 10 days' free examination the Library of Machine Shop Practice. If satisfactory, I will send \$2.50 in 10 days and \$2 monthly until the special price of \$22.50 is paid. If not wanted, I will return the books at your expense. On receipt of my first payment I am to receive, free of charge, a copy of French's Engineering Drawing.

Signed.....

Address.....

City and State.....

Position.....

Employer..... P.M. 1-28

ELECTRICITY

Complete Study Course and Pocket Library \$10



SHIPPED FREE

A set of **HAWKINS GUIDES** is a true friend to the electrical worker. It tells you how to do any job the right way—without guessing or taking chances.

Hawkins Guides put all the facts about modern electrical engineering at your finger tips. Therefore your chances for advancement in the electrical field are unlimited.

HAWKINS GUIDES DOUBLE YOUR VALUE



Electricity is king!

It is the ruling force of today—transportation, communication, light, heat, power—indeed every modern activity is dependent on electricity. Industry is crying for electrical men that know their jobs!

Hawkins Guides teach you all you need to know about electricity in easy, step-by-step lessons. Daily spare time reading of the Guides will greatly increase your value to yourself and your employer in a few weeks. Hundreds of our friends have written us and told us this!

READERS OF HAWKINS GUIDES KNOW HOW



"You can't stump him on an electrical job." "He certainly knows his business." "Certainly have to hand it to him for knowing how." —These are the things employers say about our friends who are readers of **Hawkins Guides**. No matter what question or problem comes up the Ready Reference Index enables you to give an expert answer at once.

HAWKINS STARTS YOU WHERE OTHERS LEFT OFF

Why should you work at low wages when easy reading of **HAWKINS GUIDES** will give you the money-making knowledge of the expert? Easy daily reading of the Guides will teach you in a few months what it has taken the expert a lifetime to learn!

With **HAWKINS GUIDES** in hand you have a running start to success in the electrical field. You will actually begin where others left off

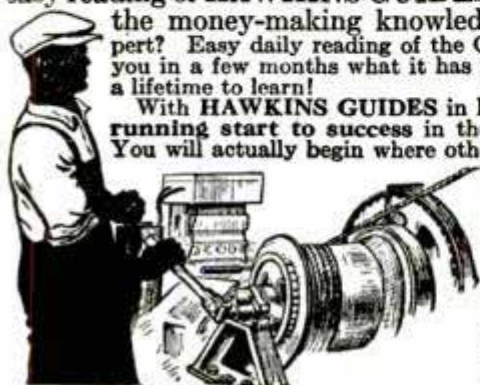

NOW!

This coupon is your golden opportunity. Tear it out—send it now!

FOR EXAMINATION!

REAL ELECTRICAL EDUCATORS

"Hawkins Guides at \$10 is the best investment I have ever made. Am able to take up almost any electrical job and have never gone to an electrical school."—**B. Roessler, Oenaville, Texas.**

AS EASY AS A. B. C.

"Everything in Hawkins Guides is very plain and anybody can read and understand them as easy as A. B. C."—**J. Knight, Tobyhanna, Pa.**

OTHER ENTHUSIASTIC READERS SAY

"Worth ten times their price." "Helped me to two raises in four months." "Better than a school of instruction." "Studied them when I was laid up and got further ahead than if I had been on the job."

Hawkins Guides Explain These Points So You Can Easily Understand:—

Magnetism—Induction—Experiments—Dynamos—Electric Machinery—Motors—Armatures—Armature Windings—Installing of Dynamos—Electrical Instrument Testing—Practical Management of Dynamos and Motors—Distribution Systems—Wiring—Wiring Diagrams—Sign Flashers—Storage Batteries—Principles of Alternating Currents and Alternators—Alternating Current Motors—Transformers—Converters—Rectifiers—Alternating Current Systems—Circuit Breakers—Measuring Instruments—Switch Boards—Wiring—Power Stations—Installing—Telephone—Telegraph—Wireless—Bells—Lighting—Railways. Also many Modern Practical Applications of Electricity and Ready Reference Index.

Hawkins Guides—10 POCKET SIZE NUMBERS

Each number easy to carry around and read in spare time. Big type and clear diagrams. Easy to study and learn. Durable, flexible binding—gold edges. 3,500 pages—4,700 illustrations. Shipped free for examination. Pay only \$1 a month if satisfied. Price of set, complete, \$10.



EXAMINE GUIDES FREE!

Let the Guides themselves demonstrate their practical value to you—as a study course, reference work and complete electrical library. You are the judge. Simply send this coupon. No obligation unless you are entirely satisfied. Tear out on dotted line—fill in—mail it NOW!

\$1 PER MO.

FREE EXAMINATION COUPON

Theo. Audel & Co., 65 W. 23rd St., New York City

Please send me (postpaid) for my approval **Hawkins Electrical Guides**, 10 numbers (price \$1 each). If satisfactory I will mail you \$1 in 7 days and further mail \$1 monthly until purchase price of \$10 is paid.

Name.....

Address.....

Occupation.....

Employed by.....

1T30

Play the HAWAIIAN GUITAR and be Popular!

Play all the latest hits just as the Hawaiians do. Be the most popular member of your set. Get in on all the good times. Entertain your friends—or play professionally. Be in demand everywhere. We will help you.



\$15
HAWAIIAN GUITAR
with Genuine Seal Grain
Fabrikoid Cover

GIVEN
when you enroll



This sweet-toned, mellow Hawaiian Guitar would cost you at least \$15 in any music store without the Genuine Seal Grain Fabrikoid Case. We can afford to give you the entire outfit free when you enroll, including picks, steel playing bar, etc., because we make them in huge quantities in our own factory. Nothing to buy—everything is furnished.

Learn in Spare Time at Home

You study in spare time—when you like—as long as you like. And even if you don't know one note from another, our method is so simple, plain and easy that you begin a piece your first lesson. In half an hour you can play it!

Famous Native Hawaiians Teach You

You receive expert instruction from such world famous players as Kolomoku, Kalaluki, Ferara and Seville. They quickly teach you the secrets of this fascinating instrument.

Complete Conservatory Course. You get 52 complete printed lessons. Nothing is omitted. Pictures explain every move. And no matter how little you know about music when you begin, no matter if you have never touched a musical instrument, you can positively learn to play by our plain, easy, picture method.

Only 4 Motions to Learn

Then you can play any music—popular songs, classical, old-time melodies, native Hawaiian airs—or real jazz—separately or with accompaniment. You'll never be lonesome after you learn to play on this beautiful Hawaiian Guitar.

Pay as You Play

We make it easy for you. You start any time—with a small first payment—then pay while learning. Write for liberal offer.

Our Written Guarantee

We guarantee in writing to teach you 45,000 successful students. And we coach and advise you after graduation—no extra cost.

Tenor Banjo and other courses—Violin, Tiple, Tenor Guitar, Banjo Ukulele, Ukulele—under well-known instructors. Write for information.

FIRST HAWAIIAN CONSERVATORY OF MUSIC, INC.

9th Fl., Woolworth Bldg., Dept. 448, New York, N. Y.

Approved as a Correspondence School Under the Laws of the State of New York

ACT! Mail This Popularity Coupon NOW!

FIRST HAWAIIAN CONSERVATORY OF MUSIC, Inc.

9th Fl., Woolworth Bldg., Dept. 448, New York, N. Y.

Please mail full information about your 52-lesson Hawaiian Guitar Course. I am not obliged to enroll unless I want to.

Name _____

Address _____

City _____

State _____

Hundreds More Needed Now



Three Months Training

THE OPPORTUNITY OF A LIFETIME For Men Who Naturally LIKE TO USE TOOLS

Without a cent of cost to you or any obligation whatever, we will send you complete details of how to enter this profitable trade and earn steady up to

\$125 A WEEK

making Crowns, Plates, Bridges, etc., for Dentists—many experts earn far more. If you are in earnest lack of money need not stop you—we have a regular arrangement for part time positions to help you pay expenses. R. R. Fare to our nearest school included.

Write Today for Free Bulletin 2

BODEE DENTAL INSTITUTE

Established over 35 years
The Pioneer in this Field

New York Philadelphia
1755 Broadway 1305 N. Broad St.

Brooklyn
85 Court St.

Learn to PAINT SIGNS and SHOW CARDS

We quickly teach you by mail, or at school, in spare time. Enormous demand. Big future. Interesting work. Oldest and foremost school.

EARN \$50 TO \$200 WEEKLY

John Vassos, N. Y., gets \$25 for single show card. Crawford, B. C., writes: "Earned \$200 while taking course." Don't delay. Send today for complete information, samples and guarantee.

DETROIT SCHOOL OF LETTERING
150 Stimson Ave. Est. 1899, DETROIT, MICH.



Learn Photography at HOME

Make money taking pictures. Prepare quickly during spare time. Also earn while you learn. No experience necessary. New easy method. Nothing else like it. Send at once for free book, OPPORTUNITIES IN MODERN PHOTOGRAPHY and full particulars.

AMERICAN SCHOOL OF PHOTOGRAPHY
Dept. 1351 3601 Michigan Ave. Chicago, U. S. A.

STAMMER

Write for my free book "Millard's Advanced Natural Corrective Course" and a free copy of my speech magazine. 10,000 cases successfully treated. Est. 24 years. Largest school for stammerers in world. Millard Inst. of Normal Speech, 2317 Millard Bldg., Milwaukee, Wis.



WHY NOT spend Spring, Summer and Fall gathering butterflies, insects? I buy hundreds of kinds for collections. Some worth \$1 to \$7 each. Simple outdoor work with my instructions, pictures, price-list. Send 10 cents (not stamps) for my illustrated Prospectus before sending butterfly.

MR. SINCLAIR, DEALER IN INSECTS,
Dept. 6, Box 1424, San Diego, Calif.

Learn Watchwork, Jewelrywork and Engraving A fine trade commanding a good salary, and your services always in demand. Address: **Horological**, Dept. P, Bradley Institute, PEORIA, ILLINOIS, for our latest catalog.



"And now I watched—
moodily, yet entranced!"

How a sailor taught me the secret of *popularity*

YOU should have seen that sailor! Talk about popularity! He seemed to be more in demand than a "movie" star at a Broadway night club. Every dance saw him whirling over the floor with one of the best looking girls there. And the music no sooner finished than excited whispering could be heard from little groups of dancers. "Who is he?"—"Introduce me, please!"—"He's giving me the next!" "How he does dance!"

Phew! It was too much for me! Earlier in the evening I had slunk away to a corner. I wasn't going to give any girl a chance to turn me down again *that night!* And now I watched—moodily, yet entranced!

I Was a Wallflower

What was it about this sailor that made the girls so "crazy over him"? Was it his dancing? Well, I'd find out!

So, later in the evening, I cornered him in the smoking room. Dejectedly, I approached. "After seeing you dance," I began, "I think I understand why the girls can't see me. But they don't have dancing teachers on warships, do they? Then how—"

Laughingly, he overlooked my gentle sarcasm. "No, Buddy, you're right. They don't! But you can go to Arthur Murray. And if you can't go to Arthur Murray, he will come to you!"

The Sailor's Tale

Before I could interrupt to ask what he meant he continued. "You know even a sailor sometimes goes ashore, and when my ship used to hit port I liked to have a good time with the rest of the boys. But somehow I was always out of it. Every time I got in a party there was dancing—and every time there was dancing I was left alone. For, no doubt about it, I was as clumsy and awkward as they make 'em. "Finally I decided I must do something—but what? And just about that time the Fleet lifted anchor and away we went for the Gulf.

"What with work aboard ship and keeping in trim there was no time to think about dancing then. But one night I was reading a magazine, and there it was, plain as day: An ad on dancing by this Arthur Murray. 'Let Me Prove I Can Teach You to Dance at Home,' it said. If that were possible, it would be fine, I thought, but I was a skeptic. Then it suddenly dawned on me—this Arthur Murray was the self-same Murray who had given personal lessons to the dancing instructors of the Naval Academy. That sounded promising. And it certainly was worth investigation—since I risked nothing.

"So I sent all the way to New York for the five free lessons offered. In a short time they came. I was amazed at the ease of this method. For I learned, right on the old ship, how to lead—how to have confidence while dancing—how to handle myself gracefully at all times.

"Buddy, it was a cinch—that's the word all right. And I did it all—right on the boat—without music or partner.

"Now whenever I'm on shore leave I have a whale of a time. Take my tip, Buddy, if you want good fun, real enjoyment and lots of friends, do what I did—and don't delay about it!"

And to all who are now in the same fix with me, I'll say just this: I'm following that sailor's advice.

Will You Accept These 5 FREE Lessons?

No matter how poorly you dance now—no matter if you've never been on a dance floor in your life—Arthur Murray's method makes you a finished dancer in 10 days, or you don't have to pay a penny. To prove it he is willing to send you five lessons from his remarkable course absolutely free! Just send the coupon (with 10 cents to cover cost of printing and mailing) and these valuable lessons will be forwarded at once. Also a free copy of his new book, "The Short Cut to Popularity." Don't wait. Mail coupon NOW! Arthur Murray, Studio 764, 7 East 43rd Street, New York City.

ARTHUR MURRAY, Studio 764,
7 East 43rd Street, New York City.

To prove that I can learn to dance at home in ten days you may send the FIVE FREE LESSONS. I enclose 10c (stamps or coin) to pay for the postage, printing, etc. You are to include free "The Short Cut to Popularity."

Name.....

Address.....

City..... State.....



High School Course in Two Years!

You Want to Earn Big Money!

And you will not be satisfied unless you earn steady promotion. But are you prepared for the job ahead of you? Do you measure up to the standard that insures success? For a more responsible position a fairly good education is necessary. To write a sensible business letter, to prepare estimates, to figure cost and to compute interest, you must have a certain amount of preparation. All this you must be able to do before you will earn promotion. Many business houses hire no men whose general knowledge is not equal to a high school course. Why? Because big business refuses to burden itself with men who are barred from promotion by the lack of elementary education.

Can You Qualify for a Better Position

We have a plan whereby you can. We can give you a complete but simplified high school course in two years, giving you all the essentials that form the foundation of practical business. It will prepare you to hold your own where competition is keen and exacting. Do not doubt your ability, but make up your mind to it and you will soon have the requirements that will bring you success and big money. **YOU CAN DO IT.**

Let us show you how to get on the road to success. It will not cost you a single working hour. Write today. It costs you nothing but a stamp.

American School

Dept. H-174, Drexel Ave. and 58th St., Chicago

American School

Dept. H-174, Drexel Ave. and 58th St., Chicago

Send me full information on the subject checked and how you will help me win success.

- | | |
|-----------------------------|---------------------------|
|Architect |Business Law |
|Building Contractor |Lawyer |
|Automobile Engineer |Machine Shop Practice |
|Automobile Repairman |Mechanical Engineer |
|Civil Engineer |Shop Superintendent |
|Structural Engineer |Employment Manager |
|Business Manager |Steam Engineer |
|Cert. Public Accountant |Foremanship |
|Accountant and Auditor |Sanitary Engineer |
|Bookkeeper |Surveyor (& Mapping) |
|Draftsman and Designer |Telephone Engineer |
|Electrical Engineer |Telegraph Engineer |
|Electric Light & Power |High School Graduate |
|General Education |Wireless Radio |
|Vocational Guidance |Undecided |

Name.....

Address.....

LEARN BY DOING

Every phase of all branches of

ELECTRICITY

taught by

Actual Practice

In one of America's foremost institutions for trade training

ESTABLISHED 1902

No Books Used

Individual Instruction
Start Any Day

Write for FREE 64-page catalog

THE NEW YORK ELECTRICAL SCHOOL
44 West 17th St., New York City

BE AN ARTIST

WE CAN TEACH YOU DRAWING in your own home during your spare time. Twenty-five years of successful teaching proves our ability. Artists receive large salaries.

Write Today for Art Year Book

SCHOOL OF APPLIED ART
ROOM NO. 2 BATTLE CREEK MICH.

MUSIC LESSONS IN YOUR HOME

You can read Music like this quickly

Write today for our **FREE** booklet. It tells how to learn to play Piano, Organ, Violin, Mandolin, Guitar, Banjo, etc. Beginners or advanced players. Your only expense about 2c per day for music and postage used. **American School of Music** 51 Manhattan Bldg., Chicago

LEARN WATCHMAKING AND ENGRAVING

BY OUR PROFIT-SHARING PLAN OUR GRADUATES SUCCEED

One of our Iowa students started in a very small way—now doing over \$30,000 a year. Another in Wisconsin, over \$10,000 the first year. Day or night classes. Call or write for **FREE BOOK**

Chicago School of Watchmaking, Dept. 3601, 4844 Lincoln Avenue, CHICAGO

"STAMMERING

Its Cause and Cure"

You can be quickly cured if you stammer. Send 10 cents, coin or stamps, for 288 page cloth bound book on Stammering and Stuttering. It tells how I cured myself after Stammering and Stuttering for 20 years. **BENJAMIN N. BOGUE**
1101 Bogue Building, 1147 N. Ill. St. Indianapolis

I'll Pay Your Railroad Fare to Chicago Without Extra Cost

UP TO \$15,000 a year for GREER GRADUATES

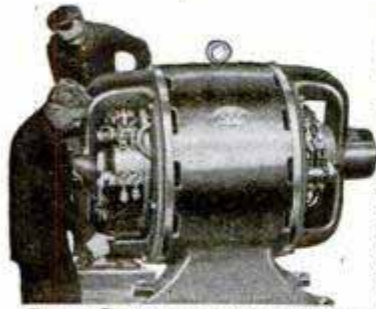

Rotary Converter, used by students for testing

ELECTRICITY, AUTOS, AVIATION now pay hundreds of trained men up to \$200 A WEEK. Here are THE 3 WORLD'S GREATEST BUSINESSES. BILLIONS—not millions, but BILLIONS of dollars are spent in them every year. CHOOSE ONE OF THESE THREE, HERE and NOW.

Amazing Opportunities for you in one of World's 3 Biggest Businesses

GREER trained men are NEEDED. I HAVE MADE hundreds of \$10,000 A YEAR MEN. 90,000 in the last 26 years have come to GREER. THOUSANDS MORE in the future will likely come here. BE ONE OF THEM. Send coupon to me for openings.

MEN WANTED

I will help you get a position while learning, also after graduation. Never before such unusual opportunities. GET MY FREE BOOK NOW. LEARN ABOUT THE BIG PAY. ELECTRICITY, AUTOS, AVIATION—lead WORLD'S BUSINESS. That's why GREER College selected these fields and ONLY THESE.



Learn to Boss the Job

ELECTRICITY

AUTOS



Learn in Only 3 Months in GREAT GREER SHOPS ON LARGE LIVE EQUIPMENT

Mine is NOT A CORRESPONDENCE COURSE. You can start any day or any evening. It is PRACTICAL, EASY, QUICK, FASCINATING training. You learn on Great, running, live Equipment in tremendous GREER SHOPS. AUTO Business is BIGGEST BUSINESS in the world. ELECTRICITY is FASTEST GROWING, and yet in its Infancy. AVIATION, most fascinating, alluring business today, is already a Billion Dollar Industry.

full of HARD THEORY—NO HEADACHES in GREER PRACTICAL SHOPS TRAINING. You learn to DO BY DOING. You learn to fly by flying.

You Get Real Help to BIG JOBS!

TWELVE PEOPLE are in my Big EMPLOYMENT DEPARTMENT getting jobs for Greer men. You get their help AS OFTEN AS YOU NEED IT, both BEFORE and AFTER Graduation.

Get My FREE BOOK NOW

Don't let money hold you back. Get my Free Book. Find out NOW, how I PAY YOUR FARE HERE, let YOU ATTEND EITHER DAYS or EVENINGS and help you find DAY or EVENING WORK to PAY YOUR EXPENSES while learning. Then when ready we help you find the real BIG PAY JOB. LEARN how I get you ready so Employers WANT YOU, and GLADLY pay you what you are worth.

Quickest, Easiest of Ways to Become Expert

I'LL PAY YOUR FARE HERE FREE of extra cost, then help you to a JOB WHILE LEARNING. Then I not only FIT YOU to get BIG PAY JOB, but I'll help YOU HOLD IT. Young and Old, Educated and Uneducated, Inexperienced and Experienced have found GREER SHOPS training EASY, FASCINATING and VALUABLE. Coupon below brings details.

Not Correspondence Course

Here at GREER SHOPS you learn on BIG, ACTUAL FULL SIZE Machinery, like you will work on out on the Big Pay Job. You get close personal supervision. NO Guess work—NO books

Erwin Greer



90,000 Students 26 Years Tremendous Success

Above is the important history of GREER COLLEGE. Note the steady 26-years growth, thru genuine SERVICE, from the tiny Shops on the left to the tremendous Building on the right, filled with GREAT TRAINING Equipment. These

moves to always greater quarters mean GROWTH—PROGRESS and SERVICE. What is it you like—ELECTRICITY—AUTOS—or fascinating AVIATION? GREER will train you in EITHER, as YOU SHOULD BE TRAINED.

GREER COLLEGE

Electricity—Autos—Aviation Dept. 101 2024 So. Wabash Ave. CHICAGO, ILL.

Get My Big Offer Now!

Would an offer of \$100 a week be OPPORTUNITY or DISAPPOINTMENT for you? If you could HOLD the JOB it would truly be OPPORTUNITY. If you can't hold the \$100 a week job, PREPARE. Be ready. Don't invite disappointment. Learn about GREER SHOPS. Right now if you act quick, I can make you a most unusual short time offer. Clip coupon NOW and find out. Address me personally

ERWIN GREER, President

SCISSORS FOR FREE BOOK

Autos Electricity Aviation

Name.....

Address.....

ERWIN GREER, President

Dept. 101 2024 So. Wabash Avenue, Chicago, Illinois

Send Free Book indicated below and details of Special offer, without obligation to me.

Discovered!

The Scientific Secret of Caruso's Amazing Vocal Power

A post mortem of Caruso's throat showed superb development of his Hyo-Glossus muscle—again proving the soundness of Eugene Feuchtinger's theories of voice production.



Eugene Feuchtinger, A. M., Musician-Scientist, who discovered this scientific method for developing the voice.

The arrow points to the all-important Hyo-Glossus muscle, the "keynote" of the Physical Voice Culture method.

The Great Discovery

Professor Feuchtinger, A. M.—famous in the music centers of Europe—discovered the secret of the Hyo-Glossus muscle. He devoted years of his life to scientific research and finally perfected a system of voice training that will develop your Hyo-Glossus muscle by simple, silent exercises right in your own home.

Since the Professor brought his discovery to America—over 10,000 happy pupils have received his wonderful training.

100% Improvement Guaranteed

The Perfect Voice Institute guarantees that Physical Voice Culture will improve your Voice 100%. You are to be your own judge—take this training—if your voice is not improved 100% in your own opinion, your entire tuition will be refunded.

Inspiring Book FREE Send the coupon below and we'll send you FREE this valuable work, "Physical Voice Culture". You assume no obligation. It may be the first step in your career. Do not delay.

Perfect Voice Institute

1922 Sunnyside Ave., Studio 13-51 Chicago

Perfect Voice Institute 1922 Sunnyside Ave. Studio 13-51 Chicago

Please send me a copy of your new book, "Physical Voice Culture", FREE. I understand that it is mine to keep and there is no obligation on my part. I am interested in

Singing Speaking Stammering Weak Voice

Name

Address

Age

ELECTRICITY

M
A
D
E

REAL WORK with REAL TOOLS on REAL EQUIPMENT

COLEMAN SYSTEM never fails when student means business

All Electrical Subjects Taught

Armature Winding; Electric Welding; House Wiring; Electric Refrigeration; Farm Lighting; A. C. and D. C. Motors and Generators; Power and Light Switchboards, Dynamos and Transformers; Radio; Storage Batteries; Automotive Electricity.

All Electrical Trades need Skilled Men—Electrical Skill is in Demand at \$200.00 to \$600.00 a Month.

FREE—Automobile Training—FREE.

Real Cars to Work On—and No Extra Charge

LET COLEMAN TELL YOU HOW—WRITE FOR FREE BOOK

COLEMAN ELECTRICAL SCHOOL
1528 K Main Street KANSAS CITY, MO.

E
A
S
Y

PREPARE FOR AN ART CAREER

—thru the only art school operated as a department of a large art organization, who have actually produced over a quarter million drawings for leading advertisers. Where else can you get so wide an experience? Home study instruction. Write for illustrated book telling of our successful students.

MEYER BOTH COMPANY
Michigan Ave. at 20th St. Dept. 16, Chicago, Ill.

LEARN WATCH REPAIRING

You can learn by our modern and original system of instruction every part of the **Watch Repairing Trade** at home as good or better than at a shop. You can earn money while learning and secure a well paying position or start in business after completing our course of instruction. Good watch repairers are always in demand and earn from \$50 to \$75 per week. For particulars apply to the **Wisconsin School of Watch Repairing** 166 Mason St., MILWAUKEE, WIS.

YMCA TRADE SCHOOL

Learn Auto Mechanic, Auto Electrical, Battery, Machine, Electrical, Radio Mechanic, Tiling, Bricklaying, Plastering, Plumbing, Welding, Drawing, Estimating, Show Card, Sign Painting, Window Dressing, Fine And Commercial Art.

Write for Catalog 50.

BROOKLYN ENGINEERING INSTITUTE
(Operated by Bedford Br. Y. M. C. A.)
1125 Bedford Ave., Brooklyn, New York City.

STAMMERING

easily, permanently corrected. Win happiness and success. Ask for full information and special phonograph record. Send dime for postage

153 Stimson Ave., The LEWIS INSTITUTE, Detroit

ALWAYS Ask For DENISON'S—52 Years of Hits

Comedy-Dramas, Farces, Musical Plays, Vaudeville Acts, Monologs, Dialogs, Comedies, Revues, Entertainments, Musical Readings, Comedy Songs, Chalk Talk Books, Minstrels, Blackface Skits, Make-up Goods. Catalog FREE.

T. S. DENISON & CO., 623 S. Wabash, Dept. 9 CHICAGO

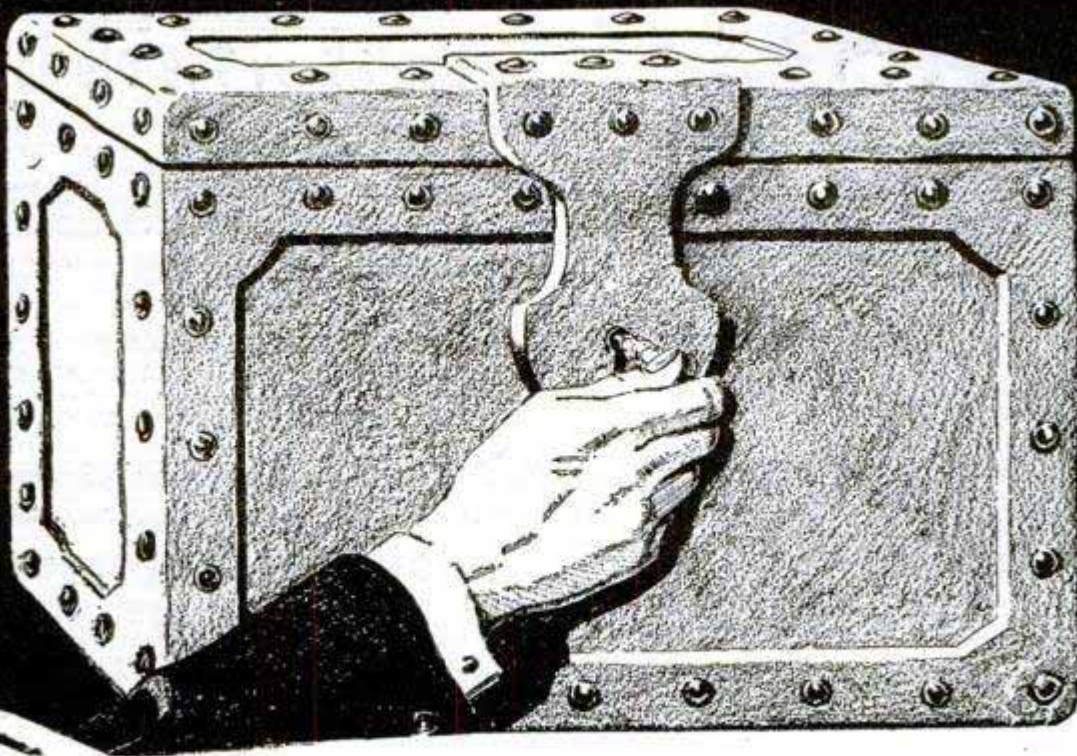

Unlocking For You the Age-Old Secrets of Magic

Baffling secrets of the world's greatest magicians—mysteries never before divulged—supernatural effects of the Orient—massive stage illusions—the most priceless, most treasured Secrets of the Magic Profession now—*for the first time*—disclosed to YOU in the great Tarbell Course in Magic. Learn to perform like a real magician in a short time—in your spare time—at home. Be the life of every party—the center of every crowd, wherever you go. Business and social success are YOURS when you know Magic. And it's EASY with the Tarbell System!

**Earn \$350 to \$1000
a Month!**

From Impromptu Tricks through Sleight of Hand to Great Stage Illusions—EVERYTHING is taught to you so that you can go right out and MAKE BIG MONEY WITH MAGIC. There is a tremendous demand for Magic Entertainment. Clubs, churches, schools, conventions, theaters are on the lookout for Magicians—and they pay \$25 to \$100 for perhaps half an hour's program. Keep your job and make a lot of EXTRA MONEY on the side. Just master a few easy tricks. Salesmen—business men—professional men—all can use Magic to gain popularity and profits. Easy for YOU to make \$250 to \$1000 a month!

Mail Coupon

You can now get this great course, endorsed by the world's greatest magicians, at a special low price. But you have to *act quickly* to get in on this offer. Write today SURE!

Tarbell System, Inc., Studio 13-51
1926 Sunnyside Avenue, Chicago, Ill.

Astonish Your Friends

Study the first lesson and your friends will be amazed at your wonderful Magical powers. You will have that Magnetic power that gives you instant popularity in any crowd. Everyone will marvel at your apparently supernatural, psychic power. YOU possess this talent now! Surprisingly *easy* to bring it out. Send the coupon below now—and find out how easily you can do it.

Tarbell System, Inc., Studio 13-51

1926 Sunnyside Avenue, Chicago, Illinois

Please send me your big FREE illustrated and colored booklet giving full information on the Tarbell System of Magic. No obligation on my part whatever.

Name

Address

City and State Age



You May Have a Desk —but do you get the salary?

The desk in the private office of Robert Pentland, Jr.—member of the Florida State Board of C. P. A. Examiners and partner in the largest firm of Certified Public Accountants in Florida—is about the same size as the desk he had when a clerk, in 1919. And there's no great difference in looks—

But his income today is more than ten times as large. His firm has offices in nine cities, and employs fifteen C. P. A.'s and thirty other accountants. And he is not yet thirty!

"This rapid progress in six short years," writes Mr. Pentland, "is largely due to my LaSalle training."

Send for Free Book—

"Accountancy, the Profession that Pays"

A complete plan whereby you can advance to positions of responsibility and power in the Accountancy field is clearly outlined in LaSalle's new 64-page book, "Accountancy, the Profession that Pays." The information it contains is of priceless value to the man eager to achieve success in business—and LaSalle will send it to you free.

If you have the urge and the will to increase your income—clip and mail the coupon NOW.

— — — Find Yourself Through LaSalle! — — —

LA SALLE EXTENSION UNIVERSITY

The World's Largest Business Training Institution

Dept. 164-HR Chicago

I should be glad to have your 64-page book, "Accountancy, the Profession that Pays," also a copy of "Ten Years' Promotion in One," all without obligation.

Higher Accountancy

Training for positions as Auditor, Comptroller, Certified Public Accountant, Cost Accountant, etc.

Other LaSalle Opportunities: LaSalle opens the way to success in every important field of business. If more interested in one of the fields indicated below, check here:

- | | |
|---|---|
| <input type="checkbox"/> Business Management | <input type="checkbox"/> Banking and Finance |
| <input type="checkbox"/> Modern Salesmanship | <input type="checkbox"/> Modern Business Correspondence |
| <input type="checkbox"/> Traffic Management | <input type="checkbox"/> Expert Bookkeeping |
| <input type="checkbox"/> Railway Station Management | <input type="checkbox"/> C. P. A. Coaching |
| <input type="checkbox"/> Law—Degree of LL.B. | <input type="checkbox"/> Business English |
| <input type="checkbox"/> Commercial Law | <input type="checkbox"/> Commercial Spanish |
| <input type="checkbox"/> Industrial Management | <input type="checkbox"/> Effective Speaking |
| <input type="checkbox"/> Modern Foremanship | <input type="checkbox"/> Stenotypy |
| <input type="checkbox"/> Personnel Management | <input type="checkbox"/> Stenography |
| <input type="checkbox"/> Stenography | <input type="checkbox"/> Credit and Collection Correspondence |

Name

Present Position

Address



Don't Envy The Plumber BE ONE!

\$11.00-\$16.00 PER DAY and work **EVERY** day,
is the Plumber's wage.

Every skilled workman will tell you that Plumbers have the best of it. WINTER and SUMMER the Plumber is busy at top wages. No skilled Plumber is ever out of a job—compare his opportunities with any trade, plus the opportunities of having your own shop.

We teach you Plumbing with **TOOLS** (not books) under Licensed Master **PLUMBERS** in one of the finest equipped schools in America. We make you a Plumber, every branch is taught thoroughly—Lead Work—Blue Print for plan reading—all other tricks.

LEARN IN 8 to 12 WEEKS without previous experience.

If you are making less than \$50.00 a week you owe it to yourself to investigate. Get **FREE** catalog that tells in pictures and words how we teach this trade. Special rates now.

UNIVERSAL PLUMBING SCHOOL
2030 Troost Ave. KANSAS CITY, MO.

Electrical Engineering

Course for men of ambition and limited time. Over 5000 men trained. Condensed course in Theoretical and Practical Electrical Engineering including the closely related subjects of Mathematics and Mechanical Drawing.

Students construct motors, in-stall wiring, test electrical machinery. Course designed to be completed in *one college year*. Prepare for your profession in the most interesting city in the world. Est. 1893. Catalog on request.

Bliss Electrical School

131 Takoma Ave., Washington, D. C.

Anyone CAN LEARN

No talent or experience necessary. Fascinating work. Pays big money. Complete instruction book tells about: Alphabets, Colors, How to Mix Paints, Show Cards, Window Board and Wall Signs, Ready made letters, Gilding, Tricks of the Trade, also gives 100 Alphabets and Designs. Book bound in flexible int. leather—gold edges, and four half bearing Show Card Pens. Sent postpaid \$3.00. (C. O. D.) 10c. ex. Ogilvie Pub. Co., 57 Rose St. Dept 20, N. Y. City

**EARN MONEY IMMEDIATELY—
WE FURNISH EQUIPMENT TO START!!**

MEN WANTED TO LEARN Motion Picture Projection

\$2,000 to \$4,000 a Year

Quickly learned. Short hours, big pay. Best equipped school in Michigan. Projectionists for Movie Houses and Road Shows.

MOVIE OPERATORS SCHOOL

61 Sproat Street, DETROIT, MICHIGAN

LEARN PIANO TUNING AT HOME

Send for **FREE** copy of the 30th ANNIVERSARY EDITION of our book, "Winning Independence". Read how students master tuning with our **TUNE-A-PHONE**, and WHY our graduates head the profession in all parts of the world. With Bryant's patented devices, tools, charts and lessons, one learns quickly and easily. Low tuition; easy terms. Diploma granted. **MONEY-BACK** if not satisfied. \$10.00 to \$25.00 a day, exceptional opportunities and an ideal profession awaits you.

BRYANT SCHOOL OF TUNING, 31 Bryant Bldg., Augusta, Michigan.

RADIO ACCESSORIES at WHOLESALE

Radio Sets, "B" Eliminators, Chargers, Tubes, Kits, Parts—everything new in Radio at lowest wholesale prices. Thousands of nationally advertised bargains. All listed and illustrated in my Big New Catalog and **FREE** Cash Book.

132 Pages of valuable Radio information—trouble finding, set building—Radio knowledge of all kinds. Write today. **HARRY SCHWARTZBERG PRES.**

AMERICAN AUTO & RADIO MFG. CO.
Dept. 264 American Radio Bldg.
Kansas City, Missouri

FREE BIG BARGAIN CATALOG

**FREE**

Write to me. I'll send you this new book. Not a catalog. My pay-raising plan and money making advice.
Engineer Dobe.

If You Earn Less Than
\$70⁰⁰
a Week!



"I will train you at home."
Engineer Dobe

Engineer Dobe
Originator of the Practical
"Kwik-Line" Drafting System
"I challenge the world to produce a better, quicker, shorter method of teaching drafting."

Let me tell you what I can do for you—send for

My Pay Raising Plan!

EARN AS YOU LEARN!

Automobile Building—Electricity—Motor Bus Building—Aviation—Building Construction

All of these great industries and hundreds of others, need Draftsmen. I train you in drafting at home by my certain, fast, new, "Kwik-Line" practical method. You keep the job you have. You only work during your spare time. You learn the profession of drafting by actually doing the work. When you finish you are a practical man. I train you to do things exactly like you will do them when you get a job. Write me for my Pay-Raising Plan, my Free book "Successful Draftsmanship." Write—Write without fail, if you are earning less than \$70.00 a week.

Draftsmen Needed

Draftsmen are needed everywhere. That's the kind of profession to get into. In Drafting, you plan and supervise the work of others or you go into business for yourself. Get started now toward a better position, paying a good straight salary the year around.

Employment Service

After training you I help you to get a job without charging you a cent for this service. Employers of draftsmen come to me for men because they know that men I train make good. I tell you also how to earn while you learn.

Age or Lack of Education No Drawback

You do not need previous experience. You do not need to be a high school graduate. My practical course gives you just the kind of training you need to become successful. Your spare time is all that is needed.

WRITE ME QUICK—
If You Earn **\$70⁰⁰** a
Less Than **Week**

Lewis Beck, trained by me, makes \$8,000.00 a year.
A. H. Bernier, trained by me, makes \$7,000 to \$9,000 a year.
Arthur Dewalt, trained by me, makes \$400.00 a month.
S. C. Stroop, trained by me, makes \$475.00 a month.
C. E. Cermak, trained by me, makes \$130.00 a week.

Get My FREE Book—

"Successful Draftsmanship"
and "My Pay-Raising Plan"

Two books sent free. You will never get any place if you hesitate. Be one of the positive do-it-quick chaps that always go to the front. Fill out the coupon and mail it immediately for my Free Books, "Successful Draftsmanship" and "My Pay-Raising Plan".

Engineer Dobe

1951 Lawrence Ave., Div. 13-51 Chicago, Ill.



Money Back If Not Satisfied

What could be fairer than that? I know what I can do so I don't ask you to take any chances. I train you under a positive Money Back Agreement. If my training does not satisfy you after you have finished you get every penny back.

\$9,000—\$7,500—\$3,500

Write to me and I will Prove to you that I have turned out draftsmen who have earned \$3,500, yes \$7,500, yes \$9,000 a year. These men saw the big opportunity in the tremendously big industries which I fitted them for as draftsmen.



You Get These Drafting Tools At Once as my Student.

You Get These Fine, Imported Drafting Instruments
The instruments pictured here are the very best obtainable for drafting work. They are identical with those used by the leading draftsmen of the world. Just as soon as you become a student, I give you this set of instruments.

FREE Book Coupon!

ENGINEER DOBE

1951 Lawrence Ave., Div. 13-51, Chicago

Send me free of all cost your books, "Successful Draftsmanship", and "My Pay Raising Plan", also plan to earn money while learning and proof of big money paying positions.

Name..... Age.....

Address.....

Post Office..... State.....



"Your letter of recommendation helped me to get my first good position"

"My I. C. S. course improved my English, raised me from a machinist to a tool designer, qualified me to become an evening school teacher of mechanical drawing and enabled me to more than triple my salary. Your letter of recommendation helped me to get my first good position."

Every mail brings letters from some of the thousands of students of the International Correspondence Schools, telling of promotions and increases in salary as the rewards of spare-time study.

What are you doing with the hours after supper? Can you afford to let them slip by unimproved, when you can easily make them mean so much?

One hour a day spent with the I. C. S. in the quiet of your own home will prepare you for the position you want in the work you like best. Yes it will! Put it up to us to prove it.

Mail the coupon for free booklet

INTERNATIONAL CORRESPONDENCE SCHOOLS "The Universal University" Box 5698-E, Scranton, Penna.

Without cost or obligation, please send me a copy of your booklet, "Who Wins and Why," and full particulars about the course before which I have marked X in the list below:

- | | |
|---|---|
| <input type="checkbox"/> Business Management | <input type="checkbox"/> Salesmanship |
| <input type="checkbox"/> Industrial Management | <input type="checkbox"/> Advertising |
| <input type="checkbox"/> Personnel Organization | <input type="checkbox"/> Better Letters |
| <input type="checkbox"/> Traffic Management | <input type="checkbox"/> Show Card Lettering |
| <input type="checkbox"/> Business Law | <input type="checkbox"/> Stenography and Typing |
| <input type="checkbox"/> Banking and Finance Management | <input type="checkbox"/> English |
| <input type="checkbox"/> Accountancy (including C.P.A.) | <input type="checkbox"/> Civil Service |
| <input type="checkbox"/> Nicholson Cost Accounting | <input type="checkbox"/> Railway Mail Clerk |
| <input type="checkbox"/> Bookkeeping | <input type="checkbox"/> Common School Subjects |
| <input type="checkbox"/> Private Secretary | <input type="checkbox"/> High School Subjects |
| <input type="checkbox"/> Spanish <input type="checkbox"/> French | <input type="checkbox"/> Illustrating <input type="checkbox"/> Cartooning |
| TECHNICAL AND INDUSTRIAL COURSES | |
| <input type="checkbox"/> Electrical Engineering | <input type="checkbox"/> Architect |
| <input type="checkbox"/> Electric Lighting | <input type="checkbox"/> Architects' Blueprints |
| <input type="checkbox"/> Mechanical Engineer | <input type="checkbox"/> Contractor and Builder |
| <input type="checkbox"/> Mechanical Draftsman | <input type="checkbox"/> Architectural Draftsman |
| <input type="checkbox"/> Machine Shop Practice | <input type="checkbox"/> Concrete Builder |
| <input type="checkbox"/> Railroad Positions | <input type="checkbox"/> Structural Engineer |
| <input type="checkbox"/> Gas Engine Operating | <input type="checkbox"/> Chemistry <input type="checkbox"/> Pharmacy |
| <input type="checkbox"/> Civil Engineer | <input type="checkbox"/> Automobile Work |
| <input type="checkbox"/> Surveying and Mapping | <input type="checkbox"/> Airplane Engines |
| <input type="checkbox"/> Metallurgy <input type="checkbox"/> Mining | <input type="checkbox"/> Agriculture <input type="checkbox"/> Navigation |
| <input type="checkbox"/> Steam Engineering | <input type="checkbox"/> Mathematics <input type="checkbox"/> Radio |

Name.....
Street Address.....
City..... State.....

Occupation.....
Persons residing in Canada should send this coupon to the International Correspondence Schools Canadian, Limited, Montreal, Canada

Learn Music



Free - Send for This Amazing Book

It will tell you how you can quickly and easily learn to play beautifully right in your home and in your spare time.

The Open Door to Popularity

Music will open wide the doors of social success—make you the center of popularity everywhere. You will be surprised and delighted to find how easily you can learn with the famous National Academy Method. 200,000 successful students. Low cost, easy terms.

Courses in Piano, Violin, Trumpet, Voice, Banjo, Tenor Banjo, Organ, Spanish Guitar, Hawaiian Guitar, Mandolin. Write Today.

NATIONAL ACADEMY OF MUSIC
Dept. 38 702 East 41st Street, Chicago



You Can Do It!

Famous Violin Maker sells Patterns, Easy Instructions, Fine Woods, other Supplies.

C. C. FRASER
Box 14, Sta. C, Grand Rapids, Mich.

Test Your Art Ability FREE



If you like to draw, test your natural sense of design, proportion, color, perspective, etc., with our Art Ability Questionnaire. Learn if your talent is worth developing, and how much training you will need. You will be frankly told what your score is.

Many Federal Students are making \$3,500, \$4,000, \$5,000 and \$6,000 yearly. The Federal course is recognized everywhere by art employers and buyers of commercial art. Learn at home in spare time, without previous training. Personal, individual criticisms on your work. Get this free test—send now for your Questionnaire.

Federal School of Commercial Designing
631 Federal Schools Bldg. Minneapolis, Minn.
Send me your free Questionnaire.

Name.....
Address.....



FREE BLUE PRINTS

AND FREE BOOK "HOW TO READ BLUE PRINTS"

SHOW YOU THE WAY TO

9 BIG PAY JOBS

- | | |
|--|---|
| 1 Building Superintendent — \$5,000 to \$12,000 | 6 Building Estimator — \$6,000 to \$10,000 |
| 2 Building Inspector—\$4,800 to \$8,000 | 7 Real Estate Expert—\$5,500 to \$12,000 |
| 3 Appraiser — \$6,000 to \$10,000 | 8 Construction Foreman—\$4,500 to \$8,500 |
| 4 Material Buyer—\$5,000 to \$7,500 | 9 CONTRACTOR AND BUILDER IN A BUSINESS OF YOUR OWN—\$5,000 to \$12,000 |
| 5 Material Salesman—\$5,000 to \$12,000 | |

FIND OUT HOW

Easy it is to Make \$4,500 to \$12,000 a Year

Learn to read Blue Prints this amazing new way! Get into the world's richest industry—Building! See how quickly and easily you can train to make \$4,500 to \$12,000 a year! My FREE Book "How to Read Blue Prints" discloses all the so-called "mysteries" of Blue Print Reading—also gives some startling facts about the nine best jobs in America. Don't send one penny—just mail the coupon!

NO longer need you spend years trying to pick up the "mysteries" of Blue Print Plan Reading. For now a quick, sure practical method has been perfected that has made thousands of men Blue Print Experts in a surprisingly short time.

This is no ordinary "school course." It is practical from start to finish. It is based on many sets of real Blue Prints—plans that would cost thousands of dollars if purchased from architects. Twenty famous experts in all lines of construction work talk over these Blue Prints with you in plain simple language. Show you every detail. Explain every short cut. Tell you the "secrets" of quick, accurate estimating. Explain Superintending. Give you for the first time many inside facts and money-making methods used by the "Giants" of the Building Industry.

This is the kind of training that quickly puts men into \$4,500 to \$12,000 a year jobs—or into profitable contracting businesses of their own. Yet now you get it right at home in only 2 or 3 months. It requires no extensive education. If you can read and understand what is written here you can easily master it.

See what this training has done for others: Bartholomew, Calif., became a contractor at an in-

crease of over 300% his first year; Blair, Okla., stepped up to Superintendent at 100% increase; Dickerson, R. I., increased his salary 700% in 12 months; Marchand, La., says: "My income has increased 200% and I now have more contracting work than I can do."

Over seven billion dollars will be spent this year in new construction! No wonder then, such tremendous opportunities are open to you when you have this "head-work" training in Blue Prints.

If you want more money—real big money! Then choose a "Blue Print" job in Building. Clerk or Salesman, Carpenter or Bricklayer, here is the one field where there are unlimited opportunities for advancement.

So accept my FREE gift of a complete set of real working Blue Prints, and my fascinating Book "How to Read Blue Prints" that tells all the interesting and instructive facts about Blue Print Plans. Don't send one penny—pay no C. O. D.—It's all FREE. Just fill out and mail the coupon today—NOW!

TWO BOOKS also FREE



IF YOU LIVE NEARBY

Visit our big day or evening school attended by over 1000 Builders. You can get the same training at home by mail—same plans, lessons and instructor. Your spare time is enough.

Chicago Technical School for Builders—Dept. A-140, Chicago Tech. Building, 118 East 26th Street, Chicago, Ill.

Please send me your free book, "How To Read Blue Prints," and complete set of real Blue Prints. I understand these are mine to keep without obligation. It is also understood that no salesman will call on me.

Name.....
 Address.....
 City..... State.....
 Age..... Occupation.....

Chicago Technical SCHOOL for BUILDERS

Dept. A-140, 118 East 26th St., Chicago, Ill.



More Money



Be a Trained Radio Expert

If you're earning a penny less than \$50 a week, get my free book of information about the Radio business. Trained Radio Experts are needed in more than twenty different lines of this new and growing profession (three hundred thousand new openings created by the swift growth of Radio in past few years). Why go along at \$25 or \$35 or \$45 a week all your life? Study Radio and after only a short time land yourself a REAL job with a REAL future! Be a man who has money in his pocket and in the bank—don't scrimp and scrape for the rest of your days.

Salaries of \$50 Up to \$250 a Week Not Unusual in Radio

The good positions in Radio pay all the way from \$50 on up to \$150, \$200, and even \$250 a week. Suppose you don't climb to the very top but that you do advance to a position that pays you \$125 a week, year in and year out. Any chance to make that much where you are now? Then send for my free book, and learn about a field where there's some

Money Back If You Aren't Fully Satisfied

I'll give you all the training you need to get into any line of the Radio business. And I back up this training by a signed agreement to refund every penny you pay me if I don't give you exactly the training you need. After you finish my training, you'll be the judge. If you think I've earned my tuition fee. I keep it. If not, ask for it and you'll get it right back.

Six Big Practical Outfits Given You To Help You Learn

I teach you both the "why" and the "how" of Radio. You learn to DO a thing, and you learn WHY it's done. I send you, WITHOUT EXTRA COST with your course, six big practical outfits of material to experiment and work with. These outfits are the real thing—not toys. The parts they contain will build approximately one hundred different Radio circuits. With all this material you do practical work from start to finish of your training. You get your hand in, and you get confidence in yourself. Then when you run into a Radio problem later on, on the job, you KNOW you can do it because you've already done it with these six outfits of practical material. With me you don't learn to be a "paper Radio Expert"—you learn to be the kind of expert that shows his worth on the payroll. Full details in my big book—sent free.

Send For Free Book of Information

real opportunity. Where good men, if they have the right training, can work their way into really big salaried jobs!

Get Book!

Find out for yourself about bigger pay waiting for you in Radio! From \$2,000,000 in 1920 to \$504,000,000 in 1926—that's the record of the Radio industry! Plenty of big Radio jobs are waiting for the man who KNOWS. John Fetzer sent for my free book—now he's Chief Engineer at WEMC and designs and builds broadcast stations. T. M. Wilcox sent for the book—now he's in his own Radio business and reports profits as high as \$70 in one day! All information will be sent to you free, without obligation—just mail coupon on opposite page.



Broadcasting and commercial Radio land station work appeal to a lot of men—it's a big, growing field and fascinating work. My course prepares you thoroughly to get into this field and make good.

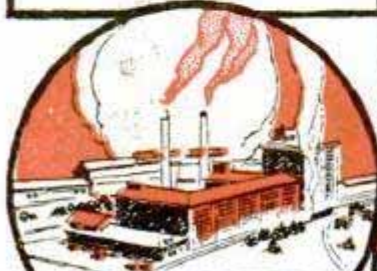

Radio manufacturing has grown faster in the last six years than any other big business ever did. It's two hundred and fifty times as big as it was. That means lots of good chances for the trained Radio Expert.

Six million Radio receiving sets in use in the United States means millions of dollars are going to Radio Service and Repair men everywhere. For this work you must be trained.

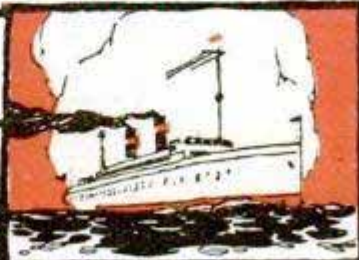

Radio operators on board ship go everywhere—see everything. You sail the world over, all your expenses paid, and draw a good salary besides. It's the life of Riley.

see coupon next page

for you in Radio

Learn Quickly, Easily

Train at Home In Spare Minutes

Stay home! Hold your job! I'll bring your Radio training to you, and you can learn in your spare time after work. No need to go to a strange city and live for months on expense when you learn my way. You study in the quiet of your own home. As for this training—it's written just as I would talk—in straightforward, every-day, understandable language. You'll get it, and you'll get it quickly—in a few months' spare time—because I've made it so clear and interesting! No particular education needed—lots of my successful students didn't finish the grades.

Earn \$15, \$20, \$30 Weekly Right Away "On the Side"

Deloss Brown, South St., Foxboro, Mass., made \$1,000 from spare-time Radio jobs before he even finished my course. H. W. Colbentz, Washington, averaged \$45 a week; Leo Auchampaugh, 6432 Lakewood Ave., Chicago, made \$500 before graduation; Frank Toomey, Jr., Piermont, N. Y., made \$833 while taking the course. All this done IN SPARE TIME away from the regular job, while these fellows were still studying the course—and they're only a few of hundreds. As soon as you start this training I begin teaching you practical Radio work. Then a few weeks later, I show you how to make use of it in spare time, so you can be making \$15, \$20, \$30 a week "on the side," all the while you're learning.

64-page Book Sent Free For the Asking

My big book of Radio information won't cost you a penny, and you won't be under any obligation by asking for it. It's put hundreds of fellows on the way to big pay and brighter futures. Sending for it has been the turning-point where many a man has made his start toward real Success. Get it. See what it's going to mean to you. Send coupon TODAY!

Address: **J. E. SMITH, President,**
National Radio Institute,

Dept. 1-H Washington, D. C.



Send No Money

J. E. Smith, President,
National Radio Institute,
Dept. 1-H, Washington, D. C.

Dear Mr. Smith: Kindly send me your big free book "Rich Rewards in Radio," giving all information about the big-money opportunities in Radio and how you will train me to take advantage of them. I understand this places me under no obligation, and that no salesmen will call on me.

Name.....

Address.....

Town.....State.....

JOBS WAITING!

In seven short years—three hundred thousand new jobs in Radio! Lots of jobs open right now, for those who have the training. The Radio industry has grown by leaps and bounds—so fast it has had to take whatever sort of men it could get. Such men, if they haven't trained themselves in the meantime, are losing out and will keep on losing out. They'll be replaced by men with the KNOW-HOW. But it's trained men ONLY that are needed.

Over 1,000 Openings For Trained Men NOW!

One great Radio manufacturing concern alone has over one thousand openings to give my graduates this year. These men will be needed all over the United States. Any graduate of mine who stands well in his home town is eligible for this work. The head of the above mentioned concern, one of the biggest Radio organizations in the country—is a graduate of mine. He knows what my training did for him. When he wants new men for his organization he wants men with the same training.

I can't possibly graduate enough men this year to fill these openings. So there will be more openings with this one concern than there will be graduates to accept them.

But there are other openings to choose from, too. My school has trained more Radio Experts than any other school in the world. It's the oldest and largest Radio home-study school in the world. There are N. R. I. trained men in almost every Radio concern of any importance in this country. Many Radio employers are themselves my graduates. That's where you get your "stand-in" as an N. R. I. graduate yourself.

Every graduate of my course is entitled to Life-Time Employment Service, without a penny's charge, from my helpful Employment Department.

Full Information Sent With Free Book

My Free Book contains full information about the Radio employment situation, and the advantages I'm in a position to give you. Also about my Life-Time Employment Service, and Life-Time Consultation Service, too.

Mail Coupon Today!



This big 64-page book, printed in two colors, crammed with interesting facts and photos about money-making opportunities in Radio, sent free to everyone who clips the coupon. No obligation by sending for the book—it's absolutely free. One of the most valuable books about Radio ever written.

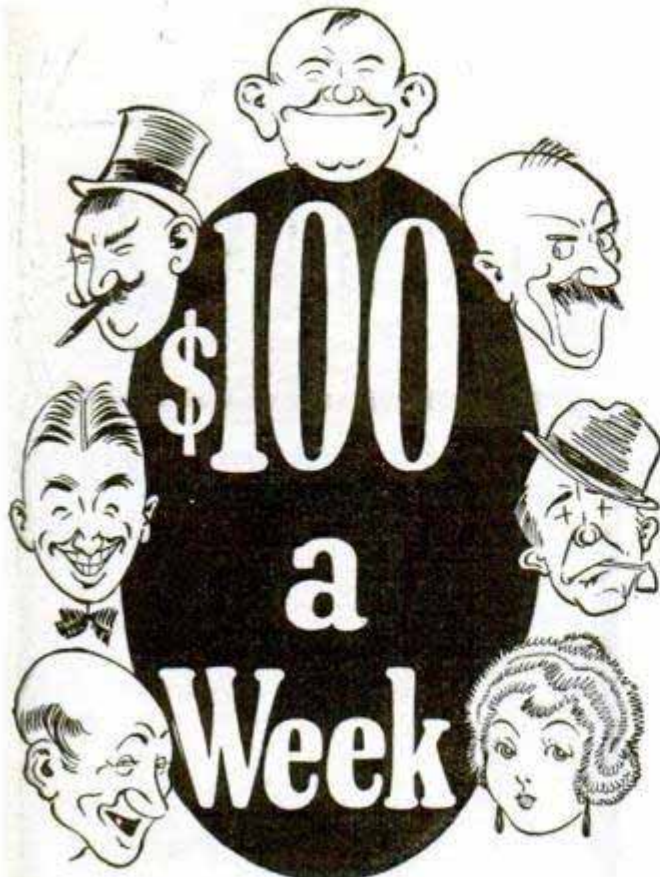

IN DRAWING CARTOONS

Why spend your time doing work that is drudgery, and get little money for it when you may be able to draw cartoons for Big Pay? Learn cartooning at home with this simple, tested method. Many students earn money while learning.

Become a high-salaried cartoonist—one of the easiest, most pleasant, and best paid of all businesses. Millions of dollars spent last year on serious, comic, sport and animated cartoons—and the demand for cartoons increases every day! Hundreds of cartoons now used by big national advertisers.

Learn Cartooning at Home In Spare Time—Simple, Tested Method

There is a knack about learning cartooning which you can master in your spare time with this simple home study method. It starts you at the very beginning—on simple fundamental principles—then takes you through every branch of humorous and serious cartooning. You will be delighted with the simplified way to learn to draw cartoons that sell. Many earn even while learning.

Send for Free Book

Get this handsomely illustrated booklet which gives the details of this remarkable home study course in Cartooning. Gives thorough outline of the cartooning field and market for cartoons. Shows how to become a cartoonist. No obligation. Send for it today. (No salesman will call.)

Washington School of Cartooning
Room 301F, 1113—15th St., N. W., Washington, D. C.

Washington School of Cartooning
Room 301F, 1113—15th St., N. W., Washington, D. C.

Please send me without obligation, your Free Booklet on Cartooning and special offer to new students.

Name Age.....
(Write Name Plainly.) (State whether Mr., Miss or Mrs.)

Address.....

City.....State.....



Learn to Write

I Teach by Mail

I CAN make a good penman of you at your home during spare time, no matter where you live or how poorly you now write. My simplified system has shown thousands of others the way to good penmanship during the past twenty years — it can and will do the same for YOU!

Beautifully Illustrated Book
“How to Become a Good Penman”

It contains general information, with testimonials and beautiful specimens **FREE!** of penmanship showing what others have accomplished by the Tamblin System. (Your name elegantly written on a card if you enclose stamp for postage.) **WRITE TODAY.** Address

F. W. TAMBLIN
 418 Ridge Bldg., Kansas City, Mo., U. S. A.





Play “JAZZ” on the Saxophone

Become a musician so quickly as to astound everyone. Learn by playing real music—instead of tiresome “exercises.” You’ll soon become the most popular person in your “set.”

New Easy Method

is a revelation. Nothing else like it for thoroughness and rapidity. So simple that young and old find it easy to play with amazing skill. No “trick music”—but actual notes, learned quickly right in your own home.

**FREE BOOK and
Demonstration Lesson**

offers this wonderful musical opportunity. Send for them today before copies are exhausted. You’ll be astounded, thrilled, fascinated, at this easy, rapid way to become a veritable master of your favorite instrument. Instruments supplied when needed, cash or credit.

LEARN TO PLAY ANY INSTRUMENT

Piano	Mandolin
Organ	Drums and Traps
Violin	Harmony and Composition
Clarinet	Sight Singing
Flute	Ukulele
Harp	Piccolo
Cornet	Trombone
Cello	Saxophone
Guitar	Voice and Speech Culture
	Automatic Finger Control
	Piano Accordion
Banjo (Plectrum, 5-String and Tenor)	

U. S. SCHOOL OF MUSIC, 71-A Brunswick Bldg., New York City

Send me your amazing free book, “Music Lessons in Your Own Home,” with introduction by Dr. Frank Crane, also DEMONSTRATION LESSON. This does not put me under any obligation. (Please Write Plainly.)

NAME.....

ADDRESS.....

INSTRUMENT.....

Have you this inst.?



Learn Electricity *in a few weeks*



"MAC" Himself

Let me teach you electricity by the sure, simple, easy, practical, proven method—right in my own completely equipped electrical training shops. No books—no printed lessons—no dry lectures, no mere theories. You get "right down to brass tacks" working on motors, generators, batteries, switchboards, autos, engines, sub-station, complete telephone system, telegraph system, house-wiring installation—everything from A to Z in both alternating and direct current electrical work. McSweeney originated the shop-plan of training and nothing yet has been found to equal it. Thousands of McSweeney-trained men will testify to the thoroughness and efficiency of McSweeney methods.

Complete, Thorough, Practical, Training by Shop Methods

Just imagine how easy it will be to learn electricity this proven way. With an amazing outlay of electrical equipment costing thousands and thousands of dollars, you do real, actual work just as you will do when you leave the McSweeney School and go out to accept a big-pay job or enter business for yourself. I teach you electrical installation from a simple bell system to a farm-lighting system, or telephone and telegraph line. I teach you how to wind armatures, operate motors, dynamos and generators; wire a house; operate a substation; how to repair motors and other electrical equipment; 90 days training under McSweeney methods will make you a better electrician than many so-called electricians who are now making many thousands of dollars every year in electrical contract work.

Get Out of the Rut NOW

Make up your mind to get into electricity while the demand for good men is so great. Mail the coupon now for my remarkable winter training offer, which includes not only tuition, but also

R. R. Fare and Board

No books to buy—no extras to pay for. I allow railroad fare from your home to either school, also make board allowance. One amazingly reasonable fee covers everything. Act promptly. Get started at once. There are no terms or periods. I'll start training you the very day you arrive. No time wasted. You get right to work and become an electrician in a wonderfully short time under the McSweeney system. Get details at once—mail the coupon—no obligation.

MC SWEENEY

ELECTRICAL SCHOOLS

Dept. 51-A-4

CINCINNATI, OHIO
CLEVELAND, OHIO

FREE



McSweeney Electrical Schools,
Dept. 51-A-4, Cincinnati, O. Cleveland, O.

(Address nearest school)

Without obligation, send me your big free book and special tuition offer including R. R. fare and board.

Name

Address

Town.....State.....

Your Choice of 1000 Good Jobs!

Think of the unlimited future in electrical work. Prepare for jobs like these:
Auto Electrician—\$110 a week.
Radio expert—\$100 a week.
Armature expert—\$100 a week.
Substation operator—\$65—\$75 a week.
Maintenance engineer—\$150 a week.
Service Station owner—\$200 a week.
House-wiring contractor, unlimited.

Plenty of other good electrical jobs pay \$40, \$50 or \$60 a week right at the start. The McSweeney course fits you for any branch of electricity you want to follow—telephone or telegraph work, installation, contracting, repairing, manufacturing. It opens up to you the whole wonderful field of electricity with your choice of a thousand and one good jobs at almost any time.

O. C. MILLER

Director
Extension
Work
American
School



The American School

A million Dollar *No-Profit* Educational Institution, now offers men a *double service*—training for a specific job, then help in finding the job. For one small price, on terms of only \$6.00 a month, you are now assured of definite benefits, both in position and salary. Write for complete information—*today!*

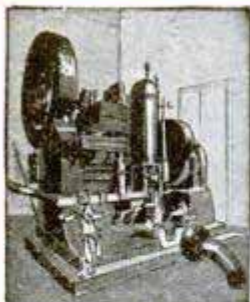

No machine can be built until the Draftsman first builds it on paper. My training prepares you for this work.



Never has the world seen anything like the building boom of today. This has created enormous demand for real Draftsmen.

5 BIG-PAY Branches

The big money in Drafting goes to men who specialize in Machine Design, or Electrical Drafting, or Architectural Drafting, or Structural, or Automotive. It is not enough merely to know *general* Drafting practice. You must know how to calculate and design and plan original work. You need many Engineering subjects to fill the kind of a Drafting position that pays \$60 to \$125 a week. The American School now includes this specialized training in its Drafting course.

Costly Drafting Outfit Given!

Fine, imported instruments like these help you learn Drafting quickly and easily. These standard quality, full size instruments, board, table, triangles, T square, ink, protractor, etc., given to every student without extra cost.

O. C. Miller, Director Extension Work

The American School

Drafting

to prove you can

We have invented a new, simplified way to teach Drafting—the first real improvement in Drafting home instruction in history. We want you to see a few of these new Job-lessons, try them, test your own ability to master them—without one penny of cost or obligation. For instance, you will see how we get away from the “copying” methods used in the past, so you develop into a DRAFTSMAN, instead of a “tracer.” See for yourself the ingenious new method which compels you to think, to solve problems, to do actual Drafting-room jobs from the very first lesson!

A New, Rapid, Simplified Training

Copying drafting lessons prepares you to be only a “tracer.” This new “Job-Method” gives you actual drafting-room jobs in a new one-step-at-a-time way. With pictures which you can understand almost without reading the “lessons.” And that is why the American School-trained Draftsmen can qualify for a good job at big pay when they graduate.

Win Success Thru Drafting

Drafting is easy, fascinating work. Short hours. Big pay. And the Draftsman is always in line for promotion to executive positions. This training is complete. It includes high school subjects (if you need them) and all the Engineering and Mathematics Drafting experts require.



FREE Job Service!

The American School now offers its students and graduates, without cost, the services of an efficient employment department keeping in constant touch with employers of Draftsmen all over the U. S. We have placed hundreds of men in good, big-pay Drafting positions. We've made this training so complete, so practical, so easy to master, that our students are bound to **make good**. And so, because the demand for real Draftsmen continues to exceed the supply and because this training actually prepares men for good Drafting positions we back it with a **Free Employment Service**.

Dept. D-174
Drexel Avenue and
58th St., CHICAGO

Lessons *Actually* FREE

learn at home in spare time!

Draftsmen Wanted!

\$60 to \$125 a Week!

yourself. Plan your future in Drafting. Even if you have only common schooling, even if you know nothing of Drafting, we guarantee to make you a real Draftsman or to refund your money! Special surprise offer right now to the first 500 men who answer this ad—reduced price, easy terms. Coupon brings complete information.

70,000 fine jobs advertised last year. Get ready to fill one. Get out of the rut. Make something of

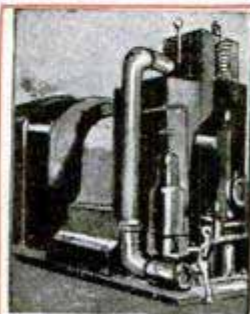

Electricity needs Draftsmen who know Electrical principles as well as general Drafting practice. I give you this training.



The demand for Draftsmen experienced in concrete and structural steel work is enormous. Many big-pay positions open.



Every great Auto factory employs Draftsmen who specialize in Automotive work — men who design bodies, plan engines, etc.

I Will Make This Contract With You



American School
—the Million Dollar
Educational Institution



WHEN you enroll for our home-training in Drafting, we agree to give you:

1. Complete Drafting training, by the new Practice-Method.
2. Professional Drafting Outfit, as illustrated.
3. We will help you get a good Drafting position at a substantial increase in pay,

4. or we'll refund every cent of your money.

O. C. Miller
Director Extension Work

Coupon Brings 3 Lessons FREE!

Get them. Test your own ability to learn Drafting and get ready for a fine job and big pay.

Coupon also brings surprise offer, and complete information about your opportunities for success in Drafting. Mail It Today!

Read These Letters!

City of Chicago
Department of Buildings
Gentlemen: The same day I received my diploma I got word that I was one of the two candidates who had successfully passed the examination for Deputy Commissioner of Buildings of the City of Chicago, a position paying \$3600 per year.

There were eight applicants examined besides myself, all men well known to the architectural and engineering profession. Seven of these failed to obtain a passing grade of 70%. My grade was 84.69. Inasmuch as I failed to pass this same examination three years before, my present success is mainly due to the knowledge gained through your School.

Yours very truly,
ROBERT KNIGHT

Liberty High School
Bethlehem, Pa.
Dear Sirs:—This is to thank the American School for all that you have done for me since I signed up for the Drafting and Design Course.

In the eight years since then, I have gradually climbed from the position of tracer to that of Head of the Department of Machine Drawing and Design in our magnificent new \$2,000,000 High School here, at many times the salary which I received at that time.

The officials of the Pennsylvania State Department, and Dr. Wm. C. Ash of the University of Pennsylvania, all claim that our Course in Drafting and Design is the best now being taught in this state. Every drafting graduate that we have turned out has proved successful, and one is now Chief Draftsman in a local steel concern. Yours sincerely,
J. S. LEAR

Has Charge of Large Jobs

"Even before I had finished my course, I was put in charge of large construction jobs in different cities. I have been doing that ever since, and the jobs are getting larger all the time. I owe my success to the American School because of the knowledge I gained in mathematics and calculations."

ELMER L. LAMB
1306 Smith St., Peoria, Ill.

Got His Draftsman's Job

"I wanted to let you know how I came out in getting that job at the Brownell Co., Dayton, Ohio. I was to start and have a trial at Drawing, and I am still in the Drawing room. The engineer seems to like the work I make, and also the other draftsmen. I thank the school very much for getting me in at this place, because your letter of recommendation helped me a whole lot to get the job."

BERNARD WEBER
730 St. Nicholas Ave., Dayton, O.

3 Drafting Lessons *Actually* FREE

O. C. MILLER, Director Extension Work
AMERICAN SCHOOL

Dept. D-174, Drexel Ave. and 58th St., Chicago.

Rush 3 Free Drafting Lessons, Job and Raise Offer, complete information, money-back guarantee, etc., to prove I can become a real Draftsman at home in spare time.

Name.....
Street No.....
City.....State.....

Automobile Mechanics are needed!

Prepare yourself now for a big-pay auto job!



THE demand for trained men in the automobile field is far greater than the supply.

More than 20,000,000 automobiles are in use in this country now, and every week the figures grow larger.

There are not enough trained automobile service and repair men to keep up with this steady growth.

If you are not satisfied with your present earnings, look into this proposition NOW.

Just Published! PRACTICAL AUTOMOBILE LIBRARY



Four Books—\$1.50 in 10 days and \$2 monthly for 6 months—only \$13.50 in all!

These four practical books, written by five well known teachers of automobile practice, will teach you, right in your own home during your leisure time, just what you need to know about automobile troubles and repair. They will teach you automobile construction, maintenance and repair as practiced by experts and will help you to earn an expert's pay.

Your Big Chance—Get Ready for it!

Hundreds of question-answering diagrams—hundreds of clearly-marked illustrations—make the books plain and readily understandable to any man with the mechanical instinct. All the explanations and descriptions are clear, simple, direct. Every chapter is packed with definite, step-by-step, how-to-do-it information.

Examine This New Library Free

No money down Small monthly payments

These books were written specially for self-instruction by men who have trained thousands of automobile operators and garage men. Examine the library for 10 days free. Just fill in and mail the attached coupon.

If you find the books what we say they are, send us \$1.50 in ten days and \$2 monthly for only six months. If you do not want the books, send them back at our expense. It costs you only a postage stamp to take a look at the books. Act now!



FREE EXAMINATION COUPON

McGraw-Hill Book Co., Inc., 370 Seventh Ave., New York

Send me for 10 days' free examination the New Practical Automobile Library. If satisfactory I will send you \$1.50 in 10 days and \$2.00 monthly until the special price of \$13.50 is paid. If not wanted, I will return the books at your expense.

Signed.....
 Address.....
 City and State.....
 Position.....
 Employer..... PM-1-28

BE A RAILWAY TRAFFIC INSPECTOR



EARN UP TO \$250 per month SALARY PLUS EXPENSES

Our students never worry about a position as one will be ready for each within a few days after completing the Traffic Inspection course. You start at \$120 or more per month plus expenses. Our contract shows why you take no risk.

As a Railway Traffic Inspector, you are practically your own boss, see new faces and places each minute, report only to high officials, are rapidly advanced. It's healthful outdoor work with regular hours.

Hundreds of Satisfied Graduates

During the last nine years, hundreds of our graduates have found satisfaction and increased incomes in Traffic Inspection. They took no chance—started on a definite salary. You can do the same. Write today for our free booklet, and contract agreeing to refund your money if position is not secured after graduation.

NO HUNTING FOR A POSITION AFTER COMPLETING YOUR TRAINING

Read what Ed. Grogan says—
 Dear Mr. Jarrell:

You will recall that I took a Correspondence Course in your school and was placed in a position a year ago. I am not going to try to say what the school and the Employment Department has done for me, but it is so much beyond my expectation that it would sound to a reader of this letter beyond reason, but I was raised to \$135 at the expiration of one month, and am now getting \$150 per month and like the work fine.

I find the men who are my superiors to be pleasant generally to meet and to work for, and they are invariably favorably impressed with your school. I am indeed grateful to you and your Institution. You have been a stepping stone to my future and I cannot thank you sufficiently. I wish I could tell some of the under-paid who are dragging along in a tough rut about your Institution. Again let me thank you.

(Signed) Ed. Grogan

STANDARD BUSINESS TRAINING INSTITUTE
 Division 2 Buffalo, New York

Big Money in Poultry



Eggs Turn into Dollars FAST!

Make \$1,000 a Year in Spare Time—Easy

Lots of room for YOU in the poultry business. 85% of the people of this country live in cities. EVERYBODY eats eggs and poultry meat—but only 15% produce them. Why not let the "other fellow" pay YOU the fancy prices? Easy to get started in back yard, on vacant lot, or farm. We GUARANTEE success if you follow our methods. We show you how to feed for eggs, in winter, when eggs are high in price; how to cut feed bills; how to keep flocks healthy; how to tell laying hens, PAY-BIRDS, from loafers. Our course, produced by eighteen famous experts, endorsed by 30 leading agricultural schools, gives you thousands of sure, proved, tested Methods that make PROFITS CERTAIN. FREE book tells what we're doing for others—and what we can do for you.

Others Say:

"You have opened up to me a pleasant and profitable way of gaining an independent living."

Seldon Anderson, R. I.

"When I enrolled for your course, I knew nothing about poultry keeping. I am now successfully operating a commercial poultry farm."

W. J. Warthen, Conn.

"Your course was a splendid investment. I recommend it for both beginners and experienced poultrymen."

Y. W. O'a, Hawaii.



Mail Coupon Today

Mail this now

The National Poultry Institute
 Washington, D. C. Dept. 411-E

I am interested in your plan on "How to Raise Poultry for Profit." Send me your FREE book, without obligation on my part.

Name.....

Address.....

Energize Your Body Through STRONGFORTISM



Your body can be and should be dynamic in its energy and powerful in every muscle. If you are a weakling—a make-believe man—a skinny, flabby outfit—it's your fault and yours alone. You don't have to be a weak, nervous, useless fellow. You can be strong—and you will be if you have the sand to follow the path thousands of others like you have followed under my guidance.

Maybe you are one of those fellows who have thought they could run wild without destructive results. Maybe you've gone the speed limit in the use or abuse of your physical powers. Maybe you thought there was no end to your vitality—that you could go it day and night and dissipate to your heart's content. Now you know better—you've learned your lesson—and what are you going to do about it? I'll tell you what you can do. I'll tell you what I've done for weak men all over the world.

Strongfortism Will Make a Man of You Men who were afflicted with all sorts of ailments—annoying, destroying, weaknesses—men who were ashamed of their lack of stamina and muscular power—men who had well-nigh given up hope of ever being strong again—these men—thousands of them—in this country, in South America, in Europe, in Australia, in Cuba, in India even—came to me and they were put on their feet, restored to health and strength and became men who were proud of their physique and who feared no one.

If you will take the time to read some of the fine testimonial letters that come from pupils everywhere you will realize the extent of the good that STRONGFORTISM has done. You will have no doubt of its value. You won't hesitate to apply it to yourself if you want robust health, vitality and muscular strength.

My Record In Body Building is Unparalleled

For over 27 years I have devoted myself to the development of men's bodies into fine specimens of manhood—not that they all wanted to be athletes, but because they wanted to possess full physical powers and feel like real men. No one in history has done more in the way of body building and restoration.

You can get rid of Constipation, Catarrh, Nervousness, Rheumatism, Indigestion, Dyspepsia, Weak Back, Insomnia, Palpitation and a whole string of other ailments if you will take up Strongfortism in dead earnest. I want to help you—and I can help you if you will give me a chance—if you will write and tell me what troubles you.

**STRONGFORT
Builder of Men**

Send For My FREE Book

This book of many pages and dozens of pictures tells of my wonderful experience—how I became the outstanding athlete of the world, performing feats others dared not attempt; how I turned the knowledge gained through developing my own body to the benefit of others, and then how STRONGFORTISM was evolved. It tells what I have done for others, what I can do for you. It doesn't mince words. It tells plain truths. "Promotion and Conservation of Health, Strength and Mental Energy," points the way from disease and weakness to health and strength. It is priceless. I'll send it to you on request—FREE. Write for your copy today.

STRONGFORT INSTITUTE
LIONEL STRONGFORT, DIRECTOR, E

Physical and Health Specialist

DEPT. 419

NEWARK, NEW JERSEY, U. S. A.

Send This FREE Consultation Coupon
ABSOLUTELY CONFIDENTIAL

Mr. Lionel Strongfort, Strongfort Institute, Dept. 419, Newark, N. J.—Please send me absolutely free my copy of your book, "PROMOTION AND CONSERVATION OF HEALTH, STRENGTH AND MENTAL ENERGY." I have marked (X) before the subjects in which I am most interested.

- | | | |
|-------------|-----------------|-------------------------|
| .. Catarrh | .. Overweight | .. Great Strength |
| .. Colds | .. Constipation | .. Lung Troubles |
| .. Asthma | .. Weak Back | .. Round Shoulders |
| .. Headache | .. Weak Eyes | .. Stomach Disorders |
| .. Rupture | .. Rheumatism | .. Increased Height |
| .. Thinness | .. Nervousness | .. Muscular Development |
| .. Pimples | .. Short Breath | |
| .. Insomnia | .. Weak Heart | |

Other Ailments.....

Name.....

Age..... Occupation.....

Street.....

City..... State.....



"Real Money in the Bank"

"Think of it, Nell—\$460! And to think that just a few months ago we couldn't save a cent.

"Remember the night we talked it over and you persuaded me to send in that I. C. S. coupon? It was the best investment we ever made.

"The boss says there will be a still better position open for me soon if I keep on showing the same interest in my work. It certainly does pay to study in spare time."

Thousands of men now know the joy of happy, prosperous homes because they let the International Correspondence Schools prepare them in spare time for bigger work.

One hour after supper each night, spent with the I. C. S. in the quiet of your home, will prepare you for the position you want in the work you like best.

This is all we ask: Without cost or obligation, put it up to us to prove how we can help you.

Mail the Coupon for Free Booklet

INTERNATIONAL CORRESPONDENCE SCHOOLS
Box 5501-F, Scranton, Penna.

Without cost or obligation, please send me a copy of your booklet, "Who Wins and Why," and full particulars about the course before which I have marked X in the list below:

BUSINESS TRAINING COURSES

- | | |
|--|---|
| <input type="checkbox"/> Business Management | <input type="checkbox"/> Salesmanship |
| <input type="checkbox"/> Industrial Management | <input type="checkbox"/> Advertising |
| <input type="checkbox"/> Personnel Organization | <input type="checkbox"/> Better Letters |
| <input type="checkbox"/> Traffic Management | <input type="checkbox"/> Show Card Lettering |
| <input type="checkbox"/> Business Law | <input type="checkbox"/> Stenography and Typing |
| <input type="checkbox"/> Banking and Finance Management | <input type="checkbox"/> English |
| <input type="checkbox"/> Accountancy (including C.P.A.) | <input type="checkbox"/> Civil Service |
| <input type="checkbox"/> Nicholson-Prouty Cost Accounting | <input type="checkbox"/> Railway Mail Clerk |
| <input type="checkbox"/> Bookkeeping | <input type="checkbox"/> Common School Subjects |
| <input type="checkbox"/> Private Secretary | <input type="checkbox"/> High School Subjects |
| <input type="checkbox"/> Spanish <input type="checkbox"/> French | <input type="checkbox"/> Illustrating <input type="checkbox"/> Cartooning |

TECHNICAL AND INDUSTRIAL COURSES

- | | |
|---|--|
| <input type="checkbox"/> Electrical Engineering | <input type="checkbox"/> Architect |
| <input type="checkbox"/> Electric Lighting | <input type="checkbox"/> Architects' Blueprints |
| <input type="checkbox"/> Mechanical Engineer | <input type="checkbox"/> Contractor and Builder |
| <input type="checkbox"/> Mechanical Draftsman | <input type="checkbox"/> Architectural Draftsman |
| <input type="checkbox"/> Machine Shop Practice | <input type="checkbox"/> Concrete Builder |
| <input type="checkbox"/> Railroad Positions | <input type="checkbox"/> Structural Engineer |
| <input type="checkbox"/> Gas Engine Operating | <input type="checkbox"/> Chemistry <input type="checkbox"/> Pharmacy |
| <input type="checkbox"/> Civil Engineer | <input type="checkbox"/> Automobile Work |
| <input type="checkbox"/> Surveying and Mapping | <input type="checkbox"/> Airplane Engines |
| <input type="checkbox"/> Metallurgy <input type="checkbox"/> Mining | <input type="checkbox"/> Agriculture <input type="checkbox"/> Navigation |
| <input type="checkbox"/> Steam Engineering | <input type="checkbox"/> Mathematics <input type="checkbox"/> Radio |

Name.....

Street Address.....

City..... State.....

Occupation.....

Persons residing in Canada should send this coupon to the International Correspondence Schools Canadian, Limited, Montreal, Canada



Learn to Draw at Home

Students Say: "IT'S EASY"

Trained artists earn from \$50 to over \$250 a week. W. R. Kent, one of our graduates in New Jersey writes "I have sold a drawing, which took less than a day to do, for \$100." Tremendous demand right now for good art work. Magazines, newspapers, advertisers, printing houses, etc.

Become an artist through wonderful, simple method right at home in spare time as Kent and many others have done. Learn Illustrating, Designing and Sketching. Actual fun learning this way. Learn to Draw and Earn Big Money. Many of our students earn big money while learning.

Send for FREE BOOK

Just printed—a new book which describes the latest developments and wonderful opportunities in Commercial Art, and gives full details of this remarkable method of learning to draw. Tells all about students—their successes—what they say—actual reproductions of their work—and how many earned big money even while learning. Write for this **Free Book** and details of **Artist's Outfit given with course**. Write name plainly and state whether Mr., Mrs. or Miss. Also give age. Mail postcard or letter now. (No salesman will call.)

WASHINGTON SCHOOL of ART, Inc.
Room 301F, 1115-15th St., N. W., WASHINGTON, D. C.

OPPORTUNITIES IN Salesmanship

Become a Salesman

Every phase of business revolves around selling. The trained salesman is in demand—he can fix his own hours, choose his own field, control his own pay. His income depends only upon his results—there is no limit to what he can earn. We train you to sell successfully thru the LaSalle problem method under supervision of expert salesmen. Train in your spare time. Low cost; easy terms. 64-page booklet, "The Modern Salesman, Ambassador of Progress," free. Send for it today.
LaSalle Extension University, Dept. 164-S Chicago



FREE

EARN PROMOTION AND COLLEGE CREDIT

through the
HOME-STUDY COURSES
in 40 different subjects given by

The University of Chicago
207 Ellis Hall, University of Chicago, Chicago, Ill.

YOU CAN LEARN TO PAINT SIGNS and SHOWCARDS

At home in spare time—fascinating work—increasing demand—future unlimited—\$150 weekly. Complete, thorough, and practical course by mail covering sign painting, show cards and commercial lettering.

Write for Free Circular

UNIVERSAL SCHOOL OF LETTERING
WATERBURY, CONN., U. S. A.

Become Auto Mechanic in a Few Weeks

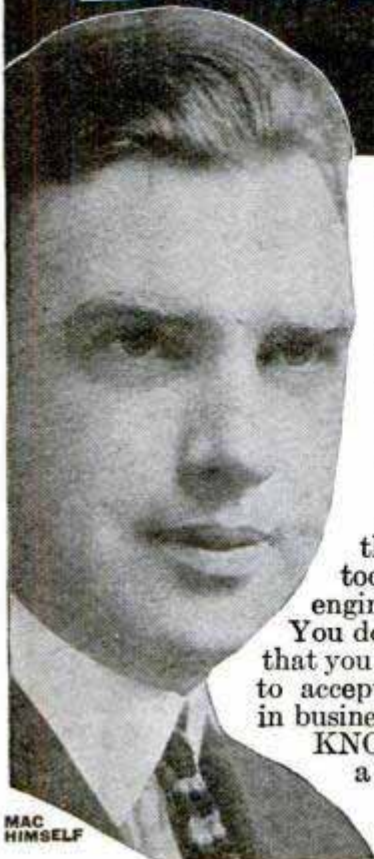

MAC HIMSELF

Step out and make something of yourself. Say good-bye to small-pay jobs. Don't waste your life waiting for raises that never come. Get into the auto-repairing business where the big money is—where real jobs are waiting for men properly trained to fill them. In eight short weeks I'll train you for jobs leading to \$50, \$60, yes \$100 and \$125 a week. Or you can go into business for yourself and make still greater profits. Don't wish you were an auto expert—be one. It's amazingly simple and easy by Mac's improved shop method of training.

Mac's Shop Plan Makes the Big-Pay Man

No books—no printed lessons—no dry lectures—no mere theories. You work with real tools and real equipment, real engines, autos, trucks and tractors. You do the work here in school that you will do when you go out to accept a big-pay job or start in business for yourself. You will **KNOW** your work. When a problem comes up, you will not hesitate or guess. That's why McSweeney trained men are always wanted.

Men who know nothing about autos or engines quickly learn under the McSweeney system. Age is no barrier. I don't care whether you are 16 or 60. If you're just an average man, willing to work and ambitious to succeed, I'll make you a capable auto mechanic in an amazingly short time.

Earn \$50 to \$125 Weekly

Satisfaction Guaranteed

I promise you satisfaction or money back. If, after you have completed my course, you are not qualified for a good job, if you are not satisfied that I have done everything possible to fit you for success as an auto expert, I'll refund your tuition. That's not only a promise but a guarantee.

McSWEENY MEN MAKE GOOD

When you complete the McSweeney course you can start a garage and repair shop of your own, or accept one of the splendid jobs that are just begging for skillfully trained men.

D. M. Collins, West Va., started as manager of a garage at \$300 a month.

George Smith of West Alexandria owns an auto agency and repair shop and makes \$200 a week and more.

C. E. Gillespie earns a nice fat salary as supervisor of a large fleet of trucks and tractors for the State Highway Commission.

L. L. Pohlman of Indiana was so successful that he owned a garage worth \$2800 in less than a year after completing McSweeney course.

Other McSweeney-trained men are doing as well and better. Thousands have started on the road to success through the McSweeney Schools.

Little Schooling Needed

Don't let lack of education, or experience hold you back.

Good Jobs Waiting—and I'll Help You Get One

For the benefit of McSweeney graduates, I maintain a special service for locating jobs and placing the right man in the right job. This service costs you nothing extra. It's yours for life. Let me tell you all about the McSweeney plan—send the coupon at once for my big **FREE AUTO BOOK** and remarkable winter tuition offer which includes

R. R. Fare and Board While Learning

Yes, I'll include your board and R. R. fare from your home to either school. One fee covers everything. No books to buy. No extras to pay for. I supply everything. You'll be amazed at the small cost. I am now prepared to handle thousands of new students—that's why I'm making the most liberal offer you ever heard of. Mail the coupon at once. Investigate. Costs you nothing to find out.

Mail Coupon NOW!

I want to send my big, beautifully illustrated auto book **FREE** to every man who is interested in a better job and bigger pay. Tells all about my training methods and big opportunities in auto and tractor repairing. It's yours free—just mail coupon.



Start NOW!

McSweeney Auto, Tractor and Electrical Schools,
Dept. 11-A-3, Cincinnati, O., Cleveland, O.
Without cost or obligation, send me your big **FREE** book on Autos; also, full details of your big offer including R. R. Fare and Board.

Name.....
Street.....
Town.....State.....

McSWEENY

AUTO, TRACTOR and ELECTRICAL SCHOOLS

Dept. 11-A-3 CINCINNATI, OHIO, CLEVELAND, OHIO

LEARN fundamentals of DRAFTING IN 4 MONTHS

CHICAGO TECHNICAL COLLEGE

If you are earning less than \$50.00 a week, send the coupon below. It brings you all the facts about Drafting's big money field—and tells how Chicago Tech. makes it possible for you to get started in this dignified, interesting, professional easily and quickly. Jobs are waiting for trained, wide awake serious-minded men—jobs that pay \$60 to \$150 a week to experts.

"Send us more draftsmen" is the call that comes to us from engineering, electrical and architectural firms, railroads and the country's great billion dollar building industry. Answer this call—prepare yourself—be ready when opportunity knocks. A Chicago Tech. fascinating short course gives you what you need to get started in this profitable field. 4 months of intensive, interesting training, then out on the job getting practical experience, and you'll be surprised how soon you will be one of the big pay men.

25th Year



FREE—84-Page Book

This book tells you all you want to know about this 25 year old school. There's so much that is interesting about this old established resident school, you will want to get all the facts. Facts about the organization, men behind it, and our well known courses in Engineering, Electricity, Architecture and Building. And just what this school can do for you—and your future. Get this book—it's interesting and helpful. Just mail the coupon. It doesn't cost you a penny.

In 4 Months at Chicago Tech.

The 4 months you spend in Chicago will be happy months. For it is the center—the hub of all engineering progress. 16 weeks of fascinating study and you're ready to begin Drafting. On your way, too, to big money. Specially trained—all set to make the big step of your life into a field abundant with opportunity. Into a field that pays big money for training and experience. You need only a common schooling. Practical Instructors. Part time work available. Free employment service. Living accommodations arranged for. Day or evening classes. Athletics. Many student activities. Enter any time.

You will never realize what Drafting and Chicago Tech. can mean to you until you have all the facts before you. Begin—make the first step to future prosperity and happiness now. Send no money. Just fill in and mail coupon today.

USE THIS COUPON

CHICAGO TECHNICAL COLLEGE
Dept. A-401, 118 E. 26th St., Chicago, Ill.

Please send me, without obligation, free and postpaid, your 84-page Blue Book and facts about how to get started in Drafting in 4 months.

Name.....

Address.....

Town or City.....

Age..... State.....

CLIP and MAIL COUPON-NOW

ELECTRICITY

Practical-Technical TRAINING

Great demand for practical-technical electricians and engineers. A brilliant future awaits you. A high salaried position or a profitable business of your own; these may be yours through our PRACTICAL-TECHNICAL courses. Opportunities unlimited.

12 Weeks Intensive Courses in PRACTICAL ELECTRICITY and POWER PLANT OPERATION open to you NOW. Extensively equipped laboratories and shops. Faculty of recognized experts. 26th successful year. One and Two Year Courses in Electrical Engineering open in September. Degrees and diplomas. Students assisted to positions. Send for free catalog.

FINLAY ENGINEERING COLLEGE
301 Finlay Bldg. Kansas City, Mo.

LAW Free Book

Write today for FREE 128-page book, "THE LAW-TRAINED MAN," which shows how to learn law in spare time through the Blackstone home-study course prepared by 80 prominent legal authorities, including law school deans, lawyers, and U. S. Supreme Court justices. Combination text and case method of instruction used. All material necessary furnished with the course, including elaborate 25-volume law library, which is delivered immediately upon enrollment. Many successful attorneys among our graduates. LL. B. degree conferred. Moderate tuition, low monthly terms. Money-Back Agreement.

Write for free book today

BLACKSTONE INSTITUTE, 4753 Grand Boulevard
Dept. 51 Chicago



Learn Watchwork, Jewelrywork and Engraving

A fine trade commanding a good salary, and your services always in demand. Address **Horological**, Dept. P, Bradley Institute, PEORIA, ILLINOIS, for our latest catalog.



"BECOME A LIGHTNING TRICK CARTOONIST"

Send \$1.00 for Laugh Producing Program of 23 Trick Drawings with Instructions. Catalog of Chalk Talk Supplies Free. **BALDA ART SERVICE**, Dept. 1, Oshkosh, Wis.



5 TUBE RADIO ONLY \$19.98

It's a wonder for power and selectivity. Famous AKL circuit. Coast to coast reception! Finely built of selected, tested parts. Thousands now in use. **FREE Log and Call Book** and New 132-p. Catalog with thousands of nationally advertised bargains. Latest in radio at big savings. Write for Free copy.

AMERICAN AUTO & RADIO MFG. CO.
HARRY SCHWARTZBERG, PRES.
Dept. 261 American Radio Bldg., Kansas City, Mo.



GOV'T. POSITIONS \$35 TO \$75 WEEKLY

- Railway Mail Clerk
- P. O. Clerk
- File Clerk
- Matron
- General Clerk
- Chauffeur-Carrier
- Skilled Laborer
- Watchman
- Postmaster
- RFD Carrier
- Meat Inspector
- Special Agent (investigator)
- Stenographer-Typist
- Immigrant Inspector
- City Mail Carrier
- U. S. Border Patrol
- Typist
- Seamstress
- Steno-Secretary
- Auditor

Instruction Bureau 111, St. Louis, Mo.
Send me particulars about positions marked "X"—salaries, locations, how to qualify, opportunities, etc.

Name.....

Address.....



RAILWAY POSTAL CLERKS

\$158 Month First Year

Raise to Maximum of \$225 Month

Many other U. S. Government Jobs Open to Men and Boys 18 up

**Post Office Clerks
Rural Mail Carriers**

**City Mail Carriers
Clerks in Customs and Internal Revenue Service**

These are steady positions. Strikes, poor business conditions, lockouts or politics do not affect them. U. S. Government employees get their pay for full twelve months every year. There is no such thing as "HARD TIMES" in the U. S. Government Service.

ALLOWANCE FOR HOTEL EXPENSES

Railway Postal Clerks now get \$1900 the first year regular, being paid on the first and fifteenth of each month. \$79.16 each pay day. Their pay is increased \$100 and \$150 a year. The maximum is \$2700 a year. \$112.50 each pay day. They get extra allowance for hotel expenses when away from home.

PAID VACATIONS

Railway Postal Clerks, like all Government employees, are given a yearly vacation of 15 working days (about 18 days). When on runs they usually work 3 days and have 3 days off duty or in the same proportion. During this off duty and vacation, their pay continues just as though they were working. When they grow old, they are retired with a pension. As Railway Postal Clerks are continually traveling, they have an excellent chance to see the country.

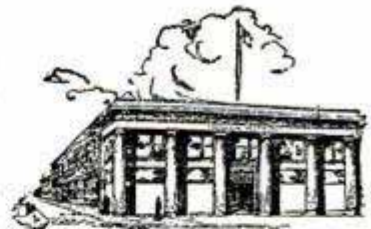

City Mail Carriers—Post Office Clerks

Clerks and Carriers get \$1700 the first year regular and automatically increase \$100 a year to \$2100 with further special increase to \$2300. They also have 15 days vacation. Many Feb. 18th examinations will be held in the larger cities. City residence is unnecessary.

What Will You Earn 5 Years from Now?

Compare these conditions with your present or your prospective condition, perhaps changing positions frequently, kicking around from post to pillar, no chance in sight for PERMANENT employment; frequently out of a position and the year's average salary very low. **DO YOU EARN \$1900 EVERY YEAR? HAVE YOU ANY ASSURANCE THAT A FEW YEARS FROM NOW YOU WILL GET \$2700 OR MORE A YEAR, EVERY YEAR?**



Get Free List of Positions

Fill out the coupon. Tear it off and mail it today—now, at once. **DO IT NOW**—This investment of two cents for a postage stamp may result in you getting a U. S. Government Job.

**FRANKLIN INSTITUTE,
Dept. T-173,
ROCHESTER,
N. Y.**

(Not connected with U. S. Government)

Rush to me entirely free of charge 32 page book with (1) a full description of the position checked below; (2) a list of U. S. Government jobs now obtainable; (3) tell me how to get the position checked.

- Railway Postal Clerk.. (\$1900-\$2700)
- Post Office Clerk..... (\$1700-\$2300)
- City Mail Carrier..... (\$1700-\$2100)
- Rural Mail Carrier..... (\$2100-\$3300)
- Clerk in Government Offices.... (\$1140-\$1860)
- Prohibition Investigator..... (\$1800-\$3000)

Name.....

Address.....

Use This Coupon Before You Mislaid It—Write or Print Plainly.

MAIL COUPON TODAY.



NOW → **ONLY \$2.00**

Giant Chest Expander

and

Progressive Exerciser

Be a muscular marvel. Have the muscles of a superman. Become strong for your health's sake or to astound your friends with extraordinary feats which only men of giant strength can do. In a few short weeks you will easily do stunts which now seem difficult—then real muscles and strength will be yours—and yours to keep.

Send No Money Use This Money Saving Coupon

If you want exercise to just keep in good shape you can reduce the strength of the Progressive Exerciser by eliminating as many cables as you wish. If you want great resistance so as to build up big solid muscles then use the full strength.

How the Giant Chest Expander and Progressive Exerciser is Made

The Giant Chest Expander and Progressive Exerciser is made with new live, springy rubber so as to give it long wearing and great resisting qualities. Do not pay more for an exerciser that has forty or less rubber strands to each cable. Get the best and most durable. The Giant Progressive Exerciser has 50 strands of the finest rubber procurable to each cable.

Free Instructions

We do not think it enough to send you an exerciser worth double what we ask, so for a limited time, we will also include instructions absolutely free. These instructions are interesting and simple to follow—they show you the short cut to health and strength. Order today before this wonderful offer is withdrawn.

Your Guarantee

The Giant Chest Expander is sold with a guarantee that you will say it is the finest you ever saw or your money back.

5 Cables or double 10 Cables for strength for

\$2 The double strength exerciser has resistance of over 200 lbs. **\$4**

How to Order—Send No Money

Sign your name and address to coupon below and get your Giant Exerciser at the present low introductory price by return mail. The price is made low because we want everyone to enjoy muscles and strength at the lowest possible cost. Don't pay more—order from us—get the most for your money. Use coupon now.

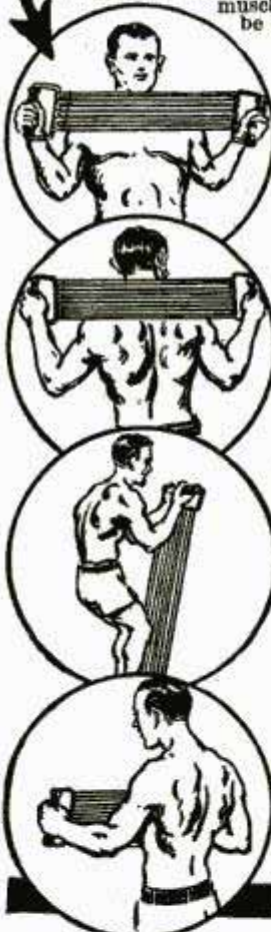

PROGRESSIVE EXERCISER CO.,
4001 Langdon Bldg.,
Broadway and Duane Street, New York

Please send Your 10 cable Progressive.
 Your 5 cable Exerciser.

Check the Exerciser you want, and it will be sent you by return mail. Pay postman introductory price, plus few cents postage on arrival. It is understood that if you are not entirely satisfied with your exerciser you may return it within 5 days and get your money back.

Name.....
Street.....
City..... State.....

If you live outside the United States, send cash with order.

OPPORTUNITIES IN Traffic Management

Become a Traffic Expert

The opportunities in traffic management are limited only by the boundaries of the business world. The trained traffic man is in demand by transportation systems and by industrial organizations.

Three Detroit Firms Pay Their Traffic Managers Over \$20,000 a Year

Prepare for this growing, profitable profession at home in your spare time under supervision of traffic experts. Low cost; easy terms. Thru the LaSalle Problem Method you learn by doing. Valuable 64-page booklet free. Send for it Now.



This Book FREE!

LaSalle Extension University, Dept. 164-T Chicago

NOW YOU CAN STUDY MUSIC AT HOME

earn \$75.00 to \$200.00 each week

With a nationally famous artist as your teacher you can learn to play classical or popular music on your favorite instrument. We guarantee our personal teaching method. Both advanced and elementary courses.

Write for catalogue
CONN NATIONAL SCHOOL OF MUSIC, INC.
506 S. WABASH AVE. Dept. 516 CHICAGO

LEARN TO PAINT SIGNS and SHOW CARDS

We quickly teach you by mail, or at school, in spare time. Enormous demand. Big future. Interesting work. Oldest and foremost school.

EARN \$50 TO \$200 WEEKLY

John Vassos, N. Y., gets \$25 for single show card. Crawford, B. C., writes: "Earned \$300 while taking course." Don't delay. Send today for complete information, samples and guarantee.

DETROIT SCHOOL OF LETTERING
154 Stinson Ave. Est. 1899 DETROIT, MICH.



THESE BOOKS MAKE PROMOTION SURE!

HERE is a complete education in power plant practice. Under the editorship of Terrell Croft, a staff of engineering specialists have put into these seven books everything the power plant man needs to know in order to get to the top.

Power Plant Practice 7 Volumes—2795 Pages
3706 Illustrations
Only \$2 a Month—8 Months to Pay

With the aid of this library hundreds of ambitious men have stepped into bigger jobs. You have the same opportunity. With a little spare-time reading you can have the identical knowledge possessed by the highest paid men in the power plant field. The library covers the entire field—boilers—valve setting—engine operation—turbines—injectors—electrical machinery—combustion—refrigeration—fuels—governors—boiler stresses—fire tubes—feed water treatment—selection of boilers and engines—pumps and pump governors—steam traps—condensers—piping, etc.



Every page is packed with information that the power plant man needs in his daily work.

If you want to get ahead—if you want to pass an examination for an engineer's license—if you want the big pay that comes with increased knowledge—get these books.

Free Trial—No Money Down—7c a Day!

FREE EXAMINATION COUPON

McGRAW-HILL BOOK CO., Inc.
370 Seventh Ave., New York

Ship to me, charges prepaid, the seven volumes of the POWER PLANT LIBRARY, price \$18.00. If satisfactory, I will send \$2.00 in ten days and \$2.00 a month until the special price of \$18.00 has been paid. If not wanted, I will return the books at your expense.

Name.....
Home Address.....
City and State.....
Occupation or Position.....
Firm or Employer.....

Pick the JOB you want!

—we'll help you land it!

Follow the example of other ambitious men, who are going after better-paid jobs by systematic reading of these wonderful books. Only 15 minutes a day will do the trick. Written so you can understand every fact instantly, even if your schooling is limited.

"LOOK IT UP" Try the REFERENCE Way!

—no studying, no memorizing

The JIFFY INDEX places the answer to any problem right at your finger tips. That's better than trying to keep it all in your head.

Without lessons or examinations you can gradually acquire the expert knowledge which pays top salaries. Big opportunities today in Electrical, Auto, Building and Manufacturing industries for men who take the trouble to really learn the work.

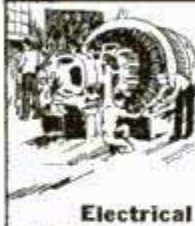
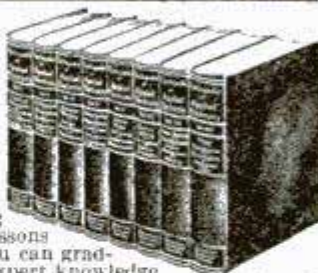

Electrical



Building

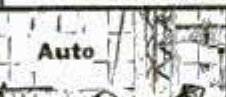

Auto



Civil Engineering

A Year's Membership FREE!

With privilege of consulting Engineers of American Technical Society. This service has often helped men win promotion and increased salary. Free with books.

Pay-raising Books SENT FREE!

Not a penny in advance. If not wanted after 15 days' free use, return charges collect and you owe us nothing. But if you prefer to keep them pay only \$2, then the balance at the rate of only \$3 a month. Coupon brings any set you wish.

Mail Coupon—Send No Money—Order by Number

	Total Price
1. Electrical Engineering, 8 vols., 4000 pages, 32,000 illustrations.....	\$34.80
2. Architecture, Carpentry & Building, 5 vols., 2500 pages, 2000 blueprints, etc.....	24.80
3. Civil Engineering, great new, 9 vol. edition, 3900 pages, 3000 illustrations.....	34.80
4. Auto Engineering, 5 big volumes, 2400 pages, 2000 charts, diagrams, etc.....	24.80
5. Business Management & Commercial Law, new 9 vol. set, richly illustrated.....	29.80
6. Modern Shop Practice, raises mechanics to experts, 6 vols., 2300 pages.....	24.80
7. Drafting—4 volumes, complete home instruction, 1678 pages, 1000 blueprints, etc.....	14.80
8. Steam & Gas Engineering, 7 vols., 3300 pages, 2500 illustrations, new DeLuxe edition.....	24.80
9. Great Library of L.A.W., complete in 13 big volumes, 6000 pages plus 24 case texts.....	49.80
10. Fire Prevention and Insurance, 4 volumes, 1500 pages, green & black binding.....	14.80
11. Sanitation, Heating, Ventilating, 4 volumes, 1450 pages, 1400 illustrations.....	14.80
12. Employment Management, 7 volumes, 1810 pages, flexible American Morocco.....	24.80

Send No Money

American Technical Society, Dept. X-119, Drexel Ave. & 58th St., Chicago

Send free for 15 days' use:

name of set..... No.....

I will pay the few cents delivery charges, and have the right to return the books, charges collect in which case I owe you nothing. But if I prefer to keep them I will pay \$2 after 15 days and the balance of your special advertising price at the rate of only \$3 a month. Please send FREE MEMBERSHIP as offered above.

Name.....

Address.....

Employed by.....

Address.....

American Technical Society Dept. X-119, Drexel Ave. & 58th Street, CHICAGO

TRAVEL - for 'UNCLE SAM'

**RAILWAY POSTAL CLERKS
MAIL CARRIERS—POSTOFFICE CLERKS
\$1700 to \$3300 a Year for Life**

No "lay-offs" because of strikes, poor business, etc.—sure pay—rapid advancement. City and country residents stand same chance. Common sense education sufficient—no political influence.

STEADY WORK

Cut coupon and mail it before turning the page.

**MEN—BOYS
18 to 45**

Use Coupon Before You Lose It

COUPON

FRANKLIN INSTITUTE, Dept. T175, Rochester, N. Y. Rush to me, entirely free of charge: (1) A full description of the position checked below; (2) 32-page book, with list of positions obtainable; (3) Particulars telling how to get the position checked.

- Railway Postal Clerk (\$1900 to \$2700)
- General Clerk (\$1140 to \$1860)
- Postoffice Clerk (\$1700 to \$2300)
- Prohibition Agent (\$1800 to \$3000)
- City Mail Carrier (\$1700 to \$2100)
- Rural Mail Carrier (\$2100 to \$3300)

Name.....

Address.....

Automobile Mechanics!

You can learn at home the ins and outs of

- 4-wheel brake adjustment
- Rebuilding an engine
- Replacing main bearings and pistons
- Care and repair of starting and lighting systems

- Reboring cylinders
- Timing an 8-cylinder motor

Not expensive Easy to learn

Mail coupon for Free Booklet

INTERNATIONAL SCHOOL OF AUTOMOBILES
Division of the International Correspondence Schools
Dept. 5502-F, Scranton, Penna.
Without cost or obligation, please send me full details of your home-study course in **AUTOMOBILE WORK**

Name.....

Address.....



How Did He Do It?

A Year Ago Ed was a Wage Slave - glad to get \$4.00 a day -

LOOK AT HIM NOW!



L. L. COOKE
-the man who makes Big Pay Men

IT'S quite a jump from \$4 a day to \$144 a week. But that's what Ed. Scrouggs did. And he's only one of the thousands of "Cooke" Trained Electrical Men who earn \$3,500 to \$10,000 a year. Why do you continue to slave away in a small-pay, no-future job when it's so easy to do what Scrouggs did - jump into Electricity, the Big-Pay field and get the Big Money. I'll show you how to do it.

Learn to Earn \$70 to \$200 A Week In Electricity

Electricity is where the Big Pay is and always will be. Today even the ordinary Electrician—the "screw-driver kind"—is making money. But it's the Trained Man—the Electrical Expert—who makes the really Big Money—\$12 to \$30 a day—\$70 to \$200 a week. Be a Big Pay Man yourself. Get in line now for one of these Big Pay Jobs.

I'll Train You At Home - Earn While You Learn

You don't need experience. You don't need to be a College Man. You don't even need a High School education. If you can read and write, that's enough. Keep right on with your regular job. My famous "Work Sheet" and "Job Ticket" method guarantees you simplified, practical training along work-shop lines in your spare time. With me you get experience as you go along. Not only that, but right away I teach you how to earn as you learn—how to make \$10 to \$30 a week extra money while training - and I give you without extra cost Six Big Outfits of tools and apparatus to work with and earn extra money with.

Money Back If Not Satisfied

That's my agreement with you. There's nothing like "Cooke" Training anywhere. It's the Training that big Electrical Men praise; it's the Training employers recommend; it's the Training a great Engineering Society has endorsed 100%; it's the Training for you! And I agree to give you every penny of your money back if you're not satisfied. A \$2,000,000 Illinois Corporation backs up this agreement.

Get Started Now - Mail Coupon

If you're now earning less than \$70 a week - don't wait a minute but mail the coupon and find out how quickly I can get you ready for a Big Pay Job. Get my Big FREE Book of Facts. See the Six Big Working Outfits that cost you nothing extra—see the hundreds of pictures, the Proofs, the letters of other Big Pay "Cooke" Trained Men. Act now! Mail coupon at once.

L. L. COOKE, Chief Instruction Engineer
L. L. COOKE SCHOOL OF ELECTRICITY
Dept. 11, 2150 Lawrence Ave., Chicago, Ill.

\$144 A WEEK

Dear Mr. Cooke:-
I am making \$24 per day now and it is impossible for me to thank you enough for what you and your course have done for me.

When I first enrolled with you the best I could do was \$4.00 a day and I had a hard time to make ends meet. Now I have my own home and it is paid for and I just bought a new Reo Six Sedan. You can always depend on me to say a good word for "Cooke" Training.

Yours truly,
E. E. SCROUGGS
2420-24th Street
Sacramento, Calif.

YOU CAN DO IT TOO!

FREE BOOK TELLS HOW

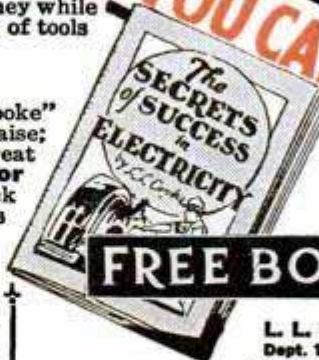

L. L. COOKE, Chief Instruction Engineer
Dept. 11, 2150 Lawrence Ave., Chicago, Ill.

Please send me at once your Big FREE Book —the same book that boosted Ed. Scrouggs' to \$144 a week; and tell me how you train men at home for Big Pay Electrical Jobs.

Name _____

Address _____

City _____ State _____

Residents of Canada send coupon to R. A. Farrow, Special Representative, 7 Medbury Lane, East, Windsor, Ontario, Canada.

The "Cooke" Trained Man is the "Big Pay Man"

Classified Advertisements

WORLD'S BEST WANT AD MEDIUM

Advertisements in this section, 30 cents per word, each insertion, minimum 10 words, payable in advance. To be inserted under proper classification in February issue, copy should be in our office December 18th.

ADVERTISING AGENCIES

Is Your present advertising bringing you satisfactory returns? If not, then let us help you to select more profitable mediums! We will gladly prepare your advertising copy and literature free of charge. For the past 30 years we have specialized in newspaper and display. One of our advertisers started and magazine mail order copy, both classified with \$1.20 weekly and is now spending \$500 each week. Proof of insertion is guaranteed or refund is made. Send for our free 56 page rate book and atlas today. Frank W. Lenhoff Advertising Agency, 600 No. Michigan Blvd., Chicago. (Established 1897.) Chicago's most progressive advertising agency.

A TEN Dollar Ad may put your proposition over. \$10 pays for a 4 line 24 word classified ad one Sunday in 8 of the largest newspapers. Reach over 6 million readers. Minneapolis Tribune, Buffalo Courier, Detroit Free Press, Kansas City Star, Pittsburgh Press, Indianapolis Star, Atlanta Journal, Cincinnati Enquirer. Free catalogue showing other lists of newspapers and magazines sent on request. Ankrum Advertising Agency, 22 West Jackson Blvd., Chicago. Largest classified advertising agency in the world.

PUT Your proposition before several million readers weekly with newspaper classified ads. 66 page catalog free showing many bargain lists. Rates. Circulation on over 1,000 newspapers and magazines. 17 years' experience. Brinckerhoff, Inc., 37 W. VanBuren, Chicago.

ADVERTISE in 24 Big Sunday Newspapers, 24 words \$15.00. Excellent for securing Agents, Salesmen, and Business Opportunities. Catalog listing 1,000 leading Dailies, Weeklies, Mail Order Magazines. Everything Free. Wade Advertising, Baltimore Bldg., Chicago.

ADVERTISE 50 monthly magazines, 5c word, \$4.00 inch; three insertions for price of two. King Co., Box 6723, Wilmington, Del.

LOWEST Rates. New Catalog. Owl Agency, Times Bldg., New York.

SIX Word Line—355 rural weeklies \$3.55. Admeyer, 4112-M Hartford, St. Louis.

FOR ADVERTISERS

ADVERTISE—28 words in 72 country town newspapers \$3.40. Lists free. Miller, 1027M Bellevue Ave., Syracuse, N. Y.

INCH Display in 50 monthlies \$2.00. Thrice \$4.00. Cope Agency, 233P, Champaign, Ill.

LETTERS, sales literature written. Long experience. Reasonable. L. Bartells, 504 52nd St., Milwaukee.

ENGRAVINGS. 25% discount. Estimates. Moulton, 1410 East 8th, Kansas City, Mo.

ADVERTISE in 275 country newspapers, 28 words, \$10. Keator, Hartford Bldg., Chicago.

28 WORDS in 200 rural newspapers, \$7.50. Roberts Agency, Forrester, Ill.

CUTS, Drawings \$1.50. Window Cartoons, 6. \$1.50. GPO. Bx471, New York.

SALES PROMOTION

\$50 TO \$50,000 Daily Sales Developed During 28 years for clients by our direct mail plans, copy, campaigns. One product, 1923, an idea; this year \$100,000 orders booked. Fifty year old concern desired 50 national representatives in 1925; we produced 40 in three months. 700 dealers in 10 months at \$3 each, for another. Ten years Sales Promotion Manager Larkin Co. Submit sales problems for free diagnosis. James C. Johnson, 118A Woodbridge Ave., Buffalo.

LETTER SPECIALISTS

BUSINESS—Building Mailorder Letters—Circulars—folders—campaigns. Investigate! Finkel Advertising, 15p Fairview, Jersey City, N. J.

SALES Letters that win. Cicero, 1725 Wilson, Chicago.

AUTOMOBILE SUPPLIES

SPINNING red, white and blue auto light. Spins with wind. Everybody notices. Nothing like it—most beautiful light—used anywhere on auto, motorcycle, airplane, radiator, mudguards, side top—rust proof, self-lubricating—easily attached any auto. Great mail-order article. Nice Christmas present. Trade discounts. Address Go Light Company, 78 Milford Ave., Newark, N. J. Pay mailman \$1.50 plus postage for sample.

YOU Are Wanted to Besilver Mirrors at Home. Immense profits plating autoparts, tableware, etc. Write for information. Sprinkle, Plater, 77, Marion, Ind.

CHARGE Batteries for real profit. You can buy the new "BT" Scoto Battery Charger for \$50 ordered direct. Start a battery shop for \$129.74. Get catalog. Adams-Barr, Columbus, Ohio.

JUNK Auto Tires cost \$10 per ton. Our Hoxie converts them into demandable, saleable mds. that sells anywhere for \$200 a ton. \$200 starts you, investigate. Address Hoxie, 108 E. 11th St., Los Angeles, Calif.

SLIP-Over tops make perfect Winter enclosures for your roadster or touring car. Patents Pending. Agents, Owners, write Slip-Over Top Co., Norwood, O.

RADIATORS at wholesale prices. All standard makes. Satisfaction guaranteed. Send for prices, stating make and model. Independent Radiator Co., 1119 S. Wabash Ave., Chicago.

AT Last! Reasonably priced Auto Emblems for every Lodge. Sells for only \$1.25. Write for attractive selling proposition and free Sample Case offer. North Central Distributors, Dept. 9, Ashland, Ohio.

VULCANIZING Auto Tires is a Paying Business. We have plants near you, \$50 up. Catalogue free. Equipment Exchange, 108 East 11th, Los Angeles, Calif.

AUTOMOBILES

PATENTS. Time counts in applying for patents. Don't risk delay in protecting your ideas. Send sketch or model for instruction or write for free book "How to Obtain a Patent" and "Record of Invention" form. No charge for information on how to proceed. Communications strictly confidential. Prompt, careful, efficient service. Clarence A. O'Brien, Registered Patent Attorney, Security Bank Building (directly across street from Patent Office), Washington, D. C. See pages 140 and 141.

AUTOMOBILE SERVICE EQUIPMENT

AUTOMATIC Air Compressors, paint spray outfits in sizes to suit the smallest and largest business. Only equipment of this kind on market using the Silent, Spiral, Bevel Transmission. Low prices, easy terms, 30 days trial. Automatic Compressor Co., Box M184, Troy, Ohio.

BARGAINS in reprocessed battery chargers. Rectifiers of all kinds and a few Constant Potential 8-Hour Chargers, two of them practically new. Very low prices and terms arranged while they last. I. C. Helmick, Box M183, Troy, Ohio.

STARTING—Lighting—Ignition Service most profitable in Automotive Field. Small investment. Big Profits. Pleasant work. New HB Test Bench brings you this business. Low Price, Easy Terms, 30 days trial. Write for new bulletin TB. HB Test Bench Division, Box M185, Troy, Ohio.

FOR FORD OWNERS

FORD Transmission Locks, regular price \$15. Will furnish surplus samples for \$1. Can easily be sold for \$5. Get yours today and make quick clean up. General Mechanical Co., 430 S. Green St., Chicago.

UNDERSLUNG with "RKO" Swing Lo Irons. See "Red-I-Kut" ad page 141.

QUICK Starting Coil—Free Circular—Fords, Chevrolets, Stans, Box 1523, Denver, Colo.

MOTORCYCLES, BICYCLES AND SUPPLIES

MOTOR Cycles Cheaper than Bicycles. \$25 to \$50. Ready to Ride. Tires, \$2.50; Frames, \$3; Forks, \$3; Tanks, \$5; Wheels, \$4; Chains, \$2; Handle Bars, \$5; Engines, \$15; Auto Tires, \$3. Send 30c in Stamps for Catalogues. Price Cutter, Deninger, Rochester, N. Y.

GOOD used parts for Indian, Harley Davidson, Excelsior, Henderson, and others at one-half of new prices or less. New parts for all makes. Quick service; expert repairing; prices right. J. B. Dahl, 3661-63 Archer Ave., Chicago, Ill.

MONEY Saving Motorcycle Bargains—Large stock of Used Harley-Davidson—\$50 and up. Send for Free bargain bulletin—Now! Motorcycle Parts, accessories, repairs. Knuth's Harley-Davidson Agency, 2525 Fond Du Lac Ave., Milwaukee, Wis.

BICYCLES—Double bar \$15. Tandems \$25. Exercising machines, Tricycle delivery. McDougald, 175 W. Lake, Chicago.

NEW and used Motor Cycle Parts. Tower Cycle Co., 3004 Kingsland Ave., Pine Lawn, Mo.

MOTORCYCLE Bargains. Used, rebuilt. Guaranteed. Shipped on approval. Catalog free. Floyd Clymer, 810 Broadway, Denver, Colo.

AVIATION

LEARN to Fly; \$100.00 including Solo. We guarantee to solo you regardless of the number of flying hours required. Our instructors are ex-army aviators and air-mail pilots with wide experience. Our training equipment is the best obtainable. Our course requires about two weeks, depending on the individual. No bond required, no charge for breakage. Eight years without an accident. 76 students graduated in 1925. Commercial aviation is a rapid growing industry. Don't delay! Enroll now in one of the oldest and best known flying schools in America. Write for booklet. Robertson Aircraft Corporation, operators of the United States Air Mail, St. Louis-Chicago, Lambert-St. Louis Airport, Annum, Mo.

BE An Aviation Expert: We now offer those who cannot come to Los Angeles the opportunity of taking our course in Aeronautical Engineering by home-study. We are nationally recognized as one of the best schools of aviation in the country. Made up from lectures written by our staff of expert instructors and covering the same work as given in daily classes at the school. Send 25 cents for our catalogue and sample lesson which shows the method in which this new profession is taught. Act now! Get in on the ground floor of the new industry! Warren School of Aeronautics, 120-126 W. Slauson Avenue, Los Angeles, California.

FLY With a winner (Nat'l Air Races 1926 and 1927) and one of America's oldest pilots. We have been building and flying airplanes for 20 years, operate a real aircraft factory with excellent equipment. Work in our factory guaranteed to day students. Terms and employment service can be arranged for students short of funds who take our special winter evening course. Airplane agency available for students. Heath Airplane Company, Chicago, Ill.

LEARN Aviation. Complete courses flying taught by experienced men the year round at one of the oldest schools in the country. Learn aviation in all its branches or specialize. Applied airplane mechanics, aerial navigation, airplane design and construction. Also a home study course. Write for details of opportunity in 1928 for aviators. Varney School of Flight, 1813 Main St., Peoria, Ill.

WINGS. New covered for Heath parasol monoplane crated \$25.00 Few sets remaining. Assortment of parts for aeroplane builders. Aeroplane motors. Lawrence new \$125, used \$90, Gnome 165 h.p. \$40. Curtiss propellers for snowsleds \$5, other types also. Two pairs army aviators goggles post-paid \$1. Write for new list. Special 50 h.p. motor \$90. Midway Aero Co., Box 283, St. Paul, Minn.

16 M/M/ Film: All well known stars for sale and rent. Join our new 16 m/m/ Library. Exclusive Film Service, Dept. P, 732 So. Wabash, Chicago.

FILMS, 200 feet 95c. Reels \$2.75—List. Edward Tieman, P. O. Box 155, Blue Island, Ill.

BE a movie exhibitor—big opportunity only moderate capital required—complete equipment at remarkably low prices. Write, Atlas Moving Picture Co., 624 So. Michigan Ave., Chicago, Ill.

MOVIE Films, 1,000 ft. reels, \$2.50 each; shipped anywhere on receipt of remittance. Particulars on request. Independent Films, 177 Golden Gate Ave., San Francisco, Calif.

BOYS! Start your own film exchange, make money, \$25 includes films and equipment, particulars free. Alton Films, 205 Brush Creek, Kansas City, Mo.

MOTION Pictures for home use, 1,000 foot rolls \$3.50. Send for list. Toy Film Company, 804 South Wabash Ave., Chicago, Ill.

NEW and Rebuilt Projectors for Theaters, Schools, Churches, Traveling Shows. Supplies and Complete Theater Equipments. Bargain Prices. Free Catalog. Monarch Theatre Supply Co., Memphis, Tenn.

FILMS and Machines, dirt cheap. Stamp for lists. Box No. 5836, Westport Station, Kansas City, Mo.

FILMS \$2.50 Reel. Cameras \$35.00-\$65.00. Stewart Marshall, Rome, Ga.

SCENERY TO RENT

WORLD'S Most Beautiful Settings for operas, plays, minstrels. Amelia Grain, Philadelphia.

EDUCATIONAL AND INSTRUCTION

U. S. GOVERNMENT wants men. \$1,700-\$1,900 and up at start. Railway Mail clerk examination coming. Let our expert (former Government examiner) prepare you for this and also Rural Carrier, Post Office, Customs, Internal Revenue, and other branches. Write today for free booklet. Dept. 8, Patterson School, Rochester, N. Y.

U. S. GOVERNMENT Jobs. \$1,140 to \$3,300 year. Men—women, 18 up. Steady pleasant work. Paid vacation. Short hours. Experience unnecessary. Common education sufficient. Thousands appointments yearly. List positions and full particulars—Free. Write today sure. Franklin Institute, Dept. T-14, Rochester, N. Y.

MECHANICAL Drafting by mail. Unusual opportunity to learn this interesting and lucrative profession from a Specialist, and at low cost. Postal brings full particulars. Henry Wilsey, 129 South Eleventh Avenue, Mt. Vernon, N. Y.

\$175-\$250 MONTH—Government positions. Steady work. Experience unnecessary. Interesting booklet free. Standard Institute, 4554-M Broadway, Chicago.

MEN wishing employment in Mexico, Cuba, Central or So. America: Send self-addressed envelope for details. Tropical Information Bureau, Box 3433-T, Miami, Fla.

MEN 18 Up. \$1,700-\$2,700 year. Railway Postal Clerks. City Mail Carriers. Common education sufficient. Write immediately for full particulars. Franklin Institute, Dept. T-3, Rochester, N. Y.

LEARN Auctioneering at home. 200 Auction sayings \$1. 393 Jokes \$1. Pay postman. American Auction School (Established 1906), Kansas City, Mo.

EXPERT Bookkeeping taught by simpler, speedier, more practical method. "Different"—that describes it! All phases. Free Folder. Kinman's, 1215 O. N. B., Spokane, Wash.

STORY Ideas Wanted for photoplays, magazines. Big demand. Accepted any form for revision, development and submission to markets. Established 1917. Send manuscripts for free criticism. Booklet mailed on request. Universal Scenario Company, 406 Western and Santa Monica Bldg., Hollywood, Calif.

STEAMSHIP Positions—Europe, Orient. Good pay. Experience unnecessary. Men and Women write for free particulars. Box 30-A, Mount Vernon, N. Y.

STUDY: Simplified Light Line Stenography or Bookkeeping, 25c; Squared-circle—Interest Problems, Free. Marr, Teacher, B605, Nashville, Tenn.

WORLD-ROMIC System, Masterkey 5,000 languages. Primers, \$1.98; Arabic, Chinese, French, German, Italian, Japanese, Russian, Spanish. Languages, 15 W. 18th St., New York.

TRACE Missing People. Excellent paying work. Open to all. Write National Headquarters, 169 East 83rd Street, New York.

BOYS—Men, 16 Up. Become Auto Mechanics. Particulars free. Franklin Institute, Dept. T-400, Rochester, N. Y.

DON'T prepare for any Civil Service Examination without seeing our catalogue. Free. Columbian Correspondence College, Washington, D. C.

FIREMEN, Brakemen, Baggage-men (white or colored), sleeping car, train porters (colored). \$150-\$250 monthly. Experience unnecessary. 810 Railway Bureau, East St. Louis, Ill.

LEARN Barbering at home. Practice on the family. Complete barber college instructions, home study, for \$1 bill or money order. Foster, Expert Barber, 6128 Michigan Blvd., Chicago, Ill.

USED educational matter sold on re-purchase basis. Also rented and exchanged. Money-back guarantee. Catalog free. (Books, etc. bought.) Lee Mountain, Fiegah, Ala.

BECOME a Landscape Architect. Uncrowded profession; wonderful opportunity for money-making. Easily mastered by mail. Earn while you learn. Est. 1916. Write for details. American Landscape School, 56, Newark, N. Y.

EARN \$25 weekly, spare time, writing for newspapers, magazines. Experience unnecessary. Details Free. Press Syndicate, 981 St. Louis, Mo.

SILVERING Mirrors, French Plate. Easily learned; immense profits. Plans free. Wear Mirror Works, Excelsior Springs, Mo.

DOUBLE Entry Bookkeeping mastered in 60 hours with 8 keys; guaranteed; diplomas. International Bookkeeping Institute, Dept. 8, Springfield, Mo.

RADIO OUTFITS AND SUPPLIES

\$10.00—RADIO A Batteries—\$10.00. Car Starting Batteries—6 Volts, 100 Ampere Hour. "Guaranteed." These batteries are manufactured from the very best of materials. Black rubber case 3/4 inch heavy duty positive and negative plates Douglas Fire heavy separators. Refund in ten days if not satisfactory. Please mention make of car or radio. Send Money Order. Velvet Chemical Company, 30 N. Michigan Avenue, Chicago, Ill. Will ship anywhere U. S. A. or Canada.

300 MILE pocket radio, \$2.00. No tubes nor batteries required. Useful and practical. Loud-speaker volume. Order direct today. Spencer Laboratories, 116 Atlas, Akron, Ohio.

SHORT Wave Super in crystallized metal cabinet, the most selective receiver. Transmitters: Master-oscillator-power-amplifier. Coupled Hartley Transmitter and receiver combined, portable for teleg. and telephon. Write for details. Star Radio Laboratory, 1292 Park Ave., New York City.

LONG Distance Radio, \$2.95 postpaid. Needs no tubes, batteries or electrical current. Over 300,000 homes have them. Picture and folder sent free. Crystal Radio Company, Wichita, Kans.

ARE You making money in radio? If not, send for booklet No. 50. Co-Operative Radio Doctors, 131 Essex St., Salem, Mass.

RECEIVERS \$4.95 up. Bargain literature free. Radio, C-427 East 16th, New York.

INDOOR Aerial equipment. Dime postpaid. Marvel, 222 State St., Albany, N. Y.

TRADE AND TECHNICAL SCHOOLS

AVERAGE Intelligence plus our home training places you in a big paying radio job. Information upon request. McKay Instrument Corp., 631 Railway Exchange Bldg., Portland, Ore.

GET a foreman's job in any trade. You will earn more money. Become an expert blue print reader. You can do it in spare time. My training will advance you quickly. Write now—tell me what trade you want—I will send my plan at once. Carroll Rumsey, 265 Drexel Building, Philadelphia, Pa.

TELEGRAPHY—Both Morse and Wireless—taught thoroughly and quickly. Tremendous demand. Big salaries. Wonderful opportunities. Expenses low; chance to earn part. School established fifty years. Catalog free. Dodge's Institute, Fern St., Valparaiso, Ind.

WE Train you for commercial radio operating and junior engineering, placing our graduates in positions paying \$150 to \$300 monthly from start. Rapid advancement. Write for catalog of course including extension course. Loomis Radio College, Dept. 5-E, Washington, D. C.

LEARN Radio and Telegraphy. Pleasant steady work. Operators earning big money. Always in demand. No experience necessary. Write Chief Operator, Illinois Telegraph, 1608 W. Madison, Chicago.

BUSINESS OPPORTUNITIES

READ The Mail Order News—America's Pioneer Mail Trade Journal. Quarter Century Old. Approximately 600 pages yearly of valuable information for beginners and established mail-order houses. Analyzes mail-order business, its opportunities. Practical mail-order ideas, legitimate money-making schemes, instructive articles. Tells how to start, what to sell. Published monthly. Subscription \$3.00 yearly. Send 25c for sample copy. None free. Mail Order News, 360 Bristol Bldg., New York.

EARN liberal second income, not interfering with your present work. Build substantial paying business in comparatively short time making world's biggest selling specialties. Investment small. Profits great! Have others selling your goods. My free, valuable, enlightening literature explaining all, how its possible, without machinery for you to manufacture Loidiac, Instant Automobile Refinish; Aemolite, guaranteed radiator anti-freeze; Re-Nu-Shu, factory refinish for old stained shoes; Klerzit, assures clear windshield vision; Aluite, wonderful all-metals polish; catalog of popular priced, Apex guaranteed formulas for 500 necessities. 30 years' experience turning beginners into successful manufacturers. Highest references. Miller, Chemist, 1706-G Jetton, Tampa, Fla.

LARGEST Corporation in the fastest growing industry of the time requires responsible, energetic branch manager. The man with the required qualifications will be given the opportunity to secure financial returns far beyond the ordinary. Must be able to finance himself to the extent of \$750. For particulars address, Sales Manager, 113-115 North May St., Chicago.

MECHANICS, painters, carpenters, start furniture refinishing, painting, handyman shop on nearly nothing; winning plan brings customers quickly. John Braceland, 1439 So. Ninth, Philadelphia, Pa.

MIRRORS Resilvered at Home. Costs less 5 cents per square foot; you charge 75 cents. Immense profits plating like new; brassy, worn-off autoparts, reflectors, tableware, stoves, etc. Outfits furnished. Details free. Sprinkle, Plater, 127 Marion, Ind.

AGENTS Wanted—To sell our New Carboray Arc Lamp, generating Sunshine and Health in every Home. Cincinnati Automatic Machine Co., Cincinnati, Ohio.

START Mail Order Business of your own at home. We supply catalogues with your address on. Winebolt Sales Co., Box 4, Woodbine, Penna.

MY article, "The Only Way of Raising Capital for a New Enterprise," sent free on request. R. Andree, 11 Park Place, New York.

NEW system mail order; big profits, instructions free. King Company, Box 672-P, Wilmington, Del.

WHY work for others? Employ agents yourself. Make your own products. Toilet Articles, Household Specialties, etc. 500% profit. Valuable booklet free. National Scientific Laboratories, 1930W Broad, Richmond, Va.

COMMERCIAL Fried-pie formula \$1. Big profits. Gerwin, Dale, Oklahoma.

WHY work for others? Employ agents yourself. Make your own products. Toilet Articles, Household Specialties, etc. 500% profit. Valuable booklet free. National Scientific Laboratories, 1930W Broad, Richmond, Va.

LADY Adella. Best formula money can buy. \$1. Bill, no stamps. Henry Matchett, 2423 N. 6th St., Philadelphia, Pa.

KANTLEAK Automatically Seals Punctures. Formula 25c. Western Chemical, R1013 Rock Springs, Wyo.

BE Independent. Go into business at home. Specialize in Commercial Printing. No experience required. Small capital needed. Complete Course, \$1.00. Supply limited. Get yours now. Ackerman's Commercial Press, Downs St., Kingston, N. Y.

OPERATE a Collection Agency. 7 Result-producing Collection Letters, \$1.00. Sample Letter, 25c. Dougherty, B-74, Phillipsburg, N. J.

WONDERFUL opportunity selling by mail. Particulars free. Robinson, Box 251, Youngstown, Ohio.

FREE Book. Start your own little business selling novelties by mail evenings. Hadwil, 71A-74 Cortlandt Street, N. Y.

PATENTS. Time counts in applying for patents. Don't risk delay in protecting your ideas. Send sketch or model for instruction or write for free book "How to Obtain a Patent" and "Record of Invention" form. No charge for information on how to proceed. Communications strictly confidential. Prompt, careful, efficient service. Clarence A. O'Brien, Registered Patent Attorney, Security Bank Building (directly across street from Patent Office), Washington, D. C. See pages 140 and 141.

LEARN Show Cards and Paint Signs. Complete Course \$2. Circular Free. Eastern Co., 266 West 41st, New York City.

BUSINESS Profession of your own and earn big income in service fees. See Stephenson Laboratories, display ad. page 144.

MAKE toys, novelties, furniture; assorted patterns and instructions \$1.00. Scroll Saw Free with order. Wm. Bogren, 2264 Hermans Avenue, New York.

SELL a Necessity at Half Store Price, still make 100%. Nationally advertised, popular as cigarettes. Repeats regularly. Established route stores, appoint agents. Twenty-page booklet 10c. Velvet Products Co., Sta. 118, Orlando, Fla.

MAIL Order Drug Store. Let us supply your drug store wants and save money. All questions answered. Mequon Drug Store, Thiensville, Wis.

START a new business. No competition. Handsome Profits. 25c coin tells how. Box 428, Middletown, N. Y.

SELL By Mail. Wonderful opportunity. Particulars Free. Mason, 3902 Broadway, Room 5, Chicago.

START Manufacturing business at home in spare time. Big profits. Only few dollars needed to start. Details free. Joseph Beksell, Box 194, Rockford, Ill.

MAKE Big Profits with a Fur Farm in your backyard. Chinchilla Rabbits, Muskrat, Mink. Write for facts. 252 Conrad's Ranch, Denver, Colo.

FURCRAFT at home. Positively the finest, surest and easiest big profits at home in spare time for men and women. Investigate now. N. W. Fur Co., Dept. 37, Omaha, Nebr.

ATTENTION! Establish for yourself new system real estate, brokerage and insurance agency; office at home; earn \$5,000 year. Stamp free booklet. Hayes Realty Association, Cincinnati, Ohio.

FEW Dollars starts one in worthwhile local and mail-order business. May operate from home. Valuable descriptive booklet, agency proposition, etc., free. Address, Manager, Box 437, Seattle, Wash.

SUCCEED With Your Own Products. Make them yourself. Formulas, Processes, Trade-Secrets. All lines. Catalog, circulars free. B. Thaxly Co., Washington, D. C.

SIGNS and Showcards Easily painted with Letter Patterns. Large variety of Styles and Sizes. Samples for stamp. John Rahn, a2120 Neva Ave., Chicago.

LET us show you how to start small mail order business, with less than \$100, that will make you quick, big, positive income. We furnish everything, with complete, detailed confidential information. The Ellis Company, Box 477, Desk 1, Stockton, Calif.

EARN Independent Income at home; anywhere; spare time. Coe, 129 East 59th St., New York.

MONEY in Dry Cleaning; we furnish instructions and machinery; experience unnecessary. Potter Manufacturing & Supply Co., 4723 Delmar Ave., St. Louis, Mo., U. S.

"SCHEMER" Alliance, Ohio, 36 p. monthly, prints Schemes, Tips, Formulas. Subscriber reports \$25,000 from three; another \$10,000 from one. Try it! Year, \$1.00; 3 months, 30c.

CHARTERS: Delaware; best, cheapest; free forms. Colonial Charter Co., Wilmington, Del.

TASTE flavor of real money selling Annie Blain Flavors, wholesale, retail; new system, samples; other unique methods. Geo. S. Parker, New Brunswick, N. J.

PATENTS Procured; Trade Marks Registered—A Comprehensive, experienced, prompt service for the protection and development of your ideas. Preliminary advice gladly furnished without charge. Booklet of information and form for disclosing idea free on request. Richard B. Owen, 30-Owen Bldg., Washington, D. C., or 41-R Park Row, New York.

UNPATENTED Ideas Can Be Sold. I tell you how and help you make the sale. Free particulars (Copyrighted). Write W. T. Greene, 810 Jenifer Building, Washington, D. C.

ARTIFICIAL marble sanitary flooring instructions, covering wood or cement flooring ½ inch thick, fireproof, waterproof, all colors, low cost. Ornamental casting, concrete, plaster, papier-mache decorations, garden furniture, statuary, flexible molds. 18 years instructing the public; particulars and illustrations free. Chris. Mahler, Huntington, N. Y.

CHEMICAL Expert will furnish Formulas and Trade Secrets. All lines. Lists Free. W. L. Cummings, Ph. D., 228 Gordon Ave., Syracuse, N. Y.

SELL by Mail! Books, novelties, bargains! Large profits! Particulars Free! B-Efco, 525 South Dearborn, Chicago.

BIG Bunch Mail. Year 15c. Catalogues, Magazines. Kentucky Agency, Covington, Kentucky.

EARN \$10 daily silvering mirrors, plating, refinishing metalware, chandeliers, head-lights, bedsteads. E. DeCle Laboratories, 225 Varick St., New York.

I MADE \$30 a Week Home. French Breadmaking. 15 years' experience; Free Booklet tells. Ashbrook 67, Marengo, Ohio.

DELAWARE Incorporator. Charters; Fees Small; forms. Chas. G. Guyer, 901 Market St., Wilmington, Del.

LEARN the collection business. Good income, quick results. Interesting booklet, "Skillful Collecting" free. National Collectors Assn., Long St., Newark, Ohio.

A BUSINESS of Your Own Making—Sparkling Glass Name and Number plates. Checkerboards, Signs. Big book and sample free. E. Palmer, 540, Wooster, Ohio.

WE Start You in Business, furnishing everything; men and women, \$30.00 to \$100.00 weekly operating our "New System Specialty Candy Factories" anywhere. Opportunity lifetime; booklet free. W. Hillyer Ragsdale, Drawer 4, East Orange, N. J.

COMPOSITION Floor Making earns industrious men \$12 and more daily if used as trade. Or make business of it with profits up to \$10,000 yearly. Openings everywhere. Semi-Tile, Dept. C, Hollis, N. Y.

MAIL-ORDER Business is your opportunity. Brenner's famous handbooks, for fifteen years have shown beginners practically how to get into this fascinating and profitable business. Continually revised, always up to date. Set of ten, \$3. One book and descriptive catalog 25c. None free. Brenner Publisher, 1607 P. Sanson, Philadelphia.

A LITTLE manufacturing business—Crispettes, delightful confection and big money maker. We start you. Adams says \$364 profit two days last summer. You might do as well this winter. Write, Long Eakins, 1960 High St., Springfield, Ohio.

OPERATE chewing-gum machines. Large profits. Small capital. Particulars Free. Robbins Company, 28 Dodworth Street, Brooklyn, N. Y.

CAPITAL—For copy of "The Promoters' Hand Book"—a leaflet on financing, send \$1.00 to Amster Leonard, East Orange, N. J.

TELEGRAPHY

TELEGRAPHY—Both Morse and Wireless—taught thoroughly and quickly. Tremendous demand. Big salaries. Wonderful opportunities. Expenses low; chance to earn part. School established fifty years. Catalog free. Dodge's Institute, H St., Valparaiso, Ind.

CHEMISTRY

CHEMICAL Analysis, Processes, Technical Information. Robert Henderson, Laboratory, Madison, Maine.

CHEMICALS and apparatus. Price list 5c. George Ott, 1218 Chestnut, Reading, Penna.

YOUR chemical problem solved and working formula or process furnished for \$5.00. Write me. W. Stedman Richard, Industrial Chemist, Box 2402, Boston, Mass.

EXPERIMENTERS' Laboratory apparatus. Chemicals. List 5c. Chemical Apparatus Co., 4402 West End, Chicago.

FORMULAS AND TRADE SECRETS

GUARANTEED Formulas for world's largest selling specialties. Play safe, get my valuable lists, special formulas. Catalog describing Apex formulas, all lines. "Exclusive but not expensive" 30 years supplying particular people, with unequalled service. Miller, Chemist, 1706-H Tampa, Fla.

500 FORMULAS and Big Catalog 20c Ideal Book Shop, Park Ridge, Ill.

SUCCEED With Your Own Products. Make them yourself. Formulas, Processes, Trade-Secrets. All lines. Catalog, circulars free. B. Thaxly Co., Washington, D. C.

SUPERIOR storage battery formula and complete manufacturing information for starting and lighting batteries. A real business opportunity. Particulars free. Moline Laboratories, Moline, Ill.

CHEMICAL Consultation. Manufacturing ideas made practical. Many valuable formulas. Write Associated Chemists, Indianapolis, Ind.

TEN World's foremost, guaranteed formulas \$1.00, including 200 artistic printed letterheads and envelopes free. Voltino Agency, Roswell, N. Mex.

SELF-Shaving Cream and Coal-Saver Formulas 10c. Burkmann, 1665 Palmetto, Brooklyn, New York.

ANY desired Formula \$1.00, guaranteed. Central Laboratories, 233P, Champaign, Ill.

15,000 FORMULAS in "Scientific American Cyclopedic of Formulas." Includes following and many others: Accidents and emergencies, agriculture, alloys and amalgams, artist's materials, beverages, cements, glues, pastes, muclages, bleaching, renovating, coloring metals, dyeing, glass, heat treatment of metals, household formulas, ice cream, confectionery, chewing gum, lapidary work, exterminating vermin, lubricants, paints, varnishes, photography, condiments, canning formulas, rubber, soap, candles, soldering, toilet preparations, perfumes, waterproofing, fireproofing, writing materials. Send no money. Just write a postal. When postman hands you book pay \$5.50 and postal charges. Popular Mechanics Press, Room 908, 200 E. Ontario St., Chicago, Ill.

AGENTS WANTED

PRIVATE brand Toilet Articles, Household Specialties, Perfumes, Soaps, Extracts, etc. We pack these goods for you under your private label. With your name on the goods you get all the repeat business. Don't sell for others but build up a profitable business for yourself. Highest quality merchandise. Extremely low prices. Quick shipments on both large and small orders. Write immediately for lowest wholesale prices and complete information regarding our amazing offer. Address Supply Department, National Scientific Laboratories, 1904W Broad, Richmond, Va.

AGENTS—\$13.80 Daily in advance, introducing New Insured Hosiery for men, women, children. Must wear or replaced free. 57 styles, 39 colors including latest "Silk to the Top" Ladies' Hose. Nyland made \$595 in one month. Edwards, \$460.60. Mrs. Bone, \$425.45. Why not you? Even spare time should pay you \$3.00 an hour. No experience needed. We furnish samples. Silk hose for your own use free. New Plan. Write Quick, Milton Mathews, Park 5861, Cincinnati, Ohio.

AGENTS—Best seller; Jem Rubber Repair for tires and tubes; supersedes vulcanization at a saving of over 800 per cent.; put it on cold, it vulcanizes itself in two minutes, and is guaranteed to last the life of the tire or tube; sells to every auto owner and accessory dealer. For particulars how to make big money and free sample, address Amazon Rubber Co., Philadelphia, Pa., Dept. 505.

AMAZING New Glass Cleaner offers you \$15 a day sure! Cleans windows, windshields, show cases, etc., without water, soap or chamois. No muss. Easily demonstrated. Housewives, motorists, garages, stores, institutions buy on sight. Write for Special Introductory Offer. Jiffy Glass Cleaner Co., 1650 Monmouth, Cincinnati, O.

AGENTS—Mosco Corn and Callous Remover will build you a steady repeat business. Send today for pocket-size trial outfit. The Moss Co., 396 Searle Bldg., Rochester, N. Y.

THE Fastest sellers in the market. Shirts, Underwear, Sweaters, Pants, Boys' Suits, Men's Overcoats, House Dresses, Hosiery, Bedspreads, May Company, Pancoe Bldg., Chicago.

EVERYDAY sellers—Shirts, Underwear, Sweaters, Hosiery, Bedspreads, Leather Vests, Sheeplined Coats, Boys' Suits—Men's and Boys' Overcoats. Northern Sales Co., 101 So. Wells, Chicago.

BE Independent. Make. Sell Your own specialties. Immense profits. Catalog dependable Formulas, special selected agents' best sellers, free. H. Lusto, 626 Reaper Block, Chicago.

NEWEST sensation, \$15.00 lined jackets only \$5.75. \$10.00 Raincoats \$2.70. Sample on trial. Hamilton, 4111-MP Gladys Ave., Chicago.

\$1,000.00 REWARD if this is not the greatest money-making house to house proposition ever known. N. R. G. tablets wash clothes in 10 minutes without rubbing. Free Samples. N. R. G. Co., H232 W. Superior, Chicago.

AGENTS—Big Seller—\$20 Daily Easy selling Taylor Caps—made-to-measure—every man buys—some want 2 or 3 caps. Samples free and Cap free to agents. Write quick for fast money-making proposition. Taylor Cap Manufacturing, Dept. D-9, Cincinnati, Ohio.

AGENTS \$240 month. Bonus besides. Sell finest line silk hosiery you ever saw. Auto furnished. Credit given. Write for samples. Wilkint Hosiery Co., Dept. 3831, Greenfield, Ohio.

AGENTS—No water, soap. Woolven, New Port Richey, Fla.

WRITE Today for Free Samples finest line Raincoats, Topcoats, Slickers and Novelties. Something different. \$10-\$25 daily easy! Worthmore, H223 W. Jackson, Chicago.

\$100.00 WEEKLY! Two Suits or Suit and Overcoat \$33.50. All wool—Made to measure. Commission \$6.00-\$7.50. Outfit free. Garfield Tailors, BD-1557 Milwaukee, Chicago.

SALESWOMEN—Salesmen, make big money taking orders for our beautiful Dress Goods, Silks, Wash Fabrics, Handkerchiefs, Hosiery, Fancy Goods. 1,000 Samples furnished. The National Importing Co., Dept. A-100, 573 Broadway, New York.

MAKE \$12 a day from start and liberal bonus selling Pioneer \$23.50 all-wool tailoring. Commissions paid in advance. Striking leather brief case and 100 large cloth samples furnished. We train the inexperienced. Write now to Pioneer Tailoring Co., 159 W. Harrison, Dept. N-1117, Chicago.

NEW Invention—400% profit. Liquid quick mend for Fabrics and Hosiery. Stops runs. Every woman buys. Hundred other fast sellers. J. E. Johnson Co., Dept. 461, 6129 Wentworth Ave., Chicago.

MIRRORS Resilvered at Home. Costs less 5 cents per square foot; you charge 75 cents. Immense profits plating autoparts, reflectors, tableware, stoves, refinishing metalware, etc. Outfits furnished. Details free. Write Sprinkle, Plater, 128, Marion, Ind.

BIGGEST Xmas sellers. No competition. Rhinestone Initial Fountain Pens, Buckles, Umbrellas, etc. No investment. We deliver. Exclusive territory. Chaton Co., 606 Blue Island, Chicago.

\$2,241 WAS Charles Hickey's profit for 5 months selling Face-A-Lites, the new scientific all-metal glare shield. Makes glares from passing autos impossible. Write for territory proposition at once. Face-A-Lite Mfg. Co., A-79 Logan Building, Mitchell, S. D.

AGENTS \$17.50 daily. Bonus besides. Sell finest line hosiery. Seven months guarantee. New selling plan gets orders. Write quick. Silk hose free for your own use. Betterknit Textile Co., Silk 1631, Greenfield, Ohio.

AGENTS \$72 a week—Take orders for Guaranteed Cutlery—Knives, Razors, etc. Big commission. Exclusive territory. Big money for spare time. Write quick. Novelty Cutlery Co., Desk 831, Canton, Ohio.

HIGH-GRADE Printing at low cost. Wonderful proposition for agents. Exclusive. A permanent business for you. Large territories open. Write Detroit Produce Bulletin, 1783 West Fort Street, Detroit, Mich.

AGENTS. Write for free catalog. 100 sure sellers. House Dresses, hosiery, underwear, flannels, rugs, etc. Economy Sales Co., 104 Grove Hall, Boston, Mass.

SHOW Us the housekeeper who likes to clean stair corners. Earn big money installing Ideal Corner Dust Shields. Write today. Ideal Stairway Equipment Co., Canton, Ohio.

\$75 WEEKLY. Man or woman wanted with ambition and industry. To distribute Rawleigh's Household Products to steady users. Fine openings near you. We train and help you so you can make up to \$100 a week or more. No experience necessary. Pleasant, profitable, dignified work. Write today. W. T. Rawleigh Co., Dept. 53PPM, Freeport, Ill.

NEW Invention—Hudson's Valve Core Tester. Every motorist prospect. Sample 50c. Get exclusive territory. For dealer-salesman—agents. Hudson Tire Co., 221 N. Ottawa, Grand Rapids, Mich.

AGENTS—Electric Flashing Plugs, Great-est Whirlwind Dollar Sellers. Cost 34c. Customers buy dozens. \$10.00 Nationally advertised Dishwashing machine costs agents \$3.75. Hustlers reaping harvest. Write quickly for illustrated literature of these and other money-makers. United Service, 500 Fifth Ave., New York.

SELL Stoppo solder; lights with a match. Formula One Dollar. Particulars—stamp. J. W. Lucey, Box 239, Ottawa, Ill.

NO peddling. Start own business. Home office. Big profits. Free particulars. Elite, 38 Elizabeth St., N. Y.

MEN—Women, \$1.80 an hour. No less. Large Mfg. Co., established 30 years. Starting new medalion dept. Amazing new sales plan. First 22 agents average \$1.80 an hour steady. Only 1 agent wanted in locality. Your Own Photo Free as sample. Art Medalion Co., Dept. 63, Corner Campbell and Jackson, Chicago, Ill.

FASTEST 15c Seller. Wonderful milk-bottle opener and cover. Individuals and stores. Profits \$12 day. Sales guaranteed. Sales outfit 10c. Uneck, 4520 Lexington, Chicago.

PERPETUAL Writing Pad, 25c. Rempe Mfg. Co., 2827 Myrtle, Oakland, Calif.

AGENTS: Liberal commissions and bonuses selling high quality hosiery, handkerchiefs, scarfs, men's ties, curtains, bedspreads, linens. Also a big line of dress goods, silks, etc. 1,000 samples furnished. Write quickly. The National Importing Co., 573 Broadway, Dept. A-100B, New York, N. Y.

GENUINE Gold Leaf Letters anyone can put on store windows. Guaranteed to never tarnish. Large Profits. Enormous Demand. Free Samples. Write today. Metallic Letter Co., 438-D North Clark, Chicago.

SUCCEED with Your Own Products. Make them yourself. Formulas, Processes, Trade-Secrets. All lines. Catalog, circulars free. B. Thaxly Co., Washington, D. C.

AGENTS—\$13.80 Daily in advance. Introducing New Insured Hosiery for men, women, children. Must wear or replaced free. 57 styles, 39 colors including latest "Silk to the Top" Ladies' Hose. Nyland made \$595 in one month. Edwards, \$460.60. Mrs. Bone, \$425.45. Why not you? Even spare time should pay you \$3.00 an hour. No experience needed. We furnish samples. Silk hose for your own use free. New Plan. Write Quick. Maccohee Company, Park 2561, Cincinnati, Ohio.

AGENTS become a regular established McConnon dealer; buy on credit; sell for cash or credit. 228 absolute household necessities; all repeaters. Enjoy a sure income 52 weeks per year, year after year. City or country trade. Capital, experience unnecessary. McConnon & Co., Dept. 842, Winona, Minn.

FLAVORING Extracts—Bottle Yourself! Concentrated—add water! Free labels, whirlwind sellers! 500% Profit! Money-making opportunity. Write Thomas Manufacturing Company, Indianapolis, Ind.

FREE Book. Start your own little business selling novelties by mail evenings. Hadwil, 72A-74 Cortlandt Street, N. Y.

BRAND New Plan. Make \$45 and up a week. Profits paid in advance. Free suit to each agent. Just show our wonderful new style outfit and take orders for our high-grade tailoring. Handsome carrying case outfit of large real cloth samples—everything furnished free. Spencer Mead Company, Sherman and Harrison, Dept. N-817, Chicago.

MAKE \$100 weekly supplying demand for new invention. Makes autos run on 7% gasoline. Free sample. Write Whirlwind Co., 999-158 E. Third St., Milwaukee, Wis.

\$1.00 AUTO necessity. Repeats like gasoline. 100% profit. Guaranteed. Taylor Products Co., 26 West Naghten, Columbus, Ohio.

MAKE Big Money selling our exclusive dollar aluminum household specialty. Every housewife a prospective buyer. Exclusive territory. Chas. H. Klein Specialty Co., Jersey City, N. J.

CASH Paid for Butterflies, Insects. See Sinclair Display Advertisement on page 24.

EARN \$10 per sale—make \$20 to \$40 daily. Sell Addac—new portable, 8 bank adding and direct subtracting machine. Capacity \$999.999.99. Fast, accurate, complete, \$24.50. Millions of new buyers at this amazing price. \$50.00 under any competitor. Write for free sales test. Addac Co., Dept. 70-A, Grand Rapids, Mich.

PATENTS. Time counts in applying for patents. Don't risk delay in protecting your ideas. Send sketch or model for instruction or write for free book "How to Obtain a Patent" and "Record of Invention" form. No charge for information on how to proceed. Communications strictly confidential. Prompt, careful, efficient service. Clarence A. O'Brien, Registered Patent Attorney, Security Bank Building (directly across street from Patent Office), Washington, D. C. See pages 140 and 141.

WHY work for others? Employ agents yourself. Make your own products. Toilet Articles, Household Specialties, etc. 500% profit. Valuable booklet free. National Scientific Laboratories, 1930W Broad, Richmond, Va.

\$40.00 SUITS for \$23.50! All one price, union-made of finest quality Virgin Wool. You don't have to know anything about selling clothing. We guarantee your success if you are honest and willing to work. Write at once. William C. Bartlett, Inc., 850 Adams, Dept. 700, Chicago.

WE Trust You!—Starter stock and re-orders on credit—no bond signers; Finest line 200 guaranteed Extracts, Pure Foods, Toiletries. Big Profits. Write for details. Perkins Products, E-3, Hastings, Nebr.

JUST Out—New Patented Apron. No strings or straps—\$20.00 a day every day; over 100% profit; commissions daily. Write for free offer. Sta-Put Co., Dept. 201, St. Louis, Mo.

AGENTS Making Big Money Selling Fibre Brooms, Push Brooms, Dust Mops, Auto Mitten Dusters. Catalog and Samples Free. National Fibre Broom Co., St. Louis, Mo.

WOMEN—\$2 an hour spare time; 100% commission; new idea sanitary necessity; sells on sight; every woman buys; new feature never before used; designed by physician; revolutionizes old uncomfortable methods; pay every day; no deliveries, no collections; no experience or capital required. Write Mary P. Coleman, Meriden, Connecticut.

AGENTS—Make two dollars hourly. Sell new kind of Sharpeners. Sharpeners all knives, tools, quickly. Demonstrating sample free. Premier Mfg. Company, Dept. 63, Detroit, Mich.

AGENTS—Make \$10 daily; engraved name plates, signs, numbers, etc. Brett Bros., Roxbury Crossing, Boston, Mass.

QUICK Cleanup for Live Agents. Cash in on this craze for colonial rugs sweeping country. Every housewife buying. Agents earning \$100.00 weekly. Better-made Puritan rugs sell at half store prices. Big commissions advanced. Write for Offer. No obligations. Puritan Rug Co., 552 South Street, Waltham, Mass., Dept. 385.

AGENTS, Men, Women, My Comb Cleaner and Needle Specialties sell easy. Good Profits. Particulars, P. Miller, Box 3, Tremont Station, New York City.

AGENTS—\$6.00 hour earnings making four sales hour. Tremendous demand! \$3.50 article; powerful selling plan. Fagley & Halpen, Dept. 40, Philadelphia, Pa.

AGENTS, \$240 month! Quickedge Sharpener. Something new. Patented. Sharpens any knife or shears in less than minute. Big winner. Wonderful seller. Big profits. Write quick. Quickedge Sharpener Co., Dept. 48, Canton, Ohio.

AGENCIES to distribute to retailers and consumers. Ink eradicators, typewriter cleaners. Samples 60c. Vano Company, 122 5th Ave., New York.

\$50,000. PICTURE Man Friedman made canvassing. Beginners can make \$100.00 weekly with my sales talk. Experienced men make more. Free book. "Profits in Portraits" explains. Sample Free. Picture Man Friedman, Dept. 8-C, 541 W. Lake, Chicago.

AGENTS Make \$3.00 an hour taking orders for our 40 fascinating kitchen specialties. No competition. Write quick. General Products Co., A207, Newark, N. J.

AGENTS, Portraits, photo-pillow tops, frames, sheet pictures, medalion photography, guaranteed hose laundry tablets, food products, toilet requisites, luminous crucifixes. Catalog 50 specialties free. 30 days' credit. Jas. C. Bailey, Dept. C-1, Chicago.

HANDPAINTED Lingerie holders. Samples 10c (Coin). E. Mack Company, 15 Mechanic, H. Canton, N. Y.

FURNITURE Refinishing. Polishing, painting, handyman shop; wonderful profits; start yours on nearly nothing. John Brace-land, 1457 So. Ninth, Philadelphia, Pa.

100 MORE active men to introduce "Chieftain" Guaranteed Tailored Shirts, 3 for \$4.95. Latest novelties, colors, styles. Dickman, Illinois, in 3 weeks made \$589; Sinton, Texas, in 12 days, \$219.60; Bend, Iowa, in 16 days, \$334.80. Why not you? No experience or capital needed. We deliver and collect. Full working outfit free. Cincinnati Shirt Company, Shop 1581, Cincinnati, Ohio.

NEW Invention — Battery Connection Tightens Terminal Wire and Battery Post at same time. Solderless. Easy to attach or remove. 25c each. Agents wanted. Evert Bloomquist, 614 Turner St., Wausau, Wis.

IF I Send You a Suit made in latest style from finest goods, will you wear it and show it to your friends as a sample of my sensational values? Could you use \$3.00 an hour for a little spare time? If so, write at once for my wonderful new proposition. Address Sales Manager, 133 South Peoria, Dept. 1, Chicago.

AGENTS: Big commissions and bonuses taking orders for our big line of fashionable Dress Fabrics, Handkerchiefs, quality Hosiery, fancy Scarfs, Linens, etc. 1,000 Samples furnished. The National Importing Co., Dept. A-100A, 573 Broadway, New York, N. Y.

MAKE \$25.00 daily selling colored Raincoats and Silkers; Red, Blue, Green, Etc., \$2.95. Hat Free. Commissions daily. Outfit Free. Elliott Bradley, 241 VanBuren, Dept. AB-1, Chicago.

"WHERE to buy half million articles Wholesale," 72-page directory offers unlimited opportunities for agents. Free particulars. Pruitt System, Brookfield, Ill.

PORTRAIT Agents. Make more money with our line, highest quality work. Reasonable prices. Prompt service! Write for Free catalog. Linder Art Co., 551 Washington St., Chicago.

NO Strings to This Offer! Two actual mops loaned you Free. Make \$10 daily showing housewives new Self-Wringing Mop and Dust Mop. No money required. You're paid daily. We deliver. Get \$5.00 outfit immediately. Delphos Mop Co., 1011-B, Washington, Delphos, Ohio.

AGENTS—Just out! \$8.88 for men's suits! Anyone can sell! Commissions \$3 in advance. Free sales kit. 888 Company, Dept. 117-A, Fort Wayne, Ind.

WANTED—Agents and salesmen, make \$15 to \$25 per day selling men's fancy Rayon silk neckwear; style No. 1170, \$6 gross; style No. 1770, \$9 per gross. Send today \$15 for 2 gross. Christmas holly boxes with fancy rayon silk tie \$12, \$18 gross. Send today \$30 for 2 gross assorted ties. Lewis Hosiery Co., 12 N. 3rd St., Phila., Pa.

WHY work for others? Employ agents yourself. Make your own products. Toilet Articles, Household Specialties, etc. 500% profit. Valuable booklet free. National Scientific Laboratories, 1930W Broad, Richmond, Va.

YOU Can Make Good Durable Paint and Varnish 40c per gallon. Write Dept. 2, Emmelmann Bros. Mfg. Co., Indianapolis, Ind.

PICTURED Sign Cards, 400% Profit. Sample free. Breneman, Lima, Ohio.

REPRESENTATIVES wanted by over 500 manufacturers, offering real money-making propositions. No need of being out of work. Write for Free copy. Opportunity Magazine, 750 N. Michigan, Service Dept., Desk H-2, Chicago.

GOLD-LEAF Sign Letters; copyrighted Manufacturing Instructions; profits 1,000%. Johnston Co., Quincy, Ill.

PLAID slickers and hat \$2.98; also New Aerotex and Hidelike coats. Outfit Free. American Waterproof, 724P Roosevelt, Chicago.

AGENTS in Foreign countries: Collect common postage stamps. Easy money. Glendale Stamp Co., 1342 Linden, Glendale, Calif.

"HOLD-ON." Here's that new "Seal-Tite" tire patch. Wholesale lot! Make \$18.12 daily. Schrieber, Nashville, Ill.

AGENTS—Make Christmas money selling our Luminous Crucifix which Shines in the Dark. An ideal Christmas gift—Easily demonstrated—Big profits. W. G. Hannan Co., Dept. B, 2539 So. State St., Chicago, Ill.

MAKE \$100 weekly; everybody buys; 300% profit; we need representatives everywhere. Free sample. Magic Products, Dept. 200, 352 E. 31st, Kansas City, Mo.

JIFFEX—Pays all profit! Invest \$1.00, make \$20.00. Enclose \$1.00 bill, receive charges prepaid Jiffex for 10 gallons (80 pints) earning you \$20. Jiffex Amazing Glass Cleaner, cleans, polishes windows, windshields, showcases without water, soap or chemicals. Wonderful demonstrator. Everybody buys on sight! Receive also many other agent's profitable paying propositions. Satisfaction guaranteed. Miller, Chemist, 1706-F Jetton, Tampa, Fla.

CHAMOIS-Ray, 250% profit, all-metal polisher; latest invention. Le Soleil Company, 1454 Wellington, Chicago.

AMAZING Discovery brilliant diamonds. Baffle experts, rivals the genuine African diamond in dazzling brilliancy. Make \$100 weekly. Particulars free. Brilliance Co., E5643 Prairie, Chicago.

HOSIERY Agents wanted to make \$25 day, selling men's rayon and silk imperfect hosiery for Christmas holiday. Men's fancies \$10 gross, novelty \$13.20, \$15, \$18, \$21, \$24 gross, price silk and wool \$24, \$30 gross. Heather \$21 gross. Send today \$15 for 10 dozen assorted samples. Lewis Hosiery Co., 12 N. 3rd St., Phila., Pa.

\$12.00 DAILY—New, highly practical, useful article for every home and office. Quick 50c seller. Hydraulik Corp., Roselle, N. J.

OHKAY Money maker. Sample free. Osman, 1728 Seventh St., N. W., Washington, D. C.

MAN in each town to plate auto parts, reflectors, bathroom fixtures, refinish beds, mirrors, chandeliers; by new method. No capital or experience required. Simple plan of manufacturing at home starts you in big money-making business. Outfit furnished. Free particulars and proofs. Gun Metal Co., Ave. H, Decatur, Ill.

WRITE Atlas Sign Works for free working equipment. Beautiful window sign letters. Penny each! Any size. Wonderful offer to general agents, K1032 E. 55th St., Chicago.

AGENTS: Stamping names on pocket-key protectors. Sample check with your name and address, 25c. Stamping outfits. Emblem checks, check-fobs, name plates. Hart Mfg. Co., Desk 2, 303 Degraw St., Brooklyn, N. Y.

RADIO Agents—Make big money—Easy! selling marvelous new sets and accessories. Buy from factory at lowest prices. Get new catalog with thousands of nationally advertised bargains. Free Call Book. Write today. American Auto and Radio Co., Dept. 268, American Radio Bldg., Kansas City, Mo.

WE pay \$50 a week and expenses and give Ford Auto to men to introduce poultry and stock compounds. Imperial Co., D23, Parsons, Kan.

SUPERKEEN! Amazing New Patented Magnetic Blade Sharpener! Sharpens All Razor Blades Instantly, Magically, By Powerful Magnetic Force! New! Absolutely different! Sensational Demonstration! Whirlwind Seller! Write for Pocket Sample! SuperKeen, Dept. B-12, Salisbury, N. C.

REAL Money selling a great new Health Invention generating Violet Ray, Vibration, Electricity and Ozone. Exclusive Territory now open. Write today. Lindstrom & Co., 30 W. Lake St., Dept. A, Chicago.

BIG Money for men and women selling wonderful Whitehouse Stove Polish, Devil Dog, Walnut Flavoring, Beauty Creations, etc. Write quick. Blair Laboratories, Lynchburg, Va.

AGENTS—Stamping names on pocket-key protectors; sample check with your name and address, 25c. Stamping outfits. Emblem checks. Check fobs, name plates. Hart Mfg. Co., Desk 2, 303 Degraw St., Brooklyn, N. Y.

AGENTS—We start you in business and help you succeed. No capital or experience needed. Spare or full time. You can earn \$50-\$100 weekly. Write Madison Company, 566 Broadway, New York.

\$31.00 PROFIT—with \$1.50 Outfit—Big Money—Easy Work. Selling Gold Monograms for Automobiles, Luggage, Windows, Wagons. No experience. No license. "Samples Free." NuLife Monograms, Hartford, Conn.

AGENTS, get our prices. Largest reliable line toilet preparations and home remedies, including valuable premium coupons. Prompt service. Established 1867. Valuable selling plans. Lab. 11, F. Ad Richter Co., Berry and S. 5th Sts., Brooklyn, N. Y.

AUTO owner tire agent wanted each locality to use and take orders for hand made Mellinger cord and balloon tires; guarantee bond 15,000 miles; shipped prepaid on approval; get your tires free; no capital or experience required; make \$100 to \$300 weekly. Write for wholesale prices and sample kit. Address Mellinger Tire Co., Dept. 400, Kansas City, Mo., or Dept. 400, Philadelphia, Pa., or Dept. 400, Oakland, Calif.

REAL Whirlwind Seller—Nopolout Custom Shirt. Every man buys them. Patented—no competition. Liberal commission. Free selling kit. Make \$15 up daily taking orders direct from consumer at manufacturer's prices. District or local agents. Write Nopolout Shirt Co., Dept. Y, Hazleton, Pa.

SELL real necessity. Novelty Shirts, Hosiery, Neckwear. Colonial Novelty Co., Geneva, N. Y.

ARVEO Polishing Cloths offer big profits to salesmen. Sample and particulars free. Arveo Industries, Box F 147, Grosse Ile, Mich.

WHY work for others? Employ agents yourself. Make your own products. Toilet Articles, Household Specialties, etc. 500% profit. Valuable booklet free. National Scientific Laboratories, 1930W Broad, Richmond, Va.

SEND name, address on postcard. Free introductory copy Salesology Magazine; contains 1,000 money-making opportunities. Offered by big reliable firms; no obligations. Salesology Magazine, Desk B-38, 500 No. Dearborn, Chicago.

AGENTS make \$100 week furnishing Cigar Lighters to merchants on free advertising plan. Particulars sent free, write at once. Drake Mfg. Co., Dept. M, Milwaukee, Wis.

FREE Sample, "Rain Shield Wiper." Retail \$1.00—Cost (25 cents). Sold Clear and Rainy Days. No Cloth—No Paste—No Attachment. (1) Rub keeps windshield clear 48 hours. Experience Unnecessary. NuLife Corporation, Hartford, Conn.

\$60-\$200 A WEEK. Genuine Gold Letters for store windows. Easily applied. Free samples. Liberal offer to general agents. Metallic Letter Co., 438-B North Clark, Chicago.

ONE of the biggest mails on earth. Sent to any address for 10c. Louisiana Distributing Service, Dept. PM, Harmon, La.

PORTRAIT Agents—Write for new Catalogue—Enlargements, Frames, Medallions, Sheet Pictures, Luminous Crucifixes. Adam J. Kroll & Co., 2539 So. State St., Chicago, Ill.

WANT Distributing Agent for HandSlick, powdered hand soap; removes anything from hands; everybody a customer; sample free. Solar Products Co., J-2142 S. Troy, Chicago.

250% PROFIT on repeat seller everyone needs. Don't miss it. Fast demonstrator. Postcard brings confidential proposition. Tite Co., Dept. 301, Bala, Pa.

PHOTO Medallion Agents Earn \$20 Daily. Easy work collecting photos. Big line; quick sellers. Capital or experience unnecessary. Give you 4-day service on beautiful photo reproductions. Reserve your district today. Write Pudlin Corp., Dept. 103, 259 Bowery, New York.

\$5,000 A YEAR—Selling Perry Photo Medallions. Big demand. Ready sales. 400% to 600% profits. Any photo copied perfectly on Medallions, Mirrors, Compacts, Jewelry, etc. Guaranteed likeness. Investigate. Free catalog, full details on request. Write Today. P.M. Perry Photo Novelty Corp., 1793 Jerome Ave., New York.

WE Start You Without a Dollar. Soaps, Extracts, Perfumes, Toilet Goods. Experience unnecessary. Carnation Co., Dept 2480, St. Louis.

AGENTS—Make a dollar an hour. Sell Mendets, a patent patch for instantly mending leaks in all utensils. Sample package free. Collette Mfg. Co., Dept. 404, Amsterdam, N. Y.

NO Dull Times Selling Food. People must eat. Federal distributors make big money; \$3,000 yearly and up. No capital or experience needed; guaranteed sales; unsold goods may be returned. We furnish you with sample case, license and Free Samples for customers—Sure repeat orders. Exclusive territory. Ask now! Federal Pure Food Co., A2307 Archer, Chicago.

POLMET—The Wonderful Polishing Cloth that cleans all metals without liquid, paste or powder. Approved by "Good Housekeeping" and "Modern Priscilla"—sells fast at 25c. Sample free. Gale & Co., Inc., 15 Edinboro St., Boston.

PHOTO Medallion Men and Women. The largest line of Photo Novelties in the world. Lowest prices, quickest service. Send for catalogue showing over 200 money makers. Photo medallions, photo medallion clocks, photo mirrors, photo fountain pens, photo powder compacts, photo jewelry and photo buttons. Gibson Photo Jewelry Co., 608-614 Gravesend Ave., Brooklyn, N. Y.

AGENTS: 500% profit. "Happy Home Make Shampoo" builds your own big business. Martin of Indiana made \$75.00 in one day. Missouri man made \$750.00 one month. Exclusive territory. Geo. A. Schmidt & Co., Dept. P, 236 W. North Ave., Chicago.

REPLATE brassy worn-off Automobile parts. Reflectors, Bath Room Fixtures, Worn Spoons, Forks, etc., with pure silver. Looks like new. Use U-Kan-Plate Polish. Positively no mercury. \$1.00 half pints. Post Paid. Satisfaction Guaranteed. Agents wanted. Dept. A, U-Kan-Plate Co., Philadelphia.

AGENTS make \$10.00 Daily selling Non-Splash Water Filters on sight. Best canvasser's article on market. Investigate. Write for particulars, Desk 14, Seed Filter Company, 73 Franklin Street, New York.

FIBRE Brooms—detachable handles, fine finish. Good profits, repeat sales. The Fibre Broom People, 147-C New Jersey Ave., Brooklyn, N. Y.

MONOGRAM Automobiles, \$1.35 Profit ten minutes' work; every owner wants them; millions without; particulars free. Motorists Accessories Co., Mansfield, Ohio.

RELIABLE aggressive agents needed to sell Holley Suction and Force Pumps. Used in clearing plugged plumbing fixtures. Sizes for every need. Readily salable, and show good profit to consistent workers. The Holley is priced below competition and offers, at the same time, exceptional quality. Worthwhile for worth-while men. Alert Products, Inc., Dept. 50, Holley, N. Y.

32 SECONDS complete tire change by Detmer, Ohio, with Morey Quick Action Rim Tool. Sold, singly, 49 three days, cleared \$100. Anderson, Mont., sold 1400 in 14 weeks. Get details for good territory. Harvest time now. M. Morey Rim Tool, Buffalo, N. Y.

NEW: Just Invented; Comb fastens anywhere. Send 10c for a 25c value. Never Lose Comb Mfg. Co., Lesueur Center, Minn.

SHOP Agents or General Agents to sell new large cans of Paste Hand Soap—fine profits—quick sales. The Connecticut Can Co., Hartford, Conn.

WHY work for others? Employ agents yourself. Make your own products. Toilet Articles, Household Specialties, etc. 500% profit. Valuable booklet free. National Scientific Laboratories, 1930W Broad, Richmond, Va.

GOLD Leaf window letters and script signs. No experience; 500% profit. Samples free. Consolidated, 69-U West VanBuren, Chicago.

REMNANT Store, Bethel, Ohio. Greatest Dry Goods Bargains on Earth. Agents and Dealers.

AGENTS—Clever Invention! Inkspoon makes every pen a fountain pen. Fast office seller; big profit, demand increasing everywhere. Exclusive territory offered. Sample free. H. Marut Company, Tribune Bldg., New York, N. Y.

GET Our Free Sample Case—Toilet articles, perfumes and specialties. Wonderfully profitable. La Derma Co., Dept. A, St. Louis, Mo.

SELL men's neckwear; wonderful proposition. Astor, 318-M Broadway, New York.

\$16 A DAY Easy—I start you in auto accessory business; no investment; no experience necessary. Landin, 4206 Montrose Ave., Chicago.

LAMB'SWOOL Polishing Mittens, Brushes. Newhall, 358 Broad, Lynn, Mass.

BIG Money and Fast Sales. Every owner buys Gold Initials for his auto. You charge \$1.50; make \$1.35. Ten orders a day easy. Write for particulars and free samples. American Monogram Co., Dept. 40, East Orange, N. J.

SELL Wonderful Hand Adding Machine. \$1 wholesale. Retail, \$4.50. Typewriter Supply, 102 Hersch Bldg., Pittsburgh.

\$1,000.00 CLEARED in 30 days by one agent. New Amazing Cleaner. Sample Free. Bestever Products Company, 4317-P, Irving Park, Chicago.

AUTOMOBILE Specialties. Guaranteed formulas for all latest money makers. Lowest prices. Write for free lists. Murphy, Chemist, Tujunga, Calif.

BIG profits distributing 5c candy specialties to dealers. Fast sellers. Exclusive territory. Universal Sales Company, 631-B Wilson Ave., Brooklyn, N. Y.

AGENTS—250% profit selling exclusive new process Artistic Signs. Finest selection of stock signs in the country, barring none. Details free. Sample 10c. Artistic Signs, 799-R Broadway, New York, N. Y.

SEND 25 cents for a one dollar Cigar Lighter, and learn how to make \$10 a day. Particulars free. Rapid Mfg. Co., 799 Broadway, New York City.

EARN \$10 daily silvering mirrors, plating, refinishing metalware, chandeliers, head-lights, bedsteads. E. Decle Laboratories, 225 Varick St., New York.

\$50.00 WEEKLY easy. Applying Gold initials on Automobiles. No experience needed. \$1.45 profit every \$1.50 job. Free samples. "Raico Monograms," X1043 Washington, Boston, Mass.

FREE: Large wholesale Specialty catalogue, showing latest best sellers from many parts of the world. Spors Co., Lesueur Center, Minn.

A BUSINESS of Your Own—Making Sparkling Glass Name and Number Plates, Checkerboards, Signs. Big Book and Sample Free. E. Palmer, 512 Wooster, Ohio.

SOMETHING New. Every motorist a buyer of our electro-magnetic-emergency Wenderlamp; takes only one minute to demonstrate and make a sale; no experience necessary; \$5.00 an hour easily made; full time or evenings. Write for sample. Wenderlamp Co., 926 Fisk Bldg., Dept. 10-A, New York.

CALIFORNIA perfumed beads selling like hot cakes. Agents coinng money. Big profits. Catalog free. Mission Factory P, 2328 W. Pico, Los Angeles, Calif.

HIGH-GRADE SALESMEN WANTED

SALESMEN—Become Independent. Own your business; experience unnecessary, selling our \$7,500 Accidental Death, \$50 Accident; \$25 Sick Weekly Benefits—\$12 50 yearly. Other amounts proportionate. Guaranteed steady income from renewals. \$250,000 Deposit Insurance Department. Universal Policy, Dept. A, 40 Clinton St., Newark, N. J.

MAKE \$25.00 daily selling colored Raincoats and Slickers; Red, Blue, Green, Etc., \$2.95. Hat Free. Commissions daily. Outfit free. Elliott Bradley, 241 VanBuren, Dept. AB1-S, Chicago.

SALESMEN—Manufacturer's established line guaranteed tools offers profitable connection to men with mechanical and some sales ability; part-time considered; two average sales daily net \$50 weekly; advance against commission. Write for free catalog and money-making plan. J. G. Woods, Inc., Dept. P, 37 W. 20th St., New York, N. Y.

MARVELOUS new instrument converts old phonograph into electrical reproducer rivaling finest modern machines. Price: \$19.50. Salesmen understanding radio can sell every other home. Write Crescendophone Co., Dept. P, Spring Arcade Bldg., Los Angeles.

SALESMEN Experienced on typewriters, cash registers, American Can Calculator and office appliances write me for best money making proposition on the market. W. G. Farnsworth, 63 Cottage Grove S. W., Grand Rapids, Mich.

WHY work for others? Employ agents yourself. Make your own products. Toilet Articles, Household Specialties, etc. 500% profit. Valuable booklet free. National Scientific Laboratories, 1930W Broad, Richmond, Va.

EASY to sell groceries and auto oils from samples to consumers. Steady profitable work. No capital or experience necessary. Commission advanced. Liberal credit. Lowery & Browne Co., Wholesale Grocers, L-1500 So. State, Chicago.

WERE You Ever Offered a Grocery Store? Our proposition is better. Let us tell you how you can handle groceries, auto oil, tires and paint. No rent, no investment in goods. Big pay. Write. Just say, "Show me." Hitchcock Hill Co., Wholesale Grocers, 38 Kinzie, Dept. 50, Chicago.

SALESMEN—Four \$15.00 sales to merchants net you \$40.00 daily. Sayers Systems, 2813 Sheffield, Chicago, Ill.

SALESMEN calling on music, phonograph and radio trade to sell new type phonograph reproducers. Can make \$500 monthly. Commission paid on reorders. Sample can be carried in pocket. State territory wanted. Baxter Mfg. Co., Elmhurst, Long Island, N. Y.

MEN and women wanted to travel. Ray Wood, San Francisco.

LIVE Wire Wanted for exclusive territory selling Cremer Black Diamond Barber Tools. 100% profit. Write quick. Cremer, 22 Beaver St., San Francisco.

MEN'S fancy silk hose, retails \$4.50 dozen pairs. Sample dozen pair and complete sales outfit \$3.00. Money back guarantee. Manager, Box 698, Peoria, Ill.

EARN \$20 a Day. Establish income for life selling for \$1 a year, \$1,500 accident policy. Write W. C. Stone, 11 So. LaSalle, Chicago.

SELL Printing. Big commissions. Outfit Free. Atlas, 2622G, East Tenth, Indianapolis, Ind.

AMAZING Invention pays agents \$150 weekly! Unique combination gear shift ball-Ash Tray. 250% profit! Lifetime Guarantee. Free particulars. Fisher, 7740 South Chicago Avenue, Chicago.

BIG money selling Bad-Debt Collecting Systems to Doctors and Merchants. We show you how to place Systems "on trial" and let them pay for themselves out of the money they collect. \$5.00 profit on every \$6.50 System sold. Exclusive territory. Adjustment Bureau, Mobile, Ala.

MR. BRUSH Salesmen: Old established New York brush manufacturers require services of men in all territories to sell their extensive line of Sanitary Twisted in Wire Brushes. We pay larger commission than any other brush house in the country. Write immediately for our proposition. Wire Grip Sanitary Brush Corporation, 15 Mercer St., New York.

AMERICA'S Greatest Tailoring Line Free. 130 large Swatch Samples—All Wool—Tailored-to-Order—Union Made—sensational low price. Get outfit at once. Address Dept. 303, Goodwear, 844 Adams, Chicago.

DISTRICT Sales Supervisors wanted to appoint and supervise salesmen to sell popular article. New plan, no competition. M. H. Driftmier, Dept. M, Shenandoah, Iowa.

SIDELINE Salesmen calling on Mines, Mills and Factories. Commissions paid on original and repeat business. Pittsburgh Insulating Company, Pittsburgh, Penna.

WONDERFUL Invention Seals Fifty Envelopes minute. Sells on sight at \$3.50. Exclusive territory. Kendall Sealer Co., C20, East Jaffrey, N. H.

BIG Season Just Ahead. Advertising pencils most popular every day—every business prospect. Our line repeats. Big commissions. Established in 1902. North American Pencil Works, 126 So. Clinton, Dept. 55-G, Chicago.

MEN—Sell dependable shrubbery, fruit trees, etc. Steady demand. Complete cooperation. Commissions paid weekly. We deliver and collect. Write Perry Nurseries, Dept. R-1, Rochester, N. Y.

\$18 TO \$25 daily. Biggest selling line of 2-piece suits \$9.95 and \$12.50; 3-piece wool suit, \$17.95 (regular \$28.00 value). All-wool overcoat, \$18.50. Splendid raincoats, slickers and boys' suits. Biggest commissions. Free outfits. "Jim" Foster, Inc., Dept. 21, 2250 S. Spaulding Ave., Chicago, Ill.

DISTRICT SALESMEN—All wool, union made suits, overcoats, \$23.50. Liberal advance commission, bonus. Write for expensive free outfit. Harvey Bros., Dept. 546, Box 00, Chicago, Ill.

TAILORING Salesmen: Selling Simpson's new \$23.50 pure virgin-wool suits, topcoats; commissions in advance; exclusive territory; big outfit 175 samples free. J. B. Simpson, 843 Adams, Dpt. 1457, Chicago.

SALESMEN for line of five auto necessities. Something for every driver. Easy Sales, Big Profits. Write for territory proposition. Erwin & Waterman, 130 Latrobe Ave., Chicago, Ill.

DENTALINE Dental Cream—free tooth brush with every tube—50c. Write Fray Products Company, 708 E. 31st, N. Portland, Ore.

PUNCHBOARD Salesmen—making small towns. One sale a day nets you \$105 weekly. Full commission on repeats. K&S Sales Co., 4395 Ravenswood Ave., Chicago.

ANY Salesmen Can Sell Them! Merchants everywhere use punchboards. Someone sells them, why not you? Collect big commissions daily. Newest, largest, elaborate catalog sent upon request. Lincoln Sales Co., 9 So. Clinton, Chicago, Dept. D.

\$80-\$200 A WEEK. Genuine Gold Letters for store windows. Easily applied. Free samples. Liberal offer to general agents. Metallic Letter Co., 438-A North Clark, Chicago.

SEND name, address on postcard. Free introductory copy Salesology Magazine; contains 1,000 money-making opportunities. Offered by big reliable firms; no obligations. Salesology Magazine, Desk B-39, 500 No. Dearborn, Chicago.

DOUBLE Spark Plug—Two spark gaps; bigger, hotter spark on weaker current and leaner mixture. Guaranteed to be better than other plugs or money refunded. 50% Commission. Agents and side-line men wanted. Affinity Spark Plug Co., Box P-329, Omaha, Neb.

COLLECTS Money from the Dead-Beats. Retail—\$3.00. Cost—\$1.00. Profit \$4.00. "New Method." Every Storekeeper, Doctor buys quickly. Wonderful Money Getter. Federal Association, Hartford, Conn.

GOLD Leaf window letters and script signs. No experience; 500% profit. Samples free. Consolidated, 69-V West Van Buren, Chicago.

PUNCHBOARD Salesmen. 2 hours daily. \$100 every week. New line. Lowest prices. Full commission on repeat business. Catalog free. Puritan Novelty Co., 1409 Jackson, Chicago.

NO high-pressure salesmanship necessary selling Luminate, our Magic Electric Window and Outdoor Salesman. Demand established. Color, light, motion gets 'em. Great quick-change letter system and snappy two-color posters land orders on demonstration. Hustlers collecting \$100 weekly, easy. Protected territory. Display Products Co., A407-9 East 31st St., Kansas City, Mo.

ANTIFREEZE prevents radiators freezing. Dricleen, the combined auto cleaner, polisher. Radiator, internal cleaner. Hand soap. Write for free shipment long-profit auto specialties. Mickman Co., St. Paul, Minn.

EARN \$10 daily silvering mirrors, plating, refinishing metalware, chandeliers, head-lights, bedsteads. E. Decle Laboratories, 225 Varick St., New York.

SHOP Representative. Sell Reed Micrometers to shop friends. Liberal commission. Reed Small Tool Works, 35 Hermon St., Worcester, Mass.

SALESMEN—Sell men's Rayon Swiss and Jacquard ties—new startling features; highest commissions. Wonder outfit free. National Service Mills, 2054—83rd St., Brooklyn, N. Y.

TRAVELING Salesmen Calling on Retail Stores wanted by large manufacturer of fast-selling specialties entirely different from the average. Year-round sales, main or sideline. Big commission paid immediately on original and repeat business. Opportunity for well paid and permanent connection with old-established firm. If not making \$150 weekly, write today. Union Specialty Works, Dept. 222, Boonville, N. Y.

40% COMMISSION selling printed business stationery at knock-out prices. Part or full time. Free outfit. L Process Service, Minneapolis, Minn.

HELP WANTED

REPRESENTATIVES wanted by over 500 manufacturers, offering real money-making propositions. No need of being out of work. Write for Free copy, Opportunity Magazine, 750 N. Michigan, Service Dept., Desk H-3, Chicago.

YOU Are Wanted to Resilver Mirrors at Home. Immense profits plating autoparts, tableware, etc. Write for information. Sprinkle, Plater, 287, Marion, Ind.

MAKE \$25.00 daily selling colored Raincoats and Slickers; Red, Blue, Green, Etc., \$2.95. Hat Free. Commissions daily. Outfit free. Elliott Bradley 241 VanBuren, Dent, Abi-M, Chicago.

FOREIGN Work-Men wanting work in romantic South America with oil, fruit, mining companies, write South American Service Bureau, 14,600 Alma, Detroit, Mich.

HOW to sell your ability and experience—Former Employment Manager for Nationally known corporations explains the three ways to sell your services—tells exactly what to do—how to do it—how he can help you. For free descriptive folder, address Box 479, South Norwalk, Conn.

SEND name, address on postcard. Free introductory copy Salesology Magazine; contains 1,000 money-making opportunities. Offered by big reliable firms; no obligations. Salesology Magazine, Desk B-40, 500 No. Dearborn, Chicago.

WE Start You in Business, furnishing everything; men and women, \$35.00 to \$100.00 weekly operating our "New System Specialty Candy Factories." Few dollars start you home or small room anywhere. Booklet free. W. Hillyer Ragsdale, Drawer 359, East Orange, N. J.

OBTAIN Employment! 70 Jobs offered one person! Get positions you want, quickly, anywhere. Complete information 50 Cents. Money promptly returned if wanted. Better Yourself! New Idea Service, Box 39-A, Station K, New York.

CASH Paid for Butterflies, Insects. See Sinclair Display Advertisement on page 24.

MAILING LISTS

1,000 NAMES interested Aviation, \$8.00. Colorado Service, Box 673, Denver.

1,000 INVESTORS in Patents, Stocks, \$1.00. Collins, Box 212, Union City, New Jersey.

1,000 WOMEN'S names. Recent buyers. \$1.00. Sheasgreen, 1427 North Penn, Minneapolis, Minn.

BUSINESS SERVICE

DETROIT branch office service, Mailing address, \$2 month. Wolverine Business Service, 9698 Grand River, Detroit, Mich.

INFORMATION

HEIRS Wanted. "Lost Heirs"—A 92-page book filled with names for lost heirs and missing kin from different parts of the world. Chancery Court of England, Ireland and Bank of England lists included. Price one dollar. International Claim Agency, Dept. 189, Pittsburgh, Pa., U. S. A.

RESEARCH Expert will supply best formula or information on any line, \$2. H. Newman, Box 343, Madison Square Station, New York.

SECRET CORRESPONDENCE

CODES For business and pleasure correspondence, absolutely secret, \$1 and up. Particulars, stamp. Southern Secret Service, Perry, Okla.

TYPEWRITERS AND SUPPLIES

START the New Year Right by owning the world's most perfect writing machine, the "Restoro Equipped" Underwood. Nothing else like it! Restoro Automatic Ribbon Inking Device makes one ribbon last for over 10,000 business letters; a year's job in a busy office. Gives perfect, uniform writing, never smudgy. Saves muss of changing ribbons. Saves \$9 to \$12 a year in ribbons. Restoro Free on manufactured Underwoods at bargain prices. Hundreds in use. All other standard typewriters at savings of 40 to 60%. EZ terms. 10 Day Trial. Big illustrated catalog free. Young Typewriter Co., 654 W. Randolph, Dept. 5101, Chicago.

ALL makes, lowest prices, 5-year guarantee. Several specials. Free illustrated catalogue. Henry Typewriter Co., 217 West 125th St., New York, N. Y.

100 TYPEWRITERS Free. Overstocked. Rent Rebuilt Underwood or Remington \$3.00 month. If you pay its value in rental, we give machine free. Particulars free. Pittsburgh Typewriter Exchange, 945 Hersch Bldg., Pittsburgh, Pa.

TYPEWRITERS, all standard makes, \$10 up. Fully guaranteed. Free trial. Write for complete illustrated lists. Northwestern Typewriter Exchange, 121 N. Francisco Ave., Chicago.

TYPEWRITERS—All standard makes, \$7 to \$25. Guaranteed. Dee Typewriter Exchange, Ada, Okla.

TYPEWRITERS, Radios, Motorcycles, \$5 to \$35.00. Knights, 1512 Locust, St. Louis, Mo.

PRINTING, ENGRAVING AND MULTIGRAPHING

12 CHRISTMAS Greeting Cards, Copperplate Engraved, including your name on each card letterpressed \$1.00. American Printery, 83 Sheridan, Wilkes-Barre, Pa.

CIRCULARS—6x9, \$4.00. 3½x6, \$2.35. Andrews, Box 1051, Fargo, N. D.

DISTINCTIVE Printing! Samples Free! Write Franklinpress, B-32, Milford, N. H.

1,000 BUSINESS letterheads or envelopes, \$5. The Rapid Printing Service, Mount Vernon, Ohio.

SPECIAL Offer—150 Bond Letterheads, 8½x11, and 150 envelopes printed to order \$1.50. J. Ferreira, 249 Eugenia St., New Bedford, Mass.

RULED Forms and Price Lists—factory and office—mimeographed and mimeocopy at fraction printing cost. Also Multigraphing. Send samples for quotation. Mailing Service Co., Elizabeth, N. J.

SEND for free samples of our New Social, Farm and Business Printing. Sunco, Mohawk, N. Y.

PRINTING—All kinds. Fine work, prices low. Battlefield Press, Gettysburg, Pa. Free souvenir.

IMITATION Typewritten Letters, (mimeographed): 500—\$3.00; 1,000—\$4.00; printed heads, 20-lb. bond, prepaid; samples, price-list, red stamp. Letter Service, 3414 East 27th, Kansas City, Mo.

50 EACH Letterheads, envelopes, cards, \$1.00. Sherman, Printer, Merriam, Kansas.

1,000 ENVELOPES \$2.95. Letterheads, circulars, folders, circular letters. We write advertising copy. Free samples. Able Printing Shop, 416 So. Dearborn, Chicago.

"NEARGRAVUREMBOSO" (type embossed) Stationery—Special 250 each Letterheads—Envelopes, \$6.75 cash, postpaid. Samples. Solldays, Knox, Ind.

5,000 LETTERHEADS, \$10.00, 20 lb. bond. Publications, catalogs big savings. Anville Printing Company, Anville, Pa.

250 BOND Letterheads, 250 envelopes, \$3.00 delivered. Satisfaction guaranteed. Curtis, 811 Harrigan, Kalamazoo, Mich.

MULTIGRAPHING business correspondence, two dollars thousand. Hammermill letterheads, four dollars. Miscellaneous printing. Mayera Corporation, Monmouth, Ill.

250 BOND Letterheads, Envelopes, Billheads, Cards, \$1.35 each. Economic Press, Leontis, N. J.

QUALITY Printing! Reasonable Prices! Send for Free Standardized samples and prices. Folders, Circulars, Catalogs our specialty. Earnest Fantus, 525 South Dearborn, Chicago.

PRINTED Personal Stationery. Ideal for Christmas Presents. Samples. Austin Press 722 Clifton Ave., Newark, N. J.

MULTIGRAPHED Letters \$1.75 Thousand. Samples. Profit, Box 1071B, Knoxville, Tenn.

PUBLISH Your Own Magazine or House Organ. Our standardized service at one-fifth ordinary prices. Samples and particulars free. Evans Printing Company, Grand Rapids, Mich.

DISTINCTIVE—Artistic Business Stationery that Creates Confidence. 1,000 Letterheads or Envelopes \$3.00. Samples. Moulton Printing Company, 1410-P East 8th, Kansas City, Mo.

WE print Stationery, Booklets, Catalogs, Circulars, Samples. Commercial Press, Batavia, Ohio.

1000 BUSINESS Cards, Envelopes, or Letterheads, \$3.00. 300, \$1.00. 108 Eureka, San Francisco.

200 NOTEHEADS and 100 envelopes \$1.15, postpaid. Oberman Company, Box 1268, Chicago.

5,000 3½x6 ENAMEL folders, \$13.75; envelope slip, \$5.00; 5½x8½ circulars, \$10. All printing lowest prices. Samples free. Good's Printery, Harrisonburg, Va.

RAISED Letter printing, 100 6x7 ripple paper, 100 envelopes, \$2. Krafts, Ames Station, Omaha, Neb.

GUMMED LABELS

THE Better Kind—Name, business, address, 250—25c; 500—40c; 1,000—60c; 2,000—\$1.00. Label Printers, Valhalla, N. Y.

PRINTING, OUTFITS AND SUPPLIES

PRINTING Presses, type, supplies. List 2c stamp. Bargains. Geo. Foster, 4342 North Robey, Chicago.

PRINTING Outfits—Presses, type supplies, type novelties. Send stamp for catalogue. Model Press, York, Penna.

COMPLETE Printing outfits, presses, type, ink, paper, supplies. Write for Catalogue, Kelsey Company, G-11, Meriden, Conn.

PRE-USED Printing Presses. Type supplies. List for 2c stamp. Popular Bargains, Richland, Pa.

RUBBER STAMPS

ILLINOIS Rubber Stamp Works, manufacturers. Send for circular. 2913 No. Rockwell St., Chicago.

DUPLICATORS AND DEVICES

STENCIL Duplicator — \$2.00 — Larger \$2.00, \$3.50, \$4.00. Returnable. Samples. Circular. Primos Specialty Co., Primos, Pa.

YOU can make 50 to 100 copies of a letter, notice, etc., at a cost of three cents on a Heyer Quality Duplicator. Write for free trial offer. The Heyer Duplicator Co., 909 Jackson Blvd., Chicago, Ill.

ADDING MACHINES

NEW \$3.50 Automatic Adding Machine. Adds, subtracts, multiplies, absolutely accurate. Capacity \$999,999.99. Fully guaranteed. 75,000 pleased users. Makes adding easy, positive, quick. Eliminates mistakes. Saves time. Postpaid \$3.50. Bassett Co., 1458-J, Hollywood Ave., Chicago.

FOR SMOKERS

PIPE Smokers—We have specialized in pipe tobaccos for 22 years. Factory to smoker. Wonderful blends and flavors. Write for free catalog and samples. The Planters Tobacco Co., Henderson, Ky.

HOMESPUN Tobacco—guaranteed, good flavor. Chewing, 5 pounds, \$1; 10, \$1.75. Smoking, 5 pounds, 75c; 10, \$1.25. Pay when received. Farmers Union, Mayfield, Ky.

CIGARS Bargain!—Hundred Coronas, 5 1/4", 10c value, \$3.75, COD. Hundred Blunts, 4 1/4", \$2.80. R. Valles, 76W 113th, New York.

SEND 10c, silver or stamps, for sample package 20 finest quality cigarettes. Large tin special smoking tobacco sent for 10c. Direct-to-Smoker. French Tobacco Company, Dept. 37, Statesville, N. C.

FOR THE HOME

BEAUTIFUL Christmas Gifts. Princess Rugs, 27x54 inches, fringed. Made from fine soft yarns. Colors: jade, gold, grey, old rose, copenhagen. Stores sell for \$3.50 each. Our holiday price 2 for \$4.98. Send No Money, pay C. O. D. Money Back If Not Pleased. Sending this ad with order gets toy rug free. Velvotux Rug Mills, Mineral Point, Wis.

MEN! Women! Make \$1 An Hour at Home. Weaving special-to-order Colonial Rugs on Union Looms. Big demand, no house-to-house selling, no store competition. You learn fascinating new craft in 30 minutes, we guarantee it. New looms at lowest prices ever. Liberal Pay-As-You-Weave terms. Write for Free Loom Book today. Union Loom Works, 480 Factory St., Boonville, N. Y.

GRANDFATHER'S Clock Works. \$5.00. Build your own case; Instructions free; make good profits selling your friends. Clock works with chimes for old or new cases. Write for full particulars. Clock Co., Ruffner St., Philadelphia.

CEDAR chests only \$11.65—"Red-J-Kut" complete with rich copper trim—you assemble and save half—send for pictures. Kuempel Furniture Company, Guttenberg, Iowa.

NEW Electric testing tool, anybody can find trouble instantly in appliances and Christmas tree lights. Price \$1. See it in December Popular Mechanics or send for circular. Dirksen & Co., 1273 Curtis St., Dubuque, Iowa.

WONDERFUL Resurrection Plant, 25c. Desert's Greatest Novelty! Blooms immediately, permanently, in water. Elegant fern-like branches. Beautiful, luxurious table decoration. Order today! Shawnee, 145 West 112th St., Chicago.

OPTICAL GOODS

SPECIAL Christmas prices on Binoculars and Crossman rifles. Send for complete catalog. Geneva Optical Company, Geneva, N. Y. The best place to make your purchases for Christmas.

RAZORS AND BLADES

GIVEN Away, absolutely free, reconditioned trial blades, to prove that hollow-ground blades give perfect shaves. Clean and save your blades, we trade you sharp blades for dull blades. No fake, no agents wanted. Manufacturing commercial blade sharpening machines since 1916. Velvet Edger Mfg. Co., 6001 Gramercy, Los Angeles, Calif.

THREE dozen best quality blades for Gillette razor, \$1.00. Frank Anderson, 815 Twentieth Ave., Rockford, Ill.

GILLETTE Safety Razor with blade, brush, soap, styptic pencil, nail-file, and comb—\$1.00 postpaid. Good quality. William King, Corvallis, Ore.

EXCELLENT quality Razor and hone \$3.00, shaving brush free, postpaid. Felt's Cutlery Shop, Huntington, N. Y.

GILLETTE Style Blades. Guaranteed new. Dozen 38 cents; 3 dozen \$1.00. Wallace Kutz, 132 Chambers, Phillipsburg, N. J.

BOATS AND LAUNCHES

BUILD Your Own Boat using our Knock-Down ready cut materials. 55 models, outboard motor speedsters, runabouts, cruisers, sail, or row. Send 25c for catalog. Brooks Boat Co., Inc., Rust Ave., Saginaw West Side, Mich.

COMPLETE Building plans of 110 square foot sail ice boat. Price 50 cents. Catalog of boatbuilding plans and books free. The Rudder, 15 Murray Street, New York.

NEW And used boat equipment. Trade new propellers for small used parts. Wm. H. Baker, Pond St., Quincy, Mass.

DIAMONDS, WATCHES AND JEWELRY

BEAUTIFUL 17-Jewel Gold Watches. Guaranteed 25 years, \$28.50, \$5.00 down—\$3.50 monthly. Catalog free. Diamonds—Jewelry. Acheson Company, 2218 West Cary, Richmond, Va.

WATCH REPAIRING

ALL makes of Watches repaired by experts. Write International Watch Service, Box 5P, Fordham Station, New York.

ANTIQUES, WAR RELICS AND INDIAN GOODS

OLD Money Wanted. Will pay \$100.00 for 1894 dime, S. Mint, \$50.00 for 1913 Liberty head nickel (not Buffalo). Big premiums paid for all rare coins. Send 4c for large coin folder. May mean much profit to you. Numismatic Co., Dept. H-3, Fort Worth, Tex.

FOR Dens, Relics and medals from Europe's Battlefields. Illustrated catalogue, 25c. International, 1889 Albany Avenue, Brooklyn, N. Y.

100 GENUINE Indian arrowheads from Arkansas \$4.00 postpaid. H. Daniel, Lamar, Ark.

SEND 5c for fine new list Indian relics, antique firearms. F. E. Ellis, Webster Groves, Mo.

INDIAN Stone relics. Catalog 2c. Grutzmacher, Mukwonago, Wis.

PHONOGRAPHS AND RECORDS

BUILD Your own phonograph. Catalog and instructions to build new type horn mailed for 10c. American Phonograph Co., 4116 West 24th Place, Chicago.

MAKE Your Old Phonograph New! Buy Starphonic Reproducer, \$2.49. Money refunded if not satisfied. Pleasing Sound Phonograph Company, 204 East 113th Street, New York.

MUSIC AND MUSICAL INSTRUMENTS

"WOODWIND" Clarinet and Saxophone Steel Ebonite Mouthpieces (scientifically faced with an accuracy of 1/2000") are being sold by over 200 dealers in America, Australia, New Zealand and Europe. For particulars, write The Woodwind Company, 131 West 45th Street, New York, N. Y.

SONG Poem or Melody writers—Have bona fide proposition. Hibbeler, D1, 2104 N. Keystone Ave., Chicago.

SONGWRITERS: Successful Songs Earn Fortunes. Submit poems. Brennen, Suite L, 1656 Broadway, New York.

I BUY, Sell, Publish Songs. Chester Escher, 12 Vroom St., Jersey City, N. J.

TEACHERS of Guitar, Tenor Banjo, Ukulele, write for dealers' liberal discount proposition on instruments. C. F. Rutt, 1750 No. Robey, Chicago.

SONG-WRITERS: Write Song Service Studio, Shubert-Rialto Bldg., St. Louis.

VIOLINS, Deep, Mellow, Soulful—on credit. Easy terms for wonderful instrument. Get details today. Gustav F. Henning, 512 University Building, Seattle, Wash.

MUSIC rolls for your composition. Dozen or more. Trading Company, 318-M Broadway, New York.

MUSIC Composed to words, words written to music. Broadway Music Writers, Inc., 1476 Broadway, G. C. P. O., Box 414, New York City.

MAKING a Violin? If perplexed ask me, William Mullen, Duff Bldg., New Bedford, Mass.

FREE—"Song Writers Guide," Beaver, 622 Goodell, Green Bay, Wis.

SONG Writers: Address Globe Music Sales, Loop End Bldg., Chicago.

"MUSIC Composed" to words. Bauer Bros., (formerly of Sousa's Band), Oshkosh, Wis.

I WANT Song Poems. Casper Nathan, 3544 N. Racine, Chicago.

SHEET-MUSIC, 10 for \$1.00. For Amateur Teacher or Student. Catalog free. Ferd. Zaro, P. O. B. 18, Sta. D., New York.

WRITE Songs. Big money and reputation. Write for information, J. Gordon Pub. Co., 201 N. Hoyne Ave., Chicago.

SONG-POEM Writers: Address Monarch, 236 W. 55th, Dept. 104, New York.

SONG Poem Writers, Write Sequoia Songwriters' Service, Sherman Branch, Los Angeles, Calif.

MUSICAL Merchandise, instruments, plating, repairing. Guaranteed work. Sternberg's, 59 E. Adams St., Chicago, Ill.

PATENT ATTORNEYS

PATENTS. Time counts in applying for patents. Don't delay in protecting your ideas. Send sketch or model for instruction or write for free book "How to Obtain a Patent" and "Record of Invention" form. No charge for information on how to proceed. Communications strictly confidential. Prompt, careful, efficient service. Clarence A. O'Brien, Registered Patent Attorney, Security Bank Building (directly across street from Patent Office), Washington, D. C. See pages 140 and 141.

PATENTS—Write for our free book, "How to Obtain a Patent" and Record of Invention Blank. Send model or sketch of inventions for inspection and instructions free. Terms reasonable. See advertisements on pages 138 and 139. Victor J. Evans & Co., 934 Ninth, Washington, D. C.

PATENTS Procured, prompt service. Personal, careful and efficient service. Highest references. Moderate fees. Send sketch or model for actual search and advice. George P. Kimmell, Master of Patent Law, 54-A Legal Bldg., Washington, D. C.

J. B. DICKMAN, Jr., Reg. Patent Attorney, 506-7 Bond Building, Washington, D. C. Patents—Trade-Marks—Copyrights.

UNPATENTED Ideas Can Be Sold. I tell you how and help you make the sale. Free particulars (Copyrighted). Write W. T. Greene, 806 Jenifer Building, Washington, D. C.

"INVENTOR'S Guide" sent free; contains valuable information. Frank Ledermann, Registered Attorney-Engineer, Woolworth Building, 1712, New York.

PATENTS And trademarks procured; very easy terms; send for free Evidence of Conception blank. H. Sanders, 7 Rand-McNally Bldg., Chicago.

LACEY'S Patent Sense. Valuable book free. See add page 142.

BROCHURE "How to Get a Patent," free. Send rough ideas or sketch. No obligation. Prompt, expert cooperation. A. L. Applebaum, Registered Patent Attorney, 41 Park Row, New York. Formerly Assistant Examiner U. S. Patent Office.

INVENTORS having ideas to patent: Write for Booklet explaining Co-operative Plan for handling your applications. Tells how to sell and safeguard your inventions at lowest cost. Ralph Burch, Patent Lawyer, Jenifer Bldg., Washington, D. C.

ADVISE Free! Patents procured—Reasonable—efficient Service. 25 years' experience. Chester W. Brown, Registered Patent Attorney, 510 Van Buren Street, Chicago.

PATENTS—Free valuable book sent upon request—Save time—Forward sketch or model for our free confidential report. Favorable report rendered only when we conscientiously believe your invention contains merit and is of commercial value. American Industries, Inc., 222 Victor Bldg., Washington, D. C.

PATENTS: Much valuable information in our illustrated book on patents and trade-marks sent free with sketch sheet. Send your invention for inspection and opinion. Write today. Bryant & Lowry, 311-A Victor Bldg., Washington, D. C.

INVENTORS—Write for our Guide Book, "How to Get Your Patent" and Evidence of Invention Blank. Send model or sketch of your invention for our prompt examination and instructions free. Randolph & Co., Dept. 430, Washington, D. C.

PATENTS, Trade-marks, Copyrights. Reliable services by an experienced practitioner devoting personal attention to each case. Inquiries invited. References furnished. B. P. Fishburne, Patent Lawyer, 525-A McGill Bldg., Washington, D. C.

PATENTS. Booklet free. Highest references. Best results. Promptness assured. Send model or drawing for preliminary examination. Watson E. Coleman, Patent Lawyer, 724 Ninth St., Washington, D. C.

PATENTS Procured: Trade Marks Registered—A comprehensive, experienced, prompt service for the protection and development of your ideas. Preliminary advice gladly furnished without charge. Booklet of information and form for disclosing idea free on request. Richard B. Owen, 30-Owen Bldg., Washington, D. C., or 41-R Park Row, New York.

PERCY S. WEBSTER, 203 Saving and Loan Building, Stockton, California. Long established organization. Patent booklet free.

LANCASTER and Allwine, 221 Ouray Bldg., Washington, D. C. "Originators of the Form Evidence of Conception." Before disclosing your invention to anyone send for blank form to be signed and witnessed. Form and patent information bulletin free.

MONROE E. MILLER, Ouray Bldg., Washington, D. C., Patent Lawyer; Mechanical, Electrical Expert. Booklet and Priority Record blank gratis.

PATENTS obtained under Cooperative Payment Plan. Write for particulars. W. E. Beck, Registered Patent Lawyer, 951 Jenifer Bldg., Washington, D. C.

RICHARD E. BABCOCK, Patent Lawyer, Washington Loan & Trust Bldg., Washington, D. C. Booklet.

SELL your invention before patenting. Write for free particulars. W. T. Greene, 802 Jenifer Bldg., Washington, D. C.

PATENTS—Free advice. Confidential. prompt personal service of Registered Patent Attorney, former Patent Officer Examiner. Booklet. Albert Jacobs, 727 Barrister Bldg., Washington, D. C.

PATENTS, Trade-Marks, Designs. This firm has 27 years' experience and gives expert personal service at reasonable rates. We properly protect your invention. Write for free information and exact cost of procuring patent before proceeding. John B. Thomas & Co., 902 F St., N. W., Washington, D. C.

INVENTORS: Send sketch or model for advice and exact cost of patent. Ask for our Free book: "How to Obtain a Patent." Tells what every inventor should know. Established twenty-eight years. Highest references. Prompt service. Reasonable charges. Chandlee & Chandlee, 414 Seventh, Washington, D. C.

ESTABLISHED 1864. Milo D. Stevens Company. Free Booklet. Patents, Trade-Marks, Copyrights. Offices, Monatnock Block, Chicago; Barrister Building, Washington, D. C.

PATENTS—Write for instructions. Carl Miller, Registered Patent Attorney (former Patent Office examiner), McGill Building, Washington, D. C.

DON'T Waste money patenting worthless inventions. Get our unbiased opinion on patentability and commercial prospects. We don't obtain patents, therefore have no inducement to report favorably unless conditions warrant. Write Patent Research Bureau, Jenifer Bldg., Washington, D. C.

FOR INVENTORS

PATENTS. If you have an invention which you wish to patent you can write fully and freely to Munn & Co. for advice in regard to the best way of obtaining protection. Please send sketches, or a model of your invention and a description of the device, explaining its operation. All communications are strictly confidential. Our Hand-Book on Patents is sent free on request. This explains our methods, terms, etc., in regard to Patents, Trade Marks, Foreign Patents, etc. "Scientific American" contains Patent Office Notes, Decisions of interest to inventors and particulars of recently patented inventions. Munn & Company, Solicitors of Patents, 1523 Scientific American Building, 24 W. 40th St., New York City; 524 Scientific American Bldg., Washington, D. C.; 1313 Tower Bldg., Chicago, Ill.; 686 Hobart Bldg., San Francisco, Calif.; 521 Van Nuyes Bldg., Los Angeles, Calif.

PATENTS—Write to B. P. Fishburne (a South Carolinian). Registered Patent Lawyer, 525-E McGill Bldg., Washington, D. C.

PATENTS obtained under Cooperative Payment Plan. Write for particulars. W. E. Beck, Registered Patent Lawyer, 950 Jenifer Bldg., Washington, D. C.

PATENTS Procured: Trade Marks Registered—A comprehensive, experienced, prompt service for the protection and development of your ideas. Preliminary advice gladly furnished without charge. Booklet of information and form for disclosing idea free on request. Richard B. Owen, 30-Owen Bldg., Washington, D. C., or 41-R Park Row, New York.

INVENTORS Universal Educator—contains 900 mechanical movements; 50 perpetual motions. Tells how to obtain and sell patents. Suggests new ideas. Explains how to select your attorney and avoid patent sharks. Price (revised edition) \$1.00 post-paid. Albert E. Dieterich, 621-Ouray Bldg., Washington, D. C.

GET your own patents. Legal blanks, complete instructions \$1. Cutting Sons, Campbell, Calif.

A MUCH needed service for inventors, patentees and manufacturers. Designs of mechanical devices perfected for marketable serviceability, sales advantage and quality production. The manufacture and sale of new products launched. Consulting service. M. Alva Zook, Industrial Engineer, Glen Ellyn, Ill. (Suburb of Chicago.)

INVENTIONS Developed—Your crude ideas developed into practical form, for your patent application. Model not necessary. Send rough sketch and description for estimate of cost and advice. 27 years' experience. Albert E. Dietrich, Engineer and Registered Patent Attorney, 621½ Ouray Building, Washington, D. C.

SELL your invention before patenting. Write for free particulars. W. T. Greene, 802 Jenifer Bldg., Washington, D. C.

UNPATENTED Ideas Can Be Sold. I tell you how and help you make the sale. Free particulars (Copyrighted). Write W. T. Greene, 807 Jenifer Building, Washington, D. C.

PATENTS. Time counts in applying for patents. Don't risk delay in protecting your ideas. Send sketch or model for instruction or write for free book "How to Obtain a Patent" and "Record of Invention" form. No charge for information on how to proceed. Communications strictly confidential. Prompt, careful, efficient service. Clarence A. O'Brien, Registered Patent Attorney, Security Bank Building (directly across street from Patent Office), Washington, D. C. See pages 110 and 111.

LACEY'S Patent Sense. Valuable book free. See ad page 142.

INVENTORS wishing to commercialize their patents safely should write "International Inventors Service Bureau," Box 252-B, Racine, Wis., for advice.

INVENTORS—Write for our free book, "How to Obtain a Patent" and Record of Invention Blank. Send model or sketch of inventions for inspection and instructions free. Terms reasonable. See advertisements on pages 138 and 139. Victor J. Evans & Co., 157 Ninth, Washington, D. C.

I AM in touch with hundreds of moneyed men and manufacturers who wish to buy good inventions. Write Hartley, 38 Court St., Bangor, Me.

WE will pay royalty for any item that we can manufacture and sell in volume. Waco Tool Works, Inc., 542 No. Parkside, Chicago.

I SELL patents. Established in 1906. Remember; they who really buy patents, rarely advertise for them. Be careful. Charles A. Scott, 773PM Garson Ave., Rochester, N. Y.

GET "Today's Patentfax-Today," advance tips, from everywhere, forwarded daily, informs you of manufacturers and patent buyers desirous buying, finance, commercialize new inventions. Information may bring you thousands dollars. Three months' service, \$10; month \$5. Today's Patentfax, 1570M, Atlanta, Ga.

1000 NEEDED Inventions, new book, edited by Raymond Francis Yates. Price \$1. See announcement page 142. Bureau of Inventive Science, Rochester, N. Y.

PATENTS wanted by manufacturers; send description. Box 126, Dowagiac, Mich.

PATENTS FOR SALE

UNITED States Patent No. 1,641,574 "Car Speed Boat." New type of automobile, adapted to travel on land and water. Royalty basis. P. Chavez, 1305½ Wall St., Los Angeles, Cal.

OUTRIGHT—New electrically operated plane. All parts are easily and quickly removed or replaced. H. Bohme, 5652 Claremont Ave., Oakland, Calif.

NEW Safety device: Automatic Brake Lock. Prevents automobiles backing on hills. Real improvement, better control. Simple, cheap to manufacture. Write W. G. Bowers and C. A. Smith, 509 Liberty Ave., Barborton, O.

OUTRIGHT—Corn-planter device eliminates the check wire in planting. Operated from seat of planters. Need financial assistance on other valuable inventions. Earl Toney, 838 W. Kalamazoo Ave., Kalamazoo, Mich.

OUTRIGHT—Automobile heater, cooler and ventilator. Can be manufactured at very low cost. Frank Phillips, 315 Evergreen Ave., Millvale, Pa.

RELIABLE Patent on practical easy selling household article for sale. Very reasonable. Good money for right party. Nelson, 5502 Kammerling, Chicago.

OUTRIGHT Or royalty on metal cigarettes case and dispenser, for pocket and table. Pat. Appl. No. 291308. Herm. Boercherts, 105 Union Ave., Mount Vernon, N. Y.

WILL sell royalty Cigarette and Match combination. Box 289, Rosalia, Wash.

OUTRIGHT—patent pending horses' hoof-trimming device. Arthur Nelson, 304 E. 5th Ave., Mitchell, So. Dak.

STATE Rights, Auto Theft Alarm. Pat. 1,454,183. Tamper proof. Give ref. Drawer 632, Meridian, Miss.

PAN Lifter—Which can be easily placed in engagement with, or disengagement from a hot pan, for lifting the same without injury or discomfort. Patent 1637227. A. B. McDaniel, Johnstown, Neb.

OUTRIGHT or Royalty—typewriter line and space indicator. Tells amount of space left at bottom of letter. Easily attached. E. W. Sippel, 311 National Bank of Commerce Bldg., Tulsa, Okla.

OUTRIGHT, reasonable, pipe joint for bath tubs, basins, toilets, sinks. Robert Dawson, Fairview Cottage, Skillman, N. J.

OUTRIGHT or Royalty. Sanding Roller for finishing and polishing. Patent 1631798. Davol, 727 E. Maple Street, Glendale, Calif.

OUTRIGHT Or royalty; very reasonable, tooth paste and shaving cream device. Readily disassembled for replacing empty tubes. Geo. Granger, P. O. Box 297, Moosup, Conn.

ROYALTY Basis, novelty candy box in shape of baseball or indoor ball. Can be used for toy when emptied. Patent pending. Fred Hirtzler, 1628 Winnemac Ave., Chicago.

ROYALTY—False bottom perfect hen nest. Simple, sanitary, eliminates egg breaking and eating. Also fruit-picking ladder and other good inventions. Richardt, R. 3, Box 29, Massena, Iowa.

INVENTIONS and Patents for Sale. Order your inventions, Patents and Trade-marks from Hip, 722 Mace Street, Greensburg, Pa.

WHY let your patents lie idle? Tell our two million five hundred thousand readers about it! The majority of our readers are especially interested in new ideas and inventions. Ask me to tell you how other inventors successfully sold their patents. M. L. Rund, Mgr., Classified Advertising, Popular Mechanics Magazine, Chicago.

FOR MECHANICS

ATTENTION—Home Mechanics: We sell unusual cabinet hardware, chest trimmings, tea wagon wheels and casters, big line small hinges, locks, etc. Upholstering supplies, electrical hardware, knocked down cedar chests, etc. Send ten cents stamps for catalog. Thurston Manual Training Supply Company, Jobbers and Manufacturers, Anoka, Minn.

SHOP Notes for 1927. Get your copy now. Only a limited edition. Contains all the articles published in the Shop Notes department of Popular Mechanics Magazine during 1926. Send no money. Just write a postal and we'll send 1927 Shop Notes and any one of the other following numbers, 1908, 1912, 1913, 1914, 1915, 1916, 1917, 1919, 1920, 1921, 1922, 1923, 1924, 1925, 1926. Pay the postman 98 cents and the postage when he hands you the two books. Popular Mechanics Press, Room 908, 200 E. Ontario St., Chicago, Ill.

ELECTRICAL

10-CONTACT 2-magnet relays \$2 post-paid. Operates 45 circuits combinations, 15-contact 105-circuit, \$3. Excellent for experimenting, burglar alarms, fire alarms, remote control. 6 dry cells sufficient. Works 200 miles as telegraph relay. Fine construction. Dundee Electric Co., Dundee, Ohio.

SURVEYING INSTRUMENTS

LARGEST stock of new and used surveying instruments in the country direct from factory. Satisfaction guaranteed or money refunded. Wissler, 619 N. Broadway, St. Louis, Mo.

MODELS AND MODEL SUPPLIES

THIRTY Years designing and building Special Machinery to reduce the cost of manufacturing. Twenty years assisting inventors to perfect their ideas and build their Models. We operate an up-to-date machine shop and model works. We do anything mechanical. With our experience and organization of expert mechanics we give results at the lowest possible cost. Before placing your order either see or write us. R. G. Clynne Engineering Co., 3502 Easton Ave., St. Louis, Mo.

OUR New Illustrated 1928 catalog. Everything for Ship Models now ready. Dime. Reduced prices on fittings, construction sets, supplies. Complete line of Books for Yachtsman's Library, boatbuilding, modelmaking, blueprints. Both catalogs, 25 cent. Roy Hancock, 323 Douglas Ave., Portsmouth, Va.

WOODS For Models, Scroll Work and Inlaying. George Wild, 510 East 11th St., New York.

MODEL Steam Locomotives, Etc. List, 10c. Frank Birch, 131 Eliza, West, Hazel Park Station, Detroit, Mich.

SHIP Models, complete materials and blueprints for building Chinese junk, Venetian sailboat, Viking galley, Nile galley, Bonnie Jean or Mediterranean galley, 60c each, postpaid; 6 for \$3.00. Casson-Craft, Dept. B, Framingham Center, Mass.

PATENTS. Time counts in applying for patents. Don't risk delay in protecting your ideas. Send sketch or model for instruction or write for free book "How to Obtain a Patent" and "Record of Invention" form. No charge for information on how to proceed. Communications strictly confidential. Prompt, careful, efficient service. Clarence A. O'Brien, Registered Patent Attorney, Security Bank Building (directly across street from Patent Office), Washington, D. C. See pages 140 and 141.

LET Our experience be your guide. Models that are models; tools and equipment for economic manfg. Patterns of all types; manufacturing in all branches. Satisfaction guaranteed. United Machinery Company, Cincinnati, U. S. A.

WE Will help you develop your invention build working models that will work, Patterns, Castings, Stampings. Light machine work, one piece or complete machine. Confidential advice free. Winton Tool Co., Cincinnati, Ohio.

SHIP Model Fittings: Send Dime for booklet. A. J. Fisher, 1002 Etowah Ave., Royal Oak, Mich.

MODEL Steam Engines, Boilers and Model Pipe line fittings. Model Making Supplies. Send 20c for this year's illustrated catalogue and hand book. Batho Mfg. Co., Dept. D, 5214 Woodland Ave., Philadelphia.

CANADIAN Modelmakers. Blocks. Dead-eyes, ship-fittings. Stamp brings circular. Anderson, 44 Butterworth Ave., Toronto, Ont.

MODEL and Experimental Work at lowest cost. Wagar Model & Machine Works, 115 So. Clinton Street, Chicago.

SHIP model plans, supplies, books, fittings. Interesting catalog of Sea Things, etc. Sea Arts Guild, 730-M, Winnebago St., Milwaukee, Wis.

THE Modelmaker, a magazine for all interested in making working models, boats, etc. Sample 10c. Modelmaker, 122 Liberty St., New York.

FAMOUS Bailey Handbook—The book that prepares you to pass the examination for any grade of license for Stationary, Marine and Diesel Engineers, Firemen and Boiler Inspector in any state of the Union or any province of Canada. Flexible cover. Handy Pocket Size. Pay Postman \$2.00 plus postage when he hands you the package. Popular Mechanics Press, Room 912, 200 E. Ontario St., Chicago, Ill.

SPECIAL machine builders, tool and die makers, inventor's models production work of all kinds. Dept. L. Quality Hardware & Machine Co. Ravenswood and Thorndale Avenues, Chicago, Ill.

WE make working models for inventors and do experimental work and carry a complete stock of brass gears and model supplies. Send for catalogue. The Pierce Model Works, Tinley Park, Ill.

MODELS, Tools, Dies and General manufacturing. Logan Machine Co., 652 W. Lake, Chicago, Ill.

MANUFACTURING

COMPLETE Manufacturing. Dies and stampings and Special Machinery. Our Engineering department will design and perfect your article; our tool room will tool it for production. Our shop will make any quantity you may need. Models made if necessary. Barth Stamping & Machine Company, 3816 West 34th St., Cleveland, Ohio.

CONTRACT Manufacturers—Dies, Stampings, Models. Castings and Forgings Machined. Automatic Screw Machine Product. Screw Machine Specialty, Susquehanna Street, Pittsburgh, Pa.

SPECIAL Machinery or parts, dies, tools, metal specialties, models, special gears, stock gears and model supplies. Send for Catalogue. The Pierce Model Works, Tinley Park, Ill.

PATTERNS, wood and metal. Models, tools and dies. Brass, bronze, aluminum and iron castings. Screw machine work, production work of all kinds. Write Modern Machine & Pattern Co., Terre Haute, Ind.

MAKE Parts of inventions as needed. Machine works for little jobs. Mechanical specialties of felt, wood, sandpaper. Buzzell Co., 200 Congress St., Boston.

WANTED, to manufacture special Trucks and Machinery. Get our prices. Gallagher Bros., Uhrichsville, Ohio.

WIRE goods made to order. Cooley Mfg. Co., 530 N. Western Ave., Chicago.

DO you like to make things? If so, you should have a copy of Popular Mechanics new book entitled "Make It Yourself." A large book of 480 pages describing how to make 900 different articles. 823 illustrations. Price \$3 postpaid. A full description will be sent upon request. Popular Mechanics Press, Room 912, 200 E. Ontario St., Chicago, Ill.

MACHINERY, TOOLS AND SUPPLIES

NEW Stear & Chase No. 5 1/2 Precision Bench Lathes, complete, regular \$250.00 value—our price \$198.00 each. Botwink Brothers, Inc., "Connecticut Machinery Merchants," 67 Water St., New Haven, Conn.

USED Woodworking Machinery: Band Saws, Jointers, Saw Benches, Surfacers, Grinders. Oliver Machinery Co., Grand Rapids, Mich.

HERE is your opportunity to obtain a real good buy on electric grinders and buffers, which are, full 1/2 HP, 110 volt, 60 cycle, single phase, AC, enclosed dust-proof motor with cord and plug, emery wheel on one side and buffer on the other, at a low price of \$16.75 each. General Distributing Co., Duluth, Minn.

PLATHER Engine Lathe No. 400—14" Swing, 6" Bed, Cross Feed, Countershaft—Price \$75.00. B. F. Sturtevant Company, Hyde Park, Boston, Mass.

PUTMAN Engine Lathe No. 93—14" Swing, 4' 6" Bed, Countershaft. Price \$65.00. B. F. Sturtevant Company, Hyde Park, Boston, Mass.

PLATHER Engine Lathe No. 316—16" Swing, Compound Rest, Cross Feed, 8' Bed—Price \$85.00. B. F. Sturtevant Company, Hyde Park, Boston, Mass.

NO. 60 Heald Cylinder Grinder, \$375.00; Marvel Cylinder Boring Machine, \$115.00; 16x9" Chard Engine lathe, latest type, \$325.00; No. 41 Becker Milling Machine, \$165.00; No. 1 Cincinnati Milling Machine, with dividing heads, \$285.00. Terms if desired. Send for catalog. Cincinnati Machinery & Supply Co., 27 West Second St., Cincinnati, Ohio.

START business of your own, small investment required, doing nickel, copper and silver plating. This work in big demand. Information free. Electro Platers Supply Co., 547 Considine Ave., Cincinnati, Ohio.

OTHERS have successfully sold their machinery through our columns—so can you. Ask me for proof. M. L. Rund, Manager, Classified Advertising, Popular Mechanics Magazine, Chicago.

CONCRETE Building Block Machine and Molds. Catalogue free. Concrete Machine Co., 5 N. Main St., St. Louis, Mo.

NO. 2 Blount Emery Wheel Standard, 5 HP Motor, Air Compressor, Lathe, Bench Vises and Lathe Chucks. Cincinnati Automatic Machine Company, Cincinnati, Ohio, Texas.

14-IN. Gould Eberhard Crank Shaper \$125. Electro Co., 547 Considine Ave., Cincinnati, Ohio.

ENGINES, MOTORS AND DYNAMOS

ALTERNATING Current, new single phase 1/4-h.p. motor complete with cord, plug and pulley, \$19.75. Same motor with buffing and grinding wheels, \$14.25. All motors in original factory packages. No shopworn, repainted or rerated motors. Send for new price list. Hyre Electric Co., 615 W. H. So. Dearborn St., Chicago.

FOR Sale: 1/2, 3/4, 1 H. P. Motors—60 cycle—alternating current—slightly used. First class condition—all motors tested before shipping. \$4.00-\$4.50 and \$5.00 while they last. Cash with order. The Maytag Chicago Co., 337 W. Madison St., Chicago, Ill.

GOVERNORS For all auto engines where used for power plants. Send for circulars. A. C-S Governor Co., Springville, N. Y. or 215 W. Manchester, Los Angeles.

STEAM Engines—one H.P. \$18.00; 1/2, \$12.00. James Chambliss, Bessemer, Ala.

BARGAINS—Motors, Machinery, Wash. Machine Motors, \$5.55; 1/2 HP, \$17.50. Electric Drills, \$14.75; Elec Grinders, \$7.45; Farm Plant Motors, \$3.45; Generators, \$15.95; Elec. Vacuum Cleaners, \$8.95. 100 other bargains. Send for new Bargain Bulletin No. 630. Acme Tool Co., 627 Washington St., Chicago.

MAKE your own—half and one horsepower electric motors. A. C. Induction motor model shows winding connections plain sight. Quick easy way. Gaines Bros., Box 481, Gainesville, Texas.

WRITE for bargain catalogs on electric motors, generators, electric drills, etc. Do not buy, consult us first. General Distributing Co., Security Bldg., Duluth, Minn.

NEW 1/4 horse 110-volt alternating motors \$5.50 each. Also other bargains all sizes direct and alternating. Write for prices stating size and kind of current. Queen City Electric Co., 1736 Grand Ave., Chicago.

SURVEYING INSTRUMENTS

LARGEST stock of new and used surveying instruments in the country direct from factory. Satisfaction guaranteed or money refunded. Wissler, 619 N. Broadway, St. Louis, Mo.

BLACKSMITHS

BE a Master Mechanic Blacksmith and Expert Tool Maker and Dresser with colored tempering charts. Price \$1.00. Valuable samples free. W. M. Toy, Sidney, Ohio.

BENDING MACHINES

THE Famous Hossfeld "Wrenchless" Universal Iron Bender is the last word in bending machines. Bends metal, cold or hot, into most any conceivable shape, including Eye Bolts and Automobile Spring Eyes. Bends up to 1" bars or 1 1/2" pipe cold. Thousands in use by all classes of trade, from the smallest shops to the largest railway systems. Write for circular and prices. Hossfeld Mfg. Co., Winona, Minn.

FOR SALE—MISCELLANEOUS

MOTOR Chair for cripple. Second-hand, \$150.00. Electro Co., 44 Santa Clara, Longbeach, Calif.

ADDRESSOGRAPHS, Letter Folders, Multigraphs, Envelope Sealers, Duplicators, less than half price. Guaranteed. Pruitt Co., 117 No. Market, Chicago.

WANTED—MISCELLANEOUS

MAIL us your discarded Jewelry, Gold, Crowns and Bridges, Watches, Diamonds, Silver, Platinum and old False Teeth. Money promptly mailed. Goods returned if offer refused. United States Smelting Works (The Old Reliable), Dept. 71, Chicago.

CASH For your discarded jewelry, diamonds, old gold. Old watches repaired or exchanged for new. Petersen's Jewelry, 2010 Division, Grand Rapids, Mich.

REAL ESTATE, FARM AND ORCHARD LANDS

FLORIDA'S Finest Orange, Grapefruit, Garden Land near fast-growing city. Only \$1.50 acre monthly. Hurd, B-591, Klamath Falls, Ore.

CANADA Tax Sale. Buy These Bargains By Mail, pay in monthly payments, \$5 or \$10. \$49.50 for 2 acres lake front, \$63.00 for 25 acres on road, \$180.00 for 100 acres with creek. \$112.50 for 1,000 yards river frontage. \$450.00 for 300 acres game preserve. \$67.50 for 5 acres on Georgian Bay. \$171.00 for 79 acres Ocean front. These are a few items taken at random from our new twenty-page illustrated booklet of Canadian properties seized and sold for taxes, which is free for the asking. Beautifully situated hunting camps and fishing lodges where there is real hunting and fishing, summer cottage sites, islands, heavily wooded acreages situated in Muskoka, Highlands of Ontario, and the New North. Also farms in Old Ontario, Quebec, the Prairie Provinces and British Columbia. You couldn't buy these for ten times the price in the ordinary way. Now is the time to invest in Canada's future—minerals, forests and farms. Don't delay. Send no money, but send for the booklet to-day so you will have first choice. Full particulars, Tax Sale Service, Room 609, 72 Queen Street West, Toronto 2, Canada.

FOR Sale By Owner: Approximately thirty-four thousand acres of land in the Rio Grande Valley, having a frontage exceeding ten miles on the Rio Grande River extending from its mouth; with the finest beach on the Gulf of Mexico for about four miles, and being the only land on the Texas coast with beach contiguous to the land. Especially adapted to resort development in addition to agriculture and stock raising. Finely situated in the Magic Valley of the Rio Grande at the most southern point, practically safe from climatic changes. Price and terms such as to make this a big bargain. Address Mrs. Esperson Stewart, Niels Esperson Building, Houston.

SOUTH AMERICA—Colony Now Forming. Your chance to own stock ranch or farm near Atlantic seaport at trifle of its value. Assured markets, healthy climate. H. Frank, 7018 Hollywood Blvd., Los Angeles, Calif.

NEAR Atlantic City, N. J. Write for bulletin, describing Fruit, Poultry, Truck Farms, Suburban and City Homes. John A. Core, Egg Harbor City, N. J.

POULTRY Farm for \$1750. Modern Home, Bath and Electricity, furnace, 6 pleasant warm rooms, garage, 1½ acres, borders brook, on state highway, 10 min. walk heart depot market town; settling estate. Details pg. 13 illus. catalog. Free. Strout Agency 255-P, 4th Ave., New York City.

OZARKS—10 acres near White River and proposed power dam, \$100, \$5 monthly. Alvin Zimmerman, 1802 N. 5th, Kansas City, Kans.

PINE Ridge Farm, Poultry, Vermont, 142 acres. Modern home, 5 bedrooms, \$8,500. M. Tremblay, 327 E. Horter St., Phila., Pa.

OREGON Homesteads (late opening) offer exceptional opportunities. Map and details \$1.00. Frank Thompson, Sheridan, Oreg.

ATTENTION! Get acquainted, cash for your property, farm, hotel or retail store, no matter where located; confidential service. Hayes Business Agency, Cincinnati, Ohio.

\$10 IS all I ask down on 20 acres in Mich. Potato Belt. Very easy terms. Near Markets, lakes and streams. Write for particulars now. G. W. Swigart, P1276 First Nat'l Bank Bldg., Chicago.

SELL your property quickly for cash, no matter where located. Don't pay big commission. Particulars free. Real Estate Salesmen Co., Desk B, Lincoln, Nebr.

PECAN-Orange-Fig Groves "On the Gulf" Monthly payments. Guaranteed care. Big, quick returns. Suburban Orchards, Dent, M. Biloxi, Miss.

861 PRACTICAL Ways to Reduce Farm Labor and Expense and Increase Income. One farmer writes he would not part with this information for \$100, if he could not duplicate it. Nothing experimental. These ideas have all been put to test and proven practical. Send today for a copy of our Handbook for Farmers and get ready to put these ideas into operation for your own benefit. Pay postman only 98 cents and the postage when he hands you the package. Popular Mechanics Press, Room 912, 200 E. Ontario St., Chicago.

SEEDS, PLANTS, TREES, ETC.

BIG money growing Ginseng. Write for seed prices. W. N. Long, Florence, Ky.

ROOTS AND HERBS

HERB Doctor Book—10 cents. 250 recipes for making herb medicine. Hazzard Company, Box 1, Vanderveer Park, Brooklyn, N. Y.

OVER 1,000 varieties Medicinal Herbs, Roots, Barks, Flowers, etc. Imported and Domestic. Dime brings valuable recipe book and complete information. Shawnee, 145 West 112th St., Chicago.

DOGS AND PETS

FOR quick sale, all of my pedigreed racing homers are going at \$5 per pair. Express prepaid. Hurry! R. L. Zimmerman, Lexington, Ky.

ST. BERNARDS, Champion bred pups, registered prizewinning stock. Scientifically raised to develop size, beauty, intelligence. Reasonably priced. Photos 10c. Brockington, 181-P McKenna Avenue, Montreal.

HUNTING Hounds Cheap: Trial, Dixie Kennels, A7, Herrick, Ill.

RAISE Guinea pigs; easy to raise; little space required; very profitable. Particulars and booklet how to raise free. Cavies Distributing Co., 3102 C. C. Station, Kansas City, Mo.

FLYING Squirrels—Rare, handsome, hardy pets. Mated pair, express paid, safe delivery guaranteed, \$5.00. Wildwoods Fur Farm, Woodville, Texas.

FOR Sale: Thoroughbred English Bull Terrier Pups and registered matrons. Reasonable. Perc Bunker, North Manchester, Ind.

GERMAN Shepherds, Eligible. Tell View Kennels (Registered), Junction City, Kans.

FOR Sale. Minks, squirrels, raccoons, foxes, ferrets, muskrats, ginseng, rabbits, skunks, wolf pups, opossums. B. Tippman, Caledonia, Minn.

POULTRY

MORE Chicken and Egg Money! \$3 per hen a year easily made with the help of our most practical and interesting journal. 4 Months' Trial for only 10c. The Poultry Item, Box 71, Sellersville, Pa.

RABBITS

MAKE big profits with Chinichilla Rabbits. Real Money-makers. Write for facts, 852 Conrad's Ranch, Denver, Colo.

HEALTH

DON'T Starve; feed, improve ambition, brain power, complexion, nerve disorders, constipation, indigestion, catarrh, anemia, obesity, underweight. Booklet 10c. Vital Diet, 7, 811 No. Fourth, Camden, New Jersey.

EAT deliciously flavored and highly nourishing bread. Recipe free. Lock Box 11, Deerbrook, Wis.

PERSONAL

THE "Sanatory Physician" an 80 page book teaching natural laws of health, also suggests reliable self-treatment of disease. Appreciated by every reader. Mrs. S., Denver, Colo., says: "I owe my regained health to that dear little book." Postpaid 20c, address, Author, Box 437, Seattle, Wash.

ANSWERS to mathematical problems of office, store, shop, bank, farm, or factory. Explains and simplifies every principle of arithmetic, mechanics and mensuration. Send No Money. Just ask for Repp's Calculator." Pay postman \$1.00 and postage. Popular Mechanics Press, 200 E. Ontario St., Room 908, Chicago, Ill.

BACKWARD children trained and cared for. Wilson Schools, Dayton, Ohio.

TOBACCO or Snuff Habit Cured or no pay. \$1.50 if cured. Remedy sent on trial. Superba Co., N3, Baltimore, Md.

WE answer your questions, 25c coin. Fred Klotz, Reading, Pa.

EAGLE Eyes. Regain normal eyesight and discard your glasses. My method gives positive results. Complete for \$2.50. H. L. Tooker, 319 E. Orange Ave., Monrovia, Calif.

MAGIC Incense, personality perfume, occult books, catalog 10c. Hindu Publishers, Garrick Building, Chicago.

753 TIME. Labor and Money Saving Ideas for all who own, drive or repair autos. These practical kinks are based upon the actual experiences of hundreds of owners and repairmen. Three books, Auto Owners', Auto Repairman's and Auto Tourists' Handbooks, regular \$1.50 value will be supplied at 98c plus the postage C. O. D. for a limited time only. Send your order today to Popular Mechanics Press, Room 912, 200 E. Ontario St., Chicago.

DREAM Dictionary and "How to Tell Fortunes With Cards"—all for 10c. G. Eisea, Bowling Green, Ohio.

FREE! Valuable book telling the uses of roots and herbs. Box 29, Station L, New York.

MISCELLANEOUS

LOCKSMITHS: Have you received my free offer? If not, a card will bring it. McLeans, 1636 Lawrence, Denver, Colo.

LINDBERGH Specials—Fine Christmas Presents. Metal plaques "Spirit of St. Louis"; Five-inch Portrait Busts, Bookends, perfume bottles; 3½-inch medallion Ruth Elder, \$1.00 each. Art Works, North Wales, Penna.

OIL-PAINTING anyone can learn. Start studio, teach, sell portraits. Free booklet. Hughes, 227½ East 1st, Los Angeles, Calif.

MIRRORS Resilvered at Home. Costs Less 5 cents per square foot; you charge 75 cents. Immense profits plating autoparts, reflectors, tableware, stores, refinishing metalware, etc. Outfits furnished. Details Free. Write Sprinkle, Plater, 288, Marion, Ind.

HOMEOPATHIC and Biochemic preparations sent postpaid to all parts of the world. Manual and booklets free. Halsey Bros. Co., 645 St. Clair St., Chicago, Ill. Established 1875.

WEEDS—Cut them with cutter bar on Shaw Garden Tractor. Also plows, cultivators and runs belt machinery. Low prices. Immediate delivery. Shaw Manufacturing Company, Department C, Galesburg, Kans.

CUTS anybody can make. Simple, cheap process. \$1. Specimens, particulars. 2c stamp. M. Day, Windfall, Ind.

GOLD, Silver, Copper, Lead, Zinc ores, 10c each. Minerals identified, \$1.00. Buskett, Joplin, Mo.

AMATEUR Cartoonists: Make money in spare time with new cartoon selling plan. Write Smith's Service, PM1194, Wenatchee, Wash.

FAMOUS Dyke's Automobile Encyclopedia—Just out, 15th edition. Fully revised to include all latest facts regarding newest developments. Information on repairing and adjusting every part of all motor cars. How to find trouble and fix it. 1,250 Pages, 4,200 illus. Price, cloth, \$6. Flexible Morocco \$7.50. Will be sent C. O. D. anywhere in U. S. Pay postman price and postage when he delivers book. Popular Mechanics Press, Room 912, 200 E. Ontario St., Chicago.

MEXICAN Made pistol holsters, cartridge belts, lariats, horse hair articles; rattlesnake belts; list free. Tex-Mex Leather Co., 399 Esperson Bldg., Houston, Texas.

BEAUTIFUL finished hand made Yew Archery Bows. W. T. Harmon, Langley, Washington.

TATTOOING—Learn how with my outfits. Descriptive circulars sent anywhere. Sergt. Bonzey, 367 South Main, Providence, R. I.

YOU can emboss your stationery as needed. Perfect work guaranteed. Simple—Inexpensive. Miller Sales Company, Dept. E, Lexington, Ky.

PRINT 250 Signs or pictures an hour without press, type or machinery. Sample and particulars 10c. Straco, 1013, Springfield, Ohio.

CASH Paid for Butterflies, Insects. See Sinclair Display Advertisement on page 24.

TATTOOING supplies direct from manufacturer. Catalogue. "Waters," 965 Putnam, Detroit.

TELL an army of 3,000,000 live readers all about your offer! If you have anything to sell, buy or exchange, or if you have any reasonable proposition, tell our readers all about it—they'll respond quickly. Our booklet "How to Create More Business" contains some very interesting, helpful facts. Write today for your copy—it's free. M. L. Rund, Manager Classified Advertising, Popular Mechanics Magazine, 200 E. Ontario St., Chicago, Ill.

HERE it is—the new revised edition of Rathbun's book Aeroplane Construction and Operation containing all the information about the latest models of planes including the ships flown by Lindbergh and Byrd. Also the latest engines such as the Wright Whirlwind, etc. Authentic data furnished by the manufacturers. Complete and right up to the minute. Price \$2.50, postpaid. Will be sent C. O. D. anywhere in the U. S. or possessions. Popular Mechanics Press, Room 912, 200 E. Ontario St., Chicago, Ill.

He Mailed This Coupon



Tired Serving Soda



Mailed This Coupon



Success in Real Estate

And Made \$8,000 In 3 Months

Learn the secret of his success. Be a Real Estate Specialist. Learn my successful System. Start at home—in your spare time. No capital or experience needed. Be your own boss. Make more money than you ever made before. Free book tells how. Mail coupon today.

After running a candy store for more than fifteen years, A. W. Fosgreen of Woodhaven, New York, grew tired of serving soda.

He says: "I was getting on in years. Keeping a candy-and-soda store open Sundays, holidays and evenings was too hard work for a man of my age. And all I got out of it was a living. So I was anxious to find a business where I would have shorter hours—easier work—more money.

"One day I saw your ad in a magazine and sent for your free book. To shorten my story, that book resulted in my getting into the Real Estate business. In the first three months I made over \$8,000—bigger, quicker money than I ever made before in my whole life.

"To the man or woman who contemplates learning your methods I would say but one thing, and that is: Do it now and profit the sooner.

"My sincere thanks to you whose co-operation has always been so complete and courteous."

Make Money My Way

If you want to get into the biggest money-making field of all—

if you want to build up a high grade, permanent, profitable business of your own—if you want to make money my way—as hundreds of other wide-awake men and women are doing—do what they did—*mail the coupon now* and get my free book "How to Become a Real Estate Specialist."

Mrs. Evalynn M. Balster, a widowed school-teacher, with three children to support, mailed the coupon—got my book—and she made \$5,500 on her very first real estate deal—more money than she had made in several years of school teaching. H. G. Stewart of Baltimore, Maryland, made \$14,400 in less than six months with my successful Real Estate System. John Bischoff, a waiter, of Kingston, New York, got my free book, started to use my System and made \$1,287.50 in three months *just in his spare time*. Morris Horwitz, a printer, was earning \$44 a week, when he sent for my book. And he made \$9,000 his first nine months in real estate. Sounds too good to be true, doesn't it? But get the free book and you will find out that it is true.

Mail Coupon Today

Many men and women will read this ad who will not mail the coupon. They are "doubting

Thomas"—people of little faith—without gumption enough even to investigate the opportunities that knock at their doors. There are others, however, like Fosgreen, Mrs. Balster, Stewart, Bischoff and Horwitz, who will lose no time in clipping the coupon, getting the book, and finding out what there is in this golden business opportunity for them. In which class do you belong? Are you a *doubter* or a *doer*? My book is free. It has brought big business success to others. What can it do for you? Mail the coupon and you will soon find out. Address President, American Business Builders, Inc., Dept. 44-I, 18 East 18 St., New York, N. Y.

**Mail This
Coupon
for
Free Book**



President, American Business Builders, Inc.
(Authorized Capital \$500,000.00)
Dept. 44-I, 18 East 18 Street
New York, N. Y.

Please send me a free copy of your book, "How to Become a Real Estate Specialist."

Name.....
Address.....
City.....State.....



**Before Kenneth McCarty
Mailed that Coupon**

**He was an
\$18.00 Clerk~**



**Today
His
Income
is
\$85.00
a Week**

After completing the course he wrote us: "Yours is the finest course ever presented for the Tenor Banjo. Before I enrolled with you, I knew nothing whatever about music. I was earning \$18.00 weekly clerking in a store. Little did I realize the opportunity that had come. I took up the course just for fun. But here I am playing in one of the best orchestras in Western Michigan and making \$85.00 a week. Your course and your kind cooperation have made me a professional Tenor Banjoist." Kenneth McCarty, Parkview Hotel, South Haven, Mich.

Play for Fun or \$5,000 a Year

Whether a salary of \$65 to \$100 a week—or spare time playing at \$5, \$10, \$15 or more a night—interests you or not—think of the fun in store for you. In one to three months we can train you at home to play this marvelous, melodious instrument with a fine, easy skill that will make you the envy of all other eyes. Think, too, of the pleasure of being able to express yourself musically when alone! You're passing up the best times of your life if you pass up an opportunity like this to learn at slight cost and with no inconvenience at all the world's most popular instrument. **DON'T DO IT!** Decide NOW to learn more about The Play-Way—the quickest, surest, short-cut ever devised to social and professional success.

FREE Book Tells How

Send at once for "The Play-Way to Popularity and Big Pay." Learn all about our unique method of training you at home, about the big, professional size Tenor Banjo, Phonograph Records and complete Outfit that we send you along with your very first lesson. Undreamed of possibilities for pleasure, popularity and big pay are open to you the minute you "become good." The book below is your first step. Take it now. Clip the coupon while it's here before your eyes.

You Get Phonograph Records, Too

Every selection of the course, fifty-five in all—comes to you on a phonograph record. You hear the instructor's playing just as though he were right at your side. The Play-Way is different, interesting, **FOOL-PROOF.** Get the good news the coupon brings. **SEND FOR IT NOW!**



Get Big Free Book

**A. F. Bloch, President
NEW YORK ACADEMY OF MUSIC,
Studio 1018, 100 Fifth Avenue,
New York City.**

Send me the book that started McCarty. No obligation whatsoever on my part, understand.

Name.....

Address.....



Learn How to BOX

JIMMY DeFOREST BOXING COURSE
Teaches by mail the Same System he taught Champion JACK DEMPSEY



In 20 weeks, under the System of Jimmy DeForest, **WORLD'S GREATEST TRAINER AND MAKER OF CHAMPIONS**, you will master the priceless knowledge that made Jack Dempsey his millions, and fortunes for a host of other Jimmy DeForest-trained ring stars. Boys who were once rank amateurs are today earning big money; weaklings have been made strong, courageous; men have learned the art of self-defense. Send today for the now famous book, "THE GOLDEN AGE OF BOXING," greatest book of its kind ever written; full of valuable information, photos of great fighters and pupils who became successes over night. Enclose 10c to cover cost of mailing, etc. **WRITE NOW.**

JIMMY DeFOREST BOXING COURSE
347 Madison Avenue, Box 126, New York City

CAN YOU DRAW?

COPY THIS SKETCH

and let us see if you have a talent for drawing.

OPPORTUNITIES ABOUND in this wonderful profession for anyone who has a liking for drawing. Develop your talent and earn a share of the millions paid each year for Commercial Art.

LEARN AT HOME—You can study anywhere, under our resultful system of home study instruction, with the constant help of artists high in their profession.

BIG ILLUSTRATED BOOK FREE

Tells you hundreds of interesting facts about illustration, commercial art and cartooning. It's an unusual publication of great value. Write for it today—there's no obligation.

NORTH AMERICAN SCHOOL OF DRAWING,

131 Station "C"

Buffalo, N. Y.

SEND SKETCH FOR FREE CRITICISM

MECHANICAL DENTISTRY

EARN UP TO \$5000 A YEAR—STEADY WORK

This money-making profession easily learned in day or evening sessions. Practical training. Individual instruction. Easy terms. Railroad fare allowed—no extra cost. Write NOW for free catalog P and special tool offer.

N. Y. SCHOOL OF MECHANICAL DENTISTRY, 147 W. 33rd St., N. Y.



**LEARN A TRADE
Be Independent**

EASY TO LEARN

Watchmaking, Watch and Clock Repairing, Engraving [and Jewelry Work]

EARN UP TO

\$100 a Week

Big Demand For Trained Men

Great shortage of watchmakers, watch and clock repair men! Grasp this amazing opportunity. Steady employment in any section of the country. Uncrowded money-making field. We help you get big-pay job. Or you can own your own repair shop—easy to start—we show you how—fine income right from the beginning. NOW is the time to start—employers are writing us for trained men. Greatest opportunity of your life!

WE TEACH YOU QUICKLY

Takes but a few months to learn. Day or night school, no books, all personal instruction. Our profit-sharing plan helps you earn tuition. Work your way through school. We help you get part-time job.

FREE BOOK Write today for interesting book on watchmaking. It shows you the tremendous growth of the watch and clockmaking industry, the need for expert watchmakers and the wonderful money making prospects for men who are trained by our competent instructors. **Write Today, SEND COUPON BELOW. NO OBLIGATION.**

NATIONAL SCHOOL OF WATCHMAKING
1340 South Michigan Avenue Dept. 28 Chicago, Ill.

NATIONAL SCHOOL OF WATCHMAKING
1340 South Michigan Avenue, Dept. 28, Chicago, Ill.

Send me FREE BOOK on watchmaking, watch and clock repairing, engraving and jewelry work.

NAME.....

ADDRESS.....



GET INTO AVIATION

The miracles of success made in the auto business, by men who looked ahead, are now about to be repeated in the new, great Business of Aviation. To train YOU for the place you want to make for yourself,—success in this new business, and big money,—the world-famous Detroit school, the "Michigan State," now has ready for you complete ground and air training under experts.

Learn Aviation in Detroit, The Airplane Center

A Business Just Being Born

Aviation is just beginning to be a business. The experimental stage is passing to the practical stage. Marvelous futures and success await the men who learn this thrilling business thoroughly now.

Get into aviation!—either as maintenance man or flyer. Five to twenty ground men are needed to maintain every flyer,—the opportunities are big in both branches. Men are needed now—five planes are being built to every one man being trained.

Thorough AIR TRAINING At Detroit's Famous School

Air and ground training under experts will fit you properly. Seventeen years of training experience backs this Air Course. It is complete, intensive. It covers:

GROUND WORK: Engine and Plane Design, Construction and Repairs.

FLYING: Including Solo Without Bond, In Standard and New, Modern Planes.

AERIAL NAVIGATION AND PHOTOGRAPHY.

The Course qualifies you for Dept. of Commerce examinations and gives you practical training for actual ground work and flying.

Endorsed by Eddie Stinson and Other Aviation Leaders

As the "Michigan State" has always had the endorsement of Auto leaders, so it now has the backing of Aviation leaders. "Eddie" Stinson, America's premier flyer and President of the Stinson Aircraft Corporation, and others, give the Course and the "Michigan State" their complete approval.

Aviation Is Ready—Are You?

Aviation is now where the Auto business was 20 years ago. Future opportunities are limited only by your vision and your training. Are you ready to act? The men who get in now will profit biggest. Prepare now—and profit by your foresight.

Training That Equips You Right

Complete, practical training at this reliable Detroit school, fits you either for ground work or for flying. Three months' Course or longer. Shop practice. Class room instruction. Ten hours of dual control flying. Solo flights with no bond required. Under direction of flyers of vast experience.

PRACTICAL TRAINING Not A Correspondence School

"Michigan State" Aviation training is practical work right here at our school, in our class rooms, on our airplanes and engines, and flying in our planes.

Write For Details

Get the jump on the "pack" by starting now. Write or send coupon for facts,—or jump on the train today for Detroit—the Auto and Air Center.

Michigan State Aviation School

Affiliated With
Michigan State
Automobile School
Established 17 years
A. G. Zeller, Pres.
3701 Woodward Ave.,
Detroit, Mich.

Learn Aviation in Detroit—The Auto and Airplane Center

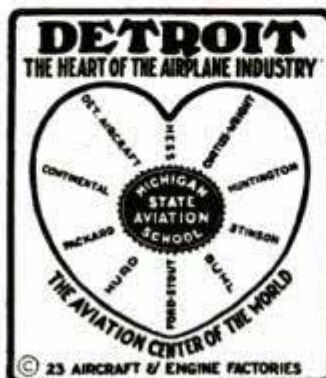

Get the Facts TODAY

A. G. Zeller, President
Michigan State Aviation School
3701 Woodward Ave., Detroit, Mich.

Send me at once the details of your Aviation Ground and Flying Course. I expect to come to Detroit about.....

Name.....

Street and No. or R. F. D.....

City and State.....

Age..... Present Work.....



Salary increased 300% in few months

Chief draftsman of big company received big increase even before he had completed his course with the I. C. S.

"AT THE time I started my I. C. S. course I was working in a paper mill," writes A. J. Hutchins, Chief Draftsman for the American Strawboard Company.

"Before I had completed the course I was called upon to make drawings in one of the company's largest mills and was appointed Superintendent of Construction at an increase in salary of 300 per cent."

Every mail brings letters from students of the International Correspondence Schools telling of increases in salary due to spare-time study.

Why don't you study too and prepare for a real job at a real salary? You can do it if you really try.

Just mark and mail the coupon and we will send you complete information about the I. C. S. Drafting courses or any other course in which you are interested.

INTERNATIONAL CORRESPONDENCE SCHOOLS
Box 5699-E, Scranton, Penna.

Without cost or obligation on my part, please tell me how I can qualify for the position, or in the subject, before which I have marked an X:

- | | |
|---|--|
| <input type="checkbox"/> Mechanical Drawing | <input type="checkbox"/> Structural Drafting |
| <input type="checkbox"/> Draftsmen's Course | <input type="checkbox"/> Ship Drafting |
| <input type="checkbox"/> Architectural Drawing | |
| <input type="checkbox"/> Electrical Engineering | <input type="checkbox"/> Architect |
| <input type="checkbox"/> Electric Lighting | <input type="checkbox"/> Architects' Blueprints |
| <input type="checkbox"/> Mechanical Engineer | <input type="checkbox"/> Contractor and Builder |
| <input type="checkbox"/> Machine Shop Practices | <input type="checkbox"/> Concrete Builder |
| <input type="checkbox"/> Railroad Positions | <input type="checkbox"/> Structural Engineer |
| <input type="checkbox"/> Gas Engine Operating | <input type="checkbox"/> Chemistry <input type="checkbox"/> Pharmacy |
| <input type="checkbox"/> Civil Engineer | <input type="checkbox"/> Automobile Work |
| <input type="checkbox"/> Surveying and Mapping | <input type="checkbox"/> Airplane Engines |
| <input type="checkbox"/> Metallurgy <input type="checkbox"/> Mining | <input type="checkbox"/> Agriculture and Poultry |
| <input type="checkbox"/> Steam Engineering <input type="checkbox"/> Radio | <input type="checkbox"/> Mathematics |
| BUSINESS TRAINING COURSES | |
| <input type="checkbox"/> Business Management | <input type="checkbox"/> Salesmanship |
| <input type="checkbox"/> Industrial Management | <input type="checkbox"/> Advertising |
| <input type="checkbox"/> Personnel Organization | <input type="checkbox"/> Better Letters |
| <input type="checkbox"/> Traffic Management | <input type="checkbox"/> Show Card Lettering |
| <input type="checkbox"/> Business Law | <input type="checkbox"/> Stenography and Typing |
| <input type="checkbox"/> Banking and Banking Law | <input type="checkbox"/> English |
| <input type="checkbox"/> Accountancy (Including C.P.A.) | <input type="checkbox"/> Civil Service |
| <input type="checkbox"/> Nicholson Cost Accounting | <input type="checkbox"/> Railway Mail Clerk |
| <input type="checkbox"/> Bookkeeping | <input type="checkbox"/> Common School Subjects |
| <input type="checkbox"/> Private Secretary | <input type="checkbox"/> High School Subjects |
| <input type="checkbox"/> Spanish <input type="checkbox"/> French | <input type="checkbox"/> Illustrating |

Name.....
Street.....
Address.....

City..... State.....

Occupation.....
If you reside in Canada, send this coupon to the International Correspondence Schools Canadian, Limited, Montreal

Learn to Dance

This New Easy Way

You can learn all the modern dances—Charleston, Black Bottom, Valencia, Canter, French Tango, St. Louis Hop, Latest Waltzes, Fox Trots, etc., at home easily and quickly. New chart method makes dancing as simple as A-B-C. No music or partner required. Learn anywhere, anytime. Win new popularity. Be in demand at parties. Same course of lessons would cost \$20 if taken privately.



Send No Money

Just send your name and address. We'll ship the complete course—323 pages, 49 illustrations—without one cent in advance. When package arrives, hand postman only \$1.08, plus delivery charges, and this wonderful course is yours. Try for 5 days. Money back if not delighted. Send your name NOW. Bargain Book Catalog, 4c.

FRANKLIN PUBLISHING COMPANY
800 No. Clark St. Dept. 9410 CHICAGO

LEARN TO WHISTLE



Be the Life of the Party I'll teach you in 24 hours to whistle the latest songs and imitate bird calls using your tongue and lips—new method. Amaze your friends, whistle solos at parties, over radio, earn extra money, be popular. FREE with order, Invisible Bird Call. Complete with instructions 25c.
JACK THE WHISTLER, Box 262, Dept. 3X, New Haven, Conn.

25c

BE AN AIRPLANE BUILDER, PILOT, MECHANIC



Blue Prints and material now ready for builders of the world's famous Lincoln Sport Plane.

Send 25c for set constructional details and book *Flight*.

Dept. P

LINCOLN AIRCRAFT CO.
LINCOLN, NEBRASKA



FREE if You Act Now
Braymer and Roe's Rewinding Small Motors

Get into the electric wiring field—big demand—big money!

THE whole wiring field covered. Kinks; helps; short cuts; practical, on-the-job electrical data, written particularly to help wiremen, trouble shooters, maintenance men, armature winders, electrical contractors and students.

American Electricians' Library
6 volumes, 2000 pages, illustrated, \$16.00 payable \$2.00 in ten days and \$2.00 a month

The books tell you all you must know about conduit wiring, armature winding, wiring for lighting circuits and switches, wiring for machinery, circuit troubles, circuit testing, or electrical machinery erection. Through a study of this great set you can push yourself into a big-pay job for life.

See it FREE—Send no money—ACT

FREE EXAMINATION COUPON

McGraw-Hill Book Co., Inc.
370 Seventh Avenue, New York

Send me the American Electricians' Library for 10 days' free examination. If satisfactory, I will send you \$2 in 10 days and \$2 monthly until the full price, \$16, is paid. If not wanted, I will return the books at your expense. Upon receipt of my first payment of \$2.00, I am to receive a copy of Braymer and Roe's REWINDING SMALL MOTORS free of charge.

Name.....
Address.....
City and State.....
Position.....
Company..... P. M. 1-28

ESCAPE!

Break Away From ~

*Long hours ~ Restrictions
on your liberties ~ Barely
enough Pay to make
both ends meet.*

THIS AMAZING BOOK

Shows How to Get **BIG PAY AT ONCE**



No longer must you struggle along at hard work, low pay, long hours—ESCAPE!

Don't put up with long hours, tiresome detail and overbearing or inconsiderate employers. Don't struggle along another minute at low pay. Quit depriving yourself of the good things of life.

Now, W. T. Walsh, the nationally-known wizard of BIG PAY, shows you the new, quick, easy way to make \$50—\$75—and \$100 a week—and even more. Just like being in business for yourself. No time clocks, no hours, no bosses. And you make pay for



every hour you work. You do work that you like. The secret is an entirely new kind of work that is sweeping men into big money class overnight. Thousands in America now doing it. And thousands of more opportunities for big pay without any investment on your part.

In the amazing book that Mr. Walsh will send you, he tells you

FREE!

Read Here How To Get It Free

This amazing book by the man who has become known all over the country as the Maker of BIG PAY MEN is yours without charge. The publishers of Opportunity Magazine are going to give it entirely free with every 2 years' subscription—24 issues—at the special price of \$2.00. And the link is completed.

KEY TO BIG PAY

In the book you will learn the secret—in its pages you will learn the exact and simple A. B. C. steps for applying the secret—and in the magazine you will find the opportunity that will make the biggest money for you.

in less than 200 words just exactly how you can break away from small pay and get into a big income AT ONCE! Then the rest of the book gives you full details for carrying out the work in this new and remunerative profession.

Don't Leave Present Job The nice part about it is this: You don't have to leave your present job and take a chance on making money. By Mr. Walsh's plan you can try out his new system in your spare time, at noons or after work or on Saturday afternoons or even on Sunday. You can work this way until you are making more from spare time than you now do from your regular job. Then you can leave the job and jump your pay to twice and three times what it was by giving Mr. Walsh's system all of your time. You take no chances. You risk nothing. You gain all!

every hour you work. You do work that you like. The secret is an entirely new kind of work that is sweeping men into big money class overnight. Thousands in America now doing it. And thousands of more opportunities for big pay without any investment on your part.

OPPORTUNITY PUBLISHING CO.

Dept. P. M. M. 128 750 No. Michigan Ave. Chicago

WE INTRODUCE YOU TO MEN WHO PAY BIG MONEY

That's what OPPORTUNITY will do for you. In its pages you will not only meet successful men and women, who will tell you how they are making \$5,000.00 to \$10,000.00, but in its columns are listed hundreds of reliable manufacturers who are looking for men and women who have the knowledge you will get from Mr. Walsh's book, and who offer big paying positions to those who can do the work we teach you to do.

DON'T SEND A PENNY

NO MONTHLY PAYMENTS! As soon as we receive your name, this magic book of Success and the first copy of Opportunity will be sent to you. Simply deposit \$2.00 with the mailman when he delivers the book. It will be your full and final payment; you do not pay another cent, now or at any other time.

Trial Guarantee

We will take the chances! We know what this money-making combination can do for your income. Let us prove it to you! Take advantage of our generous TRIAL and guarantee of satisfaction or money back.

GOOD FOR BOOK

OPPORTUNITY PUBLISHING CO.
Dept. P. M. M. 128, 750 No. Michigan Ave., Chicago

Enter my name for big introductory combination. Put me down for two years' subscription to Opportunity Magazine and send me Mr. Walsh's system and his book at once without extra charge. I will deposit \$2.00 with my mailman in full and complete payment. My money back if not entirely satisfied.

Name.....

Address.....

City.....State.....

Learn Electricity in Los Angeles

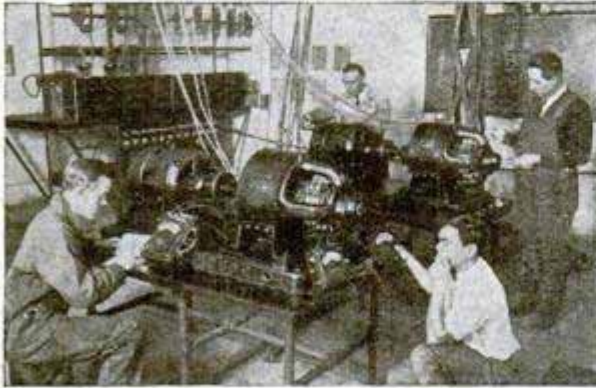

Earn \$50 to \$200 Week As Electrical Expert

Train at National, Los Angeles, in the center of California's \$100,000,000 electrical development program.

The tremendous increase in development of enormous electrical projects has created a big demand for trained men with practical knowledge. YOU can quickly get into this fascinating industry and earn \$50 to \$200 a week.

L. W. Bell Gets Two Promotions in 19 Days

"After leaving National Electrical School, I obtained employment with the So. Cal. Edison Co. as apprentice operator, and after working at this job for 10 days was promoted to assistant foreman at the Laguna Bell Sub. I worked here for 9 days and was transferred to Saticoy Sub, a switching center, as assistant operator."
(Signed) L. W. Bell,
Saticoy, Calif.

National training will qualify you. Actual work on modern electrical equipment helps make you a skilled expert in Power House Operation, Motors and Controls, Central and Sub-station Operation, Armature Winding, Motor Building, Electrical Fundamentals, Drafting, Illumination, Commercial Radio, Radio Construction, Battery Manufacture, Automotive Electricity, etc. Expert instructors; million-dollar shops; liberal "no-time-limit" training plan assure success. Over 17,000 successful graduates of this quarter-century-old institution.

Free Employment Service

National graduates are preferred by many big electrical employers. We help you get the kind of job you want upon your graduation. We also assist you to get part-time jobs to pay living expenses while training. Mail the coupon now for big free electrical book. Explains everything. Make your start to win success today.

NATIONAL ELECTRICAL SCHOOL



Dept. 514 4006 Figueroa St., Los Angeles, California

Please send me your Free, illustrated National Electrical Book describing opportunities in the electrical industry and illustrating National training methods.

Name _____

Address _____

City _____

State _____

**FREE
ELECTRICAL
BOOK**

The Quick Way to Learn PIANO

Think of it! Thousands who didn't know a note a few months ago—today are playing the piano. Their friends are amazed—"What a wonderful surprise—I didn't know you could play." But here's their secret—they learned under Art Shefte's startling, revolutionary method of teaching—the shortest, simplest piano method known. Gets you right down to essentials—to actual playing—almost at once.

You Can Learn in a Few Months

Art Shefte, himself a master pianist, shows you how to do in a few months what ordinarily required years. Saves you time and money. No long, tuneless exercises or needless theory. He knows that you want to *play* and he gets you to it quickly. That's why his method is so fascinating. You learn how to play popular music as the Artists, Radio Pianists play it.

Shefte Rapid Course in Popular Music and Syncopation \$1.00 EACH BOOK

Don't say it can't be done when hundreds are doing it and praise the Shefte Method. Try it. Pick below the volume you need and begin today. Piano playing is a distinct social advantage that can be yours. Play and be popular. If your music dealer can't supply you, send your order and remittance to our address below.

Book No. 1 For beginners with little or no knowledge of music. **Price \$1.00**

Book No. 2 For those with a fair knowledge of music. **Price \$1.00**

Book No. 3 For the advanced student or professional pianist. **Price \$1.00**

On sale wherever music is sold or sent postpaid on receipt of price.

FORSTER MUSIC PUBLISHER, Inc.
218 S. Wabash Ave., Dept. 5 Chicago, Ill.



LEARN TO FLY

Billions of dollars will be created and spent through the development of aviation. Thousands of positions will be open for those who are prepared.

Prepare now! Complete Home Study Course in Aviation arranged by America's foremost aeronautical society. Authentic yet inexpensive.

Write for further information

THE AMERICAN SOCIETY FOR PROMOTION OF AVIATION, 522 Fifth Ave., Dept. X, New York

TELEGRAPH-RADIO

Operators earn \$150 to \$350 month and up. Learn in Chicago or at home. Chance to work while training. We furnish operators to U. S. Govt., Railroads, Com'l Cos., Broadcasting Stations and Ships.
CHICAGO TELEGRAPH INSTITUTE, Dept. 1-1-8, 1338 So. Michigan Ave., CHICAGO, ILL.

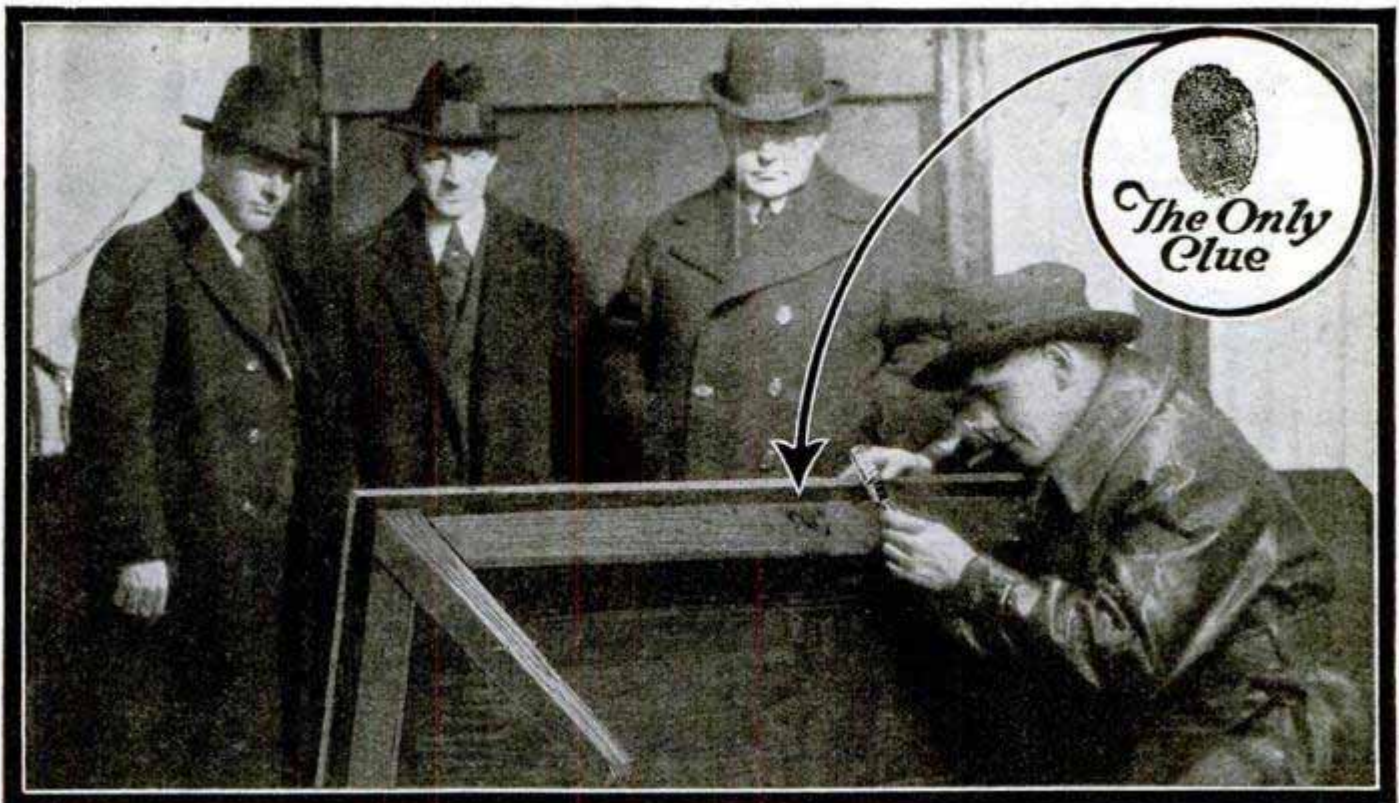

\$500 REWARD for TWO HOURS WORK

WARREN BIGELOW, the Finger Print Expert, was making his usual review in the morning newspapers. He had just finished reading the press reports of the daring robbery of the offices of the T—O—Company when the telephone on his desk rang. Central Office was calling, asking him to come immediately to the scene of the robbery.

Although he drove his high powered roadster rapidly and arrived very shortly at his destination, he had plenty of time to consider the main features of the case as reported by the press. The job had undoubtedly been done by skilled cracksmen and robbers of uncommon nerve. Sixty-five hundred dollars in currency—the company pay-roll—were gone. Not a single, apparent clew had been found by the police.

Finger Print Expert Solves Mystery

On his arrival, Bigelow was greeted by Nick Austin, Chief of Detectives, who had gone over the ground thoroughly.

"Hello, Warren. Here's a job that has us stumped. I hope you can unravel it for us."

By this time, the district officers and the operatives from Central Office had almost given up the investigation. After hours of fruitless efforts, their work was at a standstill. They were completely baffled.

With lively interest and a feeling of relief they stepped back to await the results of the Finger Print Expert's findings. They were plainly awed at his quiet, assured manner. The adroit old Chief himself was manifestly impressed at the quick, sure way in which Bigelow made his investigation.

Almost immediately Bigelow turned his attention to a heavy table which had been tipped up on its side. Examination of the glossy mahogany showed an excellent set of finger prints. The thief might just as well have left his calling card.

To make a long story short his prints were photographed and taken to Central Office, where they were matched with those of "Big Joe" Moran, a safe blower well known to the police. Moran was subsequently caught and convicted on Bigelow's testimony and finger-print proof. Most of the money was recovered. In the meantime the T—O—Company had offered a \$500.00 reward, which was given to Bigelow—his pay for two hours' work.

Learn at Home in Spare Time

Could you imagine more fascinating work than this? Often life and death depend upon decisions of finger-print evidence—and big rewards go to the Expert. Thousands of trained men are now needed in this great field. The finger print work of governments, corporations, police departments, detective agencies and individuals has created a new profession. Many experts regularly earn from \$3,000 to \$10,000 a year in this fascinating game. And now you can easily learn the secrets of this new Science in your spare time—at home. Any man with common school education and average ability can become a Finger Print Expert in a surprisingly short time.

FREE Secret Service Reports

Mail the coupon right now and we will send you free the confidential reports Operator No. 38 made to his chief and tell you of the wonderful opportunity awaiting the man like yourself, who is ambitious to get ahead in the world. We will also send you the illustrated free book on Finger Prints which explains this wonderful training in detail. Don't wait until this offer has expired. Mail the coupon now. You may never see this announcement again! You assume no obligation. You have everything to gain and nothing to lose. Write at once. Address

UNIVERSITY OF APPLIED SCIENCE
Dept. 13-51 1920 Sunnyside Avenue Chicago, Illinois

UNIVERSITY of APPLIED SCIENCE, Dept. 13-51, 1920 Sunnyside Av., Chicago

Gentlemen: Without any obligation whatever send me your new, fully illustrated, FREE book on Finger Prints and the free reports of Operator No. 38.

Name.....

Address.....

Age.....

Why don't You be a Finger Print Expert?



10 Days' Free Trial

An extraordinary offer! Genuine No. 5 L. C. Smith ball-bearing typewriter at a 50% saving—and for only \$4 a month. Here's your chance to own the finest machine made at rental prices. Only a limited number of these superb typewriters available at these low prices and easy terms. You cannot imagine the perfection of this wonderful ball-bearing typewriter until you have used it. Positively the easiest writing, fastest running, longest wearing typewriter made. Test this magnificent machine in your home or office for 10 days. Then you'll know money cannot buy a better, more beautiful, rebuilt typewriter.

**Only
\$4
a Month**

Guaranteed 5 Years

For over 20 years the L. C. Smith has been recognized as the best typewriter made. The U. S. Government bought 40,000. It is the choice of big corporations like the Standard Oil Co., etc. IT IS THE WORLD'S ONLY BALL-BEARING TYPEWRITER.

SEND NO MONEY

Just mail the coupon—we'll send you the typewriter for a 10 day trial. No one will urge you to buy. Unless the typewriter sells itself to you, return it at our expense. But you'll want to keep it, and you can for only \$3 down and \$4 a month. By using the coupon below, you receive \$3 worth of extras free. Send coupon now before the offer is withdrawn.

\$50 SAVED BY USING THIS COUPON

Smith Typewriter Sales Corp.
111-360 E. Grand Ave., Chicago.

Ship me the No. 5 L. C. Smith F. O. B. Chicago. On arrival I'll deposit \$3 with express agent. If I keep machine, I'll send you \$4 a month until the \$45.50 balance of the special \$48.50 price is paid; the title to remain in you until then. I am to have 10 days to try the typewriter. If I decide not to keep it, I will repack and return to express agent who will return my \$3. You are to give your standard 5-year guarantee.

Name.....
 Address.....
 City.....State.....
 Occupation.....
 Employed by.....



Air Commerce Needs Men!

Don't envy the Highly Paid Air Man—Be One! Air Men are in demand. Beat the other fellow to the High Salaried Jobs in Aviation. **Western** training will qualify you to enter Aviation. Learn how through our catalog, sent on request.

**Write for Free Catalog
"Airplanes and Flying"**

Aeronautical Training Division

WESTERN AIRPLANE CORPORATION
Dept. M-1 Monadnock Block Chicago, Ill.



Be a drummer!



Trap Drumming made easy in a short time. Our free instruction course furnished with genuine Ludwig Trap-Drum Outfit. Develop your natural sense of rhythm. Go to your nearest dealer or write for full details.

LUDWIG & LUDWIG, 1611 North Lincoln Street, Chicago

Learn Watchwork, Jewelrywork and Engraving

A fine trade commanding a good salary, and your services always in demand. Address **Horological**, Dept. P, Bradley Institute, PEORIA, ILLINOIS, for our latest catalog.



Try your hand

- at these Electrical questions. A knowledge of Electricity is not only valuable to every one, regardless of the nature of their work, because this is the Electrical age—but an EXPERT knowledge can be converted into a fine position and splendid pay.
1. What "makes the wheels go round" in an Electric motor?
 2. Just how does Electricity become Electric LIGHT?
 3. How is the fall of the waters at Niagara converted to Electricity?
 4. Give examples of electric, magnetic and radio currents.
 5. What vital uses are Electricity put to in the modern auto?
 6. What makes the electric toaster TOAST?
 7. What makes the telephone "speak"?
 8. Explain briefly the miracle of radio in words understandable by a school boy.

INTERESTING ELECTRICAL QUESTIONS

Questions prepared by Chief Engineer Dunlap, Electrical Div., American School, Drexel Ave. & 58th St., Dept. E-174A, Chicago, Ill.

Answers

FREE!

Chief Engineer Dunlap, Electrical Div., American School, Dept. E-174A, Drexel Ave. & 58th St., Chicago.

Please send free answers to Electrical questions at once, and other interesting facts about the Great Electrical Industry.

Name.....
 Address.....

YOU'RE NEXT

Now Watch YOUR Muscles GROW!

ONE—TWO—THREE! Just like that the boy you see at the right changed from a puny weakling into a physical GIANT! Looks like magic, doesn't it? But it isn't. It's just an example of what Titus Training has done for thousands upon thousands of men.

I've taken fellows of every size and condition and transformed them almost overnight into perfect specimens of manhood! I've been doing it for years. "Miracles worked in Muscle" people call them. But they are *scientific* miracles, because I've made a science of building men. Nobody else knows the secret of my methods—but I know, and I know they'll do the same for you as they did for the lad shown here.

In 30 Days I'll Increase Your Muscles by INCHES

Yes sir, that's all I want—30 days—and just 20 or 30 minutes a day. In that short time I'll put layer after layer of muscle all over your body till they stand out like iron bands. And they'll be panther muscles, friend—muscles as live as spring steel—with the speed of lightning and the power of a battering ram. Those are the kind of muscles that make champions, the kind of muscles that will make you laugh at men twice your size.



Wear This Medal

Strong men all over the world wear it. Made of solid statuary bronze and given to you free.

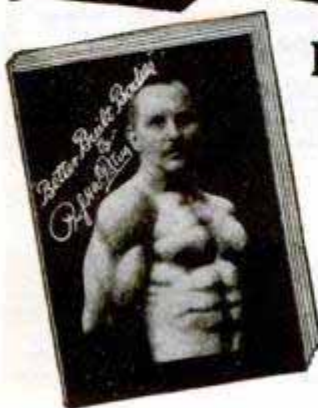
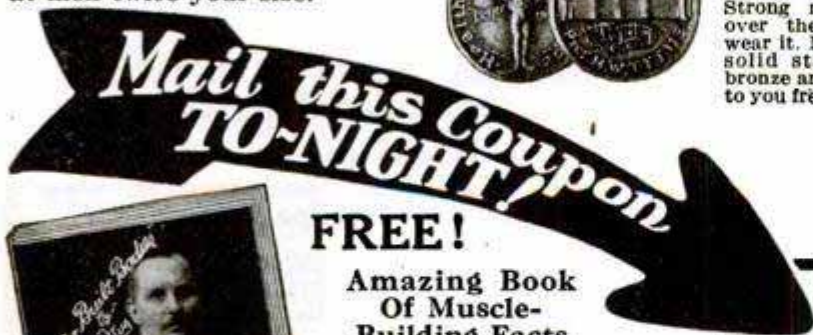

FREE!

Amazing Book Of Muscle- Building Facts

Tear off that coupon! Mail it today! It will bring you FREE the greatest book you've ever seen—a book filled with astounding photographs of men rebuilt—a book packed full of Titus's own secrets of making muscles grow. No cost or obligation—just rush the coupon to Dept. M-122.

The One and Only **TITUS** 105 E. 13th St. New York City

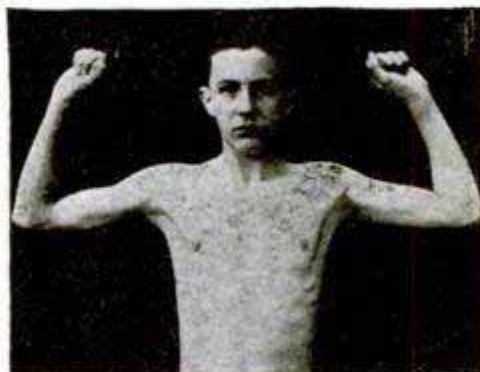

BEFORE: This boy looks pretty hopeless, doesn't he? I'll bet he hated to step out on the beach in a bathing suit, and he had to stand a lot of bullying from the other boys in the gang.



IN 30 DAYS Pipe This! Here's a real man! Just look at the way those muscles have developed in 30 days of Titus Training. That's going some, isn't it?

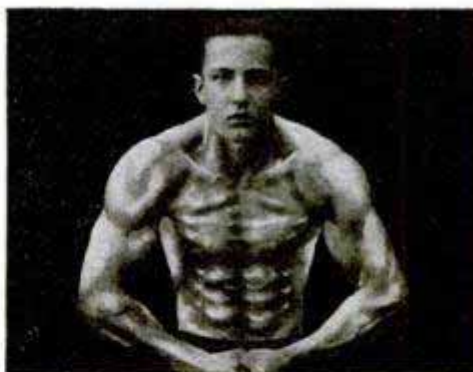

IN 60 DAYS and New Look! Every muscle in his body developed to giant size. You'd never recognize him as the same lad. Need I urge YOU to mail the coupon?

TITUS, Dept. M-122
105 E. 13th St., New York, N. Y.

Dear Professor Titus: Sure I'd like to have your book. Send it free.

Name.....

Address.....

Town.....State.....



BOYS

Make Big
Spare Time
Money
Surprise
your chums

ELECTRICITY

This Quick Easy Way

Electricity is great fun! And it pays. Lots of my boys still in school are making \$10 to \$15 a week in spare-time—and getting a real training besides for a regular he-man's Big-Pay job in Electricity when school days are over. You can, too! I'll show you how. Begin right now to prepare for a big future in this fascinating field of great opportunity. Your chances of success are simply wonderful!

Learn Right at Home

With my easily-learned, spare-time Electrical Course I will train you at home like I trained hundreds of other boys who are now big successful men. It won't interfere with your school work. And you'll find it so enjoyable it will be more like play than study. It's just the thing for you fellows who are ambitious to get somewhere and be somebody after you have finished school.

I Train You RIGHT!

My training is practical—you learn along work-shop lines by doing. I furnish you with all necessary equipment to work with. And it doesn't cost you a penny extra! Six Big Outfits of tools, material and apparatus, including a real electric motor—not toys, but the real thing. And they're yours to keep—to learn right with, and to help you do the spare-time work I tell you how to get and how to do.

Mail Coupon for Book

If you want lots of spending money—if you want to be ready to jump into a Big-Pay Electrical Job when you're through school—my Big Book will show you how. Get it—you'll like it—it's full of "dope" data and pictures that will thrill you. And it's FREE—won't cost you a penny—mail coupon for it right now!

L. L. COOKE
Chief Instruction Engineer
Dept. 011, CHICAGO, ILL.

RADIO COURSE NO EXTRA CHARGE

Every fellow wants to learn radio. And this Course is a dandy. It's simple—it's thorough. You'll be surprised what it will teach you about Radio. And it's yours without a penny of extra cost!

6 BIG OUTFITS given including a REAL MOTOR

What a thrill you'll get from these Six Big Outfits of tools and apparatus! There's enough equipment in this fine layout for you to tackle any kind of spare-time work. Imagine having all this for "keeps."

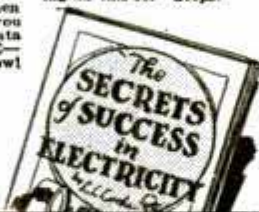

Use this SPECIAL OFFER Coupon

L. L. COOKE, Chief Instruction Engineer,
L. L. Cooke School of Electricity
Dept. 011, 2150 Lawrence Ave., Chicago, Ill.
Send me free and fully prepaid your Big Book about Electricity, and full particulars about your Electrical Course and extra Radio Course. This does not obligate me.

Name

Address

City State

(This coupon only for use of boys 15 years old or more)

WANTED!

Ornamental Iron Draftsmen at BIG PAY

Our students are getting positions before they finish our course of instruction. The demand for trained men is greater than the supply. Learn at home, in spare time. No books, higher mathematics or experience necessary. Free Employment Service to qualified students.



Get this FREE BOOK!

It gives full information. We have no agents or salesmen. Write today.

American Inst. of Ornamental
Iron & Bronze
3851 Hennepin Avenue
Minneapolis, Minnesota



WANT THIS JOB?

\$1700 to \$2300 a Year

MAIL CARRIERS—POSTAL CLERKS
FEBRUARY EXAMINATIONS EVERYWHERE
Men 18 up

Steady Work Paid Vacation
Write immediately for FREE list of positions and full particulars telling how to get a position.

FRANKLIN INSTITUTE
(Not connected with U. S. Government)

Dept. T-309 Rochester, N. Y.



BART SUPPLIES

Special 48 p. catalog "S"—Show Card and Sign Writer's supplies. Also catalog "A"—Art Supplies. Save Money—write—
BART SUPPLIES, 504 Euclid Bldg., MINNEAPOLIS, MINN.

HOW'D FREE LESSONS!

YOU
LIKE
to Play
This
Instrument?



No reason why you shouldn't. Easy Lessons show you how. 5 days' free trial in your own home. A year to pay.

THE whole world seems different when you learn to play and now you can play the most spectacular of all instruments—the Deagan Xylorimba. No long waiting. No finger or lip exercises. No tiresome practice. Start to play the very first day even if you can't read a note of music right now. Soon you'll be the "hit" of every party. Maybe, like the Musical Hallmans (Reading, Pa.) you'll make \$65 a week spare time.

Our Big FREE Book tells all about the free trial offer, the easy lessons, the wonderful payment plan. No cost or obligation—send in coupon today.

J. C. Deagan, Inc., Dept. 1451, 1770 Berteau Ave., Chicago
Send me, without obligation, full details of Free Trial offer and easy payment plan of the Deagan Xylorimba.

Name

Address

SPORTSMEN

Read This Offer!

Send the COUPON and receive a magnificent Sportsmen's Book telling you how to learn to MOUNT GAME-HEADS, BIRDS and ANIMALS. You can NOW be your own Taxidermist. Our school has over 100,000 graduates throughout the world. You can now learn AT HOME in SPARE TIME.

Mount Your Own Trophies!

Hunting and Fishing have entered a new era. All true sportsmen now kill fewer specimens, but DOUBLE their interest by mounting their trophies. The secrets of Taxidermy (mounting birds and animals) are now revealed. YOU CAN NOW LEARN TAXIDERMY FOR YOURSELF. Be a Taxidermy artist. Mount birds, animals, game-heads, fishes, tan skins and make beautiful rugs and robes. Easily and quickly learned in your own home. Adorn your home and den with nature's finest ART. If you enjoy hunting—you will enjoy Taxidermy MORE.

Big Profits Do you want to MAKE MORE MONEY? Then give your SPARE TIME to Taxidermy. Make \$50 to \$250 a month by mounting for others or selling your mounted specimens, or go into business—open a Taxidermy shop of your own, and earn \$3,000 to \$6,000 a year.



This Book FREE



Every Sportsman should have this marvelous book. You can right now, while this edition lasts, get a copy Free and prepaid by mailing the coupon NOW. Only limited number free—Send Today. Nothing like it. Just off the press. Contains 48 large pages and cover in brilliant colors. More than 100 photos of splendid game specimens and masterpieces of the National Museum at Washington. Brim full of interest to every sportsman. And think of it, this valuable unique and artistic book can be had now, by Sportsmen for the asking.

Mail the Coupon!

If you want to preserve your trophies; if you desire to make money from your spare time, if you are a nature lover—send the coupon and receive your copy by return mail.

N.W. School of Taxidermy, 3371 Elwood Bldg., Omaha, Neb.

N. W. School of Taxidermy

3371 Elwood Bldg., Omaha, Neb.

Send me your free illustrated book "Sportsmen and Their Trophies." Also tell me how I may learn this fascinating art easily and quickly by mail. No obligation.

Name

Address

FLY



Assemble this plane yourself and learn by practical experience to construct and operate aircraft. This plane won the Aircraft Performance Trophy in competition with planes of 90 to 200 H.P. Use your motorcycle motor or the IRWIN 20 H.P. engine. Parts furnished very reasonable to assemble the Meteor-plane, the World's first small plane. Send \$3.50 for complete set of Blue Prints and parts price list of this latest Model M-T-2.

IRWIN AIRCRAFT CO.
SACRAMENTO, CAL.

LANGUAGE POWER

Masterly English wins friends, increases chances for success. Sherwin Cody's wonderful new invention gives you language power in only 15 minutes a day fascinating spare-time study at home. No rules to memorize. Learn correct English this new, easy way. Write for free book today.

SHERWIN CODY SCHOOL OF ENGLISH
51 Searle Bldg. Rochester, N. Y.



DRAW CARTOONS

TURN YOUR TALENT INTO MONEY

Cartoonists earn from \$50 to \$250 per week—some even more. Remarkable Circle System of Drawing teaches you in half the usual time. Students from all parts of the world are enrolling for this exceptional instruction. Personal criticism service and up-to-the-minute instruction make it easy for National students to attain success. Send for interesting BOOKLET and SAMPLE LESSON PLATE explaining full details of the Course and what National students are accomplishing. No salesman will call.

The National School of Cartooning, 623 Penton Bldg., Cleveland, Ohio



PATENTS

Booklet Free Highest References
Promptness Assured Best Results

Send drawing or model for preliminary examination of Patent Office records.

ALL BUSINESS GIVEN PROMPT AND PROPER ATTENTION

Listed Patent Lawyer in the latest editions of the Rand-McNally Directory of Bankers and Attorneys, of Chicago, Ill.; The Baggott & Ryall Directory of Attorneys, New York City; The Lawyers Guaranteed Directory, Detroit, Michigan; The Lawyers and Bankers Quarterly, published by the Legal Directory Publishing Company of St. Louis, Mo.; the American Lawyers Annual, Cleveland, Ohio.

WATSON E. COLEMAN,
REGISTERED PATENT LAWYER

Victor Building, 724 Ninth Street, N. W.
WASHINGTON, D. C.

Get a Grip of STEEL



Send Only 25c for My
Double Strength

Krusher Grip

Increase the size and strength of your arm overnight. A strong grip is the barometer of your personality. With each *KRUSHER GRIP* I will give

FREE

a beautiful illustrated booklet filled with handsome pictures. It tells you how you can possess a manly figure packed with energy and power. How to put inches on your chest, neck, arms, and legs and get a body as shapely as Sandow.

The finest built athletes in the world posed for this booklet which I am offering for a limited time only.

Fill in the coupon and mail with your remittance and get your copy *NOW* while the offer is good.

Don't wait. You can't beat this offer. Good only for thirty days. Let's go.

The Jowett Institute of Physical Culture

597 Fifth Avenue New York City

The Jowett Institute of Physical Culture
597 Fifth Avenue, New York City

Sir:
Enclosed is 25 cents for your double strength Krusher Grip with which I am to receive your illustrated booklet FREE.

Name _____

Address _____

PMI

Play Piano ^{BY} EAR

—IN 90 DAYS!



Play anything—jazz to classical! Even if you know nothing about piano music—I'll have your fingers dancing over the keyboard with confidence in 90 days. If you can hum or whistle a tune you can play it! My students are broadcasting—making money. **MAKE ME PROVE IT!** Without puzzling notes! Without practicing tedious scales! I've found the way to bring out your musical instinct. New and original system does away with years of work. **YOU WANT THE PROOF!** I'll send it. Write me now.

D. M. SUTTLE, Director
ILLINOIS SCHOOL OF MUSIC
315 Hunter Bldg., Chicago, Ill.

Send **NOW** for **PROOF!**

FRENCH and SPANISH Demonstration Record



A condensed lesson. Printed text furnished with the record. A practical demonstration of how easily you can learn a language by this new conversational method. Endorsed by French and Spanish Embassies. Mail only 25c. Check language wanted French Spanish. International Correspondence Schools, Box 5503-F, Scranton, Penna.

only
25¢

10 Big Weekly Issues 10¢

The most valuable offer ever made by a publisher. *Ten issues of THE PATHFINDER for only 10 cents!* The liveliest, most unique and most entertaining American weekly magazine. Full of wit, humor, information, news events, special features, excellent fiction, etc. Once you read THE PATHFINDER you will never do without it. Take advantage of this limited offer immediately.

THE PATHFINDER, Dept. E-82, WASHINGTON, D. C.

FREE BOOK ON MIND TRAINING

An instructive book which explains an amazing system of mind training already used by more than 650,000 people.

Let us send you a free copy of "Scientific Mind Training". It will show you how and why Pelmanism is the *only* system of teaching for developing *all* the mental powers at the same time. Endorsed by such distinguished men as Judge Ben B. Lindsey, Sir Harry Lauder, Jerome K. Jerome, Prince Charles of Sweden and hundreds of others. Write TODAY to

THE PELMAN INSTITUTE OF AMERICA
71 WEST 45th STREET DEPT. 61 N. Y. C.

Book on Law Free



Write today for this new book. It tells you how a law training will shorten your road to success. It also carries a vital and inspiring message to every ambitious man. Find out about the opportunities that await the law trained man. Find out how you can learn law right in your own home. No obligations. The book is absolutely FREE.

Write Today—now—while low tuition fee is in force.

American Correspondence School of Law
3601 Michigan Ave. Dept. 1351 Chicago, Ill.

LEARN WATCHMAKING

and become independent. We help you secure a position.

Easy to learn. Send for FREE CATALOG.
ST. LOUIS WATCHMAKING SCHOOL, Dept. 5, ST. LOUIS, MO.

Skin Troubles

Cleared up—often in 24 hours. To prove you can be rid of Pimples, Blackheads, Acne Eruptions on the face or body, Barbers' Itch, Eczema, Enlarged Pores, Oily or Shiny Skin, simply send me your name and address today—no cost—no obligation. **CLEAR-TONE** tried and tested in over 100,000 cases—used like toilet water—is simply magical in prompt results. You can repay the favor by telling your friends; if not, the loss is mine. **WRITE TODAY.**
E. S. GIVENS, 428 Chemical Bldg., Kansas City, Mo.



BE Promoted!

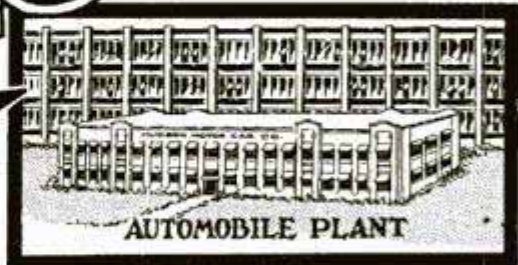

From Repair Man
to A BETTER JOB
OR HAVE A BUSINESS OF YOUR OWN



High grade training means real success for automobile men. *Every day* we enroll men who have had from two to five years' experience in automobile work—men who were working in garages all over the

country but were not getting the big money that is earned by real skill. These men are going *higher up*, because when they leave the "Michigan State," they will have what the other fellows haven't got—*knowledge in their heads and skill in their hands*. This combination earns the big money.

BIG BUSINESS Wants Trained MEN

We have standing orders from auto manufacturers and their dealers, to send them men who qualify for advancement as service executives. Good men are *always* wanted by big business.

Men are coming here daily to take the great MASTER COURSE of Automobile Training—here at Detroit's big Trade School, the "Michigan State."

They are aiming at *big jobs*—aiming at big business! *And they get it!* Our graduates of a few years ago now are Service Managers, Superintendents—owners of their own shops—managing bus or truck transportation—or climbing high in aviation, that great new branch of the motor industry.

A real course is what you want—real training—six to eight months of it—practical, intensive work—work that puts knowledge in your head and skill in your hands! That is the "Michigan State" Master Course.

Small starts lead to big futures if you know your business. Don't be half-baked in any trade! You must know it all to climb to the top. Take time now to learn,—then start real strides toward a job with real money. That's becoming independent!

THOROUGH Six to Eight Months' Training

Including Auto Service, Electricity, Batteries, Machine Shop, Welding, Tires, Service Management, Business Course. Catalog gives detailed outline of full course. It's free. (Write for it today.)

Other Courses: Straight Auto Service Course, 10 weeks. Also short courses in batteries, tires and other auto branches. Day or Night Classes. Earn while you learn, if necessary. Also Home Study Courses to start on for those who can't come now.

Leads To Air Transport Management—The skilled auto man becomes the skilled aviation leader. Another big-money opportunity. Even Lindbergh was a garage mechanic. In flying and in management of aeronautics, auto men are showing the way!

A. G. Zeller, President

MICHIGAN
State Automobile School
 301 Auto Bldg., Detroit, Mich.



The Auto Repair Man is sitting on Top of the World Today.

DETROIT THE WORLD'S AUTO CENTER

Detroit and vicinity makes four-fifths of all the autos in the world. The engineering and business brains of this mammoth business are centered here. Here you can learn most—under the expert guidance of our experienced instructors you advance beyond your greatest hopes.

Come To Detroit Now—Get in this steady, year-round, business—the big pay business with no strikes, no lay-offs. Get thorough training at this world famous school. Jump on the train for Detroit now. Or, send for full particulars about factory-endorsed Detroit-training for real success. Write, or come now!

THIS WILL BRING YOU THE FACTS

Michigan State Automobile School,
 301 Auto Bldg., Detroit, Michigan.

I want to know about Detroit training to make the most money.

Name.....

Street Number or R. F. D.....

City.....State.....

I am interested in:

- 30 weeks' Master Course. Age.....
- 12 weeks' Auto Course.
- Home Study Course.
- Aviation.

A Million Dollar CAN OPENER

Patented!

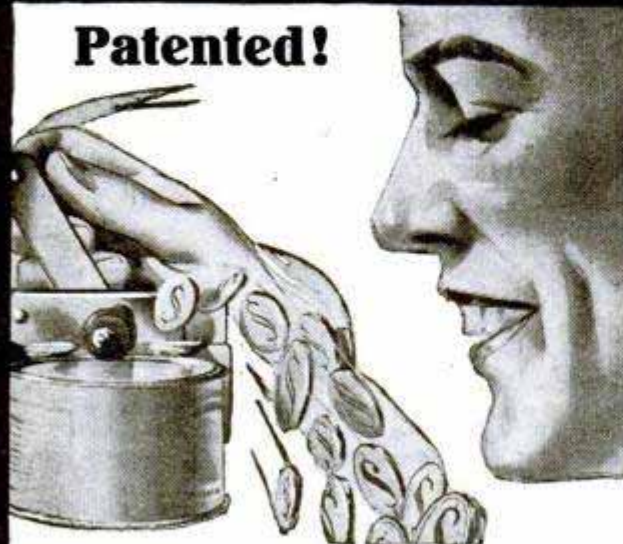

Will You Make This Free Test?

Men, this is something absolutely novel and unique. It's a queer new kind of can opener that is radically different. Needed in every home! No wonder the dollars simply pour in for Speedo representatives everywhere!

\$75 TO \$150 A WEEK—EASY!



\$265 In a Week
"Here is my record for first 30 days with Speedo: June 13, 60 Speedos; June 20, 84 Speedos; June 30, 192 Speedos; July 6, 288 Speedos. Speedo sells to 9 out of 10 prospects."
M. Orloff, Va.

Imagine an almost magical little device—so small that you can easily slip it into your coat pocket—that ends forever all the stabbing and hacking, all the danger and bother of old-style can openers! It takes hold of the can—opens it—flips up the top so you can grab it—and gives you back the can in a couple of seconds with the entire lid completely cut out, slick, smooth and clean!

Sells on Sight

Everyone knows that women all hate the awkward, dangerous old-style can opener. Imagine, then, how they welcome this startling new method—this automatic way of doing their most distasteful kitchen task!

And, men, here's the best part of it. We have worked out a sure-fire demonstration for you that opens every door for you instantly—closes sales in 10 seconds by the clock, and gives you 4 orders out of every five calls!

No Cost or Obligation

There is not space here to go into all the sensational details of this new money maker. But every wide-awake, ambitious man will see the possibilities instantly. So accept my offer. Test your profits absolutely without cost or obligation. Territories are closing fast. Get the facts about \$75 to \$150 a week, today. Mail the coupon at once.

CENTRAL STATES MFG. CO.

Dept. A-701, 4500 Mary Ave., St. Louis, Mo. Est. Over 20 Years

Central States Mfg. Co., Dept. A-701,
4500 Mary Ave., St. Louis, Mo.

Rush me details of your Free Test Offer. This does not obligate me in any way.

Name.....

Address.....

Town..... State.....

Every 3000 Miles

This Device Buys Me
A NEW TIRE!

"YES sir—this amazing little gas-saving invention is saving me the price of a new tire every 3,000 miles." Many car owners have found that the Stransky Vaporizer saves them the price of their tires—and more. In fact, it is guaranteed to save you 25% to 50% of your gasoline and end carbon troubles—or costs you nothing. Fits any car in 5 minutes. The inventor will send you samples for test at his risk. Write J. A. Stransky, A-10 Stransky Block, Pukwana, S. D. MEN WANTED as Stransky representatives. Big money, full or spare time. Ask for distributor's proposition.

GIVEN TO YOU

Choose ANY
\$20 Musical Instrument

Yes, we will give you without extra cost a \$20.00 quality Violin, Tenor Banjo, Hawaiian Guitar, Banjo, Banjo-Guitar, Cornet, Guitar, Mandolin or Banjo-Mandolin. Learn to play by note. We teach men, women, boys and girls by mail. Amazing new, simplified method. A few cents a day pays for Lessons. Instrument and first lesson sent on FREE TRIAL. Over 500,000 successful pupils. Write today.
CHICAGO CORRESPONDENCE SCHOOL OF MUSIC, INC.
1632 North Halsted Street, Dept. 448, Chicago, Illinois.

Learn Furcraft

Learn by mail, evenings at home, to Renew, Repair and Make-up all kinds of fur garments. Learn glazing, ironing and storage. Big demand, big need for your service in every neighborhood. \$3 an hour in your spare time or a real business now and a fur shop later. We teach you secret processes. Earnings start in 30 days. Uncrowded field for men and women. FREE BOOK—Send now for free book giving details. No obligation.
Northwestern Fur Co. 3371 Sunderland Bldg. OMAHA, NEBRASKA



Wonderful, new device, guides your hand; correct your writing in few days. Big improvement in three hours. No failures. Complete outline FREE. Perfect Penmanship Inst. D-34, St. Louis, Mo.

BE AN OFFICER in the U.S. Coast Guard \$1700 Up to \$7,500 Yearly

\$780 yearly at the U. S. Academy while training. You rank Ensign to Captain in service. Age requirements 18 to 22. Write Dept. H, for information.
COAST GUARD PREPARATORY SCHOOL
4000 Ga. Ave., N. W. Washington, D. C.

HYPNOTISM

Learn the secrets of Hypnotism—that strange subtle power which enables you to make others love you; overcome bashfulness; strengthen your memory, mind and will power; realize your ambitions; develop a strong magnetic personality and gain control over others. These magic secrets explained in 25 easy lessons. Complete Course, \$1.00. Satisfaction Guaranteed. Barga's Book Catalog FREE.
FRANKLIN PUB. CO., 185 N. LaSalle St. Dept. #420 CHICAGO

BIG VALUE FOR 10 CTS.

6 songs, words and music; 25 Pictures Pretty Girls; 40 Ways to Make Money; 1 Joke Book; 1 Book on Love; 1 Magic Book; 1 Book Letter Writing; 1 Dream Book and Fortune Teller; 1 Cook Book; 1 Base Ball Book, gives rules for games; 1 Toy Maker Book; Language of Flowers; 1 Morse Telegraph Alphabet; 12 Chemical Experiments; Magic Age Table; Great North Pole Game; 100 Conundrums; 3 Puzzles; 12 Games; 30 Verses for Autograph Albums. All the above by mail for 10 cents, and 2 cents postage.
ROYAL SALES CO., Desk 920, Norwalk, Conn.

He thought he could throw me—



Dear Tom: You know how Ted Brown has always been saying he could throw me with one hand tied behind him, if he wanted to. Well, yesterday, he grabbed hold of me and we had it out. Gee, I wish you'd been there. You know how much bigger Ted is than I. He thought he had me licked dead easy—

but



I wriggled around and got a hold on him that I'd learned from the Farmer Burns School of Wrestling. The next second — KERFLOP, and I had Mister Ted Brown on the ground, yelling for me to quit. It's a cinch to handle a fellow half as big again as you are if you know the secret holds. If I were you I'd write to Burns School for their free book about wrestling. So long—FRED.

Learn Wrestling Secrets from Worlds Champions Farmer Burns and Frank Gotch

Learn the marvelous holds, breaks, blocks and tricks that will enable you to handle big, strong men with ease. The renowned FARMER BURNS—"father of scientific wrestling"—and FRANK GOTCH the world's champion, have prepared a series of lessons in which they reveal the inside secrets of training that will make YOU, too, an expert wrestler. All the great secrets of self-defense and jiu-jitsu illustrated by printed word and picture. The lessons teach you how to become a great athlete, and secret knowledge enabling you to throw boys and men larger and stronger than yourself.

Wrestling Book Only 10c

Our BIG ILLUSTRATED BOOK tells you all about the advantages in health, vigor and respect that being able to wrestle brings one. It tells you how to learn to become a skilled wrestler in your spare time. Brim full of interesting information about wrestling. Also lots of pictures. INVESTIGATE. Write today for this big book. No obligations. Enclose only 10c to help pay for cost of printing and mailing. State age. Tear out and mail coupon NOW!

Farmer Burns School 3371 Railway Exchange Bldg. Omaha, Neb.



Farmer Burns School
3371 Railway Exchange Bldg., Omaha, Neb.
Please send me at once without obligation your illustrated booklet on Scientific Wrestling, Physical Culture, Self-Defense, and How to Win. I enclose 10c to help pay for printing and mailing.

Name.....
Address.....
Age.....

LEARN CARTOONING

AT HOME DURING SPARE TIME

from the School that has trained hundreds of successful cartoonists of today. The Landon Picture Chart Method of teaching ORIGINAL drawing by mail makes cartooning easy to learn. Write today for sample picture chart to test your ability and examples of the work of successful students now earning from \$75 to \$200 and more per week. Please state your age.

THE LANDON SCHOOL, 2838 National Bldg., Cleveland, Ohio



Men! Extra Money Quick

Here's An Easy Way!

—to bring you a fine cash income! Without taking any time away from your job. Pleasant easy work at home. Decorate beautiful giftwares the Fireside way. You can do it—in spare moments. No previous training required. No special ability needed. No tedious study. No memorizing. With the Three Simple Steps sent you by Monsieur Petit the great artist—Director of Fireside Industries, it is just fun! We want men in every community. Be the first!

Dept. 66-A, Adrian, Mich.

Begin Right Now!

Thousands are making Fireside decorations—making from hundreds to thousands of dollars and doing their own work besides. We supply you with everything you need. Big Generous Complete Kit WITHOUT EXTRA COST. It's a cinch! We absolutely guarantee your success.

FREE!

Fill out and mail coupon at once. Without any obligation it brings you wonderful Fireside Book in colors. Explains everything.

Act now!



Fireside Industries, Dept. 66-A, Adrian, Mich.

Send me your wonderful Free Book in colors. This does not put me under any obligation.

Name.....

Address.....

Learn Autos in Los Angeles

**Practical Shop Training
System has
Helped 17,000
Men to Earn
\$40 to
\$100 a Week**

Free Employment Service



Jobs are open now paying \$175 to \$400 a month. National will quickly train you for one of these jobs. You perform actual work, under personal supervision of expert instructors, on a half-million dollars worth of new automotive equipment. Superior advantages of National training bring students to California from all parts of the world. In 25 years National has trained 17,000 to make more money.

**Get your Money's Worth
Get Practical Training—Not a Rush "Course"**

National operates on a system that helps Students to success. We teach you everything about autos and you train here until you are competent. Stay in each department as long as you like. Our students are satisfied. They are making good because they graduate completely trained. Employers are eager to get National trained men. We help you get jobs and promotions. We help you get part-time jobs to pay your expenses while training.

Paul Briggs of Portland, Oregon, was earning \$100 a month. National training raised his income to \$335 a month.
Alex Hall was a clerk. Now he owns a \$15,000.00 business. "National training did it," he says.
Nineteen-year old Wright Fernley of Bountiful, Utah, increased his earnings 100% after training at National.
Don B. Sterling stepped out of National right into a \$75 a week job in Los Angeles.

FREE BOOK Learn what this auto school offers you. Mail coupon now for big illustrated Auto Book telling how you can get a big-pay job in the fast-growing auto industry.

NATIONAL AUTOMOTIVE & ELECTRICAL SCHOOL



Dept. 706 4006 Figueroa St., Los Angeles, California

Send me the big, FREE National Auto Book that explains how I can get a big-pay Auto Job.

Name _____

Address _____

City _____

State _____

**FREE
AUTO
BOOK**



\$1900 to \$2700 a year

Long vacations with pay. Work easy. Travel on fast trains with all expenses paid, including hotel. No worries about the future.

MY FREE BOOK TELLS HOW

Get my big free book about the Civil Service which tells all about the Railway Postal Service, and other positions, and how I can help you. Write today.

PATTERSON SCHOOL

Arthur R. Patterson, Civil Service Expert
81 Wisner Bldg. Rochester, N. Y.



ACCOUNTING

**How to
learn
Accounting**

THOUSANDS of ambitious men are earning more money today because they know Accounting. Send for our 80-page book, "How to Learn Accounting," and the first lesson. Both will be sent free.

International Accountants Society, Inc.

A Division of the
ALEXANDER HAMILTON INSTITUTE

Dept. 4, 3411 So. Michigan Ave., Chicago, Ill.

AVIATION

MEN AND WOMEN

\$3000 to \$9000 per year

A few months' training prepares you. Write Lt. John H. Miller, the Trophy Winner Spokane Air Derby, for free booklet, "How to Enter New Industry". Room 1120-608 S. Dearborn Street, Chicago, Illinois.

TELEGRAPHY

(Morse and Wireless) and RAILWAY ACCOUNTING taught thoroughly. Big salaries; great opportunities. Oldest, largest school. Endorsed by Telegraph, Railway, Radio, and Government officials. Expenses low—opportunities to earn large portion. Catalog free. **DODGE' INSTITUTE**, Jones St., Valparaiso, Ind.

ELECTRICITY Easily Learned

Learn with real tools on real equipment. No books, no lessons. A few weeks training fits you for a big-pay job \$50 a week and up. Write for BIG FREE book and remarkable tuition offer including R. R. fare and board. Address **DEPT. 51-AB McSWEENEY ELECTRICAL SCHOOLS**, Cincinnati, O. Cleveland, O.

ENCYCLOPEDIA BRITANNICA

in the New Form—at a saving of 40%

Write for full details. Address Dept. PM

THE ENCYCLOPEDIA BRITANNICA, Inc.
342 Madison Ave., New York City

YOU CAN OIL PAINT

Amazing new method teaches men or women to earn after first lesson. OIL PAINT photos—portraits, landscapes or art subjects. Earn \$18 to \$50 and more a week. OIL PAINT OUT-FIT GIVEN. Send now for free illustrated book. **PICTORIAL ART STUDIOS Inc.** Dept. MP, 2926 Broadway, Chicago, Ill.

**Read Your
FUTURE
in the STARS**

New book, Wilde's Primer of Astrology, tells how to read the future by stars. Enables you to ascertain if your past performances have had the approval of the cosmic law—your future actions to be guided accordingly. Send \$1.00 with name and address to

DAVID McKAY CO.

Dept. 21

Philadelphia, Pa.

LEARN AVIATION AT HOME

Under Lieut. Walter Hinton

AVIATION INSTITUTE OF U. S. A.

Dept. A-91, 1115 Conn. Ave., N. W., Washington, D. C.

Can You Set Your RUPTURE ?

Thousands of people go through life rupture cripples because they have never learned just exactly how to "set" their ruptures so as to give Nature a chance. A broken bone has to be "set" and held in place—so with rupture—but read on please. **No???**

Then You Want This Newest Book Now Free

YOU will want to know how science now enables rupture to be held—actually held—in the one place after it has been properly "set." You will surely be interested in the tiny device called Magic Dot that does this thing. It is so small that one ounce of them would serve 25 people. Think of that.

One man said, "I'll send the coupon later — tomorrow." That is a long time ago and since then thousands have written to us and letters keep coming in like the following:

Seventy-five Years Old

Park Rapids, Minn.

Gentlemen:

You will remember a while ago I ordered a new appliance from you. The one I purchased a year or so ago was beginning to give out and as I had no idea that my rupture was anywhere near cured, I thought I should get a new outfit. When the new appliance came, I took off the old one and what do you think? My rupture was all gone, not a sign of it.

But I decided to wait a while before writing you so as to be sure. Have not worn either the old appliance or the new one for over a week, have worked every day and still no sign of rupture. So I now feel certain that your System has cured me completely and I can hardly believe my good luck.

I want to say that your Magic Dot is the greatest thing to keep a pad in place I ever saw. No slipping or sliding around like the old time truss pad. I cannot say enough in praise of New Science.

Am nearly 75 years old, so I consider the results in my case quite remarkable. John Terweale.

Also Free Sample of Interesting Airtex

cruel springs, bars, huge pads and tight pressure. Learn about science's new way now, before the days pass into procrastination. Before the new books are gone and other things happen—as things sometimes do.

A free sample of Airtex will come if you will use the coupon today—now. Maybe you will want to use the new Air Mail, if so we will reply by Air Mail. If you don't care to use the coupon use a

postal card or letter. We will reply same day we get it and there will be no obligation now or ever.

This Coupon Brings the New Interesting Book and Interesting Sample of Airtex Free. Please write or print address very plainly to avoid disappointment.

Give Your Child the Chance He Deserves

Orville, Ohio.

Dear Sir:

Some months ago, I ordered one of your outfits for the treatment of rupture of my son. Our doctor fitted it on him, and he was skeptical that it would help to cure the condition, for it was one of the worst ruptures he had ever seen.

Five months later, I took the boy back to the doctor, and he examined him and pronounced the rupture completely healed.

I want to thank you for the interest you took in his case, and if there is anything I can do to be of assistance, I will be glad to do it. You can use my name for reference, if you choose.

D. E. Lytle.

New Science Institute
2144 Clay St.,
Steubenville,
Ohio.

Inquiries Received
by Air Mail Will
Be Answered by Air
Mail

Name.....

Address.....

City.....

State.....

Please write or print very plainly. Mail to New Science Institute, 2144 Clay St., Steubenville, O.

NEW SCIENCE INSTITUTE

2144 Clay St., Steubenville, Ohio



Mechanical Engineering Learn at Home

MECHANICAL Engineering embraces the design, construction and operation of machines and machine tools.

It is a profession which offers almost unlimited opportunities for advancement to men who combine natural mechanical ability with special technical training.

For this is The Age of Machinery. Almost every convenience, luxury or necessity which we enjoy today depends on machinery for its production or adaptability to our needs. Every new invention multiplies the opportunities for competent designers, builders, erecting engineers, etc.

One of the best ways to train yourself to secure a position as a Mechanical Engineer is through the home-study courses of the International Correspondence Schools.

These courses are especially arranged to meet the needs of the student who studies at home. The theoretical work is stated in simple and clear language and engineering data is reduced to a form in which it is easily applied.

The courses are also particularly helpful because they are written by well-known mechanical engineers who have had years of practical experience in this field.

Just mark and mail the coupon and we'll gladly send you Free Booklets describing the I. C. S. courses in Mechanical Engineering or any other course in which you are interested.

Mail the Coupon for Free Booklet

INTERNATIONAL CORRESPONDENCE SCHOOLS
Box 5696-E, Scranton, Penna.

Without cost or obligation, please send me one of your booklets and tell me how I can qualify for the position or in the subject before which I have marked an X:

- | | |
|---|--|
| <input type="checkbox"/> Mechanical Engineering | <input type="checkbox"/> Machine Shop Work |
| <input type="checkbox"/> Mechanical Course | <input type="checkbox"/> Toolmaking |
| <input type="checkbox"/> Draftsmen's Course | <input type="checkbox"/> Blacksmithing and Forging |
| <input type="checkbox"/> Mechanical Drawing | <input type="checkbox"/> Patternmaking |
| <input type="checkbox"/> Shop Practice | <input type="checkbox"/> Foundry Work |
-
- | | |
|--|---|
| <input type="checkbox"/> Steam Engineering | <input type="checkbox"/> Boilermakers |
| <input type="checkbox"/> Marine Engineering | <input type="checkbox"/> Boilermakers' Laying Out |
| <input type="checkbox"/> Internal Combustion Engines | <input type="checkbox"/> Sheet-Metal Workers |
| <input type="checkbox"/> Aeroplane Engines | <input type="checkbox"/> Sheet-Metal Pattern Drafting |
| <input type="checkbox"/> Diesel Engines | <input type="checkbox"/> Architecture |
| <input type="checkbox"/> Refrigeration | <input type="checkbox"/> Architectural Draftsman |
| <input type="checkbox"/> Electrical Engineering | <input type="checkbox"/> Architects' Blueprints |
| <input type="checkbox"/> Power House Electric | <input type="checkbox"/> Contractor and Builder |
| <input type="checkbox"/> Electric Lighting | <input type="checkbox"/> Concrete Builder |
| <input type="checkbox"/> Practical Electricians | <input type="checkbox"/> Plumbing |
| <input type="checkbox"/> Radio | <input type="checkbox"/> Heating and Ventilating |
| <input type="checkbox"/> Civil Engineering | <input type="checkbox"/> Agriculture and Poultry |
| <input type="checkbox"/> Surveying and Mapping | <input type="checkbox"/> Mathematics |
| <input type="checkbox"/> Structural Engineering | <input type="checkbox"/> High School Subjects |
| <input type="checkbox"/> Structural Drafting | <input type="checkbox"/> Common School Subjects |
| <input type="checkbox"/> Mining | <input type="checkbox"/> Business English |
| <input type="checkbox"/> Metallurgy | <input type="checkbox"/> Bookkeeping |
| <input type="checkbox"/> Chemistry <input type="checkbox"/> Pharmacy | <input type="checkbox"/> Stenography and Typing |
| <input type="checkbox"/> Civil Service | <input type="checkbox"/> Private Secretary |
| <input type="checkbox"/> Salesmanship | <input type="checkbox"/> Business Law |
| <input type="checkbox"/> Advertising | <input type="checkbox"/> Illustrating |
| <input type="checkbox"/> Better Letters | <input type="checkbox"/> Art Drawing |
| <input type="checkbox"/> Spanish <input type="checkbox"/> French | <input type="checkbox"/> Cartooning |

Name.....

Street Address.....

City..... State.....

Persons residing in Canada should send this coupon to the International Correspondence Schools Canadian, Limited, Montreal, Canada.

LAW THIS BOOK FREE!

Study at Home
Become a lawyer. Legally trained men win high positions and big success in business and public life. Greater opportunities now than ever before.

Earn \$5,000 to \$10,000 Annually!
We guide you step by step. Degree of LL.B. LaSalle law graduates practicing in every state. We furnish all text material, including 14-volume Law Library. Low cost. Easy terms. Valuable, interesting 96-page book free. Send for it NOW.



LaSalle Extension University, Dept. 164-L Chicago

3 YEARS \$1.00

The National Poultry Journal is the one practical poultry magazine edited by practical poultrymen. Full of priceless, seasonable information that you can't afford to be without. *Now offered you for three years at only \$1.* For a limited time we will send an interesting 64-page poultry book **FREE** to each new subscriber. You can't afford to ignore such a remarkable opportunity. Send your \$1.00 Now so as not to miss a single issue.

The National Poultry Journal, Dept. 30, Washington, D. C.

MAKE MORE MONEY CANDYMAKING AT HOME

BIG PROFITS being made by men and women with our **WORLD'S SPECIALITY CANDIES** new method; no expensive equipment or machinery. System operated anywhere, kitchen, shop or factory. Simplified home study course. Learn today, earn tomorrow. We furnish supplies; few dollars start you. Write today for proof of students' success. Free booklet explains.

Dept. W, 355 So. Broadway
Los Angeles, California

Liberty Candy & Supply Co.

EXTRA Look at the BARGAIN McFADDEN! Gives You.

Now Only
\$7.98

A whole Physical Culture Outfit for only \$7.98—worth \$30.00. Read list below. Includes genuine McFADDEN 15-cable Progressive Exerciser—the champion body-builder of the world. Develops GIANT muscles in 39 days. FIFTEEN big, powerful cables made of genuine live Para rubber. Develops any resistance. Five times as strong as other exercisers. Satisfaction GUARANTEED.

- What You Get**

 - 15 Cable Progressive Exerciser, worth.....\$8.00
 - Patented Progressive Handles, 1,000 pounds resistance, worth.....\$2.00
 - Patented High Tension Hand Grips, 1,000 pounds resistance.....\$1.00
 - Patented Progressive Headgear, worth.....\$3.00
 - 12 Weeks' Home Instruction Course, worth.....\$15.00
 - Michael McFadden Encyclopedia, worth.....\$1.00
 - Total.....\$30.00

Total, Worth \$30.00

Costs You Only \$7.98

Any of the above can be purchased separately at the prices shown.

Take advantage of this sensational bargain QUICKLY. Save \$22. Get this world-famous Home Gymnasium outfit for only \$7.98—complete with 15-Cable Exerciser, Handles, Headgear, Hand Grips, Instruction, Health Encyclopedia. Rush coupon with \$7.98 by check, money-order or registered mail. Money back if not delighted.

McFADDEN INSTITUTE,
103 E. 13th St., Dept. R-122,
New York City.

Send complete, genuine McFadden Muscle-Building Outfit as listed. I enclose special bargain price of \$7.98 (regularly \$30.00). My money back if I return Outfit in 5 days.

Name.....

Street.....

Town..... State.....

50 MORE JOBS NOW \$11 a day



Yes—there is a real demand for men trained in auto trades. This very day I could help 50 more men than I have available at \$11 a day. The future looks even better. There is a shortage of men trained like SWEENEY has trained thousands of men. That's why SO MANY SWEENEY TRAINED MEN get TREMENDOUS PAY and are in BIG DEMAND. Get my Free Book today and see that WELDING is only one of the BIG PAY Branches I get you ready for. If you are mechanically inclined here's your chance to do the work you like and at the same time make good pay and see the world.

Helps Graduates to Jobs

Yes, my EMPLOYMENT DEPARTMENT helped L. W. Kelley to a job at \$18.00 A DAY—IT helped J. H. Miller to a job at \$10.50 A DAY—IT helped Gordon Shyroek to a job at \$10.50 A DAY, and it, also, is helping dozens of other Sweeney Graduates to fine jobs at \$10 to \$18 a day, IMMEDIATELY after finishing ONLY A SHORT COURSE of SWEENEY TRAINING. Clip the coupon. Find out about this WONDERFUL JOB SERVICE my EMPLOYMENT DEPARTMENT renders. It will simply astonish you. Now is the time you should come. Any man can safely write or wire he is coming and rely on absolute satisfaction when he gets here. He doesn't need to correspond. 70,000 men have gone through this school. We know how to treat you, how to take care of you. You will find everything just as represented, just as you would like. Just walk right in and say "Sweeney, I am here."

Men Wanted in Auto Trades

Think of it—FIFTY-FIVE WONDERFUL JOBS OPEN TODAY for SWEENEY TRAINED men. I have ONLY FIVE MEN READY so that I can help them to these jobs. And the peculiar thing is—it takes me ONLY FOUR WEEKS to TRAIN some of these men. Now what more do you want? Challenge me. Send for my Big Free 72 Page Book. If you go on depriving yourself—if you WANT TO BE OUT OF A JOB—and don't let me help you—PLEASE DON'T READ ANOTHER SWEENEY AD. If you have—(you know what I mean) in you—you will find out NOW. Just clip the coupon below.

The Sweeney System

Teaches by practical, personal experience. You work with tools, not books. You learn by doing. Million dollar school with complete equipment. You need no previous experience. If you are looking for success in life and working at a trade you like write me today. Drivers, mechanics, repair men, testers, garage owners, painters, welders, demonstrators—thousands more are needed and opportunities are everywhere. If you are mechanically inclined simply send name today for my big free book how to fit yourself for steady high paid employment in the auto business.

FREE CATALOG AND SPECIAL OFFER

Get my big FREE 72-page catalog. It shows hundreds of actual photographs of men at work in my magnificent new school. Tells all about wages, profits, opportunities in auto business. Explains step by step how you learn. Interesting letters from graduates telling how they made good. Shows how men come from all over the world to this big school. Makes you want to join the crowd. Tells everything you want to know. I will gladly send you a copy beautifully illustrated. I'll tell you how to get into business for yourself. No colored students accepted.

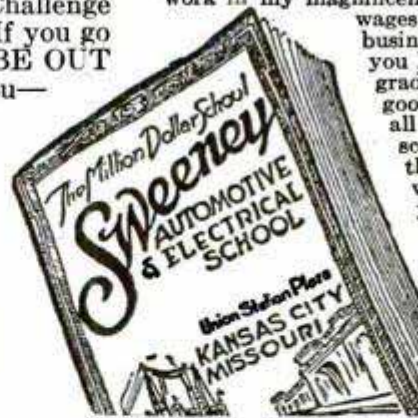

E. J. SWEENEY
President

EMORY J. SWEENEY, President
4531 Sweeney Building, Kansas City, Mo.

Send me free, without any obligation, your catalog and Special Offer!

LEARN A TRADE-
Sweeney
AUTOMOTIVE & ELECTRICAL SCHOOL
4531 SWEENEY BLDG. KANSAS CITY, MO.

NAME.....
P. O.....
STATE..... AGE.....

Pains

Vanish Almost Instantly

with Violet Ray

Scientific, Painless Treatment Used by Doctors, Hospitals, Sanitariums—Now Offered to Every Home



Thousands of men and women suffering from rheumatism, paralysis, neuritis, bronchitis, skin diseases, headaches, constipation, sprains, prostate trouble, goitre and many other ailments, even hay fever and asthma, have found quick relief, new health and vitality with this marvelous scientific invention. Try it.

Violetta **10 Days FREE Trial**
For Health—Beauty—Vigor

Every home should have one. Saves hours, days, months of suffering. No medicine. Painless, pleasant treatment. Violet Rays penetrate to every nerve affected. Also generates pure oxygen—wonderful for pulmonary trouble. Simple, safe—anyone can use VIOLETTA. Don't suffer pain and poor health when you can now try VIOLETTA 10 days FREE.

This Book Free Tells all about violet rays—how this remarkable discovery of Nikola Tesla, the electrical wizard, now brings this mysterious curative power to all. Contains many astounding testimonials from our thousands of satisfied users. Send for all the facts and our liberal trial offer.

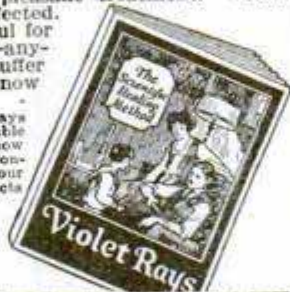

VI-REX CO., Dept. 131,
2304 Warren Avenue, Chicago

VI-REX COMPANY
2304 Warren Ave., Dept. 131, Chicago.
Please send me your free book on Violet Rays and details of your 10-day free trial offer.

Name.....
Address.....
City..... State.....
Allment.....

TRAIN IN OUR SERVICE STATION UNDER AUTO EXPERTS

Get Practical Experience in Our Shops
No Books—No Lessons—No Classes

Learn by actual work on customers' cars. All training supervised by competent factory engineers. No tires, no written work, no books, no classes, no studies. We operate one of the largest and best equipped Automobile Service Stations in the country. Practical experts show you everything under actual working conditions on real jobs. Automotive concerns demand experienced men. Our Service Station Method gives you both training and experience.

Earn \$75 to \$100 a Week

Our training makes you experienced and practical Mechanic, Battery, Ignition, and Welding Man—fully qualified to earn \$75 to \$100 a week in any of these fields. Demand for trained experienced men exceeds supply. Many of our graduates own profitable Service Stations. Others hold big pay jobs with Service Stations or with large corporations. Our connections with Automotives concerns the country over affords us unusual opportunities for placing trained men. Five-year employment service FREE!

WRITE TODAY For FREE full particulars of our new Service Station Method of training. No obligations. Learn how you can master this profitable profession by our new practical method. Write care of SUPERINTENDENT OF SERVICE.



EARN WHILE YOU LEARN
We have some openings for men who must earn while they learn. We can put you to work earning good wages while you are in training. Write for details, care of SUPERINTENDENT OF SERVICE.

AMERICAN AUTO ENGINEERS
228 N. LaSalle St. Dept. 10 Chicago, Ill.
Not a School—But an Automotive Service STATION WITH A TRAINING DIVISION

America's Standard Radio Text Book

Radio Theory and Operating

By M. T. LOOMIS

President, Loomis Radio College, Washington, D. C.

By far the best Radio Text and Reference Book ever produced

Third Edition—Revised—1927
885 Pages, 700 Illustrations, 5 1/2 x 8 Inches
Flexibly bound in red craft leather

Used by

The Department of Commerce
U. S. Naval Radio Schools
U. S. Coast Guard Academy
U. S. Signal Corps

Leading Radio Schools of U. S. and Canada

Price \$3.50 Postpaid

POPULAR MECHANICS PRESS
Room 606, 200 E. Ontario St., CHICAGO

BIG DEMAND FOR MEN WHO KNOW

The great growing Aviation Industry needs thoroughly trained men who know flying, engines, rigging, inspection—who can install motors, test ships—who know all details of air and ground work.

Learn AVIATION

Come to Marshall and learn Aviation from the ground up—where there are more airplanes, engines and equipment than you ever saw before. Brand new training planes, expert instructors. Thorough ground training in mammoth airplane factory. Here you get everything—and get it right!

FREE Aviation Book

Tells the complete story. Answers all questions. Full of interesting reading and illustrations. Write for your copy, also Special Tuition Offer for short time. Write today.

MARSHALL FLYING SCHOOL, INC.
Affiliated with the Nicholas-Beazley Airplane Co., Inc.
230 North St., MARSHALL, MO.





We Train You for Today's Golden Opportunity

The flying era is here. Commercial Aviation is crying for men. With millions invested, man power is the greatest need of the hour—eighteen ground jobs for every flyer—but in all branches every man must be trained—whether pilot, designer, mechanic, superintendent or salesman.

We provide and guarantee you the best possible complete training in the shortest possible safe time.

The largest financially responsible Company in Chicago actually engaged in air transport service with hangar and shops on Chicago's million-dollar airport and with a school using the latest commercial equipment—the only one in Chicago with Ryan Monoplane—Wright Whirlwind Motor, Laird Commercial and Motor, Laird Commercial and Swallow Planes in its fleet.

Prepare for the Big Pay Jobs!

Flight training under famous aces. Only U. S. licensed instructors and planes. Complete Army and Navy Corps training adapted to commercial needs. Ground training, including navigation, plane construction, motor repairing, etc., etc. All the necessary training to fit you for the big pay jobs.

Day or night classes, or home study.

Five years free employment service during and after training.

FREE! To be ready for the coming season's greater opportunities for you, start NOW! Send for "The Airway"! It shows you how. Intensely interesting; profusely illustrated. Write TODAY!

Address: Department P. M. 1

AVIATION SERVICE AND TRANSPORT INC.
103 N. WABASH AVE., CHICAGO, U.S.A.

Take the short Cut- ELECTRICITY to Certain Success!

WHICH WAY WILL YOU GO?

WHERE YOU ARE NOW

AGE 20 SIDETRACK TO FAILURE

AGE 30 SIDETRACK TO MEDIOCRITY

AGE 40 SIDETRACK TO FAIR LIVING

AGE 50 SIDETRACK TO MODERATE SUCCESS

A brilliant future with big pay awaits you in two new branches of electricity—Electric Refrigeration and Radio.

3 MONTHS LEARNED IN 3 months only—just 90 days you can be one of the new group of trained experts who will guide and develop the most lucrative and newest of America's gigantic industries.

Everywhere competent men to merchandise, install and service Electric Refrigeration and Radio Equipment are in great demand and are earning big pay. Now you can qualify for this opportunity by means of our complete and intensive three months' practical laboratory courses. Think of it. Only 90 days and you can be earning at this fascinating work the high salaries paid experts in a new industry.

Also HOME STUDY

If you are unable to come to Milwaukee—the Electrical center of America—for your training, we will teach you at home. Now, easy way with complete laboratory equipment starts you on the road to become an expert Electrician. Write today for full particulars of course you are interested in.

Complete, Practical ELECTRICAL EDUCATION

Learn by the thorough, approved scientific methods which our 23 years of specializing enables us to give you. Complete Electrical Engineering Courses with B. S. degree in 3 years. Shorter courses in Commercial Electrical Engineering, Junior Electrical Engineering, Automotive Electricity, Armature Winding, A. C. and D. C. Motors, and all other branches of Electricity.

FREE BOOKLETS

Experts Needed

Trained mechanics can not service these new machines of Radio and Refrigeration. Special training is essential. Experts are pitifully few and the demand is for men, men and more men with big responsibilities, well paid positions, open—waiting.

Don't miss this fortune-making opportunity. Let us prove what we say. Let us send you our literature on the course you are most interested in. It's free—no obligation—the coupon will bring it to you—no fuss—no trouble. Be sure to mention course interested in, age and education.

New Class Organizing Jan. 2—Act at Once

SCHOOL of ENGINEERING of Milwaukee

Founded 1905. Owns and operates Radio Stations WSOE and 9SO
Dept. PM128, 163 East Wells St. Milwaukee, Wis.
School of Engineering of Milwaukee,
Dept. PM128, 163 East Wells St., Milwaukee, Wisconsin.

Send me FREE, with no obligations, more details on your {Residence / Home Study} course in.....

Name.....Age.....
Address.....
City.....State.....
Education.....

MINSTRELS

Musical Comedies and Revues, with full instructions for staging. You can stage your own show with our books, Full line of plays, stage songs, crossfire monologues, afterpieces, vaudeville acts and make-up. CATALOGUE FREE.

T. S. DENISON & CO., 623 So. Wabash, Dept. 19, Chicago

WANT WORK AT HOME?

Earn \$20 to \$50 a week retouching photos. Men or women. No selling or canvassing. We teach you at home, furnish working outfit and employment service. Write today. **ARTICRAFT STUDIOS, Dept. 50, 3900 Sheridan Road, Chicago.**

AMERICA'S GREATEST TAILORING LINE

FREE 130 large Swatch Samples—All Wool—Tailored-to-Order—Union Made—sensational low price. Get outfit at once. Address Dept. 304.
GOODWEAR, 844 Adams, CHICAGO



I POSITIVELY GUARANTEE

to increase your arms one-half inch in size, chest one full inch, strength 25%, health 100% in one week's time, by following my instructions and using my exerciser 10 minutes mornings and at night. Send \$1 for complete course and exercisers. Satisfaction guaranteed or \$1 refunded. Prof. J. A. DRYER, Box 1850-P, Chicago, Ill.

Outdoor Opportunities

How to raise rabbits, guinea pigs, mitch goats, silver foxes, ferrets, white rats, white mice, dogs, cats, pigeons, pheasants, bantams, canaries, bees, frogs, mushrooms, ginseng and golden seal for profit. Practical 250-page book with 120 illustrations. Will be sent C. O. D. When postman hands you the package, pay him \$2 plus the postage.

POPULAR MECHANICS PRESS
Room 506 200 E. Ontario St. CHICAGO



**Stop
That
Pain!**

**With Violet Ray Vibration
Ozone Medical Electricity**

*The Four Greatest Curative Powers
Generated by This*

Great New Invention!



Elco Health Generators at last are ready for you! If you want more health—greater power to enjoy the pleasures and delights about you, or if more beauty is your desire—write! Ask for the book on these inventions which has just been prepared. It will be sent to you without cost. It tells you how Elco Health Generators aid you in leaving the lethargy and hopelessness of bad health and weakness behind forever. Re-vitalize yourself. Bring back energy. Be wholly alive. Write today!

Here's What Elco Users Say—

"Wouldn't take \$1000 for my Elco."
"Has done me more good in 2 weeks than doctors did in three years."



"Cured my Rheumatism." "My Eczema gone." "Cured my stomach trouble." "Cured my weakness." "Now I sleep soundly all night." "Thanks to Elco my strength and vigor are back." "No more pain." "Colds never bother me now." "Chronic Constipation banished."

These great new inventions generate Violet Ray, Vibration, Electricity and Ozone—combined or separate. They operate on the electric light in your home or on their own motive power at less than 50 cents per year. Elco Health Generators are positively the only instruments which can give you in one outfit Electricity, Violet Ray—Vibration and Ozone—the four greatest curative agents. Send the coupon below. Get the Free Book NOW!

**MAIL COUPON
for FREE BOOK**

Do not put this paper down without sending the coupon. Don't go on as you are with pains and with almost no life and energy. You owe it to yourself to be a better man or woman. You were put here to enjoy life—not just to drag through it. So do not rest another day until you have put your name on the coupon here. That will bring the whole story of these great new inventions. Do it today—now.



Lindstrom & Company
30 West Lake St. Dept. 93-51 Chicago
Please send me your free book, "Health—Power—Beauty" and full information of your 10-day Free Trial Offer.

Name.....
Address.....

Learn To Fly

Low Rates

Let E. B. Heath, one of the country's oldest flyers and winner Nat'l Air Races 1927, teach you how to build and fly airplanes. Only practical instruction in a real aircraft factory. No books—no papers to study. Our reasonable rates and convenient payment plan will enable you to get started now.



Employment Assistance to students in need of additional funds. We will help you earn while you learn. Overtime work in our factory guaranteed to students taking the day courses. **Special Agency Offer** whereby students may represent Heath built planes. **Write for Catalog** today. Complete information regarding our courses and employment offer free. Send today. No obligation.

HEATH SCHOOL of AVIATION, Dept. 3371, 2856 Broadway, Chicago, Ill.

366 SHORT CUTS FOR CARPENTRY WORK

Popular Mechanics New Carpenter's Handbook is filled with illustrated short cuts and improved methods for doing all sorts of carpentry work and odd jobs. Each idea was discovered by a practical man in the course of his work. Each idea is practical, a time-saver, a money-saver. The **229 Pictures** are so clear that in many cases, the picture itself explains the short cut. This new book is a book for professional carpenters, for amateurs, and for boys. It is destined to be just as popular as the many other handbooks published in recent months. This new book is beautifully bound in golden brown cloth, is a handy size, and sells for the remarkably low price of \$1.50.

Send No Money Simply write a postal saying that you want Popular Mechanics New Carpenter's Handbook. It will be sent C. O. D. and you may pay the postman the price of the book and the few cents postage when he delivers the book to you. If you live outside the U. S. or if you are not at home when the postman delivers your mail, send \$1.50 with your order.

POPULAR MECHANICS PRESS
Room 707, Popular Mechanics Bldg., 200 E. Ontario Street, Chicago, Ill.

Make Furniture At Home

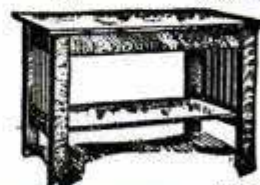

—either for your own pleasure or to sell. It is easy when you have the instructions supplied in Popular Mechanics Home Furniture Making Library. This library consists of the following cloth-bound, profusely illustrated books of which many thousands have been sold to satisfied customers everywhere:

1. Mission Furniture—Part 1
 2. Mission Furniture—Part 2
- These two practical, money-saving books contain full directions and drawings for the making of all sorts of furniture, including tables, chairs, stools, davenport, electric table lamps, and many other useful and beautiful articles of furniture.

Crystal clear instructions in 2 handy books; 240 pages—123 illustrations. Just follow directions and you'll be amazed at your good results. Use the furniture in your own home or sell it. One man writes he sold over \$1,000 worth of furniture made from these books. You can do the same.

Send No Money! Just write a postal asking that Popular Mechanics Home Furniture Making Library be sent you C. O. D. When the postman delivers the books, simply hand him \$1.98 plus the few cents postage. Money refunded if not delighted.

POPULAR MECHANICS PRESS
Popular Mechanics Bldg., Room 708, Chicago, Ill.

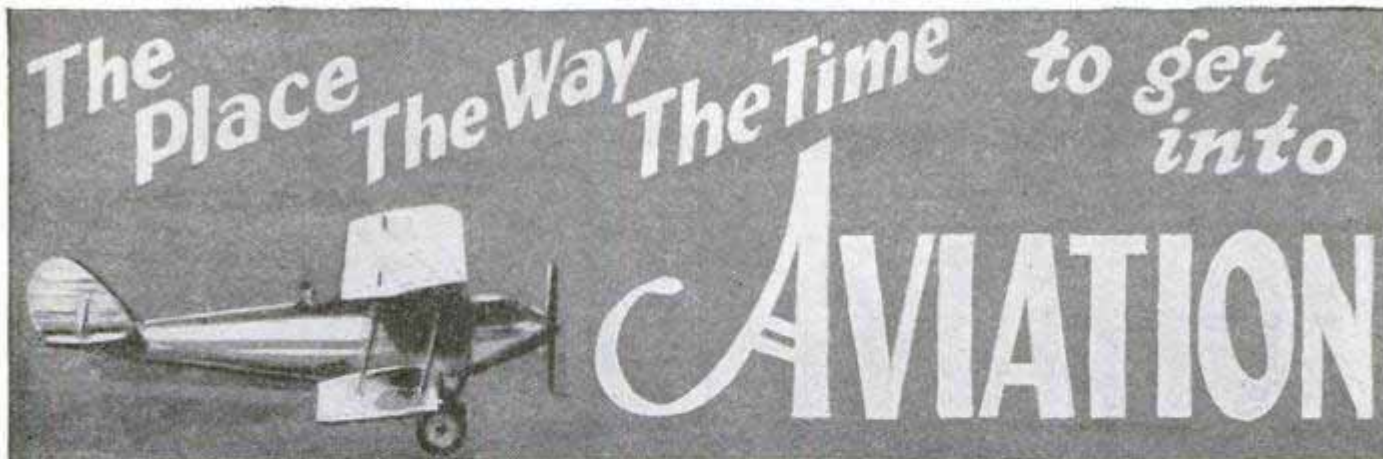

The Sweeney School—Learn to Fly by Flying

The **place** to learn aviation "from the ground up" is where there are plenty of experienced instructors, plenty of students, big flying field, ample modern equipment, where you are in touch with all that's going on—make friends and contacts that will later prove valuable to you; in a word a big recognized training center under U. S. Government inspection. Such a place is the Sweeney School.

The **way** to learn aviation is to learn ground mechanics by practical experience, all about engines, fuselage, building and repairing planes, handle latest types, not outworn "busses," then to take up flying under personal instruction, getting all the time needed to make you a pilot. All this in a flying center where there's life, activity, enthusiasm, congenial surroundings. Such is the way you learn at the Sweeney School.

The **time** to take up aviation is right now, when jobs are opening up on every hand, when big prizes are offered, manufacturers and mail service seeking men, the whole world ringing with the fame of flyers. NOW the first step is easy.

PILOT OR MECHANIC COURSE

YOU can select either the pilot course or ground mechanics course or combine the two courses. All the flying with dual controls and later solos to qualify you. All the ground work in motors, ignition, wings and construction is taught by Experts, and five men are needed on the ground for one man in the air. The cost of tuition is extremely low and living conditions are pleasant and economical. Many men just out of the army come here to take up this work. Student body very high class. No previous experience required. We use tools not books.

LEARN TO FLY BY FLYING
Sweeney
 SCHOOL OF AVIATION
 4506 SWEENEY BLDG, KANSAS CITY, MO.

OPPORTUNITIES

- | | |
|-------------------------------------|--|
| Aviation Mechanics—\$50-\$125 Week | Special Messenger Service—\$125-\$200 Week |
| Riggers—\$50-\$75 Week | Aerial Advertising—\$225-\$500 Week |
| Flyers—\$125-\$225 Week | Crop-Dusting—\$125-\$200 Week |
| Taxi Service—\$100-\$300 Week | Crop Survey—\$125-\$225 Week |
| Aerial Photo Pilot—\$200-\$250 Week | |



FREE Send name today for full details. Illustrated catalog shows pictures of students at work in shops and in the air. Everything you want to know about aviation. Lists of jobs and high pay offered aviators and mechanics. No colored students accepted.

SEND THIS NOW

EMORY J. SWEENEY, President
 4506 Sweeney Bldg., KANSAS CITY, MO.

Please send me full information about your Aviation Course.

Name..... Age.....

Address.....

Town..... State.....

**Don't Buy
a New
Phonograph**

**SEND NO
MONEY**



**10
DAYS'
TRIAL**

**The
New PHONIC
Reproducer**

**makes an up-
to-the-minute
Phonograph out
of your old one!**

\$3.85
Direct
from
Factory

Now at last you can say goodbye to the squeaky, nasal, rasping, metallic tone of your phonograph. Yet you need not buy a new phonograph. The reproducer is the HEART of any phonograph—and the New PHONIC reproducer makes your old phonograph like an entirely new one. Based on the new PHONIC principle. Makes you think the orchestra or artist is in the same room.

Never Before Such Tone

Tones never before heard are clearly distinguished when the new PHONIC reproducer is used. Test it on an old record. Hear the difference yourself. Listen to the deep low notes and the delicate high notes. Hear how plainly and clearly the voice sounds. Note the natural tone of the violin and the piano, and the absence of "tinny" music. You will be amazed. The new PHONIC reproducer is ideal for dancing or for home entertainments. Its volume is almost double that of the ordinary reproducer.

10 Days' Trial—Send No Money

You cannot realize how wonderful the New PHONIC is until you hear it. That is why we want to send it to you on 10 days' trial. Send no money now—just the coupon. Pay the postman only \$3.85 plus a few pennies postage when the New PHONIC arrives. Then if you are not delighted, send it back within 10 days and your money will be refunded. If sold in stores the price would be at least \$7.50. Our price only \$3.85. Over 350,000 people have dealt with us by mail. You take no risk. Mail coupon now for 10 days' trial. BE SURE TO STATE THE NAME OF PHONOGRAPH YOU OWN.

**CARL HENRY, Inc., Dept. 581
327 West 36th Street, New York**

Please send me a New PHONIC reproducer for..... I will pay the postman \$3.85 plus (give name of Phonograph)..... few cents postage. If I am not satisfied after trial, I will return your reproducer within 10 days and you guarantee to refund my money. Outside U. S., \$4.10 cash with order.

Name.....
Address.....
City..... State.....

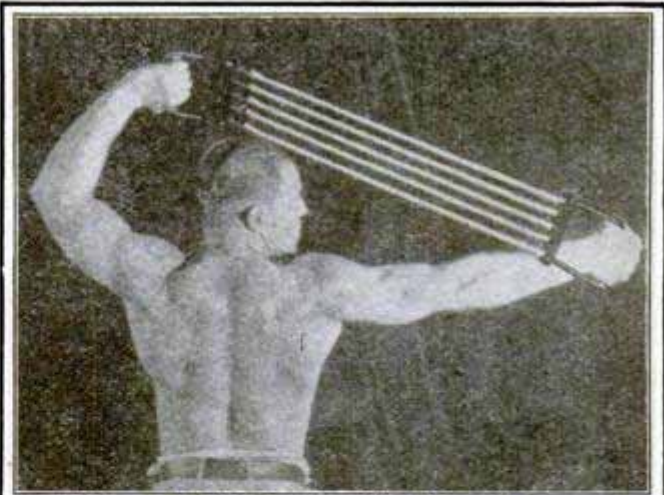

A Strong 5-Cable Exerciser like this, with Course

"HOLY CATS! WHAT AN OFFER!"

exclaimed an experienced user of cable exercisers (who knew a thing or two about muscle building apparatus) when he first saw this proposition.

HERE'S WHAT PROMPTED THE REMARK that is being perpetuated by thousands who know their physical training and can realize what a gigantic offer, for the low price, this is:

WE ARE GIVING AWAY A 5-CABLE EXERCISER AND COMPLETE COURSE FREE WITH A ONE YEAR'S STRENGTH MAGAZINE SUBSCRIPTION TO

Never before, men, has so much value been given for the insignificant sum of \$2.50, which is the regular price of the magazine for one year, no advance having been made for this offer. The 5-cable muscle and strength builder and the course explaining and illustrating its uses for best results is entirely free of extra charge. You receive a big two-dollars-and-fifty-cents' worth in the 12 large issues of the magazine alone. The cable exerciser, the course and the priceless physical benefits derived from their use are all as free as air.

If you don't want one of these exercisers for your own health and good get one anyway and give it to a friend, your brother, even your Mother, sister, wife, sweetheart, a cousin, nephew or anyone you know who needs and desires an apparatus for exercising purposes—you couldn't get them a better present when the physical benefits are weighed in and you couldn't give a present that actually cost you less. You would still have an interesting and instructive magazine to read each month for a year, you know, at no advance in price.

LARGE, SHAPELY MUSCLES ARE EASILY BUILT WITH THIS FREE APPARATUS

Just think of developing muscle, strength and perfect health with an exerciser that cost you nothing. It's a rare treat, isn't it?

This free exerciser will build up the thin and reduce the stout to firm, useful muscles. It will rid you of that tired feeling; improve your digestion and circulation. You will end the day's labors feeling fresh for the evening hours of enjoyment. You will sleep sounder and be fully rested in the morning. Wouldn't you take those physical improvements for a gift? That is just what we are offering you—improvements like those for nothing.

We Pay All Mailing Charges "STRENGTH"

is a magazine of enjoyable reading matter on all subjects of health, strength and physical development. There are sports stories; articles on how to develop the various muscles of your body; stories and articles about the doings of international strong men and men with perfect physiques. There are pictures galore of finely built men and women and many other items of interest to the man or woman interested in physical fitness.

Get This Coupon On It's Way

NOW

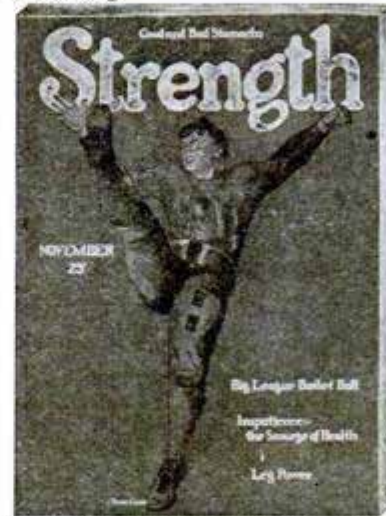

**THE MILO PUBLISHING CO.
2747 N. Palethorp St., Philadelphia, Pa.**

P. M. 1-28

Gentlemen: Enclosed you will find \$2.50 for which please enter my name for a year's subscription to your "Strength Magazine" and send me free of extra charge, whatsoever, the complete 5-STRAND EXERCISER and COURSE.

Name.....
Street.....
City..... State.....

CANADIAN ORDERS, \$2.75—FOREIGN, \$3.00

GET A BIG PAY JOB in ELECTRICITY



Give me a little of your SPARE TIME and

Up

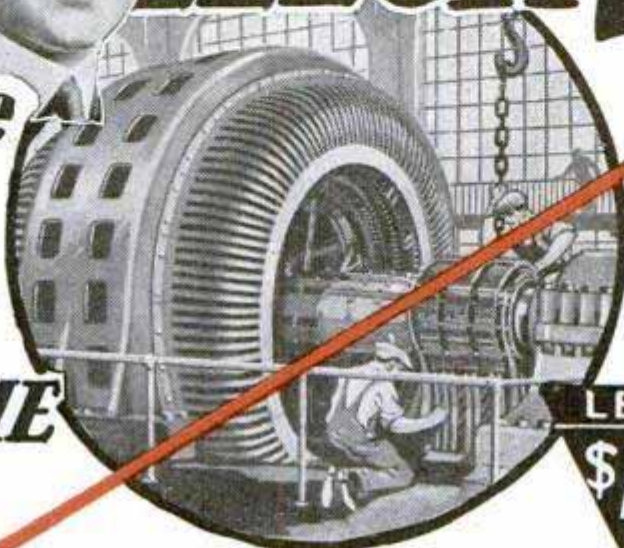

goes your PAY

LEARN TO MAKE -

\$70 to

\$200

A WEEK If

YOU ARE MAKING LESS THAN \$70 A WEEK

INVESTIGATE

SAY goodbye to poor-pay forever—cut loose from your hard-work, no-future, \$4 or \$5 a day job — jump into Electricity and learn to earn \$12 to \$30 a day. Thousands of "Cooke" Trained Men are getting \$70 to \$200 a week — \$3,500 to \$10,000 a year in Electricity. You can do it, too — it's easy! I'll show you how—give me a little of your spare time, and I'll get you ready for a Big Pay Electrical Job so quickly you'll be amazed.

Learn At Home — Earn While Learning

You don't have to quit your job—you don't even have to lose a single minute from your days work to learn Electricity with me. I teach you right in your own home, in your spare time. And you don't have to have "education" — you don't need experience. My Training is simple as A, B, C. You learn by doing, and you learn right. With my famous "Work Sheet" and "Job Ticket" Methods you learn along work shop lines. I give you without extra charge Six Big Outfits of tools and apparatus to work with. And I show you, right away, how to make as much as \$10 to \$30 a week extra spare-time money while learning.

Money Back If Not Satisfied

So sure am I that I can quickly fit you for a Big Pay Job in Electricity that I give you a written agreement to return every penny of your tuition if you're not satisfied. And a \$2,000,000 Illinois Corporation stands behind this agreement. Remember, there's nothing like "Cooke" Training anywhere. It's the Training employers recommend; it's the Training a great Engineering Society has endorsed 100%; it's the Training for you!

Get Started Now — Mail Coupon

If you're now earning less than \$70 a week — don't wait a minute but mail the coupon and find out how quickly I can get you ready for a Big Pay Job. Get my Big FREE Book of Facts. See the Six Big Working Outfits that cost you nothing extra — see the hundreds of pictures, the Proofs, the letters of other Big Pay "Cooke" Trained Men. Act now! Mail coupon at once.

L. L. COOKE, Chief Instruction Engineer

L. L. COOKE SCHOOL OF ELECTRICITY

Dept. 511 2150 Lawrence Ave., Chicago, Ill.

\$300 A MONTH IN SPARE TIME
Mr. Cooke:
I am making out my own now, making at least \$300 a month in my spare time besides my eighty-two hour and a half cents an hour at the plant.
Leo. G. Woelkers
1332 Jefferson Ave.
Scranton, Pa.



FROM 65c AN HR. TO \$12 A DAY
"Dear Mr. Cooke: A short time ago when I started your Course I was doing heavy labor at 65c an hour. I have job now that will net me \$12 a day. Put me down as an L. L. Cooke, booster."
Robert L. Kornis
217 S. Maple Ave.
Newkirk, Okla.



LEARN BY DOING



FREE BOOK COUPON

L. L. COOKE, Chief Instruction Engineer, Dept. 511, 2150 Lawrence Ave., Chicago, Ill.

Send me FREE and prepaid, your Big Book "Secrets of Success in Electricity," with all details about your Home Study Course in Electricity.

Name _____

Address _____

City _____ State _____

Residents of Canada send coupon to R. A. Farrow, Special Representative, 7 Medbury Lane, East, Windsor, Ont., Can.

The "Cooke" Trained Man is the "Big Pay" Man

3550

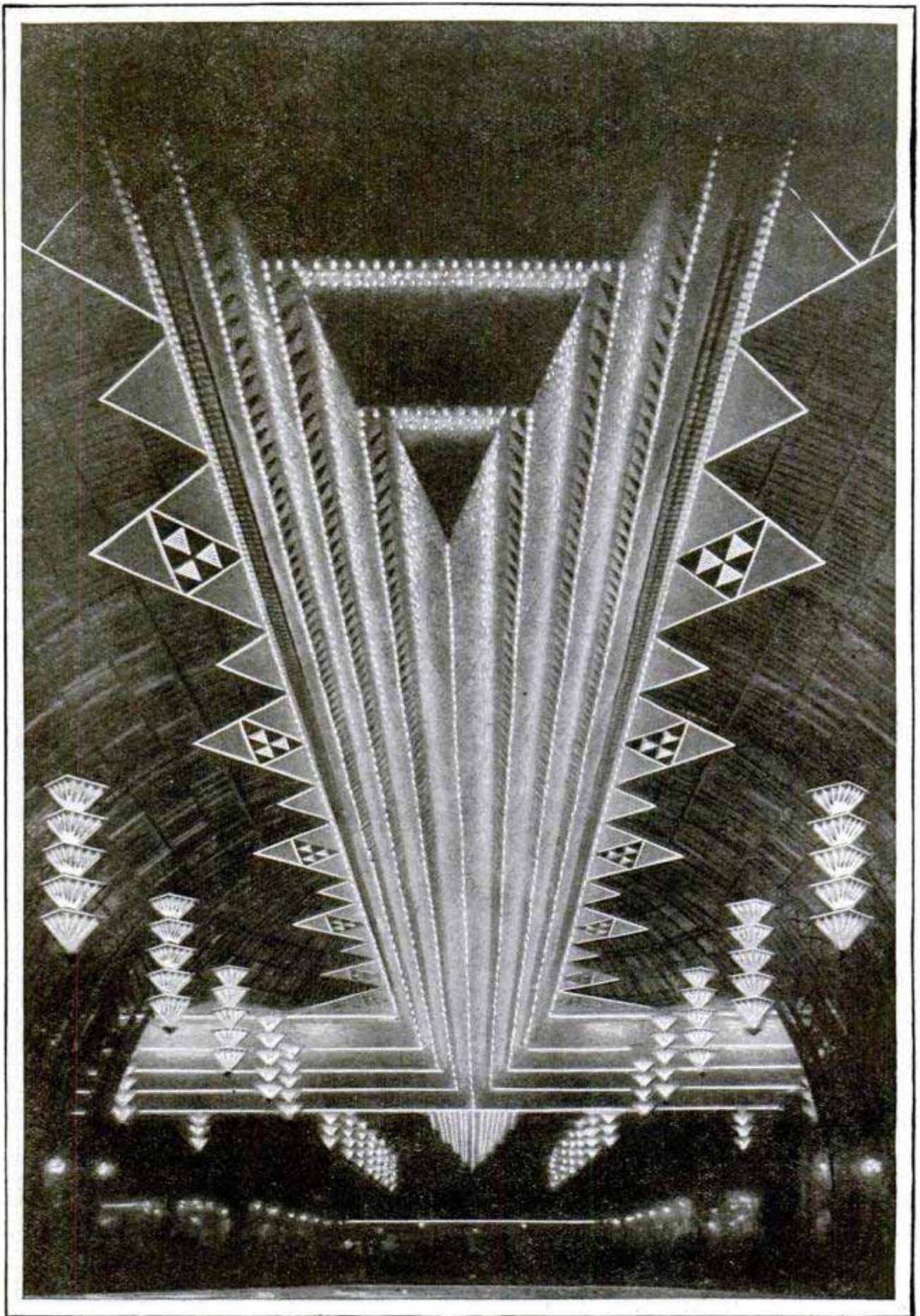

Show
© Keystone
For the French Auto Salon in the Grand Palais in Paris, Electric-Lighting Engineers Worked Out This Un-
usual Design, in Which a Myriad of Bulbs and Skillful Draperies Combined to Produce a Striking Effect,
as Seen by the Spectators on the Floor Below

Popular Mechanics Magazine

REGISTERED IN U. S. PATENT OFFICE

WRITTEN SO YOU CAN UNDERSTAND IT

Vol. 49

JANUARY, 1928

No. 1

Radio Waves *that* Cast Shadows

RADIO waves so short that, like visible light, they cast shadows behind buildings, or even men, are being employed in experiments that promise to open a new era in wireless, particularly in communication with airplanes. The waves are so short that they bring home the point, which engineers have often tried in vain to emphasize, that radio is only another form of light, and not a brother of sound.

Five-meter waves are being used in the experiments conducted by the General Electric laboratory at Schenectady, and, despite the fact that they are giants compared with light waves, the two act very much the same. The average visible light wave is only about one fifty-thousandth of an inch in length, but, though it would take nearly 10,000,000 of them, placed end to end, to equal one five-meter wave, the radio signals of that length emulate light by traveling in a straight line as well as by being blocked when they meet a hill, a house or any other obstruction.

The radio waves used in ordinary broadcasting rarely cast shadows, because of

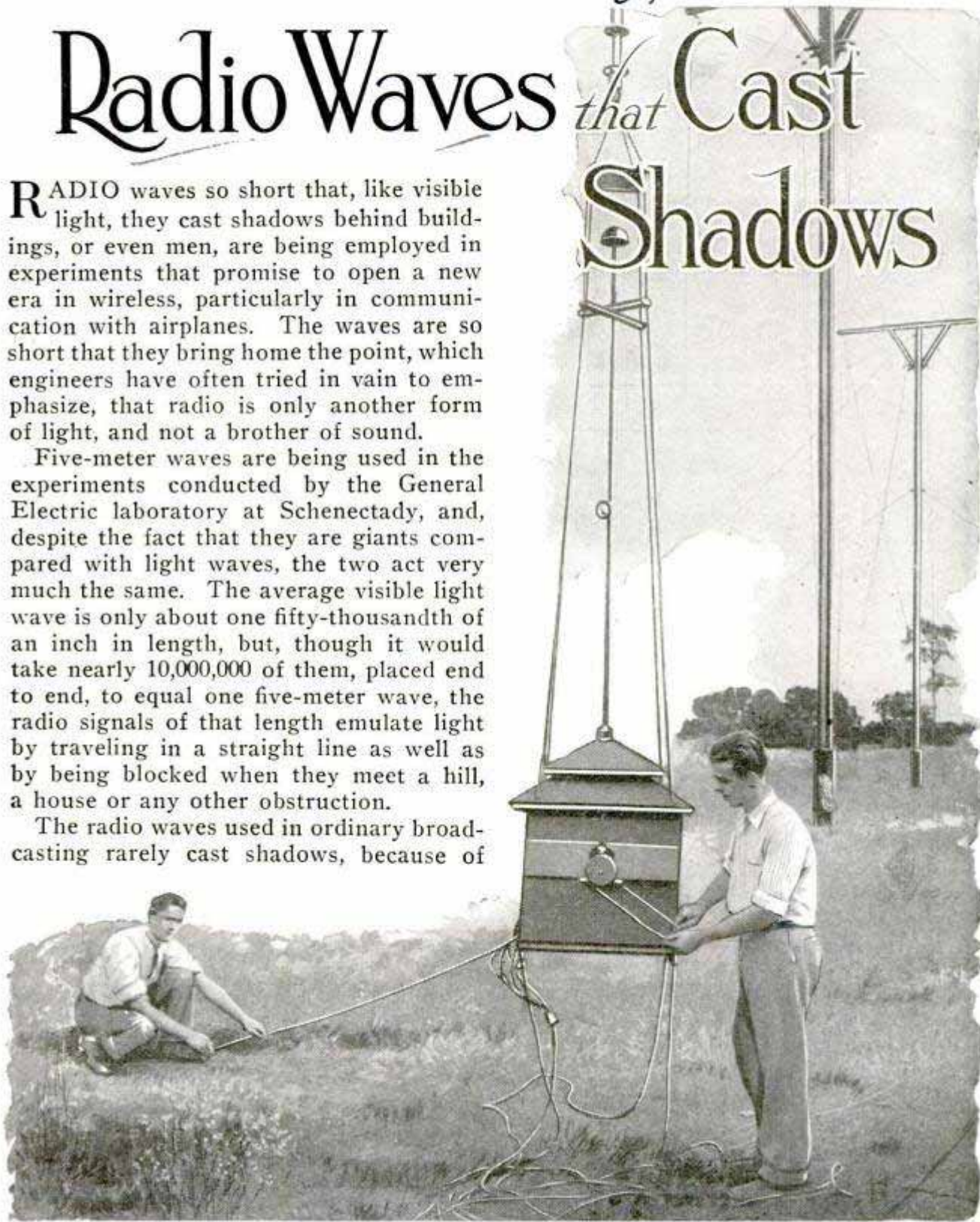

Preparing to Hoist a Radio Transmitter to the Top of a Tall Tower; It Is Tuned from the Ground by an Endless Cord, and the Small Meter on the Aerial Rod Is Read with a Telescope

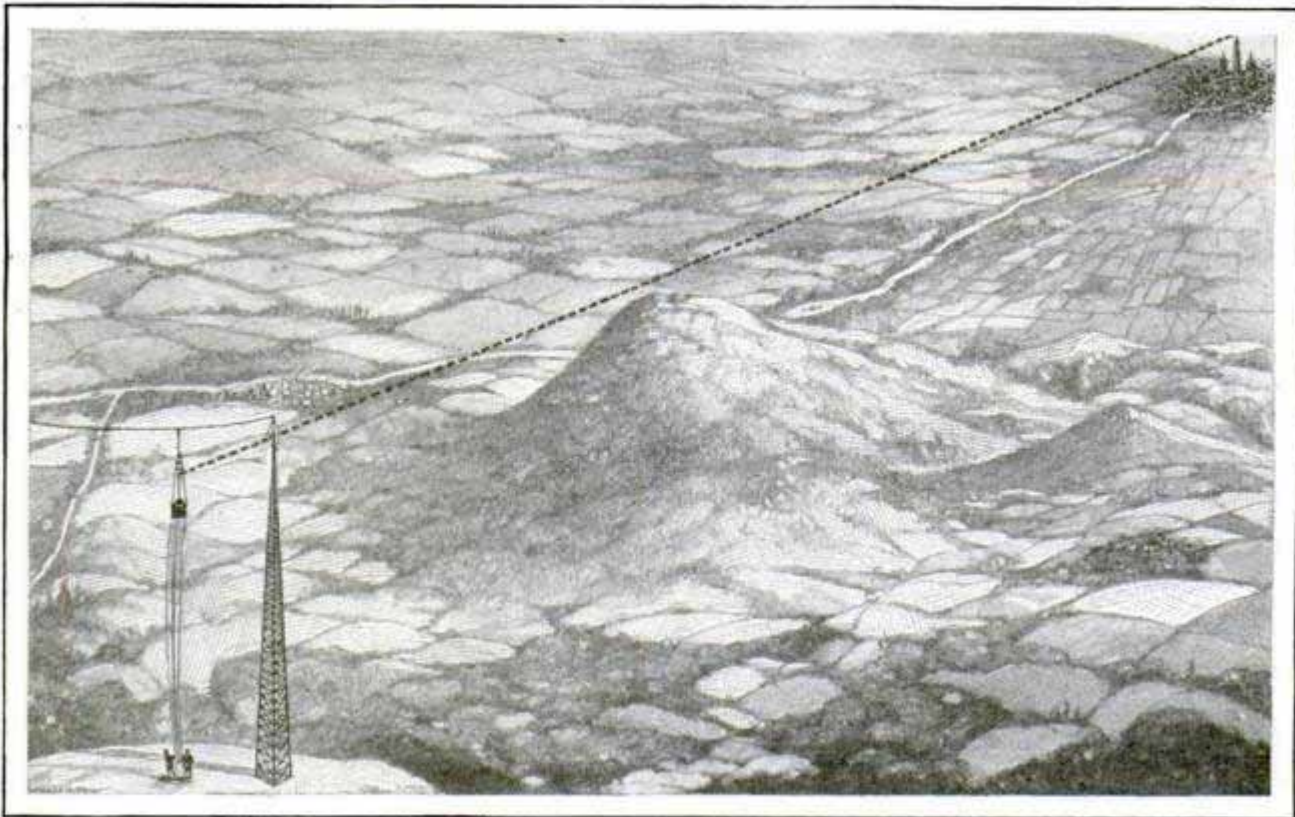

Elevated to a 300-Foot Mast, the Transmitter Will Have a Clear Line of "Vision" to the Receiver atop the Woolworth Building on Distant Manhattan Island

their great length. There are occasional exceptions, as when a near-by mass of metal, such as a gas holder, will block reception from a broadcasting station on its other side. The long waves bend as a rule around very large objects, just as visible light waves may be bent around atoms. On the basis of their comparative size, a house or office building is no more to the long radio wave than an atom to the fifty-thousandth of an inch light wave.

Because of their straight-line propagation and the shadow effect of interfering objects, unusual arrangements were necessary in the experiments with the five-meter waves. The transmitter, instead of being housed in a building or placed on the ground, was swung in the air from the top of a 300-foot aerial mast at Schenectady. An endless rope, running over a pulley on the condenser dial, made tuning possible from the ground, operating much like a chain hoist. The small output meter, fixed to the antenna, was read from the ground through a surveyors' transit. Wires dangling from the transmitter connected to the current supply on the ground.

The receiver used was a miniature "ham" set, consisting of regenerative detector and one audio amplifier. No antenna was necessary at the receiving end for the

phone cords furnished wire to pick up sufficient energy. The tiny grid-tuning coil contained but five turns of wire, a half inch in diameter, and the tickler coil was a quarter inch long and a quarter inch in diameter, inside of the grid coil. Two very small condensers were used, and to keep the leads short, they were placed as close as possible together. They were so close, in fact, that, in order to use standard-size vernier dials, extension shafts were necessary. The condensers were placed at an angle to each other and a false end was built in the receiver cabinet to accommodate the angle of the dials.

Tests were first made over a distance of thirty miles. On top of a hill, with a clear "line of vision" to the transmitter, the signals came loud and clear, but as the portable receiver was carried down the far side of the hill and passed out of the straight-wave range, the signals faded and disappeared.

Following a survey of topographical maps for the country from Schenectady to New York city, arrangements were made to place the receiver on top of the Woolworth building, as the survey showed that, from its great height on lower Manhattan island, the transmitter atop its 300-foot mast at Schenectady would have an un-

3491

obstructed path for the radio waves, passing over the Catskill foothills.

The short waves used have extremely high frequencies, a five-meter signal representing approximately 60,000,000 cycles a second. A four-meter wave would have a frequency of 75,000,000 cycles. In the 15,000,000-cycle space between four and five meters, every radio station now in use—amateur, naval, broadcasting and commercial—might be operated without interference from overlapping signals. It is that enormous number of possible wave channels in the low waves that promises to revolutionize wireless. Experience has shown that a separation of at least ten kilocycles, or 10,000 cycles, is necessary between near-by stations. On that basis there are between 200 and 550 meters—the broadcast wave band—only some ninety possible wave channels, though they cover a 350-meter band, while the single one-meter band between four and five meters contains 1,500 wave channels.

The experiments are continuing, to determine the usefulness of the short waves in broadcasting over fairly limited distances. Radio engineers have been aware for some years that short waves are best for long-distance transmission. One of the interesting facts already learned is that the short-wave bands are practically free the year around from natural static, but that man-made static, such as that caused

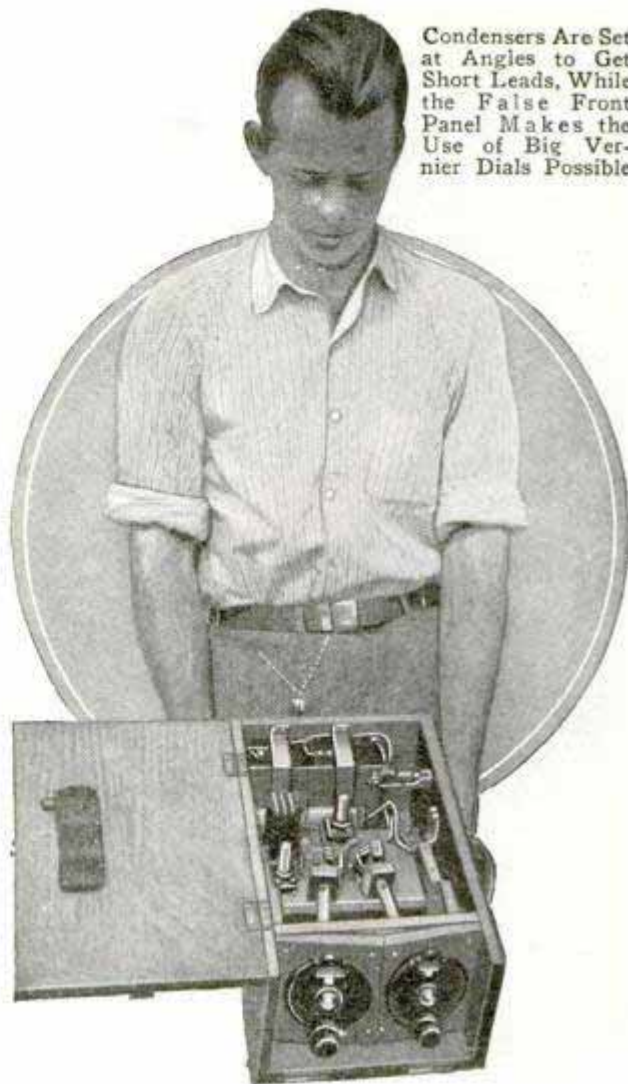

Condensers Are Set at Angles to Get Short Leads, While the False Front Panel Makes the Use of Big Vernier Dials Possible

by the ignition system of a passing automobile, is particularly noticeable.

Hamilton Standard Gas Engine Co., Oakland, Calif.

TRACTOR FITTED AS FIRE ENGINE HELPS GUARD FORESTS

By making various alterations in a familiar brand of tractor, an efficient engine has been afforded the guardians of a Cal-

ifornia forest to help combat fires. It has a six-speed transmission, pneumatic tires, a three-speed pump, reels of hose and, on the trailer, a tank holding 520 gallons of water. This may be used while the hose is being led to a creek or other natural supply. A particular advantage of the outfit is that it can climb steep grades. In a recent test, one of the tractor engines was driven 215 miles over mountain roads in ten hours. When the destination was reached, the trailer was disconnected from the tractor and a plow attached, making a firebreak up a thirty-percent grade in low gear.



Forest-Fire Engine, Made from Tractor, with Trailer Carrying the Emergency Water-Supply Tank

Hordson.

Evimude Motor Co., 27th + Florence, Milwaukee, Wis.

Cmd. Alfred J. Warshaw, 1308 Blake St., Berkeley, Calif.

THREE HUNDRED MILE AN HOUR
PLANES CARRY BALLAST

English speed planes, which took the Schneider trophy away from Italy this year, were so fast that they had to be specially weighted on the right-hand side to overcome the tendency of the plane to turn with the propeller. The winning plane, which averaged 281.49 miles an hour on the closed triangular course, attained a speed of more than 300 miles an hour at times on the straightaway. The winner, a Supermarine equipped with Napier engine, had a right-hand pontoon considerably longer and heavier than its opposite mate, as shown in the center sketch on the opposite page. It was unusual in several particulars. For one, the fuselage was built of sheet duralumin without any internal bracing or reinforcement, deriving strength from its tubular shape alone. The engine was water-cooled and the radiators occupied practically all the leading edge of the very short wings. Special ventilation was provided to blow the burned oil fumes and other gases out of the fuselage, to keep them from overcoming the pilot. Another of the English entries, which, however, crashed on its trial flight in Italy, carried all its gasoline in a large tank in the right-hand pontoon to offset the engine twist while in flight. The third type of British ship, of which two were built, was the Gloster Napier, the only biplane entered, the others being of the low-wing monoplane type, in which the wing is placed below the fuselage instead of above it. The Glosters were unusual in that the powerful engines were geared down to fairly slow turning. Wing struts

were of duralumin because strength equal to wood can be attained with considerably thinner sections. The wing radiators, used to cool the engine water, were supplemented by radiators in the pontoons, which utilize the sea water for cooling while the ships are on the surface.

Taking the Seasickness Cure on Deck; Gas Administered from the Cylinder Is Said to Relieve the Malady

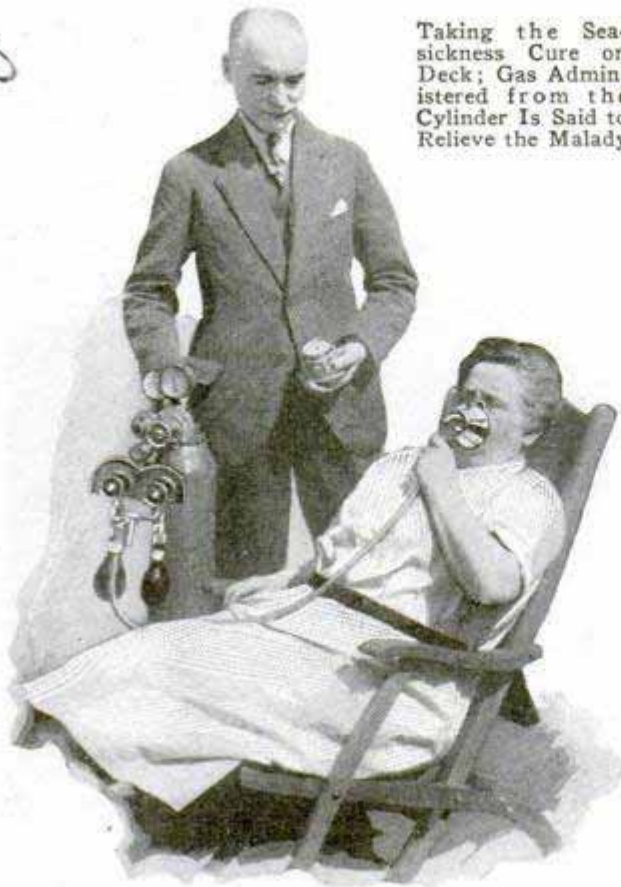

GAS FOR CURING SEASICKNESS
LATEST TRAVEL AID

Comfort for the traveler who suffers from seasickness is seen in a gas remedy a German physician has prepared. It is carried in cylinders like those used in a dentist's office and the patient inhales it through a flexible tubing and cope. Treatments can be given on deck and are said to be effective immediately.

"FIDDLE" THAT SOWS GRASS SEED
AIDS GOLF-COURSE KEEPER

Maintaining grass on golf courses is simplified with a hand-operated sower introduced in England. It works by pulling a "bow" back and forth as though playing a cello. This action causes a disk to rotate and scatter the seed which falls upon it from a holder above.

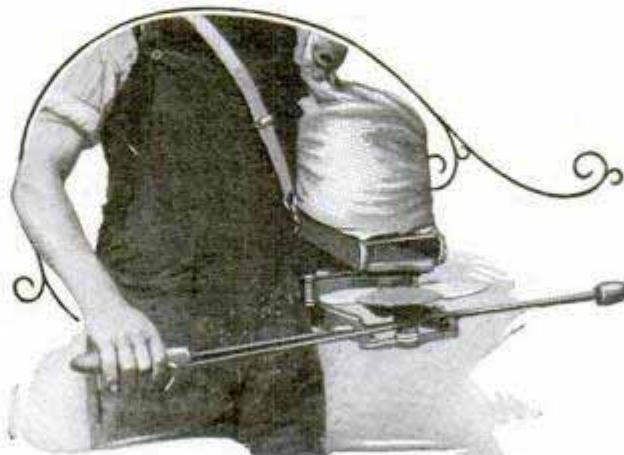

By Working the Handle Back and Forth, Disk Is Revolved and Seed Is Distributed from the Bag

34514

Dr. Dainigment,
Munich, Germany

Dr.

Used at Royal Berkshire Club
in Windsor
Direct

3433

211, The Vale
Acton W. 3, London

Original

See March, 1929

3433

373

POPULAR MECHANICS

Short Bros.

SECRETS OF THE WORLD'S FASTEST SEAPLANES

Crusader - Mess. Mercury engine

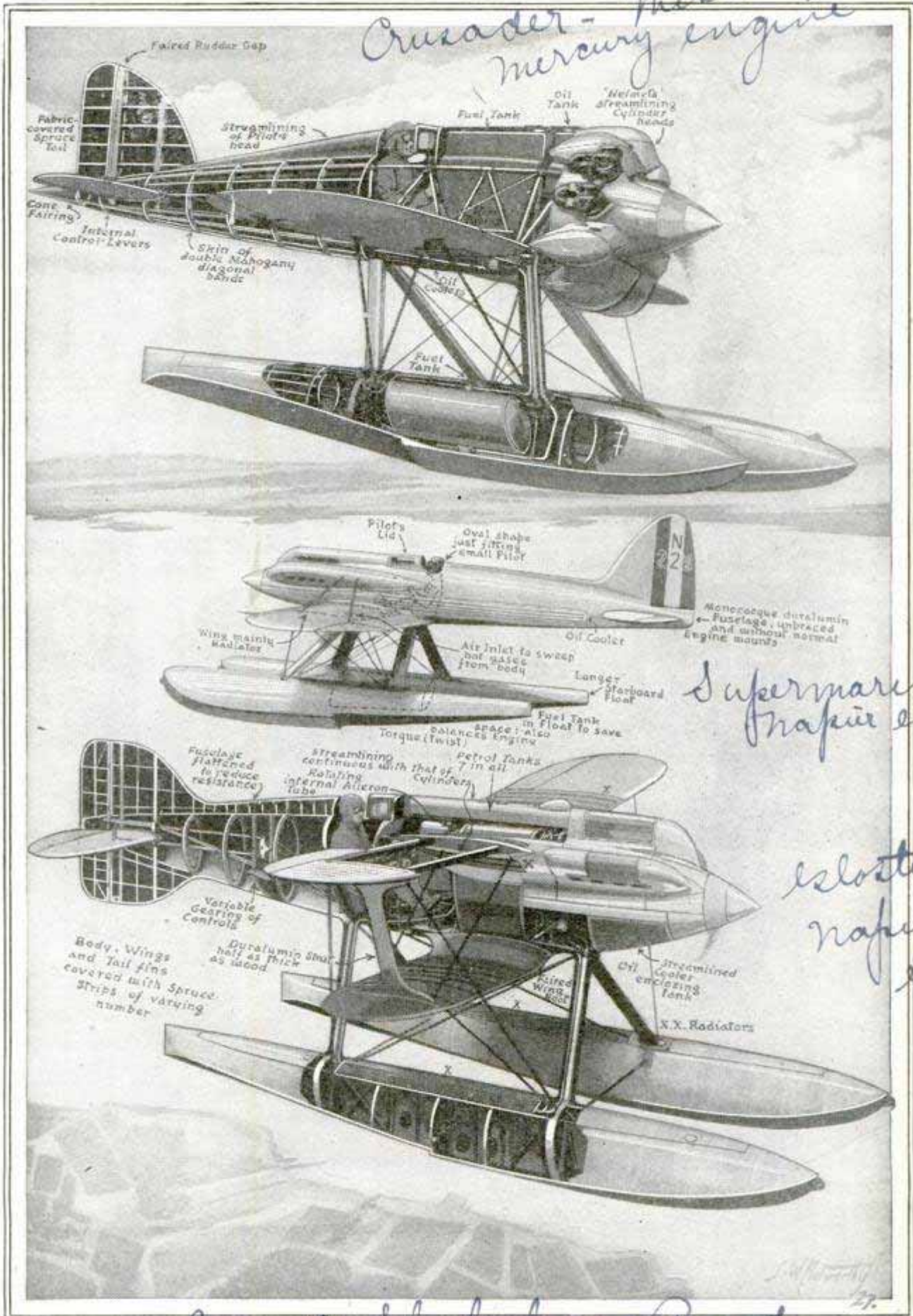

Supermarine S.5 Napier engine

Gloster IV Napier engine

*Esq. 18 Shakespeare Road
Herne Hill London
S.E. 24 Eng*

3485
6

ELECTRICAL "MAN" OBEYS HUMAN VOICE ON PHONE

Left, Mechanical "Man," Which Opened and Closed Doors, Rang Bells, Turned Lights Off and On and Responded to Other Spoken Orders, and, Below, the Master Voice That Calls Up Three Washington Reservoirs and Reports Back the Amount of Water Each Contains, the First Practical Job the Electrical "Robot" Has Undertaken

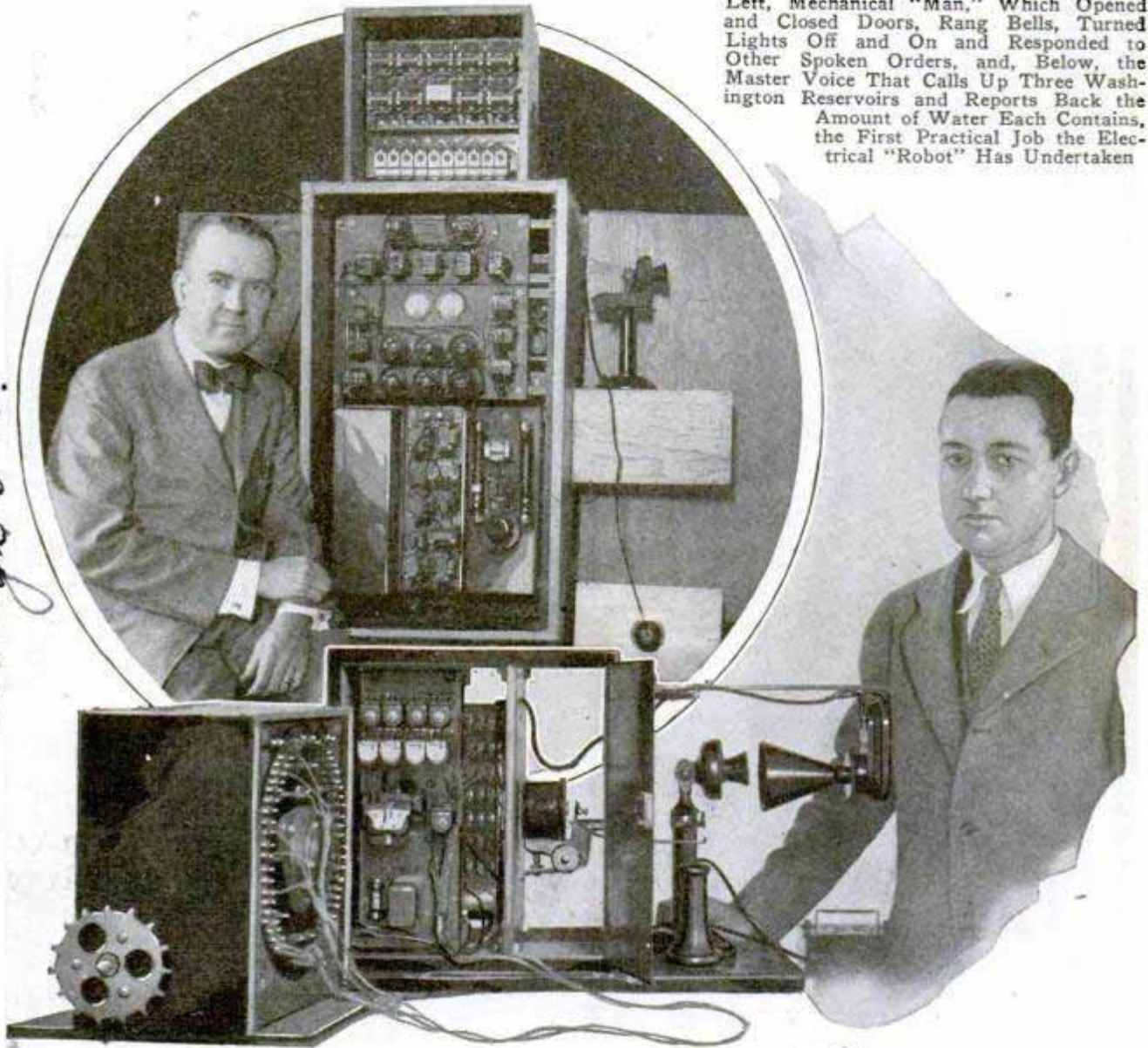

*Westinghouse Electric & Mfg Co.,
East Pittsburgh Pa.*

An electrical machine that answers the telephone, starts and stops machinery, reads the water gauges at reservoirs and can be made to perform an infinite number of other tasks, has been constructed by Dewey M. Radcliffe, a government engineer, and R. J. Wensley, of the Westinghouse laboratory staff. Three of the automatons ~~have been~~ installed in the war department at Washington, taking the place of nine watchmen who patrolled three water reservoirs. When the official in charge wishes to know the depth of water in any of the reservoirs, he calls central on the telephone, gives the proper number, and the mechanical man answers, reads the gauge and reports back the depth. A similar machine, demonstrated at the Westinghouse offices recently,

turned lights off and on, started and stopped an electric fan, operated a searchlight and an automatic sweeper, and even opened and closed a door. A laboratory model was worked by the human voice speaking into a telephone transmitter, delicate selectors and relays responding to certain tones and syllables. For practical installation, the human voice has been replaced by electrically operated tuning forks, which transmit the desired note. The mechanical man grew out of the need for a device to control distant machinery without the prohibitive expense of maintaining special private wires over long distances. At the control office in the war department, the telephone stands on a small box, which has on it three push buttons. When the waterworks official wants

usu.

to check the water level in the reservoirs, he calls the number of the reservoir, the operator completes the connection, and the bell at the other end rings. The signal operates a relay that lifts the hook and starts a buzzer that sends back through the transmitter a signal to advise the caller that contact is established and also the desired information.

BLACK BLOTTERS FOR BANKS TO DEFEAT FORGERS 3588

By using the blotter that has been applied to a signature, forgers have sometimes fashioned an accurate reproduction of the writing, but with a type of blotter now being employed in banks, they will no longer be able to do this. The blotters are black, so that the ink is almost completely lost in the color. Besides this advantage, they are not so easily disfigured.

TURN OF WRIST WORKS JACK WITH COMPRESSED AIR 3129

Raising a car with a twist of the wrist in a few seconds is accomplished with a compressed-air jack now on the market. It is operated from a service-station air line, or with a small container of air compressed to 120 pounds and released from the tube into the jack.



Jack in Place and About to Raise the Car When Compressed Air Is Released by Twisting Tube Handle

GAS MASK AS DIVER'S HELMET WOULD AID IN RESCUES

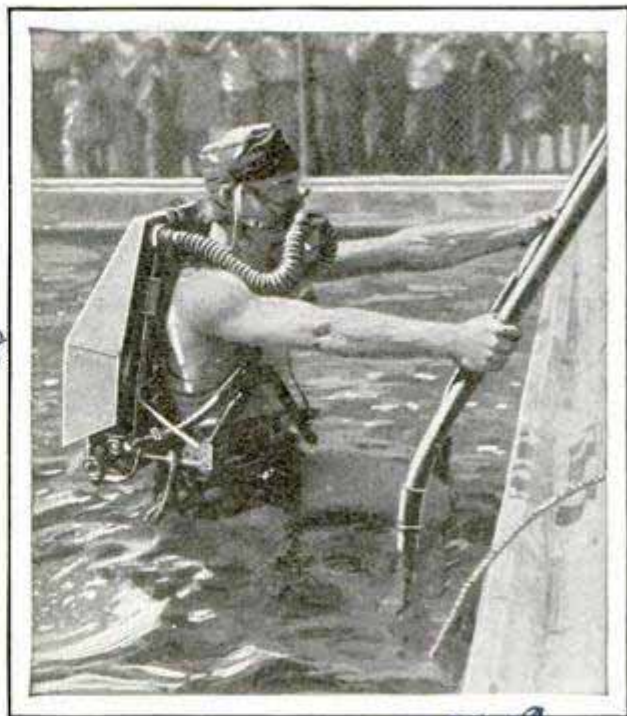

Submerging to Test Fireman's Gas Mask as a Diver's Helmet, Wearer Stayed Under Twenty Minutes

That a fireman's gas mask can be successfully used as a diver's helmet was demonstrated recently by Capt. C. H. Virdin, of the Los Angeles department. Wearing one of the masks, he remained submerged for twenty minutes. It is thought that the equipment would prove of special service to companies detailed along water fronts or where emergency calls for rescues of drowning persons are likely.

CENTER OF INDUSTRY MOVES TOWARD THE WEST 3608

Centers of industry and population of the United States are gradually moving westward toward the center of agriculture and the latter, in turn, is a bit nearer the geographical center of the country than it was a few years ago. The industrial center has moved seventy-five miles south and west in the last eighteen years, and is now in northern Indiana. The center of population is also in Indiana, in Owen county, 170 miles south and slightly west of the industrial center and almost at the Illinois state line. The agricultural center is about thirty-five miles southwest of Hannibal, Mo., and the geographical center near the middle of the northern boundary of Kansas, close to Nebraska.

H. A. Air Jack
Mfg. Co. 506 Keith Bldg.

Chicago Commerce
10/29/27

Etore Ungalli

2813 **SPEED BOAT TO CROSS ATLANTIC IN FIFTY HOURS**

Trips between New York and Paris in fifty hours are anticipated by a French in-

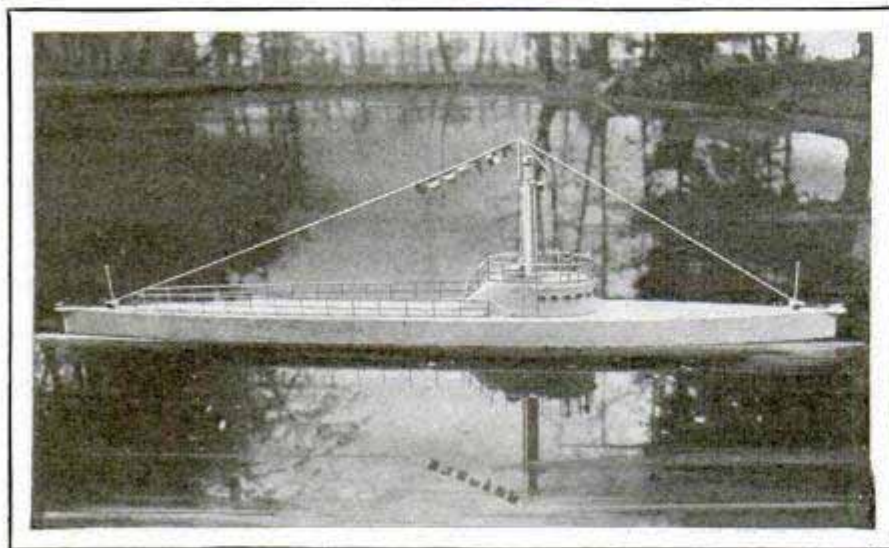

Eight-Motored Speed Boat for Rapid Trips across the Atlantic Is to Be Built after This Model

ventor in a boat he has designed to rival aircraft. It is in the model stage so far and shows similarities to a submarine, being fitted to travel under water for a considerable time. It is to have eight motors, six for forward and two for reverse travel, with a total horsepower of 2,400. A maximum rate of over eighty-six miles an hour can be attained, the designer believes.

slight that they cannot be considered "earthquakes" in the accepted sense of the term, and fewer still possess sufficient intensity to cause great damage in centers of population. Just a few weeks ago, a severe quake was registered on instruments in various parts of the world. It was believed to have occurred somewhere under the ocean off Alaska. No damage was reported, hence the quake is not recorded as a catastrophe, although it was a severe shake. Between Sept. 1, 1924, and Aug. 31, 1926, 551 notable disasters in various places were tabulated in "The World's Health," recently published in Paris. The list included sixty-six earthquakes, four volcanic eruptions, nine avalanches and landslides, 197 floods, 148 cyclones, eight tidal waves, twenty-three droughts, forty-eight big fires, seventeen famines and thirty-one plagues of locusts.

THOUSANDS OF QUAKES YEARLY BUT FEW PERIL MAN

As many as 30,000 earthquakes may occur yearly, but not more than thirty are what can be considered catastrophes so far as man is concerned, according to R. M. Wilson, of the geological survey. Sensitive seismographs show that the earth is almost constantly quaking and trembling somewhere, but hundreds of the disturbances are so

3418 **DEFECTS IN SPEECH RECORDED TO AID PUBLIC SPEAKERS**

Embryo orators and actors at the University of Southern California, have a means of studying the defects and good points of their own voices in an instrument that registers the tones as they are spoken and repeats them as a phonograph does. It is essentially a combination recorder and repeater, and the voice is sufficiently amplified as it is rendered by the machine, so that a number of persons can hear it at one time in a classroom or other place. The volume may also be diminished to suit a smaller area.



Speech Repeater in Use; Tones of the Voice Are Recorded and Amplified for Study of Defects

Section of volcanology.

3593

Los Angeles, Calif.

*Telegraphone - American
Telegraphone Co.*

Springfield, Mass.

3469 *Conrad John Anson Davis*

POPULAR MECHANICS

205 *Union League Bldg*

LIMITLESS-SPEED HIGHWAY IS BUILT FOR SAFETY

Los Angeles Calif

What is claimed to be the fastest public highway in the world for motor vehicles has been developed in the vicinity of Milan, Italy, with such success during recent months that plans have been projected that call for the ultimate addition of many hundreds of miles of such highway. These are known as "autostrade." Believing that speed in itself is no serious hazard in modern motor-car travel, because of the high degree of mechanical reliability of these vehicles, the Italian highway builders have created roads leading to four divergent points, near Milan, on which



strade. All cars are checked on entering and leaving these highways. The control gates are in charge of watchmen who exact a moderate toll from users, note the number and name of the car and, of course, are in a position to exclude any drivers who may be, for some reason, incompetent. Because fast traffic is an impossibility through towns and villages, these new roads have been laid out to avoid all intermediate centers of population. In the year just passed, the average daily traffic on the thoroughfares amounted to about 2,000 cars, and the next extensions of the system that

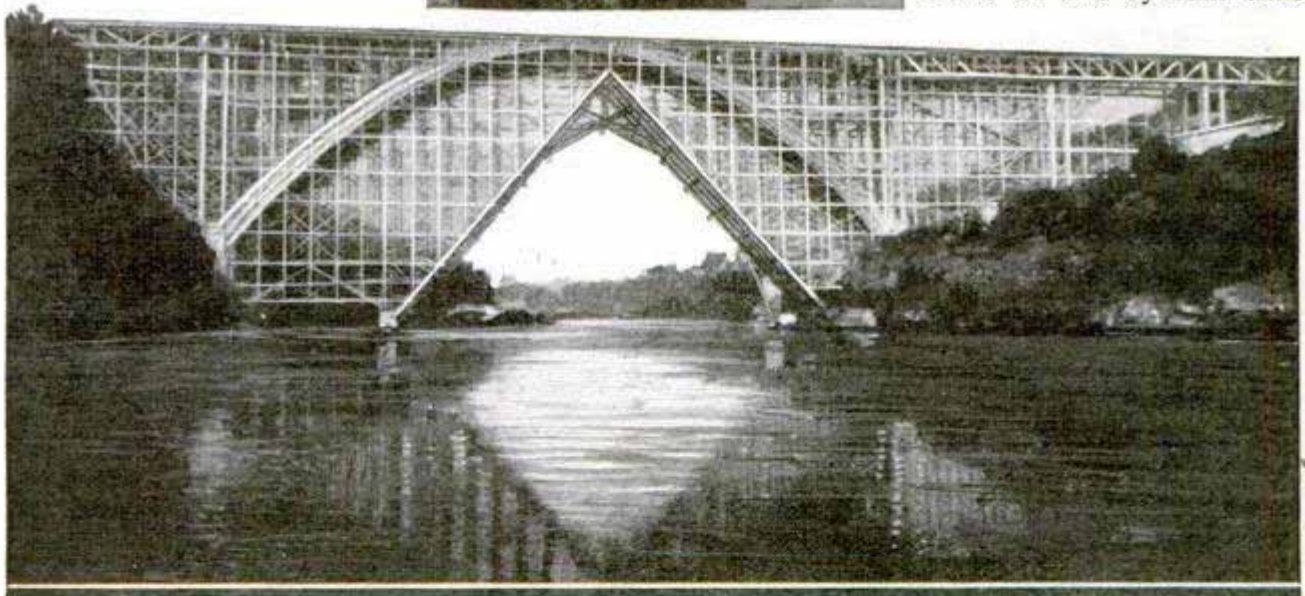

One of the Concrete Bridges on the Bergamo Branch of the "Autostrada," and a Futuristic "Billboard" Figure; It Attracts Attention Even When Motorists Drive at High Speed

there are no speed restrictions. On these broad, smooth thoroughfares, motor cars travel from fifty to eighty miles an hour and the records show an almost negligible accident factor. The engineers have reduced the number of curves to a minimum and eliminated all grade crossings. Furthermore, the road is well protected by fences which shut out possible intruders. There are no abrupt grades in the auto-

are now contemplated will be similar roads to Brescia and Venice.

CIGARET LIGHTS ITSELF

3592

Self-lighting cigarettes have been introduced by an English dealer. A tiny disk, containing paper and an igniting material, is attached to their tips. Strike them against the packet and they are lighted.

Herald Examiner

10/27/27

John W. Leake, Ventura City, Calif. cannot be found.

U.S. me

**CLOCKWORK IN SAFETY RAZOR
 MOVES BLADE SIDEWAYS**

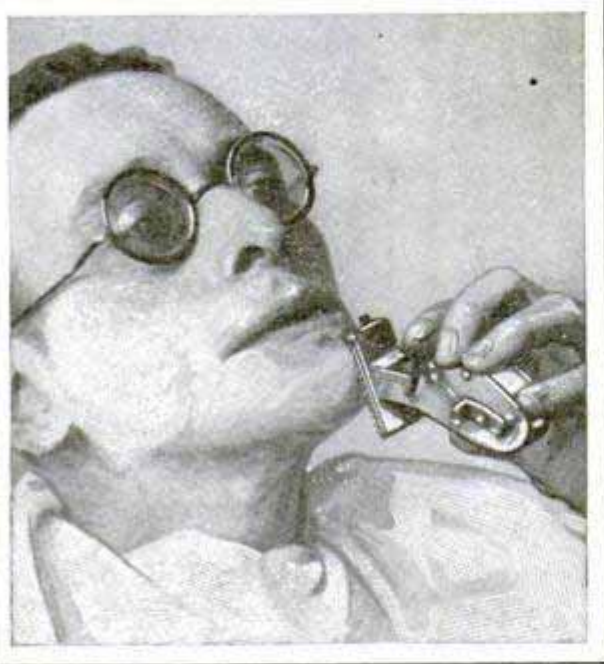

Operating the Clockwork Razor in Which the Blade Moves Rapidly from Side to Side

Shaving with a safety razor recently introduced in England is somewhat like running a mower, for the blade oscillates from side to side instead of remaining stationary with respect to the holder. This is accomplished by a clockwork mechanism in the handle. The razor is said to be especially adapted to stubborn beards.

**AIRPLANE TO FLY STRAIGHT UP
 THIRD OF A MILE A MINUTE**

Realization of one of the fondest dreams of aviation is anticipated in a plane that, it is hoped, will be able to rise vertically at the rate of 1,900 feet a minute, make perpendicular descents in safety with the motors dead and thus permit landings in restricted areas. The ship is not a helicopter, engineers report, but is classed as a vertically rising airplane. So far, its possibilities have been judged wholly on the basis of wind-tunnel tests with a model of the plane. So convincing have these demonstrations proved, however, that a large aircraft company is reported to have voted \$75,000 for the construction of a full-sized ship from the model plans. The small unit employed in the tests had four wings, but it is expected that the big ship will have only three. They are to be in a horizontal plane and will rotate at a speed

of 120 to 135 revolutions per minute. Each of the wings will have a thirty or thirty-five horsepower motor to turn it and will be mounted on a vertical shaft above the fuselage. There will be no propeller in front, the forward motion of the plane being attained simply by tipping it forward. This gives the wings a new angle, and since they are set for climbing, their revolutions will tend to send the plane ahead. Comparatively slow speeds will be made, from fifty to seventy miles an hour being all that is promised. As the ship comes down, the wings revolve, even if the motors are dead, creating a breaking drag against the force of gravity. This feature is expected to prove of great aid in forced landings, through fogs, for instance, or in alighting in confined spaces such as the tops of buildings or ship decks.

**LIGHT SHINES AROUND CURVES
 FOR SAFER AUTO DRIVING**

Hazards of driving the automobile at night are reduced by a special headlight so adjusted that a wide beam is projected to both sides of the road, without glare to approaching cars and with better illumination of the highway on curves. The lamp plainly shows the road before the driver turns. It is not intended to take the place of the regular spot or headlights, but for special service on winding roads.



Front and Rear Views of the Car Equipped with the Broad-Beam Light; Above, Illumination on Curves

Curtiss Aeroplane & Motor Co., Garden City, N.Y.

3483

3599

3292

see leafy folders in data

Chicago
 28th St.
 65 E. 28th St.
 S. Michigan
 Automobile Supply Co., Inc.
 1609 S. Michigan
 2 Spring Corp.

Inventor, M. B. Bleecker,
 24 W. Archard St.

W. Lamp Co.,
 118 W. 86th

3468

Cont. U. S. A. *Tractors*
812 E. Salmon. Portland, Oregon.

(no reply to letter.)

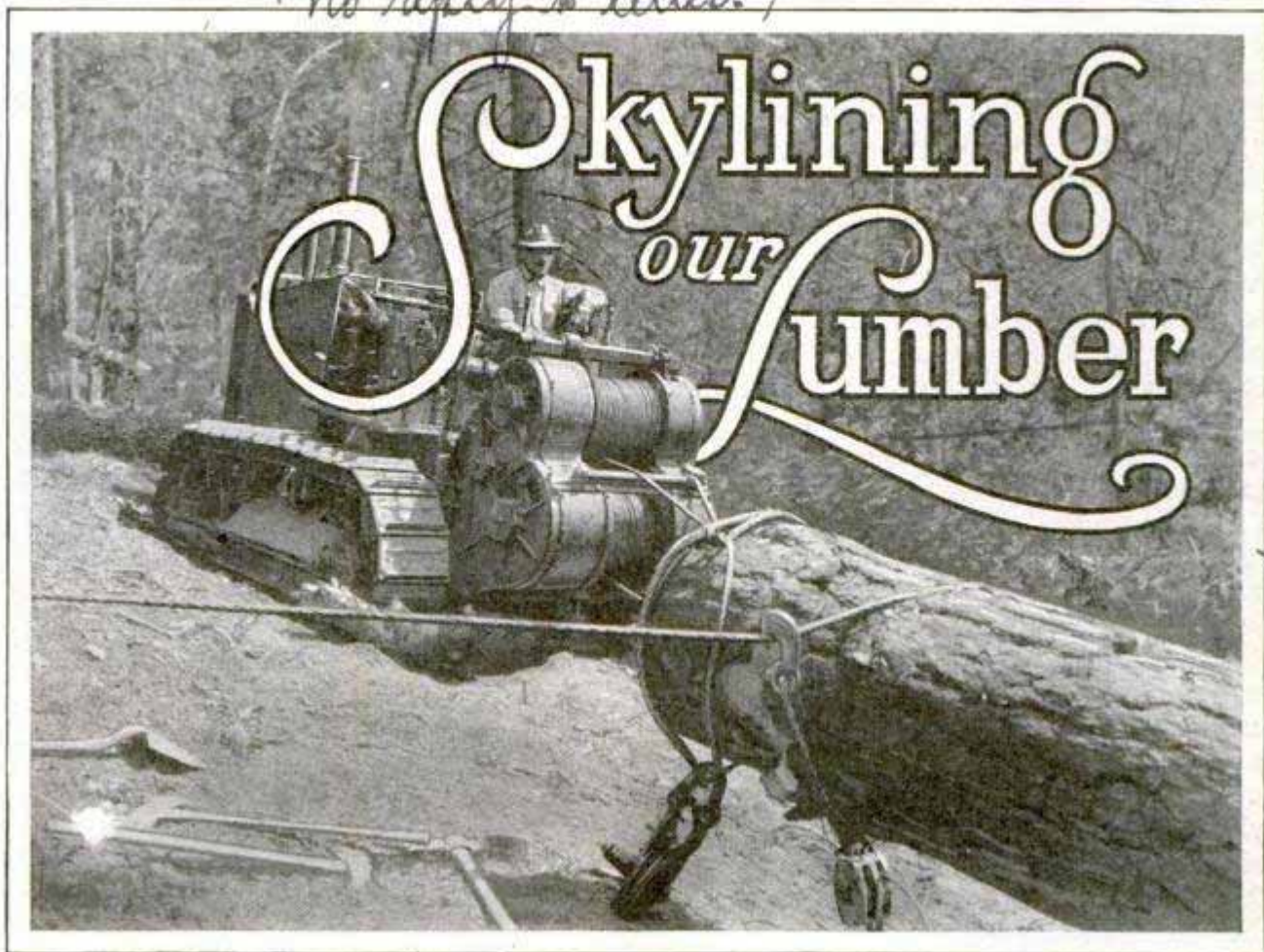

no data on machinery.

Tractors Equipped with Winches and Steel Cable Handle Enormous Logs Which Would Have Taxed the Strength of Many Teams and an Entire Crew of Men a Few Years Ago

THE last of the great industries to abandon man power has been converted to machinery. Oil and gasoline engines, electric motors and the law of gravity, applied to the forests, have brought out more logs this year than men ever moved before, made of lumbering an organized industry, and left undamaged thousands of square miles of new-growth timber to replace that which men and mules and oxen had trampled into the slopes of our mountains.

An endless-tread tractor, tanklike, but equipped for peace instead of war, rolls into the forest, three men riding it. In the midst of the grove, the great machine halts, a portable saw is unloaded and placed against a towering pine, three feet thick at the base. Power is applied from the engines. In fifteen minutes the tree lies on its side. Again the saw is moved along the log, taking off the branches one at a time. Block and tackle, with a running pulley, is attached to the upper end. A pit is dug at the base. The tractor backs away, picking up the slack in a steel cable running from the top of the fallen trunk

to a winch on the front of the machine. The tree rises again, is guyed into place, and becomes what is known among the lumberjacks as a "spar tree."

From its top, or from the top of another high tree, a gang of men, with the aid of the tractor's winches, runs a steel cable to another tree, probably half a mile away down the hill. For a radius of 500 feet around the spar tree, the tractor and its portable saw cuts trees, as a man with a mower might cut wheat. As fast as one falls, it is trimmed and shot down the hill. With two tractors and six men, one California lumber company has cut and delivered, to the pond at the mill, 40,000 feet of lumber a day. Approximately thirty men with four or five ox or mule teams would have been required under the old man-power system, to get out that much timber in two days—instead of one.

When the logs arrive at the base of the mountain—for most of our forests are now on lofty mountainsides—it may be that the mill is still miles away. If there is a large stream, the logs are rolled into

Caterpillar Tractor Co
San Francisco Calif

3468
12

it and floated down. But here, machinery has eliminated not only labor, but danger. If the logs jam, a cable from the tractor is thrown around the key log, and with sixty horsepower straining at the steel line, that particular timber is jerked out, and the jam freed. No longer do men with canthooks risk their lives amid the tumbling logs, and dynamite is no more needed to free the crossed timbers in the stream. If logs run wild, as they do in high water, sliding over the dam at the mill, the modern lumberjack, turned into an imitation cowboy, "ropes" them as they whirl in the stream, and the tractor does the rest, pulling them gently to the bank and snaking them back up to the mill.

Where there is no stream at the bottom of the aerial railway, several new mechanical means of getting the logs to the mill have been put into use this year. If a large area is to be logged, a single-track railroad is laid without much grading, and over it comes a train of great flat cars, pulled by what seems to be an interurban express car. As a matter of fact, it contains a Diesel engine, direct-connected to a generator, providing current for electric motors on the wheels. This is an entirely new factor in logging, which has been tried during the past year with great success. But, if a track cannot be laid to the base of the mountain, the tractor is called in again, and, by several methods, the logs are taken to the mill. First, there is the "bummer," a four-wheeled dolly, of which two are towed behind the tractor, a third of the log being raised up, also by tractor power, and rested on the bummer, while the remainder trails behind. Then there is the old and simple method of "snaking" the logs out, by means of chains attached to the tractor, as many as six or seven logs being handled in this manner in tandem by two men and tractor.



With the "Spar Tree" Set Up and Rigged, the Tractor Is Able to Handle All the Logs for 500 Feet Around, and Later Skyline Them to the Road or Railway

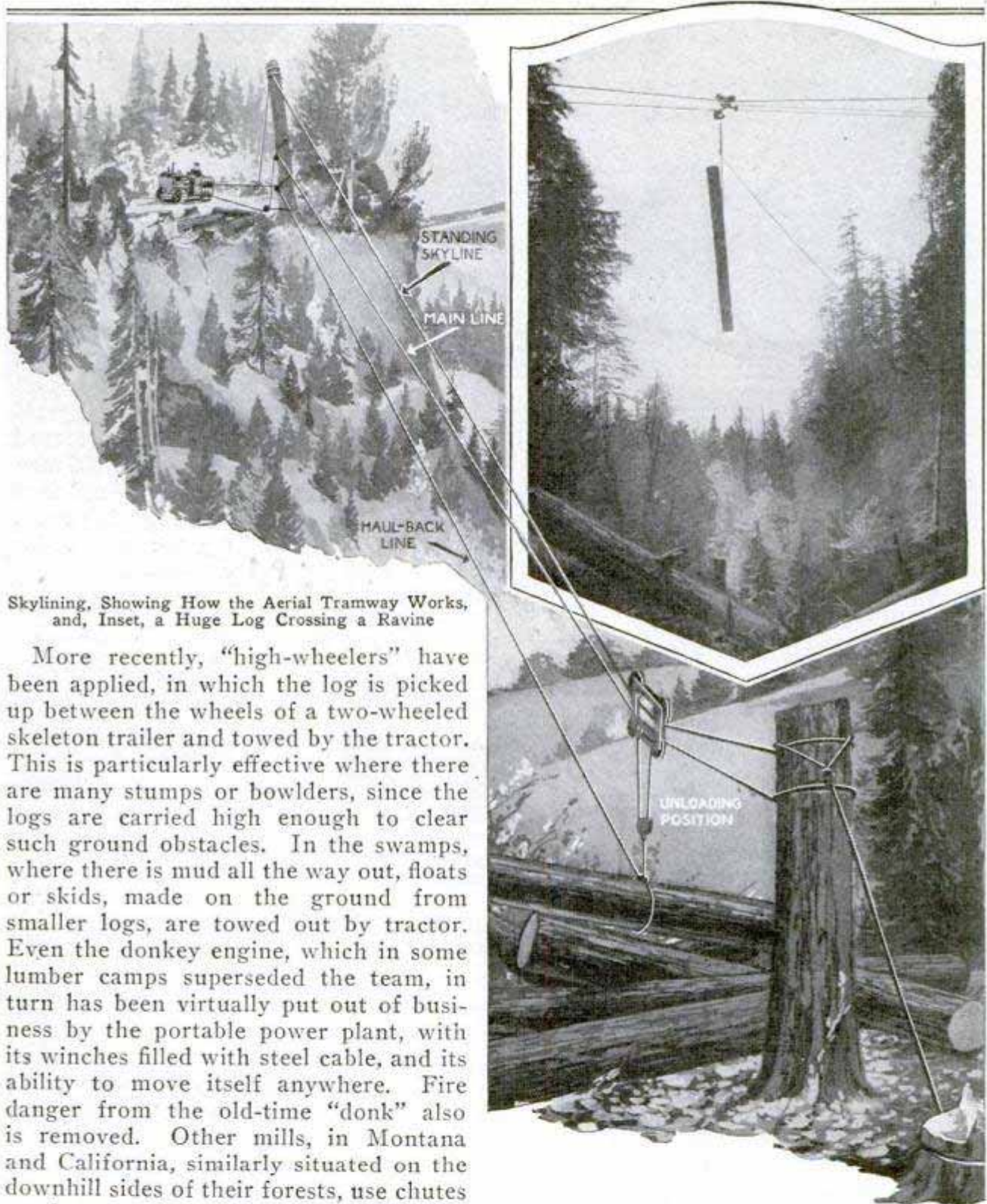

Skylining, Showing How the Aerial Tramway Works, and, Inset, a Huge Log Crossing a Ravine

More recently, "high-wheelers" have been applied, in which the log is picked up between the wheels of a two-wheeled skeleton trailer and towed by the tractor. This is particularly effective where there are many stumps or boulders, since the logs are carried high enough to clear such ground obstacles. In the swamps, where there is mud all the way out, floats or skids, made on the ground from smaller logs, are towed out by tractor. Even the donkey engine, which in some lumber camps superseded the team, in turn has been virtually put out of business by the portable power plant, with its winches filled with steel cable, and its ability to move itself anywhere. Fire danger from the old-time "donk" also is removed. Other mills, in Montana and California, similarly situated on the downhill sides of their forests, use chutes or flumes. Running sixty miles from mountain mill to railroad, in California is the longest lumber flume in the world. It handles cut timbers by a stream of water, the lumber being halted at any loading station by ropes and snubbing posts.

One large lumber company has now in process of construction, at a cost of \$250,000, an incline railroad down one side of a deep gorge and up the other, to be operated by electricity. This installation

will make available approximately half a billion feet of lumber, sufficient to occupy this mill for the next eighteen years. The distance is about ten miles. One 200,000-pound electric hoist will drop the lumber-laden cars into the canyon, where another similar hoist will lift them out. The cars will slide down and climb out at a virtually uniform speed of 600 feet a minute.

Lumbermen agree that profit in their in-

3468
14

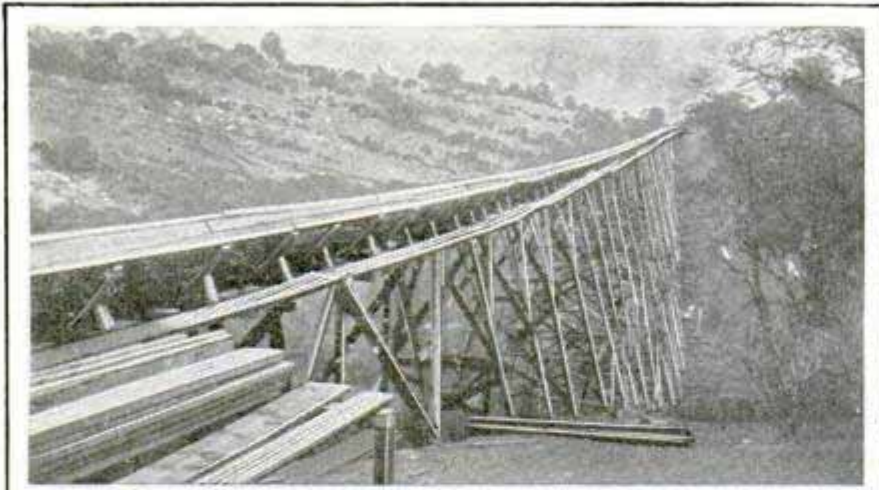

Two Views of a Sixty-Mile Flume, Built at a Cost of \$3,000 a Mile, to Carry Lumber from a California Sawmill to the Railroad

logs back by ordinary methods, since the stream was too swift for navigation. There was danger of damage to the irrigation dam, and for this reason the time-worn use of dynamite to break the jam was impossible. A tractor, with winch and steel cable, was called in, the logs snaked out one at a time, and then picked up by high-wheelers and carried back to the mill at comparatively small cost. Three men rescued all the logs, a job 100 men working under old-time methods of logging could not have accomplished.

2805

TONGS TO REMOVE CLINKERS SAVE COAL AND DIRT

Clinkers are easily removed from the furnace, without useless shaking of the grates and breaking up of the fire, with a special pair of tongs now on the market. Sharp prongs and a powerful

gripper, operated by a lever, afford a convenient and efficient tool for getting hold of the most stubborn piece.

dustry depends on three factors: first, getting the fallen tree to the mill at the lowest possible cost; second, with speed that will increase volume, and, third, with least possible damage to standing growth and young timber. The first two have been supplied by the new mechanical devices. The third is being materially helped by the elimination of large numbers of men working in gangs, the removal of long teams of mules or oxen, and the complete stoppage of sparks and other fire hazards by the use of oil and gasoline engines and electric motors.

But these mechanical devices have not taken all the adventure out of the life of the lumberjack. Half a million feet of logs recently escaped from a main boom at Merced Falls, Calif., during a sudden rise in the river and jammed against an irrigation dam three miles down the stream. There was no way to get these



Gripping Tongs That Clutch the Stubborn Clinker, to Effect Its Removal without Shaking the Grates

*Homer Furnace Co.,
Coldwater, Mich*

MACHINE SOLVES PROBLEMS TOO DEEP FOR BRAIN

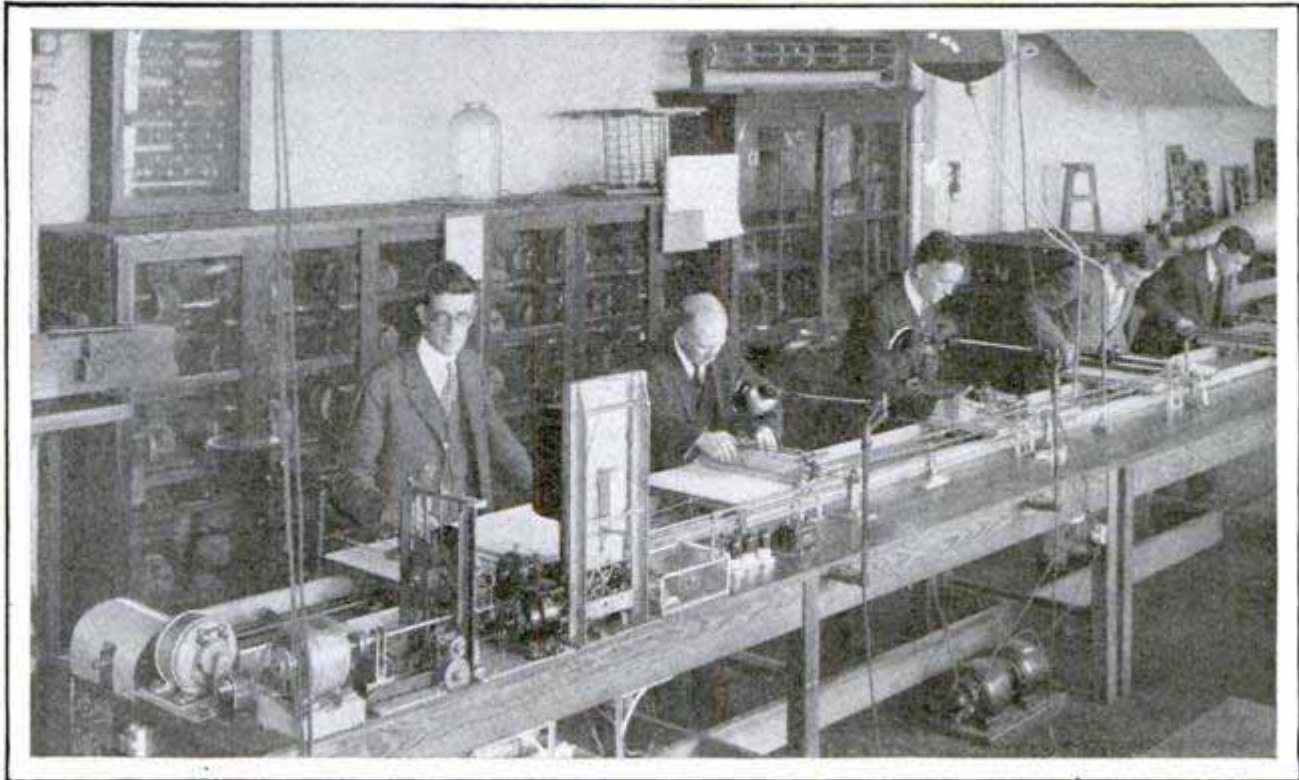

Where Answers to Profound Problems Are Ground Out by Machinery; the Electric "Brain" in Operation; It Is Described as an "Adding Machine Carried to an Extreme Design"

Answers to mathematical problems, too complex for the human brain to master, are ground out with ease on an electrical instrument devised by eastern engineers. Given the conditions of the problem, it writes out the answer as efficiently as another machine takes in lumber and chemicals and produces finished boxes of matches, the authorities report. It is called the "Product Integraph." Dr. Vannevar Bush, of the Massachusetts Institute of Technology, one of its makers, says that it might be classed "as an adding machine carried to an extreme design. Where workers in the business world are ordinarily satisfied with addition, subtraction, multiplication and division of numbers, the engineer deals with curves and graphs which represent for him the past, present

and future of the things in which he deals." The machine works especially in this field of graphs and curves. It is virtually a man-made brain which transcends human reasoning and readily plots the answer to some classes of problems that cannot now be solved by formal mathematics.

ARTIST WHO MODELS IN GLASS
PRODUCES NOVEL EFFECTS

3416



Interpreting Nature in Glass; at the Right Is a Tiny Tree of Delicate Design

Choosing glass as a medium of expression, an eastern artist has produced a wide variety of creations rivaling those of the foreign glass blowers and showing new possibilities in the material as a decorative substance. Tiny fir trees with the delicate needles reproduced in glass are among the objects which he has made

Ladislav Medgyes,
New York City

Tokyo, Japan

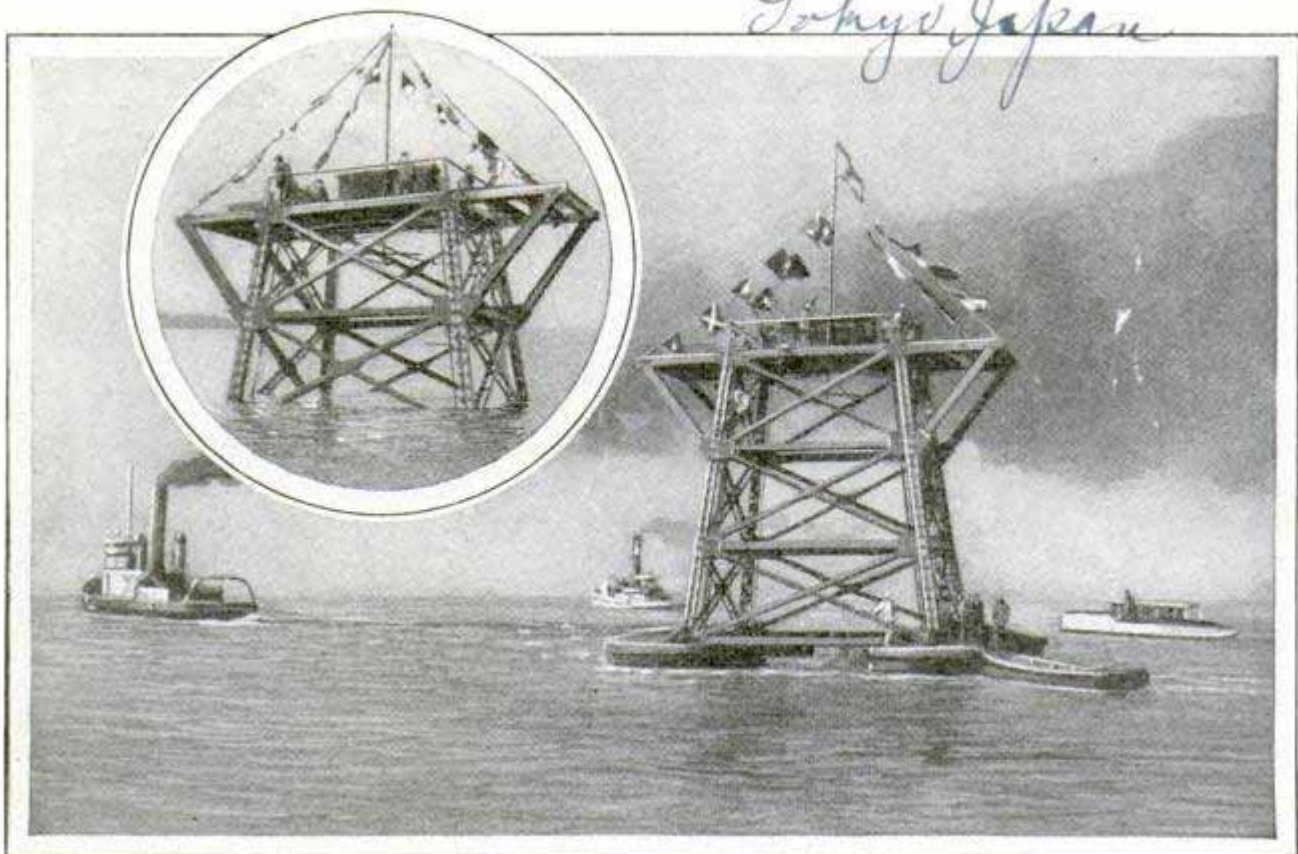

Preparing to Lower the Caissons for the Submarine Tunnel That Will Link Japanese Cities; the Passage Will Be Ten Miles Long and Will Supplement Ferry Service

TEN-MILE TUNNEL UNDER SEA TO LINK JAPANESE ISLANDS

An engineering task, rivaling anything of its kind in the world, is under way in Japan, where builders are at work on a ten-mile tunnel that will connect the cities of Moji and Shimonoseki, now linked by ferries and boats that ply between the islands. In places, the water line of the tunnel will be eighty feet below the sea bed, and difficulties, such as soft strata and other obstacles, are being encountered.

ENGINE BURNS OIL AND WATER FOR CHEAPER POWER

Oil, water and air are mixed and burned to run an engine developed by a western inventor for the cheaper production of electric power and for many other purposes. An essential unit of the apparatus is said to be a springless mushroom valve that works successfully under the 5,000 pounds' pressure required to prepare the proper emulsion for combustion. The mixture is also suitable for fuel in home-heating plants. The engine employed by the inventor to demonstrate the performance of the fuel was a one-cylinder, ten-

horsepower unit of an old model. A low grade of oil, air and water were pumped in and compressed to 5,000 pounds in a small steel cylinder. The engine was first started with gasoline and the mixture cut in later. The exhaust from the emulsified fuel was free of carbon and noxious fumes, and was cool, according to reports.

BASKET BALL WITHOUT LACING TO IMPROVE GAME



Absence of lacing, and a side valve for inflating it, are features of a basket ball introduced this season. The bladder is attached inside and air introduced through a valve screwed into an opening in the cover. When the valve is removed for playing, a little rubber flap closes the hole. The slit through which the bladder is put in, is sewed up, making a smooth surface, and the stitches do not have to be undone except to remove the bladder and put in a new one.

The Kwannon

A. L. Spalding & Brother, 211 S. State, Chicago

3600

202

Information - write C. B. Baldwin, Richmond, Calif.

10/12/27 08-9

AERIAL MAPS CUT CITY TAXES

3562

Using aerial maps to locate tax dodgers has proved successful in five Connecticut towns, according to the department of commerce. In Middletown, the first to have an aerial photographic survey made, 1,896 buildings which were not on the tax lists were disclosed by the map. Seventy-nine stores located on Main street alone were in the list. As a result of the survey, which cost \$4,000, the Middletown tax list was raised from \$20,500,000 to \$31,500,000 and the tax rate reduced from thirty mills to twenty-four mills. Rocky Hill, Conn., increased its tax list from \$1,500,000 to \$4,000,000 by locating buildings which had escaped taxation, and as a result lowered the tax rate from twenty-two to eight and a quarter mills.

Doll-House Castle Which Visitors Pay to See

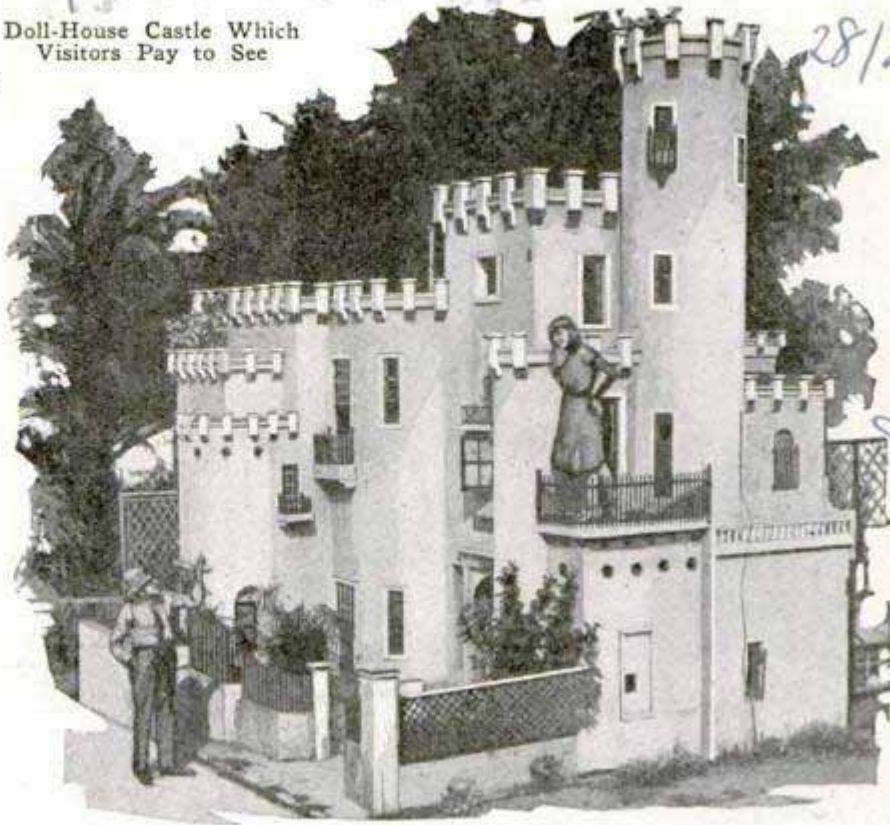

28/2

MINIATURE CASTLE DOLL HOUSE ATTRACTS CROWDS

Built in one summer as the result of a hobby for model construction, a miniature doll house in the form of a castle is proving a source of revenue for its owner, a California man. He charges admission for inspection of the curious three-story abode, and visitors gain access by stooping low under the doorways and squeezing through sidewise. The house was built after he had seen a similar model owned by a friend.

*Alexander McLean, Calif
Alhambra, Calif*

AUTO BED THAT DISAPPEARS ADDS COMFORT TO TOURS

3230

Entirely concealed when not in use, and easily extended, a folding automobile bed invented by a southern man is hidden under the rear-seat cushion, when closed, and pulls out over the front seats. It has comfortable springs and keeps the bedding shielded from dust.

*6th + 22 Rochester
Muncie, Ind*



When Not in Use, This Bed for the Auto Tourist Folds Up under the Rear-Seat Cushions

LAUNDRY USES STEEL BOXES TO COLLECT PACKAGES

3563

Steel collection boxes, resembling the large-size parcel boxes of the post office department, are used by a Nebraska laundry to collect the bundles of its patrons. The boxes are scattered through the city on private property, usually a corner occupied by a gasoline-filling station. They attract laundry customers to the filling stations, and make it convenient for them to deliver their laundry while getting gas service. The laundry-collection wagons make regular rounds, and the finished work is then delivered direct to the customers' homes.

*Druggist
John M. Sadler
A. Laugel Slobe
Lincoln, Nebr*

501 W. 12th St., Muncie, Ind.

2355

Cont. Oroya Taylor,
 90 Herald Tribune
 225 W 40th St New York

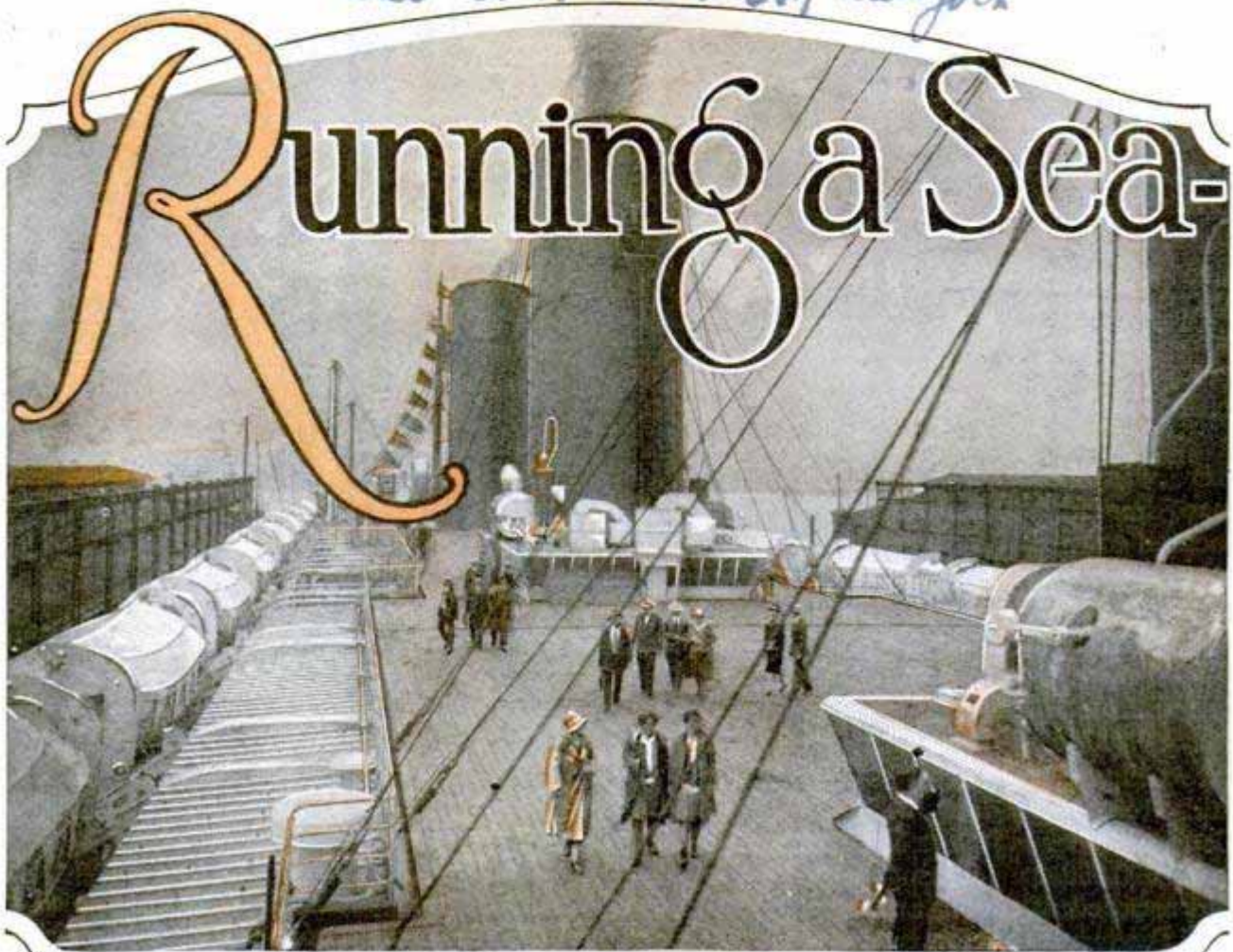

Just a Portion of the Broad Sports Field and Promenade Grounds Furnished by the Boat Deck of a Modern Liner; Here Tennis and Other Games Can Be Played at Sea

EATING your way across the Atlantic is a far different matter now from the days of clipper ships. There is no mention of salt beef or hardtack in the neat menus found in the modern steamship dining rooms.

Modern refrigeration changed the entire plan of catering on ocean liners. The passengers of these days can be served anything they desire in the way of fresh salads, eggs, milk, fruit and vegetables.

The refrigerating plants of the large ships are as big as good-sized city apartments. Each room is set aside for a particular kind of food, so that the chefs never have the unfortunate experience of the housewife who finds that her butter tastes a bit like salmon. On a ship there is at least one room for vegetables, one for butter, one for fish, one for beer and several for wine on European liners.

Catering on shipboard smacks of a science in its exactness, and like the sciences, it is careful with figures. The

stewards have estimated the number of ounces of food required for each passenger on a voyage, and they know the cost of serving meals within a quarter of a cent a meal.

The food served on the liners is bought by the purchasing departments of the companies which own them, in most cases under the supervision of former chief stewards. The ships of American registry buy a large proportion of their supplies on this side, but foreign ships buy their staples abroad and try to confine their buying in this country to fresh supplies. Despite this rule, one line, in which most of the ships are of foreign registry, bought \$2,000,000 worth of food in New York last year.

America excels so much in some foods, the stewards say, that even foreign lines buy these foods in New York for both east and west-bound passages. These foods are beef, coffee and several fruits, including grapefruit and oranges.

Going Hotel

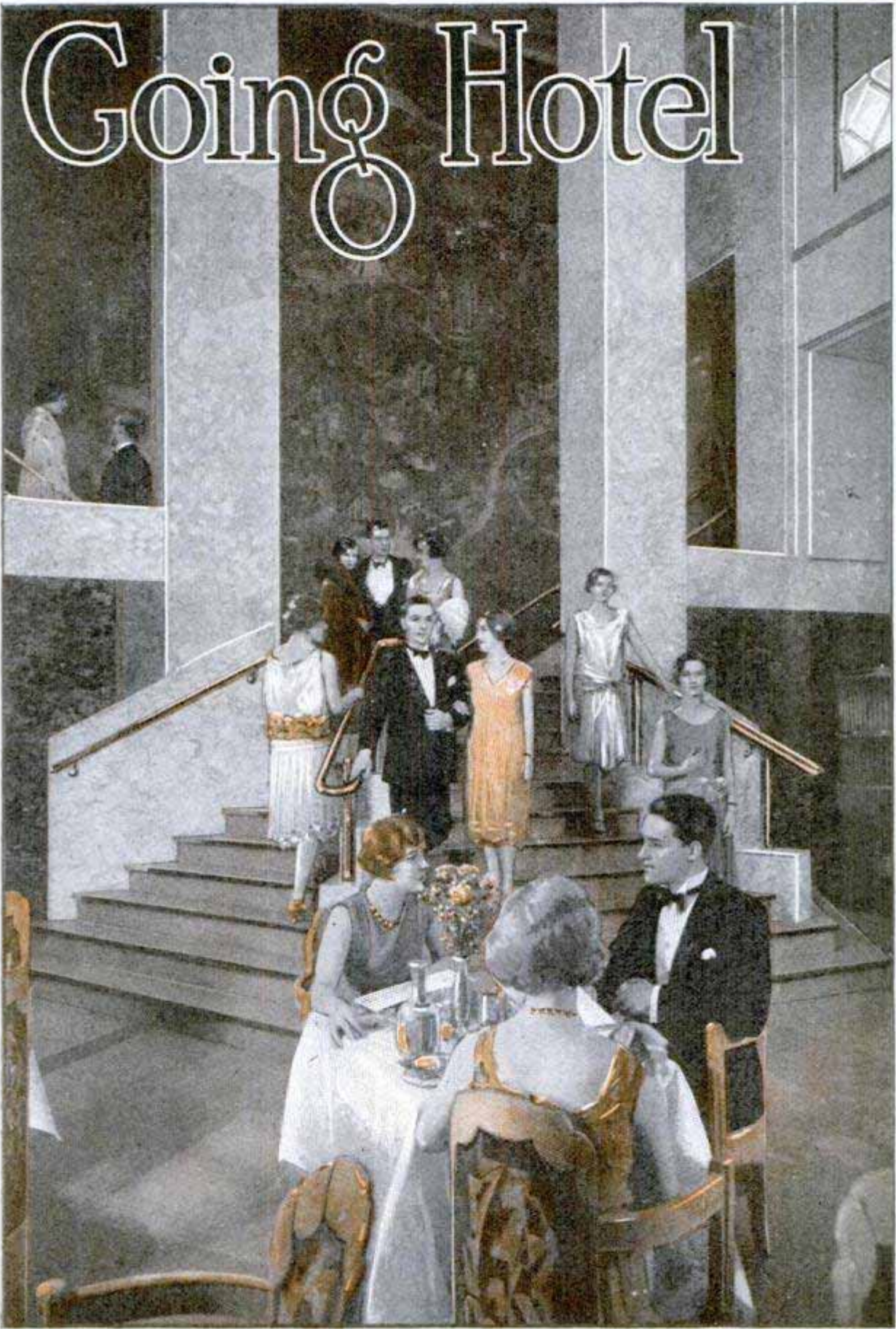

The Dream of Liner Architects and Decorators Is to Simulate a Land Hotel and Hide All Evidences of the Sea; This Main Dining Room of the "Ile de France" Achieves That End

The stewards say that the earmark of the American passenger is his insistence on grapefruit for breakfast. After the grapefruit he wants a cereal and then eggs, perhaps with bacon or ham, and toast and coffee. The Englishman is more likely to ask for a grilled bloater, ham or a rasher of bacon, a couple of fried eggs and oceans of tea. The stewards have to provide for every national taste in their international bills of fare.

Some standbys, such as roasts of beef, turkey, chicken and lamb, boiled potatoes, carrots, peas, turnips, string beans and cold meats, are on every menu. On most ships cold meats are a feature on sailing day; a table heaped with decorated cold meats is placed in the dining room. The average menu for dinner in the dining room includes soup, fish (small portions of each of these), an entree, a roast, a salad, sweets, coffee and cheese.

Most of the largest ships, for instance the "Majestic" and "Olympic," carry French restaurants. The meals in the dining room are paid for by every passenger

when he buys his ticket, but some prefer to eat in the French restaurant, which costs them an average of \$10 a day each. Those who prefer the restaurant are principally the society people on board and those who ape society's manners.

Those who eat in the dining room have breakfast between eight and ten o'clock. The lady who has her meals in the French restaurant is likely to order coffee and rolls in her room about 10 a. m. She comes to the restaurant for her first meal at 12:30 or 1 p. m. At 8 p. m. she has an elaborate dinner, remaining at the table for a couple of hours.

She will order delicacies, such as artichokes, braised chicory, salads of tender young vegetables, romaine, hearts of lettuce, snails, plover's eggs in jelly, steak Chateaubriand, which is a steak cooked between two steaks, a great variety of shellfish, pheasant and grouse.

The waiters in the dining room on English ships are English, in the restaurant, French or Italian. These waiters, or rather stewards, are paid about forty-five

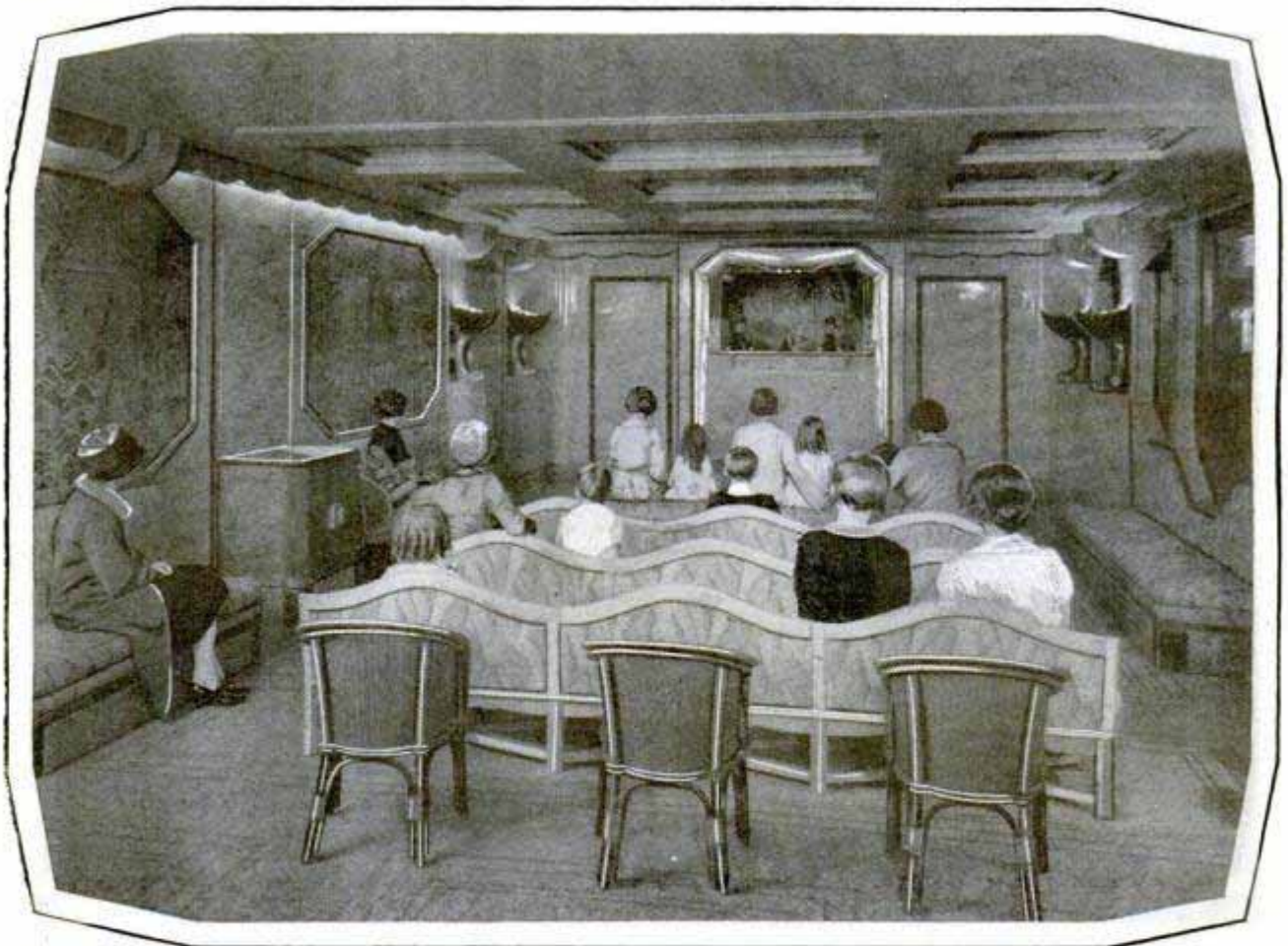

The Punch and Judy Show Has Almost Disappeared in the United States, But the French Liners Have Provided the Immortal Manikins to Entertain Children, and Grown-Ups, Too



The Play Room of a Modern Liner Even Includes a Small-Size but Electric-Driven Merry-Go-Round; Below, Church Services of Various Denominations Are Regularly Held at Sea; This Is the Altar of the Chapel on One of the New French Liners

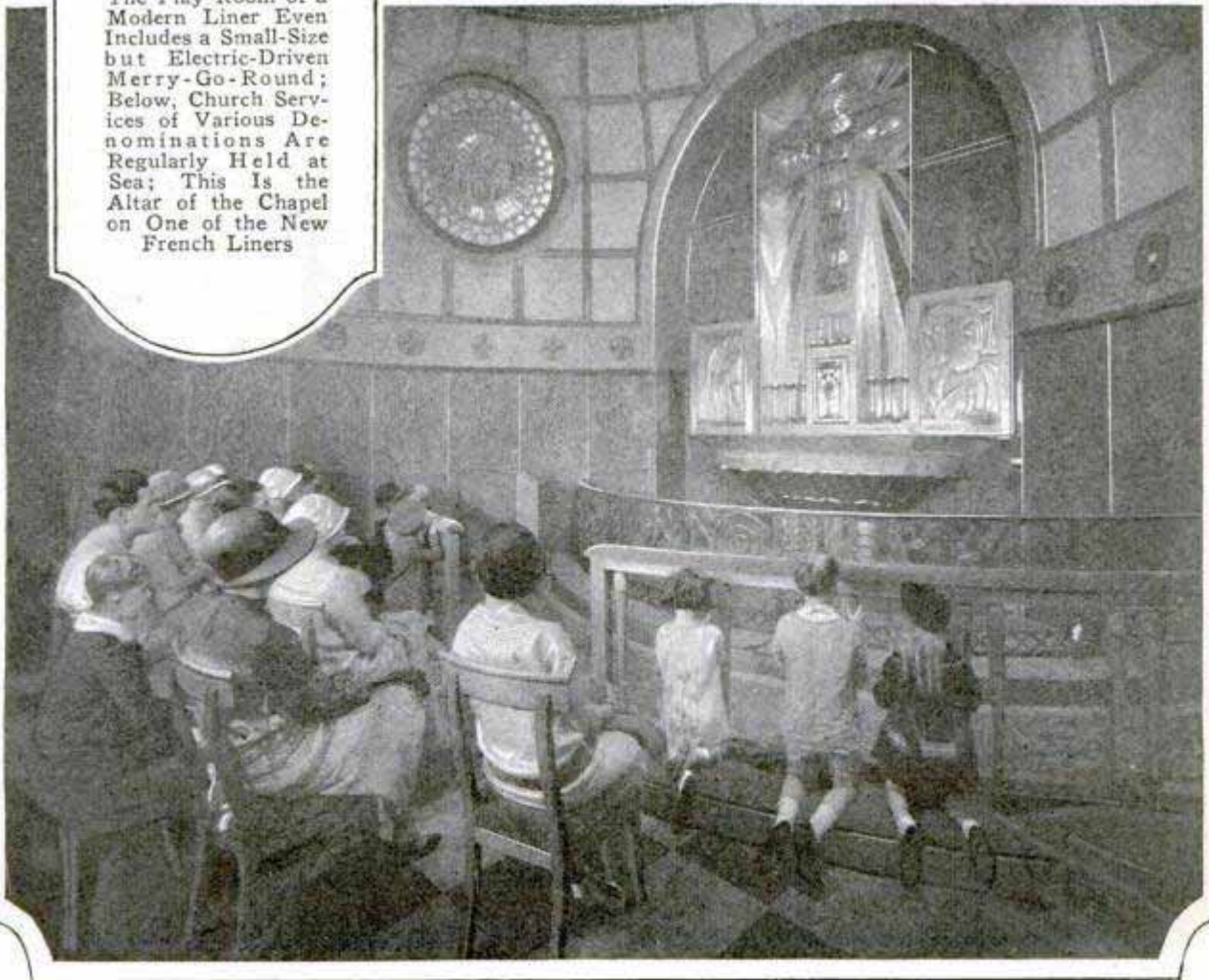

2355
22

POPULAR MECHANICS

dollars a month, in addition to their board. The normal tip for a dining-room steward is from five to ten dollars a passenger for a voyage. A steward will collect from thirty to sixty dollars a voyage in tips. He will average about one round trip a month, working three weeks and staying ashore one.

The smoking-room stewards make more in tips than the dining-room men. The chief steward of a ship is not tipped but the second steward finds nothing in tradition to keep him from taking everything that is offered. It is not unusual for a second steward to receive a tip of as much as \$100 from a wealthy passenger. The chief steward often makes more in round-about ways. He may receive advice on investments, from some financier whom he has served on many voyages, that will be worth more to him than all the tips received on a voyage by all the men who are under him.

Americans, the stewards say, have a great liking for sweets. All the ships carry pastry cooks and confectioners, compe-

tent and well-paid men. One of the most important jobs of the confectioner is to make fancy birthday cakes for passengers who have birthdays on the Atlantic.

A good chef is paid at least \$5,000 a year. The chef on the "Majestic" has under him seventy cooks, including a first, second and third meat cook, a first, second and third fish cook, etc. They cater to the tastes of passengers, who eat much more than they do on shore. The stimulation of salt air and other factors of ship life whet the appetite.

The stewards insist that few passengers miss meals because of seasickness, on the largest ships, and say that they expect and prepare for every passenger on the ship's list at every meal. On exceptionally rough voyages in the winter, however, there are many vacant chairs.

A housekeeper would be staggered by the job of caring for the kitchen and dining-room equipment on the "Majestic."

There are seventy-five tons of dishes and cooking utensils and more than three tons of silverware and cutlery.

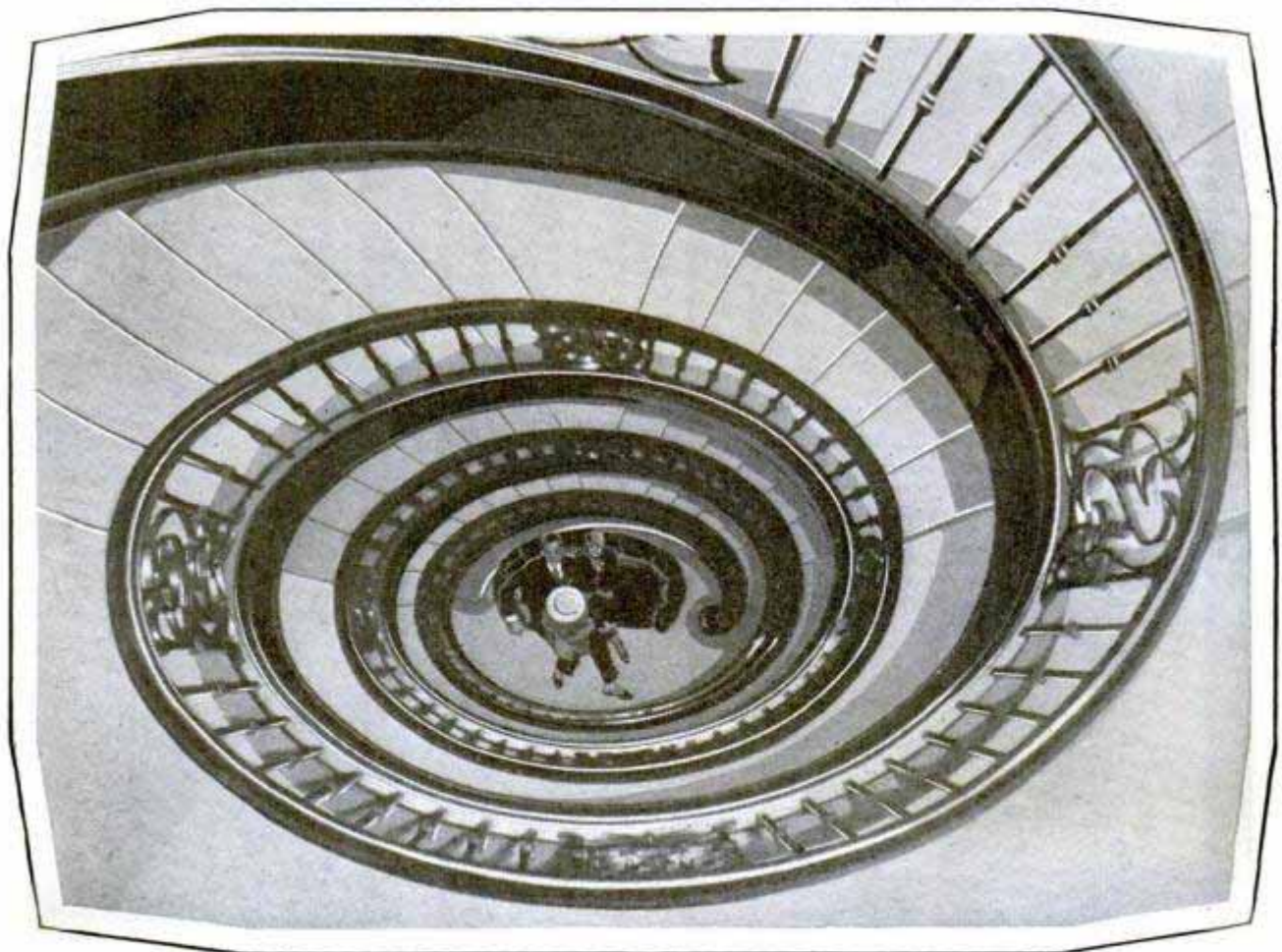

What Is It? Just a View, Looking Downward, of the Circular Stairway of a New Liner, Built to Descend Many Decks into the Depths of the Ship, and Yet Save Room

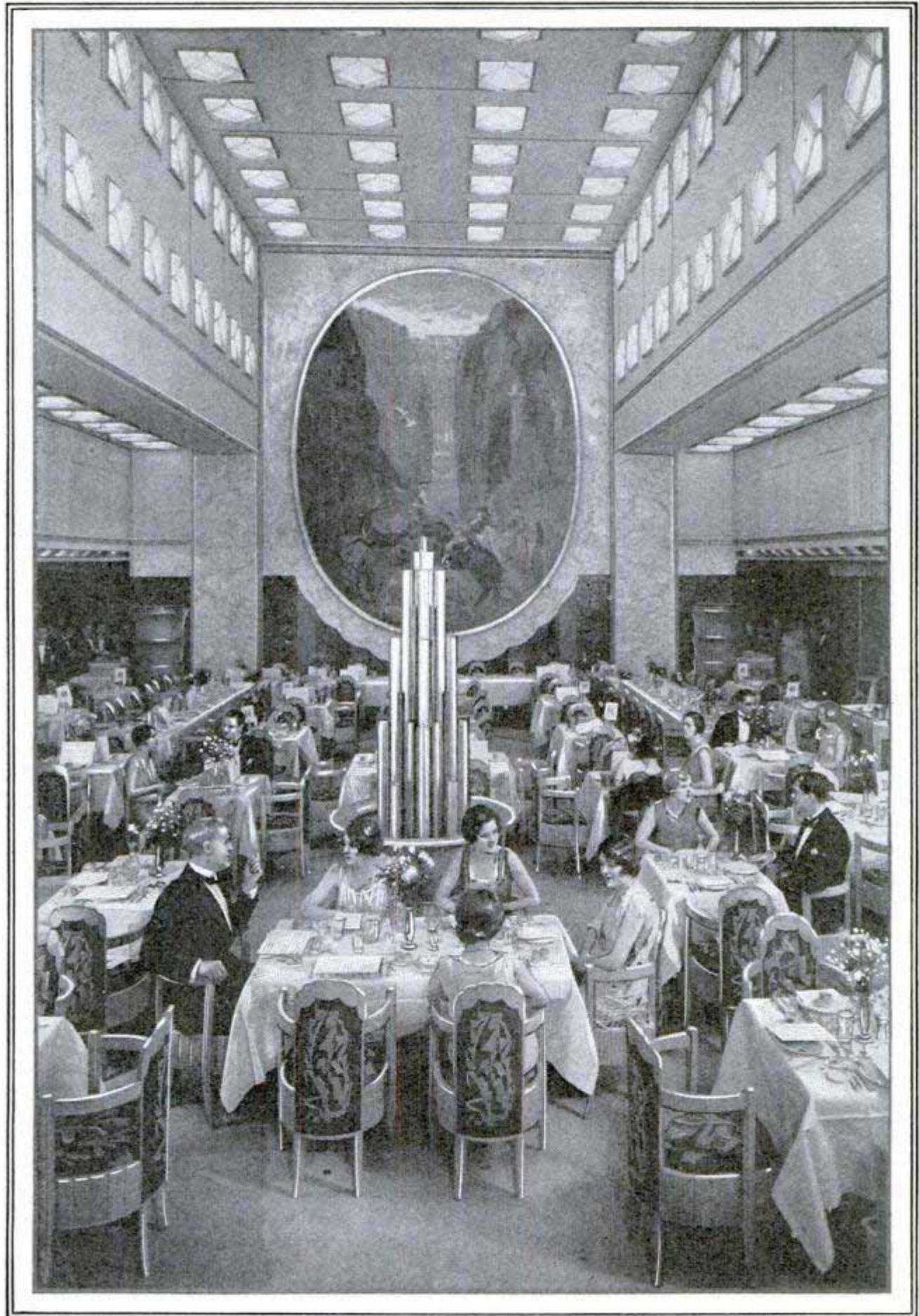

It Is Hard to Imagine, When Dining in This Luxurious Room, That One Is at Sea on the Stormy North Atlantic, for There Is No Hint of Sea in Room or Decorations

2353-24

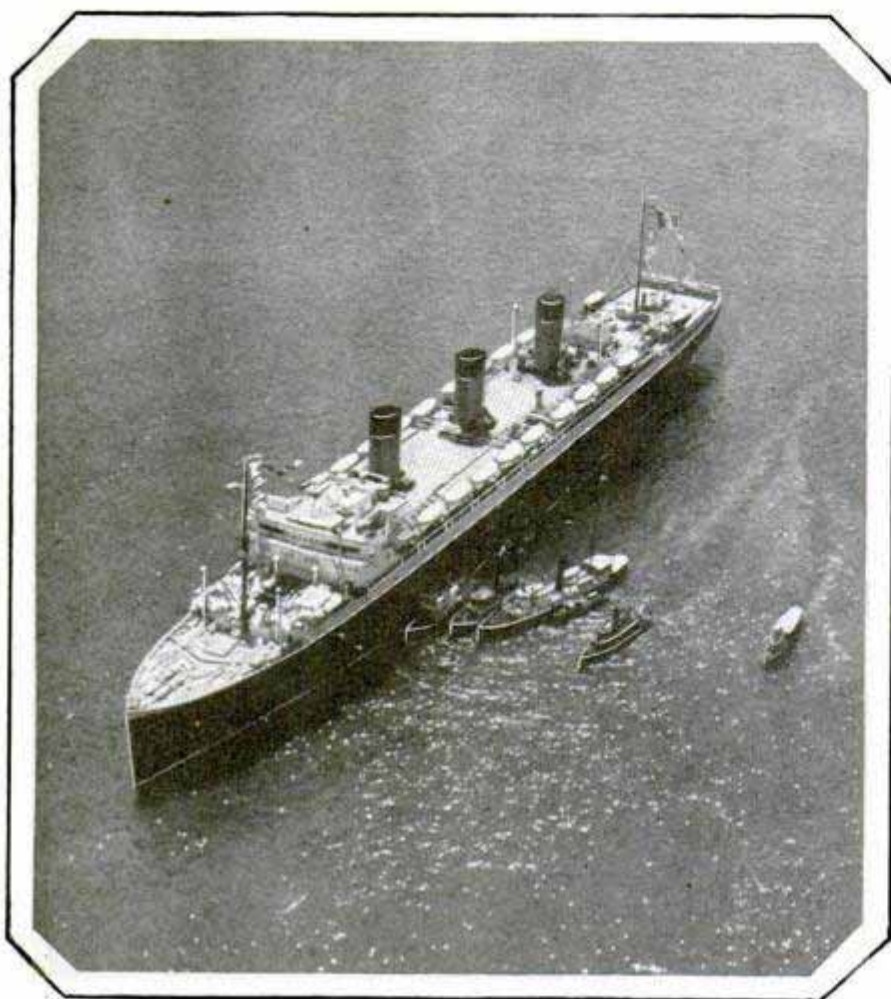

The "Ile de France" on Her Maiden Trip; Although Not So Large as Many American and English Liners, She Is One of the Most Luxurious

needed to stock the "Majestic" for a round-trip voyage over the Atlantic.

The ship can carry a total of 4,100 passengers and has a crew of about 1,000. To feed these 5,100 people for a single round trip, the ship's refrigerators are stocked with seventy-five tons of meats in addition to ten tons of ham and bacon, twenty-eight tons of fish and about eighteen tons of poultry.

The vegetables served with these meats will include thirty tons of potatoes, seven tons of carrots and turnips, ten tons of cabbage, several tons of onions and half a ton of hot-house tomatoes.

Stores for a voyage include 1,000 each of plover, quail, snipe and pheasant, 750 each of partridge and grouse and 500 wild ducks, a total of 6,000 game birds.

The steward has in his charge more than 10,000 tablecloths, 45,000 napkins and 5,000 aprons for the use of the cooks, stewards and stewardesses.

If the napkins were hung on a single line, side by side, the line would have to be seventeen miles long, and the tablecloths would occupy a line nineteen miles long.

If the ship's linen, including the bedroom linen, could be hung on a line at the rate of six pieces a minute on the basis of an eight-hour day and five-and-a-half-day week, it would take twelve weeks to complete the job.

There are 80,000 pieces of china and crockery carried by the ship, including 30,000 plates, 16,000 cups, 13,000 saucers, 10,000 cooking dishes, 2,700 pitchers and 2,400 tea and coffee pots. Glassware totals 29,000 pieces, including 8,000 tumblers, 7,000 wine and spirit glasses (one notes that water seems to be more popular than wine), 7,000 salt, pepper and mustard containers and 1,600 water bottles.

Food by the ton and by the carload is

The chef has for his menus 600 boxes of apples, 400 boxes of oranges and grapefruit, sixty boxes of pears and a ton of hot-house grapes. To prepare his desserts he has a ton of American ice cream, and has three tons of jams and marmalades.

The baker has for his ovens thirty-five tons of flour. The list of supplies includes eight tons of sugar, five tons of butter, three tons of coffee and tea, 80,000 eggs and 500 gallons of milk.

Smokers on board need not fear lacking cigarets. They are consuming a supply of 250,000 cigarets and 2,240 pounds of tobacco on a voyage, which ought to be enough for any reasonable group.

GIANT NUGGET KEPT BY BANK AS GOLD RESERVE

3375
Just
Weighing more than eighty ounces and valued at \$1,408, a gold nugget forms part of the reserve for a national bank in Baker, Oreg. It is one of the largest nuggets ever found and was mined near by.

**VOLCANO MODEL IS
FEATURE OF
EXHIBIT**

3476

Although Mt. Lassen, California's active volcano, is more than 10,000 feet high, it was graphically portrayed to visitors at an exhibition in San Francisco in a model, fifty-four feet high and with a base 300 feet long. The contours of the peak were faithfully reproduced and trees were placed about the model in such a way that, from a distance, it could hardly be distinguished from the real mountain.

3346

**COTTON RIVAL SEEN
IN ANCIENT PLANT**

Ramie plants, the fibrous stalks of which were used to clothe the Egyptian kings and to weave fabric coverings for their mummies, are being cultivated in California today. In the opinion of one grower, the crop holds great promise for the future as a source of textile material that can be used instead of cotton. An apparatus has been devised for cleaning it in large quantities and at little cost.

George Wilson
Pasadena
Calif.



Cultivating the Ramie Plants; Growers Believe That the Fibers May Be Used as Cotton Substitutes

Letter retd



The Fire-Escape Slide for Outdoor Playground Gives a Much Longer and Faster Coast

**FIRE ESCAPE AS CHILD'S SLIDE
GIVES HEALTHFUL SPORT**

One of the most popular units on an outdoor playground is an old fire-escape chute that has been converted into a slide for the children. It is securely attached to a substantial scaffold, and a flight of stairs leads to the entrance. Being higher than the average slide, it affords more thrill.

**FORTY THOUSAND GLASS EYES
USED IN U. S. YEARLY**

The United States imports 40,000 glass eyes annually, according to official reports. Many of them are works of art and so closely resemble the natural organs that they can hardly be distinguished from them. Safety experts are recommending the universal wearing of goggles by industrial workers, pointing out that hardly any occupation can be considered entirely non-hazardous with respect to the eyes.

Harry Eschert, director

3500

Decor Wiggins
138 N. 1st St. Lincoln, Neb

Emb. R.

The Bullman Co.

Q 19. 4: 103

Govt. Bulletin
Ramie (culture)
R. P. Illus.
5 cents

Digging Up the

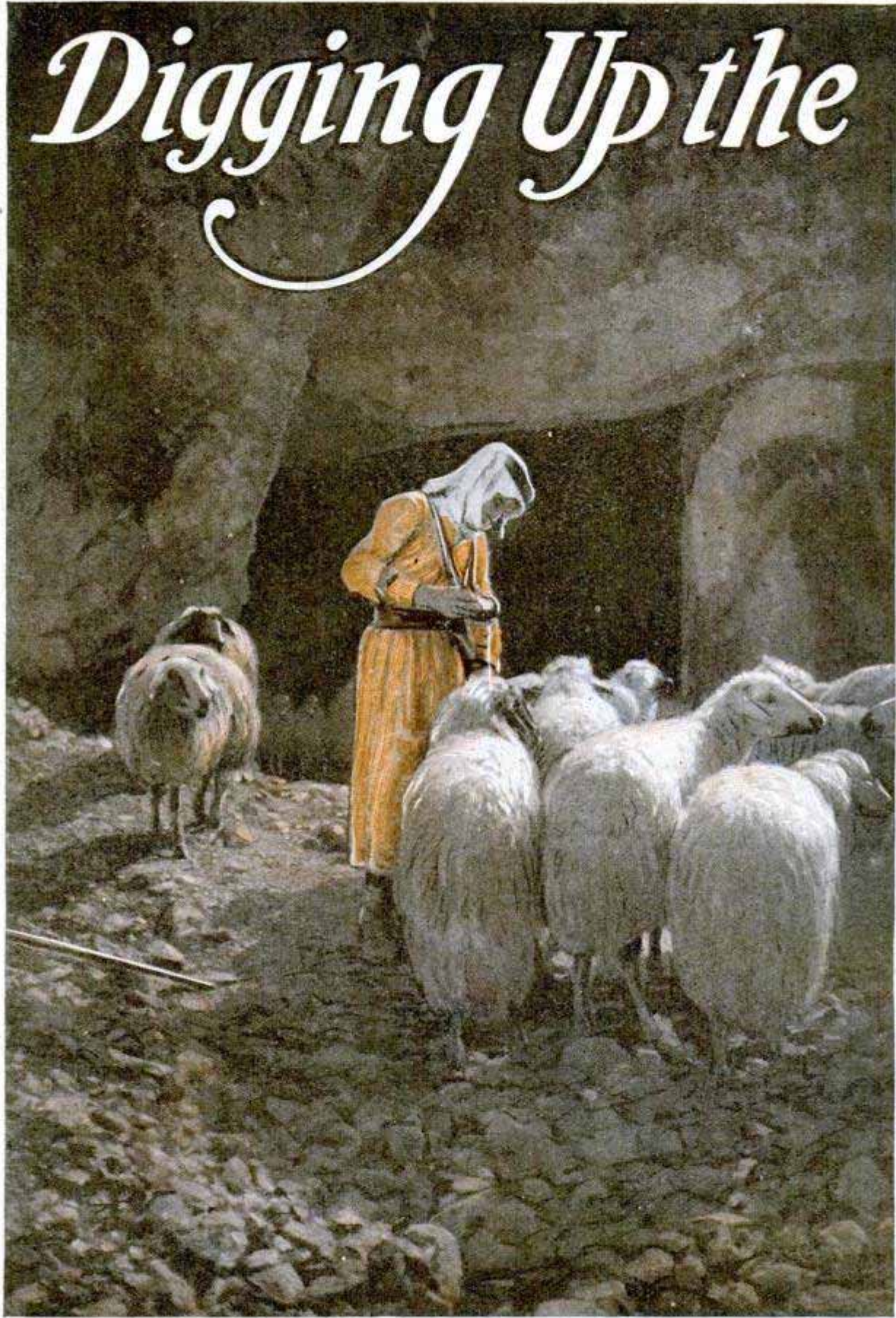

Shepherds in Flowing Robes Still Guard Their Flocks by Night in Palestine, Just as They Did More Than 1,900 Years Ago When They Saw the Star over Bethlehem

2019 P13
C...
...

Bible Lands

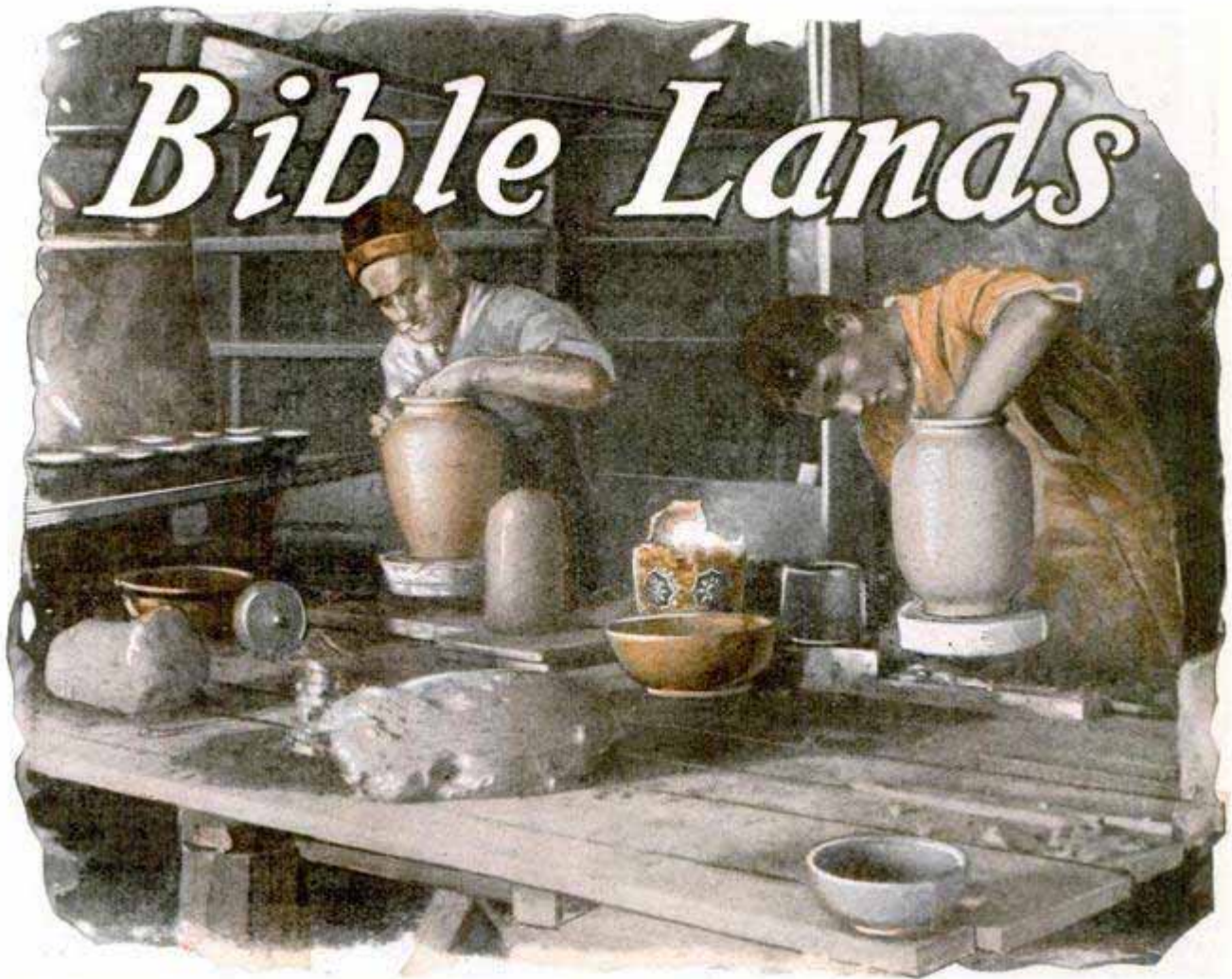

Workmen Who Are Reviving the Famous Faience Works in Jerusalem; They Shape Their Jars on the Potter's Wheel, One of the Oldest Pieces of Machinery in Existence

By HAROLD J. SHEPSTONE, F.R.G.S.,

Broomwood Road, Clapham Common, London, England.

PALESTINE is at present the scene of an intense campaign of excavation. There are no fewer than eleven different expeditions in the field, representing seven different nations, Great Britain, America, France, Italy, Denmark, Germany and Austria.

Under the Turks, excavation work in Palestine was not only costly, but the restrictions imposed were very irritating. Today, under the British, every encouragement is being given to a scientific exploration of the mounds and sites which are known to mark places of historic interest. Furthermore, valuable work is being undertaken in preserving the existing ruins. One feature of this work is the reconstruction of an ancient synagogue at Capernaum, believed to be the very one in which Christ taught.

Jerusalem itself has been the scene of much activity during the past few months.

On the site of Ophel, to the south of the present walls of the city, excavations have been made to the ancient level, and a part of the wall that inclosed the ancient Jebusite city has been discovered. It is built in the slanting manner, each course of stones being farther in than the one below it. This is the same kind of Canaanitish fortification as has been found at ancient Jericho. The Canaanitish wall continues southward, but just next to the bastion is seen a corner tower of a very different type, built of larger stones and better masonry. This is Davidic work, and, as it intervenes in the gap in the Canaanitish wall, is thought to be the "breach," which David is recorded to have built up, and may be the "Millo" which is often mentioned in the Old Testament, and which actually means a "filling up." To the east of this, there is a wall of a later period, which lies outside of the

London, England.

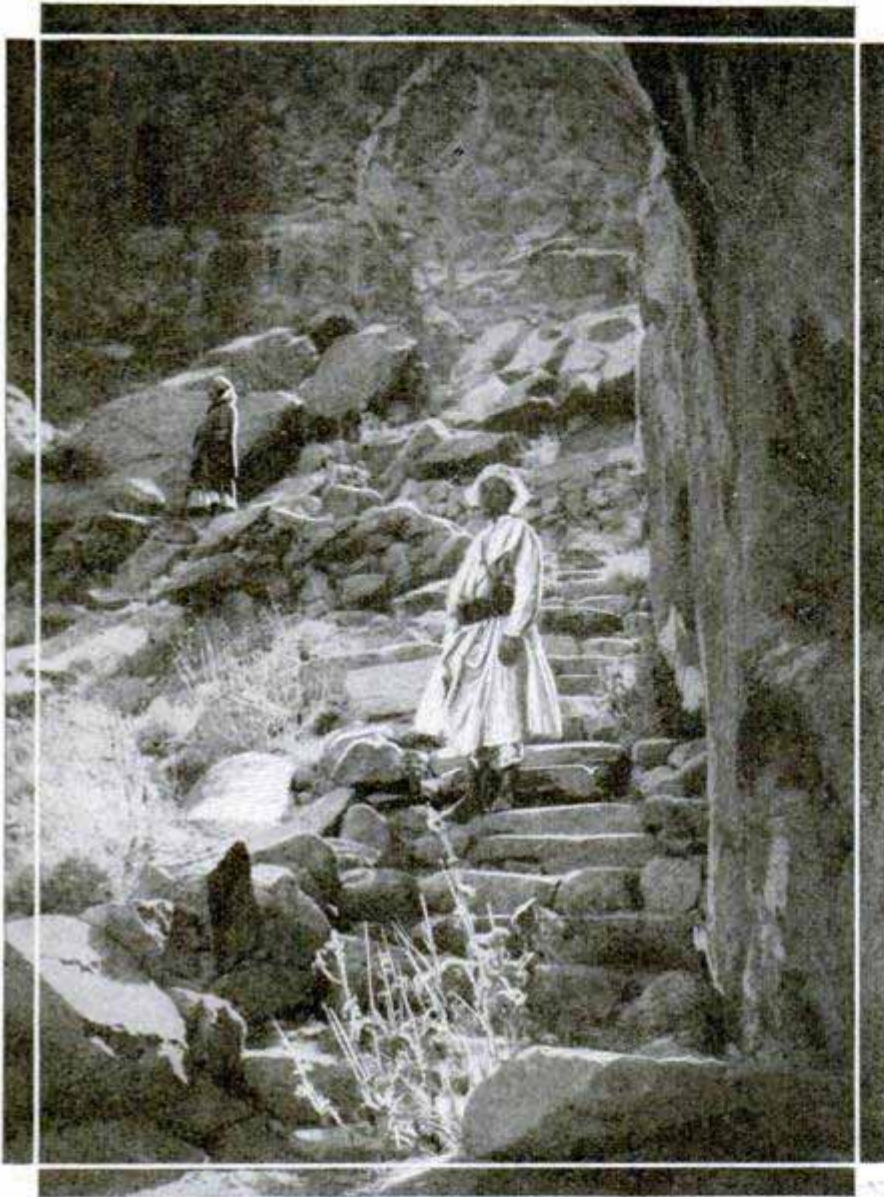

Steps That Were Carefully Matched from Natural Rock, in Biblical Time, Still Render Good Service in Palestine

Canaanitish rampart. It is virtually the finest of all and is attributed to Hezekiah. It has been suggested that it was between these two walls that Zedekiah and his men escaped when the city was besieged by Nebuchadnezzar.

Interesting also is the work which has been carried out by the Jewish Palestine exploration society in uncovering the foundations of the third, or northernmost wall of Jerusalem, built by Agrippa I, grandson of Herod. The next task will be to discover a connection between the third wall and the line of the second wall, which inclosed the city in the days of Christ. If the course of the latter wall could be ascertained, it would at once settle the vexed question as to whether the Church of the Holy Sepulcher, which marks the alleged site of the Crucifixion

and Burial, lay outside the city or not.

Mention should also be made of the recent find in Solomon's Quarries, those huge subterranean caverns close to the Damascus gate, from which it is thought Solomon obtained his stone for the erection of the Temple. Here has been found a wall which experts believe was a hiding place used by the Jews during the siege of the city by Titus in 70 A. D. There are signs of places for self-defense, as if the refugees who were hiding had fortified themselves against the besiegers.

In actual field work the American universities are taking a leading part and are carrying out valuable excavations at Kirjath Sepher and Mizpeh, as well as at Bethshan.

Ever since the discoveries in Babylon and the Hittite country of clay tablets, hopes have been entertained that in Palestine similar finds may

come to light. The site that especially attracted attention was Kirjath Sepher, for the name implies the "town of books," or library. It is referred to in Joshua in connection with the story of Caleb, one of the two spies who brought a good report of the land. But no one knew for certain where the ancient city stood. Dr. W. F. Albright, of the American school of archaeology in Jerusalem, was successful in locating it some fifteen miles to the southwest of Hebron.

Here he has been toiling with most interesting results. He has laid bare a portion of the old city wall and two well-preserved gates, practically the first of the early Israelitic period yet found in Palestine. The sloping walls, which varied from ten to twelve feet thick, and probably towered thirty feet in height, not only date

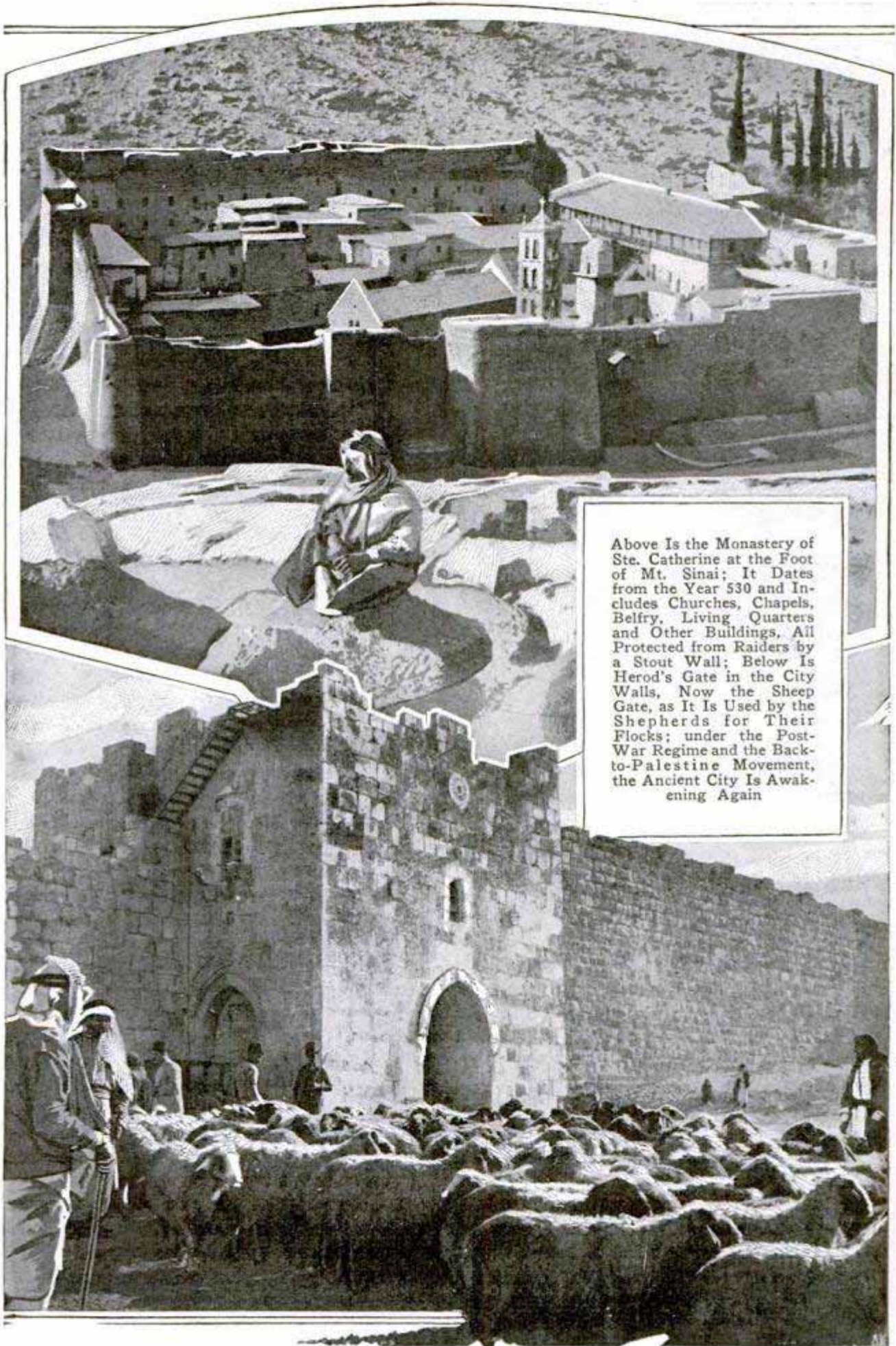

3384
50

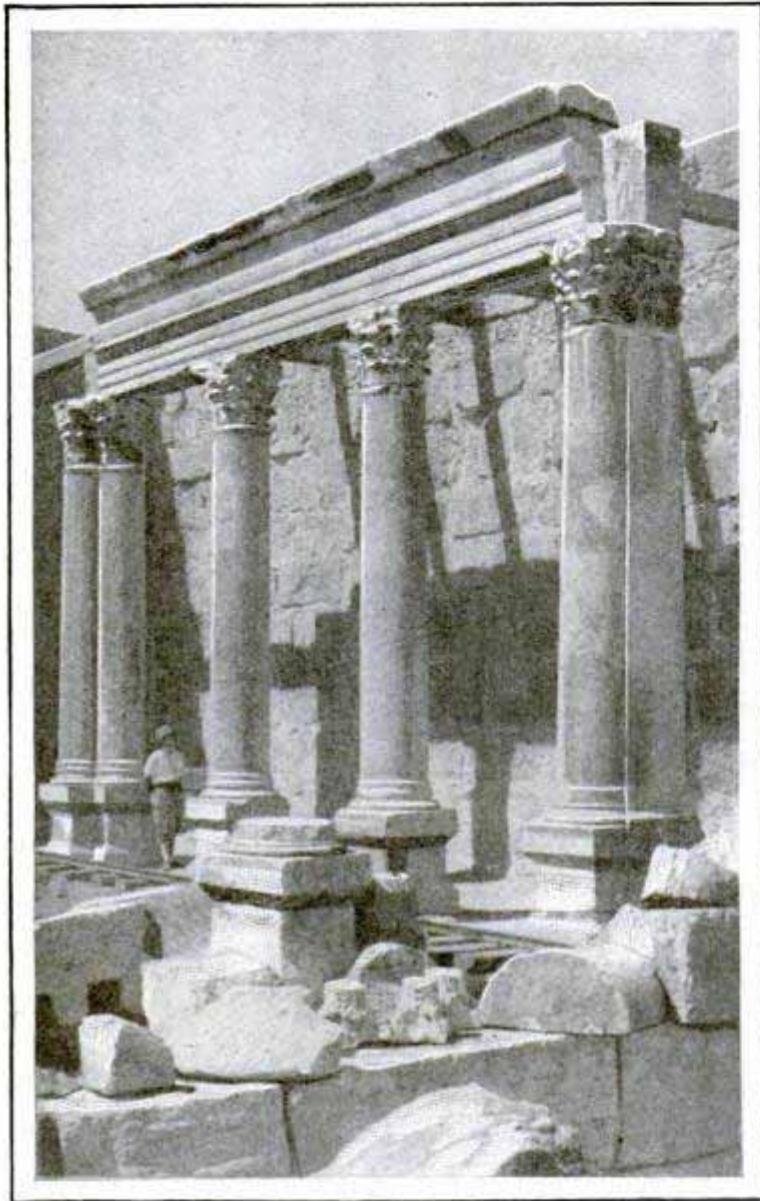

Rebuilding the Pillars of the Synagogue at Capernaum in Which Christ Preached

back to the Canaanite period, but resemble those found at Jerusalem and Jericho. The buildings were evidently made of white, compact, sun-dried bricks, such as have not been met before. A couple of hundred pottery vessels of various shapes and sizes were found, as well as weavers' weights of clay, dyeing vessels, pestles, mortars and sling stones. A shaft sunk on the site, reaching down to the level of the base of the wall where it was laid bare, seems to indicate that there were five periods of occupation, each followed by the burning of the city. The third, fourth and fifth destructions were probably the work of Othniel, Caleb's nephew; Shishak, king of Egypt, in the time of Solomon; and Nebuchadnezzar of Babylon. So far, however, the search has failed to reveal

the existence of any clay tablets. Some seven miles to the north of Jerusalem, not far from Ramallah, Dr. W. F. Bade, of the University of California, has been digging over the site of ancient Mizpeh. It is known from the sacred narrative that Mizpeh was a strongly fortified position, and it was here that Samuel judged Israel for twenty years. Quite early in the work a city wall was struck, so massive as to alter all preconceived notions of the strength of ancient fortified cities in Palestine. The wall averaged sixteen feet in thickness and this width is considerably increased at points where towers and citadels formed part of the ramparts. This defensive structure is undoubtedly of the Bronze Age and was erected long before the Hebrew occupation of Palestine. A number of silos, or grain bins, were also discovered as well as ancient cave tombs, from which many pieces of pottery were taken.

Excavations are to be resumed at Bethshan, or Beisan, in Galilee. In 1925, an American expedition dug over the site when the two temples of the Philistines mentioned in the First Book of Chronicles, in one of which the armor of Saul was placed and in the other his head,

were found. The finds then made have now been examined and the report makes most interesting reading. Beisan and the surrounding districts are replete with Biblical associations. On one side of the fertile and picturesque valley in which the city reposed, rise the mountains of Gilboa, on which Saul took his life, and on the other side the lower slopes of Little Hermon. Near by is Jezreel, where Jezebel lived, and also Endor, where Saul consulted the witch. Along the roadway through the valley here the Philistines brought the headless body of Saul and his two sons, and here came the bloody chariot of Ahab bearing his lifeless body to Samaria. All that remains of Beisan today is a large mound, 200 feet in height, which covers the ruins of several cities.

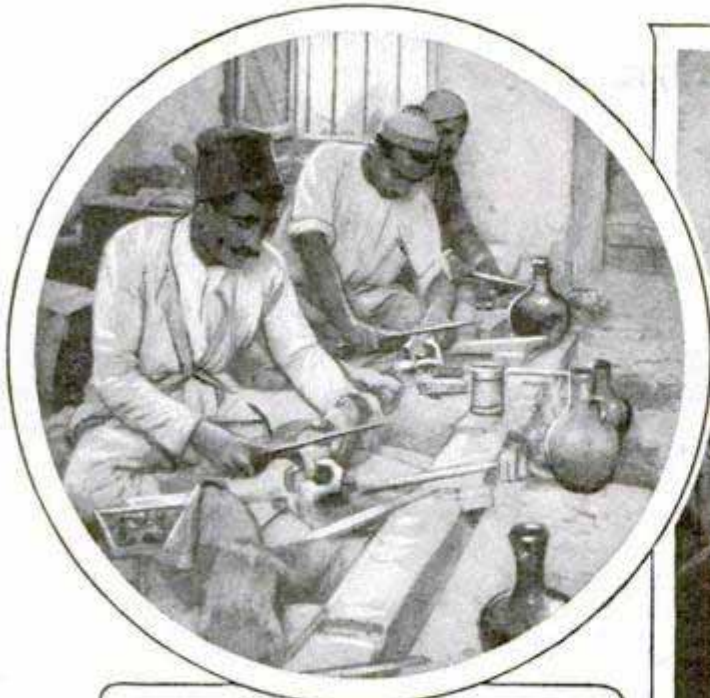

Mother-of-Pearl Workers in Bethlehem, Above, and Workmen Removing the Tombstone of the Crusader Knight, Sir Philip d'Aulngny, near the Church of the Holy Sepulcher

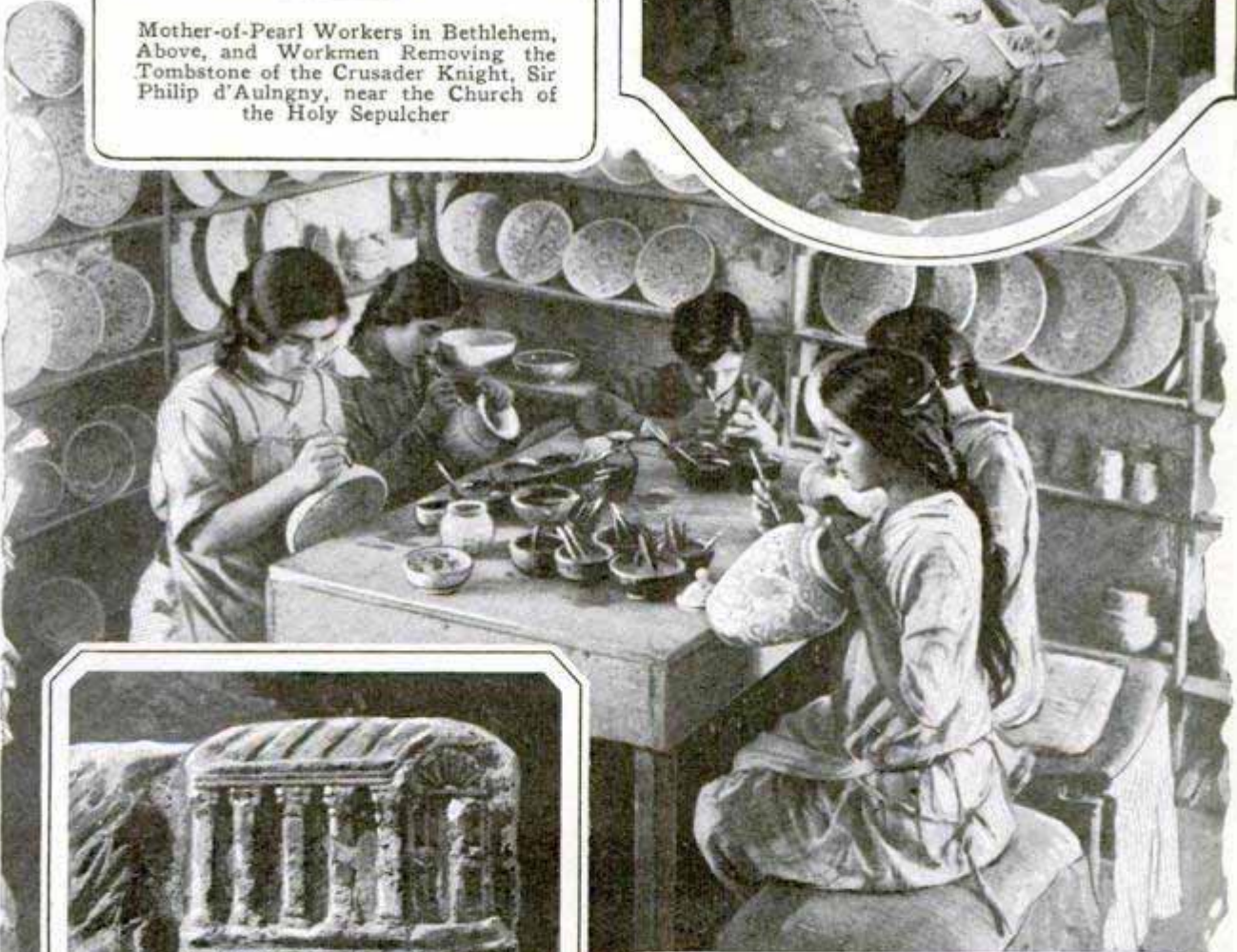

Armenian Girls Decorating Faience Vases in a Factory on the Reputed Site of Pontius Pilate's House, Above, and, at Left, Carving of a Quaint Structure on Wheels, Believed to Represent the Ark of the Covenant, Found in the Ruins of Capernaum

3496 MILLIONS SPENT ON CURVES THAT FOOL THE EYE

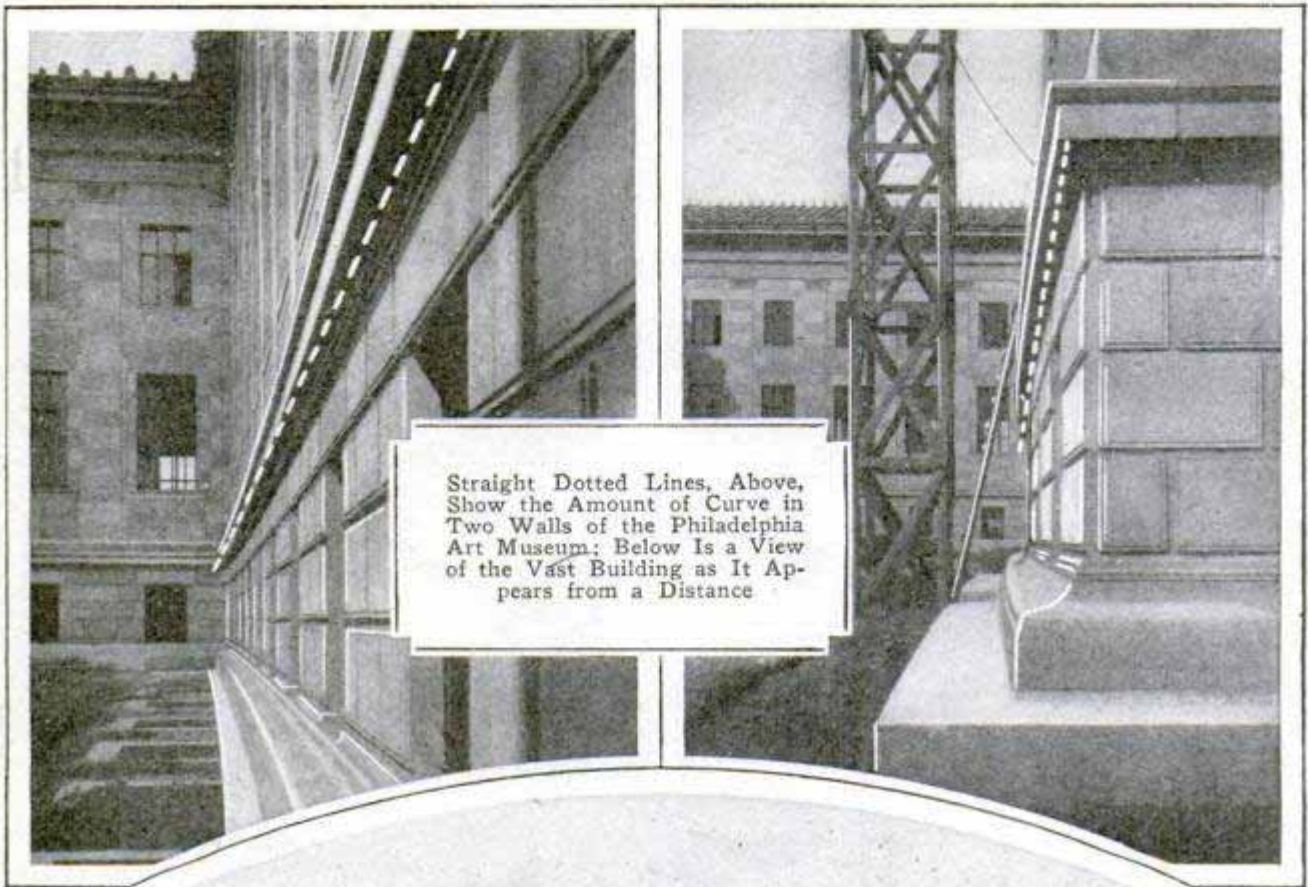

Straight Dotted Lines, Above, Show the Amount of Curve in Two Walls of the Philadelphia Art Museum; Below Is a View of the Vast Building as It Appears from a Distance



A vast stone building, to be used as an art museum, costing \$11,000,000 and spreading over a hilltop in Philadelphia, is nearing completion—without a single straight line in it. Every wall bows in or bulges out, the roof has an artful hump, and the massive columns of the porticoes lean at the top toward each other and also toward the building. Yet so carefully

out of the straight and plumb has each piece of stone been cut and fitted that, to the eye, the building is perfect, whereas if it really were as straight as it seems, the eye would be convinced that the columns were too thin in the middle, that the roof sagged and the walls were bent. There are forty great stone columns, each eighty feet high, in the porticoes. Each column

Ent. Harry Goldberg, 5412 Leavitt Road, Phila.

South

leans about four inches, so that straight lines drawn upward through their centers would all meet about two and a half miles in the air. Walls 125 feet in length, vary as much as five inches at the point of greatest curvature, and even the terracotta roof is built concave to register on the eye as a straight line against the horizon. The late Prof. W. H. Goodyear, of Brooklyn institute, worked out the corrections to the building, and from his figures a scale model was first built. The separate parts were so crooked, it seemed impossible they could be hidden, but when they were all assembled the curves could only be detected by one who knew where to find them.



Riding the Inclined "Ducking Wheel"; Many Persons Can Enjoy It at One Time, and Contests May Be Staged upon It

*Munich
Munich*

LATHER BULB REPLACES BRUSH TO SIMPLIFY SHAVING 3422

Instead of a brush, a rubber bulb and spout that produce lather for shaving, have been introduced for greater convenience and cleanliness. The lather may be applied directly from the spout to the face or squeezed into the hand and rubbed in with the fingers. Dangers of infection from unclean brushes are practically eliminated with this outfit, which is also said to save time and do away with the need of carrying an extra package of soap.



Close View of the Lather-Bulb Outfit, and, Below, the Bulb in Use

*Latheriger Corporation
452 5th Ave New York*

SPINNING WHEEL FOR BATHERS ADDS TO BEACH SPORT

Amusement and healthful exercise are afforded bathers in a targetlike wheel, set at an angle on a platform near the shore. By crowding one side of the wheel, the other one is spun upward, throwing persons clinging there into the water. As the outfit is adaptable to shallow beaches, it is safe and easily rigged. The wheel itself is about twenty feet in diameter and is strongly constructed.

AUTOMATIC RUDDERS ON PLANE INCREASE FLYING SAFETY 3499

To keep airplanes on an even keel and help prevent accidents, a German inventor has introduced an automatic steering-gear arrangement which is said to have proved efficient in actual tests. It consists chiefly of a rapidly rotating top to control a vertical rudder, a lead weight and a mercury pendulum of special construction to govern the other controls. The rig is said to be easily fitted to any machine and functions by causing a motor to correct the steering to compensate for any departure from the course decided upon.

Approximately 20,000 kinds of beetles are found in North America.

*Inventor: Franz Sprenger
Hauptplatz Berlin. Johannmühl, Germany*

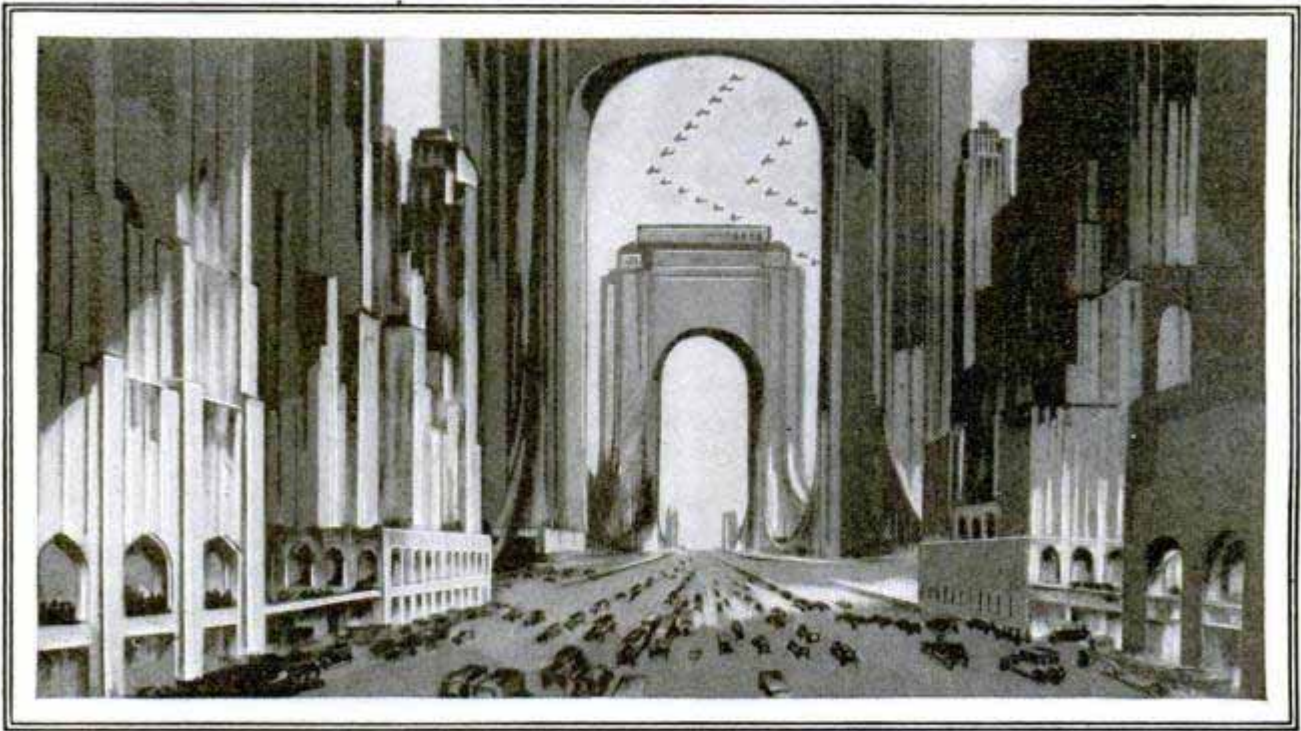

Street of the City of the Future, with the Arches of a Vast Suspension Bridge, Such as Has Been Started across the Hudson to Link New York and New Jersey, in the Background

Have Skyscrapers Reached Their Limits?

The Higher Up They Go the Deeper Down the Foundation and Sometimes There Is No Bottom

By UTHAI VINCENT WILCOX *National Press Bldg, Washington D.C.*

HAS the skyscraper reached its limit? Is the tall building becoming impossible for human beings to inhabit?

There is some evidence to indicate that American cities are about to call a halt on these tall structures that reach into the clouds and down into the earth.

Even the physical limits are being approached. The higher the building, the deeper the foundation must go. That is understood, of course. But it is not always so easy to keep on digging to find a solid rock bottom that will sustain millions of tons of concrete, steel and marble.

The thirty-four story skyscraper of the Albany, N. Y., state capital offices has discovered this to be true. For nearly a year the construction crews have been trying to find a solid bottom to support the great building. More than 2,000 concrete piles have been sunk into Capitol Hill, and the bottom needed isn't there. The vast excavation is getting deeper and in places has not yet approached the tops of some of the concrete piles which have

been driven into the hill. Meanwhile ten floors of structural steel are in storage awaiting something stable to support them.

While the troubles of the Albany contractors are many, engineers tell of similar conditions that are being encountered as the height of buildings increases. Geologists say that many cities are located on mounds of earth that are just short of liquid in their consistency as far as proper skyscraper foundations are concerned.

The troubles of contractors are illustrated by the amazing experience at Albany. It was estimated that concrete piles imbedded thirty-seven feet into the earth would each support thirty-five tons, and with enough piles the building's height would be assured. The great pile driver sent the concrete log down to within one inch of the thirty-seven foot depth. It took three blows of the five-ton hammer to drive the pile the last one inch and there was but another inch to go. The hammer came down once and hit the pile again and presto! the pile simply disappeared.

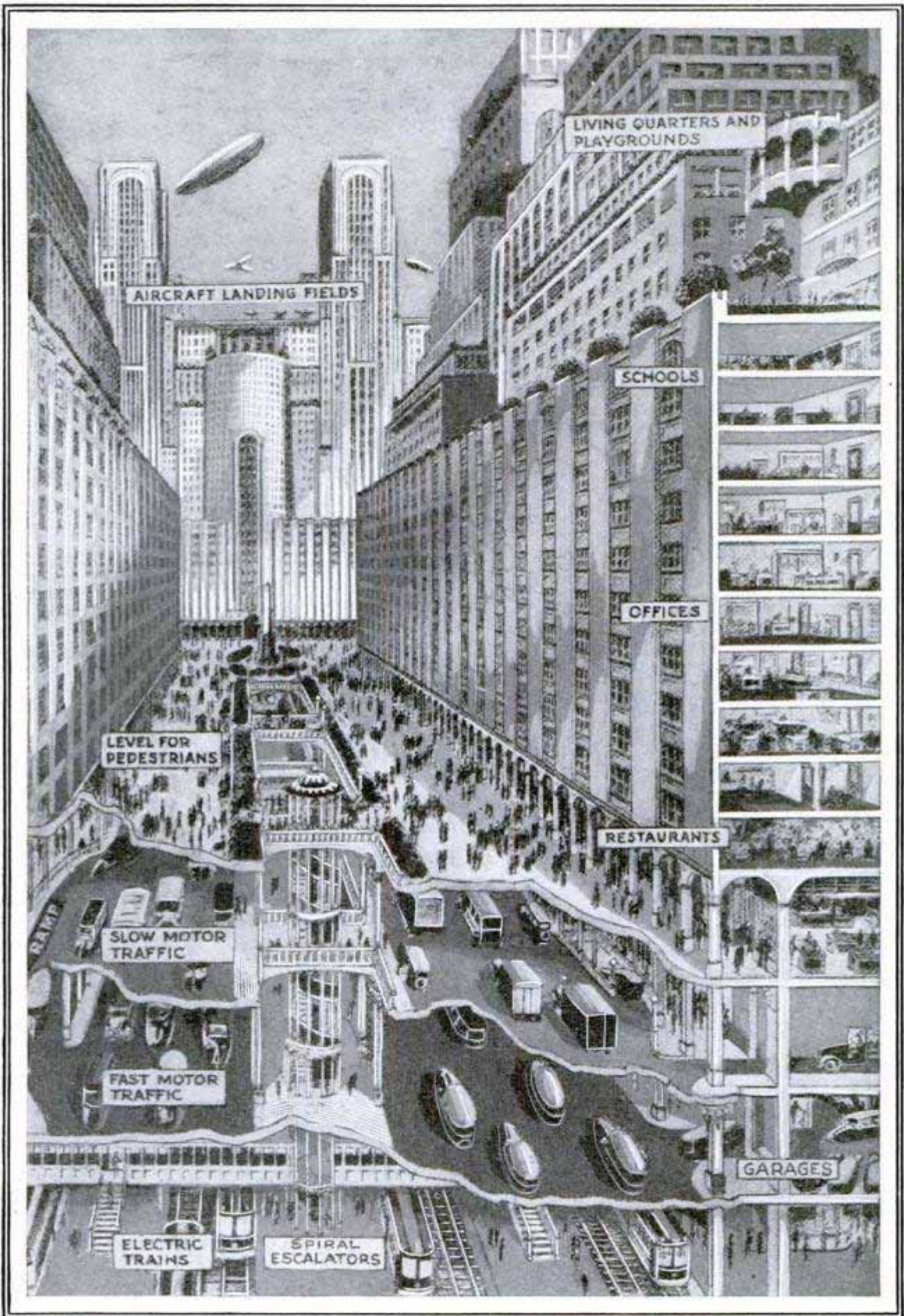

Cross Section of the Future City as Mr. Corbett Sees It, with Many Traffic Levels Underground; Top, Street for Pedestrians Only, and Airplane Landing Fields, Above

3271
36

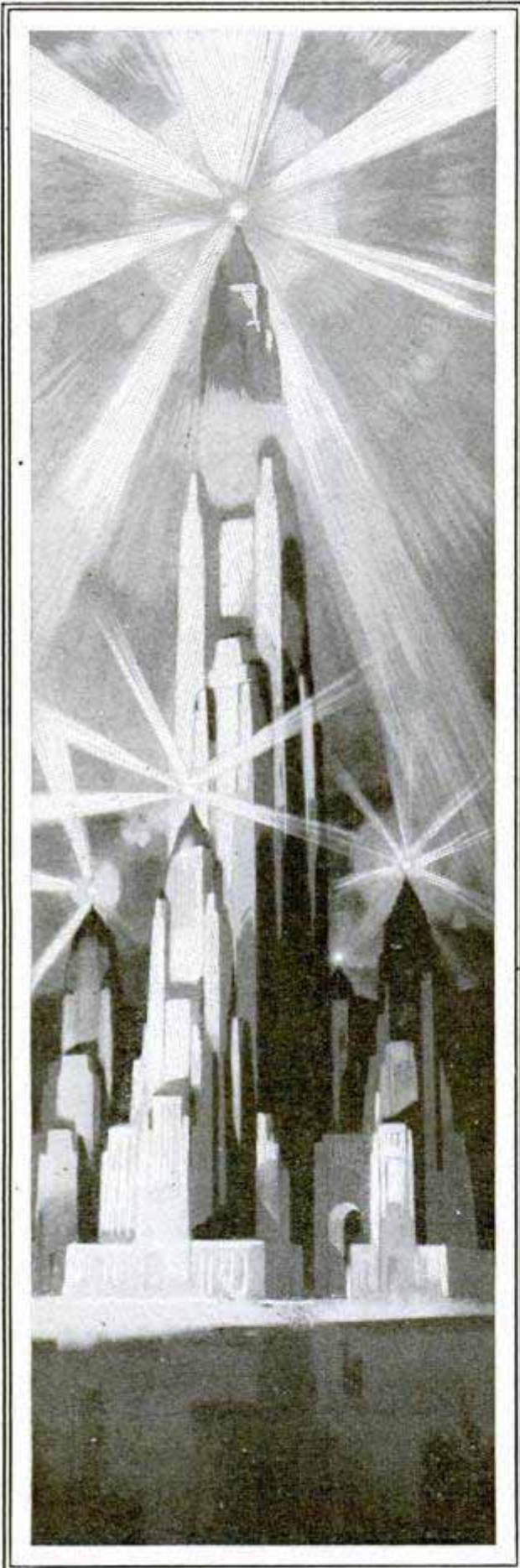

Block of Buildings Rising in Terraced Masses into the Skies, and Topped by Airplane Beacon Lights to Guide Passing Flyers

Other piles showed the same result. There was not enough resistance and the piles disappeared into the soft earth below. Then the engineers placed a twelve by twelve timber on top of one of the concrete posts and set the pile driver to work. The pile, as a consequence, went down 112 feet before it hit hardpan. Geologists who were watching said that solid rock was down still farther.

The Albany building is not a great skyscraper as such buildings are known. It is designed to be but thirty-four stories high, and such a height is dwarfed in these days. While New York is located on solid rock, some geologists claim that the weight that can be piled on this rock is limited.

Meanwhile other cities continue to plan giant buildings. Harvey Wiley Corbett, noted city planner, who champions the skyscraper, predicts that American cities will soon have buildings twice as high as those of today, which many people are claiming as too tall. Major Henry H. Curran, also of New York, opposes Mr. Corbett and points to the impossibilities of such buildings in terms of human happiness as well as construction.

Mr. Corbett as an architect shows what he believes New York will look like in 1975. There will be other cities like it—Detroit, Chicago, Philadelphia, St. Louis, perhaps. "American cities will be composed of gigantic towers," he says. "Pedestrian traffic will be separated on elevated highways from vehicular traffic moving in "canals" below.

"The big cities will be modern Venices with motors instead of water filling the canals. The big stores will have two entrances, one below for automobiles and one on the second-story level for pedestrians. Shoppers will be able to walk from store to store undisturbed by traffic. The open park plazas will be lifted to a level with the pedestrian lanes and the space below will be used for parking automobiles.

"The step-back skyscrapers of the future will have moving stairs on the outside of the buildings instead of elevators, with facilities for passengers to alight at any floor," Mr. Corbett declared. "There will be airplane landings everywhere. Artificial light, now in its infancy, will revolutionize our life, turning night completely

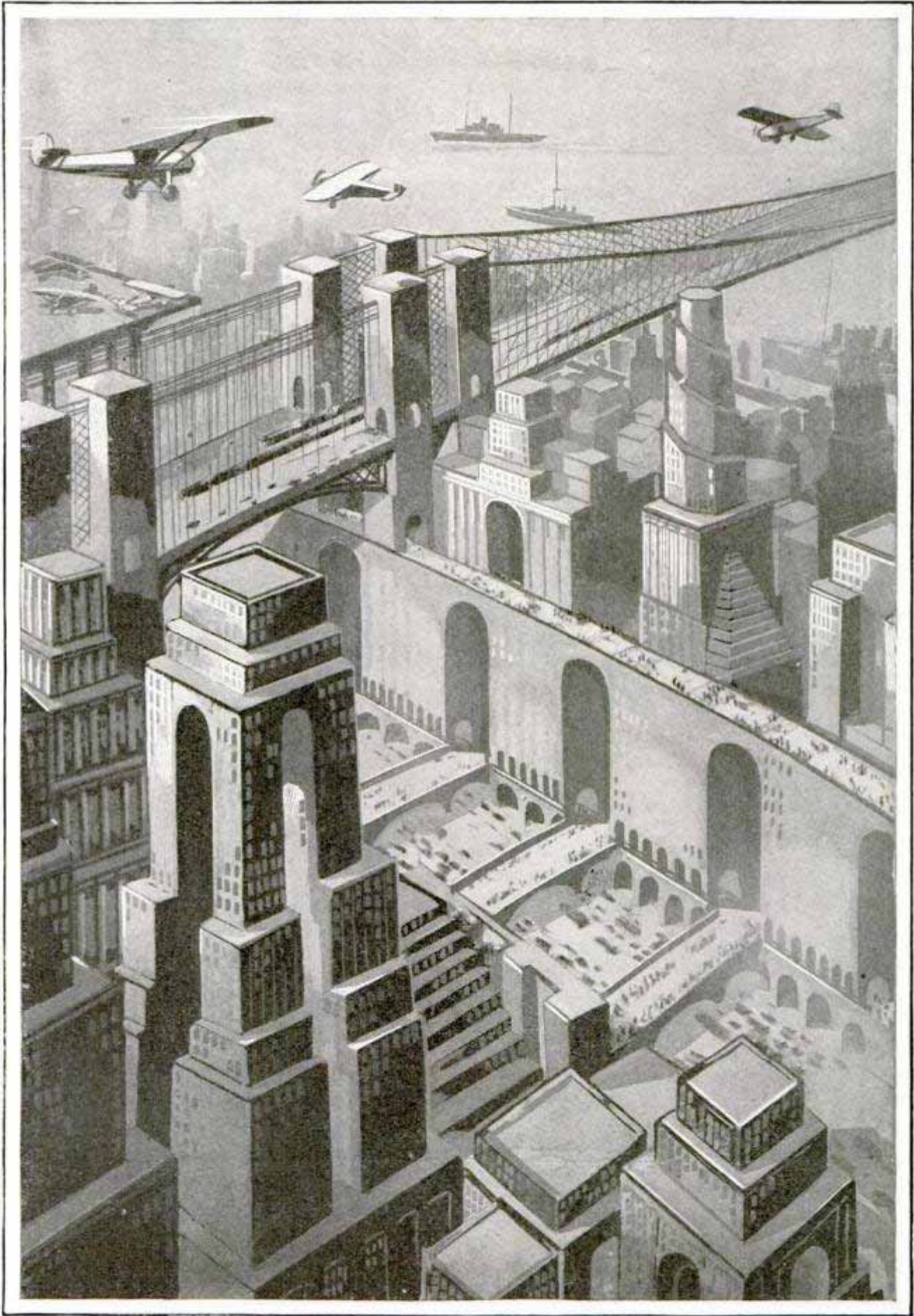

Elevated Sidewalks May Connect Various Levels of Blocks of More or Less Uniform Skyscrapers, While the Lofty Bridges Will Be Carried over the Tower Tops

327/38

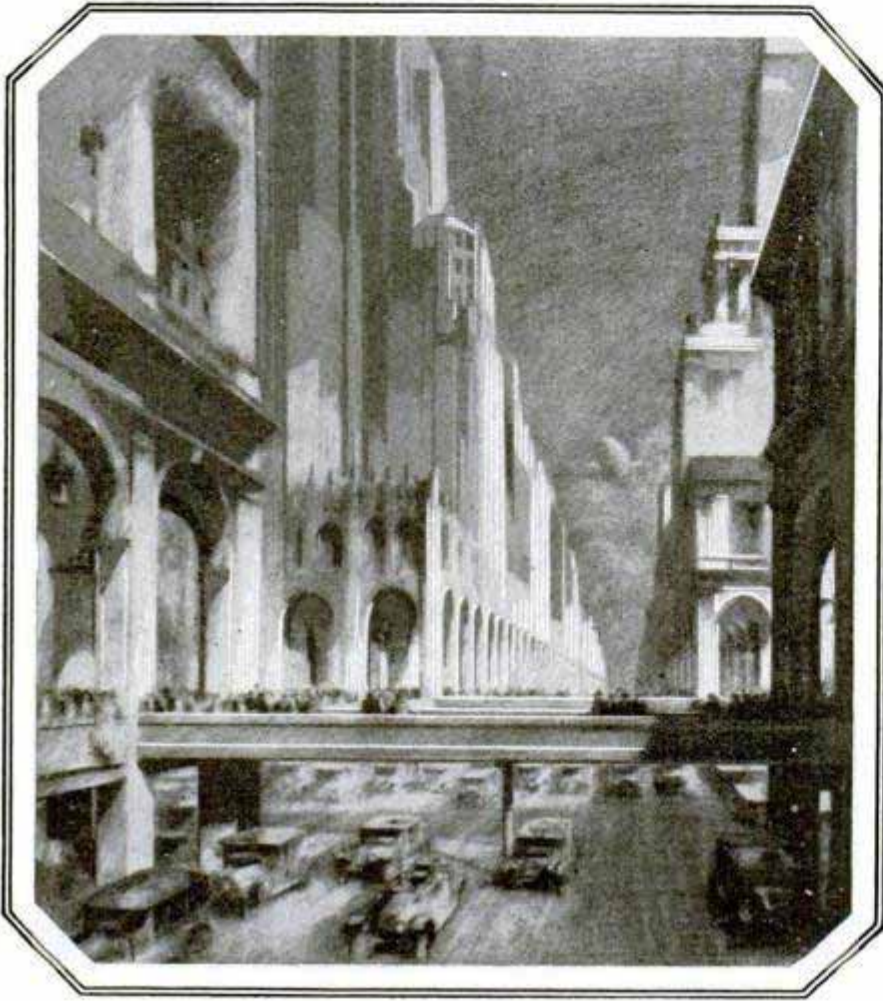

Even with the Street-Level Drives, Pedestrians May Be Cared for by Elevated Sidewalks in Colonnades

into day. The cities' business hours will be twenty-four instead of eight or ten; people will work in six-hour shifts. The churches will be located atop of the great commercial buildings, commanding attention, or be buried in nondescript buildings below."

Mr. Corbett bases his prophecies on a lifetime of leadership in designing great buildings, and is a world authority. He continued: "Buildings will cover entire blocks, reaching in series of lifts and towers to supreme heights.

"Some of the skyscrapers will be a half mile high and will house small-sized cities. Stores will occupy lower floors. Then will come banks of floors devoted to offices. Atop of this section will be the residential part, floors where those who are employed in the business division of the structure might live. Schoolrooms, churches, theaters and social features will take over the next section of floors. The roof will be used for airplane landings or station stops for air transit to various

sections of the country, or for that matter, the world.

"Imagine these new cities with no smoke, where the heat, the power and the light are all supplied by burning coal at the mine that is transformed into electric power and sent to the cities, where the upper portions of the buildings are more attractive than the lower, where we can take advantage of our terraces and use them for our gardens, if we wish."

But there are problems other than that of foundations to offset such a great dream, says Major Curran, who is counsel for the New York city club and member of the New York board of aldermen and himself an authority on city activities.

Major Curran sees in the skyscraper the cause of much discomfort. "There

are everyday workers who count their ribs on release from its elevators and the subways that take them to their offices. They must pop out of kiosks like prairie dogs and move in the center of crawling motors that spit fumes from curb to curb."

Major Curran continued: "Now a New York architect announces a building of 110 stories! This inverted spyglass is to rise 1,200 feet in the air, thus outstripping not only Detroit's effort but also the Eiffel Tower in Paris, which is still the highest piece of construction in the world."

The physical difficulty of digging into the earth may deter the super-super-super-skyscraper. Perhaps a great accident will have its effect, for as the new building's foundations must be dug, the old ones must be watched carefully, and frequently a new foundation must be placed beneath the adjoining structure. Such complicated underpinning and transferring of loads running into thousands of tons are accomplished in the face of the ever-present menace of flood, fire and explosion.

3466

MODELS HELP TEACH POLICE STREET LOCATIONS

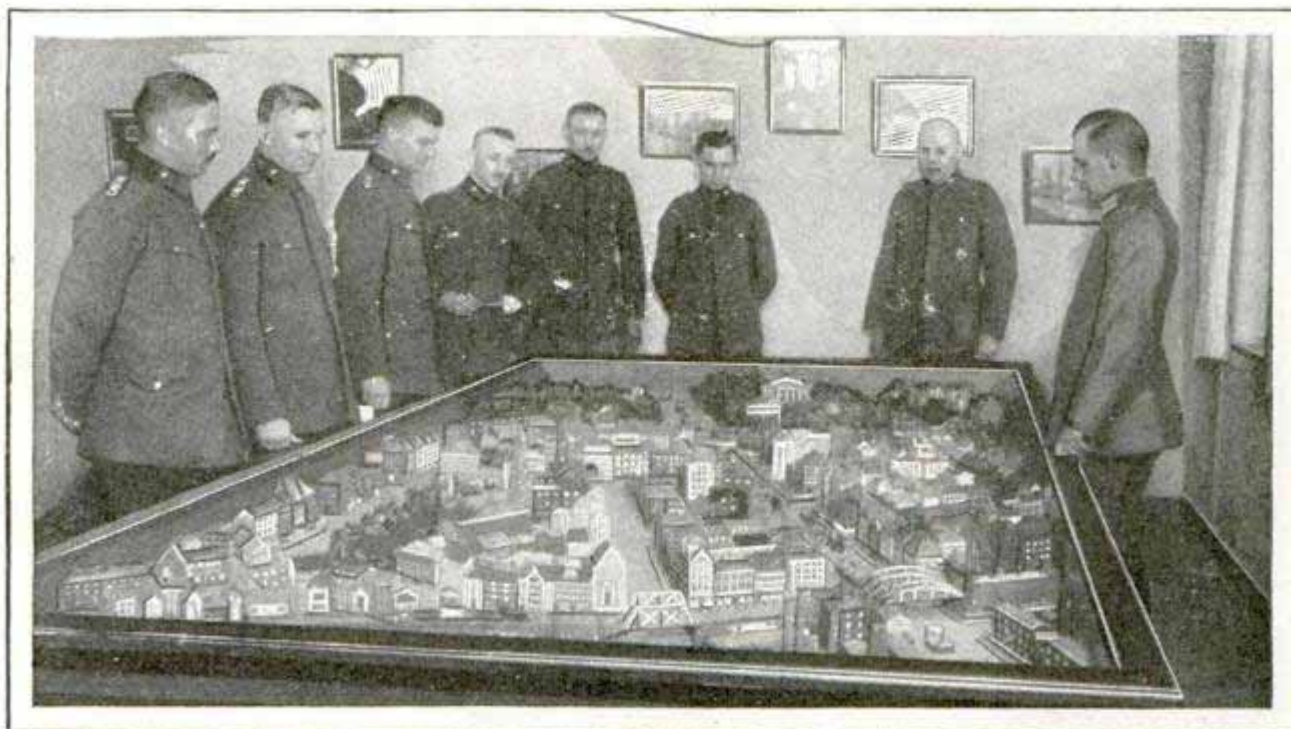

German Policemen Studying Model Section of Berlin, to Learn Location of Streets, Alarm Boxes and Other Details; the Plan Is Especially Helpful to New Recruits

Accurately constructed models of sections of Berlin and suburbs are used in teaching the police recruits the location of streets, buildings and patrol boxes. They are also of service in explaining traffic regulations and give the candidates a clear idea of the beats they are to travel.

taken on a level road as moderate gradients do not affect the performance of the indicator in any appreciable degree.

BALL IN TUBE TESTS BRAKES FOR AUTO SAFETY

we regret that we are unable to give the address of the manufacturer of this toothbrush.

INTERNATIONAL

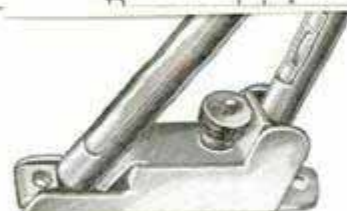

direction and at an angle to the horizontal. The tube contains a steel ball which normally rests at the bottom of the tube but, when the car is slowed down by the brakes, tends to roll upward. The extent of the movement shows the efficiency of the brakes. One advantage of the gauge is that the measurements do not have to be

given satisfactory results. It consists chiefly of a glass tube mounted on the instrument board in a fore-and-aft

ROTARY TOOTHBRUSH GIVES AID TO DENTAL HYGIENE

3484

Pull a little lever in the handle of a toothbrush and the bristles revolve, saving the hand movements and more thoroughly cleaning between the teeth, the manufacturers assert. New bristle fillings may be quickly inserted when the old ones wear out, the handle being intended to last indefinitely.

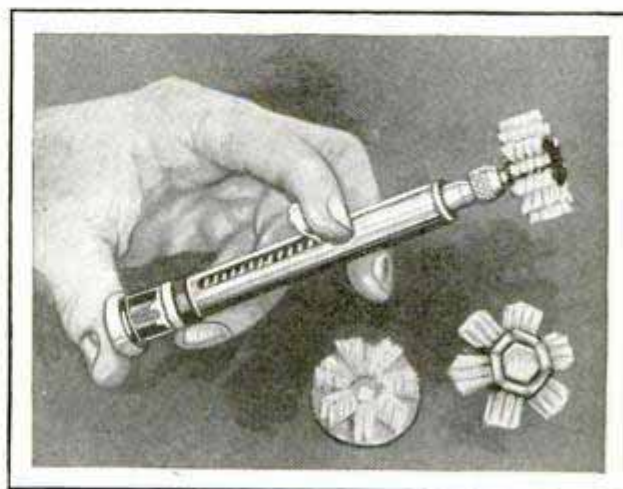

Spring-Driven Rotary Toothbrush with Replaceable Bristle Wheels, to Clean Teeth Thoroughly

*Levin Brake Co. Ltd
30 City Place*

Show at International Exhibition

34 45

Invention of Associated Edison Illuminating Companies at the Boardman

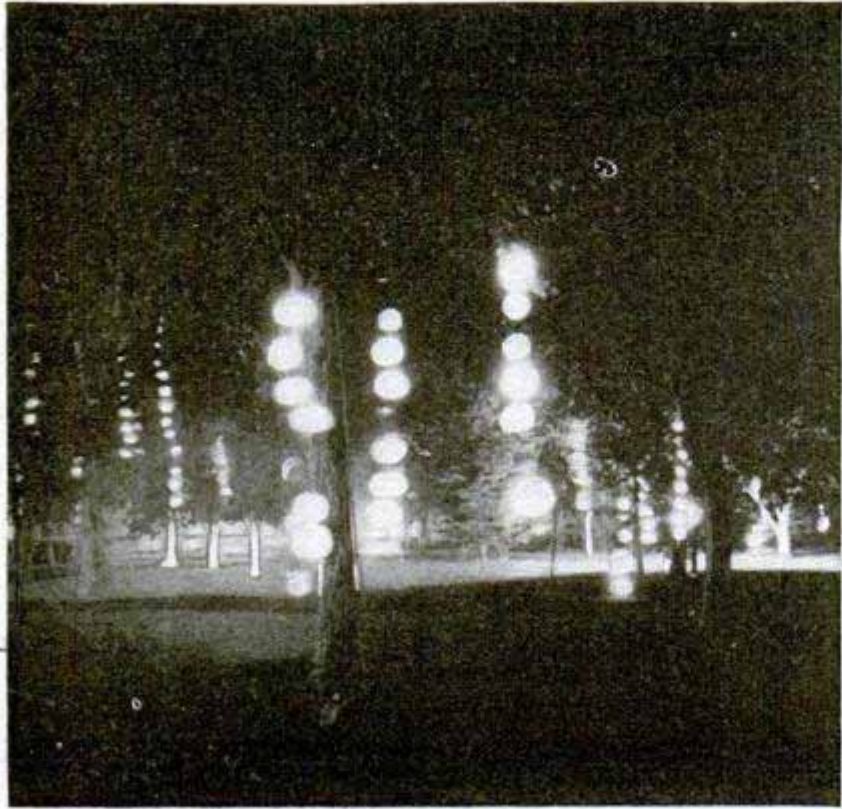

Courtesy General Electric Co.

Where Lighting Engineers Produced Unusual Effects; Part of the Garden Scene at Outdoor Party When Ultraviolet Rays Were Used

MAGIC OF INVISIBLE LIGHTS ADDS TO GARDEN FETE

For the first time in history, invisible lighting was employed for the outdoor decorations and displays at a garden party in Colorado Springs. Special ultraviolet searchlights swept the lawn and shrubbery which had been treated with chemicals, so that each leaf and twig glowed under the rays of the unseen light, and the water in a fountain contained chemicals which made the stream sparkle in multi-colored brilliance. Souvenirs, also treated with luminescent materials, were distributed among the guests who enjoyed the novelty of the changing effects as they passed in and out of the invisible beams. Dress goods, particularly those con-

taining aniline dyes, glowed under the ultraviolet stimulation, and the crowd was amused to see teeth and eyeballs curiously affected by the rays. In addition to these novelties, use was made of rubber balloons and animal-shaped shades for the ordinary lights so that the garden, in places, was transformed to a miniature zoo with glowing animals and shining balloons that enhanced the weird aspects of the luminous decorations.

OVERHEAD STRAPS WARN AUTOISTS OF CROSSINGS

3125

For the further protection of motorists, safety experts have gone to the railroads for an additional device to warn drivers of hazardous grade crossings. This unit is the overhead strap line, similar to that used on the railroads for many years at approaches to tunnels and low viaducts, warning brakemen, or others on top of the cars, to duck their heads. The strings



To Rouse the Indifferent Motorist to the Danger of the Railroad Crossing Ahead; the Straps Are Always on Duty

at Vermillion Ohio

*Mr. J. V. Williams
Cambridge Road,
Bangalore, South India.
41*

over the automobile road hang low enough to brush the top of the car close to the driver's face and so warn him, by day or night, to look out for the crossing which is not far ahead.

ROYAL ELEPHANT WEARS ROBES
STUDED WITH GEMS

352

Delroit News
THE OLDEST LIVING THINGS

So far as is known, the oldest living thing in the world today is a tree. It may be one of the giant sequoias of the Pacific coast, an East African baobab or one of the cypresses of Mexico. A tree of this kind, near Oaxaca, is said to have lived 6,000 years. It is forty-one feet through the trunk and, though its exact age cannot be determined without cutting the trunk and counting the rings, an approximate reckoning is made by comparing it with others of the same kind. By counting the rings, it has been found that some of the sequoias have lived at least 5,000 years. Among the animals, the longest-lived generally are supposed to be the big tortoises of the Galapagos islands, which are estimated to be 200 years old. Carp, kept in ponds, have lived to be 150, and parrots have lived eighty years in captivity. The longest-lived insect is the locust, but it spends all but a month of its seventeen-year existence in larva form.

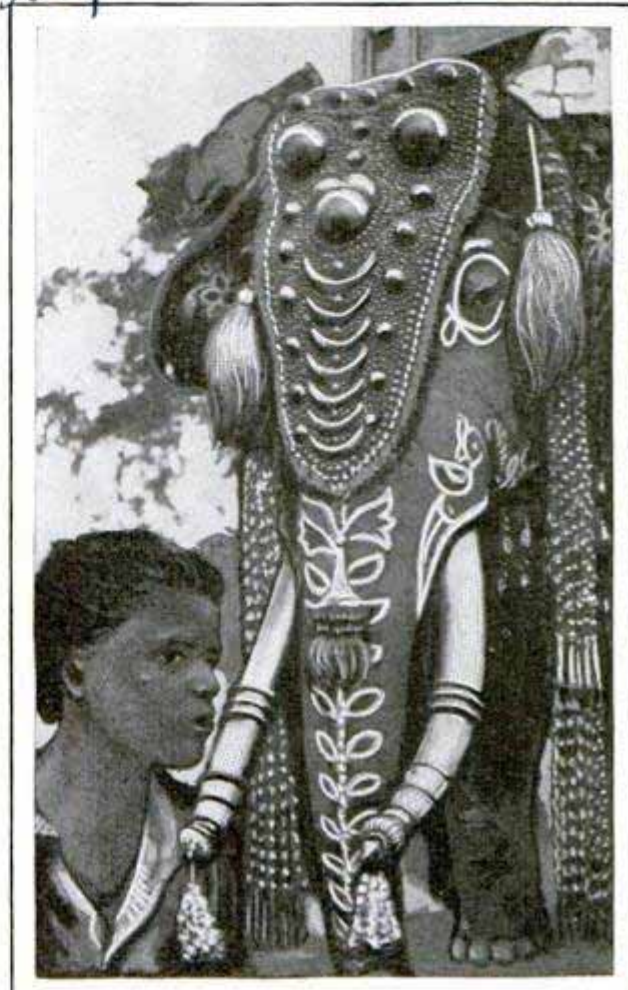

State Elephant of the Prince of Mysore, Decorated in Gold, Velvet and Jewels for the Royal Procession

PICTURES CHISELED IN BRASS
LATEST ART FAD

3442

Interesting stencil pictures can be made in brass with comparatively little work, and the results are unusual, since there is an opportunity for decorative backgrounds and development of detail. In the accompanying illustration of the national-capitol stencil, a black base for the brass emphasizes the proportions of the building and shows how the entire structure has been accurately suggested by using only the strongest and simplest features. The work of cutting the stencil consumed about three days, and it is framed under glass.

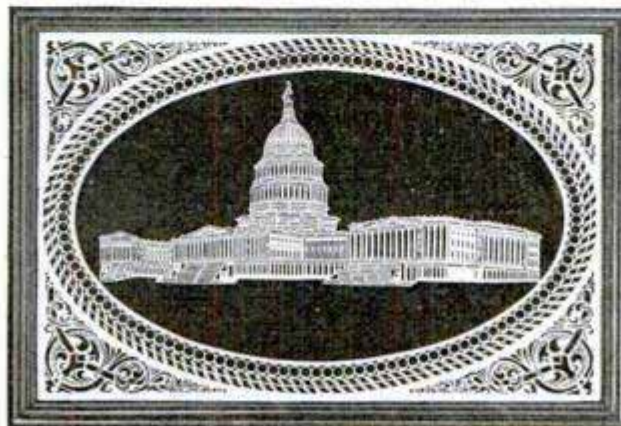

Stencil Picture of the National Capitol, Cut in Brass and with Black Background, to Emphasize Detail

When the Maharajah of Mysore recently celebrated the twenty-fifth anniversary of his coronation, Europeans invited to the ceremony witnessed one of the most gorgeous processions for which India is noted. Even the royal elephants, which participated in the parade, were clothed in plush, gold and precious gems.

The beast which bore the gold howdah of the maharajah had golden rings on his tusks, and his head, with the exception of peep-holes for the eyes, was completely covered by a jewel-studded and gold-ornamented head-dress, with a floral design painted on it in brilliant colors.

*Ed. Smith's Stencil Works,
426 Campbell St. New Orleans, La.*

Stanley & ...
Entomologist
Salicy, Ventura County

3493

Receiving Paris Fashion Designs by Radio



Courtesy Marshall Field & Co.

FASHION DESIGNS BY RADIO SPEED STYLE CHANGES

Dress designers in Paris made their sketches and, three hours later, visitors in Marshall Field's store in Chicago were looking at the drawings, for they were sent by radio and registered on a screen by the latest wireless-picture methods. The innovation was staged in connection with the celebration of the store's seventy-fifth anniversary and was made the more impressive by the models in old-fashioned costumes who paraded near the wireless machine while the latest Paris patterns were being received.

BEAUTIES OF MAPLE FLOORING SHOWN BY SPECIAL STAIN

3553

Hard-maple floors, in a wide variety of colors to accompany special schemes of decoration, are now possible by using a transparent stain and wear-resisting varnish. The finish is especially adapted to hard maple, since this wood has fibers so closely woven together that the stain does

Marietta Paint & Color Co.
Marietta, Ohio.

not change color when applied. Floors may be prepared one day and used the next because of the rapidity with which the materials dry, it is said.

WASPS RAISED TO FIGHT MOTHS THAT DEVOUR FRUIT

3328

By cultivating a wasplike parasite that destroys the codling moth, a California man hopes to reduce damage done to the walnut crop and to apples in many parts of the country. It has been known for some time that this parasite preys on the moths, but its efforts could be enlisted only where weather conditions were favorable, for the insects could not survive the winters. A plan has now been worked out whereby the "wasps" can be raised by the million and shipped to any section of the United States. Moth eggs are collected and put on coated cards in a "parasite cage" for three days. At the end of that time, the parasite has imbedded its own egg in each moth egg, which provides food for the developing insect and, at the same time, destroys the egg. These cards are easily shipped by mail so that an orchardist, bothered with the moth pests, can receive the services of an invading "army" through the post office. The parasites are said to be harmless to everything else but the codling-moth eggs.

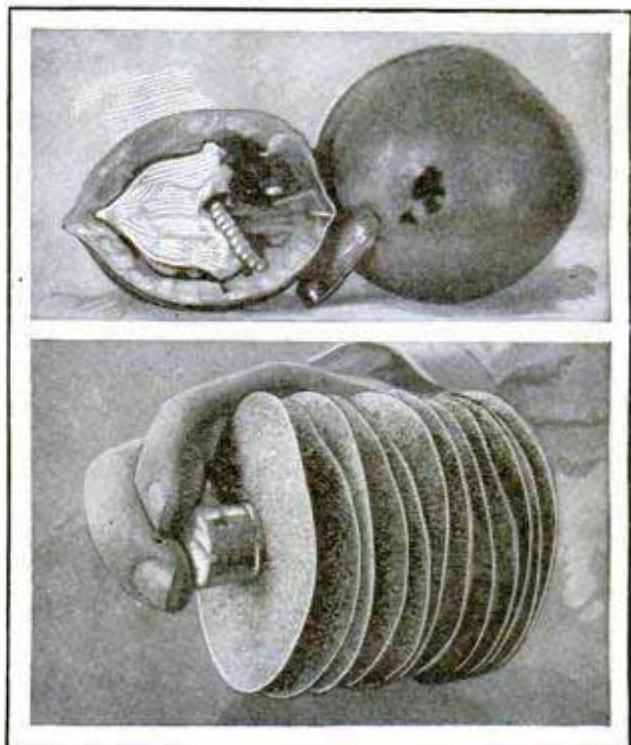

Ravages of the Moth Larva in Walnut, and Disks on Which Eggs of Helpful Parasites Are Shipped

st
etty
alia
to

3206

Ambergris } Bought by Dodge & Alcott,
89 1/2 Wall St. New York.
H. C. Still, Princeton, Mass.

Wealth from Ambergris



This Whale Is Worth About \$4,000, a Humpback Variety Common in the Pacific but Never Known to Be a Producer of Ambergris

By JOHN EDWIN HOAG

205 Union League
Bldg. Los Angeles, Calif.

IF you were walking along a piece of ocean beach, and something assailed your nostrils—a smell like all the musty, mouse-infested cellars of the world rolled into one overpowering odor—you'd probably do what most people would do under such a circumstance—flee. But the person who does that risks walking right away from the possibility of sudden and unexpected wealth—a mass of ambergris washed up by the sea. A small fragment of it is worth \$1,000. Larger masses have brought \$25,000 to \$150,000.

While ambergris may be unknown to the majority of people, it is the base of perfume's pleasing fragrance, as well as the chemical element which makes the best perfumes expensive. How a substance that smells like nothing else on earth can be transformed into the odor of roses, violets, lilies of the valley, and other delicate fragrances of the most exquisite perfumes, is merely one of the tricks of the chemical trades, and it is done as effectively as the ancient alchemists of fairy tales turned base metals into gold.

Ambergris is a product of the sperm whale. If there is romance in the prospecting of mountains and deserts for gold and other valuable minerals, the searching of the seas for ambergris is infinitely more

romantic. The "prospecting ground" for this substance is the whole seven-seas, and every mile of the shore line of all the continents and islands. It is naturally most abundant in the waters inhabited by sperm whales, which usually prefer water that is colder than that chosen by other whales. Ambergris floats, and the occasional piece of it which becomes dislodged from the body of the whale may drift for thousands of miles by wind, tide and currents. Once ashore, it may remain on the beach to disintegrate, or to be picked up by the lucky finder who is able to recognize it.

The world's supply of ambergris has never been sufficient to lower the market value to a point to make the search for it less romantic than it is today. No satisfactory substitute for it having ever been found, the price is always high. For market purposes, the substance is divided into two classes, black and gray, which serve to indicate both color and quality. Gray ambergris often has brownish tinges, or may be mottled to a sort of pepper and salt color. Gray ambergris is the best quality, and is therefore most in demand. Only limited quantities of gray ambergris have been available during the past year, with the result that the latest New York quotation upon it is now \$35 per ounce.

Drift ambergris, the kind that the sea

320 64

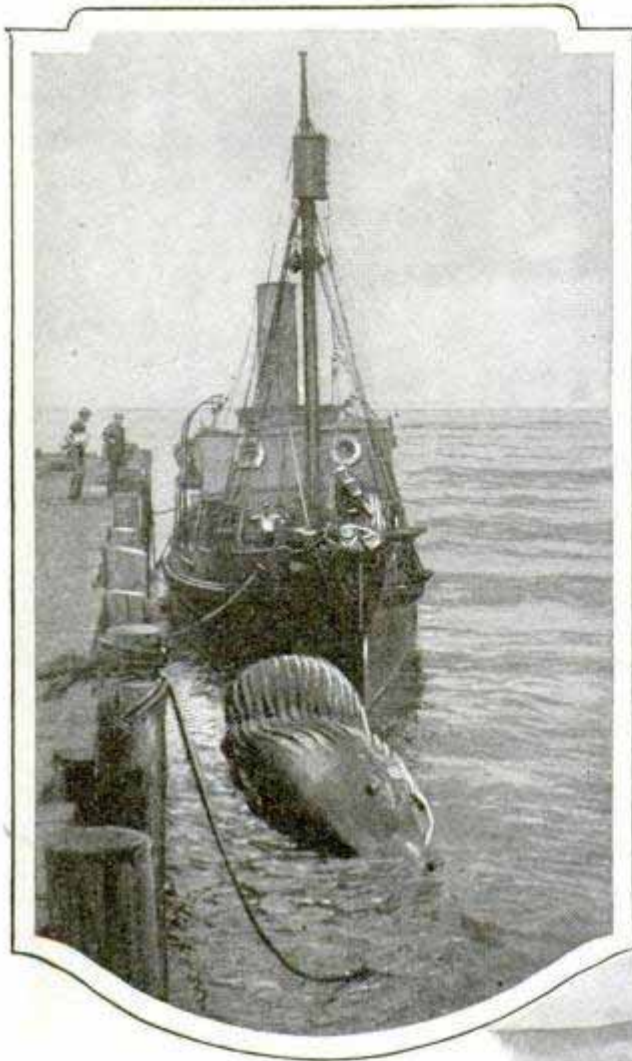

the markets, comes from the bodies of sperm whales taken by the crews of whaling ships. When a sperm whale is caught, the carcass is always carefully dissected for even the smallest piece of ambergris. The wealth derived from such a find is divided between the owners of the ship and the crew. The world's greatest source of drift ambergris, where it is usually picked up at sea before it ever reaches shore, is in the Indian ocean and the China sea. These seas are infested with thousands of Chinese junks, East Indian and Malay "proas" (native sailing canoes), "sampans" and other craft, manned by hundreds of Asiatic coolies, who ply their trade as fishermen, but who are always on the watch for any floating object that may look or smell like ambergris.

Considering the varying color, weight and consistency of ambergris, the only fairly reliable identification left for one who knows nothing about it is the smell. So, when one is at sea, or along the beaches, the source of an unusually unpleasant smell may always be considered

Into Port with a Whale, and a Lump of Ambergris That Brought Fisherman \$6,720

washes up on the beaches, may be found almost anywhere the land and sea meet. In the United States it is more abundant on the Atlantic coast than on the shores of the Pacific. This is for the obvious reason that sperm whales are scarce in the eastern Pacific, while fairly abundant in the western part of the Atlantic. Drift ambergris is usually found in small pieces but quite frequently in masses of sixty to 250 pounds.

On the Pacific coast there are six commercial whaling stations. They are scattered from Mexico to Alaska, with two in California. These stations have been in operation for years, and report only eighteen sperm whales taken among the hundreds caught. Yet, several noteworthy finds of ambergris have been made there.

As may be surmised, the greater part of the commercial ambergris now reaching

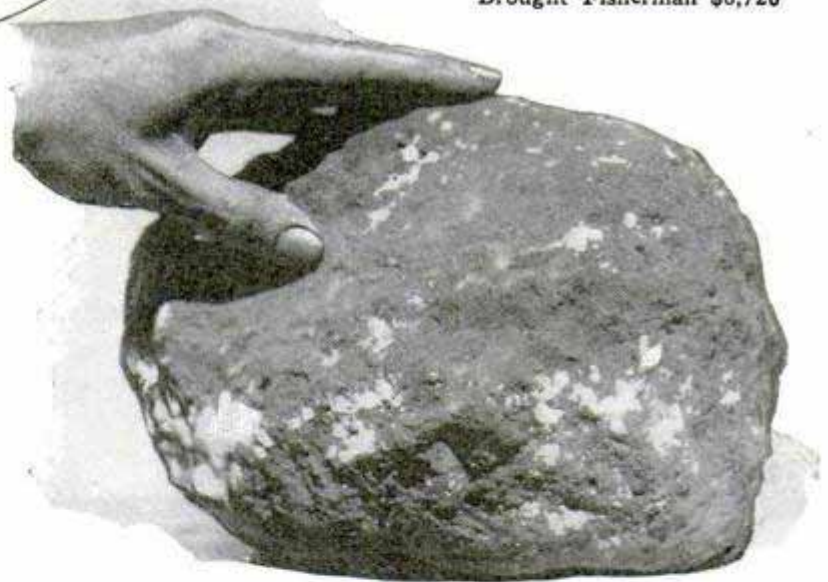

worth investigating. It may not be ambergris, but if it is—your financial worries may be ended.

☞ Popular Mechanics Magazine does not publish the name of the maker or seller of any device described in its pages, but this information is kept on file and will be furnished free upon application to our Bureau of Information.

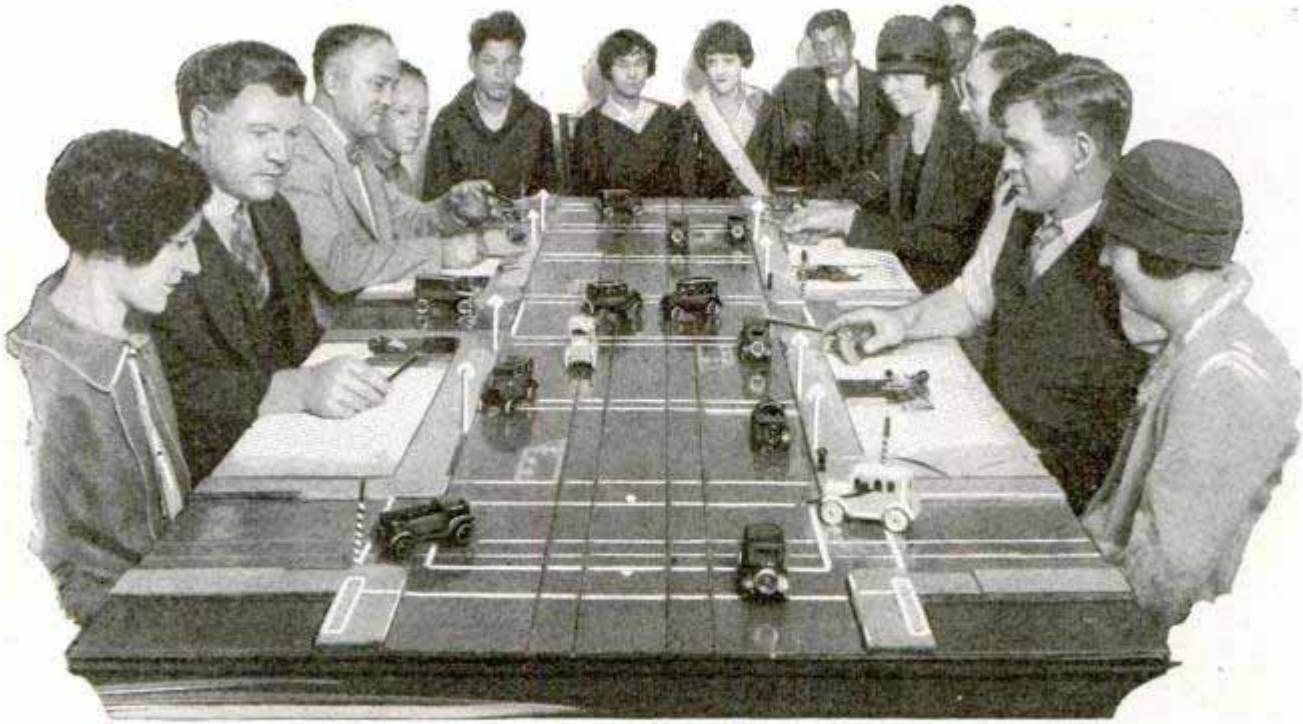

Candidates for Auto-Driving Licenses Taking Tests at the Traffic Board; Model Street and Cars Represent Actual Conditions Autoists Would Be Required to Meet

"GAME" TESTS AUTOISTS' SKILL FOR DRIVING LICENSES

People sitting at a table and apparently playing a game with tiny automobiles on a model street is a common sight in the motor-vehicle license offices at Los Angeles. But the "game" is a serious one, for the persons about the table are being tested as to their ability to solve traffic problems while driving an automobile. The examination is part of the formality connected with issuing drivers' licenses and, before permission is granted to operate a car, the candidate must prove that he can satisfactorily manage the little autos and answer the problems put to him about how he would drive his own car. His solution of the questions is illustrated with the models.

35 7 3

GROWING UMBRELLA HANDLES

Three years of careful attention are usually required to shape the young trees that are to be fashioned into umbrella handles. At the end of the first year, the tree is trimmed back, quite short, and the wood twisted into various shapes. The carvings are sometimes made at this stage, and the designs swell as the tree grows. One of the chief tasks of the cultivators is to keep the sap flowing and to prevent the

American 10/25/27

tree from dying in its crippled condition. After cutting, each stick is sun-dried and then given a vapor bath to soften the wood for the final shaping.

PAPER BEDROOM SLIPPERS GIFT TO HOTEL GUESTS

Bedroom slippers, Japanese style, made of paper, and inclosed in a paper envelope, are being provided for guests in many hotels. The slippers have a sole of cardboard and toes of a heavy crepe paper, the edges being bound with a narrow tape, sewed on, so that it also holds the toe in place. The envelope, made of the same



Souvenir Bedroom Slippers of Paper for Hotels to Supply to Their Guests

heavy crepe paper as the toes, is fitted with a snap-button fastener.
Were made by Reliance Paper Co., Marinette, Wis.

*Suggested slippers made by
Dana W. Read Co., 64 S. S. W.
Lincoln, Wis.*



Cactus Plant with Some of the Apples Used for Making Jellies and Candies

RAISE CACTUS APPLES ON FARM FOR JELLY AND CANDY

Near San Fernando, Calif., is a large farm devoted to the raising of cactus apples, the pulpy product of one of the species of the familiar desert plant. The apple is used for the making of jellies and candies or is eaten in its natural state. It has a sweet taste and is about eighty per cent water. An acre of land will produce 500 to 600 boxes of the apples, which were selling for \$1.25 a box last season.

WORKERS PRODUCE MORE TODAY DESPITE SHORTER HOURS

Sixty-seven workers, in 1923, were producing as much as 100 men did in 1899, in spite of the shorter hours prevailing five years ago, according to a survey of productive efficiency in the manufacturing industries by the national-industrial conference board. This was accomplished by the development of machinery and better

organization. Today, iron screws are being made by automatic machinery at ratio of 1,000 to every one formerly made by hand. The ratio for spikes is about 200 to one, and in various other branches of the metal trades, many articles are being made by machine methods at the rate of fifty to one by the old hand processes. In the automobile industry, thirty workers in 1925 could do as much as 100 in 1914, the board discovered. In the production of food and food products, seventy-five persons in 1925 performed as much work of all kinds as did 100 in 1899.

BIG SMOKESTACK KEPT DARK TO PROTECT BIRDS

The 506-foot smokestack of a copper company in Great Falls, Mont., ordinarily lighted at night with flood lamps, is being kept dark part of the time to protect migrating birds. For some reason, it has exerted an attraction on birds and hundreds of them have been killed by flying against the shaft. Small birds, as well as ducks, geese and other larger kinds, have met death in this way. When the Boy Scouts learned of the conditions, they requested the company officials to keep the stack in darkness during the seasons of bird migration.

AUTO HAS TWO EXTRA BODIES FOR ICE AND BAGGAGE

Fender carriers for ice and luggage are exact duplicates of the body of the automobile on a car introduced in California. Even the door handles are similar, the windows have real glass, backed by curtains, and the top is hinged at the rear, the

"sun visor" making a convenient handle. The carriers in this style are less conspicuous than the ordinary type and are said to be more efficient because of the ease with which they can be opened and the extra protection offered the contents by their construction.

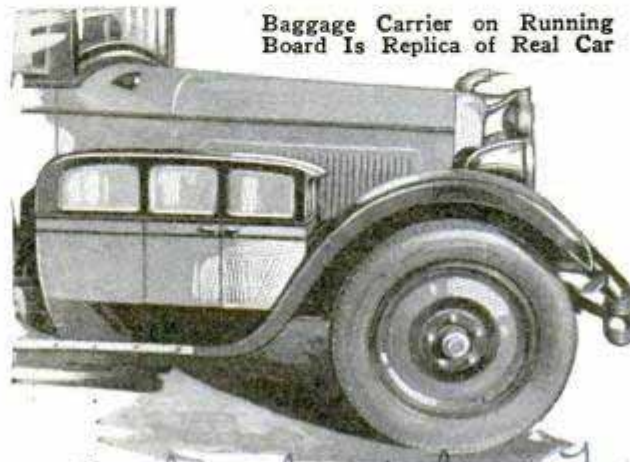

Baggage Carrier on Running Board Is Replica of Real Car

Body built by - Ted Lowdon, Valley Body & Radiator Co, Fresno - Calif.

3367

International

Auracanda Copper Mining Co

3505

3574

Chicago Daily News 11/24/27

3364

*Pacoma Canyon Dam
above City of San Fernando*

CAGING THE FLOODS BEHIND STEEL AND CONCRETE

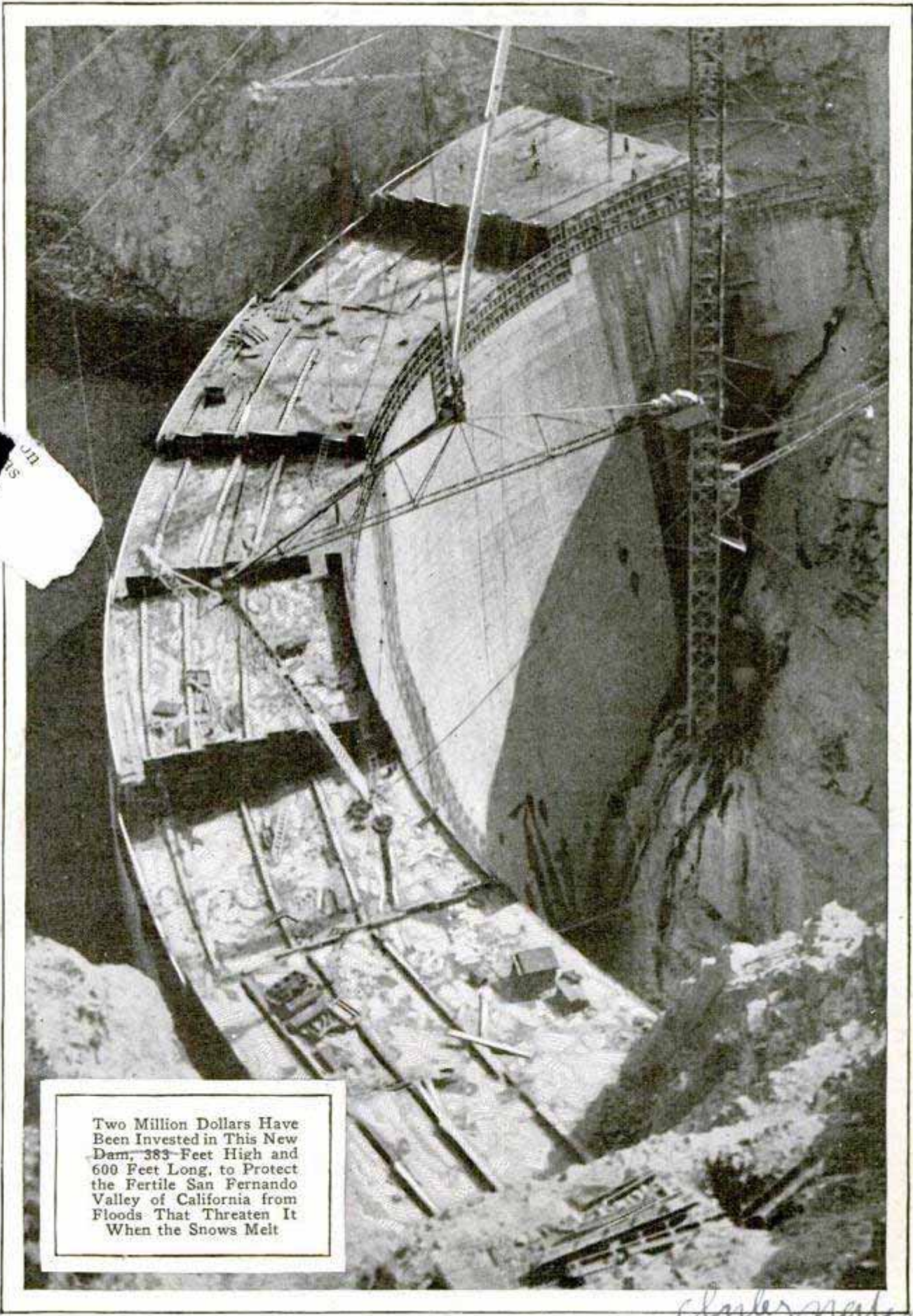

Two Million Dollars Have Been Invested in This New Dam, 383 Feet High and 600 Feet Long, to Protect the Fertile San Fernando Valley of California from Floods That Threaten It When the Snows Melt

Clarke National

First National Studio
at Burbank.

Fred U. Oberlen
Chief Chemist.

3194.

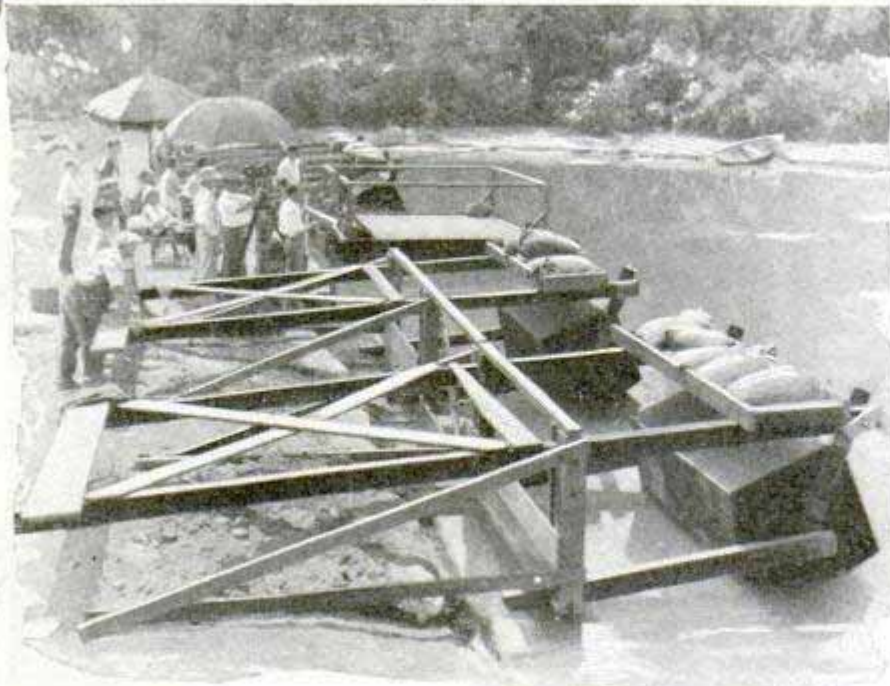

By Rocking These Boxes on Pivots, Realistic Waves Were Produced for a Motion-Picture Scene on Location near Los Angeles

WAVES ARE MADE WITH BOXES FOR MOVIE SCENE

By means of weighted boxes on levers, realistic waves were produced on a quiet pool in the Los Angeles river for depicting a South Sea island motion-picture scene. The disturbers were carefully moved to give the waves a long rolling action, as much like those of the ocean as possible. The illusion was strengthened by imitation tropical vegetation on the beach.

CHEMICAL ICE FREEZES PIPE WHILE THE SUN SHINES

Use of chemical ice solved a perplexing water problem in Washington, D. C., recently, saving much time and work and making it unnecessary to shut off the supply to Georgetown. It became necessary to cut in an extension to one of the mains, but this could not be done without first stopping the flow and there were no shut-off valves convenient for that section. To have halted the supply entirely would have resulted in a serious water famine over a

large area. An engineer suggested that the pipe be frozen on either side of the place where the break had to be made. Ice and salt were packed about the main but they only chilled the water. Finally, a chemical company was appealed to. They brought out a small box of chemical ice with a temperature of 160 degrees below zero. While the sun shone on the workers, they quickly froze the pipe, the entire process taking less than twenty minutes. The extension was cut in, the sun was allowed to thaw the pipe

out again, and a tie-up in service, that might have cost many thousands of dollars and much inconvenience, was avoided.

LUNCH CAR IS EASILY MOVED 2630 ON GIANT CASTERS

What are said to be the largest casters ever constructed have been made for a sixty-foot lunch car to simplify the task of getting it in and out of difficult places at carnivals, race tracks, fairs, and the like. The units each weigh 425 pounds, are more than twenty-five inches high and the wheel itself is twenty inches in diameter with a six-inch tread. Roller bearings facilitate moving, and there is a special locking device to keep the car steady.

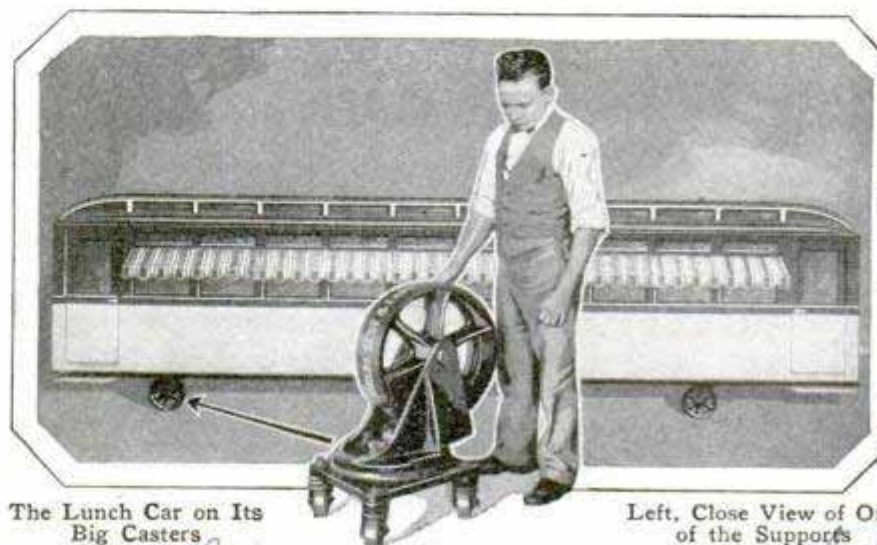

The Lunch Car on Its Big Casters

Left, Close View of One of the Supports

Service Caster & Truck Co.
Albion Michigan

American Chemical Products Co.,
1319 J. St. N.W.,
Washington, D.C.

346

1319 J. St. N.W.

3570 Horticulture from the San Jose Calif.

Bracey (2)

ORCHIDS GROWN UNDER GLASS RIVAL TROPIC KIN

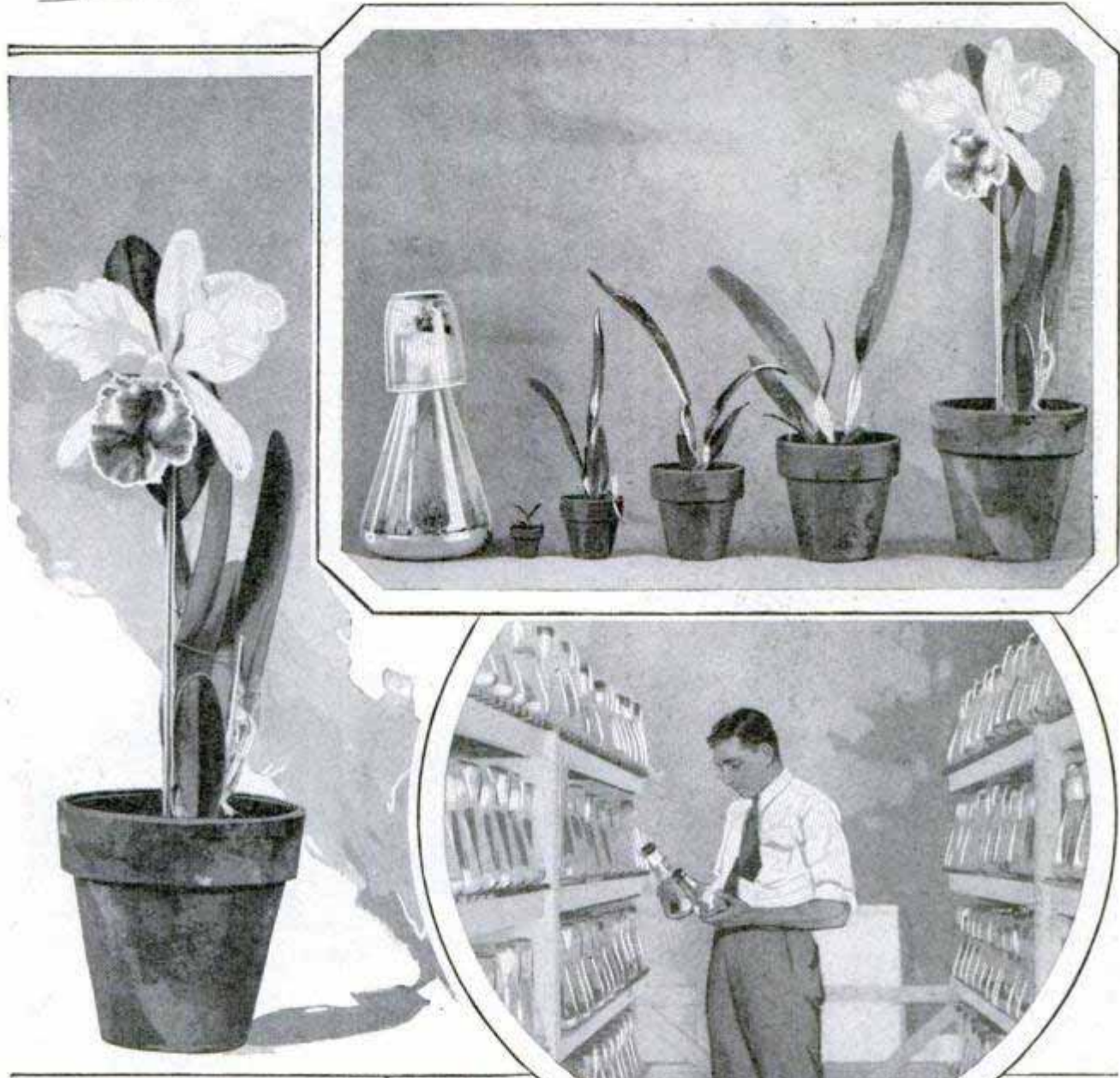

Samples of Cultivated Orchids, Various Stages in Growth of Plant, and inside the "Nursery," Where the Tender Shoots Are Grown Until They Approach Maturity

Orchids grow wild in parts of the tropics, but cultivating them under glass at a California farm is a task requiring skill and patience, for it takes nearly five years for a plant to mature from the seed and only about one seed in a million produces blossoms. The flowers will remain fresh and colorful for three weeks to three months, if left on the plant, and from ten days to two months in water after cutting. Healthy plants can be counted on to live for fifty to 100 years if properly tended. How successful cultivation has reduced prices is shown in the case of one variety that formerly sold for \$1,250 a plant. It

can now be purchased for \$15. The California producers are trying to grow an orchid twelve inches across

3438

THE MOST DANGEROUS JOBS

Firing a railroad locomotive stands fifth among the most dangerous American occupations in a table prepared by the labor bureau. The percentage of deaths from accidents among this class of workers is 43.6, while that of the highest, drivers in coal mines, is 82.1 per cent. Powder makers are second and railroad brakemen and electric linemen third and fourth.

Chicago Daily News 10/4/27

2799

Pictures from Dr. Alfred
Esradenwitz, orderclass
20, Berlin, Friedrichs Germany

Putting Your

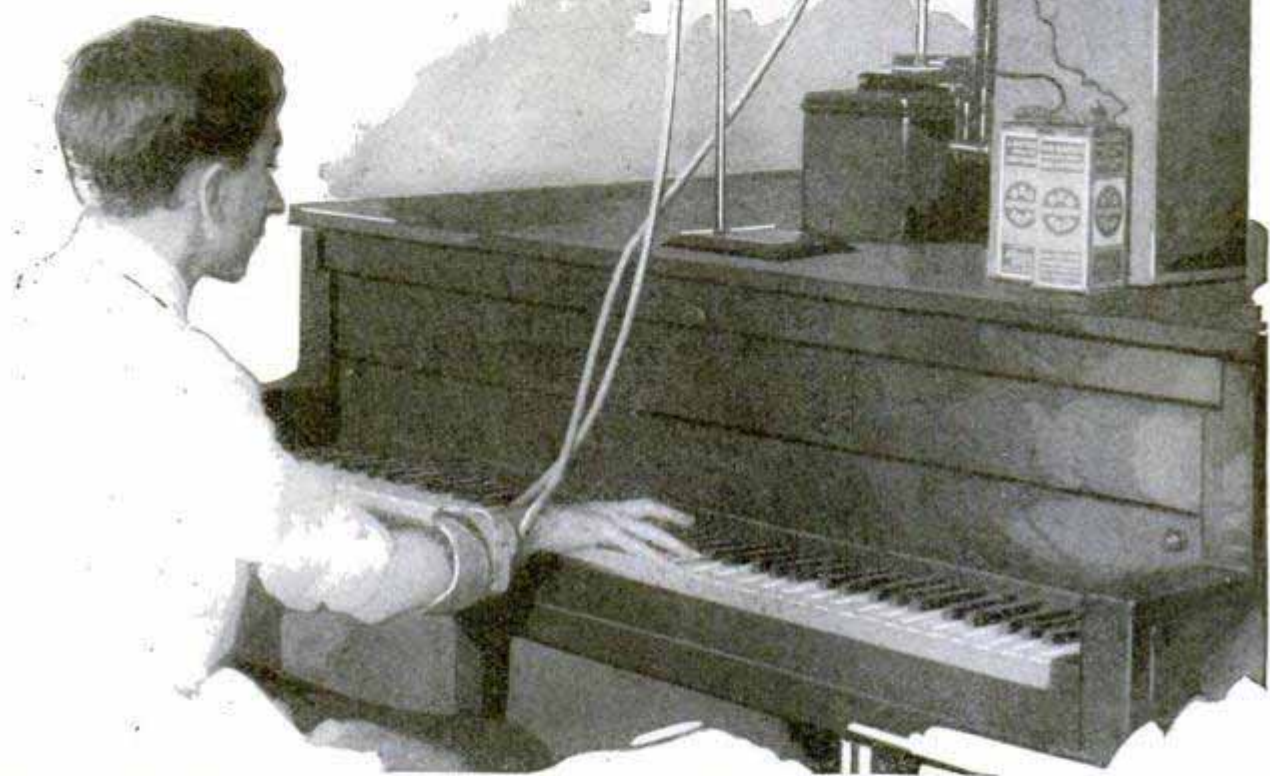

Automatic Recorder to Measure the Muscular Control of a Pianist While He Plays; the Bellows on Each Wrist Actuates the Pair of Pens Which Mark the Revolving Chart

By DONALD A. LAIRD

(Professor of Psychology, Colgate University)

“WHAT chances have I to be an inventor?” With hard work, sufficient knowledge, and a harnessed imagination the chances are good.

Inventors differ from the rest of us only by having better success at putting their imagination to work. We all have imagination, but not all of us have yet found how to make use of it.

When we look into a show window, or read a magazine, or examine a radio set, we are using our minds for discovery.

Dr. Robert S. Woodworth, head of the department of psychology at Columbia university, says that as soon as we use imagination our mental processes change from discovery into invention.

When Benjamin Franklin watched the discharge from crude batteries and the flash of lightning, he was using his mind for discovery. Franklin stepped out of the crowd when he put his imagination to work on these discoveries and made inventions.

There are five conditions which help the use of imagination for invention:

Youth is a favorable condition. The ages from twenty to forty are the best. Under twenty is the time to master the subject; after twenty is the time to use this knowledge through the imagination for invention.

Good physical condition is essential. The world's geniuses are not weaklings,

IMAGINATION to Work

although the common opinion is that they are. Most geniuses have lived longer and better than the average run.

Mastery of the subject is also necessary. There are very few "lucky" inventions that have been made accidentally.

Another requisite is hopefulness. A pessimist is rarely an inventor. The inventor has to have enough imagination and confidence to take a chance. Lindbergh was willing to take a chance.

Inventors should restrict their imagination to very definite problems. Francis Galton, the first scientist to study imagination, found that inventive mechanics had considerable imaginative ability. "The best workmen are those who visualize the whole of what they propose to do, before they take a tool in their hands," he said. This power to see things in the "mind's eye" can be helped if one systematically exercises the imagination. Day dreams are merely the play of imagination, not exercises. Reading maps and picturing in imagination the contour of the roads, the appearance of the mountains and the positions of the cities is a good exercise. Practice studying blueprints so that you can see the completed machine working in your imagination. Exercise your imagination to see how the furniture in your room would look if it were rearranged. Odd moments can be used to profit on exercises such as these.

How people are different in their imagining abilities is astonishing. Some people can easily imagine how things would look if they could be seen, but are totally unable to imagine sounds. The musician, it

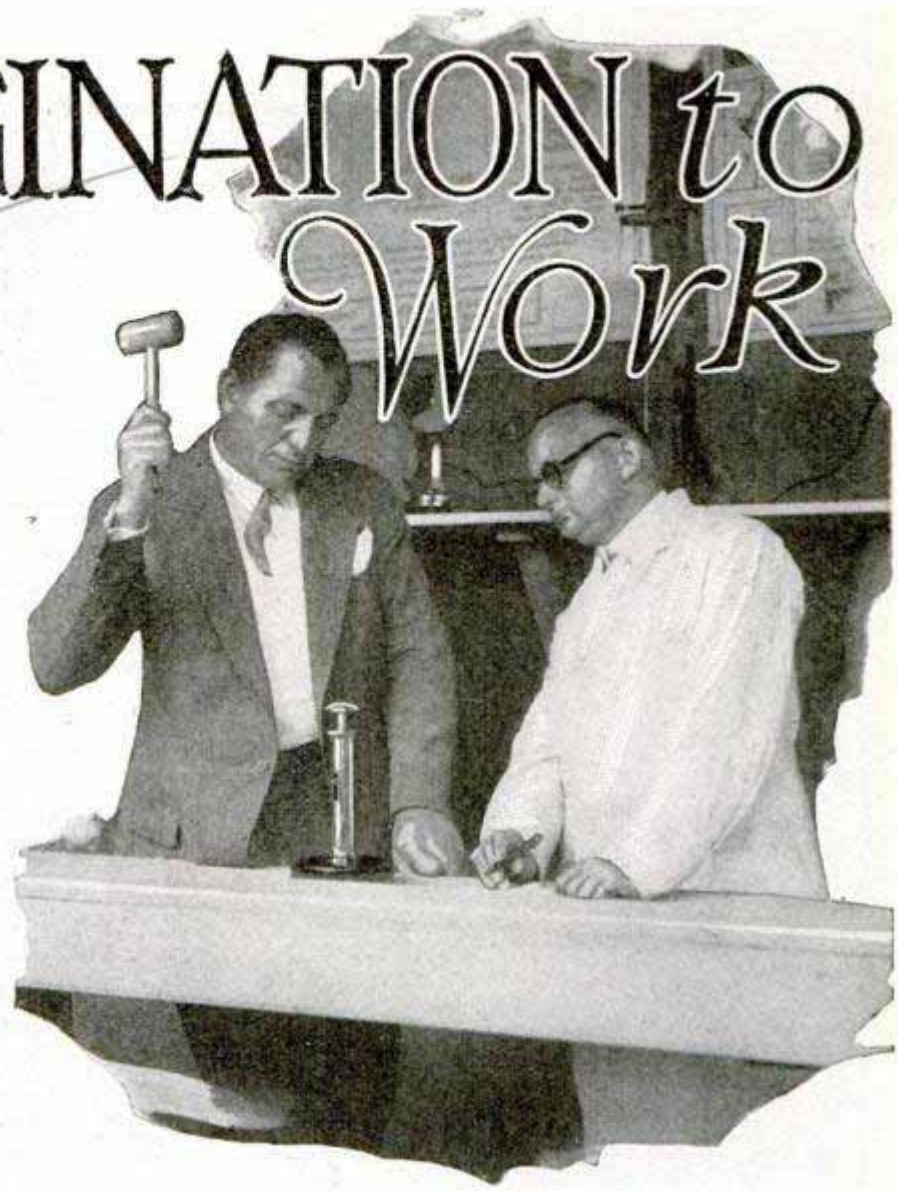

A Measure of Hitting Capacity Is Obtained with Mallet and a Scale

has been found, should have a good imagination for sounds.

The value of imagination-developing exercises is shown by eminent composers insisting that pupils compose music without the help of an instrument, using only paper and pencil. They must be able to compose by "hearing" the notes only in imagination in order to become really great composers.

Beethoven lost his hearing, but had such a well-developed imagination for musical sounds that he was able to write some of his most triumphal symphonies by hearing them only inwardly in his imagination.

Not all of us have the auditory imagination and other mental abilities to make us great musicians, but each person has some strong points in his imagination of which he should make the most use.

There was the case, for instance, of a

highly educated merchant who was born in Vienna. He was master of German, Spanish, French, Greek and Latin. His visual imagination was remarkable. He no sooner thought of persons or things than, in his imagination, they stood before him with all the clearness, sharpness and accuracy of the real object. He could add difficult columns of figures by seeing them solely in his imagination.

To depend almost entirely upon one form of imagination is often a handicap. One of the masters knew this and, in teaching art, had his pupils not only draw from memory to cultivate their visual imagination, but also had them follow the outlines of objects by moving their pencils around in the air to force them to cultivate their muscular imagination.

A curious application of this is cited by a foreign observer, whose quarters were visited by some North American Indians. The drawings in magazines which they saw there struck their fancy, and one of them, who wished to make a similar drawing on returning to his wigwam, followed the outline of the drawing with the point of his knife, so he could carve it better on his return home.

There are some inventors whose muscular imagination is so defective that they are unable to construct the machines they invent. They have to make drawings of them or describe them to someone with a good muscular imagination who builds the models.

It is visual imagination which is the greatest help for invention. Some wonderful mechanics are poor inventors because they have cultivated their muscular rather than visual imagination. The following tests may help you not only to cultivate your imagination but also to develop it:

Where is the strong part of your imagination? Grade yourself from 0 to 3 on each question as follows:

0, if you are unable to imagine it at all;

1, if you can imagine it only faintly;

2, if your imagination of it is fairly strong;

3, if it is as vivid as though it were actually present.

Visual imagination:

Try to imagine the west side of the house you are now living in.

How is your imagination of a mixed bouquet of carnations and roses?

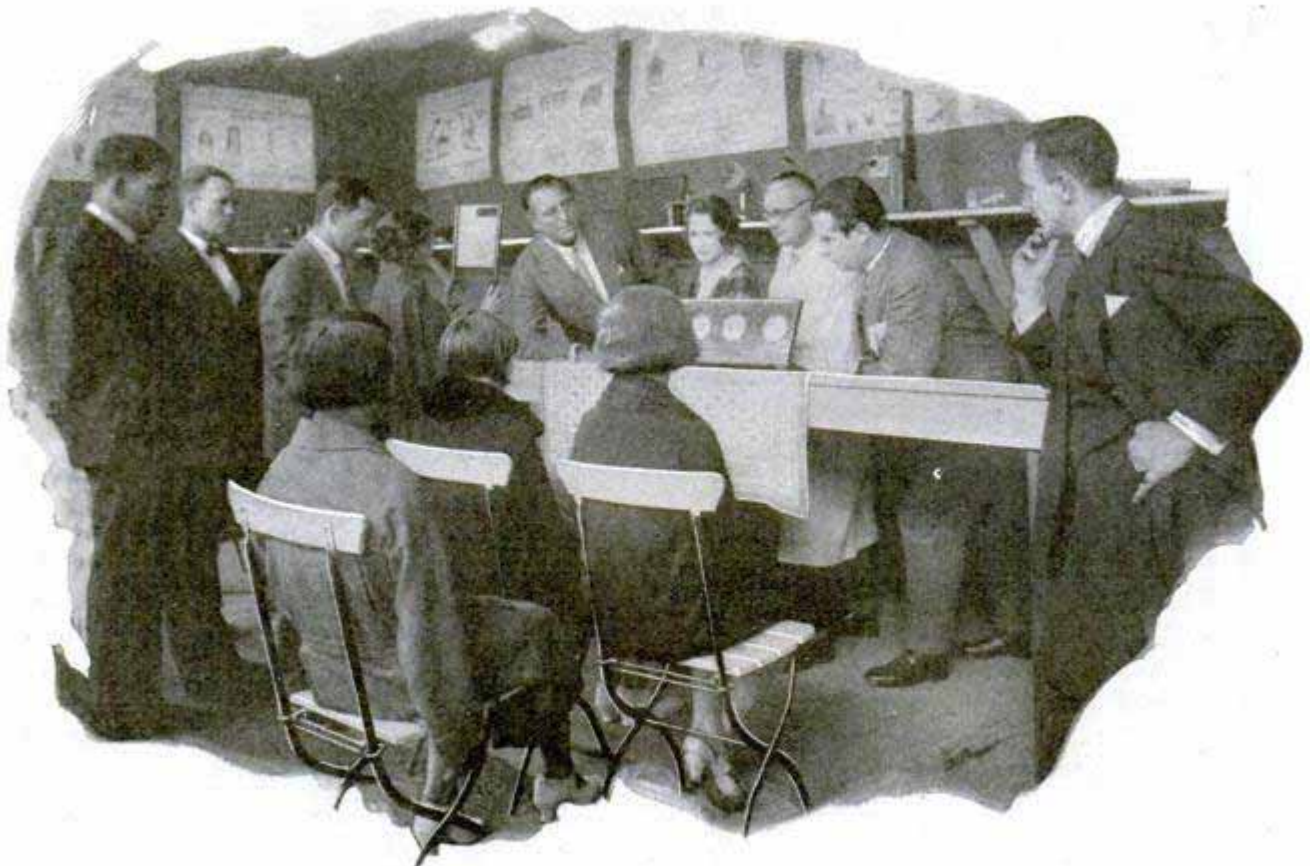

Demonstration of Apparatus Used by Scientists to Measure the Subjects' Powers of Observation; Many Industries Use Such Tests in Picking New Employees



The Ability to Withstand Fatigue Is an Important Factor in Many Lines of Work, Which Tire Some Muscles Excessively; Here Is a Woman Receiving the Fatigue Test

Get a mental image of the appearance of a schoolroom you have known.

Hearing imagination:

Imagine a four-cylinder automobile motor, with one cylinder missing.

Grade your imagination as you recall the voice of your favorite radio announcer.

How strong is your imagination in recalling the sound of a coarse file at work on brass?

Muscular imagination:

Imagine you are winding your watch. How distinctly can you feel the ratchet and the increased resistance of the spring as the watch is almost wound?

How vivid is your imagination of the muscle strain in throwing a ball with all your strength?

To get a total for each variety of imagining power add the grades you gave yourself, keeping each of the three sections separate and comparing the sums.

Use your imagination to fill in these blanks so the paragraph makes good sense:

When Fulton the first steamboat on the Hudson river a couple of men a living by ferrying from New Jersey New York. A few were engaged operating

sailboats up the river. These fought the steamboat bitterly they feared that a few would do all the they were doing and that most of them would lose their

How many words can you build with the letters e, b, a, h, t, m?

A fertile imagination will be able to see many words using only letters included in this list.

LOCK WASHER HAS EVEN GRIP TO DEFEAT VIBRATION



Rust-proof washers with "cog-wheel" edges, that grip the surface to which they are applied with numerous points about their rims, are said not to spread or jar loose and permit the use of

shorter bolts. As they are thinner than the usual kind and light in weight, they are adaptable to many special uses and are fitted for any part subjected to vibration.

The Shakeproof Screw & Nut Lock Co. 2501 N. Webster Ave. Chicago

3419



Pupils Receiving Hearing Test with Aid of Phonograph Record; Sound Is Transmitted through Headphones and Each Child Writes Down Words He Hears; Volume of Tone Can Be Varied

TESTER OF CHILDREN'S HEARING ELIMINATES GUESSWORK

Accurate tests of pupils' hearing are possible with an instrument that transmits sound from a phonograph record through a number of headphones the children wear. The record is simply a series of numbers, spoken through a reproduction of the human voice and in constantly diminishing volume. The subjects write down what they hear, the results giving a faithful report of the acuteness of hearing in both the right and left ear. This method eliminates the guesswork usually attending ordinary whisper tests and other experiments where the acoustics of the room, the nervousness of the child and other factors are not properly taken into consideration in the final judgment.

springs which reach from one axle to the other, while the car is carried by a fulcrum joint just back of the engine. The springs, designed for a car having cross springs at front and rear, give the effect of double-cantilever suspension. The front spring is discarded and part of the rear spring retained. The car body is fastened to the rear spring and pivoted at a point near the dash. It is claimed the springs eliminate the usual swaying of the body and give the small car as good riding qualities as a high-priced automobile.

AIRPLANES MADE MORE STABLE WITH VANE CONTROLS

Promise of greater safety in flying is seen in a stabilizer arrangement which is reported to have proved successful in a number of tests. Its chief service is to automatically adjust the ship to correct the pressure of air currents and changes in engine speed, so that it serves as a silent pilot when the operator, for any reason, relinquishes control of the stick, yet it is said not to interfere with his actions when he assumes charge. The apparatus consists chiefly of a pillar mounted on a universal joint and with two vanes at the upper end. It is placed clear of the propeller and where no parts of the ship are likely to cause eddying. At the lower end, two sets of wires are connected, one pair

SPRINGS AS LONG AS THE CAR ADD RIDING COMFORT

A new idea to increase the riding comfort of the small auto, provides 200-inch



For Smoother Riding in the Small Auto; Drawing to Show the "Cantilever" Springs in Place

Hyde Engineering Co.
610 Newbury St. Boston, Mass.

and no. 14, 15, 16, 17, 18, 19, 20, 21, 22, 23, 24, 25, 26, 27, 28, 29, 30, 31, 32, 33, 34, 35, 36, 37, 38, 39, 40, 41, 42, 43, 44, 45, 46, 47, 48, 49, 50, 51, 52, 53, 54, 55, 56, 57, 58, 59, 60, 61, 62, 63, 64, 65, 66, 67, 68, 69, 70, 71, 72, 73, 74, 75, 76, 77, 78, 79, 80, 81, 82, 83, 84, 85, 86, 87, 88, 89, 90, 91, 92, 93, 94, 95, 96, 97, 98, 99, 100
former flying officer
in British Air Service
POPULAR MECHANICS
Parkwater Field, Warner Flying School,
Spokane Airport
Spokane
Wash

running fore and aft to the elevator controls which govern the ship's climbs or descents. The others are connected to the wing guides which affect the airplane's side movements. In actual use, the performance of the unit is somewhat as follows: Assuming that the ship is going eighty miles an hour and flying level, the wind pressure on the vane facing the direction of flying, drives it back against the tension of the adjustable fore and aft spring. If this has been set to the proper stiffness so that the plane is balanced at eighty miles an hour, when the nose tips down and speed is thereby increased the vane is driven farther back, tension on the spring relieved and the elevator in the back comes up, leveling the ship again to an even keel. Should the plane point up, decreasing the speed, the vane, subjected to less wind pressure, comes forward, pulling with it the control in the rear to tip it back again when the normal speed rate is restored. This same principle also is applied to the operation of the aileron controls, the side vanes being helpful in balancing the ship in turns and banks in ac-

2966

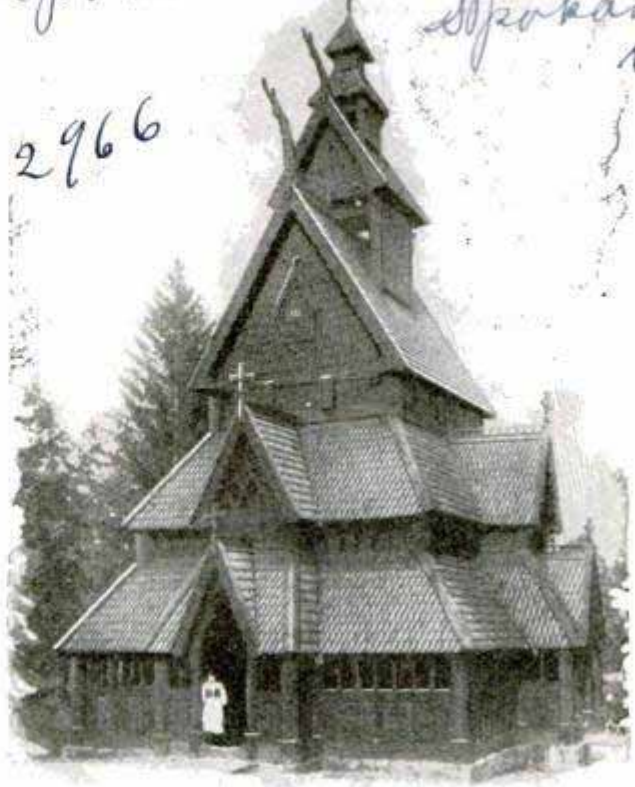

Glue and Wooden Pegs Hold This Norwegian Church Together; It Was Erected nearly 800 Years Ago

**CHURCH BUILT WITHOUT NAILS
— EIGHT CENTURIES OLD**

One of the sights of Oslo, Norway, is a wooden church, 800 years old and built entirely without nails. Glue, wooden pegs and braces hold the structure together. Its queer, pagodalike form illustrates the style of architecture peculiar to the period.

Stabilizer in Place on Airplane Wings; It Tends to Correct the Ship's Position with Respect to Air Pressure at Various Speeds

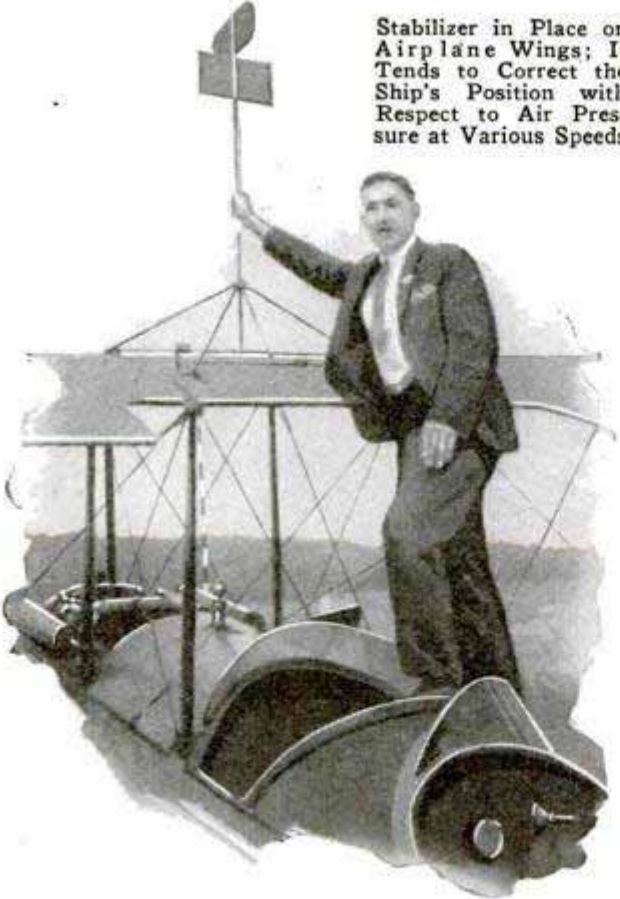

cordance with the wind pressure to which they are exposed.

**MOVIES OF BIRDS AND INSECTS
— TEACH FLYING SECRETS 3464**

Motion pictures of the dragonfly and humming bird have been prepared by the British government in the hope that the films may reveal flying secrets that will enable engineers to design more successful helicopters and other aircraft. The dragonfly and humming bird are masters of the art of pausing in the air and this is one of the feats man has been attempting to imitate in his airships for a long time. The pictures will be analyzed carefully when shown, in an effort to learn the wing and other movements. The humming bird is regarded as one of the miracles of nature because of its skill in balancing in the air without apparent effort.

Early News 10/10/27

3178. SIXTY-FIVE YEARS OF PROGRESS IN LOCOMOTIVES

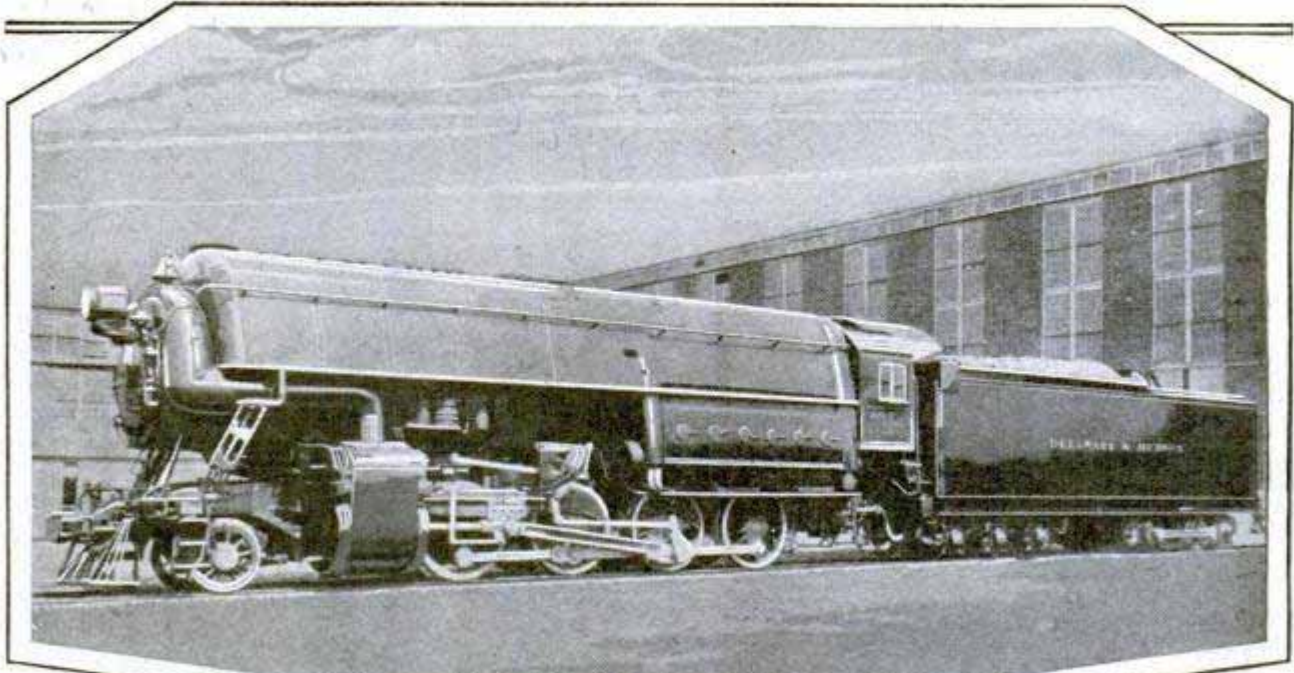

How Far the Iron Horse Has Grown in Recent Years Is Illustrated by the Delaware and Hudson's Latest Freight Engine, the "John B. Jervis," as Compared to the "William Crooks," Which, in 1862, Was the First Locomotive to Enter the Northwestern States; the "Jervis" Weighs 314 Tons and Is Just a Half Inch under Seventy-Five Feet in Length

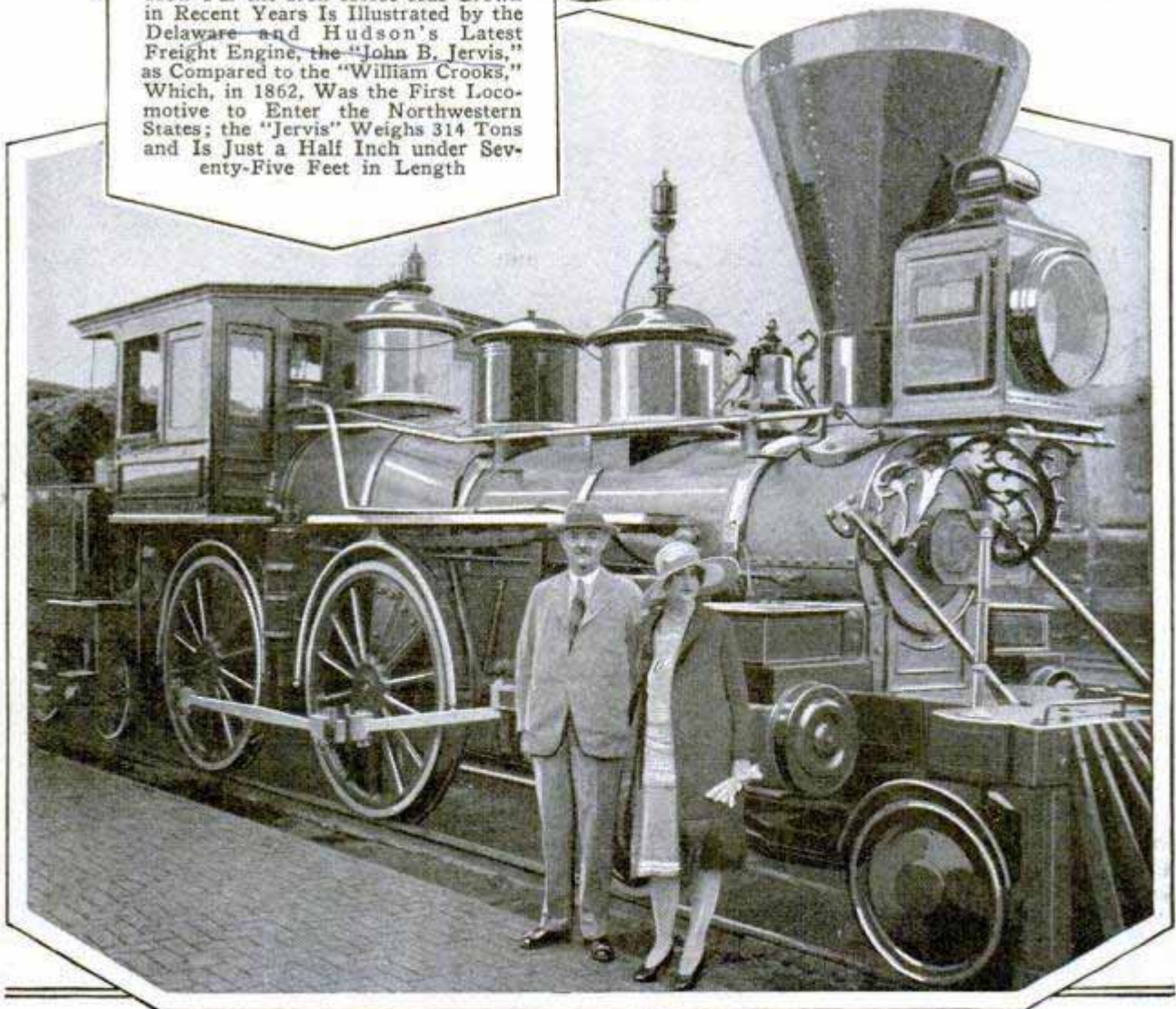

Chief Engineer

NEW THIRTY-MILLION BRIDGE TO SERVE NEW YORK *2955*

Work on another bridge for New York city, to link the boroughs of Manhattan, the Bronx and Queens, and to cost approximately \$30,000,000 has started and is expected to be finished in four years. The structure will be 16,850 feet in all, the main part will have facilities for the operation of eight lines of vehicles and the Manhattan connection, six lines. There will be two five-foot walks for pedestrians. The bridge has been designed to harmonize with the Hell Gate arch bridge and will have a central span, 1,100 feet long, and two side spans, each 500 feet. The portion over the Harlem river will consist of a double-leaf bascule affording two channels, each 150 feet wide, and a vertical clearance of fifty feet at mean high water. Toll will be charged for passage across the viaduct, which is expected to prevent a traffic-congestion crisis that might develop, due to the increase in communication between Manhattan and Queens with the opening of the new artery at West 178th street.



Steel Lattice around High Smokestacks, to Shield Their Unsightly Appearance in Residential District

STEEL "DRESS" FOR SMOKESTACK IMPROVES CITY'S LOOKS

To hide the bare outlines of tall smokestacks on a power plant near a residential district in New York city, a framework of steel has been built around them. This feature, with careful smoke control, makes the plant much less objectionable to persons living in the neighborhood.

FOOT LEVER ON WASH BASIN SAVES TIME AND WATER *3391*

Addition of a foot lever by which the water is turned on, is the latest improvement on the circular wash basin popular in large industrial plants. It leaves both hands free to use the liquid soap which is supplied from nozzles in a center rack, automatically shuts the water off when the foot is released, to prevent waste, and simplifies the cleaning of the basin. Water is poured forth as a fine circular spray, and is so distributed that ten men at one time can wash conveniently and thoroughly with no more water than ordinarily would be used by one man with an old-type single nozzle, continuously running.



Men Turn the Water On with Their Feet as They Wash at This Big Basin, Large Enough for Ten

WINDSHIELD WIPER IS HEATED TO DO BETTER WORK *3395*

Ice and snow are said to be removed from the windshield as easily as moisture, with a wiper that is electrically heated. In most respects, it resembles the ordinary unit, but has a resistance element that comes in contact with the glass, keeping frost from accumulating and also expediting the removal of water.

Chicago. 8135 Central Park Ave

*New York Central
Alcoa Niagara
Justice Woods
Inventors
Hillsdale, Mich*

Bradley Wash Fountain Co. Milwaukee Wis

3283
58

Chicago Daily News
10/2/29

J.E. Carroll, Los Angeles, Calif.
2501 Burnside Ave.

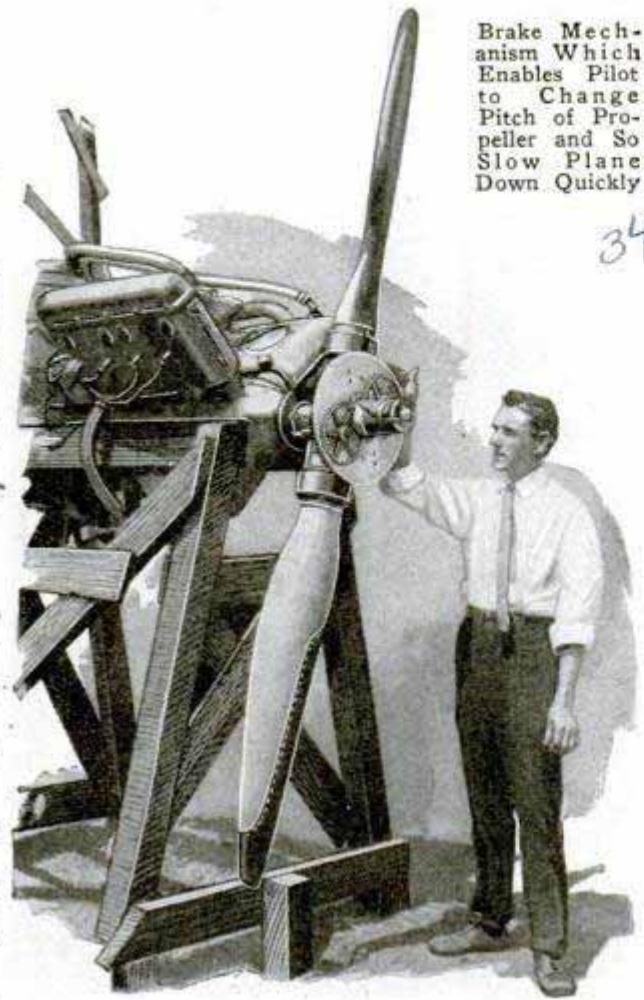

Brake Mechanism Which Enables Pilot to Change Pitch of Propeller and So Slow Plane Down Quickly

BRAKE ON AIRPLANE PROPELLER TO AID IN LANDINGS

Airplanes can be stopped within a space about twice their length when landing, according to claims of a western inventor for his propeller brake. It consists chiefly of a small motor, with push-button regulator on the control stick, whereby the propeller can be made to push the air instead of drawing it back. This is accomplished by changing the pitch of the blades with the motor apparatus. It is expected that the device will also be of aid to the pilot when the plane strikes air pockets or other "bumps" along the sky ways.

ROGUES' GALLERY OF MOVIES TO HELP CATCH CROOKS

348 Short pieces of motion-picture film, showing the subject in different poses, will be filed away in the rogues' gallery in Chicago, if present plans of the police department are carried out. It is believed that the movies will greatly help in identifying suspects, as they will show how

a man walks and performs other movements which would give additional clues to their identity.

S.B. Fallow, Westport, Conn.

FOUR-INCH PANSY-BLOSSOMS PRIZE GARDEN FLOWER

3444 Pansies with blossoms four inches across and with stems eighteen inches long, are grown by a Connecticut florist in large numbers every year. They are the result of selection of seed and care, but the grower declares that anyone could produce equally handsome flowers by proper methods. The seed is planted outdoors in summer and the plants are removed to hothouses at the approach of cold weather. They are reset in soil in which the flowers never have been grown before, and, at the end of the season, the soil is entirely replaced by new. Ordinary fertilizers are used, but one of the mysteries of the plants is that they will grow to such large size only in certain localities and, after having produced huge blossoms for a number of years, they will suddenly lose their size and quality. These constitute some of the hazards of the pansy-producing business the grower declares. In good seasons, however, he may ship as many as 75,000 blossoms in one day.



Huge Pansies beside Stack of Books, and Rule to Show Their Enormous Size

Vertical text on the right edge of the page, possibly a page number or date, partially obscured and difficult to read.

3050

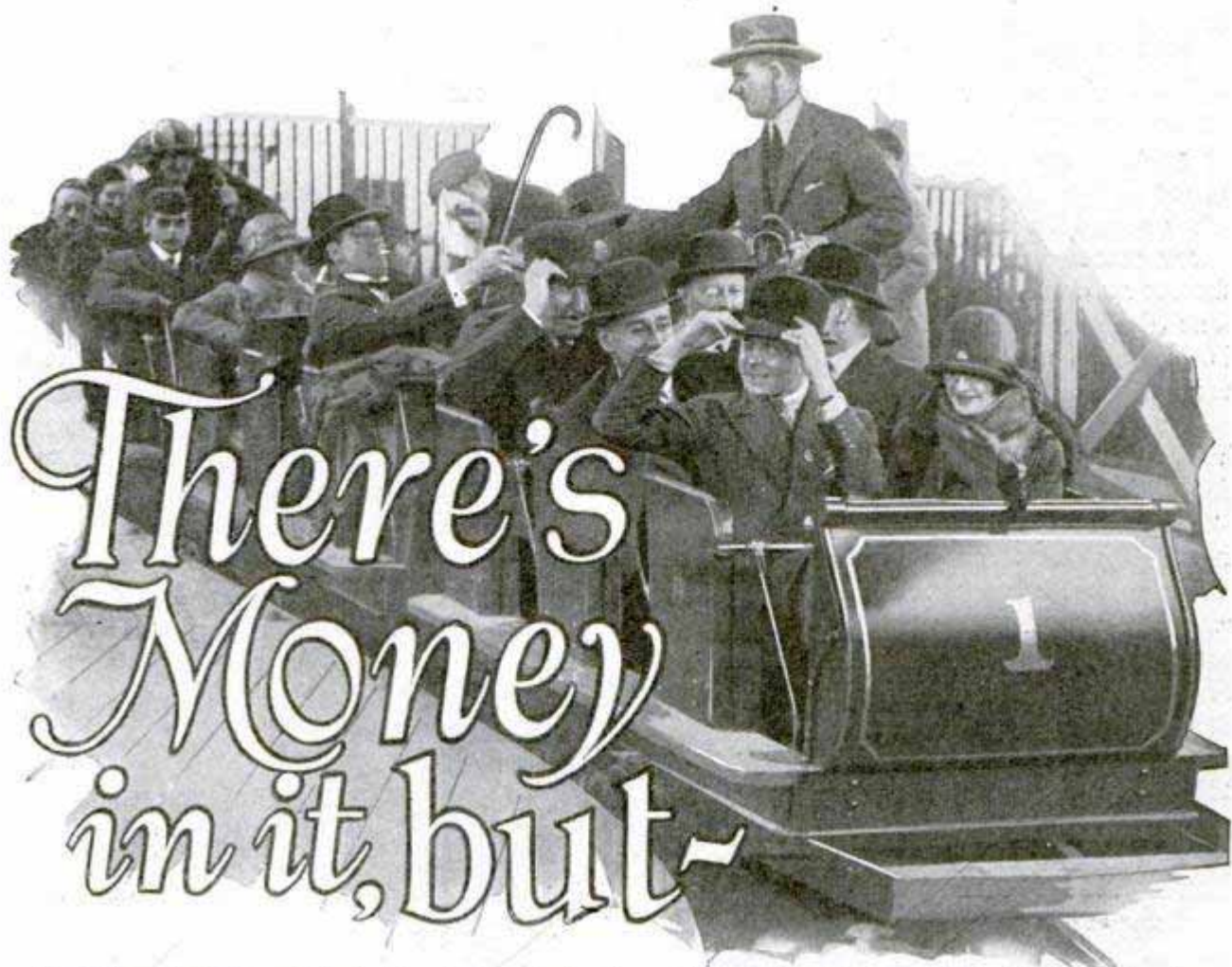

There's Money in it, but-

The Prince of Wales and Lady Mountbatten, in the Front Seat, Getting Ready to Emit Shriek Squeals, Just Like Any Other Customers at One of Coney Island's Rides

By HOMER CROY, Forest Hills, L.I., N.Y.

INVENTORS of amusement-park devices gamble on human nature. And human nature is a queer fish. No one knows when it is going to bite.

Consider the case of William F. Mangels. He has been the inventor of amusement-park devices ever since he was a boy and has more than fifty patents to his credit. He built the "Razzle-Dazzle," the "Tickler" and the "Whip." The latter is a device of cars, fastened on a drive, which travel comfortably along a flat track until they get to the end of a straight run, when they whip around the corner with a sharp snap, from which it takes its name. It was tried out in Luna park, Coney island, in 1914, and has since traveled all over the world. The royalties on it have amounted to \$300,000.

But last year Mangels got the biggest idea of all. It was much better than the "Whip" and had a novelty which the public had never seen. He drew up his blue-

prints, got in his best builders and mechanics and set to work. It was to be the biggest and finest achievement of his life. At last the device was done and it fell as flat as a porous plaster.

"Why did it fail?" I asked him.

"Because it was paced too slowly. I was ten years late."

The public wants speed, he explained. The automobile has completely revolutionized riding devices. People used to be willing to poke along, but now when they go out for a good time they want it quick and fast.

Returning to the "Whip," the idea back of it has intrigued many an inventor. The favorite plan has been to add to the thrills and give the public an extra motion. One is to make the car, when it whips around the corner, turn completely around. One inventor added an up-and-down motion. The funeral was impressive. The reason was that a person out for pleasure can't

3050

stand two motions at the same time. Instead of thrilling people, as the inventor had hoped, it made them seasick.

What will go and what will not, what will succeed and what will be a headstone, cannot be predicted. Before the World's Fair opened in Chicago, in 1893, an inventor came to the board of managers and asked for a concession to put up an amusement device. The management looked his blueprints over; they didn't think much of them, as the blueprints called for some sort of wheel extending up into the air, with seats arranged across it. He was advised against it.

"People aren't going to risk their necks on a thing like that," they told him.

But he posted the advance money and went ahead with the idea. The man's name was Ferris and he called his riding invention the "Ferris Wheel." To the astonishment of the board of managers, people rushed to risk their necks on it and the device became almost instantly world-famous. The day the fair closed, the "fool" who had invented it counted up his

money and he had taken in just \$726,000. It was new, it caught the public fancy, but it was an exotic flower that, financially, bloomed only once. The wheel was taken to St. Louis with the expectation of making a million, but it took in only \$450,000. At each succeeding exhibition its returns grew less. Ferris put out other inventions but none of them pleased the ever-fickle public, and he died on the fringe of want. The wheel, however, still appears in small size in the suburban parks, but the mastodon which amazed Chicago has joined the silent dodo.

In the world of outdoor-amusement inventions, you never know which way the "cat is going to jump." Some years ago there was a young boy working in an architect's office in Nashville, Tenn., at ten dollars a week. A fair was going up at Nashville and a prize was offered for the best architect's design for one of the buildings, and the young man entered his drawings under another name. When the award of \$2,500 was announced it was found that a lad, still in his teens, by the



Noah's Ark, One of the Successful "Walk Through" Entertainments Which Lets the Customer Do Most of the Work of Amusing Himself, While He Pays for the Privilege

name of Frederic Thompson, had won it. He took his wealth and went into partnership with an amusement man and put up an attraction at the exhibition. He made money, and then went to other fairs and exhibitions. Sometimes he won, and sometimes....

Once he rented an old coal mine at the edge of a fair grounds, lined it with red cotton flannel, put in some weird lights, called it the "Cafe de la Mort," and heard the pleasant tinkle of money coming his way. Next he went to Buffalo, where he put on "A Trip to the Moon," which made the Ferris wheel look like a peanut stand. And then, with banners flying, he marched to Coney island, the Mecca of amusement men. He put on "A Trip to the Moon" again and money still continued to roll in. And while the world was still dazzled by his brilliance, he conceived and built Luna park. He made money with both hands and spent it with a shovel.

Money meant nothing to him and he died a comparatively poor man.

Where do the invention ideas come from that make the money—sometimes—at the amusement parks? Where do the fairies come from?—from the sky, from the clouds, from the flowers. Sounds ridiculous, doesn't it? But there is history to fall back on.

During the years of the Queen's jubilee, a tired inventor went over to England to get a rest. On the way back he came up on deck one day and lay gazing idly into the sky and letting his mind wander pleasantly among the clouds. Overhead, seagulls floated.

"If I could give people the idea they were flying, they would like it," he thought.



Sliding Down a Hill Has Just as Much Allurement for Grown-Ups as It Holds for the Children

The circling of the seagulls gave him the idea of working out a device which would fly in a circle. How? With some sort of a center pole supporting the cars. He took the idea to R. S. Uzzell, an old hand in the game; there were discussions, blueprints, promotions and the airplane swing, to be found in almost every amusement park, was born. There are now about 1,500 of them in the world.

A man in Portland, Oreg., sat on the floor one evening watching his son spin a top. The lad wound it up, pushed it out of the holder and set it going. The man pondered on the fun the boy was having.

"If I could invent a top that grown-ups could play with, I'd make a fortune," he thought.

3060

The idea was alluring. "People are only children grown tall," he reasoned, and began to turn the idea over in his mind. At last, he worked out a principle by which a huge top could be constructed with cars on which people could ride, while the top spun merrily. But there was nobody in Portland familiar with the amusement game; getting on the train he went to New York. The men old in the business looked it over; it was a fine idea; passengers would be pleasantly pleased, but—its cost would be prohibitive. He was told it would require about \$18,000 to build, and he raised the money himself. It is the way fortunes are made—and lost.

When the first top was completed it had cost \$37,000. It was put up at Coney island—the "Giant Top," it was called. The inevitable happened. The people liked the sensations, it had the psychological appeal that amusement devices must have, but too much weight was concentrated in one place. Crash! The point broke, and a woman and child were injured, and two damage suits followed. It cost \$3,500 to raise the top again and to start it going once more, to say nothing of the money that went out in the lawsuits. The man with the idea failed; his home was lost and he retired from the amusement field.

Seemingly the idea was as good as the seagull idea, but . . . And that is something the amusement field is full of—buts.

Recently there was a storm in Florida and when the storm was over and the first people ventured out, a house was found balanced on the edge of a cliff. Chains and ropes were placed to secure it and curious people started walking through it to see what whimsies the storm had played. As they walked through the tilting house they had a curious sensation; they complained of being dizzy and when they came out they talked about how creepy it felt. The house became quite a local attraction.

One day an amusement-park man walked through it, and as he walked he wondered. Here was an idea; people liked it; people would pay money to see it. And so he had a house built using the same idea as that of the dislodged dwelling. He had the floors slanting and the windows set so that when a person walked in, the house seemed normal in every way; but after he had walked a few steps he thought that it must be a terrible night at sea. His feet had the curious feeling of stepping on nothing and they stumbled around like children who had been too long at ring around the rosie.



A Baby-Size Whip in the Children's Park at Coney; Trying to Improve on This Device Has Wrecked the Fortunes of No Less Than Eight Different Inventors in Recent Years

an inventor, James O. Rase
Glasgow 63 Scotland

The explanation was simple. Everything was set at such an angle that the person going through the house had nothing to orient himself by, and he had the strange and creepy feeling of a world gone mad. The house was given various names, from the "Mysterious Knockout" to "Damfino." Under such names it is operating.

2108

GEARLESS MOTOR CAR IS RUN ON TURBINE PRINCIPLE

Patent

URGE WRECKING OF OLD SHIPS TO IMPROVE FISHING

3403

A plan for converting useless old ships into assets is under consideration by the New Jersey fish and game commission. It has been found that fish are attracted to wrecks. So it is the idea of the commission to sink worthless craft off the coast where they will not be a menace to shipping and so draw the fish that feed on the marine animal and vegetable life that accumulates on the old hulls.



Adapting a Principle of Steamer Propulsion to the Automobile; the Car with Turbine Drive

HOW THE EYES REVEAL DISEASE IS SHOWN BY CAMERA

3310

Instead of tapping you on the chest and making you say "ah," doctors may peer intently into your eyes and take pictures of what they see with a special camera, if an instrument recently introduced becomes widely adopted. It is the product of Swedish experts, and, with it, physicians have traced the symptoms of various diseases in thousands of persons. The nerves, the blood vessels and the "seeing layer" of the eye are affected by maladies in such a way, the scholars say, that the changes are registered on a photographic plate and can be interpreted by a skilled doctor. A concentrated beam of light that is said to reveal minute blood vessels and nerves in the eye with the clearness of an X-ray, is utilized in connection with the camera in making the pictures.

nordenson

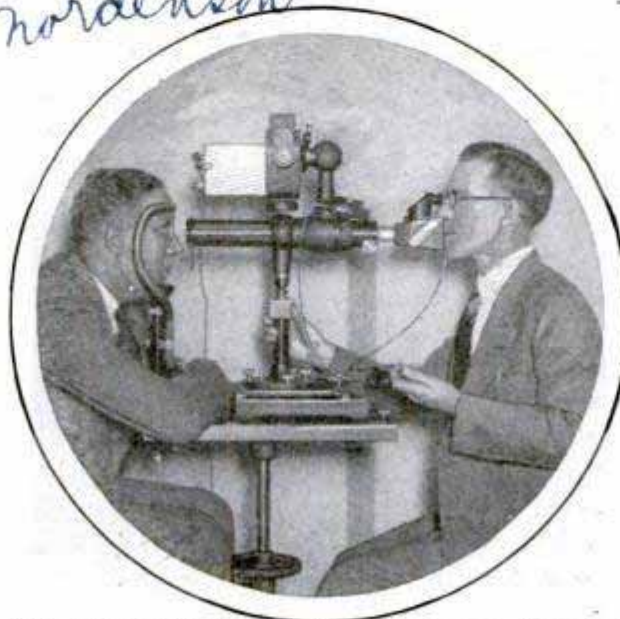

Examining Patient with the Eye Camera Which Is Said to Enable Physician to Detect Disease

Instead of a system of gears an automobile devised by a Scotch inventor operates on the turbine principle. Power from the engine is transmitted to the drive by means of sets of revolving blades through the medium of a liquid.

FIND GOLD THAT TURNS BLACK IN AUSTRALIAN MINES

3456

All gold is not alike. The Australian gold is redder than that found in California, while that from the Ural mountains is of a still deeper shade of red. Recently "black" gold was found in the famous "nuggety reef" in Australia. It assumes a silvery-white appearance when first taken from the ground, but turns black after exposure to the air. The metal is a natural alloy of gold and bismuth and, when properly refined, yields a gold equal to the nugget and sand varieties found elsewhere.

Victoria

Used by Mr A. J. Bedell

3780
64

Dr. & new York by Baron L. Shiba,
Director, Imperial Aerodynamic
POPULAR MECHANICS
Research Institute, Japan

**FAST MOVIES OF AIR CURRENTS
3489 TO HELP AVIATION**

With a camera that can take 20,000 pictures a second, movies of air currents have been prepared for reference study in aviation. Details of breezes moving at fifty miles an hour, are revealed so clearly that the eye can easily follow the movements around various obstacles. The flight of a pistol bullet through an electric-light bulb looked like the slow bending and final disintegration of the glass. Currents of air from a windmill and the passage of the air around an airplane wing were also shown. The film was recently exhibited in New York, after being prepared in Japan with the "super slow-motion" picture camera developed there. The instrument is the outgrowth of research by German scholars and craftsmen. It has two parallel disks, one with a large number of small mirrors which reflect the image obtained through the lens of the other disk, which holds the films.



Cleaning One of London's Unique Weather Vanes; the Grasshopper on Top of the Royal Exchange

**GRASSHOPPER WEATHER VANE
HONORS BUSINESS MAN**

At the tip of the staff on the Royal Exchange in London, is a huge grasshopper figure which serves as a weather vane and honors Sir Thomas Gresham, who founded the institution during the reign of Queen Elizabeth. Once a year, the vane is given a thorough cleaning by a steeplejack.

**LOW-COST PARQUETRY FLOOR
3472. IS EASILY LAID**

Parquetry flooring can be installed at about the same cost as strips, it is said, with specially prepared units, joined together with tongues and grooves on all sides. The blocks are made in two sizes, one eighteen inches and the other thirteen and one-half inches square. They are composed of carefully matched smaller pieces ready for laying, and it is claimed no special requirements are needed for the subfloor, which may be the same as that prepared for the strip flooring.

**FLEXIBLE-CABLE LANDING LIGHT
PREVENTS DAMAGING PLANE**

By anchoring the landing lights on his aviation field to flexible cable supports that bend over without breaking when struck, a Texas manager has found a way to preserve the lamps and prevent damage to airplanes. The plan was adopted after several accidents had occurred, when ships struck the rigid standards.

W. W. Fuller, Meacham



Planes May Strike but Are Not So Likely to Break This Light, as It Is Attached to Flexible Cable

J. M. Karwisch Wagon Works
228 S. Delta Place, Atlanta, Ga.

Field
Work Worth
3300.

3388

ms. and Mrs. Jesse Knapp
Van Nuys, Calif.
65

POLLEN COLLECTORS HELPING HAY FEVER VICTIMS

The old saying that it is an ill wind that blows no one good is well illustrated in the case of two enterprising former students of the University of California, who conduct a profitable business in collecting pollen to be studied by the hay-fever experts. The tiny grains are bottled and sold for \$1 to \$6 per gram, depending upon the variety. The pollen is ana-

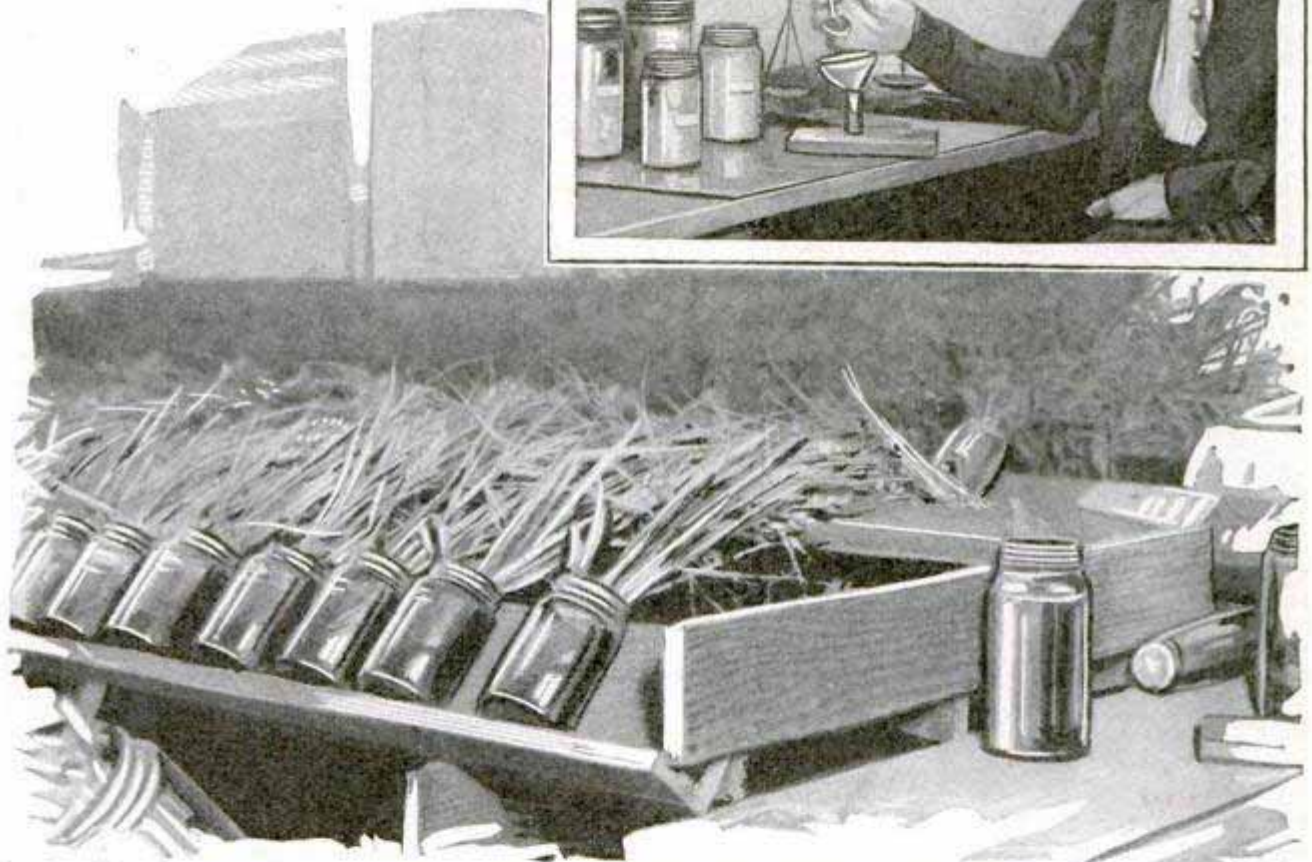

Weighing Pollen, and Some of the Plants Collected for the Dust; the Pollen Is Believed to Spread Hay Fever and a Curb Is Sought by Destroying Plants That Produce the Harmful Kinds

lyzed in laboratories to determine if it is of a kind that contributes to hay fever troubles and, if found "guilty," efforts are made to eradicate the weeds that produce it, or serums and other substances are prepared to combat it.

WHEN A SHIP IS ARRESTED

According to maritime law, ships, like men, can be arrested for failure of the owners to pay just claims against them. Some large ports have a special dock which is used as a sort of marine lockup. In case of an arrest, a sheriff's officer usu-

ally comes aboard, shows a warrant of arrest to the captain and nails the document to the mast. The ship is then legally a prisoner. According to British maritime law, anyone who has done any service for the ship, such as towing, repairing, lending money or even laboring as a seaman, can demand payment from the owners and, if this is not forthcoming, arrest proceedings are authorized. Sails, gear or other instruments can be taken to the amount of the claim. When a ship rams another, or fouls it and then steams off without making good the damage, it may be arrested within three miles of any British port.

3488
Tid - Orits London, Eng.

3197

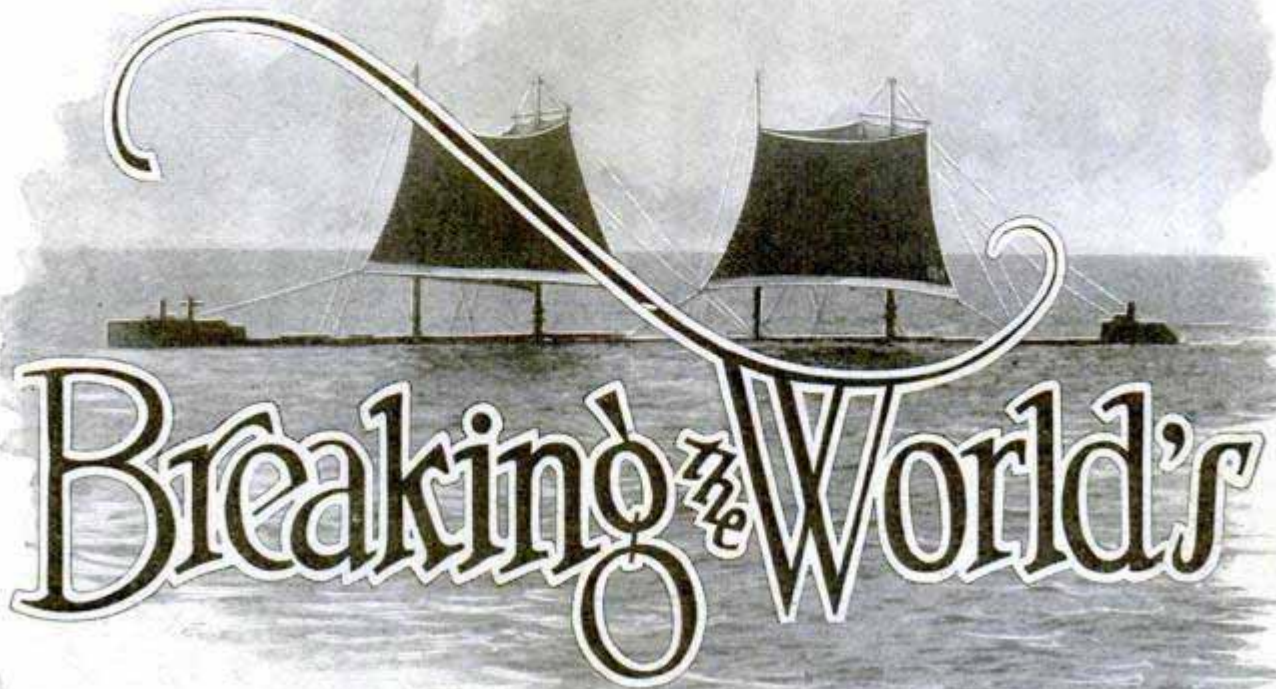

Triangular, Three-Sided Targets Used at Sea to Give Speedy Destroyers and Swooping Airplanes a Chance to Attack from Any Side, Making Complicated Maneuvers Possible

By G. K. SPENCER,

*Moore Hotel
Seattle, Wash*

SMASHING a thirty-foot target in the sea, eighteen miles away and out of sight of her gunners, the U. S. S. "West Virginia" recently has passed all world's gunnery records. Though the gunners did not have the slightest glimpse of their objective, owing to the curvature of the earth's surface, the co-operation of the fast observation planes resulted in the achievement, which brought a great sum in prize money to the gunners and the control forces.

The system by which this firing was made possible is one of the marvels of modern gunnery. Upon receiving information that their ship would be called upon to fire an unusually difficult schedule, in common with other vessels of the battleship divisions, the gunners were practiced assiduously in the southern drill fields of the Pacific ocean before they entered the Atlantic through the Panama canal. "General quarters" was sounded frequently and the men drilled by day and night at the great guns. The exhibition of morale was astonishing, but one of the most amazing

elements of all was the fact that not only the gunners, but the entire ship's company, in a divine service to which attendance was entirely voluntary, prayed for the success of their guns in the firing to come.

"The ship was in high morale that day," quietly commented an officer, who was asked to explain the result of the firing. "All hands helped us," declared a gunner, "they gave us perfect ranges from the tops, the radiomen caught every signal perfectly, the engineers gave us just the right amount of steam and power to the fraction of an inch of ship movement, the plotting room didn't make a single mistake, the "bridge" swung the ship's wheel accurately to keep our guns on the target, our captain trusted us—he knew the ship was right."

This gunner really epitomized the operation of the great ship, by which 1,400 men each performed a scientific task with perfect accuracy—and helped the gunners. He indicated that it is no longer sharp-eyed gunpointers who are solely responsible for hitting a naval target at sea, but



Gunnery Umpires, on a Platform Erected on the "California's" After-Turret Rifles, Watch the Shells Fired by the "West Virginia," While the Turret Motors Swing Them About

that 1,400 men are really behind each shell which is fired, for if the helmsman were nervous at his wheel, it is manifest the guns would be moved enough to throw them off their target. If an engineman gave too much oil to his boilers, the increased steam pressure would forge the ship ahead too rapidly; if a radioman failed to accurately receive a signal from the observing aircraft, the range would be in error, as it also would if the aircraft observing the target failed to judge correctly the number of yards by which the projectiles were going over the target or falling short of it.

The day of firing is preceded by months of practice drills. All hands must be perfect at their stations. A slight error may mean the lives of a hundred shipmates. The drudgery of the work is relieved by thoughts and hopes of the coming "shoot." Drills not only include the gunners, but the rest of the ship's company. The enginemen are at their stations simulating war conditions; the hospital corpsmen are at their battle dressing posts, the carpen-

ters and shipfitters are at their repair stations ready to "clear away wreckage." It is an inspiring moment when the "West Virginia's" bugles are sounded throughout the ship by telephonic loud speakers, and 1,400 men spring to battle stations.

Just as an intelligent trainer brings his athlete to a fighting edge and never permits him to go stale, so the shooting crews of the "West Virginia" are brought along until they are tense with the desire to see and hear the "big steel" thunder out its message to the waiting targets. Only the targets do not wait, but are towed rapidly by another vessel, which necessitates very fine adjustments to hit them. There is tension—but no nervousness. There must be perfect timing of all operations.

The turret is formed of three separate decks, all included in a great circular armored shaft of steel. On the top deck, the gunners stand on a narrow platform and work the guns; on the next deck down the shell room is located and shells are raised by electric elevators; on the next deck below is the powder room, from

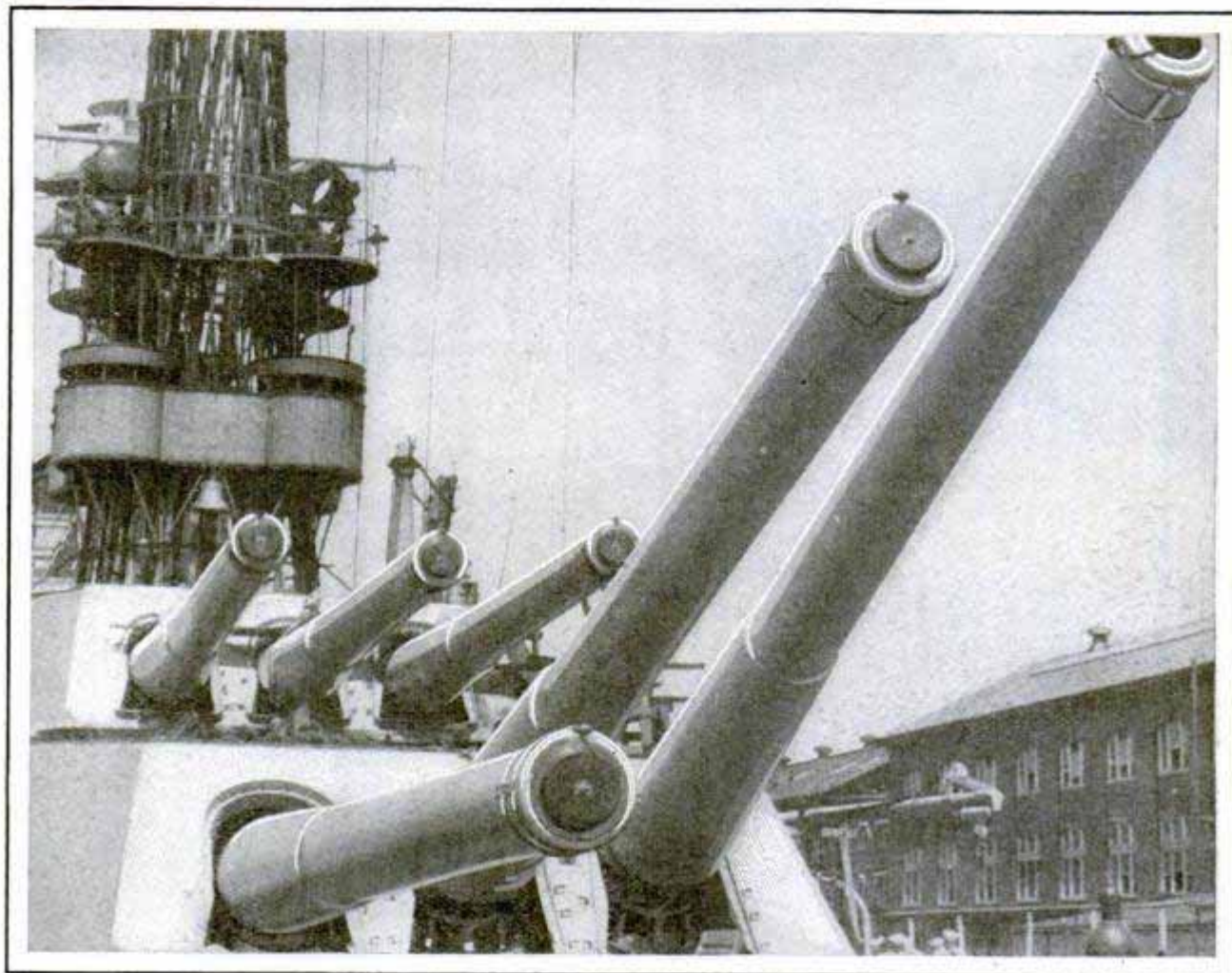

Six of the "California's" Great Rifles Undergoing Elevation Tests to Try Out the Mechanism before Putting to Sea for Target Practice after the Annual Overhauling

which powder is also raised to the guns on electric elevators. The whole system is adjusted to a point where the men in the powder and shell rooms operate their small elevators so that, as soon as the shell is rammed into the breech of the gun by an electric ram, the powder elevator is rising with the powder. In case of serious accident, every man in the turret is willing to throw the proper valves which will isolate the turret, flood it and prevent fire spreading. The magazines, too, may be flooded, and the men in them are ever willing to die themselves if it be necessary to save the ship. When the U. S. S. "Mississippi" suffered the loss of twenty-one men in her No. Three turret three years ago, the entire ship was saved from destruction by a magazine explosion only because one of the men flooded the magazines as he was dying. His hand was found firmly clenched to the valve handle. Such accidents are now believed impossible, the navy having developed a system of creating air pressure in the turrets, so

that as soon as the gun breech is thrown open after firing one projectile, the air pressure from the inside is stronger than that from without, and the air rushes out through the gun's barrel carrying all unburnt powder and other hot debris from the gun out to the deck. Previously the air would rush into the magazine from the outside through the gun muzzle, carrying the hot powder particles into the space where there were hundreds of pounds of powder bags awaiting the next loading.

The big day arrives! The ship will shoot at noon! Up on the boat deck, where the anti-aircraft guns are mounted, the officers are making a final check of everything. The "director" crews are aloft, for now the United States navy uses the scientific "director fire" method which was first used by the German navy at the battle of Jutland. A gunner, standing ready, chalks a fanciful name on his great weapon, "Battling Betsy," for instance, and an old officer, standing by, brings his

3197

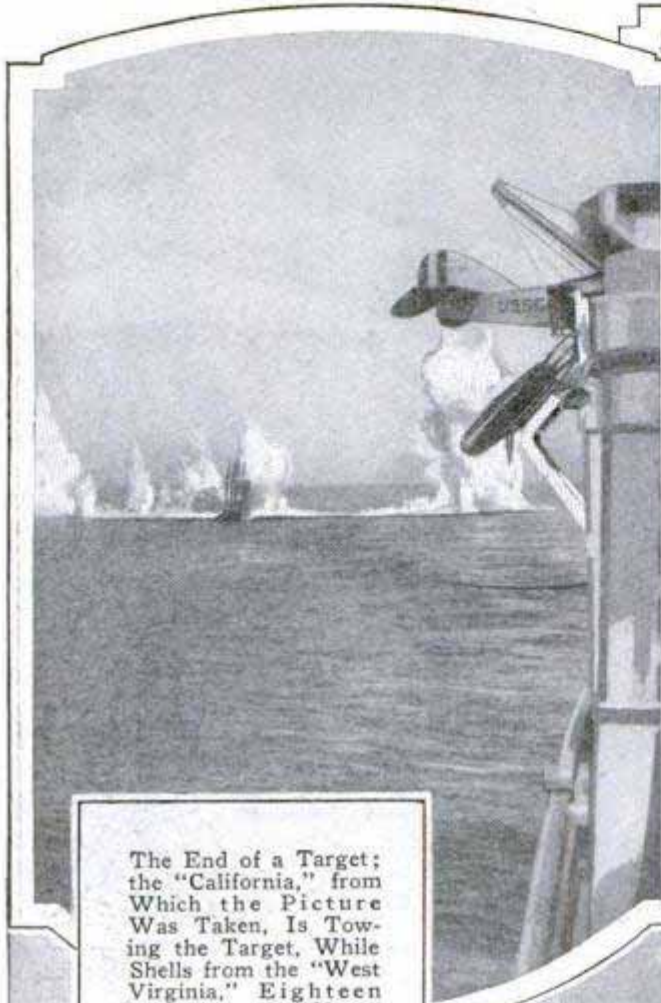

The End of a Target; the "California," from Which the Picture Was Taken, Is Towing the Target, While Shells from the "West Virginia," Eighteen Miles Away, Have Just Smashed It



Naval Aircraft Aloft, to Spot the Shots and Radio Corrections, Thus Defeating the Smoke Screen Thrown Up by the Destroyers

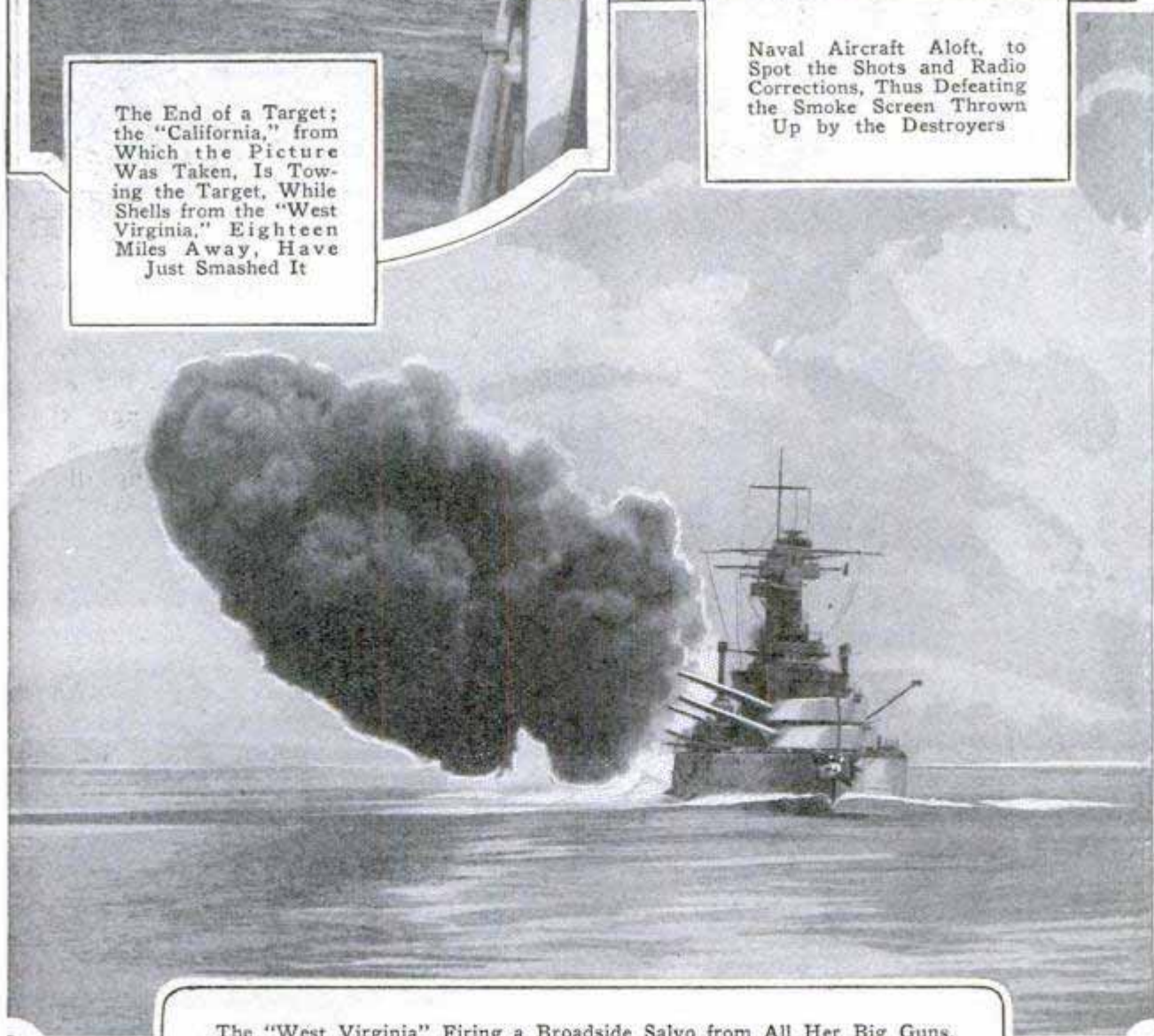

The "West Virginia" Firing a Broadside Salvo from All Her Big Guns, Which Can Be Brought to Bear on Either Side

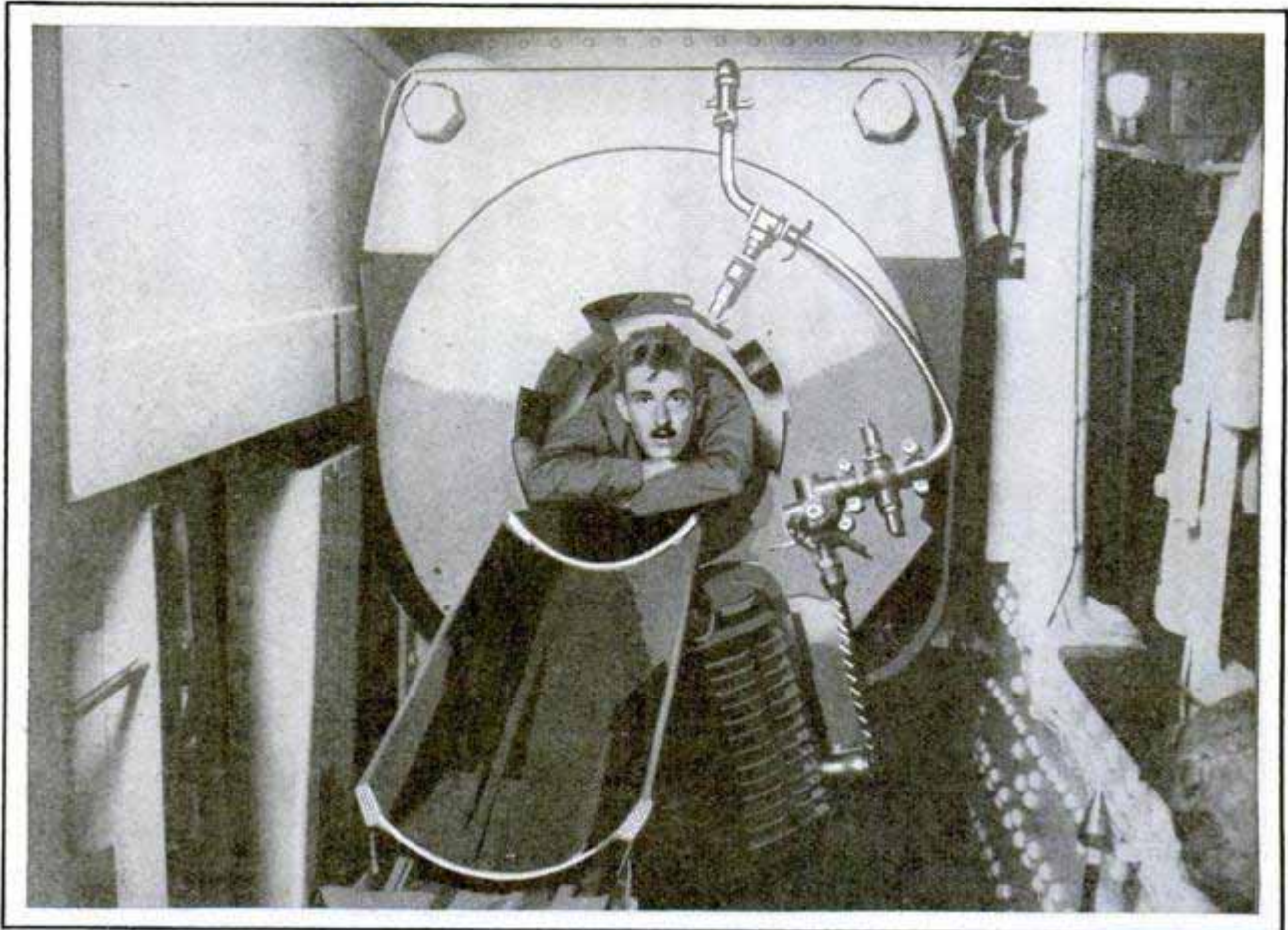

The Breech of One of the "West Virginia's" Turret Guns; the Trough in the Foreground Is the Wheeled Cart Which Brings the Huge Shell Up to Be Slid In Where the Sailor Now Rests

eyelids to a wistful half-close. He remembers that the American navy has named its guns thus from the days of Paul Jones. "Good gunner," he thinks, "fine boy, and navy to the core." A high-school boy from the middle west, blond and young.

All hands are now at action stations; the ship is stripped for war. High up on the signal bridge the ranking officers pace, awaiting word from the admiral. Signalmen stand ready to haul down the "commence firing" signal flag, and hoist the blood-red pennant which signifies the ship is manning her guns.

The radiomen are tuning their sets to the airplane wavelengths. On deck the catapult men are preparing to shoot a plane from the ship with powder, as though the plane were being fired from a gun. The plane is hoisted to the catapult, hooked on—mechanics carefully test all connections, try all valves, tighten a nut here and there—then the officer aviators come on deck in their khaki flying uniforms and carefully buckle their parachutes, on which they sit when aloft.

Suddenly a flash of red bunting breaks

from the bridge and rapidly shoots upward. The aviators scramble into their plane. Another signal flag, this time a green one, flashes upward to the main truck of the foremast and the pilot raises his hand. The catapult is fired and the plane dips and begins to take the air. From other ships planes of the same type rise, they join and take battle station in the air, some with ominous machine guns poking fore and aft to protect other planes which fly lower. The commanding officer of the air takes command and all the planes forget the surface and obey the new commander, who is in turn instructed by radio from the admiral on the "West Virginia." The fleet is ready to open fire.

Deep in the bowels of the ship, the radiomen are tense at their instruments. The observer in the planes tunes in on the predetermined wavelength, which will change as the battle progresses, in order to confuse any "enemy" listeners. In the turrets, the big steel guns rest calmly in their carriages—110 tons of dormant destructive power. It is the calm before the storm, for these 16's are as loud as they are pow-

erful. The sound of their discharge is difficult to describe. Not just an ear-splitting crash, but an infernal super-thunder that reverberates long after the shell is speeding on its flight. The writer has been on deck behind a turret when the big guns were fired and the feeling is as though some giant hands were crushing one's body from all sides.

High aloft, the speeding planes await the striking of the first shot. They see the "California" towing the target rapidly. She is so close to the target that a landsman would believe it inconceivable that another battleship, eighteen miles away, could hit the bit of canvas without at least endangering her. But naval gunfire is so accurate today that there actually is no danger. A man might appear in a rowboat 200 feet ahead of the target and be perfectly safe so long as he could keep that distance away from the target.

The radiomen in the "West Virginia" suddenly hear their call sign and begin to receive directions from the planes in the air eighteen miles away. They hear, "100 over," and immediately yell it into a voice tube which reaches the bridge and gunnery officer. Instantly the turrets change the lay of their guns and fire again. Again the monster guns crash out, and this time the planes radio, "straddle"!

The guns are "on" and the welcome words from the planes, "no change," delight the waiting crews on the guns. These were the words passed that memorable day at Gonaives off the Haitian coast when the "West Virginia" made her record.

2837

**OLD AQUARIUM USED AS CHURCH
SERVES RURAL COMMUNITY**

Having been abandoned as a home for fish, an old aquarium in an Ohio city was remodeled into a community church. Its shape afforded a roomy auditorium, and the only alterations made were an entrance and a hallway.



Aquarium Transformed into Church in Ohio City

Stow

**NOVEL SIPHON EMPLOYS BULB
TO START AND STOP**

Small Metal Siphon Designed to Extract Cream from the Milk Bottle, and a Big Tube for Barrels

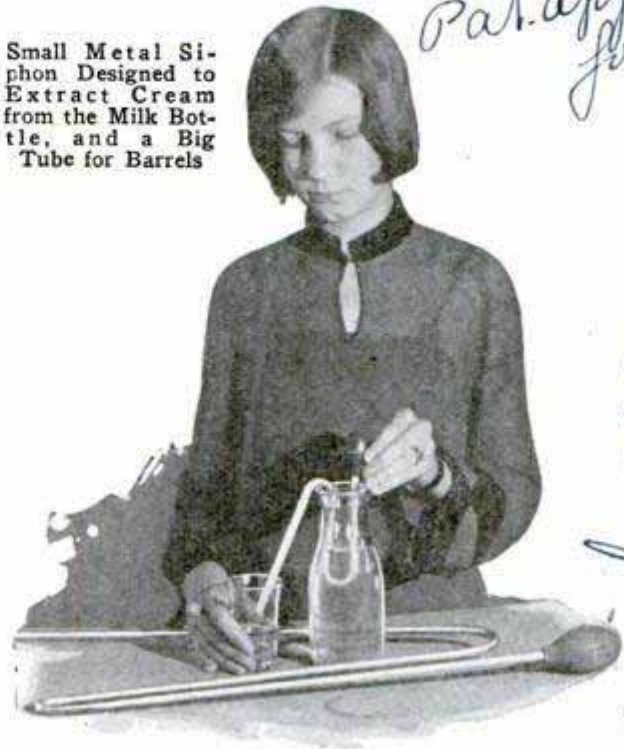

Pat. applied for

*J. A. Firsch, 3839
St. Rose, Chicago*

A novel siphon built of aluminum tubing and equipped with a rubber bulb by which it can be started without the usual sucking has been patented by a Chicago inventor, who is marketing it in sizes small enough to extract the cream from the milk bottle, through grades up to siphons big enough to empty oil and gasoline barrels. A U-shaped tube extends into the container, and a third leg is bent down over the outside to provide the outlet. The intake hole is on the top side of the bend in the container. After the siphon is inserted, the rubber bulb is pressed once to expel the air and fill the "U" with liquid. A second pressure on the bulb forces the liquid over the upper bend and starts the flow. The bulb can be held depressed, or slowly released without interfering with the action, and the flow can be stopped at any time by squeezing the bulb and releasing it quickly, which action draws the liquid back over the upper bend.

The bulb can be held depressed, or slowly released without interfering with the action, and the flow can be stopped at any time by squeezing the bulb and releasing it quickly, which action draws the liquid back over the upper bend.

3260
72

Chr. H. C. Mc
2720 Maryland Ave
POPULAR MECHANICS
Baltimore Md



Courtesy George C. Hanson

Where Modern Manufacture Is Competing with the Old; Native Mongol Hut and One of the New Variety

TAXICABS AND CAMELS MEET AT ORIENTAL FAIR

What spectators declare is the most rudely picturesque bazaar in the world is the Gandjur fair held at Barga in Manchuria, the meeting place of east and west. A camel market is a conspicuous feature, but automobiles have been introduced and one taxicab driver is said to have made \$2,000 in six days, operating his car day and night, hardly stopping for food or rest. Ready-made houses, manufactured by Europeans, and resembling in some respects the mail-order variety popular in this country, have also appeared. They are made of wood, the parts being standardized for quick assembling. The native Mongol dwelling is known as a "yurt." It is constructed of skins with a hole in the domed roof for the smoke to pass out from the fire, which is built in the center of the earthen floor. Foreign-made furniture has also been displayed in recent

ninety specimens were successfully transported. A large wooden tank was divided into compartments and fitted with steam pipes, while fresh water was pumped into the tank and kept at constant temperature by the steam.

STRIP INSULATION FROM WIRE WITH TIMESAVING TOOL

As a substitute for the slower method of removing insulation from wire with

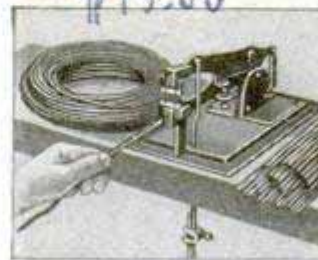

pliers or other tools, a stripper now on the market is intended to save time and work. It has two notched steel jaws, which are snapped

around the wire simply by depressing a floor pedal. This cuts the insulation without touching the wire, and an easy pull slides the covering off.

times. Much of the merchandise is hauled to the fair in native carts. The wheels are interesting details of these vehicles, the felloes being fashioned of a wooden stick from a single pole and bent into circular shape. Although the few automobiles that have appeared have proved popular in general, the exhibitors do not like them, for the machines frighten the horses and oxen.

FISH FROM TROPIC TRAVEL TO ZOO IN LUXURY

Scarlet fish, hermit crabs and jazz fish journeyed in luxury recently from the Madeira islands to the London zoo, for they swam in big tanks filled with continuously flowing steam-heated sea water, to duplicate as exactly as possible their natural surroundings. Nearly

3478
Science News Letter 10/8/27

Holey Saw Tool Co.
9-15 N.E. Main St.

3341

Mr. John Agnew Road,
205 Union League Bldg
Los Angeles Calif

CATCHING BIG GAME FISH FROM SMALL BOATS



Landing 175 Pounds of Hammerhead Shark in a 200-Pound Boat, an Excellent Catch in the Pacific Ocean



Coming Home with a 143-Pound Tuna, Caught after a Hard Fight from a Sixteen-Foot Skiff, Above; Below, an Enormous Black Sea Bass Landed from a Little Outboard Motorboat; the Fish Weighs as Much as the Boat or the Fisherman



The Big Tuna, Caught with Rod and Reel from This Small Outboard Motorboat, Weighed In at Just Eight Pounds More Than the Fisherman, Who Tipped the Scales at 145 Pounds; the Tuna Is One of the Best Fighters in Salt Water

John Agnew Road

Pollack Roller Runner
Sled Co., Inc.

POPULAR MECHANICS

74

2844 Beacon + Somerset Boston, Mass

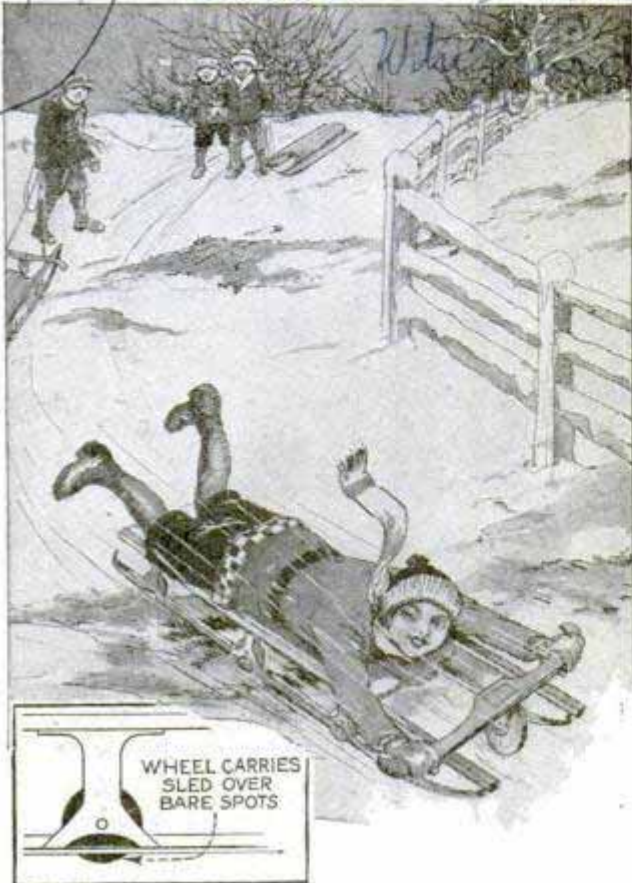

Bare Spots in the Coasting Slide Have No Terror for This Sled with Wheeled Runners

SLED WITH ROLLER RUNNERS SPEEDS OVER BARE GROUND

Bare spots on the coasting slide will not stop a roller-runner sled now on the market. Inserted in each runner, are three small wheels that project slightly so that, when bare ground is encountered, they permit the sled to pass swiftly over, yet do not interfere with the speed on snow. If the soil is not loose or muddy, the sled may be used for summer coasting and, when so employed, is easily steered by a wheel on the guiding arm. This has a spring that acts as a shock absorber if the wheel strikes an obstruction.

MAKING WEATHER FOR THE ZOO GUARDS ANIMALS' HEALTH

3462 The hippopotamus is apparently a hardy creature, but it must be given special care when winter comes to the zoos. The hippo's bath must be kept at a temperature of fifty-five to sixty degrees. Monkeys suffer from colds and more serious lung troubles if not kept in temperatures equal to those of their native haunts, so the air is cleansed and moistened by blowing it

Alfred L. Parker, Director

through damp silk cloths. Preparations for putting the animals in winter quarters are commenced late in September or the early part of October. The Siberian tiger will stand much colder temperatures than its cousins from Africa, so the first few cold days are not likely to harm it. Many of the tropical birds learn to acclimate themselves to the rigors of chilly winds and storms, and many of the fur-bearing animals display longer or shorter coats according to the season, after they have been in captivity for a number of years, although in their native surroundings there is little or no variation in their fur.

AIR-SERVICE STATION FOR AUTO ELIMINATES GAUGE

3454

No gauge is needed in using an automatic air-service station for inflating the tires. You simply turn an indicator to the desired pressure, pull out the hose on a convenient spring reel, apply the chuck to the valve and, while the tire is being filled, a bell rings. It stops when the proper amount of air has flown in. The hose is then released and coils itself up on the concealed reel. The unit is an at-

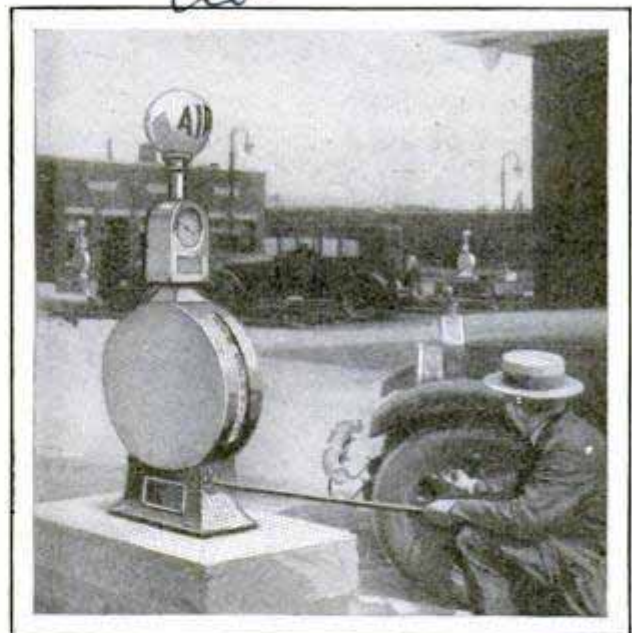

Filling Tire from the Automatic Air Station, Which Shuts Off Supply When Proper Pressure Is Reached

tractive addition to the usual service station and has a bulb labeled air at the top.

Bars of iron were used as money years ago in Great Britain.

Service Station
Equipment Co.

3335 Operated by Yuba Consolidated
Goldfields. Inc., 351 California
St., San Francisco Calif.

Eight-Cent Gold-Digger

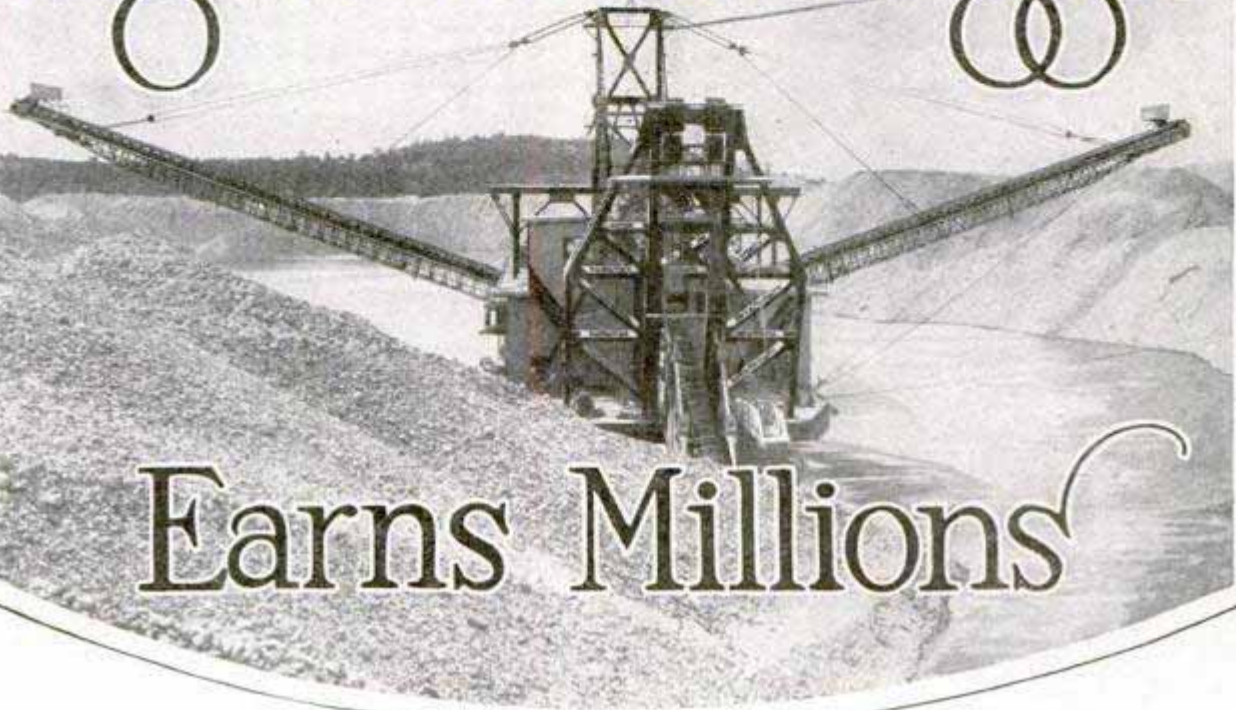

Earns Millions

Twenty-Five-Ton Steel Miner That Can Earn Big Profits from Worked-Over Gold Sands That Wouldn't Have Kept a Forty-Niner Supplied with Food; Five Men Operate the Dredge

By H. H. DUNN,

2722 Prince St.
Berkeley, Calif.

OUT of the great piles of sand and gravel discarded as worthless by the "Argonauts of Forty-nine," in their search for gold in California's mountains, new millions are being taken every year by a novel mechanical process, which does away with prospecting, makes mining a certainty and puts the yellow metal back as one of the most important products of the state. From ancient and often buried river beds, as well as from the mine dumps and tailings, handling nearly 100,000 tons a day, these great machines, the first of their kind in the world, are wringing wealth for their owners from sand and gravel running as low as eight cents a ton in gold.

These are the lowest-grade gold deposits ever worked by man. The mechanical miners that have reclaimed them are the largest in any branch of the mining industry, yet their operations are as carefully and as delicately carried on as those of any microscopic investigation ever undertaken in a laboratory.

There are six of these machines work-

ing the California mountains, digging their own paths, floating on their own rivers, piling up gravel and rock embankments, and searching out every fleck and flake of gold to a depth of more than eighty feet below their flat steel bottoms. More than 200 men are required to operate and keep them in repair; they work night and day, and consume as much electric power every twenty-four hours as a city of 60,000. They are built in the form of dry-land dredges, but they also operate on water.

Sifting a ton of sand and gravel to get eight cents' worth of gold would have been too delicate a task for the fingers of the miner of '49, and the results would not have kept him in beans and bacon, not to mention flour and molasses, since he was not able to "pan" much more than a ton of earth in a week. But the great scoops of the steel miner get it all, at a rate which has produced more than \$50,000,000 since the dredges went to work. In that time they have handled approxi-

3335
76

ree
Nov-1934-713

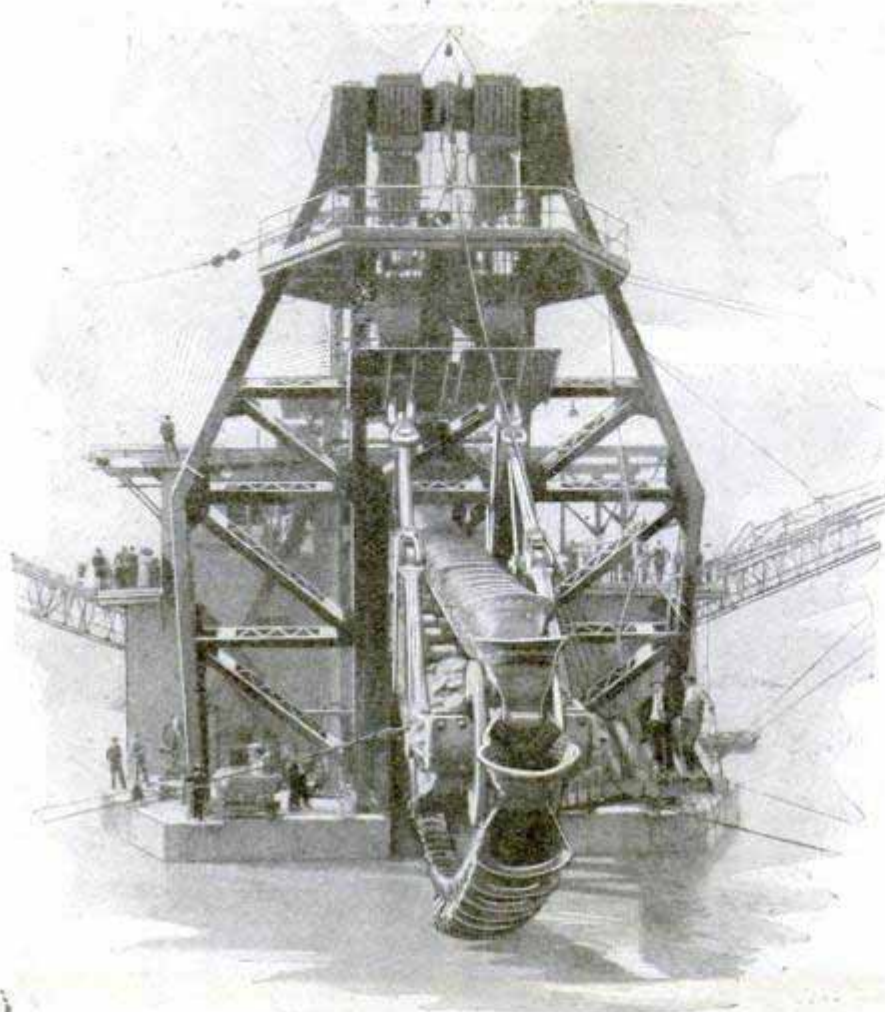

diggers' owners claim to be permanent holding walls, between which flood waters and freshets are carried away from the agricultural lands on either side.

All the work so far accomplished has been done on the barren waste of tailings, which accumulated in the days of unrestricted hydraulic mining, when millions of yards of this waste material was dumped annually along the upper reaches of the Yuba river, where the modern mechanical method of mining is being applied.

Each of the six dredges is larger than many a deep-sea steamer, being 165 feet long, 68 feet wide, and weighing approximately 2,500 tons. A set of huge steel scoops, hung on an endless chain running over the "trunk" of the metal mastodon,

* Each Scoop Bucket on the Excavating Chain Weighs 4,400 Pounds and Can Descend Over Eighty Feet below the Water

mately 135,000,000 cubic yards more of material than were excavated in the cutting of the Panama canal.

Just as the placer miner of the days of gold in California shoveled the gravel into a crude rocker, poured water over it, and depended on gravity to drop the gold to the bottom, where mercury picked it up, so the dredge, taking a ton where the miner lifted a shovelful, goes through the same process mechanically. Five men, masters of the metal monster, handle more than 15,000 tons of gravel and sand in the twenty-four-hour day. There are, of course, three shifts of five men each in that length of time, but the crew of the dredge is never more than five men at once.

Two permanent channels, each 500 feet wide and nearly three miles long, have been dredged to a depth of more than sixty feet, and two others, which will be of approximately the same length and width, are now being made. The gravel, cleaned of all the gold, is piled in solidly packed walls along these channels, furnishing what the gold-

reaches far down into the pile of gravel or the buried river bed and lifts out the dripping gravel. There are ninety-six of these scoops on the chain of each dredge, and each scoop carries one ton of material, when filled.

As the loaded chain moves sluggishly upward, dumping its content into the ever-open mouth of the mastodon, there follows a tremendous air-shaking medley of sounds, which becomes continuous as the dredge gnaws into the gravel. It is the crunching, groaning, roaring, grinding, clattering of stones from the size of a man's head down to that of a buckshot, all falling on moving metal screens and thence off these onto the shaking tables, until all has been sifted, the stones carried away and the heavier gold dropped through to be left in the grip of a pool of quicksilver.

The average depth to which the scoops go is sixty-two feet, but when a deeper pocket of gravel is found, the mastodon sends its great trunk down as much as

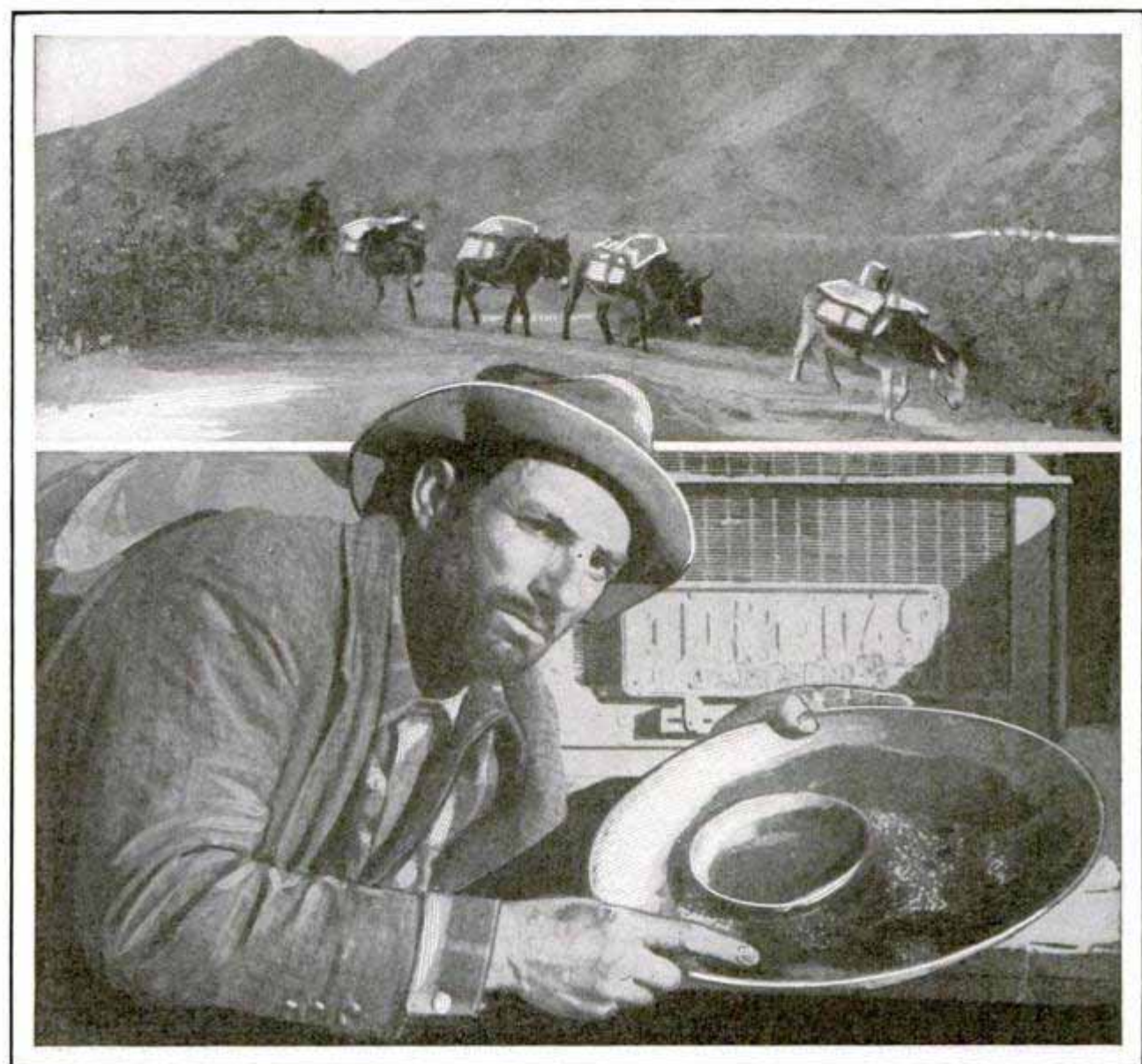

The Miner, with His Pan and Burro Supply Train, Could Handle a Ton of Gravel a Week, Whereas the Steel Miner of Today Extracts Gold from 15,000 Tons a Day

twenty feet farther—all in search of eight cents' worth of gold. Sand and gravel brought up by the scoops are dumped first into a huge steel hopper at the very top of the superstructure of the dredge. Thence they pass to a screen, which, revolving at a steady pace, separates the fine material from the coarse and discards the latter.

Water under heavy pressure is then automatically sprayed on the gravel and the finer, gold-bearing sand is thus washed through the screen into a distributor, from which it flows in a slow stream over rows of riffles, improvements over the sluice boxes of the hand miner who first worked these "diggings." In these riffles, quicksilver lies in wait to pounce on every grain of gold, so that, when the sand and gravel

leave the device, they are free of all values. In the meantime, the coarser gravel, from which the nuggets and flakes of gold had fallen away in the moving screen, is passed onto belt conveyors, which carry it over long arms and pile it at either side or to the rear of the dredge. When the engineer of this mastodon wishes it to move, he shifts a switch, and one or the other of two forty-five-ton steel legs—called "spuds"—languidly extends itself, buries its point fifteen or twenty feet in the river bed or bank, and, like a dancer turning on her toe, the 2,500 tons of dredge swings about. The second "spud" finds a hold, and the great machine either settles down to resume hunting for gold or continues "walking" on its twin steel legs.

It is estimated by engineers and mining

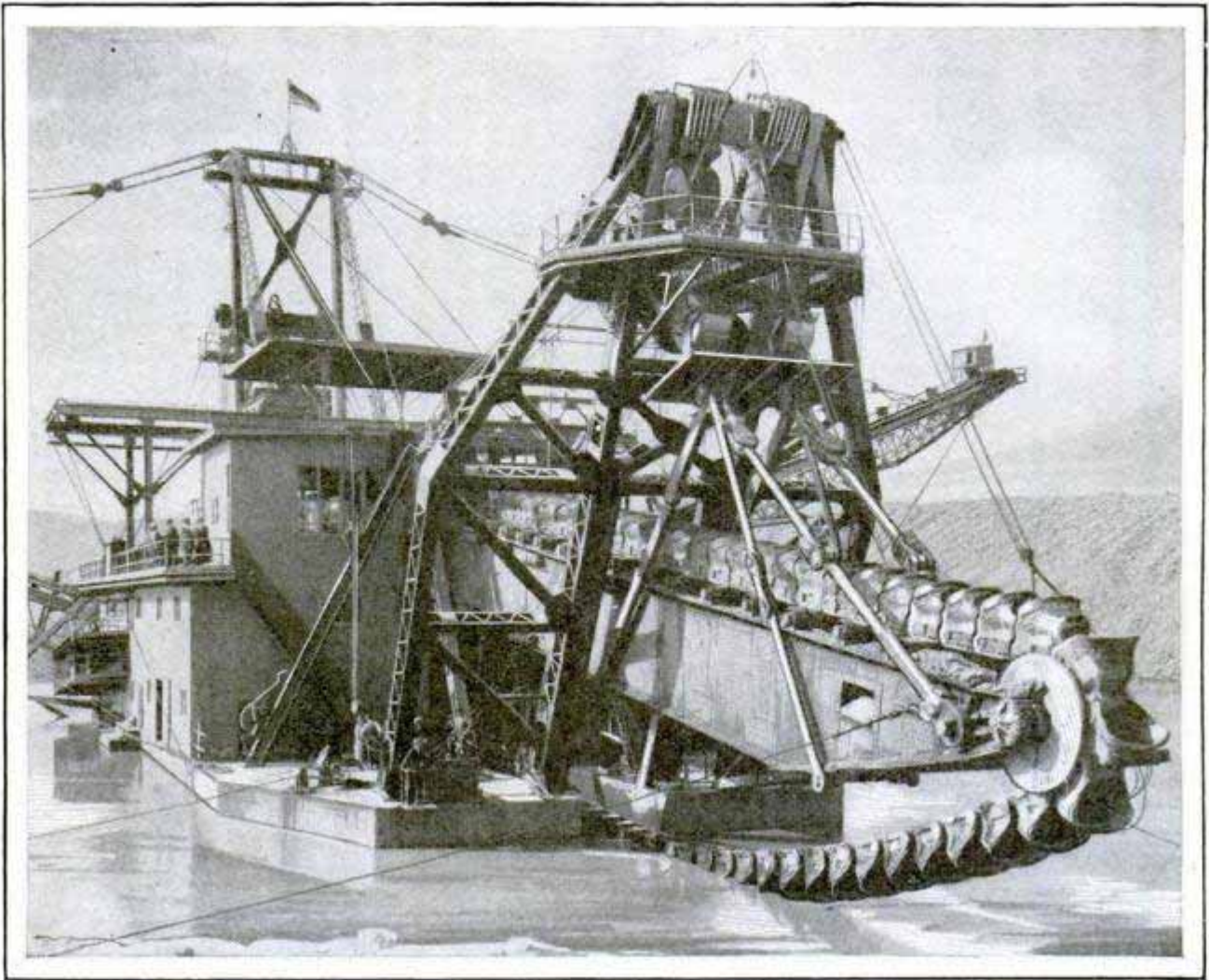

Cutting a Channel 500 Feet Wide, the Great Dredges Need Only Enough Water in the Pond to Float Them, For the Water Goes Along as They Move Forward in the Cut

experts employed by the government of California that natural treasure, beside which that taken by the dredges is trifling, is still lying in the gravel deposits of the state. From 1853 to 1909, it is stated, \$1,200,000,000 in gold was produced by hydraulic and placer-mining methods from the river beds, old and new. State engineers believe that there are at least fifty, and probably one hundred, surface and buried-river gravel beds which never have been touched by miners, though their gold content may be too low for profitable working.

LONGER LIFE FOR RUBBER SEEN IN NEW TREATMENT

Chemists have developed a new treatment for rubber goods, to prolong the life of the material by counteracting the effect of oxygen. Experts declare that some rubber articles would last almost indefinitely were it not for the results of oxidation from the air. Tires, for in-

stance, suffer a serious loss in tread abrasion, owing to this process. Besides offsetting the action of oxygen, the new substance is said to counteract the effect of high temperatures, which is of importance regarding bus and truck tubes, often exposed to heat and air at once.

SANDGLASS EGG TIMER RINGS 2211 BELL WHEN DONE

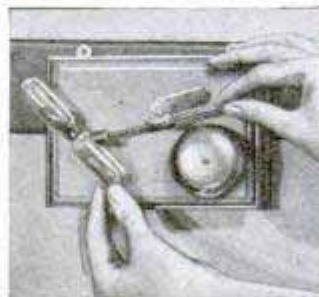

For boiling eggs up to five minutes, a timer operated by a sandglass has been introduced. It can be set for almost any interval under five, and as the sand runs

into the lower glass, the weight causes the tube to descend. This releases another weight at the proper time, and a bell rings, announcing that the eggs are done.

*E. I. du Pont de Nemours & Co.
Wilmington, Del*

*H. Islogau & Co.
538 S. Clark
Chicago*

**GAS TO BE MADE AT THE MINES
AND PIPED TO CITIES**

Believing that the gas industry is still in its infancy, engineers predict that gas soon will be produced at the coal mines and piped into distribution centers, saving the costly transportation of coal and the erection of large plants on expensive land. The chief problem in the way at the present is a means of successfully transmitting the gas long distances and, when this is solved, it is believed that the gas industry will be able to take over a much larger percentage of the home-heating and cooking tasks than can now be done and that gas will be used much more extensively in manufacturing. Another problem that must be solved is the profitable disposal of by-products. Many of these materials have a limited market at present. How the gas industry is already aiding aviation was shown by the announcement that 1,500 companies are ready to mark their huge storage tanks with insignia that will help guide pilots. New England states reported that the number of installations of home-heating plants using gas had increased from 1,308 to 2,600 in a year.

**DANCE HALL LIKE MONOPLANE
LATEST RESORT NOVELTY**

Closely resembling a huge monoplane on the exterior, a dining room and dance hall in Fort Worth, Tex., has attracted considerable attention. It is sixty feet long, twenty feet wide and accommodates a fairly large crowd with comfort.

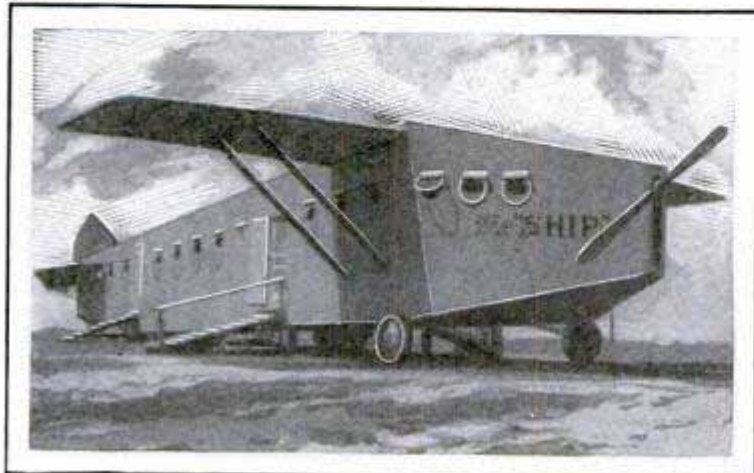

It Doesn't Fly but Dancers Enjoy It; the "Airplane" Hall near Fort Worth, Tex., for Dining and Dancing

at Meacham Field

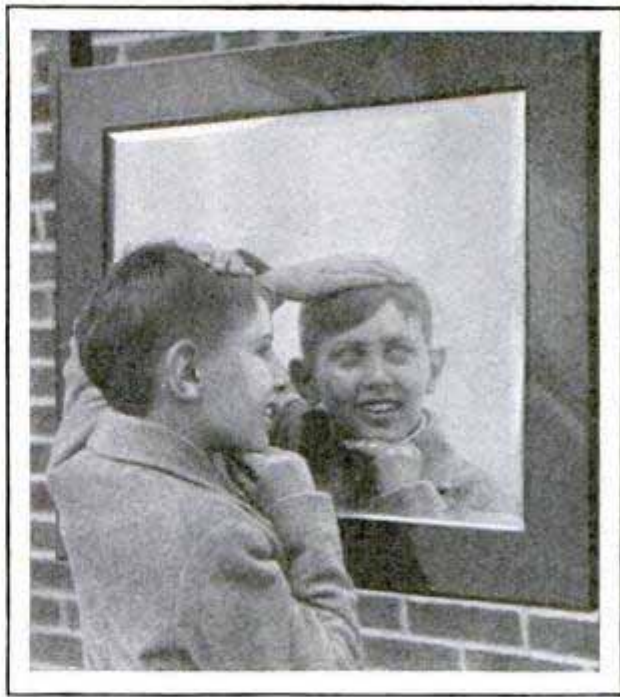

Correcting His Own Lip Movements with Aid of the Mirror; Deaf Child Learning Speech

**TALKING MIRRORS HELP DEAF
IN LEARNING SPEECH**

So that deaf children may more easily learn how to place their lips in correct position for pronouncing syllables, use is made of mirrors in a school at Atlanta, Ga. The pupils strive to imitate their teacher and with the aid of the reflectors, can correct their own errors.

Oakland

SKIN REGISTERS EMOTIONS

Recent experiments by David Wechsler, a New York psychologist, have further shown that the skin is an emotional barometer, so that the familiar description of "thick-skinned" and "thin-skinned" persons has some basis in fact. However, the difference in behavior depends not so much on the question of relative thickness as on the electric resistance of the skin. Of all tissues, the skin is one of the best insulators and, like other materials, it offers less resistance to electricity when moist. Under various emotional strains, perspiration is induced, and the consequent increase in moistness results in greater conductivity of current. Practical use of this discovery has been suggested in the field of criminal investigations.

Science News Letter
10/18/29

Mr. George D. Saul,
1537 Dearborn

2678



German Boys in the Special Car That Takes Them around the Zoo in Hamburg for Two Cents Apiece

SIGHT-SEEING BUS AT THE ZOO SERVES SMALL BOYS

For the equivalent of two cents in American money, small boys may enjoy practically all the wonders of the zoo in Hamburg even if the pens and cages are partly obscured by taller adults, for an elevated sight-seeing bus takes them all about the grounds. It holds thirteen passengers.

WHALES TAGGED WITH DARTS TO TRACE TRAVELS

Shooting silverplated darts into hundreds of whales, each dart being marked with the date and longitude and latitude, a party of British scientists have recently completed the first organized attempt to solve the life story of the big sea mammals. They spent two years in the antarctic seas, sailing in the famous old ship "Discovery," which was used by both Scott and Shackleton on their explorations of the southern ice continent. The expedition was directed by the government of the British colony in the Falkland islands, center of the whale-fishing industry of late years. The whalers have been asked to return the darts, with

Capt. J. B. Steinhouse
Commander 3458

the date and place where the whale was killed, in order that the age and migration of the big fish may be checked. The scientists hope to solve the riddle of the whale's family life, the number of his wives, and the length of his life. Although many whalers have claimed that the whales mated but once, the evidence gathered indicates that the whales really are polygamous. Besides studying the whales, they collected marine life in the southern seas to a depth of three miles. The "Discovery" was specially built for exploration in the ice pack, with plank-

ing two feet thick backed by massive cross braces to resist tons of pressure, and fitted up for scientific research.

JEWELS THAT AIDED COLUMBUS VALUED AT HALF MILLION

The jewels that Queen Isabella of Spain pawned to raise money for financing Columbus and his voyage to America are valued at approximately \$500,000, although they are worth many times that from the viewpoint of their historical interest. The set consists of 280 stones weighing 500 carats, and the largest diamond weighs fifty-four carats.



Some of the Jewels That Helped Columbus Reach America; Part of Queen Isabella's Diamond Collection

Held by Harold A. Brand

3303

Chas. Searged de Casenue

1519 Connecticut Ave Washington DC

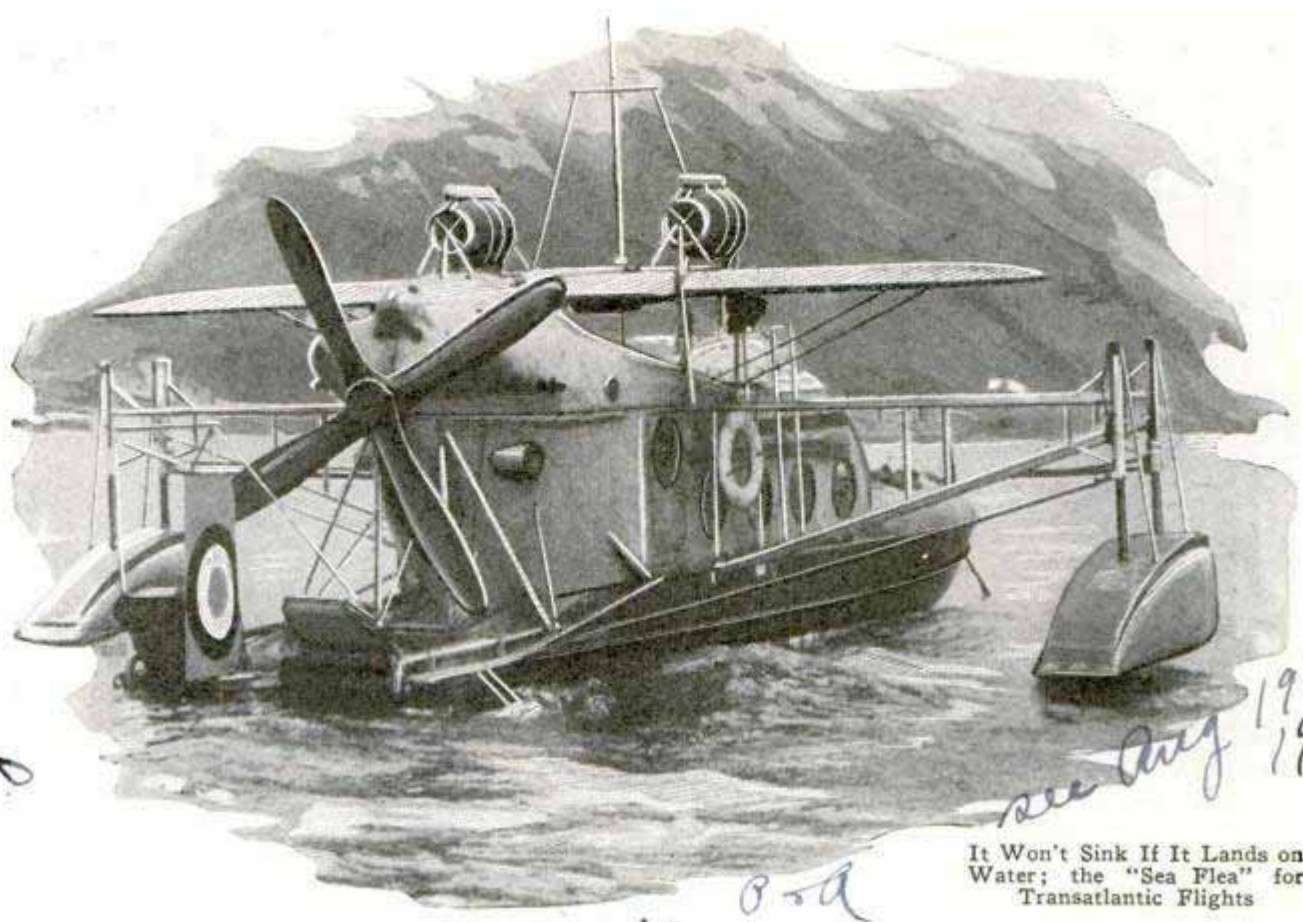

It Won't Sink If It Lands on Water; the "Sea Flea" for Transatlantic Flights

see Aug 1928 198

osa

"SEA FLEA" FOR OCEAN FLIGHT DEVELOPS HIGH SPEED

Half plane and half boat, an odd-looking craft, called the "Sea Flea," has been constructed for a flight across the Atlantic. It is designed to skim close to the surface of the water and forced landings will present no hazard, as the rig is constructed to float indefinitely. A speed of seventy-five miles an hour can be reached, it is claimed. On a test the flea crossed from France to England, a distance of twenty-one miles, in twenty-six minutes carrying three persons and the pilot.

SUPERSPEED PHOTOS OF TIRES TO REVEAL FAULTS 3461

Thirty-two hundred pictures a second! That is the performance of a superspeed camera C. Francis Jenkins has developed for taking photographs of rubber tires while they are in actual service, so that engineers can determine where the strain and stress are distributed when traveling at high speed under varying conditions. The camera differs in many respects from the usual motion-picture instrument. Instead of one, it has forty-eight matched

lenses and the film moves continuously at the rate of 200 feet a second. The lenses are set in a disk which is rotated by an electric motor.

STRIPING AUTOS MADE EASY WITH PENCIL PAINTER 3331

Applying the paint stripes to the automobile is usually left to experts because of the accuracy required. But with a striping pencil now on the market, a novice can perform the task without difficulty. The instrument is fitted with a specially designed base, which can easily be guided

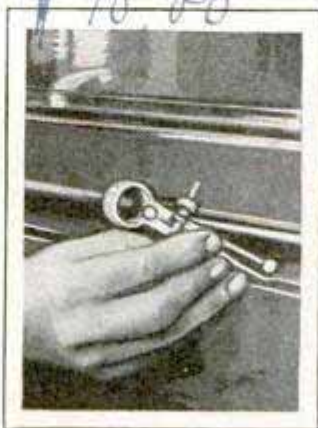

in a straight line by the car molding. A brass tube, containing paint, constitutes the pencil. It has a rubber bulb at one end for filling and a distributing point at the other from which the lacquer flows by gravity. Interchangeable barrels are provided for making stripes of different width.

Indianapolis news 90/5/27

E. M. Reeves Co. Campbell, Mo

HUNTING BEARS



I recall one day when a friend and I were walking along a mountainside and unwittingly passed by a mother bear's den. We heard her come out and dash away through the brush, so we turned back, located the den, entered and brought out three young cubs. They squalled and bawled terribly, but the mother did not come back, that day or any other, for we watched the den frequently to see if she would return. Had she kept quiet, we never would

By H. L. DILLAWAY, ²⁶¹⁷
Boylston Ave. N. Seattle Wash.

FOR twenty years I have been hunting some of the biggest game in America, though I have never carried a gun in all that time. For two decades I have photographed bears and written about them.

And still the most frequent question asked me is whether bears are dangerous.

The answer is that neither bears nor any other wild game in America is dangerous when you are letting them alone, or when something else has not happened to disturb them. But bears are individualists, just as much as human beings, and they respond to life in much the same way. We don't regard the human race as being dangerous because some people occasionally kill, and the same is true of bears.

In twenty years of hunting with a camera, I have chased bears and been chased by them, but I think it is easier to make a bear run away than to get him to run toward you. Bears may attack under certain circumstances, mother bears, for example, defending their cubs, but not all mother bears will do that, and quite a few of them will run away and desert their offspring. They really are as scared by man as he is of them.

have known there was a bear den near, but as it was, our passing along apparently ran her clear out of the country.

She got her revenge, though, for we paid dearly for the capture of those cubs. Every night for weeks they would wake up and squall until the nursing bottle was forthcoming, and never did all three get hungry at the same hour.

I have seen hundreds of bears, photographed them, studied them and tracked them, but I have never been scratched or mauled by one. I would rather take my chances, however, with any wild animal than a semi-wild one which, through captivity, has lost most of its fear of man.

A bear's eyesight is not good, and the best system when you meet one unexpectedly, is to remain perfectly still—or else charge. I have charged several bears, jerking off my coat and waving it wildly in their faces, and they have promptly turned tail and fled. Climbing a tree, if the bear belongs to the black or brown species, is useless, for they are both good tree climbers. A grizzly, on the other hand, is not, so a tree offers a safe refuge from "old Silver Tip."

Vertical handwritten text on the right margin, possibly a page number or reference.

with a **CAMERA**

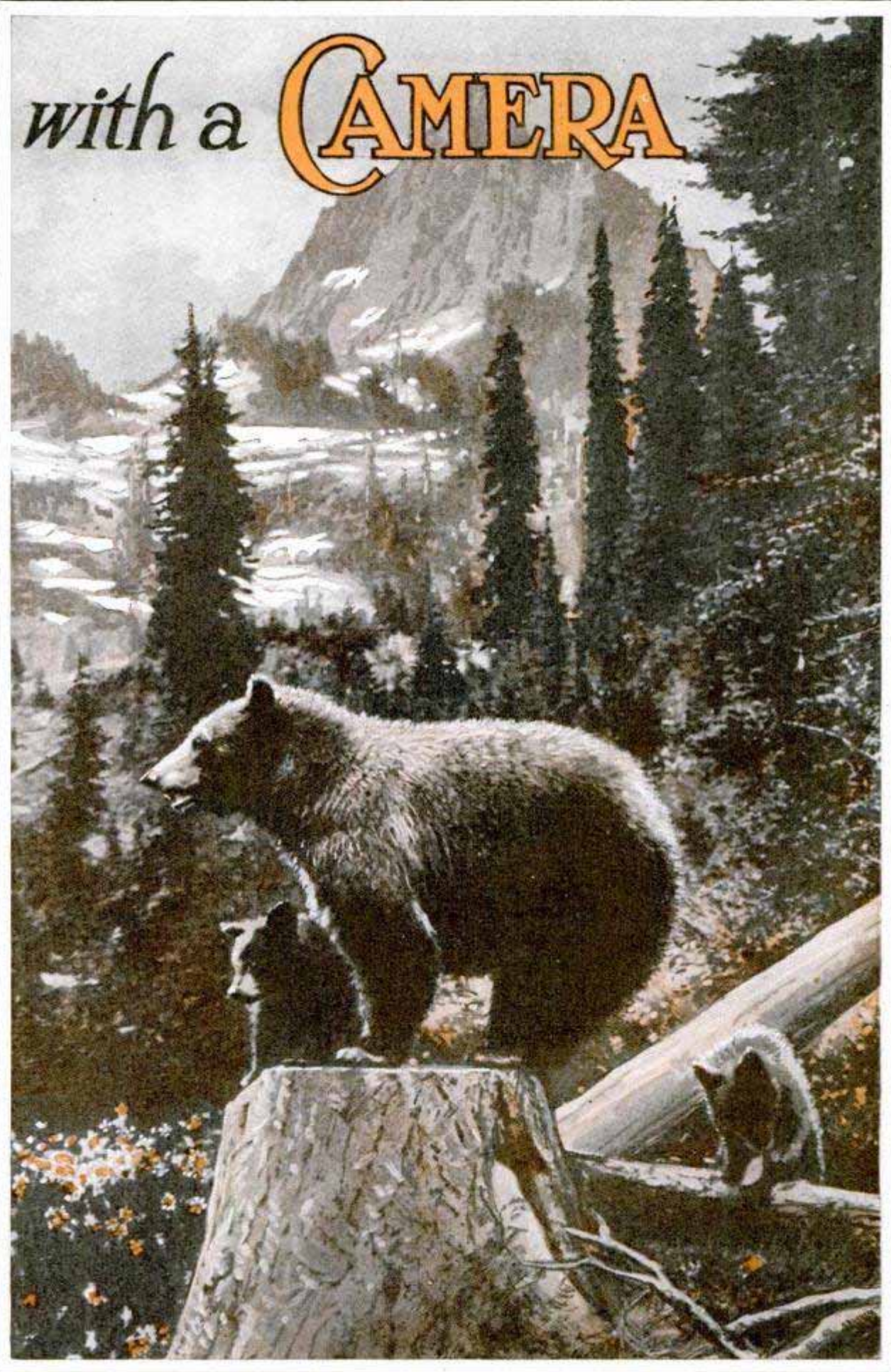

2900
84

POPULAR MECHANICS

Bears are very short-tempered, which explains most of their dangerousness. It is largely a matter of individuality, however. One bear will ignore a thing that will make another fighting mad, and on

another day their dispositions may be found quite reversed.

What they lack in eyesight, they more than make up in hearing and sense of smell. I know of one fully authenticated instance where a bear smelled carrion twenty-five miles away and headed directly for it.

In the hunt to photograph wild game, you are likely to run into new experiences. Your wits must always be working. One afternoon I was dead tired. I had scaled a high cliff and photographed a nest of baby eagles. Then I sat down to rest. I must have dozed. Suddenly I awoke, for no reason at all—just instinct. Not ten feet away was the largest brown bear I had ever seen. Bears were new to me then and I was scared stiff. The bear stood directly in front of me, waving his immense head from side to side. I never batted an eyelash; I couldn't. At last he moved away, went wearily over and sat

Pair of Small Cubs Discovering That the Trunk of a Dead Tree Is Not a Safe Refuge, and a Mother Bear, with a Rather Large Family, Snapped in an Unconscious Moment in the Woods

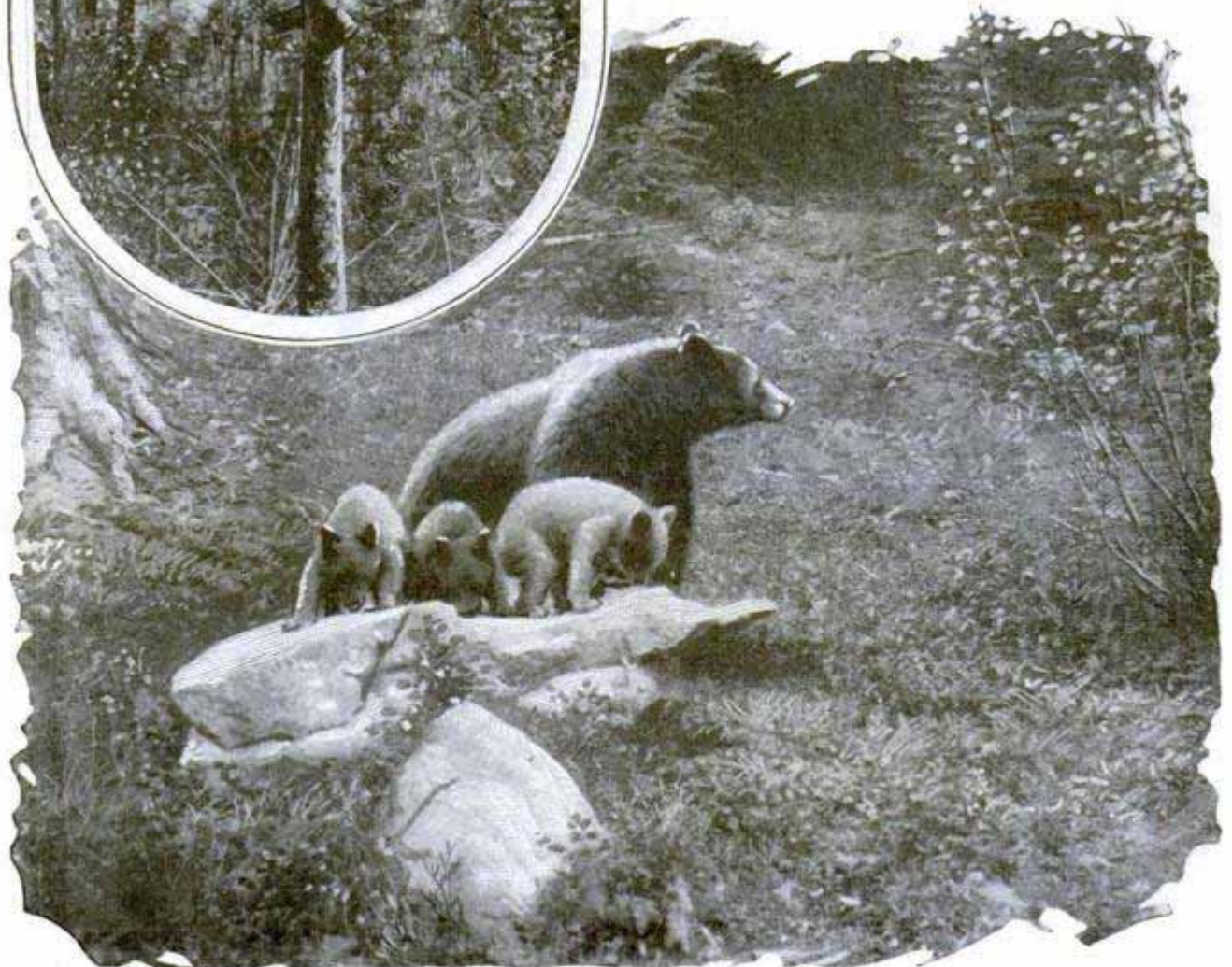

on a big log, just like a tired old man. He sat there with his forepaws hanging down to his side, limp. I never saw a bear do that before or since. Bears like to stand on their hind legs, particularly the younger ones. As they grow heavier and older they are less likely to stand up. Cubs will spar standing up, and I have seen two-year-old, wild silver-tip grizzlies do the same thing.

Bears are large, bulky and look clumsy. They have an odd wallowing, rolling, head-swaying motion peculiar to themselves. To the uninitiated they seem to be slow, but a bear can stop a squirrel, mouse or gopher with a paw movement so quick that the eye can scarcely follow, and, as for speed, they can easily outrun a man. I once had a splendid chance to race a bear along a parallel woodland trail. We started together and I did my best, but, in no time he had left me far behind.

Another opportunity to try out an experiment on one of the largest black bears I had ever seen, offered on one occasion. I came across him suddenly, and we stood face to face on a path. I used a cowboy's trick to "rush him," for I wanted to see if I could scare such an immense animal up a tree. I only had a moment to work but figured he would run. I took off my coat, waved it in his face, and "rushed him" up that tree. I was utterly amazed at his speed as he went straight up. He set his hind legs under him and gave jerky jumps until he was well up among the limbs, when he turned about and faced me. He was apparently more surprised than angry and looked down as much as to say, "What in blazes is the matter with you?" When I walked away, he still bore the same expression.

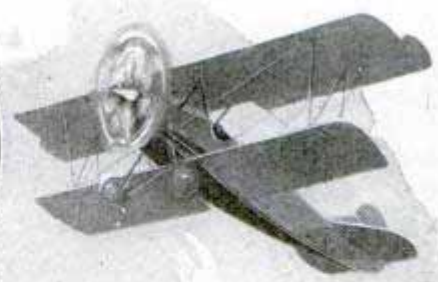

Climbing Up to Meet the Airoplane Mail at Forest-Patrol Station, and Close View of Pilot Dropping the Bundle

mt. Ough Lookout Station
**MAIL DROPPED FROM AIRPLANE
 FOR FOREST PATROL**

No one experiences greater joy at the arrival of the mailman than the forest lookout at his lonely post in the western mountains, but the sky, not the roads, is watched in this case, for the mail is delivered by plane. Special orders from the chief as well as other communications are dropped in a small package as the airplane, maintained by the forest-patrol service, glides down near the lookout tower and then zooms away for another delivery, miles away.

☐ We want all our readers to write us freely and often whenever they wish additional information on articles published in this magazine. Address Bureau of Information, Popular Mechanics, Chicago.

3334 Hammondspark, N.Y.

Tested at Marine Corps Aviation Field Quantico Va

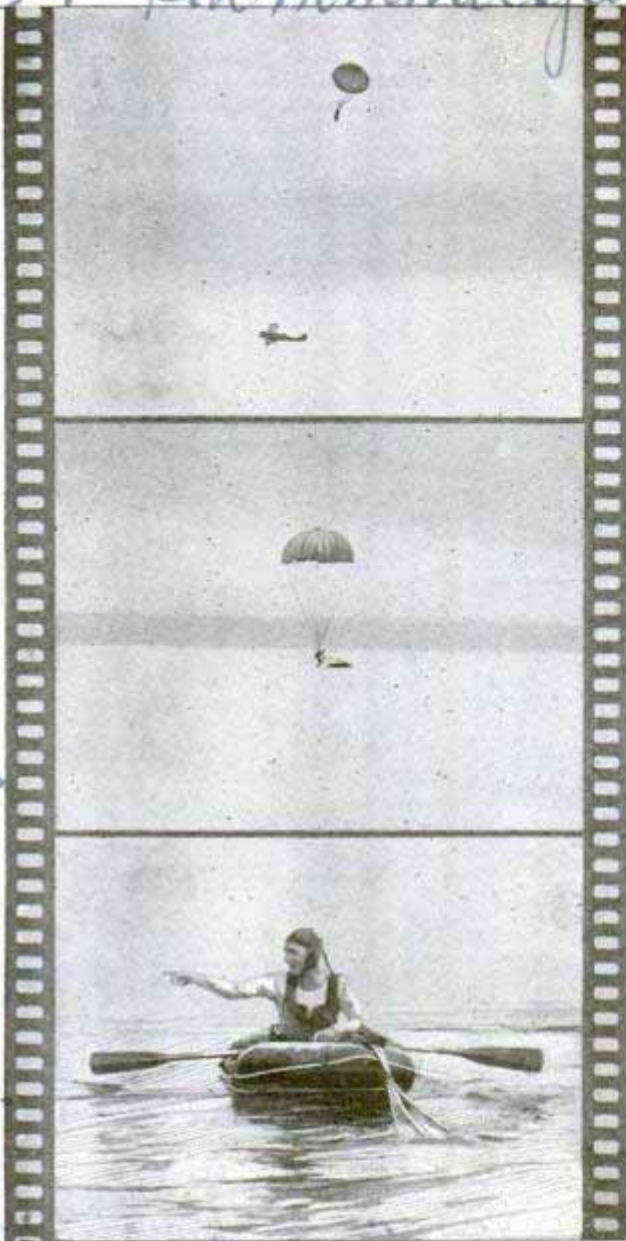

Just off the Plane, Opening the Raft and Blowing It Up, Then Safe on the Potomac River

LIFE RAFT INFLATED BY GAS AS PARACHUTE DROPS

A recent test by marine-corps aviators has established the feasibility of including deflated rubber rafts among the safety devices of flyers. After reaching an altitude of 3,000 feet, in a training plane piloted by Lieut. V. M. Guymon, of Salt Lake City, Utah, Corp. R. L. Huffman stepped from the craft. At 2,925 feet, his parachute opened, and he unpacked the raft and inflated it with the two tubes of carbon dioxide which he carried. Three minutes after leaving the plane, he dived into the Potomac river and, immediately bobbing up, swam to retrieve the parachute and fasten it to the raft. Putting together the two-piece oars, he then calmly

rowed to shore. The cylinders of carbon dioxide used to inflate the raft are only about twelve inches long and four inches in diameter. By turning the cylinder, carbon dioxide is discharged into the raft, inflating it almost instantaneously, or, in fact, in less than thirty seconds.

3517 A PERMANENT WAVE FOR TREES

Walnut trees with figured grain throughout the entire trunk are extremely rare, and efforts to cultivate them are being made by grafting the top branches of a highly figured tree to seedling walnut roots. It is hoped that this process may result in a tree with the beautiful grain so much desired for fine furniture and veneers. It is said that only about one in the half million walnut trees cut each year is an "unusual prize" as a source of the best and most fancied wood. The cause of the curly grain is somewhat of a mystery. Its occurrence at the stump has been attributed to the swaying of the tree in the wind or to the crowding of the wood laid on an inside curve of the tree.

SLEEVES FOR TROUSER LEGS. LATEST STORM GUARDS

3322 Waterproof protectors for trouser legs, which can be slipped on in a few seconds and carried in the pocket when not in use, have been introduced in England. They are simply pulled on over the shoes, button in front and keep the trousers dry from the knee to the shoe top. An elastic band holds them in place at the top, as shown.

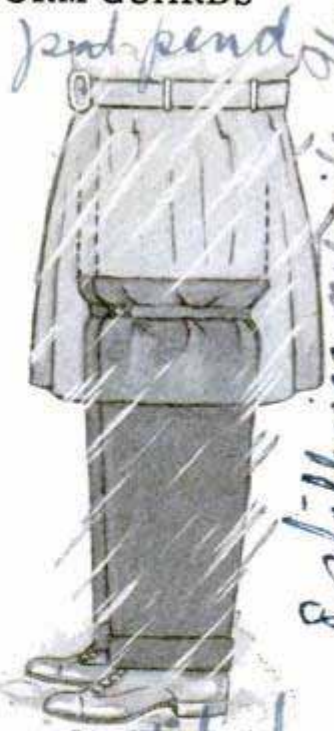

Two Shakes.

Whenever you find that you wish to know more about any article in this magazine, write our Bureau of Information.

Richard White & Co, Ltd 6 Isaline Place

American Magazine, Chicago

Phillips outside United Kingdon

3490

ARTISTIC BRICK BUILDINGS SHOW GERMAN SKILL



Courtesy Chicago Art Institute

Unique Effects with an Old-Style Material; Examples of Recent Brick Architecture in Germany

Since about 1100 A. D., when monks from Italy started making brick churches in Germany, Prussian craftsmen have excelled in the art of brick manufacture, and evidence that their skill has not declined with the years is seen in modern structures of the material being erected in Germany. The illustrations shown are all in the modern German style and utilize brick to advantage in emphasizing the plain, angular designs and broad surfaces.

FLORAL CLOCK AT CANDY STORE HELPS DRAW TRADE

From an old clock, a French merchant has devised an effective advertising display to attract customers. The dial of the instrument is of parchment, the hands are in the form of large bees and the hour markings are different flowers. As the clock ticks away, the "bees" pass from flower to flower, suggesting the gathering of sweets in which the merchant specializes.

Red

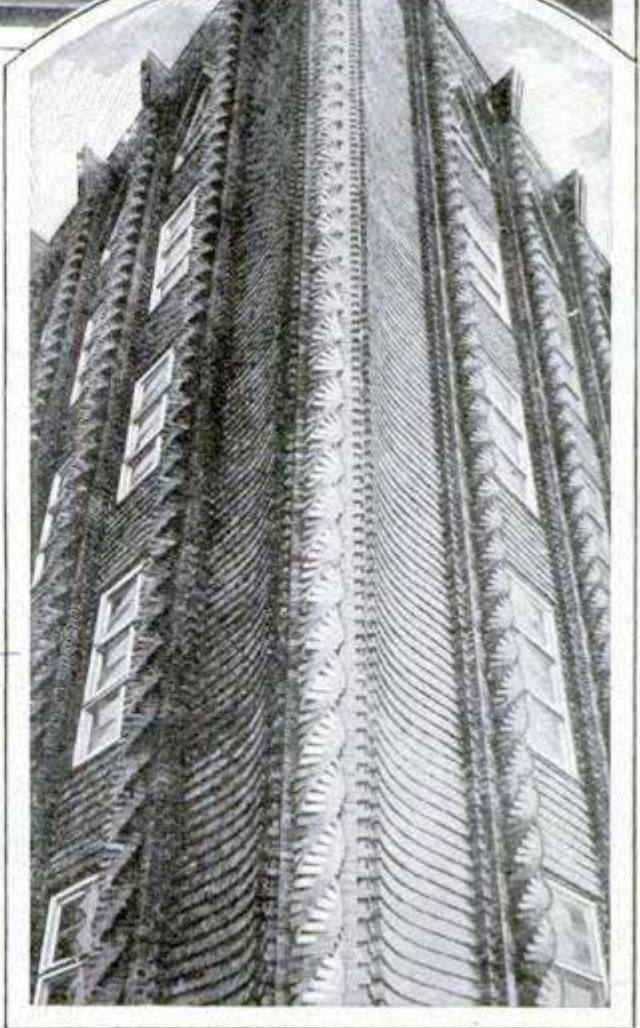

3455

3497
88

*Waltham Shoe Shining Co.,
Waltham, Mass.
Havenport, Iowa.*

POPULAR MECHANICS



Enjoying a Merry-Go-Round in the Swimming Pool; While Some of the Bathers Push the Platform with the Handles, Others Endeavor to Cling to the Rim

BATHERS' PUSH WHEEL ADDS SPORT TO SWIMMING

Bathers at a municipal natatorium in Davenport, Iowa, have fun on a push wheel that shoots persons seated on it into the water after it has attained sufficient velocity. Beneficial exercise is received in rotating it, and the riders have sport in trying to stay on as long as possible, although a final ducking is almost certain.

sugar was confined mainly to medicinal purposes and could only be afforded by wealthy persons. Today, America yearly consumes about 118 pounds per capita.

AWNING IS ADJUSTED TO SUN TO PROTECT GOODS

3409

Store awnings in strips that can be turned to admit more or less sunlight, as the time of day or position of the canopy require, have been introduced as an improvement over the one-piece variety. The strips are less likely to hold water when the awning is down in time of rain and

SUGAR WAS USED AS MEDICINE IN EARLY AGES

Humanity apparently has had a "sweet tooth" for ages, but sugar was first used as a medicine by the Arabian doctors about the seventh century A. D., according to a history of the substance prepared by the Pan-American Union. From those early times, and into the Middle Ages,

3520

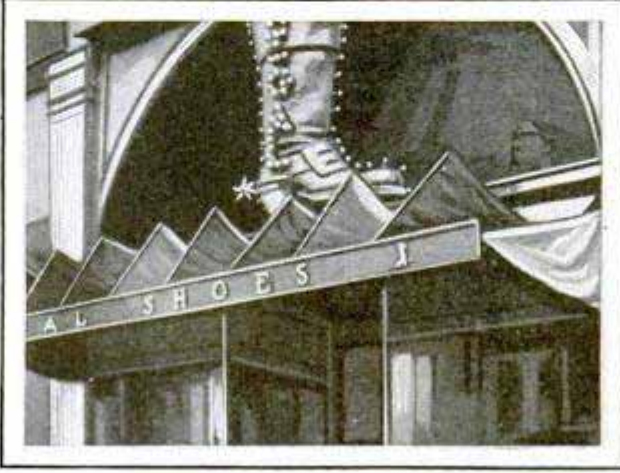

Sectional Awning. Set Angularly like Skylights, to Shield Goods without Excluding All the Sunlight

are not so liable to be ignited by cigarette or cigar stubs tossed from above, as there are gaps between the bands to allow objects to drop through. The strips can be turned to shield the contents of the display window and yet not exclude so much light that the merchandise cannot be plainly seen.

Washington, D.C.

*Regal Shoe Store
Portland Ore.*

3491
3491
Triplet
Ceres, Calif

STEM REMOVER AIDS GRAPE-CANNING INDUSTRY

3516

Development of a new phase of the canning industry is promised in the introduction of a unit which removes the stems from seedless grapes. It is said to have an output of five tons in a nine-hour day and to do the work at a cost of less than \$4 a ton. The grapes are dumped into a hopper and, as they pass through the outfit, they are caught by revolving brushes and pushed through a network of small, upright, steel pins. Thus the bunches are broken up. The small stem is removed by passing the grapes over small rubber cylinders arranged in pairs. Canning of grapes has been done on a small scale for several years, but the excessive cost of stemming them by hand workers hitherto has prevented the widespread development of the industry.



Courtesy Clyde Brown
Lorado Taft Finishing Model of the Lincoln Statue Which Has Been Erected at Urbana, Ill.

ABRAHAM LINCOLN AS LAWYER SHOWN IN LATEST STATUE

How Lincoln probably looked while pleading a case in court is seen in the latest notable Lincoln statue, made by Lorado Taft for Urbana and Champaign, Ill. It was recently unveiled near the courthouse and in front of the hotel, which stands on the site of the old inn where Lincoln stopped when his business took him to the "twin cities." The figure is of bronze and the monument is ten feet high.

CA
MOVIE CAMERA AND PROJECTOR TAKE PICTURES ON PAPER

Motion pictures on film or paper are taken with a camera recently introduced in England. Combined with it, is a projector showing the photographs. The paper film is projected by reflected light with the aid of two special lamps attached to the outfit and is said to give sharpness and definition on the screen in no way inferior to the film. The camera can be loaded in daylight, the projector shows pictures over six feet high and the set is inexpensive.



3436
10 guineas of good
8.50.00

"SICK" FLOWERS ARE REVIVED BY ARTIFICIAL SUNLIGHT *3405*

At a fashionable London restaurant, a "sunlight lamp" is used to treat sickly potted plants. A wild orchid bloomed in eight hours after exposure to the health-giving rays and a faded bouquet, worn by a woman, was placed under the light to revive it.

C.V. Jones
10/11/27
Campes Ltd, 23
City Road, London

Chickland News
8/18/27

The Most Dangerous Hour



By RUSSELL M. ARUNDEL

745 Earle Bldg., Washington, D.C.

THE clocks of a thousand cities chime five each afternoon. Stores and offices pour out millions of tired, homeward-bound workers, and in the crowded streets children start one final hour of play before dinner. America's most dangerous hour has arrived.

Ambulance drivers inspect their mounts to see that everything is in readiness; hospital attendants give the operating rooms a final look-over, and in garages, the wrecking cars are wheeled to the front. For the next sixty minutes the bulk of the day's traffic accidents will happen. More lives will be snuffed out, more people will be injured, and more automobiles destroyed than in any other hour of the day—more in fact than in several of the early morning hours combined.

Some place between the Atlantic and the Pacific, some one is being killed or injured in a traffic accident at the rate of one victim every forty-two seconds of the day. But when the statistics are plotted, the chart shows that, instead of an even distribution of deaths and injuries, they reach their peak in that one crowded hour, when senses have been dulled by a hard day's work, and reach their minimum just before dawn when most people are home in bed.

Three times as many casualties result-

ing from highway accidents occur in a single year in the United States than were suffered by the American forces during their entire participation in the World war. During 1926, approximately 25,302 persons were killed and 759,060 were seriously injured in these accidents. An estimate issued by the American Road-builders' association lists the principal causes as inattention; children playing in the street; speeding; adult jay-walking and violation of the traffic laws. Of the total number of accidents occurring last year approximately 11,183 were caused by motorists; 10,805 were the result of improper conduct on the part of pedestrians and 3,314 were caused principally by physical conditions.

Research has uncovered many peculiar facts in regard to the causes and results of highway accidents. The knowledge of these facts has given national organizations interested in the public-safety movement a basis upon which to work and is expected to bring a noticeable reduction in accident casualties within a few years. Paramount among the conclusions that have been drawn from statistics collected from various rural districts and municipalities are:

That the largest number of accidents occur between five and six in the after-

3293

noon, when business men and workers are returning hurriedly to their homes. At this period of the day, congestion on the streets and highways is at its height.

That the accidents involving pedestrians are increasing at a rate much greater than the rate of increase of other types of accidents. In Massachusetts, collisions between automobiles have actually decreased, while the calamities involving pedestrians have nearly doubled since 1921. This seems to indicate that the American motorist is becoming adept in the art of dodging other vehicles but is unable to cope with the problem of foot traffic.

Less than five per cent of all accidents are the result of faulty mechanism of vehicles or improperly designed roads and streets. The human machine is responsible for the remaining ninety-five per cent of the accident total. Carelessness and incompetency have been found to be the chief traits of the human machine resulting in disaster.

The annual death of 7,000 children of school age has caused an intensive re-

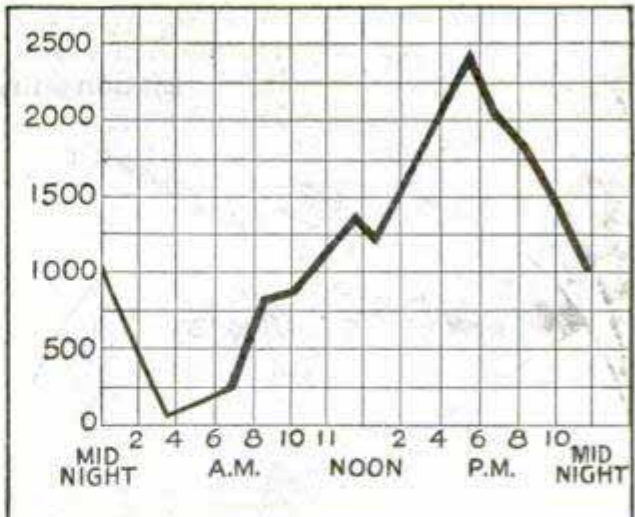

Courtesy American Roadbuilders' Ass'n

Chart Showing the Time of 28,000 Accidents in New York State, with Their Peak during the Homeward-Rush Hour between Five and Six in the Evening, When They Reached a Total of Nearly 2,500 an Hour; Below Is a Pedestrian Problem—How to Cross a Busy Street Corner Like This without Risk to Life or Limb

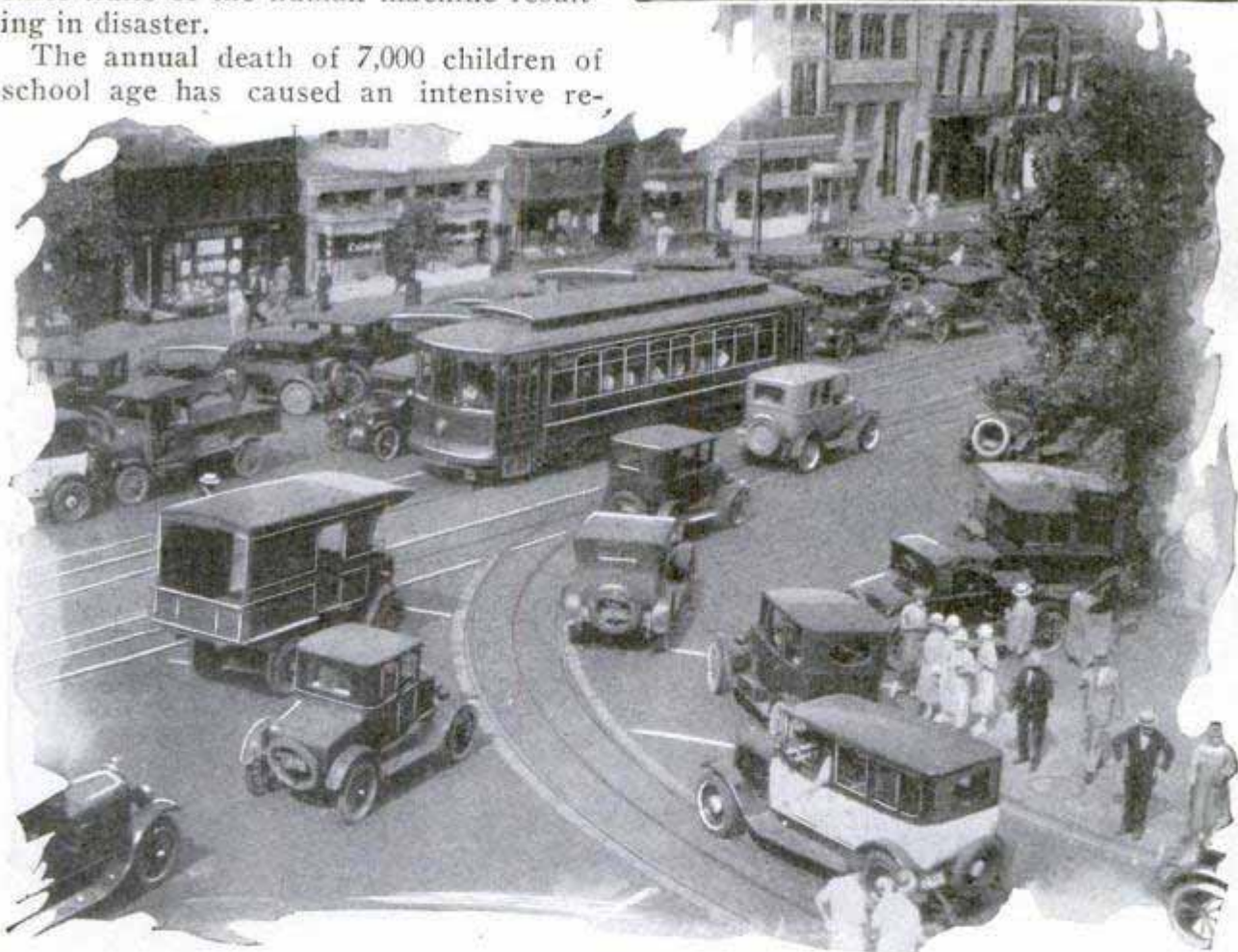

search into the causes of these youthful mortalities. It has been found that more than twice as many children between the ages of six and twelve are killed than in

any other similar group of years between one month and 70 years.

While the total number of accidents resulting from recklessness by intoxicated

3293
92

drivers is small as compared with total accidents reported, they more often result in mortalities. Drastic legislation in nearly every state has brought the number of deaths from this source to a con-

siderably lower level than in the year 1921.

A great mass of data has been collected by organizations investigating highway accidents to show that the outstanding single mental condition giving rise to casualties is fatigue which, in turn, causes carelessness, recklessness and a general decline in the ability of a driver or pedestrian to act speedily and accurately.

In the child problem, general inattentiveness has been found the chief cause of fatalities and injuries. The child at play is a bundle of trembling nerves and, in the joy of the game, is almost unconscious of any world but his own. He may run into the street and, being there, continue his pleasant pastime without regard to the motorist.

Thoughtlessness and poor judgment are the cause of more than forty per cent of all accidents. These classifications include jay-walking, inattention, confusion, inexperience and recklessness.

Various national organizations inter-

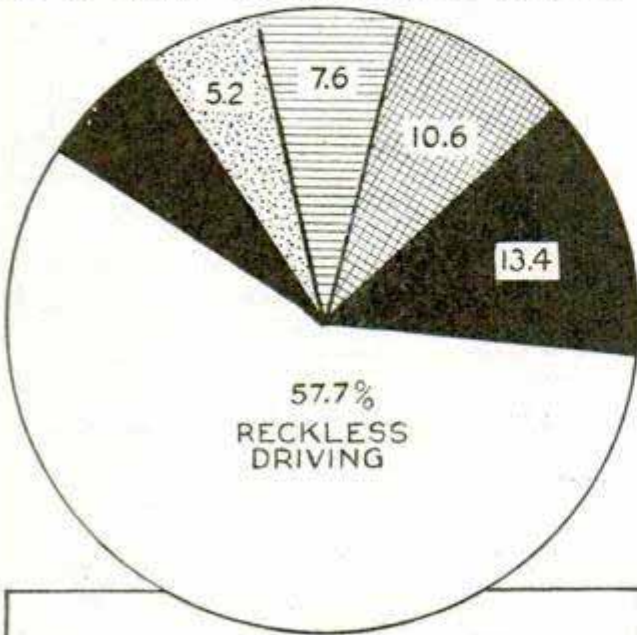

Reckless Driving Explains the Bulk of All Auto Accidents; Then, from Right to Left on the Chart, Come Careless Minor Accidents, viz., Carelessness of Both Drivers; Careless Pedestrians, Faulty Equipment and Miscellaneous Causes; Below Is the Result of Approaching a Narrow Bridge at Too High Speed; Bridges, Embankments, Sharp Curves and Blind Corners Are All Heavy Contributors to Motor Deaths

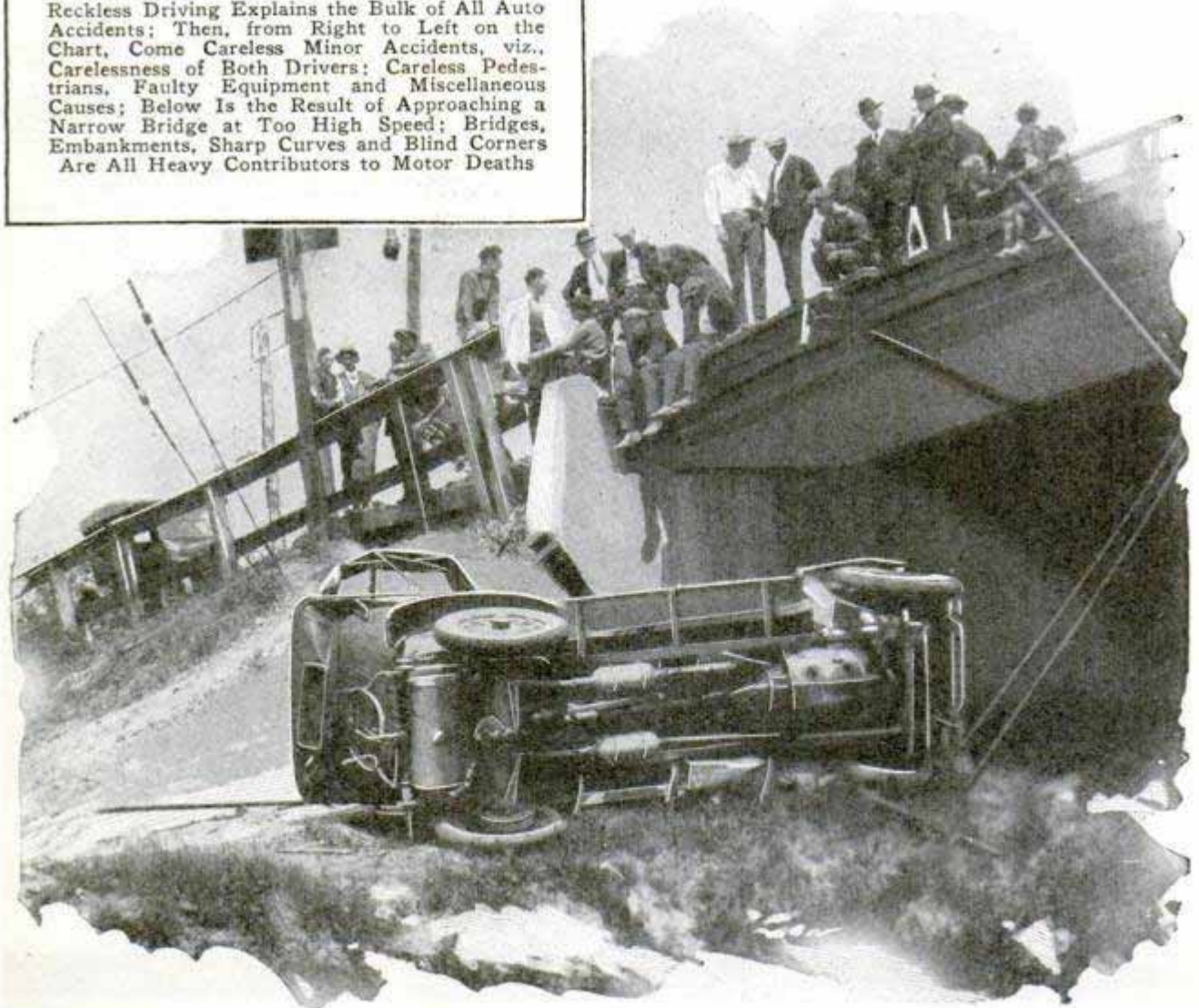

3293

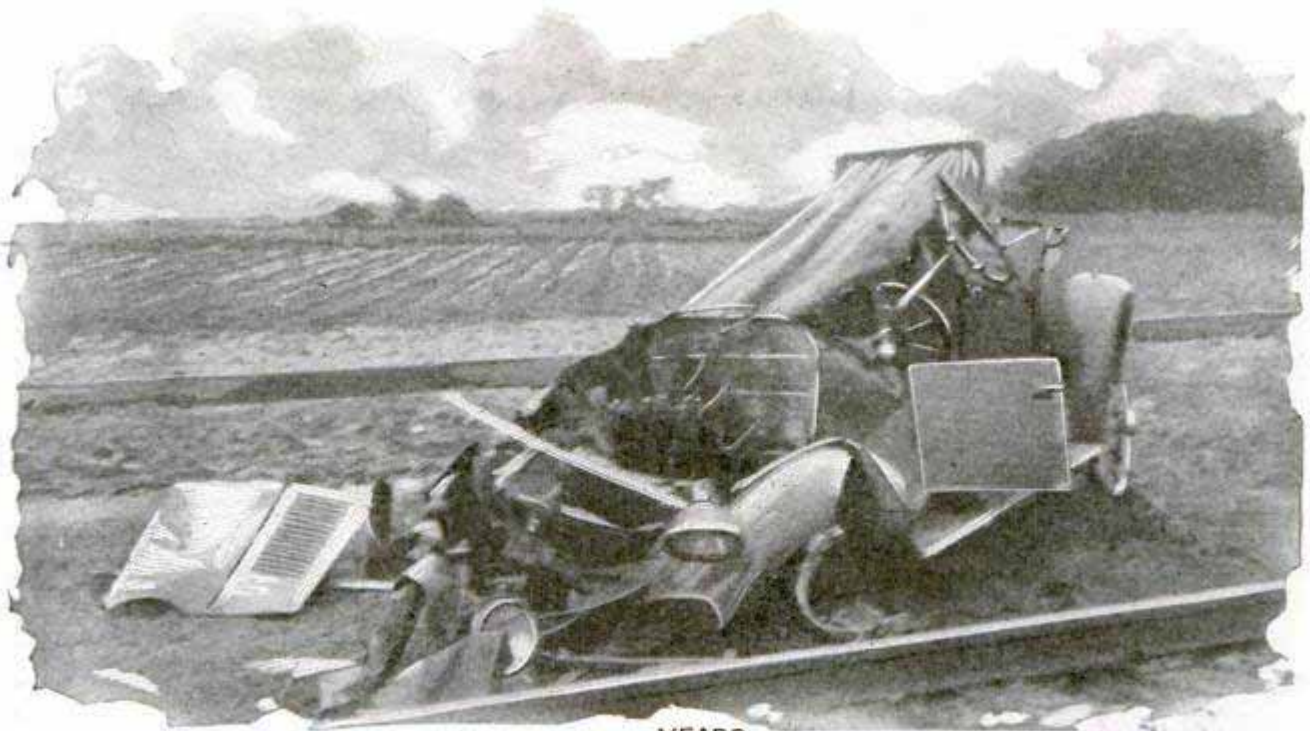

Photo by V. M. Pierce, U. S. Bureau of Public Roads

The Train Won This Race; at Right Is a Chart Showing the Ages of Highway-Accident Victims

ested in the highway-safety problem have outlined a series of objectives which are now being put under way, as follows:

First, the education and regulation of pedestrian traffic, as well as motor-vehicle traffic.

Second, the adoption of a standard code of motor-vehicle laws in every state of the union.

Third, education in safety and accident prevention will be incorporated in the schools, both public and private.

Fourth, motorists will be asked to protect the design and materials of their automobiles by periodic adjustment and replacement.

Fifth, a comprehensive program of street widening and the elimination of grade crossings will be carried out throughout the nation.

"Co-operation of motorist and pedestrian in behalf of public safety can save thousands of lives during the next few years," according to the report of the American Road-builders' association.

"Ninety-five per cent of all accidents are the result of failure of the human machine, rather

YEARS

- 0-10
- 10-20
- 20-30
- 30-40
- 40-50
- 50-60
- 60-

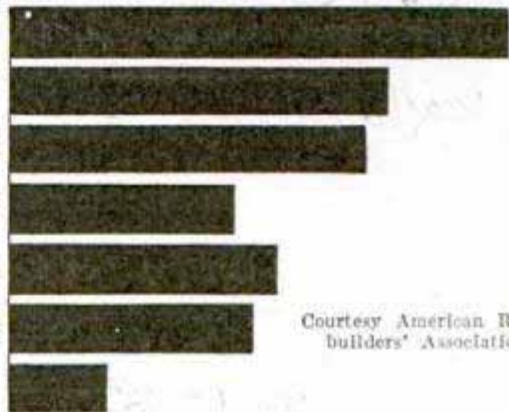

Courtesy American Road-builders' Association

than faulty mechanism or engineering. No amount of rules and regulations will eliminate these accidents unless they are embodied as a portion of the simple code of courtesy and caution."

TRIGGER GUARD FOR SHOTGUNS PREVENTS BRUISED FINGERS 2512

Taking some of the bumps out of shotgun shooting is the function of an improved trigger guard recently introduced. It permits inserting the entire hand within the frame so that when firing a double-barreled gun, the recoil is not likely to bruise the second finger, an injury frequently experienced with the usual piece if it is not held sufficiently tight.



With All the Fingers inside the Trigger Guard, the Gunner Is Less Likely to Suffer Injuries

American Essex Co. New York
314 Broadway, New York

3472

Mr. H. Dagnell & Mansfield
Essex England

The Club Aluminum Co. of America
Chicago, Ill.



SEWAGE GAS FUEL DRIVES ELECTRIC GENERATOR

Large sums of money are spent to get rid of sewage, but in the Birmingham district, England, the material is utilized, at one disposal station, to furnish gas for operating an engine that drives an electric generator. The gas comes from the bacteria that are active in the waste. It is collected in concrete containers which float on the surface of some of the receiving tanks, and is then piped away for use in an internal-combustion engine. It is said that more than enough is obtained to operate the 150-horsepower engine at the plant with highly satisfactory financial results. The gas, as it arrives at the engine, has no offensive odor.

358

Doughnut Mold in Operation; Serving Breakfast from the Electric Grill, and Close View of the Triangular Doughnuts

DOUGHNUTS COOKED AT TABLE IN ELECTRIC MOLD

Fresh, hot "triangle" doughnuts at the breakfast table, cooked as they are needed, are now possible in an electric mold of aluminum. It is operated from a lighting socket in much the same way as a waffle iron and can also be used for baking muffins and small cakes. Another table convenience is an aluminum griddle for cooking eggs, and frying bacon, ham or hot cakes. It has a roomy cover for keeping the food warm and, since no grease is required, may be employed at the table while eating. Both articles are of attractive appearance with a decorative base and high polish. The ware is of cast aluminum, and one can cook without water in other utensils of the same material, so none of the beneficial ingredients of the foods are lost.

\$14.95

waffle mold - \$14.95

\$15.95

in an internal-combustion engine. It is said that more than enough is obtained to operate the 150-horsepower engine at the plant with highly satisfactory financial results. The gas, as it arrives at the engine, has no offensive odor.

CURVED STREET-TRAFFIC GUIDE SAVES EXTRA POLICE



Three policemen were formerly required to regulate traffic in a London street, but since the installation of a special signal device, only one has been needed. The unit is operated by a control at the center of the street and shows, at either end, whether the course is clear for more traffic, thus saving communication of the "all-clear" signal by hand. The device has proved so successful that it is planned to install it at other places where suitable.

3234

For Traffic Regulation in Curved Street; the Center Guide Tells if There's Anything around Corner

Cont. A. C. Blackall Esq.
7, Vincent Square Mansions

331 at War Rockaway Beach,

L. A. New York 95

BLANKETING THE SKY WITH A CURTAIN OF DEATH

Antiaircraft batteries



Guardians of the Night, the Antiaircraft Batteries Spray the Sky with Shot and Shell as Soldiers of the Sixty-Second Regiment Test Their High-Angle Guns and Searchlights on a Target Towed behind a Plane Flying over Long Island; the Night Maneuvers Offer a Thrill for Spectators, But a Bigger Thrill for the Pilot Who Has the Long Canvas-Cone Target Hitched to a Cable a Thousand Feet behind His Ship



P. O.

2932

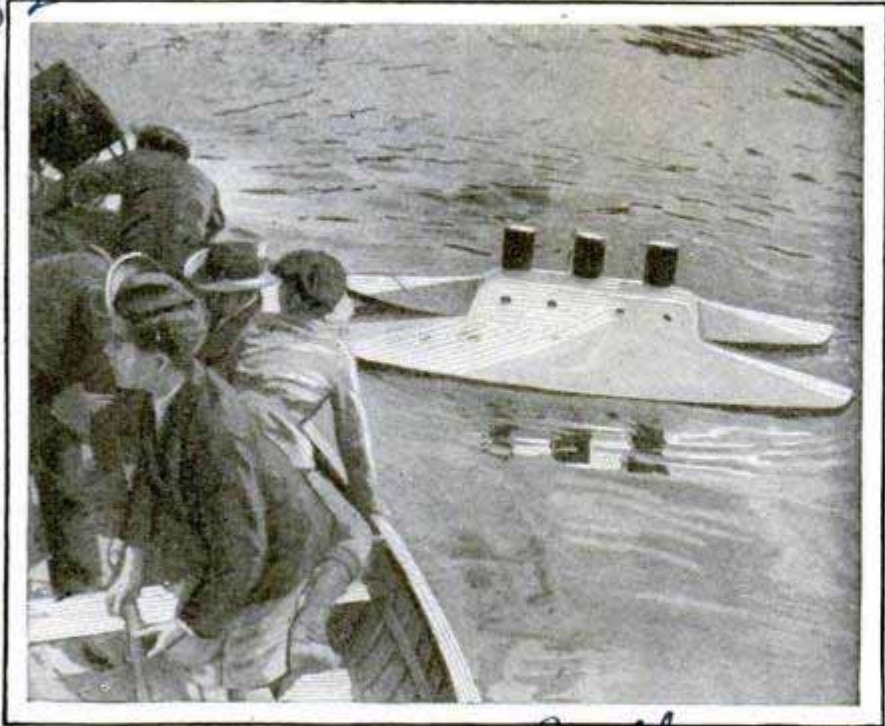

Model of Glider for Rapid Trips across the Atlantic; the Craft Is to Have Three Motors and They Will Steer It

GLIDER STEERED BY MOTORS TO CROSS ATLANTIC

Tests with a small model furnished engineers data for the construction of a hydroglider to cross the Atlantic from France. The craft was designed to be steered by speeding up or slowing down one of the three motors instead of by the usual guiding gear. Each engine develops 500 horsepower. The ship is supported on the water by two pontoons, each more than seventy feet long.

GLARE SHADE FOR AUTO MIRROR AIDS SAFER DRIVING

Disturbing reflections from headlights in the rear-view auto mirror are quickly stopped simply by pulling a little roller shade over the glass. It is made of transparent material, so that it does not curtail the service of the mirror and is attached to a spring roller so that it quickly rolls up again when the little hooks that hold it to the edge are released. The curtain can be adjusted in a second with one hand, is made to fit different sizes of

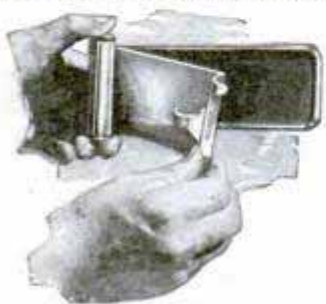

curtain can be adjusted in a second with one hand, is made to fit different sizes of

mirrors and can be attached in a minute or two. A similar aid for the driver has been introduced in a windshield shade on a roller so that it can be pulled down, when needed, or kept out of the way.

AIR DRIERS SPEED OUTPUT OF MONEY

Thousands of pounds of air are blown into big cabinets at the bureau of printing and engraving, where sheets of paper money are hung up to allow the ink to dry. The driers look like big safes and are kept locked during the process. From 150 to 200 are in constant use, and the large sheets of \$5, \$20 and \$100 bills are placed on racks, where they are "baked" for three hours.

PLUG IN CEILING-LIGHT SOCKET AIDS IN CLEANING LAMPS

The task of cleaning electric-light fixtures hung from the ceiling, has been simplified with a separable plug and hook-connecting unit, permitting the quick detachment of the fixture and its readjustment with a minimum of trouble. The plug is a simple adaptation of the usual type, and the hook supports the weight of the fixture. The janitor can easily remove globe, bulb and all, clean them in a convenient working position and return them with less labor and less likelihood of breakage.



Highways built by the ancient Romans were from eleven to fifteen feet wide.

Ans. J. Percy Ball, 9754 Winneton Ave Chicago

Compressed Air 10 27 27
Write Frank B. Rae Jr. Cleveland
4500 Euclid Ave. Ohio

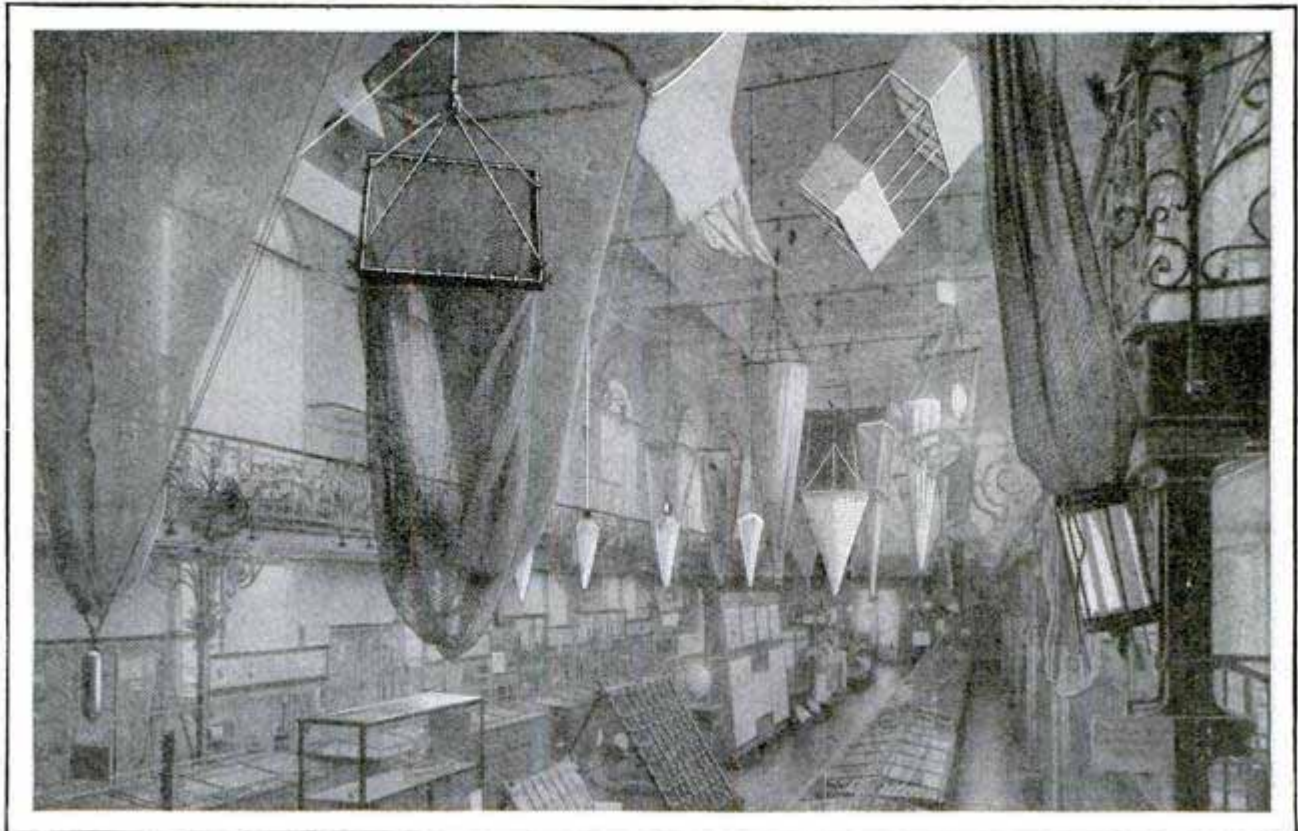

Part of the Marine Collection and the Nets and Traps of the Late Prince of Monaco, Who Utilized His Gambling-Casino Fortune to Pursue His Deep-Sea Studies

Monaco—Home of the Ocean's Story

Mysteries of the Deep Are Shown at "Bottom of the Sea" in World's Smallest Country

Commissioner By FRANCIS DICKIE *60 Canadian High Boulevard des Capucines, Paris, France*

I SPENT nearly an entire day recently in the company of hundreds of different kinds of the ocean's creatures, at the "bottom of the sea," situated in the smallest country in the world, which covers only about three square miles.

Built upon a hill overlooking the Mediterranean, Monaco is the home of the wonderful Museum of Oceanography, which is one of the outstanding places of interest in Europe, and which not only houses a unique collection of live sea creatures, but a still rarer gathering in bottles of forms of ocean life from immense depths, first made known to the world by the findings of the late ruler, Prince Albert I, who devoted the better part of his years to scientific research.

In the deep, dark basements of the museum has been constructed a reproduction of the bottom of the ocean in great tanks, where are collected hundreds of peculiar

fish, great turtles, octopus, tiny sea spiders and other sea life, strange and rare for human eyes to look upon as they move in their natural element. From a spacious entrance hall you descend until you come into a long passageway dimly lighted by electric globes, hidden within the shells of sea urchins, which throw a faint rosy light along your pathway. On either side of several long passageways are glass tanks. As you start along the dusky corridor, the impression of being a part of the ocean's bed is strongly felt. In the long line of tanks there are hundreds of strange and rare crabs, sea anemone, and fish of vivid and varied hues, red, yellow and green predominating.

The tanks are lighted from above. The first sight that startles the visitor is, however, not the fish, but apparent jets of smoke pouring from tiny tubes among the imitation rocks in all the fish tanks. These



Palace of the Princes of Monaco; the Late Prince, Who Died a Few Years Ago, Was One of the Greatest Authorities in the World on Undersea Life and Owned a Marvelous Collection

jets, in reality, are fresh sea water poured out continually in order to keep the creatures alive.

One of the strangest forms of sea life contained in these tanks is the Spirographis, a kind of worm which builds out of its own body tubes about a foot long and as thick as small gas hose. The tubes project out from the rocks. From the end of the tubes the worm extends a flower-like spiral plume that waves backward and forward, gathering minute sea life for its nutriment.

The largest form of marine life contained in the aquarium is the conger eel. The most amazing thing in connection with them is that they swim backward with as much speed as they do forward. But while the live fish and other sea life are, of course, the most interesting, and the visitor emerges from the depths with a feeling of actually having been at the bottom of the sea, the collection of fish

preserved in glass bottles on the main floor of the building is much more extensive and represents some very rare findings made in years of cruising and fishing at great depths. For this work special nets were required. In the enormous east hall on the first floor, the entire space is given over to an exhibition of the instruments used in gathering sea life at depths as great as 19,680 feet.

FOLDING AUTO-LUGGAGE TRUNK SERVES AS TRAILER

Constructed of steel, a folding auto-luggage carrier can be extended to hold such bulky articles as milk cans, tents or produce and, when closed, occupies no more space than a small chest. It easily accommodates 350 pounds of weight, is built for an extra tire and is especially suited to the needs of traveling men, merchants and farmers. The top is readily detachable.

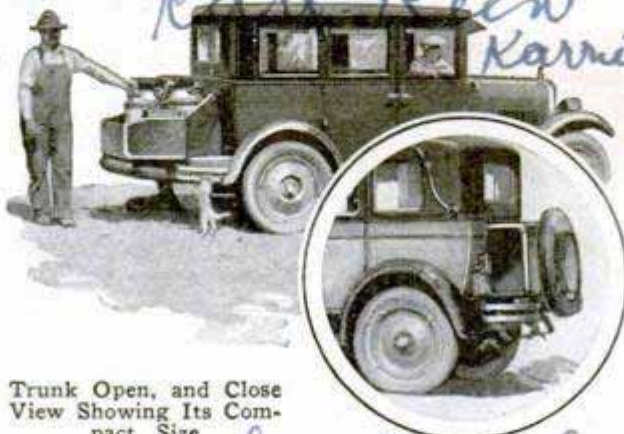

Trunk Open, and Close View Showing Its Compact Size

2658
Karl Keen
Karnis
Lier Mfg. Co. Chas.
Chicago, Ill.

SAILORS' PETS FORM ZOO COLLECTION

338 3

Nearly all of the specimens in the zoological gardens at Portsmouth, England, have been collected by sailors. One of the most interesting spots in the gardens is the place where the birds are kept, hundreds of rare species being sheltered in an environment as nearly like their natural surroundings as possible. Beside the stream where the ducks like to paddle is a willow grown from a cutting taken from a tree on the island of St. Helena, where Napoleon was banished, and there are also trees planted by the present king and queen of Britain before they came to the throne. The gardens are cared for by a number of naval pensioners, who are assisted by sailors in their spare time.



Nozzle Which Breaks the Force of the Fire Spray So That It Will Do Less Damage to Interiors

SPRAY NOZZLE ON FIRE HOSE TO REDUCE DAMAGE

Powerful streams of water from fire hose often do more harm than good, especially when the blaze is slight. To remedy this trouble, a member of the Fort Worth, Tex., fire department has devised a nozzle that can throw a spray or a condensed stream. It is said to be more effective when combating a fire at close range and is especially suitable for interior fires.

3321
H. L. McManis Bryan Ave 3145

AUTO BATTERY FILLER KEEPS WATER AT RIGHT LEVEL

Dry Automatic

336 3

Distilled water is supplied to the automobile batteries whenever needed from an automatic filler recently introduced. It consists chiefly of a glass container to hold the water and a feed line to the batteries. When the water level reaches a certain point, a "capillary attraction arm" is lowered into the tank and the liquid flows into the cells. At high level, the water raises a float and



causes the arm to ride free and clear of the water. The tank requires little attention except filling from time to time.

SUGAR FROM WOOD

3406

Dried sawdust, treated with chemicals, yields glucose and other products, but whether the process will be commercially practical for the making of sugar in any large amounts, is doubtful. From other by-products, alcohol suitable for motor fuel is obtained.

HAND-SIZE VACUUM CLEANER SIMPLIFIES HOUSE WORK

3266

Weighing but three pounds, and easily operated with one hand, a small vacuum cleaner now on the market saves getting out the larger unit for such tasks as brushing up crumbs or ashes, and, since it can be applied to curtains, furniture and clothing, it has a wider range of usefulness. The regulating switch is in the handle, and the cleaner runs on either direct or alternating current at modest expense. For cleaning lampshades, table covers, upholstery and other surfaces, it saves the labor and damage often occasioned by the use of a brush, and, of course, prevents the dirt from flying about the room.



Guaranteed Liquid Mop and Duster

Chicago-6248 McKegan

At 77 Glenpark
taken up by Belles - new hand cleaner
sold by United Motors Service

Reported by
Dr. W. O. Almandy
to Society of Chemical Industry

Hay - Trans Electric Co.
1320 Wisconsin Blvd.



Giving the Loop Thriller a New Twist; German Acrobat Rounding the Circle While Standing on His Head in Special Car

**LOOPING THE LOOP ON HIS HEAD
BERLIN ACROBAT'S THRILLER**

While standing on his head in a special car, a German acrobat slides down a runway and loops a loop at the bottom at a high rate of speed. To help him hold his position, he grips a bar inside the car which is held to the track with flanges.

**FIRE PREVENTION IN THE HOME
SHOWS GOOD HOUSEKEEPING**

Eliminating fire hazards in the home, as far as possible, is especially important in the winter. Edward Reilley, assistant chief of Chicago's fire insurance patrols, warns against risky methods of thawing out frozen water pipes, allowing piles of newspapers or other inflammable material to

accumulate in the basement, placing ashes in wooden containers and using flexible hose or like conduits for gas. Rigid pipe should be employed wherever possible, to avoid leaks and the likelihood of explosions and fires. A common practice but a dangerous one is to place tissue paper over electric-light bulbs for shade. The paper is likely to ignite and cause a blaze. In spite of constant warnings, housekeepers will persist in throwing kerosene on fires or kindling to expedite the cooking. Not long ago, a wrong can, one containing gasoline, was used and eight persons were burned to death. Leave the electric wiring to the electrician. If changes have to be made, keep lighted matches or candles out of the closets. Oil-soaked mops are a common cause of fires and should never be left in a place where they

are likely to generate heat and ignite. Fires without apparent cause in many cases are due to a pile of oil or paint-soaked rags carelessly thrown into a corner closet or other inclosed space.

**BRUSH CLEANS BETWEEN TEETH
WITH REPLACEABLE HEAD**

Bristles in a recently introduced toothbrush are shaped to clean thoroughly the interstices between the teeth and when the head becomes worn, a new one is quickly attached to the bakelite handle. By adjusting the nut that holds the brush, the bristles may be turned to any angle.



Clean-B-Tween Tooth Brush Co.

3408

daily wood Calif. St. Louis Mo

WEIRD ARCHITECTURE HELPS TO SELL ICE CREAM

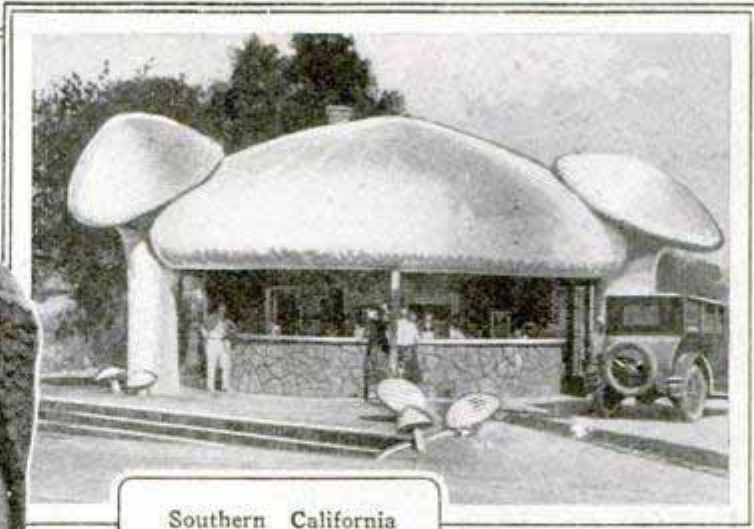
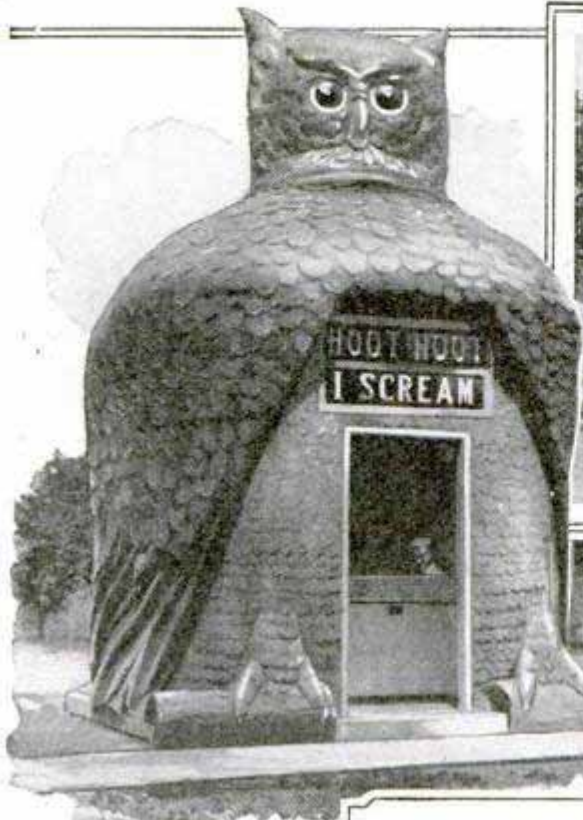

Southern California Has Taken the Lead in Producing Weird and Novel Roadside Stands, of Which These Are Examples

Strange Beasts and Birds, Enormous Mushrooms, and Replicas of Milk Cans, Ice-Cream Cones and Other Artificial Objects Are to Be Seen on Every Hand by the Tourist

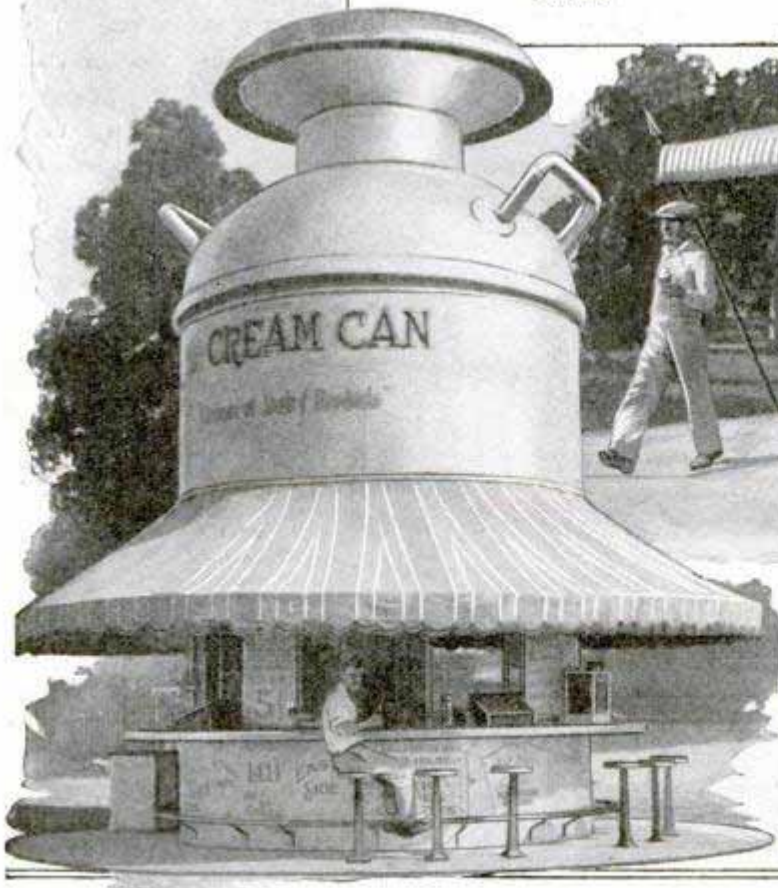

Even Gigantic Figures Molded of Concrete, Whose Spreading Skirts Shelter the Stock in Trade, the Clerks and the Customers, Sprout Up, with Their Gay-Colored Awnings, along the Concrete Highways

Handwritten signature or initials.

ALASKA REINDEER HERDS TO SUPPLY FUTURE MEAT



Courtesy Lomen Bros.

Seal-Hunting and Fishing in Alaska Are Still Necessary, but Reindeer Meat Has Increased the Natural Supplies of Food



Reindeer raised by Alaskan Eskimos may take the place of the vast cattle herds of the vanishing west as a source of meat, while the success of the herds has converted the natives from fish to meat eaters. The United States government imported the first reindeer from Siberia in 1892, landing them at Teller, later made famous when Amundsen's dirigible, the "Norge," landed there after its flight across the North Pole. In the next ten years, a total of 1,280 reindeer were brought across the Bering sea, and the original 1,200 now have more than 600,000 descendants in the vast herds that feed on the scant moss and grass of the far north. One of the largest reindeer companies operates five cold-storage plants in Alaska, where the animals are slaughtered and the meat prepared for shipment to the states. Besides furnishing meat for other lands, reindeer have proved life-savers for the natives. They are displacing dogs as sled animals, have made it unnecessary to hunt fish and seals for food, and are providing material for fur clothing independent of polar bear and seal skins.

1944

**CLOCKS STOP IN HIGH BUILDINGS
 BECAUSE OF SWAY**

337

When a grandfather clock in a tall Chicago hotel refused to run, the owner was perplexed, for it was in perfect order. A clockmaker explained the apparent mystery. The building stands in an isolated spot where it receives the full force of the winds and sways slightly, especially in the upper stories. When this movement is in the right direction with reference to the swing of the pendulum, the clock stops, the craftsman explained. He said that he had been kept busy adjusting clocks because of this difficulty. Where it was practical, a simple remedy was found simply by turning the piece at such an angle that the vibrations would not affect the pendulum. Another method was to put on a heavier pendulum and adjust the springs so that the slight sway of the building would not stop the mechanism. In skyscrapers the sway is sometimes perceptible to a person standing at the top.

**CAFE IN FORM OF LARGE SHOE
 RECALLS NURSERY RHYME**

3227

One of the latest novelties in restaurant architecture in California is a cafe building in the form of a large shoe, to suggest a nursery rhyme. An automatic "Mother Goose" flies in a circle over the structure, which has the advantage of ample lighting and ventilating facilities, because of the peculiar shape of the exterior.

Pasadena

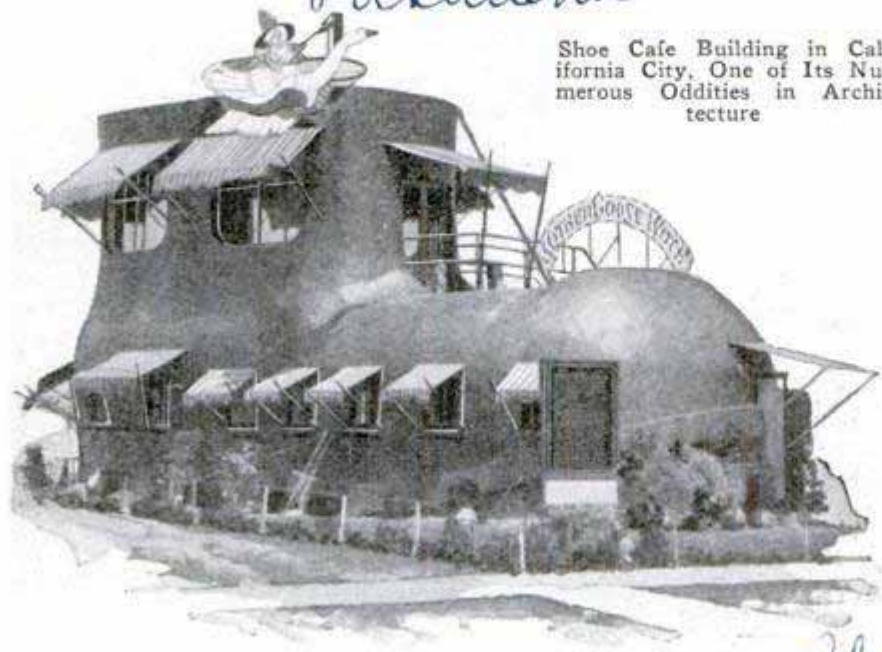

Shoe Cafe Building in California City. One of Its Numerous Oddities in Architecture



Taking Extra Copies of Fingerprint Records for Police Files; the Duplicating Apparatus in Use

**FINGERPRINTS ARE DUPLICATED
 WITH MACHINE**

Fingerprint experts of the Baltimore police department are saving considerable time and work by using a rapid duplicator for making copies of the impressions used in keeping track of suspects and identifying criminals. The apparatus is the invention of one of the members of the force, and is said to be superior to older photographic and other methods.

**BETTER AND CHEAPER STEEL
 SEEN IN NEW PROCESS**

3434

Not far from the spot where the Bessemer process for making steel was developed in England, is being constructed an experimental furnace to test a new method for refining the product. According to reports, it will result in the production of high-purity steel at less than one-half the cost of the present material, which is far from being chemically pure. No tall blast furnaces will be needed and cheaper grades of coal can be used, while low-grade ore, that cannot profitably be handled by present processes can be smelted.

Discovered by Lindley
 Bluffield, London, Eng.

Turner Lance Eng.
 127, Abbey Road, Boro. in.

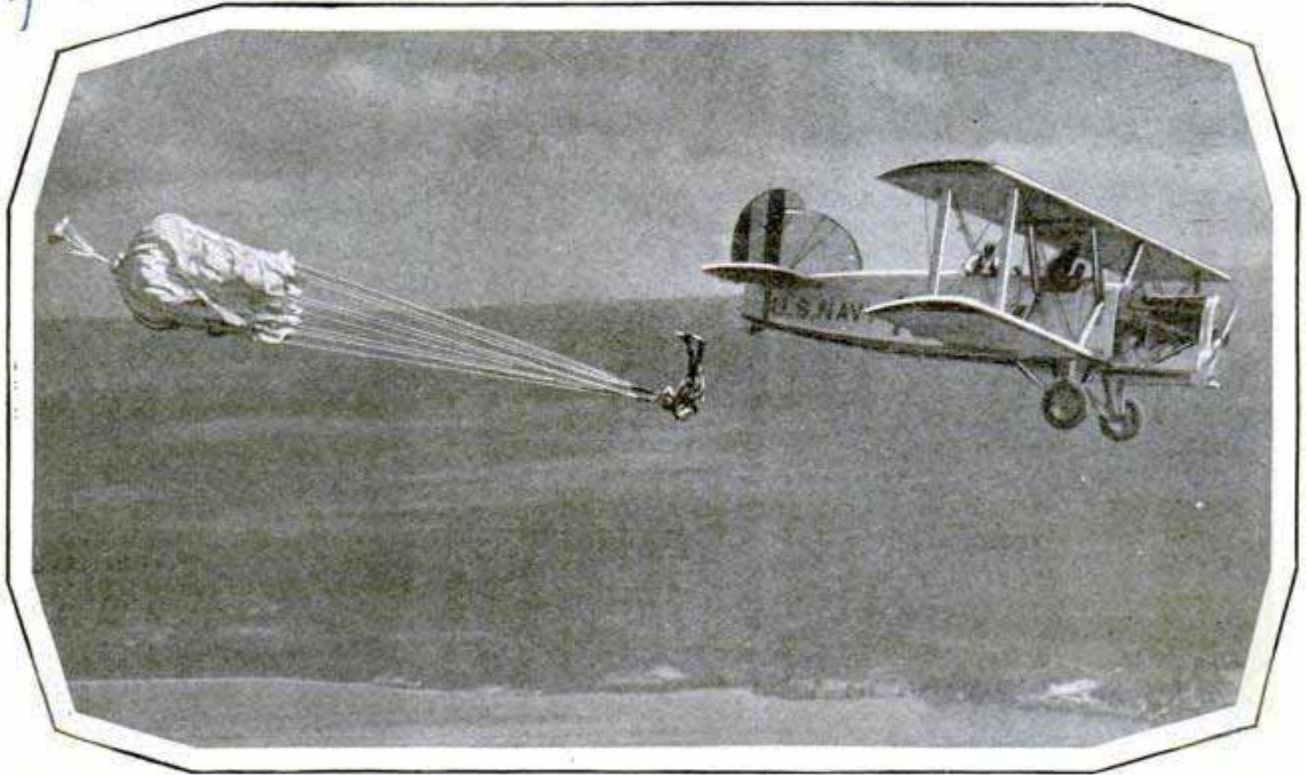

Tumbling Headfirst from a Plane, the Parachute Jumper Is Jerked Upright as the Silk Umbrella Fills with Air; at Bottom of Page, a Seat-Pack Chute Which Takes the Place of a Cushion

Dummy Flyers Help Make Air Safe

By R. BACHE

*1823 L St
Washington, D.C.*
the heaviest airman. It has a neck but no head; the legs and arms are mere stumps. The parachute equipment is fastened

DUMMY aviators are importantly helpful in trying out new ideas for parachutes. They afford just as good safety tests as live men, and, in case of accident, nobody is hurt. A fall of a few thousand feet or more doesn't bother the dummy.

The typical dummy used by aeronautic experimenters of our army and navy is made on a strong wooden frame, covered with canvas, and stuffed with any kind of material that happens to be handy, an essential requirement being that it shall weigh 180 to 200 pounds. Thus its weight corresponds to that of



upon it with a harness of straps, exactly as it would be attached to a man.

The equipment is a "seat pack," secured to the lower part of the dummy's back. This kind of pack, used as a seat cushion by an aviator, removes all weight and bulk from his person, save for the harness. It is a canvas envelope containing a parachute of light and very strong silk, twenty-four feet in diameter, carefully folded in a particular way, and weighs eighteen pounds.

When the dummy is dropped experimentally from an airplane far aloft, the rip cord connected to the pack is simultaneously jerked, releasing the parachute. But the first thing to emerge from the canvas envelope is a small "pilot chute," thrown out by springs. Catching the wind, it exerts a pull which yanks the big parachute out of the pack, and thereby the parachute is enabled to expand quickly.

It is fully opened by the time the dummy has fallen 150 feet. Then, the expanded umbrella having caught the resisting air, it floats downward toward Mother Earth at a rate of thirteen feet a second.

The loftiest height in the sky from which a parachute jumper has ever leaped was twenty-six thousand feet, or nearly five miles. It took him a little over half an hour to reach the ground, but he alighted safely. The first parachute drop from a flying machine was made in 1912, at St. Louis, by Capt. Berry. The

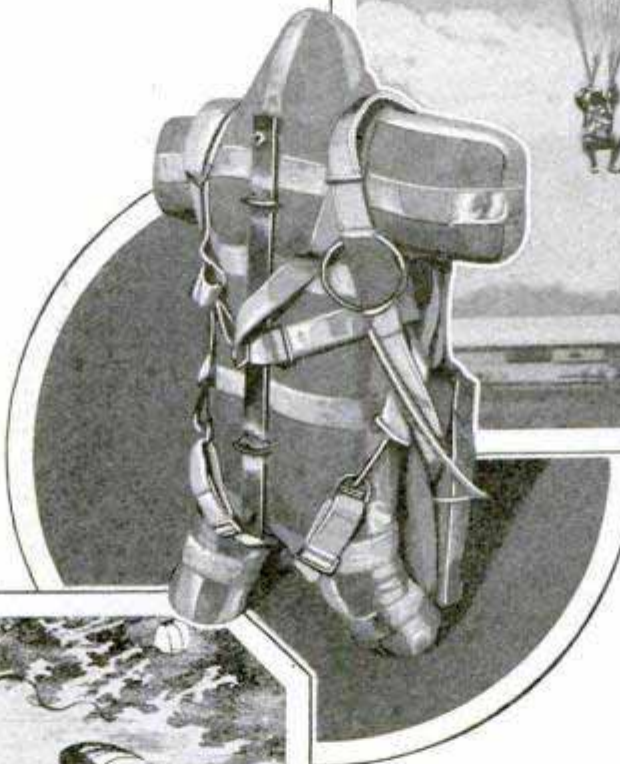

With Knees Drawn Up to Absorb the Shock, the Flyer Prepares to Land. Top; a Test Dummy, Center, and an Old Sketch of Garnerin's First Jump in England in 1802

chute was folded and stuffed into a cylindrical-conical metal container. In the following year, the first "knapsack" parachutes were developed, with a rip cord to open the pack.

The seat pack is designed for flyers who do not move about during flight. Another type is the "lap pack," which rests in the lap of the airman. It is especially for use by gunners and observers. A gunner usually has the most available room directly in front of him and below the waist line.

To learn how to use a parachute requires no natural aptitude beyond the ordinary, and very little training. The aviator, when he jumps from aloft, holds in his hand a ring to which the rip cord is fastened. All he has to do is jerk it, and the rest of the business takes care of itself. The sensation of floating downward is described as being rather agreeable than otherwise.

General Electric Co., Schenectady, N.Y.

2831

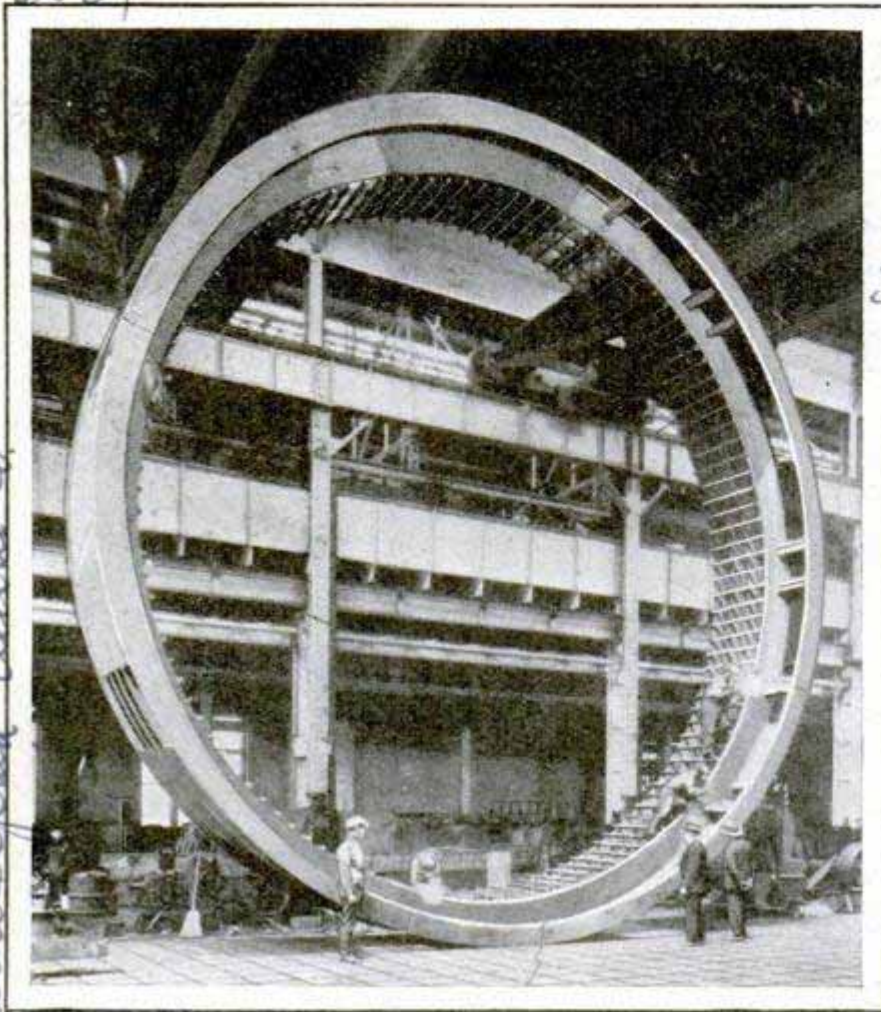

Electrically Welded Frame for One of the 50,000-Horsepower Generators Being Installed by Philadelphia Power Company

GIANT "HOOP" FOR GENERATOR IS MARVEL OF WELDING

What is said to be the largest piece of electrical machinery ever made from structural steel and electrically welded has been completed in the frame for one of the 50,000-horsepower generators for a Philadelphia company. Four of these huge units are to be installed in this plant, which will be the largest electricity "factory" in the United States except the power development from Niagara falls.

TINY FISH FANS ITS YOUNG TO SUPPLY OXYGEN

Fish placed in water that has been boiled to drive out the oxygen usually die in a short time, showing how necessary the element is to the preservation of their lives. The little stickleback fans the nest in which the young are hatched with its fins to afford an abundant oxygen supply and another species exercises the same

care, both parents taking their turn doing the fanning.

ELECTRIC HANDS MOVE CARS IN TALL GARAGE

3461 Space for parking 1,052 cars is to be provided in a twenty-eight-story garage for New York City's crowded business district. It is to be within a few feet of one of the entrances to the Grand Central terminal, and is planned to afford a maximum of storage space within the limits of the lot. After a driver has surrendered his car and received a check for it, an electrically operated truck rolls from an elevator, is stopped under the auto, the rear axle engaged in a rubber-cleated coupler, and then the car is taken back to the elevator, and run to

the desired floor, being left in its space by a reversal of the method that was pursued at the first. The little trucks are governed by push buttons in the elevator, so that the operator need not leave his post or touch the auto to store it. Elimination of ramps and useless aisles, high-speed elevators, and street-level delivery and acceptance are other features.

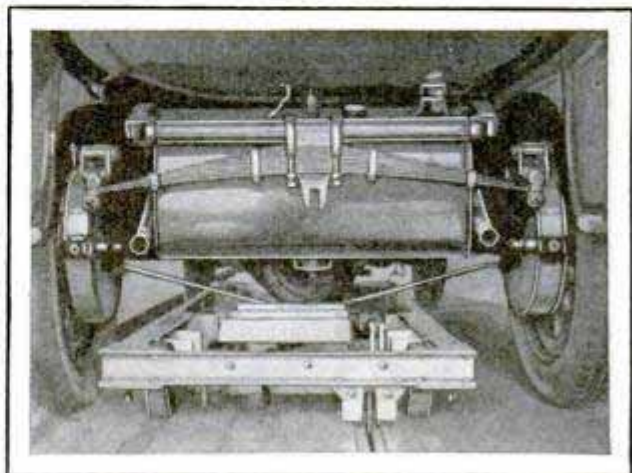

One of the "Electric Hands" That Move Cars; Truck Adjusted under Auto to Slide It on or off Elevator

Encouraging Power Development of Philadelphia Electric Co.

Auckland News 2/19/27

Ken Garage & Erecting Corp. 3500 Madison Ave.

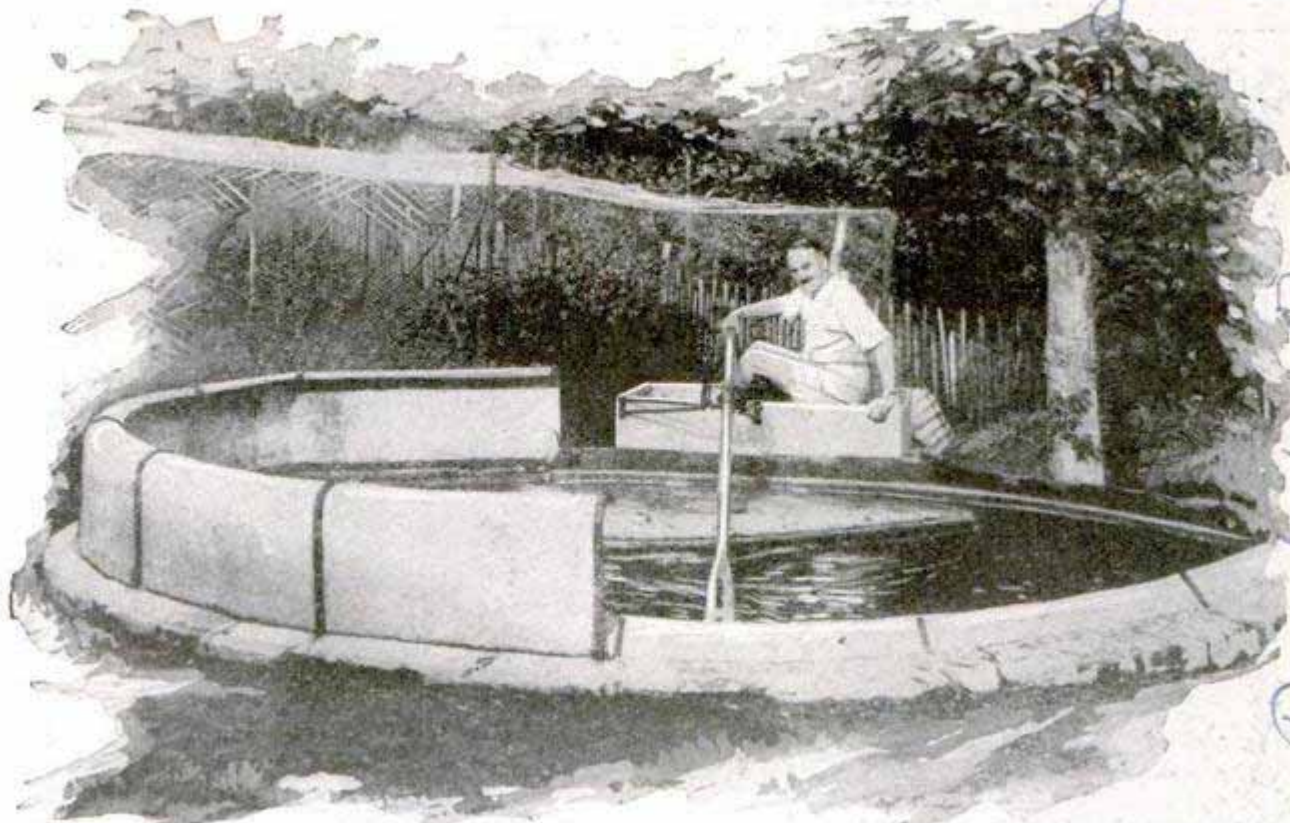

Built by Percy
 Phelps

Rowing Practice in His Yard; British Oarsman in Stationary Boat near Tank in Which He Can Keep in Training with Real Strokes; Splash Guard around Rim at Left

ROWING DRILL IN ONE-MAN TANK GIVES OARSMAN PRACTICE

To keep himself in training, a British oarsman has a private tank just large enough for one oar. He sits in a stationary "boat" and sweeps the oar through the water as though in an actual race. The boat has a sliding seat, similar to those in the usual racing hull.

34 31

INSECT WEATHER PROPHETS

If spiders are busy spinning their webs, fair weather may be expected, but if they are resting, the fact is an indication of impending storms or wet weather, some naturalists say. The reason is that the spider, knowing that its prey will not be abroad during rains or other unfavorable conditions, does not trouble to make its nest at such times, but prepares it for catches during fair weather. Bees are able to tell approaching storms and in threatening intervals will not venture far from their

hives. The noise of the screech owl at night is also claimed to be an indication of fair weather.

ENDLESS TRACK FOR TOY TRAIN NOVEL WINDOW DISPLAY

Designed especially for window display, a spiral tower for an electric toy train, permits continuous running in smaller space and adds to the interest in the operation. By means of transformers, the train ascends on a current of nine volts and comes down on five and one-half volts, in order to make sure that it will not run off the track. For home-play purposes, the outfit can be operated with but one transformer.

3100

pat pend.

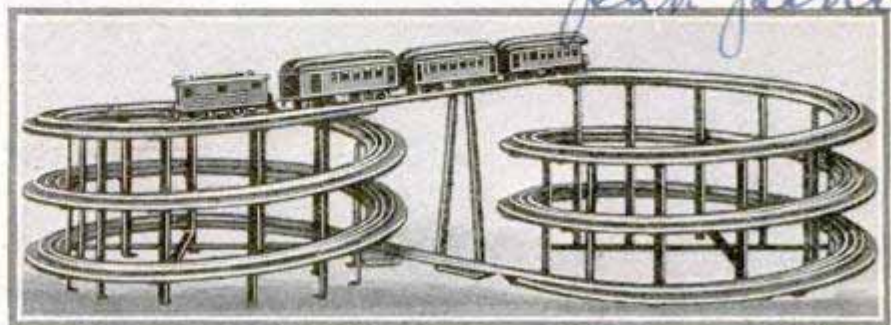

Adding Interest to the Window Display; the Double-Spiral Track for Toy Electric Train, Occupies Small Space

London, J. C. B. Co.

The George Lecker Co.
 Henderson, Ky.

SHARK SHIP HUNTS SEA TERRORS TO MAKE SHOES

3804

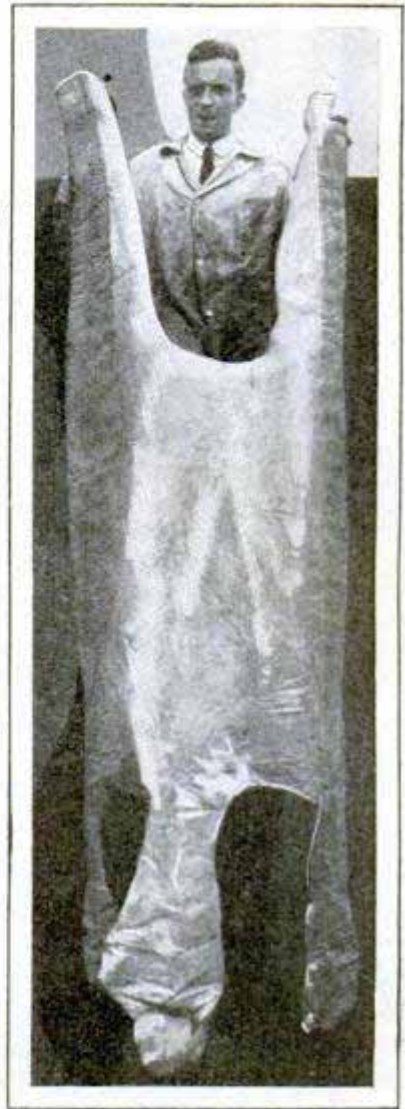
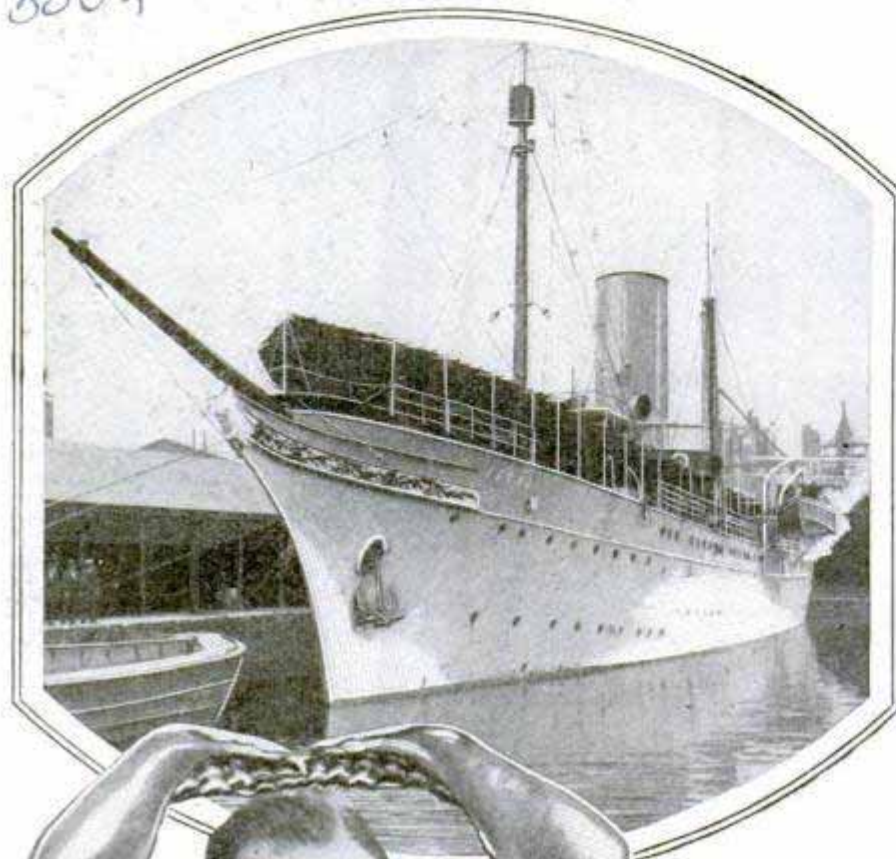

A Shark Ship, Built from a Yacht That Served in the American Navy during the War, Has Returned from Australia to London, after a Successful Season Hunting the Terror of the Seas to Turn His Hide into Shoes, Luggage and Hand Bags, His Fins into Delicacies for Chinese Epicures, His Carcass into Oil for Fine Watches, and the Odds and Ends into Fertilizer; Above Is the Ship, the "Istar," and a Shark Skin Ready for Tanning

His Fins into Delicacies for Chinese Epicures, His Carcass into Oil for Fine Watches, and the Odds and Ends into Fertilizer; Above Is the Ship, the "Istar," and a Shark Skin Ready for Tanning

© P. & A. Photos

Huge Nets, Planted by a Fleet of Ten Motorboats, Are Used to Catch the Sharks; the Big Fish in Their Fright Dash Around and Struggle Until Their Gills Close and They Suffocate; Thirty Tons of Sharks Are Often Handled Daily; Above Is a Shark Jaw and, at the Right, a Group of London Children Getting Acquainted with the Teeth of the Man-Eater



3804

EXCELSIOR BUILDING BLOCKS
NEW HOME MATERIAL

Building blocks of compressed packing excelsior, impregnated with a mineral cement which makes them practically fire-proof, are being used successfully in a new form of home construction. The blocks, four by eight by sixteen inches, are each equivalent to eight ordinary bricks in volume, but, weighing only three pounds, are less than one clay brick in weight. Each block is pierced by two four-inch holes, and when they are laid in overlapping rows, as are bricks, the holes match. After three rows or courses are piled up, steel reinforcing clips are inserted, and the holes filled with concrete. The clips are equal to four courses, and each pouring ends one below the top, so that a continuous bond is obtained. The finished wall is a series of four-inch reinforced concrete columns, spaced four inches apart, and surrounded by the compressed-excelsior blocks. At the floor levels a four by eight-inch reinforced-concrete beam is worked in, and the next wall started on top of it. Laboratory tests show the material is equal to four inches of cork in insulating value; that it is a sound deadener and that a reinforced wall built of it will carry a load of 16,000 pounds per running foot. No skilled labor is required in laying the walls, as the blocks are simply piled on top of each other, the steel reinforcing dropped into the holes, and the concrete poured from an ordinary coal scuttle. No lath is required on the inside, plaster being applied direct to the blocks, the fibers of which furnish a good bond, and stucco is applied in the same way on the outside. Owing to the mineral cement with which the blocks are impregnated, they will not support combustion.

or Builders Building

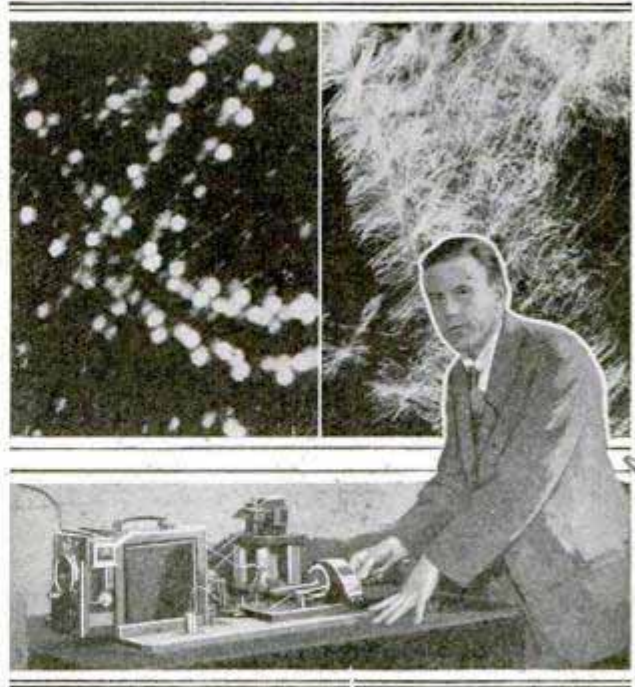

At Left, Fly Footprints and Microscopic Enlargement of Same; at Right, Showing Germ Growth

MENACE OF FLY'S FOOTPRINTS
REVEALED BY MICROSCOPE

That the fly is a spreader of dirt and disease has long been known, but the microscope reveals a particular reason why the insect should be killed. Its footprints are scarcely visible to the unaided eye, even when materials make the marks plainer, but examination of the tracks a few hours after they have been formed, explains the hazard of allowing the fly to walk across articles that should be kept clean. The microscope shows how tiny disease germs in substances carried by the fly's feet, have developed. A few hours after the photograph was taken, some of the germs had developed tiny balls of spores which were carried away in the air to seek lodgment and possible growth. Where flies have been eradicated, a marked decrease in disease has been observed.

J. Perry South, Photographer London Eng.

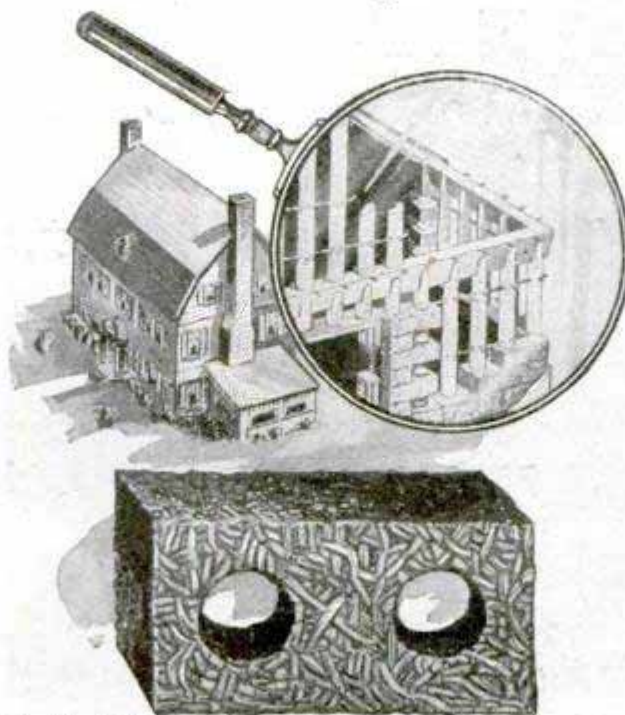

Detail of Construction with the Blocks, Showing Concrete Section and Close View of Excelsior Unit

Stockade Ind. West Corp. or Builders Building

2820

New Ways to

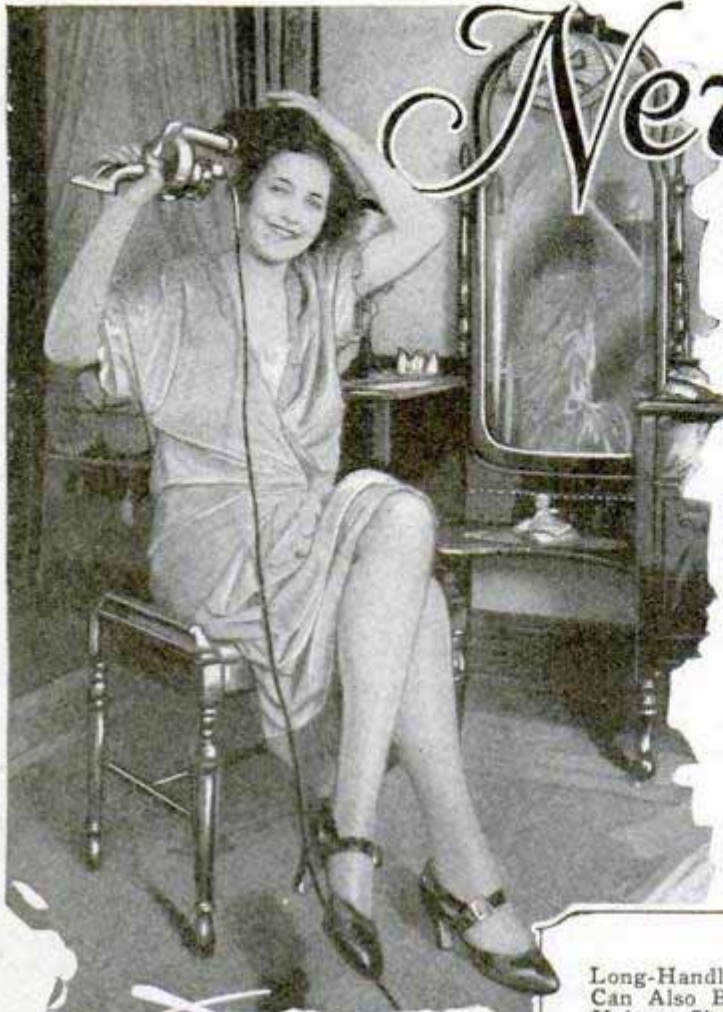

Serving Pitcher That Hides the Condensed-Milk Can; Pours Directly from the Container and Is Easily Washed and Sanitary

Long-Handled Vacuum Cleaner Can Also Be Used for Drying Hair as Shown at Upper Left; in Opposite Corner; Cleaning Draperies with Aid of Handle

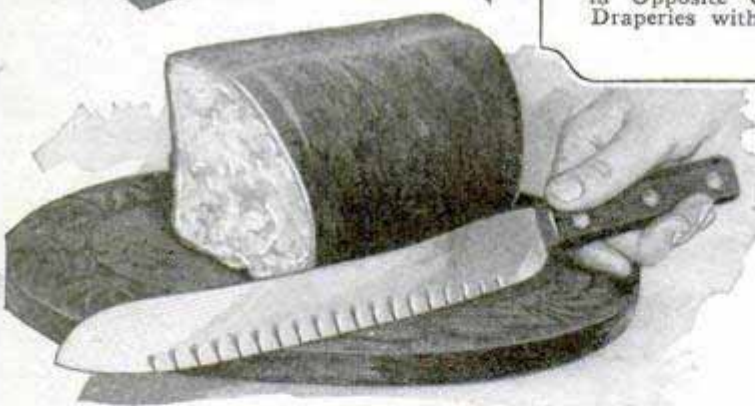

Sharpened like an Ordinary Knife, This Bread Cutter Has Saw Teeth That Maintain an Effective Edge and Are Said Not to Catch Cloth While Washing

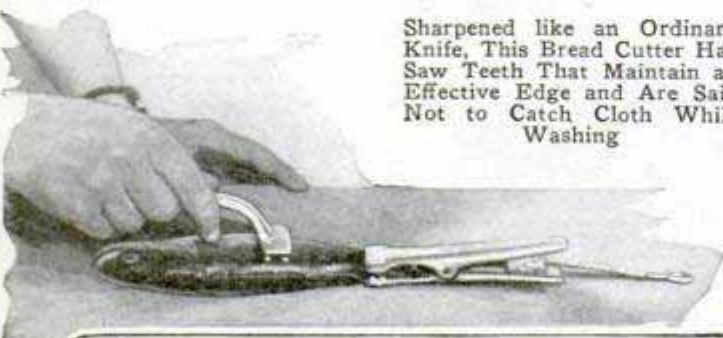

To Simplify the Task of Preparing Fish and to Save Time, the Clamp Holds It by the Tail While the Scaler Is Being Used



Avoid Home Drudgery



String Beans Are Cut in Uniform Lengths by This Outfit, Especially Adapted for Canning Large Quantities



Useful for the Children; a Step Covered with Oilcloth and Firmly Balanced So They Can Reach the Wash-bowl; Note Face on Side of Handle Grip

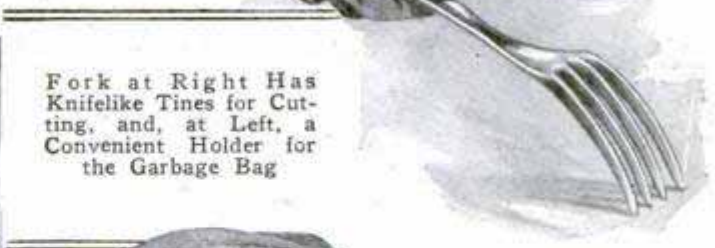

Fork at Right Has Knifelike Tines for Cutting, and, at Left, a Convenient Holder for the Garbage Bag

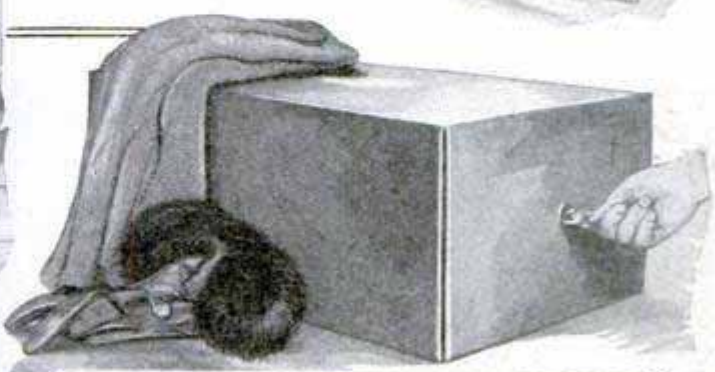

Here Is a Folding "Cedar Chest" for Many Uses; It Is Made of Paper, Treated So as to Keep Out Insects

Ans. Mrs. G. Chapman, 602 E. Howell St. Seattle Wash. POPULAR MECHANICS Philips of England.

112 CHART TO TEACH TYPEWRITING SAVES STUDENTS TIME

3354



Chart in Use and Close View Showing Perforations That Take Place of Typewriter Keys

Paper keyboards, with perforated tops to guide the fingers, have been introduced by a woman inventor to help teach typewriting. The charts make it unnecessary to use the real machines at first, so that the student can devote his entire attention to learning the position of the keys and is not distracted by the mechanical operation of the typewriter. In practice, the subject learns the correct hand and finger positions with the chart guides and then, to test his skill, writes the name of the character on the piece of paper under the openings. According to reports, results with this guide have been successful and it is recommended especially for correspondence schools.

3424 VOICE STARTS AND STOPS TRAIN BY RADIO CONTROL

Visions of what vast possibilities of service still lie in the power of radio were shown to visitors at a recent engineering exhibition in London, at a model-train display. The engines started instantly as a man said "Off," and when the word "Stop" was pronounced, they obeyed as quickly, and also reversed or went forward at spoken commands. The secret of the performance was that the vibrations

model

of the voice, passing through a microphone, affected sensitive controls which released electric current to cause the proper movements. During one of the demonstrations, a collision was avoided. One of the tiny trains ran off the track on a sharp curve. Another was rushing toward it, but the operator saw the impending disaster, shouted "Stop," and the train halted. While the system, as now developed, could not be practically adopted in commercial railroad operation, engineers point out that it holds vast promise in that direction as well as in the performance of other tasks, such as opening doors and windows and doing other duties that ordinarily require the direct muscular effort of some person. The dream of a day when a housewife can sit comfortably in her chair and deliver vocal orders to the oven door to open, the furnace draft to close, etc., is not impossible of realization, radio experts believe.

3053 ELECTRICAL PEAKS AND DIPS SHOWN BY SOLID MODEL

In a German electric station a complete record of the load fluctuations for every day of a whole year is built up in solid form by cutting out the daily graphs and arranging them side by side, as shown. Scales are arranged on two sides, indicating kilowatts, and along the base indicating months and days, and hours of the day and night. The whole gives an easily comprehensible view of the year's output.

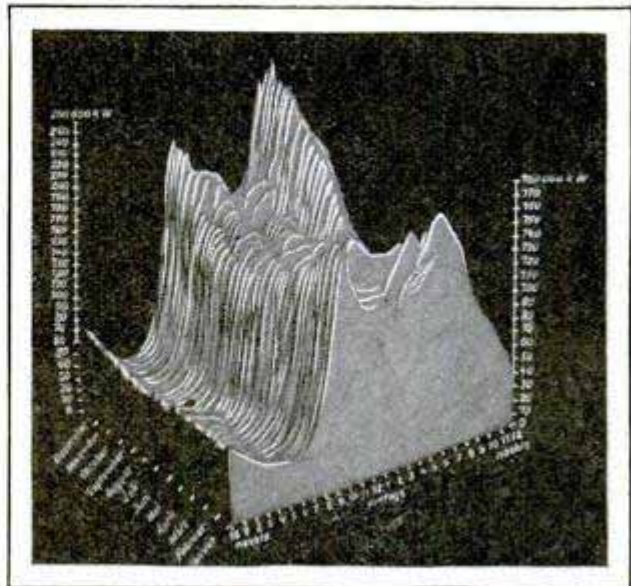

Model of Graphs to Show Electric-Load Fluctuations of German Station; Scales Printed at Sides

Technik für Alle. Aug. 1927

Wants, England

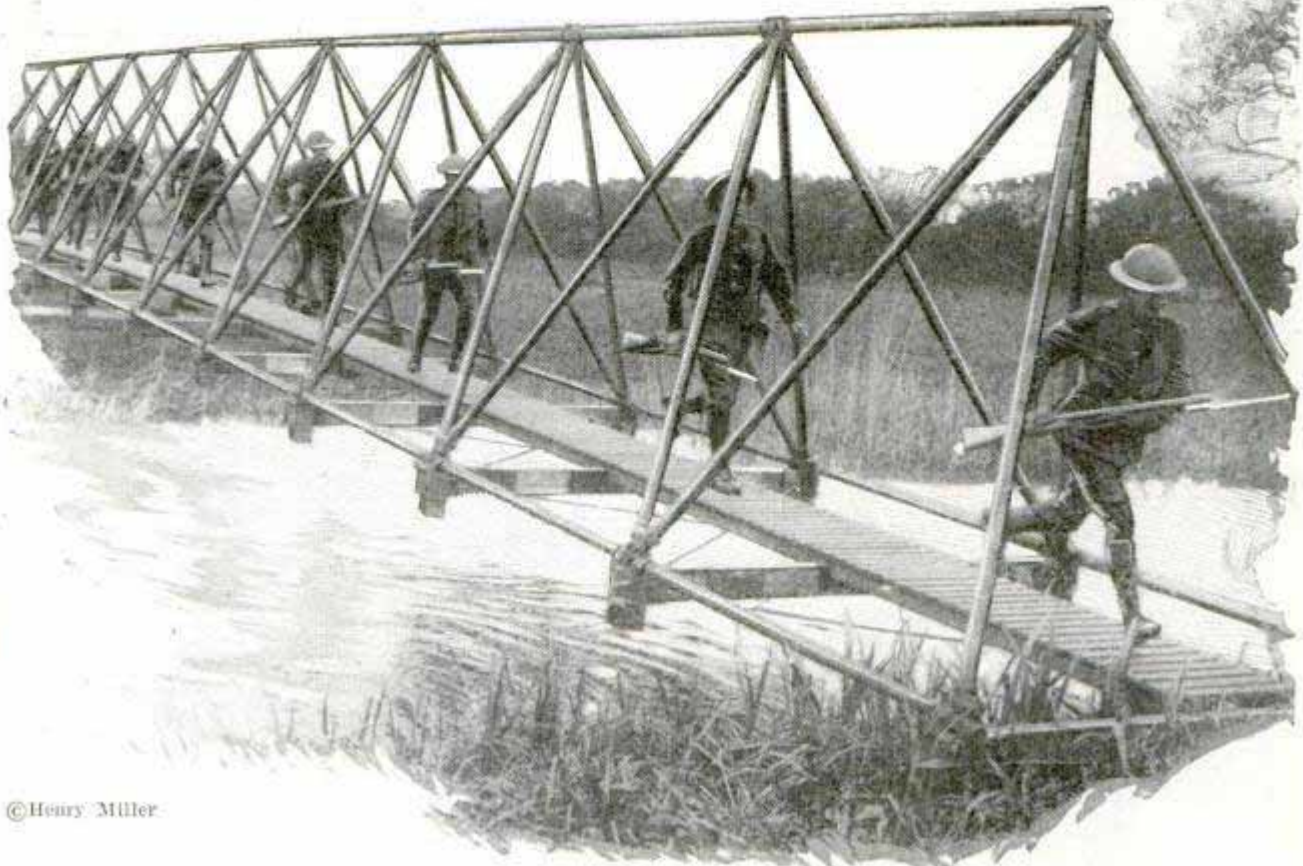

©Henry Miller

Crossing the Pipe Bridge; Soldiers on Maneuver Using the Portable Viaduct Which Is Quickly Assembled from Lengths of Piping and Is Strongly Braced

PORTABLE FOOT BRIDGE OF PIPE AIDS ARMY DRILLS

Portable bridges made of piping are being used by the British army instead of the usual wood and rope units. They are stronger and more easily assembled, being especially suited for drill maneuvers.

SEARCH FOR OIL LEADS TO SEA ON CALIFORNIA COAST

Oil wells, drilled in the surf of the Pacific along the California coast, have been producing for some time, and now various companies are making plans to sink their shafts farther out to sea in the hope of tapping more abundant supplies of "black gold." The problems involved will tax the ingenuity of engineers, but are not considered so difficult as to balk the attempts to obtain the liquid wealth below the waves. Often the oil-well derricks and machinery weigh hundreds of tons. It will be necessary to build strong foundations for this equipment. Some of the wells are planned for areas where high

tides will wash across the derrick floors part of the day. One concern has been granted permits to dig wells a quarter of a mile from shore, if it is mechanically possible to do so. Engineers estimate that it will cost approximately \$25,000 to construct each of the bases for the derricks and difficulties, not known in land operations, are expected in drilling, but if the oil is present in as large quantities as the preliminary soundings indicate, it will pay to "buy the ocean and pump it dry," in the opinion of some of the experts.

3009

PIPE-CLEANING SET IN HOLDER CARRIED LIKE PEN



no Chicago
Contained in a holder which is carried in the pocket, a pipe-cleaning set now on the market is kept from soiling the clothing and in position for use at any time. It consists of two tools, one for the bowl and the other for the stem.

Seacoff district, 6 miles W. of Ventura

Pan American Petroleum Co.
Charleston - Canfield - Midway Oil Co.

Costick Products Co.
400 W. 23rd St New York

Soper Sanitary Kitchen Co. 813 W. Lafayette Blvd. Baltimore
POPULAR MECHANICS
2720 Maryland, Md

CABINET CONCEALS COOKSTOVE AND REDUCES ODORS

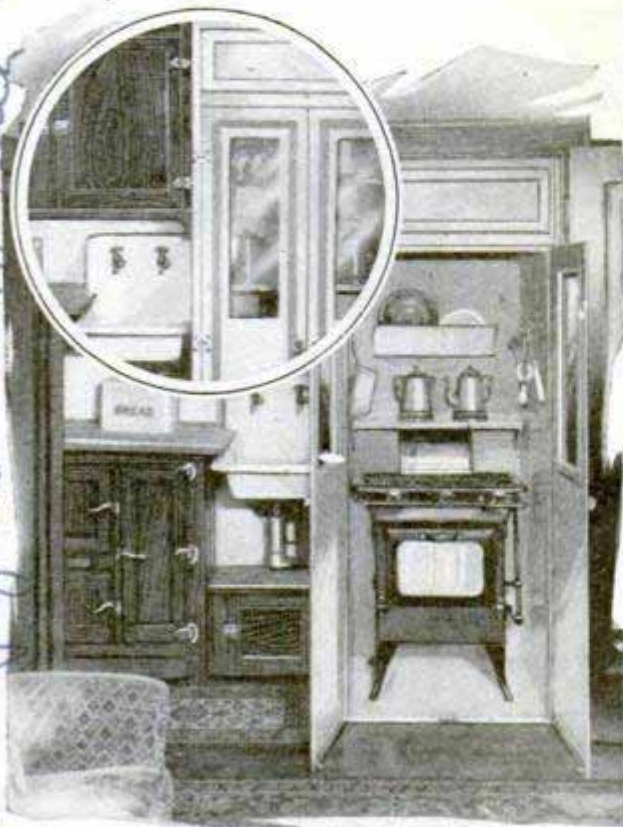

Stove Concealed in Cabinet; Inset Shows Appearance of the Unit When the Doors Are Closed

For the small home or apartment, a metal cabinet has been devised to inclose the gas cookstove, shielding the rest of the room from odors, excess heat and smoke, and adding to the appearance of the cooking quarters. The doors have louvers at the base to admit cool air from close to the floor. This sweeps up through the cabinet and out into a chimney duct at the top.

SHALE MAKES CONCRETE LIGHT WITHOUT STRENGTH LOSS

The use of burned shale or clay in place of sand and stone in concrete, for buildings and bridges, has resulted in a lighter material without a sacrifice of strength, engineers declare. Ordinary concrete weighs about 145 pounds to the cubic foot, but the shale mixture only ninety-five pounds. The material is about the same as that employed in the manufacture of brick. It is heated to a high temperature until it becomes plastic, this process expanding the mass and causing a large number of small pockets or air cells to form, owing to the escape of gas. This

light stuff is then crushed and used instead of sand for mixing with the cement. Its aid in building was illustrated recently in Kansas City, where six stories were added to a structure originally intended for but four more. Use of the lighter cement enabled the engineers to erect two extra stories without hazard.

FURNITURE HEAVIER IN SUMMER

Wooden furniture absorbs moisture, consequently, in moist seasons, is heavier, as a general rule, than it is in winter when the house is heated. A bureau, weighing 200 pounds, may be twenty-four pounds heavier under average summer humidity as compared to its normal weight when the furnace is going and the air in the rooms is drier. These changes occur in spite of paints, enamels and other finishes, tests by the United States forest service have shown. The coatings are none the less useful, for they prevent sudden checking and swelling that would result were the wood not so protected.

SOFT RUBBER AS UPHOLSTERING SUBSTITUTE FOR SPRINGS

In place of springs, sponge rubber is being used for upholstering automobile seats and other articles. The material is said to hold its shape, give the covering longer wear and to be more comfortable than other kinds. It is strong and easily shaped to give uniform resiliency.



Rubber Upholstering for Chair Bottom; Its Soft, Spongy Texture Is Revealed When It Is Squeezed

Soper Sanitary Kitchen Co. 813 W. Lafayette Blvd. Baltimore
also E. St. Louis, Mo.
Western Brick Co. Hannibal, Mo.

Haydite Mfg. Co. Kansas City
3413
403 Mutual Bldg. Kansas City, Mo.

-rubber fill-

3401

*Olshrobach Patent - Flugzeugbau -
L. v. H.,
W. 68, Friedrichstr., 203*

*Berlin,
Germany*



For Faster Trips between Hamburg and London, the Ten-Passenger Flying Boat in Action; Its Two Motors Afford a Speed of 150 Miles an Hour

FLYING BOAT THAT CARRIES TEN LINKS HAMBURG TO LONDON

One of the latest units in aerial travel between London and Hamburg is a ten-passenger flying boat. It develops a maximum speed of 150 miles an hour, has two motors, aggregating 1,300 horsepower, and when loaded weighs 23,100 pounds. The wing span is eighty-five feet. A crew of three is required to operate the ship, which is fitted with running water, electric lights, and radio-receiving and sending apparatus. It can land or take off from ground or water with equal facility.

mountains in Germany. Because of their tendency to fight, the males have to be shipped in individual cages, but 100 females can be placed in a single cage.

STOP WATCH FOR FOOTBALL TO END DISPUTES

Seconds are precious when the football score is tied and one team is within inches of the goal line. A stop watch, designed to simplify the task of allowing for intermissions, time-out intervals and other irregularities, has been introduced this season. The dial records seventy-five minutes for four quarters of fifteen minutes each and a fifteen minutes' intermission between halves. There are

CANARIES THAT CAN SING JAZZ GAIN IN POPULARITY

Roller canaries, with classical musical educations, are giving way to the chopper, a songster with shorter, brisker notes more like those of the jazz melodies and other compositions popular today. According to a bird dealer, the chopper is a twelve-to-one favorite over the roller in the markets. Owners have also noticed that frequently a jazz phonograph record will stimulate their canaries to sing when other means fail. Canaries are being imported into the United States at the rate of several thousand a week, many of the most valuable kinds coming from the Hartz

really two watches, one that records the time of playing and the other, the time taken out. By pushing a lug, the operator sets one mechanism to operating and stops the other. Markings show the official when to notify the teams to get ready to leave the dressing rooms and indicate the number of minutes remaining to play.



*Kaempfer's Bird Store
24 E. Randolph St.*

*Perfected by J. J. Lipp
Football game official.*

*Western Conference
Mr. Athletic Equipment Co., 13 N. Green Chicago.*

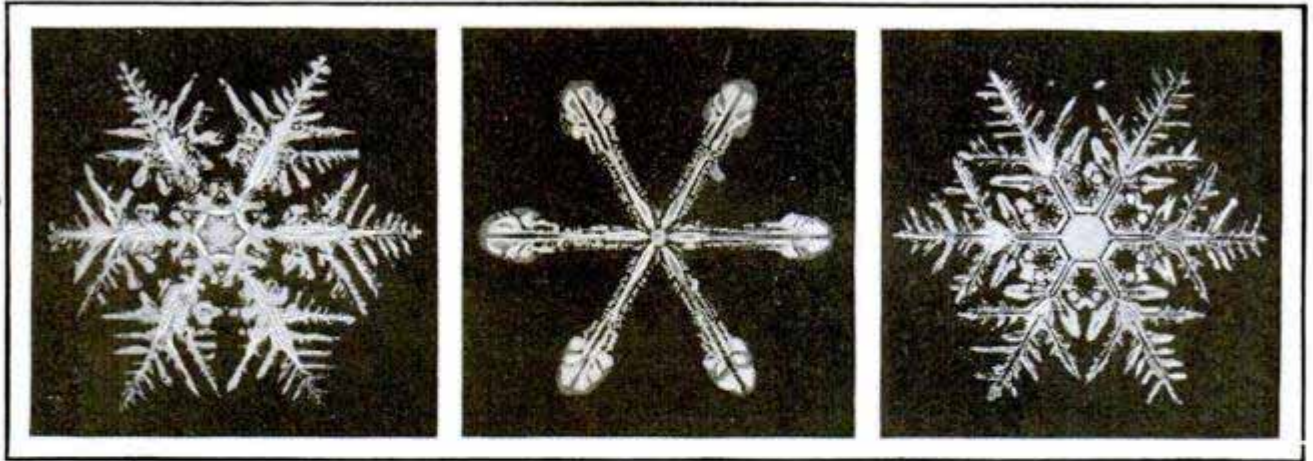

Icy Jewels of the Winter Storms

Billions of Perfectly Symmetrical Snowflakes, Falling in Each Storm, Furnish Vast Field for Nature-Made Designs

By W. A. BENTLEY, *Jericho, N.Y.*

FORTY-FIVE years ago my mother presented me with a small microscope. Searching for something to examine under it during the cold winter of Vermont, I hit upon a snow crystal, and for nearly half a century I have been looking at magnified snowflakes. Larger microscopes, and then a camera attachment, to permit permanent record of the most perfect designs, were soon added to the equipment and, in the nearly half century since, I have photographed more than 4,700 different specimens.

Studying snowflakes may appear a peculiar sort of hobby to occupy one for the greater part of a lifetime, but I find it just as fascinating today as I did when I looked through my first small microscope and discovered that a snow crystal was a work of art, a formation of which no two are ever alike. Collecting snowflake likenesses is a pursuit rewarded by rich returns. Yet it must not be assumed that it is an easy task. It takes skill, patience without limit and no little hardship to get results worth while.

When good snowflakes are falling, the true lover of them forgets cold, hunger, business, exposure, all else but the marvelous glittering gems the storm clouds are showering down upon his waiting board. With keen gaze, ever roaming about over the blackboard held to receive the glittering hosts from cloudland, the

collector stands out in the storm, brushing off every few moments, the flakes alighting thereon, until one or more promising specimens are secured. Quickly, then, the board is taken indoors, into a very cold room having outdoor temperature. At one side of the window and facing it, is the photo-microscopic camera (a microscope and camera combined). At the other side and also facing the window, is an observation microscope, having a cold glass slide. The blackboard, sprinkled over with snowflakes, is taken first to the observation microscope, and a few of its most promising snow jewels removed from it. This is accomplished by pressing very gently the point of a sharp wooden splint upon the face of the snow crystal until it adheres to it. It is then jarred off onto the glass slide. A nervous or unsteady hand spells disaster, for the least pressure crushes the flake.

From now on, the utmost haste must be used, because evaporation soon wears away the crystals. One brief glimpse of each is taken, holding the breath meanwhile, and if a masterpiece is revealed, it is pressed down flat upon the glass slide, by means of the edge of a feather, the slide placed on the stage of the photo-microscope, quickly centered and photographed, an exposure of from ten to 100 seconds being given according to time of day, cloudiness, magnification, and power of

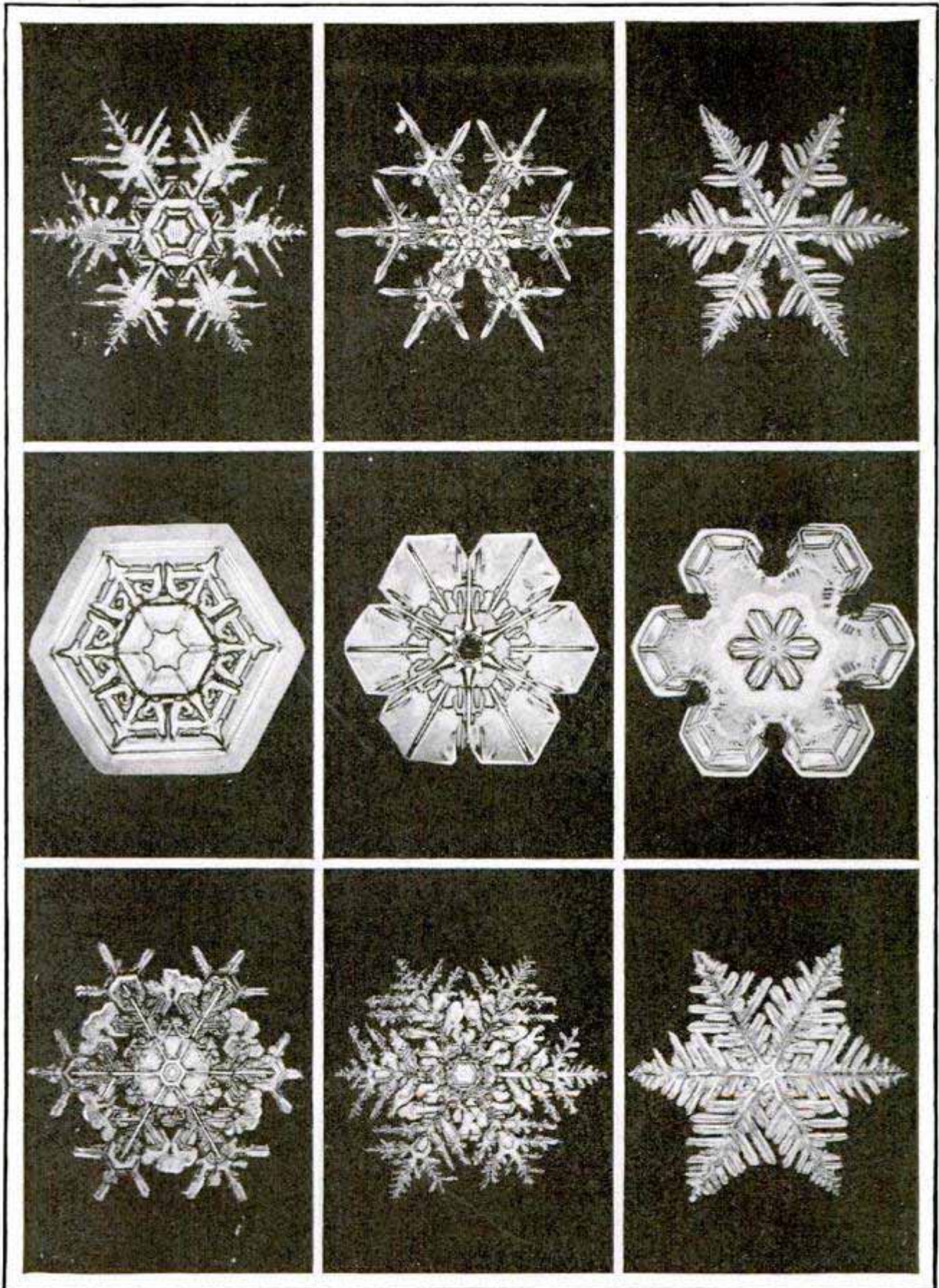

Air Bubbles Trapped by Snow Crystals Form the Dark Lines in These Designs

the lens used. The flakes are magnified from sixty-four to 3,600 times.

Location is, of course, all important in

this work; only those living where the winters are severe can be successful. Individual storms vary markedly as regards

their richness in beautiful snowflakes. A favorable winter may furnish as many as fifteen good snowfalls and 300 or more new photos.

Good snowfalls often occur during, or at the end of, a period of zero weather. Great storms and blizzards not seldom give opportunity of gathering wonderful crystals. Yet, as a rule, less intense snows, when the crystals are of but medium to small size and fall rather scatteringly, are most favorable.

The larger flakes rarely exceed one-third inch in diameter. Often the best ones are tiny bits of pure beauty from one-twentieth to one-fiftieth inch in diameter. The

with other dark features, due to abrupt changes in thickness, give great richness of design to their interiors, and serve to outline the various transitory forms the crystals assumed in cloudland. They assume most varied forms, resembling dots and dashes, lines and other strange characters. Frequently they are arranged in a wonderfully symmetrical manner. The number of divisions a crystal may assume, whether it be a snow or other crystal, is supposed to be determined by the number and arrangement of the atoms that group together to form it.

The tiny magnetic poles of these crystals attract other atoms to them and establish

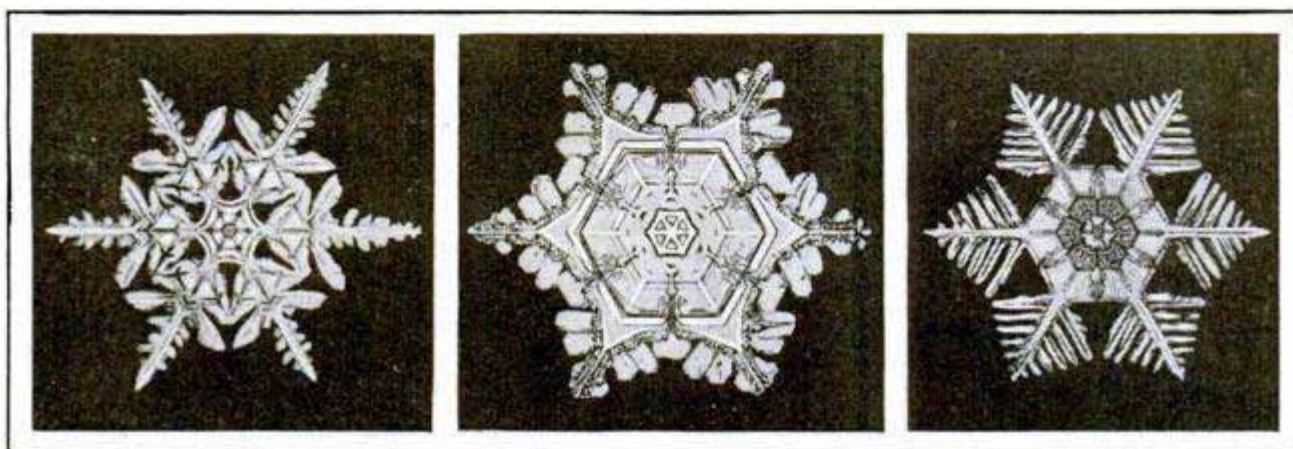

Three Examples of the Perfect Symmetry of Snow Crystals; They Probably Are Built Up Layer by Layer from the Center, Until All the Branches and Petals Are in Place

percentage of perfect crystals in a favorable snowfall varies greatly. Sometimes all will be so rarely beautiful as to make selection a bewildering task, while again one may search all day long to find one or two perfect ones.

Snow crystals are never formed as a result of the freezing of raindrops or of visible clouds. Hail and granular snow result thereby. The making of the true snow crystals is far more complex. Each cloud-born jewel is the product of a process that goes on in one of the rarest laboratories in the universe, the thin air in which we live, and through the assembling of the unseen atoms and molecules of which all crystals are built.

The snowflake is doubtless built by stages from its center outward. And as it grows, and its branches and other adornments unite, it bridges over and imprisons tiny quantities of air, in the form of minute tubes. These look dark when viewed visually or photographed, and, together

lines of growth, called axes, and the bodies grow mainly outward from them. Minor variations in form depend upon the number and arrangement of the tiny electric charges that collect upon them and establish secondary or third-degree axes, and upon their rates of growth and the temperature. Rapid rates of growth tend to produce open branching crystals; slow rates of growth, solid ones. In the case of snow crystals, the branchy ones usually form within the lower, warmer, wetter clouds, because there is more material there for rapid growth, while the more solid ones form at higher, colder, drier altitudes. Not seldom they are wafted upward and downward within the clouds, and have both of these characteristics of growth impressed upon them.

Exceptionally beautiful crystals, when photographed, are used by schools, museums, lecturers, art-craftsmen, silk manufacturers, metal workers, interior decorators and other designers.

1990
WHY HOT-WATER PIPES FREEZE MORE READILY THAN COLD

Housekeepers are sometimes puzzled at the tendency of hot-water pipes to freeze more easily than those that carry cold. The apparent mystery is explained by Leon McCulloch, research engineer of the Westinghouse laboratories. By means of a special testing apparatus he found that the freezing is due to a wall of water established by dropping temperature. Water is densest at thirty-nine degrees Fahrenheit. In a closed pipe, when the temperature falls toward thirty-nine degrees, that part which is being cooled becomes denser and then lighter below the thirty-nine-degree mark. Water that has not been cooled above the section exposed to the cold remains lighter, so that between the two areas of lesser density is a "wall" of dense water around the thirty-nine-degree region. This wall naturally limits the circulation, so that the exposed area is more likely to freeze. In the cold pipe, circulation permits the contents to remain more nearly at thirty-nine degrees, and the restricting wall is not present.

AUTO MAP LIKE ROLLER SHADE TAKES UP LITTLE ROOM 2585

Attached to the windshield with rubber vacuum cups, an auto map rolls up like a shade when not in use, and is always in handy position. It occupies but little room, does not obscure the view when shut and is protected from dust and the weather in its holder.



For Greater Convenience in Reading the Map While Driving; It Is Mounted on Roller on Windshield

Pathfinder Auto Map Co.
 308 N. 11th St. Minneapolis, Minn.

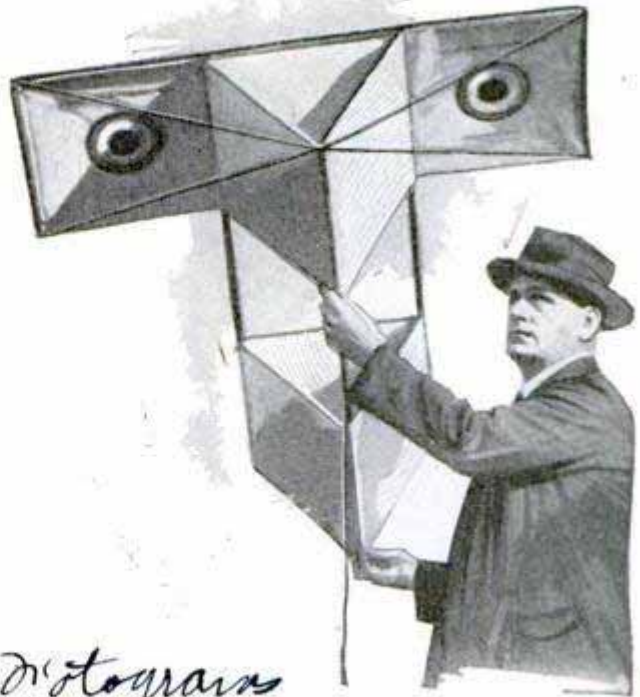

Diagrams

Perry Hale's Monoplane Kite; It Requires No Tail and in the Air Closely Resembles a Real Plane

KITE SHAPED LIKE MONOPLANE MADE BY BLIND MAN

Fashioned on the lines of a monoplane, a new type of kite has been introduced by Perry T. W. Hale, all-American football star of 1900, who was blinded in an explosion some twelve years ago. It requires no tail and is said to be extremely popular with kite enthusiasts.

BIG GARAGE IN ELECTRIC LINER LATEST TRAVEL AID 3415

Passengers on the electric ship "California" may take their automobiles with them at a minimum of trouble and risk, for the vessel has a garage with a capacity of 140 cars. The autos are loaded without hoisting, through side ports, and may be checked like baggage. The "California" uses electricity for almost everything except broiling steaks in the kitchen. Charcoal is employed for this, but the ship's propellers, clocks, elevators, steering apparatus and many other units are run with current generated by huge turbo-generators. The vessel is 601 feet long and has a beam of eighty feet. When it passes from a cold into a warm climate, the electric current is switched from the stoves to fans that drive cooled air over brine pipes. It is the largest commercial liner built under the American flag.

Chicago Evening Post
 10/11/17

Unable to secure address.

Chicago Daily News
10/8/27

2089

Where Carved Images Are Giving Way to Modern Knowledge; Disease "Scarecrows," Once Popular in Korea, Are Being Forsaken in Favor of Enlightened Health and Sanitation Methods

HOTEL TOWELS ARE POPULAR SOUVENIRS

It used to be that hotel guests favored spoons and other table articles when they desired a convenient "souvenir" to take away with them, but the manager of a large Chicago hotel declares that the public's taste has turned to towels, and that 20,000 of them disappear from the principal hostleries there every month. Loss of one towel a month to each room is the average experience, he says, and all sorts are taken, hand towels, those for the bath and all the other varieties. When hotels find towels be-



WEIRD IMAGE HEALTH GUARDS ABANDONED IN KOREA

Belief in the powers of weird faces carved on poles to cure sickness is waning in Korea, according to reports from a medical missionary there, many of the old superstitions being replaced by modern health practices. Young men are studying medicine, dentistry and public sanitation and comparatively little homage is paid the wooden "health commissioners" that once were thought to frighten sickness away and cure illness.

MOTOR BONE SAW FOR BUTCHER SAVES TIME AND WORK

Finding that his customers often grew impatient while waiting for him to saw through large bones, a butcher has devised a motorized unit that does the work much more quickly and with less effort. It is a bandsaw, rigged to a rack with a bell-shaped base on the floor. The frame can be adjusted to various heights, the saw is in an upright position, out of the way, when not in use, and a convenient starting switch for the motor is furnished in the form of a small trigger on top of the handle that guides the saw. A pull of the trigger starts the motor.

longing to another in their own laundries, they are mailed postpaid to the name tagged on them, according to a recently established custom.

FURNITURE CHILD CAN BUILD MADE OF CARDBOARD

Amusement and instruction are afforded the child in sets of collapsible cardboard furniture now on the market. The pieces are slotted so that they can easily be fitted together and, when correctly assembled, are said to be strong and serviceable for



Set of Cardboard Furniture, with Chair Taken Apart to Show How the Units Fit Together

play uses. Living-room, dining-room and other sets are furnished.

Mr. J. L. Boats

Law. Sales Ingro. Idiglee. Wadner. Missiville

See this and...

Wells Infa Corp, Three Rivers Mich.

Five Dollars Builds A-Battery and Charger

By LAWRENCE B. ROBBINS

BUILDING an efficient A-battery and charger is not only an easy but an interesting task that many radio fans

respect them for cracks or flaws. Build a wooden case to contain the three jars comprising the A-battery, provided a 6-volt type is required, reducing the dimensions given so as to take two jars if a 4-volt type is to be built. The dimensions for the case

will be found in sketches below and on page 122; $\frac{1}{2}$ -in. wood stock is used for the case and the outside measurements are 14 in. long, 6 in. high and 5 in. wide. The inside par-

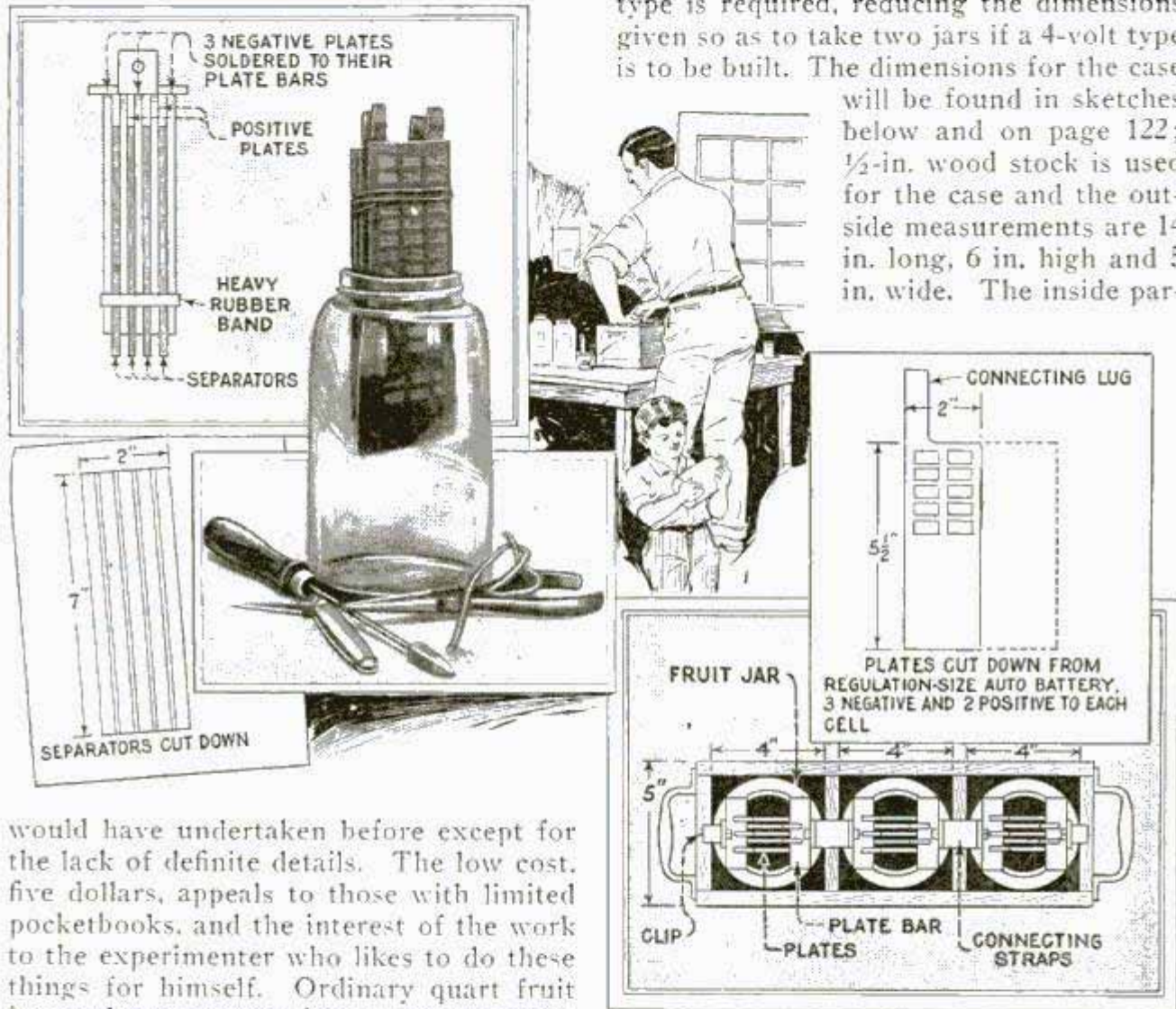

would have undertaken before except for the lack of definite details. The low cost, five dollars, appeals to those with limited pocketbooks, and the interest of the work to the experimenter who likes to do these things for himself. Ordinary quart fruit jars and auto storage-battery plates, easily obtained from the grocery and nearest battery station, respectively, are the main elements in the construction of both units. One, two or three cells can be made up to suit the needs of the builder, depending on the type of tubes he is using in his set. For instance, if the set employs tubes of the 199 type, two cells only will be required. The fruit jars cost about 10 cents each, and the plates from 15 to 20 cents apiece. Fifteen plates in all will be required for a 6-volt three-cell battery, five plates to each cell.

Select three 1-qt. fruit jars and discard the tops, clean them thoroughly and in-

stitutions are made of the same wood stock, are fitted across the inside at equal distances and reach from top to bottom. The three compartments thus formed are 4 in. square and $5\frac{1}{2}$ in. deep, inside measurement, permitting the fruit jars to fit snugly, with the tops projecting about $1\frac{1}{2}$ in. above the top of the case. The completed case should then be painted inside and out with two coats of asphaltum; when thoroughly dry, screw the handles in position at each end, as shown in the illustration. These handles may be ordinary drawer pulls from the local 5 and 10-cent store, and rubber-headed tacks for feet

may also be obtained from the same place. The plates should measure $5\frac{1}{2}$ in. from top to bottom, disregarding the lug at top, and should be 2 in. wide. Saw out these sections, including the lug, as shown on this page; by following down one of the individual lines separating the columns of paste inserts, a straight cut is assured. To further reduce the cost, a second plate, 2 in. wide, can be cut from the remaining section and a lug soldered to the top, but this is not advised. Three negative

sembled. All positive lugs should be on one side and all negative lugs on the other; snap two large rubber bands around the unit at top and bottom to hold them together. The plate bars, or lug connectors, are made from heavy sheet lead, cut and bent in the manner shown in the illus-

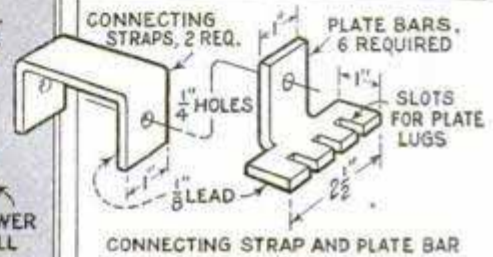
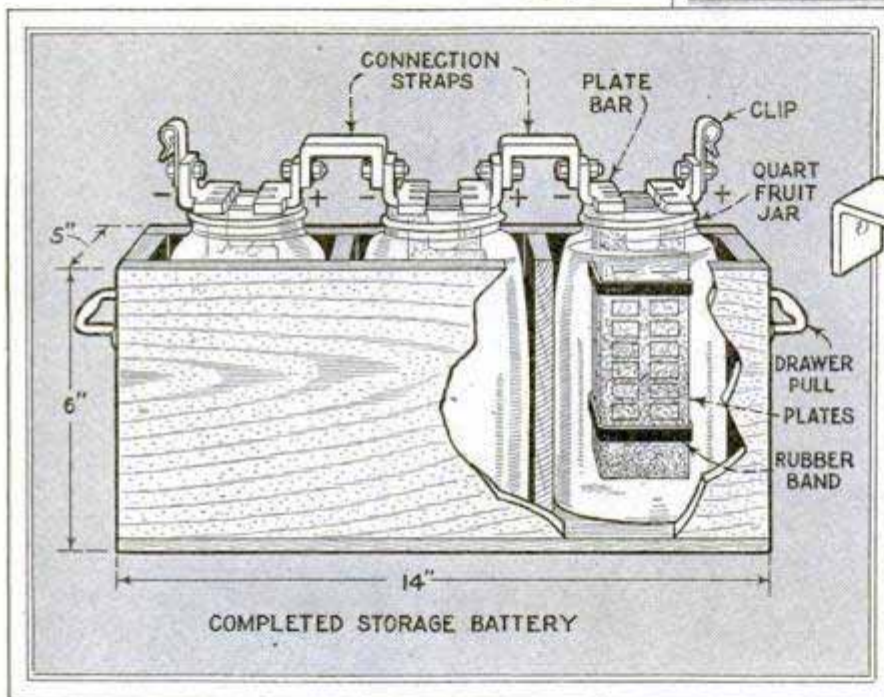
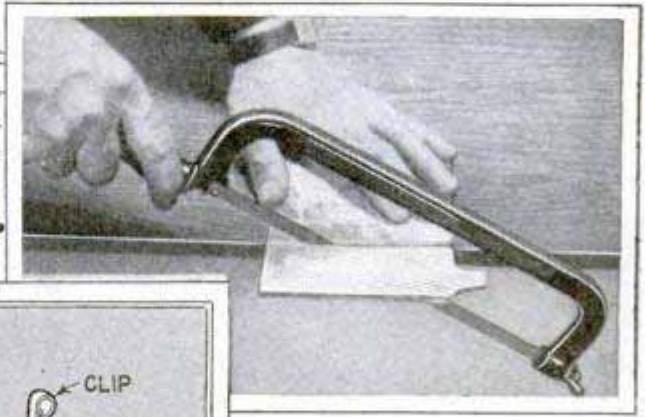

CONNECTING STRAP AND PLATE BAR

tration above. The plate lugs are soldered in the slots shown; this operation is simplified by clamping the units in a vise and using a large, hot soldering iron and plenty of solder. Care should be taken not to connect

plates and two positive plates are required for each cell, therefore, when buying the plates for the three-cell job ask for nine negative and six positive plates. The negative plates come pasted with pure, spongy lead and will have a gray color, the positive plates are a chocolate-brown color, the paste filler used being peroxide of lead. Wood or rubber separators can also be obtained from the battery-service station or garage; these are cut down from standard sizes to 7 in. long by 2 in. wide and four are required for each cell, as shown on page 121.

The plates are now assembled, first a negative, then a separator, then a positive plate with the lug on the opposite side, then the separator and so on, until three negative and two positive plates are as-

sembled. All positive lugs should be on one side and all negative lugs on the other; snap two large rubber bands around the unit at top and bottom to hold them together. The plate bars, or lug connectors, are made from heavy sheet lead, cut and bent in the manner shown in the illustration above. The plate lugs are soldered in the slots shown; this operation is simplified by clamping the units in a vise and using a large, hot soldering iron and plenty of solder. Care should be taken not to connect positive to negative plates in any way by dropping solder between them. The upright strip of the plate bar is drilled for bolting to the connecting strap as shown in the sketch; these connecting straps of heavy sheet lead being 1 in. wide and long enough to reach from one jar to the other. The plate bars soldered to the lugs extend across the edge of the jars and support the assembly in each cell; the top view on page 121, at lower right, shows all three units in position, with the connection straps across the partitions connecting the cells in series. When the cells are assembled in the case, the negative plate of one cell should face the positive plate of its neighbor; the connecting straps, drilled at each end, are then bolted to the plate bars with brass bolts and nuts,

well smeared with vaseline after tightening. Bolt a spring terminal clip to each end lug and mark the positive and negative ends for identification; a daub of red paint on the positive terminal is the usual method. The cut-away illustration of the completed storage battery, on page 122, shows the plates clearing the bottom of the jars; this is necessary to provide sediment space. The electrolyte for filling the cells is made by mixing chemically pure concentrated sulphuric acid with chemically pure water. The full-strength acid is mixed with the water to obtain the suitable specific gravity necessary for the battery; the usual proportion is 20% acid by volume. When mixing the acid, never add the water to the acid; pour the correct amount of water in a bottle, pitcher or jar and then add the acid to the water very slowly. Ready-prepared electrolyte can be obtained from the local battery-service station, saving much time and trouble, and the maker is advised to buy his electrolyte rather than make it. Fill each cell so that the electrolyte will come about $\frac{1}{4}$ in. above the tops of the plates; any space between the jars and the case should be filled with corrugated board or similar material, to hold the jars rigid.

The storage battery completed, we are

a strip of hardwood, $\frac{1}{2}$ in. wide, boiled in paraffin; the aluminum electrode is cut from a sheet of heavy aluminum, the thickness of which is not important, but the heavier the better, and it should be as pure as possible to obtain. The lead electrode is cut from heavy sheet lead; both electrodes are 7 in. long by $1\frac{3}{4}$ in. wide; drill three holes in one end of each electrode and fasten to the wood top as shown in the insert on this page, with brass wood screws, the center screw holding a spring-clip connector. Fill the jar with either a saturated solution of borax; a rather dilute solution of sodium bicarbonate, or, better still, a solution of monobasic ammonium phosphate in the proportion of one pound to the gallon of distilled water. In either case, distilled water must be used in making the solution; fill the jar to within about one inch of the top and pour a thin layer of transformer oil or other heat-resisting oil to prevent evaporation or creeping. Set the rectifier jar in a small tub of water that is provided with an inlet and an outlet to keep the water level below the top of the jar by at least 2 in. This is easily done by means of two short lengths of rubber tubing connected to a faucet and drain, the outfit, of course, being placed near the water supply. This

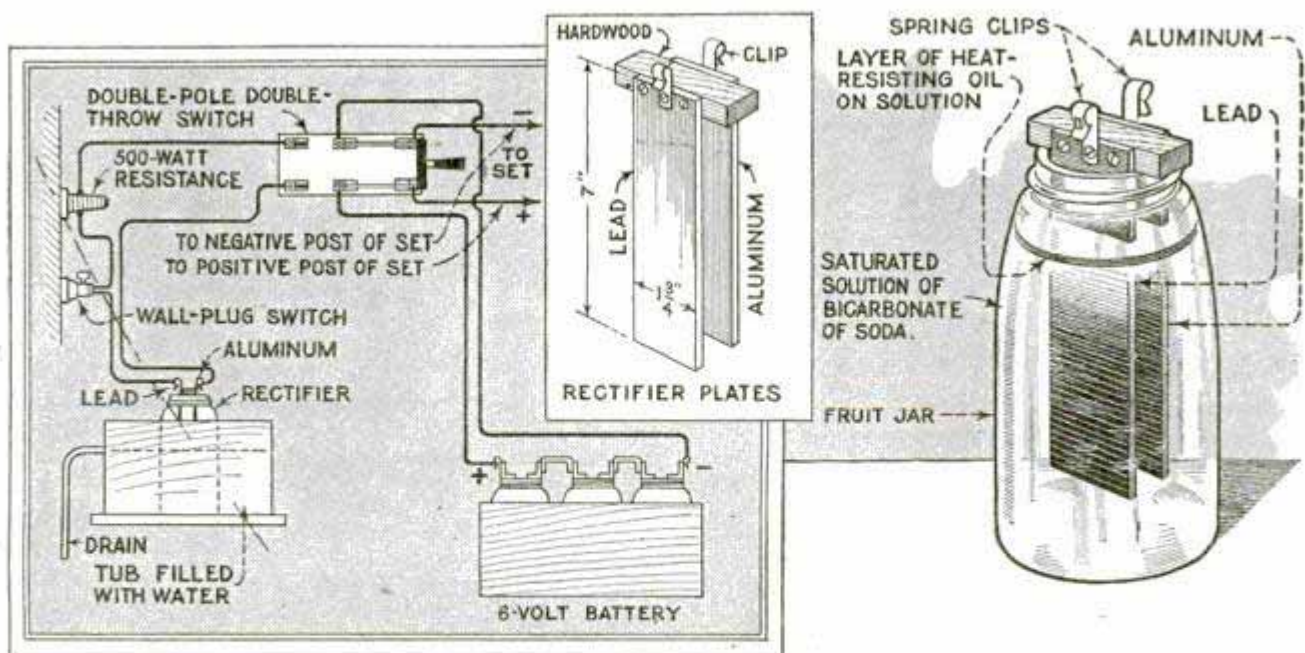

now ready for the rectifier, or charger as it is commonly known; this is made from a single quart-size fruit jar. An electrode support is made for the top of this jar from

cooling tub need not be equipped for water circulation, but this method is advised for best results. The hookup shown in sketch above is self-explanatory and needs little

comment; the 500-watt resistance may be taken from an electric heater or the heating element from a flatiron may be used. The aluminum electrode is always positive; see that this is connected through the switch so that it goes to the positive terminal of the storage battery. To charge the battery, throw the switch arm over to the connections to the rectifier and turn on the 110-volt a.c. lighting circuit; the charging rate will be about 2 amp. an hour. When the charge is completed, throw the switch arm over to the opposite side, connecting the battery with the receiving set,

and turn off the current. Ten to twelve hours will be sufficient to charge the battery even from a low hydrometer reading. Keep the rectifier as cool as possible and occasionally scrape off the white coating that forms on the aluminum electrode if a solution of borax is used. We have prepared a large blueprint showing the various steps in the construction of both units and suggested hookups. This may be obtained from Popular Mechanics radio department, 200 E. Ontario st., Chicago, for 25 cents, to cover cost and mailing. Specify blueprint No. 126.

Homemade Fuses on Battery Cable

When a set of radio tubes are accidentally burned out or the batteries are short-

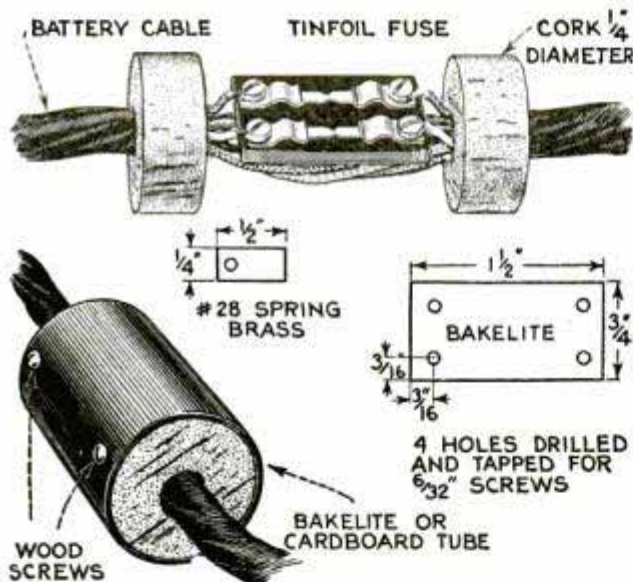

Any Radio Owner Can Provide Protective Fuses in the Battery Cable

circuited and discharged, the radio owner begins to think of safety-first methods and ways of preventing these expensive accidents. In the drawing is shown a fused battery cable. This will give protection to the tubes and it is easily and quickly made. About 1 ft. from the end of an ordinary battery cable, the braided covering is removed, leaving the insulated battery wires exposed for about 2 in. In the center of each of two large bottle corks, a hole is drilled to permit the corks to slide over the cable. They are then fastened on the cable with glue at the place where the braided covering was removed, the exposed battery wires being

between the two corks. For the fuse base, a small piece of bakelite is cut and drilled as shown in the drawing. Small brass clips, to hold the fuses, are fastened to the base with screws. These clips make it easy to renew the burned-out fuses. The B-negative and A-positive leads are cut and connected to the fuse clips. Fuses are made from the tinfoil that comes wrapped around candy and chewing gum. It is cut in strips, $\frac{1}{16}$ in. wide, for the A-battery fuse, and about $\frac{1}{32}$ in. wide for the B-battery fuse. A bakelite cardboard tube is used for a cover; this slides over the corks and protects the fuses from accidental breakage or from being short-circuited. The cover is held in place by small wood screws.—R. J. Williams, Chicago.

1309 *Ball-Antenna Kit*

It is claimed that radio reception can be improved considerably by using a ball antenna of the kind shown in the illustration. This outfit comes in a kit and can readily be assembled and installed by anyone. It consists of a bracket, glass insulator and a hollow aluminum ball, 10 in. in diameter. Being non-directional, several of these can be installed on an apartment roof without interference. Selectivity is another advantage claimed for this type of aerial.

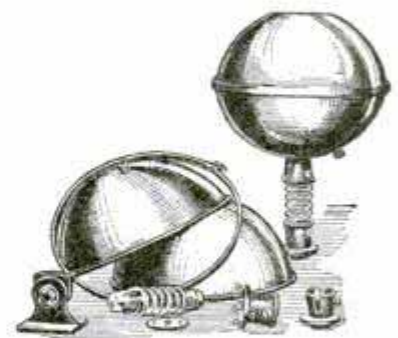

*The Morris Register Co.
Council Bluffs, Iowa.*

*Stegnite Radio Laboratory
1393 A Atchison, Kans*

Facts and Fads for Radio Fans

1422-B

*U. S. Broadcasting
Company*

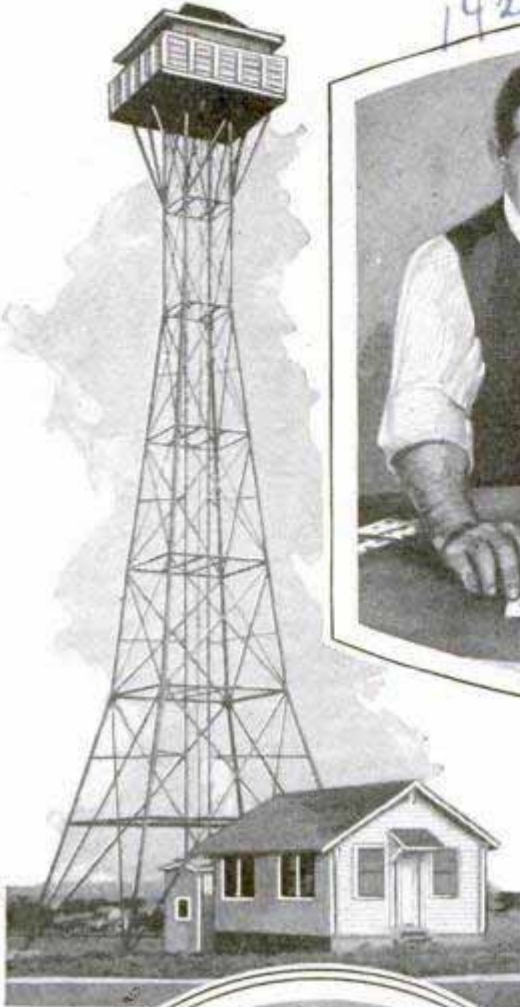

Left, Radio-Testing Laboratory Perched on Top of 125-Foot Tower Overlooking Atchison, Kans., Is Designed to Get Away from Earth Disturbances While Testing and Improving Circuits; Right, Graham McNamee and Phillips Carlin Announcing a Bridge Game

*National
Broadcasting
Company*

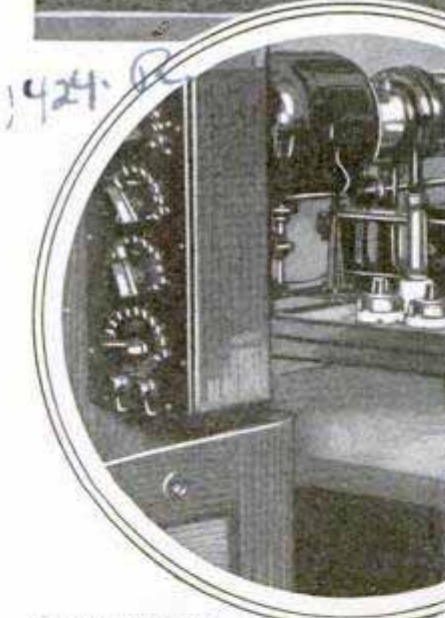

©Harris & Ewing

Above, New Radiophotogram Machine Installed in the Office of Naval Communications at Washington, D. C., Sends Photographs of Naval Messages in Facsimile Instead of the Usual Dots and Dashes; No Radio Operator Is Necessary; Philip G. Cronan, of the U. S. N., Looking Over a Specimen Message; Right, British Radio Alarm Designed to Ring a Bell When SOS Signals Are Received



AERO-DYNE SIX

POPULAR MECHANICS MAGAZINE
JANUARY 1928

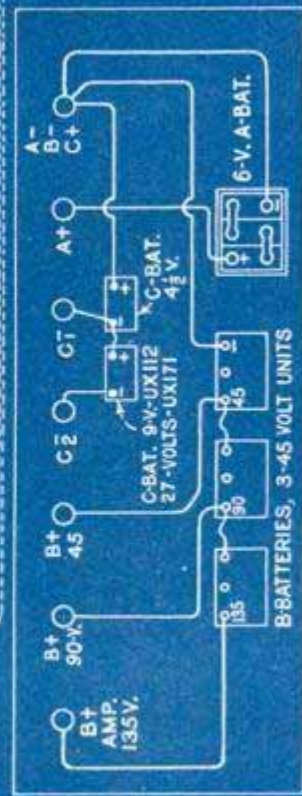
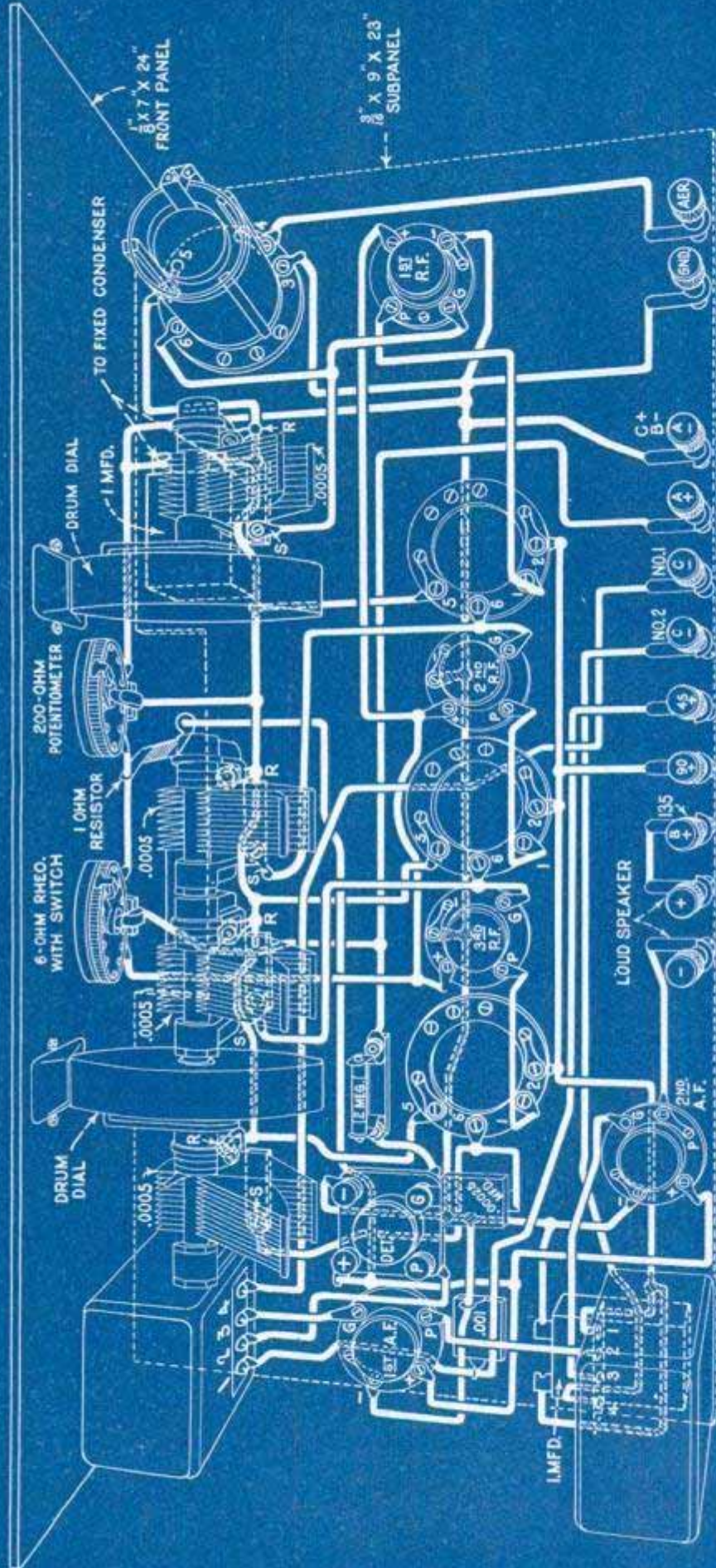

SELECTIVITY Feature of Aero-Dyne Six

By FRANK L. BRITTIN

SELECTIVITY, achieved with a minimum of controls, has been the aim of circuit designers for some time, in a set of the tuned r.f. type. In the six-tube set described in this article, selectivity and sensitivity have been attained by the use of specially designed coils and a well-balanced circuit without adding any more controls than absolutely necessary. These coils are similar in construction to the low-loss coils employed in the 15 to 550-meter set described in the November, 1926, issue, but are of the stationary instead of the plug-in type.

The set employs three stages of r.f. amplification, and has two controls of the modern drum type, facilitating easy operation of the set. A separate tuning condenser is used for the first r.f. stage, permitting perfect tuning, regardless of the length of aerial used. The detector and two stages of transformer-coupled a.f. amplification, with power-tube equipment in

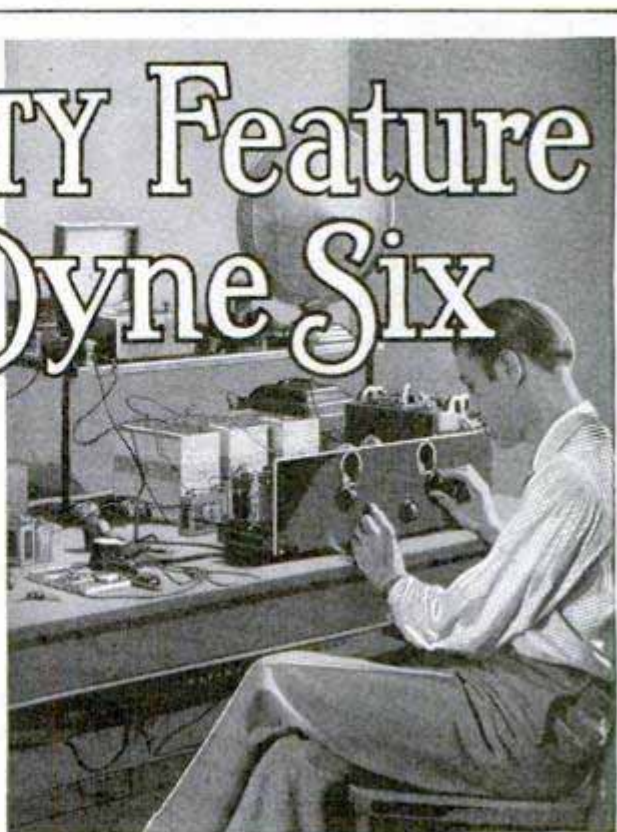

the last stage, complete the circuit. If all tuning controls were grouped for operation with one dial, an ideal condition would be realized, but, if this is done, it would be difficult to obtain perfect matching of the tuning units over the entire waveband. It would be possible to bring the receiver into perfect resonance at one wavelength on the dial, but on turning the dial to other wavelengths, this would not be true. Another point taken into consideration by the designer was the matching

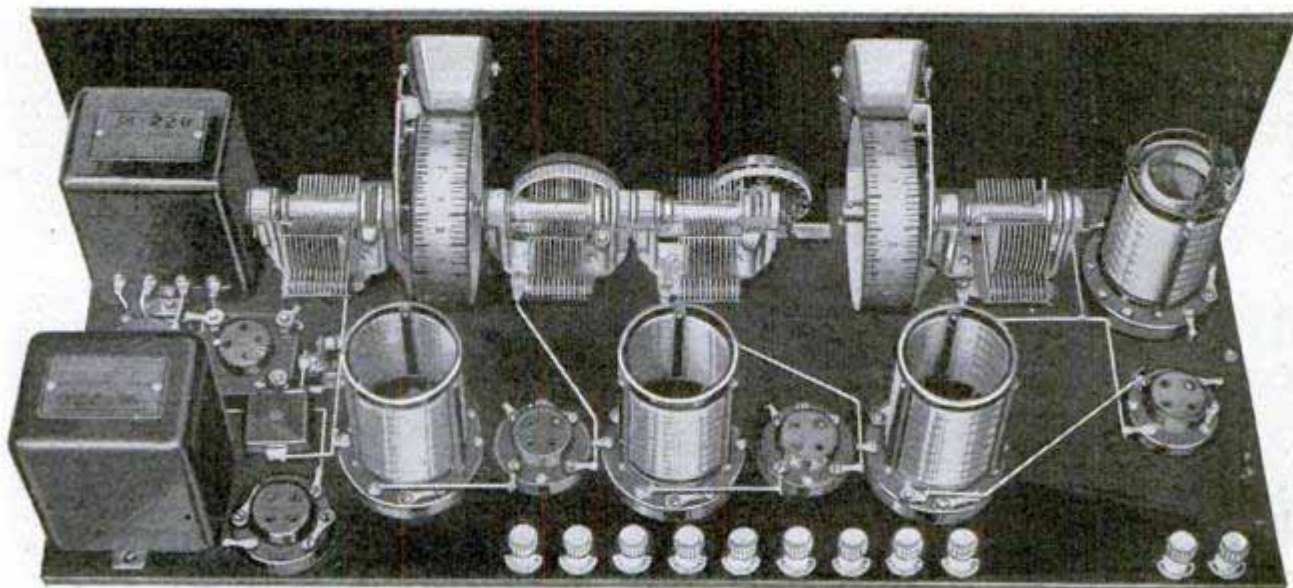

Rear View of Completed Set, Showing Simple Arrangement of Parts and Method of Wiring above Subpanel

of the coils. It was found that in the common practice of testing coils at only one wavelength of the broadcasting band, two or more coils might be perfectly matched at the wavelength at which they were tested, and yet, at some other wavelength, would be hopelessly out of tune. By testing the coils at both the upper and lower ends of the band, the coils so matched would be in close agreement over the entire band, therefore these coils are supplied in matched sets, tested at both 250 and 500 meters. The condensers used are constructed in such a way that they can be assembled in the receiver and either a long control shaft, or insulated, flexible couplings substituted for the regular shafts without disturbing the accuracy of the units. Small neutralizing or balancing condensers, made by the same manufacturer are very useful for equalizing the units of the multiple-tuning condenser, and may be fastened directly to the socket binding posts or to the condensers, simplifying the wiring connections. The audio stages consist of two heavy-type a.f. transformers, together with a power tube, mak-

ing possible beautifully rounded reproduction of the bass notes. Drilled and engraved panels are available; however, for those who wish to drill their own, full-size drilling templates of the diagrams appearing on page 129 have been prepared.

The wiring diagram on page 126 shows the simple arrangement of the instruments with the coil bases and sockets marked for position. Note, in the photo on page 129, that the subpanel is cut away at front to make room for the rheostat-switch and the potentiometer. Mount the instruments on the front panel first, as shown in the photos on this page. The brackets are then screwed to the underside of the subpanel, and the subpanel assembly completed. No. 14 round, tinned-copper busbar wire is used for wiring throughout the set. It will be noted that the last coil at the right, mounted close to the front panel, has a hinged primary which allows a very close adjustment of the coupling for aeri-als of various electrical characteristics, and different selectivity requirements. In each case, the No. 6 terminal of the coils is mounted as close as possi-

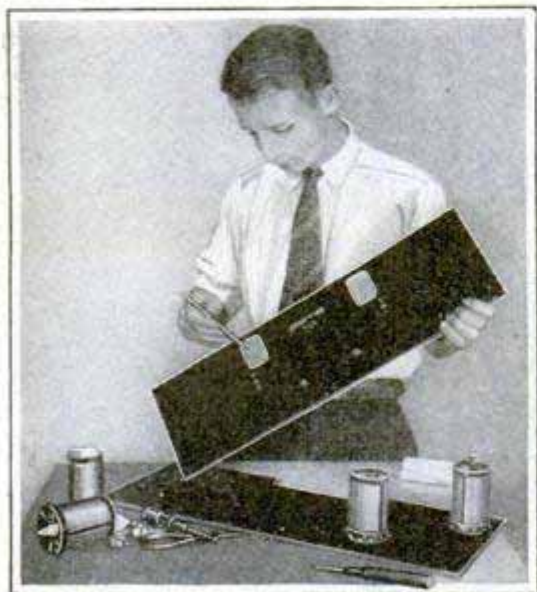
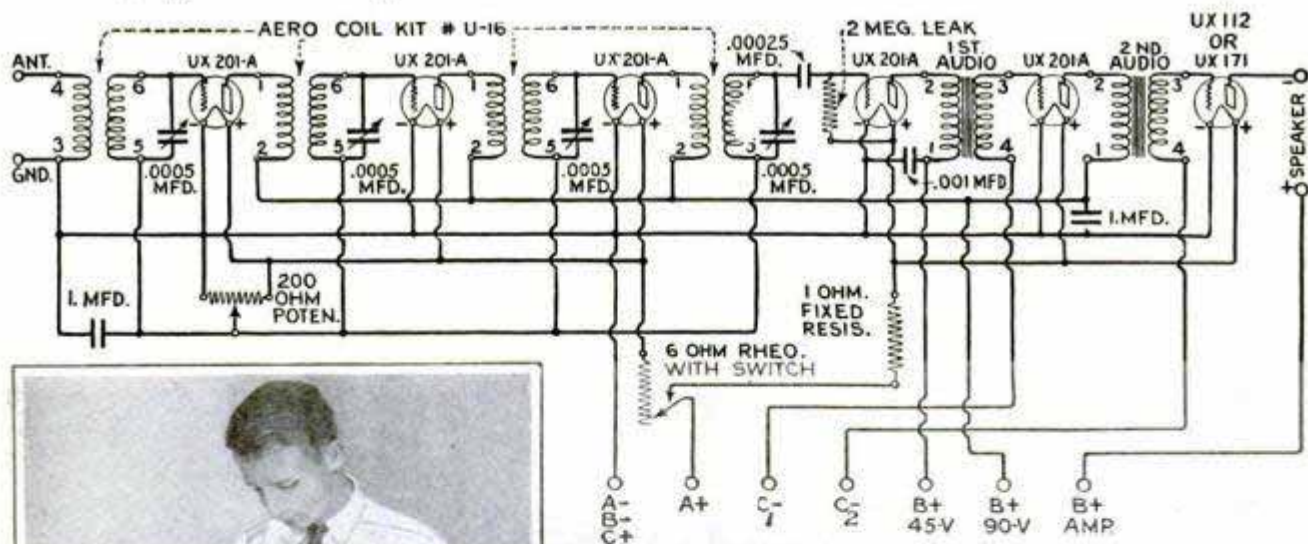

Above, Schematic Diagram; Lower Left, Front Panel Drilled, Showing Holes for Drum Dial Windows; Right, Front View of Assembled Panel

ble to the grid terminal of the tube socket to which it is to be fastened. It will also be noted that, in many cases where a lead should go through the subpanel, a special hole has not been drilled, but the lug has been joined to a soldering lug placed under a near-by mounting screw and the circuit picked up from the screw under the subpanel, thereby simplifying the operation. The underside view of the subpanel, shown on this page, gives the

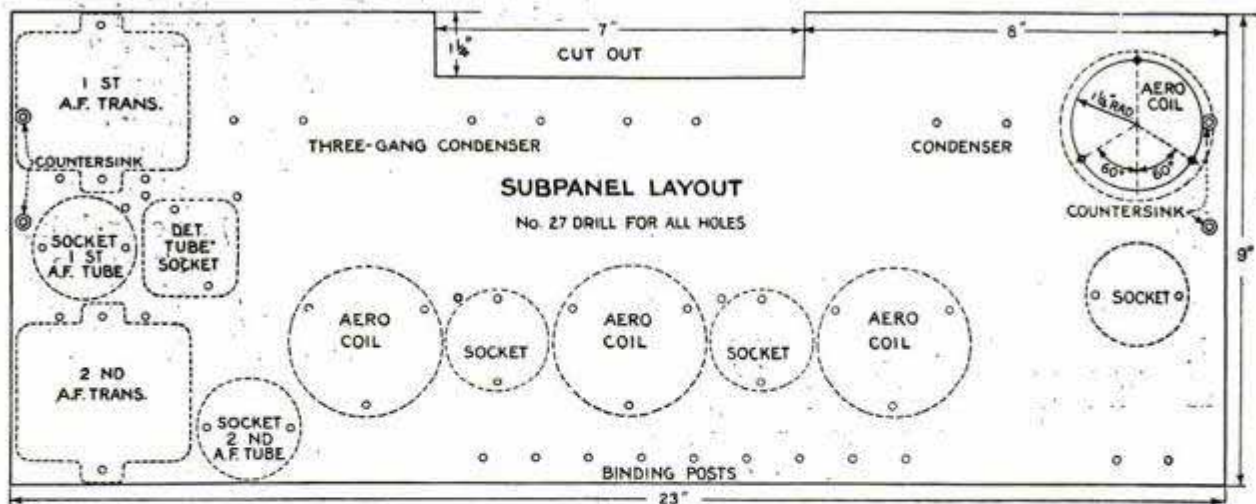
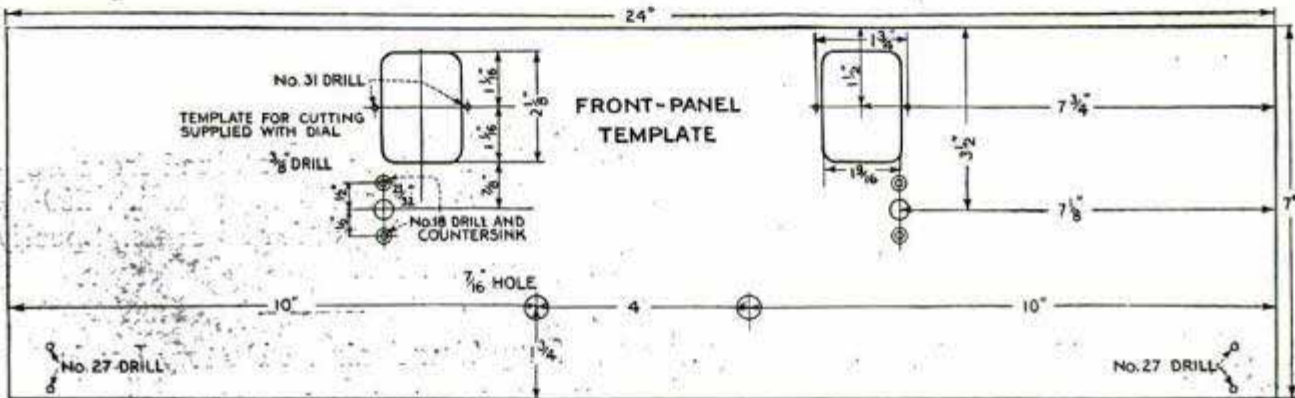
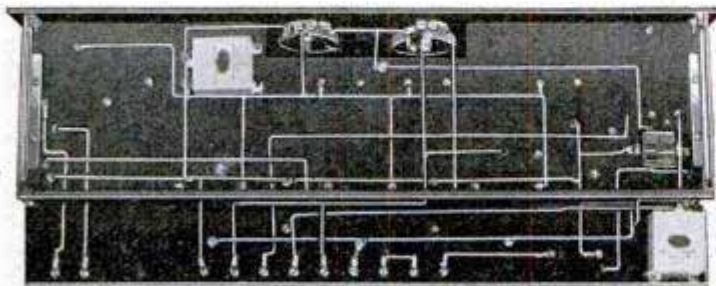

Upper Left, Underside View of Subpanel, Showing Supporting Beam; Right, Assembling Coils on Subpanel; Below, Drilling Template for Front Panel and Subpanel Layout

method of wiring and the location of all the fixed condensers except the .00025 grid condenser, which is mounted directly on the socket terminal above the subpanel. This photo shows another detail, which should be mounted at this time—the bar which is mounted across the brackets at

the rear as a supporting beam for the subpanel. It consists of a strip of panel material, $\frac{3}{16}$ by $1\frac{1}{8}$ by 23 in., and is fastened to the rear ends of the subpanel brackets by means of four short machine screws. This bar increases the rigidity of the assembly, thus assuring the continued per-

fect alinement of the condensers. Where the under-subpanel wiring runs from back to front, small holes are drilled to pass the wire, making possible permanent sepa-

turn on the filament switch; this is done by turning on the rheostat, which also turns off all the tubes in the set when turned to the extreme left. When tuning

MATERIAL LIST

- 1 front panel, 3-16 by 7 by 24 in.
- 1 subpanel, 3-16 by 9 by 23 in.
- 1 Aero U-16 kit of four coils.
- 2 S-M drum dials.
- 2 S-M, type 220, a.f. transformers.
- 4 Hammarlund .0005 mfd. condensers.
- 1 Benjamin, or similar type, spring-suspended socket.
- 5 S-M No. 511 sockets.
- 2 Tobe, or similar type, 1-mfd. fixed condensers.
- 1 Carter, or similar type, .001-mfd. fixed condenser.
- 1 .00025-mfd. grid condenser, Carter or similar type.

- 1 Yaxley, or similar type, switch-rheostat, 6 ohms.
- 1 Yaxley, or similar type, potentiometer, 200 ohms.
- 1 Yaxley, or similar type, fixed resistance, 1 ohm.
- 1 Polymet EZ, or similar type, gridleak mounting.
- 1 Tobe, or similar type, 2-meg. gridleak.
- 11 X-L, or similar type, lettered binding posts.
- 10-in. round brass rod, ¼ in. in diameter, or 3 Hammarlund insulated flexible couplings, busbar, No. 14 round, tinned-copper type, machine screws, nuts, etc.
- 5 doz. soldering lugs, long, round-hole type.

ration and neat arrangement of the various leads. After wiring as much as possible of the subpanel without the front panel, prepare the front panel for mounting. Care should be taken in the mounting that the driving mechanism of the drum dial is placed in the collar of the bracket before the panel is faced up to the subpanel assembly, after which the front panel may be pulled up with screws through the brackets. Now, with a screwdriver inserted to spread the lips of the drum driver, the dial may be slid along the condenser shaft and into the aperture and the drive mechanism released on it. At the same time the dials should be turned so as to read 100 with the condenser plates all the way in, and the dial locked in place on the shaft. The remainder of the wiring to the potentiometer and switch-rheostat may now be completed and the receiver tested.

All sockets of the receiver are to be supplied with UX-201A or CX-301A tubes, except the power-tube socket located nearest the back edge of the subpanel; this tube may be UX-112 or UX-171, as indicated in the schematic diagram. Note that the C-battery necessary for the UX-112 is 9 volts and, if the UX-171 tube is used, 27 volts of C-battery are required.

Due to the careful matching of the units, the set will not require any major adjustments for efficient operation over the entire waveband or, if any slight balancing is found necessary, this may easily be done with the small balancing condensers mentioned. Connect the A, B and C-batteries in the manner shown in the diagram on page 126, also the aerial and ground, and

for a station, keep both dials in step and when the station is located, adjust the left-hand dial independently for loudest and clearest signal; the volume is then controlled by the potentiometer.

An enlarged blueprint of the wiring diagram, shown on page 126, together with full-size drilling templates of the front and subpanel, may be obtained from Popular Mechanics radio department, 200 E. Ontario st., Chicago, for 25 cents. Specify blueprint No. 125.

1444-R

Snap Terminals on Battery Leads

Good electrical and mechanical connections are the features claimed for the "me-wary snap" type of battery terminal shown in the illustration. Small round-head studs are provided on the receiver instead of regular binding posts, and the terminals snap tightly on these studs. A multi-terminal can also be obtained,

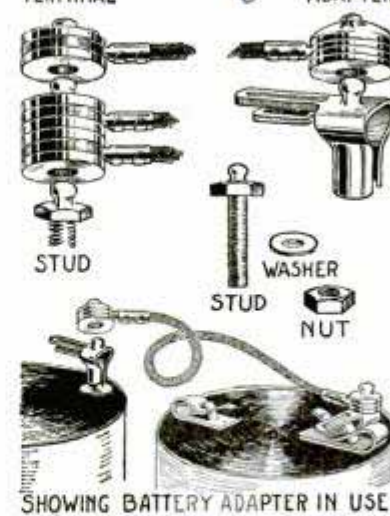

for use when two or three leads must be connected to the same stud. Vibration does not loosen these fasteners, as is the case with leads that are attached to the common type of binding post.

The Hatheway Mfg. Co.,
Bridgeport, Conn.



Helpful Hints *from* Radio Experts

THESE valuable kinks have been written especially for Popular Mechanics Magazine by prominent radio experts. They represent not merely ideas, but practical advice from the best technicians in the profession on methods that will help make your set more efficient in operation, more convenient to handle or easier to build.

Battery-Testing Kink

Here is a simple timesaver any radio owner can make at little or no cost which is especially useful to those set owners who have their batteries installed in a console or radio table-type cabinet where it is difficult to get at them to take a voltmeter reading. To make such a reading is required once in a while to determine the condition of the batteries and, in most cases, it is necessary to drag the cabinet away from the wall and reach into a crowded battery compartment, with the possibility of pulling a wire loose or short-circuiting something. I have eliminated

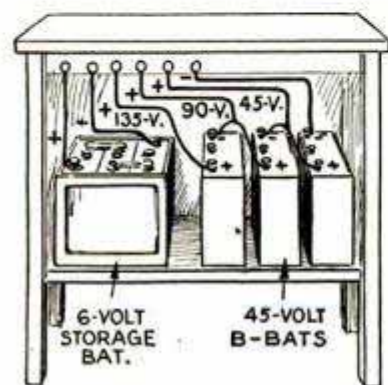

all of this trouble with my set by drilling a few $\frac{1}{8}$ -in. holes in the side panel of the radio table close to the top and about 1 in. apart; into these holes I

bolted some old nickelplated switch points taken from my scrap box. To these I fastened flexible leads inside the cabinet, connecting them to each battery in turn, as shown, so that by putting my voltmeter across any two points I can determine their condition.—H. G. Nebe, chief engineer, Station WSMB, New Orleans, La.

Output Impedance for Power Tube

With the popularity of the 171-type of power tube, I think the readers of Popular Mechanics

magazine might be interested in knowing how easy it is to make an output impedance to keep the B-battery d.c. from passing through the windings of the loud speaker. Not until I had burned out one such winding did I wake up to the fact that something should be done. For the audio choke I used most anything that passed enough current and still offered a fairly high impedance. I am now using

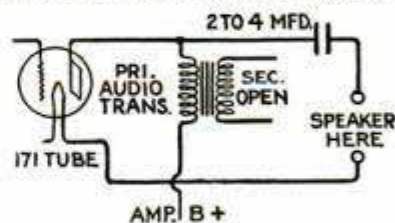

the primary of an audio transformer, as shown in the diagram. The output impedance both protects the speaker and improves the tone.—C. R. Yarger, chief engineer, Station KFNF, Shenandoah, Iowa.

Bunched Leads for Sharp Tuning

The set builder who wants selectivity should bunch all leads possible, when wiring the set, and branch each lead off as it comes to its terminal point. This is a simple thing to do, considering the fact that all leads start from the terminal strip to different parts of the set. After bunching, they can be tied or laced with string at various points and fixed with a little collodion if desired. There is one thing that is very important when wiring a set in this manner, and that is, that the leads from the grids of the r.f. tubes and detector should be as far away from the other wiring as possible. This also applies to the plate leads from the same

tubes to the r.f. transformers; these leads must be kept clear of the grid leads. The sketch illustrates the idea, and of course it is understood that the aerial lead must also be kept clear of the other wiring. When you wire a set and string wires all over the subpanel it is highly probable that they will be energized and create a much longer field than if they were bunched together in the manner described. Use stranded insulated hookup wire and try out this method when wiring your set. I have found it highly successful.—M. M. Paggi, chief engineer, Station KFWO, Avalon, Catalina Island, Calif.

Superheterodyne Kink

In superheterodynes that employ the tuned-plate, tuned-grid type of oscillator, which is subject to spurious oscillations of a frequency other than the frequency to which the coils are tuned, the following

simple remedy can be applied. We have found that a small choke coil inserted between the grid condenser and the junction of the grid coil and the grid tuning condenser effects the remedy. The choke coil need not be of special construction; a simple one may be made by coiling the busbar, at the point just mentioned, five or six times around a form 1 in. in diameter.—Wm. M. Perkins, engineer for Aero Products, Inc., Chicago, Ill.

Power Tubes Used As Detectors

One of the most valuable kinks that has come to my attention within the past few months has been the use of UX-120 and UX-171 tubes as detectors, with negative grid bias. The greatest trouble with detector tubes today is the fact that they are unable to handle the tremendous amount of current impressed upon them by radio-frequency amplifiers. Hence, the detectors distort and

chatter, due to their inability to handle the necessary current.

In a set using 199-tubes, cut out the grid condenser and leak, and apply 22 volts to the plate of a UX-120 used as the detector tube. From 3 to 6 volts of negative grid bias are required when using this tube. The 171-type is used in the same manner in sets employing the large tubes with from $4\frac{1}{2}$ to 7 volts negative grid bias. Outside of the small additional filament-current drain, there is really less drain on the B-batteries. Far more volume and better quality can be obtained with tubes of this type as detectors, and the idea is easily applied to any set.—R. V. O. Swartwout, chief engineer, Station WCAO, Baltimore, Md.

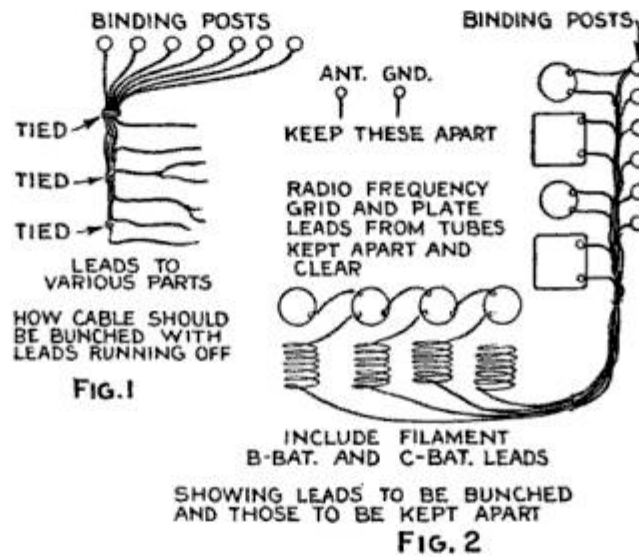

Loose or broken connections cause trouble both in manufactured and home-built sets; after checking tubes and batteries all wiring should be carefully examined.

Sprague Specialty Co. 1511 Hancock Quincy, Mass. 1404
Fixed Midget Condensers Easy to Wire

Half the usual size and one-quarter the weight of the average fixed condenser, the midget condensers now appearing on the market are easier to wire. Besides, the builder is often at a loss to find a convenient place to mount fixed condensers in the restricted space below the subpanel. The midgets are provided with presoldered lugs, making quick soldering possible with a minimum of heat. They are said to be tested at 1,500 volts, and rated as safe for continuous operation at 1,000 volts, d.c. The marked capacity is guaranteed to be within 10 per cent.

\$3.50.

Resistance C-Bias for B-Eliminator

Many of the commercial circuits, using B-eliminators, dispense with C-batteries entirely and use the voltage drop across a resistance to provide C-bias. Such an arrangement is entirely feasible when the B-eliminator gives a sufficiently high voltage output, so that part of this voltage can be utilized for the C-bias. Care must be used, however, or motorboating will develop due to coupling in the resistance. This is common to the plates of two or more of the tubes in the set. A simple instrument for regulating C-voltage is shown in the illustration. The extra bypass condenser for the detector control of the eliminator is very important. The choke coil illustrated may not be needed on some sets, but if there is any tendency toward motorboating it will be required. This choke

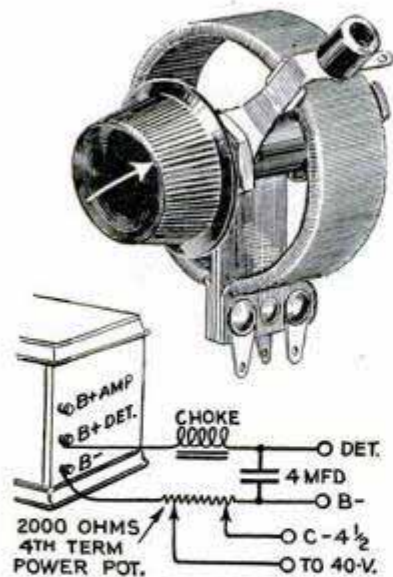

can be of the commercial types, or the primary of an old audio transformer can be used. The four-terminal power potentiometer shown is connected as in the diagram, permitting the use of a C-bias potential of from 4½ to 40 volts.

*Central Radio Laboratory
 16 Keefe Ave. Milwaukee*

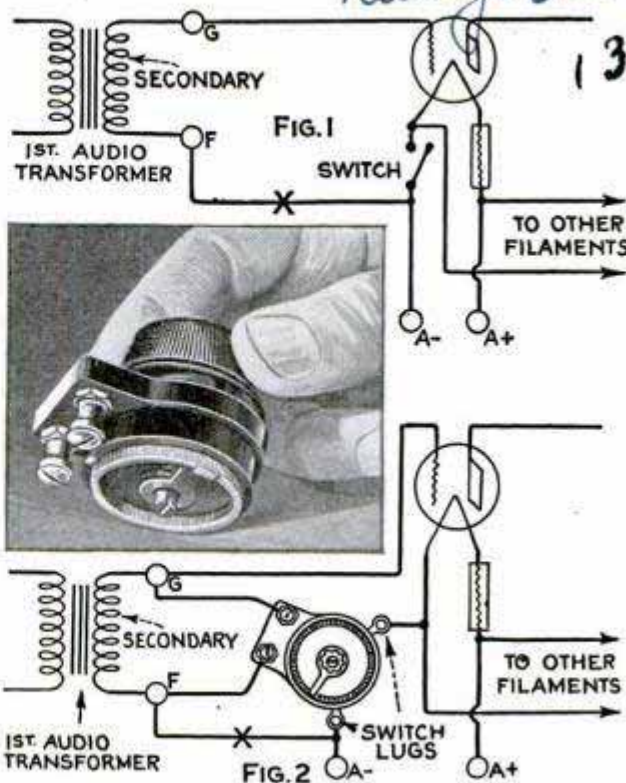

Controlling Tone and Volume

There are many sets now in use without a suitable volume control; in others, rheostats or similar devices, which are no longer in good condition, have been used for this purpose. The little device shown in the accompanying photo is said to be capable of an extremely delicate shading, from soft, whisperlike music up to powerful volume with remarkable clarity of tone. In Fig. 1 we have a circuit diagram showing the usual circuit connections before the instrument is installed. In Fig. 2 we show the instrument connected, to improve the quality and afford a means of controlling signal volume. The instrument is available in two types, one combining a filament switch and one without; the switch type is shown in the diagram. When turned as far as possible to the left, the A-battery is off. When a C-battery is desired, the circuit is broken at the point marked X, C-positive is connected to A-negative, and C-negative is connected to F-negative of the transformer secondary.

Popular Mechanics' radio department offers its information service free to all readers of our magazine. We will be glad to help you with your radio problems, and will promptly answer all inquiries directed to this department.

1354R

Tonatron

Efficient Radio Ground Easily Installed

An efficient radio ground, having a "discharge area" several times as great as a driven ground, is now available. Its walls are of heavy sheet copper, rolled into the shape of a truncated cone. A 20-ft. length of heavily enameled lead-in wire is provided, and its connection to the ground proper is made by two heavy spot welds. There are no other soldered or bolted joints and, thus, no electrolytic action is possible. The interior is filled with pure

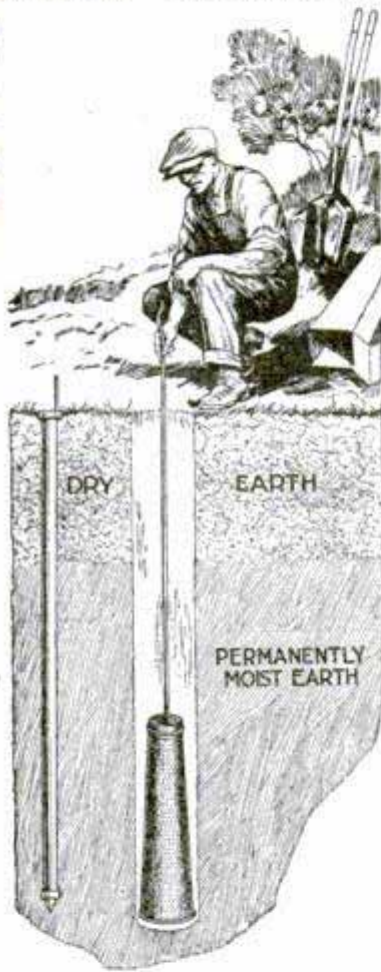

grain charcoal, which absorbs and holds moisture. The device itself, the cap being removed when it is installed, acts as a reservoir for water, providing the lowest possible resistance. Compact and convenient to handle, the unit is installed in a hole bored with an ordinary post-hole auger, no large excavations are required, and the earth adjacent to the ground need not be disturbed. The sketch shows, at the left, the comparatively small area a driven ground exposes to the moist earth and, at the right, the much greater area for discharge obtained with the new type.

Trouble-Shooting Kinks

When trouble appears in the set, investigate carefully, and the chances are that you will quickly find the cause. First examine the batteries, as run-down batteries are the cause of such troubles as the set suddenly losing volume or developing

noisy reception. Test the polarity and voltage of all batteries, including C-batteries, and replace any that are defective. Tune in the strongest local station, and if the volume from the loud speaker is still weak, tap the tubes with the fingernail to determine whether or not the amplifiers are operating; if not, a ringing sound will be heard in the loud speaker. Examine all battery connections, and clean any terminal connections that appear to be corroded. If the battery tests have been made and show no trouble either in lack of voltage or defective connections, the next step is to substitute tubes of known efficiency. Try a pair of phones in place of the loud speaker. If no sound is heard in them, remove the tubes from the set and disconnect the A-battery; then, with a pair of headphones in series with a 22½-volt B-battery, test the grid-to-filament circuits. This is done by putting the terminal of one of the headset leads on the grid contact of the socket, the other phone terminal going to the 22½-volt battery, while the other lead from the battery is put on the filament contact of the socket. When the contacts are made on the sockets, loud clicks should be heard in the headset, except in the detector-tube socket. Because of the high-resistance grid-leak here, a very weak click will be heard or, perhaps, no click at all. Test the transformer windings in the same manner. The secondary terminals are marked F and G, and the primary terminals P and B. If the trouble has not yet been located, replace the tubes in the sockets and put the set in operation. If it is possible to raise a station weakly, press down on each tube successively, and you may find one that is not making good contact in its socket. The remedy is to remove all the tubes and disconnect the batteries, at any rate remove all the tubes; then, with the fingernail or a notched stick pull up all the socket springs to insure a good contact between them and the tube prongs. Polish the ends of the latter and also switch and jack contacts, as corrosion at these points often means the difference between good and poor reception. Finally, look over the ground and aerial connections, or loop connections if a loop is used, and, if the trouble still persists, call in a reliable radio-service man.

Paragon Electricals
37 W. Van Buren
Chicago

#5.50 - West of
Rockies \$6.50

1438 a

New Tube Is Self-Neutralized

The tube shown in the photo is one of the few really new developments in the radio field for some time. Designed to give much greater amplification in the r.f. stages, this newcomer, announced by

6. The B-voltage is 135 maximum, the filament voltage is 3.3, just .3 volt more than that required for the 199-type tube, and the amperage needed is .13. The new tube is at present designed for battery operation only. Its use is limited to the improvement of amplification in the r.f.

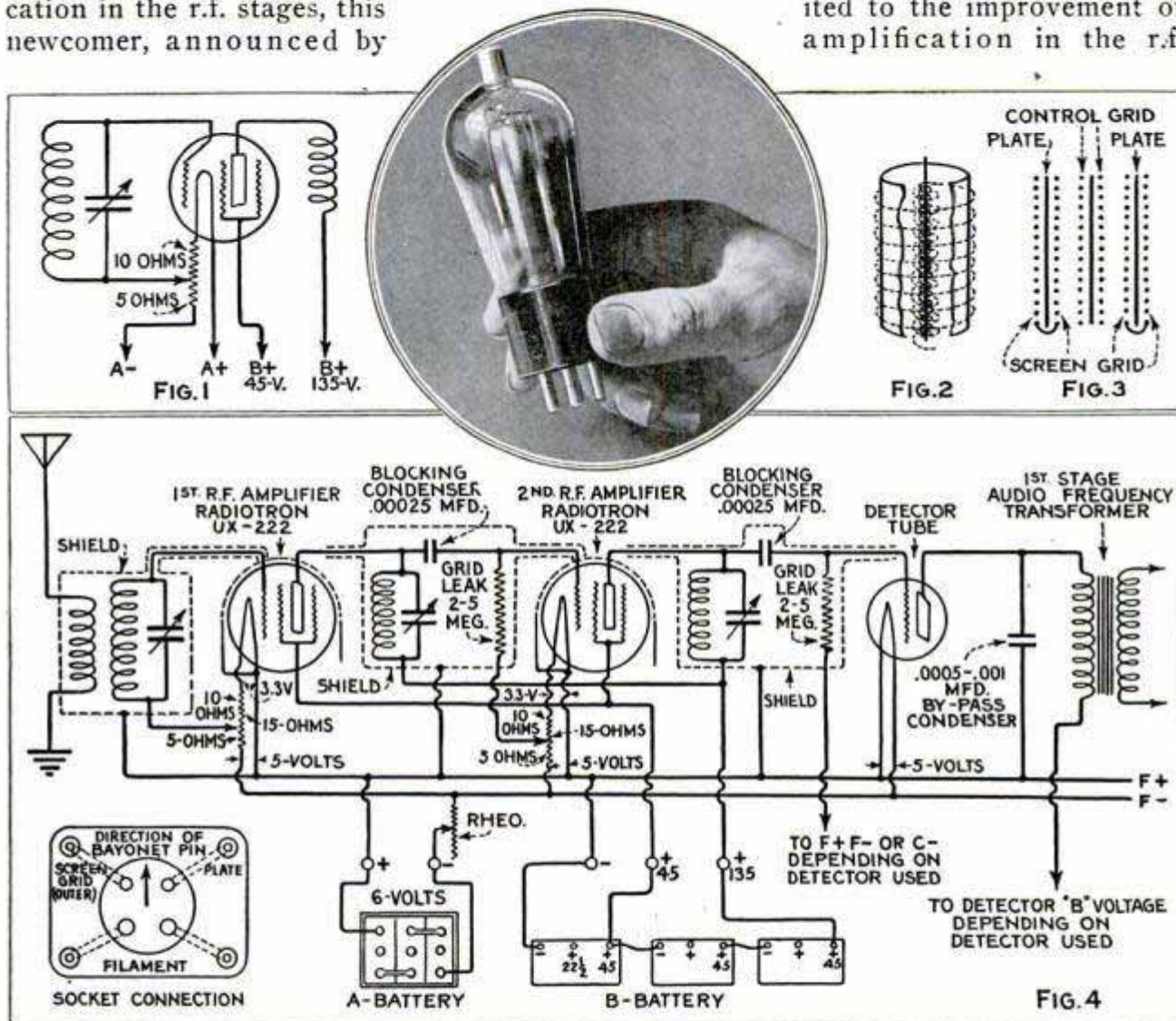

Insert, Photo of the New Tube, Showing Control Grid Connection at Top

Mr. Elmer E. Bucher, of the Radio Corporation of America, is to be known as the UX-222. The tendency to oscillate just short of the point where maximum signal strength is attained has been the outstanding fault of the standard tube. While oscillation is very desirable and necessary in generating the broadcast carrier wave, its presence in the receiver amplifying circuit renders the standard tube useless as an amplifier until oscillation is suppressed. The voltage-amplification factor of the new tube, due to its unusual construction and methods of application, is said to be from 30 to 150 without a squeal; the average r.f. amplifier gives an amplification of

stages, and it is not adaptable to present-day sets. Each stage of r.f. must be thoroughly shielded, as shown in the circuit diagram, and three tubes should be used to obtain maximum results. The tube has two grids in addition to the usual filament and plate, the extra grid being said to make the circuit more stable by preventing feedback. No neutralizing methods are required in the receiving circuit when the four-element tube is employed. Hence, the construction is simplified and the set is more easily controlled without the customary howls and squeals. The point on which the greatest interest is focused is the amplification factor, which is 30 to 50

in circuits of the tuned r.f. type and to 150 when used in sets of the superheterodyne type. The circuit for the grid return and necessary grid bias is shown in Fig. 1. The screen grid inclosing the plate, and connected to the prong in the base ordinarily connected to the grid in the standard tube, is led to the 45-volt tap of the same B-battery that supplies energy to the plates of the standard tubes in the set. The regular grid, which now becomes what is known as a "control" grid, is connected to a terminal at the top of the tube, and its outside connection is made as shown in Fig. 1. The plate voltage recommended is from 90 to 135 volts, preferably the latter.

Figs. 2 and 3 show cross sections of the elements in the tube. In Fig. 2, the heavy vertical line in the center represents the filament; the narrow solid spiral encircling it represents the control grid, similar in character to the grid of a standard tube.

Light-Sensitive Tube

Designed to fill the need for a rugged light-sensitive valve, or photo-electric cell, which can be used conveniently in apparatus by experimenters and manufacturers interested in television, talking motion pictures, alarm systems, color sorting, etc., this new tube replaces many of the make-shifts formerly used by experimenters.

The cell is mounted in a spherical bulb, 2 in. in diameter and 5 in. in over-all length, the lead-in wires being brought out to a standard Edison screw base, as shown in the photo.

The internal construction is designed to utilize all those features which are best calculated to produce a cell which is free from "spurious" or "dark" currents and from "lag" or "fatigue," in laboratory parlance. It is also said to be free from the influence of temperature and to be highly sensitive to

The dotted spiral that incloses both these elements represents the inner screen; the circular plate is shown broken away to expose the inner elements. The outermost dotted spiral is the outer screen. Both inner and outer screens are connected, thus shielding the plate on both sides. Fig. 3, also a cross section, shows the various elements in their relative positions. In Fig. 4 we have a suggested typical screen-grid r.f. amplifier circuit, consisting of two stages of r.f., employing the new tubes and a standard detector tube.

Just what the future holds in store for this new tube remains to be seen, but experimenters are very enthusiastic about it and are looking forward to its early release. At the time this article is written no definite release date has been announced by the manufacturers, although samples have been supplied to several experimental laboratories for the purpose of circuit development.

light change over the entire spectrum. The active medium used is potassium, on the surface of which is formed a film of colloidal potassium hydride. This surface is said to have a sensitivity almost a hundred times as great as the pure potassium. Further sensitivity is obtained by the presence of neon gas. The anode is a small disk placed edgewise toward the window, so that no shadow is cast upon it. With a

single step of amplification, as shown in the diagram, a deflection of 30 milliamp. has been obtained with a 100-watt lamp as a light source. In this circuit a UX-112 is used as an amplifier tube with a 90-volt B-battery, 6-volt A-battery and an 8-volt C-battery. A fixed resistance of 10 meg. is used in the grid circuit.

Technical information in the nature of formulæ, laws, and constants relating to specific problems will be furnished by the manufacturer.

Radio Electrical Works, 23 Union Square

1401 R.

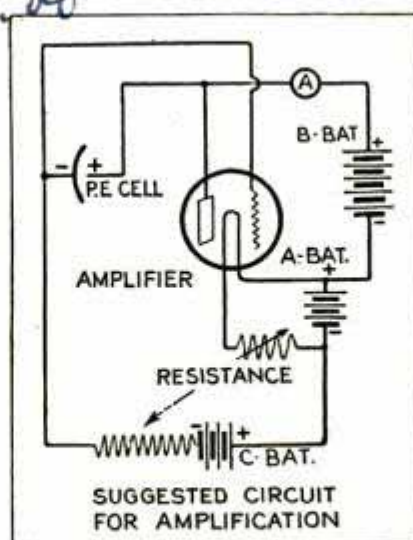

Left, Light-Sensitive Tube; Right, Diagram for Using the Tube with One Stage of Amplification

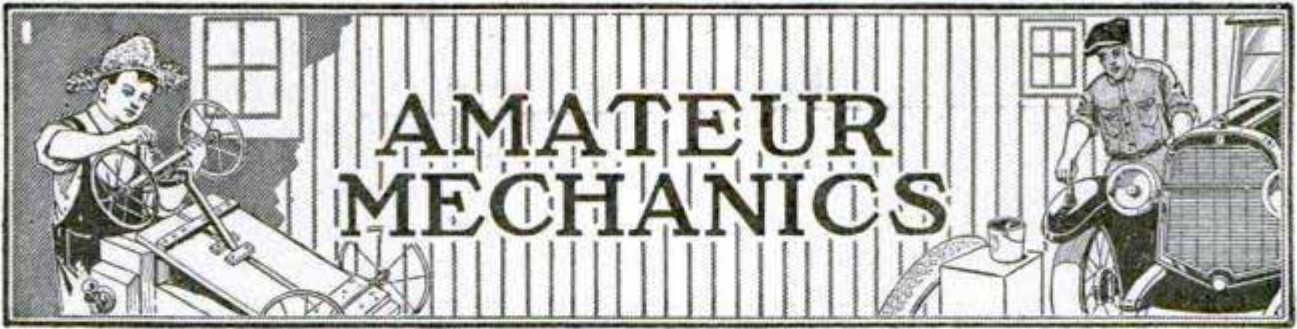

Skate-Sailing Is Thrilling Sport

By SAM BROWN

SCUDDING to leeward with the speed of an ice yacht, tacking to windward with all the nautical nicety of a center-board skiff, feeling the tug of fifty square feet of taut canvas veering into a spanking breeze—that's the thrill that comes with the skate-sail. You don't have to be a wonderful skater, or a good sailor, either, to go skate-sailing. All you need is the sail, the necessary expanse of slate-gray ice, and a moderately strong pair of ankles, and then, if you hold the sail

—no matter how—you are bound to glide off in one direction or another.

And how! Don't be surprised to find

yourself "sailing" all over the ice on some portion of your anatomy other than your feet. But don't let that discourage you. Skate-sailing, like skiing and skating, is a sport that comes bump by bump, but it is only through experiencing these beginner's mishaps that you can later enjoy the gliding swiftness, the sensation of flying, and the thrill in maneuvering that comes with the skate-sail.

In taking up skate-sailing, the first thing to do is to make the sail; and the first thing in making the sail is to cut a paper pattern of the sail proper. This can be conveniently done on 36 sheets of

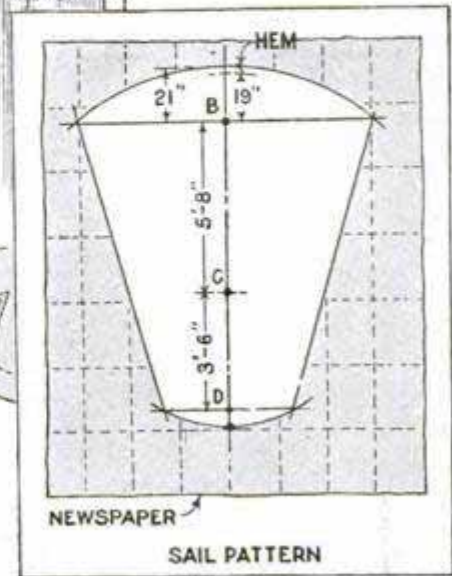
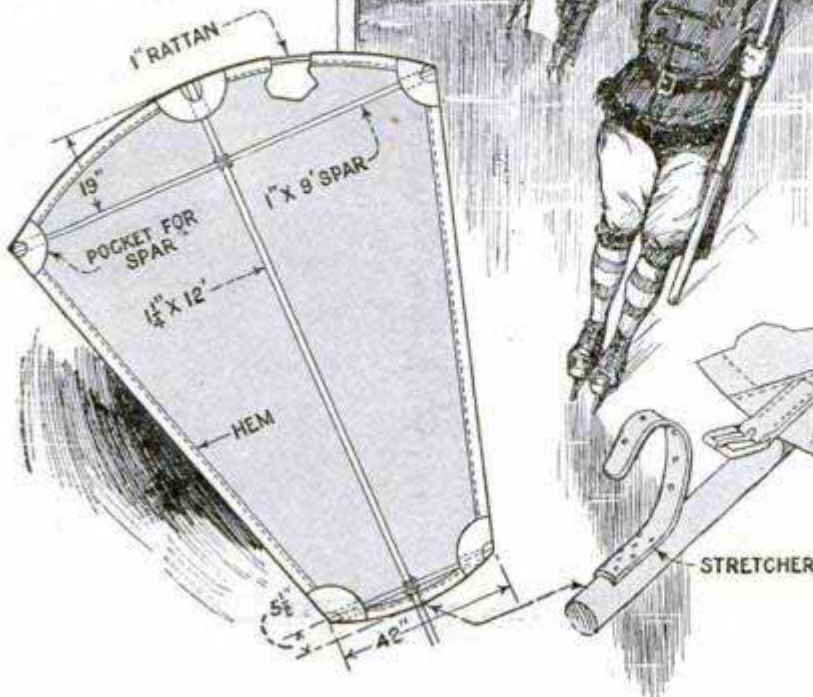
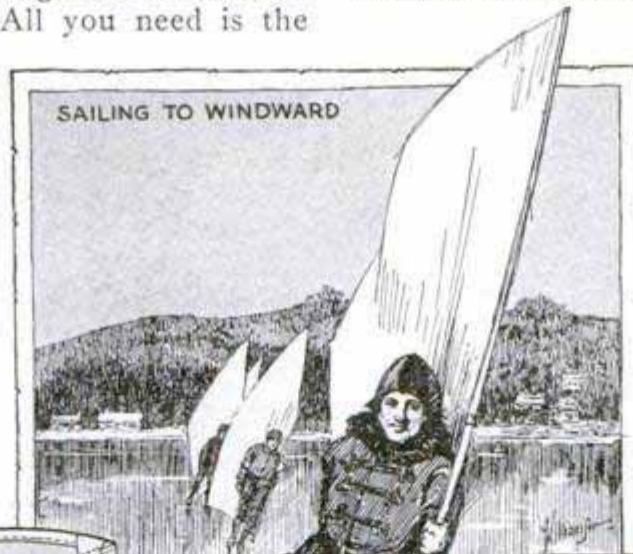

newspaper, pasted together as shown in the pattern drawing. Down the center of this pasted sheet, draw a heavy black line. On this line, close to the top, mark a dot to represent the sail top. From this dot, measure down on the line the distances indicated, and make dots B, C and D.

Draw lines at right angles to dots B and D, the upper one 9 ft. long, and the lower 42 in. long. Now, fasten a piece of string to a thumbtack, and insert the tack through the paper at the dot C. Fasten a pencil onto the string at the proper distance to draw an arc through the ends of the 9-ft. line, and then, still using the point C as a center, swing another arc through the ends of the 42-in. line. Draw lines connecting the intersections of the cross lines and arcs, and you will have a full-size pattern of the skate-sail.

The actual sail is then sewed together, using this paper pattern as a guide, and allowing 2 in. all around for hem. Material for the sail can be either 3-oz. zephyr cloth, 3-oz. duck, Egyptian cotton, balloon silk, or any other light, strong material.

Next in order come the spars. These should be cut from spruce, to the dimensions shown, and should be shaved down so that they taper slightly from the center to the ends. Pockets of light leather or very heavy canvas should be sewed to the sail to receive the ends of the spars. A stretching harness is made from straps, as shown in the sketch, and fastened to the sail at the lower end. Both the curved portions of the sail, at the top and bottom, are reinforced by having a length of light rattan inserted in the hem. Leather straps, or strong whipcord lashings, fasten the spars together where they cross.

So much for the sail. The other part of your equipment is, of course, the skates. Have these as long as possible; at least nothing shorter than the regulation 15-in. speed skate.

To learn to use the skate-sail, choose as smooth a stretch of ice as possible, and a day with a fairly stiff breeze. Hold the sail at arm's length over your head, both hands grasping the cross spar, and skate out on the ice. Face the wind. Bring the sail upright against your right

side, resting the long spar on your right shoulder. Your right hand should grip the cross spar, while your left hand goes behind your body and takes hold of the long spar. The sail is between you and the wind. Swish! Away you go!

As soon as you be-

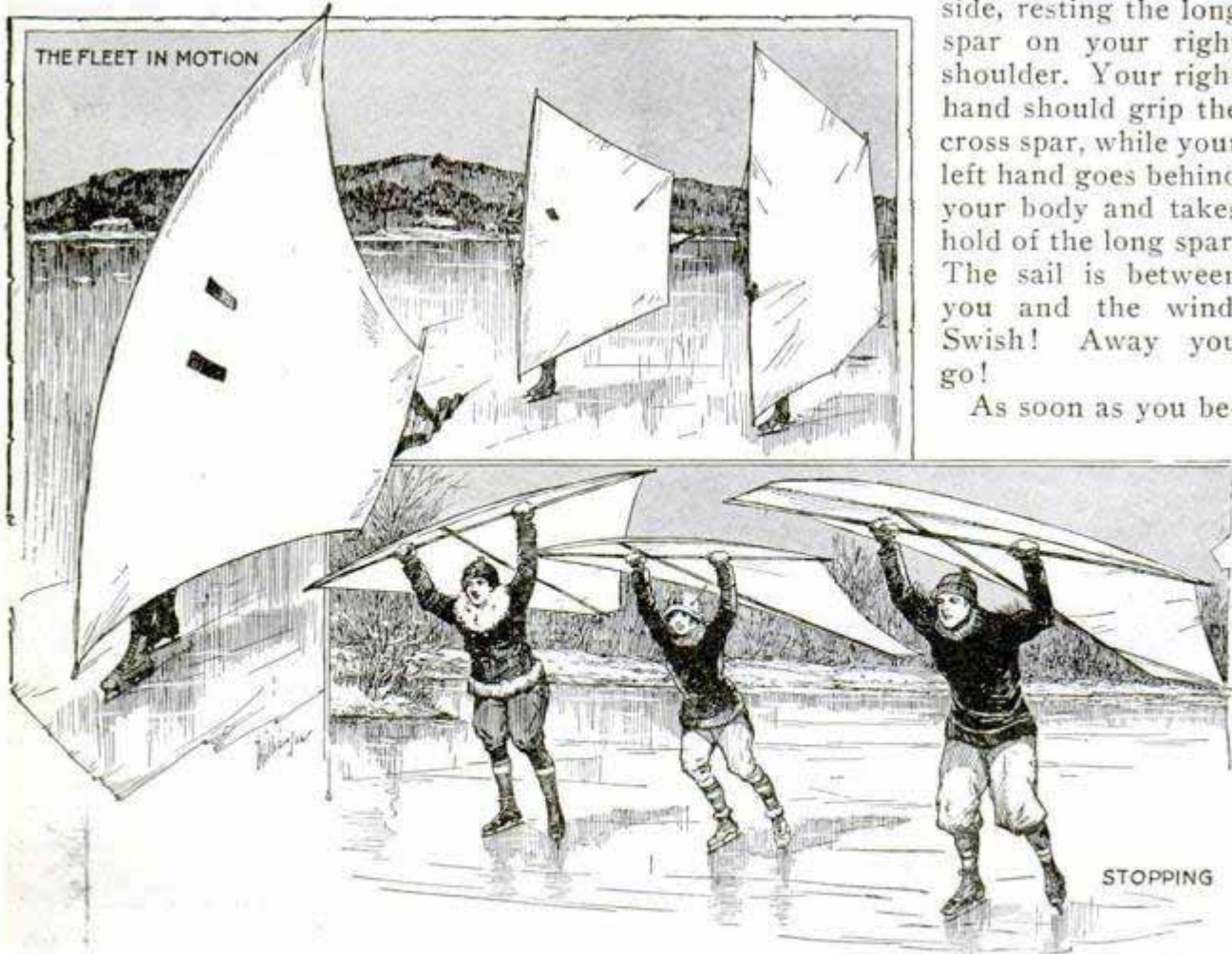



gin to feel that you are exceeding the speed limit, or your legs begin to vibrate from the rough ice, swing the sail flat over your head, and you will very soon come to a stop.

One of the first things you will learn in navigating with the skate-sail is that the sail must never be held as a point-blank target to the wind. Why not? Simply because the skate-sailor travels faster than the breeze. To illustrate: Suppose there is a 17-mile wind blowing. The inexperienced sailor, thinking to take full advantage of this, holds the sail directly at his back, presenting a point-blank target to the breeze. Of course he goes off like a shot, and gradually increases speed until he is going about $21\frac{1}{2}$ miles per hour. What happens, then, to the 17-mile-an-hour breeze? It cannot keep up with the sailor, and the result is that there is a sudden vacuum behind the sail, which is often of such intensity as to cause the sailor to lose his balance.

The correct way to sail before the wind is to hold the sail at a very slight angle away from the breeze, so that you zigzag down the wind instead of scudding directly before it. You go just as fast, and, because you are running more or less across the wind, you eliminate the disturbing factor of artificial "air pockets."

When you travel this zigzag course to the right, the sail is carried on the right shoulder, and with the right foot forward. When you desire to veer off to the left, the sail is rolled across your back, keeping the tail end low, so that the long spar



comes down on your left shoulder, while your foot position is changed so that the left foot is to the fore.

You will speedily learn that you can go directly across the wind, that is, at right angles to it, by slanting the sail a little and leaning against the wind. When sailing in this manner, your skates, biting into the ice, act in the same capacity as leeboards on a sailing canoe, and prevent you from "drifting."

By slanting the sail still more away from the breeze, you will find yourself practically going against the wind. That is, the breeze will be coming direct from the north, and you will be sailing northeast. This is nautically known as "beating to windward," and your northeast course is called a "tack." After you have covered a fair distance on the northeast tack, you start on the northwest tack, and by alternating these two directions you eventually arrive at your destination, due north.

In beating to windward, it is necessary,

when changing tacks, to alter the position of the sail, so that it is always between you and the wind. To do this you swing around into the wind, which frees the sail from your body, then quickly lift the sail, flat, over your head, and lower it on the opposite side to carry you off on the next tack.

Detachable Clothesline Reel

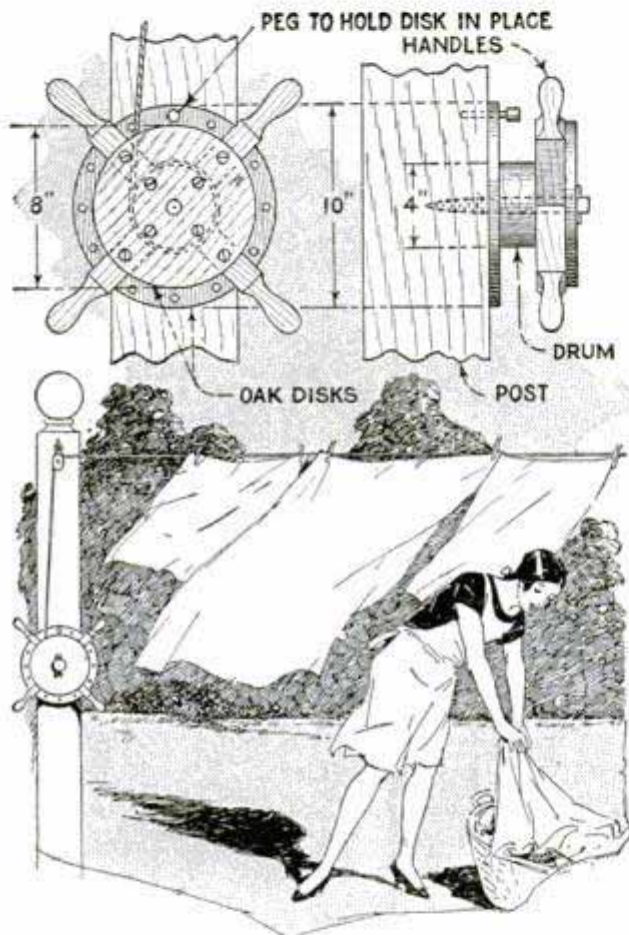

Simple Homemade Clothesline Reel Which Holds the Line Taut and Secure

The clothesline reel shown in the illustration was designed by a woman who knew just what she wanted in the way of such a device. It can be adjusted to hold the line at the proper tension, is simple to make and can be instantly detached from the pole and carried in the house to keep the line dry in damp weather. The reel consists of a hardwood drum, 4 in. in diameter. On the back of the drum a hardwood disk, 10 in. in diameter, is fastened. Two hardwood handles, crossed and mitered at right angles, are fastened across the front of the drum, as shown. Over the handles a second hardwood disk, 8 in. in diameter, is attached. Disks, han-

dles and drum are concentric with each other. A $\frac{5}{8}$ -in. hole is drilled through the exact center of the assembly and small holes 1 in. apart are drilled around the edge of the 10-in. disk. A lagscrew is driven into a convenient clothes pole 4 ft. from the ground, the head is filed off and a small hole is drilled through the end for a cotter pin. A pulley is also fastened to the top of the pole above the bolt. With the clothesline reeved through the pulley and run through holes in the other poles, the reel is placed on the bolt and the cotter pin inserted to prevent it from coming off. Then the line is reeled in until tight and a steel pin is inserted through one hole in the back disk into a hole in the pole. This holds the line taut. By removing the cotter, the reel can be instantly removed.—L. B. Robbins, Harwich, Mass.

Squeezing Paste from Tubes

A large percentage of paste used in tubes, such as toothpaste, shaving cream, glue, etc., is wasted, as it cannot be entirely squeezed out with the fingers alone. A device such as the one shown in the drawing will prevent this waste and can be made as follows: A short length of metal rod is slit down one end with a hacksaw, $1\frac{1}{2}$ or 2 in. being sufficient for the average tube. The other end is turned over and bent to form a handle. The slitted end of the rod is slipped over the flat end of the tube and the handle is turned. This will force all of the contents from the tube. When the tube is entirely rolled up, the crank may be pulled out and used for other tubes.—L. J. Flugel, Chicago.

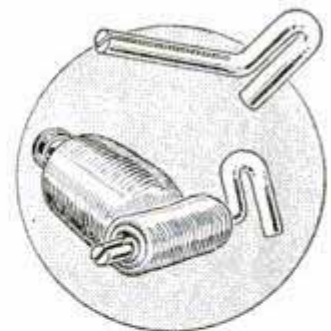

☞ The life of a floor broom can be increased considerably if it is given the following treatment every week: Dip it in a pail of hot soapy water, dash up and down several times and set it some place where air will circulate about it for some time. By doing this the fibers will not break off so easily.

Lamp for Locating Short Circuits in Auto Electric Systems

When locating short circuits in the electrical system of a car, it will be found that if short wires are soldered to the metal ends of a burned-out fuse, and then connected to a lamp of the 6-volt type, an exceedingly useful test lamp can be had. By placing this lamp-bridged fuse in the fuse clips there is no danger of damage to the wiring system of the car, and it will light until the short circuit is located and remedied.—Philip S. Mentz, Jefferson Barracks, Mo.

How to Shrink Darning Wool Before Doing Repairs with It

After studying the effects that laundering has on woolen goods, an English expert declares that the greatest deterioration occurs where the garments have been repaired, due to the fact that the wool used in the repair had not been shrunk prior to use. In tests conducted, it was found that stockings, jumpers, pull-overs and the like, when made of wool, were effectively cleaned without damage, but the places repaired by darning showed the new wool about to break away from the surrounding edges. An easy way of shrinking wool is to take a clean tin can, complete with the lid, punch or cut a hole in the latter large enough to receive the end of the kettle spout, and another hole on the top as a steam escape. Now insert the new darning wool in the can, close the lid and connect it to the steaming kettle for a few minutes when the wool will be thoroughly steamed and, after drying, will be shrunk to the same degree as the garment about to be repaired. Two brackets or feet may be attached to the steaming chamber to hold it more steadily if desired.—George H. Holden, Chesterfield, England.

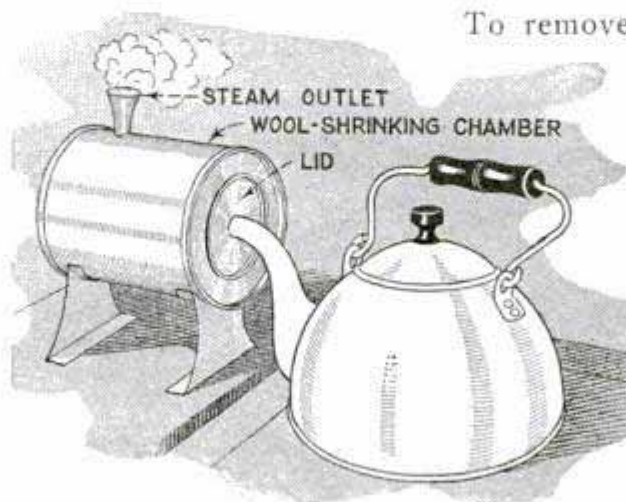

Method of Shrinking Wool Prior to Using It for the Mending of Clothing

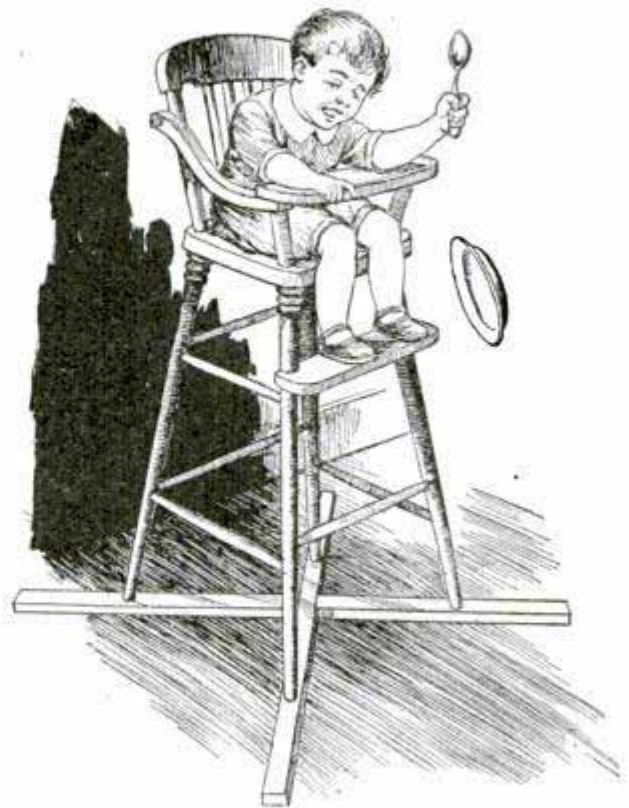

Strips of 1-In. Wood Attached to Baby Chair Prevent It from Tipping

Non-Tipping Baby Chair

A baby usually tries to climb out of his chair, which often causes it to tip over. To prevent this I nailed strips of 1 by 1-in. wood across the legs of the chair, as shown in the drawing. If these strips extend something like 5 or 6 in. beyond the chair legs, there will be no tendency of tipping, and the baby may be left safely alone.—Emil Spona, San Francisco, Calif.

Simple Way of Deodorizing Old Rat Trap

To remove all trace of a former rat or mouse victim from a spring trap, simply dip the front section in melted paraffin. This method eliminates the old trouble of having to wash and scour or burn off the trap in order to get rid of the odor that usually keeps away other mice.—W. P. Glenney, Corona, N. Y.

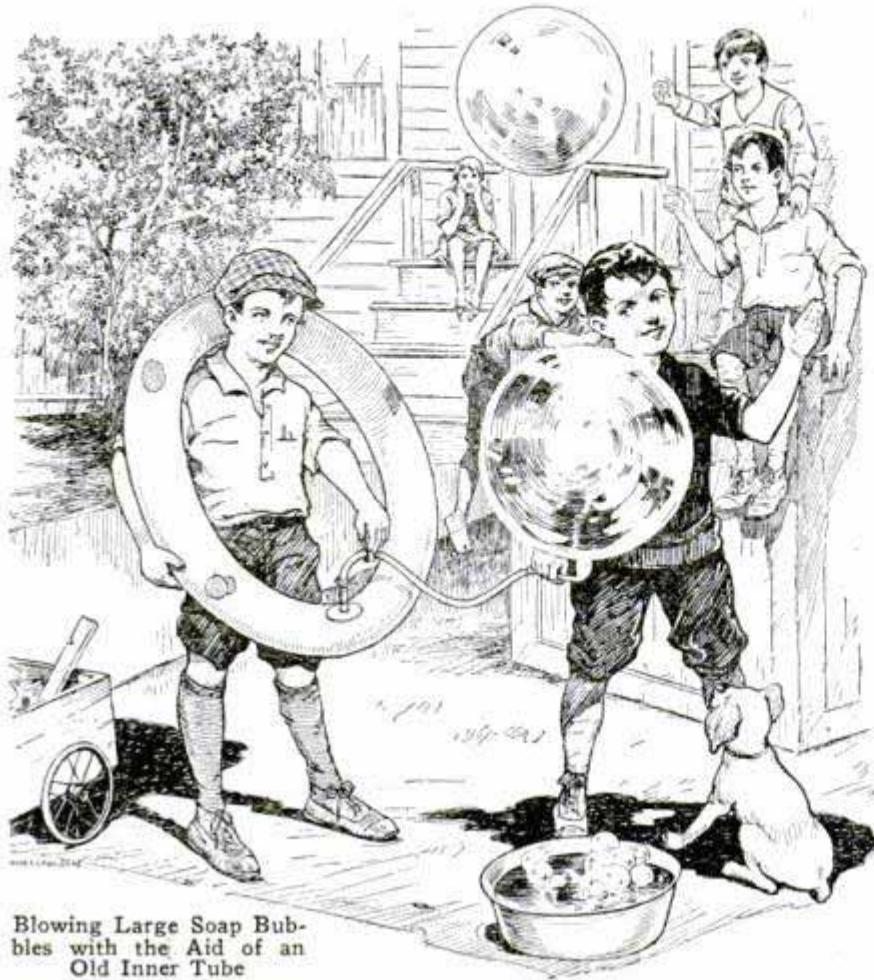

Blowing Large Soap Bubbles with the Aid of an Old Inner Tube

Blowing Giant Soap Bubbles

Blowing big soap bubbles is a lot of fun, especially if the novel method of blowing them by means of an inner tube is used, as shown in the accompanying drawing. Make a small slit in an inner tube directly opposite the valve stem. Then push a second valve stem through this slit and take up on the nuts so that no air will leak out. Remove the inner section of the valve and force the end of a length of rubber tubing over the end. Insert the stem of a clay pipe in the other end of the tubing. The tube should be held closed with a spring clothespin or clip. Pump up the inner tube with an air pump so that it will be well filled but not so far as to blow out the extra valve stem. Dip the pipe bowl in the solution, and hold it steadily down on a table, bowl up. Then release the air from the inner tube by easing up on the spring clip. When the bubble has formed and is growing nicely under a small stream of air, leave the clip in that position. In this way the bubble will grow without jarring or shaking and reach its maximum size. Use a good

soap solution into which a little glycerin has been dropped.—L. B. Robbins, Harwich, Mass.

Natural Gas for Starting Automobile

I have had several cars of the same make and somehow none of them could be started easily in cold weather. The trouble was, however, readily overcome by connecting the natural-gas house line to the intake, as shown in the illustration. Set the choke and turn on the gasoline line for starting and also turn on the gas. A few turns of the engine is all that is necessary to start it. This method saves both battery and temper. The gas connection may be made at any convenient place so that

it will suck through the manifold. A convenient way to do this is to replace the elbow on the intake, on the vacuum-tank suction tube, with a tee; into this screw an ordinary gas cock, and above this a nipple, onto which the rubber tube from the house line can be forced. Note the small $\frac{1}{16}$ -in. hole in the nipple to allow air to be taken in with the gas.—Louis F. Busch, Cincinnati, Ohio.

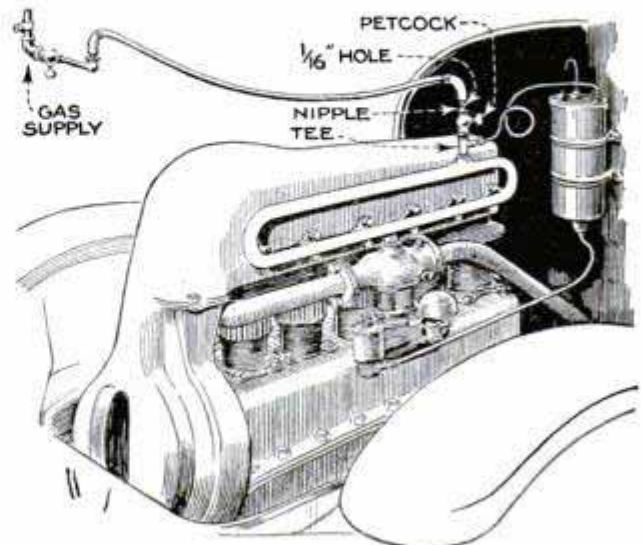

Using Natural Gas to Aid in Starting Auto during Cold Weather

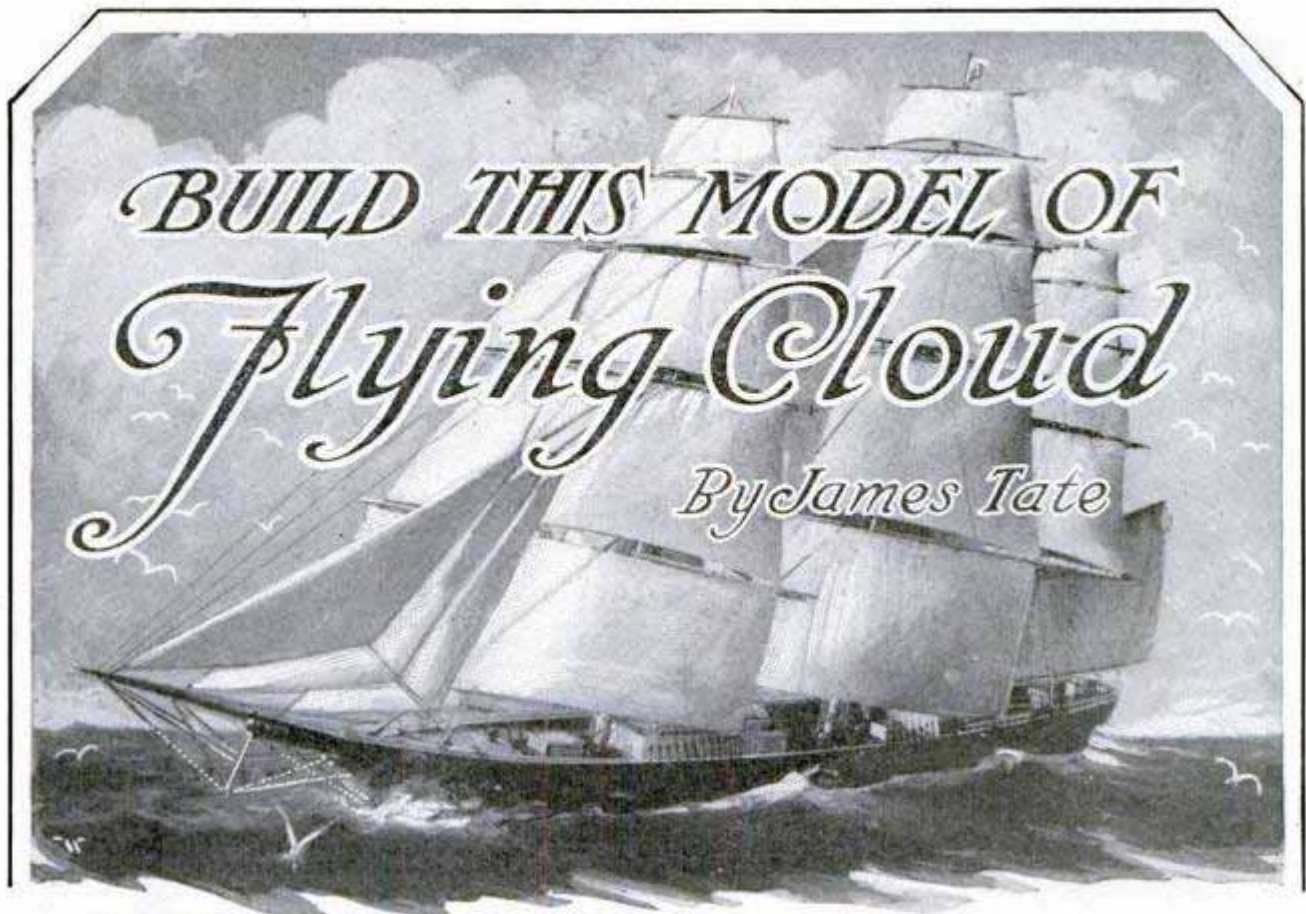

WITH the hull carved to shape, as in Fig. 19, the next step is the erection of the bulwarks. Cut a rabbet on each side of the quarterdeck, as shown in Fig. 18, and a similar one on each side of the after end of the foc's'le head. These rabbets should be about $1\frac{1}{4}$ in. long and a stout $\frac{1}{16}$ in. deep; the bottom of the rabbets should be cut in line with the deck edge. Before going any further, it will be well to mark in the deck planking. Mark center lines down the decks, and, with the dividers, lay off the planks on either side of the lines, $\frac{1}{8}$ in. wide. Rule pencil lines lightly along the decks, defining the planks. Cut a strip of wood 1 in. wide and $\frac{1}{16}$ in. thick, make one edge

when ruling and scoring the lines; the flexible wood will lie closer to the deck than a regular straightedge. Now take a putty knife or similar tool, and score in the planking lines as shown in Fig. 25. A scribe will do for this job, but the point must be slightly rounded, else it has a

tendency to follow the grain of the wood, and produce crooked "planks." The putty knife, used as shown, is an excellent tool for the job. After the deck lines have been scored in, stain the decks slightly with light-oak wood dye, made very light with turpentine. The object here is to get a deck that will look weather-worn yet "clean." The deck should

SHIP-MODEL PRIZES

FEW hobbies enable the amateur to produce such beautiful work with so few tools and such inexpensive material as ship-model building. To encourage such a worth-while and pleasant pastime, Popular Mechanics Magazine offers the following awards for the best models of the "Flying Cloud" made from plans published in this and subsequent issues:

First, \$100 cash and gold medal.

Second, \$50 cash and silver medal.

Third, \$25 cash and bronze medal.

Five awards, \$10 cash and bronze medal.

Five awards, \$5 cash and bronze medal.

Bronze medals also will be awarded for excellence in workmanship.

The contest is open to everyone, regardless of age or sex. The conditions are very simple, and full details will be supplied to every reader addressing the Editor, Amateur Mechanics department, Popular Mechanics Magazine, 200 E. Ontario st., Chicago.

be very slightly brownish-yellow. Don't leave the decks white; ships' decks were

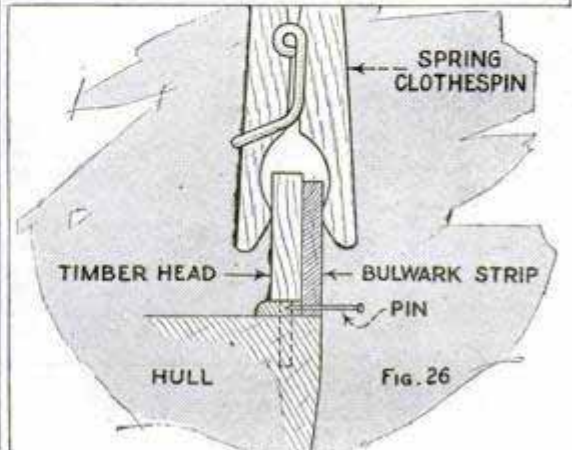
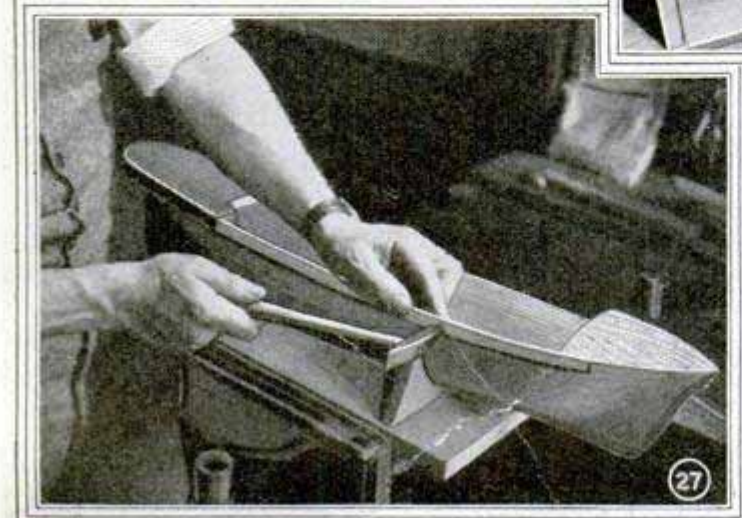
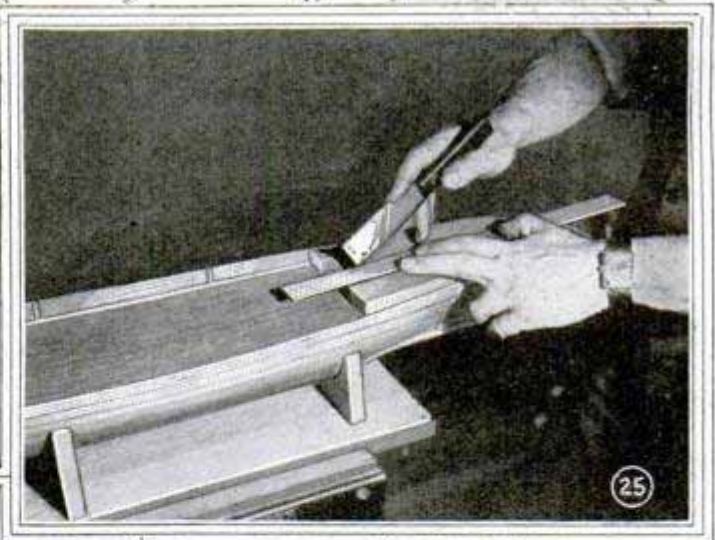
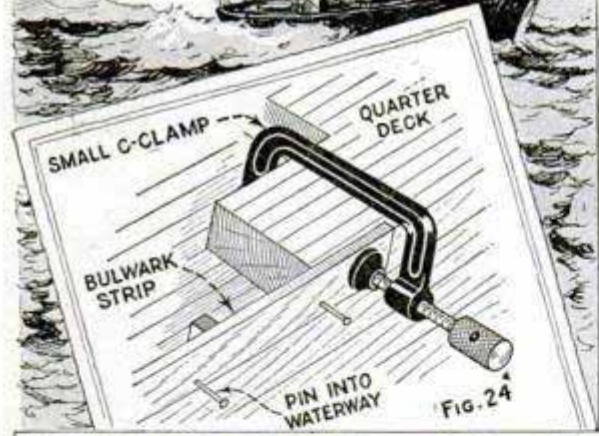
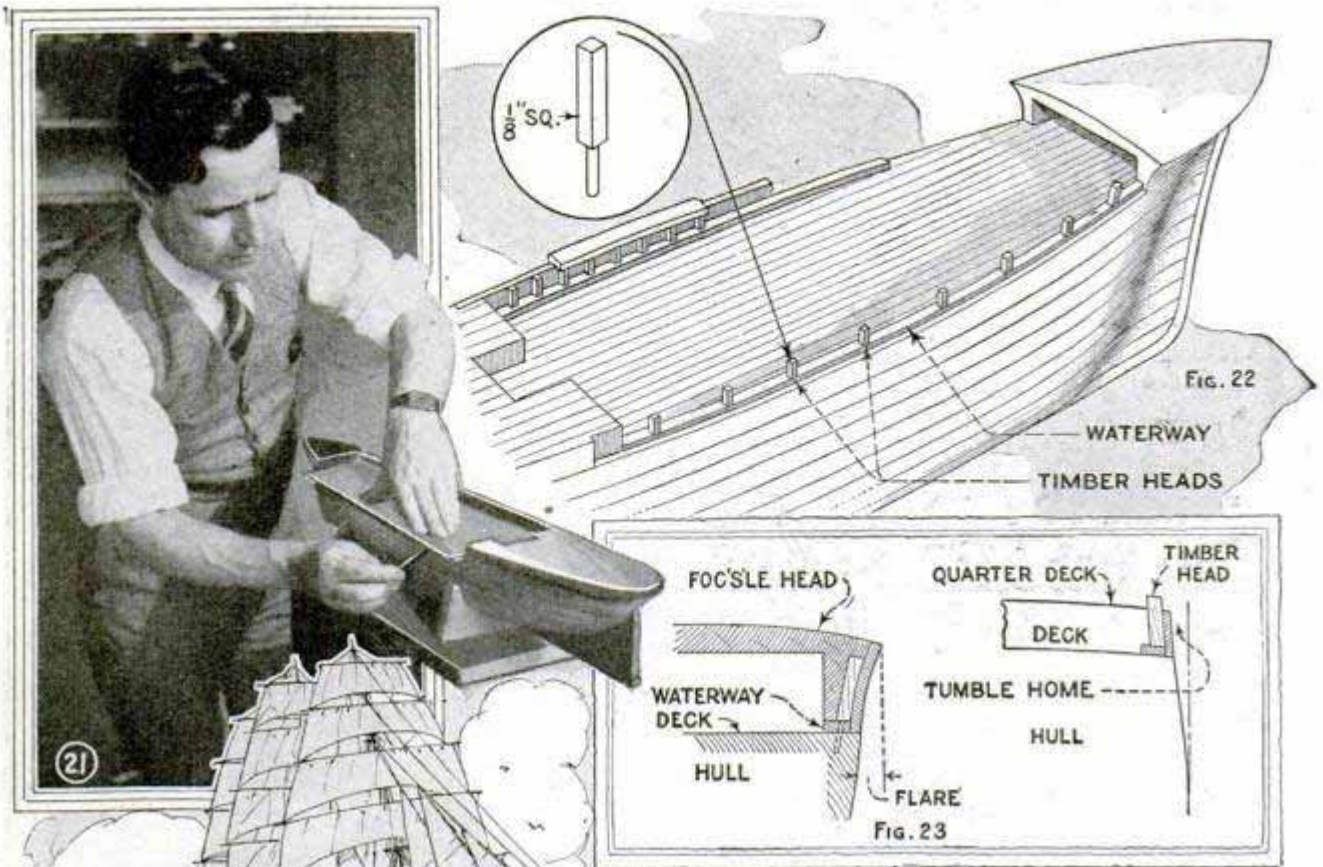

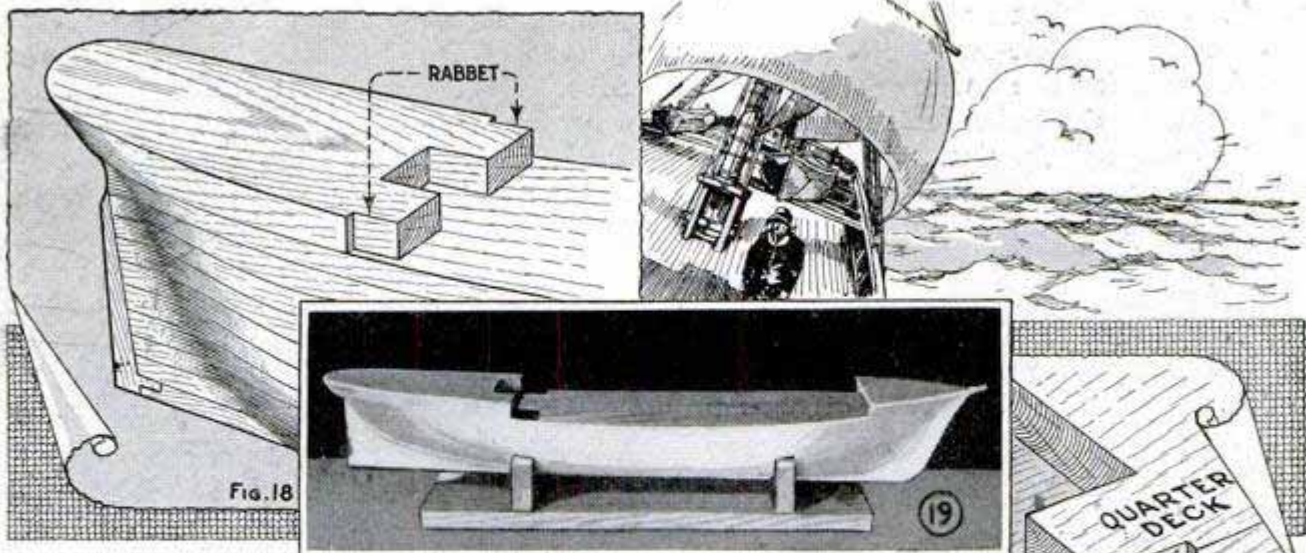

never so. After the stain has set, give the decks three coats of varnish, rubbing each coat down with the very finest steel wool; the last rubbing should leave the decks smooth, but not shiny.

Take a piece of wood, $\frac{3}{32}$ in. thick and about 3 in. wide, and cut it to length, so that it will fit snugly between the after end of the foc's'le and the forward edge of the quarterdeck, just back of the rabbets. Hold the strip down on the deck, projecting over the edge of the hull, as in Fig. 21, and run a pencil around the hull as indicated, to mark the shape of the deck edge on the strip. Cut this edge to the pencil line, and then, with the dividers set to $\frac{1}{4}$ in., run another mark along the strip inside the curved edge. Cut to this line, and you have a waterway strip, $\frac{1}{4}$ in. wide, which is glued to the deck, as indicated in Fig. 20, the outer edge of the strip being even with the back of the rabbets at each end, and an even distance from the edge of the hull all along. A few pins will assist the glue in holding. Fit a similar strip on the other side.

Make some $\frac{1}{8}$ -in. square strips of wood, and from them cut the timber heads, shown in Fig. 22, in the circle. The peg portion is $\frac{3}{8}$ in. long, and the square part 1 in. long. Here we digress a little. Amidships the sides of our model are approximately vertical and the bulwarks correspond. From amidships aft, the upper part of the hull leans inward or "tumbles home" as the nautical term has it, and the bulwarks tumble home in the same degree. From amidships forward the upper part of the hull curves outward, or "flares,"

and the flare becomes more pronounced the further forward we go, and, as the timber heads represent the upper part of the ribs in a real ship, they consequently follow the tumbling or flaring lines of the hull. (See Fig. 23.) So, in drilling the holes for the timber heads through the waterways, the flare or tumble home must be taken into account, and the holes drilled to correspond. When marking off for drilling, make the holes come so that the outer edges of the timber heads will be exactly on the outer edges of the waterways. Only four timber heads with the pegs are needed on each side; the remainder may be dummies, glued on later. There are 23 timber heads on each side, hence the pegged ones must be spaced so that, when the others are glued on, the spaces between all will be equal. Make the pegged heads the second and fifth ones from the foc's'le; one about amidships and the second one from the quarterdeck. Drill the holes and glue the heads in place, on each side.

Now cut a strip of wood a stout $\frac{1}{8}$ in. thick, long enough to reach from the outer end of the foc's'le rabbet to the outer end of the quarterdeck rabbet, and about 2 in. wide. Shape one edge very carefully until it fits the deck perfectly from rabbet to rabbet. This strip will form the bul-

wark. Get a dozen or so of wooden "applicators" or iodine-swab sticks from the drug store, for use as dowels. Glue the after end of the bulwark into the rabbet at the quarterdeck, clamping it as shown in Fig. 24; run glue into the ledge formed by the waterway and deck; glue the outer sides of the timber heads, and then proceed forward with the strip, as in Fig. 27, fastening it in place by pinning to the waterway as in Figs. 24 and 25, and clamping it to the timber heads by means of spring clothespins, as in Fig. 26. The timber heads will help spring the thin strip to shape forward and aft. At the foc's'le head, drill small holes and dowel the strip to the hull, Fig. 28. When the glue has set, remove the clamp at the after end and insert some glued dowels. Pins may be used instead of the applicators, but the advantage of the latter is that one can carve right through them, and this is of special value here, since the bulwark should run smoothly along with the hull

lines, and this usually necessitates some carving, filing and sandpapering at the ends. Now trim the top of the bulwark down until it makes a smooth curve from end to end with the sheer of the foc's'le and quarterdecks, and file the timber heads down, clamping them as in Fig. 29, while filing. Cut off and glue in place the remaining timber heads, clamping them to the bulwark with spring clothespins, spacing them equally and filing them down level with the top of the bulwark. Round off the inboard edges of the waterways, as in Fig. 30.

For work of this kind, get some packages of ordinary dressmakers' pins, and also a package or two of the very small pins known as "Lills." These are about $\frac{1}{2}$ in. long, and are essential.

It is wise, at this time, to paint the inside of the bulwarks, since they are hard to get at later. Give them three or four coats of white japan color, thinned with turps, then a final coat of eggshell-gloss

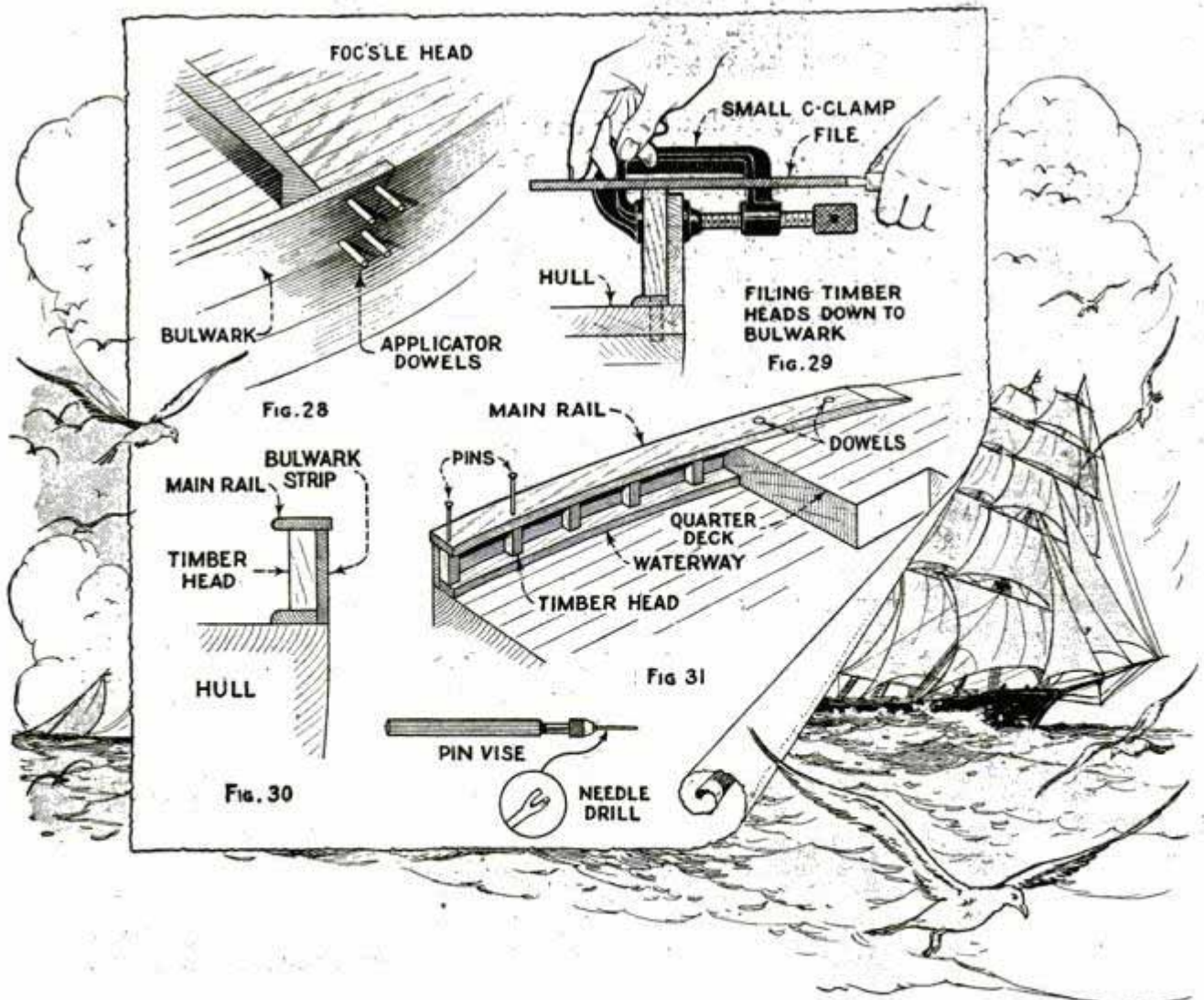

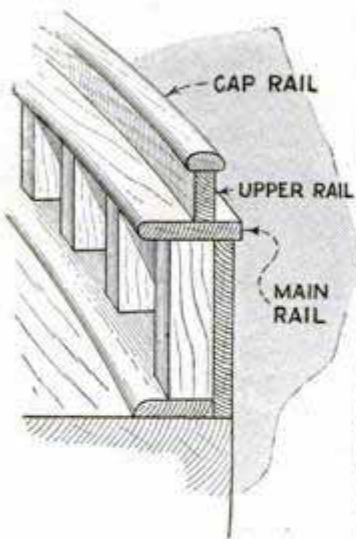

Fig. 32

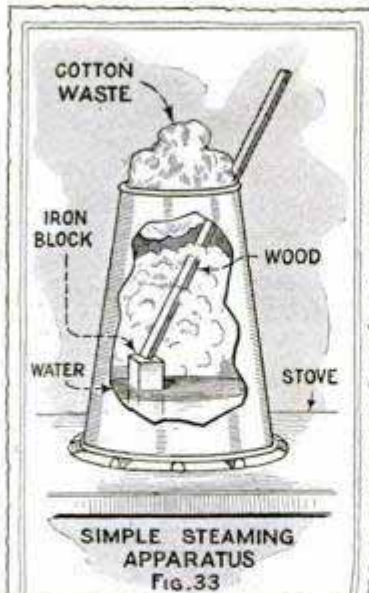

Fig. 33

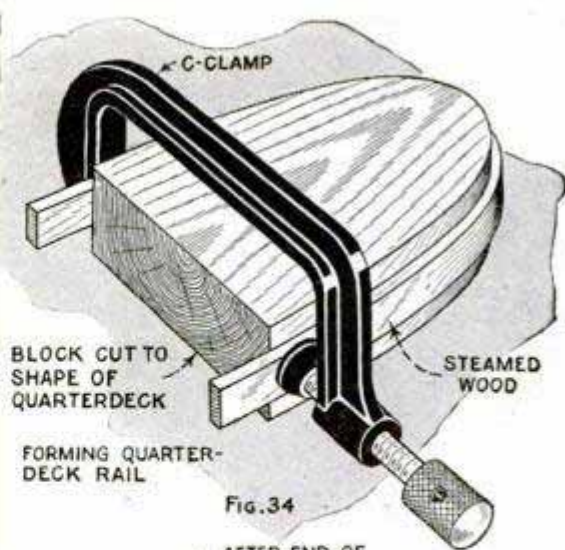

Fig. 34

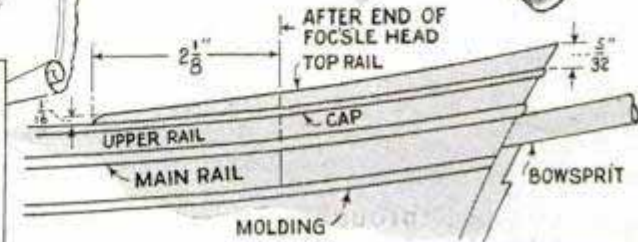
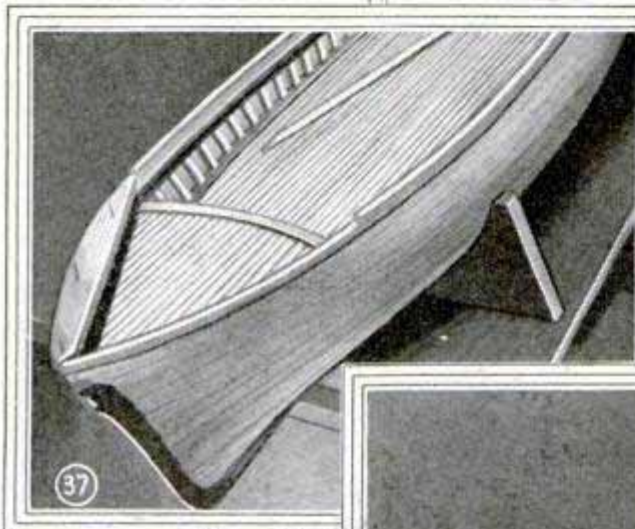

Fig. 35

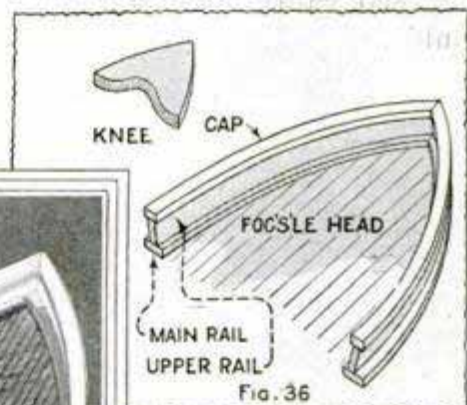
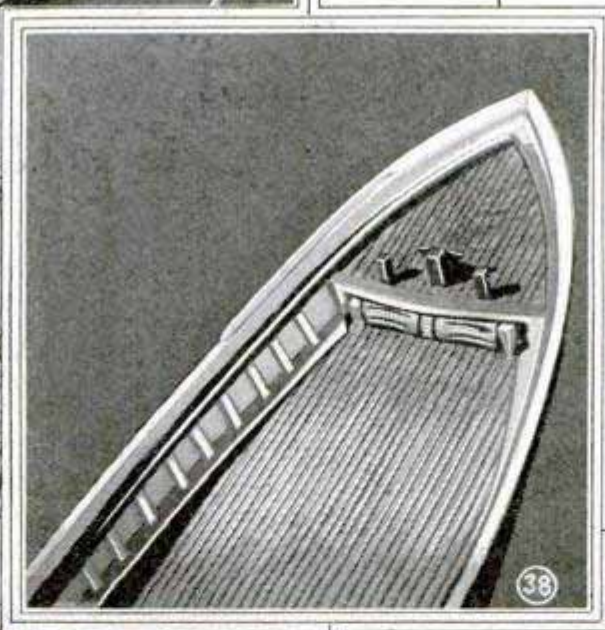
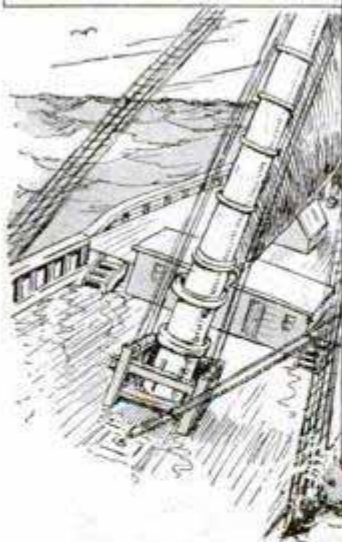

Fig. 36



38



white enamel. Don't use a full-gloss enamel anywhere on the model. The japan paint is known variously as "colors in japan," "carriage colors" and "japan colors" and they are simply what the names indicate: pigments ground in japan drier instead of in oil. They dry fast and flat. If they cannot be obtained locally, use

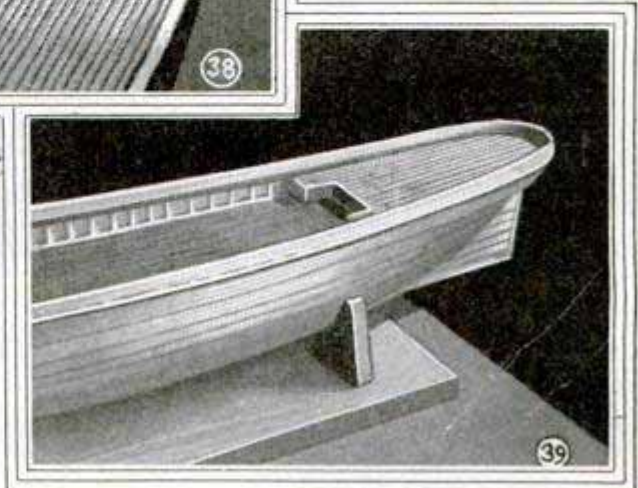

39

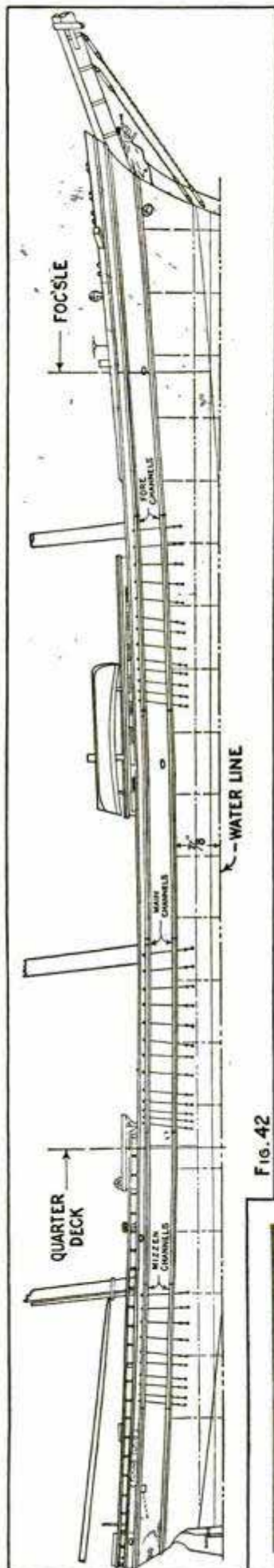

artists' oil colors, mixed with turps and japan drier. In addition to the white, a steel-gray will be needed, also a pure green, cream, brown, vermilion and ivory black.

Cut a strip of white pine, $\frac{1}{8}$ in. thick, $\frac{3}{8}$ in. wide and 16 in. long, for the main rail. Starting 3 in. back on the quarter-deck, glue and dowel the strip down as in Fig. 31, allowing the outer edge to project $\frac{1}{16}$ in. over the hull edge. Carry the strip forward, gluing and pinning it to the timber heads and the bulwark, and keeping the projection $\frac{1}{16}$ in. over the latter; pin into every timber head. The strip may be a little hard to bend at the forward curve, but patience will do it. It should end, forward, $2\frac{3}{4}$ in. back of the foc's'le, just on the curve. Scarf or bevel the ends as shown in Fig. 31. Take a wide strip of wood, of the same thickness as the rail, lay it down so that it reaches from the forward end of the rail to a point beyond the bow, Fig. 37, and mark the curve of the bulwark and foc's'le deck on it. Trim to this line, mark $\frac{3}{8}$ in. inside the trimmed edge and cut the inner curve. Glue, pin and dowel this to bulwark and foc's'le deck to form the continuation of the main rail. Cut the portion of the rail running around the quarterdeck in the same manner, then file and sand the joints. Fig. 45 shows part of the rail around the quarterdeck cut and ready for gluing.

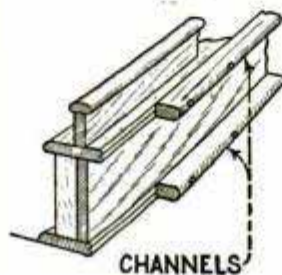

FIG. 43

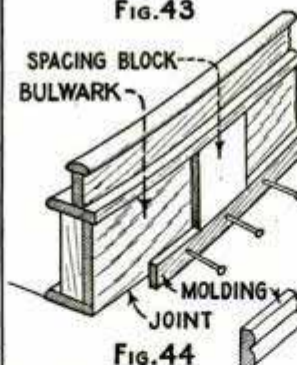
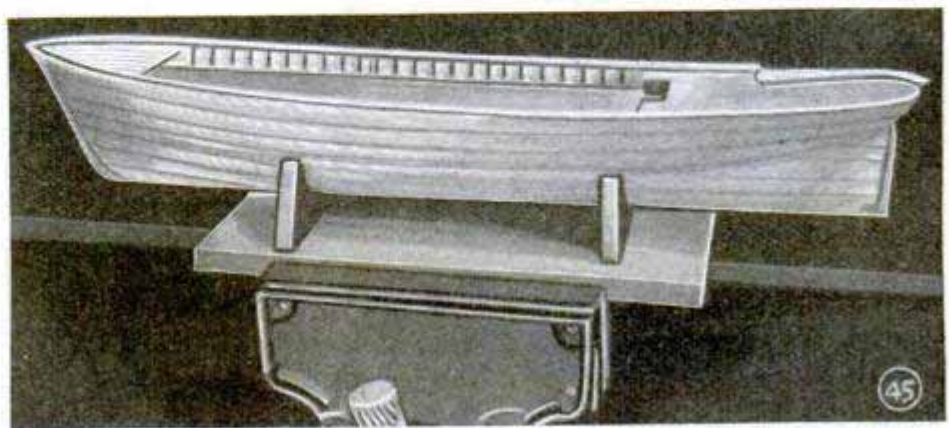

FIG. 44

FIG. 42
FITTING MOLDING OVER
JOINT BETWEEN BULWARK
AND HULL

Fig. 45 shows part of the rail around the quarterdeck cut and ready for gluing.

Above the main rail, as shown in Fig. 32, is an upper rail (sometimes called topgal-lant rail) and a cap or cap rail. The upper rail is formed from a piece $\frac{1}{16}$ in. wide and $\frac{3}{32}$ in. thick, glued and pinned to the main rail, $\frac{1}{16}$ in. back from the outer edge of the latter. Make the midship portion the same length as the corresponding part of the main rail, and scarf the ends for joints like the main rail. The upper rail around the quarters and the stern is best bent to shape as shown in Figs. 33 and 34. The receptacle used for steaming the strip should be deep enough so that the center will be thoroughly pliable, and the wood should be steamed until this will be attained. It is then clamped



around a piece of wood cut to the same shape as the quarterdeck, and left for twenty-four hours to dry. Since the upper rail on the foc's'le head should carry out the flare of the hull, it is best to cut it from a wider piece of wood, in the same manner as the main rail was fashioned, then carve it carefully on the outboard side to follow the flare of the hull lines, carving the inboard side afterward until the strip is of the proper thickness. The forward end of the first portion glued on should also be flared as it approaches the foc's'le, so that it will make a fair joint with the foc's'le rail. This may be accomplished by beveling the underside slightly, so as to make the top lean out. The flare at the bow is a little too extreme to make this easy to do with the foc's'le rail, hence the advice to cut this from a solid piece. A small knee, Fig. 36, is cut and fitted in the joint at the bow, down on the waterway, and the bow ends are glued and pinned to this.

When pinning small pieces like this, use the "Lills," and where there is danger of splitting the piece, screw a small C-clamp on the wood at the point where the pin is to be driven, and drive the pin down between the jaws of the clamp. The secret of driving these small pins straight is to use a very light hammer, and only the lightest blows; they will bend at once if struck hard. Where possible, a leading hole should be drilled for the pin, to help in keeping it straight. If small drills are hard to obtain, get a package of assorted needles, choose the size you want for the drill, and snip the eye off, leaving two little projecting prongs, as shown in Fig. 31. Take a three-cornered oil slip and sharpen the prongs in the same way as a flat drill is sharpened, slip the needle drill into a pin vise, and you will have the handiest drill possible for fine work. The modeler should have two sizes of the pin vises; one holding a drill around No. 65, the other the small needle drill. The larger drill will make leading holes for the larger pins.

When gluing the various pieces forming the bulwarks and rails together, be sure that both surfaces to be glued are well coated with the glue, but do not apply too much; then, when the pieces are pinned together and before the glue has

set, run over the joints with a sharpened toothpick or similar tool and remove the surplus glue. Nothing looks worse than to see blobs and beads of glue in the joints,

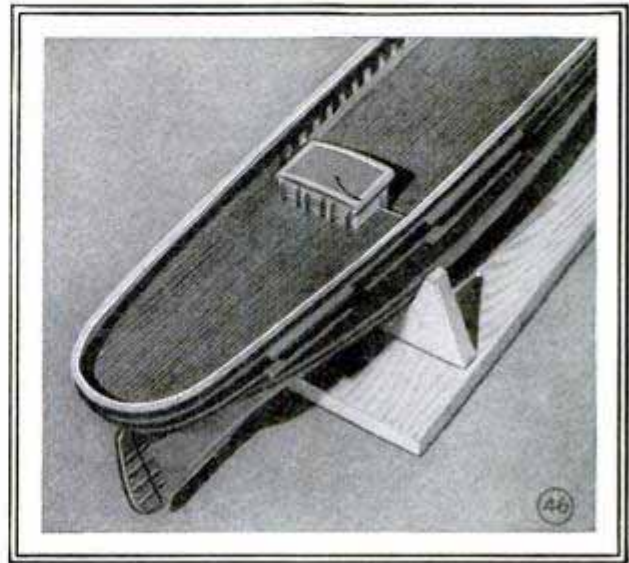

and it is only a matter of a second to remove the surplus while the glue is still soft.

The cap rail is a stout $\frac{1}{8}$ in. thick and $\frac{3}{32}$ wide. The midship and foc's'le portions are easy to bend and apply "cold," using the points of small pins for fastenings, but the after part must be steamed and bent. Use the same block as before. Since it is difficult to bend a thin strip in the direction of its width without having it buckle, cut the piece to be bent $\frac{5}{32}$ in. square, steam and bend it, then, after it is glued and pinned in place, file it down to the same thickness as the rest of the cap. Make scarf joints in the cap as in the other parts. Sandpaper the cap and the inboard edge of the main rail to the shape shown in Fig. 32.

One more rail must be added; the top rail on the foc's'le. This must be as thin as it can be made without splitting in applying, not over $\frac{5}{64}$ in., and better $\frac{1}{16}$ in. Remember that in this scale ($\frac{1}{8}$ in. to the foot) $\frac{1}{16}$ in. represents 6 in., and a 6-in. timber is a pretty "hefty" one. This rail runs from the bow to a point on the cap $2\frac{1}{8}$ in. aft of the foc's'le; it is $\frac{5}{32}$ in. high at the bow and $\frac{1}{16}$ in. high at the after end. Notice, in Fig. 42, that the bow ends of the upper rail and this top rail slope forward, and make allowance for this in fitting. Some readers may find it easier to carve the top rails from the solid in the same way as the upper rail for the foc's'le,

W. H. Anderson
 Modeler
 1000 Broadway
 New York City

but, with care, they can be formed from thin strips, bent and twisted into place.

After sanding everything smooth, paint the inboard part of the main rail steel-gray all around. (See Fig. 38.) Paint the inside of the upper rail, the cap, the knee and the top rail white. The outside of the upper rail is painted black, and the cap is white all over, thus making a narrow white bead all around the outside of the ship. Do not paint the outside of the rail just yet. Notice the flare of bulwarks and rails, in Fig. 38.

The next step is to apply the molding, Fig. 44. This is a $\frac{1}{8}$ by $\frac{1}{8}$ -in. strip, covering the deck and bulwark joint, and running parallel with the main rail from stem to stern. To insure that they are parallel, use a small block as a spacer between the two when pinning and gluing on the molding, as indicated in Fig. 44, sliding the block along as the molding is fastened. Steam the molding piece for running around the stern. After the glue has dried, cut off and drive in the pins, then take a small triangular or knife file and file grooves right down the center of

both molding and main-rail projection, so as to bead them, then sand until the molding and rail look as in the detail, Fig. 44. This is a small point, but it makes a great difference in appearance of the moldings.

The channels are the timbers on the ship's side that carry the ends of the mast shrouds, and they are shown in Figs. 42 and 43. They are $\frac{1}{8}$ in. thick and $\frac{5}{32}$ in. wide. The fore and main channels are $3\frac{7}{8}$ in. long and the mizzen channels, $2\frac{1}{2}$ in. long. See also Fig. 46.

The foremast comes $2\frac{7}{8}$ in. aft of the end of the foc's'le, and the forward ends of the fore channels are $\frac{1}{8}$ in. forward of the center line of the mast. The mainmast is $8\frac{5}{16}$ in., center to center, from the foremast, and the forward ends of the main channels are $\frac{1}{8}$ in. forward of the center line of the mast. The mizzenmast is $6\frac{5}{8}$ in., center to center, aft of the main, and the mizzen channels are $\frac{1}{8}$ in. forward of the center line, at their forward ends. Glue and pin these on strongly, using large pins, well driven in, at each end. Fig. 44 is one-fourth the size of the model.

(To Be Continued)

Latches Hold Cellar Doors Upright

Many devices have been made for holding outside cellar doors open and in such a position that

the opening will be guarded from both sides.

However, in most cases these devices are of such a cumbersome nature that they make no appeal to the busy home owner. The trigger lock, shown in the illustration, is free from the usual objections, and can be easily installed by anyone. Upon the inside of each

door, at the points shown, screweyes are placed, through which is passed a $\frac{1}{2}$ -in. rod with a lever attached to the outer end. Two holes are drilled into the siding of

the house directly above the hinged side of each door, and the trigger locks are completed. When the doors are opened, the levers on the underside are pushed forward so that the sliding rods enter the holes in the siding and lock the doors in a vertical position. When released, the levers will not interfere with the closing of the doors.

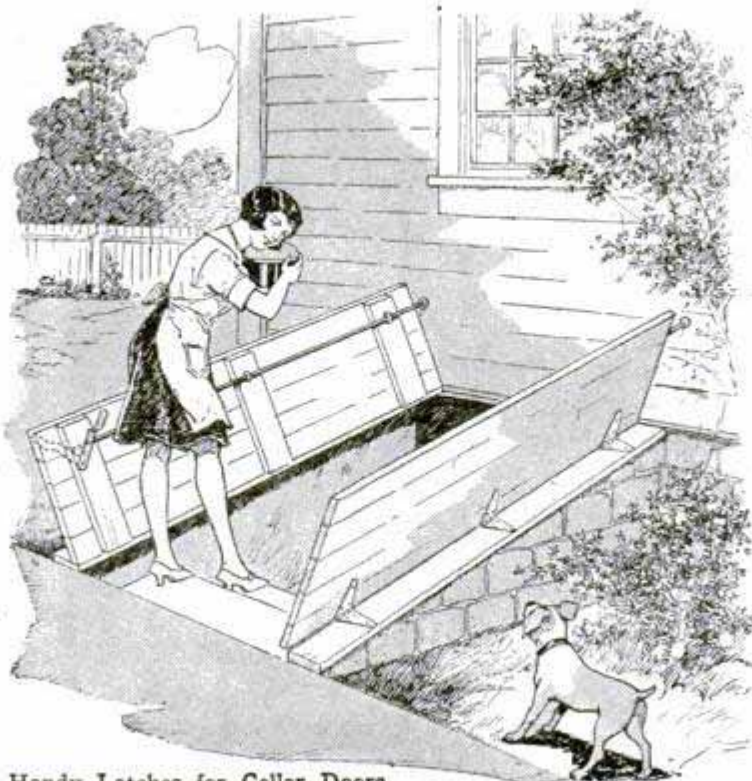

Handy Latches for Cellar Doors

Ent. No. 8. Idenrikem
 Arroyo, Wis.

Locking Ford Car Windows

The older Ford closed cars with the windows controlled by straps have no method of locking the windows. The doors can be locked by the use of locking handles but the window can be opened from the outside by prying the lower edge up from the iron strip on which it rests. A good lock for such windows can be made by drilling a $\frac{3}{16}$ -in. hole through the wood under the window frame, and into the space in which the windows are lowered. When leaving the car, large nails are inserted into the holes and the windows then cannot be dropped. The holes through the upholstery can be given a neat finish by using the parts of curtain fasteners that are clinched into the cloth of side curtains. The ball-headed screws are not used. These fasteners are attached to the cloth either by clinching them into it like an open-car side curtain, or by drilling two small holes, and using two fine wood screws.—E. T. Gunderson, Jr., Humboldt, Iowa.

Garment Hanger Keeps Moths Away

A good moth-proof garment hanger can easily be made from an ordinary wooden hanger by tacking a mothball receptacle on the underpart, as shown in the illustration. This will in no way interfere with the use of the hanger. A sheet of heavy

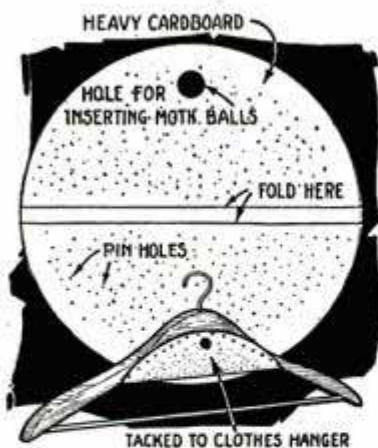

cardboard is cut to a disk, the size of which depends on the size of the hanger. It is bent at the bottom, and a 1-in. hole is cut in one side to insert the mothballs. A number of small holes

also are punched in the disk, so that the fumes of the balls will more easily penetrate the garment.

Spots on varnished surfaces often can be removed by rubbing them well with a soft rag saturated in boiled linseed oil.



Barrel-Stave Sled Requiring Considerable Skill to Balance It

Barrel-Stave Sled

A barrel-stave sled that requires considerable skill to manage and provides great sport is made by attaching a seat well back of the center of the barrel stave as shown in the drawing. On such a sled there is naturally no method of controlling it other than by movements of the body or feet, but once the trick of managing it is mastered, it is controlled as easily as a bicycle when riding without steering.

Door Silencer for the Sick Room

Slamming doors are very annoying to sick persons. The trouble can readily be remedied in a simple manner by means of a heavy rubber band or a section, cut from an old inner tube,

that is slipped over the door handles as shown in the drawing. This makes a good silencer and shock absorber, which will be highly appreciated by the patients.—Frank N. Coakley, Buffalo, N. Y.

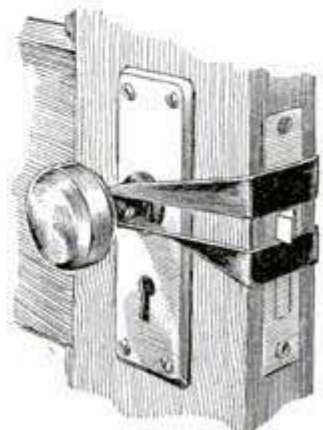



Handy Shaving Mirror for the Camp Which Can Be Attached to Tree or Post

Campers' Shaving Mirror

Campers in the woods can make a serviceable holder for their shaving mirror that can be instantly clamped to a tree or post as shown in the illustration. Remove the adjusting rod from the back of a round rear-vision mirror used on an auto. The attachments differ somewhat for different makes of mirrors. Cut out a section of a small auto tire, about 3 in. wide, and drill or punch suitable holes through the middle of the tread, into which the mirror lugs can be inserted and pinned from the inside of the shoe. This completes the mirror clamp, which can then be pushed over a small tree at any desired height for shaving and other purposes.

Filing Cabinet Aids in Kitchen

I recently came into possession of a sheet-metal filing cabinet, which had been a piece of office furniture. This cabinet makes a dustless, mouse-proof and bug-proof grocery and food container for my kitchen. The drawers close tightly and are of various sizes, the smaller ones being at the top. The shallow top drawers make excellent storage room for cookies and layer cakes, as they keep in the moisture. The next larger ones hold cereals, corn-meal and bread. The bottom one is for

sugar. While I have to stoop to reach the lower drawer, the inconvenience is compensated for in that it can be shut with the foot. The tight construction of these compartments does away with waste, and they are absolutely clean. I painted the outside to match the color scheme of my kitchen. The filing cabinet is a space saver, too, as compared with the commercial types of kitchen cabinets. It stands 47 in. high, 18 in. deep and 15 in. wide.—Miss Hilda Ellyson Allen, Onawa, Iowa.

Eliminating Alcohol Odors

The odor of alcohol, when used as an anti-freeze solution in the winter, is more or less objectionable, especially in a closed car or in a touring car when the curtains are used. The odor is caused by the escape of vapor from the overflow pipe of the radiator. To eliminate this odor from the car, get a length of rubber tubing large enough to fit the lower end of the radiator overflow pipe and fasten it to the latter. Let the tubing extend under the front side member of the frame and for about 6 in. above the bottom edge of the frame side member, where it should be fastened to the front-fender support bracket with tape or a small clamp, as shown in the drawing. In this way the vapors will all be carried away into the outer air and

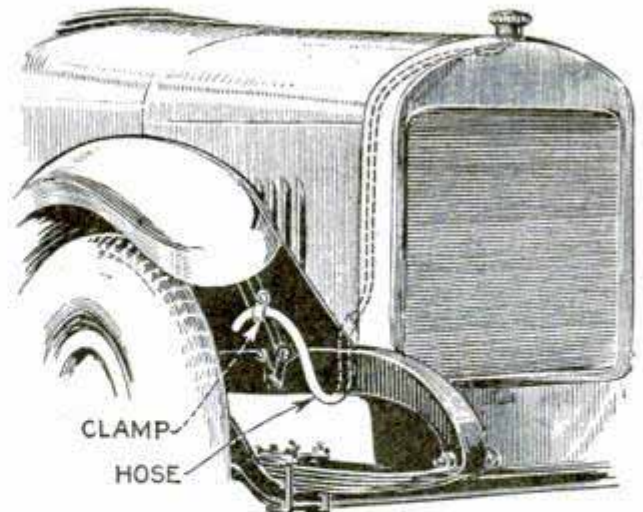

Length of Rubber Tubing, Attached to Overflow Pipe, Disposes of Alcohol Odors

will not reach the inside of the car.—G. C. Douglas, Raleigh, N. C.

☛ A sash lock can be used as a bolt on a door, if the casing is flush with the surface of the door.

Loading Box Aids Field Work with Camera

By JOHN EDWIN HOAG

SINCE cut film has supplemented glass plates for photographic work, photography has taken one of the greatest forward strides after dry plates displaced wet ones. Every photographer, however, if he does much field work, is confronted with the problem of carrying a sufficient number of holders, or reloading them on locations where he does not have access to a photographic dark room. Roll film is

sands of commercial photographers, and others who do photographic work upon a serious basis, must use either plates or cut film, and with them, loading or unloading holders in the field is always a problem.

The writer was recently called upon to do certain photographic work in a region where he was to make some 300 negatives, and where not once during a period of six

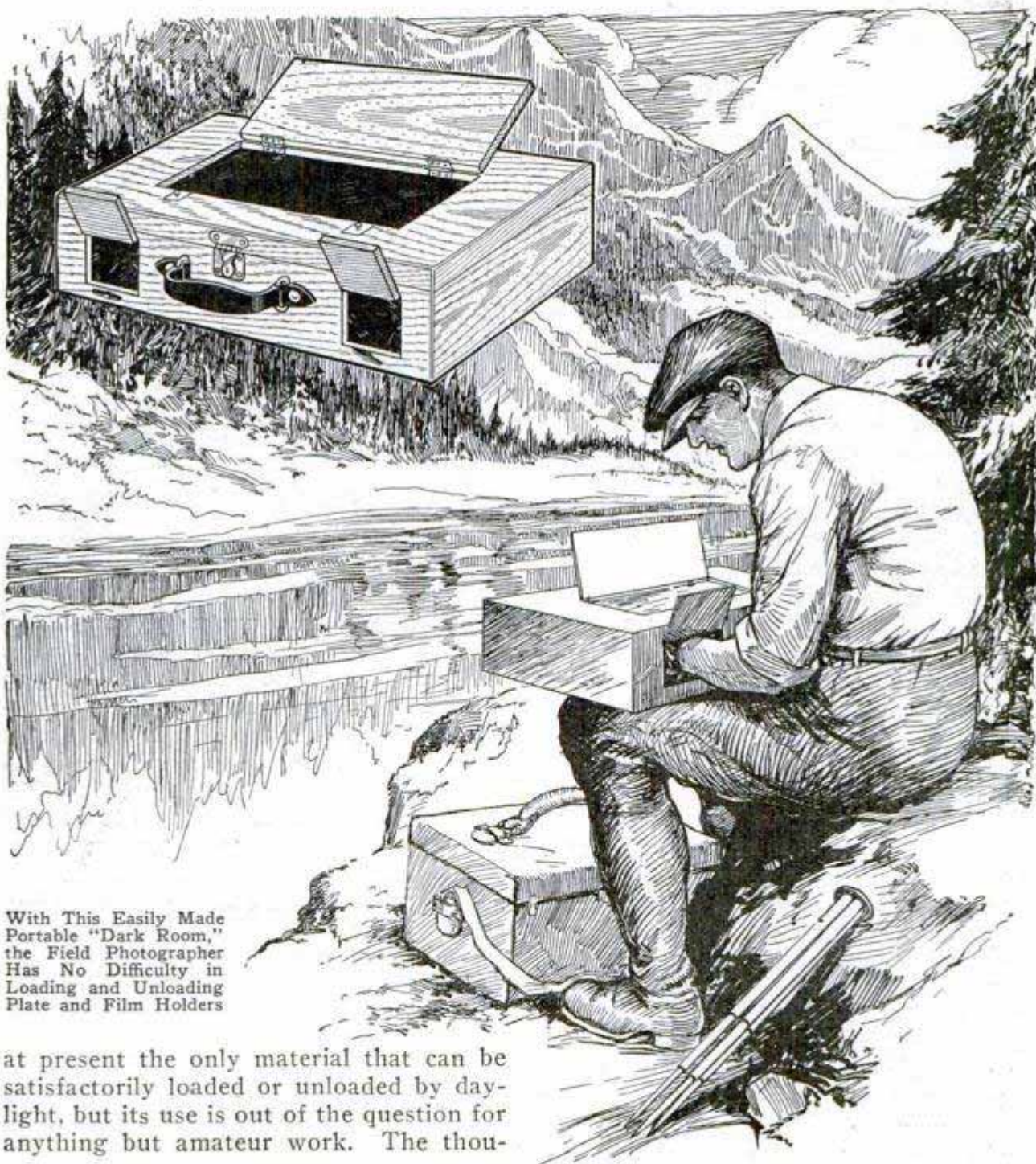

With This Easily Made Portable "Dark Room," the Field Photographer Has No Difficulty in Loading and Unloading Plate and Film Holders

at present the only material that can be satisfactorily loaded or unloaded by daylight, but its use is out of the question for anything but amateur work. The thou-



Above, Details of the Loading Box; Below, the Box Serves as a "Carryall," When Not in Use as a Dark Room

weeks did he have access to a photographic dark room. Obviously, carrying 150 loaded holders would have been out of the question (two negatives in each holder). Moreover, the use of roll film would have been impractical. Glass plates would have been impossible because of the weight and bulk, and vulnerability; therefore, the use of cut film was the only practical solution. There, again, the problem of loading and unloading the holders in the field, had to be solved.

I therefore went to work in my home workshop to develop some sort of a device that would permit the loading and unloading of cut film in the field, independent of dark rooms, or without being compelled to wait for night to do the job. After much experimenting and various trials and errors, the loading box shown in the accompanying illustrations was made up. It weighs but 8 lb., is easily portable, and turns the trick to perfection. Its use enabled me to produce 300 perfect negatives, with only six holders. I was able to load and unload these holders by daylight anywhere in the field, and to mail

the exposed negatives home for development as fast as they were put through the camera. This obviated the necessity for developing negatives under the unsatisfactory conditions one faces in the field, or taking a chance with some doubtful local laboratory technicians.

The box is made of basswood, carefully mortised, finished in cherry on the outside, and painted black inside. It is 22 in. long, 7 in. deep, and 18 in. wide. This gives ample space for handling the 5 by 7-in. cut films with which I was working. For handling larger negatives it would be easy to increase the size of the box. The box has a carrying handle like a suitcase, so it can be transported with no more

difficulty. It is also provided with means for handling panchromatic negatives, which must be loaded or unloaded in total darkness. I used more than 100 panchromatic negatives, loading and unloading them within the box, and did not have a failure with one.

Two square holes are cut in one side of the box, and fitted with hinged covers. To the inside of the holes are tacked and glued cloth armlets, made of heavy, light-tight black sateen and fitted with elastic wrist bands. A rectangular opening is cut in the top of the box and rabbeted to hold a red glass, and a lid is hinged to fit over the glass. When in use, a package of unexposed cut film is placed inside the box, on one side, and an empty cardboard box on the other. The film holder is placed in the center between the armlets, the lid closed, and the hands thrust through the armlets. The exposed film is taken from the holder and transferred to the empty box, then the holder is reloaded from the fresh package. The operator can easily see what he is doing through the ruby glass in the top.

Top for Aquarium

In order to prevent my goldfish from leaping out of the aquarium, which they tried occasionally, I made a cover for the top of the glass bowl. The cover is nothing more than a piece of ordinary mosquito wire screening stretched over a pair of wooden embroidery hoops in the same way that the ladies adjust a piece of cloth when they do embroidery work. After the screening was placed upon the smaller hoop I forced the larger hoop over it until it was only halfway in place. Then the wire screening is trimmed off neatly about $\frac{1}{8}$ in. from the edge of the hoop. When the larger hoop is forced all the way down into proper position, the entire cover is as tight as a drum without a single sharp end of screening protruding beyond the edge of the hoop.—W. C. Michel, Jersey City, N. J.

Use for Old Valve Springs

The illustration shows a number of different ways in which old valve springs can be made to give additional service after they have been discarded from the car. The ends of the spring can easily be bent into the required shape by heating them with a blowtorch or bunsen burner and

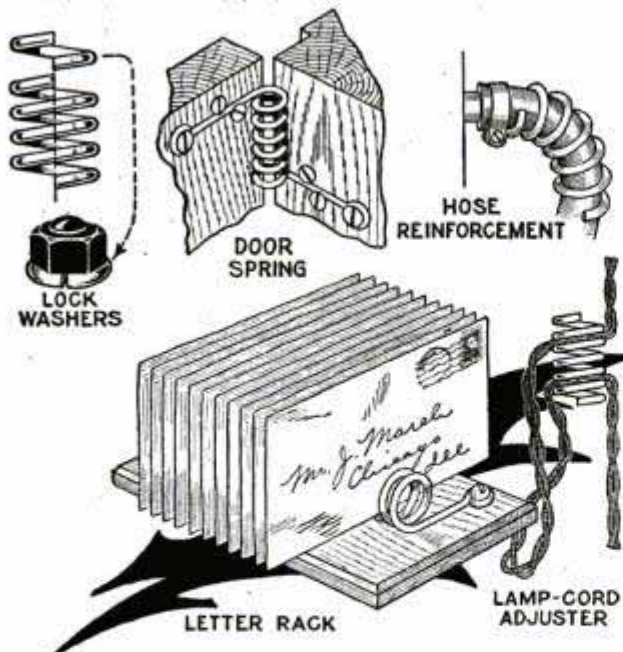

Old Auto Valve Springs Can Be Put to Various Uses around the Home

bending them while hot. After being bent, the ends should be heated to a dull red heat and plunged into cold water or oil to restore the temper.

*Harold Jackson
Route #1
Rushville, Ill.
4, Dec 14*

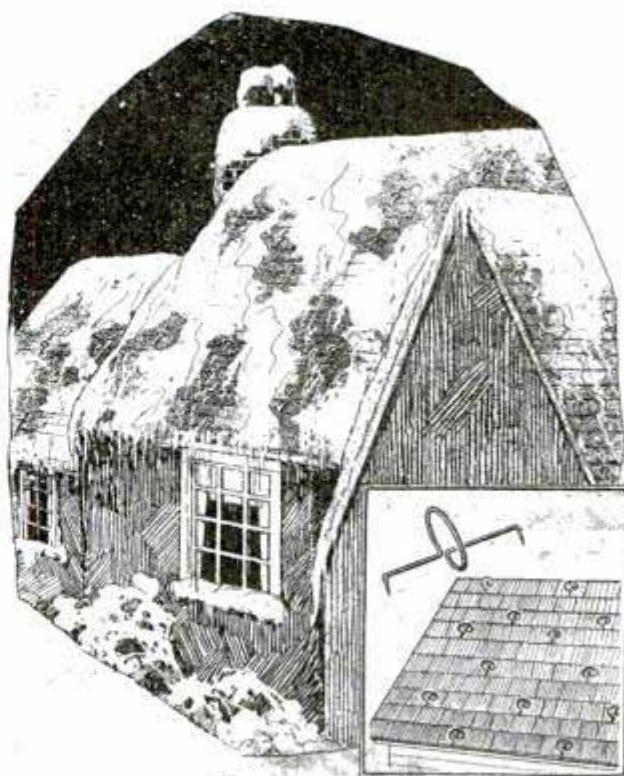

Small Wire Loops Attached to Roof Prevent Dangerous Snowslides

Wire Loops Prevent Snowslides

Where a steep roof overhangs a sidewalk or other passageway, there is danger in winter from snowslides. To obviate this trouble one home owner utilized some wire devices, as shown in the drawing. A number of 18-in. lengths of No. 10 wire are pointed at each end by cold hammering on an anvil and afterward bent in the manner described. The nail points of each device are driven into the roof with a blow or two of the hammer, and, with the loops thus attached to the surface, about 10 ft. apart, the snow or ice will remain stationary until it melts.

Spraying Lath Speeds Work

A Wisconsin contracting carpenter claims to have greatly increased the efficiency of his men while engaged in lathing, by merely spraying the bundles of lath with water as they are opened for use. Bundles of pine or hemlock, as they come from the mills or yards, are full of fine, loose splinters that often penetrate the workmen's hands, causing considerable annoyance. Spraying them with water not only softens the splinters but prevents loose particles of wood and dust from flying about when the laths are nailed on.

Auto Steering Wheel on Bicycle

The usual type of bicycle handlebars were not satisfactory to Paul Webber of



Old Automobile Steering Wheel Substituted for the Customary Handlebars on Bicycle

Bedford, Mass., so he removed them and substituted a steering wheel taken from an old Ford. This, he says, is much better than the customary handlebars.—Arthur F. Egan, Boston.

Steam Removes Wall Paper

I have just accomplished a difficult feat in the removal of paper from the wall of a room in which the first paper had been varnished after it was put on, about 40 years ago, and then papered over that thickness one to three times. The last thicknesses resisted strongly because the paperhanger apparently had used a little glue in his paste when he hung the paper. Warm water was used, but that was a slow process except where there was but one thickness over the varnished paper. I tried a commercial preparation to soften the

outer layers, as well as the varnished layer, but it was even then a very slow process. I finally conceived a plan to soften the paper with steam and this worked to perfection. I took a small teakettle and boiled the water on the stove. I filled the kettle about one-quarter full so that the steam would come out of the spout freely. Then I wired the kettle to a one-burner electric stove and switched the current on full. The kettle continued to boil and emit a full stream of steam. I then placed the nose of the spout within $\frac{1}{2}$ in. of the paper and the steam penetrated very readily, permitting the removal of the paper with a putty knife or scraper. The outer layers came off readily, and the varnished paper was softened so that I could work continuously. The electric cord was plugged in the baseboard socket and the wall sockets so that I could reach every part of the wall. As the kettle handle prevented steaming the paper near the ceiling, I added a short piece of rubber tubing at this point, and finished the work in a short time.—Harry E. Gifford, Medford, Mass.

How to Level a Clock

Most clocks do not run well unless they are set exactly level and this is sometimes a difficult thing to do, especially if one has no level. Most people raise one side of the clock up by means of a piece of cardboard or bits of paper stuck under the feet, but these often shift. A better method is shown in the drawing. Drive four small round-head screws in the bottom of the block and adjust them so that the clock stands perfectly level. Set the clock on a piece of cloth or felt to prevent the screw-heads from marring the mantel top.

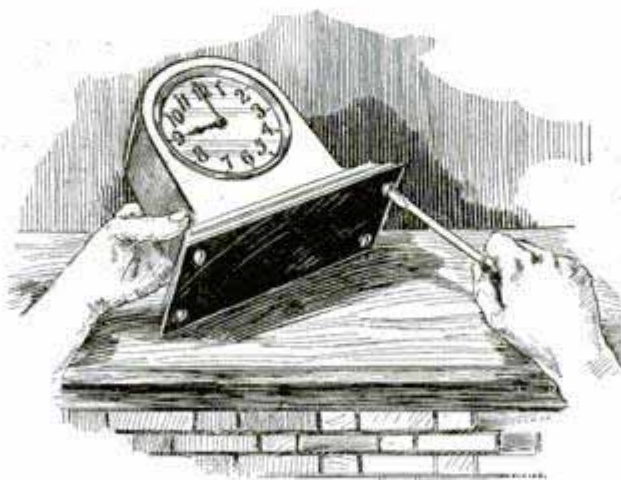

Round-Head Screws in Base of Clock, When Properly Adjusted, Make It Stand Level

Split an inner tube and cut cross-ways in two pieces. Tack or glue the pieces together, one on top of the other. This mat saves foot ache when ironing.



All Shop Notes published in 1927, in book form—Fifty Cents—from our Book Department

Insulating the Hot-Water Tank

By E. E. SCOTT

WHY place a radiator in the cellar? That is just what you do when you permit the plumbing contractor to install the hot-water tank in your new house, without covering it to prevent loss of heat. The usual 40-gal. dwelling-house tank will radiate sufficient heat to keep a 10 by 12-ft. room comfortably warm. In so doing, it causes the temperature of the water in the tank to drop about 20° below that at which it enters the tank. Furthermore this heat is not needed in the basement as the heater itself will radiate, unavoidably, sufficient warmth to keep that part of the house comfortable.

If you would have more and hotter water and save some fuel besides, cover the tank with as-

bestos cement. But, you ask, how can it be made to stick to such a smooth surface as that of a galvanized-iron water tank? First, buy sufficient wire window screening to cover the tank completely except for the top and bottom. Bind this screening around the tank with bare-copper or soft-iron wire of about No. 18 gauge and

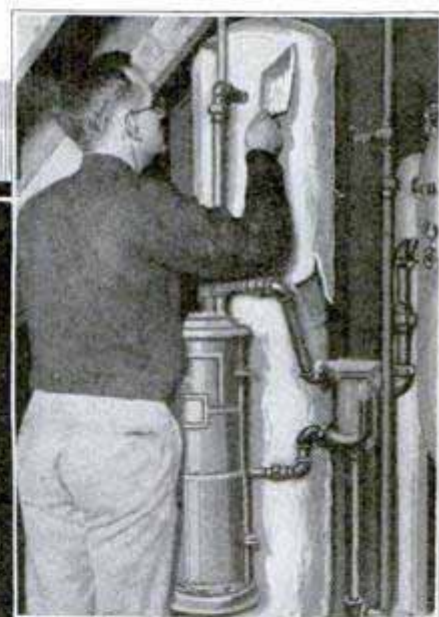
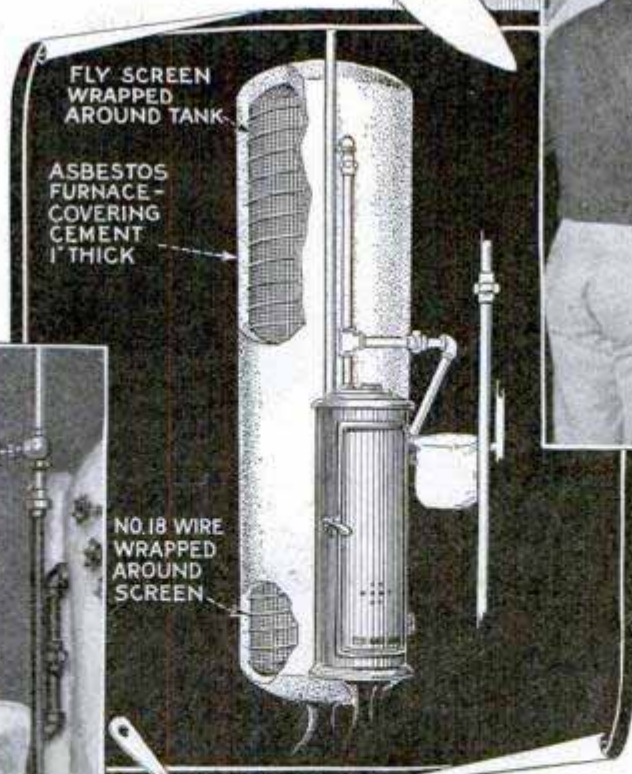
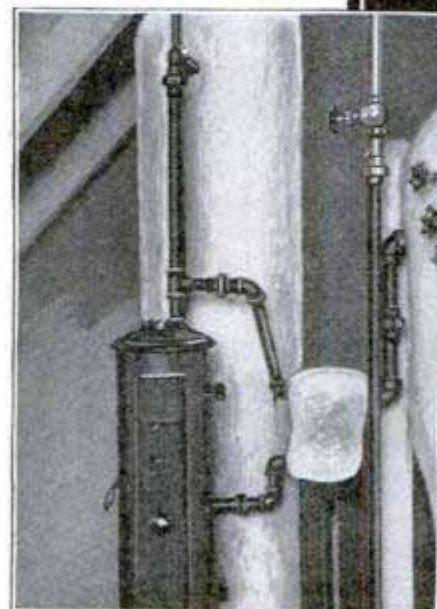

Upper Right, Applying the Asbestos; Center, How the Covering Is Anchored; Left, Completed Job; Note the Covered Heating Coil between the Tank and Boiler

draw the wire up as tightly as possible. Next purchase about 30 lb. asbestos "furnace-covering cement" from a hardware-supply house or plumbing shop; this should cost about five cents per pound when bought in bulk. Make a paste by mixing this material with

water. The consistency should be such that, when a little of the paste is thrown at the screen-covered tank, it will stick. Apply the paste with a masons' trowel; the quality obtainable at a five and ten-cent store will be satisfactory.

The first coat is known as the skin coat and should be smoothed on to a depth of about $\frac{1}{4}$ in. and allowed to set about 24 hours, until it dries white and hard. Add layers of the cement until a covering about $\frac{3}{4}$ in. in thickness is obtained. The upper half of the tank should, however, be covered a little more heavily than the lower as the hottest water is always at the top. This is also desirable because, frequently, only the upper portion of the tank contains hot water, due to a low fire or to the water having been drawn off. The thickness of the coating can be determined by sticking a pin through the asbestos to the tank. The rounded top of the tank should also be covered to a depth of 1 in. or more.

Considerable care must be expended on the finish coat. A molder's slick makes the best smoothing tool, although a large spoon, flattened somewhat on the bottom, will do. Cover only about 1 ft. at a time, and smooth it carefully before putting on more. The work can be stopped at any time, as the new wet cement will make a perfect joint with a completely dried section. In order to make the finished surface as smooth as possible, a second smoothing with the slick should be given after the cement has dried for about one-half hour. If sufficient care is taken, a smooth eggshell gloss will result, which will not only shed dust but will also permit only the very minimum amount of radiation.

Many hot-water tanks used in connection with home steam-heating

plants are heated by an external copper coil which is so connected that it is completely surrounded by hot water from the boiler. This heater is always at nearly the temperature of boiling water and should consequently be covered with an extra-heavy coating of cement, about $1\frac{1}{2}$ in.

The first layer should be quite thin, $\frac{1}{8}$ in. or so, as a heavier application will drop off in patches due to the smaller radius and sharper angles of the heater. As the piping between the heater, boiler and tank presents only a small amount of radiating surface, it may simply be painted black with stovepipe enamel. The gas or separate heater used during the summer may also be improved in appearance, while it is standing idle, with a coat of the black enamel.

Double Wheels Conquer Soft Dirt

By bolting a complete extra wheel and tire to the regular rear wheels of his Ford cars, a large landowner in the peat-sediment delta of the San Joaquin river in California has solved a difficult traction problem. The soil is of the peculiar ashy, springy type characteristic of reclaimed peat areas, and affords little traction to the

ordinary small single tire. The ranch foremen and mechanics must travel from field to field, often when cultivation is going on, and there is no time to make roads. With these double wheels a Ford can go anywhere on the ranch, even across a freshly plowed field. The photo shows how the extra wheel is attached by means of blocks of wood, through which are driven bolts, held in place by iron strips on both sides. The work was done in the ranch shop. —Logan Studio, Stockton, Calif.



Extra Rear Wheel on Ford Permits It to Cross Freshly Plowed Soft Land



Pivoted Containers for Vegetables in Grocery Store Make It an Easy Task to Transfer Them into Peck and Other Measures or to Bags

Handy Vegetable Containers for Stores

In grocery stores, clerks usually have to lift a whole basket of potatoes, apples or vegetables when transferring them into a peck measure or bag. This practice is more or less difficult and inconvenient, and can be entirely eliminated by pivoting the containers as shown in the illustration. It is advisable to use half sections of small barrels or large kegs for this purpose. Each one is securely strengthened and two 1-in. holes are drilled directly opposite each other through the side, so that the container can be slipped over a suitable length of pipe. The ends of this pipe are slipped through tees, provided on the ends of vertical standards, as indicated, the latter being securely bolted to the floor. The containers are filled, and it is an easy matter to fill either measures or bags by tilting the proper container to one side.

Steel Wool as Aluminum-Ware Cleaner

It takes little trouble to keep aluminum pots and pans shining if they are cleaned frequently with steel wool,

water, and a nonalkaline soap. Use a very fine grade of the wool, and give the utensils a few rubs frequently, rather than attempt to clean them only occasionally, when they have become more soiled.—L. P. Langan, Denver, Colo.

A Timesaver for the Draftsman

Draftsmen who make electrical diagrams find that the drawing of a large number of resistance symbols is a rather irksome task.

If slots are cut in a 30°-60° triangle, as shown in the drawing, the task becomes simply one of working between two previously established guide lines.—Reuben Jensen, Silverton, Oregon.

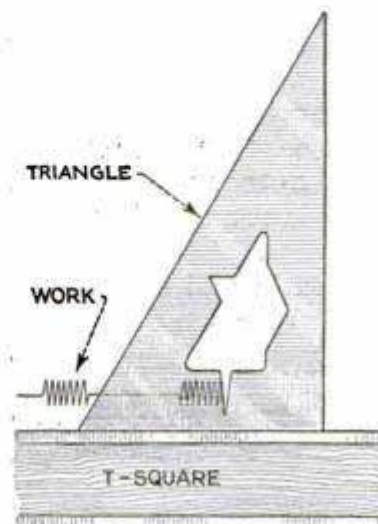

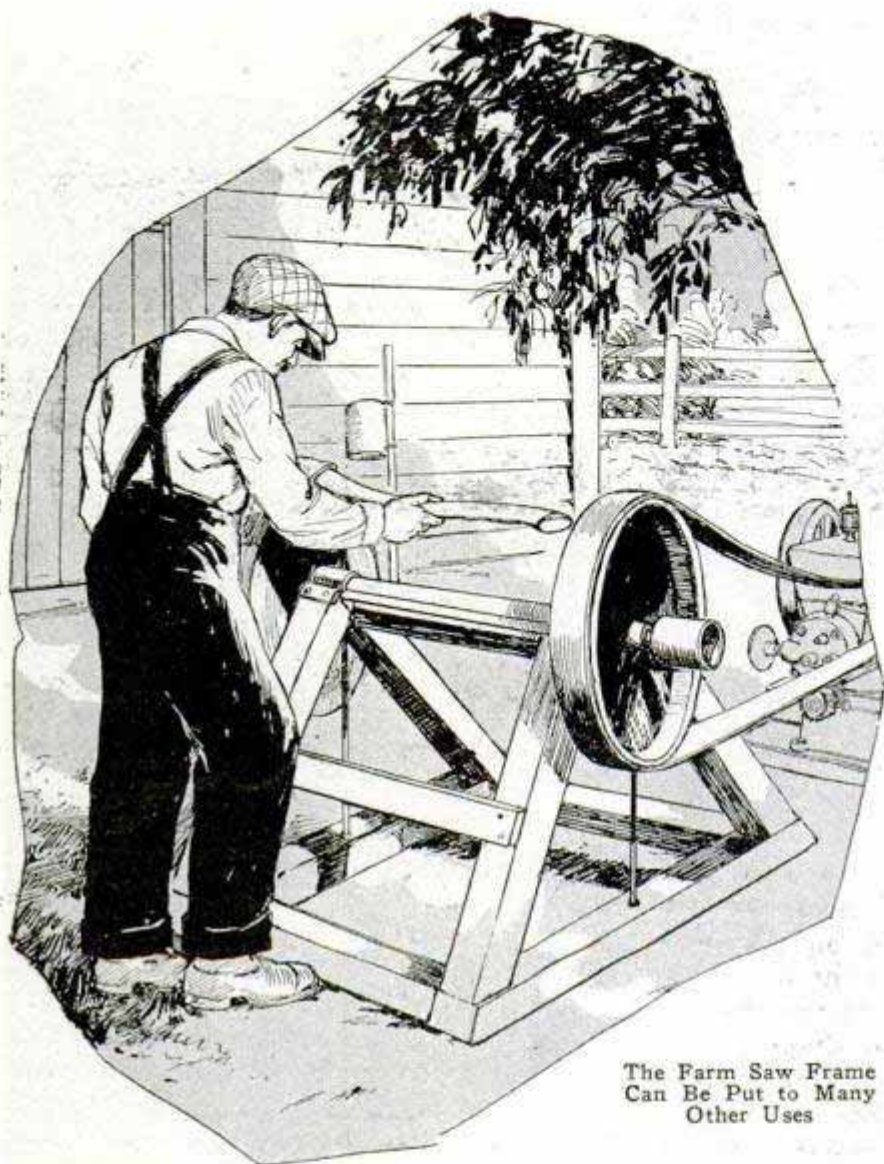

The Farm Saw Frame
Can Be Put to Many
Other Uses

Uses for the Farm Saw Frame

A Nebraska power farmer, who employs a large circular saw each winter for getting stove wood in shape, finds other uses for the machine. During the haying season he removes the saw and puts the grindstone in its place. Of course, the drive shaft is turned at low speed, about 150 r.p.m., by putting the belt onto a 4-in. pulley on the 4-hp. engine which is used to drive it. Another use to which the saw frame is put is for twisting cable for fence-corner braces. The frame is braced against end strain and the several strands are attached to the shaft. The other ends of the wires are fastened to the rear end of a heavy farm wagon. As the wires are twisted together, the over-all length is reduced. A man stands in the wagon with his hand on the brake and as the tension grows stiff, the brake is loos-

ened just enough to permit the wagon to be drawn slowly toward the saw frame. When the wires have been twisted enough, the belt is thrown and a block of wood is held against the fly wheel to prevent too much back spin. Sometimes long pieces of cable, 100 to 200 ft., are twisted at one time and are later cut up into smaller lengths of proper size.—Dale R. Van Horn, Walton, Nebr.

Effective Tool for Stirring Paint

The secret of stirring up paint to its best consistency is to churn the contents of the can thoroughly so that all the ingredients are completely mixed. This cannot be done with a stick except by long patient effort. A device that will do the trick in a much shorter time can quickly be made from a short length of stiff wire cable. Wrap some cloth around one end for a handle. Then open the strands near the bottom and bow them out in the form of a hollow ball, as shown in the drawing. Such a stirring rod will pick up all the solid matter at the bottom of the can, and the separated strands will churn it into a good mixture.—L. B. Robbins, Harwich, Massachusetts.

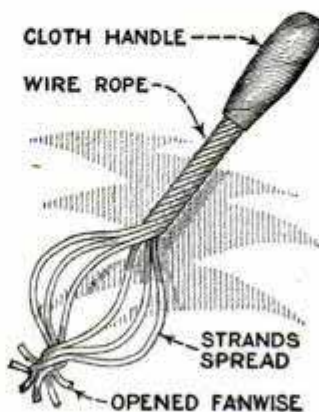

☐ A cork can be made to do the work of a glass stopper by placing it in a metal vessel and boiling it in vaseline; when dry, it is acid-resistant, unaffected by jamming it into a bottle, and will last indefinitely.

Continuous Fertilizer for the Garden

In many locations, especially in the cities, small garden spots need a great deal of fertilizing to make plants and flowers grow successfully. Take an old lime barrel or a metal can and clean it out well with water. It should be perforated with $\frac{1}{2}$ -in. holes along the sides and bottom, and is then half filled with some good fertilizer. Pour in water enough to fill the barrel. The fertilizer should be churned up every day. It has been found that the most stubborn soil conditions have been corrected in this way so that almost anything could be made to grow.—L. H. Georger, Buffalo, N. Y.

Pliers Have Stop for Bending Wire

Soft wire up to $\frac{1}{8}$ in. in diameter can be most conveniently bent with the aid of a pair of pliers and a simple stop piece, clamped in place as shown in the drawing. As an example of what can be done with this device, a number of wire squares can be made exactly the same size. The stop is made and attached in a few moments and the whole batch of pieces finished quickly. A length of strip metal is bent at right angles at both ends and clamped to the side of one of the plier jaws. To make a right-angle bend, push the wire tip to the stop and bend it close over the other jaw.

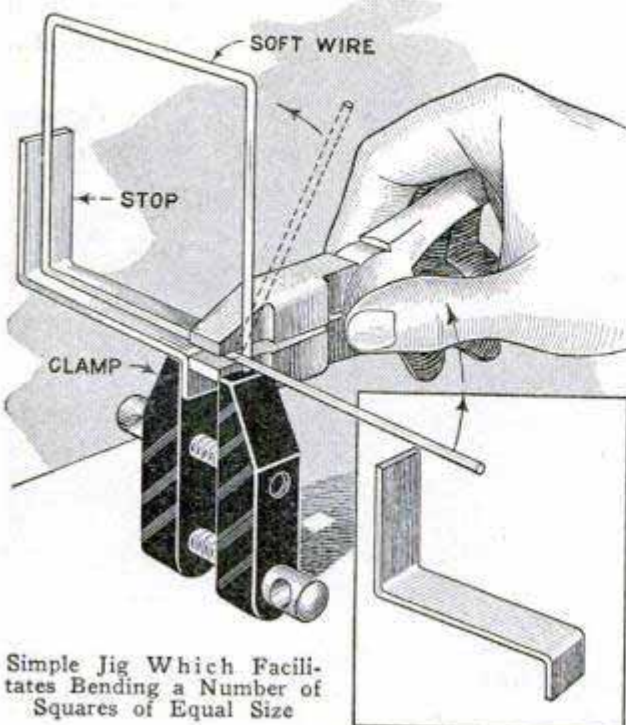

Simple Jig Which Facilitates Bending a Number of Squares of Equal Size

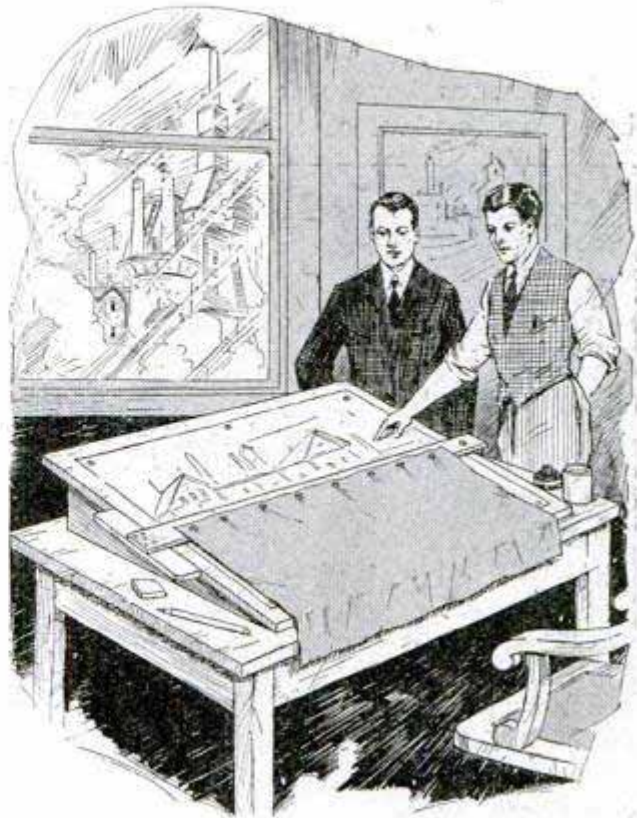

Cloth Attached to Draftsman's T-Square Prevents Drawings from Being Soiled

Protecting Drawings from Being Soiled

Draftsmen making sketches and pencil plans will find that a cloth fastened to the T-square with thumbtacks, as shown in the illustration, is of considerable service in protecting drawings from being soiled. The cloth does not interfere with the work and covers the section of the drawing not being worked on, permitting the draftsman to rest his arms on it without any risk of smudging the work.

Using Sandpaper in Plane

For sandpapering a smooth surface where it is necessary to keep the paper absolutely flat so that no hollow places will be rubbed into the surface, a common plane can be used to advantage. Remove the blade and cut a strip of sandpaper sufficiently narrow to fit through the slot in the plane, then double it over so that it will remain fixed under the clamp that is used to hold the blade in position. The free end of the paper can be brought around under the plane and up over the front to be held down by the hand grasping the knob in front. By pushing and pulling the plane over the surface it can be sanded flat and with the least exertion.

Machine to Lap Crankcases

Crankcases have not been lapped by hand in the plant of the Marmon Motor

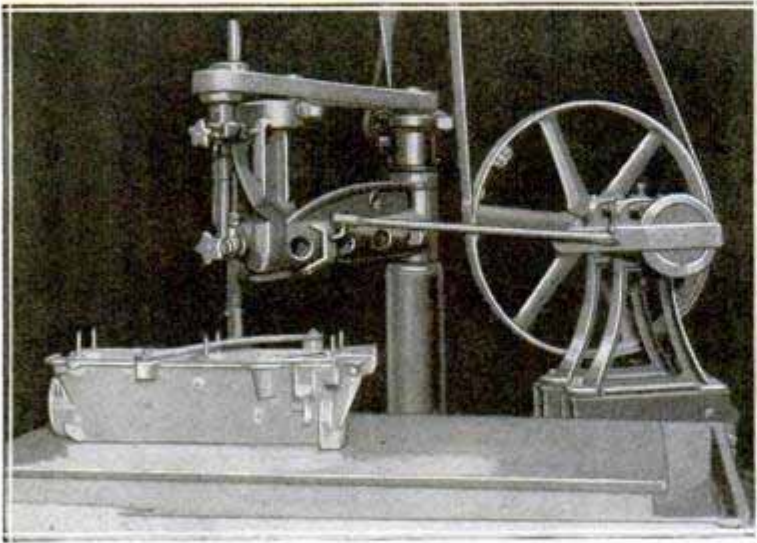

Old Radial Drill Press Converted into a Good Machine for Lapping Auto Crankcases

Car company at Indianapolis since J. W. Anderson, mechanical engineer of the company, built, at a very low cost, a machine that does the work better, and saves 47 cents on the cost of each crankcase. A discarded radial drill press, reclaimed from the junk heap, is the principal part of the apparatus. The crankcase is fastened to a rotating vertical arm of the press and is given a supplemental to-and-fro movement by an eccentrically driven shaft. Ground glass was formerly used as the lapping compound. Worn-out sand from sand-blasting machines has replaced the ground glass. Mixed with coal oil, this sand has been found more satisfactory than the ground glass.

Piston-Ring Compressor

In the absence of a regular piston-ring compressor, an excellent substitute can be

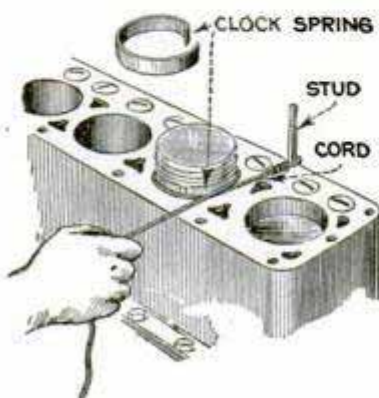

made from a piece of $\frac{1}{2}$ -in. clock spring, about an inch longer than the circumference of the ring, and a piece of stout cord. Insert the piston in the cylinder

as far as the expanded ring will permit, fit the clock spring around the first ring to be inserted, anchor the cord to a stud or other fitting, which will enable it to lie flat on top of the cylinder block, wrap it once around the clock spring and pull it tight. As a result the ring will be evenly and positively compressed and the first ring will slide into the cylinder. Loosen the cord, remove the spring and repeat the operation for the other rings.

Double Cock Handle

A method of connecting two cocks so that one handle can be used to control both is shown in the accompanying drawing. This idea is being successfully used in connection with filling an in-

closed tank with the correct amount of liquid required to make a mixture used in the printing business. The inlet cock is attached to the tank upside down, at the top, and the outlet in an upright position at the bottom. The handle is a piece of flat steel bent at right angles at both ends with square holes to fit over the squares on the plugs. Sockets are brazed to the tank to receive the cocks, one of these being brazed in place with the wrench assembled.

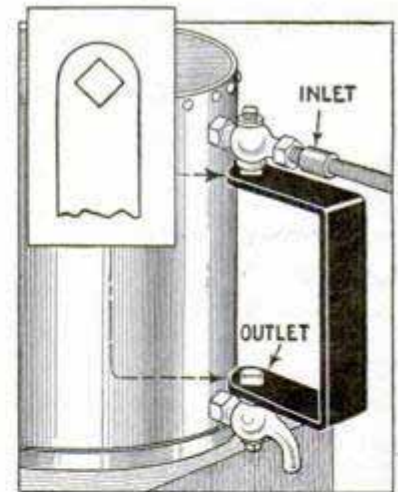

When this is done, one faucet must be open and the other shut. Thus, if the inlet is open the tank will be filled, and when the outlet is open the inlet is automatically closed. As soon as the tank is emptied the outlet is closed, which automatically opens the inlet again, filling the tank ready for the next measure.—Harry Moore, Montreal, Can.

⚠ Graphite should never be used on an engine timer as it may cause short-circuiting of the current.

Packing for Ford Window Glass

Older models of Ford closed cars had a metal frame on the glass windows. It was padded with cloth on the sides, but was merely a metal channel along the lower side of the glass. The frame was filled on both sides of the glass with some sort of wax. This is hard to find when the glass must be replaced, and if not used, the glass vibrates along the lower edge. Also, during a rain, water is likely to run into the channel and under the glass, where it will be thrown into the car by the movement of the glass. Cork strips, which may be cut from gasket material and forced down edgewise beside the glass into the frame, make good packing. The strips should be coated with shellac on both sides to keep them in place. The upper edge of the strips should be painted with black enamel, using a small brush. This is done to keep the gaskets dry, as the glue that binds the cork will be dissolved if it becomes wet.—E. T. Gunderson, Jr., Humboldt, Iowa.

Help for Drilling Vertical Holes

A mechanic who does not have access to a drill press, but is required to drill a perfectly vertical hole with an ordinary hand or breast drill, will appreciate the kink shown in the drawing. A circular level, such as used on cameras, is attached to the drill frame by means of a sheet-metal clamp. One ring of the clamp fits around the frame of the drill, preferably below the driving wheel, while the ring to which the level is attached is made the same diameter as the level, and has a wooden disk inserted in it so that the level may be screwed on it as indicated. The clamp is about $\frac{3}{8}$ in. in width.—W. J. Edmonds, Jr., Whitehall, N. Y.

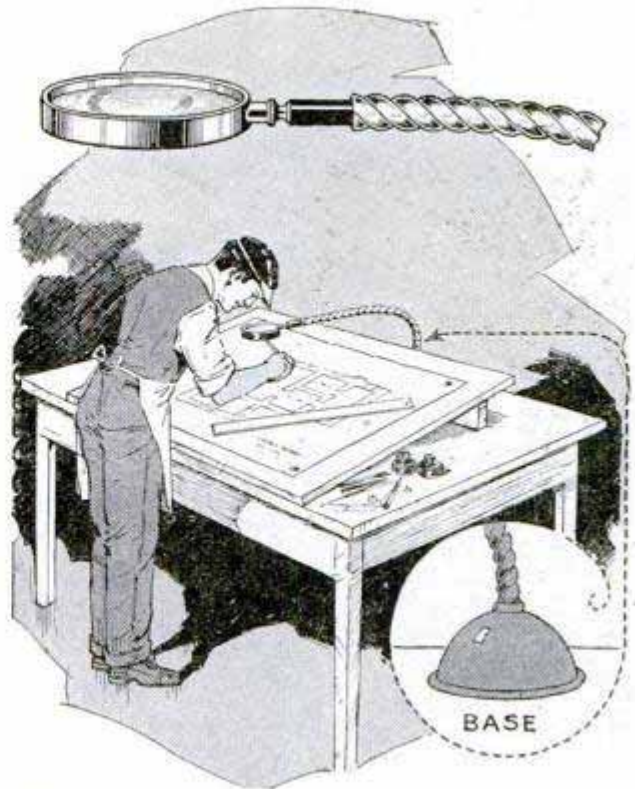
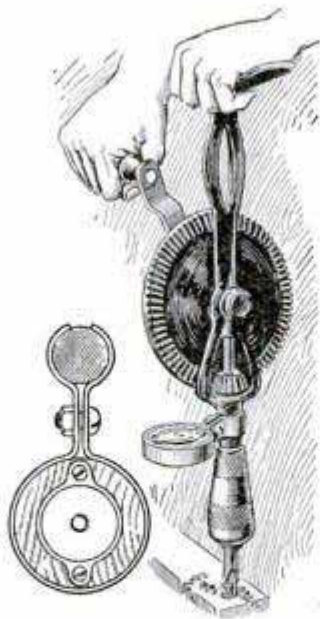

Reading Glass, Inserted in the End of a Flexible Tube of Desk Lamp, Helps Letterer

Reading Glass for Draftsmen

I had to do quite a bit of fine lettering in my high-school work and, as I worked at night, this caused a strain on my eyes. I took a lamp shade, which was an adjustable one of the hollow-tube kind, unscrewed the lamp socket, and withdrew the electric cord. Then I bought a 5-in. reading glass and whittled the wooden handle down until it fitted snugly into the end of the hose. In use, the glass is arranged directly over the work, as shown in the drawing. I showed this scheme to our drawing instructor and he has had one fixed up for himself.—Harry Lampert, Los Angeles, Calif.

Easy Way to Fill Furnace Water Pan

On pipeless furnaces the water pan is often difficult to get at. The trouble was overcome in one case by filling the pan from the register in the floor rather than from the cramped and inconvenient position in the basement. An old gasoline-stove tank was used as a funnel and the pipe attached to it was extended into the water pan. A large-sized funnel can be substituted if desired, and a length of copper tubing used instead of the pipe, the tubing being soldered to the funnel.



Improved Hangers Hold Eave Troughs in Position While Attaching Regular Hangers

Combination Eave-Trough Hanger

Tinsmiths, when handling eave troughs, often find it inconvenient to fasten the first hanger onto the edge of the roof, as one must hold the long section of the trough, place the nail and manipulate the hammer, all while maintaining a safe position on the ladder or scaffold. A Wisconsin tinsmith simplified the labor and eliminated much of the attendant danger by altering a number of common wire hangers in the manner shown. As not more than three or four of these are necessary on the average job, they are well worth the little trouble required to make them. Extra-long hangers are used for this purpose, the wire being cut diagonally at the loop end to provide a sharp point on the hook. One of the severed ends is bent in the form of a loop while the other is hooked so that the point centers within the loop. When the trough has been soldered, on the ground, the altered hanger is placed as near the middle of the trough as possible and bent to the angle of the eaves. The trough may then

be carried up the ladder and balanced in place with one hand while the other wields the hammer to drive the hook point through the loop and into the shingles. The trough being thus quickly and easily supported, the workman is free to move his ladder back and forth to fasten the remaining hangers, and the work is completed.—G. E. Hendrickson, Argyle, Wis.

Rubber Tips to Keep Finger Nails Clean

Having trouble to prevent ink from getting under the cuticle of his nails, and not caring to wear rubber gloves all the time, a printer thought of a plan for keeping his nails clean without using gloves. He took a pair of rubber gloves, cut the finger ends off about 1 in. and put the tips over his fingers, which effectively avoided the trouble.—G. R. Dement, Buffalo, N. Y.

Commutator Tool

One of the most frequent causes of trouble on direct-current motors, particularly those having undercut commutators, is short circuits between commutator bars. Serious breakdowns in the commutators or windings of the armature can be prevented if the trouble is discovered in time, by digging out the carbonized mass between bars down to the clean mica. Tools useful for this purpose can be cheaply made from pieces of old hacksaw blades. The blades should vary in thickness to take care of mica segments of different widths, and a point of the desired shape is ground on the broken end. A number of tools with differently shaped points should be made, to suit the work of various types of motors. After the desired shape and edge



have been formed on the blades, they should be hinged together by passing a rivet through the hole in the end of each and turning the head over with a hammer. This arrangement makes a very serviceable tool for the electrician and mechanics who find need of differently shaped tools of this type. It also provides a better grip than separate blades.

Making the Old Pump New

By L. B. ROBBINS

WHEN a pump commences to gurgle, suck and whistle at each stroke of the handle you may feel assured that something is wrong. Either the leathers are worn out or some air leak has developed, in the pump castings or in the pipe line above or below ground. In the majority of cases this will be found to be due to worn leathers.

For maximum efficiency, a pump depends upon a vacuum being created in the cylinder at each upstroke of the plunger. If air leaks past, this vacuum is destroyed and water will refuse to rise in the pipe. It is then that pumping water becomes a soul-searing and back-breaking job.

Now, it doesn't take a great deal of work to transform a leaky pump that requires 75 strokes to the bucket to one that will lift the same amount of water in 25 strokes

because so many pumps can be fitted with standard-size factory-cut leathers. It is simply a matter of taking the pump apart, inserting the new leathers and then reassembling as before.

There are essentially two types of dwelling-house pumps; the pitcher pump and the force pump. The former is found everywhere, and consists simply of an open-ended metal cylinder in which works a plunger with a lifting valve in the center. Between the bottom end of the cylinder and the pipe there is another valve, or deck leather. As the plunger is pushed down, the deck-leather valve closes and the plunger valve opens, thus allowing any water above the deck leather to pass through the plunger instead of being forced down into the well. When the plunger rises, the water thus brought over



Above, the Plunger Spider; Upper Right, Form of Deck Leather and Weight; Center, Removing the Cylinder

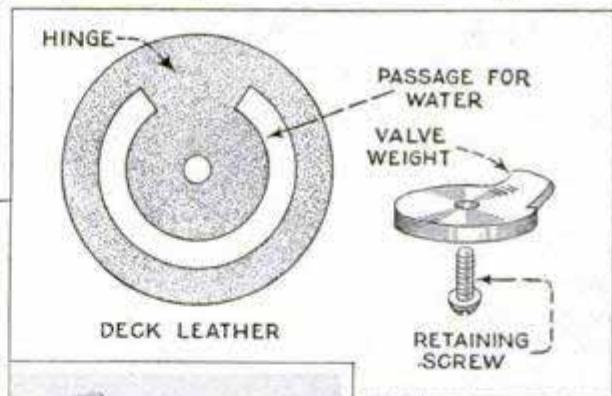

or less. In the majority of cases the trouble will be located in defective leathers. Nowadays it is a comparatively simple matter to change leathers,

it is raised higher and the suction below it lifts the deck-leather valve, and water in the pipe rises for the next stroke. In this way a more or less continuous stream of water is lifted from the depths and flows from the top of the cylinder through the open spout or "pitcher" lip. Varied forms of the pitcher pump exist, but the essentials of operation are identical.

The force pump makes use of the same principle, but the cylinder is entirely closed and the lifted water is directed into a closed chamber called the air dome. In there it comes into contact with a body of air which after compression by the inflowing water, forces the water in a continuous and steady stream to a considerable distance or height. The compressed air forms a wonderfully powerful cushion and in this manner creates an internal pressure very useful in filling overhead tanks or projecting the pumped water along a rising pipe line.

Deep-well pumps are essentially the same as the simple shallow-well pumps except the pumping cylinder may be separated many feet from the pump body. This is because the plunger can only operate at a maximum of about 28 ft. above water level. Therefore, for a 50-ft. well, the cylinder must be placed in a pit or driven to within at least 28 ft. of the water level, and the plunger operated from above ground by a long rod running down through the pipe to the plunger rod in the cylinder.

The leathering of any of these types of pumps is essentially the same. Where the entire pump is above ground, the job is simple. If one or more cylinders are below ground the job becomes more difficult. But the leathering job remains the same; the plunger and the deck leather must be renewed.

The first thing to do with a shallow-well pump is to trip the water out by forcing the plunger down until you hear a sucking noise and the water drops back into the well. Then loosen the bolts holding the cylinder and the base casting together and lift the cylinder off. This exposes the deck leather, shown clearly in the photograph illustrating this operation. The drawing on page 165 also shows the shape of a typical deck leather and its component parts. It consists of a circular ring of stiff leather inside of which is a round

leather disk attached to the ring at one side. The open space between is horse-shoe-shaped and permits the passage of water. A weight fastened to the disk helps to force it in place over the deck opening and thus make it a quicker-operating and tighter-fitting valve.

Remove this leather carefully so as not to score the metal deck or seat. If it is hard or cracked it should be discarded and a new leather provided. Remove the clapper weight by taking out the retaining screw in the center. Fit this on the new leather in its proper position, which is with the raised lug over the hinge. If no ready-cut leather can be obtained, a suitable one can be cut from a piece of $\frac{1}{8}$ -in. oak-tanned stock by placing the old one over it as a pattern and marking around it with a pencil. Then cut the new one out with a sharp knife and fit the clapper weight to it. If the old leather is beyond use as a pattern, place the new piece of leather over the deck and tap it gently but firmly with the ball end of a ball-peen hammer around the outside edge and the edge of the pipe opening. When removed, the markings of the metal edges will be plainly visible and can be followed with the cutting knife.

Before the new deck leather is placed in position, wipe the deck clean of any dirt or grit. If any slight bits of nicked metal exist along the surface, smooth them off with a fine emery stone. Soak the new leather in water an hour or two to thoroughly soften it and then lay it carefully on the deck, still wet, placing the weight uppermost. When in the proper position, place the cylinder carefully upon it so as not to disturb its position, reinsert the bolts and take up on them slowly and evenly until the leather is firmly clamped in position. Use care in taking up on these bolts, taking a part of a turn on each one at a time. This will compress the leather evenly and also prevent clamping down one side before the other, and thus insure even pressure and eliminate chances of cracking the casting from uneven pressure on either side.

On deep-well pumps the cylinder must, of course, be removed from the pipe line before the packing can be accomplished. If it is in a pit, it is only a matter of removing the pipe from above and the

sections of wooden plunger rod, and then releasing the cylinder from its base. Otherwise it must be pulled up with a pump puller and raised above ground until it can be dismantled. In any case the method of replacing is essentially as previously described for a simple above-ground pump.

Most plungers are constructed similar

Center, Soaking Deck and Cup Leathers; Below, Forming New Cup Leather

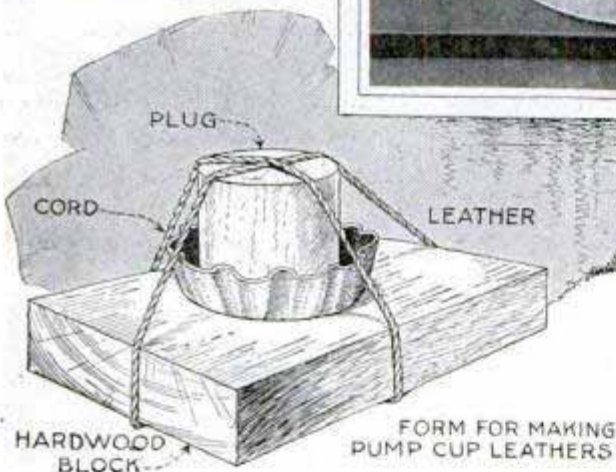

tion, using care, of course, with this procedure. If a ready-cut

cup leather cannot be procured, here is an excellent method of making one at home, using $\frac{1}{8}$ -in. oak-tanned leather as material. Put the leather to soak in water for at least 24 hours while making the former, herein described.

to the one shown in the photographs. To releather, clamp the spider carefully but firmly in a vise and then turn off the plunger end which threads onto the spider. The old leather can then be removed. If the retaining nut turns off hard, be especially careful in removing so as not to strain the spider to the cracking point. Turn it up a bit and then in the opposite direction until it will start. Sometimes a tap with a cold chisel in one of the notches will serve to start it. For general use a large pipe wrench is best suited for this job although there are special spanners that come with some makes of pumps for this purpose.

When disassembled, clean the threads on the spider and retaining nut and graphite them. Then slip the new cup leather in position, replace the nut and take up on it until the leather is held firmly in posi-

Using an expansion bit, bore a hole in the center of a hardwood block $\frac{1}{4}$ in. larger than the diameter of the plunger, and $1\frac{1}{2}$ in. deep. Then fashion a round plug of hardwood just the diameter of the plunger and about 3 or 4 in. long. Thoroughly oil both pieces, provide some strong cord and have a large bench vise handy. When the leather is sufficiently pliable, place it over the hole in the block and then place the plug end upon it directly over the hole. Carefully turn the entire assembly on its side and place between the vise jaws. Then slowly turn up on the vise and push the plug into the hole, carrying the leather with it. Work very slowly so the leather will stretch over the plug during the process. When the bottom of the hole has been reached, leave the job alone until the leather has thoroughly dried out or, if the vise must

be used for other purposes, tie block and plug together with the cord, as shown in drawing and set aside to dry.

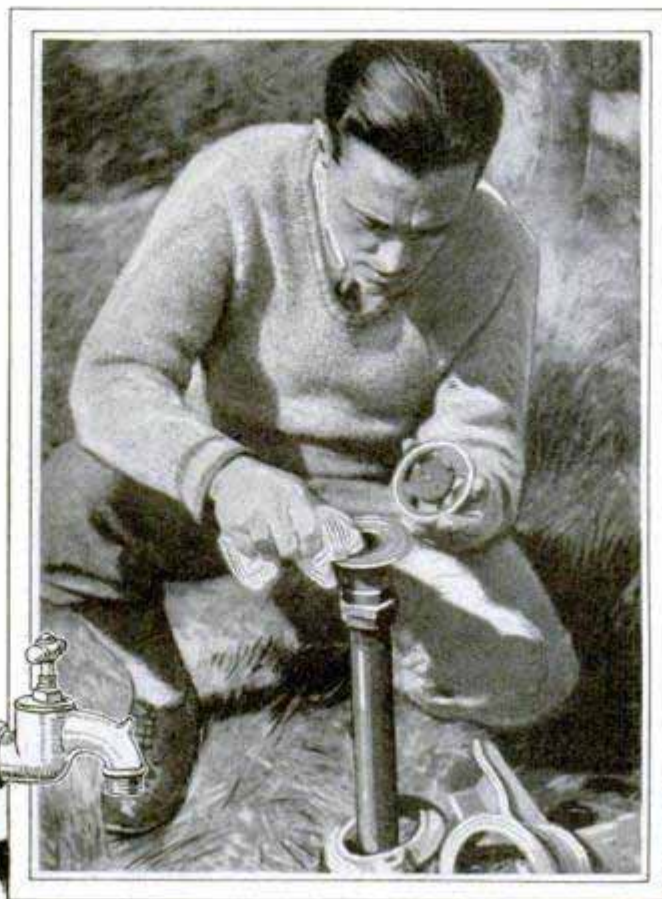
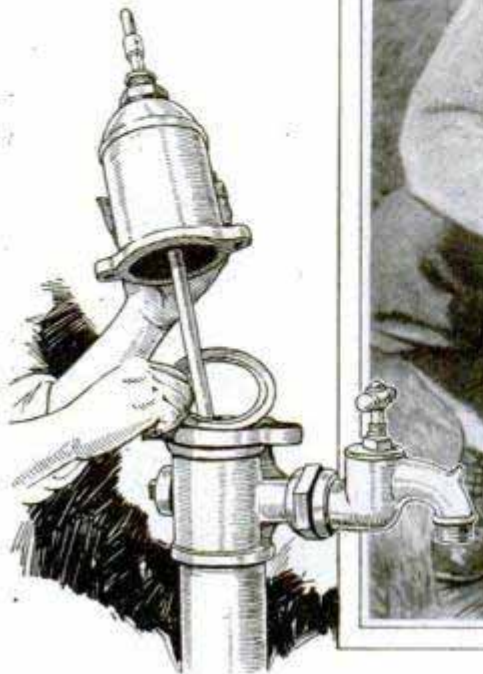

marked out, as previously mentioned, with a ball-peen hammer. Leather gaskets are best, but for this purpose a thinner stock can be used than for the section leathers.

After the pump has been releathered and assembled a few days, it will be wise to go over all bolts and take up adjustments. New leather is flexible

Left, Replacing Air-Dome Gasket; Center, Wiping Off Deck-Leather Seat; Right, Tightening Down Cylinder

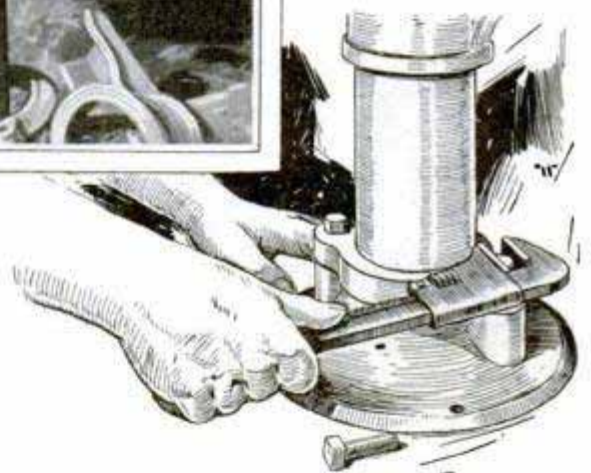

When the leather is bone-dry, take off the cord, pull out the plug, and a nicely formed cup leather will be the result. Trim off the edges with a sharp knife, bevel the top edge on the inside, and then cut a round hole in the bottom to fit snugly around the retaining nut of the plunger.

With the new leather on the plunger, soak it in water again until softened and then insert in the pump cylinder and push down until the top of the rod can be again connected to the pump handle. It is also a good plan, with unlined cylinders, to wipe out the inside with very fine emery paper to remove any rust coating that may have formed through the years. This rough surface is particularly hard on leathers and wears them out before their time. Keep the cylinder walls clean and bright and the leathers will last much longer than would otherwise be the case.

The air domes on force pumps are usually provided with leather gaskets between them and the cylinder connection. When these grow hard they should be renewed. They can be cut from leather or sheet rubber, using the old one as a pattern, or

and it will probably be found that a turn or two can be taken up on all adjustments as the leather compresses. This will insure an air-tight job and give a positive vacuum in the cylinder. The plunger will, of course, have to be removed and the retaining nut turned up in the vise as before. If the cup leather has swollen too much and it works unduly hard, shave off a little from the edges with a safety-razor blade.

Now with the pump newly releathered, it should hold water indefinitely. If the water still persists in dropping back and the pump needs priming each time it is used, you may feel absolutely sure the leak is in the mechanical end of the affair. Go over all connections to see that they are drawn up tight. Inspect the castings and pipe sections above ground for cracks or leaky couplings. If possible, grab the pump base with a large pipe wrench and

turn clockwise, rotating the entire pipe line and strainer point in the ground. This will take up any loose threads that may have developed, due to threads corroding over a long period of time. Do not, however, turn the pipe backward, as threads will undoubtedly be loosened and you will be worse off than before. In making up new connections, always use plenty of lead in the joints and turn them well home, and leaky joints will be practically impossible. By attending to this while sinking a well and assembling a pump, about the only trouble that can develop will be cracked parts due to freezing or overstrain in assembling, or faulty leathers. Other things being equal, water should flow freely always.

Accurate Perpendiculars with a 2-Ft. Rule

The 2-ft. rule is the faithful standby of the rough-and-ready draftsman who makes sketches on the job. To draw a fairly accurate perpendicular to a line not parallel with an edge of the sheet or pad is not so easy to do but often necessary to the correctness of a sketch. The photo shows how a perpendicular can be drawn which will be about as correct as any circumstance will require. Lay the rule down along the line, then lay a dollar or washer on one side of the circular middle-joint hinge of the rule, and touching it, and scribe an arc. Place the dollar on the other side and scribe another. Draw a line through the two points where the arcs intersect. This line will be perpendicular and as correct as necessary.

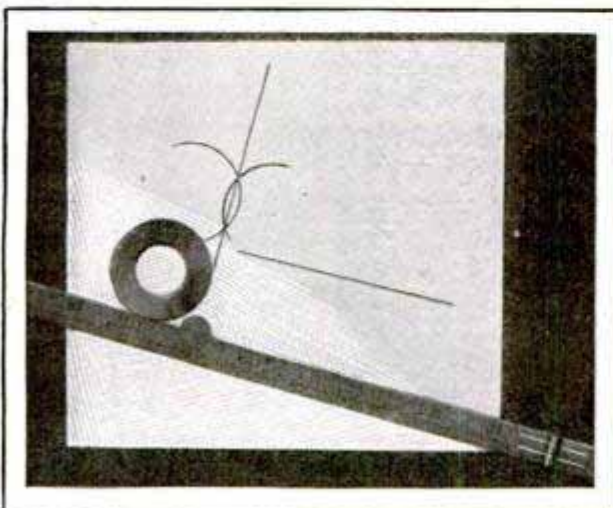

How to Draw a Perpendicular to a Horizontal Line with an Ordinary 2-Ft. Rule

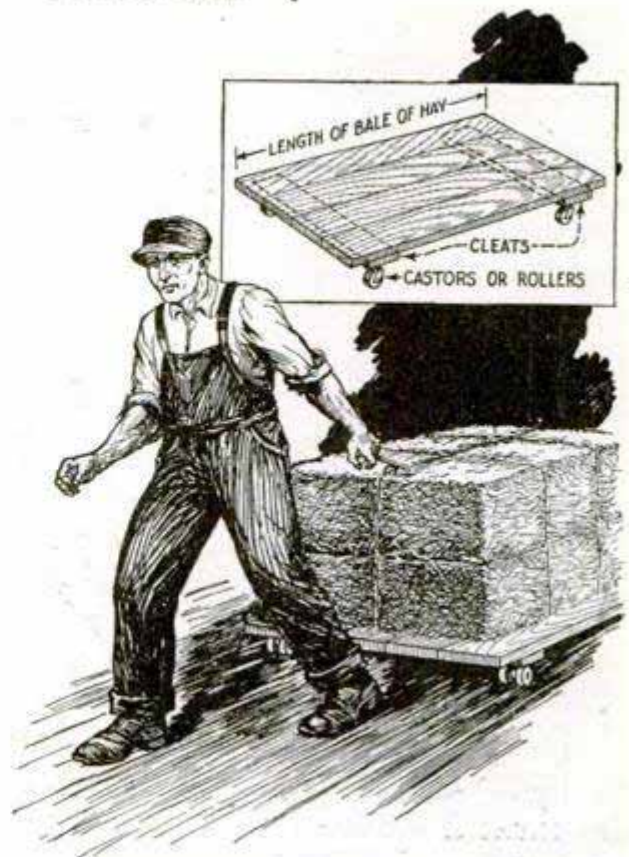

Handy Dolly, Which Can Be Swung in Any Direction, Made from Old Roller Skates

Dolly for Handling Baled Hay

When any great number of bales of hay have to be moved across the floor it becomes a heavy and tiresome task. To alleviate some of this work a dolly, as shown in the illustration, can easily be made from odds and ends. Build a small plank platform of short boards and cleat them solidly from underneath with similar stout boards. Make it about the size of a bale of hay. Fasten four roller-bearings casters, one to each corner, or four wheels removed from a pair of old roller skates. In the latter case, see that the wheels are pivoted so that they will turn in any direction.—L. B. Robbins, Harwich, Mass.

Drilling Chilled Cast Iron

Iron castings, made in chilled molds, are frequently too hard to drill. Even high-speed drills and turpentine will fail to break through the surface of the casting. The trouble can, however, be remedied in the following way: Place a lump of sulphur on the spot to be drilled and slowly bring the casting to a red heat, then allow it to cool off. This will soften the spot so that the drill will cut it readily.—G. A. Luers, Washington, D. C.

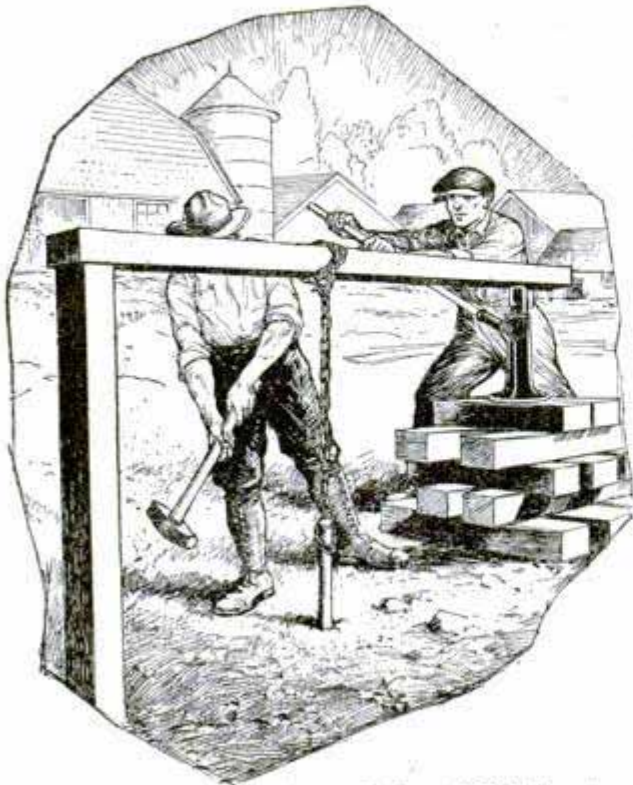

Easy Method of Removing a Driven Well Pipe from the Ground

Pulling a Driven Well Pipe

It was desired to salvage the driven pipe of an old well. Usually a driven pipe is abandoned because of the difficulty connected with its removal, but in this case the task was simplified considerably and the pipe was removed without much difficulty. A post was set about 2 ft. on one side of the pipe, the top being about 4 ft. from the ground. The crosspiece, a length of 4 by 6-in. wood, was fastened to the post at one end and at the other end it was set on a screw jack, properly supported. A chain was fastened to the crosspiece in the center, and to the pipe, on which a cap was screwed. First the jack was turned up until the chain was tight. The pipe was then struck a few light blows with a sledge while the jack pressure was being increased. In this way, combining pipe vibration with a constant pull, the pipe was readily pulled out.

Softening Hard Leather Belting

I had some old leather belting that had not been used for several years. To my knowledge it had been around the shop for over 30 years. Needing some belting I was forced to make use of this old piece, which was made soft and pliable in the fol-

lowing way: I filled a tub with boiling water and poured in about a gallon of old engine oil, which floated on top of the water. I dipped the belting to the bottom of the tub and allowed it to soak a few moments. Then I lifted it slowly through the layer of oil and repeated the operation several times. Within 15 min. the leather was as soft and pliable as though it had just been removed from a machine. The boiling water had opened up the pores of the leather and on removing it from the water, the hot oil had penetrated the pores and completely filled them. The belt is still in use after some years and is apparently good for many more.—L. B. Robbins, Harwich, Mass.

Improved Electric Crucible

A small crucible that can be used for melting chemicals and soft metals can readily be constructed, using only a porcelain lamp socket and the element of an electric heater. The socket is mounted on a small base of marble, slate or bakelite, about 6 in. square. The heating element is screwed into this socket. The heater should be of the kind that is shaped like a cup, which is mostly used in reflecting heaters. A small clay crucible is easily slipped into this cup-shaped opening. If no crucible is available, a clay pipe with the stem broken off and the hole plugged will do. A length of lampcord and plug is connected to the socket and plugged with this outfit in a few minutes. It can be placed in a metal box or case

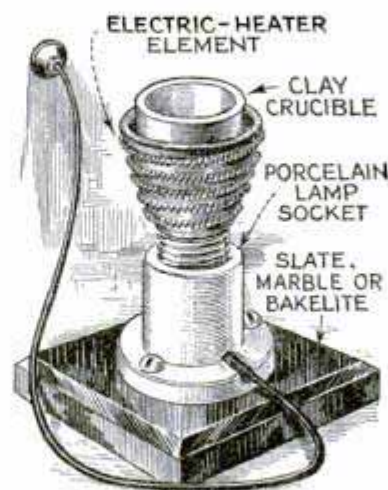

so that the heat will not be dissipated into the surrounding air, although this is not absolutely necessary. For melting lead and soft metals, such an improvised crucible is convenient, as

a cupful of scrap lead will melt in less than half a minute.—Herman R. Wallin, Brooklyn, N. Y.

How to Build a Dumb-Waiter

By ERIC B. ROBERTS

AMATEUR knowledge of carpentry is all that is necessary to build the dumb-waiter described in this article and shown in the illustrations. The first step is to choose a location where a vertical drop to the basement will meet with no obstructions. After the location has been determined, the shaft is built from the ceiling of the first story to the basement floor. The frame of the shaft consists of 2 by 4-in. material; in the kitchen this is boxed in with 1-in. stock on the inside and lathed on the outside preparatory to plastering. If desired, wallboard can be used on the outside. The basement section of the shaft is also boarded up tightly. A neat paneled door should be provided for the kitchen outlet of the waiter, but a simple board door will suffice in the basement. A wooden floor is provided at the bottom of the shaft and four holes are

drilled in the floor to hold old auto-valve springs in a vertical position to absorb the shock of the lift when it is lowered rapidly.

After the shaft has been finished, the rails or guides for the lift are fastened on the inside, leaving out a short section to permit the insertion of the lift, after which the omitted guide section also may be fastened in place. Lengths of $\frac{3}{4}$ -in. wood may be used for making the guides. Next, the lift should be made. For the average household it should weigh about 65 lb., so that it will carry a load of from 5 to 20 lb. The counterweight, which consists of scrap lead, iron, etc., must be between 5 and 10 lb. heavier than the empty waiter, to allow for the additional load. To obtain the above-mentioned weights, I

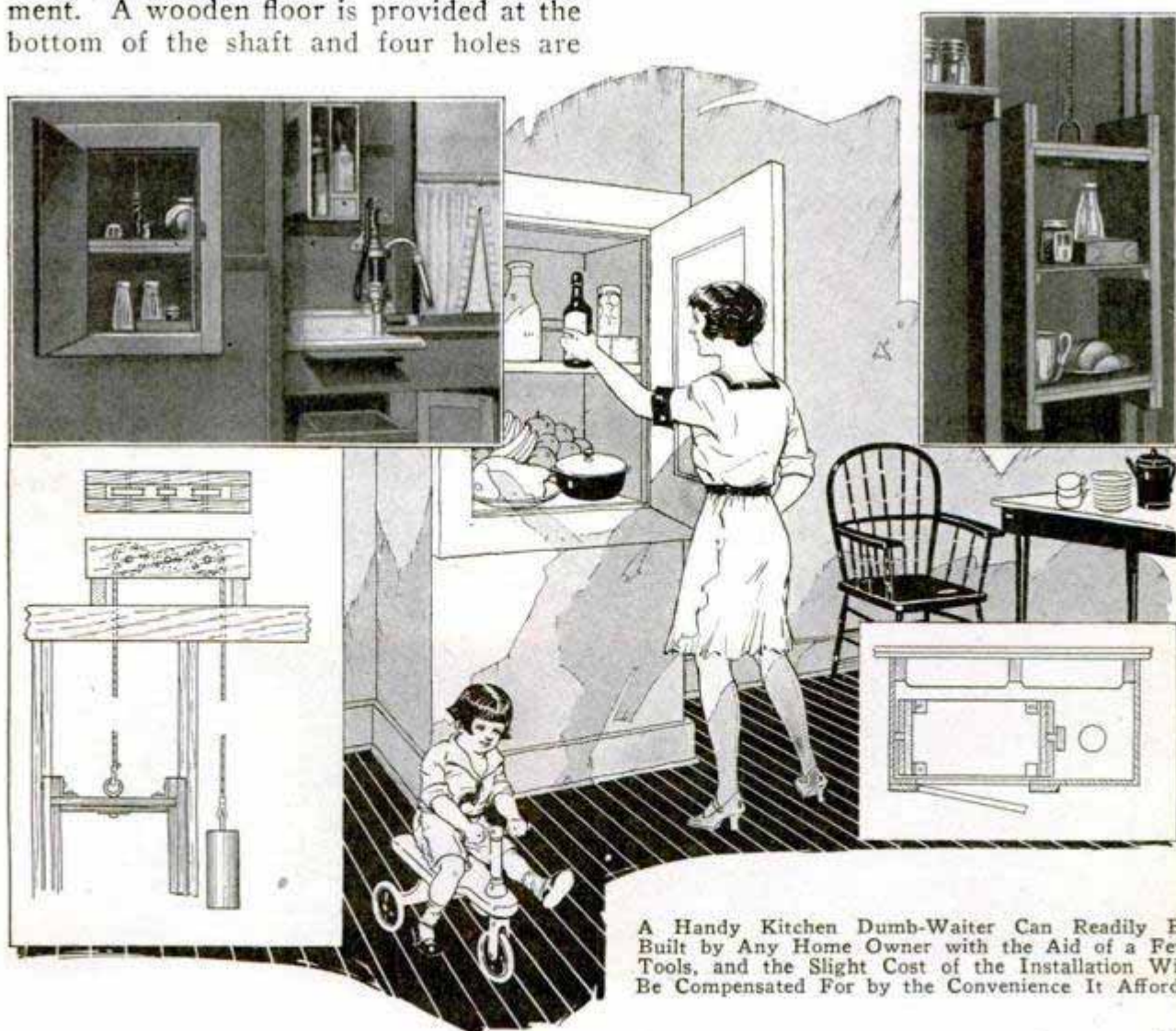

A Handy Kitchen Dumb-Waiter Can Readily Be Built by Any Home Owner with the Aid of a Few Tools, and the Slight Cost of the Installation Will Be Compensated For by the Convenience It Affords

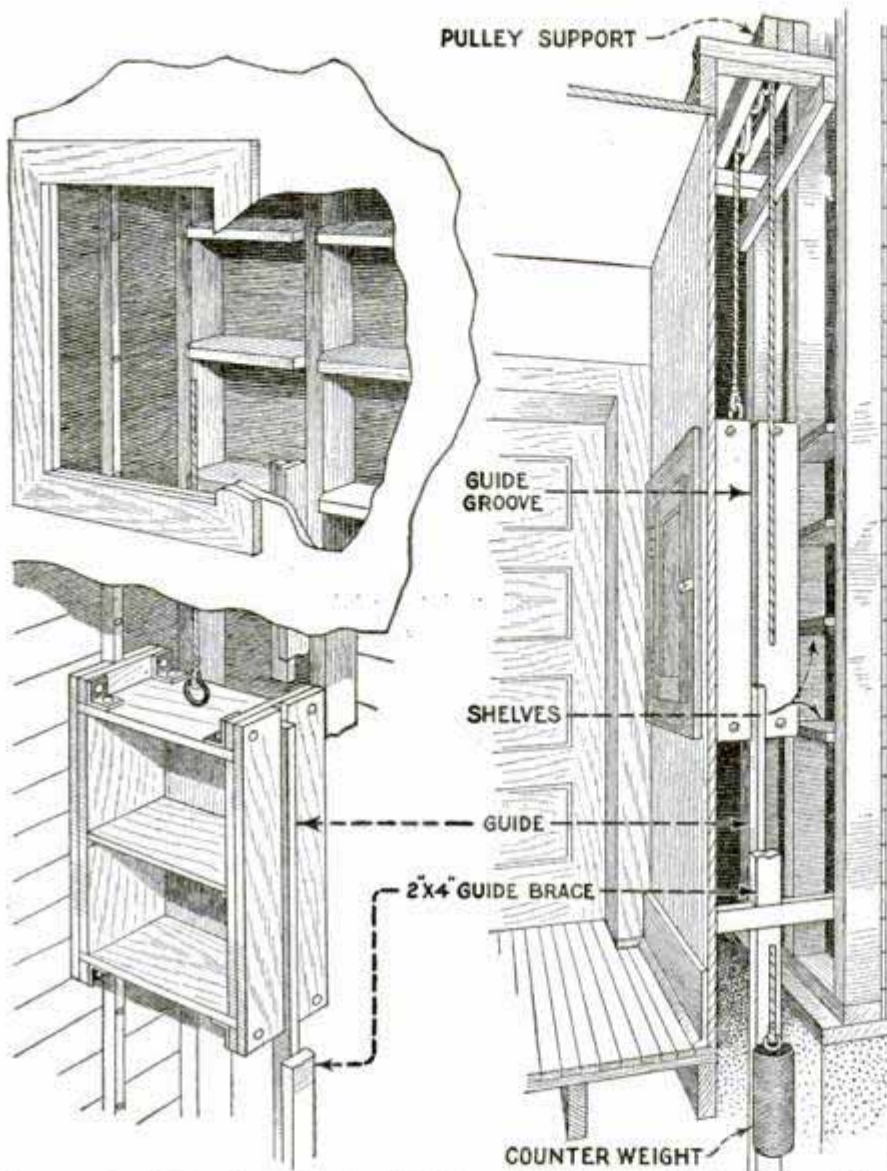

Constructional Details of the Dumb-Waiter, Showing the Shaft, Lift and the Counterweight, and the Method of Assembly

placed the materials used for making the lift on one end of a plank, pivoted in the center, to balance the counterweight on the other end. When both weights were equal, I added about 8 lb. to the counterweight. Then I proceeded to build the lift, which was made with double sides, top and bottom in order to make it solid and heavy. Ordinary 1 by 6-in. lumber was used. Angle iron may be used to add weight and rigidity but it must be remembered that no additional material must be used besides that which was balanced with the counterweight. Between the two boards forming the side, a groove is left for the guide, on each side. The pulley assembly is then made. It must be carefully calculated where the ropes and weights are to hang in order to be sure that they clear the lift while in motion or at rest, and the weight must be hung in

a position where it can do no damage if it falls. The pulleys need be of no special size; anything from 2 to 7 or 8 in. will do. They must, however, be of the grooved type and able to retain a $\frac{3}{8}$ -in. rope. Lengths of pipe or rod make good axles. I used one 2-in. and two 4-in. pulleys, the rope passing over the large ones and under the small one to provide the necessary friction to hold the waiter steady at the top or bottom, yet allow it to move freely when pulled up or let down. Ordinary sash cord is well suited for use in a dumb-waiter.

Copper Pipe Aids in Coiling Wire

Coiling wire for springs, electrical coils or for binding purposes, is accomplished usually with some means to restrain the wire and keep it under tension. Leather and wood will serve for hold-

ing the wire under tension while it is fed on a lathe mandrel at a slow speed. A new means, differing from any of the customary practices, is shown in the attached drawing, and consists of a short

LATHE OR WINDING MACHINE

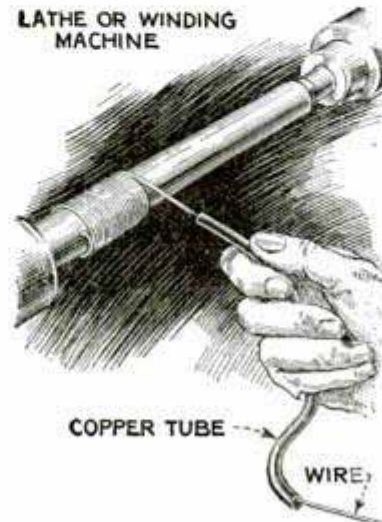

length of small copper pipe, with abrupt bends, which restrains the wire and maintains sufficient friction to insure tightly wound coils, in spite of the fact that the operation is rapid and the wire tension uniform.

Renovating Copper-Asbestos Gaskets

When the cylinder head of a car is removed for valve grinding and carbon removal, the gasket is frequently bent, dented or otherwise mutilated. Efforts to straighten it are not often successful, because the copper is usually brittle and hardened from use. This is also the case with the copper-asbestos gaskets used for the water connections, manifolds and valve seats. If installed with sharp bends and kinks in them, they are almost certain to leak. To renew the old gaskets, they are placed in the flame of a gas heater until they are quite red and then plunged in cold water. The copper is made plastic by this treatment, and, when the gasket is bolted down, it spreads and makes a tight seal.

Vulcanizing Inner Tubes

In vulcanizing small patches on inner tubes with an electric or gasoline vulcanizer, a Wisconsin repairman claims that the portion of the tube covered by the patch is apt to become overcooked or burned, and thereby weakened. To overcome this trouble, he uses four strips of asbestos paper over the tube, as shown in the illustration, leaving only the patch exposed to the full heat of the vulcanizing plate.

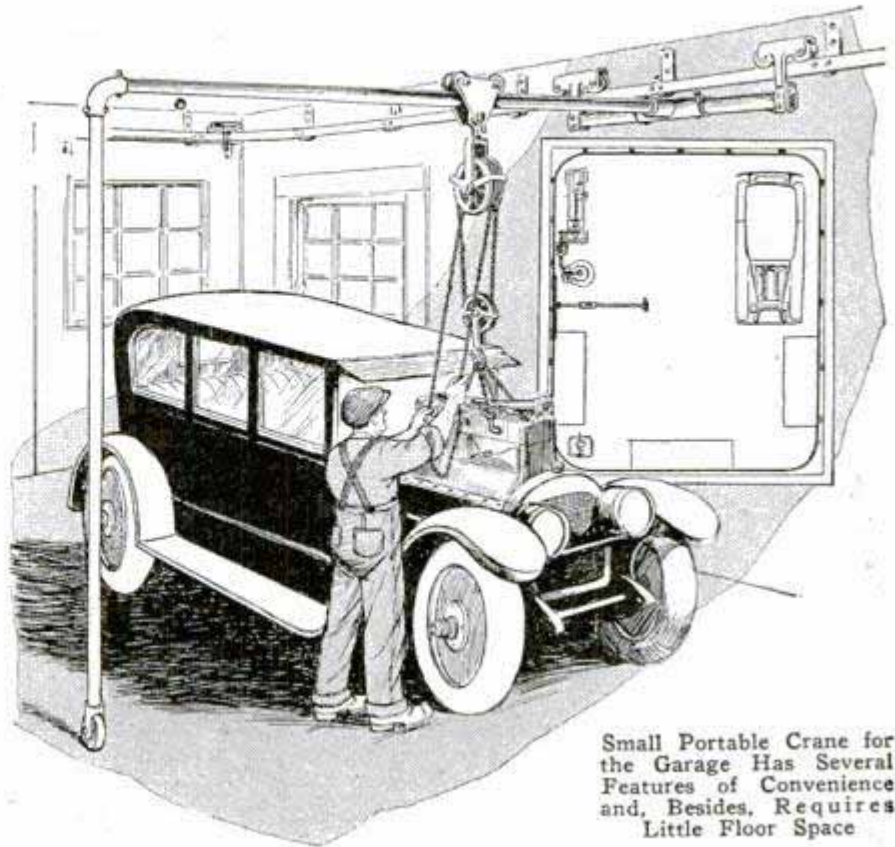

Small Portable Crane for the Garage Has Several Features of Convenience and, Besides, Requires Little Floor Space

Small Crane for the Garage

The crane shown in the accompanying drawing has a wide range of travel and is capable of transferring heavy units from the bench to the machines and to the several cars being repaired. It uses the same track as employed to support the hanging doors at the front of the garage. The provision of such a track around the four walls, is the main support for the crane. A double hanger with swivel rollers allows the crane to travel along the continuous runway. The corners are traversed on a curved track, similar to the track on which the door is supported when swung from the front to the side. A cross rail extends from these hangers and rests on a vertical support of pipe, provided with a fixed roller at the bottom. The hoist is carried by a trolley on the cross rail, which permits placing the hoist directly above the load. While every advantage of a crane is provided, the single leg, reaching to the floor, does not encroach on the available floor space, as is usually the case with four-legged portable cranes.

Insert a scratch awl in common hard soap for hardening, and it will need no drawing after the plunge.

Unscrewing Thin Tubing

When unscrewing thin tubing, there is a decided tendency for it to close under the wrench grip, especially at the open ends. To prevent damaging the pipe, the method

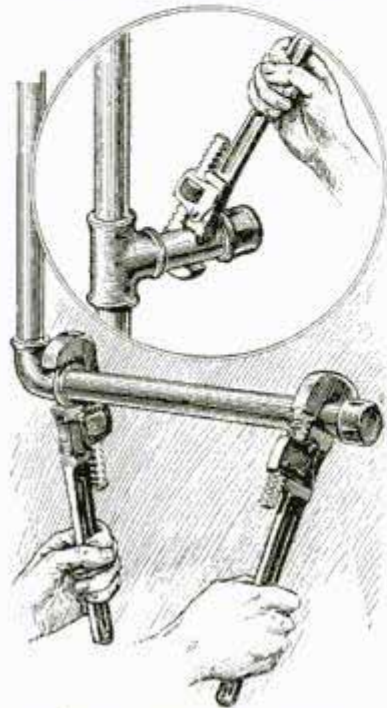

of protecting it shown in the illustration, has been found effective. It consists in screwing a pipe cap on the end of the pipe and gripping it as close to the cap as possible. Also in the removal of close nipples, this procedure is useful. The cap stiffens the nipple so that

it can be removed easily, regardless of the tendency of the pipe-joint compound to hold it tight.—G. A. Luers, Washington, District of Columbia.

Better Potato Plants

By placing a 4-in. layer of sawdust on top of his hotbed, a Mississippi farmer produced potato plants with much longer roots than usual, which made them more desirable than short-rooted plants. In making the hotbed, he first dug a hole to a depth of about 12 in. In the bottom of this he placed a 6-in. layer of barnyard manure, covering it with a layer of soil, about 5 or 6 in. thick. On top of this he placed the potatoes to be sprouted, pressing them into the earth and covering them with a thin layer of soil. A 4-in. layer of sawdust was then applied. Some 6-in. planks, held in position by stakes, prevented the sawdust from being washed away. This hotbed was not covered with glass. Besides producing long roots on potato plants, the sawdust helps to retain moisture. Potatoes should not come in contact with manure because the latter is likely to transmit certain diseases to the

former, causing the potatoes produced to be defective.—Bunyan Kennedy, McCool, Mississippi.

How to Mend Aluminum with Zinc

Holes in aluminum vessels can be mended by the following method: Paste a piece of strong paper over the hole on the inside, using shellac as an adhesive. Have the surface of the aluminum very clean by sandpapering it well. Pack the vessel with sand to hold the paper in position securely. Now take some clean zinc, melt it, clean off all the dross and pour the zinc over the hole from the outside. It will stick to aluminum, and can be finished with a file and sandpaper. We have mended canteens, hot-water bottles, kettles, pans, etc., by this simple method. If you wish to solder anything to aluminum, first coat the aluminum with melted zinc poured on, then solder to the zinc surface, using common solder and a good flux.—Robert C. Knox, Santa Barbara, Calif.

Saw Case for the Tool Chest

A number of saws are generally carried in a well-equipped tool chest, and protection for the teeth is not always easy

to provide. One carpenter uses a novel saw holder, which occupies little space and holds several blades for the detachable handle. Separate cases are used for miter and other attached-handle and backed

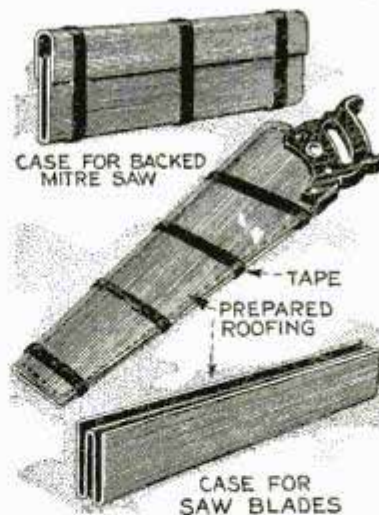

saws. Such holders are made of pieces of prepared roofing, such as comes in rolls, using a kind which does not contain crushed stone or anything injurious to the saw teeth. After cutting and forming it to the shape of the saw, a few turns of friction tape hold everything firmly, and the case may be tossed into the tool chest without risk of damaging the saws.

Restoring Contact of Third Generator Brush

When the third brush on a Ford generator is shifted to change the output, it sometimes fails to make a good contact with the commutator and there is no output at all. This is often caused by a little dirt or an uneven surface on the brush. The proper method is to sand the brush to fit, but if the brush is pressed down gently with a small stick while the motor is running slowly, it can often be made to "run itself in" and the generator will charge.

Fitting Lathe to Do Job That Requires Larger Swing

The photos show how a job of boring automobile wheels to fit the hubs was done by fitting a faceplate to the back end of the lathe spindle. The faceplate was mounted on a shaft extending through the hollow spindle and was fastened in place by means of a nut and washer. The wheels were centered by means of a tapered cone, which was mounted on a stub mandrel screwed into the opening in the center of the faceplate after the wheel was lightly fastened with bolts and clamping pieces, as indicated. The cone was then removed and the boring done by means of a tool consisting of a suitable guide piece screwed into the faceplate opening, the guide carrying a sliding member with an adjustable cutter and an operating handle.

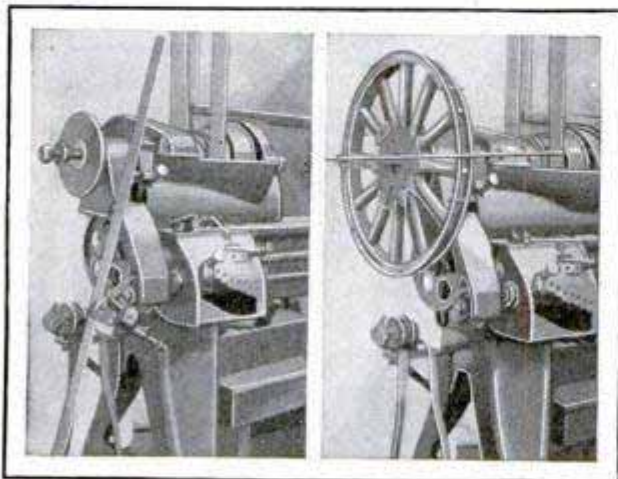

Boring Auto Wheels on Lathe Which Is Too Small to Handle Them in the Regular Way

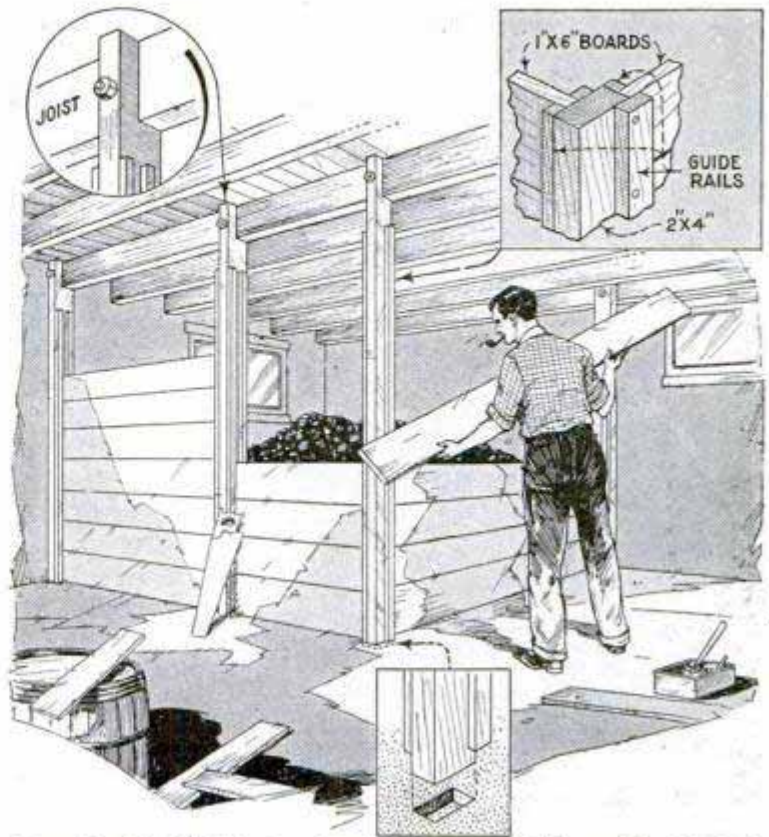

Portable Bin Which Can Be Taken Down When Not Needed for Coal Storage

Easily Built Portable Coal Bin

Many home owners have only small basements and during the months when no coal is used, a bin is not needed, unless it is filled during the summer for the following winter. A portable coal bin of the kind shown in the drawing can readily be built by anyone. It can be taken down when not in use and put up again when coal is to be taken in. It is constructed of 1-in. boards which are slipped into grooves formed by nailing strips to 2 by 4-in. uprights. These extend from the floor to the joists above, to which they are bolted with $\frac{1}{2}$ -in. bolts. The boards are slipped into the grooves near the top and are forced down tightly. These boards should not be over 4 or 5 ft. long, unless an extra 2 by 4-in. upright is provided on the outside as a brace.

Etching on Aluminum

Etching on sheet aluminum is made better and more simple by using a solution of weak hydrochloric acid. It is important that this acid be diluted and not used in its full strength, for in a diluted state it will produce better work.

30 36

Is This Your Home?

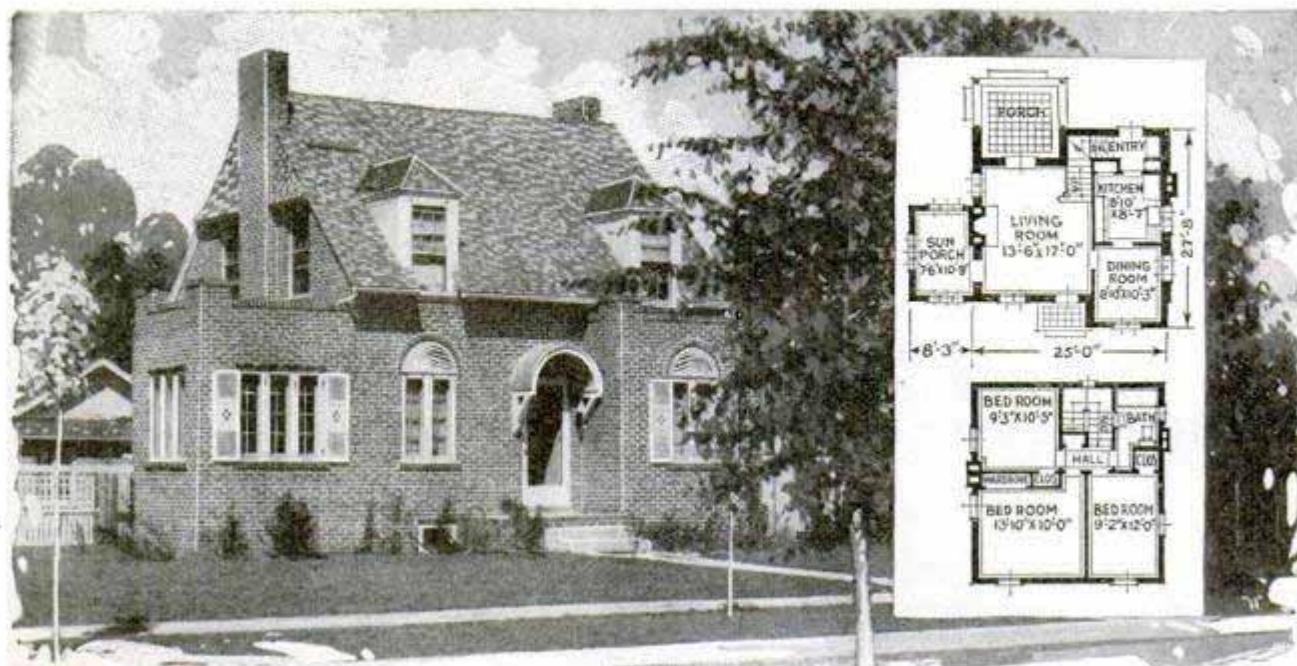

Copyright, Architects' Small House Service Bureau

Plan No. 5B16

QUESTIONS regarding home building addressed to this magazine will be answered by The Architects' Small House Service Bureau of the United States, Inc., controlled by the American Institute of Architects and indorsed by the United States department of commerce. Please inclose 10c in stamps or coin. Blueprints, specification forms, and material lists for the house shown here may be obtained from the Architects' Small House Service Bureau for a small fee. If further information is desired, literature describing the plan service and publications of The Architects' Small House Service Bureau will be sent you upon request. A booklet entitled "50 Ways to Lower Home Service Costs," illustrated by ten Bureau homes actually lived in and showing how as much as \$1,000 can be saved on a home, may be obtained for 20c.

THIS house is a model of compactness and economy of space. Omitting the sun room and rear porch, the over-all area of the plan is only about twenty-five by twenty-six feet. To many people whose means are limited and who must, therefore, reduce their requirements to the absolute minimum, this design will come as a welcome solution.

This really is a six-room house, containing the usual living room, kitchen and dining room and three bedrooms with bath. In addition there are two porches, one more properly a sun room, which, opening on the living room, not only adds considerably to the living space, but lends an extra item of interest to the exterior, for the front wall of this room, continuing in unbroken plane with the main wall of the house, gives a feeling of breadth.

The porch at the rear is open. Square wooden posts with lintels and brackets of the same material help to make the rear of the house interesting. Its floor is of

cement, marked in forms of tile, and is bordered with brick.

The living room is unusually well lighted, having windows on three sides; there is also the staircase in one corner, a fireplace, and the two porches opening upon it. The dining room and kitchen are small, but light and airy.

In the second story there are three bedrooms, well designed to accommodate the necessary furniture, each with a closet.

The kitchen equipment is complete, and with the working fixtures along the outside wall, there is an insurance of fine light and ventilation.

Suggested color scheme: Red and brown texture brick set in white mortar; woodwork painted white, the roof a combination of blue and gray.

Construction: Solid brick walls, shingle or slate roof. Size of lot: Approximately forty-five feet. Designed to face east or south, but may be built reversed for other facings.

New "YANKEE" Two-speed drill

ONLY a finger touch is necessary with this wonderful new two-speed "Yankee" Drill No. 1435, to make this difference in results.

You start on high speed, drill rapidly; then finish on low speed with double power.

Jamming is avoided in drilling through. Drills are saved. You get a perfectly clean hole. No burrs.



Try these Hand Drills

at your hardware dealer's counter on this "Yankee" Demonstrator. See how slick they work in your own hands.

No. 1435 is the smallest two-speed drill made, and no other drill accomplishes this speed change so speedily and easily. Not even necessary to remove drill from work.

Length, 11 in. Weight, 1 lb. 3 oz. 3-jaw chuck. Capacity, $\frac{1}{4}$ in.

For continuous drilling in close quarters where you can't make a full turn of the crank, use "Yankee" Ratchet Hand Drill No. 1530. One speed. Five Ratchet Adjustments, including "Yankee" Double Ratchet. Length, $10\frac{1}{2}$ in. Weight, $1\frac{1}{4}$ lbs. 3-jaw chuck. Capacity, $\frac{1}{4}$ in.

For large drilling jobs use "Yankee" Ratchet Breast Drill No. 1555. Two speeds. 3-jaw. Capacity, $\frac{1}{2}$ in.

Write for Free "Yankee" Tool Book

Shows how "Yankee" Tools make work easier: Spiral Screw-drivers. Plain Screw-drivers. Ratchet Bit Braces. Automatic Push Drills. Automatic Feed Bench Drills. Ratchet Tap Wrenches. Vises with removable base, etc.

Dealers Everywhere
Sell "Yankee" Tools

"Yankee" on the tool you buy
means the utmost in quality,
efficiency and durability.

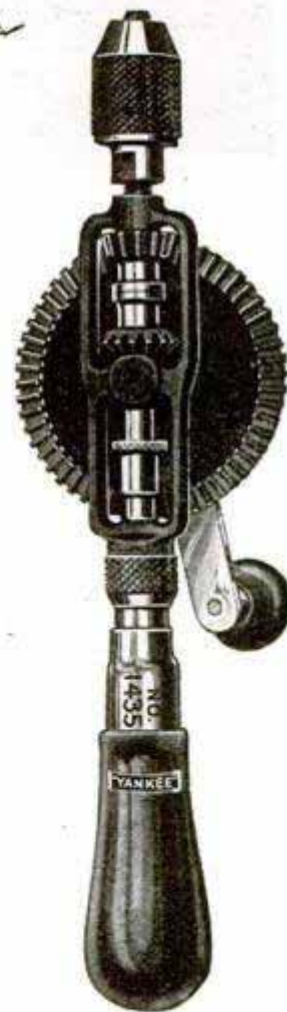

NORTH BROS. MFG. CO., Philadelphia, U. S. A.

"YANKEE" TOOLS

Make Better mechanics



Who are these Investors?

*An Advertisement of the
American Telephone and Telegraph Company*

TEN years ago fifteen of the largest corporations in the United States had a total of approximately 500,000 stockholders. Today the American Telephone and Telegraph Company alone has more than 420,000 stockholders.

This is an instance of the amazing growth of saving and investment that has taken place in this country. Who are these new investors?

American Telephone and Telegraph stockholders come from every rank and file in every state, nearly



every town and city, in the land. Mechanics and merchants, teachers and bankers, laborers and lawyers—every station of life is represented in this investment democracy. And it is a democracy, for the average holding is only 26 shares. No one person owns as much as 1% of the total stock.

The American Telephone and Telegraph Company and its associated companies comprising the national Bell Telephone System are owned by the people they serve.

To Men Who Love Good Tools



To you to whom it is a source of genuine pleasure and pride to own and work with truly fine tools let us once again pledge the integrity of workmanship and forty-eight years of accumulated skill, experience and resources that have earned for this organization its reputation as the **World's Greatest Toolmakers.**

We wish you one and all the merriest Christmas and most successful of all New Years.

THE L. S. STARRETT COMPANY

ATHOL, MASS., U. S. A.



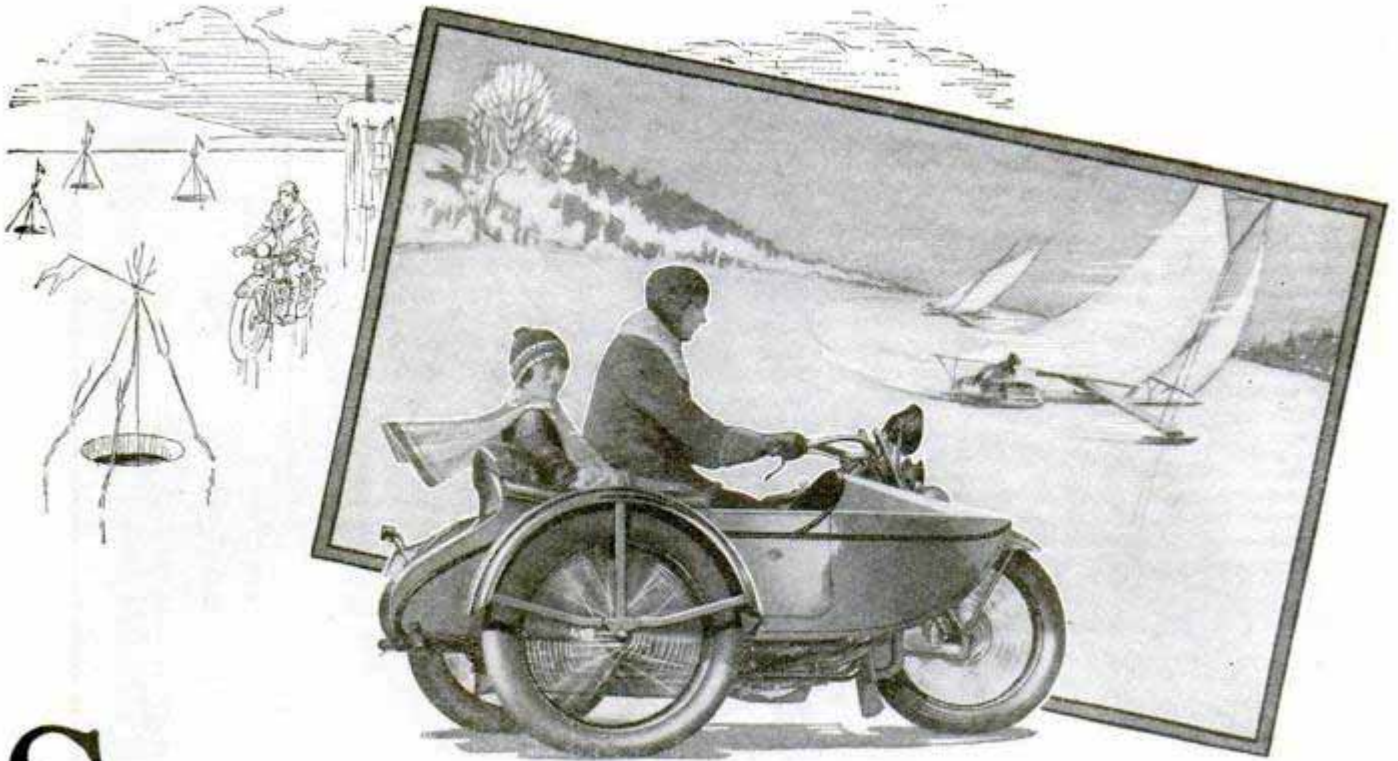

Sport for all sportsmen!

ENOY all the winter sports with a Harley-Davidson Twin. Follow them, whether they are close by or miles away. Distance means only a delightful ride, for motorcycling is a sport all its own — for everyone! *Costs only 2¢ per mile.* The Harley-Davidson Twin is slung low for balance and control. Equipped with both front and rear wheel brakes, throttle controlled motor oiler, carburetor air cleaner, and many other features.

Thrilling power and get-away. No radiator troubles. Ask your local dealer for a demonstration and details of his Pay-As-You-Ride Plan. Prices as low as \$310 f. o. b. factory.

Send the coupon for catalog.

HARLEY-DAVIDSON MOTOR COMPANY
Department P. Milwaukee, Wis.



The Single — the most economical, dependable means of quick, safe travel—80 miles to the gallon of gas—one cent a mile operating cost. Completely equipped \$235. f.o.b. factory.

HARLEY-DAVIDSON

Motorcycles

Mail
This
Coupon

HARLEY-DAVIDSON MOTOR COMPANY
Dept. P. Milwaukee, Wis.

Send me your Catalog. I am interested in
 Twin Single Your Dealer Proposition.

Write name and address in margin—tear off and mail today.

Heavy blows

SAFE *and* SURE

with this balanced tool

POUND AWAY! Drive a cold chisel; loosen a balky tire rim; straighten a bent pipe. For any heavy metal work a Plumb Ball Pein gives you power.

Balanced for its job! Head is mounted off-center to get more drive into your blows. Oblong eye takes a sturdy full-size handle which has been tested by a weight dropped upon the neck.

Or for fine, accurate work . . . spreading a tiny rivet; driving a center-punch—a Plumb falls where you want the blow, working in perfect swing with the natural move of your arm.

And safe, always! You never need work with a wobbly head. For—when steady pounding loosens this Plumb Handle, you just turn the Screw Wedge to make it tight again.

This Plumb invention eliminates loose handles for all time by giving you a way to retighten them instantly.

Buy this safe hammer for hard work . . . around your car . . . at your work bench.

FAYETTE R. PLUMB, Inc.
Philadelphia, U. S. A.



Look for the Red Handle and Black Head in your hardware store. This is No. HF-375, 1½ lbs. It costs \$1.30. Other sizes in proportion. (Slightly higher in Far West and Canada.)

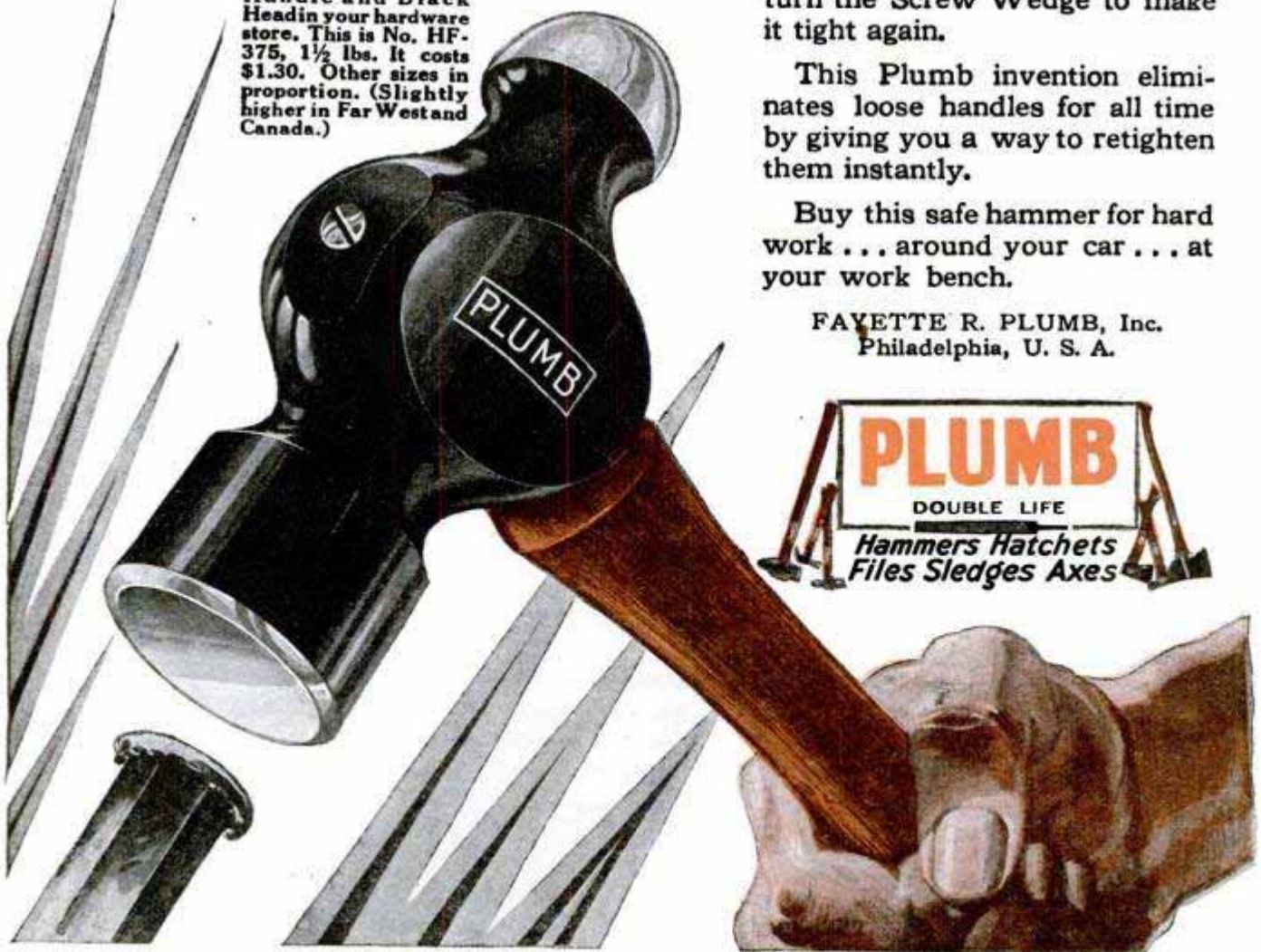

Be Sure To Build The Improved Aero-Dyne Six Receiver

This excellent circuit combines many fine qualities that insure superlative receiving performance. Long range, extreme selectivity, and wonderful tone quality are only a few of the features offered.

Built around these Super-sensitive AERO UNIVERSAL COILS

**A
wonderful
Kit**



**Adaptable
to all
tubes**

The IMPROVED AERO-DYNE SIX owes much of its wonderful performance to this kit of AERO Universal Tuned Radio Frequency Coils around which it is constructed. These AERO Coils are undeniably the finest inductance units thus far produced. This kit consists of 4 twice-matched units—adaptable to all standard tubes—201-A, 199, 112 and the new 240 and A. C. tubes. Has a tuning range below 200 to above 550 meters. So constructed that losses are practically eliminated, and receiving efficiency wonderfully increased. Each kit is carefully matched at both ends of the broadcast range. We unhesitatingly say that these coils will make any set better in selectivity, tone and range.
For .0005 Condenser, Code No. U-16 Price \$15.00
For .00035 Condenser, Code No. U-163 Price \$15.00



Code No. U-12

Other AERO KITS Employing the Improved AERO UNIVERSAL COIL

The AERO UNIVERSAL Tuned Radio Frequency Kit—Kit of 3 Coils (for Aero-Seven)
 Consists of 3 twice-matched units. Coils are wound on Bakelite skeleton forms, assuring a 95% air dielectric. Range from below 200 to 550 meters. Each kit carefully matched at both ends of the broadcast range. (This kit illustrated at the right.)
For .0005 Condenser, Code No. U-12 Price \$12.00
For .00035 Condenser, Code No. U-123 Price \$12.00

AERO Universal 3-Circuit Tuner



In the form of a 3-circuit tuner with a fixed tickler, this Aero Coil will improve any circuit. Adaptable only to 201-A, 199, 112, or the new A. C. Tubes. Has variable primary for governing selectivity.
Code U-55 (for .0005 Condenser) or Code U-553 (for .00035 Condenser).
Price.....\$4.00

AERO Radio Frequency Regenerative Kit



The supersensitive kit used in the new Aero 4 and the Chicago Daily News Receiver will improve the efficiency of any circuit. For use with 201-A, 112, 119, and the new A. C. Tubes. Used as .0005 variable condenser to tune fixed tickler.
Code U-95 (for .0005 Condenser) or Code U-953 (for .00035 Condenser).
Price.....\$8.00

AERO Universal Antenna Coupler



A highly efficient low-loss antenna coupler with variable primary, adaptable to 201-A, 119, 112, 240 and the new A. C. Tubes.
Code No. U-96 (for .0005 Condenser) or Code No. U-963 (for .00035 Condenser).
Price.....\$4.00

IMPORTANT NOTICE

We are able to furnish complete foundation units for the AERO-DYNE SIX, drilled and engraved by Westinghouse Micarta, complete with drilled bakelite sub-panel, 2 panel brackets, and blue print at \$12.50 each. This is a wonderful convenience and time saver for the home set builder. We can also supply foundation units for the Aero Short Wave, Aero 7, Aero 4, and Chicago Daily News 4 tube circuits, complete with full working blue prints. Prices on these units on application.

Any of these AERO Kits and coils should be available at your dealers. If he cannot supply you, order direct from the factory. Be sure to specify code or key numbers when ordering.

AERO PRODUCTS, Inc., Dept. 107
1772 Wilson Ave. CHICAGO, Ill.

Dorfan Electric Train Sets and "Take-apart" Engines retail from \$6.00 to \$38.50. Let us send you a new 1927 Dorfan illustrated catalogue if your dealer does not have one.



Dorfan Electric Engines Can Be Taken Apart

More fun, of course, than just watching trains run around a track. Get your friends in and see who can take apart and reassemble this Dorfan engine fastest. No other electric engine has this feature! Watch the Dorfan engine pull the *longest* train of cars up the *steepest* grade at the *fastest* speed! It is reversible, and moderately priced.

Dorfan's superior speed and power is due to the patented die cast non-magnetic housing—an exclusive Dorfan feature—which permits every bit of current to be transformed into power. There can be no loss from induction as is common with ordinary engines. The Dorfan Company, 137 Jackson Street, Newark, New Jersey.

DORFAN

TAKE-APART ENGINES

ELECTRIC TRAINS



One of the five durable Dorfan tunnels. Finished in bright colors. (Sturdy one-piece and folding tunnels available.) Price . . . \$3.50



One of the sturdy Dorfan bridges—30" long—5" high. Exceptionally well built. Price \$3.00



ESSENTIAL TO PRECISE WORKMANSHIP

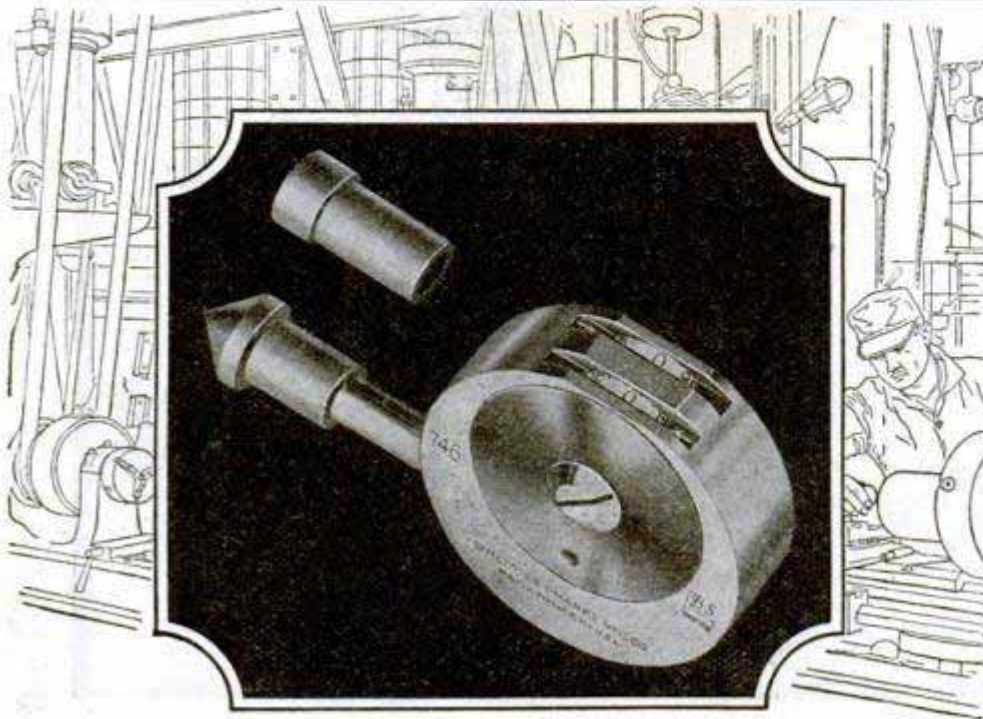

Vest Pocket Speed Indicator No. 746 for checking the speeds of shafting, etc. Easy to use. Measures all speeds accurately, giving readings in either direction. Only four major parts. Price \$1.50

For Measuring Speeds Easily and Accurately —Use No. 746

Knowing the speed of shafting, fly wheels and other revolving units is essential in mills, factories and machine shops. Vest Pocket Speed Indicator No. 746 is just the tool—handy, accurate, reliable and inexpensive.

No. 746 is only one of many Brown & Sharpe Tools that mechanics everywhere depend on for accurate measurements. And you can make measurements in your home workshop as accurate as those made in industry if you use tools that are "world's standard of accuracy."

Catalog No. 30 lists over 5,000 items. It may be had from your hardware dealer or will be sent free on request. Dept. P. M., Brown & Sharpe Mfg. Company, Providence, R. I., U. S. A.

BROWN & SHARPE TOOLS



PLANER AND SHAPER GAUGE Catalog No. 625

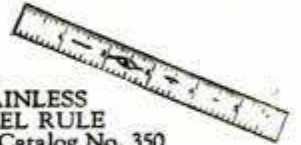

STAINLESS STEEL RULE Catalog No. 350



THICKNESS GAUGE Catalog No. 648



DIE MAKERS' SQUARE Catalog No. 552



Catalog No. 438 COMBINATION SET

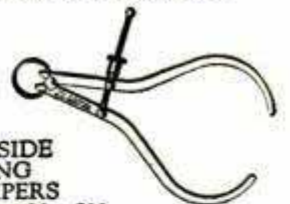

OUTSIDE SPRING CALIPERS Catalog No. 811



SCREW PITCH GAUGE Catalog No. 630

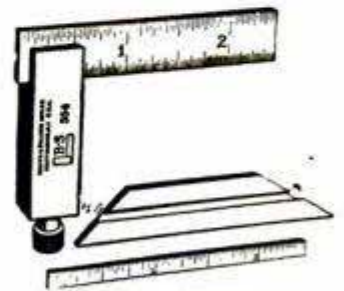

ADJUSTABLE GAUGE Catalog No. 554



"WORLD'S STANDARD OF ACCURACY"

3940 Hand-Saw Cuts Saved on This House!

Plan No. 633
\$1860
 5 Rooms
 and Bath

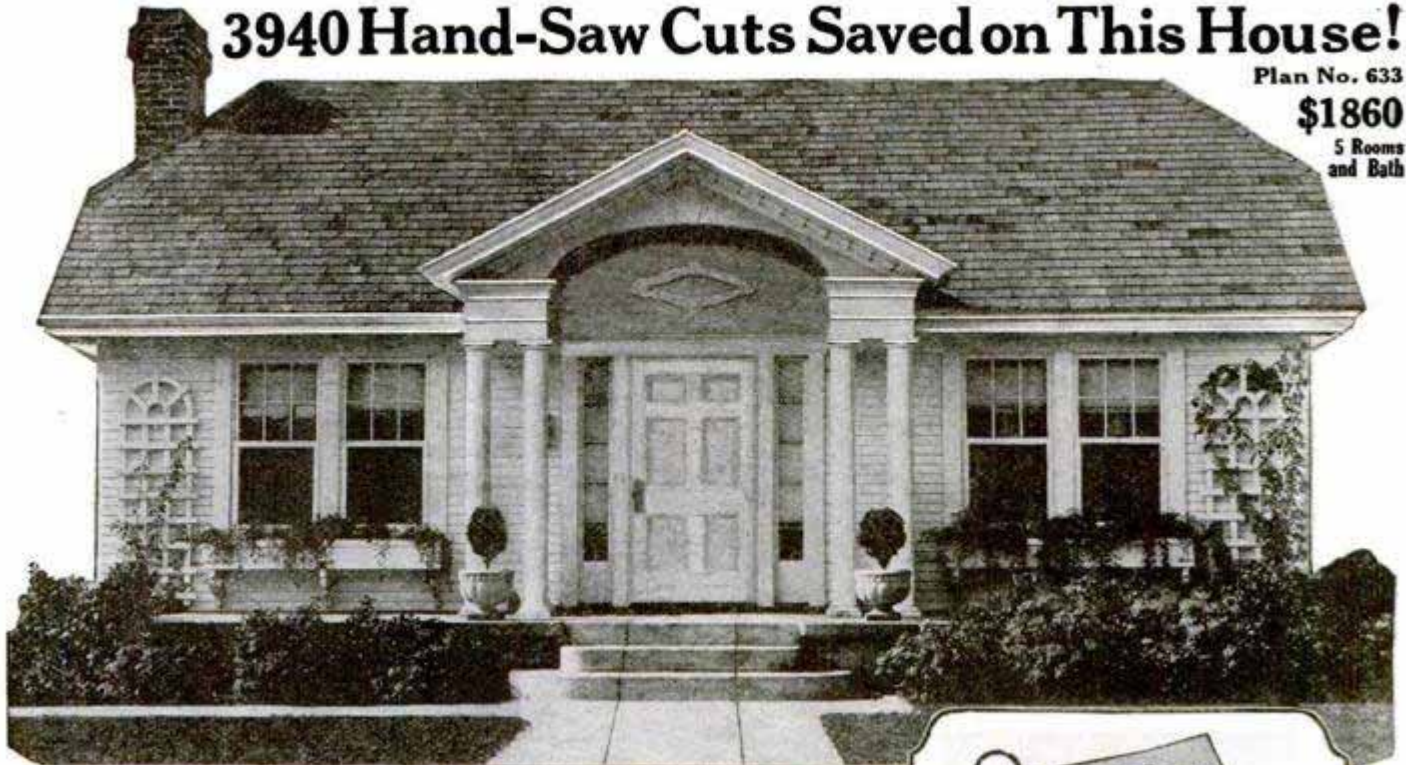

Choose From 100 Plans!
Buy Direct From Mill,
and Save \$200 to \$2,000!

You Can Build Your Own Home By the Gordon-Van Tine Plan-Cut System

We ship direct from mill all framing lumber and sheathing sawed, cut and fitted, complete blue-prints and full instructions.

Easy to build as swinging a hammer! Every part numbered according to plan. All the figuring, measuring, roof-pitches, angles already done for you. No cutting of heavy floor-joists, rafters, or timbers. Even the doors are mortised for locks.

Save 30% Labor

Hand-sawing is the costliest item in building. By our Plan-Cut method you save 30% labor and 18% lumber waste.

A Tighter, Warmer House

Machine-accuracy insures tight, solid fit of all joints. You get a stronger, stouter house, absolutely permanent.

Jap-a-Top Slate Surfaced Roofing



Green or red: 85 lbs. to roll. Fire-resisting. Other grades at lower prices.

\$2.20 Per Roll

Garages \$83 Up



Parts plan-cut, easy to build. Also Summer Cottages, Barns, Poultry Houses, etc.

5,000 Building Material Bargains

Lumber, Shingles, Lath, Flooring, Windows, Doors, Roofing, Screens, Garages, Furnaces, Glass, Paints, Varnish.

Guaranteed Price

The price you pay us includes all lumber, lath, shingles, doors, windows, trim, stairwork, hardware, paint, tinwork, nails, varnish and enamels. We guarantee there will be no extras. Cement and brickwork you buy locally.

Wholesale Prices

By buying direct from mill, you get benefit of big volume and economy operation—lowest wholesale prices!

Book of 100 Home Plans Shows photos, floor-plans, prices of 100 charming homes. 20-Year Satisfaction Guarantee.

Bldg. Material Catalog Lists and prices everything for building. Biggest stocks in America.

Quality Paint

Quality mixed paint, the best you can buy. A gallon covers 300 square feet, two coats. Per gallon.



\$2.40

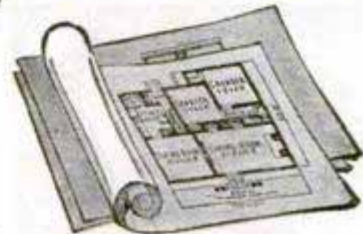

Floor Plan Home No. 633

Ordinary Rafter must have four cuts made by hand



Gordon-Van Tine Rafter comes all cut by machine

Our power-driven saws cut, notch and bevel rafters and other pieces in a fraction of the time it would take a carpenter to do by hand. Altogether we save you 3940 saw-cuts in the material for this house.

Send for These FREE BOOKS!



Mail Coupon or Post Card

Gordon-Van Tine Company
 1040 Case Street, Davenport, Iowa
 Satisfaction Guaranteed or Money Back.

Please send me Book:
 I am interested in.....

Name.....

Address.....

Gordon-Van Tine

Established 1865

PLAN-CUT Homes

for Xmas



The Complete Equipment consists of the powerful Red Jacket Drill Motor with direct drive to the Waco Craftsman's wood turning lathe (capacity 9 in. x 34 in.); a bench saw, that has depth and side gauges, scroll and jig saw; and all accessories for both portable and stationary power drilling, buffing, grinding and cleaning. Attaches to any light socket and converts your work bench into a complete private tool and machine shop.

Turning
Sawing
Winding
Spinning

Grinding
Buffing
Polishing
Drilling

Cabinet
Making
Scroll
Sawing

Repairing
Dove
tailing
Pointing

Jointing
Sharpening
Sanding
Scratching

Carving
Successful
Master
pieces

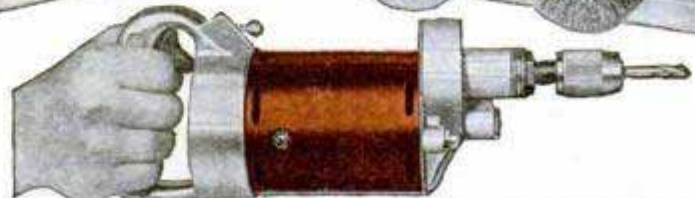
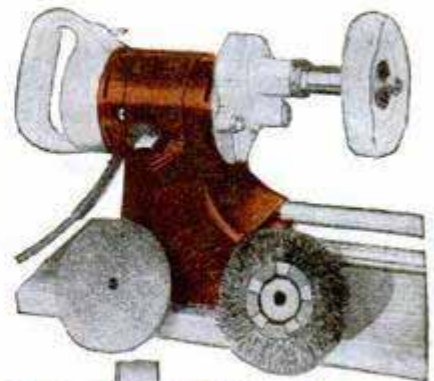
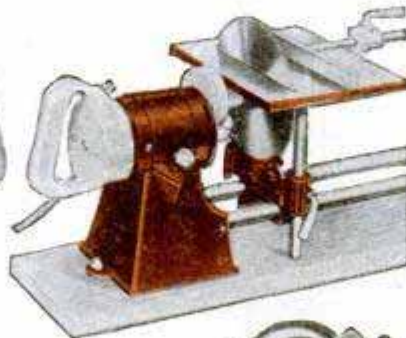
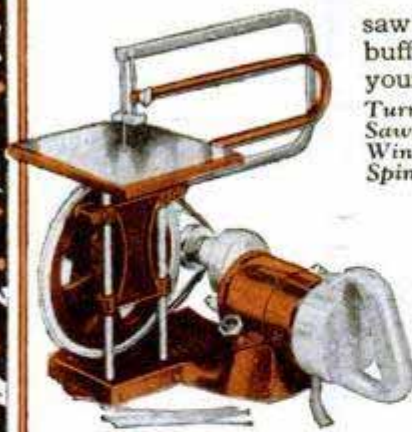

ONLY
\$10⁰⁰
DOWN

Give Him This — Craftsman's Wonder Home Work Shop

What finer Gift could a family make
to Husband, Father or Son?

What a wonderful gift to the man who loves to work, make, build and create. You keep feeding work and ideas to the "Red Jacket" and it completes each job so quickly, so interestingly and so perfectly that the results urge you on to greater accomplishments. Anything and everything is possible to the owner of a

Red Jacket Waco Craftsman's Lathe

It is a complete chest full of electrically driven tools designed by a master for the private use of tool lovers and men who create, repair and appreciate handy tools at home.

The Famous Waco Red Jacket Guarantee

If our tools are not what you want when you see them, send them back.

Look Out for Imitations: There is only one Red Jacket, one Waco, one Wm. L. Aylward, mastercraftsman.

**free
CRAFTS
COURSE**

Special Crafts Course and blueprint service is free to Red Jacket Shop owners—all that there is to know about handicraft methods, raw materials, woods, carving, sawing, turning, designing, carpentering, decorating, is taught by special correspondence.

Buy On Your Own Terms Only \$10.00 down. Liberal discounts for cash. Easy monthly payment plans. It is no hardship to own a Red Jacket.

**free
BLUE
PRINTS**

10 DAYS' FREE TRIAL

Our literature tells you how to start a job of your own. If you are not pleased return the Shop.

Interesting Literature Free Send the coupon. You will be surprised with all it contains. Beautiful, Instructive, Fascinating, Interesting.

This
Headstock
furnished
where no
electricity
is available



Mail This to Waco

WACO TOOL WORKS, Inc.
542-4 N. Parkside Ave., Chicago, Ill.

Manager, Dept. 100. Please send me particulars about 10-day free trial, free blueprints, and \$10 down payment.

Name.....

Address.....



New Model Pocket Ben

For faithful service, and correct time day after day, rely on the New Model Pocket Ben.

Pocket Ben is a sturdy, long-lived watch for men and boys who want to carry dependable time-keeping wherever they go—\$1.50. With night-and-day dial, \$2.25.

*Built by the makers of
Big Ben and other Westclox*

WESTERN CLOCK COMPANY
La Salle, Illinois

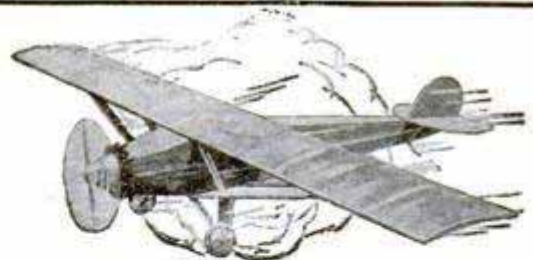

Build and Fly a 3 ft. Model of LINDBERGH'S NEW YORK—PARIS MONOPLANE

Plans for Other Model Airplanes 25c per set.
FOKKER North Pole Plane
CURTISS JN4D-2 Plane
DeHAVILLAND World Flyer
NC-4 Naval Seaplane
Bleriot, Nieuport or Taube Monoplanes
Cecil Peell Racer Plane
(All 9 Plans for \$2.00)

This IDEAL New York-Paris Monoplane is a perfect copy, 3-ft. size of the "Spirit of St. Louis" in which Lindbergh crossed the Atlantic Ocean. Any bright boy can build this model. The IDEAL Construction Outfit contains everything needed: all parts, fittings, materials and supplies, including careful instructions, plans and diagrams. The model has many features of the original and is guaranteed to fly. Complete Construction Outfit, **\$7.50** (West of Denver, Colo., and in Canada, price is \$8.00)



Ask your dealer or order direct. Plans and instructions only (No materials included), postpaid 25c. IDEAL AEROPLANE & SUPPLY CO. 408 West Broadway NEW YORK CITY

Catalog of Model Airplanes, Parts, Supplies, etc., 5c postpaid

ITALIAN ACCORDEONS

We manufacture and import all kinds of first-class hand-made

ITALIAN ACCORDEONS, the best in the world. Ten year guarantee. Our Prices are lower than any other maker's. Free Accordion instructions to buyers. Write for FREE catalog.



RUATTA SERENELLI & CO.
1014 Blue Island Ave., Dept. M Chicago, Ill.

STAR CRIMPER **\$72 a Week** MEN OR WOMEN
Big Line **BIG MONEY**—Spare or Full Time—introducing our 40 fascinating Kitchen Specialties to Housewives. Simply show samples we furnish—they sell themselves. Write for interesting Free details.
GENERAL PRODUCTS CO., Dept. 7A, Newark, N. J.

Chemical Tricks for Boys

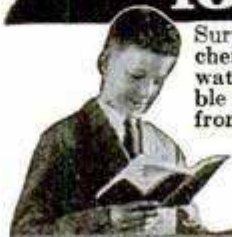

Surprise and puzzle your friends with magic chemical tricks; make ink, dye cloth, test water and soil; write secret letters with invisible ink; pour blue, brown and black liquid from a pitcher of water. All these and many more chemical stunts are easy with ChemCraft Junior. It's the best box of fun you ever had! Get yours now.

ONLY 25c POSTPAID



FREE Magazine of the ChemCraft Club to every boy who writes for it now. Full of new ideas and chemical stunts. Ask for yours!

The Porter Chemical Co.
113 Summit Ave. HAGERSTOWN, MD.

Radio's Greatest Value!

6 TUBE SUPERPHONIC 6 Radio

ALL METAL CHASSIS
+
SHIELDED
+
READY TO WIRE

ALL PARTS MOUNTED
+
CAN BE WIRED IN A FEW MINUTES



FREE!
6 TUBES -
UX-201-A TYPE

Tested & Matched

COAST TO COAST RECEPTION!

Only \$16.95

No Radio knowledge needed

Superphonic 6 is a world beater! An exceptionally high grade radio at a price that is amazing the Radio World.

Latest 6 tube tuned radio frequency circuit. Extremely selective, marvelous sensitivity. Three stages of radio frequency, detector and two stages of low ratio audio frequency, for improved tone quality. Two-dial control. Straight line frequency condensers. All metal chassis. Shielded. Clear and realistic reception guaranteed. Beautiful black front panel (7"x18"); ornamental design, degree and kilo-cycle markings in gold. Metal panel and sub-panel. Complete chassis. No extra parts to buy. All parts mounted. Simply connect a few wires. No special tools needed. Kurz-Kash indicator knobs. New type UX sockets. All hook-up wire and colored battery cable included. Value \$60.00, our price **\$16.95**

TESTED AND APPROVED

Severe laboratory tests have proved the remarkable efficiency of this set. Owners everywhere are sending us letters praising its wonderful receptive qualities. E. Richmond, Detroit, Michigan, writes: "Tried out my Superphonic first night with weak batteries. Was surprised to get all local and 7 other long distance stations loud and clear. This is some record. I expect to get even better results tonight with full power. A friend heard it and wants one too. Please ship me another outfit immediately."

B. J. Gillis, Denver, Colorado, says: "Wired set in short order. Getting stations all over the country. Plenty of volume. The set sure is a dandy."

M. A., Syracuse, N. Y., sends telegram: "Rush at once 2 more Superphonics."

M. Madsen, Chicago, Ill.: "Don't know anything about radio. Got it wired up in a little while and it works great."

C. Drysch, Chicago. "First night set was up got 12 out of town stations. Everything came in clear as a bell and nice and loud."

SIMPLE WIRING DIRECTIONS

Very easy to wire this set with the instructions we furnish. Just connect a few wires.

All you have to do is to follow numbers. That is all. Can be wired in a few minutes by anyone. No radio knowledge needed. Make money by wiring these sets in your spare time and selling them to your friends.

SEND NO MONEY!

Fill in the coupon and mail it today. We will ship you this great outfit together with 6 tubes immediately. When it arrives, pay only \$16.95 plus a small delivery charge. (Foreign countries send \$19.50 with order. We pay shipping charges.)

Mail This Coupon NOW!

RADIO EQUIPMENT COMPANY
Dept. P. J. 551 S. Wells St. Chicago, Ill.



Our instructions are as simple as adding 2 and 2. Just follow the numbers on the drawing. It will only take a few interesting minutes.

Radio Equipment Co.
551 S. Wells St.
Dept. P. J. Chicago, Ill.

Gentlemen:

Please send me at once your Superphonic 6 radio together with 6 tubes. Upon arrival I will pay \$16.95 plus a small delivery charge. (Foreign countries send \$19.50 with order. We pay shipping charges.)

Name
Address
City State

AN IDEAL

CAN BE PUT TOGETHER BY A

\$6⁹⁸ **CONSTITUTION**
Size 26 in. High, 27 in. Long, 8½ in. Wide

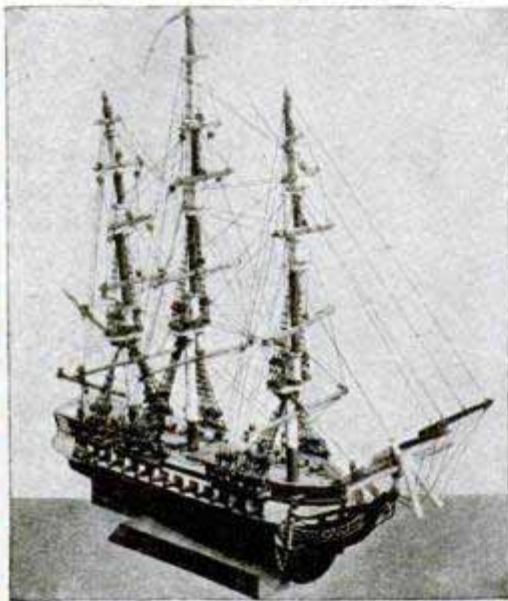

SANTA MARIA

Size 25 in. High, 11 in. Wide, 27 in. Long

Gifts that are appreciated and out of the ordinary are hard to find. The lasting value of these models will make the gift "a long remembered one." A historical ship model should be in every American Home. We supply all the parts, cut to fit, and ready to put together. Every part necessary to construct any of the models pictured. A full diagram of numbered parts comes with every kit with full detailed step by step instructions, so that it is impossible to make a mistake. All you need is a small hammer to tap the parts in place.

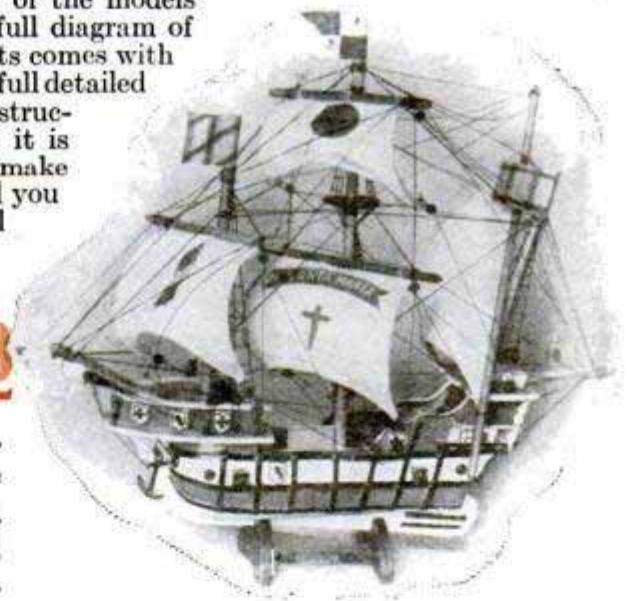

\$4⁹⁸

This is a part of the instructions copied from the regular sheet that comes with each kit. Take part No. 57, place it at the front end of No. 56 and down on No. 55. Next take part No. 58 and place it at the rear end of No. 56 and tap in place with a small hammer. So clear are the instructions that

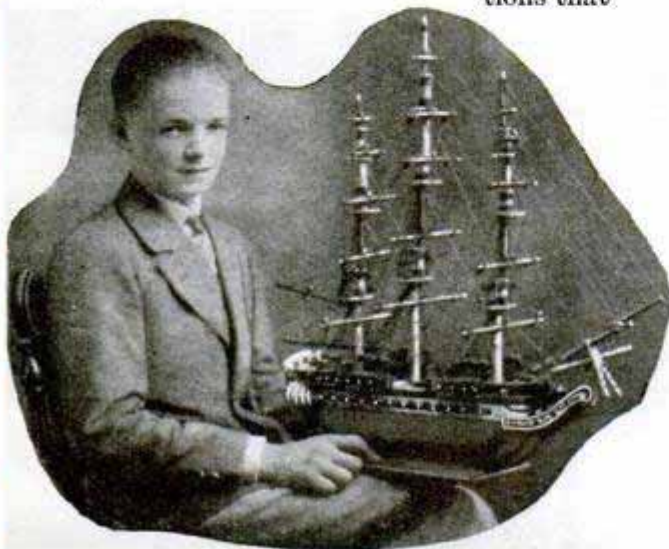

This 15 Year Old Boy Won First Prize

in a model contest held by the publishers of the Science & Invention Magazine. Hundreds of ship models were entered from all parts of the country. This model was constructed from a regular kit of our parts. The educational and historical value a boy gains in constructing one of these models can not be measured in dollars and cents. Boys like to build things. They learn as they build.

XMAS GIFT

SCHOOL BOY IN THREE HOURS

LA PINTA Size 26 in. High, 27 in. Long, 12 in. Wide
SHIP MODEL LOUD-SPEAKER

\$12⁵⁰

These models with the exception of the Constitution may be converted into a beautiful toned loud-speaker, that will serve a double purpose, "being useful as well as beautiful." The main-sail acts as diaphragm and is driven by Unit of the Electro Magnet Type. This is attached to the main-mast

that is imbedded firmly in the hull. Power amplification is not needed as the Unit will operate a 72" cone. This assures you faithful reproduction at all frequencies.

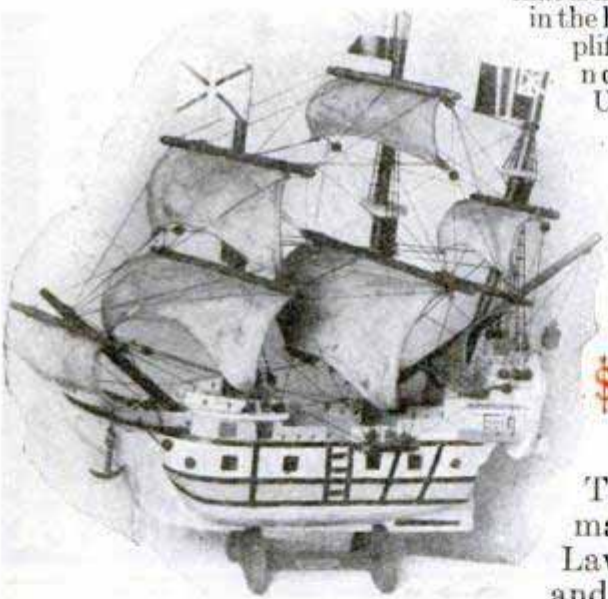

\$4⁹⁸

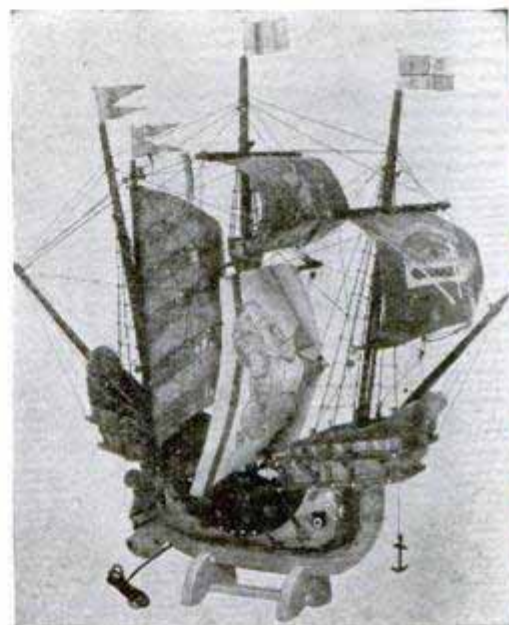

MAYFLOWER

Size 25 in. High, 10 in. Wide, 26 in. Long

models from our complete kit of parts. They have become so interested in the building of the first model that in many cases they have sent for the parts to construct all of our models. Ship Model building is indeed a fascinating pastime.

When the model is completed it makes one of the finest home decorations that money can buy, and the adventure of building your own models adds zest to the achievement. You will be proud of your model—because you are the builder.

MINIATURE SHIP MODELS, Inc.
3818-20-22-24 Baring Street, Philadelphia, Pa.

Canadian Branch: 1485 Bleury St., Montreal, Canada
Canadian Prices Slightly Higher. Send all Canadian Orders to Canadian Office

These Ship Model kits are not only for boys. They make a beautiful gift for everyone; Doctors, Lawyers, Business Men, Nurses, Stenographers and Housewives all over the country have built

SOLD ON A MONEY-BACK GUARANTEE
ORDERS SHIPPED THE DAY RECEIVED

MINIATURE SHIP MODELS, Inc., DEPT. P4
3818-20-22-24 Baring St., Phila., Pa.

Please send me complete parts, cut to fit and ready to assemble for the Constitution, \$6.98 ; Santa Maria, \$4.98 ; La Pinta, \$4.98 ; Mayflower, \$4.98 ; *Melody Ships:* La Pinta, \$12.50 ; Santa Maria, \$12.50 ; Mayflower, \$12.50 . I will pay postman purchase price plus postage (a few cents).

Check which model you want shipped.

PLEASE PRINT NAME AND ADDRESS PLAINLY

Name

Street or R. F. D.

City

State

DEVITT 8" COMBINATION SAW

8,000 IN USE!

A SHOPFUL OF TOOLS WITHIN ARMS REACH!

SAW TABLE RAISED SHOWING EMERY WHEEL, SAW GUARD AND DRILL ATTACHMENT



PLANER ATTACHMENT ON SAW TABLE

SHOWING SANDING DISC ATTACHED



TABLE TILTED FOR BEVELING

DADO HEAD ATTACHED FOR GROOVING

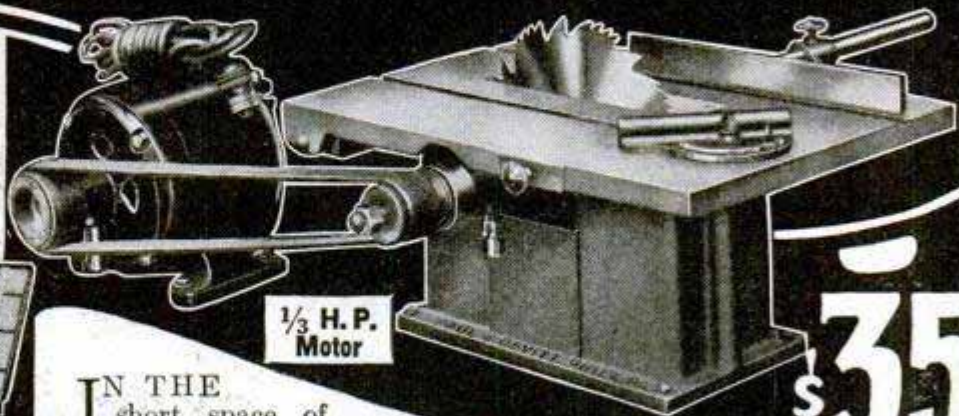

1/3 H.P. Motor

\$35

F.O.B. PHILA

In the short space of four years, the Devitt 8-Inch Combination Saw has become a practical necessity in thousands of shops, factories and households everywhere. Many imitators have sprung up, but Devitt leads them all. Think of the convenience and economy of this handy little machine that will rip, cross cut, bevel, miter, groove, mortise, tenon, drill, rabbet, grind, buff and polish. Attachments are easily and quickly adjusted. The saw and motor, when set up for work, occupy very little room. Saw is equipped with 1/3 H.P. 60 cycle, 1750 R. P. M. 110-volt A. C. Motor which can be attached to ordinary light socket, and provide power for other purposes when wanted. A cut up to 2 1/4" can be made without planing. Comes complete with following attachments—12"x16" table, 8" Combination Saw, iron pulley for saw table, 10" ripping fence, adjustable cut off miter gauge, motor-specifications as above, 1 1/4" endless leather belt, wood pulley, 8 ft. cord and plug, 6" buffing wheel, 3/8" 3 jaw drill chuck, 5" emery wheel, 6" sander, saw guard, and 2" dado insert. \$35.00 F. O. B. Phila. Height 7 1/2", shipping weight, 100 lbs.

(Only \$12 extra for Planer Attachment to fit on table top. Can smooth pieces up to 2 inches wide. Price, F. O. B. Phila.)

Send today for our attractively illustrated 4-page circular

PAUL J. DEVITT

Dept. C 1102 SOUTH 2ND ST. PHILA., PA.

Beautiful HOUSES \$900 and BUNGALOWS CAN BE BUILT FOR AND UP

This and many others in my new book, Building Plans for Modern Homes, will save you hundreds of dollars. One of the most complete and comprehensive books of plans ever published by any architect. New edition just off the press. Nearly 600 floor plans and photographs of Colonial houses, bungalows, etc., costing from \$200 up; gives sizes and cost to build. Sent postpaid for \$3.00.



FREDERICK H. GOWING ARCHITECT
101 Tremont St., BOSTON, MASS.

SHIP MODEL PLANS!

fittings and supplies. Build and sell models. Plans and instructions for Viking Galley 40c; Chinese Junk 45c. Interesting catalog of Sea Things 6c.

SEA ARTS GUILD

730A Winnebago St., Milwaukee, Wis.



AGENTS 500% PROFIT
GENUINE GOLD LEAF LETTERS



guaranteed to never tarnish. Anyone can put them on stores and office windows. Enormous demand, large profits. Paul Clark says: Smallest day \$28.70. R. L. Reel made \$920 in two months. Write today for free sample and liberal offer to general agents. METALLIC LETTER CO., 433-B N. Clark St., CHICAGO



DIE CUT OVAL PRINTS

Something new for kodakers. Send negative with dime for sample and catalog of specialties for kodakers. FRANK SCOBIE, 43-O, Sleepy Eye, Minn.



A Genuine \$2 Knife for \$1.18 Postpaid

Handy shaped Blade makes this knife best for mechanics, sportsmen and farmers; light but strong; re-sharpened easily. Stag handle. German silver finish; blades file tested, hand forged from razor steel and warranted.

Direct at Factory Prices

Sample \$1.18 3 for \$3.00 Postpaid

Hand Forged Razor Steel Blades

Send for our 100-page FREE List and "HOW TO USE A RAZOR."

Maher & Grosh Co.
106 A St., Toledo, Ohio

21 JEWEL ~ Extra Thin STUDEBAKER

The Insured Watch.

Sold Direct
From the Maker



You save 30% to 50%

An amazing offer! Just \$1.00 down brings you the famous 21-Jewel Studebaker Watch direct from factory. Balance in easy monthly payments. Lowest prices ever named for equal quality. By buying direct you save 30% to 50%. Your choice of 80 magnificent, new Art Beauty cases and dials. Latest designs in yellow, green and white gold effects. Exquisite thin models. 12 Size and 16 Size.

Send coupon for catalog of Advance Watch Styles and full particulars. Studebaker Watches have 21 Jewels, 8 Adjustments—Insured for your lifetime! Insurance Policy FREE! Ladies' Bracelet Watches, Men's Strap Watches, Diamonds and Jewelry also sold at lowest prices and on easy monthly payments. Send coupon for full details.

Mail Coupon For Six-Color Catalog!

The coupon below will bring you a copy of our beautiful new six-color catalog. It contains complete information on watch making. It tells how you can buy a 21-Jewel Studebaker Insured Watch direct from the maker—save big money and pay for it in easy monthly payments.

The Studebaker Watch Company is directed by members of the famous Studebaker family—known for 75 years of honest dealing. Over 100,000 satisfied customers own Studebaker Watches—and saved money by buying them direct. We ship anywhere.

SPECIAL OFFER! Watch Chain FREE!

For a limited time we are offering a magnificent Watch Chain Free. To all who write immediately we will include particulars of this astounding offer. Offer is limited. Send the coupon NOW!

STUDEBAKER WATCH COMPANY

*Directed by the Studebaker Family—three-quarters
of a century of fair dealing*

WATCHES • DIAMONDS • JEWELRY

Dept. E907 • South Bend, Indiana

Canadian Address: Windsor, Ontario

STUDEBAKER WATCH COMPANY
Dept. E907 South Bend, Indiana

Please send me your free catalog
of Advance Watch Styles and de-
tails of your \$1.00 down offer.

Please send me free
catalog of Jewelry
and Diamonds.

Name.....

Street or R. F. D.....

City..... State.....

Sent
for Only
\$1
down



Mail
Coupon
Today!



Going to Build Remodel or Repair?

DON'T think of building a new home or repairing an old one without a copy of our free wood-work catalog.

To those who contemplate building or remodeling, this book is a valuable work of reference. In it are found the latest ideas and most advanced styles for everything in millwork. It illustrates and describes windows and sash of all kinds, including porch and storm sash, doors, frames, mouldings, screens, porchwork, stairwork, hardwood flooring, interior finish, cabinet work—in fact, practically everything in manufactured millwork. Every article in the book shows a low money-saving price direct to you.

FREE ESTIMATES

Send us your lumber and millwork bills for a free estimate. Let us quote prices on your material and tell you the exact amount of freight. Then compare our prices with others. This service costs you nothing and places you under no obligation whatever.



CHICAGO MILLWORK SUPPLY CO., 1444 W. 37th St., Chicago, Ill.
PLEASE SEND ME YOUR FREE BOOK

Name _____ St. No. _____
Town _____
State _____
Occupation _____

Book is Free

Any Wurlitzer Instrument Try in Your Own Home

See for yourself the superior quality of these famous instruments, the result of 200 years' experience. Every known instrument. No expense for trial. Easy terms if desired.

Send for New Catalog—Free
Rudolph Wurlitzer Co., Dept. 1771
Cincinnati Chicago
New York San Francisco
Address city nearest where you live.



You can earn BIG MONEY!

with this handsome sample case filled with Rawleigh Good Health Food Products, Flavors, Spices, Toilet Preparations, etc. Hundreds of families will buy from you. No experience needed.

—we show you how. Low prices. Liberal terms. Advertising literature and sales helps free. Good locations for 1500 men and women. Write

The W. T. RAWLEIGH Co.
DEPT. 9 PPM
FREEPORT, ILL.



FREE New Book FACTORY PRICES

Save 1/3 to 1/2

New FREE book quotes **Reduced Factory Prices**. Introduces sensational **5-Year Guarantee Bond** on Stoves, Ranges, Furnaces. 200 styles and sizes. Beautiful porcelain enamel ranges and combination gas and coal ranges in soft grey and delft blue.



Mahogany porcelain enamel heating stoves. Cash or easy terms—as low as \$3 down, \$3 monthly. 24 hr. shipments. 30 day free trial.

Pipe or Pipe-\$59.55 less Furnaces \$59 up

360 day approval test. Satisfaction guaranteed. 26 years in business, 600,000 customers. Write today for your copy of this FREE book.

KALAMAZOO STOVE CO., Mfrs.

391 Rochester Ave. KALAMAZOO MICH.

"A Kalamazoo Direct to You"
Trade Mark Registered

BIG NEW CATALOG FOR RADIO BUILDERS

FREE My big 1928 Radio Catalog, Call Book and Trouble Finder. 152 pages about Radio. Chock full of newest circuits—kits, transmitter parts, short wave outfits, eliminators and speakers. Thousands of bargains at lowest wholesale prices. A regular Radio Encyclopedia—Free. Write today.

American Auto & Radio Mfg. Co.
HARRY SCHWARTZBERG, PRES.
Dept. 265 American Radio Bldg., Kansas City, Mo.

LATEST RADIO CIRCUITS



CLASS PINS 35¢ NEW CATALOG FREE!

DESIGNS SHOWN SILVER PLATE 35¢ EA \$3.50 DOZ. STERLING SILVER 50¢ EA \$5.00 DOZ. GOLD PLATE 50¢ EA \$5.00 DOZ. 3395 1 OR 2 COLORS ENAMEL ANY LETTERS AND DATE 3499

BASTIAN BROS. CO., 828 BASTIAN BLDG., ROCHESTER, N.Y.



Automatic Concertina Played With Interchangeable Rolls.

Musical Entertainers wanted everywhere and earn big money at Moving Pictures, Vaudevilles, Cabarets, Restaurants, Inns, Lunch Rooms, Outings, Dances, Weddings, Fairs, Parties, or travelling with shows all year. Entertainers charge \$10.00 per evening. Our **AUTOMATIC CONCERTINA**, played with interchangeable Rolls offers opportunity, to make big money or steady side income. You play perfect in 30 minutes Songs, Dances, Operas, Marches, Waltzes, Fox Trots, One Steps, etc. without a faint idea of music or notes. Beautiful tone and melodious as played by artists. The **AUTOMATIC CONCERTINA** possesses a charm, which no one can escape. The player is actually playing, without any study or practice. Attractive professional cards furnished without charge, lead to an income for lifetime. **AUTOMATIC CONCERTINAS** are used in Song and Dance Acts on the stage. Three Models for Home, Concerts, and Paid Entertainers, from \$30.00 to \$60.00. Descriptive circular number 2 mailed free.

TREASURE SALES COMPANY 1690 Boston Road NEW YORK

Could Christmas Bring a Finer Gift

Only
\$10
Down

Sent
on
Trial

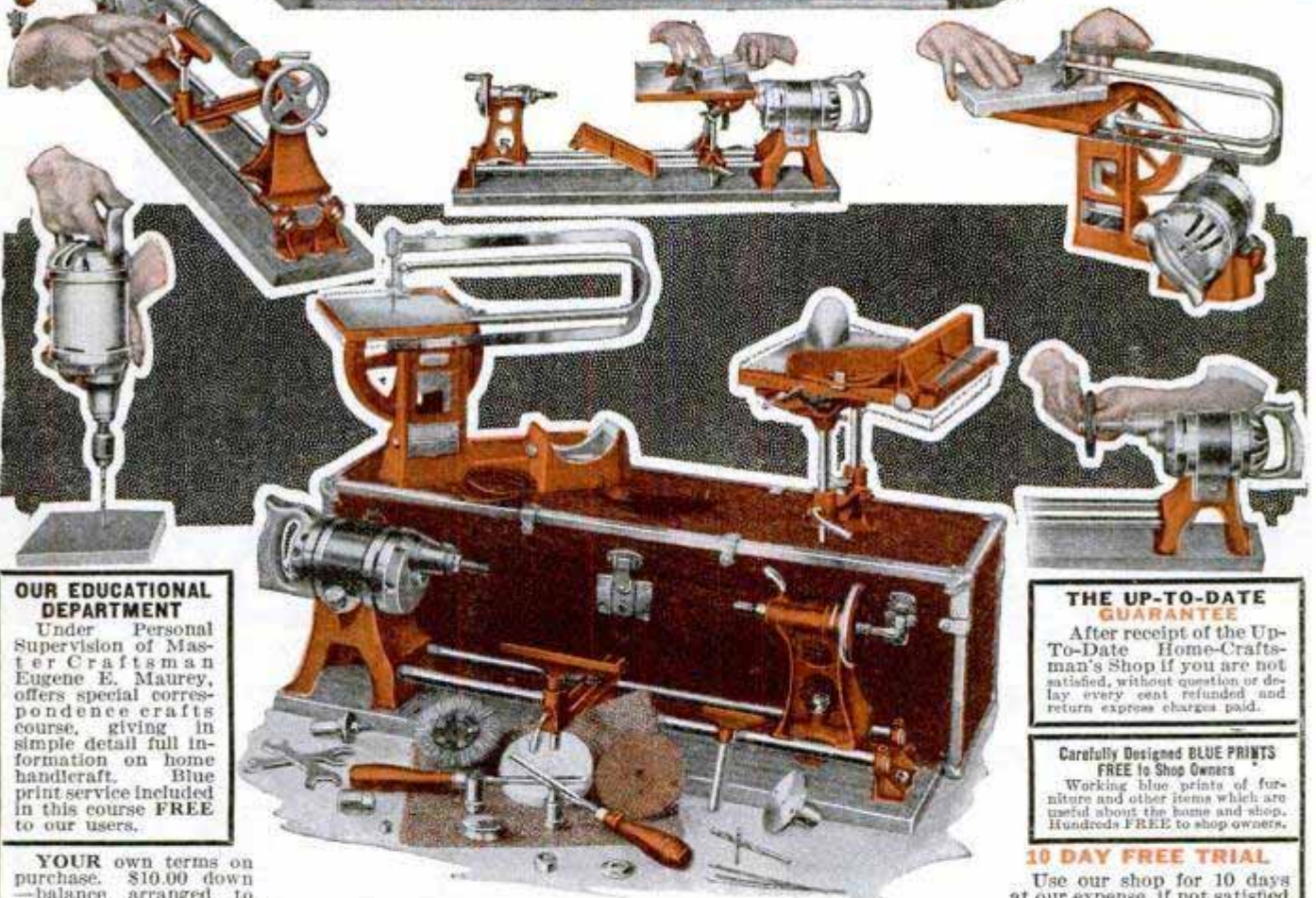

OUR EDUCATIONAL DEPARTMENT

Under Personal Supervision of Master Craftsman Eugene E. Maurey, offers special correspondence crafts course, giving in simple detail full information on home handcraft. Blue print service included in this course FREE to our users.

YOUR own terms on purchase. \$10.00 down—balance arranged to your convenience. Liberal discount for cash.

15" Band Saw
Accessory to Up-to-Date Shop

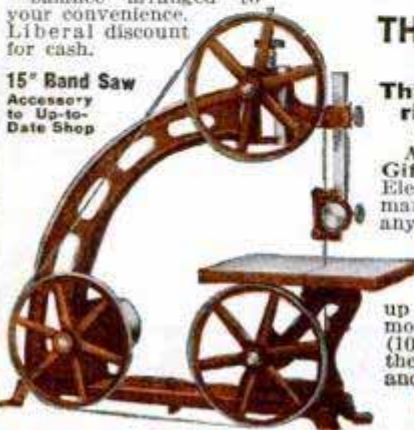

THE UP-TO-DATE HOME-CRAFTSMAN SHOP HE WILL APPRECIATE THIS

This Outfit a Superior Development Over All Others

A real Christmas Gift. The Up-To-Date Electrical Home-Craftsman Shop can be used in any home lighting fixture, thus making of your old fashioned work bench a complete machine shop, made up of a Super-power motor, an accurate lathe (10"x34") which features the bevel, a miter, side and depth gauges, a su-

perior tilting table, jig-saw, and all accessories for buffing, grinding, cleaning and all portable or stationary drilling and sawing. This collection of electrically-driven tools complete in every detail, will make you an advanced craftsman. Master mechanics have designed and skilled engineers have constructed this equipment which, after inspection, you will agree is the best of its kind. For those who build, invent, create and construct at home, it is unexcelled.

Our Literature Gives All Details **SEND FOR THEM**

THE UP-TO-DATE GUARANTEE

After receipt of the Up-To-Date Home-Craftsman's Shop if you are not satisfied, without question or delay every cent refunded and return express charges paid.

Carefully Designed BLUE PRINTS FREE to Shop Owners

Working blue prints of furniture and other items which are useful about the home and shop. Hundreds FREE to shop owners.

10 DAY FREE TRIAL

Use our shop for 10 days at our expense, if not satisfied—Return—express collect.



4" Jointer Model A-1928

MAIL THIS FOR FULL PARTICULARS TO

UP-TO-DATE MACHINE WORKS,

2915 S. Wabash Ave., Chicago, Ill.
MANAGER, Dept. J.—Without any obligation please send me full particulars about your shop, 10 day free trial, free blue prints, free crafts course. Also \$10.00 down payment offer.

Name.....

Address.....

DIAMONDS WIN HEARTS

No. 12
Beautiful blue white Diamond set in solid 18-k white gold.
\$50
\$1.25 a week

No. 849
Gorgeous blue white Diamond; solid 18-k white gold ring.
\$100
\$2.50 a wk.

Wedding Rings
No. 824—The "Elite" solid 18-k white gold. **\$7.50**
Set with 3 Diamonds, **\$22.50**; 5 Diamonds, **\$32.50**; 7 Diamonds, **\$42.50**; 9 Diamonds, **\$52.50**; 12 Diamonds, **\$67.50**. All platinum, \$25.
With 3 Diamonds, \$50; 5 Diamonds, \$70; 7 Diamonds, \$80; 9 Diamonds, \$100; circled by Diamonds, \$200.

17 Jewel Elgin No. 15, Thin Model
White gold filled, 20 year quality case; 12 size; silver dial; assorted patterns, \$23.50. \$2.35 down and **\$2.35 a month.**

All makes of Railroad Watches, guaranteed to pass inspection.
Credit at Cash Prices.

CREDIT TERMS: Pay one-tenth down; balance weekly, semi-monthly, or monthly at your convenience. All goods delivered on first payment. On request we will send any article (NO MONEY DOWN) for your free examination.

LOFTIS BROS. & CO. National Jewelers
Dept. H894, 108 N. State St., Chicago, Ill.
Stores in Leading Cities—Established 1858

LOFTIS BROS. & CO. F238

DIAMONDS, WATCHES, CASH OR CREDIT

MAKE WORTH-WHILE Christmas Gifts

A handsome genuine Diamond, or a watch, wrist watch, pearl necklace, onyx or emblem ring, mesh bag, silverware, etc., is sure to please. We have endless assortments of gifts appropriate for everyone. We invite comparisons.

SATISFACTION GUARANTEED OR YOUR MONEY BACK!

SEND FOR FREE CATALOG
Big 132-page book illustrating our Diamonds, Watches, Jewelry, Silverware and gift articles for all occasions, sent absolutely free.

WRITE TODAY!

No. 865
Man's ring, fine blue white Diamond; solid 18-k white gold.
\$50
\$1.25 a wk.

No. 881
Blue white Diamond; exquisite solid 18-k white gold ring.
\$150
\$3.75 a week

Rec-tangular Wrist Watch No. 868
Solid 14-k white gold, 15 Jewels, Gold filled bracelet to match. \$35. \$3.50 down
\$3.50 a month.

No. 872
Three blue white Diamonds; solid 18-k white gold ring.
\$125
\$3.25 a wk.

WHITE FLAME BURNERS make your old kerosene lamps and lanterns give a brilliant white light better than electricity or gas. Doubles your light. Saves oil. **NO MANTLE TO BREAK.** Guaranteed Safe and Reliable. Delights every user. Send now for complete sample postpaid 50 cents, stamps or coin, 3 for \$1.25. **Money Back If Not Satisfactory.** Live Representatives Wanted. Exclusive Territory. **WHITE FLAME LIGHT CO., 68 Clark Bldg., Grand Rapids, Mich.**

I'll Pay YOU \$100 a Week

Make \$100.00 a week and up, selling our fine made-to-measure, all-wool suits, direct to wearer. **Biggest values—positively sell on sight.** Biggest commissions paid in advance. We attend to delivery and collections. 6x9 cloth samples—over 100 styles—furnished **FREE.** Ambitious men write at once.

W.Z. GIBSON, Inc., 161 W. Harrison, Dept. N516, Chicago

BOYS!
Enter this Contest
\$500.00 Cash 1st Prize

EVERY boy will want our new, thrilling and beautifully illustrated book. It is a most interesting story and tells you all about the new Meccano. It fully explains the fun and ease with which you can build hundreds of wonderful working models in colors, such as steam shovels, wrecking cars, cranes, bridges, etc. These models are exact duplicates of the real engineering machines from which they are copied. With this book you will receive an entry blank for the great Meccano Prize Contest—first prize \$500 in cash. You may be the lucky boy. Write today. The book and entry blank will be sent to you free upon receipt of your name and address and the names and addresses of three (3) of your friends. Put No. H-3 after your own name for reference.

MECCANO
MECCANO COMPANY, INC. Div. H-3 Elizabeth, N. J.

PLUMBING-HEATING
Install Your Own—Save Half

Lowest wholesale prices on highest quality Grade A goods. Any Handy Man can install his own Plumbing and Heating BY OUR NEW **EASY METHOD.** Get the best and pay only a little each month.

Send for FREE Book

New bargain catalog just issued. With our cut-to-fit systems you save waste material and high labor cost. 50 years of economical service to home owners, farmers, builders and mechanics. Million Dollar Plants back up our Bonded Guarantee. **FREE** book gives you the whole story. **Write for your copy today.**

OVER 50 YRS. HARDIN-LAVIN Co. EST. 1876
107-17 West Pershing Road, Chicago, Ill.

Delta Handi-Shop

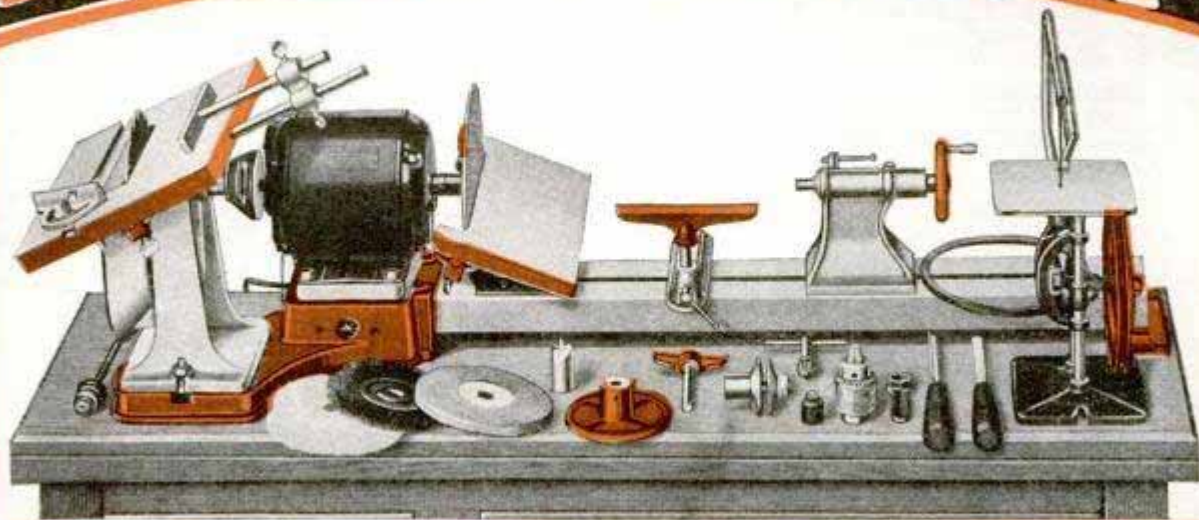

Have You Ever Seen

- A More Complete Shop Unit than the DELTA HANDI-SHOP?
- a unit as carefully designed—so well built?
- a unit as *Large, as Practical, as Efficient?*

We really doubt it—doubt it to such an extent that we earnestly urge you to send for our handsome, big 2-color folder that completely illustrates and describes the Delta Handi-Shop. That shows you many of the beautiful things you can easily make. How you can earn money on full or spare time. How to develop your ideas and inventions. How to work for profit, recreation and health! That shows you a big true picture, in actual colors, of the Delta Handi-Shop itself. That proves to you, by actual photographs, the exceptionally large range of work

possible. That shows you examples of unusual work.

In our ad last month we tried to give you a brief description and specifications of this remarkable shop. But limited space does not permit us to give even the most important features, as you should know them.

If you would gratify your longing to make beautiful things—develop your inventive and creative ability—increase your earnings—better your health through interesting diversion—then do not fail to send the coupon.

DELTA SPECIALTY COMPANY

858 3RD STREET

MILWAUKEE, WISCONSIN

Delta Specialty Co. (Dept. MP128)
858 3rd St., Milwaukee, Wis.
Send me your illustrated color folder describing
Delta Handi-Shop. Tell me about your Free
Trial Offer, Free blue prints and Easy Payment
Plan.

Name

Street Address

City State

RADIO PARTS for Discriminating Set Builders

Bradleyunit-A



This fixed resistor is scientifically treated to resist moisture. It is not affected by temperature, moisture or age. Provides the ideal resistance for B-eliminator hookups requiring fixed resistors of quality.

Bradleyohm-E

The remarkable accuracy of the Bradley-ohm-E has caused it to become standard equipment for accurate plate voltage control on many leading B-eliminators. Use it for best results on your power-unit hookups.

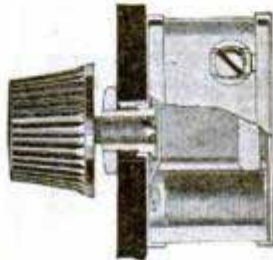

Bradleyleak

This variable grid leak provides the precise grid leak value for best results with every tube. Try it on your set and notice the greatly improved reception that results.



Bradleystat

The perfect filament control. Easily installed in place of rheostats now in service. Gives noiseless, stepless filament control for all tubes. Use Bradley-stats on your next set and learn the difference.



Allen-Bradley Co.

Electric Controlling Apparatus
MILWAUKEE, WISCONSIN



The LOGICAL Filament Control

AMPERITE is the only self-variable filament control. Automatically does the work of hand rheostats and delicate meters. Proved for 6 years. Specified in every circuit. Entirely different from fixed filament resistors. Accept nothing but AMPERITE.



FREE—"Amperite Book" of the season's best circuits and latest construction data. Address Dept. PM-1
RADIALL COMPANY
50 Franklin St., New York

AMPERITE

REG. U.S. PAT. OFF.
The "SELF-ADJUSTING" Rheostat

BIG RADIO CATALOG

From the "Big, Friendly Radio House"

NEW 1928 Book offers finest, newest well-known sets; parts, eliminators, accessories at lowest prices. DEALERS—WRITE for this CATALOG!

Western Radio Mfg. Co.

132 West Lake St., Dept. 31, CHICAGO, ILL.

RADIO PANELS

BAKELITE—HARD RUBBER

Cut, drilled and engraved to order. Send rough sketch for estimate. Our complete Catalog on Panels, Tubes and Rods—all of genuine Bakelite or Hard Rubber. Mailed on Request.

STARRETT MFG. CO. 524 S. Green St. Chicago, Ill.

Palmolive Shaving Cream

"5 New Delights for Men"

\$75 to \$125 Weekly

\$5 Down Charging Batteries Starts You

Let me show you how to make big money right from the start. I've prepared a FREE book explaining all details. First week's profit pays for all equipment. You can get all the battery charging business in your community with my Service Station Charger—it's years ahead of ordinary chargers—handles 50% to 70% more batteries. I explain everything—start you in a business of your own and put you on the way to big money. Write for FREE Book.

C. F. HOLMES, Chief Engineer, Dept. PM
Independent Electric Works, 5116 Ravenswood Ave., Chicago

FREE BOOK—Just Out





SMOKING CABINET
See LePage's Book, page 13



CEDAR CHEST
See LePage's Book, page 12

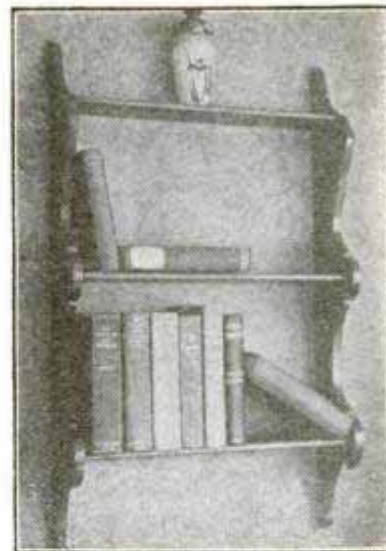

HANGING BOOK SHELVES
See LePage's Book, page 25

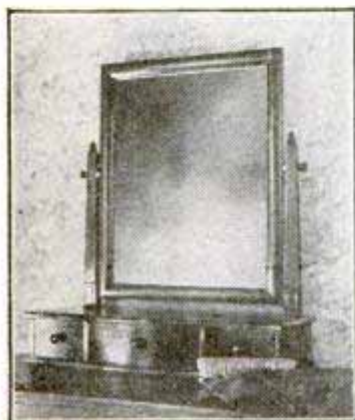

DRESSING GLASS
See LePage's Book, page 21

How to make 20 Attractive Pieces of Household Furniture

LePage's New Home Work Shop Book
will show you how

NOW with the coming of long winter evenings, comes this New LePage's Home Work Shop Book to show you how to make 20 different pieces of gift furniture, designed by an expert—attractive, artistic, useful, practical and easy to make.

New Book— greatly improved

The first LePage's Home Work Shop Book, published a year ago, proved so popular that, though advertised only a few times, over 30,000 copies were sold—an enormous edition for a book of this kind. Now the new book, of which 30,000 additional copies have already been sold, represents a wonderful improvement over the old one. Of its 20 complete projects, 16 are entirely new and never offered before.

Each project is presented in three parts—a photographic illustration of the finished project, a complete dimension drawing of its parts and simple, easy-to-follow directions, for making, given step by step from start to finish.

Handiest Tool
in your
Work Shop

Designed by Expert

For each of the 20 gift projects, the design, dimension drawings and photo-

graphs, as well as the actual articles, were made by William W. Klenke, Instructor in Woodworking, Central Commercial and Manual Training High School, Newark, New Jersey.

Assurance is therefore given that each project and the directions for making it is perfectly practical.

In addition to the four pieces illustrated above, the book includes the following 16 projects: Occasional Table, Spanish Ship Model, Folding Sewing Screen, Fernery Stand, Tilt Top Table, Piano Bench, Costumer, Priscilla Sewing Box, Table Desk, Desk Chair, Card or Console Table, Turned Bench, End Table with Book Trough, Foot Stool, Book Stand and Back Rest. Where else could you get complete directions for making all these things for only 10 cents?

In addition, this new LePage's book contains full information on how to secure plans for making eighteen more new projects, prepared by Frank I. Solar, Teacher of Manual Training in Detroit Public Schools, and widely-known tool craft writer.

Send 10 cents for this NEW LePage's Home Work Shop Book

JUST write your name and address on the coupon below, tear it out and mail to us today with 10 cents in coin or stamps, and we will at once send you a copy of LePage's New Home Work Shop Book, postage paid. Address LePage's Craft League, 554 Essex Ave., Gloucester, Mass. Tear out the coupon now so you won't forget it.



Mail this coupon

LEPAGE'S CRAFT LEAGUE,
554 Essex Ave., Gloucester, Mass.

Gentlemen: Enclosed please find 10 cents (coin or stamps) in payment for LePage's New Home Work Shop Book. Please send a copy of this book to

Name.....
Street.....
City..... State.....

LE PAGE'S
L GLUE
Bottles, Tubes & Cans

LUMINOUS PAINT

Make Your Watches, Clocks, Etc., Visible by Night

The very latest discovery in the scientific world, Hitherto, practically unobtainable except at an exorbitant price, we have at last succeeded in producing this remarkable LUMINOUS PAINT, which, applied to the surface of any article, emits rays of white light, rendering it perfectly visible in the dark. THE DARKER THE NIGHT, THE MORE BRILLIANT IT SHINES. Quite simple to use. Anyone—you can do it. A little applied to the dial of your watch or clock will enable you to tell the time by night. You can coat the push buttons or switch plates of your electric lights, match boxes, and innumerable other articles; make your own Luminous Crucifixes, Luminous Rosaries, etc. Small bottle, price 25c. Larger sizes, 50c and \$1 postpaid. **JOHNSON SMITH & CO., Dept. 817 RACINE, WIS.**



CIGARETTE MAKER

Roll your own and save money. Better and quicker; saves more than half. Use your favorite brand of tobacco. Neat, useful, handy. Pocket size, weighs 1/2 oz. Made entirely of metal, nickel plated. 25c, 3 for 65c postpaid anywhere.



GOOD LUCK RING

Very striking, quaint and uncommon. Silver finish; skull and crossbones design, two brilliant, flashing gems sparkle out of the eyes. Said to bring good luck. Only 25c ppd.



Exploding Cigarettes

JUST LIKE ORDINARY CIGARETTES. BUT SUCH REAL STARTLERS! The box contains ten genuine cigarettes of excellent quality. They appear so real, but when each cigarette is about on-third smoked, the victim gets a very great surprise as it goes off with a loud BANG! A great mirth provoker yet entirely harmless. Price 25c box.

NOVELTY BADGES



Kissing Permit 10c Two very novel metal badges, nickel plated, that you can wear, giving you fun out of all proportion to their trifling cost. 10c, each badge, 3 for 25c, or 75c per doz. postpaid anywhere.

MIDGET BIBLE

GREAT CURIOSITY Smallest Bible in the World. Size of a postage stamp. 200 Pages. Use Said to bring good luck to the owner. A genuine work of art. Must be seen to be appreciated. Make good money selling them in bars, church acquaintances, etc. PRICE 15c each, 3 for 40c, 12 for \$1.35, 100 for \$7.50. Also obtainable in Leather Binding, with gold edges. Price 50c each, 3 for \$1.25, \$4.50 per doz. Magnifying Glass for use with Midget Bible. 15c.



STAGE MONEY

With a bunch of these bills, it is easy for each person of limited means to appear prosperous by flashing a roll of these bills at the proper time and peeling off a genuine bill or two from the outside of the roll, the effect created will be found to be all that can be desired. Prices, postpaid: 40 Bills 20c, 120 for 50c, or \$3.50 thousand postpaid.

MAGIC FLUTE

The Magic Flute, or Human-tone, is a unique and novel musical instrument that is played with nose and mouth combined. There is just a little knack in playing it which, when once acquired after a little practice, will enable you to produce very sweet music that somewhat resembles a flute. There is no fingering, and once you have mastered it you can play all kinds of music with facility and ease. When played as an accompaniment to a piano or any other musical instrument, the effect is as charming as it is surprising.

JOHNSON SMITH & CO.

Dept. 817 RACINE, WIS.

A De Luxe Edition of our new 1928 CATALOG mailed on receipt of 25c. Handsome binding. Bigger and better than ever. Only book of its kind in existence. 550 pages of all the latest tricks in magic, the newest novelties, puzzles, games, sporting goods, rubber stamps, unusual and interesting books, curiosities in seeds and plants, etc., unobtainable elsewhere. Remit by Stamps, Coin, Money Order, Check, etc. Unused U. S., Canadian and Foreign Stamps also accepted.

BLANK CARTRIDGE PISTOL

Protection against Burglars, Tramps, & Dogs. Special Offer 1 Blank Cartridge Pistol 100 Blank Cartridges 1 580-page Novelty Catalog ONLY \$1.50 The Lot Shipped by Express Only Cash With Order Only

Well made and effective, modelled on latest type of Revolver; appearance alone is enough to scare a burglar. When loaded it may be as effective as a real revolver without danger to life. It takes standard .22 Cal. Blank Cartridge—obtainable everywhere. Special cash with order offer: 1 Superior quality Blank Cartridge Pistol, 100 Blank Cartridges, and our new 580 page De Luxe Catalog of latest novelties; all for ONLY \$1.50. Shipped by Express only. Cannot go by parcel post. Extra Blank Cartridges 50c per 100. Special Holster (Cowboy Type) for pistol 50c. No C. O. D. shipments.

THROW YOUR VOICE

Into a trunk, under the bed or anywhere. Lots of fun fooling the teacher, policeman or friends.

THE VENTRILO a little instrument, fits in the mouth out of sight, used with above for Bird Calls, etc. Anyone can use it.

Never Fails. A 16 page course on ventriloquism, the Ventrilo, ALL FOR 10 CENTS



PISTOL, OPERA AND FIELD GLASS 9 In One

It is made in the shape of and looks like a regular Automatic Pistol. No one is likely to stop and ask you whether it is real or not. Thus it is likely to prove itself very handy in an emergency. On pressing the trigger it opens up as shown in the illustration at the right, revealing nine most useful articles—Opera and Field Glass, Telescope, Mirror, Magnifying Glass and Burning Lens, Reading Glass, Sun Dial, Sun Compass, etc. In the handle of the revolver there is a place for various pocket necessities, such as First Aid Articles, Buttons, Pins, etc. The Pistol is of sheet metal, blue finish, that can be carried comfortably in pocket. PRICE \$1.00 postpaid.

Watch Charm Pistol \$1.75

Exact reproduction of a real pistol, actually brass. REAL BLANK CARTRIDGES of miniature size. Illustration is actual size. 1 1/2 inches long, with ring at end for attaching to watch chain.

Loads like a regular pistol. Pull the trigger and it goes off with a loud bang. Pistol is break open type; illustration shows position for loading. Made entirely of high grade steel, nickel plated, octagon barrel, handsomely engraved handles, complete in box with cleaning rod. PRICE \$1.75. Also furnished with pearl handles. \$2.50. BLANK CARTRIDGES, 50c per box of 25. **JOHNSON SMITH & CO., Dept 817, RACINE, WIS.**

MICROPHONE TRANSMITTER BUTTON



You can easily make a highly sensitive detector-telephone by using this Transmitter Button to collect the sound waves. You can build your own outfit without buying expensive equipment. It is simple and inexpensive. You can install an outfit in your home and hear conversations being held all over the house. You can connect up different rooms of a hotel. This outfit was used by secret service operatives during the war. It is being used on the stage. It is ultra-sensitive and is the greatest invention in micro-phones. You can mount the button almost anywhere—card board boxes, stove pipes, steel calendars, on the wall behind a picture frame, etc. Button is so light and small it cannot be detected. Persons can be overheard without suspecting it. You can listen in on conversations in another room. A deaf person in the audience can hear the speaker. Connected to phonograph, piano or other musical instrument, music can be heard hundreds of feet away. Button may be used to renew telephone transmitters; often makes an old line "talk up" when nothing else will. The ideal microphone for radio use; carries heavy current and is extremely sensitive. Amplifies radio signals. Countless other similar uses will suggest themselves. Experimenters find the button useful for hundreds of experiments along the lines of telephones, amplifiers, loud speakers, etc. Many fascinating stunts may be devised, such as holding the button against the throat of chest to reproduce speech without sound waves. PRICE \$1.00. **JOHNSON SMITH & CO., DEPT. 817, RACINE, WIS.**

SURPRISE MATCHES

More fun than fighting with your wife. Look just like ordinary matches. Put up in boxes just like reg-10c Safety Matches. As the victim tries to light one he gets quite a surprise. Price 10c per box, 3 boxes for 25c, 12 for 75 cents.

These clever locks cannot be opened unless you know the combination. No key necessary. For your locker, bicycle, tool chest, mail box, thousands of uses. Shackle and tumblers nickel plated. Weighs trifles over one ounce. Small yet strong. Secret and full instructions with each lock. Price 25c or 3 for 65c postpaid.



Wonderful X-Ray Tube

A wonderful little instrument producing optical illusions both surprising and startling. With it you can see what is apparently the bones of your fingers, the lead in a lead pencil, the interior opening in a pipe stem, and many other similar illusions. A mystery that no one has been able to satisfactorily explain. Price 10c, 3 for 25c, 1 dozen 75c. **Johnson Smith & Co.**

Every Boy His Own Toy Maker

A great book for boys. It gives plain, practical instructions for making all manner of toys, machines and other articles, amusing and useful. Tells how to make a Steam Engine, a Photographic Camera, a Windmill, Microscope, Electrical Machine, Galvanic Battery, Electric Telegraph, Electrotyping Apparatus, Telephone, Kaleidoscope, Magic Lantern, Aeolian Harp; how to make Bonts of all kinds, Kites, Balloons, Paper Toys, Masks, Card Racks, Wagons, Cars, Toy Houses, Bows and Arrows, Pop Guns, Slings, Fishes, Tackle, Rabbits, Bird Traps, etc. 200 Illustrations. PRICE 25c POSTPAID.

Serpent's Eggs

Box contains 19 eggs. When lit with a match, each one gradually hatches itself into a snake several feet long, which curls and twists about in a most life-like manner. Price per box, 10c postpaid, 3 for 25c.

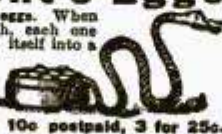

THE EXPO WATCH CAMERA



The most wonderful and ingenious camera made. It is but little larger than a watch, which it closely resembles. You can carry the Expo about in your pocket and take pictures without any one being the wiser.

Less Than 2 Cents a Picture

The Expo loads in daylight with 10 or 20 Exposure Films, costing 25c and 35c respectively, and thus the picture taking part of a whole day's outing may be had for a very nominal sum—Little more than one cent a picture.

Easy to Manipulate

Price **\$3.60** Post Paid

It is simplicity itself to operate. Takes pictures through the stem, where the Rapid Fire Lens is located. The photos (2 1/2x7-8) may be enlarged to any size. Operated as Quick as a Flash Time and instantaneous shutters; weighs but 3 ounces; nickel plated. Endorsed by amateurs and professionals the world over. Throughout the same as ordinary cameras—in daily use by the police, newspaper reporters, detectives, and the general public. Important beats have been secured with the Watch Camera by enterprising reporters. Produces clear, sharp negatives indoors or outdoors equal to any camera on the market, size or price notwithstanding. Sold Under a Positive Guarantee.

Expo Watch Camera **\$3.60** FILMS, 10 Exposures 25c, 20 Exposures 35c
Price Post Paid Leather Pocket Carrying Case, 35c



Rubber Chewing Gum



10c Pkgs. 3 for 25c P. Pd.

It is just like a regular package of chewing gum and looks so real that it fools everybody. Of course no one suspects it is not genuine until they start to chew it. There's a world of fun in this rubber chewing gum—4 sticks to the package. Price, 10c Pkgs.; 3 for 25c; 12 for 75c postpaid.

INVISIBLE INK

The most confidential messages can be written with this ink, for too writing makes no mark. Cannot be seen unless you know the secret. Invaluable for many reasons. Keep your postals and other private memorandums away from prying eyes. Great fun for playing practical jokes.

Only 15c a Bottle; 3 for 40c.



POCKET CIGAR LIGHTERS



Simplex Lighter 20c

You may pay more, but these two Lighters will do the work as well as the most expensive. The "SIMPLEX" (Illustrated on the left) sells for but 20c; lights merely by giving the wheel a turn with the thumb. The "AUTOMATIC" (on right) lights automatically; press the button, the lid flies open and lights wick at same time. Better, safer and cheaper than matches. A light instantly available whenever you want it. Prices: Simplex Lighter 20c; Automatic Lighter \$1.00; extra flints for either 5c each. All postpaid.



Automatic Lighter \$1.00

RESURRECTION PLANT



One of the most wonderful plants known. Possesses the strange power of turning in a few minutes from an apparently lifeless, dry herb to a **BEAUTIFUL** of a dark green color. Simply place the plant in saucer of water, it will open up and start to grow in 20 minutes. When taken out it will dry up and go to sleep until placed in water again. Fine house plant—summer or winter. 10 cents each or 3 for 25c., 75c per doz., postpaid.



Great Fire Eater



With the Fire Eater in his possession any person can become a perfect salamander, apparently breathing fire and ejecting thousands of brilliant sparks from his mouth, to the horror and consternation of all beholders. Harmless fun for all times, seasons and places. If you wish to produce a decided sensation in your neighborhood don't fail to procure one. We send the Fire Eater with all the materials, in a handsome box, the cover of which is highly ornamented with illustrations in various colors. Price of all complete only 30 cents, postpaid.

Send remittance (Postage Stamps accepted) for all articles listed on above and previous page to

SQUIRT ROSE

25c



A REAL STARTLER. This is the most popular of all squirt tricks. The flower in your coat locks so fresh and sweet that everyone is tempted to inhale the delightful perfume. Then is the moment to press the bulb. Cee-willikens. Don't they jump? There is a very long rubber tube that easily reaches to the pocket of your coat or trousers, and the bulb is large enough to make a dozen snorts with one loading. PRICE 25c each, or 3 for 65c postpaid

MAGICIAN'S BOX OF TRICKS

Apparatus and Directions for a Number of Mysterious Trick's Enough for an Entire Evening's Entertainment **\$1.00**

ANYONE CAN DO THEM

It is great fun mystifying your friends. Get this Conjuror's Cabinet, and you will be the cleverest fellow in your district. It contains the apparatus for ten first-class tricks, including The MAGIC BALL AND VASE TRICK (a wooden ball is placed inside, and upon replacing the lid has disappeared and is found in someone else's pocket); The HINDOO TRICK CARDS (can be made to change completely no less than five times); DISAPPEARING COIN BOX (a coin, placed in the wooden box, vanishes entirely or changes into a coin of another denomination); The GLASS GLOBE TRICK (a coin is dropped into a glass of water and when the water is poured out the coin has vanished and is found somewhere else); the RIBBON FACTORY FROM THE MOUTH TRICK (a seemingly endless supply of colored paper ribbons comes out of your mouth); the DISAPPEARING HANDKERCHIEF (a handkerchief held in the hand mysteriously vanishes); the WIZARD'S RING COIN TRICK; the ENCHANTED BOTTLE (no one but yourself is able to make it lay down); the GREAT HAT AND DICE TRICK (a large dice is placed on top of a hat, disappears, and is found underneath yet no one has touched the hat), and last, but not least, the GREAT PHANTOM CARD TRICK, or two from five leaves nothing. Full instructions are sent for performing each trick. In addition to the above, a number of other feats and illusions are fully explained for which you can easily make or procure the necessary apparatus. Price complete **\$1.00** postpaid, JOHNSON SMITH & CO.



U. S. BABY TANK

25 Cents

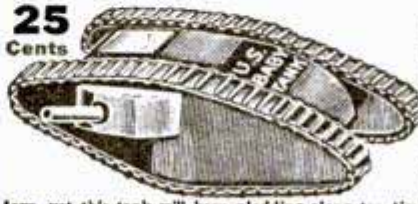

toys, yet this tank will keep plodding along ten times longer than the ordinary tank for toys. It will perform dozens of the most wonderful stunts: it will go backward or forward at will; 2 1/4 inches long. Price only 25c prepaid. JOHNSON SMITH & CO.

It goes with real Yankee Pep—by its own power

Most remarkable toy ever invented. By drawing the Tank backward, either with the hand or over the floor or table and then placing it down, it will crawl along, overcoming all obstacles in the same life-like manner as the larger Tank that proved so deadly in the great war. What makes it go is somewhat of a mystery, for there is no mechanism to wind up as is usually understood. Only mechanical



BOYS' HAND CUFFS

65c

them over the wrists and you have your pal securely handcuffed. These Handcuffs stand for Law and Order and, in the hands of the boy, inspire him with respect for Civic Virtues. They are entirely nickel-plated all over. Price only 65c pair postpaid.

Female Sex Indicator



Female Sex Indicator 25c

Male Sex Indicator

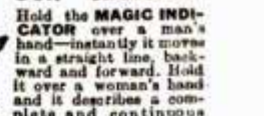

Male Sex Indicator 25c

Hold the MAGIC INDICATOR over a man's hand—instantly it moves in a straight line, backward and forward. Hold it over a woman's hand and it describes a complete and continuous circle. The same action can be obtained over a letter written by a man or woman, etc. It is fascinating; baffling. We have never seen it fail. Many novel and entertaining feats may be performed with the Sex Indicator. For example, similar results can be obtained with animals, cats, dogs, rabbits, over birds, chickens, canaries, etc. Also used to predetermine the sex of chickens and birds, etc. In fact it is sold as a patented egg tester in Europe. Price 25c, or 3 for 65c, postpaid.



SCOUT KNIFE 50c

This Scout Knife has 4 Blades—1 Large Spear, 1 Combination Screw Driver and Cap Lifter, 1 Pencil and 1 Can Opener. Jamitation stag metal handle, equipped with shankle for belt or chain. Size closed 3 1/2 in. Wonderful value at this price. Price 50c Postpaid. JOHNSON SMITH & CO.



Comical Motto Rings

Lots of harmless fun and amusement wearing these rings. Made in platinum finish (to resemble platinum), with wording on enameloid, as illustrated. Price only 25c Postpaid.

The "Little Giant" Typewriter

A First Class Writing Machine For \$1.50

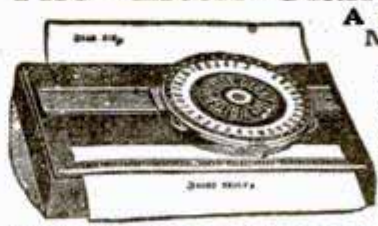

A perfect little typewriter for \$1.50. There are thousands of persons who would like to use a typewriter but whose needs and business do not warrant the expense attached to the purchase and use of a fifty or seventy-five dollar machine. To such persons we confidently recommend our Little Giant. It is strongly made, but simple in construction, so that anyone can quickly learn to operate it, and write as rapidly as they would with pen and ink. The letters of the alphabet most frequently used are so grouped as to enable one to write rapidly, the numerals 1 to 10, and the punctuation marks being together. With this machine you can send your best girl typewritten love letters, address envelopes, make out bills, and do almost any kind of work not requiring a large, expensive machine. With each typewriter we send a tube of ink and full printed instructions for using the machine. Price complete \$1.50 by mail postpaid to any address in the world.

JOHNSON SMITH & CO. Dept. 817 Racine, Wis.

PATENTS TRADE-MARKS AND COPYRIGHTS

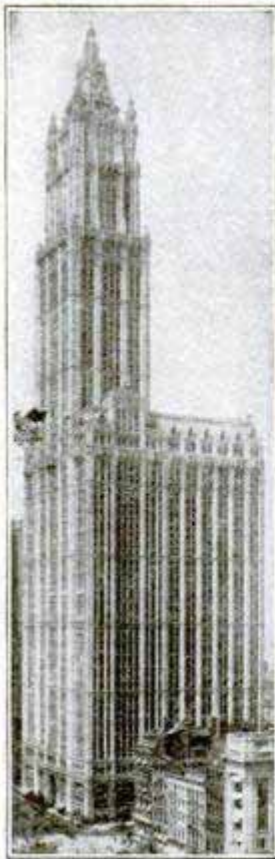

Our New York Office
Suite 1007 Woolworth Bldg.



Our Philadelphia Office
Suite 518-519 Liberty Bldg.



Our Washington Office, Victor Bldg.



Have You An Idea?

Our Offer: FOR THE PROTECTION
OF YOUR INVENTION

YOUR FIRST STEP

Before disclosing an invention the inventor should write for our blank form

"RECORD of INVENTION"

This should be signed and witnessed and returned to us together with model or sketch and description of the invention for

INSPECTION AND INSTRUCTIONS

No Charge for the Above Information

**Our Five Books Mailed
Free to Inventors**

Our Illustrated Guide BOOK

How to Obtain a Patent

Contains full instructions regarding U. S. Patents. Our Methods, Terms, and 100 Mechanical Movements illustrated and described.

Our Trade Mark Book

Shows value and necessity of Trade Mark Protection. Information regarding *Trade Marks and unfair competition in trade.*

Our Foreign Book

We have Direct Agencies in Foreign Countries, and secure Foreign Patents in shortest time and lowest cost.

Progress of Invention

Description of World's Most Pressing Problems by Leading Scientists and Inventors.

We Regard a Satisfied Client as our best advertisement, and furnish anyone, upon request, lists of clients in any state for whom we have secured patents.

**Highest References—Prompt Attention
—Reasonable Terms**

VICTOR J. EVANS & CO.

PATENT ATTORNEYS

Main Offices: 789 9th St., N. W., Washington, D. C.

Opposite U. S. Patent Office

PATENTS TRADE-MARKS AND COPYRIGHTS

IMPORTANT

HAVE YOUR CASE MADE SPECIAL TO AVOID DELAY. YOU SHOULD HAVE YOUR CASE MADE SPECIAL IN OUR OFFICE to save correspondence, secure protection and early filing date in the Patent Office. To secure **special preparation** of your case send \$25.00 on account with model or sketch and description of invention.



MAIN OFFICE, VICTOR J. EVANS & CO.—VICTOR BUILDING, WASHINGTON, D. C.

Our Lawyers Practice in all U. S. Courts and defend Clients in Suits involving Patents, Trademarks and Copyrights

All Communications and Data Strictly Confidential. Interference and Infringement Suits Prosecuted

OUR ORGANIZATION OFFERS PERSONAL SERVICE By Experienced Patent Lawyers, Solicitors and Draftsmen



Our Chicago Office Suite 1114 Tacoma Building



Our Pittsburgh Office Suite 514 Empire Building

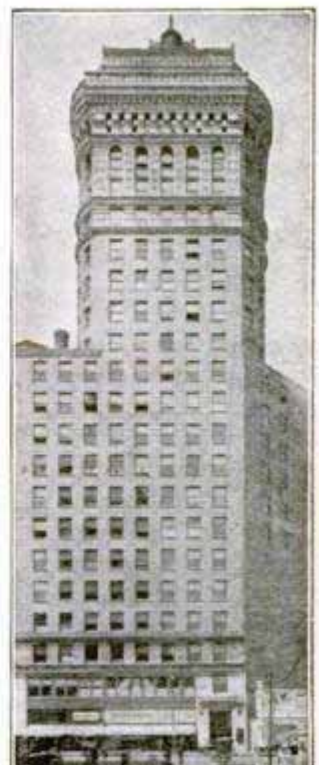

Our San Francisco Office Suite 1010 Hobart Building

FREE COUPON

VICTOR J. EVANS & CO. PATENT ATTORNEYS

NEW YORK OFFICES
1007 Woolworth Bldg.

CHICAGO OFFICES
1114 Tacoma Bldg.

PHILADELPHIA OFFICES
518-519 Liberty Bldg.

PITTSBURGH OFFICES
514 Empire Bldg.

SAN FRANCISCO OFFICES
1010 Hobart Bldg.

MAIN OFFICES: 789-9th Street, N. W., WASHINGTON, D. C.

Gentlemen: Please send me *Free of Charge* your books as described on preceding page.

Name

Address

PATENT

Protect Your Ideas

Take the First Step Today

If you have a useful, practical, novel idea for any new article or for an improvement on an old one, you should communicate with a competent Registered Patent Attorney AT ONCE. Every year thousands of applications for patents are filed in the U. S. Patent Office. Frequently two or more applications are made for the same or substantially the same idea (even though the inventors may live in different sections of the country and be entirely unknown to one another). In such a case, the burden of proof rests upon the last application filed. Delays of even a few days in filing the application sometimes mean the loss of a patent. So lose no time. Get in touch with me at once by mailing the coupon on the opposite page.

Prompt, Careful, Efficient Service

This large, experienced organization devotes its entire time and attention to patent and trade mark cases. Our offices are directly across the street from the U. S. Patent Office. We understand the technicalities of patent law. We know the rules and requirements of the Patent Office. We can proceed in the quickest, safest and best ways in preparing an application for a patent covering your idea. Our success has been built on the strength of careful, efficient, satisfactory service to inventors and trademark owners located in every state in the Union.

NO CHARGE for Information On How to Proceed

The booklet shown here contains valuable information relating to patent procedure that every inventor should have. And with it I will also send you my "Record of Invention" form on which you can sketch your idea and establish its date before a witness. Such evidence may later prove valuable to you. Simply mail the coupon and I will send you the booklet, and the "Record of Invention" form, together with detailed information on how to proceed and the costs involved. Do this NOW. No need to lose a minute's time. The coupon will bring you complete information entirely without charge or obligation.

My Patent Law Offices
Just Across
Street From
U.S. Pat. Office



Above is a view of my drafting and specification offices where a large staff of experienced experts are in my constant employ. All drawings and specifications are prepared under my personal supervision.

NEWS

Inventors Write for these Free Books

Strict Secrecy Preserved

All communications, sketches, drawings, etc., are held in strictest confidence in strong, steel, fireproof files, which are accessible only to authorized members of my staff. Feel free to write me fully and frankly. Your case will have my personal attention. It is probable that I can help you. Highest references. But **FIRST**—clip the coupon and get my free book. Do **THAT** right now.

Clarence A. O'Brien

Registered Patent Attorney

Member of Bar of: Supreme Court of the United States; Court of Appeals, District of Columbia; Supreme Court, District of Columbia; United States Court of Claims.

Practice confined exclusively to Patents, Trade marks and Copyrights

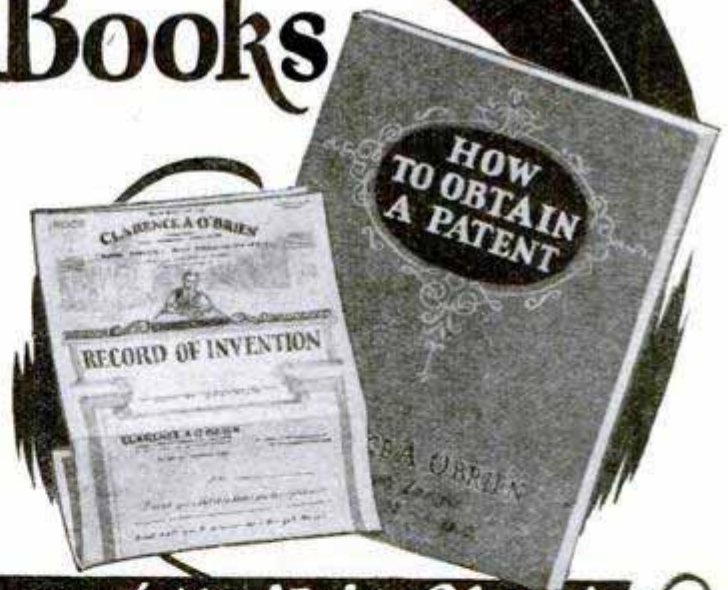

Clip this Coupon and Mail it Now!

CLARENCE A. O'BRIEN, Registered Patent Attorney

703 Security Savings and Commercial Bank Bldg., Washington, D. C.

Please send me your free book, "How to Obtain a Patent," and your "Record of Invention" form without any cost or obligation on my part.

Name.....
(Important: Write or Print name clearly.)

Address.....

Inventors— Manufacturers Opportunity

A successful manufacturing company, well capitalized, capably directed and aggressive, desires to extend its field of operation.

With this in view it wishes to hear from inventors who own patent rights to a marketable product.

Or it will purchase a smaller, going manufacturing organization which might, with greater resources, enjoy greater success.

Or it is prepared to combine with some manufacturer who is seeking the advantages which this advertiser can offer.

Every reply to this advertisement will receive thorough consideration and will be as carefully investigated as we expect to be investigated by those with whom we decide to do business.

Write Box No. 305
Popular Mechanics
Chicago, Ill.

BLUE BOOK ON PATENTS
AND PRIORITY RECORD BLANK GRATIS.
MONROE E. MILLER, PATENT LAWYER
411-2 Ouray Building, WASHINGTON, D. C.
ELECTRICAL AND MECHANICAL EXPERT

New Products Wanted

A nationally known manufacturing corporation is seeking additional lines to manufacture.

New products, in any line, which are patented or for which patents have been applied will be considered.

Submit sufficient data to enable us to determine whether further negotiations are desirable.

Address Box 306

c/o **POPULAR MECHANICS MAGAZINE**
200 E. Ontario Street Chicago

1000 Needed Inventions

Here is the most remarkable book ever offered to inventors. One Thousand needed inventions listed and described. Arranged as follows: General Problems; Automotive; Mechanical; Electrical; Chemical; Radio; Marine. Separate chapter on the Ten Most Needed Inventions. This book may give you one idea that will win you a fortune. Nothing else like it has ever been published. Compiled at enormous expense. Edited by Raymond Francis Yates, formerly Managing Editor of a leading scientific magazine. Over 100 pages durably bound. Price \$1.00.

ONLY \$1.00 POSTPAID

Cut out this advertisement, pin \$1.00 to it and send it to us with your name and address plainly written and your copy of this remarkable book will be sent immediately. (Outside U. S. \$1.25.) Money back after 10 days' examination if desired. Limited edition. Write NOW.

BUREAU OF INVENTIVE SCIENCE

Dept. 31

Rochester, New York



Deafness

Perfect hearing is now being restored in all cases of deafness caused by Catarrhal troubles, Relaxed or Sunken Drums, Thickened Drums, Roaring or Hissing Sounds, Perforated, Wholly or Partially Destroyed Drums, Discharge from the Ears, etc.

Wilson Common-Sense Ear Drums

require no medicine but effectively replace what is lacking or defective in the natural ear drums. They are simple devices, which the wearer easily fits into the ears where they are invisible.

**Free Book
on Deafness**

Soft, safe and comfortable. Write today for 168-page book on deafness giving full particulars and many testimonials. The hearing of thousands of grateful users has been restored by these "little wireless phones for the ears."

WILSON EAR DRUM CO., Incorporated
801 Todd Bldg. LOUISVILLE, KY.



GEARS ALL KINDS SMALL

The most accurate made and prices reasonable. We carry a complete line of gears in stock for immediate shipment. Can also quote on special gears of all kinds. Send us your inquiries. WRITE FOR CATALOGUE 10

CHICAGO STOCK GEAR WORKS
105-109 S. Jefferson St., CHICAGO

INVENTORS

who derive largest profits know and heed certain simple but vital facts before applying for Patents. Our book *Patent-Sense* gives those facts; sent free. Write **LACEY & LACEY**, 646 F St., Washington, D. C. Established 1869.

EDGAR M. KITCHIN Attorney & Counsellor at Law

Patent and Trade Mark Specialist

805 G St. N. W., Washington, D. C.

PATENTS Protect your Inventions and Trade-Marks today. Write for illustrated patent book and sketch sheet and terms free.

BRYANT & LOWRY, 311 Victor Bldg., Washington, D. C.

GOVERNORS

FOR GAS OR AUTO ENGINES

CANDEE SMITH GOVERNOR CO., SPRINGVILLE, N. Y.



Send for Catalog Today

BUCHSTEIN'S FIBRE LIMB

is soothing to your stump—strong, cool, neat, light. Easy payments. Braces for all deformities. **D. BUCHSTEIN CO.** 610 3rd Ave., So. MINNEAPOLIS, MINN.

PATENTS

Booklet Free Highest References
Promptness Assured Best Results

Send drawing or model for preliminary examination of Patent Office records.

ALL BUSINESS GIVEN PROMPT AND PROPER ATTENTION

Listed Patent Lawyer in the latest editions of the Rand-McNally Directory of Bankers and Attorneys, of Chicago, Ill.; The Baggott & Ryall Directory of Attorneys, New York City; The Lawyers Guaranteed Directory, Detroit, Michigan; The Lawyers and Bankers Quarterly, published by the Legal Directory Publishing Company of St. Louis, Mo.; the American Lawyers Annual, Cleveland, Ohio.

WATSON E. COLEMAN,
REGISTERED PATENT LAWYER

Victor Building, 724 Ninth Street, N. W.
WASHINGTON, D. C.

PATENTS

**Don't Lose Your Rights
To Patent Protection**

Before disclosing your invention to anyone send for blank form "EVIDENCE OF CONCEPTION" to be signed and witnessed. As registered patent attorneys we represent hundreds of inventors all over the United States and Canada in the advancement of inventions. The form "Evidence of Conception," sample, instructions relating to obtaining of patents and schedule of fees sent upon request.

LANCASTER & ALLWINE

480 Ouray Bldg. WASHINGTON, D. C.
Originators of forms "Evidence of Conception."

PATENTS

Trade Marks, Copyrights, Patent Litigation Handbook with illustrations, 100 mechanical movements. *Sent free on request.*

ALBERT E. DIETERICH
formerly member examining corps U. S. Patent Office
PATENT LAWYER and SOLICITOR

621-A, Ouray Bldg.
27 Years' Experience Washington, D. C.

Will Finance Patents

Patents of commercial value financed on royalty basis without expense to inventor. Mail models and copies of patents or full details to

KAMSTONE HOLDING CORP.
41 East 42nd Street N. Y. C.

PATENTS

To the Man with an Idea

I offer a comprehensive, experienced, efficient service for his prompt, legal protection and the development of his proposition.

Send sketch, or model and description, for advice as to cost, search through prior United States patents, etc. Preliminary advice gladly furnished without charge.

My experience and familiarity with various arts frequently enable me to accurately advise clients as to probable patentability before they go to any expense.

Booklet of valuable information and form for properly disclosing your idea free on request. Write today.

Richard B. Owen, Patent Lawyer
9-303 Owen Bldg., Washington, D.C.
41-E Park Row, New York City

TRADE-MARKS
REGISTERED

INVENTORS PROTECT YOUR IDEAS

Send for our Guide Book, **HOW TO GET A PATENT**, and Evidence of Invention Blank, sent Free on request. Tells our terms, methods, etc. Send model or sketch and description of your invention for **INSTRUCTIONS**. No charge for the above information.

RANDOLPH & CO.
301 Victor Bldg., WASHINGTON, D. C.

NAME.....

STREET.....

CITY..... STATE.....

CAN YOU SELL HEAT IN WINTER?

Hot Dollars All Winter!

Man, you don't have to sell heat. Everybody wants it. Everbrite agents cleaning up \$3000 to \$5000—no soliciting—no investment—no risk—just visiting prospects secured by our national advertising and leaving the heater for a night's trial.



When It's 23 Below Zero The Everbrite Radiant Oil Heater will keep you comfortable. Mrs. Senften, Genoa, Nebraska, writes: "23 below zero, but the Everbrite kept us warm and burned 25 hours on 1 filling." A portable heater for homes, stores, churches. Makes and burns its own gas from common kerosene. Pours out flood of pure, clean, intense heat at cost of 1 cent an hour.

FREE Just send name for amazing agents' offer. Clean up \$200 a week or more! Get a demonstration heater for your own use. Or if not interested in agency, write for special offer on heater. No wick—burns like city gas. Cleaner, cheaper, more comfortable than wood or coal. Low price.

WRITE TODAY

The EVERBRITE STOVE CO. KANSAS CITY, MO. 7216 Gateway Sta.

The EVERBRITE Radiant Oil Heater \$250 a Week

J. O. Hand, California, made over \$250 a week last year. Knabb and Godwin of Florida both did better than \$200 a week. H. T. Rees of Kansas, averaged \$300 a week. F. W. Hubbel, Iowa, beat \$400 a month. So did Senften and Cassel, Nebr., Richie of Iowa, Shook of New Mexico, Webb of Arkansas, Wilson of Louisiana, and Alfred of Kansas.

NEW VEST POCKET ADDING MACHINE



ADDS, SUBTRACTS, MULTIPLIES, DIVIDES Does work of \$300 machine. Guaranteed 5 years. NOT A TOY. Made of steel and indestructible. Million dollar capacity. Fits in pocket. Will not make mistakes. So simple child can operate it. Instructions furnished. Everybody should carry one for figuring.

FREE TRIAL \$2.50 Total Cost

SEND NO MONEY—Just name and address. We will ship Calculator immediately. On delivery pay postman \$2.50 (Plus few cents Postage). (If outside U. S. send cash). 10c additional in Leatherette Case. If not satisfied after 10 day trial you get your money back. **THOUSANDS OF SATISFIED USERS.**

This is lowest priced practical calculator made. "Why pay more for inferior imitations?" Order from this ad.

Mail Coupon Today

BABY CALCULATOR SALES COMPANY

- Dept. 41, P. O. Box 1118, CHICAGO, ILL., U. S. A.
- I am enclosing \$2.50—send adding machine prepaid.
- Send Adding Machine C. O. D. \$2.50 plus postage. (10c additional in Leatherette Case)

Name.....
Address.....
City..... State.....

AGENTS Write for big commission and territory proposition.

MAKE YOUR FORD Into The "LARK"



and new manual of other distinctive sport body patterns from \$5.50 up—"RKO" Steel "Swing-Lo" Irons, Tops and Windshields. **ORDER RIGHT NOW.**

KUEMPEL COMPANY, 92 Kuempel Bldg., GUTTENBERG, IOWA

AGENTS AND SIGN MEN

Now Making \$50.00 to \$100.00 and Up Per Week Selling Our **GOLD LEAF SIGN LETTERS**

R For store and office windows, board signs, trucks and glass signs. We also make to order script signs and business emblems singly or by the thousands. A permanent business. No capital or experience required. Big demand in every city. *Samples and Literature Free.*

CONSOLIDATED SIGN LETTER CO. 69X W. Van Buren CHICAGO, ILL.

Ethyl Gasoline Corporation

25 Broadway, New York City

BUILD YOUR OWN GRANDFATHER'S CLOCK



We furnish blue prints, finishing material and instructions. Buy the works, dial, weights and pendulum from us at surprisingly low prices. You make a fine profit building artistic clocks for your friends. **Plain Works as Low As \$5.00. Others with Chimes At All Prices.** Ask for Our Free Catalogue and Offer of Blue Prints.

American Chime Clock Company
1670 Ruffner Street
PHILADELPHIA

DO YOU

WANT a new business profession of your own, with all the trade you can attend to? Then become a **foot correctionist**, and in a few weeks earn big income in service fees,—not medical nor chiropody—easy terms for home training, no further capital needed, no goods to buy, no agency. *Address*

Stephenson Laboratory, 1 Back Bay, Boston, Mass.

DEAFNESS IS MISERY

Multitudes of persons with defective hearing and Head Noises enjoy conversation, go to Theatres and Church because they use **Leonard Invisible Antiseptic Ear Drums**. Tiny Megaphones fitting in the Ear entirely out of sight. No wires, batteries or head piece. They are **Unseen Comforts** and inexpensive. Write for booklet and sworn statement of the inventor who was himself deaf.

A. O. LEONARD, Inc., Suite 699, 70 5th Ave., New York

PATENTS

TRADE-MARKS · DESIGNS
FOREIGN PATENTS

MUNN & CO.
PATENT ATTORNEYS

Associated since 1846 with the Scientific American

SCIENTIFIC AMERICAN BUILDING
24 W. 40th St., New York City

SCIENTIFIC AMERICAN BUILDING
Washington, D. C.

TOWER BUILDING
Chicago, Ill.

VAN NUYS BUILDING
Los Angeles, Cal.

HOBART BUILDING
San Francisco, Cal.



Books and Information on Patents and Trade-Marks by Request.
Associates in All Foreign Countries.

COOKS BY BURNING AIR



Does Away With COAL!
Converts any ordinary stove into gas range. Produces clean heat much cheaper and is far more efficient than coal. Burns 96% air and 4% kerosene. Installed in few minutes. Typ. for all heating purposes. Reliable distributor wanted.
GLORIA LIGHT CO., 111-1 N. May St., CHICAGO

MOVIES AT HOME



Many models of genuine MOVIE MACHINES, some as low as \$3.75, all using standard size big theatre films. Our stock of films is the most complete and lowest in price—with an exchange service. Films of leading stars and religious subjects are available. **DON'T DELAY. WRITE FOR FREE INTERESTING CATALOGUE NOW!**

PARAMOUNT MFG. CO.
Dept. 1371 BOSTON, MASS.

Your Opportunity

Earn **45⁰⁰** to **85⁰⁰** Weekly



Any earnest Salesman will find Success quickly selling our \$40.00 value all wool suits and overcoats at

Suit or Overcoat **\$24⁵⁰** Tailored to Order

We have openings now for local representatives who are interested in establishing themselves in a permanent and profitable business of their own. Connect up with Chicago's biggest old reliable tailoring house, successful since 1895. Our clothes nationally advertised for over 30 yrs. Write at once for full details.

GREAT WESTERN TAILORING CO., Dept 116, Chicago, Ill.

Shoot the Best Gun

The NEW BENJAMIN is the finest air rifle ever made. Unlike all others. Has amazing accuracy—shoots hard and far. It's the original American genuine AIR operated rifle. One to six pump strokes compress air to any desired degree of power. Same force as in air drills and air hammers except you control the shooting force. Never loses force—no springs or levers to get out of order. Makes crack shots quickly, inexpensively. Gives years of delightful recreation with utmost safety. At your dealer's, or sent postpaid for \$5.00.

Shoot 5 Days FREE

We give you five days, ammunition supplied, to test the NEW BENJAMIN. If in this time you don't believe it to be the finest air rifle you've ever seen or used, and if you don't believe it is the one and only air rifle for you, return it, postpaid, and your money will be refunded at once.

The NEW BENJAMIN AIR RIFLE

America's Original Air Rifle

\$5 at your dealer's or sent postpaid direct from factory on FREE Trial as above if dealer does not handle it—write for our wonderful offer.

Get This Book and Details FREE

BENJAMIN AIR RIFLE & MFG. CO.
645 N. Broadway, St. Louis, Mo.

Please send your amazing offer and free copy of "The Shooter's Art," telling how to become a crack shot, how to hold, aim, and handle guns and guide others in use of guns.

Name _____

Address _____

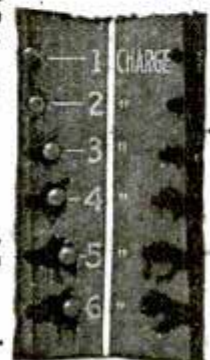

YOU CAN MAKE BIG MONEY THE YEAR 'ROUND WITH AN

American Universal Floor Surfacing Machine

**No layoffs—no dull seasons
Your Own Boss**



J. A. Thomas of Montgomery, Alabama, writes: "Floor surfacing is one of the best paying propositions I know of today for the average fellow to get into. It's nothing for me to clear better than \$100.00 a week and I'm just as busy as I can be. My 'American Universals' are responsible for my success though, because they turn out such fine work that every job brings three or four more."

You can do as well as this. This is

YOUR BIG OPPORTUNITY

to get into a business for yourself and make big money. The demand for this work is ever increasing, it is easy, fascinating, and draws big pay. Experience unnecessary. Small amount starts you. We furnish everything, teach you, help you succeed. Mail the coupon in AT ONCE.

The American Floor Surfacing Machine Co.,
523 So. St. Clair St., Toledo, Ohio.
Without obligation please send me full details about the "American Universal."

Name.....
Address.....
City..... State.....

Interlox

MASTER SLIDE RULE
2 to 8 ft., 20c lineal ft. If not at dealers, sent postpaid.



MASTERS RULE MFG. CO., 813 E. 136th Street, NEW YORK
Dealers and Agents: Write for attractive proposition.

Speeds up all measuring. Slides in and out—no folding. Direct-reading for instant inside measurements, as well as outside. Any length.



Tool Cases for Toolmakers and Machinists
Are shown in our New 1928 Catalog. Write today for a copy. Thirty sizes and styles shown. One to suit your needs.

H. Gerstner & Sons

449 Columbia St., DAYTON, OHIO

1928 MODEL WITTE

Engine

**50 New Features
2 to 30 H.P.**

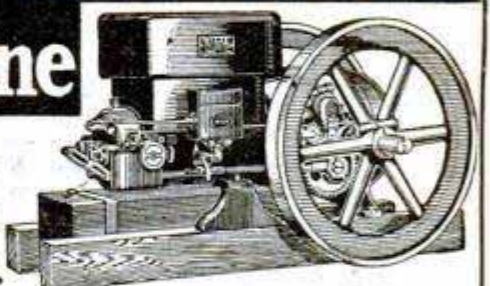

Here is the greatest engine I have ever built. . . . my 1928 model Witte. . . . the result of 58 years' engine building experience. Let me tell you about this Master Power Plant . . . about the 50 new features and how, because of selling direct from factory, I can now make lower prices than are the sensation of the engine world. Forget your previous ideas of engines. My 1928 model will out-perform anything you have ever seen. Operates efficiently on cheaper fuels. "trigger-quick" in starting even in zero weather. . . . simple and sturdy. . . . lifetime guarantee backed by the Million Dollar Witte Factory. Also log and tree saw outfits. . . . 3 in 1 saw rigs and pump outfits. Easy payments. Be the first in your community to own a 1928 Model Witte. Write me today for all details, prices, etc.

ED. H. WITTE, President.

WITTE ENGINE WORKS

1741 Oakland St., Kansas City, Mo.
1741 Empire Bldg., Pittsburgh, Pa.

New Low Prices

FOR HIS CHRISTMAS

Bartlett DROP-FORGED Compound Lever Snips \$2.70 to \$9.50

Made of high-grade Crucible Tool Steel, accurately tempered. Cuts metal up to 18 gauge easily, 7-in. size just right for household use. 7-in. stamped, \$2.70

8-in. forged, \$4.00 10-in. forged, \$6.00

12-in., \$8.00 14-in., \$9.50

Your dealer has them or can get them from his jobber. If he will not we will ship prepaid in U.S. at above prices.



FOLDER ON REQUEST

Bartlett Mfg. Co., 420 E. Lafayette Ave., Detroit, Mich.

\$6

FOR A REAL LATHE



17" Over all, 4" Swing, 11" Centers. Shipping weight 13 lbs. Largest line of small Lathes in America. Send 6 cents for 24 page catalog of Lathes, drill presses, bench, jig and band saws, etc.

SYPHER MFG. CO., Dept. L, Toledo, O.

Out of Work! Got a Foley Filer!

Now Making Big Money!

Here's how A. Stolz, 132 Hillside Ave., Richmond Hill, N. Y., got into a good paying business of his own: "I lost my job on account of a strike. I took my last money and bought a Foley Saw Filer and now I am making a comfortable living. Am doing a lot of work for carpenters."

FOLEY Automatic SAW FILER

You can make big money and be your own boss if you get a Foley. It files all kinds of saws automatically. Does better and faster work than hand filers. You get \$.50 to \$.75 for running each saw through the Foley. \$1.25 to \$1.75 for retooling. Practically no competition. Carpenters, contractors, factories, schools, and every home has steady year round business for you. A respected, skilled business! Write for free information about how to start a money-making saw filing business.

Foley Saw Tool Co., Inc., 223 Foley Bldg., 9 Main St. N. E., Minneapolis, Minn.



How do you do your work on WOOD?

—the same as your granddad did OR with a

TAKE-ABOUT Sander

Here is a belt surfacing machine of only 14 pounds that will sand more than five times faster than is possible by hand. It does work that no machine has ever done before. Simple as a plane to use.



It pays for itself in the first few jobs — completing your work quicker, at less cost and better than the slow, old-fashioned hand method of sanding. Quick, easy belt change; flexible pads to sand curved surfaces.

Write for a Free demonstration by our nearest representative.

MADE ONLY BY THE
PORTER-CABLE MACHINE COMPANY
1704-10 North Salina St. SYRACUSE, N. Y.



Crescent Wood Working Machines

are neat in design, substantially built and are intended for hard, continuous service. Users of wood working machinery who appreciate quality always investigate Crescent machines before placing their orders. Send today for circulars of Band Saws, Saw Tables, Self Feed Rip Saw, Shapers, Jointers, Variety Wood Worker, Planers, Planer and Matcher, Disk Grinders, Cut Off Table, Swing Saws, Borers, Hollow Chisel Mortisers, Tenoners, Universal Wood Workers.

The Crescent Machine Co. 93 Columbia St. Leontia, Ohio, U. S. A.

WHO SAID "FREE" AIR?

You'll make more money selling Accessories, Gas, Oil, Tires, Batteries and other Auto Supplies—if you give BETTER AIR SERVICE THAN THE OTHER FELLOWS. An HB Silent Twin Automatic Air Compressor will bring you the business. Beltless, powerful, ABSOLUTELY DEPENDABLE. Only \$12 monthly for a few months.

Write for bulletin AC9—today.

HOBART BROTHERS CO., Box M182, Troy, Ohio



A REAL MACHINE

at a reasonable cost incomparable for use in the home, shop or light woodworking factory. 8" circular saw, will rip 2 1/4" material. 20 distinct woodworking operations can be performed on this machine.

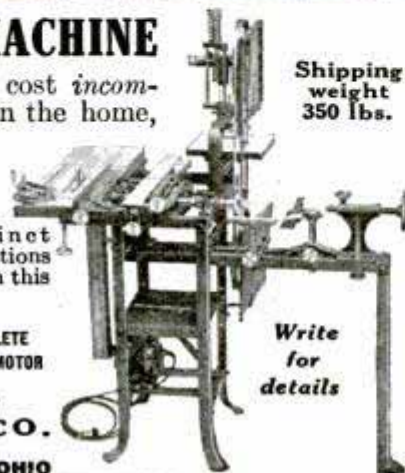

Shipping weight 350 lbs.

\$156.00 COMPLETE WITH MOTOR

Write for details

KORNAU MACHINE CO.
Station A,
CINCINNATI, OHIO

Anyone Can Make Repairs With



PLASTIC WOOD

A loose tile in the bathroom—furniture chipped or gouged—screw holes that have served their usefulness—a leak among the shingles. A carpenter's time costs money—with Plastic Wood you can do the job yourself. Make repairs in the modern way—and it's fun to do it too. It handles like putty and hardens into wood, with every wood property except the grain. Recommended for use under lacquer.

1/4 lb., 35c.; one pound \$1.00

Sold by Hardware and Paint Stores. Send coupon if they cannot supply you

ADDISON-LESLIE COMPANY
42 Bolivar Street, Canton, Mass.
Please send me 1/4 lb. can of PLASTIC WOOD for which I enclose 35c.

Name.....
Address.....

TOOLS that Do Wonderful Things!

WONDERFUL results have been accomplished with Cornwell Tools. . . . They do things that no other tools will do. . . . You will be amazed at the demonstration tests, suggested under the various tools described in booklet, for proving their astounding toughness.

We will replace any tool that does not stand these tests or give you your money back.

CORNWELL QUALITY TOOLS

Made from Special Formula Steel

The steel used in Cornwell Tools is Swedish Charcoal Process Molybdenum Steel produced under our famous Cornwell Formula. . . . They are forged, heat treated, hardened and tempered in oil. All tools made by hand. . . . NOT drop forged and case hardened.



Money Back if Not Satisfied

You take no risk in buying Cornwell Quality Tools—if you ever saw tools as good as these, return your order and get your money back.

The Cornwell Quality Tools Co., Dept. S, Mogadore, Ohio. (Formerly at Cuyahoga Falls, Ohio.)

Send me new illustrated catalog with prices on full line of Cornwell Hand-Made Tools.

.....Where Employed
Name.....
Address.....
City.....State.....

**NOW—
GET MY
GREATEST
Log Saw
Offer**

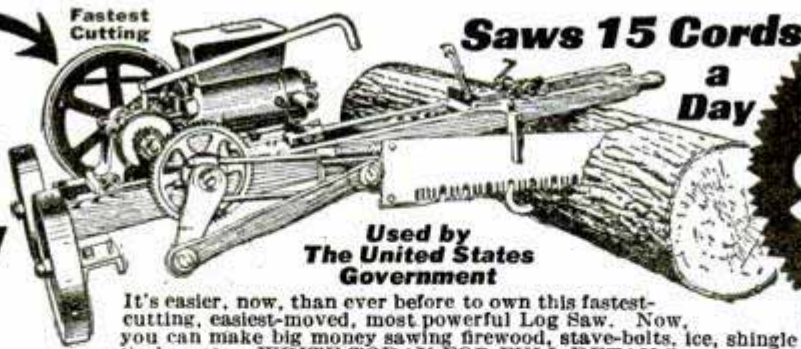

**Saws 15 Cords
a Day**

**ONLY
\$39**

**Used by
The United States
Government**

It's easier, now, than ever before to own this fastest-cutting, easiest-moved, most powerful Log Saw. Now, you can make big money sawing firewood, stove-bolts, ice, shingle timber, etc. **WRITE TODAY FOR FULL DETAILS.**

**Puts the OTTAWA
Working For You!**



**Try 30
Days**

— ONE WHOLE MONTH to use the OTTAWA at your own sawing. Every saw shipped on trial only—

Backed by 10-Year Guarantee

FREE

Send me your name and address on a postcard today for my wonderful new edition of the "Wood Sawing Encyclopedia."

HARRY OVERMAN, Pres., OTTAWA MFG. COMPANY

1745-L Wood St., Ottawa, Kans. 1745-L Magee Bldg., Pittsburgh, Penna.

Make Big Money— Wood selling at \$3 a cord brings owner \$45.00 a day. Go into the wood business. Don't let the lack of ready money stop you. Remember, we sell on very easy terms.

To Save You Freight— and get your machine to you a few days after you order. I ship from factory or nearest to you of NINE BRANCH HOUSES.

350 Cuts a Minute!

Now you have a log—in a few seconds it's all sawed up—without any hard work!

**FREE
Wood
Sawing
Encyclopedia**

**THIS
WRENCH**

has a thousand uses about the house or workshop; the equivalent in range of adjustment of a six and an eight-inch Crescent Wrench. Drop forged of special analysis steel (jaws four times as strong as ordinary steel). Easily and quickly adjusted and absolutely guaranteed to give satisfaction or your money back. At all hardware dealers. Ask for a Double End Crescent Wrench and look for the name.

**\$1.50
6-8 inch**

**CRESCENT TOOL CO.
210 Harrison St.
JAMESTOWN, N. Y.**

Wrenches Chisels Snips
Pliers Punches Hacksaws
Screw Drivers Auger Bits Nippers
Electricians' Tools

**CRESCENT
and Smith & Hemenway
TOOLS**

LIVE SALESMEN WANTED

Sell Cox HoldFast Screw Drivers. Self-holding, self-releasing. For Mechanics, Radio and Auto Work. Proposition and sample, 50c. Attachment for Yankee, 50c. **S. J. COX, Dept. F, Franklin, Pa.**

**ADRIAN
SPEED
LATHE**

**\$10.50
as shown**

**A Handy Torch
for the Repair Shop
Torit Torch 23**

You put it to work with the lighting of a match, no fuss with gasoline, charcoal, kerosene, etc. Uses acetylene only. No air nor oxygen is required. Tips suck in air.

Quick Extra Profits

Thousands of mechanics over the country are now using it—cashing in on extra profits from jobs like these—Radiator Repairing, all kinds of Soldering and Light Brazing, Lead Burning, and numerous small jobs where heat is required.

Torit 23 consists of Torch, 4 tips, soldering copper, 5 ft. tubing, and connection for Presto tank. **PRICE: \$7.50**

Order from your jobber or write direct to **St. Paul Welding & Mfg. Co., 177 W. 3rd St., Paul, Minn.**

Makes Old Ford a Tractor

Now you can convert that old Ford car into a useful farm tractor without altering any Ford parts. We furnish the traction wheels, drive gears and auxiliary axle and mountings, ready to clamp on to the Ford frame. Pulls 16' plow.

We supply a Belt Pulley also

Write for Free Particulars.
SHAW MFG. CO., Dept. S, Galesburg Kan.

**BURN YOUR NAME ON TOOLS
WITH THE
ARKOGRAF**

PROTECT YOUR TOOLS FROM THEFT Write with electricity any name or design on the hardest and finest tools and instruments, or any metal, like writing on paper with pen or pencil. **Complete Outfit \$3.50—Prepaid Anywhere** Interesting illustrated circular free. Write today. Agents wanted.
ARKOGRAF PEN CO., 1171 E. Stark St., Portland, Oregon

FOR INVENTORS, STUDENTS, AMATEUR MECHANICS

Accurate, well built. Fully guaranteed. Not a makeshift. Sold by responsible dealers. For wood and metal turning, drilling, etc. 7-inch swing, 17 inch centers, weight 22 lbs., length 30 inches. Longer bed at slight extra cost. Has 3 step pulley, adjustable bearings, 3/8 inch hole through spindle. Head and tailstock take No. 1 Morse taper. Jig saw attach. \$5.50. Compound rest \$8.00. Cir. saw attach. \$8.00. Send for literature.
H. G. CRANE Established 1905 ADRIAN, MICH.

18 Tools In One S&B SAW Money Back Guarantee 8" Combination S.B. SAW 15 DAYS TRIAL

The S&B 8-in. Combination Saw (18 tools in one) is the ideal machine for the shop, factory or the home; will rip, cross cut, bevel, miter, mortise, groove, drill, tenon, grind, rabbet, buff and polish. The greatest machine you ever saw; no other machine so complete and efficient as the S&B—actually

\$35.

F. O. B. CHICAGO

18 tools in one! You will marvel at the wonderful beveling, grooving, buffing, etc. All attachments are adjusted in a few seconds without any difficulty. Very little space is used and the motor is mounted on a base that is a part of the machine proper, this is an exclusive feature! The motor: 1/4-H.P., 60-cycle, 110-volt A.C., run from any light socket also provides power for other purposes when the saw is not in use. Complete with attachments: 12-in. x 16-in. Table, 8-in. Combination Saw, Iron Pulley for Saw Table, 10-in. Ripping fence, Adjustable Cut-Off Miter Gauge, Motor 1/4-H.P., 3-in. Iron Pulley, 6-in. Buffing Wheel, 5-in. Emery Wheel, 6-in. Sander, 3/8-in. 3-Jaw Drill Chuck, 1 1/4-in. Endless Leather Belt, 8-foot Cord and Plug, Saw Guard and 2-in. Dado Insert. Price \$35.00, F.O.B. Chicago. Shipping weight 100 lbs. (Planer attachment to fit on table top will smooth pieces up to 2 in. wide, \$12.00 extra. Flexible Shaft Grinder attachment, \$35.00 extra.)

Write for Complete Illustrated Folder

SCOTT-BANSBACH MACHINERY CO.

130 So. Clinton St.

Dept. 61

CHICAGO, ILL.



Belt Tightener

A Sensible XMAS GIFT

Now you can make the things you wanted

With table raised—saw is guarded ready for drilling, grinding or polishing.

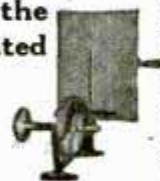

Ready for dado or planer head and special molding work—Table is adjustable.

Planer attachment—most practical ever adapted to a saw table.



Flexible shaft grinding attachment—especially good for metal patterns, routing, grinding, die-castings, etc.

The only machine that you can tilt the table to 45° without removing insert. Big advantage on pattern work.



SIMONDS SAWS

Best for every cutting purpose

SIMONDS SAW & STEEL CO., FITCHBURG, MASS.



Make Money SHARPENING SKATES

A FEW DOLLARS STARTS YOU

Universal and Keen Edge Skate Grinding Holders

As used for Lengthwise and Cross sharpening of skates. Price \$5.00 and \$3.50 each. Procurable from the Original Makers of Skate Grinding Holders.

Ferodowill Mfg. Co. 202-214 W. Indiana Ave. ST. PAUL, MINN.

MEN! BIG MONEY IN SPARE TIME And this Suit FREE

You can easily earn \$50 a week in spare time taking orders from your friends and neighbors for our fine tailoring. Orders come easy when you show our swell samples and smart styles. **We Show You How**—you don't need to know anything about tailoring—simply follow our directions—we make it easy.

YOUR SUIT FREE

Our new plan enables you to get one of our fine made-to-order suits, in any style you want, by simply taking a few orders without one penny cost to you.

FREE New Big Sample OUTFIT. New style convenient carrying case outfit; large all-wool samples and all supplies furnished **FREE.** Write at once.

PROGRESS TAILORING CO., Dept. N216, Chicago, Ill.



START to PLAY Very First Day!



YOU CAN PLAY THE XYLORIMBA

Extra Money—Hosts of Friends—Loads of Fun Within Your Reach



Fame and Money Broadcasting



Center of Attraction at Gatherings



Big Money at Dances

HAPPY DAYS are in store for you if you will only act on this suggestion! Cheery evening playing catchy music alone or with sweetheart, wife or sister; proud moments as center of interest at gatherings; nights of joy making \$5 to \$25 for work that is "play."

The Deagan Xylorimba is your Opportunity! Wonderful for home, in demand at dances and entertainments, yet easiest of all instruments to play. No teacher necessary—you actually play simple melodies the very first day even if you cannot read a note of music right now! **Earns \$60 a Week**—Ralph Smith, Chicago, says: "Played 20 minutes at wedding. Received \$20." L. E. Hallmann, Reading, Pa., writes: "Made \$300 in 5 weeks, spare time. Had never played instrument before."

SEND FOR BIG FREE BOOK! Our new book tells all about the delightful lessons; furnished with each instrument; the five-day trial that removes risk; the wonderful Deagan, easy-payment plan. No obligation—simply fill in and mail the coupon.

J. C. Deagan, Inc., Dept. A1451, 1770 Berteau Ave., Chicago Send me, without obligation, full details of Free Trial offer and easy-payment plan on the Deagan Xylorimba.

Name _____ Address _____

SHOP BY MAIL FROM THIS WINDOW OF SPECIALS

WHAT YOU DO—

SEND A DOLLAR with Name and Address, number of article desired and brief note telling us something about yourself.

Simply state: (1) how long at address, (2) age, (3) married or single, (4) name and address of employer, (5) nature of work, (6) how long in employ.

All information held strictly confidential—no direct inquiries to employer.

\$1 Brings Your Choice \$37.50 EACH

WHAT WE DO—

Upon arrival of your order, we will open a 10 month Charge Account and send selection for approval and 15 DAY TRIAL. If satisfied, pay \$3.65 monthly; otherwise return and dollar will be refunded.

To Any Adult interested in purchasing Diamonds, Watches or Jewelry, we will send without obligations this complete booklet illustrated in colors.

S-23—Two Diamonds, four blue sapphires; 14K white gold rectangular Wrist Watch; 15 Jewels. Expansion Bracelet.

S-27—Both Watch and Chain are 14K solid green gold. Guaranteed 7-Jewel Elgin movement.

S-24—AA1 blue-white diamond; Ladies' Solitaire; 18K white gold.

S-25—Three AA1 blue-white diamonds adorn this Ladies' Ring wrought in 18K white gold.

S-26—18K white gold Dinner Ring, carved and engraved; set with three AA1 blue-white diamonds

S-28—Elgin Strap Watch for Men; hand carved 14K green gold filled case; 7-Jewel Elgin movement, Radium numerals and hands.

L.W. SWEET, DEPT 1660 BROADWAY 68-F NEW YORK CITY INC.

You—and This New Machine Can Earn \$500 a Month

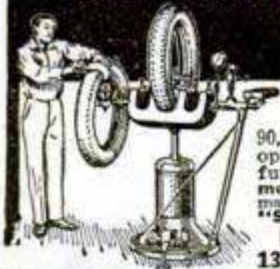

Operate a Tire Repair Shop

90,000,000 Tires in use. America's greatest opportunity for men with small capital. We furnish everything—\$100 and up. Easy payments. We train you FREE right at home. Start making money at once. Write today for Free Book "Steps to Success."

Haywood Tire Equipment Co.
1334 South Oakley Chicago, Illinois

KINKADE GARDEN TRACTOR AND POWER LAWNMOWER

A Practical, Proven Power Cultivator for Gardeners, Suburbanites, Truckers, Florists, Nurserymen, Fruit Growers.

AMERICAN FARM MACHINE CO.
1058—33rd Ave. S. E., Minneapolis, Minn.



Catalog Free

YOU CAN EASILY EARN FOUR MEN'S WAGES

Practically no investment. No payroll to meet. Start in your garage or any small space. HB Quick Spray Method of Refinishing Autos with duco, paint or lacquer enables you to easily do the work of four men the old way. Pays for itself on easy monthly payments with Big Profits for you at same time. Write today for Bulletin PS. Hobart Bros. Co., Box M183, Troy, Ohio



AGENTS!
Improved Dubeledge Stropper Pays You \$100.00 Weekly

Think of it! Over 500 clean, satisfactory shaves from a single razor blade. Tell men how to shave for over a year, with one blade, by stropping with new Dubeledge razor blade stropper. Make an easy \$100.00 a week. Sharpens all edges in one operation. Makes new blades out of old ones in a jiffy.

Sensational Features get Quick Sales

Nearly every stropper on the market sells for \$3.50 to \$5.00. Here's one with features the others do not have, yet it sells for \$2.00. Sharpens with true diagonal stroke all edges without removing blade. Easy to work—nothing to get out of order—guaranteed to last lifetime. Show these Dubeledge features and the sale is made.

Read This Big FREE Offer

We give free with every Dubeledge stropper our new patented pencil. Automatically feeds new leads, one after other by pressing top. Writes 48,000 words, or one year without refilling. Quick sales assured with this free offer.

Write for Free Plan

Get facts free. We show you how to make at least \$100.00 a week. Postcard will bring information.
MORTON SALES CO.
Dept. 801 10-15 46th Ave., Long Island City, New York



Boils 50 Gallons In Less Than Hour

No Other Compares With This

Improved Oil Burner

Use Ordinary Kerosene or Coal Oil

[Burns Outdoors as Well as Indoors]

THE most remarkable Kerosene Burner ever built. Boils down apple cider, maple syrup, molasses, etc., in half the ordinary time. Ideal burner for dairies, butchers, indispensable on the farm.

PRODUCES TERRIFIC HEAT WITH SILENT BLUE FLAME

NO NOISE SMELL SMOKE SOOT



So efficient it produces twice the amount of heat of City gas at half the cost. So simple anyone can install and operate. Double generator assures continuous operation without shut-downs. Nothing to wear out, starts in a jiffy, will last a life time. Every burner guaranteed fully. Write for special introductory price and free catalog of outdoor utility and kitchen stove oil burners.

HOME MFG. CO., Dept. 1513, 18 E. Kinzie St., CHICAGO



Your Neighbors Will Pay You \$75⁰⁰ a week for Your Spare Time

You can easily sell them your spare hours for \$3 each by serving as "radio doctor," building them sets, selling them supplies at less than retail. A membership in the Association shows you how to cash in on Radio now and trains you for the \$3,000 to \$10,000 openings awaiting qualified men. The Association starts you in business if you wish. Investigate all it has done for others, all it can do for you. A MEMBERSHIP NEED NOT COST YOU A CENT.

Earned \$500 in Spare Hours

Our members are making big money with Radio. Werner Eichler, N. Y., earns \$50 a week—Lyle Folliek, Mich., has earned \$500—F. J. Buckley, Mo.—makes as much as he receives from employer—all in spare time. Our members are starting radio stores, getting better positions, increasing their salaries, earning money spare time.

ACT NOW—for No-Cost Membership

Send post card for details of Special Membership Plan that need not—should not—cost you a cent, and our book, "Your Opportunity in the Radio Industry." It will show you how you can cash in on Radio now—and later.

Radio Association of America

4513 Ravenswood Ave., Dept. PM-1, Chicago, Ill.

FREE 1000 Illustrations **ELECTRIC FIXTURE CATALOG!**

Write today for your copy. Save 50% direct from Manufacturer. No Middleman's Profit. **OUR SPECIAL:** 8 Room Electric Set, ready to hang, \$24.50—Other bargains.

UNITED LIGHTING FIXTURE CO.
83 Flatbush Ave., Dept. M, Brooklyn, N. Y.

Do Your PRINTING

Cards, stationery, circulars, tag, labels, paper. **Complete Outfits, \$8.85 up**, Job Presses \$11 up, Rotary \$149. Card Cutters, \$3. Save money. Print for others, big profits. All easy rules sent. Write for catalog presses, type, paper, cards, ink etc. **THE KELSEY CO., M-37, Meriden, Conn.**

HEAT

LACO OIL BURNER

Economical Dependable

You won't care how cold it is this winter if you have a LACO oil burner in your furnace. LACO will give you *automatic, clean, economical* heat. Needs no attention; requires no adjustments and there's no dirty coal to handle. Made in five adaptable sizes—each the *lowest price on the market*—for any size home or building. LACO is safe as a gas range; doesn't bother radios; noiseless and it's as simple as the ordinary kerosene lamp. Guaranteed to heat the home or building to the maximum capacity of the heating plant. Write today for full details telling how LACO will give you trouble-proof, dependable, economical heat.

DEALERS! Write Today for Terms

LACO GAS BURNER CO.
702 CASS STREET
GRISWOLD IOWA

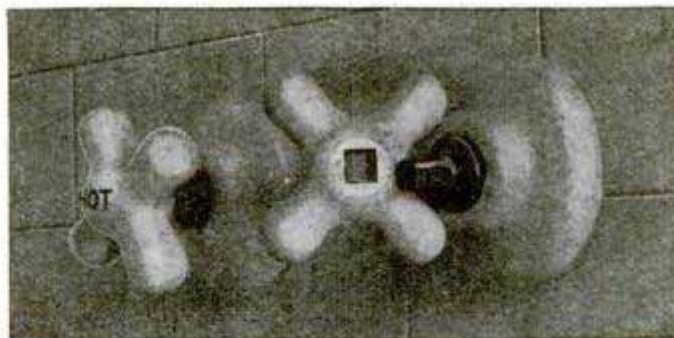

Porcelain handles will STAY tight if set with SMOOTH-ON No. 1

To make porcelain handles tight on bath tub and wash bowl faucets, and on sink and flush tank pulls, fill the hole in the handle with a soft putty of Smooth-On No. 1, and then force the handle onto its spindle. Once the Smooth-On hardens, it becomes solid metallic iron, which will keep the handle tight for all time. You yourself can make this repair equal to a professional job and at a cost of only a few cents.

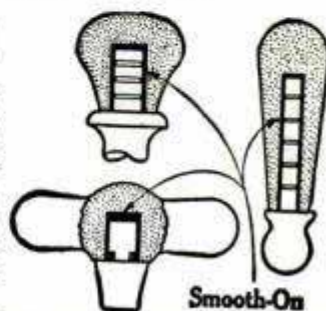

Keep Smooth-On handy and you can save much money on such repairs as: Stopping leaks in steam, water, gas, oil or stove pipes, mending cracks,

breaks or leaks in furnaces and boilers, radiators, tanks, sinks, pots and pails, making loose handles tight on umbrellas, knives, hammers, brushes, drawers, etc., tightening loose screws, hooks, locks, door knobs, etc.

Use it also on your car for making bursted water jackets and pumps good as new, stopping leaks in radiator, hose connections, gas tank and gas, oil and exhaust lines, making a fume-proof joint between exhaust pipe and tonneau heater, tightening loose headlight posts, keeping grease cups, hub caps and nuts from loosening, etc.

How to make HOME & AUTOMOBILE REPAIRS

Do it with SMOOTH-ON

Write for FREE BOOK

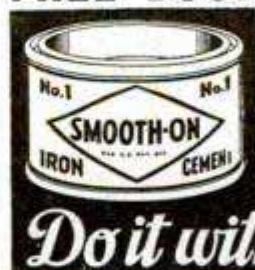

Get Smooth-On No. 1 in 7-oz., 1-lb. or 5-lb. tins at any hardware store or if necessary direct from us.

Do it with SMOOTH-ON

SMOOTH-ON MFG. CO., Dept. 37,
574 Communipaw Ave., Jersey City, N. J.

Please send the free Smooth-On Repair Book.

Name.....
Address.....
1-28.....

LEARN TO BE A REAL WOOD-WORKER

No. 990

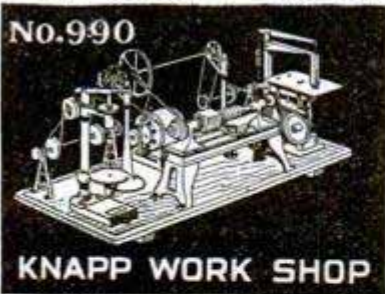

\$27.50

Denver West and
Canada — \$30.00

KNAPP WORK SHOP

NOW you can do it, for now you can buy tools that do real work, at prices you can afford. The above outfit, lathe, jig saw (described below), speed drill that will not only drill wood but bakelite, brass, iron, slate, etc., 1/35th horse-power a. c., d. c. motor, tools, equipment, instruction book. All for \$27.50—Denver West and Canada, \$30.00.

**KNAPP
JIG
SAW
No. 900**



Knapp Jig Saw No. 900
Capacity up to 3/4 in. lumber, also bakelite, celeron, etc. Handy for making radio panels, as well as jig saw and scroll work. Instruction book, wood with design laid out ready for cutting and 3 blades furnished.

\$4.00

Denver West & Can. **\$4.25**
Sh. Wt. 3 1/2 lbs.



**KNAPP LATHE No. 930
AND TOOLS**

Knapp Lathe No. 930

Turns wood up to 5 in. length, 2 3/4 in. diameter. Tool rest, head rest, tail stock all fully adjustable. Complete with 3 step pulley, 3 high grade cutting tools, and instruction book.

\$6.00

Denver West & Can. **\$6.50**
Sh. Wt. 4 lbs.



Sample of work done on Saw No. 900 from Outfit 902 which consists of 20 boards, 4 1/2 x 12 x 3/16 in. and 12 designs for making everything from toys to practical household articles.

Outfit 902, \$2.00

Canada **\$2.25**
Sh. Wt. 6 lbs.



Samples of work done on the Knapp Lathe with Outfit 935, consisting of 12 interesting and useful turning designs, and templates, 43 white pine blocks, 5 in. long, from 1/2 to 1 1/2 in. diameter.

Outfit 935, \$1.25

Canada **\$1.40**
Sh. Wt. 7 lbs.

Complete INSTRUCTIONS FREE

When you buy any of the above you get, free of charge, a complete MANUAL of Instructions, which shows you how to turn wood, do jig saw and scroll saw work, how to drill all sorts of substances, to care for, handle and sharpen your tools, etc. Fully illustrated throughout. With it you can soon learn to make ship models, toys and useful home articles. Skill is easily acquired. The work is fascinating.

Send 10c for full color catalogue fully describing this real line of miniature machine tools that work.

Go to your dealer and see a Knapp Work Shop with all these tools mounted and assembled—at any hardware, sporting goods or department store [toy dept't usually].

If out of stock we will send direct on receipt of price plus forwarding costs.

KNAPP ELECTRIC CORPORATION
Dept. 89 PORT CHESTER, N. Y.

Also manufacturers of Knapp Electric Questioner
In Canada: **W. EATON CO.**

Makes New Phonograph Out of Your Old One!

Try This Amazing New Invention 10 DAYS—AT OUR RISK

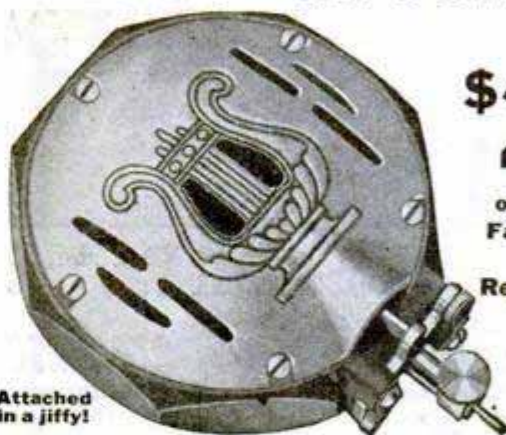

Attached in a jiffy!

ONLY

\$2.98

on **SPECIAL**
Factory Price
Offer
Regular Retail
Price
\$6.50

Produces Thrilling, Life-Like Tones, Wonderfully Rich, Deep, Powerful

New **SUPERPHONIC REPRODUCER** brings your phonograph up-to-date. Makes your machine produce music of *astounding naturalness, just like latest expensive, new type phonographs.* Brings out lowest bass notes and highest trebles heretofore "lost." The warmth and depth of tone, the tremendous volume will amaze you. **Fills the room like living singers or real orchestra.** Splendid for dancing and home entertainment. Order today on special

10-DAY TRIAL—AT OUR RISK

Don't send a penny. Just name and address. **BE SURE TO SPECIFY THE NAME OF YOUR PHONOGRAPH.** When **SUPERPHONIC Reproducer** arrives, deposit with postman *special factory price of \$2.98*, plus few pennies postage. (Canada \$3.10 cash with order.) Try it on your phonograph for ten days. Enjoy the wonderful improvement. Note increased volume, depth and richness of tone. See how your phonograph will be transformed into latest type machine. Then—if you are not delighted, return the **SUPERPHONIC** and you will not be out a penny. **Satisfaction positively guaranteed or deposit refunded. SEND TODAY!**

FACTORY DISTRIBUTORS, Dept. 15, 231 W. Randolph St., Chicago, Ill.

30 Days' Free Trial

New Models now ready for delivery direct from our factory. *Astonishing low prices and terms.* Do not buy until you get them.

RIDER AGENTS WANTED to ride and exhibit sample. Make big money. Many models \$21.50 up.

Tires Guaranteed \$1.50 each, wheels, lamps, horns, equipment at *AAJ* usual prices. **Send No Money.** Write for our marvelous prices and terms on **RANGER Bicycles.**

Mead CYCLE CO. Dept. 8-108 CHICAGO



Sport Bodies for Fords AT FACTORY PRICES!



This Model in Grey Prime **\$39.50**

Write for Booklet A-2 Showing Other Models.

SPORT FACTORIES, AURORA, ILL.

I'll Pay You \$40 A DAY!



No wind can blow it out!
How does it work?

To Show My Mysterious Cigarette Lighter to Men

Quick, easy profits with this amazing invention. Lights cigarettes and cigars in strongest wind. New principle of ignition. Does work of expensive lighters. **But sells for only 50c.** Guaranteed 10 years. Elmers sold 48 in one day. Johnson cleaned up \$63.00 in two days. No experience necessary. Work full or spare time. Smokers and dealers buy on sight. Send \$3.00 for dozen lighters or 50c for agent's sample and rapid fire selling plans. Satisfaction guaranteed.



MASTERLITE MFG. CO., Desk A-23
110 E. 23rd Street NEW YORK CITY

Amazing, New Glass Cleaner

Offers \$15 a Day-PROFIT!



HERE'S an absolutely new, money-making proposition that will bring you big profits—easy profits—QUICK PROFITS! You can make \$50 a week in spare time—\$100 in full time—taking orders for JIFFY GLASS CLEANER—a new, pure, harmless liquid that easily and instantly cleans glass surfaces without water, soap or chamois. Think of it! Unequaled for cleaning windows, mirrors, windshields, show cases, eyeglasses, etc.

Anyone, Anywhere, Can Earn Big Money

All you do is demonstrate to housewives, automobile owners, stores, garages, etc., and take orders. We do not sell dealers. All business from your locality must come through you, and you alone get the profit on every order. Every demonstration brings you two to four orders. Just moisten a cloth with Jiffy Glass Cleaner, rub over the surface of the glass and then polish with a dry cloth. Instantly removes all dust, dirt, grease and grime without streaking. After one application windows shine, gleam and sparkle like crystal—and stay clean twice as long.

Albers Made \$47 in a Day!

Henry Albers, Ohio, made \$47 in one day and he says that \$100 a week is easy for him. Men and women everywhere are making amazing profits with Jiffy Glass Cleaner and my 350 other fast-selling products. Chris. Vaughn, Ohio, made \$125 in a week; L. C. Van Allen, Ill., averages more than \$100 a week; Mrs. K. R. Roof, S. C., earned \$50 in her first week's spare time; Mrs. B. L. Hodges, N. Y., earns \$18 to \$20 a day; H. C. Hanson, N. D., makes \$75 a week in spare time. You can make this big money, too!

Send No Money

I don't want you to send me a cent. All I want you to do is let me show you how you can make \$50 to \$100 a week, without experience and without taking any course of training. I agree to furnish everything you need, to tell you what to do and say in this easy, fascinating work. You positively take no risk whatever. You can't lose a penny and yet you

have a wonderful chance to reap big profits quickly. You can make \$10 to \$20 a day right from the start.

Mail Coupon NOW

Introduce Jiffy Glass Cleaner in your locality while it's new. This is your chance to make more money than you've ever made before. Send coupon for full details—without cost or obligation to you! Act quick for big profits. Send coupon TODAY!

THE JIFFY GLASS CLEANER CO.,
37 Monmouth Ave., Cincinnati, Ohio.

Please send me full details of your money-making proposition without cost or obligation.

Name.....

Address.....

(Print or Write Plainly.)

LIGHTING FIXTURES

Ready to hang

Direct from the manufacturer. Completely wired, including glassware. Send for new catalogue No. 29. Just Reduced Prices. Special Proposition to Dealers.

Erie Fixture Supply Company, Inc.
Station A
ERIE, PA.

Catch Fish!

Eels, Mink, Muskrats with our new folding galvanized STEEL WIRE TRAP. Write for our FREE TRAP OFFER and Bargain Catalog. \$1 Box of our famous Fish Bait FREE to introduce our traps. WALTON SUPPLY CO., 3501 JUNIATA AVE., ST. LOUIS, MO.

Genuine English Broadcloth SHIRTS

World's greatest bargain for well dressed men! Guaranteed English Broadcloth whiteshirts 3 for \$6! Stores get \$5 and \$6 each! Positively guaranteed full count broadcloth, fine quality—backed by Powers, Waterloo, Ia.

\$2.00!

Agents!

No experience needed. Earn \$50 to \$150 a week. No better shirts made. Satisfaction guaranteed. Amazing low prices. Send for full details—start earning big money.

CUSTOM MADE — GUARANTEED

Sizes 14 to 17. Any sleeve length. Send no money. Merely name and address, shirt size, sleeve length, and if wanting collar attached. Pay postman only \$6 for 3! You'll be amazed and delighted. Money back if not entirely satisfied. Don't wait. Mail order today.

POWERS MFG. CO.
Dept. A
Waterloo, Iowa

Diamonds Here at 60% of Market Price

Free Bulletin lists diamonds as low as \$60 per carat, also Gems of Finest Quality at higher per carat charges, but proportionately Low Bargain Prices. This 3/4 loose 1-16 carat correctly cut diamond, a snappy biasing solitaire at \$58.50. This 75 year oldest largest Diamond Banking Firm in all the world lends money on diamonds. Thousands of unpaid loans and other bargains. Many from big cash deals direct with European Diamond Cutters. Must sell NOW.

WHY PAY FULL PRICES

Costs Nothing to See

Any Diamond sent for absolutely free examination at our risk. No obligation. No cost to you. Latest Listings—Unpaid Loans. Sent Free. Describes Diamond Bargains in Detail, gives cash loan values guaranteed. Explains unlimited exchange privilege. Write today for your copy of Diamond Bargain List. Use blank below, clip ad and mail.

\$68.50
3/4-1/16
Carat
Correctly
Cut

Name.....

Address.....

Tear out and mail today to—
Jos. De Roy & Sons,
Only Opposite Post Office
1964 De Roy Building
Pittsburgh, Pa.

RADIO IS BETTER WITH DRY BATTERY POWER



made to run
the *full* race!

ANY horse can make a good start But it takes real stamina to *finish!*

So it is with batteries. *Staying* power is the quality to look for—unfailing power over a long period of service. Millions prefer Burgess *Chrome* Batteries for just this reason. They hold up They *last*.

Next time, buy black and white striped Burgess *Chrome* Batteries. You are certain to get longer and better service for your money.

Chrome—the preserving element used in leather, metals, paints and other materials subject to wear, is also used in Burgess Batteries. It gives them unusual *staying* power. Burgess *Chrome* Batteries are patented.

Ask Any Radio Engineer

BURGESS BATTERY COMPANY
General Sales Office: CHICAGO

Canadian Factories and Offices: Niagara Falls and Winnipeg



BURGESS
FLASHLIGHT & RADIO
BATTERIES

SENSATIONAL \$3
Typewriter Offer

DON'T SEND US A CENT—we'll ship you a *genuine* L. C. Smith for a 10-Day Free Trial. Put it to any test in your home or office—no one will urge you to buy. Compare it with any machine made. Then, if you decide to keep it, we'll make you the **LOWEST PRICE EVER OFFERED** and give you **EASY MONTHLY PAYMENTS** so small you'll never miss them.

3
AFTER 10 DAY
FREE TRIAL

The ONLY Ball-Bearing Typewriter



Because of its ball-bearing construction, the L. C. Smith is the *easiest running and longest wearing* typewriter made. ALL THE 1926 ATTACHMENTS.

Guaranteed for 5 Years HIGHEST QUALITY re-noved. Don't buy any typewriter until you have tried an L. C. Smith. For the sake of your future satisfaction, accept our **FREE TRIAL OFFER**.

\$3 Worth Extras FREE

By acting now, you get Tools, Waterproof Cover, valuable Home Study Course in Touch Typewriter Free. Play safe. Use the ball-bearing L. C. Smith 10 days before deciding on any machine. Write **TODAY** for details of our Special Offer and manual of typewriter information.

Smith Typewriter Sales Corp.
91-360 East Grand Avenue, Chicago

6 TUBE RADIO 
ONE DIAL *Only \$32.50*

Latest advanced circuit. All steel chassis totally shielded. Balanced parts of best quality. Marvelous power and selectivity. Gets the long range stations as clear as a bell. One dial single control. An unsurpassed value—just one of our many mighty bargains.

FREE Log and Call Book and Big New Catalog—just off the press. Full of Radio Bargains. Send for your free copy now!

American Auto & Radio Mfg. Co.
HARRY SCHWARTZBERG, Pres.
Dept. 262 American Radio Bldg., Kansas City, Mo. 2



A&B Battery \$2
Charger ONLY

SATISFACTION GUARANTEED



Charges any type of storage A or B battery, using a few cents worth of ordinary house current, either alternating or direct. Cannot injure battery. Complete directions enclosed. Anyone can operate. No expensive "extras" to buy. Why pay \$10.00 to \$15.00 for a charger when you can get this splendid **GUARANTEED R. B. Charger** by mailing us two dollars (bills, money order, check or stamps) plus ten cents in stamps or coin to pay mailing costs. Charger will be sent postpaid. If you are not satisfied, return within five days and we will refund your money. Order at once—**TODAY**.

R. B. SPECIALTY CO.

Dept. 601-T, Address, East Third St., Cincinnati, O.

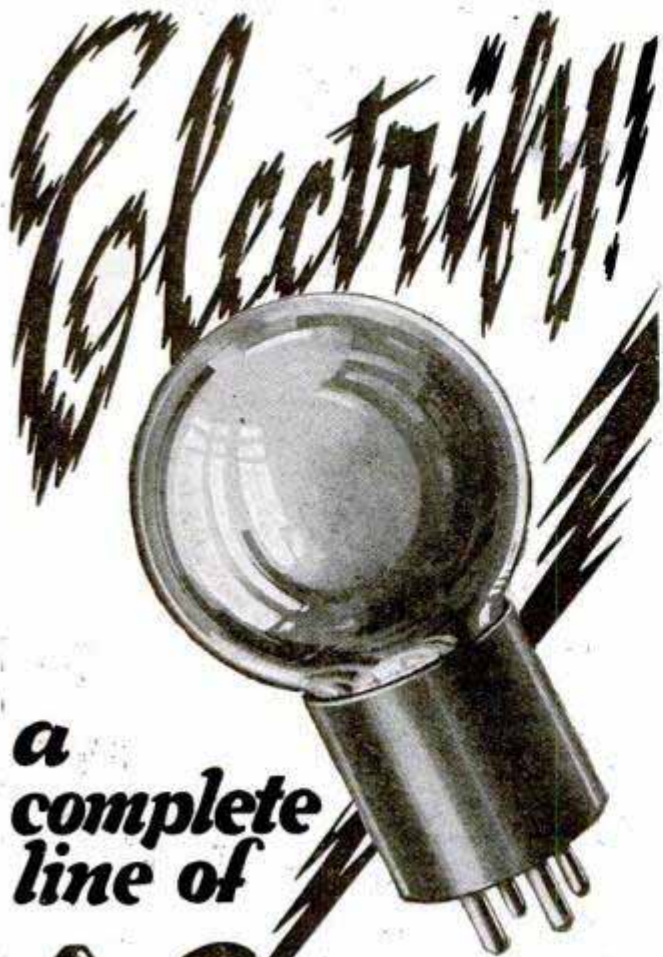

a complete line of

A-C TUBES

by DAVEN

"The Sine of Merit"
DAVEN RADIO CORPORATION
TRADE MARK *"Resistor Specialists"* REGISTERED

155 Summit St.

Newark, N. J.

“ Drive With ” CAT'S EYES SEE IN THE DARK

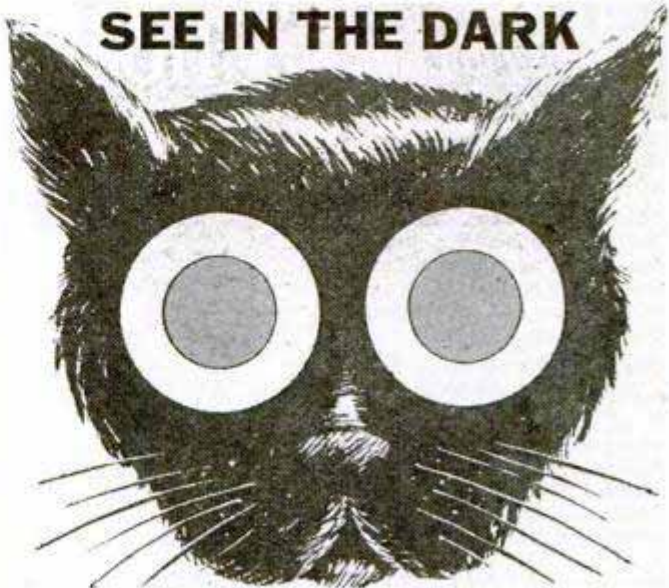

Cat's Eyes by name and Cat's Eyes by nature! They floodlight the road with an amber glow that pierces darkness, fog and rain. Shooting like a finger far ahead is a "soft spot"—a non-glare center that makes it easy for approaching drivers. Drive with bright lights—never dim. Cat's Eyes clamp over the *bulbs* of your headlights. Others are paying from \$35 up for non-glare lights. Get yours for the coupon below and a \$1 bill.

AGENTS: Cat's Eyes the sensation of the big-town markets. Come in now. Just mark the coupon "agent."



\$1 per pair

1 minute to install

MAIL THIS COUPON QUICK

BURTON MFG. CO.,
501 W. Canfield,
Detroit, Michigan

Enclosed find \$1. Send me a pair of "Cat's Eyes." I am to get my money back if not more than satisfied.

(102) Name.....
Address.....

0131 5/20/37

MOTORCYCLES



Price \$10 and up purchased through our Co-Operative Plan for as low as \$1.00 down and \$1.00 per week
Indians Harley-Davidsons Ace Henderson and Clevelands
Send ten cents for Bulletin A.
Motorcycles shipped to all parts of the world
WALKER-INDIAN CO., 78 Brookline Ave., BOSTON

MOTORCYCLES



WE WILL TRUST YOU
Pay As Low As \$2.00 per Week
Hendersons, Harley-Davidsons, Indians
Slightly used and rebuilt. Hundreds to select from.
Send 10c for list today.
MYEROW BROS. CO., 15 Berkeley St., Boston, Mass., U. S. A.



Start NOW at HOME

It's Easy to Learn on a Pan-American

Clarinet, Saxophone, Trumpet, Trombone, Sousaphone—or other band instruments.

Moderately Priced. Beautifully Toned. Easy Blowing Qualities. Splendid Workmanship. Recommended by band masters, music supervisors and professionals. Factory guaranteed.

Standard for amateur and school bands and orchestras.

Send today for *free* copy of our beautifully illustrated catalog of PAN-AMERICAN band and orchestra instruments.

MAIL THIS COUPON

PAN-AMERICAN Band Instrument & Case Co., Dept. G-14, Elkhart, Indiana.

Yes, send me copy of new catalog of PAN-AMERICAN band instruments. I would like to learn to play _____ (instrument)

Name _____

Address _____

Music dealer in my city is _____

EDWARDS METAL ROOFS
LAST LONGER · LOOK BETTER

SAVE YOU MONEY



Edwards Metal roofing, shingles, Spanish tile, sidings, ready-made garages and farm buildings, are rust-proof, fire-proof, lightning-proof. Last three times as long as ordinary kind. Quality in every detail. Styles and types for every purpose. Easy and economical to apply. Lifetime satisfaction.

We are the world's largest manufacturers of sheet metal building materials. We control every operation from the raw metal to the finished product. You can buy from us at manufacturers' prices and save all intermediate profits. Write today for our Free Samples and prices. Ask for Roofing Book No. 150 or for Garage Book.

FREE or for Garage Book.
SAMPLES, The Edwards Mfg. Co.
Books and Estimates 100-150 Butler St., Cincinnati, O.

\$200 DEPOSIT **\$125 WEEKLY**

10 DAYS FREE TRIAL **ONE YEAR TO PAY**

No. **A-279**

7 blue-white DIAMONDS in platinum disk and 2 sapphires are set in 18 Kt. solid white gold mounting **\$66**

18 K

PRICE CUT TO \$66—WORTH \$110

Cluster looks like a beautiful square solitaire worth \$500. Read description. We guarantee that if you can buy one like it for less than \$110, anywhere, we'll refund every cent you paid.

Buy Direct From Diamond Importers

You save the middleman's profits because we have been diamond importers since 1879—48 years. We sell only blue-white diamonds—no off color grades. Everything guaranteed. Our money-back-if-not-satisfied guarantee protects you.

ORDER ON TEN DAYS FREE TRIAL

Just send \$2.00 with your order. Pay balance in weekly payments. You have 10 days to decide. If not satisfied, return for refund.

Open Confidential Credit Account

To open a charge account without delay, just give a little information about yourself and a few business references. Everything strictly confidential. If under age, have parents or guardian guarantee account. Your bank is our reference.

Write for Free, Illustrated Bargain Catalog

Hundreds of bargains in Diamonds, Watches, Jewelry, etc. It brings our large Jewelry Store right into your home. \$1,000,000 stock. Buy diamonds like an expert. Contains information other jewelers dare not tell.

STERLING DIAMOND & WATCH CO. INC.
1540 BROADWAY DEPT. 2424 N.Y.

CAN YOU SELL GAS at 5c PER GAL.?

If so write me quick. My Distributors make as high as \$3,000.00 per month. Let me show you how.

SEND FOR FREE TRIAL

Proof of astounding success and my \$15.00 a day Guarantee to Distributors.

Frank Andrews, Dept. 805-A, 154 E. Erie St., Chicago, Ill.

RABBIT HUNTERS See and Try The **"SCREW-BUG"**

A mechanical ferret, for hunting Rabbits, Ground Hogs, etc.

"It travels round the curves and bends, and gets 'em out of their holes and dens." Thousands of satisfied users in the past three years.

One trial will convince you of its merits. The "SCREW-BUG" is sold and shipped by the inventor, direct to you by U. S. Mail, allowing a five day trial, with an absolute, If Not Satisfied Money back guarantee. Price \$4.00 each with order in U. S. A. Prepaid, or C. O. D. plus postage. We have no Agents. Write for Free circulars.

THE GRABOW CO., Dept. A, Franklin Square, L. I., NEW YORK



Get the facts on this New Speedster!



NEW, sensational B class speed motor. Drives racing hulls 25 miles and over. Thrilling performance—instant starting—absolute dependability. Write for literature. Elto Outboard Motor Co., Ole Evinrude, Pres., Mason St., Dept. A.A., Milwaukee.

The Super Elto Speedster

Swear Off Tobacco

Tobacco Habit Banished Let Us Help You

Quick Results

Trying to quit the tobacco habit unaided is often a losing fight against heavy odds, and may mean a serious shock to your nervous system. So don't try it! Make the tobacco habit quit you. It will quit you if you will just take **Tobacco Redeemer** according to directions.

It doesn't make a particle of difference whether you've been a user of tobacco for a single month or 50 years, or how much you use, or in what form you use it. Whether you smoke cigars, cigarettes, pipe, chew plug or fine cut or use snuff—**Tobacco Redeemer** will positively remove all craving for tobacco in any form in a few days. Your tobacco craving will usually begin to decrease after the very first dose—there's no long waiting for results.

Tobacco Redeemer contains no habit-forming drugs of any kind and is marvelously quick, scientific and thoroughly reliable.

Not a Substitute

Tobacco Redeemer is in no sense a substitute for tobacco, but is a radical, efficient treatment. After finishing the treatment you have absolutely no desire to use tobacco again or to continue the use of the remedy. It helps to quiet the nerves, and will make you feel better in every way. If you really want to quit the tobacco habit—get rid of it so completely that when you see others using it, it will not awaken the slightest desire in you—you should at once begin a course of **Tobacco Redeemer** treatment for the habit.

Results Absolutely Guaranteed

A single trial will convince the most skeptical. Our legal, binding, money-back guarantee goes with each full treatment. If **Tobacco Redeemer** fails to banish the tobacco habit when taken according to the plain and easy directions, your money will be cheerfully refunded upon demand.

Let Us Send You Convincing Proof

If you are a slave of the tobacco habit and want to find a sure, quick way of quitting "for keeps" you owe it to yourself and to your family to mail the coupon below or send your name and address on a postal and receive our free booklet on the deadly effect of tobacco on the human system, and positive proof that **Tobacco Redeemer** will quickly free you from the habit.

Newell Pharmacal Company
Dept. 300, Clayton Station, St. Louis, Mo.



Free Book Coupon

NEWELL PHARMACAL CO.,
Dept. 300, Clayton Station, St. Louis, Mo.

Please send, without obligating me in any way, your free booklet regarding the tobacco habit and proof that **Tobacco Redeemer** will positively free me from the tobacco habit or my money will be refunded.

Name.....

Street and No.....

Town..... State.....



Tobacco Tells on Nervous System



Tobacco Ruins Digestion



Tobacco Stunts Boy's Growth

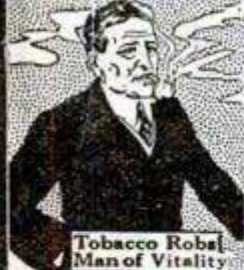

Tobacco Robs Man of Vitality



Tobacco Steals from You the Pleasures, Comforts, Luxuries of Life

Quality

Quality in
construction
means perfection
in performance.

Cunningham Radio Tubes catch, hold and reproduce the full range of the musical scale with unvarying accuracy.

Don't use old or inferior tubes with new ones—Use new tubes throughout.

To keep your set at peak performance, re-tube throughout with Cunningham Radio Tubes at least once a year.

E. T. CUNNINGHAM, Inc.
New York Chicago San Francisco

Twenty different types—
all in the Orange and
Blue Carton

Since 1915
Standard
for all
Sets

Cunningham RADIO TUBES

Improve Your Radio With this R. F. Choke

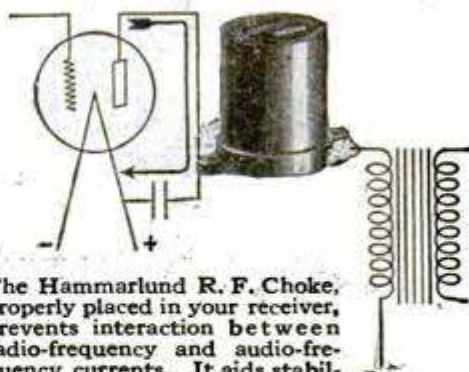

The Hammarlund R. F. Choke, properly placed in your receiver, prevents interaction between radio-frequency and audio-frequency currents. It aids stability and improves tone quality. Easily installed. Ask any radio engineer.

Two sizes—85 and 250 millihenries.

Diagram shows Hammarlund R. F. Choke in the Detector plate circuit of a radio receiver to prevent R. F. Currents entering audio-transformer.

Write for Folder

HAMMARLUND MANUFACTURING CO.
430 W. 33rd St., New York, N. Y.

For Better Radio
Hammarlund
PRECISION
PRODUCTS

AGENTS! DEALERS! BIG MONEY IN RADIO

Demonstrate Metrodynes at home. Big profits. Demonstrating set on 30 days' free trial. Write for money making proposition.

METRO ELECTRIC CO.
2161 N. California Ave. Dept. 47, Chicago, Ill.



DO IT BY POWER—From the Nearest Lamp Socket

All machines portable, electric—sturdy, efficient, reasonably priced. Just check the machines in which you are interested, write your name and address in the margin and return this ad to us for complete information. Dealers in all principal cities.

HESTON & ANDERSON 601 Western Ave. Fairfield, Ia.

Only \$1²⁵



makes this yours

Gleaming silver finish—just like Lindbergh's "Spirit of St. Louis." Shiny blue propeller. Bright red wheels with big balloon tires. 12 in. long. All metal, built to stand knocks. Strong clock-spring motor sends it "taxi-ing" round the floor with spinning propeller just like a real plane. If your toy dealer hasn't this Kingsbury Toy send us \$1.25. (If west of Miss. or in Canada, \$1.40) and we will ship this toy direct. Kingsbury Disc Wheel Balloon Tire Eraser 10c. Complete Catalog Free. Kingsbury Mfg. Company, 53a Myrtle St., Keene, N. H.

KINGSBURY Motor TOYS
Driven



Free Trial on this New Conn Saxophone

A WHOLE LIFE-TIME of joy is packed in a Conn saxophone. You play tunes in a week. Conn's easy-playing features and new instruction methods speed you along.

Pleasure, popularity, increased income—all may be yours with a Conn. You're welcome everywhere when you play. Professional engagements pay big money.

FREE TRIAL; EASY PAYMENTS on any Conn instrument for band or orchestra—saxophone, trumpet, trombone, cornet, clarinet, flute, drums, violin, etc. Send for details, mention instrument.

C. G. CONN, Ltd.
131 Conn Bldg. Elkhart, Ind.



Send for "The Nestler Plan" the book that will bring you big profits!

This book fully explains the amazingly successful Nestler method of servicing and retreading automobile tires. Tells how to start a profitable spare-time or full-time Nestler business of your own. Write to Dept. 31.

NESTLER RUBBER FUSING CO., Inc.
245 West 55th Street, NEW YORK, N. Y.

Cal. 30-40 6 Shot



\$9.75

KRAG CARBINE

All the qualities of a high price rifle. The choice of those who know. Fine used condition, all working parts guaranteed for one year. Send for our Free 50-page catalog of money saving values: Guns, Ammunition, Cutlery, Sports and Gov't goods. Outfitters for 50 years to leading Military and Society Organizations, Theatrical and Wild West Shows. Satisfied customers all over the world. Terms Cash. No C.O.D.
W. STOKES KIRK, 1627-P. M. North 10th Street, Philadelphia, Pa.

PLUMBING-HEATING

Install Your Own—Save Half



Lowest wholesale prices on highest quality Grade A goods. Any Handy Man can install his own Plumbing and Heating BY OUR NEW EASY METHOD. Get the best and pay only a little each month.

Send for FREE Book

New bargain catalog just issued. With our cut-to-fit systems you save waste material and high labor cost. 50 years of economical service to home owners, farmers, builders and mechanics. Million Dollar Plants back up our Bonded Guarantee. FREE book gives you the whole story. Write for your copy today.

HARDIN-LAVIN Co. EST. 1876
OVER 50 YRS. 107-17 West Pershing Road, Chicago, Ill.



You Can Easily **EARN \$150 to \$300**

MONTHLY Profits

COSTS Only \$16 MONTHLY

30 DAYS TRIAL

Pays for Itself—No Expense to You

Bigger Profits for You Barnum cleared \$350 the first month. Wilson cut his electric bills in two and doubled his business. Start a money-making business of your own—Make Battery Charging the biggest Money-Maker in your shop.

Auto and Radio Battery Business Good Now You can do it with HB 8 Hour Battery Service. Pulls trade from other shops because you give a far better charge in one-third the time required by others—only costs you half as much for current as old slow methods. No expensive bulbs to burn out. Start Now to get Radio as well as Auto Business.

30 DAYS' TRIAL AT OUR RISK

Pays for Itself and a Profit Besides

Where they stop they buy. Bring 'em to your Shop with Air Service better than the other fellow's. HB Silent Twin Air Service will do it. Only \$11 for a few months. Increased business easily pays for it. Check No. 2 in coupon below.

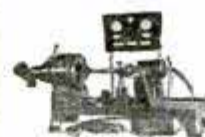

The best paying Auto Electrical work is now available to small shops with this new low-priced HB Test Bench—that does better work and makes more tests than many benches costing \$100 to \$150 more. Costs only a small part of the extra profits it brings. \$20 monthly. Check No. 3 below for particulars.

Paint 'em for \$15 and sell 'em for \$100 more. That's why HB Paint Spray is going into hundreds of Garages. Does the work of five brush painters. Big profits in contracting painting—interior decorating—or production work. No experience necessary. Check No. 4 to get more details on this profit maker.



HB Equipment built in HB Factories does more and costs less. Any item can be had on 30 Days' trial and easy monthly terms. It pays for itself with a handsome profit for you.

HOBART HB BROTHERS
Successful manufacturers ~ since 1893 ~

BOX M18 TROY, OHIO
Tear Off and Mail Today

Hobart Brothers, Box M18, Troy, Ohio.
Send me complete information on the items I've checked—your thirty day trial offer—easy payment terms—information on how HB equipment will increase my earnings.
No. 1 () HB 8 Hour Battery Charger
No. 2 () HB Air Service
No. 3 () HB Test Bench
No. 4 () HB Paint Spray

Name..... Address.....

**Campbell's
Infra-Red Ray
Lamp**

RELIEVES

- Common Colds
- Sinus Troubles
- Ear Trouble
- Deafness
- Tonsillitis
- Neuralgia
- Bronchitis
- Influenza
- Asthma
- Neuritis
- Catarrh
- Rheumatism
- Lumbago

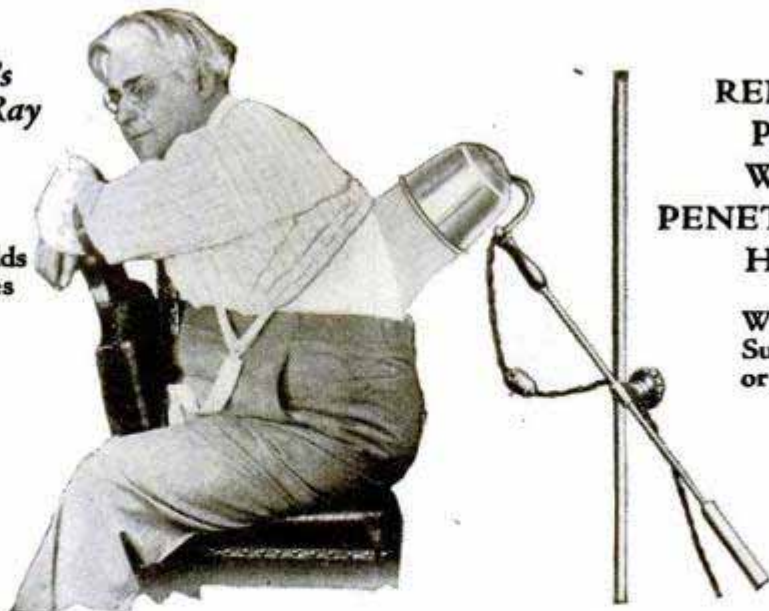

**RELIEVE
PAIN
WITH
PENETRATING
HEAT**

**Will Not
Sunburn
or Blister**

Relieve Congestion with Infra-Red Rays

Don't let lumbago, rheumatism, or similar ailments bump you off the job this winter. If you but knew how Infra-Red Ray treatments relieve these and other ailments such as neuralgia, colds in head or chest, catarrhal deafness, head noises, etc., you would never be without this wonderful therapeutic aid. Users everywhere are telling of wonderful results had with Campbell's Infra-Red Ray Lamp.

A. Harold Mayer, M. D., Alliance, Ohio (Eye, Ear, Nose and Throat Specialist), reports on two outstanding cases. Case 1. John K. Age 30. Had two mastoid operations three years previously and since then the ear had been discharging. Various treatments had been tried without success. Daily treatments brought complete

recovery in three weeks. Case 2. John D. Age 51. Cervical adenitis (gland trouble) of five months standing. 15 minute applications of the Infra-Red Ray Lamp, twice daily for three weeks, complete recovery. C. K. Morris, Chicago, got rid of a bad cold just overnight. Frank L. Wood, Petersburg, Mich., says, it has relieved him of lumbago, catarrh and inflamed eyes.

Campbell's Infra-Red Ray Lamp—this safe, therapeutic lamp sold direct from maker to user. Simple, easy to use. Connect with any electric light socket. 30 days' trial. Money-back guarantee. Easy payments or low cash price. Write at once for our booklet giving full details and healthful suggestions.

1040 Union Avenue THE WILLIAM CAMPBELL COMPANY Alliance, Ohio

RADIO AT WHOLESALE

Write for my Big 1928 Radio Catalog—just off the press. Thousands of marvelous bargains in nationally advertised goods. All the LATEST IN RADIOS and equipment. Lowest wholesale prices. Agents Wanted.

FREE

It's a regular encyclopedia on Radio. All about trouble finding. **FREE Log and Call Book and Catalog.** Get your copy today. Send postcard now!

American Auto & Radio Mfg. Co.
HARRY SCHWARTZBERG, PRES.
Dept. 263 American Radio Bldg., Kansas City, Mo. 3

DEALERS NEW 1928 CATALOG

SM

Do You Know the Secret of Quality Reproduction?

"The Secret of Quality" tells you simply and concisely how to get the most out of your amplifier—how to get quality. This 96 page booklet is yours for the asking—it's free. Write for your copy.

SILVER-MARSHALL, INC., 840 W. Jackson Blvd., Chicago, U. S. A.

SOLDERALL

METAL IN PASTE FORM

The Only convenient metal solder

Every Electrical Connection needs Solderall for perfect reception

25¢

The **SOLDERALL CO., NEWARK, N.J.**

No. 6132

\$25

This Reg. Trade Mark guarantees you genuine diamonds

**A Ring You Will Be Proud to Wear
SEND NO MONEY**

Genuine Full Cut Diamonds (No Chips)

No. 6132. Solid Gold Men's Initial or Emblem Ring. 2 Genuine Diamonds 4-100 each. 14-Kt. White Gold Top, Emblem (any lodge) or any initial (Old English) Yellow or White Gold inlaid in Genuine Hope Ruby or Black Onyx. Mention if desired in solid white gold or green gold, same price.

No. 6598. Any initial (raised gold) or Eastern Star, Rebecca, Mason, Shrine, K. of C. emblem if desired.

Send number of ring, size of finger, initial or emblem desired, and ring will be sent for inspection.

No. 6598

\$15

Terms (6 Months to pay) Ask for Free Jewelry Catalog "The Mail Order House"

DEPT. P (or at your Jeweler's)

BUFFALO, N. Y.

501 Washington St.

Ladies' Ring Genuine Black Onyx with Genuine Full Cut Diamond. 14-Kt. White Gold.



Christmas Greetings and Good Health

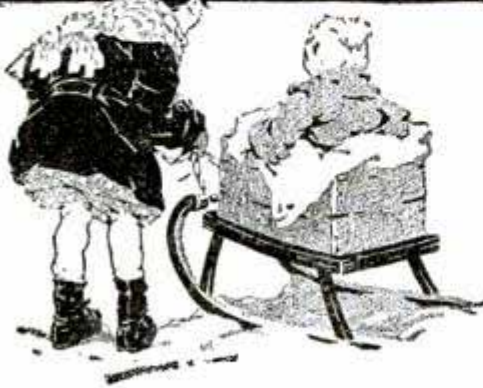

Children are
the parents
of tomorrow

Help guard
their health

Buy
Christmas Seals

The National, State, and Local
Tuberculosis Associations
of the United States



It's Easy

Boys, here's your chance to get in on the best game of life. Wouldn't it make you happy to know that a place is open for you on a team headed for money and prizes? Score the winning goal by making application on the coupon below.

Win Prizes — Earn Money

You can be a Crowell Junior Salesman and spend a few hours of your spare time delivering magazines to regular customers. We will tell you how to get these customers, and show you the way to money and prizes. Membership in a great organization is open to you! Join now!

Mr. Jim Thayer, Dept. 43
The Crowell Publishing Co., Springfield, Ohio.

Dear Jim: I want to score the winning goal. Show me how.

My Name.....

Address.....

Town..... State.....

The Open Door

to a
Substantial
Income



and
Big
Profits

with
Americas Wonder Line

You don't need to be a high pressure salesman to sell the Hamilton line of bench tailored clothes for men. Hamilton Giant Swatch Samples, a yard and a third in length, sell themselves. Just make regular calls and you'll make regular profits, plus a handsome monthly bonus. Hamilton clothes are sold on a strict Money-Back guarantee. No extra charges. Highest commissions. Six popular price ranges, \$29.50 to \$55.50 include many imported fabrics. Materials and patterns to meet every man's taste. The new Hamilton line is now ready. Line up now for big profits by writing today for full details of the four square selling plan that will net you a substantial income. In writing please enclose three business references.

THE HAMILTON TAILORING CO.
Department 4 402 West Fourth Street
Cincinnati, Ohio

HAMILTON TAILORING

A Big New Edition of **DYKE'S** Automobile Encyclopedia

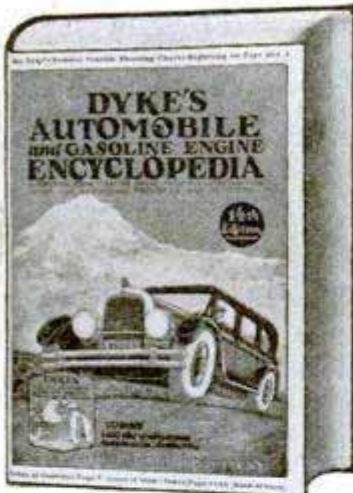

For 15 years "Dyke's" has been the one recognized and undisputed authority on the Automobile. Each succeeding edition has surpassed the last one. Now comes the greatest book of all—the wonderful 15th Edition—A. L. Dyke's crowning triumph—the super auto book of all times.

Some "High Spots" of the New Book!
1,249 pages covering every known auto fact.
4,200 Pictures, Plans, Diagrams and Charts.
15,000 lines of Index by which you can instantly locate any subject you want.

A new section of "Trouble Shooting" Charts in Colors to enable you to quickly locate any major or minor trouble on any car.

Special instructions on testing and adjusting every part of the automobile.

Specifications of Gasoline Passenger Cars, Trucks and Tractors.

Specifications for Replacements, Accessories, Interchangeable Parts and Equipment.

Large colored Combination Chart which shows the working principles of the Automobile.

Large Charts showing the working principles of Trucks and Tractors.

Cloth \$6.00; Limp American Morocco \$7.50

Sent postpaid upon receipt of price.

POPULAR MECHANICS PRESS
Room P-1—200 E. Ontario St., Chicago

Don't Be Afraid To Tackle That Concrete Job!

What is it you want to make out of concrete?



A Garage floor—Garden seat—Bird bath—Auto Drive-way—Curbs and Gutters—Flower boxes—Rural Mail Box Post—Garden Fountain—Ornamental Foot—Drinking Fountain—Boat Landing—Cistern Cap—Milk House—Engine Foundation—Watering Trough—Sidewalk—Steps—Gate-posts—Fence Posts—Tile—Blocks—Silo—Pedestal—Vases—Forge—Smokehouse—Chimney Cap—Horse Stalls—Foundation Support—Cyclone Cellar.

With the instructions found in Popular Mechanics Concrete Handbook you can make 173 different useful articles.

Build With Ease for Permanence and Beauty

With the Concrete book we send you another remarkable book called Home Mechanics. This contains 329 valuable discoveries for doing the various jobs that come up about every home, both in the house and outside. These articles cover Furnaces, Stoves and Fireplaces—Homemade Furniture and Repairs—Building Refinements—Home Shop—Home Plumbing—Kitchen Equipment—Devices for Men—Home Electric Work—Outdoor Work—Water Supply—Garden—Bees—Miscellaneous.

Simply write and ask us to send you these two books. When postman hands you the package pay him 98 cents plus the postage. If outside U. S. remit when ordering and include 15 cents extra for mailing.

POPULAR MECHANICS PRESS
Room P-1 200 E. Ontario Street CHICAGO

NEW PRACTICAL

DIESEL ENGINE BOOK

The importance of the Diesel engine in its various applications to Marine, Locomotive, and Stationary operation can scarcely be overestimated. Every progressive engineer and student of mechanical engineering will realize the necessity of extending his knowledge into this field.

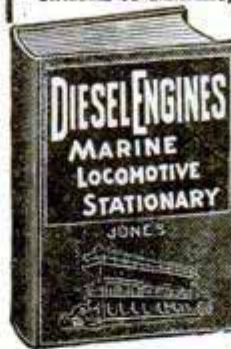

This up-to-the-minute book by D. L. Jones, Chief Machinist, U. S. Navy, is extremely practical, complete and in simplified language. Deals thoroughly with installation, operation and maintenance.

565 pages (6x9)—340 Illustrations.

Pay postman \$5.00 on delivery.

Popular Mechanics Press
200 E. Ontario St. CHICAGO

Learn How to Make Money as a COMMERCIAL ARTIST or CARTOONIST!

This Course is designed to lead you from the simplest elementary drawing to the higher branches of illustration.

**OVER 125 ILLUSTRATIONS
SHOW YOU HOW**

The drawings are explained in detail and every method or trick of the trade employed by professional artists is explained in full.

Send for this new book, Commercial Art and Cartooning, by Matthews. Pay postman \$1.25 plus the postage when he delivers the package. If outside U. S. remit when ordering and include 10 cents extra for postage.

POPULAR MECHANICS PRESS
Room 608, P-1 East Ontario St., CHICAGO

QUIT TOBACCO

No man or woman can escape the harmful effects of tobacco. Don't try to banish unaided the hold tobacco has upon you. Join the thousands of inveterate tobacco users that have found it easy to quit with the aid of the Keeley Treatment.



KEELEY TREATMENT STOPS Tobacco Habit

Quickly banishes all craving for tobacco. Write today for Free Book telling how to quickly Free yourself from the tobacco habit and our Money Back Guarantee.

THE KEELEY INSTITUTE
Dept. A905 Dwight, Illinois

EXCEPTIONAL OPPORTUNITY—Distributors Wanted for High Grade Proposition—Professionally equipped to carry stock of merchandise.

H & E WRENCH SALES CORP. Dept. R, 228 N. La Salle Street, Chicago
Dept. R, 285 E. 134th St., New York City



Beautify your NOSE
to shapely proportions—while you sleep!



ANITA NOSE ADJUSTER is SAFE, painless, comfortable. Speedy, permanent results guaranteed. Doctors praise it. No metal to harm you. Small cost. Write for FREE BOOKLET



ANITA CO., 112 ANITA Bldg., NEWARK, N. J.

Save Your Feet

When all else fails, end your suffering with the **Heefner Arch Support** No Metal



Fully patented. It re-adjusts the entire foot. Write for free book and statements from doctors and users.

Heefner Arch Support Co. 659 M. E. Taylor Bldg. Louisville, Ky.

YOUR LUCK BAD?

Change it—My FREE BOOK Tells You How. Stop worrying about the Future—Money Matters—Love—Health—Family Troubles. Enjoy life. Send 10c to cover cost of mailing for my amazing book.
RICHARD BLACKSTONE, Inc. 471 Flatiron Bldg. New York City

STOP USING A TRUSS



Reduced Fac-Simile Gold Medal

STUART'S PLAPAO-PADS are different from the truss, being mechanico-chemico applicators made self-adhesive purposely to hold the distended muscles securely in place. No straps, buckles or spring attached—cannot slip, so cannot chafe or press against the pubic bone. Thousands have successfully treated themselves at home without hindrance from work—most obstinate cases conquered. Soft as velvet—easy to apply—



Grand Prix

inexpensive. Awarded Gold Medal and Grand Prix. Process of recovery is natural, so afterwards no further use for trusses. We prove it by sending Trial of Plapao absolutely **FREE**. Write name on Coupon and send **TODAY.**

PLAPAO CO., 733 Stuart Bldg., St. Louis, Mo.

Name

Address

Return mail will bring Free Trial Plapao.

New-Amazingly Easy Method of Learning Practical ELECTRICITY

IN 12 WEEKS—NO BOOKS NO LESSONS—Not a Correspondence School

Even if you haven't had an advanced education, and know nothing about electricity, you can learn Practical Electricity in twelve short weeks. That's only 90 days. There's something to think about! Ninety days from the time you enroll in the new \$2,000,000 Coyne Electrical School, you will come out a trained man capable of earning a good salary, with an assured future.

Absolutely no Books or Lessons

My new sure method is amazingly easy. No books; no lessons—you learn by *doing*, in the great roaring Coyne Shops. You wire real amateurs; you build real switchboards; you wire real houses, you build real batteries—everything is real including the aeroplane, tractor and automobile motors which you work on. And all this time an instructor is right by your side—showing you—move by move—step by step until **NOTHING** on earth could keep you from learning.

Send For My Big Book—FREE!

I want you to fill out the coupon below and mail today. Then I'll rush my big 56 page book to you—containing 150 photographs, which will give you some idea of this mighty school. I'll help you find part-time employment while you are attending, and from then on throughout life, you'll get the benefits of the lifetime employment service. Get into the big pay class. Coyne Graduates have no trouble making good. Coyne graduates get jobs leading to \$50 a week and up, many go in business for themselves and become independent.

COYNE ELECTRICAL SCHOOL

Not a Correspondence School
H. C. Lewis Pres., Dept. 18-72C Established 1899
500 S. Paulina St., Chicago, Ill.

Send Coupon Today!

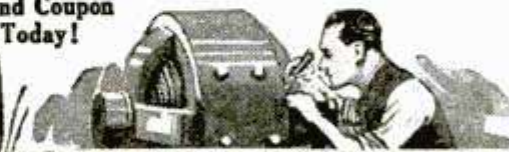

Mr. H. C. Lewis, Pres. Dept. 18-72C
COYNE ELECTRICAL SCHOOL,
500 S. Paulina St., Chicago, Ill.

Dear Mr. Lewis: Without obligation send me your big free catalog and all details of Free Employment Service, Radio, Aeroplane and Automotive Electrical Courses and how I can "earn while learning." I understand I will not be bothered by any salesman.

Name

Address

City.....State.....

Genuine Jewelry Sent On Approval

WITH ORDER



A YEAR TO PAY
All Transactions Strictly Confidential
10 Days FREE Trial
Send only \$1 with order, and your choice comes to you parcel post prepaid on 10 Days Free Trial. Pay postman only \$1 more on delivery; after free trial pay balance in 12 equal monthly payments. Satisfaction guaranteed or your money back. Royal terms make buying easy.

**4 DIAMONDS
4 SAPPHIRES**
BA1—Special offer in lady's wrist watch; solid 14 Kt. white gold hand engraved case set with 4 genuine diamonds and 4 Sapphires; 15 jewel guaranteed movement. **\$39.75**
\$3.15 a month.

FREE "Royal Book of Gems"
Thousands of special values in genuine diamonds, watches and jewelry illustrated. Adults only—write now for your copy.

NO RED TAPE
NO INTEREST



ELGIN WALTHAM

BA3—Newest model Waltham or Elgin nationally famous, gentleman's strap watch. 20 year warranted green gold filled case; radium dial; guaranteed time-keeper. \$1.87 a month. Specially priced **\$24.50**

ROYAL DIAMOND & WATCH CO.

ADDRESS DEPT. 1903, 170 BROADWAY N.Y.



STOP Ford & Chevrolet END-PLAY!

CRANKSHAFT

C-A ADJUSTABLE BEARING corrects and prevents end-play without removing motor. Eliminates many troubles. Easy to install—simply drop pan. For Fords, \$3.75; for Chevrolets, \$4.25. Ask your dealer or sent prepaid by ADJUSTABLE BEARING CO., Dept. P, 405 Virginia Ave., Indianapolis, Ind.

FROST-RADIO

DE LUXE APPARATUS

Ask your dealer to show you the new Frost Metal Frame and Bakelite De Luxe Rheostats, with and without filament switches; the new Frost Variable High Resistance Units, with Bakelite shells and pointer knobs; the new Frost Gem Rheostats—they are GOOD small rheostats—and the new Frost Fixed Resistances. Be sure to specify Frost Parts by name when ordering.



FROST-RADIO

TWO NEW FROST BOOKS FREE

Write today for your copy of our two new books, just off the press: "What Set Shall I Build?" and "Better Reception." These books contain a great deal of valuable information on popular circuits, and on the use of Frost Parts in getting the utmost in high quality reception from any set you plan to build. These books are free—write for them today.

HERBERT H. FROST, INC.





Main Offices and Factory, Elkhart, Ind.
New York Philadelphia Chicago Los Angeles
Boston Pittsburgh St. Louis St. Paul

Thompson BEATS the World on BOATS

THOMPSON
BOATS

CATALOG FREE!

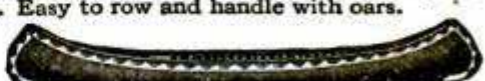
The Best that skill and experience can produce—at real money-saving prices. Prompt shipment from factories to you.

- Outboard Motor Boats** \$48.00 and up 
The very fastest racing models and a complete line of real fast, safe and sea-worthy boats.
- Rowboats** \$44.00 and up 
Improved models. Safe and seaworthy. Strong and durable. Easy to row and handle with oars.
- Canoes** \$48.00 and up 
Three models and four lengths to choose from. Including non-sinkable sponson canoes.
- Motor Boats** 20 ft. Long 
20, 25 and 30 miles an hour.

CATALOG FREE—SAVE MONEY—ORDER BY MAIL
Please state the kind of boat you are interested in (22)

—> TWO LARGE FACTORIES <—

THOMPSON BROS. BOAT MFG. CO.
213 Ann St. PESHIGO WISCONSIN (Write to Either Place)
113 Elm St. CORTLAND NEW YORK

TIRE REPAIRMEN—WRITE

for Booklet No. 22 "The Vulcanizing of Balloon and High Pressure Tires."
The SHALER Co.
2714 4th St., Waupun, Wis.



New Electric "Red Hot" Roaster

Wonderful automatic, sanitary machine soon to be announced. Get advance details. Big money maker.
FOOD DISPLAY MACHINE CO., Dept. 13-51, 350 W. Huron St., Chicago

FREE BLUE PRINTS
Show you how to make things for the home.

Make Money At Home Doing Things WITH A HARMAK SAW GUIDE

5 Tools in 1
HARMAK MFG. CO., 635-F Delmontway, St. Louis, Mo.

A Mitre, Saw Guide, T-Square, Protractor and Precision Tool. Money Back Guarantee. \$30 worth of tools for only \$2.50.

Step Into Your Own Business

Sensation of Chicago Food Show!



\$5000 to \$6000 a Year

PUFFLES New! Delicious!

STOPS THE CROWDS!

It's the mystery Puffles Machine that does the trick. Attracts INSTANT attention. Transforms the dry flavor-assorted flakes like magic into big, crisp, vari-colored Puffles. Crowds gather. They can't resist. They buy fast at 10c a sack—and become steady customers.

IT'S DIFFERENT!

Everybody likes Puffles. They're so different. Just a taste and you'll know why this "goody" was the sensation of the Chicago Food Show. Puffles process secret. Sales profit enormous. One dollar's worth of Puffles—\$4.00 clear profit. No waste!

FREE OFFER! We make it easy to step into this new, fascinating, profitable Puffles business. With your Puffles Machine we include 50 pounds of Puffles FREE which, when sold, returns your small investment, plus a nice profit. Write us—NOW—TODAY.

PUFFLES, Inc.
C-3027 S. Wabash Avenue, Chicago.

DON'T WEAR A TRUSS

BE COMFORTABLE—

Wear the Brooks Appliance, the modern scientific invention which gives rupture sufferers immediate relief. It has no obnoxious springs or pads. Automatic Air Cushions bind and draw together the broken parts. Nosalvesor plasters. Durable. Cheap. Sent on trial to prove its worth. Beware of imitations. Never sold in stores nor by agents. Every appliance made to special order and sent direct from Marshall. Full information and booklet sent free in plain, sealed envelope.



MR. C. E. BROOKS

BROOKS APPLIANCE CO., 107A State St., MARSHALL, MICH.

NEW SCIENTIFIC INVENTION APPLIES 4 WHEEL BRAKE POWER

on any car—FITS EVERY MODEL. Equalizes pressure on Both Sides of Each Brake Drum. WRITE FOR FREE TRIAL OFFER—AGENTS WANTED. SUPER BRAKE DEVICE, 1929-O Straus Bldg., CHICAGO

NO JOKE TO BE DEAF —EVERY DEAF PERSON KNOWS THAT



I make myself hear, after being deaf for 25 years, with these Artificial Ear Drums. I wear them day and night. They stop head noises and ringing ears. They are perfectly comfortable. No one sees them. Write me and I will tell you a true story how I got deaf and how I make you hear. Address



Medicated Ear Drum

GEO. P. WAY, Artificial Ear Drum Co. (Inc.)
80 Hoffman Bldg., 2539 Woodward, Detroit, Mich.

A PERFECT LOOKING NOSE Can Easily Be Yours



Trades Model No. 25 corrects now ill-shaped noses quickly, painlessly, permanently and comfortably at home (excepting cases caused by improper bone structure). It is a safe and guaranteed patent device of precise adjustment that will actually give you a perfect looking nose. Over 90,000 satisfied users. For years recommended by physicians. 16 years of experience in manufacturing Nose Shapers is at your service. Model 25 Junior for children. Write for testimonials and free booklet, which tells you how to obtain a perfect looking nose.

M. TRILETY, Pioneer Noseshaping Specialist
Dept. 2792 Binghamton, N. Y.

FREE TRIAL Grows Hair



AMAZING NEW ELECTRICAL DISCOVERY

A noted surgeon has discovered an amazing way to grow hair, called Dermo-Ray. In 30 days no more dandruff. Scalp tissues are given new life. Then within a few weeks, luxuriant new hair! The startling discovery of the almost magic effect of Infra-Red Rays on the hair-growing tissues was made by a leading surgeon. Two years ago he was himself bald. Today his hair is full and thick.

FAMOUS SURGEON'S DISCOVERY

Here is his own personal, home treatment, called Dermo-Ray. At last a home method endorsed by science. Guaranteed to bring you these same results in 30 days—or you pay nothing. You can use Dermo-Ray in any home with electricity. The warm, soothing Infra-Red Rays vitalize the scalp while you rest—a few minutes each day is all the time required.

SEND NO MONEY Complete facts about this astounding new scientific discovery, opinions of authorities, incontrovertible evidence, and details of special trial offer sent free, if you mail the coupon below. To end your scalp and hair troubles, act at once. Print your name and address plainly—and mail the coupon NOW!

FREE TRIAL OFFER

The Larson Institute
216 North Wabash Ave., Dept. 166, Chicago, Ill.

Send me at once, without obligation, full particulars—in plain envelope—of your 30-day Free Trial of DERMO-RAY.

Name.....
Address.....
City..... State.....



This illustration shows the main building of the McCleary Sanitarium and Clinic at Excelsior Springs, Missouri—the largest institution in the world devoted to the treatment of piles and other rectal troubles. (Only curable cases are accepted.)

A Serious Affliction Cured Without Surgery

THE old theory that piles can be cured only by surgery has been wholly disproved. This treacherous affliction which slowly but surely undermines the health of its victims can be cured—totally and successfully—without the dangers of a surgical operation.

Patients From All Parts of United States and Canada

For 27 years, Dr. A. S. McCleary and his associates have made an exhaustive study of rectal diseases. During that time, more than 13,000 patients from all parts of the United States, Canada and foreign countries have been successfully cured. Scores of these had been given up as incurable and many others were chronic cases of long standing.

Absolute Relief or No Pay

No matter how long you have been troubled—
No matter how distressing your case may be—
No matter how many treatments you have had without avail, if your case has not been neglected so long as to be incurable, we can promise you absolute relief or no pay.

If you or any of your relatives or friends are interested, we will gladly mail you our free book, "Piles Cured Without Surgery." This book fully describes the McCleary methods of diagnosis and treatment of all rectal troubles, and tells you exactly what is offered here at a very nominal cost.

The McCLEARY CLINIC and SANITARIUM

254 Elms Boulevard
EXCELSIOR SPRINGS, MO.

McCleary Clinic and Sanitarium
254 Elms Blvd., Excelsior Springs, Mo.

Please send me book fully describing the McCleary Method of Treating Piles Without Surgery.

Name.....

Street Address.....

Town or City..... State.....

SEND *for* SCIENTIFIC DRUM CONTROL TUNING UNIT

ONLY

\$11.00



Here's the newest, up-to-the-minute drum control for all circuits requiring three ganged condensers. The SCIENTIFIC Tuning Unit has beautiful bronze escutcheon shield. Dial is calibrated 0 to 100 with bold, clear figures and markings. Action is powerful and smooth. Develops no backlash. Friction drive drum made of finest pressed steel, improves with use. Type UXB United Scientific .00035 MF Balanced Three Gang Condenser used. Condenser and drive completely assembled at factory. Comes complete ready to be installed. Put the SCIENTIFIC in your set. Send orders to DEPT. PM-128.

UNITED SCIENTIFIC LABS.
80 Fourth Ave. New York City

The Quick Way to Music





KING Band Instruments offer you the quickest, easiest way to learn music—to play brilliantly. They are *unqualifiedly guaranteed* in writing to be perfect in design, materials, mechanism and workmanship. That's why they'll help you to learn faster and play better.

When a great musician like Edwin Franko Goldman says that King Instruments greatly improved the tone and intonation of his famous band, that's proof that a King will insure your musical success.

Start now! Tell us the instrument you want. We'll ship it to you to try—**FREE**. The price will be no more than you'd pay for a less perfect instrument. Deferred payments will make payment easy.

Why handicap yourself? You can afford to own a King—the instrument of *guaranteed superiority*. Mail the coupon Today for our Handy Reference Catalog and other interesting booklets.

KING

BAND INSTRUMENTS

The H. N White Co.,
5211-95 Superior Ave., Cleveland, O.

Please send me free copy of "The White Way" Magazine and your Handy Reference Catalog. (Check, below, instrument preferred.)

Name..... Age.....
Address.....
City..... State.....

Saxophone Trumpet Trombone Alto
 French Horn Baritone Bass Bugle

FREE

WHOLESALE RADIO CATALOG



Set Builders and all who are interested in radio should send for this large radio catalog listing thousands of radio items in sets, furniture, accessories, parts, kits, etc., at real wholesale prices.

ALL THE LATEST KITS

In this 128 page catalog you will find listed all the latest and most popular Kits. Send for your copy to-day.

The HARCO CO. 1255 S. WABASH AVE. CHICAGO ILL.

\$244.00 PROFIT *One day!*



R. W. Helmer reports this from Minnesota on Trippe Auto Reflectors. Wonderful device—100% more light and no glare! Pocket big money waiting for you now. Whirlwind seller, makes astounding demonstration—low cost—agents cleaning up—300% profit—big repeater—sells on sight. Over 300 sets sold in one town of 2,000 people. **GET YOUR FREE SAMPLE OFFER TODAY—** Wire or write.

AERIAL ELECTRIC CO.
309 W. Ohio St. CHICAGO

STEEL BLUE Elite Diamond

IF YOU CAN TELL IT FROM A DIAMOND SEND IT BACK!



\$389.00

1 Carat Elite Diamonds. Matchless for their dazzling rainbow brilliancy. You'll be delighted. Elite Rings surpass all others. Stand acid and other tests. Handsomely Engraved Ring, sterling Guaranteed. Looks like \$250.00. Proud owner offered \$85.00 5 minutes after buying one.

COLLAR AND CUFF LINKS GIVEN

With each ring order, we give free beautiful Combination Set. Set with 4 elite Diamonds. **SEND NO MONEY.** Just send name, address and finger size. On arrival pay postman \$3.89 and postage. Satisfaction Guaranteed. Write today. Cash with Canadian or foreign orders.

ELITE JEWELRY HOUSE, Dept. 397, 609 S. Paulina St. CHICAGO. ILLINOIS

AGENTS

AMAZING NEW ADDING PENCIL

ADD'S MULTIPLIES SUBTRACTS DIVIDES



MONEY MAKER Turn spare time into money just showing it to friends. Get sample and literature now

HOUK ADDING PENCIL CO., Dept. 38 St. Louis, Mo.

WANTED

MAKE THINGS AT HOME—SAVE MONEY \$13⁵⁰





PARTRIDGE WOOD TURNING LATHE

Buy the finished parts completely assembled. Build bed at home. A real tool. 6' swing. Shipping weight 21 lbs. Make radio parts, floor lamps, toys and numerous other practical and valuable articles. Also made in sizes to swing 8', 11', 13', 16', diameters.

IDEAL GIFT FOR FATHER OR SON

Send today for descriptive circular.

E. O. PARTRIDGE, Dept. J28, 2039-49 W. Lake Street, CHICAGO, ILL.

BUY AT WHOLESALE PRICES

AGENTS MAKING \$100 PER WEEK

Selling Our Guaranteed Spors Pens and Other Specialties

The special polished points and sponge in cap make the points write as smooth as a lead pencil, looks and writes like a \$7 pen. Cannot blot or clog, ideal ruling pen. No dull season. Money refunded if not pleased.

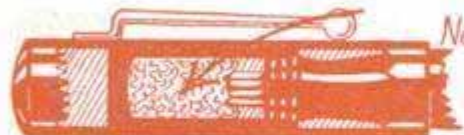

Newest Invention Rubber sponge keeps point moist. Writes like instant it touches paper



SELLS FOR \$1.25

Eight colors to choose from

AGENT'S SAMPLE 65c

IDEAL XMAS GIFT, COMES IN HOLLY BOX

FREE

Handsome roll, pen case with your first order of \$6.42 worth of our famous Spors pens.



RAZOR BLADE HOLDER



Price 15c. Wholesale Sample 10c—Dozen \$1.18

Two Color Pencil No. 280. Black lead on one end and red on the other, has rubber tip and 12 extra leads. Retail Price, 95c. Wholesale Sample, 60c—Doz., \$6.84.

Men's Pearl Vest Pocket Knife
Ideal Gift
No. 250. Price 95c. Wholesale Sample, 60c Dozen, \$6.90

Combination Fountain Pen and Pencil No. 377. 14-kt. solid gold iridium tipped point. Mahogany and Mottled Jade Green. Retail Price, \$2.50. Wholesale Sample, \$1.48—Dozen, \$16.80—Gross, \$180.00. Guaranteed Two Years.

FREE! Upon request this large wholesale specialty catalog, showing over 300 fast selling specialties, from many parts of the world.



No. 123

DANCING DOLL

Price 35c. Wholesale Sample 19c—Dozen \$1.98.

Mark Square of proposition you want.

- Send catalog, without obligation.
- I am enclosing money for article number
- Send c. o. d. article number

Name.....

Address.....

F. SPORS & CO.

1027 Main Street Le Sueur Center, Minn.

\$351⁰⁰ CLEARED ~ IN ONE DAY

So writes W. H. Adams of Ohio. Letter from V. A. Marini of California reports \$11,275 sales in three months. Jacob Gordon of New Jersey "\$4000 profits in two months." Alexander of Pennsylvania "\$3000 profits in four months." Ira Shook \$365 sales in one day. Bram bought one outfit April 5 and 7 more by August 28. Iwata, bought one outfit and 10 more within a year. Mrs. Lane of Pennsylvania says "sold 8000 packages in one day." J. R. Bert says "only thing I ever bought that equalled advertisement." John Culp says: "Everything Going Lovely. Crispette wrappers scattered all over town. It's good old world after all." Kellog, \$700 ahead end of second week.

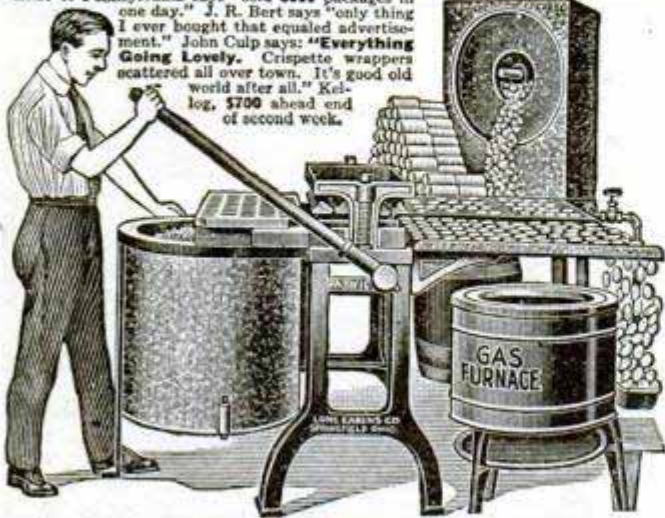

WE START YOU IN BUSINESS

Furnish secret formulas, raw materials, and equipment. Little capital required; no experience needed.

BUILD A BUSINESS OF YOUR OWN

No limit to the sale of Crispettes. Everybody likes them. It's a delicious food confection. Write for facts about a business that will make you independent. Start now in your home town.

Profits \$1000 a Month Easily Possible

Send postal for illustrated book of facts. It contains enthusiastic letters from others--shows their places of business, tells how and when to start, and all information needed. Free. Write now!

LONG-EAKINS COMPANY

128 High Street

Springfield, Ohio

The Sax' you've always WANTED to play

To learn quickly and play well you must have a perfect instrument. All great artists play the

BUESCHER

True Tone Saxophone

If you can whistle a tune you can learn to play a Buescher. 3 lessons given on request with each Buescher Sax' give you quick, easy start. Many learn scales first hour, play tunes first week, with their Bueschers.

Easy to Play - Easy to Pay

Take any Buescher Instrument home for six days' trial. See what you can do. If you decide to keep it, pay a little each month. Send for Beautiful Catalog and details of this liberal plan. No obligation. Mail the coupon today.

BUESCHER BAND INSTRUMENT CO.
Everything in Band and Orchestra Instruments
2211 Buescher Block Elkhart, Indiana



BUESCHER BAND INSTRUMENT CO. 386
2211 Buescher Block, Elkhart, Ind.
Gentlemen: Without obligating me in any way please send me your free literature. Mention instrument interested in.

Age?.....Name instrument.....
Name.....
Address.....

SEND FOR
FREE BOOK

"At 61"

"I thought I was through. I was half-living—getting up nights—constantly tormented with aches and pains. At 62 my condition became almost intolerable. Then at 63, I shook off 20 years almost overnight."



"How I Licked Wretched Old Age at 63"

IN 65% of all men, the vital prostate gland slows up soon after 40. Pain may not appear instantly. But gradually symptoms often develop that lead to sciatica, backache, bladder weakness, constipation, etc. But now a new, safe way has been discovered by a simple home treatment to restore the prostate to normal health. The reports on many cases are amazing. Many physicians use and recommend it. No drugs, medicine, surgery, or electric rays.

FREE! A 24-page illustrated book fully describes it. The edition is limited. Send for a free copy. Every man past forty should know the meaning of these frank facts. Simply write The Electro Thermal Co., 2101 Morris Ave., Steubenville, Ohio. Western Address, Suite 21-A, 303 Van Nuys Bldg., Los Angeles, Cal.

How to Avoid "Orphans"

Our new free book entitled "How to Judge a Used Car" will tell you this, and many other valuable things which are important to know in buying a used car. Send for it today. No obligation. Write The Studebaker Corporation of America, Dept. 72, South Bend, Indiana

SPEED LATHE
\$10.50

complete as shown. 7" swing, 24" metal bed, 3 speed cone pulley. Longer bed \$1.00 per additional foot.

JEFFERSON MFG. CO., Fairfield, Iowa

AGENTS

HERE is a new Household Device that beats a vacuum cleaner and all attachments. It not only sweeps thoroughly and cleans walls and ceilings but also washes and dries windows and scrubs and mops floors. Requires no electricity. Every home a prospect. Only \$2.95 Over half profit. Write your name and address at the edge of this ad and mail to us today for complete selling terms.

HARPER MFG. CO.
543 5th St., Fairfield, Iowa

Magic-Tricks-Puzzles

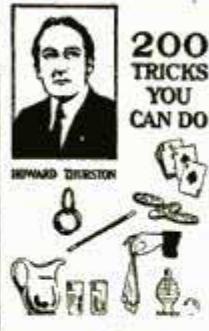

THESE books will enable you to mystify your friends and relatives as well as provide an inexhaustible fund of amusement. Why not develop a worth-while hobby that may lead to profit making on the side. Clubs, Lodges and other organizations are willing to pay entertainers who can mystify audiences.

Tricks and Magic Made Easy. Only such tricks as are easily accomplished. By Squier. **\$1.00** Cloth.

- 200 Tricks You Can Do.** For the beginner in magic. By Howard Thurston. No elaborate apparatus required. Cloth. **\$1.00**
- Modern Card Effects and How to Perform Them.** The cream of practical card tricks. By DeLawrence and Thompson. **\$1.50**
- Easy Magic for Evening Parties.** By Orrin. With illustrations and diagrams. 188 Pages. **\$1.75**
- Modern Magic.** By Prof. Hoffmann. A practical complete treatise on the art of conjuring. 563 pages. 318 illustrations. 300 tricks. Cloth. **\$2.00**
- More Magic.** By Prof. Hoffmann. Supplementary to Modern Magic. Additional tricks. 470 pages. 140 illustrations. Cloth. **\$2.00**
- Behind the Scenes with the Mediums.** By Abbott. Gives every detail of 69 tricks used by famous spiritualistic mediums. Many of these have made the greatest magicians wonder. **\$1.50**
- 33 Rope Ties and Chain Releases.** By Hull. **\$1.00** Illustrated.

Real Puzzles. If you can't resist something really absorbing, here is your book—The official book of the National Puzzlers' League. 250 original puzzles to work out. 271 pages. Cloth **\$2.00**

Send No Money—Simply pay postman price and postage, when he delivers package anywhere in U. S. Elsewhere remit when ordering.

POPULAR MECHANICS PRESS Room P1 200 E. Ontario St., CHICAGO

The Mysterious Masked Singer Who Was He?

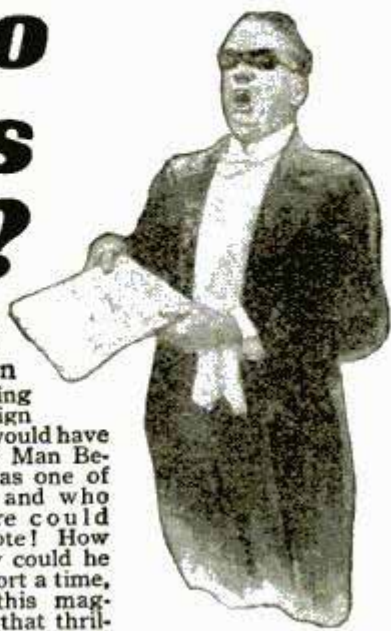

Surely that glorious, golden voice must mean long years of training under some foreign master. And who would have dreamed that The Man Behind The Mask was one of their own crowd and who six months before could scarcely sing a note! How did he do it? How could he possibly, in so short a time, have developed this magnificent voice now that thrilled and amazed his friends?

I Guarantee to Improve Your Voice 100%

There is only one answer—Physical Voice Culture! Your vocal chords are the same in construction as those of Caruso, Garden or Martinelli. But YOURS are under-developed. Your Hyo-Glossus throat muscle has probably never been used. No amount of scale singing will ever develop this muscle. But scientific muscular exercise will. And only Physical Voice Culture—the amazing discovery of Prof. Eugene Feuchtinger can show you how. Now you can build a strong, magnetic, compelling voice that will be the marvel of your friends and open the door to Success and Fame.

Scientific Voice Training

Prof. Feuchtinger accomplishes his surprising results by silent, muscular exercises that quickly bring strength and control of certain vital vocal organs, heretofore almost unknown to voice culture. No tiresome scale-singing! Practice these marvelous silent exercises in privacy. Soon you find your voice becoming stronger, richer, with ever increasing range. Thousands have done it. You can, too.

Mail Coupon for "Physical Voice Culture" Free

Your voice has marvelous possibilities that you may not even suspect. "Physical Voice Culture" will reveal them to you. Send at once for this valuable, beautifully illustrated book. Read the astounding true stories of what others have done. Send Today! The Book is FREE!

Perfect Voice Institute 1922 Sunnyside Ave., Studio 93-51, Chicago

Perfect Voice Institute, Studio 93-51
1922 Sunnyside Ave., Chicago

Please send me, FREE, and without obligation, Prof. Feuchtinger's new Book, "Physical Voice Culture." I have checked subject in which I am most interested.

Weak Voice Singing Stammering Speaking

Name.....

Address.....

City..... State.....

NEED A BETTER GRIP ON MATHEMATICS?



SEND for a copy of "Mathematics for the Practical Man," only \$1.50. By common sense methods it removes the mystery and difficulties so that algebra and even calculus are made simple.

Assuming your knowledge is limited to arithmetic you quickly and easily gain a working knowledge of Algebra, Geometry, Trigonometry and Calculus. Simply pay postman price of book plus the postage when he hands you the package.

Popular Mechanics Press
Room P1
200 E. Ontario Street, Chicago

DRAKE'S RADIO CYCLOPEDIA



Most complete radio book in print. Construction, repair, testing, care and operation of all receivers and power units in plain English. For repair men, builders, experimenters, students, salesmen and operators. 1672 headings, 985 illustrations, diagrams and layouts, 871 pages, 240 combinations of receivers, 121 reference tables.

Cloth Binding. Price \$6
Will be sent C. O. D. anywhere in U. S. Pay postman price and postage when he delivers the book.

POPULAR MECHANICS PRESS, Room P1
200 E. Ontario Street, CHICAGO

Here It Is!

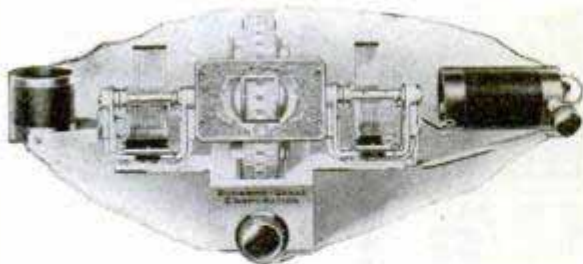

The New Official BROWNING-DRAKE Kit

Makes it easy to build the new Browning-Drake Two-Tube Tuner, which, when combined with Acme, Silver-Marshall, General Radio, Thordarson, Amertran, Victoreen, or other power apparatus, gives marvelous radio performance.

You can have a receiver that is up-to-the-minute in every respect when you build the new Browning-Drake Five-Tube Kit Set using the new Official Kit.

Construction booklets covering the assembly of these remarkable new units, may be had either from your dealer, or direct, for only 25c.

BROWNING-DRAKE CORP.
Cambridge : : : Mass.

BROWNING

PARTS CABINETS **DRAKE** KITS RECEIVERS

Ingersoll

WATCHES & ALARM CLOCKS

Investigate Boice's Complete Home Work-Shop!

The price of the Boice-Crane Home Work-Shop No. 2 consisting of three separate machines—Lathe, Handisaw and Jig Saw with heavy-duty, double-shaft, 1/4 h. p. motor, belts, pulleys, tools and 125 working drawings of furniture, toys, etc. is actually less than any other "so-called" home work-shop!

Compare the advantages of the Boice-Crane Work-Shop—three separate machines (not merely attachments), large size, more power, high quality and lower price!



Saw and lathe illustrated here are included in our Home Work-Shop Offer No. 1 which is slightly higher than Offer No. 2.

Universal Handisaw

Has table 15" x 17". Elevates for grooving.—tilts 45° for bevelling. Swings 9" saw, cuts 2 1/2" stock. Insert takes dado head 6" x 1", cope heads and 8" sand disc. Also has insert providing opening for 2" Jointer Head. Jointer attachment fits on right of table. Guides always remain parallel to saw regardless of elevation or tilt of table. No other saw of equal cost has this feature.

Send 10c for 64 page booklet, "Making It Easy to Build Things" completely describing Boice-Crane Machines and also literature on Boice's Home Work-Shop and Books of Designs.



8 Inch Bench Lathe

Swing 8". 19" center to center. Length over-all 33 1/2"; height over-all 11 1/4"; width at base 5 1/2"; height of bed 5 3/4". For wood or light metal turning.

Jig Saw Bargain \$11.00

Ideal for home shop, yet practical and sturdy enough for the manufacturer. Stroke 1 1/2". Saw to frame 8". Capacity 1 1/2" Stock. Uses blades 1-8" to 3-8" wide. Weight 18 lbs.

\$3.50

50¢ CREDIT COUPON 50¢
50¢ CREDIT COUPON 50¢
50¢ CREDIT COUPON 50¢
50¢ CREDIT COUPON 50¢
50¢ CREDIT COUPON 50¢
50¢ CREDIT COUPON 50¢
50¢ CREDIT COUPON 50¢

FREE \$3.50 PREMIUM WITH EACH PARAMOUNT LIGHTER

AMAZING Introductory Offer! LIMITED TIME ONLY!

Now a better, more efficient Pocket Lighter, absolutely dependable—that's the Paramount. Lights instantly, never fails. Fills from top. Leak-proof. Cannot ignite in pocket. Lasts lifetime. Mechanical masterpiece. Beautiful slender model appeals to men and women. Everybody wants one. Materials and appearance superior to others selling from \$7.50 up. To quickly introduce Lighter, a magnificent \$3.50 Cigarette Case given FREE! Both encased in genuine leather; metal parts and monogram shields heavily 14 kt. gold plated. Packed in very elegant gift box.

Gift Set includes SEVEN credit coupons, each worth 50c on purchase of new Lighter, which you can sell to friends or dispose of any way desired and get your Lighter and Case without cost. Astounding offer may be withdrawn without notice—so ACT NOW.

SEND NO MONEY
Pay postman only \$3.50 plus postage on delivery. Shipped PREPAID if cash with order. Details on request.

Agents \$30.00 Daily, Easy!
Biggest, fastest, easiest money-maker. Write for special agents' offer and territory. Dept.: 1A.

PARAMOUNT LIGHTER CO.
71 West 35th St. Dept. A NEW YORK CITY

\$3 commission - MEN'S SUITS

\$8.88 YOU CAN EARN EXTRA MONEY EVERY YEAR

\$2,000.00 AS OUR LOCAL REPRESENTATIVE—VARIETY OF PATTERNS, UP-TO-DATE SINGLE BREASTED STYLE! IDEAL FOR WORK OR SEMI-DRESS!

FREE SALES KIT 888 COMPANY 7-A, FORT WAYNE, IND.

Model Ship Builders "FLYING CLOUD"

Our special "Flying Cloud" construction set contains all necessary materials according to specifications. The model maker will be assured of an accurate model by purchasing one of these reasonably priced sets. Our new catalog containing reproductions of photos of various ship models, together with prices of all sorts of fittings, materials, tools, etc., sent postpaid upon receipt of 10c. Coins preferred.

MODEL SHIP SUPPLY CO., Dept. E, Mineola, N.Y.

Books on 30 Subjects

Popular Mechanics Press has specialized in supplying books on any subject. Look over this list. Check the books you want, and mail this advertisement as your order blank. Catalog with lists on 2,000 subjects free.

AMATEUR MECHANICS How to Make and How to Mend..... \$0.75	MILLWRIGHT Erecting and Operating Machinery..... \$2.00
AUCTION BRIDGE M. C. Work's Latest Book..... \$2.00	MIRRORS Silvering..... \$1.00
AUTOMOBILE ELECTRICITY Electrical Trouble-Shooting on the Motor Car..... \$4.00	OUTDOOR OCCUPATIONS Outdoor Opportunities..... \$2.00
BLUE PRINTS Blue Print Reading..... \$2.00	PLUMBING Plumber's and Fitter's Handbook..... \$1.00
BOYS How to Put on an Amateur Circus..... \$1.75	PUZZLES Real Puzzles..... \$2.00
BUILDING TRADES Building Trades Handbook..... \$1.00	RADIO Modern Radio Receiving..... \$5.00
CHALK TALKER Chalk Talk and Crayon Presentation..... \$1.25	RUSTIC WORK Rustic Carpentry..... \$1.00
CHEMISTRY Chemists' Handbook..... \$1.00	SHEET METAL Sheet Metal Work..... \$2.00
DICTIONARY Self Pronouncing, Large Type—1100 pages..... \$1.25	SHIP MODELS Clipper Ship. How to Make..... \$2.50
ELECTRIC SIGNS Electrical Advertising..... \$5.00	STEAM ENGINEER Steam Engineer's Handbook..... \$1.00
ELECTRICITY Practical Applied Electricity..... \$2.00	STEEL SQUARE A B C of the Steel Square..... \$1.00
FORD Ford Standard Electrical Equipment..... \$2.00	STORAGE BATTERY Making, Repairing, Rebuilding..... \$5.00
FURNITURE Finishing, Decoration and Patching..... \$5.00	TOOLS (Using) Tinkering with Tools..... \$2.00
GARDENING Garden Guide..... \$1.50	TRAFFIC MANAGER Traffic Handbook..... \$1.00
LETTERING AND DESIGN For Artists and Advertisers..... \$3.00	WINDOW TRIMMER Handbook of Window Display..... \$5.00
	WOOD FINISHER Wood Finishing, Plain and Decorative..... \$2.00

-----SEND NO MONEY-----

Just check the books you want, and mail the whole advertisement it is your order blank. When postman hands you books, pay him the price and the postal charges. If outside the U. S. remit when ordering and include 10 cents per book extra for postage.
POPULAR MECHANICS PRESS, Room P1, 200 East Ontario St., Chicago, Ill.

AT LAST CARBURETOR INFORMATION EVERY AUTO MECHANIC NEEDS

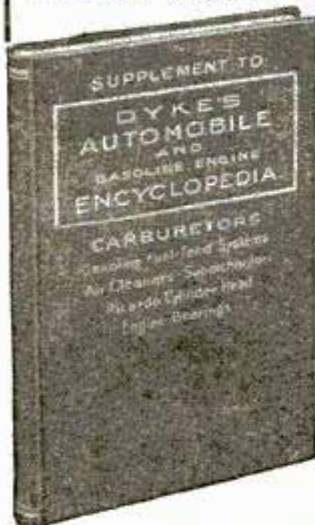

As a supplement to the well known Dyke's Automobile Encyclopedia, Mr. A. L. Dyke, America's foremost automobile authority, has written this book treating Carburetors, Gasoline Fuel-Feed Systems, Air Cleaners, Superchargers, Ricardo Cylinder Head and Engine Bearings. He deals with principles of construction and operation, adjustments, servicing and maintenance.

It is just the information that the automobile servicing business has been sorely in need of. The first chapter deals with Carburetor Types. The following makes of carburetors are then dealt with in order: Stromberg Plain Tube, Schebler, Stewart, Pierce Arrow, Carter, Marvel, Ball & Ball, Tillotson, Cadillac, Lincoln, Ford, Johnson, Zenith, Packard. This is followed by the chapters on Gasoline Fuel-Feed Systems, etc.

106 pages, 246 illustrations (many in 2 colors)
Size 7 x 10 in. Cloth binding

Will be sent C. O. D. anywhere in U. S. Pay postman \$2 and the postage. If outside U. S., remit when ordering and include 10 cents extra for postage.

POPULAR MECHANICS PRESS
Room P1 200 E. Ontario Street CHICAGO



With Violet Ray Vibration Ozone Medical Electricity

The Four Greatest Curative Powers
Generated by This

Great New Invention!

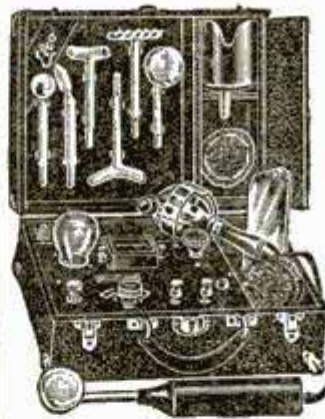

Elco Health Generators at last are ready for you! If you want more health—greater power to enjoy the pleasures and delights about you, or if more beauty is your desire—write! Ask for the book on these inventions which has just been prepared. It will be sent to you without cost. It tells you how Elco Health Generators aid you in leaving the lethargy and hopelessness of bad health and weakness behind forever. Re-vitalize yourself. Bring back energy. Be wholly alive. Write today!

Here's What Elco Users Say—

"Wouldn't take \$1000 for my Elco."
"Has done me more good in 2 weeks than doctors did in three years."



"Cured my Rheumatism." "My Eczema gone." "Cured my stomach trouble." "Cured my weakness." "Now I sleep soundly all night." "Thanks to Elco my strength and vigor are back." "No more pain." "Colds never bother me now." "Chronic Constipation banished."
These great new inventions generate Violet Ray, Vibration, Electricity and Ozone—combined or separate. They operate on the electric light in your home or on their own motive power at less than 50 cents per year. Elco Health Generators are positively the only instruments which can give you in one outfit Electricity, Violet Ray, Vibration and Ozone—the four greatest curative agents. Send the coupon below. Get the Free Book NOW!

Free Trial

MAIL COUPON for FREE BOOK

Do not put this paper down without sending the coupon. Don't go on as you are with pains and with almost no life and energy. You owe it to yourself to be a better man or woman. You were put here to enjoy life—not just to drag through it. So do not rest another day until you have put your name on the coupon here. That will bring the whole story of these great new inventions. Do it today—now.



-----Lindstrom & Company-----
30 West Lake St. Dept. 13-51 Chicago
Please send me your free book, "Health—Power—Beauty" and full information of your 10-day Free Trial Offer.
Name.....
Address.....

Be the Life of the Party



Play a Tune in 10 Minutes

Popularity—new friends—money-making opportunities come to those who can play!

Now you can pick up your favorite stringed instrument and play a tune almost instantly. NO knowledge of music needed. NO expensive lessons. NO weeks of tiresome practice. Play tunes from the start. Play by numbers. Surprise and astonish your friends. Amazing new invention makes it easy to play Ukulele, Banjo Ukulele, Tenor Banjo, Guitar, Mandolin. Just press the keys and play.

Trixie Friganza, famous Vaudeville Star, wrote: "I played in 3 minutes and never touched a stringed instrument before." John A. Crusier: "I was skeptical about anyone playing tunes instantly but have changed my ideas completely."

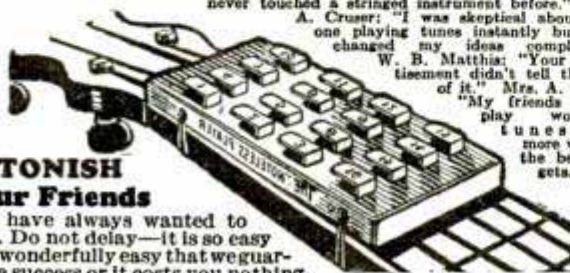

ASTONISH Your Friends

You have always wanted to play. Do not delay—it is so easy—so wonderfully easy that we guarantee success or it costs you nothing.

SEND FOR FREE BOOK!

More popularity—more fun from life—new friends—money-making opportunities! If you want to play tunes at once—send today for a free book about **Ferry E-Z Playing stringed instruments**. Soon, you, too, can know the joy of making your own music. "No play, no pay." E-Z Playing Instruments are sold complete or the E-Z Player can be attached to your own stringed instrument in a jiffy.

Mail Coupon Today!

FERRY & CO., Dept. 9772, Chicago, U. S. A.

Send free book telling how I can get more fun out of life, make more friends, have greater opportunities for getting ahead by learning to play my favorite stringed instrument in 10 minutes. No obligation.

Name.....

Address.....

City..... State.....

STANDARD GARDEN TRACTOR

Plows
Seeds
Cultivates
Mows/hay
and Lawns

A Powerful Tractor for Small Farms
Gardeners, Florists, Nurseries, Fruit
Growers and Poultrymen
DOES 4 MEN'S WORK
Walking & Riding Equipment
Free Catalog. Does Belt Work



STANDARD ENGINE COMPANY
3221 Como Ave. Minneapolis, Minn.

BOOKS ON ALL SUBJECTS
ARE SOLD BY
POPULAR MECHANICS PRESS
200 E. Ontario St., Chicago, Ill.

Photos ENLARGED

Size 16x20 inches
Same price for full length or bust
form groups, landscapes, or pet animals,
etc., enlargements of any part
of group picture. Safe return of
your own original photo guaranteed.

98c

SEND NO MONEY. Just mail photo or snapshot (any size) and within a week you will receive your beautiful life-like enlargement size 16x20 in. guaranteed fadeless. Pay postman 98c plus postage or send \$1.00 with order and we pay postage. **SPECIAL** With each enlargement we will send FREE a hand-tinted miniature **FREE OFFER** reproduction of photo sent. Take advantage now of this amazing offer—send your photo today!
UNITED PORTRAIT COMPANY
1652 Ogden Ave. Dept. 361 Chicago, Ill.



AUTO DESK

Fits steering post of any car. Holds 4x6 paper pad and pencil. Serves as holder for road maps or memoranda. Invaluable for doctors, salesmen, delivery men, taxi cabs, tourists. Well made, beautifully finished. An ideal Christmas present. Sent prepaid for \$2.50. State make of car when ordering.

LIVE AGENTS WANTED

Brainard Bros. Sacramento, Calif.



AMERICAN POULTRY JOURNAL

OLDEST, LARGEST AND BEST. EST. 1874
1 Year 25c ^{Can.} 50c 5 Years \$1 ^{Canada} \$2.00

Averages over 100 pages per issue—tells how to feed, house and breed; how to secure high egg production; how to hatch and rear poultry successfully. 25c 1 year. 5 years \$1.00.

AMERICAN POULTRY JOURNAL, 14-536 S. Clark St. CHICAGO



68 BREEDS Valuable New Poultry Book Free—100 Pages.

Fine Pure-bred Northern raised chickens, ducks, geese, turkeys, eggs, baby chicks, incubators & brooders at lowest prices. America's great industry. My 46th year.
W. A. Weber, Box 28, Mankato, Minn.

FREE Book HOW TO FEED AND CARE FOR CHICKS

Gives Money Making Secrets of Poultry Raising. Tells how to hatch, care for and feed chicks until fully grown. Gives plan of Poultry and Brooder Houses. Describes Miller's "IDEAL" INCUBATORS with Patented Egg Turning Trays. Oil and Coal Burning BROODERS. Eggs for hatching—Baby Chicks—BARGAIN PRICES. WRITE TODAY!
J. W. MILLER CO., Box 12, Rockford, Ill.



FOY'S BIG BOOK, in Colors

A complete guide to successful Poultry and Squab Raising. Low prices on CHICKS, Breeding Stock and PIGEONS.

Write Today! FREE!

FRANK FOY, Box 18, Clinton, Iowa



SQUAB BOOK FREE

Breed squabs and make money. Sold by millions at higher prices than chickens. Write at once for free 40-page book beautifully printed in colors telling how to do it. You will be surprised.

PLYMOUTH ROCK SQUAB CO.
634 H Street Melrose Highlands, Mass.



WONDERFUL POULTRY BOOK 40 BREEDS

The Nation's Great Poultry Manual tells about Mrs. Berry's success. Blood-Tested, Pure-Bred Poultry, Hatching, Feeding, Housing, Diseases & Remedies. Makes LOW PRICES on best Fowls, Eggs, Chicks, Supplies. Pulletts lay at 4 months. Send only 5c to help mail. BERRY'S POULTRY FARM, Box 29, Clarinda, Iowa



RAISE BELGIAN HARES

NEW ZEALAND REDS—Chinchillas—Flemish Giants
MAKE BIG MONEY—We supply stock and pay you following prices for all you raise: Belgian Hares \$2 each—New Zealanda \$3 each—Chinchillas \$4 each—Flemish Giants \$5 each. 32-page illustrated book, catalog and contract, also copy of *Fur Farming* magazine, tells how to raise skunk, mink, fox, etc., for big profits, all for 10c. Address

OUTDOOR ENTERPRISE CO., Box 25, Holmes Park, Mo.

PLANS for Poultry Houses

All styles, 150 illustrations; secret of getting winter eggs, and copy of "The Full Egg Basket." Send 25 cents.
INLAND POULTRY JOURNAL, Dept. 514 Indianapolis, Ind.



64 BREEDS Most Profitable chickens, ducks, turkeys and geese: Choice, pure bred northern raised.

Fowls, eggs, chicks, incubators at low prices. America's great poultry farm. At it 35 yrs. Valuable 100-page book and catalog free.

R. F. Neubert Co., Box 908, Mankato, Minn.

Free Your Skin

of pimples, boils, etc., with KLEERSKIN! It purifies the blood and rids it of the poisons that cause skin disorders. KLEERSKIN is wonderful also for treating carbuncles, blackheads and similar skin infections. KLEERSKIN is made after the formula of a celebrated German physician who, after many experiments and clinical trials, has proved it to be the remedy par excellence. Write today. Medco Medicine Co., 503 Ridge Bldg., Kansas City, Mo.

EVERYBODY'S HANDBOOK of Electrical Kinks

This is a brand new book similar to Popular Mechanics other "kink" books. It is made up of 214 ideas and short cuts for doing electrical work of all kinds. It is a book for amateurs as well as professional electricians. If you are interested in wiring, electric lighting, the making of electrical devices, experimenting, repair work, battery manufacture and repair, or telephones, you will find many helpful articles in this book. If you are interested in radio, you should have this book to learn some of the short cuts used by electricians in wiring and making apparatus.

THE BOOK CONTAINS

47 ideas on wiring	11 ideas on switches
45 ideas for making electrical devices	6 ideas on installation
19 ideas on electric light's	22 ideas on testing
5 ideas on transformers	12 ideas on repairing
5 ideas on motors	11 ideas on battery manufacture and repair
8 ideas on generators	5 ideas on telephones

There are 162 Pictures to make the ideas clear. Boys can follow the directions as well as men. If you understand the simple fundamental principles of electricity, this book will be a wonderful help to you.

Send No Money Just write your name and address on a postal card and say that you want the New book of Electrical Kinks. When the postman hands you the book, hand him \$1.50 and the few cents postage. If you live outside the U. S. or do not expect to be at home when the postman calls, send the \$1.50 with your order. Address

POPULAR MECHANICS PRESS Room P-1 Popular Mechanics Bldg. 200 E. Ontario St., Chicago

Helpful IDEAS for Home Owners

In these two practical books, you will get 502 ideas that will be helpful in making your home a better place to live in—a home to be proud of. The ideas are for the making, improving and repairing of the devices needed about and in the home. The books are:

1. Home Mechanic's Handbook No. 1
2. Concrete Handbook No. 1

These books tell how to make most everything, from door stops to a refrigerator, and from a concrete sidewalk to a lawn fountain.

Send No Money Simply write a postal card and ask that Popular Mechanics two Homeowner's books be sent C.O.D. When the postman delivers the books to you, hand him \$1.00 plus the few cents postage.

POPULAR MECHANICS PRESS

Popular Mechanics Bldg. Room P-1 Chicago, Ill.

SAVE 30 TO 80% ON AUTO PARTS

Write us for prices on your requirements. Everything for the car at prices only Warshawsky can offer!

WARSHAWSKY & CO. 1915-35 S. State St. Dept. PM1, Chicago
World's Largest Replacement Parts House

IS YOUR LOUD SPEAKER PARALYZED?

If your Speaker is one of the majority which acts "Dumb" with no apparent cause, ask your Dealer for the Muter Clarifier, or write us for full particulars about this miraculous new Radio necessity which assures Full Tone, Clarity and Volume.

Leslie F. Muter Co., 76th and Greenwood, Dept. 805-A, Chicago, Illinois



Mathematics Made Easy by ROPP'S CALCULATOR AND SHORT-CUT ARITHMETIC

Shows the Answer as Quickly as a Watch shows the Time to all Problems likely to occur in the Office, Store, Shop, Bank, Farm, or Factory.

Over 2,000,000 Sold

Explains and simplifies every principle in Arithmetic, Mechanics, and Mensuration.

PRICES POSTPAID

Desk Size, Flexible Keratol Binding, \$2.00
Pocket Size, Art Leather Binding, \$1.00
Pocket Size, Cloth Binding, \$0.50

POPULAR MECHANICS PRESS

Room P-1 200 E. Ontario St. Chicago

I Want to Send You a Santa Fe Special Watch

for You to see and examine

Our 21 Jewel Santa Fe Special Guaranteed for Life

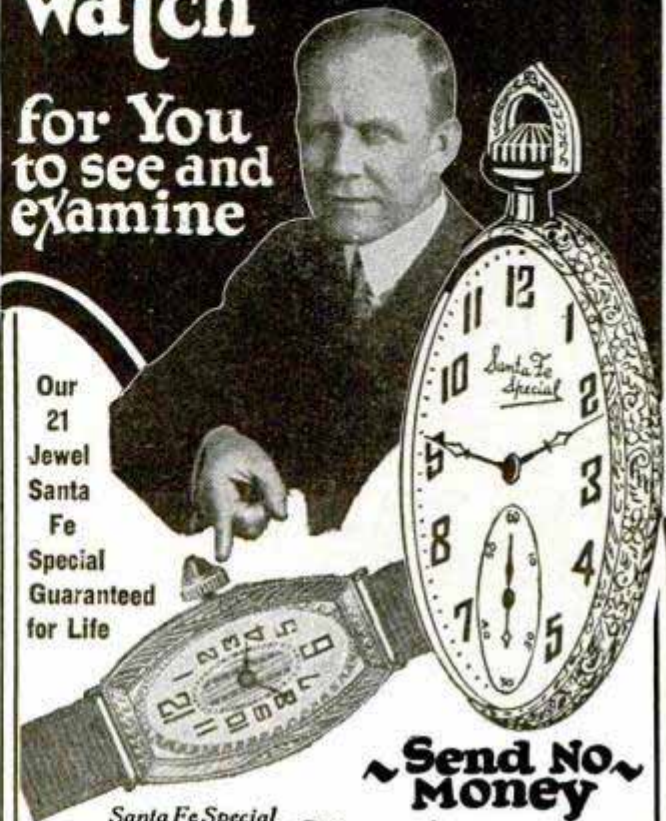

Send No Money

Watch Sent on 30 Day Free Trial

Santa Fe Special Watches are today being shipped to every civilized country in the world, and are probably the best and most favorably known watch in both Army and Navy.

In addition to our NEW LOW PRICE, I will send for your approval one of these Standard Watches, guaranteed for a lifetime of satisfactory service, not only by the Santa Fe Watch Company, but by the Great Illinois Watch Factory. So accurate, Government officials carry them; so perfect and beautiful, jewelers say they are worth 1-3 to 1-2 more than we ask for them. I will send you one to see WITHOUT ONE PENNY DOWN—allow you to wear it 30 days FREE—then sell it to you on easy payments.

WHY NOT OWN A 21 JEWEL SANTA FE SPECIAL WATCH?

You will never miss the few cents a day that will make you own one of these watches—SEND FOR WATCH BOOK—illustrating in beautiful colors hundreds of designs and combinations in cases in the POCKET WATCH, MEN'S STRAP WATCH and LADIES' WRIST WATCH. You can have your name or monogram and any emblem you may desire engraved in the Case to suit your own ideas. Write today for Free Watch Book, and make your selection at once, while this offer lasts.

FREE A limited offer! With every Santa Fe Special, beautiful gold chain or strand of exquisite pearls. Write today. Mail coupon for both Watch and Diamond Catalog

WRITE FOR SPECIAL 30 DAYS CASH OFFER

SANTA FE WATCH COMPANY

Dept. 16, Thomas Building Topeka, Kans.
(Home of the Great Santa Fe Railway)

Mail coupon to-day!

SANTA FE WATCH COMPANY
Dept. 16, Thomas Building, Topeka, Kansas

Please send prepaid and without obligation your Watch Book Free, explaining your "No Money Down" Offer on the Santa Fe Special Watch.

Name.....

Address.....

City.....State.....

No OPEN CIRCUITS

with the

New



all
duty

DAVOHM

After months of research, Daven—the Resistor Specialists are giving to the Radio Fans of America, what they honestly believe to be the most perfect wire wound resistor—Davohm.

Davohms are built to the most exacting specifications. The enamel is a special composition which resists the highest temperatures. Davohms will not open circuit. Davohms will carry their full rated current capacity, plus an overload safely without excessive heat.

Constant Efficiency

Davohms are accurately rated when you buy them—and they remain accurate. If you draw 125 milliamps from a Davohm, it will continue to deliver 125 milliamps—indefinitely. No other resistor that we know of will give the same unchanging efficiency as Davohm.

For All Power Packs A B or C Eliminators using 171 or 210 Tubes

Davohms are made in 4 sizes; in values; from 500 to 25,000 ohms and for all current carrying requirements, dissipating all wattages specified in power packs and eliminators, using 171 or 210 Tubes. The Resisto-Prop, an exclusive Daven product, makes mounting a simple matter.

The Sine of Merit

DAVEN RADIO CORPORATION

Resistor Specialists

157 Summit St., Newark, N. J.

DAVOHM

RADIO At Half Usual Cost

30 Days' Free Trial

Now,—buy direct from factory and get lowest prices on latest 5, 6 and 7 tube—ONE DIAL—Coast to Coast Radio Sets. Our prices save you almost half and we give you 30 Days Trial in your own home. Every set guaranteed—over 15,000 satisfied owners.

24 Models to Choose From

Our FREE catalog shows the last word in Radio and biggest values ever offered. 24 models to choose from. Table styles, Console models, and handsome De Luxe Cabinet outfits as low as \$31.25 and up.

Why Not Be Our Agent?

Make big money in your spare time. We show you how. Don't buy any Radio until you write for our FREE Radio Catalog,—30 Day Trial Offer and Agents' low prices.

Westgale Electric Co.

Dept. 101

1751 Belmont Ave., Chicago, Ill.



ONE HANDLE TAKES THE PLACE OF MANY

WITH THIS NEW FLEXIBLE HANDLE SOCKET SET

^{1/4}" square connection. Six sockets 7-16", 3/4", 9-16", 5-8", 11-16", 3/4" hex openings. Chrome Vanadium steel. Speedy. Guaranteed. Money back if 10 days' trial doesn't satisfy \$3.65, prepaid, cash with order \$3.00. C. O. D. AGENTS WANTED. Tool Service Sales Co., Box 4605, Sellwood Sta., Portland, Ore.

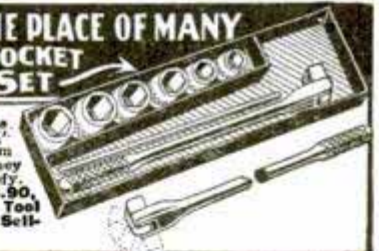

Simplified Radio Blueprints

Blueprints for the most popular sets described in Popular Mechanics Magazine can be obtained for a charge just sufficient to cover the cost of production and mailing. The sets for which blueprints are available are:

Simple One-Tube Receiver.....	April 1926	— 25c
Three-Tube, Cockaday Receiver.....	April 1925	— 25c
Three-Tube, Low-Loss, Short-Wave Set.....	Oct. 1925	— 25c
Three-Tube, Loud Speaker, Loop Set.....	Dec. 1926	— 25c
Three-Tube, 15 to 550 Meter Set.....	Nov. 1926	— 25c
Four-Tube, Loop Set, for Car or Home.....	Aug. 1926	— 25c
Six-Tube, Self-Contained Receiver.....	July 1925	— 25c
Six-Tube, Counterphase Receiver.....	Feb. 1926	— 25c
Six-Tube, Portable, Loop Set.....	June 1926	— 25c
Electrolytic B-Eliminator.....	Feb. 1927	— 25c
Non-Radiating Unit.....	May 1926	— 25c
Simple Tube Tester and Chart.....	July 1926	— 25c
New Perfect-Tone Six.....	Mar. 1927	— 25c
Two-Tube Loud Speaker Set.....	Oct. 1927	— 25c
A.B.C. Power Unit.....	June 1927	— 25c
Four-Tube Set for Power Unit.....	July 1927	— 25c
New Browning-Drake Receiver.....	Sept. 1927	— 25c
Economy Nine Superheterodyne; Sixty dollars builds this Super. Complete drilling templates and blueprint diagrams.....	Nov. 1927	— 50c

Address the RADIO DEPT.

Popular Mechanics Magazine
200 E. Ontario St., CHICAGO

Back numbers of the magazines describing the construction of the sets can be obtained from our Circulation Department, price 25 cents each.

See here, you little tinker!

SEE here, there and everywhere with a good flashlight that puts the light right where you want it—testing the "A" battery, hooking up your "B," fixing a broken aerial or lead-in some night in the middle of a good program.

No matter what you use a flashlight for, see that you are getting the best it can give you, by using genuine Eveready Batteries. Yes, it DOES matter. I'll say it does! These batteries are made in the same shops that make your Eveready "B's." You know they're the best.

When you press the button, your flashlight will always come through with bright, white light if you insist on Eveready reloads. Nothing else will do. "I found that out," as Moran and Mack say.

Get the flashlight habit. It's a scientific habit . . . and how!



This twin-blade cleaner doubles your range of vision

THESE two blades will change your whole idea of driving. Rain—snow—what do you care when your whole windshield is kept clear as crystal?

\$8.50

The new twin-blade Visionall with its powerful, noiseless suction motor costs nothing to run. Not connected to your battery.

The two blades wipe straight across the windshield, each one cleaning its own half—with the steady speed that cleans to perfection. The cleared area is 254 square inches.

The Visionall is easily, quickly installed utilizing the same air line as your old cleaner. Price only \$8.50 in U.S. Use coupon if dealer cannot supply you. *Made by the world's largest manufacturers of windshield equipment.*

TRICO VISIONALL

Automatic Windshield Cleaner

Patented: U. S. A. and Principal Foreign Countries

TRICO PRODUCTS CORPORATION, BUFFALO, N. Y.

As advertised in Popular Mechanics, please send me one Trico Visionall with instructions for installing. I enclose draft or money order for \$8.50. I have written my dealer's name in the space below.

Name

Address

Dealer's Name

1 DOWN **21 Jewel Burlington**

Nothing less than 21 Ruby and Sapphire Jewels a good enough for the Burlington masterpiece.

Quality and Style

Adjusted to the second—temperature—isochronism—positions. 25 four Gold Strata Case, in 100 designs. 21 down. Balance in small monthly payments. Send for free book.

BURLINGTON WATCH CO. Dept. 13-51
19th St. & Marshall Blvd. Chicago, Illinois

25,000,000 AUTO OWNERS
Need This **GAS SAVER!**

Earn \$100. Weekly Selling Them!

An amazing new gas saving invention has been perfected. Owners who have equipped their cars with it report amazing gas saving and notice instant starting, quick pick-up, more power, and disappearance of carbon. Automotive engineers in actual tests have run

Forty Miles on a Gallon of Gas

Men are now being appointed in each locality to take care of the tremendous demand. Territory is going fast. Our men easily can make \$5,000.00, \$6,000.00, yes, even \$10,000.00 a year. Spare time workers make \$20.00 and even more daily. Send your name today for this free sample and wonderful money making offer. Whirlwind Carb. Company, 999-153 E. Third Street, Milwaukee, Wisconsin.

FREE SAMPLE OFFER

A Whirlwind gas saver is provided our workers to enable them to equip their own car or carry it for demonstration purposes. —Adv.

DYNAMO TIMER CO.
999-153 E. Third St.
Milwaukee - - Wis.

“Footwork



the secret
of power
and
speed”

IN a booklet written for boys a champion athlete says: “Shoes must be exactly right!”

It's no wonder that this great athlete plays in Keds! And that most champion players in many sports—championship teams from coast to coast—choose Keds.

This new Keds special basketball shoe has a sure grip on the fastest floor. Its sole is non-slipping, light and springy. It is specially built to absorb shocks that tire muscles.

Keds uppers are light, too. But they're strong, to protect against strains. And there's the special Feltex innersole to keep your feet always cool and comfortable.

Ask for Keds by name. But be sure the name Keds is on the shoe. Keds come in all popular styles at prices from \$1.25 to \$4.50.



United States Rubber Company

“SPRING-STEP”—This new special Keds basketball shoe has a tough sure-gripping sole and is shaped to fit your feet. White with black trim.



They are not **Keds** unless
the name Keds is on the shoe

PARKS

WOODWORKING MACHINES

Cabinet
Shop
Special
No. 10

\$290
with Motor

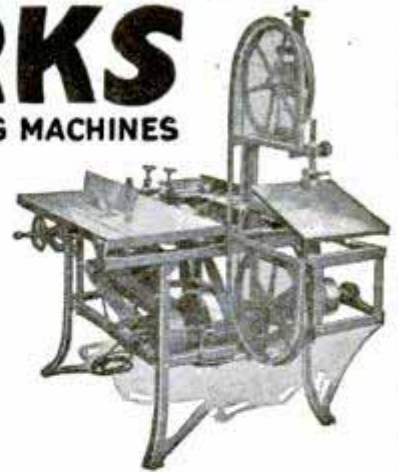

You ought to have this handy Parks in your shop. It is a compact, complete machine designed just like a big production outfit at one-fifth the cost. Includes 8-inch circular rip and cross cut saw with polished cast-steel saw table, 16-inch band saw with tilting table for bevel-sawing, 6-inch jointer, and motor operating from any light socket. Just plug in and go to work! Fits in a corner of your basement. Does any kind of cabinet and joinery work. Add lathe, shaper and other attachments any time at small cost. For the man who does “odd jobs” in his off time this Parks is a big money maker. Turn out as much as a four-man shop working by yourself.

Write for circular and Parks complete catalog of handy woodworking machinery.

The Parks Woodworking Machine Co.

1500-1540 Knowlton St.

Cincinnati, Ohio

Canadian Factory: 208 Notre Dame East, Montreal, Can.

Newest Methods of Home Decoration

These latest and up-to-date instructions enable the home owner to secure the most beautiful effects.

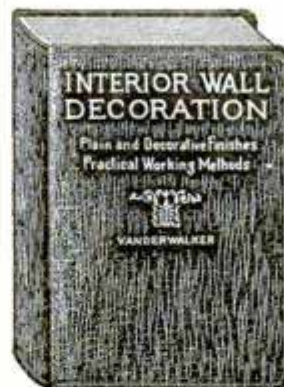

Interior Wall Decoration. Plain and Decorative Finishes. Practical Working Methods. 450 Pages. Leatherette. **\$4.00**

Ross Crane Book of Home Furnishing and Decoration. 275 Pages. Cloth. **\$3.00**

Furniture Finishing, Decoration and Patching. 400 Pages. Cloth. **\$5.00**

Mixing of Colors and Paints. 292 Pages. Cloth. **\$2.00**

Wood Finishing, Plain and Decorative. 360 Pages. Cloth. **\$2.00**

House Painting Methods. Brush and Spray Gun. 386 Pages. Cloth. **\$2.00**

New Stencils and Their Use. 148 Pages. Cloth. **\$1.25**

New Hardwood Finishing. 320 Pages. Cloth. **\$1.50**

Owen's Paint Guide. Pocket Size. Cloth. **\$1.00**

Graining and Marbling. Cloth. **\$0.75**

Any of these books sent postpaid to any address in the world upon receipt of price.

POPULAR MECHANICS PRESS

ROOM 605

200 E. Ontario St. : : CHICAGO

For
Christmas
Give
**NORTHLAND
SKIS**

When 90% of the world's best skiers use them, you can't go wrong in making them your choice. Look for the deerhead trademark. Send for free booklet, "How to Ski."

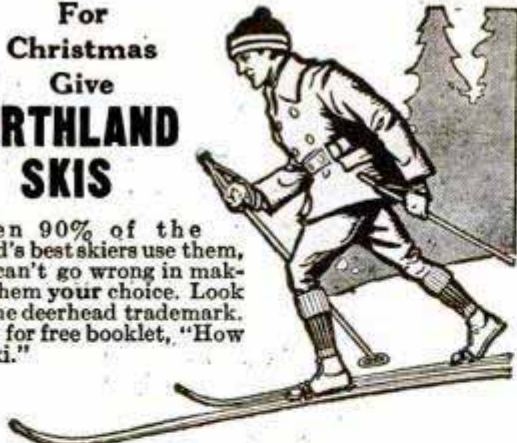

NORTHLAND SKI MFG. CO.
95 Merriam Park, St. Paul, Minn.



**YO HO!
AND A
TREASURE CHEST**

for the Things You Value Most
Now any boy can have a marvelous roomy strong box of his own that no one can open but himself.

Captain Kidd Treasure Chest
Size 15 3/4 x 10 1/4 x 7 3/4. Pirate ship at full sail etched on cover. Handles that make it easy to carry. Special hinges that allow cover to drop back—and best of all a secret lock with no keys to lose!
Send for One Today
Just write your name and address on a piece of paper—pin two dollars to it and mail to us. (Send \$2.25 if you live west of the Rockies). Your Treasure Chest will be sent immediately. We pay transportation charges.

Only
\$2.00
Delivered
(\$2.25 West
of Rockies)

**Secret
Lock!
Pirate Bark
Illustration**

D. M. GOODWILLIE CO.

22nd St. and Racine Ave., 805-A, Chicago, Ill.

Here It Is Boys! Look It Over

R. O. Goeden of Michigan made \$321.05 in 9 days—sold 5 machines in 2 1/2 hours.

**THE EUREKA ADVERTISER
(The Merchant's Friend)**

Automatically prints the merchants' "ADS" on his wrapping paper in one or two colors. Costs only what it costs to have "AD" printed on twenty rolls of paper. Flint of New York sold four machines in two hours. You collect and keep your commission. We deliver. Every merchant a prospect. Many buy five or more machines—one for each paper rack they use.

SALESMANAGER, Dept. A1, 1201 Cortland Street, Chicago, Illinois



**HAND-FORGING
AND WROUGHT-IRON
ORNAMENTAL WORK**

Complete instructions, with photographs and drawings, for making the most attractive styles of ornamental iron work.

- | | | |
|-------------|---------------|--------------|
| Andirons | Grilles | Rosettes |
| Scroll Work | Leaf Work | Hinges |
| Bulbs | Drawer Pulls | Door Plates |
| Window | Door Keeps | Spiral Deco- |
| Fasteners | Fire Sets | rations |
| Lamps | Candle Sticks | Picture |
| Coat Racks | Chains | Frames |

Thomas F. Googerty, the author, is one of the best-known makers of this type of metal work. The illustrations are all of work made by the author. Almost every page has one or more illustrations either made from drawings or from photographs. Anyone interested

in this type of work can soon develop his ability so that he can make these articles for his own use or for sale. There is a growing demand for articles of this type.

Send No Money Simply write a postal for this book of instructions, asking that "Hand-Forging" be sent C.O.D. When postman hands you the book, pay him the postal charges and \$2.00.

POPULAR MECHANICS PRESS, Room 702, 200 East Ontario St., Chicago, Illinois

What About Your

**A
L
C
O
H
O
L**

**This Winter
?**



The ZeroMeter

Takes the worry out of winter driving. A permanent instrument. Install one now!

Is a constant and accurate check upon the amount of alcohol present in the cooling system of your car. Always working.

TOO MUCH alcohol is sheer waste, for it evaporates out on the first mild day.

NOT ENOUGH alcohol means a frozen radiator and cracked cylinder block.

JUST RIGHT means economy and no worry,—
"The ZeroMeter Way."

The all aluminum ZeroMeter makes a handsome attachment on any car. Easily installed on the radiator hose by any one. Saves its cost in alcohol. Once installed, it can be taken apart in a moment—without affecting the water in the radiator.

—SENT ON APPROVAL—

Fill in the coupon below and get a ZeroMeter on approval. If you are not satisfied with it, your money will be refunded.

CHRISTIE-COUSE CORPORATION
2928 Migel Pl., Bronx, N. Y.

Please send me a ZeroMeter on approval. I will pay the postman \$3.50 and postal charges on receipt of the Meter. I can return the Meter within 10 days and my money will be refunded.

Name

Street and No.....

City..... State.....

(Please print)

Sent postpaid if \$3.50 check or money order is enclosed.

Canada, \$4.00 postpaid.



FREE

140-Page Book of life-size ruled forms, completely filled in. Answers problems of accounting and record keeping for any business or profession.

Book Sent FREE when requested on business stationery.

JOHN C. MOORE CORPN.
(Established 1839)
4085 Stone St. Rochester, N. Y.

MOORE'S LOOSE LEAF SYSTEMS
Used In 300,000 Offices

Ask about the New
MOORE'S VISIBLE RECORDS



THIS 100 PAGE RADIO CATALOG FREE

Special proposition for Dealers, Agents' Set Builders

Contains "Hook Ups" 75 Radio Illustrations 500 Over 1,000 Articles

"Build your own with 'RASCO' Parts"
RADIO SPECIALTY CO., 98 E Park Place, New York, N. Y.

Free Wholesale Radio Catalog **Send for it today**

1928 Catalog
Dealers, set builders — make this your biggest radio season. **Shure's great wholesale catalog** insures the best in quality at lowest prices. This wonderful book is jammed full of the newest offerings of **Nationally known** radio parts, kits, sets, accessories, table and console cabinets, etc. Also contains **short wave sections** showing the finest electrical apparatus for short wave receiving and transmitting. Your request brings our book of a thousand bargains, price list and discount sheet. **Write for a copy today.**

2000 Items **Big Values**

Shure Radio Company
343D Madison St. Chicago, Ill.



CORONA IN COLORS!

Beautiful Duco finishes. Write for new illustrated folder.

L C Smith & Corona Typewriters Inc 112 E. Washington St., Syracuse, N. Y.

Control Your Radio Set!

Control loud-speaker volume; match transformers for best tone quality; tune the loud-speaker to your taste; get maximum sensitivity out of r. f. and detector tubes; control regeneration micrometrically, especially with short-wave receiver—all with the Volume Control Clarostat. It's compact, good looking, 6-500,000 ohm range, screw binding posts, one-hole mounting job—and only \$1.50 list.

Use the larger Standard Clarostat for B-eliminator applications, and the giant Power Clarostat for A-B-C power units, line-voltage control, and power amplifiers.

There's a Clarostat for every purpose. Make sure, however, you get a genuine Clarostat—look for the green box and name CLAROSTAT stamped on nickel shell.

Ask your dealer for literature on Clarostats and how to improve your radio set. Or write direct to

American Mechanical Laboratories, Inc.

RMA

285 N. Sixth Street Brooklyn, N. Y.

VOLUME CONTROL CLAROSTAT

OUTDOOR SPORTS THE YEAR 'ROUND

Popular Mechanics New Useful Book—Outdoor sports appeal to us all. But the fun is double when you make your own devices. There are 226 clearly written and concise articles telling how to make equipment for new and popular sports of many kinds in the new **Outdoor Sports book**. There are clever devices for such sports as:

Swimming	Trapping	Photography	Kite Flying
Camping	Tobogganing	Tennis	Summer Games
Football	Baseball	Outdoor winter games	Nutting
Swinging	Fishing	Pushmobiling	
Trolley Coasting	Golf	Racing	
Roller Skating	Boat sailing	Boating	Skiing
		Toy Making	

It is easy to make the devices described above because there are 317 helpful illustrations. The articles are clear enough for boys, yet interesting enough for any man.

This offer also includes a copy of our valuable Boat Book which tells

HOW TO BUILD 21 KINDS OF BOATS

Complete and simple directions and illustrations are given for building the following: **Fast Runabout Motor Boat; Canadian Model Canoe; Open Sailing Canoe; Portable Folding Boat; Motor Canoe; PETERSBOROUGH Canoe; Canvas Covered Cedar Canoe; Hydroplane Catamaran; Cruising Catamaran; Paper Boat; Long Island Scooter; Paddle Wheel Boat; Log Canoe; House Boat; Sea Gull Sail Boat; Pile Driver Punt; Inexpensive Motor Boat; Steel Boat; Concrete Boat; Bicycle Boat and Power Driven Catamaran.** Just write us to send these two books. When the postman hands you the package pay him \$1.98 plus the postage. If outside U. S. remit when ordering and include 15 cents extra for postage.

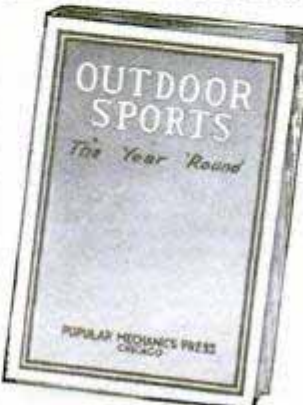

Popular Mechanics Press
Room P1 200 E. Ontario St., Chicago

Save 1/2! 30 days FREE TRIAL Satisfy yourself

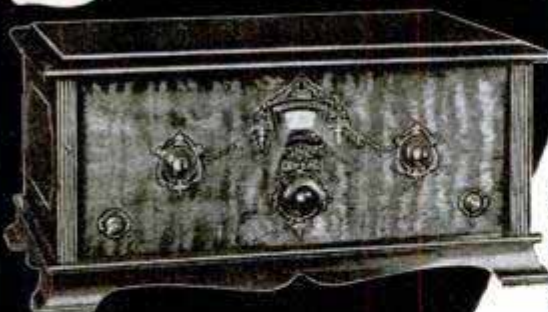

CON-RAD
SINGLE DIAL CONTROL

6

6 TUBE SETS

Completely assembled

\$34.75
to **\$66.66**

RETAIL PRICES

**Completely Shielded
Genuine Licensed Circuits**

Manufactured under license grants of
Radio Corporation of America
and affiliated companies

The set that's the talk of the radio trade. Acknowledged as the greatest radio value. A Con-Rad six tube completely shielded chassis with single illuminated dial control. Absolutely the latest in radio receivers. Manufacture under license grants, insures highest quality; chassis incorporates all the features found in most efficient receivers. Complete shielding insures freedom from all foreign noises. Both table and console cabinets come in the newest styles and most beautiful woods. All are well constructed, carefully finished and will add beauty to any room.

Prove It Yourself - 30 Day Free Trial

Quality and price are what you are most interested in. A Con-Rad receiver is ready to undergo any test you demand. Try it in your home on our 30 day Free Trial offer and be satisfied. If you are not, return the receiver to us and your money will be refunded. You must be satisfied!

MAIL COUPON NOW!

Write today for complete information. Our catalog gives full details of the Con-Rad line of 1928 and our liberal 30 day Free Trial offer.

**BIG DISCOUNTS
to AGENTS & DEALERS**

Demonstration set sent on Free Trial. Make big money working full or spare time taking orders for Con-Rad Radios. Write today for special prices and proposition.

CONSUMERS RADIO CO.
Dept. 100
4721 Lincoln Ave., Chicago, Ill.

Consumers Radio Co.,
4721 Lincoln Ave., Dept. 100
Chicago, Ill.

Gentlemen:
Please send me full particulars and catalog of the Con-Rad Line of 1928 and your 30 day Free Trial offer. No obligation.

Name

Street

City State



LATEST SCIENTIFIC MOTOR Price
Runs 10 Hours on 1 Gallon **\$38.50**
Wonderful Gasoline Engine

Operates Washing Machine, Cream Separators, Lathes, Etc. Also handle Castings for other Engines. Books and Supplies of every kind for **HANDY-MAN, MECHANICS and MODEL MAKERS.**

Complete Catalogue 25c which is allowed on first \$2 order.
AMALGAMATED SALES & SERVICE CORPORATION
327 T So. LaSalle St. Chicago, Ill.

**PORTABLE
WONDER SAW**

BUILT-IN MOTOR

Not a toy, adaptable for use in schools, laboratories, pattern shops, manufacturing and home use. It rips, cross-cuts, also jig and scroll saw. Automatic splash lubrication. Operates from light socket. Write for further information—
THE MACHINE CRAFT CO.
VALPARAISO : INDIANA



\$22.50
to
\$42.50



Your Coat and Vest Can Be Matched with New Trousers

Save the price of a new suit. We match hundreds of coats and vests satisfactorily every day. Each pair tailored to your measure. 80,000 patterns. We submit sample of cloth for your approval. Just mail your vest or a sample of the suit.

We employ no agents.

ACME PANTS MATCHERS
Dept. BN-14, 20 W. Jackson, Chicago

Enclose return postage if vest is sent.

SAVE 50% GAS AND START MOTOR INSTANTLY IN ZERO WEATHER

Users world over enthusiastically report wonderful new, simple device called "Quickstart" starts motor instantly in any weather; and saves up to 50% gas. Put on in few minutes. Write for Free Sample Offer and Big Money Drawing Account and Traveling Expense proposition for Agents.

RALPH CURTIS

Dept. 805-A, 154 E. Erie St. Chicago, Ill.

10c NEW SCIENTIFIC WONDER "X-RAY" CURIO
3 for 25c



BOYS You apparently see thru Clothes, Wood, Stone, any object. See Bones in Flesh. FREE—PKG. RADIO BIG FUN PICTURE FILM. Taken pictures without camera. "You'll like 'em." 1 pkg. with each 25c order.
MARVEL MFG. CO. Dept. 31 NEW HAVEN, CONN.

This is the GUITAR

you hear on the radio and records. The Gibson Mastertone Guitar, with its rich tone of such depth beauty and carrying power, embodies finest materials and most expert craftsmanship; acclaimed as world's finest guitar. Easy playing qualities make it easy to learn.



Send coupon NOW for FREE BOOK and details of Easy Payment plan. Mention which interests you: Guitar; Banjo; Mandolin; Ukulele.

Gibson

GIBSON, Inc. 103 Parsons St. Kalamazoo, Mich.
Gentlemen: Send Free Book and details of payment plan on

Name
St. or R.F.D.
City State

LYNCH



Write for this book—

The famous Lynch 3 tube de Luxe Deck. Simplifies home set-building at greatly reduced cost. Fully described in this booklet.

Learn the Usefulness of "Resistance in Radio"

Radio fans will find a wealth of reliable, boiled-down, and interesting information in "Resistance the 'Control Valve' of Radio." Simply written and clearly illustrated. This valuable hand-book is worth dollars—you can get a copy for only 25-cents.

ARTHUR H. LYNCH, Inc.
1775 Broadway at 57th Street
General Motors Bldg., New York, N. Y.
Sales offices in most large cities

Mr. Arthur H. Lynch
1775 Broadway, New York City
Dear Mr. Lynch:

Please send me a copy of your new booklet "Resistance the 'Control Valve' of Radio." I am enclosing 25-cents.

Name.....
Street.....
City..... State.....

P. M.

The man who studies gets ahead. Popular Mechanics Press will advise you what books to read to advance in your trade. 200 East Ontario Street, Chicago, Illinois.

Oh Boy! See All!

Big 3 1/2 Ft. Telescope

Lend wings to your eyes! People and objects miles away seem close. Wonder telescope brings new pleasures to home, farm, camp, travel, sport. Study the mysterious Sun spots; see Moon and Stars as never before. See people on the beach, on the mountains, etc.

FREE Yes, absolutely free! A handsome leatherette Carrying case and Shoulder Strap. Also Solar Eye Piece to view the sun—a special feature, found only on expensive instruments.



CLIP THIS AD

5 Sections
8 Power Lenses

Brass bound; measures 12 in. closed; powerful achromatic lenses

protected by dust caps.

Thousands Pleased

P. Brush wrote: "Watched submarines three miles off coast." Ed. Foster: "Tell time on clock five miles away." C. Scribner: "See lighthouse 18 miles away." Mrs. Yarbrough: "Could tell color of airplanes four miles away." S. M. Gearhart: "Can see men working seven miles away."



Sports



Touring



Beach Views

SEND NO MONEY

On delivery of Telescope, free Case, Strap and Eye Piece pay Postman only \$1.85, plus postage (2 complete outfits \$3.50). Satisfaction guaranteed or money refunded. Send today, entertain your friends! Be first to have one.

FERRY & CO., Dept. 1772, Chicago, U. S. A.

TYPewriter PRICES CUT

All Standard Makes your choice of the World's best typewriters—Underwood, Remington, Oliver—full size, late model, completely rebuilt and re-finished brand new. Prices smashed down to half. Act quick.



Free Trial

\$2 and it's yours

Just send your name and address and we will mail you our complete FREE CATALOG prepaid, fully describing and showing actual photographs of each beautiful machine in full colors. Tells every detail of our direct-to-you small-payment plan. Write now for tremendous saving. No obligation whatever. Still time if you act now.

International Typewriter Exchange

184 W. Lake St. Department 194 Chicago, Illinois



WADE AMATEUR MECHANICS, REPAIR SHOPS, INVENTORS, STUDENTS

BENCH LATHE A real machine tool for the home work bench—capacity 4" dia. x 12" length. For Metal—Wood—Composition Materials. Turning—Facing—Boring—Drilling—Winding—Thread Cutting. Accurate—Strong—Quiet—Compact. Slide-rest has travel entire length of bed. Leadscrew inside bed. No. 1 Lathe, plain headstock, \$28.00. No. 2 Lathe, bevel-gear headstock, \$58.00. Extra for lathes with 18 inches between centers, \$7.00. Complete line of accessories at equally low prices. Write for free catalog.

THE GEROLD CO. Dept. P-39 120 Liberty St. New York

WIN Buick Sedan - 4 Big Cars Given!

What is wrong with this Car? Send Answer today

WIN A BUICK or \$1800 In Cash!

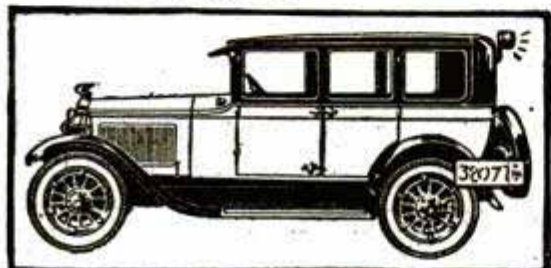

Puzzle Fans—Here's where you have a REAL chance to WIN ONE of 4 Big New Sedans. Tell me "What's wrong with this car?"—The artist has purposely made some clever changes on this picture. Can you find where he has made 4 changes. Can you find even ONE change—if you can—cut out this ad—mark it—send me your answer—HURRY!

\$505.00 Cash Extra for Promptness!

Any man, woman or child CAN WIN—if they will only follow my simple EASY directions. You've never had such a big liberal opportunity. 25 Other big prizes. Duplicate prizes given those tying. Everybody rewarded. Offer backed by big million dollar concern. Over 83 years old. Money in bank to protect you. Have already given over 50 big cars. NOW—you have your opportunity. Hurry!—Get \$505.00 Cash Extra for promptness.

T. W. KELLY, Dept. 153
500 N. Dearborn Street, Chicago, Illinois

ELECTRIC DRIVE 9 inch LATHE

*Ready to
Plug in
Any
Light Socket*

A Precision Lathe for the
Manufacturing Plant, Ma-
chine Shop, Service Station
and Electrical Shop

\$228

EASY PAYMENTS
IF DESIRED

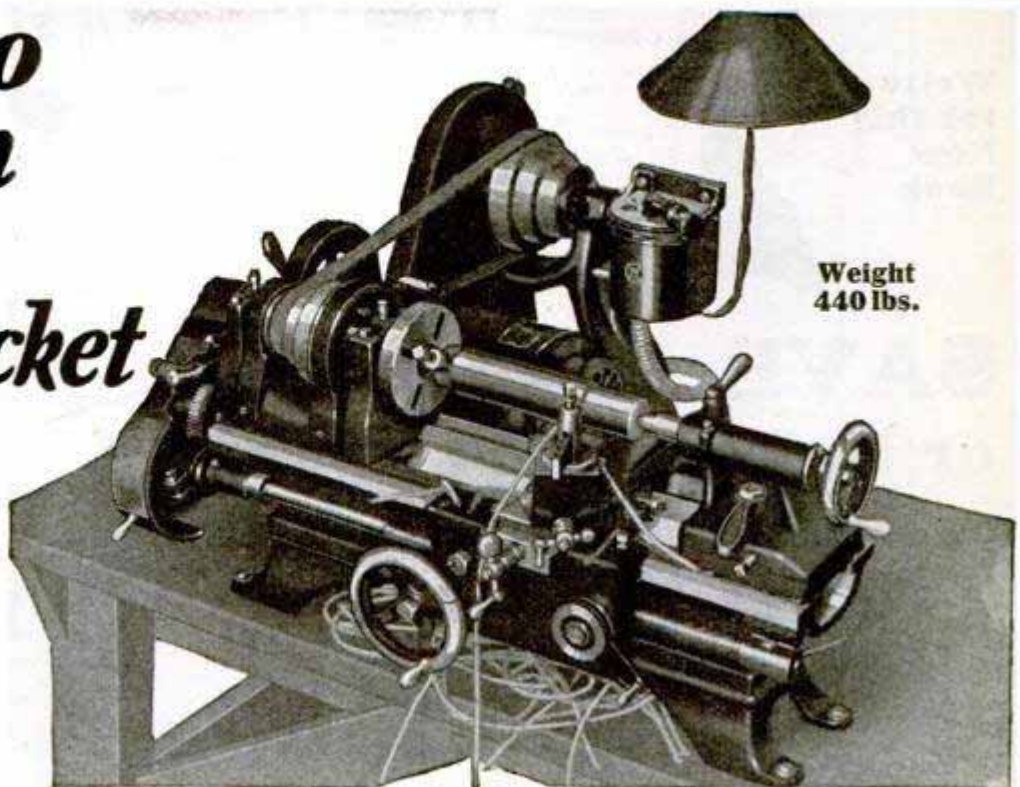

Weight
440 lbs.

Back Geared—Screw Cutting—Reversing Drive

This is the popular New Model 9 in. South Bend Lathe built in the same plant and with the same accuracy as the 38,000 fine Precision Lathes this Company has supplied to the U. S. Government, Ford, U. S. Steel Corporation, and hundreds of other large industries in the U. S. and 65 Foreign Countries.

Features and Specifications

Power Feed to Carriage
Set-over for Taper Turning
 $\frac{3}{4}$ " hole through spindle
Six Spindle Speeds

Width of belt, 1 inch
Maximum draw-in collet size $\frac{1}{2}$ "
Equipped with $\frac{1}{4}$ H. P. Reversing
Motor

Twelve Practical Attachments can be fitted to this Lathe

Easy Payment Terms If Desired

Balance in Ten Equal Monthly Payments

A small down payment brings you the Lathe to use while you are paying for it. In this way it earns its cost by the work it does and savings it makes.

Other Popular Selling Sizes

Size of Lathe	Shipping Weight	Not Electric Driven but Complete with Countershaft and Regular Equipment	
		Standard Change Gear	Quick Change Gear
9" x 3'	490 lbs.	\$235.00	\$270.00
11" x 4'	725 lbs.	300.00	335.00
13" x 5'	1110 lbs.	352.00	402.00
15" x 6'	1550 lbs.	430.00	490.00
16" x 8'	2035 lbs.	510.00	570.00
18" x 10'	2840 lbs.	685.00	750.00

All above sizes can be furnished with Electric Drive at extra cost. The complete line ranges from 9 to 24 in. swing and from 2½ to 16 ft. bed.

Write for name and address of your nearest dealer, and

Ask for Booklet 22-K and Complete Catalog No. 88

South Bend Lathe Works 633 E. Madison Street,
South Bend, Ind., U. S. A.
New York City Salesroom: 183 Centre St.



9" x 2½' New Model Junior South Bend Bench Lathe, weight 350 lbs. Complete with Countershaft and Equipment....\$150

Other 9-inch Bench Lathes

Complete with Countershaft and Equipment same as shown in illustration below.

Size of Lathe	Between Centers	Weight	Price
9" x 3'	18-in.	375 lbs.	\$155.00
9" x 3½'	23-in.	400 lbs.	160.00
9" x 4'	29-in.	425 lbs.	165.00
9" x 4½'	36-in.	450 lbs.	170.00

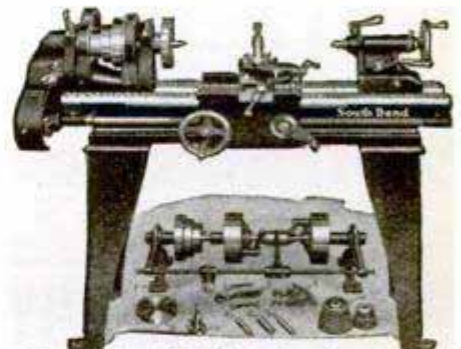

9" x 3' New Model Junior South Bend Precision Lathe with floor legs, Countershaft and Equipment. Wt. 490 lbs. \$165

SOUTH BEND LATHES

Write for this New Book

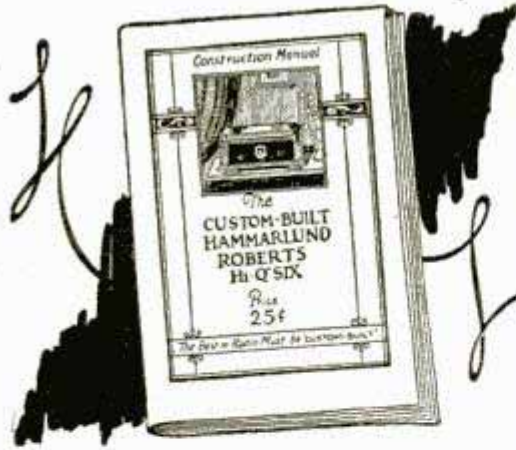

SAVE \$100.00 or Make Big Money on America's Finest CUSTOM-BUILT RECEIVER

This 48-page Manual describes with text, charts, diagrams and photos every detail in building the "Hi-Q Six"—the CUSTOM-BUILT RECEIVER that is made with America's finest parts—the Receiver that gives perfect CUSTOM-BUILT results—the receiver that saves you at least \$100.00 over finest factory-assembled sets—and the receiver that is making large incomes for professional set-builders.

The advanced "Hi-Q SIX" incorporates every modern feature known in radio—a shielded receiver with four completely isolated tuning stages, automatic variable coupling, symphonic transformers and power tube. An important feature is even and maximum amplification over the entire tuning band. The set is absolutely non-oscillating. Sensitivity and selectivity are unsurpassed by any receiver regardless of price. And tone quality is beyond words to describe.

If you want to save at least \$100.00 on this receiver for your own use send 25 cents for the complete "Hi-Q SIX" Manual to-day before first edition is exhausted. If you are interested in this nationally advertised receiver as a making-money business we will supply you with every advertising and selling help you need to develop a big local business. Nearly 2,000 young men have qualified for our authorized Radio-Trician proposition and are making the same surprising incomes that this remarkable proposition offers you.



Associate Manufacturers

- | | | |
|-------------------|-------------------------|--------------------------|
| Carter Radio Co. | Hammarlund Mfr. Co. | International Resistance |
| Samson Elec. Co. | Benjamin Elec. Mfr. Co. | Co. (Durham Resistors) |
| Saugamo Elec. Co. | Acme Wire Co. (Parvot) | Radiall Co. (Amperite) |
| Yaxley Mfg. Co. | H. H. Eby Mfg. Co. | Westinghouse Micarta |

Hammarlund-Roberts, Inc., 1182 Broadway, Dept. X, New York

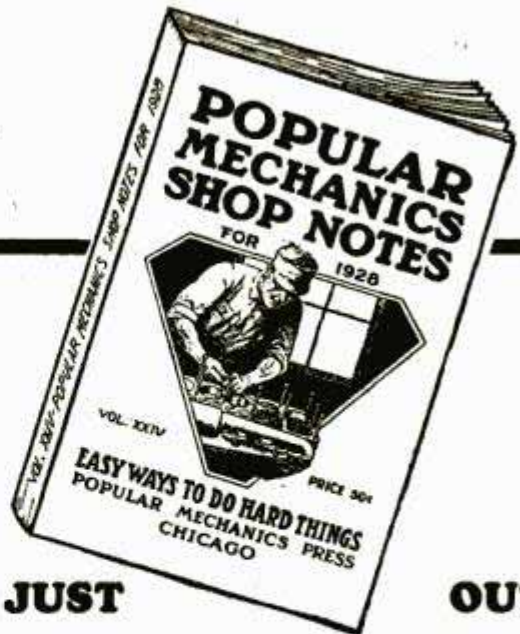

JUST OUT SHOP NOTES

500 Articles FOR 1928 400 Pictures

This announcement will be welcomed by thousands because they have learned that each yearly issue of Shop Notes contains dozens of short cuts that save time and money. Every article is written by some man who has tried the idea and found it worth money. The variety of subjects covered is one reason why so many buy Shop Notes each year. In many ways the 1928 issue surpasses previous numbers. The following brief list will give you an idea of the variety of subjects covered.

SOME OF THE SUBJECTS

- | | | |
|-------------------------------|------------------------------|--------------------------------------|
| Artificial Ice Making | Battery Charging | Killing Moths in Furniture |
| Sheet Metal Working | Building-In a Sewing Machine | Flaestone Walks |
| Painting Kinks | Cleaning Rifles | Hints for the Builder |
| Carpentry | Bee Keeper's Kit | Ship Plaque Making |
| Automobile Repairing | Culvert Work | Refinishing Soft-Wood Floors |
| Machine Shop Work | Automobile Repainting | Making a Pirate Chest |
| Farm Mechanics | Portable Sewing Machine | Homemade Apple Wiper |
| Tool Repairing | Hot-Flame Blowpipe | Setting Window Glass |
| Lock Repairing | Automatic Fire Extinguisher | Etching Brass and Copper |
| Key Making | Lawn Mower Repairing | Making a Sewing Cabinet |
| Concrete Work | Beautifying Your Home | Glue and Its Use |
| Cutting Your Coal Bill 75% | Portable Air Compressor | Proper Hot-Water Heater Installation |
| Poultry Appliances | Gasoline Pump Extension | |
| Plumbing Kinks | Log Cabin Construction | |
| Electrical Kinks | Folding Bed for Roadster | |
| Power-Line Pole Straightening | Cutting Glass | |

6,000 Ideas on All Shop Work

There are now 16 volumes of Shop Notes available. And this unrivaled library of shop helps may be had for a special price of \$7.50. If you do not have the back numbers of Shop Notes, you should purchase the entire library. The following are now available: 1908, 1912, 1913, 1914, 1916, 1917, 1919, 1920, 1921, 1922, 1923, 1924, 1925, 1926, 1927, 1928

Amateur's Guide PROFESSIONAL'S HANDBOOK

Both amateurs and professionals find Shop Notes of wonderful value. The articles are so clearly written and so thoroughly illustrated that even a boy can follow them. Teachers of Manual Training should have the complete library.

SEND NO MONEY

Don't send a penny. Just fill in the coupon with your name and complete address, indicate whether you want the whole library or the special offer of 1928 Shop Notes and Lathe Handbook for 98 cents. When the books are delivered to you, pay the postage and deposit price of books with postman.

--- SPECIAL OFFER COUPON ---

POPULAR MECHANICS PRESS,
200 E. Ontario St., Room P1, Chicago, Ill.

Send me, as per your special offer the following books. I will pay postage and the price of books when they arrive. My money will be refunded if I am not satisfied. (Check what you want.)

1928 Shop Notes and Lathe Handbook, 98 cents Complete Shop Notes Library (16 vols.) \$7.50

Name.....

Street and No.....

City..... State.....

20 Years ahead in Shaving Comfort



SUPERKEEN

Sensational
NEW

Never before has there been such a wildfire seller introduced to the specialty salesmen of this country. Here is a neat, compact article, the wonder of the age. Twenty years ahead of all other developments in shaving satisfaction. Made of beautiful, jade-green Bakelite. Attractive, a real addition to man's toilet accessories. No work. No cranks to turn. No fuss or muss. Nothing could be simpler. Just put your blade on the drawer, slide it into place—**THAT'S ALL.** Your Razor Blade is sharpened instantly—it will be everlastingly sharp and you'll enjoy years of shaving comfort, satisfaction and economy.

Startling
Demonstration

You see the wonderful action of SuperKeen when you use our Visible Closer. You see with your own eyes the magic of this marvelous precision instrument. You see the exact action that takes place on the very edge of your razor blade that gives you a life-time of satisfaction and comfort by using SuperKeen.

This little Demonstrator is the cleverest thing ever devised to close sales. Clever because what a man sees with his own eyes he cannot question. Its action convinces the most skeptical. Pass the demonstrator over your SuperKeen. Note how the minute particles of steel are affected—magnetically—in just the same way your razor blade is affected. Without effort—**instantly—positively—magnetically—magically,** through the powerful force of the magnetic waves generated in SuperKeen the blade is sharpened instantly and kept everlastingly sharp.

Sharpens Blades

INSTANTLY

by **POWERFUL
MAGNETIC
FORCE**

A sales force consisting of 500 key men is being formed. Don't lose a minute. We know what we are talking about. Millions will be sold. These 500 key men will make \$10,000 or more during the next year. Our literature explains a guarantee that leaves no doubt in your mind regarding us or our product. **ACTION—LET'S GO!**

THE SUPERKEEN CO., Inc., Dept. S-23, Salisbury, N.C.
Manufacturers of Precision Instruments

**SUPERKEEN CO., Dept. S-23
Salisbury, N. C.**

Rush complete details to—

Name

Address

City State

If you don't want to lose time, enclose \$2.50 and we will send one SuperKeen, one Visible Closer (demonstrator) and supplies. Refund when you want it.

WANTED!

Radio Dealers PROFESSIONAL Set Builders and Radio Fans

IN every community to introduce and become our Factory Representative on the newest, most revolutionary radio development in the history of the industry... The SUPER HILODYNE Circuit, a radio circuit that is modern and independent. See December issue of Radio News.

The SUPER HILODYNE is a new basic circuit employing nine tubes. Its all around performance will amaze you. You can help repeat Radio History and make money by representing us in your community in your full or spare time. Write TODAY for details. Dept. PM-128.

ALGONQUIN ELECTRIC CO., Inc.
245 Fifth Avenue : - : NEW YORK CITY

3-ft. Cone Speaker Wall Type, Complete with Wall Frame, only

Famous G. R. P. 3-ft. Single Cone Speaker! You've read and heard about its wonderful tone quality, equal to \$60 and \$75 speakers. Reproduces every note of every instrument in a complete symphony orchestra; gets the low notes; mellows the high; reproduces naturally; equally good on music, singing, speaking. Endorsed by leading editors and radio authorities. Radio's finest speaker and greatest value. Easily assembled in half an hour.

G·R·P
3 FOOT
CONE SPEAKER
Build It Yourself

If your dealer hasn't genuine G. R. P. 3-ft. Cone Speaker Kit No. 4 send us money order, bank draft or check for \$10.50. It will be the best radio buy you've ever made.

G. R. P. PRODUCTS CO., Inc.
104 Fifth Ave. Suite 1995 New York City

\$10⁵⁰

f. o. b.
N. Y. C.

I purchased my second 3-ft. Cone Speaker yesterday. If it is as good as the first one was I will be more than satisfied. *Rev. A. C. Van Koolbe.*

Have wonderfully fine results. *R. D. Merrill.*

Finest speaker for quality and volume. *Frank Andrich.*

Best I ever heard! I put aside a \$30 "—" never to use again as long as yours works. *Louis Daleympte.*



Convert Your Receiver to A. C. with a KARAS A-C-FORMER

Write us today for full details as to how you can change your present set so as to use the new Cunningham, RCA or CeCo A. C. Tubes for lamp socket operation with the NEW Karas A-C-Former Filament Supply, Type 12. Modernize your receiver at small cost. Ask us for particulars and complete information.

KARAS ELECTRIC COMPANY, 4028-A N. Rockwell St., Chicago

MONEY FOR WORKING CAPITAL

If your business needs money let me show you a practical and satisfactory way to raise it. Prompt, confidential and reasonable service. Dept. 27.

W. HARRISON COLE
507 FIFTH AVENUE NEW YORK CITY

NOW! You Can Do Your Own NICKEL-PLATING Make \$150 to \$500 a Week

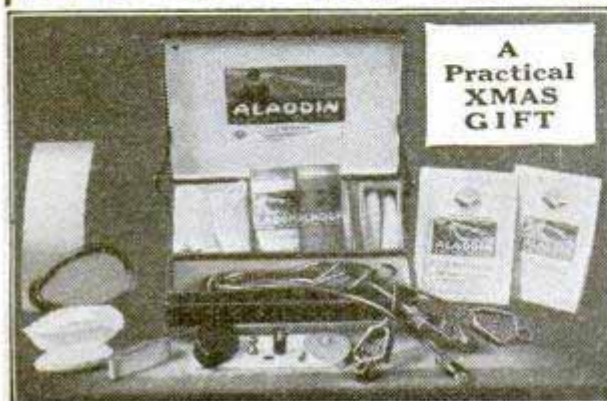

A
Practical
XMAS
GIFT

New Scientific Invention Enables Anyone To Nickel-Plate Anywhere with Aladdin Portable Outfit

This Marvelous Invention enables anyone to NICKEL-PLATE anything—anywhere; in the Home, Garage, Office, Store or Shop—in fact, you can do all the NICKEL-PLATING on any automobile with the

ALADDIN ELECTRO PORTABLE OUTFIT in a very short time—without **SEE THE NICKEL FLOW** removing any of the parts. This interests every auto owner (and others) because you can

NOW take the Plater to the job instead of taking the job to the Plater. This offers wonderful ECONOMY to users and BIG MONEY-MAKING possibilities to AGENTS. Be the first in your locality. **WRITE FOR FREE BOOKLET.**

\$6⁵⁰

F. O. B.
RACINE

P. J. F. BATENBURG

RACINE, WISCONSIN

—AGENTS—
WANTED EVERYWHERE

WE PAY FREIGHT

The Sterling & Big Rooms, 2 Closets, Porch

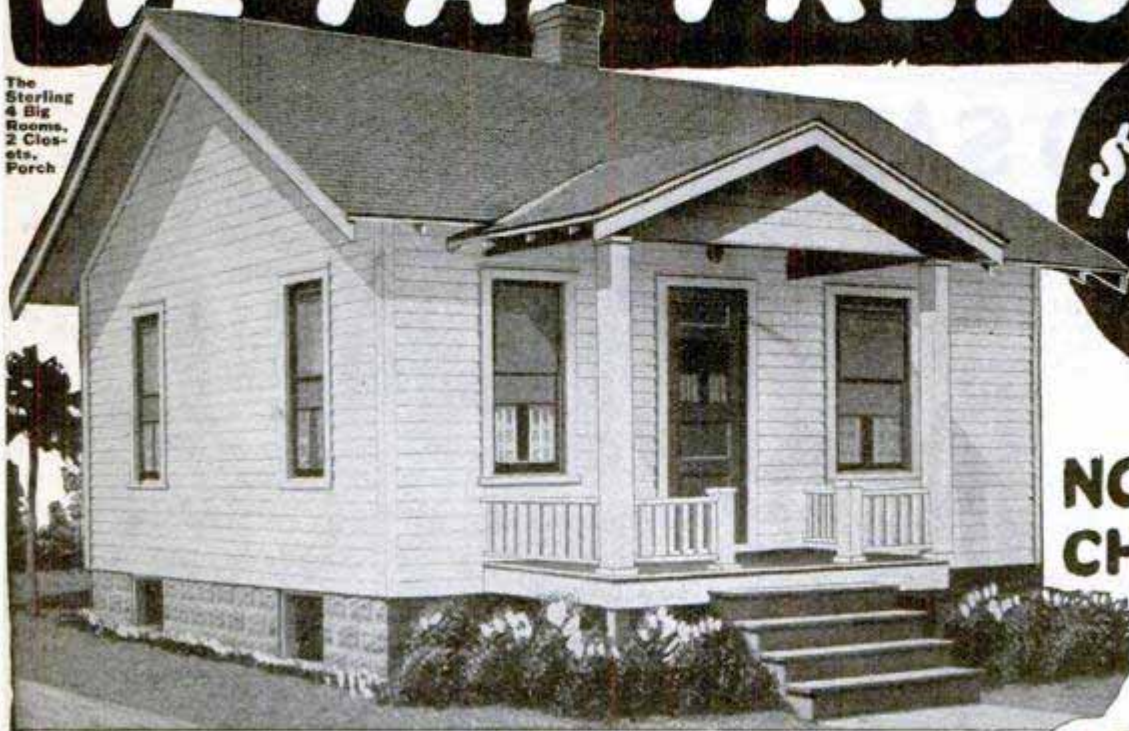

ONLY
\$596

COMPLETE

NO EXTRA CHARGES

ONE PRICE INCLUDES EVERYTHING

Buy At Wholesale!

Most amazing money-saving prices ever offered.



\$796

6 Rooms, Porch, 2 Closets

"Saved \$1,000 on House and Garage"

YOU can get all materials direct from mill and make 4 big savings on your home! Owners tell of \$200 to \$1,500 actual savings on single homes. Mill-cut lumber saves you 40% labor. Not portable. Sturdy, substantial, permanent homes. Guaranteed materials delivered to your station, freight paid.

SEND FOR THIS BOOK FREE

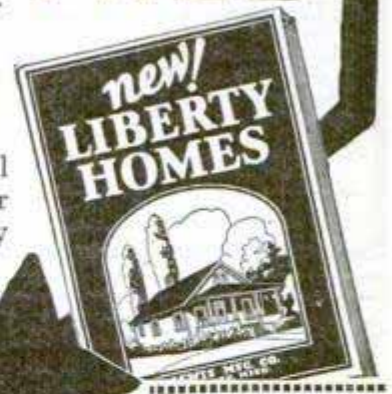

PRICE INCLUDES

all the highest quality lumber cut to fit, doors, windows, stairs, high grade interior woodwork, bath, shingles, hardware, glass, paints, nails, etc., complete. Working plans, instructions, FREE. Time payments may be arranged if desired. All materials fully guaranteed. Freight paid east of Mississippi river and north of Mason-Dixon line, also to Minnesota, Iowa, Missouri.

says Mrs. Coombs, "counting labor and lumber. All is as you said. I have advised my brother to order one of your homes" . . . "Believe I saved \$500 by buying from you," writes B. A. Anderson of Nebraska . . . Mr. Davissaved "between \$1,000 and \$1,500" on his home. **You can do as well.** Every home owner who built a Liberty saved money.

FREE HANDSOME BIG BOOK OF HOMES—FULL COLORED—WRITE

AMAZING NEW PLAN

We send you complete materials. You send us no money. Inspect quality and quantity on your own lot for 5 days. You do not pay one penny for materials unless completely satisfied. Is there any better proof of the confidence we have in Liberty homes? 31 years square dealing behind our guarantee. Send coupon for Big New Book of Homes today.

Shows amazing home values from \$379 to \$1,483. 44 plans—wonderful 4 to 7-room bungalows. 1½ and 2-story homes. American, Dutch Colonial, English designs. Practical—beautiful. Book shows table of construction time for each home. Also garages, letters from home owners, actual practical facts and figures to save you money. Remember—an iron-clad guarantee protects you—it costs nothing to get complete information and you'll save yourself hundreds of dollars. Send coupon TODAY.

**LIBERTY HOMES
LEWIS MANUFACTURING CO.
Dept. 12-A, Bay City, Mich.**

**LEWIS MFG. CO.,
Dept. 12-A, Bay City, Mich.**

Please send me, FREE, your new big book containing full color photographs and plans of homes, construction time for each home, and other building information.

Name.....
Address.....
City..... State.....

The New Red Jacket

BAND SAW

HERE IT IS!

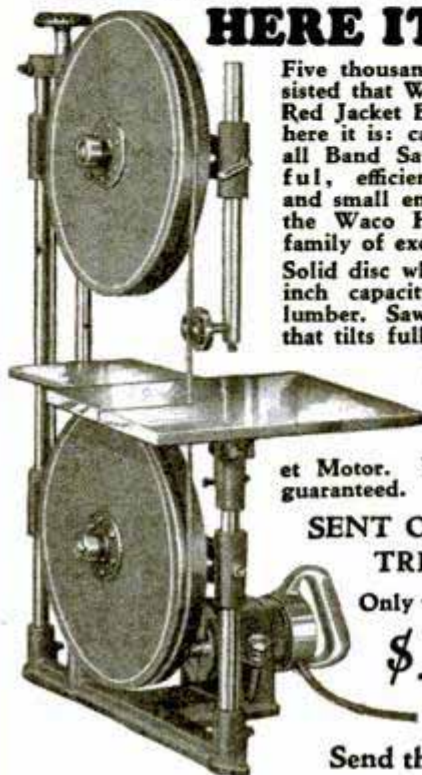

Five thousand craftsmen insisted that Waco produce the Red Jacket Band Saw. Now here it is: capable of doing all Band Saw work, powerful, efficient, dependable, and small enough to fit into the Waco Home-Workshop family of excellent tools.

Solid disc wheels giving 12-inch capacity on four-inch lumber. Saw table 9" x 12" that tilts full 45 degrees for all miter requirements. Direct gear drive from the famous Red Jacket Motor. Unconditionally guaranteed.

SENT ON 10-DAY TRIAL

Only \$35.00

Not Including Motor

Send the Coupon

WACO TOOL WORKS, Inc.

Waco Tool Works, Inc., Dept. 100-A,
542 North Parkside Avenue,
Chicago, Illinois.

- I am enclosing \$31.50. This is the full price less 10% for cash.
- I am enclosing \$10.00 as down payment and if I keep this band saw, I will remit \$10.00 monthly. This band saw is sent on 10 days trial and may be returned for full refund.

Name.....
Address.....
City and State.....

Books on 67 Practical Subjects

Popular Mechanics Press specializes in supplying the outstanding best book on any subject. Check the books you want, and mail this advertisement as your order blank.

- ARCHITECT**
Architectural Drawing \$1.50
- ARMATURE WINDER**
Armature Winding.... \$3.00
- ARTIST**
Practical Art..... \$5.00
- ARTS CRAFTS**
Art Metal Work..... \$4.25
- ASTRONOMY**
Amateur Telescope Making..... \$2.00
- AUTOMOBILE**
Dyke's Encyclopedia... \$6.00
- AVIATOR**
Practical Aviation.... \$3.00
- BOAT BUILDER**
22 Different Boats.... \$0.50
- BOOKKEEPER**
Bookkeepers' Handbook..... \$1.00
- BOYS' BOOKS**
The Boy Mechanic (4 vols.)..... \$7.00
- BRICKLAYER**
Plain and Fancy Brickwork..... \$1.50
- CABINET MAKER**
Furniture Making.... \$3.50
- CALCULATOR**
Ropp's Calculator.... \$1.00
- CARPENTER**
Carpenter's Handbook \$1.50
- CARTOONING**
Cartooning Made Easy \$2.00
- CHEMISTRY**
General Chemistry... \$3.75
- CIVIL SERVICE**
Course in Civil Service \$1.50
- CONCRETE**
173 Ways of Using Concrete..... \$0.50
- COOKING**
Winston Cook Book... \$1.50
- DETECTIVE**
Instruction for Detectives..... \$1.00
- DIESEL ENGINES**
Diesel Engines, Marine, Locomotive, Stationary..... \$5.00
- DOG FANCIER**
Dog Encyclopedia.... \$2.00
- DRAWING**
Drawing Made Easy... \$1.25
- DRILLING**
Drilling and Thread Cutting..... \$0.50
- ELECTRICIAN**
American Electricians' Handbook..... \$4.00
- ELECTROPLATER**
Electroplating..... \$1.00
- ENGINEER**
Bailey's Handbook for Stationary, Marine, Diesel..... \$2.00
- ENGLISH**
Self-Improvement in English..... \$2.50
- ENTERTAINMENTS**
Producing Amateur Entertainments..... \$2.00
- ETIQUETTE**
Book of Etiquette (2 vols.)..... \$1.98
- FARMER**
Popular Mechanics Handbook for Farmers..... \$1.00
- FORD**
My Ford, Its Care and Repair..... \$3.00
- FORMULAS**
10,000 Formulas..... \$4.00
- FUR RAISER**
Outdoor Opportunities \$2.00
- FURNITURE MAKING**
Mission Furniture Making, (3 vols.)..... \$3.00
- GLASS WORKER**
Decorative Glass Processes..... \$3.25
- HAND FORGING**
Hand Forging and Wrought Iron Ornamental Work..... \$2.00
- HOME BUILDING**
Concrete Houses..... \$3.00
- HOME REPAIRS**
Practical Book of Home Repairs..... \$2.50
- INTERIOR DECORATOR**
Interior Wall Decoration..... \$4.00
- INVENTOR**
Inventors' Manual.... \$1.50
- LATHE WORK**
Lathe Handbook..... \$0.50
- LEATHER WORKER**
Leather Work..... \$1.50
- LETTER WRITING**
Better Business Letters \$1.00
- LOOM FIXER**
Practical Loom Fixing.. \$1.50
- MACHINIST**
Complete Practical Machinist..... \$3.00
- MAGIC**
Modern Magic..... \$2.00
- MASON**
Practical Stone Masonry..... \$1.25
- MATHEMATICS**
Mathematics for the Practical Man... \$1.50
- MECHANICAL DRAFTSMAN**
Practical Course in Mechanical Drawing... \$1.00
- MODEL MAKING**
Model Making..... \$3.00
- OUTDOOR SPORTS**
Outdoor Sports the Year 'Round..... \$1.50
- PAINTING**
House Painting Methods \$2.00
- POULTRY RAISER**
\$1,223 from a Town Lot \$1.00
- PSYCHO-ANALYSIS**
Outwitting Our Nerves \$2.50
- RABBIT RAISING**
Practical Rabbit Keeping..... \$1.50
- RADIO**
Lefax Radio Handbook \$3.50
- REFRIGERATION**
Homemade Refrigerating Machine..... \$0.50
- SHIP MODELS**
Ship Model Making... \$2.50
- SHOP WORK**
Shop Notes (16 vols.).. \$7.50
- SPIRITUALISM**
Behind the Scenes with the Mediums..... \$1.50
- TAXIDERMIST**
Methods in Taxidermy \$3.50
- TOY MAKER**
Toy Manufacture..... \$1.50
- WELDER**
Welding Encyclopedia.. \$5.00
- WIRING**
House Wiring..... \$1.00
- WOOD WORKER**
Wood-Working for Amateur Craftsmen.... \$1.00
- WRITER**
Free-Lance Writers' Handbook..... \$5.00

Books sent C. O. D. anywhere in U. S.

Just check the ones you want, write your name and address below, and mail the whole advertisement. It is your order blank. When postman hands you books, pay him the price and the postal charges. If outside the U. S. remit when ordering and include 10 cents per book extra for postage. We have many other books on these subjects and on 2,000 other subjects. Catalog free.

Name.....
City.....State.....
Address.....

Mail to Popular Mechanics Press,
Room 708, 200 East Ontario St., Chicago, Ill.

No Better Christmas Present for \$2.50

than a year's subscription to

Popular Mechanics Magazine
Containing 4500 Pictures and 3600 Articles

Much of it Interests Everybody

Most of it Interests Anybody

All of it Interests Somebody

Order through your Newsdealer or address the Publisher

POPULAR MECHANICS COMPANY

200 East Ontario Street, CHICAGO, ILL.

Buy separately or in assortments

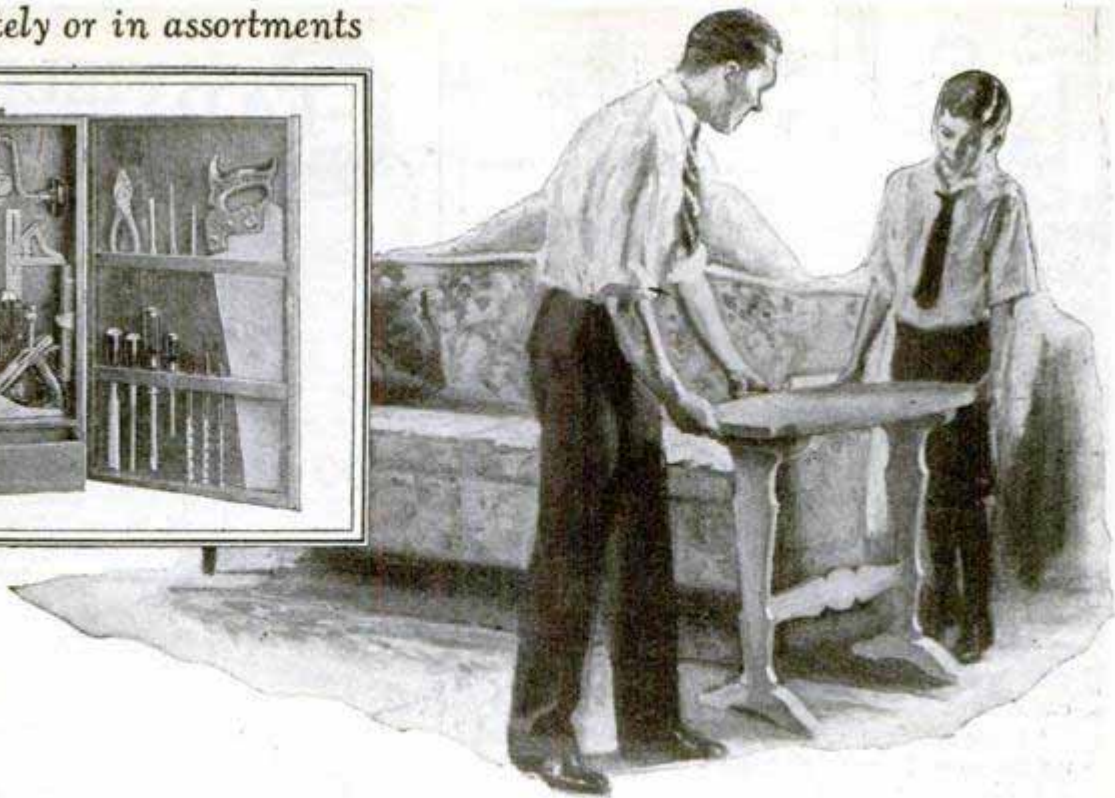
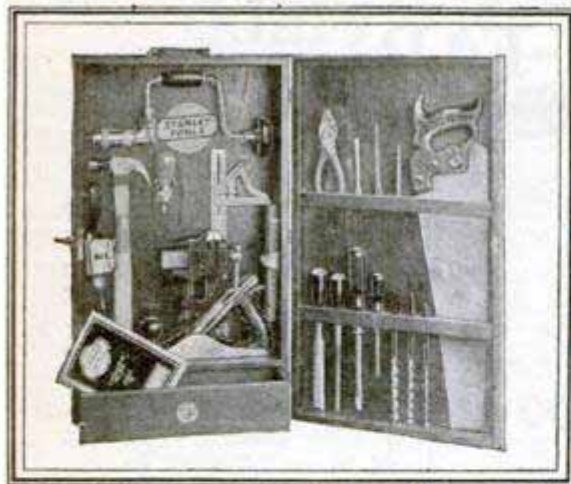

The center table comes to an end!

Make an end table from Plan No. 16d

END tables are now the vogue. To a great extent they have taken the place of center tables. How would you like an end table like the one shown above in your sun parlor, living room or library? Stanley Plan No. 16d gives descriptive drawings and detailed instructions for making this table. For a real evening's relaxation you can't beat making things with tools!



The better the tools the better the work will be. Actually, the amateur user needs good tools even more than the professional. Stanley Tools are used by nearly every carpenter and manual training instructor. Why? Because these men know from experience that the Stanley name assures durability, correct design, and right "feel."

You can buy Stanley Tools separately and so collect your set. For your convenience in buying there are also complete sets of Stanley Tools in chests at a wide variety of prices from \$15 to \$95. Or there are assortments in strong cardboard boxes containing directions for making your own tool chest. Priced from \$5 to \$20.



Your hardware dealer has Plan No. 16d as well as other Stanley Plans for making useful articles, or he can get them for you. The plans cost only 10c each. Ask him also for Catalog No. Sd50, which shows many useful Stanley Tools. It is free. If he cannot supply you, write direct to The Stanley Works, New Britain, Conn.

The best tools are the cheapest to use
Ask your hardware dealer



STANLEY TOOLS



"I wish we had more men like him"

"I've given him two promotions in the last year and he's made good each time.

"I always feel safe in moving him up because I know that he's preparing himself to handle bigger work.

"The International Correspondence Schools keep me advised of the progress he is making and I've encouraged him to keep on. His spare-time studying certainly has made him a valuable man to this firm."

Why don't *you* study and get ready for promotion too? We'll be glad to help you if you will only make the start. And the way to do that is easy.

Choose the work you like best in the coupon below; then mark and mail it to the International Correspondence Schools today. This doesn't obligate you in the least, but it will bring you information that will help to start you on a successful career. This is your opportunity. Don't let it slip by.

Mail the Coupon for Free Booklet

INTERNATIONAL CORRESPONDENCE SCHOOLS "The Universal University" Box 5697-E, Scranton, Penna.

Without cost or obligation, please send me a copy of your booklet, "Who Wins and Why," and full particulars about the course before which I have marked X in the list below:

BUSINESS TRAINING COURSES

- | | |
|--|---|
| <input type="checkbox"/> Business Management | <input type="checkbox"/> Salesmanship |
| <input type="checkbox"/> Industrial Management | <input type="checkbox"/> Advertising |
| <input type="checkbox"/> Personnel Organization | <input type="checkbox"/> Better Letters |
| <input type="checkbox"/> Traffic Management | <input type="checkbox"/> Show Card Lettering |
| <input type="checkbox"/> Business Law | <input type="checkbox"/> Stenography and Typing |
| <input type="checkbox"/> Banking and Finance Management | <input type="checkbox"/> English |
| <input type="checkbox"/> Accountancy (Including C.P.A.) | <input type="checkbox"/> Civil Service |
| <input type="checkbox"/> Nicholson Cost Accounting | <input type="checkbox"/> Railway Mail Clerk |
| <input type="checkbox"/> Bookkeeping | <input type="checkbox"/> Common School Subjects |
| <input type="checkbox"/> Private Secretary | <input type="checkbox"/> High School Subjects |
| <input type="checkbox"/> Spanish <input type="checkbox"/> French | <input type="checkbox"/> Illustrating <input type="checkbox"/> Cartooning |

TECHNICAL AND INDUSTRIAL COURSES

- | | |
|---|--|
| <input type="checkbox"/> Electrical Engineering | <input type="checkbox"/> Architect |
| <input type="checkbox"/> Electric Lighting | <input type="checkbox"/> Architects' Blueprints |
| <input type="checkbox"/> Mechanical Engineer | <input type="checkbox"/> Contractor and Builder |
| <input type="checkbox"/> Mechanical Draftsman | <input type="checkbox"/> Architectural Draftsman |
| <input type="checkbox"/> Machine Shop Practice | <input type="checkbox"/> Concrete Builder |
| <input type="checkbox"/> Railroad Positions | <input type="checkbox"/> Structural Engineer |
| <input type="checkbox"/> Gas Engine Operating | <input type="checkbox"/> Chemistry <input type="checkbox"/> Pharmacy |
| <input type="checkbox"/> Civil Engineer | <input type="checkbox"/> Automobile Work |
| <input type="checkbox"/> Surveying and Mapping | <input type="checkbox"/> Airplane Engines |
| <input type="checkbox"/> Metallurgy <input type="checkbox"/> Mining | <input type="checkbox"/> Agriculture <input type="checkbox"/> Navigation |
| <input type="checkbox"/> Steam Engineering | <input type="checkbox"/> Mathematics <input type="checkbox"/> Radio |

Name.....

Street Address.....

City..... State.....

Occupation.....

Persons residing in Canada should send this coupon to the International Correspondence Schools Canadian, Limited, Montreal, Canada

C-FAR FIELD GLASSES

The Happy Gift for Christmas



G—new and novel—cost only \$2—yet work like binoculars costing 8 times as much. Two lenses in handy leather case that slips easily into vest pocket or purse. Easy to carry, easy to use. At your optical or sporting goods dealer, or by mail, post-paid for \$2.

Take it anywhere
Use it always

DEALERS: Write for attractive proposition.



MAKES RADIO STATIC UNHEARD

A simple, amazing device has been invented by C. H. Geppert, A-207 Hewitt Bldg., Des Moines, Ia., which, users say, filters 50 to 90 per cent of static in radio receiving sets. They also report that when static is not bad, you can increase your volume tremendously, bring in more distant stations, save 30 to 40 per cent on batteries, eliminate local stations from running in, give your set at least one more stage of radio reception and greater selectivity. Works on all radios; can be attached instantly by any one without change to set. Mr. Geppert wants agents and is willing to send a no cost sample. Write him today.

Genuine Imported German \$10 Value PIPES



DIRECT FROM THE VATERLAND

The coolest, most delightful smoke you ever had, you'll agree once you try this pipe. And it is the most beautiful money can buy.

Bowls are beautifully painted. Stems carved horn, nickel trimmed and in 4 to 8 sections according to length of pipe—a wonderful gift for Xmas! **RUSH ORDERS TODAY!** Only a limited quantity available at this low price. 16½ in., \$1.95; 21½ in., \$2.95; 26 in., \$4.25; 29½ in., \$6.75—shipped charges prepaid. Send check, express or money order.

COLUMBIA IMPORTING CO.
Dept. 56 902 West Madison Street Chicago

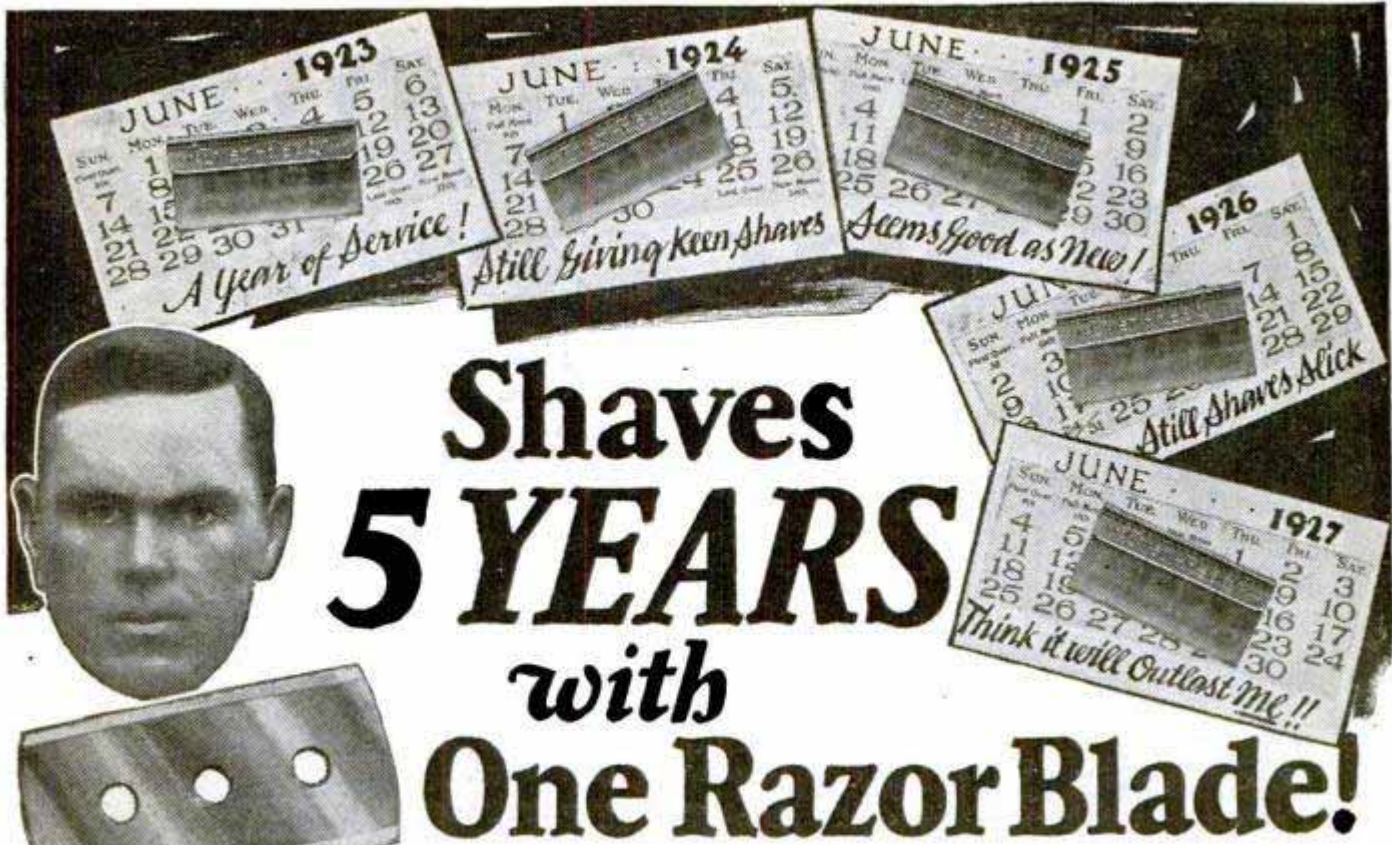

Shaves 5 YEARS with One Razor Blade!

AGENTS!

\$50 to \$200 a Week

KRISS-KROSS is so astonishingly effective in rejuvenating all makes of razor blades that any number of men are earning surprising sums by representing us in their territories. Even spare-time men, office and factory workers make as much as \$6-\$12 a day extra, just showing KRISS-KROSS to friends and fellow-employees. Jas. Tillotson paid entire expenses of a 30-day vacation trip with KRISS-KROSS profits. One day he made \$114! H. King made \$66 in a day—R. Vanderhof sold 27 in 8½ hours—cleared over \$50! Emil Ham made \$200 his first four days, while S. Kantala made \$154 in 3 weeks, working just an hour or two each evening! Why not get your share of these easy profits? We furnish everything and back you to the limit. Check bottom line of coupon and get our big-profit plan at once!



"WHO says it costs a lot of money to operate a safety razor?" demands Mr. M. T. Main of Kenosha, Wisconsin. "Using KRISS-KROSS stropper, I have been getting slick shaves out of one blade for five years, and from the looks of things, the blade will outlast me!" You men who think you are lucky if you get a week's service out of a blade—think that over! But don't waste time envying the man who is banking the money he used to throw away on razor blades! Join the army of KRISS-KROSS shavers right now! You'll never know real shaving

comfort and economy until you do. For KRISS-KROSS actually rejuvenates all makes of safety razor blades (except Durham). It makes them keener than new! Eleven seconds in a KRISS-KROSS Stropper will actually make the oldest blade you own deliver a shave so cool and velvet-smooth that you won't believe your own eyes! That's because KRISS-KROSS actually duplicates the diagonal stropping stroke of a master barber! No wonder more than a million men say KRISS-KROSS has solved their shaving problem forever!

Amazing Offer Means ... No More Razor Blades to Buy!

You can't possibly realize how KRISS-KROSS will brighten your mornings and save you money until you have seen and tried it yourself. So don't fail to take advantage of our liberal trial offer which is now in effect. This

offer includes an amazing new kind of razor, now given Free to KRISS-KROSS enthusiasts. Absolutely unique and different. Adjusts three ways in a jiffy. Requires no cleaning or assembling. Gives a sliding stroke that decreases beard resistance 45%! Comes with five new-process blades—probably the last you'll ever need to get! Do not delay, for this unusual offer is limited and may be withdrawn at any time. Mail the coupon. It will bring full details without obligating you in any way.



Rhodes Mfg. Co., Dept. A-372,
1418 Pendleton Ave., St. Louis, Mo.

Send full details of KRISS-KROSS and your Free razor offer. This request does not obligate me.

Name

Address

City State

Check if interested in making money as a KRISS-KROSS Representative.

Rhodes' KRISS KROSS
Rhodes Mfg. Co., Dept. A-372
1418 Pendleton Ave., St. Louis, Mo. **STROPPER**
World's Largest Manufacturers of Mechanical Stoppers

A Sensational Success!

**They are
Enthusiastic**

Being absolutely pleased with the Eliminator bought from you last June, it is really a pleasure for me to order two more for some of my relatives. Find enclosed money order. Leopold O'Reilly, Montreal, Quebec.

Your Eliminator is certainly working fine. I have it hooked up to a 6 tube No. 20 Atwater Kent and I get better reception than I have had since I owned the set. John W. Jackson, Painesville, Ohio.

The Eliminator I purchased from you six months ago has given perfect satisfaction. I have it connected to a six tube Columbia and get better results than I ever had with B batteries. Bernard V. Dugan, Lockport, N. Y.

I have one of your Eliminators purchased from you last winter. It has been in use constantly ever since and want to say it has been perfect in every respect and cannot be beat by any other. Fred H. Kembel, Hastings, Nebr.

**You will be
enthusiastic, too!**

Townsend "B" Townsend Laboratories Socket Power 713 Townsend Street, Dept. 15 Chicago, Ill.

Send for Literature

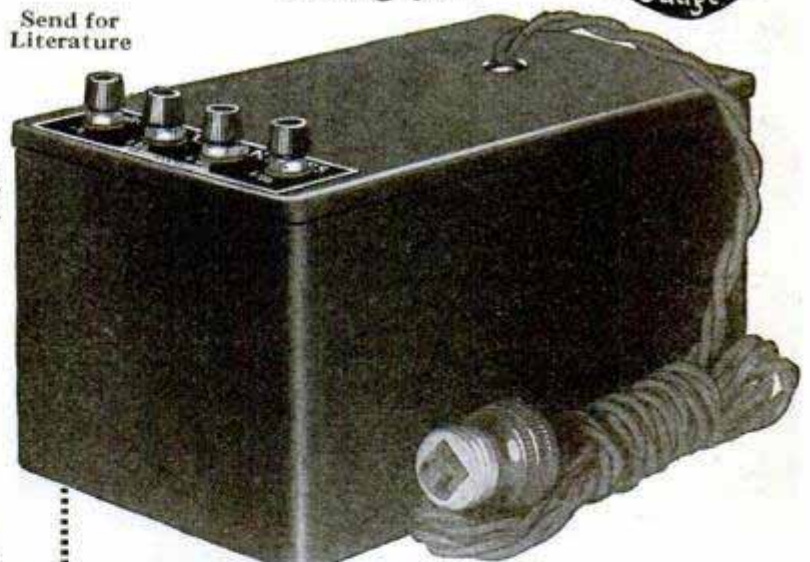

**10 Days
FREE
TRIAL**
You are the
Judge!

TOWNSEND LABORATORIES,
713 Townsend St., Dept. 15, Chicago, Ill.
Gentlemen: Attached find \$1.00. Kindly send at once Townsend "B" Socket Power Unit, C. O. D. for \$5.85, plus postage, on guaranteed 10-day free trial.

Name.....
Address.....
City..... State.....

Complete
\$6.85
\$1.00 Down
Balance C.O.D.
**Attach
only \$1.00
to this coupon**

*Over 25,000 sold
the first 6 months*

Overwhelming evidence that VALUE is quick to be recognized and appreciated.

Unsurpassed quality is built into the Townsend "B" Socket Power Unit with money saved by unified production methods and lower merchandising costs.

You get more—you pay far less—for the most remarkable value in Radio today.

New thousands of Radio set owners are learning this daily by installing Townsend "B" Socket Power.

Sold on REAL GUARANTEE OF MONEY BACK IF NOT SATISFIED. Delivers up to 100 volts on any set, on D. C. or A. C.—any cycle. Full tone, clarity and volume.

Send Order Today Simply fill out the coupon and slip it into an envelope with only \$1.00 and mail it at once. Your Townsend "B" Socket Power Unit will be sent promptly. Deposit only \$5.85 plus postage with the postman. Try out for 10 days—then if it does not do everything we say, return it to us and purchase price will be refunded.

Approved and passed by the rigid laboratory tests of Popular Radio and Radio News.

"Why-It's a Whole Machine Shop!"



Its Grip Locks

AN APPRECIATED XMAS GIFT

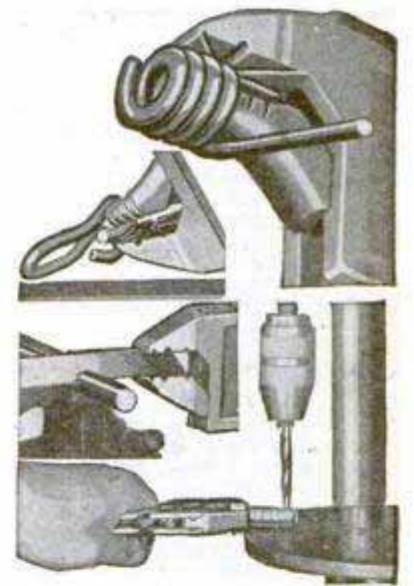
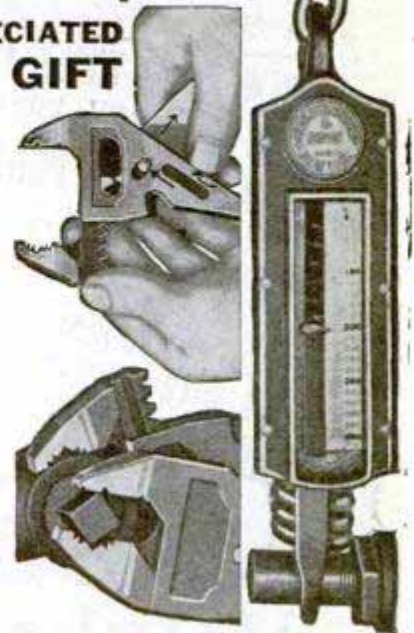

—that is what Users call the EIFEL-FLASH Plier-Rench KIT, because instead of using a dozen tools on One Job they do a thousand jobs with the PlierRench KIT alone! And if this page could show "Mechanics" readers what this Kit can do for them, the Kits reserved for the Special Offer below would not last one day, but—space permits only "a word to the wise."

Helped Win WORLD FLIGHT

USED BY U. S. World Flyers; on U. S. S. Shenandoah, S. S. Leviathan, U. S. Army, Navy, and Mail Planes. By MAKERS of Buick, Chevrolet, Nash, Packard, Reo, Studebaker, etc., Automobiles; each with its employees buying from 200 to 1000 Kits.

Thousands of Housewives are using the PlierRench too, because it is the only tool giving a woman's hand a 1/2-TON grip and enabling her easily to do mechanical work difficult for a man using other tools!

A SUPER PLIER-WRENCH-VISE WITH A 1-TON POWER-GEAR

The PlierRench out-speeds, out-works and out-wears, dozens of best other tools in an incomparably superior way. In 1/8 second the Ratchet Gear-shift fits the Jaws to the work and the handles to the size of Your hand. The One-Ton POWER-GEAR automatically LOCKS and releases the grip on the Corners and "flats" of Any shape and in addition applies 1/2 to 1 TON Direct pressure—64 to 128 TONS per square inch! It is a Perfect Ratchet Turning Wrench!

OUTGRIPS A 40-POUND VISE!

The force of the 1-TON PlierRench Grip is beyond belief—it must be experienced. It Out-grips a 40-LB. VISE; twists round heads off 1/4-in. stove bolts and heads off 1/2-in. Bolts! It will easily, instantly, remove worn, chewed, and chiseled, nuts, broken taps, drills, studs, etc., in tightest places, with next-to-nothing to get hold of—when all other tools fail!

Its smooth Jaws with 4-Way V-Grooves will hold a hair, and all possible shapes from 0" to 1 1/2" diameter with a rigid, clinching grip that never chews or slips one bit. They coil 1/16" to 1" diameter springs of fine and heavy spring wire, and—do a thousand other "impossible" things quickly and easily.

ALL TOOLS in a 24-Ounce KIT

The PlierRench Kit is a Guaranteed, Time-perfected, Super-quality Master Tool, having a Universal Utility that defies Imagination. "The PlierRench Way" Manual of Mechanics—64 Pages with 145 Pictures—shows most valuable uses and advantages!

HUNDREDS OF THOUSANDS of men are using these wonder Kits to make their Homes and Estates more comfortable—Farms, Shops, etc., more profitable; to get more and better service from Automobiles and all mechanical devices, with an enormous saving in money, time and energy!

JUST TRY a PlierRench Kit once, and you would no more go back to other tools than you would to the ancient Ox-cart!

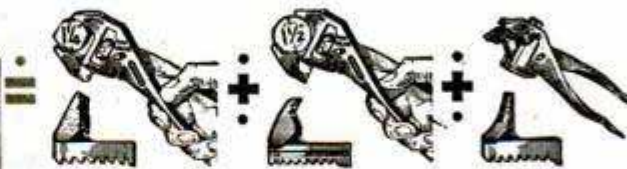
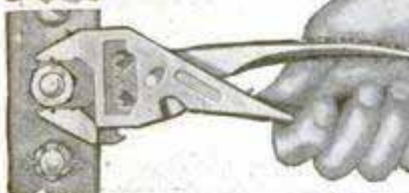
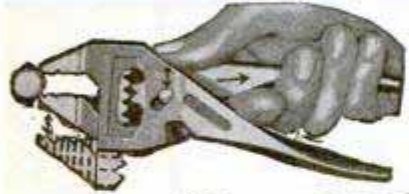

Ltd. Special Introductory PRICE ONLY \$3.75
(Regular Price \$5.00)

The KIT has 3 Gear-Jaws. In 1/8 Second you convert the Universal PlierRench into the Pipe-and-Fitting PlierRench, or into the Wire-Chain-Cable PlierRench—each the Master in its field.

This \$5.00, 1 1/2-Lb., Kit will do the work of 60 Lbs. of other tools costing \$50.00—Quicker, better, easier.

MAKES WONDERFUL GIFTS. Show on Coupon, Kits Wanted on 2-Weeks' MONEY-BACK OFFER—

MAIL TODAY, SAVE \$1.25 PER KIT!

Agents: \$200 a Week

PlierRench representatives earn amazing incomes demonstrating this wonderful new tool. One man alone sold nearly 10,000 in just one state. Fastest seller known. Factories buy by hundreds. Every auto and home owner buys. We have wonderful special proposition to agents. Mail coupon for full details. Why not earn \$75 to \$200 and more a week, spare or full time!



THE FLASH SALES CORP'N
MP-4809 N. Ashland Ave., CHICAGO, ILLINOIS

Plus—
The Flash Sales Corp'n, MP-4809 N. Ashland Avenue, Chicago, Ill.
Name.....
R.F.D.
St.....
P.O.
City.....
State.....
If not delivered I may return within 2 weeks and deposit will be refunded as cash.
Send me only user literature.
I am interested in Salesman's Big Proposition.

Amazing New A C radio tubes eliminate batteries by use of electric house current

NEW RADIO TUBES TO USE ORDINARY HOUSE CURRENT FOR POWER

NEW YORK, Jan. 3rd.—Much interest was aroused in radio circles today by the announcement that a radio tube had at last been perfected which used ordinary electric house current in the operation of...

NEW RADIO TUBE WILL OBSOLETE BATTERY POWER

WASHINGTON, Mar. 5 15th.—... who from the electric... have waited... work from... to be done

ELECTRICAL WIZARD RUNS RADIO WITH ORDINARY HOUSE LIGHTING CURRENT

... A radio receiver...

in the CROSLLEY AC BANDBOX 6 tubes Genuine Neutrodyne



STORIES in regard to the coming of AC tubes which would operate from house-lighting circuits have appeared in various newspapers, arousing a climax of anticipation in the public mind last spring.

With the acquisition of a license by the Crosley Radio Corporation under a large group of patents controlled by the Radio Corporation of America, American Telephone and Telegraph Company, General Electric Company, Westinghouse Electric and Manufacturing Company, etc., and Crosley AC Bandbox is possible through the use of the new R.C.A. alternating current tubes, UX226 and UY227. These tubes utilize for their filaments and heating regular alternating current from the house-lighting circuit. The current is stepped down by means of a transformer without need of rectifiers to supply the heat necessary for the functioning of the tubes. The converter box, which is included with the Crosley AC Bandbox can be tucked away out of sight. It is connected to the Bandbox by a cable and also supplies the current

Now
\$110
without tubes

for the plate voltages on the tubes replacing B batteries. Thus the Crosley AC Bandbox functions entirely from the regular house-lighting current without need of batteries, battery chargers, or any of the other usual paraphernalia which requires attention, care and early replacement.

This set incorporates the famous Mershon self-healing electrolytic condenser. It eliminates the danger of blowing out paper condensers which have caused so much difficulty in electrically operated sets.

The Crosley AC Bandbox with the new alternating current tubes is truly revolutionary, and brings to the radio user an entirely new conception of care-free radio. This AC model together with the battery type "BANDBOX" which works with standard power supply units and storage batteries is the country's most talked of radio! The popularity centers around two major factors:

1. The imposing array of patents under which it is built.
2. The number and quality of the features Power, Crosley, Jr., has built in it for the price!

—And what value Crosley has added in:

1. Complete shielding of all elements.
2. Absolute balance (genuine Neutrodyne.)
3. Volume control.
4. Acuminators for sharpest tuning.
5. Single cable connections.
6. Single station selector.
7. Illuminated dial.
8. Adaptability to ANY type installation.

Today's radio must be adaptable to the home. It must fit into all kinds of conditions. Perhaps you have a bookcase corner—a desk compartment—a chest—or even a bureau drawer where it could be tucked away. Maybe you want it to be part of the furnishings, as an impressive console or credenza cabinet. The Bandbox fits in everywhere.

This is the kind of a radio you have been waiting for—the real direct electric set that requires absolutely no attention. What if it does run all night! Who cares? No run down batteries greet you in the morning. You owe it to yourself to see the Bandbox and listen to its remarkable performance. If you cannot easily locate the nearest Crosley dealer, his name and address will be supplied on request. Write Dept. 15.

Montana, Wyoming, Colorado, New Mexico and West, prices slightly higher.

CROSLLEY RADIO

THE CROSLLEY RADIO CORP.

Power Crosley, Jr., Pres.,
Cincinnati, Ohio

"You're there with a Crosley"

Crosley is licensed only for
Radio Amateur, Experimental and
Broadcast Reception.

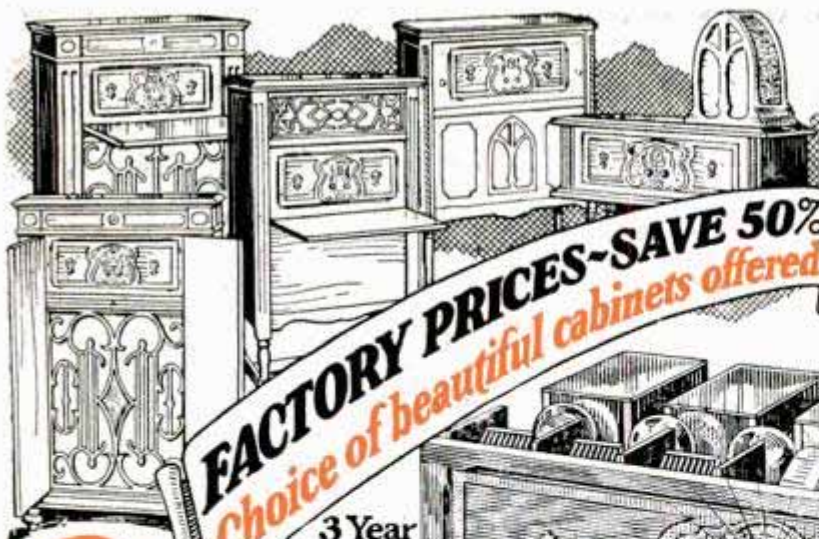

FACTORY PRICES—SAVE 50%
Choice of beautiful cabinets offered

3 Year Guarantee

TRY IT 30 DAYS FREE

BEFORE YOU BUY

ALL METAL SHIELDED CHASSIS

8 tube—
one dial
MIRACO
 TRADE MARK REGISTERED

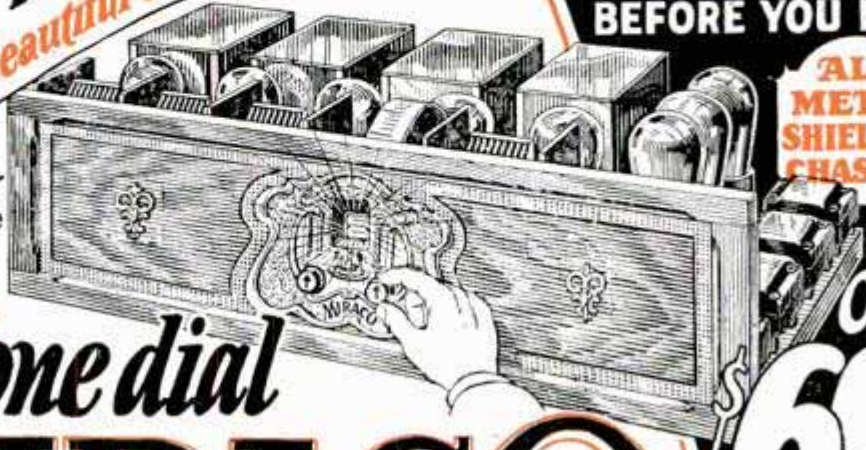

Only
69⁷⁵
 Retail List Completely Assembled

MAGNIFICENT TONE—SUPER SELECTIVE—POWERFUL DISTANCE GETTER

All Electric or Battery Set *Big Discounts to User-Agents*

America's big, old, reliable Radio Corporation (8th successful year) **guarantees** in its big, powerful, latest 6, 7 and 8 tube Miraco sets "the finest, most enjoyable performance obtainable in **high grade radios.**" Unless 30 days use in your home fully satisfies you a Miraco is unbeatable at any price for beautiful, clear cathedral tone, razor-edge selectivity, powerful distance reception, easy operation, etc.—**don't buy it!** Your verdict final! Save or make lots of money on sets and equipment—write for testimony of nearby users and **Amazing Special Factory Offer.**

cathedral tone quality of costliest sets. Don't confuse Miraco's with cheap, "squawky" radios. Miraco's have finest parts, latest approved shielding, metal chassis, etc.—as used in many \$200 sets.

DEAL DIRECT WITH BIG FACTORY

Your Miraco reaches you completely assembled, rigidly tested, fully guaranteed. Easy to connect and operate. **30 days trial free.** 3 year guarantee if you buy. You take no risk, you insure satisfaction, you enjoy **rock-bottom money-saving prices** by dealing direct with one of radio's oldest, most successful builders of fine sets. 8th successful year.



7 tube one dial METAL SHIELDED CHASSIS \$49⁷⁵ RETAIL LIST

MIRACO "Powerplus" sets—8 and 7 tube models—have magnificently beautiful, clear cathedral tone quality. Turn one dial for stations everywhere. Ultra-selective. Latest all-metal shielded chassis. Illuminated dial. Fully guaranteed. Try one free for 30 days! Big selection of beautiful cabinets.



Dealers Write! **USER-AGENTS!** Make big profits showing Miraco to friends. Get Our Special Wholesale Prices! **MID-WEST RADIO CORPORATION, Cincinnati, O. BEAUTIFULLY ILLUSTRATED CATALOG AND AMAZING SPECIAL OFFER**

Free!

SEND NO MONEY—30 DAYS' TRIAL, Special Wholesale Price Offer to User-Agents, Bank References, testimony of nearby Miraco users—all the proof you want—sent with catalog.

mail coupon right now!

ANOTHER BIG BARGAIN! Famous powerful big Miraco Super 6, 1928 model—ultra selective! Thousands find it outperforms sets of much higher price. **30 Days' Trial Free. Fully Guaranteed.**



6 tube Super \$36⁷⁵ RETAIL LIST

Electrify Any Radio with MIDWEST NO-BATTERY AC Light Socket Power Units

Save \$'s "A", "B" and "C" power, direct from light socket, without batteries! Write for Midwest prices and discounts. Units are highest grade—lastingly dependable, quiet in operation, fully guaranteed. Mail coupon!

MIDWEST RADIO CORP'N
 Pioneer Builders of Sets
 407-G Miraco Bldg., Cincinnati, Ohio.

THIS COUPON IS NOT AN ORDER

WITHOUT OBLIGATION, send me free literature. AMAZING SPECIAL WHOLESALE PRICE OFFER, testimony of nearby users, etc.

User Agent Dealer

NAME _____

ADDRESS _____

Miracos work equally fine on "AC" electric house current or with batteries. Take your choice. Many thousands of Miraco users—who bought after thorough comparisons—enjoy programs Coast to Mexico, Canada to Mexico, loud and clear—with the magnificent

The Super-Speed Way Shop

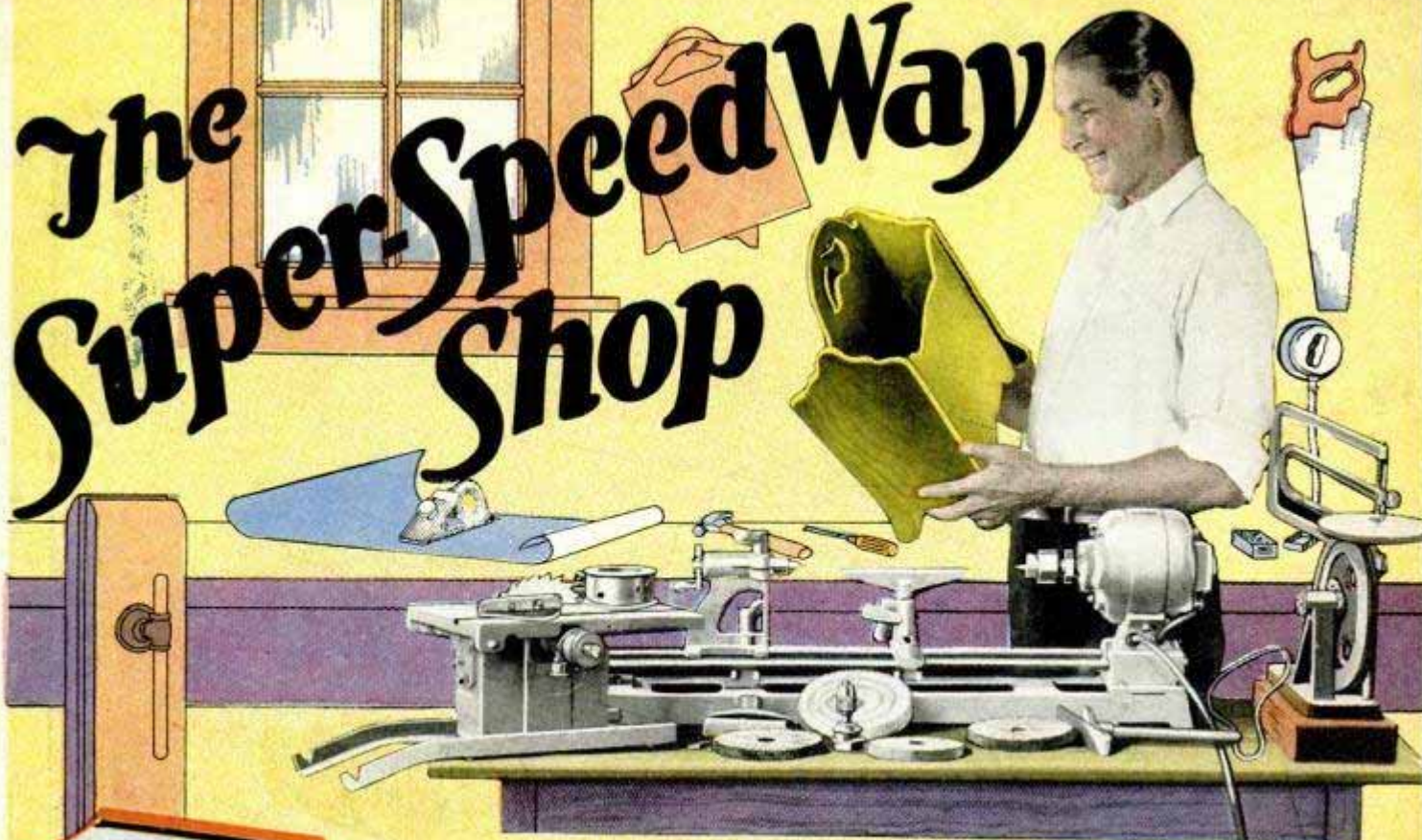

**10 Days
free
trial**

Completely Motorizes your work bench

Ten Days of Fun at Our Expense

Now you can make that special cabinet or table lamp or the many other things that you've been wanting to make, but have given up for lack of adequate tools. We'll help you with a SpeedWay Shop. It's yours for a ten day trial. If you'll start just one article and see the job through, you'll never return your SpeedWay Shop. Users of the Super-SpeedWay Shop are enthusiastic in their praise. They say: "Fascinating, intriguing, profitable." It's true, too—you can make almost anything—attractive pieces of furniture, toys, home and garden improvements, radio cabinet and consoles, bric-a-brac, bookshelves, countless other articles. There is a thrill of joy and pride of workmanship when your workbench is MOTORIZED WITH THE SUPER-SPEEDWAY SHOP.

SpeedWay Shop Even Meets Needs of Commercial Users

Job Men, Contractors, Builders, Tool Lovers, in Shops and in Homes, are cutting cost-increasing profits with the new SpeedWay Shop. Everything about this Super-SpeedWay Shop shown above is strong and sturdy—built for both commercial and home use yet it is so portable that it operates from any light socket. Just snap a switch and presto—you have motorized your work bench.

9 Practical Heavy Motor Driven Tools

- The Super-SpeedWay Shop (Model "SS") shown above, embodies the following:
1. Motor driven lathe on solid cast-iron base, works up to 10" diameters and 18" lengths, (extra length rails for 36" work if desired).
 2. Power drill for 3/8" in steel and 1/2" in wood.
 3. Bench Saw with 6" Novelty blade for ripping and cross cutting. Mitres and grooves too.
 4. Pattern makers jig-saw, will handle 20" work.
 5. Motor-driven grinder with 5" emery—noiseless.
 6. 6" double metal scratchbrush for removing paint and rust.
 7. 6" Buffer and Polisher for finishing woods and metals.
 - 8 and 9. Home made drum and disk sanding attachments. Nothing left to buy; the shop is complete as it comes to you.

Buy Only the Tools You Need

We offer 9 models to select from. A combination to suit everyone. No matter what work you want motorized tools for, there is a SpeedWay Shop combination to fit your individual requirements.

A Combination to Suit You

From the very smallest assembly to the Super-SpeedWay Shop shown above you'll find the same high standard of precision that has made the name SpeedWay known throughout the industrial world for its famous Portable Electric Tools. Our new 20-page catalogue describes them all. It's yours for the asking.

Pay While You Use It!

We want to make it as easy as possible for you to own a SpeedWay Shop. If you mean business, give us a small down payment, as evidence of your good faith and we'll ship you one of these shops immediately. Subject to your approval. If you like it (and you will) keep it and pay the balance as you use it—in small monthly installments.

24 FREE Blue Prints

24 working blue prints of toys, furniture, etc., are furnished free with each SpeedWay Shop.

**10⁰⁰
down**

**Easy
terms**

**money
back
guarantee
no shipping
delay!**

Wood Turning

The SpeedWay Lathe shown with work in place. Note firm grip and sturdy appearance of this assembly.

Drilling

Shows drill chuck with bit in place. Tail stock may be run up on rails to provide pressure feed, drill press for hard drilling or for mortising.

Grinding

Use your SpeedWay Shop for all grinding jobs. Photograph shows 5" grinding wheel fitted on to accessory arbor. Direct drive, no vibrations. No noise.

Polishing and Buffing

The illustration at left shows buffing wheel as used on the accessory arbor. May be used for all kinds of polishing and for putting fine finishes on wood. Double metal scratch brush may be used in same manner.

Bench Saw

Photograph below shows No. 266 Bench Saw. Drives at 4,000 RPM. Note simple supporting arrangement. No nuts to tighten. Lifts on and off. Rips, cross-cuts, mitres and grooves.

Don't Delay—Write Today for Special Offer!

Don't waste time—write to this big factory today and benefit by our 20 years' experience in making Portable Electric tools. We have Sales and Service Stations in 15 of the principal cities—ask for name of local distributor if you want demonstration. Send the Coupon Today.

ELECTRO MAGNETIC TOOL CO.
Department 2-J 1830 S. 52nd Avenue
CICERO (Adjoining Chicago) ILLINOIS

Remember, this is the only Company in the world making a complete line of Portable Electric Saws, Hammers, Drills, and Grinders.

SEND COUPON NOW!

Electro Magnetic Tool Co., Dept. 2-J,
1830 S. 52nd Ave., Cicero, Ill.

Gentlemen: Please send me one of your new big catalogues describing in full the SpeedWay Shop, along with details about your 10-day Free Trial Plan, Free Blue Prints, and Easy Down Payments, Personal Service, etc.

Name.....
Address..... City..... State.....