

# POPULAR MECHANICS

## MAGAZINE

WRITTEN SO YOU CAN UNDERSTAND IT

REG'D. TRADE MARK, GREAT BRITAIN, No. 410428

REG. U. S. PAT. OFF.



SEE PAGE 716

When They Try  
To Come Back  
—*Tex Rickard*



# ATKINS

## SILVER STEEL SAWS

Mr. Happy Man Says— "Save When You Saw"

A genuine ATKINS "Silver Steel" Cross Cut Saw will save you more than it costs.

Only ATKINS can give you "Silver Steel" to make YOUR Saw outlast two or three "cheap" saws, and hold its sharp cutting edge longer.

Only ATKINS can give you a real "segment ground" saw to cut faster and easier through years of hard service.

In leading lumber camps they KNOW the facts and use ATKINS. Why should YOU try to save a little in first cost on a "cheap" saw and pay for it in every minute you try to use it? Look for the ATKINS name on the blade, when you buy a saw for any use. It means saving in sawing.

E. C. ATKINS & CO., Est. 1857  
426 S. Illinois St., Indianapolis, Ind.

*Leading Manufacturers of Highest Grade Saws for Every Use; Saw Tools, Saw Specialties, Plastering Trowels, Machine Knives, Grinding Wheels and Files.*





# Try a New Conn FREE

Conn trumpets  
are easiest to  
blow, brilliant  
in tone.



The new Conn  
saxophone has  
many exclusive  
features.



Conn Trombones  
are used by pop-  
ular and sym-  
phony artists.



The new Conn  
sterling silver  
armored clari-  
net is the "last  
word."



Conn cornets are  
distinguished by  
rich, full tone.



**CONN**  
BAND  
INSTRUMENTS  
WORLD'S LARGEST MANUFACTURERS

THINK OF IT, you can have any one of the newest models of Conn instruments for band or orchestra, to try in your own home, *free and without the slightest obligation!*

Simply pick out the instrument which interests you most—send us the coupon, and we'll gladly send complete literature and details of this amazingly liberal free trial offer.

With a new Conn saxophone you learn to play tunes almost immediately. A short period of pleasurable practice enables you to entertain yourself and friends. Amateur quartets have been formed and played popular music within ten days. *Cultivate your musical "bump" now with a Conn.*

Conn instruments—cornets, trumpets, trombones, saxophones, clarinets, flutes, drums, etc.—are used and endorsed by world famous artists. And the famous hydraulic expansion process, distinctive with Conn, makes every instrument of the same high quality.

## EASY PAYMENTS

Send the coupon today for free literature and details of free trial, easy payment plan on any Conn. And remember, Conn is the only maker of every instrument used in the band. With all their exclusive features Conn instruments cost no more than others. Get the facts NOW.

C. G. CONN, Ltd., 931 Conn Building  
Elkhart, Indiana

## MAIL THIS COUPON

G. G. CONN, Ltd., 931 Conn Bldg., Elkhart, Indiana  
Please send free literature and details of free trial, easy payment plan on

(Instrument) \_\_\_\_\_

Name \_\_\_\_\_

St. or R. F. D. \_\_\_\_\_

City \_\_\_\_\_

State \_\_\_\_\_

County \_\_\_\_\_



788V-CDG-68WE



# \$15,000<sup>00</sup> in cash prizes for a slogan about WOOD

*Read the fascinating story of Nature's most friendly and useful material. Know more about its beauty, durability and economy. Learn the truth about America's vast and permanent supply of timber. Then send us your slogan!*

This message may mean \$5,000 to you. And remember that these slogan contest prizes are seldom won by professional writers or technical experts. Nearly always the winners are people who never expected to win. So do not skip anything—not one word.



### No timber shortage

Almost everyone has been induced to believe that this country is confronted by an acute shortage of timber. This is not true.

In fact, Col. William B. Greeley, U. S. Forester, urges the nation to "Use wood and conserve the forests." For timber is a *crop*. It needs to be cut when ripe. Failure to do so means *waste*.

There is enough standing timber in the United States today to build a new six-room house for every family in this country, Canada, South America, all of Europe and the entire British Empire! And the *additional* lumber supplied by the *yearly growth* of standing trees would build a continuous row of these houses along both sides of a street reaching from New York to San Francisco.

### Better lumber than ever

Not only plenty of lumber—but *better* lumber! Today, *American Lumber Standards*, adopted by the industry and endorsed by the U. S. Government, give the purchaser protection he never had before.

Universal adoption of reliable standards has won for the Lumber Industry high praise from Secretary of Commerce Herbert Hoover.

### Wood built America

Without wood there could have been no America!

Stout wooden ships brought the settlers of America across the wide stretches of the stormy Atlantic. Wood sheltered them in sturdy log cabins and wood housed their de-

scendants in colonial mansions—many of which endure today.

Throughout the Thirteen Colonies wood built the homes, the churches, the town halls, the schools. Wood built the wharves, the warehouses, the stockades, the barns, the corn cribs, the bridges.

Later, the Forty-Niners battled their way over the long cruel trail to California in covered wagons made of wood. On ties of wood the railroads advanced unceasingly, West, East, North and South.

### Uses constantly increasing

Twenty years ago there were less than 2600 commercial and industrial uses for wood. Today there are more than 4500.

From the staunch timbers in mine shafts to the buoyant strength of Lindbergh's immortal plane, wood serves mankind in countless and ever-increasing ways.

### Wood endures

The oldest and most beautiful homes in America are houses built of wood. Many of them stand today, as sound in timber and beam, and *as livable*, as they were before the Revolution.

Wood endures—and the supply is enduring. It is the only one of our natural resources that *grows*.

### Wood is beautiful

Wood possesses a pleasing natural beauty of grain and texture that mellow and deepens with age and defies imitation. Wood can be fashioned and carved and fitted into thousands of charming designs.

And surely it is significant that the American architect prefers lumber for his own home!

### Wood is friendly

Of all materials there is none so *friendly* as wood. The handle of a tool, the steering wheel of your car, the arm of your chair, the bowl of your pipe—you like the feel of them because they are wood.

### Wood is economical

Wood is easily and cheaply fitted to special forms for special needs. Its moderate cost is due, in no small measure, to the elimination of waste. There is a grade of lumber for every purpose, a right wood for every need.

To inspire renewed and greater appreciation of wood, manufacturers of American Standard Lumber in the National Lumber Manufacturers Association are preparing an extensive educational campaign. The first thing the Association wants is a "slogan." Send your coupon *now!*

NATIONAL LUMBER  
MANUFACTURERS ASSOCIATION  
Washington, D. C.  
*Manufacturers of American Standard Lumber*

*This free booklet may mean  
\$5,000<sup>00</sup> to you*

*Send today!* Mail coupon below and booklet will be sent you postpaid. It contains the *Official Blank On Which Your Slogan Must Be Submitted*. This may mean \$5,000.00 added to your bank account. So mail your coupon right now.

First Prize . . . . .	\$5,000
Second Prize . . . . .	2,000
Third Prize . . . . .	1,000
Four Prizes (each) . . . . .	500
Fifty Prizes (each) . . . . .	100
Total . . . . .	15,000

*In case of tie the full  
prize will be paid to  
each tying contestant*

Contest  
Closes  
December 15



National Lumber  
Manufacturers Association  
P. O. Box 811, Washington, D. C.

Gentlemen:—I want to enter your \$15,000 Prize Slogan Contest. Please send me free copy of your booklet, "The Story of Wood," so that I may qualify.

Name.....  
Street.....  
R. F. D., Town or City.....  
State.....

P. M.  
11.27



# Popular Mechanics Magazine

200 E. Ontario Street, Chicago, U. S. A.

H. H. WINDSOR, Founder

H. H. WINDSOR, Jr., Editor and Publisher

London: Hachette & Cie.,  
16-17 King William Street, Charing Cross, W. C. 2

Paris: Hachette & Cie.,  
111 Rue Reaumur

Melbourne: Gordon & Gotch  
509-513 Little Collins St.

ISSUED MONTHLY

SUBSCRIPTION:

SINGLE COPY, 25 CENTS

In United States and its possessions, also Canada, Cuba, and Mexico, per year, postpaid . . . \$2.50

To all other countries in the Postal Union . . . . . 3.00

All subscriptions are discontinued at expiration. Please examine the date printed on your wrapper.

Entered as Second Class Matter Sept. 15, 1903, at the Post Office at Chicago, Illinois, under Act of March 3rd, 1879.

Entered as Second Class Matter at the Post Office Department, Canada.

Published monthly by POPULAR MECHANICS CO.

Copyright, 1927, by Popular Mechanics Co.

Copyright in Australia. Copyright in France

Vol. 48

Contents for November, 1927

No. 5

Agricultural Implements—farm problems solved by machinery . . . . .	809	Children—window sun room for baby . . . . .	707
Agriculture—methods to reduce farming costs studied in England . . . . .	818	Chromium—scarcity in U. S. handicaps industry . . . . .	760
Airplane		Clouds—thickness of . . . . .	767
detachable pontoon for seaplane serves as a boat . . . . .	802	Cosmetics—centuries old found in Austrian ruins . . . . .	792
spare tire aids safer flying . . . . .	791	Crime—"safest safe" robbery puzzles police . . . . .	754
Anæsthetic—for patients with lung disorders . . . . .	792	Crops—coining surplus into money . . . . .	795
Animals		Crystal Palace—cleaned by expert climbers . . . . .	736
lifelike museum exhibits . . . . .	708	Damascus—covered street resembles pipe line . . . . .	800
wild, die early, "census" shows . . . . .	721	Dogs	
Archæology—century-old mystery relics from Mexico . . . . .	797	how the world looks to . . . . .	782
Architecture—animal and plant life to be carved on cathedral . . . . .	737	life belts for . . . . .	707
Arctic—expedition to, will aid navigation . . . . .	785	wins five first prizes . . . . .	721
Astronomy—mystery of Saturn's rings . . . . .	802	Drinking Glass—that won't spill . . . . .	735
Automobiles		Drinking Trough—automatic, for cattle . . . . .	709
breaking them up to improve them . . . . .	819	Dust—enormous amount floats over cities . . . . .	806
jumps obstacle at 60 miles an hour . . . . .	768	Earth—diamond drills may reveal secrets of interior . . . . .	786
potato on Idaho license . . . . .	769	Education—textbooks illustrated with "movies" . . . . .	775
Automobiles—Accessories		Electric Lights—night floor light has glow regulator . . . . .	806
air gun for greasing . . . . .	824	Eyes—rate of functioning of . . . . .	798
anti-froster gives clear view always . . . . .	792	Fire Fighting	
ash tray and gear shift combined . . . . .	776	water gun on boat throws fifty gallons a second . . . . .	783
brake adjuster on dashboard . . . . .	807	with the fire-insurance patrol . . . . .	755
fuel meter registers waste . . . . .	816	Fish and Fishing	
lamp to heat radiator prevents freezing . . . . .	731	fish-basket top holds hooks and lines . . . . .	806
shade prevents day or night glare . . . . .	709	fish caught by electricity . . . . .	715
Automobiles—Driving		folding reel to dry line . . . . .	719
extra steering wheel promotes safety . . . . .	767	Foods—odd, in many lands . . . . .	823
gauge measures foot action to test drivers . . . . .	762	Football	
Automobile—Tires		building beef and brawn for . . . . .	716
automatic valve gives accurate pressure . . . . .	769	meter to locate ball on field . . . . .	721
"totem pole" of used, marks desert road . . . . .	809	Fruit—ripened quickly if stored in gas . . . . .	737
Aviation		Furnace—combustion unit for, to reduce coal bill . . . . .	812
air landing planned for post-office roof . . . . .	816	Garage—Equipment—wrecking car like locomotive . . . . .	718
air truck makes deliveries by parachute . . . . .	777	Garden—toadstool canopy is novel decoration . . . . .	728
high-school course to promote flying . . . . .	731	Gas—carried across auto road in flat pipes . . . . .	727
how high can man fly? . . . . .	778	Golf—tee and score pencil combined . . . . .	799
Lindbergh tells future of . . . . .	738	Grass—rice, protects sea wall and helps reclaim land . . . . .	794
radio beacon to guide planes through storm . . . . .	824	Gun—man shot from . . . . .	775
transfer of new plane parts in air . . . . .	759	Health—creeping helps children with weak spines . . . . .	718
vapor light penetrates fogs . . . . .	728	Heater—in platters, helps keep food warm . . . . .	823
weather "cards" promote flying safety . . . . .	807	Highways—patrol service removes glass from . . . . .	737
Baby Carriage—rocked by motor . . . . .	762	Horses—spectacles for race . . . . .	824
Beauty Culture—face bath of light and vapor . . . . .	719	Household Devices . . . . .	814
Bees—secrets of raising taught at German school . . . . .	777	House Plan . . . . .	880
Bicycle—riding on whirling disk . . . . .	754	Insects—caught with bow and arrow . . . . .	817
Birds		Leprosy—1,000 cases cured in five years . . . . .	732
girl trains for movies . . . . .	785	Lions—jungle scenes painted for cage . . . . .	817
hunting birds of Paradise . . . . .	722	Magnet—extracts metal from eyes . . . . .	732
Boats and Boating—speed boat to cross ocean in 24 hours . . . . .	809	Mail—speeding overseas . . . . .	705
Bridge		Mileage—determined by wheel with special speedometer . . . . .	727
new Hudson river to be largest steel structure . . . . .	718	Mirror Gauge—gives measure of person's height . . . . .	800
old stone, more beautiful than modern steel . . . . .	794	Moleskins—trade in, totals millions yearly . . . . .	732
Burros—used in taming horses . . . . .	761	Moths—trapped by electricity to protect tomatoes . . . . .	727
Butterflies—profit and pleasure from farm . . . . .	822	Moving Pictures—portable camera for close-ups . . . . .	715
Cactus—craftsman makes beautiful objects from . . . . .	745	Mudguards—detachable, for shoe heels . . . . .	802
Camera—used to produce wood graining . . . . .	726	Navigation—sound compass device aids ships . . . . .	803
Canoe		Navy—of the future . . . . .	746
paddled by arms for surf sport . . . . .	769	Octopus—huge, killed by diver . . . . .	785
pocket sponson for, ends danger . . . . .	736	Oil Well—spiral stem for bit, insures straight hole . . . . .	725
Carbon—essential to life . . . . .	783	Organ—pipe, outdoors for park concerts . . . . .	792
Cement—steel mixer for, serves as supply cover . . . . .	794	Ozone—produced from generator attached to electric fan . . . . .	801
Check Protector—in pocket bill fold . . . . .	806	Paints and Painting	
		electric mixer . . . . .	818
		joc that never ends . . . . .	728
		Patent Office—queer things in nature's . . . . .	810
		Paving—cement tamper speeds . . . . .	768

[Continued on Page 4]



## [Contents—Continued]

Physical Culture	
gauge shows pep of gymnasium students	754
reduction exerciser also develops arm muscles	802
Pianos—untuned, cause loss to students	754
Pile Driver—giant, drives two at same time	767
Playground Equipment—parcel chute makes children's slide	744
Poles—"vaccinated" to prevent rot	770
Police—Canadian Royal Mounted replace dogsleds with plane	784
Prize Fighting—when they try to come back	710
Radio	
causes of static	838
how to prevent "motorboating"	825
portable tester for service men	829
shielding a.c. line to prevent hum	829
Radio—Applications	
fire alarm helps protect city	768
photographs convey navy orders	727
picture, larger than life on giant receiver	776
Radio—Batteries—rate of discharge in idle	835
Radio—B-Eliminator—combined with power amplifier	829
Radio—Condenser—adjustable three-gang	836
Radio—Construction—eliminating unnecessary leads	836
Radio—Loud Speaker	
combined with art tapestry	838
efficient cone, combined with table lamp	836
Radio—Pictorial	837
Radio—Receiver—nine-tube superhet built for \$50	831
Radio—Tubes—light-socket supply for power	838
Railroads	
engine pictured in plants for anniversary	770
test line to run cars 200 to 300 miles an hour	794
train is announced by bugle	735
Rainfall—gauge shows record	801
Refreshment Stand—lemon-shaped, draws crowd	732
Reptiles—skins used for shoes and trimmings	793
Rubber	
from cactus promises lower tire cost	720
new uses for	800
Sardines—putting the can around	763
Sculpture—with beach sand	726
Searchlight—giant, rivals the sun	776
Seaweed—new industries from in California	728
Ships and Shipping—lightweight metal to reduce the weight of vessels	812
Skyscrapers—huge task to care for	766
Snow Cutter—and blower clears roads quickly	813
Soapsuds—extinguish oil or gasoline fires	753
Soil—samples preserved in government library	761
Spectacles	
safety, for sports	783
with mirrors afford rear view	715
Speedometer—first was used on Mormon wagon	719
Steam—instead of sandblast to clean buildings	798
Steamboat—John Fitch invented first	745
Steam Power—the romance of	729
Stovepipe—flue in, facilitates cleaning	801
Street Car—children build as kindergarten lesson	782
Street Lights—cleaning simplified by telescope ladder	737
Surgery—doctor uses strange implements in operation at sea	736
Surveying	
colored sight cards aid	817
with thermometer aids in accurate	731
Swimming Pool—artificial waves add thrill to	807
Target Shooting—leg strap helps marksman take accurate aim	745
Theater	
children's, on wheels	799
expert noise maker for	818
Thermometer—first, a toy	762
Toaster—rapid action, electric	813
Treasures—old Roman found under Bank of England	770
Tree—valuable, guarded by lightning rods	709
Tropics—conditions of, reproduced in test chamber	784
Truck—hand, loaded by lever	798
Turkey—feathers replace ostrich plumes	771
Ultraviolet Rays—reveal secrets of fossils	753
Umbrella—worn on shoulders leaves hands free	709
Walnuts—black, husker cleans bushel in five minutes	760
Watch—tells world time and predicts weather	823
Water Tank—heated with electric belt	769
Weather—what to believe about weather lore	733
Wells—horizontal, save expense in water supply	823
Whaling—ship that swallows whales is successful	808
Windows	
cleaned from inside through inset pane	801
show, protected against thieves by falling shutter	798
Wolves—hunted with dogs carried in special car	760

## AMATEUR MECHANICS

Armor—how to make wall piece	846
Automobiles—Accessories—charging rate controlled by rheostat	842
Automobiles—Driving—road map mounted on spring roller	860
Automobiles—Equipment and Supplies	
concealed switch prevents theft	845
reflux condenser for radiator	840
Automobiles—Repairing	
leaky Ford radiator	852
replacing window and door glass	843
Basin—repairing cracked soil	853
Boats and Boating	
easy way of handling outboard motors	839
laying up the boat for the winter	854
Corkscrew—substitute for	840
Costume—mask made from corrugated fiber boxes	842
Drilling—level holes with brace and bit	841
Eave Trough—screen covering prevents stoppage and overflow	843
Emery—non-scratching, for polishing	860
Flowers	
chemical garden	844
watered with lamp wicks	852
Galoshes—how to put on easily	844
Golf—sweeper for greens	843
Hogs—feeder for young	841
Household Devices	
milk bottle caps to seal jelly tumblers	851
preventing picture marks on walls	853
Locks—assembling flush extension bolt in door lock	841
Paints and Painting—decorating iron castings	840
Palette—pocket, for artist	851
Paper Cups—used for funnels	845
Photography—focusing shield for box camera	853
Rats—kept away with roofing tar	844
Roof—repairing leaks around chimney	853
Saws and Sawing—clamp holds logs and knotty sticks	860
Serving Tray—waterproofing a	844
Sewer Pipes—marking position of	860
Stepladder—extra legs steady	845
Stovepipe—how to crimp	853
Telephone—lock for dial	842
Tent—self-closing flies for	843

## SHOP NOTES

Advertising—glass window signs	874
Agricultural Implements—paint on harvester keeps straw from beneath slats	866
Automobiles—emergency grease gun for differential	866
Automobiles—Equipment and Supplies	
reflector illuminates oil indicator	868
spotlight that turns with wheel	878
Automobiles—Repairing	
removing overhead valve cages	877
tightening Ford door handles	869
Blowtorch—useful accessory for	869
Bushings—compressor for	865
Circle—to scribe without compass	878
Clay—molding, for casts	866
Corrosion—preventing on shafting	874
Cuspidors—sanitary carrier for	877
Draftsman's Kinks—friction button holds triangle	873
Drill—truck support is advantageous	869
Drill Press—combination scraper and brush for	874
Earth Fill—making without trestle	867
Gas—method for locating leaks	865
Glass—as substitute for tracing cloth	868
Glue—uses for, around the home	861
Heaters—hot-water, that work	870
Lathe—chip guard for	879
Paints and Painting—two-color job on chair legs	877
Photography—kinks in washing negatives and prints	879
Polishing Wheel—side shields for	879
Saws and Sawing	
jigsaw blade for hard material	874
to repair saw handle	875
Sewing Machine—movable stand and cabinet	876
Steel—acid test for	879
Tool Bits—doubling life of	867
Tractor—removing heavy wheel	875
Wagon Tongue—ladder made from	868
Wheelbarrow—guards for handles for close quarters	874
Windmill—coil spring easily starts	866
Woodworking—heat aids	878



# DRAKE'S PRACTICAL MECHANICAL BOOKS

## THEY WILL RAISE YOUR PAY— ORDER ON 5-DAY TRIAL

The books listed below will perfect you in your chosen trade—pave the way to the big positions. Written in non-technical language—easy to read and understand. Every book covers its subject completely. An entire course of instruction condensed into one volume. Your choice sent postpaid—you benefit 5 days—money refunded in full if not entirely satisfactory. Order direct from this page.

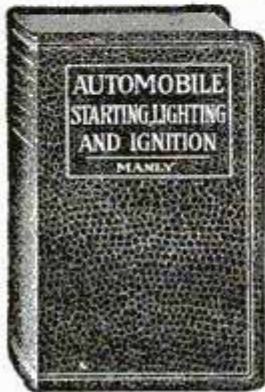

### Automobile Books

- Automobile Starting, Lighting and Ignition, by Manly... 700 pp. **\$3.00**
- Brookes' Automobile Handbook... **\$2.00**
- Ford Motor Car, Truck and Tractor, by Manly... Cloth **\$1.50**
- Automobile Battery, Care and Repair, by Manly... Leatherette **\$2.00**
- Motocycle Handbook, by Manly... **\$1.50**

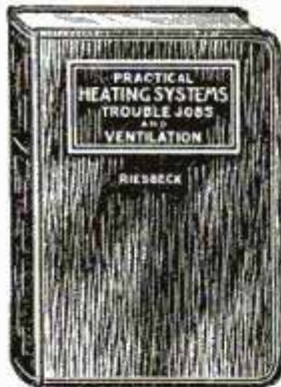

### Shop Practice Books

- Practical Heating Systems, Trouble Jobs and Ventilation... **\$4.00**
- Sheet Metal Workers' Manual... **\$2.00**
- Oxy-Acetylene Welding and Cutting... Cloth **\$1.25**
- Slide Rule and Logarithmic Tables... **\$2.00**
- Handbook for Millwrights... Cloth **\$2.00**
- Machine Shop Practice... Cloth **\$2.00**
- Mechanical Drawing and Machine Design... Cloth **\$2.00**

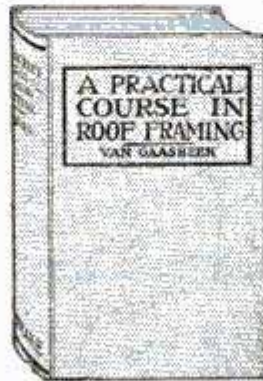

### Carpentry Books

- Cloth Binding
- Modern Carpentry, 2 vols... **\$3.00**
  - The Steel Square, 2 vols... **\$3.00**
  - Modern Estimator... **\$1.50**
  - Timber Framing... **\$2.00**
  - Builders' Architectural Drawing... **\$2.00**
  - Concretes... **\$1.50**
  - Practical Bungalows... **\$1.00**
  - Roof Framing, by Van Gaasbeek... **\$1.50**

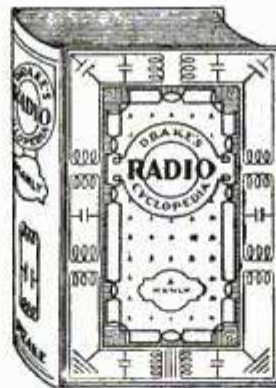

### Drake's Radio Cyclopaedia

By H. P. Manly  
870 Pages, 985 Illustrations, 1700 Subjects, arranged alphabetically. For Service and Repair Men, Dealers, Salesmen, Experimenters and Designers. Bound in Art Buckram. Price... **\$6.00**



### Painting and Decorating

- Furniture, Furniture Finishing, Decoration and Patching... **\$5.00**
- Ross Crane Book of Home Furnishing and Decoration... Cloth **\$3.00**
- House Painting Methods with the Brush and Spray Gun, by Vanderwalker... Cloth **\$2.00**
- Interior Wall Decoration, by Vanderwalker... Leatherette **\$4.00**
- The Mixing of Colors and Paints, by Vanderwalker... Cloth **\$2.00**
- Studio Handbook—Letter and Design... **\$3.00**
- A Show at Sho' Cards... Cloth **\$4.00**
- Sign Painting, by Atkinson... Cloth **\$4.00**
- Strong's Book of Designs, Leatherette **\$4.00**
- Modern Painters' Cyclopaedia, Cloth **\$2.00**
- Automobile Painting... Cloth **\$1.50**
- New Hardwood Finishing... Cloth **\$1.50**
- Wood Finishing, Plain and Decorative... Cloth **\$2.00**
- Owen's Paint Guide... Cloth **\$1.00**

### Steam Engineering

- Swingle's Handbook for Steam Engineers and Electricians... Leatherette **\$4.00**
- Examination Questions and Answers for Marine and Stationary Engineers... Leatherette **\$2.00**
- Steam Boilers... Leatherette **\$2.00**
- Swingle's Catechism of Steam, Gas and Electrical Engineering... Leatherette **\$1.50**

### Modern Languages

- By Prof. P. S. Allen, U. of Chicago
- French without a Teacher... Cloth **\$1.25**
- Spanish without a Teacher... Cloth **\$1.25**
- German without a Teacher... Cloth **\$1.25**
- Everyday French... **\$1.25**
- Everyday Spanish... **\$1.25**

## ORDER DIRECT FROM THIS PAGE—ON OUR MONEY-BACK PLAN

The books listed above are only a few of the many in our catalogue, which you will receive promptly after filling out and mailing us the attached coupon. For quick action order direct from this page—cross name of each book wanted and send in with price quoted. We prepay postage and send the books on our money-back plan.

## FREDERICK J. DRAKE & CO.

Publishers

1008 Michigan Ave. CHICAGO  
Drake Books Are For Sale at All Book Stores

Mail Coupon For Free Catalogue  
Your Guide to Home Study

FREDERICK J. DRAKE & CO.  
1008 Michigan Avenue  
Chicago, Ill.

GENTLEMEN:—Please send me free, postage paid, your illustrated catalogue which lists and describes 200 Practical Mechanical Books for Home Study.

My name is .....

and my address .....



Would you  
like two  
pay-checks  
instead  
of one—  
each week  
in 1927  
?



LaSalle Extension University,  
Chicago, Illinois.

Gentlemen:

My schooling stopped when I was fourteen; and when I first enrolled with LaSalle for training in Higher Accountancy I was earning only \$150 a month.

Yet that training enabled me to make certain suggestions to the firm I worked for which resulted in a trip to Washington with all expenses paid and a commission of \$2,126. That alone paid for the training seventeen times over!

Since then I have followed thru with two other LaSalle courses; I am now on my fourth. And for two years past my earnings have been in excess of \$11,000 a year.

I used to think you were too extravagant in your claims for LaSalle training. Now I honestly believe you are too conservative. Why don't you tell the full truth about what LaSalle can do and is doing to lift men out of the low-pay class and put them in command of the really important places in the business world?

Sincerely yours,

*E. J. Dryden*  
Auditor

**F**RANKLY—are you in earnest in wishing to increase your income, but doubtful as to the aid you could get from home-study business training?

E. J. Dryden, of Laredo, Texas, was doubtful, too. But he determined to try, and to measure his results by the good old sign of the dollar!

He was earning \$150 a month when he started with LaSalle. His course in Higher Accountancy was completed in eighteen months. His salary-increase paid for the training plus \$1.00 an hour for every hour spent in study.

After his first lesson in Business Management, dealing with Selling, he tried out his newly acquired knowledge. In six weeks he made \$750 in commissions working after hours.

He has since followed thru with Commercial Spanish, and is now completing his fourth course—in

American Law and Procedure. For two years past his earnings have been better than \$11,000 a year.

Again we ask—are you in earnest in your desire to increase your salary?

### Send for Free Book About Your Own Field

You are faced with a problem—and the only way you can solve it is to get the facts.

A special 64-page booklet describes the opportunities in your field of business and outlines a definite plan that will enable you to realize them.

**The coupon will bring this booklet to you free—and with it your copy of "Ten Years' Promotion in One," all without obligation.**

Dreaming—wishing—you've had enough of that! Send for those booklets NOW.

### Find Yourself Thru LaSalle!

LA SALLE EXTENSION UNIVERSITY, Dept. 1164-R CHICAGO

I shall be glad to have your 64-page booklet about the business field I have checked below. Also a copy of "Ten Years' Promotion in One," all without obligation.

- |   |  |
|---|--|
| <input type="checkbox"/> Business Management                        | <input type="checkbox"/> Traffic Management—Foreign and Domestic     |
| <input type="checkbox"/> Higher Accountancy                         | <input type="checkbox"/> Railway Station Management                  |
| <input type="checkbox"/> Modern Salesmanship                        | <input type="checkbox"/> Banking and Finance                         |
| <input type="checkbox"/> Law: Degree of LL. B.                      | <input type="checkbox"/> Personnel Management                        |
| <input type="checkbox"/> Commercial Law                             | <input type="checkbox"/> Modern Business Correspondence and Practice |
| <input type="checkbox"/> C. P. A. Coaching for Advanced Accountants | <input type="checkbox"/> Expert Bookkeeping                          |
| <input type="checkbox"/> Effective Speaking                         | <input type="checkbox"/> Business English                            |
| <input type="checkbox"/> Modern Foremanship                         | <input type="checkbox"/> Commercial Spanish                          |
| <input type="checkbox"/> Industrial Management                      |  |

Name \_\_\_\_\_ Present Position \_\_\_\_\_

Street \_\_\_\_\_ City \_\_\_\_\_ State \_\_\_\_\_



these books free



# BUILDERS TRADE GUIDES



## AUDELS CARPENTERS AND BUILDERS GUIDES—4 VOLS. \$6

**\$1 PER MO.**  
 Inside Information for Carpenters, Builders, Joiners, Building Mechanics—all Woodworkers. **1600 pages; 3700 diagrams; flexible; pocket size.** Short-cut instructions, new methods, ideas, solutions, plans, systems—money saving suggestions. An easy progressive course for the apprentice. A practical daily helper and Quick Reference for the master worker. A Helping Hand to Easier and Better Work and Better Pay. To get this aid for yourself, simply fill in and mail the **FREE COUPON** below.

### INSIDE TRADE INFORMATION ON:

How to use steel square; How to file and set saws; How to build furniture; How to use mitre box; How to use chalk line; How to use rules; How to make joints; Carpenters' arithmetic; Mensuration problems; Estimating strength of timbers; How to set girders and sills; How to frame houses and roofs; How to estimate costs; How to build houses, barns, garages, bungalows, etc.; How to read and draw plans; Drawing up specifications; How to excavate; How to use settings 12, 13 and 17 on the steel square; How to build hoists and scaffolds—skylights; How to build stairs; How to put on interior trim; How to hang doors; How to lath—lay floors; How to paint.

"Audels Guides worth four times their price—handy too as I carry them in pocket for reference." **W. J. Bates, Knoxville, Pa.**



## AUDELS PLUMBERS AND STEAMFITTERS GUIDES—4 VOLS. \$6

**\$1 PER MO.**  
 A new set—just out! A practical, illustrated, Reference Library and Study-Course for Master Plumbers, Journeymen and Apprentice Steamfitters, Gas Fitters and Helpers, Sheet Metal Workers, Draughtsmen, Master Builders, Engineers and all Building Trade Students. **1670 pages; 3642 diagrams; flexible; pocket size.** Guides explain all the principles, advances and short cuts of the Plumbing and Heating trade. Contains instructions on how to figure and estimate jobs. Use **FREE COUPON** below to examine, without obligation, this valuable work.

### INSIDE TRADE INFORMATION ON:

Soldering, tinning, joint wiping, bending, beating. Pipe—iron—steel, threading. Mathematics, tables, physics. Materials—iron, steel, copper, brass, lead, tin, antimony. Sheet metal—galvanized—plate. Sanitation, syphonage, tanks. Drainage, sewage, purification. Fixtures—bath—kitchen. Pipe fittings, soil pipe, tools. Laying out work. Roughing. Screwed fittings, flanges, joints. Pipe bending, examples. Elbows. Heating, ventilation, refrigeration. Water supply, mains, wells, tanks. Gas-fittings. Underwriters. Sheet metal work, problems, methods, brazing, heating, lead burning. Welding, various welds, methods. Blacksmithing, forges, tools.

"Audels Guides are practical, easy to understand, reliable. Cover the field in plain language." **W. F. Arminger, Annapolis, Md.**

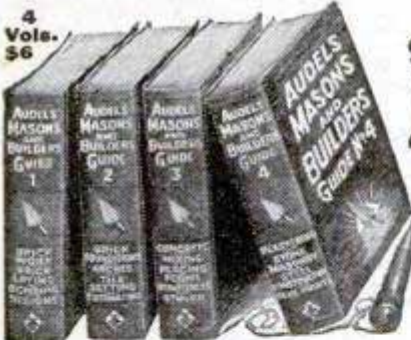

## AUDELS MASONS AND BUILDERS GUIDES—4 VOLS. \$6

**\$1 PER MO.**  
 A new, complete, illustrated trade reference library, for Bricklayers, Cement Workers, Plasterers, Tile Setters and Stone Masons, including a practical outline of Steel Construction. **1100 pages; 2067 diagrams; flexible; pocket size.** A practical Trade Assistant explaining modern methods of masonry construction. Easy to understand and apply. A reliable and authentic reference work and study-course for Master Journeyman and Young Mechanic. Use **FREE COUPON** below and find out for yourself, without obligation, whether this set will benefit you.

### INSIDE TRADE INFORMATION ON:

Bricklaying, tools, materials; Brick designs, patterns, bonds; Setting frames and foundations; Mortars, scaffolds, estimating; Mortars and mortar mixing; Tile setting, mosaic, hollow tile; Straight edge test, troweling; How to figure brick work; Safe loads, piers, chimneys; Boiler settings, anchors, fire stops; Laborables; Concrete, forms; How to figure concrete work; Stucco—on old and new buildings; Plastering—wood lath—metal; Plasterers agreement; Plastering on various surfaces; Stone masonry; Cutting, finishing, estimating stone; Derricks, rigging; Steel construction; Fire proof; How to read blue prints.

"Audels Masons Guides are the best books on the subject I have laid brick 12 years and am able to judge." **H. A. Senneker, Corliss, Pa.**

## PRACTICAL ELECTRICITY — 1 VOL. \$4

**\$1**  
 Audels Handy Book of Practical Electricity is a simplified Ready Reference and Study Course in one pocket size, leather bound volume—for Engineers, Professional Electricians and Students. **1040 pages; 2600 diagrams; flexible red leather bound.** A reliable authority and handy helper for every electrical worker. Contains important and valuable wiring diagrams, calculations, machine sketches, helps on maintenance and repair. Use this **FREE COUPON** today and find out, without obligation, how this handy book will help you in your daily work.

Complete in one handy, red leather bound volume

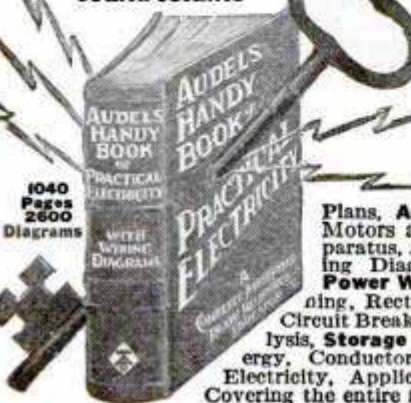

### INSIDE TRADE INFORMATION ON:

Electro-Therapeutics, X-Rays, Shocks, Welding, Brazing, Radio Hook-ups, Motion Pictures, Telephone, Telegraph, Cranes, Bells, Elevators, Pumps, Tools, Ship Drive, Railways, Vehicles, Automobile Electric Systems, Ignition, Generation, Lighting, Plant Management, Power Plans, Armature Winding, Repairing, A. C. Motors and Apparatus, D. C. Motors and Apparatus, Alternator Construction, Dynamos, Wiring Diagrams, Sign Flashers, Cable Splicing, Power Wiring, Outside Wiring, Switches, Lighting, Rectifiers, Converters, Transformers, Fuses, Circuit Breakers, Rheostats, Electro Plating, Electrolysis, Storage Batteries, Magnetism, Electrical Energy, Conductors, Insulators, Static, Dynamic, Radio Electricity, Applications, Ready Reference and Index Covering the entire field of Modern Electricity.

## Learn More and You Will Earn More!

Know your job and you'll never be without one. The skilled man is always in demand. Knowledge is power. Learn your trade thoroughly by easy reading. This coupon is your opportunity for advancement and better pay. You risk nothing in sending for Audels Guides for free examination. Send it NOW!

**FREE EXAMINATION COUPON**

**THEO. AUDEL & CO.,**  
 65 W. 23 ST., NEW YORK CITY

Please mail me for free examination the books marked (x) below. If I find them satisfactory, I agree to mail \$1 in 7 days, on each set ordered, and to further mail \$1 monthly on each set until I have paid the purchase price.

- 4 CARPENTERS GUIDES \$6  4 PLUMBERS GUIDES \$6
- 4 MASONS GUIDES \$6  1 ELECTRICIANS HANDY BOOK \$4

NAME .....

ADDRESS .....

OCCUPATION .....

EMPLOYED BY..... 11T30



# Be an ELECTRICAL & MECHANICAL AUTO EXPERT



I WILL TRAIN YOU AT HOME

**\$100**  
a  
**Week**  
and his business growing fast!  
says Geo. C. Deal



## Will You Be Earning \$50 to \$100 a Week by May First?

The world's biggest business needs you! Why slave away at small pay when there are so many opportunities to make money QUICK in the Auto Business! Mail Coupon now. Get all the facts about "Job-Way" Auto home Training.

### CLIP COUPON NOW!

**4** testing and repair OUTFITS given

Without Extra Cost

Tools, Test Bench, Electrical Experimental Outfit and Wiring Diagram Charts included. Coupon brings details.

When you read that there are now 22 MILLION Autos, trucks and tractors—that car owners are paying out SIX THOUSAND MILLION DOLLARS A YEAR for upkeep, you will realize that here is the business to get into! You'll understand why scores of men are making \$40, \$50 and \$60 a week, just a few months after enrolling for "Job-Way." My Free Book tells all. Get it!

### FREE! AUTO BOOK

B. W. COOKE, Directing Engineer,  
CHICAGO MOTOR TRAINING CORPORATION,  
1916 Sunnyside Avenue, Dept. 816, CHICAGO, ILL.

Send me FREE Auto Book, and proof that you will show me the QUICK WAY toward a BIG JOB and a RAISE IN PAY. Also your 4 working outfits offer. It is understood that this obligates me in no way.

.....Name

.....Address

### The Only "Job-Way" Training

Mine is the original, genuine "Job-Way" Training. I train you with (1) Lessons, (2) Job Tickets, (3) Tools which I give you without extra cost, and (4) Actual Auto Jobs. 15,731 letters in my files, all telling of actual auto experience, prove that "Job-Way" is the Practical Training for you! I give you complete instruction in every important branch of Auto Work, both Mechanical and Electrical. And my Employment Department helps you find a good job!

### Go Into Business!

I can show you men who are making as much as \$175 a week in their own Auto Businesses! They are exceptions—but there are dozens who are making anywhere up to \$5,000 a year. George C. Deal was earning only \$10 a week as a farmer, but is now making \$100 a week in his own business. James T. Summers, of Statesville, N. C., was making only \$25 a week. Now it's \$50 to \$75 a week!



Geo. C. Deal  
High River,  
Alberta,  
Canada

**Earn While You Learn!** Get my new Book today! It's Free! See how hundreds of men are making as high as \$30 a week extra money in their spare time only. See what you can do. Send Coupon.

**Big Auto Book FREE!** If you are between the ages of 17 and 50—can read, write, and understand plain English, and are a normal, live fellow—send for this Free Book. Whether you're experienced or not, I'll train you for Quick Success and my written Money-Back Agreement protects you! Get all the FACTS! Mail coupon now!

**B. W. COOKE, Directing Engineer,**  
CHICAGO MOTOR TRAINING CORPORATION  
Dept. 816 1916 Sunnyside Ave. CHICAGO



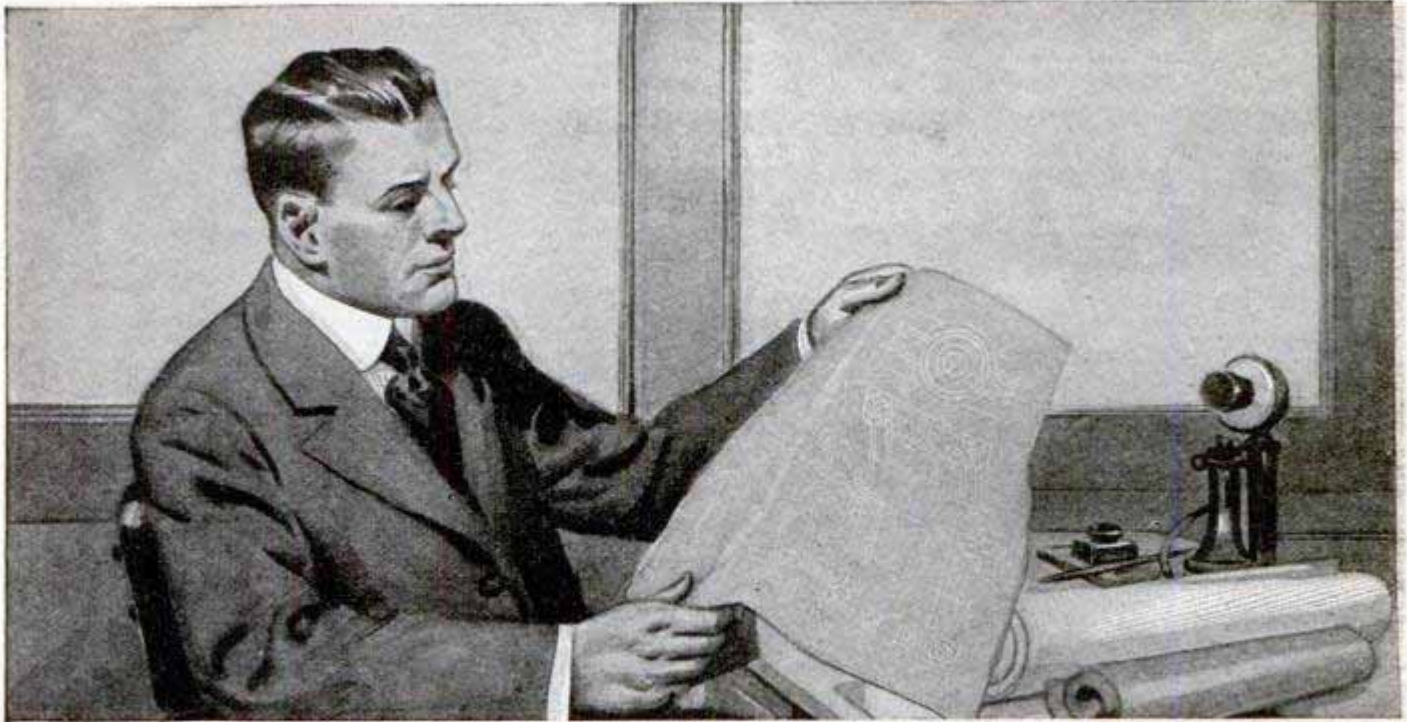

# Mechanical Engineering

## Learn at Home

MECHANICAL Engineering embraces the design, construction and operation of machines and machine tools.

It is a profession which offers almost unlimited opportunities for advancement to men who combine natural mechanical ability with special technical training.

For this is the age of machinery. Almost every convenience, luxury or necessity which we enjoy today depends on machinery for its production or adaptability to our needs. Every new invention multiplies the opportunities for competent designers, builders, erecting engineers, etc.

One of the best ways to train yourself to secure a position as a Mechanical Engineer is

through the home-study courses of the International Correspondence Schools.

These courses are especially arranged to meet the needs of the student who studies at home. The theoretical work is stated in simple and clear language and engineering data is reduced to a form in which it is easily applied.

The courses are also particularly helpful because they are written by well-known mechanical engineers who have had years of practical experience in this field.

Just mark and mail the coupon and we'll gladly send you Free Booklets describing the I. C. S. courses in Mechanical Engineering or any other course in which you are interested.

**Mail the Coupon Today for Free Booklet**

INTERNATIONAL CORRESPONDENCE SCHOOLS, Box 5683-E, Scranton, Penna.

*"The Universal University"*

Without cost or obligation, please send me one of your booklets and tell me how I can qualify for the position or in the subject before which I have marked an X:

- |  |  |   |   |  |
|--|--|---|---|--|
| <input type="checkbox"/> Mechanical Engineering      | <input type="checkbox"/> Draftsmen's Course                          | <input type="checkbox"/> Shop Practice                | <input type="checkbox"/> Toolmaking                                   | <input type="checkbox"/> Patternmaking |
| <input type="checkbox"/> Mechanical Course           | <input type="checkbox"/> Mechanical Drawing                          | <input type="checkbox"/> Machine Shop Work            | <input type="checkbox"/> Blacksmithing and Forging                    | <input type="checkbox"/> Foundry Work  |
| <input type="checkbox"/> Steam Engineering           | <input type="checkbox"/> Civil Engineering                           | <input type="checkbox"/> Boilermakers                 | <input type="checkbox"/> Agriculture and Poultry                      |  |
| <input type="checkbox"/> Marine Engineering          | <input type="checkbox"/> Surveying and Mapping                       | <input type="checkbox"/> Boilermakers' Laying Out     | <input type="checkbox"/> Mathematics                                  |  |
| <input type="checkbox"/> Internal Combustion Engines | <input type="checkbox"/> Structural Engineering                      | <input type="checkbox"/> Sheet-Metal Workers          | <input type="checkbox"/> High School Subjects                         |  |
| <input type="checkbox"/> Aeroplane Engines           | <input type="checkbox"/> Structural Drafting                         | <input type="checkbox"/> Sheet-Metal Pattern Drafting | <input type="checkbox"/> Common School Subjects                       |  |
| <input type="checkbox"/> Diesel Engines              | <input type="checkbox"/> Mining <input type="checkbox"/> Metallurgy  | <input type="checkbox"/> Architecture                 | <input type="checkbox"/> English <input type="checkbox"/> Bookkeeping |  |
| <input type="checkbox"/> Refrigeration               | <input type="checkbox"/> Chemistry <input type="checkbox"/> Pharmacy | <input type="checkbox"/> Architectural Draftsman      | <input type="checkbox"/> Stenography and Typing                       |  |
| <input type="checkbox"/> Electrical Engineering      | <input type="checkbox"/> Civil Service                               | <input type="checkbox"/> Architects' Blueprints       | <input type="checkbox"/> Private Secretary                            |  |
| <input type="checkbox"/> Power House Electric        | <input type="checkbox"/> Salesmanship                                | <input type="checkbox"/> Contractor and Builder       | <input type="checkbox"/> Business Law                                 |  |
| <input type="checkbox"/> Electric Lighting           | <input type="checkbox"/> Advertising                                 | <input type="checkbox"/> Concrete Builder             | <input type="checkbox"/> Illustrating                                 |  |
| <input type="checkbox"/> Practical Electricians      | <input type="checkbox"/> Better Letters                              | <input type="checkbox"/> Plumbing                     | <input type="checkbox"/> Art Drawing                                  |  |
| <input type="checkbox"/> Radio                       | <input type="checkbox"/> Spanish <input type="checkbox"/> French     | <input type="checkbox"/> Heating and Ventilating      | <input type="checkbox"/> Cartooning                                   |  |

Name..... Street Address.....

City..... State.....

Persons residing in Canada should send this coupon to the International Correspondence Schools Canadian, Limited, Montreal, Canada



**See Life**  
*Win Applause...Thrills*  
**Big Money**

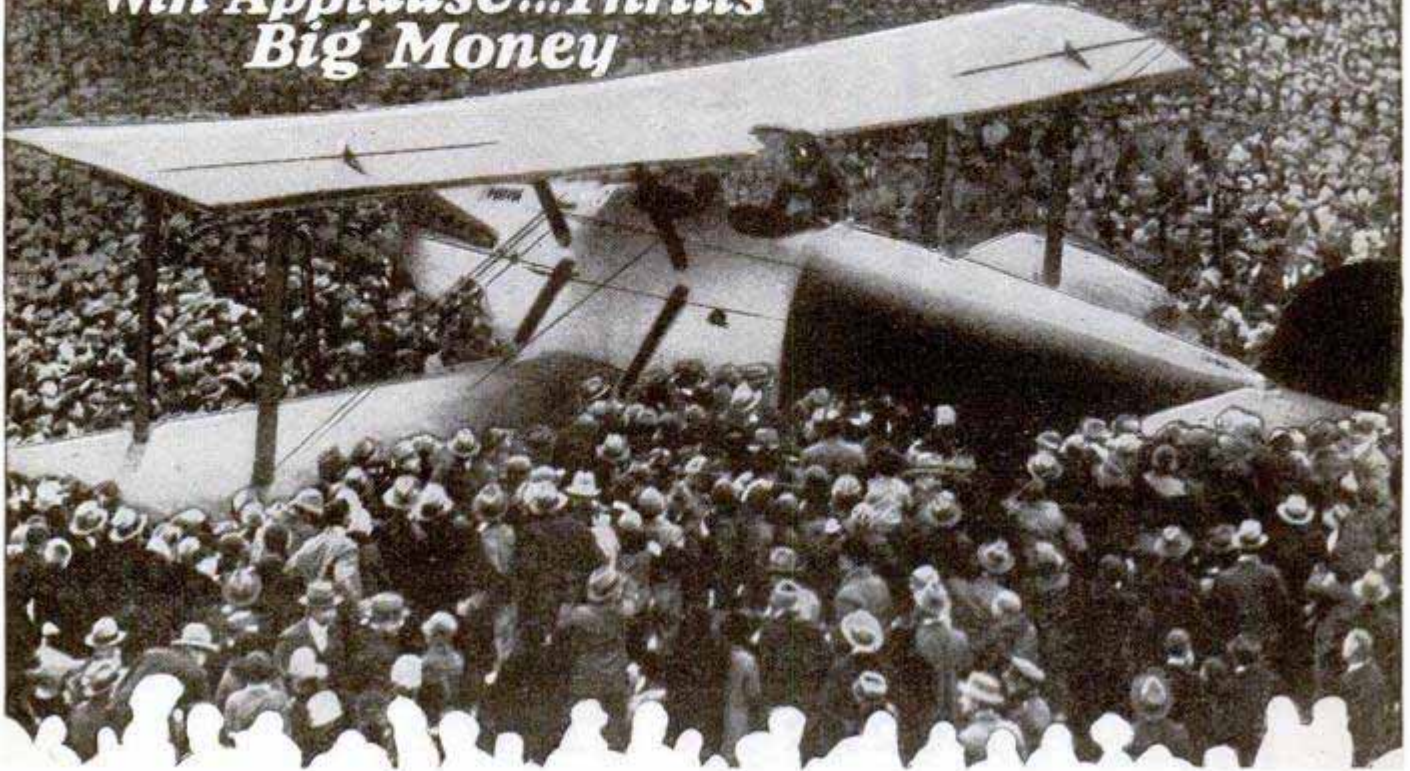

# Get Into Aviation!

**S**EIZE the biggest thrill ever offered to man—the biggest adventure since time began—smash into Aviation—the game for men with sporting blood! Step into a life of excitement, daring and big money—away from a tame, narrow, humdrum existence.

Think what Aviation offers you, Thrills such as you never had before! The praise and plaudits of the multitude. And a chance to get in on the ground floor where rewards will be unlimited!

## Amazing Opportunities

Aviation is growing so swiftly that one can hardly keep track of all the astonishing new developments. Air mail routes have just been extended to form a vast aerial network over the entire U. S. Airlines and airplane factories are springing up all over the country. Men like Henry Ford are investing millions in the future of commercial Aviation in America! The possibilities are so tremendous that they stagger imagination!

Everything is set for the greatest boom in history. Big fortunes came out of the automobile industry and out of motion pictures. Big fortunes will also come out of Aviation. The development of Aviation as an industry is bringing with it a call for trained men. The opportunities open cannot be overestimated. Those who qualify quickly should find themselves on the road to undreamed of money—success—popularity—and prominence.

## Easy to Become an Aviation Expert

Get into this thrilling business at once while the field is new and uncrowded. Now—by a unique new plan—you can quickly secure at home, during spare time, the preliminary training necessary to get a start in the Aviation Industry. Experts will teach you the secrets—give you the inside facts that are essential to your success. And the study of Aviation

by our method is almost as fascinating as the actual work itself. Every lesson is chockful of interest—and so absorbing that you actually forget you are studying. But best of all are the ultimate rewards you are fitting yourself to gain.

## BIG PAYING JOBS

Get Ready Now for One of These Positions

Airplane Repairman  
 Airplane Mechanician  
 Airplane Inspector  
 Airplane Salesman  
 Airplane Assembler  
 Airplane Builder  
 Airplane Pilot  
 Airplane Instructor  
 Airplane Contractor  
 Airplane Engineer  
 Aerial Photography  
 Aerial Advertising

## Send for FREE Book

Send the coupon for our new, free book, just out—*Opportunities in the Airplane Industry*. It is unusually interesting, reads like a romance, and gives vital facts about Aviation you never even dreamed of. You owe it to yourself to at least read it. We offer you a free copy now. No obligation. Mail the coupon for yours today.

free—  
**AMERICAN  
 SCHOOL OF  
 AVIATION**

Dept. 1358  
 3601 Michigan Ave.  
 Chicago, Ill.



American School of Aviation,  
 Dept. 1358, 3601 Michigan Ave.,  
 Chicago, Ill.

Without any obligation please send me your FREE book, *Opportunities in the Airplane Industry*. Also information about your course in Practical Aviation.

Name..... Age.....

Address.....

City..... State.....



# Electricity!

Runs the



# World

**Learn It In 90 Days - Start NOW**  
**Quick Method - Not by Correspondence**

**No Books - But On Actual Live Machinery - No Lessons**

Electricity is *The Field*. The greatest, largest, most profitable and least crowded of all industries. My new, quick, easy method will enable you to learn practical electricity in 90 days. I don't care whether you ever had a day's experience or whether you have only a common school education, I will train you so you can quickly get into the big pay class. It's the greatest opportunity of the age.

**No Books - No Lessons** This is not a correspondence school. It is a Chicago resident school. In my new two million dollar school, you are taught with actual electrical equipment. Giant dynamos, great power plants, enormous switch boards, mighty transmitting stations, farm lighting equipment—all full size, working every day. After you are in my school you will work on real electrical apparatus, winding real motors, building real batteries, wiring real houses—and every minute there is an instructor ready to give undivided attention; remember—Chicago is the world's greatest electrical center. You go to visit great plants.

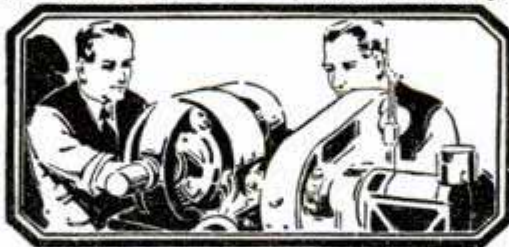

### **Lifetime Employment Service**

My graduate and employment department stands ready to give you every assistance after graduation, and should you need part time work we will help you get it. In fact, I'll take a personal interest in you and do everything possible to make your stay enjoyable. And when you graduate my employment department will give you lifetime service.

**Big Future—Big Pay** It's the trained man who gets the big job these days. Coyne students get positions leading to \$50 a week and up and many go in business for themselves and make much more. My system of teaching gives you such a thorough training that you will know far more than the average electrician. You will be qualified to step out and get a real job on graduating.

You can start in anytime—no waiting. Each student learns individually.

### **Send for Big Book!**

Fill out and mail the coupon below and I will rush you my big 56 page book with 150 photographs showing actual scenes in the great roaring Coyne shops. You need this book. It will solve your future for you. Getting this book will not obligate you in the least. So ACT NOW—MAIL COUPON at ONCE.

My Course Includes **Aeroplane Electricity**  
 Training in

NOT A CORRESPONDENCE SCHOOL

# COYNE Electrical SCHOOL

H. C. LEWIS, Pres., Dept. 87-72P—Established 1899  
**500 South Paulina Street, Chicago**

Mr. H. C. Lewis, Pres. Dept. 87-72P  
**COYNE ELECTRICAL SCHOOL,**  
**500 S. Paulina St., Chicago, Ill.**

Dear Mr. Lewis: Without obligation send me your big free catalog and all details of Free Employment Service, Radio, Aeroplane and Automotive Electrical Courses, and how many "earn while learning." I understand I will not be bothered by any salesman.

Name .....

Address .....

City..... State.....



# You can make the BIG Money



## in Auto Painting

—Because here is the biggest uncrowded field in the world today. Prove it to yourself by the next 20 cars you see. Yes Sir, 17 out of 20 need painting.



**G. KING FRANKLIN**  
Famous Auto  
Painting Authority

**I will have you ready in a few months**

NOW—how many auto painters do you know? . . . I thought so. Well, who's going to do the work? You are—after you get the right training and you're going to make more money than you ever dreamed of! The world is looking for trained auto painters. Cash in on this big demand!

## You Can Own Your Own Business!

In auto painting it's no trick to be your own boss—own your own business and be independent!

You don't have to start out with the biggest building on the busiest corner. You can begin small with little or no capital, but I don't know of another business where you can get big so fast. We show you how to open your own shop.

## You Can Make from \$60 to \$90 a Week

After you get my training you can get a job anywhere. You can travel and know at your destination there will be a job waiting for you that pays big money. Remember—I don't forget you when you complete the course. I help you get a real job. You also get a life consultation service without extra charge.

## 17,000,000 Cars Need Painting

Just imagine! There are t-w-e-n-t-y m-i-l-l-i-o-n cars in the U. S. alone—and 17 million need priming, surfacing, painting, ducoing, varnishing, striping and the whole works—and take it from me, I teach you the whole works so you can get in on the Big Money—or I'll refund every penny of the small price you pay.

I realize that you are up against quite a problem in deciding what field to enter, but on my say-so, and my guarantee to you, just come into auto painting with me and you'll be glad of it all your life.

Men like yourself who have taken my advice are now making \$5,000 to \$10,000 a year.

**PROOF**  
Chicago Duco says: "Skilled Duco men are scarce. We can place many at \$1.00 to \$1.25 an hour." Binks, one of the largest auto equipment manufacturers says "The big auto manufacturers are insisting that their dealers repaint all used cars." Stockton, Illinois, says "No shop here. All work must go to Freeport. Believe plenty of work to make paying business." Nash says "This is a big field and splendid opportunities for your graduates in repainting cars." Many, many more like these.

## MAIL the COUPON

G. King Franklin, Supt.,  
American Auto Painting School,  
Dept. 801, 425 S. Ashland Ave., Chicago.

Send sample shop-tickets free and information on how I may learn auto painting and Duco at home in spare time.

Name.....

Street No.....

City.....

State.....

## LEARN at HOME!

And the beauty of my proposition is that you can learn at home in your spare time—evenings—and keep your present job while learning.

By my Shop Type Method you learn quickly and easily—the greatest advance in home study training assures you success—no car needed—work on wood and metal panels. 13 big outfits given without extra charge.

Get information now! Don't wait. Get my big illustrated booklet Free—you will not be obligated.

G. KING FRANKLIN, Supt.

American Auto Painting School  
Dept. 801, 425 South Ashland Avenue, CHICAGO



# Complete Electrical Engineering Course

—backed with an agreement to help you find a better job with a raise in pay or money refunded

**2<sup>in</sup> years**  
**At Home**

We invite ambitious men to look into this combination training and employment offer. It gives you the chance you've been waiting for—to learn **Electrical Engineering** and get into a billion dollar industry with the equipment to get ahead fast.

## Electricity Offers Unlimited Opportunities

Learn **Electrical Engineering** and you can take your choice of many fine, well-paid positions. Or go into some profitable branch of it, in business for yourself. Men denied an early education, men who are in lines of work with little chance to get ahead, men who are working too hard at too small pay—are invited to mail the coupon below for details of our astonishing offer to prepare you for an **Electrical Engineer's** position, and then to help you find it.

### “Can I learn Electrical Engineering?” you ask

“Can I make good in Electricity?” “Can I afford this training?” I'll answer all these questions to your satisfaction. I'll prove to you that with the backing of this million-dollar institution you have education enough to learn **Electrical Engineering** and get ready for a better job and bigger pay.

### Start with the Coupon

Get the **FACTS** about your opportunities in Electricity—they're greater than you ever dreamed. Get 5 Job-Tickets (FREE) to see how easy and practical this instruction has been



## 5 Job-Tickets FREE

Carl H. Dunlap, E. E.  
American School, Dept. E-874,  
Drexel Ave. & 58th St., Chicago.

Send 5 Electrical Job-Tickets FREE and information about the opportunities for me in **Electrical Engineering**.

Name.....  
St. No.....  
City.....State.....

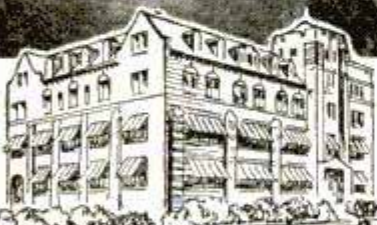

### THE American School

offers home-training prepared by over 200 of America's leading engineers, executives, and educators. Chartered 30 years ago as an educational institution NOT FOR PROFIT, like the best resident schools and colleges.

### New, Simplified, Rapid Method —with Lessons, Job-Tickets, and Outfits

Particularly adapted to men with only common schooling. Starts at the very beginning of elementary Electricity and carries you along by easy stages through **Electrical Engineering** subjects. The theory and laws in lessons. Actual practice provided with seven outfits of standard tools and materials, which we supply without extra charge, combined in a new way with Job-Ticket instructions.

### Training Built by 29 Noted Engineers

We have engaged recognized authorities in each branch of Electricity to prepare this instruction, men from the greatest corporations and universities in the U. S.

1. General Electric Co.
  2. Commonwealth Edison
  3. Cutler-Hammer Co.
  4. American Telephone & Telegraph Co.
  5. Westinghouse Electric & Mfg. Co.
  6. Western Electric Co.
  7. Underwriters Lab.
  8. Columbia University
  9. Dartmouth College
  10. Massachusetts Inst.
  11. Armour Institute.
- and many others.



made. Finally, get the facts about our agreement to help you better your position and salary which for the first time assures men who take home-training of the results they seek, or money refunded. Coupon brings everything—mail at once!

CARL H. DUNLAP, E. E.  
**American School**  
Dept. E-874  
Drexel Ave. and 58th St.  
CHICAGO



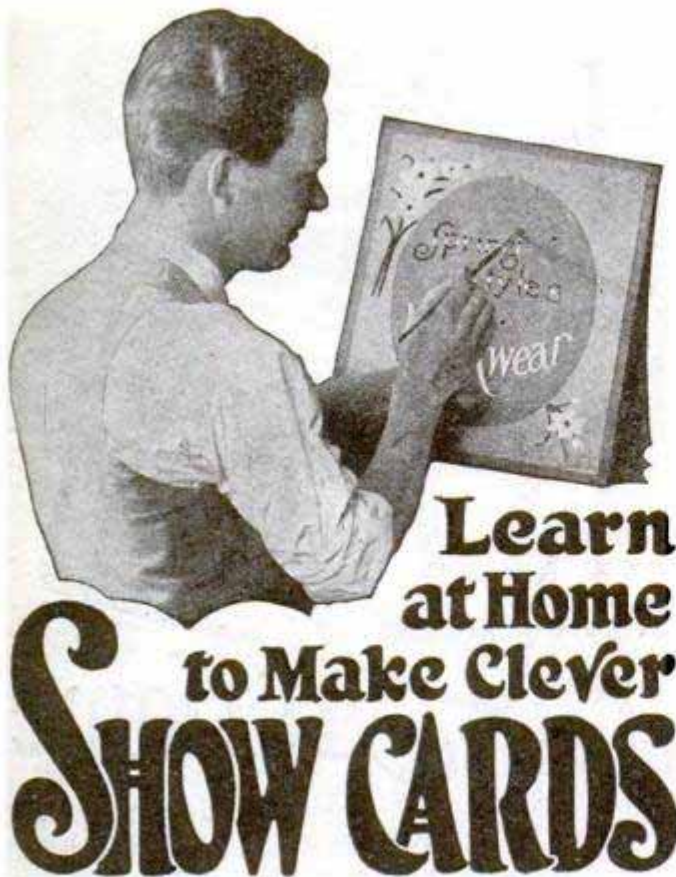

A profitable Business of Your Own for full or spare time. Earn \$25 or more a week in spare time. Double your full time pay. This practical method of home instruction has simplified everything.

Why work for low pay? Clever "sales-increasing" display material is always needed by progressive business enterprises of every description. \$10 to \$20 is often paid for a single attractive show card. Skilled Show Card Writers command high salaries—right from the start.

Prepare now. No special ability needed. Learn at home in spare time through this most complete, practical method. Student R. A. Hart writes: "I make not less than \$2.00 an hour making show cards in spare time." Ray Underwood (while still a student) wrote: "Am with a large sign company. People ask me to do work after regular hours and I clear \$25 to \$35 a day." Many others have learned Show Card Writing by this method. So Can You if you will simply apply yourself as they did.

Take advantage of the money-making opportunities open in the Show Card field. Make Show Cards for your present employer or for several merchants at one time. Have a profitable business of your own. Earn up to \$100 a week—more if you're ambitious.

#### Send for FREE Book

Get busy. Boost your pay. Don't delay another hour. Send coupon now for big, Free Illustrated Book and full information. Mail coupon now. No obligation. No salesman will call.

Washington Show Card School, Dept. 3011-E  
1117-15th Street, N. W., Washington, D. C.

Washington Show Card School, Dept. 3011-E  
1117-15th Street, N. W., Washington, D. C.

Please send me FREE and without obligation, a copy of the new 32-page book, "Quick Success in Show Card Making," and special offer to new students.

Name .....

(Write name plainly and state whether Mr., Mrs., or Miss)

Address .....

City ..... State .....

Age .....

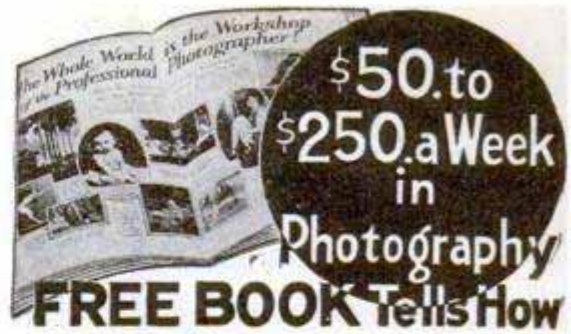

You can quickly qualify for big-paying positions in Motion Picture, Portrait, Commercial or News Photography, or start your own business. No experience needed.

**CAMERA GIVEN WITHOUT EXTRA CHARGE**  
Learn at home or in our great New York Studios. Easy to learn. Write today for Free Book, Job Chart and Camera offer.  
**NEW YORK INSTITUTE OF PHOTOGRAPHY**  
Dept. 49 18 West 33rd St. New York

## Don't Envy The Plumber BE ONE!

**\$11.00-\$16.00 PER DAY** and work EVERY day,  
is the Plumber's wage.

Every skilled workman will tell you that Plumbers have the best of it. WINTER and SUMMER the Plumber is busy at top wages. No skilled Plumber is ever out of a job—compare his opportunities with any trade, plus the opportunities of having your own shop.

We teach you Plumbing with TOOLS (not books) under Licensed Master PLUMBERS in one of the finest equipped schools in America. We make you a Plumber, every branch is taught thoroughly—Lead Work—Blue Print for plan reading—all other tricks.

**LEARN IN 8 to 12 WEEKS** without previous experience. If you are making less than \$60.00 a week you owe it to yourself to investigate. Get FREE catalog that tells in pictures and words how we teach this trade. Special rates now.

**UNIVERSAL PLUMBING SCHOOL**  
2030 Troost Ave. KANSAS CITY, MO.

## Electrical Engineering

Course for men of ambition and limited time. Over 5000 men trained. Condensed course in Theoretical and Practical Electrical Engineering including the closely related subjects of Mathematics and Mechanical Drawing.

Students construct motors, install wiring, test electrical machinery. Course designed to be completed in one college year. Prepare for your profession in the most interesting city in the world. Est. 1893. Catalog on request.



## Bliss Electrical School

121 Takoma Ave., Washington, D. C.

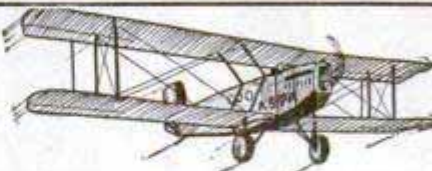

## LEARN TO FLY

Billions of dollars will be created and spent through the development of aviation. Thousands of positions will be open for those who are prepared.

Prepare now! Complete Home Study Course in Aviation arranged by America's foremost aeronautical society. Authentic yet inexpensive. Write for further information  
THE AMERICAN SOCIETY FOR PROMOTION OF AVIATION, 522 Fifth Ave., Dept. X, New York

## LEARN WATCHMAKING

and become independent. We help you secure a position.

Easy to learn. Send for FREE CATALOG.  
ST. LOUIS WATCHMAKING SCHOOL, Dept. 5, ST. LOUIS, MO.

## MEN WANTED

TO LEARN

## Motion Picture Projection

\$2,000 to \$4,000 a Year

Quickly learned. Short hours, big pay. Best equipped school in Michigan. Projectionists for Movie Houses and Road Shows.

## MOVIE OPERATORS SCHOOL

61 Sproat Street,

DETROIT, MICHIGAN



# Kill This Man!

**T**HERE'S a devil inside of you. He's trying to kill you. Look out for him! He tells you not to work so hard. What's the use? the boss only piles more work on you. He tells you not to bother with your body. If you're weak—you always will be weak. Exercise is just a lot of rot. Do you recognize him? Of course you do. He's in us all. He's a murderer of ambition. He's a liar and a fool. *Kill him!* If you don't, he will kill you.

## Saved

Thank your lucky stars you have another man inside of you. He's the human dynamo. He fills you full of pep and ambition. He keeps you alive—on fire. He urges you on in your daily tasks. He makes you strive for bigger and better things to do. He makes you crave for life and strength. He teaches you that the weak fall by the wayside, but the strong succeed. He shows you that exercise builds live tissue—live tissue is muscle—muscle means strength—strength is power. Power brings success! That's what you want, and gosh darn your old hide! you're going to get it.

## Which Man Will It Be?

It's up to you. Set your own future. You want to be the Human Dynamo? Fine! Well, let's get busy. That's where I come in. That's my job. Here's what I'll do for you:

In just 30 days I'll increase your arm one full inch with real live, animated muscle. Yes, and I'll add two inches to your chest in the same time. Pretty good, eh? That's nothing. Now come the works. I'll build up your shoulders. I'll deepen your chest. I'll strengthen your whole body. I'll give you arms and legs like pillars. I'll literally pack muscle up your stomach and down your back. Meanwhile I'll work on those inner muscles surrounding your vital organs. You'll feel the thrill of life shooting up your old backbone and throughout your entire system. You'll feel so full of life you will shout to the world, "I'm a man and I can prove it!"

Sounds good, what? But listen! That isn't all. I'm not just promising these things. *I guarantee them!* It's a sure bet. Oh, boy! Let's ride.

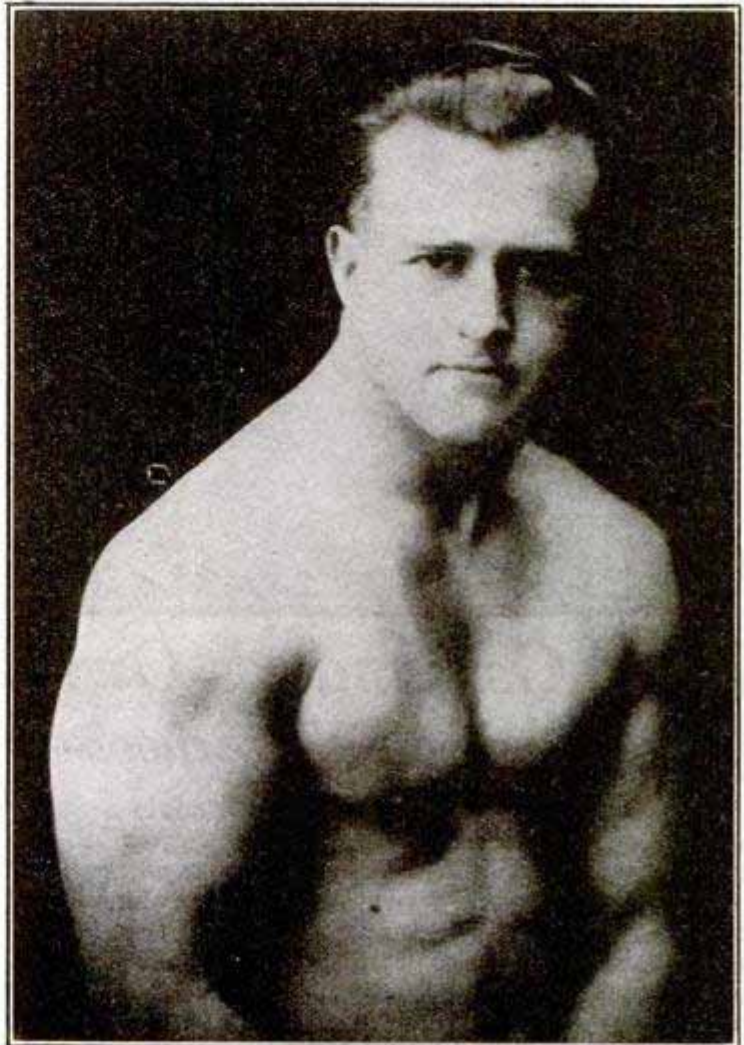

**EARLE E. LIEDERMAN, The Muscle Builder**  
Author of "Science of Wrestling," "Muscle Building,"  
"Secrets of Strength," "Here's Health," "Endurance," etc.

Send For My New  
64 Page Book  
*"Muscular Development"*  
IT IS FREE

I don't ask one cent. And it's the peppiest piece of reading you ever laid your eyes on. I swear you'll never blink an eyelash till you've turned the last cover. And there are over four dozen full-page photos of myself and some of my prize-winning pupils. This is the finest art gallery of strong men ever assembled. And every last one of them is shouting my praises. Look them over. If you don't get a kick out of this book, you had better roll over—you're dead.

Come on, then. Take out the old pencil and sign your name and address to the coupon. Remember, it's something for nothing and no strings attached—no obligation. **GRAB IT!**

**Earle E. Liederman**

Dept. 2011 305 Broadway, New York City

**DON'T  
SEND ONE  
PENNY**

**YOUR  
NAME  
AND  
ADDRESS  
ON A  
POSTAL  
WILL DO**

**EARLE E. LIEDERMAN**

Dept. 2011, 305 Broadway, New York City

Dear Sir: Please send me, without any obligation on my part whatever, a copy of your latest book, "Muscular Development." (Please write or print plainly.)

Name.....

Street.....

City..... State.....



**Earns \$100 a Week as  
MECHANICAL DENTIST**



R. G. Ostrander, owner of the dental laboratory pictured at the left. He averages \$100 a week. And he has only just begun to grow!

## Read Ostrander's Own Story of Success After Graduating from This School—Earned as High as \$45 a Day

"After completing the course in your school in five months, I was determined to open up a laboratory of my own instead of going to work for someone else. So I made arrangements with a dental supply house to equip my laboratory completely, paying them a certain amount down and arranging to pay balance in monthly installments. I have now been in business over a year and am glad to say that in that time I was able to pay off an indebtedness of \$1,000 to the dental supply house, in addition to maintaining an apartment, running a car, and saving money besides. I do gold and rubber work of all kinds and have on my books a total of fourteen dentists."

### You Can Do What This Man Did

\$100 a week inside of a year is pretty good. You can do the same! Get into this money-making profession—leave your blind-alley job—be your own boss—go and come as you please! Ostrander won out, other men are doing the same, so why not you? "No trick for me to make \$30.00 a day," writes one McCarrie graduate. Another says, "I was a \$30 a week bookkeeper and have built a business netting me \$150.00 a week and growing all the time."

### What Is Mechanical Dentistry?

Mechanical Dentistry is the laboratory bench work which the dentist turns over to the laboratory worker. Master this profession and help meet the demands of 64,000 dentists for laboratory work. Every city and every town where dentists are located offers work to the mechanical dentist. We train you in a few months in *day or night school* for this uncrowded field—*no classes—no books—no special educational requirements.*

### MAIL THE COUPON

Get our illustrated *free book on Mechanical Dentistry*. Learn the fascinating facts about this money-making business, how you can prepare for certain success like Ostrander and many others. Read scores of letters written by McCarrie graduates telling the wonderful stories of their progress. Mail the coupon and get full details of our liberal offers, and how you can begin at once to train for success!

**McCARRIE SCHOOL OF MECHANICAL DENTISTRY**

Dept. 146 1338 S. Michigan Avenue CHICAGO, ILL.

"My expense in operating the lab is small and the profits big. I have done as high as \$54.00 worth of business in a single day and I am sure that the profits on this business amounted to close to \$45. I figure that I have done an average of \$100 a week since I have been in business. As I was naturally slow at first, the average for the last six months of the year would be higher than for the first. I have taken on an assistant and am now making arrangements to cater to the Dentists in the surrounding territory, thus greatly increasing my business. I want to thank the McCarrie School for their good training, and assistance they gave me whenever I asked for it."

R. G. OSTRANDER.

### Work Your Way Through School

We will assist you in finding a sparetime job to meet part of your expenses while taking McCarrie training. And we will help you find satisfactory living quarters when you arrive. Schools located in **Chicago, Detroit, Cleveland, Boston, and Philadelphia.**

Day or  
Night  
Schools

FREE  
BOOK

Mail coupon today and get this handsomely illustrated story of **MECHANICAL DENTISTRY!**



**FREE BOOK**

McCarrie School of Mechanical Dentistry,  
1338 S. Michigan Ave.,  
Dept. 146, Chicago, Ill.

Without obligation, please send me your free Book with complete information about how I may become a Mechanical Dentist, how you will help me open a Laboratory, how you will help me find a job while I take my training, etc.

Name.....

St. No. or R. F. D.....

City.....State.....



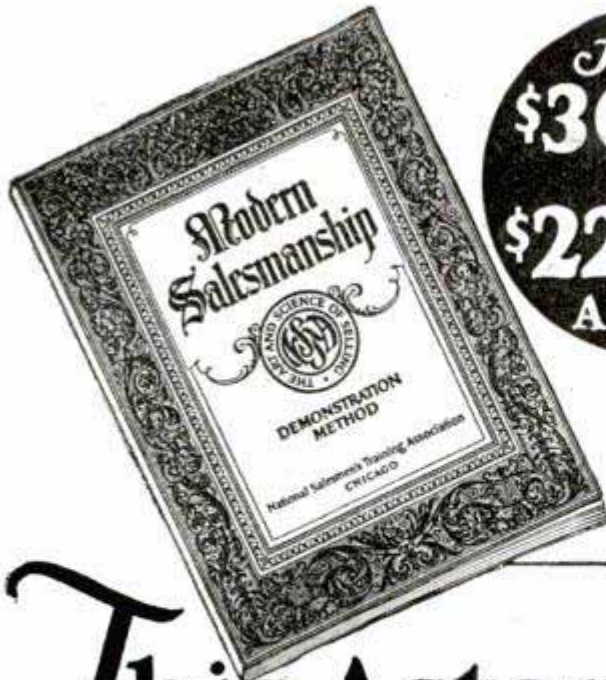

From  
**\$30** A WEEK  
to  
**\$22,500**  
A YEAR

\$30 A WEEK

\$5,000 A YEAR

\$7,500 A YEAR

\$22,500 A YEAR

START. 1<sup>ST</sup> YEAR 2<sup>ND</sup> YEAR 3<sup>RD</sup> YEAR

# This Astonishing Book Showed Him How

How One Man Uncovered Hidden Possibilities He Never Suspected Within Himself and Raised His Yearly Income \$20,940! An Illuminating Message of Vital Interest to Every Man Who Ever Aspires to Earn \$10,000—\$20,000—or More a Year! SEE FOR YOURSELF this remarkable Volume That Has Led So Many Men Into the Five-Figure Salary Class!

## Where Shall We Send Your Copy . . . FREE?

TRUTH is stranger than fiction! And the true story that happened to V. H. Harelson proves it! His experience is not only intensely INTERESTING—but it will prove a revelation and positive inspiration to every ambitious man who reads this page.

Not long ago—three years to be exact—Harelson was working as a clerk in a grocery store. His salary was \$30 a week. (Today he looks back with a laugh and calls it a "paltry sum.") But it was no laughing matter in those days—because it meant skimping and petty economies that are bound to irk ANY ambitious man. Naturally he was keenly dissatisfied—but like so many other men caught in blind-alley jobs, he didn't know how to get out!

And then one day something happened! A certain book fell into his hands. Between its covers he discovered a certain force that eventually led him to rewards beyond his fondest expectation. Inspired to action and with his feet firmly guided to the first rungs of the ladder to Success, Harelson made \$5,000 his next year. The following year he boosted his income to \$7,500! And last year HE CLEARED A TOTAL OF \$22,500!

### SALARY INCREASES—200% TO 900%!

A lucky accident? Not a bit of it! Harelson is not alone in his achievement of success after reading this remarkable book. OTHER men who have increased their salaries amazingly after reading these vital facts are numbered in the thousands! For example, C. W. Birmingham of Ohio read it and his salary raised from \$15 a week to \$7,500 a year. Wm. Shore of California made \$3,000 his first 5 months. R. B. Hansen of Ohio commenced earning over \$10,000 a year. And O. D. Oliver of Oklahoma, who used to earn \$200 a month, now makes as much as \$1,000 in a single week!

### THE SECRET OF BIG PAY

How did they do it? What did the book show them? Just this:—Every one of these men realized that Salesmanship offers BIGGER rewards and delivers them QUICKER than any other line of work under the sun. This vital book, "Modern Salesmanship," introduced them to hundreds of surprising and little-known facts about the highest paid of all professions. It revealed to them the real TRUTH about the art of selling. It blasted dozens of old theories, explained the science of selling in simple terms and told them exactly how the great sales records of nationally-known star salesmen have been achieved. And not only that, it outlined a simple plan that will enable almost any man to master scientific salesmanship without spending

years on the road—without losing a day or dollar from his present position.

### A FEW WEEKS—THEN BIGGER PAY

There was nothing "different" about these men when they started. Salesmanship is just like any other profession. It has certain fundamental rules and laws—laws that you can master just as easily as you learned the alphabet. And through the NATIONAL DEMONSTRATION METHOD—an exclusive feature of the N. S. T. A. system of SALESMANSHIP training—you can acquire the equivalent of actual experience while studying. Hundreds of men who never sold goods in their lives credit a large portion of their success to this remarkable training.

### FREE TO EVERY MAN

If we were asking two or three dollars a copy for "Modern Salesmanship" you might hesitate. But it is now FREE. We cannot urge you too strongly to take advantage of this opportunity to see for yourself what salesmanship has done for others—and what the National Salesmen's Training Association stands ready and willing to do for you. Find out exactly what the underlying principles of salesmanship are—and how you can put them to work for you. No matter what your opinion is now, "Modern Salesmanship" will give you a new insight into this fascinating and highly-paid profession. Mail the coupon now!



Dept. S-100 N. S. T. A. Bldg. Chicago, Ill.

NATIONAL SALESMEN'S TRAINING ASS'N.  
Dept. S-100, N. S. T. A. Bldg.,  
Chicago, Illinois.

Without cost or obligation you may send me your free book "Modern Salesmanship."

Name .....

Address .....

City ..... State .....

Age ..... Occupation .....



# See the World FREE!



## Taste Romance and Adventure In the Far Lands of the Earth.

How often you've longed to see for yourself the awe of Egypt's pyramids—the beauties of the gorgeous Mediterranean sunset—the squalor of China's ancient cities!

Spend a few years, or the rest of your life, tasting high adventure on the seven seas and in all the world's great ports—roving the earth's highways and byways! You can do it FREE—all your expenses paid—and earn a good salary besides!

Only one profession will carry you around the world at will, travelling like a gentleman, but that's the most interesting and pleasant work there is—Radio Operating! Easily and quickly learned, there's no other profession like it for the man who wants the experiences and pleasures of world-travel. Radio operators are needed—all sea-going ships like the one shown here must carry from one to half a dozen or more.



## Take a Look Beyond the Skyline Without a Penny's Expense

Radio operators aboard ocean liners live luxuriously—they rank as officers of the ship. Meals, a private cabin, all other living needs are furnished free, and besides the operator draws a good salary. You can learn quickly and easily at home in your spare time to be a Radio operator through our practical training methods. Take a look at the FREE BOOK which tells how—mail coupon below.

This U. S. Government-recognized school has been training successful operators since 1914. Our graduates are all over the world. We maintain an Employment Department to help put you on your own ship. The world-famous NATROMETER, our own patented invention, obtainable only by students of this Institute, is recognized as the best and easiest way to learn the Radio code. A few short months, with the aid of the famous Natrometer and our quick home training, and you too can be a fully qualified Radio operator, sitting in your cabin like the one shown above, bound out for Liverpool or Nagasaki!

Read the Free Book that tells all about this fascinating profession and our practical Government-recognized methods of training you for it. Send coupon TODAY—no obligation. Special tuition offer now on, includes world-famous Natrometer free of extra cost with your course! Act at once.

**NATIONAL RADIO INSTITUTE  
WASHINGTON, D. C.**

### SPECIAL OFFER COUPON

National Radio Institute,  
Dept. OO-85, Washington, D. C.

Gentlemen: Without obligating me in any way send me your free book and information about your offer of Natrometer with course.



World-Famous Natrometer

Name .....

Address .....

# LOOK!

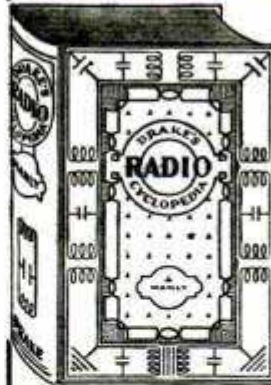

## The Last Word in RADIO

Radio is an exact science, yet so new there is still much that is incorrect and unscientific in present equipment. The results are faulty reception and complaints.

To meet this need we have compiled the exact facts covering the entire scope of radio science and every type of receiver into one big, fine, new book. With it you can now Be The Man Who Knows!

## DRAKE'S RADIO CYCLOPEDIA Solves the Dealer's Service Problems

If you design, build, repair or service radio receivers you need this book. All subjects alphabetically arranged, with hundreds of cross references so you quickly find what you want. 1672 headings, 985 illustrations, 871 pages. Nothing else like it. It is the book of radio, just out. SEND TODAY. \$6.00 postpaid. Also for sale at all bookstores.

Big catalog of useful books sent free.

## FREDERICK J. DRAKE & CO.

Publishers

1010 S. Michigan Blvd.

Chicago

# LAW Free Book

Write today for FREE 128-page book, "THE LAW-TRAINED MAN," which shows how to learn law in spare time through the Blackstone home-study course prepared by 80 prominent legal authorities, including law school deans, lawyers, and U. S. Supreme Court justices. Combination text and case method of instruction used. All material necessary furnished with the course, including elaborate 25-volume law library, which is delivered immediately upon enrollment. Many successful attorneys among our graduates. LL. B. degree conferred. Moderate tuition, low monthly terms. Money-Back Agreement.

Write for free book today

**BLACKSTONE INSTITUTE, 4753 Grand Boulevard  
Dept. 58 Chicago**



# LAW STUDY AT HOME

Become a lawyer. Legally trained men win high positions and big success in business and public life. Be independent. Greater opportunities now than ever before. Big corporations are headed by men with legal training. Earn \$5,000 to \$10,000 Annually

We guide you step by step. You can train at home during spare time. Degree of LL.B. conferred. LaSalle students found among practicing attorneys of every state. We furnish all text material, including fourteen-volume Law Library, low cost, easy terms. Get our valuable 168-page "Law Guide" and "Evidence" books FREE. Send for them NOW. LaSalle Extension University, Dept 1164-L Chicago  
The World's Largest Business Training Institution

## PREPARE FOR AN

# ART CAREER

—thru the only art school operated as a department of a large art organization, who have actually produced over a quarter million drawings for leading advertisers. Where else can you get so wide an experience? Home study instruction. Write for illustrated book telling of our successful students.

## MEYER BOTH COMPANY

Michigan Ave. at 20th St. Dept. 16, Chicago, Ill.



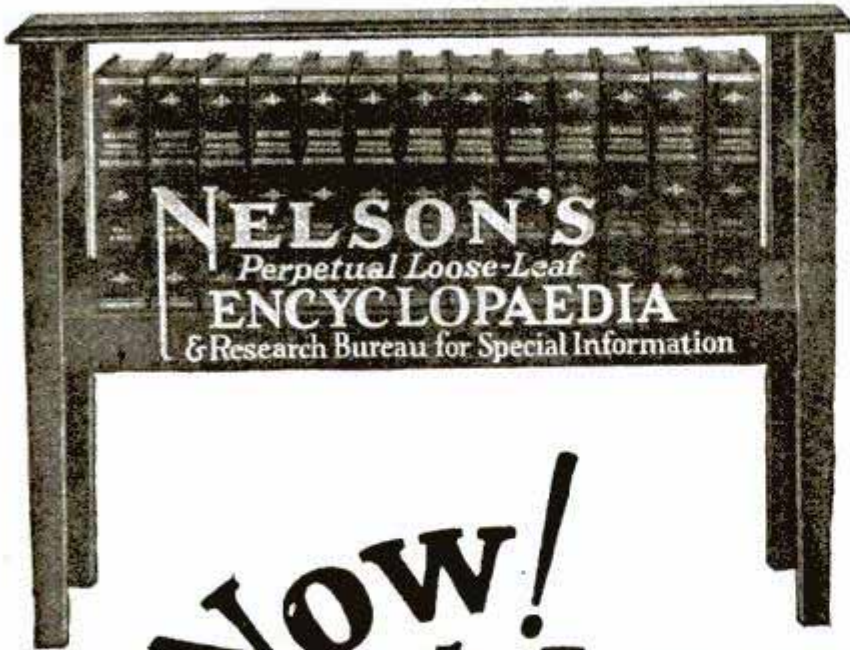

# Now!

## An Encyclopaedia that

## Never Grows Old ★

### What you Get in Nelson's Loose-Leaf Encyclopaedia

A handsomely bound, beautifully printed encyclopaedia that is new now and will always be up-to-date.

More profusely illustrated than any other encyclopaedia. By means of the loose-leaf binding device, new information that can always be substituted for obsolete matter. A complete Atlas of the World including up-to-date maps. The latest population statistics of the countries and leading cities of the world and all towns in the United States having more than 2000 population.

Biographies of prominent men and women of today, as well as of the past.

An Index Volume containing over 200,000 references makes instantly available to you thousands of facts in Nelson's.

Nelson's Reader's Guide—33 full study college courses on as many subjects.

NELSON'S is the representative, authoritative American Encyclopaedia. Used in the Library of Congress, U. S. Senate, U. S. Supreme Court, and in Libraries, Universities, and Schools in every state in the Union.

The value of an encyclopaedia is dependent on its up-to-dateness. Because it is Loose-Leaf, NELSON'S ENCYCLOPAEDIA NEVER GROWS OLD. The importance of this feature is best illustrated by the fact that about 2000 changes are made yearly.

Think what this means to you—an Encyclopaedia to last a lifetime. Every

★ Stop a moment and think—Lindbergh's amazing flight, the situation in Italy, electric refrigeration, television, electricity in medicine and surgery, new statistics in all branches of commerce and trade, oil burners, the Mississippi Flood, the last ten years in Europe—these—and hundreds of other things are what intelligent people want to know about. Fast-bound encyclopaedias Are Always Out of Date.

Nelson's Loose-Leaf Encyclopaedia never grows old. Because of the loose-leaf binding device it is the only encyclopaedia in which you will find the latest information

encyclopaedia, except Nelson's, is out of date within six months after it is published. Nelson's Loose-Leaf Encyclopaedia is the only encyclopaedia that is always up-to-date. There are no "new editions" to buy—it is always new!

Every one has felt that he would like to own an authoritative encyclopaedia—many have hesitated, knowing that encyclopaedias get "old" so quickly. But now you can buy Nelson's Encyclopaedia knowing that it will last you a lifetime and always be up to the minute. For surprisingly little money, too!

The coupon below will bring beautifully illustrated sample pages including many illustrations and maps in full colors. Also full details about free membership in Nelson's Research Library Service Bureau and the Free Reader's Guide Service.

**This coupon  
puts you un-  
der no obli-  
gation. Mail  
it TODAY!**

#### THOMAS NELSON & SONS

*Publishers Since 1798*

**Originators of the Loose-Leaf Reference System**

P. M. O. 381 Fourth Ave., New York City

Send me, FREE, your Book of Specimen Pages with full information of your offer telling how I can own Nelson's Loose-Leaf Encyclopaedia on the Small Monthly Payment Budget Plan.

Name.....

Street.....

City..... State.....

(Adv. Copyright, 1927, by Thomas Nelson & Sons)



# THERE'S MONEY IN SUCCESS

For Any Man who likes Mechanical Work the Shortest Way to Financial Independence is **Making Crowns, Plates, Bridges, Inlays, Etc. for Dentists.** Steady Earnings up to \$5,000 a year—some earn far more in this Profitable Professional Trade.

### THREE MONTHS TRAINING

will qualify one to enter this most rapidly growing professional trade—Mechanical Dentistry. Best opportunity for men who like to use tools—dignified work, steady income, rapid advancement, no "slack seasons" as in other trades.

### LEADING THE FIELD

Bodee training is recognized by dentists everywhere, owing to our 35 years' experience at this work—established 1892—the oldest school. Bodee-trained men make good. After only a few years you find them prominent in this profitable trade—on good salaries or conducting their own laboratories. There's room for many more—think it over! We conduct a Placement Bureau to select suitable positions, and, should you desire to open your own laboratory, we assist you in securing a location and equipping your laboratory.

### FOUR EXCEPTIONAL OFFERS WITHOUT ADDITIONAL COST

- 1—R. R. Fare to Our Nearest School.
- 2—10% Reduction of Tuition.
- 3—\$50 Outfit of Standard Tools.
- 4—Post Graduate Instruction.

### LEARN BY "DOING"

Individual instruction—No classes whatever—Practical work. You use regular standard tools and learn to do exactly the kind of work which will later be required of you by Dentists.

### EARN WHILE YOU LEARN

Lack of money need not stop you. We assist in securing whole or part time positions to help our students pay expenses.

### JUST COMPARE!

Compare this trade with what you are now doing, or with the best you can find in any other line! Compare our unexcelled training—step by step—every point thoroughly covered—no time wasted! Consider also the very reasonable cost of this exceptional training.

Send for Catalog No. 2



## BODEE DENTAL INSTITUTE

NEW YORK  
1755 Broadway

PHILADELPHIA  
1305 N. Broad Street

BROOKLYN  
85 Court Street



MAC HIMSELF

# Big Jobs Waiting for McSweeney Trained Men

## It Takes Only 8 Weeks

training to make any man a competent auto, tractor and electrical mechanic. 8th grade schooling is sufficient—age is no barrier—I train 'em all ages from 16 to 60. Ten thousand men have been qualified by my practical, easy-to-learn shop method of teaching with real tools and real equipment. No tedious book study. You learn by DOING. I tell you WHY, then show you HOW—that's why McSweeney trained men are wanted everywhere, get the biggest jobs and best pay. They "know their stuff." Thousands of big jobs are waiting for rightly trained men. Get ready. Start now. Write at once for my big special offer which includes

## R. R. FARE and BOARD PAID While Learning

Accept this amazing offer and you have nothing further to worry about. No extras to buy. After 8 weeks of my skillful training you'll be ready to step out and get a real job with big pay—and I'll help you get one of the very best jobs in the country. If you're just an average man and can read and write, I'll guarantee you can learn by my simple, easy, practical method. Furthermore, I'll refund your tuition if you're not satisfied with what I have done for you.

### Electrical Course

of extra cost to those who enroll soon. You get full training in auto and tractor mechanics, plus the electrical course, all for the one amazingly low fee. Hurry! Enroll now! The auto and tractor field is begging for well trained men. Write at once for full details and my big auto book FREE. Send coupon to school nearest you.

**FREE**



## Auto Mechanics Wanted

In all parts of the U. S. Tractor mechanics and electricians needed, too. Start your McSweeney training at once and qualify for one of the big pay jobs that are begging for trained men. Never in the history of the business have such high wages been paid. Many now earning

**\$75 to \$125 Per Week**

McSweeney Auto, Tractor and Electrical Schools. Dept. XM-302, (Address school nearest you) Cincinnati, Ohio; Cleveland, Ohio.

Without any obligation send me your big free book on Autos. Also information regarding Special Price Tuition offer.

Name.....

Address.....

City..... State.....

**McSWEENEY SCHOOLS**  
AUTO, TRACTOR AND ELECTRICAL  
DEPT. XM-302, CINCINNATI, OHIO; CLEVELAND, OHIO





# They Thought I Was A Weak Sister -But I Took Their Breath Away!

ALL of a sudden the office was very quiet, as sometimes happens for an instant or two, and a few words reached me. "Oh, he won't dare kick," the manager was saying, "he's a pretty weak sister."

Mechanically I went on with my work, wondering vaguely who the weak sister could be. A new man had just been hired for our department and desks were being moved to make room for him. A minute later I looked up and saw the chief clerk standing at my side. "Bob," he crisply ordered, "move your desk back in that corner, I want this space for the new assistant I've hired." Then he turned and strode away.

I gulped and wilted down into my chair. I was the weak sister! And I was actually being demoted! The new man was being hired for my place! This was my reward for all my hard work—this was how I won out by waiting patiently for my turn to be promoted. I had even congratulated myself on my close-lipped, reserved manner—I thought I was showing strength of character by sticking to my work and not trying to push myself—to show off.

And that was the whole trouble. I had plenty of steel in my makeup, but I had no ability to express myself. I was timid, self-conscious, and actually afraid of my own voice. I would study out the office problems and find solutions for our difficulties, but I didn't know how to present these ideas to the man up ahead. Several of the boys who had started at the time I did were now department managers—because they had the knack of forceful speech, self-confidence and personality—the very qualities I lacked. It made me good and mad—and I resolved to show them—to get rid, once and for all, of my timidity and shyness—my bashfulness and lack of poise.

## In Twenty Minutes a Day

And then suddenly I discovered a new, easy method which made me into a good talker—a forceful and powerful speaker—almost overnight. I learned how to say just the right words at the right time, how to win and hold the attention of those around me, how to bend others to my

will, how to dominate one man or an audience of thousands. My self-consciousness began to vanish. One morning I got up my courage and presented the manager and the chief clerks with a complete plan for rearranging our department—stating it simply and clearly, but in a pleasing, interesting and forceful way. I actually took their breath away—they were so amazed that they gave me full power to carry out my ideas!

Soon I had won salary increases, promotion, popularity, power. And I accomplished all this by developing the natural power of speech possessed by everyone, but cultivated by so few—by simply spending 20 minutes a day in the privacy of my own home on this most fascinating subject.

## Send for This Amazing Book

This new method of training is fully described in a very interesting and informative booklet which is now being sent to everyone mailing the coupon below. This book is called, *How to Work Wonders With Words*. In it you are shown how to conquer stage fright, self-consciousness, timidity, bashfulness and fear—those things that keep you silent while men of lesser ability get what they want by the sheer power of convincing speech. Not only men who have made millions, but thousands have sent for this book—and are unstinting in their praise of it. You are told how to bring out and develop your priceless "hidden knack"—the natural gift within you—which will win for you advancement in position and salary, popularity, social standing, power and real success. You can obtain your copy absolutely free by sending the coupon.

## North American Institute

3601 Michigan Ave. Dept. 1358 CHICAGO, ILL.

### What 20 Minutes a Day Will Show You

How to talk before your club or lodge  
How to propose and respond to toasts  
How to address board meetings  
How to make a political speech  
How to tell entertaining stories  
How to make after-dinner speeches  
How to converse interestingly  
How to write letters  
How to sell more goods  
How to train your memory  
How to enlarge your vocabulary  
How to develop self-confidence  
How to acquire a winning personality  
How to strengthen your will-power and ambition  
How to become a clear, accurate thinker  
How to develop your power of concentration  
How to be the master of any situation

NOW SENT  
**FREE**



NORTH AMERICAN INSTITUTE,  
3601 Michigan Ave., Dept. 1358,  
Chicago, Ill.

Please send me FREE and without obligation my copy of your inspiring booklet, *How to Work Wonders With Words*, and full information regarding your Course in Effective Speaking.

Name.....  
Address.....  
City..... State.....



# \$100 for One Good Commercial Drawing



## Become An Artist This Tested Way

Thousands who never dreamed they could draw can now become artists at home, in spare time, by amazingly simple way. Students write telling us they never realized that learning to draw could be so easy. Many are able to earn good money making drawings before completing our training. Miss Hartleigh made \$235 after 12 lessons; David Gould made \$225 on one job while still just a student. E. V. Fritsch wrote, "I earn \$10 to \$15 a day."

### Big Money in Commercial Art

Millions of dollars are being spent this year on advertising and story illustrations, commercial designs, and cartoons. And even more will be spent next year. Commercial art is a tremendous field—and a field where very big money is gladly paid anyone who can produce good art work. Advertisers, magazines, newspapers, printing houses, business concerns all need trained artists. Competent artists easily earn from \$50 to over \$250 a week. Why don't you too enter this fascinating, big pay business?

### Learn to Draw by This Simple Method

You will be amazed at the ease with which you learn—amazed too at your rapid progress. You start at the very simplest fundamentals, yet almost before you realize it, you are taught how to produce salable work. It's actual fun learning to draw this way. You learn at home yet your work receives the personal attention and criticism of competent Art Instructors. Many students actually sell enough work during their training to pay for it many times over!

### Mail Coupon for FREE BOOK

A new handsomely illustrated book has just been printed, which gives all the most up-to-date information on the thousands of wonderful opportunities in Commercial Art and shows how this startling, simple method enables you to enter this field. It tells about our students—their successes—what they say—actual reproductions of their work—how they made big money while studying. This attractive book will be sent without cost or obligation. Send for it. Mail coupon NOW. (No salesman will call).

WASHINGTON SCHOOL OF ART, Inc.

Room 3011-E, 1115-15th Street, N. W., Washington, D. C.

Washington School of Art, Inc.

Room 3011-E, 1115-15th St., N. W., Washington, D. C.

Please send me without cost or obligation your new book on "How to Become an Artist" and details of your offer to new Students.

Name.....  
(Write name plainly and state whether Mr., Mrs., or Miss)

Address.....

City..... State.....

Age.....



# Popular?

## You Know It!

Why not learn to play? Music will open wide the doors of social success to you; make you many fine friendships—the center of interest and popularity everywhere.

### Learn Music Quickly and Easily

You need know nothing about music to begin. We give you personal, individual instruction right from the start. You will be surprised and delighted to find that music can be made so easy and interesting. Over 200,000 successful Students, Musicians and Teachers endorse and recommend our methods. Courses in Piano, Violin, Trumpet, Voice, Banjo, Tenor Banjo, Spanish Guitar, Hawaiian Guitar, Organ, Mandolin.

### Send for Beautiful New Catalog, FREE

It will tell you all about this great School—now in its 25th successful year; our exceptionally low prices and easy terms, and how you can quickly and easily gain the pleasure, popularity and earning opportunities that Music will bring to you. Send for this wonderful book NOW—TODAY.

**NATIONAL ACADEMY OF MUSIC**  
Dept. 10 702 East 41st Street, Chicago

## Learn to PAINT SIGNS and SHOW CARDS

We quickly teach you by mail, or at school, in spare time. Enormous demand. Big future. Interesting work. Oldest and foremost school.

**EARN \$50 TO \$200 WEEKLY**  
John Vassos, N. Y., gets \$25 for single show card. Crawford, E. C., writes: "Earned \$200 while taking course." Don't delay. Send today for complete information, samples and guarantee.

**DETROIT SCHOOL OF LETTERING**  
154 Stimson Ave. Est. 1892 DETROIT, MICH.



## LEARN WATCHMAKING AND ENGRAVING

BY OUR PROFIT-SHARING PLAN  
**OUR GRADUATES SUCCEED**

One of our Iowa students started in a very small way—now doing over \$30,000 a year. Another in Wisconsin, over \$10,000 the first year. Day or night classes. Call or write for FREE BOOK

Chicago School of Watchmaking, Dept. 3401, 4844 Lincoln Avenue, CHICAGO

# GOV'T. POSITIONS

## \$35 TO \$75 WEEKLY

- |                        |                                  |
|------------------------|----------------------------------|
| ( ) Railway Mail Clerk | ( ) Meat Inspector               |
| ( ) P. O. Clerk        | ( ) Special Agent (investigator) |
| ( ) Forest Ranger      | ( ) Stenographer-Typist          |
| ( ) File Clerk         | ( ) Immigrant Inspector          |
| ( ) Matron             | ( ) City Mail Carrier            |
| ( ) General Clerk      | ( ) U. S. Border Patrol          |
| ( ) Chauffeur-Carrier  | ( ) Typist                       |
| ( ) Skilled Laborer    | ( ) Seamstress                   |
| ( ) Watchman           | ( ) Steno-Secretary              |
| ( ) Postmaster         | ( ) Auditor                      |
| ( ) RFD Carrier        |                                  |

Mr. Ozment, Dept. 111, St. Louis, Mo.  
Send me particulars about positions marked "X"—salaries, locations, opportunities, etc.

NAME.....  
ADDRESS.....



# AUDELS ENGINEERS & MECHANICS GUIDES

EXAMINE FREE!

For Every

Engineer  
Mechanic

Machinist  
Electrician

Fireman; Oiler  
Engineer Student



\$12  
Complete  
Set  
8  
Guides

**T**HIS Master Set is a gold mine of daily, practical helps for workers in every branch of engineering. A self-educating study course for the student; the standard reference work for the chief. Thousands of rules, tables, calculations and diagrams make it easy to read and learn. Latest inside information on theory and practice of modern engineering for reference study and review. Thousands of new short-cuts that make the job easier. Examine free! Pay \$1 a month (less than 4c a day) if satisfied that this set will help you to a better job—or make your present job easier.

## AUDELS STANDARD LIBRARY

With Questions and Answers That Solve Your Problems

EASY  
TERMS

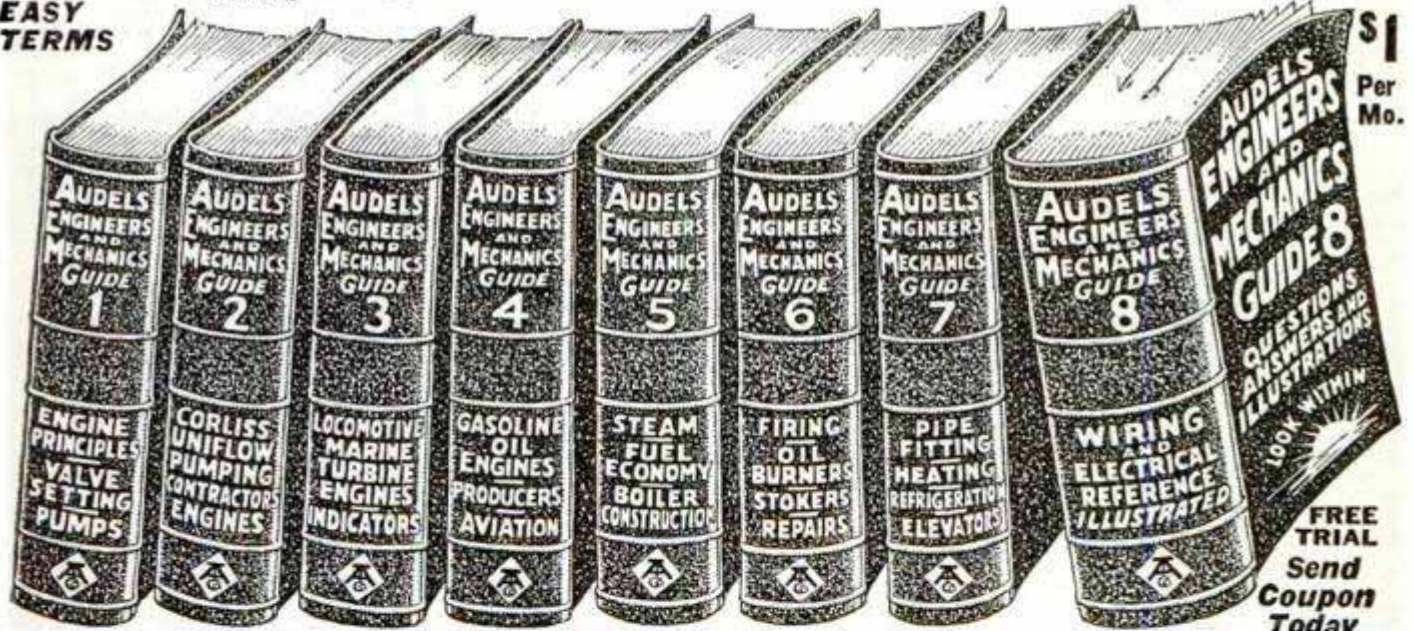

**8 GUIDES—8754 PAGES—4750 ILLUSTRATIONS—POCKET SIZE**

8 pocket numbers with Ready Reference Index. 8754 pages, 4750 illustrations. Easy to read. Highly endorsed. A good help in securing Engineer's License. Price \$12; terms, \$1 per month. Free Trial.

**INFORMATION: — In A Handy Form.** Answers to Your Questions and Problems. Here is a partial list of the subjects covered:—**Engine Principles, Valve Setting, Pumps, Corliss Engines, Uniflow Engines, Pumping Engines, Contractors Engines, Locomotives, Marine Engines, Turbine Engines, Gas Engines, Oil Engines, Indicators, Producers, Aviation, Steam, Fuel Economy, Boiler Construction, Firing, Oil Burners, Stokers, Boiler Repairs, Pipe Fitting, Heating, Refrigeration, Elevators, Dynamos, Motors, Lighting, Wiring, Electrical Diagrams, Radio, Electrical Reference and Calculations.**

**FREE BOOK—FOR LIMITED TIME.**



While the edition lasts, "Audel's Answers" will be included with each set of Audel's Guides. Contains special information for those who want to go before the board to get a license. Makes Engineers exams. easy. Send this coupon at once.

**THEO. AUDEL & CO., 65 West 23rd St., New York City**

Send me AUDELS ENGINEERS AND MECHANICS GUIDES, 8 numbers, \$12 and "Audel's Answers" for free examination. If satisfactory, I will send you \$1 in 7 days, then \$1 monthly until \$12 is paid.

Name.....  
Address.....  
Occupation.....  
Employed by.....





## “What would I do if I lost my job?”

SUPPOSE your employer notified you tomorrow that he didn't need you any longer? Have you any idea where you could get another position?

Don't have this spectre of unemployment hanging over your head forever. Train yourself to do some one thing so well that your services will be in demand. Employers don't discharge such men. They promote them!

Decide today that you are going to get the specialized training you must have if you are ever going to get—and keep—a real job at a real salary. It is easy if you really try.

Right at home, in the odds and ends of spare time that now go to waste, you can prepare for the position you want in the work you like best. For the International Correspondence Schools will train you just as they are training thousands of other men—no matter where you live—no matter what your circumstances or your needs.

At least find out how, by marking and mailing the coupon printed below. There's no cost or obligation, and it takes only a moment of your time, but it may be the means of changing your whole life.

### Mail the Coupon Today for Free Booklet

INTERNATIONAL CORRESPONDENCE SCHOOLS  
Box 5685-E, Scranton, Penna.

Without cost or obligation, please send me a copy of your booklet, "Who Wins and Why," and full particulars about the course before which I have marked X in the list below:

#### BUSINESS TRAINING COURSES

- |  |   |
|--|---|
| <input type="checkbox"/> Business Management                     | <input type="checkbox"/> Salesmanship                                     |
| <input type="checkbox"/> Industrial Management                   | <input type="checkbox"/> Advertising                                      |
| <input type="checkbox"/> Personnel Organization                  | <input type="checkbox"/> Better Letters                                   |
| <input type="checkbox"/> Traffic Management                      | <input type="checkbox"/> Show Card Lettering                              |
| <input type="checkbox"/> Business Law                            | <input type="checkbox"/> Stenography and Typing                           |
| <input type="checkbox"/> Banking and Finance Management          | <input type="checkbox"/> English  |
| <input type="checkbox"/> Accountancy (including C.P.A.)          | <input type="checkbox"/> Civil Service                                    |
| <input type="checkbox"/> Cost Accounting                         | <input type="checkbox"/> Railway Mail Clerk                               |
| <input type="checkbox"/> Bookkeeping                             | <input type="checkbox"/> Common School Subjects                           |
| <input type="checkbox"/> Private Secretary                       | <input type="checkbox"/> High School Subjects                             |
| <input type="checkbox"/> Spanish <input type="checkbox"/> French | <input type="checkbox"/> Illustrating <input type="checkbox"/> Cartooning |

#### TECHNICAL AND INDUSTRIAL COURSES

- |   |  |
|---|--|
| <input type="checkbox"/> Electrical Engineering                     | <input type="checkbox"/> Architect                                       |
| <input type="checkbox"/> Electric Lighting                          | <input type="checkbox"/> Architects' Blueprints                          |
| <input type="checkbox"/> Mechanical Engineer                        | <input type="checkbox"/> Contractor and Builder                          |
| <input type="checkbox"/> Mechanical Draftsman                       | <input type="checkbox"/> Architectural Draftsman                         |
| <input type="checkbox"/> Machine Shop Practice                      | <input type="checkbox"/> Concrete Builder                                |
| <input type="checkbox"/> Railroad Positions                         | <input type="checkbox"/> Structural Engineer                             |
| <input type="checkbox"/> Gas Engine Operating                       | <input type="checkbox"/> Chemistry <input type="checkbox"/> Pharmacy     |
| <input type="checkbox"/> Civil Engineer                             | <input type="checkbox"/> Automobile Work                                 |
| <input type="checkbox"/> Surveying and Mapping                      | <input type="checkbox"/> Airplane Engines                                |
| <input type="checkbox"/> Metallurgy <input type="checkbox"/> Mining | <input type="checkbox"/> Agriculture <input type="checkbox"/> Navigation |
| <input type="checkbox"/> Steam Engineering                          | <input type="checkbox"/> Mathematics <input type="checkbox"/> Radio      |

Name.....

Street Address.....

City..... State.....

Occupation.....

Persons residing in Canada should send this coupon to the International Correspondence Schools Canadian, Limited, Montreal, Canada

# ELECTRICITY

M

**REAL WORK with REAL TOOLS on REAL EQUIPMENT**  
**COLEMAN SYSTEM never fails**  
 when student means business  
**All Electrical Subjects Taught**  
 Armature Winding; Electric Welding; House Wiring; Electric Refrigeration; Farm Lighting; A. C. and D. C. Motors and Generators; Power and Light Switchboards, Dynamos and Transformers; Radio; Storage Batteries; Automotive Electricity.  
 All Electrical Trades need Skilled Men—Electrical Skill is in Demand at \$200.00 to \$600.00 a Month.  
**FREE—Automobile Training—FREE**  
 Real Cars to Work On—and No Extra Charge  
**LET COLEMAN TELL YOU HOW—**  
 WRITE FOR FREE BOOK  
**COLEMAN ELECTRICAL SCHOOL**  
 1628 H Main Street      KANSAS CITY, MO.

E

A
D
E

E
A
S
Y

## MUSIC LESSONS IN YOUR HOME



Write today for our **FREE** booklet. It tells how to learn to play Piano, Organ, Violin, Mandolin, Guitar, Banjo, etc. Beginners or advanced players. Your only expense about 2c per day for music and postage used. **American School of Music, 51 Manhattan Bldg., Chicago**

## Learn Advertising at HOME

Many of the highest paid men in the world are advertising men. You can learn easily and quickly at home during your spare time. We guarantee satisfaction. Bigger opportunities now in advertising than ever before. Constant demand for our graduates at splendid pay.

Send for **FREE** Book, giving interesting information and vital facts—just what you want to know about advertising. Write today.  
**PAGE-DAVIS SCHOOL OF ADVERTISING**  
 Dept. 1358      3601 Michigan Ave., Chicago, U. S. A.

## STAMMER

**IF YOU** Write for my free book "Millard's Advanced Natural Corrective Course" and a free copy of my speech magazine. 10,000 cases successfully treated. Est. 24 years. Largest school for stammerers in world. Millard Inst. of Normal Speech, 2317 Millard Bldg., Milwaukee, Wis.

**Learn Watchwork, Jewelrywork and Engraving** A fine trade commanding a good salary, and your services always in demand. Address: **Horological, Dept. P, Bradley Institute, PEORIA, ILLINOIS**, for our latest catalog.

**WHY NOT** spend Spring, Summer and Fall gathering butterflies, insects? I buy hundreds of kinds for collections. Some worth \$1 to \$7 each. Simple outdoor work with my instructions, pictures, price-list. Send 10 cents (not stamps) for my illustrated Prospectus before sending butterfly! **MR. SINCLAIR, DEALER IN INSECTS, Dept. G, Box 1424, San Diego, Calif.**

## 5 TUBE RADIO ONLY \$19.98

It's a wonder for power and selectivity. Famous ARL circuit. Coast to coast reception! Finely built of selected, tested parts. Thousands now in use. **FREE** Log and Call Book and New 133-p. Catalog with thousands of nationally advertised bargains. Latest in radio at big savings. Write for Free copy.  
**AMERICAN AUTO & RADIO MFG. CO.**  
 HARRY SCHWARTZBERG, PRES.  
 Dept. 261 American Radio Bldg., Kansas City, Mo.





# That girl's diary "showed me up"



"There," she sputtered, "read that, and see if you can take your medicine like a man!"

WHEN Evelyn gave that party I naturally expected to receive an invitation. We had been good friends for so long. And yet when the night arrived most of our group went along—and I didn't. I wondered why!

The next time I called to see her I determined to find out. If she couldn't give me a good explanation, I'd—I'd—anyway, I asked her point-blank. At first she dodged the question. "Just like a woman!" I thought. Then she became defiant. "All right, if you *must* know the truth, I'll give it to you!"

## I Learn the Secret

In a moment she had rushed out of the room, returned with a small book, opened it and thrust it into my hands. "There," she sputtered, "read that, and see if you can take your medicine like a man!"

I was flabbergasted! *Her diary!* I read the hastily penned record. The last burning sentence came like a lightning flash—"I wish someone would give Jim a tip about his dancing!"

So that was it! Instantly I understood. I certainly did look foolish in her eyes.

All along I had been bluffing my way as a dancer and kidding myself that I was "getting by" with it. Now at last I realized that I hadn't fooled anyone but myself. They all knew I was a stiff, old-fashioned "walk-around"—they laughed up their sleeves when I tried to imitate the steps of really good dancers—

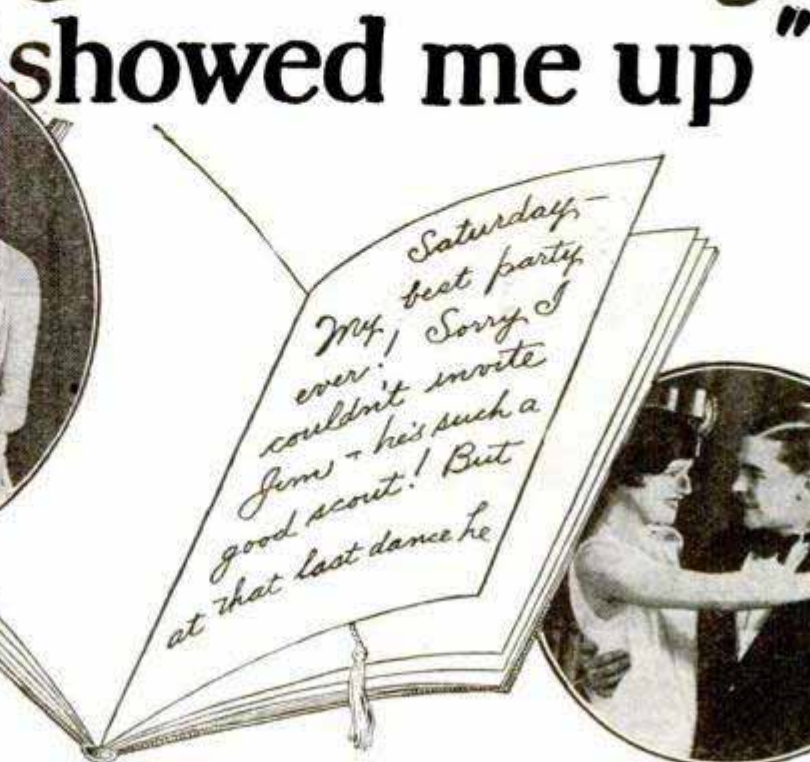

Saturday—  
My, best party  
ever! Sorry I  
couldn't invite  
Jim—his such a  
good scout! But  
at that last dance he

## — but when I met her again

and the pity of it was that I never realized how clumsy I looked on the dance floor—until that diary opened my eyes!

### A Short-Cut to Good Times

The very next evening I wrote to Arthur Murray, world-famous dancing master. I knew that he charged \$10.00 a lesson in his studio, but I knew also that he had five lessons in dancing that he offered free. I asked him to send those five lessons to me.

When they came I followed the simple directions and diagrams, practicing before a mirror. What a fun-spoiler I must have been! The lessons showed me how many mistakes I had been making in dancing—how many unpardonable blunders I had been guilty of. I had been holding my partner wrong—leading wrong—pivoting wrong—doing the simplest steps incorrectly. And as for the modern style of dancing—I was utterly ignorant of it.

Yet in a few evenings I learned the modern waltz—the modern Fox Trot, and many delightful variations of the very *latest* steps—all without music, partner or teacher!

### On the Road to Popularity

A week later I attended a dance. What a triumph! I glided around the floor like an expert. I did the most difficult steps with the ease and precision of a professional. My dancing was a complete success. And, best of all, Evelyn was right there to congratulate me!

This story is typical and it shows you just the chance you have been looking for—a chance to become an accomplished dancer right in your own home at a trifling small cost.

No matter how poorly you dance now—no matter if you've never been on a dance floor in your life—Arthur Murray's new method makes you a finished dancer in ten days, or you don't have to pay a penny for the lessons.

Just think! In ten days' time you'll be able to do the French Tango, the Fox Trot, the Waltz and all the other smart new steps.

### Five Lessons FREE

To prove that he can make you a finished dancer in ten days' time, Arthur Murray is willing to send you five lessons from his remarkable course absolutely free. Just send the coupon (with 10c to cover cost of printing and mailing)—and these valuable lessons will be forwarded at once. Also a free copy of his new book, "The Short Cut to Popularity." Don't delay. Mail coupon NOW. Arthur Murray, Studio 739, 7 East 43rd Street, New York City.

Arthur Murray, Studio 739,  
7 East 43rd St., New York City.

To prove that I can learn to dance at home in ten days, you may send the FIVE FREE LESSONS. I enclose 10c (stamps or coin) to pay for the postage, printing, etc. You are to include free "The Short Cut to Popularity."

Name.....

Address.....

City.....State.....





# High School Course in Two Years!

## You Want to Earn Big Money!

And you will not be satisfied unless you earn steady promotion. But are you prepared for the job ahead of you? Do you measure up to the standard that insures success? For a more responsible position a fairly good education is necessary. To write a sensible business letter, to prepare estimates, to figure cost and to compute interest, you must have a certain amount of preparation. All this you must be able to do before you will earn promotion. Many business houses hire no men whose general knowledge is not equal to a high school course. Why? Because big business refuses to burden itself with men who are barred from promotion by the lack of elementary education.

### Can You Qualify for a Better Position

We have a plan whereby you can. We can give you a complete but simplified high school course in two years, giving you all the essentials that form the foundation of practical business. It will prepare you to hold your own where competition is keen and exacting. Do not doubt your ability, but make up your mind to it and you will soon have the requirements that will bring you success and big money. **YOU CAN DO IT.**

Let us show you how to get on the road to success. It will not cost you a single working hour. Write today. It costs you nothing but a stamp.

### American School

Dept. H-874, Drexel Ave. and 58th St., Chicago

### American School

Dept. H-874, Drexel Ave. and 58th St., Chicago

Send me full information on the subject checked and how you will help me win success.

- |                             |                           |
|-----------------------------|---------------------------|
| ....Architect               | ....Business Law          |
| ....Building Contractor     | ....Lawyer                |
| ....Automobile Engineer     | ....Machine Shop Practice |
| ....Automobile Repairman    | ....Mechanical Engineer   |
| ....Civil Engineer          | ....Shop Superintendent   |
| ....Structural Engineer     | ....Employment Manager    |
| ....Business Manager        | ....Steam Engineer        |
| ....Cert. Public Accountant | ....Foremanship           |
| ....Accountant and Auditor  | ....Sanitary Engineer     |
| ....Bookkeeper              | ....Surveyor (& Mapping)  |
| ....Draftsman and Designer  | ....Telephone Engineer    |
| ....Electrical Engineer     | ....Telegraph Engineer    |
| ....Electric Light & Power  | ....High School Graduate  |
| ....General Education       | ....Wireless Radio        |
| ....Vocational Guidance     | ....Undecided             |

Name.....

Address.....



# Young outdoor men wanted

Interesting, vigorous outdoor work in a growing organization where merit wins advancement. Good starting wages. Permanent positions and a real future for men who make good. Our present field force of Davey Tree Experts cannot meet the increasing demand. So we are selecting now, to enter our employ, a few sturdy, clean young men, thorough Americans, single, between 20 and 30 years old, free to travel, industrious, with good practical education, and able to give good references. Write for qualification blank to serve in place of personal interview. The Davey Tree Expert Co., Inc.,

840 Federal Bldg., Kent, Ohio



## Get into the electric wiring field—big money for you

Great demand in wiring field. These books prepare you.

**KINKS**; helps; short cuts; practical, on-the-job electrical data, written particularly to help wiremen, trouble shooters, maintenance men, armature winders, electrical contractors and students. The whole wiring field covered; concrete and usable details about new and better ways for doing the kind of work you have to do.

### American Electricians' Library

6 volumes, 2000 pages, illustrated, \$16.00 payable \$2.00 in ten days and \$2.00 a month

The books tell you all you must know about conduit wiring, armature winding, wiring for lighting circuits and switches, wiring for machinery, circuit troubles, circuit testing, or electrical machinery erection. Through a study of this great set you can push yourself into a big-pay job for life.

See it FREE—Send no money—ACT

### FREE EXAMINATION COUPON

McGraw-Hill Book Co., Inc.  
370 Seventh Avenue, New York

Send me the American Electricians' Library for 10 days' free examination. If satisfactory, I will send you \$2 in 10 days and \$2 monthly until the full price, \$16 is paid. If not wanted, I will return the books at your expense. Upon receipt of my first payment of \$2.00, I am to receive a copy of Braymer and Roe's REWINDING SMALL MOTORS free of charge.

Name.....

Address.....

Position.....

Company..... P. M. -11-27



# An Offer YOU Can't Afford to Miss!

**N**EW marvels in the world today can make or re-make your life. It is because of this that every intelligent person needs this new Britannica.

## The Very Latest BRITANNICA in the New Form for Family Use

For a short time only, YOU can get the very latest Britannica in the popular NEW FORM for FAMILY USE, at a *Clear Saving of 40%*. This tremendous reduction in price is now possible because the popular NEW FORM is printed from the *same identical plates* as the higher-priced Cambridge Issue and the 32 volumes are bound as 16.

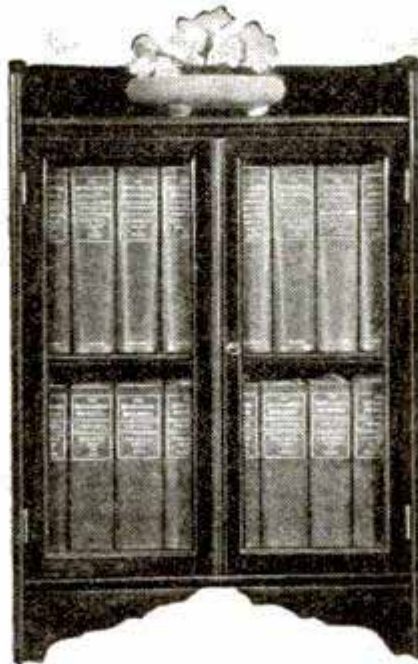

**T**HE mass of human knowledge; to which new facts are being added every day, is so enormous that no one man can ever hope to compass half of it.

Handsome Bookcase

## FREE

While this Offer Lasts

If You Act Quickly, we will include with each set of the new Britannica purchased in the NEW FORM for FAMILY USE, a Handsome Bookcase in rich mahogany finish, with glass doors, ABSOLUTELY FREE. This is the greatest money-saving offer the Britannica Company has ever made. The Britannica will pay you handsomely.

## You Can Save 40% If You Act NOW!

**T**HIS limited-time offer is YOUR opportunity to own the very latest Britannica, in the NEW FORM for FAMILY USE, at a *sweeping reduction of 40%* as compared with the higher-priced Cambridge Issue. It is your opportunity to possess the genuine Encyclopaedia Britannica, recognized

the world over as the highest authority on every subject of importance. This is an offer of *tremendous importance* to every man and woman in the world today who knows the value of accurate knowledge, and its *vital need* in this marvelous age of swift progress.

### This Is What You Get

While this Special Offer lasts you can get:

1. The Complete 13th Edition of the Britannica—new facts, ideas, practical suggestions—not elsewhere available.
2. You get it in the large-page, large-type NEW FORM for FAMILY USE (32 volumes bound as 16) with 33,000 pages, 45,000 separate articles, 50,000,000 words, written by 2500 world authorities

from 50 different countries; more than 600,000 important indexed subjects, over a million facts; 15,000 illustrations, including 640 maps, etc.

3. You get Six Valuable Reading Courses, selected from the series known as the Britannica Home University, and—

4. A Handsome Bookcase (value \$25.00), in rich mahogany finish, with gleaming glass doors, ABSOLUTELY FREE.

Send for this **FREE Booklet TODAY**

Act now—At Once—THIS MINUTE! The demand for this New Britannica has already far surpassed all previous records. Soon this Extra Special Offer will have to be withdrawn. Fill in and mail the coupon below for handsome illustrated booklet, which we'll gladly send you FREE. It tells all about this Amazing Offer, and explains the Easy Terms of Payment. Tear out this Coupon NOW—and mail it before the last collection tonight.



### This EXTRA SPECIAL Offer

is an opportunity you cannot afford to miss. While offer lasts, you make a clear saving of 40% and get Handsome Bookcase FREE. For an initial payment of only \$5, balance in convenient monthly amounts, you can have this new Britannica delivered to your home *immediately!*

### USE THIS COUPON

The ENCYCLOPAEDIA BRITANNICA, Inc.  
342 Madison Avenue, New York 7PM-P2

Please send booklet; also particulars of the New Form (40% saving); and full details of your Special Bookcase Offer and Easy Payment Plan.

Name.....

Address.....

City.....State.....

**Mail This Coupon Now** →





*Freedom  
from a  
Small-Pay Job  
Come to New York  
the city of 100,000 jobs*

ANY MAN who can read and write and use a pair of pliers can become an electrical expert and free himself forever from the long hours and drudgery of a small pay job.

And you can learn the BIG PAY profession of electricity right in New York City—the heart of the electrical world—the city of 100,000 jobs. At the same time you are learning the BIG PAY profession you can be enjoying the sights and wonders of New York, the modern Bagdad.

**Be An Electrical Expert**

Graduates of the NEW YORK ELECTRICAL SCHOOL are in demand by all the big electrical companies. Or, if you prefer the independence of a business of your own, there are thousands of opportunities for efficient, dependable men to become electrical contractors. When you are your own boss the money you can make is limited only by your own energy and ability.

**Personal Instruction**

The NEW YORK ELECTRICAL SCHOOL is not a correspondence school. You learn by doing—by personal instruction on full size standard electrical equipment under the personal supervision of trained instructors.

At N. Y. E. S. you train your hands and mind at the same time. You learn the theories of electricity—and then you are shown how to put the theories into actual practice by solving the problems with your own hands.

The man who has learned electricity by actually doing electrical work under intelligent personal instructors can go to any part of the world and be sure of a good living. There are N. Y. E. S. graduates in all the countries of the world.

Write today for the 48-page booklet giving full information about the N. Y. E. S. Course and showing pictures of the equipment available for your personal use in our two seven-story buildings. Mail coupon now! The New York Electrical School, 44 W. 17th Street, New York.

The New York Electrical School  
44 W. 17th Street, New York

Please send me FREE your 48-page booklet. It is understood that this request puts me under no obligation.

Name.....

Address.....



**\$1900 to \$2700 a year**



Long vacations with pay. Work easy. Travel on fast trains with all expenses paid, including hotel. No worries about the future. Ex-service men get preference.

**MY FREE BOOK TELLS HOW**

Get my big free book about the Civil Service which tells all about the Railway Postal Service, and other positions, and how I can help you. Write today.

**PATTERSON SCHOOL**  
Arthur R. Patterson, Civil Service Expert  
811A Wisner Bldg. Rochester, N. Y.

**Salesmen—  
increase your sales!**

Be more than an "order-taker"—become a more expert salesman! Learn how to obtain a favorable hearing with the man who greets you with, "I'm not interested." Learn how better to analyze him, classify him—how to anticipate and meet his every objection—how to close the order more easily. There's a science to selling! Master it, and you can quickly distinguish yourself as a topnotcher. Thousands, including many experienced salesmen, have increased their sales volume more than 100 per cent thru LaSalle home-study training in Modern Salesmanship. Low cost; easy terms. Our free book, "The Modern Salesman, Ambassador of Progress," tells you how. Send for it today. **FREE**



LaSalle Extension University, Dept. 1164-S, Chicago

**LEARN WATCH REPAIRING**

Be a watchmaker—you can learn this profitable trade by correspondence in a few weeks in your own home by the DeSelms Chart System. After you complete the course you will know a watch from A to Z. You will know just what the matter is and how to repair one. When you graduate you will be a practical watchmaker and repairer and competent to fill any position. Positions for our graduates. Ask for our Free Book. It explains our system and terms.



THE DeSELMS WATCH SCHOOL  
LOGANSPORT, INDIANA

**"STAMMERING**

**Its Cause and Cure"**

You can be quickly cured if you stammer. Send 10 cents, coin or stamps, for 288 page cloth bound book on Stammering and Stuttering. It tells how I cured myself after Stammering and Stuttering for 20 years. BENJAMIN N. BOGUE  
694g Bogue Building, 1147 N. 111. St. Indianapolis



Wonderful, new device, guides your hand; correct your writing in few days. Big improvement in three hours. No failures. Complete outline FREE. Write C. J. Ozment D-34, St. Louis, Mo.

**BE AN ARTIST**

WE CAN TEACH YOU DRAWING in your own home during your spare time. Twenty-five years of successful teaching proves our ability. Artists receive large salaries.

Write Today for Art Year Book

SCHOOL OF APPLIED ART  
ROOM NO. 2 BATTLE CREEK MICH.





# It Was the Greatest Shock of My Life to Hear Her Play

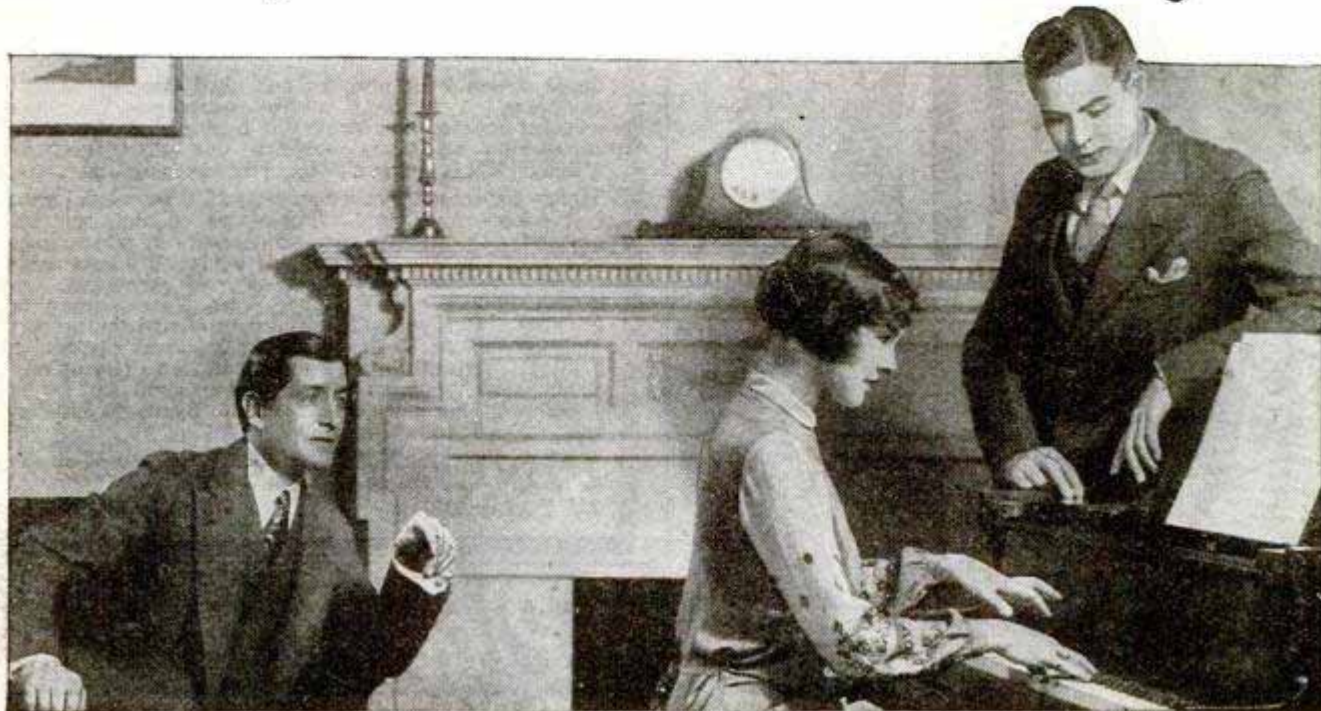

## —how had she found time to practice?

“WELL, Jim—I told you I had a surprise for you!”  
She beamed at her husband, delighted to see how surprised—and pleased—he was.

And I was astonished, too. Quite casually she had gone to the piano, sat down—and played! Played beautifully—though I had never seen her touch a piano before. Neither of us could conceal our curiosity.

“How did you ever do it?” her husband asked. “When did you find time to practice?”

“And who is your teacher?” I added.

“Wait, wait!” she laughed. “One question at a time. I have no teacher, that is, no private teacher, and I do my practicing between dishes.”

“No teacher?”

“No—I learned to play the piano an entirely new way—without a teacher. You see, all my life I wanted to play some musical instrument. I thought I’d never learn how to play, though—for I haven’t much time to spare, and I thought it would take long hours of hard work. And I thought it would be expensive, too.”

“Well, it is hard work, and it is expensive,” I said. “Why, I have a sister—”

“I know,” she laughed, “but I learned to play the piano through the new simplified method. Some time ago I saw an announcement of the U. S. School of Music. It told how a young man had learned to play the piano during his spare time without a teacher. I found that thousands of others had learned to play

their favorite musical instruments in this same delightful, easy way, and so I decided to enroll for a course in piano playing.”

“But you didn’t tell me anything about it,” Jim said.

“Well, you see, that was my big surprise. Ever since I received my first lesson I’ve been practicing by myself—during the day while you’ve been away at business. I turned my spare moments between housekeeping and shopping into something pleasant and profitable.”

“If you planned to surprise me—you’ve certainly succeeded,” said Jim.

### Learn to Play at Home

This story is typical. Thousands of men and women have learned to play their favorite musical instruments through the U. S. School of Music.

Are you letting priceless moments slip by when you could be learning to play some musical instrument—easily, quickly?

You simply can not go wrong. First you are told how a thing is done, then by illustration and diagram you are shown how, and when you play—you hear it.

Thus you actually teach yourself to become an accomplished musician right in your own home. Without any long hours of tedious practice. Without dull or uninteresting scales you learn how to play real music from real notes.

Here is your chance to become a good player—quickly—without a teacher. The U. S. School of Music will make you a capable and efficient player. Many of our

pupils now have positions with professional bands and orchestras.

### Demonstration Lesson Free

Half a million people have already taught themselves to play their favorite instruments right in their own home. To prove that you, too, can learn music this fascinating way, let us send you our free book, “Music Lessons in Your Own Home,” which fully explains this remarkable method. We will include also our Free Demonstration Lesson.

### Mail Coupon Today

If you really want to gain new happiness and increase your popularity—send off this coupon at once. Forget the old-fashioned idea that “talent” means everything. Decide which instrument you want to play, and the U. S. School of Music will do the rest. At the average cost of only a few pennies a day! Act Now. Mail coupon today for the fascinating free book and Demonstration Lesson. U. S. School of Music, 711 Brunswick Bldg., New York City.

U. S. School of Music,  
711 Brunswick Bldg., New York City.

Please send me your free book “Music Lessons in Your Own Home” with introduction by Dr. Frank Crane. Demonstration Lesson and particulars of your offer. I am interested in the following course:

.....

Have you above instrument?.....

Name.....  
(Please Write Plainly)

Address.....

City..... State.....

Choose Your Course	
Piano	Drums and Traps
Organ	Mandolin
Violin	Harmony and Composition
Piccolo	Sight Singing
Clarinet	Ukulele
Flute	Trombone
Harp	Coronet
Cello	Hawaiian Saxophone
Guitar	Guitar
Guitar	Voice and Speech Culture
Hawaiian Saxophone	Automatic Finger Control
Guitar	Piano Accordion
Voice and Speech Culture	Banjo (Plectrum, 5-string or Tenor)



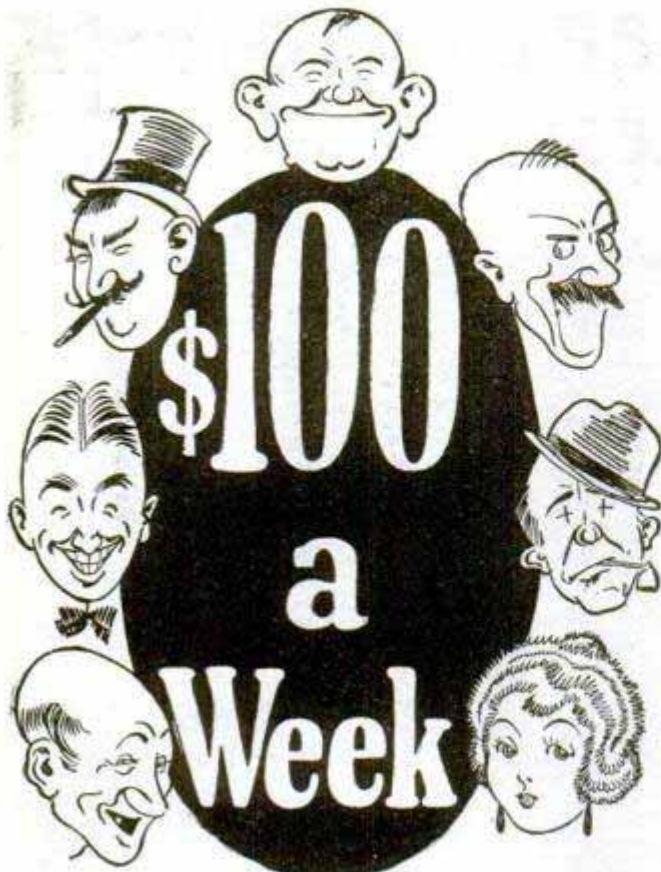

# IN DRAWING CARTOONS

Why spend your time doing work that is drudgery, and get little money for it when you may be able to draw cartoons for Big Pay? You can now learn cartooning at home with this simple, tested method. Many students earn money while learning.

Become a high-salaried cartoonist—one of the easiest, most pleasant, and best paid of all businesses. Millions of dollars spent last year on serious, comic, sport and animated cartoons—and the demand for cartoons increases every day! Hundreds of cartoons now used by big national advertisers.

## Learn Cartooning at Home In Spare Time—Simple, Tested Method

There is a knack about learning cartooning which you can master in your spare time with this simple home study method. It starts you at the very beginning—on simple fundamental principles—then takes you through every branch of humorous and serious cartooning. You will be surprised how quickly you can draw cartoons that will sell. Many earn even while learning.

### Send for Free Book

Get this handsomely illustrated booklet which gives the details of this remarkable home study course in Cartooning. Gives thorough outline of the cartooning field and market for cartoons. Shows how to become a cartoonist. No obligation. Send for it today. (No salesman will call.)

**Washington School of Cartooning**  
Room 3011E, 1113—15th St., N. W., Washington, D. C.

Washington School of Cartooning  
Room 3011E, 1113—15th St., N. W., Washington, D. C.

Please send me without obligation, your Free Booklet on Cartooning and full details of your home study method of teaching Cartooning.

Name.....  
(Write Name Plainly.) (State whether Mr., Miss or Mrs.)

Address.....

City..... State.....

# ELECTRICITY

## Practical-Technical TRAINING

Great demand for practical-technical electricians and engineers. A brilliant future awaits you. A high salaried position or a profitable business of your own; these may be yours through our PRACTICAL-TECHNICAL courses. Opportunities unlimited.

Finlay condensed method now in 25th successful year trains head and hand. Thousands of high salaried graduates throughout the world testify to the success of Finlay training. Extensively equipped laboratories and shops. Faculty of recognized experts. One and Two Year courses in Electrical Engineering open in September; 12 Weeks courses in Practical Electricity and Power Plant Operation open at any time. Degrees, diplomas and certificates of efficiency awarded. Students assisted to positions.

**FINLAY ENGINEERING COLLEGE** Fall term starts September 15th  
125 Finlay Bldg. Kansas City, Mo.

SEND FOR FREE CATALOG

# Play Piano BY EAR

-IN 90 DAYS!



Play anything—jazz to classical! Even if you know nothing about piano music—I'll have your fingers dancing over the keyboard with confidence in 90 days. If you can hum or whistle a tune you can play it! My students are broadcasting—making money. MAKE ME PROVE IT! Without puzzling notes! Without practicing tedious scales! I've found the way to bring out your musical instinct. New and original system, does away with years of work. YOU WANT THE PROOF? I'll send it. Write me now.

D. M. SUTTLE, Director  
ILLINOIS SCHOOL OF MUSIC  
115 Hunter Bldg., Chicago, Ill.

Send NOW for PROOF!

# GOV'T. POSITIONS

Forest rangers, start \$125 a month; cabin and vacation; patrol forests; protect game. Railway mail clerks, postoffice clerks-carriers, rural carriers, prohibition agents and internal revenue agents. For list of positions and how to qualify, write Mokane, Dept. 315, Denver, Colo.

# Learn MECHANICAL DENTISTRY



In 3 Months Earn Up to \$5000 A Year

WHY spend the best years of your life at uncertain jobs at small pay? You can EARN WHILE LEARNING this NEW money-making profession and become independent. Age no barrier, and no previous training required. You LEARN BY DOING PRACTICAL work. Day or night sessions. INDIVIDUAL INSTRUCTION. Easy terms. Railroad Fare allowed—no extra cost. Address SECRETARY N. Y. SCHOOL OF MECHANICAL DENTISTRY, 147 West 33 St., NEW YORK.

SEND FOR FREE BOOK



Clip and Mail Name..... Street..... City..... State.....



# These Real Blue Prints **and two Books** Sent **FREE**

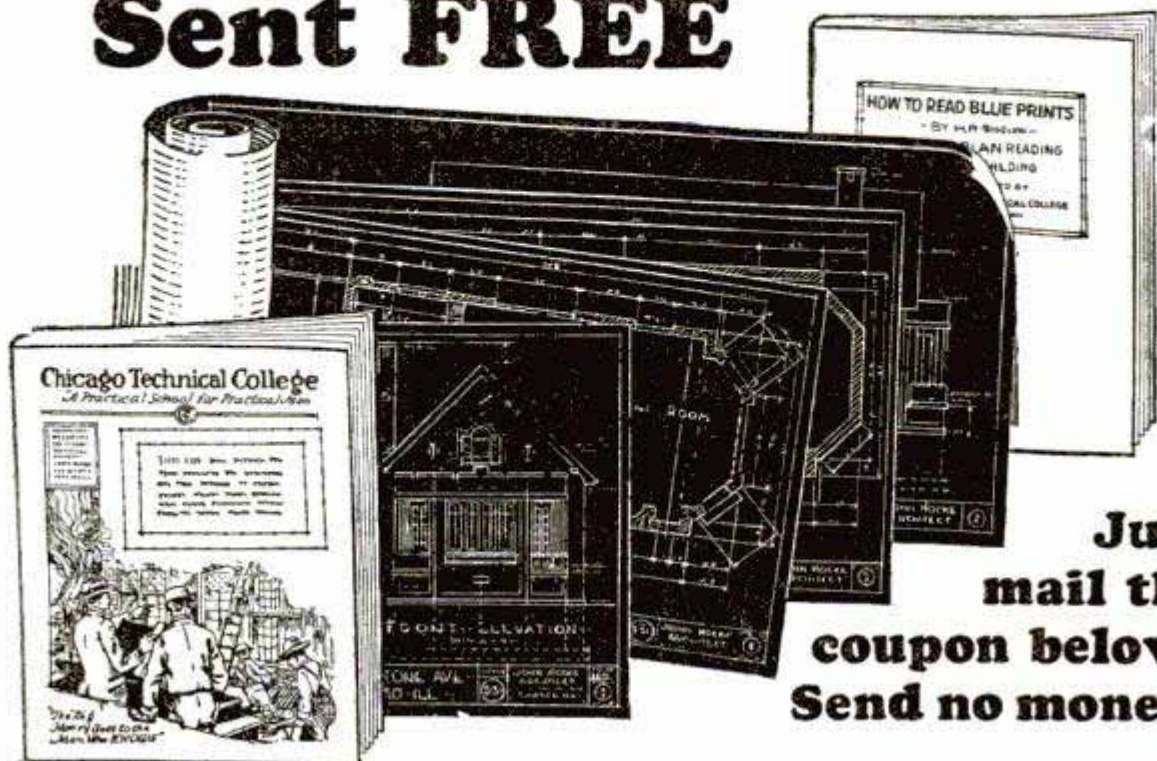

**Just  
mail the  
coupon below!  
Send no money!**

Every builder can get these real blue print plans and our book "How to Read Blue Prints" without sending us a penny. Just send the coupon. Lots of valuable and interesting information—all *free*. Yes, and we'll send along another book on building; it tells why "the big money goes to the man who *knows*." It explains the practical Chicago Tech. easy method of home-training for men in the building trades. Learn how to get the jobs that pay most money or how to get into your own business as a building contractor.

## **Plan Reading—Estimating—Superintending, etc.** Train at Home to **MAKE MORE MONEY** No Schooling Necessary

Learn how to read plans, lay out work and run jobs. Your spare time is enough. Wherever you may be—whatever your job—we can help you quickly to fill a higher place and have a bigger income. Age does not matter. Previous school

training is not needed. This is a practical course for practical men, prepared by practical instructors who have been through every branch of the building game themselves. You owe it to yourself to find out how to make more money.

### **To Builders Living in or Near Chicago**

Visit our Day or Evening School for builders and see with your own eyes the work we do. 1000 builders attend each year. You can get the same training *at home*. Same lessons—same blue prints—same practical instructors—same successful results.

**Get the Facts** Find out how little time it takes to make more money—much more money—in building. Write today. The coupon brings all *Free*.

**Chicago Technical  
SCHOOL for BUILDERS**

Dept. P-140, 118 East 26th St., Chicago, Ill.

### **Mail the Coupon—NOW**

**Chicago Technical  
SCHOOL for BUILDERS**

Dept. P-140, 118 East 26th St., Chicago, Ill.

Please send me without obligation, Free and Postpaid, your two Books and Blue Prints for Builders. It is understood that no salesman will call on me.

**[Please Write or Print Name Plainly]**

Name.....

Address.....

City..... State.....

Age..... Occupation.....





## “Four Raises in Two Years”

“AND it hasn't been hard to get them, either. Why, it seems only yesterday that I was wondering if I would ever make as much as \$45 a week. And now I'm making \$75.

“Tom Dawson was speaking about it today. ‘Gee,’ he said, ‘I wish I had started studying with the I. C. S. when you did. Here I am plugging away at the same old job and the same old salary while you've gone ‘way up.’

“I told him it wasn't too late and he said he was going to send in the I. C. S. coupon right away.

“I hope he does, because an I. C. S. course is the very thing he needs to get out of the rut. I wouldn't be making anywhere near \$75 a week if I hadn't started to study just when I did.”

How much longer are you going to wait before you take the step that will bring you advancement and more money? To *earn* more you've got to *learn* more. And to learn more you've got to study in that hour after supper that most men throw away.

One hour a day, spent with the International Correspondence Schools in the quiet of your own home, will prepare you for the position you want in the work you like best.

### Mail the Coupon for Free Booklet

INTERNATIONAL CORRESPONDENCE SCHOOLS  
Box 5684-E Scranton, Penna.

Without cost or obligation, please send me a copy of your booklet, “Who Wins and Why,” and full particulars about the course before which I have marked X in the list below:

#### BUSINESS TRAINING COURSES

- |  |   |
|--|---|
| <input type="checkbox"/> Business Management                     | <input type="checkbox"/> Salesmanship                                     |
| <input type="checkbox"/> Industrial Management                   | <input type="checkbox"/> Advertising                                      |
| <input type="checkbox"/> Personnel Organization                  | <input type="checkbox"/> Better Letters                                   |
| <input type="checkbox"/> Traffic Management                      | <input type="checkbox"/> Show Card Lettering                              |
| <input type="checkbox"/> Business Law                            | <input type="checkbox"/> Stenography and Typing                           |
| <input type="checkbox"/> Banking and Finance Management          | <input type="checkbox"/> English  |
| <input type="checkbox"/> Accountancy (including C.P.A.)          | <input type="checkbox"/> Civil Service                                    |
| <input type="checkbox"/> Cost Accounting                         | <input type="checkbox"/> Railway Mail Clerk                               |
| <input type="checkbox"/> Bookkeeping                             | <input type="checkbox"/> Common School Subjects                           |
| <input type="checkbox"/> Private Secretary                       | <input type="checkbox"/> High School Subjects                             |
| <input type="checkbox"/> Spanish <input type="checkbox"/> French | <input type="checkbox"/> Illustrating <input type="checkbox"/> Cartooning |

#### TECHNICAL AND INDUSTRIAL COURSES

- |   |  |
|---|--|
| <input type="checkbox"/> Electrical Engineering                     | <input type="checkbox"/> Architect                                       |
| <input type="checkbox"/> Electric Lighting                          | <input type="checkbox"/> Architects' Blueprints                          |
| <input type="checkbox"/> Mechanical Engineer                        | <input type="checkbox"/> Contractor and Builder                          |
| <input type="checkbox"/> Mechanical Draftsman                       | <input type="checkbox"/> Architectural Draftsman                         |
| <input type="checkbox"/> Machine Shop Practice                      | <input type="checkbox"/> Concrete Builder                                |
| <input type="checkbox"/> Railroad Positions                         | <input type="checkbox"/> Structural Engineer                             |
| <input type="checkbox"/> Gas Engine Operating                       | <input type="checkbox"/> Chemistry <input type="checkbox"/> Pharmacy     |
| <input type="checkbox"/> Civil Engineer                             | <input type="checkbox"/> Automobile Work                                 |
| <input type="checkbox"/> Surveying and Mapping                      | <input type="checkbox"/> Airplane Engines                                |
| <input type="checkbox"/> Metallurgy <input type="checkbox"/> Mining | <input type="checkbox"/> Agriculture <input type="checkbox"/> Navigation |
| <input type="checkbox"/> Steam Engineering                          | <input type="checkbox"/> Mathematics <input type="checkbox"/> Radio      |

Name.....

Street Address.....

City..... State.....

Occupation.....

Persons residing in Canada should send this coupon to the International Correspondence Schools Canadian, Limited, Montreal, Canada

## BIG MONEY IN ELECTRIC REFRIGERATION

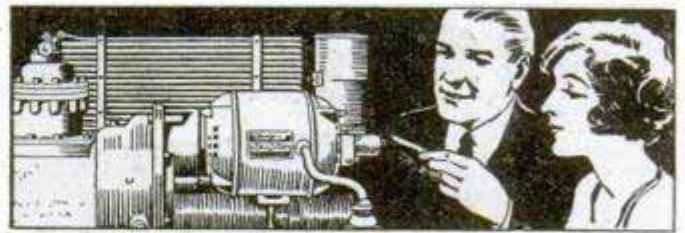

### We Train You at Home

Overnight a billion dollar industry has arisen. Trained men are wanted for installing, servicing and selling Refrigerators. A bigger opportunity than the auto or radio. Own your own shop, get out of doors, meet refined people. Big pay. Our easy to understand, home study course teaches you about every type. Nothing like it. Get in on the ground floor. Write for catalog. Just get the facts. *Now's the time!*

Utilities Engineering Service, Educational Division, Dept. 111  
3120 North Clark Street CHICAGO

## LEARN WATCH REPAIRING



You can learn by our modern and original system of instruction every part of the **Watch Repairing Trade** at home as good or better than at a shop. You can earn money while learning and secure a well paying position or start in business after completing our course of instruction. Good watch repairers are always in demand and earn from \$50 to \$75 per week. For particulars apply to the **Wisconsin School of Watch Repairing** 166 Mason St., MILWAUKEE, WIS.



## Be a drummer!

Trap Drumming made easy in a short time. Our free instruction course furnished with genuine Ludwig Trap-Drum Outfit. Develop your natural sense of rhythm. Go to your nearest dealer or write for full details.

LUDWIG & LUDWIG, 1611 North Lincoln Street, Chicago

## EARN PROMOTION AND COLLEGE CREDIT

through the HOME-STUDY COURSES in 40 different subjects given by

The University of Chicago  
207 Ellis Hall, University of Chicago, Chicago, Ill.

## YMCA TRADE SCHOOL

Learn Auto Mechanic, Auto Electrical, Battery, Machine, Electrical, Radio Mechanic, Tiling, Bricklaying, Plastering, Plumbing, Welding, Drawing, Estimating, Show Card, Sign Painting, Window Dressing, Fine And Commercial Art.

Write for Catalog 50.  
BROOKLYN ENGINEERING INSTITUTE  
(Operated by Bedford Br. Y. M. C. A.)  
1125 Bedford Ave., Brooklyn, New York City.

## “BECOME A LIGHTNING TRICK CARTOONIST”

Send \$1.00 for Laugh Producing Program of 23 Trick Drawings with Instructions. Catalog of Chalk Talk Supplies Free.  
BALDA ART SERVICE, Dept. 1, Oshkosh, Wis.

### Learn Watchwork, Jewelrywork and Engraving

A fine trade commanding a good salary, and your services always in demand. Address **Horological**, Dept. P, Bradley Institute, PEORIA, ILLINOIS, for our latest catalog.





# They Grinned When the Waiter Spoke to Me in French

—but their laughter changed to amazement at my reply

WE had dropped into Pierrot's for dinner—Pierrot's, that quaint French restaurant where the waiters speak nothing but French. Jack Lejeune, who boasted a smattering of French, volunteered to act as interpreter.

"Now tell me what you want to eat," announced Jack grandly, after we were seated, "and I'll 'parley' with the waiter."

With halting French phrases and much motioning of hands, Jack translated our orders to the waiter. Finally Jack turned to me.

"What's yours, Fred?" he asked.

"Virginia ham and scrambled eggs," I replied.

Jack's face fell. He knew that my order would be difficult to translate into French. However, he made a brave effort.

"Jambon et des—et des—" but Jack couldn't think how to say "scrambled eggs." He made motions as if he were scrambling eggs in a frying pan, but the waiter couldn't get what he was driving at.

"I'm afraid you'll have to order something else, Fred," he said finally. "I can't think of the word for 'scrambled eggs.'"

Everybody smiled—everybody except me. With great ceremony I beckoned to the waiter. "I'll explain my order to the waiter," I said. A chuckle ran around the table.

"Fred can't speak French, can he?" I heard a girl whisper to Jack.

"No—he never spoke a word of French in his life," came the answer. "But watch him. This will be funny. He'll probably give an imitation of a hen laying an egg."

## A Tense Moment

The waiter addressed me. "Monsieur a fait son choix?" he asked.

There was a pause. All eyes were on me. I hesitated—prolonged the suspense as long as possible. Then in perfect French I said to the waiter: "Oui, donnez-moi du jambon aux oeufs brouillés—jambon de Virginie."

The effect on my friends was tremendous. The laughter stopped. There were gasps of amazement. In order to

heighten the effect, I continued for several minutes to converse in French with the waiter. I asked him all sorts of questions—what part of France he was from—how long he had been in America, and many other queries. When I finally let the waiter go, everybody started firing excited questions at me.

"Fred! Where did you learn to speak French like that?" "Why didn't you tell us you could talk French?" "Who was your teacher?"

"Well, folks," I replied, "it may sound strange, but the truth is I never had a teacher. And just a few months ago I couldn't speak a word of French."

"Quit your kidding!" laughed Jack. "You didn't develop that knowledge of French in a few months. I thought it took years to learn to talk like that."

"I have been studying French only a short while," I insisted. And then I told them the whole story.

## How I Learned French without a Teacher

"Did you ever hear of the House of Hugo?" I asked.

Jack nodded. "That's that famous Language Institute over in London, isn't it?"

"Yes," I replied. "They've been teaching languages for over a century. Thousands of Europeans have learned foreign languages in a surprisingly short time by their 'at-sight' method."

"The authorities of the House of Hugo recently decided to condense their experience in teaching French—the secrets of their wonderful method into a course of printed lessons."

"This course turned out to be the most ingenious method of learning French ever devised. It was simply marvelous. It enabled people to learn French in their own homes, in an incredibly short time."

"Just a few months ago I didn't know a word of French. Now I can speak and understand French, when it is spoken to me. And I didn't study much—just a few minutes a day. No laborious exercises to do—no tiresome rules—no dull class-room drills. It was actually fun learning. Everything was so clear, so simple, so easy. Honestly, the Hugo

'At-Sight' French Course is the most remarkable thing of its kind I have ever seen!"

## Try It 5 Days FREE

This story is typical. You, too, can now learn French at home—quickly, easily, pleasantly—just as thousands of others are doing by the celebrated Hugo "At-Sight" Method. Twenty-four fascinating lessons, carefully planned. Whole generations of language-teaching experience in all the leading European cities are behind this French course.

The Hugo method makes you *your own teacher*. At home—in minutes that might otherwise be wasted—you learn, phrase by phrase, sentence by sentence, to speak the language correctly and well.

No money is necessary now. We shall be glad to send you the complete course FREE FOR 5 DAYS so that you may see it and judge it for yourself. Within the free examination period you have the privilege of returning the course without cost or obligation, or keeping it as your own and sending only \$2 as a first payment, and thereafter \$2 a month until the full price of \$12 has been paid.

*You are the judge.* Simply return the course within 5 days if you are not fascinated and delighted with it. If you act promptly, a valuable French-English Dictionary, containing 45,000 words, will be included without additional cost.

We urge you to clip and mail this coupon to-day. Doubleday, Page & Co., Dept. F-3711, Garden City, New York.

**Doubleday, Page & Co., Dept. F-3711  
American Representatives of Hugo's  
Language Institute of London  
Garden City, New York**

Please send me the Hugo "French-at-Sight" Course, in 24 lessons, for free examination and include the French-English Dictionary. Within 5 days I will either return the course and dictionary or send you \$2 at that time and \$2 each month thereafter until \$12 has been paid.

Name.....  
Address.....  
City.....State.....  
Occupation.....  
5% discount for cash with order.



O. C.  
MILLER

Director  
Extension  
Work

American  
School



## The American School

A million Dollar *No-Profit* Educational Institution, now offers men a *double* service—training for a specific job, then help in finding the job. For one small price, on terms of only \$5.00 a month, you are now assured of definite benefits, both in position and salary. Write for complete information—*today!*

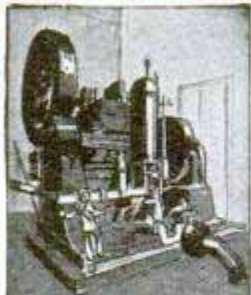

No machine can be built until the Draftsman first builds it ON PAPER. My training prepares you for this work.



Never has the world seen anything like the building boom of today. This has created enormous demand for real Draftsmen.

# 5 BIG-PAY Branches

The big money in Drafting goes to men who specialize in Machine Design, or Electrical Drafting, or Architectural Drafting, or Structural, or Automotive. It is not enough merely to know *general* Drafting practice. You must know how to calculate and design and plan original work. You need many Engineering subjects to fill the kind of a Drafting position that pays \$60 to \$125 a week. The American School now includes this *specialized training in its Drafting course.*

## Costly Drafting Outfit Given!

Fine, imported instruments like these help you learn Drafting quickly and easily. These standard quality, full size instruments, board, table, triangles, T square, ink, protractor, etc., given to every student without extra cost.

O. C. Miller, Director Extension Work

The American School

Dept. D-874  
Drexel Avenue and  
58th St., CHICAGO

# Drafting

to prove you can

We have invented a new, simplified way to teach Drafting—the first real improvement in Drafting home instruction in history. We want you to see a few of these new Job-lessons, try them, test your own ability to master them—without one penny of cost or obligation. For instance, you will see how we get away from the “copying” methods used in the past, so you develop into a DRAFTSMAN, instead of a “tracer.” See for yourself the ingenious new method which compels you to think, to solve problems, to do actual Drafting-room jobs from the very first lesson!

## A New, Rapid, Simplified Training

Copying drafting lessons prepares you to be only a “tracer.” This new “Job-Method” gives you actual drafting-room jobs in a new one-step-at-a-time way. With pictures which you can understand almost without reading the “lessons.” And that is why the American School-trained Draftsmen can qualify for a good job at big pay when they graduate.

## Win Success Thru Drafting

Drafting is easy, fascinating work. Short hours. Big pay. And the Draftsman is always in line for promotion to executive positions. This training is *complete.* It includes high school subjects (if you need them) and all the Engineering and Mathematics Drafting experts require.



## FREE Job Service!

The American School now offers its students and graduates, without cost, the services of an efficient employment department keeping in constant touch with employers of Draftsmen all over the U. S. We have placed hundreds of men in good, big-pay Drafting positions. We've made this training so complete, so practical, so easy to master, that our students are bound to **make good.** And so, because the demand for real Draftsmen continues to exceed the supply and because this training actually prepares men for good Drafting positions we **back it with a Free Employment Service.**



# Lessons Actually FREE

learn at home in spare time!

## Draftsmen Wanted!

### \$60 to \$125 a Week!

yourself. Plan your future in Drafting. Even if you have only common schooling, even if you know nothing of Drafting, we guarantee to make you a real Draftsman or to refund your money! Special surprise offer right now to the first 500 men who answer this ad—reduced price, easy terms. Coupon brings complete information.

70,000 fine jobs advertised last year. Get ready to fill one. Get out of the rut. Make something of

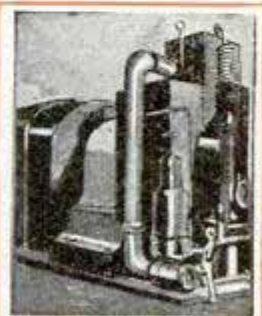

Electricity needs Draftsmen who know Electrical principles as well as general Drafting practice. I give you this training.



The demand for Draftsmen experienced in concrete and structural steel work is enormous. Many big-pay positions open.



Every great Auto factory employs Draftsmen who specialize in Automotive work — men who design bodies, plan engines, etc.

**I Will Make This Contract With You**

WHEN you enroll for our home-training in Drafting, we agree to give you:

1. Complete Drafting training, by the new Practice-Method.
2. Professional Drafting Outfit, as illustrated.
3. We will help you get a good Drafting position at a substantial increase in pay,
4. or we'll refund every cent of your money.

*O. C. Miller*  
Director Extension Work



American School  
—the Million Dollar Educational Institution

## Coupon Brings 3 Lessons FREE!

Get them. Test your own ability to learn Drafting and get ready for a fine job and big pay. Coupon also brings surprise offer, and complete information about your opportunities for success in Drafting. **Mail It Today!**

## Read These Letters!

**City of Chicago**  
Department of Buildings  
Gentlemen: The same day I received my diploma I got word that I was one of the two candidates who had successfully passed the examination for Deputy Commissioner of Buildings of the City of Chicago, a position paying \$3600 per year.

There were eight applicants examined besides myself, all men well known to the architectural and engineering profession. Seven of these failed to obtain a passing grade of 70%. My grade was 84.69. Inasmuch as I failed to pass this same examination three years before, my present success is mainly due to the knowledge gained through your School.  
Yours very truly,  
**ROBERT KNIGHT**

**Liberty High School**  
Bethlehem, Pa.  
Dear Sirs:—This is to thank the American School for all that you have done for me since I signed up for the Drafting and Design Course.

In the eight years since then, I have gradually climbed from the position of tracer to that of Head of the Department of Machine Drawing and Design in our magnificent new \$2,000,000 High School here, at many times the salary which I received at that time.  
The officials of the Pennsylvania State Department, and Dr. Wm. C. Ash of the University of Pennsylvania, all claim that our Course in Drafting and Design is the best now being taught in this state. Every drafting graduate that we have turned out has proved successful, and one is now Chief Draftsman in a local steel concern. Yours sincerely,  
**J. S. LEAR**

**Has Charge of Large Jobs**  
"Even before I had finished my course, I was put in charge of large construction jobs in different cities. I have been doing that ever since, and the jobs are getting larger all the time. I owe my success to the American School because of the knowledge I gained in mathematics and calculations."  
**ELMER L. LAMB**  
1306 Smith St., Peoria, Ill.

**Got His Draftsman's Job**  
"I wanted to let you know how I came out in getting that job at the Brownell Co., Dayton, Ohio. I was to start and have a trial at Drawing, and I am still in the Drawing room. The engineer seems to like the work I make, and also the other draftsmen. I thank the school very much for getting me in at this place, because your letter of recommendation helped me a whole lot to get the job."  
**BERNARD WEBER**  
730 St. Nicholas Ave., Dayton, O.

# 3 Drafting Lessons Actually FREE

**O. C. MILLER, Director Extension Work**  
**AMERICAN SCHOOL**  
Dept. D-874, Drexel Ave. and 58th St., Chicago.  
Rush 3 Free Drafting Lessons; Job and Raise Offer, complete information, money-back guarantee, etc., to prove I can become a real Draftsman at home in spare time.

Name.....  
Street No.....  
City.....State.....



# Play the HAWAIIAN GUITAR and be Popular /

Play all the latest hits just as the Hawaiians do. Be the most popular member of your set. Get in on all the good times. Entertain your friends—or play professionally. Be in demand everywhere. We will help you.



**\$15**  
**HAWAIIAN GUITAR**  
with Genuine Seal Grain  
Fabrikoid Cover  
**GIVEN**  
when you  
enroll

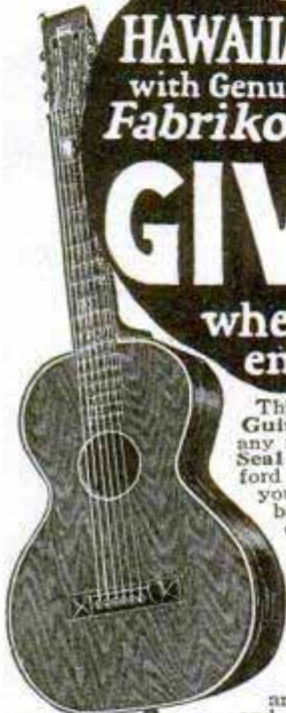

This sweet-toned, mellow Hawaiian Guitar would cost you at least \$15 in any music store without the Genuine Seal Grain Fabrikoid Case. We can afford to give you the entire outfit free when you enroll, including picks, steel playing bar, etc., because we make them in huge quantities in our own factory. Nothing to buy—everything is furnished.

### Learn in Spare Time at Home

You study in spare time—when you like—as long as you like. And even if you don't know one note from another, our method is so simple, plain and easy that you begin a piece your first lesson. In half an hour you can play it!

### Famous Native Hawaiians Teach You

You receive expert instruction from such world famous players as Kolomoku, Kalaluki, Ferrara and Seville. They quickly teach you the secrets of this fascinating instrument.

**Complete Conservatory Course.** You get 52 complete printed lessons. Nothing is omitted. Pictures explain every move. And no matter how little you know about music when you begin, no matter if you have never touched a musical instrument, you can positively learn to play by our plain, easy, picture method.

### Only 4 Motions to Learn

Then you can play any music—popular songs, classical, old-time melodies, native Hawaiian airs—or real jazz—separately or with accompaniment. You'll never be lonesome after you learn to play on this beautiful Hawaiian Guitar.

### Pay as You Play

We make it easy for you. You start any time—with a small first payment—then pay while learning. Write for liberal offer.

### Our Written Guarantee

We guarantee in writing to teach you, 45,000 successful students. And we coach and advise you after graduation—no extra cost.

**Tenor Banjo** and other courses—Violin, Tiple, Tesor Guitar, Banjo Ukulele, Ukulele—under well-known instructors. Write for information.

### FIRST HAWAIIAN CONSERVATORY OF MUSIC, INC.

9th Fl., Woolworth Bldg., Dept. 448, New York, N. Y.

Approved as a Correspondence School Under the Laws of the State of New York

**ACT! Mail This Popularity Coupon NOW!**

FIRST HAWAIIAN CONSERVATORY OF MUSIC, Inc.  
9th Fl., Woolworth Bldg., Dept. 448, New York, N. Y.

Please mail full information about your 52-lesson Hawaiian Guitar Course. I am not obliged to enroll unless I want to.

Name \_\_\_\_\_

Address \_\_\_\_\_

City \_\_\_\_\_ State \_\_\_\_\_

# Wrestling

## Learn at Home

# Book 10c



Secrets of expert wrestling revealed by worlds champions—Farmer Burns and Frank Gotch. Be a great athlete—a winner. Every man and boy needs this wonderful book. Send for it today. This school teaches expert wrestling, ju-jitsu, physical culture. Learn in your own home by mail to be an all-round athlete. Train to win in all sports—football, baseball, running, vaulting, boxing. Handle big, strong men with ease. Have a beautiful attractive body that all admire. Surprise your friends, and the "bully" with your great ability. Learn to protect yourself, your mother, sister or sweetheart. You can be a great athlete if you'll try. Develop the great ability that is within you.

Send only 10c, coin or stamps, for this wonderful 32 page, illustrated book that tells you how to become a real man. Don't be a weakling—be a leader—a winner. This valuable book tells how: Tells the secrets of the big champions; gives many truths, holds and other valuable information. A costly book which we send for only 10c—the cost of packing and postage. Grasp this opportunity now. Send today. State age.  
**Farmer Burns School** 3378 Railway Exchange Bldg., OMAHA, NEB.

# 6 TUBE RADIO

**ONE DIAL** Latest advanced circuit. All steel chassis totally shielded. Balanced parts of best quality. Marvelous power and selectivity. Gets the long range stations as clear as a bell. One dial single control. An unsurpassed value—just one of our many mighty bargains.

**FREE Log and Call Book** and Big New Catalog—just off the press. Full of Radio Bargains. Send for your free copy now!

**American Auto & Radio Mfg. Co.**  
HARRY SCHWARTZBERG, Pres.  
Dept. 262 American Radio Bldg., Kansas City, Mo. 2

**AMERICAN RADIO BARGAINS**

**Only \$32.50**

## \$50 to \$100 a Week

—AT HOME OR TRAVELING—

Making raised letter SHOW CARDS and NOVELTIES NEW and ORIGINAL

Learn in a few weeks by mail.

No tiresome brush work. Complete outfit with course.

Write for special inducement to men and women enrolling at once.

MAILKO, INC., Department 24

8-10-12-14 West 125th Street, New York, N. Y.

# LEARN TO FLY

Earn big money and fame by getting in on the ground floor in Aviation. This is your Golden Opportunity. Be quick and enroll in one of our Fall classes and be ready for Spring rush. Our equipment and teachers of the very best.

## PARKS AIR LINES, Inc.

202 Missouri Building

St. Louis, Missouri

# Skin Troubles

Cleared up—often in 24 hours. To prove you can be rid of Pimples, Blackheads, Acne Eruptions on the face or body, Barbers' Itch, Eczema, Enlarged Pores, Oily or Shiny Skin, simply send me your name and address today—no cost—no obligation. **CLEAR-TONE** tried and tested in over 100,000 cases—used like toilet water—is simply magical in prompt results. You can repay the favor by telling your friends; if not, the loss is mine. **WRITE TODAY**  
E. S. GIVENS, 428 Chemical Bldg., Kansas City, Mo.



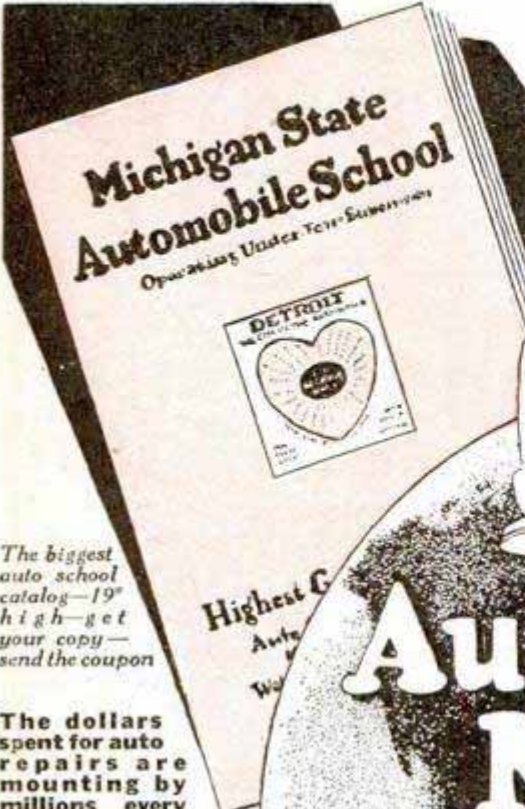

**Mail Me!**  
 Michigan State Automobile School  
 311 Auto Building, Detroit, Mich.  
 Send me free and without obligation full information about Detroit training to make the most money.

Name \_\_\_\_\_  
 Street Number or R. F. D. \_\_\_\_\_ State \_\_\_\_\_  
 City \_\_\_\_\_  
 I am interested in \_\_\_\_\_  
 12 weeks' Auto Course  
 30 weeks' Master Course  
 Home Study Course  
 Aviation

The biggest auto school catalog—19th highest—get your copy—send the coupon

The dollars spent for auto repairs are mounting by millions every year—Car owners have to pay out all the time,—it's \$15 here, \$100 there. 24 million cars running now,—and every one of them has to be repaired regularly. You can get in now on this big and bigger growing business. Make big money. A few weeks' Detroit training at this world's famous auto school will start you to success. This great school, endorsed by auto factories, has put thousands of men on easy street. Send the coupon above for particulars.

**Auto Repair MEN**  
**Are Sitting on Top of the World**  
**To-day**

**Get this BOOK Free**

We have more calls for trained men than we can fill. We can train you quick to make big money. Learn a trade that is good the year round. Become a trained auto repairman, welder or machinist. Auto repairing has jumped to a tremendous world-wide business. Be trained to get part of this fortune. Wonderful opportunities for jobs or to open a shop of your own.



**YOU CAN GET THERE QUICK**



**Auto Business Wants Trained Men**  
 To promote to bigger jobs. We have standing orders from manufacturers and dealers for service executives. Men come here daily to take our 30-week "Master" Course to qualify for advancement. Here in Detroit the auto center you learn right, at the old reliable "Michigan State." Here you have new cars to study on,—actual equipment supplied to us by auto makers. Expert instructors teach you every detail. You learn with tools. You get head training too. The knowledge we put in your head guides the skill we put in your hands.

**Business Course Included**  
 So you can run your own shop, we teach you thoroughly business methods, stock-keeping, systems, banking. A leading business man of Detroit teaches this course. No extra cost. This is just another one of the big advantages of learning at "Michigan State."  
**Aviation—Another Coming World Business**  
 As a money-making business, aviation will soon rival the auto industry. Skilled men are needed in this new industry. The time is ripe. Our Aviation Course will train you for ground work or flyer. Ask for details.

**Home Study Course**  
 If you cannot come to Detroit now, start by learning at home. Our home study course is taught by the same instructors who teach our resident course. This will enable you to get a job or will be the foundation for your practical course if you can come here later.  
**Write Us Today**  
 Get full particulars about all of our courses for starting you in good paying business.

**MICHIGAN STATE AUTOMOBILE SCHOOL**  
 A. G. ZELLER, President and General Manager  
 The Old Reliable School—Established 17 Years 311 Auto Bldg., **DETROIT, MICH.**



# More Money



## Be a Trained Radio Expert

If you're earning a penny less than \$50 a week, get my free book of information about the Radio business. Trained Radio Experts are needed in more than twenty different lines of this new and growing profession (three hundred thousand new openings created by the swift growth of Radio in past few years). Why go along at \$25 or \$35 or \$45 a week all your life? Study Radio and after only a short time land yourself a REAL job with a REAL future! Be a man who has money in his pocket and in the bank—don't scrimp and scrape for the rest of your days.

## Salaries of \$50 Up to \$250 a Week Not Unusual in Radio

The good positions in Radio pay all the way from \$50 on up to \$150, \$200, and even \$250 a week. Suppose you don't climb to the very top but that you do advance to a position that pays you \$125 a week, year in and year out. Any chance to make that much where you are now? Then send for my free book, and learn about a field where there's some

## Money Back If You Aren't Fully Satisfied

I'll give you all the training you need to get into any line of the Radio business. And I back up this training by a signed agreement to refund every penny you pay me if I don't give you exactly the training you need. After you finish my training, you'll be the judge. If you think I've earned my tuition fee. I keep it. If not, ask for it and you'll get it right back.

## Six Big Practical Outfits Given You To Help You Learn

I teach you both the "why" and the "how" of Radio. You learn to DO a thing, and you learn WHY it's done. I send you, WITHOUT EXTRA COST with your course, six big practical outfits of material to experiment and work with. These outfits are the real thing—not toys. The parts they contain will build approximately one hundred different Radio circuits. With all this material you do practical work from start to finish of your training. You get your hand in, and you get confidence in yourself. Then when you run into a Radio problem later on, on the job, you KNOW you can do it because you've already done it with these six outfits of practical material. With me you don't learn to be a "paper Radio Expert"—you learn to be the kind of expert that shows his worth on the payroll. Full details in my big book—sent free.

## Send For Free Book of Information

real opportunity. Where good men, if they have the right training, can work their way into really big salaried jobs!

### Get Book!

Find out for yourself about bigger pay waiting for you in Radio! From \$2,000,000 in 1920 to \$504,000,000 in 1926—that's the record of the Radio industry! Plenty of big Radio jobs are waiting for the man who KNOWS. John Fetzer sent for my free book—now he's Chief Engineer at WEMC and designs and builds broadcast stations. T. M. Wilcox sent for the book—now he's in his own Radio business and reports profits as high as \$70 in one day! All information will be sent to you free, without obligation—just mail coupon on opposite page.



Broadcasting and commercial Radio land station work appeal to a lot of men—it's a big, growing field and fascinating work. My course prepares you thoroughly to get into this field and make good.

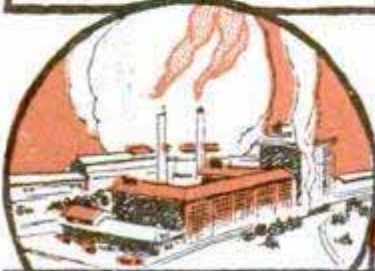

Radio manufacturing has grown faster in the last six years than any other big business ever did. It's two hundred and fifty times as big as it was. That means lots of good chances for the trained Radio Expert.



Six million Radio receiving sets in use in the United States means millions of dollars are going to Radio Service and Repair men everywhere. For this work you must be trained.



Radio operators on board ship go everywhere—see everything. You sail the world over, all your expenses paid, and draw a good salary besides. It's the life of Reilly.

see coupon next page



# for you in Radio

## Learn Quickly, Easily Train at Home In Spare Minutes

Stay home! Hold your job! I'll bring your Radio training to you, and you can learn in your spare time after work. No need to go to a strange city and live for months on expense when you learn my way. You study in the quiet of your own home. As for this training—it's written just as I would talk—in straightforward, every-day, understandable language. You'll get it, and you'll get it quickly—in a few months' spare time—because I've made it so clear and interesting! No particular education needed—lots of my successful students didn't finish the grades.

### Earn \$15, \$20, \$30 Weekly Right Away "On the Side"

Deloss Brown, South St., Foxboro, Mass., made \$1,000 from spare-time Radio jobs before he even finished my course. H. W. Colbentz, Washington, averaged \$45 a week; Leo Auchampaugh, 6432 Lakewood Ave., Chicago, made \$500 before graduation; Frank Toomey, Jr., Piermont, N. Y., made \$833 while taking the course. All this done IN SPARE TIME away from the regular job, while these fellows were still studying the course—and they're only a few of hundreds. As soon as you start this training I begin teaching you practical Radio work. Then a few weeks later, I show you how to make use of it in spare time, so you can be making \$15, \$20, \$30 a week "on the side," all the while you're learning.

### 64-page Book Sent Free For the Asking

My big book of Radio information won't cost you a penny, and you won't be under any obligation by asking for it. It's put hundreds of fellows on the way to big pay and brighter futures. Sending for it has been the turning-point where many a man has made his start toward real Success. Get it. See what it's going to mean to you. Send coupon TODAY!

Address: **J. E. SMITH, President,**  
**National Radio Institute,**

Dept. O-85

Washington, D. C.



## Send No Money

J. E. Smith, President,  
National Radio Institute,  
Dept. O-85, Washington, D. C.

Dear Mr. Smith: Kindly send me your big free book "Rich Rewards in Radio," giving all information about the big-money opportunities in Radio and how you will train me to take advantage of them. I understand this places me under no obligation, and that no salesmen will call on me.

Name.....

Address.....

Town.....State.....

### JOBS WAITING!

In seven short years—three hundred thousand new jobs in Radio! Lots of jobs open right now, for those who have the training. The Radio industry has grown by leaps and bounds—so fast it has had to take whatever sort of men it could get. Such men, if they haven't trained themselves in the meantime, are losing out and will keep on losing out. They'll be replaced by men with the KNOW-HOW. But it's trained men ONLY that are needed.

### Over 1,000 Openings For Trained Men NOW!

One great Radio manufacturing concern alone has over one thousand openings to give my graduates this year. These men will be needed all over the United States. Any graduate of mine who stands well in his home town is eligible for this work. The head of the above mentioned concern, one of the biggest Radio organizations in the country—is a graduate of mine. He knows what my training did for him. When he wants new men for his organization he wants men with the same training.

I can't possibly graduate enough men this year to fill these openings. So there will be more openings with this one concern than there will be graduates to accept them.

But there are other openings to choose from, too. My school has trained more Radio Experts than any other school in the world. It's the oldest and largest Radio home-study school in the world. There are N. R. I. trained men in almost every Radio concern of any importance in this country. Many Radio employers are themselves my graduates. That's where you get your "stand-in" as an N. R. I. graduate yourself.

Every graduate of my course is entitled to Life-Time Employment Service without a penny's charge, from my helpful Employment Department.

### Full Information Sent, With Free Book

My Free Book contains full information about the Radio employment situation, and the advantages I'm in a position to give you. Also about my Life-Time Employment Service, and Life-Time Consultation Service, too.

### Mail Coupon Today!



This big 64-page book, printed in two colors, crammed with interesting facts and photos about money-making opportunities in Radio, sent free to everyone who clips the coupon. No obligation by sending for the book—it's absolutely free. One of the most valuable books about Radio ever written.





## From \$1,800 to \$10,000 in Four Years

### Thanks to Higher Accountancy

"LaSalle training in Higher Accountancy has enabled me in four years to increase my business more than 500 per cent." So writes John H. Lansing, Public Accountant, Income Tax Specialist, and prominent citizen of Amsterdam, New York, who deliberately resigned as purchasing agent for a large carpet manufacturing company to start on his own as a Public Accountant.

Mr. Lansing was 43 when he enrolled with LaSalle, and at the time was earning from his newly adopted profession less than \$2,000 a year.

Today, the firm of which he is head is auditing the books of 100 business houses, including 20 corporations; and his Income Tax Department has more than 500 clients. Each year his business shows a healthy increase.

"When you consider that the average bookkeeper does not receive over \$40 a week," writes Mr. Lansing, "it is obvious that \$10,000 a year has advantages well worth the consideration of any ambitious man or woman. I shall always be grateful to LaSalle for the help it has given me in building a greater income."

### Send for This Book—It's Free

Do you appreciate what Accountancy means in the business world? Do you realize that it constitutes the indispensable foundation for success in any business undertaking? Would you seriously fit yourself for positions paying \$3,000, \$5,000, \$10,000 a year and even better?

LaSalle has prepared a 64-page book entitled "Accountancy, the Profession that Pays." The information it contains is of very real and definite value. It will pay you well to read it. And—LaSalle will send it to you free.

Balance the two minutes that it takes to fill out the coupon against the rewards of a successful career—then clip and mail the coupon—NOW.

### Find Yourself Thru LaSalle!

## LA SALLE EXTENSION UNIVERSITY

The World's Largest Business Training Institution

Dept. 1164-HR Chicago

I would welcome details of your salary-increasing plan, together with copy of "Accountancy, the Profession that Pays," also a copy of "Ten Years' Promotion in One," all without obligation.

### Higher Accountancy

Training for positions as Auditor, Comptroller, Certified Public Accountant, Cost Accountant, etc.

### Other LaSalle Opportunities

LaSalle opens the way to success in every important field of business. If more interested in one of the fields indicated below, check and mail now.

- |   |  |
|---|--|
| <input type="checkbox"/> Business Management        | <input type="checkbox"/> Personnel Management                        |
| <input type="checkbox"/> Modern Salesmanship        | <input type="checkbox"/> Banking and Finance                         |
| <input type="checkbox"/> Traffic Management         | <input type="checkbox"/> Modern Business Correspondence and Practice |
| <input type="checkbox"/> Railway Station Management | <input type="checkbox"/> Expert Bookkeeping                          |
| <input type="checkbox"/> Law—Degree of LL.B.        | <input type="checkbox"/> C. P. A. Coaching                           |
| <input type="checkbox"/> Commercial Law             | <input type="checkbox"/> Business English                            |
| <input type="checkbox"/> Industrial Management      | <input type="checkbox"/> Commercial Spanish                          |
| <input type="checkbox"/> Factory Management         | <input type="checkbox"/> Effective Speaking                          |
| <input type="checkbox"/> Modern Foremanship         | <input type="checkbox"/> Stenotypy                                   |



Name.....

Present Position.....

Address.....

*Learn to Write*

## I Teach by Mail

I CAN make a good penman of you at your home during spare time, no matter where you live or how poorly you now write. My simplified system has shown thousands of others the way to good penmanship during the past twenty years—it can and will do the same for YOU!

### Beautifully Illustrated Book "How to Become a Good Penman"

It contains general information, with testimonials and beautiful specimens of penmanship showing what others have accomplished by the Tambllyn System. (Your name elegantly written on a card if you enclose stamp for postage.) **FREE!** WRITE TODAY. Address

F. W. TAMBLYN  
418 Ridge Bldg., Kansas City, Mo., U. S. A.



# GIVEN



## \$20 Musical Instruments

Your choice of a Violin, Tenor Banjo, Hawaiian Guitar, Banjo, Cornet, Ukulele, Banjo Ukulele, Guitar, Mandolin or Banjo Mandolin. You will be proud to own any one of these instruments and we will give you one without cost. A few cents a day for lessons is your only expense. Our system of teaching is so easy that you can play several pieces by note with the first four lessons. We guarantee success or no charge. Instrument and lessons sent on one week's free trial. Write for booklet today, no obligation. Over 200,000 satisfied pupils.

CHICAGO CORRESPONDENCE SCHOOL OF MUSIC, INC.  
1632 North Halsted Street, Dept. 382, Chicago, Illinois.

# STAMMERING

easily, permanently corrected. Win happiness and success. Ask for full information and special phonograph record. Send dime for postage  
153 Stimson Ave., The LEWIS INSTITUTE, Detroit

# PHARMACY



GRADUATE Pharmacists are always in demand. The work is interesting and pleasant and salaries are good. Many young men open drug stores of their own and become independent.

There's an easy way to learn Pharmacy. Right in your own home, in spare time, the International School of Pharmacy will help to prepare you to pass your State Board Examination. Mail coupon for Free Booklet.

## INTERNATIONAL SCHOOL OF PHARMACY

Associated with the  
International Correspondence Schools  
Box 5681-E, Scranton, Penna.

Without cost or obligation, please send me full details of your home-study course in

### PHARMACY

Name.....

Address.....



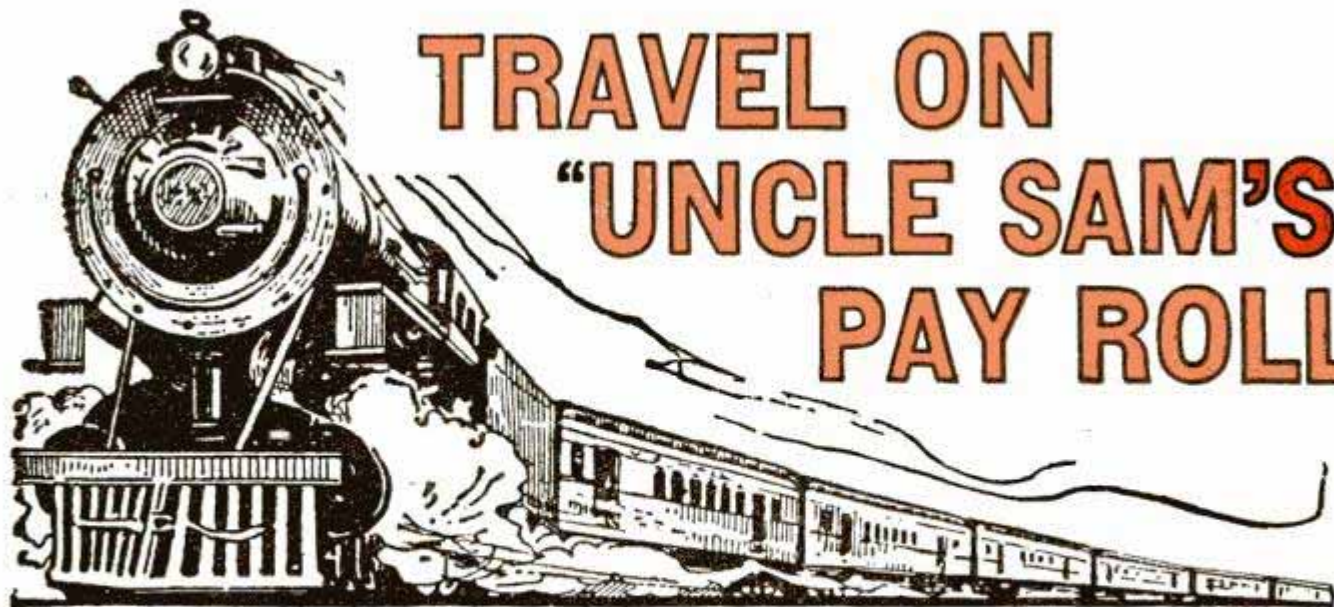

# TRAVEL ON "UNCLE SAM'S" PAY ROLL

## RAILWAY POSTAL CLERKS

**\$158 Month First Year**

**Raise to Maximum of \$225 Month**

**Many other U. S. Government Jobs Open to Men and Boys 18 up**

**Post Office Clerks  
Rural Mail Carriers**

**City Mail Carriers  
Clerks in Customs and Internal Revenue Service**

These are steady positions. Strikes, poor business conditions, lockouts or politics do not affect them. U. S. Government employees get their pay for full twelve months every year. There is no such thing as "HARD TIMES" in the U. S. Government Service.

### ALLOWANCE FOR HOTEL EXPENSES

Railway Postal Clerks now get \$1900 the first year regular, being paid on the first and fifteenth of each month. \$79.16 each pay day. Their pay is increased \$100 and \$150 a year. The maximum is \$2700 a year. \$112.50 each pay day. They get extra allowance for hotel expenses when away from home.

### PAID VACATIONS

Railway Postal Clerks, like all Government employees, are given a yearly vacation of 15 working days (about 18 days). When on runs they usually work 3 days and have 3 days off duty or in the same proportion. During this off duty and vacation, their pay continues just as though they were working. When they grow old, they are retired with a pension. As Railway Postal Clerks are continually traveling, they have an excellent chance to see the country.

### City Mail Carriers—Post Office Clerks

Clerks and Carriers get \$1700 the first year regular and automatically increase \$100 a year to \$2100 with further special increase to \$2300. They also have 15 days vacation. Examinations are frequently held in the larger cities. City residence is unnecessary.

### What Will You Earn 5 Years from Now?

Compare these conditions with your present or your prospective condition, perhaps changing positions frequently, kicking around from post to pillar, no chance in sight for PERMANENT employment; frequently out of a position and the year's average salary very low. DO YOU EARN \$1900 EVERY YEAR? HAVE YOU ANY ASSURANCE THAT A FEW YEARS FROM NOW YOU WILL GET \$2700 OR MORE A YEAR, EVERY YEAR?



### Get Free List of Positions

Fill out the coupon. Tear it off and mail it today—now, at once. DO IT NOW—This investment of two cents for a postage stamp may result in you getting a U. S. Government Job.

**FRANKLIN INSTITUTE,  
Dept. R-173,  
ROCHESTER,  
N. Y.**

(Not connected with U. S. Government)

Rush to me entirely free of charge 32 page book with (1) a full description of the position checked below; (2) a list of U. S. Government jobs now obtainable; (3) full particulars telling how to get them

- Railway Postal Clerk.. (\$1900-\$2700)
- Post Office Clerk..... (\$1700-\$2300)
- City Mail Carrier..... (\$1700-\$2100)
- Rural Mail Carrier..... (\$2100-\$3300)
- Clerk in Government Offices.... (\$1140-\$1860)
- Prohibition Investigator..... (\$1800-\$3000)

Name.....

Address.....

Use This Coupon Before You Mislaid It—Write or Print Plainly.

MAIL COUPON TODAY



# Want a good Electrical Job?



Here's the easiest, quickest way to get an Electrical Expert's job, paying all the way from \$50 to \$100 a week—borrow this great American Library of Electrical Engineering for 15 days FREE. Look over the 4000 pages, the 3200 illustrations in the 8 big volumes. And you'll see how other men JUST LIKE YOU have mastered Electricity at home in spare time—without studying or memorizing, without lessons or examinations—at one-fourth the cost of trade courses! If not wanted, return, charges collect. If kept, pay only \$2.00 after 15 days, then \$3.00 a month until \$34.80 is paid.

# Want a well-paid Auto Job?

If you are ambitious to be an Auto Expert—or if you are an auto owner and seek to know your car for greater pleasure and economy—or if you are a Service Station Superintendent and want an instant answer to the toughest problems in the day's work, borrow a set of "Auto Engineering" and see how the JIFFY INDEX brings to your fingers' ends every needed fact and explanation about autos. 5 DeLuxe volumes, flexible gold-stamped bindings, 2400 pages, over 2000 illustrations. \$2.00 after 15 days free loan, then only \$3.00 a month until \$24.80 is paid.



# Pick the job—We'll help you land it!



"READ YOUR WAY to bigger pay" with these great vocational libraries. Don't try to keep thousands of facts and figures in your head. But know where to put your finger on the right one—instantly. The wonderful JIFFY INDEX in these volumes does the trick.

"Civil Engineering"—Written so you can understand it. Includes Steel Structures, Surveying, Railroads, Public Works. New 9-volume edition, \$2 after 15 days, then \$3 a month until \$34.80 is paid.

## Pay-Raising Books Loaned Free!

Modern Shop Practice—Machine Shop, Foundry and Factory Practice and Management, Drafting, etc. 6 volumes, 2300 pages, 2500 illustrations. \$2 after 15 days, then \$3 a month until \$24.80 is paid.

American Law Library—With reading course of 24 texts, 13 volumes, intended for the business man as well as for the prospective lawyer. \$2 after 15 days, then \$3 a month until \$49.80 is paid.

Drafting—Mechanical and Architectural—4 volumes, 1378 pages, 1000 pictures, blueprints, etc. \$2 after 15 days, then \$3 a month until \$14.80 is paid.

Steam and Gas Engineering—7 volumes, 3300 pages, 2500 illustrations, only \$2 after 15 days, then \$3 a month until \$24.80 is paid.

Fire Prevention and Insurance—4 volumes, 1500 pages, 600 illustrations. \$2 after 15 days, then \$3 a month until \$14.80 is paid.

Employment Management and Safety Engineering—7 volumes, 1800 pages, 540 charts and pictures. \$2 after 15 days, then \$3 a month until \$24.80 is paid.

Sanitation, Heating and Ventilating—4 volumes, 1454 pages, 1450 pictures. \$2 after 15 days, then \$3 a month until \$14.80 is paid.

Business Management and Commercial Law! Here's the quick way to PROMOTION for men eager to win success in business. The "last word" in Accounting, Finance, Production, Sales, Advertising, Commercial Law, 9 great volumes by Bell, McKinsey, Simons, Gauss, Chamberlain and others. A reference work for executives, a complete reading course for the student. \$2 after 15 days free loan, then \$3 a month until \$29.80 is paid.

**AMERICAN TECHNICAL SOCIETY**  
Dept. X-819, Drexel Ave., & 58th St., CHICAGO

# Send No Money Coupon

- Architecture, Building & Carpentry, 5 vol., \$24.80.
- Civil Engineering, 9 volumes, \$34.80.
- Electrical Engineering, 8 volumes, \$34.80.
- Auto Engineering, 5 volumes, \$24.80.
- Business Management, 9 volumes, \$29.80.
- Modern Shop Practice, 6 volumes, \$24.80.
- Law, 13 volumes, \$49.80.
- Drafting, 4 volumes, \$14.80.
- Steam and Gas Engineering, 7 volumes, \$24.80.
- Civil Engineering, 9 volumes, \$34.80.

No C. O. D.—Send no money.

American Technical Society,  
Dept. X-819, Chicago, Ill.

Please loan me FREE set marked X below. In return for this favor, I agree to pay the few cents express on same and to look them over carefully. If I decide to keep them I will pay \$2 after 15 days and then \$3 a month until special price is paid. But I may return them at your expense if I wish and owe you nothing.

- Fire Prevention and Insurance, 4 volumes, \$14.80.
- Sanitation, Heating & Ventilating, 4 volumes, \$14.80.
- Employment Management, etc., 7 volumes, \$24.80.

Name.....  
Address.....  
(Attach letter stating references' and employer's names and addresses, or write same in margin plainly.)

# BE A RAILWAY TRAFFIC INSPECTOR



EARN UP TO

**\$250**

**Per Month SALARY and Expenses**

A Position Promotion and Satisfaction awaited Graduate **JOE ETTLE**



Gentlemen: I am writing this letter in appreciation for what the course in Traffic Inspection has done for me. I graduated January 25th, 1927, was offered and accepted a position as agreed by you February 4th, 1927, at a salary of \$120 per month. April 10th

I was raised to \$135 per month and June first I accepted a position paying \$175 per month, with one of the largest and best Railway companies in U. S. A. Thanking you very kindly for what you have done for me and the personal interest shown me, from the day the first lesson arrived to the present hour, I am, Yours very truly, Joe Ettle.

For nine years our graduates have been offered positions as Traffic Inspectors at definite salaries, plus expenses, a few days after completing their studies. Traffic Inspectors start at \$120 or more per month and rise rapidly to \$175, \$200 or \$250 per month.

As a Railway Traffic Inspector, you are practically your own boss, see new faces and places each minute, report only to high officials, are rapidly advanced. It's healthful, outdoor work, with regular hours.

## Hundreds of Satisfied Graduates

Write today for booklet D-2, giving full details and contract agreeing to refund your money if position is not offered after graduation.

**Standard Business Training Inst.**  
BUFFALO, NEW YORK



# 1,000 Hotel Positions Open!

**H**OTELS, restaurants, clubs, apartments, hospitals, institutions, schools and colleges everywhere need trained men and women. Over 70,000 high-class positions paying \$2,500 to \$10,000 a year open annually in the hotels of the United States. Nearly one and three-quarter billions of dollars' worth of **NEW HOTELS, CLUBS AND INSTITUTIONS** being built this year will need over 200,000 trained men and women. Hotels start you at salaries up to \$3,500 a year, with living usually included. At any time there are over 1,000 hotel positions open.

## Previous Experience Unnecessary

You can have one of these fascinating, big-pay positions. The Lewis Schools guarantee to give you the valuable knowledge that it has taken some of the most successful hotel men years to obtain. Age is no obstacle—young and old alike have equal chance for success. Past experience absolutely unnecessary. A common school education is all you need. We train you in your spare time with the Lewis Simplified Study Plan and put you in touch with big opportunities. All of your training under the personal supervision of Clifford Lewis, Managing Consultant for over 225 hotels throughout the United States. Our students employed by leading hotels everywhere. Send coupon today for Free Book, "Your Big Opportunity," showing how we can train you for one of these splendid positions and explaining our Money-Back Agreement.

## FREE BOOK COUPON

**LEWIS HOTEL TRAINING SCHOOLS,**  
Room AM-385, Washington, D. C.

Send me without obligation the Free Book "Your Big Opportunity."

Name.....  
Address.....  
City..... State.....



To Men Getting  
**BALD**  
Here's My Contract

Give Me 15 Minutes  
a Day for 30 Days

and I'll give you  
new hair or no cost

By **ALOIS MERKE**  
Founder of the Merke  
Institute, 5th Avenue,  
New York



I DON'T care whether your hair has been falling out for a year or 10 years—whether you've tried one remedy or a hundred remedies. Give me 15 minutes a day and I guarantee to give you a new growth of hair in 30 days or I won't charge you a penny.

At the Merke Institute, 5th Avenue, New York, which I founded, many people have paid as high as \$100 for results secured through personal treatments. Now through my Home Treatment I offer these same results at a cost of only a few cents a day or money instantly refunded.

In most cases of baldness the hair roots are not dead, but dormant—asleep. Ordinary tonics fail because they treat only the surface skin. My treatment goes beneath the surface—brings nourishment direct to dormant roots and stimulates them to new activity.

**Free Book Explains Treatment**

"The New Way to Make Hair Grow" is the title of a 32-page illustrated book which explains the Merke Treatment—tells what it has done for thousands—contains valuable information on care of hair and scalp. This book is yours Free—to keep. Mail coupon TODAY! Allied Merke Institutes, Inc., Dept. 1611, 512 Fifth Ave., N. Y. C.

Allied Merke  
Institutes, Inc.,  
Dept. 1611, 512 Fifth Ave.,  
New York City

Please send me in a plain wrapper—without cost or obligation—a copy of your book, "The New Way to Make Hair Grow," describing the Merke System.

Name.....  
(State whether Mr., Mrs. or Miss)

Address.....

City..... State.....





**These books will qualify you for a big-pay job!**

The Library of Machine Shop Practice—nine big volumes packed to the covers with sound, pay-raising information—puts training right within your arm's reach. The books are the last word on modern machine shop practice—the most complete, the most thorough, the most practical set of books ever published in this field. Use them to increase your earning power—to win promotion!

**Machine Shop Practice**

**9 volumes—3065 pages—3608 illustrations**  
(A combined home-study course and reference library)

The Library of Machine Shop Practice was written from the practical man's viewpoint. Every word—every illustration is easy to grasp and apply, yet its treatment is so accurate that it is used as a constant reference work by experts in the best-known shops of the country. It explains the simple principles of shop work, then carries you quickly and surely over to the more intricate operations that every mechanic has to know in order to command a higher daily wage. Every topic is thoroughly covered to insure perfect mastery. These books are rich with the essentials of advanced methods, used by men who receive big pay for "knowing how."

They give you in convenient easily understood form more worthwhile knowledge and time-saving suggestions than any one man could possibly gain in a lifetime of practice.

**25% Reduction and a Great Book FREE!**

The regular price of the nine books in the Library of Machine Shop Practice is \$30.00. You get them at a special discount of 25%, and in addition receive, at no additional cost, a copy of French's Engineering Drawing—probably the greatest book on mechanical drawing ever written. Your saving on the ten books is \$11.50.

**10 Days FREE TRIAL Just Mail the Coupon!**

**No money down — 11 months to pay!**

On receipt of the coupon we will send the books to you, all charges prepaid. You look them over for ten days. If you like them—send us your first payment of \$2.50. The balance you pay at the rate of \$2.00 a

month until the special price of the set has been paid.

**FREE EXAMINATION COUPON**

McGRAW-HILL BOOK CO., Inc., 370 Seventh Ave., New York

Send me for 10 days' free examination the New Library of Machine Shop Practice. If satisfactory, I will send you \$2.50 in 10 days and \$2 monthly until the special price of \$22.50 is paid. If not wanted, I will return the books at your expense.

On receipt of my first payment of \$2.50, it is understood that I am to receive, free of charge, a copy of French's Engineering Drawing.

Signed.....  
Address.....  
City and State.....  
Position.....  
Employer..... P.M. 11-27

**\$2500 DRAWING COURSE for \$298**



Haven't you often wished that you could draw cartoons, illustrate some idea, sketch some pretty face, etc.? You can do all of these things. One of America's most famous Cartoonists and Illustrators has developed a great, simple system for success in all branches of Commercial Art. This system has revolutionized the entire theory of drawing. It means that drawing can be as easy for you as writing—much simpler than learning shorthand, bookkeeping or typewriting. We are now placing this original system for learning Drawing, Art and Cartooning, consisting of 34 lessons with over 500 illustrations, within reach of every one. If you will devote a few hours each week to the Course WE ABSOLUTELY GUARANTEE that you will learn to draw and draw well before you have half finished the Course. If we fail to make this claim good, we will refund every cent paid us. By eliminating a large office force for answering correspondence, expensive catalogs, etc., we are enabled to make a price of \$2.98, the cheapest price ever known for a high-grade, home study course. Many have sent us letters similar to that of Rob't P. Davis of Detroit, who wrote: "I can't see how you ask so little. It is more than I expected." Learn to draw. It is a big asset, no matter what field you are in.

**Send No Money**

Just order the course and **\$2.98** on arrival pay postman. Plus a few cents postage, payment in full for the entire Course and Drawing Outfit. If not entirely satisfied, return within five days and we will Refund Money. Address:

If you order the course at once, we will include a drawing outfit, consisting of artist's pencils, pens, paper, erasers, thumb tacks, etc., enabling you to go to work without any additional cost.

**LEDERER SCHOOL of DRAWING**, Dept. 4808-A, Chattanooga, Tenn. Orders from outside the U. S. A. are payable \$3.28 cash with order.

**Learn Photography at HOME**

Make money taking pictures. Prepare quickly during spare time. Also earn while you learn. No experience necessary. New easy method. Nothing else like it. Send at once for free book, OPPORTUNITIES IN MODERN PHOTOGRAPHY and full particulars.

**AMERICAN SCHOOL OF PHOTOGRAPHY**  
Dept. 1358 3601 Michigan Ave. Chicago, U. S. A.

**LEARN PIANO TUNING AT HOME**

Send for FREE copy of the 30th ANNIVERSARY EDITION of our book; "Winning Independence". Read how students master tuning with our TUNE-A-PHONE, and WHY our graduates head the profession in all parts of the world. With Bryant's patented devices, tools, charts and lessons, one learns quickly and easily. Low tuition; easy terms. Diploma granted. MONEY-BACK if not satisfied. \$10.00 to \$25.00 a day, exceptional opportunities and an ideal profession awaits you.

**BRYANT SCHOOL OF TUNING**, 31 Bryant Bldg., Augusta, Michigan.

**Raise Poultry MAKE BIG MONEY**

**Results Quick—Part or Full Time**  
Take up poultry raising. It's interesting, healthful, PROFITABLE. Easy to sell all you can produce at big prices. Our new course by Henry M. Lamou, former gov't expert, gives short cuts to success. Write for free book, "How to Raise Poultry for Profit."

**NATIONAL POULTRY INSTITUTE**, Dept. 411-C, Washington, D. C.

**MAKE YOUR VIOLIN**  
**You Can Do It!**  
Famous Violin Maker sells Patterns, Easy Instructions, Fine Woods, other Supplies.  
**C. C. FRASER**  
Box 14, Sta. C, Grand Rapids, Mich.

**10c NEW SCIENTIFIC WONDER**  
**3 for 25c "X-RAY" CURIO**  
BOYS You appear thru Clothes, Wood, Stone, any object. See Bones in Flesh. FREE—PKG. RADIO PICTURE FILMS. Takes pictures without camera. "You'll like 'em." 1 pkg. with each 25c order.  
**BIG FUN**  
**MARVEL MFG. CO.** Dept. 31 NEW HAVEN, CONN.



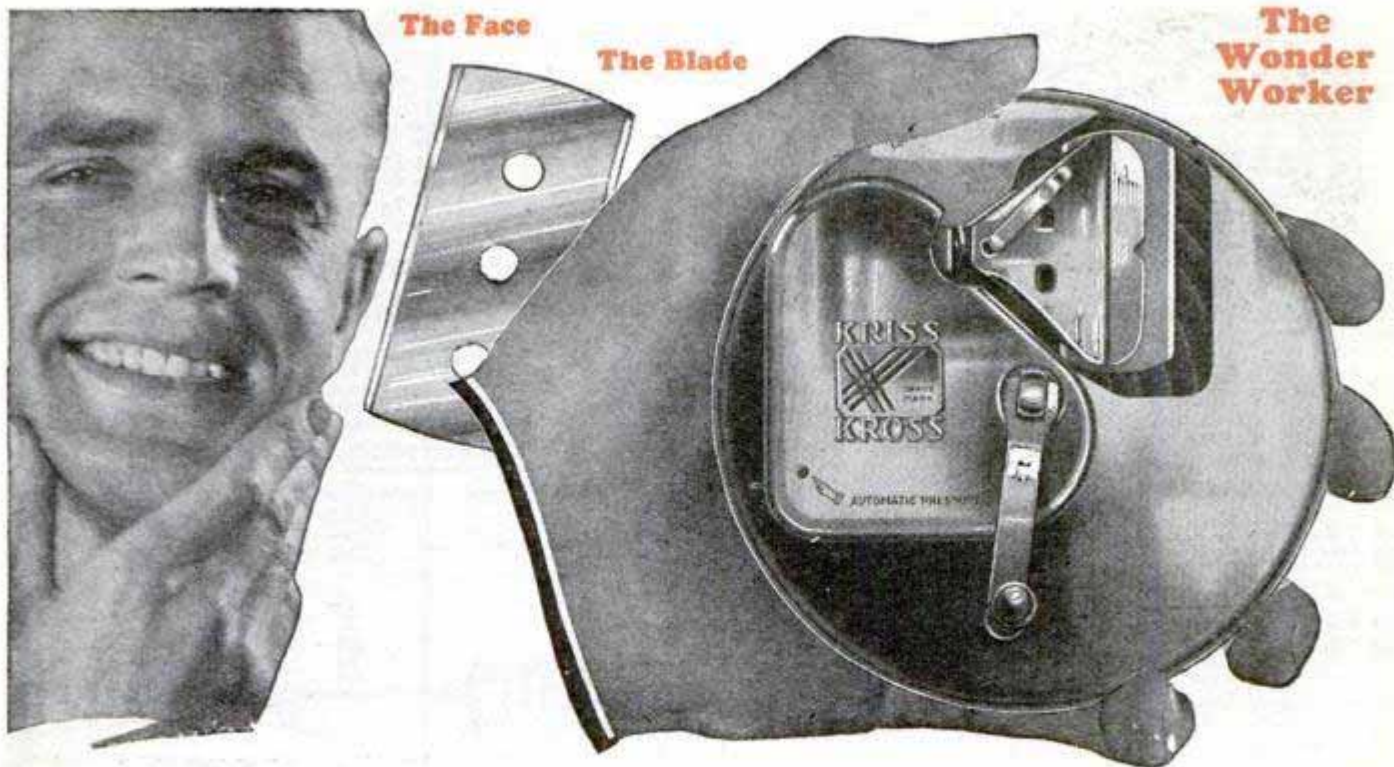

# 365 Shaves With the Same Blade —and Still Going Strong!

**THINK** of it! 365 keen, cool shaves a year—and not one penny for blades during the whole time! That's what an amazing new shaving invention did for J. W. Starksbury of Oklahoma! And W. D. Carroll of Pennsylvania got two solid years of slick shaves out of an old blade that was just about worn out to begin with! No wonder experts everywhere are simply astonished!

**KRISS-KROSS**—the remarkable invention that makes such long-distance shave records possible—deserves to be called much more than a stropper. Rather it is a *super-stropper* or blade *rejuvenator*. Almost literally, it makes a new blade out of an old one every day—makes hundreds of keen, quick shaves blossom where only one grew before. Until you've seen **KRISS-KROSS** and tested its uncanny ingenuity, you'll never know how really sensational it is!

### MAGIC DIAGONAL STROKE

**KRISS-KROSS** employs the diagonal stroke, same as a barber uses. Never before has anyone captured the secret of reproducing this stroke automatically. Eight "lucky leather grooves" do the trick in 11 seconds with a precision it takes a master barber years to attain.

But that's not all. **KRISS-KROSS** embodies still another feature that has hitherto baffled mechanical reproduction. It stropps from *heavy to light*. It's absolutely uncanny the way the strokes grow lighter and lighter until an adjustable, automatic jig files up and notifies you that your blade is ready—ready with the keenest cutting edge that steel can take!

### SENSATIONAL OFFER

To introduce **KRISS-KROSS** I am giving with it Free a new kind of razor. Instantly adjustable to any shaving position. A flip of the finger makes it T-shape; straight or diagonal (new way). Gives a

**Rhodes' KRISS KROSS**

**RHODES' MFG. CO. STROPPER**

Dept. S-372, 1418 Pendleton Ave., St. Louis, Mo.

sliding instead of pulling stroke. Reduces beard resistance 45%. Comes free with 5 special-process blades which, renewed with **KRISS-KROSS** stropper, should last you from five years to a lifetime, without any exaggeration!

### GET FREE OFFER!

Send for full information on these surprising new inventions today. **KRISS-KROSS** products are never sold in stores. You deal direct with me or my authorized representative. Write for illustrated description and full details of free razor offer. It's even more remarkable than I can tell you in this short space. Clip the coupon now. Mail it today.

## AGENTS \$150 A WEEK AND UP

Make big money with **KRISS-KROSS**. Giving away **FREE** razors boosts your profits amazingly. H. King made \$66 in one day. N. C. Paige made \$104 in 3 days. Others average \$350 and up to \$750 a month! **SPARE-TIME** workers, **OFFICE** and **FACTORY** men make \$6-\$12 extra a day showing **KRISS-KROSS** to friends and fellow employees. Get details at once. Check bottom of coupon and mail it tonight!

Rhodes Mfg. Co., Inc., Dept. S-372,  
1418 Pendleton Avenue,  
St. Louis, Missouri.

Without obligation, please send me illustrated description and full details of your special introductory offer on **KRISS-KROSS** super-stropper and **FREE** 3-way razor.

Name.....

Address.....

Town..... State.....

Check here if interested in making money as authorized **KRISS-KROSS** representative.



# Quickly Learn to Play Hawaiian Guitar

## Play Like This Native

Bring the romantic, enchanting, entrancing and melodious strains of the great instrument of the Hawaiian Islands into your soul. Become popular and successful. This **short cut method** of home instruction enables you to quickly master Hawaiian Guitar so you will **play as well as Native Hawaiians.**

Our staff of Hawaiian instructors have perfected a method of teaching, so **simple**, that without musical knowledge, you quickly learn to play real music from notes. **Simple as learning your A B C's**, and it will not be long before you will play latest Broadway hits.

**Only four simple motions to learn.** You will then play any music, whether it be popular, dance or classical. Almost from first lesson, you play love songs like Aloha Oe.

To help you get started, we furnish without extra charge when you enroll as a student, a beautiful, full tone, genuine \$18.00 Hawaiian Guitar. Only 1,000 free instruments given away; if you want to get in on this offer, write for particulars at once—you must act quickly.



**New Invention—**  
**Kno-All-Chart**  
**QUICKLY TEACHES YOU HOW TO PLAY**  
The newest invention of our Hawaiian instructor, which is exclusively used by us and which we call the "Kno-All-Chart,"

quickly teaches you how to play and read notes. So simple is this device that anyone can understand it and begin to **play immediately.**

### Picture Method Easy

We do not depend upon our printed instructions alone for your success as a student, but we also supply you with many pictures of our professors' playing. This enables you to imitate the pictures. **Isn't this easy?**



**GIVEN \$18 Hawaiian Guitar when you enroll!**

### Phonograph Records Given

As an additional guide, we also furnish you with **phonograph records** of our Hawaiian instructor's own playing of the piece you are learning. This practically brings our professors from our studio to your own home and enables you to listen to their playing just as if they were actually in front of you.

### Genuine \$18.00 Hawaiian Guitar Given

Enroll as a student, and secure a beautiful, full tone, genuine \$18.00 Hawaiian Guitar. We also furnish every bit of equipment so it is never necessary for you to spend an extra penny. When you graduate, you get a **beautifully engraved diploma** and after graduation, we also give you **six months' free service** and consultation. Send for free particulars now.

**JAZZ**

**Your Way to Popularity and Success**

No forming class to wait for. Start at once and join band wagon of success and popularity. Do it through Hawaiian Guitar.

Send for free **First Lesson and Book**. So positive are we you will become one of our students, that if you write at once, we will send you **free**, our first lesson which will enable you to see just what you can expect when you enroll. You will also receive our **big book** of full particulars. Write for your copy and **free lesson** today.

Write at **Hawaiian Studio No. 5211** of New York Academy of Music, 100 Fifth Ave., New York, N. Y.

**HAWAIIAN STUDIO No. 5211** of New York Academy of Music, 100 Fifth Avenue, New York, N. Y.

Please rush your book, "How to Learn Hawaiian Guitar," and my first free lesson. Also reserve a Hawaiian Guitar for me without extra charge. This obligates me in no way whatever.

Name.....  
Address.....  
City..... State.....

# LAW THIS BOOK FREE!

**Study at Home**  
Become a lawyer. Legally trained men win high positions and big success in business and public life. Greater opportunities now than ever before.

**Earn \$5,000 to \$10,000 Annually!**

We guide you step by step. Degree of L.L.B. LaSalle law graduates practicing in every state. We furnish all text material, including 14-volume Law Library. Low cost. Easy terms. Valuable, interesting 96-page book free. Send for it NOW.

**LaSalle Extension University, Dept. 1164-LA Chicago**



**NOW ONLY \$2.00**

Grow strong and healthy this quick new way. The Giant Chest Expander and Progressive Exerciser will keep you fit and full of pep and vitality. Only \$2 for 5 cables or \$4 for 10 cables. Why pay more? Complete instructions for scientific progressive exercising sent with each exerciser.

Send no money. Simply pay the postman, plus a few cents postage, on delivery. Every exerciser fully guaranteed. **Money back in five days if dissatisfied.** Write

**PROGRESSIVE EXERCISER CO., Dept. 4011** Langdon Bldg., Duane St. & Broadway, New York City

## Anyone CAN LEARN

No talent or experience necessary. Fascinating work. **Pays big money.** Complete instruction book tells about: Alphabets, Colors, How to Mix Paints, Show Cards, Window Board and Wall Signs, Ready made letters, Gliding, Tricks of the Trade, also gives 100 Alphabets and Designs. Book bound in flexible int. leather, gold edges, and four half bearing Show Card Pens. Sent postpaid \$3.00, (C.O.D. 110c ex. Ogilvie Pub. Co., 57 Rose St. Dept 20, N.Y. City)



**EARN MONEY IMMEDIATELY— WE FURNISH EQUIPMENT TO START!!**

**MINSTRELS** Musical Comedies and Revues, with full instructions for staging. You can stage your own show with our books, Full line of plays, stage songs, crossfire monologues, afterpieces, vaudeville acts and make-up. **CATALOGUE FREE.**

**T. S. DENISON & CO., 623 So. Wabash, Dept. 19, Chicago**

# ELECTRICITY

LEARN at home in spare time through courses of International School of Electricity. Written by such well-known men as:

- EDGAR KNOWLTON—Electrical Engineer, Alternating Current Engineering Department, General Electric Co.;
- J. LESTER WOODBRIDGE, E.D. and M.E.—Chief Engineer of the Electric Storage Battery Co.;
- O. J. BUSHNELL—Superintendent of the Meter Department, Commonwealth Edison Co.;
- S. A. FLETCHER—Electrical Engineer, Superintendent of Service, Alabama Power Co., and
- S. H. MORTENSON—Designer of Alternating Current Motors and Generators, Allis-Chalmers Manufacturing Co.

**Mail Coupon for Free Booklet**

**INTERNATIONAL SCHOOL OF ELECTRICITY**  
Associated with the International Correspondence Schools  
Box 5682-E, Scranton, Penna.

Without cost or obligation, please send me full details of your home-study course in **ELECTRICITY.**

Name.....  
Address.....



Building Industry

Motor Industry

Radio Industry

Railroad Industry

Aeroplane Industry

World Transportation

Civil Engineering

# \$29,500

## a Year Made By These 4 Men

Here's proof positive that these four Dobe-trained draftsmen have also made good with a bang! Their yearly earnings total \$29,500! They saw the Big Future in Drafting. They didn't wait for opportunity to knock. They reached out and grabbed him. They read my advertisement and sent for my Free Book "Successful Draftsmanship." They read it—decided I was actually turning out real draftsmen—and *jumped at the chance* to learn by my simple, practical, easy drafting method of teaching! Look where they are NOW! And their *first step* towards Success was sending for my Free Book. Let me send you a copy this very day. Use the coupon!

## Learn Drafting at Home!

Men, I say you can learn drafting at home in your spare time! That's exactly what Bowen—Bernier—Stroop and Dewalt did! I offer you the identical opportunity. Isn't it logical for you to believe that what these men did—you can do? Maybe you can't do as well as the four big earners pictured here—but you've got to admit that it's at least worth a try. Even if you could earn only half as much when you finish my course! Most men would be satisfied with that.

## 500 Industries Need Draftsmen!

Five hundred and more industries not only *need* trained draftsmen *now* but will ALWAYS need them! Plans must *first* be drawn by draftsmen *before* any machine, building, or invention *can* be built! That's the wonderful, big field I train you for by my practical, quickly learned course. These men have had steady, profitable employment year after year! My easy, interesting, learned-at-home-in-spare-time-training fits you to enter this great profession! Decide *now* to Get Started! Write for my Free Book "Successful Draftsmanship." Cut the coupon—mail it!

## Mail Coupon for FREE Book—

"Successful Draftsmanship"

Send a postcard or a letter or mail the coupon for the Free Book, "Successful Draftsmanship," which Dobe has written for the benefit of all men who are interested in drafting. It's a great book about a great profession—and you ought to read it. These four men are certainly glad they read it and took Dobe's word that he could make real draftsmen out of them. No matter who you are, where you are, or what your job is you should send for this book NOW. You should send for it unless you are making all the money you want already.

**DOBE EASY DRAFTING**  
Established 1900  
1951 Lawrence Ave.,  
Div. 13-58 CHICAGO



\$1000 a month.

A.H. Bowen



\$475 a month.

S.C. Stroop



\$7000 a year.

A.H. Bernier



\$400 a month.

Arthur Dewalt



**DOBE EASY DRAFTING**

1951 Lawrence Ave., Div. 13-58 Chicago

Please send me free your book, "Successful Draftsmanship", and names of other big money earning draftsman you have trained.

Name.....Age.....

Address.....

Post Office.....State.....



# You Fellows Who Want BIG PAY

Get into

**WHY** earn \$15 or \$20 or \$30 a week, when in the same six days as an Electrical Expert, you can make \$70 to \$200 — and do it easier — not work half so hard. Why, then, remain in a small-pay, no-future job that offers no chance for big promotion — no chance for big income? Fit yourself for a real job. **Get into Electricity.** That's where the big money is being made, and always will be made.

### Electricity — The Big Pay Field

Today even the ordinary Electrician — the "screw driver" kind — is making money — big money. But it's the trained man — the Electrical Expert, — who makes the really big money, — \$12 to \$30 a day — \$70 to \$200 a week. Be a Big-Pay man, yourself. Get in line, now, for one of these "Big-Pay" Jobs.

### I'll Train You At Home

I'll train you at home, — in your spare time. You work just as you are working now — at your same job. My now famous "Work-Sheet and Job-Ticket" method, guarantees you simplified, practical training along work-shop lines. In a few short months you can step out of your old job into a new job — into electrical work where you can be a Big-Pay man in this Big-Pay field.

### You Earn As You Learn

To learn Electricity my way you don't have to be a College man, or even a High School graduate. You can read. You can write. That's enough. With me, you get experience as you go along and make good money while learning. I'll show you how, — and I'll give you, without extra cost tools and apparatus to work with — 6 Big Outfits in all.

### Money Back If Not Satisfied

That's what I agree to do. And back of me in this agreement stands the Chicago Engineering Works, a \$2,000,000 Illinois Corporation. There's nothing like "Cooke" Training, anywhere. It's the Training that big Electrical men are praising; it's the Training that employers recommend; it's the Training that one of our greatest Engineering societies, has endorsed 100 percent. **It's the Training for you.**

### If You're Earning Less Than \$70 A Week — Investigate

Don't wait a minute! Find out today why "The Cooke Trained man is the Big-Pay Man", everywhere! Find out how "Cooke" Training will help you boost your pay! Mail coupon right now for my Big FREE Book of Facts. See the Six Big Working-Outfits I give you without extra charge. See the hundreds of pictures, the proofs, the Big-Pay letters of other "Cooke" Trained Men. Get this great free Book. Send for it today. Clip, sign, and mail coupon RIGHT NOW!

L. L. COOKE, Chief Instruction Engineer

## L. L. COOKE SCHOOL OF ELECTRICITY

Dept. 18  
2150 Lawrence Ave.  
Chicago, Illinois

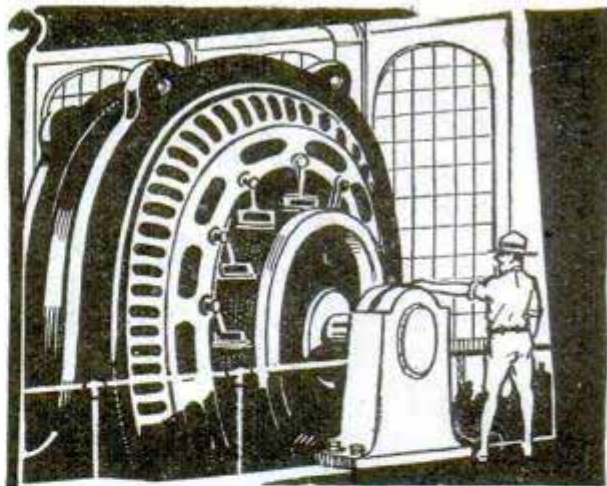

# ELECTRICITY

Hundreds of Men I have trained are now earning

**\$70 to \$200 A WEEK**

So Can You

If you earn less than \$70 a week **INVESTIGATE** **ACT NOW**



I'll train you at home in a few short months.  
L. L. COOKE

### FREE BOOK COUPON

L. L. COOKE, Chief Instruction Engineer, Dept. 18, 2150 Lawrence Ave., Chicago, Ill.

Send me FREE and prepaid, your Big Book "Secrets of Success in Electricity," with all details about your Home Study Course in Electricity.

Name \_\_\_\_\_  
Address \_\_\_\_\_  
City \_\_\_\_\_ State \_\_\_\_\_

Residents of Canada send coupon to L. A. Farrow, Special Representative, 1 Medbury Lane, East, Windsor, Ontario, Canada.

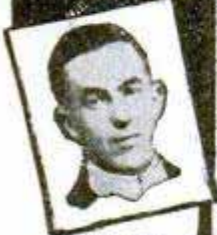
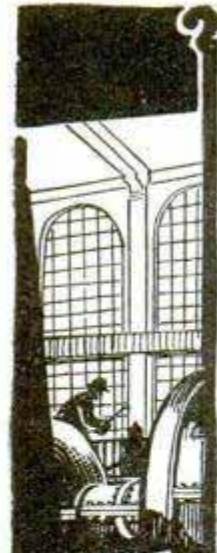
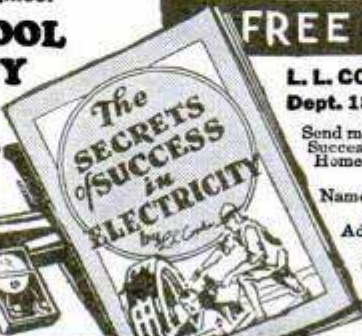

**\$30 A DAY**  
Dear Mr. Cooke: I was making \$25 a week when I enrolled. Now with my own Electrical Shop I make as high as \$30 a day. A. J. Daigeanult, 225 Worcester, Southbridge, Mass.



**\$1.50 AN HOUR**  
Dear Mr. Cooke: I had to work like a slave for 40c an hour before I enrolled. Now, thanks to you, Mr. Cooke, I make \$1.50 an hour. G. W. Opres, 4229 N. Meade Av., Chicago, Ill.

**6 BIG OUTFITS NO EXTRA COST**



The "Cooke" Trained Man is the "Big Pay" Man



# Classified Advertisements

## WORLD'S BEST WANT AD MEDIUM

Advertisements in this section, 30 cents per word, each insertion, minimum 10 words, payable in advance. To be inserted under proper classification in December issue, copy should be in our office October 18th.

### ADVERTISING AGENCIES

**SECURE and Increase Your Business** by going after out of town trade. Our Service department guides you on every detail. Copy and literature composed free. Your 24-word ad (4 lines) inserted in the following 10 leading Sunday papers for only \$10.00. Circulation 1,500,000. Gazette, Little Rock; American, Atlanta; Star, Indianapolis; Journal, Minneapolis; Star, Kansas City; World-Herald, Omaha; Courier, Buffalo; Enquirer, Cincinnati; Gazette Times, Pittsburgh; Banner, Nashville. Proof of insertion guaranteed or money refunded. 56 page rate Book and Atlas sent free. Frank W. Lenhoff Advertising Agency, 600 North Michigan Blvd., Chicago. (Established 1897.) Chicago's Most Progressive Advertising Agency.

**A TEN Dollar Ad may put your proposition over.** \$10 pays for a 4 line 24 word classified ad one Sunday in 8 of the largest newspapers. Reach over 6 million readers. Minneapolis Tribune, Buffalo Courier, Detroit Free Press, Kansas City Star, Pittsburgh Press, Indianapolis Star, Atlanta Journal, Cincinnati Enquirer. Free catalogue showing other lists of newspapers and magazines sent on request. Ankrum Advertising Agency, 22 West Jackson Blvd., Chicago. Largest classified advertising agency in the world.

**ADVERTISERS Rate Guide Free.** 36-page Directory showing classified and Display rates of best producing newspapers and magazines. Other information. We can place your advertisement in any publication at lowest rates. Our experience saves you money. Checking copies guaranteed. Write for Free Directory. E. H. Brown Advertising Agency, Dept. 1245, 140 S. Dearborn St., Chicago, Ill.

**TEXAS** cotton picked and sold. Oil wells gushing. Lumber industry booming. Rice and corn farmers prosperous. Texas has money. Tell them what you have to sell. 24 words, 4 lines, 18 biggest Texas dailies, \$12.80. Skinner Agency, Chronicle Building, Houston, Texas.

**ADVERTISE** in 24 Big Sunday Newspapers, 24 words \$15.00. Excellent for securing Agents, Salesmen, and Business Opportunities. Catalog listing 1,000 leading Dailies, Weeklies, Mail Order Magazines, Everything. Free. Wade Advertising, Baltimore Bldg., Chicago.

**ADVERTISE** 50 magazines \$4.00 inch, three \$8.00; circulation proven. King, Box 672-P, Wilmington, Del.

**LOWEST Rates.** New Catalog. Owl Agency, Times Bldg., New York.

**NEWSPAPER** — Magazine advertising — Classified, mailorder, Catalog. Martin, 276B West 43rd, New York.

**SIX Word Line**—355 rural weeklies \$3.55. Admeyer, 4112-M Hartford, St. Louis.

### FOR ADVERTISERS

**ADVERTISERS**—The wonderful success of such concerns as Frank Spores Co., Magic Products Co., Opportunity Magazine, Pruitt Publishing Co., are made largely through the use of our Mailing Lists. Our "ad" in Agents' Column in this and other similar publications, bring us over 500 replies per month. Let us furnish you a trial 1,000 of these latest addresses typed to you for \$2.00. Order today! Action counts. The Master Card Co., 820 Chestnut, St. Louis.

**NEATLY** printed government post card mailed to 1,000 our fresh names, mail order buyers, salesmen, will increase your business. 1,000 trial names \$1.00. Get our free booklet showing magazine, newspaper advertising and quality printing bargains. Waring Advertising Co., Dundee, Mich.

**SPECIALIZED Service.** Lists—Cooperative Mailing, Mimeographing, Printing, Advertising. Field's, 1145 East 99th, Cleveland, Ohio.

**40 WORDS** insert 50 magazines \$2.00. Empire Agency, Shawano, Wis.

**TWENTY-FIVE cents** (coin) will put your 30-word classified advertisement before 100,000 mail-order buyers of the Sky Line Bulletin. Address, Bulletin, Tujunga, Calif.

**I WRITE** letters, folders, booklets, complete followup for manufacturers, mail order dealers. Long experience. Write for details. L. Taylor, 201 S. Day, Rockford, Ill.

**ADVERTISE** in 275 country newspapers, 28 words, \$10. Keator, Hartford Bldg., Chicago.

**CUTS.** Drawings \$1.50. Window Cartoons, 6, \$1.50. GPO, Bx471, New York.

### SALES PROMOTION

**\$50 TO \$50,000 Daily Sales Developed** During 28 years for clients by our direct mail plans, copy, campaigns. One product, 1923, an idea; this year 100,000 orders booked. Fifty year old concern desired 50 national representatives in 1925; we produced 40 in three months. 700 dealers in 10 months at \$3 each, for another. Ten years Sales Promotion Manager Larkin Co. Submit sales problems for free diagnosis. James C. Johnson, 118A Woodbridge Ave., Buffalo.

**I SAVE** my clients enough on printing alone to pay for my complete service on catalogs, booklets, sales letters, and other literature. Dudley Bunn, Advertising Service, Savanna, Okla.

**THREE** Resultful Advertisements written for Your Business, Three Dollars. Prize Winner Payne, 728 Chronicle Building, Houston, Texas.

### LETTER SPECIALISTS

**POWERFUL Literature!** Famous for famous results. Reasonable rates. Finkel-Advertising, 15P Fairview, Jersey City, N. J.

### AUTOMOBILE SUPPLIES

**AT Last!** Reasonably priced Auto Emblems for every Lodge. Sells for only \$1.25. Write for attractive selling proposition and free Sample Case offer. North Central Distributors, Dept. 9, Ashland, Ohio.

**VULCANIZING Auto Tires** is a Paying Business. We have plants near you from \$50 up. Catalog Free. Instruction Book \$1. Equipment Exchange, 108 East 11th, Los Angeles, Calif.

**NEW Generators, Magnets, Carburetor, Electrical Equipment, Bearings, and everything in Automotive Equipment and Parts.** Write for 150-page illustrated catalogue of bargains. Leterstone Sales Company, 2515 Wabash Ave., Chicago, Ill.

**RADIATORS** at wholesale prices. All standard makes. Satisfaction guaranteed. Send for prices, stating make and model. Independent Radiator Co., 1119 S. Wabash Ave., Chicago.

**YOU** are wanted to resilver mirrors at home. Immense profits plating autoparts, tabware, etc. Write for information. Sprinkle, Plater, 77, Marion, Ind.

**\$17.50 DAILY** Easily Made—Demonstrating Amazing new Moisture Gas Saver. All autos. 1 free. Critchlow, EI-805, Wheaton, Ill.

**A FULL** size sample of a good selling auto necessity with your own label; fully guaranteed \$1.00. General Sales Co., Muncie, Ind.

**SEND** for our catalog giving you the advantage of wholesale prices on Battery Shop Equipment and Supplies. Dealers only. Adams-Barr, Columbus, Ohio.

**IMPROVED Ford Timer.** Price \$1.00. Pectso Laboratories, Wauwatosa, Wis.

### AUTOMOBILE SERVICE EQUIPMENT

**ELECTRICAL** service on the automobile offers unlimited opportunities. Practically no investment required. Successfully operated independently or in connection with other auto work. Full information without obligation. Write E. C. Galbreath, Box M-1173, Troy, Ohio.

**15-BATTERY 8-Hour Charger** complete with special charging equipment at bargain price. Your opportunity to get into money-making branch of automotive service with small investment. Hobart Industries, Box M-1172, Troy, Ohio.

**BUSINESS** builder for every shop engaged in auto service of any kind. Automatic air service compressors on payments as low as \$11 monthly. Most popular type on the market. 30 days trial. Write for full particulars. W. E. Jordan, Box M-1174, Troy, Ohio.

### AUTOMOBILES

**PATENTS.** Time counts in applying for patents. Don't risk delay in protecting your ideas. Send sketch or model for instruction or write for free book "How to Obtain a Patent" and "Record of Invention" form. No charge for information on how to proceed. Communications strictly confidential. Prompt, careful, efficient service. Clarence A. O'Brien, Registered Patent Attorney, Security Bank Building (directly across street from Patent Office), Washington, D. C. See pages 156 and 157.

### FOR FORD OWNERS

**\$17.50 DAILY** Easily Made—Demonstrating Amazing new Moisture Gas Saver. All autos. 1 free. Critchlow, E2-805, Wheaton, Ill.

**UNDERSLUNG** with "RKO" Swing Lo Irons. See "Red-i-Kut" ad page 151.

### MOTORCYCLES, BICYCLES AND SUPPLIES

**GOOD** used parts for Indian, Harley Davidson, Excelsior, Henderson and others at one-half of new prices or less. New parts for all makes. Quick service; expert repairing; prices right. J. B. Dahl, 3661-63 Archer Ave., Chicago, Ill.

**MONEY** Saving Motorcycle Bargains—Large stock of Used Harley-Davidson—\$50 and up. Send for Free bargain bulletin—Now! Motorcycle Parts, accessories, repairs. Knuth's Harley-Davidson Agency, 2525 Fond Du Lac Ave., Milwaukee, Wis.

**1927 MODEL** Super Ex. Like New, \$195.00. John A. Mast, 1410 Race St., Cincinnati, O.

**BICYCLES, Tandems, Tricycle delivery,** reducing machines. McDougald, 175 W. Lake, Chicago.

**MOTORCYCLES** at Reduced prices. Save 25% to 50%. Send for our Bargain Bulletin. American Motor Cycle Company, 2041-2047 Chicago Ave., Chicago.

**MOTORCYCLE** Bargains. Used, rebuilt. Guaranteed. Shipped on approval. Catalog free. Floyd Clymer, 810 Broadway, Denver, Colo.

### AVIATION

**THOROUGH** instruction in flying and building airplanes can only be had in a well equipped school. We offer our students the combined facilities of a real aircraft factory, excellent flying equipment and experienced instructors. Learn to fly in five weeks for \$100.00 with one of America's oldest pilots. Employment given to students who are short of funds or who wish to take our special fall and winter evening course. Special agency offer to students to represent our airplanes in their territories. Heath Airplane Company, Inc., Chicago, Ill.

**SET** absolutely new covered wings for Heath Parasol monoplane crated \$20.00. If building one chance save money. Curtiss Jenny \$490.00. 2 pair army aviators' goggles \$1.00, postage paid. New unused Curtiss propeller, boxed, \$3.00 each. Gnome engine \$35.00. Midway Aero Co., Box 283, St. Paul, Minn.

**SEND** for largest and most complete aviation school catalog ever issued and special offer. Gives all information, answers all questions. Marshall Flying School, 231 North St., Marshall, Mo.



**LEARN to Fly; \$100.00 including Solo.** We guarantee to solo you regardless of the number of flying hours required. Our instructors are ex-army aviators and air-mail pilots with wide experience. Our training equipment is the best obtainable. Our course requires about two weeks, depending on the individual. No bond required, no charge for breakage. Eight years without an accident. 76 students graduated in 1925. Commercial aviation is a rapid growing industry. Don't delay! Enroll now in one of the oldest and best known flying schools in America. Write for booklet. Robertson Aircraft Corporation, operators of the United States Air Mail, St. Louis-Chicago, Lambert-St. Louis Airport, Angham Mo.

**AVIATION'S Best, Cheapest, Home Study Course—\$10.00.** Thorough, complete, including Nomenclature, Motors, Wings, Fuselage, Rigging, Assembly, Manufacture, Design, Flight Principles, Flying, Air Rules, Navigation, Meteorology, Drawings and fifty other subjects. Diploma given. Free employment service. Enroll now or write. \$12.00 on time, \$2.00 down. Romby National Aeronautical Service, Desk 1, Box 43, Santa Monica, Calif.

**FLY!** Get into the flying game right. Build a sport monoplane. My booklet tells you how. Price \$1.00. T. A. Hodgdon, 324 Bay St., Springfield, Mass.

**AUTO-PLANE—A** miniature all-metal monoplane that flies. Latest and distinctive automobile radiator-cap ornament, for cars with or without motometers. Price \$3.50. Send stamp for illustrated folder. Wright Mfg. Co., 47 So. 12th Ave., Mt. Vernon, N. Y.

**EAGLE ROCK,** government certified safety airplane at \$2,475. Denver or may be purchased on time payments. Pilots pay as they earn. Low charge for student instruction. Write for new complete course Airplane operation "Modern Flight." One Dollar. Alexander Aircraft Company, 3333 S. Broadway, Denver, Colo.

**BUILD your own sport Monoplane.** Blueprints and instructions, \$2.50. Allison Airplane Co., Lawrence, Kans.

**HEATH** propellers represent the most efficient method of aerial drive. Each propeller individually designed for the particular work to be done, as laid out by America's oldest aeronautical engineers. Propeller catalog 4c. Heath Airplane Company, Chicago, Ill.

**BUILD!** fly! scale Models, E-Z system; everything for the model builder; list for stamp. Ace Airplane, 131 Prospect Street, Jersey City, N. J.

**MEN** interested in aviation offered unusual opportunity to secure lucrative positions and training as pilots. Aero Institute of America, 357 West 63rd St., Chicago, Ill.

**BUILD and Fly Your Own Monoplane.** 20-Foot Wing Spread, 72 MPH, with Only 12 HP. Motor. Plans and Working Drawings Complete, \$10.00. Warner Co., 311 Edwards Bldg., Cincinnati, Ohio.

**85 MPH Aerodrive Sled—Blueprints.** Only 50c. Other sled and boat prints 50c each. Ostergaard Aircraft, 4305 North Narragansett, Chicago.

**THE American School of Aviation** announces a new correspondence course in Mechanics of Aviation. A thorough training in Practical Aeronautics. American School of Aviation, Dept. 1861, 3601 Michigan Ave., Chicago, Ill.

**DICTIONARY of Aviation,** \$3.90. Languages Publishing Company, 15 W. 18th Street, New York.

**SEND** dime for 12 inch mounted propeller and circulars on free three foot model aeroplane. No selling. Aero Shop, 3050 Hurlbut Ave., Detroit, Mich.

**BIGGEST, Best Catalog Model Airplanes, Parts Supplies;** 5c postpaid. Ideal Company, 165½ Spring Street, New York.

**A JOB** for you while you learn to fly. We can arrange employment for fifteen young men in an aircraft factory which will pay enough for room and board while taking their course. Permanent employment if you make good. 15-hour course \$250. Porterfield Flying School, 2330 Harrison Street, Kansas City, Mo.

**SPORT** Plane builders. Send one dollar for booklet on Nomenclature, Stability, Controllability, Design, Charts, Illustrations, etc. Donald Smith, 1247 Loma Vista Drive, Long Beach, Calif.

**PATENTS.** Time counts in applying for patents. Don't risk delay in protecting your ideas. Send sketch or model for instruction or write for free book "How to Obtain a Patent" and "Record of Invention" form. No charge for information on how to proceed. Communications strictly confidential. Prompt, careful, efficient service. Clarence A. O'Brien, Registered Patent Attorney, Security Bank Building (directly across street from Patent Office), Washington, D. C. See pages 156 and 157.

**OPPORTUNITY** is calling. Be a Wallace Trained Man. We teach you to fly, build and design airplanes. Low rates to students. Salary to qualified men. Wallace Aircraft Co., Builders of "Wallace Mohawk." Dealers wanted in every state. 4716 Irving Pk. Blvd., Chicago, Ill.

#### BOOKS AND PERIODICALS

1927, **THIRD** edition revised. "Radio Theory and Operating," by Mary Texanna Loomis, President Loomis Radio College; member Institute Radio Engineers. 886 pages, 700 illustrations. Used in all Government and private radio schools, many colleges and high schools. Comprehensive, up to date, the standard on radio. Price \$3.50, postage paid. At your book store, or order direct from Loomis Publishing Company, Dept. M., 465 Ninth, Washington, D. C.

**Old Money Wanted.** Do you know that coin collectors pay up to \$100.00 for certain U. S. cents? And high premiums for all rare coins? We buy all kinds. Send 4c for large coin folder. May mean much profit to you. Numismatic Co., Dept. H-2, Fort Worth, Tex.

**THE** greatest booklet on money-making stunts that ever has been published, mailed to you for 10c. Cervence System, Box 4, Buffalo, N. Y.

**FREE!** Valuable book telling the uses of roots and herbs. Box 29C, Station L., New York.

**"THE Personal Liberty Course"**—A clever combination of mirth, information and instruction for quickly overcoming fear, bashfulness and physical complexes in men. No drugs, no gymnastics. Full particulars free, sealed. Harry J. Gardener, P. O. Box 607, Station C, Los Angeles, Calif.

**INDUSTRIAL Alcohol.** Wright's book. Full directions for making, fully illustrated. \$2.50. Spou & Chamberlain, 120 P.M. Liberty Street, New York, N. Y.

**PAINTERS, Decorators, Artists—Books** 10c up. Circulars free. King, Box 1482, Indianapolis, Ind.

#### PICTURES AND POSTCARDS

**20 ORIENTAL** girl models. Dollar bill. Art Photo Galleries, 10 Temple Road, Colombo, Ceylon.

**ART** Pictures, Books and Novelties. Catalog 10c. Howard Sales Co., Dept. 15, 1188 Folsom St., San Francisco, Calif.

**FREE—Send** address for beautiful 5x16 art print. C. C. Dry, 1112½ 21st N. W., Canton Ohio.

**FREE—True-Blue Book.** Exchange postcards, stamps. Ericson, Elroy, Wis.

#### MAGIC TRICKS, BOOKS AND JOKER NOVELTIES

**NEW 1927 "Fun—Magic—Mystery"** now ready. 100 Pages, profusely illustrated. Over 750 Tricks—Illusions—Jokes—Puzzles—Books—European Novelties, at Reduced Prices. Postpaid 10c. Lyle Douglas, Station A, Dallas, Texas.

**MAGIC—Tricks, Books and Supplies.** For Amateurs as well as the great professionals. Anyone can learn through our instructions. Feature Acts in Mind-Reading, Spiritualism, Rope Ties, etc. Large illustrated Professional Catalog, 20c. Chicago Magic Co., 140 So. Dearborn St., Dept. B, Chicago, Ill.

**FREE** with \$25 order die box. Send 20c for our large catalogue of tricks, wigs, sensational escapes. Oaks Magical Co., Dept. 548, Oshkosh, Wis.

**ELECTRIC Fun!** Seventy stunts, 110 volts. \$1. Tacutting, Campbell, Calif.

**CARD** Tricks, Coin Trick, Hypnotism, Ventriloquism. 64-page books. Complete guides 10c each. Geo. Fenner, 2401 Jefferson, Louisville, Ky.

**MAGIC** Trick Cards that are absolutely guaranteed; Bees, Bicycles, Steamboats. Free samples. C. D. Blankenship, Adrian, W. Va.

**MAGIC** Catalog, Fifteen Tricks, 10c. Chesters Magic, 403 No. State, Chicago.

**SEVEN** Magical Delusions and Catalogs—25c. Gilmagic, Morgan Park, Ill.

#### GAMES, ENTERTAINMENTS AND PLAYS

**VENTRILLOQUISM** taught almost anyone at home. Small cost. Send 2c stamp today for particulars and proof. George W. Smith, Room 8-216, 125 N. Jefferson Ave., Peoria, Ill.

**PLAYS,** Musical comedies and revues, minstrel music, blackface skits, vaudeville acts, monologs, dialogs, recitations, entertainments, musical reading, stage handbooks, make-up goods. Big catalog free. T. S. Denison & Co., 623 So. Wabash, Dept. 11, Chicago.

**PUZZLE** catalogue and leader free. B. Z. Puzzles, Fairview, Mass.

**100 LIGHTNING** Chalk Talk Stunts \$2.00. Cartoonist, 2925 Euclid, Kansas City, Mo.

#### NOVELTIES, CURIOS, ETC.

**MAKES** lovely changing colors in Log Fires; safe, lasting; large package 50c and \$1.00 postpaid. Jobbers, dealers wanted. Fred Hitt, Los Gatos, Calif.

#### STAMP COLLECTING

**500 DIFFERENT** Stamps for 25c! Big Collection 500 Different Stamps from Bosnia-Herzegovina, Crete, Epirus, Hong Kong, Iceland, Kenya and Uganda, Liberia, Malta, Nyassa, Tanganyika, Wallis, and Futuna, Zanzibar, and other "hard" countries. Catalogue value \$10.00. Price only 25c to Approval Applicants! Special Bargains: 1,000 different 79c; 15 triangle stamps 49c; 100 Africa 50c; 100 Asia 60c; 100 Balkan States 35c; 100 British Colonies 25c; 100 French Colonies, 30c; 100 Portuguese Colonies 50c; All 8 packets for \$3.00! Illustrated Lists Free. Loma Stamp Co., 3926 32nd St., San Diego, Calif.

**ANCHERS \$\$\$** Outfit—only 12c! Fine triangle stamp; set German stamps with (pre-war) value forty million dollars (interesting!); perforation gauge, mme. scale; small album; airmail set; scarce stamp from smallest republic on earth; newspaper set; packet good stamps from Travancore, Malay, Dutch India, etc. Entire outfit for 12c to approval applicants! (Nice pocket stock book, value 25c, with every order!) Ancher Stamp Co., 148½ Clerk St., Jersey City, N. J.

**MYSTIC'S "Queer Country"** Packet! Contains scarce stamps from the following strange lands: San Marino, Antioquia, Congo, Cyprus, Fiji Islands, Gwallor Hyderabad, Iceland, Jhind, Kenya, Uganda, Lebanon, Monaco, North Borneo, Nyassa, St. Thomas Prince, Port. Guinea, Siam, Sierra Leone, Tanganyika, Trinidad Tobago, Ubangi, Upper Volta, Wallis Futuna, Zanzibar. Get this wonderful packet of "freak countries" and make your friends envious! Price only 10c to approval applicants! Write today. Mystic Stamp Company (Dept. 8), Camden, New York.

**\$1.00 FREE.** Black U. S. Postage, Given Away with each order. Pioneer Stamp Album with 500 illustrations, 150 different stamps from 40 countries, Syria, Lebanon, Hejaz, Liberia, New French Colonies, British, Portuguese Colonies, South Africa, Australia, 500 hinges, 36 page illustrated catalogue. All for 15c. Big Commission to Agents for the Best approval sheets of stamps ever offered. Write for sample outfit. Hussman Stamp Co., Dept. M, 620 Olive St., St. Louis, Mo.

**WONDERFUL** collection 205 different stamps from Gwallor, Haute-Volta, Kouang-Tebeou, St. Thomas, South Africa (Springbok), and other "hard" countries; fine triangle stamp; package hinges; millimetre scale, ruler; copy largest stamp in the world (China "Wild Goose," cat. 40c!); big illustrated lists. Total Value \$1.50. All for 10c! Also approvals. Indian Stamp Co., 103 Howard St., Bangor, Maine.

**FREE** 12 Diff. large, showy picture stamps for a request for my popular approvals. Premiums with every purchase. A Bauer, Palmyra, N. J.

**ANNIVERSARY Offer!** Seven following sets: "Anniversary," "Jubilee," "Charity," "Airmail," "Eagles," "Prisoners," "Pictorials." Four following packets: (British, French, Dutch Colonies), (Precancelled), (Bulgaria), (International) 15c to approval applicants. Deering, Fairmount, Marlborough, Mass.

**24 VARIETIES** Cuban stamps, 10 cents. List of 6,000 low-priced stamps free. Address Chambers Stamp Co., 111P, Nassau St., New York City, N. Y.

**110 DIFFERENT** Stamps, many unused, high values, free to collectors requesting our Net Approvals. Postage 2 cents. Christensen, Milwaukee, Wis.



**A SNAP**—300 Different Foreign and 60 Different U. S. Stamps, including \$1 and \$2 revenues, all for only 25c. Free, with each order, our pamphlet which tells "How To Make a Stamp Collection Properly," together with our price lists of albums, supplies, and hundreds of bargains in sets, packets, etc. Queen City Stamp & Coin Co., Room 36, 604 Race Street, Cincinnati, Ohio.

**BARGAIN Offer**—Packet of 48 different stamps, including two scarce Costa Rica (cat. 60c), Niger Coast, Gabon, etc., and large price list of bargains in sets. All for ten cents. Shaw Stamp Co., Bear River, Nova Scotia, Canada.

**FREE**. Choose one. Illustrated book "Postage Stamps Worth Fortunes," 200 different foreign stamps, 25 airmail, 40 Japan, 100 Austria, 50 Poland, 15 Newfoundland or 50 Africa by remitting 25c for absolutely original three months subscription. McKee's Weekly Stamp News, Beverly, Mass.

**1,000 DIFFERENT, \$0.80; 2,000, \$3.50.** Fred Onken, 639 79th Street, Brooklyn.

**TRIANGLES**; 75% discount special approval sheets with each 5c packet containing set triangles, 2 sets war tax; set airplane, U. S. stamp before 1880, etc.; over 100 different stamps. Murray Stamp Co., 515A Tower Bldg., St. Louis.

**50 DIFFERENT United States 12c** to approval applicants. Clearfield Stamp Company, Box 94, East Liberty, Pittsburgh, Pa.

**1,000 ALL different stamps \$1.00.** New price list of all United States stamps free. Voorhees, 7 South Dearborn St., Chicago.

**\$1.00 LINCOLN** and 111 different 5c. Approvals. Golden Rule Stamp Co., Box 1248, Chicago.

**1000 MIXED Foreign Stamps 25c.** Phil Lundstedt, Cape Cottage, Maine.

**YOUR Government** has over 100 different unused United States stamps for sale to collectors at face value. List and pamphlet about Government Philatelic Agency, only 10c. C. E. Nickles, 212 Seaton, N. E., Washington, D. C.

**50,000 VARIETIES** for approvals and want lists. Liberal discounts. Try these. Reference required. Tower Stamp Co., 42 Westville St., Dorchester, Mass.

**LOOK, Boys!** Nickel packets. All stamps different. 10 Australia; 10 Argentina; 10 Brazil; 4 Chad; 10 China; 4 Dahomey; 4 French Congo; 4 Guadelupe; 5 Gwallior; 5 Hyderabad; 4 Jhind; 20 Liechtenstein; 5 Malay; 2 Orange River; 5 Siam; 20 Spain; 5 South Africa. Any three 15c; any six 25c; any thirteen 50c. Premiums too. Illustrated lists free. Reimers, 2 Flatiron Bldg., Fort Worth, Texas.

**50 DIFFERENT South Central America \$1.15; 100 \$4.5; 200 \$1.10; 300 \$2.50.** Fred Onken, 639 79th Street, Brooklyn.

**200-200-200-200—ALL different stamps;** 200 hinges; approval sheet to hold 200 stamps; perforation gauge, millimeter scale and ruler; duplicate stamp container—all for only 15c to approval applicants. Edgewood Stamp Company, Milford, Conn.

**CANADIAN Confederation Jubilee stamp,** 5 Newfoundland and bargain lists free with 25 different Canadian for only 10c if you ask for approvals. Victoria Stamp Co., London, Canada.

**FIRST Flight Keywest—Havana.** Nice cancellation. Price 20c. Theodore Schreier, Plainfield, N. J.

**BIG bargains, 1/4c up.** Babcock, 407 E. Fort, Detroit, Mich.

**REVENUES—Telegraphs—Every country.** Pretty—Intriguing—Cheap. Mint \$5.00 revenue free to applicants with references. Vanderloof, 1114 Logan, Denver, Colo.

**APPROVALS at 70% discount.** Reference, C. Owens, Box 43, Philadelphia.

**STAMPS on approval 1/4c up.** Premium 2c. Herbert Keigwin, Middletown, N. Y.

**87 DIFFERENT countries!!** Georgia, Indore, Jhind, Sudan, etc. Marvelous packet 87 different stamps from 87 different countries; many scarce. Only ten cents. But only with our approvals. Free premiums to buyers. Lists free. Reimers, 2 Flatiron, Fort Worth, Texas.

**292 DIFFERENT Germany, 60c; 25 Alpstet, 15c; 16 Armenia, 12c; 25 Cuba, 16c; 40 Denmark, 12c; 20 Egypt, 10c; 20 Finland, 10c; 25 Japan, 8c; 25 Oceania, 10c; 50 Turkey, 30c.** Frederick Jackson, Des Rios, Calif.

**DANZIG Stamps Free**—Interesting packet from Danzig with big catalogs free for 2c. Midland Stamp Company, Toronto, Can.

**OLD New Brunswick** and old Canadian stamps included in our wonderful packet of 100 British Colonial stamps, all different. This valuable packet to approval applicants for only 25 cents. Large illustrated price list with many special bargains included with each order. The supply is limited so get yours now. Prospect Stamp Co., 401 Quebec Ave., Toronto 9, Canada.

**500 MIXED U. S. and Foreign Stamps 15c.** 5 different complete sets 15c. Glenwood Stamp Co., 30 Athol St., Springfield, Mass.

**100 FOREIGN postage stamps 4 cents postage; 50% off approvals, references.** Write for our big bargain lists of packets, sets and approvals. Palmer Stamp Co., 8221 Linwood Ave., Detroit, Mich.

**PRECANCELS—1,000 Bulk, \$1.50.** Good Foreign approvals, nice first premium. Petter Bros., 962 S. Boulevard, Atlanta, Ga.

**25 DIFF. British Col. 12c;** will catalog at least \$1.00, with a request for my popular approvals. Chas. Businell, 4728 Princeton Ave., Lacony, Philadelphia, Pa.

**GENUINE Mexican \$5 bill free with purchase of 100 different foreign stamps for a dime.** B. Nagle, 1101 Marion, Reading, Pa.

**WILL trade stamps for United Certificates.** Send 2c for list. Universal Stamp Exchange, 91 Gelston Ave., Brooklyn, N. Y.

**1000 STAMPS 52c 'do' used, 37c.** Hinges: 12c and 15c. Marney's, 400 Broadway, East St. Louis, Ill.

**FREE 40 Czecho Slovakia Stamps** to approval applicants. 2c Stamp Lightbown's, Osborne Rd., Southsea, England.

**5 NEWFOUNDLAND: 10 stamps, Africa, Jamaica, Peru; 20 Mint; 20 U. S. and 20 other Foreign,** with price lists, 15c. F. T. Rudolph, Box 92, Newton, Kansas.

**TIP-TOP Premium of 50 different, stunning stamps, pocket stamp book, perforation gauge, mm. scale, ruler, good stamp from Kenya & Uganda (cannibal land), Gold Coast, Persia, all for 10c to applicants for Tip-Top approvals.** Tip-Top Stamp Co., Colorado Springs, Colorado.

**100 DIFFERENT U. S. stamps 40c;** no cut squares. Approvals all countries; send reference to M. L. Cook, 527 West 40th Street, Chicago, Ill.

**FREE! Loose Leaf Postage Stamp Album** at rate of 8 pages each month given with subscription to monthly Journal. Send 2c stamp for prospectus. United Stamp Co., Marquette Bldg., Chicago, Ill.

**FREE—100 stamps to approval applicants.** Sending 4c postage. Hodgdon, 1 Stevens Rd., Needham, Mass.

**50 DIFFERENT United States 10c.** 60% approvals. Seidenberg, Baroda, Mich.

**50 BR. COL. 10c, 100, 25c; 200, \$1.** C. Hollister, 1757 School St., Chicago, Ill.

**FREE—100 diff. Postage 3c.** Abrams, 2549 N. 30th, Philadelphia.

**HONDURAS—20 varieties 15c postpaid.** Lists free. Allison, Angola, Ind.

**15 DIFFERENT Airpost and 5 Different Triangles—15c with Beautiful Approvals.** The Stamp Mart, 943 Marshall Ave., St. Paul, Minn.

**TRIANGLES 2 different Union South Africa 14c.** Free—British Colonial Bargain Price List. F. Buffham, Lake Avenue, Racine, Wis.

**100 DIFFERENT stamps free to approval applicants.** Reference required. Lists free. A. Frisch, 83-47 Victor Place, Elmhurst, L. I., N. Y.

**FREE Set and Bargain Lists 2c stamp.** Lindsay, 873 North 11th, Philadelphia.

**START Newfoundland With These:** 40 standard varieties and my 16-page 1928 Catalogue for \$1.20. Rev. Butler, St. Georges, Newfoundland.

**FREE: 6 rare Luxemburg to approval applicants.** A. & L. Stamp Co., 3905 Norfolk Ave., Baltimore, Md.

**GREAT Hoodoo Packet for 10c; Monkey Set 10c.** S. J. Frey, 527 E. Market St., York, Pa.

**FREE — True-Blue Book.** Exchange stamps, postcards. Erickson, Elroy, Wis.

**1,100 UNUSED Stamps \$1.00.** (Catalog \$25.00.) International Stamps, Emporia, Kan.

**FRENCH Colonies, etc., free to approval applicants.** References, William F. Ayers, 47 Arch St., Naugatuck, Conn.

**FREE Premium to Approval Applicants.** Grant, 6317 18th Avenue, Brooklyn.

**BEST one-cent approvals in America.** F. P. Hand, 1117 So. 60th St., Phila., Pa.

**FREE—British Colonial and Latin American Stamps catalog ten, thirty, and forty cents each, and copy of the world's worst Stamp Papers for four cents postage.** Paul Mole, Southampton, N. Y.

**FREE—25 Different French Colonies to Approval Applicants.** Beal, 1209 Park Rd., Washington, D. C.

**STAMPS sent on approval.** References please. Pine Tree Stamp Co., Box 159, Lewiston, Maine.

**FREE—Twenty Different Unused Stamps.** "Philatelist," 1409 Cass, Omaha, Nebr.

**LUCKY 13—13 sets 15c to approval applicants.** Austria, charity; Greece, dues; Russia; Netherlands; Caribou; Greece, charity; Austria, Karls fund; Dutch Indies; Azores; Bosnia; Cuba; Finland; Hungary, charity. Deunle, 7763 Logan, Detroit, Mich.

**RADIO station stamps bought, sold and exchanged.** Chas. A. Phidius, 510 East 120 St., New York, N. Y.

**STAMP collector's outfit only 15c,** includes 100 stamps from Cochín, Gabon, Sudan, U'bangi, etc. Illustrated album, 100 hinges, mammoth illustrated bargain lists; also trial approvals. Ioor, 802 State Life Bldg., Indianapolis.

**25 DIFFERENT Airmail Stamps,** with approval selections, 16c. C. Owens, Box 43, Philadelphia.

**FREE! 110 different stamps to Approval Applicants, 2c postage.** Paige Stamp Co., Oak Park, Ill.

**BEAUTIFUL set free!** Bargain Approvals. Van's Stamp Company, Walla Walla, Wash.

**NEWFOUNDLAND Postage Stamps—40 standard varieties \$1.00.** Rev. Butler, St. Georges, Newfoundland.

**200 DIFFERENT stamps 10c; 1,000 Hinges 10c.** R. H. Carlton, 380 W. So. Temple, Salt Lake, Utah.

**110 NEW Europe All Different,** a wonderful collection cataloguing several dollars, free to collectors requesting our Net Approvals. Postage 2 cents. Badger Stamp Co., Milwaukee, Wis.

**FREE Hungary Charity No. 565 to 567** and a surprise packet given to those requesting for my 1, 2, and 3c approvals, and also my 50% discount. Chas. W. Schmidt, P. O. Box 4832, Frankford Station, Philadelphia, Pa.

**100 DIFFERENT, Arabia, Azerbaijan, Zanzibar, etc., 10c to approval applicants.** Floyd Marsh, 524 Hamilton Ave., Indianapolis, Ind.

**FRENCH Colonies, 25 different, 5 cents.** Big lists free. Challenge Stamp Company, 425 McDonough Street, Brooklyn, N. Y.

**OUR Latest 20-page U. S. and Canadian price list free.** Stanley Gibbons, Inc., 37 Ann St., New York City.

**STAMPS, 100 varieties, Africa, Brazil, Peru, Cuba, Mexico, etc., 10c; 25 different U. S., 25c; 1,000 mixed, 40c; 1,000 hinges, 10c.** List free. C. Stegman, 5941 Cote Brillante, St. Louis Mo.

**LIBERIA Snake Triangle and two other triangles in our packet of 53 genuine foreign stamps for five cents.** Crowder Company, Waverly, Baltimore, Md.

**COVERTCO Packet, 250 varieties unused and used stamps 15 cents.** Covert Stamp, 39 State, Rochester, N. Y.

**BEAUTIFUL Picture Stamps Sent Free.** Paul Cornish, Schenectady, N. Y.

**MINT—53 different unused stamps free to applicants for World-wide approvals.** Postage 2 cents. Arthur Taylor, Box 560, Chicago.

**COMPLETE Sets on approval.** Obsolete Set free to applicants. Gopher Stamp Co., Canby, Minn.

**MOST Sensational values; over 140 diff. Algeria, Airplanes, Azerbaijan, Barbadoes, Cameroun, Gabon, Guyane, Irish set, large French Colony packet, largest stamp, 40 year old U. S., gauge, etc., for 10c to approval applicants.** List free, 100 diff. U. S. 25c—1,000 hinges 9c—50 Bavaria 7c. Hawkeye Stamp Co., Cedar Rapids, 39, Iowa.

**STAMPS sent on approval at 70% discount.** Reference required. Emory Renoll, Hanover, Pa.

**PENNY Approvals that Satisfy.** Neff Grohberg, R. x 5441, Philadelphia, Pa.

**THOUSAND Foreign Stamps, 50c; catalog free.** Prof. McCreery, Chatham, Ontario.

**105 CHINA, etc. 2c.** Album (500 Illustrations) 2c. Bullard Sta., A. Boston.

**200 DIFFERENT Stamps, Zanzibar; Album, 12c.** Liberty, 3974 Arsenal, St. Louis, Mo.



ONLY 5c! 10 Airmail stamps, including scarce Esthonia triangle; Greece Red Cross set; packet fifty different stamps—all unused—from Guyane, Ubangi, etc. All for 5c! Approvals and free lists with each order. Curhan Stamp Company, Gloucester, Mass.

STAMPS, 100 all different. Postage 2c. Lists free. P. M. Quaker Stamp Co., Toledo, Ohio.

#### RARE COINS

40 OLD coins all different, \$1.00. 25 different coins, 50c. 100 different coins, \$3.00. 200 different coins, \$5.00. 100 Mixed Foreign coins, \$1.25. Monroe Half-Dollar, Uncirculated, \$1.00. 50 different Germany Banknotes, 50c. 300 different Germany City Bills, \$1.00. 300 different Austria City Bills, \$1.00. 5 different Porcelain coins, \$1.00. Claud Denney, Box 315, Dallas, Texas.

50 ASSORTED coins and bills 50c. Oddehon, Box 681, Kansas City, Mo.

50 WAR Coins 50c. 30 Different Coins 35c. 10 Handsome bills 25c. 10 Confederate bills 40c. Revolutionary War bills 1776 40c. 20c piece 55c. Sesqui \$½ \$2.00. 5 Roman coins 2000 years old 75c. War medals 50c. 5 Curious India coins 75c. 10 Arrowheads 60c. Illustrated Coin Book 10c. Nagy, 8 P. South 18th, Philadelphia.

CALIFORNIA gold quarter 27c; Half 52c; 1803 cent 30c; Confederate \$10, 10c; \$1 Virginia, 10c. A. Wylie, Wheaton, Ill.

COLLECTION of Old U. S. Half Dime, 3c Silver, 2c piece, Large Copper Cent, Eagle Cent, 10 Foreign Coins, Foreign Bank Note and Special Price List, \$1. Anthony F. Torchea, P. O. Box 111, Utica, N. Y.

OLD Money Wanted. Will pay fifty dollars for nickel of 1913 with Liberty head (no Buffalo). We pay cash premiums for all rare coins. Send 4c for large coin folder. May mean much profit to you. Numismatic Co., Dept. H, Fort Worth, Tex.

\$2 TO \$500 Each Paid for hundreds of old and odd coins. Keep all old money, it may be very valuable. Send 10c for illustrated coin value book, 4x6. Get posted. Guaranteed prices. We buy and sell. Clarke Coin Office, LeRoy, N. Y.

HUNDREDS Foreign, War, etc., coins and bills. Catalogue, two War bills, 15c. Waeker-Dickman, Minster, Ohio.

TWENTY silver and other American-foreign coins \$1.00. Durso, 25 Mulberry, N. Y. City.

COINS, 3 different foreign coins, 4 different foreign Notes and Catalog 10c. Geo. Best, Cedar Rapids, Iowa.

OLD Coins Bought and Sold. Rare Coin Book 65c. 700 Illustrations. Send 10c for Coin collecting booklet. Gutttag Bros., 16 Exchange Place, New York.

UNITED STATES and Foreign Money; Military Decorations Catalogue and Greek coin 10c. Alexis Mengelle, Colorado Springs, Colo.

UNITED STATES, Large Cent, two-cent bronze, three-cent nickel and Bargain List, 2c. Fifteen dates large cents, \$1.00. George Coffin, Greenwood Mountain, Me.

GET Profit and Pleasure in collecting Old Coins. Send 10c for Large Illustrated Coin Catalogue. You'll be delighted with it. Send for it right now. B. Max Mehl, Numismatist, Mehl Bldg., Dept. P, Fort Worth, Texas. Largest Rare Coin Firm in the U. S.

OLD Coins, Large fall Selling catalogue of coins for sale free. Catalogue quoting prices paid for coins, ten cents. William Hesslein, 101A Tremont Street, Boston, Mass.

CALIFORNIA Gold—Quarter Size, 27c; ½ size, 53c; 3c Piece and Catalogue, 10c Norman Shultz, Box 746, Salt Lake, Utah.

#### FOR BOYS

NEW Illustrated Catalogue, Toy and Fractional hp. Electric Motors. Lathes, complete Machine Shop, etc. Catalog 10c. Manhattan Co., 333a W. Manhattan Blvd., Toledo, Ohio.

EARN Christmas Money. Order 50 Sets Christmas Seals. Sell for 10c set. When sold return \$3.00, you keeping \$2.00. No Work—Just Fun. St. Nicholas Seal Co., Dept. 43PM, Brooklyn, N. Y.

#### CAMERAS AND PHOTO SUPPLIES

PHOTOGRAPHIC equipment and accessories of every description are listed and illustrated in our 228-page catalog. It will pay you to secure a copy which is issued free, as our prices are low. We also deal in used goods which are sold under the same guarantee as new goods. Ask for our Bargain Book. Central Camera Co., Dept. E125, 112 S. Wabash Ave., Chicago, Ill.

TRANSFER Photographs to metal, china, etc. Patented process. Makes beautiful miniatures. A real art. Lots of fun and profit. Anyone can do it. Outfit supplied to members only. Write about membership. Kyograph Photo System, 21-c W. 17th St., New York.

HAVE You a Camera? Write for Free sample of our big magazine, showing how to make better pictures and earn money. American Photography, 116 Camera House, Boston, 17, Mass.

EARN big money with your camera in your spare time, using Halldorson Home Portrait Lamp. Write for booklet "Home Portrait Photography" and catalog—both free. The Halldorson Company, 4747 N. Western Ave., Chicago.

KODAK Film—Special Trial Offer—Your next roll developed 5c, prints 3c each. Beautiful 6x10 mounted Enlargement 40c. Fleet Photo Service, 425 G St., N. W., Washington, D. C.

MAKE money in Photography. Learn quickly at home. Spare or full time. New plan. Nothing like it. Experience unnecessary. American School of Photography, Dept. 3432, 3601 Michigan Ave., Chicago.

BIG Money Saved on Photographic Lenses and Apparatus—goods exchanged; repairing done. Ralph J. Golsen, 1128 Argyle St., Chicago, Dept. P.

FILMS Developed. Special Trial Offer. Any Size Kodak film developed 5c, prints 3c each. Trial 6x10 Enlargement in handsome folder 40c. Overnight Service. Roanoke Photo Finishing Co., 209 Bell Ave., Roanoke, Va.

PHOTOGRAPHERS—"Fishing From the Boat Photography," Sheasgreen's great business "Fable-Jolts," \$1.50. His "Location Analysis Guide," development-choosing, \$1.00. Both \$2.25. Standard Cost, PM1427 North Penn, Minneapolis, Minn.

#### MOTION PICTURES

16 MILLIMETER films \$4.50; 16 millimeter camera, spring motor, \$50; 16 millimeter projector, \$50; 80 foot spring motor, 35 millimeter camera, \$85; \$150 Sept with leather case, \$37.50; fresh 35 millimeter negative stock, 2½ cents foot; movie twin arc lights, \$40; printer, \$25; developing outfit, \$30; films \$2 a reel. Ray, 296 5th Ave., New York.

\$1,250.00 FOR a Photoplay Story by an unknown writer and sold through our Sales Dept. We revise, copyright and market. Located in the heart of Motion Picture Industry, we know the demand. Established 1917. Send Manuscript for free criticism. Booklet on request. Universal Scenario Company, 206 Western and Santa Monica Bldg., Hollywood, Calif.

WANTED to Buy—Second-Hand Power's, Simplex and Motograph Machines. Also extra mechanisms and stands. Must be bargains. P. O. Box 202, Birmingham, Ala.

SEND 10c in stamps for the 1928 edition of the famous Bass Book of Cinema Apparatus, greater than ever. Send \$2.00 for catalog and new book on "How to Make Motion Pictures," by Cameron. Bass Camera Company, 179 West Madison St., Chicago.

MOTION Pictures for home use. 1,000 foot rolls \$3.50. Send for list. Toy Film Company, 804 South Wabash Avenue, Chicago, Ill.

BE a movie exhibitor—big opportunity only moderate capital required—complete equipment at remarkably low prices. Write. Atlas Moving Picture Co., 624 So. Michigan Ave., Chicago, Ill.

FILMS, 200 feet 95c. Complete reels \$3.25—list. Edward Tieman, P. O. Box 155, Blue Island, Ill.

POWERS and Motograph \$75.00 each. Films, rewinder, curtain free. Merton Craig, Montgomery Center, Vt.

FILMS—Comedies, cartoons, westerns. Better films, lowest prices. Alton Films, 205 Brush Creek, Kansas City, Mo.

MOVIE Films, 1,000 ft. reels, \$2.50 each; shipped anywhere on receipt of remittance. Particulars on request. Independent Films, 177 Golden Gate Ave., San Francisco, Calif.

1000 FEET of Comedy, \$2.00. No list. Sunset Film Exchange, 298 Turk St., San Francisco, Calif.

COMEDIES, westerns, \$2.50. New movie-cameras \$40.00. Stewart Marshall, Rome, Ga.

FILMS ½c foot. Searles, 130 Fisk St., Providence, R. I.

NEW and Rebuilt Projectors for Theaters, Schools, Churches, Traveling Shows. Supplies and Complete Theater Equipments. Bargain Prices. Free Catalog. Monarch Theatre Supply Co., Memphis, Tenn.

FILMS: \$3.00 per reel up. Comedy, Western, Cartoon, Drama, Serial, Educational, Special Features. Best Movie Stars. Free List. Toy Film 200 Feet Postpaid \$1.50. Dixie Film Co., Box 2042, Memphis, Tenn.

FILMS and Machines, dirt cheap. Stamp for lists. Box No. 5834, Westport Station, Kansas City, Mo.

BARGAINS—Theatre and Road-show machines, films and accessories. Box No. 481, General Postoffice, New York.

#### SCENERY TO RENT

WORLD'S Most Beautiful Settings for operas, plays, minstrels. Amelia Grain, Philadelphia.

#### EDUCATIONAL AND INSTRUCTION

U. S. GOVERNMENT wants men. \$1,700-\$1,900 and up at start. Railway Mail clerk examination coming. Let our expert (former Government examiner) prepare you for this and also Rural Carrier, Post Office, Customs, Internal Revenue, and other branches. Write today for free booklet. Dept. 8, Patterson School, Rochester, N. Y.

MEN to train for locomotive firemen on railroads nearest their homes—everywhere; beginners \$150-\$250 monthly; promoted, locomotive engineer, \$3,000-\$4,000 yearly. Best paying positions on railroads. Railway Association, Desk M1, Brooklyn, N. Y.

GO Into Business. Be a Commercial Printer. No experience required. Details sent free. Ackerman's Commercial Press, Dept. 25, 78 Downs St., Kingston, N. Y.

FOREMANSHIP—Short course. Easy Terms. Write. Industrial and Commercial Institute M-11, Arlington Ave., Middletown, Ohio.

STORY Ideas Wanted for photoplays, magazines. Big demand. Accepted any form for revision, development and submission to markets. Established 1917. Send manuscripts for free criticism. Booklet mailed on request. Universal Scenario Company, 403 Western and Santa Monica Bldg., Hollywood, Calif.

START your own Business. Learn Interior Home Decorating, Repaint—Retrim old cars Liknu, manufacture automobile specialties. Unlimited Demand. Learn while you work at home. De Wilde, Sheboygan, Wis.

EARN \$25 weekly, spare time, writing for newspapers, magazines. Experience unnecessary. Details Free. Press Syndicate, 981 St. Louis, Mo.

USED educational matter sold on repurchase basis. Also rented and exchanged. Money-back guarantee. Catalog free. (Books, etc. bought.) Lee Mountain, Pisgah, Ala.

DOUBLE Entry Bookkeeping mastered in 60 hours with 8 keys; guaranteed; diploma. International Bookkeeping Institute, Dept. 8, Springfield, Mo.

WORLD-ROMIC System. Masterkey 5,000 languages. Primers, \$1.98; Arabic, Chinese, French, German, Italian, Japanese, Russian, Spanish. Languages, 15 W. 18th St., New York.

EARN \$150 to \$250 month—Government Positions. We prepare you at home. Experience unnecessary. Illustrated booklet free. Standard Institute, 5155-M Broadway, Chicago.

NOTES, drawings, Coyne electrical course lectures \$13. Harrison, 1934 Hamburg Turnpike, Lackawanna, N. Y.

LEARN Barbering at home. Practice on the family. Complete barber college instructions, home study, for \$1 bill or money order. Foster, Expert Barber, 6128 Michigan Blvd., Chicago, Ill.

DON'T prepare for any Civil Service Examination without seeing our catalogue. Free. Columbian Correspondence College, Washington, D. C.

MECHANICAL drafting by mail. Unusual opportunity to learn lucrative profession at low cost. Postal brings particulars. Wilsey, Box 401, Mt. Vernon, N. Y.

GOVERNMENT Pays big salaries. Prepare for next examination now. Expert coaching. Booklet free. Write I. Hampton, Box 1818-X2, Washington, D. C.



**MEN Wanted**—prepare as firemen, brakemen, colored train or sleeping car porters, wire for application blank; experience unnecessary; first class roads. Good Pay. Name position wanted. Railway Institute, Dept. 35, Indianapolis, Ind.

**MEN** wishing employment in Mexico, Cuba, Central or So. America, send self-addressed envelope for particulars. Tropical Information Bureau, Box 3433-B, Miami, Fla.

**FIREMEN**, Brakemen, Baggage-men (white or colored), sleeping car, train porters (colored), \$150-\$250 monthly. Experience unnecessary. \$10 Railway Bureau, East St. Louis, Ill.

**ALL Men-Women** wanting Permanent Government Positions, commence \$125-\$250 month, write for Free Book, "How To Qualify." Ozment's Instruction Bureau, 101, St. Louis, Mo.

**U. S. GOVERNMENT Jobs**, \$1140 to \$3300 year. Men-women, 18 up. Steady, pleasant work. Paid vacation. Short hours. Experience unnecessary. Common education sufficient. List positions and sample coaching with full particulars—Free. Write today sure. Franklin Institute, Dept. R-14, Rochester, N. Y.

**BECOME a Landscape Architect**. Uncrowded profession of wonderful opportunity for money-making. Easily mastered by mail. Earn while you learn. Write for book. American Landscape School, 56-E, Newark, N. Y.

**STENOGRAPHY** offers young men greatest possibilities. Home training. Noel Institute, 1712 South New Hampshire, Los Angeles, Calif.

**MEN-Women, 18 Up**. Get U. S. Government Life Jobs, \$1140 to \$3300 year. Many Railway Mail Clerks—Clerks—Carriers, appointed every year. Inside and Outside work. Experience unnecessary. Common education sufficient with our coaching. List positions and full particulars—Free. Write today sure. Franklin Institute, Dept. R-3, Rochester, N. Y.

**BECOME Auto Mechanics**, \$1820-\$2600 year. Sample lessons free. Franklin Institute, Dept. R-400, Rochester, N. Y.

**MEN** wanting outdoor work, qualify for forest ranger position. Start \$125 month; cabin and vacation; patrol the forests, protect the game; give tourists information. Write Mokane, Dept. M-21, Denver, Colo.

**SILVERING Mirrors, French Plate**. Easily learned; immense profits. Plans free. Wear Mirror Works, Excelsior Springs, Mo.

**STEAMSHIP Positions—Europe, Orient**. Good pay. Experience unnecessary. Men and Women write for free particulars. Box 30-A, Mount Vernon, N. Y.

#### RADIO OUTFITS AND SUPPLIES

**300-MILE "Pocket" Radio** \$3.00 complete. No tubes nor Batteries required. Loudspeaker Volume. Order direct today. Spencer Laboratories, Akron, Ohio.

**YOU** can make a beautiful Console Cabinet for your homemade set. No difficult cabinet joints, no glue. Clever screw construction. Easily read blue print and helpful directions \$1. Joseph Parkas, P. O. Box 861, Joliet, Ill.

**SILICON Transformer steel**, 15 cents pound; 10 pound minimum, postage extra. George Schulz, Calumet, Mich.

**RADIO**—Make money, don't spend it. Get our proposition. No selling. Co-Operative Radio Doctors, Dept. H, 131 Essex St., Salem, Mass.

**LONG Distance Radio**, \$2.95 postpaid. Needs no tubes, batteries or electrical current. Over 300,000 homes have them. Picture and folder sent free. Crystal Radio Company, Wichita, Kans.

**FOUR Tube Radios** in solid walnut cabinets, while 100 last, at only \$13.00. Worth \$60. Money back guarantee. Petso Laboratories, Watwatosa, Wis.

**BARGAIN parts list Free**. Sets \$4.95 up. Radio, C427 East 16th St., New York.

#### TRADE AND TECHNICAL SCHOOLS

**LEARN Telegraphy**. Pleasant, steady work. Operators earning big money. Always in demand. No experience necessary. Write Chief Operator, Illinois Telegraph, 1608 W. Madison, Ch. Chicago.

**TELEGRAPHY**—Both Morse and Wireless—taught thoroughly and quickly. Tremendous demand. Big salaries. Wonderful opportunities. Expenses low; chance to earn part. School established fifty years. Catalog free. Dodge's Institute, Fern St., Valparaiso, Ind.

**YOUNG Men** may prepare at home for positions \$40 to \$100 weekly. Write for particulars and catalog of our Extension Course. (It is not a correspondence course.) Loomis Radio College, Dept. 5-E, 405 Ninth, Washington, D. C.

#### BUSINESS OPPORTUNITIES

**NOTHING** on earth offers bigger opportunity for building wonderful business this summer than manufacturing these popular profitable, big-selling specialties. Start small—watch business grow. Write today for valuable formula literature relative to making: Sealite, guaranteed puncture proof liquid; Ducopol, automobile polish; Cellulac, Duco finishes in color, quick drying; Solvit; powdered hand cleaner; Miracle, non-thermic ice cloths, mendit, fabric patching liquid; Liqui-Seal, radiator cement; Vanil-Ozone, "million-dollar" vanilla flavor; Fruitina; concentrated summer drinks; and a hundred other real honest-to-goodness, money-making propositions. 30 years headquarters for best formula service. Miller, Chemist, 1706-B Jetton, Tampa, Fla.

**READ The Mail Order News**—America's Pioneer Mail Trade Journal. Quarter Century Old. Approximately 600 pages yearly of valuable information for beginners and established mail-order houses. Analyzes mail-order business, its opportunities. Practical mail-order ideas, legitimate money-making schemes, instructive articles. Tells how to start, what to sell. Published monthly. Subscription \$3.00 yearly. Send 25c for sample copy. None free. Mail Order News, 360 Bristol Bldg., New York.

**PATENTS**. Time counts in applying for patents. Don't risk delay in protecting your ideas. Send sketch or model for instruction or write for free book "How to Obtain a Patent" and "Record of Invention" form. No charge for information on how to proceed. Communications strictly confidential. Prompt, careful, efficient service. Clarence A. O'Brien, Registered Patent Attorney, Security Bank Building (directly across street from Patent Office), Washington, D. C. See pages 156 and 157.

**COMPOSITION Floor Making** earns industrious men \$12 and more daily if used as trade. Or make business of it with profits up to \$10,000 yearly. Openings everywhere. Semi-Tile, Dept. C, Hollis, N. Y.

**MANUFACTURE** and sell new novelties, toys, unique molded and fancy goods, wood-glass-metal articles, foods, beverages, secret preparations. Learn to make newest profitable products of genuine merit. Interesting literature free. Write today. Manufacturer's Bureau, R40, 1127 E. 31st, Kansas City, Mo.

**CHRISTMAS** holiday offers a live, responsible person in each city the opportunity to make a profit to carry him over the next year. Every family, business, public house, theater, etc., decorates for Christmas. We have the best line and want a representative in each important city. Boys and girls can be obtained to canvass. Full details with illustrated catalog free. Everitt's Seed Store, Desk 32, Indianapolis, Ind.

**WANTED**—Man or woman to manage and operate new system chain store in your community. \$35.00 to \$100 weekly. Enclose 2c stamp for details. Salesmanager, Box 74, Beaver Dam, Wis.

**A LITTLE** manufacturing business—Crispettes, delightful confection and big money maker. We start you. Adams says \$361 profit two days last summer. You might do as well this winter. Write, Long Eakins, 1950 High St., Springfield, Ohio.

**MAKE Money** with potato Maiden-Flakes \$10.00 starts you. Sample and particulars 2 dimes. General Sales Co., Muncie, Ind.

**SELL By Mail**, wonderful opportunity. Particulars Free. Mason, 3902 Broadway, Room 5, Chicago.

**REPAIRMEN Notice**: Nearly every home, also barbers own Hair Clippers that need sharpening regularly. My new Bench Grinder will sharpen them in 2 minutes, your profit 75c. Write, Grinder, 1656 Lawrence, Denver, Colo.

**WE** can manufacture for you economically small items of steel, brass or bronze. Full, modern equipment of automatic feed machinery. Write us today. Desk P, Julian J. Behr Co., 435 Dixie Terminal Bldg., Cincinnati, Ohio.

**NEED More money?** Our method for mail order business offers unlimited opportunities. Particulars for stamp. Zoll Bros., Box 1753, Los Angeles, Cal.

**BUSINESS** profession of your own and earn big income in service fees. See Stephenson Laboratories, display ad, page 155.

**DON'T** sell for others. Employ agents yourself. Make your own products. Toilet Articles, Household Specialties, etc. 500% profit. We furnish everything and show you how. Valuable booklet free. Write at once. National Scientific Laboratories, 1910W Broad, Richmond, Va.

**MAKE Money!** Spare time! Start mail order business, home, evenings. Easily, quickly learned. Operated anywhere. Ask for particulars. Hilco Service, Room 223, 62 South Sherman, Denver, Colo.

**MAIL-ORDER Business** is your opportunity. Breniser's famous handbooks, for fifteen years have shown beginners practically how to get into this fascinating and profitable business. Continually revised, always up to date. Set of ten, \$3. One book and descriptive catalog 25c. None free. Breniser Publisher, 1607 P. Sansom, Philadelphia.

**START Mail Order Business**. Article costs 25c, sells for \$5.00. Folder free. Pitts, Amana, Iowa.

**LAY Sanitary Flooring**. Large profits. Guaranteed directions \$1.00. Universal Supply Co., Auburn, N. Y.

**OPERATE** chewing-gum machines. Large profits. Small capital. Particulars Free. Robbins Company, 28 Dodworth Street, Brooklyn, N. Y.

**MIRRORS** resilvered at home. Costs less 5 cents per square foot; you charge 75 cents. Immense profits plating like new; brassy, worn-off autoparts, reflectors, tableware, stoves, etc. Outfits furnished. Details Free. Sprinkle, Plater, 127 Marion, Ind.

**SELL** by mail. Do you believe there are id\$eas? Write Grower, 111 Farren, New Haven, Conn.

**SELL** by mail: Booklet, circulars. Samples 4c. Harvey Teeple, Decatur, Ind.

**MECHANICS**, painters, carpenters, start furniture refinishing, painting, handyman shop on nearly nothing; winning plan brings customers quickly. John Bracland, 1435 So. Ninth, Philadelphia, Pa.

**CAPITAL**—For copy of "The Promoters' Hand Book"—a leaflet on financing, send \$1.00 to Amster Leonard, East Orange, N. J.

**NEW** system mail order; big profits, instructions free. King Company, Box 672-P, Wilmington, Del.

**TWENTY** Money-making methods. For particulars write Bruce Hudson, Clarks Green, Penna.

**LEARN Dry Cleaning**. Million housewives using my book; spotting formulas, pressing, etc. Send 50c. Hoffmann's Laboratories, Cap. Hill, Denver, Colo.

**SELL** by mail. Free literature tells how. Norris Donlon, Box 99, Floral Park, N. Y.

**MILLIONS** use paint. Start business of your own manufacturing paint, oils, varnish and turpentine for less than 50c gal. No capital, experience, machinery. Big profits. We help you. Not a formula scheme or book. Free literature. Illinois Business Service, Dept. 708, 72 E. Madison, Chicago.

**OF** Our 10 propositions one should lead you to financial success. Particulars. The Modern Method Co., Box 101, Hollywood Station, Los Angeles, Calif.

**"SCHEMER"** Alliance, Ohio, 36 p. monthly, prints Schemes, Tips, Formulas. Subscriber reports \$25,000 from three; another \$10,000 from one. Try it! Year, \$1.00; 3 months, 30c.

**CHARTERS**: Delaware; best, cheapest; free forms. Colonial Charter Co., Wilmington, Del.

**YOU** can have an independent business of your own, and I am here to show you the way. Write at once! Wm. E. Heinemann, 2415 Montrose Ave., Chicago, Ill.

**ARTIFICIAL** marble sanitary flooring instructions, covering wood or cement flooring ½ inch thick, fireproof, waterproof, all colors, low cost. Ornamental casting, concrete, plaster, papier-mache decorations, garden furniture, statuary, flexible molds. 18 years instructing the public; particulars and illustrations free. Chris. Mahler, Huntington, N. Y.

**DELAWARE** Incorporator. Charters; Fees Small; forms. Chas. G. Guyer, 901 Market St., Wilmington, Del.

**LEARN** the collection business. Good income, quick results. Interesting booklet, "Skillful Collecting" free. National Collectors Assn., Long St., Newark, Ohio.

**MAKE Money** Sparetime. Hundreds of opportunities for the home worker. Big mail free. Mogensen, 1409 Cass, Omaha, Nebr.



**SIGNS and Showcards** Easily painted with Letter Patterns. Large variety of Styles and Sizes. Samples for stamp. John Rahn, a2120 Neva Ave., Chicago.

**TASTE** flavor of real money selling Annie Blain Flavors, wholesale, retail; new system, samples; other unique methods. Geo. S. Parker, New Brunswick, N. J.

**PATENTS** Procured; Trade Marks Registered—A Comprehensive, experienced, prompt service for the protection and development of your ideas. Preliminary advice gladly furnished without charge. Booklet of information and form for disclosing idea free on request. Richard B. Owen, 30-Owen Bldg., Washington, D. C., or 41-R Park Row, New York.

**UNPATENTED** Ideas Can Be Sold. I tell you how and help you make the sale. Free particulars (Copyrighted). Write W. T. Greene, 810 Jenifer Building, Washington, D. C.

**CHEMICAL** Expert will furnish Formulas and Trade Secrets. All lines. Lists Free. W. L. Cummings, Ph. D., 228 Gordon Ave., Syracuse, N. Y.

**SELL** by Mail! Books, novelties, bargains! Large profits! Particulars Free! B-Klco, 525 South Dearborn, Chicago.

**BIG Bunch Mail** Year 15c. Catalogues, Magazines, Kentucky Agency, Covington, Kentucky.

**EARN \$10** daily silvering mirrors, plating, refinishing metalware, chandeliers, head-lights, bedsteads. E. Decie Laboratories, 225 Varick St., New York.

**I MADE \$30** a Week Home. French Breadmaking. 15 years' experience; Free Booklet tells. Ashbrook 67, Marengo, Ohio.

**75 WINNERS** for mail dealers. Successful sales plans. Everything supplied. K. Home, 3949 Metropolitan, Chicago.

**MONEY** for working capital; incorporate and sell shares in your business. 27 years organizing and raising money for businesses of merit. Terms reasonable. Prompt and confidential service. W. Harrison Cole, 507 5th Ave., Suite 510, New York.

**SUCCEED** With Your Own Products. Make them yourself. Formulas, Processes, Trade-Secrets. All lines. Catalog, circulars free. B. Thaxly Co., Washington, D. C.

**MONEY** in Dry Cleaning; we furnish instructions and machinery; experience unnecessary. Potter Manufacturing & Supply Co., 3750-52 Easton Ave., St. Louis, Mo., U. S.

**THOUSANDS** of opportunities to make money in spare hours, managing own business; mail-order or local. Particulars free. Publishers, 6652-J Gravois, St. Louis, Mo.

**MAKE** toys, novelties, furniture; assorted patterns and instructions \$1.00. Scroll saw Free with order. Wm. Bogren, 2264 Hermany Ave., New York.

**BUSINESS** Opportunities; Men and Women—something new. Big Profits. Send for information. E. A. Barr Co., Shamokin, Pa.

**A BUSINESS** of Your Own Making—Sparkling Glass Name and Number plates, Checkerboards, Signs. Big book and sample free. E. Palmer, 540, Wooster, Ohio.

**WE Start** You in Business, furnishing everything; men and women, \$30.00 to \$100.00 weekly operating our "New System Specialty Candy Factories" anywhere. Opportunity lifetime; booklet free. W. Hillyer Ragsdale, Drawer 4, East Orange, N. J.

#### TELEGRAPHY

**TELEGRAPHY**—Both Morse and Wireless—taught thoroughly and quickly. Tremendous demand. Big salaries. Wonderful opportunities. Expenses low; chance to earn part. School established fifty years. Catalog free. Dodge's Institute, H. St., Valparaiso, Ind.

#### CHEMISTRY

**YOUR** chemical problem solved and working formula or process furnished for \$5.00. Write me. W. Stedman Richard, Industrial Chemist, Box 2402, Boston, Mass.

#### FORMULAS AND TRADE SECRETS

**CHEMICAL** Consultation. Manufacturing ideas made practical. Complete service, \$6. Valuable formulas. Long experience. Write. Associated Chemists, Indianapolis, Ind.

**500 FORMULAS** and Big Catalog 20c Ideal Book Shop, Park Ridge, Ill.

**TATTOO** Remover Formula \$1.00, Supply Catalogue, "Waters," 965 Puttman, Detroit.

**DON'T** sell for others. Employ agents yourself. Make your own products. Toilet Articles, Household Specialties, etc. 500% profit. We furnish everything and show you how. Valuable booklet free. Write at once. National Scientific Laboratories, 1910W Broad, Richmond, Va.

**MAKE** Composition Gold-like Nuggets. They have weight, color and look like genuine. Everybody deceived. Formula and complete copyrighted directions \$1.00. Casperson, 902 Hastings, Coeur D'Alene, Idaho.

**FORMULAS:** Absolutely guaranteed. Best chemical science has devised. Don't risk your money till you've investigated these wonderful processes for all lines. Get my valuable "eye-opening" literature. Highest references. 30 years supplying the best. Miller, Chemist, 1708-P Jetton, Tampa, Fla.

**SUCCEED** With Your Own Products. Make them yourself. Formulas, Processes, Trade-Secrets. All lines. Catalog, circulars free. B. Thaxly Co., Washington, D. C.

#### AGENTS WANTED

**PRIVATE** brand Toilet Articles, Household Specialties, Perfumes, Soaps, Extracts, etc. We pack these goods for you under your private label. With your name on the goods you get all the repeat business. Don't sell for others but build up a profitable business for yourself. Highest quality merchandise. Extremely low prices. Quick shipments on both large and small orders. Write immediately for lowest wholesale prices and complete information regarding our amazing offer. Address Supply Department, National Scientific Laboratories, 1904W Broad, Richmond, Va.

**100% PROFIT** on Every Sale selling Christmas Greeting Cards in Box Assortments. Our wonderful Box Assortment is the finest published. Agents earn \$2 to \$4 per hour. We have a magnificent Box Assortment containing 21 high-grade Christmas Greeting Cards and Folders, each with envelope, Steel Engraved, Colored, Paneled, and Bordered. Sells for \$1.00; costs 50 cents. Nothing ever sold begins to compare with the sale of Christmas Box Assortments. Write immediately for particulars and free samples. Waltham Art Publishers, 7 Water St., Dept. B-26, Boston, Mass.

**WE** want Direct to Consumer salesmen or agents in every community for our Magnetic Trouble Lamp—Brite-Lite—the fastest selling auto necessity in the world—retails \$3. Brite-Lite sells itself on sight—agents make big money. National sales force now being organized. Here is a chance to join a live organization and have exclusive territory. Send details of your past experience and a Brite-Lite will be mailed with full information. Address National Electrical Corporation, P.O. Box 90, Dept. C, Newark, N. J.

**AGENTS**—Best seller; Jem Rubber Repair for tires and tubes; superseded vulcanization at a saving of over 800 per cent.; put it on cold, it vulcanizes itself in two minutes, and is guaranteed to last the life of the tire or tube; sells to every auto owner and accessory dealer. For particulars how to make big money and free sample, address Amazon Rubber Co., Philadelphia, Pa., Dept. 505.

**AGENTS** with established rural routes to handle high-grade line of Herb medicines. Shawnee Herbalists, 145 West 112th St., Chicago.

**AGENTS**—Big Profits selling useful novelty. Good side line for any class of trade. Sample and circular free. Travella Sales Co., Dept. P, 123 Liberty St., New York.

**AGENTS**—Make \$15 Daily. Show samples and distribute teas, coffee, spices, extracts; 200 products; things people eat. I go 50-50 and furnish Chrysler closed car. Offer made to first person answering in your locality. Write or wire Health-O-Quality Products Company, Dept. 101-M, Cincinnati, Ohio.

**CHRISTMAS** Box assortment 21 Steel engraved cards in envelopes. Sells for \$1.00. Sample box 50c. Dozen \$6. Also Tags, Seals, Stamps, Booklets. Samples 15c. Klees Co., 1710 Undercliff Ave., New York.

**PERSONAL** and Boxed Christmas Cards, steel engraved designs, finest in America. Moderate prices. 40% commission. Free outfit. Lonsdale Bartholomew, St. Albans, Vt.

**WE TRUST YOU!**—Starter stock and re-orders on credit—no bond signers; Finest line 200 guaranteed Extracts, Pure Foods, Toilettries. Big Profits. Write for details. Perkins Products, E-3, Hastings, Neb.

**AMAZING** New Glass Cleaner offers you \$15 a day sure! Cleans windows, windshields, show cases, etc., without water, soap or chamois. No muss. Easily demonstrated. Housewives, motorists, garages, stores, institutions buy on sight. Write for Special Introductory Offer. Jiffy Glass Cleaner Co., 9597 Monmouth, Cincinnati, O.

**MEN-WOMEN:** Make \$25.00 daily easy, all or spare time, representing America's foremost Candy Manufacturer. Sell World's Famous Benedetto-Allegretti Chocolates and Bon Bons direct to consumer. Complete Candy store in one elaborate sample case free to producers. Benedetto-Allegretti Co., 36 S. State, Chicago.

**AMAZING** new scientific invention making agents \$15-\$20 daily kitchen necessity; dollar seller with big profit; sell two or more every call. Cooking Disc Co., V163, E. Superior, Chicago.

**AGENTS,** become a regular established McConnon dealer; buy on credit, sell for cash or credit. 185 Absolute household necessities; all repeaters. Enjoy a sure income 52 weeks per year, year after year. City or country trade. Capital, experience unnecessary. McConnon & Co., Dept. S28, Winona, Minn.

**WE** Pay \$48 a Week, furnish auto and expenses to introduce our Soap and Wash-in Powder. Buss-Beach Company, Dept. A42, Chippewa Falls, Wis.

**MIRRORS** Resilvered at Home. Costs Less 5 cents per square foot; you charge 75 cents. Immense profits plating auto-parts, reflectors, tableware, stoves, refinishing metalware, etc. Outfits furnished. Details free. Write Sprinkle, Plater, 128 Marion, Ind.

**5-10-25 YEAR** records of our representatives prove we have the proposition for you. New plan offers few additional people same cleantest \$25 to \$75 a week opportunity. No capital needed. Great Eastern Coffee & Tea Co., Dept. S-1041, St. Louis, Mo.

**"WHERE** to buy half million articles wholesale." 72-page directory offers unlimited opportunities for agents. Free particulars. Fruit System, Brookfield, Ill.

**75c PROFIT** on \$1.00 sale. Auto, furniture and glass cleaner. Your name on label. Exclusive rights; free sample. Mfg. E. 213 Griswold, Detroit, Mich.

**AGENTS,** \$72 a week—Biggest line Guaranteed Cutlery ever offered. Knives, Razors, etc. We give exclusive territory. Extra commission. Big money for spare time. Write quick. Novelty Cutlery Co., Desk 431, Canton, Ohio.

**FREE** coat and \$10.00 daily advanced selling \$2.95 Slickers, Leatherette Sport Coats and Raincoats. Outfit free. Unecda Raincoat Co., B1579 Milwaukee Ave., Chicago.

**AGENTS:** Our gold-eyed Needle Cases are wonderful sellers; immense profits; \$50 to \$500 weekly; proof and particulars free; sample outfits 10c; factory prices. Paty Needle Co., 231 Davis Square, Somerville, Mass.

**FLAVORING** Extracts—Bottle Yourself! Concentrated—add water! Free labels. Whirlwind Sellers! 500% Profit! Money-making opportunity. Write Thomas Manufacturing Company, Indianapolis, Ind.

**AGENTS**—\$10 daily. New, exceptionally useful 50c article for home and office. Pocket sample. Hydraulik Corporation, Roselle, N. J.

**AGENTS:** \$15 Electric corn popper. Big commissions. Northsides Co., 1306 Fifth, Des Moines, Iowa.

**AGENTS**—\$13.80 Daily in advance, introducing New Insured Hosiery for men, women, children. Must wear or replaced free. 57 styles. 39 colors including latest "Silk to the Top" Ladies' Hose. Nyland made \$395 in one month. Edwards, \$460.60, Mrs. Bone, \$425.45. Why not you? Even spare time should pay you \$3.00 an hour. No experience needed. We furnish sample. Silk hose for your own use free. New Plan. Write Quick. Maccochee Company, Road 25611, Cincinnati, Ohio.

**MEN** with cars to take orders and deliver sanitary brushes; guaranteed salary and commission. Full details on request. North Ridge Brush Co., Freeport, Ill.

**FURNITURE** Refinishing. Polishing, painting, handyman shop; wonderful profits; start yours on nearly nothing. John Brace-land, 1457 So. Ninth, Philadelphia, Pa.

**NEW** Household Device washes—dries windows, sweeps, cleans walls, scrubs, mops. Costs less than broom. Over half profit. Harpers, 132 Third St., Fairfield, Iowa.



**AGENTS, \$240 month.** Dri-Klean—it makes any car look like new. Removes mud grease, tar road oil, all in one operation. No soap or water used. Cleans any car for 10c. Wonderful seller. Exclusive territory. Big opportunity to make \$5,000 a year. Write quick for particulars and free sample. American Accessories Co., Desk 1631, Cincinnati, Ohio.

**PAY-DAY every day!** Every man can use a new suit or overcoat. You can make big money selling New York styles priced at \$19.75, \$24.75, \$29.75, \$34.75. Write for particulars about our elaborate outfit and quick selling plan—it's Free. Harrison Bros., Dept. 868, 133 W. 21st St., New York.

**NEW Invention—400% profit.** Liquid quick mend for Fabrics and Hosiery. Stops runs. Every woman buys. Hundred other fast sellers. J. E. Johnson Co., Dept. 459, 6129 Wentworth Ave., Chicago.

**\$100.00 WEEKLY!** Two suits or suit and overcoat, \$33.50. All wool—made to measure. Commission, \$6.00—\$7.50. Outfit Free. Garfield Tailors, H1557 Milwaukee, Chicago.

**AGENTS—We start you in business and help you succeed.** No capital or experience needed. Spare or full time. You can earn \$50-\$100 weekly. Write Madison Company, 566 Broadway, New York.

**AGENTS, \$240 month.** Bonus besides. Introduce finest line silk hosiery. Guaranteed 7 months. We furnish auto and give you fine silk hosiery for your own use. New plan gets business fast. Samples furnished. Write quick. Betterknit Textile Co., Silk-1231, Greenfield, Ohio.

**DISTRIBUTOR wanted in each county** to take exclusive handling new auto fuel saver. Install on any car. Automatic. No overheating. Shuts off at low and very high speeds. Approved by mechanics. Retail \$6.00. Liberal commission. No investment necessary. Fine opening for worker. Standard Vaporizer Co., Box 83, Mobile, Ala.

**AGENTS—\$6.00 hour earnings making** four sales hour. Tremendous demand \$3.50 article. powerful selling plan. Pagley & Halpen, Dept. 40, Philadelphia, Pa.

**\$18 to \$25 daily.** Biggest selling line of 2-piece suits, \$9.95 and \$12.50; 3-piece wool suit, \$17.95 (regular \$28.00 value). All-wool overcoat, \$18.50. Splendid raincoats, slickers and boys' suits. Biggest commissions. Free outfits. "Jim" Foster, Inc., Dept. 211, 2250 S. Spaulding Ave., Chicago, Ill.

**MAKE \$10 daily silvering mirrors, etc.** Guaranteed instructions and formula 25c. Sherdore, 217 Sheridan Ave., Albany, N. Y.

**AGENTS: Make \$500.00 monthly.** Pay daily. No investment. Rhinestone initial buckles and novelties. Sell easy everywhere. Exclusive territory. Chaton Novelty Co., 606 Blue Island, Chicago.

**EVERYBODY uses Toilet Preparations.** Sell dainty, exquisite, delicately scented. Duo compacts, perfumes, powders, creams and lotions, Flavoring Extracts and Specialties. Duo Co., TP-1, Attica, N. Y.

**EASY money wearing free shirts.** Be my local distributor. Greatest values ever offered. Big profits. Fashionwear Shirt Co., Dept. P-943, 1220 Jackson St., Cincinnati, Ohio.

**AGENTS—Big Seller—\$20 daily easy** selling Taylor Caps—made-to-measure—every man buys—some want 2 or 3 caps. Samples free and Cap free to agents. Write quick for fast money-making proposition. Taylor Cap Manufacturers, Dept. B-54, Cincinnati, Ohio.

**\$31.00 PROFIT—with \$1.50 Outfit—Big** Money—Easy Work. Selling Gold Monograms for Automobiles, Luggage, Windows, Wagons. No experience. No license. "Samples Free." NuLife Monograms, Hartford, Conn.

**AGENTS: for big, quick profits try our** new adjustable waterproof aprons; 100% profit. B. & G. Rubber Company, Department 270, Pittsburgh, Pa.

**BIG profits selling our Silverware and** Solid Brass Novelties—Handsome Holiday gifts. Write Granite Company, 304 South Seventh, St. Louis.

**DON'T sell for others.** Employ agents yourself. Make your own products. Toilet Articles, Household Specialties, etc. 500% profit. We furnish everything and show you how. Valuable booklet free. Write at once. National Scientific Laboratories, 1910W Broad, Richmond, Va.

**IF I Send You a Suit made in latest** style from finest goods, will you keep it, wear it, and show it to your friends as a sample of my sensational \$19.50 suits guaranteed regular \$40.00 values? Could you use \$3.00 an hour for a little spare time? If so, write me at once for my wonderful new proposition. Just write your name and address on a card and mail to Salesmanager, Peoria and Adams, Dept. 866, Chicago.

**WOMEN—\$2 an hour spare time; 100%** commission; new idea sanitary necessity sells on sight; every woman buys; new feature never before used; designed by physician; revolutionizes old uncomfortable methods; pay every day; no deliveries, no collections; no experience or capital required. Particulars mailed in plain envelope. Write Mrs. Mary P. Coleman, Meriden, Conn.

**AGENTS make \$3.00 an hour taking or** ders for our 40 fascinating Kitchen Specialties. No competition. Write quick. General Products Co., Dept. K-207, Newark, N. J.

**RELIABLE People Wanted—place** Eggine in stores and appoint agents. Used same way as eggs in baking and cooking, rate 9c dozen. Always fresh. Large package 10c postpaid, with particulars of our other fast sellers. Morrissey Company, 4417-25 Madison St., Chicago.

**AGENTS—Biggest hit of season—FitsU** adjustable Caps and mufflers to match. \$1.70 commissions in advance on every combination order. \$10 to \$20 a day easy. Write quick for free outfit and free cap offer. FitsU Cap Co., Dept. CM-75, Cincinnati, Ohio.

**100 MORE active men to introduce** Chieftain Guaranteed Tailored Shirts 3 for \$4.95. Latest novelties, colors. Dickman, Illinois, in 3 weeks made \$589; Sinton, Texas, in 12 days, \$219.60; Bend, Iowa, in 15 days, \$334.80. Why not you? No experience or capital needed. We deliver and collect. Full working outfit Free. Cincinnati Shirt Company, Lane 15811, Cincinnati, Ohio.

**\$17.50 DAILY Easily Made—Demonstrating** Amazing new Moisture Gas Saver. All autos. 1 free. Critchlow, E5-805, Wheaton, Ill.

**SELL real necessity. Novelty Shirts,** Hosiery, Neckwear. Colonial Novelty Co., Geneva, N. Y.

**JUST Out—New Patented Apron.** No strings or straps—\$20.00 a day every day; over 100% profit; commissions daily. Write for free offer. Sta-Put Co., Dept. 211, St. Louis, Mo.

**MAKE \$100 weekly supplying demand for** new invention. Makes autos run on 7c gasoline. Free sample. Write Whirlwind Co., 999-491 E. Third St., Milwaukee, Wis.

**AGENTS—Make a dollar an hour.** Sell new kind of sharpeners. Sharpens all knives and tools quickly. Demonstrating sample free. Premier Mfg. Company, Dept. 73, Detroit, Mich.

**\$50,000. PICTURE Man Friedman made** canvassing. Beginners can make \$100.00 weekly with my sales talk. Experienced men make more. Free book. "Profits in Portraits" explains. Sample Free. Picture Man Friedman, Dept. 8-A, 541 W. Lake, Chicago.

**AGENTS, portraits, photo-pillow tops,** frames, sheet pictures, medallions, photo-jewelry, guaranteed hose laundry tablets, food products, toilet requisites, luminous crucifixes. Catalog 50 specialties free. 30 days' credit. Jas. C. Bailey, Dept. C-11, Chicago.

**BIG Winner for Agents.** New patented cigarette case. Holds package cigarettes and box safety matches; beautiful, compact, flexible container; large profits; write for liberal proposition. All-in-One, Dept. A-11, 2810 Portland Ave., Minneapolis, Minn.

**MAKE Big money selling LaFleurette** Solid Perfumes. Tremendous demand everywhere. Particulars free. Quality Laboratories, Dept. M-82, 296 Broadway, New York.

**DIRT-DYNAMITE, the Soap Paste of a** hundred uses in Shop, Home and Office. Entirely new sales plan means sure and certain success to hustlers. Big profits and exclusive territory. Carter Products Co., Dept. 100, Albuquerque, New Mex.

**MAKE \$25.00 daily selling colored** Raincoats and Slickers; Red, Blue, Green, Etc., \$2.95. Hat Free. Commissions daily. Outfit free. Elliott Bradley, 241 VanBuren, Dept. AB-11, Chicago.

**WHY not sell us your spare time? \$2** an hour, \$19.70 daily easy full time, introducing new style guaranteed Hosiery for men, women, children. Silk hose for your own use free. No capital or experience required. Your pay daily. Monthly Bonus Extra. We furnish samples. Macochee Hosiery Company, Road 58611, Cincinnati, Ohio.

**AGENTS—\$10 daily up demonstrating** nationally advertised Everbrite Heater. Needed in homes, schools, churches, offices everywhere. Amazing offer. Write today. Everbrite Co., 801 Gateway Sta., Kansas City, Mo.

**AGENTS—Make big profits selling** Rose Blush Face Creams and Powder. Particulars sent free. Send \$1.00 for samples worth \$1.50; exclusive territory. Rose Blush Co., Union City, N. J.

**COMBINATION leatherettes \$6.98.** Commission \$1.75. 6x9 swatches increase sales. Complete line raincoats, topcoats, slickers, \$2.68 up. Elaborate outfit free. Amazon, 1101 N. Robey, Chicago.

**AGENTS: \$5.00 to \$10.00 profit each** sale with our New Octagon Portraits and Frames. \$50 to \$75 weekly easy. Catalog free. Write Linder Art Company, 551 W. Washington, Chicago.

**PLAID Slicker and hat \$2.98.** Big selection; Going big. Pay daily. Outfit free. American Waterproof, 721 Roosevelt, Dept. PM-2, Chicago.

**\$15 DAILY, easy.** Pay advanced. New two-tone aviator-style rain coats. Outfit and coat Free. Flisk Warner, 443 South Dearborn, Dept. 11, Chicago.

**AGENTS, get our prices.** Largest reliable line toilet preparations and home remedies, including valuable premium coupons. Prompt service. Established 1867. Valuable selling plans. Lab. 11, F. Ad Richter Co., Berry and S. 5th Sts., Brooklyn, N. Y.

**CHRISTMAS Novelty.** Every store, office and home a prospect. Sold day or evening. Plan now to make \$25.00, daily, upward, during December. Cash sales—no order taking. Sample and literature Free. Consolidated, 65-C, West Van Buren, Chicago.

**NEW! Amazing "twin" invention!** Automatic machine for opening cans: "Magic Groove" sharpener for knives, scissors, tools. Needed everywhere. Big profits. Complete outfit furnished. Write quick for introductory Test Offer. Central States Mfg. Co., Dept. P-931, 4500 Mary Ave., St. Louis, Mo.

**STATE Representatives and Agents** wanted for genuine Cremer Black Diamond Barber Tools. 100% profit. Cremer, 22 Beaver St., San Francisco.

**AGENTS—America's greatest sensation.** 6 new record-breaking sellers. Enormous demand; tremendous profits. Write quick for details. United Service, 500 Fifth Ave., New York.

**WANTED: Local agent as partner in** shoe business. No experience or capital needed. Earn \$90 to \$125 a week plus share profits. Style-Arch Shoe Co., Desk X-102, Cincinnati, Ohio.

**THOUSANDS of housewives are waiting** for these two new Kitchen Specialties. Just out. They sell at sight. Over 200% profit. Write us today. Samples 35c. Universal Utility Co., Dept. 226, Gloversville, N. Y.

**SILK Dresses.** Our expensive showroom samples (slightly handled). Cheap! Dress dealers, peddlers, others interested, write Hirschlar's Dress Bargain House, 467 Broadway, New York.

**AGENTS—100% profits selling our** low-priced beautiful and attractive Felt Rugs. Perfect color combinations insure quick sales. Excellent opportunity to build substantial business. Eastern Mills, Everett, Mass.

**AGENTS Sell cigars.** Big commissions. Samples free. Valles, 76W, 113th, New York.

**\$100 WEEKLY showing famous** Brilliance Diamond. Baffles experts, rivals the genuine African diamond in dazzling brilliancy. Free details. Brilliance Co., 5643 E. Prairie Ave., Chicago.

**AGENTS—Big Money! Sell dress goods.** Wholesale prices. Highest commissions—bonus. Full—spare time. North American Importing Co., 1223 Broadway, Dept. A-1, New York.

**MAGNETIC Health Belt, fine-t quality.** Women and invalids demand them. Big money. Agents wanted. Electro-Magnetic Appliances, Box 3306, Portland, Ore.



**DON'T** sell for others. Employ agents yourself. Make your own products. Toilet Articles, Household Specialties, etc. 500% profit. We furnish everything and show you how. Valuable booklet free. Write at once, National Scientific Laboratories, 1910W Broad, Richmond, Va.

**SELL** dairyman my one piece valveless yet one way flow water bowl. At \$2.00 wholesale must please customer 30 days. Circular? G. A. Hatton, 367 Neshannock Ave., New Castle, Pa.

**REPRESENTATIVES** wanted by over 500 manufacturers, offering real money-making propositions. No need of being out of work. Write for Free copy. Opportunity Magazine, 750 N. Michigan, Service Dept., Desk 2, Chicago.

**CHAMOIS-RAY** polishes all metals; latest invention; profits extraordinary; sample 25c. Le Soleil Company, 1454 Wellington Ave., Chicago.

**DON'T** Read This unless 300% profit interests you. Everybody buys on sight. Free Sample. Magic Products, Dept. 200, Oak and 31st, Kansas City, Mo.

**ARVEO** Polishing Cloths offer big profits to salesmen. Sample and particulars free. Arveo Industries, Box F 147, Grosse Ile, Mich.

**\$150 WEEKLY**—New women's Leatherette aviator rain-topcoat. Low priced. Outfit Free. Guarantee Raincoat, 172 AC—North Halsted, Chicago.

**AMAZING** invention pays agents \$150 weekly! Unique combination gear shift ball-Ash Tray, 250% profit! Lifetime Guarantee. Free particulars. Fisher, 7738 South Chicago Avenue, Chicago.

**HOUSEHOLD** article—Inexpensive—every home a prospect. Geo. Jentzen, 772 40th St., North Bergen, N. J.

**NEWEST** Invention! Abolishes kinks and snarls. Automatically coils telephone, electric iron and lamp cords. Housewives, companies actually buying 5 to 50. Tremendous profits. Samples furnished all salesmen. Neverknot, Dept. 11-A, 4503 Ravenswood, Chicago.

**BIG** money easily made without peddling our outfits. Free particulars. Elite, 35H Elizabeth St., New York.

**MEN**—Women, \$1.80 an hour. No less. Large Mfg. Co., established 30 years. Starting new metalion dept. Amazing new sales plan. First 22 agents average \$1.80 an hour steady. Only 1 agent wanted in locality. Your Own Photo Free as sample. Art Medallion Co., Dept. 58, Corner Campbell and Jackson, Chicago, Ill.

**AGENTS**—\$11.25 starts a route of Stores in your town working for you, bringing you \$47.25 per week. Samples displayed in stores get the business. "Master," 818 Chestnut, St. Louis.

**PHOTO** Mirror (colors), 70c. Send photo. Jabe Studio, Kansas City, Mo.

**VALUABLE** information for Beginners, Mail-Order Men, Agents, 200% Profit. Samples Free. Nite Mail-Order Supply Co., 609—27th St., Denver, Colo.

**CASH** Paid for Butterflies, Insects. See Sinclear Display Advertisement on page 24.

**SELL** "Lustro" Polishing Cloth. Polishes all metals without liquid, paste, powder. Great 25c Seller; sample free. Schrieber, Nashville, Ill.

**PENNANTS**—Your city or school \$2.00 dozen. Stores and students get busy. American Pennant Co., 66 Hanover St., Boston, Mass.

**BIG** Pay every day. Complete guaranteed line direct to wearer. Dress shirts, work shirts, flannels, overalls, pants, leather coats, sweaters, playsuits, \$10-\$25 daily. Experience unnecessary. Big outfit free. Nimrod Co., Dent. 8, 4922-28 Lincoln Ave., Chicago.

**AGENT** Repeaters cost 10c, sell 50c. List free. Thorn-Burr, Carthage, Ill.

**FASTEST** 15c seller, wonderful milk bottle opener and cover. Individuals and stores. \$12 day. Free demonstration outfit. Will guarantee sales. Hurry. Murico, 946 Lawrence, Chicago.

**ATTENTION**, Carpenters. Industrials Education schools. Perfect saw filers. Files carpenters' saws to thousandths of an inch. Price \$12.50. Particulars. Hoof Mfg. Co., Minneapolis, Minn.

**AGENTS**—Big money quickly! Complete line beautiful hosiery, lingerie. Every woman wants—buys. Wholesale prices. Big commissions. Free samples. Gold Medal Textiles, 122 Fifth Ave., Dept. A1, New York.

**TAKE** orders for Orthophonic Portables, Phonographs. Samples free. Orthophonica Mfg. Co., 757-F, Broadway, New York.

**AGENTS**, \$80 to \$125 weekly supplying amazing new specialty to retail stores. Everybody needs. Real selling plan. Investigate quick. York & York, Hammond, Minn.

**ARE** You Old at Forty? See our advertisement on page 161 of this issue. The Electro Thermal Company, 2175 Main St., Steubenville, Ohio.

**EVERY** Woman Wants a Sewing Set. Home Sewing Sets contain 142 useful sewing articles. \$4 an hour easily made with this 50c seller. Lee Bros., 128 E. 23rd St., New York.

**REAL** Whirlwind Seller—Nopolout Custom Shirt. Every man buys them. Patented—no competition. Liberal commission. Free selling kit. Make \$15 up daily taking orders direct from consumer at manufacturer's prices. District or local agents. Write Nopolout Shirt Co., Dept. Y, Hazleton, Pa.

**\$60-\$200** A WEEK. Genuine Gold Letters for store windows. Easily applied. Free samples. Liberal offer to general agents. Metallic Letter Co., 438-B North Clark, Chicago.

**\$17.50** DAILY Easily Made—Demonstrating Amazing new Moisture Gas Saver. All auto. 1 free. Critchlow, E4-805, Wheaton, Ill.

**AGENTS**—Make \$15 a day setting pearls. Every woman a customer. Oriental Pearl, 151 Fifth Avenue, New York.

**LIVE** Agents Wanted for patented Weatherstrip; can be installed without removing sash. Busy season now. Allan Manufacturing Co., Morris, Ill.

**RADA-DIAMONDS** Rival Genuine. Same Rainbow Fire; Stands Test. Sensational Seller, Low Price, Big profits. Get sample Case Offer Free. National Co., Box 1171-P, Omaha, Nebr.

**MAKE** more money than ever before. Something new, quick profits and big repeat business. Write now. Holmes Service, 140 Grand St., Waterbury, Conn.

**\$8 TO \$12** a day. Man or Woman Wanted. Part or full time. To distribute well known line of cosmetics and toilet preparations in their locality. No experience necessary. We train you. Big profits. Large repeat sales. Free sample offer. Write Franco-American Hygienic Company, 123 E. 13th Street, Chicago, Ill.

**AGENTS**—Canvassers—Full or part time. The fastest selling and Sharpest Stainless Steel Knives on the market. Exclusive territory. Carrol Knife Co., Clyde, Ohio.

**AGENTS**—Steady income. Large manufacturer of handkerchiefs, dress goods, linens, wishes representative in each locality. Factory to consumer. Big profits, honest goods. Credit given. Send for particulars. Freeport Mfg. Co., 59 Main St., Brooklyn, N. Y.

**AGENTS**—Mosco Corn and Callus Remover will build you a steady repeat business. Send today for pocket-size trial outfit. The Moss Co., 387 Searle Bldg., Rochester, N. Y.

**SIMPLEX** Vaporizer—Wonderful invention; 25-60% increased mileage guaranteed; retails \$1; free trial; exclusive territory. American Fixture Co., 234 West Water, Milwaukee, Wis.

**SEND** name, address on postcard. Free introductory copy Salesology Magazine; contains 1,000 money-making opportunities. Offered by big reliable firms; no obligations. Salesology Magazine, Desk B-38, 509 No. Dearborn, Chicago.

**AGENTS** make \$100 week furnishing Cigar Lighters to merchants on free advertising plan. Particulars sent free, write at once. Drake Mfg. Co., Dept. M, Milwaukee, Wis.

**FREE** Sample, "Rain Shield Wiper." Retail \$1.00—Cost (25 cents) Sold Clear and Rainy Days. No Cloth—No Paste—No Attachment. (1) Rub keeps windshield clear 48 hours. Experience Unnecessary. NuLife Corporation, Hartford, Conn.

**AGENTS**, \$240 month. Bonus besides. New auto given. Introduce new guaranteed hosiery, 126 styles, colors. Finest silks. Credit given. Samples furnished. Wilknt Hosiery Co., Dept. 3431, Greenfield, Ohio.

**MONEY** Talks—You can have plenty of it selling Amazing New Moth Bag. Absolutely air-tight. Never on market before. Sells on sight. Write today. S. & P. Products Co., Dept. 1, St. Louis, Mo.

**FREE** Sample of lace handkerchief. Lightning-quick seller. Big profits. Earn \$30.00 daily. Send 10c for mailing charges. Other flash sellers also. Lewis Importing Co., 143 Fifth Ave., New York.

**AUTO** owner tire agent wanted each locality to use and take orders for hand made Mellinger cord and balloon tires; guarantee bond 15,000 miles; shipped prepaid on approval; get your tires free; no capital or experience required; make \$100 to \$300 weekly. Write for wholesale prices and sample kit. Address Mellinger Tire Co., Dept. 400, Kansas City, Mo., or Dept. 400, Philadelphia, Pa., or Dept. 400, Oakland, Calif.

**PHOTO** Medallion Agents Earn \$20 Daily. Easy work collecting photos. Big line; quick sellers. Capital or experience unnecessary. Give you 4-day service on beautiful photo reproductions. Reserve your district today. Write Pudlin Corp., Dept. 103, 259 Bowery, New York.

**\$5,000** A YEAR—Selling Perry Photo Medallions. Big demand. Ready sales, 400% to 600% profits. Any photo copied perfectly on Medallions, Mirrors, Compacts, Jewelry, etc. Guaranteed likeness. Investigate. Free catalog, full details on request. Write Today. P.M. Perry Photo Novelty Corp., 1793 Jerome Ave., New York.

**GENUINE** Gold Leaf Letters anyone can put on store windows. Guaranteed to never tarnish. Large Profits. Enormous Demand. Free Samples. Write today. Metallic Letter Co., 438-D North Clark, Chicago.

**RADIO** Agents—Make Big Money. Easy! selling Marvelous New Sets and accessories. Buy from factory at lowest prices. Get New Catalog with thousands of nationally advertised bargains. Free Call Book. Write today. American Auto and Radio Co., Dept. 268, American Radio Bldg., Kansas City, Mo.

**SUCCEED** With Your Own Products. Make them yourself. Formulas, Processes, Trade-Secrets. All lines. Catalog, circulars free. B. Thaxly Co., Washington, D. C.

**AGENTS**—Big money! Fast selling line beautiful Christmas greeting cards. Dollar box assortment sells on sight. Big commissions. Free samples. Doehla, Fitchburg Mass.

**WRITE** Atlas Sign Works for free working equipment. Beautiful window sign letters. Penny each! Any size. Wonderful offer to general agents. K1032 E. 55th St., Chicago.

**PATENTS**. Time counts in applying for patents. Don't risk delay in protecting your ideas. Send sketch or model for instruction or write for free book "How to Obtain a Patent" and "Record of Invention" form. No charge for information on how to proceed. Communications strictly confidential. Prompt, careful, efficient service. Clarence A. O'Brien, Registered Patent Attorney, Security Bank Building (directly across street from Patent Office), Washington, D. C. See pages 156 and 157.

**NEW**: Just invented; Comb fastens anywhere. Send 10c for a 25c value. Never Lose Comb Mfg. Co., Lesueur Center, Minn.

**JUST** Out, new cigarette vendor. Positively the most beautiful high-class dependable Vending machine made. Practically Slug Proof. Built to last indefinitely. Agents make fortunes by acting quickly. Manufactured exclusively by the National Sales Machine Company, Dept. B, 1926 Chestnut St., St. Louis.

**SHOP** Agents or General Agents to sell new large cans of Paste Hand Soap—fine profits—quick sales. The Connecticut Can Co., Hartford, Conn.

**ATLAS** Sign Works manufactures beautiful gold window letters. Penny each! Why pay 8c? Write for Free samples. M1032 E. 55th St., Chicago.

**AGENTS** to distribute sample puzzles and catalogues, evenings. Catalogue for stamp. B. Z. Puzzles, Fairview, Mass.

**SELL** Wonderful Hand Adding Machine. \$1 wholesale. Retail, \$4.50. Typewriter Supply, 102 Hersch Bldg., Pittsburgh.

**RAINCOATS**—Full line, all prices. Also Sheeplined coats—shirts. Outfit free. Commission 25% with bonus. Hydro Raincoat Co., 718 Independence, Dept. 45, Chicago.

**\$100.00** WEEKLY. Sell nationally known product and appoint agents. N-R-G Co., H234 W. Superior, Chicago.

**BE** Independent. Establish your own business. We furnish flavors, toilet preparations, etc., complete with your own labels. Lowest wholesale prices—less than your cost to manufacture. Edral Co., Dept. Y-10, Cincinnati, Ohio.

**EARN** \$80.00 weekly with Paris Fashion Frocks for women. Big line new styles at factory prices. Big advance commissions. No experience necessary. New plan. Fashion Frocks, Dept. CY-105, Cincinnati, Ohio.



**DON'T** sell for others. Employ agents yourself. Make your own products. Toilet Articles, Household Specialties, etc. 500% profit. We furnish everything and show you how. Valuable booklet free. Write at once, National Scientific Laboratories, 1910W Broad, Richmond, Va.

**\$17.50 DAILY** Easily Made—Demonstrating Amazing new Moisture Gas Saver. All autos. 1 free. Critchlow, E3-805, Wheaton, Ill.

**EARN \$10 daily** silvering mirrors, plating, refinishing metalware, chandeliers, head-lights, bedsteads. E. Debie Laboratories, 223 Varick St., New York.

**\$50.00 WEEKLY** easy. Applying Gold initials on Automobiles. No experience needed. \$1.45 profit every \$1.50 job. Free samples. "Raico Monograms," X1043 Washington, Boston, Mass.

**FREE:** Large wholesale Specialty catalog, showing latest best sellers from many parts of the world. Spors Co., Lesueur Center, Minn.

**MAKE \$1,000** before Christmas selling exclusive personal Christmas cards in distinctive steel engraved designs. Expensive Sample Book free. Wetmore, Jones and Sugden, Rochester, N. Y.

**GOLD-LEAF** Sign Letters; copyrighted Manufacturing Instructions; profits 1,000%. Johnston Co., Quincy, Ill.

**\$16 A DAY** Easy—I start you in auto accessory business; no investment; no experience necessary. Landin, 4206 Montrose Ave., Chicago.

**LAMB'SWOOL** Polishing Mittens, Brushes. Newhall, 358 Broad, Lynn, Mass.

**BIG Money** and Fast Sales. Every owner buys Gold Initials for his auto. You charge \$1.50; make \$1.35. Ten orders a day easy. Write for particulars and free samples. American Monogram Co., Dept. 40, East Orange, N. J.

**RELIABLE** aggressive agents needed to sell Holly Suction and Force Pumps. Used in clearing plugged plumbing fixtures. Sizes for every need. Readily salable, and show good profit to consistent workers. The Holly is priced below competition and offers, at the same time, exceptional quality. Worthwhile for worth-while men. Alert Products, Inc., Dept. 50, Holly, N. Y.

**32 SECONDS** complete tire change by Detmer, Ohio, with Morey Quick Action Rim Tool. Sold, singly, 49 three days, cleared \$100. Anderson, Mont., sold 1400 in 14 weeks. Get details for good territory. Harvest time now. M. Morey Rim Tool, Buffalo, N. Y.

**AT Last!** Diamond Rival Discovered! Amazing blue white Rajah Gem astounds jewelry world and deceives experts. Beautiful sample case free! \$100 weekly. Quick! Rajah Diamond Co., Dept. F20, Salisbury, N. C.

**SELL** men's neckwear; wonderful proposition. Astor, 318-M Broadway, New York.

**AGENTS** make \$40 to \$80 weekly selling typewriters re-manufactured like new by the "Young Process." Lowest prices and easiest terms ever offered. Big commission—no investment—real opportunity to start in business for yourself. Write today. Young Typewriter Co., Dept. 710B, 654 W. Randolph St., Chicago, Ill.

**AGENTS.** Get our prices on Coffee, Tea, Desserts, Soaps, Perfumes, etc. Endless variety, superb quality, quick service. Sample display free. Address Blair Laboratories, Lynchburg, Va.

**CALIFORNIA** perfumed beads selling like hot cakes. Agents coinng money. Big profits. Catalog free. Mission Factory P, 2328 W. Pico, Los Angeles, Calif.

**HUNDREDS** of manufacturers, formerly agents selling other goods now owe their success to Miller's Guaranteed Formulas for making biggest-selling, advertised specialties in all lines. Investment small. No machinery needed. Profits great. Make your own goods—get the profit you're entitled to. Write today for my "eye-opening" literature. It's free and tells all. Miller, Chemist, 1766-W Jetton, Tampa, Fla.

**A BUSINESS** of Your Own—Making Sparkling Glass Name and Number Plates, Checkerboards, Signs, Big Book and Sample Free. E. Palmer, 513 Wooster, Ohio.

**SOMETHING** New. Every motorist a buyer of our electro-magnetic-emergency Wonderlamp; takes only one minute to demonstrate and make a sale; no experience necessary; \$5.00 an hour easily made; full time or evenings. Write for sample. Wonderlamp Co., 926 Fisk Bldg., Dept. 16-A, New York.

**WE Start You** Without a Dollar. Soaps, Extracts, Perfumes, Toilet Goods. Experience unnecessary. Carnation Co., Dept 2480, St. Louis.

**AGENTS**—Make a dollar an hour. Sell Mendets, a patent patch for instantly mending leaks in all utensils. Sample package free. Collette Mfg. Co., Dept. 404, Amsterdam, N. Y.

**NO Dull Times** Selling Food. People must eat. Federal distributors make big money; \$3,000 yearly and up. No capital or experience needed; guaranteed sales; unsold goods may be returned. We furnish you with sample case, license and Free Samples for customers—Sure repeat orders. Exclusive territory. Ask now! Federal Pure Food Co., A2307 Archer, Chicago.

**POLMET**—The Wonderful Polishing Cloth that cleans all metals without liquid, paste or powder. Approved by "Good Housekeeping" and "Modern Priscilla"—sells fast at 25c. Sample free. Gale & Co., Inc., 15 Edinboro St., Boston.

**PHOTO Medallion** Men and Women, the largest line of Photo Novelties in the world. Lowest prices, quickest service. Send for catalogue showing over 200 money makers. Photo medallions, photo medallion clocks, photo mirrors, photo fountain pens, photo powder compacts, photo jewelry and photo buttons. Gibson Photo Jewelry Co., 608-614 Gravesend Ave., Brooklyn, N. Y.

**AGENTS:** 500% profit. "Happy Home Make Shampoo" builds your own big business. Martin of Indiana made \$75.00 in one day. Missouri man made \$750.00 one month. Exclusive territory. Geo. A. Schmidt & Co., Dept. P, 236 W. North Ave., Chicago.

**REPLATE** brassy worn-off Automobile parts, Reflectors, Bath Room Fixtures, Worn Spoons, Forks, etc., with pure silver. Looks like new. Use U-Kan-Plate Polish. Positively no mercury. \$1.00 half pints. Post paid. Satisfaction Guaranteed. Agents wanted. Dept. A, U-Kan-Plate Co., Philadelphia.

**AGENTS** make \$10.00 Daily selling Non-Splash Water Filters on sight. Best canvasser's article on market. Investigate. Write for particulars, Desk 14, Seed Filter Company, 73 Franklin Street, New York.

**FIBRE Brooms**—detachable handles, fine finish. Good profits, repeat sales. The Fibre Broom People, 147-C New Jersey Ave., Brooklyn, N. Y.

**MONOGRAM** Automobiles, \$1.35 Profit ten minutes' work; every owner wants them; millions without; particulars free. Motorists Accessories Co., Mansfield, Ohio.

**ONE** of the biggest mails on earth. Sent to any address for 10c. Louisiana Distributing Service, Dept. PM, Harmon, La.

**PORTRAIT** Agents—Write for new Catalogue—Enlargements, Frames, Medallions, Sheet Pictures, Luminous Crucifixes. Adam J. Kroll & Co., 2339 So. State St., Chicago, Ill.

**WANT** Distributing Agent for Handslick, powdered hand soap; removes anything from hands; everybody a customer; sample free. Solar Products Co., J-2142 S. Troy, Chicago.

**ALL-YEAR-ROUND** profitable business selling wonderful new water softener and cleaner. Removes grease, oil, ink and dirt quickly. Every home and business place a live prospect. 100% profit. Big repeat orders. Exclusive territory. Write for free sample. Seacoast Laboratories, Sea Bright, N. J.

**GOLD** Leaf window letters and script signs. No experience; 500% profit. Samples free. Consolidated, 69-U West VanBuren, Chicago.

**REMNANT** Store, Bethel, Ohio. Greatest Dry Goods Bargains on Earth. Agents and Dealers.

**AGENTS**—Clever Invention! Inkspoon makes every pen a fountain pen. Fast office seller; big profit, demand increasing everywhere. Exclusive territory offered. Sample free. H. Marul Company, Tribune Bldg., New York, N. Y.

**GET** Our Free Sample Case—Toilet articles, perfumes and specialties. Wonderfully profitable. La Derma Co., Dept. A, St. Louis, Mo.

**BIG** Profits: Steady Income our line food products, toilet articles, soaps. No cash or experience needed. Sample case free. Write Linro Co., Dept. 242, St. Louis, Mo.

**OUR** Luminous Crucifix Shines in the Dark. Every one amazed at the wonderful effect. Easily demonstrated. Easily sold. W. G. Hannan Co., Dept. B, 2539 So. State St., Chicago.

**UNDER** Your Name or Brand, Sell Our Laundry Tablets. Amazing profits. Samples, circulars free with order. Costick Products, 400 West 23rd, New York.

**\$1,000.00 CLEARED** in 30 days by one agent. New Amazing Cleaner. Sample Free. Bestever Products Company, 4317-P, Irving Park, Chicago.

**AUTOMOBILE** Specialties. Guaranteed formulas for all latest money makers. Lowest prices. Write for free lists. Murphy, Chemist, Tujunga, Calif.

**BIG** profits distributing 5c candy specialties to dealers. Fast sellers. Exclusive territory. Universal Sales Company, 631-B Wilson Ave., Brooklyn, N. Y.

**AGENTS**—500% profit selling exclusive new process Artistic Signs. Finest selection of stock signs in the country, barring none. Details free. Sample 10c. Artistic Signs, 739-R Broadway, New York, N. Y.

**SEND** 25 cents for a one dollar Cigar Lighter, and learn how to make \$10 a day. Particulars free. Rapid Mfg. Co., 799 Broadway, New York City.

**DON'T** sell for others. Employ agents yourself. Make your own products. Toilet Articles, Household Specialties, etc. 500% profit. We furnish everything and show you how. Valuable booklet free. Write at once, National Scientific Laboratories, 1910W Broad, Richmond, Va.

#### HIGH-GRADE SALESMEN WANTED

**NO** high-pressure salesmanship necessary selling Luminate, our Magic Electric Window and Outdoor Salesman. Demand established. Color, light, motion gets 'em. Greatest quick-change letter system and snappy two-color posters land orders on demonstration. Hustlers collecting \$100 weekly, easy. Protected territory. Display Products Co., A467-9 East 31st St., Kansas City, Mo.

**SALESMEN**—Our line patented steel products selling to automotive, department store and hardware trade will make you money. Exclusive territory and liberal commission. Write Marion Mfg. Corp., Marion, Ohio.

**EVERY** hardware jobber buys Lambert Cream Skimmers. Endorsed by National Women's Magazines. Ten exclusive features. Coat-Pocket sample. Only weighs two ounces. Liberal commissions paid promptly. Give territory and references. Lambert Mfg. Co., Wichita, Kans.

**SALESMEN:** Live wire specialty men to sell news pictures for window attraction. Big seller. Liberal commission. Dispatch, 207 W. 25th St., New York.

**DON'T** sell for others. Employ agents yourself. Make your own products. Toilet Articles, Household Specialties, etc. 500% profit. We furnish everything and show you how. Valuable booklet free. Write at once, National Scientific Laboratories, 1910W Broad, Richmond, Va.

**SALESMEN,** Sideline—SELL "No-Bumps" garages, accessory, tire dealers; sensational springs sitting under front coach seat; makes car ride like rocking chair; sell \$1.50; good commission. General Steel Products, 609½ Marquette Ave., Minneapolis, Minn.

**SALESMEN**—Sell men's Rayon Swiss and Jacquard ties—new startling features; highest commissions. Wonder outfit free. National Service Mills, 2054-83rd St., Brooklyn, N. Y.

**MR. BRUSH** Salesmen—Old Established New York brush manufacturers require services of men in all territories to sell their extensive line of Sanitary Twisted in Wire Brushes. We pay larger commission than any other brush house in the country. Write immediately for our proposition. Wire Grip Sanitary Brush Corporation, 15 Mercer St., New York.

**ANTIFREEZE** prevents radiators freezing. Drielean, the combined auto cleaner, polisher, Radiator internal cleaner. Hand soap. Write for free shipment long profit auto specialties. Mickman Co., St. Paul, Minn.

**EASY** to sell groceries and auto oils from samples to consumers. Steady, profitable work. No capital or experience necessary. Commission advanced. Liberal credit. Leverin & Browne Co., Wholesale Grocers, 1590 So. State, Chicago.

**EARN \$20 A DAY.** Establish income for life selling for \$1 a year, \$1,500 accident policy. Write W. C. STONE, A11 So. La Salle, Chicago.

**40% COMMISSION** selling printed business stationery at knock-out prices. Part or full time. Free outfit. L Process Service, Minneapolis, Minn.



HOW about becoming my partner in a tailoring business right in your own city? It is a clean, permanent connection paying real money—and more each new season. You risk nothing; we furnish everything but your selling effort. Been at it for 35 years and can get results for you. Write us your story and let us tell ours. E. E. Oplinger, Genl. Mgr., 641 Arch St., Philadelphia, Pa.

**MEN**—Sell dependable shrubbery, fruit trees, etc. Steady demand. Complete cooperation. Commissions paid weekly. We deliver and collect. Write Perry Nurseries, Dept. R-11, Rochester, N. Y.

**AGENTS**—Salesmen—Demonstrators—Make \$75.00 to \$150.00 per week with Chieftain Guaranteed Shirts. Easily sold to men, 3 for \$4.95. Experience unnecessary. Just write orders. We deliver and collect. Every day pay day. Samples and new selling plan—Free. Cincinnati Shirt Company, Lane 29411, Cincinnati, Ohio.

**SALESMEN**, sell the new fast selling Commercial Electric Corn Popper; sells for \$15; commission \$5. Dealers in every town waiting for it. Leonard E. Dickerson, Dept. E, Springfield, Mo.

**\$30.00 A DAY** Guaranteed to Workers taking orders for Goodwear tailored-to-measure clothes at sensational new low price. Tremendous assortment Virgin Wool fabrics. Biggest cash commissions paid daily and special cash bonus besides, makes ours best-paying line in America. \$25.00 Sales Outfit free. Exclusive Territory. Write at once to Dept. 251, Goodwear, Chicago, Inc., 844 West Adams, Chicago.

**75c PROFIT** on \$1.00 sale. Auto, furniture and glass cleaner. Your name on label. Exclusive rights; free sample. Mfg. E, 213 Griswold, Detroit, Mich.

**FOUR \$7.50** sales to merchants net you \$20.00 daily. Savers Systems, 2813 Sheffield Ave., Chicago, Ill.

**OUR men** making \$100 to \$1,000 monthly; also commission on repeats; only high grade salesmen wanted. Dept. D, Box 1029, Cedar Rapids, Iowa.

**SALESMEN**—\$3 to \$6 an hour introducing amazing new Waterless Cooker. Endorsed by food authorities. Every home a prospect. Going Big. Sure-fire sales plan. Men, women, district managers, write for real money-making offer. Health Cooker Co., Dept. M-50, Massillon, Ohio.

**NO need** to be idle when you can earn \$1.00 to \$25.00 a day selling Jobbers and Dealers our merchandise. Exclusive territory contract to thoroughly responsible persons only. Sellstrom Mfg. Co., 1120 N. Franklin, Chicago, Ill.

**SELL** as a Sideline—The Kern Price Card holder (best on the market), removable and interchangeable figures. Especially for groceries. Outfit carried in pocket. John Ph. Kern, PM, 1295 W. Market, Louisville, Ky.

**BIG Season** Just Ahead. Advertising pencils most popular every day—every business prospect. Our line repeats. Big commissions. Established in 1902. North American Pencil Works, 126 So. Clinton, Dept. 55-E, Chicago.

**REPRESENTATIVES** wanted by over 500 manufacturers, offering real money-making propositions. No need of being out of work. Write for Free copy. Opportunity Magazine, 750 N. Michigan, Service Dept., Desk 1, Chicago.

**WONDERFUL** invention. Seals Fifty Envelopes minute. Sells on sight at \$3.50. Exclusive territory. Kendall Sealer Co., 420, East Jeffrey, N. H.

**PUNCHBOARD** Salesmen Take Notice: New, fascinating game Excitement. Can be used all states. \$200 weekly easy. One-minute sales talk. Pay daily. Cigar Stores Novelty Co., Dept. G, Peoria, Ill.

**A GUARANTEED** salary and commission selling new specialty among all retailers. Enormous opportunity. New Specialty Corp., Cedar Rapids, Iowa.

**FRE9** Pants and Free Mufflers with \$15.00 Suits or Overcoats. Agents Make \$1.00. Beautiful Patterns and Colors. Fastest Sales Proposition. Large Samples Free. Universal Tailoring Co., 640 Broadway, Dept. 16, New York.

**MAKE \$25.00** daily selling colored Raincoats and Slickers; Red, Blue, Green, Etc., \$2.95. Hat Free. Commissions daily. Outfit Free. Elliott Bradley, 241 VanBuren, Dept. AB11-S, Chicago.

**SENSATIONAL** profits selling amazing new foot-control Zipper-Dimmer. Fits all cars. Makes night driving safer. 90% of car owners buy. Retail \$2.00, sample \$1.25 postpaid. Details free. Zipper-Dimmer Company, Dept. D-20, Loraine, Ohio.

**MAKE** More money selling exclusive line of engraved personal Xmas cards. Largest commission paid. Art Craft Engraving Co., Dept. C, 117 N. Wells, Chicago.

**SHOP** Representative. Sell Reed Micrometers to shop friends. Liberal commission. Reed Small Tool Works, 35 Hermon St., Worcester, Mass.

**YOUNG** Men wanted in industrial cities throughout U. S. to sell subscription for high class, industrial magazine to manufacturing firms and officials. Excellent commission. Fine chance to make extra money for Christmas. Manufacturers News, 231 So. La Salle St., Chicago.

**AUTO** Radiator Shutter, new patent. Retail \$1.50. \$20 daily easy. Write for sample. Jones, 804 N. Clark, Chicago.

**SIDELINE** Salesmen calling on Druggists, Department Stores, Beauty Parlors, Barbers, communicate with us at once. New, original seller needed by millions. Commissions paid on present and repeat business. Williams Chemical Laboratory, Dept. M, Charleston, S. Car.

**EXPERIENCED** Magazine, book, newspaper, insurance salesmen. Sell two-year subscription, popular publication and \$7,500 accident policy for \$7.80. Commission \$3.00. Complete free outfit. Burns Company, Johnstown, Pa.

**TRAVELING** Salesmen Calling on Retail Stores wanted by large manufacturer of fast-selling specialties entirely different from the average. Year-round sales, main or sideline. Big commission paid immediately on original and repeat business. Opportunity for well paid and permanent connection with old-established firm. If not making \$150 weekly, write today. Union Specialty Works, Dept. 222, Boonville, N. Y.

**TAKE** orders for coffee, flour, dried fruits, canned goods, meat, staple groceries, toilet articles, paints, tires, auto and tractor oils. No capital or bond required. We deliver and collect. Permanent business. Big pay. Write at once. Hitchcock-Hill Co., Dept. 59, Chicago.

**SALESMAN**—Manufacturer of established line guaranteed tools offers profitable connection to men with mechanical and some sales ability; part time men considered; two average sales daily net \$50.00 weekly; advance against commission. Write for free catalogue and money-making plan. J. G. Woods, Inc., Dept. 102, 37 West 20th St., New York, N. Y.

**SEND** name, address on postcard. Free introductory copy Salesology Magazine; contains 1,000 money making opportunities. Offered by big reliable firms; no obligations. Salesology Magazine, Desk B-39, 500 No. Dearborn, Chicago.

**DOUBLE** Spark Plug—Two spark gaps; bigger, hotter spark on weaker current and leaner mixture. Guaranteed to be better than other plugs or money refunded. 50% Commission. Agents and side-line men wanted. Affinity Spark Plug Co., Box P-329, Omaha, Neb.

**COLLECTS** Money from the Dead-Beats. Retail \$5.00. Cost—\$1.00. Profit \$4.00. "New Method." Every Storekeeper, Doctor buys quickly. Wonderful Money Getter. Federal Association, Hartford, Conn.

**WRITE** Atlas Sign Works for free working equipment. Beautiful window sign letters. Penny each! Any size. Wonderful offer to general agents. N 1032 E. 55th St., Chicago.

**EARN \$10** daily silvering mirrors, plating, refinishing metalware, chandeliers, head-lights, bedsteads. E. Deele Laboratories, 225 Vartek St., New York.

**SALESMEN**—Become Independent. Own Your business, experience unnecessary selling our \$7,500.00 Accidental Death; \$50 Accident; \$25 Sick Weekly Benefits—\$12.50 Yearly. Other Amounts proportionate. Guaranteed steady income from renewals. \$250,000 Deposited Insurance Department. Universal Policy, Dept. A, 30 Clinton St., Newark, N. J.

**PUNCHBOARD** Salesmen—making small towns. One sale a day nets you \$105 weekly. Full commission on repeats. K&S Sales Co., 4295 Ravenswood Ave., Chicago.

**ANY** Salesmen Can Sell Them! Merchants everywhere use punchboards. Someone sells them, why not you? Collect big commissions daily. Newest, largest, elaborate catalog sent upon request. Lincoln Sales Co., 9 So. Clinton, Chicago, Dept. D.

**\$50-\$200 A WEEK**. Genuine Gold Letters for store windows. Easily applied. Free samples. Liberal offer to general agents. Metallic Letter Co., 438-A North Clark, Chicago.

**GOLD** Leaf window letters and script signs. No experience; 500% profit. Samples free. Consolidated, 69-V West Van Buren, Chicago.

**PUNCHBOARD** Salesmen. 2 hours daily. \$100 every week. New line. Lowest prices. Full commission on repeat business. Catalog free. Puritan Novelty Co., 1409 Jackson, Chicago.

## HELP WANTED

**OBTAIN** Employment! 70 Jobs offered one person! Get work quickly, using our methods, or we'll promptly return your money. Complete instructions 50 cents. Better Yourself! New Idea Service Co., Box 39-A, Station K, New York.

**REPRESENTATIVES** wanted by over 500 manufacturers, offering real money-making propositions. No need of being out of work. Write for Free copy. Opportunity Magazine, 750 N. Michigan, Service Dept., Desk 3, Chicago.

**CASH** Paid for Butterflies, Insects. See Sinclair Display Advertisement on page 24.

**STOP!** Big Money Refinishing Furniture. Spare-time, Full-time. Experience unnecessary. Write F. Jackson, 716 W. Exchange, Owosso, Mich.

**MAKE \$25.00** daily selling colored Raincoats and Slickers; Red, Blue, Green, Etc., \$2.95. Hat Free. Commissions daily. Outfit free. Elliott Bradley, 241 VanBuren, Dept. AB11 M, Chicago.

**ARE** You Old at Forty? See our advertisement on page 161 of this issue. The Electro Thermal Company, 2175 Main St., Steubenville, Ohio.

**SOUTH AMERICA:** How to obtain Positions. Booklet. Lists prospective employers. \$1.00. Box 342, South Bend, Ind.

**SEND** name, address on postcard. Free introductory copy Salesology Magazine; contains 1,000 money-making opportunities. Offered by big reliable firms; no obligations. Salesology Magazine, Desk B-40, 500 No. Dearborn, Chicago.

**WE** Start You in Business, furnishing everything; men and women, \$35.00 to \$100.00 weekly operating our "New System Specialty Candy Factories." Few dollars start you home or small room anywhere. Booklet free. W. Hillyer Ragsdale, Drawer 350, East Orange, N. J.

## MAILING LISTS

**99% GUARANTEED** Mailing lists. Accurate. Reliable. Guaranteed. The kind that produces business; compiled for every possible business or individual. Lists of every kind of any business or individuals compiled for your individual needs anywhere. Catalog and information on request. National List, 877 Broad, Newark, N. J.

**10,000 AGENTS** (1927), \$3.00 thousand. 200 name buyers, \$2.00. Interstate Co., Box 700, Minneapolis, Minn.

**MAILING** list 800 names, \$1. Brennan, 1329 Third Ave., New York.

**400 NAMES** of Small-Town People for Sale. Each name represents a different family. First time offered for sale. Price \$1.00. W. S. Horne, Saint George, S. C.

**1927 RURAL** women's names. 1000 One Dollar. Sheasgreen, P1427 North Penn, Minneapolis, Minn.

## INFORMATION

**GET** expert information, advice or formula, any line. Write H. Newman, Box 343, Madison Square Station, New York City.

**HEIRS** Wanted. "Lost Heirs"—A 92-page book filled with names for lost heirs and missing kin from different parts of the world. Chancery Court of England, Ireland and Bank of England lists included. Price one dollar. International Claim Agency, Dept. 189, Pittsburgh, Pa., U. S. A.

## BUSINESS SERVICE

**REPRESENTATION** in Washington, D. C. Information. Anything. Anytime. Service. Victor Hild.

**\$1.00 BRINGS** inquiring Executives proven Business Analysis Forms assuring less leaks—greater profits 1928. Hundreds used. Mention line Standard Cost, P1427 North Penn., Minneapolis, Minn.

**COLLECTION** Letters series of six firm, friendly appeals \$1. Credit Manager, Box 315, Forest Park, Springfield, Mass.



## TYPEWRITERS AND SUPPLIES

**TYPEWRITERS**—All standard makes. Fully guaranteed. Real bargains. Free trial. Free particulars. Typewriter Bargain House, Ada, Okla.

**UNDERWOOD** Typewriters—only \$3.00 down. Easy monthly payments. Low prices at less than manufacturers, 10 days' free trial. Rebuilt, all worn parts replaced. Just like a new machine. 5-year guarantee. Write for a big free catalog. Shipman-Ward Mfg. Co., 1518 Shipman Bldg., Chicago, Ill.

ALL makes, lowest prices, 5-year guarantee. Several specials. Free illustrated catalogue, Henry Typewriter Co., 217 West 125th St., New York, N. Y.

100 **TYPEWRITERS** Free. Overstocked. Rent Rebuilt Underwood or Remington \$3.00 month. If you pay its value in rental, we give machine free. Particulars free. Pittsburgh Typewriter Exchange, 945 Hersch Bldg., Pittsburgh, Pa.

**TYPEWRITERS**, all standard makes. \$10 up. Fully guaranteed. Free trial. Write for complete illustrated lists. Northwestern Typewriter Exchange, 121 N. Francisco Ave., Chicago.

**TYPEWRITERS**, Radios, Motorcycles, Cars \$3 to \$45.—Knights, 1512 Locust, St. Louis, Mo.

DO you want good live agents—fellows who can get the business? Ask me how others are doing it. I'll gladly render the necessary assistance without cost to you. Address, M. L. Rund, Mgr. Classified Advertising, Popular Mechanics Magazine, Chicago.

## PRINTING, ENGRAVING AND MULTIGRAPHING

5,000 5½x8½ **CIRCULARS**, \$10.00. Printing Samples Free. Good'n Printery, Harrisonburg, Va.

**NEGRAVUREMBOSO** (type embossing) Printed Stationery. For those particular. Samples stamp. Solldays, Knox, Ind.

200 **LETTERHEADS** and 100 envelopes, \$1.00 postpaid. Oberman Company, Box 1288, Chicago.

OUR Low Prices good smiles that never rub off! Printers, Valhalla, N. Y.

**GUMMED** Labels, 500 name, address, 2 lines 35c. 3-55. Catalog. Eastern Label Co., B. Clintonville, Conn.

1000 **BUSINESS** Cards, Envelopes, or Letterheads, \$3.00, 300, \$1.00, 108 Eureka, San Francisco.

150 **BOND** Letterheads, 8½x11, and 150 Envelopes printed to order, \$1.50; 100 Lined Calling Cards, 75c. J. Ferreira, 249 Eugenia St., New Bedford, Mass.

**PRINTING**—Stationery, Circulars, Booklets. Fine work; prices right. Battlefield Press, Gettysburg, Pa. Free battlefield souvenir.

**BLOTTER** Cards—200, two colors, \$1.00; 1000 business cards, \$2.50. Acorn Press, Covington, Ky.

**FREE** Card Case with your name in gold with each order of calling or business cards. Booklet 25c. Samples free. Agents wanted. Good commission. All other printing at the cheapest prices. Mail Order Printing Co., 3702 Oregon, St. Louis, Mo.

1,000—6½ **WHITE** envelopes printed, \$2.35; 5,000—\$8.85. Letterheads, 1,000—\$2.95. Spors Printery, Lesueur Center, Minn.

\$3.00 **DELIVERED**, 500 watermarked bond letterheads 8½x11 and 250 envelopes. Cash. Catalog free. Printing bargains. National Printing, Goshen, Ind.

**IMITATION** Typewritten Letters. (mimeographed); 500—\$3.00; 1,000—\$4.00; printed heads, 20-lb. bond, prepaid; samples, price-list, red stamp. Letter Service, 3414 East 27th, Kansas City, Mo.

**PUBLISH** Your Own Magazine or House Organ. Our standardized service at one-fifth ordinary prices. Samples and particulars free. Evans Printing Company, Grand Rapids, Mich.

**DISTINCTIVE**—Artistic Business Stationery that Creates Confidence. 1,000 Letterheads or Envelopes \$3.00. Samples. Moulton Printing Company, 1410-P East 8th, Kansas City, Mo.

WE print Stationery, Booklets, Catalogs, Circulars. Samples. Commercial Press, Batavia, Ohio.

**MULTIGRAPHING** business correspondence, two dollars thousand. Hammermill letterheads, four dollars. Miscellaneous printing. Mayera Corporation, Monmouth, Ill.

250 **BOND** Letterheads, Envelopes, Billheads, Cards, \$1.35 each. Economic Press, Leonia, N. J.

**QUALITY** Printing! Reasonable Prices! Send for Free Standardized samples and prices. Folders, Circulars, Catalogs our specialty. Earnest Fantus, 525 South Dearborn, Chicago.

500 **HAMMERMILL** Letterheads, noteheads or billheads \$1.95. Samples, Easton Press, Lohrville, Iowa.

## PRINTING, OUTFITS AND SUPPLIES

**PRINT** your own cards, stationery, circulars, paper, etc. Complete outfits, \$8.85; Job presses, \$11, \$29; rotary, \$149. Print for others, big profit. All easy, rules sent. Write for catalog presses, type, paper, etc. Kelsey Company, F-11, Meriden, Conn.

**PRINTING** Presses, type, supplies. List 2c stamp. Bargains. Geo. Foeter, 4342 North Robey, Chicago.

**PRINTING** Outfits—Presses, type supplies, type novelties. Send stamp for catalogue. Model Press, York, Penna.

## GUMMED LABELS

1,000 **PRINTED**; Name, Business, Address, 50c. JBS Co., Box 93, Holyoke, Mass.

## RUBBER STAMPS

**RUBBER** Stamps! Name, Address, two lines 35c; Three lines 50c. Brush & Co., Auburn, Nebr.

## DUPLICATORS AND DEVICES

**STENCIL** Duplicating Machine (Post Card Size) Prints 500 copies of post cards, blotters, notices, etc., with or without illustrations, for 15c. Simple, speedy, guaranteed. Sent on trial. Send for literature and actual samples of printing. Complete outfit \$7.50. Keller Manufacturing Company, Pasadena, Calif.

YOU can make 50 to 100 copies of a letter, notice, etc., at a cost of three cents on a Heyer Quality Duplicator. Write for free trial offer. The Heyer Duplicator Co., 909 Jackson Blvd., Chicago, Ill.

## ADDING MACHINES

**NEW** \$3.50 Automatic Adding Machine. Adds, subtracts, multiplies absolutely accurate. Capacity \$999,999.99. Fully guaranteed. 75,000 pleased users. Makes adding easy, positive, quick. Eliminates mistakes. Saves time. Postpaid \$3.50. Bassett Co., 1458-H Hollywood Ave., Chicago.

**FREE** trial, Marvelous Calculator, Adds, Subtracts, Multiplies. Divides automatically. Work equals \$300.00 machines. Five year guarantee. Price only \$15.00. Write today for free trial offer. Special: \$3.00 Pocket Calculator, only \$2.00 cash. Lightning Calculator Co., Dept. E, Grand Rapids, Mich.

## FOR SMOKERS

**SEND** 10c, silver or stamps, for sample package 20 finest quality cigarettes. Large tin special smoking tobacco sent for 10c. Direct-to-Smoker. French Tobacco Company, Dept. 43, Statesville, N. C.

## GUNS, SPORTING GOODS, ETC.

**ARE** You a rotten shot? Hunting season now open. Our shotgun peep-sight makes you a good shot, \$2.50 postpaid. Booklet "Wing Shooting Made Easy," 10 cents. Wilbur Gun Sight, Box 185, Times Square, New York City.

## FOR THE HOME

**ASTOUNDING** Was the discovery of Valspar, the only varnish known which is not turned white or injured by boiling water. Today this remarkable finish, made in numerous colors as well as the clear varnish, is used to protect and beautify thousands of articles and surfaces, indoors and outdoors, the world over. Ideal for automobiles, machines, radio cabinets, sporting equipment, bicycles, aircraft, furniture, boats, and other surfaces in the shop, store, home, farm and office. Valspar is absolutely waterproof and weatherproof and is not injured even by strong soaps or acids. Prove its extraordinary qualities yourself! Send 20c for 40c sample, stating color desired—Red (light and deep), Green (medium and deep), Blue (light, medium and deep), Vermilion, Yellow, Brown, Ivory, Gray, Orange, Black, White, Mahogany, Oak (light, dark), Walnut, Cherry, Moss Green, Clear. You'll be delighted with Valspar. Valentine & Company, Dept. 3, 456 Fourth Avenue, New York, N. Y.

**GRANDFATHER'S** Clock Works, \$5.00. Build your own case; Instructions free; make good profits selling your friends. Clock works with chimes for old or new cases. Write for full particulars. Clock Co., Ruffner St., Philadelphia.

**CEDAR** chests only \$11.65—"Red-i-Kut" complete with rich copper trim—you assemble and save half—send for pictures. Kuempel Furniture Company, Guttenberg, Iowa.

**TUFTING** Needles 10c. J. J. Whitaker, Dalton, Ga.

**FINE** old maps and Colonial prints—the newest thing for lampshades or framing. Interesting catalogue 6c. Sea Arts Guild, 730-X Winnebago St., Milwaukee, Wisc.

**TABLE** Cover support—Valuable. E. H. Parsons, Box 246, R-3, Pensacola, Fla.

## RAZORS AND BLADES

**CARVERS'** tools, razors, knives, hones, strops of finest American and imported makes. Catalogue Free. Felt's Cutlery Shop, Huntington, N. Y.

**WANTED**—1,000,000 discarded, clean blades. What have you? Send address. We manufacture commercial sharpening machines. Velvet Edger, 6001 Gramercy, Los Angeles, Calif.

**GILLETTE** Style Blades. Guaranteed new. Dozen 38 cents; 3 dozen \$1.00. Wallace Kutz, 132 Chambers, Phillipsburg, N. J.

## BOATS AND LAUNCHES

**BUILD** Your Own Boat using our Knock-Down ready cut materials. 55 models, outboard motor speedsters, runabouts, cruisers, sail, or row. Send 25c for catalog. Brooks Boat Co., Inc., Rust Ave., Saginaw West Side, Mich.

**HUBBELL** Marine Coolers convert Ford engines into marine motors. Booklet free. Ford speedboat, easily built, large blue-print and directions one dollar. C. C. Hubbell, Perry Ave., Norwalk, Conn.

## DIAMONDS, WATCHES AND JEWELRY

**FINEST** Jewelry, Diamonds, Watches. Easy Terms. Acheson Company, 2218 West Cary, Richmond, Va.

## WATCH REPAIRING

ALL makes of Watches repaired by experts. Write International Watch Service, Box 5P, Fordham Station, New York.

## ANTIQUES, WAR RELICS AND INDIAN GOODS

**OLD** Money Wanted. Will pay \$100.00 for 1894 dime, S. Mint., \$50.00 for 1913 Liberty head nickel (not Buffalo). Big premiums paid for all rare coins. Send 4c for large coin folder. May mean much profit to you. Numismatic Co., Dept. H-3, Fort Worth, Tex.

**INDIAN** eagle feather war bonnets only \$10.00. Indian silver bracelets \$5.00. (Send 25c for arrow head, foreign coin and catalogue.) Indiancraft P. Company, 466 Connecticut, Buffalo, N. Y.

**FOR** Dens. Relics and medals from Europe's Battlefields. Illustrated catalogue, 25c. International, 1889 Albany Avenue, Brooklyn, N. Y.

**SEA** Curiosities. 40 All Different \$1.00. Ray Oviatt, Sarasota, Florida.

100 **GENUINE** Indian arrowheads from Arkansas \$4.00 postpaid. H. Daniel, Lamar, Ark.

**SEND** 5c for fine new list Indian relic antique firearms. F. E. Ellis, Webster Groves, Mo.

## PHONOGRAPHS AND RECORDS

**BUILD** Your own phonograph. Catalog and instructions to build new type horn mailed for 10c. American Phonograph Co., 4116 West 24th Place, Chicago.

**RECORDS**, latest selections thirty cents each. Write for catalogue. Pleasing Sound Phonograph Company, 204 East 113th Street, New York, N. Y.

## MUSIC AND MUSICAL INSTRUMENTS

**MUSICAL** Merchandise, instruments, plating, repairing. Guaranteed work. Sternberg's, 59 E. Adams St., Chicago, Ill.

**SONG** Writers, songs published free. Particulars for 4 cent stamps. Premier Music Publishers, 2014 W. Washington St., Chicago.

**FREE**—"Song Writers Guide." Beaver, 622 Goodell, Green Bay, Wis.



**SONG-POEM Writers:** Address Monarch, 236 W. 55th, Dept. 104, New York.

**SONG Poem Writers,** Write Squoia Song-writers' Service, Sherman Branch, Los Angeles, Calif.

**VIOLINS,** Deep, Mellow, Soulful — on credit. Easy terms for wonderful instrument. Get details today. Gustav F. Henning, 2424 Gaylord St., Denver, Colo.

**"MUSIC Composed"** to words. Bauer Bros., (formerly of Sousa's Band), Oshkosh, Wis.

**I WANT Song Poems.** Casper Nathan, 3544 N. Racine, Chicago.

**I BUY, Sell, Publish Songs.** Chester Escher, 455 Wayne St., Jersey City, N. J.

**SHEET-MUSIC,** 10 for \$1.00. For Amateur Teacher or Student. Catalog free. Ferd. Zarb, P. O. B. 18, Sta. D., New York.

**WHITE Songs.** Big money and reputation. Write for information. J. Gordon Pub. Co., 201 N. Hoyne Ave., Chicago.

**CORNETISTS—Trombonists—Saxophonists—Clarinetists.** Get "Free Pointers." Name instrument. Virtuosi School, Buffalo, N. Y.

**SONG Poem Writers—Address** Hibbeler, DL, 2194 No. Keystone Av., Chicago.

**MUSIC** composed to words. Art Melody Co., Art Theater Bldg., Kansas City, Kans.

### PATENT ATTORNEYS

**PATENTS.** Time counts in applying for patents. Don't risk delay in protecting your ideas. Send sketch or model for instruction or write for free book "How to Obtain a Patent" and "Record of Invention" form. No charge for information on how to proceed. Communications strictly confidential. Prompt, careful, efficient service. Clarence A. O'Brien, Registered Patent Attorney, Security Bank Building (directly across street from Patent Office), Washington, D. C. See pages 156 and 157.

**INVENTORS** having ideas to patent: Write for booklet explaining Co-operative Plan for handling your applications. Tells how to sell and safeguard your inventions at lowest cost. Ralph Burch, Patent Lawyer, Jenifer Bldg., Washington, D. C.

**MILLIONS** spent annually for ideas! Hundreds now wanted! Patent yours and profit! Write today for free book—tells how to protect yourself, how to invent, ideas wanted, how we help you sell, etc. American Industries, Inc., 500-Victor Bldg., Washington, D. C.

**INVENTORS—Write** for our Guide Book, "How to Get Your Patent" and Evidence of Invention Blank. Send model or sketch of your invention for our prompt examination and instructions free. Randolph & Co., Dept. 430, Washington, D. C.

**PATENTS.** Trade-marks, Copyrights. Reliable services by an experienced practitioner devoting personal attention to each case. Inquiries invited. References furnished. B. P. Fishburne, Patent Lawyer, 525-A McGill Bldg., Washington, D. C.

**UNITED STATES and Foreign Patents** and Trade Marks; Low rates; easy terms. H. Sanders, Registered Patent Attorney, 7 Rand McNally Building, Chicago.

**ESTABLISHED 1864.** Milo D. Stevens Company. Free Booklet. Patents, Trade-Marks, Copyrights. Offices, Monadnock Block, Chicago; Barrister Building, Washington, D. C.

**PATENTS** Procured, Prompt Service. Personal, careful and efficient service. Highest references. Moderate fees. Send sketch or model for actual search and advice. George P. Kimmell, Master of Patent Law, 54-M Legal Bldg., Washington, D. C.

**PATENTS—Free** advice. Confidential, prompt personal service of Registered Patent Attorney, former Patent Office Examiner. Booklet. Albert Jacobs, 727 Barrister Bldg., Washington, D. C.

**PATENTS, Trade-Marks, Designs.** This firm has 27 years' experience and gives expert personal service at reasonable rates. We properly protect your invention. Write for free information and exact cost of procuring patent before proceeding. John B. Thomas & Co., 902 F St., N. W., Washington, D. C.

**UNPATENTED Ideas** Can Be Sold. I tell you how and help you make the sale. Free particulars (Copyrighted). Write W. T. Greene, 806 Jenifer Building, Washington, D. C.

**LACEY'S Patent Sense.** Valuable book free. See add page 160.

**PATENTS—Write** for our free book, "How to Obtain A Patent" and Record of Invention Blank. Send model or sketch of inventions for inspection and instructions free. Terms Reasonable. See advertisement on page 159. Victor J. Evans & Co., 334 Ninth, Washington, D. C.

**INVENTORS:** Send sketch or model for advice and exact cost of patent. Ask for our Free book: "How to Obtain a Patent." Tells what every inventor should know. Established twenty-eight years. Highest references. Prompt service. Reasonable charges. Chandlee & Chandlee, 414 Seventh, Washington, D. C.

**INVENTIONS** Patented. Send sketch or model for advice and costs. M. Miller, 910 Gee St., Washington, D. C.

**PATENTS.** Booklet free. Highest references. Best results. Promptness assured. Send model or drawing for preliminary examination. Watson E. Coleman, Patent Lawyer, 724 Ninth St., Washington, D. C.

**PATENTS** That protect. Prompt service. Send sketch for free information and opinion. Ehrlich, Garrick Bldg., Chicago.

**"INVENTORS' Guide"** sent free on request; this book contains illustrations of patented inventions and gives valuable information and advice for all who have original ideas or improvements. Frank Ledermann, Registered Attorney and Engineer, Woolworth Bldg., 1712, New York.

**PATENTS** Procured: Trade Marks Registered—A comprehensive, experienced, prompt service for the protection and development of your ideas. Preliminary advice gladly furnished without charge. Booklet of information and form for disclosing idea free on request. Richard B. Owen, 30-Owen Bldg., Washington, D. C., or 41-R Park Row, New York.

**PERCY S. WEBSTER,** 203 Saving and Loan Building, Stockton, California. Long established organization. Patent booklet free.

**LANCASTER and Allwine,** 221 Ouray Bldg., Washington, D. C. "Originators of the Form Evidence of Conception." Before disclosing your invention to anyone send for blank form to be signed and witnessed. Form and patent information bulletin free.

**MONROE E. MILLER,** Ouray Bldg., Washington, D. C., Patent Lawyer; Mechanical, Electrical, Expert. Booklet and Priority Record blank gratis.

**PATENTS** obtained under Cooperative Payment Plan. Write for particulars. W. E. Beck, Registered Patent Lawyer, 951 Jenifer Bldg., Washington, D. C.

**RICHARD E. BABCOCK,** Patent Lawyer, Washington Loan & Trust Bldg., Washington, D. C. Booklet.

**SELL** your invention before patenting. Write for free particulars. W. T. Greene, 801 Jenifer Bldg., Washington, D. C.

**PATENTS—Write** for Instructions. Carl Miller, Registered Patent Attorney (former Patent Office examiner), McGill Building, Washington, D. C.

**INVENTOR'S** Advisor valuable patent book, sent free. Labinere, 3 Parkrow, New York.

### FOR INVENTORS

**PATENTS.** If you have an invention which you wish to patent you can write fully and freely to Munn & Co., for advice in regard to the best way of obtaining protection. Please send sketches, or a model of your invention and a description of the device, explaining its operation. All communications are strictly confidential. Our Hand-Book on Patents is sent free on request. This explains our methods, terms, etc., in regard to Patents, Trade Marks, Foreign Patents, etc. "Scientific American" contains Patent Office Notes, Decisions of interest to inventors and particulars of recently patented inventions. Munn & Company, Solicitors of Patents, 1523 Scientific American Building, 24 W. 40th St., New York City; 524 Scientific American Bldg., Washington, D. C.; 1313 Tower Bldg., Chicago, Ill.; 666 Hobart Bldg., San Francisco, Calif.; 521 Van Nuys Bldg., Los Angeles, Calif.

**PATENTS—Write** to B. P. Fishburne (a South Carolinian), Registered Patent Lawyer, 525-E McGill Bldg., Washington, D. C.

**PATENTS** obtained under Cooperative Payment Plan. Write for particulars. W. E. Beck, Registered Patent Lawyer, 950 Jenifer Bldg., Washington, D. C.

**INVENTIONS** Developed—Your crude ideas developed into practical form for your patent application. Model not necessary. Send rough sketch and description for estimate of cost and advice. 27 years' experience. Albert E. Dietrich, Engineer and Registered Patent Attorney, 621½ Ouray Building, Washington, D. C.

**MAKE** Money From Your Ideas or Patents—Will buy or manufacture on royalty. New ideas or patents. Toys, Novelties, Useful devices, preferably which can be made mostly of small wooden pieces or veneer. What have you? Burnham Lumber Co., Richland Center, Wis.

**PENDING** patents successfully marketed through cooperation. Booklet free. Chartered Association American Inventors, Barrister Building, Washington, D. C.

**I SELL** Patents. Established in 1900. Original methods. Not imitations of a successful Pioneer. Charles A. Scott, 773PM Garson Avenue, Rochester, N. Y.

**PATENTS.** Time counts in applying for patents. Don't risk delay in protecting your ideas. Send sketch or model for instruction or write for free book "How to Obtain a Patent" and "Record of Invention" form. No charge for information on how to proceed. Communications strictly confidential. Prompt, careful, efficient service. Clarence A. O'Brien, Registered Patent Attorney, Security Bank Building (directly across street from Patent Office), Washington, D. C. See pages 156 and 157.

**A UNIQUE** service establishing contact between manufacturers and inventors. We have connections with manufacturers interested in patentable and salable products. We are in excellent position to place meritorious inventions, royalty or outright sale. Complete details on application. Manufacturer's Service Bureau, P. O. Box 182, Station A, Hartford, Conn.

**WE** will buy suitable inventions. Write, Martin Laboratories, Gap, Pennsylvania.

**MANUFACTURER** with national sales connection desires additional items for hardware or automotive trade. Simonsen Iron Works, Sioux Rapids, Iowa.

**INVENTORS—Write** for our free book, "How to Obtain A Patent" and Record of Invention Blank. Send model or sketch of inventions for inspection and instructions free. Terms Reasonable. See advertisement on page 159. Victor J. Evans & Co., 157 Ninth, Washington, D. C.

**LACEY'S Patent Sense.** Valuable book free. See ad page 160.

**PATENTS** Wanted by manufacturers. Send description. Box 128, Dowagiac, Mich.

**WANTED:** Patented articles suitable for sale through retail stores. L. R. Johnson, 296-300 Main Street, Springfield, Mass.

**SELL** your invention before patenting. Write for free particulars. W. T. Greene, 802 Jenifer Bldg., Washington, D. C.

**UNPATENTED Ideas** Can Be Sold. I tell you how and help you make the sale. Free particulars (Copyrighted). Write W. T. Greene, 807 Jenifer Building, Washington, D. C.

**WANTED—Well** equipped steel specialty plant, Pittsburgh district, desires correspondence with concern or individual, having device to manufacture (preferably patented device used by railroads or traction lines), who could utilize part of our facilities under agreeable arrangement. Address P. O., Box 917, Pittsburgh, Pa.

**PATENTS** Procured: Trade Marks Registered—A comprehensive, experienced, prompt service for the protection and development of your ideas. Preliminary advice gladly furnished without charge. Booklet of information and form for disclosing idea free on request. Richard B. Owen, 30-Owen Bldg., Washington, D. C., or 41-R Park Row, New York.

**INVENTORS** Universal Educator—contains 900 mechanical movements; 50 perpetual motions. Tells how to obtain and sell patents. Suggests new ideas. Explains how to select your attorney and avoid patent sharks. Price (revised edition) \$1.00 postpaid. Albert E. Dietrich, 621-Ouray Bldg., Washington, D. C.

**GET** your own patents. Legal blanks, complete instructions \$1. Cutting Sons, Campbell, Calif.

### PATENTS FOR SALE

**PATENT** Rights for sale, Automobile novelty; nothing out like it. Robt. Schulz, 222 Bay St., Saginaw, Mich.



**OUTRIGHT** or royalty. U. S. patent 1603923, emergency overshoot, fits in vest pocket. Retail 25c; small cost. Sold through drug department, ten cent stores, vending machines. Unusual opportunity someone to make fortune on article reaching every one at small cost. Write Harry Powers, 310 South Michigan Avenue, Chicago.

**ROYALTY**—Headlight Dimmer—Over bulb. Automatic, different, a protection and novelty. For particulars write Hill & Meyer, 321 S. Osage, Wichita, Kans.

**METAL** Specialty keeps Hat from blowing away. Louis Pichler, 670 E. 102, Cleveland, Ohio.

**MECHANICAL** Box Car Seal, which can be manufactured cheap and will stand the test. Patent 196,238. Michael Rebarchak, 503 Rush St., Chicago, Ill.

**INVENTIONS** Safely Sold Before Patenting. Secure your own Patent. Patents Payment Plan. Patent Sales Co., 415 American Bank Building, Kansas City, Mo.

**AUTOMOBILE** Essential—possible market for 200,000,000 repeatedly. Wm. Bryan, 11 Bentley Ave., Jersey City, N. J.

**AUTOMOBILE** Safety Signal of Real merit. Straight ahead, Right and Left Turns. Can be seen from both oncoming and traffic in rear. Also from side. Want someone to take on royalty basis, or will sell outright. C. H. Williamson, 1014 West 80th St., Los Angeles, Calif.

**OUTRIGHT**: Brake for car trucks. Fluid pressure against piston associated with axle causes cushion action. Geo. Gates, 1733 So. Broad St., Trenton, N. J.

**FOR** Sale—Electric Handsaw, Reciprocating Mitre Gauge and Ripping Guide Combined. Patent Appl. No. 127853, \$10,000 Cash or Royalty. Fred L. Campbell, 1732 No. Robey, Chicago.

**OUTRIGHT**—Newly patented safety razor. John Erikson, 5050 Fourth Ave., Detroit, Mich.

**PATENTED** Picture Book—Tells story of successive events in their proper sequence, using motion pictures. Improved process of telling a story or teaching a game. Royalty. Merriam, 35 Broad St., N. Y. City.

**UNITED STATES** and Canadian Patents, Cash or Royalty. My Patents, Spring Pool Cue, E. S. Coyle, Nanton, Alta., Canada.

**ROYALTY**—Telephone Note-Rack and Pencil Holder, recently patented. Also adaptable as an advertising novelty. Theo. V. Breyer, New Philadelphia, Ohio.

**FOR** Sale—Patent on simple and novel Electric Heater, for heating air in dwellings, etc. Full of possibilities. May be readily supported beneath usual hot-air registers. A Genuine Bargain price for American Rights, outright or royalty. For further particulars address L. Joseph, Lévesque, Bagotville, Que., Can.

**FOR** Sale or Royalty—Buck and wing darning toy (entirely different). Best offer accepted. A. G. Balbridge, Fulton, Ky.

**ADVERTISING** Novelty. Milk Bottle Cap and Coin and Ticket Receipts. Made of paper. Outright or royalty. Edw. D. Smith, 1057 W. 22d St., Erie, Pa.

**PAT.** 1,626,503—Power-operated Hand-gaws. Cash or royalty. Write to Felix Bjorklund, 224—4th St., Fairport Harb., Ohio.

**OUTRIGHT**, reasonable, p. joint for bath tubs, basins, toilets, sinks. Robert Dawson, Fairview Cottage, Skillman, N. J.

**WHY** let your patents lie idle? Tell our two million five hundred thousand readers about it! The majority of our readers are especially interested in new ideas and inventions. Ask me to tell you how other inventors successfully sold their patents. M. L. Rund, Mgr., Classified Advertising, Popular Mechanics Magazine, Chicago.

### ELECTRICAL

**ELECTRICAL** and radio apparatus. Bargain list for Experimenters. Nelson Huff, Confluence, Ky.

### SURVEYING INSTRUMENTS

**LARGEST** stock of new and used surveying instruments in the country direct from factory. Satisfaction guaranteed or money refunded. Wissler, 619 N. Broadway, St. Louis, Mo.

### MODELS AND MODEL SUPPLIES

**MODEL** and Experimental Work at lowest cost. Wagar Model & Machine Works, 115 So. Clinton Street, Chicago.

**SHIP** model plans, supplies, books, fittings. Interesting catalog of Sea Things, 66 Sea Arts Guild, 730-M, Winnebago St., Milwaukee, Wis.

**PATENTS**. Time counts in applying for patents. Don't risk delay in protecting your ideas. Send sketch or model for instruction or write for free book "How to Obtain a Patent" and "Record of Invention" form. No charge for information on how to proceed. Communications strictly confidential. Prompt, careful, efficient service. Clarence A. O'Brien, Registered Patent Attorney, Security Bank Building (directly across street from Patent Office), Washington, D. C. See pages 156 and 157.

**SHIP** Models: Complete Parts and Blueprints for Chinese Junk, Venetian Sailboat, Nile Boat, or Viking Galley, 606 Postpaid, Casson-Craft, Dept. B, Framingham, Mass.

**LET** our experience be your guide. Models that are models; Tools and equipment for economic manufg. Patterns of all types; manufacturing in all branches. Satisfaction guaranteed. United Machinery Company, Cincinnati, U. S. A.

**MODEL** Steam Locomotives and Stationary Engines. List, 10c. Frank Birch, General Delivery, Highland Park, Mich.

**CANADIAN** Modelmakers. Blacks, Dead-eyes, Ship-fittings. Stamp brings circular. Anderson, 44 Butterworth Ave., Toronto, Ont.

**WE** make models, dies, manufacture your invention, help perfect it. Do experimental work. Free information. Strand Mfg. Co., 644 West Randolph, Chicago.

**SHIP** Model Fittings: Send stamp for booklet. A. J. Fisher, 1002 Etowah Ave., Royal Oak, Mich.

**SPECIAL** machine builders, tool and die makers, inventor's models production work of all kinds. Dept. L. Quality Hardware & Machine Co. Ravenswood and Thorndale Avenues, Chicago, Ill.

**WE** make working models for inventors and do experimental work and carry a complete stock of brass gears and model supplies. Send for catalogue. The Pierce Model Works, Tinley Park, Ill.

**MODELS**, Tools, Dies and General manufacturing. Logan Machine Co., 652 W. Lake, Chicago, Ill.

**EVERYTHING** for Ship Models. Catalog, dime. Roy Hancock, 323 Douglas Ave., Portsmouth, Va.

**WOODS** for Models, Scroll Work and inlaying. George Wild, 510 East 11th St., New York.

**THE** Modelmaker, a magazine for all interested in making working models, boats, etc. Sample 10c. Modelmaker, 122 Liberty St., New York.

**MODEL** steam engines and boilers. Boat and boiler fittings. Send 10c stamp for catalog. Refunded with first order. Model Machine Shop, 212 Price St., Rahway, N. J.

### MANUFACTURING

**COMPLETE** Manufacturing. Dies and stampings and Special Machinery. Our Engineering department will design and perfect your article; our tool room will tool it for production. Our shop will make any quantity you may need. Models made if necessary. Barth Stamping & Machine Company, 3816 West 24th St., Cleveland, Ohio.

**CONTRACT** Manufacturers—Dies, Stampings, Models, Castings and Forgings Machined. Automatic Screw Machine Product. Screw Machine Specialty. Susquehanna Street, Pittsburgh, Pa.

**SPECIAL** Machinery or parts, dies, tools, metal specialties, models, special gears, stock gears and model supplies. Send for Catalogue. The Pierce Model Works, Tinley Park, Ill.

**PATTERNS**, wood and metal. Models, tools and dies. Brass, bronze, aluminum and iron castings. Screw machine work, production work of all kinds. Write Modern Machine & Pattern Co., Terre Haute, Ind.

**WANTED** to manufacture on royalty basis—some mechanical appliance or automobile accessory. Cincinnati Automatic Machine Co., Cincinnati, Ohio.

**WANTED**, to manufacture special Trucks and Machinery. Get our prices. Gallagher Bros., Uhrichsville, Ohio.

**INVENTIONS** developed, manufactured and packed ready for market. Models, dies, special machinery. Established 20 years. Swanberg, 5121 N. Kildare Ave., Chicago.

**MANUFACTURING** Models, Dies, Stampings, Brass Work, one or thousands. Baum's Metal Specialties, Kansas City, Mo.

**WIRE** goods made to order. Cooley Mfg. Co., 530 N. Western Ave., Chicago.

**STAMPING** and light manufacturing. Acme Tool Co., Mason City, Ia.

### MACHINERY, TOOLS AND SUPPLIES

**NO. 60** Heald Cylinder Grinder, \$375.00; Marvel Cylinder Boring Machine, \$115.00; 16x9' Chard Engine lathe, latest type, \$325.00; No. 41 Becker Milling Machine, \$165.00; No. 1 Cincinnati Milling Machine, with dividing heads, \$285.00. Terms if desired. Send for catalog. Cincinnati Machinery & Supply Co., 27 West Second St., Cincinnati, Ohio.

**START** business of your own, small investment required, doing nickel, copper and silver plating. This work in big demand. Information free. Electro Platers Supply Co., 547 Considine Ave., Cincinnati, Ohio.

**5 HP MOTOR** \$50.00; Air Compressor \$25.00; Emery Grinder \$20.00; 15 HP Gas Engine \$125.00; One Ton Electric Hoist \$250.00; Lathe and Drill Chucks and Bench Vises; Cincinnati Automatic Machine Co., Cincinnati, Ohio.

**18x6 LATHE**, 20 drill, motor, grinder, shafting, \$225.00. Particulars. Buzzell Co., 200 Congress St., Boston.

**HERE** is your opportunity to obtain a real good buy on electric grinders and buffers, which are, full ¼ HP, 110 volt, 60 cycle, single phase, AC, enclosed dust-proof motor with cord and plug, emery wheel on one side and buffer on the other, at a low price of \$19.75 each. General Distributing Co., Duluth, Minn.

**60 HEALD** Cylinder Grinder; Nice condition, \$350.00. Lucas & Son, Bridgeport, Conn.

**SPEED** Lathe \$10.50 complete, 7 inch swing, 3 speed cone. Jefferson Mfg. Co., Fairfield, Iowa.

**OTHERS** have successfully sold their machinery through our columns—so can you. Ask me for proof. M. L. Rund, Manager, Classified Advertising, Popular Mechanics Magazine, Chicago.

**CONCRETE** Building Block Machine and Molds. Catalogue free. Concrete Machine Co., 5 N. Main St., St. Louis, Mo.

**MOTOR-DRIVEN** Engraving Machine with full equipment, practically new. Will sacrifice for \$75.00. Almost automatic in operation. Theo. Shaw, P. O. Box 7, Woonsocket, R. I.

**HYDRAULIC** Garage Press easily made; for particulars address Box 134 Ft. Collins, Colo.

**BUILD** Your own buzz saw, ¼" Arbor \$3.00 Ball bearing, \$5.00. E. A. Pophal Mfg. Co., Wausau, Wis., builders of Bench Saws, Band Saws, Lathes and Jointers. Write for catalog.

### ENGINES, MOTORS AND DYNAMOS

**NEW** ¼ horse 110-volt alternating motors \$5.50 each. Also other bargains all sizes direct and alternating. Write for prices stating size and kind of current. Queen City Electric Co., 1736 Grand Ave., Chicago.

**GUARANTEED** Alternating current new single phase motors. ½ h.p., \$26.00; ¾ h.p., \$35.00; 1½ h.p., \$55.00. Many other bargains. Tell us your needs. Send for new price list. Hyre Electric Company, 615 NK So. Dearborn St., Chicago, Ill.

**BARGAINS**—Motors, machinery. Wash. machine motors, \$1.55; ½ h.p., \$17.50; electric drills, \$14.75; electric grinders, \$7.45; farm plant motors, \$3.45; generators, \$15.95; electric vacuum cleaners, \$8.95. 100 other bargains. Send for new bargain bulletin, No. 633. Acme Tool Co., 627 Washington St., Chicago.

**APPROXIMATELY** 1/20 H. P. Universal Motor, 110 volt, \$6.50. Store price, \$12.00. Never been used. Nickel plated. Lionel Perry, P. O. Box 126, Woonsocket, R. I.

**NEW** 1-6 H.P. A.C. Washing and Ironing Machine motors, \$6.00, while they last. Elle & Co., 1018 W. Lake, Chicago, Ill.



MAKE your own—half and one horse-power electric motors. A. C. Induction motor model shows winding connections plain sight. Quick easy way. Gaines Bros., Box 481, Gainesville, Texas.

STEAM Engines—one H.P. \$18.00; 1/2. \$12.00. James Chambliss, Bessemer, Ala.

GOVERNORS for all auto engines where used for power plants. Send for circulars. A. C-S Governor Co., Springville, N. Y. or 215 W. Manchester, Los Angeles.

FOR Sale—4 K.W., 32 Volt, Robbins & Myers D. C. generators at 1500 R.P.M. with pulley, \$20.00 each. A. H. Nimmo Electric Co., 856 Michigan Ave., Detroit.

WRITE for bargain catalogs on electric motors, generators, electric drills, etc. Do not buy, consult us first. General Distributing Co., Security Bldg., Duluth, Minn.

MOTORS—New GE 110 or 220 volt 60 cycle Single Phase 1/2 HP. \$11.90; 1/4 HP. \$28.53; 1 HP. \$38.50. Mail \$3 check or money order. We will ship COD anywhere. Motor Specialties Co., Crafton, Penna.

#### BLACKSMITHS

BE a Master Mechanic Blacksmith and Expert Tool Maker and Dresser with colored tempering charts. Price \$1.00. Valuable samples free. W. M. Toy, Sidney, Ohio.

#### BENDING MACHINES

THE Famous Hossfeld "Wrenchless" Universal Iron Bender is the last word in bending machines. Bends metal, cold or hot, into most any conceivable shape, including Eye Bolts and Automobile Spring Eyes. Bends up to 1" bars or 1 1/2" pipe cold. Thousands in use by all classes of trade, from the smallest shops to the largest railway systems. Write for circular and prices. Hossfeld Mfg. Co., Winona, Minn.

#### FOR SALE—MISCELLANEOUS

PHONOGRAPH, Practically New; Improved Tone Chamber. Write, Mengis, Waterville, Minn.

ADDRESSOGRAPHS. Letter Folders, Multigraphs, Envelope Sealers, Duplicators, less than half price. Guaranteed. Pruitt Co., 117 No. Market, Chicago.

#### WANTED—MISCELLANEOUS

MAIL us your discarded Jewelry, Gold, Crowns and Bridges, Watches, Diamonds, Silver, Platinum and old False Teeth. Money promptly mailed. Goods returned if offer refused. United States Smelting Works (The Old Bellable), Dept. 71, Chicago.

#### REAL ESTATE, FARM AND ORCHARD LANDS

122 ACRES, Riverview Home, \$40 Weekly Income—All \$3800. Estimated 250,000 ft. lumber, good 6-room house worth \$3000, A-1 bldg. Price includes team, 4 cows, sow and pigs, poultry, implements, crops; part cash. Details pg. 89 big illus. Catalog Free. Strout Agency, 255-P 4th Ave., New York City.

REAL estate appraisals any place Nebraska \$5.00. State Bureau, Box 709, Omaha.

\$5 MONTHLY Secures 5 Acres Rich "Blueberry" Land, Near Baker, Florida. Best Paying Crop. Only \$250. Geo. D. Williams, Mt. Vernon, Ill.

\$10 IS all I ask down on 20 acres in Mich. Potato Belt. Very easy terms. Near Markets, lakes and streams. Write for particulars now. G. W. Swigart, P1276 First Nat'l Bank Bldg., Chicago.

COME to Virginia where seasons are right. Buy direct from owner. Write for list. Chamber of Commerce, Emporia, Va.

OREGON Homesteads (late opening) offer exceptional opportunities. Map and details \$1.00. Frank Thompson, Sheridan, Oreg.

SELL your property quickly for cash, no matter where located. Don't pay big commission. Particulars free. Real Estate Salesmen Co., Desk B, Lincoln, Nebr.

KEY to Real Estate Success. The Real Estate Educator, new, 1927 edition. Most valuable work on real estate selling, buying, advertising, appraising, investigating, leasing, sub-letting, transferring, insuring, mortgaging, etc., in simple, practical, usable form. Based on the experience of leading realtors. Pay postman \$2 and postage when he delivers the book. Popular Mechanics Press, Room 908, 200 E. Ontario St., Chicago.

PECAN-Orange-Fig Groves "On the Gulf" Monthly payments. Guaranteed care. Big, quick returns. Suburban Orchards, Dept. M, Biloxi, Miss.

OZARKS—10 acres near White River and proposed power dam, \$100, \$5 monthly. Alvin Zimmerman, 1802 N. 5th, Kansas City, Kans.

FARM—Ozarks, 40 Acres; House, Spring, Fruit, Fencing; \$500, \$50 Down, \$10 Month. Box 198, Mt. Vernon, Ill.

#### SEEDS, PLANTS, TREES, ETC.

BIG money growing Ginseng. Booklet on Golden Seal 10 cts. W. N. Long, Florence, Ky.

#### TREE KILLERS

CONDENSED Bo-Ko, enough to kill 100 Trees, \$2.00. Bo-Ko Co., Jonestown, Miss.

#### HONEY

FANCY White Clover Honey, 5-pound Pail, \$1.00; 10, \$1.75. Pay when received. Agents Wanted. Wisconsin Honey Producers, Sheldon, Wis.

#### ROOTS AND HERBS

MEDICINAL Herbs, Roots, Barks, Flowers, Etc. Imported and domestic. Over 1,000 varieties. Valuable Herb Doctor Book containing over 250 recipes and other information, 10c (coin). Shawnee, 145 West 112th Street, Chicago.

HERB Doctor Book—10 cents. 250 receipts for making herb medicine. Hazard Company, Box 1, Vanderveer Park, Brooklyn, N. Y.

#### DOGS AND PETS

FOR Sale—Long eared Arkansas hounds at reduced prices, long trial and guaranteed, 30 years dog experience, list and reference free. W. B. Caraway, Alma, Ark., U. S. A.

WANTED—Guinea pigs. J. Walter Brendle, Littlestown, Pa.

SPRINGER Puppies—very popular hunting and companion dogs; champion bloodlines, great hunters; puppies that will help you in hunting water-upland game. For prices delivered to you, write Alvin Skretteberg, Shadepill, So. Dak.

BEAUTIFUL Newfoundland puppies, pedigree. None better. Dime brings photos. Lone Cedar Farm Kennels, Hartsville, Ind.

FOR Sale—My A 1 Coonhound Lead. "Good as goes into the woods." Priced right for trial. C. Hicks, Sedalia, Ky. (E120).

FOR Sale. Minks, squirrels, raccoons, foxes, ferrets, muskrats, ginseng, rabbits, skunks, wolf pups, opossums. B. Tippman, Caledonia, Minn.

HUNTING Hounds Cheap; Trial. Dixie Kennels, C2, Herrick, Ill.

#### RABBITS

MAKE big profits with Chinchilla Rabbits. Real Money-makers. Write for facts. 852 Conrad's Ranch, Denver, Colo.

#### PERSONAL

THE Face is the most interesting story. Learn how to read it. Send ten cents coin and two-cent stamp for my booklet, "How to Read Character From the Face." Josef J. Brabender, Port Washington, Wis.

MAGIC Incense, \$1.00; Personality Influence Perfume, \$2.00; Yoga Development, \$5.00. Hindu Publishers, Garrick Building, Chicago.

THE Age of the Air is Here. For reliable information on both airplane building and flying we recommend "Aeroplane Construction and Operation," by Rathbun. All features of construction treated. Send no money. Pay postman \$2.50 and postage. Popular Mechanics Press, Room 908, 200 E. Ontario St., Chicago, Ill.

THE "Sanatory Physician" an 80 page book teaching natural laws of health, also suggests reliable self-treatment of disease. Appreciated by every reader. Mrs. S. Denver, Colo., says: "I owe my regained health to that dear little book." Postpaid 20c, address, Author, Box 437, Seattle, Wash.

TELL Fortunes With Cards — Become popular. Mystify, entertain others. Easy to learn; easy to do. New book of complete, easy instructions—also Dream Dictionary—all for 10c. G. Elsea, Bowling Green, Ohio.

QUESTIONS answered 25c coin. Languages translated. Fred. Klotz, Reading, Pa.

TOBACCO or Snuff Habit Cured or no pay. \$1.50 if cured. Remedy sent on trial. Superba Co., N3, Baltimore, Md.

GET a better grip on mathematics. Write for "Mathematics for the Practical Man." "Common sense methods remove mystery and difficulties. Algebra and calculus made simple. Assuming knowledge limited to arithmetic you quickly and easily gain working knowledge of algebra, geometry, trigonometry and calculus. Pay postman \$1.50 and postage when he delivers package. Popular Mechanics Press, Room 908, 200 E. Ontario St., Chicago, Ill.

#### MISCELLANEOUS

10c PUTS name on Mailing List. (Receive Samples—Publications—Propositions.) National Mailing Service, 6135 Chabot, Oakland, Calif.

BRIEF Numerals. Send for samples. Address Hyrum Thomas, Glenwood, Iowa.

CANE Becomes Ukulele by Removing Secret Cover, \$3.50. Broadway Music Co., Bayonne, N. J.

YOU Are Wanted to Resilver Mirrors at Home. Immense profits plating autopaarts, tableware, etc. Write for information. Sprinkle, Plater, 288, Marion, Ind.

SHOOTING pigeons 50c per pair; prompt shipment. J. Walter Brendle, Littlestown, Pa.

ATTENTION Builders and Cement Workers—Diamond granite a new invention. Sparkles like diamonds. Harder than genuine granite. Cheaply manufactured. Sample 24c—Complete instructions \$2.00. Guaranteed. F. D. Gibson, 8 Eden Park Terrace, Cincinnati, O.

FREE Sample — Maltona, Wonderful vitamin drink. List other Health Foods. Natural Food Products Co., Dayton, Ohio.

AMATEUR Cartoonists: Make money in spare time with new cartoon selling plan. Write Smith's Service, PM1194, Wenatchee, Wash.

MEXICAN Made pistol holsters, cartridge belts, lartats, horse hair articles; rattlesnake belts; list free. Tex-Mex Leather Co., 309 Esperson Bldg., Houston, Texas.

CASH Paid for Butterflies, Insects. See Sinclair Display Advertisement on page 24.

YOU can emboss your stationery as needed. Perfect work guaranteed. Simple—inexpensive. Miller Sales Company, Dept. E, Lexington, Ky.

PRINT 250 Signs or pictures an hour without press, type or machinery. Sample and particulars 10c. Straco, 1013, Springfield, Ohio.

THE Charleston Flapper, newest joke novelty with a real kick, 10c. Bowman Novelty Co., Racine, Wis.

MICROFLOSCOPE—Examine bugs, insects, etc. \$1.00. Sepeco, 4518 North Central Park Ave., Chicago.

HOMEOPATHIC and Biochemic preparations sent postpaid to all parts of the world. Manual and booklets free. Halsey Bros. Co., 645 St. Clair St., Chicago, Ill. Established 1855.

WEEDS—Cut them with cutter bar on Shaw Garden Tractor. Also plows, cultivates and runs belt machinery. Low prices. Immediate delivery. Shaw Manufacturing Company, Department C, Galesburg, Kans.

CUTS anybody can make. Simple, cheap process. \$1. Specimens, particulars. 2c stamp. M. Day, Windfall, Ind.

AERONAUTICS! "Aeroplane engines in Theory and Practice," by Rathbun, describes engines fully. Includes all makes. For mechanic, builder and flyer. Send no money. Just order on a postal. When postman hands you book, pay him \$2.50 and postage charges. Popular Mechanics Press, Room 908, 200 E. Ontario St., Chicago, Ill.

TELL an army of 3,000,000 live readers all about your offer! If you have anything to sell, buy or exchange, or if you have any reasonable proposition, tell our readers all about it—they'll respond quickly. Our booklet "How to Create More Business" contains some very interesting, helpful facts. Write today for your copy—it's free. M. L. Rund, Manager Classified Advertising, Popular Mechanics Magazine, 200 E. Ontario St., Chicago, Ill.



# How I Made \$100,000 With a "Fool" Idea

*Learn my money-making secret—Be a Real Estate Specialist—Start at home, in your spare time—Use my successful System—Free book shows how*

"IT'S a fool idea!"

That's what my friends said, when I told them about my idea for starting a real estate business "on the side."

But with that "fool" idea I made more than one hundred thousand dollars net profit.

No matter who you are, where you are, or what your sex or present occupation, if you want to do what I did—if you want to get out of the \$25-a-week crowd and build up a high-class, money-making, business of your own—right at home—in your spare time—send at once for my free book which opens wide the door of the biggest and best money-making business opportunity you ever heard of in your whole life.

## Use My Successful System

When I started in real estate, I tossed overboard all the hit-or-miss, haphazard, rule-of-thumb methods of the past, and put into operation a system of my own which is as superior to the old way as the modern Mazda lamp is superior to the tallow candle of our forefathers.

With little education—no experience—no influence—and less than five dollars capital—I started in my spare time and met with instant success.

If you want to follow in my footsteps—if you want to use my amazingly successful system—send for my free book now. It tells how I succeeded—how I have helped other men and women win big success—how you, too, can succeed—how you can have a splendid business of your own and make more money than you ever made before.

## A Wonderful Business

Real estate—conducted my way—is a great business. It is as



A well-known cartoonist's conception of my idea

permanent as the earth itself. It is getting bigger and bigger as the country grows. It doesn't require years of study to learn like most other businesses and professions. It offers enormous earnings to ambitious men and women. Users of my system are making \$1,000—\$5,000—\$10,000—on single deals—as much as the average man gets for months and years of hard work. And the business is practically unlimited. Ten million properties are now on the market for rent, sale or exchange. And you can start with little or no capital—right at home—in your spare time. I did. So did others. So can you. My free book tells you how.

## Read These Records

Here are just a few brief extracts from the many letters received from happy users of my money-making real estate system:

"Made \$5,500 on first deal after getting your system."—Mrs. Evalynn Balster, Chicago. (Former School Teacher.) "Sold a lot by your methods in less than one hour and my commission was \$800."—J. A. Ferguson, Fort Lauderdale, Fla. (Former Dry Cleaner.) "Sold over \$100,000 worth of property my first year with your methods."—H. D. Van Houten, Passaic, N. J. (Former Grocery Clerk.) "Have sold thousands of dollars worth of property your way. Have deals that will go beyond the \$300,000 mark."—Carrie Marshall, Ocean Springs, Miss. (Former Housekeeper.) "My first day's work in real estate netted me \$435. I recommend your system to anyone wishing to get into a pleasant and profitable business."—F. B. Bennett, San Diego, Cal. (Former Planing Mill Man.) "Have sold one \$5,000 lot and 3 houses so far, with your system."—Mrs. B. H. Morehouse, Brooklyn, N. Y. (Former Housewife.)

These are just a few samples of success that you will read about in my free book. Get it. Read it. Follow its instructions. Make big money my way.

## Get Free Book Now

My big, new, illustrated book is filled with fascinating facts about my kind of a real estate business—what I did—what others are doing—what you can do.

Mail coupon right now and get this valuable, money-making information free. It doesn't cost you a nickel to find out what this book can do for you. So, act at once. You will never forgive yourself if you turn your back on this unusual chance to win big, business success. Address PRESIDENT, American Business Builders, Inc., Dept. 44MM, 18 East 18 Street, New York.

PRESIDENT,  
American Business Builders, Inc.  
(Authorized Capital, \$500,000.00)  
Dept. 44MM, 18 East 18 St., New York, N. Y.

Mail me your free book telling how you made \$100,000 in a new kind of real estate business—how others are making big money—and how I can do the same.

Name.....

Address.....

City.....State.....



# New- Amazingly Easy Method of Learning Practical ELECTRICITY

**IN 12 WEEKS -  
NO BOOKS  
NO LESSONS -  
Not a Correspondence  
School**

Even if you haven't had an advanced education, and know nothing about electricity, you can learn Practical Electricity in twelve short weeks. That's only 90 days. There's something to think about! Ninety days from the time you enroll in the new \$2,000,000 Coyne Electrical School, you will come out a trained man capable of earning a good salary, with an assured future.

**Absolutely no Books or Lessons**  
My new sure method is amazingly easy. No books; no lessons—you learn by *doing*, in the great roaring Coyne Shops. You wind real amateurs; you build real switchboards; you wire real houses, you build real batteries—everything is real including the aeroplane, tractor and automobile motors which you work on. And all this time an instructor is right by your side—showing you—move by move—step by step until NOTHING on earth could keep you from learning.

**Send For My Big Book—FREE!**  
I want you to fill out the coupon below and mail today. Then I'll rush my big 56 page book to you—containing 150 photographs, which will give you some idea of this mighty school. I'll help you find part-time employment while you are attending, and from then on throughout life, you'll get the benefits of the lifetime employment service. Get into the big pay class. Coyne Graduates have no trouble making good. Coyne graduates get jobs leading to \$50 a week and up, many go in business for themselves and become independent.

## COYNE ELECTRICAL SCHOOL

*Not a Correspondence School*  
**H. C. Lewis Pres., Dept. 87-35 Established 1899  
500 S. Paulina St., Chicago, Ill.**

Send Coupon  
Today!



**Mr. H. C. Lewis, Pres. Dept. 87-35  
COYNE ELECTRICAL SCHOOL,  
500 S. Paulina St., Chicago, Ill.**

Dear Mr. Lewis: Without obligation send me your big free catalog and all details of Free Employment Service, Radio, Aeroplane and Automotive Electrical Courses and how I can "earn while learning." I understand I will not be bothered by any salesman.

Name.....  
Address.....  
City..... State.....

**Win a  
NASH  
Sedan**



**or  
\$1400.00  
in cash**

Someone who answers this ad will receive a fully equipped De Luxe Model Nash Sedan, or full value in cash if preferred (\$1,085.00). In addition to this Nash Sedan we give away, a latest model Chevrolet Coach or its cash value (\$595.00), a Brunswick Panatrophe Phonograph, a Six Tube, Single Dial Freshman Radio, a Corona Portable Typewriter—many other valuable prizes and Hundreds of Dollars in Cash.

### Solve This Puzzle

The numbers in the squares to the right spell two words. The alphabet is numbered. A is 1, B is 2, C is 3, etc. Can you make out what the two words are? When you do this, send me your answer right away. It may mean winning the Nash Sedan or \$1,400.00 in cash.

### \$315.00 Cash For Promptness

In addition to the two automobiles, the many other valuable prizes and Hundreds of Dollars in Cash, we are also offering a Special Prize of \$315.00 in Cash for Promptness. First prize winner will receive \$1,400.00 in cash, or the Nash Sedan and \$315.00 in cash. In case of ties duplicate prizes will be awarded each one tying. Get busy right away. Solve the puzzle and send me your answer together with your name and address written plainly. **EVERYBODY REWARDED.** Address **M. L. BOEING, Dept. 1778  
323 So. Peoria St., Chicago, Ill.**

14  
1  
19  
8  
19  
5  
4  
1  
14

## ANOTHER MILO STAR PUPIL

Mr. Manger is one of the many recent star pupils of the Milo Methods. Did you ever see a more evenly-developed physique? We know you haven't. But Mr. Manger has enormous strength as well as a superb build. And HE ATTRIBUTES HIS PHENOMENAL SUCCESS TO THE MILO BAR BELLS and the Milo Methods of using them.



A. MANGER

Mr. Manger is one of the thousands that have been developed into star pupils of superb physiques and enormous power by the Milo Methods and Bar Bells.

The following will give you an idea of the advancement he has made. When he started using Milo Bar Bells, he weighed only 130 pounds. His present weight, stripped, is 183 pounds. A gain of 53 pounds of solid muscles. Our expert in charge of all pupils took charge of Mr. Manger's training and with this personal service, which every Milo pupil is entitled to, he became a national champion in just sixty days. Mr. Manger's Two Hands Clean and Jerk Lift of 260 pounds is a national record for his weight.

We could more than fill the rest of this page with the names of Milo Pupils who have not only achieved great success in getting a wonderful build, but who have also built up a reputation for themselves so great that you would remember each name as having done great things in the strongman game. **IF YOU WILL BECOME A MILO BAR BELL OWNER YOU, TOO, CAN BECOME A MILO STAR.** USE THE COUPON BELOW FOR A FREE MILO BOOKLET—MORE PUPILS, PRICES AND TYPES OF BELLS ARE SHOWN THEREIN.

The Milo Bar Bell Co.,  
Dept. 602, 2747 N. Palethorp St.,  
Philadelphia, Pa.

Gentlemen:  
Please mail me, without charge or obligation on my part, your free booklet, "Health, Strength and Development and How to Obtain Them."

Name.....  
Address.....  
City..... State.....



# Money and Thrills

Aviation as a business is filled with a thousand thrills. It is the great modern romantic adventure — the glory of the air — pioneering — seeing the world — meeting the finest people in all lands. It is work with a kick in it. And with the whole character of the industry on a high



© Underwood & Underwood

# Both Big in Aviation

plane, it pays *big*.

You can learn the fundamentals of Aviation at home, in your spare time—no interference with your present employment. Our free book tells you how you can get ready to cash in on the rapid growth of this rich new field of endeavor. Send for it now.

## Many Opportunities—Easy to Start



Walter Hinton, First Trans-Atlantic Pilot, N. C. 4 fame, President of Aviation Institute and prominent in the development of aviation.

The fastest growing industry in the world is hungry for men and women who know its fundamentals. There are over 4,000 airports in America—6,000 privately owned planes—20 air mail lines—American Express air service operating — Guggenheim Foundation financing passenger lines—trans-oceanic service coming—giant factories building planes and parts. Big pay in the air and on the ground.

No experience needed to

take course. No previous training in mechanics. Lieut Walter Hinton and his staff guide your instruction —it is simple, workable, practical —easy to understand.

If you wish to become a pilot after you graduate, flying instructions are given at our own flying field here in Washington or at other fields in all parts of the United States, at reasonable rates, in cooperation with the Institute.

*First flight free to every graduate.*

**FREE**

This book tells all



## AVIATION INSTITUTE OF U. S. A.



Get all the facts about the Institute course and the way it leads to Opportunity. Do it now. Send the coupon today without fail.

Aviation Institute of U. S. A., Suite 411  
1115 Connecticut Ave., N. W., Washington, D. C.  
You may send me without obligation a Free copy of "Aviation and You."

Name .....

Age (Not under 16) .....

Street .....

City ..... State .....





**Before Kenneth McCarty  
Mailed that Coupon**

**He was an  
\$18<sup>00</sup> Clerk~**

**Today  
His  
Income  
is  
\$85<sup>00</sup>  
a Week**



After completing the course he wrote us:

"Yours is the finest course ever presented for the Tenor Banjo. Before I enrolled with you, I knew nothing whatever about music. I was earning \$18.00 weekly clerking in a store. Little did I realize the opportunity that had come. I took up the course just for fun. But here I am playing in one of the best orchestras in Western Michigan and making \$85.00 a week. Your course and your kind cooperation have made me a professional Tenor Banjoist." Kenneth McCarty, Parkview Hotel, South Haven, Mich.

**Play for Fun or \$5,000 a Year**

Whether a salary of \$65 to \$100 a week—or spare time playing at \$5, \$10, \$15 or more a night—interests you or not—think of the fun in store for you. In one to three months we can train you at home to play this marvelous, melodious instrument with a fine, easy skill that will make you the envy of all other eyes. Think, too, of the pleasure of being able to express yourself musically when alone! You're passing up the best times of your life if you pass up an opportunity like this to learn at slight cost and with no inconvenience at all the world's most popular instrument. **DON'T DO IT!** Decide NOW to learn more about The Play-Way—the quickest, surest short-cut ever devised to social and professional success.

**FREE Book Tells How**

Send at once for "The Play Way to Popularity and Big Pay." Learn all about our unique method of training you at home, about the big, professional size Tenor Banjo, Phonograph Records and complete Outfit that we send you along with your very first lesson. Undreamed of possibilities for pleasure, popularity and big pay are open to you the minute you "become good." The book below is your first step. Take it now. Clip the coupon while it's here before your eyes.

**You Get Phonograph Records, Too**

Every selection of the course, understand—fifty-five in all—comes to you on a phonograph record. You hear the instructor's playing just as though he were right at your side. The Play-Way is different, interesting, FOOL-PROOF. Get the good news the coupon brings. **SEND FOR IT NOW!**

A. F. BLOCH, President,  
N. Y. Academy of Music,  
100 Fifth Avenue,  
New York City.



**Get Big Free Book**

A. F. BLOCH, PRESIDENT,  
NEW YORK ACADEMY OF MUSIC,  
100 Fifth Avenue,  
New York City.

Send me the book that started McCarty. No obligation whatsoever on my part, understand.

Name.....

Address.....



**NO MORE BALD HEADS**



WHEN our VACUUM CAP is used a few minutes daily. We accept no pay until you have tried the Cap 60 days and are satisfied. The Vacuum Cap is an appliance that draws the blood to the Hair Roots and starts a new healthy crop of hair. It stops Dandruff, stops the hair from falling out.

Bought by Doctors and men who know that it is the only reasonable HAIR GROWER known to science. No Drugs Used. Write for application blank, testimonials and booklet on "HAIR," sent sealed in plain envelope, FREE.

**THE MODERN VACUUM CAP CO.**  
559 Quincy, Denver, Colo.

**WANT WORK AT HOME?**  
Earn \$18 to \$60 a week RETOUCHING photos. Men or women. No selling or canvassing. We teach you and furnish WORKING-OUTFIT given with each enrollment. Limited offer. Write today, Artercraft Studios, Dept. 50, 3900 Sheridan Rd., Chicago.



**AMERICAN POULTRY JOURNAL**

OLDEST, LARGEST AND BEST. EST. 1874  
**1 Year 25c** Can. \$2.00 **5 Years \$1** Canada \$2.00  
Averages over 100 pages per issue—tells how to feed, house and breed; how to secure high egg production; how to hatch and rear poultry successfully. 25c 1 year. 5 years \$1.00.

AMERICAN POULTRY JOURNAL, 14-536 S. Clark St. CHICAGO

**FREE Book HOW TO FEED AND CARE FOR CHICKS**

Gives Money Making Secrets of Poultry Raising. Tells how to hatch, care for and feed chicks until fully grown. Gives plan of Poultry and Brooder Houses. Describes Miller's "IDEAL" INCUBATORS with Patented Egg Turning Traps, Oil and Coal Burning BROODERS. Eggs for hatching—Baby Chicks—BARGAIN PRICES. WRITE TODAY! J. W. MILLER CO., Box 12, Rockford, Ill.



**FOY'S BIG PIGEON BOOK**  
In NATURAL COLORS, a complete guide to successful Squab and Poultry Raising. Tells how to feed, breed, grow and make money raising squabs. Quotes low prices. Write today. FREE.

F. FOY Box 18 CLINTON, IOWA



**SQUAB BOOK FREE**

Breed squabs and make money. Sold by millions at higher prices than chickens. Write at once for free 40-page book beautifully printed in colors telling how to do it. You will be surprised.

PLYMOUTH ROCK SQUAB CO.  
634 H Street Melrose Highlands, Mass.



**PLANS for Poultry Houses**

All Styles, 150 Illustrations; secret of getting winter eggs, and copy of "The Full Egg Basket." Send 25 Cents.  
INLAND POULTRY JOURNAL, Dept. 514, Indianapolis, Ind.

**STOP USING A TRUSS**



Reduced Fac-Simile Gold Medal

STUART'S PLAPAO-PADS are different from the truss, being mechanico-chemico applicators made self-adhesive purposely to hold the distended muscles securely in place. No straps, buckles or spring attached—cannot slip, so cannot chafe or press against the pubic bone. Thousands have successfully treated themselves at home without hindrance from work—most obstinate cases conquered. Soft as velvet—easy to apply—



Grand Prix

inexpensive. Awarded Gold Medal and Grand Prix. Process of recovery is natural, so afterwards no further use for trusses. We prove it by sending Trial of Plapao absolutely FREE. Write name on Coupon and send TODAY.

**PLAPAO CO., 733 Stuart Bldg., St. Louis, Mo.**

Name.....

Address.....

Return mail will bring Free Trial Plapao.



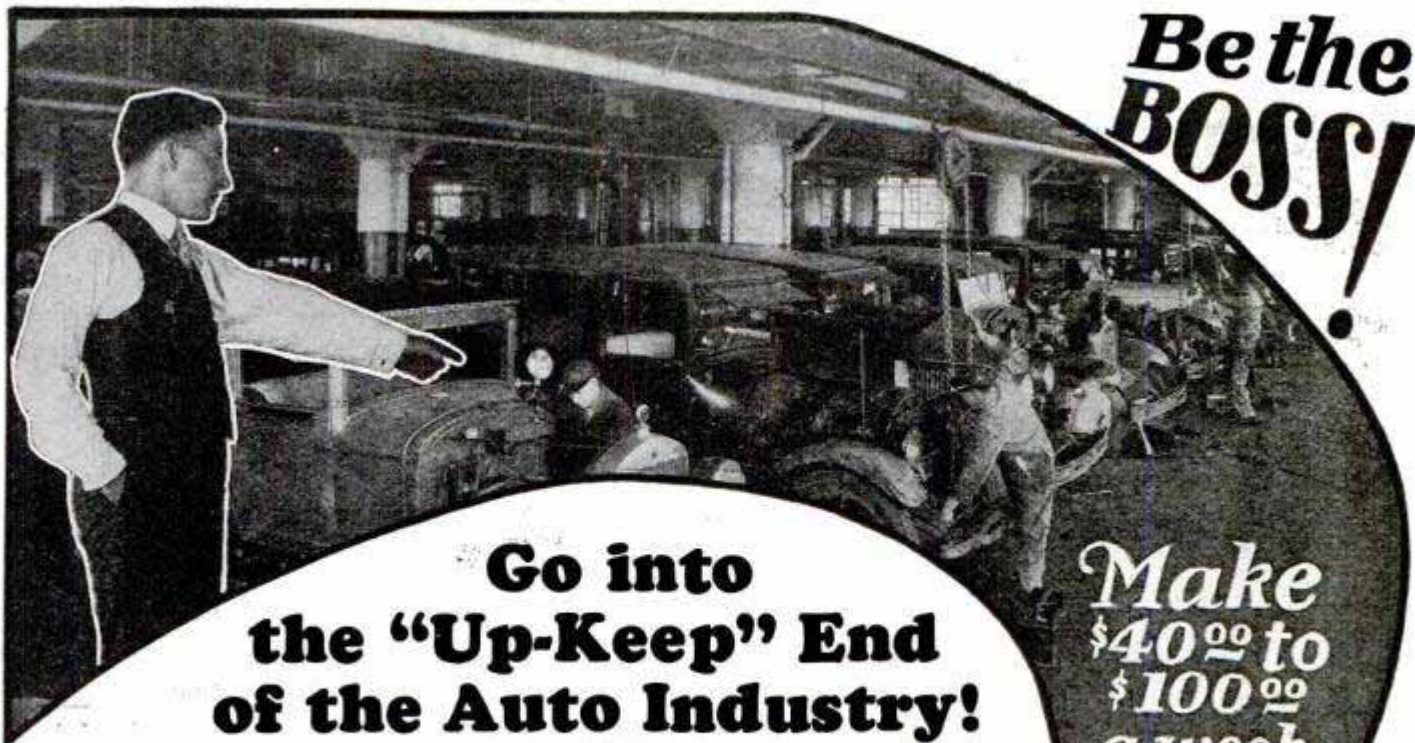

**Be the BOSS!**

**Go into the "Up-Keep" End of the Auto Industry!**

**Make \$40<sup>00</sup> to \$100<sup>00</sup> a week**

If you want to be sure of a good job—ALWAYS—if you want real opportunities to get ahead—if you're looking for a line of work that pays **BIG MONEY**—just remember the repair and "Up-Keep" of autos is now a ten billion dollar industry, **four times as big as the manufacture of new cars!** Mechanical and Electrical Auto **EXPERTS** are urgently needed—by garages, service stations, repair shops, electrical stations. Men who **KNOW** autos, who can locate trouble and tell the mechanics how to **FIX IT**, can almost name their own salary.

**Maintenance — Now the BIG MONEY End!**

They build less than 3 million new cars a year, but there are 22 million autos, trucks, tractors, busses, and taxis to **SERVICE**—to keep going. And the day of the tinkerer and dub is over. Dealers must have **EXPERTS** for their service stations, the public insists on **EXPERTS**. And so any man who will take the trouble to really learn the mechanical and electrical end of autos is "setting pretty." The demand will exceed the supply for many years to come.

**But get away from the grease—be the SUPERINTENDENT**

Men who have a little practical experience, who can do what the **BOSS** tells them to do, are always sure of a \$35 to \$50 a week job. **But \$50 is just about the limit for mere mechanics.** And there's not much joy to a life-time of hard, dirty, greasy work. And so I urge you to aim for the job **HIGHER UP**. Be the foreman, manager or superintendent. Or go into business for yourself. **YOU CAN**, if you'll pay the price—which is simply **LEARNING** every branch of Automotive Engineering work. You can prepare yourself for the **BIG MONEY** and tremendous opportunities in automotive work. No matter if your education is limited, and even if you

have no practical auto experience, we'll show you the quick, easy, sure way other men **LIKE YOU** have found to get into auto work—**RIGHT**—with the training and equipment needed to succeed.

**11 Famous Auto Engineers Guide You to Success!**

—men from **STROMBERG, STANDARD OIL, STUDEBAKER, BUICK** and leading Universities, members of noted Engineering Societies, men who employ Auto Experts and know the requirements for holding down a well paid job speak to you from the pages of this **great Reading Course**.

**Don't Send a Penny**

**Learn**

**AT HOME — the QUICK, Sure Way!**

You don't have to keep a million facts and figures "in your head"—when you know where to find them **INSTANTLY**. Here is a home training service which brings you **real help** in your search for the **QUICK**, sure way to advancement. We have made it so simple, so easy to understand, that any man, even with only grammar schooling can master the work without hard studying or memorizing. A hundred thousand men have taken this way to a better job, and you need only follow their example.

**Question and Answer Service**

No examinations, no "lessons," no costly outfits, no \$100 or more to pay out, by our method. We send you the 5 volume Library containing the entire material, for 15 days free loan. 2400 pages, over 2,000 charts, wiring diagrams and tables. **Coupon brings it.** You can keep it or return it, as you please. The total price is only \$24.80, and the terms are \$2 down and \$3 a month. You can go as fast or as slow as you please. And you can get any questions answered, any problem solved, **simply by writing in for the answer.**

**Start with the Coupon!**

Here is the pay-raising service you have been looking for. All the auto facts you can ever need—literally at your finger-tips in the **JIFFY INDEX**. We'll guarantee it contains the answers to any problem you'll encounter in your daily work—or our staff of engineers will supply it. **Don't risk a penny!** Don't take our word alone. See for yourself. Let us prove the opportunities in Auto Work and the **reading way** to qualify for them. Just mail the coupon, send no money—that's all.

**LOANED FREE!**

American Technical Society, Dept. A-819, Drexel Ave. at 58th St., Chicago, Ill.

Please loan me for 15 days, free, the new 5 volume library of "Auto Engineering". I will pay the few cents delivery charges when books are received, and I have the privilege of returning them at your expense within 15 days, in which case I will owe you nothing. If I decide to keep them, I will send you \$2, after 15 days, then \$3 a month until your special advertising price of \$24.80 is paid. This includes a year's Consulting Membership in the American Technical Society **FREE**.

Name.....

Address.....

Attach a letter stating employer's and reference's names and addresses, or write same plainly on margin.

**AMERICAN TECHNICAL SOCIETY**

Dept. A-819 Drexel Ave. at 58th St. Chicago, Ill.



# The Day-Dreamer

Will he ever wake up?



**HIS** life is made up of rosy visions. He sees himself in a manager's office—as the president of a firm—with a \$20,000 salary—perhaps even as a millionaire with a Rolls Royce, a rakish yacht and a swell country estate.

But all this grandeur is in his day dreams. He lives in the golden PARADISE OF TOMORROW—and it never comes.

He does nothing with the opportunities that surround him TODAY. He will always be somebody else's servant, instead of master of his own destiny.

How does he get into such a mental state? Because he uses only about ONE-TENTH of his mental energies in doing the vital things that count.

We are nearly all victims of the vicious habit of living far below our God-given endowments! The proof of it is that you have failed to reach the high mark ONCE set for yourself.

You admit it. What you want to know is, **WHAT CAN BE DONE ABOUT IT?**

There is one very simple thing that you CAN do—now. You can find out what Pelmanism has done for 650,000 men and women, some of whom were facing THE VERY SAME DISSATISFACTION with their attainments that you are feeling.

Since Pelmanism is the science of applied psychology, it brings SELF-REALIZATION to all classes and conditions of men and women—prominent and famous as well as obscure and unknown. And among the better known persons who used and advocate it are:

- T. P. O'Connor, "Father of the House of Commons."
- The late Sir H. Rider Haggard, Famous Novelist.
- General Sir Robert Baden-Powell, Founder of the Boy Scout Movement.
- Judge Ben. B. Lindsey, Founder of the Juvenile Court, Denver.
- Frank P. Walsh, Former Chairman of National War Labor Board.

- Jerome K. Jerome, Novelist.
- Gen. Sir. Frederick Maurice, Director of Military Operations, Imperial General Staff.
- Admiral Lord Beresford, G. C. B., G. C. V. O.
- Sir Harry Lauder, Comedian
- W. L. George, Author.
- Baroness Orczy, Author
- Prince Charles of Sweden.

—and others, of equal prominence, too numerous to mention here. The first principle of YOUR success is to do something radical in your life. You cannot make just an ordinary move, for you will soon again sink into the mire of discouragement. Let Pelmanism help you FIND YOURSELF. A remarkable book called "Scientific Mind Training" has been written about Pelmanism. IT CAN BE OBTAINED FREE. Don't put it off. Mail the coupon below now—now, while your resolve to DO SOMETHING ABOUT YOURSELF is strong.

THE PELMAN INSTITUTE OF AMERICA

Approved as a correspondence school under the laws of the State of New York

71 West 45th Street Suite 611 New York City

The Pelman Institute of America, 71 West 45th Street, Suite 611, New York City.

I want you to show me what Pelmanism has actually done for over 650,000 people. Please send me your free book, "Scientific Mind Training." This places me under no obligation whatever.

Name.....  
 Address.....  
 City..... State.....



## Air Commerce Needs Men!

Don't envy the Highly Paid Air Man—Be One! Air Men are in demand. Beat the other fellow to the High Salaried Jobs in Aviation. **Western** training will qualify you to enter Aviation. Learn how through our catalog, sent on request.

**Write for Free Catalog "Airplanes and Flying"**

Aeronautical Training Division

**WESTERN AIRPLANE CORPORATION**  
 Dept. M-11 Monadnock Block Chicago, Ill.



## BART SUPPLIES

Special 48 p. catalog "S"—Show Card and Sign Writer's supplies. Also catalog "A"—Art Supplies. Save Money—write—**BART SUPPLIES, 502 Eustis Bldg., MINNEAPOLIS, MINN.**

## LEARN PHOTO-ENGRAVING

Earn \$200 to \$500 monthly. Photo-Engraving and Photog-raphy taught by largest college of its kind in the world. Es-tablished 1893. Big demand for graduates. **Write for free book.**

**Illinois College of Photography, Box 4117, Effingham, Ill.**

## TELEGRAPH-RADIO

Operators earn \$150 to \$350 month and up. Learn in Chicago or at home. Chance to work while training. We furnish operators to U. S. Govt., Railroads, Com'l Cos., Broadcasting Stations and Ships. **CHICAGO TELEGRAPH INSTITUTE, Dept. 1-11-7, 1338 So. Michigan Ave., CHICAGO, ILL.**

## Big Money for You as an Automobile Mechanic

These four practical books, written by five well known teachers of automobile practice, will teach you right in your own home during your leisure time just what you need to know about automobile troubles and repair. They will teach you automobile construction, maintenance and repair as experts know them and will help you to earn an expert's pay. **Practical Automobile Library: Four Books—\$1.50 in 10 days and \$2 monthly for 6 months—only \$13.50 in all!**

Hundreds of question-answering diagrams—hundreds of clearly-marked illustrations—make the books plain and readily understandable. All the explanations and descriptions are clear, simple, direct. Every chapter is packed with definite, step-by-step, how-to-do-it information. Here is your opportunity to enter a big-pay field.

**Sent FREE**

Send No Money Mail the Coupon



## FREE EXAMINATION COUPON

**McGRAW-HILL BOOK CO., Inc., 370 Seventh Ave., New York**

Send me for 10 days' free examination the New Practical Automobile Library. If satisfactory, I will send you \$1.50 in 10 days and \$2.00 monthly until the special price of \$13.50 is paid. If not wanted, I will return the books at your expense.

Signed.....  
 Address.....  
 City and State.....  
 Position.....  
 Employer..... P. M.—11-27



# Strongfort for Strong Men! —Weaklings Stand Aside.



**STRONGFORT**  
**Builder of Men**

Compare Lionel Strongfort's physique, faithfully pictured here, with that of any of the hundreds published of other athletes and strong men. Compare the lines. See the muscles. Note the fact that Strongfort is not crouching, nor pressing, nor expanding—he stands up straight, naturally, normally—the finest and most perfect specimen of physical and health development the world has known.

weakness to health and strength. It is priceless. I'll send it to you on request—FREE. Write for your copy today.

**STRONGFORT INSTITUTE**  
**LIONEL STRONGFORT, DIRECTOR,**  
**PHYSICAL AND HEALTH SPECIALIST**  
DEPT. 394 NEWARK, NEW JERSEY, U. S. A.

## Be defiant, courageous, MANLY!

You won't be regarded as a real man if you are a slouching, nervous, fidgeting grouch—slinking along, afraid of your shadow, timid in company; sallow-complexioned, pimply-faced—with shifting, cowardly eyes; round-shouldered, with unsteady step; a cold, clammy grip—lacking pep, punch or personality—you simply won't get anywhere.

**Fellows of this type are not wanted.** If you are a weakling, sickly, nervous and always pessimistic—you will feel your inferiority wherever you go. Men will shun you. Women will not be attracted to you. Even dogs will bark at you!

**It is the penalty you pay for weakness!**—but you won't have to pay this price if you will face the facts and make up your mind you are going to go to the mat with ill-health and fight to a finish. It's up to you—to you alone. You can overcome weakness.

## You Can Be Strong and Healthy

Like thousands of those who have come to me in a pitiable state of physical bankruptcy you can be restored through **STRONGFORTISM**, the basic science of health and strength. You can be raised from the depths of despair and dependency to the heights of glorious manhood. You can be strong, vigorous, happy and successful if you but give Nature a chance to work through my proven system.

# STRONGFORTISM

## Creates New Energy and Strength

Through **STRONGFORTISM** men all over the world have been rejuvenated and restored to health and strength after they have suffered untold mental and physical horrors as the inevitable result of excesses, fast living, and abuse of their physical power. **STRONGFORTISM** has a record unparalleled—there is no other system, or method, or course that compares with it in restoring impaired human beings to health and strength. **STRONGFORTISM** begins at the source to create new energy and strength by utilizing Nature's forces scientifically. It builds up the internal muscular system first and thus gets rid of constipation, dyspepsia, indigestion, heart ailments, bad blood, catarrhal troubles, rheumatism and other afflictions, increasing your energy and stamina. External muscular development follows quickly and you become a new man inside and out—a fellow to be reckoned with and envied wherever you go.

## NO APPARATUS—NO DRUGS

Strongfort's Course does not depend upon artificial means or stimulants—no dope nor drugs, Nature does the work—all you do is give Nature a chance. Only a little of your time, in the privacy of your home, is all that is required. You will be surprised at how easy it all is, how astonishing the results, how speedily you will feel the effects of the new life animating your whole body.

## I Want to Send You MY FREE BOOK

This book of many pages and dozens of pictures tells of my wonderful experience—how I became the outstanding athlete of the world, performing feats others dared not attempt; how I turned the knowledge gained through developing my own body to the benefit of others, and then how **STRONGFORTISM** was evolved. It tells what I have done for others, what I can do for you. It doesn't mince words. It tells plain truths.

"Promotion and Conservation of Health, Strength and Mental Energy," points the way from disease and weakness to health and strength. It is priceless. I'll send it to you on request—FREE. Write for your copy today.

## FREE CONSULTATION

Clip and Send this Coupon—Absolutely Confidential

Mr. Lionel Strongfort, Strongfort Institute, Dept. 394, Newark, N. J.—Please send me absolutely free my copy of your book, "PROMOTION AND CONSERVATION OF HEALTH, STRENGTH AND MENTAL ENERGY." I have marked (x) before the subjects in which I am most interested.

- |               |                 |                         |
|---------------|-----------------|-------------------------|
| .. Colds      | .. Weak Eyes    | .. Great Strength       |
| .. Catarrh    | .. Flat Chest   | .. Lung Troubles        |
| .. Asthma     | .. Despondency  | .. Poor Circulation     |
| .. Headache   | .. Emaciation   | .. Round Shoulders      |
| .. Rupture    | .. Rheumatism   | .. Skin Troubles        |
| .. Thinness   | .. Nervousness  | .. Stomach Disorders    |
| .. Pimples    | .. Constipation | .. Increased Height     |
| .. Insomnia   | .. Short Breath | .. Muscular Development |
| .. Overweight | .. Weak Heart   |                         |
| .. Weak Back  |                 |                         |

Name.....  
Age..... Occupation.....  
Street.....  
City..... State.....



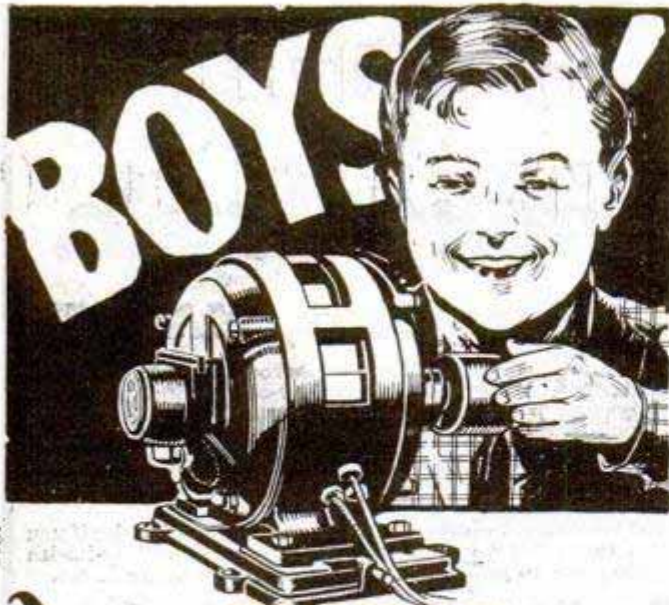

# Here's FUN and SPENDING MONEY

How would you like to earn two or three dollars every evening after school and prepare yourself for a fine big job at the same time? Here's the opportunity of a lifetime for you fellows who like Electricity. Begin right now to prepare yourself for a regular man's size job in this fascinating field. Your chances for a big success are simply wonderful—the pay is big (\$70 to \$200 a week) and advancement comes swift and sure.

## I Will Train You at Home

With my easily learned, spare time Electrical Course I will train you at home like I have trained hundreds of other boys who are now big successful men. It will not interfere with your school work and you can earn more than the small cost of the course doing odd electrical jobs in your spare time. The Course pays for itself. I will show you how to get this work and how to do it. Some of my boy students make \$10 to \$15 a week this way.

## Tools, Apparatus and Radio Course— Given Without Extra Charge

Send me the coupon below and I will tell you all about the big outfit of tools, apparatus and instruments and a new Radio Course that I am giving to my students for a limited time at no extra cost. I will also send you my big interesting Electrical Book Free of cost. You will be tickled with the things I will send you Free. Mail the coupon right now.

### This Boy Makes \$200 a Month

"Dear Mr. Cooke: When I began with you I was a sophomore in High School. Was making \$40 a month as grocery clerk. Now I am a \$200 a month electrician. Not so bad for a 17 year old boy, eh?"  
Oliver P. Cooper  
1131 Middle St.  
Ashland, Pa.

**L. L. COOKE,**  
Chief Instruction  
Engineer  
**L. L. Cooke**  
School  
of Electricity  
Dept. 018  
CHICAGO, ILL.

**6 BIG**  
WORKING  
OUTFITS  
NO EXTRA  
CHARGE

## Use this FREE BOOK COUPON

**L. L. COOKE,** Chief Instruction Engineer,  
**L. L. COOKE** School of Electricity,  
Dept. 018, 2159 Lawrence Ave., Chicago, Ill.

Send me your big Electrical Book, and particulars about your Electrical Course and extra Radio Course. This does not obligate me in any way.

Name.....

Address.....

(This Coupon only for boys 15 years old or more)

# ACCOUNTING



The uncrowded, highly paid profession of Accountancy offers marvelous opportunities to ambitious men and women. Send for our 80-page book, "How to Learn Accounting," and the first easy lesson. Both will be sent free.

**INTERNATIONAL ACCOUNTANTS SOCIETY, Inc.**

A Division of the  
**Alexander Hamilton Institute**

3411-X South Michigan Ave., Chicago, Ill.

## Learn to PAINT SIGNS and SHOW CARDS

We quickly teach you by mail, or at school, in spare time. Enormous demand. Big future. Interesting work. Oldest and foremost school.

**EARN \$50 TO \$200 WEEKLY**

John Vassos, N. Y., gets \$25 for single show card. Crawford, E. C., writes: "Earned \$200 while taking course." Don't delay! Send today for complete information, samples and guarantee.

**DETROIT SCHOOL OF LETTERING**  
150 Stimson Ave. Est. 1899 - DETROIT, MICH.



# PIANO JAZZ

By Note or Ear. With or without music. Short Course—Adult beginners taught by mail. No teacher required. Self-instruction Course for Advanced Pianists. Learn 259 styles of Bass, 684 Syncopated Effects, Blue Harmony, Oriental, Chime, Movie and Café Jazz, Trick Endings, Clever Breaks, Space Fillers, Sax Sturs, Triple Bass, Wicked Harmony, Blue Obligato, and 247 other Subjects, including Ear Playing. 133 pages of REAL Jazz, 25,000 words. A Postal brings our FREE Special Offer.

**Waterman Piano School, 1826 W. Adams St. Los Angeles, Cal.**

# Learn to Dance

You can learn all the modern dances—Charleston, Black Bottom, Valencia, Canter, French Tango, Latest Waltzes, Fox Trots, etc. at home easily and quickly. New chart method makes dancing as simple as A-B-C. No music or partner required. Don't be a wallflower. Learn to dance. Complete course—323 pages, 49 illustrations only \$1.00. Equals \$20.00 course. Satisfaction Guaranteed. Bargain Book Catalog FREE.

**FRANKLIN PUBLISHING COMPANY**  
106 N. LaSalle St., Dept. 9408 CHICAGO



# FOREST RANGERS

MEN, get Forest Ranger job; \$125-\$200 mo. and home furnished; permanent; hunt, fish, trap. For details, write

**NORTON, 2530 TEMPLE COURT, DENVER, COLORADO**

# Strength

is not so much muscle as skill. Police Captain Wallander's illustrated "Physical Training Manual" explains fine points of Jiu Jitsu, Boxing and Wrestling. Makes you invincible. A complete course in physical culture, astounding police secrets and simple health rules. Sent C. O. D. for \$1.97 plus postage. Siebel Press, 34-N W. 20 St., New York, N.Y.

# DRAFTING



Made Easy

Wonderful opportunity for ambitious men and boys. Pleasant work. Good salaries. Permanent positions. Learn at home—easily and quickly—in spare time through the same school that has taught thousands of other men in just your circumstances. Individual instruction. Mail coupon today for interesting Free Booklet.

## INTERNATIONAL SCHOOL OF DRAFTING

Associated with the  
International Correspondence Schools  
Box 5680-E, Scranton, Penna.

Without cost or obligation, please send me full details of your home-study course in

**DRAFTING**

Name.....

Address.....



# Learn to Mount Specimens like These

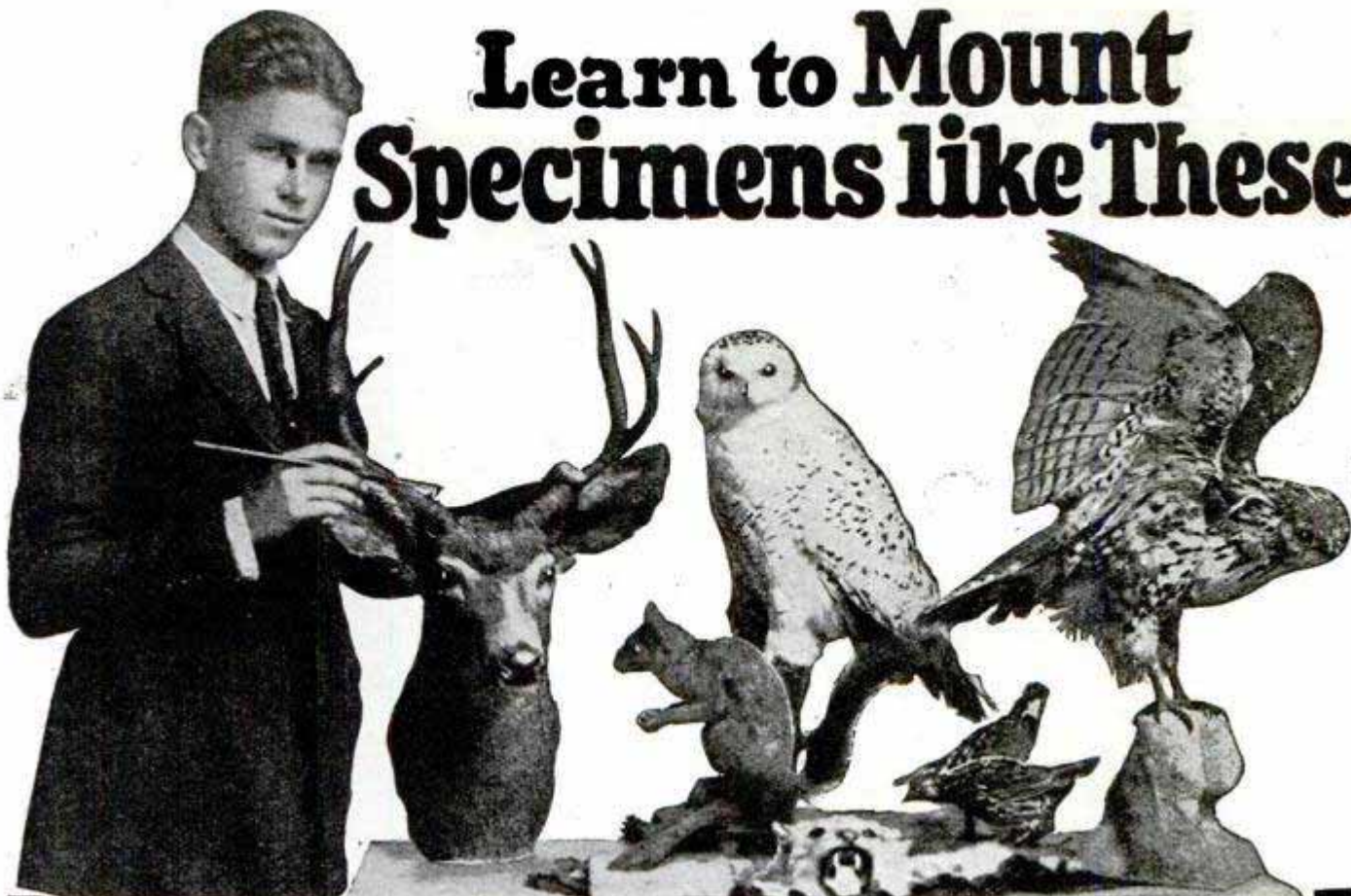

**L**EARN to mount and stuff all kinds of game, animals, birds, fish—tan furs and skins, make beautiful rugs, robes, etc. You can learn *easily and quickly* during your spare time by mail. *Great sport and lots of fun.* Lessons are easy and intensely interesting. Latest museum methods. This school is 20 years old, high class and reliable, and has 75,000 graduates. *Success guaranteed.* Don't delay, but start to learn this extremely fascinating art NOW.

## FREE

Beautifully illustrated book, "How to Mount Game." Explains the secrets of taxidermy. Dozens of photos of mounted specimens. Tells how you can learn this great art, no longer a secret, right in your own home during *spare time*. Tells how to

become a taxidermy artist, how to save your own splendid trophies, how to beautify and decorate your room and home with nature's choicest art.

Tells how young men and boys can make the **BIGGEST MONEY** from their spare time. Don't delay. Clip coupon now. Send **TODAY** for this Free Book.

## Make Big Money—

Taxidermy is the most profitable OF ALL spare time work. Sell your mounted specimens. Mount trophies for your friends, hunters, trappers and fishermen. Have a side business of your own. Be independent. Have plenty of spending money—for athletic goods, radio, books, traps, and for vacations. Here is your opportunity. Don't delay. Send the coupon right NOW.

## Free Book Coupon

Northwestern School of Taxidermy  
8378 Elwood Bldg., Omaha, Nebr.

Send me, absolutely free, your illustrated book, "How to Mount Game." Also tell me how I may learn to be an expert taxidermist easily and quickly by mail. No obligation.



Name \_\_\_\_\_

Address \_\_\_\_\_

## Learn Watchwork, Jewelrywork and Engraving

A fine trade commanding a good salary, and your services always in demand. Address **Horological**, Dept. P, Bradley Institute, PEORIA, ILLINOIS, for our latest catalog.

## TELEGRAPHY

(Morse and Wireless) and RAILWAY ACCOUNTING taught thoroughly. Big salaries; great opportunities. Oldest, largest school. Endorsed by Telegraph, Railway, Radio, and Government officials. Expenses low—opportunities to earn large portion. Catalog free. **DOGGE'S INSTITUTE**, Jones St., Valparaiso, Ind.

## WANTED—Men who earn less than \$40 a wk.



## Bigger PAY in the Civil Service

**T**HE difference between what you *earn now* and what you *can earn* working for Uncle Sam may mean \$5000 to you in a very few years. Why work hard for small pay? Uncle Sam offers you a fine position as a Railway Postal Clerk. Travel on fast trains sorting mail. Travel expenses paid. \$1900 a year TO START. \$100 RAISE EVERY YEAR until you reach TOP PAY. Long vacations.

### FREE Information About These Fine Jobs

Let Arthur R. Patterson help you qualify for a position as a Railway Postal Clerk or in Customs, Internal Revenue, Departmental, Immigration, Postmaster, Post Office and Rural Branches. He trained thousands now in Civil Service. Write for FREE BOOK. Tells how Mr. Patterson coaches you to pass exams. Also read his agreement that in one year after rating you will be offered a position—or your money back. Mail coupon now.

**ARTHUR R. PATTERSON, Principal**  
Patterson School, Dept. 811, Wisner Bldg., Rochester, N. Y.

**Arthur R. Patterson,**  
Civil Service  
Expert, Principal  
Patterson School,  
Dept. 811, Wisner Bldg.,  
Rochester, N. Y.

Sir: Send me without charge your catalog describing Railway Postal Clerk and other Civil Service positions.

Name \_\_\_\_\_ Age \_\_\_\_\_

Address \_\_\_\_\_ City \_\_\_\_\_ State \_\_\_\_\_



# WOW! SEE Those Muscles GROW!



BEFORE



AFTER 30 DAYS OF TITUS TRAINING

TALK about putting on muscle! Look at those two pictures at the right. That's just one of the boys I've made over. Yes, sir, changed him almost overnight from a puny weakling into a powerful, two-fisted HE MAN.

Want me to do the same for you? Just give me a few minutes a day in your own home. In 30 days I'll cover your body from head to foot with the finest set of muscles you ever saw! Don't take my word for it, I GUARANTEE you big muscles.

Come on, friend, don't go plugging along with half your spark plugs dead and your engine missing. I'll make you hit on ALL SIX. Say, I'll give you so much speed and

pep that when you start to mix it with the other boys you'll look like the "Mystery S" racing a steam roller.

My amazing secrets of muscle-building have built champions and strong men all over the world. I don't care where you live—how old you are—whether you're big or little. Just follow my personal directions for a few minutes a day, and you'll fairly SEE your muscles grow! I'll load your arms with muscle—I'll deepen your chest, broaden your shoulders, give you the legs of a six-day bike racer. Boy, you'll be proud to put on a bathing suit!

## FREE "BETTER BUILT BODIES"

### My Amazing New Big Book—Check Full of Muscle-Building Facts

I want every reader of Popular Mechanics to have this great book. It's crammed with actual photographs showing MIRACLES WORKED IN MUSCLE—and Titus' own wonderful secrets of MAN-BUILDING. Also details of my \$2,000 Muscle-Building Contest. Let me send YOU a copy FREE. The most valuable book you ever read. No obligation. Just shoot me your name and address on the coupon.

TITUS (Dept. P-120),  
105 E. 13th St., New York, N. Y.

Please send me FREE your wonderful new Book, "Better Built Bodies." Also details of your \$2,000 Muscle-Building Contest.

Name.....

Address.....

Town..... State.....

The One **TITUS** 105 E. 13th St.  
and Only New York City

He looked like a mosquito when he first read a Titus ad. The boys in his town called him "Sparrow" and he was the butt of every joke they could think of. He was too weak to defend himself and had to take it all. But they don't play jokes on him any more. He took the TITUS course at home without letting anyone know. Some big bruiser started one of the old jokes. *Snash!!!* That's a thrill that comes once in a lifetime. Let me give it to YOU!

**AT HOME LEARN TELEGRAPHY AT HOME**

**TEACH YOURSELF** in half usual time, at trifling cost, with the wonderful Automatic Transmitter, **THE OMNIGRAPH**. Sends unlimited Morse or Continental messages, at any speed, just as an expert operator would. Adopted by U. S. Government, and leading Universities, Colleges and Telegraph Schools. Catalog 6 cents.

**OMNIGRAPH MFG. CO., 13-19 Hudson St., NEW YORK**



## LEARN CARTOONING AT HOME DURING SPARE TIME

from the School that has trained hundreds of successful cartoonists of today. The Landon Picture Chart Method of teaching ORIGINAL drawing by mail makes cartooning easy to learn. Write today for sample picture chart to test your ability and examples of the work of successful students now earning from \$75 to \$200 and more per week. Please state your age.

**THE LANDON SCHOOL, 2838 National Bldg., Cleveland, Ohio**



## COMMAND A LARGE, STEADY INCOME!

The Technical man always wins. Technically trained men are in constant demand. Become independent by using your spare time at home to master any of the crafts listed opposite. The St. Louis Technical Institute is one of the most thorough institutions for Technical home study to-day. Our methods and lesson material are so plainly and clearly defined that you will be astonished at your rapid progress. Check the subject in which you are interested and we will send you complete information. Special drafting courses arranged.

**ST. LOUIS TECHNICAL INSTITUTE**

**EST. 1910**

**HOME STUDY**

- ... Drafting } .. Architectural .. Machine
- } .. Electrical .. Structural Steel
- ... Heating & Ventilating Engineering
- ... Plumbing & Sanitary Engineering
- ... Sheet Metal Designing & Drafting
- ... Boiler Maker Laying Out & Inspection
- ... Steel Ship Laying Off & Plan Reading
- ... Contracting & Estimating
- ... Mathematics & Slide Rule Reading

**4545 CLAYTON AVE., ST. LOUIS, MO.**





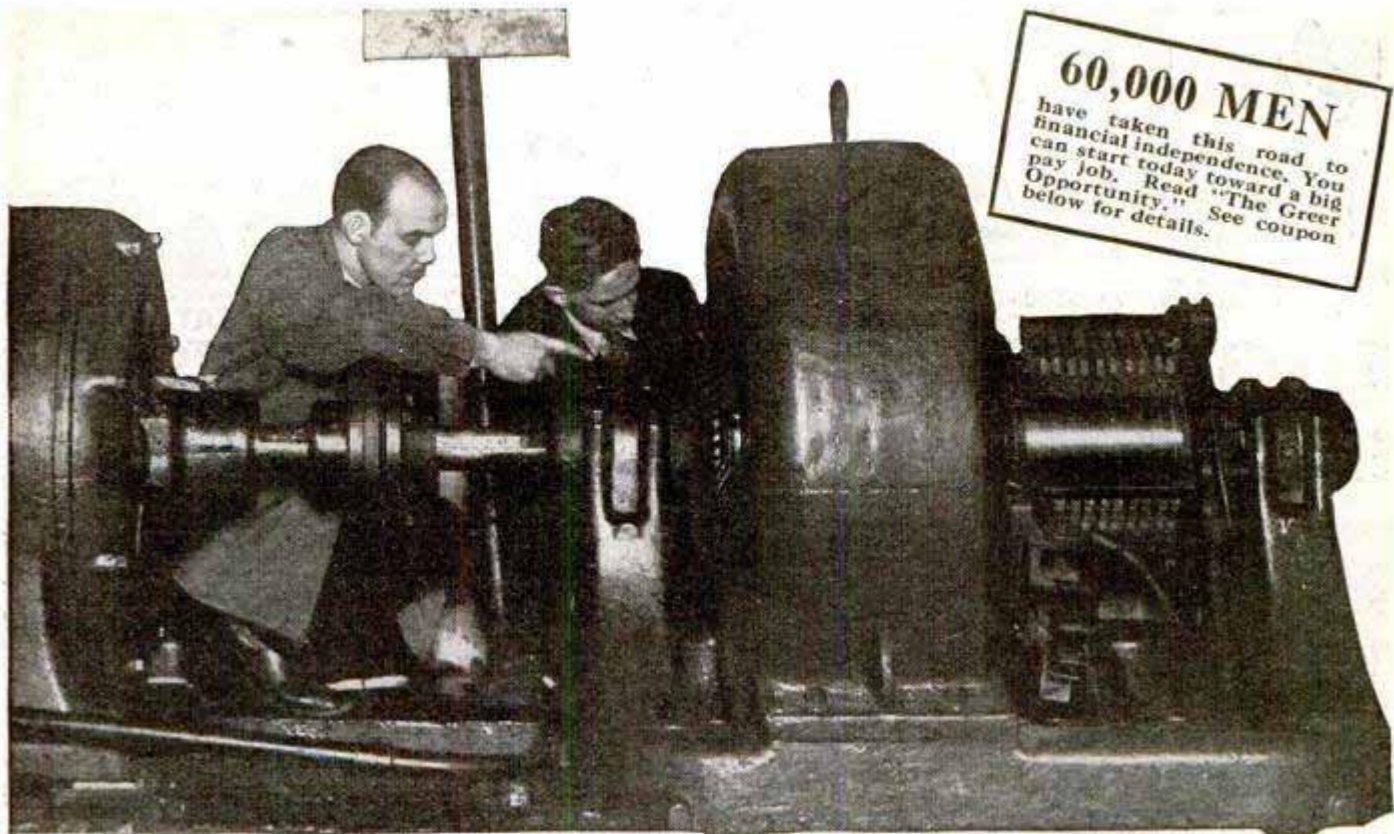

**60,000 MEN**  
 have taken this road to  
 financial independence. You  
 can start today toward a big  
 pay job. Read "The Greer  
 Opportunity." See coupon  
 below for details.

**"I was a \$30 a week clerk  
 —but electricity now pays  
 me \$10,000<sup>00</sup> per year"**

**That's what happened when  
 I stepped out for a big-pay  
 job—Greer paid my fare to  
 Chicago**

What this man did you can do. Five years ago he clipped a coupon like that on this ad. He didn't have much money. He was slave to a clerical job that paid starvation wages.

I paid his way to Chicago. When he got here I got him a part time job and found him a place to live.

In my shops he learned by actually working on motors, dynamometers—all the costly equipment I've gathered. My friendly instructors guided his work until he knew more than many highly paid electricians. Now he's independent—connected with a big company, drawing big pay.

### Like Electricity?

**—Make it Pay You Big Income**

If you like to fool with the "juice" that runs our industries you can get into this big pay class. I've trained over 60,000 others. I'll turn you out fit for the work big corporations need high paid men to do. They are searching

**GREER COLLEGE OF ELEC-  
 TRICAL ENGINEERING**

Dept. 1101 • 2024 S. Wabash Ave. • Chicago

for these men. Those from Greer College, because they've learned by actual experience on the newest equipment, pick the desirable positions.

There isn't room here for further details, but send for my book, "The Greer Opportunity." It tells full facts about the course, how I get you a part time job, find you a place to live—and even pay your fare to Chicago.

### Take Automobile Course at Same Time

By learning automobile—another big opportunity—at the same time you save considerable money. Or you can learn Electricity only. Just which to go into you will know better when you have all the facts.

### Act Promptly

To get anywhere in life you have to act. Don't put off sending for "The Greer Opportunity." It costs nothing.

Write your name and address on the coupon, and mail it direct to me. Then see just what you will learn—look over the photos of the Greer shops—study the facts about both Electrical and Automobile courses.

Do this at once. It is time to enroll now. Mail coupon today.

ERWIN GREER, President, Greer College  
 Dept. 1101, 2024 S. Wabash Ave., CHICAGO.

Please send me your FREE BOOK and offer for  
 It is understood I am not obligated in anyway

Electrical  course  
 Automobile  course

Name .....

Address .....





# PAIN and DISEASE

Quickly Conquered by

## VIOLET RAY



Let us tell you how thousands of men and women suffering from rheumatism, neuritis, paralysis, nervousness, skin diseases, headaches, constipation, sprains, prostate trouble, goitre and many other ailments, even hay fever and asthma, have found quick relief—new health and vitality with this marvelous, scientific invention. Pains vanish almost instantly.

# Violetta

Ten Days FREE Trial

For Health—Beauty—Vigor

Endorsed and used by hospitals, sanitariums and physicians. Every home can now have one. Saves hours, days, months of suffering. No medicine. Painless, pleasant treatment. Only the violet ray can penetrate to every nerve affected. Simple, safe, painless—anyone can use VIOLETTA. Why suffer pain and poor health when you can try VIOLETTA 10 days FREE.

## This Book FREE

Tells all about violet rays—how this marvelous discovery by Nikola Tesla, the electrical wizard, now brings this mysterious curative power to all. Contains many astounding testimonials from our thousands of satisfied users. Send for the facts and our liberal trial offer today. Mail the coupon now.



VI-REX CO., Dept. 1131  
2304 Warren Avenue, Chicago

VI-REX CO., 2304 Warren Ave., Dept. 1131 Chicago  
Please send me your free book on Violet Rays and details of your 10 days' free trial offer.

Name.....

Address.....

City.....State.....

Ailment.....

## QUIT TOBACCO



No man or woman can escape the harmful effects of tobacco. Don't try to banish unaided the hold tobacco has upon you. Join the thousands of inveterate tobacco users that have found it easy to quit with the aid of the Keeley Treatment.

## KEELEY TREATMENT STOPS Tobacco Habit

Quickly banishes all craving for tobacco. Write today for Free Book telling how to quickly Free yourself from the tobacco habit and our Money Back Guarantee.

THE KEELEY INSTITUTE  
Dept. A903 Dwight, Illinois

## NO JOKE TO BE DEAF

—EVERY DEAF PERSON KNOWS THAT



I make myself hear, after being deaf for 25 years, with these Artificial Ear Drums. I wear them day and night. They stop head noises and ringing ears. They are perfectly comfortable. No one sees them. Write me and I will tell you a true story, how I got deaf and how I make you hear. Address



GEO. P. WAY, Artificial Ear Drum Co. (Inc.)  
80 Hoffman Bldg., 2539 Woodward, Detroit, Mich.

## A PERFECT LOOKING NOSE

Can Easily Be Yours



Trades Model No. 25 corrects now ill-shaped noses quickly, painlessly, permanently and comfortably at home (excepting cases caused by improper bone structure). It is a safe and guaranteed patent device of precise adjustment that will actually give you a perfect looking nose. Over 90,000 satisfied users. For years recommended by physicians. 16 years of experience in manufacturing Nose Shapers is at your service. Model 25 Junior for children. Write for testimonials and free booklet, which tells you how to obtain a perfect looking nose.

M. TRILETY, Pioneer Noseshaping Specialist  
Dept. 2792 Binghamton, N. Y.

# FREE TRIAL Grows Hair



AMAZING NEW ELECTRICAL DISCOVERY

A noted surgeon has discovered an amazing way to grow hair, called Dermo-Ray. In 30 days no more dandruff. Scalp tissues are given new life. Then within a few weeks, luxuriant new hair! The startling discovery of the almost magic effect of Infra-Red Rays on the hair-growing tissues was made by a leading surgeon. Two years ago he was himself bald. Today his hair is full and thick.

## FAMOUS SURGEON'S DISCOVERY

Here is his own personal, home treatment, called Dermo-Ray. At last a home method endorsed by science. Guaranteed to bring you these same results in 30 days—or you pay nothing. You can use Dermo-Ray in any home with electricity. The warm, soothing Infra-Red Rays vitalize the scalp while you rest—a few minutes each day is all the time required.

**SEND NO MONEY** Complete facts about this astounding new scientific discovery, opinions of authorities, incontrovertible evidence, and details of special trial offer sent free, if you mail the coupon below. To end your scalp and hair troubles, act at once. Print your name and address plainly—and mail the coupon NOW!

## FREE TRIAL OFFER

The Larson Institute  
216 North Wabash Ave., Dept. 116, Chicago, Ill.

Send me at once, without obligation, full particulars—in plain envelope—of your 30-day Free Trial of DERMO-RAY.

Name.....

Address.....

City.....State.....



# -takes only 8 weeks to get a big job



George Smith owns an agency and repair shop in West Alexandria, Ohio. He makes \$200 a week.



D. M. Collins, Williamsville, West Virginia, writes, "After finishing McSweeney training, I started as manager of a garage at \$300 a month."

## and Earn \$75 to \$125 a Week As Auto Expert

Learn the auto and tractor business by the McSweeney method, then step out and get a good job at \$75 to \$125 a week or open your own repair shop and make up to \$10,000 a year. Trained men are needed everywhere. Opportunities galore! Eight weeks training fits you to open repair shop or go with one of the big firms waiting for trained men. Read what George Smith, D. M. Collins and C. E. Gillespie have done. Hundreds of other McSweeney trained men can tell as interesting facts. Every month McSweeney men who complete their training are taking the place of half-trained and incompletely self-trained men.

### Learn in 8 Weeks

Simple, thorough, practical shop methods. You learn the "why" of everything you do, then learn to do it right. You do real work with real tools and real equipment. No book studying. Very little schooling necessary. Any man from 16 to 60 can learn. Write today for Big Special Limited Time Tuition Offer, including

### R. R. FARE PAID and BOARD While Learning

Also FREE ELECTRICAL COURSE to those who enroll soon. Don't delay—write at once for complete details and BIG AUTO BOOK FREE. Mail coupon to nearest school—NOW!

**FREE**  
Course in  
**Electrical Work**  
to those who enroll soon. Not a cent extra to pay. No extras to buy. Get my big special offer today.

### Money Back Guarantee

If, after completing my training, you are not satisfied, if you are not qualified to accept a big-pay job, your tuition will be refunded. Don't miss this remarkable opportunity. Save by enrolling at once. The sooner you start, the sooner you will be ready to earn big pay or go into business for yourself.

(Mail coupon to school nearest you)



C. E. Gillespie has charge of a fleet of trucks and tractors for the State Highway Commission, due to McSweeney training.

# MC SWEENEY

**AUTO, TRACTOR and ELECTRICAL SCHOOLS**  
Dept. XF-302  
CINCINNATI, OHIO  
CLEVELAND, OHIO



McSweeney Auto, Tractor and Electrical Schools,  
Dept. XF-302, Cincinnati, O. Cleveland, O.  
Without cost or obligation, send me your big FREE book on Autos; also, full details of your big offer including R. R. Fare and Board Paid, and FREE electrical course.

Name.....  
Street.....  
Town..... State.....

# Air Transport Company will train you to

Big commercial aviation corporation with hangars, shops and flying field at CHICAGO MUNICIPAL AIR PORT, with new 1927 planes of best commercial types, will train ambitious men in ground-work and actual flying by same methods used in U. S. Air Corps. The QUICK, safe way to a fine job as pilot, or ground-expert. Your best chance to get in on "ground floor" of new, rapidly growing industry, backed by billions of dollars.

# FLY

by  
**U. S. Government Methods with U. S. Licensed PILOTS!**

### Pilots earn \$7 an hour

The biggest men in America are interested in commercial aviation. The opportunities are like those in the Auto Industry 30 years ago. School education doesn't count. We want men of courage and character for flying jobs, and foresighted fellows to get into the mechanical and business end. We'll give you training in ALL branches under men who are among the greatest flyers and teachers of aviation in the world—men who trained hundreds of Army and commercial aviators.

### Get Ground-work at HOME, Actual Flying at Chicago within few weeks

Amazing new combination home-study and resident school instruction, at a cost within your reach so you can get started at once. Sponsored by big aviation company now actually engaged in transporting passengers and freight by air, and in aerial photography. A complete, modern, practical, thorough training service obtainable for the first time. Open to real men and women who can furnish good references.

**GET INTO AVIATION!**  
8 Ground Jobs to Each Flyer

There are 20 jobs in aviation for every trained man. Not necessary to be a flyer. There are big pay jobs open for expert ground men, mechanics, etc. Aviation needs you, write today for particulars.



JOHN MILLER  
Former U. S. Chief Instructor at Air Corps Technical School, Kaintoul, Illinois.



NIMMO BLACK  
Former U. S. Army Instructor and Mail Flyer. Famous Commercial Ace.

### Sensational Offer to Men Who Qualify!

Send no money—just mail the coupon for all the facts about FLYING, about the business and mechanical end of AVIATION and how we prepare you for the BIG MONEY in them. If you want excitement combined with big opportunities—write me today!

**Aviation Service and Transport, Inc. Dept. 508, 203 N. Wabash Ave. CHICAGO**

Aviation Service and Transport, Inc.,  
Dept. 508, 203 N. Wabash Ave., Chicago.

Send FREE complete information about your training for AVIATION, flying and ground-work, and the opportunities open to ambitious men.

Name.....  
Address.....





**DRAFTING  
ENGINEERING, ELECTRICITY  
and ARCHITECTURE**

**CHICAGO  
TECHNICAL  
COLLEGE**

One of "America's oldest and largest schools of specialized engineering" offers you a maximum of practical training in a minimum of time, here at Chicago, the country's building and engineering center. Technical training of college standard for men who have neither the time, money nor preliminary education to attend a university. Each year more than 1000 men and women enroll in day and evening classes.

**Short, Intensive Training**

practical in every respect, puts you quickly into a high salaried position. Many of our students are assisted to responsible positions before graduation . . . they earn while they learn.

**In Spare Time  
At Home**

if you can't come to Chicago, learn Drafting at home. Your spare time is enough. Same practical course. Quick, easy—yet thorough.

**Trial Lesson  
FREE**

Test yourself and see how easy you can learn Drafting by the Chicago Tech. method. Trial lesson sent free if interested in homestudy. Address Dept. P-209.

**COURSES** are arranged to suit your needs—2 year diploma; 3 year B. S. degree; special 3 and 4 months' short courses adapted to the individual. Expert instructors actively at work in the very professions they teach.

Tuition low, terms easy. Enter any time. Day and Evening Classes.

**Write for FREE  
84 Page Blue Book**

It tells about all the courses . . . fully describes them; about the great demand for Chicago Technical College trained men; about college athletics and other interesting facts you'll want to know. Gives you a vivid picture of what you may expect at this leading technical college. There is no obligation. Send for this free Blue Book today . . . now!

Address Registrar P-75

**Chicago TECHNICAL College**  
Dept. P-75 118 East 26th St., Chicago

**Popular**

because  
he can

**Play**

and  
earn

**\$75.00**

to  
**\$200.00**

each week  
**CONN NATIONAL SCHOOL OF MUSIC INC.**  
506 So. WABASH AVE., DEPT. 516 CHICAGO



**LEARN AT HOME**

With a nationally famous artist as your teacher you can learn to play classical or popular music. We guarantee our personal teaching method. Both advanced and elementary courses on all instruments. Write for catalogue

**Does Your English Help  
or Hurt You?**

Wonderful new way to improve your English. No rules to learn. No hard study. Grammar, spelling, punctuation, and expression, taught in 15 minutes a day—at home. Self-correcting feature makes it fascinating as a game. Write today for Free Book "How to Speak and Write Masterly English." Address



**SHERWIN CODY SCHOOL OF ENGLISH**  
511 Searle Building Rochester, N. Y.

**YOU CAN OIL PAINT**

Amazing new method teaches men or women to earn after first lesson. OIL PAINT photos—portraits, landscapes or art subjects. Earn \$18 to \$30 and more a week. OIL PAINT OUT-FIT GIVEN. Send now for free illustrated book. PICTORIAL ART STUDIOS Inc. Dept. MP. 2926 Broadway, Chicago, Ill.

**FREE A 5-CABLE EXERCISER FREE**

and Instructions  
**WITH ONE YEAR'S SUBSCRIPTION TO "STRENGTH" AT THE REGULAR PRICE**

Here's a proposition, fellow, you can't equal—12 big issues of this magazine "Strength," sent to your home each month free of mailing charges and a 5 elastic cable exerciser with instructions on how to use it for developing your physical strength and bodily proportions as well as for improving your general health.

**12 BIG ISSUES  
and the EXERCISER  
ONLY \$2.50**

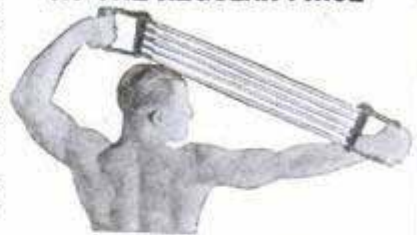

The cables are all of the best rubber and are the strongest made. The grips are finely finished and strong. The instruction will give you exercises.

**"STRENGTH"**

**THE MAGAZINE FOR THE HEALTH, STRENGTH AND MUSCLE SEEKER**

"Strength" is a he-man's magazine which contains articles and pictures upon all branches of the health, strength and muscular development subject. It shows you how to become healthier; how to increase your physical strength and how to improve your development and proportions. There are loads of pictures each month of men who have acquired marvelous physiques and great strength through the methods outlined in this Magazine. There are pictures of beautifully formed women who have obtained their shapes through physical training methods. There are fight, base-ball, field sports articles, etc. in each issue.

**SEND YOUR NAME, ADDRESS and \$2.50 NOW—We Pay All Charges**

MILO PUB. CO., P. M. 11-27  
2747 N. Palethorp Street, Philadelphia, Pa.

Gentlemen: Please find enclosed \$2.50 for which send me immediately a 5-cable exerciser and course free and enter my name on your mailing list for a year's subscription to "Strength."

Name.....

Address.....

City..... State.....



# What is this Magical Device?



**In Only 4 Short Months  
It Has Shown 2,478 Men  
a New Way to  
\$100 a Week**

Men, this sensational message is short. Read all of it. Learn the startling, yes, almost incredible facts about this amazing new invention that has revolutionized an entire business. Note also that I have FREE TRIAL OUTFITS for 2,500 more men. Then act!

WHEN my revolutionary new invention was offered to salesmen a few months ago, experts told me that it had all the earmarks of a big money-maker for agents. So I took their word for it and made the plunge. But it was the first venture of this big, 20-year-old company into direct selling. I was only taking the word of my experts for it that we had a real knock-out seller.

### Taking the Country by Storm

Then suddenly, actually almost over night, agents flooded me with letters that let the cat out of the bag with a whoop that was heard from Maine to California! They disclosed what are, unquestionably, among the most tremendous profit records in all the history of direct selling. Did they back up those reports with orders? They did! Not by the tens and scores, but by the hundreds and thousands!

Gray, Pa., made \$12 his first half day. Mrs. Smith, D. C., sold 6 out of 8 prospects her first evening. Marshall, Ill., made \$5 from 6:30 to 7:30 P.M. his first evening. Duncan, Mont., cleaned up \$19.50 his first day. These figures are

typical for beginners. No wonder experienced men report easier selling than they ever dreamed of before and the biggest money of their lives!

### Needed in Every Home

Yet why shouldn't these people all make big money? Why shouldn't you? My invention takes the place of something used every day in every home, rich and poor alike. Does *automatically* what is now one of women's hardest and most detested kitchen tasks. Banishes forever all make-shift, dangerous, wasteful, old-style methods! Not a fad or a mechanical gimcrack, but a real, serviceable household necessity! Will last a lifetime. *Is guaranteed in writing for 5 years!* Sells at a price that every home can afford. Sold also in stores, factories, etc. Is approved by Good Housekeeping Institute, Modern Priscilla Proving Plant and other experts. And men, listen to this. I have a unique new "combination" sales offer that pays you astonishing big profits on every sale!



Mail  
This  
Coupon  
Today  
for the  
Greatest  
Specialty  
of  
1927

### 2500 TERRITORIES NOW OPEN

You don't need experience to sell this marvelous invention. We train you and furnish everything. I now have EXCLUSIVE TERRITORIES and COMPLETE SALES OUTFITS waiting for 2,500 more ambitious men. The smartest salesmen in America will see the tremendous possibilities and snap up this generous offer, so you must act quick. Just mail the coupon for my FREE OUTFIT and FREE TEST Offers. Get in on the ground floor. Act quick. Write me this minute.

D. D. EVANS, Sales Director

**Central States Mfg. Co.**

Dept. P-701

4500 Mary Ave., ST. LOUIS, MO.

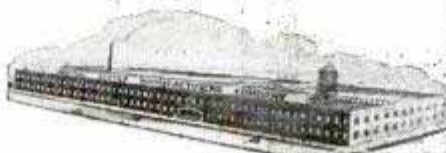

D. D. Evans,  
Sales Director,  
Dept. P-701  
Central States Mfg. Co.  
4500 Mary Ave.  
St. Louis, Mo.

Rush me the facts about your FREE TEST and FREE OUTFIT Offers. This does not obligate me in any way.

Name.....

Address.....

Town..... State.....

Territory preferred.....



# Look at this Bargain! Genuine McFADDEN Muscle-Builder

Now Only \$1.98

HERE'S the offer that startled the whole physical culture world—and no wonder! This overwhelming BARGAIN will make you rub YOUR eyes!

Think of it! Only \$1.98 for the Genuine McFADDEN Muscle Builder, the champion muscle making Exerciser! The McFADDEN is the real stuff all the way through. It develops tremendous resistance—that's the secret of BIG muscles. You can use as many cables as you please, the McFADDEN is Progressive. Made to stand the gaff—carefully selected materials, strong, durable construction. And you don't risk a cent. Our iron-clad GUARANTEE makes YOU the judge and jury.

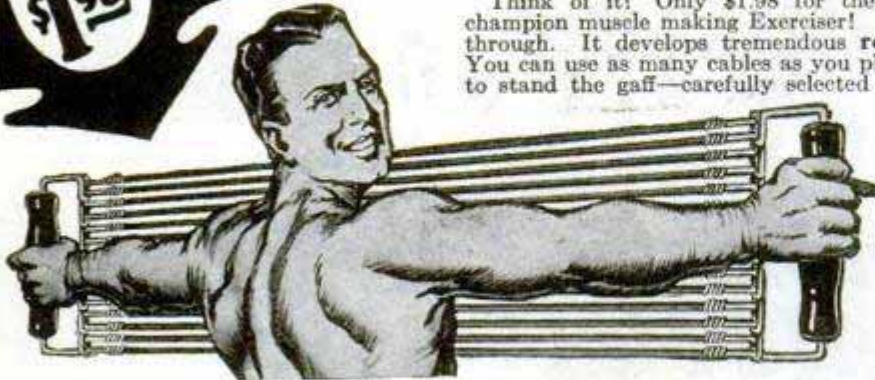

## Develop Giant Muscles Quick

This sensational offer will bring a flood of orders. A Genuine McFADDEN Exerciser has never been sold at such a low price before. Don't wait or you'll lose out. Shoot the coupon along NOW. State whether you want 5, 10 or 15 cables.

McFADDEN PHYSICAL CULTURE INSTITUTE  
(Dept. R-120)

840 Broadway, New York, N. Y.

I enclose (check which)

- \$5.87 for a 15 Cable McFadden Exerciser
- \$3.98 for a 10 Cable McFadden Exerciser
- \$1.98 for a 5 Cable McFadden Exerciser

If I am not entirely satisfied with this outfit I will return it within a week and you agree to refund my money in full.

Name.....

Address.....

City..... State.....

Check here for C. O. D. shipment. Postage extra.

**RUSH COUPON:** Fill out the coupon below before you turn the page. Mail your order tonight. Every penny of your money is perfectly safe. You need not keep the outfit if you do not want to. Act now and get the biggest bargain ever offered the physical culture world.

**McFADDEN PHYSICAL CULTURE INSTITUTE**

(Dept. R-120)

840 Broadway

New York, N. Y.

# EARN \$12.00 Per DAY AS A TRADESMAN!

## When a Grown Man Goes to School

it is because he wants a better job and more money in as short a time as possible, and, more than that, he wants to be sure of a Big Pay Job when he completes his training.

Bricklaying  
Carpentry  
Electricity  
Painting

Paperhanging  
Plastering  
Plumbing  
Sign Painting

Auto Painting  
Auto Striping  
Auto Trimming  
Tool Making

Metal Finishing  
Ignition  
Welding  
Batteries

are all Big Pay Trades and are easily learned in a comparatively short period of time, at minimum expense, by actually doing the work—not by reading books.

### Learn a Trade

Join the ranks of the Skilled Tradesmen and stop worrying about where you will work and what you will earn a few years from now. You may Learn a Trade in your spare time if you wish.

**Detroit School of Trades**  
Detroit Michigan

## Send Coupon Today!

**DETROIT SCHOOL OF TRADES,**  
Dept. 1027-A,  
217 Woodward Avenue, Detroit, Michigan.

Gentlemen: Please forward to me without any obligation on my part a copy of "The Book of Big Pay Trades." I am interested

in.....

Name.....

Address.....

City..... State.....



# One Little Ounce of Magic Dots Will Hold 25 Ruptures!!

**FREE!**

Amazing new book explains new discoveries on rupture relief. Now sent free to rupture sufferers. Also get free sample of Airtex, the new way to hold rupture without pressing. Not a penny to pay, now or future. Simply tear out-coupon below!

**N**O wonder over 20,000 rupture sufferers have switched to this new way to relieve rupture!

Magic Dot is so light in weight, so small and inconspicuous, that twenty-five of them weigh only one ounce! It would take fully three hundred of them to equal the weight of one truss that consists of steel springs, leg straps and hard cushions!

Think what this invention means to rupture sufferers in convenience alone! Yet convenience is only one of Magic Dot's many benefits in the correction of rupture and the end of constant pain, discomfort and embarrassment!

## How It Works

If you could always hold your rupture together with

your thumb and forefinger, your rupture would probably disappear in time. That is all the pressure it needs. And that is exactly the way Magic Dot operates. It weighs less than a feather, measures little larger than a quarter. Once fixed in place, it stays in place until you take it off.

But how does it stay always fixed against the rupture despite any movement of the body? The answer is Airtex—the most radical improvement in rupture appliances yet discovered. It is a flesh-soft pad about the size of your palm—filled with myriad air cells that sweep a constant flow of fresh cool air in, through and around the rupture.

## You Be the Judge

You cannot fully appreciate the radical difference and marvelous improvement of Magic Dot until you see it fully described in the book now being sent free to rupture sufferers . . . until you feel the velvet-like softness of Airtex. Read the case histories below. Probably these cases and many others relieved by Magic Dot were worse than yours. Why suffer needless pain, discomfort and embarrassment? Mail the coupon below now! New Science Institute, 2142 Clay St., Steubenville, Ohio.

### Were These Rupture Cases Worse Than Yours?

"Am nearly 75 years old so consider the results of my case remarkable. The appliance I purchased from you a year or so ago was beginning to give out, so I thought I should get a new outfit. I took off the old one and my rupture was all gone. Have not worn either the old or new appliance for over a week, have worked every day, and still no sign of rupture." John Terweale, Park Rapids, Minn.

"My rupture is entirely cured. I believe the cure was complete within sixty days after I put on the appliance. However, I kept wearing it for six months, but now I use nothing of the appliance. I had been ruptured 20 years and my rupture dropped clear down into the scrotum." M. P. Brumbaugh, Juniata, Penna.

"My rupture was entirely cured in less than 90 days. I have had no trouble from it since. I will be 80 years old in November next. I do not give your truss credit for the full recovery. Think my extreme youth had something to do with the healing." F. B. Hubbard, Centralia, Wash.

New Science Institute, 2142 Clay St., Steubenville, Ohio.  
Yes, send me your interesting free book describing the wonders of the New Science System of rupture relief. This request does not obligate me.

Name . . . . .  
Address . . . . .  
City . . . . .  
State . . . . .



# GENUINE CORONA

Limited Offer



**\$200**  
DOWN  
BALANCE  
EASY  
TERMS

HERE'S your chance to secure that Corona you've wanted —on the easiest terms ever offered —at ONE-THIRD OFF regular price! Complete in every detail; two color ribbon, back spacer, beautifully re-newed, NEW MACHINE GUARANTEE. Recognized the world over as the finest, strongest, sturdiest portable built. Only a limited number of these splendid machines available. To get one, you must act now!

**Yours For 10 Days FREE  
Send No Money**

Experience the joy this personal writing portable typewriter can give you! Use it 10 days free! See how easy it is to run and the splendidly typed letters it turns out. Ideal for the office desk, home, travelling. Small, compact, light, convenient. Don't send out letters, reports, bills in poor handwriting when you can have this Corona at such a low price or on such easy terms.

**Carrying Case Included  
—If You Act Now**

Leatheroid carrying case, oiler, instructions free on this offer. Send no money—just the coupon. Without delay or red tape we will send you the Corona. Try it 10 days. If you decide to keep it, send us only \$2—then \$3 a month until our special price of \$36.25 is paid (cash price, \$33.10). Now is the time to buy. This offer may never be repeated. Mail coupon now.

**\$16 SAVED**

by using this coupon

SMITH TYPEWRITER SALES CORP.  
84B-360 E. Grand Ave., Chicago.

Ship me the Corona, F. O. B. Chicago. On arrival I'll deposit \$2 with express agent. If I keep machine, I'll send you \$3 a month until the \$34.25 balance of \$36.25 price is paid; the title to remain with you until then. I am to have 10 days to try the typewriter. If I decide not to keep it, I will repack and return to express agent, who will return my \$2. You are to give your standard guarantee.

Name.....  
Address.....  
Employed by.....

## Learn How to BOX

### JIMMY DeFOREST BOXING COURSE

Teaches by mail the Same System he taught Champion JACK DEMPSEY

In 20 weeks, under the System of Jimmy DeForest, WORLD'S GREATEST TRAINER AND MAKER OF CHAMPIONS, you will master the priceless knowledge that made Jack Dempsey his millions, and fortunes for a host of other Jimmy DeForest-trained ring stars. Boys who were once rank amateurs are today earning big money; weaklings have been made strong, courageous; men have learned the art of self-defense. Send today for the now famous book, "THE GOLDEN AGE OF BOXING," greatest book of its kind ever written; full of valuable information, photos of great fighters and pupils who became successes over night. Enclose 10c to cover cost of mailing, etc. WRITE NOW.



JIMMY DeFOREST BOXING COURSE

347 Madison Avenue, Box 124, New York City

## No Joke to be Bald



Grow  
New  
Hair  
Quick

### Let Me PROVE It To You FREE

What I accomplished on my own head, pictured above, I believe I can do for you, provided you are under 45 years of age and loss of hair was not caused by burns or scars. Anyhow, I must succeed or you pay nothing. No apparatus—my home treatment is simple, quick and inexpensive.

Send No Money Just your name and address and I will mail you full information with PHOTOGRAPHS, NAMES and addresses of men and women who have successfully used my treatment for dandruff, falling hair and particularly for baldness. Write Now. A postal will do.

**VREELAND'S,** 1358 Euclid-Windsor Bldg. CLEVELAND, OHIO



## Deafness

Perfect hearing is now being restored in all cases of deafness caused by Catarrhal troubles, Relaxed or Sunken Drums, Thickened Drums, Roaring or Hissing Sounds, Perforated, Wholly or Partially Destroyed Drums, Discharge from the Ears, etc.

### Wilson Common-Sense Ear Drums

require no medicine but effectively replace what is lacking or defective in the natural ear drums. They are simple devices, which the wearer easily fits into the ears where they are invisible.

### Free Book on Deafness

Soft, safe and comfortable. Write today for 168-page book on deafness giving full particulars and many testimonials. The hearing of thousands of grateful users has been restored by these "little wireless phones for the ears."

WILSON EAR DRUM CO., Incorporated  
664 Todd Bldg. LOUISVILLE, KY.

## Correct your NOSE

A shapely nose makes a beautiful face. Improve your good looks with the marvelous ANITA NOSE ADJUSTER. Reshapes any type nose perfectly at home. Quick, painless, permanent results guaranteed. Can be worn night or day. Doctors praise it. Send no money. Write for FREE BOOKLET.



BEFORE



AFTER

ANITA CO., Dept. M-12, Anita Building, NEWARK, N. J.



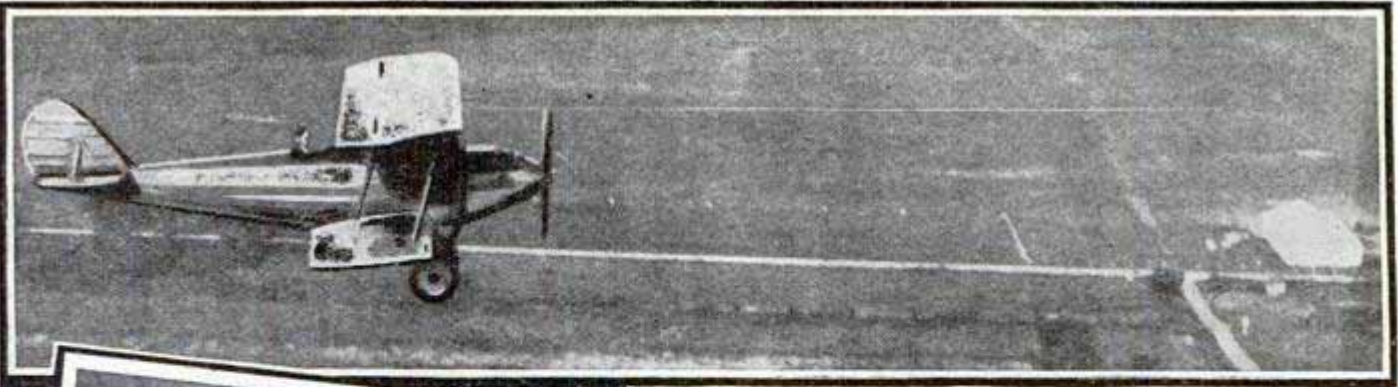

# The Sweeney School

With planes, equipment and instructors under U. S. Govt. inspection, the million dollar Sweeney School, with its 150 acre private flying field, club house, hangar and thousands of dollars worth of latest tools, machinery and equipment for aviation, offers young men the most efficient, economical and practical method of getting into this great business. Picture above shows Dr. Brock, a Sweeney flyer, in the air over the Sweeney Air Port. Hangar at upper right.

## Pilot or Ground Course

YOU can select either the pilot course or ground mechanics course or combine the two courses. All the flying with dual controls and later solos to qualify you. All the ground work in motors, ignition, wings and construction qualify you to become an expert and five men are needed on the ground for one man in the air. The cost of tuition is extremely low and living conditions are pleasant and economical. Many men just out of the army come here to take up this work. Student body very high class. No previous experience required. We use tools, not books.

## Col. Lindbergh Advises You

"Aeronautics in the U. S. today are in a position no other industry has ever been in. It is probable the great transcontinental air lines of the future will pass thru Kansas City. Kansas City is naturally located to become this hub."

**FREE** Send name today for full details. Illustrated catalog shows pictures of students at work in shops and in the air. Everything you want to know about aviation. Lists of jobs and high pay offered aviators and mechanics. No colored students accepted.



Fuselage & Assemble

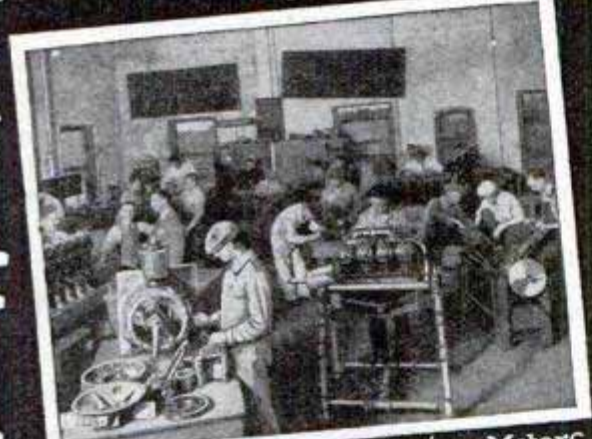

Working on Motors

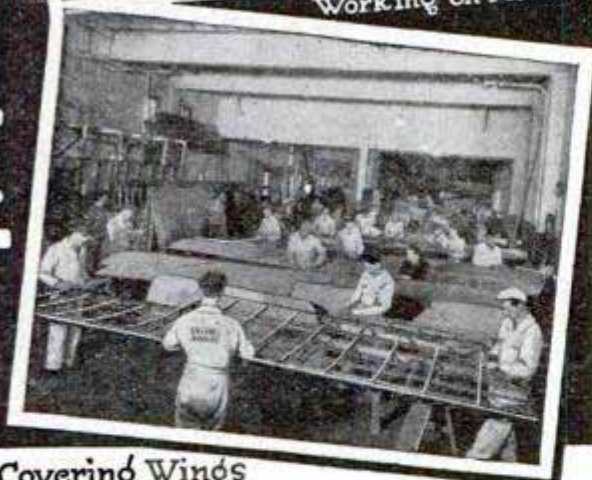

Covering Wings

LEARN TO FLY BY FLYING  
**Sweeney**  
 SCHOOL OF AVIATION  
 4306 SWEENEY BLDG., KANSAS CITY, MO.

SEND THIS NOW

EMORY J. SWEENEY, President  
 4306 Sweeney Bldg., KANSAS CITY, MO.

Please send me full information about your Aviation Course.

Name..... Age.....

Address.....

Town..... State.....



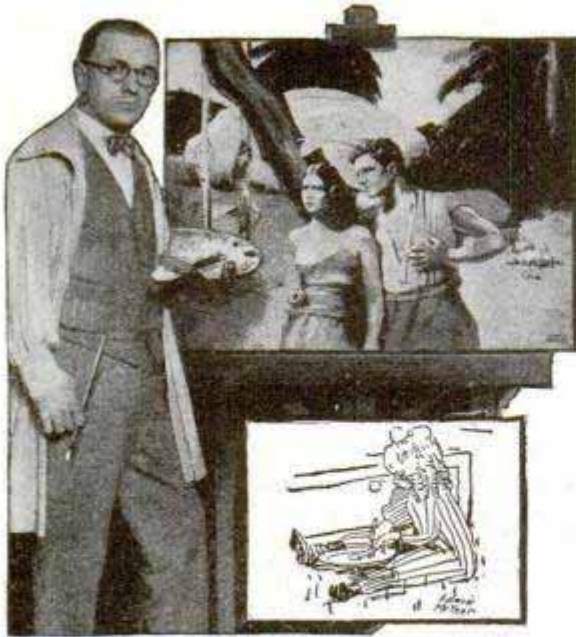

Here is Edwin McTeer (address on request) and some of his work. The crude pen drawing was made before he had any training and the striking story illustration (worth \$100) was made after he took the Federal Home Study Course.

# He did it— Why don't you?

Edwin McTeer is only one of the hundreds of young men (and young women, too) who are succeeding in commercial art with the help of the practical training offered by the Federal Home Study Course. Well trained artists earn \$50, \$75, \$100, \$150 a week and more.

## SUCCESS IN COMMERCIAL ART

begins with a liking for drawing and the ambition to follow through with the right training. Mr. McTeer was thirty years old when he clipped a coupon like the one at the bottom of this ad, and took up the Federal Course. He progressed rapidly, increasing his earnings each year until, at the end of five years he was making around \$10,000 a year. Read what he wrote us:

"I was not very talented when I entered this training with you people as you certainly know, and I had not even had high school training and I know any one with a love for the work can accomplish even more than I if they will just let you people, the Federal Schools, help them.

"I suppose you remember I opened my own independent commercial art studio and to make a long story short, my earnings are now at the rate of over \$10,000.00 a year."

## SEND FOR "YOUR FUTURE"

If you like to draw—send for book "Your Future" and find out what amazing progress you can make with the right art training. Use the coupon now, giving age and occupation.



# Federal School

of Commercial Designing

630 Federal Schools Bldg.,  
Minneapolis, Minn.  
Please send me "Your Future."

Age ..... Present Occupation .....

Name .....

Write your address plainly in margin.

# LEARN WATCHMAKING

Earn up to  
**\$100<sup>00</sup>**  
a week



## Big Demand For Trained Men

Great shortage of watchmakers, watch and clock repair men! Grasp this amazing opportunity. Steady employment in any section of the country. Uncrowded money-making field. We help you get big-pay job. Or you can own your own repair shop—easy to start—we show you how—fine income right from the beginning. NOW is the time to start—employers are writing us for trained men. Greatest opportunity of your life!

## WE TEACH YOU QUICKLY

Takes but a few months to learn. Day or night school, no books; all personal instruction. Our profit-sharing plan helps you earn tuition. Work your way through school. We help you get part-time job.

**FREE BOOK** Write today for interesting book on watchmaking. It shows you the tremendous growth of the watch and clockmaking industry, the need for expert watchmakers and the wonderful money making prospects for men who are trained by our competent instructors **Write Today. NO OBLIGATION.**

**NATIONAL SCHOOL OF WATCHMAKING**  
1340 South Michigan Avenue Dept. 13 Chicago, Ill.



## Learn To FLY

Get up into the sky! Get the thrill of flying and make big money. Complete Ground Courses qualifying you as air-planes builder, inspector, rigger, engine man, etc. Flying instruction on new training planes. Ground instruction in modern factory, building new ships. Send at once for finest and most complete school catalog ever issued. Gives full particulars, many pictures, answers all questions. Write now and get details of special offer.

**MARSHALL FLYING SCHOOL**  
230 North Street Marshall, Mo.

## WATCH GIVEN



**BOYS**—Get Silver-Dial Octagon Watch—just ask six friends to read great outdoors sports magazine. Outfit and dog pictures **FREE** if you write today. Send postcard with name to Sportsman's Digest, Dept. 9-M, Cincinnati, O.

## FREE—U. S. GOVERNMENT

Has for free distribution a limited supply of thousands of different publications. Interesting. Instructive. For Men, Women, Boys, Girls. Names of Publications, Instructions on how to apply in our Catalogue, 25c coin.

**East Publishing Co., Columbian Bldg., Washington, D. C.**

## Mathematics Made Easy by ROPP'S CALCULATOR AND SHORT-CUT ARITHMETIC

Shows the Answer as Quickly as a Watch shows the Time to all Problems likely to occur in the Office, Store, Shop, Bank, Farm, or Factory.

Over 2,000,000 Sold



Explains and simplifies every principle in Arithmetic, Mechanics, and Mensuration.

**PRICES POSTPAID**  
Desk Size...\$1.50  
Leatherette, Pocket Size...\$1.00  
Pocket Size, Cloth...\$0.50  
Pocket Size, Paper...\$0.35

Popular Mechanics Press, Room 208, 200 E. Ontario St., Chicago



# Electrical Experts are in Big Demand

I'll Train You  
These Men To Fill  
Learn to



At Home Like  
A Big Pay Job  
earn \$3500 to

**\$10,000**  
a year

**MAKES \$90 A WEEK**  
Dear Mr. Cooke: I am only half way through your Course, but am making around \$90 a week. Everybody says I'm the best electrician in town.  
W. A. SCHULTZ  
1016 Madison St., Brownsville, Texas

**OFFERED \$12,000 JOB**  
Dear Mr. Cooke: I am offered the job of Chief Electrician for a Big Coal Mine at \$12,000 a year. But I am doing good in my own business. Do you think I should take the job?  
E. M. HUGHES  
1656 2nd Ave., Terre Haute, Ind.

**EARNS \$40 A DAY**  
Dear Mr. Cooke: Instead of the \$3 a day I was making about a year ago when I enrolled, my earnings now run as high as \$40 to \$50 a day.  
ED. LEHMANN  
1521 Market St., Oakland, Calif.

**GETS 200% MORE PAY**  
Dear Chief: When I enrolled I was an oiler at \$80 a month. Now I have advanced to Chief Operator getting three times more pay.  
BRYANT WEEKS  
Mona Lake, Calif.

## Cooke Training Did It! and there's a place for you, too, in this big pay field

CALL it luck — Call it "bunk" — Call it anything you like — But these four and many thousands of other Cooke Trained Electrical Men are earning this big pay. They earn from \$3500 to \$10,000 a year and the same road they took is open to you — Now!

Why stick to your no-future \$25 to \$30 a week job when these thousands of men no smarter than you and with no previous experience are jumping ahead of you — easily earning two to four times what you earn, year in and year out?

Electricity needs you. It has a place for you and thousands of other red-blooded, honest-to-goodness young fellows who want a real job and REAL MONEY and who have gumption enough to trade a little of their spare time for a chance to get it. Electricity is the world's greatest business. Over 750 million dollars are being invested in it every year. In the power house end of the industry alone, 15 thousand new and additional jobs were created last year. Electricity is an op-

portunity — a future — "Success" — for thousands of men. Will you risk two pennies for a stamp to find out what it will do for you?

Chief Engineer Cooke has written a wonderful book about electricity, its opportunities for young men, and what these opportunities mean to you. It is printed in colors, has 64 pages and more than 100 pictures. It's the same book that started ten thousand other men on the road to big pay. It's FREE — and it may help you like it helped them. Anyway, send for the book and decide for yourself. No agent will call on you — no one will bother you and you won't be obligated in any way. What you do in the next minute may mark the turning point in your life. Mail the Coupon — NOW — to —

**L. L. COOKE, Chief Instruction Engineer**

**L. L. COOKE SCHOOL  
OF ELECTRICITY**

Dept. 518 2150 Lawrence Ave. Chicago, Ill.

**BIG OUTFITS  
NO EXTRA COST**



**FREE BOOK COUPON - Mail it!**



**L. L. Cooke, Chief Instruction Engineer**  
Dept. 518 2150 Lawrence Ave. Chicago, Illinois  
Without obligation send me your FREE book on Electricity and other information regarding your training.

Name \_\_\_\_\_

Address \_\_\_\_\_

City \_\_\_\_\_ State \_\_\_\_\_

Residents of Canada send coupon to R. A. Farrow, Special Representative, 7 Medbury Lane, East, Windsor, Ontario, Canada.

**The "Cooke" Trained Man is the "Big Pay" Man**



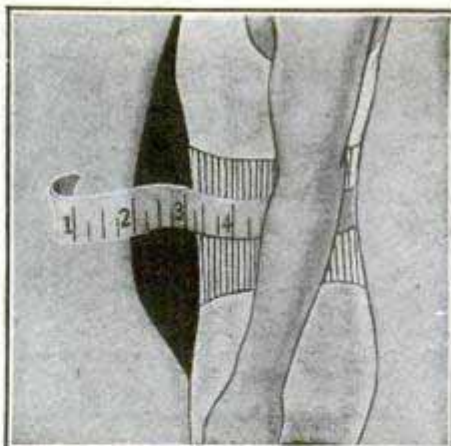
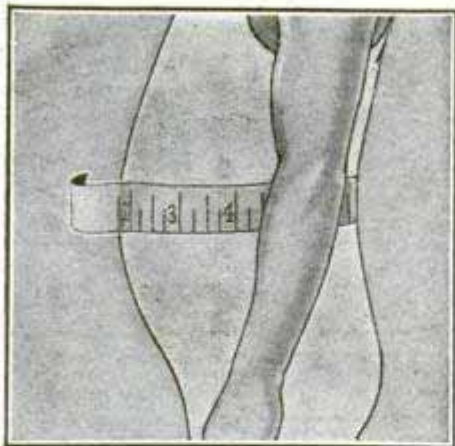

# Free Proof That WAISTLINE FAT Can Be Quickly Reduced —without drugs, diets or exercises

**I**NSTEAD of wasting your time—instead of risking your health by weakening diets, exhausting exercises and pill-taking, in an effort to get rid of bulging waistline fat—try the popular Weil Reducing Belt for 10 days—at our expense.

Made of scientifically treated rubber it causes a gentle, unnoticed massage action as it comes in contact with flabby flesh. So that with every move you make unwanted fat is being moulded away—and kept away for good—and at a fraction of the price charged by expert masseurs.

### Look Thinner Instantly

Take your waist measurement before and after this Free 10-Day Trial. Note the difference in inches. Feel the improvement in your general condition. According to the terms of our absolute guarantee, you must be thoroughly satisfied with the results secured—or you pay nothing.

### Coupon Brings Free Details

Write us at once and you will receive our Special 10-Day Trial offer—a detailed description of this most successful reduc-

ing method, the principles of which are highly endorsed by leading physicians and professional athletes everywhere. For the sake of your health and appearance take advantage of this offer at once. Send no money. Write now. The Weil Company, 911 Hill Street, New Haven, Conn.

-----  
**THE WEIL COMPANY,**  
911 Hill Street, New Haven, Conn.

Gentlemen: Please send me complete description of the Weil Scientific Reducing Belt and also your Special 10-Day Trial Offer.

Name.....

Address.....

City.....State.....



## Learn To FLY

Get up into the sky! Get the thrill of flying and make big money. Complete Ground Courses qualifying you as airplane builder, inspector, fitter, engine man, etc. Flying instruction on new training planes. Ground instruction in modern factory, building new ships. Send at once for finest and most complete school catalog ever issued. Gives full particulars, many pictures, answers all questions. Write now and get details of special offer.

**MARSHALL FLYING SCHOOL**  
230 North Street Marshall, Mo.

## 30 Days' Free Trial

New Models now ready for delivery direct from our factory. Astonishing low prices and terms. Do not buy until you get them.

**RIDER AGENTS WANTED** to ride and exhibit sample. Make big money. Many models \$21.50 up.

**Tires** Guaranteed \$1.50 each, wheels, lamps, horns, equipment at half usual prices. Send No Money. Write for our marvelous prices and terms on RANGER Bicycles.

**MEAD CYCLE CO. Dept. 3110 CHICAGO**



## HYPNOTISM

Learn the secrets of Hypnotism—that strange subtle power which enables you to make others love you; overcome shyness; strengthen your memory, mind and will power; realize your ambitions; develop a strong magnetic personality and gain control over others. These magic secrets explained in 25 easy lessons. Complete Course, \$1.00. Satisfaction Guaranteed. Bargain Book Catalog FREE.

**FRANKLIN PUB. CO., 186 N. LaSalle St. Dept. 9418 CHICAGO**

## BE AN OIL EXPERT!

Trained men needed! Geologists, Drillers, Refiners (Chemists and Still Men), Oil Salesmen, earn 2 to 10 times more than in other fields. Write today! FREE Booklet! Petroleum Engineering University, Dept. 231, Fort Wayne, Ind.

## WOLF

**COYOTE, FOX and SKUNK EXTERMINATOR CAPSULES.** Got 9 coyotes one night. Brought \$121.50.

**Free Circular. Free Formulas and Instructions.**  
GEORGE EDWARDS, Livingston, Montana



## DRAW CARTOONS

**TURN YOUR TALENT INTO MONEY**

Cartoonists earn from \$50 to \$250 per week—some even more. Remarkable Circle System of Drawing teaches you in half the usual time. Students from all parts of the world are enrolling for this exceptional instruction. Personal criticism service and up-to-the-minute instruction make it easy for National students to attain success. Send for interesting BOOKLET and SAMPLE LESSON PLATE explaining full details of the Course and what National students are accomplishing. No salesman will call.

**The National School of Cartooning, 623 Penton Bldg., Cleveland, Ohio**





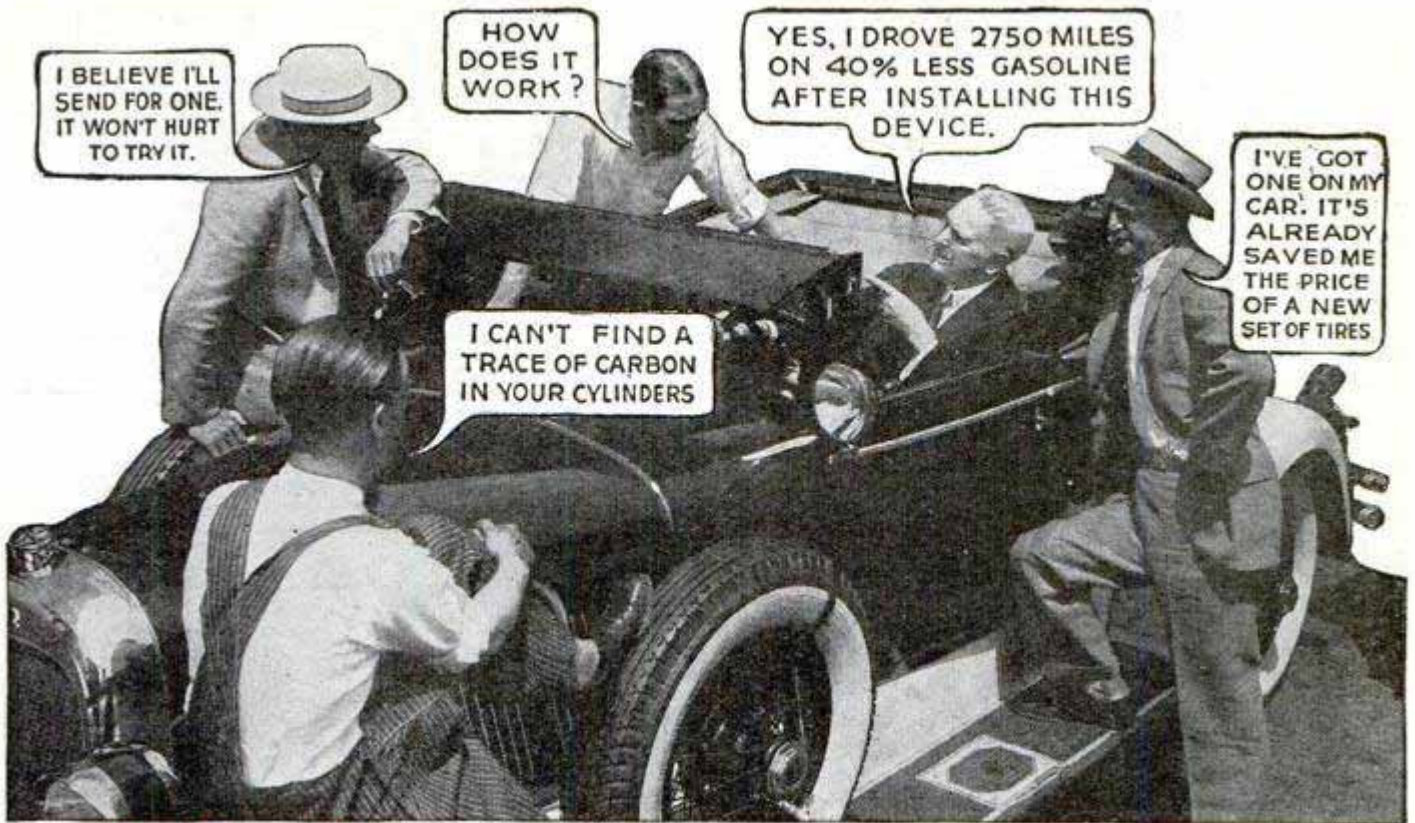

I BELIEVE I'LL SEND FOR ONE. IT WON'T HURT TO TRY IT.

HOW DOES IT WORK?

YES, I DROVE 2750 MILES ON 40% LESS GASOLINE AFTER INSTALLING THIS DEVICE.

I'VE GOT ONE ON MY CAR. IT'S ALREADY SAVED ME THE PRICE OF A NEW SET OF TIRES

I CAN'T FIND A TRACE OF CARBON IN YOUR CYLINDERS

# At Last! A GUARANTEED WAY TO CUT YOUR GASOLINE BILLS

*Inventor's Amazing Device Must Increase Your Gas Mileage 25% to 50%... OR COSTS YOU NOTHING*



### Saved Half the Price of a New Car

H. H. Cummings, Ford owner, has saved 1,905 gallons of gasoline on 50,000 miles! "I have used one on my 1922 Ford which I have driven over 50,000 miles. I am getting 30 miles a gallon where before I got only 12 to 14 miles a gallon."



### Almost Doubled Gas Mileage

L. M. Skorupski made 26 miles a gallon on a Reo Six, which formerly made only 14 miles a gallon. His sister, Lillian Skorupski, drives a Dodge and writes: "I made 41 miles on one gallon of gasoline with the Stransky Vaporizer."

**H**OW much gasoline can you save? Perhaps the price of a new set of tires, as many have saved. Perhaps half the price of a new car, as related by H. H. Cummings. Over two million have adopted this new way to lower fuel costs and repair expenses. Over ten thousand enthusiastic and unsolicited reports already received say that this invention has saved them gasoline—made carbon trouble and expense a thing of the past—gave old and new engines greater power and speed.

### You're Wasting Valuable Power

Authorities now say that the average car owner wastes two or three gallons of gasoline of every ten he buys. You pour this excess gasoline into your engine which cannot absorb it quickly enough. Thus arises carbon deposits, the worst evil that can happen to your engine. Carbon scores and pits the cylinders, develops knocks, causes wasted power and lost speed—and costs heavy repair bills.

With this wonderful device on your car your gas is under positive control. It explodes cleanly and sharply—every atom of it. Thus carbon cannot form from unexploded gasoline. Also you have a new convenient way to remove carbon already formed, the same way carbon is removed from the famous Diesel engine. It is simple, automatic and amazingly effective.

### How This Invention Works

The Stransky Vaporizer is built on the sound

engineering principle of multiplying the vapor power of your gasoline. It fits any car, works automatically, and can be installed in a few minutes. It is not a powder or mixture, but a simple metal device little larger than a dollar.

It has no mechanism to get out of order and should outlive the car itself. Already it is being used on practically every make of car, truck, tractor—even on an aeroplane. The reports shown on the left are typical of thousands received.

### Men Wanted Earn \$75 in a Week

Here is an ideal full-or-spare time proposition for ambitious men. Big profits are frequent among Stransky representatives all over the world. Herrick made \$157 in one day. Foster \$137.50 in one week. No experience required — we show you simple, easy way to make quick profits. Mail coupon below for details without obligation.

### You Can't Lose—Mail Coupon Now

"Suppose it doesn't save me gasoline and remove carbon?" "How do I install it?" "How much does it cost?" These and other questions can be more satisfactorily answered upon receipt of coupon below. It will bring you full description of the Stransky Vaporizer, tell

you about our free sample offer, price to agents, and other details. J. A. Stransky Mfg. Co., P-10 Stransky Block, Pukwana, South Dakota. **Mail Coupon Now**

J. A. Stransky Mfg. Co. P-10 Stransky Block, Pukwana, So. Dak.

Yes, send me full details of the Stransky Vaporizer and Decarbonizer, your free sample offer and your agent's proposition. This request does not obligate me.

Name.....  
Address.....  
City.....State.....



# Learn Electricity IN LOS ANGELES

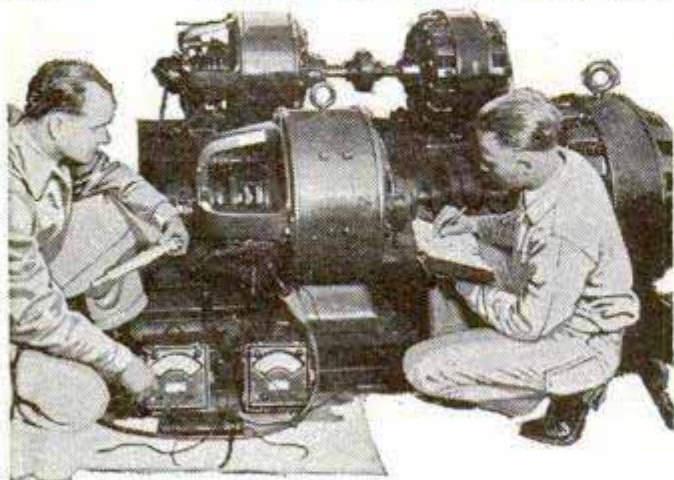

## FREE Employment Service!

There are more calls for "National-Trained-Electrical-Men" than we can supply. Jobs are open now paying \$50 to \$200 a week—but you must first get the right training. Get it at National—a world-famous institution with a quarter century record of success in training big pay men.

### All These Advantages:

1. Unlimited Training Until Competent.
2. Free Employment and Welfare Service.
3. Million Dollar Training Shops.
4. Personal, individual Training guaranteed.
5. You actually perform work that employers pay big money for.
6. Official Diploma and certified record of work performed.

## FREE

Read how National insures your success. Send for this free Electrical catalog—illustrated by actual photos of students training under instructors on a half million dollars' worth of new electrical equipment. Mail coupon now.



This Big, Free Book Shows You How to Quickly Make BIG PAY



# National Electrical School

Dept. 512, 4006 Figueroa St., Los Angeles, California.

Send me your big free illustrated catalog of Electrical Opportunities.

Name.....  
 Address.....  
 Age..... City..... State.....



Radium Dial Jeweled Movement

Silveroid Cushioned Shaped Case

This wonderful, fully guaranteed Men's Wrist Watch, also worn by women and girls as sport model wrist watch. Accurate, durable, handsome, GENUINE leather strap, given free as a reward for helping us advertise. Send name and we'll send only 20 handsome pictures to dispose of on 25c offer. Send the \$5 you collect and as a reward will send watch. C. M. THOMAS, 337 W. Madison St. II A 91 CHICAGO

ALWAYS Ask For DENISON'S—52 Years of Hits Comedy-Dramas, Farces, Musical Comedies, Revues, Musical Readings, Comedy Songs, Chalk Talk Books, Minstrels, Blackface Skits, Make-up Goods. Catalog FREE. T. S. DENISON & CO., 623 S. Wabash, Dept. 9 CHICAGO

## Free Your Skin

of pimples, boils, etc., with KLEERSKIN! It purifies the blood and rids it of the poisons that cause skin disorders. KLEERSKIN is wonderful also for treating carbuncles, blackheads and similar skin infections. KLEERSKIN is made after the formula of a celebrated German physician who, after many experiments and clinical trials, has proved it to be the remedy par excellence. Write today. Medco Medicine Co., 503 Ridge Bldg., Kansas City, Mo.

## Save Your Feet

When all else fails, end your suffering with the

### Heefner Arch Support

No Metal



Fully patented. It re-adjusts the entire foot. Write for free book and statements from doctors and users.

Heefner Arch Support Co. 657 M. E. Taylor Bldg. Louisville, Ky.

## What Made His Hair Grow?

### Read His Letter for the Answer



"Two years ago I was bald all over the top of my head.

"I felt ashamed for people to see my head. I tried different preparations, but they did no good. I remained bald, until I used Kotalko.

"New hair came almost immediately and kept on growing. In a short time I had a splendid head of hair, which has been perfect ever since—and no return of the baldness."

This verified statement is by Mr. H. A. Wild. He is but one of the big legion of users of Kotalko who voluntarily attest it has stopped falling hair, eliminated dandruff or aided new, luxuriant hair growth. KOTALKO is sold by busy druggists everywhere.

## FREE Trial Box

To prove the efficacy of Kotalko, for men's, women's and children's hair, the producers are giving Proof Boxes. Use coupon or write, to

KOTAL CO., F-187, Station L, New York  
 Please send me FREE Proof Box of KOTALKO.

Name.....  
 Address.....





# GET INTO AVIATION

The miracles of success made in the auto business, by men who looked ahead, are now about to be repeated in the new, great Business of Aviation. To train YOU for the place you want to make for yourself,—success in this new business, and big money,—the world-famous Detroit school, the "Michigan State," now has ready for you complete ground and air training under experts.

## Learn Aviation in Detroit, The Airplane Center

### A Business Just Being Born

Aviation is just beginning to be a business. The experimental stage is passing to the practical stage. Marvelous futures and success await the men who learn this thrilling business thoroughly NOW.

Get into aviation!—either as maintenance man or flyer. Five to twenty ground men are needed to maintain every flyer,—the opportunities are big in both branches. Men are needed now—five planes are being built to every one man being trained.

#### Thorough AIR Training At Detroit's Famous School

Air and ground training under experts will fit you properly. Seventeen years of training experience backs this Air Course. It is complete, intensive. It covers:

**GROUND WORK** Engine and Plan Design, Construction and Repairs.

**FLYING** Including Solo Without Bond, In Standard and New, Modern Planes.

#### AERIAL NAVIGATION AND PHOTOGRAPHY

The Course qualifies you for Dept. of Commerce examinations, and gives you practical training for actual ground work and flying.

### Endorsed by Eddie Stinson and Other Aviation Leaders

As the "Michigan State" has always had the endorsement of Auto leaders, so it now has the backing of Aviation leaders. "Eddie" Stinson, America's premier flyer and President of the Stinson Aircraft Corporation, and others, give the Course and the "Michigan State" their complete approval.

### Aviation Is Ready—Are You?

Aviation is now where the Auto business was 20 years ago. Future opportunities are limited only by your vision and your training. Are you ready to act? The men who get in now will profit biggest. Prepare now—and profit by your foresight.

#### Training That Equips You Right

Complete, practical training at this reliable Detroit school, fits you either for ground work or for flying. Three months' Course or longer. Shop practice. Class room instruction. Ten hours of dual control flying. Solo flights with no bond required. Under direction of flyers of vast experience.

#### Practical Training Not A Correspondence School

"Michigan State" Aviation training is practical work right here at our school, in our class rooms, on our airplanes and engines, and flying in our planes.

#### Write For Details

Get the jump on the "pack" by starting now. Write or send coupon for facts,—or jump on the train today for Detroit—the Auto and Air Center.

## Michigan State Aviation School

Affiliated With  
Michigan State  
Automobile School  
Established 17 years  
A. G. Zeller, Pres.  
3711 Woodward Ave.,  
Detroit, Mich.

**Learn Aviation  
in Detroit—  
The Auto and  
Airplane Center**

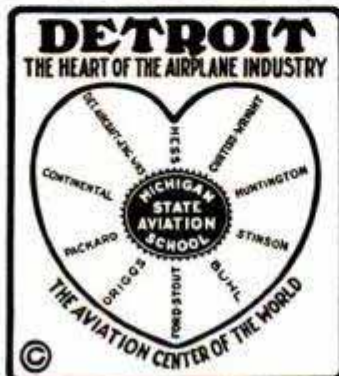

### Get the Facts TODAY

A. G. Zeller, President  
Michigan State Aviation School  
3711 Woodward Ave., Detroit, Mich.

Send me at once the details of your Aviation Ground and Flying Course. I expect to come to Detroit about.....

Name.....

Street and No. or R. F. D.....

City and State.....



# Decorate these Giftwares and Make Money



Earn money at home,  
this fascinating new way,  
in spare time

We Show You How

THIS is the most delightful work you could imagine; you will enjoy every minute you devote to it. Many people do it solely for the artistic pleasure they get in creating beautiful things. But it also pays surprisingly well, for there is an enormous demand for giftwares. Many of our members make \$10 to \$25 a week, and have built up profitable businesses from small beginnings. Think of decorating a Hanging Shelf, for example, requiring only 3 hours work, and realizing a profit of \$10.50. What other work could be so interesting, and pay so well?

## No Special Ability Needed

The national association of homeworkers known as Fireside Industries now has openings for new members. This is your opportunity. Find out how you can secure a membership. The work is easily learned, and easy to do. You have only to follow the simple directions given by Gabriel Andre Petit, the Art Director, and you can easily learn the latest methods of decorating wooden toys, parchment lamp shades, painted furniture, book-ends, greeting cards, batik and other objects of art. You are furnished a complete outfit of materials, worth \$10.00, without extra cost. You can start making money almost at once.

## Money-Back Offer

What thousands of others are doing in Fireside Industries, you also can do. So sure are we of your success in this fascinating work that we refund your money in full if, after completing your instruction, you are not entirely pleased. You take no risk whatever.

## Beautiful Book FREE

The beautiful Book of Fireside Industries, illustrated in color, explains all about this new way to earn money at home. It will be sent you, absolutely FREE and without obligation. Just mail the coupon, or write, enclosing 2c stamp for postage. But do this at once, while openings for new members are being offered.

## FIRESIDE INDUSTRIES

Dept. 66-S, Adrian, Mich.

Fireside Industries, Dept. 66-S,  
Adrian, Michigan.

Please send me, Free, the book on Fireside Industries, which explains how I may earn money at home. I enclose 2c stamp.

Name.....

Address.....

City..... State.....

(Write in pencil—ink will blot)

# RADIO and TELEGRAPHY

EARN  
BIG MONEY

Amazing new methods qualify you quick in Telegraphy, Radio, Railroad accounting. Travel, earn good money. Thousands of positions open. Full details FREE. Act now! Write Illinois Telegraph, 1608 W. Madison St., Chicago, Ill., Dept. A.

## MAIL PILOTS RECEIVE \$7,500 to \$12,000 Yearly

We qualify you for this and 20 other BIG PAY AVIATION Jobs. Thrilling, fascinating work. Special Home Course. Final training at our huge Airport in Chicago. Write for FREE BOOKLET ABOUT AVIATION.

E. E. La PARLE, Chief Instructor  
CHICAGO AERONAUTICAL SERVICE, Inc.  
608 S. Dearborn St. CHICAGO, ILL.

# MECHANICS

SHOP BOOKS SENT FREE!

It's knowing the WHY as well as the HOW of all production operations that puts you in line for a better-paid job. Here in these six volumes America's greatest mechanical engineers have worked it all out for you. Be sure and see this wonderful new edition—just off the press! See how you can benefit from the experience of successful men, without taking a life-time to dig it out for yourself. See why thousands of men just like you have smashed their way ahead with the help of the earlier editions.



## RAISE YOUR OWN PAY!

The more you know about modern shop ways, the more money you can demand. And remember, if you put your HEAD to work as well as your HANDS, you can DOUBLE your pay! What will it be worth to you in dollars and cents to know mechanical drafting, designing, tool-making, metallurgy, mass-production and the other THOUSAND subjects made so EASY to master in these volumes?

## CAN YOU—

calculate and design a special tool or an automatic machine? Can you fit your little job into the big picture of your entire plant and the industry back of it? Can you read blueprints and draw plans? Can you take charge of men and machines and material and turn out production economically? Are you a mechanic with the ambition to become expert, foreman or superintendent?

## Put the JIFFY INDEX to work!

Don't try to keep it all "in your head." The new QUICK, easy way is to look up the fact you need! No tedious study or memorizing or do lessons and examinations. Amazing benefits waiting for you when you use this set as reference books.



## These Books Tell How!

Shop Management, "Short-Cuts," Welding, Die-making, Foundry work, Malleable, Forging, Heat-treatment, tempering and annealing, Pattern-making, Auto-Shop work, Mechanical Drafting, Machine Designing—A THOUSAND SUBJECTS in 6 big DeLuxe Volumes. 2300 pages, 2500 photos, plans, blue-prints, charts and tables. The latest and greatest work on Modern Shop Practice we have ever published.

## Year's Consulting Membership FREE!

Brings you the valuable privilege of consulting the Engineers of this million-dollar Technical Society on any mechanical subject without cost. Mail coupon and books will be shipped immediately.

American Technical Society Dept. M-819, Drexel Ave. & 58th St., CHICAGO, ILL.

# Don't Send a Penny!

American Technical Society  
Dept. M-819, Drexel Ave. and 58th St., Chicago, Ill.

I certainly want to take advantage of your free offer to see the new edition of Modern Shop Practice, without obligation to buy. I will gladly pay the few cents delivery charges, but if I choose to return the books within 15 days, charges collect, I will owe you nothing. If, however, I prefer to keep them, I will send you \$2, then only \$3 a month until the special advertising price \$29.90 is paid. Be sure and send free membership card, as offered above.

Name.....

Address.....

Employed by.....

Address.....



# He Left His Calling Card

—*Telltale Finger Prints!*



**Written In Blood!**



**Big Demand for Trained Men  
Make \$2500 to \$10,000 a Year**

Finger Print Experts solved every one of these weird, blood-curdling crimes! Finger Print Experts gathered in the great big rewards—were appointed to high official positions for their work! Every day more and more trained men are needed. New Bureaus of Identification, new positions are opening up all the time. The field is uncrowded! Opportunities are unlimited!

YOU can learn Finger Print Identification easily, in a short time—in your spare time—at home! YOU can make \$2500 to \$10,000 a year as a Finger Print Expert. Find out how you can enter this most thrilling, adventure-some profession and make big money fast!

## The Knock of Opportunity

Is the knock of the postman as he brings this book, "Finger Prints," to you. It brings you fascinating true detective stories. And more! It tells you how YOU can become a Finger Print Expert quickly and easily. It offers you a professional Finger Print Outfit and a Course in Secret Service Intelligence. *Act Quick!*

**University of Applied Science**  
1920 Sunnyside Ave., Dept. 13-58 Chicago, Ill.

**T**HREE bloody finger prints on the cash register! He might as well have left his calling card—his doom was already written! These silent witnesses told the story—identified him—convicted him! Live through these thrilling adventures right with Detective McDonald as he gets Arizona's first finger print conviction. Mail the coupon below and get this gripping story **FREE**, with 12 others just as exciting!

## 13 True Detective Stories—FREE!

Gripping Mysteries! Gruesome Tragedies! Daring Deeds! Hair-Raising Climaxes! Every story will thrill you—grip you! You won't be able to lay it down until you have finished.

Think of it! Real Secret Service Operators give you "inside dope" on real crime cases. They reveal their secret workings—how they solved big crimes that baffled the police all over the country—how they won handsome rewards! These stories are **YOURS FREE!**—if you act quick! You would pay a good sum for them at a bookstore or news-stand. Here they are yours **FREE!**—for the asking. Mail the Coupon **NOW!**

**Send for this Free Book!**

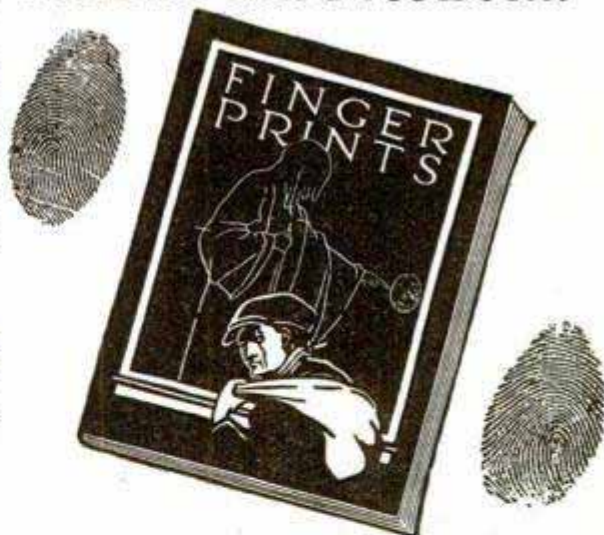

**Mail This NOW for Free Book**

University of Applied Science,  
1920 Sunnyside Avenue, Dept. 13-58 Chicago, Ill.

Without any obligation whatever, send me your new, fully illustrated, **FREE** book of authentic detective tales, "Finger Prints"; also your offer of a **Free Professional Finger Print Outfit and Free Course in Secret Service Intelligence.**

Name

Address

City and State  Age



# Make Furniture At Home



—either for your own pleasure or to sell. It is easy when you have the instructions supplied in Popular Mechanics Home Furniture Making Library. This library consists of the following cloth-bound, profusely illustrated books of which many thousand have been sold to satisfied customers everywhere:

1. **Mission Furniture—Part 1**  
2. **Mission Furniture—Part 2**  
These two practical, money-saving books contain full directions and drawings for the making of all sorts of furniture, including tables, chairs, stools, davenport, electric table lamps, and many other useful and beautiful articles of furniture. Crystal clear instructions in 2 handy books; 240 pages—123 illustrations. Just follow directions and you'll be amazed at your good results. Use the furniture in your own home or sell it. One man writes he



sold over \$1,000 worth of furniture made from these books. You can do the same.

**Send No Money!** Just write a postal asking that Popular Mechanics Home Furniture Making Library be sent you C. O. D. When the postman delivers the books, simply hand him \$1.98 plus the few cents postage. Money refunded if not delighted.

**POPULAR MECHANICS PRESS**  
Popular Mechanics Bldg., Room 705, Chicago, Ill.

## Time, Labor and Money Saving Ideas for Auto Repairmen

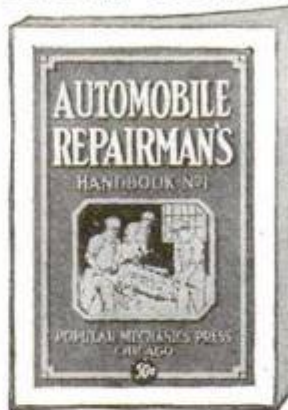

334 Valuable Discoveries made by Hundreds of Auto Mechanics are contained in our Automobile Repairman's Handbook. 337 Illustrations.....Price 50c

301 Ways to use drills, drill presses, taps and dies with more effectiveness are given in our Drilling and Thread Cutting Handbook.

298 Illustrations.....Price 50c

259 Kinks furnished by 106 of the most successful Lathe Operators are found in our Lathe Handbook.

212 Illustrations.....Price 50c

These three books (regular \$1.50 value) are offered for a limited time only for 98 cents plus the postage. Pay postman when he delivers the package. If outside U. S. send remittance and include 15 cents extra for postage.



**POPULAR MECHANICS PRESS**  
Room 604  
200 E. Ontario St. CHICAGO

# LEARN AUTOS IN LOS ANGELES

## Jobs Open Now—\$40 to \$100 a Week

You are urgently needed to help repair the one and a half million autos in California. Trained auto repair men are also needed badly in every other state. The rapidly increasing number of cars means prosperity and big pay for auto men—more garages, tire shops, battery stations are needed. You can be one of the highly paid men in this fastest growing industry—if you get the right training.

**YOU CAN BE An Auto Expert!**

National Automotive special, practical Shop Training makes it easy for you to become an Auto Expert. In a quarter century this great institution has trained

16,000 men for bigger pay. It will help YOU make more money by giving you individual instruction on repairing Packards, Buicks, Cadillacs, Fords, etc., all types of electrical equipment, machine shop equipment, etc. You learn **every** thing RIGHT at National.



### Paul Briggs Earns \$4000 a Year

"I want to thank you for the big part National has played in helping me to success in auto work. I am now assistant sales manager and made \$4,000 this year—which is more than I would have made in three years at my former work."—Paul Briggs, Portland, Ore.

### Money-Making Book



### Earn While You Learn

Free employment service. Spare time jobs help pay expenses while training. All tools included. No extras. Send for big free illustrated catalog explaining how National trains you for bigger pay. Learn the opportunities for you in California. Mail coupon now.

**Million Dollar Training Headquarters for Auto Experts**



**NATIONAL AUTOMOTIVE, Dept. 704, 4006 Figueroa St., Los Angeles, Calif.**

Send me, absolutely free, your big illustrated catalog of Automotive Opportunities.

Name.....  
Address.....  
Age..... City..... State.....



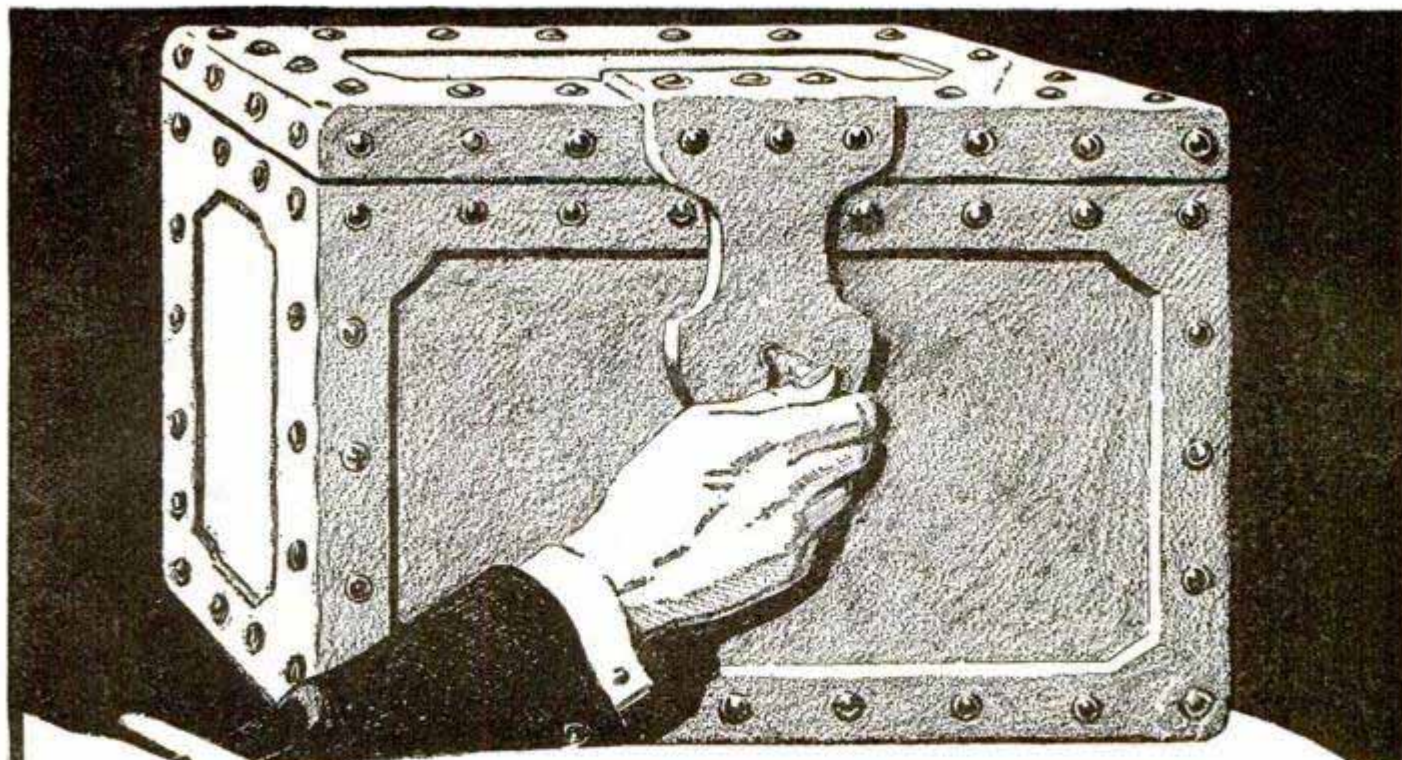

# Unlocking For You the Age-Old Secrets of Magic

Baffling secrets of the world's greatest magicians—mysteries never before divulged—supernatural effects of the Orient—massive stage illusions—the most priceless, most treasured Secrets of the Magic Profession now—*for the first time*—disclosed to YOU in the great Tarbell Course in Magic. Learn to perform like a real magician in a short time—in your spare time—at home. Be the life of every party—the center of every crowd, wherever you go. Business and social success are YOURS when you know Magic. And it's EASY with the Tarbell System!

**Earn \$350 to \$1000  
a Month!**

From Impromptu Tricks through Sleight of Hand to Great Stage Illusions—EVERYTHING is taught to you so that you can go right out and MAKE BIG MONEY WITH MAGIC. There is a tremendous demand for Magic Entertainment. Clubs, churches, schools, conventions, theaters are on the lookout for Magicians—and they pay \$25 to \$100 for perhaps half an hour's program. Keep your job and make a lot of EXTRA MONEY on the side. Just master a few easy tricks. Salesmen—business men—professional men—all can use Magic to gain popularity and profits. Easy for YOU to make \$250 to \$1000 a month!

## Mail Coupon

You can now get this great course, endorsed by the world's greatest magicians, at a special low price. But you have to *act quickly* to get in on this offer. Write today SURE!

**Tarbell System, Inc., Studio 13-58**  
1926 Sunnyside Avenue, Chicago, Ill.

## Astonish Your Friends

Study the first lesson and your friends will be amazed at your wonderful Magical powers. You will have that Magnetic power that gives you instant popularity in any crowd. Everyone will marvel at your apparently supernatural, psychic power. YOU possess this talent now! Surprisingly *easy* to bring it out. Send the coupon below now—and find out how easily you can do it.

**Tarbell System, Inc., Studio 13-58**

1926 Sunnyside Avenue, Chicago, Illinois

Please send me your big FREE illustrated and colored booklet giving full information on the Tarbell System of Magic. No obligation on my part whatever.

Name .....

Address .....

City and State..... Age.....





# Choose as Your Profession Electrical Engineering

Electricity offers a brilliant future to the young man who is about to choose his career. Never before has there been such wonderful opportunity in this great field. Big paying positions in electrical work the world over are open to trained men—men who possess specialized, practical knowledge. Come to the School of Engineering of Milwaukee—the largest and best equipped electrical school in America. Here you are trained in both theory and practice by a faculty of experts. You learn in large, completely equipped laboratories. If you have 14 high school credits or equivalent, you can become an Electrical Engineer with a Bachelor of Science degree. Any credits you may lack can be made up in the short intensive Junior Electrical Engineering Course.

**B.S. Degree In 3 Years**

**A Complete, Practical, Electrical Education**  
Learn by the thorough, approved scientific methods which our twenty-three years of specializing enable us to give you. In addition to Electrical Engineering, the following complete courses are given: **A. C. and D. C. Armature Winding—Wiring and Testing—Junior Electrical Engineering—Commercial Electrical Engineering—Automotive Electricity—Radio Sales Service and Broadcasting—Electrical Refrigeration.**

**Earn While You Learn**  
By our special system you may earn part of your way while learning. Our Employment Department will secure you a position to which you may devote a part of each day, spending the remainder at the school. This plan both solves the students' financial problems and provides splendid experience at the same time. Low tuition fee. Board and room reasonable. Daily Broadcasting WSOE. School Orchestra. Fraternities.

**New Term Begins Nov. 7th**

## Write for FREE Catalog

Write today for our free, illustrated catalog. Read about this wonderful institution and the great opportunities that lie before you. Find out about our specialized method of training and the details of our "Earn While You Learn" plan.



**SCHOOL OF ENGINEERING OF MILWAUKEE**  
Dept. P. M. 1127 163 East Wells St. Milwaukee, Wis.  
Without obligating me in any way, please mail free 72-page illustrated book, "Electricity and the One Best Way to Learn It," and particulars regarding the course I have marked with an X.  
 .... **Electrical Engineering, B. S. Degree.**  
 .... **Commercial Electrical Engineering.**  
 .... **Armature Winding.**  
 .... **Light, Motor Wiring and Testing.**  
 .... **Electrical Refrigeration.**  
 .... **Practical Electricity.**  
 .... **Automotive Electricity.**  
 .... **Radio Sales Service and Broadcasting.**  
 .... **Home Laboratory Service.**  
 .... **I am interested in your "Earn While You Learn" Plan.**

Name ..... Age .....

Address .....

City ..... State .....

Education .....

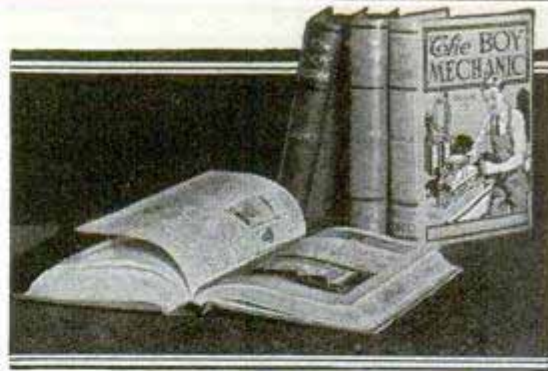

# BOYS It's Fun to Make Things



Let the other boys wonder how you can make so many interesting things. Make your own automobile. Make your own radio. Make your own kites and gliders. You can learn how to make almost anything that any boy could want by following the pictures and the simple directions in

## The Boy Mechanic Library

And just think of it, there are nearly 4,000 separate articles in the four beautiful volumes! Some of the most fascinating subjects are listed below:

### How to Make Things

- |                   |                       |
|-------------------|-----------------------|
| Boats             | China painting        |
| Winter sports     | Decorative metal work |
| Camping           | Furniture making      |
| Ice boats         | Farming               |
| Water sports      | Poultry               |
| Toboggans         | Models                |
| Tents             | Laboratory helps      |
| Skills            | Household helps       |
| Indian snowshoes  | Wood working          |
| Skating           | Electrical devices    |
| Gymnasium         | Photography           |
| Wind wagons       | Music                 |
| Motor sleds       | Outdoor games         |
| Radio             | Stoves                |
| Magic             | Furnaces              |
| Trapping          | Wireless              |
| Pets              | Tricks                |
| Leather work      | Puzzles               |
| Carpentry         | Bicycle               |
| Painting          | Flowers               |
| Toys              | Hunting               |
| Fishing           | Kites                 |
| Fruit growing     | Metal working tools   |
| Entertainments    | Secret locks          |
| Automobile        | Swings                |
| House decorations | Sleds                 |
| Drafting          | Power devices         |

Buy the complete library, including Book 1, Book 2, Book 3 and Book 4 for \$7, thus saving \$1 as single volumes are \$2. If you want individual books at \$2 each order by number 1, 2, 3 or 4.

When the postman delivers the books to your door, pay him the price of the books and the postage. That is all. If outside U. S. remit when ordering and include 28 cents per volume extra for postage.

**POPULARMECHANICS PRESS**  
200 E. Ontario St.  
Room 608 CHICAGO, ILL.



# Men Wanted in Auto Trades

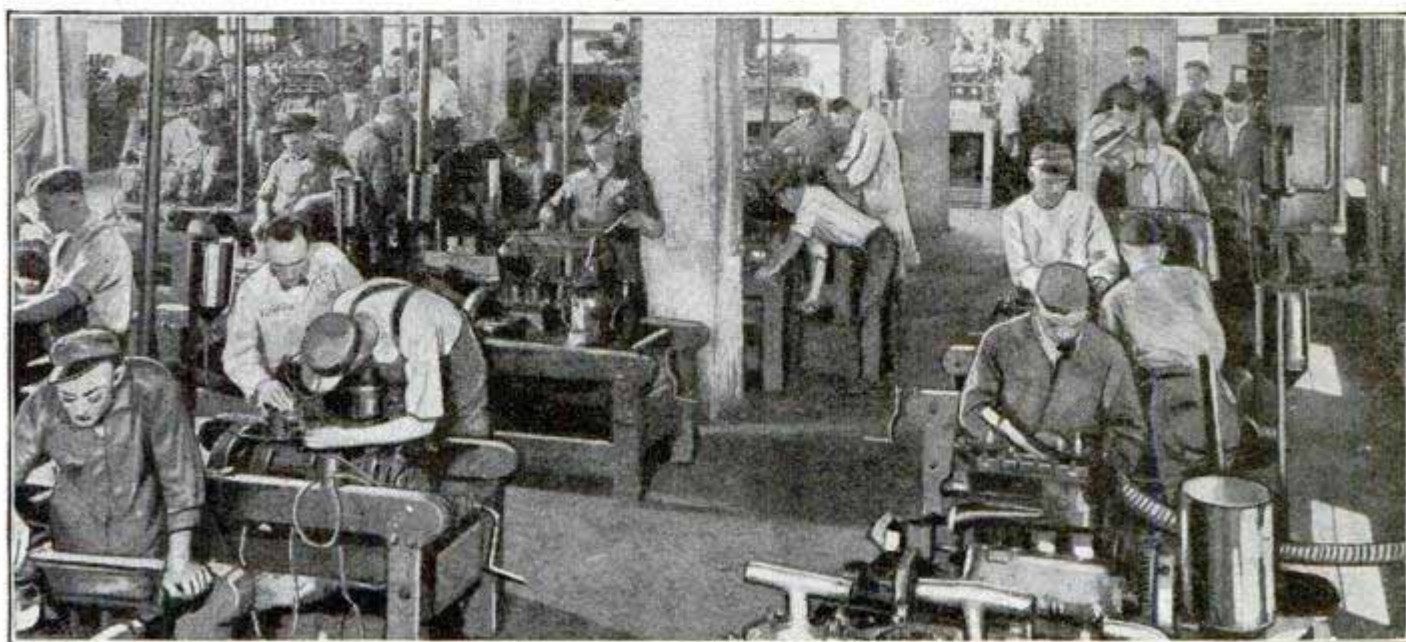

Battery and Ignition Dept.

Young man, if you are mechanically inclined, this is the most important month of your life. Now is the time when you should come straight into the Sweeney Auto School and learn in a few short weeks the automobile trades and fit yourself for a sure-fire big pay job doing work you like. You can send for a catalog but that isn't necessary. 70,000 men have gone through this school and you can just write or wire when you are coming and all will be ready for you. Don't worry about previous experience or any scholarship; no experience is necessary and we have even made good mechanics out of men who could barely read or write. We teach with tools, not books. Right now you want to know all about the NEW FORD CAR and thousands of jobs are open for men who can handle the new Ford. You will learn this at Sweeney's. Many old mechanics now coming in for this special work. Yes, my EMPLOYMENT DEPARTMENT helped L. W. Kelley to a job at \$18.00 A DAY — IT helped J. H. Miller to a job at \$10.50 A DAY—IT helped Gordon Shyroek to a job at \$10.50 A DAY, and it, also, is helping dozens of other Sweeney Graduates to fine jobs at \$10 to \$18 a day. IMMEDIATELY after finishing ONLY A SHORT COURSE OF SWEENEY TRAINING.

## The Sweeney System

Teaches by practical, personal experience. You work with tools, not books. You learn by doing. Million dollar school with complete equipment. You need no previous experience. If you are looking for success in life and working at a trade you like write me today. Drivers, mechanics, repair men, testers, garage owners, painters, welders, demonstrators-- thousands more are needed and opportunities are everywhere. If you are mechanically inclined simply send name today for my big free book how to fit yourself for steady high paid employment in the auto business.

**LEARN A TRADE**  
**Sweeney**  
 AUTOMOTIVE & ELECTRICAL SCHOOL  
 4331 SWEENEY BLDG. KANSAS CITY, MO.

## FREE CATALOG AND SPECIAL OFFER

Get my big FREE 72-page catalog. It shows hundreds of actual photographs of men at work in my magnificent new school. Tells all about wages, profits, opportunities in auto business. Explains step by step how you learn. Interesting letters from graduates telling how they made good. Shows how men come from all over the world to this big school. Makes you want to join the crowd. Tells everything you want to know. I will gladly send you a copy beautifully illustrated. I'll tell you how to get into business for yourself. No colored students accepted.

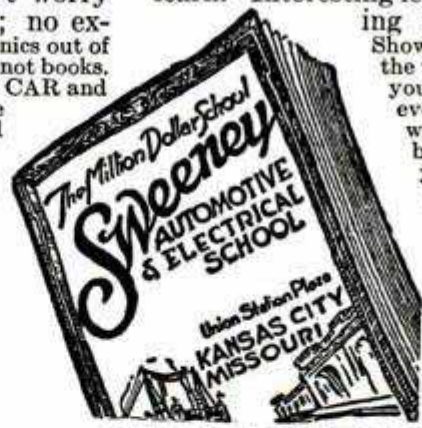

**E. J. SWEENEY**  
 President

To save time, write or wire when you'll arrive and we'll be looking for you! No need to delay—Just come along!

**EMORY J. SWEENEY, President**  
 4331 Sweeney Building, Kansas City, Mo.

Send me free, without any obligation, your catalog and Special Offer!

NAME.....

P. O. ....

STATE.....AGE.....



# We Guarantee to Improve Your Voice

# 100%



Read how to do it in "PHYSICAL VOICE CULTURE", the greatest book ever written on voice building. It will show you the one scientific, tested way to build a powerful singing or speaking voice. Send coupon below for—

# Free Book!

### Glad to Tell Everybody What Your Course Did

I shall certainly be delighted to tell anyone what your course did for me. In fact, I have been telling people for the last three years and started several people in the work in Japan.

When one lives in New York, as I do now, and sees the number of wholly unqualified people who are teaching singing, it seems as if there ought to be some test for teachers. I think that learning ten operatic roles, one after another, is a pretty good test of the condition of a person's throat, don't you? My voice doesn't seem to have suffered in the least from it. Florence Mendelson, New York City.

### Wouldn't Part With Course for \$1,000.00

I have a great deal to say about this wonderful course, and want you to know that I am a happy man since taking it up. I needed your course badly, very badly. Being a teacher, I have to speak, at times, quite loud, and the strain on my throat was actually felt, and hoarseness followed. My voice is absolutely clear and resonant now. In fact, I have no words to thank you enough. I wouldn't part with my course for a thousand dollars. Julio C. De Vosconcellos, New Bedford, Mass.

### Lost Voice Restored—Sings Better Than Ever

I am very glad to be able to inform you that the study and practice of your exercises is making a great change in my voice.

You may appreciate what this means to me when I tell you that an illness while in France, weakened my throat to such an extent that I feared I would never sing again. However, after studying your lessons, I find that I can sing better than ever. In fact, I was told by a friend who had heard me sing at a reception that I had never been in better voice than I am now. J. Ralph Bartlett, Newton, N. H.

PERFECT VOICE INSTITUTE, Studio 13-58  
1922 Sunnyside Ave., Chicago, Ill.

Gentlemen: Send at once, free and without obligation, your beautifully illustrated book "Physical Voice Culture" and full information regarding your home study method of voice building. It is understood that I do not have to pay a cent for this book, either now or later, and that I do not have to return it.

Name .....

Address .....

**T**HE three letters on this page are from men and women who have learned that *Physical Voice-Culture* is the one, infallible, tested, scientific method of voice building. They are just a few of the thousands telling the same stories of success, in many cases, after all other methods of voice building had failed.

The new book, *Physical Voice-Culture* will show you how to build up a superb voice by the development of muscles whose existence you never suspected. No matter what condition your voice is in now, it will be improved at least 100% or every cent of tuition will be cheerfully refunded when you have finished the course.

Just a few years ago, Bert Langtre's voice was almost destroyed by catarrh and asthma. An impediment in his speech caused him untold embarrassment and suffering. Now he is singing in Grand Opera in California. "An unusual case," you say. Not at all. He merely took advantage of the opportunity you are given here.

Build up your voice the simple, easy, natural way by silent physical exercises in the privacy of your own home. The *Physical Voice-Culture* method is ideally adapted to home study. It is being taught as successfully by correspondence as by personal instruction. No one need know that you are studying until you have developed a strong, beautiful voice. When you are constantly urged to sing or speak at your church, at private receptions or public functions—when you are the most popular person in your circle of acquaintances, then you will know the rich rewards of *Physical Voice-Culture*.

### Mail This Coupon!

Find out at once about the wonderful possibilities of your voice—possibilities that you have never realized! Simply send coupon for this book. Read the astounding true stories of what others have done. This may be the turning point in your life. Mail the coupon today.

Perfect Voice Institute  
1922 Sunnyside Ave.  
Studio 13-58 Chicago, Ill.



Now  
Free



# Modern

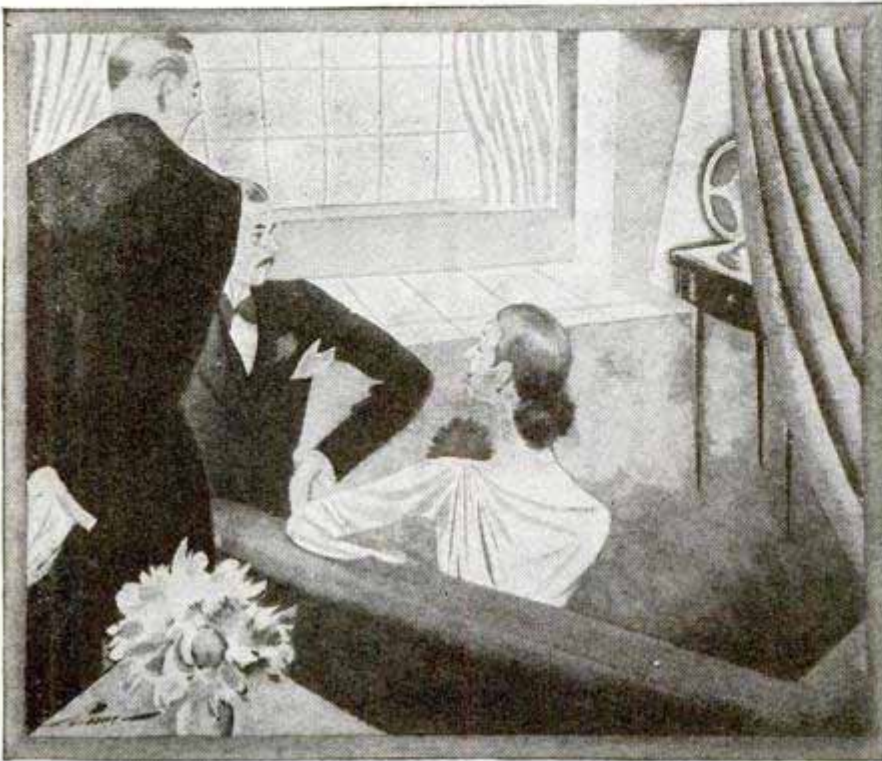

## Radio is better with *Battery Power*

NOT because they are new in themselves, but because they make possible modern perfection of radio reception, batteries are the modern source of radio power.

Today's radio sets were produced not merely to make something new, but to give you new enjoyment. That they will do. New pleasures await you; more especially if you use Battery Power. Never were receivers so sensitive, loud-speakers so faithful; never has the need been so imperative for pure DC, Direct Current, that batteries provide. You

must operate your set with current that is smooth, uniform, steady. And only from batteries can such current be had.

So batteries are needful if you would bring to your home the best that radio has to offer. Choose the Eveready Layerbilt "B" Battery No. 486, modern in construction, developed exclusively by Eveready to bring new life and vigor to an old principle—actually the best and longest-lasting Eveready Battery ever built. It gives you Battery Power for such a long time that you will find the



Here is the Eveready Layerbilt "B" Battery No. 486, Eveready's longest-lasting provider of Battery Power.

cost and effort of infrequent replacement small indeed beside the modern perfection of reception that Battery Power makes possible.

NATIONAL CARBON CO., INC.  
New York San Francisco



Unit of Union Carbide  
and Carbon Corporation

Tuesday night is Eveready Hour  
Night—9 P. M., Eastern Standard  
Time

WEAF—New York	WOC—Davenport
WJAR—Providence	WCCO—{ Minn.
WEEL—Boston	{ St. Paul
WFI—Philadelphia	KSD—St. Louis
WGR—Buffalo	WDAF—Kansas City
WCAE—Pittsburgh	WRC—Washington
WSAI—Cincinnati	WGY—Schenectady
WTAM—Cleveland	WHAS—Louisville
WWJ—Detroit	WSB—Atlanta
WGN—Chicago	WSM—Nashville
	WMC—Memphis

Pacific Coast Stations—9 P. M.,  
Pacific Standard Time

KPO—KGO—San Francisco
KFOA—KOMO—Seattle
KFI—Los Angeles
KCW—Portland

**EVEREADY**  
**Radio Batteries**  
—they last longer

The air is full of things you shouldn't miss



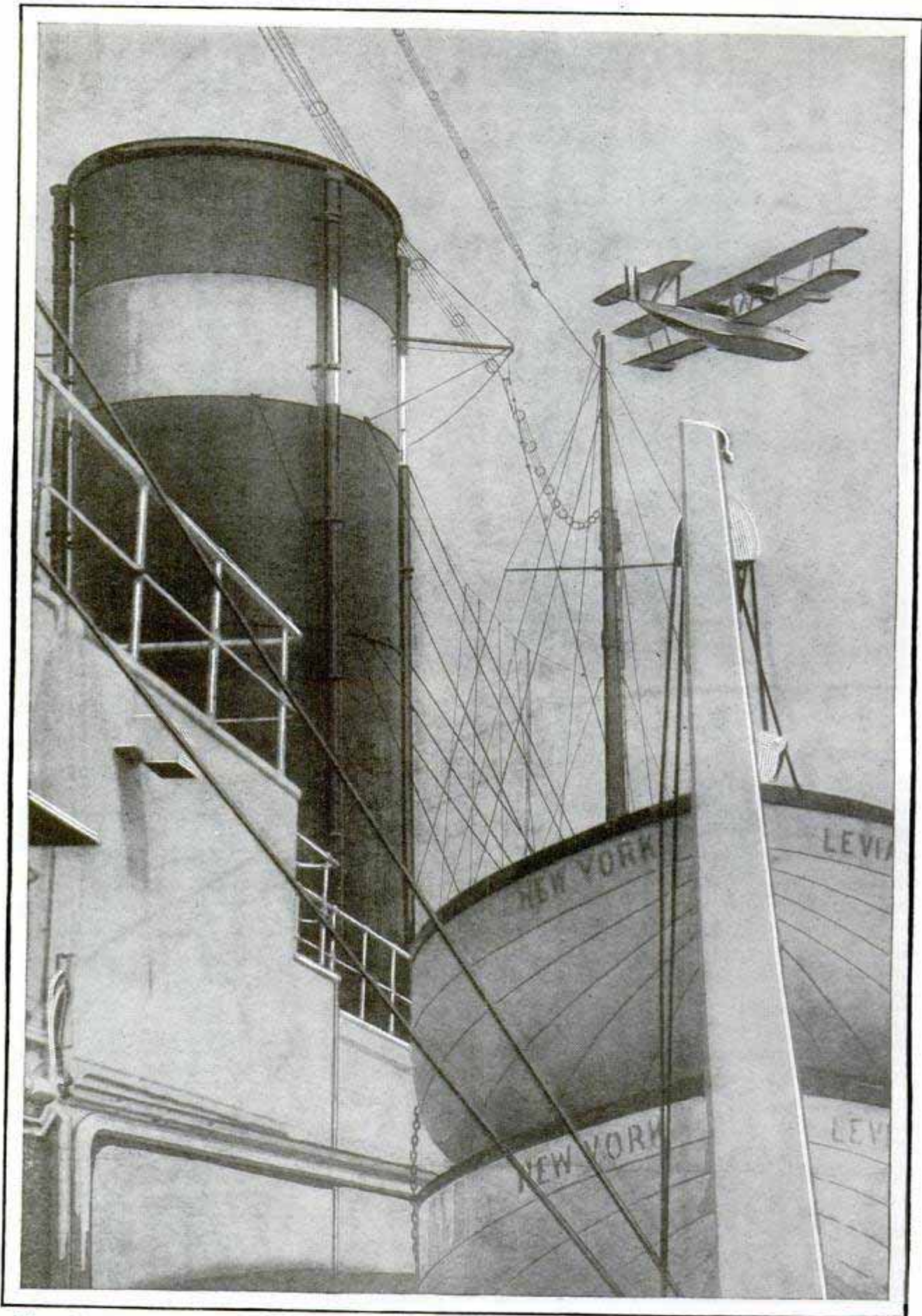

Lieut. Charles H. Schildhauer, U. S. N., Flying over the "Leviathan" in His Big "PN-10" Bomber, to Gauge the Size of the Target, on Which He Later Was Prevented from Dropping His Mail Bags Because of a Thick Fog, 500 Miles at Sea, Which Made It Impossible to Find the Ship



# Popular Mechanics Magazine

REGISTERED IN U. S. PATENT OFFICE

WRITTEN SO YOU CAN UNDERSTAND IT

Vol. 48

NOVEMBER, 1927

No. 5

## 2953 Speeding the Overseas Mail *Flarey*

### Airplanes, Flying to Ships off Shore and Returning with Letters and Passengers, May Cut Trip across Atlantic by Two Days

**C**UTTING a day to a day and a half off the mail time from New York to Europe, the United States shipping board and post office have joined in paying the way for a combined airplane and steamer service which may eventually reduce even the passenger time across the Atlantic from five to three days, or less.

In one experiment they have shown

Clarence Chamberlin's Land Plane Poised on the Temporary Runway Constructed on the Boat Deck of the "Leviathan," from Which He Took Off for a Successful Flight

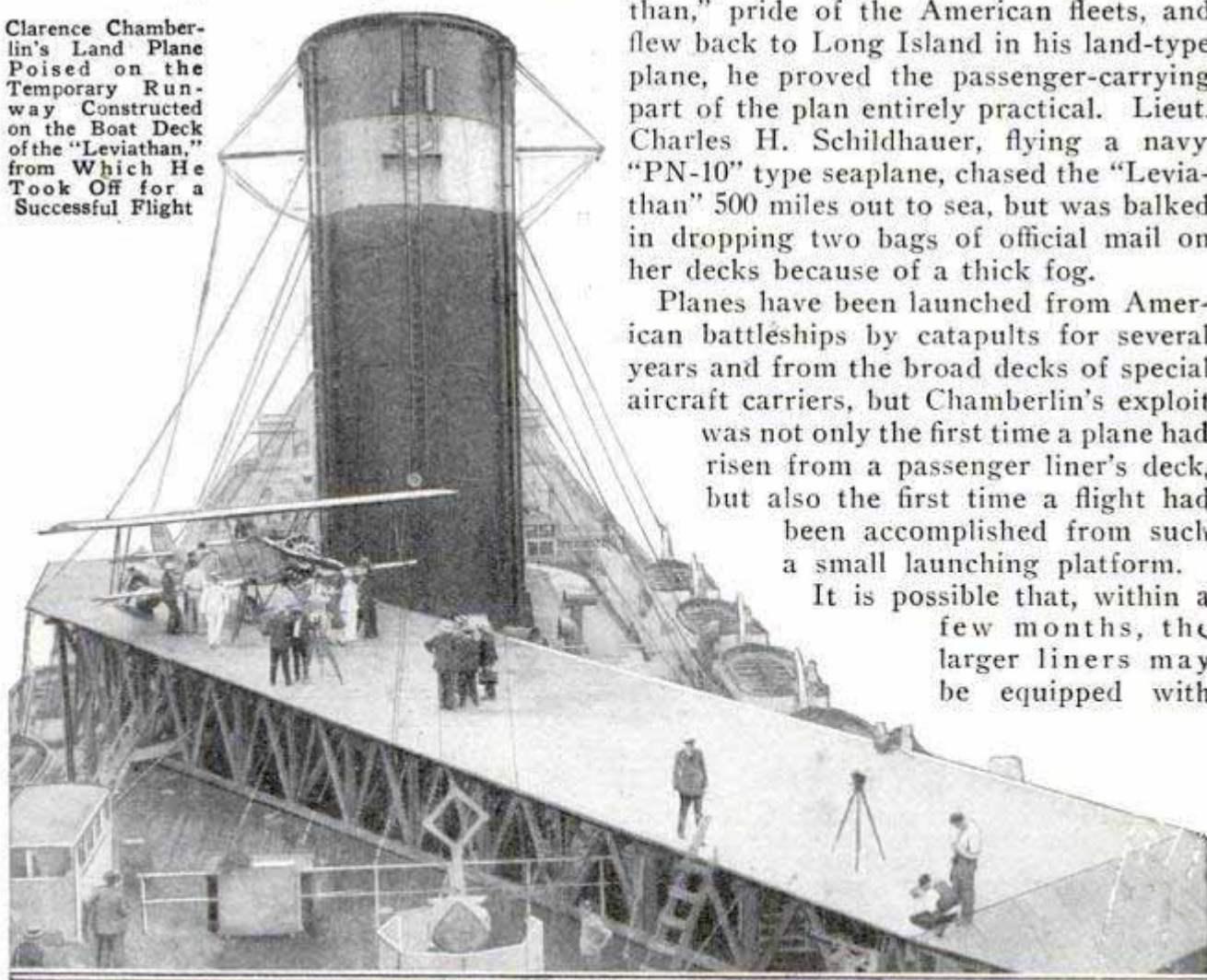

the practicability of landing mails and passengers from ocean liners while they are still a day and more out at sea, and plans have been made to deliver mail to outbound ships the same distance from land. When Clarence Chamberlin, hero of the New York to Germany non-stop flight, took off from an improvised flying platform on the boat deck of the "Leviathan," pride of the American fleets, and flew back to Long Island in his land-type plane, he proved the passenger-carrying part of the plan entirely practical. Lieut. Charles H. Schildhauer, flying a navy "PN-10" type seaplane, chased the "Leviathan" 500 miles out to sea, but was balked in dropping two bags of official mail on her decks because of a thick fog.

Planes have been launched from American battleships by catapults for several years and from the broad decks of special aircraft carriers, but Chamberlin's exploit was not only the first time a plane had risen from a passenger liner's deck, but also the first time a flight had been accomplished from such a small launching platform.

It is possible that, within a few months, the larger liners may be equipped with

*Comd. J. Alvin Howe, CB 2307  
130 W. 42nd St, New York*



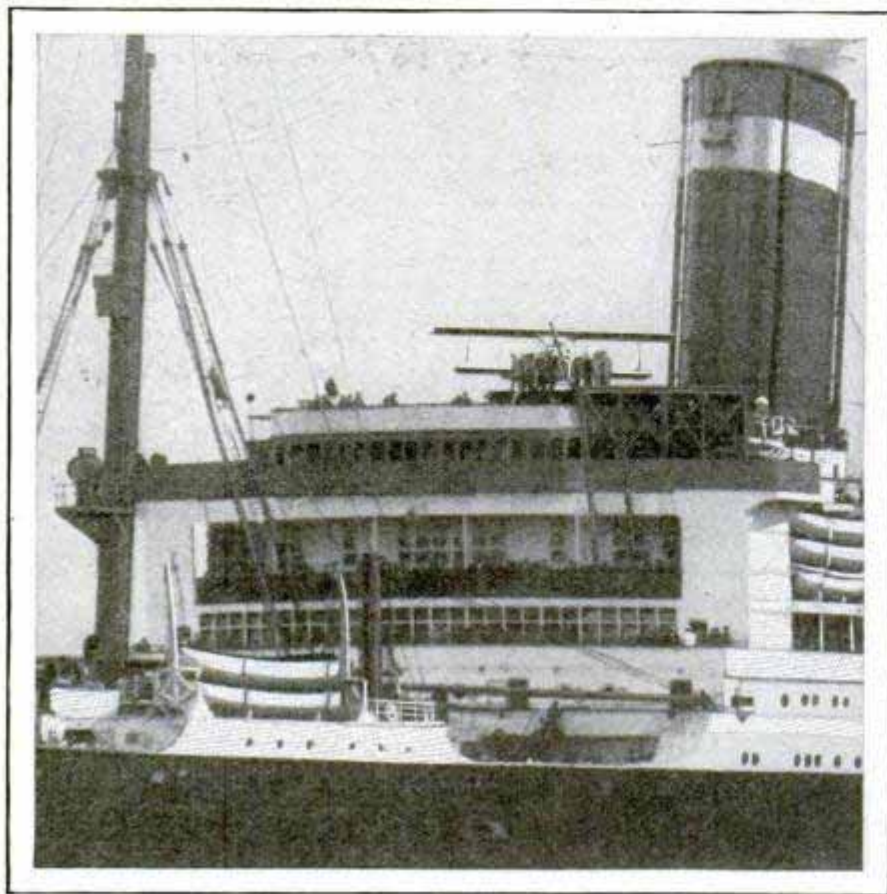

Chamberlin's Plane on the Runway, More Than a Hundred Feet above the Sea, Ready for the Flight

catapults, just like battleships, for the navy has demonstrated that big seaworthy flying boats of the Loening amphibian type can be launched into the air by the latest style power-propelled catapults with the same ease as small pursuit and observation planes. Using Loening or similar airplanes, it would be possible to send important mail in from a ship 500 to 800 miles at sea, and even passengers with urgent business ashore could be ferried in through the air. In effect, the passenger liners would take the place of the floating islands proposed by several aviation authorities to make transoceanic flying feasible.

The dropping of mail sacks onto outbound ships, making it possible to catch them with mail that did not arrive until the day after they sailed, is a simple task, given enough visibility for the flyer to find the ship. A trained bomber can hit a target the size of the "Leviathan" from a height of several thousand feet, but it is not necessary to take even that chance in delivering mail aboard ship, for the plane can come so low it barely clears the upper decks, making a miss impossible.

If such a service is established on this side, it is considered certain that foreign countries, particularly England, will follow suit, and, if not, the ships' own planes, operated by the steamer lines, could duplicate the service overseas and save another day, day and a half or two days.

Such a saving is more than a stunt, for every minute's delay in the transmission of financial papers may cost thousands in interest. Uncle Sam recognized that years ago when he organized the marine mail service in New York harbor. In the old days, an arriving liner docked, discharged her passengers and cargo, and then, after twenty-four to forty-eight hours' delay, leisurely unloaded

her mail sacks on the pier.

Now the government-owned mail boat "President," assisted by a fleet of steam lighters, meets arriving liners at quarantine, or even, occasionally, outside the harbor when they are fog-bound, and takes their mail sacks aboard to rush them up the harbor and into waiting trucks and mail cars for distribution all over the world. Cargoes of five or six thousand sacks of mail are not unusual on the larger liners, and often hours, or even a day, is saved in getting them on their way. Mail from steamers arriving in the morning is frequently sorted, dispatched and delivered to New York, Philadelphia and other points in time for financial papers to go through the clearing house the same day.

Not all the mail arriving in New York harbor is destined for American cities. Vast quantities come for reshipment to Canadian points, and across the continent to steamers bound for China, Japan, New Zealand and the islands of the Pacific. Special mail trains are made up and waiting on the docks when the "President" comes in. Sometimes they are held for an hour or more at the government mail pier



295 3

Pinkenfeld, 337 Ave

2809 Brooklyn, N.Y.

to take on bags destined for the other side of the Pacific, thereby catching a steamer and saving ten days in reaching the mail's destination.

More than a million incoming mail sacks were handled in New York in 1926, and the number for this year is estimated at 1,200,000, or something like 50,000,000 pounds of mail. This averages sixty-odd tons a day throughout the year. Postal officials estimate that 500,000 sacks will contain first-class mail, or about one and three-quarter billion letters, from overseas. More than 1,600 mail ships docked in New York last year. One day the "Beren-garia" broke the records of all time by coming in with 11,552 sacks in her holds.

When the big liners sail from the other side, they report by wireless the time of their arrival and the number of sacks aboard, and when they reach quarantine, where they must anchor for health inspection, the "President" is waiting to dash alongside. While her lines are being made fast, a canvas chute is rigged and the sacks begin coming down to the waiting force of clerks and sorters. If the steamer has a heavy mail cargo, a lighter ties up on the other side, to double the discharge rate.

The handlers and sorters classify the bags as they check them off on the invoice list, and by the time the "President" reaches her dock, they are ready to load the New York district mail onto trucks, the American and Canadian sacks into the proper trains, the trans-Pacific allotment to the cross-continent cars, and the South American mail is sent to the proper ship docks. "The President" is on duty twenty-four hours a day, and has three captains and three full crews, to man the three eight-hour shifts.

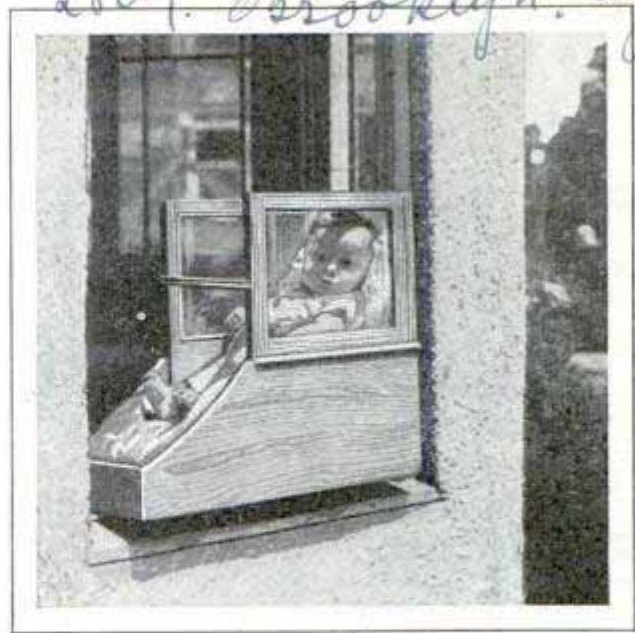

Enjoying His Own Private Sun Porch; Cabinet for Baby Adjusted to Window Ledge

### WINDOW SUN ROOM FOR BABY HELPS DEVELOP HEALTH

Sun baths in a specially constructed window booth have helped develop a prize-winning Brooklyn baby, doctors declare. There is a strap to keep the child from falling out, and the booth has curtains.

### LINER'S LIFE BELTS FOR DOGS LATEST TRAVEL CONVENIENCE

3090



Safety for Dogs as Well as Passengers on New Steamer; the Preservers Are in Three Sizes

Dangers of ocean travel have been reduced to a minimum, but passengers on the "Ile de France," accompanied by their pet dogs, have extra assurance that the animals will also be protected in case of an emergency, as special life belts for the dogs are part of the steamer's equipment. They are quickly strapped on and are made in three sizes for big and little dogs. The plan has received favorable comment from various humane societies.

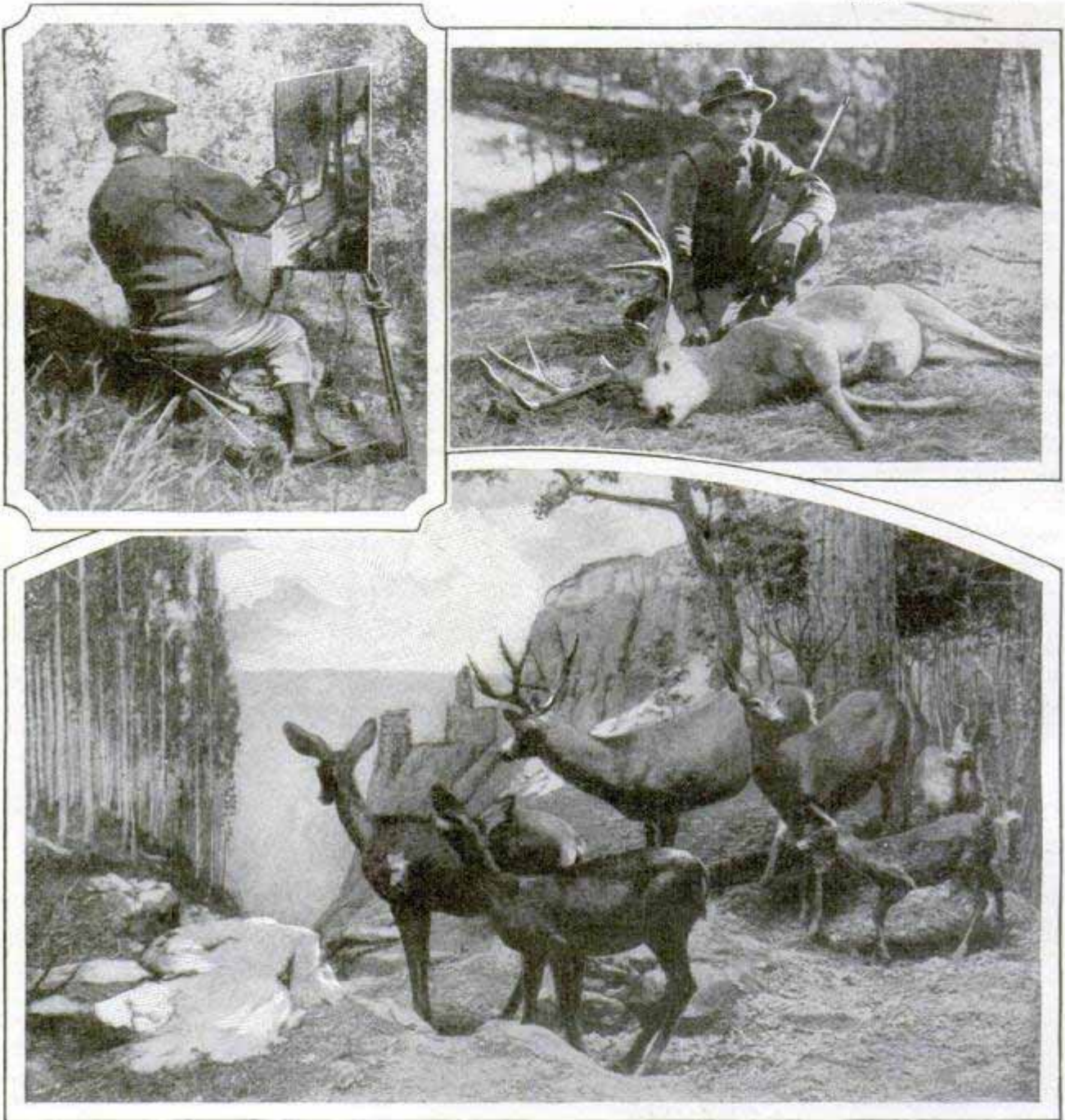

3/2<sup>3</sup> WILD ANIMALS RETURNED TO "LIFE" IN MUSEUM
 Just

Courtesy Field Museum of Natural History

Corwin Painting a Scene; C. J. Albrecht, Who Collected and Prepared the Group, with Deer He Has Just Shot, and the Finished Display as It Appears in Museum Cabinet

So that wild life may be more accurately studied and appreciated by means of museum exhibits, artists, taxidermists and photographers unite in preparing animal and other groups with exacting care. This is illustrated in the recently completed mule-deer booth at the Field museum of natural history. The animals were killed in the Kaibab forest in northern Arizona, and within a few minutes after they were shot, casts were made of their heads for accurate reproduction in the models.

These death masks preserved the natural expression. Skins and larger bones, excepting the backbone, were taken to the museum laboratories and, while these were being made ready, Charles A. Corwin, museum artist, made paintings of actual scenes in the forest area. These paintings furnished the material for the colorful and realistic background in the case. The skull and larger leg bones were used in forming the skeleton upon which to mold the animal model. A composi-



tion substance was employed and, when it was ready, the skin was carefully adjusted over it. The work of grouping the animals in lifelike manner and arranging each in a convincing pose was a special task in itself. One of the aids in this work was a small model of the display, fashioned in a miniature case with a painted background, lighting, and other details that would suggest almost exactly how the completed group would look.

**COWS DRAW DRINKING WATER ON PRINCE'S FARM** 3191

Among the modern improvements on the Nottingham farm owned by the Prince of Wales, in England, is an automatic drinking trough for cattle. The animals press their noses on it at the sight of a small quantity of liquid, and the force releases a fresh stream which stops as soon as the cows lift their heads. This reduces waste by evaporation and insures a supply of fresh water at all times.

**AUTO SHIELD PREVENTS GLARE BY DAY OR NIGHT** 2944

Greater safety and comfort in day or night automobile driving is afforded by an adjustable celluloid shade attached to the windshield and easily regulated according to the driver's needs. When not wanted, it is readily swung entirely out of the line of vision.

no. eslare \$1.50

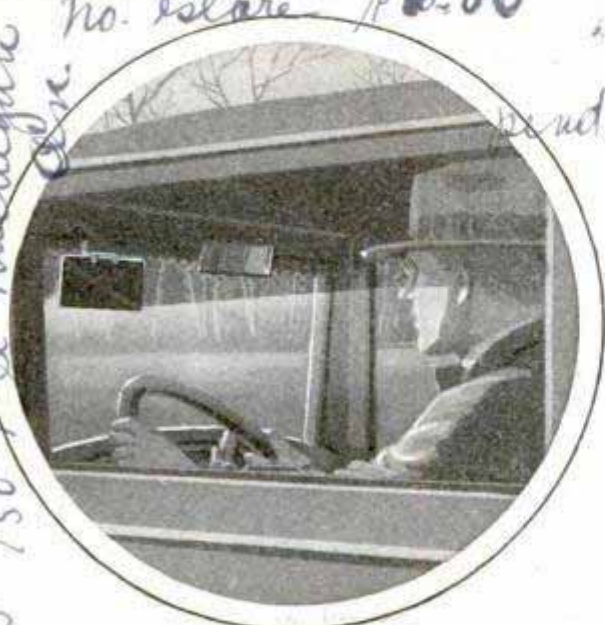

Protecting the Eyes from Glare While Driving; the Adjustable Shield in Place on Auto

Honold Mfg Co



Shoulder Umbrella in Place, Showing How It Leaves the Hands and Arms Free for Work

**WEAR UMBRELLA ON SHOULDERS TO LEAVE HANDS FREE**

Umbrellas or sunshades are often a bother, especially when climbing or working outdoors, but German craftsmen have found a way to eliminate this difficulty by constructing a canopy arrangement that is worn on the shoulders, leaving the hands free. It is light in weight, strongly braced with steel tubing, and can be folded when not in use. It has proved especially popular among gardeners, artists and others who work out in the open.

**LIGHTNING ROD GUARDS TREE VALUED AS LANDMARK** 319

Because of its associations and abundant shade, a hickory tree near the summer home of a Wisconsin man is so highly valued that lightning rods have been attached to it to protect it in storms. The house is not so guarded, the builder declaring that he could erect another but the tree could not be replaced.

Henry Hulning on Fox River, north of

Unv. Mas. n. 30. ... Hofmarkt 25. 3122 Dresden a 21

Vertical handwritten text on the right side of the page, including 'Hofmarkt 25', 'Dresden a 21', and 'Hofmarkt 25'.

Chicago - Winkemillers Taylor, 1507 Michigan Ave.



# WHEN they



bound to spell the end of a champion. That is what it has done in every case heretofore. Somehow, the dethroned champion of the past has never risen out of the depths of defeat. It hangs over him like an everlasting doom. It takes a mighty fighting man to brave the hardships and hazards that lie in the way of a come-back.

If it does not seem too presumptuous on my part, I might venture to say that I know Jack Dempsey better than any other man. I have studied him for years. I know him as a man and I know him as a fighter. Of course, I do not mean to draw conclusions from the Tunney match. So I shall leave Tunney out of the discussion. It is Dempsey, the phenomenon of the prize ring, who interests me.

*Page 103*

Dempsey Giving the Dummy a Stiff Battle in a Workout before a Fight

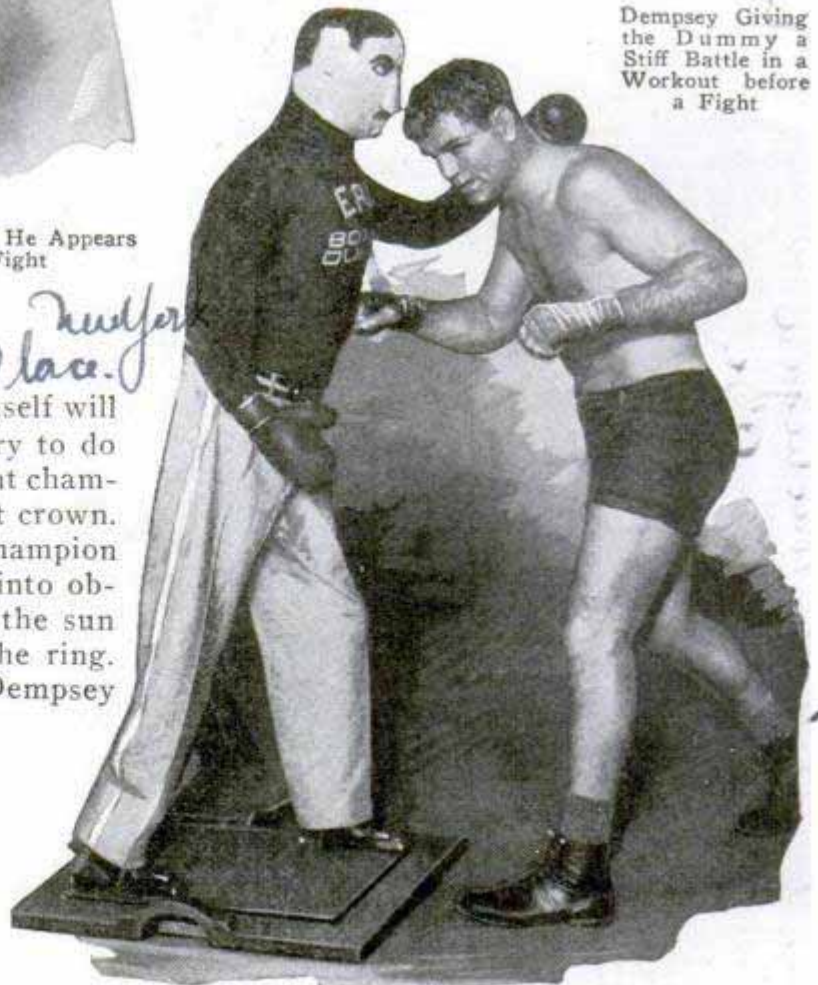

Jack Dempsey, Unshaven and Scowling, as He Appears When He Enters the Ring for a Fight

By **TEX RICKARD**

(As told to A. A. Albali)

*of Daily News 25 Park Place.*

NO one but Jack Dempsey himself will ever know what it cost to try to do what no other world's heavy-weight champion has ever done—regain a lost crown.

Usually a champion or a near-champion gets knocked out and fades fast into oblivion. There is nothing under the sun which can entice him back to the ring. He's through. But, you know, Dempsey was not knocked out when he lost his championship. If Tunney had put him away in Philadelphia, I do not think he would have ever made his way back to the front lines this year. The mental hazard would have been against him. A knock-out is



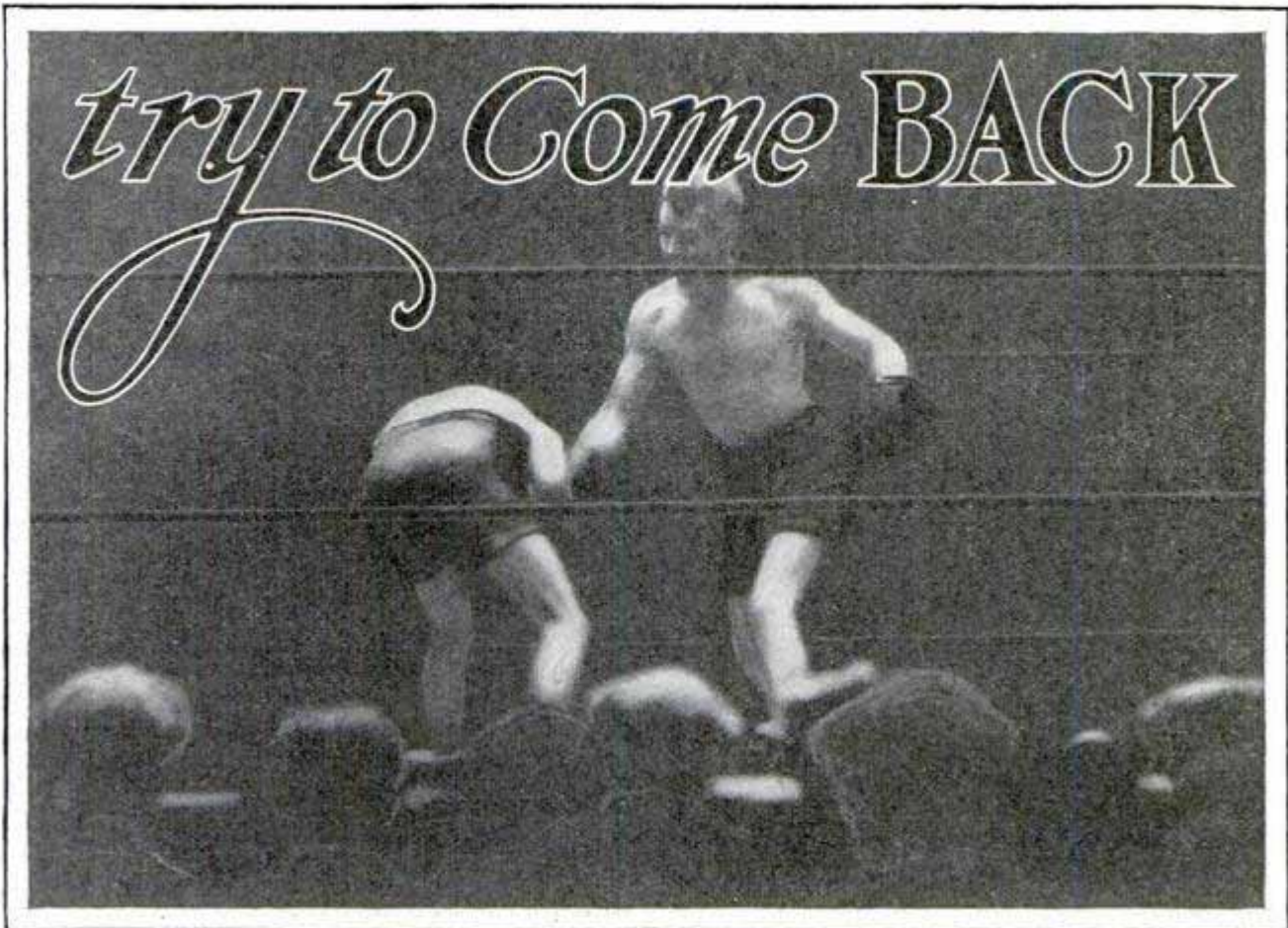

Bud Taylor Using Both Left and Right on Tony Canzoneri Just before the End of Their Battle, in Which Taylor Won the Bantam-Weight Crown; Several Championships Are Now Vacant

Every world's heavy-weight champion has tried to come back after losing his crown. Great fighters of modern times, like Jim Corbett, Bob Fitzsimmons and Jack Johnson, tried to get back to the top. But they failed. There was something saddening in their failures. They were beaten by Father Time. In the ring game the onrushing years mean the downrushing ability of the fighter.

Circumstances for a come-back were different during the early part of the century. When Jim Corbett came back to recapture what Bob Fitzsimmons snatched from him in that memorable fight in Carson City, Nev., in 1897, he did not have to step across a third gladiator to reach his old crown. Nor did Fitzsimmons later have to cross gloves with any other than the mighty Jim Jeffries. And then, after Jeffries retired, he did not have to make his way across pugilistic battlefields. He had been in retirement for five years when he tried to climb back. The title was still his when he fought Jack Johnson, in 1910. But the idleness of Jeffries told. Here, also, time took its toll.

And when Johnson met Jess Willard in the sun-scorched ring in Havana, time and indolence were again fatal factors. Johnson's skill and stamina had waned. Johnson could not come back. Willard stretched him out there and put a finis to the career of a great fighter. Idleness and time proved a nemesis for Willard too. He never had any great desire to fight after he won the crown in 1915. Eventually, defying time and tradition, he tried to come back and defend his title against the youthful and almost nondescript Dempsey at Toledo. That was in 1919. You remember how Willard was put away in the third round. Another failure.

That knock-out doomed Willard. Once, years later, he tried to leap back into the spotlight when he fought Luis Firpo. You remember how Firpo knocked him out in the eighth round.

Incidentally, the New York boxing commission wouldn't allow that fight in the state of New York. Despite the fact that Willard protested he was in the pink of condition and thought he was never so fit in his life, the commission knew he was



310 3  
712

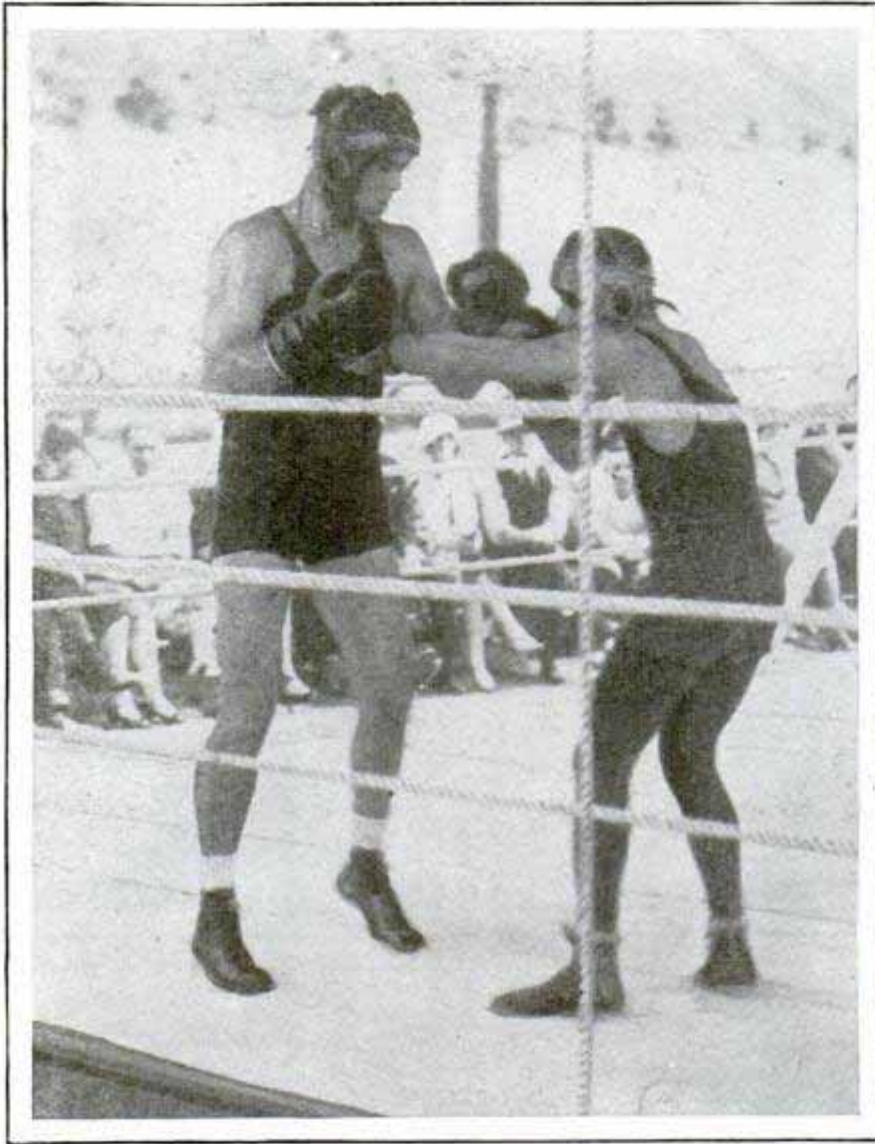

With His Head Protected by a Mask, to Guard against Cauliflower Ears, Dempsey Spars with Jack Petty

knocked out of the ring himself in the first round. Nobody ever dreamed that, three years later, Dempsey himself would go down to defeat at the hands of Gene Tunney. That overthrow bit deep into his heart. As he gazed into a mirror and looked at his swollen face after the fight, he said, "I will be repaid for that."

You recall how he withdrew six months ago into the recesses of the Ventura mountains in California and began his come-back grind. I'm sure that to him it meant more than to other champions of the past who tried to retread their way to the throne. He surveyed the list of those who had tried to recover their crown and found that Stanley Ketchel, whose middle-weight title had been lifted from his brow by Billie Papke, was the only one to come back and beat the same man who had previously dethroned him.

forty. "Too old," they said. The fight was barred there.

Georges Carpentier was another great heavy-weight who never recovered his bearings after having been knocked out. Dempsey flung him into limbo after that "Battle of the Century," at Boyle's Thirty Acres, in 1921. Carpentier lasted four rounds. He tried feebly to come back, but another defeat at the hands of Tunney, in 1924, sent him to seclusion in his own land.

But Dempsey was blind to the fates of his predecessors and his victims. He never stopped to think what had brought their downfall. So, from 1921 to 1923, he sat back idly upon his throne. He had made a fortune. The lull in his career was interrupted by Firpo, whom he defeated in September, 1923, in two rounds, but not until after he had been floored and

Dempsey worked like a blue devil, and last July he finished the first leg of his come-back stunt when he knocked out Jack Sharkey. In this fight he showed himself to be his former self, not a shadow or ghost, but more like the Dempsey who could mow down Willards and Firpos.

What was it that lured Dempsey and other champions back to the throne? Was it the glitter of gold? Was it the plaudits of the multitudes? What was it?

Mercenary men will say it was the big purses. Adventurers with romantic minds will say it was the love of the game. Psychologists will say it is something innate in man to crave the spotlight and to bask in its glare.

These allurements exist today. They did not prevail in bare-knuckle days of two centuries ago. In the "fair, stand-up-fight days" of Figg and Mendoza, things



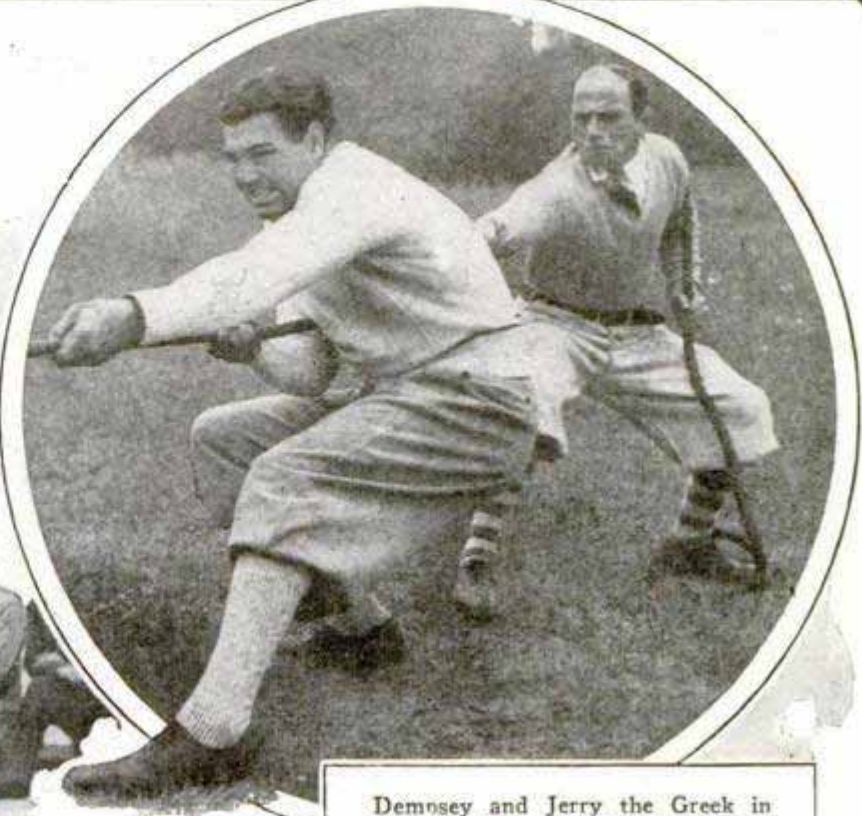

Dempsey and Jerry the Greek in a Tug of War at Saratoga Springs

Dempsey Punching the Bag at Atlantic City Before He Lost His Title to Gene Tunney

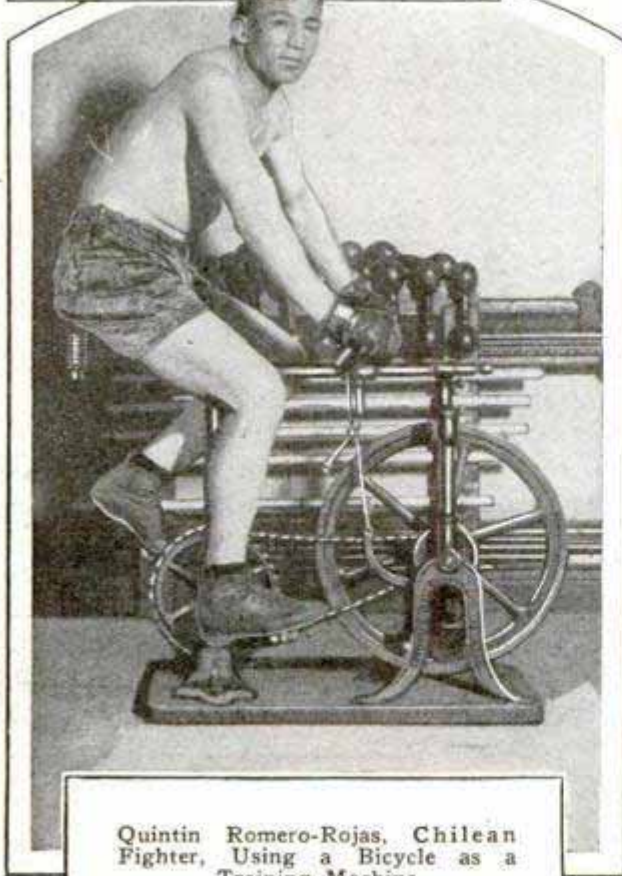

Quintin Romero-Rojas, Chilean Fighter, Using a Bicycle as a Training Machine

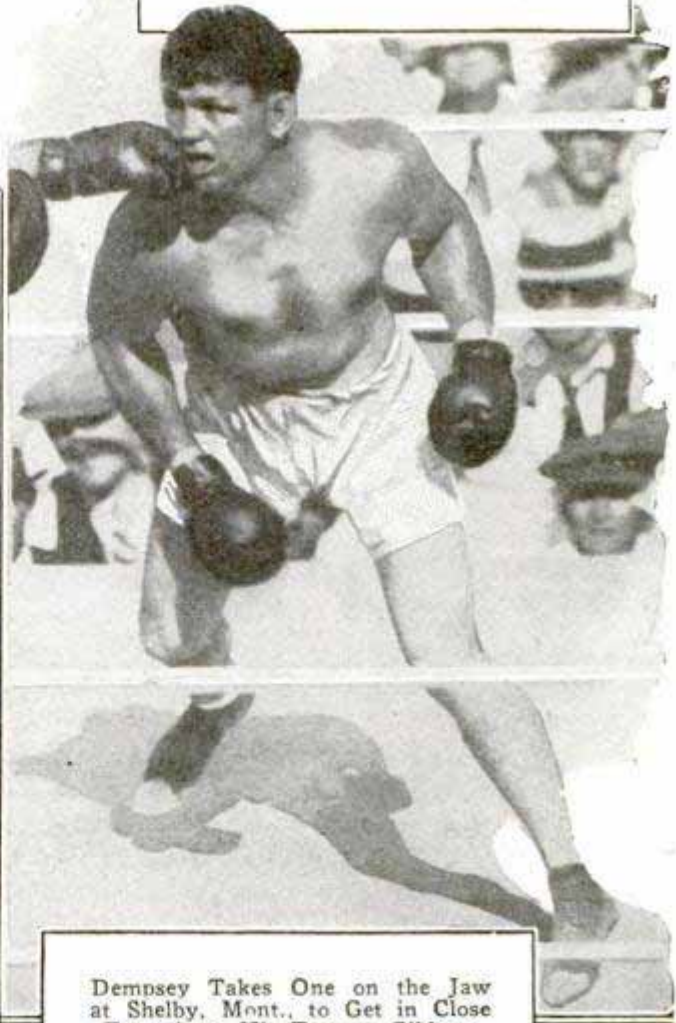

Dempsey Takes One on the Jaw at Shelby, Mont., to Get in Close Enough to Hit Tommy Gibbons



Dempsey in Training Camp Before He Eliminated Sharkey as a Heavy-Weight Contender; Jerry the Greek, the Trainer of Dempsey in Recent Years, Is Removing the Gloves after a Workout

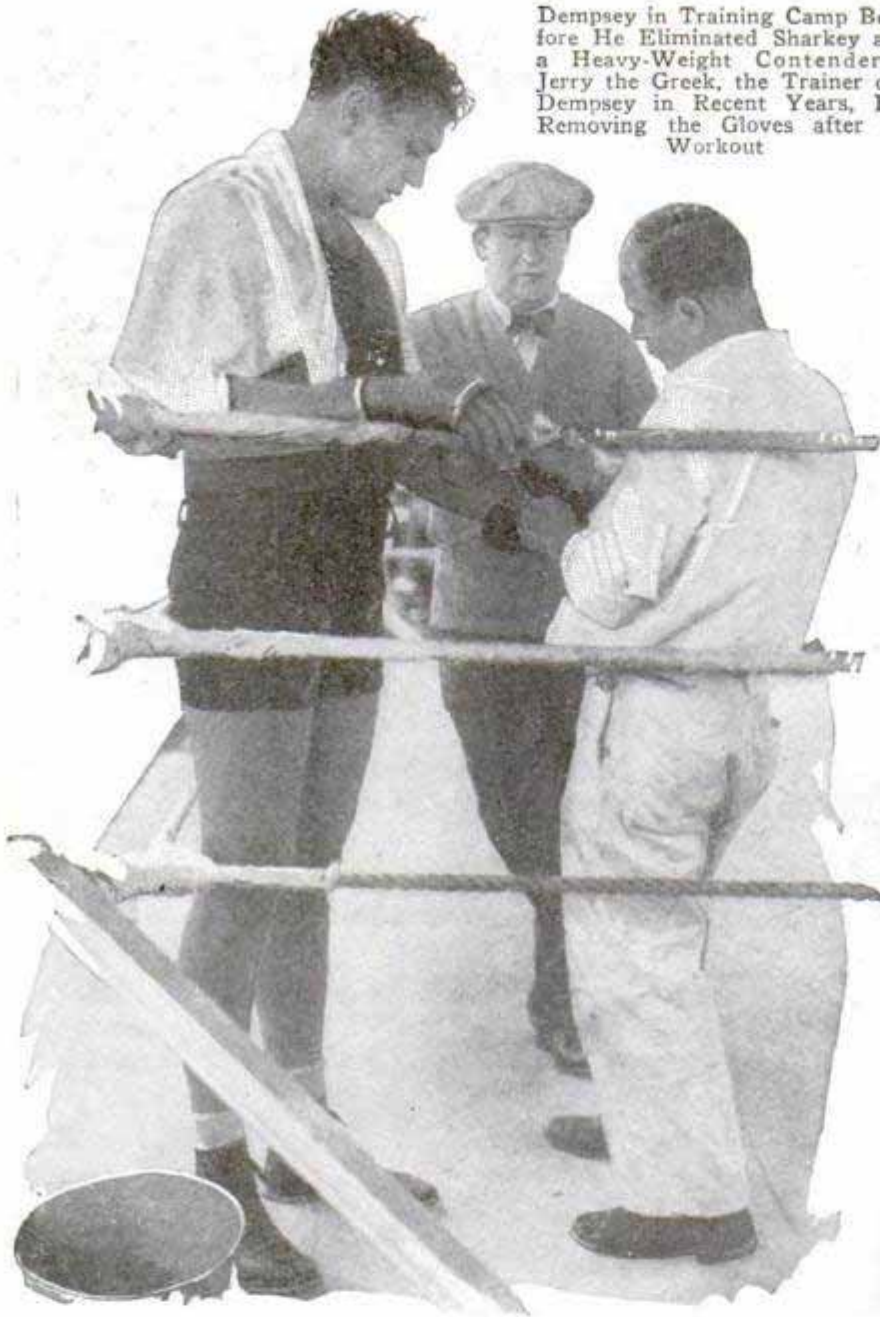

championship fight is carefully supervised. No detail is overlooked. Trainers get their boxers to an acme of physical perfection. The ancient Athenians would gasp in astonishment if they could gaze upon the physique of the modern prize fighter. He would make a fine subject for the greatest of sculptures.

So, after weeks of grueling training, the fighter is ready for battle. It is no longer a battle between men of far-divergent ages. It is a battle between youth. In the old days when a prize fight was sheer overwhelming by brute force, a man of forty or fifty might have vanquished a lad in his late teens or twenties. But not today. Now it is a battle of technique. Knowing how to hit. Hitting hard and effectively. Stamina are needed.

The large purses of modern times are sufficient inducement for most fighters to attempt a come-back. When Dempsey knocked out Firpo, he received \$750,-

were different. Ring mechanics and science were different. Purses were different. There was little glory. Those were gory battles for purses which hardly ever exceeded \$25,000 and usually were around \$500.

The evolution of prize fighting in the professional sense has wrought a multitude of changes. The brutally sanguinary aspects of the fight have been eliminated. It is a genuine sport today, no more dangerous than football and, so far as accidents go, no more harmful than tennis. Boxing today is a fully developed science. The fighter is part of an organization, a vast scheme.

There are weeks of systematic training. Every movement of the boxer before a

000 for exactly three minutes and fifty-seven seconds of actual fighting. On the other hand, the big purse is not always the fundamental element which figures in a come-back try. The psychological effects of defeat often force a fighter to retire straightway from the ring. He feels himself shamed before the world that worshiped him. Freddy Welsh never got over the defeat he suffered at the hands of Benny Leonard.

But this fellow Dempsey, who cannot be considered an old man at thirty-two, liked the glamor of victory as well as its fruits. Candidly, as I know Dempsey, I think that it was the glory that lured him back into the ring more than the money he might make there.



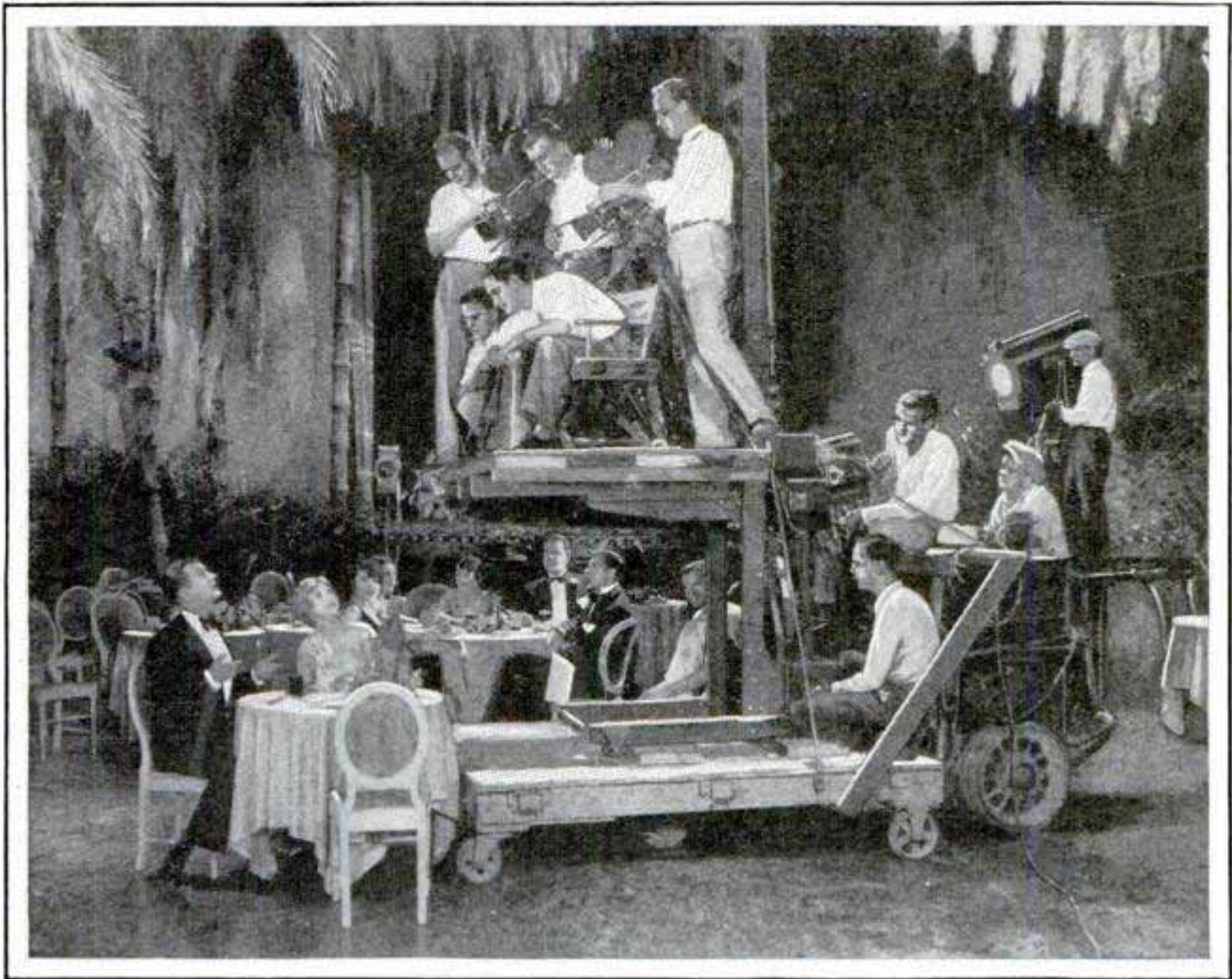

Portable Camera Truck for Obtaining Close-Ups on Large Sets; It Is Pushed or Pulled around by Electric Unit, and the Platform Can Be Raised or Lowered

**CAMERA TRUCK HAS LIFT CRANE FOR MOVIE "SHOTS"**

Saving the time and expense of arranging a number of separate groupings, an electrically operated truck can be steered about on the motion-picture set, enabling the photographer to take closer views from almost any angle. A feature of the apparatus, as adapted at one Hollywood studio, was the lift platform on the truck on which the director and cameramen could be raised for "shots" looking down on different groups.

**FISH CAUGHT BY ELECTRICITY IN GERMAN STREAM**

Fishing with electricity has been introduced in Germany. A restricted section of a stream is subjected to a heavy electrical charge which stuns the fish so that they rise to the surface and are captured. Pike and other enemies to fish of more desirable kinds are killed, the marketable

varieties are retained and undersized ones returned at once to the water, where they revive. While the method has been successful, it is suggested that stringent rules be made governing its practice to prevent too rapid exhaustion of supplies.

**Mr. Charles Weiber SPECTACLES WITH MIRRORS AFFORD REAR VIEW**



Designed especially for the automobile driver, a pair of very wide-rimmed glasses, now on the market, has a small mirror on each side so that the wearer can see the road behind him. The reflectors do not interfere with

the vision ahead and are backed by material like that of the frame.

Mr. Chas Weiber #6 Esplanade Place Weiber

8/19/27

Pub. National Electric Light Ass'n. 29 W. 39th

St. Louis, Mo.



3096  
716

# POPULAR MECHANICS

## BUILDING BEEF AND BRAWN FOR THE CLASHES

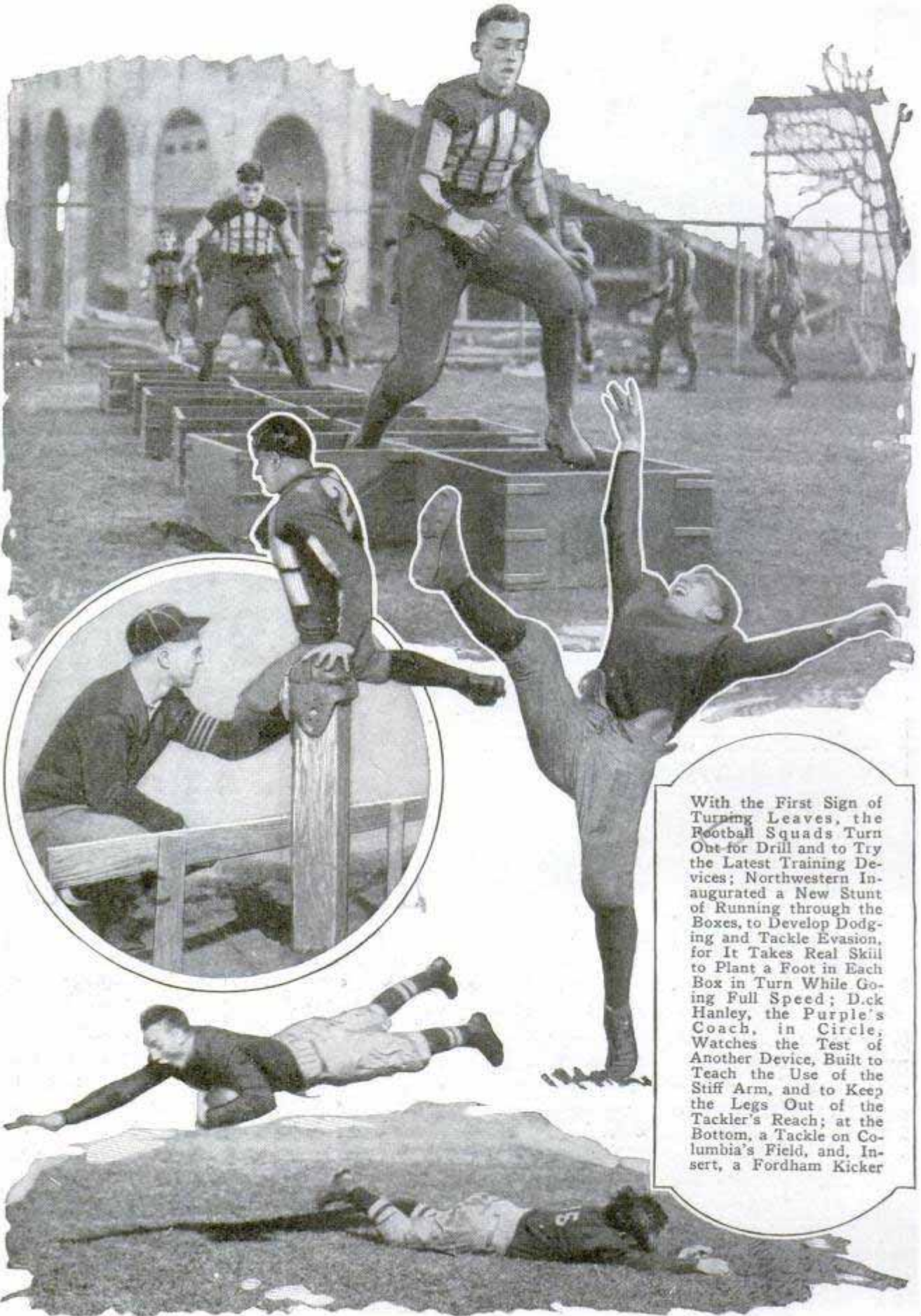

With the First Sign of turning leaves, the football squads turn out for drill and to try the latest training devices; Northwestern inaugurated a new stunt of running through the boxes, to develop dodging and tackle evasion, for it takes real skill to plant a foot in each box in turn while going full speed; Dick Hanley, the Purple's coach, in circle, watches the test of another device, built to teach the use of the stiff arm, and to keep the legs out of the tackler's reach; at the bottom, a tackle on Columbia's field, and, insert, a Fordham kicker

USA  
International



3076

THAT DRAW MILLIONS TO COLLEGE STADIUMS

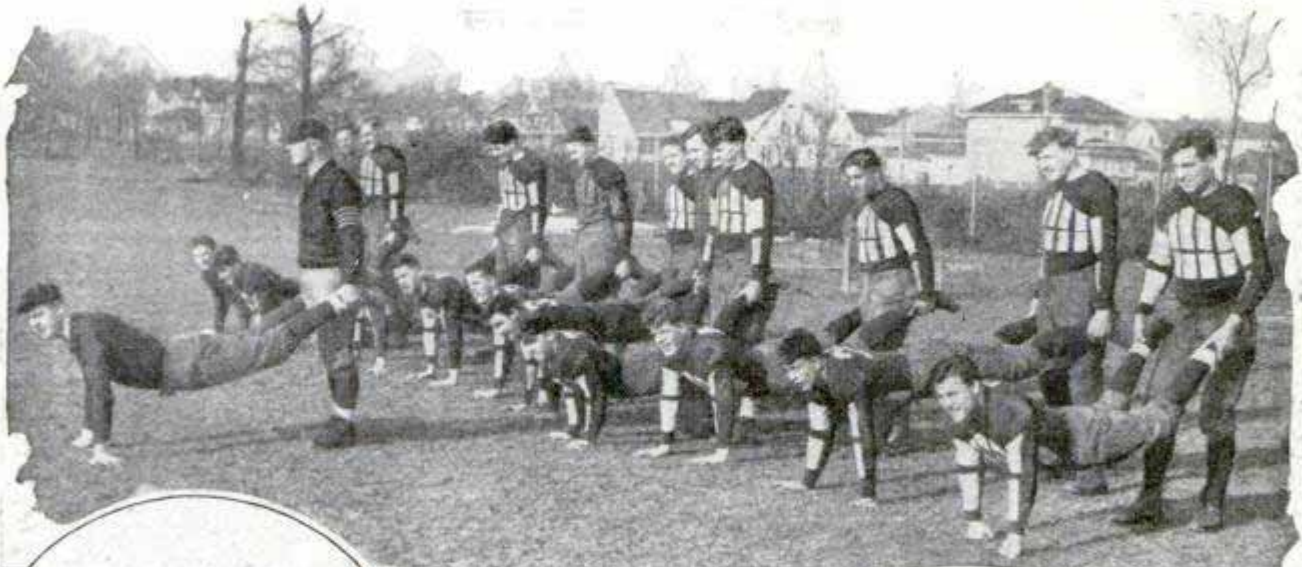

Dick Hanley introduced a number of new training stunts last spring in the Middle West; above is the Northwestern Squal at wheelbarrow drill, which is good for the arm muscles; the coach demonstrates the stunt on Tim Lowry before the squad; at right is a hard double tackle being practiced on Columbia's field during training of the New York team; West Point develops its beef on the weight machine, shown below, with the Army squad pushing the heavy contraption across the field; the timber sled is a good exerciser for developing line buckers and the mass defense of a heavy football team.

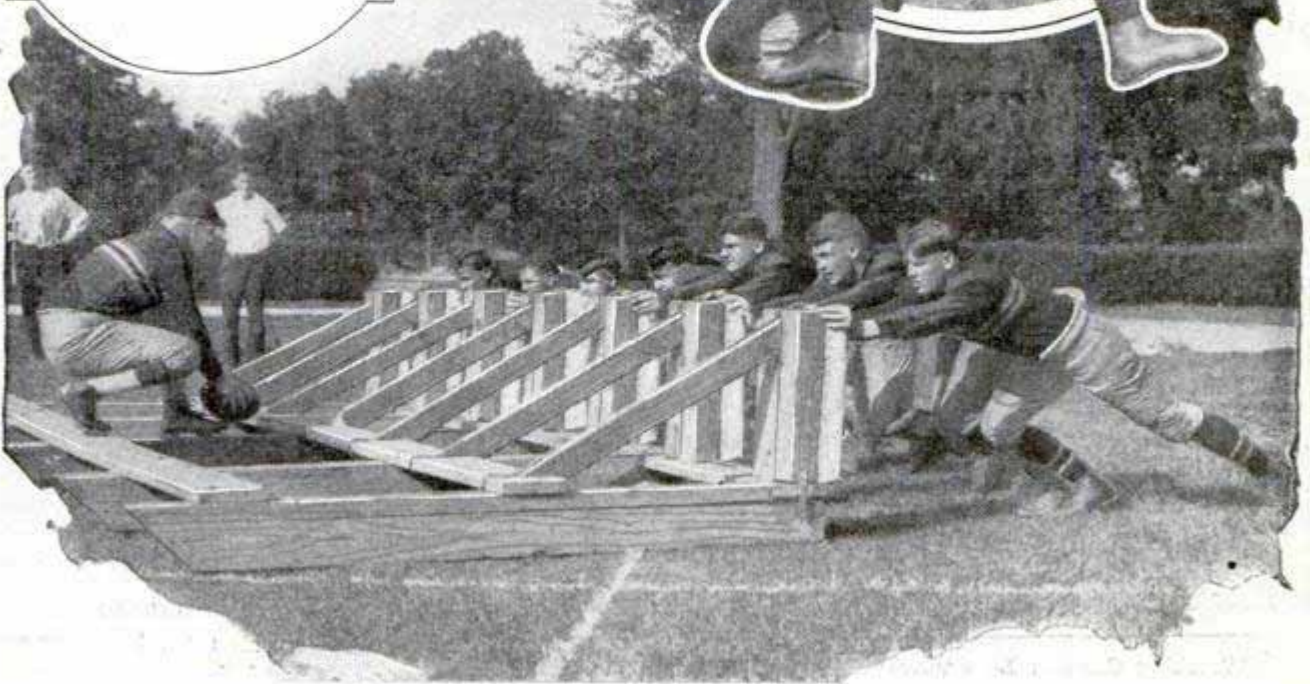



**3084. CREEPING HELPS STRENGTHEN CHILDREN'S SPINES**

*Evangelical St. John's Home, Berlin, Germany*

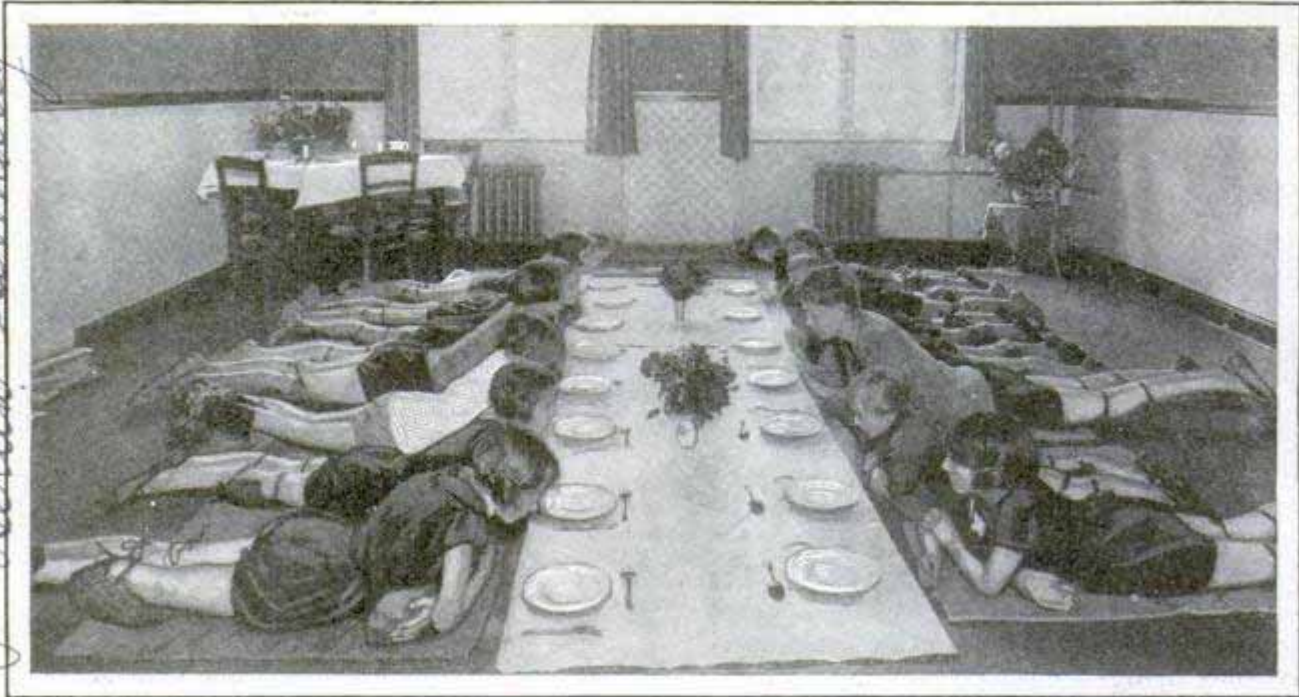

Meal Time for the Creeping Class; These Children in German Hospital Are Forbidden to Walk While Taking Special Treatments to Strengthen Their Spines

Children with weak spines at a German hospital are taught to creep instead of walk, so that there will be less weight on the backbone and undue strains will be removed. Knees, feet and elbows are guarded with special protectors. They lie prone at their meals. It is said that many cures have been effected by this system.

smokestack, and the tender conceals most of the crane and other apparatus when not in use. Besides being efficient, the outfit helps advertise the shop that operates it.

**TOWING CAR LIKE LOCOMOTIVE ADVERTISES SHOP**

**NEW BRIDGE WORLD'S BIGGEST STEEL STRUCTURE**

*3101*

Built in the form of a locomotive, an automobile-wrecking car in Portland, Ore., has a bell and air whistle, the exhaust of the motor passes out by the

Calling for bids for the new Hudson river suspension bridge, to link New York city with the New Jersey shore, recently revealed that the bridge was the biggest steel structural contract ever let. The plans call for approximately 150,000 tons of steel. The main span will be 3,500 feet in length, as compared with the present

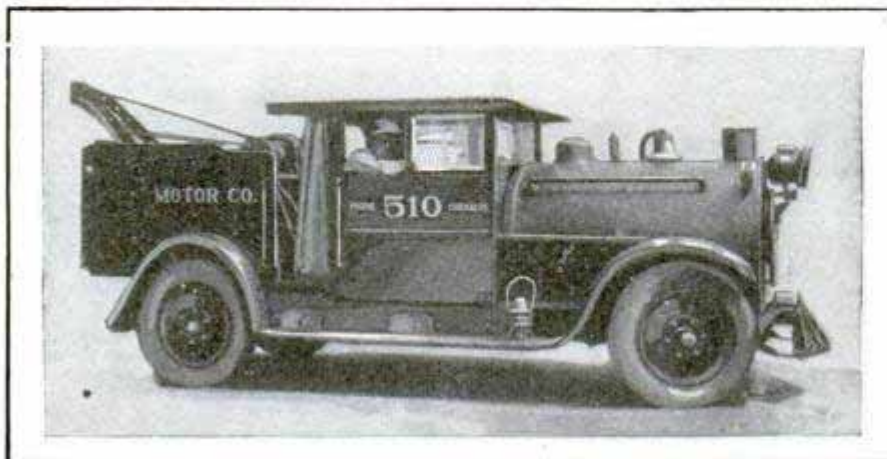

Auto-Wrecking Car like Locomotive; Fumes from the Exhaust Are Passed through the Smokestack

world's biggest suspension bridge, the new Philadelphia-Camden link, which has a span of 1,750 feet. The Brooklyn bridge, on the other side of New York city from the new structure, has a 1,600-foot span. Total cost of the Hudson river bridge is estimated at \$75,000,000, and it will carry eight traffic lanes for vehicles on the upper deck and four tracks for

*8/25/21*

*Chas. Carlton Isroak, 311 Commonwealth Bldg. Portland Ore.*



784 Astor St.  
Milwaukee Wis

street cars on the lower. Despite the huge size, the plans have been drawn in such a way as to utilize standard structural parts, requiring no new equipment in the shops to fabricate them. Each of the masonry towers at the ends of the main span will be reinforced inside with sixteen steel towers, all made up of structural members forming a six-foot square box. Bids were sought on two types of bridges, one made up of wire cables, as used in the Delaware river, Brooklyn, Manhattan and Williamsburg bridges, and the other of heat-treated eye bars, pinned together at the ends, as used in the St. Lawrence, Queensboro and Memphis bridges. If wire cables are used, there will be four of them, three feet in diameter, and each containing 26,474 wires. The present biggest bridge at Philadelphia has four thirty-inch cables of 18,666 wires each. The biggest eye-bar bridge, over the St. Lawrence, has thirty-two chains of bars, each sixteen by two and three-sixteenths inches, with a strength of 80,000 pounds per square inch.



Reel Extended, Showing the Projecting Arms and Screw for Attaching It to Wall

**FOLDING REEL TO DRY FISHLINE SAVES ROT AND TROUBLE**

Drying the fishing line is easily done on a folding aluminum reel that fits in almost any tackle box. It has three extension arms that collapse flat for packing, and are quickly made ready for holding the line by adjusting a knurled nut. The reel may be screwed into any convenient place for use, takes line of any length and enables easy rewinding of the rod reel.

**FACE BATH OF LIGHT AND VAPOR LATEST BEAUTY AID**

For facial treatments, French beauty experts have introduced a cabinet that gives light and vapor baths. The steam is said to open the pores, while blue rays from the special lamps stimulate the circulation. The outfit is compactly constructed and permits the subject to remain comfortably seated while the face is being treated.



Light and Steam Face Treatment at Beauty Parlor; an Advantage Is That the Hair Is Not Disturbed

**FIRST SPEEDOMETER ON WAGON EARLY RECORDS SHOW**

Speedometers are commonly believed to have appeared at the beginning of the bicycle and automobile age, but early historical records indicate that the idea originated with one of the Mormon immigrants on their way by wagon caravan to Utah. The travelers had no way of determining how far they had gone each day until William Clayton, in charge of one of the vehicles, measured off a mile, then counted the number of revolutions the wheel required to traverse the distance. He devised a ratchet that moved a cogwheel apparatus to record the revolutions automatically and so obtained a speedometer similar to the modern instrument.

G. E. Cannelli  
24 Ave. de Paradis

Kansas City Times  
8/26/20

8500

3193



*The Cactus Rubber Company of America, 1309 Commercial Exchange Bldg. 8th - Alere, Los Angeles, Calif.*

3/4/1

RUBBER FROM CACTUS PROMISES LOWER TIRE COST

*Editorial Department  
Los Angeles Evening Herald  
Los Angeles Calif.  
Mr. E. H. Davis*

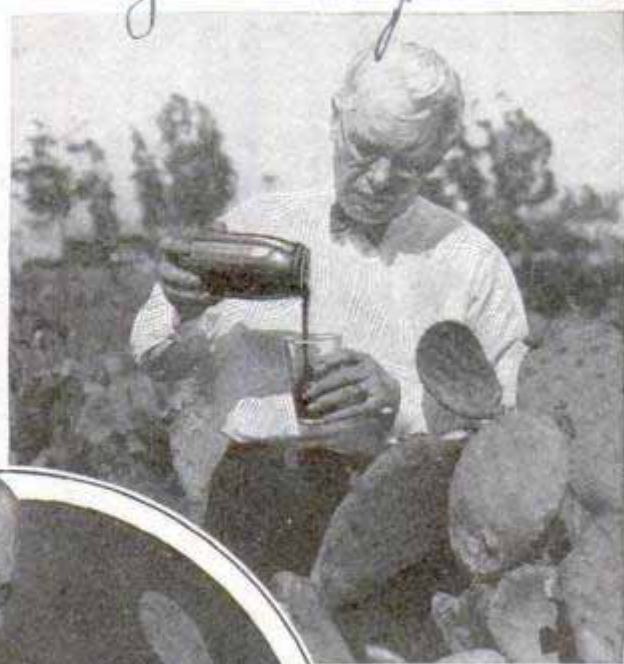

Dr. Wichmann Pulling Cactus Lobe Apart, to Show the Sticky Sap, and Steps in Making the Substitute

Synthetic rubber, said to have many of the qualities of the natural product, has been produced from cactus by patented processes developed by Dr. John C. Wichmann, of Los Angeles. While the material has not yet been tested in auto

tires or tubes, it promises to be so satisfactory a substitute for other rubber articles, that more pure rubber will be available for tire purposes, thus making possible a reduction in prices. "Rubber" already has been produced from potatoes, cabbages, bananas, milkweed and other plants, but production costs have been too great to justify commercial application of the processes. An advantageous feature of the cactus is that only the lobes of the plant are used, leaving the stalk to produce more the following season, and the best rubber substitute seems to have been made from the cactus that grows wild on the unwatered plains, indicating that special cultivation will not be necessary and that thousands of acres of land, now yielding nothing in the way of crops,

may be made to return wealth in the form of rubber-producing cactus. According to reports, the material from cactus, mixed with Para rubber, formed a heel that was both tougher and had greater tensile strength than the ordinary va-

riety. The cactus rubber gum, mixed with benzole, formed a cement with exceptionally good adhesive qualities. Mats with a base of the cactus rubber were tougher than those of Para rubber, the inventor reported, and he found that it could be "loaded" with other materials for the manufacture of various articles without the danger of crumbling. Pure Para rubber curdles if too much foreign substance is introduced, but the cactus product is said to hold far larger quantities of added materials. Besides rubber, the cactus yields a varnish, a lacquer, cow fodder and a pulp for making paper. To obtain the products, the cactus lobes are crushed, and cooked half an hour at 240 degrees to extract the gummy liquid. This is then treated until the rubber is formed.



**WILD CREATURES DIE EARLY  
 ANIMAL "CENSUS" SHOWS**

3167  
 Few wild animals live out the span of their natural life, and the reasons some species attain so much greater longevity than others are not altogether clear to students. From data collected by naturalists, a fairly reliable "life-expectancy" table has been compiled for a large number of animals. It reveals several points not generally realized; for instance, that earth worms may linger for ten years or more, some kinds of ants have lived in captivity for ten to fifteen years and, though the queen bee is engaged in the almost constant production of eggs, it lives for four or five years, while the average life span of the busy workers is not over six weeks. Elephants sometimes live to be 200 years old; tortoises, especially the giant species, to 300; carp and pike may reach 150. Among birds, the crane has a life expectancy of forty to fifty years; the heron sixty; the owl sixty-eight; doves, ostriches and woodpeckers, sixty to seventy. Domestic fowls may live to be twenty years old; sheep ten to fifteen; dogs and wolves, ten to fifteen, and cats nine to ten. Canaries attain the age of twenty and more; mice commonly live three or four years, and horses may reach forty or fifty. Fresh-water pearl mussels may live to be sixty or seventy years old, and crabs over twenty.

**DOG WINS FIVE FIRST PRIZES  
 AT ENGLISH SHOW**

2864  
 "The Jockey," a French poodle, was awarded five first-place ribbons at a recent show in London against a number of high-class competitors. These dogs are believed to have been developed from the spaniels and are characterized by their extremely long, curly hair, intelligence and vivacity. They are favorites among circus trainers. Dogs are judged on forty or more points.



Winner of Five First Prizes, the Long-Haired French Poodle

Owner - Mrs. Ervins  
 London, England

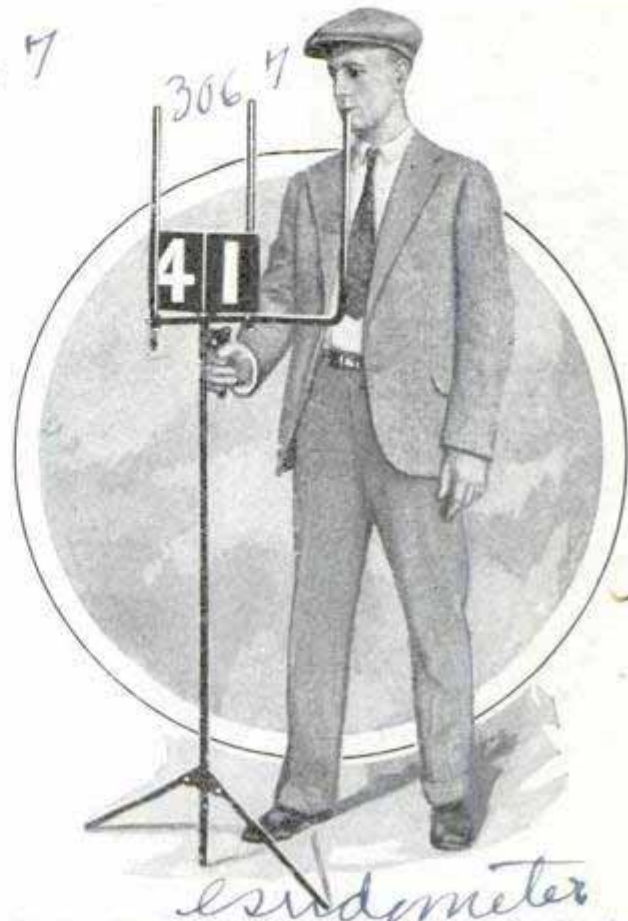

esudometer  
 Football Meter with Sights for Quickly Lining Up the Ball, to Gauge Its Position on Field

**METER TO LOCATE FOOTBALL  
 SAVES LINEMEN'S TIME**

Determining the exact location of the football on the field after a play is sometimes a difficult task, especially when the side lines are obliterated by snow or water, but this task is now simple with the aid of a special meter which has just been introduced. It is essentially a sighting device with two legs resting on the side lines to form right angles with the sights above. With the meter in the proper position on the line, it is moved along until the tip of the ball is in alinement with the sights. If the side marks are obscured, correct checking is made with the aid of two stakes which are placed parallel to the side line at one end of the field. The "gridometer" is the invention of two Iowa men.

Invention W. H. Payne and  
 A. B. Parns; Page across down.



2737

Colombier - Barnburnt Glass, Besley Acad. near London, England

# Hunting BIRDS

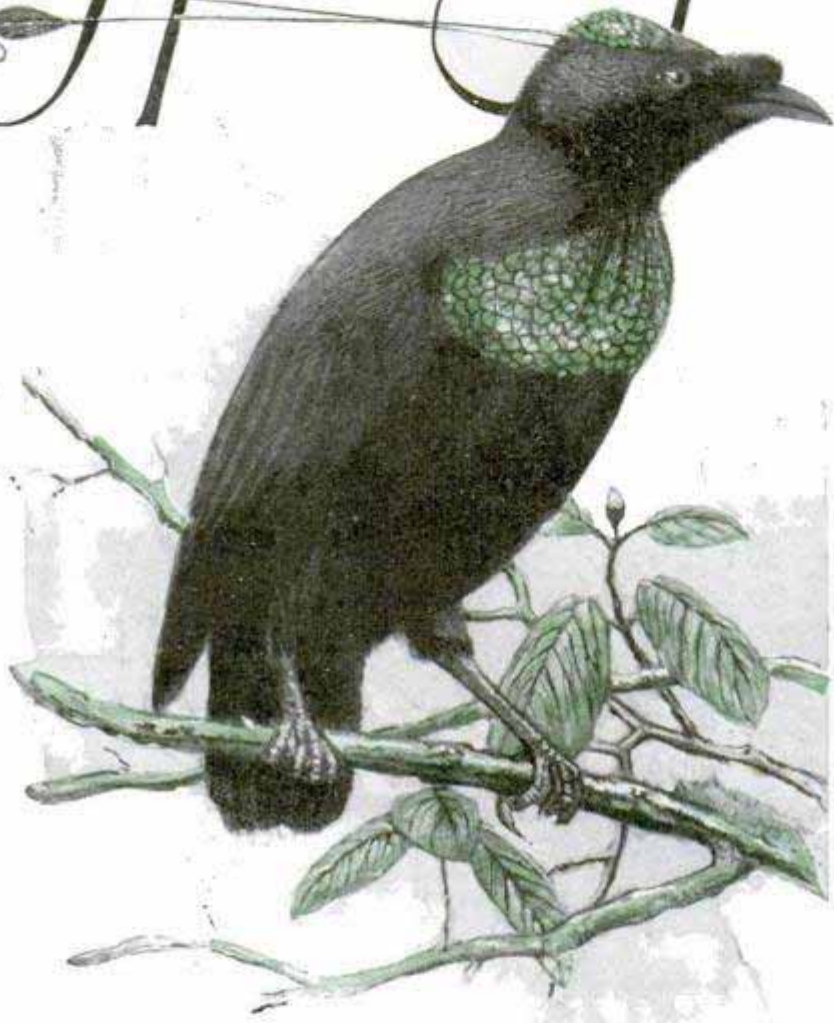

Jet-Black Bird of Paradise with Green Top Knot and Breast and the Two Long Quill-Like Feathers Growing from the Head; This Is a Newly Discovered Species

By HAROLD T. WILKINS, Esq.

DEEP in the fastnesses of woods in the cannibal islands of the South seas, collectors daily risk their lives to supply something new and more lovely in millinery. The hunter runs the double hazard of death at the hands of unseen savages of the stone age, who shoot poisoned arrows from dense thickets, and of ruined health from deadly fevers contracted in wading through tropic swamps, where stinging insects try to keep him back from the remote haunts of the gorgeous bird of paradise.

haunts the coast regions, and now the hunter has to go far inland to reach the remote forest-clad mountains where other lovely species of these birds live and dance.

In New Guinea, the birds are a monopoly of the chiefs of the coast tribes, who buy them cheaply of the mountain Papuans. The white or yellow trader, or the scientist who collects the birds for American and British museums, enlists his carriers from the tribes of the lowlands. It is not easy to get native carriers on an adventurous trip into the in-

Around this El Dorado of the tropical bird world, legends have clustered thickly. The old Dutch East India travelers said these brilliant birds had neither wings nor feet, and passed their lives in air, hanging by their wire tail feathers from the top branches of some lofty tree where they fed on the nectar of flowers.

The hunter of the bird of paradise plunges into the tangled bush of gloom and darkness about April to reach the far-away New Guinea mountains about May, when the male bird whirls in a magnificent golden-fan dance, surrounded by admiring mates in brown plumage in the tree tops.

The high prices put on the lovely plumes have led the native hunter to kill the birds in a reckless manner. The Papuans sell the skins to traders who give them opium in exchange. The lure of this drug led to the practical extinction of the beautiful blue "Rudolphi" bird of paradise, which



# OF PARADISE



Cannibals of the Aru Islands in the South Seas, Decked Out in Headdresses of Priceless Feathers from the King Bird of Paradise, Worn in the Annual Harvest Ceremonies

terior, because of their fear of the mountaineers, who are cannibals and the deadly enemies of the Papuans of the plains.

The first stage of the journey is by river steamer, 150 miles up country. Then the white collector embarks on a launch and steams for two days upstream to where canoes will ferry him to the foot of the mountains. Hundreds of portages around rapids will have to be passed, and many days will be spent going around these rapids, on an ascent, which, on the return, will be done in six hours.

Way back on the mountains, the loveliest specimens of the birds of paradise will be found. At night, a cold, damp mist comes up from the ground, and the trees and shrubs drip wet. The atmosphere is that of a London fog, and you are back in the stone age among natives armed with stone adzes, and bows and arrows. Dense forests are all around, and dangerous precipices overlook swamps infested by giant mosquitoes.

Each of the seventy-eight or so known

species of the birds of paradise, enumerated by the English collector, Lord Rothschild, lives in a restricted area, and all of them have each a definite locality. When the mating season comes, in early summer, the male birds dance on trees with great spreading tops. The hidden watcher below on the dark forest floor, looks up through the branches to witness a wonderful spectacle.

A dozen birds, in full plumage, stretch out their wings, forming two golden fans, deep-red at the base and fading to pale-brown at the finely tufted wing tips.

The birds keep their wings stretched out horizontally, and the neck and beak bent around, while the long plumes are erected into a graceful tuft on each side above the wings. In this attitude they dance up and down, entirely oblivious to all danger.

A Papuan boy, standing at the base of the tall trees, shoots bird after bird, collecting them as they fall through the branches. The methods used by the na-



tives to kill or snare these birds are most ingenious. The great object of the native hunter is, of course, to prevent any possible damage to the plumage.

The lonely Aru islands, 250 miles west of Dutch New Guinea, are the home of several beautiful species of birds of paradise. Here, about a dozen men, women and children occupy a shed in a clearing of a village in a swamp, which the trader reaches by canoe. The native hunters of the birds live in the jungle outside the village. A hunter builds a lofty hut in the branches of trees known to be frequented by the birds. At dawn, he climbs up into the fork of the tree to wait hidden behind a shelter of cunningly woven branches and thatch.

Just before sunrise, he hears loud cries resounding through the forest, and continually changing their direction. It is the great king bird of paradise. Presently, the hunter catches sight of a golden star-bearing tail flashing in delicate flight across the tree tops. As soon as the bird

perches on the tree tops to peck at the red fruit it loves, the hidden hunter lets fly with a blunt-headed arrow, topped with a conical woven cap, which stuns the bird but does not pierce its flesh.

Off the coast of New Guinea is the little Waigiou island, the only home of the red bird of paradise, which the natives catch in a very clever way. They know these wonderful birds are very fond of a scarlet fruit. So the hunters fasten this fruit to a stout forked stick, and, providing themselves with a fine strong cord, seek out a tree in the forest on which the birds perch. They climb up by hitching the stick to a branch, and then arrange the cord in a noose so ingeniously that



Courtesy Dr. Ernst Hartert

Courtesy Macmillan & Co.

**Newly Discovered Paradise Bird That Rivals the Peacock in the Brilliance of Its Green, Red, Blue and Purple Feathers; Above, the Red Bird of Paradise in Full Courting Plumage**



when the bird flies down to eat the fruit, its legs are caught, and by pulling on the end of the cord, which hangs down to the ground, the bird is trapped.

Organized drives on the birds are arranged by the natives, who pick out a likely-looking place on the saddle of the spur of a mountain and then cut a lane leading from it through the trees of the forest. The birds are then left to get accustomed to this road through the trees. One day, great nets are set up at the end of the lane, and shouting and whooping, the natives drive the birds down the cutting through the trees, until they are beaten into the funnel-shaped nets.

The eggs of the birds of paradise, with their strange markings, are a rare and coveted prize for the ornithologist and the museums. Fuzzy-headed natives say the bird of paradise nests in an anthill, and never lays more than one egg.

Lord Rothschild, of England, has the world's biggest collection of skins of birds of paradise housed in the galleries of the famous zoological museum at Tring, Hertfordshire. Many of the finest skins have been acquired from traders in the heart of British and Dutch New Guinea.

### SPIRAL STEM FOR OIL-WELL BIT INSURES A STRAIGHT HOLE

One of the difficulties in drilling oil wells is that when the bit strikes a formation that is harder on one side than on the other, it glances off to the soft side, making a crooked hole. An improved spiral stem, or drilling connection between

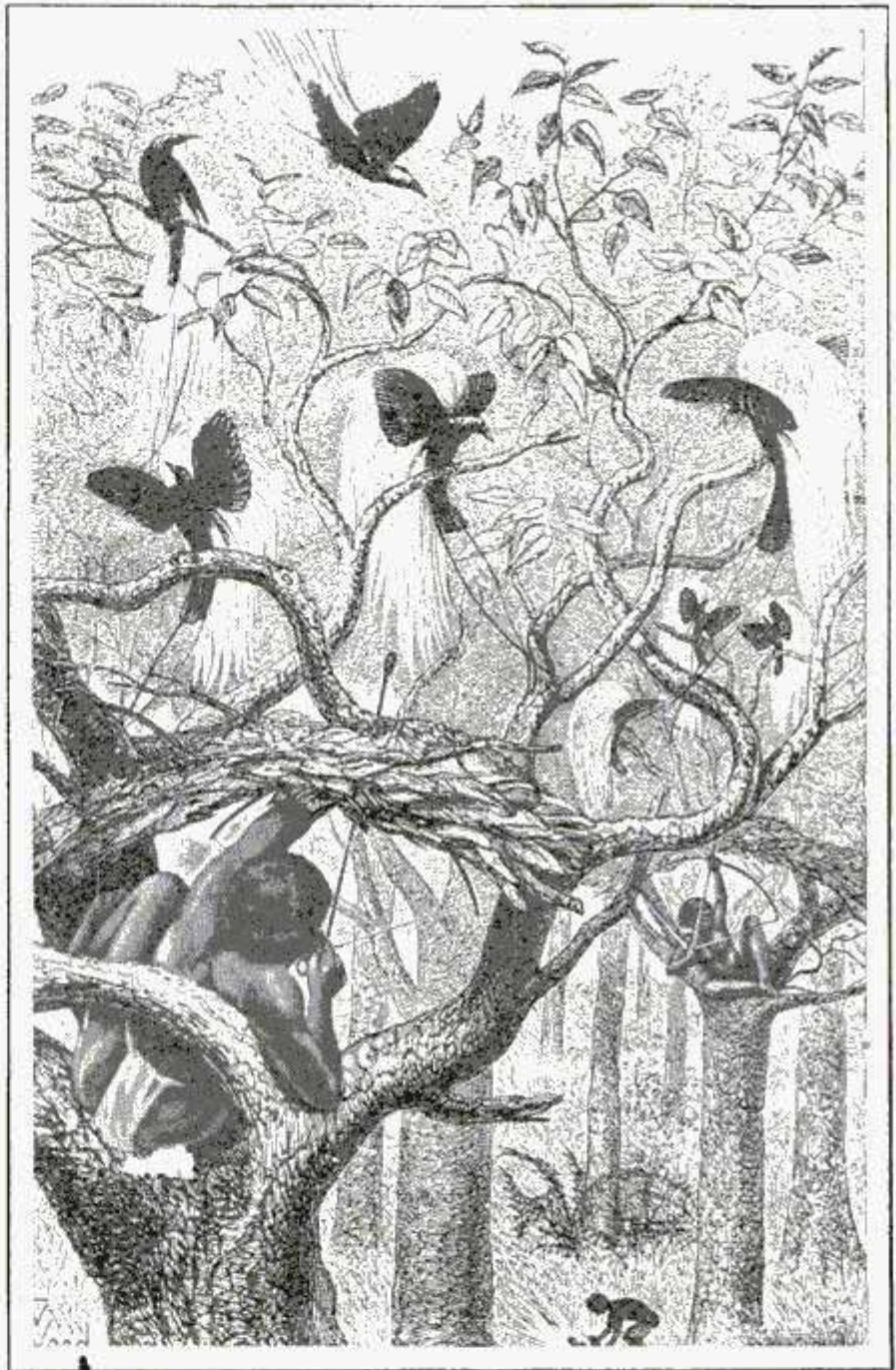

Courtesy Macmillan & Co.

Aru Native, Hidden in a Tree Fork beneath a Thatch Blind, Shooting King Birds of Paradise with a Blunt-Tipped Arrow

the cable and the bit, fills the hole and is said to force the bit to cut straight through all obstructions, making a vertical hole. An additional feature is that a spiral groove provides ample passageway for water and aids in mixing the mud thoroughly, so that it may readily be bailed out. The unit is not designed for the purpose of straightening crooked or flat holes, but to prevent these troubles.

☐ Music of the tree crickets is produced by the insect drawing the right fore wing across the left.

Rebergall - maker.  
Titusville, Fla. Pa. Titusville Pa.



### SCULPTURE AT BEACHES DEVELOPS ARTIST'S SKILL

3085



Samples of Sand Sculptures, and Sand Was

ture at German Beach; the Designs Were Outlined in White Pebbles Mixed to Proper Consistency to Assure Considerable Durability

With a little care and patience, remarkably accurate figures can be made from beach sand, moistened to the proper consistency and not allowed to dry too soon. The turtle shown here was strong enough to carry the child's weight, and more elaborate representations are made with the help of a skeleton support. Addition of pebbles to the designs proved an effective way of outlining the figures.

#### USE CAMERA IN WOOD GRAINING INSTEAD OF BRUSH

3170

To keep pace with the constantly growing demand for the reproduction of wood graining on metal furniture, and other

articles, the camera has been pressed into service to supplant the slower and more costly hand methods. A plate, thirty by eighty-seven inches in size, is employed to photograph various hardwood finishes. The pattern is then etched on a copper plate and over it is smeared a graining compound of the consistency of printers' ink. An impression of the grain is taken from the plate on specially prepared composition rolls which are used to transfer the pattern on the surface, already painted the color of the wood that is to be imitated. Another drying follows the transfer, and the article is placed in a ventilating booth and sprayed under pressure with lacquer or varnish which is finally baked on. The

(New York Times 8/21/27)  
Wood Grain Reproducing Co. 141 East Ave



photographic process is used also in copying marble patterns on slate and other materials for soda-fountain and similar installations.

**RADIO PHOTOGRAPHS CONVEY NAVY ORDERS** 3166

Successful tests in sending photographs of written orders by radio instead of by dot-and-dash messages, have been completed between the U. S. S. "Seattle" and the navy department in Washington, indicating the possibility of this form of communication for greater accuracy and secrecy. There are three obstacles to the immediate adoption of the method on a large scale, however. The receiving and sending apparatus costs \$13,000, the equipment is bulky and a message covering a relatively small space requires an hour to send.

*Kansas City Star*

**GAS IS CARRIED IN FLAT PIPES ACROSS AUTO ROAD** 2346

How to install a gas main between the top of a subway and the street paving above proved a problem in Cincinnati recently, as there was only a foot of vertical space available and sixteen-inch pipe was being used. A solution was reached in a pair of flat, box-shaped steel conduits, requiring but a few inches of depth. They were placed on the concrete roof of the subway and connected to the ground mains.

*across Central Parkway*



Flat Gas Pipe and Its Connection with the Main Conduit at Point of Crossing under Pavement

*Union Gas & Electric Co.*

Gauging Approximate Distance of Bus Routes with the Measuring Wheel; Meter at Top Records Mileage, Saving More Elaborate Survey on Curves



*Burton*

**WHEEL THAT MEASURES MILES GAUGES BUS ROUTES**

Bus-route distances are calculated in a foreign city with the aid of a hand-propelled wheel that carries a special speedometer to register the miles. One man runs the wheel while another notes down the distances between points. The device is especially helpful in computing the mileage of proposed routes with many curves.

**TRAP MOTHS BY ELECTRICITY TO PROTECT TOMATOES** 3154.

Killing moths with electricity and kerosene has been successful on a truck farm near Danville, Va. The gardens are wired for electric lights to attract the tomato-worm moths and, as they fly close to the bulbs, they fall into pans of kerosene placed below the lamps. Before this trapping method was adopted, approximately half of the crop was lost. The farm owner estimates that a saving of from \$2,000 to \$4,000 has been realized yearly.

*Con. Emmet Daugherty  
514 Woodward Bldg  
Washington, D.C.*



*New York Times 8/21/27*

Type of Gas-Electric Light  
 Devised for Landing-Field  
 Beacon as Special Aid in  
 Fogs; the Rays Have Far  
 Greater Mist Penetration than  
 Those of Ordinary Lights

**NEW INDUSTRY FROM SEAWEED  
 DEVELOPED IN CALIFORNIA**

3169 Agar, a substance long used in medicine and in chemistry and now coming into demand as an auxiliary food product, is being produced from seaweed along the California coast, the industry promising a source of revenue to gatherers of the weed and freeing the United States from dependence on Japan for supplies of the material. The seaweed is dried in the open air, washed in wooden tanks and forke into wire baskets. A six-hour treatment and other processes follow, which yield the dried gelatinous extract. The product is sacked for shipment and is said to be superior to imported varieties as it contains fewer bacteria, is more uniform in quality and absorbs more water, a characteristic which makes it useful in various industries.

*American Agar Co., San Diego, Calif.*

*2760 and  
 Conroy Hewitt Co  
 Steeple Jack Bldg  
 Boston, N.J.*

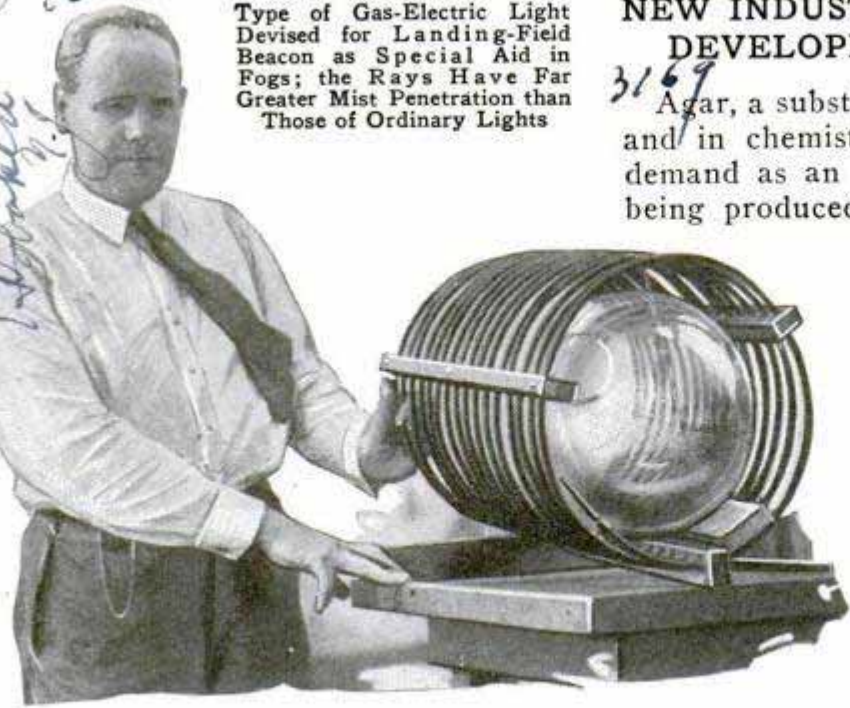

**PINKISH GLOW OF VAPOR LIGHT  
 TO CONQUER FOGS**

More effective aid for aviators while landing in fogs is promised in a beacon light being developed by eastern engineers. It is a neon-gas type of lamp, affording illumination through the glow of the vapor rather than by a filament, and the pinkish color of the light is said to be much more successful in penetrating fogs and mists.

**JOB THAT NEVER ENDS**

3155 It takes three years for the steeple-jack painters to cover the bridge over the Firth of Forth and, when they have completed it once, it is time to begin all over. Many of the men now working on it have been engaged since 1890, when the bridge was opened. It is approximately four miles long and principally of steel, the area to be covered with paint being the equivalent of 135 acres. During the operation, trains are crossing every five or ten minutes, and a motor launch constantly patrols the waters beneath, to rescue any man who might fall.

*Daily Mail 8/9/27*

**TOADSTOOL GARDEN CANOPY  
 275 US NOVEL DECORATION**

From the trunk of an old tree, some lumber, sheet metal and stucco, an Ohio man has fashioned a novel canopy for his garden. It is shaped in the form of a giant toadstool, ten feet high and sixteen feet across. Below is a brick floor and marble benches, arranged for serving tea.

Toadstool Shelter over Garden Seats, Formed from the Trunk of an Old Tree, Lumber, Sheet Metal and Stucco

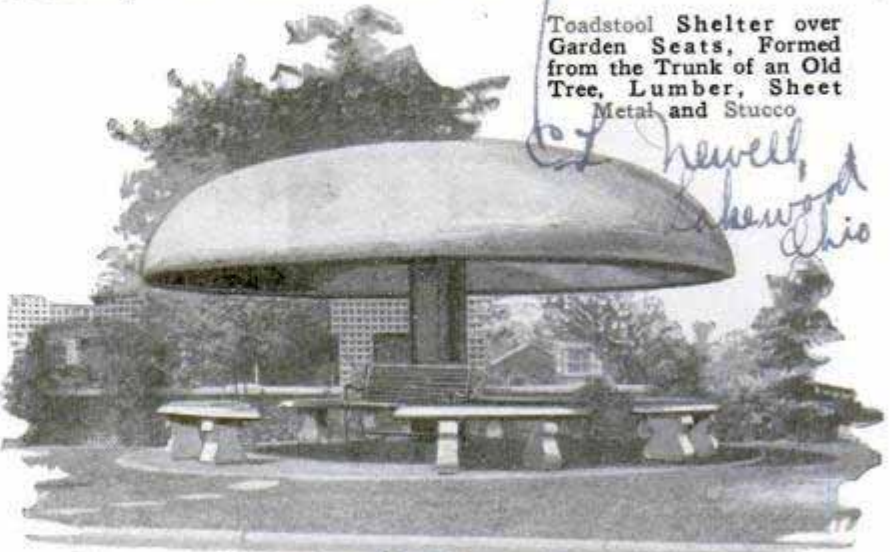

*St. Newell, Lakewood Ohio*

*Arch. P.C. Esrose  
 Mc Comb Ohio*



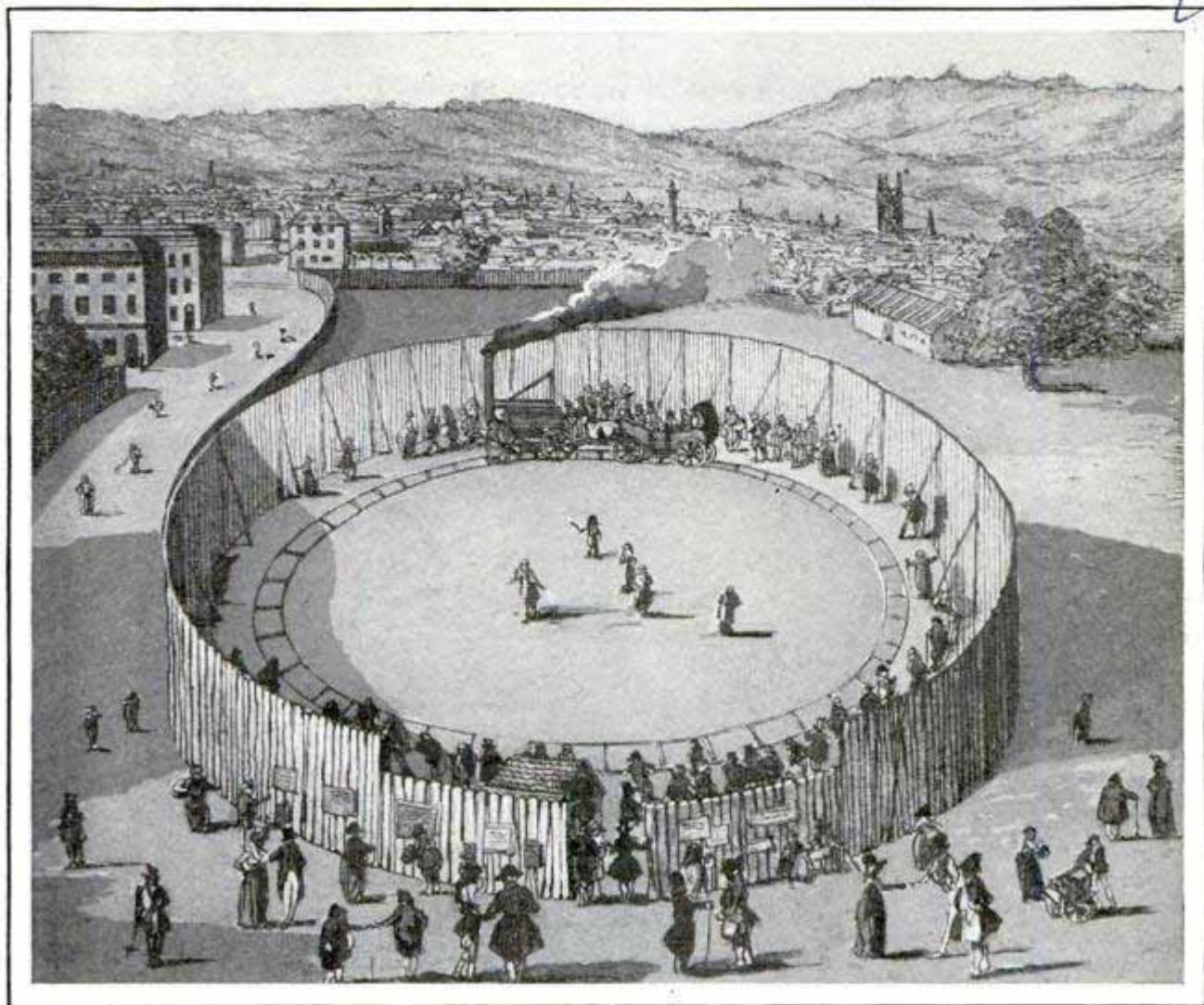

Old Sketch of the First Steam Locomotive to Haul Passengers for Pay Traveling on a Circular Track, inside a Stockade in London, Where an Enterprising Showman Earned Big Profits

## The Romance of Steam Power

### Pioneers Who Put Boiling Water to Work in Factory, Mine and on Rails Had Continuous Battle with Poverty

THE recent centenary of the death of Samuel Crompton at Bolton, Lancashire, Eng., where he did the experimental work on his spinning "mule" and revolutionized the cotton industry of the world, recalled, in its observance, the romance of the sudden rise of steam power, within a few years at the end of the eighteenth and beginning of the nineteenth century.

All of the names that are associated with the application of steam to work in factories, mines and on rails for transportation, also are associated with battles against poverty and the general apathy of the public. They include Edmund Cartwright, inventor of the loom in 1787; Arkwright, who produced the spinning

frame in 1769; the "spinning jenny" of Hargreaves, invented in 1770; John Kay's fly shuttle in 1773; the Jacquard loom of 1806 and Crompton's mule, which he perfected in 1779. Like most inventors, he made little out of the invention, and, though he lived for forty-eight years after it was introduced and saw others make fortunes from it, he died at Bolton in abject poverty.

While these inventors were revolutionizing the textile industry for steam-power production, others were at work on transportation. James Watt's first condensing steam engine became a success about 1776, and then, just before 1800, Richard Trevithick, of Cornwall, evolved the high-



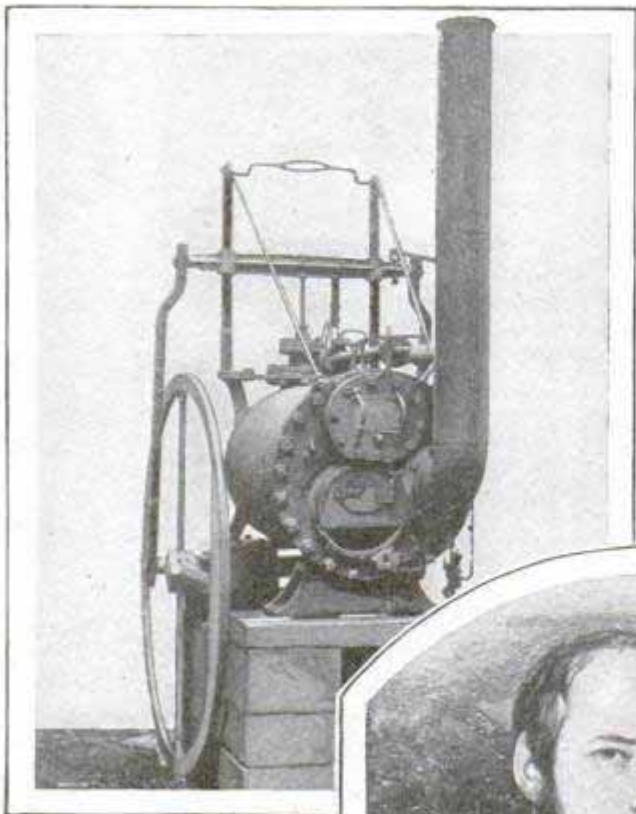

pressure boiler. Trevithick, though his name is almost unheard outside engineering circles, may be regarded as one of the greatest engineers of all time. Like his father before him, he was chief engineer at a famous tin mine in Cornwall. He realized that the future of the steam engine depended on increasing the pressure to get more power for a given weight of engine. Watt insisted on five or six pounds' pressure, and even tried to get a law through parliament forbidding the use of higher pressures as dangerous.

Trevithick, however, turned out the original of all "Cornish" boilers when he built one to operate on more than twenty pounds to the square inch—a very mod-

est pressure as compared to modern practice with high-tensile steel. The Trevithick boiler really made the locomotive possible, for with its invention it was feasible to develop the necessary power without an excessive weight. He realized that, and at once started building a model locomotive. On Christmas Eve, in 1801, he tried out a large locomotive which he had had built in a blacksmith's shop, and succeeded in driving it up a hill and back again. Another of his engines was driven through the streets of London in 1804, and the same year he built the first railway in the world, a ten-mile line serving a colliery

at Penydaran, Wales. The engine could drag the train of small coal cars, really wagons on flanged wheels, at four miles an hour.

The same year another of his locomotives was sent to the northeast coast of England for the Wylan colliery, where it was modified and improved by Hackworth, Hedley, Blenkinsop and Foster. Hedley, in 1816, constructed the famous "Puff-

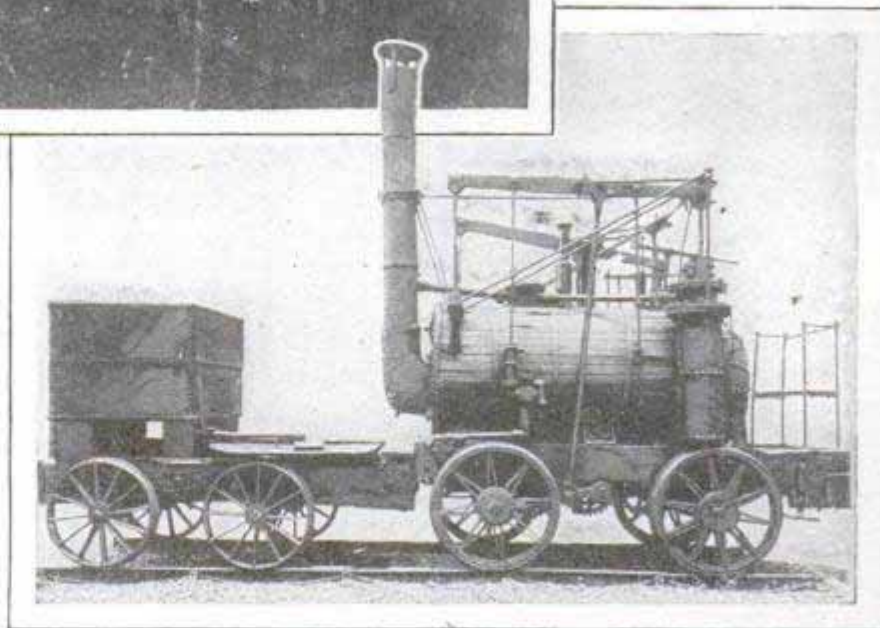

At the Top Is Shown Trevithick's First High-Pressure "Cornish" Boiler and in the Center, the Inventor, from an Oil Painting in South Kensington Museum; at the Bottom, "Puffing Billy," Built by Hedley in 1816



2839

ing Billy," now preserved in the South Kensington museum.

Although George Stephenson is popularly given the credit for inventing the locomotive, there were dozens in operation on short colliery roads before the Stockton and Darlington railroad opened, in 1825, with his "Locomotion No. 1" as the motive power. What Stephenson did do was building the first engine used to haul passengers, but the locomotive itself was a mixture of Blenkinsop and Hedley's designs, and contained all of Trevithick's original inventions, including the Cornish boiler, gauge glass to show water level, use of the exhaust steam in the flue, and the flanged rails on which it ran.

Trevithick had exhibited a large engine in London in 1809. He called it the "Catch-me-who-can," and showed it on a circular track inclosed behind a high board fence, charging admission to see it and a shilling a ride for a trip in the carriage which it drew. Stephenson's passenger train was the first to travel between two given points, but Trevithick's circular road was probably the first to receive pay for rides.

Like Crompton, Trevithick made little out of his inventions, and died in poverty. Besides his work on the locomotive, he invented the first steam dredge, the first steam-driven threshing machine, and was the first to try to tunnel under the Thames, nearly losing his life in the attempt.

**LAMP TO HEAT AUTO RADIATOR PREVENTS CAR FREEZING**

Attachable to a lighting socket, a reflector lamp is hung by a chain from the radiator cap and keeps the water from freezing. In an unheated garage, during cold weather, the car will be safe, will start more easily and there will be a consequent saving on batteries by using this lamp, it is claimed. The reflector is intended to insure distribution of the heat where it is most needed.

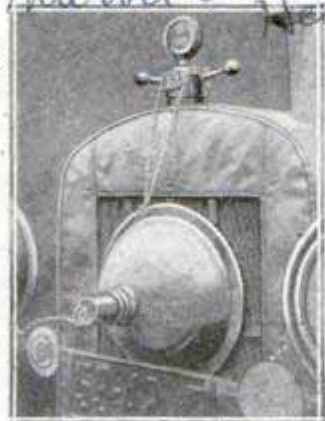

Benjamin Electric Mfg Co,  
120 S. La Salle St. Chicago

2958

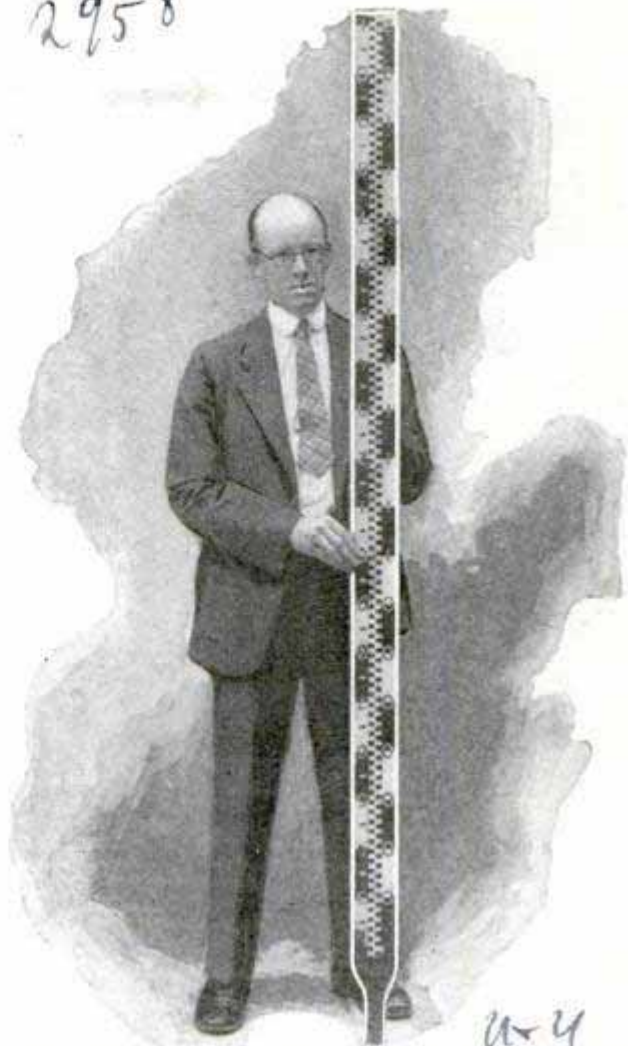

For Accuracy in Surveys; Rod Is Little Affected by Temperature Changes and Has Thermometer

**THERMOMETER IN LEVEL ROD AIDS ACCURATE SURVEYS.**

For running lines to determine the elevation of points above sea level, the coast and geodetic survey employs a special rod that is said to change scarcely at all in length under the most trying conditions of temperature and humidity. It is made of invar alloy, and carries a built-in thermometer for temperature corrections.

**HIGH-SCHOOL AVIATION COURSE TO PROMOTE FLYING**

Fundamentals of flying will be taught to Chicago high-school students, according to present plans of the board of education. Aviation and radio experts have been invited to assist in preparing a suitable course. The subjects will be made part of a general mathematics course.

Buttercups and daisies are found in great profusion north of the Arctic circle.



Inventor, Dr. Richard  
 Cruise, King's Specialist and  
 732  
 Honorary Surgeon to Royal

730 Beacon St.  
 Los Angeles, Calif.  
 Record 8/16/27

Westminster Hospital  
 London, Eng.

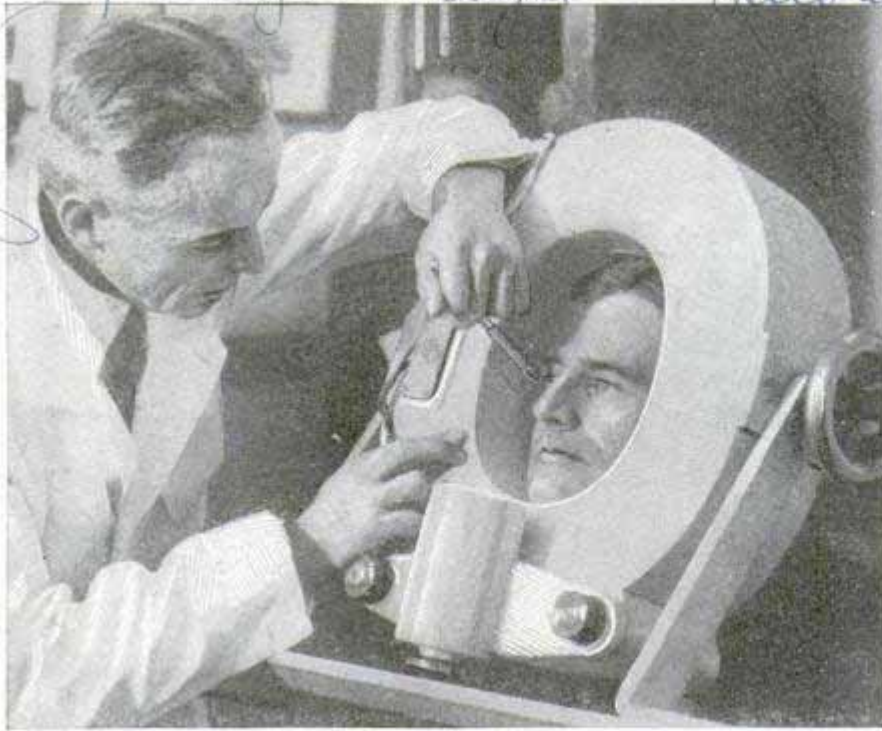

Drawing Metal Fragments from Patient's Eye with Aid of Special Magnet;  
 Current Is Turned On in Rim about Face

is sometimes of benefit in  
 destroying harmful in-  
 sects. In certain localities,  
 trapping moles has proved a  
 profitable undertaking, twenty  
 often being taken from one spot.

**THOUSAND LEPROSY  
 CASES CURED IN  
 FIVE YEARS**

3/17/ That leprosy is yielding to science is shown by reports from the Philippine islands, where 1,000 cases have been cured in the last five years and many others kept under control. The progress has been attained by treatment with a special oil which has been found

**METAL EXTRACTED FROM EYES  
 WITH RING MAGNET**

One of the most effective aids to the eye surgeon is a magnet for pulling out particles of metal that may become lodged in the organ where they cannot be removed easily by other means. The patient's head is placed inside a ring, the current is switched on and a metal instrument collects the fragments of metallic substance that may be in the eye.

of benefit in curing the malady. Some medical men declare that almost complete eradication of the disease will be possible within ten or twelve years. An appropriation of \$2,000,000 was asked from the United States to help fight the plague.

**LEMON-SHAPED DRINK STAND  
 HELPS DRAW CROWDS**

2961 Thirsty motorists traveling a highway in Oregon are attracted to a refreshment stand, shaped like a huge lemon, at the side of the road. It is brightly colored and is equipped with modern conveniences for the serving of soft drinks.

**AMERICAN MOLESKIN PARTS AND  
 TRADE IN MOLESKINS FOR FUR  
 TOTALS MILLIONS YEARLY**

Once considered chiefly as a pest, the mole is now regarded as an important article of commerce, since the demand for its fur involves a business of more than \$2,000,000 in this country annually. The most desirable varieties come from abroad, but more than \$100,000 worth of raw American moleskins have been marketed for fur. While the animal works considerable injury to crops, it

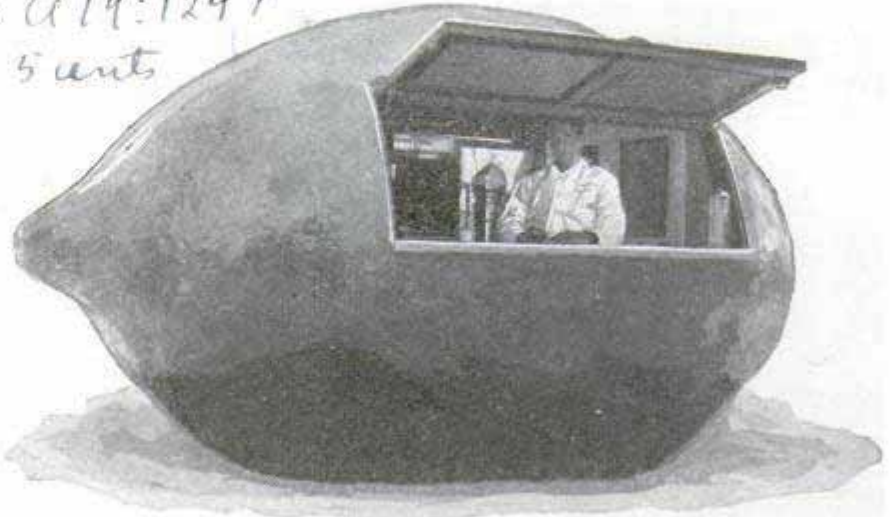

Novel and Useful, the Lemon-Shaped Refreshment Stand Can Be Tightly Closed to Protect Contents from Weather

new article March 19, 27-442  
 Ranching in Swampland 3/16

Dear Producers. A 19:1247  
 5 cents

New York Times  
 8/21/27

Carlton Isroak,  
 The Empress Theatre  
 Los Angeles, Ore



2811

Weather house

Barometer thermometer

332 W. 21st St  
Grand white 419  
& Water St  
Milwaukee  
Wis



Three Primitive but Ingenious Weather Prophets; Atmospheric Changes Draw the Monk's Cowl over his Head When Storms Come, Make the Weather-House Inmates Move, and Color the Weather Plant

## What You Can Believe about Weather Lore

### Many Proverbs, Proved to Be Useful Records of Human Experience, Tersely Put

**F**ORECASTING weather must have been one of the earliest forms of prophecy. Even nowadays there is scarce a village community that has not its local seer, and what the weather bureau calls "folk meteorology." Many of the proverbs regarding the weather are the useful records of human experience, tersely put.

Almost everyone knows, for instance, that the amount of moisture in the atmosphere affords in some degree an indication of coming weather. If the air is dry, there is prospect of clear skies; if increasingly humid, rain may be expected.

Dwellers along the seacoast of New England hang up a dried bunch of seaweed to obtain advance notice of weather changes. When a storm is approaching, it becomes damp and flabby. When it dries out, there is reason to expect clearing.

There are a number of other weather-forecasting devices which also depend for their usefulness upon absorption of moisture with more than ordinary readiness. Among them is catgut, which is the operative element of the familiar toy called a "weather house."

In Germany, where that kind of toy is made, the two figures that alternately

come out of the doors are called the "little weather husband" and the "little weather wife." With clearing weather, the woman appears; threat of a storm brings out the man. Both stand on a platform which is suspended by a string of twisted catgut. When the air turns moist, the catgut absorbs some of the wet and tends to untwist; when dry, it twists tighter. The platform turns responsively, the figures swinging in and out.

Another contrivance is a figure representing a man in monkish costume, with a cowl. In moist weather, the cowl is drawn over his head, to protect him from the damp; when the skies are clearing, the cowl drops down behind. Again it is a concealed catgut string that pulls the hinged cowl over the monk's head or allows it to fall back.

Yet another is a manikin that lifts an umbrella over its head in anticipation of rain. Projecting backward from between its shoulders is a horizontal pin, to which a tiny umbrella is attached by its handle. Around the pin is coiled a long-beaked geranium seed. When the air is damp, the seed coils itself tightly and raises the umbrella to the vertical; as it grows dry,

hat  
Life  
gati  
EVE



*Jan 1926*

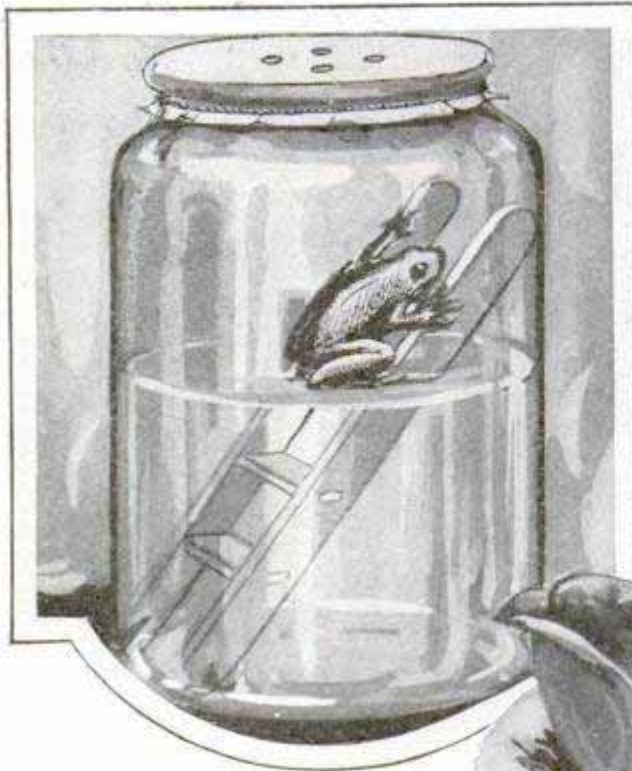

A Live Frog in a Glass Jar Indicates Weather Changes, by Climbing the Ladder When the Look-out Is Fair, and Descending before Storms; Right, a Chemical Barometer in the Form of a Flower

the seed uncoils and the umbrella drops to the rear.

In Germany and Switzerland a living four-legged prophet is commonly kept in houses to foretell atmospheric changes. It is a little green tree frog, and its domicile is a glass jar, half full of water and covered with a piece of muslin tied on with a string, to prevent the prisoner's escape. In the jar is placed a small ladder. When bad weather is in prospect, froggy stays at the bottom. With clearing skies, it mounts the ladder, and if the day is going to be fine, it ascends to the top, out of the water.

An Australian, named Nowack, spent a fortune in trying to persuade the world of the usefulness of a certain plant for weather forecasting. It was the "pater-noster pea." When the outlook is for fair weather, its leaves stand upright. With

approaching rain they decline. If a big storm is coming, they hang straight down. Nowack claimed that the plant would foretell earthquakes.

Familiar in our own country are weather-predicting devices which owe their invention to a Frenchman named Lenoir. They may take the form of an artificial flower or the dress of a female manikin. The flower or the dress is made of paper treated with a chemical solution of which the principal ingredient is chloride of cobalt. It is blue when dry, but changes to lilac and then to pink with increasing moisture in the atmosphere.

The farmer, the sailor, and the fisherman are staunch believers in weather "signs," some of which are fairly reliable, while others possess no value whatever. In the latter category is a notion, commonly held, that thick husks on ears of corn portend a cold winter. If acorns are unusually plentiful, there is a like prospect. Many people have firm

*Harry Prenter  
381 7th St.  
New York*

THE MAGIC BAROMETER FLOWER  
This little flower you must grant  
Is something of a sensitive plant.  
Place it in the open air; Blue when fair,  
Tis pink when stormy. Lilac hue  
And turns a lovely Lilac hue  
When undecided which 'twill do.

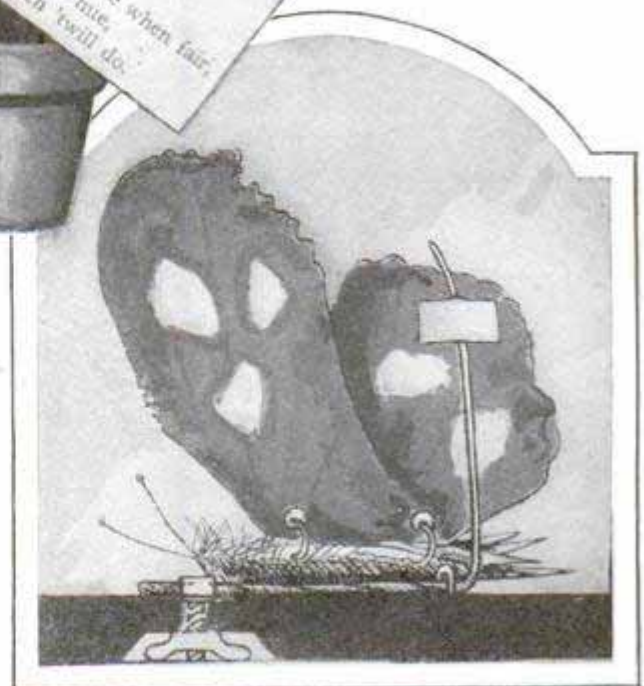

The Wild-Oat Butterfly Changes the Position of Its Wings When Rain or Shine Is the Prospect



faith in the "goosebone"—the breastbone of a goose eaten at Thanksgiving—which, if thick and solid, means a hard winter coming. If thin, the weather will be mild; if mottled, it will be changeable.

Also, there is a popular belief that muskrats build their houses earlier when a severe winter is in prospect. In like case, it is said, the opossum takes up winter quarters underground, whereas, if the weather is going to be mild, a hollow tree is preferred. Squirrels are alleged to store greater quantities of nuts in expectation of more than ordinary cold.

None of these ideas seems to have any basis in fact. Nor is there any good reason for believing that pigs "smell" an approaching storm. Insects, however, are incommoded by condensation of moisture on their hairs. Hence bees, sensitive to the increase in humidity that precedes a shower, return to the hive to escape getting wet. It is true also that swallows fly low before a storm, and they do so because the insects fly low, the air near the ground being less humid than aloft.

A collection of weather proverbs made by the weather bureau shows that such sayings contain much sound sense, based as most of them are upon correct observation. This remark applies particularly to atmospheric phenomena. Where the heavenly bodies are concerned, popular notions regarding their influence upon weather are said to be erroneous. The common belief that the moon exercises more or less control over the weather is wholly unsupported by scientific fact.

Nevertheless, the moon is not without its usefulness for weather observation, inasmuch as its appearance varies with atmospheric conditions:

"If the moon show a silver shield,  
Be not afraid to reap your field.  
But if she rises haloed around,  
Soon we'll tread on deluged ground."

The "silver shield" indicates a dry atmosphere, promising clear weather for the next day. The "haloed" appearance betokens a moist atmosphere, suggestive of coming rain.

The "new moon with the old moon in its arms" has long been accepted as a sign of coming fair weather. And rightly so, inasmuch as the phenomenon is only visible when the atmosphere is very dry.

*Ceramique a l'arr de la  
madeleine*  
735  
*5 bis rue Beranger*  
DRINKING 'GLASS WON'T SPILL

2719 IN ANY POSITION

Designed especially for the convenience of travelers and sick persons who must remain in reclining position while drink-  
*Paris IIIe*  
*Kana*



Drinking Glass with Spout Prevents Spilling; a Specially Desirable Feature When Traveling

ing, a glass introduced by a Paris physician has a spout-shaped top which is said to prevent spilling the contents. It may be used with ease on rough sea voyages as well as in the sick room, and when upright and in a stationary position it keeps the liquid from spilling.

3048  
**TRAIN IS ANNOUNCED BY BUGLE  
AS SUBSTITUTE FOR VOICE**

Passengers, awaiting the departure of the Broadway limited from the Pennsylvania station in New York, are not likely to miss the train through any oversight in the announcement of its leaving. To summon travelers to the gates, a bugler blows the army assembly call five times from three different places in the station, and one minute before the train departs, the forward call is blown from a position near the coaches. The innovation has attracted wide attention throughout the huge terminal and suggests an earlier time in transportation, when horns were used on horse-drawn stagecoach routes.

*Cmt. Louis J. Henderson,*  
*525 Union Station*



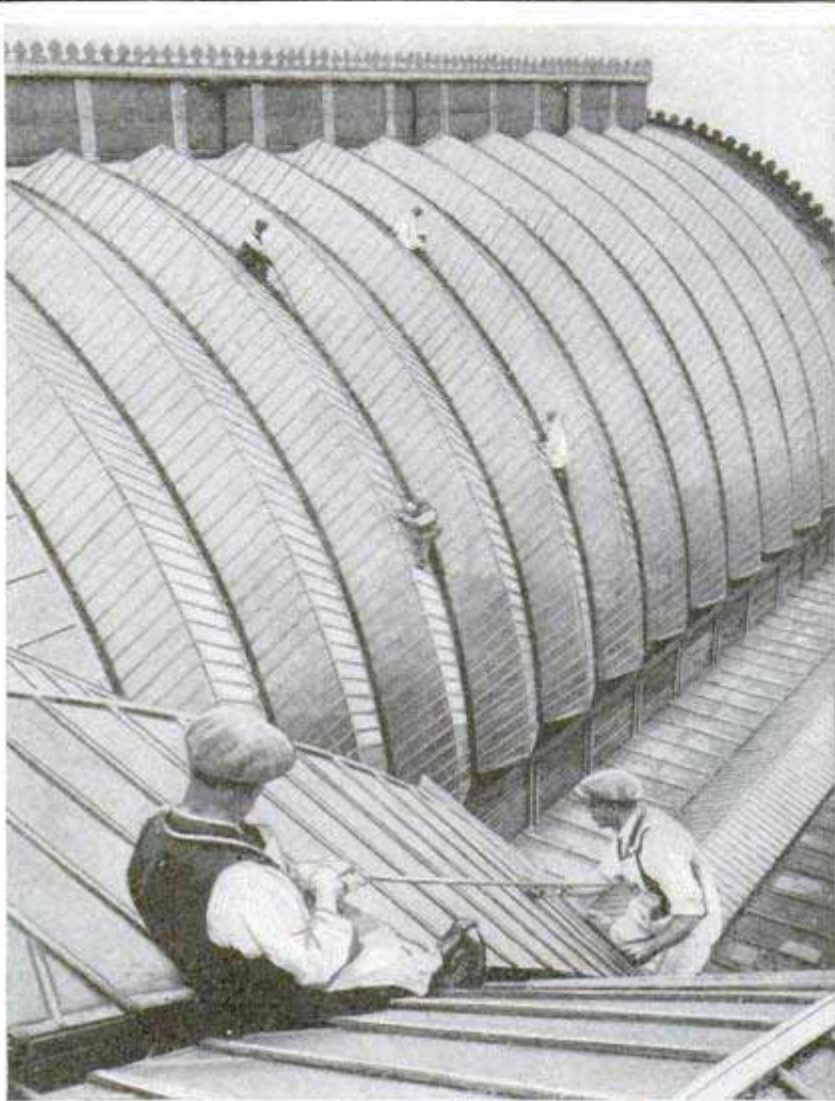

Roped Together for Safety, These Workmen Are Polishing Some of the 100,000 Pieces of Glass in Roof of Crystal Palace

### CLEANING "MOUNTAIN" OF GLASS REQUIRES EXPERT CLIMBERS

While overhauling and cleaning the 100,000 pieces of glass that make up the roof of the Crystal Palace in London, workmen were roped together like Alpine climbers and had to exercise the greatest skill in order to avoid falls that would probably have been disastrous to life, and property as well. The inspection is made once a year.

### DOCTOR OPERATES WITH SPOONS TO SAVE SEAMAN'S LIFE

How a ship's surgeon, using such crude implements as spoons, safety pins and meat hooks, performed an emergency operation for appendicitis on a fireman of the steamer "Port Auckland" while round-

ing the Horn was told recently by members of the ship's crew. The doctor, A. S. Hethrington, was on his way to England for the first time after being graduated from Dunedin university, in New Zealand, when the fireman's illness was reported to him. Examination showed that an operation was needed at once. Converting the steamer's dining salon into an operating room, and enlisting the services of a woman passenger, who had been a nurse, and two of the ship's officers, the surgeon made the incision with a pair of scissors after administering ether and chloroform to the patient through a tea strainer covered with a towel. The patient's tongue was immobilized with a safety pin, and the wound was kept open with bent spoons, clothes pegs and meat hooks. The instruments were sterilized by boiling water from the

cook's galley. Although the vessel's engines were stopped, there was considerable movement of the ship because of the waves, yet the operation was successfully completed after nearly three hours.

### POCKET CANOE SPONSON ENDS DANGER OF "SPILLS"

Ordinary canoes can be quickly transformed into "unsinkable" boats by attaching inflated rubber supports to the sides. The bags are of cloth and rubber, about four feet long and six inches wide, and can easily be blown up with the breath. When deflated, they fit in the pocket.



Commonwealth and  
Imperial Line

Fiala Outfits, Inc.,  
25 Warren St.



*University of Minnesota  
 Minneapolis, Minn*

737  
 2847

**FRUIT RIPENED MORE QUICKLY  
 BY STORING IT IN GAS** 3159

By placing fruits and vegetables in an atmosphere of ethylene gas and air in the proportion of one part to 1,000 by volume, a Minnesota professor has developed a process for ripening the products more quickly and preserving and improving their color. The treatment is not injurious to the articles or to the consumer and is not expensive. Tests with it have shown that celery can be bleached in twenty to thirty hours; bananas, tomatoes and melons are ripened in forty to fifty hours and green fruits can be kept in storage longer without fear of spoiling. The fruits and vegetables are kept in gas-tight cellars at a temperature of sixty degrees Fahrenheit and about thirty-five cubic feet of gas is sufficient to treat twenty to forty carloads of products, it is said.

**GLASS PATROL ON MOTOR ROADS  
 SAVES AUTO TIRES** 2648

One of the latest aids to motorists in California is a special patrol service to remove bits of broken glass from the highways. A man with motorcycle and sidecar keeps constant vigil over the roads, sweeping up fragments of glass, etc., that are likely to puncture tires. The plan will, no doubt, save autoists thousands of dollars annually.

Gathering Up the Glass Fragments Before They Puncture Tires; the Patrol Detail on Duty

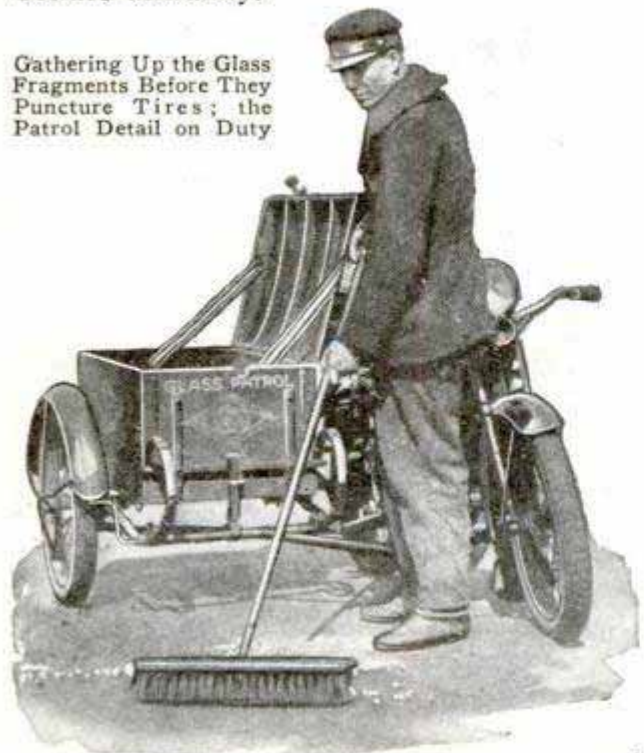

*California Automobile Association*



Ladder for Washing Overhead Street Lamps Does Not Obstruct Traffic, and Saves Time

**TELESCOPE LADDER SIMPLIFIES  
 STREET-LAMP CLEANING**

Street lights in Switzerland are kept clean by frequent washings, and one of the aids to the work is a portable, telescoping ladder. It is easily extended or folded up and is so securely balanced that the workman can safely mount it. The rig does not obstruct traffic.

**POSSUM CARVING ON CATHEDRAL  
 LATEST DECORATION-IDEA** 3152

In keeping with the provision that various forms of animal and plant life found within the area be used for decoration motifs on the cathedral of Sts. Paul and Peter, in Washington, D. C., an opossum is to have its likeness carved into the great structure now under way. The animal was captured on the cathedral grounds and was posed for a sculptor. When finished, the building will constitute a stone record of the animal, bird, insect and flower life of the neighborhood.

*Episcopal*

*Emd. Allen P. Child East 693  
 Kansas City, Mo.*



3114

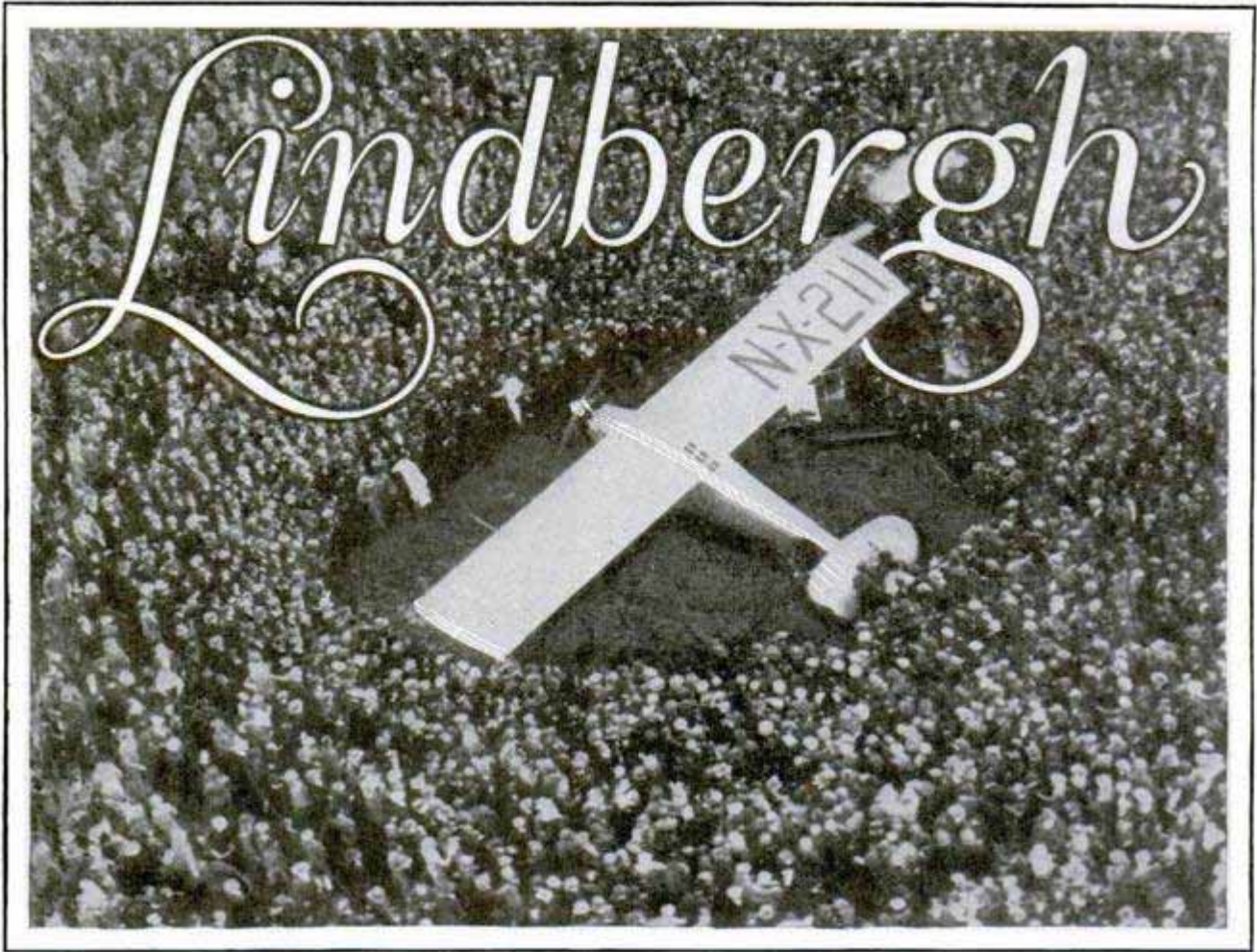

One Small Section of the Crowd Which Swept through the Police Lines at Croydon Field, Just Outside London, to Greet Col. Charles Lindbergh When He Landed in the British Capital

By DONALD E. KEYHOE

**A**MERICAN commercial aviation, until recently a topic of ridicule, will lead the world within a few years, according to Col. Charles A. Lindbergh, transatlantic flight hero.

"Of course, no one can accurately forecast the final effect of aviation upon the world," he said. "We can go ahead a few years and show the general trend beyond that, but no one can tell just how far flying will take us.

"It will have a great effect, just as have steamships, railroads and automobiles. But I believe the change will come more quickly, because the airplane has developed more rapidly. In less than twenty-five years it has grown from the crudest experimental stage to a safe, reliable carrier with many conveniences and comforts."

He turned to a table on which was spread a map of the world.

"The best basis for estimating the future is to look at the present. You can

see that Europe seems to have everything its own way in regard to commercial lines. On many of these lines they are using large multi-engined cabin ships, equipped as comfortably as Pullman cars. They run on regular schedules and are used by travelers just as we use our own trains in the United States.

"The real reason for their success is that they are subsidized by their governments. Almost every European commercial line is subsidized from fifty to ninety per cent of its operating cost. Naturally they have been very successful, for they do not have to worry about overhead and deficits."

He drew the map closer and indicated the United States, over which a smaller network of airlines was drawn.

"This country began slowly. The post office department established an air-mail line in 1919, from which grew the trans-continental route. This line has been very successful. It is the backbone of



# tells Future of AVIATION

the present contract air-mail system, as almost all other routes feed into it from outlying sections. The mail airways now cover between 7,000 and 8,000 miles, and over 16,500 miles are flown daily on these routes. This is regular, scheduled flying, and does not include miscellaneous operations, such as photographic work, cotton dusting, sight-seeing, taxi work and similar projects.

"These lines are the basis of the future great passenger lines. Even now, some of them carry passengers, and others are planning such service. Five lines are beginning express service. New routes are being established to transport mail, express and passengers, so that, by the end of 1927, there will be over 11,000 miles of airways, and more than 22,000 miles flown daily—on schedule."

"What kinds of planes will be used on these lines?" I asked.

"Modern ships," he answered with emphasis. "On a few routes mail alone will be carried, but most contractors are trying to include passengers and express. On shorter runs, or in starting new lines, small ships may be used, such as single-engined cabin or open types capable of transporting from two to four passengers besides the pilot. As the traffic increases, and on the longer lines, these will eventually be replaced by multi-engined planes with large cabins, equipped with heating and ventilating devices, wide

windows, comfortable seats and many other conveniences. Such ships are now in existence and are in use on a few routes."

"Hasn't most of this sudden increase of aviation interest followed your transatlantic flight?" I suggested.

"Each one of the recent flights has had a part in arousing interest," Col. Lindbergh countered. "The people of the United States may be fairly said to have become 'air-minded.' However, this could not have happened if our natural progress did not warrant it. It is not a boom which will let down in a short time. The change is here. People are ready to fly and to use airlines as fast as they are established. Capital has been quick to note the swerve of the public, and is ready to back new



"Lindy" Ready to Take Off in a Fast Army Pursuit Plane, in Which He Flew from Washington to New York





Ambassador Myron T. Herrick Pointing to "Lindy's" Cross of the Legion of Honor, Conferred by the President of France

routes as rapidly as they are advertised for mail contracts. The industry is advancing swiftly."

Enthusiasm began to show in Col. Lindbergh's manner and his tone as he went deeper into his favorite subject.

"The government should be credited for the increase in public confidence, at least to a large degree. The department of commerce has done valuable work in establishing lighted and marked airways, similar to the greater portion of the transcontinental. The resulting night flying will speed up business mail from all parts of the country.

"For example, take the line which is now being lighted from New York to Atlanta, and which will soon commence operation. A letter mailed at the end of the business day in New York will be in Atlanta by six o'clock next morning. It will immediately be transferred to another mail plane, which will give delivery during the early part of the business day at Jacksonville, Miami and other Florida cities.

"Similar cases are found in the feeder lines from Dallas, Boston, the Twin Cities, St. Louis, Detroit, Pittsburgh, Pasco, Los Angeles, Seattle and numerous cities between these terminals. All the cities on the transcontinental, from San Francisco

to New York, benefit by this efficient mail service."

He paused for a moment.

"What about safety?" I inquired. "The public is still hazy about that."

"Regular commercial flying is safe," he replied with conviction. "Almost all scheduled service is given by licensed planes, operated by licensed pilots and maintained by licensed mechanics. This is required in interstate commerce by federal law. Even in intrastate commerce, pilots must obey federal air-traffic rules, and planes must bear identification numbers. The end of the reckless 'gypsy' flyer with his unsafe plane is in sight.

State laws will probably be passed requiring federal licenses, or the equivalent, and concurring with other federal air laws.

"Most of the accidents have been due to unsafe equipment and inexperienced pilots—that is, in commercial aviation. In military work and experimental flying certain risks are necessary which are not a part of commercial flying. Straight flying in a commercial ship is as safe as riding in an automobile, and often more so."

"Many people believe that the airplane is a fair-weather craft," I told him. "What is your opinion of that?"

"Airplanes can fly now under all conditions but in sleet," he stated. "Sleet forms on the wings and changes the camber, in addition to increasing the weight. Heating the wings or some other method will change that. The only other difficulty is flying in fog. The actual flying is not hard, for with modern instruments a pilot can take off today and fly without seeing ground or sky for a long time. In landing, however, he has trouble. This latter obstacle will be overcome in the near future by radio signals, fog-piercing lights, special altitude instruments or some other means. The radio beacon is a great help in fog, as a pilot can tell when he is even slightly off his course on either side."



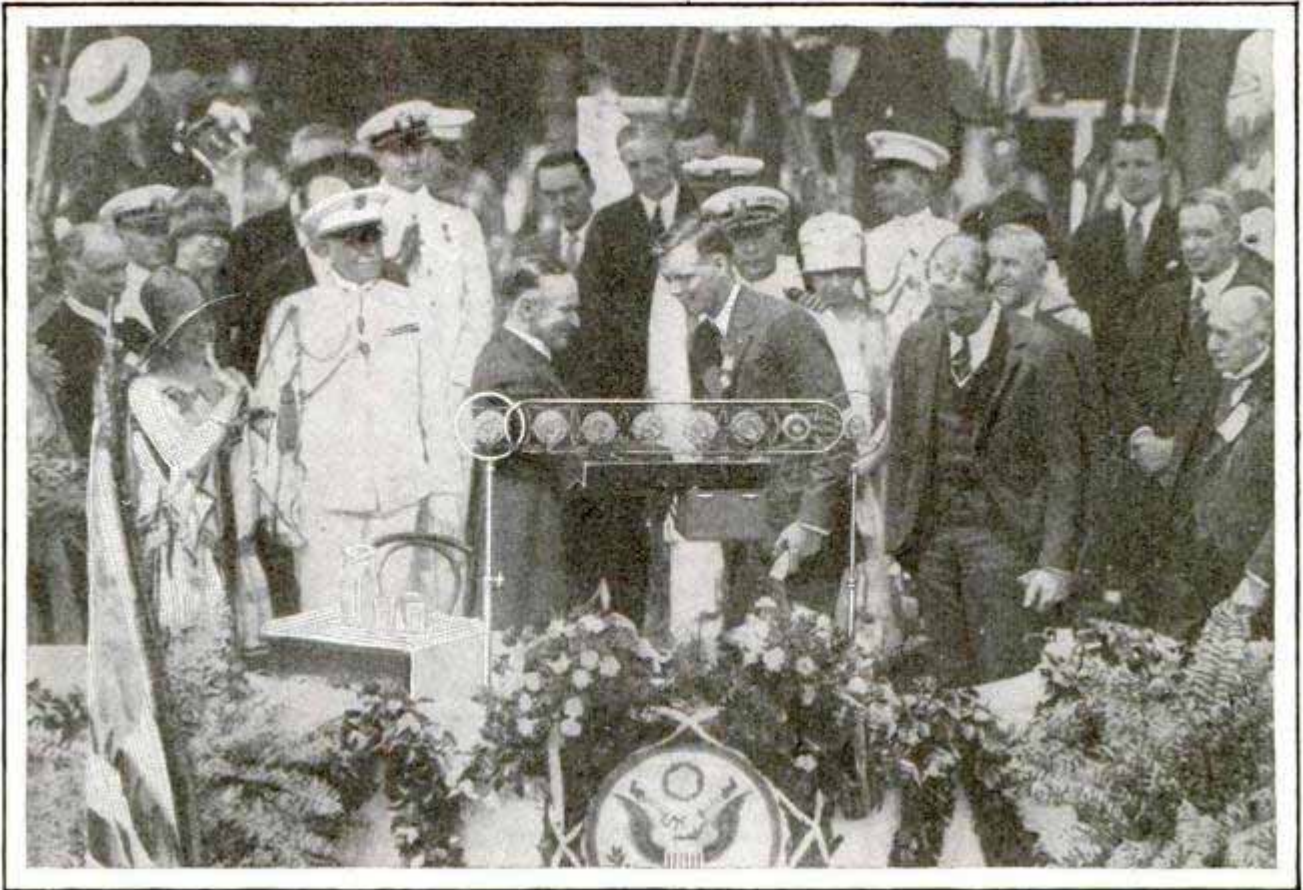

While Mrs. Coolidge, at the Left, Smiles Broadly and His Mother Looks On, Col. Lindbergh Receives the Distinguished Flying Cross from President Coolidge in Washington

Col. Lindbergh stopped and considered for a few seconds.

"That is a general picture of our commercial aviation today," he continued finally. "It has grown up on the solid foundation of private enterprise. Now that the public is realizing its value, and is supporting it, commercial flying will grow rapidly.

"With all this as a foundation, we can make a survey of the immediate future. Within the next few years a very complete network of mail, passenger and express lines will cover the United States, connecting with Canada and Mexico. The most modern ships will be used, and will be flown by licensed pilots of long experience, and under strict regulation. They will use the civil air lanes, which will be plainly marked and lighted, with landing fields at intervals necessary for safety. The whole country will be air-marked, so that day or night pilots will be able to tell where they are, except when visibility is very poor. Then the radio beacon and other radio signals will be used.

"Experts will provide complete weather forecasts and reports for any desired route

or airport on a route, to eliminate danger of flying into bad conditions. Most of this information will be given planes in the air by radio. Airplane pilots will receive orders just as engineers now get them from train dispatchers, and lines will be handled as methodically as railroads.

"The planes used will be increased in size according to the demand. Dining compartments, sleeping berths and other similar improvements already have been proved practicable, and will be put into regular use in the United States as soon as the public wishes them. Judging from the constant increase of interest and enthusiasm, that time is not very far ahead."

"What will be the first apparent changes?" I asked him.

"Establishment of airports all over the country," he replied tersely. "Then, marking of cities, towns, villages and prominent objects to guide airmen. Next, passing of the idea that flying in commercial ships is a great hazard. The next generation will be born without a fear of the air, because the airplane will be accepted just as the automobile is today.

"The United States will pull ahead of



other nations because of its favorable geographic situation. By that, I mean the long distances between important business centers, and the good flying country intervening. Also, the high value Americans place on their time will help, as will our efficient production methods. Manufacturers today cannot keep up with the demand for planes. This will soon force them into quantity production, putting the aeronautic industry in its rightful position."

"You have been quoted in various ways in regard to transoceanic flight," I remarked. "What is your idea of this?"

"Transoceanic flight will not be regularly established for several years," he answered. "There is need for more research, and for development of special planes intended for that service. Probably flying boats will be used, with some reliable means of fueling them at sea. Land ships will probably not be used, as this would be about the same as using seaplanes for regular service across the continent. Commercial operations in the Atlantic will come before such activity in the Pacific, mainly because of the greater business over the Atlantic."

"Beyond the immediate future, what do you think aviation will mean?" was my next question.

Col. Lindbergh hesitated.

"That is hard to say," he answered slowly. "Of course, we shall have heavy air traffic. It will bring difficulties in handling, particularly as to air lanes, altitudes, parking of aircraft and other related matters, but all these will be solved because of the necessity. Air commuting will become customary, I believe, and probably living in the open country will be more popular. Real-estate values will be changed, and open stretches between neighboring cities may become very well settled. Communities will naturally be brought closer together, and all business will be transacted more efficiently through speedy communication and travel. The airplane will never entirely supplant the railroad or the automobile, however, as each has its own place in our lives. It will be a good, safe carrier, ready to serve anyone who demands speed."

"There is one matter you have not touched," I said. "That is the effect of commercial aviation on preparedness."

He considered carefully before answering this.

"Building up of commercial aviation will certainly give us more protection by adding to our air resources," he said at last. "By having the means to enforce respect we shall keep out of trouble. Everyone

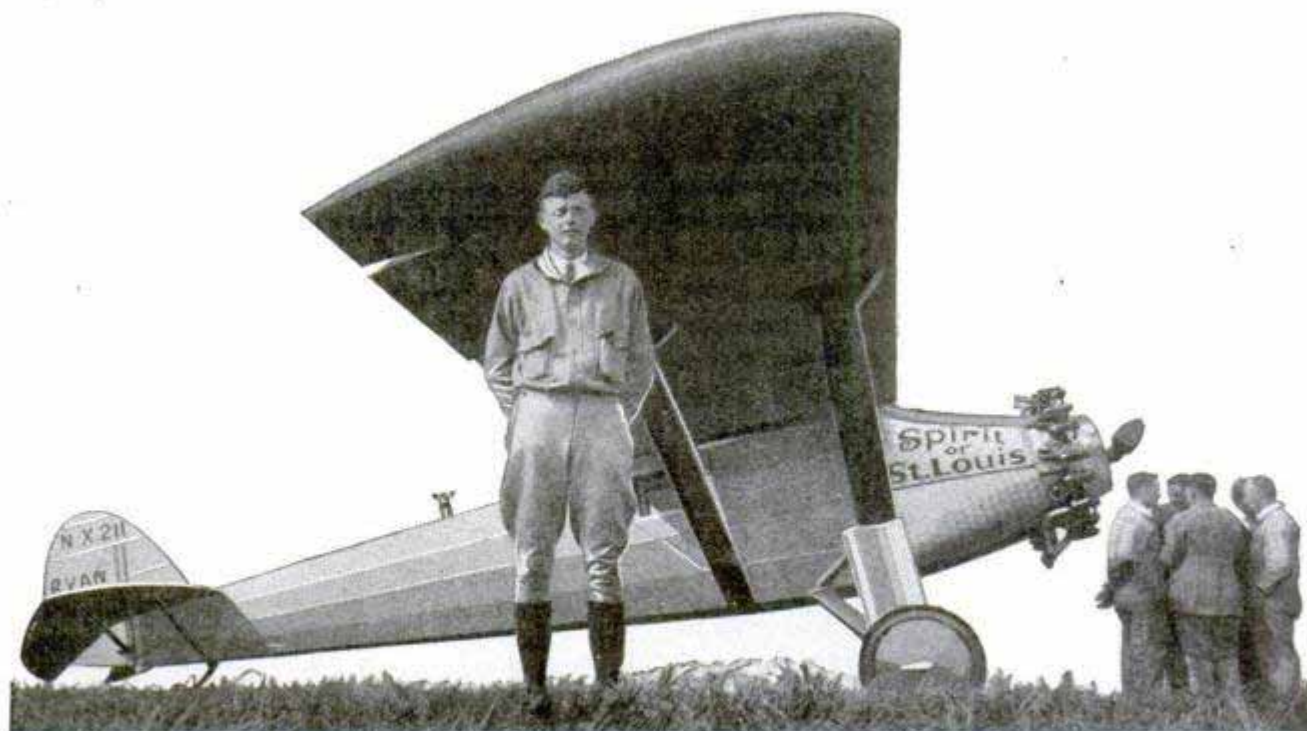

When He Was Just "Slim," a Mail Pilot, Waiting in New York for Favorable Weather to Hop Off for Paris in the "Spirit of St. Louis," the Plane That Is to Be Presented to the Smithsonian



should realize that commercial-airplane factories will be available for turning out military planes if necessity should arise. Commercial ships themselves will not be of much use as war planes, but no great change in machinery will be required to turn out military types, after factories are built and forces of designers and constructors are skilled in that particular work.

"In addition, commercial pilots could be trained for military flying without much difficulty. In this way commercial aviation is certain to be of great value by keeping us supplied with the means for aerial protection."

"With these great developments in aviation, there should be many opportunities for young men," I said. "What is your advice to those who would like to take up that work?"

"That depends on each case," he replied. "If a man wished to follow the engineering and construction phase, he would be best fitted by attending a college or university which gives a complete aeronautical-engineering course. There are several of these already. If he wished to get into actual flying, he might try the army-cadet course, which is as complete as any in the world. If the age limit or the lack of vacancies prevented this, he could try one of the various commercial schools."

"In your own case, though, didn't you follow this method for some time prior to your first flight?" I inquired.

Col. Lindbergh grinned frankly at this.

"Yes, I did some 'barnstorming' and 'gypsy' flying before I soloed. It consisted in parachute jumping, wing walking and cross-country flying. My first instruction was at Lincoln, Nebr., in 1922, but I did

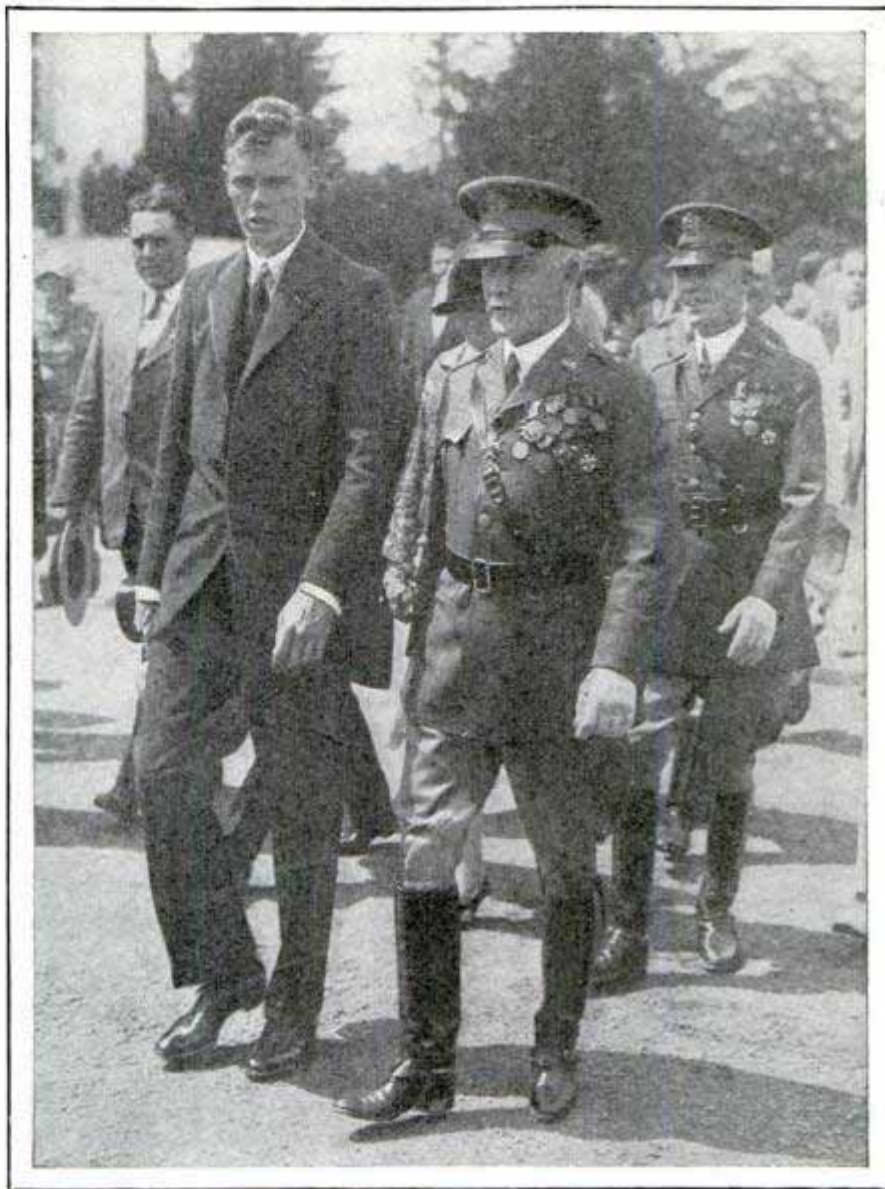

"Lindy," Leaving the Tomb of the Unknown Soldier at Arlington Cemetery with Maj. Gen. Samuel P. Rockenback and His Staff

not fly alone until 1923, at Americus, Ga. In fact, I had not been in a ship for over six months before the day I soloed."

"Don't you think this 'barnstorming' experience helped you in learning to fly?" I interposed. "That is, the time when you were not at the controls?"

"Yes, it did," he replied. "I think any time put in as a passenger helps the student flyer. It takes away the feeling of strangeness and makes him more at home in the air. I know many instructors disagree with me, but I think even riding as a passenger in a cabin plane has its value."

He paused and smiled reminiscently.

"I was thinking of my first solo," he explained. "Of course, no pilot ever forgets that. I had bought an army 'Jenny' (JN-4) at Americus, and had had it assembled. No one paid much attention to



me, because I was supposed to have soloed before. I started to take off when the plane was ready, but the air was rather bumpy and I found I had not retained the full feeling of control, so I decided to wait until there was less wind.

"Luckily, another pilot at the field gave me a 'check' hop, during which I made several landings. That brought back my flight sense and also my confidence, so that, when the air calmed a little toward evening, I made ready to take off.

"There was an unusual incident in that first flight which few people know. The first few minutes went all right. I took off carefully and climbed gently, without any steep turns. My confidence grew with every second, and I began to feel very glad that I had at last reached this moment, my first time alone in the air—but just then the motor sputtered and started to cut out.

"I was directly over the center of the field. I remember nosing the ship down, wondering whether I would be able to make a safe landing, for it looked as though my first would be a forced one. It seems funny now, for the field was big enough to put any plane down, but it wasn't funny then. While I was still figuring what to do, the engine picked up again. That made me feel better, for the roar of your engine is a great comfort to you on that first solo hop.

"After about fifteen minutes I throttled down and glided in for my first landing. It was all right—at least I was able to take off and try again. I made several short hops that evening, stopping when darkness came."

"One more question," I requested. "Do you think the average man can learn to fly, or does it take especial skill?"

"I believe the average

man can learn to fly without difficulty with the present commercial plane. Also, I think that learning will be easier in the future, when controls will be simpler and planes will be built which will not stall or spin under any circumstances. For military flying, I think more than ordinary instinct is necessary. Some people are born flyers and there will be more such in the future, but even now the average man can make a good pilot."

### PARCEL CHUTE AS CHILD'S SLIDE GIVES FUN AND EXERCISE

2925 From an old package chute, taken from a store, a Los Angeles man fashioned a children's slide which has proved popular in his neighborhood. The only work required was to build supports to hold the metal trough upright and to erect a stairway to the top. A pile of sawdust at the bottom serves as a cushion.



No Longer Useful for Store Purposes, This Parcel Chute Has Been Put to Good Services on Children's Playground

Cont. dra W. Isuldner  
5206 Alverine Ave.  
Los Angeles, Calif.



### FITCH THE FATHER OF STEAMBOAT

3175

While the invention of the steamboat is popularly associated with the first trip of Robert Fulton's "Clermont" from New York to Albany, Aug. 11, 1807, proof has been disclosed showing that John Fitch was ahead of Fulton by at least twenty years with a steamer that was a mechanical success, although it failed to win its inventor the recognition that his successor attained. Walter W. Jamison, of the Massachusetts Institute of Technology, has discovered that, by 1790, the legislatures of New Jersey, Delaware and Pennsylvania had voted Fitch "exclusive rights in navigation by steam and fire," and that a committee of the New York legislature declared, in 1817, that Fulton's steamboat was, in substance, "the invention patented by Fitch in 1791." According to Gov. W. J. Fields of Kentucky, there is a letter in the records of congress showing that Fulton himself recognized Fitch as the inventor of the steamboat. On Aug. 22, 1787, according to data gathered by Mr. Jamison, Fitch tried out his third steamboat on the Delaware river before members of the constitutional convention, but the speed of four miles an hour did not satisfy those financially interested in the project. Next year, he succeeded in building a larger vessel, and it made a trip of twenty miles with thirty passengers in three and one-quarter hours, but still the speed did not meet with the approval of those backing the undertaking. Fitch's later efforts met with financial failure, and he died in disappointment.



An Apparently Cramped Position, But It Proved a Good One for Marksman

### LEG STRAP HELPS MARKSMAN TAKE ACCURATE AIM

What is the best position for accurate rifle shooting? A British marksman demonstrated that departure from conventional form is sometimes effective, if it affords a steady support for the piece and a good view of the sights. A strap fastened to his right leg and held between his teeth braced him while firing.

*Lieut. Mr. Robertson England in contest at Bisley.*

### BEAUTY CREATED FROM CACTUS BY UNIQUE CRAFT

3017

To most persons, the giant cactus of the deserts is a worthless growth, but to an Arizona craftsman, the plant is a source of livelihood and furnishes the materials from which he makes beautiful and useful objects. Lamps, watch charms, cushions and many other articles are among the things he constructs, and some of the products are further decorated by means of a process he has discovered for plating the material with metals, such as copper, gold and silver. He has followed the craft for years and won awards at the Chicago world's fair.



Created from Cactus, Lamp Shades and Bases of Desert Growth Make Unique Decorations

*Fred E. White  
Florence, Ariz*



2918

Commander C. H. Sinker  
1752-17th St. N.W.

Washington, D.C.

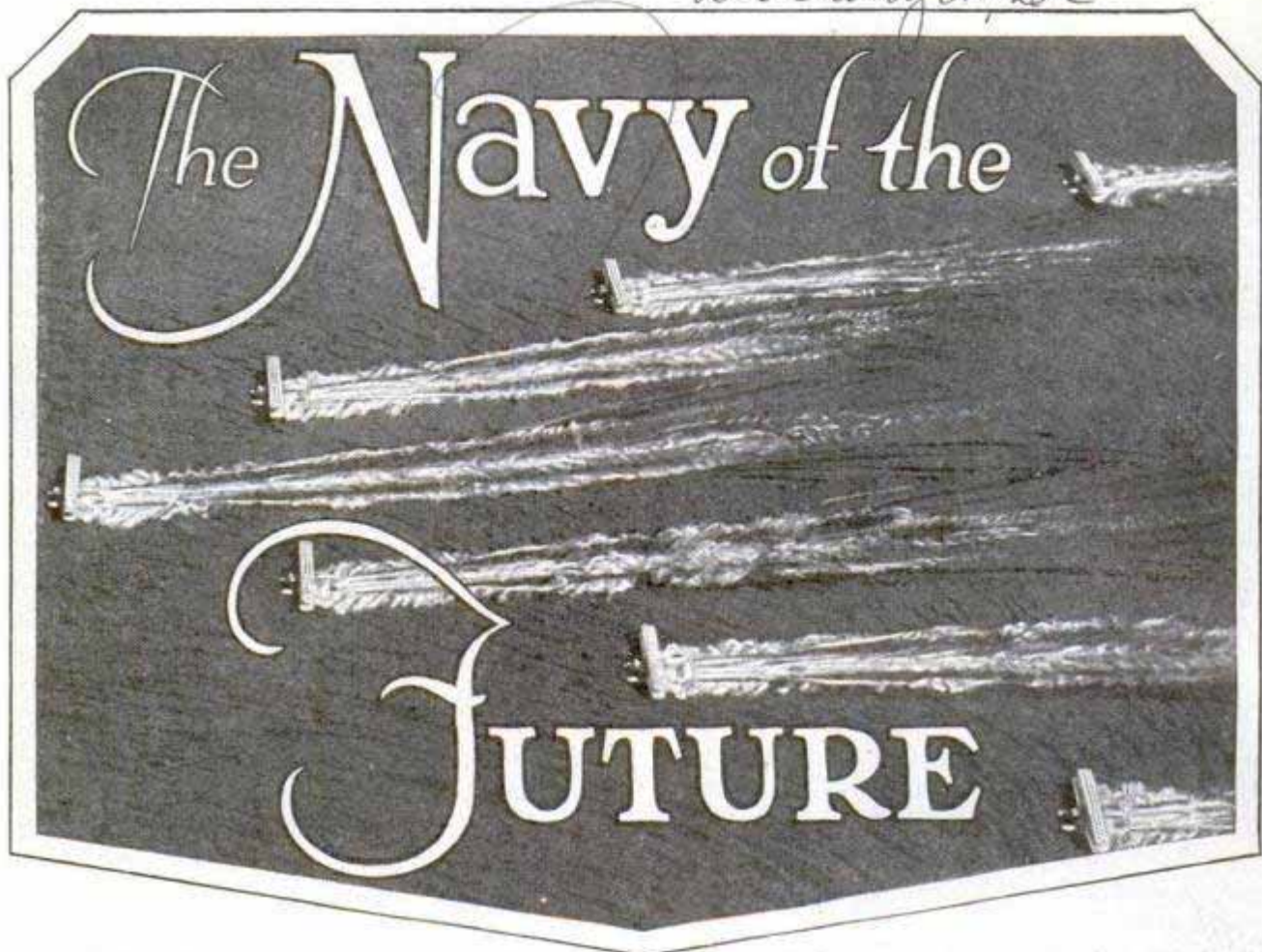

The Boiling Wake of a Squadron of Seaplanes, Speeding across San Diego Bay in Perfect V-Formation, Preparatory to Taking the Air as the Eyes of the Pacific Battle Fleet

**F**IVE epochal flights across the seas, three to France and two to Hawaii, last spring revived again the recurrent claims that forty-million-dollar battleships are obsolete and that the war of the future will be fought in the air.

A fleet of medium-sized coast-defense submarines to protect principal ports against surprise attack, and a vast fleet of flying fighters to carry on the war in the air, are all that is needed in the way of a navy, according to the enthusiasts. But leading naval authorities, while giving full credit to the marvelous performances of Lindbergh, Chamberlin, Byrd, Maitland and Smith, refused to be disturbed by the prospect of any immediate revolution in naval warfare.

For, they hold, the development of aircraft, which has been swift and startling, is not an indication that battleships are doomed, but that battleships, in conjunction with aircraft and utilizing the services that aircraft can perform, will become more and more deadly as weapons in future wars. And to accomplish that union

of sea and air, they have quietly been revolutionizing the surface ships, while speeding the development of faster, bigger and better-armed planes.

Owing to the disarmament treaty reached at Washington, little has been done to develop the world's navies in accordance with the lessons of the World war and to utilize aircraft to the best advantage, for it has prevented the building of a single post-war battleship in the United States and only four have been built abroad, the "Rodney" and "Nelson" in England and the "Mutsu" and "Nagato" in Japan. But the United States, within a few months, will have added to its fighting fleet the last word in airplane carriers, when the powerful and mighty "Lexington" and "Saratoga" go into commission. Their keels were laid before the Washington conference, and, had that treaty not been signed, they would have been completed as great battlecruisers, rivals of England's 41,000-ton "Hood," largest warship in the world. Instead, under the treaty terms which permitted



2718

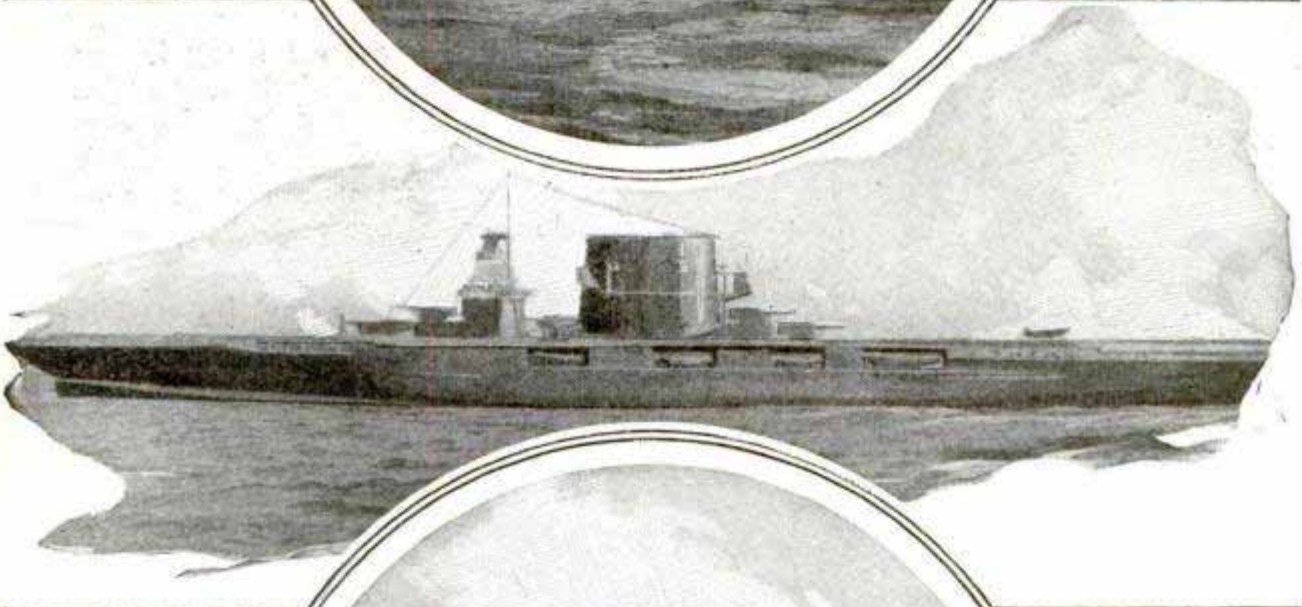

New Ships of the World's Three Greatest Navies; the Japanese Battleship "Nagato." Top, Showing the Tripod-Supported Conning Tower; America's New Aircraft Carrier "Lexington," as She Will Appear When Commissioned, Looking Like a Mammoth Submarine, and Bottom, the Bow of Britain's Aircraft Carrier "Furious." Looking Up to the Airplane Landing Deck



England to complete the "Rodney" and "Nelson" and scrap four or five older battleships, the United States was allowed to change its plans and complete the pair as aircraft carriers.

When they go into commission, the American navy will have three of the finest floating aircraft hangars in the world, including the "Langley," which was constructed from the old fleet collier "Jupiter." Few laymen realize the fact that the United States is leading the world in development of its seagoing air force. Every major battleship and cruiser is equipped with planes and a launching catapult. England has just begun to experiment with catapults, and the rest of the world lags far behind, whereas we have had them for several years. We have the only submarines equipped with their own scouting planes, carried in water-tight steel drums on deck and capable of being assembled and launched in five minutes. We have the fastest naval pursuit planes in actual service, the highest-climbing planes, the fastest-climbing planes, and the greatest load carriers for their speed and "ceiling"—all records that were being set while

the transatlantic flights were on, and therefore almost totally overlooked in the general excitement over those more spectacular feats.

The aircraft carriers are the most weird and wonderful ships that ever put to sea. To get the maximum width of flying deck, they are built with an enormous flare, and all the superstructure, control rooms, smokestack, wireless masts and other accessories are placed far over at one side, to leave the deck clear. Huge freight elevators lift the planes from the hangar deck below, bringing them up through great trapdoors, completely assembled and ready to fly. Below this deck is an airplane factory and machine shop, capable of rebuilding an entire plane, or making any necessary repairs. Even the lifeboats and tenders have been moved from their davits and are carried slung in recesses along the side of the hull in the "Lexington" and "Saratoga."

Though they officially rank as aircraft carriers, both vessels are well armed, with double turrets fore and aft, so that they are capable of standing off an attack by destroyers or fast scout cruisers.

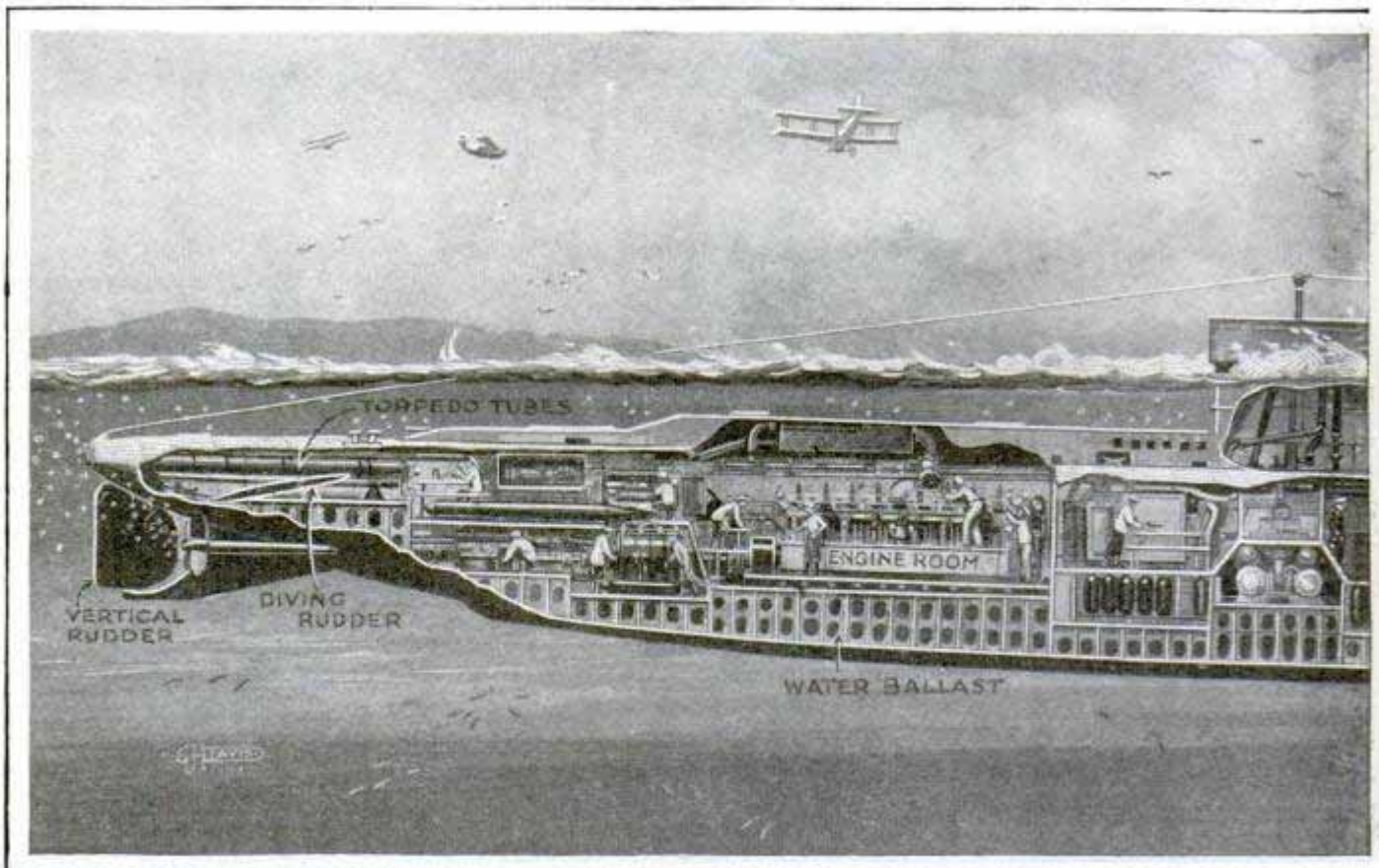

Cross Section of a British Submarine in the Act of Diving, Showing the Entire Crew at Stations, the Diving Rudders Set to Force the Ship Down and a Torpedo Being Shoved into Its Tube

Courtesy London



While the aircraft carriers have been building, the rest of the fighting fleet has been modernized and equipped to withstand attack by hostile airplanes. Greater deck armor to resist bombs dropped from above, bigger and better anti-aircraft guns, replacement of the old-style basket masts with trimmer, more efficient-looking tripods supporting the conning towers and the fighting tops, the range-finding compartments, gun-control rooms and other superstructures, are some of the changes being made, along with elevation of the guns to permit firing at a higher angle and, therefore, at considerably longer distances.

The new British and Japanese battleships, however, show to an even greater degree the lessons learned at Jutland. While naval critics still disagree as to who won that battle, even the most partisan British writers have admitted that the German fleet apparently had better fire control. In the "Nelson" and "Rodney," and in the two Japanese ships, greater attention has been paid to the superstructure, which houses the eyes of the ship, and, in doing so, some of the supposedly

basic rules of naval architecture have been cast by the board.

The two British ships are surmounted by eight-story armored towers, as big as an eight-story apartment house, and presenting an equally good target to the enemy. To protect such a tower from being blown to pieces, the ship carrying it must be faster than anything it meets and its guns must have a longer range. The American naval experts have not yet accepted the armored-tower idea, and it remains to be seen, when new battleships are built after the Washington agreement expires in 1931, whether they will follow the British and Japanese lead.

Since long before the time of Capt. Mahan, U. S. N., who wrote the book that still remains the leading textbook of sea fighting, it has been an axiom of naval strategy that the best defense is a strong offense. The "Rodney" and "Nelson" are the last words in that theory, for they are built to make an attack and not to run away. Their heavy batteries, nine sixteen-inch guns, are concentrated forward in three triple-gun turrets, while the stern is protected only by six pairs of six-inch rifles,

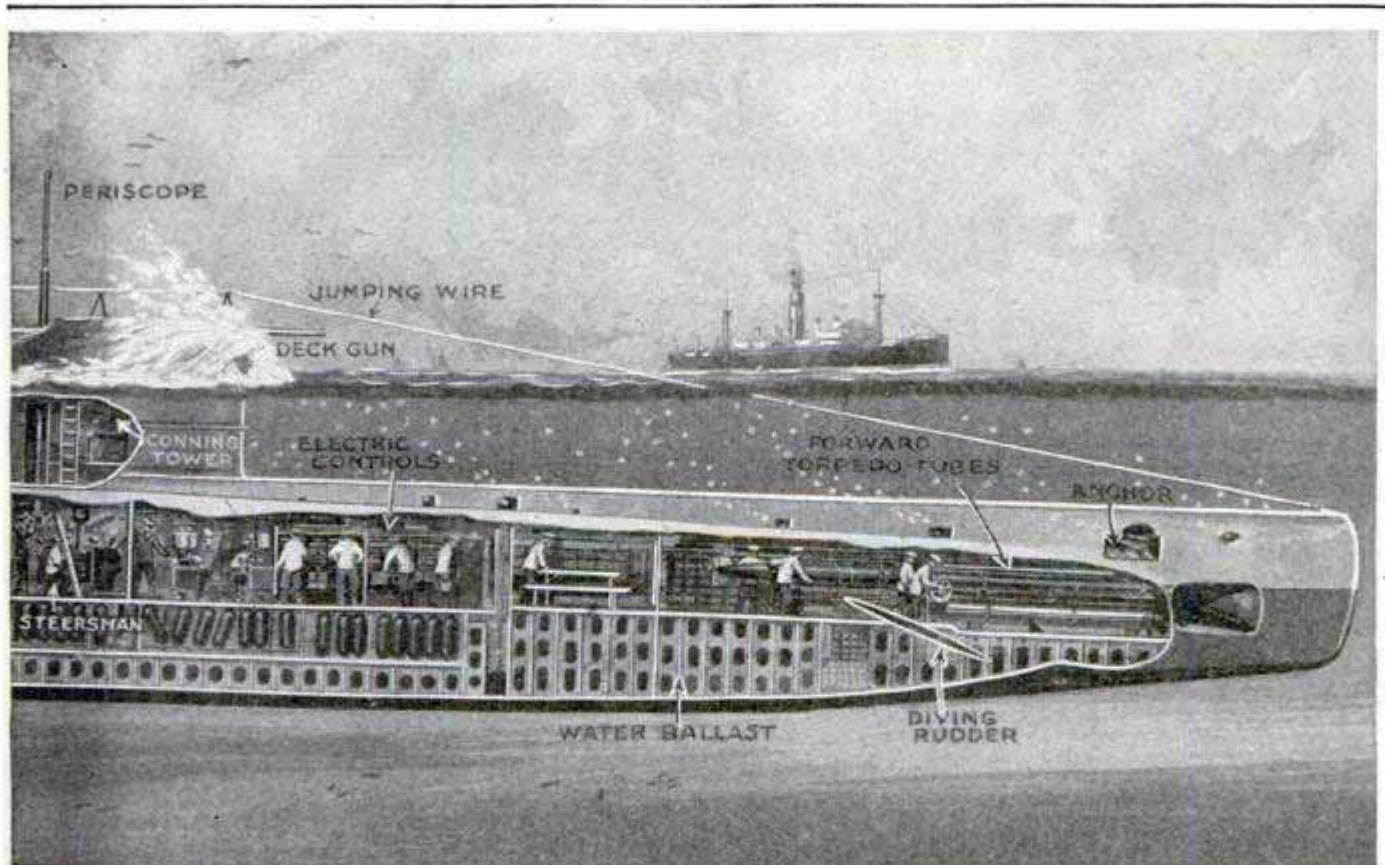

Illustrated News

This Is a Composite Picture of Boats of Various Types and Does Not Reveal the Secrets of the Latest Big British Submarines; Note the "Jumping Wire" to Clear Submarine Nets



2918

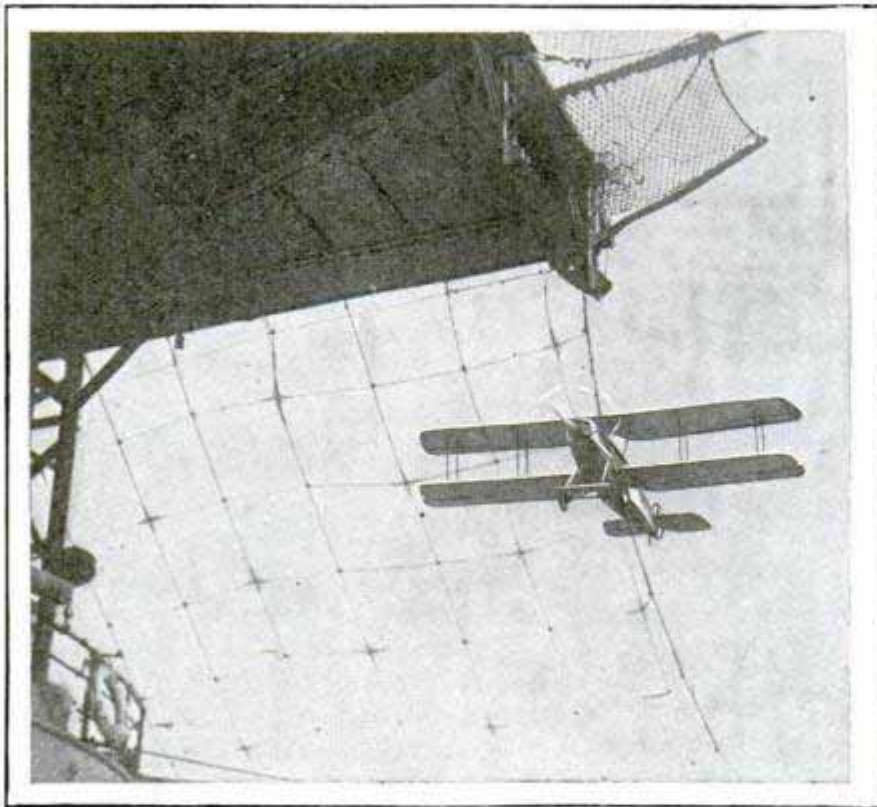

Plane Landing on the U. S. S. "Langley"; the Big Wire Net Protects the Lower Deck, and the Small Net Is for the Landing-Deck Crew to Dodge Into

mounted in three pairs on either side, to keep off the destroyers and scout cruisers which might attempt to harry the stern and sides. With a length of 702 feet, a beam of 106 feet, and carrying a crew of 1,300 officers and men, the "Nelson," first of the pair commissioned, cost about \$35,-

ers centers. The first two of its eight floors provide sleeping quarters for the officers and men who must be constantly within reach of the control compartments. The third floor corresponds to the conning tower of present warships, and contains the navigating instruments, the steer-

000,000. Her decks are protected with a bomb-proof coating of hardened steel. Internal bulkheads and walls and external blisters, or torpedo bulges, enable her to withstand the simultaneous shock of four torpedoes exploding at the same time.

A single funnel, behind the armored conning tower, serves all her boilers. Behind it is a single mast, a tripod supporting a single pole, while four horizontal arms, stretching out, from the tripod top carry the ends of a maze of vertical wireless aerials.

It is in the armored tower, however, that the interest of naval designers

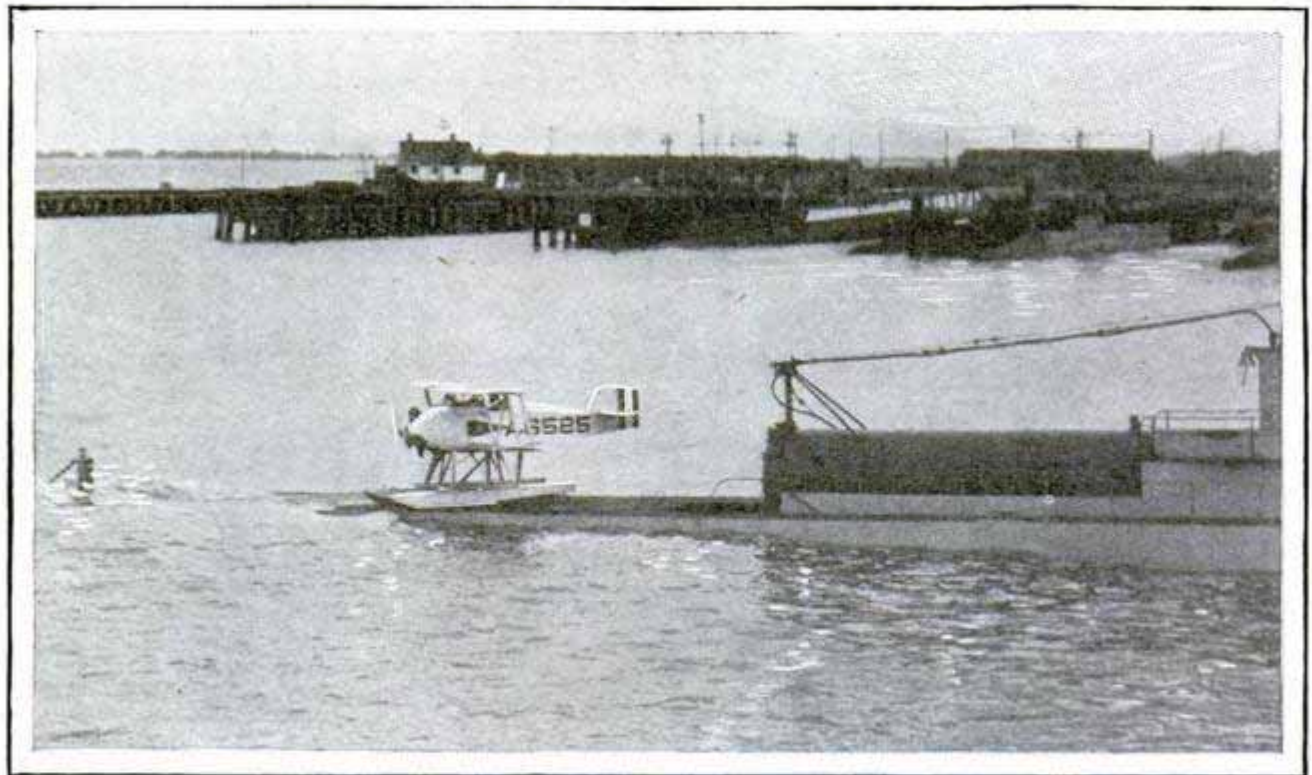

Assembled in Five Minutes from Parts Carried in the Big Steel Tank on the Deck of the Submarine "S-1," This Tiny Plane Is Ready to Take the Air as Its Mother Ship Submerges



ing wheel, engine-room telegraphs, and signal systems, telephones and loud speakers communicating with every part of the vessel. The next story is for the captain, navigator and their telephone operators and messengers. Above them is the signaling position, wireless and radio-telephone operators. Next come the gunnery assistants, who work out the necessary paper calculations to regulate the gun fire. The main calculating station, receiving telephonic reports from aloft, is protected far below the water line. The seventh story of the tower is set aside for the officers and men whose duties require a full view around the horizon, so that they can instantly calculate the position, course and speed of the enemy ship. The topmost floor houses the fire directors, and, in the new British ships, a single telescopic sight in the direction station may be trained on the enemy, and, through electrical connections, it automatically lays every gun on the target, while the fire director, by pressing a button, can fire the entire broadside at the mark. The gunners themselves may never see the target, and have nothing to do but load the gun, clean and reload, while the observer far overhead does the actual directing and firing.

The "Nelson" and "Rodney" represent what can be done within the present limitation on size, but, unless the disarmament treaty is renewed or extended in 1931, there is no limit to what may be done in the future. Ships of 60,000 tons instead of the 35,000 of the two British battleships and the 41,000 tons of the battlecruiser "Hood" are quite feasible. With that extra weight, immensely heavier deck armor to resist aerial bombs, side armor to withstand gun fire, and underwater protection against torpedoes are quite possible. Such a ship would cost so much that the price would be prohibitive to all but the most wealthy nations—in fact cost is the only limiting factor, outside of disarmament treaties—on the de-

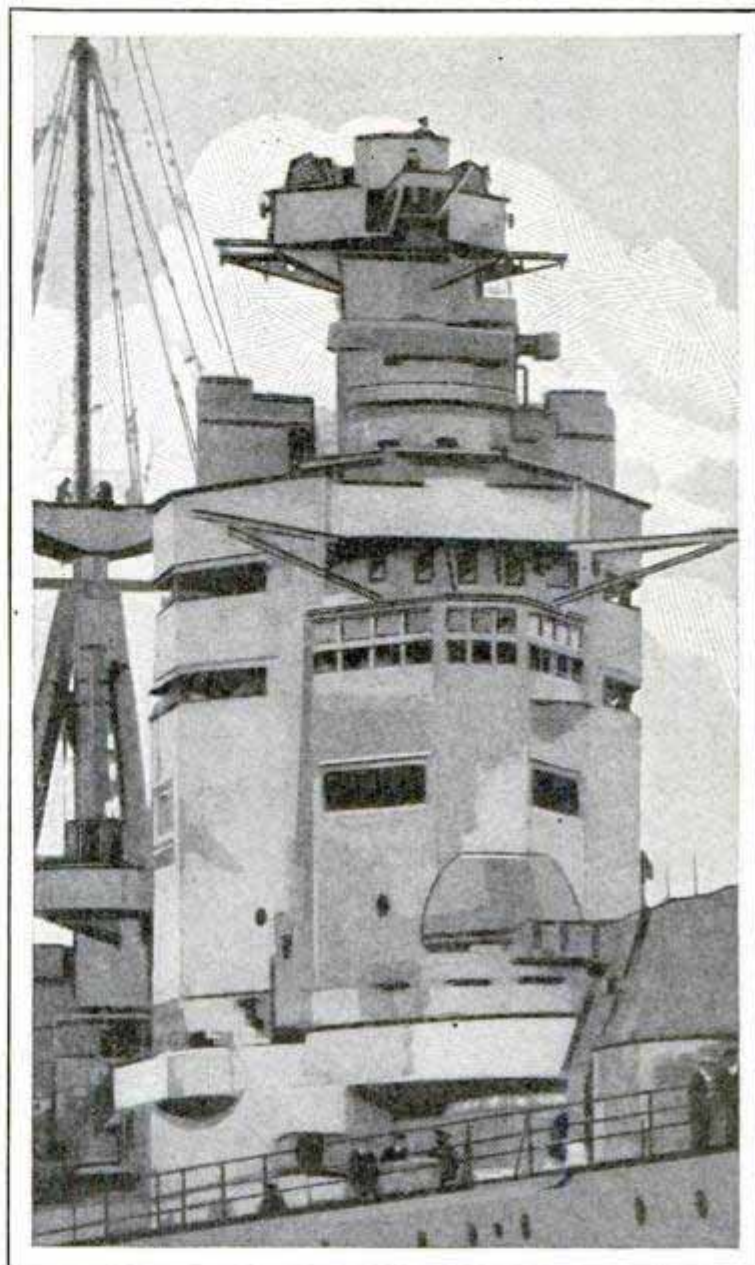

Eight Stories High and Violating, Because of Its Vulnerability, All the Accepted Rules of Naval Architecture, the Armored Control Tower of the "Nelson," England's Newest Warship, and, with Her Sister Ship, the "Rodney," the Biggest Battleship Afloat

velopment of a navy that could withstand aerial, surface or sub-sea attack.

Naval constructors, however, are considering the possibility that the next war will introduce weapons unused in the last one. Poison gas, for example, was not tried at sea, despite the fact that the ability of a fast warship to maneuver to windward of the enemy renders it quite easy to lay down an invisible screen which would be carried downwind with disastrous results. To meet the threat of such an attack, ships are being equipped with powerful air fans, capable of directing such a blast against every opening in the hull that gas fumes could not enter. Such



fans already are in use in the gun turrets to prevent the dangerous flarebacks which some times wipe out an entire gun crew. When a gun is fired, it leaves an enormous vacuum about the muzzle, as the air is driven away by the expanding gases. If the breach is opened quickly, the air, rushing back into the void, may sweep down the barrel and carry particles of smoldering powder bags back into the turret, to ignite the powder which has been hoisted up for the next charge. The powerful ventilating fans are designed to prevent anything blowing back into the turret.

The future battleship may replace the present airplane catapults with an all-over flying deck. The "Lexington" and "Saratoga" designs, with their four gun turrets, approach the combination aircraft carrier and battleship. The flying deck may possibly be armored with two or three inches of steel to resist thin-walled aerial bombs. Below it, the protective deck would be heavily armored, as at present, to stand off plunging shell and penetrating bombs. The turrets would be placed on this deck, firing from beneath the flying deck above.

Such ships may be called on to meet more powerful weapons than anything yet used in battle. The modern sixteen-inch gun can fire a one-ton projectile a distance of 40,000 yards. No armor, so far known, can withstand the shock of a direct hit from such a shell. Yet there is no reason why, if battleships of 60,000 tons are built, twenty-one-inch guns might not fire two-ton shells 60,000 yards, equal to thirty-four land miles, for the ship could be built to withstand the

shock of the recoil of even such an enormous gun. The higher control towers make it possible to sight the enemy at these great distances or fire could be controlled from airplanes flying overhead.

The torpedoes used under water in the World war were mostly of the twenty-one-inch class, but already thirty-two-inch torpedoes have been built and tried, and forty-inch ones are quite feasible, carrying correspondingly heavier charges. Such a mammoth projectile would pierce any present underwater armor. If the blisters and other protective devices are increased to offset the bigger torpedoes, it is possible to replace them entirely with high-speed motorboats, carrying a ton or more of explosive in the bow, controlled by radio and moving so rapidly and presenting such a small target that they would be practically immune from gun fire. Such boats have been built and successfully tested by several navies. In some ways, they are an improvement over torpedoes, for the latter, once fired, are out of all human control, and an error of minute proportions at a distance of several thousand yards is sufficient to make them miss the enemy ship entirely. The surface boat, radio-controlled, could be turned to meet every twist and turn of the enemy and guided visibly to its target.

If such boats are used in the next war, the world will be going back to the ancient fire boats of the Greeks, except that the modern type will be a million times more dangerous than the flaming craft that once drifted down the tide to burn the wooden galleys of the Mediterranean.

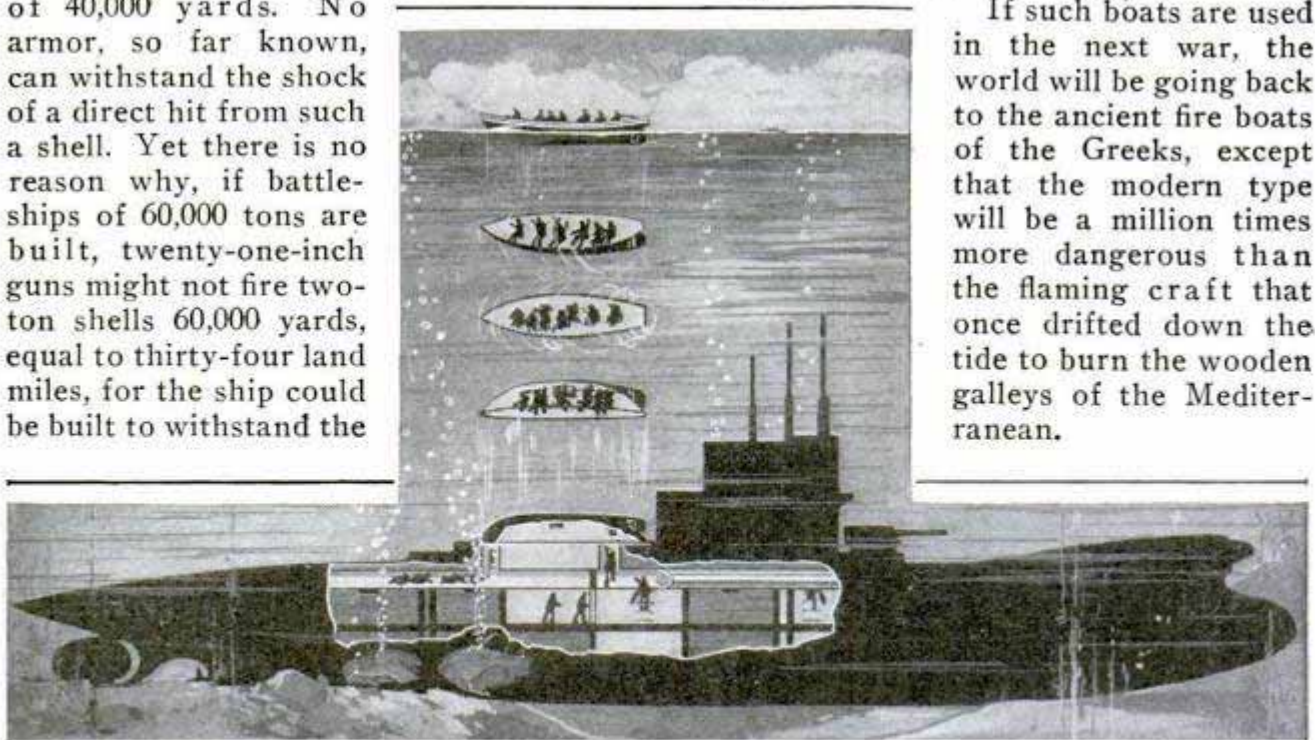

New German Plan for Saving a Submarine's Crew When Things Go Wrong; the Inclosed Lifeboat, Carried on Deck, Lifts the Men to the Surface, Turns Over, and Then Is Opened to the Air



INVISIBLE LIGHT REVEALS SECRETS OF FOSSILS

2777 Dr. Alfred Eschenhagen  
 Brosslerstrasse 20, 753  
 Berlin Friedenau, Germany

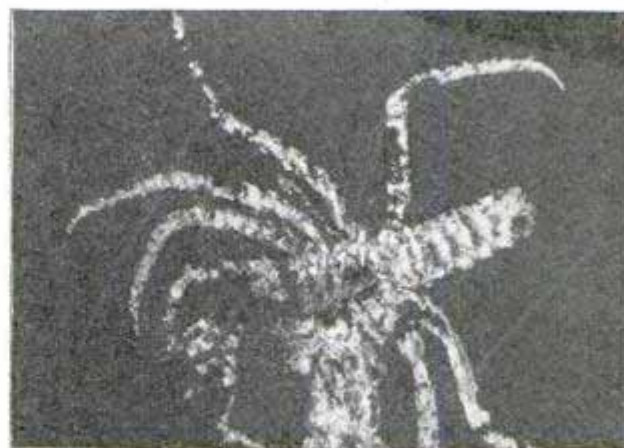

At the Left, Photographs of Fossils as They Appear in Natural Light, and at Right, under the Ultraviolet Rays; Structures Hardly Visible in Ordinary Illumination Are Clearly Revealed

Scientists now have a wonderful tool for studying fossils in ultraviolet light, invisible to the eye but effective in revealing structures that would escape ordinary observation. The secret of the light's action lies in its play on the material of the fossil. This it renders fluorescent but has no effect on the stony background, so that the fossil stands out with clearness, its character is more fully shown, especially the inner structure, and imitation fossils can be detected. It is believed that traces of organic material in the formation produce the glowing outlines under the impact of the light. Shortly before his death, the late Prof. Adolphe Miethe opened up a way for using the invisible rays by developing means for photographing the fossils when exposed to the ultraviolet radiations. A new filter material had to be found, as those first tried allowed rays to pass that obscured the photographically active ultraviolet rays. A prismatic glass vessel, containing a special solution, was inserted behind or in front of the objec-

tive during the picture-making process, causing the rock to appear clearly and the fossil to stand out in all details. Traces of dust, fingerprints, and other features invisible to the unaided eye, were plainly distinguishable in the developed plate, so that the utmost cleanliness had to be observed. Scholars believe that the method will enlarge the field of investigation with respect to fossils and bring to light many facts which have heretofore remained hidden because of the impossibility of more thorough study of the specimens.

**SOAPSUDS EXTINGUISH FIRES OF OIL OR GASOLINE**

One of the Berlin fire-engine companies is equipped with a soapsuds-generating unit to combat oil, gasoline and other fires. Powdered soap and water are mixed in large quantities and with great speed, the capacity of the apparatus being 8,000 quarts of suds per minute. The preparation smothers the flames.

Germany  
 Los Angeles Herald  
 8/5/27

Y to your letter of the 28th ult, I would  
 a attached to the Engineer... Col,  
 Charles...



*Dead*  
1954

**GAUGE SHOWS PEP OF STUDENTS  
IN GYMNASIUM SCHOOL**



*Sargent School for  
Physical Education  
Cambridge  
Mass*

© Keystone  
Jumping against the Special Scales, to Register Force  
of Her Leap and Give Measure of "Pep"

Young women attending an eastern school of physical training undergo an interesting muscular-energy test to show their fitness for special work and their general condition. The subject stands under an indicator, with a movable disk at the top, and jumps. As she does so, the disk is pushed up and held there by a locking mechanism. On the basis of the height to which the gauge was raised, the examiner is able to gather data as to the strength of the subject's legs and toes and her vitality with special relation to her weight.

**UNTUNED PIANOS  
CAUSE LOSS TO  
STUDENTS**

Eight-tenths of the pianos in this country are always out of tune, according to the president of the national association of piano tuners, with the result that many

*Charles Klentzman  
Chicago*

thousand dollars of the \$900,000,000 spent annually for musical education, are wasted. He explains that, when the instrument is out of tune, the student's ear is likely to be harmfully affected.

**ROBBERING OF THE "SAFEST SAFE"  
PUZZLES LONDON POLICE**

*306*

London's safe in the wall, a strong box on the exterior of the Golders Green hippodrome, was robbed of \$1,500 recently, presenting detectives with a puzzling problem and somewhat disturbing the faith of its owners. Being exposed to constant view, it was supposed to discourage thieves, but apparently they found a way to disguise themselves as theater workers and evidently used a skeleton key, or a duplicate of the real one.

*n.w. England*

**BICYCLE RIDE ON WHIRLING DISK  
LATEST STAGE THRILLER**

*3042*

One of the most recent theatrical novelties presented in Germany involves a feat of bicycle riding on a swiftly turning disk, pitched to a steep angle. The rider must maintain careful balance, while timing his speed to the disk's.

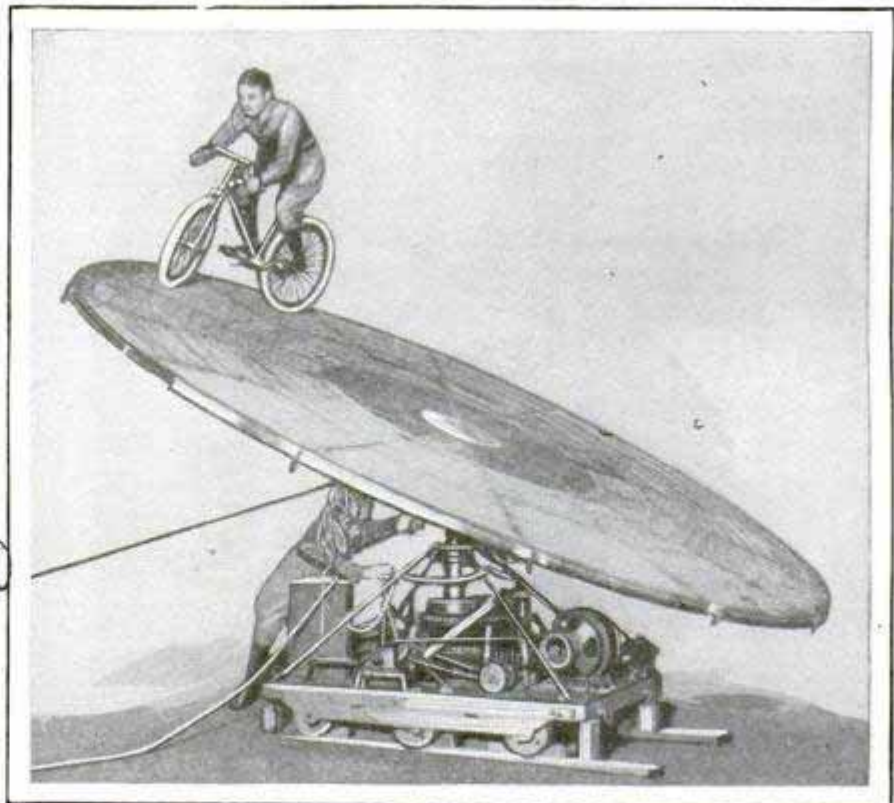

Riding the Whirling Disk: the Cyclist Must Keep His Balance on Steep Incline, While Pitting His Speed against That of Platform

*Carl George F. Paul  
527 S Dearborn St.*





By PAUL PADDOCK

SEVEN men dash up a flight of stairs, pry the stop strip off the jamb of a locked door and burst into a room piled with furniture and boxes. In one corner, behind a glass partition, an overhead sprinkler is gushing. A man darts under it, gives a quick twist with a pair of tongs and the flow ceases. Three men climb to the top of a tall rack and cover it with big widths of canvas.

"Get help," shouts the leader. "Call three companies." Another man runs to a fire-alarm box, opens the inner door and taps a little key. First, the number 212, once repeated, the call for the fire department, then 26, also repeated, the number of the box, and then 183, the last digit being the number of companies wanted. Back comes the tick 2212, the department's O. K. signal.

Drillmaster Edward Reilley consults his stop watch. "Four minutes even," he announces. "Not bad; the record is 3.29."

You are watching Company Five, of Chicago's fire-insurance patrol, the water fighters, at drill in one of the queerest schools in the world, the first and only one of its kind.

Here students are required to break in the door to get to classes, and hurrying through lessons as fast as possible is encouraged. The room's odd furniture is arranged to represent conditions that might be met at almost any fire. The problem is to shield everything in it with the canvas and rubber covers so that water could do little damage. The sprinkler was shut off at the head, for there was not time to look for the standpipe, and sending in the alarm correctly is an essential that every man must learn. Had the signaler made a mistake, it would have been detected on a receiving apparatus in another part of the building, and he would have been required to give the alarm again and correctly.

In the four minutes, you have seen the men spread nineteen covers, fourteen feet wide and nineteen feet long, each weighing about thirty pounds, arrange them so that they formed catch-alls between the piles of goods, basins capable of holding from fifty to sixty gallons of water, and fold the edges of the sheets in such a way that water would not run under the material. Just a few weeks ago, these

School, at Hill and Orleans Sts.  
Chicago



756  
2344



Down the Pole at the Gong; Like Regular Firemen, the Men of the Patrols Are Experts at Getting to Fires on Split-Second Schedules



Where Students "Crash the Gates" to Get to Classes; Squad Using the Door Opener to Enter Drill Room



Drillmaster Reilly Giving Patrol Class Pointers on Chemical Extinguishers; How They Are to Be Used and Filled



Shutting Off Sprinkler at the Head, to Prevent Further Damage from Water



tactics and eleven covers saved \$123,000 worth of silk from damage when a sprinkler broke in a department store. Last year, the city's nine patrol companies answered 14,013 alarms, traveled 37,546 miles and spread 22,053 covers at fires involving nearly \$500,000,000 in insurance.

Firemen try to beat the fire, but the patrols must beat the firemen, to get their covers down before the hose is turned on, for water, when it has spent its force against a blaze, often causes serious damage. The patrols are maintained by the insurance companies, two per cent of the premiums going to their upkeep. The service is the constructive, salvaging branch of the fire - fighting game. The work of the patrols begins when the fire starts and often does not end until long after, for goods must still be protected from the weather and

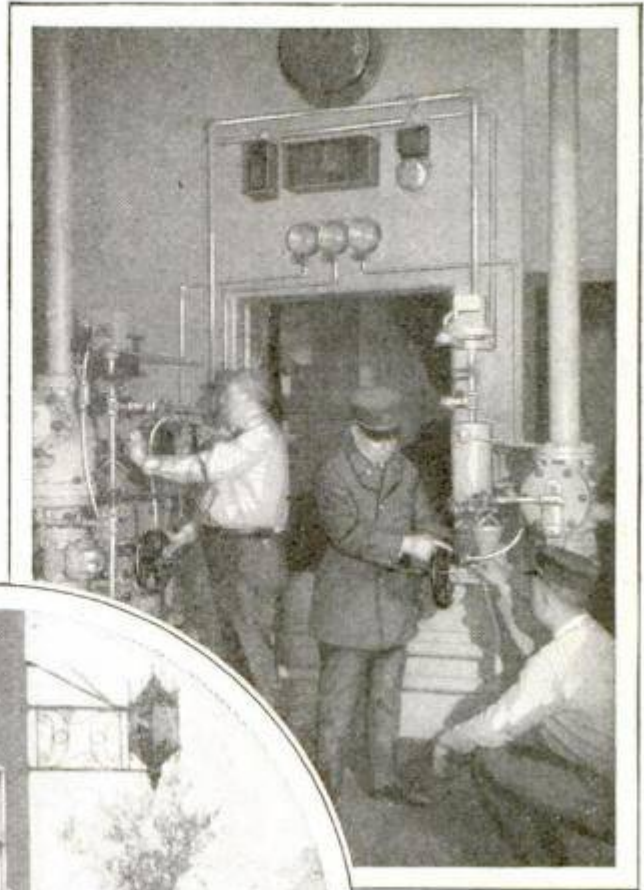

other damage when the blaze is extinguished. No charge is made for the work either to insured or uninsured. Besides protecting and saving property, the patrols render first aid to the injured,

assist in rescue duty, and often their chemical equipment puts out a fire before the arrival of other apparatus.

The men are picked for their speed, skill and courage. The water fighters work under the fire, where ceilings are likely to collapse. It is a department tradition never to pull the covers until necessity demands. The sheets cost about \$1 a pound and the stuff under them may be worth millions. Hence, the men of the patrols are among the first to enter and the last to leave a burning building, often remaining until flames show through cracks in the walls and smoke is threatening suffocation. Just the other day, five men were killed in New York. Piles of rags soaked up tons of water on an upper



Learning How to Control the Wet and Dry Sprinkler System, the Patrol Car Answering a Call, and the Watch on Duty



floor. Under the unexpected weight, the supports gave way and the load buried men, covers and all.

Not long ago a Chicago company escaped death by a matter of seconds. They were on the fifth floor, the fire was on the sixth. In some mysterious manner, it got under them on the fourth. "Gee, it's hot coming up those stairs," a fireman remarked. The chief, warned of the peril by the chance word, investigated and ordered the men out just as the flames broke in on the fifth floor. Recently another company won honors for quick action in a life-saving emergency. A woman was balancing on a fourth-floor ledge, determined to jump, although no net had been spread. Grabbing one of the big covers, the patrol company held it tight and she leaped. The canvas didn't hold her, but broke the force of her fall sufficiently to prevent serious injury.

Fighting water requires special strategy and, for that reason and as the result of years of observation and experience, Chief Frank C. McAuliffe, former battalion chief in the Chicago fire department, decided to establish the school where men, entrusted with the task of saving millions of dollars worth of property yearly, could receive training under conditions as nearly like those of an actual fire as possible.

The classroom is in a building recently erected by the board of underwriters. It is completely equipped with fire-signal and receiving instruments, wet and dry sprinkler systems, the latter operating with compressed air so that water will not have to be kept in pipes exposed to freezing, sprinkler-control units and various kinds of chemical extinguishers.

Arrived at a fire, the patrol-company captain must be able to size up the situation instantly. Shall he call for more help? What kind of a building is it, sturdy or flimsy? What's on the upper floors, heavy machinery, stoves or other articles likely to come crashing down if the lower supports give way, or is there reasonable safety of load? What kind of stock is in the structure? Where is the fire now and where is it likely to spread? How many lines of hose will probably be played? Are dangerous chemicals stored anywhere? Does any part of the building need immediate ventilating? These and scores of other questions must be answered almost instantly, for a few seconds may mean loss of life and property.

Of all types of blazes, the patrols dread those in bowling alleys most. There is much space to cover and complete protection is difficult. A stock of stoves is hated for two reasons: If they are on an

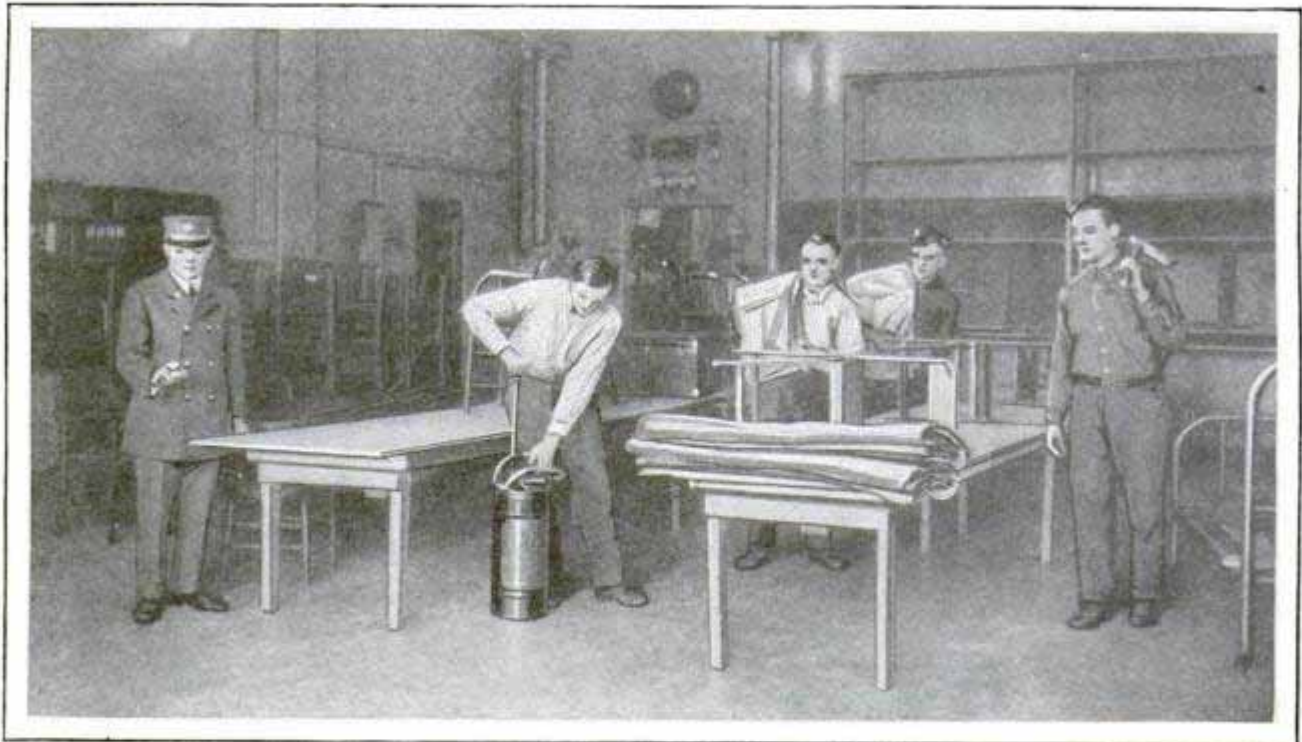

Leaving the Classroom after Drill; Chief Reilly Has Timed the Squad with His Stop Watch, Covers Have Been Folded Up and the Men Are Now Ready for First-Aid Practice



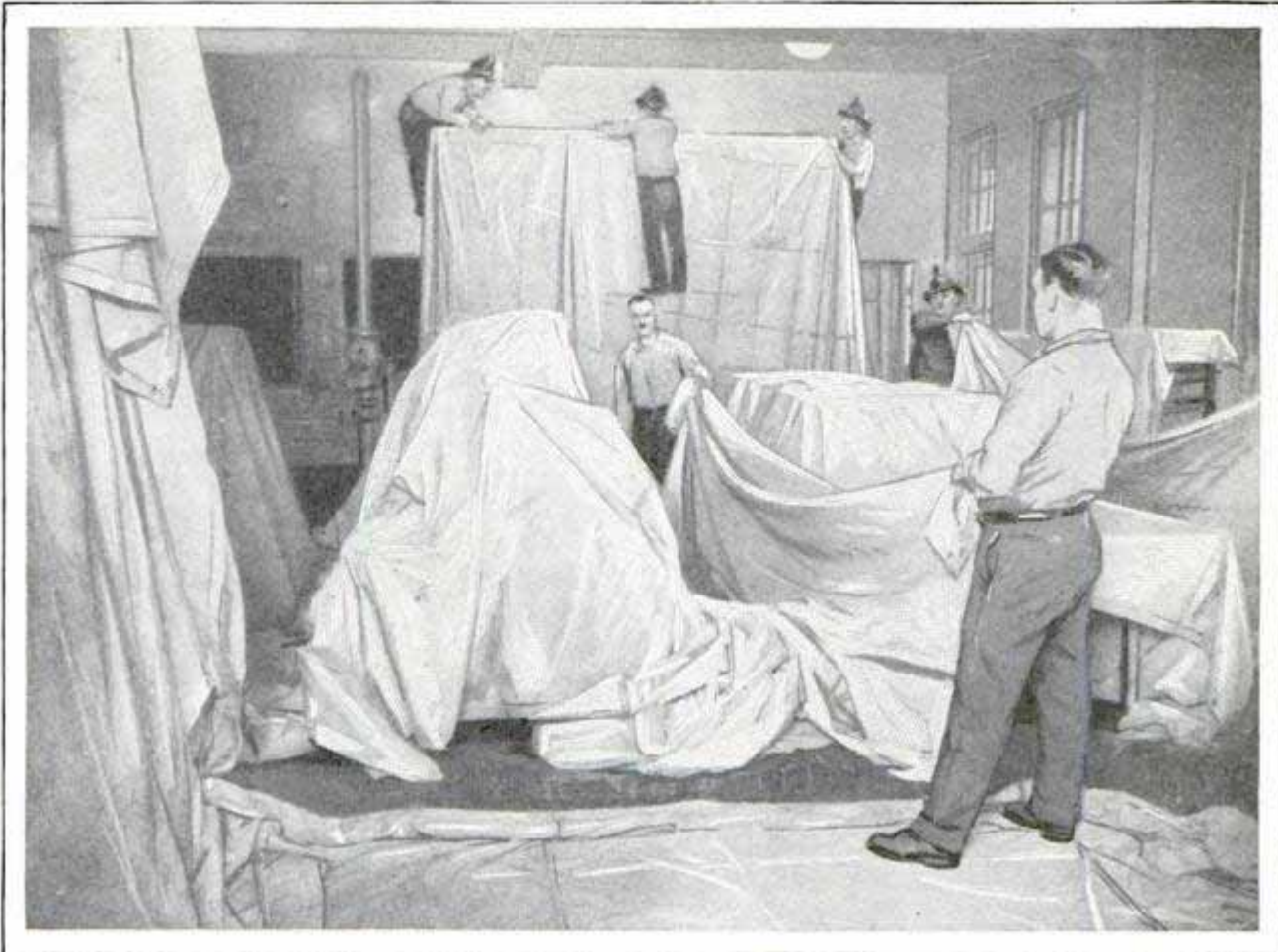

Spreading Covers in the Drill Room; Boxes and Articles of Furniture Are Arranged to Represent Conditions at an Actual Fire; the Object of the Practice Is to Robe Everything in Waterproof Tarpaulins and Rubbers

upper floor, they peril men below them and sharp edges are likely to tear the covers. In a residence fire, extreme care must be taken in piling furniture for adequate covering and handling costly pictures and bric-a-brac that may represent fortunes in insurance. Skyscrapers of modern type are protected against fire, but water damages things in them as well as in frame houses.

To enter the patrol-training school, you must be between twenty-one and thirty-one years old, five feet seven inches tall, or more, and weigh at least 145 pounds. After qualifying, men are placed on probation for six months and then, if they have fulfilled requirements, they become full-fledged members of the patrol.

### PLANE GETS NEW PARTS IN AIR BY DARING TRANSFER

Refueling airplanes while they are in motion has been done successfully for some time, and now the moving repair station is seen as a possibility as a result

of an interesting incident near Luke field, Hawaii. An army bombing plane had taken the air when it was discovered that the landing gear had been damaged. The pilot then dropped a note, asking that repairs be sent up. A service plane with the desired equipment was dispatched. After a vain attempt to transfer the parts by rope, the two planes were guided close together and, while one man clung to the tip of the bomber's wing, the repairs were handed to him by a lieutenant in the smaller plane, who also had crawled far out on the wing of his machine. Efforts were then made to fix the landing gear, but failed. The bomber was started for a water landing. One of the motors was stopped when a parachute became entangled in the propeller, and the plane dropped with considerable force, throwing its occupants into the water, but they were not injured.

Arctic fur seals have been found in the antarctic regions, showing that they are among the greatest rovers in the world.

*manned by Lieut. George B. Polk  
accompanied by Staff Sergeant*



1381

*Rochester, N.Y.*



Robbing the Walnut Harvest of Its Most Unpleasant Feature, Removing the Hulls in Motor-Driven Machine

### BLACK-WALNUT HUSKER CLEANS BUSHEL IN FIVE MINUTES

Utilization of thousands of bushels of black walnuts, now wasted every year because of the expense of removing the hulls, is seen as a result of the introduction of a motor-driven husker. It is said to clean a bushel in less than five minutes, turning out each nut as bright and clean as though it had been scrubbed with a brush. The huller is made in various sizes and running water is used for cleaning. Walnut culture is being urged because of the food value of the product and the ease with which the nuts can be grown. The trees thrive in low land unsuited for other crops on account of drainage problems and the likelihood of floods. In the so-called Corn Belt, it is estimated that there is enough land to make a state half the size of Illinois or Iowa, which is now a waste, although rich, level and fertile, but would be excellent for walnut culture.

### SCARCITY OF CHROMIUM IN U. S. HANDICAP TO INDUSTRY

Although the United States is the largest consumer of chromium in the world, this country produces practically none of the metal, being dependent upon South Africa, Asia and New Caledonia for most of its supply. In 1926, 200,000 tons were imported. For the manufacture of certain steels, there is no known substitute. It produces a hardness and toughness extremely desirable in some grades of steel and is also used in rustless and stainless steel and in special alloys. In case of a war, or other emergency shutting off the traffic in chromium, the United States would face a problem, as the reserves would last but a short time, experts declare. The metal is not found in the free state in nature, at least in commercial quantities, being derived from chromite.

### WOLF HUNTER'S AUTO CARRIES KENNEL FOR DOGS

Speeding over the plains in his specially equipped automobile, Charles Cummings of DeSmet, S. Dak., makes vigorous warfare against the wolves that menace live stock. In the rear of his car is a kennel for his hunting dogs. A release, controlled from the driver's seat, allows them to jump out, and a loud fire siren is used to scare the wolves from their hiding places. Last winter, Cummings and his dogs killed 151 wolves, netting him \$1,800.



How the Auto Helps the Hunting Dog; Special Car Which Carries Dogs in Rear Compartment for War against Wolves in West



# "BOOKS" IN STRANGE LIBRARY ARE BOTTLED SOILS



Much of the Earth Is Represented in This Room, the Government's Soil Library in Washington, Where Samples of Dirt from All over the Globe Are Indexed after Tests

Fifty thousand bottles of soil, the world's largest collection of such material, fill the shelves, cases and compartments of Uncle Sam's strangest library. These carefully identified and indexed specimens include every type of earth known to science. Soil explorers have braved the hardships of the wilderness and bandit-infested lands in procuring material. Agricultural specimens of the earth's crust have been secured in South and Central America, Cuba, Europe, Australia, Russia, Africa, Asia—and where not. Naturally, you will be amazed to learn that our government has mapped and tested 4,053 different varieties of soil in the United States. One thousand of these soils are important in our food-producing economy. A great soil map of the nation, which will classify every square inch of land surface, is now being made at a cost of many million dollars. Standardized and systematized farming results from this soil research. Farmers who move to new localities have only to study the maps to find out what crops are the most profitable.



## BURRO AIDS IN TAMING HORSES ON MEXICAN BORDER 3081

The easy-going burro of the Mexican-border country is being used successfully by farmers in taming wild horses. The trick, said to have been invented by Mexican truck growers, involves yoking the horse and the burro together with a strong rope or chain and letting the animals wander at large. The wildest animal of the range will wear itself out within a few hours, owing to the obstinate character of the donkey. South of San Antonio, the method has developed to a fine point. After a few days of companionship with the docile burro, the horse is so tame that it may be harnessed to a wagon or plow.

☐ The temperature of water at hot springs is seldom above boiling.

Cont. Wm. Allen Ward  
Box 1614, Dallas, Texas.



*Amontol, James J. Beck,*  
 1921 Blue Island Ave  
 POPULAR MECHANICS  
 Chicago, Ill.

762  
 17

**MOTOR ROCKER FOR BABY BUGGY SAVES MOTHER'S TIME**

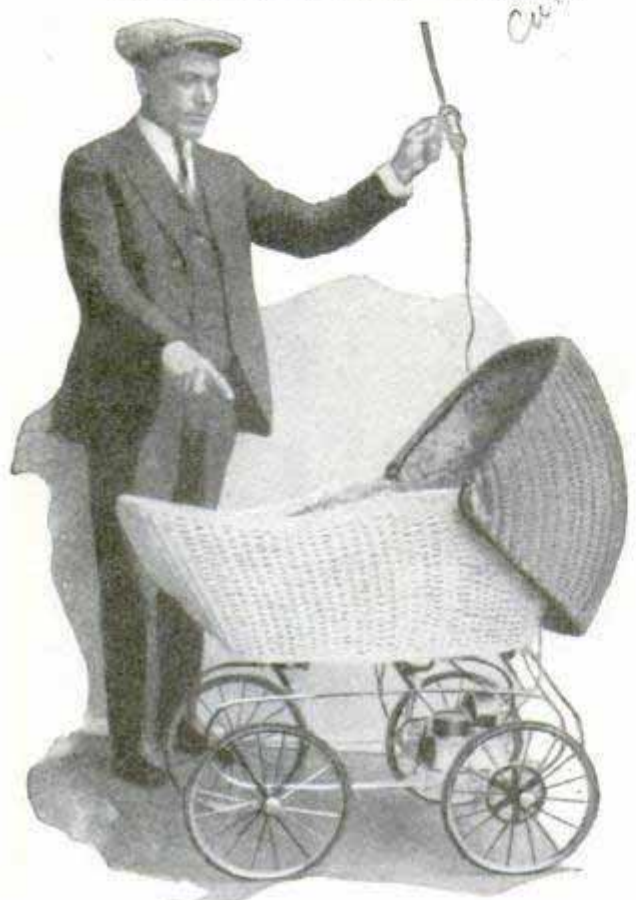

Rocking Apparatus Installed under Baby Buggy and Connected to a Lighting Socket for Operation

Rocking the baby by motor is now possible in an attachment fitted to the carriage. It rocks the body of the buggy from side to side and also rolls the entire vehicle alternately forward and backward. Controls are provided for regulating the action and, once started, the outfit requires no attention.

**FIRST THERMOMETER A TOY DEvised BY GALILEO**

3015

Like many important inventions, the thermometer, one of the most useful of man's appliances, had a humble beginning. Galileo is credited with devising the forerunner of the modern instrument. It was simply a glass bulb containing air and connected to a glass tube of small bore which dipped into a colored liquid that rose or fell in the tube according to temperature changes. The gauge had no scale and was regarded merely as a scientific toy, one of Galileo's numerous playthings of a like nature. Later one of his pupils,

*New York Herald-Tribune*  
 7/21/27

Francisco Sagredo, substituted wine for the colored liquid and a member of the faculty of the university of Padua, realizing that Galileo's toy had great possibilities, adapted it to the measurement of the heat of the body, so that fevers could be detected. Between 1630 and 1640 the grand duke of Tuscany made still further improvements, hermetically sealing the open end and partly filling the tube with alcohol. In 1714, Fahrenheit instituted the scale which is in use at present, marking thirty-two degrees as the freezing point and 212 as the boiling point of water. Many reasons have been given as to why he chose to graduate his scale between the freezing and boiling points into 180 divisions, one being that since he was a maker of astronomical instruments, the division followed the principle of a marking by degrees, 360 for a full circle and 180 for a half. The Reaumur thermometric scale, designating the freezing point at zero and the boiling point at eighty degrees, was invented by a French scientist of that name, in 1727, and Christin, of Lyons, revised the scale proposed by Anders Celsius, in 1742, to make the present centigrade division.

**GAUGE MEASURES FOOT ACTION TO TEST AUTO DRIVERS**

2101

How the feet behave under excitement is told on a gauge German examiners are using in testing candidates for automobile drivers' licenses. It shows the pressure exerted in varying degrees of emotional disturbance, indicating how the subject would control brake and accelerator under different situations while driving a car.

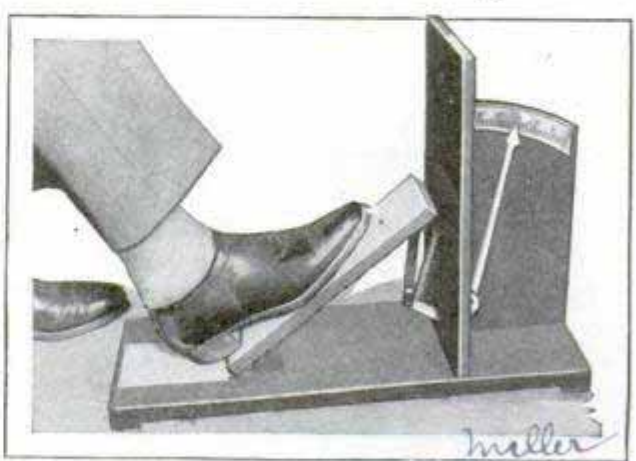

Gauge Used in Testing Foot Action of Automobile Driver License Candidates

*In Berlin.*



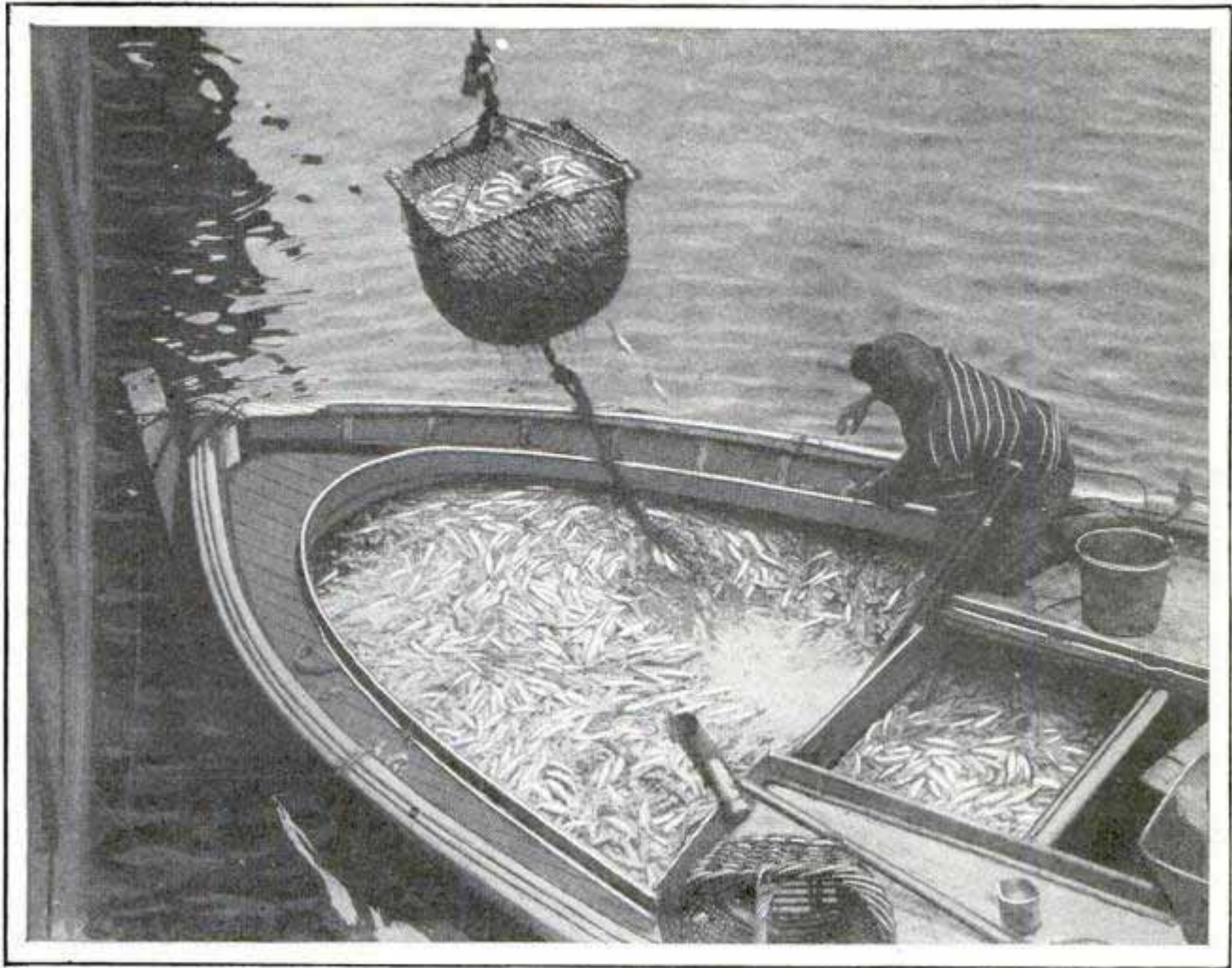

Silvery Sardines in Basket Loads Are Swung Aloft and into the Cannery When the Fishing Boats Come into Port with Their Catch, Often Running into the Millions

## Putting the Can around the Sardine

How Smallest Fish Taken Commercially Is Caught at Sea  
During Night in Lakes of Cold Flame

By H. H. DUNN

2722 Divisadero St.  
Berkeley, Calif.

**M**ORE than 300,000,000 pounds of sardines were taken from the Pacific ocean last year. Their value was close to \$12,000,000. Though this is the smallest fish taken commercially, it furnished more than three times as much, in both weight and value, as any other food taken from the ocean on the western coast of the United States.

The business of taking these uncounted millions of sardines, cooking them and putting them into tin cans so that they may be shipped and sold all the way from San Francisco to Shanghai and from Medicine Hat to Buenos Aires, occupies the time of more than 12,000 persons, and it is

conservatively estimated that 50,000 depend on the industry for their livelihood. More than 1,000 boats are engaged in the capture of the sardine, and fifteen packing plants prepare him—or her—for the distant table. Seines used in harvesting this sea food, if woven into one huge net, would surround a school of fish twelve miles in diameter.

From the time he is lifted in a great lampara net, or a purse seine, from the Pacific, until he appetizingly appears on the table, the sardine is the hero of a double romance—of the sea and of modern mechanical industry. Particular types of boats, special seines and peculiar methods





Fishermen's Harbor in San Francisco a Quarter of a Century Ago When the Motorboats, at the Right, Were Just Beginning to Replace the Quaint Craft with Lateen Sails at the Left

of fishing have been developed to get him out of the sea. Equally specialized machinery has been built to get him into the can, and the government of a state has set all its legal machinery in motion to give Sir Sardine such protection that he may remain forever a source of millions of dollars annually to the commercial fisheries of California.

Since the first step in canning your sardine is to catch him, let me take you on "Lina," a modern "sardiner," built last winter, on one of several all-night voyages after a few tons of the little fish.

For some reason not well known, the bigger schools of the larger sardines come to the surface, and also swim closer inshore, during the night; therefore "Lina," captained by Pete, engineered by Gus, and crewed by four fishermen, with myself as supercargo, put out from Monterey on a night in January. "Lina" is of the type known as "Japanese boat," because first developed in the California fisheries by the Japanese, but later improved by Austrian, Scandinavian and American boat operators. "Lina" is forty-eight feet long, about twelve feet wide, draws five or six feet, and is driven around twelve miles an hour by a Diesel engine. She has the

sheer to be a "dry ship," no matter how heavy the water runs, and the wide tail to help lift her clear of following seas. Spotlessly white as a private yacht, save for a green stripe along her gunwales, the only dark blot on "Lina's" hull was the lampara piled in her stern. This seine, 400 fathoms long by thirty fathoms wide, with a heavily woven pocket, or "bunt," at the middle of its length, where the sardines at last are caught and held, was bone-dry from two days in the sun, and coiled so as to run as easily from the stern as a cowboy's "rope" is running from the loop in his hand.

As we set "Lina's" nose steadily westward, I learned from Pete that smelt and anchovies can be distinguished from sardines—while still in the water—by the manner in which they swim away from the approaching boat. The smelt swims in an undulating course, leaving a murky, wavering line of phosphorescence; the anchovy, a weak swimmer, makes short, curved dashes, while the sardine swims swiftly away in a strong, slightly bent path of glowing water, reminding one of a submarine rocket. In the daytime, the fishermen locate the schools of fish by the clouds of seabirds following them, but at



night the phosphorescent glow betrays their presence.

We went ahead for an hour, night becoming deeper and darker; then another hour, with all dimmed except the red, green and white riding lights. Ahead, in the bow, one of the crew watched the sea, and at the end of another half hour shouted back:

"Easy on the port!"

When it was pointed out to me by the sharper eyes of the lookout, I could see a dull glow on the ocean, an area as large as a twenty-acre farm, which seemed to be filled with smoldering fire. Then, as we drew closer, tiny flashes appeared, miniature cascades of liquid gold, where the millions of sardines leaped and played in their lake of cold flame. This phosphorescence is due to the presence of myriads of microscopic organisms, called dinoflagellates, which, when disturbed, give off a "frozen fire."

We maneuvered to the opposite side of the great school of fish, so that the



wind might not blow the lampara back into the propeller of the boat. Once there, a skiff with two men in it was dropped and immediately steadied with a drag made by casting a ten-gallon keg full of cement and then knocking off the staves, an iron ring-bolt having been sunk through the cement while the

latter was soft. The free end of the long seine was taken into the skiff, and, with Gus at the wheel, "Lina" set out to surround such a part of the thousands of tons of swimming sardines as the lampara would hold. Then I realized that we had been running without lights the better to see the size and limits of the school.

As we swung along the open-sea side of the school, Pete and two other men payed out the seine, seeing that it ran free from the table in the rear of the boat, and that the weighted side was down. When he came to the bunt which marks the center of the length of the net, Pete signaled to Gus, who brought the boat about and swung her back to the skiff, whose location was marked by a flashlight turned



Fisherman Paying Out the Enormous Net; Unloading the Catch into a Belt Conveyor at the Cannery, and, Top, Hauling In the Net



on and off by one of the men in the small craft. As two men worked each wing of the seine, Pete, standing in the center of the stern, worked up and down a weighted board attached to some ten feet of line, creating such a splashing at the open end of the net that none of the fish escaped. The pulling became harder; the weight of the fish began to tell on the arms of even the husky four; and a fiery, agitated mass glowed in the water as the seething ball of sardines confined in the bunt approached the surface.

The wings having been dragged in, two men took turns shoveling the sardines up to the deck of the motor fisher, using specially devised scoops, made of strong webbing stretched on oval iron frames, with long wooden handles. Two other men, on the deck, with ordinary scoop shovels threw the sardines as far forward as possible. With the bunt emptied and the lampara repiled, the boat was again set on the trail of the moving lake of cold fire which marked the progress of the vast sardine school up the coast. Twice more the lampara was dropped over and hauled in, before "Lina's" deck was filled. Her cargo was a little better than ten tons.

On each trip to the cannery, the fish were unloaded by the simple process of

shoveling them into elevators, in which they were carried to the scaling and washing machine, a long, revolving tube of heavy wire mesh. Thence, thoroughly drained of all water, fragments of seaweed and other debris, they were taken on automatic conveyors to the frying pans, distributed into these, and cooked in ovens for a fixed period. Thereafter they were placed in cans, passed for two hours through a temperature of 212 degrees, and finally sealed and inspected. Virtually all this work, with the exception of the inspection of the cans, is done by automatic machinery.

After the inspection, the labels are put on, also by machinery, and the cans packed in cases. Less than forty-eight hours after we had found the school of sardines, twenty-six tons of them were in the cans, ready for shipment to any point in the world for use as food.

#### KEEPING HOUSE IN SKYSCRAPER INVOLVES BIG TASK

Just to remove pencil marks and scratches from the offices and corridors of a New York skyscraper costs \$27,000 a year. The owner of another building has spent \$300,000 on the polished-marble

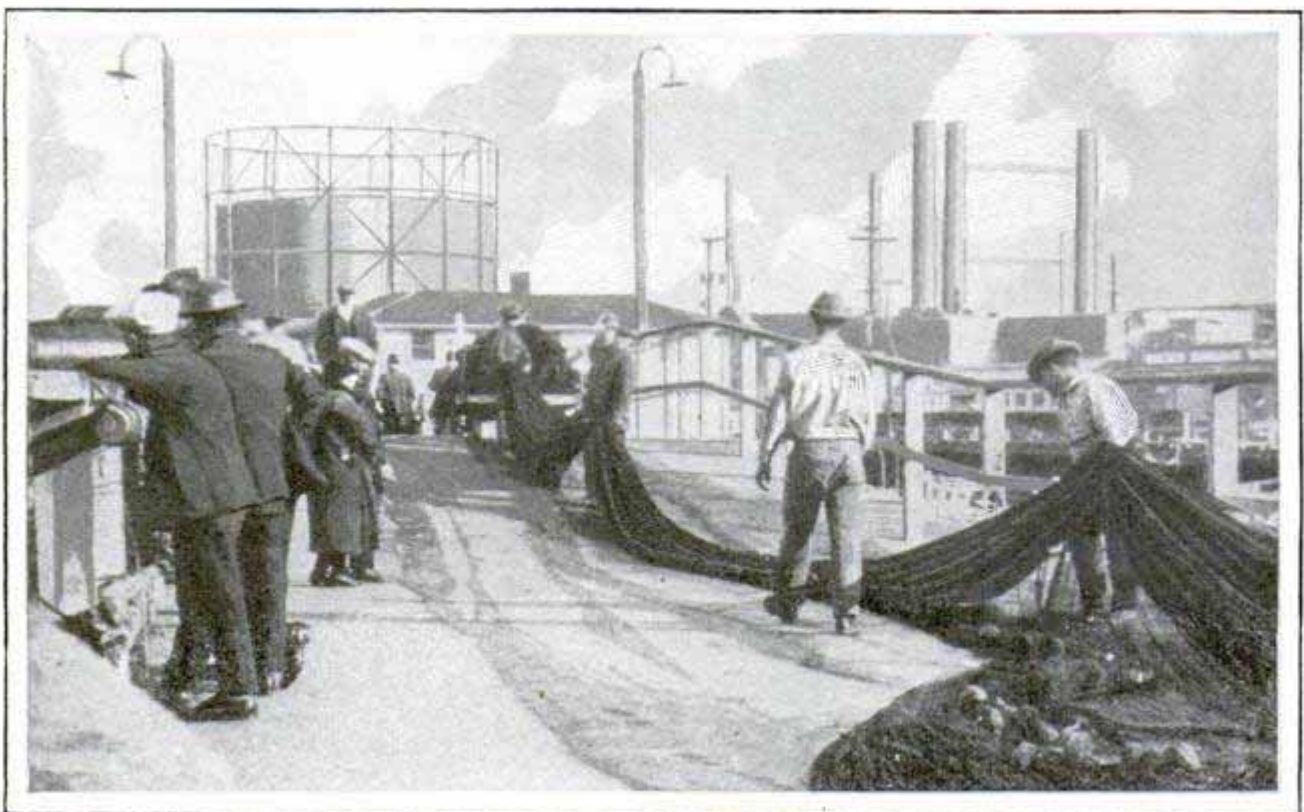

The Lampara, or Purse Net, Is Often 2,000 Feet Long and 150 Feet Wide, and the Services of Many Men Are Required to Handle It When Brought Ashore for Drying



7/31/27

2964

Mac Kinnon Brooklyn N.Y.  
 700 Ocean Av. Brooklyn N.Y.  
 Cmb. A. 2

wainscoting for the hallways, and it is estimated that simply keeping the offices clean takes about sixty per cent of the total outlay for maintaining big business structures in sanitary condition. According to one manager, taxes are the largest items of the many involved in operating and keeping up big buildings. The next is the daily cleaning cost, which is absorbed by armies of men and women hired to wash windows, wainscoting, furniture and other parts. Painting is a big expense in some structures. Among items that the average person does not usually consider in connection with the task of the skyscraper "housekeeper" are those of keeping up special hospital quarters in the building, and reading and writing rooms for business women. Many opportunities are offered for savings, one being the use of hardware that does not require polishing, and some builders have adopted unlacquered bronze and a special kind of cast iron as the most satisfactory finishes. Managers also must keep the good will of their tenants and, to that end, select building attaches who will display courtesy and efficiency.

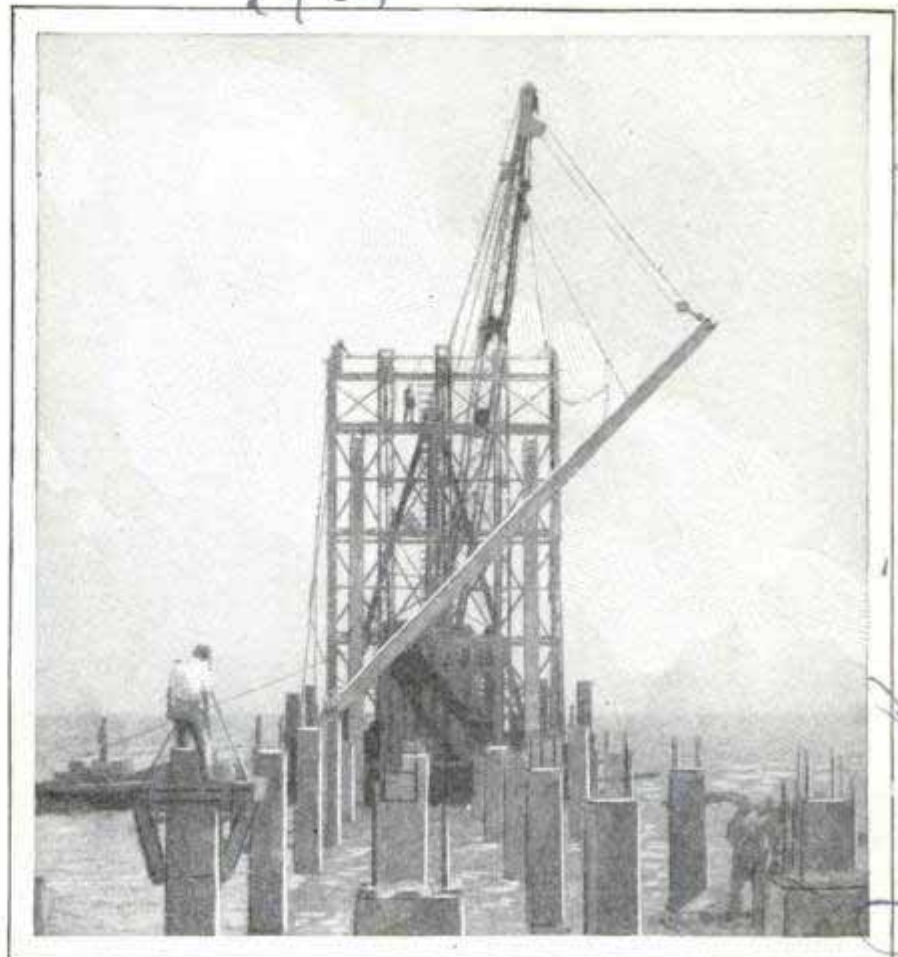

Swinging Eighty-Foot Concrete Pile into Place for Driving; Part of the Equipment That Did Rapid Work on New Orleans Bridge

### GIANT PILE DRIVER DRIVES TWO AT SAME TIME

A mammoth pile driver, capable of driving two eighty-foot concrete piles at the same time, was used on the new highway bridge across Lake Pontchartrain, built to give New Orleans its long-desired outlet to the east and north. The bridge, which is approximately fourteen and a half miles long, required 2,800 concrete piles, two feet square and eighty feet long, driven to an average depth of fifty-seven feet. In order to rush the bridge through so that a continuous highway could be opened this year from Jacksonville, Fla., to San Diego, Calif., the big pile driver was built with four sets of movable leads, handling the piling for both sides of the bridge at the same time. Across the piles the thirty-five-foot bridge spans were laid at the rate of twenty a week, and a floating concrete mixer poured the highway deck at the rate of 400 cubic yards every eight hours.

Some clouds measure as much as ten miles in thickness.

### EXTRA AUTO-STEERING WHEEL PROMOTES DRIVING SAFETY

Reduction of driving risks is anticipated in a supplementary wheel on the steering post. It controls the headlight changes and the horn so that the hands do not have to be removed from the main wheel in making adjustments. The attachment was introduced recently in France.



2558

Write H. M. Delano,  
The Delano Service



AUTO JUMPS OBSTACLE AT SIXTY MILES AN HOUR



Try This in Your Car; Test with the Leaping Auto on French Roadway; Dashing up a Steep Incline, It Easily Cleared Another Car and Made a Safe Landing without Damage

Andre Mercier

Railway Exchange Bldg. Chicago

For a motoring thrill and to test the springs and other parts of his car, a French driver demonstrated the jumping possibilities of his auto recently. At a speed of sixty miles an hour, the machine was driven up an incline and easily cleared another car by the side, rising to a height of more than ten feet. The landing was made without mishap.

to 15 feet high

WIRELESS FIRE ALARM HELPS PROTECT CITY

When a fire alarm sounds in Dallas, Tex., the signal is instantly recorded on radio-receiving sets installed in the chief's and other cars of the department, so that officials are immediately in touch with the central office. The receiver is constructed to react only to the wavelength of the sending unit, which is actuated through a relay connected with the fire-alarm apparatus. The transmitter is equipped with four fifty-watt tubes which are continually kept warm by a ten-volt current through a rheostat. When an alarm is sounded, this rheostat is cut out by a relay and the tubes get full voltage. Another

relay starts the motor generator and a third operates the fire-alarm circuit to hit the number of the box. The generator is automatically released fifteen seconds after the fire-alarm system is quiet. Tests have shown that the installation is reliable at all times and requires practically no attention. It is the invention of Henry Garrett, Dallas superintendent of police and fire signals and a pioneer in the development of electrical traffic controls.

CEMENT TAMPER AND FINISHER SPEEDS PAVING

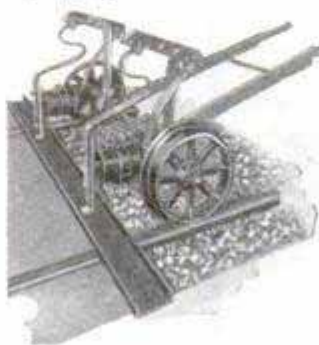

Work that ordinarily requires several men is quickly and efficiently done with a pavement-finishing outfit, recently introduced. It is pulled along on rails, tamping the layer of concrete below with electric-driven pounders and smoothing off the finer mixture that rises to the top.

Equipment Co. Electric Tamper

Inventor, Henry Garrett, Supt. Police & Fire Signal System



J. J. Wood Chicago. 2-

1933 W. Lake between 10 and 4.

### AUTOMATIC VALVE GIVES ACCURATE TIRE PRESSURE

2956

A valve to fit the free-air hose and inflate tires to a predetermined pressure, eliminating guesswork and removal of the hose to test the air, has been invented. The valve consists of two cylinders, with a by-pass between them. The upper cylinder has a sliding sleeve, and is marked in pounds. To use, the sleeve is moved to the point where the figure for the desired pressure appears, and locked in place with a quarter turn. The device is then applied to the tire valve in the usual way, and passes air into the tube until the desired pressure is reached. At that point, any excess air is by-passed through the upper cylinder, escaping at the rear with a whistling noise to warn the user, and no more than the predetermined pressure can be put into the tire.

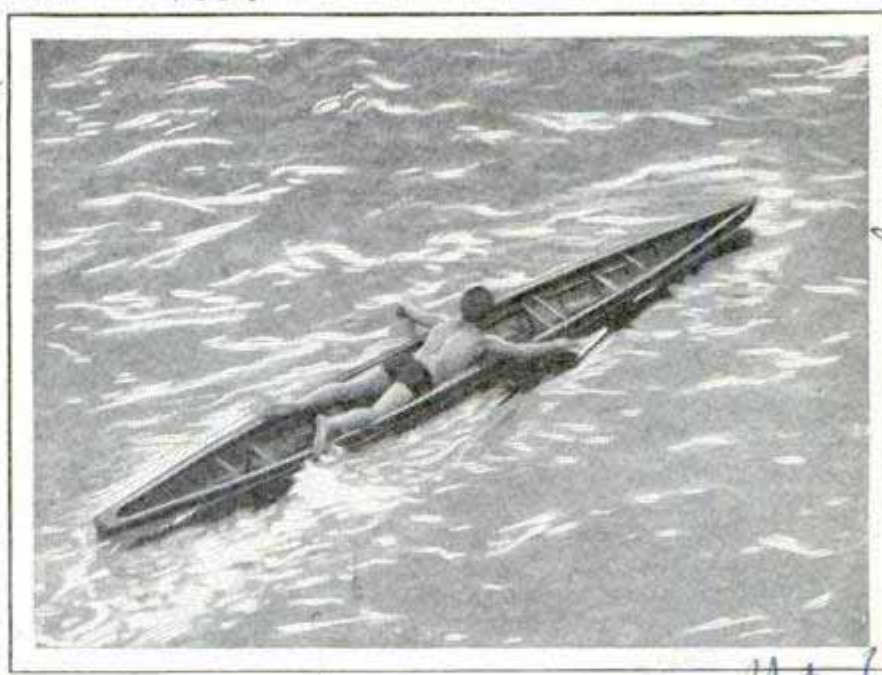

Surf-Riding in the Hand-Propelled Canoe; the Slender Craft Is Easily Managed and Combines Features of Boat and Surf Board

### TINY CANOE PADDLED BY ARMS FURNISHES SURF SPORT

Hawaiian surf-board experts have recently introduced a shell-like canoe paddled with the hands and arms for exercise and sport in the waves. It accommodates one person who lies prone with the arms extending at the sides. In calm water, considerable speed can be attained.

### ELECTRIC BELT TO HEAT WATER STRAPS AROUND TANK

2965

To maintain a supply of hot water for the home, an electric belt has been introduced in England. It is simply strapped about the tank and warms the water above it by heat caused by the resistance to the passage of the current through the conductor, which is adapted to 500, 750 or 1,000 watts. An asbestos-lined cover insulates the heating element, and if desired, two belts may be used on the same container to insure a more abundant supply of heat.

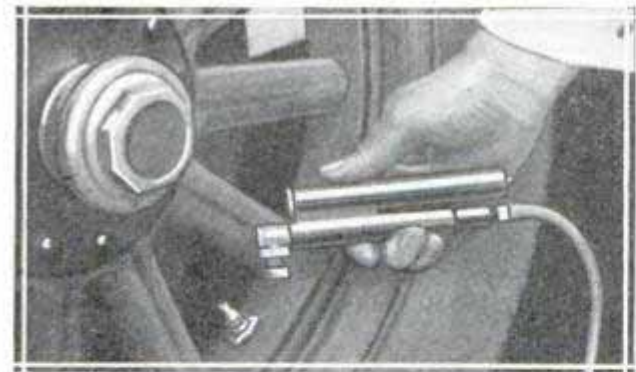

Air-Hose Valve That Automatically Fills Tire Only to Desired Pressure

### POTATO ON IDAHO AUTO LICENSE BOOSTS STATE'S PRODUCT

Idaho automobile-license tags for 1928 will bear an embossed representation of a potato in natural colors against a green background, and the words "Idaho Potatoes" will appear at the bottom of the tag. This plan of advertising a state's leading product on the auto licenses was started by Massachusetts with the figure of a codfish on the plate.

Com. A. E. Smith  
Box 45, Milford Utah

Santon electric belt.  
Price about \$6.00

Santon's Ltd., Santon  
 Electric Works, Dock St.,  
 New York. Manufacturers, Wales  
 Mansions, London S.W.1. Eng.  
 7 Vincent Square  
 A.C. Bleachall, Eng.



*Lobra Army & my day in Germany*  
*Read - Kissingen, Germany*

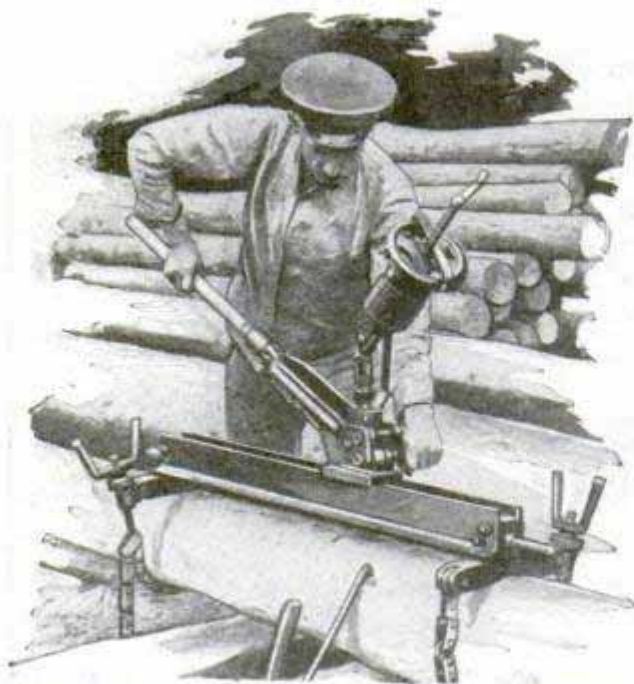

Injecting Charges of the Preservative in Timbers to Prevent Decay; Material Applied with Great Force

### "VACCINATE" POLES TO CURE ROT AND PROLONG LIFE

German chemists have developed a process for arresting decay in poles, posts and other wood products by injecting special chemicals under pressure. A first treatment is designed to kill fungus growths and the second, to provide an antiseptic against decay bacteria.

### OLD ROMAN TREASURES FOUND UNDER BANK OF ENGLAND

Relics of the first city of London, connecting it to early Roman times, were discovered recently as workmen were digging in the soil twenty feet below the ground level, while making alterations in the Bank of England. Their picks turned up fragments of little cups, plates and bowls, manufactured 1,800 years ago and shipped to London in Roman galleys. The glaze was still bright in spite of the long period under the clay. There were also black and gray pottery and various metal and leather objects, well preserved. Among them

*daily mail and London*  
*daily Express*

were Roman sandals, that, oiled and cleaned, could be used again, for the leather regains its elasticity. Bone hairpins, with which the Roman women secured their hair, vinegar and salt dishes, a carpenter's folding rule and small spoons with a bowl at one end and a sharp point at the other, which was used to extract the meat of shellfish and open eggs, were among some of the other articles discovered. Fir-tree cones were also found. They were shut tight when removed from the soil but opened in the moist air. Discovery of the relics suggests that the site of what is now one of the most valuable plots of land in the world was a rubbish heap in Roman days. The district was evidently a marsh into which the housewives threw their broken pots. London was a Roman city for 400 years, but most of the objects found date from the first to the middle of the second century.

### ENGINE IS PICTURED IN PLANTS FOR RAILROAD ANNIVERSARY

More than 26,000 plants of metallic colors were used in making a flowerbed design of the "Tom Thumb," pioneer American locomotive, for the centenary anniversary of the Baltimore and Ohio railroad. Hubs and wheels were worked in plants of a light shade, brass trimmings in yellow, and boiler, smokestack and other parts by a plant which turns almost black at maturity. The design was seventy-five by fifty feet in size.

*at Baltimore, Md*



Floral Replica of Pioneer Engine Celebrates Railroad's Anniversary; Plants of Metallic Colors Were Chosen





Tree Tops Protect the Turkey from Prowling Animals While It Sleeps, but Do Not Save It from the Thanksgiving Dinner Table and the Feather Fancier Who Seeks Its Plumes

## From Turkey Feathers to Ostrich Tips

### Texas Gobblers Displace Lordly Plume Bearers When Feather Makers Find Way to Produce Imitation Decorations

**T**WO hundred thousand ostriches in a single South African district have been slaughtered recently because the disappearance of the hat plume for fashionable wear rendered the birds incapable of earning their keep.

At least that is the reason the ostrich breeders gave when they wiped out their farms, but a new American feather business credits the Texas gobbler for transferring the ostrich-plume business from Africa to the United States. For the feather dealers have found a way to make ostrich plumes from turkey feathers.

Before the Thanksgiving bird appears on the table, he has been divested of a side line of plumage which, divided and subdivided according to trade classifications, numbers more than fifty varieties.

The short tail feathers are made into small dusters. The long wing pointers become arrows for the rapidly increasing sport of archery. The long tail quills are fashioned into fishing tackle. The heavy wing quills become feather boning for whips and riding crops. The soft body feathers are used in stuffing cushions and mattresses, or are exported for bedding to those countries which still cling to the old-fashioned feather bed. The soft down from hips or thighs becomes the "marabou" of commerce, for, contrary to popular belief, very little of that which passes in the feather trade for marabou is obtained, as is commonly supposed, from the tail or wing of the African stork. In fact, to quote one of the biggest distributors of feathers in the United States,



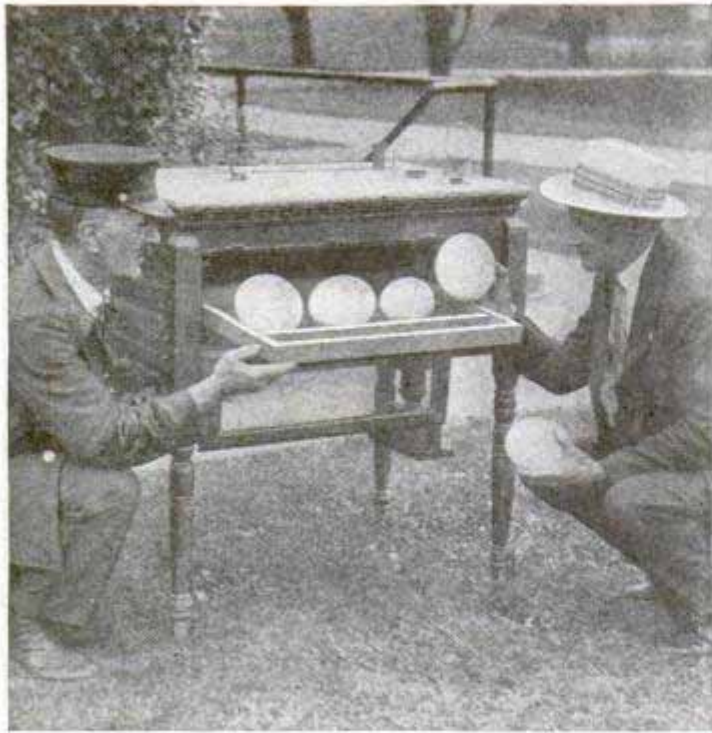

Officials of the Philadelphia Zoo Preparing to Hatch Their Own Ostriches in an Incubator

diversified industry. Ducks, chickens, geese and turkeys now supply the world with an endless variety of feathers."

Naturally, because of its size, the turkey furnishes more feathers per head than does any other domestic fowl. A turkey dressed for the market yields about one pound of feathers. That does not sound like a great deal, but, considering the enormous number of turkeys needed to make a Thanksgiving or Christmas holiday in the United States alone, and the further fact that the plumage of 20,000 turkeys fills a ten-ton car, it will be seen that the turkey is a bird of plumage which is not to be discounted.

Last year one factory received 150 carloads of turkey feathers, mostly from Texas. And while it is true that this state produces more turkeys than any other, it

supplies only about one-tenth of the annual "harvest," the balance being distributed more or less equally among the other states and territories. Why emphasize the Texas turkey? What of the New England turkey of historical renown?

In the early days of our colonial history, our forefathers feasted on wild turkeys when celebrating their annual Thanksgiving for a bountiful harvest. At that time, the turkey ranged wild from Canada to the Gulf of Mexico. The do-

"There is not enough marabou grown in South Africa to supply one day's demand when the feather business is good."

As for ostrich tips, while ostrich fans and ostrich-plume trimming have for years had a certain spasmodic popularity, even in the days when ostrich fans waved furiously and every woman had at least one picture hat with its trailing plume, the ostrich was no diamond mine for its owner. It looks imposing in a circus menagerie or zoological garden, but as a bird of commerce, its feed bill is too high, its annual output of plumage too limited, and the bird itself too singular of purpose, to be a financial success. I asked Frank S. Foster of Peoria, Ill., the "feather king" of the United States, what caused the downfall of the ostrich and he said:

"The ostrich sang its own death dirge. It was always a liability and not an asset. It ate too much and was too hard to catch. While there is always some demand for ostrich feathers, it is not sufficient to pay a profit to the ostrich farmer at the present time. So, most of the birds have been destroyed, the owners keeping only enough for breeding purposes. The passing of the trimmed hat has, of course, affected all feather trades, but hat trimming is only one branch of the business—a widely



Bales of Turkey Feathers en Route to the Factory, to Be Transformed into Ostrich and Paradise Plumes

*Foster Feather works, Wyoming, U.S.A. (?)*

*Lead*

*W. B. Fish, 411 Fifth Ave } New York  
John Ciracola, 538 W. B. roadway }*



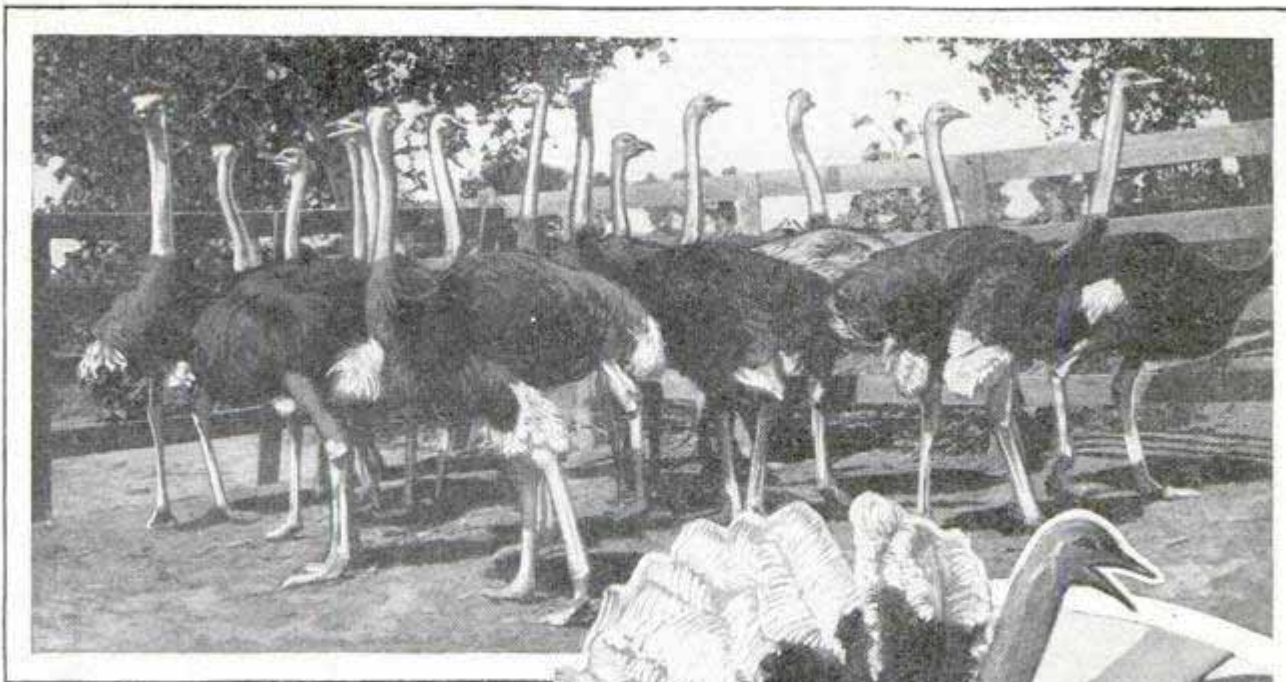

Doomed by Their Own Appetites and General Uselessness; Part of a Herd of Ostriches, Above, and an Ostrich Being Fanned with Its Own Plumes, Right; Below, Scraping a Synthetic Plume Made from a Turkey Feather

mestic bird has now taken the place of its wild brother at the holiday feast, but it has never been so thoroughly domesticated as to cease its wandering. It loves the great open spaces. As civilization spread in the east, Mr. Turkey moved west, first to Ohio, later to Illinois, still later to Iowa. Now it thrives in Texas, where range is free and spaces are wide. When Texas becomes too thickly settled, the turkey, like its forerunner of the range, the Texas longhorn, will probably be driven across the border into Mexico, for in the realm of free ranges, Texas is the turkey's last stand in this country. In spite of its roving habits, the turkey is a tractable bird. When its owner is ready to send his stock to market, he rounds them up cattle-wise and drives them in great flocks to the nearest shipping point.

With the ostrich it is a different story. It is hard to catch. Like its first cousin, the South American rhea, which thrives on the pampas of Argentina, the African ostrich is a prize sprinter. In Africa it is hunted over the veldt by natives on fleet-footed horses. In Argentina, the rhea—smaller than its African cousin, with three



toes instead of two and an undeveloped tail—is captured by gauchos (Argentine cowboys).

And after ostrich or rhea is caught, what have you? A tough carcass that



*2620*  
*Turkey millinery feathers*  
*at the O. S. O. (*  
*411 - 5th Ave.*  
*John Cirasola*  
*538 W. Broadway*  
*me*

can't be served on a dinner table; a supply of eggs that no one wants for breakfast and a bundle of plumes. Even if the plumes are salable, raising birds for plumage alone is too expensive a process in these days of business efficiency, when such plumage has no utilitarian value other than popular fancy.

Times have changed since the days of old when knights as well as their ladies wore plumed headgear. Ostrich tips were then the vogue and continued so down to modern times until they reached the peak of their popularity some twenty years ago with the introduction of the willow plume. It was an American milliner who, improving on nature, conceived the idea of the willow plume—a cascade of feather plumage which sprang into instant popularity with the wearers of picture hats, and for two short seasons dominated the millinery market without rival.

A few years later the war came. Women entered business. The motor car became a household word. Bobbed hair sprang into

fashion. Simple styles prevailed and the small, untrimmed hat appeared. The dealer who traded in feathers wholly as items of wearing apparel was out of luck.

But the turkey kept on gobbling. Long before the willow plume had waved its brief triumph over the world of fashion turkey plumage had been popular. Perhaps it was the memory of his grandmother's turkey-tail fan or her turkey-wing duster, that gave Frank Foster the idea of turning turkey feathers into money. It was in 1895 he branched out from his original poultry-dressing and packing plant into the business of renovating and selling the feathers which previously had been discarded as waste.

By selecting and shipping to a New York millinery jobber a collection of high-grade "downs" from Texas turkeys which he believed would make as good marabou as any grown in Africa, Foster opened up for himself a branch of the feather business which has grown by leaps and bounds.

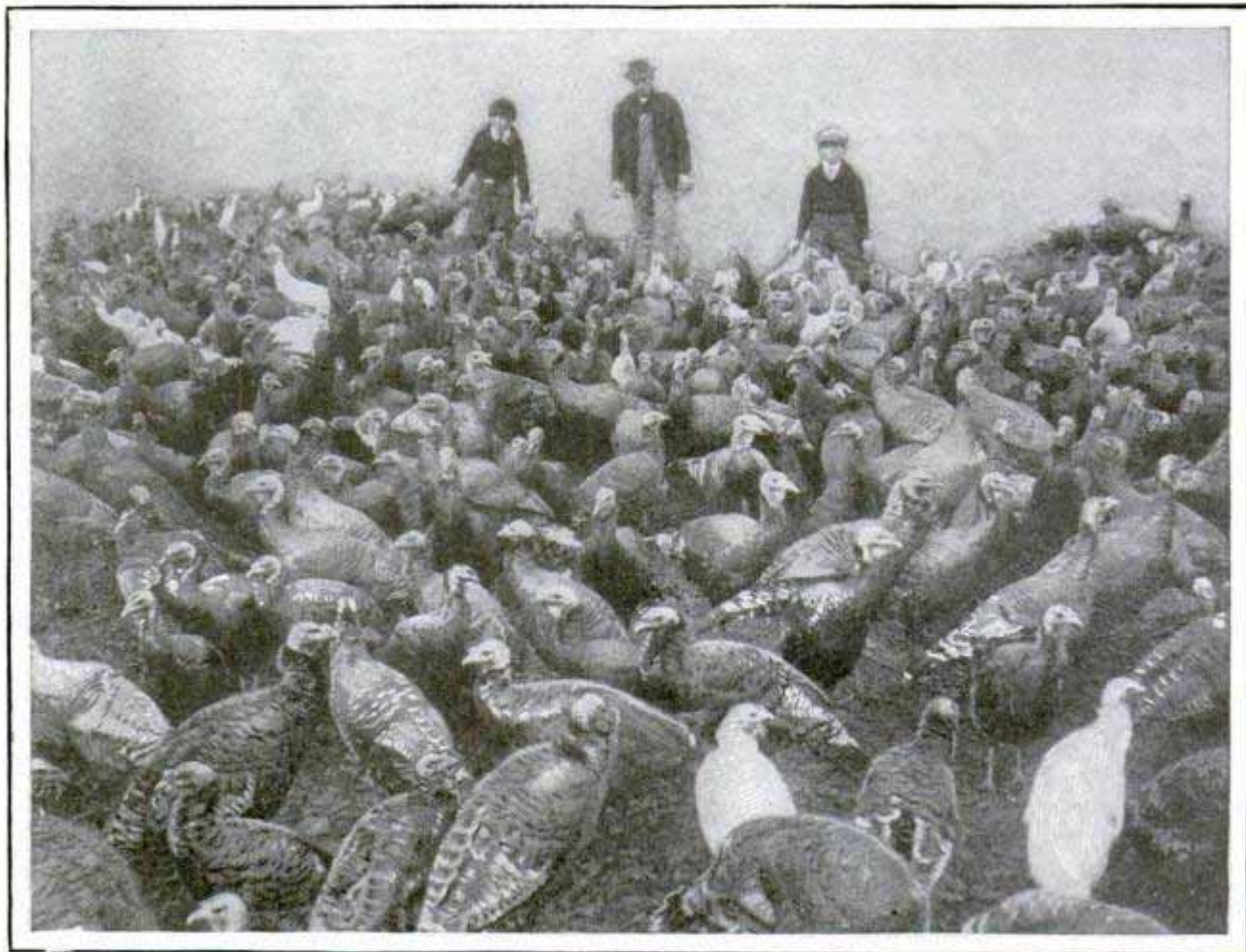

Part of a Flock of Texas Gobblers Which Furnish Meat for the Table and Feathers for the Hat and Other Purposes; the Lone Star State Is a Turkey-Growing Center

Copyright, Underwood & Underwood



2620

Ugo Zaccchini,  
Turin, Italy 775

His first order, as a result of that experimental shipment, was for 1,000 pounds of down, which meant that 33,000 pounds of turkey feathers had to be sorted, since a ton of feathers yields only sixty pounds of down. Today, when the business is good, it is no uncommon sight to see a train of twenty-five cars, all loaded with feathers baled up like cotton, steam away from the tracks of this factory. Not all turkey feathers, of course, but duck, chicken and goose feathers as well, though the turkey feathers are the biggest part.

All these feathers are merely a by-product of birds that are raised for their food value, and killed so that the plumage is unharmed. The entire process of killing and dressing a bird for the market requires just about one minute.

The peak of the feather business is reached when the Thanksgiving and Christmas poultry is dressed for market. Then, when business is dull, the feather magnates sit around and conjure up new methods of stimulating the market. It was on one such dull day that a manufacturer conceived the idea of making a bird of paradise by taking the long wing quills of a black turkey, tearing out certain flues, or barbs, to give it an uneven appearance, softening and bending the quill to give it the grace of the true "paradise," and another made a white aigrette from the tail of a white turkey.



Human "Bullet" Emerging from the Cannon; the Man Was Shot 130 Feet and Landed Unharmed in a Net

**MAN IS SHOT FROM BIG CANNON OVER HUNDRED FEET**

Converting himself into a human projectile, an Italian stunt performer recently was shot from a special motor cannon invented by his brother. He landed 130

feet away in a net, none the worse for his experience. A carefully measured charge of powder was used for the experiment.

**"MOVIES" PRINTED IN BOOK AS AID TO STUDENTS 3061**

The familiar device of successive, slightly different pictures, bound so that the loose edges can be flipped off the thumb, exposing the scenes so rapidly as to create the illusion of moving pictures, has been adapted by an enterprising inventor to give visual instruction to students. Instead of the usual illustrations in a text book, his plan provides for series of movies, the pictures being printed along the edge of the pages. When thumbed, they appear to have life, and the student can stop and inspect any of them.

Ugo Zaccchini,  
Turin, Italy

Es. P. Putnam's Sons  
2 W. 45 th St.  
New York



*Announced by several  
Engineering Management  
Corp., Charlottesville, Va.*

30.24

*Radio Corporation of America  
New York  
Woolworth Bldg.*

Part of the Radio-Picture Apparatus and Samples of the Work, Showing What Large Photographs Are Reproduced; an Important Part of the Process Is Accomplished by Means of Compressed Air on Treated Paper



**RADIO PHOTO BIGGER THAN LIFE ON GIANT RECEIVER**

Radio pictures larger than life-size, adaptable to show window or stage presentation where many persons can see them at one time, have been recorded on a huge receiver devised by Capt. Richard H. Ranger. At a recent banquet, written messages from men in distant lands were received by radio and displayed so that all present could see them. The apparatus promises a substitute for the usual posted newspaper bulletin. Placed in an office window, it could register messages in such large form that copying news dispatches for public display would be unnecessary. The operation of the apparatus is not complicated, an essential unit being a "gun" which forces jets of air upon chemically treated paper according to incoming electric impulses to form little dots that constitute the finished picture. In this outfit, light and dark areas are produced, not by dots of different size, but by variations in spacing. The gun moves smoothly back and forth across the machine, about twelve seconds being required to make a complete trip, and, with each journey, the paper is automatically taken up about one-tenth of an inch. The

transmitting equipment is essentially like that of other radio-picture machines. A beam of light passes through the film and actuates a photoelectric cell to set up electric currents proportionate to the light and dark areas on the original. These currents are amplified at a radio-sending station and made to actuate the gun on the receiving apparatus.

**GIANT LIGHT RIVALS SUN**

*3105* Visible at 200 miles the beam of a giant searchlight can produce the effect of sunburn at two miles and will blister the skin of a person 1,000 feet away. It is of 1,385,000,000 candlepower, much more powerful than any beacon heretofore in use. Engineers estimate that the crater of its arc is the hottest spot on earth, about 38,000 degrees Fahrenheit, and as bright as the sun at noon. One engineer declared that if the Mt.

Wilson observatory were on Mars, it would be possible for a person looking through it there to tell the minute and the hour the huge light was turned on.

**ASH TRAY AND GEAR SHIFT COMBINED IN ONE**

*2920*

The perplexing problem of where to put an ash tray in an automobile has been solved by one manufacturer, who points out that his combination of the ash receiver with the ball atop the gear shift makes one piece of apparatus do the work of two. The combination ball and tray is heavily enameled in bright colors and fitted with a removable nicked ring at the top. This has a projecting tube extending down into the hollow ball, which is so designed that, when the lever is shifted out of the vertical, the ashes are trapped behind the tube.



*Hisher & Rockwell  
7740 S. Chicago Ave*



*Amman Me*

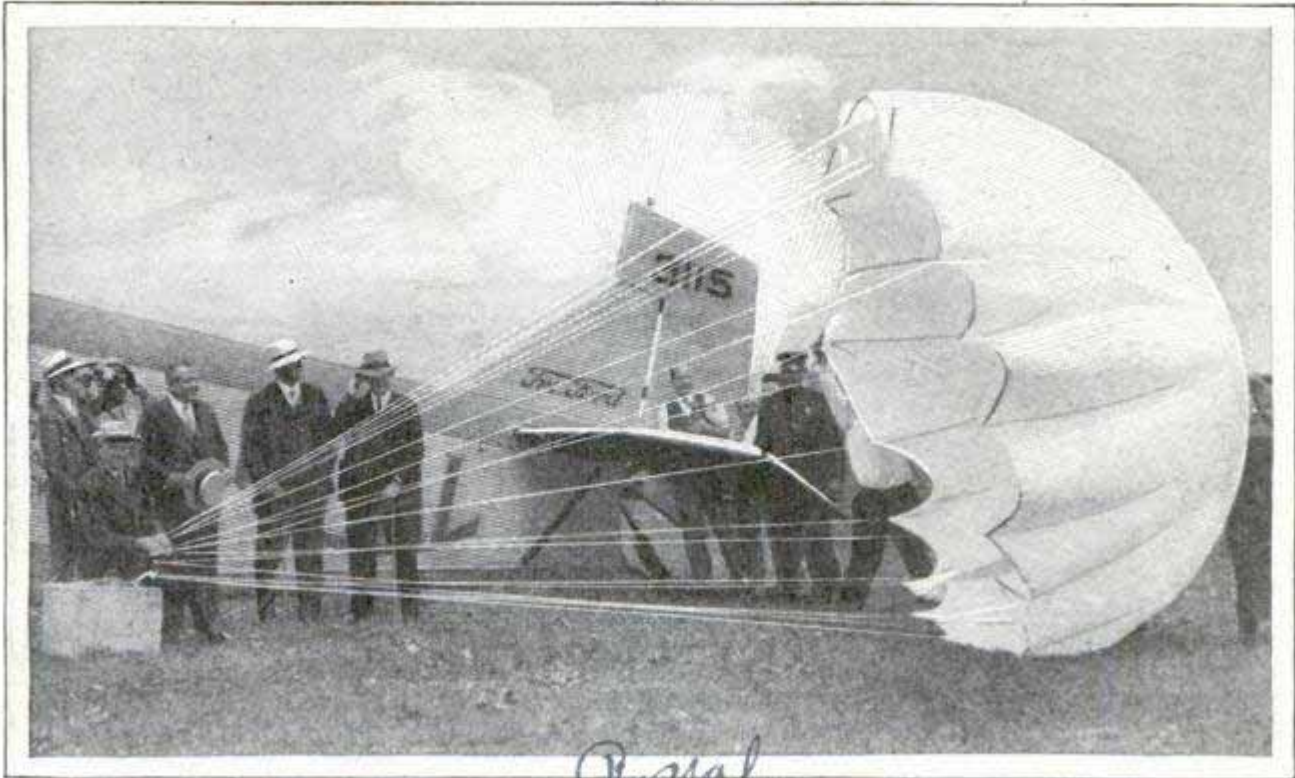

*Royal*

Safely Down from the Airplane; Crated Typewriter Attached to Parachute, with Which It Was Landed from Moving Ship. Showing How Deliveries Can Be Made in Transit

### AIR TRUCK MAKES DELIVERIES BY PARACHUTE

Successful delivery of typewriters from midair was accomplished recently, pointing a way to still further use of the airplane as a factor in commerce. The machines were specially packed to avoid damage by jarring and were received in perfect condition, as the parachute allowed the box to settle gently to the ground. By saving a landing, the plan expedites deliveries and decreases cost.

For this purpose, a well-equipped laboratory with microscopes and other instruments is provided. For demonstration purposes, various types of hives and frames are used and outdoor lectures are part of the course. One of the most interesting units is a special gauge that shows the temperature inside the hives at all times. A feature of the school is the strict cleanliness that is observed in all the laboratories, lecture rooms and places where the honey is extracted.

### SECRETS OF BEE-RAISING TAUGHT AT NOVEL GERMAN SCHOOL

There are more tricks to successful bee culture than the average person realizes, and recognizing this fact and the importance of the business as a source of revenue without the necessity of large investment, German experts have organized a school for bee raisers at Erlangen. All phases of the work are taught in a highly scientific manner. Students are shown a huge model of a bee so that they may become familiar with its honey-gathering organs and other parts. They are also taught to recognize various diseases of the insects and how to treat them.

304

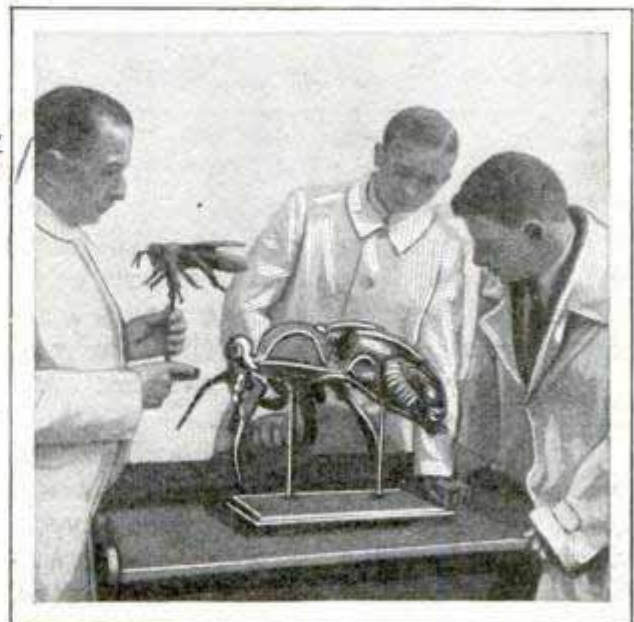

Students of Bee-Raising School Examining Model

*Cont. George F. Paul  
539 Dearborn*



28/8

Capt. S. D. Winters, District  
National Bank Bldg  
Washington, D. C.

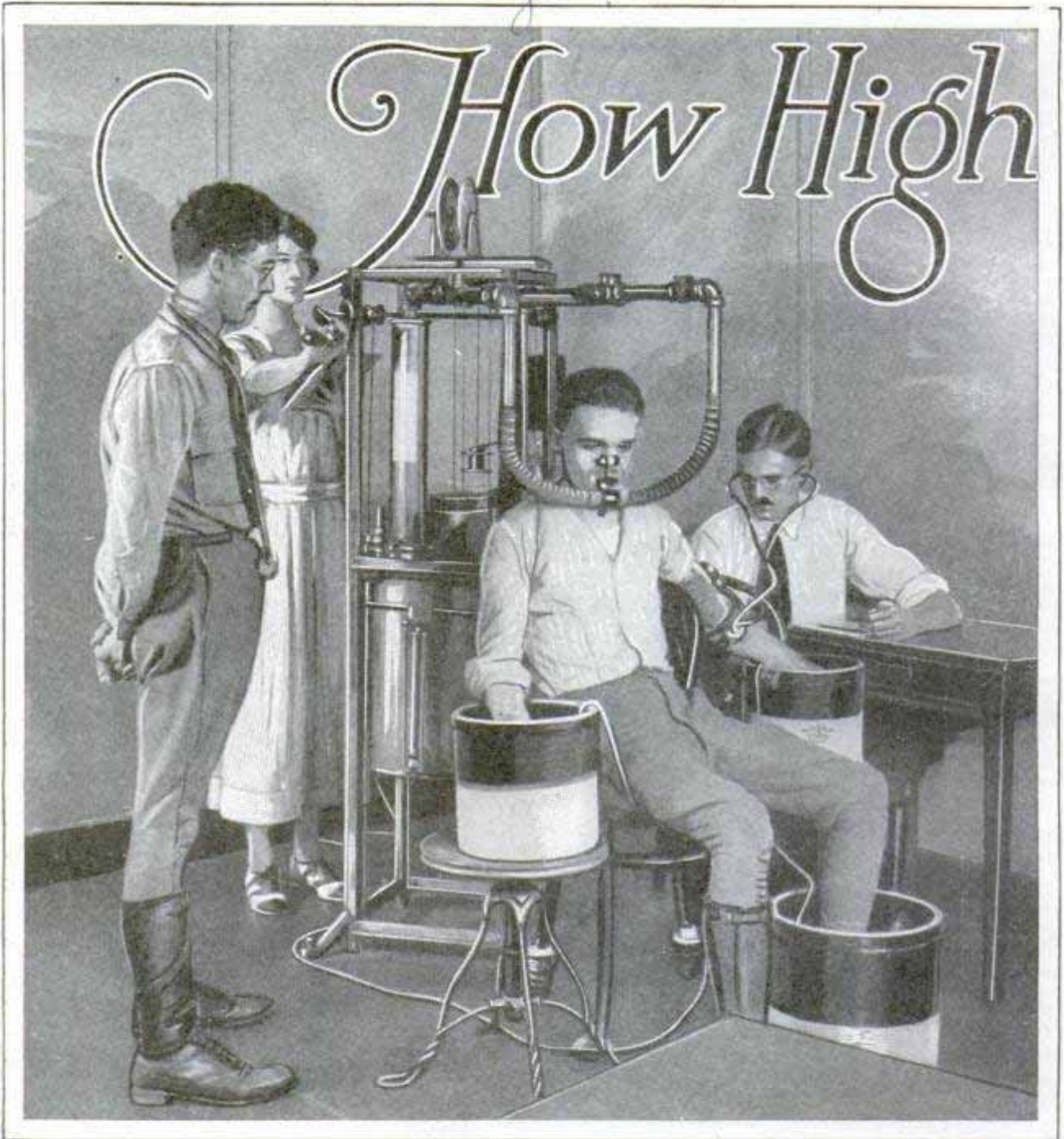

With Hands and Feet in Jars of Saline Solution and a Breather Mask over the Face to Analyze the Breath, an Army Flyer Undergoes the First Step in High Altitude Testing

**T**HE dream of flyers and scientists for many years of some day ascending 50,000 feet above the earth will never be realized, at least with any existing form of equipment, according to the results of tests made by the school of aviation medicine of the war department.

Somewhere in the neighborhood of 45,000 feet, or slightly more than eight and a half miles, is the absolute limit, beyond which the human body, even when reinforced with oxygen-breathing apparatus, cannot go. As Capt. Hawthorne C. Gray, army balloonist, reached 42,470, or 230 feet

more than eight miles, in a recent world's record-breaking balloon flight, the absolute limit has almost been reached.

The army air medicine school found the limit by the simple process of reproducing upper-air conditions in the laboratory at Washington. Subjects were placed in an air-tight tank, equipped with oxygen-breathing apparatus, and the air then pumped out until the pressure had been reduced as low as it becomes in the higher altitudes. Through glass windows the experimenters watched their subjects as they tried to perform designated tasks, and



28/8

A.W.

# Can Man Fly?

when, by their aimless actions, they showed they had gone out of their minds and were on the verge of collapse, the pumps were reversed and air gradually restored to normal pressure.

"The life of man is dependent not on the quantity or percentage of oxygen in the atmosphere but upon its pressure," declares Dr. L. H. Bauer, former commandant of the school of medicine. "Somewhere between 40,000 and 50,000 feet is undoubtedly the absolute limit for man, even when supplied with oxygen, under ordinary circumstances. Somewhere between these limits, the exact point varying according to the temperature of the air, the barometric pressure is reduced to 100 millimeters of mercury,

in other words, the air will support the weight of only that small fraction of an inch of mercury, instead of supporting about thirty-nine inches, as it does at sea level. From this atmospheric pressure must be deducted forty-seven millimeters of water vapor, which accumulates in the inspired air before it reaches the lungs. This leaves fifty-three millimeters possible available oxygen pressure if pure oxygen could be breathed. If a man was breathing absolutely pure oxygen this would be sufficient to sustain life, but under no present available method of taking oxygen, either through a tube or a mask, does the oxygen remain undiluted. It does be-



Testing the Field of Vision for Form and Color with the Perimeter; One of the First Eyesight Examinations for Flyers

come diluted by the nitrogen in the air. Also, under the effects of the diminishing pressure, nitrogen is given off by the blood, as in caisson disease, which attacks workers digging deep foundations. This nitrogen from the blood still further dilutes the air. If the oxygen pressure could be kept up to about fifty-three millimeters, it still would be necessary to maintain the carbon-dioxide pressure."

That is the technical explanation of what the doctors find happening. How it feels to the aviator is something else. Capt. Gray, after his altitude flight, described the limit as the point where one feels as though the surrounding air wall, which is





practically missing, was needed to give the muscles operating the lungs something against which to push. To the man suffering from want of oxygen the feeling is that the lungs lack leverage to do their work and inhale the life-giving gas.

One way of defeating the high altitude would be to inclose the flyer in an air-tight cabinet or cabin in which ground pressure could be maintained, no matter to what level he goes. That may come in time, but to date the only experiment in which it was tried nearly ended in disaster.

An airplane with an air-tight cabin was built at McCook field, the army experimental laboratory at Dayton, for Lieut. John A. MacReady to use in one of his attempts to break the altitude record in a heavier-than-air machine. To insure against leakage of the air, the manhole through which MacReady entered the plane was equipped with a door that screwed on from the inside, so that the pressure within the ship would hold it tight and seal the joint. The lesser the pressure outside, it was reasoned, the more

pressure against the door and hence the better the joint.

The theory proved out almost too well, for, while flying at an immense height, MacReady's oxygen apparatus went bad. He began to descend, and, as the air within his cabin grew more and more stale, he struggled to remove the door and admit fresh air from outside. But the pressure against the manhole cover was so great that even after the bolts were removed it stuck in its place and all his efforts could not dislodge it. MacReady was almost unconscious before he reached a low enough

level to balance the inside and outside pressures and free the door.

A somewhat similar air-tight balloon basket was built at McCook field and sent to Capt. Gray for trial, but the balloonist refused to risk it. He pointed out that, when ascending or descending slowly, an aeronaut's body could adjust itself to enormous changes in air pressure, but that a flyer imprisoned in an air-tight cabinet

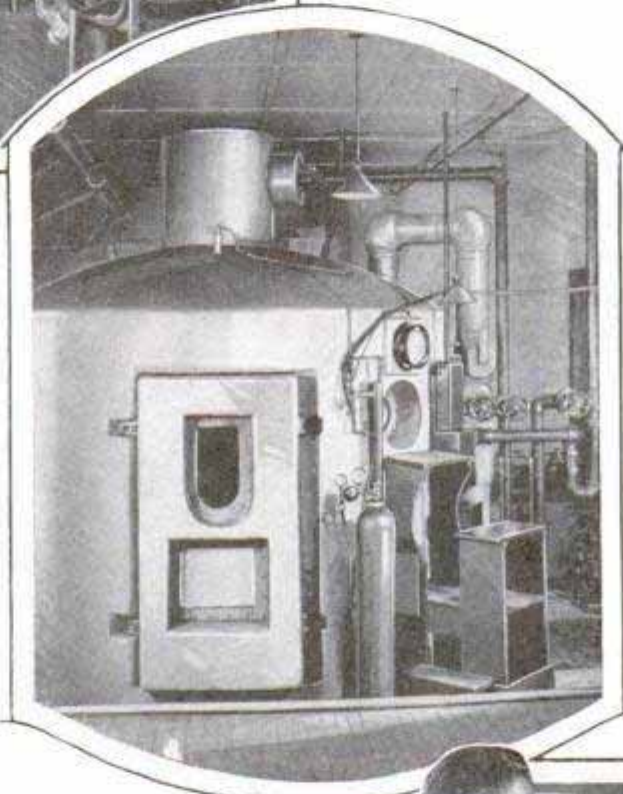

Two Other Visual Tests for Flyer Candidates, Depth-Perception and Eye-Convergence Measurements; Center, the Low-Pressure Chamber



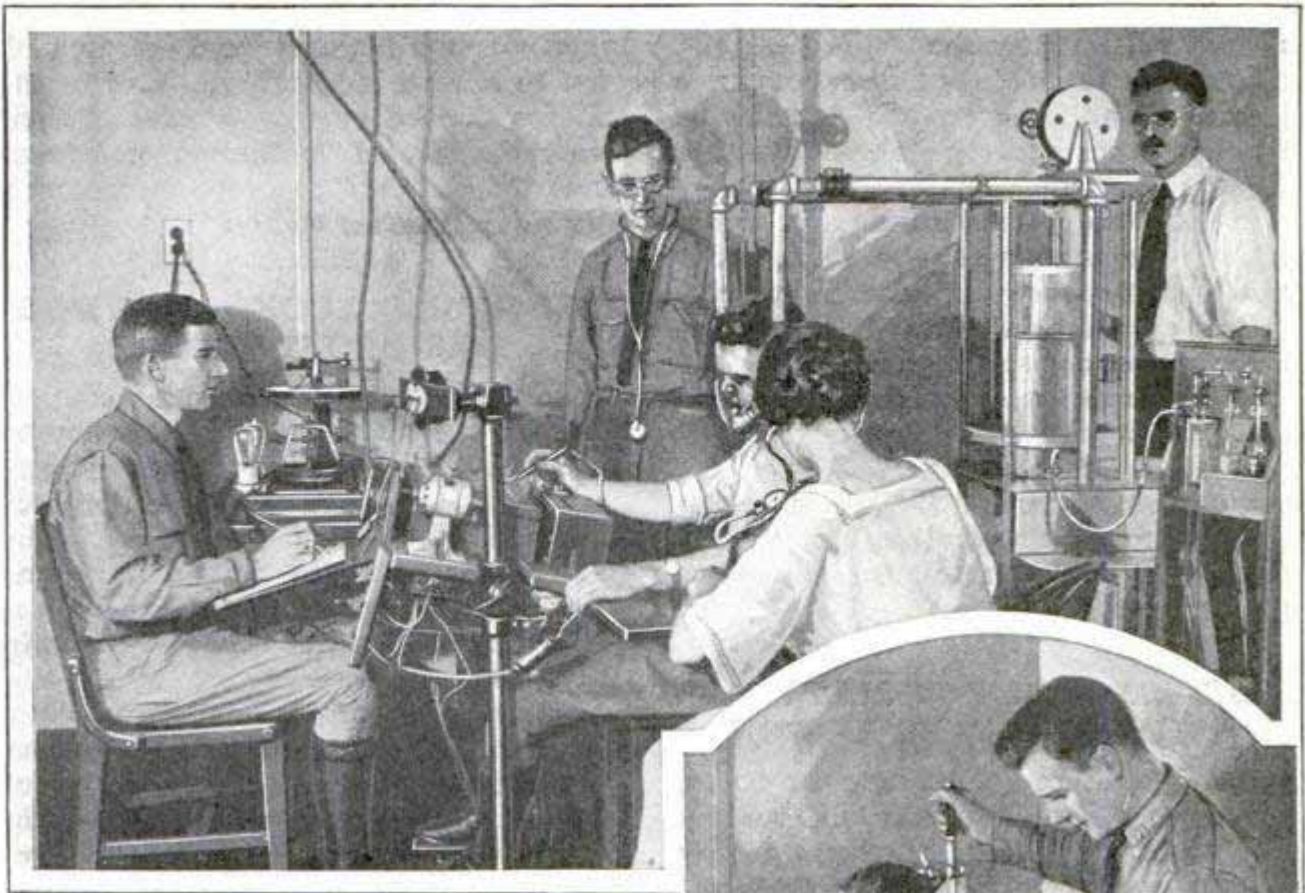

Rebreather Apparatus Which Measures the Chemical Change of the Breath, and a Rotation Test

would be lost if anything should go wrong at an immense height and make it necessary for him to take to his parachute. Under such circumstances it would be fatal to open the door and try to escape, for the sudden transition from ground pressure to a semi-vacuum would be more than blood vessels could stand and they would probably burst.

Another method suggested is to equip the flyer with a suit somewhat like that worn by divers, but so constructed that the high pressure inside would not expand and tear it. With a pneumatic suit it might be possible for the wearer to move freely and even leave his ship by parachute, if necessary, provided the chute was built big enough to carry the added weight. Such a suit, or even an air-tight cabinet, would have to be provided with some means of absorbing the excess carbon dioxide, for, while a small amount is necessary, too much is dangerous.

The tests in the army pressure chambers in Washington and at flying fields in various parts of the country have shown that the effects of altitude on a flyer usually steal on him unaware. The most



striking effect is on the nervous system and takes the form first of stimulation and a feeling of well-being. This is followed immediately by a decrease in the field of attention, in which the aviator is easily distracted from his work, loses control of voluntary muscles and finds it increasingly



hard to concentrate on his tasks. His muscles fail to obey the brain messages, and he may reach in one direction for a control, as he believes, and actually be reaching in an entirely different quarter. Yet he is not conscious of doing a thing wrong. As the tests continue and higher altitudes are simulated, the flyers suffer from loss of memory, judgment and hearing and even their vision is impaired just before unconsciousness comes.

The experiments show that the oxygen apparatus should be turned on when a flyer gets not higher than 20,000 feet, and that between 23,000 and 25,000 is the absolute limit to which even the best of men can go and retain consciousness without using oxygen.

*Street*

### CHILDREN BUILD TROLLEY CAR AS KINDERGARTEN LESSON

*2728* After a visit to the electric-car barns, children of a San Francisco kindergarten constructed a realistic replica of a trolley car to show how many details they had absorbed on their sight-seeing tour. Bell

cord, controller and fare boxes, straps and other common features were represented, even to advertising posters. Two of the children donned blue paper caps of their own make, labeled "motorman" and "conductor," for a "trip" to a reproduction of a park nook the class had made.

### HOW WORLD LOOKS TO A DOG; 3032 EYES OF LITTLE USE

The world looks entirely different to a dog than it does to a man, according to Dr. Donald A. Laird, of Colgate university. Tests have proved that a dog sees black and white, but is color-blind. The American flag is seen by the animal as white and gray stripes, for it has been disclosed that his eyes are very deficient in discriminating patterns. A small flag looks to him like a solid, light gray. While a dog can see no more details than a man can through a telescope that is badly out of focus, his eyes are especially keen in sensing motion. Chickens and monkeys have much better pictures of the world, being able to see patterns more clearly,



Toy Street Car Constructed by San Francisco Kindergarten Children after a Visit to the Trolley Barns; the Class Took an Imaginary Journey to a Model Park They Had Made in the Room



Com. *George A. ...*  
 Sci. U. Colgate University  
 Hamilton, N.Y.

POPULAR MECHANICS

See data file 783 2626

and also to see many colors. Almost all animals are unable to see colors, except monkeys, birds, and possibly some fishes. The dog shares his handicap of color-blindness with the bull, for instance. Many people believe that the bull is angered by the sight of red, when, as a matter of fact, the bull cannot tell red from gray. While the dog is blind to all colors, most birds can see all colors except blue and violet, and although fish have color vision, many of them are apparently afraid of red. In a heavy twilight, men are totally color-blind, and also unable to distinguish patterns. It is then that we probably see the world the most like it looks to a dog. As a compensation, the sense of smell is keener in many animals than in man, and especially in dogs.

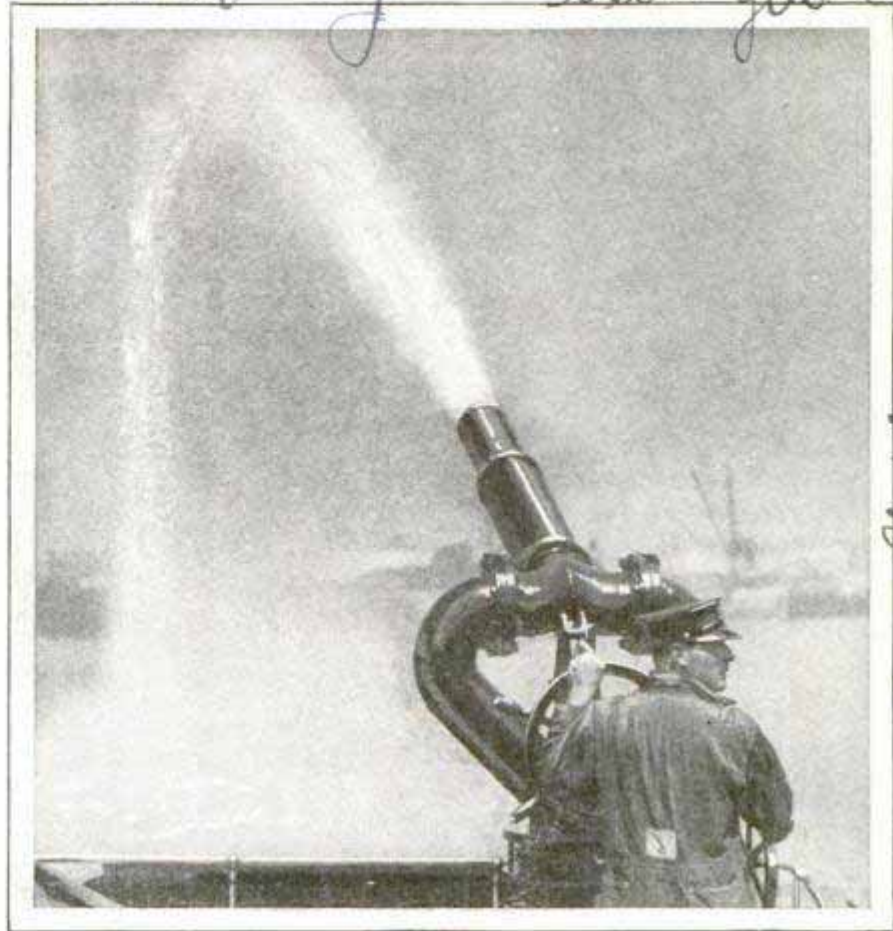

At One End of the Big Nozzle That Throws 3,000 Gallons of Water a Minute; View on Los Angeles Fireboat

**FIREBOAT WATER GUN THROWS FIFTY GALLONS A SECOND**

Los Angeles claims one of the most efficient fireboats in the world in a ninety-nine-foot vessel propelled with gasoline motors. It is equipped with twenty-nine nozzles that have a combined capacity of 12,000 gallons of water a minute, one of them throwing 3,000 gallons in that time.

**CARBON ESSENTIAL TO LIFE**

While carbon makes up less than one per cent of matter, it is the characteristic element of living material and is increasingly important in industry, being the basic element of all combustibles. A boy who weighs seventy pounds has in him about forty-four pounds of oxygen, twelve of carbon and six of hydrogen. Carbon forms part of all foodstuffs, and has the remarkable characteristic of uniting with almost all the solids and gases. It is derived from the air, from carbonic acid, and, absorbed by plants, goes to the building up of living matter and of foodstuffs.

**SAFETY GLASSES FOR SPORTS GUARD WEARERS' EYES**

Persons who must wear glasses are guarded from injuries to the eyes while engaged in sports by a double-rimmed spectacle frame. The lens is in the rim nearer the eyes, the outer one shielding it from breakage. The frame is made of a strong nickel alloy and a metal strap above the nose affords additional security.



Write our Bureau of Information if you wish to know who makes or sells any article described in this magazine. Send no postage; the service is free.

Bausch & Lomb  
 Rochester, N.Y.

plex pumps, main

Chicago. 5 N Wabash Ave

Los Angeles Shipbuilding Co  
 San Pedro Calif.

Attn L.E. Cavalry

Kansas City Star  
 7/30/29



784  
30 40  
PLANE REPLACES DOGSLEDS FOR ROYAL MOUNTED



© P. & A.

"Queen of the Yukon," Sistership of the "Spirit of St. Louis," Lindbergh's Famous Plane, Now on Regular Schedule for Royal Canadian Mounted Police Duty between White Horse and Dawson

*Byan*

The Royal Canadian Mounted Police, famous peace preservers and man hunters of the Arctic regions of the New World, have taken to the air. Their new monoplane, "Queen of the Yukon," sistership to that in which Charles Lindbergh flew the Atlantic, is now on regular schedule between White Horse and Dawson, piloted by a veteran of the air force. The plane takes the place of twelve dog teams and sledges, which have been carrying mail, express and passengers. These dogsleds have been the only means of communication over the 360 miles between the two points, requiring thirteen to fourteen days to make the trip, while the plane makes it in four and one-half to five hours. Regular schedule will be maintained by the new "Queen of the Yukon" and mail and a limited quantity of express will be carried on each trip. It will be at the command of the police at any

time, to pursue outlaws, either along its regular route or over any part of the British domain in the Pacific northwest.

310 TEST CHAMBER SHOWS IF MEN CAN STAND TROPIC LIFE

To determine if candidates for positions in its colonial possessions can withstand tropical climate, two scientists have constructed for the French government a testing chamber in which subjects are placed and, for two days or more, are exposed to conditions closely duplicating those of the torrid regions. The room is lined with cork to maintain an even temperature, the chamber itself is of metal incased in wood, two inches thick, and there is a double door of glass. A bed, a chair and a bicycle are the chief articles of furniture. The subject rides on the latter at times, this form of exercise having

*Paris, France*

*Com. Francis Schick  
90 Canadian Commissioner  
117 Boulevard des Capucines*



been demonstrated as establishing a basis for the measurement of muscular energy. Reactions of the body are measured, and evaporations in the room are drawn off and tested. Food is conveyed through a special aperture in the walls, so arranged that the air within is not disturbed. While the chamber has been constructed especially for testing prospective colonial workers, it is adapted to similar examinations for men in various other industries.

**GIRL TRAINS BIRDS FOR MOVIES** 2994

"Teach them while they are young," is the motto of Caroline Conger, twelve years old, who raises and trains birds to perform in the movies. At her "school" near Hollywood, she has ladders and other apparatus for the birds to learn to climb, and begins instruction almost as soon as her pets can leave the nest.



*Pittsburgh Calif.*  
 Caroline Conger and a Few of Her Young Bird Pets Which She Trains for Movies; Teaching Starts Before They Can Fly

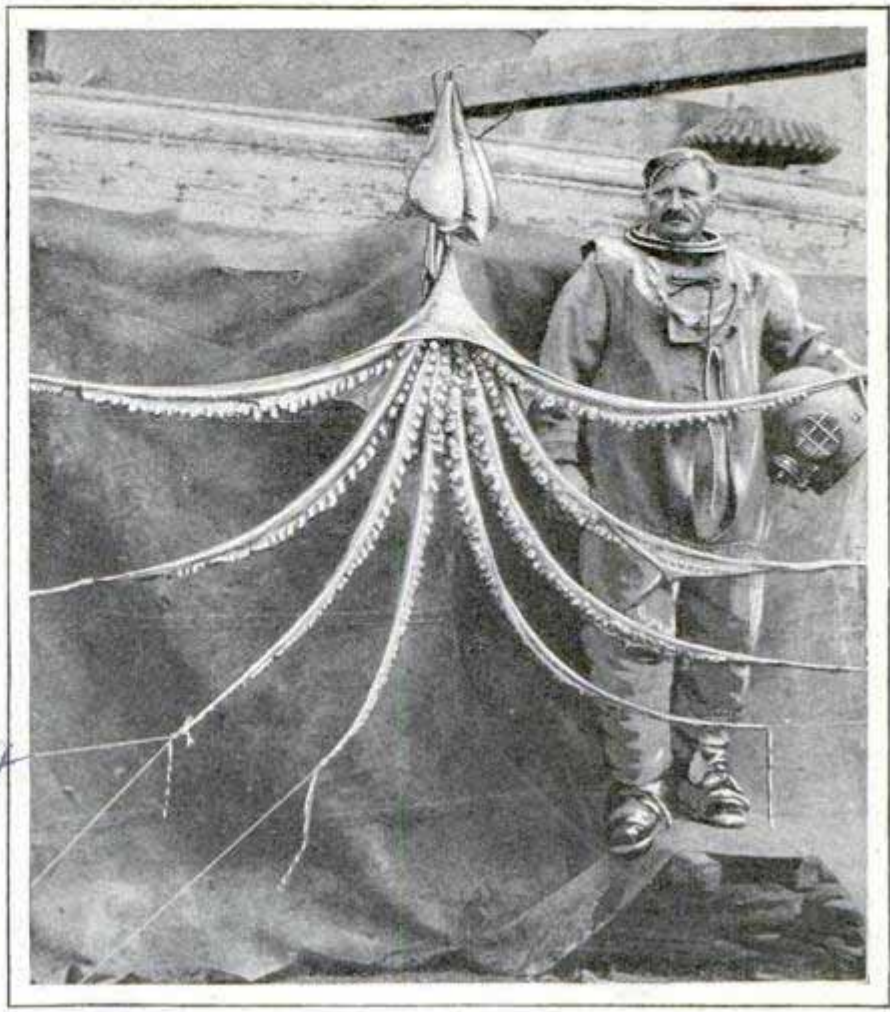

Capt. Eliassen and Huge Octopus He Killed after an Encounter While at Work in Sunken Vessel; He Escaped from Six Others

**DIVER SLAYS HUGE OCTOPUS IN SUBMARINE BATTLE**

Incidents in fiction were duplicated in reality recently, when Capt. Ole Eliassen, of Newport Beach, Calif., killed a large octopus he encountered while at work in the submerged hulk of an old vessel. He was armed only with a knife, but managed to slash the tentacles that encircled him and behead the octopus. He escaped from a larger one and five small ones.

**PLAN LONG STAY IN THE ARCTIC TO AID NAVIGATION** 3111

To establish observation posts along the south shore of the Hudson strait and make aerial surveys for weather data, an expedition has sailed from Halifax for a proposed stay of fifteen months in the Arctic. Information gathered will be used in planning for maritime commerce in the strait following the completion of the Hudson bay railway.

*Weekly Mail 7/30/27*



# Diamond Drills Reveal



Tremendous Pressure of Oil and Gas Gushers Is One of the Problems of the Earth's Interior

By J. EARLE MILLER

**P**EOPLE who are inclined to declare that now, with the poles conquered, the Atlantic and half the Pacific bridged by air, all but the world's highest mountain scaled, and infinite space bridged by giant telescopes, man has no worlds left to conquer, are overlooking one great, and almost untapped, field of exploration.

For we don't know yet what the inside of our own earth is like!

The failure to probe the interior of the earth, whose center is only a matter of 4,000 miles or so away, is the more strange when compared with the achievements of astronomy in solving the composition, temperature and living conditions, or rather lack of them, on stars billions of miles away.

While the air, the most unstable of all the elements, has been conquered and man has been up more than eight miles above the earth, the farthest he has been into it is only a mile or so, in a few exceptionally deep mines. And the farthest his proving tools have penetrated is less than 10,000 feet, or considerably under two miles, in the world's deepest oil well, now being drilled in California.

As long ago as 1904, and again in 1919, Sir Charles Parsons, inventor of the steam turbine which bears his name, proposed that a great hole be bored ten or twelve miles into the earth, not only to find what the underlying rock and mineral strata were like, but to tap and utilize the internal heat of the world as a new source of power. While inventors have been trying for ages to tap two of the world's three great undeveloped sources of energy—the rise and fall of the tides due to the attraction of the moon and the heat received from the sun—it is only in recent years that steps have been taken to put the internal heat of the earth to work. In California and in Italy steam emerging from underground jets, where water is being heated and vaporized, has been harnessed to boilers and heating plants. Similar experiments are being carried on in other parts of the world blessed with natural steam jets, but it is unfortunately the fact that these limited cases of physical phenomena are few and far between and usually far from the scene where power is needed.

Sir Charles Parsons' suggestion, however, is applicable at any place in the world where power is needed. E. W. Rice, Jr., honorary chairman of the board



# Earth's Secrets



The Marvels of Such Vast Underground Caverns as the Mammoth Cave in Kentucky Have Been But Partly Explored, Giving Some Light on the Secrets Hidden within the Earth

of the General Electric company, speaking before the World Power conference in London, in 1924, urged that the leading nations of the world combine to finance the sinking of an experimental shaft.

"I heartily agree with Sir Charles," he said, "in his statement that the cost of such an experiment is trivial compared with the value of the possible information which may be gained by the investigation into this unexplored region of the earth. The cost would be much less than the cost of a single battleship. If only the people and their representatives had the faith and the vision of science, the value of such an idea would have been put to practical use long ago. It is a big idea, worthy of a nation's enthusiastic support; in fact, it is worth undertaking as an international scientific enterprise, a suitable subject for co-operative work between friendly nations."

Aside from the possible unlimited power which might be developed, the tube idea

holds forth other fascinating possibilities. It might uncover new and hitherto unknown minerals; it might shed new light on the problem of earthquakes; it might clear up some of the remaining mysteries of volcanic action; it might reveal hitherto unsuspected deep-lying deposits of oil; it might help solve the mystery of how oil is made within the earth; it might fix the thickness of the earth's outer and solid shell and show how it shifts and moves over the more fluid layer beneath, causing the gradual rise and fall of islands and mountain ranges, and their movement.

The ancient idea that the earth's center was a molten, flaming mass, has been discarded long ago, and scientists are fairly well agreed that it is a solid, in fact more solid than the outer shell, for during the ages, as the surface has heaved and twisted in the spasms of getting settled, the heavier material, iron and other minerals in the main, has settled to the center, and forced the lighter rocks to the surface.



2803

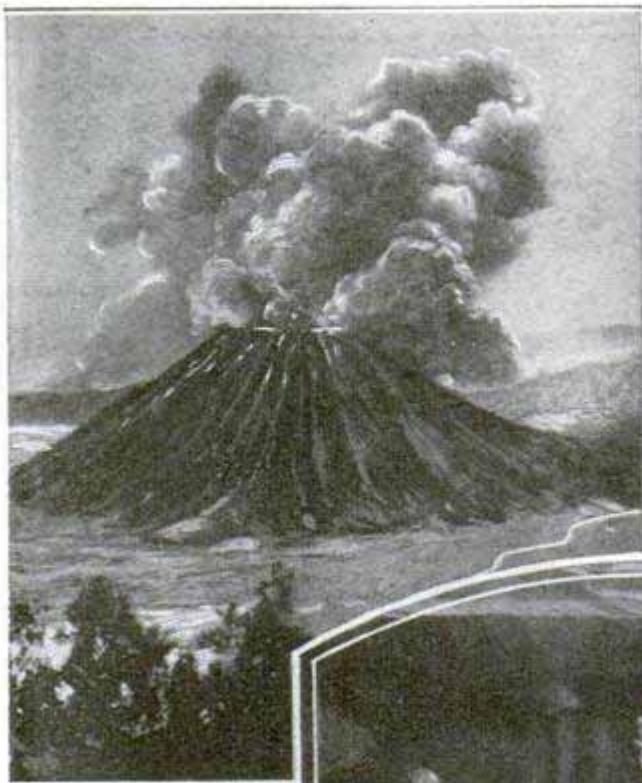

In the process of settling, the lightest of the material has been raised the highest, as was proved when it was discovered that mountain masses had a lower specific gravity than the rock of the plains. Iron, nickel and similar materials are the principal ingredients of the meteors that are occasionally found on the surface of the earth after falling from the skies, and these heavy metals are prominent, in molten or gaseous form, in the stars, so it is safe to assume, scientists believe, that they may compose a fairly large portion of the earth's interior, and in a much purer form than they are found on the surface. Because of their greater weight, the metals, when found in surface deposits, are scattered through a mixture of lighter material, from which they must be separated.

The mystery of mineral oil, from which comes our gasoline, is still unsolved, though the product has been known for centuries. The school that believes oil to be an inorganic compound, the result of chemical changes taking place within the earth, is overbalanced by the more

general belief that it is an organic product, probably due to the decomposition of such organic material as fishes, seaweeds and even the trees and vegetation of past ages, wiped out and buried deep by the advancing debris of the several long-past glacial epochs.

The idea that our motor cars and airplanes are being propelled by the fish which sported in the waters that covered the United States millions of years ago, long before the day of the mammoth and the saber-tooth tiger and the great cave bear, is not as odd as it may seem, for another of our most useful commodities

comes from that same era and from a relative of the fishes. That is our building limestone. Place a piece of it under a microscope and it is revealed as the preserved shells of myriads of tiny shellfish.

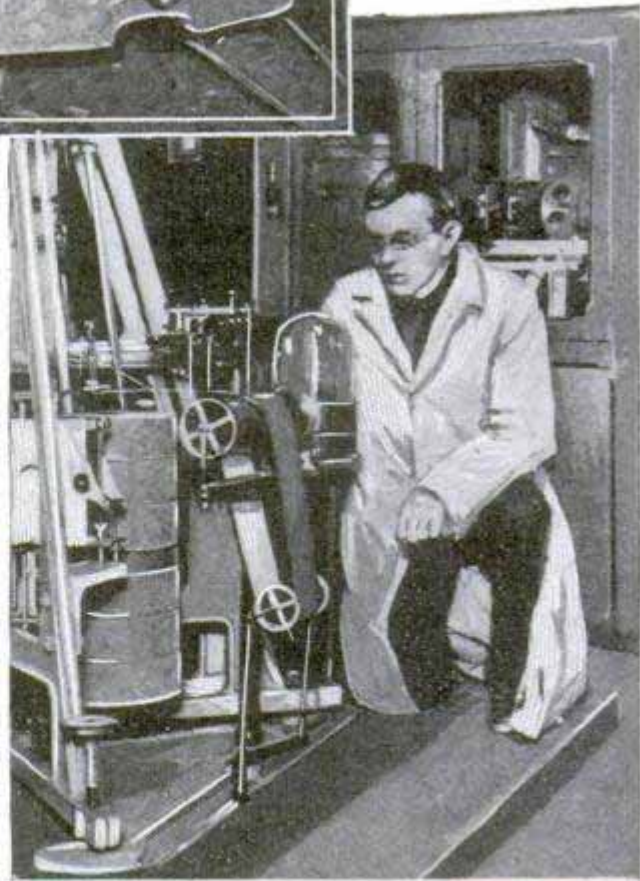
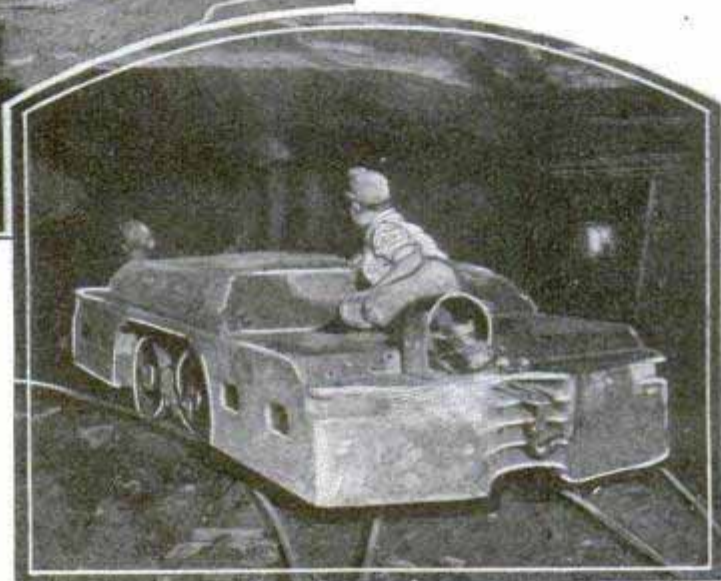

A Javanese Volcano, a Coal-Mine Work Train, and Father Tondorf in His Earthquake Laboratory at Georgetown University



SCIENCE EXPLAINS JAPAN'S RECENT EARTHQUAKES

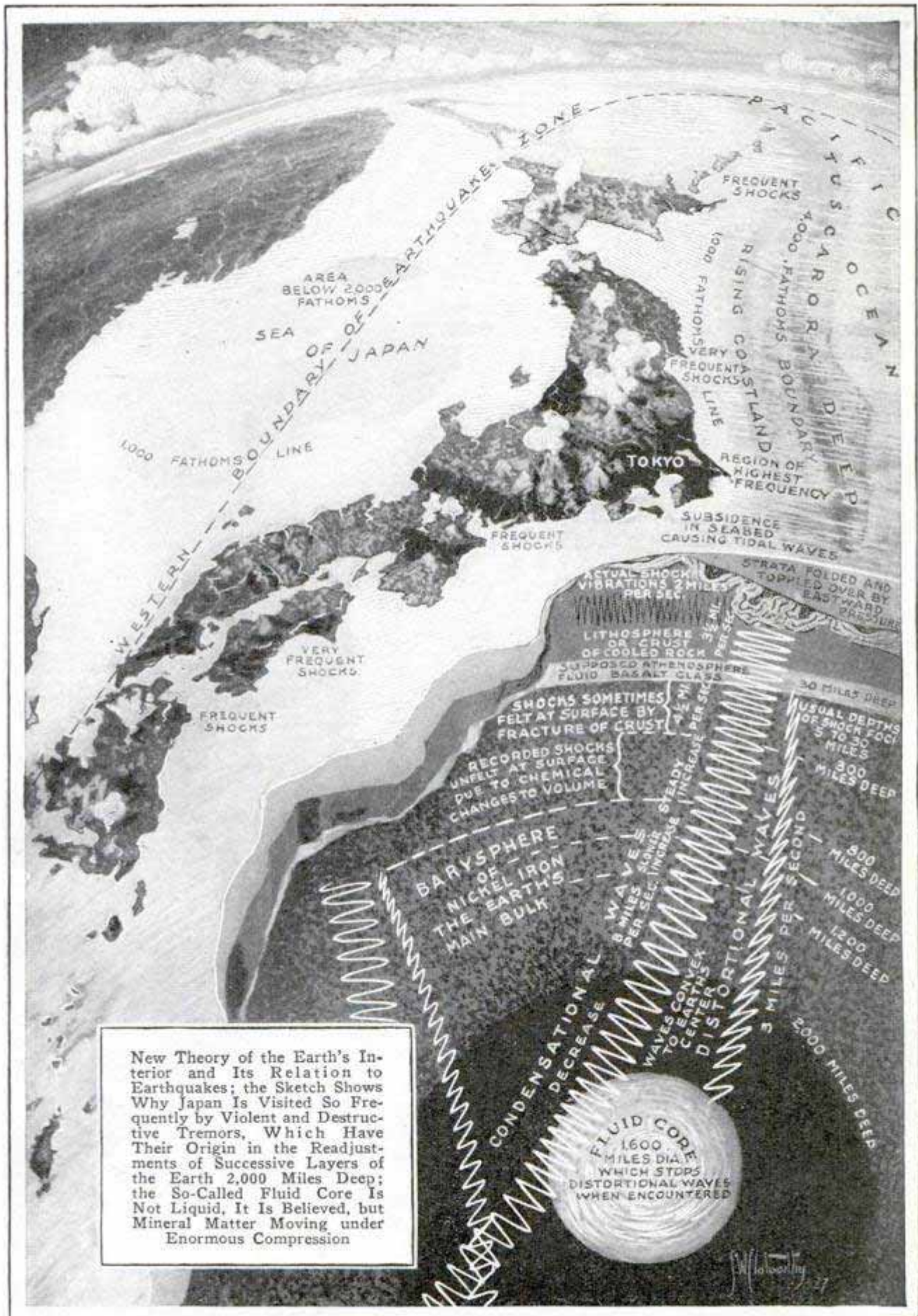

New Theory of the Earth's Interior and Its Relation to Earthquakes; the Sketch Shows Why Japan Is Visited So Frequently by Violent and Destructive Tremors, Which Have Their Origin in the Readjustments of Successive Layers of the Earth 2,000 Miles Deep; the So-Called Fluid Core Is Not Liquid, It Is Believed, but Mineral Matter Moving under Enormous Compression



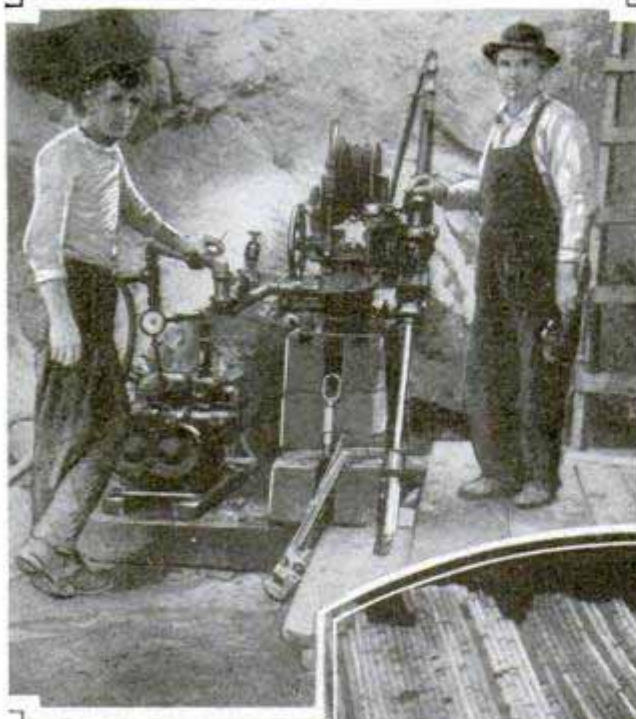

Our coal deposits, too, date from ages ago when the central United States was a great tropical jungle. The jungle disappeared under the last of the glacial waves, and the trees and ferns slowly turned to carbon, just as peat beds much nearer the surface are doing today. To sink an experimental shaft into the earth to a depth of ten or twelve miles is not so difficult of accomplishment as might be imagined. It would not be necessary to make a mine shaft of it, or to send men down into the earth to get a first-hand picture of what that interior is like. The diamond drill has solved all that, and made it a simple matter to remain on the surface and get an accurate sample of every inch of depth to which the drill is sunk. The diamond drill is a hollow rod, fitted at its end with a ring of tiny diamond fragments—the hardest substance known to man. As it is sunk into the earth, the

drill is rotated by an engine on the surface, cutting out a cylindrical core, which is then hoisted for examination.

Prof. Rudolph Leschot, a French civil engineer, invented the drill as a result of his observations of the hardness of diamonds. As generally used to explore for new oil and mineral fields, it consists of hollow rods or tubes, screwed together in five or ten-foot sections, lowered, as the cutting progresses, by mechanical or hydraulic pressure. At intervals, ranging from five to thirty feet of drilling, the string of tubes is hoisted out of the hole and the core removed and examined. All

the cores, from the surface down, are assembled in rows, so that the entire collection gives a true picture of every stratum from the surface to the bottom of the drill hole. For ordinary prospecting work in hard mineral formations, cores of an

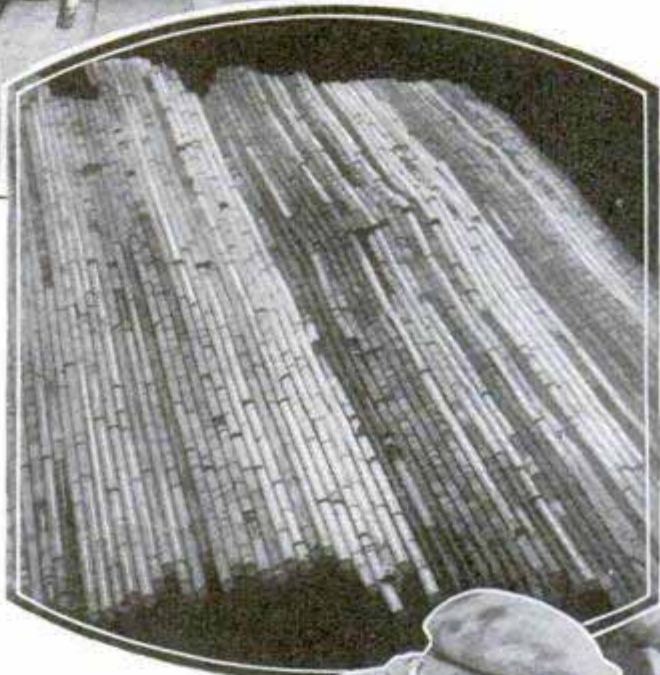

Diamond Drillers at Work, Top; Center, Drill Cores Laid Out in Order to Show Nature of Strata in a Field, and, Bottom, the Drilling Bit of the World's Deepest Oil Well



2802

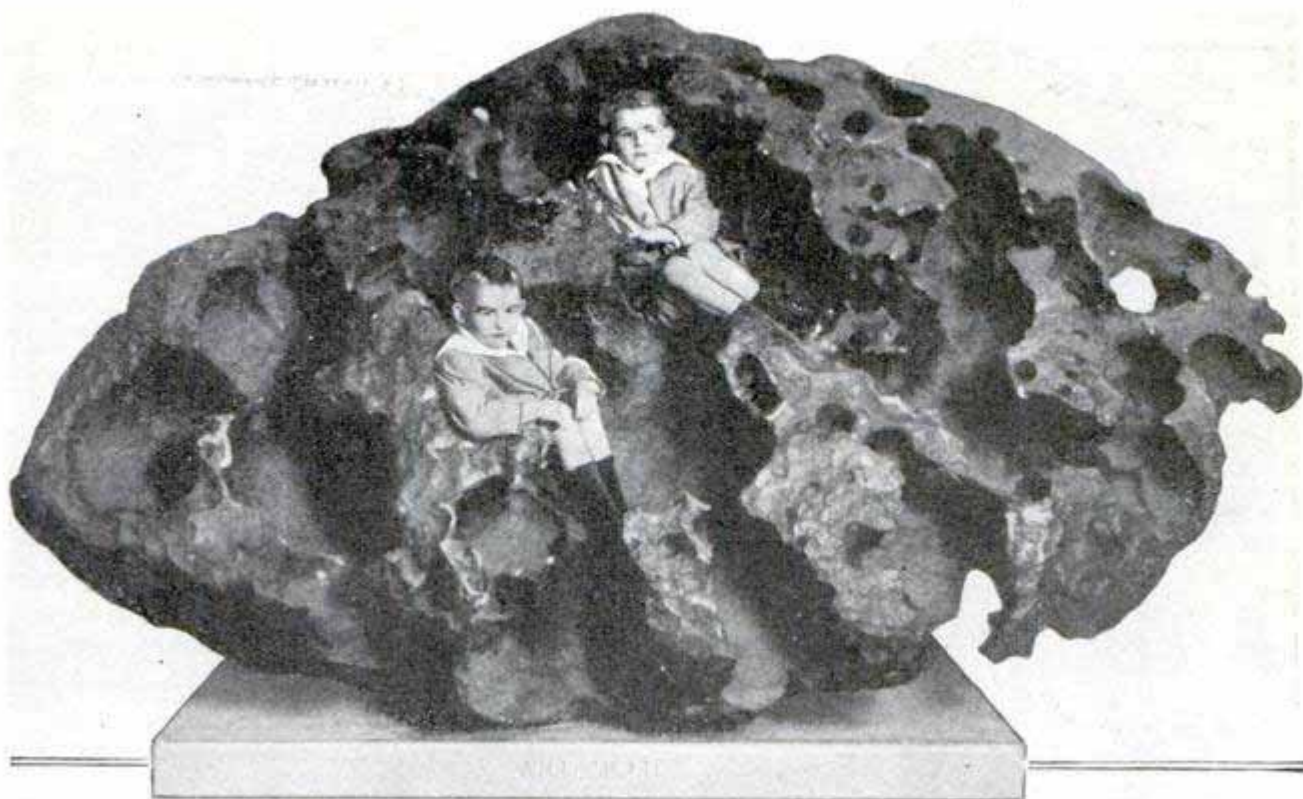

The Willamette Meteorite, Found in Oregon, Weighs 31,107 Pounds and Is Ninety-One Per Cent Iron, Eight Per Cent Nickel, and One Per Cent Mixed Cobalt, Sulphur and Phosphorus

inch or an inch and a half are usually extracted, while in softer material, such as coal, salt or similar substances, it is customary to use a two-inch outfit. Drills of much larger size can be made, however, so a six or eight-inch shaft might be sunk. The small sizes are used merely because supplies are not needed, and would not justify the additional cost of diamonds for a bigger bit. From two to fifty diamonds are commonly used in a bit, depending on the hardness of the material to be encountered.

The only problem to be solved in building a drilling outfit for a ten or twelve-mile tube is the handling and turning of the enormous weight of drill shaft and drill. It might, however, be possible to solve it by building a drill and core tube of fairly short length, driven by an attached electric motor, the whole supported by a single cable.

Modern drills do not use white-diamond chips, but in-

stead employ the black diamonds, or "carbonados," which are found in the state of Bahia, Brazil.

Exploring the interior of the earth may not be so spectacular as jumping across the oceans by plane or flying over the poles, but if the Parsons shaft is ever sunk, it may have a more far-reaching effect on daily life than any single exploit in history.

2962

**SPARE TIRE FOR ARMY PLANE  
AIDS SAFER FLYING**

Some of the new army planes at a western flying field have been equipped with a spare tire for the landing gear. It is carried underneath

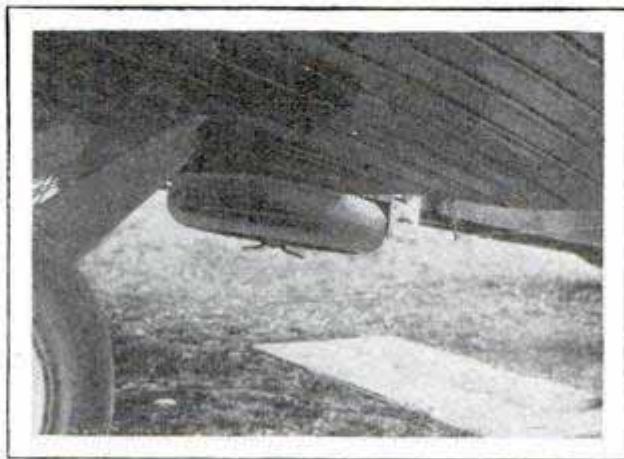

Ready for an Emergency: Airplane Equipped with Spare Tire for Its Landing Gear

the control pit, where it is ready for service in case of an emergency. Forced landings on rough ground frequently result in damage to the tires, and the spare simplifies the task of fitting the plane for another take-off if the tires should be punctured.

*Conk Carleton Crook Theatre  
Go Empire  
The Shakes Ar*



*6/9/27*

*Roosevelt Memorial, near Torrance*

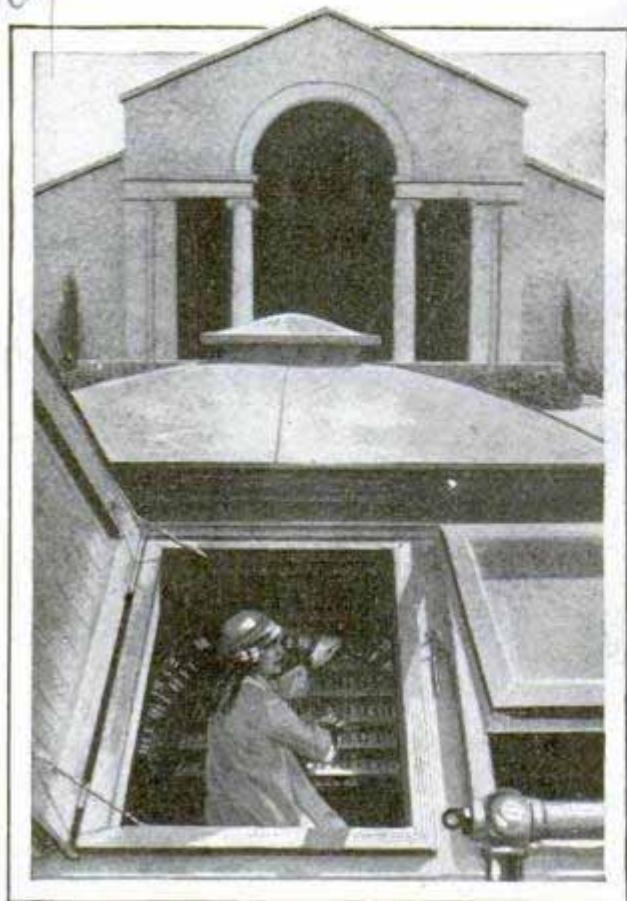

Outdoor-Organ Console Placed Some Distance from the Pipes, to Prevent Injurious Effects of Vibrations

### PIPE ORGAN PLACED OUTDOORS FOR CONCERTS IN PARK

Visitors at a park near Los Angeles may enjoy pipe-organ music in the open, a huge instrument having been erected near the center of the grounds. Because of the strong vibrations, from the bass pipes particularly, it was necessary to place the console more than 100 feet away and shield it in glass to protect the keys from the jar and also to shelter the organist.

### FIND LIPSTICKS CENTURIES OLD IN AUSTRIAN RUINS

That the lipstick is not a modern innovation is shown by interesting finds in lower Austria, where relics of the pre-stone age have been unearthed. Among the ruins were sticks of graphite, probably used as eyebrow pencils, lumps of ocher and receptacles containing rouge powder. This collection of cosmetics is possibly 25,000 years old and was found with the carved figure of a woman made from a mammoth's tusk, and bones of an ice fox, probably placed to propitiate the

gods of the Chase, for it is known that man of this era always buried the bones and hides of various animals he desired to kill as an offering to the gods. The graphite stick had smooth, worn surfaces where it was applied to the face with reindeer fat, to make it adhere to the skin.

### NEW ANAESTHETIC IS INJECTED TO AVOID LUNG TROUBLES

Berlin physicians are reported to have developed an anaesthetic especially suited to patients who have lung disorders that make it unwise or impossible to administer narcotics by inhaling. The new substance is a liquid which is injected into the system and is effective when total or local anaesthesia is desired. Alcohol and bromine are mixed in the preparation.

### CLEAR VIEW IN ANY WEATHER GIVEN BY ANTI-FROSTER

An effective means to prevent the accumulation of frost or moisture on the automobile windshield has been found in a circular sheet of transparent material held to the glass by vacuum cups. To overcome frost or steaming it is attached on the inside, but to the outside when driving in a snowstorm. An additional feature is an amber-colored glare preventer which can be adjusted to meet requirements. The preventer may be cleaned by washing it in lukewarm water and rinsing in cold.



Circular Disk in Place on Windshield, Showing How It Clears a Wider Space for the Driver's Vision

*Willindor*

*Dr. Bayer, director of*

*Hulett Co. Minn*



REPTILES SERVE THE ULTRA WHIMS OF FASHION

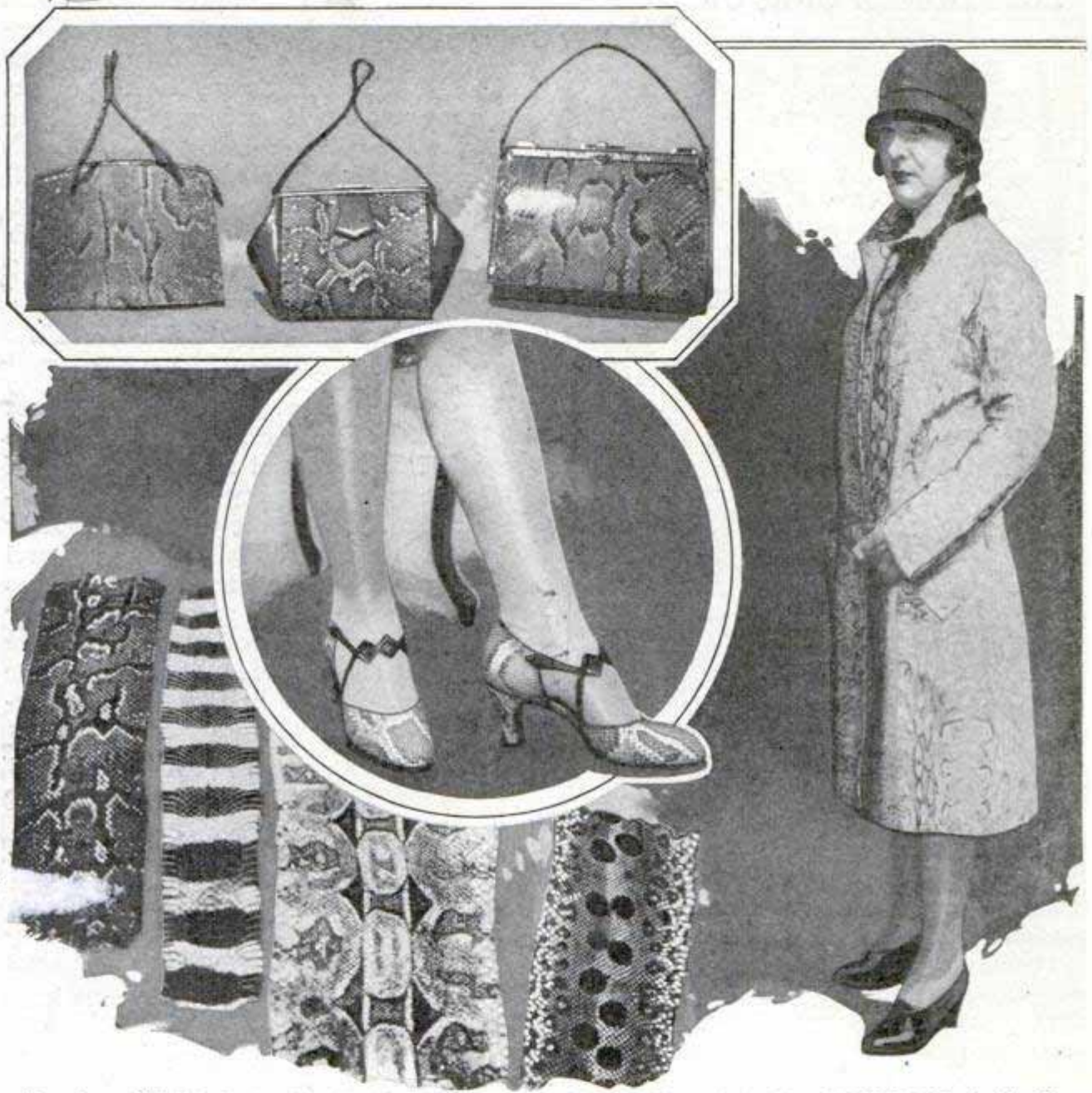

large  
not

How Long Will the Snake-Skin Fad in Fashions Last? Typical Uses of the Material Which Is Applicable to Many Purposes; the Markings Have Been Widely Duplicated in Fabrics

The vogue of fancy leathers for shoes and trimmings has created a demand for the skins of snakes, lizards and crocodiles. Complete costumes even are being made from the coverings of reptiles. When tanned, the skins of certain species from tropical countries reveal an infinite variety of color and design. English and Dutch merchants were the first to place on the market articles made from the water snake of Java, Borneo and Sumatra, while the Parisian specialists of today obtain pythons from equatorial and occidental Africa and Madagascar, pelophiles, with brown or black spots, from Guiana

and the terrible boa constrictor and the Eunecte, with grayish scales mottled with red, from the Antilles. But the fabrication of handbags, portfolios, belts or small trunks, from the skins necessitates most delicate operations. The tanning of reptile skins is accomplished by means of certain mixtures, the secret of which is jealously guarded by each manufacturer. When tanned, the skins of reptiles pass to the hands of the leather workers who make the articles. The worker cuts the skins after models which have been given to him, his implements being plaques of zinc and a shoemakers' knife.



794  
 2796

**BEAUTY OF OLD STONE BRIDGES  
 LOST IN NEW ONES OF STEEL**

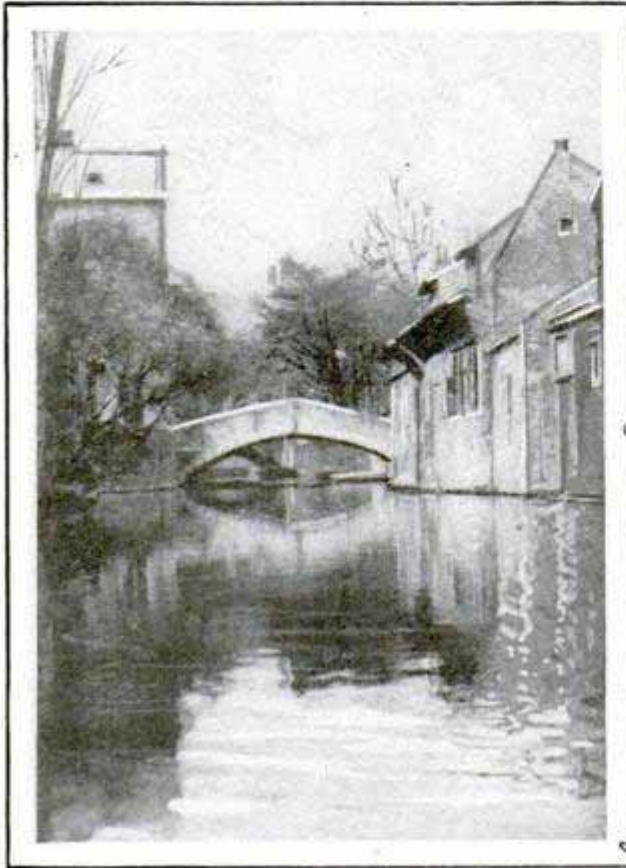

Landmark of the Type That Is Fast Disappearing in Belgium; Old Arch Bridge of Times before the War

While restoration of war-torn areas in Belgium and other countries has left many features better than they were before the conflict, the substitution of steel for stone in rebuilding some of the old bridges has been deplored because much of the beauty of the ancient structures is lost. The reason for the change of material is largely due to the scarcity of skilled labor since the war. There are fewer masons who know how to build the stanch stone arches, hence the employment of steel has been necessary in many cases. Although more serviceable than the stone viaducts, the new ones do not harmonize so completely with their environment.

**FIVE MILES A MINUTE ON RAILS  
 OBJECT OF NEW LINE**

Railroad speed of from 200 to 300 miles an hour will be common if a test line being built by an English engineer is successful. He plans to eliminate trains, substituting a single car containing the propelling unit, which will be operated by

*Cont. H. Journeux, Ing.  
 Thundersley Essex, Eng.*

electricity or gasoline and streamlined to decrease air resistance to the utmost limit. Each car will carry from sixty to 350 persons, and there is a special arrangement replacing the usual flange tire to prevent derailment. Grade crossings would be eliminated to insure fast schedules with safety and it is expected that the car will be able to climb steep grades with ease, as a special design of outer tires of high frictional capacity has been provided.

**GRASS TO GUARD SEA WALL  
 HELPS RECLAIM LAND**

To protect the sea walls along the coast of Essex, England, rice grass, a rushlike growth that appeared in that section of the country about sixty years ago, is being planted. It has the peculiar property of collecting mud, thus raising the level of the shore inch by inch, so that acres can be reclaimed for pasture and other purposes. The cost of maintaining the sea wall is also reduced. Success of the method has led to exportation of hundreds of the plants to other countries.

*3148  
 Spartina Tournesudi*

*8/8/27  
 Daily Express*

**STEEL MIXER BOX FOR BUILDERS  
 SERVES AS CEMENT COVER**

Said to outlast a dozen wooden boxes, a welded-steel mixing vat for preparing cement, plaster and other building materials, prevents loss through seepage, fires can be built under it in winter time to keep batches from freezing, and, by turning

Steel Box for Mixing Mortar Has Sloping Ends That Help Shed Water When It Is Used as a Cover for Cement and Other Materials, and Prevents Loss by Seepage

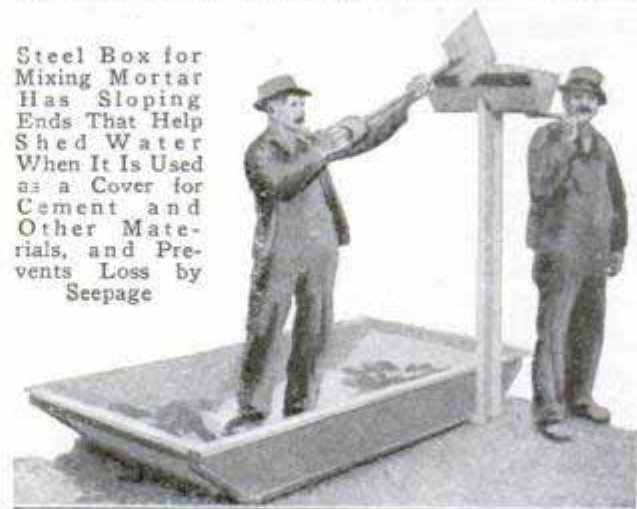

it over when empty, it forms a convenient cover for a pile of cement or other supplies. It is easy to clean and facilitates mixing because of its smooth, level bottom.

*Commercial Shearings  
 + Stamping Co. 1775 Logan*



# Coining Surplus Crops into Money

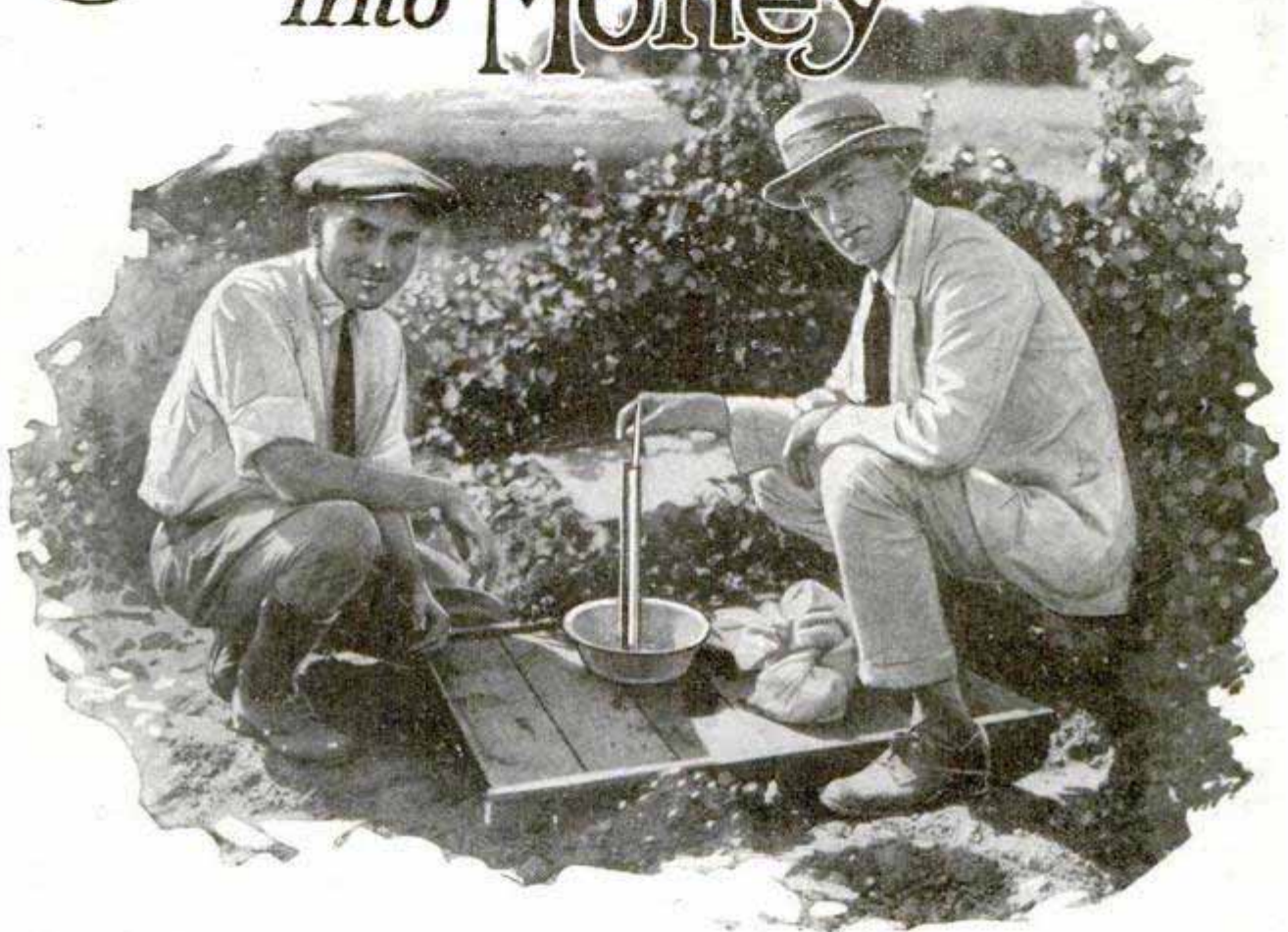

Testing Raisins with a Saccharometer, to Determine Whether They Have Gained the Proper Sugar Content for Picking; the Instrument Eliminates All Guesswork in the Vineyards

By C. MORAN,

3825-13th St. N.W.  
Washington D.C.

**F**ARMERS are solving their surplus problems by developing new uses for their crops, ranging from the manufacture of apple sauce to xylan, which is a base for sulphur dyes.

California fruit growers are using surplus oranges and lemons in manufacturing fruit juices, oils, pectin, marmalade, and the like. Consolidated raisin growers are building a factory for the manufacture of raisin sirup and a feed for dairy cows. Surplus cranberries are being made into sauce and apples into apple sauce. The walnut growers are making high-grade charcoal from shells.

Potatoes also are being made into starch; wheat straw into gas; rice hulls into cellulose which is used in the manufacture of hundreds of commodities, from

imitation leather to artificial silk; peanut shells into dynamite fillers and cattle feed. More than 150 uses for shelled corn, cornstalks, leaves and cobs are listed, ranging from acetic acid to wax. The list includes axle grease, car wheels, cob sidewalks, doormats, fiber, floor rugs, incense, laundry soap, linoleum, phonograph records, punk, sofa pillows, and radio equipment. No need for a corn surplus, say the chemists, when there are so many products into which corn can be converted profitably and cheaply.

It is estimated that from 15,000,000 to 20,000,000 tons of corncobs are wasted annually on American farms. Yet laboratory work has developed cheap processes for extracting from the cob a synthetic resin from which telephone receivers,





Up to the present time peanut hulls have been used for polishing tin plate, as a dynamite filler, a fertilizer filler and, mixed with molasses, as a cattle food. The development of new processes for utilizing California citrus fruits has been the outcome of more than ten years of chemical research. Thousands of tons of cull fruits were being wasted annually, and production was increasing. The saturation point in consumption was at hand, and it was a question of developing new uses for the fruit or of curtailing production. The result has been the establishment of new industries in California the last two years, which are doing an aggregate business of \$1,000,000 a year.

phonograph records, and noiseless gears can be made; furfural which has many uses in industry, including a base for varnish and mucilage; xylan, a valuable base for sulphur dyes; cellulose from which artificial silk is made, and which is used also in waterproofing, paper sizing and in cement.

All these materials are obtained from substances less plentiful and less efficient than corncobs. The use of them in the manufacture of a lumber substitute, where high tensile strength is not required, also has been developed recently. The substitute withstands wear and tear as well as any hardwood and will tolerate a pressure of 10,000 pounds to the square inch.

Uses for seed-flax straw include rugs, carpets, fiberboards, insulating material, upholstery, tow and thatched roofs. Flaxseed already is being used in medicines, varnish, linoleum, patent leather, artists' oil, explosives, and many other industrial products. Why a wheat surplus, the chemists ask, when the production of flax is insufficient for domestic needs, and there are more than fifty different uses for the seed and the seed-flax straw?



One concern in Los Angeles uses sixty tons of citrus fruit a day in making juice. As citrus oils are worth approximately \$2.50 a pound, the extraction and utilization of the oil means an additional return of \$12.50 for each ton of cull fruit. Formerly it cost the producers \$1 a ton to have the waste fruit hauled away. Another plant manu-

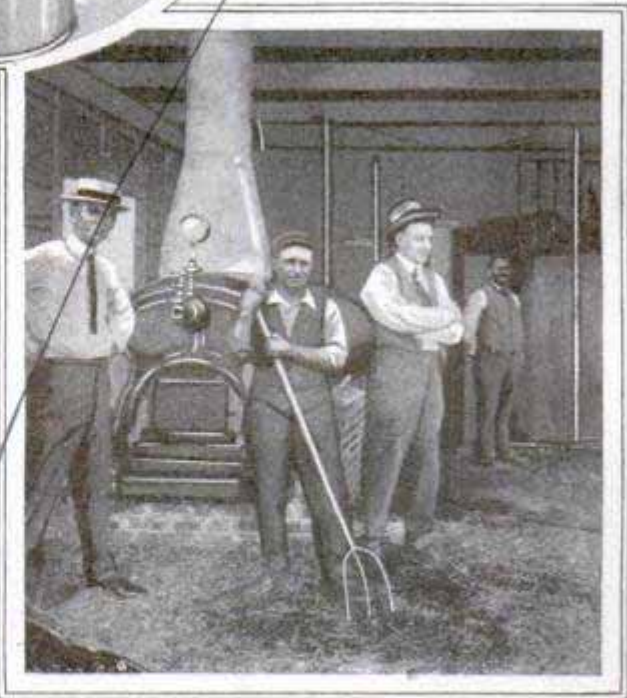

Top, Wheat Grading; Center, Device for Measuring the Liquid Content in Canned Foods, and, Bottom, Furnace in Which Wheat Straw Is Converted into Gas

*Production of sweet orange oil  
and new machine for peeling citrus fruit Bk.*





Class in a Government School Receiving a Lesson in How to Grade and Analyze Grain; Government Inspectors Play an Important Part in the Marketing of Crops

factured 50,000 pounds of orange oil having an estimated wholesale value of approximately \$100,000.

The disposal of orange pulp from which the juice had been extracted was once a distinct problem, costing about \$800 a month. A method was found for the preparation and disposal of orange pulp as feed for dairy cows, and now the profits from this source amount to from \$2,500 to \$3,000 a month.

Similar work is being undertaken by the growers of pomegranates in the manufacture of sirups and concentrates for use at soda fountains. A satisfactory concentrated juice and jelly have been extracted experimentally, and commercial processes are being developed. Experiments with pineapples are yielding methods of extracting juice from the hitherto wasted skins and cores.

The demands of the market for more carefully graded fruits and vegetables result each year in larger quantities of culls remaining at the producing centers. One of the pressing problems of fruit and vegetable growers is to find more profitable outlets for the culls and for the surplus which cannot be marketed profitably fresh.

The development of new processes for utilizing fruits and vegetables is slow and

tedious work, requiring extensive and patient research. The composition of fruits and vegetables as a rule is very complex, and the various chemical substances contained in these products can be determined only by laborious methods.

### MYSTERY RELICS FROM MEXICO ARE CENTURIES OLD 2722

Said to be among the oldest relics ever found on the North American continent, curious images of sun-baked clay have been unearthed near *Guadalupe 30 miles S. to* Guadalupe, Mexico.

They are thought to belong to a period of at least 6,000 years ago, and represent human heads on four-legged bodies, two-headed reptiles and other odd designs. Scholars

of the Los Angeles museum are investigating the age and character of the pieces, which were found in volcanic ash about four feet beneath the surface.



*Found by John B. Small,*



2862

made by Mr. W. H. ... and J. H. K. Moss

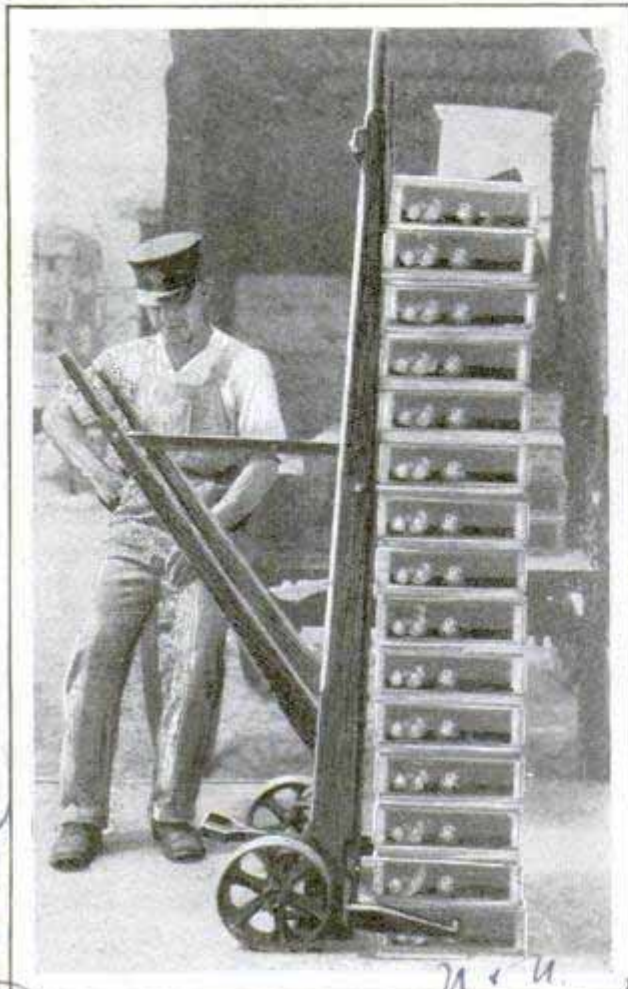

Truck on End, Showing the Foot Lever That Controls the Loading and Unloading Extension

**HAND TRUCK LOADED BY LEVER PREVENTS BREAKING BOXES**

With the usual type of hand truck, boxes and other articles often are damaged or broken by the sharp blade at the bottom of the carrier. This objection is said to be eliminated in a truck equipped with pointed rods that can be clamped against the bottom box by pressing a lever with the foot so that the load may be tipped on the rack with little difficulty. The rods are easily released for unloading.

**FALLING SHUTTER TRAPS THIEF TRYING TO STEAL JEWELS**

For the protection of show windows and display cases containing jewelry or other valuable articles, a falling shutter arrangement has been introduced in England to foil the smash-and-grab thieves that have been active there. It can be made to fit almost any shape or size of window or case and is entirely concealed when folded up. Tampering with the glass or frame

instantly releases the support for the shutter, which is made of metal, and it falls heavily, cutting or breaking the thief's wrist and setting off an alarm at the same time. The secret of the shutter's operation is a vacuum device that holds it up. The vacuum is destroyed when vibration smashes a glass slide, allowing the heavy shutter to fall.

**3134 EYES' SPEED LIMIT**

In order to distinguish an object, the average eye must remain in a stationary position for about one-seventh of a second, tests have disclosed. The eye appears to act on a sort of skip-stop system, and no amount of illumination will speed its rate of functioning, the experimenters found. One of the interesting facts revealed by the tests was that most homes and factories are not brightly enough lighted to enable the eye to work as rapidly as it would function under the most favorable conditions of illumination.

**2639 CLEAN BUILDINGS WITH STEAM INSTEAD OF SANDBLAST**

Jets of live steam as a substitute for sandblast and acid washes have been used by the bureau of standards in cleaning a building in Washington, D. C. The force of the vapor is controlled through a special nozzle, and parts that cannot ordinarily be easily reached are said to be cleaned thoroughly by the steam.



Scouring Building's Decorations with Blast of Steam; an Advantage Is That Crevices Are Cleaned

Emb. A. C. Blackball Exp. Vincent Square Marions, Londn. S. W. 1, England

made by Mr. W. H. ... and J. H. K. Moss

Scouring Building's Decorations with Blast of Steam; an Advantage Is That Crevices Are Cleaned

Emb. M. C. M. O'Brien London, England Emb. J. A. Winters District National Bank Bldg



30 39

*Quoted by Day of Journal Dept  
Oakland Calif*

# THEATER ON WHEELS ENLIVENES PLAYGROUNDS

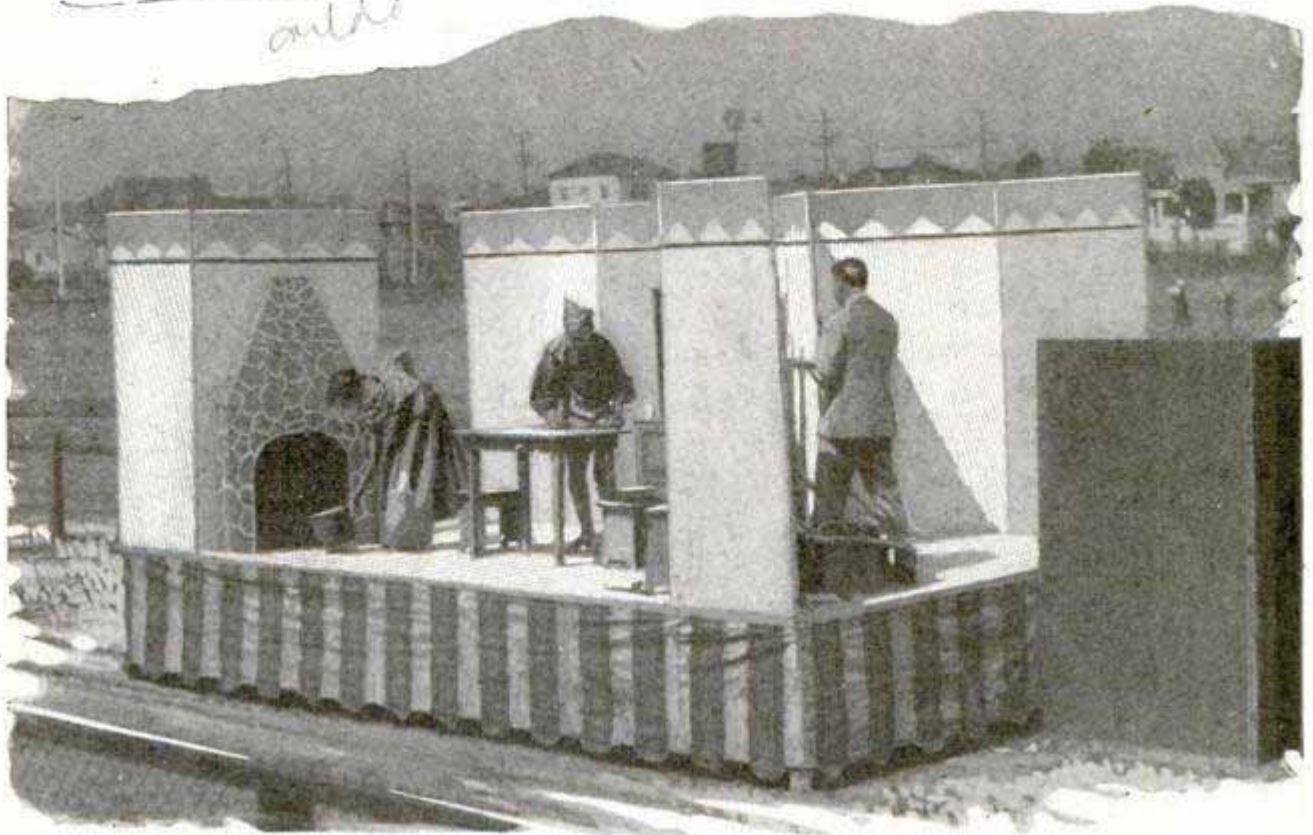

Arranging Scenery on the Stage of the "Vagabond" Theater, a Trailer Towed by a Motor Truck; It Makes the Rounds of Playgrounds in Oakland, Calif., to Entertain Hundreds of Children

Completely contained on a trailer, and towed by a motor truck, a "vagabond" theater, built by the playgrounds department of Oakland, Calif., entertains audiences of 200 to 500 children every weekday afternoon in the fifty-two playgrounds of that city. Stage, scenery, plays and acting are all done by the boys and girls of the grammar and junior high schools, and the same play is never presented twice by the same children, so that all the youngsters are given an opportunity to write plays, in competition, and to act them as well. The motor-truck theater, which is believed to be the first of its kind ever built, is simple in construction. The floor of the stage consists of two sections, hinged down their length, one-half being bolted to the chassis of the trailer. The upper half is equipped with folding steel legs along the outer rim and, when not in use, folds over on the lower half, which forms the bed of the trailer. A motor truck, which carries the scenery, costumes and other equipment, tows this trailer. The hinged side of the stage floor is placed next the audience and the upper half swung over to rest on the folding

legs. A looped curtain is then draped around it, covering the wheels of the trailer and the legs of the forward half of the stage. Holes in the stage engage pegs in the lower edge of the scenery, backdrops and stage "props." Complete setting of the stage for an indoor play requires only fifteen minutes, while that for an outdoor scene takes somewhat longer. The plays, which never require more than twenty minutes in presentation, are written by pupils of the junior high schools.

## GOLF TEE AND SCORE PENCIL COMBINED IN ONE 2261



One of the latest novelties for golf is a convenient tee, the sharp point of which contains a lead for writing the score. The pencil is made in two colors, red and yellow, is al-

ways accessible and saves the trouble of carrying an extra article.

*Wm. Specialty Co. Inc.  
18 be points for 25¢*



2692

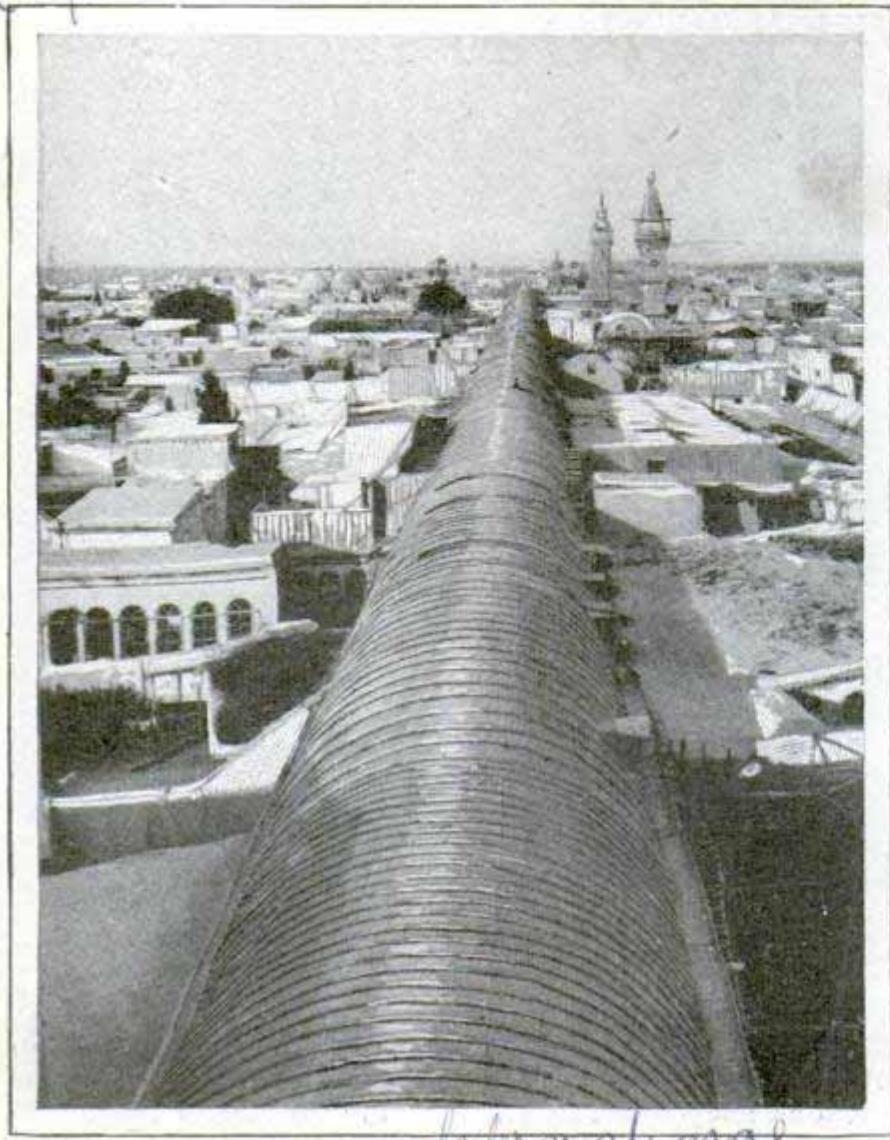

Canopy over Damascus Street Gives the Effect of a Huge Pipe Line; It Is Strongly Constructed to Withstand Winds

**COVERED STREET IN DAMASCUS RESEMBLES PIPE LINE**

Over the famed "street called Straight" in Damascus, a canopy has been erected so that, on first glance from an elevated position, the way has the appearance of a huge pipe line with braces at regular intervals. The covering shields pedestrians from the heat of the sun and is strongly built to withstand the winds.

**RUBBER WALLS FOR OFFICES TO REDUCE NOISE**

Rubber walls in office buildings to decrease vibrations, and streets and sidewalks paved with rubber, are among the recent uses chemists have found for the product. They have also adapted the material to the making of interior decora-

ses. *morarty, manager.*  
5,000 acre rubber plantation

tions and for coating silk and other fabrics so that scarcely a trace of the resilient substance can be detected. The rubber for use in buildings is in the form of blocks or slabs which are built up vertically on the wall face. According to the inventor of the process, it affords a screen or buffer in which all vibrations expend themselves.

**RULE ON MIRROR TELLS YOUR HEIGHT**

3028 A fairly accurate measure of a person's height is shown on a ruled mirror especially suited to display in public places or for advertising purposes. The glass is ruled with a scale of inches and the mirror is placed a certain distance from the floor so that a glance in the glass shows how tall you are. The accuracy of the device is based on the fact that the distance from the pupil of the eye to the crown of the head is approximately the same in all people.

*Beaver Photo Service  
Read. to Atlanta Ave*

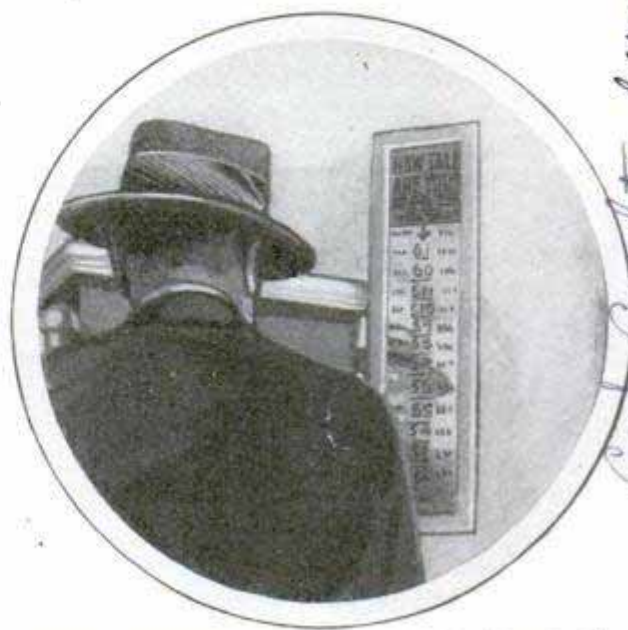

Mirror Gauge That Tells Height in Position for Use

*Emb. Carltonbrook,  
311 Commonwealth*

*Peerless Scale Co  
Detroit.*



*Magnum Co.,  
Box 840,  
Washington, D.C.*

**POPULAR MECHANICS**

*Innovation Window Co.,  
820 Tower Court,  
Chicago, Ill. (2716)*

**GAUGE SHOWS RECORD RAINFALL  
OVER INCH A MINUTE** *3/20*

Up to the time of this writing, the world's record rainfall was observed in a district on the west front of the San Gabriel range. Here, on April 5, 1926, a fall of 1.02 inches in one minute was measured on a weighing rain gauge and was reported by the United States weather bureau and the Los Angeles county flood-control commission, joint operators of the observation station. By chance, a second gauge of the same pattern had been installed near the other, for test purposes, and as both instruments made the same record, additional testimony of its accuracy was afforded. The previous rainfall record was observed in Panama. On Nov. 29, 1911, a fall of 2.47 inches was registered in three minutes at the weather station in Porto Bello.

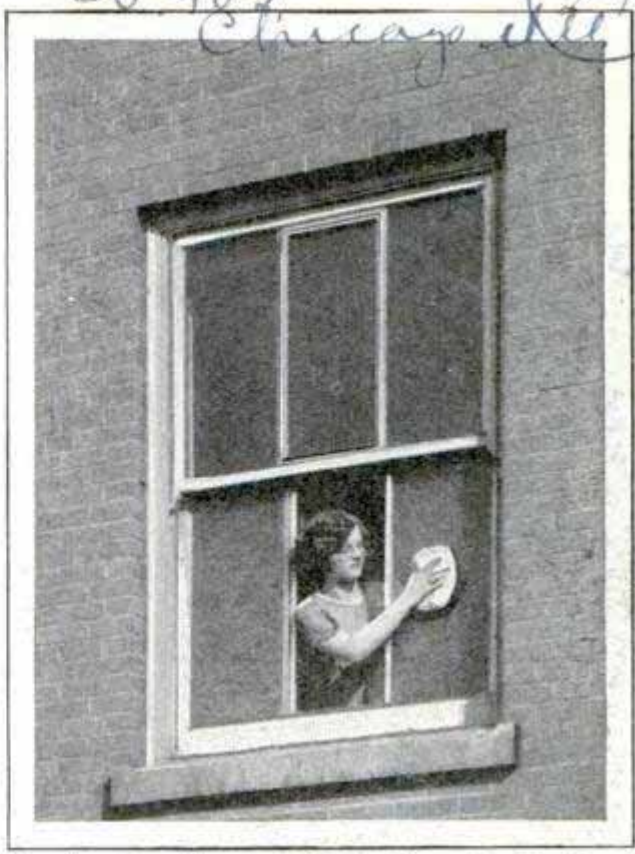

Showing How Simple It Is to Clean the Outside of the Window from Within through Inset Pane

**SAFETY FLUE IN STOVEPIPE  
REDUCES FIRE HAZARD** *2974*

Soot and rubbish accumulating in the stovepipe elbow are usually removed only with considerable trouble and constitute a fire hazard but can now be quickly taken out through a safety flue, an opening in front of the elbow. It

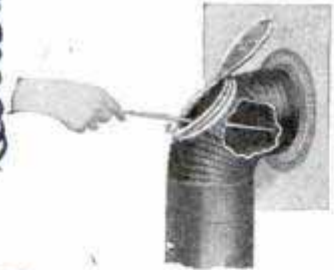

eliminates the necessity of lifting the pipe out and also serves as a check damper for use in case the pipe becomes too hot. In addition, by insuring a constantly clean opening, it saves fuel.

**WINDOW CLEANED FROM INSIDE  
THROUGH INSET PANE**

Both upper and lower panes can be cleaned from the inside through the swinging center of a window recently introduced especially for office buildings, hospitals, schools and similar installations. It can be placed in any style of sash, old or new, is made in bronze or aluminum and also serves as a ventilator. The outside of the entire window frame and sash can be painted through the swinging pane,

saving the erection of special scaffolding and, in washing the windows, the hazards and trouble of climbing on the outer sill are done away with.

**ELECTRIC FAN MAKES OZONE  
TO PURIFY AIR** *2928*

Purification as well as circulation of the air is sought in an electric fan recently introduced in France. It produces ozone from a small generator attached to it, the gas being blown outward by the rapidly revolving blades. Ozone is used in sterilizing water and may sometimes be detected by its odor after a flash of lightning.



Whenever you find that you wish to know more about any article in this magazine, write our Bureau of Information.

*Safety  
Hubbard, Spencer, Bartlett  
& Co. Inc. Electric Corp.,  
Decorators, etc.*

*Procedes Algonair,  
54, rue de Lancry, Paris, France*

*211 E. N. Water St.*



2972  
802

POPULAR MECHANICS

*Alene, France  
Charlotte  
Paris France*

*Venus Mfg. Co., Los Angeles  
1750 S. Los Angeles St., Calif.*



One of the Exercises on the Weight-Reducing Puller; It Develops Strength and Grace While Helping to Remove Superfluous Fat

**REDUCING EXERCISER ALSO DEVELOPS ARM MUSCLES**

Superfluous fat is said to be removed from the waist line and the muscles of the arms receive beneficial exercise by a gymnasium unit especially for the home. It consists chiefly of a cord on a friction reel which furnishes sufficient resistance when the rope is pulled to require considerable effort on the part of the user. An advantage of the exerciser is that the user can sit or stand in several positions.

**SEAPLANE PONTOON IS TURNED INTO FLYING BOAT**

Increased utility of the seaplane is promised in a three-pontoon flying machine.

The center one is detachable and serves as a boat to which an outboard motor may be attached to simplify the task of landing or getting back to the plane. The other two pontoons are sufficient to support the ship. The removable unit is secured to the craft by four bolts and, with its motor attached, may be used to maneuver the plane independent of the big engine. The pontoon may also serve commercial craft for conveying cargo to and from shore.

**MUDGUARDS FOR SHOE HEELS EASILY DETACHED**

To keep mud from soiling the backs of women's shoes, a French shoemaker has introduced a guard that is quickly attached to the rear of the heel and may be removed before entering the house. It is made of transparent material so that it is hardly noticeable, and is shaped to keep the mud down off the shoe even if the heel sinks in. The guard is also adaptable to men's shoes and helps keep the trouser bottoms from becoming soiled and, consequently, worn out quickly.



**MYSTERY OF SATURN'S RINGS EXPLAINED BY METEORS?**

Little is known for a certainty about the rings of Saturn, but one explanation is that they consist of small solid pieces like meteors, shining by reflected sunlight. Although they are but a few miles thick, they are 173,000 miles across. Viewed edgewise, they disappear even under powerful telescopes and are clearly seen only when they are tilted. Their origin is obscure. Some scholars believe they are survivals of rings which encircled all planets.



Pontoon of Flying Boat, Which Serves as Separate Craft

*Inventor, Clarence W. MacFarlane, Houston*

*R. W. Baker in Detroit News*



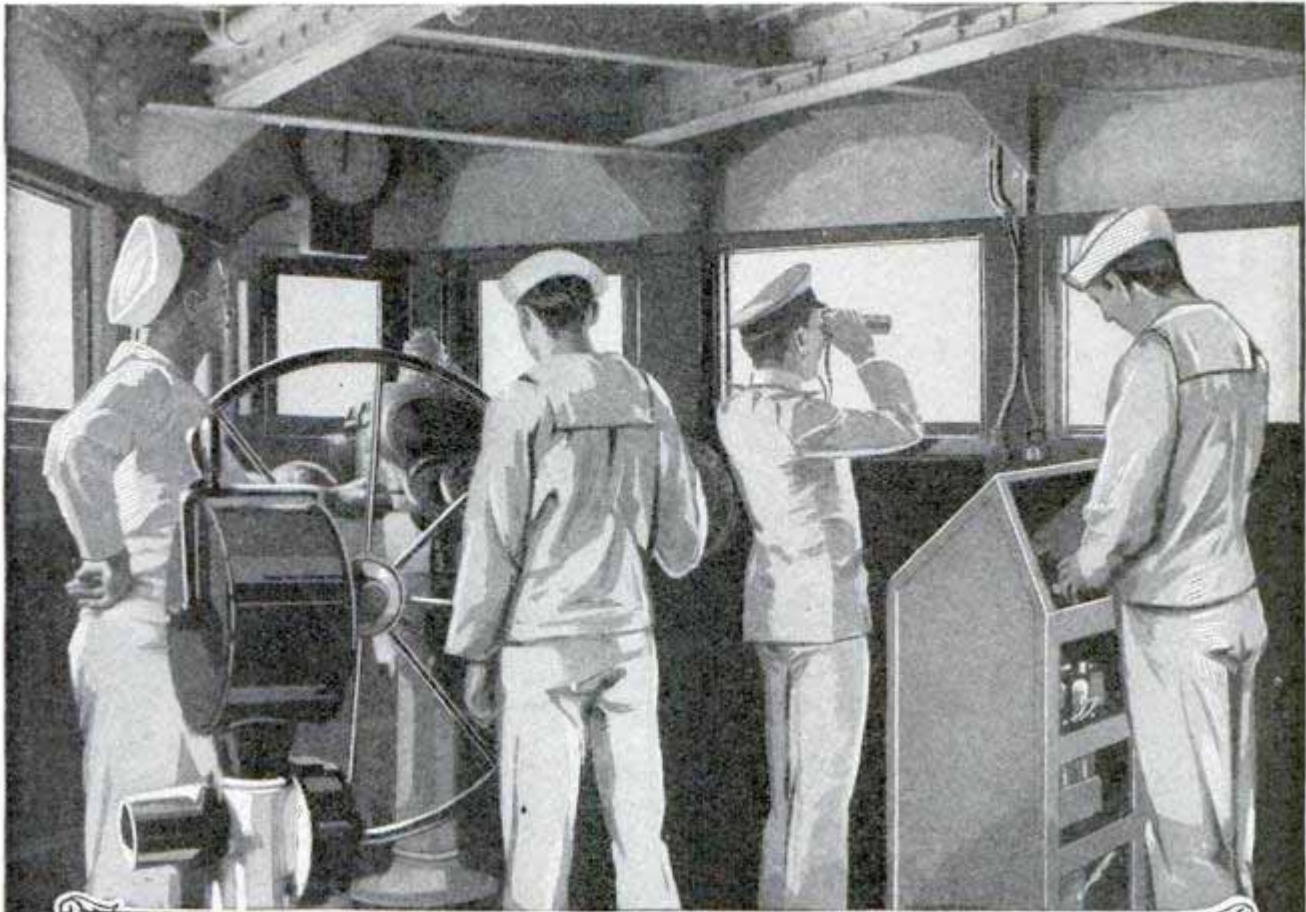

# SOUND WAVES SAVE SHIPS

**T**HROUGH fog so thick that the look-out on the bow could not see the stern, a ferryboat carrying 800 passengers crept across San Francisco bay. In the pilothouse, the captain at the wheel, with the first and second officers on either side of him, watched two small, square-topped black boxes, or peered through the windows, while the third officer played search-lights against the gray wall that loomed ahead of the vessel.

Suddenly a brilliant red light glowed for an instant on the revolving disk atop one of the boxes. In a fraction of a second, a similar light flashed on the other box. An indicator needle, spinning between the two, stopped at 700 feet. The red lights flashed again, both seemingly in the same direction. At the first flash, on the port bow, the captain spun his wheel to starboard, and, through his pilot-house controls, drove his heavy propelling motors full speed ahead.

Hardly had the ferryboat changed her

course, when, so close that a marble could have been tossed on board, an express liner, in from the Pacific, rushed by at top speed. Had the ferry continued her course, she would have been shattered by the great steamer. The newest life preserver of the sea—the sound compass—had saved her.

Running automatically, constantly telling the direction and distance of sounds and signals, this new device is being given exhaustive tests on some of the forty-one ferryboats which, day and night, weave their way across the Bay of St. Francis, and the above incident is only one of several unexpected, and undesired, demonstrations of its value.

The sound compass consists essentially of a receiving device in the form of a hollow half globe, mounted on a rotating shaft. Attached to the same shaft, either directly or by gearing or remote electrical drive, is an indicator. This is so arranged that it rotates at exactly the

*Cook H. H. Dunn, 2722 Prince St  
 Berkeley, Calif.*



2742

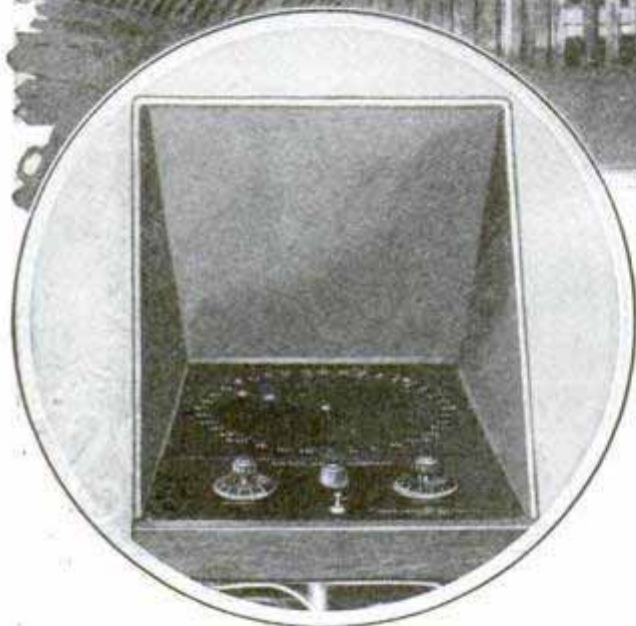
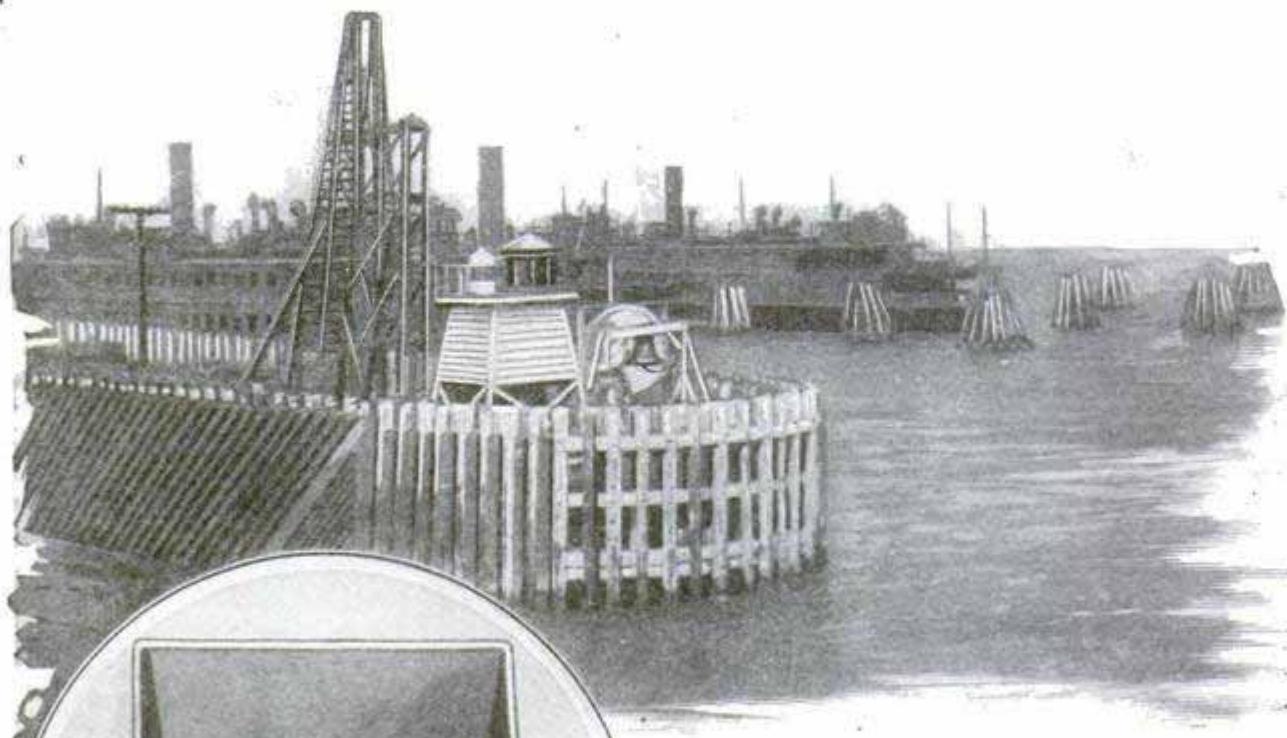

Ferry Slip Fitted with Beacon Transmitter to Guide Ships, and, Left, the Sound-Compass Dial

same angular speed as the sound receiver. The indicator consists of a vacuum bulb filled with a gas, such as neon, which will glow brightly when excited by an electric current. The sound-receiving device is arranged to convert the vibrations received by it into electrical vibrations, which are amplified, if great sensitivity is required, and then transmitted to the indicator, where they cause the lamp on the disk to flash.

Assume, now, that a whistle is being blown continuously at a distance from the vessel. The sound-receiving device, as it rotates, comes into a position where it is strongly actuated by the vibrations from the whistle. The glow lamp on the rotating indicator then flashes, and, being in the same angular position as the sound receiver, the observer, by locating the flash, may read from the indicator the bearing of the sound with respect to his ship.

In the experiments with the sound compass, it was found to have a particular application—in addition to locating other vessels in fog—to the problem of navigating ships into slips, berths or harbor entrances, and past obstacles at night or in fog. Sound beacons of varying pitch were devised and placed on ferry slips, rocks, points and other similar positions where the experiments were carried on. The sound-receiving instruments, on the boats on which the trials were made, were particularly sensitized to different individual sound beacons, without interfering with the ability of the receiver to pick up whistles from other vessels and indicate their direction. It was found that each ferry captain knew at all times the bearing of his slip on the opposite side of the bay, a distance of about four miles. Warning also was automatically laid before him of a point on an island along his course across the bay, on which one of the sound beacons was located.

One feature of particular interest is the accuracy with which the sound-locating device performs when the frequency of pitch of the sound beacon is increased. Signals, of a pitch far too high to be heard by the human ear, instantly attract the attention of the sound receiver and appear brilliantly in the neon light on the in-



indicator in the pilothouse. This provides a means whereby sound beacons of a pitch beyond, say, 15,000 vibrations a second, may be maintained in continuous operation without in any way interfering with the use of audible signals. This is of especial value in guiding ships, ferries or tugboats through heavy fog:

The device also may be used to obtain distance as well as direction readings, by mounting two of the devices, one at each end of the bridge of a vessel, and placing their respective indicators side by side in the pilothouse. Readings taken of the two indicators simultaneously may be plotted to give both the direction and distance of the sound.

While the confusion due to the spreading of, or the echo from, a sound in a fog, renders the human sense of hearing somewhat undependable, the sound compass, in such conditions, shows two flashes in the neon light on the indicator—a very strong flash from the direction of the origin of the sound, and a weak flash from the direction of the echo. This makes recognition of the exact direction comparatively easy.

In many ways the sound com-

pass is quite similar to the directional radio beacons being developed to guide airplanes, and possibly the two services may in the future be combined over such frequently fog-shrouded areas as San Francisco. The Golden Gate has been a problem to flyers from the start and for some time the transcontinental air mail did not even approach it.



Receiver of the Sound Compass in Position at the Bow of a Frisco Bay Ferry, and, Above, the Front of the Receiver and the Recording Cabinet to Which It Is Connected



2685



Metal Top for Fish Basket Has Space for Bait, and a Rule That Tells How Big Are the Ones You Catch

**METAL TOP FOR FISH BASKET HOLDS HOOKS AND LINES**

Shaped to fit any standard-size fish basket, a metal top, one inch thick, holds hooks, lines and other accessories. There is a space in the center compartment for bait and a one-foot measure is marked on one side so that the accurate dimensions of the fish may be obtained. A round lid in the middle of the top can be turned for placing fish in the basket.

**CHECK PROTECTOR IN BILL FOLD LATEST MONEY GUARD**

Check-book holder, bill fold and check protector are combined in one pocket article recently introduced by a southern manufacturer. After a check is written,

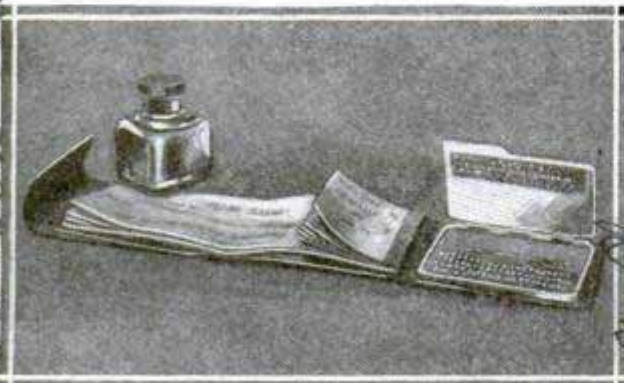

Check-Protecting Outfit Complete; the Perforating Stencil Unit Is at the Right with the Flap Raised

it is laid under a hinged metal flap and perforated, at the same time receiving an inking, so that any attempt to erase or alter the original writing will result in smears. The entire unit folds up to fit the pocket and additional fillers of checks are easily inserted.

*Thrift Magazine*  
**FLOATING MOUNTAIN OF DUST OVER AMERICAN CITIES**

2598 According to reliable estimates, enough soot and dirt float over American cities in one year to bury every street on Manhattan island to a depth of twenty-one feet. It would form a pyramid 1,500 feet high and five miles across at the base, if gathered into one large mass. These calculations have been prepared on actual measurements of the soot and smoke found in the air at different times of the year and over many different cities.

**NIGHT FLOOR LIGHT IN WALL HAS GLOW REGULATOR**

2752 Subdued illumination for the floors or landings in hospitals, theaters and similar places is provided by an electric lamp installed from twelve to eighteen inches above the flooring. The degree of light displayed up to the maximum capacity of the unit, can be regulated by means of a small screw on the outside. This controls a shutter attachment inside. The light is housed in a metal box which is easily accessible for wiring or repairs, and the glass through which the rays shine is tilted to provide the most satisfactory diffusion and focus.



The Popular Mechanics' Bureau of Information offers its free service to all readers of our magazine. Names and addresses of manufacturers and dealers in articles described, and any other details in our possession, will be promptly furnished by addressing the bureau.

*Harry C. Fields, Sole Distributor of Rossid Check Protector 624 Boardman Ave. Portland, Oe.*

*The Rossid Infy Corp  
 1000 W. Church St.*

*Curtis Lighting, Inc.  
 1119 W. Jackson Blvd.*



ARTIFICIAL WAVES ADD THRILLS TO BATHING POOL

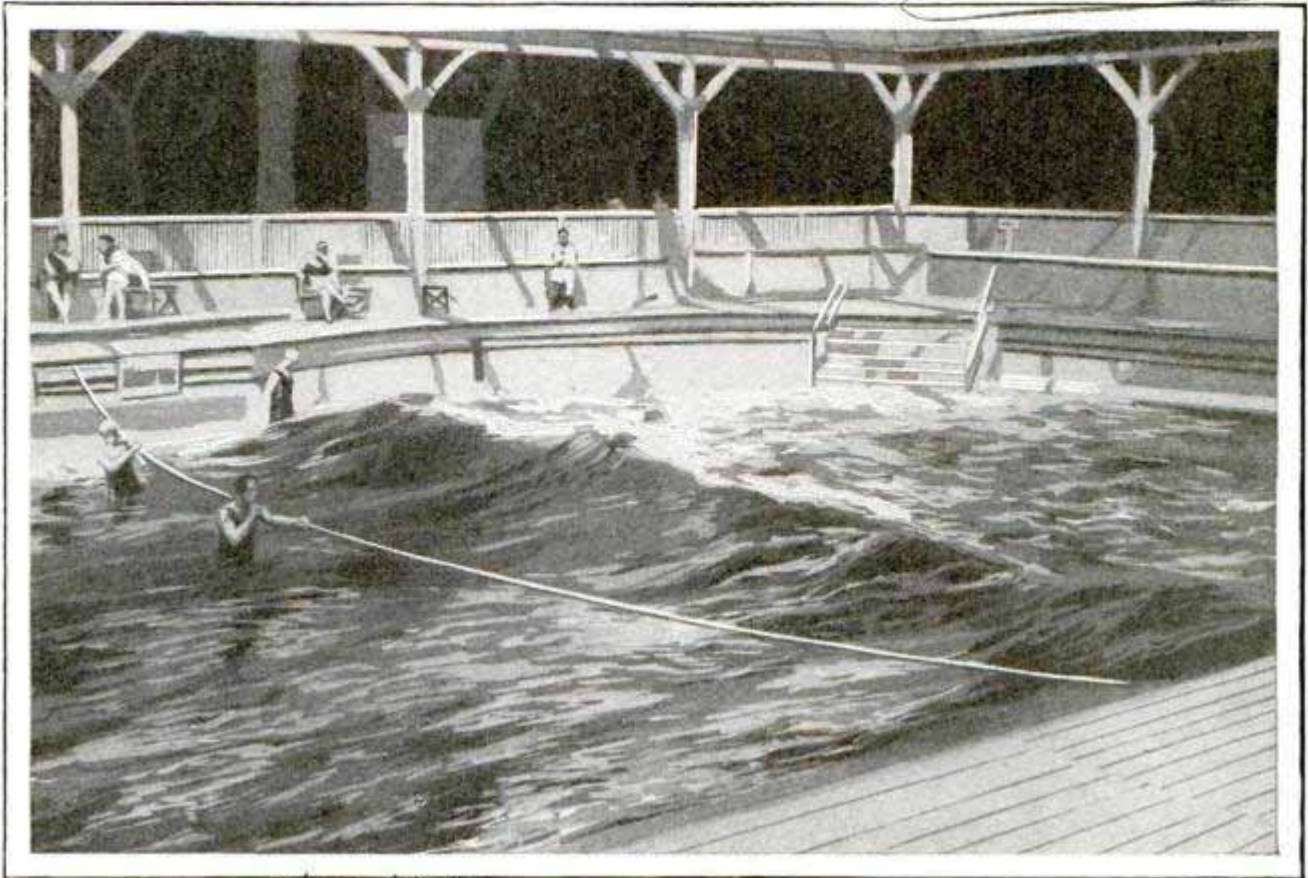

Courtesy The Sphere 7/23/27  
Bringing the Pleasures of the Open Beach to the Swimming Pool; Artificial Waves, Formed by Agitator, and a Sandy Shore, Which Add to the Delights of This Berlin Bathing Resort

Pleasures of an ocean beach are afforded patrons of an open-air swimming pool in Berlin. It has a sandy shore and a special wave-making apparatus that produces "breakers" like those of the sea. Besides providing an enjoyable surf, the wave maker helps purify the water.

auto is in motion. Like the ignition, it can be locked, affording an additional protection against theft, and eliminates waste of time in adjustment of the brakes.

WEATHER "CARDS" FOR AIRMEN PROMOTE FLYING SAFETY 2333

Aviators taking off from the Croydon flying field, the English air port, for the continent, consult the "cards" before a journey, but not for any superstitious reason. The cards, in this case, are disks on a special board, showing what weather conditions will probably be encountered at various points along the route. For instance, one set shows if it is to be clear, raining or snowing, another indicates visibility, a third shows if the clouds are hanging low and a fourth tells the distance between the base of the clouds and the ground. Wind warnings are displayed by a conical sign which is illuminated at night.

AUTO BRAKE ADJUSTER ON DASH REDUCES MOTOR HAZARD 2757

Turn a little handle on the dashboard and your brakes are equalized and safely adjusted to the road and weather conditions. This is the claim for a recently introduced motoring accessory quickly attached and simple in operation. It saves

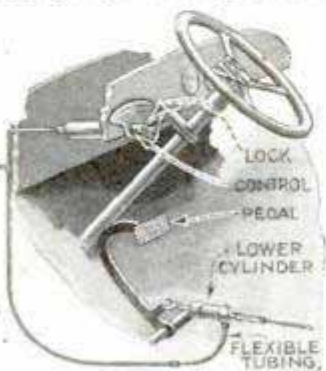

tightening bolts or rods, getting out and under the car, and can be used while the

Yellowstone national park is visited by more than 200 species of birds annually.

17.50 installed last of Mississippi West 18.00

Kel. Sloan Sales Corp. 4416 N. Clark



# SHIP THAT SWALLOWS WHALES PROVES A SUCCESS

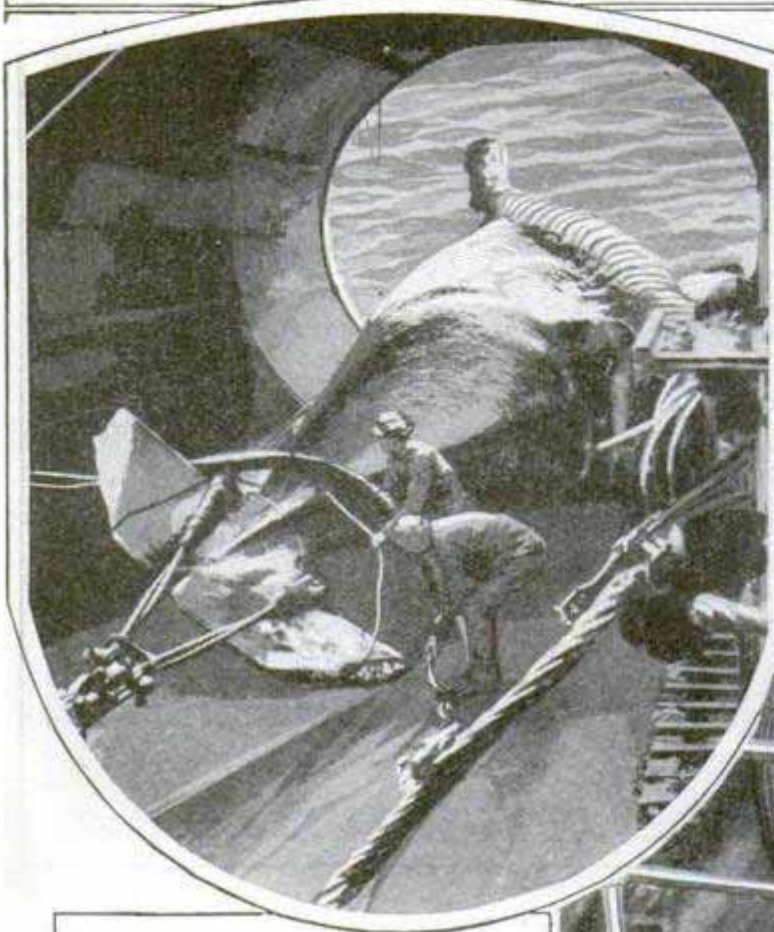

Hauling a Whale through the Door in the "Larsen's" Bow; the Opening, Sixteen Feet in Diameter, Is Big Enough to Accommodate 150-Ton Leviathans of the Deep

Part of a Whale, Being Cut Up; the Picture Shows the Curious Pleated Appearance of a Whale's Underside

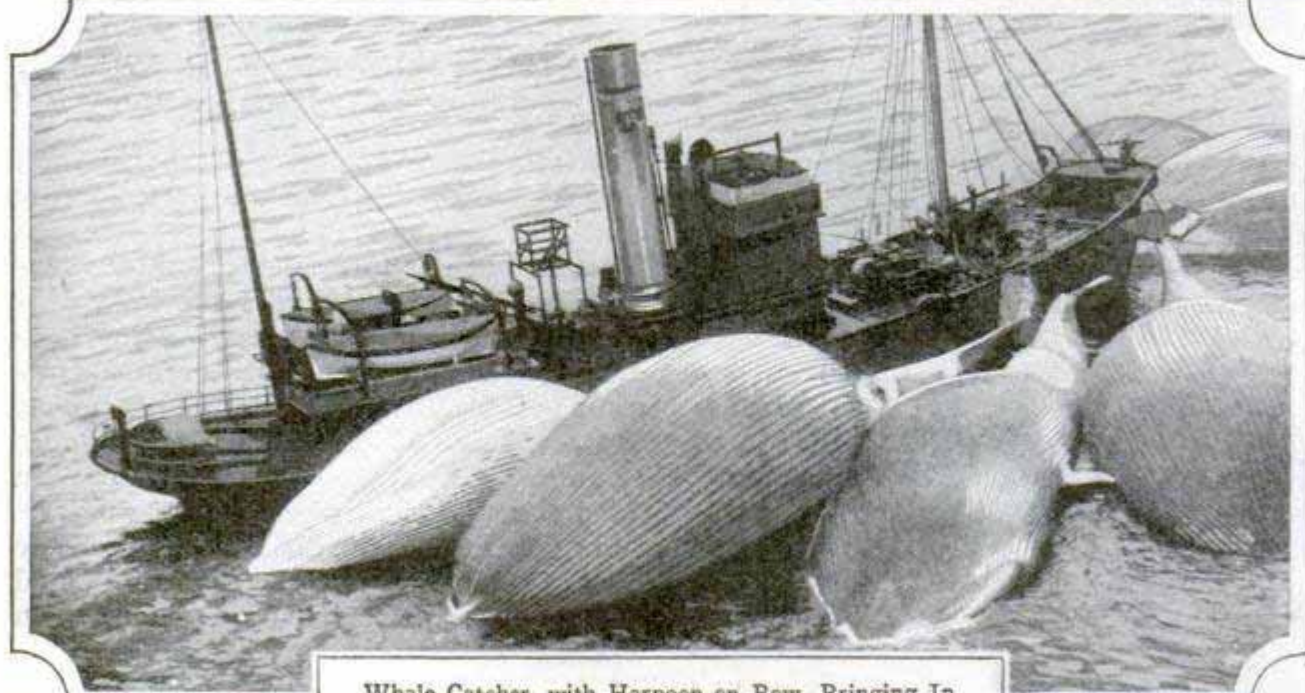
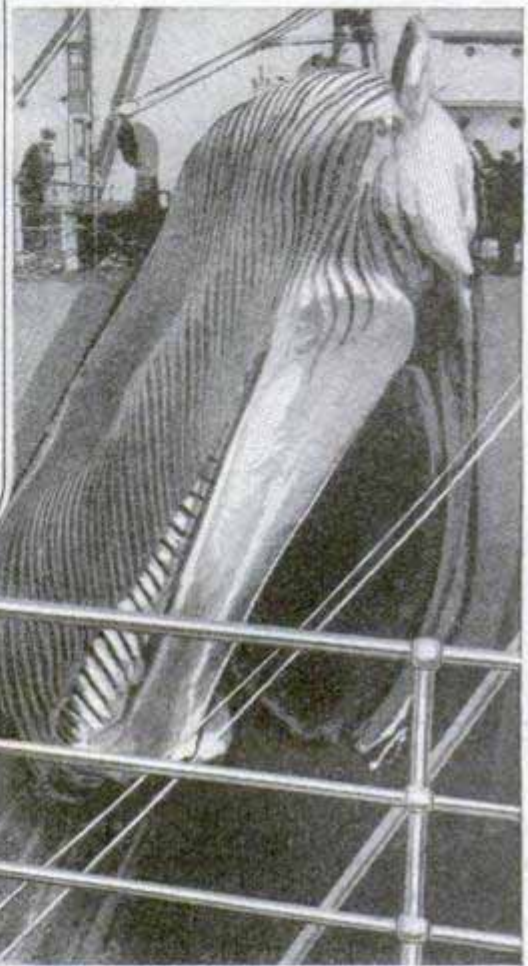

Whale Catcher, with Harpoon on Bow, Bringing In Six Whales to the Mother Ship

O. A.



**FARM PROBLEMS BEING SOLVED BY USE OF MACHINERY** 313

How extensively machinery has reduced hand labor on the farm was forcibly illustrated last season when it was estimated that from 80,000 to 90,000 fewer harvest hands were required in the wheat belt than were necessary a few years ago. Between 1900 and 1927, the number of work horses on farms declined from 21,047,000 to 15,179,000. One student of the question sees the era of machinery transforming the farmer from a grower into a "manufacturer of foodstuffs," and the day of the "agricultural engineer," rather than the farmer, is said to have arrived. Combined wheat harvesters, that cut and thresh the grain in one operation, mechanical corn huskers and cotton pickers are among the units that are supplanting hand work in the larger agricultural tasks, while the tractor has lightened considerably the burden of the small farmer in all parts of the country. As the use of machinery makes further development of land practical, several interesting effects are noticed. One is that still larger production of wheat is assured, keeping prices low and thus making its growing unprofitable to the owner of high-priced land. In Texas and other parts of the south, still larger cultivation of cotton is predicted as a result of improved picking equipment. In 1790, at the time of the first census, the work of seven rural families was required to supply one townsman with food and raw materials. At present, seven rural families supply about eighty-four townspeople. In 1820, it took sixty hours of man labor to bring an acre of corn through the crop cycle by hand methods. At the present time, with improved machinery, the work can be done in five man-hours. Similar savings have been effected in other crops.

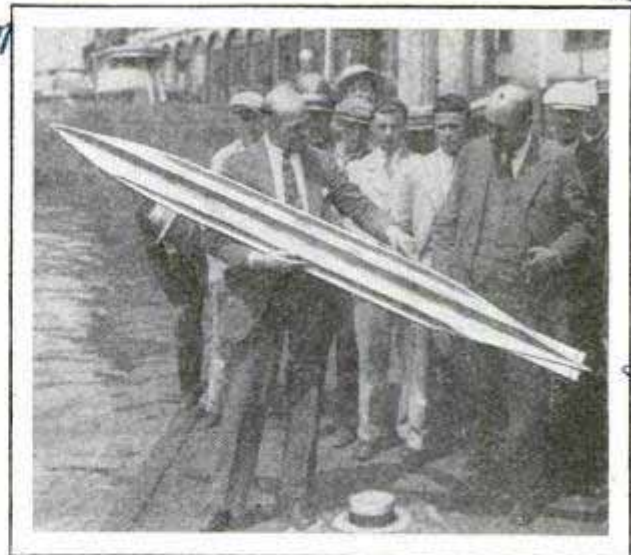

Model of Boat Body for Fast Atlantic Trips; It Is Expected to Make 180 Miles an Hour

**SPEED BOAT TO CROSS OCEAN IN TWENTY-FOUR HOURS**

Trips across the Atlantic ocean can be made in twenty-four hours, an eastern inventor hopes, in a special speed boat he is designing. He expects the craft to develop a speed of 180 miles an hour. As indicated by the small model he is shown demonstrating here, the body of the boat is long and slender with grooved bottom intended to decrease the resistance of the water.

*Max Kleon. Inventor.*



**"TOTEM-POLE" OF USED AUTO TIRES MARKS DESERT ROAD** 2931

Tribute is paid to the "Great Spirit of Departed Mileage" in an odd totem pole on the road between Needles and Los Angeles. It is formed of old auto tires, many worn out from desert travel. Tourists add their contributions to the lot and, last year, a garage owner is said to have sold 300 tires from it as junk.

Odd Totem Pole of Today; Worn-Out Auto Tires Stacked near Desert Highway; a Garage Owner Sells the Yearly Offerings for Junk

*at Newberry Springs on National Old Trails*



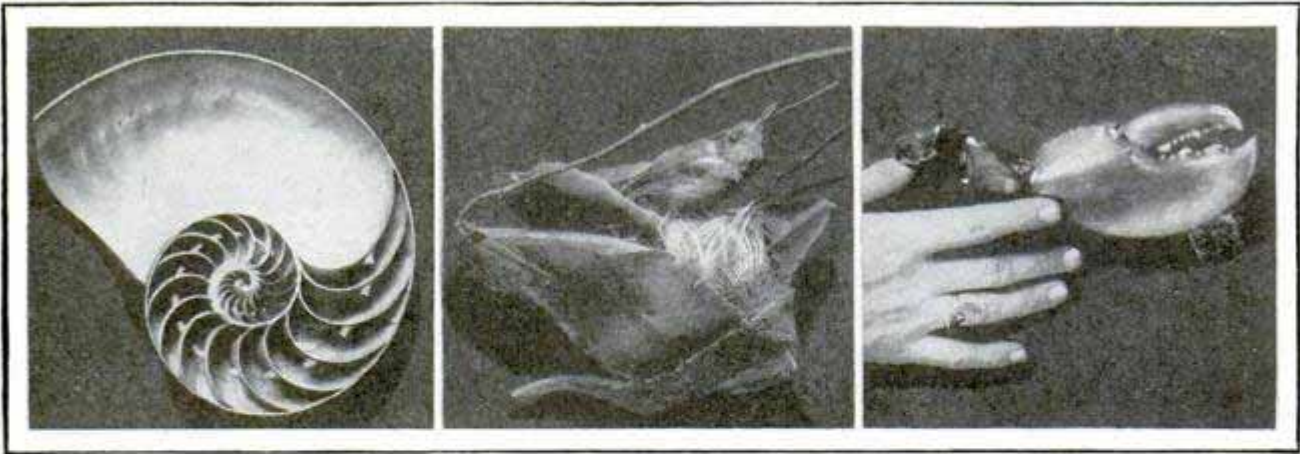

Three of Nature's Inventions, the Original Pneumatic Tube Connecting the Chambers of the Pearly Nautilus; the Tailor Bird Stitching Leaves Together, and the Lobster's Fine Pincers

## Queer Things in Nature's Patent Office

How Man's Mechanical and Other Contrivances Follow along the Lines of Things Known Ages Ago

By RENE BACHE, 1823 Q St., Washington, D.C.

**N**ATURE is the great inventor. Hers was the first patent office. To a very large extent, man's mechanical and other contrivances follow the lines of her ideas.

Nature solved the flying problem ages ago. Langley, in working out the problem of the airplane, studied the soaring flight of buzzards from the top of a tall wooden tower. A dirigible balloon in the air looks remarkably like a gigantic fish. It is streamlined in the same way for swiftness, and there is a fish that resembles a balloon. It is the swellfish, about eight inches long, a common species in Chesapeake bay. When caught on a hook, it inflates itself to almost spherical shape by taking in air between its parchment-like skin and the muscular coat of its body. Fishermen say that it rises to the top of the water and, inflating itself, is blown along over the waves by the breeze.

The parachute, so valuable a safety contrivance for aviators and balloonists, might well have been suggested by the humble dandelion, whose seeds, to accomplish their dispersal, are wafted far aloft by the winds and carried on long journeys by air, each one kept afloat by the bit of fluff.

The idea that columns for supporting structures can be rendered much stronger, relative to weight, by making them hollow is comparatively new in engineering but

incalculably old in nature, as illustrated by the stems of bamboo and wheat.

The origin of the screw is lost in the mists of antiquity, yet its form is perfectly illustrated by the interior of the shell of a mollusk called terebra, which, when the outer wall is removed, is absolutely screwlike.

Pumps are now in use that are modeled closely after the human heart, with a similar arrangement of valves. The ball-and-socket joint is a familiar device in nature as it is with that kind of joint that a man's arms and legs are joined to his body.

Who was it that first thought of a hinge? Doubtless some prehistoric person who ate an oyster or a clam. The shell of every bivalve mollusk has its hinge.

In a relative sense, our acquaintance with electricity is new. Storage batteries have been developed only within recent years. Yet such batteries, of high efficiency, were in existence millions of years ago, and are in use today by certain fishes. The torpedo ray, a common species in the deeper waters of Buzzards bay and Vineyard sound, is a terror to fishermen, being able to deliver a shock that will knock a man down. The creature carries two storage batteries, one on each side of its head. They are large oval masses composed of cells filled with a jellylike substance.



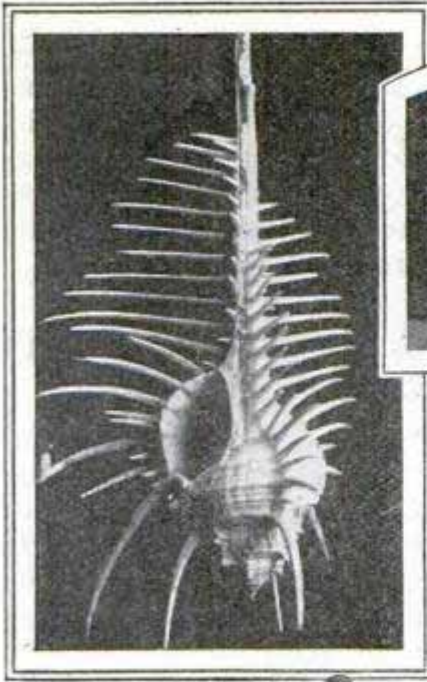

The First Combs Were Grown by This Species of South Sea Island Life, and Perhaps Gave Man the Idea

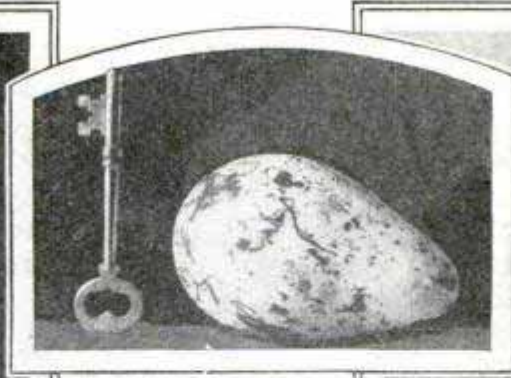

Nature's Invention, in an Egg, of a Rounded Box That Cannot Roll Off a Shelf, as It Can Only Roll in a Circle

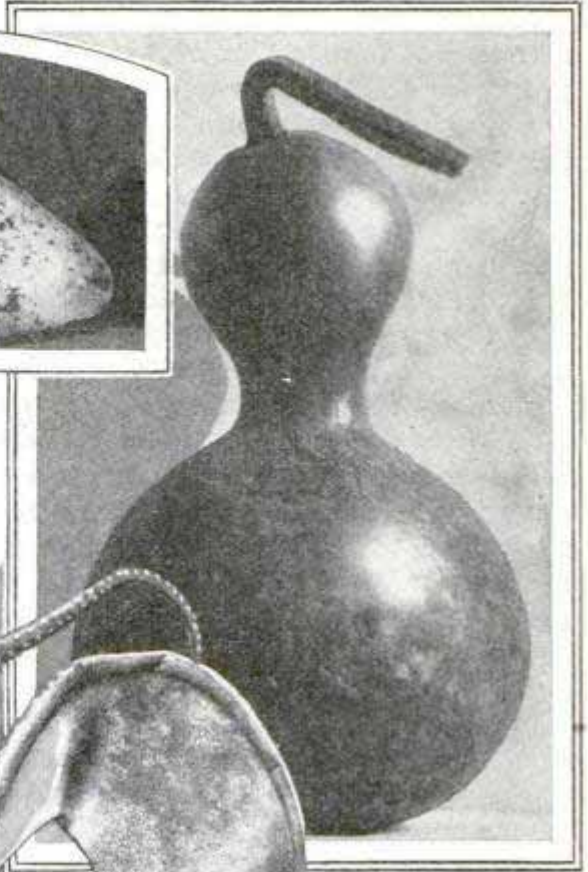

Above Is the First Bottle, Another of Nature's Inventions; in This Case the Common Gourd, Still Used as a Liquid Container

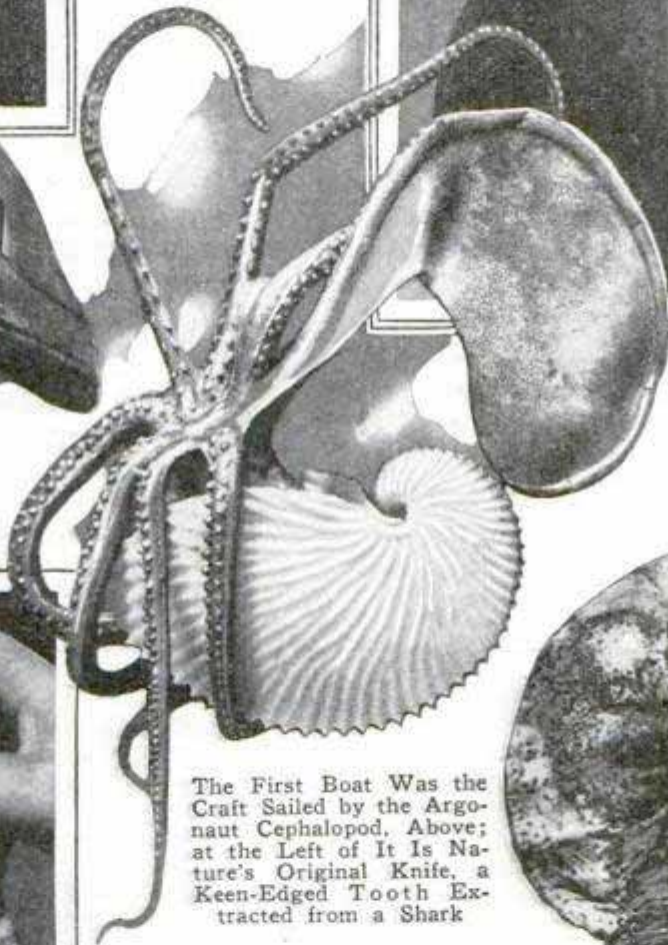

The First Boat Was the Craft Sailed by the Argonaut Cephalopod, Above; at the Left of It Is Nature's Original Knife, a Keen-Edged Tooth Extracted from a Shark

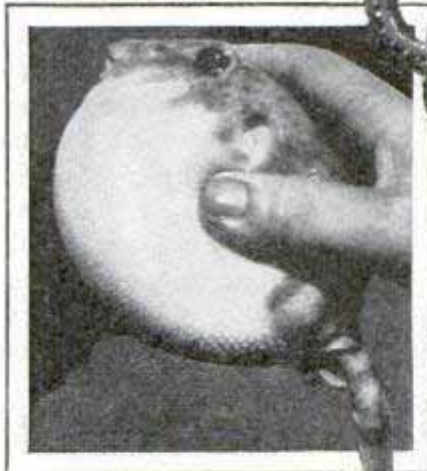

Above Is the Original Balloon, a Swellfish, Which Blows Itself Up with Air; at the Right Is Nature's Patent-Office Model of a Spinning Machine, the Caterpillar, Which Produces Silk and Spins It into a Cocoon; Above the Caterpillar Is a Pre-Edison Electric Battery, in the Form of a Torpedo Ray, with a Shocking Sting

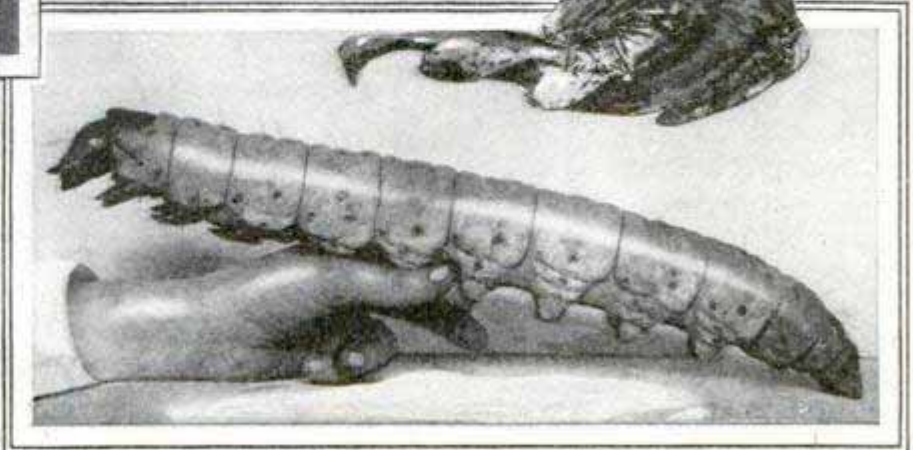



2 98 812

Trading Co. Inc. Tokyo, Japan

# POPULAR MECHANICS

Weaving was one of man's earliest industries, but nature "beat him to it." In the tropics certain trees weave their inner bark into excellent cloth, the strands of fiber laid crisscross to make wool and weft, as if with deft fingers.

Nearly three centuries ago, the Spaniards in Mexico sent to the king of Spain, for a birthday gift, a magnificent collar of lace. Save for the shaping and finishing, it was made by no human hands, being a product of the lace tree, whose bark, when soaked for many hours in water, splits into layers. Another very ancient industry is pottery making. But the potter was made the daintiest imaginable pottery ages before man first knew the need of vessels for food and water.

The first bottle was a gourd. Every egg is a neatly made box, and so likewise is every nut. The egg of a sea-fowl, called the murre, in itself represents a curious invention—that of a rounded box which cannot roll off a shelf. The hen bird lays her eggs on bare and often narrow ledges of lofty cliffs, off which they would be likely to roll were it not for the fact that, being pointed at one end, they roll in a circle when disturbed.

The tailor bird, a species of finch, might have been the first teacher of the art of sewing. It makes its nest by sewing leaves together. Caterpillars may be said to have invented spinning. In the manufacture of the artificial silk called rayon, the machines imitate the spinning apparatus of the silkworm.

The earliest comb was a molluscan shell (still used for that purpose by natives of Polynesia), which is ornamented with long spines arranged in rows. For ages wasps have built their nests of paper made from wood-pulp. Nature was the first manufacturer of glass, which

is produced in enormous quantities by volcanoes from melted quartz rock.

All of the evolution of life, both animal and vegetable, on earth has been a history of invention, with innumerable experiments, many of them eventually rejected, while those that proved successful have been retained.

## SHIP METAL OF LIGHT WEIGHT TO MEET NAVY PROBLEM

3046 While the question of total tonnage for navies has proved a perplexing international problem, the Japanese are reported to have discovered a strong, lightweight steel alloy which will permit them to build more ships than would be possible with ordinary materials under restrictive regulations. It is said to be extremely hard, but will reduce the weight of a vessel by nearly half. The Japanese naval department is maintaining great secrecy concerning the alloy, and officials would neither confirm nor deny the report.

## "BREATHING-TUBE" FURNACE TO REDUCE COAL BILLS

1825 Buckwheat and other small sizes of coal can be economically burned in the ordinary furnace without the likelihood of smothering the fire, according to claims

made for a combustion unit devised by a scientist of the department of agriculture. It is essentially a series of tubes so perforated that when it is placed in the furnace firebox, a strong draft is afforded, giving sufficient oxygen for the burning of powdered fuel. As this kind generally sells at much lower prices than the lump variety, a saving for the consumer is open without the expense of remodeling his furnace.

Coal Buckwheat Coal Burner

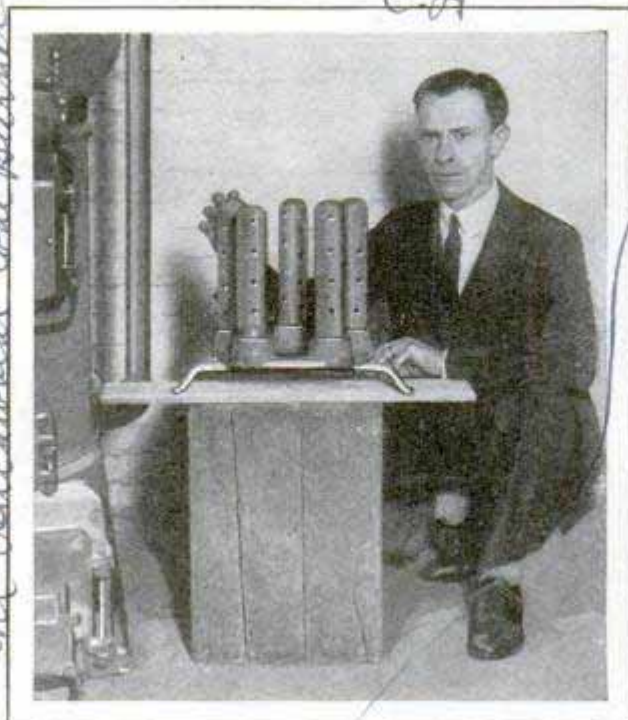

Air Tubes for the Furnace, to Permit Burning of Small-Size Coal; They Increase Oxygen Supply

Mr. W.A. Noel  
National Heating Engineers





Boring through a Drift and Throwing the Snow over the Fence; the Machine in Action, Illustrating Its Powerful Blowing Force; It Is Said to Operate Effectively in All Kinds of Snow

### SNOW-CUTTER AND BLOWER QUICKLY CLEARS ROADS

Snow of any depth, whether dry, wet, hard or loose, is quickly removed from roads with a combined cutter and blower unit that is said to have performed satisfactorily under practically all conditions of snow and roads. Tempered cutting augers bore into the drifts, break them up and by the forward movement of the machine, the snow is forced against a powerful blower that hurls it over fences, completely off the roadway, to the right or left, high or low. The outfit is made as a complete unit, only one motor being required to operate the augers and the blower, and to propel the machine. An additional feature is that snow is removed from the sides of the roads to permit drainage during thaws.

### SLICE OF TOAST IN TWO SECONDS ON QUICK-ACTION TOASTER

Toast at the rate of twenty-four to fifty slices per minute, depending upon the condition of the bread, is browned in an electric unit for which patents have been sought. It has rollers like those of a wringer. A piece of bread is dropped be-

tween them and pops out at the bottom, evenly and thoroughly toasted, due to the action of heat from the rolls, which run on graphite bearings that serve as brushes to take off the current. One roller swings on a pivot, permitting variation in thickness of the slices from one-quarter of an inch to an inch.



Toasting Bread in the Roller Unit; Speed and Even Browning Are Special Features of the Machine

*Inventor, E. W. Roberts, 222 W. Fourth St. Cincinnati, Ohio*



2460

# To SAVE WORK in your HOME

Light May Be Directed at Any Angle from This Floor Lamp for Many Purposes; One Bulb Is Sufficient



Rapid Comb Cleaner Gets between Teeth

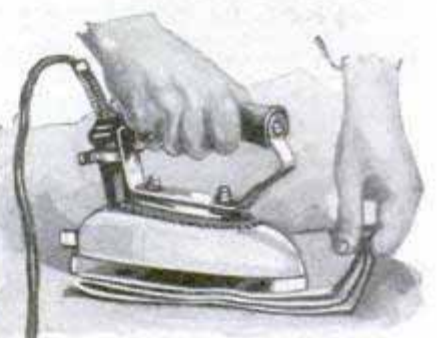

Electric Iron with Special Stand Shuts Itself Off If It Becomes Overheated

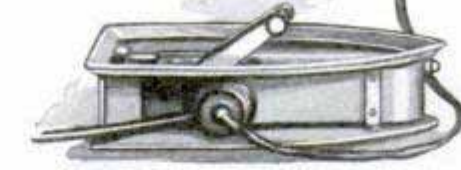

Left, Adjustable Glove-Drying Racks Fit Any Size and Prevent Wrinkles and Shrinking



Right, Jumper Seat for Baby Is Safe, Gives Healthful Exercise and Keeps Him from Floor



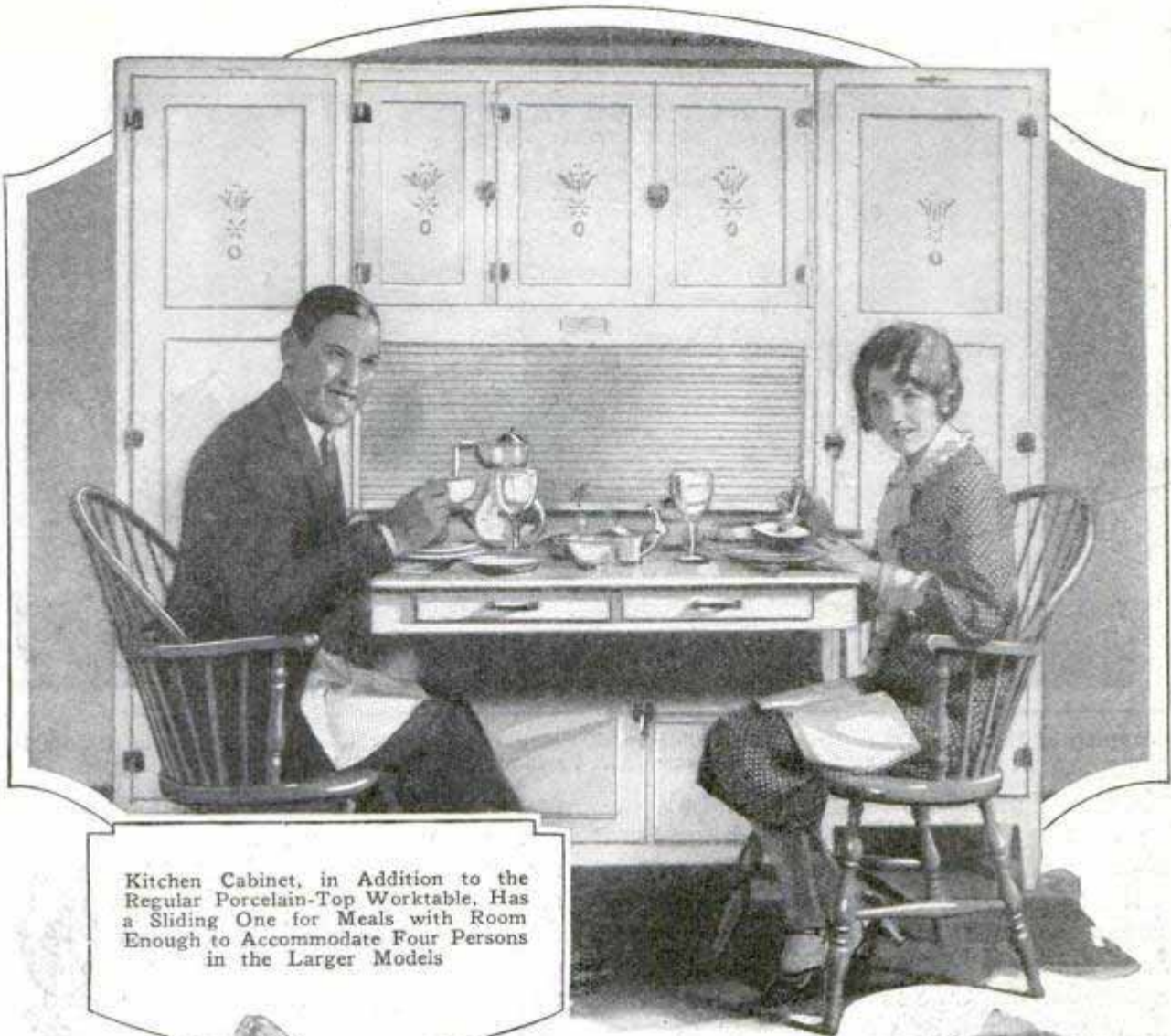

Kitchen Cabinet, in Addition to the Regular Porcelain-Top Worktable, Has a Sliding One for Meals with Room Enough to Accommodate Four Persons in the Larger Models

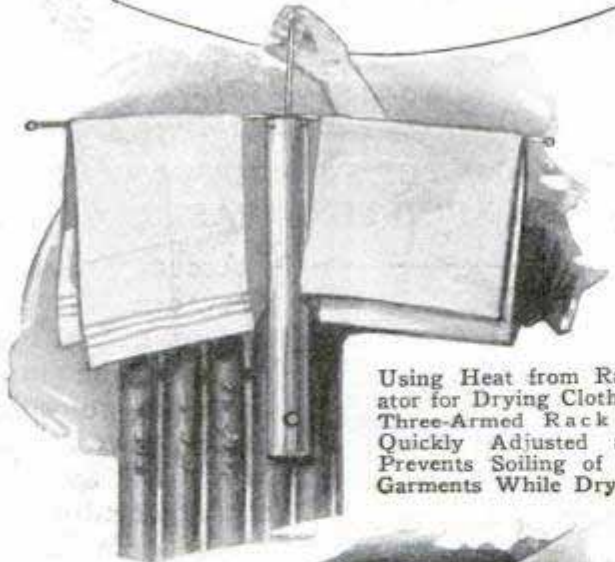

Using Heat from Radiator for Drying Clothes; Three-Armed Rack Is Quickly Adjusted and Prevents Soiling of the Garments While Drying

For Convenience and Added Cleanliness, Metal Cover for the Milk Bottle Has Space for Coins or Tickets and Can Be Used Practically Indefinitely



Below, Grinder for Sharpening Shears or Knives Does the Work Quickly and Easily



Detachable Knife Edges Save Sharpening; Put On a New One When Old Is Dull

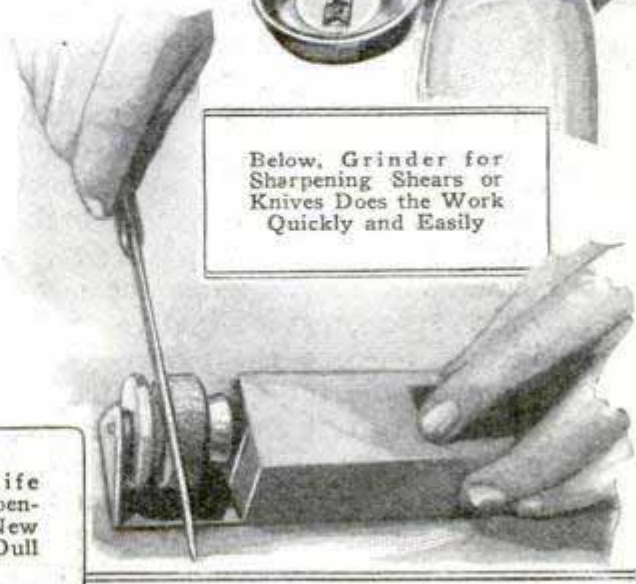







there is any waste of fuel from some unknown cause. The instrument is said to be accurate within two per cent, is easily attached and will operate with practically any liquid that flows through a pipe with reasonable speed.

**BOW AND ARROW TRAP INSECTS**

3002  
"Shooting" insects with a bow and arrow suggests an impractical method, especially when some of the game is so small that it can hardly be seen by the unaided eye, but this is the way one of the government scientists obtains specimens for the National museum. The feathers on the arrows are smeared with liquid glue and the shaft is shot into swarms of insects flying over tree tops and in other places difficult to reach. As it passes through the swarm, the insects are trapped on the glue and fall to the ground with the arrow. Although some are shaken off, enough are left to serve the collector's purposes. By this method, species of high-flying insects, rarely collected before, are caught.

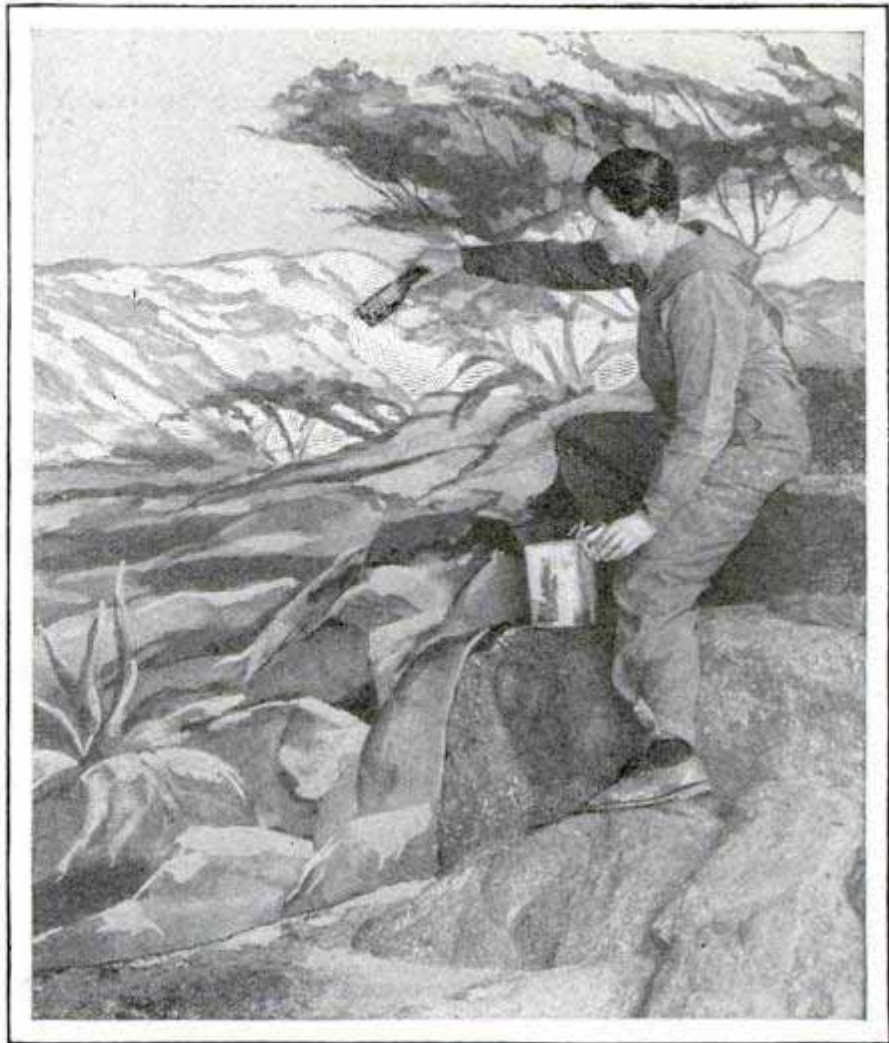

Constructing Realistic Backgrounds for Specimens in New York's Outdoor Animal Cages; Woman Painter at Work on Scenic Detail

**PAINTING SCENERY FOR LIONS  
WOMAN'S NOVEL TASK**

Painting jungle scenes in the outdoor cage for the lions at the New York zoological garden, is a woman artist's specialty. The decorations are said to make the beasts feel more at home.

**SURVEYORS HELPED BY COLORS  
USED ON SIGHT CARDS 3031**

Engineers surveying for a cabin site in the mountains, near Seattle, Wash., had difficulty in using their instruments as the darkness of the woods made it hard to take the readings from the sight card beyond a few hundred feet. An artist utilized his knowledge of color values to make a new card that could be seen more than 1,000 feet away with little trouble. Instead of having the usual four-square pattern in contrasting colors, his card was of red with a vertical bar in the center.



Bow and Arrow Equipment Used in Collecting Insects; Glue on the Feathers Traps Specimens in the Air

Cmt. Es. H. Slacy,  
4639 Montgomery Ave.

Cmt. L. W. Pedrose,  
667 Pacific Block



*Chickman & ...  
Monday 8/6/27*



Manne, with Some of the Instruments Used in Theater for Making Interpretative Noises to Accompany Productions

**EXPERT IN NOISE MAKING ADDS JOY TO THEATERGOING**

To make as much noise as he can and in as many different ways as possible is the task of Max H. Manne, who produces sound effects to accompany the films and feature numbers at Roxy's theater. Wire brushes rubbed over the kettledrum, give the effect of a locomotive's noise; a reed whistle has been made to imitate an infant's cry; catgut, variously used, mimics the calls of a number of animals and, to reproduce a dog's bark, a string drawn through a tin can and caressed by rosined fingers is effective. Mr. Manne has been granted a number of patents on noise makers, and the percussion room of the theater, where articles are stored, is an interesting museum of musical novelties.

☐ The weight of tungsten is about twice that of lead.

**STUDY QUICKER BERRY PICKING TO REDUCE FARMING COSTS**

3059

Farming costs in Great Britain can be reduced without a corresponding reduction in wages, according to findings of experts who recently completed a series of tests on workers with a view to abolishing antiquated and inefficient methods. Strawberry pickers were observed with special care. It was found that a fast picker spent more than half an hour in actually picking and seventeen minutes fumbling at the leaves. Slow pickers spent over a quarter of an hour hesitating with the leaves. They increased their output rate by picking more than one berry at a time before bringing the hand back to the receptacle; by using both hands, keeping the basket as near to the bush as possible, and refraining from "dodging about." For currant pickers, a special stool was introduced. It could be adjusted to three different heights and was also adapted to use in the packing sheds. The investigators found that women are superior to

men in handling milk cows, especially when the animals are restless, because the women speak to them more often than men and in soothing voices.

**ELECTRIC PAINT MIXER WORKS FROM LIGHTING SOCKET**

1823

Saving of time, labor and materials is claimed for a paint mixer, an electric motor which operates with current from the lighting socket. It is furnished in a floor or wall model, parts of which are interchangeable, and is adapted to a wide variety of other mixing operations.

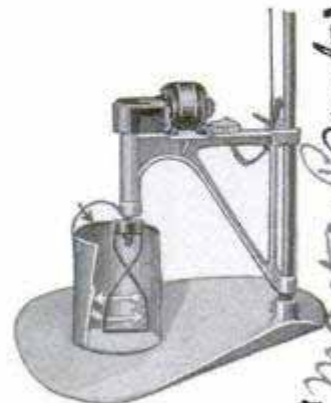

*Master Painter Mixer*

*Simmonds Co.,  
292 E. 26th St.*



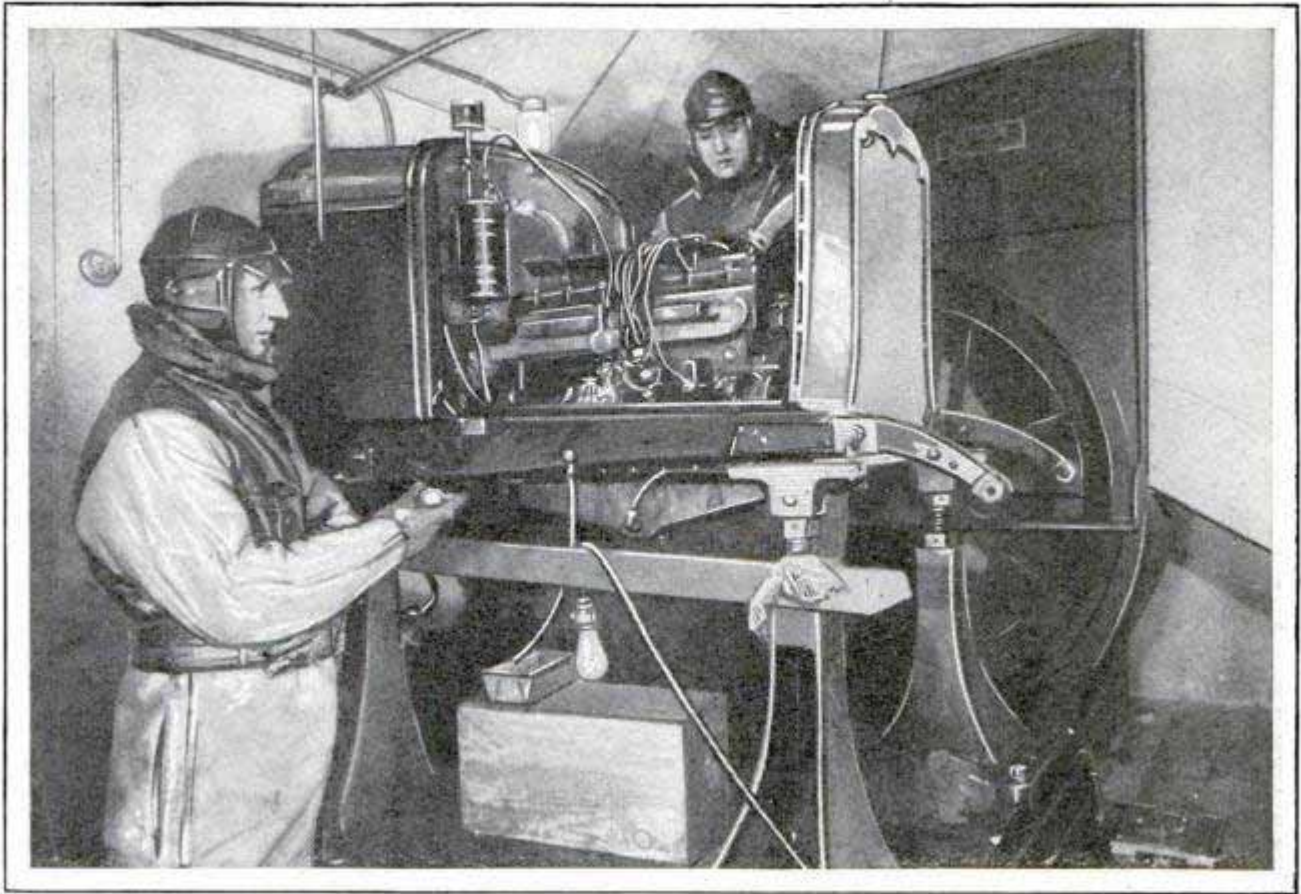

Clad in Aviator's Fur Suits, Testers in the Subzero Room of Automobile-Test Grounds Operate Sample Engines under the Most Trying Conditions to Which They Can Be Subjected

## Breaking 'em Up to Make Them Better

### How Scientists Devise Destructive Tests to Find New Methods of Improving Your Car

THAT mythical raincoat salesman, with the Sahara desert as his territory, has nothing on the experts in the laboratories of the big Detroit automobile factories, for their intricate devices, made by the score, have no market beyond their own workshops and no one bothers about seeking patents on them.

"We are always inventing ways to wreck cars," explained L. A. Danse, chief metal expert for a factory producing one of the highest-priced cars. "Inventors in the past have centered their efforts on means to make automobiles; none saw the necessity of breaking them up."

Mr. Danse pointed to a device for breaking a steering rod. "The average break comes when a front wheel hits an unexpected rut," he explained. "Well, we had to invent a machine that would duplicate this sort of a jar, not only on the right front wheel but the left. We keep this

jarring up, increasing the violence of the jolts until something breaks. The steel at the breaking point is examined and, if feasible, we advise the substitution of a different grade of metal."

Gears and their tendency to strip, have offered no end of opportunity for the experts. The teeth in the gears, Mr. Danse explained, must have a surface made of the hardest steel possible and at the same time, to prevent brittleness, the core must be of softer metal. To test the hardness of the gear tooth's surface, a machine was rigged up in the automobile laboratory. It consists of a tiny diamond ball that is dropped upon the various gear teeth, the rebound of the ball being automatically recorded. The higher the bounce, the harder the steel, explained the engineer.

Just the other day Mr. Danse and his assistants started an experiment in this



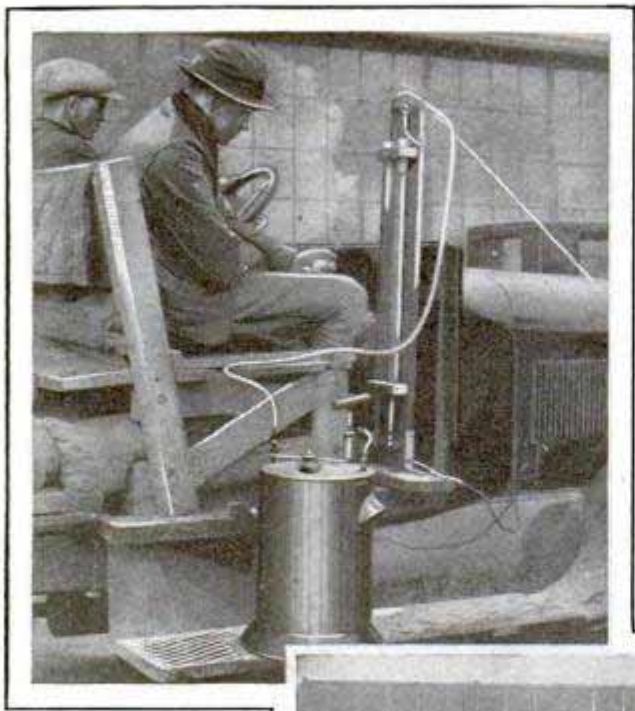

matter of hardening steel for gear teeth. "We'll know whether we are successful or not about two years from now," he said. "This is one of the big problems in the manufacture of automobiles. The present method of hardening surfaces for gears consists in combining carbon with

the steel, the steel absorbing the carbon. The gear must undergo an intense heat during the process. The heat must be quenched in water or oil. The trouble lies in the fact that the great heat and the sudden quench invariably cause warp.

"Now we believe that by nitrating the steel instead of carbonizing, the same hardness will result, and there will be no occasion for the tremendous heat nor, therefore, any warping. The automobile of the future, if this thing is done, will have fewer stripped gears."

Plowing furrows in fields of polished steel is a method adopted in this remarka-

ble laboratory, with a finer grade of automobile anticipated as the harvest. Steel is shipped into the factory of various grades. Some is meant for gears, others for the cylinders and still others for the chassis. Before any of it is used, however, Danse "goes plowing."

His plowshare is made of a tiny point of sapphire and the steel is polished until it might serve as a mirror. Across the field the sapphire plow is dragged and, by looking closely, one may discern a faint scratch. But, the scratch becomes a great furrow when placed under a microscope that enlarges 4,000 times. In some places deeper tracks are found, and here is where the experts do their work. Tiny crystals

are removed from the deeper tracks and examined more closely. They represent the "fatigue point" in steel and, if there are too many of them, the steel is at once rejected.

The microscope itself in this wonder laboratory was

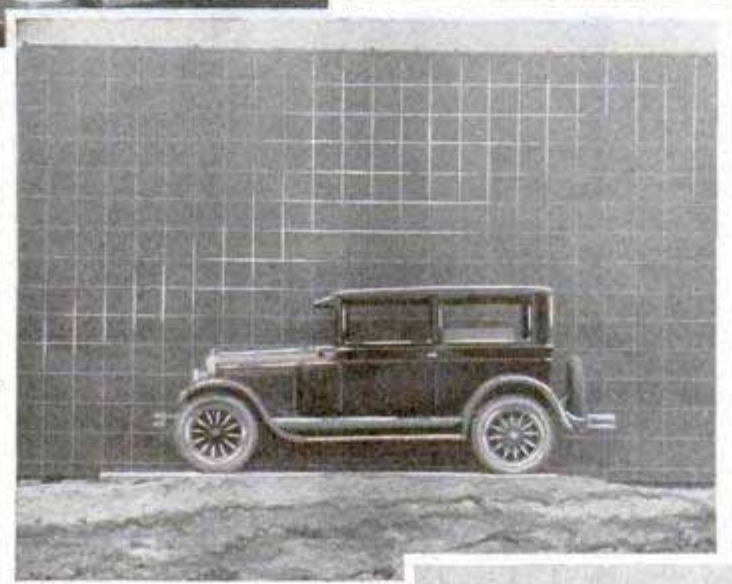

An Accurate Measure of Fuel Consumption Made by Special Apparatus, Top; and Checkered Background against Which Cars Are Photographed to Compare the Contours of Various Makes and Models

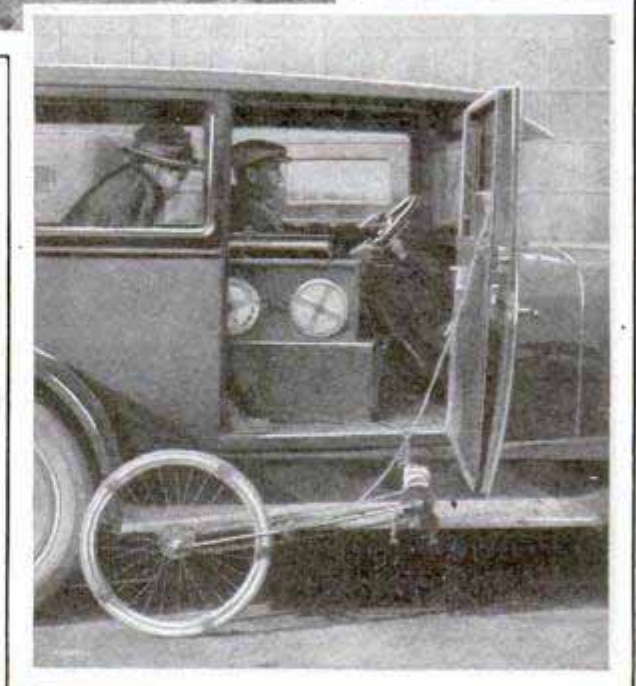

Bicycle Wheel and Chain Drive Operating the Electrical Apparatus That Makes a Written Record of Acceleration Tests at the Proving Grounds



virtually invented by the men who break up cars for a living. It carries, Mr. Danse says, the first binocular eyepiece ever used, the result of failing eyesight of one of the laboratory scientists. It possesses a short illuminant — microscope makers laughed when Danse ordered one—so he made his own. The arc light for the point of light to the center on the specimen has been done away with, and a simpler method substituted, and the whole has been mounted on springs so as to nullify the vibrating influences of a busy factory.

So carefully are steel tests made in the manufacture of automobiles, that in Danse's workshop the set of balances is so delicate that it can give the exact weight of one fiftieth part of an eyelash. Even the heat of an electric bulb influences the weighing of a specimen, and it is a laboratory rule that the light must be kept burning for at least fifteen minutes before the balances are used.

"Here is a contrivance that took

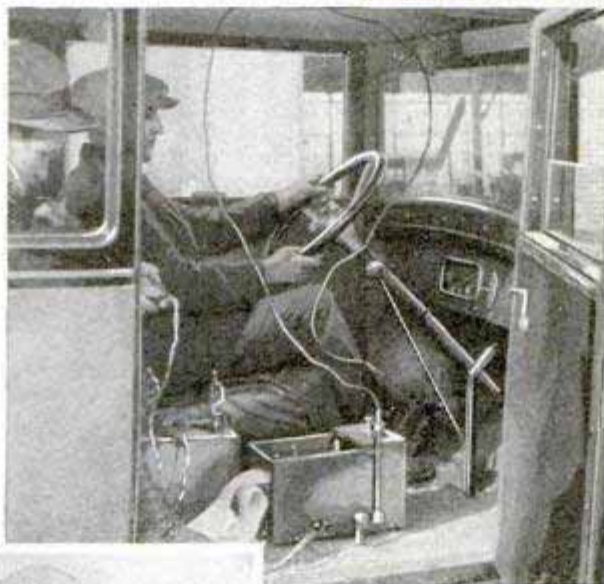

considerable time to fix up," said Mr. Danse, pointing to a roaring mechanism in one corner of the laboratory. "It's a test for rear-axle gears. We imagined a car driven in low gear up a fifteen-percent grade at thirty miles an hour, carrying a heavy load and operating for exactly 2,500 miles. When the machine has run for this distance,

Duplicate Steering-Wheel Device Used to Measure Steering Effort, Top; and an Electrical Brake-Pedal Pressure Recorder, Center

we take off the gears, break them up and find out which portions are worn most."

Recently Dr. Harold Hough, prominent Detroit minister, commented upon complaints that "romance has gone from the world." A trip through any automobile-factory laboratory, said the minister, would destroy this idea. It would prove, he said, that the discovery of America was but an afternoon's incident when compared with the discoveries being made daily in the field of science.

"The more we learn about steel here, the more we realize what wonderful things are being found out," said Mr. Danse.



How Much Pressure Does It Take to Operate Your Clutch? The Testing Engineers Do Not Guess, But Use This Spring Scale to Get Accurate Figures



2977  
822

### BUTTERFLY FARM BRINGS PROFIT AND PLEASURE



She decided to take the eggs home and watch them hatch. The proceedings were so interesting that she went back for more, until she finally had most of the species found in that part of the country and had created a wide interest in her unusual farm. She seeks the handsome species rather than the very rare, and sometimes

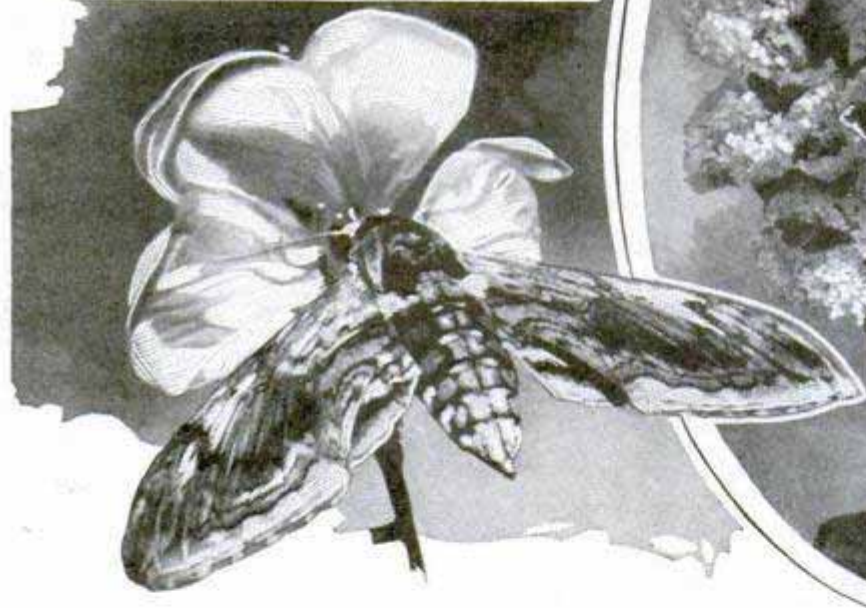

Some of the Butterflies and Moths Iowa Woman Cultivates on Her "Farm," Which Was Started as a Hobby and Has Developed into a Paying Enterprise; Specimens Are Mounted and Sold to Schools

Several hundred dollars in spare-time profits and the pleasure of pioneering in a little explored field are among the rewards enjoyed by an Iowa woman from her butterfly "farm." She hatches hundreds of the insects in a screened porch each year and mounts them for tray and table decorations while many schools of the state rely on her for supplies of butterflies and larvæ to be used in laboratory study. The venture was started as the result of the chance discovery of a cluster of butterfly eggs on the bark of a tree while she was walking through the woods.

includes dragon flies in the collection because of their brilliant and beautifully marked wings. When specimens are ready for mounting, they are painlessly put to sleep in jars filled with cyanide gas. The wings are then pressed and mounted. Backgrounds of weeds and leaves with sprinklings of "diamond dust" have proved effective for use on the tray and table decorations. The collection now numbers some 400 species and is easily maintained as leaves furnish the chief food. While raising the butterflies for sale, interesting facts have been discovered about them

*Fr. W. Casterline, Ipfston, Iowa.*

*Wm.*



Mr. V. Martin  
7913 Sheridan Road

and other insects, and the hobby has taken the collector into the outdoors, an activity recommended by her physician. She has found that bright-colored flowers are the most attractive to butterflies and moths.

### HORIZONTAL WELL SAVES CITY EXPENSE IN WATER SUPPLY

By means of a horizontal well instead of several vertical ones, the city of St. Joseph, Mich., has saved itself many thousands of dollars in connection with its water supply. The well was constructed by driving sheet-steel piling through the sand, fourteen feet below the level of the lake, in parallel rows, fifteen feet apart and 150 feet long. The sand between the steel was excavated, forming a long trench, which was bedded with crushed rock, and a perforated pipe, twenty-four inches in diameter, was laid at the bottom between manholes built at each end of the trench. This pipe, in turn, was packed with layers of crushed rock, and the trench filled. As water seeped in from the lake, it was filtered and drawn up for use through pumps. The supply is proving adequate for this city of 8,000 population, and the intakes are unclogged in winter.

### ODD FOODS IN MANY LANDS

Crocodile meat is considered a good food by natives of Africa and southern negroes relish the tails of alligators. In the West Indies, fish eyes are regarded as a delicacy. Jellyfish are eaten in Japan and, in many places of the world, squid and octopus are valued for food. In Polynesia, a sea worm, the "palolo," which averages about sixteen inches when fully grown, is caught and prepared into an appetizing stew. Sentiment is against snakes, but they are eaten in some places and travelers testify that they are often very tasty. Hawks, herons and parrots are commonly killed for food in parts of the tropics.



Weather Prophet, Watch and Compass, All in One; the Instrument Has 292 Parts



For Hot Meals on the Dining Cars; Platter with Bowl in Base, to Hold Warm Water

### HEATING PLANTS IN PLATTERS KEEP FOOD WARM

For its dining-car service, a western railroad is using platters with a metal bowl in the base, which is filled with hot water to keep the food warm. A stopper keeps the contents from spilling. The same principle is applied to butter dishes, with cold water or ice to prevent the butter from melting on warm days.

### WATCH TELLING WORLD TIME ALSO PREDICTS WEATHER

Constructed of 292 parts, a watch designed by a French craftsman is a small observatory in itself, for besides telling the time for the principal cities of the world, it has a thermometer and barometer, a compass, gives the signs of the zodiac and strikes the hours and quarter hours. With it, an observer can tell the day of the week, month, year, decade, the quarter of the moon and the time when the sun will rise and set for any day of the year.

10 Mc We Lands Maryland are  
720  
Hallmark  
Md.

Made by Le Roy, Paris, France

Mr. Austria K. Clark, 4717 E. 16th St. Detroit, Mich.  
Smithsonian Institution, 16. Ave de la Paix, Paris, France.



2836

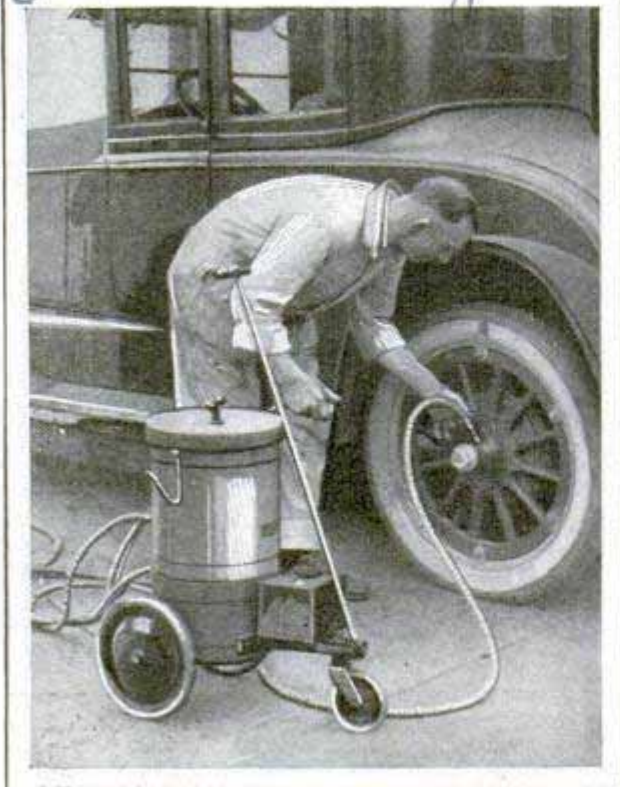

Greasing the Car with the Gun; Compressed Air from the Tank Forces Lubricant into Parts

### CARS ARE GREASED BY AIR GUN AT TOUCH OF BUTTON

Press a button, and grease is forced from a portable receptacle into stubborn shackle bolts, bearings and other parts of an automobile in an instant and at a saving of unpleasant work. The "gun" is operated from an ordinary air tank, such as is used for inflating tires, and is equipped with a "booster" unit, inside which the pressure may be raised as high as 10,000 pounds if desired. This is employed only when the gun is to be used. The outfit is moved about easily on a three-wheeled carriage, holds fifty pounds of lubricant and is readily refilled.

### RADIO BEACON TO GUIDE PLANES THROUGH STORM AND FOG

Directing airplanes by means of radio signals has been successfully accomplished for some time and now wireless is adapted still further to the service of the airman in a beacon devised by C. Francis Jenkins, of Washington. Under his plan, planes would fly safely through a "radio channel" regardless of storms or fogs, for a little lamp, lighted by energy from a series of radio stations along the way, would burn

brightly on the instrument board as long as the pilot kept to his course, but would begin to grow dim if the ship went astray. The transmitting units, Mr. Jenkins declares, could be erected at the same points where there are now lights to direct flyers, and the lamp towers already installed could be used to support antennæ of a vertical type, which would send out short waves and be placed about twenty-five miles apart. Each unit would cost not more than \$250, it is estimated, and could be attended by the same men that operate the present beacons. The system would serve many planes at the same time, the inventor points out, and would operate when fogs and storms obscured the lights.

### SPECTACLES FOR RACE HORSES RELIEVE VISION ILLS

Race horses have been known to stumble at a crucial moment, losing their chance of victory and seriously impairing their value. It has been discovered that this tendency is not always due to faulty feet but to defective vision. Recently, a well-known owner of "blue bloods" had a special pair of glasses made to fit a two-year old, afflicted with imperfect eyesight. The lenses were incased in a wide, comfortably fitting holder kept snugly in place with straps and bands. Marked improvement in the horse's performance was noted while wearing the glasses.

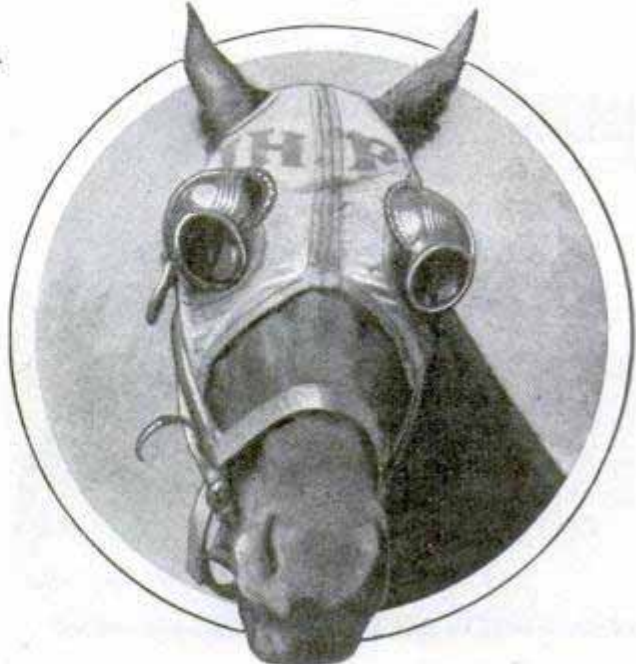

Spectacles and Goggles Combined to Aid Vision of a Valuable Race Horse and Keep It from Stumbling

*Veronus belonging to E. R. Bradley*

3023



# “How to Prevent MOTORBOATING”

by I. F. Jackowski

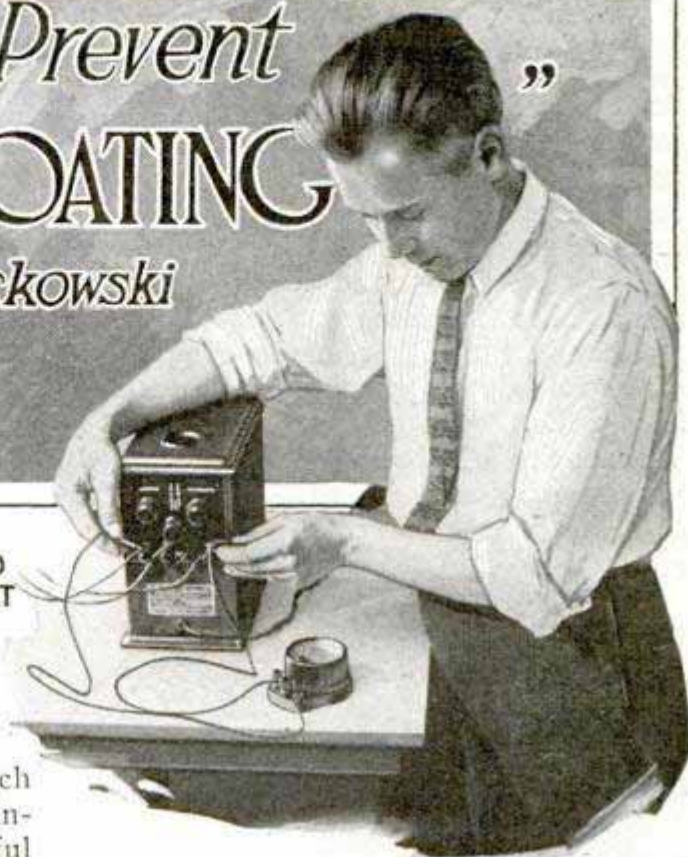

WITHIN the past year the term “motorboating” has frequently been heard in connection with B-eliminators and resistance-coupled radio circuits. The term was used because it clearly defines the put-putting sound heard in the speaker, which under aggravated conditions seriously interferes with the program. A careful check of the set is required to eliminate this noise, but when the cause is understood, it is a simple matter. Blocking, distortion, whistles and other similar troubles are often symptoms that derive from the same cause.

One of the most common causes will be found in B-batteries that have fallen below the necessary potential for producing good results. Such batteries are tested in the manner shown in the upper photo on page 827. A d.c. voltmeter, reading to 50 volts, is used, and if the average voltage has dropped, say, to 18 volts in a 22½-volt block, it should be discarded. In a 45-volt block, a drop to 38 volts will often cause trouble, and the remedy is a new unit. It is always best to renew all units as the new cells will quickly drop to the level of the older ones when connected in series. As the voltage decreases, the internal resistance of the battery increases, resulting in a common high impedance, or resistance caused by reactance. High resistance at any point in the installation means poor output voltage. New B-batteries of good quality have a low internal resistance and maintain, in most cases, a constant voltage. The situation is somewhat different in most B-

TO  
SET

eliminators, because the output voltage decreases as the current flow increases. In the correctly designed eliminator, a surplus of power is provided so that in actual operation the plate or B-potential will be correct at all times.

Study the needs of your set and be sure that the correct B-voltage is applied to the terminals, as designated by the designer of the set. The ordinary d.c. voltmeter, even though designed to cover the maximum B-voltage, is not suitable for checking B-eliminators. A true reading will not be obtained unless the voltmeter is of the high-resistance type, of 1,000 ohms per volt, and a maximum voltage range. Such instruments are now available in a small table type, shown in the headpiece. The eliminator may be tested under operating conditions and will give an accurate reading. It is then a simple matter to adjust the control knobs on the eliminator to obtain the required voltage at the terminals. The average five-tube radio set consumes 40 milliamp. of plate current; the drain of plate current on the B-supply depends on conditions in the set and is increasingly proportioned through each tube, the greatest change



taking place in the last audio tube. When the set is connected to the B-supply, it constitutes a resistance, which changes with the modulation of the received signals, the B-voltage unit passing current accordingly. This variation in the signal strength will produce a rapid charge and discharge of the condensers in the filter circuit of the B-supply, which, if effected by high-resistance conditions, is unable to respond to the changes. The fault may lie either in the set or in the eliminator, and the remedy is applied to either or both of the units.

A capacity of about 30 mfd., shunted across the output of the B-eliminator, a low-resistance rectifier and choke coils

properly applied remedy this trouble. The average experimenter will find this rather hard to do, but much of the trouble in the unit is now overcome, owing to improvements in eliminators, and the large condenser shunted across the output, as shown in the diagram on this page, will correct the average deficiency in this respect. Condensers of this type are now available and very easy to install.

A very common cause of motorboating is an imperfectly designed or defective resistance-coupled audio-amplifier unit in the set. Those who are contemplating using an amplifier of this type with a B-eliminator for the first time, will very likely be introduced to the effects of motorboating, unless the instrument has been designed especially to prevent this. The cause lies in certain reactions that take place within the unit from improper values of resistance, although the unit may work well with the ordinary dry B-batteries. The usual resistance-coupled unit designed for battery operation will employ a resistance of 100,000 ohms (.1 meg.) in the plate circuit of the detector tube, as pointed out in the photo on page 827; this is satisfactory for dry B-

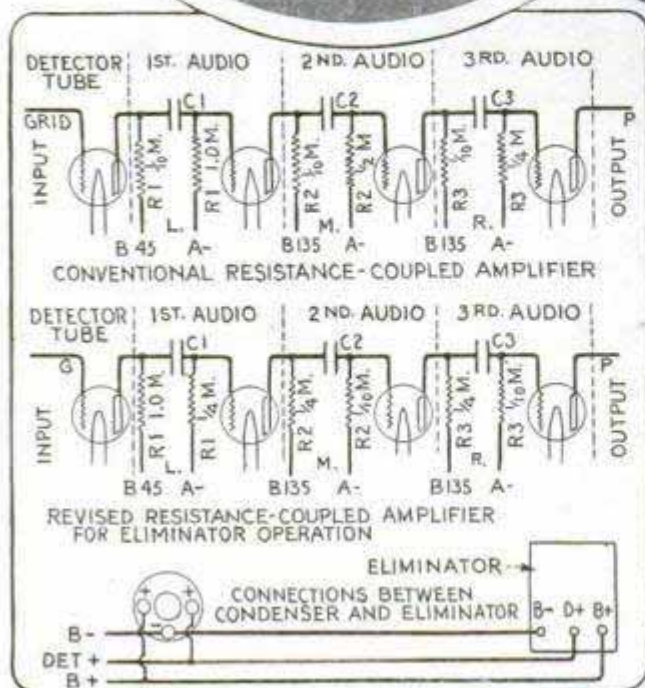

In Circle, Discharging Fixed Condenser; Above, Charging Condenser



batteries but the B-eliminator will supply an excess of voltage to the plate of this tube and, unless a resistor of higher value is used, the result will be motorboating. Resistance-coupled amplification is far more sensitive to low frequencies than to higher frequencies; therefore, the residual hum of the alternating current is amplified, and this, when added to the modulated signals, aggravates distortion, and motorboating occurs. The upper diagram



Above, Testing 45-Volt B-Battery Unit; Left, Pointing Out Resistor in Plate Circuit of Detector Tube

condenser of any residual charge it may contain. This is done by placing a knife blade, or other metallic instrument, across the terminals, as shown in the insert on page 826. When tested, there may still be a faint click in the phones on first contact. If so, remove the contact and again apply it; if no click is heard, the condenser may be considered efficient or at least to contain no short circuit.

on page 826 shows the usual standard resistor combination, and the one below a combination that engineers have worked out especially for use with B-eliminators.

To further filter the noises referred to as caused by the a.c. current, the electrolytic condenser of 30 mfd., or one of similar type, across the eliminator output may or may not be required, depending on the efficiency of the eliminator as a full-wave rectifier. Defective blocking condensers in the amplifier until will cause serious trouble. To check such fixed condensers, remove them from the unit, if possible, and check them with a pair of phones in series with a battery. An accurate check is obtained by discharging the

The ability of a condenser of this type to hold its charge may be determined by charging it as shown in the lower photo on the same page and setting it aside for a minute or two before testing. The strength of the click at the end of this period will determine the strength of the charge retained. If defective, the condenser will quickly lose its charge through leakage, due, perhaps, to defective workmanship or poor insulation. When replacing a condenser, be sure that the new instrument is of the same rated value and of good quality. If a highly regenerative set is used in connection with a resistance-coupled amplifier, several complications often occur even with the best of B-eliminators. The variations in the a.c. line voltage must be compensated for, so that, when the set is tuned just below the point of self-oscillation at normal B-voltage, a slight fluctuation in the line



will not throw the set into oscillation, with resultant motorboating. A new ballast tube has been designed for this purpose,

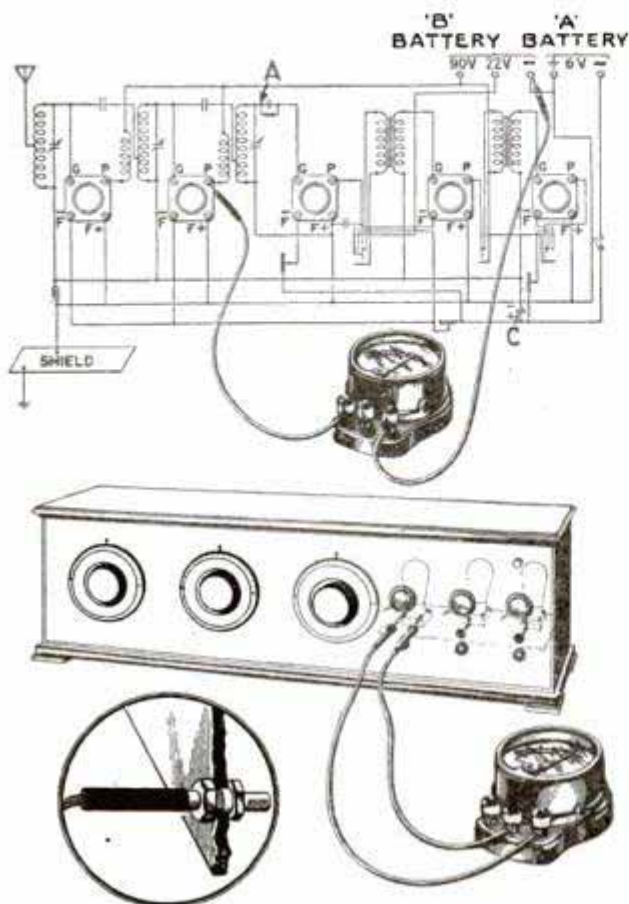

Suggested Tests Obtained with Dual-Range Voltmeter

a constant-current device that will take care of line fluctuations. Directions for installing this tube will be found on a sheet that comes with the tube. This tube is known as the UV-876 or C-376, and is placed in series with the primary of the transformer supplying the eliminator.

Now that we have covered the most common cause and remedy for motorboating, still further check can be made in the set to locate other possible sources of trouble. Here again a voltmeter of the d.c. dual-range type or a dual-range B-eliminator voltmeter may be used for measurements within the range of the instrument. Circuit-continuity tests are familiar to most experimenters, and the procedure is outlined in the diagram on this page. In general, it is only necessary to test from the batteries to the four binding posts on each tube base in the following manner: Connect the voltmeter for the low-range reading to test the filament circuit to each tube and see that the read-

ing is as specified by the tube manufacturer. The negative connection from the voltmeter is, of course, connected to the negative terminal of the A-battery, and the positive connection moved from one positive terminal to the other on each tube socket. The rheostat controlling each tube is adjusted to the best operating voltage which, in the case of a 201-A tube rated at 5 volts, may be as low as 4 or  $4\frac{1}{2}$  volts; the main advantage being to see that excessive voltage harmful to the tube is not applied. A permanent installation of midget jacks, mounted on the front panel as shown below the diagram, may be used, greatly simplifying these tests.

To test the grid-circuit wiring of the detector tube, use the same connectors and touch the wiring at the point marked A in the diagram. In the case of the neutrodyne circuit shown, this will check both the detector-grid circuit and the secondary of the second r.f. transformer. To test the wiring, main switch, rheostats and jacks between the negative side of the A-battery and the F-negative posts of the filaments, connect the positive side of the A-battery to the low-range post on the voltmeter and, with the negative terminal of the other cable connected to the negative post on the instrument, touch the negative F-post on each tube successively. To test the wiring between the positive side of the B-battery and the plate, the primary windings of all transformers and all jacks, connect the negative side of the B-battery to the negative post on the voltmeter and, with the terminal of the cable connected to the high-range post on the instrument, touch the posts marked P on each tube socket successively. This connection is shown in the upper diagram. To test the wiring between the C-battery and the grids, and the secondary sides of the transformers, excepting the grid circuit of the detector tube and the secondary of the second r.f. transformer, connect the positive post on the C-battery to the low-range post on the voltmeter and, with the other cable from the negative post on the voltmeter, touch the G-post on each socket successively. This makes a complete test for continuity for this particular type of circuit, and it is a simple matter to adapt it to any set you have.

Any deflection of the voltmeter pointer



*Radio Receiver*  
*106- Seventh Ave*  
*New York*

indicates that the circuit is continuous to that particular point. If no deflection is obtained, which is the indication of a fault, it is necessary to go back on this circuit toward the battery, touching the various points until a deflection takes place. The faulty part is then readily found. For some types of circuits, it is advisable to test the transformers separately; in this case, connect a 6-volt storage battery or several dry cells in series with the voltmeter and the transformer winding. The continuity tests give you a true idea of what is going on in the set and further demonstrates the value of a good dual-range voltmeter.

**Shielding A. C. Line to Prevent Hum**

Alternating-current hum caused by socket leads may be eliminated by shielding the lead with tinfoil. Cut the foil in strips, and wrap it around the wire, also wrapping bare copper wire over the foil and grounding one end to a water pipe.

*1335-R*

**Tester for Service Men Is Portable**

This tester is useful for radio-service men and experimenters who go deeply into the subject of checking their work in order to obtain maximum results at all times. For measuring the various voltages in either a battery or a battery-eliminator operated set, both at the battery terminals and at the tube sockets, and for



*\$175.00*

testing tubes under operating conditions this tester is ideal. Tests may also be made for continuity and condition of circuits, all of them being made with the regular batteries or battery eliminator used in the radio set without change in connections. The voltage ranges have a sensitivity of 1,000 ohms per volt, which means that full-scale deflection is produced with a current of only 1 milliamp.

used in the radio set without change in connections. The voltage ranges have a sensitivity of 1,000 ohms per volt, which means that full-scale deflection is produced with a current of only 1 milliamp.

**Power Amplifier and B-Eliminator Combined in One Unit**

*1343-R*

Combining all the good points of the latest type of power amplifier with an ef-

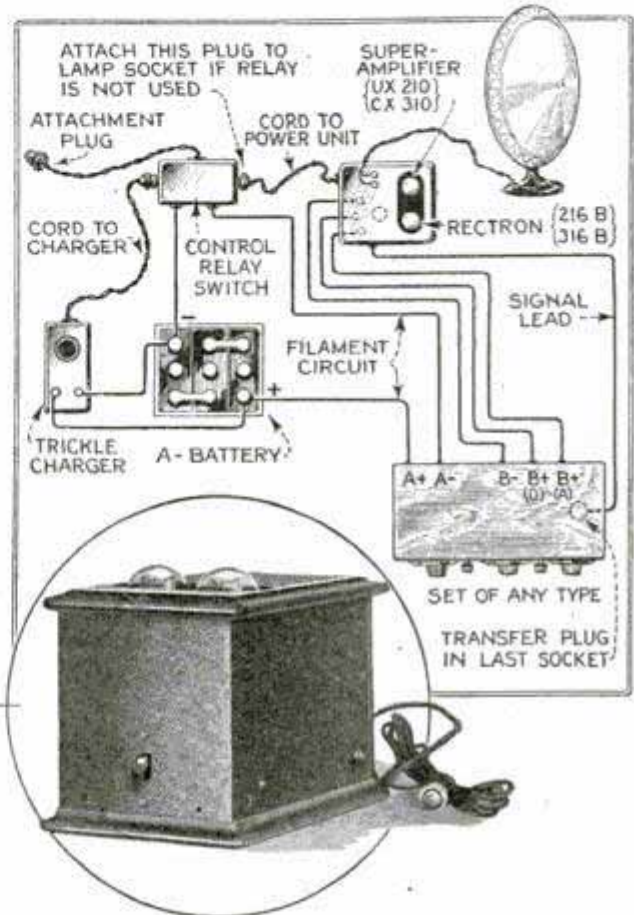

Amplifier and Diagram of Connections for Power Amplification and B-Elimination

ficient B-eliminator, this compact device may be used with any radio receiver. The wiring diagram shows the power unit replacing the usual B-batteries and, in addition, supplying the necessary high voltage for the power-amplifier tube. The loud speaker is removed from the set and plugged in at the power-amplifier outfit. An automatic relay switch, trickle charger and storage battery complete the installation, forming a complete power plant. The plug from the relay switch is connected into the 110-volt house-lighting line and the power supply is controlled from the switch on the front panel of the set. This simple method of bringing the old receiver up to date or making a new one better, without complicating the wiring, fills a long-felt need. The signal lead from the power unit is plugged into the last audio socket, and the full benefit of the 210 super-amplifier tube is thus obtained.

*Weston Electric Instrument Co., Newark, N.J.*  
*4 Weston Ave. Waverly Park*







# SIXTY DOLLARS *builds* *Nine-Tube* SUPERHET

by  
FRANK L. BRITTIN



**D**ECLARED by experts to equal, if not excel, the finest superheterodynes hitherto available, the latest development of Popular Mechanics radio laboratory fills a long-felt want. Not a single thing has been sacrificed for efficiency; in fact, through simplicity of construction and the elimination of nonessentials much has been gained, and, best of all, this set really costs less than many four and five-tube sets, as \$60 completely covers the cost of all materials, except tubes and batteries. Tests covering a period of six months have been highly satisfactory and no set that we have seen has better tone, selectivity and range.

The circuit is similar to our previous models, but several improvements have been made in the oscillator and intermediate-frequency amplifier. The controls on the front panel have been reduced to three, and the operation is so simple that the set can be tuned by a child. The circuit consists of an oscillator, first detector, four stages of resistance-coupled intermediate-frequency amplification, second detector, one stage of transformer-coupled audio and a second audio stage of the resistance-coupled type. Due to the complete shielding, the howls usually associated with supers are absent, and selectivity is increased to a point where near-by powerful stations may be separated by a one or two-degree movement of the dials. One standard socket is used for the oscillator tube, but all other sockets are built up directly on the subpanel. No effort has been made to use cheap material; all parts specified are of the highest grade and in this lies much of the success of the new receiver.

The intermediate stages are built up across the subpanel in individual units; resistors and condensers of highest effi-

ciency and the new 240, 30-MU tubes are employed. These are specially designed for use in resistance-coupled sets, and, since the amplification in resistance coupling is entirely due to the amplification constant of the tube itself, the advent of these tubes, of exceptionally high amplification factor, is of prime interest. They have the same filament characteristics as the standard 201-A type, namely, 5 volts and .25 amp. The plate voltage, on the other hand, can and should be about 135 volts; the plate-coupling resistor should be 250,000 ohms (.25 meg.) instead of the usual 100,000 ohms (.1 meg.). These tubes may also be used as detectors, if desired, in which case the plate voltage would be  $67\frac{1}{2}$  or 90. The 200-A type, however, is specified for this circuit.

The detailed wiring diagram given further illustrates the extreme simplicity of the set; the rear of the front panel is shown in detail and the subpanel is dotted in, giving an "X-ray view" of the wiring. The few wires that show above the subpanel are shaded and by referring to the rear-view photo these wires are easily located. Drilled and engraved panels will be available for those who do not wish to drill their own, and full-size templates and enlarged layout diagrams have been prepared, simplifying construction to such an extent that the set can be built by a



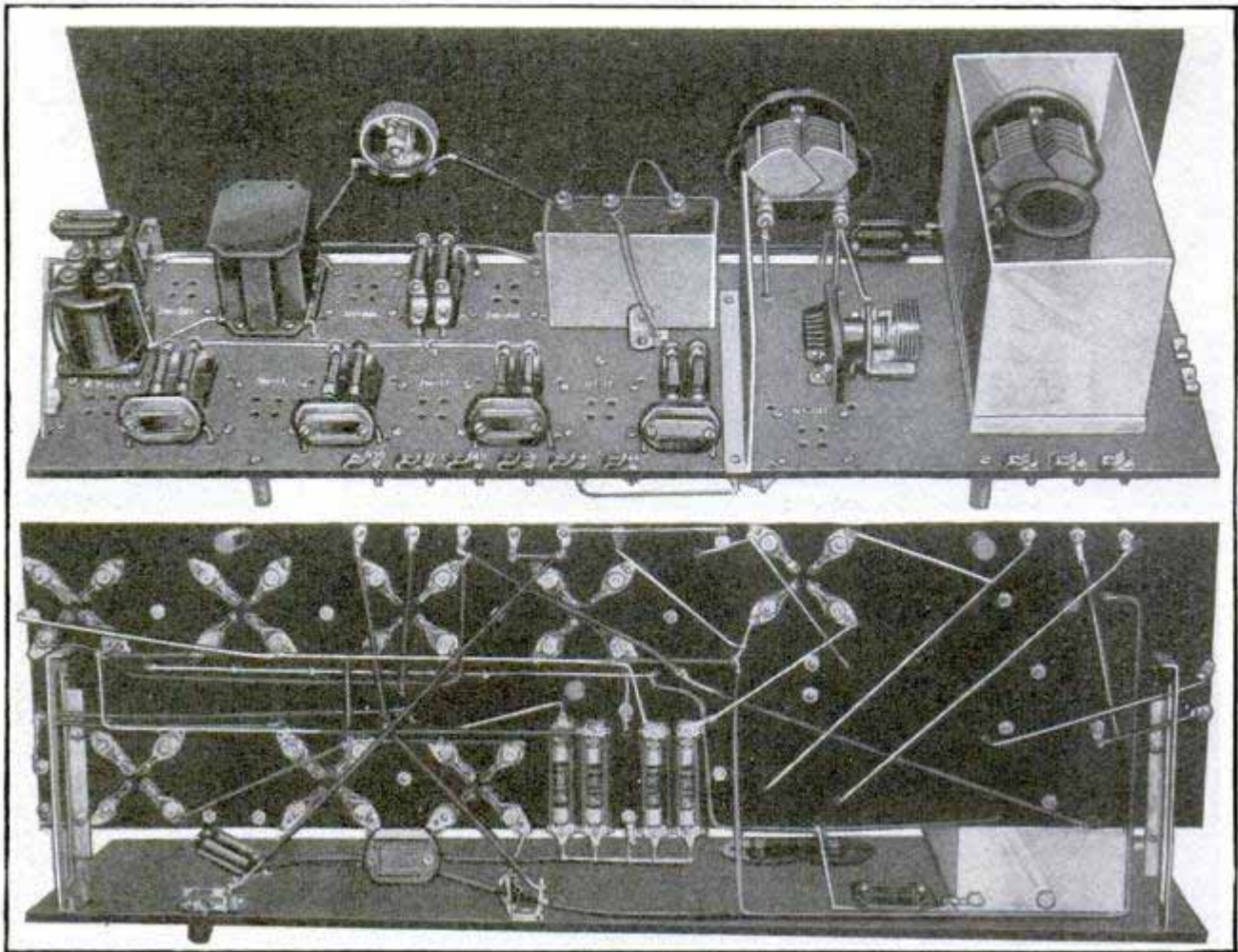

Top, Rear View of Completed Set with Lid of Oscillator Shield Removed; Center, Undersubpanel Showing Method of Wiring and Instrument Assembly There; Left, Side View of First-Detector Shield

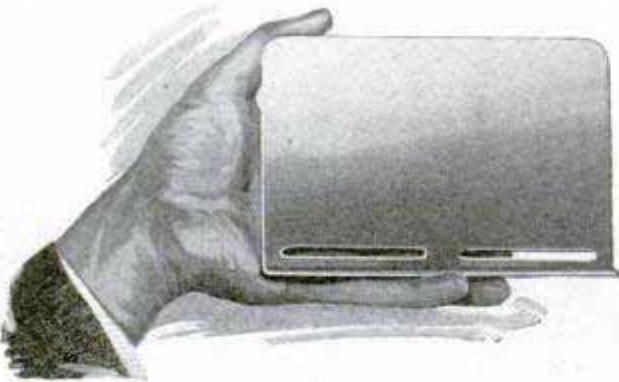

novice. The necessary tube-prong clips, machine screws and nuts for building up the sockets on the subpanel come in sets, the manufacturer also providing a steel jig for properly locating the holes. A sketch of this jig or template, showing the various drill sizes, will be found at the lower left on the simplified wiring diagram on page 830.

C-battery No. 1 consists of two  $4\frac{1}{2}$ -volt units connected in series and is connected to the Fahnestock clips on the left side of the subpanel as shown; use 3 or  $4\frac{1}{2}$  volts for the first audio stage and 9 volts for the second. C-battery No. 2 is a sin-

gle  $4\frac{1}{2}$ -volt unit and is connected at the extreme right side of the subpanel as indicated at the right.

After the instruments have all been assembled on the front and subpanel, and the subpanel brackets are in position, screw the front panel to these brackets, and place long round-hole soldering lugs under each terminal that is to be connected in the circuit. Referring to the photos on this page, it should be noted that while only two wooden pins that support the rear of the subpanel are visible, there is a third one in the center. These supports are made from dowel stock,  $\frac{7}{16}$  in. in diameter and  $1\frac{1}{4}$  in. long, and are held in position by oval-head nickelplated wood screws,  $\frac{1}{2}$  in. long. The instruments located on the underside of the subpanel are clearly shown in the lower photo; the filament-control units are grouped in the center at front. The  $\frac{1}{2}$ -amp. type controls the filament of the power tube; the



two  $\frac{3}{4}$ -amp. units control three tubes each, and the  $\frac{1}{4}$ -amp. unit, the first detector tube. The oscillator is manually controlled by the rheostat on the front panel, and the operator will soon learn that the proper handling of this rheostat in tuning gives the set unusual flexibility. The three small fixed condensers shown are the two .0025-mfd. and the .006-mfd. shown in the detailed wiring diagram. The negative lead from the rheostat is connected to a lug bolted to the bottom of the aluminum can at the front, the can itself thus becoming the negative side and automatically grounded to the common A and B-negative line. The negative lead to the filament of the oscillator tube is taken to the socket post from a lug bolted to the bottom of the can at the rear. The 1-mfd. fixed condenser, shown at the front of the can base and located directly below the oscillator condenser, is laid flat on the bottom of the can, as shown in the upper photo on this page. The tube socket, coil socket and 1-mfd. condenser are all mounted on the can base, in position on the subpanel, and soldered in the circuit before the can is

Upper Right, Close-Up of Oscillator-Unit Assembly on Base of Shield; Midget Condenser, Wavelength Condenser and First-Detector Socket at Left; Center, Completed Set; Bottom, I. F. and A. F.-Amplifier Section.

placed in position. Enlarge the holes with a reamer where the leads pass through the can base, and use good black spaghetti tubing on these wires to prevent shorts.

Now remove the oscillator condenser and prepare the front side of the can for mounting. Place the open can in position on the base, and, with an icepick or other sharp instrument, mark off the positions

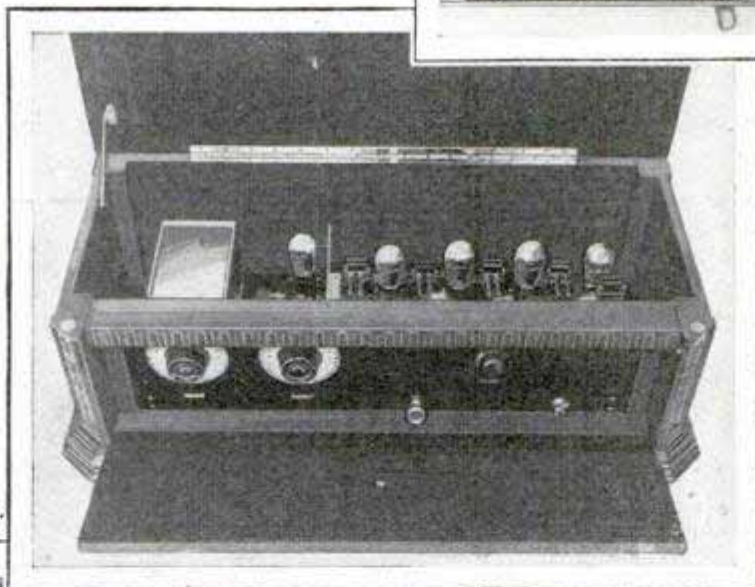
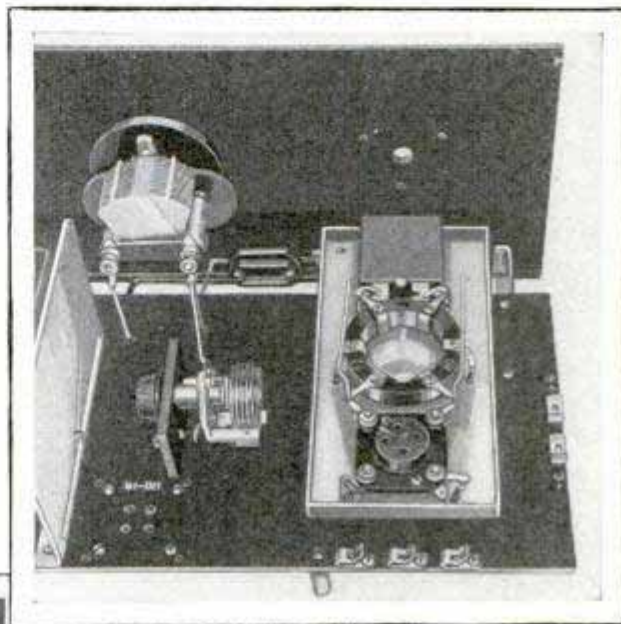

of the various holes for the condenser at the front, through the front panel. Drill and ream out the holes so that the mounting bosses on the front of the condenser fit flat against the bakelite front

panel, and see that the condenser-shaft hole is amply large to clear the shaft. With the open can in position, the condenser is now remounted, and the leads from points 4 and 5 on the coil socket soldered to the variable-condenser lugs. These leads should be bent so as to clear the coil when it is in the socket, and should clear both coil and can sides by about one-half inch.

The shield between the first de-

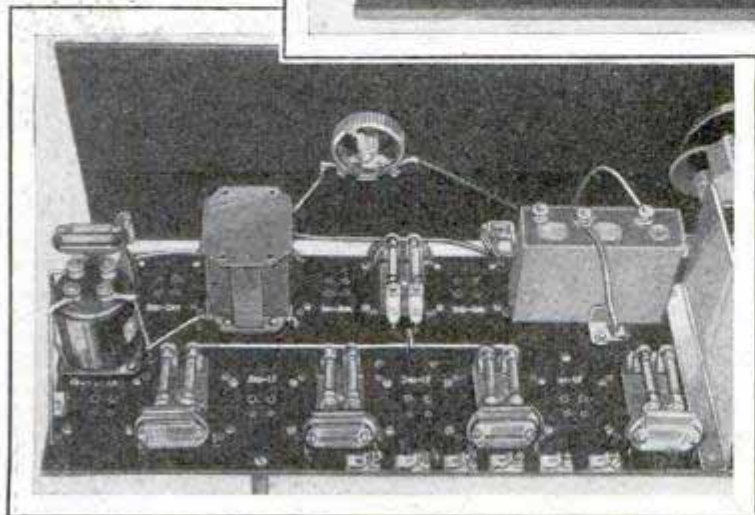



tector and the first intermediate amplifier unit can be a standard heavy aluminum shield, or made of heavy sheet brass, 4½ by 6 in. If homemade, a ½-in. flange is turned at the bottom for mounting on the subpanel, as in the manufactured type shown in the photo. This shield is grounded to the common A and B-negative post, as shown in the diagram. The midget condenser can be mounted on a strip of bakelite by means of two small brass brackets in the manner shown. (The newer type of the condenser specified will be provided with a mounting bracket.) The tuned-stage transformer or filter shown at the extreme left is tuned to a frequency of 45 kilocycles by means of the .00025-mfd. fixed condenser shown across the secondary at F and G. A second clip on the G-post supports the combination grid condenser and gridleak for the second detector tube. Any good filter, tuning between 40 and 80 kilocycles, can be used and, because of the construction of the intermediate amplifier, no haphazard matching of intermediate stages has to be contended with, as in the transformer-coupled type.

The first a.f. amplifier consists of a good heavy-type transformer, and \$6 has been allowed in the specifications for a good

instrument. The better this transformer is, the better the tone of the set will be, and a few extra dollars invested here are well spent. The last audio stage is of the resistance-coupled type, the coupling condenser at this point being .006 mfd. This coupling may range from .006 to .05 mfd., but for general purposes the .006-mfd. is satisfactory. The plate-coupling resistor is 250,000 ohms (.25 meg.), and either a 100,000-ohm (.1 meg.) or 250,000-ohm (.25 meg.) resistor for the grid. In the bottom photo on page 833, note the position of the 4½-volt C-battery, only 3 volts being used for further biasing the grids of the intermediate stages. This battery is held in position by two metal brackets, fitted with Fahnestock clips for terminals, and the assembly is bolted to the subpanel with short brass machine screws. No template of the front panel or subpanel is given because of the lack of space necessary to show them in working detail, but full-size drilling templates of both panels will accompany the blueprints.

After the wiring is completed, connect the batteries to the set and place one tube in each socket successively with the filament switch turned on; if the tube lights correctly in each socket, all tubes may be plugged in. The loop, which must be of

#### MATERIAL LIST

- |  |   |
|--|---|
| 2 panels, 3-16 by 7 by 26 in.  | 2 resistors, 1-10 meg. (1), Electrad, Lynch, Durham, Daven or similar type. |
| 1 pair S-M No. 540 subpanel brackets.                                      | 1 resistor, 2 meg (2), Electrad, Lynch, Durham, Daven or similar type.      |
| 2 Remler condensers, No. 639, .0005 mfd.                                   | 2 filament-control units, ¼ amp., Amperite, Ballast or similar type.        |
| 2 Remler dials, No. 636.   | 1 filament-control unit, ¼ amp., Amperite, Ballast or similar type.         |
| 1 25-ohm rheostat, Frost, Yaxley, Electrad, Carter or similar type.        | 1 filament-control unit, ½ amp., Amperite, Ballast or similar type.         |
| 1 open-circuit jack, short type, Frost, Carter, Yaxley or similar.         | 16 Fahnestock clips, small single type.                                     |
| 1 filament switch, Frost, Carter, Yaxley or similar type.                  | 10 lengths round tinned-copper busbar wire, No. 14.                         |
| 1 Hammerlund midget condenser, 50 mmf.                                     | 4 lengths good black spaghetti tubing.                                      |
| 1 Benjamin, X-type, spring-suspended socket.                               | 60 soldering lugs, long, round-hole type.                                   |
| 8 packages American UX prong contacts, style A.                            | 4 small brass angle brackets, 1-16 by ¼ by ¼ in.                            |
| 1 American Radio Hardware Co. steel template for UX prong contacts.        | 3 doz. 6-32 nickelplated round-head brass machine screws, ½ in. long.       |
| 1 S-M aluminum shield, type 631.   | 5 6-32 round-head brass machine screws, ¾ in. long.                         |
| 1 S-M plug-in coil, type 110-A.  | 5 6-32 round-head brass machine screws, 1 in. long.                         |
| 1 S-M universal socket, type 515.  | Above material not to exceed \$60 at retail prices.                         |
| 1 a.f. transformer, S-M No. 240 or any similar type.                       |   |
| 1 Remler tuned-stage transformer, type 610, or filter of similar type.     |   |
| 5 Sangamo condensers, .0005 mfd., one with gridleak clips.                 |   |
| 2 Sangamo condensers, .0025 mfd.   |   |
| 1 Sangamo condenser, .00025 mfd.   |   |
| 1 Sangamo condenser, .006 mfd.   |   |
| 1 Alcoa aluminum or brass shield, 4½ by 6 in.                              |   |
| 1 condenser, 1 mfd., series A, Acme, Tobe or similar type.                 |   |
| 5 double resistor mounts, Lynch, Electrad or similar type.                 |   |
| 6 resistors, ¼ meg. (.25), Electrad, Lynch, Durham, Daven or similar type. |   |

#### SUGGESTED EQUIPMENT

- |   |
|---|
| 4 Diatron 240, or UX-240, CX-340 (30 MU type).                              |
| 3 Diatron, 200-A, or 200-A UX or CX types.                                  |
| 2 Diatron, or UX or CX 201-A tubes.   |
| 1 Diatron, or UX-112 power tube.  |
| 4 Burgess C-batteries, type 2370, or Eveready, type 771.                    |
| 3 heavy-duty 45-volt B-batteries.   |
| 1 6-volt storage battery.   |
| 1 S-M output transformer, type 222, or similar (optional).                  |
| 1 loop, three-tap box type, Quali-Tone or similar type for .0005 condenser. |



the three-tap type designed for use with a .0005-mfd. condenser, is then connected. the midget condenser to the point that gives the loudest and clearest signal. Once

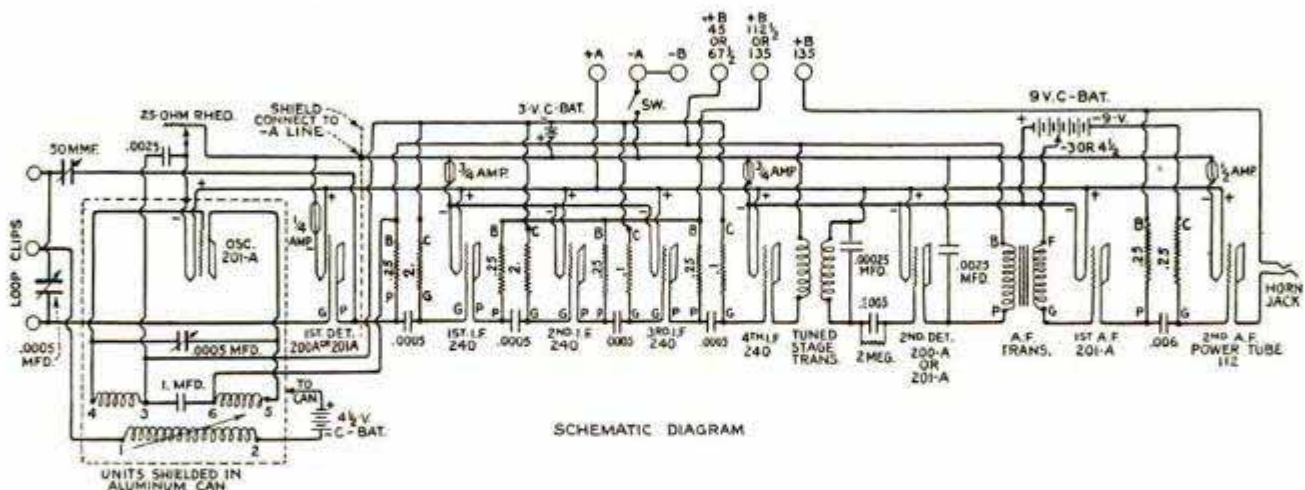

Above, Schematic Diagram; Below, Close-Up of Front Panel, Showing the Simple Controls, the Horn Jack and the Filament Switch

Note that the center loop clip, marked with an X in the detailed diagram, must always be connected to the center loop lead, while the two outer loop leads may be connected to either of the two outside loop clips on the subpanel. Keep the loop leads as short as possible.

To test the set, plug in the coupler coil and place the rotor of the coupler at an angle of about  $45^\circ$ , replacing the lid of the can firmly so that it will not vibrate. Plug in a good loud speaker and turn on the filament switch. Turn the rheostat up from one-fourth to one-half its range from the left, exact position to be found by trial. To pick up a station, slowly rotate the dials in step, never turning them independently when locating a station. When the signal is heard at good volume, leave the oscillator dial as it is, and turn the wavelength dial a few points on either side of the oscillator setting, to bring the signal in at maximum strength. This tuning must be slowly done as the set tunes very sharply, and if the dials are tuned by jerks, it is quite possible that the station will be passed over. Now adjust

found, this setting need not be changed. These first tests should be made when local stations are known to be on the air. The best B-battery combinations will be found by trial; for the first test use 45,  $112\frac{1}{2}$  and 135 volts on the clips, as indicated in the detailed wiring diagram. If this combination is not satisfactory, use  $67\frac{1}{2}$  on the clip marked 45. The use of a good output transformer between the set and the loud speaker, although optional with the builder, greatly increases the handling power of the speaker. The device is shown next to the speaker in the photo at the head of the article; it is very easily installed at any convenient point either in the cabinet or near the speaker.

Popular Mechanics radio laboratory will be glad to answer any inquiries regarding the construction of the set, and a complete set of enlarged blueprints of the simplified diagram and full-size drilling templates have been prepared. These may be obtained from Popular Mechanics Radio department, 200 E. Ontario st., Chicago, Ill., for 50 cents, which covers cost and packing. Specify blueprints No. 123,



*Aristocrat Corporation America*

836

*115 W. 23rd St*

POPULAR MECHANICS

*New York*

14 06-

Art Lamp and Cone Speaker Combined

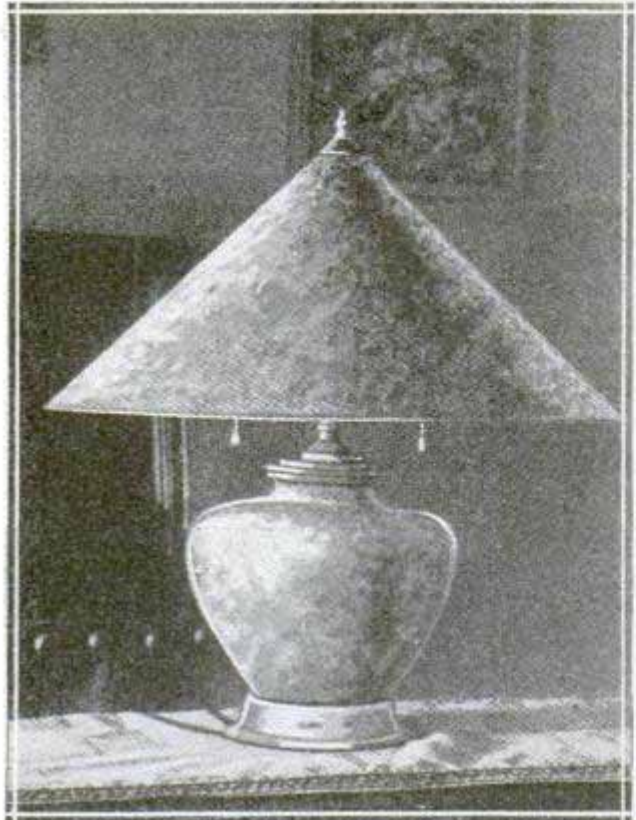

Art Lamp Speaker Connected to Radio Set Is Placed on Near-By Table

Combining a table lamp with an efficient cone speaker, this attractive and useful outfit is one of the new devices on the radio market. The loud-speaker unit is sturdy, dustproof and unaffected by weather and temperature changes. Twenty feet of silk radio cord and 8 ft. of lamp cord come as regular equipment with the speaker. The bowl is of artistic pottery, and the cone serves both as loud speaker and lamp shade.

Eliminating Unnecessary Leads

Much has been said in regard to keeping the leads in a radio receiver as short as possible, but not only can they be shortened; some of them may be entirely done away with. The following suggestions will be of interest not only to the set builder, but also to the fan who would like to simplify and improve his present set. Before making any changes in the wiring, however, it is well to make a diagram of the circuit for reference. It will be found that a wire from the ground post connects with one of the filament leads. Remove this post and lead, and connect the ground directly to the A-battery pos-

itive or negative terminal, whichever the case may be. As the batteries are usually on the floor or a shelf under the table, you are doing away with about 3 ft. of wire right here. A binding post for the B-negative connection is unnecessary. Run a lead from the B-battery negative directly to the A-battery, usually the positive terminal. Consult your diagram. For more than one reason, it is best to place the C-battery inside the cabinet. Because of its comparatively long life, it can be wired into the set permanently. Start a wire at the F-post of the first a.f. transformer, run it straight to the same post on the second transformer and then to the negative terminal of the C-battery. The positive terminal of the C-battery connects to the nearest point in the A-negative busbar, between the rheostats and the battery. Place all the batteries close together on a shelf under the set and connect them with short lengths of No. 14 rubber-and-fabric insulated wire. Long straggling pieces of small wire increase the resistance and invite short circuits.—John C. Heberger, Rochester, N. Y.

*1394-R*

Three-Gang Condenser Is Adjustable

An adjustable three-gang condenser, making possible the balancing and tuning of any desired number of circuits with one dial, is now available. Provided with a special adjustment feature and employing a tool supplied with each unit, as shown in the photo, the condenser can be set for perfect equalization of all circuits after the receiver has been completely wired. This eliminates the necessity for using vernier or trimmer condensers. Complete instructions for making this adjustment are supplied with the unit. The shaft may be shortened or

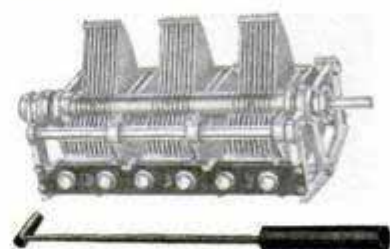

lengthened or entirely removed without affecting the adjustment of the rotor plates.

The condenser is so designed that it may be mounted from either end. A variable spring tension is provided and the rotor is mounted on ball bearings.

*Carnfield Radio Mfg Co. 357 E Ohio*



# Facts and Fads for Radio Fans

14 11 - R.

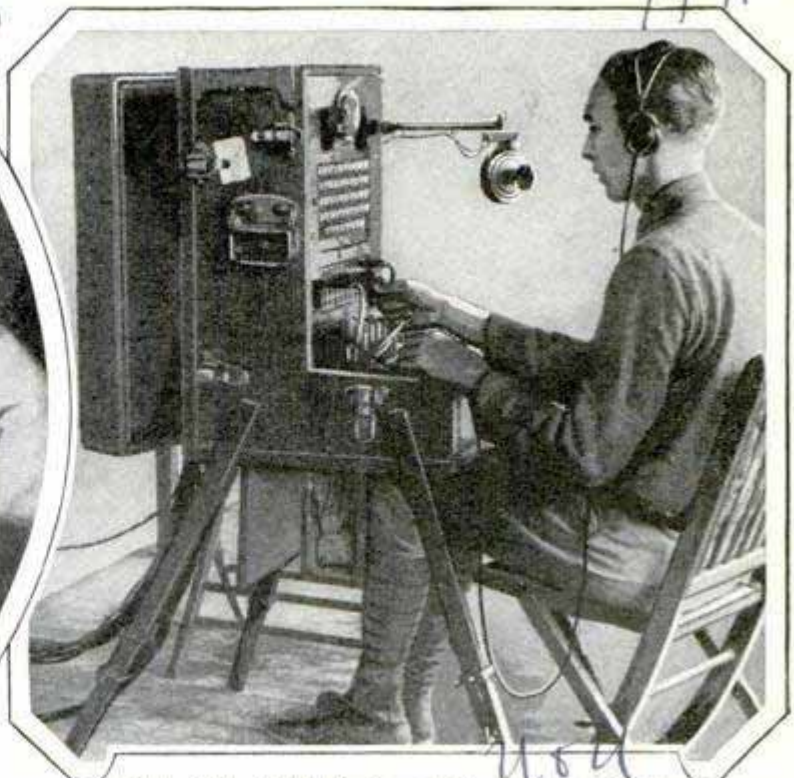

With This Field Equipment U. S. Army Maintains Radio Communication with Moving Units and Headquarters; the Signal Corps Switch-Board Installation Shown Here Was Used during Recent Combined Air-Ground Maneuvers

James Carrigan, Former Juvenile Star of the Movies, Invents New Loud Speaker, Employing Two or More Cylinders and a Conical Diaphragm

*Test made at P. Weidling house Laboratories, Pittsburgh Pa*

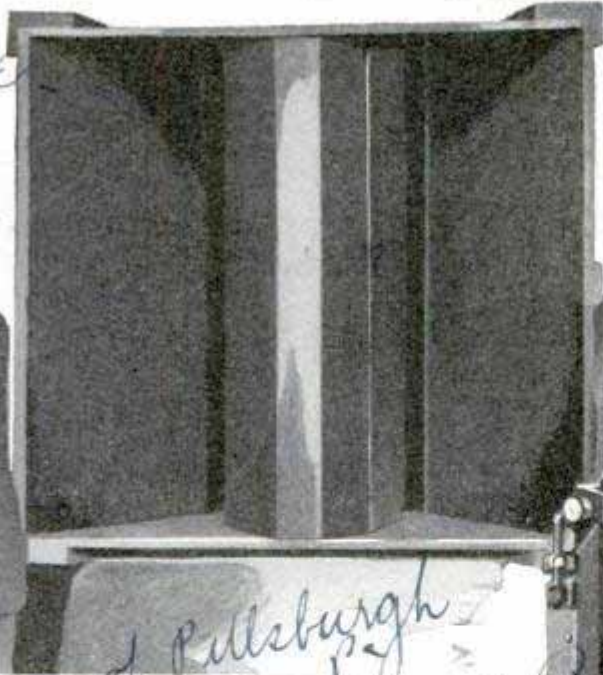

Above, Clinton B. Hanna and Dr. Joseph Slepian with Their New Horn Designed on Mathematically Correct Enlargement of the Tone Chamber; in Tests, It Is Said to Have Broadcast Voice and Music Three-Quarters of a Mile without Distortion; Right, the Radio Receiver Attached to the Telephone Is the Invention of George F. Mitchell, of Washington, D. C.; the Telephone Receiver Serves as an Earphone, and the Instrument Does Not Interfere with the Use of the Phone

*Bureau of Chemistry, Department of Agriculture*



**Light-Socket Supply for Power Tubes**

Light-socket supply for power tubes is not a new idea, but very few simple devices have been shown to obtain the result. As

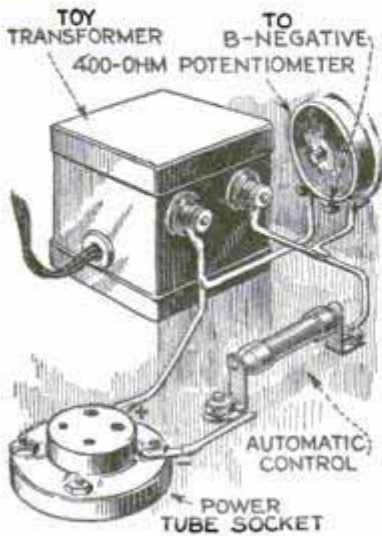

all radio experimenters know, the filament requirements of any power tube are such that there are few sources of low-voltage current that are not seriously depleted when the operation of these tubes is continued over many

hours. A simple method of employing the house-lighting current is shown in the sketch; a small a.c.-current transformer of the type used for operating toy trains is required. These transformers are inexpensive, and are usually tapped from six to ten volts; this voltage does not always remain constant due to line fluctuations, so some method must be used to keep the filament supply steady. This is easily done with one of the standard automatic filament-control units now in common use. These control units have the unique property of automatically changing in resistance as the filament supply changes, keeping the filament at the proper temperature at all times. The 400-ohm potentiometer across the transformer output tends to further stabilize the device and should be connected as shown and mounted on the front panel at any convenient point.—L. H. Georger, Buffalo, N. Y.

**Friction of Air Layers Cause of Static**

Anyone who owns a radio set is more or less familiar with the troublesome disturbance known as static. The cause of this frying, rumbling or crashing noise, frequently encountered during the summer months, is not generally understood. Often these noises are attributed to the set when it is in no way responsible for the trouble. Static and fading phenomena

have been carefully studied and many interesting data obtained without materially helping the situation. It is, however, an accepted fact that the combination of temperature and barometric pressure occurring most frequently in summer is the cause of static.

Comparatively quiet air heated in varying degrees rises and mixes with the cold air above. This warm, moisture-carrying air, mixing with the cold air in the higher altitudes, causes the moisture to condense into clouds, and the friction between the moving air layers produces electrical energy. This energy, having no definite character such as radio waves, travels in all directions and cannot be controlled by human means, entering the receiving set at will. Interfering with the radio waves sent out by the broadcasting station, these outlaw waves cause the disturbance known as static. The same conditions in the upper atmosphere, in a more intense form, cause the severe electrical storms where the disturbing element appears in the form of lightning discharges.

**Speaker Combined with Art Tapestry**

A modern loud speaker combined with an artistic piece of neatly framed tapestry, has made its appearance among the new speakers offered for the coming season. Fine wiring, run along the picture molding to the set, which may be placed in another room if desired makes an installation puzzling to the uninitiated.



As the speaker looks entirely unlike the usual type, the visitor is at a loss to account for the exact location of the sound, which comes out at the top of the speaker, travels to the ceiling and rebounds, with even volume, to all parts of the room.

*Wall Art Picture Speaker*

*Everhot Mfg Co  
Maxwood, Ill.*



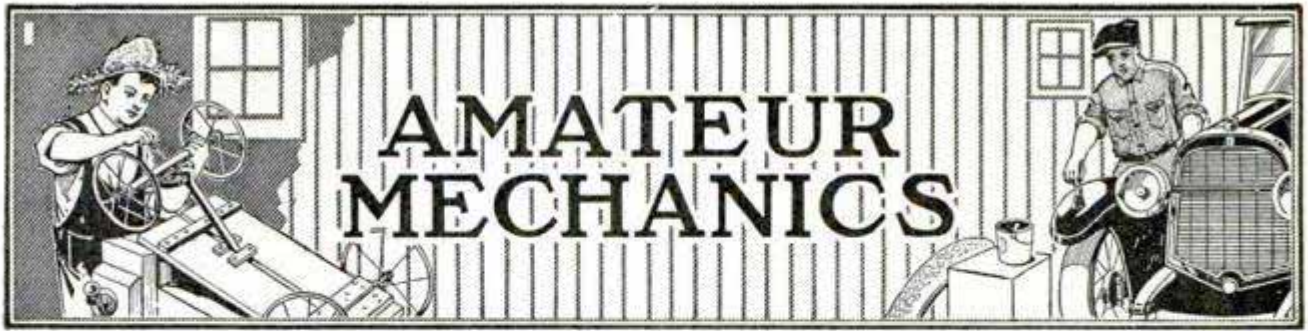

## Easy Way of Handling Outboard Motors

By JOHN EDWIN HOAG

WITH the increasing popularity of the large and powerful types of outboard motors, which are supplanting the smaller lightweight ones, the problem of handling the former is beginning to receive more attention from boating enthusiasts. Anyone who has ever attempted to carry one of these motors and fit it on the stern of a boat knows what a difficult task it is, for twin-cylinder motors weigh from 90 to 110 lb.

The trouble of doing this has been eliminated almost entirely by one outboard-motor enthusiast. At his recreation camp on a beautiful bay on the island of Oahu,

he has a small wharf to which the boats are moored. This permits carrying the outboard motor on an ordinary baggage truck, as shown in the illustration. The truck is fitted with a wooden support, attached with the aid of lengths of strap iron. The clamps of the motor are slipped over this support, and are then tightened to prevent the motor from slipping off. It is an easy matter to push the truck to the end of the wharf.

The work of lowering the motor from the wharf into the boat and fastening it to the stern, is accomplished by means of the small hoist shown in the photo. It con-

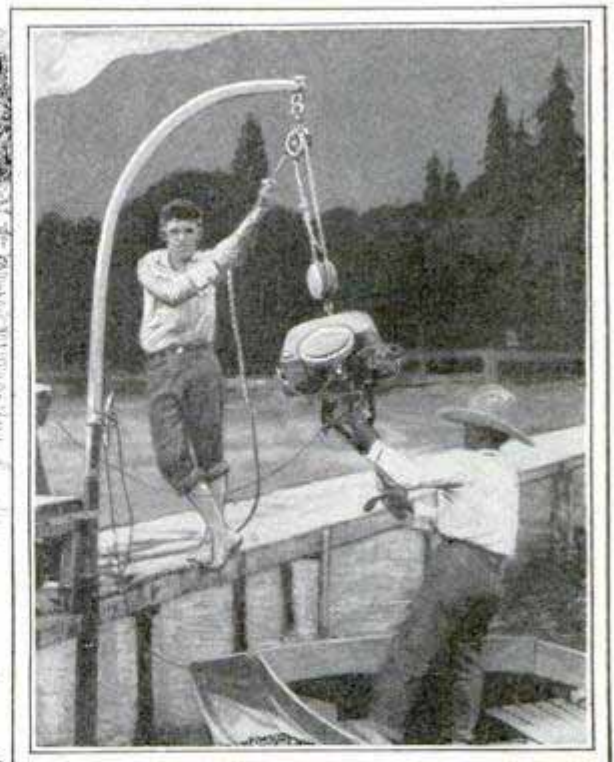
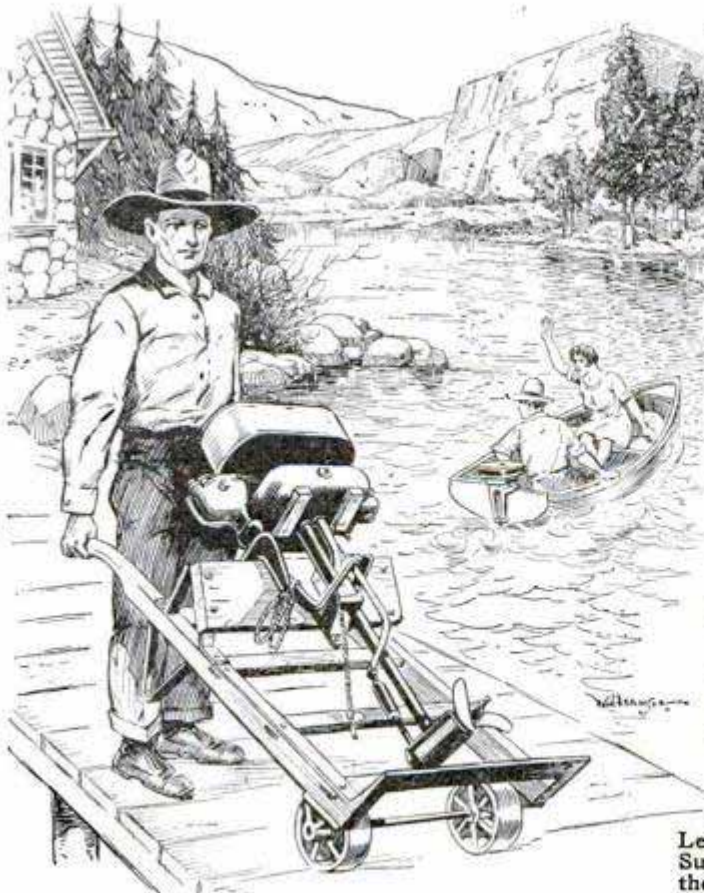

Left, Ordinary Baggage Truck Fitted with Wooden Support Facilitates Carrying Outboard Motor; Right, the Small Hoist Eliminates the Hard Task of Lifting the Motor from Boat to Wharf or Vice Versa



sists of an old ship's davit rigged with block and tackle. This permits the work to be done with ease and speed, one person handling the tackle and another, in the boat, placing the motor in position. Pulling the motor up from the boat is done just as easily and can be accomplished with a minimum of muscular exertion. Anyone can provide these simple means of handling an outboard motor, and the cost of the material is very small, amounting to about \$10 in the above case.

### Substitute for Corkscrew

Two pocketknives make a very effective substitute for a corkscrew. Insert one



blade between the glass and cork on one side of the bottle neck, and the other blade on the side directly opposite, with the cutting edges pointing in a clockwise direction. Place the index finger between the handles of the knives, and, pressing the thumb and middle finger against the handles, pull upward with a gradual turn, or pull down on the bottle, turning the knives around in the direction indicated by the arrows.—J. A. Langreich, Brooklyn, N. Y.

Albany Foundry Co., Albany, N.Y.

### Decorating Iron Castings

Gray-iron castings for doorstops, candlesticks, bookends, andirons, door knockers, and other articles, can be obtained, and anyone can decorate them to his own taste. A coat of flat, white paint is first applied to the casting. When this is thoroughly dry, the color decoration is applied with an even stroke (the long way of the work, not across). A great assortment of paints is unnecessary, as with a tube each of red, blue, yellow, black and white oil colors it is possible to obtain any intermediate tint. For example, a mixture of red and blue produces purple; yellow and blue

make green; red and yellow make orange. Shading adds greatly to the beauty of the work. When a yellow flower is painted, shade the spaces between the petals with darker yellow. High lights or prominent surfaces should be kept light, while recesses and low places should be dark. The antique finish, which adds to the beauty of the work is produced as follows: A small can or tube of Van Dyke brown, ground in japan, is obtained, and a small quantity is thinned out to make a watery mixture, using turpentine as a solvent. After the colors have been thoroughly dried and hardened, cover the entire surface with this brown paint, and immediately wipe off with a cheesecloth or a piece of rag, leaving the brown in the recesses. Bronze powders may be applied in one of the two following ways:

The commoner way is to mix the bronzing liquid with the bronze powder and apply with a camel's-hair brush, just like paint. Another method consists in coating the work with flat varnish and, when this has become almost dry or tacky, dusting on the bronze powder with a rather heavy camel's-hair brush. The different designs on the same piece may carry a separate shade of bronze, as bronze powders are made in a variety of colors. If a brilliant, highly polished surface is desired, use enamel or lacquer paints. The low parts, and those farthest away from you, should be painted first, and the color is then applied to the highest points of the design. A coat of flat varnish or white shellac, applied after the painting has been completed, will preserve the finish.—J. S. Hagans, Chicago.

### Reflux Condenser for Auto Radiator

The alcohol in radiators may be saved from evaporation by soldering a reflux condenser on the cap, as shown in the illustration. The overflow pipe is closed with a wooden plug; so that all the vapor must pass through the coiled tube on the cap. When the vapor strikes the cool tube it condenses and flows back into the radiator. This suggestion comes from the cold woods of

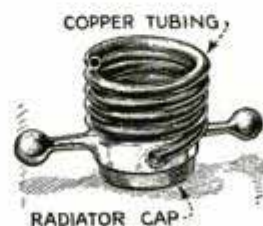



Maine where the thermometer has reached 20 below zero. The radiator on which this condenser is used is protected by only 1 gal. of alcohol, and, although the machine stands outside at all times, the water has not frozen in the radiator, proving that the loss by evaporation is very slight. Anyone can make this device. It consists of 2 ft. of  $\frac{1}{4}$ -in. copper tubing, wound around a bottle or similar cylindrical object, so as to get a smooth, even coil. A hole to fit the tube is drilled in the cap, and the tube is soldered to it, inside and outside. Radiator caps equipped with a thermometer can also use the device, by placing the coil in front of the meter. In this case a better job can be done if  $\frac{1}{8}$ -in. tubing is used and a smaller coil is wound.—Edward Engel, Orono, Maine.



Tubes with Rubber Nipples Leading to Pails Solved Feeding Problem for Young Pigs

### Assembling Bolt in Door Lock

When assembling a flush extension bolt on a double door, I found that it was rather difficult to discover the tapped hole into which the end of the bolt was screwed. The trouble was readily overcome by soldering a short length of wire to the end of the bolt, as

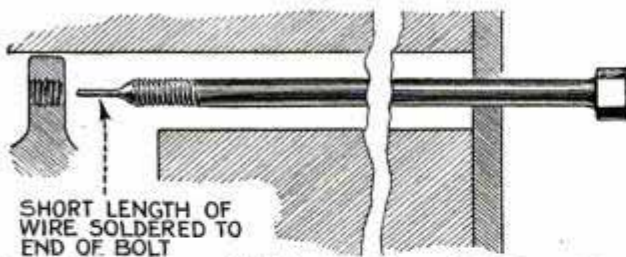

Finding the Tapped Hole for a Long Bolt in a Door Lock

shown in the illustration. The extension served as a feeler and enabled me to find the hole quickly. When this method is used, care must, of course, be taken not to get solder between the threads of the bolt.—Rivers Peterson, Indianapolis, Ind.

☞ When a candle does not fit in a holder, the end is usually scraped down. A better method is to hold the end in hot water until it becomes soft. Then it can be forced into the holder without difficulty.

### Feeder for Young Pigs

The accompanying drawing illustrates a contrivance that can readily be made by pig breeders for the feeding of young pigs that have lost their mothers. It is quite a simple, yet perfectly satisfactory, arrangement. At intervals along a wide board are fixed plugs with rubber nipples attached. Tubes lead from the nipples into pails of milk against which the board is propped. The pigs take to this device at once.—Thos. Goudie, Rangoon, Burma.

### Drilling Level Holes with Brace and Bit

There are often occasions when one is called upon to drill holes horizontally, but to get them perfectly level is usually quite difficult. However, here is a simple hint which will aid the worker to get them as straight as is required. Before placing the bit in the brace, place a metal washer on the shank of the bit. This will plainly show how the brace is being held and, with repeated practice, will in time develop a better eye for the work.



*Original, chronic &  
Hollander, 12/4/40  
79th St  
New York*

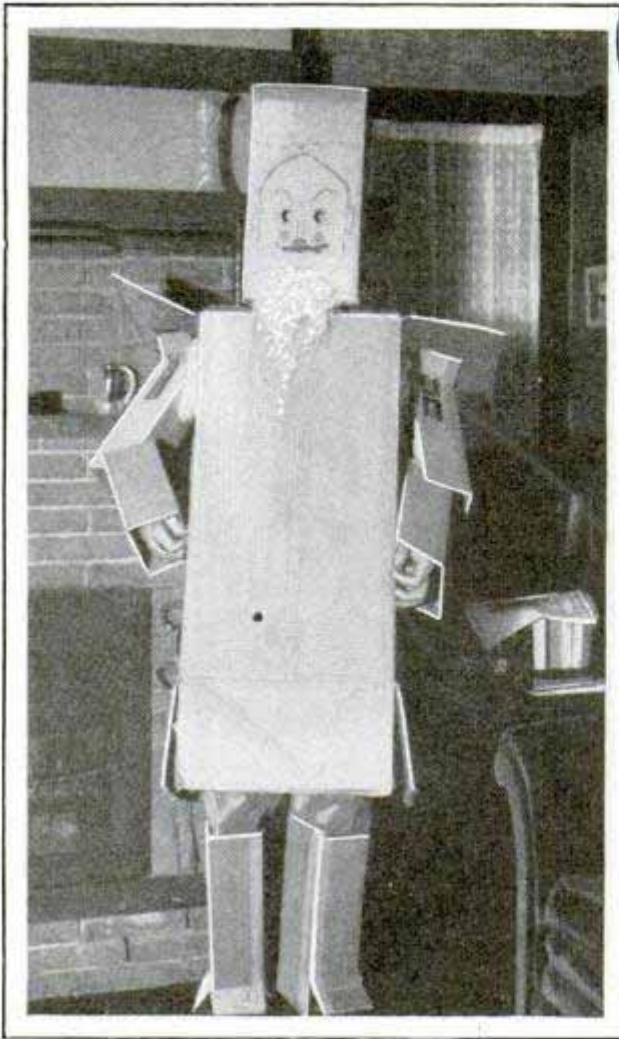

Masked Costume Made from Cardboard Boxes of Various Shapes and Sizes

### Novel Costume Made from Corrugated Fiberboard Boxes

Corrugated fiber boxes of various sizes and shapes make up the disguise shown in the photo, a costume which recently won first prize at a masked party. The legs are sections of a box originally used to ship the handle of a vacuum cleaner. Two corners of each of these sections are slit so that one side forms a flap to cover the fore part of the shoes. The arms are made from the same kind of box, with three sides cut through at the elbow to form a flexible joint, so that the arm can be bent. A large box forms the main portion of the costume, covering the body. All four flaps at the bottom are opened to give the appearance of a skirt. At the top, two of the flaps are opened outward at the sides to form epaulets. The other two flaps are sealed down and a hole cut through, large enough to admit the head of the wearer. Holes are also cut in the sides to admit the arms.

The box for the head is completely sealed, and then a hole is cut through at the bottom. This box is not fastened to the other but merely rests on it. Excelsior sewed to the upper box makes highly appropriate whiskers. The whole thing is quickly made and offers a complete disguise.—Leon I. Thomas, Oak Park, Ill.

### Lock for Dial on Telephone

In an office where the dial telephone was located so that anyone in the office could make private calls at the company's expense, in many cases long-distance calls, it was found necessary to devise some method of preventing unauthorized use of the telephone. An ordinary small padlock was used to lock the dial, and this effectively prevented anyone from calling out, although it did not keep employes from answering an incoming call. It was estimated that the lock saved the office at least \$50 per month.

### Rheostat Controls Auto Charging Rate

I mounted a 6-ohm radio rheostat on the instrument board of my car, and ran wires to the generator, placing the rheostat in series with the third brush—the one that controls the strength of the field flux—thereby regulating the rate of charge. Then, I moved the control brush up to a fairly high rate of charge with the resistance of the rheostat all out. By cutting the resistance in, a very nice adjustment is possible. This eliminates the need of burning the lights to prevent overcharging the battery on long trips, and makes it possible to lower the rate when driving at high speeds, and to raise it when driving at night. Also, by turning the rheostat off, the field is open and no charge is given, which takes a certain load off the engine and does the generator no harm.—Harold I. Calkins, Lomita, Calif.

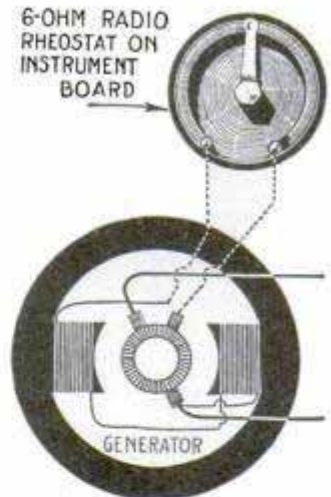



### Replacing Auto Window and Door Glass

Replacing broken plate glass in the car is a rather tedious job unless the operator has some knowledge of the work. The first trouble encountered is in removing the broken glass from the channel. When this is done, the shattered pieces are usually broken into small fragments. The proper way to remove them is to obtain two small blocks of soft wood and clamp the projecting broken ends of the glass between the blocks in the vise. Then pull the channel away from the glass. In this way its removal is easy. When replacing the glass, be sure that you have it centered in the channel, and that it is of the proper size and shape. Stand the glass on its edge on a wooden floor and drive the channel down on it, but be sure to hold the glass perfectly vertical when you do this, and use a block of wood in driving down the channel, otherwise the glass may be broken. If the glass has a sharp edge, it can be smoothed easily by means of a file. This is less trouble than grinding and there is no danger of chipping the glass.

### Sweeper for Golf Greens

Four brooms, held together by slats, make a good sweeper for the greens of a golf course. The handles are cut off the



Efficient Green Sweeper on Golf Course Is Made from Four Old Brooms

two end brooms and the handles of the two center brooms are left in place, permitting the worker to drag the sweeper over the green without difficulty.

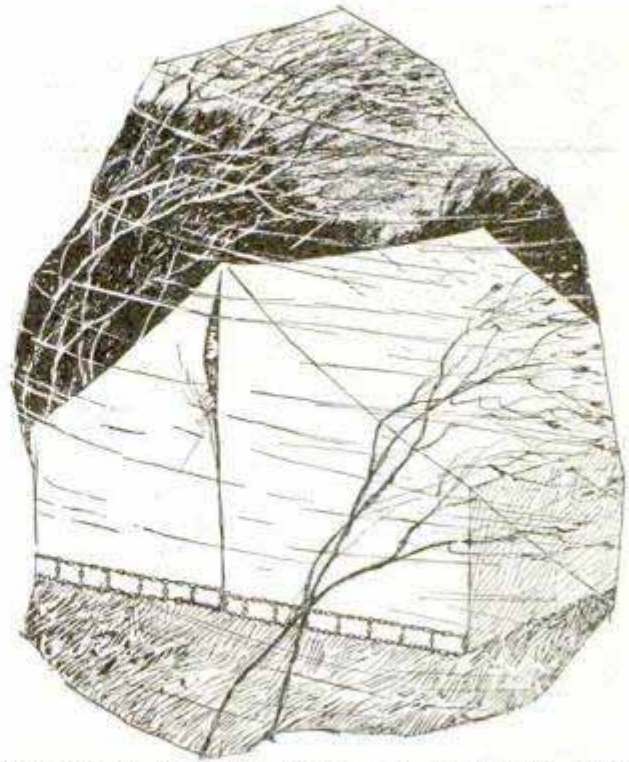

Tire Chains Sewed to Bottom of Tent Flies Keep Them Shut in the Wind

### Self-Closing Flies on Campers' Tent

To hold tent flies from blowing open in windy weather, it is usually necessary to fasten them with ropes or cords to pegs, and this causes more or less annoyance and loss of time when going in and out. To overcome this trouble a party of fishermen used a pair of tire chains, stitched along the bottom hem of each fly. The weight of the chains held the flies closed against the wind and yet allowed them to be swung open without the least trouble.

### Full-Length Screen over Eave Troughs Prevents Stoppage and Overflow

Almost everybody likes a few trees around a home. However, the eave troughs may be choked by accumulations of leaves and other loose substances, and especially the down spouts. Wire cages are often provided at these points, but they plug up quickly. It is much better to inclose the whole gutter with screen. Narrow strips of galvanized or copper fly screen are placed over the tops of the eaves. The screen can be soldered on with little difficulty. When the leaves are dry, they readily blow off the mesh and cannot get into the gutters.—L. H. Georger, Buffalo, New York.



### How to Put on Galoshes Easily



When wearing shoes with rubber heels it is often quite difficult to pull on a pair of galoshes, owing to the friction of the rubber against the fleece lining of the overshoes. To simplify the task, place a piece of wax paper in the position shown in the illustration, and you will find that the shoe will slip into the rubber without any trouble.

The paper is left in the heel of the overshoe and may be used over and over again.—G. E. Hendrickson, Argyle, Wis.

### Waterproofing a Serving Tray

Serving trays are frequently spoiled by liquid coming into contact with the embroidery, picture, or other work which may be placed beneath the glass to beautify the tray. In order to prevent this, a water-tight joint between the edge of the glass and the edge of the tray, extending over the glass, should be made. To do this, bicycle tape, about  $\frac{7}{8}$  in. wide, should be inserted into the joint. Remove the bottom of the tray, and then the glass. Clean the inner edge of the tray frame of glue and rough spots. Press the tape into the square corners around the edge of the frame. The four corners may be turned by cutting the tape on the upper edge and stretching it into the proper form. If the tape is cut in two at the corners, there is more likelihood of a leak. The open spaces in the corners should be filled with small pieces, but care must be taken not

to form lumps. Replace the glass and see that it rests evenly on the tape all the way around, and reassemble the tray.

### Roofing Tar Keeps Rats Away

Broken stone, glass bottles, sheet metal and other material of a like nature seem to do little good in the prevention of rats under porches and other similar projections of a home or other building. However, an excellent method has been found for keeping these pests away effectively. Get a small quantity of cold tar, the kind which is used by roofers for closing seams. This does not need heating. With a small brush apply a liberal coating on the inside of the holes and you will notice that the rats will practically disappear. Such an application need only be made about once every week for a short time during the summer months.—L. H. Georger, Buffalo, New York.

### Chemical Flower Bed

For a few cents enough materials can be obtained to produce a chemical flower bed, such as is shown in the illustration. Get a small goldfish bowl or similar clear-glass receptacle. Fill the bottom with fine sand to a little over  $\frac{1}{2}$  in. Buy the following at any drug store: copper sulphate, 2 oz.; a few small pieces of pure zinc about the size of postage stamps; a



piece of alum broken into small fragments and enough to fill a tablespoon; a teaspoonful of crystals of potassium bichromate; one can of water glass, and a 3 or 4-in. length of aluminum wire, cut into  $\frac{1}{2}$ -in. pieces. Scatter the materials over the sand in the bowl in a "hit-or-miss" fashion. Mix one part of the water glass with three parts of water and pour the mixture slowly over the chemical-strewn sand, being careful not to disturb anything. The depth of the liquid should not exceed 4 to 6 in. Set the jar aside in



a place where it will not be shaken or jarred. Soon you will see queer little colored growths appearing here and there, which, in the course of a few days, will grow upward and assume various shapes. In about a week or two, you will have a chemical garden somewhat similar to the one shown in the drawing. Some of the larger puffy growths are whitish or yellowish and look like mushrooms or puff-balls. Some are brownish and resemble other fungoid forms. Others are slender and green, and look like grasses and sedges. Still other growths are reddish and orange. Nearly every color of the spectrum is represented. Most curious of all are the growths which extend downward into the sand and along the sides of the glass. If not jarred or shaken, the chemical flower bed will last for several weeks. Then, like living things, the growths will slowly disintegrate.—Dr. L. A. Hausman, New Brunswick, N. J.

### Concealed Switch Prevents Theft

The concealed device shown in the drawing is a means of disconnecting the auto switch from the battery. It consists of a sleeve, made of hard insulating material, which contains a terminal with one threaded end, and another terminal with a knurled and a threaded end, to which the wire is soldered, as indicated. The inside of the insulating sleeve is threaded to correspond to these parts. In use, the parts are turned in one direction to break the circuit and in the other to complete it. This switch can be used on most circuits.

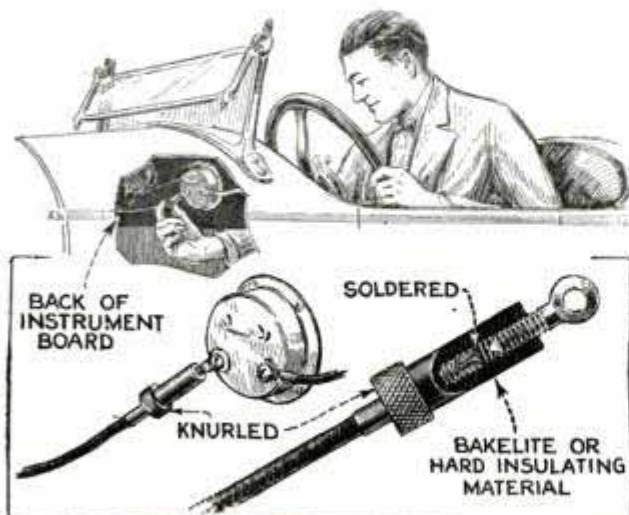

Concealed Device. Cut into Line from Battery to Switch, Helps to Prevent Auto Theft

### Extra Legs on Stepladder

Most stepladders are a little wiggly. This trouble can be completely eliminated by providing two extra legs, as shown in



the drawing. They are hinged to the top, and their outward swing is limited by lengths of sash cord. Holes are drilled through the center of the legs and the cord passed through and knotted on the inside. When folded, the extra legs take up little space, and when set up, they make the ladder steady and safe.

### Paper Cups Serve as Funnel

While cone-shaped paper cups are generally used for drinking purposes only, their shape lends them to adaptation for other purposes. It has been found that they are especially useful as funnels. Just nip the bottom off, and the funnel is ready. Many motorists may find this a handy kink when filling up the vacuum tank, after running out of gas on a country road. Manufacturers of batteries also advocate the use of these cone-shaped cups for filling the cells with electrolyte. The slightly waxed surface of the paper makes it stand up under the action of strong acids.—A. S. Bowes, Chicago.



# Make This Arms-Trophy Wall Piece

By Edwin M. Love

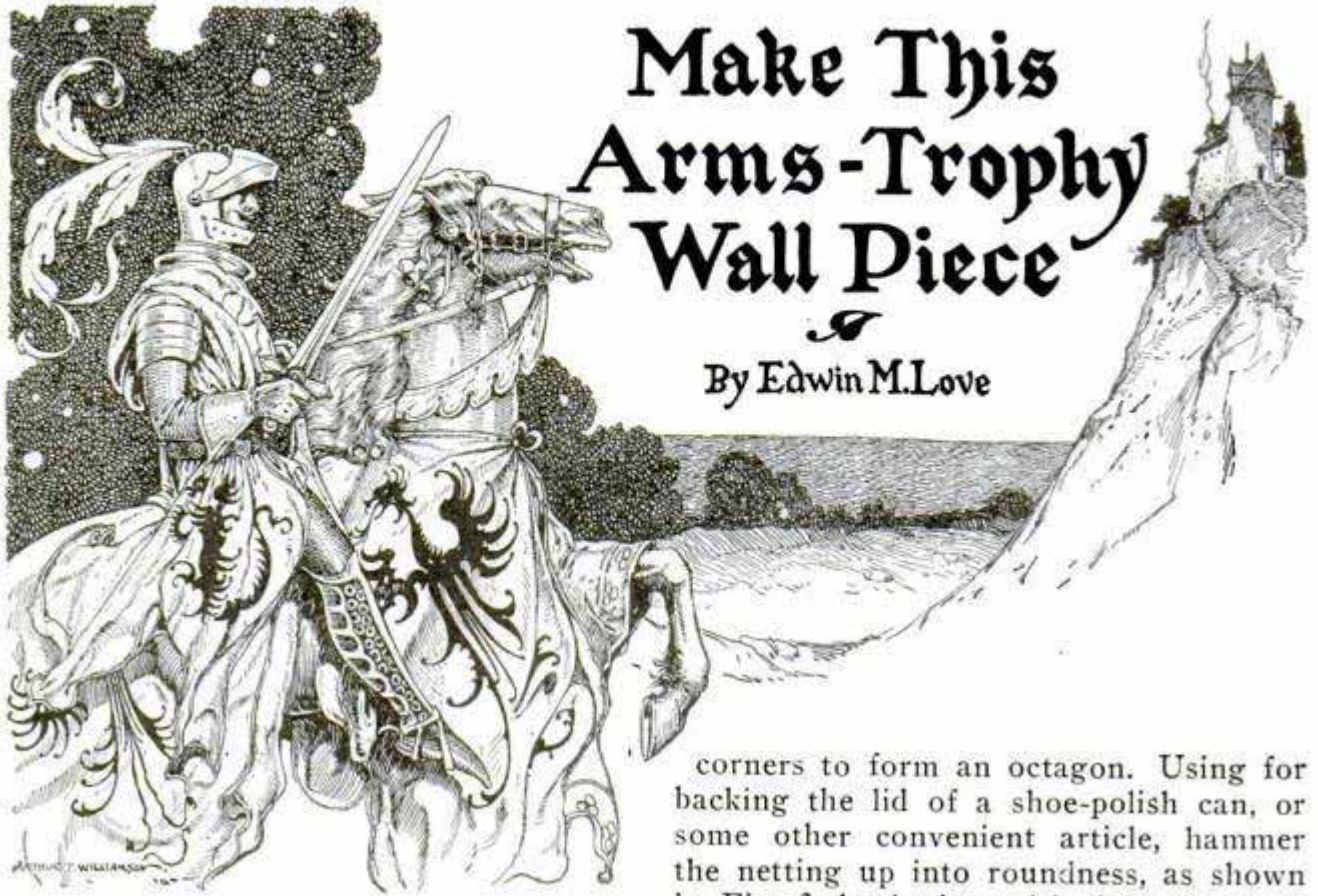

**S**UITS of armor are eagerly sought by collectors who are unhindered by financial restraints. Folk of ordinary means, as well, can have pieces reminiscent of the age of chivalry. Such a piece is the interesting wall model of helmet, sword and shield, illustrated in Fig. 1, based on a design of 1330 A. D. The cost of materials need not be more than \$1.50, and only a little skill is required in the making of it.

The construction of the helmet, or "basinet," as this form was technically known, is illustrated in Fig. 2 and the drawings following. It is built up of papier-mache and "plastic wood," over  $\frac{1}{4}$ -in. mesh galvanized-wire netting. Cut a piece of netting, 8 in. square, and snip off the

corners to form an octagon. Using for backing the lid of a shoe-polish can, or some other convenient article, hammer the netting up into roundness, as shown in Fig. 3, beginning with light blows in the center, and working around in circles toward the edges. Since this is a bending, rather than a stretching process, as in hammering sheet metal, there is an obstinate tendency to lopsidedness in the resulting piece; but by hammering down

the folds with several thicknesses of paper for backing, as in Fig. 5, a fair degree of roundness can be obtained. In the original helmet, the headpiece was oval, but the model is made spherical, both to simplify the work and to reduce the depth from front to back, since it is to hang from the wall.

Having brought the netting to the form of a hemisphere, 4 in. in diameter, trim the edges even and nail to a 4-in. disk of  $\frac{3}{8}$ -in. wood, to give rigid-





ity. Now make a thin paste of wheat flour and water, and build over the netting a thin shell of newsprint soaked in the paste, as in Fig. 6. Since it does not stick to the netting, lace it on with twine looped over the projecting edges of the mesh. Cover this with more paper, and again make a twine net over it. Set aside to dry, and, while it is drying, begin work on the shield.

Good work on the shield is more a matter of careful chiseling than of measuring. It is made of 1-in. pine, 8 by 9 in. in size. The pattern is copied from Fig. 7 by laying out a 4 by 9-in. paper rectangle in 1-in. squares, through the lines of which the outline is drawn, as shown. Trace one-half the shield, turn the pattern over, and trace the other side. It may be cut out

bent around the helmet just inside the edges of the top, a face opening,  $2\frac{1}{2}$  in. wide, is left. It is a simple matter to attach this by stitching with fine copper wire, as in Fig. 9, pricking holes through the paper with an awl or darning needle. This done, build up the whole piece with plastic wood, a 35-cent can of which is obtainable at any hardware store. Spread smoothly and firmly over the netting and paper, applying a small amount at a time, since it dries rapidly. Press the wood into the bare netting to a thickness of  $\frac{1}{4}$  in. While trying for evenness, do not waste too much time in smoothing, for it is easily dressed to shape with a chisel. Allow it to set thoroughly before doing further work on it.

The first step in surfacing the shield

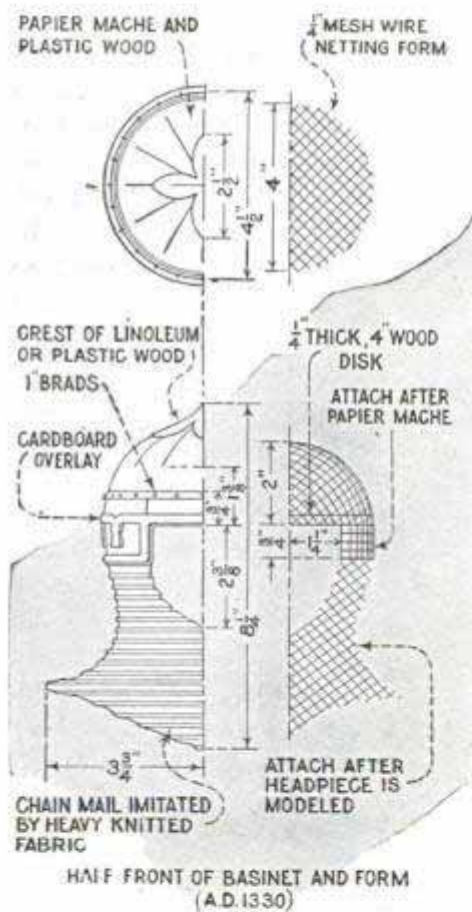

②

with a compass saw, but perhaps the easiest way is to rough it out with a hand-saw and chisel to the line, as in Fig. 8. Smooth with a spokeshave.

By this time the papier-mache should be dry enough for further work on the helmet. Cut a straight band of netting,  $\frac{3}{4}$  in. wide and of such length that, when

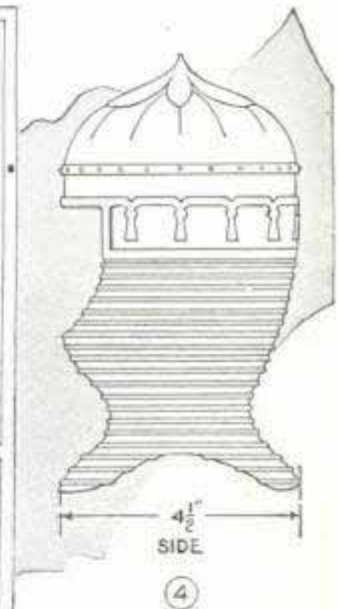
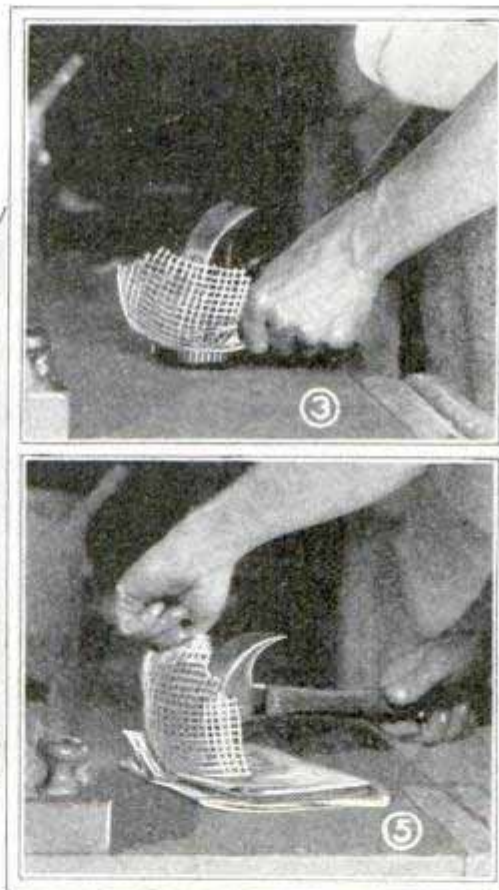

④

is to carve a wide chamfer around it on the face side. Gauge a pencil line around the edge,  $\frac{1}{8}$  in. from the back, and one on the face,  $\frac{3}{4}$  in. from the edge.

Guiding on these, cut the bevel, as in Fig. 10. A wide butt chisel, honed very sharp, is best for this, although a narrower one will do. Work with the grain, with chisel bevel up, unless crossgrain is encountered. Do fairly accurate work. To cut the upper edge, which is across the grain, clamp the shield in a vise (see Fig. 11). Now work off the corners, and with careful strokes pare down the surface un-



til it is uniformly curved throughout. Inspect it often from all edges, noting the high spots. When it is reduced to a good curve, scrub across the grain with coarse sandpaper, removing the chisel marks. Sand with the grain to take out the scratches and smooth with fine sandpaper.

When the helmet is dry, trim and sand it smooth, rounding off all corners. Fig. 12 illustrates the cardboard overlay which ornaments the lower part of the helmet. It is cut from a strip,  $1\frac{3}{16}$  in. wide, the exact length being found by measurement. Divide it in 10 equal spaces, forming a  $\frac{3}{16}$ -in. band all around, with conventionalized tassels, as shown, marking the divisions. The ends of these are  $\frac{5}{16}$  in. from the border. Cut out with the point of a sharp knife and glue in place. A few wraps of twine will hold it tight while it is drying.

Centering on the top, describe a circle  $1\frac{3}{8}$  in. above the face opening, and draw 12 equidistant radii pointing to the tassels. With a  $\frac{1}{8}$ -in. gouge, which may be a wood-carver's eye tool or a sharpened length

of umbrella bow (a three-cornered file can also be used), cut furrows,  $\frac{1}{16}$  in. deep, as shown in Fig. 13. With a chisel widen these to  $\frac{1}{8}$ -in. V-grooves (see Fig. 14). Round the corners with sandpaper, and fix to the top with glue and brads the four-pointed linoleum leaf shown in Fig. 2. This crest ornament is  $2\frac{1}{2}$  in. wide. Glue on an additional piece,  $\frac{3}{4}$  in. square, and when dry, carve into the form shown, sloping gracefully from thin points to the peak at the center, with the edges also tapered thin. To facilitate carving, the brads may be removed. If preferred, the crest may be modeled with plastic wood.

A  $\frac{3}{16}$ -in. cardboard band is glued around the helmet with the upper edge  $\frac{3}{4}$  in. above the tassel ornament. On the original helmet, this band apparently bore hooks that held the mail hood, but in the model the hooks are represented by 1-in. wire brads driven through the band above the tassels and centering between them. When the glue dries, smooth off the corners of the overlay and glue strips of coarse knitted fabric (such as material

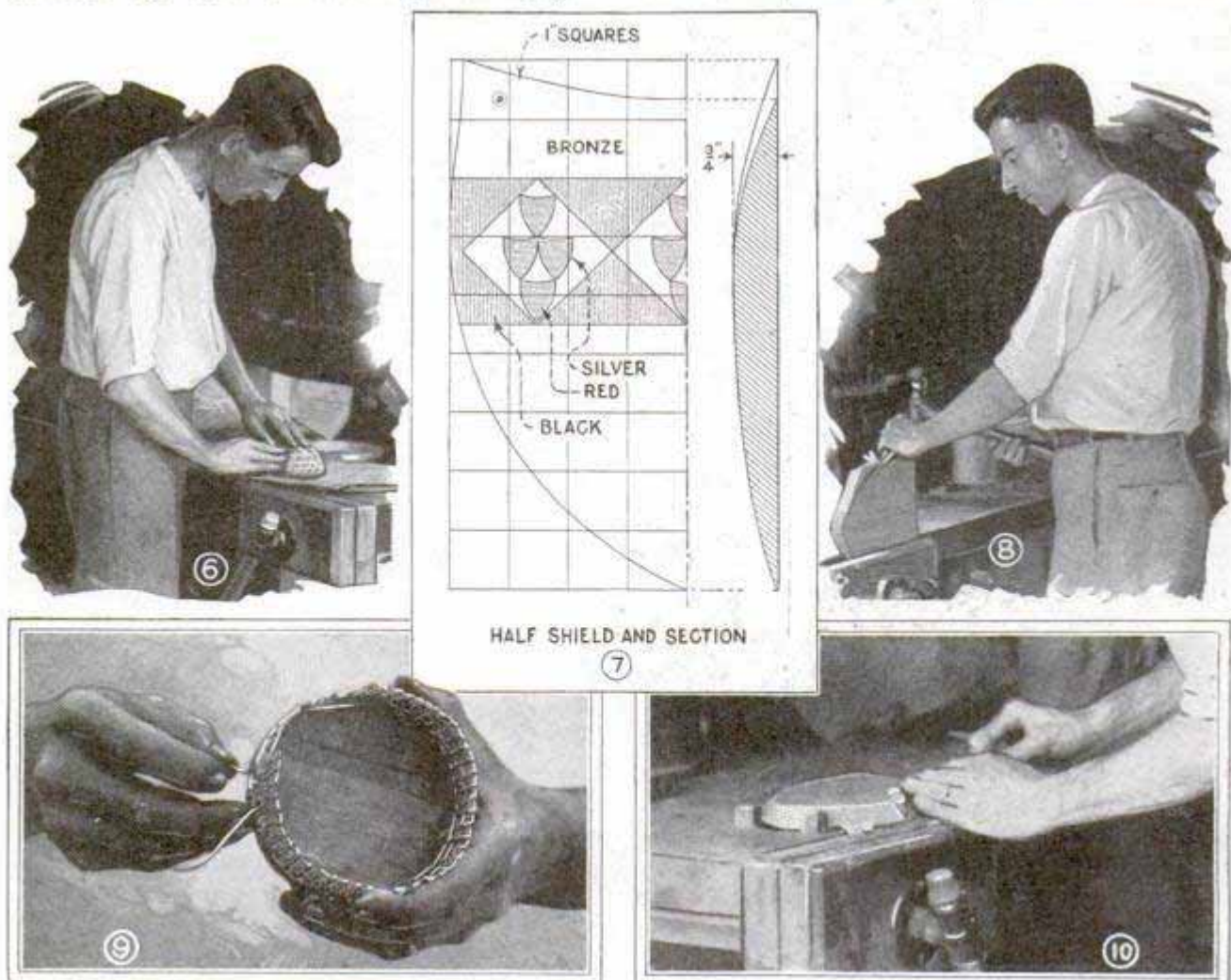



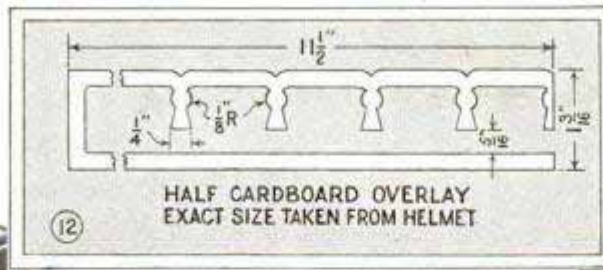

from an old sweater) between the bands, to represent mail, as shown in Fig. 15.

To hold the neck mail in place, make a form of netting as indicated in Fig. 2. This is bent around in cape shape and the narrow top opening is trimmed even. To form the inward bend at the neck, it is necessary to make a slit here and there for lapping. As Fig. 4 shows, it must bend in from back and front as well. The face opening is egg-shaped,  $2\frac{1}{2}$  in. wide and  $2\frac{3}{8}$  in. long from top to bottom. When properly shaped, slip the top inside the helmet and attach with wire stitches through small holes drilled in the plastic wood, tying inside. With tin snips, as in Fig. 16, trim the bottom edge to shape, giving a total length of  $8\frac{1}{4}$  in. to the helmet, a front width of  $7\frac{1}{2}$  in., and a side width of  $4\frac{1}{2}$  inches.

To attach the "mail," fold a hem on the top edge and stitch through the netting with twine. Fold over the edges of the netting and sew with a whip stitch. To hide the rough inside, sew a piece of black velvet into the face opening when the painting is done. If an



old mesh bag is available, it can be used for mail with good effect.

The sword stock is  $\frac{3}{8}$  by  $1\frac{1}{4}$  by 1 ft.  $10\frac{1}{8}$  in.

The blade length is 18 in. Reduce the hilt width to  $\frac{3}{4}$  in., and taper the blade width from  $1\frac{1}{4}$  in. at the hilt to  $\frac{3}{4}$  in. at a distance of 1 in. from the point, and the thickness from  $\frac{3}{8}$  in. to  $\frac{3}{16}$  in. Round off the point as shown. Draw center lines on sides and edges, and with a chisel bevel the blade to the lozenge shape indicated. Finish with a plane and sandpaper. Whittle the pommel  $\frac{3}{4}$  in. in diameter, and round the edges of the grip as shown, its greatest width being  $\frac{5}{8}$  in. The width at the blade is  $\frac{1}{2}$  in., forming a tenon to be

straddled by the hilt, which is made of two pieces called quillons. The latter are made from  $\frac{3}{8}$ -in. pine,  $\frac{3}{4}$  in. wide and  $4\frac{1}{2}$  in. long. Whittle on each end a  $\frac{3}{8}$ -in. ball, taper the edges to suit, and cut a  $\frac{1}{2}$ -in. notch,  $\frac{1}{16}$  in. deep, in the center of one edge. Glue to the sword hilt and make solid with a brad driven through the front and clinched behind. Glue a small block of wood in the back and trim off flush.

The grip is wound





with  $\frac{1}{8}$ -in. twisted cord. Carpenters' chalk line is good. To give more roundness to the grip, tie on each side a piece of paper, folded several times to give thickness. Drill a small hole just above the quillons to thread the starting end of the string through, and below the pommel, on one edge, gouge out a furrow,  $\frac{1}{2}$  in. long. Wind the cord tightly on the grip until this furrow is reached, when a loop of small copper wire is laid in it and covered with the four remaining turns. Pass the cord end through the wire loop, and with pliers pull the ends of the wire until the cord end is drawn under, as in Fig. 18. Draw out the wire. The sword, ready for finishing, is shown in Fig. 17.

The finishing of the shield is typical of all. Apply with a small brush or rag a coat of orange shellac and allow to dry for a few minutes, until it is just barely tacky. Pour a couple of teaspoonfuls of shellac into a small lid and shake in enough dull bronze powder to make it of a creamy consistency. With two fingers smear this mixture uniformly over the shield, working with a circular motion from the left upper corner to the right and back until the whole surface is covered. Go over

it a second time in the same way, and finally shake the dry powder liberally over it, rubbing it in. With a little care, a dry surface is produced which has a curious corroded-bronze appearance, polished in some places and dull in others. Allow this finish to dry well before attempting to add the decorations.

The ornamental bar is  $2\frac{1}{2}$  in. wide and straight, located 2 in. below the upper corners. Rule the edges with a pencil, and trace the center square ornament, shown in Fig. 19. Trace the other squares just touching the corners of the first. With a small brush carefully paint the squares with aluminum. When dry, trace on the small shields. Paint these vermilion with oil color, or with light red showcard color, which, in drying, shows minute cracks through which the silver shines. Lastly paint the background of the bar with black, the drying of which may be hastened by the addition of a little litharge.

Finish the helmet and sword hilt in bronze, and the sword blade with aluminum. If desired, a touch of color can be added to the helmet by coloring the bars silver and the tassels red.

To assemble the model, nail a  $1\frac{1}{4}$ -in.

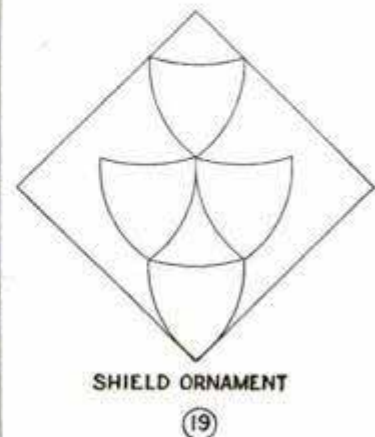
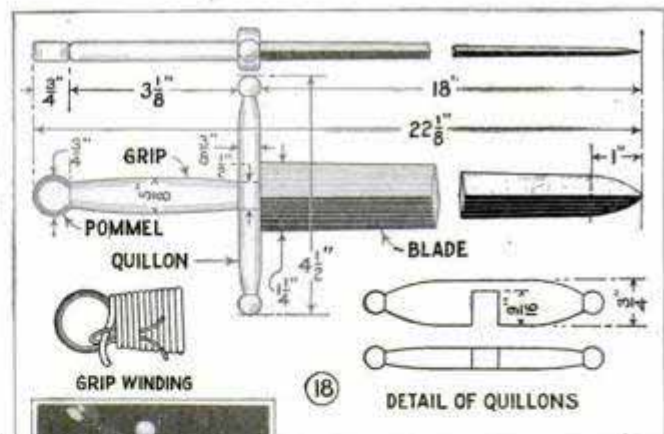



wooden block 2 in. from the right corner and 1 in. below the top on the back of the shield, and to the center, just above the bottom point, two blocks forming a  $\frac{3}{16}$ -in. groove at an angle of  $20^\circ$  with the center, into which a stiff wire, attached to the helmet, is forced. Drive a wire staple about midway between the center line and left edge, near the top, as an additional support for the helmet standard. Nail the sword to the blocks, showing  $2\frac{1}{2}$  in. of the blade above the shield, and attach the helmet as shown by bending a stiff wire into suitable shape and tying it inside the netting with wire loops. The shield should slope from the vertical about 25 degrees.

If desired, two swords can be made, and the shield mounted with these crossed, and the helmet vertical in the center. If this is done, the swords should be half-lapped where they cross at the back, so they are no thicker than a single one.

### Wax Seals on Jelly Tumblers

Homemade jellies or marmalades are often put up in glass tumblers and sealed with melted paraffin, which is poured over the surface. Although this method is sanitary and efficient, it presents some difficulties when the seal is broken, as the solidified paraffin often crumbles when it is removed, and the pieces become mixed

with the contents of the tumbler. To eliminate this trouble, take a milk-bottle cap and place it over the contents of the tumbler, and then pour the paraffin over it, letting the tab of the cap project above the surface of the paraffin. It is then a simple matter to pull the cap and the paraffin off without the use of a knife or any other instrument. Pieces of cardboard or heavy paper may be used instead of caps if the latter are not available.



### Pocket Palette for the Artist

Anyone who likes to go sketching outdoors with oil colors can make a pocket

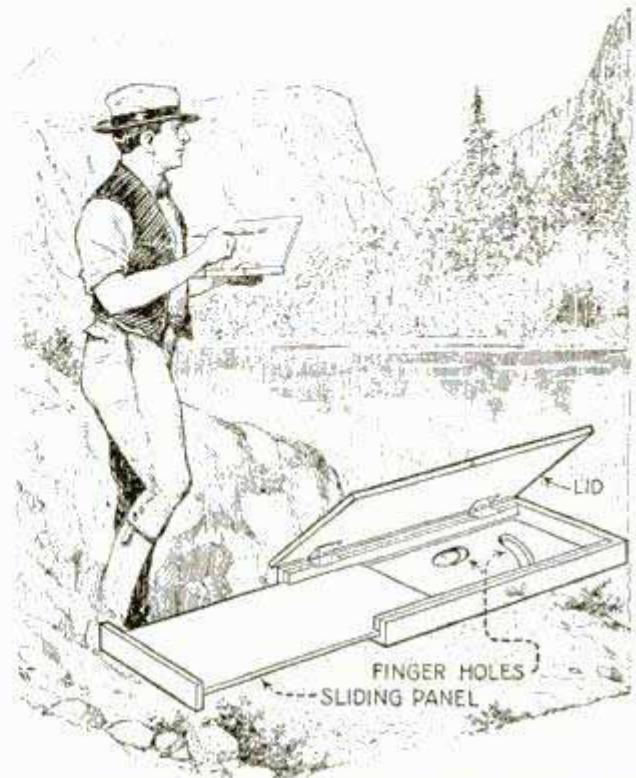

Artist's Pocket Palette Can Be Carried Along Conveniently for Sketching

palette that will aid in reducing the equipment necessary to carry on such trips. The construction is clearly shown in the illustration, and it can be made from good grained cigar-box wood. Saw two pieces to the same size, sandpaper them smooth and then oil or shellac them. Cut a thumb and finger hole in one panel as shown and nail slides for the second panel around two sides and one end. These should be about  $\frac{1}{2}$  in. high. The second panel should have an end stop nailed and glued to it and is pushed into the grooves of the slides on the first panel until the stop forms the fourth side of a shallow box. The top consists of a third panel, hinged to one side and fitted with a hook, to close the box when not in use. For the sake of easy carrying, the total width should not exceed 5 or 6 in., so that the box can be conveniently slipped into a pocket.—L. B. Robbins, Harwich, Mass.

☛ Iodine stains on clothes can be removed by applying a solution consisting of 1 oz. of photographic hypo and 2 oz. of clear water.



Simple Method of Effecting a Permanent Repair on a Leaky Ford Radiator



### Simple and Effective Repair for Leaky Ford Radiator

The radiator on my Ford car recently sprung a bad leak. In outward appearance it was as good as ever and showed no dents or breaks anywhere. I found, upon inspection, that three tubes in the outside row were leaking near the bottom. I then drained off the water, removed the outside shell and cut a hole in the brass tank at the top, as shown in the drawing. The hole was cut over or adjacent to the tubes that were leaking. I plugged these tubes with strips of rag, forcing them down to the bottom with a wire. In doing this I completely filled the tube ends at the top with wood plugs. This prevented water from settling in them and avoided freezing in cold weather. Before closing up the hole I filled the radiator with water to make sure that the leak had been stopped effectively. I then folded back the lap of metal and closed the seam with solder. In this way circulation was cut out of three tubes of the radiator, but, of course, it is not desirable to close any more, as this would reduce the cooling effect too much. The method, however, is much better than putting in so-called liquid solders and other anti-leak compounds as they rarely effect a permanent

repair, and very often do more damage than good, plugging the entire radiating system, with resultant overheating and lowered efficiency. My method was, perhaps, somewhat crude, but it worked and was done in about an hour's time. It was not even necessary to remove the radiator from the car.—H. L. Wheeler, Syracuse, New York.

### Lamp Wick Waters Flowers in Owner's Absence

Did you ever go away for a few days and return to find the plants and flowers in the house drooping for want of water? Here is a simple and effective method of keeping them watered for a week or more at a time, with the assurance that you can return and find them just as fresh and green as when you left. Arrange two, three or four plants around a water container, such as a pitcher, bucket or small tub. The more plants there are and the larger they are, the larger the water container must be. Fill the container with water to the brim, and then bury one end of a large lamp wick in the dirt in each pot, and drop the other end in the water clear to the bottom. Also water the plants thoroughly before leaving. The wicks



Plants and Flowers Can Be Watered Effectively by Using Ordinary Lamp Wicks

will transfer the water to the flowerpots by capillary attraction and you will be surprised how much water has been absorbed by the soil at the end of a week. If lamp wicks cannot be obtained, it is



just as effective to use strips of felt rolled into tubular shape, or any soft loosely woven cloth, to transfer the moisture.

### Repairing a Cracked Soil Basin

One of the children allowed the seat and cover to drop on the soil basin, which cracked the bowl between two of the little flush holes in the water channel inside, so that, when the bowl was flushed, a stream of water gushed out on the floor. A plumber tried to repair it by putting a patch of rubber and putty on the outside and lashing it on, but when the bowl was flushed it blew off. As this happened on Saturday, the plumber said he could not install a new bowl before the following Monday. In the meantime, I hit upon a handy plan that saved me a lot of inconvenience and the price of a new basin at that time. I mixed up a cup of plaster of paris to a fairly thick cream and injected it into the small holes near the crack with a glass dropper taken from the medicine cabinet. As the water channel was wet it thinned out the plaster, and let it flow into the crack where it could be seen oozing out on each side. The plaster was allowed to set a couple of hours, and when the bowl was flushed not a drop of water showed on the outside. The repair stood the test for eight months and was good when a new bowl was put in.—Mrs. P. H. Murray, Fall River, Mass.

### How to Crimp Stovepipe

When fitting lengths of stovepipe together it is usually necessary to make crimps in the small ends of the joints so that they can be assembled more easily. This is difficult to do without a special tool, but by clamping two nails in the jaws of a pair of pliers, as shown in the illustration, the work can be done effectively. The nails are held at right angles to the pliers, and the improvised crimper is operated by placing it over the pipe end and twisting in a horizontal plane.

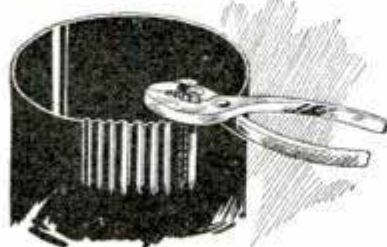

### Focusing Shield for Box Camera

While taking pictures on a bright day, I found it difficult to shield the focusing glass with the hand and manipulate the camera efficiently at the same time. The difficulty suggested a simple shield, which proved very effective. A post card was folded and cut with rounding corners, and was attached to the camera by means of a rubber band. The shield shadowed the ground glass of the focusing lens so that the reflected objects could be seen clearly.—G. E. Hendrickson, Argyle, Wis.



### Preventing Picture Marks on Walls



An easy method of preventing picture marks on wall paper, as a result of the dust collecting on the backs of the pictures, is to drive two small brads or tacks on the backs, about two inches above the bottom corners, to hold the lower edges of the frames slightly away from the paper.—Mrs. M. R. Wells, Cleveland, Ohio.

### Roof Leaks around Chimney

Many roofs develop leaks around chimneys, which are not only difficult to repair but often continue leaking even though new flashings are provided. The proper method of repair in such cases is not to remove the flashing, but to cement the entire face of the flashing with a mixture of cold tar and sand, using the same quantity of each. Apply it with a brush so that it can be worked into the crevices around the brickwork as well as at the flashing, and there will be no more leakage.



# Laying Up the Boat for the Winter

**S**TRAINED timbers, unpainted wood and rust-bitten metal quickly spell disaster with a boat. The ravages of winter work quickly and soon take their toll unless the craft has been properly hauled from the water, blocked up and otherwise protected from the elements. Several hundreds, or maybe thousands, of dollars' worth of boat should no more be neglected than an equally expensive car.

Just when to haul the boat out is, of course, somewhat dependable upon location and inclination. Most boating enthusiasts put it off until the last gasp and one cannot blame them. But to do the work properly and make a sure and safe job of it, the boat should be hauled out early enough to avoid hurry and carelessness. Only small craft, like sailing dories, shallow-draft boats, small motorboats and practically any boat under 18 ft. in length can be hauled out quickly at the last moment. Deep-draft boats, and those of considera-

ble length and weight, require time and thought, and one should get busy some time in October or the first of November, at the latest.

However, locations and time of year will set the rule. Northern localities, especially near fresh water, mean early cold and the job must be done before ice forms. In warmer climates, the hauling can be deferred until late in the winter. In any case, the reader must use his own judgment and arrange to haul up when he knows the time is ripe for his locality.

In salt water, arrange to put the boat on the ways near the full of the moon, to take advantage of the extra-high tides. The next best is to work on the tides at new moon. In fresh-water lakes, and rivers without tides, brute force at the winch must be entirely relied upon. Watch the papers and try to choose a period of quiet weather. Raise the moorings, or else let the chain drop with a marking buoy at-

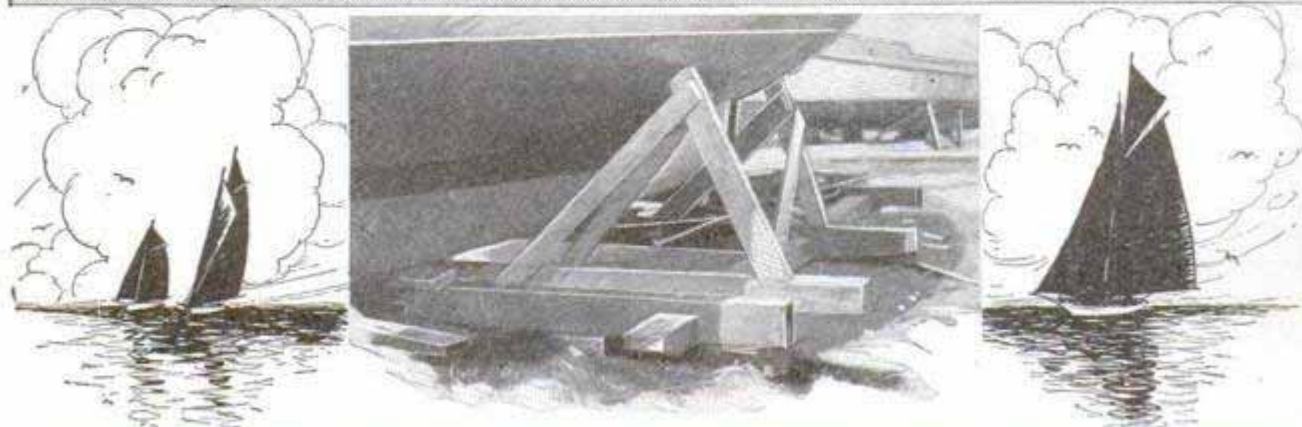
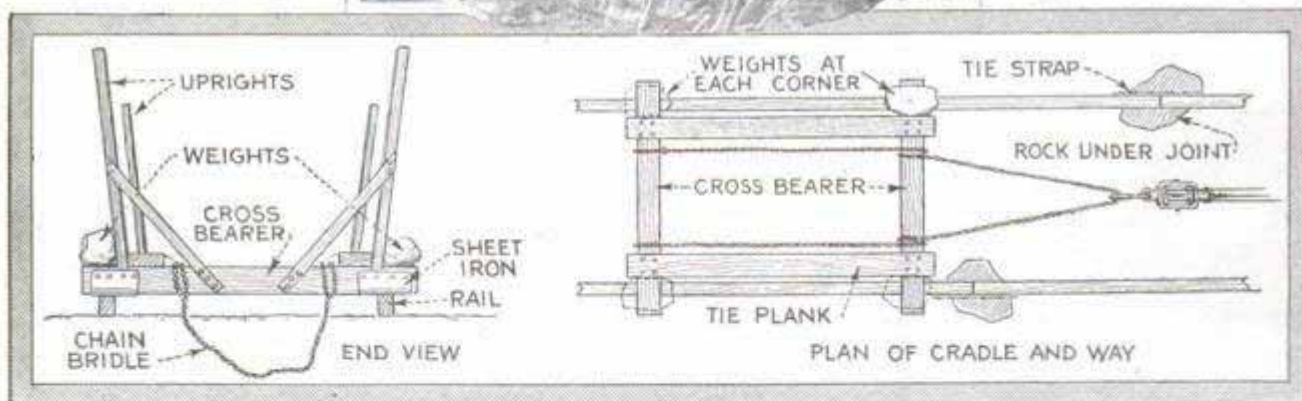

Top, This Boat Is Well Covered with Canvas; Center, Details of the Cradle and Way Used to Haul the Boat; Bottom, One Method of Cradling a Boat, Showing Props, Braces and Cross Bearers



tached, so that the chain can be picked up again in the spring. As the milling of broken ice will often break the buoy lines, it is even safer to tie a bundle



wisely and carefully from the start. A day or two before intending to haul, build the cradle and the ways. Construct the latter as far out on the beach as low

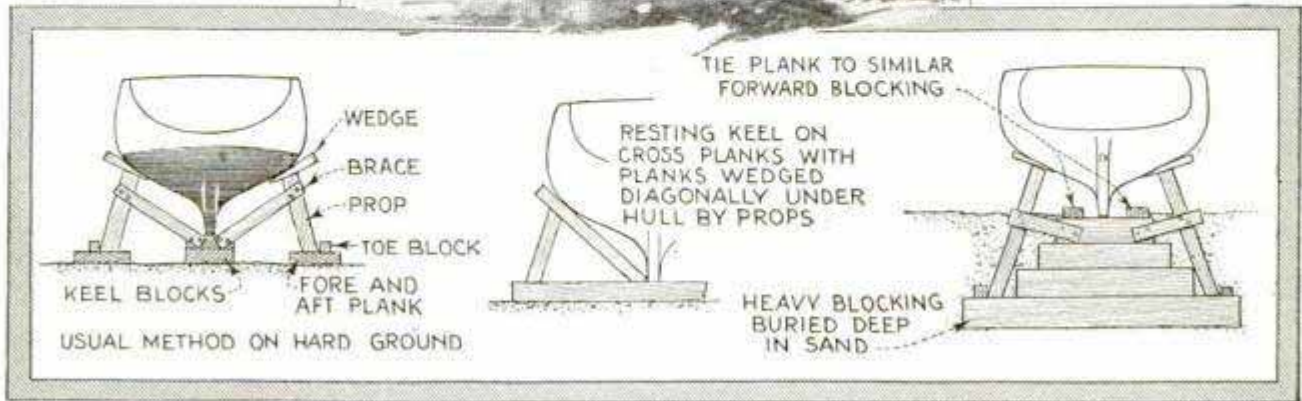

Top, Cradle on the Ways with Tackle Attached, Ready for Hauling When the Tide Rises; Center, Methods of Bracing Boats on Hard and on Sandy Ground; Bottom, a Good Method of Shoring on Firm Ground

of old wire to the chain before letting it go. Then, in the spring, it will be a simple matter to grapple up the wire after locating its bearings.

When the mooring is disposed of, bring the boat up to the dock or alongshore and pass all movable property, such as life belts, sails, tools, spare spars, galley utensils, etc., ashore where they can be safely stored. You will feel much safer by doing this than by leaving them aboard over the winter.

Small boats can be pulled directly upon the beach by means of several rollers placed under the keel, the rollers working over a single track of planks, and the boat is pushed and guided by several men. It can then be chocked up to rest on an even keel and covered with canvas. The deeper-draft boats, however, present real problems in engineering and must be handled

tide will allow you to work; then the water will cover the cradle at low tide and still be deep enough to float the boat up to it. If posts cannot be driven far enough out to hold down the rails, their lower ends must be kept down by weights. Rails can be made of any straight timbers and should be well greased before they are lowered into the water.

The cradle consists of two heavy timbers resting directly across the rails and connected by two heavy planks bolted to them, parallel to the rails. The former are known as cross bearers and are often made of old railroad ties. They should be far enough apart so that the keel will rest on them without danger of any down sweep touching the sand and so that the weight of the boat will be well distributed. It should be thoroughly built and proper measurements taken before the boat is run



on it. If it can be conveniently done, nail some sheet iron under the cross bearers where they rest on the rails, and the sliding action on the rails will be much improved. Spike two heavy uprights to each side plank and brace them diagonally, inside, to the cross bearers, so that the brace will come under the boat's bilges. Take a hitch with one end of a heavy chain, such as a mooring chain, around one end of the rear cross bearers and lead it forward where a couple of hitches should be taken around the forward one. Then leave sufficient chain to make a bridle and return the chain along the opposite side of the cradle in the same manner. The bight in the bridle should be several feet long, as indicated in the diagram, to allow plenty of play in adjusting the tackle. Weight the cradle at both ends to hold it down in the water, then attach the hauling tackle to the bridle in readiness for the pull.

Lay the track in as straight a line as possible and all rails at the same pitch. Stagger the abutting ends of the rails so no two ends will come opposite each other. Tie the planks together with short pieces of board nailed to the sides. Rocks, driven into the sand under these joints, will prevent them from sagging. With the track laid and thoroughly greased, the cradle weighted down and in place

and high water coming in, the boat can be run into the cradle. Have an anchor line on the after deck as well as forward. Attach guy lines to the masthead, if it is a sailboat, and to the highest points on a motorboat and lead them to each side. If it is a motorboat that is to be hauled out, be particularly careful not to crush any outside piping or connections running along the bottom of the hull. The rudder and propeller should be unshipped just as soon as they can be reached in the water. Head the boat into the cradle at the flood of the tide and under slow headway. Enter it slowly and carefully until the keel rests at about the proper point. If the keel fails to touch, haul up the cradle slightly and follow it with the boat until the keel rests on the cross bearers firmly and steadily. With a heavy boat, it may be necessary to throw out the stern anchor before the cradle is reached and check the speed slowly by snubbing the line around a stern cleat.

When the boat is squarely seated in the cradle, fasten the bow line and take up on the stern-anchor line until both are taut. This holds the boat from slipping from position. Pay off the guy lines from the

The Work of Shoring a Motorboat Depends on Its Size, a Small One Requiring No Cradle; Insert, Blocking Up a Large Boat Which Is Left in the Cradle over Winter

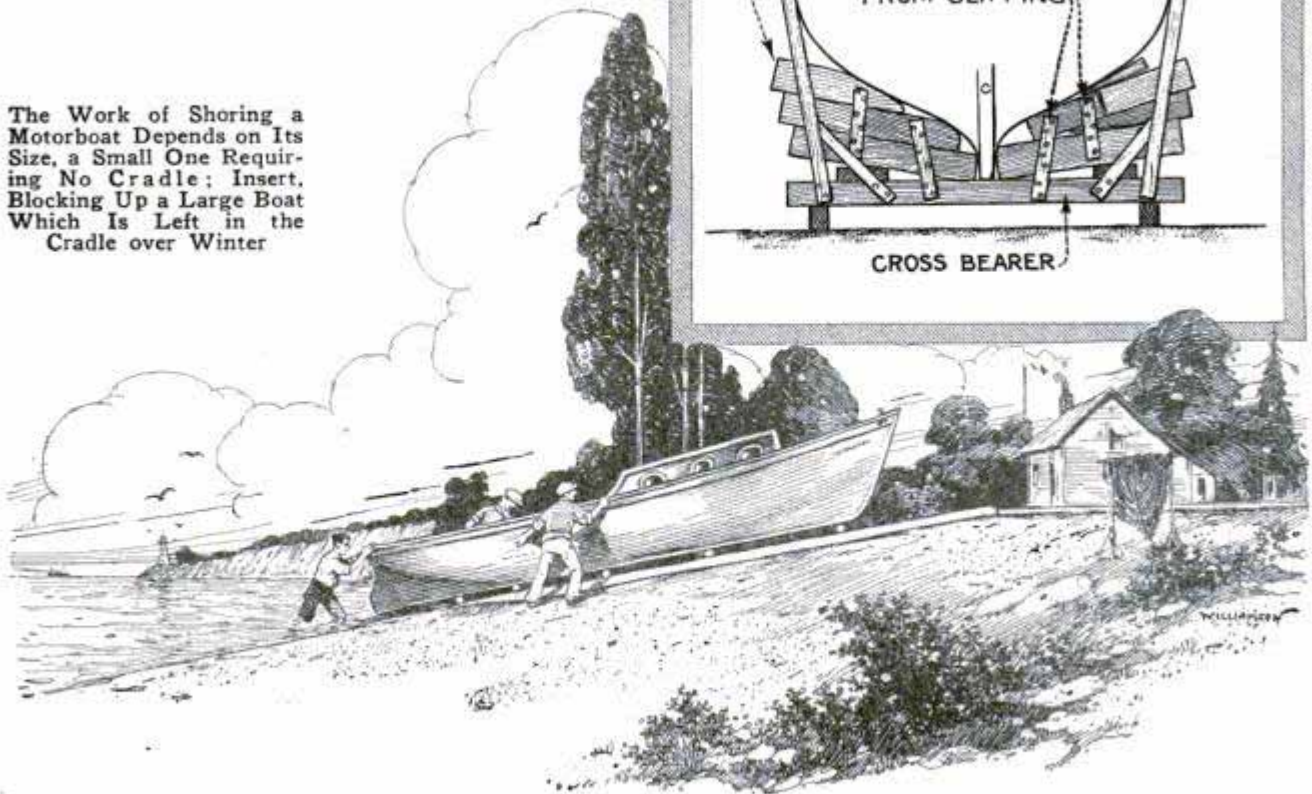



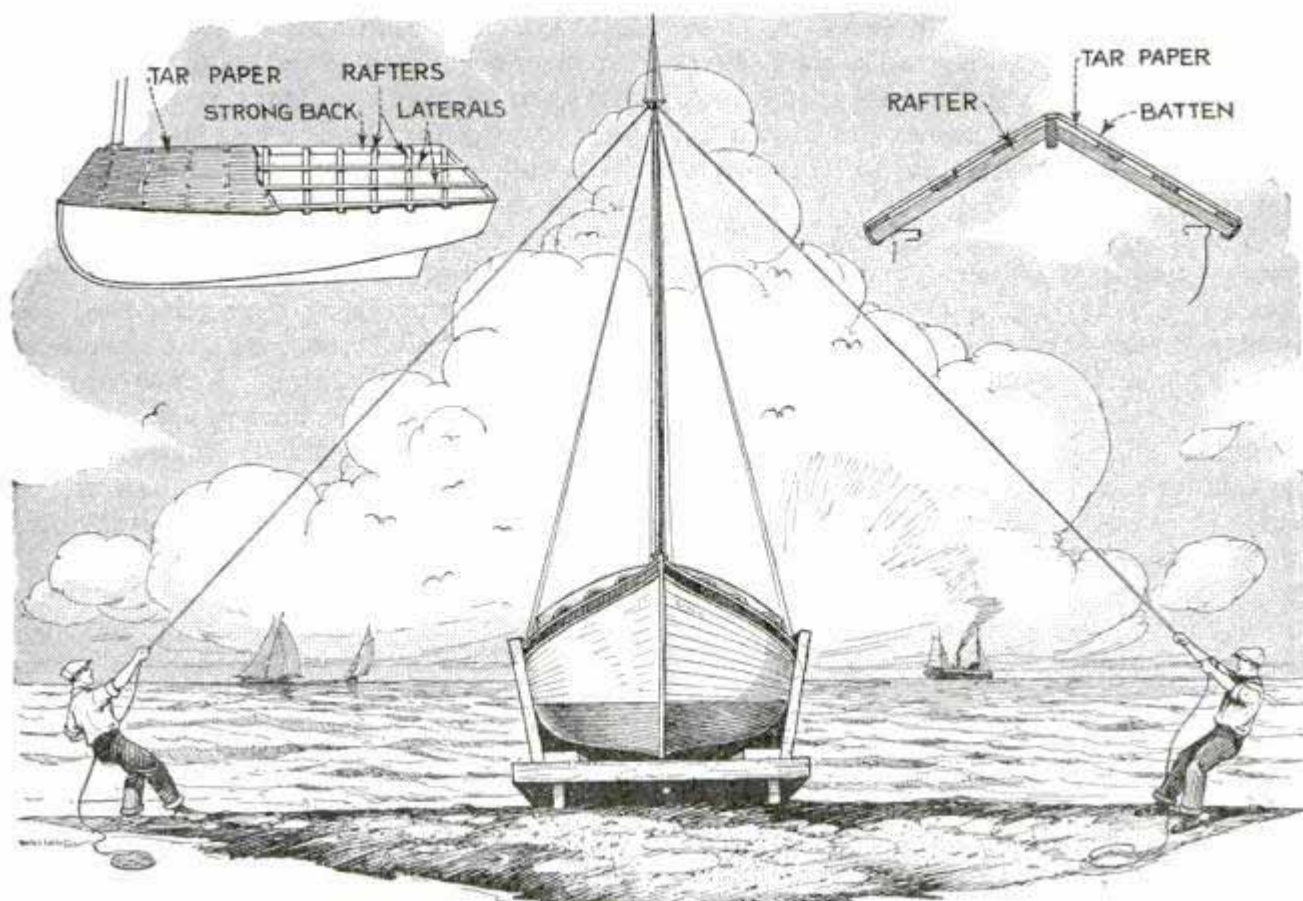

How Sailboats Are Kept Upright When Shoring Them; Details Show Method of Covering the Boat with Tar Paper in Order to Keep Out the Rain and Snow

mast or deck house and fasten them securely so that the boat will remain upright as the water recedes. Use care with this, for if a heavy boat tilts suddenly because a guy line breaks, it may mean broken planking or other serious damage to the hull. Take in any slack that may show as the boat settles into its cradle, and do it often. This can best be cared for by inserting falls into the line. As soon as possible, wade out into the water and chock up under the hull with short blocking, laid over the cross bearers and spiked together to hold. If the tide still flows in, haul the boat up as much as possible during the flood to gain the most benefit from its lift. As the tide recedes, go out with a scraper and a stiff broom and clean off all the barnacles and marine growth from the outside of the hull and scrub the bottom clean.

Then commence the haul. If a winch is not available, the work can be done by several strong men at the end of a three or four-strand tackle attached to the bridle of the cradle. Line them up the track and, if possible, take advantage of a favoring wind. Keep the tracks well greased

all along and have one man stand by with a maul and a couple of wooden wedges. A tap with the maul on the track joints will help the cradle over them, if it tends to stick, and a wedge can be driven under the cradle if, by any cause, it starts to slide back. Let two men handle the guy lines and thus always keep the boat upright. A low boat can be steadied without guy lines by lashing a rope about it and the cradle when the latter is clear of the water. Every boat should be chocked solidly just as soon as it is possible to steady it. Haul the boat far above the high-water mark, for in winter this always exceeds that of summer storms. In fresh water, haul well above the storm line. Here tides are left out of consideration in all operations, and hauling, cleaning and beaching must be done from a fixed water level.

At the top of the track comes the job of shoring up. This consists in blocking the hull up rigidly and permanently for the season, which must be done carefully to withstand the washing out of sands, the pressure of severe winds and all forces of the elements. The simplest way is to



leave the boat on the cradle—but it is not always the best. The cradle may have been built hurriedly and is only temporary. The best way is to remove the blocking, then the cradle and let the hull rest on a firm foundation.

To shore up and make a good job of it, first gather a number of good, solid wooden blocks, railroad ties, or other equally strong material, and place them under the keel at points where they will bear the weight of the boat evenly distributed. Then build up on these with the smaller blocks until the latter fit snugly under the keel. Place some heavy planks on each side of the hull, parallel to it, and bury them slightly. Cut two or three props for each side, as shown in the diagram and photos, and, resting their butts on the planks, incline them slightly under the hull so the two meet. Wedge short planks between the tops of the props and the keel diagonally under the hull and drive smaller wedges, as indicated, until the hull is absolutely rigid. With this arrangement, it cannot fall or tip unless the earth underneath gives way. It is safest to fasten the bottom ends of the props in order to prevent them from slipping out.

If the beach is so sandy that there is danger of its washing away, it is necessary to build up heavy blocking from a trench in the sand to hold the boat's weight. Otherwise, any undermining of the sand will cause the props to drop from under the boat, which may seriously strain it. Build up a solid triangular blocking from the bottom of a deep trench running in the direction of the cradle cross bearers. The top log should come about level with the beach. Do this at both ends, just in front of the cradle. Tie the top logs together by spiking heavy planks to them on each side of the keel. Rest the keel-blocks on these. Then heavy props can be placed on these planks and wedged in the manner just described, blocking the toes of the props to prevent them from slipping. When completed, carefully undermine the cradle and remove it from under the boat, then fill in the trenches and tamp them down.

An open boat must be covered. This can best be done by using heavy canvas, such as an old sail, or a canvas cover made to fit. One method of covering a sailboat

is to use the boom as a ridge, draping the canvas over it and tying it down fore and aft, then lashing the sides several inches over the gunwales. This lap must be made to keep out drift snow and sleet. Be sure to arrange the canvas to dip in all directions to carry off rain water or that from melting snows. Patch any torn places before using and see that the canvas is stretched tight over the frame to prevent it from leaking. A few narrow boards, running lengthways of the boat under the canvas, will help holding it out, making a better water shed than if the canvas is allowed to sag and stretch, thus forming into pockets.

Tar paper can also be used for boat covering where canvas cannot be procured. First make a "strongback" consisting of a timber, running the length of the boat and lashed to the masts or otherwise centered. It acts like the ridge of a roof. Nail light wood to it down to the gunwales and far enough apart to take the width of a strip of tar paper. Lastly, over these "rafters," nail more light strips, running parallel to the strongback and about 30 in. apart. This forms a lattice with 30-in. squares. The paper can then be tacked to the rafters and battened down with laths outside, to prevent it from tearing and allowing water to leak in. If it is properly made, such a cover will prove weather-tight and inexpensive. Light lumber can be used and, in the spring, the pieces can be numbered, taken down and stowed away for another year's use.

All standing spars should be doped with a mixture of linseed oil, tallow and yellow ocher. Mix and warm until the tallow melts, and then the ingredients can be stirred to a paintlike consistency. Apply while warm with an old brush, starting from the masthead and working down. If spars are removed before laying up the boat, which is the best method, they can be laid on horses or blocking and doped in the same way. It protects them from the weather and prevents cracking. All other exposed varnished surfaces can be treated in the same way with very good effect. Cover the masthole with a canvas boot or tar paper to keep out the water.

With sailboats the rudder should be removed or well lashed in place to prevent it from swinging in gales. Make sure the



centerboard is well up and fastened, or it may drag during the hauling and split or break off. We have already assumed that the propeller has been removed. Open the cabin ports slightly, to give a little ventilation, but batten down all hatches and companionways into which snow or rain might drive. Open all seacocks, toilet drains, bilge ports and any other plumbing that might freeze and burst if water is left in them.

The removal of the powerplant from either motorboat or auxiliary is optional and conditional upon the needs of the engine or transmission. In small boats, it is an easy job to take out the engine but with a large boat the task becomes heavy and complicated. Much of the overhauling can be done aboard, but when the engine is in bad shape it is best, if possible, to remove it and do the overhauling indoors. If the engine is to be left aboard until spring, a few general precautions for the winter's housing should be taken. Drain the water jacket and the pumping system and remove the plug from the jacket. Also remove batteries, spark coils and any wiring that may become saturated with moisture. In fact, it is wise to rewire each year with heavy cable and thus insure yourself against defective wiring and possible ignition troubles while at sea. Remove the magneto from the engine and store it, as well as the spark plugs, in a dry place. Before taking the ignition system apart, run the engine a few moments

with the water drained off, in order to heat and dry it out. Remove the exhaust and intake ports and stuff with rags and also close the water-pipe openings and spark-plug holes in the same manner. Pour a pint or so of heavy oil in each cylinder and then turn the engine over by hand, to distribute the oil over the cylinder walls. Paint the engine with a mixture of white lead and tallow, to prevent it from rusting, and throw a piece of canvas over it as a final precaution. Then pull out the packing from the propeller stuffing box on the skeg and fill the gland with the same "dope" as was used on the engine.

In a sailboat, remove all the ballast and pile it outside. Then clean the bilges of water and mud and dry out by some safe heat. Give it a couple of coats of white-lead paint, being careful to keep the limbers clear. These latter are the openings cut in the bottom of the ribs to lead bilge water to the lowest point. Then replace the bilge flooring.

With all these details completed and the cover over the cockpit of a full-open boat, you may feel well assured that you will find the craft in prime condition when spring returns. Lack of such care will invariably mean a rotting interior, impaired machinery and, perhaps, a punctured or sagging hull due to careless shoring. This means expense and constant trouble. The time and material spent in preparing the boat for winter will pay dividends every time, and in more ways than one.

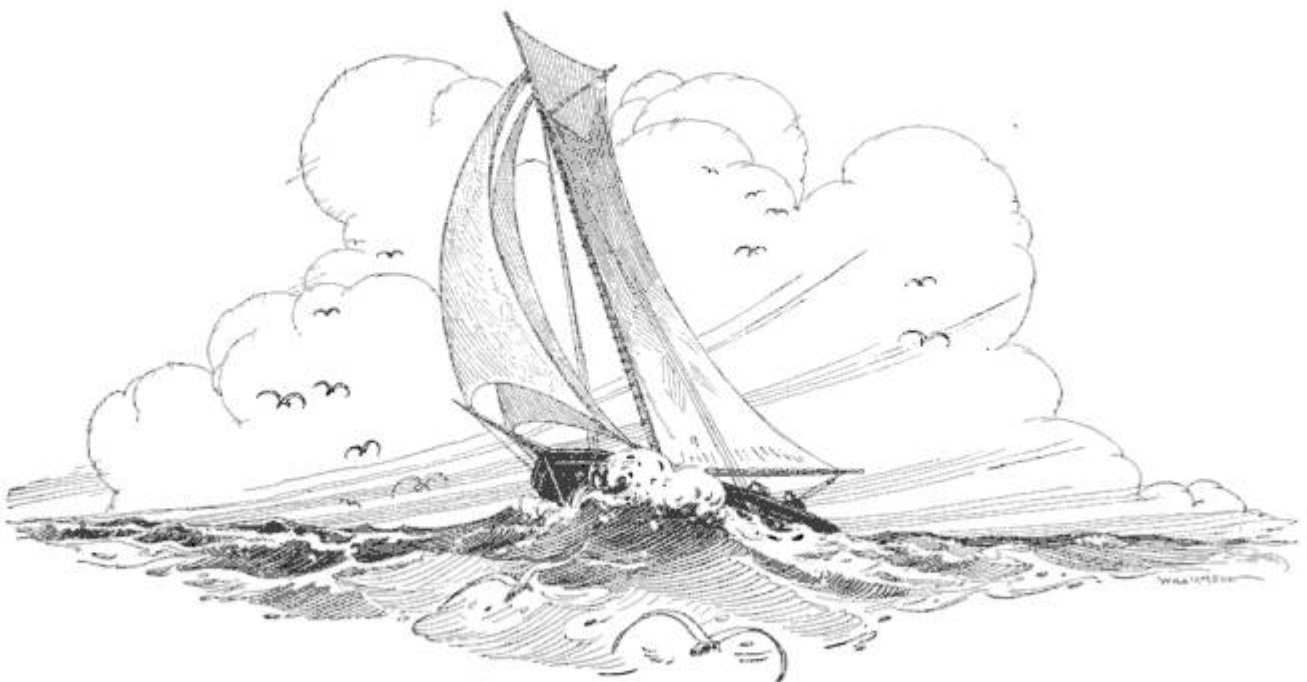



### Road Map Mounted on Spring-Roller Shade Is Convenient

Ordinary maps are rather difficult to handle as they are quite large and therefore are apt to be torn easily. The diffi-

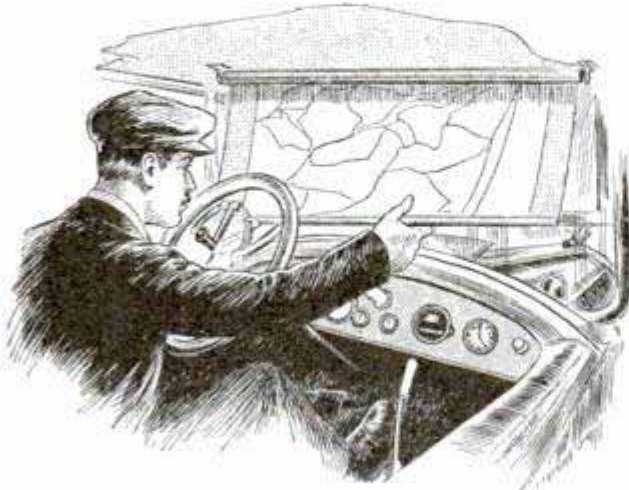

The Road Map Is Mounted on a Spring-Roller Window Shade Attached to the Auto Windshield

culty was eliminated in one case by attaching an ordinary shade roller to the windshield, and gluing the map to the shade, as shown in the drawing. Whenever it is necessary to look at the map, the shade is pulled down and after consulting the map, the shade is rolled back.—T. F. Krey, East Orange, N. J.

### Non-Scratching Emery for Polishing

There are many instances where emery would be used for polishing purposes if it would not scratch. Non-scratching emery can be obtained by the following simple method: Take any bottle, which will hold practically  $\frac{1}{2}$  pt., and fill it with 7 parts machine oil and one part flour emery, by bulk. Shake the bottle well for a few moments and then let it stand for a half hour. You will find that, after settling, some of the emery will be suspended in the oil. Pour this

top liquid into another bottle without disturbing the sediment on the bottom. The liquid poured off contains the finest particles of emery, which will not scratch.

### Marking Position of Sewer Pipes

Sewer or water pipes not laid in a straight line may be easily marked by laying a row of brick on or near the surface of the ground, where they may be located in case of trouble. Joints may be marked by laying a brick directly over them, sideways. This method will prove a great timesaver when it becomes necessary to get at the pipe, especially if new pipe is used, which may not require attention for several years.—Charles E. Forgette, Plattsburgh, N. Y.

### Clamp for Logs and Knotty Sticks

If one of the shade trees about your cottage dies or is blown down, its ornamental usefulness may be prolonged by turning its trunk and gnarled limbs into rustic seats and tables, attractive supports for plant tubs, sundials, gates, pergolas, etc. However, it is usually difficult to saw the trunk and heavy limbs on trees lying on the ground. A great convenience in doing such work is the clamping device shown in the illustration. It will hold the crooked and knotty sticks firmly in any desired position for sawing, drilling or attaching other parts. It is made of a hewn piece of timber, about 4 ft. long, which

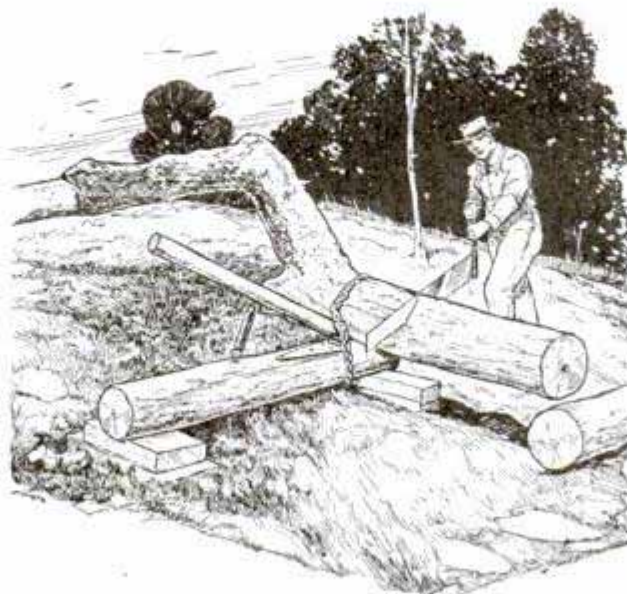

Strong Clamp for Holding Tree Trunk Lightens Labor of Sawing It

has a V-shaped notch close to one end and two supporting blocks nailed to the underside. It can also be made of two pieces of 2 by 6 or 2 by 8-in. lumber, nailed together. A lever is attached to it with a stout strap hinge, and a coil spring, not too long but stiff enough to exert a strong pull, is fastened between the parts by means of two screweyes.



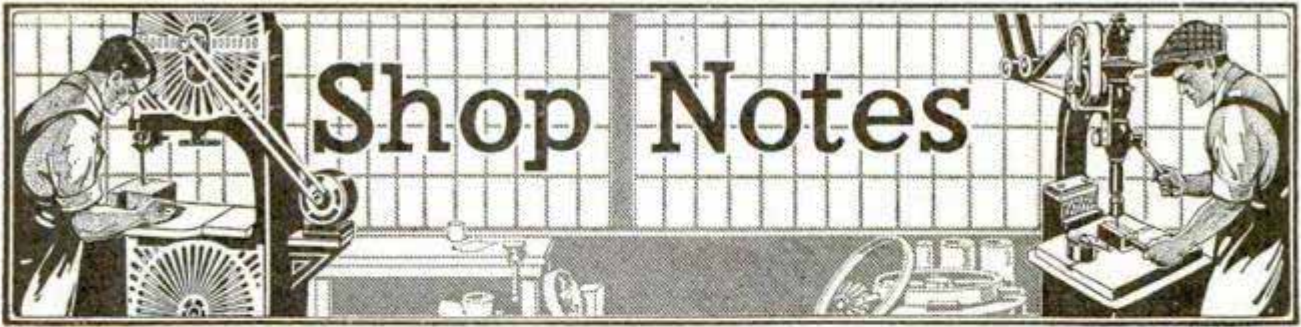

All Shop Notes published in 1926, in book form—Fifty Cents—from our Book Department

## Glue and Its Use Around the Home

By L. B. ROBBINS

**M**ODERN glues come both in the flake or crystal form and as a liquid. Today the latter is most generally used because of its handiness, keeping qualities and adhesive powers. Of course, the hard glues can be converted into liquid form with a little trouble and in some cases may

even be preferable to the liquid stock. The uses for glue around the modern home are many. Probably every family has a chair, picture frame, or whatnot, that is discarded because a rung or a portion of it has become disjointed. Statuettes may have become broken, book

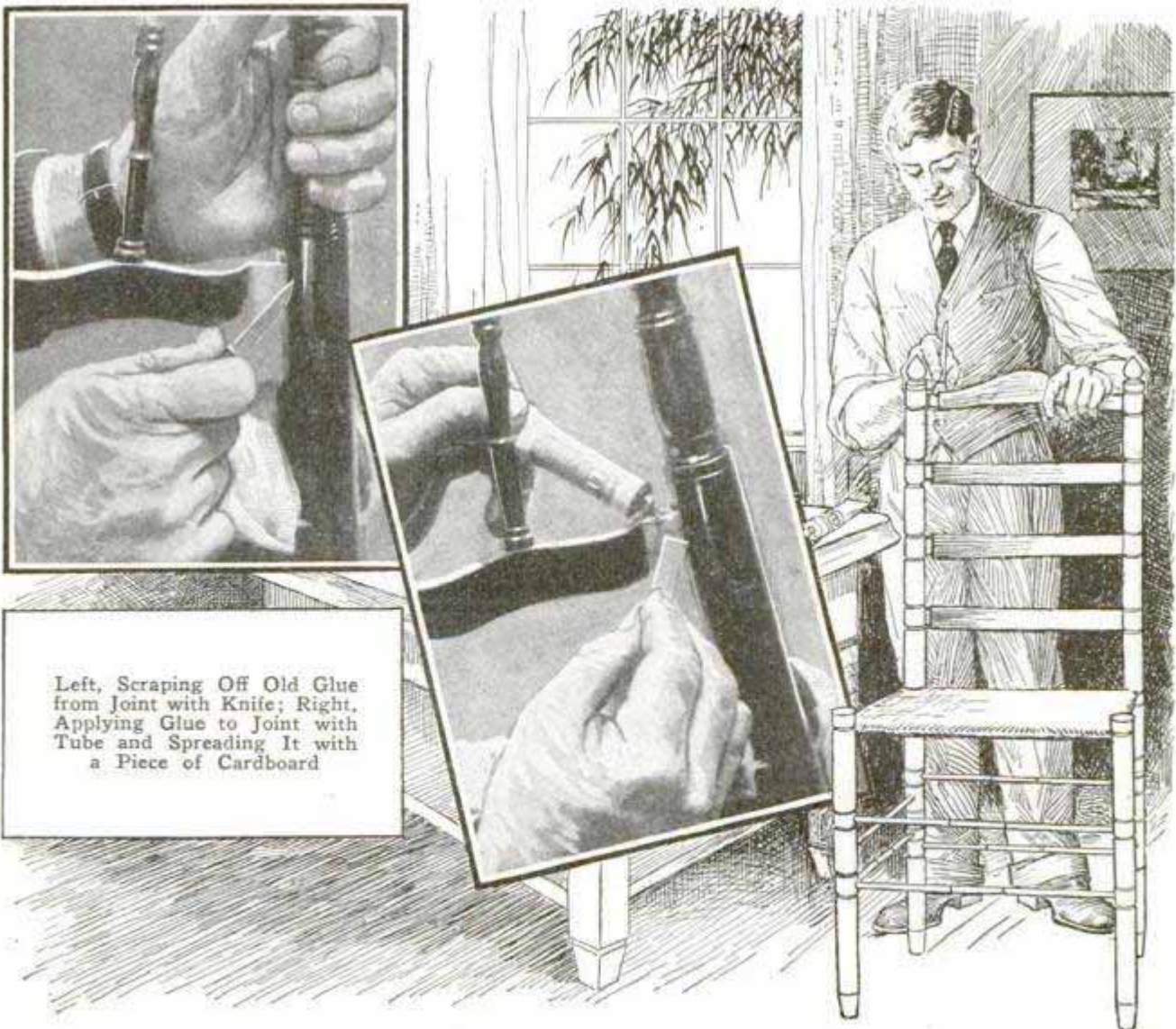

Left, Scraping Off Old Glue from Joint with Knife; Right, Applying Glue to Joint with Tube and Spreading It with a Piece of Cardboard



covers torn off or veneer has parted from its foundation on a costly piece of furniture. The children can be amused for hours by making cardboard toys with the aid of glue. In fact, ten cents' worth of glue will pay a bigger dividend than any other household necessity one can mention. It is simple to use and accomplishes wonders when properly applied.

For home repairs wood is probably the material most to be reckoned with. Now, let us suppose a valuable chair has loosened up in the joints so it is almost unsafe. The proper procedure for making a permanent gluing job is about as follows:

First, separate the jointed portions so they are entirely exposed. Scrape off the old glue clear to the wood and dig it out from all of the holes and crevices. A sharp knife blade or freshly broken glass can be used for this. Then sandpaper to smooth the surface and give it a tooth. Be sure both surfaces of the joint are clean and dry; then apply a thin coating of glue direct from the can or tube. Allow this first coat to nearly dry so it feels quite "tacky" to the touch. Then apply a second generous coat and let that, too, become tacky, and finally fit the joints together evenly and as firmly as possible. In the case of a chair or any irregularly shaped object, the pressure may have to be maintained between the glued parts by tying with strong cord. With picture frames and flat surfaces glued together, the parts can often be clamped, using common carpenters' clamps or boat clamps to press the parts together. Any glue that oozes out from the joint under pressure should be allowed to set nearly hard before removing it with a knife blade or other suitable tool. Do not press the joint so hard, however, that most of the glue will be squeezed out, for some of it should remain between the surfaces to make the job a good one. By allowing at least 24 hours for a joint to dry, you will have a perfect job and one that will stand up under the most trying conditions.

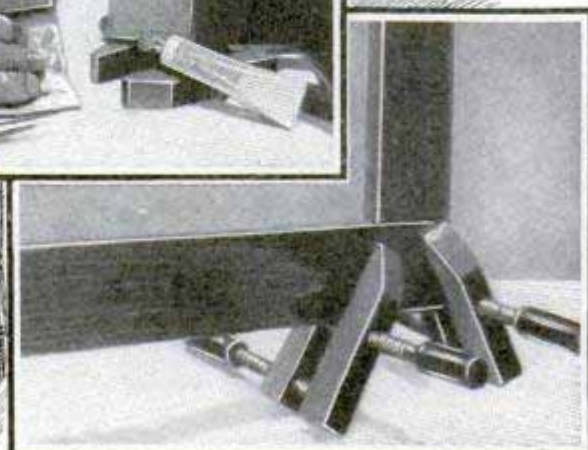
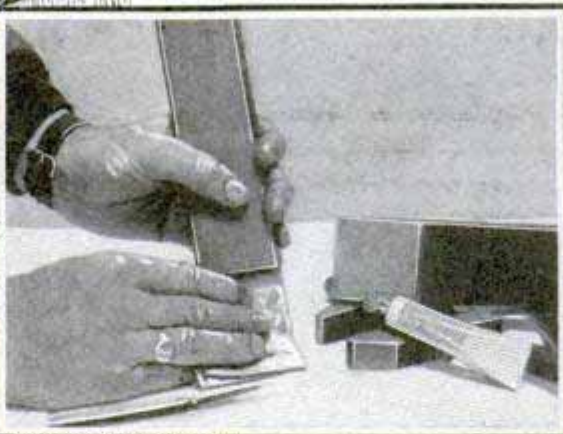
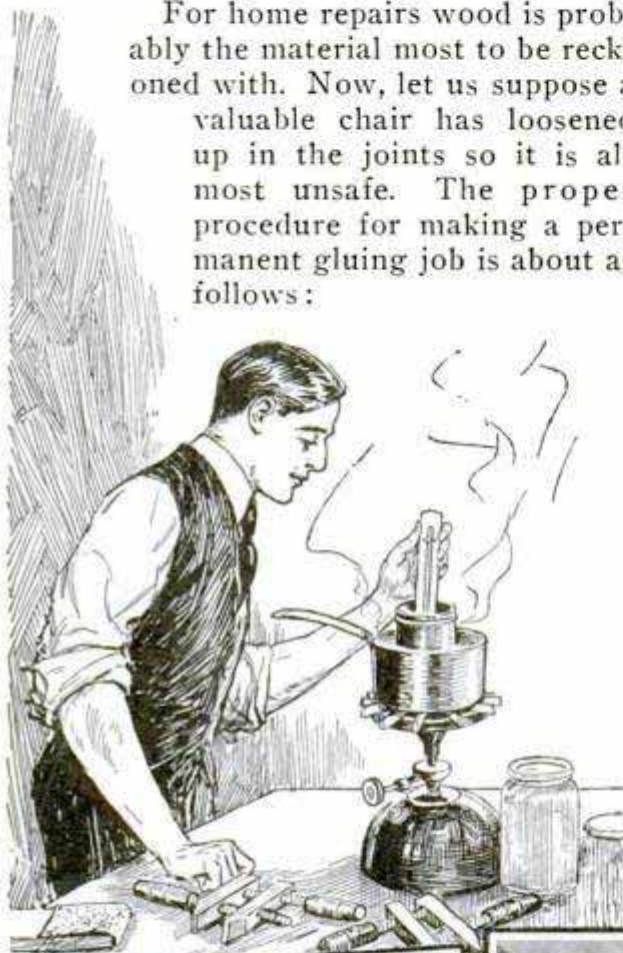

Left, Double Boiler for Heating Flake Glue; Center, Smoothing Mitered Joint; Below, Clamping Joint



New wood should be properly fitted before gluing and made thoroughly dry before applying the glue. For soft woods, it will be well to allow a thinned coating of glue to sink into the pores before applying the two regulation coats as just described. This will increase the holding power considerably.

Now a word regarding the use of hard glues. The principal characteristic of hard glues are that they set quicker than liquid ones and must be dissolved and heated before applying. For general work, therefore, the prepared liquid glue is preferable, but where an especially solid joint is desired or when liquid glue cannot be procured, hard glue must be used.

First soak the glue until it is soft, using cold water. This will take from 4 to 12 hours, depending upon whether the glue is in pulverized or sheet form. Do not prepare the mixture by guesswork. Use enough water to thoroughly soften the material but not so much as to dilute it. When soft, put the glue into the pot and add a little water as the glue heats and melts. Use a double boiler and slow heat, making sure there is plenty of water in the outer jacket of the boiler. A good boiler can be made from two tin cans, as shown in one of the photographs. As long as water and glue are kept in the cans, the solder cannot melt from the heat. Use a thermometer during the melting process and be careful not to let the temperature rise above 160° F. If glue is allowed to become too hot, it rapidly loses its strength and, if this excess heat is continued, the glue will be ruined.

Apply to the job while warm and in a fairly fluid state, setting the work instantly and clamping and tying it as has been previously described.

In recent years there has been revived a glue-impregnated material that was used by the ancients in molding decorative work and filling imperfections in hand-craft articles. It goes by the name *gesso* and, in modern terms, is a combination of glue, varnish, whiting and linseed oil. It is plastic like putty, dries hard and can be worked, sandpapered, sawed, chiseled, painted, waxed or varnished exactly like wood. Thus it can be used to advantage in filling in chipped places in valuable furniture, correcting errors in wood-



Left, Mixing Gesso on a Glass Slab; Center, Pouring the Gesso into a Paper Funnel; Right, Three Forms of Attachment for Paper Gluing



working, as a filler and in molding decorations on picture frames, etc. Gesso is simple to make and will keep indefinitely for instant use, if properly cared for.

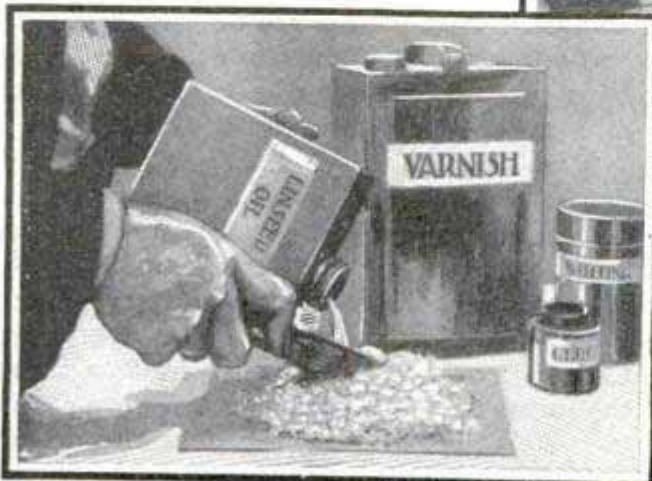

Put a cup and a quarter of whiting in a mixing bowl or on a glass or marble slab. Then pour in the center of the whiting, stirring all the while, a gill of best



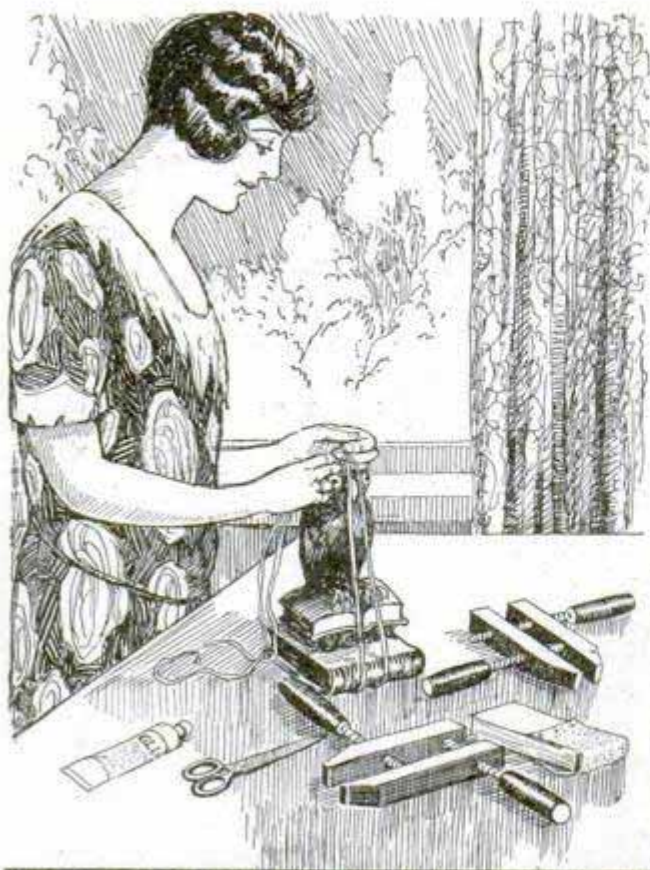

By placing the gesso in a fruit jar, covering it with a little water and sealing the cover, it will keep indefinitely. Just pour off the water and it is ready for use.

Now suppose you have built a cabinet and one of the joints shows an unsightly gap. Just fill the gap with gesso and let it harden. Then it can be shaved or planed down, sandpapered smooth and finished with the same finish as the wood, and the defect will hardly be noticeable. Suppose a sliver is torn from a hand-carved ornament. Instead of attempting to fit a piece of wood to the break, just mold the surface up with the gesso and finish it to

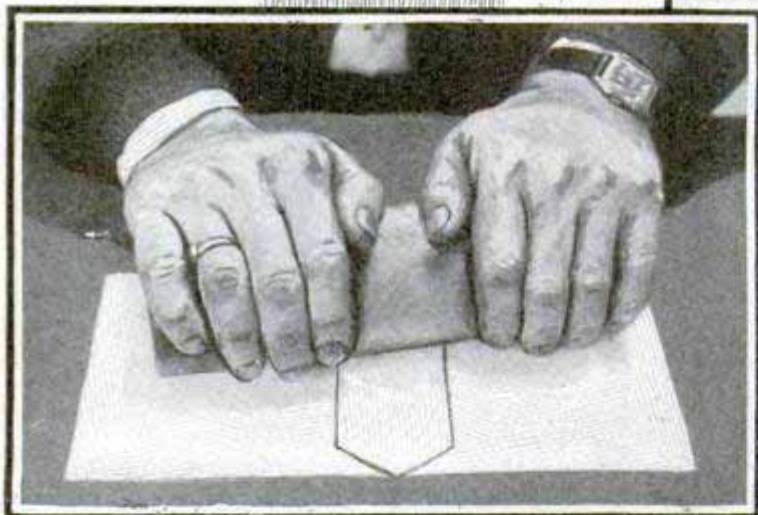

Bottom, Sheets of Paper or Cardboard Pressed Together Firmly by Rolling with a Mailing Tube; Above, Mending Broken Plaster Ornaments with Glue

grade liquid glue, three teaspoonfuls of linseed oil and three teaspoonfuls of varnish. Stir slowly for two or three minutes and until the ingredients are mixed thoroughly and smooth. If the mixture is oily and does not stick to the bowl or slab, add a little more glue and stir longer. When ready, the mixture should remain piled up wherever it is laid and stick to the utensil or container. If the pile settles down, it is still too thin, and a little whiting should be added until it acts like an immobile mass that can be molded as desired. If too thick, add a little water.

match. Broken decorations on elaborate picture frames can be restored with gesso so as to go undetected, and chipped pieces from statuary filled in as well. A gesso joint has about one-third the holding power of a pure-glue joint, but is sufficiently strong for all ordinary purposes. It is also a good filler and putty substitute. It will fill countersunk holes better than a wood plug. Gesso can be

best applied to a long open joint by pouring it into a rolled paper funnel and allowing it to run from the small end. This method can also be employed when molding raised figures on a frame.

Making paper and cardboard toys and decorative objects, such as lampshades, is fascinating work, but certain rules should be followed to get the best results. First, do not use too much glue and remember that liquid glue is much to be preferred for this work. Squeeze just enough from the tube to cover the surface to be cemented. Spread it evenly over the material with the spreader or a piece of card-



board. Let it become almost dry and then lay the second piece over it and press together. This method will prevent the surfaces from slipping, and the glue will dry quickly. A few heavy books piled over the joining will hold it solid until dry, or two thin pieces of wood, one on each side of the material and held tight by a pair of clamps, will make the job easy.

In making paper objects there are three essential methods used in joining two abutting pieces. One is by means of a flange. This consists of a narrow strip of material, folded lengthways, with the ends of one half clipped off at an angle. This is used in joining two edges meeting at a sharp angle. A hinge is used to straddle a joint and is similar to a flange except that both ends of the piece are beveled. When a flange is to be bent around a curved piece, it must be saw-toothed and the teeth glued to the face of the circular part. All three are shown on page 863.

Keep the scissors sharp for paper working and have a clean cloth and bowl of water handy to wash and dry the fingers occasionally. A good method of smoothing a glued surface and removing all air bubbles, before putting the work in the press to dry, is to use a piece of mailing tube as a roller. This thoroughly presses the surfaces together and is an inexpensive tool that you will find it easy to pick up almost anywhere.

Mending plaster casts and similar objects should be done carefully to insure a lasting job. Dry the surfaces by holding the article over a slow heat for some time. Then thin down a little glue with water and thoroughly soak it into each surface until the pores are filled. After that apply one coating of normally thick glue, letting it nearly dry, then the final coat, and press into position for drying.

The illustrations that accompany this article fully illustrate the essential points in using glue, and if they are followed carefully, along with the directions, you should have no difficulty in doing a satisfactory job. Remember to use only a good grade of glue for good work and do not hurry. You can save many dollars' worth of otherwise useless furniture and household utensils besides constructing new things that will be a pleasure to use and to look upon.

### Bushing Compressor

The use of split bushings is fairly common on certain kinds of machines, and a simple tool for compressing these, so that they may be easily slipped into place, will be interesting to many. Two pieces of hardwood are joined by a nut and bolt, to form arms, and a shorter piece is joined to one of the arms in the same way, to form a stop. Wire rope, of a length to suit the bushings, is slipped through holes in the arms and knotted. To operate the

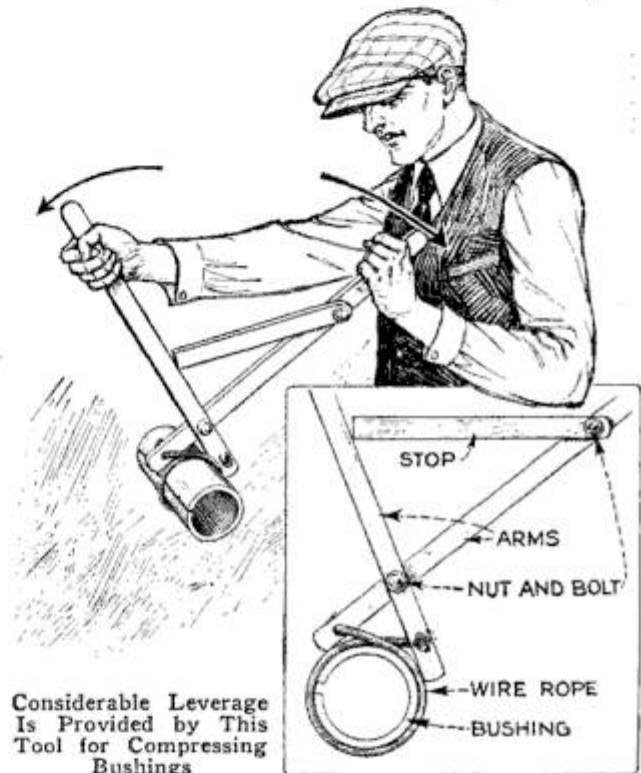

tool, give the rope a single twist to make a loop and slip it over the bushing. Now pull the arms apart to tighten the rope and so squeeze in the bushing, and the stop piece will drop down and hold the arms securely, while the unwrapped part of the bushing is pushed into the handle. The tool is then removed and the rest of the bushing is tapped or pressed into place.

### Method of Locating a Gas Leak

Never use matches when looking for a gas leak. The following method is much safer: Mix a solution of hot water and soap, making the water very soapy. With an old paintbrush apply the soapy water to the points where leaks are suspected. Bubbles will appear wherever there is a leak.—L. H. Georger, Buffalo, N. Y.



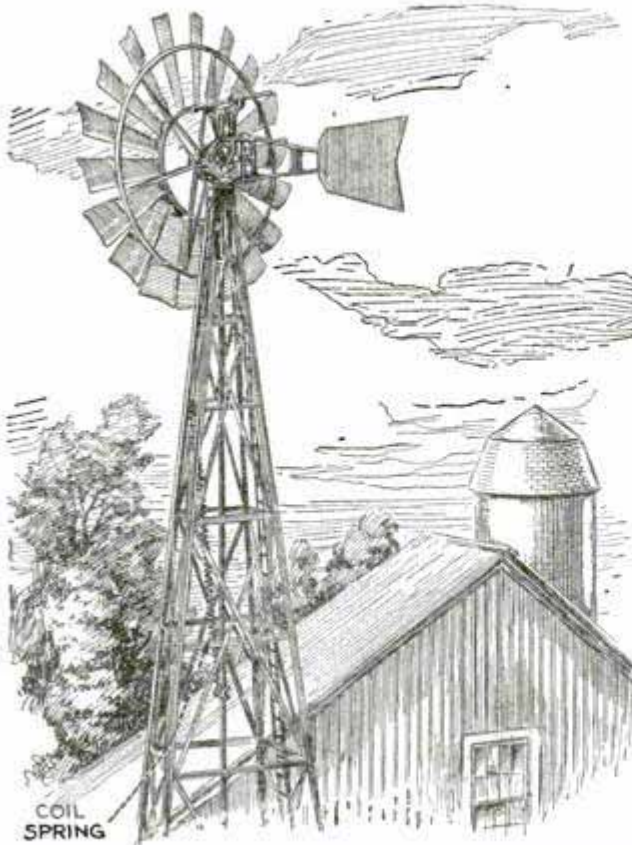

Coil Spring Attached to Pitman and Windmill Frame Facilitates Pumping

### Coil Spring on Windmill

In a windmill, the upward movement of the pitman requires the most force as it is necessary to lift the total weight of the pitman and also the column of water which the pump is drawing up. Obviously, the windmill will start much more easily on a downward stroke because gravity aids in pulling the pitman down. To equalize the force required to raise and lower the pitman, a strong coil spring will be found convenient. It is attached to the frame of the windmill and to the pitman as shown in the drawing. The pump will then start easily in the slightest breeze.—H. J. Curley, Salem, S. Dak.

### Paint Keeps Straw from Beneath Slats on Harvester

When harvesting, trouble is usually encountered due to straw pushing beneath the slats on the elevator and butter canvas, until these become clogged and slip, making it necessary to stop and clear away the straw. To prevent this trouble, I apply paint thickly along the canvas next to the front side of the slat, first oiling the edge of the slat with a rag so

that the paint will not stick to it. The paint is laid on thickly enough to form a ridge on the canvas just in front of the slat, and so forms a guard to prevent the straw from sticking.—G. G. McVicker, North Bend, Nebr.

### Modeling Clay for Casts

Modeling clay, which can be obtained in most toy departments of retail stores, is excellent material for use in casting simple objects in plaster of paris. When taking an impression, the object should be dusted with talcum and, after the plaster has been poured and hardened, the clay can be peeled off without difficulty. A Wisconsin window decorator saves many dollars with this compound by making small accessories for his displays.—G. E. Hendrickson, Argyle, Wis.

### Emergency Grease Gun for Differential

Filling the differential of an auto is a task which can easily be done with the emergency filler shown in the illustration, when a regular grease gun is not available. It consists of a piece of heavy wrapping paper rolled to the shape of a large cone. This is filled with lubricant, and the wide, open end folded over. To transfer the grease to the differential, tear off the point and slip the small open end into the filling hole. Then roll the cone like a tube of toothpaste, thus forcing the contents into the differential.—G. A. Luers, Washington, D. C.

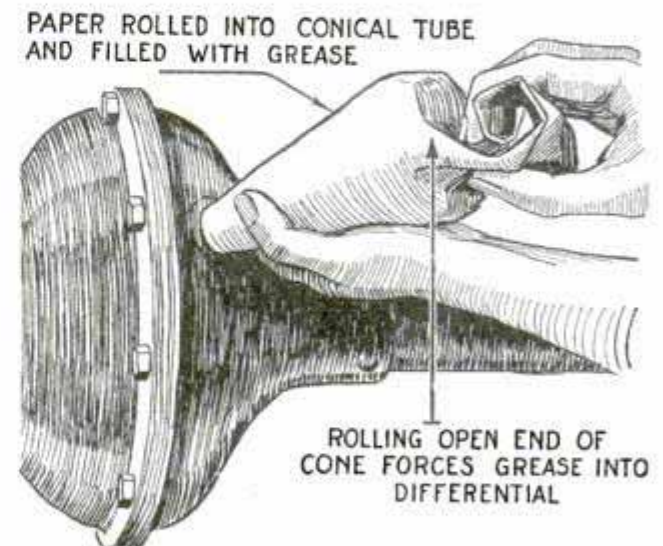

Filling Auto Differential with an Emergency Paper Grease Gun



### Making Earth Fill without Trestle

It was desired to strip the clay overburden on a gravel deposit and to use the clay to construct a fill across a channel. The equipment for the work consisted of a steam shovel with a  $\frac{3}{4}$ -yd. dipper, a locomotive and a number of 4-yd. side-dump cars. The locomotive and cars were 36-in.

shore. Two full-length rails were then connected to the rail ends on the pontoon and extended onto the shore on that side. The pontoon was then taken out. After



Eliminating the Expense of Building a Trestle for Making an Earth Fill

gauge. The water in the channel was 14 ft. deep, and it was desired to have the grade 8 ft. above the water. In order to eliminate the expense of building a trestle to carry the cars while dumping, a framework was built on a pontoon, 8 by 16 ft. and 2 ft. deep. This framework was to support the outer ends of two steel rails, weighing 65 pounds to the yard and 30 ft. long. The rails were clamped in the center to hold them to gauge, and were fastened to the frame of the pontoon and to the ends of the track on the shore. This allowed a clear space of 9 ft. for dumping between the shore and the pontoon. The arrangement also permitted the forward pair of wheels to run out over the edge of the fill so that the load could be dumped into the water.

After the work of filling had progressed to the pontoon the rails were disconnected at the joint on shore, the pontoon pushed forward 9 ft., and the track laid in the gap on the new grade. This was repeated as the grade was filled until the pontoon was against the opposite



a narrow grade had been made across the channel, it was an easy matter to bring the grade up to the desired width by dumping the leveling-off on both sides of the track. By using this method the need of a trestle was eliminated and the dumping

was done in a highly satisfactory manner.—A. W. Burg, Lake View, Iowa.

### Doubling the Life of Tool Bits

The life of tool bits of the turned-shank type can be prolonged by an average of approximately 100 per cent, by using the simple tool holder shown in the drawing.

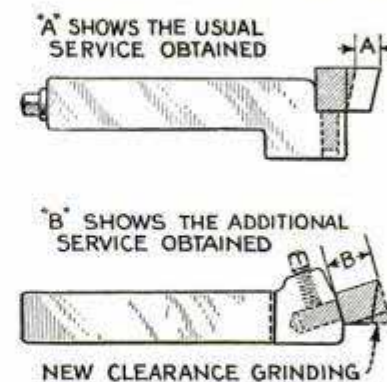

The upper detail shows the regular way of using these tools. A shows the amount of service obtained from a tool. Instead of scrapping the tool at this point, it is placed into the holder shown in the lower detail, and is ground with the proper clearance, which makes it good for more service than it has already given.—E. H. Dreider, Lancaster, Pa.





Handy Ladder  
Made from a Dis-  
carded Wagon  
Tongue

### Wagon Tongue Makes Handy Ladder

For use about his farm buildings, a Wisconsin man has made a serviceable ladder from a discarded wagon tongue, using bolts for rungs. The tip of the tongue, which had been broken off in an accident, was sawed off to provide a smooth end. Holes were drilled at intervals for the insertion of  $\frac{1}{2}$ -in. bolts, 8 in. long. Besides the simplicity of its construction, this ladder commends itself on account of the ease with which it can be carried from place to place, and the width of its base, which makes it safe. It is especially convenient for use at stacks of hay or straw or for picking fruit, and may even be used as a binding pole when hauling fodder.

### Glass as a Substitute for Tracing Cloth

Instead of using tracing cloth or paper, in instances where the tracing is not to be kept as a record, a plain sheet of glass makes a good substitute, and one that possesses certain advantages. A piece of glass that is perfectly clean and dry will take the drawing ink excellently, and no sizing need be used. The ink dries as quickly as on paper, and, when dry, the tracing may be dusted or wiped off with-

out the slightest injury. When the tracing is no longer wanted, a damp cloth will quickly remove the ink, and the glass is then available for another tracing. The centers are located by means of a small piece of rubber, leather, or the like, moistened and placed on the glass. This gives a good rest for the point of the compass. This idea simplifies the blueprinting work, as it does away with tracing cloth, and a single glass will do for many tracings, besides which the glass always lies flat, without the use of thumbtacks, and the finest line is readily seen.

### Reflector Illuminates Oil Indicator

When the oil supply of an auto engine is diminished to the point where the pump fails, the burning out of the connecting rods or the scoring of the cylinders is almost certain to result. The dash oil indicator is visible in the day, but at night many drivers are unaware of the oil supply, due to lack of illumination. To safeguard the car by being able to read the oil indicator at night, a small dash lamp can be mounted directly over the gauge, duplicating the dash light over the speedometer. A simpler method, however, is to mount a small mirror on one side of the oil indicator, as shown in the illustration. The mirror, set in a sheet-metal holder, is fastened to the dash at such an angle as to direct the light from the dash lamp directly onto the indicator.

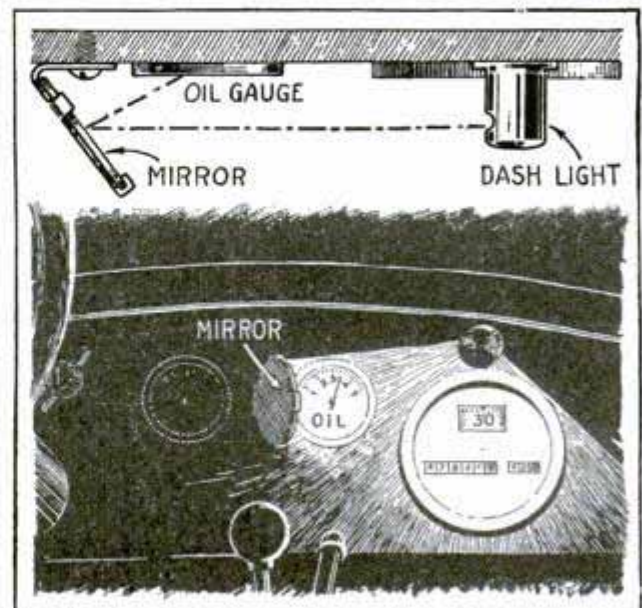

Reflector to Illuminate the Oil Indicator on the Auto Instrument Board



### Drill Supported by Truck

A structural-steel workshop finds that the illustrated method of supporting a drill speeds up the work on girders, transoms, and the like, in which rivet and bolt holes are drilled. Much of the work is

the drill up against the work by bearing down on the handles. The wheels permit the free movement of the drill from one hole to another, or around the shop. This

Heavy Girders, Trestles and Other Work Can Be Drilled for Rivets with the Aid of This Truck

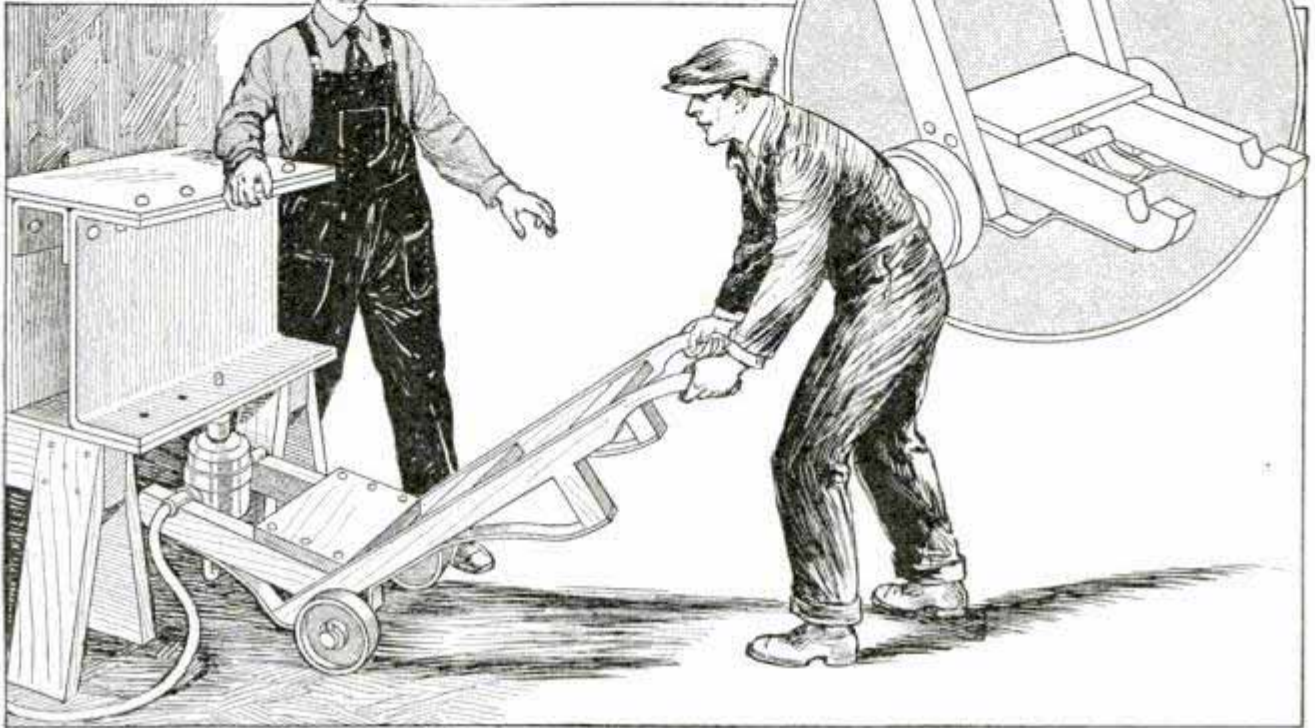

erected on low trestles and the greater part of the drilling can be done from below. Extensions are fitted on a truck to hold a drill, and the operator can thrust

truck is useful in any shop where drilling can be done advantageously from below, the height of the drill truck being determined by the height of the fixtures.

### Tightening Ford Door Handles

The later models of Ford closed cars have crank handles on the door-glass lifters, which fit over square shanks. The handles are secured on the shanks by small setscrews. The screws are a rather loose fit in their holes and the handles are not very strongly made, which prevents much tightening of the setscrews. Consequently, the handles often shake loose and fall to the floor of the car. They can be kept in place, however, by means of a small piece of heavy cloth, about  $\frac{1}{2}$  in. wide at one end and tapering to a point at the other. This is laid on the square shank of the lifters with the pointed end out, and the crank is then driven on by tapping lightly with a piece of wood and a small

hammer, after which the setscrews are tightened. The handles will be more difficult to remove, but this is seldom required.

### Useful Accessory for the Blowtorch

To direct the flame of a blowtorch upward against the bottom of a babbitt ladle or against small tempering plates, a gaspipe elbow can be used as shown in the illustration. A small hole is drilled and tapped in the rim of the elbow to receive a setscrew, with which the device can be attached.

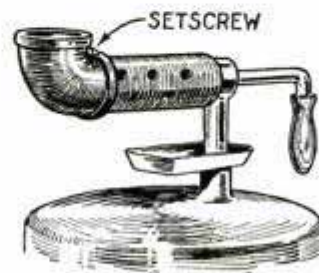



*27 Van Buren Ave  
West Hartford, Conn.*

# Hot-Water Heaters That Work

By ROBERT S. KRUSE,

*27 Van Buren Ave.  
West Hartford Conn.*

**L**IVING in rented homes is an automatic education in water heaters, if one only observes and tests a bit. My own experience has been to the general effect that there must be something like a sacred tradition against a proper installation of gas-operated hot-water systems—in spite of the fact that it does not cost any more to do a thing right than wrong.

In Fig. 1 we have an installation that is typical and is all wrong. First of all, the heater should have a pipe to the chimney, but that is a minor point and will presently be taken care of by the safety codes of all cities. The lack does not stop the heater from working. On the lower heater nipple

we have an L-K coupling; a fitting with a left-hand thread in one end and a right-hand thread in the other. I have never yet seen one that did not leak sooner or later, and most of them must be taken off with a chisel—in pieces—when the job needs attention, as all heater coils do at intervals. A union should be used as in the upper connection. It costs a few cents more at first and many cents less later on.

In place of the elbow below the tank there should be a faucet, not merely to drain the system but to draw off dirt, rust and scale. It is a good idea to work that faucet a couple of times a year, partly for the reasons mentioned and partly to keep

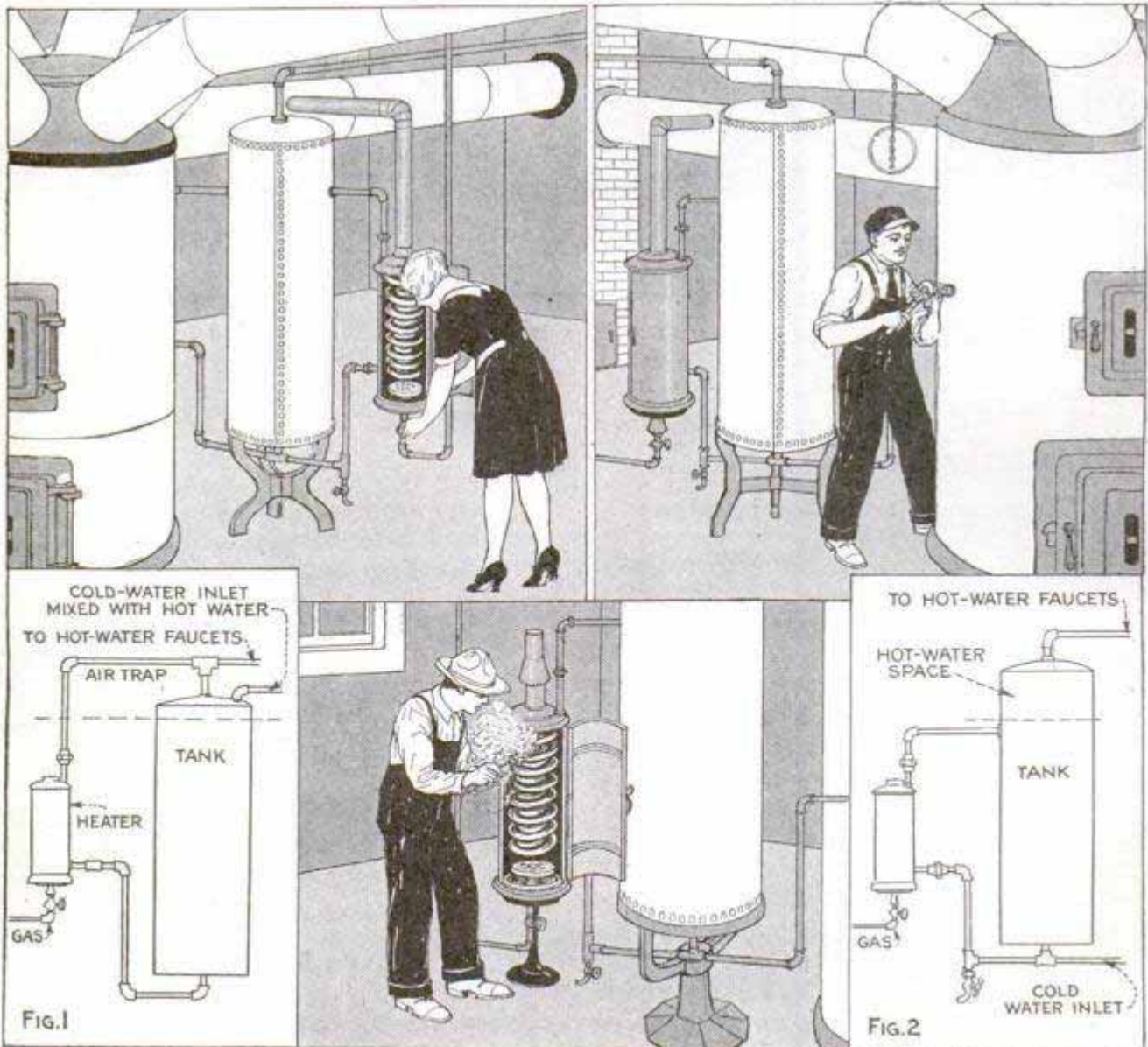



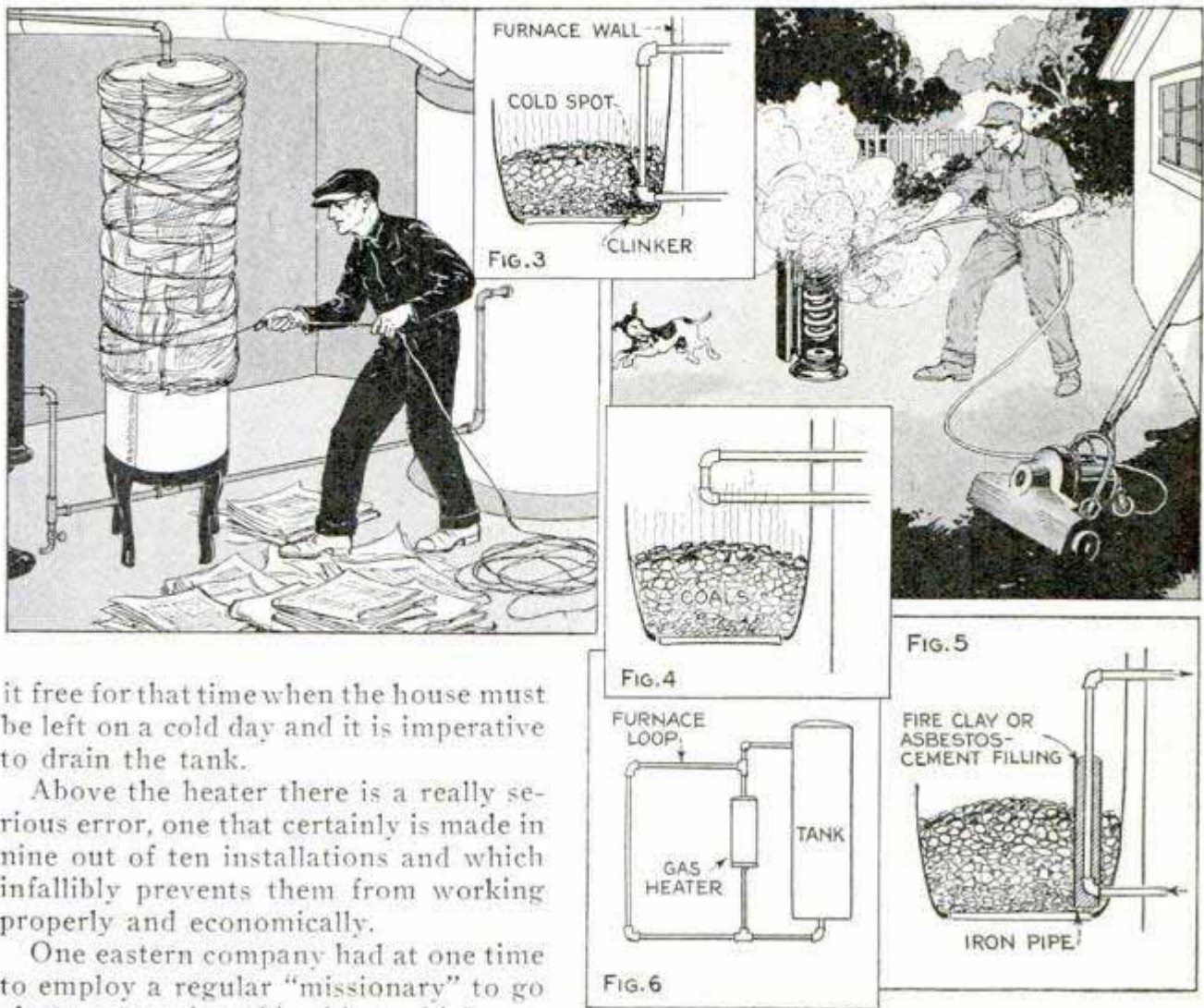

it free for that time when the house must be left on a cold day and it is imperative to drain the tank.

Above the heater there is a really serious error, one that certainly is made in nine out of ten installations and which infallibly prevents them from working properly and economically.

One eastern company had at one time to employ a regular "missionary" to go about correcting this thing which was causing heaters to be denounced as no good. When the change was made they all functioned. The error itself is simple enough; the pipe from the top of the heater coil should go into the side of the tank and not the top. If connected as shown in Fig. 1, air will be certain to collect above the dotted line. This sounds harmless, but when an attempt is made to heat water the results are very slow in coming, because it is necessary to boil the water in the heater so that steam is produced and driven into the tank, taking the air along. Then, finally, the water starts circulating. But things are still wrong for we are compelled to make the whole tankful lukewarm and then hot-taking (in a test case in East Hartford) something like an hour. The same job, when changed, as in Fig. 2, would produce a small amount of boiling water in five minutes and a tankful of the same in twenty minutes.

In Fig. 2, the suggested changes have

been made. The coil connections are both unions, making it possible to take the heater down from the ceiling without too much trouble. The clean-out and draining faucet has been added, though there is no special reason for the type shown—any type would do—and above the heater coil the important change has been made that triples the speed of heating. This works every time; it has been tried on dozens of jobs. The reason is partly that the air trap has been removed and circulation starts at once. In addition, the hottest water goes to the top (above the dotted line) at once, thereby giving a small immediate supply of 5 gal. or so. If your tank has no side opening to permit this connection, don't take it. Gas is expensive.

Another worth-while change has been made in running the cold water in at the bottom to prevent it from mixing with the hot water. This prevents the hot-water faucet from delivering hot water for a moment and then dead-cold water, seemingly



for no reason, as quite a few jobs do where the cold water can cut across from the inlet to the outlet.

It will be gathered from the foregoing that, if a new heater does not work, the trouble usually isn't with the heater itself.

Assuming that the installation has been made well, one naturally wants to keep it in working order. Perhaps the simplest way to do this is to cut down the amount of work it must do by padding the tank very liberally with heat insulation. If the heater is a foot or so away from the tank, it is generally safe to use a "quilt," 1 in. thick, of ordinary newspapers fastened on by a wrapping of cord or wire. This is crude, but will save half the gas easily where hot water is wanted often during the day. The real way to do the thing is, of course, to use some of the cellular asbestos lagging made for the purpose. Such lagging is also safe where the heater is close enough to endanger a paper wrapping. Once properly installed, the heater will work until soot, scale and dirt slow it down. The soot is difficult to remove with brushes and the like. My wife thought of a quicker way, which is a bit rough but very prompt. The idea is simply to use the exhaust hose of the vacuum cleaner with any small nozzle, or none at all. The soot gets out instantly, and if you move rapidly not too much will settle on you. This is a good summer job. It can be done outside because the heater should (except where the city water is chemically treated to remove lime) be taken down each summer so that scale may be removed from the inside of the coil. To do this, the heater coil is plugged at one end and commercial hydrochloric (muriatic) acid is poured in until the coil is full. When this has stood for a while, the liquid is poured out and the process repeated until acid can be run through the coil freely. After that a great deal of water is run through from the garden hose, and the heater reinstalled.

The openings in the burner may need attention also. The simplest way to clean them is with a hand drill or a twist drill of the proper size, unless the openings are in the shape of slits, which can be freed of dirt with the aid of a hacksaw or thin metal sheet notched with a file.

Several people told me lately that a tank-heater loop put into a furnace will

"stop the furnace from heating" and "will never heat water and always have to be taken out again." This was indeed news, because I have lived with a great many such jobs that work beyond criticism, and have had to do with a number of others that also work well.

As nearly as I can make out, the unsatisfactory jobs were installed as shown in Fig. 3. Since the loop is often filled with quite cold water the tendency is to create a "cold spot" in the fire, as shown in the sketch, and also to cause clinking on the grate near by, as indicated in Fig. 3.

A loop installed as shown in Fig. 4 works beautifully. The proper height of the loop above the fire depends on the coal used. For anthracite 10 in. is about right, while the long-flame soft coals can stand 18 in. very nicely. The idea is to place the coil so high that it does not chill the flame and cause sooting. If the coil tends to become sooty, it is too far down.

If one happens to own a furnace in which the openings are so placed as to compel the use of a coil of the type shown in Fig. 3, the dead spot in the fire can be avoided by using the dodge shown in Fig. 5. A piece of iron pipe is slipped over the pipe of the heater loop after having been notched so as to permit the latter to go out through the side of the outer pipe. The notch should not be made too deep, else the iron pipe will get down far enough to fight with the grate bars. It is a good idea to make the iron pipe come flush with the lower side of the elbow at the bottom of the furnace loop. The outer pipe should have an inside diameter 1 to 2 in. larger than the outside diameter of the inner one. The space between is filled with asbestos cement or fire clay. By juggling properly, the whole contrivance can be slipped into place, after which the iron pipe will heat up enough to prevent a dead spot in the fire, while the top part of the loop will heat all the water that is wanted.

When everything else has been done satisfactorily, one sometimes finds that the whole business is killed by a piping layout such as the one suggested in Fig. 6. In these, the water goes up through the one heater and down through the other while the tank sits alongside and neither gives nor takes. The effect is that, in winter, the furnace heats the gas-heater coil and in



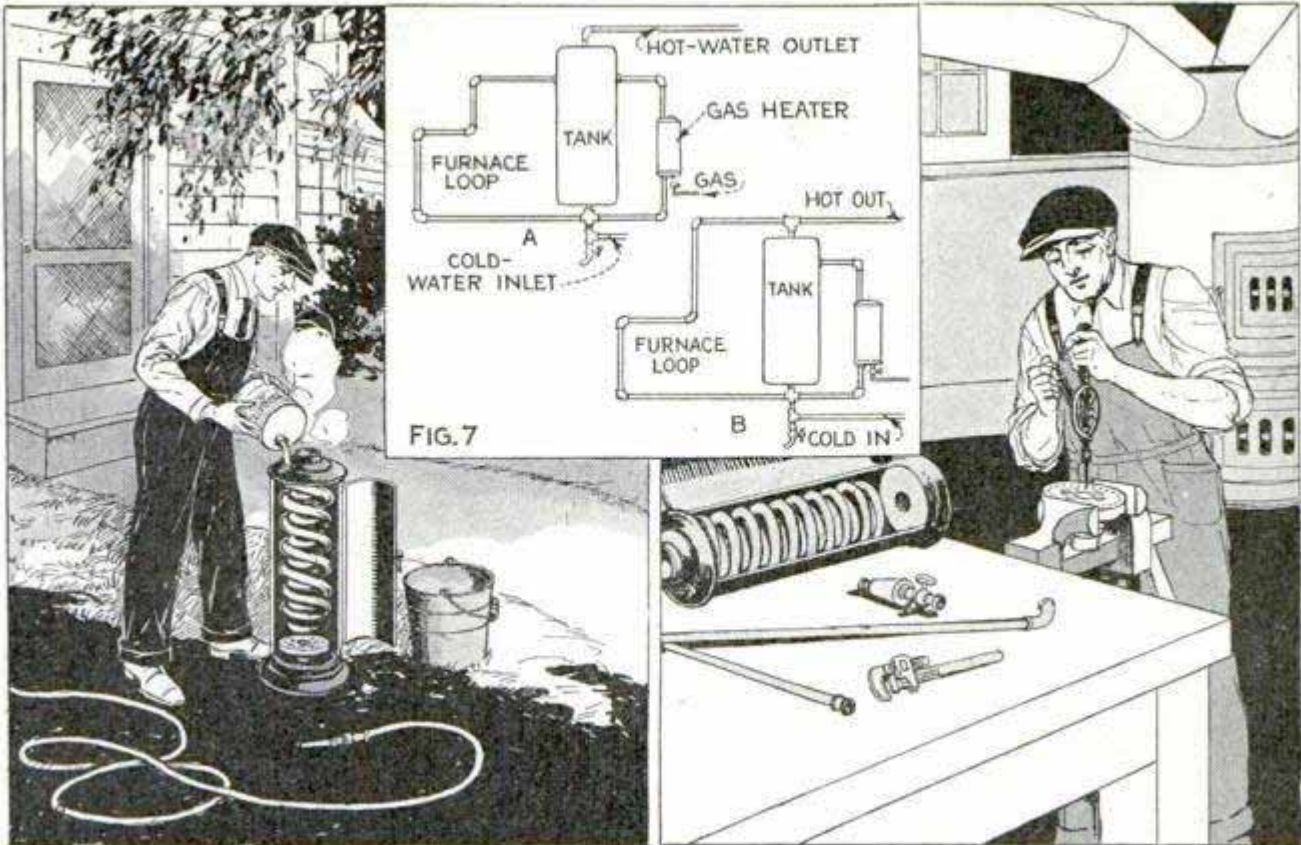

FIG. 7

summer one burns gas to warm up the empty furnace, while the tank stays cool.

Since a furnace loop is worthless in the summertime, one naturally wants a combination arrangement. A scheme similar to Fig. 6 will work all right, if shut-off valves are placed to prevent local circulation (other than through the tank), but some one may forget to turn the valve some day and cause real trouble; therefore it is best to use one of the piping layouts shown in Fig. 7. That shown at A covers all the requirements suggested, but calls for a tank with an opening in each end and two at the sides near the top. I have seen such, but suspect they were made to order. The layout in B can be used with an ordinary tank. At first sight, it seems to violate the rule about a top return to the tank, but only the furnace loop is so returned, and, since it either operates continuously or not at all, the air-trap difficulty does not develop except once in the fall when the furnace is started, and then the trap can be broken by opening any hot-water faucet and letting the air and water escape together until the system is clear. Several drainings may be necessary as the furnace heats up the first time, after which there will be small difficulty unless the water in the loop is heated to boiling for a long

time, which happens only with careless firing or with a loop too near the grate.

The danger of raising steam is frequently brought up as an objection to a furnace loop. Experimentally one was allowed to operate under conditions where this was possible. What happened was just what one would expect; the pressure did not rise above that of the city water system, but finally the loop became hot enough so that a pinhole or crack opened up and sprayed the fire, which promptly went out. The danger never did impress me to begin with and, after that experiment, it certainly does not seem any greater. Nobody in his right mind ever fired (for heating purposes) as we did to persuade the thing to let go. Inasmuch as that was a cast-iron loop, the brass ones seem doubly safe.

### Friction Buttons Hold Triangle

To facilitate the use of triangles when making drawings at odd angles, it has been found practical to provide a 45° triangle with three rubber friction buttons. These buttons, made from inner tubing, should be about 1/2 in. in diameter and fastened to the triangle with collodion. The use of this tool obviates the customary pressure and care.



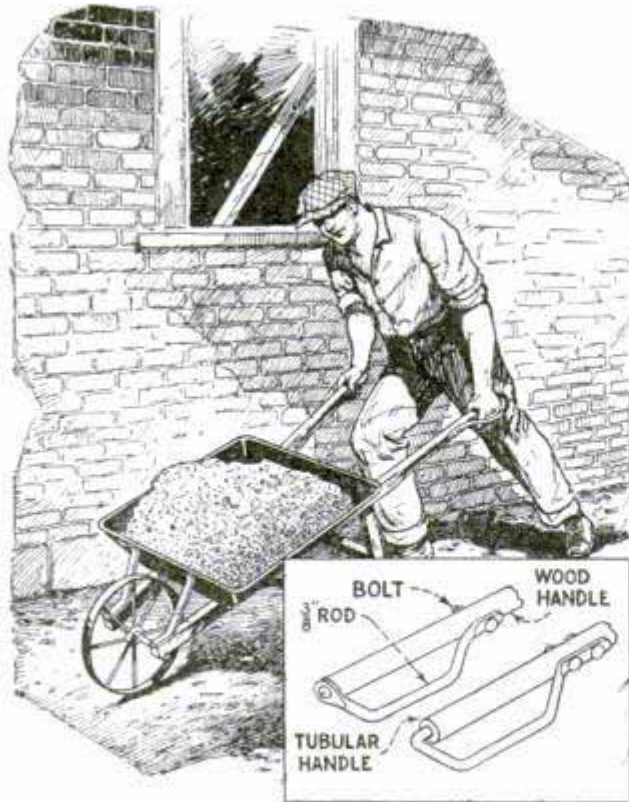

Guards on Wheelbarrow Handles Protect Workers' Hands in Close Quarters

### Guards on Wheelbarrow Handles for Close Quarters

When using wheelbarrows in close quarters on construction jobs, the workers often injure their hands by scraping them against walls or other obstructions. This trouble can be prevented by attaching guards to the handles, as shown in the drawing. The guard consists of a length of  $\frac{3}{8}$ -in. iron rod, bent to the shape shown and fastened to the wooden handles of the barrow with bolts and screws.—Robert D. Peebles, Bridgeport, Conn.

### Preserving Shafting from Corrosion

In a laboratory it was very difficult to keep the lineshaft and countershafts bright and free from rust, owing to the fumes and gases issuing from the several fume closets within the same room. The following method was tried and proved very satisfactory: The shafting was covered with two coats of flat white paint and allowed to dry, after which a coat of white enamel was applied, giving it a clean, glossy and sanitary appearance. This eliminated all the trouble of cleaning it with emery cloth, and it also made it appear in harmony with the other furnishings of the laboratory.

### Glass Window Signs

To keep his signs on the outside of his windows from being washed off by the rain, a store proprietor painted them on a piece of window glass, 24 by 24 in. in dimensions, and set this piece inside of the window against the plate glass. Although the signs could have been painted on the inside of the windows, this practice involved the difficulty of painting them backward. Shoppers would see through the glass to the goods in the window, and new signs could be painted at any time.—Arthur Flinner, Manhattan, Kans.

### Scraper and Brush in One for Drilling

Operators of drill presses often use a piece of sheet metal to scrape away the cuttings from the drill plate and then clean off the surface with an ordinary flat brush. When I have work to do which requires the use of a drill plate, I keep the plate clean with a combined scraper and brush. Besides saving time, this device keeps the brush clean, eliminating the

trouble of pulling out curled cuttings from it. The scraper is made of sheet metal, bent to fit the metal binding on the brush tightly. It should be set so that normal pressure on the brush brings the scraper in contact with the surface to be cleaned.—Harry Moore, Montreal, Can.

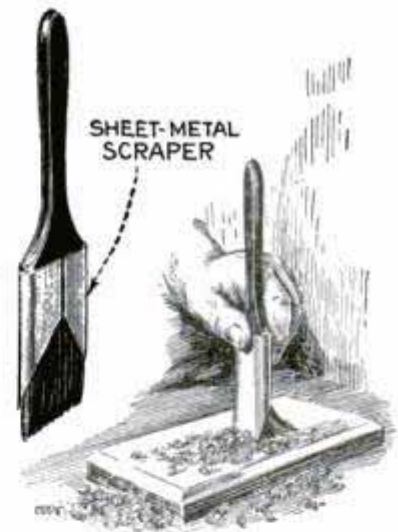

### Jigsaw Blade for Cutting Hard Material

Insulating material, composition and various hard veneered stocks will quickly dull the usual jigsaw blade. One shop has adopted the use of metal-cutting hacksaw blades for jigsaw work, merely modifying the blade by grinding off the back of the blade until only about  $\frac{3}{16}$  in. of metal remains behind the teeth. This blade will



readily cut the veneers and any other hard material. Care must be taken, however, not to crowd the work or jam the saw. While it is capable of hard cutting, such a blade will not stand much bending and should therefore be given more care than is usual with soft-wood cutting blades.—G. A. Luers, Washington, D. C.

### How to Repair a Saw Handle

When your favorite saw handle cracks, it can easily be repaired as shown in the illustration. Two holes, from  $\frac{3}{16}$  to  $\frac{1}{2}$  in. in diameter, are drilled on each side of the crack or break, and a saw cut is made between them. Counter-sink the holes on both sides and then, with one side held on a flat surface, pour in melted babbitt, which, upon hardening, holds the cracked parts together securely. It is a good idea to slip a bent wire into the slot to reinforce the babbitt, as shown in the lower detail. Put a flatiron over the babbitt before it sets, to force it down into all the hollows. After it has set, the surplus can be filed down even with the saw handle. The upper insert shows how a screw, having a stripped thread, can be held in place securely by making a babbitt nut. First put the screw in place and then pour the babbitt in from the other side. The hole for the nut is counterbored.—Geo. H. Cappel, Wilmer, Ala.

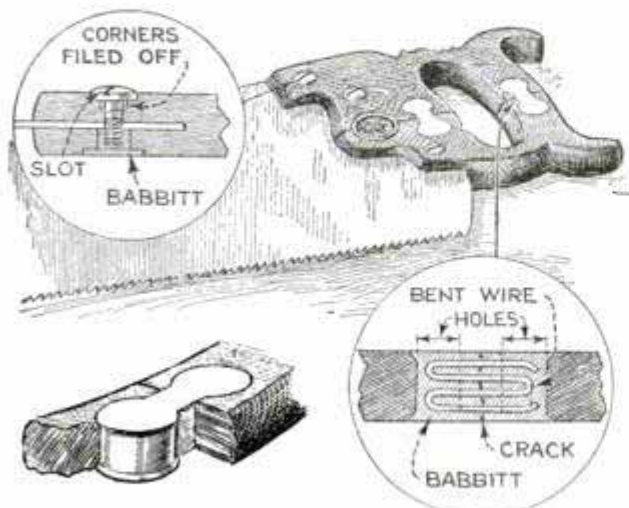

How to Make a Simple and Efficient Repair on Cracked Saw Handles



Heavy Wheel of Farm Tractor Can Be Removed Single-Handed with the Aid of This Sling

### Removing a Heavy Tractor Wheel

The drivewheel of a farm tractor is usually more than one man can handle, and when it becomes necessary to remove one of these single-handed, some means has to be used to hold the wheel. This can be done by driving the tractor under a strong branch of a tree. After placing a jack beneath the axle to hold the wheel from the ground, pass a rope over the tree branch at a point above, but about the width of the wheel tire outside of, the wheel. The rope is left doubled and the ends are tied together. A stick is inserted between the ropes and the latter are twisted together and then lifted slightly and tied, as indicated. After it is loosened the weight of the wheel will cause it to slide from the axle. When replacing the wheel, the rope is moved farther out on the branch so that the wheel will swing toward the tractor. The very slight movement necessary to permit pushing the wheel on the axle can be effected by twisting or untwisting the rope.

☐ A column of water 27.6 in. will have a pressure of 1 lb. per square inch.



# Movable Sewing-Machine Stand and Mending Cabinet

By WALTER LEWIS

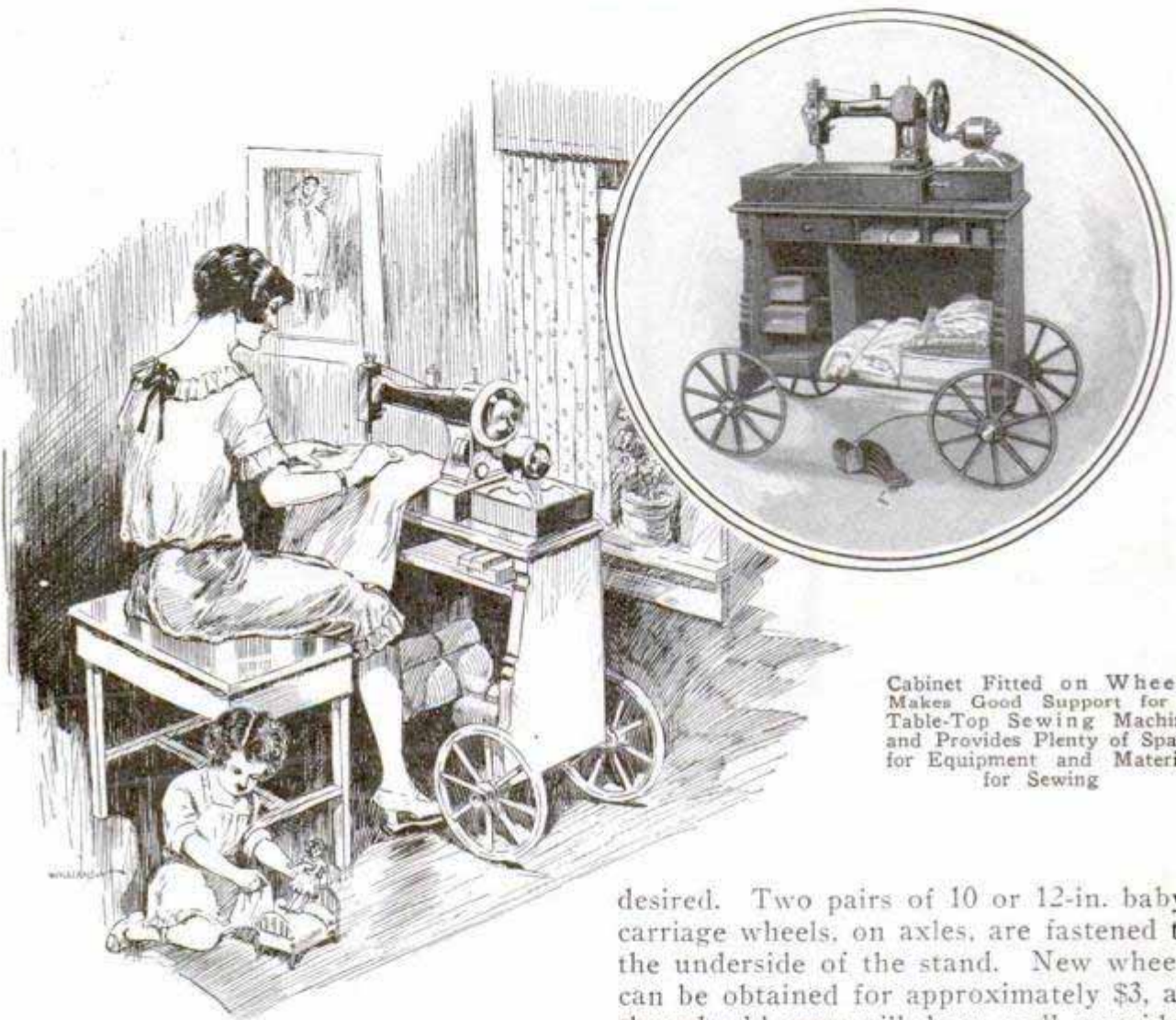

Cabinet Fitted on Wheels Makes Good Support for a Table-Top Sewing Machine and Provides Plenty of Space for Equipment and Material for Sewing

**T**HERE are a great many women who possess a portable or table type of sewing machine, and, no doubt, most of them dislike to carry it back and forth to the spare room where it is kept. A box of mending material, thread, scissors, etc., must also be brought out every time the sewing machine is used, and this adds to the inconvenience.

For this reason a movable stand, resembling a tea cart, will be of considerable utility to hold both the sewing machine and the odds and ends, which should be at hand when the machine is used. Any kind of cabinet, box or part of a small desk will do for the body, provided there are drawers or lockers. Suitable pigeonholes can be arranged in the lower compartment, if

desired. Two pairs of 10 or 12-in. baby-carriage wheels, on axles, are fastened to the underside of the stand. New wheels can be obtained for approximately \$3, although old ones will do as well, provided they are in good condition. They can easily be repainted to look presentable. Two bolts through each axle are sufficient to hold them in place securely. If an electric motor is used to run the sewing machine, additional space should be calculated for the motor. The cord to the foot rheostat can be threaded through holes in the top and bottom, the cord running inside of the cabinet. The foot rheostat can then be stored in the lower compartment when the machine is not in use.

When assembling the stand, measurements should be taken to determine the most suitable height for sewing. When the machine is needed, it can readily be wheeled out. Refinishing it with varnish will add to its appearance.



### Removing Overhead-Valve Cages

Overhauling the valves on some cars is often a difficult job. The drawing shows a simple and extremely efficient method of doing the job on a Buick or other overhead-valve motors. After the rocker-arm assemblies have been removed, the first step is to compress and remove the valve springs. The only equipment necessary for this is a 6-in. piece of strap iron or hardwood. Two holes are drilled in it so that it will drop over the two studs which hold the rocker-arm assembly, as shown in the upper insert. The nuts are turned on the studs above the strap, and an open-end wrench of suitable size is used as indicated. By lifting on the free end of the wrench the spring is easily compressed so that the pin can be removed. The operation is repeated for the remaining sets of valves. A hardwood rack is then made, long enough to straddle all the valves and rest on the block. A C-clamp is drilled and a notch is sawed out, as shown in the lower insert. The illustration clearly shows the method of using it, the valve pin being replaced for this operation. Valve cages that are badly stuck can be more easily started by giving the clamp a slight hammer blow, but in most cases the cages will slide out readily as the force is exerted in direct line with the axis of the cage.—Robert B. Warman, Buffalo, New York.

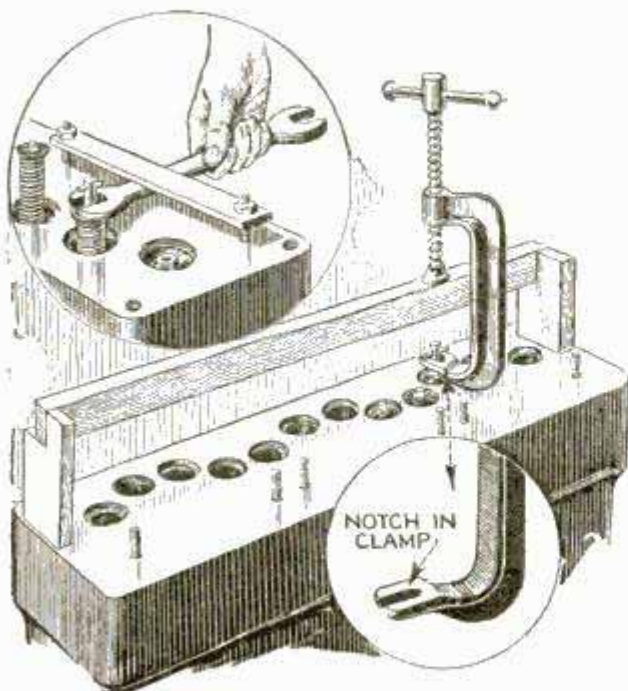

Easy Method of Removing Overhead-Valve Cages without Special Tools

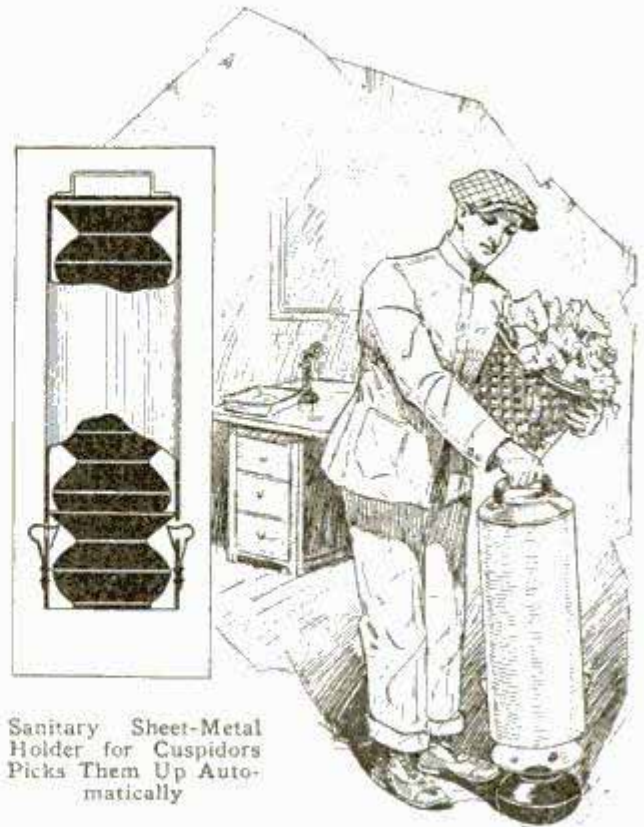

Sanitary Sheet-Metal Holder for Cuspidors Picks Them Up Automatically

### Sanitary Carrier for Cuspidors

The proprietor of a Wisconsin office building has provided his janitors with a simple device for carrying cuspidors, so that the work of removing and cleaning them can be done more easily. The device consists of a bottomless cylinder with a permanent cover, having a handle attached. Near the bottom of the cylinder are two stout self-acting grippers, made from flat spring steel. These are bent so that the operator need merely slip the cylinder over a cuspidor to engage and hold it. The cylinder is then carried to the next cuspidor, which is taken up in the same manner, and this operation is repeated until five cuspidors have been gathered. To empty the container it is placed on the floor, the two springs are pulled outward and the cylinder can then be raised.—G. E. Hendrickson, Argyle, Wis.

### Two-Color Paint Job on Chair Legs

When painting or lacquering breakfast-room chairs in two colors, tie a piece of cotton cord tightly around the legs, near the bottom, where the two colors meet. The cord will absorb the paint and prevent it from running. After the job is dry, the cord is cut off.—Hiram Caulking, New Iberia, La.



### Scribing a Circle without Compasses

It is occasionally necessary for the mechanic to scribe a circle when no compasses are at hand; if a square is available this can easily be done.



Tack a piece of paper down on the bench-top and lay off the diameter. A small nail is driven at each end of this line, and an ordinary carpenter's square laid against the nails as indicated. The point of a pencil is held in the corner of

the square, which is then swung around, keeping it against the nails, so that the corner describes a complete semicircle. The other half of the circle is scribed in the same way.

### Heat as Aid in Woodworking

It is often desirable to fit a piece of wood into a piece of metal by means of cutting a thread in the metal and screwing the wood therein. This can be accomplished by heating the metal to a little over the boiling point of water and screwing the wood piece into the metal while hot; or, if it is impractical, on account of size, to heat the metal, make a screw plate by cutting a thread in a small piece of metal, the size and thread corresponding to the hole into which the wood piece is to be inserted, and heating it to the required temperature, then running the wood with some pressure through the thread. The wood can then be screwed into the larger piece, where it will hold firmly.

The process of heating wood without the aid of steam can be used to advantage in a number of ways; for instance, a hammer handle that is crooked can be straight-

ened by careful heating without burning; also billiard cues, or almost anything of hardwood. It is surprising how easily it is done and how permanent the repair will be. The Indians at one time made their arrows from small hardwood twigs which were almost always crooked to start with, but after being dried they were warmed over a fire and straightened.

Another use for the application of heat is the following: When it is desired to place a screw in a fragile piece of wood that is likely to split, if the screw is heated to a blue color and turned into the wood while hot, there will be scarcely any danger of splitting. In this case do not use oil or lubricant of any kind, as the screw is sure to seize before it is driven home.

### Spotlight Turns with Wheel

Spotlights are especially handy to illuminate sharp corners, but they are rather inconvenient to manipulate unless they are set at a certain angle and then switched on only while turning a corner. But as corners have different radii, the illumination often does not fall where it should, and the light is of little or no help to the driver. An improvement is shown in the illustration. The spotlight is attached to the front-wheel spindle so that it turns

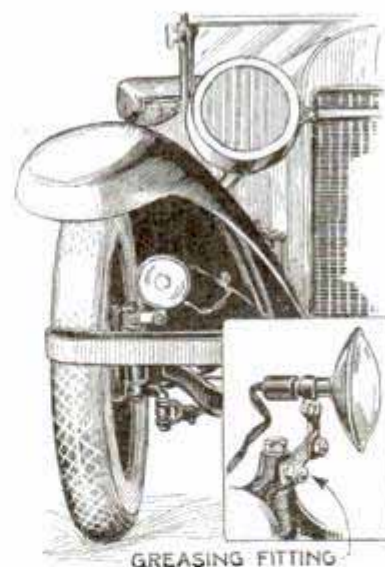

with the wheel. The supporting bracket can be clamped to the spindle, or, if a stronger attachment is desired, the alemite fitting may be removed and a small bolt, running through a hole previously drilled in the light bracket, substituted. However, if this

method is used, the bolt must be removed to permit greasing the king pin.

CA small piece of rosin stirred into melted babbitt will improve and make it run better. The rosin-treated babbitt will run into places where the plain will not.



### Kinks in Washing Photographic Negatives and Prints

Photographic defects, spots, stains, etc., are often due to insufficient washing. In the common method of washing negatives or prints under the tap, in a dish, the water is not changed quickly enough. If the negatives are placed film downward and supported at the edges, the washing is quicker and more thorough. Films as well as glass negatives are in the same class in the matter of washing. Films should not stick together, and the sharp edges must not be permitted to cause scratches.

### Chip Guard for the Drill or Lathe

Drill chips are more or less of a nuisance around automatic machines, especially those long endless chips which get into stops or ratchets and clog the machine. It is possible to prevent these chips from working back, if a chip guard of the type shown in the drawing is made and attached to the drill, outside of the cutting depth. Make the guard of iron or steel, forming an abrupt cone, to turn the chip. Tap for a setscrew, which will hold it securely to the drill or the drill socket. This fixture is of service in either the automatic lathe or in the spindle of multiple-spindle drills of the type that uses numerous stops and automatic features.

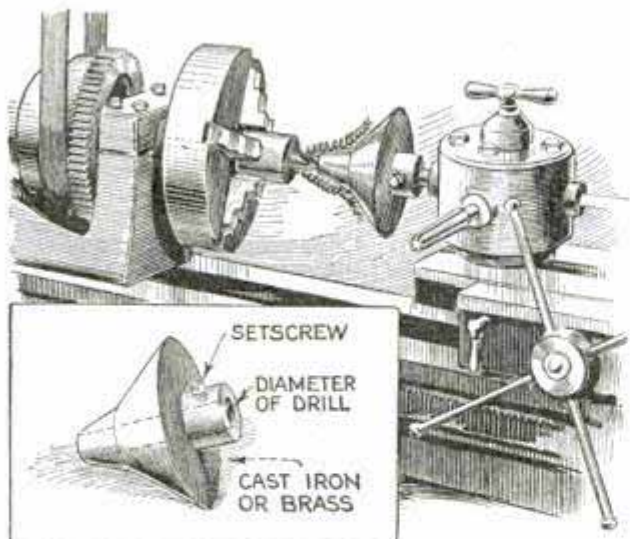

Cone-Shaped Device for Turning Away Long Chips on Automatic Machines



Side Guards on Shop Grinder Prevent Injury to Workman

### Side Shields for Polishing Wheel

A favorite way of polishing long slender rods is to pass them over the top of the wheel. This allows greater freedom for the arms than any other way, but is rather dangerous because the rod is likely to slip off the side of the wheel and cause injury to the operator. To prevent this is a simple matter: Make two metal guards, a little larger in diameter than the wheel and fasten them in place with the regular washers and nuts used on the machine, as shown in the illustration. The guards effectively prevent side slip.

### An Acid Test for Steel and Iron

File, or grind, the pieces to be tested and polish them smooth, then place them in a dilute nitric or sulphuric-acid solution for a day. Wash and dry the pieces, and if they are of the best steel, the surface will have a frosty appearance. Ordinary steel will have a honeycomb surface, and iron will present a fibrous structure running parallel to the direction in which the metal was worked.

**I**N accordance with the editorial policy of this magazine never to accept compensation in any form for what appears in our reading pages and also to avoid the appearance of doing so, we are obliged to omit the name of the maker or the seller of any article described. This information, however, is kept on file and will be furnished free, by addressing Bureau of Information, Popular Mechanics Magazine, Chicago.



2713

## Is This Your Home?

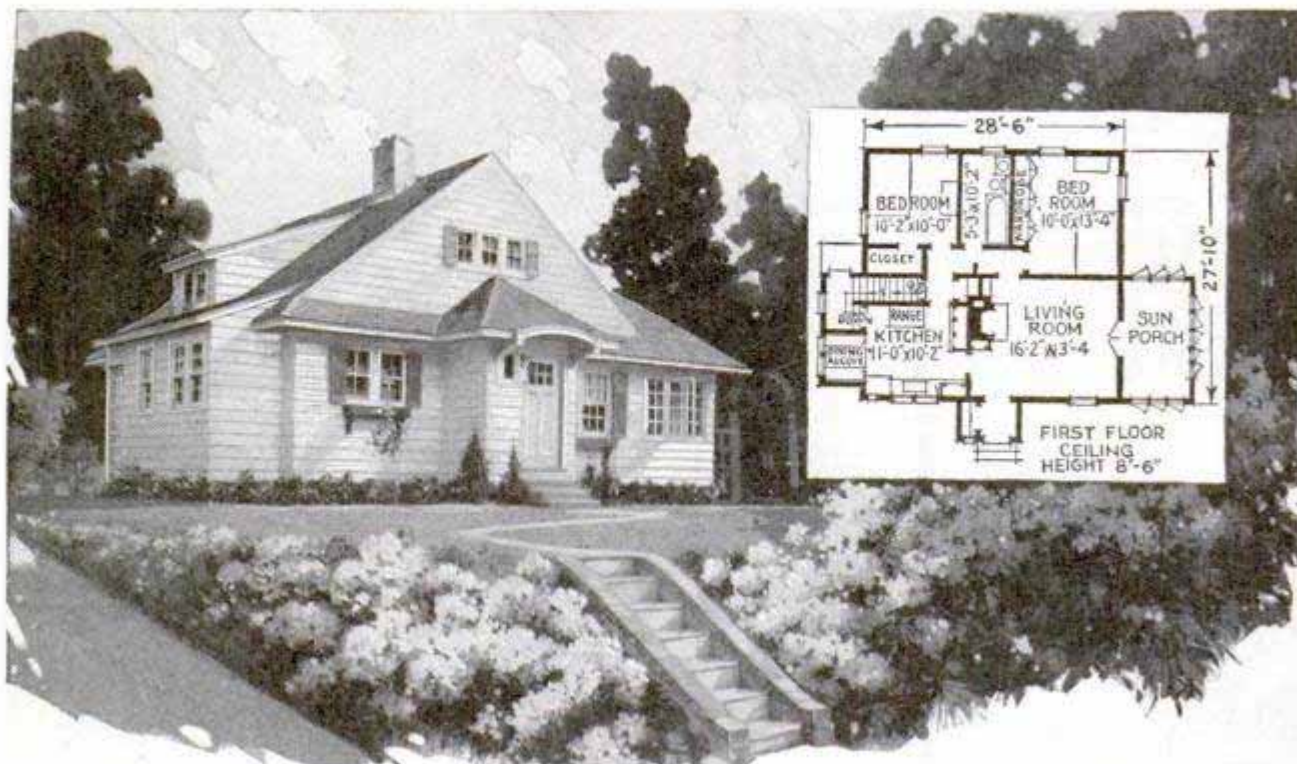

Copyright, Architects' Small House Service Bureau

Plan No. 4A13

**Q**UESTIONS regarding home building addressed to this magazine will be answered by The Architects' Small House Service Bureau of the United States, Inc., controlled by the American Institute of Architects and endorsed by the United States Department of Commerce. Please inclose 10c in stamps or coin. Blueprints, specification forms, and material lists for the house shown here may be obtained from The Architects' Small House Service Bureau for a small fee. If further information is desired, literature describing the plan service and publications of The Architects' Small House Service Bureau will be sent upon request. A booklet entitled "50 Ways to Lower Home Building Costs," illustrated by ten Bureau homes actually lived in and showing how as much as \$1,000 can be saved on a home, may be obtained for 20c.

**A** SUCCESSFUL home is a combination of a pleasing, well-designed exterior and a good practical plan. Good construction is the third necessary element. This house has been designed to provide a workable plan for a small family. The windows, doors and walls of the house are proportioned and little touches have been added so as to take it distinctly out of the commonplace. Also every acknowledgment has been given to the necessity of sound and economical construction.

The design brings out the natural beauty of the wood finish. The wide siding gives a splendid texture to the walls. A so-called Germantown hooded roof, broken to emphasize the entrance, recalls the old Pennsylvania houses. Its style, however, is not a slavish following of a tradition.

There are four excellent rooms, two of them bedrooms, and in addition a commodious sun porch, which may be open if

it is desired to decrease expense. A good-size dining alcove, off the kitchen, should be sunny and pleasant because of the two windows at the head of the built-in table. Linen may be kept under the seats and china in a closet above them. The living room has a large open fireplace with built-in bookcases adjacent to it at one end and a little cupboard built into the chimney on the other.

There is plenty of space here for a family of three or four. The bedroom to the left might readily be made into a sewing room with a modern folding bed designed to go into the large closet. The plan may be swung around in many ways to vary the effect, but the house should be placed so that the living room and sun porch have southern exposure.

The construction is wood frame with wide siding as a finish, shingle or composition roof, and cement base course.



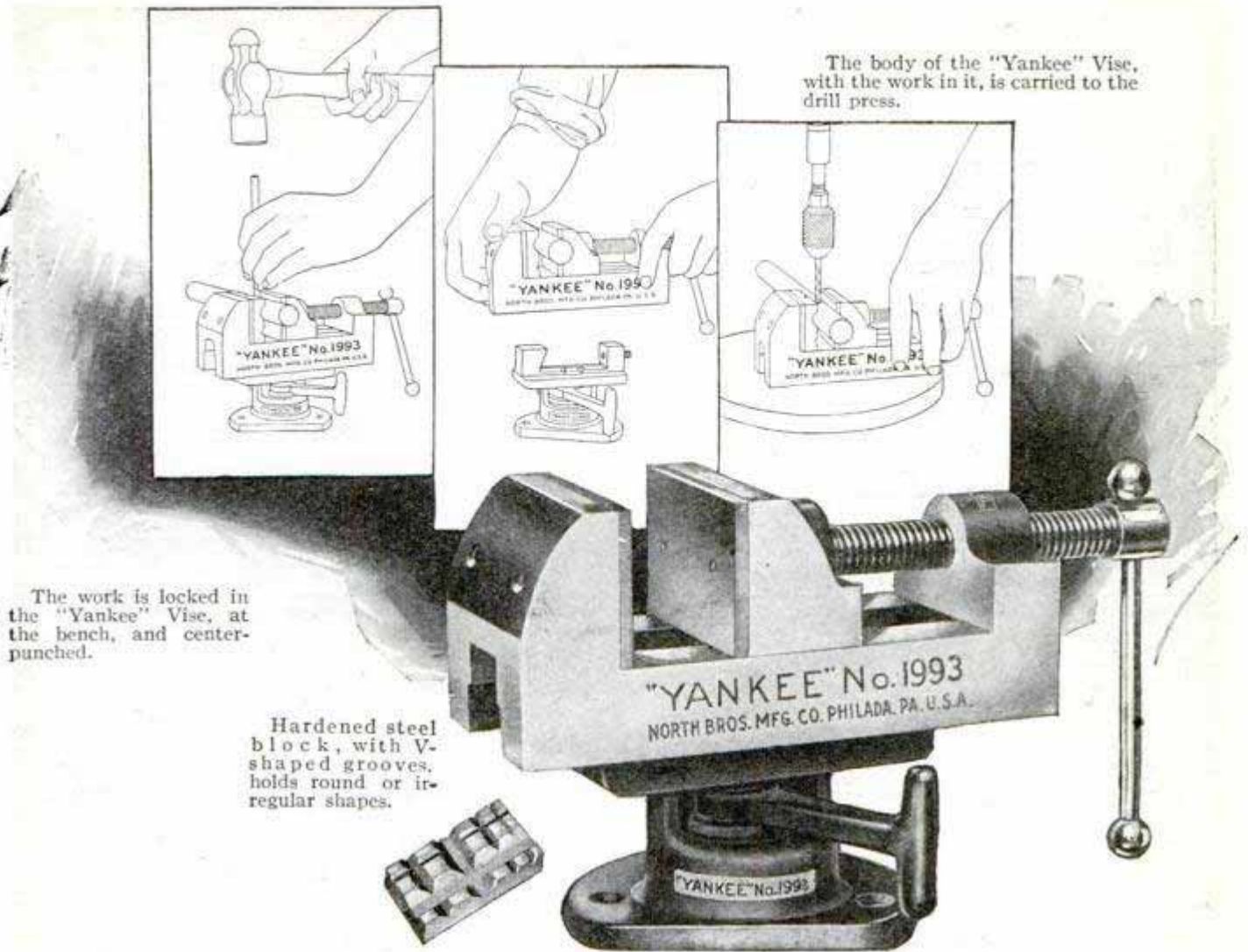

The work is locked in the "Yankee" Vise, at the bench, and center-punched.

Hardened steel block, with V-shaped grooves, holds round or irregular shapes.

The body of the "Yankee" Vise, with the work in it, is carried to the drill press.

## The Handiest Vise in the World

Even if you have other vises, you need this "Yankee," because you can do work with it that is impossible with any other, and do it with speed, accuracy and ease.

Not only has a swivel base, so you can turn it around in any position, but detaches from its base. You don't have to remove work from vise until entire job is completed—simply lift vise, work and all, off base, and carry to drill press, milling machine, etc.

Sides, ends, bottom and top are machined true. Work is kept in perfect alignment at all times.

Cam-throw lever locks vise in any position. You can get the size most convenient for your work.

- No. 1994—Jaws open 4 in.
- No. 1993—Jaws open  $3\frac{1}{8}$  in.
- No. 1992—Jaws open  $1\frac{15}{16}$  in.
- No. 1991—Jaws open  $1\frac{1}{2}$  in.

Some other "Yankee" Tools are: Automatic Feed Bench Drills, Ratchet Breast, Hand and Chain Drills, Ratchet Tap Wrenches, Ratchet Bit Braces, Automatic Push Drills, Plain Screw-drivers, Spiral and Ratchet Screw-drivers, etc.



**FREE**  
New "Yankee"  
Tool Book

This interesting little book is for all lovers of fine tools. It tells just what you want to know about all the famous "Yankee" Tools for making work easier and quicker. Write for it.

Dealers Everywhere Sell "Yankee" Tools

"Yankee" on the tool you buy means the utmost in quality, efficiency and durability.

NORTH BROS. MFG. CO., Philadelphia, U. S. A.

# "YANKEE" TOOLS

*Make Better mechanics*







# Sport! Adventure! Action!



## Far from traffic jams!

### fore wheel brake

first time in America!

This and other new features make the 1928 Harley-Davidson Twin the most advanced mount in the history of the motorcycle industry.



The Single—our famous solo mount that travels "80 miles per gallon" and is priced at only \$235, complete, f. o. b. factory.

A QUIET country road, carpeted with rustling autumn leaves—the tang of Indian summer in the crisp, bracing air—a spin down a winding trail—new things to see — adventures you'll never forget!

And it costs only 2¢ a mile with a Harley-Davidson Twin—the mount that gets you there quickly, comfortably, safely. Plenty of room in the sidecar for your outfit or a pal. Prices as low as \$310 f. o. b. factory on easy Pay-As-You-Ride terms. See your dealer. *Send coupon for catalog.*



### New Model Sport-Solo Twin

Power and speed aplenty! A real sport mount, smaller wheels — 25" x 3.85 balloon tires — roadster handlebars, Dow-metal pistons, racing type, optional at slight increase in price.

HARLEY-DAVIDSON MOTOR CO.  
Department P Milwaukee, Wis.

# HARLEY-DAVIDSON

## Motorcycles

Twin and Single cylinder models in a wide range of prices. Get our catalog.

HARLEY-DAVIDSON MOTOR CO.,  
Dept. P, Milwaukee, Wisconsin

Interested in  Twin,  Single.  
Send catalog and full details.

Name.....

Address.....



# FOR EVERY HOME



**T**HE Remington Portable is everybody's typewriter. For the young and old, and for all ages in between, it is always the same handy little helper and time saver. So simple and easy to operate that anyone can quickly learn to type at a speed far surpassing the pen.

The Remington Portable is the lightest

and smallest of all standard keyboard portables—weighs only  $8\frac{1}{2}$  pounds net and fits in a case only four inches high, but it is a strong and reliable machine—complete in every feature.

Can be purchased on terms as low as \$5 monthly. Send for our booklet, "For You—For Everybody" to Department 12.

REMINGTON TYPEWRITER CO.

*Division of Remington Rand*  
374 BROADWAY, NEW YORK

Branches and Dealers Everywhere

# Remington PORTABLE

RECOGNIZED LEADER—IN SALES AND POPULARITY

Remington-made Paragon Ribbons and Red Seal Carbon papers always make good impressions.





*Free!* this  
new LIONEL

## Railroad-Planning Book..

... Plan a "Father-and-Son" Model Railroad

**T**HE sooner you begin planning your Lionel "Father and Son" Railroad—the sooner your fun begins. Send now for our new Railroad Planning Book—*free!* Prepare for a Lionel Christmas—the most thrilling Christmas in any boy's life.

Lionel makes the only efficient 100% Electrically-Controlled Railroad. The entire system (trains, switches, and every modern railroad accessory) can be controlled and operated from a Lionel Switch Tower—at any distance from the track.

*Boy!*—you and your Father can sit at the Switch Tower and magically direct the operation of your Lionel Model Train by simply manipulating the control levers. You can send the train on its way—stop it, start it, reverse it, or run it at any speed!

Down the track you see the new Lionel Train-Control-Semaphore! As the train approaches, red light shines, semaphore arm drops—and train stops. After a short interval, the electric light changes to green, semaphore arm raises—train proceeds. Crossing gates go up and down automatically—warning bells ring at the grade crossings. Everything is *real—thrilling!*

Now, Lionel Electrically-Controlled Railroads are made for "O" Gauge as well as "Lionel Standard" Track. A few additions to your present set and you have a complete Electrically-Controlled Railroad. Lionel Super-Motor Locomotives are modeled exactly from "rail giants", strong and solid, capable of pulling twenty cars. Cars are all life-like—Pullmans, Diner, Baggage Cars and twenty-nine different Freight Cars to choose from, including the new Dump Car and the wonderful Derrick Car with operating boom and tackle.

The LIONEL CORPORATION  
15 E. 26th Street New York, N. Y.

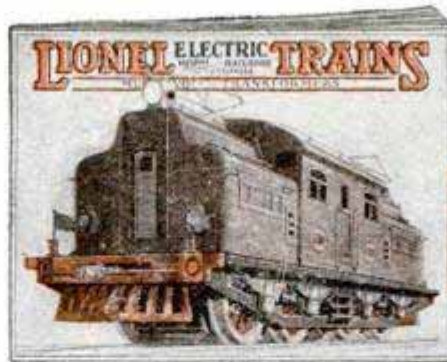

A. Lionel  
Switch Tower  
No. 437

New Train Control  
Semaphore  
Nos. 82 and 082  
—Almost human  
in its action.

SEE Lionel Trains demonstrated at the Leading Department Stores, Toy, Hardware, Electrical, Sporting Goods and Furniture Stores.

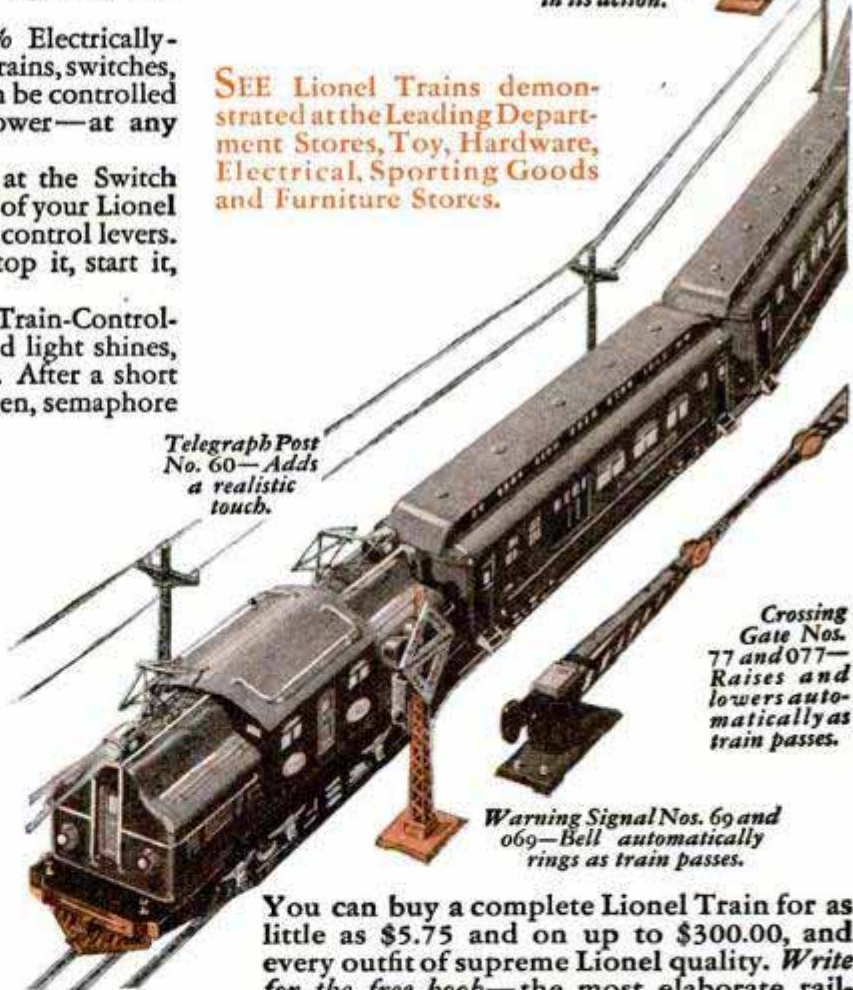

Telegraph Post  
No. 60—Adds  
a realistic  
touch.

Crossing  
Gate Nos.  
77 and 077—  
Raises and  
lowers auto-  
matically as  
train passes.

Warning Signal Nos. 69 and  
069—Bell automatically  
rings as train passes.

You can buy a complete Lionel Train for as little as \$5.75 and on up to \$300.00, and every outfit of supreme Lionel quality. Write for the free book—the most elaborate railroading book published! Dept. G.

"STANDARD OF THE WORLD SINCE 1900"

# LIONEL ELECTRIC TRAINS

MODEL RAILROAD ACCESSORIES

"MULTIVOLT" TRANSFORMERS



**GOODELL - PRATT**



**Inside Micrometer—618.** Gauges the precise diameter of any automobile cylinder from 2 to 6 inches, showing maximum—for re-boring or grinding. Extra rods are inserted for diameters above 2 inches. Barrel clearly etched and easy to read. Extra rods carried in hollow handle. Long handle reaches where hand cannot. Hardened steel anvils adjustable to compensate for wear. Complete, \$12

**Outside Spring Calipers—500.** For transferring measurements to steel rule. Every part subject to wear is hardened. Legs are hard crucible steel. Stiff, properly tempered springs. Extra-long screw gives greater measuring capacity. Size 2½ inches. With Solid Nut. . . . \$0.95

**Feeler Gauge—359.** For gauging gaps, as in spark plugs, platinum points and valve tappets, etc. 9 leaves, 2½ inches long—½ inch wide. .0015 to .015. Used in combination, these will measure any gap from .0015 to .0615. . . . \$1.80

**Steel Rule—213.** Light Tempered. 6 x ¾ x 1/20 inches. Clearly graduated both sides and ends. Accurate in between as well as over all. . . . \$1

**Micrometer Depth Gauge—31-R.** With 3 rods, for measuring slots, holes, etc., from 0 to 3 inches, by 1/1000ths. Ratchet mechanism. Base 2½ in. x 11/32 in., hardened, ground and accurately lapped at right angles to rods. . . . \$11

**GOODELL - PRATT**

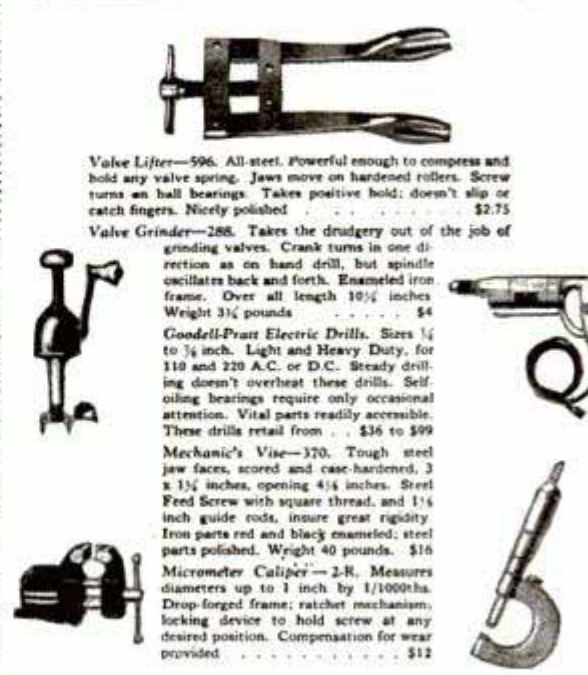

**Valve Lifter—596.** All-steel. Powerful enough to compress and hold any valve spring. Jaws move on hardened rollers. Screw turns on ball bearings. Takes positive hold; doesn't slip or catch fingers. Nicely polished. . . . \$2.75

**Valve Grinder—288.** Takes the drudgery out of the job of grinding valves. Crank turns in one direction as on hand drill, but spindle oscillates back and forth. Enameled iron frame. Over all length 10¼ inches. Weight 3½ pounds. . . . \$4

**Goodell-Pratt Electric Drills.** Sizes ¼ to ¾ inch. Light and Heavy Duty, for 110 and 220 A.C. or D.C. Steady drilling doesn't overheat these drills. Self-oiling bearings require only occasional attention. Vital parts readily accessible. These drills retail from . . . \$36 to \$99

**Mechanic's Vise—370.** Tough steel jaw faces, scored and case-hardened. 3 x 1½ inches, opening 4½ inches. Steel Feed Screw with square thread, and 1½ inch guide rods, insure great rigidity. Iron parts red and black enameled; steel parts polished. Weight 40 pounds. \$16

**Micrometer Caliper—2-R.** Measures diameters up to 1 inch by 1/1000ths. Drop-forged frame; ratchet mechanism; locking device to hold screw at any desired position. Compensation for wear provided. . . . \$12

THE ten automobile repair tools pictured here are single examples of the sizes in which each is made. The catalog also features all kinds of tools for machinists, and professional and amateur mechanics.

# Tools that speed up automobile repair work

You'll find them all in this free  
400-page catalog

**VALVE LIFTERS**—that raise and hold positively—never slip or catch fingers. **Valve Grinders**—that make valve-grinding as easy as hand drilling, and lift your fingers clear of the vertical cylinder-head bolts. **Feeler Gauges**—that take the guesswork out of spark-plug, platinum-point and valve-tappet adjustments.

**Electric Drills** that drill steadily hour after hour on the most gruelling job, without distress or overheating. The ¼-inch Heavy Duty

Goodell-Pratt Electric Drill goes through ½-inch cold rolled steel in 13 seconds. **Precision Tools**—that tell depths and diameters, lengths and outside measurements, accurately, to the thousandth of an inch.

These and many more good automotive tools are pictured and described in the Goodell-Pratt 400-page Catalog shown above.

Some of these tools will be new to you—will show you quicker, more convenient ways in automobile repairs and adjustments. These tools are sold by good hardware stores, mill supply houses and automotive supply dealers. The catalog is free. Write for it. Select the tools you want. Then see your dealer.

GOODELL-PRATT COMPANY, GREENFIELD, MASS., U. S. A.

MAKERS OF *Toolsmiths* MR. PUNCH

# GOODELL-PRATT

1500 GOOD TOOLS



# FREE 10 DAYS TRIAL

## THE NEW IMPROVED INKOGRAPH \$1.50

### The Perfect Writing Instrument GREATEST VALUE EVER OFFERED

NEVER before has any manufacturer of a standard writing instrument which is guaranteed to give perfect satisfaction, offered you so great a value. Remember, the Inkograph answers the purpose of both pen and pencil combined. Its point is shaped like a fine lead pencil point and writes with ink free and easy without a miss, skip or blur. The steady uniform flow of ink actually improves your handwriting. Won't blot, scratch, leak or soil hands.

You who already possess a standard fountain pen will find the Inkograph a most valuable addition to your writing equipment, for it will do everything any fountain pen can do and many very important things which it is impossible to accomplish with any fountain pen at any price.

#### Combines the Best Features

of both pen and pencil, minus the weak points of both, plus improvements not found in either. The lead pencil smudges, the point breaks and its writing soon is obliterated. Most fountain pens skip, scratch, flood, clog, leak, blot, soil hands and clothing. The old, stylographic ink pencil dries up, balks, blots, writes heavy, flows unevenly and is never reliable. The Inkograph feeds as fast and uniform on the 20th page as it did on the first.

#### Makes 3 to 4 Carbon Copies

at one time with original in ink. Bear down as hard as you like without fear of bending, spreading, injuring or distorting its 14 Kt. solid gold point. Are you a salesman?—use an Inkograph, make out your orders in ink and retain a duplicate for your records. Do you wish to keep a copy of your private correspondence?—use an Inkograph. Do you do office work which requires clear carbon copies?—use an Inkograph. Do you make out bills or sales slips?—use an Inkograph and make a permanent original in ink with carbon copies. You can permit any one to write with your Inkograph, for no style of writing can affect the Inkograph point as it will a fountain pen.

#### Draws Lines to a Ruler

Without smearing, smudging or blurring the paper. Writes with any color of ink.

#### Cannot Leak

Not the tiniest drop of ink will spill, although one filling is sufficient to write thousands of words. Will write on any quality of paper.

#### Requires No Blotter

The ink dries as fast as you write, because the flow is fine, even and uniform.

#### Patent Automatic Feed

Prevents clogging. No complicated mechanism to clean or get out of order. A year's guarantee certificate with full directions accompanies each Inkograph and is your absolute protection.

#### An Instrument of Refinement

In appearance it is the equal of writing instruments which sell for a great deal more. Its beautifully highly polished finest quality of hard rubber, its 14 Kt. solid gold point and feed, safety screw cap, nickel self-filling lever and clip make it an instrument of distinctive elegance and refinement. Made of black Hard Rubber—each Inkograph is designed and finished to please the eye and fit the hand of all.

#### You Who Are Dissatisfied with Your Fountain Pen

Try the Inkograph—remember, all we ask you to do is try it, for if it does not prove thoroughly satisfactory and if it is not handier and does not write smoother and is not far superior to any fountain pen you ever owned, whether it cost \$5, \$6, \$7 or \$8, return the Inkograph to us and we'll refund your money—no questions asked.

#### SEND NO MONEY

Your name and address are sufficient. Pay postman \$1.50, plus postage on delivery. When cash accompanies order, Inkograph will be sent postage prepaid. If within ten days the Inkograph does not prove satisfactory return it and we'll refund your money without further correspondence. It is because we are sure the Inkograph will meet your requirements to perfection that makes it possible for us to make you so attractive an offer.

#### DEALERS

Send for Catalog and Trade Prices



My Inkograph is the first and only writing utensil I ever owned that I can use with pleasure. To be without it for any time would upset my business day. It has always worked perfectly. I have never had any difficulty with it.

ARTHUR L. FOX, Ass't Buyer  
515 Lightner Bldg.,  
Centerville, Mich.

I am a bank teller, have used all kinds of fountain pens but can honestly say for my work I never found a pen so easy and tireless to write. You can pick it up any time in any position and write immediately and all numbers and words will be the same! Try and do it with any other pen. My buddies all agree that it is best for our work.

O. R. MORLEY,  
Allentown, Pa.

Delighted! It writes bully—you have invented a pen that is perfection. It is so much more rapid than my \$9.00 fountain pen. I wish you abundant success.

S. L. CARLTON,  
Aurora, Ill.

#### A Few of the Many Unsolicited Letters from Satisfied Inkograph Owners

Inkograph has proven so satisfactory and has elicited considerable favorable comment. An enclosing money order for three more. T. J. TROW,  
Travelling Claims Agent,  
Joplin, Mo.

The Inkograph fully justifies all claims you make. I own a Waterman but Inkograph is far preferable.  
FRANK R. SARGENT,  
Oakland, Calif.

You have one of the best writing instruments I ever used regardless of price. I use the lowest grade stationery and and there is never a blot or scratch because of it's round smooth point. It is a wonderful invention.

L. H. ORLEY, Albano, Va.

Oh Boy, I am tickled skinny to have the Inkograph. It's a darling. I can now make carbon copies in taking orders and send original in ink to factory instead of a penciled sheet. It surely flows over the paper as if it was grease instead of ink. No trouble at all had a thing I could not do before to trace straight lines very fine and clean. No smear, no muss of any kind. It's just great.

E. A. SIMMS, Jersey City, N. J.

My Inkograph is the smoothest writing instrument with which I have ever written. That is saying a lot. I am a teacher by profession. I have a \$7.00 pen and another that cost more than the Inkograph, but Inkograph is better than either. It is the greatest improvement in writing instruments since the Babylonians recorded their thoughts on clay tablets with a triangular pointed oed.

JOHN R. ATWELL,  
Chadwick, North Carolina.

**SAME SIZE AS**  
**\$7 & \$8.75**  
FOUNTAIN PENS

**INKOGRAPH CO., Inc. 199-55 Centre St., New York, N. Y.**

#### THIS COUPON PROPERLY FILLED OUT

is all that's necessary. Send it to-day and procure one of the New Improved Inkographs on a 10-Day Free Trial with no strings tied to it.

(Specify If You Want Ladies' Style)

**INKOGRAPH CO., INC.**  
199-55 Centre St., New York, N. Y.

Gentlemen: You may send me your Inkograph. I will pay postman \$1.50, plus postage on delivery.

Name.....

Address.....

City..... State.....

**AGENTS** Sell Inkographs, make bigger profits, more sales, without investment. Quicker commissions, popular prices, no competition. Send for an Inkograph or write for special sales plan booklet.



**WATCH THE YOUNGER CROWD PICK THE WINNERS!**

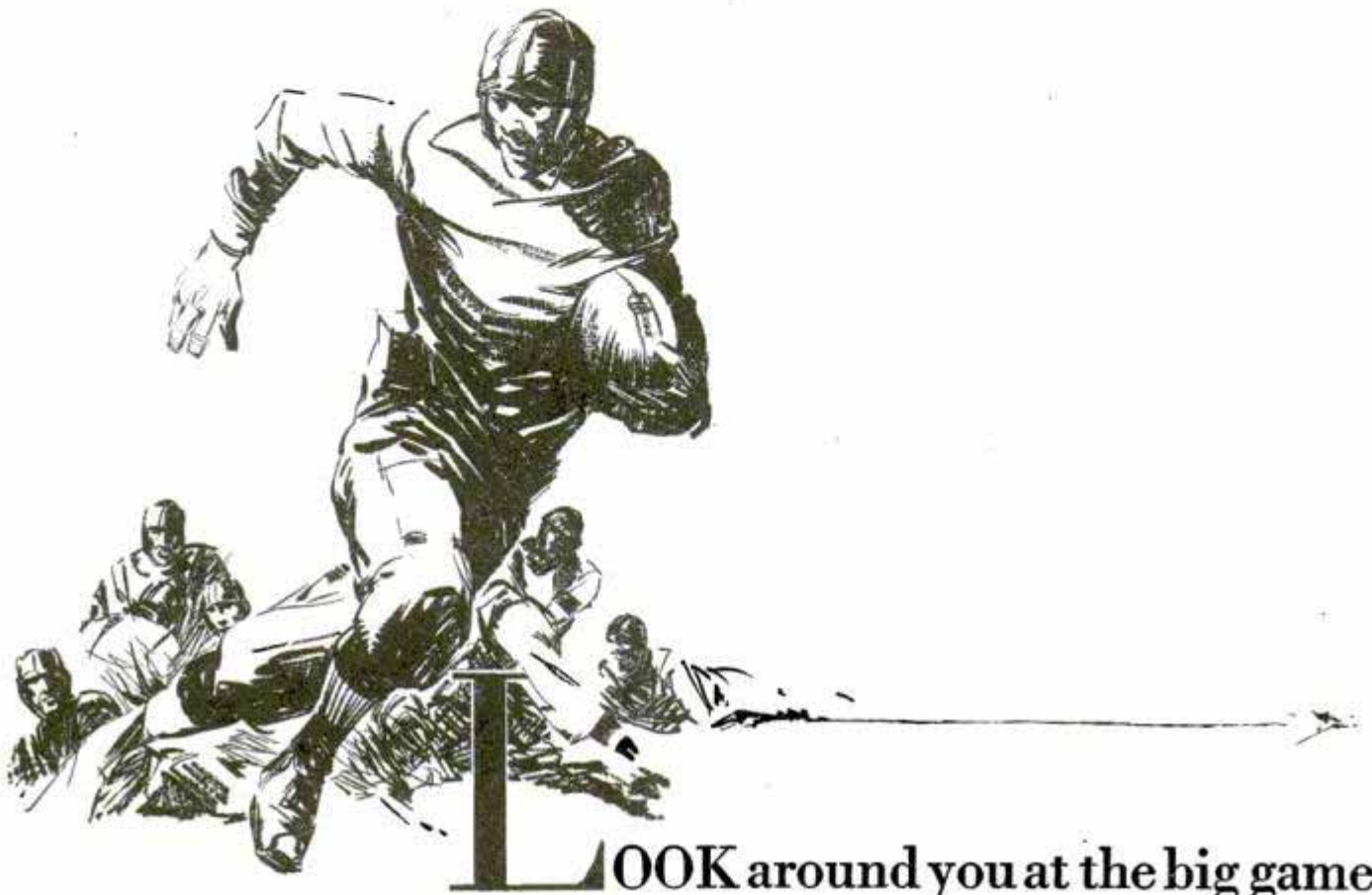

**L**OOK around you at the big game —and see the Fatima packages pop out! No gathering of the younger set, large or small, fails to extend this extraordinary record. Unquestionably, Fatima has pleased more smokers for more years than any other cigarette.



**F A T I M A**

*The most skillful blend in cigarette history*



**30  
DAYS  
FREE  
TRIAL**

# 7 Tube Set

## Single Dial Radio



*The Metrodyne*  
**ONLY ONE DIAL TO TUNE**

**Metrodyne  
Radio Sets**

Are Equipped For

**BATTERY or  
ELECTRIC  
operation**

Wonderful offer direct from the factory! The world's greatest radio! A perfect working, single dial control, 7 tube receiver! And just to prove our claims, we will ship it to your home for 30 days' free trial. Test it under all conditions. Test it for distance, volume and tonal quality—and if you are not convinced that it is the best single dial set you ever heard, return it to the factory. We don't want your money unless you are completely satisfied.

Retail Price

**\$75<sup>00</sup>**

**COMPLETELY  
ASSEMBLED**

**BIG DISCOUNTS to  
Agents and Dealers**

**BIG PROFITS TO  
AGENTS AND DEALERS**

Our Agents and Dealers make big money selling Metrodyne Sets. You can work all or part time. Demonstrate the superiority of Metrodynes right in your home. Metrodyne Radios have no competition. Lowest wholesale prices. Demonstrating set on 30 days' free trial. Greatest money-making opportunity. Send coupon, letter or postal for our agent's proposition.

**Three Year Guarantee**

**Metrodyne Super-Seven Radio**

A single dial control, 7 tube, tuned radio frequency set. Tested and approved by Popular Science Institute of Standards, Popular Radio Laboratory, Radio News Laboratory and by America's leading Radio Engineers. Designed and built by radio experts. Only the highest quality low loss parts are used. Magnificent, two-tone walnut cabinet with beautiful, gilt metal trimmings. Very newest 1928 model.

Easiest set to operate. Only one small knob tunes in all stations. The dial is electrically lighted so that you can log stations in the dark. The volume control regulates the reception from a faint whisper to thunderous volume, 1,000 to 3,000 miles on loud speaker! The Metrodyne Super-Seven is a beautiful and efficient receiver, and we are so sure that you will be delighted with it, that we make this liberal 30 days' free trial offer. You to be the judge.



**30 Days' Free Trial—3 Year Guarantee**  
**Metrodyne Super-Six**

New 1928 model Metrodyne 6 tube, two dial, long distance tuned radio frequency receiver. Approved by leading radio engineers. Highest grade low loss parts, completely assembled in a beautiful walnut cabinet. Easy to operate. Dials easily logged. Tune in your favorite station on same dial readings every time—no guessing.

Mr. Howard, of Chicago, said: "While five Chicago broadcasting stations were on the air I tuned in seventeen out-of-town stations, including New York and San Francisco, on loud speaker, loud and clear."

We are one of the pioneers of radio. The success of Metrodyne sets is due to our liberal 30 days' free trial offer, which gives you the opportunity of trying before buying. Thousands of Metrodynes have been bought on our liberal free trial basis.

**6  
Tube Set  
\$48<sup>50</sup>**  
RETAIL PRICE  
Completely  
Assembled

**MAIL THIS  
COUPON**

or send a postal or letter. Get our proposition before buying a radio. Deal direct with manufacturer—**SAVE MONEY—WRITE NOW!**

**Mail COUPON Below!**

Let us send you proof of Metrodyne quality—our 30 days' free trial offer and 3 year guarantee

MRS. WM. LEFFINGWELL, WESTFIELD, N. J., writes: "The Metrodyne Radio I bought of you is a wow! This is as good as any \$225 machine I have ever seen."  
N. M. GREENE, MAYWOOD, ILL., writes: "My time is up and the Metrodyne works fine. I got Havana, Cuba, Oakland, Calif., Denver, Colo., Toronto, Canada, all on the loud speaker."

J. W. WOODS, LEADVILLE, COLO., writes: "Received the 7-tube Metrodyne in fine condition. Had it up and working same day received. Was soon listening to Los Angeles, San Diego, Oakland and other California points; also St. Louis, Kansas City and other east and south stations—all coming in fine. Am more than pleased. Sure enjoying it."

We will send you hundreds of similar letters from owners who acclaim the Metrodyne as the greatest radio set in the world. A postal, letter or coupon brings complete information, testimonials, wholesale prices and our liberal 30 days' free trial offer.

**METRO ELECTRIC COMPANY**  
2161-71 N. California Ave., Dept. 43, Chicago, Ill.  
Gentlemen:

Send me full particulars about Metrodyne 6 tube and 7 tube sets and your 30 days' free trial offer.

Name.....

Address.....

If you are interested in AGENT'S proposition, place an "X" in the square

**METRO ELECTRIC COMPANY**  
2161-71 N. California Ave., Dept. 43, Chicago, Illinois



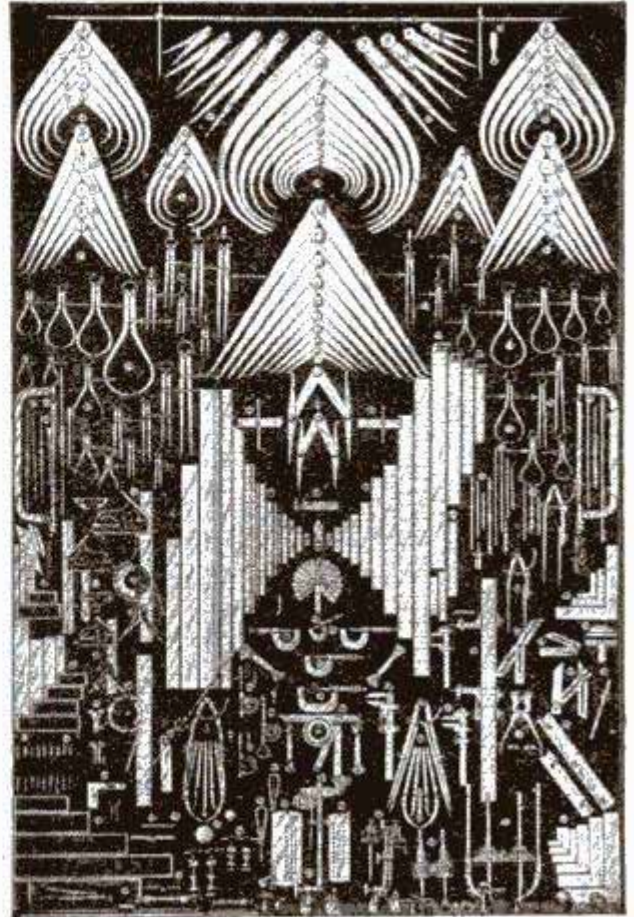

## *There are more than 2500 reasons*

why Starrett Tools have earned The L. S. Starrett Co. its reputation as the world's greatest toolmakers. Every Starrett Tool sets the standard for quality and accuracy.

That is why the big Starrett Catalog No. 23 "AP" illustrating and describing the 2500 and more Starrett Tools is considered an indispensable reference by men who appreciate fine tools.

*Starrett Catalog No. 23 "AP" is free. Simply send us your name and address.*

**THE L. S. STARRETT CO.**

World's Greatest Tool Makers. Manufacturers  
of Hacksaws, Unexcelled Steel Tapes  
—Standard for Accuracy.

ATHOL, MASS.

U. S. A.

1223



# Use Starrett Tools



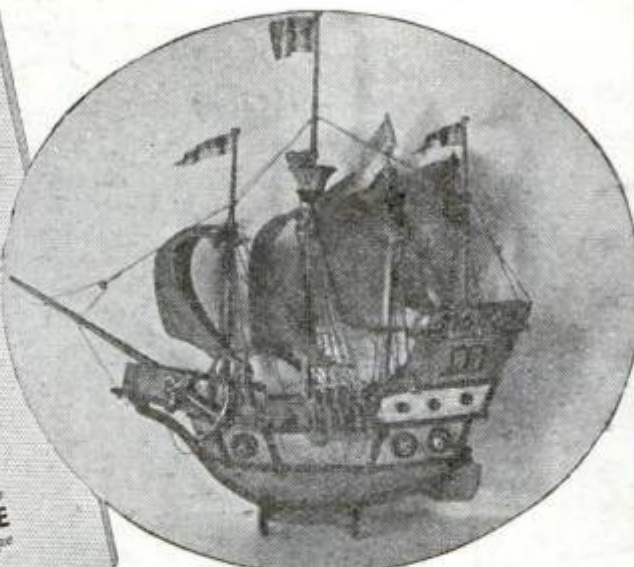

SPANISH SHIP MODEL  
See LePage's Book, page 4



SMOKING CABINET  
See LePage's Book, page 13

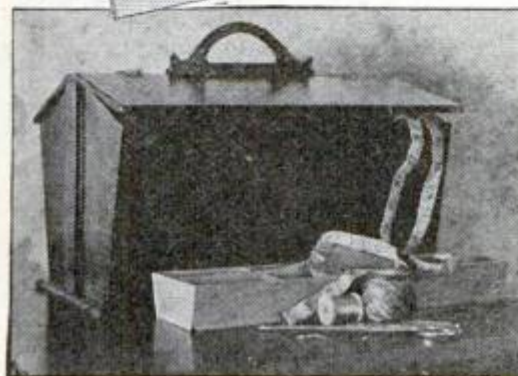

PRISCILLA SEWING BOX  
See LePage's Book, page 11

## This NEW Book will show you how to make 20 attractive pieces of furniture

NEVER before has a book been offered that contains so much practical work shop help at so low a price. It contains complete information for making 20 different pieces of gift furniture, designed by an expert—attractive, artistic, useful, practical, and easy to make. Any one of them is ideally suited to be a prized and handsome Christmas gift.

### New Book—greatly improved

THE first LePage's Home Work Shop Book, published a year ago, proved so popular that, though advertised only a few times, over 30,000 copies were sold—an enormous edition for a book of this kind. Now the new book, just off the press, represents a wonderful improvement over the old one. Of its 20 complete projects, 16 are entirely new and never offered before.

Each project is presented in three parts—a photographic illustration of the finished project, a complete dimension drawing of its parts, and simple, easy-to-follow directions, for making, given step by step from start to finish.

### Designed by expert

For each of the 20 gift furniture projects, the design, dimension drawings and photographs, as well as the actual articles, were made by William W. Klenke, Instructor in

Woodworking, Central Commercial and Manual Training High School, Newark, New Jersey. Assurance is therefore given that each project and the directions for making it are perfectly practical.

In addition to the three pieces illustrated above, the book includes the following 17 projects: Occasional Table, Folding Sewing Screen, Fernery Stand, Tilt Top Table, Piano Bench, Costumer, Cedar Chest, Table Desk, Desk Chair, Card or Console Table, Book Stand, Turned Bench, Dressing Glass, End Table with Book Trough, Foot Stool, Back Rest, and Hanging Book Shelves. Where else could you get complete directions for making all these things for only 10 cents?

In addition, this new LePage's book contains full information on how to secure plans for making eighteen more new projects, prepared by Frank I. Solar, Teacher of Manual Training in Detroit Public Schools, and widely-known tool craft writer.

### Send 10 cents for this NEW LePage's Home Work Shop Book

Just write your name and address on the coupon below, tear it out and mail to us today with 10 cents in coin or stamps, and we will at once send you a copy of LePage's New Home Work Shop Book, postage paid. Address LePage's Craft League, 553 Essex Ave., Gloucester, Mass. Tear out the coupon now so you won't forget it.

Handiest Tool in  
your Work Shop



**LE PAGE'S**  
**GLUE**  
*Bottles, Tubes, Cans*

### MAIL THIS COUPON

LEPAGE'S CRAFT LEAGUE,  
553 Essex Ave., Gloucester, Mass.

Gentlemen: Enclosed please find 10 cents (coin or stamps) in payment for LePage's New Home Work Shop Book. Please send a copy of this book to:

Name.....

Street.....

City..... State.....



Buy separately or in assortments

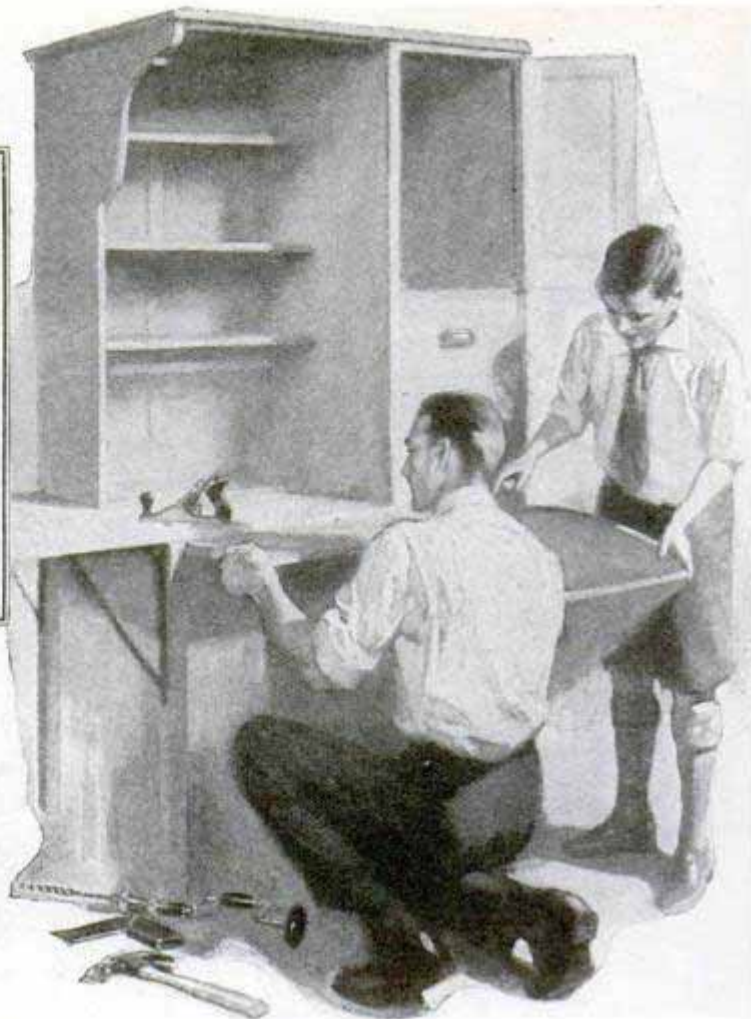
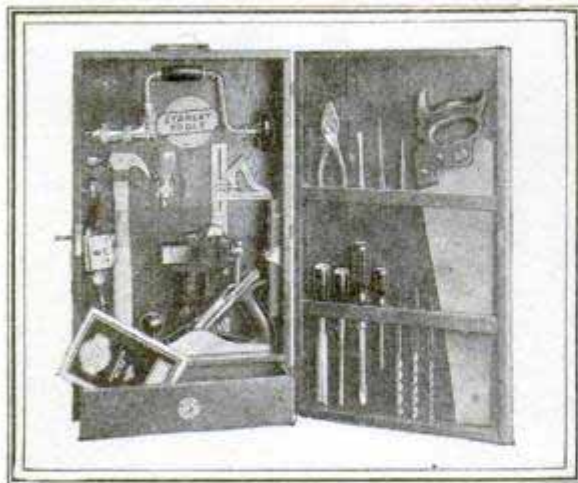

If men  
were cooks!

### Make a Kitchen Cabinet from Plan No. 13d

If men had to get the meals we venture the prediction that kitchen cabinets would quickly become as numerous as front doors! Few Christmas gifts are more welcome than a kitchen cabinet. Stanley Plan No. 13d tells just how to make a cabinet like the one shown above.



Isn't this true?—The better the tools the more pleasure you will get from your work with them. The amateur needs good tools even more than the professional. Most carpenters and manual training instructors use Stanley Tools because they know from first-hand experience that the Stanley name assures durability, correct design, and right "feel."

You can buy Stanley Tools separately and

so collect your own set. For your convenience in buying there are also complete sets of Stanley Tools in chests at a wide variety of prices from \$15 to \$95. Or there are assortments in strong cardboard boxes containing directions for making your own tool chest. Priced from \$5 to \$20.



Your hardware dealer has Plan No. 13d as well as other Stanley Plans for making useful articles, or he can get them for you. The plans cost only 10c each. Ask him also for small Catalog No. Sd50—which shows many useful Stanley Tools. It is free. If he cannot supply you write to The Stanley Works, New Britain, Conn.

The best tools are the cheapest to use  
Ask your hardware dealer



# STANLEY TOOLS



Let the new  
**Speed Way**  
**Shop**

*Motorize  
your tool kit!*

Only  
**1000**  
Down





# Now-Electric Radio Power— without acids, liquids or charging bulbs - -



KUPROX "A" TRANSIFIERS—Batteryless, noiseless, electric "A" power. Dry, dependable, needs no attention. Operates any receiver. 4-volt or 6-volt, \$28.50 and up.

**Dry, permanent power  
that requires no attention!**

*The most startling development  
of the radio season!*

NOW, for the first time, radio is really and truly electric.

No more of the bother and worry . . . none of the troublesome watering and attention that until now all socket powers required. KUPROX has eliminated

KUPROX is all metal . . . it is dry . . . it needs no watering or watering . . . it cannot wear out. Install KUPROX Devices on your set and forget them. A variety of models, from Trickle Chargers to Combination Models which supply all radio



Let the new  
**SpeedWay  
Shop**

Motorize  
your tool kit!

Only  
**1000**  
Down



**Free - in your home 10 Days**

**J**OB men, contractors, builders, tool lovers in shops and homes, are cutting costs and increasing profits—besides having hours of pleasure and fun with one of the SpeedWay Shops. Everything about this model Super-SpeedWay Shop shown above is big and heavy—built for commercial use, yet it operates from any lamp socket. Snap a switch and presto! you have motorized your tool kit! Gives you a complete motor driven work shop in a jiffy!

Furthermore, there is a combination to suit you! No matter what special uses you want them for, there is a SpeedWay Shop combination. From the \$42.50 Shop to the Super-SpeedWay Shop shown above, you'll find the same high standard of precision and workmanship. Our new catalog describes them all. It's yours for the asking!

### SEVEN HEAVY MOTOR-DRIVEN TOOLS

The Super-SpeedWay Shop (Model 265) shown above embodies a—

- 1—Motor Driven Lathe on heavy cast-iron base, takes up to 10" diameter and 18" length.
- 2—SpeedWay Bench Drill, 3/4" in steel or 1/2" in wood.
- 3—Bench Saw with 6" blade for ripping and cross-cutting.
- 4—Pattern Makers' Jig Saw with capacity for 20" work.
- 5—Motor-driven Grinder—5" emery wheel.
- 6—The 6" Scratch Brush is quickly attached.
- 7—Buffer or Polisher, with 6" rag wheel.

All necessary parts supplied, including two chisels, jig saw blades, etc.

**24 FREE  
Blue Prints**

**24 working blue prints of toys, furniture, etc., are furnished free with each SpeedWay Shop.**

**Pay While  
You Use It**

Our terms are very liberal—we want every man who can use a SpeedWay to order it for 10 Days' Free Trial in his own shop or home. If you like it you pay the balance a little at a time.

**DON'T DELAY — WRITE TODAY  
FOR SPECIAL OFFER!**

Don't waste time—write to this big factory today and benefit by our 20 years' experience in making Electrically Driven tools. We have Sales and Service Stations in 15 of the principal cities—Send the Coupon Today.

**ELECTRO MAGNETIC TOOL CO.**

Address Department 14-N, 1830 S. 52nd Ave.  
[Adjoining Chicago] Illinois

Cicero

Remember, this is the only Company in the world making a complete line of Portable Electric Saws, Hammers, Drills and Grinders.

Electro Magnetic Tool Co.,  
Address Dept. 14-N,  
1830 S. 52nd Ave., Cicero, Ill.

Gentlemen: Please send me full particulars about 10 Days' Free Trial, Free Blue Prints, and your Easy Payment Plan on SpeedWay Shops.

Name .....

Address .....

City.....State.....



# Now-Electric Radio Power— without acids, liquids or charging bulbs —

**Dry, permanent power  
that requires no attention!**

*The most startling development  
of the radio season!*



**KUPROX "A" TRANSIFIERS**—Batteryless, noiseless, electric "A" power. Dry, dependable, needs no attention. Operates any receiver. 4-volt or 6-volt. \$28.50 and up.



**KUPROX A & B TRANSIFIERS**—All radio power from a single unit. Controlled from set switch. Absolutely dry, requires no attention. \$57.50 and up.



**KUPROX "B" TRANSIFIERS**—Dry, permanent, free of hum. Guaranteed voltage at rated output. Models for all sets and circuits. \$14.50 and up.

NOW, for the first time, radio is really and truly electric.

No more of the bother and worry . . . none of the troublesome watering and attention that until now all socket powers required. KUPROX has eliminated all this. It has brought absolute freedom from radio cares. It makes your set entirely electric.

KUPROX is all metal . . . it is dry . . . it needs no watching or watering . . . it cannot wear out. Install KUPROX Devices on your set and forget them. A variety of models, from Trickle Chargers to Combination Models which supply all radio power from a single compact unit. See the complete KUPROX line at your dealer's.

**[ FREE BOOKLET FOR YOU: "The Secret of Successful Battery Elimination," describing KUPROX Devices, will be mailed free on request. Write for it. ]**

**THE KODEL RADIO CORPORATION, 517 E. Pearl St., Cincinnati, O.**

# KUPROX RADIO POWER DEVICES



**KUPROX REPLACEMENT UNIT**—For replacing the acid jar on all standard trickle chargers and power units. Eliminates all watering and attention. \$4.50.



**KUPROX TRICKLE CHARGERS**—Absolutely dry; 1-amp. rate. Large model gives 2½-amp. booster charge. \$10.50 and \$18.50.



# CASH IN ON RADIO Now

ACT AS A  
RADIO  
DOCTOR

HELP YOUR  
DEALER

BUILD SETS FOR  
YOUR NEIGHBORS

## EARN \$75<sup>00</sup> a Week

**Follow the Example of Thousands  
Join the Radio Association  
Learn Radio**

## Take Advantage of Radio's Big-Pay Opportunities

THE RADIO ASSOCIATION OF AMERICA will help you make money in Radio, full or part-time, by training you to be a "radio doctor," to build sets "tailored" to your neighborhood needs that you can sell for less than the "ready-made" sets offered by your local dealer, or to become a Radio Service Man for a radio dealer. Hundreds earn \$3 an hour spare-time serving as "radio doctors."

### Earned \$500 in Spare Hours

Member Lyle Follick, Mich., reports \$500 earnings so far in spare-time. Member Werner Eichler, N. Y., earns \$50 weekly spare-time. Member F. J. Buckley, Mo., earns as much spare-time as he gets from his employer.

If interested in Radio, join the Association. You will receive a comprehensive and practical training in Radio that will not only enable you to earn money in spare hours but to fit yourself for Radio's big-pay opportunities. Scores of our members are now connected with big radio organizations in different capacities. Membership in the Association has increased the salaries of innumerable men.

Member W. E. Thon, Chicago, was a clerk in a hardware store. The training we gave him enabled him to secure the managership of a Radio Department at a 220% increased salary.

"I attribute my success entirely to the Radio Association," he writes. "Your method of instruction is wonderful."

### We Will Start You in Business

Our cooperative plan will start you in business without capital. "In 1922 I was a clerk," writes Member K. O. Benzing, Ia., "when I enrolled. Since then I have built hundreds of sets—from 1-tube Regenerative to Superheterodynes.

"I am now operating my own store and my income is 400% greater than when I joined the Association. My entire success is due to the splendid help you have given me."

Membership gives you the benefit of proven money-making plans, the privilege of buying radio parts at wholesale, the cooperation of our Employment Department, the backing, advice of the Association in carrying out your plans. Investigate all it can do for you!

### ACT NOW—for No-Cost Membership

The success of the Association during 1926 was so tremendous that we can offer a limited number of memberships that need not cost you a cent. Write today for details and our book, "Your Opportunity in the Radio Industry" that will open your eyes. Let us hear from you at once.

RADIO ASSOCIATION OF AMERICA  
Dept. PM-11, 4513 Ravenswood Avenue,  
Chicago, Ill.

Gentlemen:

Please send details of your Special Memberships and copy of your book, "Your Opportunity in the Radio Industry."

Name.....

Address.....

City..... State.....





Army  
vs.  
Navy



\$1.50

## New Model Pocket Ben

Nearly a hundred thousand people will flock to the great Army-Navy football game this month.

Many thousands of them carry the New Model Pocket Ben.

That's because it combines good looks with reliable time-keeping.

Pocket Ben—made by the makers of Big Ben and other Westclox—is sold everywhere for \$1.50. With night-and-day dial \$2.25.

**WESTERN CLOCK COMPANY**  
La Salle, Illinois

**All Metal Chassis Shielded**

# 6 TUBE SUPERPHONIC

**RADIO KIT COMPLETE**

**Only \$16.95**

**FREE! 6 TUBES UX 201-A TYPE Tested and Matched**

**Can be built in 2 hours**

Latest 6 tube tuned radio frequency circuit. Extremely selective, marvelous sensitivity. 2 stages of radio frequency, detector and 3 audio amplifiers for improved tone quality. 2 dial control. All metal chassis. Shielded. Clear and realistic reception guaranteed. Beautiful ornamental design on front panel, crystalline finish. Metal panel and subpanel; all holes drilled making mounting of parts very simple. No special tools needed. Vernier dials for fine tuning. New type UX sockets. All hook-up wire and colored battery cable included. Value \$60.00. Our price \$16.95.

**COAST TO COAST RECEPTION**

**MAKE MONEY IN YOUR SPARE TIME!**

**COMPLETE SET OF SIMPLE PLANS AND DIRECTIONS TO BUILD**

Very easy to build this set with the plans and instruction we furnish. No complicated drawings. Can be built in two hours. Instruction for operation also included. Make money by building these sets in your spare time and selling them to your friends.

**SEND NO MONEY**

Just write your name and address on a post card and ask us to send you this great kit together with 6 tubes. We will ship them right away. When they arrive, pay only \$16.95 plus a small delivery charge.

**RADIO EQUIPMENT CO.**

Dept. PG 549 S. Wells St. CHICAGO, ILL.

**For Better Filament Control** on your radio set use the **NEW Lynch EQUALIZOR** in place of rheostats. \$1 complete with mounting. At your dealer's or post-paid. Money back if dissatisfied. In ordering, state number and types of tubes in your receiver. **ARTHUR H. LYNCH, Inc., Manufacturers of the Lynch Metalized Resistor, 250 West 57th Street, NEW YORK, N. Y.**

**FREE!**

**Wholesale Agents' Specialties**

*From every part of the World*

1928

**Frank Spors & Co.**  
IMPORTERS EXPORTERS  
LA SUEUR CENTER, MINN.

**UPON REQUEST THIS**

Large wholesale Specialty Catalog, showing over 300 fast selling specialties, from many parts of the world.

**F. SPORS & CO., 927 Main St., Lesueur Center, Minn.**



# I Want to send you a Santa Fe Special Watch

for your  
Examination  
21 Jewels Approval



Watch Sent on 30 Days Free Trial

Send No Money

In addition to our New Low Price, I will send for your approval one of these Standard Watches, guaranteed for a lifetime of satisfactory service, not only by the Santa Fe Watch Company, but by the Great Illinois Watch Factory. They are found in the pockets of men in the service on every railroad in this country. Senators, Congressmen and Governors keep their official appointments by "Santa Fe Special" time. Army officers and Privates carried them all through the Greatest War in history—thousands of these splendid watches are in use all over the World. If you want one on my liberal new LOW PRICE PLAN, you had better write for my Free Watch Book today and make your selection without delay. I will send the Watch for you to see WITHOUT ONE PENNY DOWN—I will even allow you to wear the Watch 30 days FREE—then sell it to you on a binding money-back guarantee.

## Why Not Own A 21 Jewel Watch

You will never miss the few cents a day that will make you own one of these watches—SEND FOR WATCH BOOK—illustrating in beautiful colors hundreds of designs and combinations in cases in the POCKET WATCH, MEN'S STRAP WATCH and LADIES' WRIST WATCH. You can have your name or monogram and any emblem you may desire engraved in the Case to suit your own ideas.

### New Case Designs

I want you to see the new models and wonderful case design in the Santa Fe Special, the Santa Fe Mogul, the Santa Fe Strap Watch and the Petite Santa Fe Princess

Watch. No matter what your choice of a watch may be there is a Santa Fe Watch to please you. Send coupon for our beautiful FREE catalogue showing hundreds of designs and models in watches and newest creations in Diamond Rings and Jewelry.

WRITE FOR SPECIAL CASH OFFER — GOOD FOR 30 DAYS

Mail  
Coupon  
for Beautiful  
**FREE Watch**  
and  
**Diamond Book**

**SANTA FE WATCH COMPANY**  
B-6 THOMAS BUILDING TOPEKA, KANSAS  
(HOME OF THE GREAT SANTA FE RAILWAY)

Santa Fe Watch Company,  
B-6 Thomas Building, Topeka, Kansas.  
Please send prepaid and without obligation your Watch Book Free explaining your "No Money Down" Offer on the Santa Fe Special Watch.

Name.....  
Address.....  
City..... State.....

**FREE** A limited offer! With every Santa Fe Special, a beautiful gold chain or strand of exquisite pearls. Write today.





## Here's Happiness With a Pan-American Saxophone



Pleasure, Pride, Popularity, Profit—all these wonderful advantages and more are yours when you've learned to play a PAN-AMERICAN Saxophone. Here's an instrument you'll treasure highly for the real pleasure it will bring. Made as only PAN-AMERICAN knows how to make really fine saxophones, with clear, sweet, beautiful tones—handsomely finished, mechanically perfect.

**AS EASY TO OWN  
AS IT IS TO PLAY**

No other saxophone—not one—can possibly give you such fine quality—such real satisfaction, plus an iron-clad factory guarantee, at a cost so *surprisingly low*. And it's easy to learn how to play this splendid instrument. Decide now to get full particulars about our free trial offer and easy payment plan on Saxophones and the full line of better PAN-AMERICAN band and orchestra instruments. You'll be glad you did.

### FREE TRIAL

**Send No Money  
Just Mail Coupon**

The Pan-American Band Instrument & Case Co.,  
Dept. G-12, Elkhart, Indiana

Send Along full information and low prices on Pan-American Saxophones and other band instruments. I want to learn to play..... (instrument).

Name.....

Address..... City..... State.....

My local music dealer is.....

## NEW VEST POCKET ADDING MACHINE



**BABY CALCULATOR**  
CHICAGO U.S.A.  
PATENT APPLIED FOR

ADDS, SUBTRACTS, MULTIPLIES, DIVIDES  
Does work of \$300 machine. Guaranteed 5 years.  
**NOT A TOY.**  
Made of steel and indestructible. Million dollar capacity. Fits in pocket. Will not make mistakes. So simple child can operate it. Instructions furnished. Everybody should carry one for figuring.

**FREE TRIAL \$2.50**  
Total Cost

**SEND NO MONEY**—Just name and address. We will ship Calculator immediately. On delivery pay postman \$2.50 (Plus few cents Postage). (If outside U. S. send cash). 10c additional in Leatherette Case. If not satisfied after 10 day trial you get your money back. **THOUSANDS OF SATISFIED USERS.**  
This is lowest priced practical calculator made. "Why pay more for inferior imitations?" Order from this ad.

Guaranteed

----- Mail Coupon Today -----

**BABY CALCULATOR SALES COMPANY**  
Dept. 41, P. O. Box 1118, CHICAGO, ILL., U. S. A.

I am enclosing \$2.50—send adding machine prepaid.

Send Adding Machine C. O. D. \$2.50 plus postage.  
(10c additional in Leatherette Case)

Name.....

Address.....

City..... State.....

**AGENTS** Write for big commission and territory proposition.



Price only  
**\$10.50**  
Weight 20 lbs.  
Write for circular.

**THE ADRIAN SPEED LATHE**  
for wood and light metal turning. 7" swing, 17" centers.

**H. G. CRANE, Adrian, Mich.**



## Build and Fly a 3 ft. Model of LINDBERGH'S NEW YORK—PARIS MONOPLANE

Plans for Other Model Airplanes 25c per set.  
**FOKKER North Pole Plane**  
**CURTISS JN4D-2 Plane**  
**DeHAVILLAND World Flyer**  
**NC-4 Naval Seaplane**  
**Bleriot, Nieuport or Taube Monoplanes**  
**Cecil Peell Racer Plane**

(All 9 Plans for \$2.00)

This IDEAL New York-Paris Monoplane is a perfect copy, 3-ft. size of the "Spirit of St. Louis" in which Lindbergh crossed the Atlantic Ocean. Any bright boy can build this model. The IDEAL Construction Outfit contains everything needed: all parts, fittings, materials and supplies, including careful instructions, plans and diagrams. The model is wonderful; has many features of the original and is guaranteed to fly. Complete Construction Outfit, **\$7.50** (West of Denver, Colo., and in Canada, price is \$8.00)

**Ask your dealer or order direct. Plans and instructions only (No materials included), postpaid 25c.**

**IDEAL AEROPLANE & SUPPLY CO.**  
408 West Broadway NEW YORK CITY



*Catalog of Model Airplanes, Parts, Supplies, etc., 5c postpaid*

## CAN YOU SELL GAS at 5c PER GAL.?

If so write me quick. My Distributors make as high as \$3,000.00 per month. Let me show you how.

**SEND FOR FREE TRIAL**

Proof of astounding success and my \$15.00 a day Guarantee to Distributors.

**Frank Andrews, Dept. 805-P, 154 E. Erie St., Chicago, Ill.**



## STEEL BLUE Elite Diamond

IF YOU CAN TELL IT FROM A DIAMOND  
**SEND IT BACK!**

**\$3.89 COD**

1 Carat Elite Diamonds. Matchless for their dazzling rainbow brilliancy. You'll be delighted. Elite Rings surpass all others. Stand acid and other tests. Handsomely Engraved Ring, sterling Guaranteed. Looks like \$250.00. Proud owner offered \$85.00 5 minutes after buying one.

**COLLAR AND CUFF LINKS GIVEN**

With each ring order, we give free beautiful Combination Set. Set with small Elite Diamonds. **SEND NO MONEY.** Just send name, address and finger size. On arrival pay postman \$3.89 and postage. Satisfaction Guaranteed. Write today. Cash with Canadian or foreign orders.

**ELITE JEWELRY HOUSE, Dept. 375, 609 S. Paulina St. CHICAGO, ILLINOIS**

## BUILD YOUR OWN GRANDFATHER'S CLOCK



We furnish blue prints, finishing material and instructions. Buy the works, dial, weights and pendulum from us at surprisingly low prices. You make a fine profit building artistic clocks for your friends.

Plain Works as Low As \$5.00. Others with Chimes At All Prices. Ask for Our Free Catalogue and Offer of Blue Prints.

**American Chime Clock Company**  
1670 Ruffner Street  
PHILADELPHIA



# BUILD OLD IRONSIDES

for \$6.98

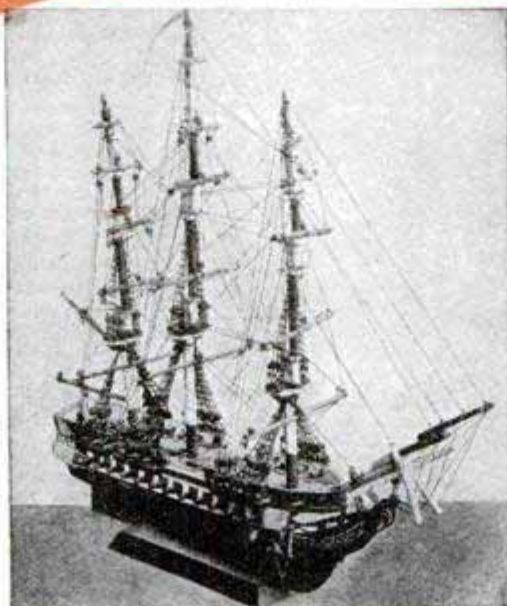

\$6.98

You can build a model of the United States Navy's most famous fighting vessel in a few hours of pleasant pastime.

Size: 30 inches high; 32 inches long; 10 inches wide. An exact duplicate of the U. S. S. Constitution in every detail.

Fifteen year old Carl Rayborn built a model of the Constitution using only our cut-to-fit and ready to assemble parts as supplied in our kit for \$6.98.

He submitted the completed model in a contest by the publishers of Science and Invention, and it

## WON FIRST PRIZE

in competition with a thousand ship models submitted to the magazine by builders from all parts of the country. Previous to building the model of Old Ironsides, Carl Rayborn had never constructed a ship model in his life.

You, too, can build a prize winning model from our cut to fit and ready to assemble parts of historic ships, including the Constitution, the Mayflower, the Santa Maria and the La Pinta. Prices for the kits of parts range from \$4.98 to \$6.98.

You need not know anything about ship building or carpenter work in order to build one of these ships. No special knowledge of ship model building is necessary either. **THE WORLD'S LARGEST BUILDERS OF SHIP MODELS AND MELODY SHIPS WILL** supply all the parts from the hull down to the smallest piece of rigging, all cut to fit and ready to assemble. You cannot go wrong. Diagrams and plans of parts that are included with each kit tell exactly what to do with each part.

These plans show you step by step just how the model is constructed. Everything is made so simple that even a small child can build a beautiful model.

All you need is a small hammer to tap the parts into place. Here is part of the instructions copied word for word from the diagram and instruction sheet that goes with the kits. "Take part No. 57, place it in front end of part No. 56 and tap lightly with a hammer. Next take part No. 58 and place it up against No. 57 and tap it with a hammer to bring it into place."

Canadian prices slightly higher. Send all Canadian orders to Canadian office.

**MINIATURE SHIP MODELS, Inc.**  
3818-20-22-24 Baring St., Philadelphia, Pa.  
Canadian Branch: 1485 Bleury St., Montreal, Canada

Easy! Nothing simpler. The instructions are like that from beginning to end. Do this and that and before you realize it a beautiful ship model has grown before your eyes.

The model of the Constitution is exact in every detail. The hull, masts, spars, riggings, cannons and anchors are exactly like those on the original ship. Those who have constructed models from our cut to fit parts are so well pleased with them that they will not sell them for \$50 or even \$100. We have letters from all over the world telling us how much pleasure it was to build these models and the enticing money offers the builders have received for them when completed. Many persons have built up a wonderful business selling completed models which they have made from our kits.

If, after assembling the model you do not think it worth many times the purchase price, return it to us in good condition and we will gladly refund your money.

Write for our free, beautifully illustrated catalog which contains photographs of all our models, together with complete details and price of each. We will send this catalog without obligation to you. Fill in the coupon below and we will act upon it immediately.

MINIATURE SHIP MODELS, Inc., DEPT. P. 2.  
3818-20-22-24 Baring St., Phila., Pa.

Please send me the complete parts, cut to fit and ready to assemble for the model Constitution. I will pay postman \$6.98 plus postage (a few cents).

PLEASE PRINT NAME AND ADDRESS PLAINLY  
Name.....  
Street or R. F. D.....  
City.....  
State.....



RADIO • IS • BETTER • WITH • DRY • BATTERY • POWER



made to run  
the *full* race!

ANY horse can make a good start . . . . . But it takes real stamina to *finish!*

So it is with batteries. *Staying* power is the quality to look for—unfailing power over a long period of service. Millions prefer Burgess Chrome Batteries for just this reason. They hold up . . . . . They last.

Next time, buy black and white striped Burgess Chrome Batteries. You are certain to get longer and better service for your money.

**Chrome**—the preserving element used in leather, metals, paints and other materials subject to wear, is also used in Burgess Batteries. It gives them unusual *staying* power. Burgess Chrome Batteries are patented.

Ask Any Radio Engineer

BURGESS BATTERY COMPANY  
General Sales Office: CHICAGO

Canadian Factories and Offices: Niagara Falls and Winnipeg



**BURGESS**  
**FLASHLIGHT & RADIO**  
**BATTERIES**

**YOU NEED THIS BOOK**

**Just Out HARRY ALTER'S New Radio Book**



You, as a retailer need the extra profit that is figured for you in our plan of selling at rock-bottom prices. Fourteen thousand dealers are sharing in the advantages of our overnight service.

**JUST OUT! WRITE TODAY!**

for your copy of this—the most famous of all radio catalogs. No matter what your customer wants we have it for you. Get your copy quick.

Note: We sell only to radio retailers.

**The Harry Alter Co.**

1780 Michigan Ave. Chicago, Ill.

**SOLDERALL**

METAL IN PASTE FORM

The only convenient metal solder



Every Electrical Connection needs Solderall for perfect reception

25¢

The SOLDERALL CO., NEWARK, N.J.

**RADIO PANELS**

**BAKELITE—HARD RUBBER**

Cut, drilled and engraved to order. Send rough sketch for estimate. Our complete Catalog on Panels, Tubes and Rods— all of genuine Bakelite or Hard Rubber.

Mailed on Request.

**STARRETT MFG. CO.** 524 S. Green St. Chicago, Ill.

**Radio on Terms**  
Play While You Pay!



A marvelous set for distance, tone, selectivity, 6 tube—dial (illuminated). Beautiful cabinet. Easy monthly payments while you enjoy nation-wide programs. **FREE Log and Call Book** and Big Catalog containing thousands of Radio Bargains. Write today for copy.

**AMERICAN AUTO & RADIO MFG. CO.**

HARRY SCHWARTZBERG, PRES.

Dept. 267 American Radio Bldg., Kansas City, Mo.

**\$985**

PUTS IT IN YOUR HOME

**New 1928 Wholesale Radio Catalog FREE to Dealers**

136 pages of the greatest values ever offered. Beautiful color illustrations showing **electric and non-electric sets**. High quality "A" and "B" Eliminators at new low prices. **Astonishing low prices** on nationally advertised parts, kits, loud speakers, chargers, cabinets, consoles and other radio accessories. Write for it on your letterhead today.

**HAMILTON-CARR RADIO CORP.**  
711 W. Lake St. Dept. 136 Chicago



# This Wonder-Working Shop

Will Make You a Craftsman

Only **\$1000** DOWN

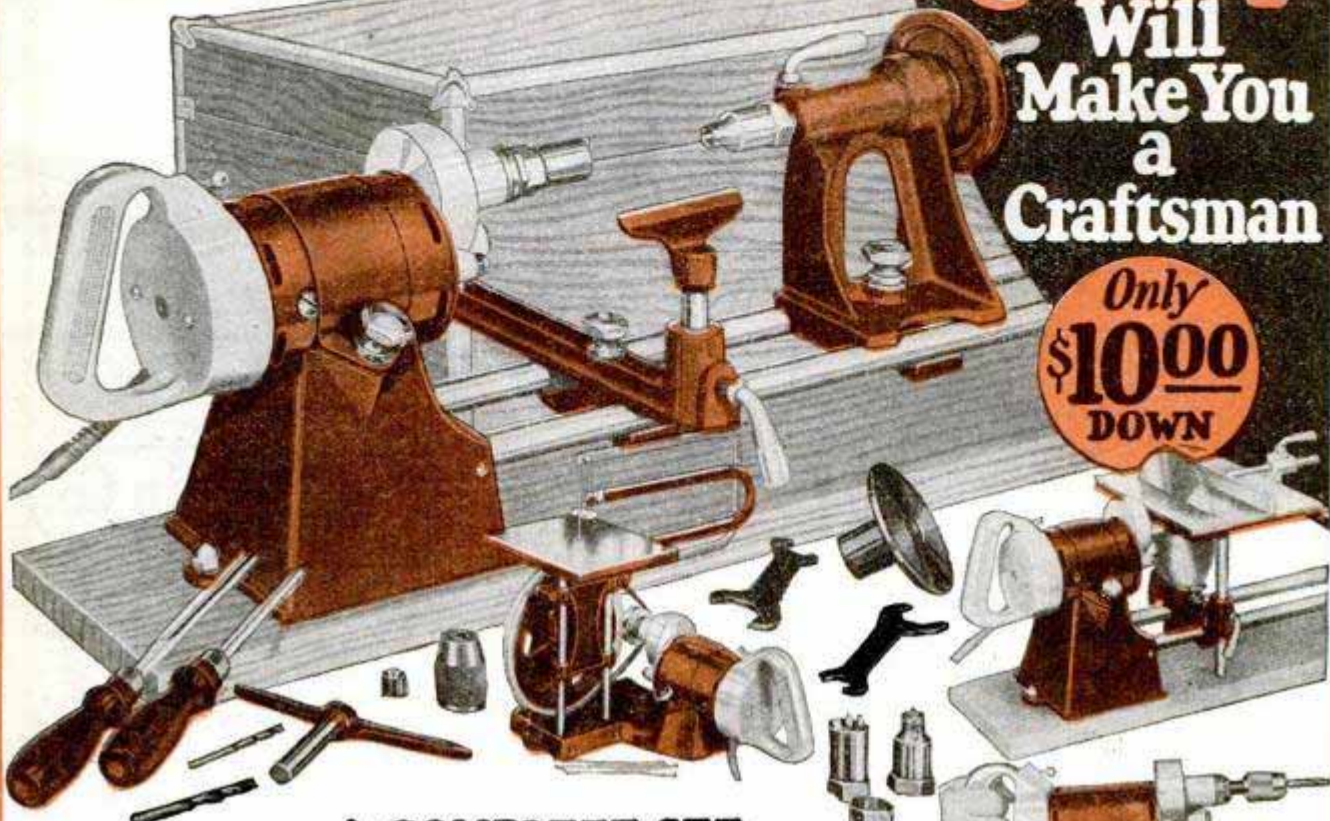

## A COMPLETE SET of Craftsman's Home Working Tools

Now! You can make beautiful things at home—You can do "Masterpieces in Wood" with the most perfect, efficient and powerful set of Craftsman's tools ever assembled and offered as a complete, portable home work shop set. All of these tools are made possible by use of the Red Jacket Drill Motor—a most unusual, all purpose electric motor power.

### The **Red Jacket** Home Work Shop

is a chest full of tools designed by a master for the private use of tool lovers and men who want to build, construct, invent and create at home. It is a complete, made to order, electric work bench that turns out work like magic. Small and compact enough for portable use and so inexpensive that any man or boy may have one. You will be able to make everything—attractive odd furniture—toys, home and garden improvements, all around manufacturing and repairing.

**The Complete Equipment** consists of the new Red Jacket Motor, with direct drive to the Waco Craftsman's wood turning lathe (capacity 9 in. x 34 in.); a bench saw, that has depth and side gauges, scroll and jig saw; and all accessories for both portable and stationary power drilling, buffing, grinding, cleaning, etc. Attaches to any light socket and converts your work bench into a complete private tool and machine shop.

### The Famous WACO **Red Jacket** Guarantee

*If our tools are not what you want when you see them, send them back.*

LOOK OUT FOR IMITATIONS—There is only one Red Jacket—one Waco—one Wm. L. Aylward master craftsman

### SENT ON TRIAL Special Crafts' Course

And blueprint service is free to Red Jacket Shop owners—all that there is to know about handicraft methods, raw materials, woods, carving, sawing, turning, designing, carpentering, decorating, is taught by correspondence.

### Buy On Your Own Terms

\$10.00 down. Liberal discounts for cash. Easy monthly payment plans. It is no hardship to own a Red Jacket.

### Interesting Literature Sent Free

Just send the coupon. You will be surprised with all it contains. Beautiful, Instructive, Fascinating, Interesting.

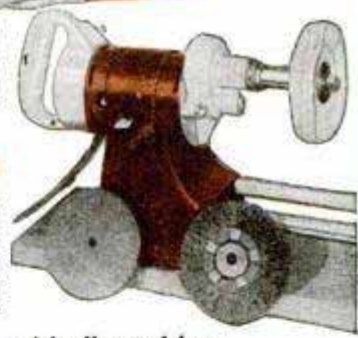

- Turning
- Sawing
- Spinning
- Grinding
- Buffing
- Polishing
- Cabinet Making
- Drilling
- Repairing
- Joining
- Sharpening
- Sanding
- Scratching
- Carving
- Successful Masterpieces

### 10 Days' Free Trial

Our literature tells you how to start a job of your own. If you are not pleased return the Shop.

### 2 Ounces

of interesting reading will be sent you gratis. Send the coupon below. Sit back—see what we send you. It's free.

### Mail This to Waco

**WACO TOOL WORKS, Inc.**  
542 N. Parkside Ave., Chicago, Ill.

Manager, Dept. 111. Please send me particulars about 10-day free trial, free blueprints, and \$10 down payment.

Name.....

Address.....





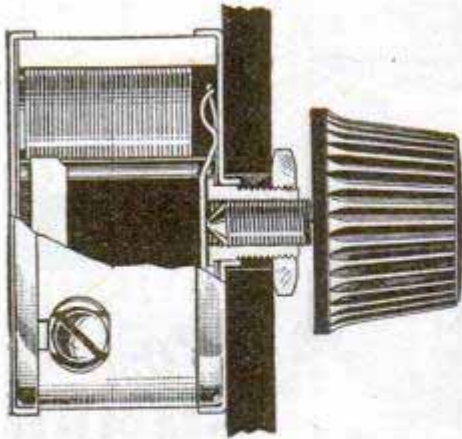

**Bradleyohm-E**  
PERFECT VARIABLE RESISTOR

The graphite disc principle, utilized in the construction of Bradleyohm-E, assures noiseless, stepless regulation of plate voltage when used in B-Eliminator hook-ups. By turning the bakelite knob, the plate voltage output of the B-Eliminator can be adjusted, without steps or jumps, to the precise value for maximum volume. That is why prominent B-Eliminator manufacturers have adopted Bradleyohm-E. Ask your dealer for Bradleyohm-E in the distinctive checkered carton.



**Bradleyunit-A**  
PERFECT FIXED RESISTOR

This is a solid, molded fixed resistor that does not depend upon hermetic sealing for accuracy. It is not affected by temperature or moisture and can be soldered without disturbing its rating. For resistance-coupling, grid leaks, and other applications, ask your dealer for Bradleyunit-A in any desired rating.

**Allen-Bradley Co.**  
ELECTRIC CONTROLLING APPARATUS

280 Greenfield Ave.  Milwaukee, Wis.



**FREE**  
Standard parts and equipment at money-saving prices, with discounts that show you a real profit. Electrical Phonograph—pickups—latest kits! New A C tubes and transformers—parts for any circuit—power audio equipment—short wave supplies—they are all in our big new 1928 Catalogue. Write for it today, with discount sheet. 12-hour shipment guaranteed.

**Van-Ashe Radio Co.**

206 N. 10th St.,  St. Louis, Mo.



**Western Radio Mfg. Co.**  
132 West Lake St., Dept. 38—CHICAGO, ILL.

**"B" BATTERY ELIMINATOR**

Only \$ **7.95**

**NEW IMPROVED 1928 MODEL**  
No more worry with "B" Batteries! Hook up a Roll-O "B" Battery Eliminator and forget battery troubles forever. This wonderful new invention means better reception, sharper tuning. Gives you more real pleasure from your set. Completely Equipped—No "Extras" to Buy. Operates perfectly on direct or alternating current, giving up to 90 volts current, and using the full wave of the power supply. Simple directions enclosed—anyone can plug it in to any kind of set up to six tubes. Constant voltage gives set more power. Costs no more than set of good "B" Batteries. Solidly built in beautifully finished metal case, with genuine Bakelite top. **SEND YOUR ORDER NOW**  
Don't blame your set because run down "B" Batteries won't let it work right. Order your Eliminator NOW. Write name and address on a piece of paper, pin a dollar bill to it, and mail it TODAY. Pay postman balance (\$6.95 plus a few cents postage) when he delivers your Eliminator. Use it ten days. If not more than satisfied, return it and get your money back.  
**THE ROLL-O RADIO CO.**  
Dept. B-200, 3d & Sycamore, Cincinnati, O.

Send \$1.00





Sent for  
only

**\$1.00**  
down  
**DIRECT FROM FACTORY**

Here is the greatest buying opportunity today! Just \$1.00 down brings you the famous 21-Jewel Studebaker Watch direct from factory. Balance in easy monthly payments. Lowest prices ever named for equal quality. You save fully 30% to 50%. Your choice of 80 magnificent, new Art Beauty cases and dials. Latest case designs in yellow, green and white gold effects. Exquisite thin models. 12 Size and 16 Size. Send coupon for catalog of Advance Watch Styles and full particulars.

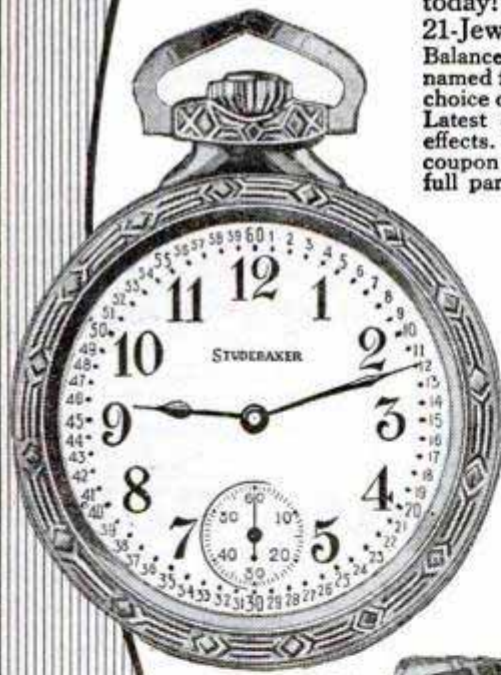

21 JEWEL ~ Extra Thin  
**STUDEBAKER**  
*The Insured Watch.*

The Studebaker Watch Company is directed by members of the famous Studebaker family—known throughout the world for three-quarters of a century of honest dealing. Studebaker Watches have 21 Ruby and Sapphire Jewels, 8 Adjustments—for heat, cold, isochronism and 5 positions. Made so good we insure them for your life-time. Insurance policy free with every Studebaker Watch. Ladies' Bracelet Watches, Men's Strap Watches, Diamonds and Jewelry also sold at lowest prices and easy monthly payments. Send coupon for details.

**MAIL COUPON**  
**for FREE BOOK!**

Watch direct from the maker—save big money—and pay for it in easy monthly payments. Mail the coupon.

Let us send you a copy of our beautiful new 6-color catalog. It contains complete information on watch making. It tells how you can buy a 21-Jewel Studebaker Insured

**SPECIAL OFFER! Watch Chain FREE!**

For a limited time we are offering a magnificent Watch Chain Free. To all who write immediately we will include particulars of this astounding offer. Time is limited. Send the coupon NOW before this offer expires!

**STUDEBAKER WATCH COMPANY**

*Directed by the Studebaker family—three-quarters of a century of fair dealing.*

Watches • Diamonds • Jewelry  
Dept. P-806 • South Bend, Indiana  
Canadian Address: Windsor, Ontario

Mail This  
Coupon



Our Diamond and Jewelry Catalog is just off the press. Your copy will be sent you FREE if you mail coupon.

**STUDEBAKER WATCH COMPANY**

Dept. P-806 South Bend, Indiana

Please send me your free catalog of Advance Watch Styles and details of your \$1.00 down offer.

Please send me free catalog of Jewelry and Diamonds.

Name .....

Street or R. F. D. ....

City.....-State.....





# Keep That School-boy Complexion

Shave with Barbasol, and you leave the natural oils right in the skin. Perpetual youth! No brush. No rub-in. Try Barbasol—3 times—according to directions.



“Mister, you’re next!”

# Barbasol

For Modern Shaving

The Barbasol Company  
Indianapolis, Ind.

I enclose 10c. Please send trial tube.

Name .....

Address .....

P-M-11-27

## REGISTERED TRADE MARK

# CHEM-CRAFT

THE CHEMICAL OUTFIT

### Laboratory Work Bench

Here at last is a real Chemical Lab. Just what every Experimenter has wanted. The Work Bench is 44 in. long; 20 in. wide; 47 in. high; strongly made and nicely finished. Provides running water, a sink, shelves for chemicals and apparatus, and plenty of table space. Equipment consists of 60 chemicals, an assortment of useful apparatus and a Chemical Manual containing 608 experiments with descriptions, instructions and chemical information.

Laboratory Work Bench and Equipment \$35.00. Weight packed for shipment, 43 pounds.



### FREE Magazine

of the Chemcraft Chemists' Club sent to every one who writes for it now. Full of interesting chemical ideas and experiments. A post card will do—but do it now!

The PORTER CHEMICAL CO.,  
2113 Summit Avenue,  
Hagerstown, Maryland.

## 250 POWER MICROSCOPE

MADE IN U.S.A.

\$16<sup>50</sup>

Educational and entertaining, this fine instrument familiarizes young and old with life around us that is invisible to the unaided eye. Tiny insects appear as monsters. Plant and mineral life reveal new beauties in form and color. Ideal for students, home, office, dentists, physicians, scientists and laboratory. Precise optical qualities, giving variable magnification from 100 to 250 diameters. Tilting stand. Black finish, nickel trim. Complete with plush lined case, prepared slide and instructions. 100 Power model with same precise optical qualities and finish, without tilting stand, \$8.50. At your dealer or direct, post-paid. Money back guarantee.



Further information free upon request.

Wollensak Optical Company  
967 Hudson Ave., Rochester, N. Y.



# \$60 a week

Make \$60 a week and be your own boss simply taking orders for my amazing new, fast selling All-Weather Coat. World's biggest value—only \$3.98. At my bargain price every man, woman, child a red-hot prospect. Everyone buys! Stone cleared \$605 in 30 days.

### AMAZING NEW RAINCOAT

Never before such a value! This new coat is so attractive you'd expect it to cost twice its price. Finely tailored of high-quality, guaranteed rubberized fabric. Popular style. Six striking, vivid colors. Windproof, dust-proof and waterproof.

ONLY \$3<sup>98</sup>

### NO EXPERIENCE NEEDED

No capital required. I tell you what to do—I furnish everything absolutely FREE. Sample coat for demonstration at no cost. Spare time or full time. If \$60 a week sounds good to you, write at once for details of my amazing new money-making plan. No cost or obligation. Don't delay, write today.

C. E. COMER, Comer Mfg. Co.  
Dept. W-5126 Dayton, Ohio

# MOTORCYCLES



Price \$10 and up purchased through our Co-Operative Plan for as low as \$1.00 down and \$1.00 per week  
Indians Harley-Davidsons Ace  
Henderson and Cleverlands

Send ten cents for Bulletin A.  
Motorcycles shipped to all parts of the world  
WALKER-INDIAN CO., 78 Brookline Ave., BOSTON

# MOVIES AT HOME



Many models of genuine MOVIE MACHINES, some as low as \$3.75, all using standard size big theatre films. Our stock of films is the most complete and lowest in price—with an exchange service. Films of leading stars and religious subjects are available. DON'T DELAY, WRITE FOR FREE INTERESTING CATALOGUE NOW!

PARAMOUNT MFG. CO.  
Dept. 1371 BOSTON, MASS.

## New Improved SPORS Fountain Pen. 60 Day Trial. Money back if not pleased

GUARANTEED 2 YEARS—Improved Point  
LADIES' OR MEN'S STYLE



Comes in Red or Green

Agent's Sample 65c Sells for \$1.25. Writes like a \$7 Pen  
Make \$10 Daily Easily  
F. SPORS CO.

MAKES \$8.40 IN TEN MINUTES  
I sold my dozen pens in about 10 minutes. Will order another dozen soon. Tracy Kraus, Nebraska.  
Write for FREE Wholesale Specialty Catalog  
927 Main St. - Lesueur Center, Minn.



# All Electric Radio



*The Randolph*

## 7 Tubes-Single Control

**J**UST plug this Randolph Radio into the electric light socket—and tune in. A powerful, selective radio that gives dependable coast to coast reception. **No batteries, chargers, eliminators, acids or liquids.** Easy tuning with one control brings on all stations. Illuminated drum allows you to operate the radio in the dark and has space for logging stations. Every detail of the Randolph is modern and perfected, unsurpassed regardless of price. It is this wonderful radio that you test and try for 30 days FREE before you buy. When it convinces you by actual performance it is the ideal radio—you can buy it direct at factory prices. Be sure you write for free descriptive literature today.

### Beautiful Ampliphonic Console



Made of the finest carefully selected heavy solid burl finish walnut. Has built-in genuine large cone speaker that compares with any on the market. Assures unlimited reception of high and low notes clear as a bell. Completely electric—uses no batteries of any kind. Be sure you send for fully illustrated, full color folder giving complete details.

### Genuine Walnut Cabinets

The finest of heavy, genuine, solid burl finish walnut is used in the making of all Randolph cabinets. No picture can do them justice. You must see them to appreciate them.

### 6-Tube Radio

Do not compare this set with old-style, 2-dial, 6-tube sets selling for about the same price. The Randolph 1928 Senior Six has also been tested and approved by the leading radio engineers. Beautiful solid walnut cabinet. Single control. Illuminated drum with space for logging. Very selective. **Sent for 30 days free trial.**

**All Sets  
Guaranteed**

**30  
DAYS  
FREE  
TRIAL**

**6  
Tube  
\$55  
Retail  
Price**

**Biggest  
Discounts  
To  
Agents**



**Biggest Discounts to Agents**  
Work either full or part time and make big money. Sensationally big discounts to agents. No experience required. Randolph All-Electric Sets sell on first demonstration. Tremendous advertising campaign helps you. Men and women both make big money this way. Demonstrating set sent on 30 Days TRIAL. **WRITE NOW** for proposition.

**USE THIS COUPON TODAY!**

**Randolph Radio Corporation**  
711 W. Lake St., Dept. 226  
Chicago, Illinois

Send me full particulars about the RANDOLPH Six and Seven-Tube Electric and Battery Table and Console Sets with details of your 30 Day FREE Trial Offer.

Name.....

Address.....

City..... State.....

Mark here  if interested in Agent's proposition.

**RANDOLPH RADIO CORPORATION**  
711 W. Lake Street, Dept. 226 Chicago, Ill.



# Cunningham RADIO TUBES

There is an appreciable difference in tone quality and the performance of your set, with a Cunningham Radio Tube in every socket.

To neglect quality in even one of your tubes—the nerve center of your receiver—is to endanger the over-all performance of your set.

Your dealer will tell you the correct types of Cunningham Radio Tubes your set is designed to use.

*Twenty types—all in the Orange and Blue cartons*

**E. T. CUNNINGHAM, Inc.**  
New York Chicago San Francisco



## AT LAST! — Control of RADIO Reception from Your Easy Chair

Turn set on and off—get station after station—swiftly—surely—DX—without leaving your easy chair.



The NEW  
*Thermodyne*

### REMOTE CONTROL RADIO TUNING UNIT

No other tuning unit in the world like it. Tune your set from any room

of your home. Attached to any single dial receiver with removable dial in a few minutes by removing old dial and attaching adapter plate with Remote Control Unit.

Mechanical Model . . . . . \$18.00  
Electrical Model . . . . . \$60.00  
West of Rockies, add 10%

Write today for circular describing radio's newest and most revolutionary development.



**ALGONQUIN ELECTRIC COMPANY, Inc.**  
Leo Potter, President  
245 Fifth Avenue New York City

## ALL THAT'S NEWEST IN RADIO GOODS



with better service, quicker shipments and lower prices that give you, as a retailer tremendous advantages over your competitors. Write at once for the

### Greatest Catalog of Radio Goods, Sets, Kits and Parts—GET YOURS!

No order too small—none too large to receive painstaking attention. Check the prices in this wonderful book with invoices you are paying. Note: We sell only to radio retailers. Write today!

**The Harry Alter Co.**  
1782 Michigan Avenue CHICAGO



# THE THINGS YOU WANT WITH THE KIND OF TOOLS YOU MOST DESIRE

**ONLY  
\$10  
DOWN**

**SENT  
ON  
TRIAL**

**YOUR**

**Own  
Terms on  
Purchase**

**\$10.00  
down—  
balance  
arranged  
to your  
conven-  
ience.  
Liberal  
discount  
for cash.**

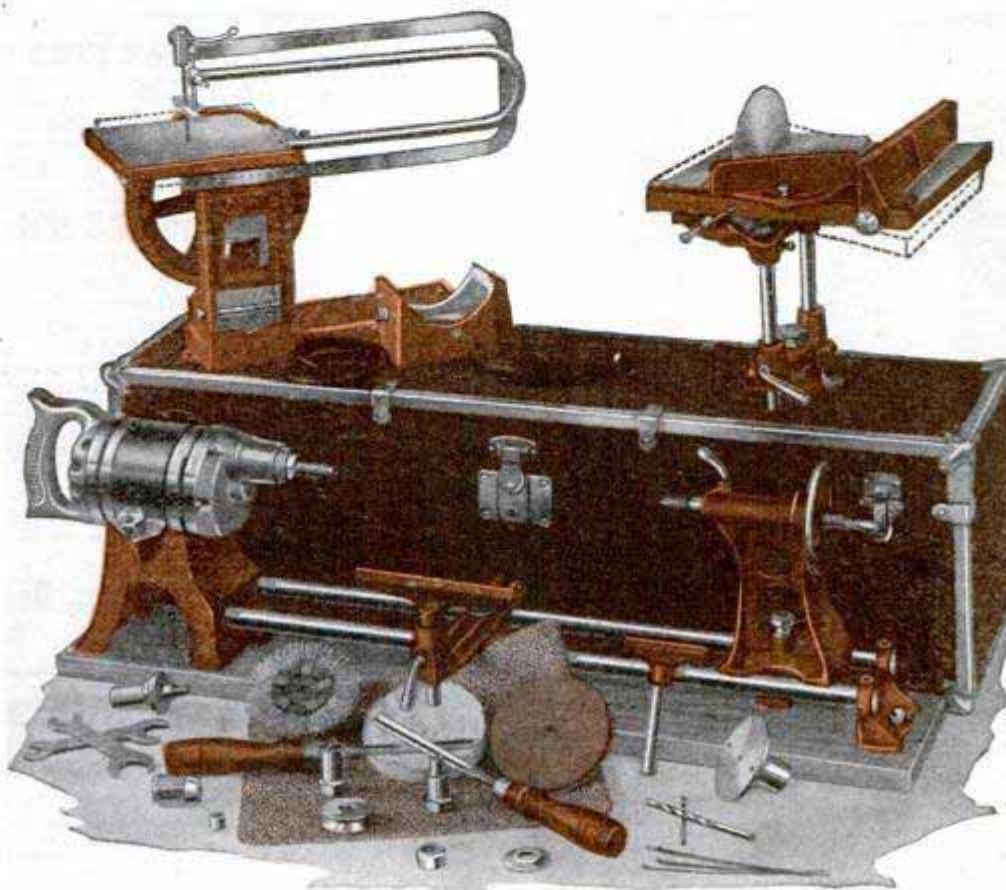

**OUR**

**Liter-  
ature  
Gives  
All  
De-  
tails**

## UP-TO-DATE HOME-CRAFTSMAN SHOP

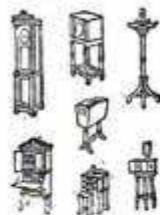

Home Craftsmen, Cabinet and Pattern Makers, and manufacturers have found our shop invaluable in making the commodities of their business. Portable, compact and inexpensive, this Shop can be afforded by any Home or Shop mechanic. **\$10.00 down** makes it possible to outfit your bench with this equipment equal in efficiency and accuracy to any professional machine shop.

The Up-to-Date Home Craftsman Shop, shown above, which can be operated from any home electric light fixture, consists of a Super-

½ Horse Power Motor, a Genuine Precision Lathe—(10 in. x 34 in.), a six-inch Circular Saw, featuring the Tilting Table Bevel, Miter, Side and Depth Gauges, a Superior Jig Saw for scroll work, all accessories for buffing, grinding, etc., and all portable or stationary drilling and sawing.

Volumes of interesting literature explaining the shop in detail may be had without any obligation on your part by mailing the corner coupon.



**15" Band Saw Accessory to Up-to-Date Shop**



**Our Educational and Blue Print Departments**

Under personal Supervision of Master craftsman Eugene E. Maurey offers FREE to our users a special correspondence crafts course giving in simple detail full information on home handicraft. Working blue prints and other items are given free with this course.

**4" Jointer Accessory to Up-to-Date Shop**

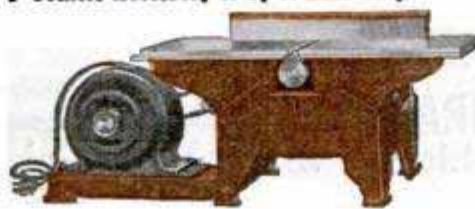

**GUARANTEE**

After receipt of the Up-to-Date Homecraftsman's Shop if you are not satisfied, without question or delay every cent refunded and return express charges paid.

**10 DAY FREE TRIAL**  
Use our shop for 10 days at our expense. If not satisfied—return—express collect.

**MAIL THIS**

for full particulars to

**Up-to-Date Machine Works  
2915 S. Wabash Ave., Chicago, Ill.**

MANAGER, Dept. B. Without any obligation, please send me all particulars about your shop, 10-day free trial, free blue prints, free crafts course, also \$10.00 down payment offer.

NAME.....  
ADDRESS.....





# Transformers

An Amazing Achievement in Audio Amplification

The new C-16 and C-25 Transformers will work in any circuit and will improve any Radio Set. Endorsed by America's Leading Engineers. Guaranteed by the Manufacturers

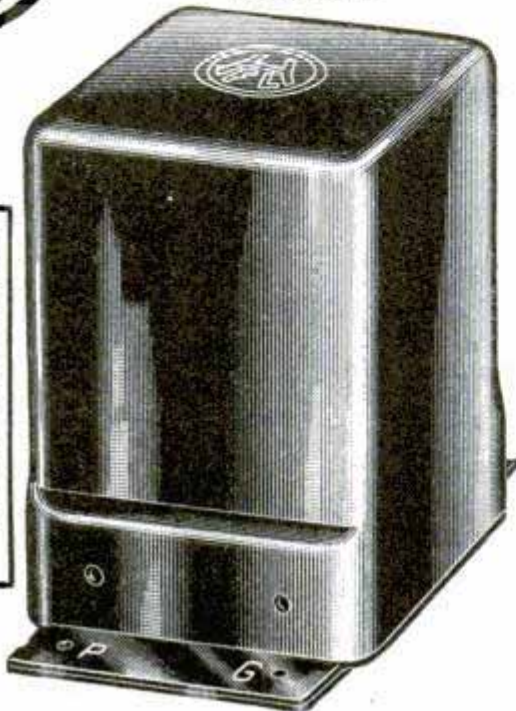

## Two additions to last year's Radio Sensation

H.F.L. C-16 is the most efficient Audio Transformer built. It carries signals at highest volume and lowest amplitude without blasting or developing harmonics. Operates with all power tubes as well as standard tubes.

H.F.L. C-25 Output Transformer handles the voltage output of power amplifying tubes, at the same time matches the impedance of the average speaker to the tubes. Protects loud speaker unit without reducing plate voltage.

Mechanical features of these two transformers are: A coil designed and treated to exclude moisture and withstand heavy electrical surges without breaking down—complete magnetic shielding to avoid inter-stage coupling—terminals brought out so as to insure short leads.



### PRICES

- H-210 Tran. \$8.00
- H-215 Tran. 8.00
- C-16 Transf. 8.00
- L-425 R. F. Choke... 5.50
- L-430 R. F. Transform. 5.50
- C-25 Output Transform. 8.00

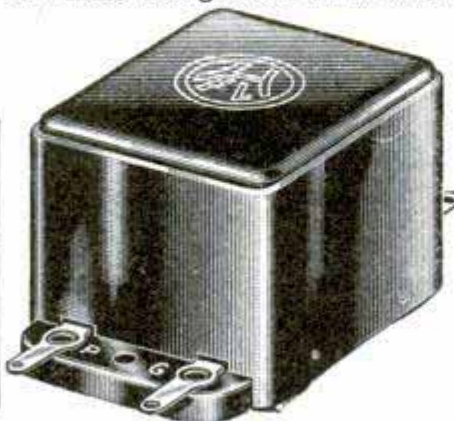

**SET BUILDERS! Write Us for the Name of Our Nearest Distributor**

**HIGH FREQUENCY LABORATORIES**  
131K—North Wells St., Chicago, Ill.

## The Famous AERO SHORT WAVE KIT NOW IMPROVED

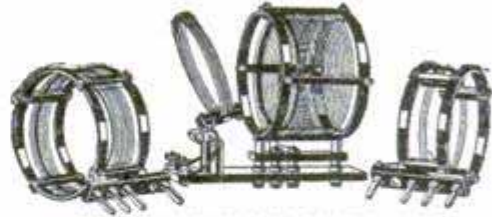

### AERO LOW WAVE TUNER KIT

Code No. L. W. T. 125..... Price \$12.50

Always the prime favorite of all experts and amateurs insistent upon the very best in short wave reception, the AERO Low Wave Tuner Kit for this season has been made even better than ever!

### Range 13 to 725 Meters

The AERO Low Wave Tuner Kit illustrated above is completely interchangeable. The kit itself includes 3 coils and base mounting covering U. S. bands 20, 40 and 80 meters. You can increase the range of this kit to 725 meters by use of AERO interchangeable coils No. 4 and 5 (Price \$4.00 each) or you can decrease the range to go as low as 13 meters by use of AERO interchangeable coil No. 0 (Price \$4.00).

By all means build the new AERO Short Wave Set. The AERO coils used in its construction can be procured from your dealer or direct from our factory. We have also arranged to furnish the Westinghouse Micarta drilled and engraved panel for this receiver direct from our factory. Write us at once for full information.

**AERO PRODUCTS, Inc., Dept. 107**

1772 Wilson Avenue

CHICAGO, ILL.

## MUSIC IN THE AIR!



This wonderful new invention makes it possible A high grade radio loud speaker in a beautiful tapestry picture, handsomely framed. Does away entirely with old style speakers—and beautifies your home.

### YOUR OWN FREE!

Write today! Let us show you how to get your own WALART Speaker absolutely FREE by introducing it in your community. Act NOW!

**WALART SPEAKER CO.**

619 D South Tenth Ave.

Maywood, Ill.

**\$75 to \$125 Weekly**

**5 Down Charging Batteries Starts You**



Let me show you how to make big money right from the start. I've prepared a FREE book explaining all details. First week's profit pays for all equipment. You can get all the battery charging business in your community with my Service Station Charger—it's years ahead of ordinary chargers—handles 50% to 70% more batteries. I explain everything—start you in a business of your own and put you on the way to big money. Write for FREE Book.

**C. F. HOLMES, Chief Engineer, Dept. PM**  
Independent Electric Works, 5116 Ravenswood Ave., Chicago

**FREE BOOK—Just Out**





**TRY IT 30 DAYS FREE**  
BEFORE YOU BUY

**ALL METAL SHIELDED CHASSIS**

**FACTORY PRICES - SAVE 50%**  
Choice of beautiful cabinets offered

3 Year Guarantee

**8 tube - one dial**  
**MIRACO**  
TRADE MARK REGISTERED

**Only \$69.75**  
Retail List Completely Assembled

**MAGNIFICENT TONE - SUPER SELECTIVE - POWERFUL DISTANCE GETTER**

**All Electric or Battery Set** *Big Discounts to User-Agents*

America's big, old, reliable Radio Corporation (8th successful year) **guarantees** in its big, powerful, latest 6, 7 and 8 tube Miraco sets "the finest, most enjoyable performance obtainable in **high grade radios.**" Unless 30 days use in your home fully satisfies you a Miraco is unbeatable at any price for beautiful, clear cathedral tone, razor-edge selectivity, powerful distance reception, easy operation, etc. — **don't buy it!** Your verdict final! Save or make lots of money on sets and equipment — write for testimony of nearby users and **Amazing Special Factory Offer.**

Miracos work equally fine on "AC" electric house current or with batteries. Take your choice. Many thousands of Miraco users — who bought after thorough comparisons — enjoy programs Coast to Coast, Canada to Mexico, loud and clear — with the magnificent

cathedral tone quality of costliest sets. Don't confuse Miraco's with cheap, "squawky" radios. Miraco's have finest parts, latest approved shielding, metal chassis, etc.—as used in many \$200 sets.

**DEAL DIRECT WITH BIG FACTORY**

Your Miraco reaches you completely assembled, rigidly tested, fully guaranteed. Easy to connect and operate. **30 days trial free.** 3 year guarantee if you buy. You take no risk, you insure satisfaction, you enjoy **rock-bottom money-saving prices** by dealing direct with one of radio's oldest, most successful builders of fine sets. 8th successful year.

**7 tube one dial METAL SHIELDED CHASSIS \$49.75 RETAIL LIST**

MIRACO "Powerplus" sets—8 and 7 tube models—have magnificently beautiful, clear cathedral tone quality. Turn one dial for stations everywhere. Ultra-selective. Latest all-metal shielded chassis, illuminated dial. Fully guaranteed. Try one free for 30 days! Big selection of beautiful cabinets.

**Dealers Write!**

**MIRACO Radio gets 'em Coast to Coast**

**USER-AGENTS!** Make big profits showing Miraco to friends. Get Our Special Wholesale Prices! **MID-WEST RADIO CORPORATION, Cincinnati, O.**

**BEAUTIFULLY ILLUSTRATED CATALOG AND AMAZING SPECIAL OFFER**

**Free!**

SEND NO MONEY—30 DAYS' TRIAL, Special Wholesale Price Offer to User-Agents, Bank References, testimony of nearby Miraco users — all the proof you want—sent with catalog.

**mail coupon right now!**

**Electrify Any Radio with MIDWEST NO-BATTERY AC Light Socket Power Units**

"A", "B" and "C" power, direct from light socket, without batteries! Write for Midwest prices and discounts. Units are highest grade—lastingly dependable, quiet in operation, fully guaranteed. Mail coupon!

**ANOTHER BIG BARGAIN!** Famous powerful big Miraco Super 6, 1928 model—ultra selective! Thousands find it outperforms sets of much higher price. **30 Days' Trial Free. Fully Guaranteed.**

**6 tube Super \$36.75 RETAIL LIST**

**MIDWEST RADIO CORP'N**  
Pioneer Builders of Sets  
407-C Miraco Bldg., Cincinnati, Ohio.

WITHOUT OBLIGATION, send me free literature, AMAZING SPECIAL WHOLESALE PRICE OFFER, testimony of nearby users, etc.

NAME \_\_\_\_\_

ADDRESS \_\_\_\_\_

**THIS COUPON IS NOT AN ORDER**



# 18 Tools In One S & B SAW *Money Back Guarantee* 8" Combination S & B. *15 DAYS TRIAL*

The S&B 8-in. Combination Saw (18 tools in one) is the ideal machine for the shop, factory or the home; will rip, cross cut, bevel, miter, mortise, groove, drill, tenon, grind, rabbet, buff and polish. The greatest machine you ever saw;

**\$35**

F. O. B. CHICAGO

no other machines so complete and efficient as the S&B—actually 18 tools in one! You will marvel at the wonderful bevel-

ing, grooving, buffing, etc. All attachments are adjusted in a few seconds without any difficulty. Very little space is used and the motor is mounted on a base that is a part of the machine proper, this is an exclusive feature! The motor: 1/4-H.P., 60-cycle, 110-volt A.C., run from any light socket also provides power for other purposes when the saw is not in use. Complete with attachments: 12-in. x 16-in. Table, 8-in. Combination Saw, Iron Pulley for Saw Table, 10-in. Ripping Fence, Adjustable Cut-Off Miter Gauge, Motor 1/4-H.P., 3-in. Iron Pulley, 6-in. Buffing Wheel, 5-in. Emery Wheel, 6-in. Sander, 3/4-in. 3-Jaw Drill Chuck, 1 1/4-in. Endless Leather Belt, 8-foot Cord and Plug, Saw Guard and 2-in. Dado Insert. Price \$35.00, F.O.B. Chicago. Shipping weight 100 lbs. (Planer attachment to fit on table top will smooth pieces up to 2 in. wide, \$12.00 extra. Flexible Shaft Grinder attachment, \$35.00 extra.)

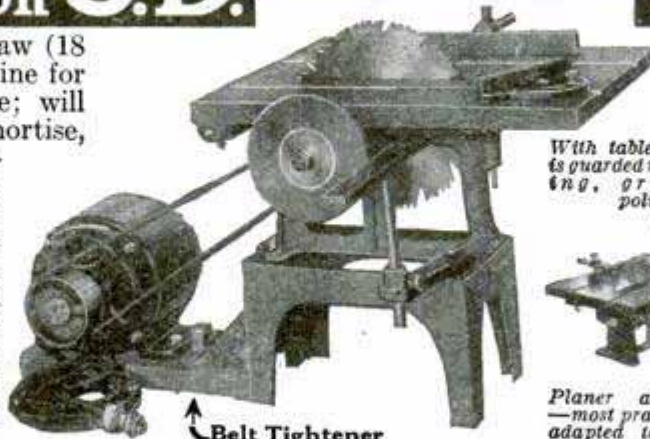

Belt Tightener

With table raised—saw is guarded ready for drilling, grinding or polishing.



Ready for dado or planer head and special molding work—Table is adjustable.

Planer attachment—most practical ever adapted to a saw table.



Flexible shaft grinding attachment—especially good for metal patterns, routing, grinding, die-castings, etc.



The only machine that you can tilt the table to 45° without removing insert. Big advantage on pattern work.

Write for Complete Illustrated Folder

**SCOTT-BANSBACH MACHINERY CO.**

130 So. Clinton St.

Dept. 57

CHICAGO, ILL.

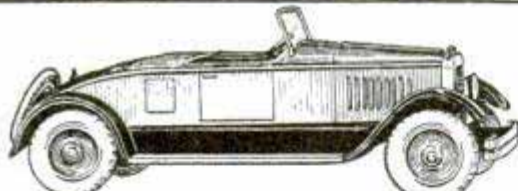

Kingsbury Roadster No. 343  
13 1/4 in. long. Price \$3.00

Prices slightly higher west of Miss. and in Canada

**LOTS OF SPORT!**

This little toy sport car will be the envy of all the boys and girls around! In every detail just like the big new 1928 roadsters. Stream line model with handsome ivory body and red top. Big balloon tired wheels. Bumpers, spare wheel, etc. Ask to see it at the store where your toys are usually bought. If it isn't yet being shown, write us for free catalog.

**KINGSBURY MFG. CO.**

83 Myrtle Street

KEENE, N. H.

**KINGSBURY MOTOR DRIVEN TOYS**

Send 10c for the Kingsbury Disc Wheel Eraser

DEALERS: Kingsbury toys are always "best sellers." Write for our Proposition.

## RADIO AGENTS Make Big Money

EASY to sell American Radios and Supplies. Nationally advertised, high quality merchandise at wholesale. Big profit on every sale. No capital to invest. No stock to carry. Order direct from my huge warehouse as you sell.

Get My Liberal Offer and also Big New 182-page Catalog and Guide—"How to Sell Radios"—Free. Full of Bargains—all latest in Radio. Write today.

**AMERICAN AUTO & RADIO MFG. CO.**

HARRY SCHWARTZBERG, PRES.

Dept. 266 American Radio Bldg., Kansas City, Mo.



**NEW TIMER FOR FORDS**  
MARVELOUS INVENTION  
FREE OFFER TO USERS  
**FORDYNA MO**  
60,000 MILES WITHOUT TROUBLE

WRITE TODAY FOR FREE OFFER

Agents Wanted Everywhere

Eclipse Timer Co., 2932 Meinecke Av., Milwaukee, Wis.

Information on any book free. Write Popular Mechanics Press, Chicago, Ill.

# I'll Pay Your Bills



and give you a steady income for the rest of your life, if you'll take care of my business in your locality. No experience needed. Full or spare time. You don't invest one cent, just be my local partner. Make \$15.00 a day easy. Ride in a Chrysler Sedan I furnish and distribute teas, coffee, spices, extracts, things people eat. I furnish everything including world's finest super sales outfit. Lowest prices. Big, permanent repeat business. Quality guaranteed by \$25,000.00 bond.

**GET FOOD PRODUCTS**

I'll send big case of highest quality products, 30 full size packages of home necessities.

**WRITE AT ONCE**

for full information. With person I select as my partner, I go 50-50. Get my amazing offer for your locality. Write or wire.

**C. W. VAN DE MARK**

Dept. 101-MM, 117 Duane St., Cincinnati, Ohio.



# Radio Inventor Discovers MAGIC DIAL THAT "FILTERS OUT" STATIC!

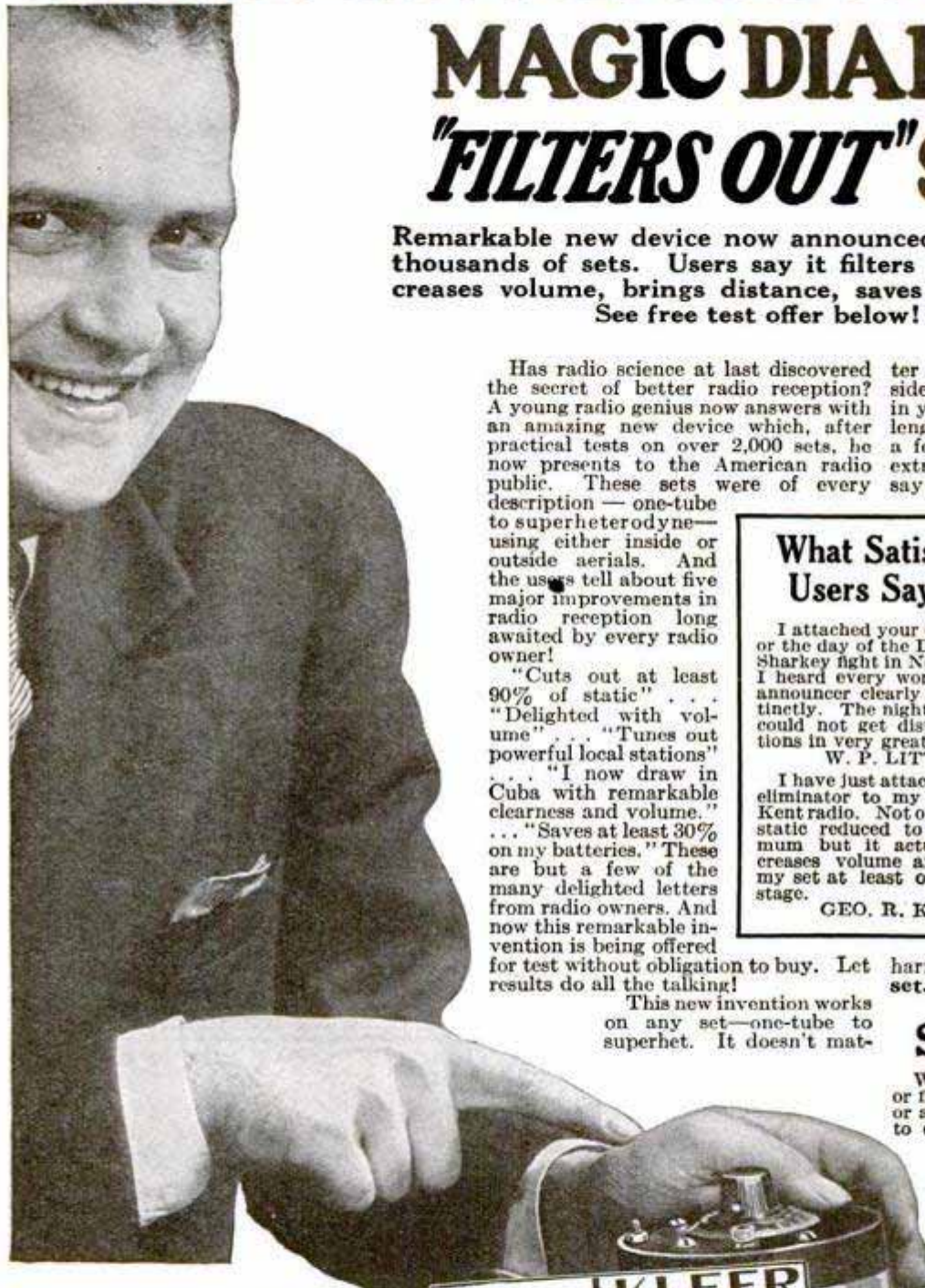

Remarkable new device now announced after test on thousands of sets. Users say it filters out static, increases volume, brings distance, saves battery wear. See free test offer below!

Has radio science at last discovered the secret of better radio reception? A young radio genius now answers with an amazing new device which, after practical tests on over 2,000 sets, he now presents to the American radio public. These sets were of every description — one-tube to superheterodyne—using either inside or outside aerials. And the users tell about five major improvements in radio reception long awaited by every radio owner!

"Cuts out at least 90% of static" . . .  
"Delighted with volume" . . . "Tunes out powerful local stations" . . .  
"I now draw in Cuba with remarkable clearness and volume." . . .  
"Saves at least 30% on my batteries." These are but a few of the many delighted letters from radio owners. And now this remarkable invention is being offered for test without obligation to buy. Let results do all the talking!

This new invention works on any set—one-tube to superhet. It doesn't mat-

ter whether you have an outside or inside aerial. And no change is necessary in your present hook-up. With a small length of wire anybody can attach it in a few minutes. And by just a little extra care in fine tuning, radio owners say it works miracles.

### What Satisfied Users Say—

I attached your eliminator the day of the Dempsey-Sharkey fight in New York. I heard every word of the announcer clearly and distinctly. The night before I could not get distant stations in very great volume.  
W. P. LITTELL.

I have just attached your eliminator to my Atwater Kent radio. Not only is the static reduced to a minimum but it actually increases volume and gives my set at least one more stage.  
GEO. R. KLINE.

### What Science Knows About Static

All radio authorities agree that no apparatus yet discovered has been successful in completely wiping out static and other interfering noises—to which the inventor takes no exception. But he says: "I have approached the solution of static from an entirely new angle. I have not attempted to block it, but have worked on the principle of filtering these noises down to a

harmless degree before they enter the set.

### See for Yourself

Whether you bought your set yesterday or five years ago—whether it's homemade or a late model—this is your opportunity to experience the same marvelously improved reception that is attested to on this page. Don't send a penny now. Simply fill your name and address in the coupon.

It will bring you full description of Kleeer-tone and how you can test it on your set to make sure of results before you buy. No obligation, of course, so tear out the coupon now. C. H. Geppert, Pres., Geppert Mfg. Co., P-207 Hewitt Bldg., Des Moines, Iowa.

## AGENTS! BIG MONEY

Find out about the money-making plan back of this new service to radio owners. Every radio owner wants to improve his reception. Easy demonstration and fast profits. Fred Johnson made \$75.00 in one week, just devoting evenings and Saturday afternoons. Ryan sold 36 in one afternoon. No experience required. We show you how to demonstrate quickly. See if this isn't the proposition that doubles your income. Check coupon at the right and mail today while your territory is still open.

Geppert **KLEER TONE**  
for RADIOS

FREE, SIMPLY SEND YOUR NAME

C. H. Geppert, Pres.,  
Geppert Mfg. Co.,  
P-207 Hewitt Bldg., Des Moines, Iowa

Yes, send me full details of Kleeer-tone and your free test offer. This request does not obligate me to buy.

My Name is.....

Address.....

City..... State.....

( ) Check here if you want to receive agent's money-making plan.



The Old Reliable Credit Jewelers **LOFTIS** BROS. & CO. EST'D 1858 Dept. F-894 108 N. State St., Chicago, Ill.

## DIAMONDS FOR CHRISTMAS

Genuine Diamonds Guaranteed **CASH OR CREDIT**

For 69 Christmases Loftis has served the American public with better gifts at lower prices. Let us help you make some loved one happy. Our Diamonds are exquisitely beautiful gems set in solid 18-k white gold hand engraved rings. Buy from a house of established reputation—our prices defy competition.

**Diamonds Win Hearts** **Win Her with a Diamond**

Satisfaction guaranteed or money back. Goods sent for your free examination on request. Credit terms: Pay one-tenth down; balance weekly, semi-monthly, or monthly at your convenience. All goods delivered on first payment.

**WEDDING RINGS**  
No. 824—The "Elite" \$7.50 solid 18-k white gold  
Set with 3 Diamonds, \$22.50; 5 Diamonds, \$32.50; 7 Diamonds, \$42.50; 9 Diamonds, \$52.50; 12 Diamonds, \$67.50.  
Men's strap watch, nickel, cushion shape, high-grade movement, fine leather strap ..... \$8.50

**Wrist Watch No. 866**  
Solid 14-k white gold. High grade 15-Jewel movement. Fancy corners; \$15.00, \$1.50 down and \$1.50 a month.

**Men's Diamond Ring No. 860**  
Solid 18-k white gold—fine blue white Diamond. Special bargain! \$75.00, \$1.75 a week.  
All makes of Railroad Watches, guaranteed to pass inspection. Credit at Cash Prices.  
All standard makes this model watches, green or white gold to suit your needs—\$10 and up.

**CHRISTMAS CATALOG FREE!**  
Big 132-page book, illustrating our Diamonds, Watches, Jewelry, Silverware, and gift articles for all occasions, sent absolutely free. Write today. On request we will ship any article (NO MONEY DOWN) subject to your free examination and approval.

**SHIP MODEL PLANS!**  
fittings and supplies. Build and sell models. Plans and instructions for Viking Galley 40c; Chinese Junk 45c. Interesting catalog of Sea Things 6c.  
**SEA ARTS GUILD**  
730A Winnebago St., Milwaukee, Wis.

The man who studies gets ahead. Popular Mechanics Press will advise you what books to read to advance in your trade. 200 East Ontario Street, Chicago, Illinois.

The **QUICKEST** and **MOST ECONOMICAL RESULTS**  
**JUNIOR CABINET WORKER**  
**\$156.00**  
complete with motor

Make just what you want, now you want it and when you want it. Nothing else to buy.

**KORNAU MACHINE CO.**  
Station A, CINCINNATI, OHIO

This machine does it all.  
Write for details

The **NEW** 3 Ft. Cone Loud **"ENSCO"** Wall Type Speaker

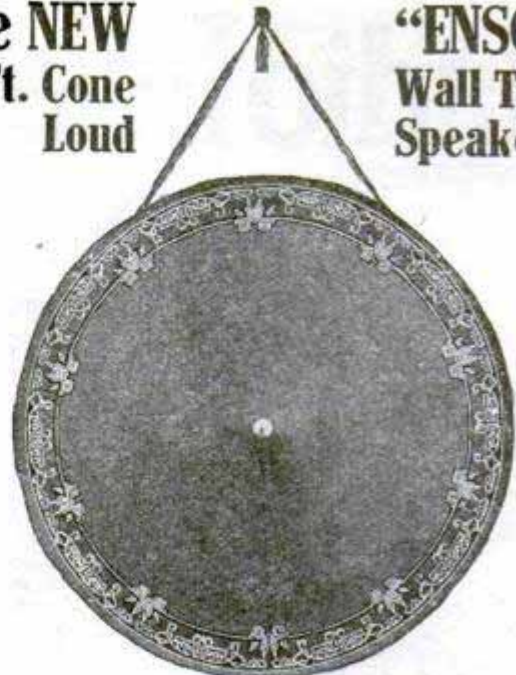

**STANDARD "ENSCO" KIT - - - \$10.00**  
**With Hardwood Frame - - - \$11.00**

As described in the July issue of Popular Mechanics  
Anyone can assemble the "World's Finest Loud Speaker" in less than an hour, from the complete "Ensko" Kit. Six styles and 3 sizes to choose from. All described in the illustrated instruction book. Fully patented. At your dealer's or direct from any of the offices listed below. Send check, money order or C. O. D. (Shipping charges paid). In Canada \$11.50 and \$12.50. Absolute money back guarantee.

**ENGINEERS' SERVICE COMPANY**

25 Church Street, New York 73 Cornhill, Boston  
28 E. Jackson Blvd., Chicago 331 Bay St., Toronto, Canada

**\$25.00 A DAY PROFIT**  
You and the wonderful new HB Paint Spray Outfit can do the work and get the wages of 5 men with Brushes. Paint Autos, Houses, Barns, Factories and Furniture—do any paint job in one-fifth the usual time.  
**Painting By New, Quick Method!**  
No special experience necessary. Pays for itself on easy monthly payments with practically no expense to you. Full information in Bulletin M1171.  
**HOBART BROTHERS CO., Box M1171, Troy, O.**

**LIGHTING FIXTURES**  
*Ready to hang*  
Direct from the manufacturer. Completely wired, including glassware. Send for new catalogue No. 28. Just Reduced Prices. *Special Proposition to Dealers.*  
**Erie Fixture Supply Company, Inc.**  
Station A ERIE, PA.

**Agents!**  
**\$10 a Day!**

Sell Hutchins made-to-measure trousers at factory prices. Sensational values, big saving, makes men buy quick. Many order two and three pairs. Collect your big profit in advance. \$10 to \$20 a day is easy. Many make more. Seal of Ohio cleared \$33 in one day. No experience necessary. We show you how.

**Outfit and Trousers FREE**

Send no money—just name and address on postal. Big new outfit with scores of new patterns, new line men's belts, full instructions and **FREE PANTS** offer sent at once. Write quick! Best season right now.

**HUTCHINS PANTS CO.**  
Dept. N-160, Cincinnati, Ohio



Fastest Cutting

Saws Fifteen Cords a Day!



Men—  
Let Me Send You My  
Greatest LOG SAW Offer!

**ONLY**  
**\$39**

Puts the OTTAWA Working for YOU!

It's easier now than ever before to own this fastest-cutting, easiest-moved, most powerful Log Saw. Now, you can make big money sawing firewood, stave-bolts, ice, shingle timber, etc. Write today for full details of this most wonderful offer. Know how easy it is to make big money sawing fifteen cords of wood a day with no hard work.

**350 Saw Cuts a Minute—**

nearly six each second. Just think of it—now you have a log—in a few seconds it's all sawed up into lengths you can use—without any hard work! The OTTAWA has balanced crank shaft, power force feed, friction clutch.

**Make BIG MONEY—**

Wood selling at \$3 a cord brings owner \$45 a day. Saw your own wood—go into the wood business. Don't let the lack of ready money stop you. Remember, we sell on very easy terms. More in use than all others combined.

"I average \$20 profit a day with my OTTAWA."—J. Schill, New York. "My OTTAWA has earned \$700 for me."—S. Graham, Wisconsin. "I can make more money with the OTTAWA than by farming."—D. Goff, Missouri.



# OTTAWA 4 H.P. LOG SAW

**30 Days to Try**—one whole month to use the OTTAWA at your own sawing. Shipped on trial only—backed by 10-year guarantee. Prove to yourself how easy you can saw 15 cords or more a day—at a cost of 1 1/2¢ a cord.

**To Save You Freight**—and get your machine to you a few days after you order, I ship from: Ottawa, Kan.; Pittsburgh, Pa.; St. Paul, Minn.; Albany, N. Y.; Memphis, Tenn.; Indianapolis, Ind.; Pueblo, Colo.; Ft. Worth, Texas; Portland, Ore.; San Francisco, Cal.

**FREE** Send me your name and address on postcard today, so I can send you my wonderful new edition of the "Wood Sawing Encyclopedia." Educational, instructive. Be sure to investigate—will help you to make big money.

**HARRY OVERMAN, Pres. OTTAWA MFG. CO.**  
1742-P Wood St., Ottawa, Kans. Room 1742-P, Magee Bldg., Pittsburgh, Pa.



Lathes \$6.00 to \$75.00. Largest line of small lathes in America. Send four cents for 24 page catalog of lathes, drill presses, bench saws, jig saws, band saws, etc.

**SYPHER MANUFACTURING COMPANY**  
Dept. D Toledo, Ohio

**\$10.00**  
**DOWN**  
**Brings this Lathe to You**

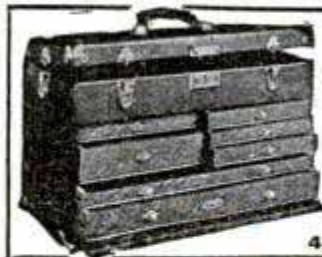

High Quality. Long Life. Right Prices. These are found in all Gerstner **TOOL CASES AND CHESTS** for Machinists and Toolmakers. A postal brings free catalog.

*Gerstner Sons*

447 Columbia St., DAYTON, OHIO

## YOU NEED SARGENT PLANES

See them at your hardware dealer's. For booklet write **Sargent & Company, Manufacturers**  
49 Water Street New Haven, Conn.

## Makes Old Ford a Tractor

Now you can convert that old Ford car into a useful farm tractor without altering any Ford parts. We furnish the traction wheels, drive gears and auxiliary axle and mountings, ready to clamp on to the Ford frame. Pulls 16" plow.

Write for Free Particulars.  
**SHAW MFG. CO., Dept. S, Galesburg, Kan.**



Comes from the Can Like Putty

## PLASTIC WOOD

Hardens into Solid Wood

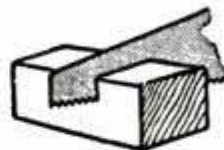

It solves the problem of damaged woodwork and is invaluable around the house. It sticks everlastingly to metal, wood, stone, plaster or fabric; takes paint, stain, varnish or lacquer; is workable with tools, but will not chip or splinter.

1/4 lb., 35c.; one pound \$1.00

Sold by Hardware and Paint Stores. Send coupon if they cannot supply you

**ADDISON-LESLIE COMPANY**  
47 Bolivar Street, Canton, Mass.  
Please send me 1/4 lb. can of **PLASTIC WOOD** for which I enclose 35c.

Name.....  
Address.....



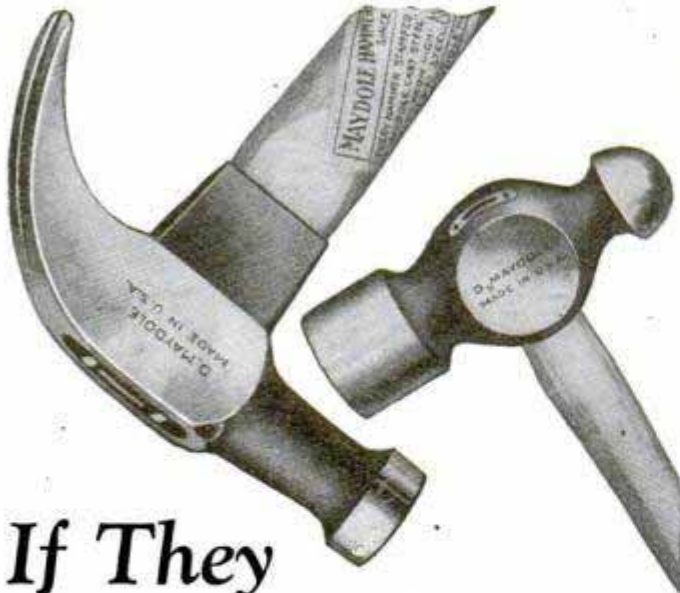

## If They Cost \$10. Apiece

If you had to pay as much for your hammers as for the more expensive tools in your kit—you'd buy Maydoles.

Maydole Hammers are built as painstakingly as the finest precision tools. The heads are press-forged from the best tool steel obtainable and then tempered with exacting accuracy. The handles are shaped from clear, second growth air-dried hickory and put on to stay.

Ask your dealer to show you the genuine Maydole Hammer. He carries the style and weight you prefer. Write us to send you a free copy of useful Pocket Handbook 23 "L".

**YOUR HAMMER SINCE 1843**  
**Maydole**  
**Hammers**

The David Maydole Hammer Co., Norwich, N.Y.



1171

# \$5.00 Down buys a WITTE Engine

**Write Me Today**—for new FREE Witte Book telling how you can buy a WITTE Engine for ONLY \$5.00 Down and small EASY Payments. No interest. Absolutely the greatest engine made. Guaranteed for a lifetime. Used all over the world—from the frozen wastes of Alaska to the burning sands of Arabia. Will increase your farm profits \$500.00 to \$1,000.00 a year. Runs on all fuels. Simple, sturdy. Gives most power at least expense. Sizes 1 1/4 to 30 H. P. Engines; also 3-in-1 Saw Rigs and Pump Outfits. Write me today for FREE book and Easy Terms Offer.

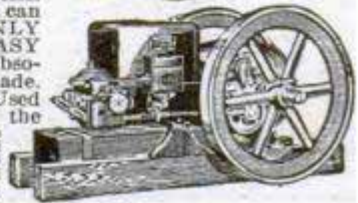

**Witte Engine Works**  
 1748 Witte Bldg., Kansas City, Mo.  
 1748 Empire Bldg., Pittsburg, Pa.

## Crescent Wood Working Machines



are neat in design, substantially built and are intended for hard, continuous service. Users of wood working machinery who appreciate quality always investigate Crescent machines before placing their orders.

Send today for circulars of Band Saws, Saw Tables, Self Feed Rip Saw, Shapers, Jointers, Variety Wood Worker, Planers, Planer and Matcher, Disk Grinders, Cut Off Table, Swing Saws, Borers, Hollow Chisel Mortisers, Tenoners, Universal Wood Workers.

**The Crescent Machine Co.** 93 Columbia St. Leontia, Ohio, U. S. A.

## I made \$250<sup>00</sup> extra in 3 months with my TORIT handy Torch



**THOUSANDS OF MECHANICS** in the U. S. and Canada are doing the same—Cashing in on quick, easy profits. One man writes, "I received my Torit Torch in the morning and by night had made an extra \$7.50 on jobs I ordinarily turn down. The Torit has already paid for itself and is now the **HANDIEST TOOL IN THE SHOP.**" Beats anything you ever tried for soldering, lead burning, radiator repairing, etc.



TIP 24, MEDIUM FLAME



TIP 20, FOR RADIATOR & BATTERY WORK



TIP 28, LARGE FLAME



TIP 23, FOR HEATING SOLDERING COPPER



SOLDERING COPPER USE WITH TIP NO 23



ADAPTER - E USE WITH TIPS 20 & 28

PAT. JAN. 5, 1926

Uses Acetylene Only. No oxygen or air pressure is required. Tips suck in air. Simply connect to Presto auto tank, light gas, and outfit is put to work. Consists of torch, 4 tips, soldering copper, 5 ft. rubber tubing, tank connection and instructions. Price **\$7.50**

**ST. PAUL WELDING & MFG. CO., 177 W. 3rd St., St. Paul, Minn.**



# SIMONDS

**CIRCULAR SAWS  
AND MACHINE KNIVES  
FOR EVERY CUTTING PURPOSE**



## GOOD TOOLS STOP WASTE

Tardy production means avoidable waste. Waste due to tool failures can be eliminated by using Simonds Saws, Machine Knives and Files.

**SIMONDS SAW AND STEEL COMPANY**

"The Saw Makers"

Fitchburg, Mass.

Established 1832

Branch Stores and Service Shops in Principal Cities

### BURN YOUR NAME ON TOOLS

#### WITH THE **ARKOGRAF**

#### PROTECT YOUR TOOLS FROM THEFT

Write with electricity any name or design on the hardest and finest tools and instruments, or any metal, like writing on paper with pen or pencil. **Complete Outfit \$3.50**—Prepaid Anywhere Interesting Illustrated circular free. Write today. Agents wanted. **ARKOGRAF PEN CO., 1171 E. Stark St., Portland, Oregon**



## Interlox "A good rule that works both ways"

### MASTER SLIDE RULE

for accurate inside and outside measurements. Quickest, handiest, strongest. It slides—no folding. All lengths, 2 to 8 ft., 20c per lineal ft. If not at dealers, sent postpaid.



**MASTER RULE MFG. CO., 813 E. 136th St., New York**  
Dealers and Agents: Write for attractive proposition.

## \$25.00 a DAY-CLEAR

### SURFACING FLOORS

Write Quick for Details

Scores of inexperienced men whom we started as American Universal Floor Surfacing Contractors are making up to \$10,000 a year in this wonderful new, uncrowded field. Electrically driven American Universal Machines do 500% more work and 100% better work than most expert hand scraper, and earn six men's pay. Work is plentiful, fascinating, immensely profitable. Experience unnecessary. Small amount starts you. We furnish everything, teach you, help you succeed. Opportunity of lifetime to be your own boss and make big money.



**AMERICAN FLOOR SURFACING MACHINE CO.**  
523 So. St. Clair St. TOLEDO, OHIO

## This BOOK Sent Free



Get this new, valuable catalog, describing amazing tests of "Cornwell" Tools. **MAIL COUPON TODAY**

**CORNWELL** Quality Hand-Made Tools are guaranteed superior to any other tools you can buy. Catalog illustrates, describes and prices full line of automotive service tools, explaining *unbelievable tests which no other tools will stand.*

### CORNWELL Hand-forged Tools Accomplish Amazing Results

Remarkable results are accomplished every day with "Cornwell" Tools—They do things that no other tools will do. "Cornwell" Tools are strictly hand-forged from the very highest grade Chrome Molybdenum Steel produced under our famous "Cornwell" formula—They are forged, heat treated and hardened and tempered in oil—*Not drop forged and case hardened.*

### Read About All These Amazing Tests

Mail the coupon today and get this free catalog. *Our money-back guarantee is your assurance that these tools will do everything we claim.*



**The Cornwell Quality Tools Co., Dept. Q, Mogadore, Ohio.**  
(Formerly at Cuyahoga Falls, Ohio.)

Send me new illustrated catalog with prices on full line of **CORNWELL** Hand-made Tools.

.....Where Employed

Name.....  
Address.....  
City..... State.....



**SW**  
**SHOCK-PROOF**

**2-IN-1 STRAP WATCH**



**FREE Trial!**

*Amazing Performance!*

**A TRIUMPH!** Illinois "Sportsman"—the 2-in-1 Strap Watch—for SPORTS-wear! for DRESS-wear! Has remarkable SHOCK-PROOF movement, RESILIO wheels, plates, escapement, secret process tempered. Genuine Ruby Jewels—not 7 or 15—but 17 JEWELS for Precision! Created by ILLINOIS WATCH CO., Springfield, Illinois. The U. S. Government, during the World War, requested their entire output of Military Watches because they proved best.

**BUSINESS MEN, Professional Men, Executives, Sportmen are ASTOUNDED** at its splendid performance under action! Terrific drives down the fairway, smashes on the tennis courts; vigorous lines of work, motoring, office use, intense heat or cold, do not affect its time-keeping! It's SHOCK-PROOF! WEATHER-PROOF! DUST-PROOF! MOISTURE-PROOF! Green or White Case. Handsome Cushion Shape. RADIUM dial GLOWS time BRIGHTLY in darkness! Men are PROUD to display it! List Price \$50. Our price for LIMITED TIME to advertise our Direct-to-User values... **\$33.95**

*Our Plan is Different!*

*It is arousing nation-wide comment! We ask for NO money in advance! NOTHING on Delivery. See, try, test, ENJOY, "Sportsman" for 10 Days ABSOLUTELY FREE! If pleased you may pay on Budget Plan: \$6.00 MONTHLY*

If you prefer to pay cash at end of 10 DAYS, deduct \$2.70 and send Check or Money Order for **\$31.25** in FULL SETTLEMENT. Otherwise return it. Order NOW at this Special Price!

**SEEVER-WILLIAMS CO.**

*Importers, Exporters, International Mail Order House*

365 WASHINGTON ST. BOSTON, MASS.

*Sole Distributors of SHOCK-PROOF "Sportsman" Watch*

Gentlemen:—Send me \$33.95 Illinois "Sportsman" Watch for 10 days' FREE TRIAL on your "NO Money in Advance—NO Money on Delivery" Plan. Check color of Case.  Green.  White.

Name.....

Address.....

*Tear out—mail coupon NOW! If a new customer please tell something about yourself. We will appreciate and respect the information. THANK YOU. Pop. M. 11-27*

**PIN A DOLLAR BILL TO THIS**

and get this genuine leather 5-window-pass case. Holds Railroad Passes, Auto License, Lodge Cards, etc. Masonic or Shrine Emblem stamped on in gold free. Your name or other stamping 35c extra per line. Cash must accompany order.



We carry

**EVERYTHING MASONIC**

Send for free catalogue No. 10 P. M., of Books, Monitors, Jewelry; No. 11 P. M., of Lodge Supplies.

*We Have Been in Business 67 Years!*

**REDDING & COMPANY**

200 Fifth Ave., Desk P. M.

NEW YORK

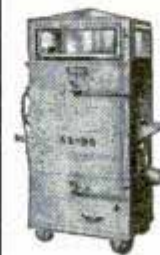

**\$10<sup>00</sup> to \$25<sup>00</sup> a Day!**

**Selling Freshly Roasted Peanuts**

Wherever you find a crowd, hot, savory peanuts and crisp, sweet popcorn are in demand. Set up a Kingery Machine anywhere—in stores, at ball games, races, fairs. Profits 250%. Machines take little room; are easy and inexpensive to operate. Barbecue machines, too. Write now for Free Catalog.

**The Kingery Mfg. Co.** Dept. P. M. 11, 410 E. Pearl St. CINCINNATI, OHIO

**You and This New Machine Can Earn \$500 a Month**

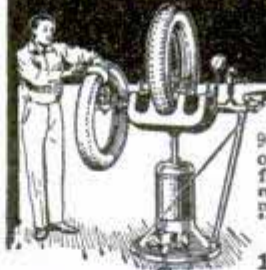

**Operate a Tire Repair Shop**

90,000,000 Tires in use. America's greatest opportunity for men with small capital. We furnish everything—\$100 and up. Easy payments. We train you FREE right at home. Start making money at once. Write today for Free Book "Steps to Success."

**Haywood Tire Equipment Co.** 1334 South Oakley Chicago, Illinois

**Ask for Keds by name**

*They are not Keds unless the name Keds is on the shoe*



**ALL FREE**

10 year guar. Watch with chain and ring, large Eastman Roll Film Camera or 22 cal. Hamilton Rifle. yours for introducing finest assorted liquid perfume at 15c a bottle. Send for 20 bottles and choose gift as per order in our catalog. We trust you—just write to **BELL PERFUME CO., Dep. B153, Chicago, Ill.**



**HOLLAND PRINTS**

Wonderful new way of binding kodak pictures. Keep a photographic record. Sample Holland print from your negative for 10c.

**FRANK SCOBIE, 43-H, SLEEPY EYE, MINN.**



**STOP FORD CRANKSHAFT END-PLAY!**

**C-A ADJUSTABLE BEARING** corrects and prevents end-play without removing motor. Eliminates many troubles. Easy to install—simply drop pan. Only \$3.75. Ask your dealer or sent prepaid by **ADJUSTABLE BEARING CO., Dept. P, 405 Virginia Ave., Indianapolis, Ind.**



**A Genuine \$2 Knife for \$1.18 Postpaid**

Handy shaped Blade makes this knife best for mechanics, sportsmen and farmers; light but strong; re-sharpened easily. Stag handle. German silver finish; blades file tested, hand forged from razor steel and warranted.

**Direct at Factory Prices**

Sample \$1.18 3 for \$3.00 Postpaid

Hand Forged Razor Steel Blades

Send for our 100-page FREE List and "HOW TO USE A RAZOR."

**Maher & Grosh Co.** 106 A St., Toledo, Ohio





**AUTOMATIC  
CONCERTINA  
PLAYED WITH  
INTERCHANGEABLE  
ROLLS**

Play this most wonderful Musical Instrument on earth, without any knowledge of Music or notes. Simply insert a small roll and start playing. Play the biggest hits in Dance Music, Operas, Songs, etc. Rolls changed in fraction of a minute. Everyone will think you are an artist.

At home, outings, dances and parties, you will be the musical entertainer. Music is always wanted and welcomed everywhere. You play this Concertina without having to study and practice, just by drawing apart and closing the bellows. The "Automatic Concertina" will bring you happiness, pleasure and recreation and if you look for it, MONEY beside. MADE IN THREE MODELS. For Home, Concerts and Paid Entertainers. Interesting descriptive Circular mailed free upon request.



**TREASURE SALES  
COMPANY**  
1690 Boston Road  
NEW YORK CITY

**Introduce 40 Handy Things  
\$75 to \$125 Every Week! FOR THE KITCHEN**

Even beginners make sensational earnings with our line of 40 fascinating "Handy Things" for the kitchen. New, novel, practical, and low priced. Women buy on sight. You show samples we furnish and walk off with a good profit. 100 per cent to 200 per cent CLEAR PROFIT. That's what you earn. And agents report that 9 out of 10 calls pay a profit. \$1 to \$3 an hour easy for part time workers. No experience required. Rush name today for details of amazing proposition and FREE SAMPLE OFFER. Good territories going fast, so write today.

**GENERAL PRODUCTS CO.**  
Dept. 7-M, Newark, N. J.

**FREE Samples to Agents**

**EGG BOILER**  
**JAR WRENCH AND BOTTLE OPENER**  
**PIE CRIMPER**

**Restores Health!**

**Vit-O-Net endorsed by scores of physicians and hospitals**

The Vit-O-Net Electro-Magnetic Blanket eliminates poisons, relieves pain, promotes rest and sleep. Dissolves congestions responsible for many ailments. Recommended by physicians for Rheumatism, Arthritis, Nervousness, Neuritis, Blood Pressure, Catarrh, Kidney troubles, etc. Builds robust health and vitality.

Read this: "Can attribute good health to Vit-O-Net," writes sufferer from Rheumatism. J. E. E., Peoria, reduced blood pressure forty points in three weeks. Write for free book revealing valuable health secrets.

**VIT-O-NET MFG. CO., 2613-C No. Ashland Ave.**  
Desk PM-117, Chicago, Ill. **Representatives wanted**

**Do Your PRINTING**

Cards, stationery, circulars, tag, labels, paper. Complete Outfits, \$8.85 up, Job Presses \$11 up, Rotary \$14.9. Card Cutters, \$3. Save money. Print for others, big profits. All easy rules sent. Write for catalog presses, type, paper, cards, ink etc. **THE KELSEY CO., G-37, Meriden, Conn.**

**GENUINE FRENCH BRIAR PIPE SET**

for Only **\$2.75**

Magnificent smoking outfit, beautifully polished and engraved, imported when the French franc was lowest. Manufactured to retail at the \$10 price stamped in each box, we are offering them to you direct from our wholesale dept. at only \$2.75. Set consists of two genuine French Briar pipes treated to require no breaking-in. Amberlite mouthpieces; fancy Amberlite cigar and cigarette holders. Each set is fitted in a beautiful strongly made plush and silk-lined case. Complete, \$2.75.

Send No Money Pay postman \$2.75 plus postage on delivery. Money refunded if not satisfied.

**H. & H. SALES CO., 81 Bowery, Dept. P 51, NEW YORK, N. Y.**

**Ring Up  
\$150 to \$300  
MONTHLY  
PROFIT**

**With an  
HB  
8-Hour  
Battery  
Charger**



Mechanics, garages, battery shops and filling stations are all adding tremendous profits this season with this new 8-Hour Battery Charging Business. Practically no expense or investment required. No special experience necessary. 8-Hour Service gives you a big advantage over other shops; saves 30% to 50% on electric bills over rectifiers. Find how easily you can have these profits by checking No. 1 below.

**Only \$16 Monthly  
Easily Paid by Increased Profits**

**FREE AIR SERVICE**

For only \$12 Monthly for a few months you can have the advantage of Automatic Air Service bringing customers to your door. Beltless, Silent, Ball Bearing. Lowest prices for such quality equipment. Get full details without obligation by checking No. 2 below.

**\$12 Monthly**

**The HB TEST BENCH**

Best paying equipment for automotive electrical work. Tests starting, lighting, ignition systems. Brings you business from other shops. Priced \$100 to \$150 below similar quality outfits. Write today for full information without obligation. Check No. 3 below.

**\$20 Monthly**

**The HB PAINT SPRAY**

Does the work of five men with brushes. Paints cars, furniture, houses, barns, garages. You can do better, quicker work at lower prices, yet make far more money than old time painters. No experience necessary. Investigate—Check No. 4 below.

**\$11 Monthly**

**HOBART BROTHERS**  
Successful manufacturers **since 1893**

**BOX M117 TROY, OHIO**

**Tear off Coupon and Mail Today**

**HOBART BROTHERS CO.**  
Box M117, Troy, Ohio.

Send me complete information on the items I've checked with your 30 day trial offer, easy payment terms, and information on how HB equipment will increase my earnings.

- One Day Battery Service Profits
- Better Automatic Air Compressor
- Electrical Test Bench Opportunities
- Portable Paint Spray Business

Name.....

Address.....





**Kept Cool**  
Like the best Airplane Motors

# TRUVOLT

*An All-Wire Variable Voltage Control*

Here is the finest voltage control you can possibly buy for your power devices! Its special mechanical construction gives greater radiation area and keeps it cool like an air-cooled engine. This prevents deterioration and assures permanent accuracy with long life. Resistance made entirely of nichrome wire with very low temperature coefficient and exposed directly to air—heat not held in by enamel coverings as in other resistances. Permits potentiometer control and gives positive metallic contact at all times with thirty exact readings of resistance. Eight stock types with resistances up to 50,000 ohms. All rated at 25 watts. List \$3.50. Also full line of fixed wire resistances.

Write for free circular

*"This Is An Eliminator Year"*  
Dept. 17A, 175 Varick Street, New York

# ELECTRAD

**Fansteel Products Company, Inc.**  
North Chicago, Illinois



## WANTED at once!

700 men for rural localities; 1500 men and women for cities, who are industrious, steady. Let us help you start profitable, permanent business in which thousands who had no previous experience now make \$50 to \$200 weekly sales year round; in every state and province. 32,000,000 packages sold last year of our 150 necessities. Particulars free. Write today.

**The W.T. RAWLEIGH Co.**  
Dept. 2PPM Freeport, Ill., U.S.A.

# PARKS

## Manual Trainer

### \$35<sup>00</sup>

Without Motor



For your home shop! Combination 11-inch band saw and 11-inch wood lathe. If you have a knack for wood working you can turn out first-class bridge lamps, cabinets, furniture, ship models, etc., in fast time. Get one!

Write for specification circular

**THE PARKS WOODWORKING MACHINE CO.**  
1500-40 Knowlton Street Cincinnati, Ohio  
CANADIAN FACTORY: 208 Notre Dame East, Montreal, Canada



# RADIO WHOLESALE

Write for my Big 1928 Radio Catalog—just off the press. Thousands of marvelous bargains in nationally advertised goods. All the LATEST IN RADIOS and equipment. Lowest wholesale prices. Agents Wanted.

**FREE** Log and Call Book and Catalog. Get your copy today. Send postcard now!

**AMERICAN AUTO & RADIO MFG. CO.**  
HARRY SCHWARTZBERG, PRES.  
Dept. 263 American Radio Bldg., Kansas City, Mo. 3

**DEALERS NEW 1928 CATALOG**

## Beautiful HOUSES \$900 and BUNGALOWS

CAN BE BUILT FOR AND UP

This and many others in my new book, Building Plans for Modern Homes, will save you hundreds of dollars. One of the most complete and comprehensive books of plans ever published by any architect. New edition just off the press. Nearly 600 floor plans and photographs of Colonial houses, bungalows, etc., costing from \$200 up; gives sizes and cost to build. Sent postpaid for \$3.00.



**FREDERICK H. GOWING ARCHITECT**  
101 Tremont St., BOSTON, MASS.

## Sport Bodies for Fords AT FACTORY PRICES!



This Model in Grey Prime **\$39.50**

Write for Booklet A-2 Showing Other Models.

**SPORT FACTORIES, AURORA, ILL.**

**BUCHSTEIN'S FIBRE LIMB**  
is soothing to your stump—strong, cool, neat, light. Easy payments. Braces for all deformities.



Send for Catalog Today

**D. BUCHSTEIN CO.**  
610 3rd Ave., So. MINNEAPOLIS, MINN.

Information on any book free. Write Popular Mechanics Press, Chicago, Ill.



## WADE AMATEUR MECHANICS, REPAIR SHOPS, INVENTORS, STUDENTS

# BENCH LATHE

A real machine tool for the home work bench—capacity 4" dia. x 12" length. For Metal—Wood—Composition Materials. Turning—Facing—Boring—Drilling—Winding—Thread Cutting. Accurate—Strong—Quiet—Compact. Slide-rest has travel entire length of bed. Leadscrew inside bed. No. 1 Lathe, plain headstock, \$28.00. No. 2 Lathe, back-geared headstock, \$58.00. Extra for lathes with 18 inches between centers, \$7.00. Complete line of accessories at equally low prices. Write for free catalog.

**THE GEROLD CO.** Dept. P-37 120 Liberty St. New York





**Your Bank** can look us up in commercial agencies. Other references: Bank of Pittsburgh, N. A.; Marine Natl. Bank; Union Trust Co., Pittsburgh.

Examine FREE~  
**\$69<sup>50</sup>** 3/4-1/16 Ct.  
 Faultless Cutting  
 Try to Match at \$115.00

See this snappy, accurately cut solitaire diamond—3/4 less 1/16 Ct. in this handsome mounting at only \$69.50. Special list! Many other bargains equaling that shown here now offered by this 75 year old house. A reason you rarely think of makes possible **Radically Low Prices**, even for **Finest Quality Diamonds**. Examination Free. Send coupon for Latest Bargain List.

**Unpaid Loans**—Low as \$60 a Ct.—Offers Now Ready. Send for Free List, Use the Coupon.

The very diamond you want may be in this list at a price that will amaze you. Costs nothing to see. Write now. Use the coupon and—

**SEND FOR Latest Bargain List**

Jos. DeRoy & Sons, 1962 DeRoy Bldg., Pittsburgh, Pa.

**MAKE FORD Into The "LARK" YOUR**

**\$5.00** Red-i-Kut life size patterns Class—Snap



and new manual of other distinctive sport body patterns from \$3.50 up—RKO Steel "Swing-Lo" Irons, Tops and Windshields. ORDER RIGHT NOW.

KUEMPEL COMPANY, 90 Kuempel Bldg., GUTTENBERG, IOWA

**Catch Fish!**

Eels, Mink, Muskrats with our new folding galvanized STEEL WIRE TRAP. Write for our FREE TRAP OFFER and Bargain Catalog. \$1 Box of our famous Fish Bait FREE to introduce our traps.

WALTON SUPPLY CO., 3501 JUNIATA AVE., ST. LOUIS, MO.

**The Super Elto** WRITE FOR CATALOG! Address Dept. AA  
 ELTO OUTBOARD MOTOR CO., MILWAUKEE

**AGENTS! EXPERIENCE UNNECESSARY**

Science has finally produced it. An instantaneous metal cleaner—neither sloppy liquid nor messy paste. Dry magic floss. Touch it to nickel, copper or brass. The metal shines bright and clean instantly. No hard rubbing! Lightning Silver Cloth does same for Silverware. Lightning Furniture Floss instantly cleans and puts high lustre on Furniture. No liquid! Lightning Polishing Cloth is approved by Good Housekeeping Institute. Agents making up to \$30 a day!

Makes a Sensational Demonstration! Everybody Buys These Products. Housewives buy the Lightning Silver Cloth and Furniture Floss. Autolets buy Lightning Polishing Floss. Sell all three to stores and offices in big quantities. Nothing else like them. Sure big, quick MONEY GETTERS.

Sample Free! Exclusive territory. Real cooperation. Triple profit. Answer this ad at once. Make big money. Easy! Quick! Don't delay. Write NOW! FREE test sample and proposition by return mail. G. V. LIGHTNING PRODUCTS CORP., 1773 Greenleaf Ave., Chicago



**AMAZING DISCOVERY ABOLISHES METAL AND FURNITURE POLISH**

Imagine! Touch tarnished articles with a Lightning Polishing Cloth or Floss and you make them bright as new. Demonstrations positively astound! Every one a sale! Agents collect real money on every call.

Now You Can Own **Diamonds** 60% of Market Price

Offers of a 3/4 Century House Bankers, Lawyers, Merchants and other shrewd buyers reaping this real advantage here. World's oldest, largest diamond banking institution (10 large loan firms now combined) rated over \$1,000,000.00, now selling the diamonds on which money was loaned but not repaid. Diamonds too, from other advantageous sources.

**Why Pay Full Prices**

Diamonds, and other gems of unusual qualities (also watches)—at an entirely different price basis—viz: Loan values not market values. Every diamond completely described—exact weight, color, quality, etc. All details and free examination at no cost to you. Guaranteed amounts you can borrow. Exchanges at full price paid. Send at once for latest bargain list. Limited number of lists available. Get this unusual, Free Examination Offer. No obligation to buy. List is Free.

**Mail Coupon Now**

**Jos. DeRoy & Sons,** (10 Large Loan Firms Combined)  
 Opposite Post Office 1962 DeRoy Bldg., Pittsburgh, Pa.  
 Without obligation, send me free, in plain envelope, latest list and/or Special List as checked below:—

I could be interested in Diamonds, \$50 to \$200   
 I could be interested in Diamonds, \$200 to \$500

Name \_\_\_\_\_  
 Address \_\_\_\_\_  
 City \_\_\_\_\_ State \_\_\_\_\_

**Shoot the Best Gun**

The NEW BENJAMIN is the finest air rifle ever made. Unlike all others. Has amazing accuracy—shoots hard and far. It's the original American genuine AIR operated rifle. One to six pump strokes compress air to any desired degree of power. Same force as in air drills and air hammers except you control the shooting force. Never loses force—no springs or levers to get out of order. Makes crack shots quickly, inexpensively. Gives years of delightful recreation with utmost safety. At your dealer's, or sent postpaid for \$5.00.

**Shoot 5 Days FREE**

We give you five days, ammunition supplied, to test the NEW BENJAMIN. If in this time you don't believe it to be the finest air rifle you've ever seen or used, and if you don't believe it is the one and only air rifle for you, return it, postpaid, and your money will be refunded at once.

**The NEW BENJAMIN AIR RIFLE**

America's Original Air Rifle  
**\$5** at your dealer's or sent postpaid direct from factory on FREE Trial as above if dealer does not handle it—write for our wonderful offer.

**Get This Book and Details FREE**

BENJAMIN AIR RIFLE & MFG. CO.  
 645 N. Broadway, St. Louis, Mo.

Please send your amazing offer and free copy of "The Shooter's Art" telling how to become a crack shot, how to hold, aim, and handle guns and guide others in use of guns.

Name \_\_\_\_\_  
 Address \_\_\_\_\_

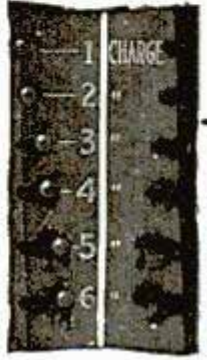



# EDWARDS WILL SAVE YOU MONEY ON METAL ROOFS

We own our own steel mills, roll our own sheets, make them into high-grade REO METAL SHINGLES, Sidings, Ceilings and Roofings of every type and style for every kind of building. We control every operation from the raw material to the finished roof and we sell direct from our factories to the user. Not a dollar to divide with anybody but the customer! You get better value for less money.

## OUTLAST THREE ORDINARY ROOFS

EDWARDS METAL ROOFS are weather-proof, lightning-proof, fire-proof! The galvanizing bends with the metal. No tools required.



## LOW-COST ALL-METAL GARAGES

Any size. Any style. Portable. Ready to erect. Complete with frames, doors, sash and hardware. Ornamental, durable, economical. Blue-prints and complete instructions FREE.

Write today. Get our low prices and Free Samples. Ask for Roofing Book No. 150 or for Garage Book No. 150.

THE EDWARDS MFG. CO.  
1100-1150 Butler St. Cincinnati, O.



# The One-Profit WITTE Log and Tree Saw



**LOW PRICE  
EASY TERMS**

COMPLETE OUTFITS—everything you need for working in timber. Saws 15 to 40 cords a day! Change to tree saw in 3 minutes.

**FREE** Simply send name for NEW CATALOG, new Lower Prices and offers. 3 Hours Shipping Service.

## WITTE ENGINE WORKS

7748 Witte Building  
7748 Empire Building

KANSAS CITY, MO.  
PITTSBURGH, PA.

# AGENTS EVERY AUTOIST WILL BUY

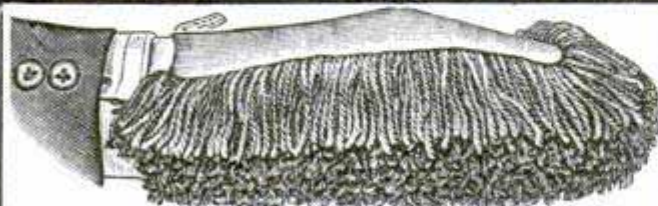

*Fits the hand like a Glove*

## AUTO MITTEN DUSTERS

Chemically treated yarn MITTEN DUSTER, for auto and home use. Dusts, Cleans and Polishes. Agents are Cleaning Up Big. Costs you 25c each, less in gross lots, sells for 75c. Sample and selling instructions postpaid 25c.

Send for Free Details and Sample Case Offer

NATIONAL FIBRE BROOM CO., Dept. P. M., St. Louis, Mo.



TELLS ALL ABOUT THE  
15 New Features

as well as the many other features of the wonderful Motor that thrilled the world in 1926 by its remarkable speed and power. You will want to know especially about "The Pilot"—a NEW device that steers your boat in any course you choose—straight or curved, without attention from anyone. Leaves you free to cast, or troll or rest. The New—

# LOCKWOOD FORMERLY BOAT MOTOR

also offers you many other advantages—improvements in Power, in Speed, in Ease of Starting, in Stopping, in Convenience and Durability. Find out all about them before you choose any Motor. Get the facts now.

## WRITE FOR FREE FOLDER

Just out—See how Lockwood is blazing the way by advanced engineering methods backed by 23 years of marine engine building experience. (24)

**LOCKWOOD**  
MOTOR COMPANY  
716 Jackson St. Jackson, Mich.

# Bodies of Rare Beauty for Fords At Factory Prices!

Write for circular  
A-3 showing  
Chummy Sportster  
and others.

\$22.75 and up



SPORT FACTORIES

AURORA, ILL.

# MOTORCYCLES



**WE WILL TRUST YOU**  
Pay As Low As \$2.00 per Week  
Hendersons, Harley-Davidsons, Indians

Slightly used and rebuilt. Hundreds to select from.

Send 10c for list today.

MYEROW BROS. CO., 15 Berkeley St., Boston, Mass., U. S. A.

# RAISE BELGIAN HARES

NEW ZEALAND REDS—Chinchillas—Flemish Giants  
**MAKE BIG MONEY—We supply stock and pay you**  
following prices for all you raise: Belgian Hares \$2 each—  
New Zealands \$3 each—Chinchillas \$4 each—Flemish Giants  
\$5 each. 32-page illustrated book, catalog and contract, also  
copy of *Fur Farming* magazine, tells how to raise skunk,  
mink, fox, etc., for big profits, all for 10c. Address

OUTDOOR ENTERPRISE CO., Box 25, Holmes Park, Mo.

**DENINGER WILL TRUST YOU**

SEND 20c IN STAMPS FOR CATALOGUES  
**BIG MONEY SAVING FOR YOU**

Used and rebuilt motorcycles \$25 to \$100,  
used bicycles \$9.50, tandems \$20.  
All machines fully guaranteed.  
New bicycles and motorcycles  
at factory prices, save dealers'  
profits. Motorcycle and auto-  
mobile tires \$3. Complete tire  
frames, springs, supplies.

DENINGER PRICE CUTTER, ROCHESTER, N. Y.

**PAY AS YOU RIDE**



# Boys Write Today For this Book FREE!

Every boy will want this new, thrilling and beautifully illustrated book. It is a most interesting story and tells you all about the new Meccano. It fully explains the fun and ease with which you can build hundreds of wonderful working models in colors, such as steam shovels, wrecking cars, cranes, bridges, etc. These models are exact duplicates of the real engineering machines from which they are copied.



## \$500 CASH PRIZE

With this book you will receive an entry blank for the great Meccano Prize Contest—first prize \$500 in cash. You may be the lucky boy. No experience necessary.

Write today. The book and entry blank will be sent to you free upon receipt of your name and address and the names and addresses of three (3) of your friends. Put No. H-1 after your own name for reference.

Meccano Company, Inc., Div. H-1, Elizabeth, N. J.

# MECCANO



# I'll Pay You \$40 A DAY!

## To Show My Mysterious Cigarette Lighter to Men

Quick, easy profits for you with this amazing invention. Lights cigarettes and cigars in strongest wind. New principle of ignition. Does work of expensive lighters. But sells for only 50c. Guaranteed for 10 years. Elmers sold 48 in one day. Johnson cleaned up \$63.00 in two days. No experience necessary. Work full or spare time. Send \$3.00 for dozen lighters or 50c for agent's sample. You make 100% clear profit. Satisfaction guaranteed or money back.



No wind can blow it out!

How does it work?

MASTERLITE MFG. CO., Desk K-23  
119 E. 23rd Street NEW YORK CITY

## AGENTS AND SIGN MEN

Now Making \$50.00 to \$100.00 and Up Per Week Selling Our GOLD LEAF SIGN LETTERS



For store and office windows, board signs, trucks and glass signs. We also make to order script signs and business emblems singly or by the thousands. A permanent business. No capital or experience required. Big demand in every city. Samples and Literature Free.

CONSOLIDATED SIGN LETTER CO. 69X W. Van Buren CHICAGO, ILL.

**SOLD 1800 \$900.00**

CHRISTMAS BOX ASSORTMENTS PROFIT

Is what V. Strandberg, Minn., sold in 1925. Last year he sold 3800 boxes. Many of our agents in a short time earn large sums of money selling our Christmas Greeting Cards in Box Assortments. We publish a Magnificent Christmas Box Assortment, containing 21 high-grade Christmas cards and folders, Steel Engraved, Colored, Paneled and Bordered, each with an envelope, which sells for \$1.00 and costs our agent 50c. A value never equaled.

### EACH SALE MEANS 100% PROFIT

Nothing that an agent has ever sold begins to compare with the sales they make with our Christmas Box Assortments. Write us immediately, and we will send full particulars and free samples.

WALTHAM ART PUBLISHERS

7 Water St., Dept. 5-N, Boston, Mass

# You can now Own a Typewriter!



Guaranteed for 5 years



Be up-to-date—know the pleasure and convenience of having one in your home. You'll be amazed at the uses everyone in your household will find for this real Underwood typewriter. Every member of the family will use and enjoy it! Don't send a cent—but do get our big special offer—our valuable book on typewriters and typewriting—FREE.

## Any One Can Learn to Operate a Typewriter!

You can learn to write on this standard-keyboard machine in one day; it's so simple that even a child can use it. A week after the expressman has brought it, you'd feel LOST without it. A trial will PROVE it—and doesn't cost you a penny!

## SPECIAL FREE TRIAL OFFER

We don't want a penny now. Nor any money at all unless this proves the typewriter bargain of your life. The trial is FREE. If you buy, our easy terms make it a pleasure to pay. There's no excuse now, for not owning a typewriter—and the finest make!

We include all tools, a cover, etc., all complete, all ready to write. Write us now. Deal direct; we are the largest factory of the kind.

Our plan gives you the opportunity of a thorough trial before you buy. You run no risk whatever. You start to pay for your typewriter AFTER you have found it the only machine for you!

But get the facts before this lot of machines is all in use. Clip the information coupon before you turn the page. It will pay you! Note the very useful book you will receive free! Write for full particulars at once.

## The Greatest Typewriter Offer Ever Made

If you know typewriters, you know the perfect work and the ease and speed of a Shipman Ward rebuilt Underwood typewriter.

New machines are guaranteed for only one year; WE GUARANTEE EVERY ONE OF OUR MACHINES FOR FIVE YEARS! If you have never owned a typewriter, start with the finest! You can try this one at our risk. But, the time to act is NOW. Don't miss out on this present bargain offer whereby you can get this genuine Underwood at a big savings. Don't do longer without the convenience of a typewriter.

**FREE!** Get our catalog free; lowest prices and terms. A manual free, too; valuable instruction for learning rapid typing.

## Mail Today!

Shipman Ward Manufacturing Co.,  
2128 Shipman Building, Chicago, Ill.

Please send me your Free Trial Plan and Typewriter Book, together with your special offer on prices, terms, free course in Touch Typewriting and also how I can make money with this typewriter, without obligation. This is not an order.

Name.....

Street or R. F. D.....

City.....

State.....



# CAN YOU SELL HEAT IN WINTER?

# Hot Dollars All Winter!

Man, you don't have to sell heat. Everybody wants it. Everbrite agents cleaning up \$3000 to \$5000—no soliciting—no investment—no risk—just visiting prospects secured by our national advertising and leaving the heater for a night's trial.



**When It's 23 Below Zero** The Everbrite Radiant Oil Heater will keep you comfortable. Mrs. Senften, Genoa, Nebraska, writes: "23 below zero, but the Everbrite kept us warm and burned 25 hours on 1 filling." A portable heater for homes, stores, churches. Makes and burns its own gas from common kerosene. Pours out flood of pure, clean, intense heat at cost of 1 cent an hour.

**FREE** Just send name for amazing agents' offer. Clean up \$200 a week or more! Get a demonstration heater for your own use. Or if not interested in agency, write for special offer on heater. No wick—burns like city gas. Cleaner, cheaper, more comfortable than wood or coal. Low price.

WRITE TODAY

**The EVERBRITE STOVE CO. KANSAS CITY, MO.**

5216 Gateway Sta.

*The* **EVERBRITE**  
Radiant Oil Heater  
**\$250 a Week**

J. O. Hand, California, made over \$250 a week last year. Knabb and Godwin of Florida both did better than \$200 a week. H. T. Rees of Kansas, averaged \$300 a week. F. W. Hubbel, Iowa, beat \$400 a month. So did Senften and Cassel, Nebr., Richie of Iowa, Shook of New Mexico, Webb of Arkansas, Wilson of Louisiana, and Alfred of Kansas.

## Relieve rheumatic pain!



Keep muscles and joints limber and free from stiffness. Absorbine, Jr. rouses the blood to renewed action and brings quick relief from soreness. Don't fear to rub—it cannot burn.

\$1.25 a bottle at your druggist's  
W. F. Young, Inc. Springfield, Mass.



## Just Turn This Handle

# Make \$12 a Day!

Demonstrate this amazing new *Self-Wringing Mop*. Any man or woman without previous experience can earn at least \$12 daily, just turning handle.

## Sells Quickly

Remarkable device wrings mop perfectly dry. Handle on mop wrings out water in a jiffy. No more "back-breaking." No more getting hands into dirty mop water. "Lucky 7" cleans floors in one-fourth the time. Every woman a prospective buyer. Quick demonstration brings easy sales. Big profits for you.

**THE DELPHOS MOP CO.**  
16211 Washington St.  
DELPHOS, OHIO



**GET SAMPLE MOP—FREE OFFER**  
Show "Lucky 7" to women. Take orders fast. Huron made \$7 the first hour. Mrs. B. C. Blyth took 30 orders from neighbors. Others making amazingly big incomes everywhere. Write immediately for full details and **FREE MOP** offer.



# ITALIAN ACCORDEONS

We manufacture and import all kinds of first-class hand-made

## ITALIAN ACCORDEONS,

the best in the world. Ten year guarantee. Our Prices are lower than any other maker's. Free Accordion instructions to buyers. Write for **FREE** catalog.



**RUATTA SERENELLI & CO.**  
1014 Blue Island Ave., Dept. M Chicago, Ill.

## Own a CORONA

The portable typewriter built like an office machine. Has four-row keyboard and big-machine features throughout. Write to



**L C Smith and Corona Typewriters, Inc.**  
1112 E. Washington St., Syracuse, N. Y.

## WHITE FLAME

**BURNERS** make your old kerosene lamps and lanterns give a brilliant white light better than electricity or gas. Doubles your light. Saves oil. **NO MANTLE TO BREAK.** Guaranteed Safe and Reliable. Delights every user. Send now for complete sample postpaid 50 cents, stamps or coin, 3 for \$1.25. **Money Back If Not Satisfactory.** Live Representatives Wanted. Exclusive Territory.  
**WHITE FLAME LIGHT CO., 68 Clark Bldg., Grand Rapids, Mich.**



# I Offer You \$100 a Week

Without experience, training or capital you can establish a big business for yourself. Be your own boss, work when you please, spare time or full time, and make from \$25 to \$100 a week.

## Ford Auto Given

We want men and women to represent us. Wonderful plan. 350 Household Necessities direct from factory to home. We provide all instructions and equipment, including automobile. Write quick for offer.

**AMERICAN PRODUCTS CO., Dept. 7533, Cincinnati, Ohio**





# THE BIGGEST SELLING HIGH GRADE REEDS IN THE WORLD



Most widely advertised and internationally known

For sale at all Music Stores

Buy a sample dozen today.

**J. Schwartz Music Co., Inc.**

Dept. No. 600

10 West 19th Street  
NEW YORK, N. Y.

	12 Ft.	18 Ft.
Clarinet	25	2.40
Sax. Sop.	25	2.40
Alto Sax.	20	2.00
Baritone Sax.	40	4.00
Tenor Saxophone	40	4.00
Baritone Saxophone	25	2.50
Bass Saxophone	45	4.50

Don't forget the Snap-Kap

# save 1/3 to 1/2



New FREE book quotes Reduced Factory Prices. 5-Year Guarantee Bond on Stoves, Ranges, Furnaces. 200 styles and sizes. Beautiful porcelain enamel ranges and combination gas and coal ranges. Mahogany porcelain enamel heating stoves. Cash or easy terms. 24-hr. shipments. 30-day free trial. 360-day test. Satisfaction guaranteed. 26 years in business. 600,000 customers. Write today for FREE book.

**Kalamazoo Stove Co. Manufacturers**  
391 Rochester Avenue  
Kalamazoo, Mich.

Ranges \$49.95 up

"A Kalamazoo Direct to You"

# AGENTS 500% PROFIT

## GENUINE GOLD LEAF LETTERS

**S** guaranteed to never tarnish. Anyone can put them on stores and office windows. Enormous demand, large profits. Paul Clark says: Smallest day \$28.70. R. L. Reel made \$920 in two months. Write today for free sample and liberal offer to general agents.

**METALLIC LETTER CO., 433-B N. Clark St., CHICAGO**

# DO YOU WANT a new business profession of your own, with all the trade you can attend to? Then become a foot correctionist, and

in a few weeks earn big income in service fees,—not medical nor chiropody—easy terms for home training, no further capital needed, no goods to buy, no agency. Address

Stephenson Laboratory, 1 Back Bay, Boston, Mass.

**MEN! DOUBLE YOUR INCOME**

**SELL PIONEER \$23.50 TAILORING** Full or Part Time

**Cash Paid Daily**

Make \$12 a day from start—part time men \$5 an hour selling famous Pioneer tailored-to-measure, all-wool suits at \$23.50. Commissions paid in advance. Striking leather brief case containing 100 large swatch samples furnished—other equally remarkable values at \$29.50 and \$34.50. We train the inexperienced. Men with determination and willingness to work for success write for this big money-making opportunity—today!

**PIONEER TAILORING CO., 159 W. Harrison St., Dept. L1116, Chicago**



## With Violet Ray Vibration Ozone Medical Electricity

The Four Greatest Curative Powers Generated by This

# Great New Invention!



Elco Health Generators at last are ready for you! If you want more health—greater power to enjoy the pleasures and delights about you, or if more beauty is your desire—write! Ask for the book on these inventions which has just been prepared. It will be sent to you without cost. It tells you how Elco Health Generators aid you in leaving the lethargy and hopelessness of bad health and weakness behind forever. Re-vitalize yourself. Bring back energy. Be wholly alive. Write today!

Here's What Elco Users Say—

"Wouldn't take \$1000 for my Elco."  
"Has done me more good in 2 weeks than doctors did in three years."  
"Cured my Rheumatism."  
"My Eczema gone."  
"Cured my stomach trouble."  
"Cured my weakness."  
"Now I sleep soundly all night."  
"Thanks to Elco my strength and vigor are back."  
"No more pain."  
"Colds never bother me now."  
"Chronic Constipation banished."



These great new inventions generate Violet Ray, Vibration, Electricity and Ozone—combined or separate. They operate on the electric light in your home or on their own motive power at less than 50 cents per year. Elco Health Generators are positively the only instruments which can give you in one outfit Electricity, Violet Ray, Vibration and Ozone—the four greatest curative agents. Send the coupon below. Get the Free Book NOW!

## MAIL COUPON for FREE BOOK

Do not put this paper down without sending the coupon. Don't go on as you are with pains and with almost no life and energy. You owe it to yourself to be a better man or woman. You were put here to enjoy life—not just to drag through it. So do not rest another day until you have put your name on the coupon here. That will bring the whole story of these great new inventions. Do it today—now.



..... **Lindstrom & Company** .....

30 West Lake St. Dept. 13-58 Chicago

Please send me your free book, "Health—Power—Beauty" and full information of your 10-day Free Trial Offer.

Name.....

Address.....



# PATENT

## Protect Your Ideas

### Take the First Step Today

If you have a useful, practical, novel idea for any new article or for an improvement on an old one, you should communicate with a competent Registered Patent Attorney AT ONCE. Every year thousands of applications for patents are filed in the U. S. Patent Office. Frequently two or more applications are made for the same or substantially the same idea (even though the inventors may live in different sections of the country and be entirely unknown to one another). In such a case, the burden of proof rests upon the last application filed. Delays of even a few days in filing the application sometimes mean the loss of a patent. So lose no time. Get in touch with me at once by mailing the coupon on the opposite page.

### Prompt, Careful, Efficient Service

This large, experienced organization devotes its entire time and attention to patent and trade mark cases. Our offices are directly across the street from the U. S. Patent Office. We understand the technicalities of patent law. We know the rules and requirements of the Patent Office. We can proceed in the quickest, safest and best ways in preparing an application for a patent covering your idea. Our success has been built on the strength of careful, efficient, satisfactory service to inventors and trademark owners located in every state in the Union.

### NO CHARGE for Information On How to Proceed

The booklet shown here contains valuable information relating to patent procedure that every inventor should have. And with it I will also send you my "Record of Invention" form on which you can sketch your idea and establish its date before a witness. Such evidence may later prove valuable to you. Simply mail the coupon and I will send you the booklet, and the "Record of Invention" form, together with detailed information on how to proceed and the costs involved. Do this NOW. No need to lose a minute's time. The coupon will bring you complete information entirely without charge or obligation.



My Patent Law Offices  
Just Across  
Street From  
U.S. Pat. Office



Above is a view of my drafting and specification offices where a large staff of experienced experts are in my constant employ. All drawings and specifications are prepared under my personal supervision.

# NEWS

*Inventors*  
*Write for these* **Free Books**

### Strict Secrecy Preserved

All communications, sketches, drawings, etc., are held in strictest confidence in strong, steel, fireproof files, which are accessible only to authorized members of my staff. Feel free to write me fully and frankly. Your case will have my personal attention. It is probable that I can help you. Highest references. But **FIRST**—clip the coupon and get my free book. Do **THAT** right now.

### Clarence A. O'Brien

*Registered Patent Attorney*

Member of Bar of: Supreme Court of the United States; Court of Appeals, District of Columbia; Supreme Court, District of Columbia; United States Court of Claims. Practice confined exclusively to Patents, Trade marks and Copyrights

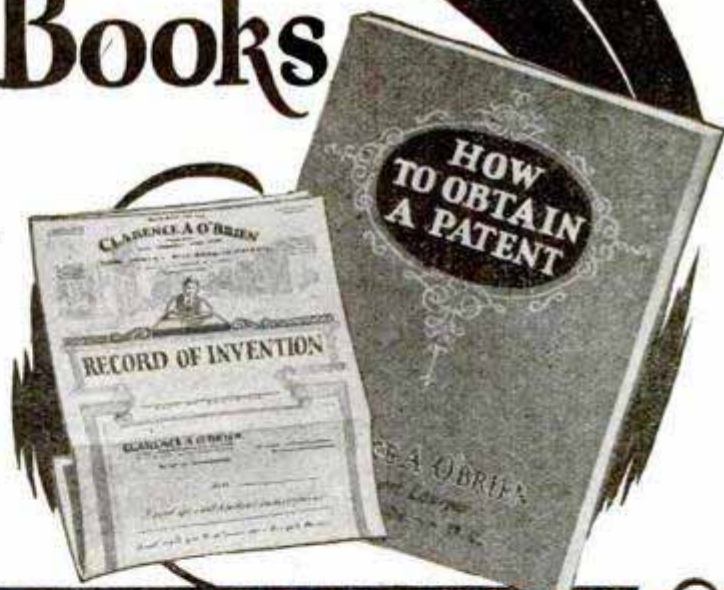

**Clip this Coupon and Mail it Now!**

**CLARENCE A. O'BRIEN, Registered Patent Attorney**

701 Security Savings and Commercial Bank Bldg., Washington, D. C.

Please send me your free book, "How to Obtain a Patent," and your "Record of Invention" form without any cost or obligation on my part.

Name.....  
*(Important: Write or Print name clearly.)*

Address.....



# PATENTS

TRADE-MARKS ·· DESIGNS  
FOREIGN PATENTS

MUNN & CO.  
PATENT ATTORNEYS

*Associated for 81 years with the Scientific American*

SCIENTIFIC AMERICAN BUILDING  
24 WEST 40th STREET  
*New York*

SCIENTIFIC AMERICAN BUILDING  
*Washington, D. C.*

TOWER BUILDING  
*Chicago, Ill.*

HOBART BUILDING  
*San Francisco, Cal.*

VAN NUYS BUILDING  
*Los Angeles, Cal.*



Books and Information on Patents  
and Trade-Marks by Request.  
Associates in All Foreign Countries.



# PATENTS TRADE-MARKS AND COPYRIGHTS

## OUR OFFER: FOR THE PROTECTION OF YOUR INVENTION

**YOUR FIRST STEP.** The inventor should write for our blank form—"RECORD OF INVENTION." This should be signed, witnessed and returned to us together with model or sketch and description of the invention for INSPECTION and INSTRUCTIONS FREE!

### Our Four Books Mailed Free to Inventors Our Illustrated Guide Book

#### HOW TO OBTAIN A PATENT

Contains full instructions regarding U. S. Patents, Our Methods, Terms, and 100 Mechanical Movements illustrated and described.

#### OUR TRADE-MARK BOOK

Shows value and necessity of Trade-Mark Protection. Information regarding *Trade-Marks and unfair competition in trade.*

#### OUR FOREIGN BOOK

We have Direct Agencies in Foreign Countries and secure Foreign Patents in shortest time and at lowest cost.

#### PROGRESS OF INVENTION

Description of World's Most Pressing Problems by Leading Scientists and Inventors

All Communications and Data Strictly Confidential. Interference and Infringement Suits Prosecuted.

#### IMPORTANT

TO MAKE YOUR CASE SPECIAL AND AVOID DELAY YOU SHOULD HAVE YOUR CASE MADE SPECIAL IN OUR OFFICE to secure protection, save correspondence and obtain early filing date in Patent Office. To secure special preparation of your case send \$25.00 on account with model or sketch and description of your invention.

*Our Lawyers Practice in all U. S. Courts and defend Clients in Suits involving Patents, Trade-Marks and Copyrights*

All Communications and Data Strictly Confidential. Interference and Infringement Suits Prosecuted

OUR ORGANIZATION OFFERS  
PERSONAL SERVICE  
By Experienced Patent Lawyers,  
Solicitors and Draftsmen

We Regard a Satisfied Client as our best advertisement, and furnish anyone, upon request, lists of clients in any state for whom we have secured patents.

*Highest References—Prompt Attention—Reasonable Terms*

WRITE TODAY

## VICTOR J. EVANS & CO.

Registered Patent Attorneys

MAIN OFFICES: 792 Ninth St., Washington, D. C.

New York Offices, 1007 Woolworth Bldg.; Philadelphia Offices, 518-519 Liberty Bldg.; Pittsburgh Offices, 514 Empire Bldg.; Chicago Offices, 1114 Tacoma Bldg.; San Francisco Offices, 1010 Hobart Bldg.

Gentlemen: Please send me FREE OF CHARGE your books as described above.

Name.....

Address.....





# PATENTS

**Booklet Free Highest References  
Promptness Assured Best Results**

Send drawing or model for preliminary examination of Patent Office records.

## ALL BUSINESS GIVEN PROMPT AND PROPER ATTENTION

Listed Patent Lawyer in the latest editions of the Rand-McNally Directory of Bankers and Attorneys, of Chicago, Ill.; The Baggott & Ryall Directory of Attorneys, New York City; The Lawyers Guaranteed Directory, Detroit, Michigan; The Lawyers and Bankers Quarterly, published by the Legal Directory Publishing Company of St. Louis, Mo.; the American Lawyers Annual, Cleveland, Ohio.

**WATSON E. COLEMAN,**  
REGISTERED PATENT LAWYER

Victor Building, 724 Ninth Street, N. W.  
**WASHINGTON, D. C.**

# PATENTS

## To the Man with an Idea

I offer a comprehensive, experienced, efficient service for his prompt, legal protection and the development of his proposition.

Send sketch, or model and description, for advice as to cost, search through prior United States patents, etc. Preliminary advice gladly furnished without charge.

My experience and familiarity with various arts frequently enable me to accurately advise clients as to probable patentability before they go to any expense.

*Booklet of valuable information and form for properly disclosing your idea free on request. Write today.*

Richard B. Owen, Patent Lawyer  
9-303 Owen Bldg., Washington, D.C.  
41-E Park Row, New York City

**TRADE-MARKS  
REGISTERED**

# PATENTS

## Don't Lose Your Rights To Patent Protection

Before disclosing your invention to anyone send for blank form "EVIDENCE OF CONCEPTION" to be signed and witnessed. As registered patent attorneys we represent hundreds of inventors all over the United States and Canada in the advancement of inventions. The form "Evidence of Conception," sample, instructions relating to obtaining of patents and schedule of fees sent upon request.

### LANCASTER & ALLWINE

480 Ouray Bldg. WASHINGTON, D. C.  
*Originators of forms "Evidence of Conception."*



# PATENTS

Send us sketch or model for advice and exact cost of patent. Our book "How to Obtain a Patent" sent free. It tells how to apply for Patents, Trade Marks, Foreign Patents, Copyrights, etc.; gives information on Patent Procedure; tells what every inventor should know. Thousands of Inventors, who are our clients, are our reference.

**CHANDLEE & CHANDLEE, 25 Years' Experience**  
410 Seventh St. Washington, D. C.

## BLUE BOOK ON PATENTS

AND PRIORITY RECORD BLANK GRATIS.

**MONROE E. MILLER, PATENT LAWYER**  
411-2 Ouray Building, WASHINGTON, D. C.  
ELECTRICAL AND MECHANICAL EXPERT

## INVENTORS

who derive largest profits know and heed certain simple but vital facts before applying for Patents. Our book *Patent-Sense* gives those facts; sent free. Write **LACEY & LACEY, 646 F St., Washington, D. C. Established 1869.**

# INVENTORS PROTECT YOUR IDEAS

Send for our Guide Book, **HOW TO GET A PATENT**, and Evidence of Invention Blank, sent Free on request. or sketch and description of your invention for **INSTRUCTIONS**. No charge for the above information.

**RANDOLPH & CO.**  
301 Victor Bldg., WASHINGTON, D. C.

Tells our terms, methods, etc. Send model

NAME.....

STREET.....

CITY..... STATE.....



# Men Past 40

## MAKE THIS AMAZING TEST

Medical science claims that 65% of all men past middle age are victims of prostate trouble, either in a mild or severe form. Loss of vitality, sciatica, bladder weakness, nervousness, aches in back, legs and feet, frequent urination and chronic constipation are a few of the more common symptoms oftentimes mistaken as attributes of old age. A new drugless gland stimulant, perfected by a well-known American scientist, now offers victims of this devitalizing ailment a wholly advanced method that has shown startling results in many of the 40,000 cases where it has been used. Test it on our Gilt Edge Agreement, that UNLESS YOU FEEL TEN YEARS YOUNGER IN ONE WEEK, YOU PAY NOTHING. This bonafide guaranty accompanies each treatment. Send today for the intensely interesting booklet, "Why Many Men Are Old At Forty," written by the scientist who discovered this method. It contains information that every man should know and explains in a pleasantly frank manner all about this common ailment which oftentimes makes a man old before his time. It is absolutely FREE. Send for it today. Simply address: The Electro Thermal Company, 2175 Main Street, Steubenville, Ohio. Western Address: Suite 21-U, 303 Van Nuys Bldg., Los Angeles, Calif.

## PATENTS

Trade Marks, Copyrights, Patent Litigation Handbook with illustrations, 100 mechanical movements. Sent free on request.

**ALBERT E. DIETERICH**  
formerly member examining corps U. S. Patent Office  
**PATENT LAWYER and SOLICITOR**

621-A, Ouray Bldg.  
27 Years' Experience Washington, D. C.

## Will Finance Patents

Patents of commercial value financed on royalty basis without expense to inventor. Mail models and copies of patents or full details to

**KAMSTONE HOLDING CORP.**  
41 East 42nd Street N. Y. C.

# 1000 NEEDED INVENTIONS!

Here is the most remarkable book ever offered to inventors. One Thousand needed inventions listed and described. Arranged as follows: General Problems; Automotive; Mechanical; Electrical; Chemical; Radio; Marine. Separate chapter on the Ten Most Needed Inventions. This book may give you one idea that will win you a fortune. Nothing else like it has ever been published. Compiled at enormous expense. Edited by Raymond Francis Yates, formerly Managing Editor of a leading scientific magazine. Over 100 pages, durably bound. Send only \$1.25 (nothing more to pay) and your copy of this remarkable book will be sent immediately. (Outside U. S. \$1.45.) Money back after 10 days' examination if desired. Limited edition. Write NOW.

**BUREAU OF INVENTIVE SCIENCE**

Dept. 311

Rochester, New York

**FULL YEAR TO PAY**

**32<sup>ND</sup> Anniversary SALE**

**BIG BARGAINS**

**SEND ONLY**



**AD1-Lady's diamond wrist watch: 2 genuine diamonds, 4 French blue sapphires set in 14k solid white gold engraved case. Guaranteed 15 jewel movement. \$2.31 a month. Anniversary sale price \$29.75**



**AD2-Flashing, genuine blue white diamond set in lady's 18k solid white gold newest hand pierced basket design mounting. \$3.87 a month. Anniversary Sale price \$48.50**



**AD3-Anniversary sale offering 3 fiery genuine diamonds set in new style richly hand pierced 18k solid white gold lady's mounting. \$2.89 a month. \$36.75**

**A FULL YEAR TO PAY**

**10 Day Free Trial**

Anniversary values unequalled anywhere! 32 years of honest dealing is your guarantee. Pin only \$1 to your order and your choice comes to you parcel post prepaid on 10 Days Free Trial. Pay postman just \$1 more on delivery; after free trial period pay balance in 12 equal monthly payments. A written guarantee with each purchase. Your money refunded if you can buy cheaper for cash.

**Use Your Credit**

**Buy today—Year to pay**

**Free ROYAL BOOK OF GEMS**

Thousands of special values in genuine diamonds, jewelry, watches and silverware. Send for your free copy at once.



**AD4-5 perfectly matched genuine diamonds, 4 French blue sapphires, gorgeous new lace design, lady's dinner ring, of 18k solid white gold. \$4.56 a month. Anniv. Sale price \$56.75**



**AD5-Gentleman's massive, hand made ring: 18k solid white gold, set with fiery genuine diamond. \$5.87 a month. Sale price \$72.50**



**AD6-Newest model Waltham or Elgin nationally famous strap watch; 20 year guaranteed green gold filled case; radium dial, dependable timekeeper. \$1.87 a month. Anniversary Sale Price \$24.50**

**ROYAL DIAMOND & WATCH CO.**

ESTABLISHED 1895

ADDRESS DEPT. 1868 170 BROADWAY N.Y.



## GEARS ALL KINDS SMALL

The most accurate made and prices reasonable. We carry a complete line of gears in stock for immediate shipment. Can also quote on special gears of all kinds. Send us your inquiries.

WRITE FOR CATALOGUE 10

**CHICAGO STOCK GEAR WORKS**  
105-109 S. Jefferson St., CHICAGO



# Now! Amazing New Bath Tub

No Plumbing

ALL 3 for the Price of ONE



**Try It FREE For 10 Days!**

NOW you can enjoy the comfort and convenience of a real, full-sized Bath Tub in your home without the expense of plumbing and costly fixtures. Just to prove that this new amazing combination Bath Tub and Handy Kitchen Table is the greatest step-saving, labor-saving convenience ever invented for farm women, the children and the entire family—we will put a TABL-TUB in your home on 10 Days' Approval and let you use it to your heart's content.

## The TABL-TUB

### Combination Bath Tub, Kitchen Table and Laundry Tub

The Tabl-Tub combines in one unit a big "man-size" Bath Tub and a large, roomy, porcelain top work table for the kitchen. Think of it! A luxurious Bath Tub—a handy Kitchen Table—a Laundry and Rinsing Tub—a Lunch Table—or a Study Table—ALL IN ONE, at a price LESS THAN HALF the cost of installing a regular bath tub. The Tabl-Tub does away with

the fuss and muss of the old wash tub method of bathing. Saves steps, saves work, saves drudgery, and brings joy and better health to all the family. Endorsed and recommended by Home Economic experts and hundreds of enthusiastic owners. Strongly built yet light to handle, finished with indestructible Duco Enamel with a gleaming white porcelain table top.

### You Take No Risk—Use It 10 Days!

If Not All We Claim, Your Money Promptly Refunded

Thousands of Tabl-Tubs are being used with complete satisfaction. This is why we do not hesitate to place one in your home for 10 days on approval. If by that time

the Tabl-Tub does not prove to be all we claim, return it at our expense and we'll refund your money immediately. Write today for illustrated folder telling all about it.

**TABL-TUB—7006 Grant Ave.—Cleveland, O.**

# Wow! FIRST QUALITY - EXCELLO-TRON Radio TUBES

BUY direct from factory at BIG SAVING

Non-Microphonic

EQUAL or SUPERIOR to ANY TUBE MADE

Unconditional Guarantee

Combination No. 2

5 STANDARD TUBES X-201-A \$3.95 REGULAR LIST PRICE \$8.75

Combination No. 1

1 Power tube X-171 or X-112. Specify which one \$4.50

1 Power detector X-200-A \$4.00

4 Standard tubes X-201-A at \$1.75 \$7.00

6 tubes Total \$15.50

OUR PRICE FOR ALL \$6.25

REGULAR LIST PRICE \$15.50

**SINGLE TUBE BARGAINS**

X-201-A Standard tube—Regular list price \$1.75...our price, 89c

X-200-A Power detector—Regular list price \$4.00...our price, \$1.55

X-171 Power tube—Regular list price \$4.50...our price, 1.75

WE MANUFACTURE 20 VARIETIES OF TUBES

If the tube you want is not listed write us

The most amazing value ever offered. Only because of enormous factory production are we able to make this astounding offer.

**OUR IRON CLAD GUARANTEE**

We absolutely guarantee every tube to be perfect; to meet with your satisfaction in every respect and to replace within 30 days, any tube found to be defective.

**QUALITY THROUGHOUT**

EXCELLO-TRON tubes are so sturdily constructed as to render them NON-MICROPHONIC. The three elements, Plate, Grid and Filament are scientifically spaced, adjusted and securely held in place, thus insuring proper flow of electrons, producing a tone value and volume unexcelled. This feature, not found in ordinary tubes, reduces noise, distortion, squeals and howls to a minimum.

Just write your name and address on a post card and order the tubes you want. We ship immediately. Pay costs as advertised plus a small delivery charge.

**Excello-Tron Tube Works, Dept. P., 2019 Michigan Ave., Chicago, Ill.**

SEND NO MONEY!

AGENTS Write for our Special Proposition

## Your Coat and Vest Can Be Matched with New Trousers

Save the price of a new suit. We match hundreds of coats and vests satisfactorily every day. Each pair tailored to your measure. 80,000 patterns. We submit sample of cloth for your approval. Just mail your vest or a sample of the suit.

We employ no agents.

**ACME PANTS MATCHERS**  
Dept. BL-14, 20 W. Jackson, Chicago

Enclose return postage if vest is sent.

## Hunters! Write for New V&A Gun Catalog

A BOOK that tells all about the best guns and hunters' equipment. Sent to you free. Lowest market prices. Prompt service. Money back guarantee.

Write today. Ask for Catalog No. T1FF

**VON LENGERKE & ANTOINE**  
Sporting Goods Exclusively  
33 South Wabash Avenue, Chicago, Illinois

Free

# TYPewriter PRICES CUT

Your choice of the World's best typewriters—Underwood, Remington, Oliver—full size, late model, completely rebuilt and refinished brand new. Prices smashed down to half. Act quick.

**\$2 and it's yours**

Free Trial

Just send your name and address and we will mail you our complete FREE CATALOG prepaid, fully describing and showing actual photographs of each beautiful machine in full colors. Tells every detail of our direct-to-you small-payment plan. Write now for tremendous saving. No obligation whatever. Still time if you act now.

**International Typewriter Exchange**  
186-188 W. Lake Street. Department 1194, Chicago, Ill.



# \$20.00 PRICE REDUCTION!

On each 9" Junior New Model South Bend Back Geared Screw Cutting Lathe

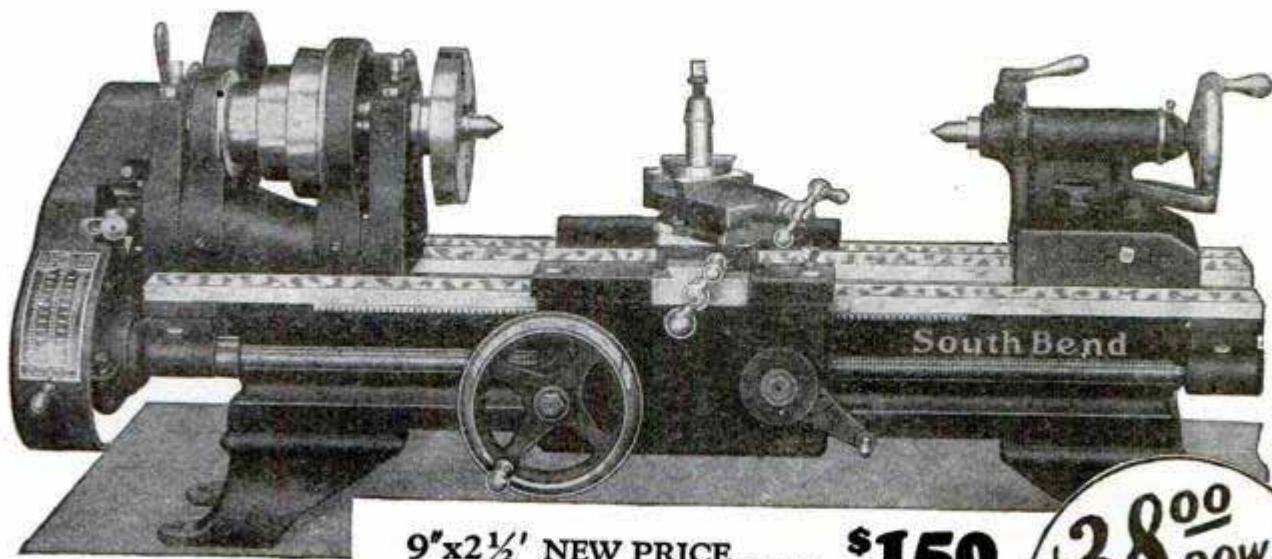

9" x 2 1/2' NEW PRICE ..... **\$150**

**\$38<sup>00</sup> DOWN**  
**\$11<sup>20</sup>**  
*a month*  
*for 10 months*

## New Model Junior Precision Screw Cutting Lathe

New Reduced Prices of 9" Junior Lathes,  
 Countershaft Drive

- 9" x 2 1/2' — 11" between centers.....\$150.00
  - 9" x 3' — 18" between centers..... 155.00
  - 9" x 3 1/2' — 23" between centers..... 160.00
  - 9" x 4' — 29" between centers..... 165.00
  - 9" x 4 1/2' — 36" between centers..... 170.00
- Also furnished in three types of Motor Drive

### FEATURES

Compound Rest; Power Feed to Carriage; Set-over for Taper Turning; 3/4" Hole through Spindle; Six Spindle Speeds; Width of belt 1"; Cut Threads from 4 to 40; Maximum Draw-in Collet Size 1/2".

### REDUCED PRICE

Operates from Lamp Socket

1/4 H. P. Reversing Motor and Reversing Switch drives lathe directly from lamp socket.

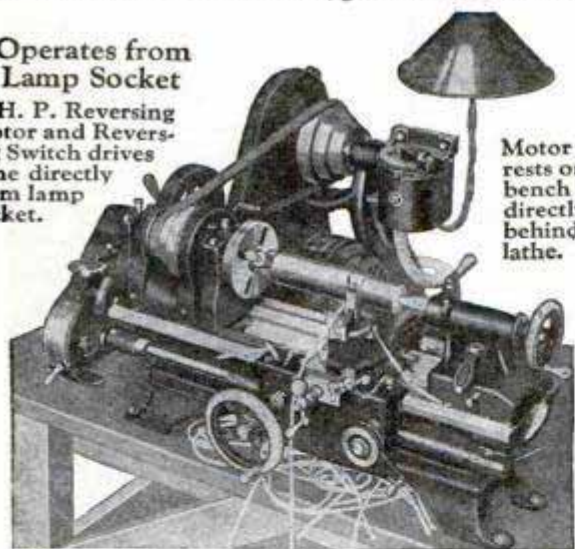

Motor unit rests on bench directly behind lathe.

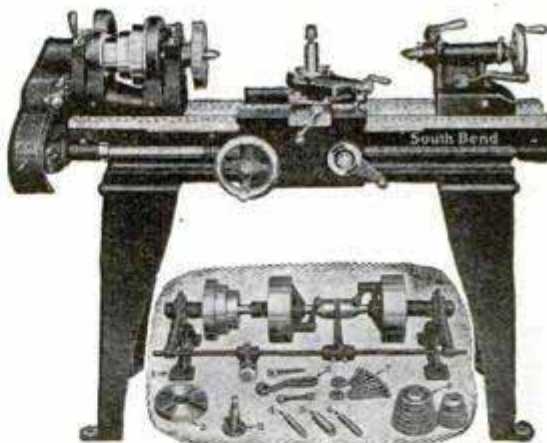

9" x 2 1/2' New Model Junior Lathe with floor legs, countershaft drive—NEW REDUCED PRICE..... **\$160**

Equipment shown beneath the lathe furnished as regular equipment with all countershaft driven lathes, including the bench lathe shown at top of page.

### FREE — New Booklet No. 22-K

Booklet No. 22-K contains prices and descriptions of the 9" Junior Lathe in all types and drives. 150 illustrations, 24 pages, Free on request.

9" x 2 1/2' New Model Junior Self-Contained Motor Driven Bench Lathe—NEW REDUCED PRICE... **\$228**

**Easy Payment Plan—10 Months to Pay**  
 25% or 1/4 down payment, balance in ten equal monthly payments or you can purchase through your nearest machinery dealer.

ESTABLISHED 1906 — OVER 38,000 LATHES IN USE

# SOUTH BEND LATHE WORKS

Main Office and Works: 631 East Madison Street, South Bend, Indiana, U. S. A.  
 New York City Salesroom, 183 Centre Street.



# Heats 8 Rooms

at about the

# Cost of One!

"The Bulldog doesn't burn very much more coal than my old stove used to, and it heats my whole 8-room house, where my stove would heat only the one room it was in." Ernest H. Marzoli, 72 South St., Milford, N. H.

### More Heat with Half the Coal

"I had a hot air furnace in our house before I got the Bulldog and our 7-room house was always cold. With the Bulldog it only takes *half* as much coal and we had weather below zero, and the house was nice and warm in the morning when we got up. We never have the draft on more than a half hour at a time, and it has the place red hot." Jess. T. Conrad, Shamokin, Pa.

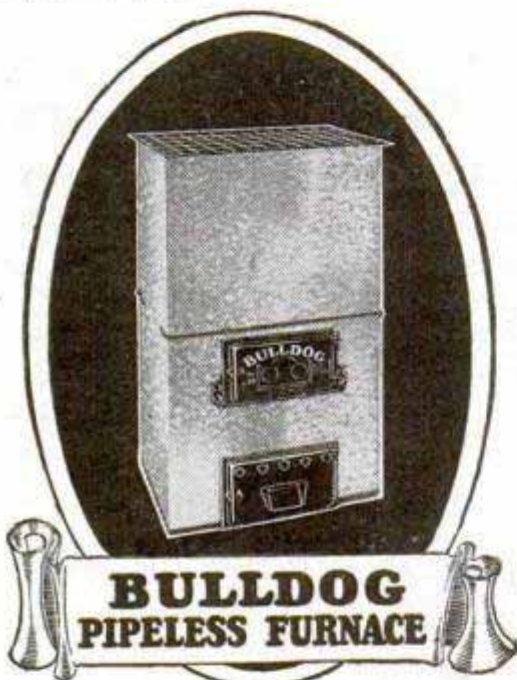

**BULLDOG  
PIPELESS FURNACE**

If you are even thinking of a pipeless furnace, or any furnace, write for our free catalog. The Bulldog is one furnace you **MUST** investigate. Comes completely erected. Fits any height of basement and you install it yourself.

# No Money Down

### Small Monthly Payments

The Bulldog is sent for free inspection. Then, if satisfied, you make only small monthly payments at our amazingly low price. Factory connections in both East and West. We ship from nearest point. Write at once for our special offer and our free catalog together with the wonderful record of Bulldog success. Mail this coupon today.

### Bulldog Furnace Co.

Babson Bros., Sole Distributors

19th and California Ave., Dept. 13-58 Chicago

Without obligating me in any way please send me your free catalog and special offer on the Bulldog Pipeless Furnace.

Have you a basement? Yes  No

Name.....

Address.....

## Books on 67 Practical Subjects

Popular Mechanics Press specializes in supplying the outstanding best book on any subject. Check the books you want, and mail this advertisement as your order blank.

<b>ARCHITECT</b> Architectural Drawing..... \$1.50	<b>FUR RAISER</b> Outdoor Opportunities..... \$2.00
<b>ARMATURE WINDER</b> Armature Winding..... \$3.00	<b>FURNITURE MAKING</b> Mission Furniture Making (3 vols.)..... \$3.00
<b>ARTIST</b> Practical Art..... \$5.00	<b>GLASS WORKER</b> Decorative Glass Processes..... \$3.25
<b>ARTS CRAFTS</b> Art Metal Work..... \$4.25	<b>HAND FORGING</b> Hand Forging and Wrought Iron Ornamental Work..... \$2.00
<b>ASTRONOMY</b> Amateur Telescope Making..... \$2.00	<b>HOME BUILDING</b> Concrete Houses..... \$3.00
<b>AUTOMOBILE</b> Dyke's Encyclopedia..... \$6.00	<b>HOME REPAIRS</b> Practical Book of Home Repairs..... \$2.50
<b>AVIATOR</b> Practical Aviation..... \$3.00	<b>INTERIOR DECORATOR</b> Interior Wall Decoration..... \$4.00
<b>BOAT BUILDER</b> 22 Different Boats..... \$0.50	<b>INVENTOR</b> Inventors' Manual..... \$1.50
<b>BOOKKEEPER</b> Bookkeepers' Handbook..... \$1.00	<b>LATHE WORK</b> Lathe Handbook..... \$0.50
<b>BOYS' BOOKS</b> The Boy Mechanic (4 vols.)..... \$7.00	<b>LEATHER WORKER</b> Leather Work..... \$1.50
<b>BRICKLAYER</b> Plain and Fancy Brickwork..... \$1.50	<b>LETTER WRITING</b> Better Business Letters..... \$1.00
<b>CABINET MAKER</b> Furniture Making..... \$3.50	<b>LOOM FIXER</b> Practical Loom Fixing..... \$1.50
<b>CALCULATOR</b> Ropp's Calculator..... \$1.00	<b>MACHINIST</b> Complete Practical Machinist..... \$3.00
<b>CARPENTER</b> Carpenter's Handbook..... \$1.50	<b>MAGIC</b> Modern Magic..... \$2.00
<b>CARTOONING</b> Cartooning Made Easy..... \$2.00	<b>MASON</b> Practical Stone Masonry..... \$1.25
<b>CHEMISTRY</b> General Chemistry..... \$3.75	<b>MATHEMATICS</b> Mathematics for the Practical Man..... \$1.50
<b>CIVIL SERVICE</b> Course in Civil Service..... \$1.50	<b>MECHANICAL DRAFTSMAN</b> Practical Course in Mechanical Drawing..... \$1.00
<b>CONCRETE</b> 173 Ways of Using Concrete..... \$0.50	<b>MODEL MAKING</b> Model Making..... \$3.00
<b>COOKING</b> Winston Cook Book..... \$1.50	<b>OUTDOOR SPORTS</b> Outdoor Sports the Year 'Round..... \$1.50
<b>DETECTIVE</b> Instruction for Detectives..... \$1.00	<b>PAINTING</b> House Painting Methods..... \$2.00
<b>DIESEL ENGINES</b> Diesel Engines, Marine, Locomotive, Stationary..... \$5.00	<b>POULTRY RAISER</b> \$4,223 from a Town Lot..... \$1.00
<b>DOG FANCIER</b> Dog Encyclopedia..... \$2.00	<b>PSYCHO-ANALYSIS</b> Outwitting Our Nerves..... \$2.50
<b>DRAWING</b> Drawing Made Easy..... \$1.25	<b>RABBIT RAISING</b> Practical Rabbit Keeping..... \$1.50
<b>DRILLING</b> Drilling and Thread Cutting..... \$0.50	<b>RADIO</b> Lefax Radio Handbook..... \$3.50
<b>ELECTRICIAN</b> American Electricians' Handbook..... \$4.00	<b>REFRIGERATION</b> Homemade Refrigerating Machine..... \$0.50
<b>ELECTROPLATER</b> Electroplating..... \$1.00	<b>SHIP MODELS</b> Ship Model Making..... \$2.50
<b>ENGINEER</b> Bailey's Handbook for Stationary, Marine, Diesel..... \$2.00	<b>SHOP WORK</b> Shop Notes (16 vols.)..... \$7.50
<b>ENGLISH</b> Self-Improvement in English..... \$2.50	<b>SPIRITUALISM</b> Behind the Scenes with the Mediums..... \$1.50
<b>ENTERTAINMENTS</b> Producing Amateur Entertainments..... \$2.00	<b>TAXIDERMIST</b> Methods in Taxidermy..... \$3.50
<b>ETIQUETTE</b> Book of Etiquette (2 vols.)..... \$1.98	<b>TOY MAKER</b> Toy Manufacture..... \$1.50
<b>FARMER</b> Popular Mechanics Handbook for Farmers..... \$1.00	<b>WELDER</b> Welding Encyclopedia..... \$5.00
<b>FORD</b> My Ford, Its Care and Repair..... \$3.00	<b>WIRING</b> House Wiring..... \$1.00
<b>FORMULAS</b> 10,000 Formulas..... \$4.00	<b>WOOD WORKER</b> Wood-Working for Amateur Craftsmen..... \$1.00
	<b>WRITER</b> Free-Lance Writers' Handbook..... \$5.00

## Books sent C. O. D. anywhere in U. S.

Just check the ones you want, write your name and address below, and mail the whole advertisement. It is your order blank. When postman hands you books, pay him the price and the postal charges. If outside the U. S. remit when ordering and include 10 cents per book extra for postage. We have many other books on these subjects and on 2,000 other subjects. Catalog free.

Name.....

City..... State.....

Address.....

Mail to Popular Mechanics Press,  
Room 708, 200 East Ontario St., Chicago, Ill.



# 30 Days FREE TRIAL



## One Dial Westgale Radio Sets

**5-6-7  
Tube Sets  
\$47.00  
to  
\$72.00  
RETAIL PRICES**

NOW!—the new 1928 WESTGALE line of Radio Models are ready for you to try. And we stand ready to put any one of our 24 new styles in your home and let you use it to your heart's content on 30 DAYS' TRIAL. Entertain your family and friends. Listen to programs from all over the country. Note the distance, selectivity, and volume. But most of all, hear their amazing deep, mellow tone,—then if you are not convinced that WESTGALE gives you more for your money than you can get elsewhere,—YOU DON'T HAVE TO KEEP IT.

*The Last  
Word in  
Guaranteed  
Radio  
Sets  
and the  
Biggest  
Values  
Ever  
Offered*

### Why Not Be Our Agent?

Buy at cost. We want Agents and Dealers in every locality to demonstrate and take orders for these amazing new 1928 Westgale Models. This is your chance to get a Westgale Radio at a big discount and make it pay you big money. Millions of radios will be sold this season. Get a Westgale set on 30 Days' Trial—demonstrate to your neighbors and friends and get your share of these big radio profits.

### Your Own Radio FREE

Our new Catalog also explains a plan whereby you can put a Westgale Radio in your home on 30 days' Trial—demonstrate it to your neighbors and friends in your spare time and get your own set without cost before the trial period is up.

### Special Discounts to Agents and Dealers

To quickly introduce these wonderful new 1928 models we are offering for a limited time a big reduction, way below retail prices on the FIRST Westgale set placed in each community. So get busy now. Be first in your locality to mail the coupon for our FREE catalog and get full particulars of this special discount offer.



**Only  
\$85.00  
Retail  
Price  
Including Speaker**

**WESTGALE ELECTRIC CO.**  
(Formerly Westingale Electric Co.)  
Dept. 211  
1751 Belmont Ave. Chicago, Ill.

### Mail Today - Don't Delay

Westgale Electric Co.,  
Dept. 211, 1751 Belmont Ave.,  
Chicago, Ill.  
Please send me your FREE catalog on the new  
1928 Westgale Radio Sets. Also full particulars  
of your Special Discount Offer on the first  
outfit placed in each community.

Name.....  
Address.....



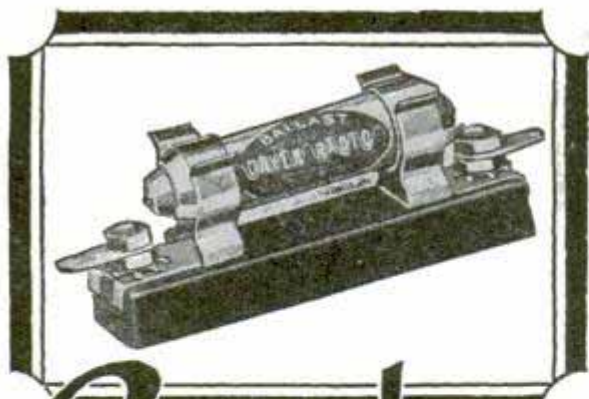

# Good for LIFE! The DAVEN BALLAST

You never need to worry about your automatic filament controls again—no danger of burning out—no possibility of changing characteristics, after you have changed to the Daven Ballast.

Make your last change now—or better yet put Daven Ballasts in the new set you are building, with the positive knowledge that they will still be as good as new after the set has been discarded.

Made in 1/4, 1/2, 3/4, and 1 and 1 1/4 amperes and supplied either with or without the special mounting illustrated.

## GLASTOR THE TRANSPARENT RESISTOR

- Permanent
- Accurate
- Noiseless

as long as the glass remains unbroken.

The Daven Glastor is unlike any other resistor made, the resistance material is part of the glass itself, its value cannot change, it cannot become noisy and its resistance is always what the label says it is.

Make your last change now, replace your old type resistors and grid leaks with the new permanent Daven Glastors and forget them. Made in all sizes and sold by good dealers everywhere.

### FREE CATALOG

The new Daven Catalog is ready for distribution. Your Copy will be sent you free upon request.

*"The Size of Merit"*

**DAVEN RADIO CORPORATION**  
Resistor Specialists

151 Summit Street

Newark, N. J.



## A Condenser That Has Made Radio History

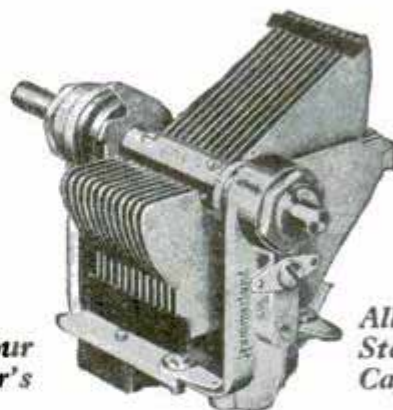

At Your Dealer's

All Standard Capacities

For perfect tuning and trouble-free service install the Hammarlund "Midline" Condenser in your next receiver.

Praised and recommended by radio engineers and fans throughout the world.

Write for Folder

HAMMARLUND MANUFACTURING CO.  
430 W. 33rd St., New York, N. Y.

For Better Radio  
**Hammarlund**  
PRECISION  
PRODUCTS



## MAKE \$75 to \$300 WEEKLY Selling ZENTOLA RADIOS

Make these big profits selling public-preferred ZENTOLA RADIOS. ZENTOLA Six-Tube, Two Dial and Single Dial Sets, \$29.50 and up. Chargers, Eliminators and Tubes at special low prices. Console models, \$42 up. Highest-grade walnut cabinet consoles only \$19.50 up. ZENITH "A" batteries, \$6.95. Write for our liberal proposition.

Cabinet Model  
\$29.50 up

ZENITH AUTOMOTIVE MFG. CO.  
4416 OLIVE ST. ST. LOUIS, MO.

## Simplified Radio Blueprints

Blueprints for the most popular sets described in Popular Mechanics Magazine can be obtained for a charge just sufficient to cover the cost of production and mailing. The sets for which blueprints are available are:

Simple One-Tube Receiver.....	April 1926	— 25c
Three-Tube, Cockaday Receiver.....	April 1925	— 25c
Three-Tube, Low-Loss, Short-Wave Set.....	Oct. 1925	— 25c
Three-Tube, Loud Speaker, Loop Set.....	Dec. 1926	— 25c
Three-Tube, 15 to 550 Meter Set.....	Nov. 1926	— 25c
Four-Tube, Loop Set, for Car or Home.....	Aug. 1926	— 25c
Six-Tube, Self-Contained Receiver.....	July 1925	— 25c
Six-Tube, Counterphase Receiver.....	Feb. 1926	— 25c
Six-Tube, Portable, Loop Set.....	June 1926	— 25c
Electrolytic B-Eliminator.....	Feb. 1927	— 25c
Non-Radiating Unit.....	May 1926	— 25c
Simple Tube Tester and Chart.....	July 1926	— 25c
New Perfect-Tone Six.....	Mar. 1927	— 25c
Two-Tube Loud Speaker Set.....	Oct. 1927	— 25c
A.B.C. Power Unit.....	June 1927	— 25c
Four-Tube Set for Power Unit.....	July 1927	— 25c
New Browning-Drake Receiver.....	Sept. 1927	— 25c
Economy Nine Superheterodyne; Sixty dollars builds this Super. Complete drilling templates and blueprint diagrams.....	Nov. 1927	— 50c

Address the RADIO DEPT.

**Popular Mechanics Magazine**  
200 E. Ontario St., CHICAGO

Back numbers of the magazines describing the construction of the sets can be obtained from our Circulation Department, price 25 cents each.



Plug In-and Tune In

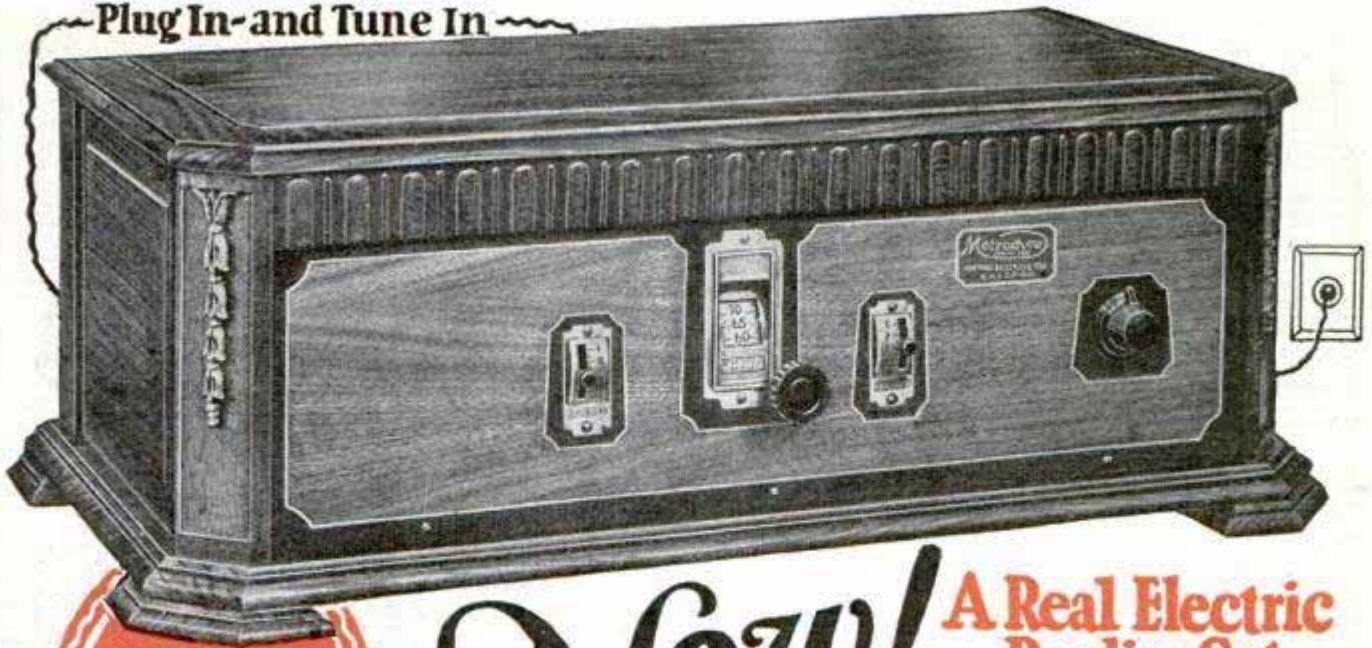

**30 Days Free Trial**

**Now!** **A Real Electric Radio Set**  
 Three-Year Guarantee  
 Shipped direct from our factory at rock bottom prices—costs less than most battery sets  
**No Batteries, Chargers or Eliminators**  
 No Acids; No Liquids—Plug In—Press Button—“Tune In”

**Metrodyne**  
 ALL ELECTRIC RADIO

**7 Tubes—Single Dial Set**

**100% Electric Radio**

At last! The radio you've dreamed about! If you have electricity in your home you can now really enjoy coast to coast radio reception without the care, bother and muss of batteries, chargers, eliminators, etc. The Metrodyne All Electric is a real, genuine batteryless radio set. Simply insert the plug in the socket, press the switch button and “tune in.” You could not possibly buy a better radio set than the Metrodyne All Electric, no matter what price you paid.

**BEAUTY—EFFICIENCY  
 DEPENDABILITY**

The Metrodyne All Electric Radio is a 7 tube, single dial set. Only the highest quality low loss parts are used throughout. Solid walnut cabinet, beautiful two-tone effect, with handsome gilt metal trimmings. Size of cabinet, 28 inches long, 13 inches deep, 10 inches high. Has electrically lighted dial so that you can log stations in the dark. Only one dial to tune in all stations. Excellent tone qualities—wonderful volume—very selective.

**Costs Less Than Most Battery Sets**

Do not confuse the Metrodyne electric radio with ordinary light socket sets, because the Metrodyne is truly an all electric radio—consumes less than 2c worth of power a day. Comes to you direct from the factory. Its low cost brings it down to the price of an ordinary battery set. We are so confident that you will be delighted with this wonderful, easy-to-operate batteryless radio that we offer to ship it to your home for thirty days' free trial—you to be the judge.

**Mail This Coupon**

We are one of the pioneers of radio. The success of Metrodyne sets is due to our liberal 30 days' free trial offer, which gives you the opportunity of trying before buying. Thousands of Metrodynes have been bought on our liberal free trial basis. Write Today!

**METRO ELECTRIC COMPANY**  
 2165 N. California Ave., Dept. 619  
 Chicago, Illinois

Gentlemen:

Send me full particulars about Metrodyne All Electric Radio sets and your thirty days' free trial offer.

Name.....

Address.....

If you are interested in AGENT'S proposition place an "X" in the square.

**Agents! Dealers—Big Profits!**  
 Make big money taking orders for Metrodynes. All or part time. Metrodyne All Electric Radios are in a class by themselves. Unequaled for quality, performance and price. Demonstrate at home and take orders. Lowest wholesale prices. Your demonstrating set on 30 days' free trial. Mail coupon below for details.

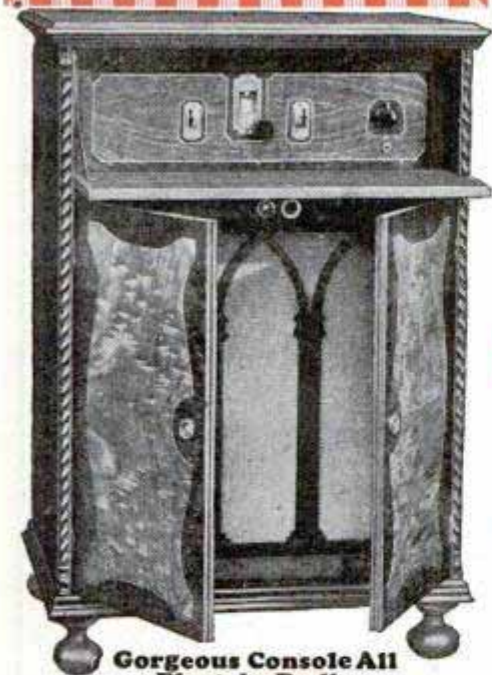

**Gorgeous Console All Electric Radio**

Genuine walnut cabinet, in a beautiful two-tone finish. Has a built-in genuine Metro-Cone large size speaker. Brings in programs with great volume, reproducing the entire range from the lowest to the highest notes with remarkable clearness and distinction. All metal parts finished in old gold. Wonderful electric radio, in a cabinet that will beautify any home.

**METRO ELECTRIC COMPANY**  
 2165 N. California Ave., Dept. 619, Chicago, Illinois





# LUMINOUS PAINT

### Make Your Watches, Clocks, Etc., Visible by Night

The very latest discovery in the scientific world... LUMINOUS PAINT, which, applied to the surface of any article, emits rays of white light, rendering it perfectly visible in the dark. THE DARKER THE NIGHT, THE MORE BRILLIANT IT SHINES. Quite simple to use. Anyone—you can do it. A little applied to the dial of your watch or clock will enable you to tell the time by night. You can coat the push buttons or switch plates of your electric lights, match boxes, and innumerable other articles; make your own Luminous Crucifixes, Luminous Rosaries, etc. Small bottle, price 25c. Larger size, 50c and \$1 postpaid. JOHNSON SMITH & CO., Dept. 815 RACINE, WIS.



## CIGARETTE MAKER

Roll your own and save money. Better and quicker; saves more than half. Use your favorite brand of tobacco. Neat, useful, handy. Pocket size, weighs 1/2 oz. Made entirely of metal, nickel plated. 25c, 3 for 65c postpaid anywhere.



## GOOD LUCK RING

Very striking, quaint and uncommon. Silver finish; skull and crossbones design; two brilliant, flashing gems sparkle out of the eyes. Said to bring good luck. Only 25c pdd.



## Exploding Cigarettes

JUST LIKE ORDINARY CIGARETTES, BUT SUCH REAL STARTLERS! The box contains ten genuine cigarettes of excellent quality. They appear so real, but when each cigarette is about one-third smoked, the victim gets a very great surprise as it goes off with a loud BANG! A great mirth provoker yet entirely harmless. Price 25c box.

## NOVELTY BADGES



Kissing Permit 10c. Garter Inspector 10c. Two very novel metal badges, nickel plated, that you can wear, giving you fun out of all proportion to their trifling cost. 10c, each badge, 3 for 25c, or 75c per doz. postpaid anywhere.

## MIDGET BIBLE

GREAT CURIOSITY. Smallest Bible in the World. Size of a postage stamp. 200 Pages. Said to bring good luck to the owner. A genuine work of art. Most to be seen to be appreciated. Make good money selling them to friends, church acquaintances, etc. PRICE 15c each, 3 for 40c, 12 for \$1.35, 100 for \$7.50. Also obtainable in Leather Binding, with gold edges. Prices 50c each, 3 for \$1.25, \$4.50 per doz. Magnifying Glass for use with Midget Bible, 15c.



## STAGE MONEY

With a bunch of these bills, it is easy for each person of limited means to appear prosperous by flashing a roll of these bills at the proper time and peeling off a genuine bill or two from the outside of the roll. The effect created will be found to be all that can be desired. Prices, postpaid: 40 Bills 20c, 120 for 50c, or \$3.50 thousand postpaid.

## MAGIC FLUTE

The Magic Flute, or Humanatone, is a unique and novel musical instrument that is played with nose and mouth combined. There is just a little knack in playing it which, when once acquired after a little practice, will enable you to produce very sweet music that somewhat resembles a flute. There is no fingering, and once you have mastered it you can play all kinds of music with facility and ease. When played as an accompaniment to a piano or any other musical instrument, the effect is as charming as it is surprising.



Post Paid 25c

## SURPRISE MATCHES

More fun than fighting with your wife. Look just like ordinary matches. Put up in boxes just like regular Safety Matches. As the victim tries to light one he gets quite a surprise. Price 10c per box, 3 boxes for 25c, 12 for 75 cents.



These clever locks cannot be opened unless you know the combination. No key necessary. For your locker, bicycle, stool chest, mail box, thousands of uses. Shackle and tumblers nickel plated. Weighs a trifle over one ounce. Small yet strong. Secret and full instructions with each lock. Price 25c or 3 for 65c postpaid.



## Wonderful X-Ray Tube

A wonderful little instrument producing optical illusions both surprising and startling. With it you can see what is apparently the bones of your fingers, the lead in a lead pencil, the interior opening in a pipe stem, and many other similar illusions. A mystery that no one has been able to satisfactorily explain. Price 10c, 3 for 25c, 1 dozen 75c. Johnson Smith & Co.

## Every Boy His Own Toy Maker

Greatest boys' book written. Tells how to make a Pinhole Camera, a Canoe, model Railroad, a Telephone, Boomerang, Telegraph Instrument, Box Kite, Talking Machine, Microscope, Electric Motor, Electric Door Bell, Water Wheel, Paddle Raft, a pair of Skis, a Dog Sled, Bird House, Rabbit Yard, etc. 64 pages, 150 illustrations. PRICE, 10c postpaid; 3 for 25c postpaid.

## Serpent's Eggs

Box contains 12 eggs. When lit with a match, each one gradually hatches itself into a snake several feet long, which curls and twists about in a most life-like manner. Price per box, 10c postpaid, 3 for 25c.



# BLANK CARTRIDGE PISTOL

Protection against Burglars, Tramps, & Dogs. Social Offer. 1 Blank Cartridge Pistol. 100 Blank Cartridges. 1 650-page Novelty Catalog. ONLY \$1.50. The Lot Shipped by Express. Cash With Order Only.



Well made and effective, modeled on latest type of Revolver; appearance alone is enough to scare a burglar. When loaded it may be as effective as a real revolver without danger to life. It takes standard .22 Cal. Blank Cartridge—obtainable everywhere. Special cash with order offer: 1 Superior quality Blank Cartridge Pistol, 100 Blank Cartridges, and our new 550 page De Luxe Catalog of latest novelties; all for ONLY \$1.50. Shipped by Express only. Cannot go by parcel post. Extra Blank Cartridges 50c per 100. Special Holster (Cowboy Type) for pistol 50c. No C. O. D. shipments.

# THROW YOUR VOICE

Into a trunk, under the bed or anywhere. Lots of fun fooling the teacher, policeman or friends.



## THE VENTRILLO

a little instrument, fits in the mouth out of sight, used with above for Bird Calls, etc. Anyone can use it. Never Fails. A 16 page course on ventriloquism, the Ventrillo, ALL FOR 10 CENTS



It is made in the shape of and looks like a regular Automatic Pistol. No one is likely to stop and ask you whether it is real or not. Thus it is likely to prove itself very handy in an emergency. On pressing the trigger it opens up, as shown in the illustration at the right, revealing nine most useful articles—Opera and Field Glass, Telescope, Mirror, Magnifying Glass and Burning Lens, Reading Glass, Sun Dial, Sun Compass, etc. In the handle of the revolver there is a place for various pocket necessities, such as First Aid Articles, Buttons, Pins, etc. The Pistol is of sheet metal, blind finish, that can be carried comfortably in pocket. PRICE \$1.00 postpaid.

# MEXICAN JUMPING BEANS

Scientists are unable to give a reasonable explanation for what purpose nature created these curious Jumping Beans. They are found growing on small trees in the high mountainous regions of Mexico. The Beans Wiggle, Move, Jump, Flop Over, Etc. It is amazing to see them keep up this endless activity. Send for a few of these great curiosities. Three Sample Beans sent for 25c, 12 for 75c, or One Gross (144) for \$7.50 Postpaid. JOHNSON SMITH & CO., Dept. 815, RACINE, WIS.

## MICROPHONE TRANSMITTER BUTTON



You can easily make a highly sensitive detector-then by using this Transmitter Button to collect the sound waves. You can build your own outfit without buying expensive equipment. It is simple and inexpensive. You can install an outfit in your home and hear conversations being held all over the house. You can connect up different rooms of a hotel. This outfit was used by secret service operatives during the war. It is being used on the way. It is ultra-sensitive and is the greatest invention in micro-physics. You can mount the button almost anywhere—card board boxes, stove pipes, stiff easelers, on the wall behind a picture frame, etc. Button is so light and small it cannot be detected. Persons can be overheard without suspecting it. You can listen in on conversations in another room. A deaf person in the audience can hear the speaker. Connected to phonograph, piano or other musical instrument, music can be heard hundreds of feet away. Button may be used to renew telephone transmitters; often makes as clear "talk up" when nothing else will. The ideal microphone for radio use; carries heavy current and is extremely sensitive. Amplifies radio signals. Countless other similar uses will suggest themselves. Experimenters find the button useful for hundreds of experiments along the lines of telephones, amplifiers, loud speakers, etc. Many fascinating stunts may be devised, such as holding the button against the throat or chest to reproduce speech without sound waves. PRICE \$1.00. JOHNSON SMITH & CO., DEPT. 815, RACINE, WIS.

# JOHNSON SMITH & CO.

Dept. 815 RACINE, WIS.

A De Luxe Edition of our new 1928 CATALOG mailed on receipt of 25c. Handsome binding. Bigger and better than ever. Only book of its kind in existence. 550 pages of all the latest tricks in magic, the newest novelties, puzzles, games, sporting goods, rubber stamps, unusual and interesting books, curiosities, in seeds and plants, etc., unprocureable elsewhere. Remit by Stamps, Coin, Money Order, Check, etc. Unused U.S., Canadian and Foreign Stamps also accepted.



**This is the BANJO**

YOU have been wanting—brilliant, powerful, musical tone, easy-playing qualities, expert craftsmanship, handsome appearance. Beginners and professionals choose the Gibson Mastertone.

Payment plan makes it easy to own a Gibson. Send the coupon for details.



Gibson stringed instruments are today's most popular instruments. Mention which interests you: Banjo; Mandolin; Guitar; Ukulele.

**Gibson**

GIBSON, Inc. 1103 Parsons St. Kalamazoo, Mich. Gentlemen: Send Free Book and details of payment plan on

[Instrument]

Name \_\_\_\_\_  
St. or R.F.D. \_\_\_\_\_  
City \_\_\_\_\_ State \_\_\_\_\_

PATENT NO. 1,418,960

**MYERS ELECTRIC IRON CORD HOLDER**

A wonderful invention. Keeps cord out of way while ironing. Grips the ironing board. Tested and approved by Good Housekeeping Institute.

**AGENTS WANTED**

Sample 50 cents postpaid.

**C. A. MYERS CO.**  
6339 Woodlawn Ave., CHICAGO, ILL., U.S.A.

Send for "The Nestler Plan" the book that will bring you big profits!

This book fully explains the amazingly successful Nestler method of servicing and retreading automobile tires. Tells how to start a profitable spare-time or full-time Nestler business of your own. Write to Dept. 3N.

**NESTLER RUBBER FUSING CO., Inc.**  
245 West 55th Street, NEW YORK, N. Y.

**WRIST WATCH GIVEN**

**GUAR. 10 YRS.**

This dandy boy's or Men's Wrist Watch shows time in the dark—it's yours for introducing exquisite perfumes at 15c per bottle. A purse-size packet of Famous Mad Cap Rouge and a Valuable Silverware Certificate Free with each bottle. *Best offer of all.* Send for 20 bottles and easy double plan for getting this watch. **BELL PERFUME CO., Dept. B-152, Chicago, Ill.**

**Physical Training for Height Increasing**

My scientific physical training Course and apparatus have for their special object the increase of height. They have been remarkably successful, beside giving buoyant "pep," abundant health, and improved appearance. To be of full height means more efficiency and ability to increase your earning power.

Course is easy, inexpensive, and results sure. Satisfaction guaranteed on money back basis.

Write today for Free and Complete information, stating present height.

**L. GLOVER A 37 Sausalito, Cal.**

**SEE MILES AWAY WITH Big 3 1/2 ft. Telescope**

Has unusually powerful lenses—magnifying 8 times. Brings people and objects miles away close to your eyes. Brings new pleasures to home, farm, camp, travel, sport. See moon and stars as never before. New Ferry "Wonder" telescope has 5 sections—opens out over 3 1/2 ft. long, measures 12 inches closed. Brass bound with knurled edges. Sections made of special, smooth finish fibre, easy to slide in and out. Brass safety caps at each end to keep out dust.

**5 DAY TRIAL**



3 1/2 ft. long open  
12 in. long closed  
FIVE SECTIONS  
8-power Lenses  
Thousands of Delighted Users!

"I am delighted with the 'Wonder' telescope. Today I have been watching submarines 3 miles off the coast."  
—Philip Brush. "I can see across the Mississippi 3 miles and see people fishing."  
—M. L. Thorn. "I am nearly 80 years old and if I could not get another would not take \$10.00 for it."  
—A. R. Walker. "I can tell time on the church clock 5 miles away."  
—Edward Foster. "Could tell color of aeroplane 4 miles away."  
—Mrs. L. M. Yarbrough.

**Free!**

YES, ABSOLUTELY FREE! Handsome Carrying Case, light strong, complete with strap. Case is 12 in. long, 2 1/2 in. in diameter. Protects from dust and damage. Handy for farmers, auto tourists and hikers.

**Send No Money**

Send coupon and Wonder 3 1/2 ft. Telescope with free Carrying Case will come by return mail. Pay postman special bargain price of \$1.85 plus postage. (Or send \$1.85 and we pay postage.) Two for \$3.50. Try for 5 days. Satisfaction guaranteed or money back. Send coupon today!

FERRY & Co., Chicago, Ill.

Ferry & Co., Dept. 1770, Chicago, Ill.

Send me 3 1/2 ft. Wonder Telescope and Free Carrying Case. I will pay postman \$1.85 plus postage on arrival. If, at the end of 5 days, I am not satisfied you will refund my money.

Name \_\_\_\_\_  
Address \_\_\_\_\_  
City \_\_\_\_\_ State \_\_\_\_\_



# "Boye" Handy Pocket Rule Tool [PATENTED]

FOR  
**CARPENTERS—MECHANICS—AMATEURS**  
**\$15<sup>00</sup> WORTH OF TOOLS \$1<sup>50</sup>**



PITCH GAUGE



CENTER GAUGE

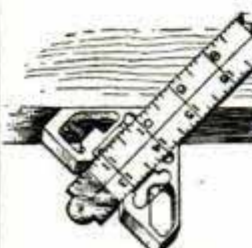

RIGHT BEVEL

We Purchase and Distribute Patented Metal Specialties

A  
**RIGHT BEVEL**  
**LEFT BEVEL**  
**PLUMB**  
**LEVEL**  
**COMPASS**

*Positively*  
*a Most*  
*Valuable*  
*Tool*

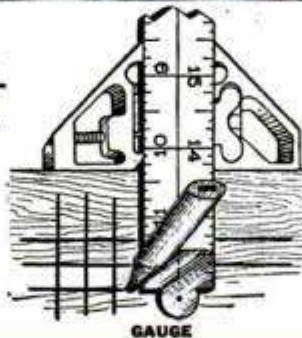

GAUGE

**TEN TOOLS IN ONE**  
**MONEY BACK**  
**GUARANTEE**

A SQUARE  
**CENTER GAUGE**  
**INSIDE GAUGE**  
**DEPTH GAUGE**  
**PITCH GAUGE**

Size: 3 1/4 x 3 1/4 x 3 1/2

*No Kit*  
*Complete*  
*Without*  
*It*



SQUARE

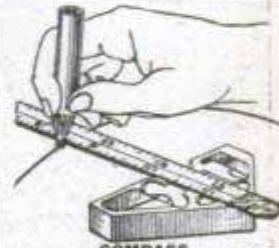

COMPASS



PLUMB LEVEL

If Your Dealer Can't Supply You Use the Coupon

(SEND FOR YOURS TODAY)

The Boye Needle Co.,  
 4343 Ravenswood Ave., Chicago, Ill.

Gentlemen: As per your Special Offer kindly mail me C. O. D. plus a few cents postage one Handy Pocket Rule Tool.

Name.....  
 St. or R. F. D.....  
 City..... State.....

Let us recommend the best books to study on any subject. Popular Mechanics Press, Chicago, Illinois.

Books on all subjects are sold by Popular Mechanics Press, 200 East Ontario Street, Chicago, Illinois.

## SHOP BY MAIL FROM THIS WINDOW OF SPECIALS

### WHAT YOU DO—

SEND A DOLLAR with Name and Address, number of article desired and brief note telling us something about yourself.  
 Simply state: (1) how long at address, (2) age, (3) married or single, (4) name and address of employer, (5) nature of work, (6) how long in employ.  
 All information held strictly confidential—no direct inquiries to employer.

**\$1 Brings Your Choice \$37<sup>50</sup> EACH**

### WHAT WE DO—

Upon arrival of your order, we will open a 10 month Charge Account and send selection for approval and 15 DAY TRIAL. If satisfied, pay \$3.65 monthly; otherwise return and dollar will be refunded.  
 To Any Adult interested in purchasing Diamonds, Watches or Jewelry, we will send without obligation this complete booklet illustrated in colors.

S-23—Two Diamonds, four blue sapphires, 14K white gold rectangular Wrist Watch; 16 Jewels, Expansion Bracelet.

S-27—Both Watch and Chain are 14K solid green gold. Guaranteed 7-Jewel Elgin movement.

S-24—AA1 blue-white diamond; Ladies' Solitaire; 18K white gold.

S-25—Three AA1 blue-white diamonds adorn this Ladies' Ring wrought in 18K white gold.

S-26—18K white gold Dinner Ring, carved and engraved; set with three AA1 blue-white diamonds

S-28—Elgin Strap Watch for Men; hand carved 14K green gold filled case; 7-Jewel Elgin movement. Badium numerals and hands.

**L.W.SWEET, DEPT 1660 BROADWAY 67-S NEW YORK CITY INC.**



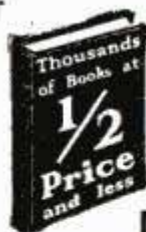

## ANY BOOK IN PRINT

Delivered at your door. We pay the postage. Standard authors, fine editions, new books, all at biggest savings. Be sure to send postcard for Clarkson's catalog.

**FREE** Write for our great book catalog. This catalog is a short course in literature and is so used by some of America's leading universities; 300,000 book lovers buy from it. Free if you write now.

**DAVID B. CLARKSON** THE BOOK BROKER  
1121 CLARKSON BLDG. CHICAGO, ILL.



## FREE CATALOG

Shows Hunting Shoes, Leather Hats, Caps, etc.

Sixty items for hunter and fisherman. 80 photos.

**L. L. BEAN**  
1 Main Street  
Freeport, Me.

**Home Mechanics** 329 ideas for repairing, improving and making devices needed about the home. Home Mechanics and Concrete Handbook, 98c. Sent C. O. D.

POPULAR MECHANICS PRESS, Popular Mechanics Bldg., Rm. 717, Chicago, Ill.

## Make Decorative Metal Articles

Pictures and instructions for making: book ends, desk sets, jewelry, desk clocks, drawer pulls, hinges, bookmarks, stationery rack, candlestick, letter holder, whisk broom holder, and many similar articles. Send no money. Just write a postal for "Metal Work and Etching", our 88-page book. Pay postage and 98c to postman.

Popular Mechanics Press, Room 710, 200 E. Ontario St., Chicago, Ill.

## 861 PRACTICAL IDEAS for REDUCING FARM LABOR and INCREASING INCOME



One farmer writes: "I would not take \$100 for my copy if I could not secure another."

The Handbook for Farmers contains: 138 ideas for the farm shop, 35 on fencing, 98 on auto, truck and tractor, 61 on farm buildings, 36 on field machines, 48 on concrete work, 22 on orchard work, 23 on painting, 15 on live stock, 34 on poultry, 54 on garden work, 25 on electrical work, 22 on farm tools, 16 on hunting, fishing and trapping, 140 household helps.

**394 HELPFUL KINKS to LIGHTEN**

## the LABOR of the FARMER'S WIFE

The Handbook for Women contains: 83 kitchen and dining room helps, 17 on garden and flowers, 19 on sewing and mending, 37 on furniture, pictures and fixtures, 38 on laundry and cleaning, 32 on house cleaning, 12 on music, 14 on sleeping rooms, 11 on care of children, 16 on lights, 9 on photography, 14 on clothing and shoes, 23 on house temperatures, 12 on water and drains, 10 on insect pests, and 47 miscellaneous.

**SPECIAL OFFER BOTH for \$1**  
(Regular \$1.50 Value)

For a limited time you are offered both books for \$1 plus the postage. Pay postman when he delivers package, if outside U. S. send remittance and include 15 cents extra for postage.

POPULAR MECHANICS PRESS  
Room 707, 200 E. Ontario St., Chicago

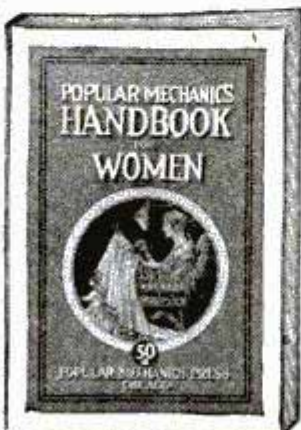

## Create Your Own Music, Too



**YOU** who find joy in building things—who profit through the work of your brain and hands—create your own music, too! You can do it just as easily and as surely as you now build radio sets, furniture, boat and airplane models.



To build fine things one must have good tools. To make beautiful music one must likewise own a good instrument. You need not ponder over which is best.

There is one name in the Band Instrument field that stands for the best wherever good musicians gather. That name is King. It stands for mechanical precision—for watch-like accuracy in every detail.



King Band Instruments will help you learn faster and play better. But we can't tell you all the reasons here.

Let us send you a full description of the instrument you are most interested in, and a booklet that tells of the joy and profit that can be yours through music.

There is joy in music. Look around you. See how closely music is interwoven with every happy activity. And there is profit in music. In every theatre and dance orchestra, in symphonies and circuses, in churches and auditoriums, musicians are earning worth while incomes.

Write for these booklets Today. Learn of our free-trial plan and our convenient time-payment terms. Learn how easy it is to own a King—how much happier you can make yourself by creating your own music.

# "KING"

## BAND INSTRUMENTS



**KING** THE H. N. WHITE CO.  
5211-93 Superior Ave., Cleveland, Ohio

Please send me free copy of your illustrated magazine "The White Way" and your Handy Reference Catalog. (Check, below, the instrument preferred.)

Name..... Age.....

Address.....

City..... State.....

Saxophone  Trumpet  Trombone  Alto  
 French Horn  Baritone  Bass  Bugle



# Swear Off Tobacco



Tobacco Tells on Nervous System



Tobacco Ruins Digestion



Tobacco Stunts Boy's Growth

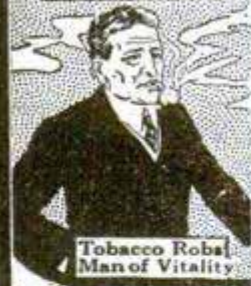

Tobacco Robs Man of Vitality



Tobacco Steals from You the Pleasures, Comforts, Luxuries of Life

## Tobacco Habit Banished Let Us Help You

### Quick Results

Trying to quit the tobacco habit unaided is often a losing fight against heavy odds, and may mean a serious shock to your nervous system. So don't try it! Make the tobacco habit quit you. It will quit you if you will just take **Tobacco Redeemer** according to directions.

It doesn't make a particle of difference whether you've been a user of tobacco for a single month or 50 years, or how much you use, or in what form you use it. Whether you smoke cigars, cigarettes, pipe, chew plug or fine cut or use snuff—**Tobacco Redeemer** will positively remove all craving for tobacco in any form in a few days. Your tobacco craving will usually begin to decrease after the very first dose—there's no long waiting for results.

**Tobacco Redeemer** contains no habit-forming drugs of any kind and is marvelously quick, scientific and thoroughly reliable.

### Not a Substitute

**Tobacco Redeemer** is in no sense a substitute for tobacco, but is a radical, efficient treatment. After finishing the treatment you have absolutely no desire to use tobacco again or to continue the use of the remedy. It helps to quiet the nerves, and will make you feel better in every way. If you really want to quit the tobacco habit—get rid of it so completely that when you see others using it, it will not awaken the slightest desire in you—you should at once begin a course of **Tobacco Redeemer** treatment for the habit.

### Results Absolutely Guaranteed

A single trial will convince the most skeptical. Our legal, binding, money-back guarantee goes with each full treatment. If **Tobacco Redeemer** fails to banish the tobacco habit when taken according to the plain and easy directions, your money will be cheerfully refunded upon demand.

### Let Us Send You Convincing Proof

If you are a slave of the tobacco habit and want to find a sure, quick way of quitting "for keeps" you owe it to yourself and to your family to mail the coupon below or send your name and address on a postal and receive our free booklet on the deadly effect of tobacco on the human system, and positive proof that **Tobacco Redeemer** will quickly free you from the habit.

**Newell Pharmacal Company**  
Dept. 300, Clayton Station, St. Louis, Mo.



### Free Book Coupon

**NEWELL PHARMACAL CO.,**  
Dept. 300, Clayton Station, St. Louis, Mo.

Please send, without obligating me in any way, your free booklet regarding the tobacco habit and proof that **Tobacco Redeemer** will positively free me from the tobacco habit or my money will be refunded.

Name.....

Street and No.....

Town..... State.....



# HEAT Without Coal!

Amazing new invention does away with coal or wood. The new International Oil Burner, with automatic features, simply sets in fire box of any stove, range, or hot air, steam, or hot water furnace. The new International is the first inexpensive oil burning device for homes with low operating cost. Burns without waste 96% air and 4% oil, which it transforms into Instant-Gas, the cheapest and safest fuel known. Gives three times the heat of coal if desired. Better cooking and baking. Absolutely safe. Quickly installed without damage to stove or furnace. Easily moved, if you move.



Burner with Safety Valve Approved by Underwriters Laboratories.

## 30-DAY FREE TRIAL OFFER



The new International is the cheapest to install and operate. No noisy motors, no moving parts, no gas or electricity necessary. Sold on money-back guarantee. Over 60,000 International Burners in use. Write today for free trial offer and Free Book, "Scientific Oil Burning."

**Agents** We pay \$60 a week. Write immediately for free sample offer.

**INTERNATIONAL HEATING CO.**  
Heat Without Coal Dept. 110-O, 3939 Magnolia, ST. LOUIS, MO.

## Amazing Invention! Brings You Big Profits

**\$10 to \$25 a Day!**

Take orders for "Self-Flex"—the Belt that Breathes! Hidden springs make belt expand and contract with every body movement. Made of finest leather. Contains no rubber. No other belt like it. Positively 100% more comfortable than rigid belt or suspenders. Keeps trousers up, shirt down. In handsome leather, shark-skin, lizard-skin, cow-hide. Latest styles and colors. Initial buckle FREE. SELLS EVERYWHERE. Every man wants one on sight. Orders come fast. No experience needed. Mission, Pa. made \$27.50 first day. Lawrence, Kansas coast to coast, earning \$150 weekly. Millionaire.



### PRICES

"Self-Flex" sells at \$2, \$3, \$4 and \$5. Order one now. Send remittance and waist measure. Satisfaction or money back.

Write to present 26 "Self-Flex" Belts to Los Angeles 1926 Champion Baseball team. Send for attractive selling outfit. Sample "Self-Flex" belt included. Write immediately. **Woodward & Cochey Mfg. Co.,** 220 Institute Place, Dept. 1125, Chicago, Illinois.

**Sample Belt GIVEN**



### LATEST SCIENTIFIC MOTOR Runs 10 Hours on 1 Gallon Wonderful Gasoline Engine

Operates Washing Machine, Cream Separators, Lathes, Etc. Also handle Castings for other Engines. Books and Supplies of every kind for **HANDY-MAN, MECHANICS and MODEL MAKERS.**

Complete Catalogue 25c which is allowed on first \$2 order. **AMALGAMATED SALES & SERVICE CORPORATION** 327 P So. LaSalle St. Chicago, Ill.

## PLUMBING-HEATING Install Your Own—Save Half



Lowest wholesale prices on highest quality Grade A goods. Any Handy Man can install his own Plumbing and Heating BY OUR NEW EASY METHOD. Get the best and pay only a little each month. **Send for FREE Book**

New bargain catalog just issued. With our cut-to-fit systems you save waste material and high labor cost. 50 years of economical service to home owners, farmers, builders and mechanics. Million Dollar Plants back up our Bonded Guarantee. FREE book gives you the whole story. **Write for your copy today.**

**OVER 50 YRS. HARDIN-LAVIN CO. EST. 1876**  
107-17 West Pershing Road, Chicago, Ill.



# Here's an Amazing New Business THAT PAYS UP TO \$1,000 A MONTH

**MEN**, here is a real, red hot money-making opportunity! It's a chance to jump into business for yourself and make more money every week than the average man makes in a month. Surprising as it may sound, we actually put you in a business, with the first day's profits often running from \$18 to \$55. \$350 to \$600 the first month is not unusual for ambitious men.

## Cut in on the Big Money

All you need is the ambition to make real money. We supply you with complete equipment to make and sell that famous new food specialty—Brown Bobby—a greaseless doughnut baked by electricity! It's a crispy, flaky, delicious new kind of doughnut cooked without one drop of oil or grease. Easily digested by everyone. More appetizing than old-style doughnuts ever were. Costs less to make. Sells four times as fast. No baker's skill required. Just add water to our prepared "Mix." You can open a shop; rent cheap floor space in a grocery, delicatessen, lunch-counter, drug store, etc. Or start at home—and make up to \$250 your very first week.



## Start At Once ANYWHERE!

"I made \$3,000 in 3 months from my greaseless doughnut business!" — T. Chas. Minch, Fla.

Men and women everywhere are starting in this business daily! YOU cannot afford to delay! Details will gladly be sent without obligations of any sort. Such an amazing money maker may never come your way again. So fill in and send the coupon at once! **TODAY!**

## MAIL COUPON NOW!

**Food Display Machine Corp.,**  
Dept. 13-58, 350 W. Huron St., Chicago, Ill.

Gentlemen: Please send me the plan by which I can cash in on Brown Bobby, the Greaseless doughnut. It is understood that this obligates me in no way whatever.

Name.....

Address.....

City..... State.....



# Have you a Wet Cellar?

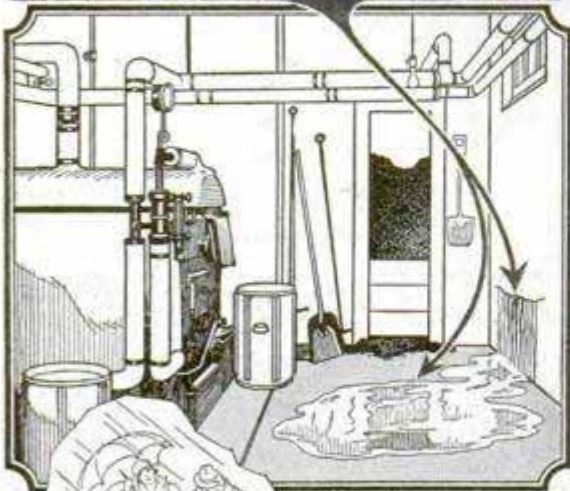

Dampness and flooding from ground water getting in is easily stopped by filling the cracks and painting over the porous spots in concrete or brick walls and floor with

## SMOOTH-ON NO. 7

—the only effective waterproofing material that can be applied from inside and to wet or dry surface.

Excellent also for waterproofing boiler pits, cisterns, tanks, ponds, wash-room, garage and stable floors, etc. About 25 lbs. required for each 100 sq. ft. of surface.

*You should also know*

## SMOOTH-ON NO. 1

—The good old standby for stopping leaks in pressure joints, mending cracks, making loose handles, screws, etc., tight, stopping leaks in automobile radiators and hose connections, keeping lubricators, hub caps and nuts from loosening, etc.

### The Free Smooth-On Repair Book

will show you how, and by doing the work yourself you make big savings. Mail the coupon for free copy.

Get Smooth-On No. 7 in 1 or 5-lb. can, or 25, 50 or 100-lb. keg and Smooth-On No. 1 in 7-oz. or 1 or 5-lb. can. At any hardware store, or from us direct.



# Do it with SMOOTH-ON

SMOOTH-ON MFG. CO., Dept. 37,  
574 Communipaw Ave., Jersey City, N. J.

Please send the free Smooth-On Repair Book.

Name.....

Address.....

# Townsend "B" Socket Power "Best in World!"

Says A. W. GALE, of Gloversville, New York

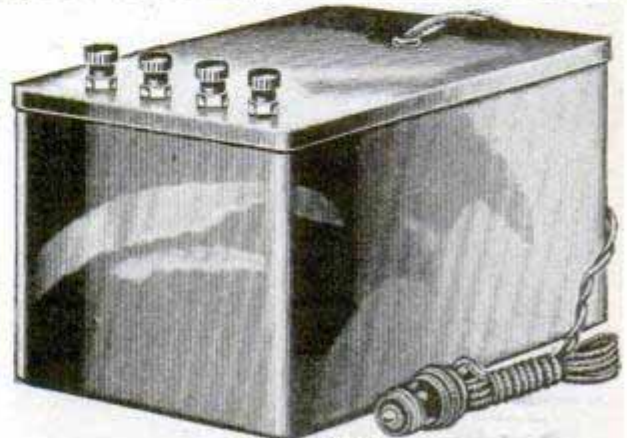

COMPLETE

Below is a reproduction of Mr. Gale's letter of May 8th, 1927.

48 W. Fulton St.,  
Gloversville, N. Y.

"Received the Townsend all O. K. It is the best in the World and that is saying some. I have a Radiola 4 tube. Get more stations than ever before. Some of them are CFCF, CKNC, WGY, KDKA, WGZ, WIP, WWJ, KTBS, KOP, KOA, WHAF, WTAM and KSD—besides four in Chicago, all in the East and then some."

A. W. Gale.



## Replaces "B" Batteries

The letter above speaks for itself—proves beyond doubt that the Townsend "B" Socket Power is the most remarkable value in Radio today. Sam E. Fry, of 1415 Holmes St., Kansas City, Mo., writes: "Eliminator works fine. Showed it to a friend and he wants one also. I will say it sure beats batteries. I get stations I never got before on a 6 tube set." Charles Ellis, 88 Jones Ave., Columbus, Ohio, says: "Your Eliminator is working fine. Have had station WJAX and others over 1,000 miles distant. Picked up 22 different stations one evening and around 30 another time. My neighbor has a \$27.50 Eliminator and I don't see that it works any better than yours." Delivers up to 100 volts on any set, on D. C. or A. C.—any cycle. Full tone, clarity and volume.

Tested and approved by America's leading Radio authorities—Radio News and Popular Radio Laboratories

## ORDER TODAY!

Simply fill out the coupon and slip it into an envelope with only \$1.00 and mail at once. Your Townsend "B" Socket Power Unit will be sent promptly. Deposit only \$5.85 plus postage with the postman. Try out for 10 days—then if not delighted with improvement in reception, return it to us and purchase price will be refunded.

TOWNSEND LABORATORIES

713 Townsend St., Dept. 15., Chicago, Ill.

Attach Only \$1 to this Coupon!

SEND TODAY



TOWNSEND LABORATORIES

713 Townsend St., Dept. 15, Chicago, Ill.

Gentlemen: Attached find \$1.00. Kindly send at once Townsend Socket Power Unit, C. O. D., for \$5.85, plus postage, on guaranteed 10-day free trial.

Name.....

Address.....

City..... State.....



# CLAROSTAT



**FOLLOW THE SPECIFICATIONS.**  
 In seeking the *reliability* of fixed resistance with the convenience of *variable* resistance, radio authorities invariably specify CLAROSTAT. Manufacturers of better grade radio power units invariably use CLAROSTAT. Radio laboratory workers invariably employ CLAROSTAT.

**WHY?** Over five years of persistent, concentrated, specialized efforts have gone into developing the present CLAROSTATS. An entire plant is devoted to making just CLAROSTATS. Specialization, then, has produced the desired result.

Now you may be offered devices "just as good as the CLAROSTAT." You may be imposed upon with imitations at bargain prices. But if you seek results, follow the specifications! Use only the standard of variable resistance, which you will find in the familiar green box and bearing the name CLAROSTAT stamped on the nickel-plated shell of the Universal type (20 watt) and the Power type (40 watt).

Ask your radio dealer for literature on the application of Clarostat for improving your present set or building a better one—or write us direct.

**American Mechanical Laboratories, Inc.**  
 Members R. M. A.  
 Specialists in Variable Resistors  
 285 North 6th St. Brooklyn, N. Y.

**FREE** 1000 Illustrations **ELECTRIC FIXTURE CATALOG!**

Write today for your copy. Save 50% direct from Manufacturer. No Middleman's Profit. **OUR SPECIAL:** 8 Room Electric Set, ready to hang, \$24.50—Other bargains.



**UNITED LIGHTING FIXTURE CO.**  
 83 Flatbush Ave., Dept. M, Brooklyn, N. Y.

**Here It Is Boys! Look It Over**

R. O. Gosden of Michigan made \$321.05 in 9 days—sold 5 machines in 2 1/2 hours.

**THE DE LUXE ADVERTISER**  
 (The Merchant's Friend)

Automatically prints the merchants' "ADS" on his wrapping paper in one or two colors. Costs only what it costs to have "AD" printed on twenty rolls of paper. Flint of New York sold four machines in two hours. You collect and keep your commission. We deliver. Every merchant a prospect. Many buy five or more machines—one for each paper rack they use.



**SALES MANAGER, Dept. A, 1201 Cortland Street, Chicago, Illinois.**

# New 21 Jewel Burlington



## Only \$1.00 Down

brings you the NEW Burlington Watch. Then small monthly payments. The famous Burlington—always a masterpiece—is now better than ever! Sent on approval. Rock bottom, direct-to-you prices.

**Write Quick!** While this special offer lasts. Get free the NEW Burlington Book. Shows in colors all the latest styles and over 100 exquisite designs. Tells how to avoid over priced watches. A postcard will do—

**BURLINGTON WATCH CO.** 19th St. & Marshall Blvd. Dept. 13-58 CHICAGO

# Now Available at \$10.00

## Taylor STORMOGUIDE JR.

THE  
 WEATHER  
 ADVISOR

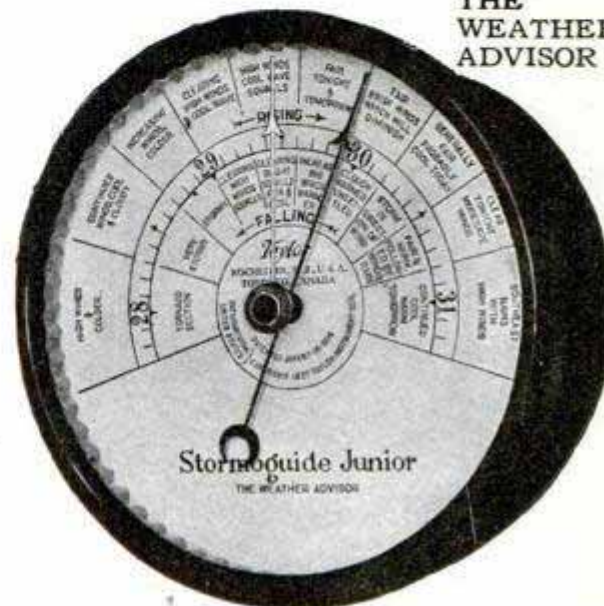

Stormoguide Junior  
 THE WEATHER ADVISOR

### Good Time Insurance at a Low Premium Takes the Guess Out of Your Holiday Plans

**FIT** your plans to the weather. Pick out the good days—go suitably prepared on the stormy ones.

The Stormoguide Jr. has simple, easily understood forecasts on its dial. "Clear tonight, fair with fresh winds tonight and tomorrow; storm brewing in direction of wind." Indicating probabilities for 12 to 24 hours in advance. No puzzling words of ordinary barometer, fair, change, stormy. *Enables you to plan your activities with the weather.*

**WHAT IS IT?** A domesticated weather prophet. Behind its dial an accurate, precise, scientifically made barometer. On the face of it complete weather forecasts. Simple to read as today's paper. Up to the split-second record, while newspaper reports are hours behind.

If a storm threatens, engagements can be postponed to a better day. You'll quickly get the habit of consulting the Stormoguide Jr. regularly and planning business or pleasure by what it indicates.

**YOU CAN'T PREVENT BAD WEATHER,** but you can know what's coming and organize if you possess the

*Taylor*  
**STORMOGUIDE JUNIOR**  
 The Weather Advisor

This STORMOGUIDE is made with the same precision as the other 8,000 types and styles of temperature and meteorological instruments made by this company, which, because of their dependability, are used in every important laboratory in the country.

*Description*—STORMOGUIDE JR., 4 1/2-inch white dial, mahogany finish, bakelite case, glass crystal, good grade aneroid movement; adjustable for altitudes 0 to 2500 feet.

**PRICE.....\$10.00**

*Taylor Instrument Companies*  
 ROCHESTER, N. Y., U. S. A.

CANADIAN PLANT      MANUFACTURING DISTRIBUTORS  
 TYCOS BUILDING      IN GREAT BRITAIN  
 TORONTO              SHORT & MASON, LTD., LONDON

Fill Out the Coupon

*Taylor Instrument Companies*  
 Rochester, N. Y.

I want a STORMOGUIDE JR. My dealer.....

.....does not handle. For the enclosed ten dollars send me one, guaranteeing safe delivery.

Print your name and address in the margin below.



# Play a Tune in 10 Minutes

Be the "Life" of the Party



## Amazing New E-Z Playing UKULELE, BANJO-UKE GUITAR, MANDOLIN, TENOR BANJO

equipped with exclusive patented invention that enables you to play tunes in a few Minutes! Simple as A. B. C. Just press the keys and play tunes from the very start. No knowledge, of music required with E-Z Playing Instruments. No long months of tiresome practice. No expensive lessons. Play by numbers at first—learn to play by notes **Automatically** while playing tunes. Astonish your friends. Be center of attraction at all parties. Produce real music, rich harmony, old-time favorites, syncopated jazz. Loads of fun! New Friends! Money-making chances in dance orchestras radio and stage! All yours when you play an instrument. Over 50,000 people have learned to play tunes in a few minutes with E-Z Playing Instruments. Four success guaranteed.

### FREE TRIAL—Easy Payments

Choose your favorite instrument on Special 10-Day Free Trial Offer. You be the judge in your own home. Play tunes at once or trial costs you nothing. If you keep instrument—pay on liberal easy terms **At Rate of Few Cents a Day**. Send today for

### FREE CATALOG

of E-Z Playing Instruments carrying life-time guarantee. Contains money-saving values in high grade instruments. Also full details of 10-Day Free Trial Offer. You risk nothing. No obligation. (If you have an instrument now, you can secure E-Z Playing Method separately.) For more fun—more popularity—more money—send coupon today.

**FERRY & COMPANY, Dept. 9770, CHICAGO**  
 Send me Free Big Catalogue of bargains in patented E-Z Playing Instruments and full details of Special 10-Day FREE TRIAL Offer. No obligations.

Name.....  
 Address.....  
 City..... State.....

## WATCHES AND JEWELRY

**12 MONTHS TO PAY**  
**Special for Xmas**  
**Diamond Dinner Ring \$49**  
**\$1 down—\$1 weekly**  
 No. A752—4 blue-white diamonds, 4 sapphires 18Kt. solid white gold, latest dove design dinner ring.



**Buy From Diamond Importers**  
 You save middleman's profits because we have been diamond importers since 1879—48 years. We sell only blue-white diamonds—no off color grades. Everything guaranteed as represented. Our money-back-if-not-satisfied guarantee protects your order.

**Ten Days Free Trial**  
 Just send \$1.00 with your order. Pay balance in weekly, semi-monthly or monthly payments beginning February. You have 10 days to decide. If not satisfied, return for full refund.

**Open Confidential Credit Account**  
 To open a charge account without delay. Just give a little information about yourself and a few business references. Everything strictly confidential. No one will know what or from whom you are buying. If under age, have parents or guardian guarantee account.

**Write for Catalog** Hundreds of bargains in Diamonds, Watches, Jewelry, etc. It brings our large Jewelry Store right into your home. Buy diamonds like an expert. Know grades, qualities and values before buying. Contains information other jewelers dare not tell, such as weights and grades of diamonds.

**STERLING DIAMOND & WATCH CO.**  
 1540 BROADWAY, Dept. 2353, N. Y.

## COOKS BY BURNING AIR



**Does Away With COAL!**  
 Converts any ordinary stove into gas range. Produces clean heat much cheaper and is far more efficient than coal. Burns 96% air and 4% kerosene. Installed in few minutes. Types for all heating purposes. Reliable distributor wanted.

**GLORIA LIGHT CO., 111-11 N. May St., CHICAGO**

## MAKES \$18.08 In Few Hours

Without experience E. Lube earned \$18.08 in one afternoon with our beautiful dress goods, silks and wash fabrics. No capital needed. We show you how to succeed. Write for samples and complete selling instructions.

**The National Importing Company**  
 Dept. Y-6 569-573 Broadway New York City



## MAKE THINGS AT HOME—SAVE MONEY \$13.50



**PARTRIDGE WOOD TURNING LATHE**  
 Buy the finished parts completely assembled. Build bed at home. A real tool. 6" swing. Shipping weight 21 lbs. Make radio parts, floor lamps, toys and numerous other practical and valuable articles. Also made in sizes to swing 8", 11", 13", 16", diameters.

**IDEAL GIFT FOR FATHER OR SON**  
 Send today for descriptive circular.

**E. O. PARTRIDGE, Dept. PM-11, 2039-49 W. Lake Street, CHICAGO, ILL.**

**\$13.50**  
 f. o. b. Chicago

## 5 tools in 1—A Mitre, Saw Guide, T-Square, Protractor and Precision Tool

**NOW YOU CAN SAW EASILY and ACCURATELY**



**The Harmak Saw Guide Shows You How.** Everyone can now do their own carpentry work—picture framing, garden seats and ornaments, shelving, cabinets—all the jobs around the house that require a neat, true angle. No tool kit complete without one.

**Make Money at Home Doing Things**

Don't ruin good lumber. Use a Harmak Guide. Operates anywhere and cuts any angle, simple or irregular. If your hardware or department store does not handle, order direct or write us for folders.

**\$30 Worth of Tools for Only (Special) \$2.50**

**HARMAK MFG. CO., 635 Delmonte Way, St. Louis, Mo. Regular Price \$4.00**

**One-Half of any Carpenter's Outfit**



**SM**

**Selected for Popular Mechanics Economy Nine**



**S-M Audios Are Specified Again**

S-M audio transformers again are specified in the banner design of Popular Mechanics. Once a year Mr. Frank L. Britton describes a multi-tube receiver which stands out as "the" receiver development of the Popular Mechanics Laboratory. Last year it was the Popular Mechanics super-heterodyne—this year it is the Economy Nine—S-M audios in each. That S-M audios were selected after months of experimenting simply confirms the findings of most other well known radio authorities—that the best 1928 circuits give you the one real guarantee of tone quality—S-M audios—for you'll find them in more than half of the season's popular designs.

S-M 240 audio and 241 output transformers are guaranteed superior to any other in their price class—their performance is similar to the famous 220's and 221's, except for less accentuation of notes below 80 cycles. 240 audio transformers \$6.00—241 output transformers \$5.00.

Do you know that you can bring the tone quality of your Atwater Kent receiver up to 1928 standards and a few minutes of fun by installing a pair of 240's? The improvement in tone will be a revelation, and there's not a hole to drill. Put your last year's set on a par with receivers of today—give it a tone quality that will surprise you by a \$12.00 investment in a pair of S-M 240's.

**Coil and Stage Shield**

The S-M 110A plug-in coil, selected as the best for the Economy Nine, is an example of the most advanced coil design to be found. Low loss construction confined magnetic field—secondary of enameled wire space wound and almost entirely air supported, and adjustable rotor. Range 190-550 meters with .00035 mfd. condenser. Price \$2.50. Universal coil socket \$1.00.

The S-M 631 stage shield is specified in the Economy Nine to prevent unit



**For Complete Light-Socket Operation**

The new S-M 652A, ABC power unit less than 7 inches square, will furnish all ABC power to any standard receiver, suitably rewired for A. C. tubes. It will furnish 1.5, 2.5 and 5 volts A. C. and 45 volts, 10 M. A., 90 volts, 45 M. A., and 220 volts at 20 M. A. (40 for C, 180 B for a 171 power tube) when connected to any 105 to 120 volt 60 cycle light socket. Its initial and upkeep cost is less than for batteries, and it will operate any set with a few circuit changes, and A. C. tubes.

Price less tube, 652A kit, \$36.50, or type 656A, wired and assembled, ready to use, \$40.50.

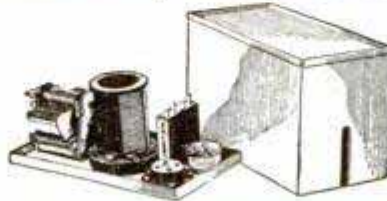

interaction and to avoid the pick-up of parasitic noises. Removable top and bottom, pierced to accommodate standard S-M units. Price \$2.00.

*We can't tell you here about all the new S-M developments but if you'll send us 10c for postage we'll send you more information on real power equipment, super audio amplification and other pertinent subjects than you can read in a week.*

**Silver-Marshall, Inc.**  
840 West Jackson Blvd.  
Chicago U. S. A.

**Silver-Marshall, Inc.** PM 11-27  
840 West Jackson Blvd., Chicago

Please send me full information on the new S-M developments for which I enclose 10c.

Name.....  
Address.....

**new—much better**  
**180 volt**  
**"B" Eliminator**

Brand new—radically different in design—obviously better—and guaranteed for years! The first "B" Eliminator ever offered at a reasonable price which combines high power output with real long life. Delivers every voltage required by the modern multi-tube set. 5, 8, 10 tubes—it makes no difference. Plenty of pure, smooth, hum-free power for any set—then enough left over for the proper operation of a "171" or "210" power tube. Uses Q. R. S. or Raytheon 85 Mt. Tube. And we let you try it free before you buy.

**The First 180 Volt "Lifetime" B at a Reasonable Price**

Do not confuse this new, advanced type "B" unit, with chemical rectifier types or with cheap eliminators having only a single filter choke or employing short lived single paper filter condensers. The Cloverleaf Lifetime "B" is all that its name implies. It is the true Lifetime unit; good for long years of dependable service, even under heavy load. Only the very finest quality materials go into the Cloverleaf Lifetime "B"—two oversize filter chokes—the very finest grade high voltage heavy duty filter condensers that money can buy—the best, longest lived, newest type of thoroughly dependable wire-wound voltage control resistances that experts could design. Every part, every bit of workmanship is the best. Yet, the Cloverleaf Lifetime, high voltage "B" costs only half what others of equal capability cost you.

**ONLY 1/2 THE PRICE OF OTHERS**



**TRY IT ON YOUR OWN SET FREE**

We want you to try the Cloverleaf: to put it to any test you can. Hook it on to 8 or 10 tubes. Make it drive a power tube. Compare it with any "B" eliminator at any price. Compare its performance—compare its many detailed advantages such as the absence of exposed binding posts and many other important refinements. Make this test at our risk under our FREE TRIAL GUARANTEE OFFER. Then decide why, if at all, you should pay more for a "B" eliminator than the ridiculously low price at which the Cloverleaf Lifetime "B" is sold. Mail coupon at once for full particulars of this great new "B" and for details of our FREE TRIAL OFFER.

**CLOVERLEAF MANUFACTURING CO.**  
2712-H Canal Street Chicago, Illinois

CLIP AND MAIL NOW  
**CLOVERLEAF MANUFACTURING CO.**  
2712-H Canal St., Chicago Ill.  
Tell me more about the Cloverleaf "B" Eliminator and particulars of your FREE TRIAL OFFER.  
Name.....  
Town.....  
State.....





# Like having a JAZZ BAND in Your Home

THE New PHONIC Reproducer gives you twice the volume of music that you ever before got out of a phonograph. It will fill the largest dance hall with the strains of your favorite jazz orchestra, yet the tones are so natural and full rounded that it is just like having a jazz band in the room. As different from the ordinary phonograph music as a \$10 phonograph is different from a \$1000 phonograph.

## New PHONIC Reproducer

makes your old phonograph like one of the new expensive Phonic machines. No screeching, no blasting, no "tinny" music. Gets all the high and low tones. Ideal for dancing or for home treatment. Can be quickly attached to any make of phonograph in 10 seconds.

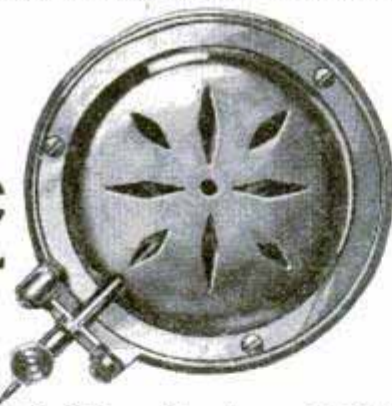

## Send No Money—10 Days' Trial

You cannot realize how wonderful the New PHONIC is until you hear it. That is why we want to send it to you on 10 days' trial. Send no money now—just the coupon. Pay the postman only \$3.85 plus a few pennies postage when the New PHONIC arrives. Then if you are not delighted, send it back within 10 days and your money will be refunded. If sold in stores the price would be at least \$7.50. Our price only \$3.85. Over 350,000 people have dealt with us by mail. You take no risk. Mail coupon now for 10 days' trial. BE SURE TO STATE THE NAME OF PHONOGRAPH YOU OWN.

**NATIONAL MUSIC LOVERS, Inc., Dept. 5811  
327 West 36th Street, New York**

Please send me a New PHONIC reproducer for.....  
.....I will pay the postman \$3.85 plus  
(give name of phonograph) a few cents postage. If I am not  
satisfied after trial, I will return your reproducer within 10 days  
and you guarantee to refund my money. (Outside U. S. \$4.10,  
cash with order.)

Name.....  
Address.....  
City..... State.....

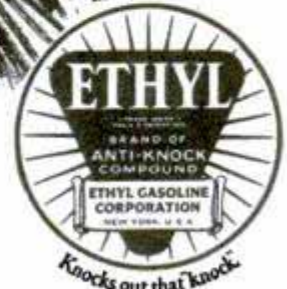

Colder  
weather  
is coming—use

# ETHYL GASOLINE

You motorists who have enjoyed the benefits of Ethyl Gasoline in warm weather will get an even better car-performance from Ethyl this fall and winter.

Ethyl gives the *extra* power you need to meet the extra strain cold weather puts on your engine. It gives the *extra* pull you need for snow and slush and muddy roads. It cuts down gear-shifting and quickens pick-up in the season when driving is hardest. Most of all, Ethyl Gasoline "knocks out that 'knock'."

And if you own one of the new high compression engines, Ethyl will give a still bigger thrill.

Ride with Ethyl the year round. *It's the superior fuel for all seasons.* On sale throughout the United States and Canada at thousands of pumps which display the "ETHYL" emblem shown above. Fill your tank today.

**ETHYL GASOLINE CORPORATION  
25 Broadway, New York City**



# What's He Doing?

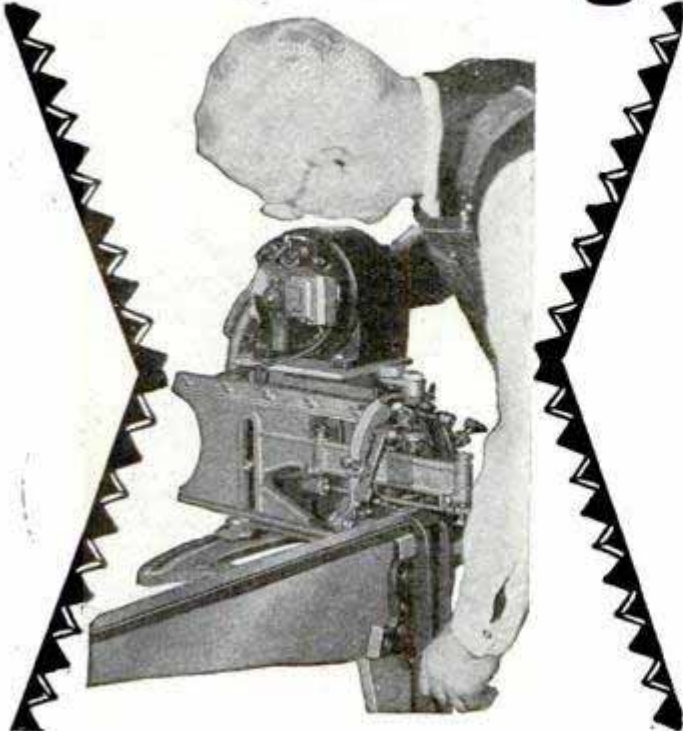

**Making \$15 to \$20  
a Day With the**

## FOLEY Automatic SAW FILER

Here's a quick way to get into a good paying business of your own: file saws for the carpenters, contractors, woodworking plants, factories, schools, butchers, and homes. With a Foley you can file all kinds of saws automatically, better than the most expert hand filers and four to six times as fast. Get \$0.50 and more for filing hand saws and \$1.25 to \$1.50 for retooling them. Think of the money Nelson Savage of Gravity, Iowa, is making—here's what he says, "I have already filed 431 saws since getting your machine."

### NO COMPETITION

There is a big demand in every town for a good saw filing service. You'll have a steady, year around cash business with the Foley. It's a clean, dignified business. Requires no experience because the Foley works automatically. Mail the coupon now for full information about how to get into this good paying business of your own.

Foley Saw Tool Co., 221 Foley Bldg.,  
9 Main St., N. E., Minneapolis, Minn.

Please send me complete illustrated description of the Foley Saw Filer.

Name.....

Address.....

# This Marvelous Wrench Pays \$1000 a Month

## No Thumb Screw Adjustment

That simple slide motion locks securely, with a better hold than is possible with any other wrench. Does away with the old thumb screw idea that was always a handicap.

## First and Only One Hand Monkey Wrench

Any job can be tackled and finished with ONE HAND quicker with the H&E WRENCH than any tool on the market. Fully Patented and the first and only tool of its kind.

## Slides Up and Down Locks Automatically

It creates a sensation wherever shown, its simplicity, smooth action, strong grip, and practical value arouses the interest of everyone. Mechanics are wild over it.

## Saves Time

As a labor and time saver it simply can't be beat. Any job is done quicker and easier.

## Agents Wanted Every- where

Rapid sales with a handsome profit makes this a very attractive proposition for Agents and on account of this increased demand we want Agents everywhere and the opportunity is open to you NOW but you must ACT PROMPTLY.

## Pressure 8,000 Inch Pounds

All tests passed Government specifications. Actual service with Railroads assures High-Class Practical Value.

## Praised by Big Concerns

C. B. & Q. Railroad and many other large Corporations have acknowledged its value and endorsed it. Factories, Machine Shops, Garages, in fact, wherever tools are used need it. Every home should have one.

## MAIL TODAY GET YOURS FREE

H & E WRENCH SALES CORP.  
Dept. M, 228 No. LaSalle St., Chicago, Ill.  
Dept. M, 285 East 134th St., New York City.  
Gentlemen:—Please mail me free particulars. This does not obligate me in any way.

NAME.....

ADDRESS.....

STATE..... R.F.D.....





# All Who Love to make things

*Model Makers ~ Amateur Mechanics Experimenters, etc.* Study the specifications of this ultra-quality line of dependable machine tools, selling at prices you can afford.



**Knapp Lathe No. 930**  
Turns wood up to 5 in. length, 2 3/8 in. diameter. Tool rest, head rest, tail stock all fully adjustable. Complete with 3 step pulley, 3 high grade cutting tools, and instruction book.  
**\$6.00, Denver West \$6.50**  
Shipping Wt. 4 lbs.

Samples of work done on the Knapp Lathe with Outfit 935, consisting of 12 interesting and useful turning designs, and templates, 43 white pine blocks, 5 in. long, from 1/2 to 1 1/2 in. diameter.

**Outfit 935, \$1.25**  
Shipping Wt. 7 lbs.



**Knapp Jig Saw No. 900**  
Capacity up to 3/8 in. lumber, also bakelite, celeron, etc. Handy for making radio panels, as well as jig saw and scroll work. Instruction book, wood with design laid out ready for cutting and 3 blades furnished.

**\$4.00, Denver West \$4.25**  
Shipping Wt. 3 1/2 lbs.

Sample of work done on Saw No. 900 from Outfit 902 which consists of 20 boards, 4 1/2 x 12 x 3/16 in. and 12 designs for making everything from toys to practical household articles.

**Outfit 902, \$2.00**  
Shipping Wt. 6 lbs.



**Knapp Speed Drill No. 910**  
Takes 1/16 in. to 3/16 in. dia. drills. Drills wood, iron, copper, brass, aluminum, lead, slate, bakelite. No workshop, whether you work wood or metals, complete without one. Instruction book.

**\$4.50, Denver West \$4.75**  
Shipping Wt. 4 lbs.

Send 10¢ for full color catalogue fully describing Knapp American Industry in Miniature—a real line of miniature machine tools that work.

Go to your dealer and see a Knapp Work Shop with all these tools mounted and assembled \$27.50—at any hardware, sporting goods or department store (toy dept usually).

*If out of stock we will send direct on receipt of price plus forwarding costs.*

**KNAPP ELECTRIC CORPORATION**  
Dept. 89 PORT CHESTER, N. Y.

*Also manufacturers of Knapp Electric Questioner*

In Canada: THE T. EATON CO., Limited  
(Canadian prices slightly higher)

# BUILD!

## The Two Tube Official Browning-Drake

This new assembly has been designed to be used with any good audio transformer system such as Amertram, Thordarson, etc. Only the R. F. and detector tubes are used. The combination gives an exceptional tone quality. Browning-Drake Corp. parts used are the Official Browning-Drake Kit, special type T foundation unit, cartridge resistance and neutralizer. If your dealer does not carry all of the specified parts, write us direct. Send for folder P. M.

### DEALERS

Almost three times as many BROWNING-DRAKE parts are sold as those of the nearest competitor. If your jobber cannot supply you, write or wire us TODAY.

**BROWNING-DRAKE CORP.**  
Cambridge, Mass.



# BROWNING DRAKE

## TIRE REPAIRMEN—WRITE

for Booklet No. 22 "The Vulcanizing of Balloon and High Pressure Tires."

The SHALER Co.  
2712 4th St., Waupun, Wis.

# SHALER

  
VULCANIZERS

Let us recommend the best books to study on any subject. Popular Mechanics Press, Chicago, Illinois.

## No Better Christmas Present for \$2.50

than a year's subscription to

## Popular Mechanics Magazine

Containing 4500 Pictures and 3600 Articles

Much of it Interests Everybody

Most of it Interests Anybody

All of it Interests Somebody

Order through your Newsdealer or address the Publisher

## POPULAR MECHANICS COMPANY

200 East Ontario Street, CHICAGO, ILL.



# Win a Buick or \$1500.00 In Cash

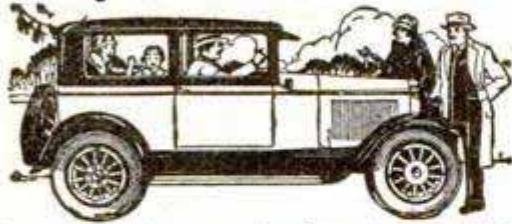

I am going to give away a brand new, latest model Buick Sedan to someone who answers this adv. We have already given away many autos. This is the most liberal offer ever made. It is your chance to win this ideal car. You can win it; why not try? The Sedan will be delivered to the winner, or winner may have the full cash value (\$1,195.00)!

## SOLVE THIS PUZZLE

2	21	9	3	11	7	9	22	5	14
---	----	---	---	----	---	---	----	---	----

Can you make out the two words spelled by the numbers in the squares above? The alphabet is numbered, A is 1, B is 2, etc. What are the two words? Send your answer today—not a cent of cost to you now or later.

## \$305 for Promptness

I will also give away a Chevrolet Coach, Orthophonic Victrola and many other valuable Prizes—besides hundreds of dollars in Cash—and \$305.00 Special Extra Prize for Promptness. First Prize winner will receive \$1,500.00 cash or Buick Sedan and \$305.00 cash. All who answer can share in cash and prizes. In case of ties the prizes will be duplicated. EVERYBODY REWARDED. Now, get out your pencil and solve the puzzle—send your answer today with name and address plainly written.

**WILLIAM LEROY,**  
315 So. Peoria St., Chicago, Ill.  
Dept. 1778



**MEN'S STRAP WATCH**  
DIRECT FROM SWITZERLAND  
Radium Dial Jeweled Movement Silveroid, Cushion Shaped Case  
This fully guaranteed watch cannot be manufactured in America for less than \$12. Genuine leather strap. Accurate—durable—handsome. SEND NO MONEY. Pay on delivery \$3.99 plus postage. "FED CO." U. S. Swiss Agents, 561 Broadway, New York City, Dept. W-10

## Boils 50 Gallons In Less Than Hour

No Other Compares With This

## Improved Oil Burner

Use Ordinary Kerosene or Coal Oil

[Burns Outdoors as Well as Indoors]

THE most remarkable Kerosene Burner ever built. Boils down apple cider, maple syrup, molasses, etc., in half the ordinary time. Ideal burner for dairies, butchers, indispensable on the farm.

PRODUCES TERRIFIC HEAT WITH SILENT BLUE FLAME

**NO NOISE  
SMELL  
SMOKE  
SOOT**



So efficient it produces twice the amount of heat of City gas at half the cost. So simple anyone can install and operate. Double generator assures continuous operation without shut-downs. Nothing to wear out, starts in a jiffy, will last a life time. Every burner guaranteed fully. Write for special introductory price and free catalog of outdoor utility and kitchen stove oil burners.

HOME MFG. CO., Dept. 133, 18 E. Kinzie St., CHICAGO



## "How we saved our first \$500"

"MARY and I had been married four years, but we couldn't save a cent. Fact is, we were constantly in debt and I was always worried for fear I would lose my position.

"Then one night I saw that something must be done, so I told Mary I was going to take up a course with the International Correspondence Schools. 'I've been hoping you would do that,' she said. 'I know you can earn more money if you really try.'

"So I started studying after supper at night, in the spare time that used to go to waste. It wasn't hard and pretty soon I began to see it was helping me in my work. In three months a new position was open and the Boss said he'd give me a chance at it because he'd heard I was studying with the I. C. S.

"Well, that was the start. Before the end of the year I received another raise in salary and we began to save a little each week. We've got \$500 in the bank now and we're going to have a lot more soon. The Boss says he's going to give me a still better position if I keep on studying with the I. C. S."

For thirty-five years the International Correspondence Schools have been helping men to win promotion, to earn more money, to get ahead in business and in life.

You, too, can have the position you want in the work you like best. Yes, you can.

At least, find out how by marking and mailing the coupon printed below. It doesn't cost you a penny or obligate you in any way to do this, but it may be the means of changing your entire life. Do it now.

### Mail This Coupon for Free Booklet

#### INTERNATIONAL CORRESPONDENCE SCHOOLS

"The Universal University"

Box 5686-E, Scranton, Penna.

Without cost or obligation, please send me a copy of your booklet, "Who Wins and Why," and full particulars about the course before which I have marked X in the list below:

#### BUSINESS TRAINING COURSES

- |  |   |
|--|---|
| <input type="checkbox"/> Business Management                     | <input type="checkbox"/> Salesmanship                                     |
| <input type="checkbox"/> Industrial Management                   | <input type="checkbox"/> Advertising                                      |
| <input type="checkbox"/> Personnel Organization                  | <input type="checkbox"/> Better Letters                                   |
| <input type="checkbox"/> Traffic Management                      | <input type="checkbox"/> Show Card Lettering                              |
| <input type="checkbox"/> Business Law                            | <input type="checkbox"/> Stenography and Typing                           |
| <input type="checkbox"/> Banking and Finance Management          | <input type="checkbox"/> English  |
| <input type="checkbox"/> Accountancy (including C.P.A.)          | <input type="checkbox"/> Civil Service                                    |
| <input type="checkbox"/> Nicholson Cost Accounting               | <input type="checkbox"/> Railway Mail Clerk                               |
| <input type="checkbox"/> Bookkeeping                             | <input type="checkbox"/> Common School Subjects                           |
| <input type="checkbox"/> Private Secretary                       | <input type="checkbox"/> High School Subjects                             |
| <input type="checkbox"/> Spanish <input type="checkbox"/> French | <input type="checkbox"/> Illustrating <input type="checkbox"/> Cartooning |

#### TECHNICAL AND INDUSTRIAL COURSES

- |   |  |
|---|--|
| <input type="checkbox"/> Electrical Engineering                     | <input type="checkbox"/> Architect                                       |
| <input type="checkbox"/> Electric Lighting                          | <input type="checkbox"/> Architects' Blueprints                          |
| <input type="checkbox"/> Mechanical Engineer                        | <input type="checkbox"/> Contractor and Builder                          |
| <input type="checkbox"/> Mechanical Draftsman                       | <input type="checkbox"/> Architectural Draftsman                         |
| <input type="checkbox"/> Machine Shop Practice                      | <input type="checkbox"/> Concrete Builder                                |
| <input type="checkbox"/> Railroad Positions                         | <input type="checkbox"/> Structural Engineer                             |
| <input type="checkbox"/> Gas Engine Operating                       | <input type="checkbox"/> Chemistry <input type="checkbox"/> Pharmacy     |
| <input type="checkbox"/> Civil Engineer                             | <input type="checkbox"/> Automobile Work                                 |
| <input type="checkbox"/> Surveying and Mapping                      | <input type="checkbox"/> Airplane Engines                                |
| <input type="checkbox"/> Metallurgy <input type="checkbox"/> Mining | <input type="checkbox"/> Agriculture <input type="checkbox"/> Navigation |
| <input type="checkbox"/> Steam Engineering                          | <input type="checkbox"/> Mathematics <input type="checkbox"/> Radio      |

Name.....

Street Address.....

City..... State.....

Occupation.....

Persons residing in Canada should send this coupon to the International Correspondence Schools Canadian, Limited, Montreal, Canada



# Take One Home on Six Days' Trial

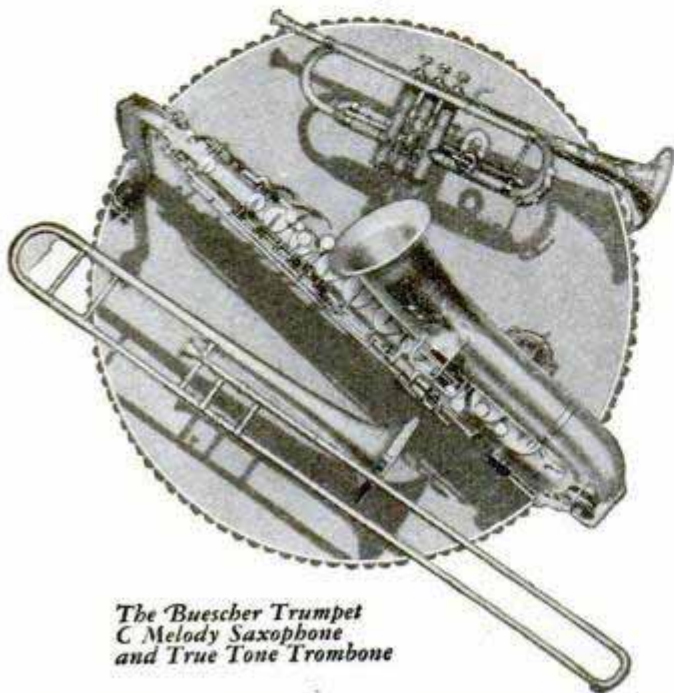

The Buescher Trumpet  
C Melody Saxophone  
and True Tone Trombone

What is your favorite wind instrument? Saxophone, Trumpet, Trombone, Cornet? You can have any Buescher you choose for six days' trial in your own home.

Show Dad and Mother what you can do in just those few days.

*You can soon Master a Buescher*

Every boy wants to play some musical instrument. Because the boy who can play has more fun and many opportunities that boys who cannot play, do not have. You can soon master a Buescher. Many play scales the first hour, easy tunes the first week.

*—if you can pass this test*

But you must be able to pass this test. [1] Whistle a tune, any tune. [2] Keep step with the band or other march music. If you can do these things you can learn to play in no time.

*Nothing like a Buescher*

But remember! Only with a Buescher Instrument is rapid progress assured. Because Buescher Instruments are easy to finger and easy to blow. That is why the great professionals play Bueschers. Finest instruments made.

Sign the coupon below and mail it today for complete information as to how you can get one of these wonderful instruments for six days' trial. This will not obligate you in any way. Besides, we will send you also a beautiful catalog showing all the models of your favorite instrument. Mail coupon now. Mention instrument you like best.

**BUESCHER BAND INSTRUMENT CO.**  
Everything in Band and Orchestra Instruments  
2001 Buescher Block Elkhart, Indiana

BUESCHER BAND INSTRUMENT CO. 378  
2001 Buescher Block, Elkhart, Ind.

Gentlemen: Without obligating me in any way please send me your literature. Mention instrument interested in.

Age?.....Name Instrument.....

Name.....

Address.....

## FROST-RADIO DE LUXE APPARATUS

Best for your set

We build Frost-Radio De Luxe Apparatus better in order to have it best for your set. We use highest grade Nichrome or Chormel resistance wire in our rheostats and potentiometers. We wind this wire on special flexible Bakelite mounting strips because it has been found the most sturdy, longest-lived material for this purpose. We hand-buff all exposed metal parts after nickel plating. The result: A quality product.



FROST-RADIO



FROST-RADIO

Ask your dealer to show you the new Frost Metal Frame and Bakelite De Luxe Rheostats, with and without filament switches; the new Frost Variable High Resistance Units, with Bakelite shells; the new Frost Gem Rheostats—they are GOOD small rheostats—and the new Frost Fixed Resistances. The latter cost but a few pennies, but when you install them in your set, they surely make a tremendous difference! Be sure to specify Frost-Radio Parts when ordering.

### HERBERT H. FROST, INC.

Main Offices and Factory, Elkhart, Ind.  
New York Philadelphia Chicago Los Angeles  
Boston Pittsburgh St. Louis St. Paul

**RADIO ACCESSORIES at WHOLESALE**

Radio Sets, "B" Eliminators, Chargers, Tubes, Kits, Parts—everything new in Radio at lowest wholesale prices. Thousands of nationally advertised bargains. All listed and illustrated in my Big New Catalog and FREE Call Book. 132 Pages of valuable Radio information—trouble finding, set building—Radio knowledge of all kinds. Write today. HARRY SCHWARTZBERG PRES. AMERICAN AUTO & RADIO MFG. CO. Dept. 264 American Radio Bldg. Kansas City, Missouri

**FREE BIG BARGAIN CATALOG**

**Make Money SHARPENING SKATES**

**A FEW DOLLARS STARTS YOU Universal and Keen Edge Skate Grinding Holders**

As used for Lengthwise and Cross sharpening of skates. Price \$5.00 and \$3.50 each. Particulars on request. The Original Makers of Skate Grinding Holders.

**Ferodowill Mfg. Co. 202-214 W. Indiana Ave. ST. PAUL, MINN.**

### PLUMBING - HEATING WATER SYSTEMS

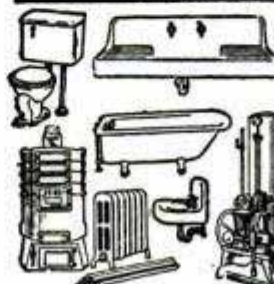

**SAVE UP TO 40%**

Wonderful bargains—everything guaranteed. Full line of plumbing and heating supplies. Hot water, steam heating plants and fixtures and water systems at big savings.

**Install Them Yourself**

Finest materials all brand new and perfect. Tell us your wants and mail us a rough sketch of your rooms.

**SEND FOR PRICE LIST**  
800 S. KEDZIE AVE.  
B. KAROL & SONS CO. Dept. 20 CHICAGO



# RADIO CATALOG *free*

**2000**  
*Exceptional*  
**Radio**  
*Values*



**LOWEST**  
**PRICES**  
**to**  
**DEALERS**

**Economy Nine Super** Described in this issue. Retail price \$67.25.

This is the lowest priced Super kit of quality that the Radio market offers. Our extremely large discount makes your net price extremely low.

**EVERY SET BUILDER NEEDS THIS BOOK** Every live dealer in radio, sets, parts, accessories, supplies, etc., should have a copy of this bargain catalog. You will be amazed at the thousands of money saving radio items illustrated and listed in this storehouse of everything you could possibly need in radio.

**The GUIDE BOOK to Bigger RADIO PROFITS FOR YOU** The book contains all the latest and most popular kits—all the famous, nationally known radio parts, accessories and supplies—the very newest types and designs of table cabinets and consoles—everything at prices that mean bigger profits for you.

**Short Wave Section** Our catalog contains a section devoted to a showing of the highest grade short wave receiving and transmitting apparatus. Also the finest electrical appliances for use in the home.

**DEALERS Make More Money!** Tie up with a house that carries large, complete stocks, that gives you the highest quality radio parts, that insures speedy shipments and 100% satisfactory service. Our wholesale vest pocket price list and discount sheet and catalog will be sent to you on request. **But Write Quickly.**

**SHURE RADIO COMPANY** 339 D. West Madison Street CHICAGO, ILLINOIS

Make This a Big Radio Season!

# Save fuel-

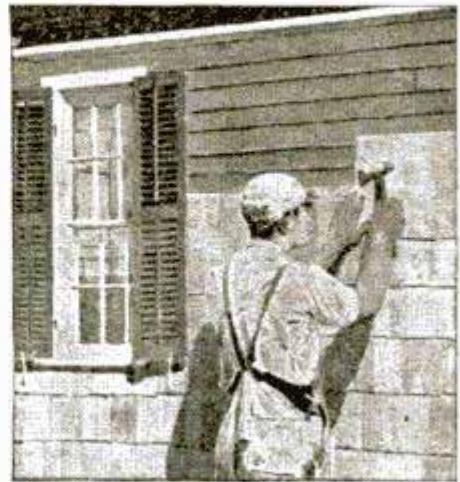

## Creo-Dipts over side-walls *Reduce yearly fuel bills 15% to 25%*

**L**AY Creo-Dipt Stained Shingles right over the side-walls of your present home. It costs only about one-third more than re-painting, and most owners testify it *lowers their fuel bills almost one-fourth.*

And that's only part of Creo-Dipt savings. They save paint—enough in 5 to 7 years to pay their entire cost. And their fresh colors add new beauty—new dollar and cents value—to your old house. Mail the coupon now! Find out about genuine Creo-Dipts for covering old side-walls, re-roofing, or for a new home. Or, ask your lumber dealer today.

Leading lumber dealers everywhere have *genuine* Creo-Dipts in stock. When you buy, look for the name *Creo-Dipt* on each bundle.

# CREO-DIPT

## *Stained Shingles*

SEND FOR PHOTOGRAPHS



Creo-Dipt Co., Inc., 1232 Oliver St., No. Tonawanda, N. Y. (In Canada: Creo-Dipt Co., Ltd., 1610 Royal Bank Bldg., Toronto.) Sales offices in principal cities.

Enclosed find 25c for portfolio of large-size photographs of Creo-Dipt homes, booklet of color suggestions, and name of local Creo-Dipt dealer, who will recommend a reliable carpenter-contractor.

Check the use that interests you  Building new  Re-roofing  
 Covering old side-walls

NAME.....

ADDRESS.....

# H&A Equipment

## For Every Wood-Working Job

### PORTABLE ELECTRIC



Band Saw



Cut-Off Saw



Rip Saw



Bench Jointer



Wood Lathe

**I**F YOU work in wood, you need one or more of these sturdy, efficient, reasonably priced H & A machines. Whether you have a million dollar factory or a little basement shop in your home, you can depend upon the quality and accuracy of the work turned out on any H & A machine. Remember, they're all **PORTABLE**. Move them right to the job and save unprofitable hand labor. Built for years of dependable service—and you couldn't buy finer equipment at **ANY** price. Each machine performs a wide variety of operations.

Just check the machines in which you are interested, fill in your name and address, tear out the whole ad and return it to us. We'll give you complete information by first mail.

## Heston & Anderson

637 N. W. Depot St. Fairfield, Iowa

Name.....

Address.....

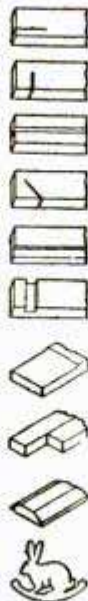



# DEVITT 8" COMBINATION SAW

## 8,000 IN USE!

**A SHOPFUL OF TOOLS WITHIN ARMS REACH!**

**SAW TABLE RAISED SHOWING EMERY WHEEL, SAW GUARD AND DRILL ATTACHMENT**

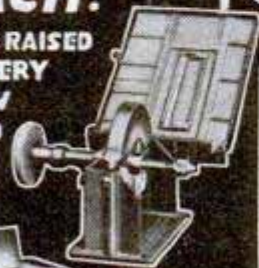

**PLANER ATTACHMENT ON SAW TABLE**

**SHOWING SANDING DISC ATTACHED**



**TABLE TILTED FOR BEVELING**

**DADO HEAD ATTACHED FOR GROOVING**

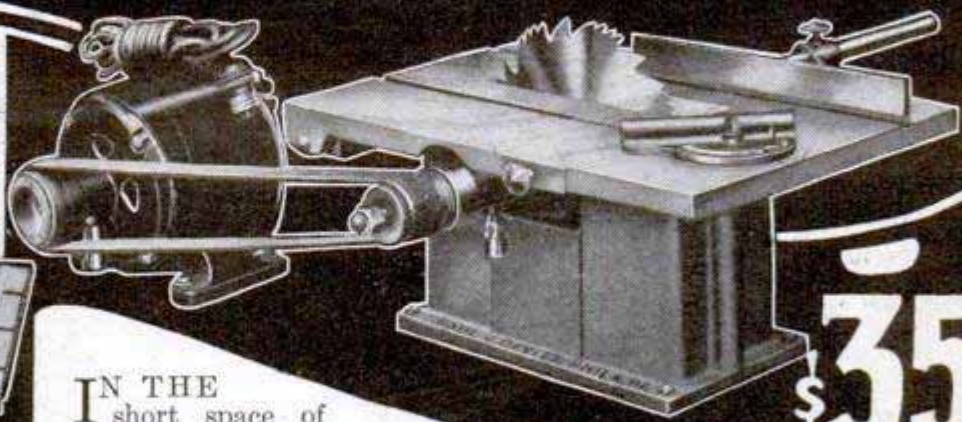

**\$35**

**F.O.B. PHILA**

**I**n the short space of four years, the Devitt 8-Inch Combination Saw has become a practical necessity in thousands of shops, factories and households everywhere. Many imitators have sprung up, but Devitt leads them all. Think of the convenience and economy of this handy little machine that will rip, cross cut, bevel, miter, groove, mortise, tenon, drill, rabbet, grind, buff and polish. Attachments are easily and quickly adjusted. The saw and motor, when set up for work, occupy very little room. Saw is equipped with 1/4 H.P. 60 cycle, 110-volt A. C. Motor which can be attached to ordinary light socket, and provide power for other purposes when wanted. A cut up to 2 1/4" can be made without planing. Comes complete with following attachments—12"x16" table, 8" Combination Saw, iron pulley for saw table, 10" ripping fence, adjustable cut off miter gauge, motor-specifications as above, 1 1/4" endless leather belt, wood pulley, 8 ft. cord and plug, 6" buffing wheel, 3/8" 3 jaw drill chuck, 5" emery wheel, 6" sander, saw guard, and 2" dado insert. \$35.00 F. O. B. Phila. Height 7 1/2", shipping weight, 100 lbs.

*(Only \$12 extra for Planer Attachment to fit on table top. Can smooth pieces up to 2 inches wide. Price, F. O. B. Phila.)*

Send today for our attractively illustrated 4-page circular

# PAUL J. DEVITT

**Dept. A 1102 SOUTH 2ND ST. PHILA., PA.**

Books on all subjects are sold by Popular Mechanics Press, 200 East Ontario Street, Chicago, Illinois.

Let us recommend the best books to study on any subject. Popular Mechanics Press, Chicago, Illinois.

**Make a Six Pointed Star**

**Just Draw Six Straight Lines With Four Dots on Each Line**

I will give away four sedans and 30 other big prizes making a total of \$5,000.00 in prizes. We have already given over \$42,000.00 in prizes to advertise our business—including 9 Buicks and many other cars. Now YOU can get YOUR Buick Sedan or \$1,800.00 in cash. **GET BUSY**

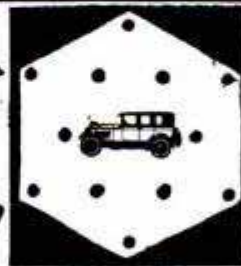

**and WIN NEW 1928 BUICK or \$1800.00 CASH!**

**4 New Autos Given!**



1st prize, Buick Sedan, 2nd prize, Nash Sedan, 3rd prize, Essex Sedan, 4th prize, Chevrolet Sedan. 28 other valuable prizes, total \$5,000.00.

**Send No Money** Just your answer—it costs nothing! Draw each line making a six-pointed star with a Buick in center. Draw the lines—cut out the ad, send your name and address; that's all and I'll tell you all about this offer. It may mean your winning a Buick Sedan or

**You Can Win \$1800.00 Cash**

Any winner can have cash instead of prize won. First prize winner can have Buick Sedan worth \$1295.00 and \$505 in cash, total \$1,800. You do not risk one cent, now, later, or ever! Leola I. Markus of Virginia, Minn., received \$2,500.00 check. H. A. Andrews, Horse Creek, Wyo., received Buick Sedan. Big list of former prize winners sent you. Everyone doing good work is rewarded. Act quick.

**T. W. KELLY, 500 N. DEARBORN ST. CHICAGO**

*Puzzle Fans Here's a Brand New One!*

**\$505 EXTRA for promptness**



# Saw It Quick with the New Porter-Cable

## KWICK SAW



Not "just another electric saw"  
BUT the lightest, simplest  
—direct drive  
—no gears, at only..... **\$65**

Saves power, saves expense, saves repairs. Only 12 pounds—easily operated with one hand. Compact—low center gravity—depth adjustable. Fan inside of guard where it belongs. 10,000 r.p.m. for smooth cutting. All parts of aluminum. Furnished with combination saw—the famous Simonds "60." Write today for demonstration or free printed matter.

**PORTER CABLE MACHINE CO.**  
1704-10 North Salina St. SYRACUSE, N. Y.

### IS YOUR LOUD SPEAKER PARALYZED?

If your Speaker is one of the majority which acts "Dumb" with no apparent cause, ask your Dealer for the Muter Clarifier, or write us for full particulars about this miraculous new Radio necessity which assures Full Tone, Clarity and Volume.

Leslie F. Muter Co., 76th and Greenwood, Dept. 805-P, Chicago, Illinois

### PLAY this UKULELE Like an Expert in 10 MINUTES

Pictures show everything.  
No knowledge of music  
needed. Play right away.  
Learn jazzy Hawaiian  
finger strokes  
Romance! Fun!  
New friends!  
Popularity!



**FREE** NEW METHOD 200 SONGS

New Method and Book of 200 Favorite Songs and Strumming Pick—all FREE with big Jumbo size Hawaiian Uke. Rich, sweet tone. Beautiful mahogany finish, non-slip pegs. Regular \$6 value.

**Send No Money** On arrival free outfit, deposit with Postman bargain price of only **\$2.98**, plus postage. Play 6 days. If not delighted, deposit refunded. Satisfaction guaranteed. Send now. **FERRY & CO. Dept. 7770 CHICAGO, U.S.A.**

Mrs. O. Brown, of Philadelphia, Pa.: "New Method makes it all very easy. I am very much pleased." C. C. Jacinto, Hawaii: "Your Ukulele is a much better value than anything I can get in Hawaii."

# Speed Way Drill & Saw Kit



**5 Tools  
in Case**

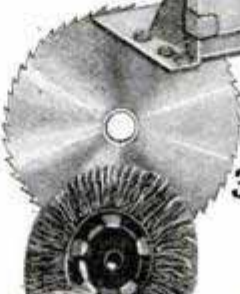

## Free Trial

Long before your ten-day free trial is over you will know what a wonder it is. Works from any lamp socket.

### Five Tools in Case

Outfit packs into handy steel case (No. 11). Take it to the job. Handy; compact.

### HERE THEY ARE

1. Speed Way Portable Drill, with capacity of 1/4" in steel; 1/2" in wood.
2. Guard and handle for portable saw driven by Drill Motor.
3. Saw blade—6-inch.
4. Wire Scratch Brush.
5. Buffer wheel for polishing.
6. Cradle to convert the Portable to a Bench Drill.
7. 3" Emery Wheel.
- 8, 9, 10. For attaching above.
11. Steel Carrying Case, leather handle.

### Easy to Pay For

We ship on receipt of small down payment. Pay balance in small monthly amounts, while you are using it.

### A Money Maker

Sign painters use the Kit to scratch,—clean old paint or rust; plumbers grab it on the way to a job, for cutting out floors, etc. All sorts of mechanics are using it to speed up jobs.

Just attach the blade, with guard, and your drill becomes a handy, husky, portable saw, ready to go to work on any sort of a job. Takes but a moment to put Grinder, Buffer or Polisher into action.

### WRITE TODAY

Get our catalog. We are the world's only manufacturers of a complete line of Portable, Electrically Driven Saws, Hammers, Drills, Shops and other Lamp Socket Tools.

## Send Coupon Today—It Will Pay

Electro Magnetic Tool Co.,  
1830 S. 52nd Ave., Cicero, Ill. (Adjoining Chicago).  
Manager, Dept. 2-N. Please send me full particulars about your 10-day free trial on Drill and Saw Kit.  
If interested in other tools, please check here

Name.....  
Address.....

# SAVE 30 to 80% On New and Used AUTO PARTS!

Warshawsky's newest catalog offers you an amazing list of bargains—thousands of them! Timken Axles, Bearings, Brown-Lipe Transmissions, Pistons, Rings, Hayes and Firestone Wheels, Rims, Tires, Tubes and a complete line of accessories—new, except where specified.

**FREE** write for **CATALOG**

**WARSHAWSKY & Co.**  
World's Largest Replacement Parts House  
1915 S. State St. Dept. PM 11, Chicago, Ill.



**START to PLAY Very First Day!**

**Free Easy Lessons Show You How**



*Here at Last is*  
**YOUR Magic Key to Fun, Profit, Popularity**

**YOU'VE** often heard Deagan Xylorimbas on the stage and over the radio—most artists use them. You've admired their snap, melody and beautiful tone. Like a million others you've wished you could play.

**Your Golden Chance For Lifelong Pleasure and Profit**

Now your chance has come. The Deagan Xylorimba—wonderful for the home, in demand at dances and parties, an instant "hit" wherever you go—is nevertheless the *easiest of all instruments to play*. No teacher is necessary. On the very day you get your instrument you play simple melodies! A few weeks of pleasant practice and a *new life* is opened to you—pleasures you never dreamt of, extra money, new friends, invitations galore. *Xylorimbists regularly earn \$5 to \$25 a night for work that is play.*

**Plays in Public in Six Months**

Marvin Wood, Brook, Ind., was making big money in public *six months* after purchasing his Xylorimba. L.E. Hallman, Reading, Pa., makes *\$65 a week* spare time—had never played an instrument before. Ralph Smith, Chicago, played 20 minutes at wedding—got \$20.

Remember, these are not "supermen". They're everyday fellows like yourself who had the gumption to get ahead—to enjoy the pleasure that comes from creating music—to earn the cash and glory the world gladly pays to those who *entertain*.

**Five-Day Free Trial—A Year to Pay**

And now it's as easy to own a Xylorimba as to play one. Styles to fit every age and pocketbook, with such easy terms that the money it takes to learn to play some other instrument will usually pay for a Xylorimba! Five days' free trial in your own home—an entire year to pay.

Send today for the big FREE Book that tells all about the Deagan Xylorimba, our free trial offer and wonderful easy payment plan. It may be the turning point in your entire career. Don't therefore delay—mail the coupon *today*.



J. C. Deagan, Inc., Dept. 1458, 1770 Berceau Ave., Chicago

Please send me full details on the Free Trial offer and easy payment plan of the Deagan Xylorimba.

Name \_\_\_\_\_

Address \_\_\_\_\_



*Baby Grand*

**A High Quality Bench Lathe at Low Cost**

A practical lathe of small size identical with large lathes in construction, precision and operation. Built complete in our own shop by practical machinists for use in light manufacturing, repairing and experimental work in wood or metal. Comes with plain or back-gear head; has 6 in. swing; 12 in. or 18 in. between centers. Four speeds 180 to 1750 R.P.M. Not a plaything, but a practical machine for both practical men and amateurs who want the best. Our production facilities explain the low cost. Write for circular fully describing Baby Grand Lathe with all tools and attachments before buying any lathe.

**Baby Grand Drills and Grinder**



Two practical machines with scores of uses in any shop. Drill has 4 speeds, complete with chuck. Capacity 0 in. to 3/4 in. drills. As well designed and built as any large drill press. Grinder has two 4 in. grinding wheels of 1/2 in. face, tool rests and guards as shown. The biggest little Grinder made.



**Get the Most for Your Money!**

Compare Baby Grand Tools with others before you buy. Write today for circular and prices on the full line of Baby Grand tools. You'll be surprised at the values offered.

**The Watson Mfg. Co.**

111 Watson Bldg.

Toledo, Ohio

**\$351<sup>00</sup> CLEARED IN ONE DAY**

So writes W. H. Adams of Ohio. Letter from V. A. Marini of California reports \$11,275 sales in three months. Jacob Gordon of New Jersey "44000 profits in two months." Alexander of Pennsylvania "33000 profits in four months." Ira Shook \$365 sales in one day. Bram bought one outfit April 5 and 7 more by August 28. Iwata, bought one outfit and 10 more within a year. Mrs. Lane of Pennsylvania says "sold 2000 packages in one day." J. R. Bert says "only thing I ever bought that equaled advertisement." John Culp says: "Everything Going Lovely. Crispette wrappers scattered all over town. It's good old world after all." Kellogg, \$700 ahead end of second week.



**WE START YOU IN BUSINESS**

Furnish secret formulas, raw materials, and equipment. Little capital required; no experience needed.

**BUILD A BUSINESS OF YOUR OWN**

No limit to the sale of Crispettes. Everybody likes them. It's a delicious food confection. Write for facts about a business that will make you independent. Start now in your home town.

**Profits \$1000 a Month Easily Possible**

Send postal for illustrated book of facts. It contains enthusiastic letters from others—shows their places of business, tells how and when to start, and all information needed. Free. Write now!

**LONG-EAKINS COMPANY**

1128 High Street

Springfield, Ohio



# SOUTH BEND LATHES

FOR  
**TOOL ROOM  
 MANUFACTURING  
 MACHINE SHOP  
 REPAIR SHOP  
 SERVICE STATION  
 LABORATORY  
 ENGINEERING SHOP**

*Precision  
 Popular Prices  
 Practical Attachments  
 Easy Payment Terms*

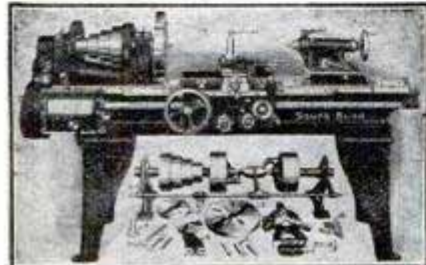
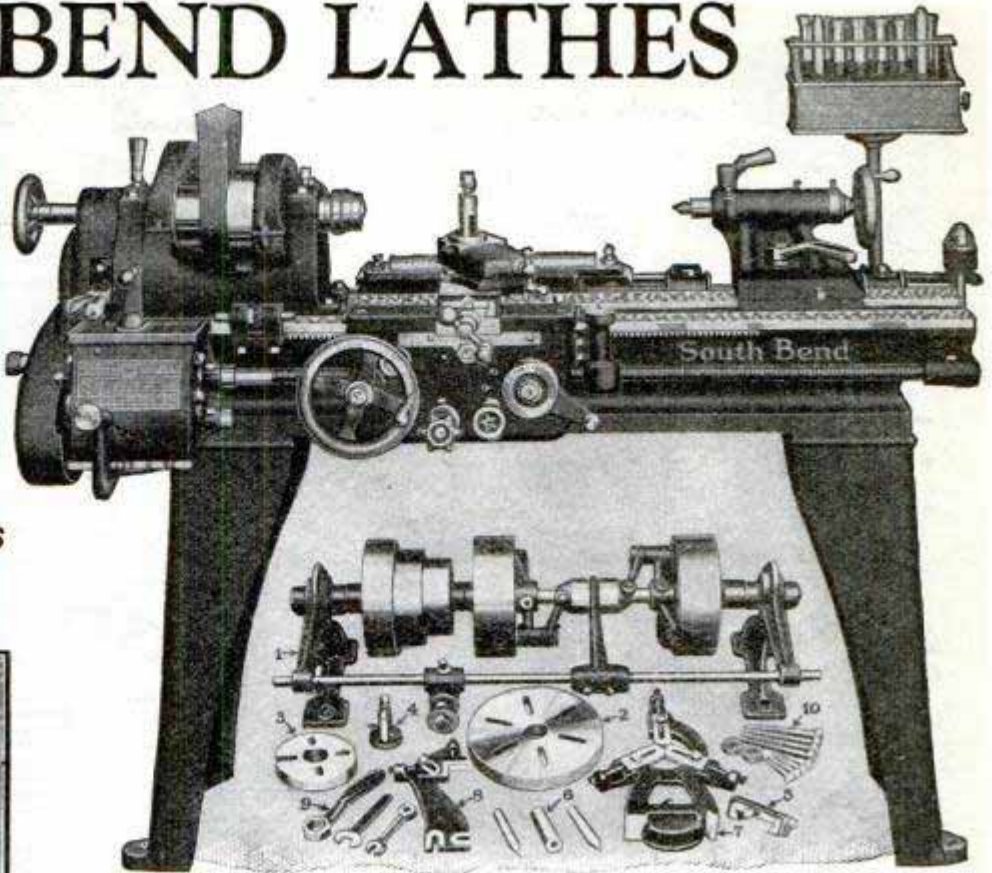

**16" x 8' Quick Change Gear \$570**  
 Lathe, Straight Bed.....  
*Described fully in Booklet No. 16*

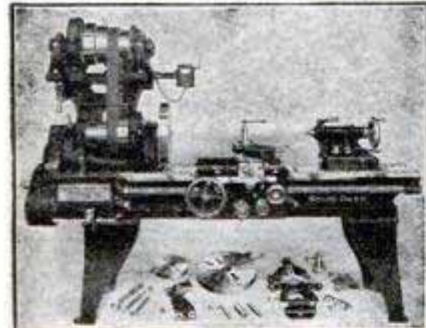

**18" x 8' Quick Change Gear \$908**  
 Motor Driven Lathe.....  
*Detailed specifications given in Special Booklet No. 18*

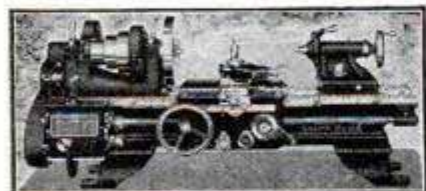

**11" x 4' Quick Change Gear \$325**  
 New Model Bench Lathe.....  
*Shown Complete in Booklet No. 11*



**16" x 6' Quick Change Gear \$620**  
 Gap Bed Lathe.....  
*Shown complete in Booklet No. 16*

**11" x 4' New Model Precision Tool Room Lathe with Countershaft and \$335**  
 Regular Equipment.....  
*One of the types illustrated in Special Booklet No. 11*

## Other Popular Selling Sizes

### The Prices of Popular Selling Sizes with Countershaft and Equipment

Size of Lathe	Shipping Weight	Standard Change Gear	Quick Change Gear
9" x 3"	490 lbs.	\$235.00	\$270.00
11" x 4'	725 lbs.	\$300.00	\$335.00
13" x 5'	1110 lbs.	\$352.00	\$402.00
15" x 6'	1550 lbs.	\$430.00	\$490.00
16" x 6'	1875 lbs.	\$480.00	\$540.00
16" x 8'	2035 lbs.	\$510.00	\$570.00
18" x 10"	2840 lbs.	\$685.00	\$750.00

*(See also Page 163 of this magazine)*

## Easy Payment Plan — 10 Months to Pay

25% or 1/4 down payment, balance in 10 equal monthly payments, or you can purchase through your nearest machinery dealer.

## FREE—Write for No. 88 Catalog and New Booklets.

Six special descriptive booklets listed below illustrate, describe, and price 210 sizes and types of NEW MODEL South Bend Lathes. New General Catalog also illustrates and describes the complete line of New Model Lathes, Attachments, Chucks and Tools. Over 300 illustrations showing work the lathes will do.

Check off in the squares below, indicating the lathes in which you are interested. Tear this sheet out of the book and mail to us. Special booklets and Catalog No. 88 mailed free postpaid on request.

- |  |  |
|--|--|
| <input type="checkbox"/> 9" Lathe Booklet  | <input type="checkbox"/> 16" Lathe Booklet               |
| <input type="checkbox"/> 11" Lathe Booklet | <input type="checkbox"/> 18" Lathe Booklet               |
| <input type="checkbox"/> 13" Lathe Booklet | <input type="checkbox"/> New General Catalog No. 88      |
| <input type="checkbox"/> 15" Lathe Booklet | <input type="checkbox"/> "How to Run a Lathe," price 25c |

ESTABLISHED 1906—OVER 38,000 LATHES IN USE

## SOUTH BEND LATHE WORKS

Main Office & Works, 627 E. Madison St., South Bend, Ind., U. S. A.  
 New York City Salesroom, 183 Centre Street





## RADIO SET BUILDERS

Here's Information You Can Depend On

Leading radio engineers have prepared authoritative design manuals

containing much original information of greatest practical value to those interested in improving the operation, bettering the quality of reproduction, or applying power equipment to their sets.

**Audio Amplification**, Sent upon receipt of 25 cts.

**B Eliminator and Power Amplifier Construction**. Send 10 cts.

**Make-Em-Better Sheet**, showing use of RF and AF Chokes in 17 popular circuits or your own receiver. Send 5 cts.

**Inductance Units Bulletin**, contains RF Amplifier and coil formulae. Send 10 cts.

All four sent on receipt of 50 cts.

# Samson Electric Co.

MAIN OFFICE: CANTON, MASS.  
Manufacturers Since 1882  
Factories at Canton and Watertown, Mass.

**AUTOMATIC OIL HEAT**

Good Bye  
Coal

**HI-LO OIL BURNER**

Does away with coal, ashes, soot and dirt. Performs with amazing efficiency in your heating plant or furnace at home. (Hot water, Steam or Hot Air.) **Noiseless and frees you of all worry. Automatically adjusts temperature under all weather conditions. The low cost, clean, efficient HI-LO way is far the easiest and best.**

Responsible Distributors Wanted

**GLORIA LIGHT COMPANY**  
115-11 N. May Street  
CHICAGO

LOW COST WAY

## Better Than A Brush

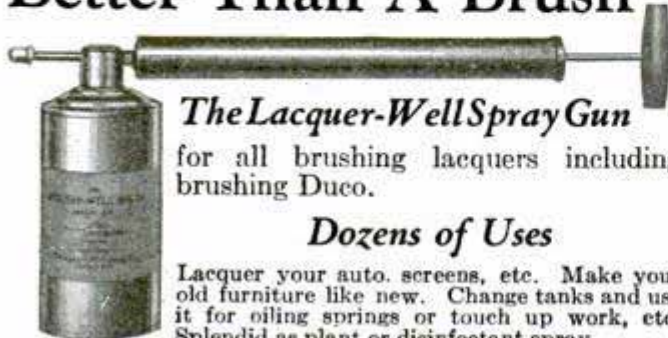

**The Lacquer-Well Spray Gun**

for all brushing lacquers including brushing Duco.

### Dozens of Uses

Lacquer your auto. screens, etc. Make your old furniture like new. Change tanks and use it for oiling springs or touch up work, etc. Splendid as plant or disinfectant spray.

Sturdy, lasting service, quality made—Sent postpaid anywhere in U. S. upon receipt of only \$2.00, extra tanks 25c each.

**THE LACQUER-WELL SPRAY COMPANY**  
Dept. R 2012 East 105th St. Cleveland, Ohio

## The LOGICAL Filament Control

AMPERITE is the only self-variable filament control. Automatically does the work of hand rheostats and delicate meters. Proved for 6 years. Specified in every circuit. Entirely different from fixed filament resistors. Accept nothing but AMPERITE. **FREE—"Amperite Book"** of the season's best circuits and latest construction data. *Autumn: 1928; ept. P.M.-11*



**RADIALL COMPANY**  
50 Franklin St., New York

## AMPERITE

REG. U.S. PAT. OFF.  
The "SELF-ADJUSTING" Rheostat

**BIG NEW CATALOG FOR RADIO BUILDERS**

**FREE** My big 1928 Radio Catalog, Call Book and Trouble Finder. 122 pages about Radio. Chock full of newest circuits—kits, transmitter parts, short wave outfits, eliminators and speakers. Thousands of bargains at lowest wholesale prices. A regular Radio Encyclopedia—Free. Write today.

**American Auto & Radio Mfg. Co.**  
BARRY SCHWARTZBERG, PRES.  
Dept. 265 American Radio Bldg., Kansas City, Mo.

**LATEST RADIO CIRCUITS**

**RADIO SPEAKER**

**Timmons Cabinet Speaker \$7.25**

This is the Adjustable Type Speaker. Beautiful Mahogany Cabinet. Dealers write for Discount. Will Ship Anywhere in U. S. **ACT QUICKLY AS SUPPLY IS LIMITED.**

**MYEROW BROS. CO.** 15 Berkeley St. BOSTON, MASS.

## FREE—NEW CATALOG

DEALERS AND SET BUILDERS—Write today for our new 1928 Catalog. It's FREE. Shows latest and best nationally advertised radio equipment. Complete Kits as specified in articles in leading radio magazines now ready for shipment. No delays in filling orders. Best Prices.

**MILLER-WELLES CO., 20-K W. Kinzie St., CHICAGO**

## PUNCTURE-PROOFS Tires in ONE minute

Agents—Big—Quick Profits

Tires hammered full of nails, leak no air. Amazing new invention banishes puncture trouble forever. Punctures heal instantly. Stops slow leaks. Preserves rubber. Increases tire life. Clean, scientifically correct. *Not a Liquid.*

**FREE SAMPLE** Immediate—Tremendous profits. No talking—just drive nails in an old tire. **GET THE FACTS.** Territory going fast. Full particulars—Big Book and a **FREE SAMPLE** postpaid by return mail. **Send No Money**, just your name but **ACT NOW.**

**C. F. JOHNSON & CO., 19 W. Jackson Blvd., Dept. 679, CHICAGO**

**THREAD CUTTING LATHE**

A REAL Lathe. 9" swing; 30" between centers. Speedy and accurate. Special attachments and tools available. Write today for Circular and 12" Band Saw Powerful, practical. Not a toy. Prices on these Has tilting table. Saws 6" stock. and other machines. **Rossbacher Machine Co., 1516 Fernwood Ave. TOLEDO, OHIO**





**Without Continuous Wiping  
Keeps Windshield Clear**

RUBBER wipes off dirt—FELT puts on a chemical that keeps vision-area on windshield clear for hours *without continuous wiping*, in rain, mist, fog, snow.

**CHRISTEN'S  
SAFETY WINDSHIELD BLADE  
WIPER**

This new wiper blade fits any style of automatic, or hand, windshield wiper—just take out the old blade and insert the Christen blade. Like a new car, or new pair of shoes, it has to be "broken in" before you will get the best results. It comes to you with the Felt slightly higher than the Rubber, because after two or three good storms used as an ordinary wiper blade the Felt squashes down to the level of the Rubber, the excess chemical is worked out and you get results that mean lasting satisfaction. Same good service for life of blade. Guaranteed for one year. Metal part rust-proof because Parkerized.

**35<sup>c</sup>** standard 7½ in. size. Special 9 in. size, 50c. Ask for it by name wherever auto accessories are sold.

V. H. CHRISTEN MFG. CO.  
321 Orleans Street. Detroit

Willcot (Parent) Company, Ltd. Fishponds,  
Bristol, England. *Distributor for Europe and  
British Colonies except Canada.*

## NEED A BETTER GRIP ON MATHEMATICS?

SEND for a copy of "Mathematics for the Practical Man," only \$1.50. By common sense methods it removes the mystery and difficulties so that algebra and even calculus are made simple.

Assuming your knowledge is limited to arithmetic you quickly and easily gain a working knowledge of Algebra, Geometry, Trigonometry and Calculus. Simply pay postman price of book plus the postage when he hands you the package.

**Popular Mechanics Press**  
Room 108  
200 E. Ontario Street, Chicago



## Don't be "Sold"

*When you're convinced, buy. In the meantime, accept this 10-day test we offer to prove our claims*

GENTLEMEN:

Men are slow to change a habit. So we have found in offering them this remarkable new shaving cream that it is better to offer a test, *at our expense*, than merely try to *argue* them into a change.

Results prove the big majority of men who try Palmolive Shaving Cream stick to it. For they find the things we say are true. And they tell others, in extravagant terms, things we would never dare to claim.

So now we urge you to clip the coupon as a reminder. Try this ten-day test, and prove to yourself that what you seek, we've got. You owe it to yourself to know from your own experience.

### 5 exclusive advantages

1. Multiplies itself in lather 250 times.
2. Softens the beard in one minute.
3. Maintains its creamy fullness for 10 minutes on the face.
4. Strong bubbles hold the hairs erect for cutting.
5. Fine after-effects due to palm and olive oil content.

### Won't you try it?

It costs nothing to learn what we have done. We count on winning you strictly on merit. Your present method may suit, still there may be a better. Send the coupon before you forget.

THE PALMOLIVE-PEET COMPANY, Chicago, Illinois

377

### 10 SHAVES FREE

and a can of Palmolive After Shaving Tale

Simply insert your name and address and mail to Dept. B-1416, Palmolive, 3702 Iron Street, Chicago, Ill.

Residents of Wisconsin should address Palmolive, Milwaukee, Wis.

.....  
.....  
(Please print your name and address)





This article in N. Y. Sun was written by our chief engineer.

# ABC POWERIZER

New scientific way of making every radio a DeLuxe Electric!

Now you can have any radio set powerized—all ready to plug into light socket. Alternating current direct to A. C. Radiotrons in set the only practical scientific method of electrification.

Deep bass notes—vibrant chords of the organ—are reproduced with the richness and mellowness achieved only by powerized amplification.

Write for literature explaining details of real A B C socket-power and tone quality.

RADIO RECEPTOR CO., Inc.  
106 Seventh Ave., New York, N. Y.

LICENSED BY RADIO CORPORATION  
of America and Associated Companies



Model for Atwater Kent—without tubes \$60.00  
Universal Model—for majority of 6-tube RFL and Neutrodyne circuits—without tubes \$60.00  
Radiola "20" Model—without tubes \$59.00

## Amazing New Ground Antenna



Gets Far Away Stations Loud and Clear Regardless of Static Conditions

Radio Engineers and hundreds of users report that Aer-O-Liminators, the sensational new Ground Antenna, gets better long distance reception, almost unbelievable freedom from static and outside noises, far greater selectivity and marvelously clear and sweet tone quality.

R. Curtis of Ill., says "There's no such thing as static trouble since I got my Aer-O-Liminators. I get stations I never got before—so loud and clear I would almost swear they were in the next room." In addition you are free from troublesome overhead aerials that everyone now knows are static-gatherers. Aer-O-Liminators (Ground Antenna) is simple and easy to install. Takes but a few minutes.

### FREE TRIAL

Make this thrilling test at our risk!

Install an Aer-O-Liminators (Ground Antenna). Leave your old overhead aerial up. Try out on a night when static is bad. If you do not get a wonderful improvement in freedom from static, greater selectivity and clear sweet tone without interfering noises, if you can't get good reception on stations that are drowned by static on your old aerial, you need not pay us a red cent for this test. Write us today for scientific

explanation of Aer-O-Liminators (Ground Antenna), proof of performance, and our conclusive iron-bound guarantee and remarkable Free Trial Offer. Write today!

Curtan Mfg. Co., 154 E. Erie St., Dept. 805-P, Chicago, Ill.

## ELECTRICIAN'S PLIERS



This No. 1950 side cutting plier is ideal for all electrical, telephone and radio work. It is drop-forged of special analysis steel. The cutters are tempered and will hold their edge. An exceptionally fine tool—sold with a money-back guarantee by hardware dealers everywhere.

No. 1950

CRESCENT TOOL CO.

210 Harrison St.

JAMESTOWN, N. Y.

Wrenches Chisels Snips  
Pliers Punches Hacksaws  
Screw Drivers Auger Bits Nippers  
Electricians' Tools



## CRESCENT and Smith & Hemenway TOOLS



**30 Days  
FREE  
TRIAL  
5 Year  
Guarantee**

**MARWOOD**

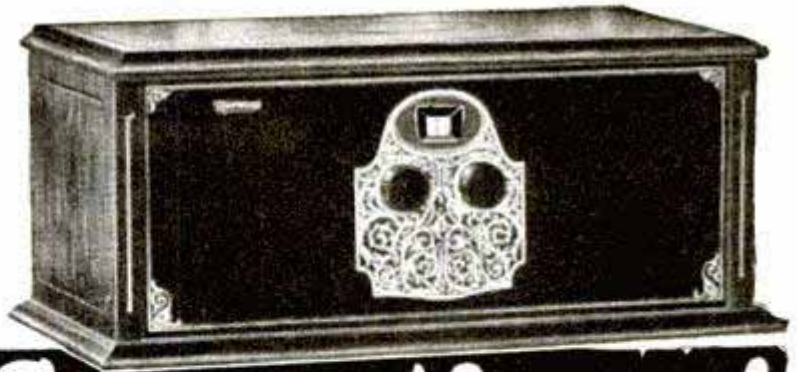

# The 1928 Sensations! 8 Tube-1 Control

**ALL ELECTRIC OR BATTERY OPERATION**

Only  
**\$69** RETAIL PRICE  
Big Discount to Agents  
From This Price



ALL ELECTRIC  
8 Tube  
1 Control  
**\$98** RETAIL PRICE

AGAIN Marwood is a year ahead—with the Radio sensation of 1928—at a low price that smashes Radio profiteering—the marvelous 8 Tube Single Control Marwood for BATTERY or ALL ELECTRIC operation. Direct from the factory for only \$69.00 retail price—a price far below that of smaller, less powerful Radios. Big discount to Agents from this price. To prove Marwood can't be beat we let you use it on 30 Days Free Trial. Compare it with any Radio at any price. If you don't say it is a wonder, return it. We don't want your money unless the Marwood does all we claim. We take the risk.

### New Features

Coast to coast with enough volume to fill a theatre. Amazing distance that only super-power Radios like the Marwood 8 can get. Ultra-selectivity to cut out interference. Every Marwood is perfectly BALANCED—a real laboratory job. One dial control gets the stations with ease. A beautiful, guaranteed, super-efficient Radio in handsome walnut cabinets and consoles.

### Buy from Factory—Save Over Half

Why pay profits to several middlemen? A Marwood in any retail store would cost practically three times our low direct-from-the-factory price. Our policy is highest quality plus small profit and enormous sales. You get the benefit. Marwood is a pioneer, responsible Radio. If you want next year's improvements NOW—get a Marwood.

### AGENTS GET YOUR RADIO at Wholesale Price Make Big Money in Spare Time

It's easy to get orders for the Marwood. We want agents and dealers in each territory to handle the enormous business created by our national advertising. Big money made in spare time demonstrating at home. No experience or capital needed. We show you how. This is the biggest season in Radio history. Rush coupon for 30 Days' Free Trial, 1928 Catalog, Agents' Confidential Prices and Agents' New Plan.

**MARWOOD RADIO CORP.**  
Dept. A-13  
5315 Ravenswood Ave., Chicago, Ill.

### Get Our Discounts

before you buy a Radio. Save half. Try any Marwood on 30 Days' Free Trial. Compare it with any Radio regardless of price. If you don't get the surprise of your life, return it. We take the risk. Don't let Marwood low prices lead you to believe Marwood is not the highest quality. Guaranteed 5 years.

### 6 Tube—1 Control

for BATTERY or ALL ELECTRIC operation. Get coast to coast on loud speaker with great volume. Only \$47.00 retail price. Big discount to Agents from this price. Comes in handsome walnut cabinets and consoles. Has the volume of 7 tube sets.

**\$47**

RETAIL PRICE  
Big Discount to Agents  
From this Price



### Rush for Free Trial

Marwood Radio Corporation,  
5315 Ravenswood Ave., Dept. A-13,  
Chicago.  
Send Agents' Confidential Prices, 30 Days' Free Trial, New Catalog and Agents' New Money Making Plan. No obligations on my part.  
Name.....  
Address.....  
St. or R. F. D.....  
City.....State.....

Big Discount to Agents  
From this Price

Has  
**Complete  
A-B Power  
Unit**

A REAL ALL ELECTRIC Radio with one of the best A-B Power Units on the market—at the world's lowest price. No batteries needed. If you have electricity in your home, just plug into the light socket and forget batteries. Costs less than 2c a day to operate. Always have 100% volume. ALL ELECTRIC Radios are high priced, but we cut profit to the bone and offer a \$250.00 outfit for \$98.00 retail price. Big discount to Agents from this price.



# Finally—the Perfect “A” Eliminator

For Your Present Set or the Set you eventually buy

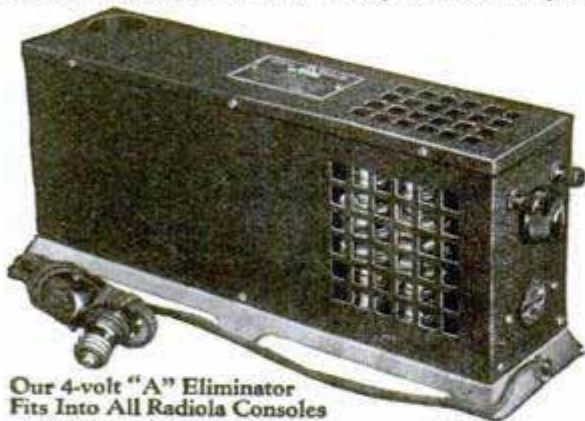

Our 4-volt “A” Eliminator Fits Into All Radiola Consoles

## Silver Beauty POWER

Replaces “A” storage battery and charger; has full wave “dry” rectification; maintains required voltage in uniform, constant flow; operates automatically by moving a switch; economical—uses minimum amount of current (about 1-10 cost of using electric iron); has rheostat control for additional refinement in voltage and reception; gives maximum power to radio tubes and lengthens their life; no acids to test or spill. Satisfactory results guaranteed.

*Its principle is simple and correct!*

The 110 volts Alternating Current is scientifically reduced with the famous “Silver Beauty” transformer coil to deliver the proper voltage to an especially developed dry, noiseless rectifier, which transforms the electricity to direct current. This current of exact voltage, is then transmitted through a patented special filter which clarifies the current, eliminating all foreign noises caused by rectifier or generator.

Endorsed by prominent radio engineers—adopted by leading distributors and dealers—approved by thousands of users.

<b>\$39<sup>50</sup></b>	<b>\$43<sup>50</sup></b>	<b>\$39<sup>50</sup></b>
6-volt; 2 amp.	6-volt; 3 amp.	4-volt; ½-amp.
<i>\$2 Higher West of Rockies</i>		

## Silver Beauty “B-C” UNIT

Does away with “B” and “C” batteries

Embodies every up-to-date refinement and principle, insuring smooth, unflinching reception. As beautiful as it is efficient.

No. 450—180 Volts  
40 Milliamperes

**\$45**

No. 460—135 Volts  
35 Milliamperes

**\$35**

## Silver Beauty CHARGERS

Employing an entirely new method of rectification. Two models—with or without bulbs.

Individual adjustment adapted to all sets

See Your Dealer or Jobber



## Triple-A-Specialty Company

Manufacturers of the famous Silver Beauty Chargers

312-316 South Hamilton Ave. Chicago, Ill.

# SAVE \$100.00 ON WORLD'S FINEST CUSTOM-BUILT SET!

This new Hi-Q Construction Manual is the most important radio book of the year—shows you how to save at least \$100.00 or how to make a big, steady income through the CUSTOM-BUILT Hi-Q SIX—the advanced radio instrument that is establishing totally new standards

in radio performance. Prepared by ten of America's leading manufacturers, this 48-page manual gives you thorough, practical and complete de-

Write for  
This Book!



Hammarlund  
ROBERTS  
Hi-Q SIX

scription, charts, diagrams and photos—also complete instructions on building Power Supply Units. Used by professional radio men everywhere. Equally practical for novice builders. If you want to save at least \$100.00 on your own set—or if you want to make a handsome income from building the world's most popular CUSTOM-BUILT RECEIVER, send 25 cents to-day for your copy. Write to-day before 1st edition is exhausted.

### Associate Manufacturers

Carter Radio Co.  
Samson Elec. Co.  
Sangamo Elec. Co.  
Yaxley Mfg. Co.

Hammarlund Mfg. Co.  
Benjamin Elec. Mfg. Co.  
Acme Wire Co. (Parvott)  
H. H. Eby Mfg. Co.

International Resistance Co. (Durham Resistors)  
Radiall Co. (Amperite)  
Westinghouse Micaarts

Hammarlund-Roberts, Inc. 1182 N. Broadway, New York City

AGENTS	<b>AMAZING NEW ADDING PENCIL</b>	TOTAL SHOWS HERE	WANTED
	ADD'S MULTIPLIES SUBTRACTS DIVIDES	Guaranteed Absolutely Accurate. Fountain pen size. Ends all mis- takes. Send for yours Today.	
	<b>AGENTS</b>	Great money maker. Everybody interested. Reserve territory immediately.	
	<b>HOUK ADDING PENCIL CO., Dept. 38 St. Louis, Mo.</b>		
\$148.75 + \$103.00 = \$251.75 + \$3 + \$75 + 0 = \$260.85 \$164.60 - \$4 + 60 = \$178.75 + \$102.00 = \$280.75 + \$20.00			

## CARPENTERS SAVE YOUR TIME



This remarkable pocket-size book gives you thousands of rafter lengths, hips, valleys and jacks, in feet, inches and nearest sixteenths, in less time than you can figure one!

House widths from 1 to 41 ft. and rise in inches from 2 to 14.

No carpenter, master or amateur, can afford to be without this wonderful pocket companion. Save Time! Avoid Mistakes and Trouble! Send for Your Copy Now!

Price \$1.00. Agents price 50 cents in lots of 3 or more.  
T. W. MARTIN, 714 E. 4th Street, CHARLOTTE, N. C.

## KNICKERBOCKER 4 The Wonder Set

### 2-Dial Karas Equamatic 5-Tube Receiver

These two famous receivers as well as scores of other well known sets owe no small part of their marvelous performance to the use of Karas parts. Karas Condensers, Transformers, Filters, Coils and Dials are the perfected products of a factory which has been building precision electrical apparatus for more than a third of a century. Write today for complete catalog of all Karas Parts, and details of the Knickerbocker 4 and the 2-Dial Karas Equamatic.

KARAS  
Elec-  
tric  
Co.



4025-K No.  
Rock-  
well  
St.,  
Chicago



# THIS Sensational <sup>NEW</sup> Invention Applies Real 4 Wheel Brake Power on EVERY AUTO TRUCK TAXI

Anyone Can Install in a Few Minutes on Any 2 or 4 Wheel Brake Car **POSITIVELY THE MARVEL OF THE AUTO AGE**

**TRIPLES**  
The Life of  
Brake Linings



**40 Horse Brake Power on 2 Wheel Brakes**  
**60 Horse Brake Power on 4 Wheel Brakes**

**Acts Instantly**

**Stops Skidding**

Wonders never cease—and here is the sensation of the year! **JUST THINK**—a simple idea that has been overlooked all these years and now is boiled down to a device that anyone can easily attach to their own car in a few minutes—and from that day on your car stops with a feeling of **SAFETY**—without undue strain—Stops your car almost on a straight line.

You must experience this **NEW SUPER BRAKE DEVICE**; that smooth yet forceful stop without skidding in all kinds of weather and wet streets—Relieves the pressure on the axle and shaft—The **Greatest Brake Device Ever Invented**—Almost unbelievable stopping power on any level road; up or down grade; forward or backward—and if necessary will stop "on a dime."

**The Super Brake Device Equalizes Pressure on Both Sides of Each Brake Drum**



Guard Against This

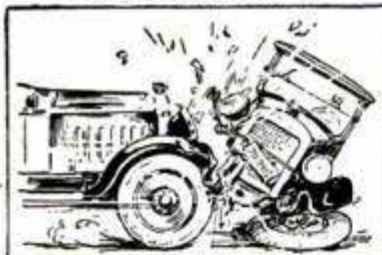

Avoid This

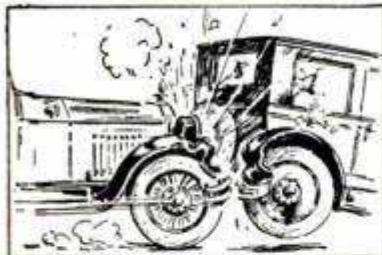

Prevent This



No More of This

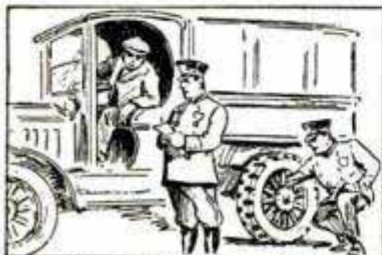

Passes City Inspection

The **SUPER BRAKE DEVICE** puts real 4 wheel brake power on cars with 2 brakes and puts 6 wheel brake power on cars with 4 wheel brakes. The minute your foot touches the brake pedal you feel that security of good brakes without the continuous worry of damage to other cars and property as well as your own car—Then there is always that danger (with weak brakes) of hitting pedestrians mostly caused by brakes failing to respond promptly.

**AGENTS \$1500 a Month**

HERE is a **NEW FIELD** of Big-money Making Possibilities. Every Auto Owner is interested—and the low price makes sales come easy—This device sells easy on performance. Territory is being assigned.

The protection that the **SUPER BRAKE DEVICE** offers cannot be estimated in dollars and cents. The smallest kind of an accident, such as a dented fender or broken bumper or a smashed head-light usually could be avoided with good brakes—In such cases the **SUPER BRAKE DEVICE** saves its small cost many times over. Fortunately the **COST IS SMALL ENOUGH** so that every car owner can enjoy this **NEW DRIVING COMFORT**.

**Limited Special Offer \$4.98**

Each car calls for a different style **SUPER BRAKE DEVICE**, therefore it is very necessary that you give us the **NAME** and **MODEL YEAR** of your car and your set will be made to fit your car and with the aid of a pair of pliers can be promptly installed. This Special Low Price of \$4.98 is for a Limited Time Only.

**Don't Risk Your Life With Poor Brakes**

**AVOID ACCIDENTS**—You would not knowingly drive a car without good brakes—the risk is too great, especially in this day when automobile traffic is moving faster and faster—this means that in the emergency—you are forced to stop your car very suddenly a great many times—this is the time that accidents happen. Why risk your life and the life of others with poor brakes?

**SUPER BRAKE DEVICE**

1929 Straus Bldg. Chicago, Ill.

**GIVE NAME AND MODEL CAR**

**SUPER BRAKE DEVICE**, 1929 Straus Bldg., Chicago, Ill.

Gentlemen:—Enclosed find remittance of \$4.98. Kindly rush to me one **SUPER BRAKE DEVICE** for my ..... Car.

Model ..... It is understood that my money will be refunded if I am not well pleased.  My family.

Mail me **FREE** particulars only.

Name .....  
St. or R. F. D. ....  
City .....  
State .....



# As Thin As A Dime

**B.S.**

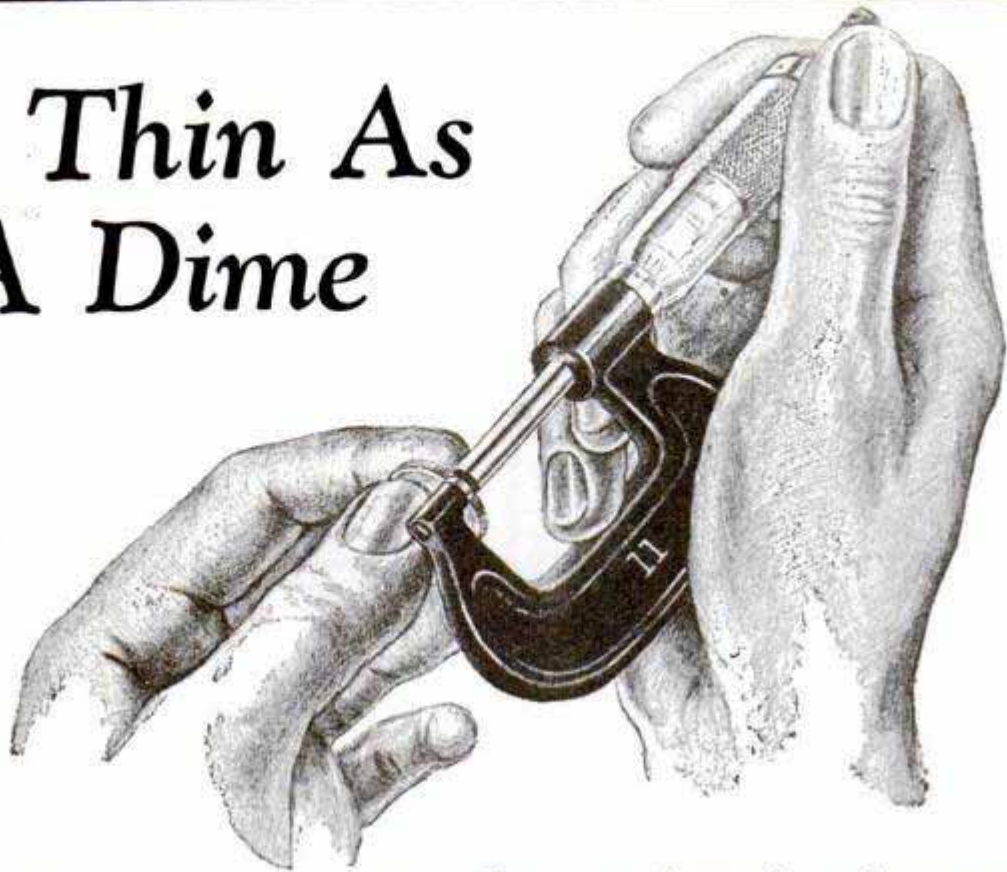

You frequently hear the expression "as thin as a dime" in referring to some unit of measurement.

As it comes from the mint, the average thickness of the edge of a dime is about one thirty-second of an inch.

To many this may seem a small unit of measurement—but not to the hundreds of mechanics who work with Brown & Sharpe precision tools.

These men frequently make measurements daily, accurate to one thousandth of an inch—often to one quarter thousandth of an inch and not infrequently to one ten thousandth of an inch.

The performance of Brown & Sharpe tools sets a standard of accuracy among mechanics everywhere.

Hardware dealers can supply you with Catalog No. 30—or we will be glad to send one free on request.

Dept. P. M.  
BROWN & SHARPE MFG. CO.  
Providence, Rhode Island, U. S. A.

## **BROWN & SHARPE TOOLS**

*"World's Standard of Accuracy"*

# NEW BOICE-CRANE UNIVERSAL HANDISAW

Boice-Crane, The World's Largest builders of small bench machines, has perfected another time and labor saver. It is amazing the work this machine will do.

Table, 15 in. x 17 in., elevates for grooving. Tilts 45 degrees for beveling. Swings 9-in. saw, cuts 2½-in. stock. Saw guard with splitter. Insert takes dado head

6 in. x 1 in., Cope Heads and 8-in. Sand Disc. Another insert provides opening for 2-inch Jointer Head. Jointer Attachment quickly fits on right of table. Machine as illustrated rips and joints boards 2 in. thick without stopping. Other NEW, low-cost attachments for the Universal Handisaw will PLANE BOARDS TO THICKNESS, mortise, shape, bore, tenon, drum sand, grind,

disc sand, rout, polish and make mouldings.

Write for complete information and price of this Universal Handisaw. Also free 64-page booklet describing complete line of Boice-Crane Saws, Bench Saws, Jointers, Lathes, Drills, Mortisers, Jig Saws and Motors.

**W. B. & J. E. BOICE, P. M. 11-C, TOLEDO, OHIO**

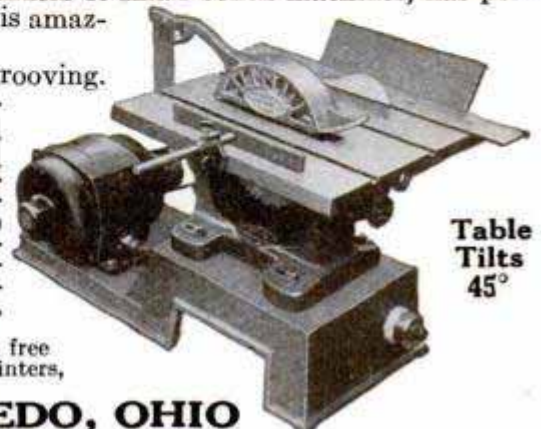

Table  
Tilts  
45°



# 30<sup>DAYS</sup> FREE TRIAL

## Battery or All-Electric OPERATION

**T**RY this powerful seven-tube RANDOLPH RADIO for thirty days. After it brings in stations from coast to coast with amazing clearness—with easy one dial tuning—after it easily equals any other radio—after you are more than satisfied, then you can buy it direct at factory prices. Every RANDOLPH must make good before it is sold.

This RANDOLPH can be had for use with batteries or connected direct to the electric light socket—absolutely batteryless—no batteries, chargers or acids—just plug in and tune in. 100% efficient either way. Its construction and performance have been tested and approved by leading radio engineers and authorities—by leading radio publications and laboratories.

### 7 Tubes—Single Control Illuminated Drum

One drum dial operated by one simple vernier control tunes in all stations with easy selectivity to tremendous volume. No overlapping of stations. Illuminated drum permits operation in the dark. Volume control for finer volume modulation. This is a seven-tube tuned radio frequency receiver with power transformers and power amplification. Space wound solenoid coils. Full and completely shielded. Tremendous distance, wonderful tone quality, simple to operate.

### Beautiful Walnut Console Built-in Cone Speaker

The Randolph Seven-tube Amphiphonic Console illustrated above is housed in a genuine burl-walnut cabinet with two-toned hand rubbed finish giving it unsurpassed beauty. The same expert cabinet work has gone into the making of these consoles as in the finest furniture. Has built-in cone loud speaker that compares with any on the market. Accurately reproduces complete range of musical notes from the highest to the lowest pitch.

### What Users Say

I have logged more than 50 stations from coast to coast.—Lloyd Davenport, Littlefield, Texas. I have logged 52 stations from Cuba to Seattle, the set is a world beater.—J. Tampkinson, Detroit, Mich. Your set is a revelation, has all others tied to the post for distance and selectivity.—Waldo Powers, Vergennes, Vermont. On strength of its performance sold two more sets this week.—T. Scanlow, Orlando, Florida.

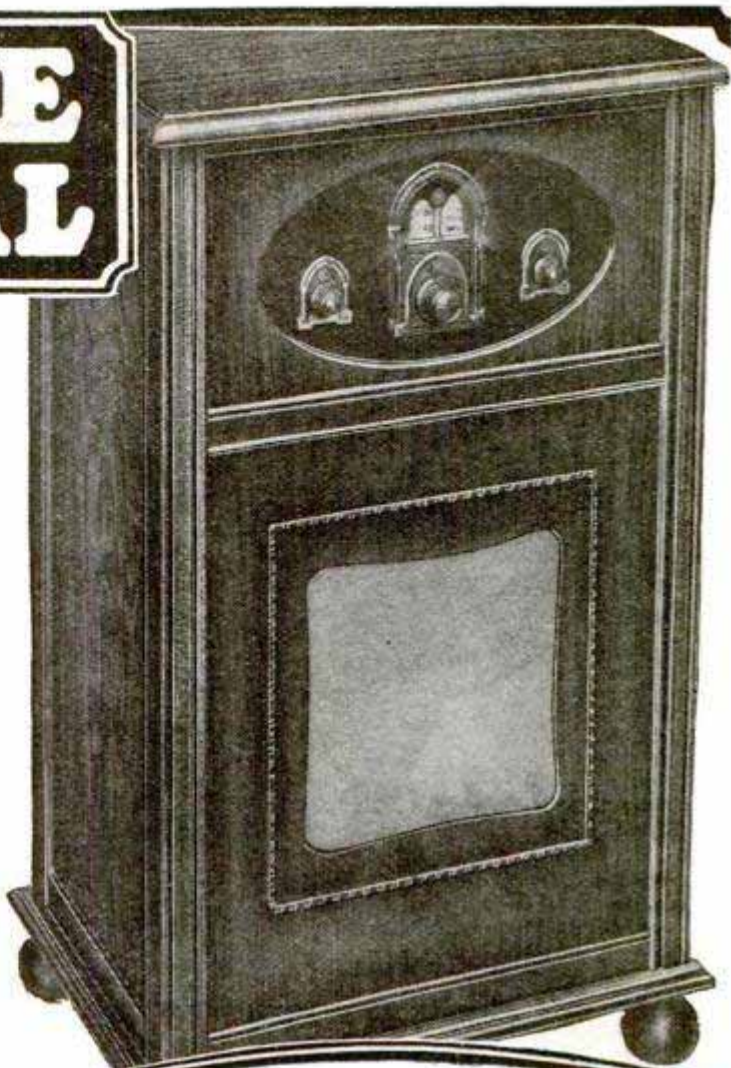

*The Randolph* \$ **99**  
**7-Tube Console**  
**Single Control**  
**RETAIL PRICE**  
 Completely Assembled



### The Senior Six

Do not compare this set with old style 2-dial 6-tube sets selling for about the same price. The Randolph 1928 Senior Six has also been tested and approved by the leading radio engineers.

Beautiful solid walnut cabinet. Single control. Illuminated drum with space for logging. Very selective. Sent for 30 Day's FREE Trial.

**6-Tube**  
**\$55**  
 Retail Price  
 Single Control

**MAIL COUPON NOW!**

The Randolph Radio Corporation are pioneers in the manufacture of radios. Long and successful experience in the radio business makes us perfectly confident in sending Randolph Radio on trial. We know what it will do. Mail us the coupon for the greatest radio offer ever made.

**Sensationally Big Discounts to Agents**

Work either full or part time and make big money. Tremendous advertising campaign helps you sell. Regardless of whether you have ever sold before, be sure to get our proposition. The Randolph sells on first demonstration. Men and women both can make money this easy way. Get your demonstration set for thirty day's FREE TRIAL.

**Use This Coupon NOW!**

**Randolph Radio Corporation**  
 711 W. Lake St., Dept. 252  
 Chicago, Illinois

Send me full particulars about the RANDOLPH Six and Seven Tube All-Electric and Battery Table and Console Sets with details of your 30 Day FREE Trial Offer.

Name .....

Address .....

City ..... State .....

Mark here  if interested in Agent's proposition.

**RANDOLPH RADIO CORPORATION**  
 711 West Lake Street Dept. 252 Chicago, Illinois





a complete line of

**A-C TUBES**  
by **DAVEN**

Modernize your Receiver with Daven AC Tubes—the proper tube for every socket. Four prongs—fit any standard socket. Standardize on Daven AC Tubes—no hum, non-microphonic. Insist on the round tubes with the Platinum Filament.

**Daven AC-1 Radio and Audio Amplifier**  
Made for use in all radio frequency sockets and for the first audio stage where transformers are used.  
1½ volt—1.05 Ampere Platinum Filament.

**Daven AC-15 High Mu Audio Amplifier**  
The AC-15 should be used in the first two audio stages when resistance or impedance audio is used. Amplification factor 15.  
1½ volt—1.05 Ampere Platinum Filament.

**Daven AC-D1 Special Detector**  
For use in all circuits. Due to special construction filament currents are distributed in such a way as to reduce AC hum to a minimum.  
1 volt—1 Ampere Platinum Filament.

**Daven AC-10 Power Tube**  
Should only be used in the last audio socket. The AC-10 is a real power tube operating on 400 volts. Delivers 2.5 watts of undistorted power output.  
7½ volt—1.25 Ampere Platinum Filament.

**Daven AC-R1 Rectifier Tube**  
A single wave rectifier which delivers 65 milliamperes at 400 volts. Silent, perfect power from your "B" Eliminator. Exceptionally long life.  
7½ volt—1.25 Ampere Platinum Filament.

**FREE CATALOG** containing full description of these and other new Daven Products on request.

"The Sine of Merit"  
**DAVEN RADIO CORPORATION**  
TRADE MARK "Resistor Specialists" REGISTERED

152 Summit St.

Newark, N. J.

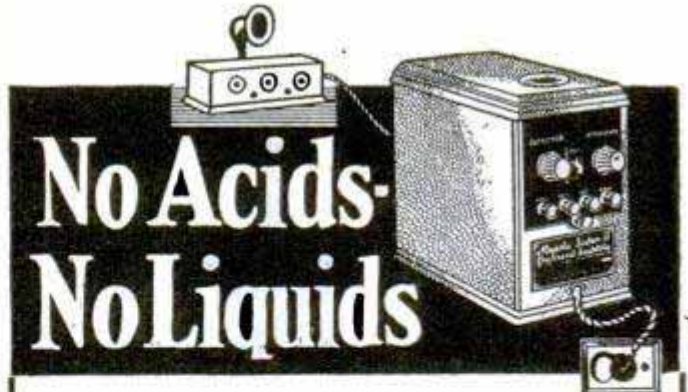

**No Acids  
No Liquids**

**100 Per Cent Electric  
Majestic  
"B" Current Supply  
Plugs Into Light Socket**

Costs a fraction of a cent per hour. Positively eliminates hum and blast caused by partially drained "B" Batteries. Gives better radio reception. Any good radio dealer will sell you a Majestic on approval. Test it out on your own set!

**The Majestic Super "B"**  
**\$29<sup>50</sup> Complete with Tube**  
Write for booklet on "Better Radio Reception"  
GRIGSBY-GRUNOW-HINDS CO., 4508 Armitage Ave., Chicago

**CLASS PINS 35¢**  
**NEW CATALOG FREE!**  
DESIGNS SHOWN SILVER PLATE 35¢ EA \$3.50 DOZ. STERLING SILVER 50¢ EA \$5.00 DOZ. GOLD PLATE 50¢ EA \$5.00 DOZ. 1 OR 2 COLORS ENAMEL, ANY LETTERS AND DATE  
3395 3499

**BASTIAN BROS. CO. 828 BASTIAN BLDG. ROCHESTER, N.Y.**

**RADIO GREATEST RADIO BARGAIN \$18.45**  
**in U. S. 5-Tube Chassis**  
Coast to coast reception. Certified circuit. Dealers write for special proposition. AGENTS WANTED. Write today for folder.  
**A. J. MUSSELMAN, Inc.**  
239 Machinery Hall CHICAGO, ILL.



**FREE CATALOG**

Send today for this marvelous catalog of army goods bargains. 52 pages, 100 illustrations, money saving values, Guns, Ammunition, Cutlery, Sport and Army clothing. Full line of Camping needs. Outfitters for 50 years to leading Military, Sports, Theatrical and Society organizations. Satisfied customers all over the world.

**W. STOKES KIRK, 1627 P. M. N. 10th St., Philadelphia**

**Play Tunes at Once  
ON JAZZY SAX**

**Only \$5.98**

Any one can play this Big imported Jazzy Sax right away. No knowledge of music required, no lessons. Play by numbers instead of notes.

Be popular at parties, dances, picnics, entertainments. Handsome polished finish. Over 134 feet long; weighs 2 lbs. Looks like regular saxophone.



**87 SONGS FREE**

Popular music, Jazz tunes, old favorites. Surprise your friends. Beautiful clear tones and delightful harmony.

**Send No Money**

**Play Jazz Right Away**

Send your name. When Sax and 87 FREE Songs arrive pay Postman Only \$5.98 plus postage. Or send \$5.98 and we pay postage. **Play 5 days. Satisfaction Guaranteed or money refunded.** Don't delay, act now!  
**FERRY & CO., Dept. 8770, CHICAGO, U. S. A.**

\*Could play several tunes on Jazzy Sax within an hour.  
—H. M. Vinson, Rank, Tex. —Lawrence Gerf, Bronson, Minn. —L. Mitchell, New Orleans. —Handis, —L. Mitchell, New Orleans.



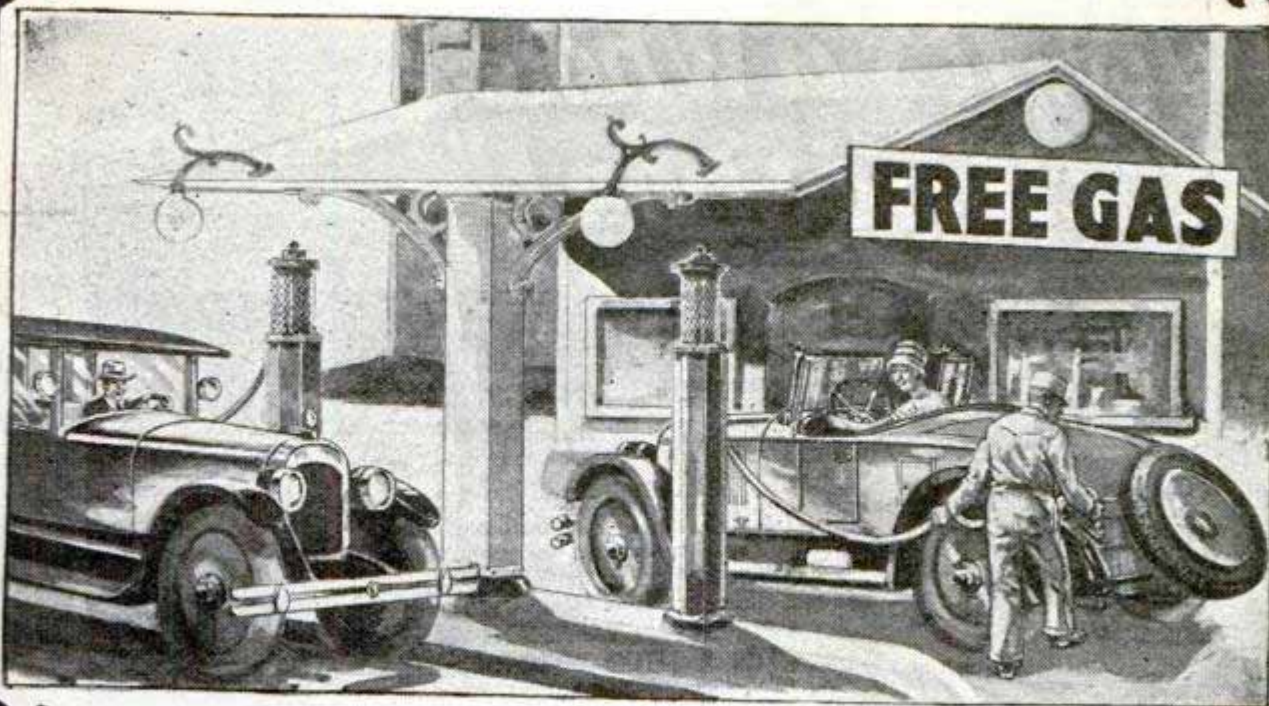

# Drive on **FREE** Gas

**T**HOUSANDS of car owners have already installed a marvelous new invention called the "Whirlwind" and are driving many miles on Free Gas. This new invention is so simple in its principle and construction that it can be installed in a few minutes on any make of car. Automotive engineers have made every conceivable test with the Whirlwind and have obtained as high as 40 miles on a gallon of gas. Reports come in from owners telling of mileage tests that seem almost unbelievable. It is estimated conservatively that this invention will save for the average car owner 200 gallons of gas a year. Think of it—

## 200 Gallons of Gasoline for Nothing

This saving is effected through the installation of this invention and in addition, amazing improvement in the running of the car. Cars equipped with the Whirlwind run smoother, accelerate faster, throttle down, gives more power, starts instantly and carbon formation disappears.

## Wanted A 1,000 Men To Make \$100 Weekly

Additional men are needed to cover territory not yet assigned. To these men an opportunity is offered that is limited only by the amount of time devoted. Auto owners do not have to be sold on something that will give them 200 gallons of gasoline free a year. They will grab it on sight. All our men do is make calls. The Whirlwind sells itself.

Auto registration shows over twenty million cars. Owners are flooding us with requests for this miraculous gas saver. In many districts we have already appointed men to take care of the demand. These men are making handsome profits. Every day their business is growing by leaps and bounds.

**FREE OFFER** To become properly enthused about the Whirlwind you have to have one installed on your own car or on the car of a friend. We furnish our workers with a Whirlwind free so that they can convince themselves of its unusual merits.

## If You Are Looking for Big Profits— We Want You

Salesmanship is one of the things you do not require to make a success with us. If you will only get out and show the Whirlwind and the literature and sales helps we supply, orders are going to be handed to you. Can you think of an automobile owner that would refuse an opportunity of saving hundreds of gallons of gasoline a year? Even if you only devote spare time, it is easily possible to make \$5, \$6 even \$10 an hour.

Remember, we can only use one man in each territory, so don't delay even one day. Send the coupon below for our free offer of a sample Whirlwind Gas Saver and full particulars of our \$100 a week money making offer.

WHIRLWIND MFG. CO., 999-110E Third St., Milwaukee, Wisc.

## Read What Others Say

We have on file in our office a multitude of letters reporting mileage savings and greater motor efficiency through the use of the Whirlwind; also letters attesting to the profits our men are making. Below we are quoting excerpts from just a few of the many received.

### 48 Miles on Gallon

I tried out the Whirlwind you forwarded to me last week and am very much pleased with results. After a thorough test, I got 48 miles to the gallon of gas. Norwood J. Fleming, Ala.

### 35 Miles per Gallon on Chevrolet

Since installing the Whirlwind on my Chevrolet, I can make 35 miles per gallon and am very proud of it. John Hardman, Pa.

### Car Owners Are Waiting for Whirlwinds

Enclosed find a money order for Whirlwinds. Please rush as I need them at once, as car owners are waiting for them. I certainly am getting great reports of mileage from people who have installed Whirlwinds. Reports are coming in from 7 to 10 miles increase per gallon in mileage. H. A. Ebbert, Ohio.

# Mail GAS Coupon

WHIRLWIND MFG. CO.,

999-110E Third St., Milwaukee, Wisc.

Gentlemen: Tell me how I can get 200 gallons of gasoline for nothing; also send me full particulars of your \$100 a week money making proposition and free sample offer.

NAME.....

ADDRESS.....

COUNTY.....

CITY..... STATE.....



# "Why-It's a Whole Machine Shop!"



Its Grip Locks

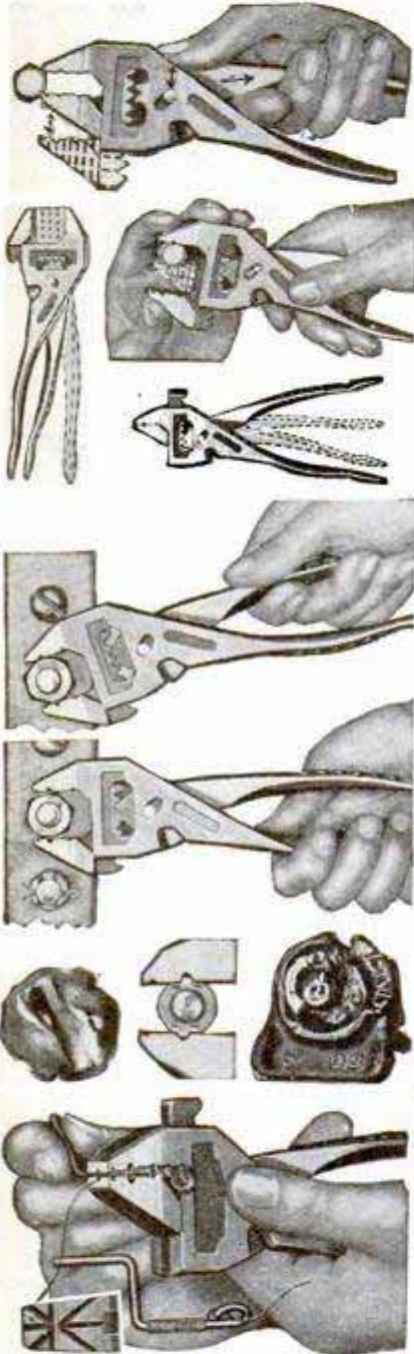

—that is what Users call the EIFEL-FLASH Plier-Rench KIT, because instead of using a dozen tools on One job they do a thousand jobs with the Plier-Rench KIT alone! And if this page could show "Mechanics" readers what this Kit can do for them, the Kits reserved for the Special Offer below would not last one day, but—space permits only "a word to the wise."

### Helped Win WORLD FLIGHT

USED BY U. S. World Flyers; on U. S. S. Shenandoah, S. S. Leviathan, U. S. Army, Navy, and Mail Planes. By MAKERS of Buick, Chevrolet, Nash, Packard, Reo, Studebaker, etc., Automobiles; each with its employees buying from 200 to 1000 Kits.

Thousands of Housewives are using the Plier-Rench too, because it is the only tool giving a woman's hand a 1/2-TON grip and enabling her easily to do mechanical work difficult for a man using other tools!

### A SUPER PLIER-WRENCH-VISE WITH A 1-TON POWER-GEAR

The Plier-Rench out-speeds, out-works and out-wears, dozens of best other tools in an incomparably superior way. In 1/8 second the Ratchet Gear-shift fits the Jaws to the work and the handles to the size of Your hand. The One-Ton POWER-GEAR automatically LOCKS and releases the grip on the Corners and "flats" of Any shape and in addition applies 1/2 to 1 TON Direct pressure—64 to 128 TONS per square inch! It is a Perfect Ratchet Turning Wrench!

### OUTGRIPS A 40-POUND VISE!

The force of the 1-TON Plier-Rench Grip is beyond belief—it must be experienced. It Out-grips a 40-LB. VISE; twists round heads off 1/4-in. stove bolts and heads off 1/2-in. Bolts! It will easily, instantly, remove worn, chewed, and chiseled, nuts, broken taps, drills, studs, etc., in tightest places, with next-to-nothing to get hold of—when all other tools fail!

Its smooth Jaws with 4-Way V-Grooves will hold a hair, and all possible shapes from 0" to 1 1/2" diameter with a rigid, clinching grip that never chews or slips one bit. They coil 1/16" to 1" diameter springs of fine and heavy spring wire, and—do a thousand other "impossible" things quickly and easily.

### ALL TOOLS in a 24-Ounce KIT

The Plier-Rench Kit is a Guaranteed, Time-perfected, Super-quality Master Tool, having a Universal Utility that defies Imagination. "The Plier-Rench Way" Manual of Mechanics—64 Pages with 145 Pictures—shows most valuable uses and advantages!

HUNDREDS OF THOUSANDS of men are using these wonder Kits to make their Homes and Estates more comfortable—Farms, Shops, etc., more profitable; to get more and better service from Automobiles and all mechanical devices, with an enormous saving in money, time and energy!

JUST TRY a Plier-Rench Kit once, and you would no more go back to other tools than you would to the ancient Ox-cart!

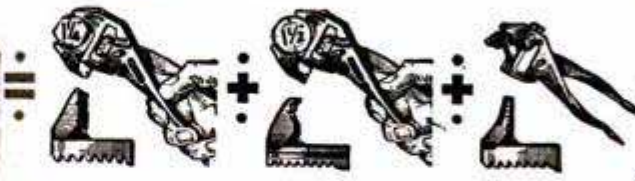
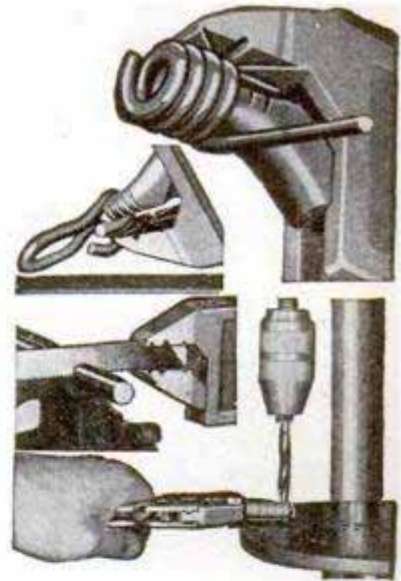

Plus—

Ltd. Special Introductory PRICE ONLY \$3.75  
(Regular Price \$5.00)

The KIT has 3 Gear-Jaws. In 1/8 Second you convert the Universal Plier-Rench into the Pipe-and-Fitting Plier-Rench, or into the Wire-Chain-Cable Plier-Rench—each the Master in its field.

This \$5.00, 1 1/2-Lb., Kit will do the work of 60 Lbs. of other tools costing \$50.00—Quicker, better, easier.

Use the Coupon to get your Kit on the MONEY-BACK 2-Weeks Free Trial Offer—

**MAIL TODAY AND SAVE \$1.25**

### Agents: \$200 a Week

Plier-Rench representatives earn amazing incomes demonstrating this wonderful new tool. One man alone sold nearly 10,000 in just one state. Fastest seller known. Factories buy by hundreds. Every auto and home owner buys. We have wonderful special proposition to agents. Mail coupon for full details. Why not earn \$75 to \$200 and more a week, spare or full time!



**THE FLASH SALES CORP'N**  
KP-4809 N. Ashland Ave., CHICAGO, ILLINOIS

The Flash Sales Corp'n, KP-4809 N. Ashland Avenue, Chicago 40, Ill.  
 1. Rush Plier-Rench Kit. Will deposit \$3.75 (U. S. A. Price) with Postage on arrival. If not delivered I may return within 2 weeks and deposit will be refunded at once.  
 2. Send me only user literature.  
 3. Am interested in Salesman's Big Proposition

Name.....  
 R.F.D. No.....  
 State.....  
 P.O. City.....  
 State.....



# \$244.00 PROFIT *One day!*

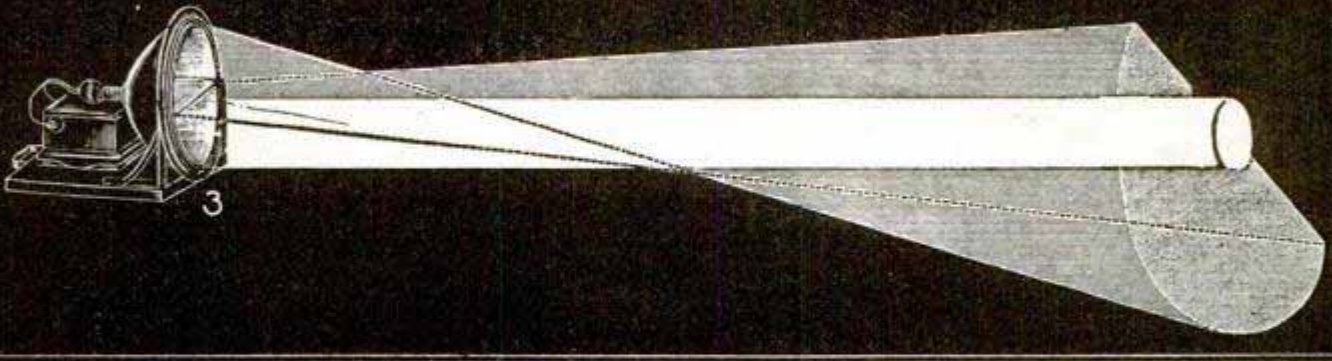

*The only light in the world that throws two separate beams at one and the same time*

## That's what R. W. Helmer made—\$244.00 Profit in One Day—without experience,—just showing most amazing light you ever saw—38,000 Candle Power without Glare

**F**ITS inside regular reflector—easy to install reflector—Wonderful Patented Device—100% more light—no glare. Pocket big money waiting for you now—whirlwind seller makes astounding demonstration, low cost, agents cleaning up.

### 300% Profit

Big repeater, sells on sight. Enthusiastic customers multiply your sales. Over 300 sets sold in one town of 2,000 people.

### Prominent Users

The Governor of Minnesota, the Governor of Colorado, the Mayor of Milwaukee, the General Manager of Milwaukee Motor Club and the Vice-President of Carolina Motor Club are all users of Trippe Offset Reflectors.

### Orders Pouring In From All Over the World

Our first advertising appeared in March and we are already shipping TRIPPE OFFSET REFLECTORS to England, South Africa, Australia, Egypt, Cuba, Mexico and Canada. Many other countries are sending in for information regarding this—the greatest automobile headlight of all time.

### Salesmen Enthusiastic

"I have just sold the Anderson-Howard Headlight Service Co. 500 sets TRIPPE OFFSET REFLECTORS, with an additional contract of 500 sets per month, beginning November 1st."—Frank B. Finch, Kansas.

"Have just sold Claude P. Madden 100 sets TRIPPE OFFSET REFLECTORS. Mr. Madden is the best known man in this county, having been mayor of this city two times and is a live wire."—C. S. Helm, Illinois.

"Cramer & Kirkwood, my local agents for this city took over my entire first shipment of 100 sets TRIPPE OFFSET REFLECTORS. Please rush another 100 sets."—C. R. Smith, Arkansas.

"Any man who could not sell TRIPPE OFFSET REFLECTORS, could not give food to a starving crowd."—J. G. Oblander.

"Friday night I had headlights inspected by State Inspectors. They said it was the greatest light they had ever put on the screen."—A. F. Wilbur, New York.

J. E. Dudd, of Washington, wires order for 200 sets and says, "Here goes for big business, and I feel that I am doing the public a favor in giving them the right kind of light."

Ideal Advertising Co., of Wisconsin, writes, "Am enclosing check for 100 sets TRIPPE OFFSET REFLECTORS. We plan on putting out at least ten salesmen."

Powell, of Canada, wires in an order for 200 sets and says, "We have set a quota of 2,000 sets during the next two months and WE CAN DO IT."

Jackson Bros. & Jones, of Colridge, England, say, "We are pleased to inform you that TRIPPE OFFSET REFLECTORS are just what you claim them to be in every detail."

### Wonderful Demonstration

"I set up the demonstrator on my back roof tonight and the whole neighborhood opened the windows and wanted to know what the h— was going on. I agree with them that the light is simply terrific, yet the glare is removed when attached the correct way to the cars."—W. H. Lamb, Maine.

### 24,000,000 Prospects Want This Light

Thousands killed in 1926 by weak lights—or glare. Countrywide movement for long, low, level, powerful beam that protects driver without blinding other fellow. Only Trippe Offset Auto Reflectors do this perfectly. Trippe light floods roads and side ditches. No glare to bewilder other drivers. Makes spotlights unnecessary.

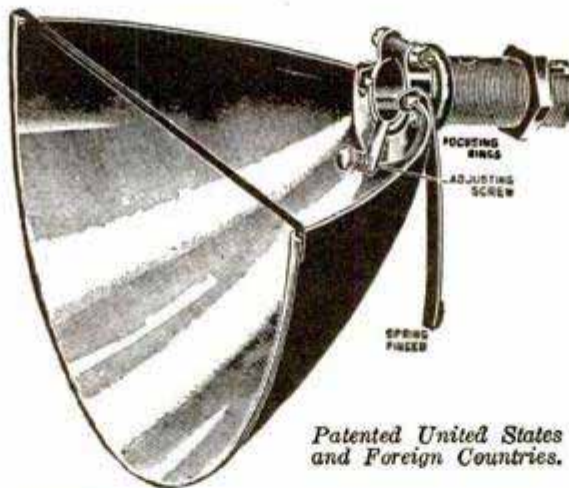

Patented United States and Foreign Countries.

### Eliminates Glare Without Dimming or Tilting

Motorists are sick and tired of clumsy headlights, fragile dimmers, flimsy tilters and makeshift reflectors. These obsolete devices fail because they're not accurately designed. The Trippe Offset is scientifically correct—let us prove it.

### 38,000 Candle Power

Certified to in Report No. 42306 of The Electrical Testing Laboratory of New York City, the official testing laboratory of the Society of Automobile Engineers. The report says that TRIPPE OFFSET REFLECTORS meet every requirement of the S. A. E.

### Managers

Here is your opportunity to get exclusive territory and make \$1,000.00 and more monthly. Get crews started everywhere. Sell to agents. Clean up big this year and next. This is a real permanent offer.

### Exclusive Territory

If you write NOW—tomorrow may be too late. It does not cost one cent to see this remarkable device. At our own risk, we will send you FREE SAMPLE. Test it in every way. It does all we say. Anyone can sell Trippe Offset Reflectors and make big money.

### Free Sample Offer—Write Now

Don't hesitate to investigate this big money-making plan immediately. Only the coupon, a postal or letter is needed. You are losing money every day you wait! At least get this proposition in front of you and study it carefully before deciding. One of the greatest money-making schemes ever put before specialty salesmen. No matter what your experience in selling has been—no matter what you are now selling or what you are making you cannot afford not to get the facts.

Write WHILE YOU ARE THINKING OF IT. Address

**AERIAL ELECTRIC COMPANY**  
107 West Kinzie Street, CHICAGO

### MAIL NOW

AERIAL ELECTRIC CO.,  
107 West Kinzie St., Chicago.

Without any obligation, please send FREE SAMPLE offer and Trippe Offset Reflector OPPORTUNITY OFFER for

Salesmen.

Distributors.

Name.....

Address.....

City..... State.....



*When the ball goes 'round the end for 40 yds.*

**"You're there with a Crosley!"**

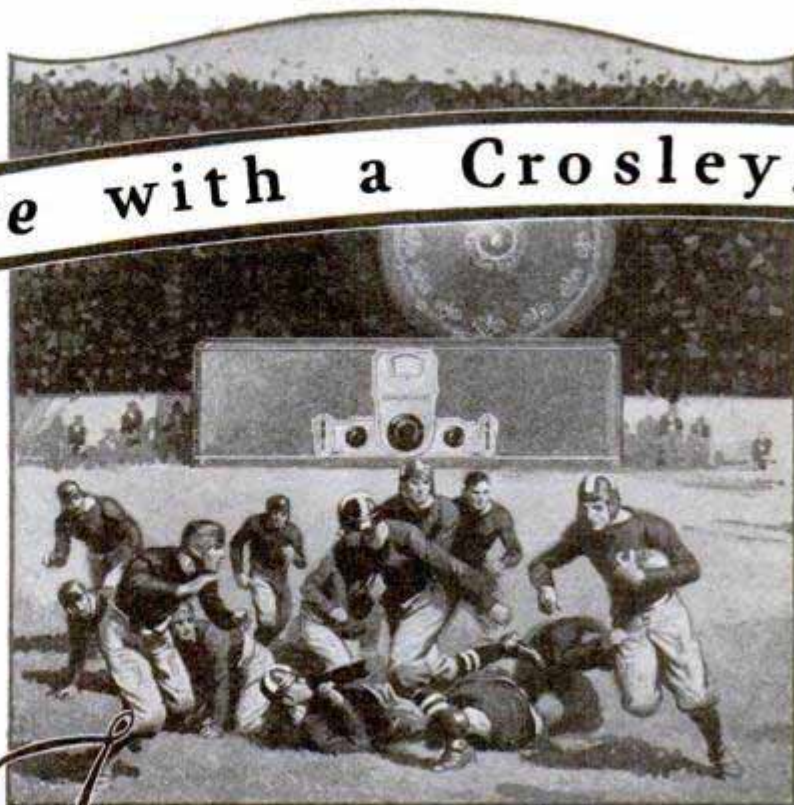

**Approved Consoles**



\$35



\$65



\$85

Selected by Powell Crosley, Jr., as ideal, acoustically and mechanically for the installation of the Crosley "Bandbox." Genuine Musicone built in. Crosley dealers secure them from their jobbers through

**H. T. ROBERTS CO.**  
1340 S. Michigan ave.,  
Chicago, Ill.

Sales Agents for Approved Console Factories  
Shoups Brothers Company  
The Wolf Mfg. Industries

*THIS new Crosley Bandbox*  
6 TUBE RECEIVER *de luxe*  
*is the national radio hit at \$55.*

The "All American" radio of 1928! With license to participate in the enormous radio resources of The Radio Corporation of America, The General Electric Co., The Westinghouse Co., The American Telephone and Telegraph Co., and The Hazeltine and The Latour Corporations, the Crosley Bandbox of 1928 is an "eleven" of super-efficient features and amazing co-ordinated performance. In it are incorporated:

1. The best idea of balancing.
2. The best ideas of shielding.
3. The best ideas of sharp tuning.
4. The best idea of controlling volume.
5. The best idea of station selection.
6. The best idea of finish and color.
7. The best idea of power tube use.
8. The best idea of console installation.
9. The best idea of power supply connections by enclosing all leads in a cable.
10. The best idea of AC tube operation.
11. The best idea of converting AC current to necessary radio DC.

Operation of the Bandbox receiver from house current is possible with the AC model at \$65, which uses the new amazing R. C. A. AC tubes. Power converter costs \$60 more.

These new Bandbox receivers are now on display at over 16,000 Authorized Crosley dealers. Their faultless reception of the many wonderful events constantly on the air is proving such a startling demonstration that a national enthusiasm sweeps the country in the natural exclamation—"You're there with a Crosley!" If you cannot locate the nearest dealer write Dept. 15 for descriptive literature.



**Improved Musicones**

*Musicones improve the reception of any radio set. They are perfect affinities in beauty and reproductive effectiveness for Crosley Radios. A tilt-table model with brown mahogany finish stands 36 inches high, \$27.50—16-inch Super-Musicone as pictured above with "Bandbox," \$12.75—12-inch Ultra-Musicone, \$9.75.*

# CROSLEY RADIO

*Crosley is licensed only for Radio Amateur, Experimental and Broadcast Reception.*



**THE CROSLEY RADIO CORPORATION**  
Powell Crosley, Jr., Pres. Cincinnati, Ohio  
Prices slightly higher west of the Rocky Mts.





One Dial  
LONG DISTANCE  
**5 TUBE RADIO**

**\$25.00**

**EVERYBODY**, including experienced radio engineers, said—it cannot be done. But we did it—produced a high grade, long distance single dial control radio to operate a loud speaker to retail for \$25.00—and yet allow liberal discount to agents.

This marvelous instrument is the result of five years' hard work by an organization of trained radio engineers. It is no experiment—thousands are in use—the results speak for themselves.

**There Will Be a Radio in Every Home**

Thousands have been waiting for just such a radio—a real long distance, powerful instrument—but at a price they can afford.

It is here, and live, wide-awake salesmen will recognize their opportunity immediately—they won't lose a single minute writing for full information.

Just as there are 100 Fords to one high-priced car, just so will there be 100 Vikings to every \$75.00 and \$100.00 radio—think what this means to men who get in on the ground floor right now.

**A \$25 Radio Which Will Equal a \$75 Radio**

Put a Model 599 Viking, which retails for \$25.00, alongside any radio retailing for \$75.00 and even more. Compare them for ease of tuning—only one dial to

tune on the Viking—distance received, volume and tone. The results will make any man say, "I'll save that \$50.00"

Radio is today the biggest and quickest selling line—thousands are being sold—salesmen have made unheard-of profits. But here is a far greater, a far more interesting radio proposition than anyone ever dreamed of.

**Agents Wanted  
Make \$100.00 a Week**

**You Should Make \$100.00 a Week Easily**

You can't help it—many will make more. Some will control a county—others will control many counties. We have the liveliest radio selling plan of today—instruments of all prices—a radio price to fit every pocket book.

Any man who will follow our teaching cannot help but add big money to his present income and start to do it immediately. If you want more money here is your chance, but you'll have to act quick—others will jump at this chance.

**Sell Radio in Your Spare Time—Evenings**

You don't even have to give up your present position. The only time radio can be sold is in the evening—by demonstration. So here is a chance to add to your present income. During the past five years we have trained 4364 men in this very profitable business.

You'll be the first one with a real low priced long distance radio—your price will startle everybody—the results will be even far more startling. Once you demonstrate you're sure of a sale. No one can think of investing \$75.00 to \$100.00 in a radio when this instrument will equal the results and your retail price is only \$25.00. Just think of the advantage you have. Sell a radio for only \$25.00, and yet make a handsome commission.

**Territory Is Going Fast—  
Better Write Today**

Someone is going to get the big profit on the sale of these instruments in your community—is that someone going to be you? Write today for our illustrated book which fully describes not only this wonderful instrument but also a full line of radio at all prices. It's FREE for the asking.

**Use This Coupon**

W. B. Fischer,  
122 W. Austin Ave.  
Chicago, Ill.

I am interested in selling your 5 tube set in this territory. Please send me your illustrated book, FREE.

Name: \_\_\_\_\_

Address: \_\_\_\_\_ City: \_\_\_\_\_

County: \_\_\_\_\_ State: \_\_\_\_\_

**SEND FOR SPECIAL ILLUSTRATED FREE BOOK**



# WURLITZER

TRADE MARK REGISTERED  
THE WORLD'S LARGEST MUSIC HOUSE



## Try Any Wurlitzer Instrument in Your Own Home

**E**XAMINE it, show it to your friends, play it as much as you wish. An ample free trial—no obligation to buy. We make this liberal offer because we want you to see for yourself this superior quality of Wurlitzer instruments, the result of 200 years' experience. Noted musicians praise them for unusual tone quality, artistic workmanship and ease of playing. They are used in the finest bands and orchestras throughout the country.

### Easy Payments

If you decide to buy, payments are arranged in small monthly sums. A few cents a day pays for your instrument. Special offers on complete musical outfits. Buy direct from Wurlitzer and save money.

### SEND FOR New Catalog

The greatest musical catalog ever published! Over 3,000 articles—every known instrument described and illustrated; many of them shown in full colors. Gives you lowest prices and all details of Free Trial, Easy Payment plan. All sent FREE—no obligation. Just clip coupon and mail today.

Clip and Mail

THE RUDOLPH WURLITZER CO., Dept. 1778

117 E. 4th St., Cincinnati 120 W. 42nd St., New York

329 S. Wabash Ave., Chicago 250 Stockton St., San Francisco

Send me, absolutely free, new illustrated catalog, with prices and details of Free Trial Easy Payment plan. No obligation.

Name.....

Address.....

City..... State.....

Instrument.....

(State Instrument in which you are interested)