

POPULAR MECHANICS

MAGAZINE

WRITTEN SO YOU CAN UNDERSTAND IT

REGD. TRADE MARK GREAT BRITAIN No. 410420

REG. U.S. PAT. OFF.



SEE PAGE 544

GUNDIACH

ATKINS

SILVER STEEL SAWS

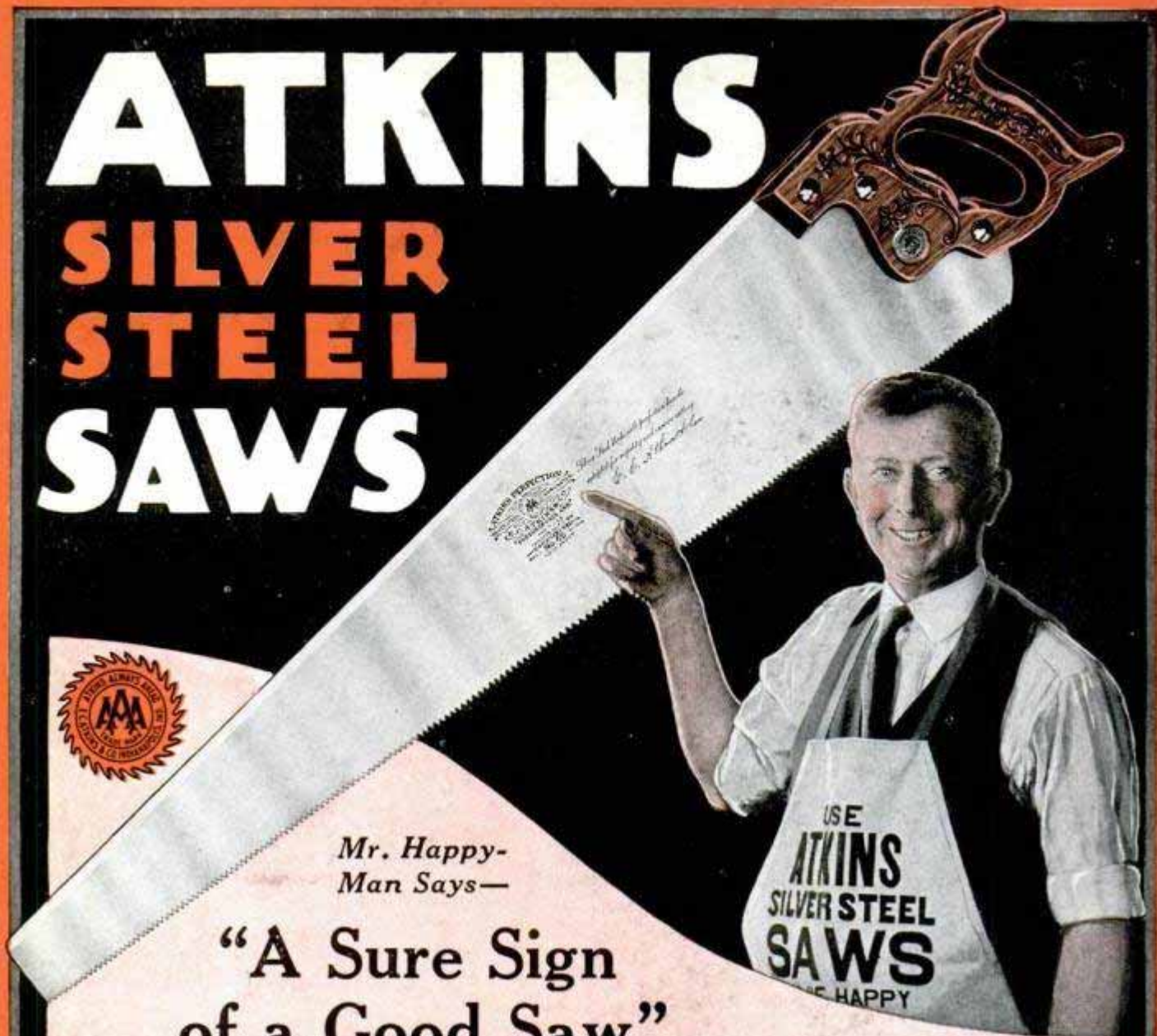

*Mr. Happy-
Man Says—*

“A Sure Sign of a Good Saw”

LOOK for the ATKINS name on the blade when you buy a saw. This world-famous trade-mark guarantees you a better saw—one that will save you time, money and labor every day you use it.

Your hardware dealer will show you a genuine ATKINS “Silver Steel” Saw ready for a lifetime of better service in your home, or in your work. It not only cuts easier and faster, but outwears many “cheap” saws.

No matter whether you want to cut wood, metal, stone, bone or any other material—there’s an ATKINS Saw ready to give better service. Ask or write for one of our free folders, “Saws in the Home,” “Saw Sense” or “Saws on the Farm.” YOUR hardware dealer will gladly show why “It Pays To Buy Better Tools!”

E. C. ATKINS & CO., Est. 1857, 426 S. Ills. St., Indianapolis, Ind.

Leading Manufacturers of Highest Grade Saws for Every Use; Saw Tools, Saw Specialties, Plastering Trowels, Machine Knives, Grinding Wheels and Files.

Win Friendship Fame—Fortune With a New Conn Saxophone



JUST a few short weeks of pleasurable practice with one of these new Conn saxophones and Boy! what fun! You'll be welcome everywhere; on top o' the world, socially.

You can entertain yourself and friends. The field of professional playing will open to you if your ambition lies that way. You can devote all or part time to highly paid professional engagements.

Conn's exclusive features and new, easy instruction methods enable you to play quickly. World-famous artists choose the Conn as supreme and have acclaimed the *new* Conn models as the last word in saxophones.

Ever since Conn built the first saxophone ever produced in America Conn leadership in this important field has been maintained. Exclusive features which improve the tone quality and make it easier to play have been developed in the great Conn laboratories.

Free Trial, Easy Payments On Any Conn Instrument

Send the coupon now for free literature and details of our easy payment plan on any Conn instrument. Remember, we are the only makers of every instrument used in the band—cornets, trumpets, trombones, clarinets, flutes, drums, etc. Whatever instrument interests you, send now for further information. No obligation is involved; get our new free books. Be sure to mention instrument.

CONN
BAND
INSTRUMENTS
WORLD'S LARGEST MANUFACTURERS

C. G. CONN, Ltd., 1031 Conn Bldg., Elkhart, Indiana

Gentlemen: Please send free literature and details of free trial offer on

_____ (Instrument) _____

Name _____

St. or R. F. D. _____

City, State _____

County _____



"ACE HIGH" WITH THE YOUNGER CROWD!

ORDINARILY, this modern generation scorns precedent.

History is nevertheless repeating—in a way which we find interesting and gratifying. Something about Fatima—its greater delicacy, its more skillful blending of flavors—has made it, as in other days, an outstanding favorite with the younger set.

F A T I M A

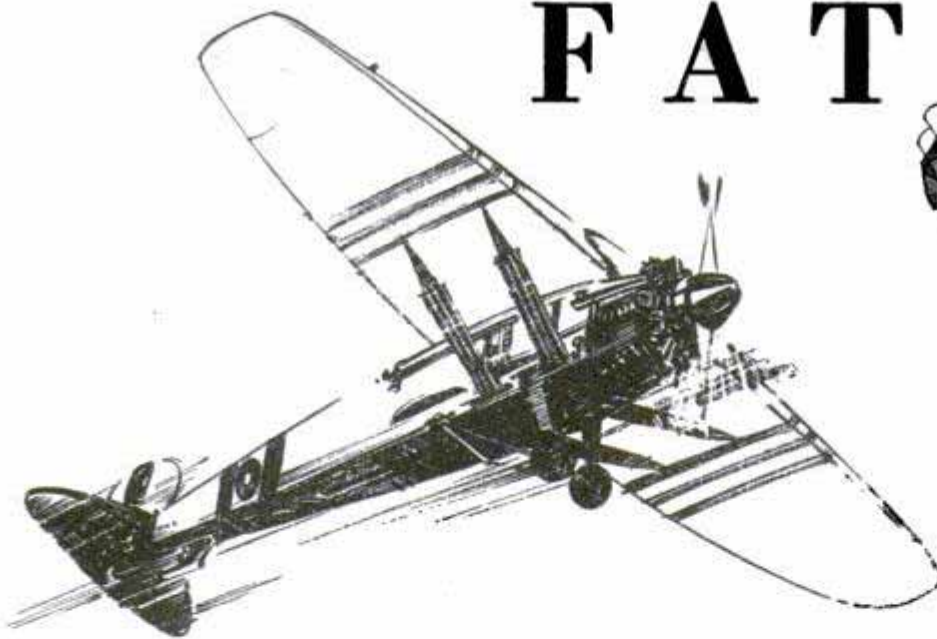

QUALITY *that makes friends everywhere!*

Popular Mechanics Magazine

200 E. Ontario Street, Chicago, U. S. A.

H. H. WINDSOR, Founder

H. H. WINDSOR, Jr., Editor and Publisher

London: Hachette & Cie.,
16-17 King William Street, Charing Cross, W. C. 2

Paris: Hachette & Cie.,
111 Rue Reaumur

Melbourne: Gordon & Gotch
509-513 Little Collins St.

ISSUED MONTHLY

SUBSCRIPTION:

SINGLE COPY, 25 CENTS

In United States and its possessions, also Canada, Cuba, and Mexico, per year, postpaid - \$2.50

To all other countries in the Postal Union - 3.00

All subscriptions are discontinued at expiration. Please examine the date printed on your wrapper.

Entered as Second Class Matter Sept. 15, 1908, at the Post Office at Chicago, Illinois, under Act of March 3rd, 1879.

Entered as Second Class Matter at the Post Office Department, Canada.

Published monthly by POPULAR MECHANICS CO.

Copyright, 1927, by Popular Mechanics Co.

Copyright in Australia. Copyright in France

Vol. 48

Contents for October, 1927

No. 4

569

Advertising—lion's head spouts perfume to advertise store	587	Dictaphone—used to chart New York harbor	551
Airplane		Dustpan—with flexible edge aids clean sweeping	561
battle, carries bombs and six guns	542	Eagle—training as falcon	647
can drop motor for emergency landings	621	Eclipses—prediction of	594
"flivver" has body like auto sedan	534	Efficiency Tests—machine picks girls for special work	620
greater speed object of tunnel tests	533	Elephants—extinguish fire in Indian jungle	632
Army—pistol charge develops marksmanship of cavalrymen	577	Electric Timer—regulates various machines	554
Automobiles		Ferryboat—for autos, guided by steering wheel	569
for track inspections fitted for accident aid	583	Fireflies—bowls of, gift to Japanese princess	536
Massachusetts license plate bears codfish	570	Fish and Fishing	
ventilation tests show how to decrease heat in	584	bait can with self-closing lid hooks to belt	533
Automobiles—Accessories		many species can change color	554
can of tire patches has knife attached	593	primitive methods of fishing	603
folding shield for rumble seat	613	Fog Signals—triangle used as gong	588
folding table fits all cars	540	Food—feeding experiments with rats aid tests	598
gas tank cap has chain attached	577	Fruit—picking tower saves time	536
Automobiles—Design		Garage—double-deck parking for Chicago beach	534
how "cheat" lines fool your eyes	606	Gas Masks—guard engine men while passing tunnels	621
roll top for	573	Geography—made pleasant with sectional globe	598
Automobiles—Driving		Goldfish—grown in dark to develop bulging eyes	588
green-colored highway to reduce glare	559	Gold Rush—ghost cities of the west	633
grooved highway across stretch of sea	626	Golf	
power steering eases driver's task	605	perfect swing taught by machine	623
Aviation		practice in iron circle for proper swing	531
airplane hop from liner points to faster mail	568	Guns—sight for anti-aircraft, leaves hands free	632
air-port tower at Chicago to honor Lindbergh	573	Harrow—tread-drive tractor, can make short turns	641
channel record shows safety of air travel	626	Hat Rack—has lock to prevent theft	551
commercial air traffic increasing in U. S.	551	Hats—decorated with tinfoil	635
hum of planes to light lamps on landing field	587	Health—public, air samples tested, to guard	592
spring stick to increase safety of student flyers	552	Highway Construction—the new billion dollar science	589
what's left for air heroes to conquer	642	House—stranded during grading of street	636
Balloon—motor, for army use	635	Household Devices	638
Battleships—electric fans end blasts on	600	easy ways to save work in the home	578
Beauty Culture—self-operated marcel waver won't burn hair	543	House Plan	704
Bed—folding, has lock frame and sagless spring	640	Hunting—big game in Rubberland	611
Biology—bacteria can live without oxygen	610	Kites	
Birds		life-saving, to drop line over wreck	544
miniature city attracts warblers	599	used to hoist radio antenna aid to airplanes	593
routed with roman candles	624	Lawn Mower—made with old safety-razor blades	569
Books—protected by worm-proof paper	603	Liberty Statue—flames from torch only chemical smoke	568
Boring Machine—for ceilings has saw attachment	594	Life Saving—heroes of underground world	562
Bottle Opener—fastened to wall saves furniture	610	Light—fog-penetrating, to aid flyers	614
Bricks—molded in different shapes to aid laying	584	Lobsters—trained to do tricks	600
Bridge—natural, scientist studies to determine safety	614	Magic—how it is made	546
Burbank, Luther—his work is being carried on	627	Mail Clerks—must have remarkable memory	625
Camera—trap for burglars	641	Mirror—combined with photograph and lamp	588
Canes—unique, carved by Detroit man	632	Mold—ingot-casting, weighs 91 tons	615
Chemicals—many valuable in Dead sea	615	Motorboats—faster	537
Chemistry—synthetic products are plausible	560	Motor Bus—highway "liners" have many luxuries	560
Chicken Picker—electrical saves butchers' time	603	Motor Trucks—used to launch boats from dry-land shipyard	552
Chickens—Uncle Sam's experimental farm	595	Moving Pictures—mystery solo with organ latest stunt	541
Clock—street, plays organ	610	Music—odd assortment of instruments for mechanical orchestra	631
Coal—powdered, tried in ships	573	Nail Brush—in cake of soap prevents waste	582
Colors—whirling disk shoots sparks	531	Nails—umbrella headed, prevent leaks	636
Concrete		Navy—British in electric pageant	532
mixing ice in makes porous blocks	531	Nervous System—intricate model of human	584
rustic, wooden-appearing park furniture from	585	Ocean Levels—Pacific is higher than Atlantic	588
Cooler—portable, for fruit cars	617	Orchestra—one man plays 22-piece	535
Crane		Organ—portable console for theater	587
combined with sawmill saves labor	640	Payroll—delivered in armored car	545
wrecking, lifts boat over dam spillway	583	Pea Shell—fits on dish and saves time	568
Curling Iron—coin-in-the-slot electric	552	Petroleum—believed to be still forming	545
Desert—of Sahara, buries treasure	623	Physical Culture—reducing exerciser fits in small space	535
		Piano—rollers for keyboard aid in playing scales	532

Cities school 633
[Continued on Page 4]

Miner rescue 562

[Contents—Continued]

Plants			
in electric hotbed mature early	543		
may be used for laboratory tests	615		
Platinum—fortune waits discovery of extraction process	536		
Plow			
electric, speeds crops and kills weeds	624		
firebreak, curbs spread of brush blazes	626		
Power Transmission—electric, new cable	620		
Psychology—ability to learn increases until twenty	621		
Quoits—played with old tires	605		
Rack—tipping, simplifies draining of barrels	624		
Radio			
automatic SOS for ships helps sea safety	535		
development of marine through vacuum tube	532		
novel fan	662		
station goes to sea	617		
tester aids service men	660		
Radio—Aerials			
automobile bumper serves as	658		
for wall, resembles tapestry	660		
high not good for tube sets	659		
Radio—Amplifiers—resistance-coupled power	662		
Radio—Applications			
grid-glow tube controls electric power	558		
street organ replaced by radio on wheels	600		
Radio—B-Eliminators—tapped resistance unit for	653		
Radio—Batteries			
auto-timer cable for leads	653		
handy test board for B	657		
selection and care of storage	658		
Radio—Coils—new, require no shielding	659		
Radio—Installation—making loop connections	657		
Radio—Loud Speakers—building a six foot	649		
Radio Pictorial	661		
Radio—Receivers			
new kit for Browning-Drake set	657		
two-tube set works loud speaker	655		
vest-pocket crystal	659		
where to look for trouble	662		
Radio—Rheostats—hints on variable resistors	659		
Radio—Tubes			
advantage of adjustable plate voltage	660		
aid power lines	561		
specializing	660		
Railroads			
freight car dumps from side	554		
the world's queerest	618		
unique, across desert, taps rich mine	544		
Raincoat—paper, weighs little and is cool	540		
Rattlesnakes—bought by yard	570		
Refrigeration—ice-making unit fits old box	575		
Rubber			
electric wood filler, more effective than hand	630		
plating process for, improves products	575		
Safety Devices and Measures			
crossing gates shut by train	637		
headlamp fits on fireman's helmet	613		
Sash Pulley—fitted with guard keeps rope in place	553		
Sawing—guide for saw-log carriage saves timber	560		
Seals—hunting from the air	555		
Ships and Shipping			
engine room of "Tampa" is cool	624		
"Malolo" defeats sea on first trip	574		
odd craft disposes of refuse	559		
Shopping Bag—on rollers simplifies marketing	623		
Sleep—how hard do you sleep?	529		
Smokestack—holds auto truck	594		
Store—traveling, for rural districts	625		
Submarine Cable—thrills in repairing	622		
Submarine Detector—adapted to peace-time usefulness	635		
Surgery—bloodless by means of electric knife	604		
Survey—quartz sight aids	542		
Taxicabs—muscle test for drivers	576		
Telephone—ton of coal to make million calls	577		
Telephone Poles—cradle for, saves work	570		
Temperature—inside furnaces determined by telescopic instrument	582		
Textile Designs—new, acquired by photographing shadow patterns	648		
Theater Chairs—anchor for, provides footrest	605		
Tower of Jewels—musical, feature of exhibition (Cleveland)	576		
Toys			
eight-wheeled wagon will not upset	539		
electric train comes apart	616		
scooter, wagon, sled, etc., in one	561		
Traffic			
automatic gates at street intersections promote safety	553		
problem solved by overhead crossings	616		
Trapping—sport of pheasant trapping	571		
Trees			
cavities filled with cork to check decay	545		
huge fallen Sequoia used as			
Valve Seats—renewed with simple cutting tool	647		
Ventilation—made to order air protects pictures in museum	648		
Visor—for women's hats shields eyes	615		
Watch			
converted into traveling clock by leather case	625		
how to care for	593		
Water Lilies—raising millions of	601		
Windows—cleaning with chemical rag	575		
Wire Stretcher—two-handed, simplifies fence repairs	631		
X-Rays—uses of, in industry	636		
AMATEUR MECHANICS			
Automobiles			
protecting car finish	684		
windshield wiper kink	667		
Automobiles—Accessories			
chemical windshield wiper	670		
match scratcher on steering wheel	684		
Automobiles—Repairing—rear axle of Ford car	669		
Batteries—truck for carrying storage	671		
Bill File—made from tobacco can	668		
Bottle Labels—substitute for paper	670		
Brass Plaques—make your own portrait	663		
Camera—rubber band prevents accidental exposure	684		
Candlestick—for camp, made of wire	668		
Canoe—carried on touring car	678		
Concrete—how to mend broken articles	665		
Dogs—teaching to open door	670		
Flashlight—holder that hooks on belt	683		
Flower Boxes—to prevent wood rot	671		
Flypaper—held on paper spindle	670		
Funnel—for bottling beverages	682		
Furnace—automatic draft accelerator for	669		
Games—combination "roll-down" and seesaw	667		
Hunting			
ammunition belt made from pocketbooks	669		
how to build good shooting blinds	672		
how to make wooden decoy ducks	678		
Lawn—how to make and keep a good	679		
Oils—test for lubricating	666		
Pail—holding lid tightly	684		
Paints and Painting			
homemade paint-remover paste	668		
varnish remover	671		
Pump—coil spring saves windmill	677		
Refrigerator—drip pan	683		
Rubbers—can, make mat for sink	671		
Safety Pin—used for switch	671		
Sewing Machine—sharpening needles	678		
Slide Rules—remedy for jerky	666		
Stoppers—to remove stuck glass	666		
Stove—made from oil drum	666		
Table—casters for kitchen	683		
Telephone—right-handed, for deaf	678		
Tents—tension regulator for	668		
SHOP NOTES			
Automobiles—old gaskets may be used over again	701		
Automobiles—Repairing—relining Ford brake bands	688		
Ax—handy holder	702		
Bolts—handy holders	700		
Bridge—flood water flows over top of	688		
Cuts—inexpensive, for multigraphing	702		
Drawing Board—non-slipping	701		
Emery Wheels—uses for old	703		
Etching—brass and copper	691		
Faucet—automatic shut-off for shop	701		
Fences—tightener for barbed wire	703		
Filler—labor-saving, for liquids	689		
Fumigation—of school books	700		
Gauge—self-centering ring, for lathe work	702		
Harness			
hanger for heavy	701		
hanger aids in hitching and unhitching	690		
Marble—how to repair	689		
Paints and Painting			
holder for sign painters' brushes	689		
rapid method of coloring backgrounds	695		
to protect glass when painting auto	690		
Photography—polish for ferrotype plates	697		
Plaster of Paris—how to keep soft	695		
Poultry—automatic switch for house	696		
Rope—coiled in tub is easy to handle	695		
Sewing Cabinet—building a "Priscilla"	698		
Shock Absorbers—for farm lumber wagon	703		
Steaming Chamber—improved for wood	690		
Tiles—pipe carrier for drain	697		
Vise—spring opener for	697		

Whispering duck shoots sparks 531

DRAKE'S PRACTICAL MECHANICAL BOOKS

THEY WILL RAISE YOUR PAY—

ORDER ON 5-DAY TRIAL

The books listed below will perfect you in your chosen trade—pave the way to the big positions. Written in non-technical language—easy to read and understand. Every book covers its subject completely. An entire course of instruction condensed into one volume. Your choice sent postpaid—you benefit 5 days—money refunded in full if not entirely satisfactory. Order direct from this page.

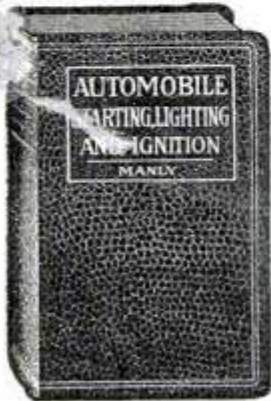

Automobile Books

- Automobile Starting, Lighting and Ignition, by Manly... 700 pp. \$3.00
 Brookes' Automobile Handbook... \$2.00
 Ford Motor Car, Truck and Tractor, by Manly... Cloth \$1.50
 Automobile Battery, Care and Repair, by Manly... Leatherette \$2.00
 Motorcycle Handbook, by Manly... \$1.50



Shop Practice Books

- Practical Heating Systems, Trouble Jobs and Ventilation... \$4.00
 Sheet Metal Workers' Manual... \$2.00
 Oxy-Acetylene Welding and Cutting... Cloth \$1.25
 Slide Rule and Logarithmic Tables... \$2.00
 Handbook for Millwrights... Cloth \$2.00
 Machine Shop Practice... Cloth \$2.00
 Mechanical Drawing and Machine Design... Cloth \$2.00

ORDER DIRECT FROM THIS PAGE—ON OUR MONEY-BACK PLAN

The books listed above are only a few of the many in our catalogue, which you will receive promptly after filling out and mailing us the attached coupon. For quick action order direct from this page—cross name of each book wanted and send in with price quoted. We prepay postage and send the books on our money-back plan.

FREDERICK J. DRAKE & CO.
 Publishers

1008 Michigan Ave. CHICAGO
 Drake Books Are For Sale at All Book Stores

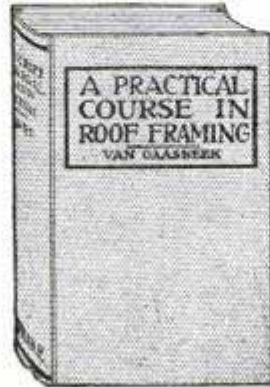

Carpentry Books

- Cloth Binding
 Modern Carpentry, 2 vols... \$3.00
 The Steel Square, 2 vols... \$3.00
 Modern Estimator... \$1.50
 Timber Framing... \$2.00
 Builders' Architectural Drawing... \$2.00
 Concretes... \$1.50
 Practical Bungalows... \$1.00
 Roof Framing, by Van Gaasbeek... \$1.50

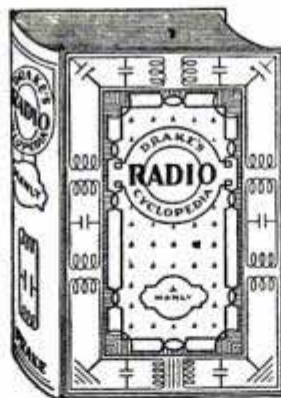

Drake's Radio Cyclopedia

By H. P. Manly

870 Pages, 985 Illustrations, 1700 Subjects, arranged alphabetically. For Service and Repair Men, Dealers, Salesmen, Experimenters and Designers. Bound in Art Buckram. Price... \$6.00



Painting and Decorating

- Furniture, Furniture Finishing, Decoration and Patching... \$5.00
 Ross Crane Book of Home Furnishing and Decoration... Cloth \$3.00
 House Painting Methods with the Brush and Spray Gun, by Vanderwalker... Cloth \$2.00
 Interior Wall Decoration, by Vanderwalker... Leatherette \$4.00
 The Mixing of Colors and Paints, by Vanderwalker... Cloth \$2.00
 Studio Handbook—Letter and Design... \$3.00
 A Show at Sho' Cards... Cloth \$4.00
 Sign Painting, by Atkinson... Cloth \$4.00
 Strong's Book of Designs, Leatherette \$4.00
 Modern Painters' Cyclopedia, Cloth \$2.00
 Automobile Painting... Cloth \$1.50
 New Hardwood Finishing... Cloth \$1.50
 Wood Finishing, Plain and Decorative... Cloth \$2.00
 Owen's Paint Guide... Cloth \$1.00

Steam Engineering

- Swingle's Handbook for Steam Engineers and Electricians... Leatherette \$4.00
 Examination Questions and Answers for Marine and Stationary Engineers... Leatherette \$2.00
 Steam Boilers... Leatherette \$2.00
 Swingle's Catechism of Steam, Gas and Electrical Engineering... Leatherette \$1.50

Modern Languages

- By Prof. P. S. Allen, U. of Chicago
 French without a Teacher... Cloth \$1.25
 Spanish without a Teacher... Cloth \$1.25
 German without a Teacher... Cloth \$1.25
 Everyday French... \$1.25
 Everyday Spanish... \$1.25

FREDERICK J. DRAKE & CO.
 1008 Michigan Avenue
 Chicago, Ill.

GENTLEMEN:—Please send me free, postage paid, your illustrated catalogue which lists and describes 200 Practical Mechanical Books for Home Study.

My name is

and my address

Mail Coupon For Free Catalogue
 Your Guide to Home Study

How Men Make Opportunities with Westinghouse



S. E. FERRY,
Supervisor of Industrial Training,
Westinghouse Electric &
Manufacturing Company

"Of Inestimable Value In My Everyday Work"

"The executive training in Business Management which I have pursued to completion with LaSalle University has been of inestimable value to me in my everyday work of selecting, training, and placing young men in the engineering, manufacturing and distribution fields of the Westinghouse Company.

"Having personally benefited so greatly from the training I took with LaSalle, I am in a position to appreciate the worthwhileness of a properly organized and properly administered program of employee training."

(Signed) S. E. FERRY,
Supervisor of Industrial Training.

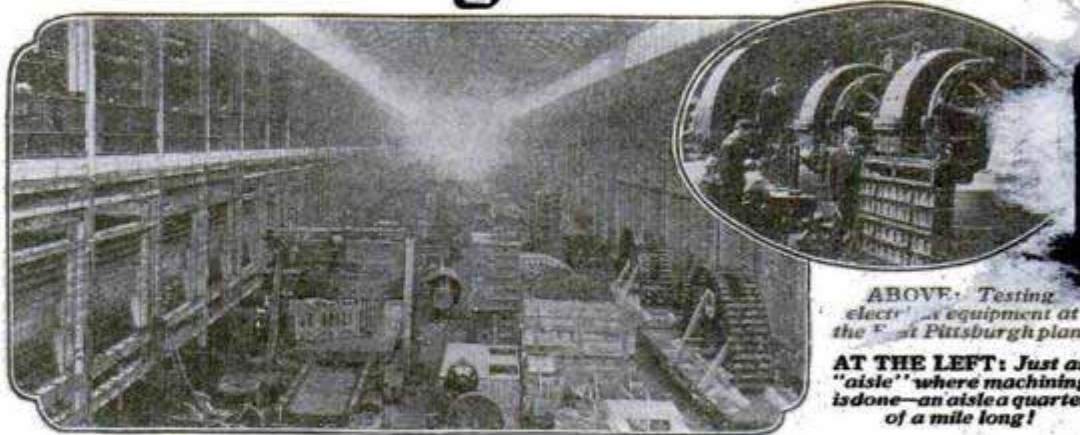

ABOVE: Testing electrical equipment at the Westinghouse Pittsburgh plant

AT THE LEFT: Just an "aisle" where machining is done—an aisle a quarter of a mile long!

—where more than 5,000 employees are training for leadership

"When we find a man with sufficient faith in himself to spend his own time, energy and money to complete a home-study course, we consider him as being in that group from whom our future leaders will be drawn."

So writes C. S. Coler, Manager of the Educational Department of the Westinghouse Electric and Manufacturing Company, East Pittsburgh, Pa.; and he, if anyone, ought to know how training increases the productive capacity of an organization, for under his observation are more than 5,000 Westinghouse employees, all pursuing educational courses.

The Westinghouse Company, with an organization of 50,000 men and women (20,000 of whom are at the East Pittsburgh plant), maintains a very elaborate system of employee education, with three- and four-year courses in engineering, accounting, business management, and the various trades, as well as short courses in stenography, English and other personal development studies.

When it is considered that a large percentage of the employees who train with Westinghouse specialize in engineering, it is the more significant that out of the 5,000 at the East Pittsburgh plant who are taking educa-

tional courses, 234 are at present enrolled for home-study training with LaSalle Extension University. Evidently LaSalle training supplies a breadth of experience which is recognized by Westinghouse as of the utmost value in fitting men for leadership.

Included among the LaSalle members is S. E. Ferry, Supervisor of Industrial Training, who by reason of his place as head of a division of the Westinghouse Educational Department, is in a position to speak with authority of the work LaSalle is doing. Read his comments in the column at the left.

Bigger Profits? Larger Income? Find Out How—Today

If you are an employer, LaSalle training for your executives and men will quickly prove its worth to you in greater production, lessened overhead, increased net profits.

If you are an employee, LaSalle adult business training will quickly clear your path to larger efficiency and increased earnings. Mail the coupon for a definite plan that properly applied will add thousands of dollars to your income.

Whether employer or employee, you face a period of the most intense competition American business has ever been called upon to face. If you choose for leadership, LaSalle can help you. Find out how—today.

LASALLE EXTENSION UNIVERSITY

THE WORLD'S LARGEST BUSINESS TRAINING INSTITUTION

FIND YOURSELF THRU LASALLE!

LASALLE EXTENSION UNIVERSITY Dept. 1064-R Chicago

I would welcome an outline of your salary-increasing plan, together with a copy of "Ten Years' Promotion in One," all without obligation.

- | | | |
|--|---|--|
| <input type="checkbox"/> Business Management: Training for Official, Managerial, Sales and Departmental Executive positions. | <input type="checkbox"/> Law: Training for Bar; LL.B. Degree. | <input type="checkbox"/> Commercial Law. |
| <input type="checkbox"/> Higher Accountancy: Training for position as Auditor, Comptroller, Certified Public Accountant, Cost Accountant, etc. | <input type="checkbox"/> Banking and Finance. | <input type="checkbox"/> Expert Bookkeeping. |
| <input type="checkbox"/> Modern Salesmanship. | <input type="checkbox"/> Modern Business Correspondence and Practice. | <input type="checkbox"/> Business English. |
| <input type="checkbox"/> Traffic Management—Foreign and Domestic. | <input type="checkbox"/> Modern Foremanship. | <input type="checkbox"/> Commercial Spanish. |
| | <input type="checkbox"/> Personnel Management. | <input type="checkbox"/> Effective Speaking. |
| | <input type="checkbox"/> Railway Station Management. | <input type="checkbox"/> C. P. A. Coaching for Advanced Accountants. |
| | <input type="checkbox"/> Industrial Management. | <input type="checkbox"/> Stenotypy: Training in the new superior shorthand, Stenotypy. |



free!
mail
coupon
now

Name..... Present Position..... Address.....

BUILDERS TRADE GUIDES

AUDELS CARPENTERS AND BUILDERS GUIDES—4 VOLS. \$6

Inside Information for Carpenters, Builders, Joiners, Building Mechanics—all Woodworkers. **1600 pages; 3700 diagrams; flexible; pocket size.** Short-cut instructions, new methods, ideas, solutions, plans, systems—money saving suggestions. An easy progressive course for the apprentice. A practical daily helper and Quick Reference for the master worker. A Helping Hand to Easier and Better Work and Better Pay. To get this aid for yourself, simply fill in and mail the FREE COUPON below.

INSIDE TRADE INFORMATION ON:

How to use steel square; How to file and set saws; How to build furniture; How to use mitre box; How to use chalk line; How to use rules; How to make joints; Carpenters' arithmetic; Mensuration problems; Estimat-	ing strength of timbers; How to set girders and sills; How to frame houses and roofs; How to estimate costs; How to build houses, barns, garages, bungalows, etc.; How to read and draw plans; Drawing up specifications; How	to excavate; How to use settings 12, 13 and 17 on the steel square; How to build hoists and scaffolds—skylights; How to build stairs; How to put on interior trim; How to hang doors; How to lath—lay floors; How to paint.
--	---	---

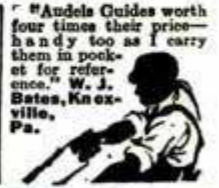

AUDELS PLUMBERS AND STEAMFITTERS GUIDES—4 VOLS. \$6

A new set—just out! A practical, illustrated, Reference Library and Study-Course for Master Plumbers, Journeymen and Apprentice Steamfitters, Gas Fitters and Helpers, Sheet Metal Workers, Draughtsmen, Master Builders, Engineers and all Building Trade Students. **1670 pages; 3642 diagrams; flexible; pocket size.** Guides explain all the principles, advances and short cuts of the Plumbing and Heating trade. Contains instructions on how to figure and estimate jobs. Use FREE COUPON below to examine, without obligation, this valuable work.

INSIDE TRADE INFORMATION ON:

Soldering, tinning. Joint wiping, bending, beating. Pipe—iron—steel, threading. Mathematics, tables, physics. Materials—iron, steel, copper, brass, lead, tin, antimony. Sheet metal—galvanized—plate. Sanita-	tion, syphonage, tanks. Drainage, sewage, purification. Fixtures—bath—kitchen. Pipe fittings, soil pipe, tools. Laying out work. Roughing. Screwed fittings, flanges, joints. Pipe bending, examples. Elbows. Heating, ven-	tilation, refrigeration. Water supply, mains, wells, tanks. Gas-fittings. Underwriters. Sheet metal work, problems, methods, brazing, heating, lead burning. Welding, various welds, methods. Blacksmithing, forges, tools.
--	---	---



AUDELS MASONS AND BUILDERS GUIDES—4 VOLS. \$6

A new, complete, illustrated trade reference library, for Bricklayers, Cement Workers, Plasterers, Tile Setters and Stone Masons, including a practical outline of Steel Construction. **1100 pages; 2067 diagrams; flexible; pocket size.** A practical Trade Assistant explaining modern methods of masonry construction. Easy to understand and apply. A reliable and authentic reference work and study-course for Master Journeyman and Young Mechanic. Use FREE COUPON below and find out for yourself, without obligation, whether this set will benefit you.

INSIDE TRADE INFORMATION ON:

Bricklaying, tools, materials; Brick designs, patterns, bonds; Setting frames and foundations; Mortars, scaffolds, estimating; Mortars and mortar mixing; Tile setting, mosaic, hollow tile; Straight edge test, trow-	elling; How to figure brick work; Safe loads, piers, chimneys; Boiler settings, anchors, fire stops; Laborables; Concrete, forms; How to figure concrete work; Stucco—on old and new buildings; Plastering—wood lath—metal;	Plasterers agreement; Plastering on various surfaces; Stonemasonry; Cutting, finishing, estimating stone; Derricks, rigging; Steel construction; Fire proof; How to read blue prints.
--	---	---



PRACTICAL ELECTRICITY — 1 VOL. \$4

Audels Handy Book of Practical Electricity is a simplified Ready Reference and Study Course in one pocket size, leather bound volume—for Engineers, Professional Electricians and Students. **1040 pages; 2600 diagrams; flexible red leather bound.** A reliable authority and handy helper for every electrical worker. Contains important and valuable wiring diagrams, calculations, machine sketches, helps on maintenance and repair. Use this FREE COUPON today and find out, without obligation, how this handy book will help you in your daily work.

INSIDE TRADE INFORMATION ON:

Electro-Therapeutics, X-Rays, Shocks, Welding, Brazing, Radio Hook-ups, Motion Pictures, Telephone, Telegraph, Cranes, Bells, Elevators, Pumps, Tools, Ship Drive, Railways, Vehicles, Automobile Electric Systems, Ignition, Generation, Lighting, Plant Management, Power Plans, Armature Winding, Repairing, A. C. Motors and Apparatus, D. C. Motors and Apparatus, Alternator Construction, Dynamos, Wiring Diagrams, Sign Flashers, Cable Splicing, Power Wiring, Outside Wiring, Switches, Lighting, Rectifiers, Converters, Transformers, Fuses, Circuit Breakers, Rheostats, Electro Plating, Electrolysis, Storage Batteries, Magnetism, Electrical Energy, Conductors, Insulators, Static, Dynamic, Radio Electricity, Applications, Ready Reference and Index Covering the entire field of Modern Electricity.

Learn More and You Will Earn More!

Know your job and you'll never be without one. The skilled man is always in demand. Knowledge is power. Learn your trade thoroughly by easy reading. This coupon is your opportunity for advancement and better pay. You risk nothing in sending for Audels Guides for free examination. Send it NOW!

FREE EXAMINATION COUPON

THEO. AUDEL & CO.,
65 W. 23 ST., NEW YORK CITY

Please mail me for free examination the books marked (x) below. If I find them satisfactory, I agree to mail \$1 in 7 days, on each set ordered, and to further mail \$1 monthly on each set until I have paid the purchase price.

4 CARPENTERS GUIDES \$6 | 4 PLUMBERS GUIDES \$6

4 MASONS GUIDES \$6 | 1 ELECTRICIANS HANDY BOOK \$4

NAME

ADDRESS

OCCUPATION

EMPLOYED BY..... 10T30

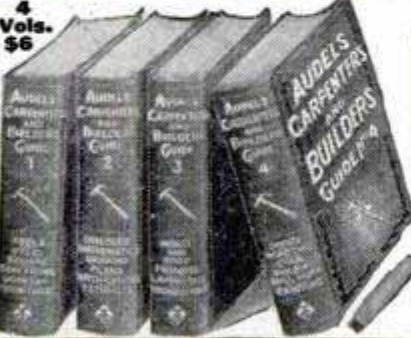

Be an AUTO EXPERT

I Train You
At HOME

up to
EARN
\$5000
A YEAR



Start to Make Money Quick Like Morriston

M. J. Morriston, Parkersburg, W. Va. (photo at right), never had a day's experience on cars before starting my training. Read what he says when less than half-way through his "JOB-WAY" course. "What I have already learned is worth over \$500 to me. I have gone into business and I'm making over \$50 a week clear, with wonderful prospects." And what Mr. Morriston and hundreds of others have done I will help you to do!



M. J. MORRISTON, Parkersburg, W. Va.

Clip this Coupon Now for my Big **FREE AUTO BOOK**

The World's biggest, most fascinating business needs you!

You needn't slave away at small wages another minute—mail coupon and I'll tell you how I train you at home in your spare time for positions paying up to \$150 a week. Unlimited opportunities for trained Electrical and Mechanical Auto Experts. Let me show you how my "JOB-WAY" training has prepared hundreds of men just like yourself for a quick, brilliant success in the Auto business.

Earn Up to \$150 a Week!

Don't sell your time for low pay! You don't need to when you have my "JOB-WAY" training. As Directing Engineer of this Institution I know what training you need to succeed, AND I GIVE YOU THAT TRAINING right in your own home. MASTER every branch of Auto, Truck and Tractor work. I train you with JOBS—not books. I bring the original "JOB-WAY" training to YOUR HOME!

Read My Agreement!

Ten agreements in my big free Auto book. No. 1 is "I will refund every cent of your money if after receiving my training you are not absolutely satisfied." This and nine other wonderful agreements make my "JOB-WAY" course the training for you! Be sure to get my book and read all ten agreements.

Experience, Education Not Needed!

I don't care how little schooling you have, I will train you to become an Auto Mechanic or refund your money! Boys and men of all ages have become Garage owners and managers, Superintendents, Foremen, Auto Experts, BIG PAY executives, after completing Cooke "JOB-WAY" training. I prove to you that I will prepare you to take advantage of the many wonderful opportunities of the great auto business!

Get My Big Book Quick!

I will send it to you without one penny of cost. Read all the facts, find out about the demand for trained Auto Experts. Let me tell you how easily and quickly you, too, may become an Auto Expert. Splendid offer right now to ambitious men. Coupon brings complete information. Mail it today!

Tools and Test Bench Equipment Included

I supply every Cooke JOB-WAY student with 4 big, complete, costly outfits absolutely free of extra cost! Many students use these outfits to make money shortly after starting my training. Mail coupon for this remarkable offer!



Address Me Personally **B. W. COOKE** DIRECTING ENGINEER
CHICAGO MOTOR TRAINING CORPORATION
1916 Sunnyside Ave., Dept. 716, CHICAGO, ILL.

MAIL THIS COUPON NOW!

Free Auto Book

B. W. COOKE, Directing Engineer, Chicago Motor Training Corp., Dept. 716, 1916 Sunnyside Avenue, Chicago. Send me FREE your Big Auto Book "Auto Facts" and proof that you will train me in spare time at home. Also reserve 4 Outfits without obligating me.

Name.....

Address.....

City..... State.....

Are YOU afraid you'll be fired?



ARE you sitting on the anxious bench wondering what will happen to you if business slacks up? Are you one of the many small-salaried, untrained workers who are always the first to go when employers start cutting the salary list?

Why have this spectre of unemployment hanging over you all the time? Why not decide today that you are going to make yourself so valuable to your employer that he can't get along without you?

You can do it if you really want to, right at home in spare time, through the International Correspondence Schools. In just an hour a day you can get the special training that you must have if you are ever going to get—and keep—a real job at a real salary.

You're ambitious, aren't you? And you want to get ahead? Then don't turn this page until you have clipped the coupon, marked the line of work you want to follow and mailed it to Scranton for full particulars. Surely it is worth at least a two-cent stamp to find out all about the I. C. S. and what it can do for you.

Mail the Coupon for Free Booklet

INTERNATIONAL CORRESPONDENCE SCHOOLS, Box 5674-E, Scranton, Pa.

"The Universal University"

Without cost or obligation, please send me one of your booklets and tell me how I can qualify for the position or in the subject before which I have marked an X:

BUSINESS TRAINING COURSES

- | | | | |
|---|---|--|---|
| <input type="checkbox"/> Business Management | <input type="checkbox"/> Accountancy (including C.P.A.) | <input type="checkbox"/> Salesmanship | <input type="checkbox"/> Civil Service |
| <input type="checkbox"/> Industrial Management | <input type="checkbox"/> Cost Accounting | <input type="checkbox"/> Advertising | <input type="checkbox"/> Railway Mail Clerk |
| <input type="checkbox"/> Personnel Organization | <input type="checkbox"/> Bookkeeping | <input type="checkbox"/> Business Correspondence | <input type="checkbox"/> Common School Subjects |
| <input type="checkbox"/> Traffic Management | <input type="checkbox"/> Private Secretary | <input type="checkbox"/> Show Card Lettering | <input type="checkbox"/> High School Subjects |
| <input type="checkbox"/> Business Law | <input type="checkbox"/> Spanish | <input type="checkbox"/> Stenography and Typing | <input type="checkbox"/> Illustrating |
| <input type="checkbox"/> Banking and Finance Management | <input type="checkbox"/> French | <input type="checkbox"/> English | <input type="checkbox"/> Cartooning |

TECHNICAL AND INDUSTRIAL COURSES

- | | | | | |
|---|--|--|--|--|
| <input type="checkbox"/> Electrical Engineering | <input type="checkbox"/> Gas Engine Operating | <input type="checkbox"/> Architect | <input type="checkbox"/> Chemistry | <input type="checkbox"/> Pharmacy |
| <input type="checkbox"/> Electric Lighting | <input type="checkbox"/> Civil Engineer | <input type="checkbox"/> Blueprint Reading | <input type="checkbox"/> Automobile Work | <input type="checkbox"/> Airplane Engines |
| <input type="checkbox"/> Mechanical Engineer | <input type="checkbox"/> Surveying and Mapping | <input type="checkbox"/> Contractor and Builder | <input type="checkbox"/> Navigation | <input type="checkbox"/> Agriculture and Poultry |
| <input type="checkbox"/> Mechanical Draftsman | <input type="checkbox"/> Metallurgy | <input type="checkbox"/> Architectural Draftsman | <input type="checkbox"/> Mathematics | |
| <input type="checkbox"/> Machine Shop Practice | <input type="checkbox"/> Steam Engineering | <input type="checkbox"/> Concrete Builder | | |
| <input type="checkbox"/> Railroad Positions | <input type="checkbox"/> Radio | <input type="checkbox"/> Structural Engineer | | |

Name.....

Address.....

Canadian address—International Correspondence Schools Canadian, Limited, Montreal

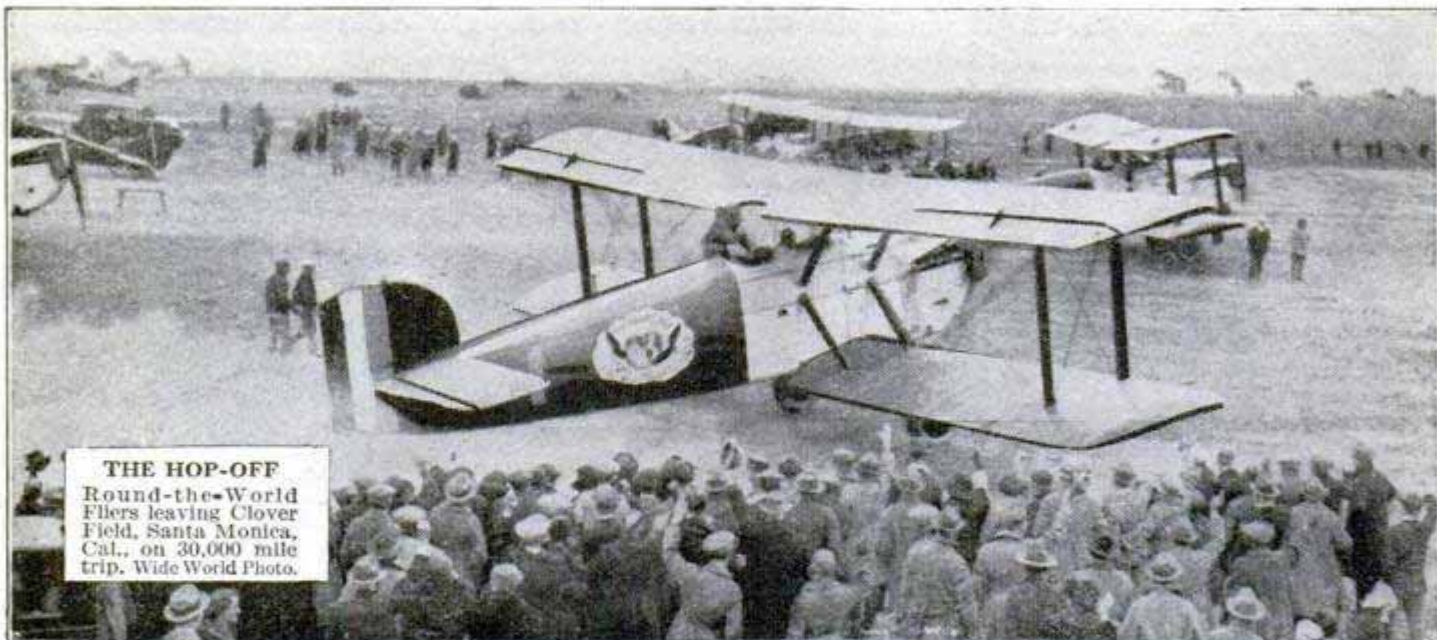

THE HOP-OFF
 Round-the-World
 Fliers leaving Clover
 Field, Santa Monica,
 Cal., on 30,000 mile
 trip. Wide World Photo.

Daring Young Men Needed in Aviation

THERE is no field of work in the world today which offers such amazing opportunities to young men of daring and who love adventure as does Aviation. Although still in its infancy, there is a crying demand in Aviation for young men with courage, nerve and self-reliance. For those who can qualify there will be thousands of highly paid jobs which will lead quickly and surely to advancement and success.

Big Opportunities Await The Trained Man

Look over the fields of work which are open to the young man today. You will find that Aviation is the ONE FIELD that is not overcrowded—the ONE FIELD in which there is plenty of room at the top. Think of it. Only 21 years ago Orville and Wilbur Wright made the world's first airplane flight. Now airplanes fly around the world. Yes, Aviation offers the same wonderful opportunities today that the automobile and motion picture industries did 15 and 20 years ago. Men who got in on the ground floor of those industries made fortunes before others woke up. AVIATION IS NEW! It clamors for nerry young men—and the trained man has the world before him in Aviation.

Easy to Become an Aviation Expert

You can qualify now quickly for one of these exciting highly paid jobs through a new, sure, easy method of training. The study of Aviation is almost as interesting as the work itself. Every lesson is fascinating and packed full of interest. That's why Aviation is so easy to learn—you don't have to force yourself

to study—once you start, you can't get enough of it. Only one hour of spare time a day will give you the basic training in an amazingly short time.

PICK YOUR JOB!

- Airplane Instructor
- Airplane Engineer
- Airplane Repairman
- Airplane Assembler
- Airplane Mechanician
- Airplane Inspector
- Airplane Builder
- Airplane Salesman
- Exhibition Manager
- Airplane Contractor
- Airplane Motor Expert
- Airplane Designer

One student, S. F. McNaughton, Chicago, says: "Your lessons are like a romance, and what is more, after one reading, the student gets a thorough understanding. One never tires of reading them." James Powers, Pa., another student, says: "I am indeed surprised that such a valuable course can be had from such practical men for so little cost."

Personal Instruction by Experienced Men]

Men who have had actual experience in Aviation give you personal attention and guide you carefully through your training. They select the lessons, lectures, blueprints and bulletins. They tell you the things that are essential to your success. Every lesson is easy to read and quickly understood.

Big Book on Aviation FREE



Send coupon below for New Free Book, just out, *Opportunities in the Airplane Industry*. It is interesting and instructive and will show you many things about Aviation which you never knew before. Only a limited number offered—get yours before the edition is exhausted.

American School of Aviation
 Dept. 1357, 3601 Michigan Ave., Chicago, Ill.

.....
AMERICAN SCHOOL OF AVIATION,
 3601 Michigan Ave., Dept. 1357, Chicago, Ill.
 Without any obligation, send me your Free Book, *Opportunities in the Airplane Industry*, also information about your Course in Practical Aeronautics.
 Name.....Age.....
 Street.....
 City.....State.....

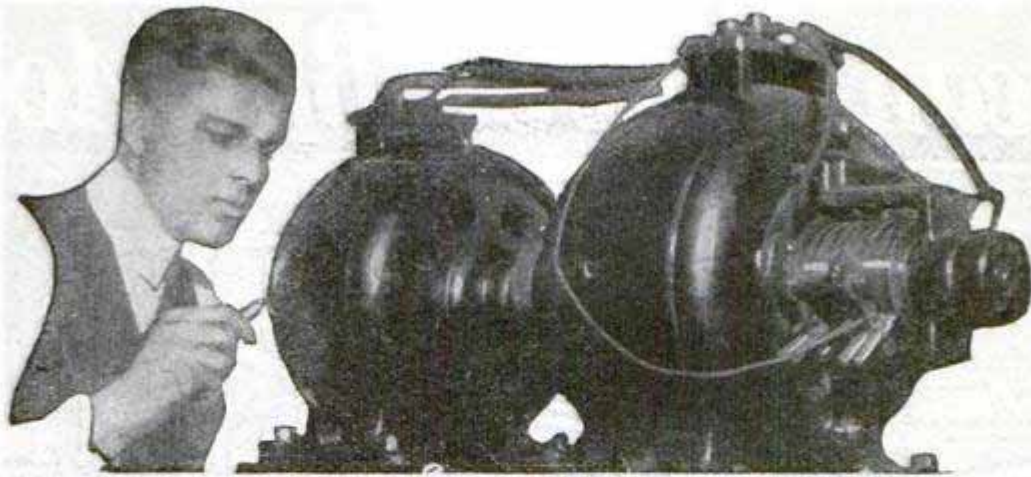

Amazingly Easy Way to get into ELECTRICITY

Don't spend your life waiting for \$5 raises in a dull, hopeless job. Now . . . and forever . . . say good-bye to 25 and 35 dollars a week. Let me teach you how to prepare for positions that lead to \$50, \$60 and on up to \$200 a week in Electricity—NOT by correspondence, but by an amazing way to teach that makes you a Real Electrician in 90 days! Getting into electricity is far easier than you imagine!

Learn Without Lessons in 90 DAYS

LACK of experience—age, or advanced education bars no one. I don't care if you don't know an armature from an air brake—I don't expect you to! It makes no difference! Don't let lack of money stop you. Most of the men at Coyne have no more money than you have. That's why I have worked out my astonishing offers. **FREE**

Employment Service

I will allow your railroad fare to Chicago, and assist you to part time work while training. Then, in 12 brief weeks, in the great roaring shops of Coyne, I train you as you never dreamed you could be trained . . . on one of the greatest outlays of electrical apparatus ever assembled . . . real dynamos, engines, power plants, autos, switchboards, transmitting stations . . . everything from doorbells to farm power and lighting . . . full-sized . . . in full operation every day!

No Books—No Printed Lessons

No dull books, no baffling charts . . . all real actual work . . . building real batteries . . . winding real armatures, operating real motors, dynamos and generators, wiring houses, etc., etc. That's a glimpse of how we help to make you a REAL



Prepare For Jobs Like This

Here are a few of hundreds of positions open to Coyne-trained men. Our free employment bureau gives you lifetime employment service.

Armature Expert	\$100 a Week
Substation Operator	\$65 a Week
Auto Electrician	\$110 a Week
Inventor	Unlimited
Maintenance Engineer	\$150 a Week
Service Station Owner	\$200 a Week
Radio Expert	\$160 a Week

Now in Our New Home

This is our new fireproof, modern home where it is installed thousands of dollars' worth of the newest and most modern Electrical equipment of all kinds. We now have the largest amount of floor space devoted to the exclusive teaching of practical electricity in the world. Every comfort and convenience has been arranged to make you happy and contented during your training.

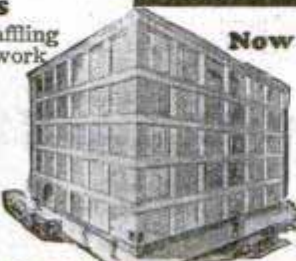

electrician, teaching you far more than the average ordinary electrician ever knows and fitting you to hold big jobs.

Jobs, Pay, Future

Don't worry about a job, Coyne training settles the job question for life. Big demand for trained men. Our employment department gives you lifetime service. Two weeks after graduation, Clyde F. Hart got a position as electrician with the Great Western Railroad at over \$100 a week. That's not unusual. We can point to many Coyne men making up to \$600 a month. \$60 a week is only the beginning of your opportunity. You can go into radio, battery or automotive electrical business for yourself and make up to \$15,000 a year.

Get the Facts

Coyne is your one great chance to get into electricity. Every obstacle is removed. This school is 28 years old—Coyne training is tested—proven beyond all doubt—endorsed by many large electrical concerns. You can find out everything absolutely free. Simply mail the coupon and let me send you the big, free Coyne book of 150 photographs . . . facts . . . jobs . . . salaries . . . opportunities. Tells you how many earn expenses while training and how we assist our graduates in the field. This does not obligate you. So act at once. Just mail coupon.

Get
this
FREE
Book



Mr. H. C. Lewis, Pres.
COYNE ELECTRICAL SCHOOL, Dept. 77-72
500-524 S. Paulina St., Chicago, Ill.

Dear Mr. Lewis:

Without obligation send me your big free catalog and all details of your Railroad Fare to Chicago offer, Free Employment service, Radio and Automotive Courses without extra cost, and how I can "earn while learning." I understand I will not be bothered by any salesman.

Name.....

Address.....

City..... State.....

COYNE ELECTRICAL SCHOOL
H.C. LEWIS, Pres., Dept. 77-72
500-524 S. PAULINA ST. Founded 1899 CHICAGO, ILL.

You can make the BIG Money



in Auto Painting

—Because here is the biggest uncrowded field in the world today. Prove it to yourself by the next 20 cars you see. Yes Sir, 17 out of 20 need painting.



G. KING FRANKLIN
Famous Auto
Painting Authority

I will have you ready in a few months

NOW—how many auto painters do you know? . . . I thought so. Well, who's going to do the work? You are—after you get the right training and you're going to make more money than you ever dreamed of! The world is looking for trained auto painters. Cash in on this big demand!

You Can Own Your Own Business!

In auto painting it's no trick to be your own boss—own your own business and be independent!

You don't have to start out with the biggest building on the busiest corner. You can begin small with little or no capital, but I don't know of another business where you can get big so fast. We show you how to open your own shop.

You Can Make from \$60 to \$90 a Week

After you get my training you can get a job anywhere. You can travel and know at your destination there will be a job waiting for you that pays big money. Remember—I don't forget you when you complete the course. I help you get a real job. You also get a life consultation service without extra charge.

17,000,000 Cars Need Painting

Just imagine! There are t-w-e-n-t-y m-i-l-l-i-o-n cars in the U. S. alone—and 17 million need priming, surfacing, painting, ducoing, varnishing, striping and the whole works—and take it from me, I teach you the whole works so you can get in on the Big Money—or I'll refund every penny of the small price you pay.

I realize that you are up against quite a problem in deciding what field to enter, but on my say-so, and my guarantee to you, just come into auto painting with me and you'll be glad of it all your life.

Men like yourself who have taken my advice are now making \$5,000 to \$10,000 a year.

PROOF

Chicago Duco says: "Skilled Duco men are scarce. We can place many at \$1.00 to \$1.25 an hour." Binks, one of the largest auto equipment manufacturers says "The big auto manufacturers are insisting that their dealers repaint all used cars." Stockton, Illinois, says "No shop here. All work must go to Freeport. Believe plenty of work to make paying business." Nash says "This is a big field and splendid opportunities for your graduates in re-painting cars." Many, many more like these.

MAIL the COUPON

G. King Franklin, Supt.,
American Auto Painting School,
Dept. 701, 425 S. Ashland Ave., Chicago.

Send sample shop-tickets free and information on how I may learn auto painting and Duco at home in spare time.

Name.....

Street No.....

City.....

State.....

LEARN at HOME!

And the beauty of my proposition is that you can learn at home in your spare time—evenings—and keep your present job while learning.

By my Shop Type Method you learn quickly and easily—the greatest advance in home study training assures you success—no car needed—work on wood and metal panels. 13 big outfits given without extra charge—

Get information now! Don't wait. Get my big illustrated booklet Free—you will not be obligated—

G. KING FRANKLIN, Supt.

American Auto Painting School
Dept. 701, 425 South Ashland Avenue, CHICAGO

Be the BOSS!

Go into the "Up-Keep" End of the Auto Industry!

Make \$40⁰⁰ to \$100⁰⁰ a week

If you want to be sure of a good job—ALWAYS—if you want real opportunities to get ahead—if you're looking for a line of work that pays **BIG MONEY**—just remember the repair and "Up-Keep" of autos is now a ten billion dollar industry, **four times as big as the manufacture of new cars!** Mechanical and Electrical Auto **EXPERTS** are urgently needed—by garages, service stations, repair shops, electrical stations. Men who **KNOW** autos, who can locate trouble and tell the mechanics how to **FIX IT**, can almost name their own salary.

Maintenance — Now the BIG MONEY End!

They build less than 3 million new cars a year, but there are 22 million autos, trucks, tractors, busses, and taxis to **SERVICE**—to keep going. And the day of the tinkerer and dub is over. Dealers must have **EXPERTS** for their service stations, the public insists on **EXPERTS**. And so any man who will take the trouble to really learn the mechanical and electrical end of autos is "setting pretty." The demand will exceed the supply for many years to come.

But get away from the grease—be the SUPERINTENDENT

Men who have a little practical experience, who can do what the **BOSS** tells them to do, are always sure of a \$35 to \$50 a week job. **But \$50 is just about the limit for mere mechanics.** And there's not much joy to a life-time of hard, dirty, greasy work. And so I urge you to aim for the job **HIGHER UP**. Be the foreman, manager or superintendent. Or go into business for yourself. **YOU CAN**, if you'll pay the price—which is simply **LEARNING** every branch of Automotive Engineering work. You can prepare yourself for the **BIG MONEY** and tremendous opportunities in automotive work. No matter if your education is limited, and even if you

have no practical auto experience, we'll show you the quick, easy, sure way other men **LIKE YOU** have found to get into auto work—**RIGHT**—with the training and equipment needed to succeed.

11 Famous Auto Engineers Guide You to Success!

—men from **STROMBERG, STANDARD OIL, STUDEBAKER, BUICK** and leading Universities, members of noted Engineering Societies, men who employ Auto Experts and know the requirements for holding down a well paid job speak to you from the pages of this **great Reading Course.**

Don't Send a Penny

Learn

AT HOME — the QUICK, Sure Way!

You don't have to keep a million facts and figures "in your head"—when you know where to find them **INSTANTLY**. Here is a home training service which brings you **real help** in your search for the **QUICK**, sure way to advancement. We have made it so simple, so easy to understand, that any man, even with only grammar schooling can master the work without hard studying or memorizing. A hundred thousand men have taken this way to a better job, and you need only follow their example.

Question and Answer Service

No examinations, no "lessons," no costly outfits, no \$100 or more to pay out, by our method. We send you the 5 volume Library containing the entire material, for 15 days free loan. 2400 pages, over 2,000 charts, wiring diagrams and tables. **Coupon brings it.** You can keep it or return it, as you please. The total price is only \$24.80, and the terms are \$2 down and \$3 a month. You can go as fast or as slow as you please. And you can get any questions answered, any problem solved, **simply by writing in for the answer.**

Start with the Coupon!

Here is the pay-raising service you have been looking for. All the auto facts you can ever need—literally at your finger-tips in the **JIFFY INDEX**. We'll guarantee it contains the answers to any problem you'll encounter in your daily work—or our staff of engineers will supply it. **Don't risk a penny! Don't take our word alone.** See for yourself. Let us prove the opportunities in Auto Work and the **reading way** to qualify for them. Just mail the coupon, send no money—that's all.

LOANED FREE!

American Technical Society, Dept. A-719, Drexel Ave. at 58th St., Chicago, Ill.

Please loan me for 15 days, free, the new 5 volume library of "Auto Engineering". I will pay the few cents delivery charges when books are received, and I have the privilege of returning them at your expense within 15 days, in which case I will owe you nothing. If I decide to keep them, I will send you \$2. after 15 days, then \$3 a month until your special advertising price of \$24.80 is paid. This includes a year's Consulting Membership in the American Technical Society **FREE.**

Name.....

Address.....

Attach a letter stating employer's and reference's names and addresses, or write same plainly on margin.

AMERICAN TECHNICAL SOCIETY
Dept. A-719 Drexel Ave. at 58th St. Chicago, Ill.

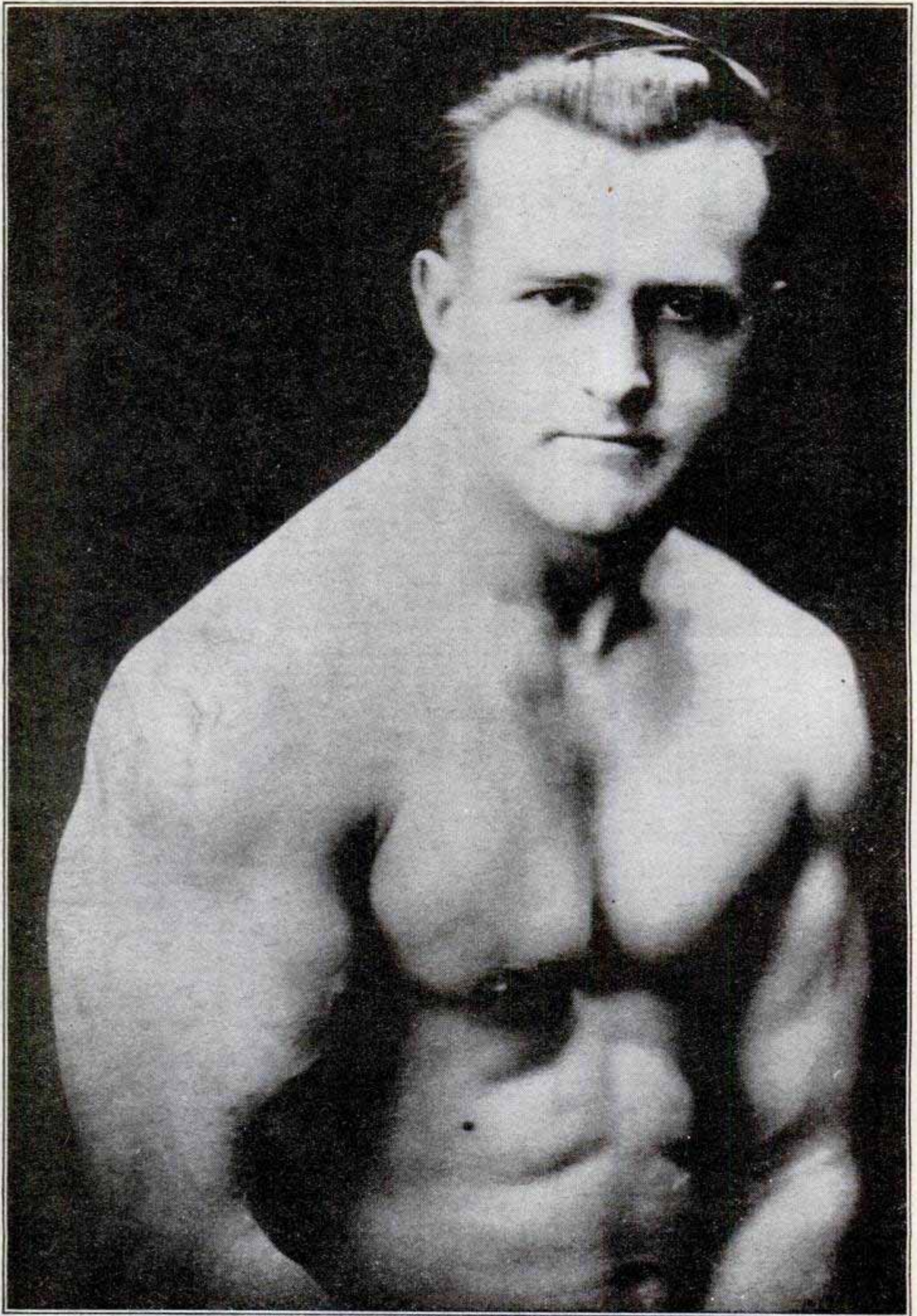

EARLE E. LIEDERMAN, *The Muscle Builder*

Author of "Science of Wrestling," "Muscle Building," "Secrets of Strength," "Here's Health," "Endurance," etc.

Earle Liederman Says:-

- 1 "He Can Make Anyone Strong"
- 2 "He Can Put One Inch on Your Arm in 30 Days"
- 3 "He Can Put Two Inches on Your Chest in 30 Days"
- 4 "He Will Give You a Physique To Be Proud of"
- 5 "He Will Add Many Healthy Years To Your Life"
- 6 "He Will Make You The Popular Idol of Your Gang"
- 7 "He Will Take The Wrinkles Out of Your Spine"

He Doesn't Promise—

He Guarantees

He has done all these things and more for thousands of others. That's why he backs up his statements with an iron-clad guarantee. You want muscle—you want health and you want the pep that only supermen have. You can have them all—almost as quick as a wink!

Put Him to the Test

An ounce of action is worth a thousand words. Make him prove that he can put one inch of muscle on your arm and two inches on your chest in less than 30 days. Make him prove that he can make anyone strong. Make him prove that he can give you a physique to be proud of. Make him prove that he will add many healthy years to your life. Make him prove that he will make you the popular idol of your gang. Make him prove that he will take the wrinkles out of your spine. He likes to be challenged because he is sure he can make good. Put him to the test. His guarantee protects you against risk.

You Can't Lose

If Liederman doesn't make good every single promise, you are out nothing. He takes all the risk. He has been guaranteeing to make physical marvels out of all sorts of muscleless men, for many years—that's why they call him the muscle builder. You'll call him that, too, before 30 days roll by. Write him today.

He Never Fails

There must be a reason for his success—there is. He discovered the secret of muscles and health. And he knows how to give help to others. He doesn't give you a lot of "don'ts." He tells you what to do. He gives you the "know-how" of strength getting. That's why he never fails. That's why you should write to him today.

Send For My New
64 Page Book

"Muscular Development"

IT IS FREE

It contains forty-eight full-page photographs of himself and some of the many prize-winning pupils he has trained. Many of these are leaders in their business professions today. He has not only given them a body to be proud of but made them better doctors, lawyers, merchants, etc. Some of these came to him as pitiful weaklings, imploring him to help them. Look them over now and you will marvel at their physiques. This book will prove an impetus and a real inspiration to you. It will thrill you through and through. The book is yours. He wants you to have it with his compliments. Keep it. This will not obligate you at all, but for the sake of your future happiness and health, do not put it off. Send today—right now before you turn this page.

EARLE E. LIEDERMAN
Dept. 2010, 305 Broadway, New York City

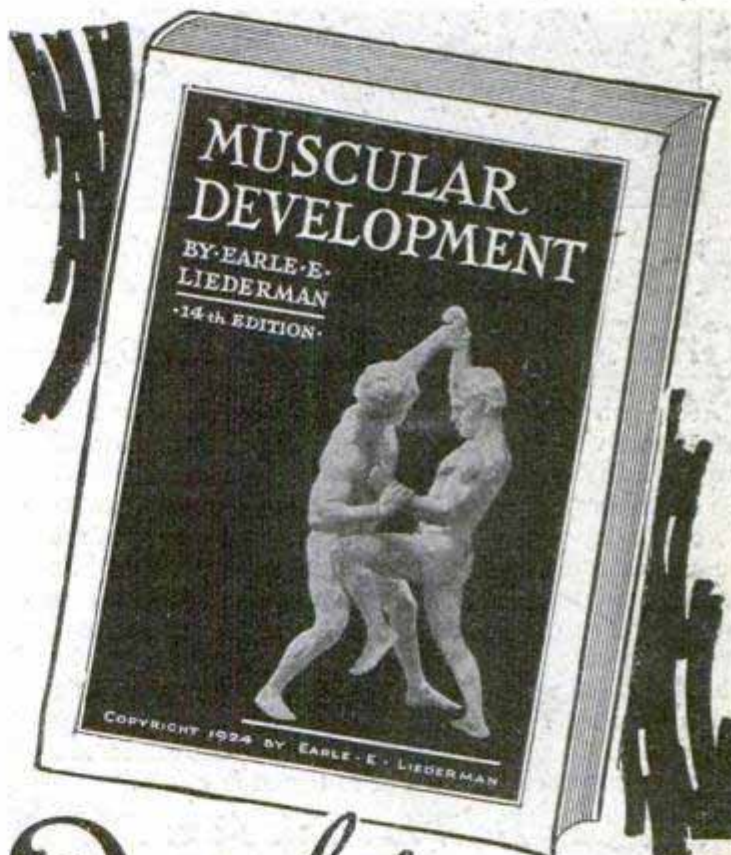

DON'T
SEND ONE
PENNY

YOUR
NAME AND
ADDRESS
ON A
POSTAL
WILL DO

EARLE E. LIEDERMAN
Dept. 2010, 305 Broadway, New York City

Dear Sir:—Without any obligation on my part whatever please send me a copy of your latest book, "Muscular Development."

Name.....

Street.....

City..... State.....

(Please write or print plainly)

**Earns \$100 a Week as
MECHANICAL DENTIST**



R. G. Ostrander, owner of the dental laboratory pictured at the left. He averages \$100 a week. And he has only just begun to grow!

Read Ostrander's Own Story of Success After Graduating from This School—Earned as High as \$45 a Day

"After completing the course in your school in five months, I was determined to open up a laboratory of my own instead of going to work for someone else. So I made arrangements with a dental supply house to equip my laboratory completely, paying them a certain amount down and arranging to pay balance in monthly installments. I have now been in business over a year and am glad to say that in that time I was able to pay off an indebtedness of \$1,000 to the dental supply house, in addition to maintaining an apartment, running a car, and saving money besides. I do gold and rubber work of all kinds and have on my books a total of fourteen dentists."

You Can Do What This Man Did

\$100 a week inside of a year is pretty good. You can do the same! Get into this money-making profession—leave your blind-alley job—be your own boss—go and come as you please! Ostrander won out, other men are doing the same, so why not you? "No trick for me to make \$30.00 a day," writes one McCarrie graduate. Another says, "I was a \$30 a week bookkeeper and have built a business netting me \$150.00 a week and growing all the time."

What Is Mechanical Dentistry?

Mechanical Dentistry is the laboratory bench work which the dentist turns over to the laboratory worker. Master this profession and help meet the demands of 64,000 dentists for laboratory work. Every city and every town where dentists are located offers work to the mechanical dentist. We train you in a few months in *day or night school* for this uncrowded field—*no classes—no books—no special educational requirements.*

MAIL THE COUPON

Get our illustrated free book on *Mechanical Dentistry*. Learn the fascinating facts about this money-making business, how you can prepare for certain success like Ostrander and many others. Read scores of letters written by McCarrie graduates telling the wonderful stories of their progress. Mail the coupon and get full details of our liberal offers, and how you can begin at once to train for success!

McCARRIE SCHOOL OF MECHANICAL DENTISTRY
Dept. 144 1338 S. Michigan Avenue CHICAGO, ILL.

"My expense in operating the lab is small and the profits big. I have done as high as \$54.00 worth of business in a single day and I am sure that the profits on this business amounted to close to \$45. I figure that I have done an average of \$100 a week since I have been in business. As I was naturally slow at first, the average for the last six months of the year would be higher than for the first. I have taken on an assistant and am now making arrangements to cater to the Dentists in the surrounding territory, thus greatly increasing my business. I want to thank the McCarrie School for their good training, and assistance they gave me whenever I asked for it."

R. G. OSTRANDER.

Work Your Way Through School

We will assist you in finding a sparetime job to meet part of your expenses while taking McCarrie training. And we will help you find satisfactory living quarters when you arrive. Schools located in **Chicago, Detroit, Cleveland, Boston, and Philadelphia.**

Day or
Night
Schools

FREE
BOOK

Mail coupon today and get this handsomely illustrated story of **MECHANICAL DENTISTRY!**



FREE BOOK

McCarrie School of Mechanical Dentistry,
1338 S. Michigan Ave.,
Dept. 144, Chicago, Ill.

Without obligation, please send me your free Book with complete information about how I may become a Mechanical Dentist, how you will help me open a Laboratory, how you will help me find a job while I take my training, etc.

Name.....

St. No. or R. F. D.....

City.....State.....

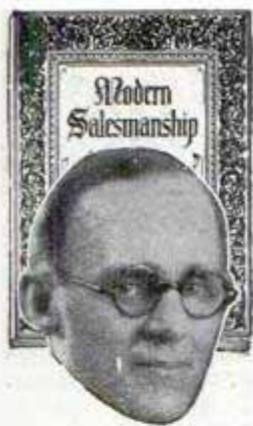

\$7,500 A Year!

C. W. Birmingham of Dayton, Ohio, was formerly a clerk in a shop, earning \$15 a week. Within a short time he has increased his earnings 900% so that, today, he is making \$7,500 a year. The book—"Modern Salesmanship"—proved the first rung in his ladder to Success!



\$10,000 A Year!

C. V. Champlin of Danville, Illinois, counts it a "red letter day" when he first read this remarkable book—"Modern Salesmanship." He says "It enabled me to learn more, earn more, and BE MORE!" Today he is president of his company and his earnings exceed \$10,000 a year!



\$1,000 A Week

O. D. Oliver of Norman, Oklahoma, was local manager of a mercantile business for 17 years—finally getting \$200 a month. "Modern Salesmanship" opened his eyes and started him on the road to big pay. Today he earns more in a week than he previously earned in 5 months—or \$1,000 in the last 7 days!



700% Increase

F. G. Walsh of Springfield, Mass., was a clerk earning \$1,000 a year, and trying to support a wife and three children. He had to do something. N. S. T. A. training built up his income last year to \$7,256—an increase of over 700 per cent.

-and They Started By Reading This Amazing Book!

Now—For a Limited Time Only—This Remarkable Man-Building, Salary-Raising Volume Is Offered FREE to Every Ambitious Man! If You Ever Aspire to Earn \$10,000 a Year or More, Read It Without Fail.

Where Shall We Send Your Copy FREE?

A BOOK! Just seven ounces of paper and printer's ink—but it contains a most vivid and inspiring message that every ambitious man should read! It reveals the facts and secrets that have led hundreds of ambitious men to success beyond their fondest expectations! So powerful and far reaching has been the influence of this little volume, that it is no wonder a famous business genius has called it "The Most Amazing Book Ever Printed."

This vital book—"Modern Salesmanship"—contains hundreds of surprising and little-known facts about the highest paid profession in the world. It reveals the real truth about the art of selling. It blasts dozens of old theories, explains the science of selling in simple terms, and tells exactly how the great sales records of nationally-known star salesmen are achieved. And not only that—it outlines a simple plan that will enable almost any man to master scientific salesmanship without spending years on the road—without losing a day or dollar from his present position.

What This Astonishing Book Has Done!

The achievements of this remarkable book have already won world-wide recognition. The men who have increased their earning capacities as a direct result of reading "Modern Salesmanship" are numbered in the thousands. For example, there is E. E. Williams of California who was struggling along in a minor position at a small salary. "Modern Salesmanship" opened his eyes to things he had never dreamed of—and he cast his lot with the National Salesmen's Training Association. Within a few short months of simple preparation, he was earning \$10,000 a year! Today he receives as much in 30 days as he used to receive in 365!

And then there's E. G. Kinzie, of Northville, Mich. He, too, read "Modern Salesmanship" and found the answer within its pages. He quickly raised his salary from \$8 a week to \$100 a week, and is now organizing a company of his own. L. A. Timmes of Minneapolis made over \$600 the first month after he had mastered Salesmanship. He had formerly been working as a machinist at \$160 a month. And this amazing book led Robert Ellis of New Bedford, Mass., into three promotions and trebled his income.

A Few Weeks—Then Bigger Pay

There was nothing "different" about these men when they started. Any man of average intelligence can duplicate the success they have



NOW FREE

achieved—for their experience proves that salesmen are made—not born, as some people have foolishly believed.

Salesmanship is just like any other profession. It has certain fundamental rules and laws—laws that you can master as easily as you learned the alphabet. And through the **National Demonstration Method**—an exclusive feature of the N. S. T. A. system of SALESMANSHIP training—you can acquire the equivalent of actual experience while studying. Hundreds of men who never sold goods in their lives credit a large portion of their success to this remarkable training.

Free to Every Man

If we were asking two or three dollars a copy for "Modern Salesmanship" you might hesitate. But it is now FREE. We cannot urge you too strongly to take advantage of this opportunity to see for yourself what salesmanship has done for others—and what the National Salesmen's Training Association stands ready and willing to do for you. Find out exactly what the underlying principles of salesmanship are—and how you can put them to work for you. No matter what your opinion is now, "Modern Salesmanship" will give you a new insight into this fascinating and highly-paid profession. Mail the coupon now!



Dept. R-100, N. S. T. A. Building, Chicago, Ill.

National Salesmen's Training Assn., Dept. R-100, N. S. T. A. Building, Chicago, Ill.

Without cost or obligation you may send me your free book, "Modern Salesmanship."

Name.....

Address.....

City..... State.....

Age..... Occupation.....

Do You Make these Mistakes in ENGLISH?

Many persons say "Did you hear from him today?" They should say "Have you heard from him today?" Some spell calendar "calender" or "calander." Still others say "between you and I" instead of "between you and me." It is astonishing how many persons use "who" for "whom," and mispronounce the simplest words. Few know whether to spell certain words with one or two "c's" or "m's" or "r's," or with "ie" or "ei." Most persons use only common words — colorless, flat, ordinary. Their speech and their letters are lifeless, monotonous, humdrum. Every time they talk or write they show themselves lacking in the essential points of English.



Sherwin Cody

Every time you talk, every time you write, you show what you are. When you use the wrong word, when you mispronounce a word, when you punctuate incorrectly, when you use flat, ordinary words, you handicap yourself enormously. A striking command of English enables you to present your ideas clearly, forcefully, convincingly. If your language is incorrect it hurts you more than you will ever know, for people are too polite to tell you about your mistakes.

Wonderful New Invention

For many years Mr. Cody studied the problem of creating instinctive habits of using good English. After countless experiments he finally invented a simple method by which you can acquire a better command of the English language in only 15 minutes a day. Now you can stop making the mistakes which have been hurting you. Mr. Cody's students have secured more improvement in five weeks than previously had been obtained by other pupils in two years!

Learn by Habit—Not by Rules

Under old methods rules are memorized but correct habits are not formed. Finally the rules themselves are forgotten. The new Sherwin Cody method provides for the formation of correct habits by calling to your attention constantly only the mistakes you yourself make—and then showing you the right way, without asking you to memorize any rules.

One of the wonderful things about Mr. Cody's course is the speed with which these habit-forming practice drills can be carried out. You can write the answers to fifty questions in 15 minutes and correct your work in 5 minutes more. The drudgery and work of copying have been ended by Mr. Cody! You concentrate always on your own mistakes until it becomes "second nature" to speak and write correctly.

FREE—BOOK ON ENGLISH

A command of polished and effective English denotes education and culture. It wins friends and makes a favorable impression upon those with whom you come in contact. In business as well as in social life correct English gives you added advantages and better opportunities, while poor English handicaps you more than you now realize. And now, in only 15 minutes a day—in your own home—you can actually see yourself improve by using the 100% self-correcting method.

A new book explaining Mr. Cody's remarkable method is ready. If you are ever embarrassed by mistakes in grammar, spelling, punctuation, pronunciation, or if you can not instantly command the exact words with which to express your ideas, this new free book, "How to Speak and Write Masterly English," will prove a revelation to you. Send the coupon or a letter or postal card for it now. SHERWIN CODY SCHOOL OF ENGLISH, 510 Searle Building, Rochester, N. Y.

SHERWIN CODY SCHOOL OF ENGLISH
510 Searle Building, Rochester, N. Y.

Please send me your Free Book "How to Speak and Write Masterly English."

Name.....
Address.....
City..... State.....

Get More Money and Get it Faster!

It isn't so hard - if you really try. For 20 years, The B. E. I., operated by Bedford Branch Y. M. C. A., has been helping men to win promotion, to earn more money, to get ahead in business and in life. Surely we can do for you what we have done for so many others.

Put the great forces of this organization behind your ambition to succeed, and you can break down every obstacle that can stand between you and success.

Learn AUTO MECHANICS or other IMPORTANT TRADES at BROOKLYN ENGINEERING INSTITUTE

The B. E. I. affords superior training at minimum cost, in addition to privileges not easy to duplicate anywhere in America. At this school you get -

Small classes, permitting individual instruction from teachers with a life-time of experience in their respective fields.

Practical work in \$200,000 plants.

Free use of gymnasium, swimming pool, etc., and use of billiard room, bowling alleys.

Attractively furnished private sleeping quarters for out of town students.

Position secured through placement bureau.

Lower cost per week than at any school of the same calibre and easiest payment plan.

If you have a learning inclined motor car, our auto mechanics course, at small cost, will equip you to live a successful life. If other courses are more in your line, observe the wide choice of careers at this school.

BATTERY REPAIR - ELECTRICITY - BRICK-LAYING - PLUMBING - WELDING - SHOW CARD WRITING - WINDOW DRESSING - REAL ESTATE - INSURANCE - RADIO MECHANICS - TILE SETTING - PLASTERING - FINE AND COMMERCIAL ART - ARCHITECTURAL AND MECHANICAL DRAWING.



Insure your own financial progress - now. Write post-card, phone or call for free catalogue. Bedford Branch Y. M. C. A. - 1115 to 1125 Bedford Avenue, Brooklyn, New York City.

LIVE, LEARN, WORK and PLAY in BROOKLYN-The Heart of New York City



Be a drummer!

Trap Drumming made easy in a short time. Our free instruction course furnished with genuine Ludwig Trap-Drum Outfit. Develop your natural sense of rhythm. Go to your nearest dealer or write for full details.

LUDWIG & LUDWIG, 1611 North Lincoln Street, Chicago

IF YOU STAMMER

Write for my free book "Millard's Advanced Natural Corrective Course" and a free copy of my speech magazine. 10,000 cases successfully treated. Est. 24 years. Largest school for stammerers in world. Millard Inst. of Normal Speech, 2317 Millard Bldg., Milwaukee, Wis.

Learn Watchwork, Jewelrywork and Engraving

A fine trade commanding a good salary, and your services always in demand. Address Horological, Dept. P, Bradley Institute, PEORIA, ILLINOIS, for our latest catalog.

LAW High-Grade Instruction By Correspondence Prepares You for the Bar—Est. 1892

University Methods. Standard Text-Books. Approved by Bench and Bar. Graduates practicing in every state. Send today for Free Catalog and Rules for Admission to the Bar. CHICAGO SCHOOL OF LAW, 802 Reaper Block, Chicago, Ill.



PIANO JAZZ

By Note or Ear. With or without music. Short Course. Adult beginners taught by mail. No teacher required. Self-Instruction Course for Advanced Pianists. Learn 259 styles of Bass, 684 Syncopated Effects, Blue Harmony, Oriental, Chime, Movie and Café Jazz, Trick Endings, Clever Breaks, Space Fillers, Sax Slurs, Triple Bass, Wicked Harmony, Blue Obligato, and 247 other Subjects, including Ear Playing. 133 pages of REAL Jazz, 25,000 words. A Postal brings our FREE Special Offer.

Waterman Piano School, 1826 W. Adams St. Los Angeles, Cal.

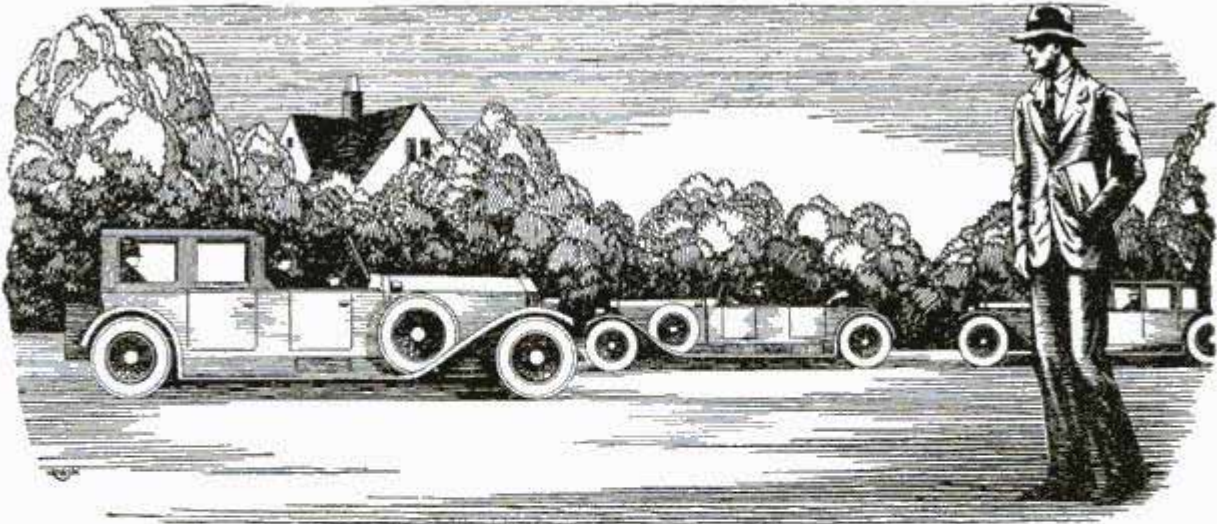

Many times in the old days, while I trudged home after work to save carfare, I used to gaze enviously at the shining cars gliding by me, the prosperous men and women within. Little did I think that inside of a year, I too should have my own car, a decent bank account, the good things of life that make it worth living.

I Thought Success Was for Others

*Believe It or Not, Just Twelve Months Ago
I Was Next Thing to "Down - and - Out"*

TODAY I'm sole owner of the fastest-growing Radio store in town. My wife and I live in the snuggest little home you ever saw, right in one of the best neighborhoods. And I'm on good terms with my banker, too—not like the old days only a year ago, when often I didn't have one dollar to knock against another in my pocket.

It all seems like a dream now, as I look back over the past twelve short months, and think how discouraged I was then, at the "end of a blind alley." I thought I never had had a good chance in my life, and I thought I never would have one. But it was waking up that I needed, and here's the story of how I got it.

I WAS a clerk, working at the usual miserable salary such jobs pay. Somehow I never found any way to get into a line where I could make good money.

Other fellows seemed to find opportunities. But—much as I wanted the good things that go with success and a decent income—all the really well-paid vacancies I ever heard of seemed to be out of my line, to call for some kind of knowledge I didn't have.

And I wanted to get married. A fine situation wasn't it? Mary would have agreed to try it—but it wouldn't have been fair to her.

Mary had told me, "You can't get ahead where you are. Why don't you get into another line of work, somewhere that you can advance?"

"That's fine, Mary," I replied, "but what line? I've always got my eyes open for a better job, but I never seem to hear of a really good job that I can handle." Mary didn't seem to be satisfied with the answer but I didn't know what else to tell her.

It was on the way home that night that I stopped off in the neighborhood drug store where I overheard a scrap of conversation about myself. A few burning words that were the cause of the turning point in my life!

With a hot flush of shame I turned and left the store, and walked rapidly home. So that was what my neighbors—the people who knew me best—really thought of me!

"Bargain counter sheik—look how that suit fits," one fellow had said in a low voice. "Bet he hasn't got a dollar in those pockets." "Oh, its just 'Useless' Anderson," said another. "He's got a wish-bone where his back-bone ought to be."

As I thought over the words in deep humiliation, a sudden thought made me catch my breath. Why had Mary been so dissatisfied with my answer that "I hadn't had a chance?" *Did Mary secretly think that too?* And after all, wasn't it true that I had a "wish-bone" where my back-bone ought to be? Wasn't that why I never had a "chance" to get ahead? It was true, only too true—and it had taken this cruel blow to my self-esteem to make me see it.

With a new determination I thumbed the pages of a magazine on the table, searching for an advertisement that I'd seen many times but passed up without thinking, an advertisement telling of big opportunities for trained men to succeed in the great new Radio field. I sent the coupon in, and in a few days received a handsome 64-page book printed in two colors, telling all about the opportunities in the radio field and how a man can prepare quickly and easily at home to take advantage of these opportunities. I read the book carefully, and when I finished it I made my decision.

WHAT'S happened in the twelve months since that day, as I've already told you, seems almost like a dream to me now. For ten of those twelve months, I've had a *Radio business of my own!* At first, of course, I started it as a little proposition on the side, under the guidance of the National Radio Institute, the outfit that gave me my Radio training. It wasn't long before I was getting so much to do in the Radio line that I quit my measly little clerical job, and devoted my full time to my Radio business.

Since that time I've gone right on up, always under the watchful guidance of my friends at the National Radio Institute. They would have given me just as much

help, too, if I had wanted to follow some other line of Radio besides building my own retail business—such as broadcasting, manufacturing, experimenting, sea operating, or any one of the score of lines they prepare you for. And to think that until that day I sent for their eye-opening book, I'd been wailing "I never had a chance!"

NOW I'm making real money. I drive a good-looking car of my own. Mary and I don't own the house in full yet, but I've made a substantial down payment, and I'm not straining myself any to meet the installments.

Here's a real tip. You may not be as bad-off as I was. But, think it over—are you satisfied? Would you sign a contract to stay where you are now for the next ten years, making the same money? If not, you'd better be doing something about it instead of drifting.

This new Radio game is a live-wire field of golden rewards. The work, in any of the 20 different lines of Radio, is fascinating, absorbing, well-paid. The National Radio Institute—oldest and largest Radio home-study school in the world—will train you inexpensively in your own home to know Radio from A to Z and to increase your earnings in the Radio field.

Take another tip—No matter what your plans are, no matter how much or how little you know about Radio—clip the coupon below and look their free book over. It is filled with interesting facts, figures, and photos, and the information it will give you is worth a few minutes of anybody's time. You will place yourself under no obligation—the book is free, and is gladly sent to anyone who wants to know about Radio. Just address J. E. Smith, President, National Radio Institute, Dept. M-85, Washington, D. C.

**J. E. Smith, President,
National Radio Institute,
Dept. M-85, Washington, D. C.**

Please send me your 64-page free book, printed in two colors, giving all information about the opportunities in Radio and how I can learn quickly and easily at home to take advantage of them. I understand this request places me under no obligation, and that no salesman will call on me.

Name.....

Address.....

Town..... State.....

THERE'S MONEY IN \$ H C C L \$ \$

For Any Man who likes Mechanical Work the Shortest Way to Financial Independence is **Making Crowns, Plates, Bridges, Inlays, Etc. for Dentists.** Steady Earnings up to \$5,000 a year—some earn far more in this Profitable Professional Trade.

THREE MONTHS TRAINING

will qualify one to enter this most rapidly growing professional trade—Mechanical Dentistry. Best opportunity for men who like to use tools—dignified work, steady income, rapid advancement, no "slack seasons" as in other trades.

LEADING THE FIELD

Bodee training is recognized by dentists everywhere, owing to our 35 years' experience at this work—established 1892—the oldest school. Bodee-trained men make good. After only a few years you find them prominent in this profitable trade—on good salaries or conducting their own laboratories. There's room for many more—think it over! We conduct a Placement Bureau to select suitable positions, and, should you desire to open your own laboratory, we assist you in securing a location and equipping your laboratory.

FOUR EXCEPTIONAL OFFERS WITHOUT ADDITIONAL COST

- 1—R. R. Fare to Our Nearest School. 2—10% Reduction of Tuition.
3—\$50 Outfit of Standard Tools. 4—Post Graduate Instruction.

LEARN BY "DOING"

Individual instruction—No classes whatever—Practical work. You use regular standard tools and learn to do exactly the kind of work which will later be required of you by Dentists.

EARN WHILE YOU LEARN

Lack of money need not stop you. We assist in securing whole or part time positions to help our students pay expenses.

JUST COMPARE!

Compare this trade with what you are now doing, or with the best you can find in any other line! Compare our unexcelled training—step by step—every point thoroughly covered—no time wasted! Consider also the very reasonable cost of this exceptional training.

Send for Catalog No. 2

BODEE DENTAL INSTITUTE

NEW YORK
1755 Broadway

PHILADELPHIA
1305 N. Broad Street

BROOKLYN
85 Court Street



MONEY IN YOUR NEIGHBORHOOD

Here's a Wonderful Way to Get It

Our beautifully illustrated book tells how. It tells all about our new methods of art decoration, art treatment and how anybody can learn without previous training or experience. It contains page after page of handsome color illustrations of what you can make and sell. You can make good money and this book is free. Our system is amazingly easy to learn and the profits are larger than in almost any other business. You can produce beau-

tiful finished art objects almost from the beginning. You don't have to know how to draw or have any experience. Begin making money now.

FREE

All supplies are sent by us with the instructions and many have made \$25 the first week. Some men and women have taken up this work for their own amusement.—Either way, pleasure or profit, it's the most delightful home work you can imagine. Write Now for your copy of this valuable book; it's FREE.

Fireside Industries

DEPT. 66-P

ADRIAN, MICH.



TRAVEL—for 'UNCLE SAM'

**RAILWAY POSTAL CLERKS
MAIL CARRIERS—POSTOFFICE CLERKS
\$1700 to \$3300 a Year for Life**

No "lay-offs" because of strikes, poor business, etc.—sure pay—rapid advancement. City and country residents stand same chance. Common sense education sufficient—no political influence.

STEADY WORK

Cut coupon and mail it before turning the page.

**MEN—BOYS
18 to 45**

Use Coupon Before You Lose It

COUPON

FRANKLIN INSTITUTE, Dept. P174, Rochester, N. Y.
Rush to me, entirely free of charge, (1) A full description of the position checked below; (2) 32-page book, with list of positions obtainable; (3) Particulars telling how to get the position checked.

- Railway Postal Clerk (\$1900 to \$2700) Customs Positions (\$1140 to \$1860)
 Postoffice Clerk (\$1700 to \$2300) Prohibition Agent (\$1800 to \$3000)
 City Mail Carrier (\$1700 to \$2100) Rural Mail Carrier (\$2100 to \$3300)

Name

Address



Thousands Have This Priceless Gift —and Never Discover It!

Many men rob themselves of success, popularity, achievement and position which could rightfully be theirs if they would uncover the priceless gift which nature gave them. They go through life timid, self-conscious, fearful and retiring instead of using this natural gift of powerful speech to dominate and control others and become leaders among men. Seven men out of every nine have this gift. You can now find out for yourself, by means of this amazing FREE test, if you are one of these.

No sane man would deliberately and knowingly throw away a chance to become an outstanding, influential and important figure occupying a high-salaried job. Yet, without knowing it, thousands of men are neglecting a priceless gift which would bring them influence, position, popularity, power, leadership and money.

Nearly every man has in him the knack of powerful and convincing speech. This magic power is that thing which often rises up within you and demands expression, but is never heard because you lack the confidence in your ability—you get "stage fright."

What 20 Minutes a Day Will Show You
 How to address business meetings.
 How to propose and respond to toasts.
 How to make a political speech.
 How to tell entertaining stories.
 How to write better letters.
 How to enlarge your vocabulary.
 How to develop self-confidence.
 How to acquire a winning personality.
 How to strengthen your will-power.
 How to be the master of any situation.

Now Easy to Become a Powerful Speaker

I don't care what work you are now doing. I don't care what may be your station in life. I don't care how timid and self-conscious you now are when called upon to speak. If you will give me just 20 minutes each day in the privacy of your home I will make you an accomplished and powerful speaker in a few short weeks or it will not cost you a single penny. You need not have a college education nor any previous voice training. By this amazingly easy method you have only a few simple, easy to re-

member principles to learn. Then you will see how really easy it is to have the power of effective, convincing speech.

Why Powerful Speakers are Picked for Important Jobs

If you will take particular notice, you will find that the big, important, high-salaried jobs invariably go to the men who are powerful talkers. Often you will see a man of this type forge ahead in business at an amazingly fast rate, while men of even greater ability stand tied to one small job. That is the reason you are often astonished to see a man jump over the heads of many superiors into a job among the big leaders. It is the power and ability to speak with force and conviction that flashes men from obscurity and low wages to prominence and high salaries.

Amazing Book FREE—Mail Coupon

If you will fill in and mail the coupon at once, you will receive a remarkable new book called *How to Work Wonders With Words*. This book gives you an amazing test by which you can determine for yourself in five minutes whether you are one of the seven men out of every nine who possess the "hidden knack" of powerful speech, but do not know it. Decide for yourself if you are going to allow 20 minutes a day to stand between you and success. Thousands have found this to be the biggest step forward in their lives. If it has played such an important part in the lives of many big men, may it not in yours? Then mail the coupon at once.



NORTH AMERICAN INSTITUTE
 3601 Michigan Ave., Dept. 1357, Chicago, Ill.

North American Institute,
 3601 Michigan Ave., Dept. 1357, Chicago, Illinois.

Please send me FREE and without obligation my copy of your inspiring booklet, *How to Work Wonders With Words*, and full information regarding your Course in Effective Speaking.

Name.....

Address.....

City.....State.....



IN DRAWING CARTOONS

Why spend your time doing work that is drudgery, and get little money for it when you may be able to draw cartoons for Big Pay? You can now learn cartooning at home with this simple, tested method. Many students earn money while learning.

Become a high-salaried cartoonist—one of the easiest, most pleasant, and best paid of all businesses. Millions of dollars spent last year on serious, comic, sport and animated cartoons—and the demand for cartoons increases every day! Hundreds of cartoons now used by big national advertisers.

Learn Cartooning at Home In Spare Time—Simple, Tested Method

There is a knack about learning cartooning which you can master in your spare time with this simple home study method. It starts you at the very beginning—on simple fundamental principles—then takes you through every branch of humorous and serious cartooning. You will be surprised how quickly you can draw cartoons that will sell. Many earn even while learning.

Send for Free Book

Get this handsomely illustrated booklet which gives the details of this remarkable home study course in Cartooning. Gives thorough outline of the cartooning field and market for cartoons. Shows how to become a cartoonist. No obligation. Send for it today. (No salesman will call.)

Washington School of Cartooning
Room 3010E, 1113—15th St., N. W., Washington, D. C.

Washington School of Cartooning
Room 3010E, 1113—15th St., N. W., Washington, D. C.

Please send me without obligation, your Free Booklet on Cartooning and full details of your home study method of teaching Cartooning.

Name.....
(Write Name Plainly.) (State whether Mr., Miss or Mrs.)

Address.....

City.....State.....

BIG MONEY IN ELECTRIC REFRIGERATION

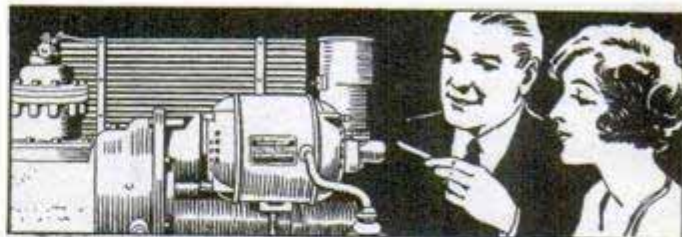

We Train You at Home

Overnight a billion dollar industry has arisen. Trained men are wanted for installing, servicing and selling Refrigerators. A bigger opportunity than the auto or radio. Own your own shop, get out of doors, meet refined people. Big pay. Our easy to understand, home study course teaches you about every type. Nothing like it. Get in on the ground floor. Write for catalog. Just get the facts. *Now's the time!*

Utilities Engineering Service, Educational Division, Dept. 110
3120 North Clark Street CHICAGO

MEN WANTED

TO LEARN

Motion Picture Projection

\$2,000 to \$4,000 a Year

Quickly learned. Short hours, big pay. Best equipped school in Michigan. Projectionists for Movie Houses and Road Shows.

MOVIE OPERATORS SCHOOL

61 Sproat Street, DETROIT, MICHIGAN

"STAMMERING

Its Cause and Cure"

You can be quickly cured if you stammer. Send 10 cents, coin or stamps, for 288 page cloth bound book on Stammering and Stuttering. It tells how I cured myself after Stammering and Stuttering for 20 years. BENJAMIN N. BOGUE
6948 Bogue Building, 1147 N. Ill. St. Indianapolis

Learn Photography at HOME

Earn \$3000 to \$10,000 a year. Prepare quickly during spare time. Also earn while you learn. New easy method. Nothing else like it. Send at once for free book, "Opportunities in Modern Photography" and full particulars. Special offer open now.

AMERICAN SCHOOL OF PHOTOGRAPHY
Dept. 1357 3601 Michigan Ave. Chicago, U. S. A.

Learn Watchwork, Jewelrywork and Engraving

A fine trade commanding a good salary, and your services always in demand. Address: **Horological**, Dept. P, Bradley Institute, PEORIA, ILLINOIS, for our latest catalog.

Skin Troubles

Cleared up—often in 24 hours. To prove you can be rid of Pimples, Blackheads, Acne Eruptions on the face or body, Barbers' Itch, Eczema, Enlarged Pores, Oily or Shiny Skin, simply send me your name and address today—no cost—no obligation. **CLEAR-TONE** tried and tested in over 100,000 cases—used like toilet water—is simply magical in prompt results. You can repay the favor by telling your friends; if not, the loss is mine. **WRITE TODAY**
E. S. GIVENS, 428 Chemical Bldg., Kansas City, Mo.

ELECTRICITY

Complete Study Course and Pocket Library \$10



SHIPPED FREE

A set of **HAWKINS GUIDES** is a true friend to the electrical worker. It tells you how to do any job the right way—without guessing or taking chances.

Hawkins Guides put all the facts about modern electrical engineering at your finger tips. Therefore your chances for advancement in the electrical field are unlimited.

HAWKINS GUIDES DOUBLE YOUR VALUE



Electricity is king! It is the ruling force of today—transportation, communication, light, heat, power—indeed every modern activity is dependent on electricity. Industry is crying for electrical men that know their jobs!

Hawkins Guides teach you all you need to know about electricity in easy, step-by-step lessons. Daily spare time reading of the Guides will greatly increase your value to yourself and your employer in a few weeks. Hundreds of our friends have written us and told us this!

ing of the Guides will greatly increase your value to yourself and your employer in a few weeks. Hundreds of our friends have written us and told us this!

READERS OF HAWKINS GUIDES KNOW HOW



“You can’t stump him on an electrical job.” “He certainly knows his business.” “Certainly have to hand it to him for knowing how.” —These are the things employers say about our friends who are readers of **Hawkins Guides**. No matter what question or problem comes up the Ready Reference Index enables you to give an expert answer at once.

HAWKINS STARTS YOU WHERE OTHERS LEFT OFF

Why should you work at low wages when easy reading of **HAWKINS GUIDES** will give you the money-making knowledge of the expert? Easy daily reading of the Guides will teach you in a few months what it has taken the expert a lifetime to learn!

With **HAWKINS GUIDES** in hand you have a running start to success in the electrical field. You will actually begin where others left off!



NOW!

This coupon is your golden opportunity. Tear it out—send it now!

FOR EXAMINATION!

REAL ELECTRICAL EDUCATORS

“Hawkins Guides at \$10 is the best investment I have ever made. Am able to take up almost any electrical job and have never gone to an electrical school.”—**B. Roessler, Oenaville, Texas.**

AS EASY AS A. B. C.

“Everything in Hawkins Guides is very plain and anybody can read and understand them as easy as A. B. C.”—**J. Knight, Tobyhanna, Pa.**

OTHER ENTHUSIASTIC READERS SAY

“Worth ten times their price.” “Helped me to two raises in four months.” “Better than a school of instruction.” “Studied them when I was laid up and got further ahead than if I had been on the job.”

Hawkins Guides Explain These Points So You Can Easily Understand:—

Magnetism—Induction—Experiments—Dynamoes—Electric Machinery—Motors—Armatures—Armature Windings—Installing of Dynamoes—Electrical Instrument Testing—Practical Management of Dynamoes and Motors—Distribution Systems—Wiring—Wiring Diagrams—Sign Flashers—Storage Batteries—Principles of Alternating Currents and Alternators—Alternating Current Motors—Transformers—Converters—Rectifiers—Alternating Current Systems—Circuit Breakers—Measuring Instruments—Switch Boards—Wiring—Power Stations—Installing—Telephone—Telegraph—Wireless—Bells—Lighting—Railways. Also many Modern Practical Applications of Electricity and Ready Reference Index.

Hawkins Guides—10 POCKET SIZE NUMBERS

Each number easy to carry around and read in spare time. Big type and clear diagrams. Easy to study and learn. Durable, flexible binding—gold edges. 3,500 pages—4,700 illustrations. Shipped free for examination. Pay only \$1 a month if satisfied. Price of set, complete, \$10.



EXAMINE GUIDES FREE!

Let the Guides themselves demonstrate their practical value to you—as a study course, reference work and complete electrical library. You are the judge. Simply send this coupon. No obligation unless you are entirely satisfied. Tear out on dotted line—fill in—mail it NOW!

\$1 PER MO.

FREE EXAMINATION COUPON

Theo. Audel & Co., 65 W. 23rd St., New York City

Please send me (postpaid) for my approval **Hawkins Electrical Guides**, 10 numbers (price \$1 each). If satisfactory I will mail you \$1 in 7 days and further mail \$1 monthly until purchase price of \$10 is paid.

Name.....
 Address.....
 Occupation.....
 Employed by..... 10T39

Play the HAWAIIAN GUITAR and be Popular!

Play all the latest hits just as the Hawaiians do. Be the most popular member of your set. Get in on all the good times. Entertain your friends—or play professionally. Be in demand everywhere. We will help you.



\$15
HAWAIIAN GUITAR
with Genuine Seal Grain
Fabrikoid Cover
GIVEN
when you
enroll



This sweet-toned, mellow Hawaiian Guitar would cost you at least \$15 in any music store without the Genuine Seal Grain Fabrikoid Case. We can afford to give you the entire outfit free when you enroll, including picks, steel playing bar, etc., because we make them in huge quantities in our own factory. Nothing to buy—everything is furnished.

Learn in Spare Time at Home

You study in spare time—when you like—as long as you like. And even if you don't know one note from another, our method is so simple, plain and easy that you begin a piece your first lesson. In half an hour you can play it!

Famous Native Hawaiians Teach You

You receive expert instruction from such world famous players as Kolomoku, Kalaluki, Ferara and Seville. They quickly teach you the secrets of this fascinating instrument.

Complete Conservatory Course. You get 52 complete printed lessons. Nothing is omitted. Pictures explain every move. And no matter how little you know about music when you begin, no matter if you have never touched a musical instrument, you can positively learn to play by our plain, easy, picture method.

Only 4 Motions to Learn

Then you can play any music—popular songs, classical, old-time melodies, native Hawaiian airs—or real jazz—separately or with accompaniment. You'll never be lonesome after you learn to play on this beautiful Hawaiian Guitar.

Pay as You Play

We make it easy for you. You start any time—with a small first payment—then pay while learning. Write for liberal offer.

Our Written Guarantee

We guarantee in writing to teach you. 45,000 successful students. And we coach and advise you after graduation—no extra cost.

Tenor Banjo and other courses—Violin, Tiple, Tesor Guitar, Banjo Ukulele, Ukulele—under well-known instructors. Write for information.

FIRST HAWAIIAN CONSERVATORY OF MUSIC, INC.

9th Fl., Woolworth Bldg., Dept. 448, New York, N. Y.

Approved as a Correspondence School Under the Laws of the State of New York

ACT! Mail This Popularity Coupon NOW!

FIRST HAWAIIAN CONSERVATORY OF MUSIC, Inc.

9th Fl., Woolworth Bldg., Dept. 448, New York, N. Y.

Please mail full information about your 52-lesson Hawaiian Guitar Course. I am not obliged to enroll unless I want to.

Name _____

Address _____

City _____ State _____

PREPARE FOR AN ART CAREER

—thru the only school operated as a department of a large art organization. Commercial Artists trained the "Meyer Both Way" earn as high as \$10,000 per year. We today have hundreds of students who had previously studied art elsewhere. Why? Because your instruction is based upon our everyday experience in meeting the art needs of leading advertisers. Home study instruction. Write for illustrated book telling of the success of our students.

MEYER BOTH COMPANY
Michigan Ave. at 20th St., Dept. 16, Chicago, Ill.

RADIO WHOLESALE
Write for my Big 1928 Radio Catalog —just off the press. Thousands of marvelous bargains in nationally advertised goods. All the LATEST IN RADIOS and equipment. Lowest wholesale prices. Agents Wanted.

It's a regular encyclopedia on Radio. All about trouble finding. **FREE Log and Call Book and Catalog.** Get your copy today. Send postcard now!

DEALERS NEW 1928 CATALOG

American Auto & Radio Mfg. Co.
HARRY SCHWARTZBERG, PRES.
Dept. 263 American Radio Bldg., Kansas City, Mo. 3

LEARN WATCH REPAIRING

Be a watchmaker—you can learn this profitable trade by correspondence in a few weeks in your own home by the DeSelms Chart System. After you complete the course you will know a watch from A to Z. You will know just what the matter is and how to repair one. When you graduate you will be a practical watchmaker and repairer and competent to fill any position. Positions for our graduates. Ask for our Free Book. It explains our system and terms.

THE DeSELMS WATCH SCHOOL
LOGANSPORT, INDIANA



Learn Advertising at HOME

Many of the highest paid men in the world are advertising men. You can learn easily and quickly at home during your spare time. We guarantee satisfaction. Bigger opportunities now in advertising than ever before. Constant demand for our graduates at splendid pay. Send for **FREE Book**, giving interesting information and vital facts—just what you want to know about advertising. Write today.

PAGE-DAVIS SCHOOL OF ADVERTISING
Dept. 1357 3601 Michigan Ave., Chicago, U. S. A.

GOV'T. POSITIONS

\$35 TO \$75 WEEKLY

- | | |
|------------------------|-------------------------|
| () Railway Mail Clerk | () Meat Inspector |
| () P. O. Clerk | () Special Agent |
| () Forest Ranger | () (investigator) |
| () File Clerk | () Stenographer-Typist |
| () Matron | () Immigrant Inspector |
| () General Clerk | () City Mail Carrier |
| () Chauffeur-Carrier | () U. S. Border Patrol |
| () Skilled Laborer | () Typist |
| () Watchman | () Seamstress |
| () Postmaster | () Steno-Secretary |
| () RFD Carrier | () Auditor |

Mr. Ozment, Dept. 111, St. Louis, Mo.
Send me particulars about positions marked "X"—salaries, locations, opportunities, etc.

NAME.....

ADDRESS.....

I thought he was a "Flat Tire"



... until he started
to dance

THERE he was, coming toward me! What could I do? To refuse would be impolite. And yet, to accept—I hated the thought of it! Oh, why did I have to be the one he selected!

Just then the music started—a catchy, irresistible melody. Almost unconsciously I allowed him to engage my arm—and away we whirled.

A few hesitating steps—yes, he would soon be walking all over my feet—and yet—*what a surprise!* Could this be the same fellow everyone had warned me against? Could this be the one whom my brother jokingly referred to as a "flat tire"? Absolutely! I was positive—*still*, he was *dancing divinely*—really the most graceful dancer I had met that evening!

When the music died away I just couldn't help it—I had to congratulate him!

"Why, I really didn't believe you could dance at all," I laughed, admiringly.



"And the fact is, I couldn't—until a month ago," he answered. "I was getting pretty tired of staying alone at home nights—of sitting on the 'side lines' when I did occasionally go to a party. And, unfortunately, I didn't know what to do—until I saw Arthur Murray's ad."

"But that's a course in learning to dance by mail," I interrupted. "You can't learn that way!"

"So I thought, too, for a while. But when I finally realized that I had been skeptical long enough, I decided, since there was no financial risk, to find out whether I was right or wrong.

"So I wrote to Arthur Murray and asked for his five free lessons. When they came I found it was real fun following the simple diagrams and directions. The first night I mastered a fascinating fox trot and Charleston step. Soon I was ready for the best of them. Even tonight, though, the fellows believed I was trying to get by on my nerve. So I certainly did appreciate your faith in me. Shall we have the next dance?"

How wonderful he was! "I'd love to!" I murmured.

Learn to Dance at Home

This story is typical and it offers you the chance to become an accomplished dancer—right in your own home at a small cost.

No matter how poorly you dance now—no matter if you've never been on a dance floor in your life—Arthur Murray's new method makes you a finished dancer in ten days, or you don't have to pay a penny for the lessons.

Just think! In ten days' time you'll be able to do the Charleston, the Valencia, the French Tango, the Ritz Fox Trot, the Debutante Waltz and all the other smart new steps.

So simple and easy to understand that you can do any of the latest steps in one evening. And in ten days' time you will be ready to take your place as the best dancer in your set!

Five Lessons FREE

To prove that Arthur Murray can make you a finished dancer in ten days' time, he is willing to send you five lessons from his remarkable course absolutely free! Just send the coupon (with 10c to cover cost of printing and mailing) and these valuable lessons will be forwarded at once. Also a free copy of his new book, "The Short Cut to Popularity."

Don't wait—you owe it to yourself to clip and mail this coupon NOW. Arthur Murray, Studio 731, 7 E. 43rd Street, New York City.

Arthur Murray, Studio 731
7 East 43rd Street, New York City.

To prove that I can learn to dance at home in ten days you may send the FIVE FREE LESSONS. I enclose 10c (stamps or coin) to pay for postage, printing, etc. You are to include free "The Short Cut to Popularity."

Name.....

Address.....

City.....State.....



DRAFTING ENGINEERING, ELECTRICITY and ARCHITECTURE

CHICAGO TECHNICAL COLLEGE

One of "America's oldest and largest schools of specialized engineering" offers you a maximum of practical training in a minimum of time, here at Chicago, the country's building and engineering center. Technical training of college standard for men who have neither the time, money nor preliminary education to attend a university. Each year more than 1000 men and women enroll in day and evening classes.

Short, Intensive Training

practical in every respect, puts you quickly into a high salaried position. Many of our students are assisted to responsible positions before graduation . . . they earn while they learn.

In Spare Time At Home

If you can't come to Chicago, learn Drafting at home. Your spare time is enough. Same practical course. Quick, easy—yet thorough.

Trial Lesson FREE

Test yourself and see how easy you can learn Drafting by the Chicago Tech. method. Trial lesson sent free if interested in home study. Address Dept. N-200.

COURSES are arranged to suit your needs—2 year diploma; 3 year B. S. degree; special 3 and 4 months' short courses adapted to the individual. Expert instructors actively at work in the very professions they teach.

Tuition low, terms easy. Enter any time. Day and Evening Classes.

Write for FREE 34 Page Blue Book

It tells about all the courses . . . fully describes them; about the great demand for Chicago Technical College trained men; about college athletics and other interesting facts you'll want to know. Gives you a vivid picture of what you may expect at this leading technical college. There is no obligation. Send for this free Blue Book today . . . now!

Address Registrar N-75

Chicago TECHNICAL College
Dept. N-75 118 East 26th St., Chicago



You, Too, Can Easily Learn to Play

You need not sit on the sidelines and envy the popularity of others. You, too, can be sought after, popular, welcome everywhere. A few short months of fascinating study, right at home, in your spare time, with the wonderful National Academy Courses will give you the finest of all social accomplishments—the ability to play beautifully.

Easy as A B C

You need know nothing about music to begin. We give you personal, individual instruction right from the start. You will be surprised and delighted to find that music can be made so easy and interesting. Over 200,000 successful Students, Musicians and Teachers endorse and recommend our methods. Courses in Piano, Violin, Trumpet, Voice, Banjo, Tenor Banjo, Spanish Guitar, Hawaiian Guitar, Organ, Mandolin.

Send for Our Beautiful New Catalog, FREE

It will tell you all about this great School—now in its 25th successful year; our exceptionally low prices and easy terms, and how you can quickly and easily gain the pleasure, popularity and earning opportunities that Music will bring to you. Send for this wonderful book NOW—TODAY.

NATIONAL ACADEMY OF MUSIC

Dept. 1 702 East 41st Street Chicago



WHY NOT spend Spring, Summer and Fall gathering butterflies, insects? I buy hundreds of kinds for collections. Some worth \$1 to \$7 each. Simple outdoor work with my instructions, pictures, price-list. Send 10 cents (not stamps) for my illustrated Prospectus before sending butterfly. MR. SINCLAIR, DEALER IN INSECTS, San Diego, Calif. Dept. 6. Box 1424.



"BECOME A LIGHTNING TRICK CARTOONIST"

Send \$1.00 for Laugh Producing Program of 23 Trick Drawings with Instructions. Catalog of Chalk Talk Supplies Free. BALDA ART SERVICE, Dept. 1, Oshkosh, Wis.



Wonderful, new device, guides your hand; correct your writing in few days. Big improvement in three hours. No failures. Complete outline FREE. Write C. J. Ozment, D-34, St. Louis, Mo.

LEARN WATCHMAKING AND ENGRAVING



BY OUR PROFIT-SHARING PLAN OUR GRADUATES SUCCEED

One of our Iowa students started in a very small way—now doing over \$30,000 a year. Another in Wisconsin, over \$10,000 the first year. Day or night classes. Call or write for FREE BOOK

Chicago School of Watchmaking, Dept. 3301, 4844 Lincoln Avenue, CHICAGO



Raise Poultry MAKE BIG MONEY

Results Quick—Part or Full Time

Take up poultry raising. It's interesting, healthful, PROFITABLE. Easy to sell all you can produce at big prices. Our new course by Henry M. Lamon, former gov't expert, gives short cuts to success. Write for free book, "How to Raise Poultry for Profit."

NATIONAL POULTRY INSTITUTE, Dept. 411, Washington, D. C.

Lowest Price Ever Quoted for a New Edition of the BRITANNICA

in the compact
NEW FORM for FAMILY USE

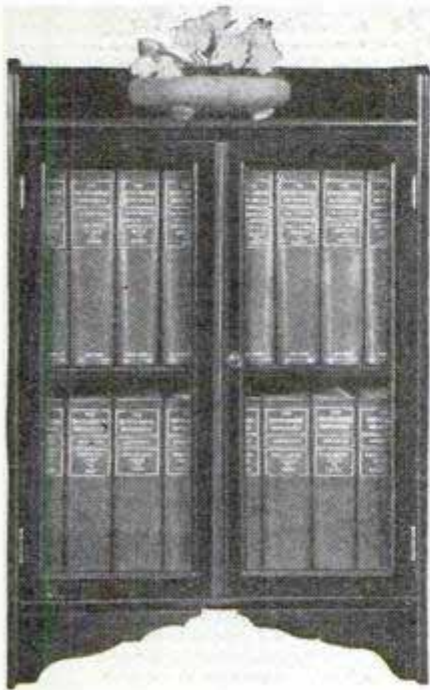

Handsome Bookcase FREE

NOW IS THE TIME for YOU to gratify your lifelong wish to own a set of the ENCYCLOPAEDIA BRITANNICA!

While This Offer Lasts, we will include with each set of the new Britannica a handsome mahogany-finished Bookcase with glass doors, ABSOLUTELY FREE!

Never before, in all the history of publishing, has a new edition of the Britannica in such a compact and convenient form been offered at such an amazingly low price!

Here are the 28 volumes of the latest standard edition, 3 supplementary volumes, and an enlarged Index—32 vols. in all—richly bound as 16 double volumes, in the world-famous NEW FORM for FAMILY USE.

All the magnificent color plates are here—all the latest maps and charts and illustrations—all the text matter contained in the higher-priced Cambridge Issue.

You Can Save 40% If You Act NOW!

WE want YOU to know this new Britannica—and so we have set the price so low that anyone can now possess it.

If you act NOW, you can get this NEW FORM Britannica at a clear saving of more than 40%, as compared with the price of the Cambridge Issue, and a handsome Bookcase FREE! This sweeping reduction in price is made possible by binding the 32 volumes as 16 (2 vols. in 1 cover); and by printing the NEW FORM Britannica from the same plates used in the higher-priced Cambridge Issue, thus saving the expense of resetting the 33,000 pages of type.

One Work You Must Have!

The very features which make this new Britannica so valuable to every doctor, lawyer, student, scientist and business executive, also make it absolutely indispensable to YOU. One great thought from it may transform your whole future.

The amazing story of recent world-progress is told by men and women who are themselves an integral part of that story. These famous men and women are pre-eminently fitted to give you a clear insight into the future, because they themselves are chiefly responsible for the profound changes which have done away with the past.

The Britannica is everywhere accepted as the su-

preme authority on every subject of importance. It is the one complete library of universal knowledge.

Why You Must Act Quickly

If YOU wish to take advantage of this Special Low Price Offer, and get a Britannica Bookcase FREE, you have no time to lose. Already thousands of sets have been sold and ninety out of every hundred purchasers are demanding the NEW FORM in preference to the higher-priced Cambridge Issue. This tremendous demand is rapidly reducing the number of sets on hand. Soon this Special Offer will be withdrawn.

Send for this BOOKLET Today

Act Now—At Once—THIS MINUTE! Fill in and mail the Coupon below for handsome illustrated booklet, which we'll gladly send you FREE. It tells all about this Amazing Bargain Offer, and explains the easy terms of Payment. Tear out this Coupon NOW—before you turn this page. And drop it in your nearest mail box tonight.



The ENCYCLOPAEDIA BRITANNICA, Inc.
342 Madison Avenue, New York 7 PM-N1

Please send Booklet; also NEW FORM Bargain Offer (40% saving); and particulars of Free Bookcase Offer and Easy Payment Plan.

Name.....

Address.....

City..... State.....

Mail This Coupon Now →

ELECTRICITY MADE EASY

FREE
Complete
Automobile
Course

Enroll now and
get the Auto
Training without
Extra Charge.



Actual Work with
Actual Tools on
Actual Equipment.
The Coleman Sys-
tem enables you to
learn quickly and
easily — under in-
structors who are
thorough, practi-
cal, electrical men.

**We Tell You Why—We Show You How
—We Have You Do It**

Up-to-the-minute training for forward-looking men. Our system never fails when a student means business.

Every Electrical Subject Taught

Armature winding on real armatures; radio building and repairing on real sets; house-wiring on skeleton house; automobile electricity on live cars; lead burning and re-building of storage batteries right off the car or radio; electric welding; electric refrigeration, ranges and household appliances; power plant work; power and light switchboards; thorough training on A. C. and D. C. motors and generators.

Complete Automobile Course FREE

Each man answering this advertisement and enrolling for electrical course will be given, absolutely free, a thorough training in automobile and truck repairs. You'll be taught how to do first-class work on motors, transmissions, rear axles, carburetors, valve timing, etc. No extra charge for this training. And you have real cars to work on.

The Trade of Big Opportunity

Every day brings new uses for this mighty power—electricity—and an increasing demand for trained workers. \$200.00 to \$600.00 a month easily earned by skilled men. Specialists in demand for all electrical trades. Get into electricity, young man, and grow up with the industry.

WM. H. COLEMAN, President

COLEMAN ELECTRICAL SCHOOL
1628G Main Street Kansas City, Mo.

Mail This Coupon Today!

IT WILL BRING YOU THE FREE COLEMAN BOOK

Wm. H. Coleman, President,
COLEMAN ELECTRICAL SCHOOL,
1628G Main St., Kansas City, Mo.

Please send me free and postpaid and without any obligation on my part, the COLEMAN catalog, which will tell me how to get an electrical training at your special tuition price.

NAME.....

ADDRESS.....

TOWN.....STATE.....

Young outdoor men wanted



To a few sturdy young men—lovers of fresh air and sunshine—who want to get away from the grind of indoor work—John Davey's national organization, The Davey Tree Expert Company, offers an exceptional opportunity. Constantly increasing demand will create a limited number of openings. Those young men selected will be thoroughly trained by the Company and given a permanent position if they make good. If you are single, between 20 and 30 years of age, free to travel, healthy, industrious, having a good practical education, and able to furnish satisfactory references, you have a good chance to qualify. Pay is good at start, advancement assured on merit. We want only men who desire permanent employment in a growing organization and will accept only clean, sturdy young men, thorough Americans, not afraid of vigorous outdoor work. Write for additional information and qualification blank to serve in place of personal interview. The Davey Tree Expert Co., Inc., 839 Federal Bldg., Kent, Ohio.

Don't Envy The Plumber BE ONE!

\$11.00-\$16.00 PER DAY and work EVERY day,
is the Plumber's wage.

Every skilled workman will tell you that Plumbers have the best of it. WINTER and SUMMER the Plumber is busy at top wages. No skilled Plumber is ever out of a job—compare his opportunities with any trade, plus the opportunities of having your own shop.

We teach you Plumbing with TOOLS (not books) under Licensed Master PLUMBERS in one of the finest equipped schools in America. We make you a Plumber, every branch is taught thoroughly—Lead Work—Blue Print for plan reading—all other tricks.

LEARN IN 8 to 12 WEEKS without previous experience. If you are making less than \$60.00 a week you owe it to yourself to investigate. Get FREE catalog that tells in pictures and words how we teach this trade. Special rates now.

UNIVERSAL PLUMBING SCHOOL
2030 Troost Ave. KANSAS CITY, MO.

No Joke to'
STAMMER
Be successful. Master perfect speech. Win happiness. Send for full information and special phonograph record. Dime covers postage.
153 Stimson, The Lewis Institute, Detroit

YOU CAN OIL PAINT

Amazing new method teaches men or women to earn after first lesson. OIL PAINT photos—portraits, landscapes or art subjects. Earn \$18 to \$50 and more a week. OIL PAINT OUT-FIT GIVEN. Send now for free illustrated book. PICTORIAL ART STUDIOS Inc. Dept. MP, 2926 Broadway, Chicago, Ill.

LEARN WATCH REPAIRING



You can learn by our modern and original system of instruction every part of the **Watch Repairing Trade** at home as good or better than at a shop. You can earn money while learning and secure a well paying position or start in business after completing our course of instruction. Good watch repairers are always in demand and earn from \$50 to \$75 per week. For particulars apply to the **Wisconsin School of Watch Repairing** 166 Mason St., MILWAUKEE, WIS.

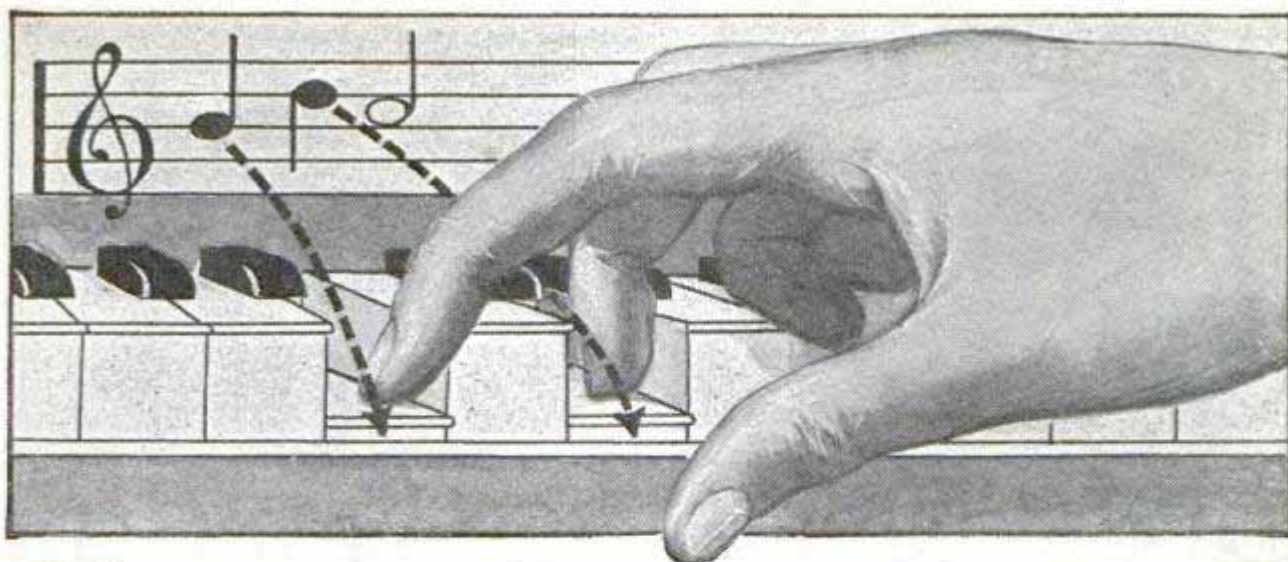

Easy to Learn Piano this *Print and Picture* Way

Half a million people have learned to play the piano, violin, saxophone and other instruments by this simple "Print and Picture" method. You can, too!

IT MAY be difficult to believe—but thousands of people can tell you it's so! You can master your favorite musical instrument by means of a "Print and Picture" method so simple you will be astonished!

You don't need a teacher. You learn by yourself—right in your own home. You learn *quickly*. You play simple tunes right from the start. And almost before you know it you are playing real music from real notes.

The cost of the lessons averages only *a few cents a day*, because instead of long, monotonous periods of practice and expensive private lessons—you teach yourself through the inexpensive "Print and Picture" method.

And it's real fun to learn music this way! No tiresome scales—no dull exercises. You'll be delighted to see how you play music right from the start. You'll understand after the first lesson why this new method is sweeping the country!

Like Learning to Spell Simple Words

The "Print and Picture" method is so clear and simple, so easily mastered, that people who once

thought they'd never have the time or opportunity to learn how to play a musical instrument—are now actually playing! Some of them are even earning fine incomes as members of bands and orchestras.

This method is like putting letters together to make simple words. F—A—C—E, for example, represent the four spaces. Thus, if you see a note in the second space, you

know it is A. If you see a note in the fourth space, you know it is E. All you need to remember is how to spell *face*!

You simply can't go wrong. You are told in simple print how to proceed. Then a picture *shows* you. Then you play it on your instrument and *hear* it. Step by step you learn to play real notes from real music—and once you know the secret, you can pick up any piece of music and play it right off!

Choose Your Instrument!

What instrument would you like to play? The piano? The saxophone? The violin? The banjo?

Choose your favorite instrument now, and let the U. S. School of Music teach you how to play! You don't need any special talent or aptitude. All you need is the *desire* to play, the *eagerness* to learn music, the *ambition* to be more popular. The U. S. School of Music will do the rest! And please remember that no matter which instrument you choose, the cost of your lessons will average just a few cents a day.

Send for Free Book and Demonstration Lesson

Thousands of successful students never dreamed they possessed musical ability until it was revealed to them by our "Musical Ability Test" which is sent free with our interesting booklet. If you are really in earnest about learning how to play, send for your copy of this free book and the test **NOW**. We will include also a Demonstration Lesson which will show you how simple the "Print and Picture" method is. No obligation, of course.

If you are really interested in mastering your favorite instrument, we would suggest that you act promptly—without delay. Sign and mail the convenient coupon now. Instruments supplied when needed, cash or credit. U. S. School of Music, 710 Brunswick Bldg., New York City.

U. S. SCHOOL OF MUSIC
710 Brunswick Bldg., New York City

Please send me your free book, "Music Lessons in Your Own Home," with introduction by Dr. Frank Crane, Demonstration Lesson and particulars of your offer. I am interested in the following course:

.....
Have you above instrument?.....
Name.....
(Please write plainly)
Address.....
City..... State.....

Learn to Play Any Instrument

Piano	'Cello
Organ	Cornet
Violin	Harmony and
Drums	Composition
and Traps	Sight Singing
Banjo	Ukulele
(Plectrum, Guitar	
5-string or Hawaiian	
Tenor)	Steel Guitar
Saxophone Piccolo	
Mandolin Harp	
Clarinet Trombone	
Flute	
Voice and Speech Culture	
Automatic Finger	
Control	
Piano Accordion	

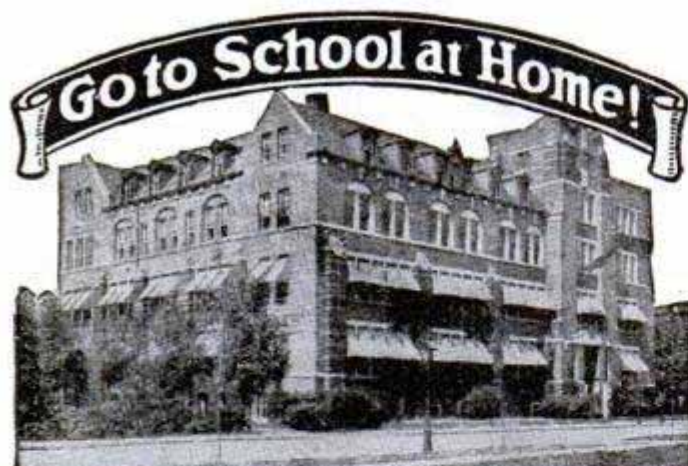

High School Course in Two Years!

You Want to Earn Big Money!

And you will not be satisfied unless you earn steady promotion. But are you prepared for the job ahead of you? Do you measure up to the standard that insures success? For a more responsible position a fairly good education is necessary. To write a sensible business letter, to prepare estimates, to figure cost and to compute interest, you must have a certain amount of preparation. All this you must be able to do before you will earn promotion. Many business houses hire no men whose general knowledge is not equal to a high school course. Why? Because big business refuses to burden itself with men who are barred from promotion by the lack of elementary education.

Can You Qualify for a Better Position

We have a plan whereby you can. We can give you a complete but simplified high school course in two years, giving you all the essentials that form the foundation of practical business. It will prepare you to hold your own where competition is keen and exacting. Do not doubt your ability, but make up your mind to it and you will soon have the requirements that will bring you success and big money. YOU CAN DO IT.

Let us show you how to get on the road to success. It will not cost you a single working hour. Write today. It costs you nothing but a stamp.

American School

Dept. H-774, Drexel Ave. and 58th St., Chicago

American School

Dept. H-774, Drexel Ave. and 58th St., Chicago

Send me full information on the subject checked and how you will help me win success.

- | | |
|-----------------------------|---------------------------|
|Architect |Business Law |
|Building Contractor |Lawyer |
|Automobile Engineer |Machine Shop Practice |
|Automobile Repairman |Mechanical Engineer |
|Civil Engineer |Shop Superintendent |
|Structural Engineer |Employment Manager |
|Business Manager |Steam Engineer |
|Cert. Public Accountant |Foremanship |
|Accountant and Auditor |Sanitary Engineer |
|Bookkeeper |Surveyor (& Mapping) |
|Draftsman and Designer |Telephone Engineer |
|Electrical Engineer |Telegraph Engineer |
|Electric Light & Power |High School Graduate |
|General Education |Wireless Radio |
|Vocational Guidance |Undecided |

Name.....

Address.....



Double Your Pay This Easy Way

SCORES of ambitious fellows earn more than their regular salaries simply by using a few pleasant hours a week of their spare time making show cards for local stores. Every retailer in your neighborhood will pay big money for clever sales-producing display cards. Learn at home through easy professional method. Earn \$25 to \$50 a week spare time—\$50 to \$100 a week in full time. Business of your own. Wonderful future. Earn even while you learn.

Send for new illustrated booklet, "Quick Success in Show Card Making." Also for details on Show Card Outfit given to new students. No obligation. Write now to

WASHINGTON SHOW CARD SCHOOL

Dept. 3010E, 1117—15th St., N. W., WASHINGTON, D. C.

GOV'T. POSITIONS

Forest rangers, start \$125 a month; cabin and vacation; patrol forests; protect game. Railway mail clerks, postoffice clerks-carriers, rural carriers, prohibition agents and internal revenue agents. For list of positions and how to qualify, write Mokane, Dept. 315, Denver, Colo.

TELEGRAPHY

(Morse and Wireless) and RAILWAY ACCOUNTING taught thoroughly. Big salaries; great opportunities. Oldest, largest school. Endorsed by Telegraph, Railway, Radio, and Government officials. Expenses low—opportunities to earn large portion. Catalog free. DODGE'S INSTITUTE, Jones St., Valparaiso, Ind.

LEARN PHOTO-ENGRAVING!

Earn \$200 to \$500 monthly. Photography and Photo-Engraving taught in few months by largest college of its kind. Established 1893. Big demand for graduates.

Write for free book.

Illinois College of Photography, Box 4107, Effingham, Ill.

LEARN WATCHMAKING

and become independent. We help you secure a position.

Easy to learn. Send for FREE CATALOG.

ST. LOUIS WATCHMAKING SCHOOL, Dept. 5, ST. LOUIS, MO.

Strength is not so much muscle as skill. Police Captain Wallander's illustrated "Physical Training Manual" explains fine points of Jiu Jitsu, Boxing and Wrestling. Makes you invincible. A complete course in physical culture, astounding police secrets and simple health rules. Sent C. O. D. for \$1.97 plus postage. Siebel Press, 34-M W. 20 St., New York, N.Y.

MUSIC LESSONS IN YOUR HOME



Join Dobe's Draftsmanship Army. March to Success!

Turn Spare-Time into Profit—learn Drafting!

\$600
Monthly. I refused that salary because I'm making more.
Carl Johnson

\$130
a week.
That's my income as a Draftsman.
C. E. Cornsack

\$400 a Month
I average that!
Edna Smith

\$1000 a Month
is what I make.
B. H. Brown

\$7000-9000
Yearly
That's what I earn
W. H. ...

\$475
a Month
—I make that from drafting.
S. C. Stroup

\$43,400 a year!

Yes, Drafting pays these six Dobe-trained Draftsmen \$43,400 a year! They learned Drafting at home in their spare time after reading my Free Book — Successful Draftsmanship. YOU should write for it now! You must take that step first. Do it today. Mail the FREE Coupon at the bottom.

Learn a Fundamental, Basic Profession — Drafting!

These 6 Successful Draftsmen wrote for my Free Book. Will you?

You, Too, Can Learn Drafting At Home

Before Dobe's "Easy Drafting Training at Home" it was almost necessary to go away to college to learn drafting. But now you can stay home, hold down the job you've got, keep on earning money and easily and quickly equip yourself to enter the drafting profession. All the men you see pictured here did just that. Get into drafting. It is a big, appealing field! Drafting is growing bigger and more important every

year. Before any house or machine or factory can be built there must be a PLAN.

That plan must be DRAWN. A draftsman must DRAW it. Learn how now. Be ready when the time comes. It is smart to choose a profession that has always been and always will be. A profession which is standard and essential. A profession which the world must have. Mail Coupon. Do that Now.



WRITE! FOR FREE BOOK— Successful Draftsmanship!

Read this book! After you have read it, make up your mind whether you want to be a draftsman! But write for it today. Certainly reading the book can't hurt you. Mr. Dobe will tell you about other men besides those pictured above who have been successful—many—many of them. No matter what you are making now ask for the book today.

DOBE EASY DRAFTING
1951 Lawrence Ave., Div. 13-57 Chicago

DOBE EASY DRAFTING
1951 Lawrence Ave., Div. 13-57 Chicago

Please send me free your book, "Successful Draftsmanship", and names of other big money earning draftsmen you have trained.

Name..... Age.....

Address.....

Post Office..... State.....

Advertising Builds Fortunes

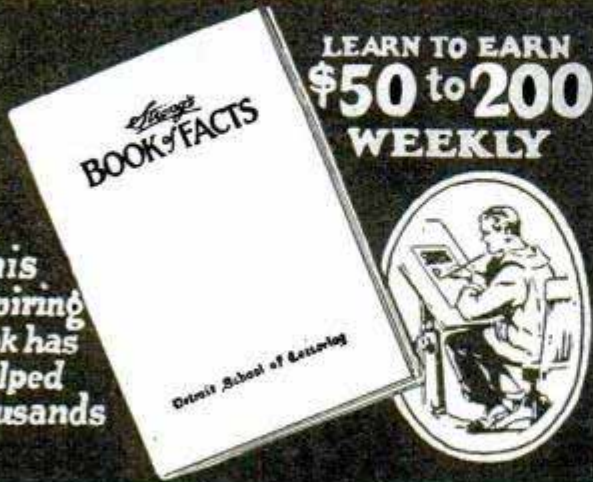

This inspiring book has helped thousands

LEARN TO EARN
\$50 to 200
WEEKLY

Get into this fascinating field —Learn quickly to be an expert Sign and Show-Card Writer

Advertising is the greatest single factor in modern business. It shapes the buying habits of nations and keeps the industries of the world busy. Millions are spent—more millions made—in this amazing, fascinating, stupendous profession. Sign painting, show-card writing and poster designing is the fastest-growing branch of the advertising business. It is this remarkable, fertile field that offers boundless opportunities to thousands upon thousands of young men and women of ordinary ability.

BIG DEMAND—BIG MONEY

Wherever you go you see signs, show-cards and posters. The demand for good work is tremendous. Astonishing prices are paid. Experts are swamped with orders. A single poster often sells for hundreds of dollars. This interesting work is easily and quickly learned. While other professions require years of study—this one is successfully taught in a few weeks. We know of no other profession or trade that offers the average person such great worth-while opportunities so quickly. Strong's original method of instruction is amazingly simple. Anyone with ambition and ordinary ability can learn. Every step is clearly explained. Every process is thoroughly described. Nothing is left to your imagination. Lessons are fascinating. Your work is criticized by experts, your mistakes shown, your good points developed.

LEARN IN SPARE TIME

Many students earn while they learn. Some have taken excellent positions before completing the course. Hundreds have gone into business for themselves and made good. Young man—here is your great chance for success. Study at home in spare time or attend our resident school. All instruction is individual. There is no tedious classwork. Nothing for you to figure out for yourself. Your instructors give you close, personal attention. Write now for Strong's Book of Facts—an inspirational pamphlet which fully explains the opportunities open to you and describes our quick, easy, thorough method of instruction. It's free. Just sign and mail the attached coupon. Read what our students say—learn what others have done.

DETROIT SCHOOL OF LETTERING

(Established 1899)

176 Stimson Ave., Detroit, Mich.

Detroit School of Lettering,
176 Stimson Ave., Detroit, Mich.

Send free and without obligation Strong's Book of Facts and full information about your courses of instruction.

Name..... Age.....

Address.....

City..... State.....

Occupation.....

ELECTRICITY

Practical-Technical TRAINING

Great demand for practical-technical electricians and engineers. A brilliant future awaits you. A high salaried position or a profitable business of your own; these may be yours through our PRACTICAL-TECHNICAL courses. Opportunities unlimited.

Finlay condensed method now in 25th successful year trains head and hand. Thousands of high salaried graduates throughout the world testify to the success of Finlay training. Extensively equipped laboratories and shops. Faculty of recognized experts. One and Two Year courses in Electrical Engineering open in September; 12 Weeks courses in Practical Electricity and Power Plant Operation open at any time. Degrees, diplomas and certificates of efficiency awarded. Students assisted to positions.

SEND FOR FREE CATALOG

FINLAY ENGINEERING COLLEGE Fall term starts September 15th
124 Finlay Bldg. Kansas City, Mo.

Save Your Feet

When all else fails, end your suffering with the Heefner Arch Support



No Metal

Fully patented. It re-adjusts the entire foot. Write for free book and statements from doctors and users.

Heefner Arch Support Co. 656 M. E. Taylor Bldg. Louisville, Ky.

Be a Civil Engineer!

Learn at Home!



Cyclopaedia of Civil Engineering

9 great volumes. 4000 pages. 3000 illustrations. New edition just off the press, by twelve of America's greatest engineers. Includes: Surveying, bridges, railroads, steel structures, municipal engineering, water supply, road building, etc.

Earn \$5000 a Year—and Up!

"CIVIL ENGINEERING"—in plain English written so you can understand it, even if you have only a limited education. Prepares you for a well-paid railroad structural or public works position. Covers every branch of Civil Engineering practice. At once a reading course for the ambitious student and an authoritative reference work for the experienced engineer. Borrow a set—free. Look over the test questions which help you master each subject quickly. Mail the coupon without obligation today!

American Technical Society Dept. C-719 Chicago

Loaned Free!

to prove you can learn Civil Engineering at home in your spare time. And because no description here could do it justice, to let you see for yourself the scope and simplicity, the authority and quality of this great home reading course. Cost and terms are within your reach. Send no money—just mail the coupon.

American Technical Society, Dept. C-719, Chicago.

I want to BORROW the CIVIL ENGINEERING Cyclopaedia for 15 days FREE. I will gladly pay the few cents express, but I am to pay nothing for the loan of the 9 big volumes if I return them within 15 days. If I wish to keep them I will send you \$2 after the 15 days, then \$3 a month until special advertising price, \$34.80, is paid.

Name.....

Address.....

(Attach letter stating age, occupation, employer's and references' names and addresses.)



PLAY PIANO BY EAR

Be a Jazz Music Master

Anyone who can remember a tune can easily and quickly learn to play popular jazz or American rhythm *by ear* at a very small cost. The new Niagara Method makes piano playing wonderfully simple.

No matter how little you know about music—even if you “have never touched a piano”—if you can just remember a tune, you can quickly learn to *play by ear*. The Niagara Method is entirely new—so simple, so easy and teaches so many little tricks that it just comes natural to pick out any piece you can hum. Why not master our 20 lessons and soon be playing catchy, jazz music—all by ear? Thousands who could not learn by the old-fashioned method have grasped the Niagara idea readily—and succeeded.

A Simple Secret to Success

No need to devote years to learn piano nowadays. Special talent now unnecessary. Every lesson is so easy, so fascinating that you just “can’t keep your hands off the piano.” Give it part of your spare time for a few months and you will be playing and entertaining almost before you realize it. No tiresome scales, no arpeggios to learn—no do-re-mi—no difficult lessons or meaningless exercises. You learn a bass accompaniment that applies to the songs you play. Once learned, you have the secret for all time—your difficulties are over and

You Play the Piano by Ear

More than a hundred latest forms and styles of Jazz, Blues, Ragtime and piano embellishments. Modern and up-to-the-minute. For beginners, as well as advanced students. 10 years successful teaching.

A special service department gives each pupil individual attention.

Learn Quickly
at home in a
few months

Be Popular in Every Crowd

One who can sit down any time *without notes or music*, reel off the latest jazz and popular song-hits that entertain folks, is always the center of attraction, the life of the party, sought and invited everywhere. Make yourself that center of attraction—master the piano by spending an hour a day learning the simple but fascinating Niagara Method. As easily as thousands of others have learned, so you too, can learn and profit—not only through the pleasure it provides, but also by playing for the radio or at dances, motion picture houses and other entertainments.

Decide to Begin Now!

Just spend only a part of your spare time with a few easy, fascinating lessons and see how quickly you “catch on” and learn to play. You will be amazed, whether you are a beginner or an advanced student.

Don’t wait another day. Send the coupon now for the “Niagara Secret.” This book is yours absolutely FREE. If 10c (coin or stamps) is enclosed you also receive wonderful booklet “How to Entertain at Piano.”

Niagara School of Music, Niagara Falls, N. Y.

CLIP THIS COUPON NOW

Niagara School of Music, 209 Cleveland Ave., Niagara Falls, N. Y.
Without obligation mail me your book “The Niagara Secret.” I enclose 10c for book “How to Entertain at Piano.”

Name.....

Town..... State.....

St. and No. or R. F. D.....

Age..... Ever take Piano lessons?..... How many?.....



This Book
FREE

O. C. MILLER
 Director
 Extension
 Work
 American
 School



The American School

A million Dollar *No-Profit* Educational Institution, now offers men a *double* service—training for a specific job, then help in finding the job. For one small price, on terms of only \$5.00 a month, you are now assured of definite benefits, both in position and salary. Write for complete information—*today!*

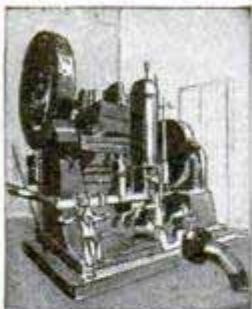

No machine can be built until the Draftsman first builds it on PAPER. My training prepares you for this work.



Never has the world seen anything like the building boom of today. This has created enormous demand for real Draftsmen.

3 Drafting

to prove you can

We have invented a new, simplified way to teach Drafting—the first real improvement in Drafting home instruction in history. We want you to see a few of these new Job-lessons, try them, test your own ability to master them—without one penny of cost or obligation. For instance, you will see how we get away from the "copying" methods used in the past, so you develop into a DRAFTSMAN, instead of a "tracer." See for yourself the ingenious new method which compels you to think, to solve problems, to do actual Drafting-room jobs from the very first lesson!

A New, Rapid, Simplified Training

Copying drafting lessons prepares you to be only a "tracer." This new "Job-Method" gives you actual drafting-room jobs in a new one-step-at-a-time way. With pictures which you can understand almost without reading the "lessons." And that is why the American School-trained Draftsmen can qualify for a good job at big pay when they graduate.

Win Success Thru Drafting

Drafting is easy, fascinating work. Short hours. Big pay. And the Draftsman is always in line for promotion to executive positions. This training is *complete*. It includes high school subjects (if you need them) and all the Engineering and Mathematics Drafting experts require.

5 BIG-PAY Branches

The big money in Drafting goes to men who specialize in Machine Design, or Electrical Drafting, or Architectural Drafting, or Structural, or Automotive. It is not enough merely to know *general* Drafting practice. You must know how to calculate and design and plan original work. You need many Engineering subjects to fill the kind of a Drafting position that pays \$60 to \$125 a week. The American School now includes this *specialized training* in its *Drafting course*.

Costly Drafting Outfit Given!

Fine, imported instruments like these help you learn Drafting quickly and easily. These standard quality, full size instruments, board, table, triangles, T square, ink, protractor, etc., given to every student without extra cost.

O. C. Miller, Director Extension Work



FREE Job Service!

The American School now offers its students and graduates, without cost, the services of an efficient employment department keeping in constant touch with employers of Draftsmen all over the U. S. We have placed hundreds of men in good, big-pay Drafting positions. We've made this training so complete, so practical, so easy to master, that our students are **bound to make good**. And so, because the demand for real Draftsmen continues to exceed the supply and because this training actually prepares men for good Drafting positions we back it with a **Free Employment Service**.

The American School

Dept. D-774
 Drexel Avenue and
 58th St., CHICAGO

Lessons *Actually* FREE

learn at home in spare time!
Draftsmen Wanted!
\$60 to \$125 a Week!

yourself. Plan your future in Drafting. Even if you have only common schooling, even if you know nothing of Drafting, we guarantee to make you a real Draftsman or to refund your money! Special surprise offer right now to the first 500 men who answer this ad—reduced price, easy terms. Coupon brings complete information.

70,000 fine jobs advertised last year. Get ready to fill one. Get out of the rut. Make something of

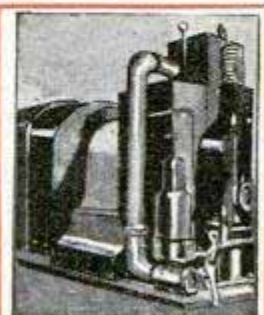

Electricity needs Draftsmen who know Electrical principles as well as general Drafting practice. I give you this training.



The demand for Draftsmen experienced in concrete and structural steel work is enormous. Many big-pay positions open.



Every great Auto factory employs Draftsmen who specialize in Automotive work — men who design bodies, plan engines, etc.

I Will Make This Contract With You



American School
 —the Million Dollar Educational Institution



- WHEN you enroll for our home-training in Drafting, we agree to give you:
1. Complete Drafting training, by the new Practice-Method.
 2. Professional Drafting Outfit, as illustrated.
 3. We will help you get a good Drafting position at a substantial increase in pay,

4. or we'll refund every cent of your money.

O. C. Miller
 Director Extension Work

Coupon Brings 3 Lessons FREE!

Get them. Test your own ability to learn Drafting and get ready for a fine job and big pay. Coupon also brings surprise offer, and complete information about your opportunities for success in Drafting. *Mail It Today!*

Read These Letters!

City of Chicago
 Department of Buildings
 Gentlemen: The same day I received my diploma I got word that I was one of the two candidates who had successfully passed the examination for Deputy Commissioner of Buildings of the City of Chicago, a position paying \$3600 per year.

There were eight applicants examined besides myself, all men well known to the architectural and engineering profession. Seven of these failed to obtain a passing grade of 70%. My grade was 84.69. Inasmuch as I failed to pass this same examination three years before, my present success is mainly due to the knowledge gained through your School.

Yours very truly,
ROBERT KNIGHT

Got His Draftsman's Job

"I wanted to let you know how I came out in getting that job at the Brownell Co., Dayton, Ohio. I was to start and have a trial at Drawing, and I am still in the Drawing room. The engineer seems to like the work I make, and also the other draftsmen. I thank the school very much for getting me in at this place, because your letter of recommendation helped me a whole lot to get the job."
BERNARD WEBER,
 730 St. Nicholas Ave., Dayton, O.

Liberty High School
 Bethlehem, Pa.
 Dear Sirs:—This is to thank the American School for all that you have done for me since I signed up for the Drafting and Design Course.

In the eight years since then, I have gradually climbed from the position of tracer to that of Head of the Department of Machine Drawing and Design in our magnificent new \$2,000,000 High School here, at many times the salary which I received at that time. The officials of the Pennsylvania State Department, and Dr. Wm. C. Ash of the University of Pennsylvania, all claim that our Course in Drafting and Design is the best now being taught in this state. Every drafting graduate that we have turned out has proved successful, and one is now Chief Draftsman in a local steel concern. Yours sincerely,
J. S. LEAR

Has Charge of Large Jobs

"Even before I had finished my course, I was put in charge of large construction jobs in different cities. I have been doing that ever since, and the jobs are getting larger all the time. I owe my success to the American School because of the knowledge I gained in mathematics and calculations."
ELMER L. LAMB,
 1306 Smith St., Peoria, Ill.

3 Drafting Lessons *Actually* FREE

O. C. MILLER, Director Extension Work
AMERICAN SCHOOL
 Dept. D-774, Drexel Ave. and 58th St., Chicago.

Rush 3 Free Drafting Lessons, Job and Raise Offer, complete information, money-back guarantee, etc., to prove I can become a real Draftsman at home in spare time.

Name.....
 Street No.....
 City.....State.....

Who are the Young Men that are Setting the Pace to-day?

Lindbergh — Byrd — Acosta — Chamberlain — Hagenberger — Maitland—Smith. **THE AIRMEN!**

The whole world acclaims them! Every other business or profession doffs its hats to them! Honor—Fame—Wealth—are theirs! Everything that fires the red-blooded young man's ambition and brings his most dazzling dreams within realization.

Why Plod? Why Waste Time? You Too Can Soon Be An Aviator!

We make it easy for you! We teach you by U. S. Government methods—with U. S. Licensed Pilots—with new 1927 planes. **RIGHT HERE IN CHICAGO!** At the Municipal Air Port. Here in the midst of the big things in aviation—great flying fields—hangars—repair shops—visits by the most famous heroes of the air—daily government air service—planes leaving and landing—all the life and interests of the great city around you. Become a commander pilot—or aerial photographer. In all our months of operation we have never had the slightest accident.

You Can Begin at Home In Your Spare Time

We will give you your preliminary instructions at home. Get the first points in your odd hours. There's ground work. There are a dozen jobs in air service besides flying. In a very short time you will be ready to come to us. We will qualify you as a designer—builder—engineer—contractor— assembler—inspector—instructor—mechanician—expert repair man.

Aviation Service & Transport Incorporated

Dept. 401, 22 West Monroe St. . . . Chicago

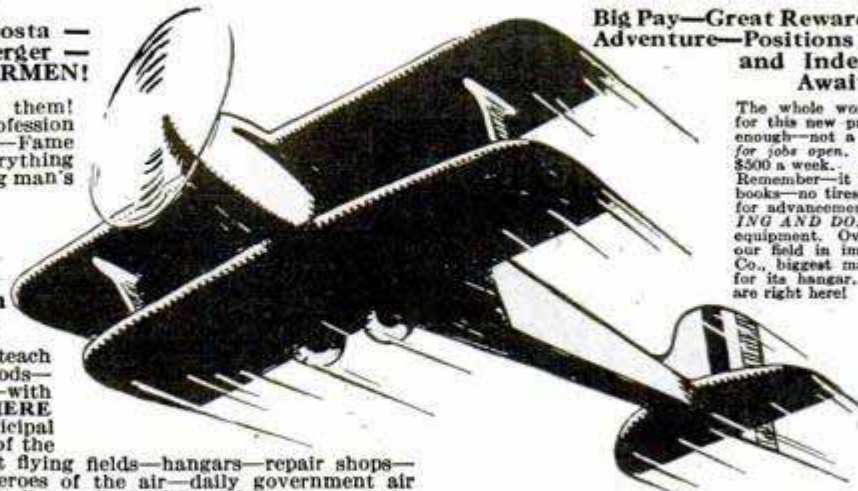

Big Pay—Great Rewards—Travel Abroad—Adventure—Positions That Insure Money and Independence for Life Await Men Like You

The whole world is crying for young men for this new profession. There are not half enough—not a tenth enough—now qualified for jobs open. Jobs that pay from \$75 to \$500 a week. Remember—it doesn't take a long course of books—no tiresome plugging or waiting years for advancement. **YOU LEARN BY SEEING AND DOING.** Latest 1927 planes and equipment. Over 1/4 million already spent on our field in improvements. Boling Aircraft Co., biggest mail carriers, selected our field for its hangar. Biggest chances to be had are right here!

The Cost—So low that any ambitious young man can afford it!

No high school education needed. No experience. Just a good body—a clear brain—and **WILLINGNESS.** Our instruction makes it easy—thorough—safe and quick. Write today for full information. Send the coupon—**NOW**

AVIATION SERVICE & TRANSPORT, INC.
 Dept. 401, 22 W. Monroe St., Chicago
 Send me full information on how you will train me for Aviation. This does not put me under any obligation.
 Name.....
 Address.....

HUMPTY DUMPTY DRAWING TABLE \$10

All metal, guaranteed non-breakable. Light weight, absolutely rigid—no wobbling. Easily adjustable for height, and any position from vertical to horizontal. Board easily revolved. The most convenient drawing table made—your money back if not satisfied. Price, without board, \$10.00, with 23 in. x 31 in. board, \$11.00. Write for complete art and show card supplies catalog.

BART SUPPLIES
 444 Eustis Bldg., MINNEAPOLIS, MINN.

BUCHSTEIN'S FIBRE LIMB

is soothing to your stump—strong, cool, neat, light. Easy payments. Braces for all deformities. **D. BUCHSTEIN CO.** 610 3rd Ave., So. MINNEAPOLIS, MINN.

Send for Catalog Today

LAW STUDY AT HOME

Become a lawyer. Legally trained men win high positions and big success in business and public life. Be independent. Greater opportunities now than ever before. Big corporations are headed by men with legal training. Earn **\$5,000 to \$10,000 Annually**

We guide you step by step. You can train at home during spare time. Degree of LL.B. conferred. LaSalle students found among practicing attorneys of every state. We furnish all text material, including fourteen-volume Law Library. Low cost, easy terms. Get our valuable 108 page "Law Guide" and "Evidence" books FREE. Send for them NOW. **LaSalle Extension University, Dept 1064-L Chicago**
 The World's Largest Business Training Institution

Learn Watchwork, Jewelrywork and Engraving

A fine trade commanding a good salary, and your services always in demand. Address **Horological Institute, Dept. P, Bradley Institute, PEORIA, ILLINOIS,** for our latest catalog.

LEARN CARTOONING AT HOME DURING SPARE TIME

from the School that has trained hundreds of successful cartoonists of today. The Landon Picture Chart Method of teaching ORIGINAL drawing by mail makes cartooning easy to learn. Write today for sample picture chart to test your ability and examples of the work of successful students now earning from \$75 to \$200 and more per week. Please state your age.



THE LANDON SCHOOL, 2838 National Bldg., Cleveland, Ohio

TRAVEL FOR "UNCLE SAM" RAILWAY POSTAL CLERKS

\$158 to \$225 Month
 Mail Coupon Before You Lose It

FRANKLIN INSTITUTE, Dept. P-177, Rochester, N. Y.

Sirs: Rush to me without charge—copy of 32-page book, "How to get U. S. Government Jobs," with list of positions obtainable and full particulars telling how to get them.

Name.....
 Address.....

Steady Work—No Layoffs—Paid Vacations
 Travel—See Your Country Common Education Sufficient
MEN—BOYS 18 UP

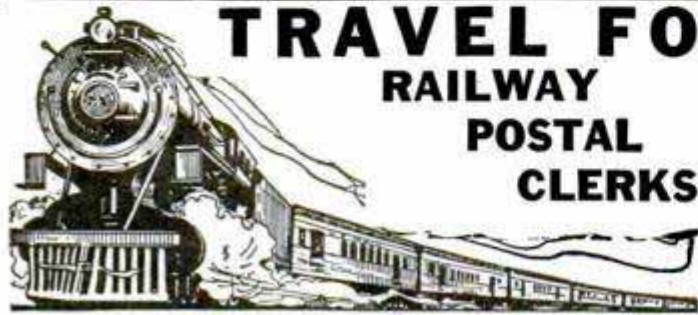

No More Razor Blades To Buy!



365 KEEN SHAVES A Year With One Single Blade

"I want to say that KRISS-KROSS Stropper is the best thing I ever saw. I have been using one blade continuously for one year and nine months and have no idea how much longer it will last."
C. S. Stephenson, Okla.

Inventor Discovers Amazing New Way to Shave! -Without Buying Blades!

K EEN, velvety shaves forever and no more blades to buy! That's what this astonishing invention offers the great army of American shavers today!

KRISS-KROSS is destined to revolutionize all existing traditions of shaving! Its performance is so sensational that it seems hardly fair to call it a stropper. Rather it is a *super-stropper* or *blade-rejuvenator*! No longer do you find that your blades "die" after five or six shaves. KRISS-KROSS "brings 'em to life" a surprising way! Actually—you can take a blade right out of a fresh package and improve it as much as 100% in eleven seconds with KRISS-KROSS!

MAGIC DIAGONAL STROKE

KRISS-KROSS employs the famous *diagonal stroke*, same as a master barber uses. Never before has anyone captured the secret of reproducing it automatically. Eight "lucky leather grooves" do the trick in 11 seconds with a precision it takes a master barber years to attain. Stropps from *heavy to light*. Adjustable, automatic jig flies up and notifies you that your blade is ready—*ready with the keenest cutting-edge that steel can take!*

KRISS-KROSS produces unbelievable sharpness and prolongs the life of any razor blade for months and even years. Fits all brands and makes except Durham. Eliminates 83% of shaving costs and solves your blade problem for all time!

SENSATIONAL OFFER

And now for my surprising offer. To introduce KRISS-KROSS, I am giving with it Free a new kind of razor. Possesses

Rhodes' KRISS KROSS

RHODES MANUFACTURING CO. **STROPPER**

Dept. P-372 1418 Pendleton Ave. ST. LOUIS, MO.

Largest Manufacturers of Mechanical Stroppers in the World.

remarkable features. Instantly adjustable to any shaving position. A flip of the finger makes it (1) T-Shape; (2) straight (old style); (3) or diagonal (new way). Gives a *sliding* instead of *pulling* stroke. Simply zips right through the toughest crop of whiskers. Made of *rustless* metal. Comes with 5 special-process blades and is entirely unlike anything you ever saw before!

GET FREE OFFER

Send for full information on these surprising new inventions today. KRISS-KROSS products are never sold in stores. You deal direct with me or my authorized representative. Write for illustrated description and full details of free razor offer. It's even more remarkable than I can tell you in this short space. Clip the coupon now. Mail it today.

Agents \$30 a Day and Up

Make big money with KRISS-KROSS. Giving away FREE razors boosts your profits amazingly. H. King made \$66 in one day. N. C. Palge made \$104 in 3 days! Others average \$350 and up to \$750 a month! *Spare-time workers, Office and Factory men make \$6-\$12 extra a day showing KRISS-KROSS to friends and fellow employees. S. Kantala made \$154 extra just working evenings 3 weeks. Get details at once. Check bottom of coupon and mail it tonight!*

Rhodes Mfg. Co., Dept. P-372,
1418 Pendleton Ave., St. Louis, Mo.

Without obligation, please send me illustrated description and full details of your special introductory offer on KRISS-KROSS super-stropper and FREE 3-way razor.

Name.....

Address.....

Town..... State.....

() Check here if interested in making money as authorized KRISS-KROSS representative.



BOYS

Make Big Spare Time Money
Surprise your chums

Learn

ELECTRICITY

This Quick Easy Way

Electricity is great fun! And it pays. Lots of my boys still in school are making \$10 to \$15 a week in spare-time—and getting a real training besides for a regular he-man's Big-Pay job in Electricity when school days are over. You can, too! I'll show you how. Begin right now to prepare for a big future in this fascinating field of great opportunity. Your chances of success are simply wonderful!

Learn Right at Home

With my easily-learned, spare-time Electrical Course I will train you at home like I trained hundreds of other boys who are now big successful men. It won't interfere with your school work. And you'll find it so enjoyable it will be more like play than study. It's just the thing for you fellows who are ambitious to get somewhere and be somebody after you have finished school.

I Train You RIGHT!

My training is practical—you learn along work-shop lines by doing. I furnish you with all necessary equipment to work with. And it doesn't cost you a penny extra! Six Big Outfits of tools, material and apparatus, including a real electric motor—not toys, but the real thing. And they're yours to keep—to learn right with, and to help you do the spare-time work I tell you how to get and how to do.

Mail Coupon for Book

If you want lots of spending money—if you want to be ready to jump into a Big-Pay Electrical Job when you're through school—my Big Book will show you how. Get it—you'll like it—it's full of "dope" data and pictures that will thrill you. And it's FREE—won't cost you a penny—mail coupon for it right now!

L. L. COOKE

Chief Instruction Engineer
Dept. O17, CHICAGO, ILL.

RADIO COURSE NO EXTRA CHARGE

Every fellow wants to learn radio. And this Course is a dandy. It's simple—it's thorough. You'll be surprised what it will teach you about Radio. And it's yours without a penny of extra cost!

6 BIG OUTFITS given, including a REAL MOTOR

What a thrill you'll get from these Six Big Outfits of tools and apparatus! There's enough equipment in this fine layout for you to tackle any kind of spare-time work. Imagine having all this for "keeps."



Use this SPECIAL OFFER Coupon

L. L. COOKE, Chief Instruction Engineer,
L. L. Cooke School Of Electricity
Dept. O17, 2150 Lawrence Ave., Chicago, Ill.

Send me free and fully prepaid your Big Book about Electricity, and full particulars about your Electrical Course and extra Radio Course. This does not obligate me.

Name.....
Address.....
City.....State.....
(This coupon only for use of boys 15 years old or more)



Get out of the RUT

Get on the Highway to Success

Quit slaving along. Get out of that rutty road where the going is hard. Get on the smooth highway that will take you to your goal quickly, as every ambitious man wants to go.

New Scientific Plan Enables You to Earn Living in Three Hours a Day

We have a marvelous new plan with which we guarantee you'll make money for yourself. With it, you can make your living in three hours a day. Not only that, but it will enable you to carry out your most cherished ambitions—to go into business for yourself—to be your own boss—to become financially independent. All these things our plan will do for you—provided you're not afraid to sell.

Past experience, age, location, are not important. All that's required is willingness on your part. If you have it, get in touch with me at once. Write name and address on coupon and mail to

LOUIS S. SCHWARTZ, General Manager
Dept. 207, 844 W. Adams St., Chicago

Name.....
Address.....
Town.....State.....



SQUAB BOOK FREE

Breed squabs and make money. Sold by millions for more than chickens. Write at once for free 40-page book beautifully printed in colors telling how to do it. You will be surprised.

PLYMOUTH ROCK SQUAB CO.
634 N Street Melrose Highlands, Mass.



1,000 Hotel Positions Open!

HOTELS, restaurants, clubs, apartments, hospitals, institutions, schools and colleges everywhere need trained men and women. Over 70,000 high-class positions paying \$2,500 to \$10,000 a year open annually in the hotels of the United States. Nearly one and three-quarter billions of dollars' worth of **NEW HOTELS, CLUBS AND INSTITUTIONS**, being built this year will need over 200,000 trained men and women. Hotels start you at salaries up to \$3,500 a year, with living usually included. At any time there are over 1,000 hotel positions open.

Previous Experience Unnecessary

You can have one of these fascinating, big-pay positions. The Lewis Schools guarantee to give you the valuable knowledge that it has taken some of the most successful hotel men years to obtain. Age is no obstacle—young and old alike have equal chance for success. Past experience absolutely unnecessary. A common school education is all you need.

We train you in your spare time with the Lewis Simplified Study Plan and put you in touch with big opportunities. All of your training under the personal supervision of Clifford Lewis, Managing Consultant for over 225 hotels throughout the United States. Our students employed by leading hotels everywhere. Send coupon today for Free Book. "Your Big Opportunity," showing how we can train you for one of these splendid positions and explaining our Money-Back Agreement.

FREE BOOK COUPON

LEWIS HOTEL TRAINING SCHOOLS,
Room AL-385, Washington, D. C.

Send me without obligation the Free Book "Your Big Opportunity."

Name.....
Address.....
City.....State.....

Secrets of Personal Magnetism

that *anyone* can use

-will you try them 5 days -FREE?

NO matter what your walk in life—no matter how many failures you may have had—these startling secrets of personal magnetism will show you how to become forceful in business—popular in social life—successful and well-liked wherever you go!

Don't envy the man whose magnetic personality dominates every situation! Don't envy the man who is always so sure of himself, so utterly self-confident that you can't help but believe in him! Don't envy the man who has a knack for making people like him and do things for him! *You can be that man!*

There is no magic, no trick about developing personal magnetism. Through these amazing secrets *anyone* can easily and quickly change an utterly colorless, timid, self-conscious personality into an aggressive, dominant, compelling magnetic one!

Think of the magnetic men and women you have known. What were their outstanding traits? Were they not distinguished by a charming, fascinating manner—a tense, purposeful walk—magnetic eyes—a vibrant, winning voice—perfect poise under all circumstances? *These secrets of personal magnetism will develop the same traits within you!*

What These Secrets Will Do for YOU

These secrets of personal magnetism will completely transform your life. They will magnetize your personality so that people will be drawn to you at once, irresistibly.

These secrets of personal magnetism will show you how to use the amazing principle of instantaneous magnetic control to win quick and conspicuous success in your business or profession.



These secrets of personal magnetism will place in your hands the key to supreme power and happiness—give you a great new confidence in yourself—overcome almost at once any timidity or self-consciousness you may have.

These secrets of personal magnetism will give you a glorious new magnetic personality so that you can influence the minds of others—attract people to you instantly—get your full share of the good things of life.

These secrets of personal magnetism will enable you to forge ahead in anything you undertake with amazing strides. They will enable you to realize the very heights of your ambition!

Best of all there is no long waiting for results. You can apply these secrets of personal magnetism the moment you read them. And with the great power of personal magnetism you will be enabled to go through life supremely happy, reaping the glowing rewards which personal magnetism—and only personal magnetism—can give you.

Once for the wealthy only—now within the reach of all!

These secrets of personal magnetism are the result of years of patient study and research—the work of a lifetime—by

that great student of the human mind, Edmund Shaftesbury. Forty years ago Shaftesbury set out to discover the secret of personal magnetism. He applied his discoveries to his friends. Results were astonishing! His methods seemed to have the magical power of transforming people into *entirely new beings!*

Shaftesbury's fame spread. World celebrities came to him. Among his first students and friends were such names as Gladstone, Queen Victoria, Edwin Booth, Henry Ward Beecher and Cardinal Gibbons. Until recently, Shaftesbury's teachings have been available only to those who could pay \$25 to \$50 each for instruction books. But now, through the efforts of a group of his students, all that he taught on the development of personal magnetism, with a great deal more he discovered during recent years *which has never before appeared in print*, have been gathered into one great volume, priced *within the reach of all.*

5 Day Free Proof Offer

It is impossible to tell in this short space, the whole story of this wonderful volume. You must see it for yourself—examine it. Thrill to its strange power. Apply its amazing secrets—let them give you a *new personality*—magnetic, irresistible!

The coupon below will bring you this remarkable volume, with cover in handsome dark burgundy cloth, gold embossed, for 5 days' FREE EXAMINATION. If you aren't stirred and delighted in the 5 day free period return it and it costs you nothing. Otherwise keep it as your own and remit the Special Wholesale Price of \$3 in full payment. This volume was originally published to sell at \$5, but in order to reach many readers it is being offered at this special reduced price. No obligation. You are the sole judge. You do not pay unless you are absolutely delighted. And then only \$3. You simply can't delay. Take your pen or pencil—and fill out the coupon NOW!

Ralston University Press
Dept. 13-S Meriden, Conn.

Ralston University Press,
Dept. 13-S, Meriden, Conn.

All right—I'll be the judge. You may send me the volume "Instantaneous Personal Magnetism" for 5 days' FREE EXAMINATION in my home. Within the 5 days I will either remit the special low price of only \$3.00 or return the book without cost or obligation.

Name.....

Address.....

City.....State.....

PROOF!

"Made me a success—financially, socially and morally."

"Have surprised both myself and my friends with the results obtained. Have gained priceless benefits."—R. D. B.

"I regard it as the biggest and best investment a man could make. Realized the experience of entering a new realm of life."—H. L. W.

"I would not give up what you have taught me for \$100,000."



Switch

If you are now earning less than \$40 a week, if you're short of schooling, you'll have to face these questions, sooner or later:

What are your chances in your present line of work? How much more will your job pay you next year? Can you overcome the handicaps of neglected education? Will you get "fired" when times get bad?

You may not like your own answers to these questions. And if you don't, my advice is, GET INTO A DIFFERENT FIELD where there are plenty jobs, big salaries and real opportunities for advancement.

ELECTRICITY—the wonder-industry offers you such unlimited opportunities. I'll prove that to you here. And I'll tell you how you can SWITCH TO ELECTRICITY without losing a day's time or a dollar's pay.

Electricity Offers You Amazing Opportunities

The map on the next page shows 112,000 miles of electric trunk lines, but that's just to carry the "juice" from the power plants to the homes and factories and shops and skyscrapers and farms of the U. S. The map can't show the million USES of electricity, the millions of men already employed at high wages in this fascinating industry, nor can it even suggest the future of Electricity. Marconi, Edison, Insull and other leaders say Electricity is still in its infancy! And that men who enter the field TODAY have a bigger chance, even, than the "pioneers" of 30 years ago.



Great power-plants like these don't run themselves. It takes men, trained men, highly paid men to design and install, to manufacture and operate, to repair and manage the thousands of central stations or privately owned electrical power plants in America.



I will help you get a well-paid job — or money refunded

You don't need to be a high-school or college graduate to succeed in Electricity. I have placed hundreds of men in fine electrical jobs and I'll be glad to tell you how I can help you to get a well-paid electrical position. Mail coupon for the most remarkable offer ever made to ambitious men.

29 Executives

—men from Westinghouse, Allis-Chalmers, Western Electric, General Electric, Commonwealth Edison and other great corporations and the leading Universities of the U. S.—helped us develop a remarkable service for preparing and placing ambitious men in fine electrical positions. It will pay you to get all the facts of this startling service. Coupon on next page brings them.

The railroads are turning from steam to electricity. Notable installations are on the C. M. & St. P. in the "Rockies" and in New York City terminals. The Rubber industry is 80% electrified—machinery is 81% and the steel industry 54% electrified. 14 million homes in the U. S. are wired for electric light. Radio is a billion dollar "baby" of the industry, only 6 or 7 years old commercially. Even this entire magazine is not big enough to contain all the interesting facts of the importance of the electrical industry.

Chief Engineer Dunlap, Electrical Division,

to Electricity

— World's Greatest, Fastest Growing Industry

Even electricians and skilled electrical mechanics are earning \$15 to \$20 a day in the big cities. And the EXPERTS are getting more than that. In no other line is there the tremendous need for men. No other great industry continues to grow so rapidly. *Come into electricity* and your future is **SECURE!**

Many \$60 to \$125 a Week Jobs!

Chief Electricians, Superintendents of Electric Power Plants, Electrical Construction and Installation Experts, Electrical Contractors, Electrical Engineers—are sitting on top of the world these days. The demand is bigger than the supply. That is why I am urging men to come into Electricity. Here they can have their chance of many fine positions. Here they are sure of big pay. Here they can bank on rapid promotion.

The Electrical industry has ridden through wars and panics without a backward step. You never hear of the men in an Electrical plant getting "laid off." That's because the use of Electric current is growing every minute. Whether times are good or bad we continue to light our homes and ride in street cars and turn over machinery with Electric power motors. This is the **ELECTRICAL AGE**. And you'll be wise to hook-up with its basic industry.

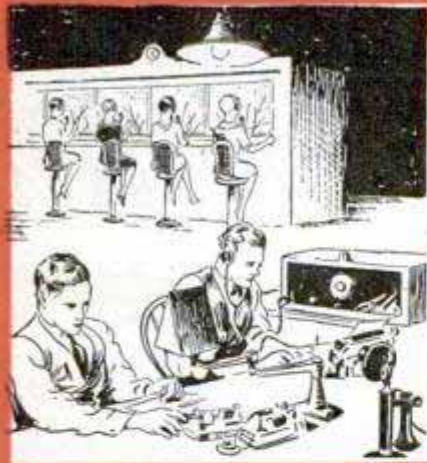

Radio, telegraph, telephone. Now pictures come over the air electrically. Much transportation, all communication, over half of all industry is Electrical.

112,000 miles of Electrical trunk-lines in the U. S. Super-power in voltage is carried hundreds of miles. Giant hydro-electric plants are dotting the map too. Get my free book and get more fascinating facts about this most interesting industry.

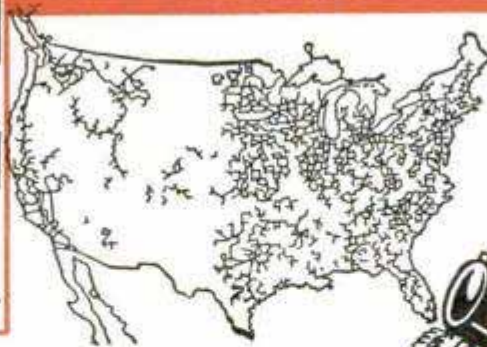

Confidential Surprise Offer

to men earning less than \$40⁰⁰ a week

I am prepared to enter into a written contract with any ambitious man who seeks a fine, well-paid Electrical job. To help him get ready **AND TO HELP HIM GET PLACED.**

We are now bound by similar agreements to deliver this pay-raising **JOB-SERVICE** to over 15,000 men. Backed by our entire resources of over a million and a half dollars.

I will show **YOU** how **YOU** can break into the giant electrical industry, how to qualify for and **GET** a wonderful position, paying at least 50% more than you earn today. And offering opportunities for advancement that are simply dazzling.

All without a penny's risk to you—I promise you that.

This offer is for ambitious men only. Lack of schooling will not bar you. Lack of ready money will not bar you. Send me the coupon and I'll give you the chance to cash in, too.

Chief Engineer Dunlap,
Electrical Division
The American School,
Dept. E-774,
Drexel Avenue & 58th Street,
Chicago.

I may want to **SWITCH** to Electricity.

I am ambitious. Send Confidential Surprise offer, to.....

Address.....

Age..... Occupation.....

The American School Dept. E-774, Drexel Ave. and 58th St., Chicago, Ill.

Travel on "Uncle Sam's" Payroll RAILWAY POSTAL CLERKS MAIL CARRIERS

\$1700 to \$3000 Year
Many other U. S. Government Jobs obtainable
MEN—BOYS, 17 Up SHOULD MAIL COUPON IMMEDIATELY
Steady Work No Layoffs Paid Vacations



FRANKLIN INSTITUTE,
Dept. P178, Rochester, N. Y.
Sirs: Rush to me without charge: FREE 32-page book with list of U. S. government positions open to men and boys and full particulars telling how to get them.
Name.....
Address.....

AT HOME LEARN TELEGRAPHY AT HOME
TEACH YOURSELF in half usual time; at trifling cost, with the wonderful Automatic Transmitter, **THE OMNIGRAPH**. Sends unlimited Morse or Continental messages, at any speed, just as an expert operator would. Adopted by U. S. Government, and leading Universities, Colleges and Telegraph Schools. Catalog 6 cents.
OMNIGRAPH MFG. CO., 13-19 Hudson St., NEW YORK



Must Men Suffer *after 40?*

A well known scientist's new book about old age reveals facts, which to many men will be amazing. Did you know that two-thirds of all men past middle age are said to have a certain seldom mentioned disorder? Do you know the frequent cause of this decline in vitality?

Common "Old-Age" Symptoms

Medical men know this condition as hypertrophy of the prostate gland. Science now reveals that this swollen gland—painless in itself—not only often cheats men of vitality, but also bears on the bladder and is often directly responsible for sciatica, backache, pains in the legs and feet, and dizziness. When allowed to run on it is frequently the cause of cystitis, severe bladder inflammation.

65% Are Said to Have This Gland Disorder

Prostate trouble is now reached immediately by a new kind of safe home hygiene that goes directly to the gland itself, without drugs, medicine, massage or application of electricity. Absolutely safe. 40,000 men have used it to restore the prostate gland to normal functioning. The principle involved is recommended by many physicians. Amazing recoveries often made in six days. Another grateful effect is usually the immediate disappearance of chronic constipation. Usually the entire body

is toned up. Either you feel ten years younger in six days or the treatment costs nothing.

Send for FREE Book

If you have this gland trouble, or any of the symptoms mentioned, write today for scientist's free book, "Why Many Men Are Old At Forty." You can ask yourself certain frank questions that may reveal your true condition. Every man past 40 should make this test, as insidious prostate disorder often leads to surgery. This book is absolutely free, but mail coupon immediately, as the edition is limited. Address

THE ELECTRO THERMAL CO.

2174 Main Street Steubenville, Ohio

W. J. Kirk, Pres. The Electro Thermal Company,
2174 Main Street, Steubenville, Ohio.

Please send me Free, and without obligation, a copy of your booklet, "Why Many Men Are Old at 40." Mail in plain wrapper.

Name.....

Address.....

City.....State.....

Western Address:
Suite 21-T, 303 Van Nuys Bldg., Los Angeles, Calif.

FORD

40 Miles on a Gallon

J. T. Jackson, Mich., reports he drove a 1914 model Ford 40 miles on one gallon.

STUDEBAKER

Saves 50%

F. A. Cole writes he put one on a Studebaker Special Six. Reports a saving of 50% in gasoline.

BUICK

36 Miles on 1 1/4 Gallons

"Yesterday I made a trip of 36 miles and used only 1 1/4 gallons."—L. L. Robinson.

CHEVROLET

43 Miles on a Gallon

"We have tried them out. Chevrolet got 43 miles."—F. S. Carroll. Rex Dean, another Chevrolet owner, reports he got 25 miles a gallon. Took the device off and mileage dropped to 19. Put it back and mileage moved up to 25.

OLDSMOBILE

Almost Double

J. R. Wood writes he increased mileage on his Oldsmobile from 17 miles a gallon to 30 miles a gallon by actual count on 3,000 miles.

INTERNATIONAL TRUCK

Saves 41%

"I find it better than you recommend it. On the International Truck we use, we are saving by positive test 41% in gas and our engine uses less oil."—George Bell.

Sworn Affidavit

I, L. G. Stransky, Vice-President J. A. Stransky Mfg. Company, being first duly sworn depose and say that the J. A. Stransky Mfg. Company have in their files thousands of unsolicited testimonials from satisfied users all over the world.

Signed, L. G. Stransky, Vice President.

Subscribed and sworn to before me this 29th day of November, 1926.

(Signed) Ernest Henegar, Notary Public.



With This Amazing Device I Drove 1300 Miles Without Buying Gasoline

No wonder over two million car owners have installed the Stransky Vaporizer. Here's a remarkable instance of gas-saving (one of many) reported by J. R. Wood of St. Louis. Before installing it, he got only 17 miles on a gallon. On a 3,000 mile test after installing it, he got 30 miles on a gallon. Thus he saved 77 gallons of gas which, at 17 miles a gallon gave him 1300 miles without buying gasoline! Read the inventor's daring no-risk offer to you.

\$75 to \$200 in a Week

SELDOM if ever has such a money-making opportunity been offered distributors—experienced or otherwise—full time or spare time. Think how fast the money rolls in when Foster could make \$137.50 in a week—Fuller \$104.50 in five days—Cronk \$51 in an hour!

If your present job doesn't pay you \$75 to \$200 in a week, think fast! Full page newspaper ads are being used all over America. Over a million car owners have installed it already—on all makes of cars, trucks and tractors—even on an aeroplane. Thousands of car owners have ordered direct from the factory because they couldn't find a distributor. Jump in quick and get your share of the cream!

How It Works

The Stransky Vaporizer was invented by J. A. Stransky, former candidate for Governor of South Dakota. It is based on a newly-discovered scientific engineering principle that has stood

thousands of tests by car owners, dealers, garage mechanics and other authorities. It has no delicate parts to get out of order. There is nothing complicated about it. You can attach it to your engine in about three minutes and it needs no further attention.

Official tests show that most car owners waste 20 to 30% of their gas by improper combustion. Thousands of car owners say that this amazing device has saved them as much as 50%; that it picks up power more quickly, ENDS spark plug and carbon troubles, and works in all weathers or roads. And so convinced is the inventor that it will prove its story that he makes the following no-risk offer.

Mail Coupon Below

Over one million car owners have installed the Stransky Vaporizer at the inventor's risk. This coupon will bring you full details of our plan to let you test this device on your car in the same way. You will also learn a definite plan that has helped others earn \$75 to \$200 in a week, full or spare time. Your request will not obligate you.



Rush the coupon today.

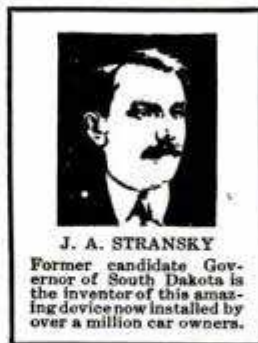

J. A. STRANSKY

Former candidate Governor of South Dakota is the inventor of this amazing device now installed by over a million car owners.

The STRANSKY VAPORIZER

Saves Gasoline

J. A. STRANSKY MFG. CO.

M-10 Pukwana, S. D.

Resources \$500,000.00

Free Gasoline Offer

J. A. Stransky Mfg. Co., M-10, Pukwana, S. D. Yes, send me without obligation full details of your no-risk test offer. Also tell me about your distributor's money-making plan.

Name.....
Address.....
City.....State.....



From \$1,800 to \$10,000 in Four Years

Thanks to Higher Accountancy

"LaSalle training in Higher Accountancy has enabled me in four years to increase my business more than 500 per cent." So writes John H. Lansing, Public Accountant, Income Tax Specialist, and prominent citizen of Amsterdam, New York, who deliberately resigned as purchasing agent for a large carpet manufacturing company to start on his own as a Public Accountant.

Mr. Lansing was 43 when he enrolled with LaSalle, and at the time was earning from his newly adopted profession less than \$2,000 a year.

Today, the firm of which he is head is auditing the books of 100 business houses, including 20 corporations; and his Income Tax Department has more than 500 clients. Each year his business shows a healthy increase.

"When you consider that the average bookkeeper does not receive over \$40 a week," writes Mr. Lansing, "it is obvious that \$10,000 a year has advantages well worth the consideration of any ambitious man or woman. I shall always be grateful to LaSalle for the help it has given me in building a greater income."

Send for This Book—It's Free

Do you appreciate what Accountancy means in the business world? Do you realize that it constitutes the indispensable foundation for success in any business undertaking? Would you seriously fit yourself for positions paying \$3,000, \$5,000, \$10,000 a year and even better?

LaSalle has prepared a 64-page book entitled "Accountancy, the Profession that Pays." The information it contains is of very real and definite value. It will pay you well to read it. And—LaSalle will send it to you free.

Balance the two minutes that it takes to fill out the coupon against the rewards of a successful career—then clip and mail the coupon—NOW.

— — — Find Yourself Thru LaSalle! — — —
LA SALLE EXTENSION UNIVERSITY
The World's Largest Business Training Institution

Dept. 1064-HR Chicago

I would welcome details of your salary-increasing plan, together with copy of "Accountancy, the Profession that Pays," also a copy of "Ten Years' Promotion in One," all without obligation.

Higher Accountancy

Training for positions as Auditor, Comptroller, Certified Public Accountant, Cost Accountant, etc.

Other LaSalle Opportunities

LaSalle opens the way to success in every important field of business. If more interested in one of the fields indicated below, check and mail now.

- | | |
|---|--|
| <input type="checkbox"/> Business Management | <input type="checkbox"/> Personnel Management |
| <input type="checkbox"/> Modern Salesmanship | <input type="checkbox"/> Banking and Finance |
| <input type="checkbox"/> Traffic Management | <input type="checkbox"/> Modern Business Correspondence and Practice |
| <input type="checkbox"/> Railway Station Management | <input type="checkbox"/> Expert Bookkeeping |
| <input type="checkbox"/> Law—Degree of LL.B. | <input type="checkbox"/> C. P. A. Coaching |
| <input type="checkbox"/> Commercial Law | <input type="checkbox"/> Business English |
| <input type="checkbox"/> Industrial Management | <input type="checkbox"/> Commercial Spanish |
| <input type="checkbox"/> Factory Management | <input type="checkbox"/> Effective Speaking |
| <input type="checkbox"/> Modern Foremanship | <input type="checkbox"/> Stenotypy |



Name.....

Present Position.....

Address.....

Electrical Engineering

Course for men of ambition and limited time. Over 5000 men trained. Condensed course in Theoretical and Practical Electrical Engineering including the closely related subjects of Mathematics and Mechanical Drawing.

Students construct motors, install wiring, test electrical machinery. Course designed to be completed in one college year. Prepare for your profession in the most interesting city in the world. Est. 1893. Catalog on request.



Bliss Electrical School

120 Takoma Ave., Washington, D. C.

LEARN PIANO TUNING AT HOME

DURING SPARE TIME AND EARN \$50 TO \$100 A WEEK.



Our Tune-A-Phone Makes It Easy. With it any one who has ordinary hearing can acquire the knack quickly and accurately. Esmay, Long Beach, Cal., says: "never dreamed there was so much money in Piano Tuning. I earned \$265 in ten days." He is but one of many. Write for Free copy of our book "Winning Independence" and Guarantee Plan. BRYANT SCHOOL, 71 BRYANT BLDG., AUGUSTA, MICH.

6 TUBE RADIO
ONE DIAL Latest advanced circuit. All steel chassis totally shielded. Balanced parts of best quality. Marvelous power and selectivity. Gets the long range stations as clear as a bell. One dial single control. An unsurpassed value—just one of our many mighty bargains.

Only \$32.50



FREE Log and Call Book and Big New Catalog—just off the press. Full of Radio Bargains. Send for your free copy now! American Auto & Radio Mfg. Co. HARRY SCHWARTZBERG, Pres. Dept. 262 American Radio Bldg., Kansas City, Mo. 2



\$100.00 for one Drawing

Learn to Draw at Home

Students Say: "IT'S EASY"

Trained artists earn from \$50 to over \$250 a week. W. R. Kent, one of our graduates in New Jersey writes "I have sold a drawing, which took less than a day to do, for \$100." Tremendous demand right now for good art work. Magazines, newspapers, advertisers, printing houses, etc.

Become an artist through wonderful, simple method right at home in spare time as Kent and many others have done. Learn Illustrating, Designing and Sketching. Actual fun learning this way. Learn to Draw and Earn Big Money. Many of our students earn big money while learning.

Send for FREE BOOK

Just printed—a new book which describes the latest developments and wonderful opportunities in Commercial Art, and gives full details of this remarkable method of learning to draw. Tells all about students—their successes—what they say—actual reproductions of their work—and how many earned big money even while learning. Write for this **Free Book** and details of **Artist's Outfit given with course**. Write name plainly and state whether Mr., Mrs. or Miss. Also give age. Mail postcard or letter now. (No salesman will call.)

WASHINGTON SCHOOL of ART, Inc.

Room 3010E, 1115-15th St., N. W., WASHINGTON, D. C.



Makes \$18 First Day

"Received my first 24 Speedos yesterday; the entire lot is now delivered and more sold. In all my years of selling I never saw anything that met with such universal approval."
—W. R. Duncan, Mont.



\$5.00 His First Hour

"Received Speedo outfit April 1st. Left the house at 6:30 P. M. Returned just one hour later with 6 orders. Speedos are a necessity in every home.—W. W. Marshall, Ill.



Let These Twin Inventions Hand You

Double Profits...\$5 to \$11 IN AN HOUR!

Men, here's a proposition that's amazingly simple. Yet the profit possibilities are nothing short of startling! For now, an old, well-known manufacturer offers you direct, *two* unique, patented inventions. Items used every day in every home. Yet so revolutionary that they positively sell on sight! So just read the facts below. Then mail coupon for FREE OUTFIT and FREE TEST OFFERS.



Works Like a Charm

Just insert can in holder and turn crank. Top is cut completely out *inside* the "lid." Juices can't spill out.



Food Pours Right Out

No fuss or mess. No scraping or "spooning." Even foods frozen in the can slip out easily.



No Jagged Edges

Speedo cuts the top out, smooth, slick, and clean. Ends danger of cut fingers.

EVERY man who has cut his eye teeth in the selling game knows this! The big clean-ups are always made by men who get in on the ground floor with something new and sensational. Think, then, what a doubly sensational chance to coin money is now yours! For here are offered you two unique devices—pronounced by experts everywhere to be absolutely revolutionary—approved by Good Housekeeping Institute, Modern Priscilla, etc.—and real necessities in every home. In your wildest dreams, could you conjure up such an amazing opportunity for quick, easy profits?

A Real Million-Dollar Can Opener

Imagine an *automatic* machine that opens any can, round, square or oval, simply at the turn of a crank. Cuts the entire top out, slick, smooth and clean! No more stabbing and hacking with old-style can openers. No more fingers cut and infected on jagged tin-can edges. For Speedo holds the can—strips the top out—flips up the lid—all in a couple of seconds! No wonder women simply go wild over it. And no wonder 4 out of 5 buy on a 10-second demonstration!

The "Magic Groove" Sharpener

Women never saw anything even remotely like this other "twin" invention, the Speedo Sharpener. Just demonstrate the "Magic Groove" and watch their eyes

pop open with amazement. Now anyone can put a keen, smooth edge on everything that cuts. Even scissors! Every woman sees instantly that here is an end to the drudgery of dull knives and tools. That's why agents report as much as \$10 and \$12 in a single hour with Speedo sharpener alone!

Generous Co-operation

This company has been in business over 20 years. Speedos are made entirely in our own big factories, under exclusive patents. Each item is backed by a printed guarantee of *5 years perfect service*. We give you exclusive territory. Over 100% profit! We train you from A to Z, and supply you with a complete selling outfit FREE.

Mail The Coupon TODAY

Any ambitious man with just ordinary common sense can see the possibilities of the proposition at a glance. If you are that kind of a man, I want to send you my FREE OUTFIT and FREE TEST OFFERS. I want to show you what real big money means. Mail the coupon today. Then get set to test the fastest, dizziest profit makers of your life. Write me this minute!



Sharpens Like Magic
Just rest blade in Magic Groove, turn handle. Sharpens a ten-inch knife in six seconds. Puts a razor edge on everything that cuts.



Grinds Scissors Perfectly
Rest blade against guide, give handle a couple of turns—Fresto! Scissors are sharp as new.

Central States Mfg. Co., Dept. M-701, 4500 Mary Ave., St. Louis, Mo.

Rush me details of your proposition and FREE TEST OFFER.

Name.....

Address.....

Town..... State.....

CENTRAL STATES MANUFACTURING CO.

Dept. M-701, 4500 Mary Avenue, St. Louis, Mo.

THIS IS YOUR CHANCE AT BIG MONEY

\$3500
a year
and up
IN ELECTRICITY



\$100 A Week

"Dear Chief:

I had only a grammar school education and knew nothing about Electricity. But your lessons were easy and am now making \$100 a week.

R. M. HINES,
Dellview Resort,
Mirror Lake, Wis.



Big Increase

"Dear Mr. Cooke:
With only a country school education, was a truck driver at 42¢ an hour. Today am Electrician at 3 times more pay. With your help a fellow is sure to win."

A. R. GROLL,
256 Uhler Ave.,
Marion, Ohio



\$100 A Week

"Dear Mr. Cooke:
I am now manager of the Regina Electric Cleaner Co. in this district and make on an average of \$100 a week—very nice money compared with my wages when I was mining coal."

JOHN WRIGHT,
Smith-Mill, Pa.

Triples Pay in 7 Months

"Dear Mr. Cooke:

I was in the common labor class getting \$18 a week, but now I've jumped to \$50 a week and over, all in 7 mos. You have the greatest Course in the world."

W. H. STEPHENS
44 Mechanic Street
Pt. Edward, N. Y.



Now Gets \$90 A Week

"Dear Mr. Cooke:

I am well pleased. Am only 20 years old and was making \$16 a week in a small company. Now make \$90 a week and have a share in the business."

A. J. CURTIS,
875 West End Avenue,
Atlanta, Georgia

Stop Right Here!

This is YOUR Opportunity! Electricity needs you, wants you, offers Big Pay to get you. \$12 to \$30 a day—that's the pay of the Electrical Expert. And thousands of "Cooke" Trained Men are making \$3,500 to \$10,000 a year in this biggest-paying field. Get in line for one of these Big Jobs. You can do it. I'll show you how.

The Job For You

Why stick to work that offers no chance, no promotion, no big income. It's a shame for you to earn only a mere \$4, \$5 or \$6 a day, when you could make \$12 to \$30 in the same 8 hours in Electricity? That's the kind of a job for you—that's the kind of money you ought to be making. And you can do it. It's easy when you know how, and—

I'll Train You At Home

Give me a little of your spare time and I'll get you ready for Big Pay almost before you realize it! And my Training is practical. It is simple, thorough, easily learned and quickly mastered. With my now famous "Work Sheets" and "Job Tickets" you learn by **doing**—and you learn RIGHT. I teach you Electricity from A to Z—right in your own home,



Earn While Learning

That's the way I teach Electricity—so you can make it pay as you learn! Yes, sir! I show you how to get work and how to do it. Lots of my "boys" make \$10 to \$30 a week extra money this way. You can, too. You can pay for my Course many times over this way, and bank real money besides!

Six Outfits Given

—at no extra cost—you get Six Big Outfits of Tools and Apparatus—everything you need to learn Electricity right, and to make real spare-time money while learning. They're not toys, but the real thing—and yours to keep—and to help you get "on-the-job" experience for the Big-Pay Job that's to come later on.



The "Cooke" Trained Man Is The

There is Always a BIG DEMAND

for ELECTRICAL EXPERTS ~

and "COOKE" TRAINED MEN are getting the BIG MONEY in ELECTRICITY everywhere

Electrical Men Needed Everywhere Electricity, the world's greatest profession offers you countless opportunities. Even ordinary electricians — the "screw driver" kind — are making big money. \$40 a week is only ordinary pay in Electricity. \$70 to \$200 a week is what thousands of my "boys" are making. Yet none of them were any smarter than you. Think of that! Picture yourself in such a job! Here is your opportunity — here is your chance for Big Money! Get into this great field. You can do it with "Cooke" Training — yes, you can do it easily!

Nothing Like "Cooke" Training Don't confuse my Training with "book learning" — don't confuse it with anything else you've ever heard of. "Cooke" Training is different — it's practical — it's successful. Don't be satisfied with anything else. It stands alone in the field — there's nothing like it anywhere. It's the Training that Electrical Men are praising — the Training that great Electrical Companies recommend to their employees — the Training that has jumped thousands of other men into work paying \$3,500 to \$10,000 a year. It's the Training for you!

Lack Of Schooling No Drawback Don't think you need "education" to make good with "Cooke" Training. Don't hesitate because you didn't get very far in school. That makes no difference to me. Many of my "boys" never finished the grade school. But look at them now — Big Pay Men! They learned — and so can you — because "Cooke" Training is simple as A-B-C — there's nothing like it under the sun for putting men into the Big Money class!

L. L. COOKE
Chief
Instruction
Engineer



This
**FREE
BOOK**
TELLS YOU
HOW!

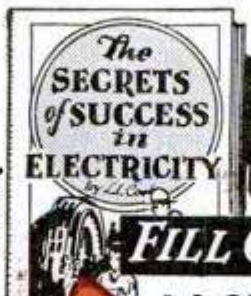

Employment Service — No Extra Charge Not only do I train you for a Big-Pay job in Electricity — but I help you get it. My Unlimited Employment Service is to be yours without extra charge as long as you want it. Last year I placed more than a thousand men at big raises in pay. Hundreds of others were promoted by their employers through the help of my Vocational Service and other hundreds went into business for themselves with the help of my Special Business Training. And all this Service is yours without a penny of extra cost.

Your Money Back If Not Satisfied That's what I agree to do! So sure am I that after Training with me you, too, can get into the Big-Pay class in Electrical work, that I will send you a signed Money Back Agreement which reads that if, after completing my Course, you are not fully satisfied, back comes your money — every cent of it! You're to be the judge and jury all in one. And back of me in this Agreement stands a \$2,000,000 Illinois Corporation.

Get Started — Mail Coupon NOW! Right now — this minute — make the first step toward Big Pay. Start at once in the direction of a \$70 to \$200 a week job. Mail coupon for my Big FREE Book of Facts — the same great, pay-raising Book which has put thousands of other men into this Big-Pay field. See the scores of Pictures — the Facts — the Proof! Read the startling letters of other successful "Cooke" Trained Men. See how easily you, too, can jump from a "bossed" to a "bossing" job paying \$300 to \$900 a month.

Get this amazing book — send for it today — no obligation — it's absolutely FREE — mail coupon for it right now!

L. L. COOKE, Chief Instruction Engineer

**L. L. COOKE SCHOOL
OF ELECTRICITY**

Dept. 17

2150 Lawrence Avenue
Chicago, Illinois

FILL OUT & MAIL AT ONCE

L. L. COOKE, Chief Instruction Engineer,
Dept. 17, 2150 Lawrence Avenue, Chicago, Illinois

Please send copy of your Big FREE book — "Secrets of Success in Electricity," and full particulars about your home study Course in Electricity.

Name _____

Address _____

City _____ State _____

(Residents of Canada send coupon to R. A. Farrow, Special Representative, 7 Medbury Lane, East, Windsor, Ontario, Canada.)

MAIL THE COUPON NOW!

6 BIG OUTFITS

to work with - no extra cost

"Big Pay" Man



IF YOU WERE FIRED TOMORROW

If the boss came down with a grouch—or you made a mistake—And You GOT FIRED, could you get another job at the same pay right away? Or would you have to go job-hunting like any ordinary untrained man who gets fired? Think it over! If you are tired of being a cog in a machine—or tired of working in an uncertain, 2x4-inch job with no future—here is a real opportunity! Read about it—it may be the big turning point of your whole career!

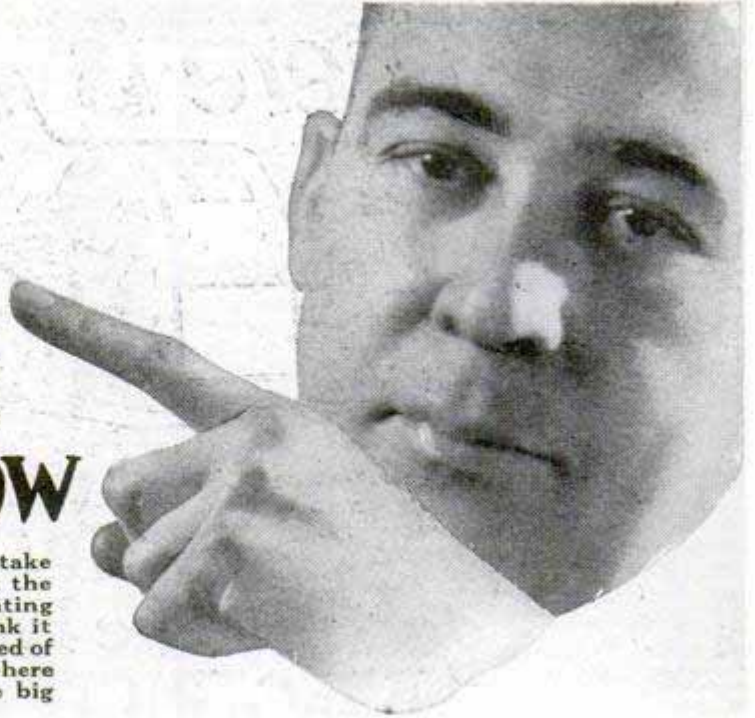

Stop Gambling With Your Future and LEARN ELECTRICITY

WHERE JOBS HUNT MEN AT \$50 A WEEK AND UP

LET me make you a real money-maker. Let me take you out of the "hired-help" class—and start you on the road to real success, in 90 days. Make up your mind to say good-bye forever to precarious, tiresome, routine jobs—crabby bosses—and low pay that can never be more than \$35 or \$40 a week! You don't need to tolerate them any longer!

Amazing Opportunity

Electricity is calling for trained men—and Coyne 12-week graduates are among the preferred class. Many of them have stepped out of our doors into wonderful jobs paying from \$50 and up a week! And our free employment bureau gives life employment service.

LEARN Without Lessons

Electricity is surprisingly easy to learn this practical way *without* books or lessons. That's the secret of Coyne training. All training consists of *ACTUAL* and *PRACTICAL* work on fine big electrical equipment—dynamos, transformers, etc. (Real ones—not models.) You learn by *doing*—and experts work right with you every step of the way.

COYNE
ELECTRICAL SCHOOL

H. C. LEWIS, President
Dept. 77-78
500 S. Paulina Street
CHICAGO, ILL.



Now in Our New Home

This is our new, fireproof, modern home wherein is installed thousands of dollars worth of the newest and most modern Electrical equipment of all kinds. We now have the largest amount of floor space devoted to the exclusive teaching of practical electricity in the world. Every comfort and convenience has been arranged to make you happy and contented during your training.

I Allow Your R.R. Fare

Right now I am making a special offer to allow any man's railroad fare to Chicago from any point in the U. S., upon enrollment. Send coupon for details.



No Experience or Advanced Education Needed!

Practically any man can master the "ins-and-outs" of Electricity—as taught in the Great Shops of Coyne. You don't need one bit of previous experience or any more than common-school education. Some of our highly successful graduates never completed eighth grade.

2 Extra Courses FREE

If you act now—I'll not only allow your railroad fare to Chicago—but I'll include two big, extra courses absolutely without charge—**RADIO** and **AUTOMOTIVE ELECTRICITY**. Furthermore I'll help to locate part-time work for students. **FREE** employment service after graduation, too. We help place men in wonderful jobs every week!

Send for FREE Book

Just give me a chance to tell you about the wonderful things that Electricity has in store for you after 12 happy weeks at COYNE. Send the coupon for my free, illustrated book containing over 150 photographs and details of my special offer. No obligation. Mail it today!

Big Book Free

Coyne Electrical School,
H. C. Lewis, Pres., Dept. 77-78,
500 S. Paulina St., Chicago, Ill.

Dear Mr. Lewis:

Without obligation, send me your free illustrated catalog and details of your offer.

Name.....

Address.....

City..... State.....

Classified Advertisements

WORLD'S BEST WANT AD MEDIUM

Advertisements in this section, 30 cents per word, each insertion, minimum 10 words, payable in advance. To be inserted under proper classification in November issue, copy should be in our office September 18th.

ADVERTISING AGENCIES

SECURE and Increase Your Business by getting after out of town trade. Our Service department guides you on every detail. Copy and literature composed free. Your 24-word ad (4 lines) inserted in the following 10 leading Sunday papers for only \$10.00. Circulation 1,500,000. Gazette, Little Rock; American, Atlanta; Star, Indianapolis; Journal, Minneapolis; Star, Kansas City; World-Herald, Omaha; Courier, Buffalo; Enquirer, Cincinnati; Gazette Times, Pittsburgh; Banner, Nashville. Proof of insertion guaranteed or money refunded. 56 page rate Book and Atlas sent free. Frank W. Lenhoff Advertising Agency, 600 North Michigan Blvd., Chicago. (Established 1897.) Chicago's Most Progressive Advertising Agency.

A TEN Dollar Ad may put your proposition over. \$10 pays for a 4 line 24 word classified ad one Sunday in 8 of the largest newspapers. Reach over 6 million readers. Minneapolis Tribune, Buffalo Courier, Detroit Free Press, Kansas City Star, Pittsburgh Press, Indianapolis Star, Atlanta Journal, Cincinnati Enquirer. Free catalogue showing other lists of newspapers and magazines sent on request. Ankrum Advertising Agency, 22 West Jackson Blvd., Chicago. Largest classified advertising agency in the world.

ADVERTISE in 24 Big Sunday Newspapers, 24 words \$15.00. Excellent for securing Agents, Salesmen, and Business Opportunities. Catalog listing 1,000 leading Dailies, Weeklies, Mail Order Magazines, Everything. Free. Wade Advertising, Baltimore Bldg., Chicago.

ADVERTISERS: One Inch Display Ad, 88 magazines, \$15.00. Free Sample magazine. Waring Advertising Co., Dundee, Mich.

ADVERTISE 50 magazines \$4.00 inch; three \$8.00; circulation proven. King, Box 672P, Wilmington, Del.

LOWEST Rates. New Catalog. Owl Agency, Times Bldg., New York.

NEWSPAPER — Magazine advertising—Classified, mailorder, Catalog. Martin, 276B West 43rd, New York.

SIX Word Line—355 rural weeklies \$3.55. Admeyer, 4112-M Hartford, St. Louis.

FOR ADVERTISERS

ADVERTISERS: Did you notice the large increase in the circulation of Opportunity Magazine? They and others are having a great success with the Mailing List we furnish them. Our "ad" in Agents Column brings us over 500 replies a month. Let us furnish you a trial 1000 of these addresses typed to you for \$2.00. You will have the same success. Master Card Co., 820 Chestnut, St. Louis.

25 WORDS 375 weeklies \$25. Monroe Agency, Jerusalem, Ohio.

I WRITE letters, folders, booklets, complete followup for manufacturers, mail order dealers. Long experience. Write for details. L. Taylor, 201 S. Day, Rockford, Ill.

PSYCHOLOGY names (liberal buyers), thousand, \$5.00; thousand circulars mailed, \$3.00. Co-operators wanted. Popular Science, 430-OP Milwaukee Ave., Chicago.

ADVERTISE in 275 country newspapers, 28 words, \$10. Keator, Hartford Bldg., Chicago.

CUTS, Drawings \$1.50, Window Cartoons, 6, \$1.50. GPO, Bx471, New York.

40 WORDS insert 50 magazines \$2.00. Empire Agency, Shawano, Wis.

SALES PROMOTION

FOR every one person who reads magazine advertising, there are five who will read a good sales letter. Dudley Bunn, Advertising Service, Savanna, Okla. Sales Letters a Specialty.

THREE Resultful advertisements written for your business. \$3. Prize Winner Payne, 728 Chronicle Bldg., Houston, Tex.

\$50 TO \$50,000 Daily Sales Developed During 28 years for clients by our direct mail plans, copy, campaigns. One product, 1923, an idea: this year \$100,000 orders booked. Fifty year old concern desired 50 national representatives in 1925; we produced 40 in three months. 700 dealers in 10 months at \$3 each, for another. Ten years Sales Promotion Manager Larkin Co. Submit sales problems for Free diagnosis. James C. Johnson, 118A Woodbridge Ave., Buffalo.

LETTER SPECIALISTS

POWERFUL Literature! Famous for famous results. Reasonable rates. Finkel-Advertising, 15P Fairview, Jersey City, N. J.

AUTOMOBILE SUPPLIES

NOB-URN, the Beautiful and Useful Gear Shift Ball, not just another ball, but a combination Ash Receiver, Cigar Holder and Gear Shift Ball, all in one. Finished in the following colors: scarlet, maroon, green, blue, orange, and cream. This Nobby Ash Tray can be installed, in place of ordinary ball, in a few seconds. Postpaid \$1.00. Send make and year of car, also color wanted. Agents Wanted. Fisher & Rockwell, 7740 South Chicago Ave., Chicago, Ill.

NEW Generators, Magnets, Carburetor, Electrical Equipment, Bearings, and everything in Automotive Equipment and Parts. Write for 150-page illustrated catalogue of bargains. Leterstone Sales Company, 2515 Wabash Ave., Chicago, Ill.

BRAKE Tester to test 2-&-4 wheel brakes. \$2.00. Walert Co., 1495 10th St., Milwaukee, Wis.

AMAZING Invention, Simple, Lasting, Scientific. Literature free. 3 Pair mailed \$1. Reynolds Glare Eliminator, Madison, So. Dak.

YOU Are Wanted to Resilver Mirrors at Home. Immense profits plating autoparts, tableware, etc. Write for information. Sprinkle, Plater, 77, Marion, Ind.

WHOLESALE Prices on Tire and Battery Shop supplies and equipment. Send for our new catalog, stating in what business you are interested. Adams-Barr, Columbus, Ohio.

AT Last! Reasonably priced Auto Emblems for every Lodge. Sells for only \$1.25. Write for attractive selling proposition and free Sample Case offer. North Central Distributors, Dept. 9, Ashland, Ohio.

VULCANIZING Auto Tires is a Paying Business. We have plants near you from \$50 up. Catalog Free. Instruction Book \$1. Equipment Exchange, 108 East 11th, Los Angeles, Calif.

KEY Container, for auto keys. Knife shaped. Keys fold like knife blades, \$1.00. Keifers, Fifth and Lehman, Lebanon, Pa.

WE Need Reliable Men to Demonstrate the Marco Contact Arm for Chevrolets. Prevents back fire, gives smoother performance and more speed. Price \$1.00. Marion Manufacturing Co., Hannibal, Mo.

RADIATORS at wholesale prices. All standard makes, Satisfaction guaranteed. Send for prices, stating make and model. Independent Radiator Co., 1119 S. Wabash Ave., Chicago.

FAST selling accessory! County, State distributors and agents wanted. General Products, 415 Plymouth Building, Minneapolis, Minn.

42.8 MILES on 1 Gallon. Wonderful Moisture Gas Saver. All autos. 1 free. Critchlow, D1-805, Wheaton, Ill.

AUTOMOBILE SERVICE EQUIPMENT

EIGHT-HOUR Battery Charging offers big opportunity. Let me tell you how you can install equipment with practically no investment and make big money. Bargains in used outfits. Write today. L. C. Helmick, Box M1073, Troy, Ohio.

BUILD Business with the best of air service. Brings car owners to your door—no matter what branch of automotive service. Costs less to operate than any other. Easy, pay-for-itself terms. Free Trial. W. E. Jordan, Box M1075, Troy, Ohio.

AUTOMOTIVE Electrical Service with low priced testing equipment pays big profits. Small down payment brings-it—pays for itself with handsome income besides. Write for details, no obligation. E. C. Galbreath, Box M1074, Troy, Ohio.

PAINT Spray Outfit on easy terms like rent. Profit on one job carries monthly payment. One man does 5 painters' work. Full information—no obligation. Write Hobart Industries, Box M1076, Troy, Ohio.

AUTOMOBILES

PATENTS. Time counts in applying for patents. Don't risk delay in protecting your ideas. Send sketch or model for instruction or write for free book "How to Obtain a Patent" and "Record of Invention" form. No charge for information on how to proceed. Communications strictly confidential. Prompt, careful, efficient service. Clarence A. O'Brien, Registered Patent Attorney, Security Bank Building (directly across street from Patent Office), Washington, D. C. See pages 156 and 157.

FOR FORD OWNERS

KEEP your Ford Motor in shape. Stop repair bills. Keep oil clean. Three vital points. Murray's Oil Strainer helps in all. Saves much time and from \$2.00 to \$5.00 every six months. You install in five minutes. By mail, \$1.00. Try thirty days; return if not satisfactory and price refunded immediately. Good Agent's Proposition. Murray, 828 Fern Street, New Orleans, La.

VENTED Spark Plug, with air valve; will not foul. \$1.50. Walert Co., 1495 10th St., Milwaukee, Wis.

42.8 MILES on 1 gallon. Wonderful Moisture Gas Saver. All autos. 1 free. Critchlow, D2-805, Wheaton, Ill.

UNDERSLUNG with "RKO" Swing Lo Irons. See "Red-i-Kut" ad page 160.

OLD Cars made selfstarting. Device \$10 delivered. American Simplex Co., Anderson, Ind.

MOTORCYCLES, BICYCLES AND SUPPLIES

BICYCLES, Tandems, Tricycle delivery, reducing machines. McDougald, 175 W. Lake, Chicago.

MOTORCYCLES \$50.00 each. All makes; they run; send cash; ride. Others \$75, \$100, \$150, \$200. Rebuilt Hendersons \$300. Look like new. John F. Ballak & Co., 100 N. 12th, St. Louis, Mo.

MOTORCYCLES at Reduced prices. Save 25% to 50%. Send for our Bargain Bulletin. American Motor Cycle Company, 2041-2047 Chicago Ave., Chicago.

GOOD Second Hand Parts for Indian, Harley, Henderson, Ace and Excelsior Motorcycles. No Junk. Ship C. O. D. No Lists. J. B. Dahl, 3661-63 Archer Ave., Chicago, Ill.

MOTORCYCLE Bargains. Used, rebuilt. Guaranteed. Shipped on approval. Catalog free. Floyd Clymer, 810 Broadway, Denver, Colo.

AVIATION

EAGLEROCK, government certified safety airplane at \$2,475. Denver or may be purchased on time payments. Pilots pay as they earn. Low charge for student instruction. Write for new complete course Airplane operation "Modern Flight." One Dollar. Alexander Aircraft Company, 3333 S. Broadway, Denver, Colo.

FLY! Build a Sport Monoplane that will really fly. My booklet tells you how to design it, build it yourself, and fly it. Price, \$1.00. T. A. Hodgdon, 324 Bay St., Springfield, Mass.

LEARN to Fly! \$100.00 including Solo. We guarantee to solo you regardless of the number of flying hours required. Our instructors are ex-army aviators and air-mail pilots with wide experience. Our training equipment is the best obtainable. Our course requires about two weeks, depending on the individual. No bond required, no charge for breakage. Eight years without an accident, 76 students graduated in 1925. Commercial aviation is a rapid growing industry. Don't delay! Enroll now in one of the oldest and best known flying schools in America. Write for booklet. Robertson Aircraft Corporation, operators of the United States Air Mail, St. Louis-Chicago, Lambert-St. Louis Airport, Anglum, Mo.

AEROPLANE, motor-boat Engines. Monoplane, biplane, JN4D, C wings. Fuselages, Parts. Russell Free, Richmond, Ind.

AIRPLANES, flying boats, motors, aircraft supplies, 130 hp. Clerget motors \$150, 100 hp. Gnome motors Florida \$75. White cloth helmet \$2.75; leather helmet \$3.75; wide-vision non-shatterable goggles \$4.00; oval \$2.50. Everything for aircraft. Logan Aviation, 716 W. Superior, Cleveland.

LEARN Aviation! Earn your way if you lack the cash. Varney Aircraft Co., Peoria, Ill.

CLASSY racing planes; 30", 75c; 24", \$1. Exceptional fliers. Marx Aircraft, 668 E. 8th South, Salt Lake, Utah.

LUXOR goggles made with optical precision. Used by foremost aviators; U. S. Army and Navy pilots. Endorsed by Col. Lindbergh, Com. Byrd and others. Also worn by automobile and motorcycle racing drivers. Noted for clear vision and comfort. \$6.75 up. Special U. S. Air Service Model \$10.75. Write for circular. E. B. Meyrowitz, 520 Fifth Avenue, New York.

LEARN To Fly at New York's nearest airfield. Teterboro Airport. Home of Fokker Aircraft Corp., Atlantic Aircraft Corp., Wright Aeronautical Corp., Colonial Airlines, Inc., Clarence Chamberlain and our own factory. Address, School Division Gates Flying Circus, Lodi, New Jersey.

LEARN To Fly in Chicago—the world's greatest aviation center. Now is the time to get in on this big new enterprise. We teach you to fly in a few weeks and make you a competent pilot. Licensed instructors, modern planes, all equipment furnished. Special money saving proposition to those who answer this advertisement. Room 1357 A, 122 South Michigan Ave., Chicago, Ill.

AVIATION'S Best and cheapest home study, ground school course. Ten Dollars, or write, Romy National Aeronautical Service, Box 43, Santa Monica, Calif.

THE American School of Aviation announces a new correspondence course in Mechanics of Aviation. A thorough training in Practical Aeronautics. American School of Aviation, Dept. 1861, 3601 Michigan Ave., Chicago, Ill.

DICTIONARY of Aviation, \$3.90. Languages Publishing Company, 15 W. 18th Street, New York.

BLUEPRINTS, Prices reduced. "Aerodrive" boats, sleds. Blueprints only 50c each. Ostergaard Aircraft, 4305 No. Narragansett, Chicago.

SEND dime for 12 inch mounted propeller and circulars on free three foot model aeroplane. No selling. Aero Shop, 3050 Hurlbut Ave., Detroit, Mich.

BIGGEST, Best Catalog Model Airplanes, Parts Supplies; 5c postpaid. Ideal Company, 165½ Spring Street, New York.

A JOB for you while you learn to fly. We can arrange employment for fifteen young men in an aircraft factory which will pay enough for room and board while taking their course. Permanent employment if you make good. 15-hour course \$250. Porterfield Flying School, 2330 Harrison Street, Kansas City, Mo.

SPORT Plane builders. Send one dollar for booklet on Nomenclature, Stability, Controllability, Design, Charts, Illustrations, etc. Donald Smith, 1247 Loma Vista Drive, Long Beach, Calif.

IF you would get into the game of our new way to fly, write F. O. Parsons, Indianola, Iowa.

"PULL-ME-CAR" Monoplane. \$1.25 pre-paid to any address. Realistic durable replica. Beautifully lacquered. An action toy. Every boy wants one. Rew Troxell, 915 West 39th St., Los Angeles, Calif.

PATENTS. Time counts in applying for patents. Don't risk delay in protecting your ideas. Send sketch or model for instruction or write for free book "How to Obtain a Patent" and "Record of Invention" form. No charge for information on how to proceed. Communications strictly confidential. Prompt, careful, efficient service. Clarence A. O'Brien, Registered Patent Attorney, Security Bank Building (directly across street from Patent Office), Washington, D. C. See pages 156 and 157.

BUILD your own Sport Monoplane. Blueprints and Instructions, \$2.50. Allison Airplane Co., Lawrence, Kans.

SET Absolutely new wings for Heath monoplane crated for shipment \$20.00. If you are building one save money. Curtiss Jenny new wings used engine ready to assemble \$450.00. Time payments. New Curtiss propeller tipped boxed \$3.00. Midway Aero Co., Box 283, St. Paul, Minn.

BOOKS AND PERIODICALS

"CASHING In On What You Have," a serial article by Clarence A. Hough, famous industrial writer, beginning in the Sept. issue of Manufacturers News, contains best possible advice for the ambitious. Many other valuable features in same number. Send 35c in stamps for a copy or \$1.00 for series of four issues. Manufacturers News, 231 S. La Salle St., Chicago.

1927, **THIRD** edition revised. "Radio Theory and Operating," by Mary Texanna Loomis, President Loomis Radio College; member Institute Radio Engineers, 886 pages, 700 illustrations. Used in all Government and private radio schools, many colleges and high schools. Comprehensive, up to date, the standard on radio. Price \$3.50, postage paid. At your book store, or order direct from Loomis Publishing Company, Dept. M., 405 Ninth, Washington, D. C.

"THE Personal Liberty Course"—A clever combination of mirth, information and instruction for quickly overcoming fear, bashfulness and physical complexes in men. No drugs, no gymnastics. Full particulars free, sealed. The Gardener Pep Club, Lock Box 607, Station C, Los Angeles, Calif.

MODERN, Worth while books on health, diet, life, love and all kindred subjects of special interest to adults; 2 sample books and catalog 25c. The National Booksellers, Owosso, Mich.

"WHERE'D Cain Get Wife?" 15 pages 20c. Jabe Studio, Kansas City, Mo.

MESMERISM, Mindreading, 25c copy; both, 40c. Housinger, 8236 Cornell, Chicago.

WANTED—Books on Business subjects. Send stamp for exchange list. Orion Smith, 566 Sheridan, Rockford, Ill.

SELF-STUDY—Marr's Light Line Short-hand and Simplified Bookkeeping, 50c. Teacher, B605, Nashville, Tenn.

AUTHORS, write for circular "Cooperative Book Publishing." Meador Publishing Company, 27 Beach, Boston, Mass.

INDUSTRIAL Alcohol, Wright's book. Full directions for making, fully illustrated. \$2.50. Spon & Chamberlain, 120 P.M. Liberty Street, New York, N. Y.

PAINTERS, Decorators, Artists—Books 10c up. Circulars free. King, Box 1482, Indianapolis, Ind.

"HOW To Box." Book leading sportsmen indorse. 30c. Otto Regling, 251 Pacific St., Jamaica, N. Y.

HYPNOTISM wins Health, Wealth, Fame, etc. 25 Easy Lessons and 248-page illustrated reference guide \$2.00. Popular Science, 430-OP Milwaukee Ave., Chicago.

PICTURES AND POSTCARDS

JOIN Live Postcard Club; Membership lists including Catalog, 10c. Harvey Teeple, Decatur, Ind.

20 **CEYLONESE** Girl Models. Dollar bill, Art Photo Galleries 10, Temple Road, Colombo, Ceylon.

FREE—True-Blue Book. Exchange postcards, stamps. Ericson, Elroy, Wis.

ART Pictures, Books and Novelties. Catalog 10c. Howard Sales Co., Dept. 15, 1188 Folsom St., San Francisco, Calif.

FREE—Send address for beautiful 5x16 art print. C. C. Dry, 1112½ 21st N. W., Canton, Ohio.

POST-CARD views of the Panama Canal during Construction days, 25 assorted for \$1.00. W. Ramey, Box 571, Cristobal, Canal Zone.

MAGIC TRICKS, BOOKS AND JOKER NOVELTIES

NEW 1927 "Fun—Magic—Mystery" now ready. 100 Pages, profusely illustrated. Over 750 Tricks—Illusions—Jokes—Puzzles—Books—European Novelties, at Reduced Prices. Postpaid 10c. Lyle Douglas, Station A, Dallas, Texas.

MAGIC—Tricks, Books and Supplies. For Amateurs as well as the great professionals. Anyone can learn through our instructions. Feature Acts in Mind-Reading, Spiritualism, Rope Ties, etc. Large illustrated Professional Catalog, 20c. Chicago Magic Co., 140 So. Dearborn St., Dept. B, Chicago, Ill.

LOOK Here! Wizard's Manual Collection contains the valuable secrets of ventriloquism, hypnotism and mind reading; 22 tricks fully explained, 8 songs, 21 puzzles and problems, 10 funny readings and 57 valuable money making secrets; all for 15c postpaid. Benedek, 2300 Mason, Chicago.

SEVEN Magical Delusions and Catalogs—25c. Gilmagico, Morgan Park, Ill.

MAGICS, Novelties, Etc. Magical Sensation; Lighted Cigarette through handkerchief, 50c; Card trick and list, 10c. Swivel, 114 Huntington, New Brunswick, N. J.

CARD Tricks, Coin Trick, Hypnotism, Ventriloquism. 64-page books. Complete guides 10c each. Geo. Fenner, 2401 Jefferson, Louisville, Ky.

ILLUSION Catalog 10c. Magic Catalog 7c. Lynn's, 105 Beach, Jersey City N. J.

MAGIC Trick Cards That Are Absolutely guaranteed. Free samples. Write me today. C. D. Blankenship, Adrian, W. Va.

FREE with \$25 order die box. Send 20c for our large catalogue of tricks, wigs, sensational escapes. Oaks Magical Co., Dept. 548, Oshkosh, Wis.

ELECTRIC Fun! Seventy stunts, 110 volts, \$1. Tacutting, Campbell, Calif.

GAMES, ENTERTAINMENTS AND PLAYS

PLAYS, Musical comedies and revues, minstrel music, blackface skits, vaudeville acts, monologs, dialogs, recitations, entertainments, musical readings, stage handbooks, make-up goods. Big catalog free. T. S. Denison & Co., 623 So. Wabash, Dept. 11, Chicago.

VENTRILLOQUISM taught almost anyone at home. Small cost. Send 2c stamp today for particulars and proof. George W. Smith, Room S-215, 125 N. Jefferson Ave., Peoria, Ill.

BOYS! Boys! Look! Big illustrated catalogue of Tricks, Puzzles, Novelties, Jewelry. Send 10c for your copy today. Sincere Studios, 24 E. 21st St., New York, Dept. 10.

PUZZLE catalogue and leader free. B. Z. Puzzles, Fairview, Mass.

100 **LIGHTNING** Chalk Talk Stunts \$2.00. Cartoonist, 2925 Euclid, Kansas City, Mo.

NOVELTIES, CURIOS, ETC.

BLOW Rings with your cigar, pipe or cigarette. A knockout. Smoke Ring Blower 25c each. F. Kelly, 3438 Minnesota Ave., St. Louis, Mo.

MEXICAN Jumping Beans—Nature's Greatest Curiosity, 3 for 25c; 20 for \$1.00. Swinden Supply Co., Tilton, N. H.

STAMP COLLECTING

\$5.00 **IN** rare stamps for 34c! To introduce Park Approvals by Countries, we offer a collection of 34 different stamps from Costa Rica, Crete, New Guinea, Gold Coast, North Borneo, old Newfoundland, Siam, Fiji Islands, etc. All genuine, catalogue over \$5.00, for only 34c! Money back if not delighted. Packet specials. All stamps different. Amazing value. 50 Soviet Russia (cat. \$3.40), 36c; 16 ship stamps, 10c; 23 aeroplanes, 16c; 15 Congo, 20c; 10 Crete, 15c; 25 Egypt (cat. 75c.), 16c; 10 German Colonies, 20c; 10 Epirus, 15c; 10 Iceland, 12c; 10 Siam, 15c. Entire 10 packets (cat. over \$8.00)—Only \$1.50! Park Stamp Co., 589 Beacon St., Boston, Mass.

500 **DIFFERENT** Stamps for 25c! Big Collection 500 Different Stamps from Bosnia-Herzegovina, Crete, Epirus, Hong Kong, Iceland, Kenya and Uganda, Liberia, Malta, Nyassa, Tanganyika, Wallis, and Futuna, Zanzibar, and other "hard" countries. Catalogue value \$10.00. Price only 25c to Approval Applicants! Special Bargains: 1,000 different 79c; 15 triangle stamps 49c; 100 Africa 50c; 100 Asia 60c; 100 Balkan States 35c; 100 British Colonies 25c; 100 French Colonies, 30c; 100 Portuguese Colonies 50c; All 8 packets for \$3.00! Illustrated Lists Free. Loma Stamp Co., 3928 32nd St., San Diego, Calif.

ANCHERS \$\$\$ Outfit—only 12c! Fine triangle stamp; set German stamps with (pre-war) value forty million dollars (interesting!); perforation gauge, mme. scale; small album; airmail set; scarce stamp from smallest republic on earth; newspaper set; packet good stamps from Travancore, Malay, Dutch Indies, etc. Entire outfit for 12c to approval applicants! (Nice pocket stock book, value 25c, with every order!) Ancher Stamp Co., 148½ Clerk St., Jersey City, N. J.

MYSTIC'S "Queer Country" Packet! Contains scarce stamps from the following strange lands: San Marino, Antioquia, Congo, Cyprus, Fiji Islands, Gwallor Hyderabad, Iceland, Jhind, Kenya, Uganda, Lebanon, Monaco, North Borneo, Nyassa, St. Thomas Prince, Port. Guinea, Siam, Sierra Leone, Tanganyika, Trinidad Tobago, Ubangi, Upper Volta, Wallis Futuna, Zanzibar. Get this wonderful packet of "freak countries" and make your friends envious! Price only 10c to approval applicants! Write today. Mystic Stamp Company (Dept. 8), Camden, New York.

\$1.00 FREE. Black U. S. Postage. Given Away with each order. Pioneer Stamp Album with 500 illustrations. 150 different stamps from 40 countries, Syria, Lebanon, Hejaz, Liberia, New French Colonies, British, Portuguese Colonies, South Africa, Australia, 500 hinges. 36 page illustrated catalogue. All for 15c. Big Commission to Agents for the Best approval sheets of stamps ever offered. Write for sample outfit. Hussman Stamp Co., Dept. M, 629 Olive St., St. Louis, Mo.

WONDERFUL collection 205 different stamps from Gwallor, Haute-Volta, Kouang-Tcheou, St. Thomas, South Africa (Springbok), and other "hard" countries; fine triangle stamp; package hinges; millimetre scale, ruler; copy largest stamp in the world (China "Wild Goose," cat. 40c!); big illustrated lists. Total Value \$4.50. All for 10c! Also approvals. Indian Stamp Co., 103 Howard St., Bangor, Maine.

CANADIAN Confederation Jubilee stamp, 5 Newfoundland and bargain lists free with 25 different Canadian for only 10c if you ask for approvals. Victoria Stamp Co., London, Can.

MAGNIFICAROCIOUS Packet foreign stamps, beauties from distant lands. (Many richly colored, unusual designs!) free for 2c. Gray Stamp Company, Toronto, Can.

105 DIFFERENT from 35 countries 6c to those requesting approvals. 1,000 mixed 25c; 100 different Central and South America 60c; 15 Triangle stamps 47c; 100 French Colonials 30c; 50 Japanese 35c. P. M. Glendale Stamp Co., 1342 Linden Ave., Glendale, Calif.

70 DIFFERENT Foreign Stamps from 70 Different Foreign Countries, including Africa, Asia, Australia, Europe, West Indies, etc., for only 16c. Free with each order, our pamphlet which tells "How to Make a Stamp Collection Properly," together with our price lists of albums, supplies, and hundreds of bargains in sets, packets, etc. Queen City Stamp & Coin Co., Room 36, 604 Race Street, Cincinnati, Ohio.

FREE stamps to new customers. Valley Stamp Company, 3128 Texas, St. Louis, Mo.

EXCHANGE your duplicates at only 25% discount. Stamp Exchange, P. O. Box 396, St. Louis, Mo.

50 DIFFERENT Rare Greek stamps, catalogue over \$3.00, only 27c. Reliant Stamps, 65 Nassau, New York.

VERY Special—500 Different 25c, 1,000 different 75c; 50 varieties U. S. postage, 30c. To approval applicants only. Cleveland Stamp Co., Caxton Bldg., Cleveland, Ohio.

\$10.00 FOR 25c. A choice assortment of 500 all different stamps guaranteed to catalogue over \$10.00, offered to approval applicants for only 25c. Edgewood Stamp Co., Milford, Conn.

25 DIFFERENT Airmail Stamps, with approval selections, 16c. C. Owens, Box 43, Philadelphia.

PICTURESQUE French Colonial Stamps, 25 different 9c—100 diff. 42c. Mountain City Stamp Co., Box 335, Mannington, West Va.

1000 DIFFERENT foreign postage stamps, cataloging \$25.00 for 60c, together with a selection of pretty approvals. 500 different cataloging \$10.00 for 10c. Rotnem Stamp Co., 809 N. W. Bldg., Minneapolis, Minn.

100 DIFFERENT U. S. 25c. Tausig, 2701 Ave. J, Brooklyn.

100 DIFFERENT Stamps Free to Approval Buyers. Postage 3c. Write now. Wineholt Stamp Co., Woodbine, 26, Penna.

87 FAR-OFF Countries!! Georgia, Indore, Jhind, Sudan, etc. Marvellous packet 87 different stamps from 87 different countries; many "scarce" ones. Only ten cents! Also bargain lists and approvals. C. D. Reimers Company, Fort Worth, Texas.

BEST one-cent approvals in America. F. P. Hand, 1117 So. 60th St., Phila., Pa.

WANTED to Exchange—Australian and New Zealand stamps with collectors in all parts of the world. J. H. McDonald, Taradale, New Zealand.

SIXTY Different United States 15c. Premium with approvals. Prall, Somerville, New Jersey.

FREE! 110 different stamps to Approval Applicants, 2c postage. Paige Stamp Co., Oak Park, Ill.

FREE Premium for Stamp. Sanford Oare, Sta. H, Columbus, Ohio.

WANT to write to Foreign Countries? Want to swap stamps, letters, coins, pictures with people everywhere? Write us. Hobby News Exchange Club, Jacksonville, Fla.

FREE Premium to those requesting our approvals. Pine Tree Stamp Co., Box 150, Lewiston, Maine.

BEAUTIFUL set free! Bargain Approvals. Van's Stamp Company, Walla Walla, Wash.

POOLE'S United States Loose-leaf album. Highest awards six International Exhibitions. Price \$3.00, carriage paid. Descriptive list free. Poole, 629a Washington Building, Los Angeles, Calif.

FREE—100 different foreign stamps. Ioor 802, State Life Building, Indianapolis.

MINT! 101 varieties unused, 5c to approval applicants. Commonwealth Stamp Company, Box 1507, Boston, Mass.

GREAT Surprise Packet—4c postage. Monkey set 10c. S. J. Frey, 527 E. Market St., York, Pa.

NEWFOUNDLAND Postage Stamps—10 standard varieties \$1.00. Rev. Butler, St. Georges, Newfoundland.

FREE! Illustrated Bargain List. Premium cataloging 40c for names of two collectors. Penna. Stamp Co., Greensburg, Pa.

200 DIFFERENT Stamps, Zanzibar; Album, 12c. Liberty, 3974 Arsenal, St. Louis, Mo.

100 DIFFERENT stamps free to applicants for my 60% approvals. Reference required. Lists free. A. Frisch, 83-47 Victor Place, Elmhurst, L. I., N. Y.

FREE—True-Blue Book. Exchange stamps, postcards. Ericson, Elroy, Wis.

FINE Approvals, better prices. References please. Stamp Drawer, Rockville, Conn.

50,000,000 MARKS free to approval applicants. Alexander Stamp Co., 4725 Sheridan, Chicago.

FOREIGN Revenues, Telegraphs, Locals, envelopes, rolls, etc. pretty, different, cheap. Stamped Marine Policy free to applicants with references. Vanderhoof, 1114 Logan, Denver, Colo.

200 DIFFERENT stamps 10c; 1,000 Hinges 10c. R. H. Carlton, 380 W. So. Tennesse, Salt Lake, Utah.

110 NEW Europe All Different, a wonderful collection cataloging several dollars, free to collectors requesting our Net Approvals. Postage 2 cents. Badger Stamp Co., Milwaukee, Wis.

FREE Hungary Charity No. 565 to 567 and a surprise packet given to those requesting for my 1, 2, and 3c approvals, and also my 50% discount. Chas. W. Schmidt, P. O. Box 4832, Frankford Station, Philadelphia, Pa.

109 DIFFERENT, Arabia, Azerbaijan, Zanzibar, etc., 10c to approval applicants. Floyd Marsh, 524 Hamilton Ave., Indianapolis, Ind.

FRENCH Colonies, 25 different, 5 cents. Big lists free. Challenge Stamp Company, 425 McDonough Street, Brooklyn, N. Y.

OUR Latest 20-page U. S. and Canadian price list free. Stanley Gibbons, Inc., 37 Ann St., New York City.

STAMPS, 100 varieties, Africa, Brazil, Peru, Cuba, Mexico, etc., 10c; 25 different U. S., 25c; 1,000 mixed, 40c; 1,000 hinges, 10c. List free. C. Stegman, 5941 Cote Brillant, St. Louis Mo.

LIBERIA Snake Triangle and two other triangles in our packet of 53 genuine foreign stamps for five cents. Crowder Company, Waverly, Baltimore, Md.

READY October 24th, 1928 Edition Scott's Standard Postage Stamp Catalogue. This Edition is notable for many important price changes in many countries. Order your copy now. Bound in Cloth, \$2.00; Cloth with thumb index, \$2.50. Shipping wt. 3 lbs. For sale at all dealers. More than 1000 50% Approval Books. Tell us what countries you are interested in and we will send you a wonderful selection from our great library of 50% approvals. References if not known to us, please. Scott Stamp and Coin Co., 1 West 47th Street, New York, N. Y.

COVERTCO Packet, 250 varieties unused and used stamps 15 cents. Covert Stamp, 39 State, Rochester, N. Y.

BEAUTIFUL Picture Stamps Sent Free. Paul Cornish, Schenectady, N. Y.

50 DIFFERENT United States 10c. 60% approvals. Reference please. Seidenberg, Baroda, Mich.

FRENCH Colonies Free—Jungles, Tigers, Native Chief, 2c postage. Empire Stamp Co., Toronto, Canada.

MAP Stamps, 10 different, and a packet of animals, birds, scenery stamps, all for 10 cents to approval applicants. S. E. Saxe, 1427 N. 58th, Philadelphia, Pa.

150 UNUSED Stamps from Nyassa, Carinthia, Montenegro, Etc., Dime, Magnificent lot. Royal Stamp Co., Lebanon, Pa.

MINT—53 different unused stamps free to applicants for World-wide approvals. Postage 2 cents. Arthur Taylor, Box 560, Chicago.

GUATEMALA—15 var., 15c postpaid. Lists free. Allison, Angola, Ind.

COMPLETE Sets on approval. Obsolete Set free to applicants. Gopher Stamp Co., Canby, Minn.

MOST Sensational values; over 140 diff. Algeria, Airplanes, Azerbaijan, Barbadoes, Cameroun, Gabon, Guyane, Irish set, large French Colony packet, largest stamp, 40 year old U. S., gauge, etc., for 10c to approval applicants. List free. 100 diff. U. S. 25c—1,000 hinges 9c—50 Bavaria 7c. Hawkeye Stamp Co., Cedar Rapids, 39, Iowa.

CANADIAN—23 different only 10c and asking to see our Excellent Approvals; receive Beautiful Confederation Jubilee stamp, 5 Newfoundland and Bargain Lists free. Victoria Stamp Co., London, Canada.

FREE, 12 Diff. large, showy picture stamps for a request for my popular approvals. Premiums with every purchase. A. Bauer, Palmyra, N. J.

ANNIVERSARY Offer! Seven following sets: "Anniversary," "Jubilee," "Charity," "Airmail," "Eagles," "Prisoners," "Pictorialists." Four following packets: (British, French, Dutch Colonies), (Precancelists), (Bulgaria), (International) 15c to approval applicants. Deering, Fairmount, Marlborough, Mass.

24 VARIETIES Cuban stamps, 10 cents. List of 6,000 low-priced stamps free. Address Chambers Stamp Co., 111P, Nassau St., New York City, N. Y.

110 DIFFERENT Stamps, many unused, high values, free to collectors requesting our Net Approvals. Postage 2 cents. Christensen, Milwaukee, Wis.

APPROVAL applicants sending 2c for postage will receive five stock transfer slips containing United States and New York State Revenue Stamps. Herbert Keigwin, 192, Middletown, N. Y.

ONLY 5c! 10 Airmail stamps, including scarce Estonia triangle; Greece Red Cross set; packet fifty different stamps—all unused—from Guyane, Ubangi, etc. All for 5c! Approvals and free lists with each order. Curhan Stamp Company, Gloucester, Mass.

PREMIUM List and new offers for Stamp and References. Marney's, 400 Broadway, East St. Louis, Ills.

STAMPS, 100 all different, Postage 2c. Lists free. P. M. Quaker Stamp Co., Toledo, Ohio.

STAMPS sent on approval at 70% discount. Reference required. Emory Renoll, Hanover, Pa.

PENNY Approvals that Satisfy. Neil Gronberg, Box 5441, Philadelphia, Pa.

150 GOOD mixed foreign stamps, 3 cents. Stanton, Niantic, Conn.

THOUSAND Foreign Stamps, 50c; catalog free. Prof. McCreery, Chatham, Ontario.

1,000 DIFFERENT Fine Stamps, 69 cents. Approvals. Kenilworth Stamp Co., Ridge-wood, N. J.

105 CHINA, etc. 2c. Album (500 illustrations) 3c. Bullard, Sta. A, Boston.

RARE COINS

COINS, 3 different foreign coins, 4 different foreign Notes and Catalog 10c. Geo. Best, Cedar Rapids, Iowa.

OLD Coins Bought and Sold. Rare Coin Book 65c. 700 illustrations. Send 10c for Coin collecting booklet. Gutttag Bros., 16 Exchange Place, New York.

UNITED STATES and Foreign Money; Military Decorations Catalogue and Greek coin 10c. Alexis Mengelle, Colorado Springs, Colo.

UNITED STATES. Large Cent, two-cent bronze, three-cent nickel and Bargain List, 25c. Fifteen dates large cents, \$1.00. George Coffin, Greenwood Mountain, Me.

GET Profit and Pleasure in collecting Old Coins. Send 10c for Large Illustrated Coin Catalogue. You'll be delighted with it. Send for it right now. B. Max Mehl, Numismatist, Mehl Bldg., Dept. P, Fort Worth, Texas. Largest Rare Coin Firm in the U. S.

OLD Coins, Large fall Selling catalogue of coins for sale free. Catalogue quoting prices paid for coins, ten cents. William Hesslein, 101A Tremont Street, Boston, Mass.

CALIFORNIA Gold—Quarter Size, 27c; 1/2 size, 53c; 3c Piece and Catalogue, 10c Norman Shultz, Box 746, Salt Lake, Utah.

100 ASSORTED foreign coins and bills, \$1.00. Oddehon, Box 681, Kansas City, Mo.

50,000 COINS, medals, bills. Catalogue free. NAGY, 8 P South 18th, Philadelphia.

20 DIFFERENT Foreign Coins 43c. Greenclay, 1626 Washington, Denver, Col.

8 COINS 25c; list 4c. Brooks, 2725 1/2 Live Oak, Dallas, Texas.

COIN Guide and 100,000 mark note 25c. Durso, 25 Mulberry, N. Y. City.

CALIFORNIA gold quarter 27c; Half 52c; 1816 cent 40c; 1787 75c; Confederate \$100, 20c. A. Wylie, Wheaton, Ill.

HUNDREDS Bills, Coins, never sold in America. Catalog Hamburg City Bill 15c. Wacker-Diekman, Minster, Ohio.

\$2 TO \$500 Each Paid for hundreds of old and odd coins. Keep all old money, it may be very valuable. Send 10 cents for illustrated coin value book, 4x6. Get posted. Guaranteed prices. We buy and sell. Clarke Coin Office, LeRoy, N. Y.

40 OLD coins, all different, \$1.00. 25 different coins 50c. 100 Fine Mixed Coins \$1.25. Monroe Half-Dollar, Unc., \$1. 300 different Germany City Bills \$1.00. 300 different Austria War-Bills \$1.00. 60 different Germany Banknotes, 75c. Claud Denney, Box 315, Dallas, Texas.

FOR BOYS

PLAYHOUSE—Build Uncle Tom's Cabin of northern Wisconsin timber, \$2.00 Make money. Lee Henderson, Stanley, Wis.

EARN Christmas Money. Order 50 Sets Christmas Seals. Sell for 10c set. When sold return \$3.00, you keeping \$2.00. No Work—Just Fun. St. Nicholas Seal Co., Dept. 43PM, Brooklyn, N. Y.

CAMERAS AND PHOTO SUPPLIES

PHOTOGRAPHIC equipment and accessories of every description are listed and illustrated in our 228-page catalog. It will pay you to secure a copy which is issued free, as our prices are low. We also deal in used goods which are sold under the same guarantee as new goods. Ask for our Bargain Book. Central Camera Co., Dept. E122, 112 S. Wabash Ave., Chicago, Ill.

PROFITABLE Photography: Twenty-five practical methods of making money with your camera. The Photo-Miniature No. 197, 40 cents. Tennant and Ward, 70 Fifth Avenue, New York.

TRANSFER Photographs to metal, china, etc. Patented process. Makes beautiful miniatures. A real art. Lots of fun and profit. Anyone can do it. Outfit supplied to members only. Write about membership. Kyograph Photo System, 21-c W. 17th St., New York.

HAVE You a Camera? Write for Free sample of our big magazine, showing how to make better pictures and earn money. American Photography, 116 Camera House, Boston, 17, Mass.

EARN big money with your camera in your spare time, using Hallidorsen Home Portrait Lamp. Write for booklet "Home Portrait Photography" and catalog—both free. The Hallidorsen Company, 4747 N. Western Ave., Chicago.

KODAK Film—Special Trial Offer—Your next roll developed 5c, prints 3c each. Beautiful 6x10 mounted Enlargement 40c. Fleet Photo Service, 425 G St., N. W., Washington, D. C.

MAKE money in Photography. Learn quickly at home. Spare or full time. New plan. Nothing like it. Experience unnecessary. American School of Photography, Dept. 3432, 3601 Michigan Ave., Chicago.

BIG Money Saved on Photographic Lenses and Apparatus—goods exchanged; repairing done. Ralph J. Golsen, 1128 Argyle St., Chicago. Dept. P.

FILMS Developed. Special Trial Offer. Any Size Kodak film developed 5c, prints 3c each. Trial 6x10 Enlargement in handsome folder 40c. Overnight Service. Roanoke Photo Finishing Co., 209 Bell Ave., Roanoke, Va.

MOTION PICTURES

\$1,250.00 FOR a Photoplay Story by an unknown writer and sold through our Sales Dept. We revise, copyright and market. Located in the heart of Motion Picture Industry, we know the demand. Established 1917. Send Manuscript for free criticism. Booklet on request. Universal Scenario Company, 206 Western and Santa Monica Bldg., Hollywood, Calif.

WANTED to Buy—Second-Hand Power's, Simplex and Motiograph Machines. Also extra mechanisms and stands. Must be bargains. P. O. Box 202, Birmingham, Ala.

SEND 10c in stamps for the 1928 edition of the famous Bass Book of Cinema Apparatus, greater than ever. Send \$2.00 for catalog and new book on "How to Make Motion Pictures," by Cameron. Bass Camera Company, 179 West Madison St., Chicago.

BARGAINS, Machines, Films, Supplies, Stereopticons. National Equipment Co., Duluth, Minn.

NEW \$150 Spring Motor Camera \$37.50; Home Projector, \$25; Movie Printer, \$25; Developing Outfit, \$20; 16 millimeter Movie Camera, \$50; Projector, \$50. All new 16 millimeter cameras and projectors and films at reduced prices. Cameras, Projectors and Films bought, sold, exchanged and rented. Negative film 2 1/2c foot. Kodak bargains. Ray, 294 5th Ave., New York.

POWER'S 6A Motor-Drive Motion Picture Machine, with 60-cycle compensator; good condition. Price, \$125. Albee, 3 Dusenbury Place, White Plains, N. Y.

FILMS for Toy Machines, Cartoons, Comedies, Westerns. Free List. Alton Films, 205 Brush Creek, Kansas City, Mo.

FILMS and Machines, dirt cheap. Stamp for lists. Box No. 5836, Westport Station, Kansas City, Mo.

BARGAINS—Theatre and Road-show machines, films and accessories. Box No. 481, General Postoffice, New York.

MAKE Movies! Make Money! with the Real Professional Institute Standard Motion Picture Camera—the kind used by largest studios. 200 and 400 feet film capacity. F3.5 lens. Ideal for educational, Industrial and News film. Free Booklet sent. New York Institute of Photography, Dept. 9, 14 West 33rd St., New York.

NEW and Rebuilt Projectors for Theaters, Schools, Churches, Traveling Shows. Supplies and Complete Theater Equipments. Bargain Prices. Free Catalog. Monarch Theatre Supply Co., Memphis, Tenn.

FILMS: \$3.00 per reel up. Comedy, Western, Cartoon, Drama, Serial, Educational, Special Features. Best Movie Stars. Free List. Toy Film 200 Feet Postpaid \$1.50. Dixie Film Co., Box 2042, Memphis, Tenn.

COMEDIES, Westerns, \$2.50. Professional Camera \$89.00. Stewart Marshall, Rome, Ga.

MOVIE Films, 1,000 ft. reels, \$2.50 each; shipped anywhere on receipt of remittance. Particulars on request. Independent Films, 177 Golden Gate Ave., San Francisco, Calif.

1000 FEET of Comedy, \$2.00. No lists. Sunset Film Exchange, 298 Turk St., San Francisco, Calif.

SCENERY TO RENT

WORLD'S Most Beautiful Settings for operas, plays, minstrels. Amelia Grain, Philadelphia.

EDUCATIONAL AND INSTRUCTION

AMATEUR Cartoonists: Make money in spare time with new cartoon selling plan. Write Smith's Service, PM1194, Wenatchee, Wash.

STORY Ideas Wanted for photoplays, magazines. Big demand. Accepted any form for revision, development and submission to markets. Established 1917. Send manuscripts for free criticism. Booklet mailed on request. Universal Scenario Company, 403 Western and Santa Monica Bldg., Hollywood, Calif.

HANDBOOK of Useful Facts and Information, containing Key to High School Home Study Course, memory, fasting, heredity, will power, magnetic personality, sleeplessness, etc. Single copies 25 cents; wholesale prices to mail-order dealers. Eugene Fenn, Box 473, St. Louis, Mo.

GO Into Business. Be a Commercial Printer. No experience required. Details sent free. Ackerman's Commercial Press, Dept. 25, 78 Downs St., Kingston, N. Y.

SHOWCARD Course, 90 Alphabets, 100 examples, \$1.00 complete. Used New York Schools. Satisfaction guaranteed. Stamps accepted. Educator Press, 19 Park Row, New York. Dept. P. M.

BIG Money in Hat Renovating. Learn this profitable trade in a few weeks. Uncrowded field. Write for particulars. Walter A. Hugo, Dept. 24, 212 de Young Bldg., San Francisco.

DRAW Comics! Ten complete lessons, \$1 postpaid. Circular free. Carlson Cartoon Service, Dept. M, 116 West 39th Street, New York.

EARN Increased Income while you learn Landscape Architecture. Profitable profession easily acquired by correspondence. Write today free literature. National School of Landscape Design, 504 1/2 Equitable Bldg., Des Moines, Iowa.

FIREMEN, Brakemen, Baggage men (white or colored), sleeping car, train porters (colored), \$150-\$250 monthly. Experience unnecessary. \$10 Railway Bureau, East St. Louis, Ill.

BEGINNERS prepared for positions in hotels. Carolinas, Bermuda, Florida. Write Lee Hotel Institute, Drawer 1508, Boston.

START your own Business. Learn Interior Home Decorating, Repaint—Retrim old cars. Liknu, manufacture automobile specialties. Unlimited Demand. Learn while you work at home. De Wilde, Sheboygan, Wis.

EARN \$25 weekly, spare time, writing for newspapers, magazines. Experience unnecessary. Details Free. Press Syndicate, 981 St. Louis, Mo.

USED educational matter sold on repurchase basis. Also rented and exchanged. Money-back guarantee. Catalog free. (Books, etc. bought.) Lee Mountain, Pisgah, Ala.

DOUBLE Entry Bookkeeping mastered in 60 hours with 8 keys; guaranteed; diploma. International Bookkeeping Institute, Dept. 8, Springfield, Mo.

WORLD-ROMIC System, Masterkey 5,000 languages. Primers, \$1.98; Arabic, Chinese, French, German, Italian, Japanese, Russian, Spanish. Languages, 15 W. 18th St., New York.

RADIO OUTFITS AND SUPPLIES

LATEST three-tube circuit and construction data, 25c. Equals six tubes. Radioman, 4528 Adams Street, Chicago.

GUARANTEED "Pocket" Radio \$3.85 complete. No accessories required, everything built-in. Useful and practical. Order direct today. Spencer Laboratories, Akron, Ohio.

WANTED—Men to work with National Radio Service Organization. No selling scheme. Co-operative Radio Doctors, Dept. B, 131 Essex St., Salem, Mass.

20 TO 50% discount on standard makes radio receivers, speakers, chargers, eliminators. Mention your wants. Write Radioman, Lake, New York.

REPAIR Radios or burnt-out tubes. Simple instructions; either process \$1.00, both \$1.50. Duck Mfg. Co., Freeport, Ill.

CHOKE Coils 30H 60M.A. shielded \$2.25. Write for Radio Lists, Radio Parts Sales Co., Orange, N. J.

BARGAIN parts list Free. Sets \$4.95 up. Radio, C427 East 16th St., New York.

GENUINE Apollo \$2.50. Guaranteed UX201A tubes, prepaid, \$1.22; five, \$5.50. Gordon G. Atwell, Shreveport, La.

TRADE AND TECHNICAL SCHOOLS

NEW Scientific way to repair auto radiators. Simple, easy. Learn at home or our school. Complete instructions. Bixler Radiator Institute, Frankfort, Ky.

GET a Foreman's job in any trade. You will earn more money. Become an expert Blue Print Reader. You can do it in spare time. My training will advance you quickly. Write now—tell me what trade you want—I will send my plan at once. Carroll Rumsey, 265 Drexel Building, Philadelphia, Penna.

TELEGRAPHY—Both Morse and Wireless—taught thoroughly and quickly. Tremendous demand. Big salaries. Wonderful opportunities. Expenses low; chance to earn part. School established fifty years. Catalog free. Dodge's Institute, Fern St., Valparaiso, Ind.

LEARN Barbering at home. Practice on the family. Complete barber college instructions, home study, for \$1 bill or money order. Foster, Expert Barber, 6128 Michigan Blvd., Chicago, Ill.

YOUNG Men may prepare at home for positions \$40 to \$100 weekly. Write for particulars and catalog of our Extension Course. (It is not a correspondence course.) Loomis Radio College, Dept. 5-E, 405 Ninth, Washington, D. C.

BUSINESS OPPORTUNITIES

NOTHING on earth offers bigger opportunity for building wonderful business this summer than manufacturing these popular profitable, big-selling specialties. Start small—watch business grow. Write today for valuable formula literature relative to making: Sealatite, guaranteed puncture proof liquid; Ducopol, automobile polish; Cellulac, Duco finishes in color, quick drying; Solvit; powdered hand cleaner; Miracle, non-thermic ice cloths, mendit, fabric patching liquid; Liqui-Seal, radiator cement; Vanil-Ozone, "million-dollar" vanilla flavor; Fruitina; concentrated summer drinks; and a hundred other real honest-to-goodness, money-making propositions. 30 years headquarters for best formula service. Miller, Chemist, 1706-B Jetton, Tampa, Fla.

100 QUICK profit, guaranteed workable mail order plans including working specifications of well known operators. A new, high-class publication. Written from 20 years close study of successful systems. Covers all departments. Gives proved successful systems in detail and also teaches you clearly to originate plans of your own and put them into immediate operation. The only work of its kind ever published. Price \$4.15 postpaid. Free particulars. Agencies wanted. Northwestern Mail Order Service, 93 Main Post Office, Omaha, Neb.

READ The Mail Order News—America's Pioneer Mail Trade Journal. Quarter Century Old. Approximately 600 pages yearly of valuable information for beginners and established mail-order houses. Analyzes mail-order business, its opportunities. Practical mail-order ideas, legitimate money-making schemes, instructive articles. Tells how to start, what to sell. Published monthly. Subscription \$3.00 yearly. Send 25c for sample copy. None free. Mail Order News, 360 Bristol Bldg., New York.

PATENTS. Time counts in applying for patents. Don't risk delay in protecting your ideas. Send sketch or model for instruction or write for free book "How to Obtain a Patent" and "Record of Invention" form. No charge for information on how to proceed. Communications strictly confidential. Prompt, careful, efficient service. Clarence A. O'Brien, Registered Patent Attorney, Security Bank Building (directly across street from Patent Office), Washington, D. C. See pages 156 and 157.

COMPOSITION Floor Making earns industrious men \$12 and more daily if used as trade. Or make business of it with profits up to \$10,000 yearly. Openings everywhere. Semi-Tile, Dept. C, Hollis, N. Y.

MAKE Composition Gold Nuggets that deceive experts and cannot be told from the genuine article. Fast sellers, good profits. Formula and full directions, also dollar. Money Making Book, all \$1.00. Clayton Dawson, Coshocton, Ohio.

BIG Bunch Mail. Year 15c. Catalogues, Magazines. Kentucky Agency, Covington, Kentucky.

DON'T sell for others. Employ agents yourself. Make your own products. Toilet Articles, Household Specialties, etc. 500% profit. We furnish everything and show you how. Valuable booklet free. Write at once. National Scientific Laboratories, 1905 W. Broad, Richmond, Va.

SELL By Mail, wonderful opportunity. Particulars Free. Mason, 3902 Broadway, Room 5, Chicago.

NEW System mail order; big profits, instructions free. Evans P. King Company, Wilmington, Del.

POSTAL Success tells you how to earn more money. A practical monthly magazine of live cashable ideas for mail order, agents, beginners and others. One of the oldest and best. Copy and \$1 free coupon 10c. None free. Porter's Publications, 9416a 115th St., Richmond Hill, N. Y.

EARN \$10 daily silvering mirrors, plating, refinishing metalware, chandeliers, headlights, bedsteads. E. Declé Laboratories, 225 Varick St., New York.

INCORPORATING—South Dakota; liberal laws; lowest expense. Free forms. Wren & Chapman, Billings, Mo.

OWN Your Own Business—no capital required; learn Real Estate; Business Brokerage and Insurance Agency; earn \$5,000 year. Office at home. Stamp, free booklet. Hayes Realty Association, Cincinnati, Ohio.

I MADE \$30 a Week Home. French Breadmaking. 15 years' experience; Free Booklet tells. Ashbrook 67, Marengo, Ohio.

75 WINNERS for mail dealers. Successful sales plans. Everything supplied. K. Home, 3919 Metropolitan, Chicago.

MONEY for working capital; incorporate and sell shares in your business. 27 years organizing and raising money for businesses of merit. Terms reasonable. Prompt and confidential service. W. Harrison Cole, 507 5th Ave., Suite 510, New York.

WORK For yourself. Profits come continuously by mail from small start. It's easy with a wealth of usable information and how to handle it, to pick from. Request information. Service, 612 Liberty, Findlay, Ohio.

TWENTY Money-Making Methods. For particulars write Bruce Hudson, Clarks Green, Pa.

YOU are wasting time working for other people. Let us show you how to control your own business and make \$100 a week. Capital unnecessary; immediate profits. American Products Company, 9449 Monmouth, Cincinnati, O.

SUCCEED With Your Own Products. Make them yourself. Formulas, Processes, Trade-Secrets. All lines. Catalog, circulars free. B. Thaxly Co., Washington, D. C.

MIRRORS Resilvered at Home. Costs less 5 cents per square foot; you charge 75 cents. Immense profits plating like new; brassy, worn-off auto parts, reflectors, tableware, stoves, etc. Outfits furnished. Details free. Sprinkle, Plater, 127, Marion, Ind.

MONEY in Dry Cleaning; we furnish instructions and machinery; experience unnecessary. Potterf Manufacturing & Supply Co., 3750-52 Easton Ave., St. Louis, Mo., U. S.

THOUSANDS of opportunities to make money in spare hours, managing own business; mail-order or local. Particulars free. Publishers, 6652-J Gravois, St. Louis, Mo.

FLAVORING Extract Business Pays 400% profit. Let us tell you how to build your own business. Particulars free. Moline Laboratories, Moline, Ill.

BUSINESS profession of your own and earn big income in service fees. See Stephenson Laboratories, display ad, page 150.

FEW dollars starts one in worthwhile local and mail-order business. May operate from home. Valuable descriptive booklet, agency proposition, etc., free. Address Manager, Box 437, Seattle, Wash.

MAKE toys, novelties, furniture; assorted patterns and instructions \$1.00. Scroll saw Free with order. Wm. Bogren, 2264 Hermany Ave., New York.

BUSINESS Opportunities; Men and Women—something new. Big Profits. Send for information. E. A. Barr Co., Shamokin, Pa.

HALF million supply sources offer unlimited opportunities for agents. Complete information 10c. James E. Boyce Co., 1222 Leland Ave., Chicago, Ill.

A BUSINESS of Your Own Making—Sparkling Glass Name and Number plates, Checkerboards, Signs. Big book and sample free. E. Palmer, 540, Wooster, Ohio.

WE Start You in Business, furnishing everything; men and women, \$30.00 to \$100.00 weekly operating our "New System Specialty Candy Factories" anywhere. Opportunity lifetime; booklet free. W. Hillyer Ragsdale, Drawer 4, East Orange, N. J.

MECHANICS, painters, carpenters, start furniture refinishing, painting handyman shop on nearly nothing; winning plan brings customers quickly. John Braceland, 1439 So. Ninth, Philadelphia, Pa.

SPLENDID Sideline. Excellent profits selling to trade finest complete line vending machines, etc. No samples, sell from catalog. Specialty Mfg. Co., N 724 N. Racine, Chicago.

WE Start You—Silvering mirrors, plating tableware, autoparts, headlights, etc.; refinishing metalware, chandeliers, bedsteads, etc. Immense profits. Wesco, B-1246, A, Wichita, Kans.

LEARN Dry Cleaning. Book used by millions, housewives, cleaners. Formulas for spotting, pressing, pleating. Send 50c. W. Hoffmann's Laboratories, Capitol Hill, Denver, Colo.

LEARN Automobile painting at home in your spare time. A full instruction copyrighted booklet \$1.00. Agents wanted. Helbig Co., 41 Astor, Newark, N. J.

"SCHEMER," Alliance, Ohio, 36 p. monthly, prints Schemes, Tips, Formulas. Subscriber reports \$25,000 from three; another \$10,000 from one. Try it! Year, \$1.00; 3 months, 30c.

CHARTERS: Delaware; best, cheapest; free forms. Colonial Charter Co., Wilmington, Del.

YOU can have an independent business of your own, and I am here to show you the way. Write at once! Wm. E. Heinemann, 2415 Montrose Ave., Chicago, Ill.

ARTIFICIAL marble sanitary flooring instructions, covering wood or cement flooring 1/2 inch thick, fireproof, waterproof, all colors, low cost. Ornamental casting, concrete, plaster, papier-mache decorations, garden furniture, statuary, flexible molds, 18 years instructing the public; particulars and illustrations free. Chris. Mahler, Huntington, N. Y.

DELAWARE Incorporator. Charters; Fees Small; forms. Chas. G. Guyer, 901 Market St., Wilmington, Del.

LEARN the collection business. Good income, quick results. Interesting booklet, "Skillful Collecting" free. National Collectors Assn., Long St., Newark, Ohio.

\$750,000,000 MAIL order business last year. Many grew rich in this great trade. Sell merchandise, information, patented articles various preparations. Breniser's Famous Mail Order Handbooks tell how. Eleven brochures \$3. One book with complete catalog, 25c; none free. Breniser (Established 1900), 1607 Sansom, Philadelphia.

EARN \$70 a week at home silvering Mirrors. French mirror expert is giving a \$25 guaranteed formula in English or Spanish postpaid for \$1.85. Eduardo Haliberto, Gasometro 32, Santiago de Cuba.

SIGNS and Showcards Easily painted with Letter Patterns. Large variety of Styles and Sizes. Samples for stamp. John Rahn, a2120 Neva Ave., Chicago.

TASTE flavor of real money selling Annie Blain Flavors, wholesale, retail; new system, samples; other unique methods. Geo. S. Parker, New Brunswick, N. J.

PATENTS Procured; Trade Marks Registered—A Comprehensive, experienced, prompt service for the protection and development of your ideas. Preliminary advice gladly furnished without charge. Booklet of information and form for disclosing idea free on request. Richard B. Owen, 30-Owen Bldg., Washington, D. C., or 41-B Park Row, New York.

UNPATENTED Ideas Can Be Sold. I tell you how and help you make the sale. Free particulars (Copyrighted). Write W. T. Greene, 810 Jenifer Building, Washington, D. C.

CHEMICAL Expert will furnish Formulas and Trade Secrets. All lines. Lists Free. W. L. Cummings, Ph. D., 228 Gordon Ave., Syracuse, N. Y.

SELL by Mail! Books, novelties, bargains! Large profits! Particulars Free! R-Elfco, 525 South Dearborn, Chicago.

CAN you stand prosperity? Are you ready to make yours? We can show you the way to make big money. No peddling. No competition. F. D. Gibson Co., 209 Bell Block, Cincinnati, Ohio.

150% PROFIT. Spare-time business of your own. Article needed every home. Particulars, 2c stamp. Hughes Sales Co., 501 E. South St., South Bend, Ind.

MAIL Order Business Positively Your Big Opportunity. Start Right. Grow. Win. Free Circular. Send Today. Macrae, Publisher, 402M, Oregonian Building, Portland, Ore.

START Mail Order Business of your own at home. We supply catalogues with your address on. Winebolt Sales Co., Box 4, Woodbine, Penna.

TELEGRAPHY

TELEGRAPHY—Both Morse and Wireless—taught thoroughly and quickly. Tremendous demand. Big salaries. Wonderful opportunities. Expenses low; chance to earn part. School established fifty years. Catalog free. Dodge's Institute, 11 St., Valparaiso, Ind.

CHEMISTRY

YOUR chemical problem solved and working formula or process furnished for \$5.00. Write me. W. Stedman Richard, Industrial Chemist, Box 2402, Boston, Mass.

CHEMICALS and apparatus for experiments. Price list 5c. George Ott, 1218 Chestnut, Reading, Pa.

FORMULAS AND TRADE SECRETS

WE Are Better Able to Supply you with reliable formula service because of our twenty-five years' experience as research chemists. No matter what kind of formula service you may require be sure to get our advice first. Formulas and methods are constantly improving and only the best and most up to date are worth while. We supply practical working formulas for Flavoring Extracts, Soft Drinks, Shoe Polishes, Toilet Preparations, Barber Supplies, Automobile Specialties, Paints, Food Products, etc. Make your own goods at home and make the long profits. Why give it to the other fellow? Lists free. Arthur Windecker Research Laboratories, Box 536-M, Oak Park, Ill.

FORMULAS: Absolutely guaranteed. Best chemical science has devised. Don't risk your money till you've investigated these wonderful processes for all lines. Get my valuable "eye-opening" literature. Highest references. 30 years supplying the best. Miller, Chemist, 1706-P Jetton, Tampa, Fla.

NEW chemical method of chimney sweeping will make you big money. Do it from basement. Every home owner wants it done. If you are handy man, not afraid of a little work, can make real money. Formula and full instructions—three dollars. Flue Kleen Co., 22 Columbia, Champaign, Ill.

SENSATIONAL Money-Making Formulas, selected best sellers. List free. Specialty Mfg. Service, 801 So. Farragut, Bay City, Mich.

DON'T sell for others. Employ agents yourself. Make your own products. Toilet Articles, Household Specialties, etc. 500% profit. We furnish everything and show you how. Valuable booklet free. Write at once. National Scientific Laboratories, 1905 W. Broad, Richmond, Va.

SUCCESS With Your Own Products. Make them yourself. Formulas, Processes, Trade-Secrets. All lines. Catalog, circulars free. B. Thaxly Co., Washington, D. C.

CHEMICAL Consultation. Manufacturing ideas made practical. Guaranteed economic formulas prepared, \$5.00. With sample, \$6.00. Associated Chemists, Indianapolis, Indiana.

NEW and Improved Formulas Each 60c. Research Specialists, Box 800, Huron, So. Dak.

CHEMICAL Formulas and technical information. Glen Young, M. D., 503 Liggett Bldg., Detroit.

500 FORMULAS and Big Catalog 20c. Ideal Book Shop, Park Ridge, Ill.

TATTOO Remover Formula \$1.00. Supply Catalogue. "Waters," 965 Putman, Detroit.

AGENTS WANTED

AGENTS—Here it is—Just invented new orthophonic portable phonograph something new, different from ordinary phonographs, wonderful loud tone, sells easily, quickly, meets every demand. Low priced. Taking the country by storm. Built just like a suitcase. Fully guaranteed. \$84 to \$126 a week, extra bonus besides. The fastest musical invention the world has ever known. Beats Radio. You book orders, we deliver and collect. Pay you daily in advance. No experience needed. Exclusive territory given, part time brings you \$3 an hour. Write for sample. Orthophonola Mfg. Co., 757-F Broadway, New York City.

DON'T Sell for others. Employ agents yourself. Make your own products. Toilet Articles, Household Specialties, etc. 500% profit. We furnish everything and show you how. Valuable booklet free. Write at once. National Scientific Laboratories, 1905 W. Broad, Richmond, Va.

100% PROFIT on Every Sale selling Christmas Greeting Cards in Box Assortments. Our wonderful Box Assortment is the finest published. Agents earn \$2 to \$4 per hour. We have a magnificent Box Assortment containing 21 high-grade Christmas Greeting Cards and Folders, each with envelope, Steel Engraved, Colored, Paneled, and Bordered. Sells for \$1.00; costs 50 cents. Nothing ever sold begins to compare with the sale of Christmas Box Assortments. Write immediately for particulars and free samples. Waltham Art Publishers, 7 Water St., Dept. B-26, Boston, Mass.

OWN your own business. Inexperienced workers, spare time or full time, build profitable business with our new plan. Show marvelous line of actual shoes. Men's women's and children's. Also durable silk hosiery. We start you by furnishing \$40 sample outfit. Patented measurement system insures perfect fit. Every day pay-day. Larger variety of styles and sizes than any store. If you want a permanent business, send for free book "Getting Ahead." Write now. Tanners Manufacturing Co., 6310 C Street, Boston, Mass.

WE want Direct to Consumer salesmen or agents in every community for our Magnetic Trouble Lamp—Brite-Lite—the fastest selling auto necessity in the world—retails \$3. Brite-Lite sells itself on sight—agents make big money. National sales force now being organized. Here is a chance to join a live organization and have exclusive territory. Send details of your past experience and a Brite-Lite will be mailed with full information. Address National Electrical Corporation, P.O. Box 90, Dept. C, Newark, N. J.

AGENTS—\$13.80 Daily in advance. Introducing New Insured Hosiery for men, women, children. Must wear or replaced free. 57 styles, 39 colors including latest "Silk to the Top" Ladies' Hose, Nyland made \$59; in one month, Edwards, \$160.60. Mrs. Bone, \$125.45. Why not you? Even spare time should pay you \$3.00 an hour. No experience needed. We furnish samples. Silk hose for your own use free. New Plan. School line now ready. Write quick, Milton Mathews, Road 25610, Cincinnati, Ohio.

LIVE Representative. Newly patented automatic "Check-Draft." Positively automatic. Absolutely controls changeable winds. Extraordinary fuel saver. Wonderful invention. Excellent proposition. Exclusive territory. Automatic Damper Co., 303 Ellicott-Square, Buffalo, N. Y.

DON'T Read This unless 300% profit interests you. Everybody buys on sight. Free sample. Magic Products, Dept. 200, Oak and 31st, Kansas City, Mo.

SEND name, address on postcard. Free introductory copy Salesology Magazine; contains 1,000 money-making opportunities. Offered by big reliable firms; no obligations. Salesology Magazine, Desk B-38, 500 No. Dearborn, Chicago.

MEN! Women! Big Money selling Packard Tailored Shirts direct from factory. Experience unnecessary. Huge fabric assortment. Low prices. Superior workmanship brings tremendous repeat orders. Powerful selling outfit free. Packard Mfg. Co., Dept. 828, 466 W. Superior, Chicago.

AGENTS—Best seller; Jem Rubber Repair for tires and tubes; supersedes vulcanization at a saving of over 800 per cent; put it on cold, it vulcanizes itself in two minutes, and is guaranteed to last the life of the tire or tube; sells to every auto owner and accessory dealer. For particulars how to make big money and free sample, address Amazon Rubber Co., Philadelphia, Pa., Dept. 505.

AGENTS—Earn \$100 Weekly handling Best Yet Cement. Repairs wood, glass, ivory, dishes, etc. Resists heat. Sells to every family. Get our Proposition at once. Moser Cement Company, Richland Center, Wis.

MEN-Women—Sell beautiful household linens; wholesale prices. Big commissions. Everybody buys. Full-spare time. Milton Linens, 354 Fourth Ave., Dept. 91, New York.

AGENTS make \$100 week furnishing Cigar Lighters to merchants on free advertising plan. Particulars sent free, write at once. Drake Mfg. Co., Dept. M, Milwaukee, Wis.

MAKE \$2.00 Every Hour. Sell every home wonderful preparation; mends hosiery and clothing without sewing; invisible. Results guaranteed. Send for free sample of work. Queen City Laboratories, Dept. P. O. P. 10, Cincinnati, Ohio.

PRIVATE brand Toilet Articles, Household Specialties, Perfumes, Soaps, Extracts, etc. We pack these goods for you under your private label. With your name on the goods you get all the repeat business. Don't sell for others, but build up a profitable business for yourself. Highest quality merchandise. Extremely low prices. Quick shipments on both large and small orders. Write immediately for lowest wholesale prices and complete information regarding our amazing offer. Address Supply Department, National Scientific Laboratories, 1904 W. Broad, Richmond, Va.

WHY not sell us your spare time, \$2.00 an hour, \$19.70 daily easy full time? Introduce 12 months Guaranteed Hosiery—47 styles, 39 colors for men, women, children, including latest "Silk to the Top" Ladies' Hose—No capital or experience needed. We furnish samples. Silk hose for your own use free. New Plan, Milton Mathews, Road 25610, Cincinnati, Ohio.

CHRISTMAS Novelty. Every store, office and home a prospect. Sold day or evening. Plan now to make \$25.00 daily, upward during December. Cash sales—no order taking. Sample and literature free. Consolidated, 65-C West Van Buren, Chicago.

AGENTS. Solicitors, Canvassers for big honest quick profits try our new adjustable waterproof aprons. Dept. 267, B. & G. Rubber Mfg. Co., Pittsburgh, Pa.

EARN \$5.00 to \$25.00 Every Day. A responsible manufacturer with a staple line of merchandise desires local representatives to handle their line in restricted territory. Applicant must be able to make a \$100.00 bond or a cash deposit of \$50.00 security. Particulars, Sellstrom Co., 1120 N. Franklin, Chicago.

MEN—Women, \$1.80 an hour. No less. Large Mfg. Co., established 30 years. Starting new medallion dept. Amazing new sales plan. First 22 agents average \$1.80 an hour steady. Only 1 agent wanted in locality. Your Own Photo Free as sample. Art Medallion Co., Dept. 45, Corner Campbell and Jackson, Chicago, Ill.

EVERY Car Owner Will Buy Auto Mitten Dusters. Sample and Selling Instructions 25c Postpaid. National Fibre Broom Co., St. Louis, Mo.

\$8 TO \$12 a day. Man or Woman Wanted. Part or full time. To distribute well known line of cosmetics and toilet preparations in their locality. No experience necessary. We train you. Big profits. Large repeat sales. Free sample offer. Write Franco-American Hygienic Company, 123 E. 13th Street, Chicago, Ill.

IF I Send You a Suit made in latest style from finest goods, will you keep it, wear it, and show it to your friends as a sample of my sensational \$19.50 suits guaranteed regular \$40.00 values? Could you use \$3.00 an hour for a little spare time? If so, write me at once for my wonderful new proposition. Just write your name and address on a card and mail to Salesmanager, Peoria and Adams, Dept. 831, Chicago.

42 8 MILES on 1 gallon. Wonderful Moisture Gas Saver. All autos. 1 free. Critchlow, D5-805, Wheaton, Ill.

AGENTS—Canvassers—Full or part time. The fastest selling and Sharpest Stainless Steel Knives on the market. Exclusive territory. Carroll Knife Co., Clyde, Ohio.

GET set for life with regular income. Join 42-year-old company. Many representatives with us 5 to 25 years. Make \$25 to \$75 weekly supplying free premiums with quality household products. Great Eastern Coffee & Tea Co., Dept. M-1041, St. Louis, Mo.

PHOTO Medallion Agents Earn \$20 Daily. Easy work collecting photos. Big line; quick sellers. Capital or experience unnecessary. Give you 4-day service on beautiful photo reproductions. Reserve your district today. Write Puddin Corp., Dept. 103, 259 Bowery, New York.

PORTRAIT Agents Make more money. Our fine work will bring you more profitable deliveries. Most reasonable prices. Prompt service. Write for catalog. Linder Art Co., 551 W. Washington, Chicago.

A NEW discovery positively cuts gasoline cost in half. Special offer to agents—good for \$15-\$25 profit daily. Blancke, 600-J, W. Lake, Chicago.

\$6.50 COMMISSION advanced on every order! 2 Suits, or Suit and Overcoat, \$38.50. All Wool! Made to Measure! Better quality brings repeat orders. Free Outfit. Leading Tailors, A-1471 Milwaukee, Chicago.

\$40.00 SUITS for \$23.50! All one price. Union-made of finest quality Virgin Wool. You don't have to know anything about selling clothing. We guarantee your success if you are honest and willing to work. Write at once. William C. Bartlett, 550 Adams, Dept. 585, Chicago.

FREE Sample, "Rain Shield Wiper." Retail \$1.00—Cost (25 cents). Soid Clear and Rainy Days. No Cloth—No Paste—No Attachment. (1) Rub keeps windshield clear 48 hours. Experience Unnecessary. NuLife Corporation, Hartford, Conn.

SALESMEN—You can make \$130 extra each month selling only one policy a day. Policy pays \$5,000. Death; \$25 weekly benefit for injury or sickness. Entire cost \$10 yearly. Salary and commission. Permanent income from renewals. \$100,000 Deposit with State. Address Underwriters, 702 Bonnell Bldg., Newark, N. J.

WORLD'S First Electric Safety Razor with facial and scalp attachments. Awarded Medal Sesquicentennial. Free Sales Kit! 20th Century Manufacturing Co., Dept. M10, 2530 Woodward, Detroit, Mich.

AGENTS—Big money. Sell guaranteed silk hosiery for men, women, children. Seven months' guarantee. New selling plan gets business fast. Many agents earn \$98 a week. Write for samples. We give you extra fine silk hosiery for your own use. Betterknit Textile Co., Silk 1031, Greenfield, Ohio.

AGENTS, \$72 week. Bonus besides. Introduce finest line guaranteed hosiery. Beats store prices. 126 styles, colors. Credit given. Samples furnished. Auto to travel in. Write quick. Wilknit Hosiery Co., Dept. 3231, Greenfield, Ohio.

\$31.00 PROFIT—with \$1.50 Outfit—Big Money—Easy Work. Selling Gold Monograms for Automobiles, Luggage, Windows, Wagons. No experience. No license. "Samples Free." NuLife Monograms, Hartford, Conn.

MONEY Talks—You can have plenty of it selling Amazing New Moth Bag. Absolutely air-tight. Never on market before. Sells on sight. Write today. S. & P. Products Co., Dept. I, St. Louis, Mo.

AGENTS, portraits, photo-pillow tops, frames, sheet pictures, medallions, photo-jewelry, guaranteed hose laundry tablets, food products, toilet requisites, luminous crucifixes. Catalog 50 specialties free. 30 days' credit. Jas. C. Bailey, Dept. C10, Chicago.

BIG Winner for Agents. New patented cigarette case. Holds package cigarettes and box safety matches; beautiful, compact, flexible container; large profits; write for liberal proposition. All-in-One, Dept. A10, 2810 Portland Ave., Minneapolis, Minn.

\$50,000. PICTURE Man Friedman made canvassing. Beginners can make \$100.00 weekly with my sales talk. Experienced men make more. Free book. "Profits in Portraits" explains. Sample Free. Picture Man Friedman, Dept. 8-M, 541 W. Lake, Chicago.

AGENTS—Make a dollar an hour. Sell new kind of sharpeners. Sharpens all knives and tools quickly. Demonstrating sample free. Premier Mfg. Company, Dept. 72, Detroit, Mich.

JUST Out—New Patented Apron. No strings or straps—\$20.00 a day every day; over 100% profit; commissions daily. Write for free offer. Sta-Put Co., Dept. 210, St. Louis, Mo.

BIG money easily made without peddling our outfits. Free particulars. Elite, 38 Elizabeth St., New York.

AGENTS—\$6.00 hour earnings making four sales hour. Tremendous demand \$3.50 article. powerful selling plan. Fagley & Halpen, Dent. 40, Philadelphia, Pa.

DON'T Sell for others. Employ agents yourself. Make your own products. Toilet Articles, Household Specialties, etc. 500% profit. We furnish everything and show you how. Valuable booklet free. Write at once. National Scientific Laboratories, 1905 W. Broad, Richmond, Va.

42.8 MILES on 1 gallon. Wonderful Moisture Gas Saver. All autos. 1 free. Critchlow, D6-805, Wheaton, Ill.

AUTO owner tire agent wanted each locality to use and take orders for hand made Mellinger cord and balloon tires; guarantee bond 15,000 miles; shipped prepaid on approval; get your tires free; no capital or experience required; make \$100 to \$300 weekly. Write for wholesale prices and sample kit. Address Mellinger Tire Co., Dept. 400, Kansas City, Mo., or Dept. 400, Philadelphia, Pa., or Dept. 400, Oakland, Calif.

100 MORE active men to introduce Chief-tain Guaranteed Tailored Shirts, 3 for \$4.95. Latest novelties, colors. Dickman, Illinois, in 3 weeks made \$589; Sinton, Texas, in 12 days, \$219.60; Bend, Iowa, in 16 days, \$334.80. Why not you? No experience or capital needed. We deliver and collect. Full working outfit free. Cincinnati Shirt Company, Lane 15810, Cincinnati, Ohio.

FREE Sample of lace handkerchief. Lightning-quick seller. Big profits. Earn \$30.00 daily. Send 10c for mailing charges. Other flash sellers also. Lewis Importing Co., 143 Fifth Ave., New York.

SELL Christmas Cards! Beautiful engraved assortment of 15 cards sells on sight at \$1.00 per box. No salesmanship required to make \$10.00 per day. Send 65c for sample and free plan. Engravo Co., 440 West 42nd Street, New York City.

SHOW and sell nationally known Pure Silk hosiery and lingerie. Amazing values. Make \$12.00 daily. Experience unnecessary. Free sample outfit. Pure Silk Hosiery Co., 298 W. Monroe, Dept. R180, Chicago.

WANT \$15 a day? New way to make quick cash selling fine shirts. Actual samples free. Write Fashionwear Shirt Co., W-943, Jackson St., Cincinnati, O.

NEW Household Device washes, dries windows, sweeps, cleans walls, scrubs, mops. Costs less than brooms. Over half profit. Harpers, 132 Third St., Fairfield, Iowa.

TIRED of Working for other people? Without experience, training or capital I'll show you how you can become financially independent. Easy, pleasant work. \$100 profit every week. Free automobile. Write today for particulars. Albert Mills, Mgr., 2213 Monmouth, Cincinnati, O.

AGENTS—Men-Women—Sell guaranteed hosiery; wholesale prices; spare-full time. Experience unnecessary. Exclusive territories. Big commissions daily. Sample outfits. Glenridge Textiles, 400 East Fordham Road, Dept. B, New York.

AGENTS—Steady income. Large manufacturer of handkerchiefs, dress goods, linens, wishes representative in each locality. Factory to consumer. Big profits, honest goods. Credit given. Send for particulars. Freeport Mfg. Co., 59 Main St., Brooklyn, N. Y.

AGENTS—Moss Corn and Callous Remover will build you a steady repeat business. Send today for pocket-size trial outfit. The Moss Co., 387 Searle Bldg., Rochester, N. Y.

SIMPLEX Vaporizer—Wonderful invention; 25-60% increased mileage guaranteed; retails \$1; free trial; exclusive territory. American Fixture Co., 234 West Water, Milwaukee, Wis.

DISTRIBUTORS, Agents, Salesmen—\$60 a week. Biggest line guaranteed cutlery ever offered. Knives, Razors, etc. Extra commission. Territory given. Write quick for particulars. Novelty Cutlery Company, Desk 231, Canton, Ohio.

SILK Dresses. Our expensive showroom samples (slightly handled). Cheap! Dress dealers, peddlers, others interested, write Hirschler's Dress Bargain House, 467 Broadway, New York.

EARN \$100 Weekly Representing Large Direct-to-Wearer Company. Complete unbeatable shirt and necktie line. Everyone buys. Advanced commissions and bonus. Experience unnecessary. Elaborate sales compelling outfit free. Howard Shirts, 1215 Van Buren, Dept. H-10, Chicago.

AGENTS, become a regular established McConnon Dealer; buy on credit, sell for cash or credit. 185 absolute household necessities; all repeaters. Enjoy a sure income 52 weeks per year, year after year. City or country trade. Capital, experience unnecessary. McConnon & Co., Dept. 821, Winona, Minn.

\$5,000 A YEAR—Selling Perry Photo Medallions. Big demand. Ready sales. 400% to 600% profits. Any photo copied perfectly on Medallions, Mirrors, Compacts, Jewelry, etc. Guaranteed likeness. Investigate. Free catalog, full details on request. Write Today, P.M. Perry Photo Novelty Corp., 1793 Jerome Ave., New York.

WRITE Today For Free Samples, finest line Raincoats, Topcoats, Slickers and Novelties. Something different. \$10-\$25 daily easy! Worthmore, H223 W. Jackson, Chicago.

GENUINE Gold Leaf Letters anyone can put on store windows. Guaranteed to never tarnish. Large Profits. Enormous Demand. Free Samples. Write today. Metallic Letter Co., 438-D North Clark, Chicago.

SELL New Adjustable Nut Cracker. Splits shell away, leaves kernel. Large commission. Clark Nut Co., Harrisburg, Pa.

RADIO Agents—Make Big Money. Easy! selling Marvelous New Sets and accessories. Buy from factory at lowest prices. Get New Catalog with thousands of nationally advertised bargains. Free Call Book. Write today. American Auto and Radio Co., Dept. 268, American Radio Bldg., Kansas City, Mo.

MAKE \$25.00 daily selling colored Raincoats and Slickers; Red, Blue, Green, Etc., \$2.95. Hat Free. Commissions daily. Outfit free. Elliott Bradley, 241 VanBuren, Dept. AB-10, Chicago.

AGENTS—Big Seiler. \$20 Daily Easy selling Taylor Caps—made-to-measure—every man buys—some want 2 or 3 caps. Samples Free and Cap free to agents. Write quick for fast money-making proposition. Taylor Cap Manufacturers, Dept. A-80, Cincinnati, Ohio.

THANCO Flavors—Bottle yourself! Concentrated—add water! Free Labels! Whirlwind seller! 500% profit! Lifetime opportunity! Write Thomas Manufacturing Company, Indianapolis, Ind.

WILL you wear a pair of genuine tailor-made shoes at my expense? Will you show them to your friends and take their orders? I will also send you free our big selling outfit showing 70 shoe styles and 60 actual leather samples. I pay my agents \$8.00 daily. Write quick. Tailor-Made Shoe System, 932 Wrightwood, Dept. AA 10, Chicago.

NEW Invention—400% profit. Liquid Quick Mend for Fabrics and Hosiery. Stops runs. Every woman buys. Hundred other fast sellers. J. E. Johnson Co., Dept. 458, 6129 Wentworth Ave., Chicago.

AGENTS—Biggest hit of season—FitsU adjustable Caps and mufflers to match. \$1.70 commissions in advance on every confirmation order. \$10 to \$20 a day easy. Write quick for free outfit and free cap offer. FitsU Cap Co., Dept. CL-80, Cincinnati, Ohio.

AGENTS—Startling new automatic device banishes can openers! Patented. Absolutely unique. Holds can on wall. Simple turn of crank cuts top out clean. Sells fast. Write for Free Test Offer. Central States Manufacturing Co., Dept. M-931, 4500 Mary Ave., St. Louis, Mo.

SUCCESS With Your Own Products. Make them yourself. Formulas, Processes, Trade-Secrets. All lines. Catalog, circulars free. B. Thaxly Co., Washington, D. C.

MAKE \$20 daily selling \$1.00 changeable letter store window display sign. Experience unnecessary. Get free sample offer. Maze Company, 544 W. Washington Street, Chicago.

AGENTS—Get into the house by invitation. Plan 25c coin. Copy Shop, Freeport, Ill.

MAKE \$100 weekly supplying demand for new invention. Makes autos run on 7% gasoline. Free sample. Write Whirlwind Co., 999-490 E. Third St., Milwaukee, Wis.

AGENTS—Big money! Fast selling line beautiful Christmas greeting cards. Dollar box assortment sells on sight. Big commissions. Free samples. Doehla, Fitchburg Mass.

SELL Non-Corrosive Battery Terminals. No soldering; easily attached. For any car or battery. This line pays you liberally. Hiawatha Sales Company, Atehison, Kans.

MAKE \$10.00 daily selling auto and wall emblems; complete line; all lodges; no competition. Season on. Free samples. Crafts Co., 15611 Myrtle Ave., Dept. M, Harvey, Ill.

SAFETY Razor Stropper saves \$35.00 annually. Big profits, sure repeater. Instructions, sample \$1.00. Details free. Tel. Box 205, Elmira, N. Y.

SOBERMINT. A deliciously flavored preparation; guaranteed to sober one up in a few minutes. Trial bottle, \$1.00. Agents wanted. Large profits. Hygienic, 1674 Broadway, New York City.

AGENTS—\$10 daily. Highly useful 35c article for home and office; just out. Pocket sample. Hydrowilk Corporation, Roselle, N. J.

WRITE Atlas Sign Works for free working equipment. Beautiful window sign letters. Penny each! Any size. Wonderful offer to general agents. K1032 E. 55th St., Chicago.

MEXICAN Jumping Beans. Nature's greatest curiosity. They move, roll and jump as if alive. Quantity prices 2c each or 20 sample beans \$1.00. The Aztec Novelty Co., Nogales, Ariz.

PATENTS. Time counts in applying for patents. Don't risk delay in projecting your ideas. Send sketch or model for instruction or write for free book "How to Obtain a Patent" and "Record of Invention" form. No charge for information on how to proceed. Communications strictly confidential. Prompt, careful, efficient service. Clarence A. O'Brien, Registered Patent Attorney, Security Bank Building (directly across street from Patent Office), Washington, D. C. See pages 156 and 157.

AGENTS—Men and Women making remarkable records with our Empress Quality Line of Household Specialties. Full or Spare Time. Hess Mfg. Co., Dept. C, Freeport, Ill.

NEW: Just invented: Comb fastens anywhere. Send 10c for a 25c value. Never Lose Comb Mfg. Co., Lesueur Center, Minn.

MAKE \$50 to \$75 a week. Everyone needs shoes. Sell Mason's all-leather shoes, amazingly low prices. 85 styles—men's, women's, children's. No experience needed. Big outfit free. Mason Shoe Mfg. Co., Dept. 2510, Chippewa Falls, Wis.

JUST Out, new cigarette vendor. Positively the most beautiful high-class dependable Vending machine made. Practically Slug Proof. Built to last indefinitely. Agents make fortunes by acting quickly. Manufactured exclusively by the National Sales Machine Company, Dept. B, 1926 Chestnut St., St. Louis.

SAMPLES displayed start a route of stores in your town working for you, bringing you a large, steady weekly income. No Selling. "Master," 818 Chestnut, St. Louis.

EARN \$15 daily (pay advanced) with our fast sellers. Guaranteed tailored slickers \$2.95. Selling outfit and slicker free. Fisk Warner, 443-X—, South Dearborn, Chicago.

\$5 HOURLY! Women's Leatherette Aviator-rain-topcoat. Other Men-Women numbers. Outfit free. Guarantee, 172-X—, North Halsted, Chicago.

CHRISTMAS cards—Start early. \$2.00 hourly spare time. 133 Samples. Every one buys. "The Windermere," 6706 Dorchester, Chicago.

NEWEST Invention! Abolishes kinks and snarls. Automatically coils telephone, electric iron and lamp cords. Housewives, companies actually buying 5 to 50. Tremendous profits. Samples furnished all salesmen. Neverknot, Dept. 10-A, 4503 Ravenswood, Chicago.

ARTIFICIAL Stone Houses, \$100! (Patent pending.) Scientific American calls this stone everlasting. Agents' bonanza. Sample free. Bardley, Box 1586, Cincinnati.

BEAUTIFUL, colorful. Embossed Signs. Quick sellers; big profits. Money back guarantee. Free sample. Synograf, 201 Douglas Bldg., Los Angeles.

SELL "Lustro" Polishing Cloth. Polishes All metals without liquid, paste, powder. Great 25c Seller; sample free. Schrieber, Nashville, Ill.

SHIP Agents or General Agents to sell new large cans of Paste Hand Soap—fine profits—quick sales. The Connecticut Can Co., Hartford, Conn.

MAKE \$75.00 Upward Weekly. New Plan Brings Quick Sales. Guaranteed Quality Tailored Shirts; Wonderful Values! Samples Furnished. Amity Shirt Corp., 1440 Broadway, N. Y.

GREAT neckwear line now free; features finest quality neckwear at factory prices. Collect big commissions daily. Write for free tie offer and free outfit. Nawco Neckwear, Desk 10-ZK, Covington, Ky.

AGENTS make \$3.00 an hour taking orders for our 40 fascinating Kitchen Specialties. No competition. Write quick. General Products Co., Dept. J-297, Newark, N. J.

ATLAS Sign Works manufactures beautiful gold window letters. Penny each! Why pay 8c? Write for Free samples. M1032 E. 55th St., Chicago.

AGENTS to distribute sample puzzles and catalogues, evenings. Catalogue for stamp. B. Z. Puzzles, Fairview, Mass.

DON'T Sell for others. Employ agents yourself. Make your own products. Toilet Articles, Household Specialties, etc. 500% profit. We furnish everything and show you how. Valuable booklet free. Write at once. National Scientific Laboratories, 1905 W. Broad, Richmond, Va.

42.8 MILES on 1 gallon. Wonderful Moisture Gas Saver. All autos. 1 free. Critchlow, D3-805, Wheaton, Ill.

SELL Wonderful Hand Adding Machine. \$1 wholesale. Retail, \$4.50. Typewriter Supply, 102 Hersch Bldg., Pittsburgh.

RAINCOATS—Full line, all prices. Also Sheep-lined coats—shirts. Outfit free. Commission 25% with bonus. Hydro Raincoat Co., 718 Independence, Dept. 45, Chicago.

\$100.00 WEEKLY! Two suits or Suit and Overcoat \$33.50. All Wool—Made to measure. Commission \$6.00-\$7.50. Outfit Free. Garfield Tailors, H-1557 Milwaukee, Chicago.

\$100.00 WEEKLY. Sell nationally known product and appoint agents. N-R-G Co., H234 W. Superior, Chicago.

AGENTS—Make \$500.00 monthly. Pay daily. No investment. Rhinestone Initial Buckles and Novelties. Sell easy everywhere. Exclusive territory. Chaton Novelty Co., 606 Blue Island, Chicago.

MIRRORS Resilvered at Home. Costs less 5 cents per square foot; you charge 75 cents. Immense profits plating autoparts, reflectors, tableware, stoves, refinishing metalware, etc. Outfits furnished. Details free. Write Sprinkle, Plater, 128, Marion, Ind.

MAKE \$100 a week up, selling better-quality, all-wool made-to-measure suits and overcoats. Biggest values. Highest Commissions, paid in advance, and extra bonus for producers. Large swatch samples furnished free. Write W. Z. Gibson, Inc., 161 West Harrison, Dept. K-517, Chicago.

PARTNER wanted to introduce beautiful fit-to-measure Style-Arch shoes for women. No capital required. We will furnish everything, including sample shoes. Amazing values at \$3.95 and \$4.95. Can make \$60 to \$135 in cash, plus semi-yearly share of company's profits. Write at once for full details. No experience necessary. Style Arch Shoe Co., Desk W-102, Cincinnati, O.

EARN \$10 daily silvering mirrors, plating, refinishing metalware, chandeliers, headlight bedsteads. E. Decle Laboratories, 225 Varick St., New York.

AGENTS and salesmen to handle fast selling low priced article, wholesale and retail stores, theatres, garages, hotels and homes. Nothing better on market for live wires. Melabar Specialties Co., 107 Colin St., Yonkers, N. Y.

\$50.00 WEEKLY easy. Applying Gold initials on Automobiles. No experience needed. \$1.45 profit every \$1.50 job. Free samples. "Raleo Monograms," X1043 Washington, Boston, Mass.

AGENTS—Sell chic raincoats; better kind only; sells at sight. Liberal commission and bonus. H. R. Schmidt Co., 15 Park Row, New York.

ARE You Old at Forty? See our advertisement on page 42 of this issue. The Electro Thermal Company, 2174 Main St., Steubenville, Ohio.

CASH Paid for Butterflies, Insects. See Sinclair Display Advertisement on page 26.

FREE: Large wholesale Specialty catalog, showing latest best sellers from many parts of the world. Spors Co., Lesueur Center, Minn.

AGENTS—Salesmen—Look! Men's hosiery. Silk, Rayon, plaited, plain, fancy, jobs, imperfections. Prices of a gross pairs \$10.00, \$12.00, \$14.00, \$15.00, \$18.00, \$24.00; knitted ties gross \$7.00-\$12.00. Send \$10.00 for the above 8 sample dozen, save and buy direct from manufacturers. Lewis Hosiery Co., 12 N. 3rd St., Philadelphia, Pa.

MAKE \$1,000 before Christmas selling exclusive personal Christmas cards in distinctive steel engraved designs. Expensive Sample Book free. Wetmore, Jones and Sugden, Rochester, N. Y.

REPRESENTATIVES wanted by over 500 manufacturers, offering real money making propositions. No need of being out of work. Write for Free Copy. Opportunity Magazine, 750 N. Michigan, Service Dept., Desk 2, Chicago.

GOLD-LEAF Sign Letters: copyrighted Manufacturing Instructions; profits 1,000%. Johnston Co., Quincy, Ill.

\$16 A DAY Easy—I start you in auto accessory business; no investment; no experience necessary. Landin, 4206 Montrose Ave., Chicago.

ARVEO Polishing Cloth do the job the way it should be done. Write for our remarkable introductory selling plan to new agents. Arveo Industries, Box F 147, Groese Il., Mich.

LAMB'SWOOL Polishing Mittens, Brushes. Newhall, 358 Broad, Lynn, Mass.

AMAZING New invention. Abolishes rubber stamps. Sells to every office. Big commission. Write Stenograph, 1271 California St., San Francisco, Calif.

PENNANTS—Your city or school \$2.00 dozen. Stores and students get busy. American Pennant Co., 66 Hanover St., Boston, Mass.

SELL Surety, the original, genuine, powdered hand soap, and make \$5,000 yearly. We furnish sales plans, advertising, free samples. Write quick. Surety Mfg. Co., Dept. H-10, 26 W. Washington, Chicago.

PLAID Slicker and hat \$2.98. Big selection, going big. Pay daily. Outfit Free. American Waterproof, 724 Roosevelt, Dept. PM-1, Chicago.

BIG Pay every day! Complete guaranteed line direct to wearer. Dress Shirts, Work Shirts, Flannels, Overalls, Pants, Leather Coats, Sweaters, Playsuits, \$10-\$25 daily. Experience unnecessary. Big outfit free. Ninrod Co., Dept. 8, 4922-28 Lincoln Ave., Chicago.

EMBOSSED, Engraved lodge emblems for Autos. L. Belle Mfg. Co., 96 Friendship, Providence, R. I.

EVERY Woman Wants a Sewing Set. Home Sewing Sets contain 142 useful sewing articles. \$4 an hour easily made with this 50c seller. Lee Bros., 128 E. 23rd St., New York.

REAL Whirlwind Seller—Nopolout Custom Shirt. Every man buys them. Patented—no competition. Liberal commission. Free selling kit. Make \$15 up daily taking orders direct from consumer at manufacturer's prices. District or local agents. Write Nopolout Shirt Co., Dept. Y, Hazleton, Pa.

\$60-\$200 A WEEK. Genuine Gold Letters for store windows. Easily applied. Free samples. Liberal offer to general agents. Metallic Letter Co., 438-B North Clark, Chicago.

WILLIAMS' Powdered Hand Soap has taken auto owners by storm. Cleans dirtiest hands instantly. Easy demonstration sells on sight. Free Sample and particulars. W. B. Williams, Inc., Dept. 266, Montclair, N. J.

BIG Money and Fast Sales. Every owner buys Gold Initials for his auto. You charge \$1.50; make \$1.35. Ten orders a day easy. Write for particulars and free samples. American Monogram Co., Dept. 40, East Orange, N. J.

WRITE for Opportunity List. Guaranteed high-class specialties. Every one "Leader." Miller Sales Company, Dept. P, Lexington, Ky.

RELIABLE aggressive agents needed to sell Holley Suction and Force Pumps. Used in clearing plugged plumbing fixtures. Sizes for every need. Readily salable, and show good profit to consistent workers. The Holley is priced below competition and offers, at the same time, exceptional quality. Worthwhile for worth-while men. Alert Products, Inc., Dept. 50, Holley, N. Y.

AGENTS—New Plan, makes it easy to earn \$50.00 to \$100.00 weekly, selling shirts direct to wearer. No capital or experience needed. Represent a real manufacturer. Write now for Free Samples. Madison Company, 566 Broadway, New York.

32 SECONDS complete tire change by Detmer, Ohio, with Morey Quick Action Rim Tool. Sold, singly, 49 three days, cleared \$100. Anderson, Mont., sold 1400 in 14 weeks. Get details for good territory. Harvest time Now. M. Morey Rim Tool, Buffalo, N. Y.

AT Last! Diamond Rival Discovered! Amazing blue white Rajah Gem astounds jewelry world and deceives experts. Beautiful sample case free! \$100 weekly. Quick! Rajah Diamond Co., Dept. F20, Salisbury, N. C.

SELL men's neckwear; wonderful proposition. Astor, 318-M Broadway, New York.

DO you want good live agents—fellows who can get the business? Ask me how others are doing it. I'll gladly render the necessary assistance without cost to you. Address, M. L. Rund, Mgr. Classified Advertising, Popular Mechanics Magazine, Chicago.

AGENTS. Get our prices on Coffee, Tea, Desserts, Soaps, Perfumes, etc. Endless variety, superb quality, quick service. Sample display free. Address Blair Laboratories, Lynchburg, Va.

CALIFORNIA perfumed beads selling like hot cakes. Agents coining money. Big profits. Catalog free. Mission Factory P, 2328 W. Pico, Los Angeles, Calif.

HUNDREDS of manufacturers, formerly agents selling other goods now owe their success to Miller's Guaranteed Formulas for making biggest-selling, advertised specialties in all lines. Investment small. No machinery needed. Profits great. Make your own goods—get the profit you're entitled to. Write today for my "eye-opening" literature. It's free and tells all. Miller, Chemist, 1766-W Jetton, Tampa, Fla.

DON'T Sell for others. Employ agents yourself. Make your own products. Toilet Articles, Household Specialties, etc. 500% profit. We furnish everything and show you how. Valuable booklet free. Write at once. National Scientific Laboratories, 1905 W. Broad, Richmond, Va.

WE Start You Without a Dollar. Soaps, Extracts, Perfumes, Toilet Goods. Experience unnecessary. Carnation Co., Dept 2480, St. Louis.

AGENTS—Make a dollar an hour. Sell Mendets, a patent patch for instantly mending leaks in all utensils. Sample package free. Collette Mfg. Co., Dept. 404, Amsterdam, N. Y.

NO Dull Times Selling Food. People must eat. Federal distributors make big money; \$3,000 yearly and up. No capital or experience needed; guaranteed sales; unsold goods may be returned. We furnish you with sample case, license and Free Samples for customers—Sure repeat orders. Exclusive territory. Ask now! Federal Pure Food Co., A2307 Archer, Chicago.

POLMET—The Wonderful Polishing Cloth that cleans all metals without liquid, paste or powder. Approved by "Good Housekeeping" and "Modern Priscilla"—sells fast at 25c. Sample free. Gale & Co., Inc., 15 Edinboro St., Boston.

PHOTO Medallion Men and Women, the largest line of Photo Novelties in the world. Lowest prices, quickest service. Send for catalogue showing over 200 money makers. Photo medallions, photo medallion clocks, photo mirrors, photo fountain pens, photo powder compacts, photo jewelry and photo buttons. Gibson Photo Jewelry Co., 608-614 Gravesend Ave., Brooklyn, N. Y.

AGENTS: 500% profit. "Happy Home Make Shampoo" builds your own big business. Martin of Indiana made \$75.00 in one day. Missouri man made \$750.00 one month. Exclusive territory. Geo. A. Schmidt & Co., Dept. P. 236 W. North Ave., Chicago.

REPLATE brassy worn-off Automobile parts, Reflectors, Bath Room Fixtures, Worn Spoons, Forks, etc., with pure silver. Looks like new. Use U-Kan-Plate Polish. Positively no mercury. \$1.00 half pints. Post Paid. Satisfaction Guaranteed. Agents wanted. Dept. A, U-Kan-Plate Co., Philadelphia.

AGENTS make \$10.00 Daily selling Non-Splash Water Filters on sight. Best canvasser's article on market. Investigate. Write for particulars, Desk 14, Seed Filter Company, 73 Franklin Street, New York.

FIBRE Brooms—detachable handles, fine finish. Good profits, repeat sales. The Fibre Broom People, 147-C New Jersey Ave., Brooklyn, N. Y.

MONOGRAM Automobiles, \$1.35 Profit ten minutes' work; every owner wants them; millions without; particulars free. Motorists Accessories Co., Mansfield, Ohio.

ONE of the biggest malls on earth. Sent to any address for 10c. Louisiana Distributing Service, Dept. PM, Harmon, La.

MAN in each town to plate auto parts, reflectors, bathroom fixtures, refinish beds, mirrors, chandeliers; by new method. No capital or experience required. Simple plan of manufacturing at home starts you in big money-making business. Outfit furnished. Free particulars and proofs. Gun Metal Co., Ave. H. Decatur, Ill.

OUR Luminous Crucifix Shines in the Dark. Every one amazed at the wonderful effect. Easily demonstrated. Easily sold. W. G. Hannan Co., Dept. B, 2539 So State St., Chicago.

A BUSINESS of Your Own—Making Sparking Glass Name and Number Plates, Checkerboards, Signs, Ric Book and Sample Free. E. Palmer, 512 Wooster, Ohio.

SOMETHING New. Every motorist a buyer of our electro-magnetic-emergency Wandlerlamp; takes only one minute to demonstrate and make a sale; no experience necessary; \$5.00 an hour easily made; full time or evenings. Write for sample. Wandlerlamp Co., 926 Fisk Bldg., Dept. 10-A, New York.

AGENTS wanted to sell Velvet Hand Soap, a very fine mechanics' hand soap; this soap is a good seller with unusual merits. One giving their entire time can make a very fine commission. However, we would like some to take as side line. Territorial rights given. Velvet Chemical Company, 30 N. Michigan Ave., Chicago.

AGENTS Wanted for fast, easy seller—Marvel pipe cleaner; literature free. Costick Products, 400 West 23rd, New York.

NEW, Fast Seller; 150% profit: "Best-ever Powdered Hand Soap"; removes grease, paint, ink, dirt; great repeater. Sample Free. Bestever Prod. Co., 4319-P, Irving Park, Chicago.

PORTRAIT Agents—Write for new Catalogue—Enlargements, Frames, Medallions, Sheet Pictures, Luminous Crucifixes. Adam J. Kroll & Co., 2539 So. State St., Chicago, Ill.

WANT Distributing Agent for Handsilk, powdered hand soap; removes anything from hands; everybody a customer; sample free. Solar Products Co., J-2142 S. Troy, Chicago.

ALL-YEAR-ROUND profitable business selling wonderful new water softener and cleaner. Removes grease, oil, ink and dirt quickly. Every home and business place a live prospect. 100% profit. Big repeat orders. Exclusive territory. Write for free sample. Seacoast Laboratories, Sea Bright, N. J.

GOLD Leaf window letters and script signs. No experience; 500% profit. Samples free. Consolidated, 69-U West VanBuren, Chicago.

REMNANT Store, Bethel, Ohio. Greatest Dry Goods Bargains on Earth. Agents and Dealers.

AGENTS—Clever Invention! Inkspoon makes every pen a fountain pen. Fast office seller; big profit, demand increasing everywhere. Exclusive territory offered. Sample free. H. Marul Company, Tribune Bldg., New York, N. Y.

GET Our Free Sample Case—Toilet articles, perfumes and specialties. Wonderfully profitable. La Derma Co., Dept. A, St. Louis, Mo.

BIG Profits; Steady Income our line food products, toilet articles, soaps. No cash or experience needed. Sample case free. Write Linro Co., Dept. 242, St. Louis, Mo.

OVER 100% Profit. Self Lighting Gas and Cigar Lighters; Everybody interested, repeat business. Sell individuals, dealers, subagents. Particulars Free. P. Bernhard, 127 West 30th St., New York.

UNDER Your Name or Brand. Sell Our Laundry Tablets. Amazing profits. Samples, circulars free with order. Costick Products, 400 West 23rd, New York.

\$1,000.00 CLEARED in 30 days by one agent. New Amazing Cleaner. Sample Free. Bestever Products Company, 4317-P, Irving Park, Chicago.

AUTOMOBILE Specialties. Guaranteed formulas for all latest money makers. Lowest prices. Write for free lists. Murphy, Chemist, Tujunga, Calif.

BIG profits distributing 5c candy specialties to dealers. Fast sellers. Exclusive territory. Universal Sales Company, 631-B Wilson Ave., Brooklyn, N. Y.

AGENTS—250% profit selling exclusive new process Artistic Signs. Finest selection of stock signs in the country, barring none. Details free. Sample 10c. Artistic Signs, 799-R Broadway, New York, N. Y.

SEND 25 cents for a one dollar Cigar Lighter, and learn how to make \$10 a day. Particulars free. Rapid Mfg. Co., 799 Broadway, New York City.

HIGH-GRADE SALESMEN WANTED

DEMAND for Electric Window Displays is Established. Our Hustlers easily hitting \$100 weekly with the Leader—Mazig Window Salesman—Color, Light, Motion, High-class. Buyers fall quick on demonstration. Greatest quick-change Letter System known, and new, snappy, Two-color Poster Service the answer. Live salesmen getting protected territory now. Display Products Co., A407-9 East 31st, Kansas City, Mo.

TRAVELING Salesmen Calling on Retail Stores wanted by large manufacturer of fast-selling specialties entirely different from the average. Year-round sales, main or sideline. Big commission paid immediately on original and repeat business. Opportunity for well paid and permanent connection with old-established firm. If not making \$150 weekly, write today. Union Specialty Works, Dept. 222, Boonville, N. Y.

TWENTY-SEVEN dollars daily selling Fifth Avenue Clothes. Sell every man. Four times as much profit. Prices to fit every pocket book. \$19.75, \$24.75, \$29.75, \$34.75. Commission, \$3.00 to \$7.00. Also raincoats and overcoats. Majority of salesmen with us two and three years doing a record-breaking business. Leatherette Case, with all-wool patterns, actual photos free. Write H. W. High, Pres., Harrison Bros., Dept. 867, 133 West 21st Street, New York.

HOW about becoming my partner in a tailoring business right in your own city? It is a clean, permanent connection paying real money—and more each new season. You risk nothing; we furnish everything but your selling effort. Been at it for 35 years and can get results for you. Write us your story and let us tell ours. E. E. Oplinger, Genl. Mgr., 640 Arch St., Philadelphia, Pa.

IF you are sincere and ambitious to build a permanent repeat business, we have a profitable proposition for you. Our factory is known from coast to coast for its fine quality men's dress shoes, not the middle or low grade, but the best. Every pair is sold direct to the consumer and fully guaranteed. Good commission. Protected territory. Write Colt Shoe Company, 750 Atlantic Ave., Boston, Mass.

\$30.00 A DAY Guaranteed to Workers taking orders for Goodwear tailored-to-measure clothes at sensational new low price. Tremendous assortment Virgin Wool fabrics. Biggest cash commissions paid daily and special cash bonus besides, makes ours best-paying line in America. \$25.00 Sales Outfit free. Exclusive Territory. Write at once to Dept. 206, Goodwear, Chicago, Inc., 844 West Adams, Chicago.

EASY to sell groceries to consumers from samples. Steady, profitable work. Capital or experience unnecessary. 55 years in business. Loverin & Browne Co., Wholesale Grocers, 1500 So. State, Chicago.

DISTRICT Managers and salesmen of highest ability with a past record of success are wanted to sell the finest line of popcorn machines on the market. Extremely liberal commissions. Star Mfg. Co., 1236 N. Clark St., Chicago.

EARN \$20 a day. Establish income for life selling for \$1 a year, \$1,500 accident policy. Write W. C. Stone, A-11 So. La-Salle, Chicago.

IF you can devote two to four hours an evening to profitable spare time work, write us at once. We pay \$2.00 to \$4.00 an hour. No experience necessary. Nawco Company, Dept. 10-ZH, Covington, Ky.

WINKER Salesmen Are Making Wonderful Money. Sell Every Merchant: In all Lines of Business. 150% Profit. Sample, 50 Cents. Flash Electric Co., 61 Hall St., Brooklyn, N. Y.

MAKE \$25.00 daily selling colored Raincoats and Slickers; Red, Blue, Green, Etc., \$2.95. Hat Free. Commissions daily. Outfit Free. Elliott Bradley, 241 VanBuren, Dept. AB10-S S. Chicago.

40% COMMISSION selling printed Business Stationery at knock-out prices. Free outfit. L. Process Service, Minneapolis, Minn.

WANTED Agents, also salesmen capable of organizing sales force. We have manufactured fine shirts and pajamas since 1863; recently decided to sell our product direct. Write for our line and free samples. This is a wonderful opportunity. Bostonian Mfg. Co., 72 Summer St., Boston, Mass.

TAKE orders for coffee, flour, dried fruits, canned goods; meat, staple groceries, toilet articles, paints, tires, auto and tractor oils. No capital or bond required. We deliver and collect. Permanent business. Big pay. Write at once. Hitchcock-Hill Co., Dept. 50, Chicago.

ONE sale daily means \$300 monthly. Smallwood sold twenty in three hours. Improved 3-lb. Calculator. Retail \$15.00. Work equals costly machines. Fully guaranteed. For details, Trial Offer and protected territory, address Lightning Calculator Co., Dept. F, Grand Rapids, Mich.

TAILORING Agents. Earn \$35.00 to \$75.00 weekly, showing fine 100% Pure Virgin Wool \$23.50 suits, union hand-tailored to measure. Equal usual \$35 to \$40 suits. Old reliable \$4,000,000.00 firm offers pay in advance, exclusive territory, generous backing and big outfit of hundreds of large samples free. Write J. B. Simpson, 843 Adams St., Dept. 1381, Chicago.

OWN your own business. Inexperienced workers, spare time or full time, build profitable business with our new plan. Show marvelous line of actual shoes. Men's, women's and children's. Also durable silk hosiery. We start you by furnishing \$40 sample outfit. Patented measurement system insures perfect fit. Every day pay day. Larger variety of styles and sizes than any store. If you want a permanent business, send for free book "Getting Ahead." Write now. Tanners Shoe Manufacturing Co., 3510-C Street, Boston, Mass.

THE Biggest Money-Maker in the field. Gibraltar 14-point Shirts. Tailored to custom requirements. 41 Fabrics. 5 Models. Better Values, Lower Prices. No extra charge for large sizes or long sleeves. Large swatches, 4x16 inches doubled. No Stunts—but Bigger Commissions in full. Write for Free Kit Today. Gibraltar Shirt Corp., Dept. PM-9, 35 West 22nd St., New York.

SALESMAN—Manufacturer of established line guaranteed tools offers profitable connection to men with mechanical and some sales ability; part time men considered; two average sales daily net \$50.00 weekly; advance against commission. Write for free catalogue and money-making plan. J. G. Woods, Inc., Dept. 102, 37 West 20th St., New York, N. Y.

PUNCHBOARD Salesmen. 2 hours daily. \$100 every week. New line. Lowest prices. Full commission on repeat business. Catalog free. Puritan Novelty Co., 1413-A, Jackson, Chicago.

SEND name, address on postcard. Free introductory copy Salesology Magazine; contains 1,000 money making opportunities. Offered by big reliable firms; no obligations. Salesology Magazine, Desk B-39, 500 No. Dearborn, Chicago.

DON'T sell for others. Employ agents yourself. Make your own products. Toilet Articles, Household Specialties, etc. 500% profit. We furnish everything and show you how. Valuable booklet free. Write at once. National Scientific Laboratories, 1905 W. Broad, Richmond, Va.

BIG Season Just Ahead. Advertising pencils most popular every day—every business prospect. Our line repeats. Big commissions. Established in 1902. North American Pencil Works, 126 So. Clinton, Dept. 55-D, Chicago.

MEN—Sell dependable shrubbery, fruit trees, etc. Steady demand. Complete co-operation. Commissions paid weekly. We deliver and collect. Write Perry Nurseries, Dept. R-10, Rochester, N. Y.

SALESMEN—Either full or part time, to sell salesbooks, autographic registers, rolls and flat packs, interfolded forms for billing machines and printed gummed tape. There is a steady demand and repeat business for these items. Syracuse Salesbook Co., 406 Chamber of Commerce Bldg., Syracuse, N. Y.

SALESMEN—Just out, \$8.88 for men's suits; commission \$3 in advance; free selling kit. The 888 Company, Dept. M-10, Fort Wayne, Ind.

DOUBLE Spark Plug—Two spark gaps; bigger, hotter spark on weaker current and leaner mixture. Guaranteed to be better than other plugs or money refunded. 50% Commission. Agents and side-line men wanted. Affinity Spark Plug Co., Box P-329, Omaha, Neb.

MR. BRUSH Salesmen—Old Established New York Brush Manufacturers require services of men in all territories to sell their extensive line of Sanitary Twisted Wire Brushes. We pay larger commission than any other Brush House in the country. Write immediately for proposition. Wire Grip Sanitary Brush Corporation, 15 Mercer Street, New York.

COLLECTS Money from the Dead-Beats. Retails—\$5.00. Cost—\$1.00. Profit \$4.00. "New Method." Every Storekeeper, Doctor buys quickly. Wonderful Money Getter. Federal Association, Hartford, Conn.

RICHARDSON'S Electric Window Display Signs—wonderful selling features; unique factory co-operation and personalized demonstration effects closes sales fast. Protected territory. Write quickly. Arthur A. Richardson (Not Inc.), Cole Ave., Pittsfield, Mass.

WRITE Atlas Sign Works for free working equipment. Beautiful window sign letters. Penny each! Any size. Wonderful offer to general agents. N 1032 E. 55th St., Chicago.

EARN \$10 daily silvering mirrors, plating, refinishing metalware, chandeliers, head-lights, bedsteads. E. Decie Laboratories, 225 Varick St., New York.

GET our tool selling offer. Champion Sales Co., Box 604, Minneapolis, Minn.

TOOL Salesmen for complete line tools, shop equipment, sold direct to mechanics, repair shops. Protected territory. 30% commission. Automotive Tool Mfg. Co., Milwaukee, Wis.

SPECIALTY Sideline Salesmen don't look further. Our fast, new specialty 4 sales \$22 a day; easy. Mrs. Products Distributors, 186 No. LaSalle, Chicago.

ADVERTISING Calendars and Novelties, Money-makers for real salesmen. Select line; quick sellers. Full time or sideline. Wm. Miller Son Co., Charlestown, N. H.

SELL printing. Big commissions. Outfit Free. Atlas, 2622-G, East Tenth, Indianapolis, Ind.

DISTRICT Salesman—All wool. Union Made suits, overcoats, \$23.50. Liberal advance commission, bonus. Write for expensive Free outfit. Harvey Bros., Dept. 513, Box 00, Chicago, Ill.

TO market 3A garage Door Holders. Simple Automatic action; Easy, Quick installation instantly attracts Private Garage Owners, Builders and Dealers. Write for attractive, exclusive territory proposition. Knowlson-Stevenson Company, 1118 Packard, Ann Arbor, Mich.

SALESMEN—Become Independent. Own Your business, experience unnecessary selling our \$7,500.00 Accidental Death; \$50 Accident; \$25 Sick Weekly Benefits—\$12.50 Yearly. Other Amounts proportionate. Guaranteed steady income from renewals. \$250,000 Deposited Insurance Department. Universal Policy, Dept. A, 30 Clinton St., Newark, N. J.

A GUARANTEED salary and commissions selling new specialty among all retailers. Enormous opportunity. New Specialty Corp., Cedar Rapids, Iowa.

REPRESENTATIVES wanted by over 500 manufacturers, offering real money making propositions. No need of being out of work. Write for Free Copy. Opportunity Magazine, 750 N. Michigan, Service Dept., Desk 1, Chicago.

FOUR \$7.50 sales to merchants net you \$20.00 daily. Sayers Systems, 2803 Sheffield Ave., Chicago, Ill.

ANY Salesmen Can Sell Them! Merchants everywhere use punchboards. Someone sells them, why not you? Collect big commissions daily. Newest, largest, elaborate catalog sent upon request. Lincoln Sales Co., 9 So. Clinton, Chicago, Dept. D.

\$60-\$200 A WEEK. Genuine Gold Letters for store windows. Easily applied. Free samples. Liberal offer to general agents. Metallic Letter Co., 438-A North Clark, Chicago.

DISTRICT Managers: 16 hosiery styles, 10 lingerie styles; over 60 colors. We deliver. \$10.00 sample outfit furnished to representatives (no deposit); 10% bonus. Premium to customer. Advertising and office allowance. Send three references, stating experience, to see Samples Dept. G, S. Q. S., Lexington, Ky.

WALKER Made \$165.00 First Day selling Collection System to Doctors and Merchants. Retails \$8.50, Collects \$65.00, Costs \$1.50. Adjustment Bureau, Mobile, Ala.

GOLD Leaf window letters and script signs. No experience; 500% profit. Samples free. Consolidated, 69-V West Van Buren, Chicago.

HELP WANTED

AGENTS—Do You Want \$87.00 Every Week in Advance? Then write at once. New selling plan has everything beat. A. Seaholm made \$20.30 a day; George Sundholm, \$18.47 in 9 hours; O. E. Jarrett, \$15.25 in 5 hours. Just take orders for New Style Guaranteed Hosiery; we deliver and collect. Your pay begins at once, monthly cash bonus and free auto. We furnish samples. No capital or experience needed. Milton Mathews, Road 26010, Cincinnati, Ohio.

SOUTH AMERICA: How to obtain Positions. Booklet. Lists prospective employers. \$1.00. Box 342, South Bend, Ind.

REPRESENTATIVES wanted by over 500 manufacturers, offering real money making propositions. No need of being out of work. Write for Free Copy. Opportunity Magazine, 750 N. Michigan, Service Dept., Desk 3, Chicago.

GET a job! 70 offered one person! "How To Obtain Employment" must get you work within 30 days or money returned. 50 cents, postpaid. Better Yourself! New Idea Service, Box 39-A, Station K, New York.

SEND name, address on postcard. Free introductory copy Salesology Magazine; contains 1,000 money-making opportunities. Offered by big reliable firms; no obligations. Salesology Magazine, Desk B-40, 500 No. Dearborn, Chicago.

MONEY! Yes, Big Money Refinishing furniture, radio-cabinets, etc. Spare-time, full-time. Experience unnecessary. Write F. Jackson, 716 W. Exchange, Owosso, Mich.

DISTRICT Manager: Tailoring Experience. Selling direct to consumer. Wonderful proposition. Attractive popular prices Men's clothing. Unusual co-operation to man who qualifies. Brighton Tailoring Co., 640 Broadway, New York, Dept. P. M.

WE Start You in Business, furnishing everything; men and women. \$35.00 to \$100.00 weekly operating our "New System Specialty Candy Factories." Few dollars start you home or small room anywhere. Booklet free. W. Hillyer Ragsdale, Drawer 350, East Orange, N. J.

MAKE \$25.00 daily selling colored Rain-coats and Slickers; Red, Blue, Green, Etc., \$2.95. Hat Free. Commissions daily. Outfit free. Elliott Bradley, 241 VanBuren, Dept. AB10-M, Chicago.

ARE You Old at Forty? See our advertisement on page 42 of this issue. The Electro Thermal Company, 2174 Main St., Steubenville, Ohio.

CASH Paid for Butterflies, Insects. See Sinclair Display Advertisement on page 26.

COUNTY, State and Canadian Representatives for credit reporting. Liberal drawing account. Western Credit Index, 266 Lankershim Building, Los Angeles, Calif.

HELP WANTED—INSTRUCTION

STEAMSHIP Positions—Europe, Orient. Good pay. Experience unnecessary. Men and Women write for free particulars. Box 30-A, Mount Vernon, N. Y.

GOVERNMENT positions pay \$35 to \$75 weekly. We help you get them. Big List Free. Write, Mr. Ozment, 101, St. Louis, Mo.

SILVERING Mirrors, French Plate. Easily learned; immense profits. Plans free. Wear Mirror Works, Excelsior Springs, Mo.

U. S. GOVERNMENT wants men. \$1,700-\$1,900 and up at start. Railway Mail clerk examination coming. Let our expert (former Government examiner) prepare you for this and also Rural Carrier, Post Office, Customs, Internal Revenue, and other branches. Write today for free booklet. Dept. 8, Patterson School, Rochester, N. Y.

YOU Are Wanted. Men-Women 18 up. Get U. S. Government Life Jobs. \$95.00 to \$250.00 Month. Steady work. Short hours. Paid summer vacation. Pull or experience unnecessary. Common education sufficient. We coach you without leaving home. 32-page book with full particulars free. Write immediately. Franklin Institute, Dept. P3, Rochester, N. Y.

LEARN Telegraphy. Pleasant, steady work. Operators earning big money. Always in demand. No experience necessary. Write Chief Operator, Illinois Telegraph, 1608 W. Madison, Chicago.

\$1820-\$2600 YEAR. Learn Auto Repairing. Sample lessons free. Franklin Institute, Dept. P400, Rochester, N. Y.

GOVERNMENT pays big salaries. Prepare for next examination now. Expert coaching. Booklet free. Write L. Hampton, Box 1818-X, Washington, D. C.

EARN \$150 to \$250 month. We prepare you at home for government positions. Permanent work. Experience unnecessary. Master course of instructions. Low price. Easy terms. Illustrated booklet free. Standard Institute, 5155 Broadway, Chicago.

BECOME a Landscape Architect. Uncrowded profession of wonderful opportunity for money-making. Easily mastered by mail. Earn while you learn. Write for book. American Landscape School, 56-E, Newark, N. Y.

\$158 TO \$225 Month. Railway Postal Clerks. Men 18 up. 25 coached free. Common education sufficient. Write immediately. Franklin Institute, Dept. P14, Rochester, N. Y.

\$158-\$225 MONTH. Railway Postal Clerks. Men 18 up. 25 coached free. Write immediately. Franklin Institute, Dept. P14, Rochester, N. Y.

MEN wanting outdoor work, qualify for forest ranger position. Start \$125 month; cabin and vacation; patrol the forests, protect the game; give tourists information. Write Mokans, Dept. M-21, Denver, Colo.

MEN to train for locomotive firemen on railroads nearest their homes—everywhere; beginners \$150-\$250 monthly; promoted, locomotive engineer, \$3,000-\$4,000 yearly. Best paying positions on railroads. Railway Association, Desk M1, Brooklyn, N. Y.

MAILING LISTS

99% GUARANTEED Mailing lists. Accurate. Reliable. Guaranteed. The kind that produces business; compiled for every possible business or individual. Lists of every kind of any business or individuals compiled for your individual needs anywhere. Catalog and information on request. National List, 847 Broad, Newark, N. J.

1927 RURAL women's names. 1000 One Dollar. Sheagreen, PM1427 North Penn, Minneapolis, Minn.

NAME lists 50c hundred; \$5.00 thousand; dependable. Hester Young, 503 Liggett Bldg., Detroit.

GUARANTEED Lists, original letter names. Mail order buyers, agents, opportunity seekers, others. Thousand, \$4.00. Reduction on quantities. Price list free. Demuth Company, Englewood, N. J.

INFORMATION

COMPREHENSIVE Research service, specializing in formulas that are dependable and explicitly written, \$1. State essential requirements. Aram Amirian, 263 Jackson, Jersey City, N. J.

ABSOLUTELY secret codes for business and pleasure correspondence. Guaranteed. Southern Secret Service, Perry, Okla.

BUSINESS SERVICE

REPRESENTATION in Washington, D. C. Information. Anything. Anytime. Service, Victor Bldg.

NEW YORK address, \$5.00. Broadway Service Co., 42 Broadway.

TYPEWRITERS AND SUPPLIES

TYPEWRITERS, all standard makes, thoroughly re-manufactured by the famous "Young Process" and shipped direct from factory to you on 10 days' trial. Guaranteed 5 years. Easy monthly payments. Write today for free catalog. Young Typewriter Company, Dept. 574A, 654 W. Randolph St., Chicago.

ALL makes, lowest prices, 5-year guarantee. Several specials. Free illustrated catalogue. Henry Typewriter Co., 217 West 125th St., New York, N. Y.

100 TYPEWRITERS Free. Overstocked. Rent Rebuilt Underwood or Remington \$3.00 month. If you pay its value in rental, we give machine free. Particulars free. Pittsburgh Typewriter Exchange, 945 Hersch Bldg., Pittsburgh, Pa.

TYPEWRITERS, Radios, Motorcycles, \$3-\$35. Knights, 1512 Locust, St. Louis, Mo.

UNDERWOOD Typewriters—only \$3.00 down. Easy monthly payments. Low prices at less than manufacturers, 10 days' free trial. Rebuilt, all worn parts replaced. Just like a new machine. 5-year guarantee. Write for a big free catalog. Shipman-Ward Mfg. Co., 1517 Shipman Bldg., Chicago, Ill.

TYPEWRITERS—All makes; real bargains; guaranteed. Typewriter Bargain House, Ada, Okla.

TYPEWRITERS, all standard makes. \$10 up. Fully guaranteed. Free trial. Write for complete illustrated lists. Northwestern Typewriter Exchange, 121 N. Francisco Ave., Chicago.

PRINTING, ENGRAVING AND MULTIGRAPHING

250 LETTERHEADS and 125 envelopes, \$1.50, postpaid. Oberman Company, Box 1268, Chicago.

1,000—6½ WHITE envelopes printed, \$2.35; 5,000—\$8.85. Letterheads, 1,000—\$2.95. Spors Printery, Lesueur Center, Minn.

\$3.00 DELIVERED, 500 watermarked bond letterheads 8½x11 and 250 envelopes. Cash. Catalog free. Printing bargains. National Printing, Goshen, Ind.

SOCIETY Stationery, 48 Sheets, 48 Envelopes, 50 Visiting Cards, All \$1. Mogensen, 1409 Cass, Omaha, Nebr.

LETTERHEADS, Envelopes, 500 each, \$3.00. No delay. G. Bixler, Frankfort, Ky.

5,000 LOTS, Art Advertising slips, \$5.00; 5½x8½ colored bond circulars, \$10.00; elegant enamel folders, \$13.75. Samples. Good's Printery, Harrisonburg, Va.

1,000 PRINTED; Name, business, address, 50c. JBS Co., Box 93, Holyoke, Mass.

200 HAMMERMILL Letterheads, envelopes, billheads or cards, \$1.00. Race Printery, Hudson, N. Y.

250 HAMMERMILL Bond Letterheads, Envelopes, \$3.00. Samples. Midland Press, 543 West Hickory, Kankakee, Ill.

"NEARGRAVURE" Process Printed Stationery. If you're particular. Samples, stamp appreciated. Sell days, Knorr, Ind.

250 6½ ENVELOPES \$1.00 Postpaid, Daniel Printery, Heber Springs, Ark.

\$2.95, 1000 BOND Letterheads. Ewan, 49 Pearsall, J. C., N. J.

BOND Letterheads, \$2.95 per 1,000 delivered; cash with order. Atoka Press, Atoka, Okla.

150 BOND Letterheads, 8½x11, and 150 Envelopes printed to order \$1.50. 125 Business Cards \$1.00. J. Ferreira, 249 Eugenia St., New Bedford, Mass.

50 PANELLED Visiting cards printed \$1.00. Rees Colorotype, Danville, Ill.

200 ENVELOPES \$1, 200 lettersheets \$1. P. Laffin, Coshocton, O.

1000 BUSINESS Cards, Envelopes, or Letterheads, \$3.00, 300, \$1.00. Hurley, 108 Eureka, San Francisco.

IMITATION Typewritten Letters, (mimeographed): 500—\$3.00; 1,000—\$4.00; printed heads, 20-lb. bond, prepaid; samples, price-list, red stamp. Letter Service, 3414 East 27th, Kansas City, Mo.

200 HIGH-GRADE Bond Letterheads, Envelopes, \$1.00; other printings. Ask for samples. De Toledo Printing Co., 455 N. 51st Street, Philadelphia, Pa.

100 CALLING cards and genuine leather case \$2.00; over one line 10c line extra. 200 standard business cards \$1.00; over 5 lines 10c line extra. Sample for stamps. Business Card Specialty Co., Q552, Jackson, Mich.

PUBLISH Your Own Magazine or House Organ. Our standardized service at one-fifth ordinary prices. Samples and particulars free. Evans Printing Company, Grand Rapids, Mich.

1,000 LETTERHEADS or Envelopes, \$3.00. Sent Prepaid. Samples Free. Monitor Press, Morrisville, Pa.

PRINTING—Stationery, Circulars, Booklets. Fine work; prices right. Battlefield Press, Gettysburg, Pa. Free battlefield souvenir.

200 SHEETS and 100 Envelopes printed, \$1.00. Write for samples. J. Brooks, Printer, Glasgow, Ky.

DISTINCTIVE—Artistic Business Stationery that Creates Confidence. 1,000 Letterheads or Envelopes \$3.00. Samples. Moulton Printing Company, 1410-P East 8th, Kansas City, Mo.

WE print Stationery, Booklets, Catalogs, Circulars. Samples. Commercial Press, Batavia, Ohio.

MULTIGRAPHING business correspondence, two dollars thousand. Hammerrill letterheads, four dollars. Miscellaneous printing. Mayers Corporation, Monmouth, Ill.

250 BOND Letterheads, Envelopes, Billheads, Cards, \$1.35 each. Economic Press, Leonia, N. J.

GUMMED Labels—The Better kind, with name, business and address, 500—40c; 1,000—60c; 2,000—\$1.00. P. Wetzel, Valhalla, N. Y.

QUALITY Printing! Reasonable Prices! Send for Free Standardized samples and prices. Folders, Circulars, Catalogs our specialty. Earnest Fantus, 525 South Dearborn, Chicago.

PRINTING, OUTFITS AND SUPPLIES

PRINTING Presses, type, supplies, list 2c stamp. Bargains. Geo. Foster, 4342 North Robey, Chicago.

COMPLETE printing outfits, presses, type, ink, paper, supplies. Write for Catalogue, Kelsey Company, G-11, Meriden, Conn.

PRE-USED Printing Presses, Type supplies. List for 2c stamp. Popular Bargains, Richland, Pa.

PRINTING Outfits—Presses, type supplies, type novelties. Send stamp for catalogue. Model Press, York, Penna.

RUBBER STAMPS

RUBBER Stamps—First line 15c; additional lines 10c. Newman & Son, Desk 44, Auburn, Neb.

MAKE Your own stationery. Three line rubber stamp, name, street and address, complete with pad, \$1. Check, money order or cash with order. Any stamp made to specifications. Agents wanted. Write for information. Victor Rubber Stamp Company, 218½ W. Fourth St., Los Angeles, Calif.

DUPLICATORS AND DEVICES

MULTIGRAPHIS, complete, \$63.00, \$78.00; Duplicator \$8.00; Multipost stamp affixer \$16.00; Adding, listing machine \$29.00; Rebuilt checkwriters \$3.00, up. Earl Warring, Parkersburg, Iowa.

YOU can make 50 to 100 copies of a letter, notice, etc. at a cost of three cents on a Hoyer Quality Duplicator. Write for free trial offer. The Hoyer Duplicator Co., 909 Jackson Blvd., Chicago, Ill.

ADDING MACHINES

NEW \$3.50 Automatic Adding Machine. Adds, subtracts, multiplies absolutely accurate. Capacity \$999,999.99. Fully guaranteed. 75,000 pleased users. Makes adding easy, positive, quick. Eliminates mistakes. Saves time. Postpaid \$3.50. Bassett Co., 1458-II Hollywood Ave., Chicago.

FREE trial, Marvelous Calculator, Adds, Subtracts, Multiplies, Divides automatically. Work equals \$300.00 machines. Five year guarantee. Price only \$15.00. Write today for free trial offer. Special: \$3.00 Pocket Calculator, only \$2.00 cash. Lightning Calculator Co., Dept. E, Grand Rapids, Mich.

FOR SMOKERS

CIGARS, Spanish hand-made, mild, aromatic tobacco, 25 Coronas, 5¼", 10c retail value, \$1.10; hundred, \$3.75, C.O.D. Samples 10c. Agents wanted. R. Valles, 76 W. 113th St., New York.

BETTER Tobacco! Fragrant, mellow! Ten pounds smoking, \$1.50. Four pounds chewing, \$1.00. Farmers' Club, 57, Hazel, Ky.

FOR THE HOME

CARPENTERS make novelty furniture for Xmas trade; make of any common wood, finishing with new lacquer shades. Blueprints, two each, writing desks, end tables, smoking stands, telephone stands, sewing cabinets. One Dollar. Box 121, Benton, Wis.

GRANDFATHER'S Clock Works. \$5.00. Build your own case; Instructions free; make good profits selling your friends. Clock works with chimes for old or new cases. Write for full particulars. Clock Co., Ruffner St., Philadelphia.

CEDAR chests only \$11.65—"Red-i-Kut" complete with rich copper trim—you assemble and save half—send for pictures. Kuempel Furniture Company, Guttenberg, Iowa.

OIL Burners, power type, manual control, for home heating; were \$295, now \$75. The Progressive Oil Burner Co., Ann Arbor, Mich.

RAZORS AND BLADES

10 GILLETTE Style Razor Blades 30c. Stamp for circular. Courtney Co., 2900 W. Lafayette, Baltimore, Md.

GILLETTE Style Blades. All new, 3 dozen \$1.00. Wallace Kutz, 132 Chambers, Phillipsburg, N. J.

"PERFECTEDGER" safety razor blade sharpener. Agents wanted—commission \$50.00. Horton Manufacturing Company, Minneapolis, Minn.

BOATS AND LAUNCHES

BUILD Your Own Boat using our Knock-Down ready cut materials. 85 models, outboard motor speedsters, runabouts, cruisers, sail, or row. Send 25c for catalog. Brooks Boat Co., Inc., Rust Ave., Saginaw West Side, Mich.

HUBBEL Marine Coolers convert Ford engines into marine motors. Booklet free. Ford speedboat easily built, blueprint and directions, sixty cents. C. C. Hubbell, Perry Ave., Norwalk, Conn.

PROPELLER, stuffing boxes, bearings, rudders, etc. Wm. H. Baker, Pond St., Quincy, Mass.

WATCH REPAIRING

ALL makes of Watches repaired by experts. Write International Watch Service, Box 5P, Fordham Station, New York.

ANTIQUES, WAR RELICS AND INDIAN GOODS

ANTIQUE firearms, swords, bowlerhorns, daggers. Catalogue free. NAGY, 8A South 18th, Philadelphia.

100 GENUINE Indian arrowheads from Arkansas \$4.00 postpaid. H. Daniel, Lamar, Ark.

SEND 5c for fine new list Indian relics, antique firearms. F. E. Ellis, Webster Groves, Mo.

SEA Shells, cigar box full, \$1.00. C. G. Drake, Box 791, Clearwater, Fla.

FOR Dens, Relics and medals from Europe's Battlefields. Illustrated catalogue, 25c. International, 1889 Albany Avenue, Brooklyn, N. Y.

PHONOGRAPHS AND RECORDS

BUILD Your own phonograph. Catalog and instructions to build new type horn mailed for 10c. American Phonograph Co., 4116 West 24th Place, Chicago.

MUSIC AND MUSICAL INSTRUMENTS

ERNEST Pechin—Jaroslav Cimera cornet and trombone virtuoso, presents elementary artists courses of instruction for cornet, trumpet, trombone and baritone, arranged in four parts for systematic study. Illustrated and exemplified with phonograph records to guide your work. Each part fully demonstrated; you hear it done as you study and learn correctly. Send for full information about course, stating instrument. Apollo Music Co., P. O. Box 1321, Chicago, Ill.

I BUY, Sell, Publish Songs. Chester Echer, 455 Wayne St., Jersey City, N. J.

MUSIC composed and arranged: Art Melody Co., Art Theatre Bldg., Kansas City, Kans.

SONG Poem Writers, address Hibbeler, Dl, 2194 N. Keystone Av., Chicago.

SONG-POEM Writers: Address Monarch, 236 W. 55th, Dept. 104, New York.

SONG Poem Writers, Write Sequoia Song-writers' Service, Sherman Branch, Los Angeles, Calif.

VIOLINS, Deep, Mellow, Soulful — on credit. Easy terms for wonderful instrument. Get details today. Gustav F. Henning, 2424 Gaylord St., Denver, Colo.

"MUSIC Composed" to words. Bauer Bros., (formerly of Sousa's Band), Oshkosh, Wis.

I WANT Song Poems. Casper Nathan, 3544 N. Racine, Chicago.

FREE-Song Writers' Guide. Beaver, 1239 Elm, Green Bay, Wis.

SHEET-MUSIC, 10 for \$1.00. For Amateur Teacher or Student. Catalog free. Ferd. Zarb, P. O. B. 18, Sta. D., New York.

WRITE Songs. Big money and reputation. Write for information. J. Gordon Pub. Co., 201 N. Hoyne Ave., Chicago.

PATENT ATTORNEYS

PATENTS—Free preliminary advice. Confidential, prompt. Registered Patent Attorney, formerly Examiner United States Patent Office. Albert Jacobs, Barrister Building, Washington.

INVENTORS having ideas to patent: Write for Booklet explaining Co-operative Plan for handling your applications. Tells how to sell and safeguard your inventions at lowest cost. Ralph Burch, Patent Lawyer, Jenifer Bldg., Washington, D. C.

MILLIONS spent annually for ideas! Hundreds now wanted! Patent yours—profit! Write today for free book—tells how to protect yourself, how to invent, ideas wanted, how we help you sell, etc. American Industries, Inc., 500-Victor Bldg., Washington, D. C.

INVENTORS—Write for our Guide Book, "How to Get Your Patent" and Evidence of Invention Blank. Send model or sketch of your invention for our prompt examination and instructions free. Randolph & Co., Dept. 420, Washington, D. C.

PATENTS, Trade-marks, Copyrights. Reliable services by an experienced practitioner devoting personal attention to each case. Inquiries invited. References furnished. B. P. Fishburne, Patent Lawyer, 525-A McGill Bldg., Washington, D. C.

UNITED STATES and Foreign Patents and Trade Marks: Low rates; easy terms. H. Sanders, Registered Patent Attorney, 7 Rand McNally Building, Chicago.

ESTABLISHED 1864. Milo D. Stevens Company. Free Booklet. Patents, Trade-Marks, Copyrights. Offices, Monachnock Block, Chicago; Barrister Building, Washington, D. C.

INVENTOR'S Advisor valuable patent book, sent free. Labiniere, 3 Parkrow, New York.

PATENTS Procured, Prompt Service. Personal, careful and efficient service. Highest references. Moderate fees. Send sketch or model for actual search and advice. George P. Kimmell, Master of Patent Law, 54L Legal Bldg., Washington, D. C.

SELL your unpatented ideas. If you want to sell yours and make money send sketch to us at once. Information free. Mutual Sales Co., 713 Mills Bldg., Washington, D. C.

INVENTORS: Send sketch or model for advice and exact cost of patent. Ask for our Free book: "How to Obtain a Patent." Tells what every inventor should know. Established twenty-eight years. Highest references. Prompt service. Reasonable charges. Chandlee & Chandlee, 414 Seventh, Washington, D. C.

LACEY'S Patent Sense. Valuable book free. See ad page 160.

PATENTS—Write for our free book, "How To Obtain A Patent" and Record of Invention Blank. Send model or sketch of inventions for inspection and instructions free. Terms Reasonable. See advertisement on page 159. Victor J. Evans & Co., 534 Ninth, Washington, D. C.

PATENTS. Time counts in applying for patents. Don't risk delay in protecting your ideas. Send sketch or model for instruction or write for free book "How to Obtain a Patent" and "Record of Invention" form. No charge for information on how to proceed. Communications strictly confidential. Prompt, careful, efficient service. Clarence A. O'Brien, Registered Patent Attorney, Security Bank Building (directly across street from Patent Office), Washington, D. C. See pages 156 and 157.

INVENTORS: Send sketch or model for advice and exact cost of patent. Ask for our Free book: "How to Obtain a Patent." Tells what every inventor should know. Established twenty-eight years. Highest references. Prompt service. Reasonable charges. Chandlee & Chandlee, 474 Seventh, Washington, D. C.

PATENTS. Booklet free. Highest references. Best results. Promptness assured. Send model or drawing for preliminary examination. Watson E. Coleman, Patent Lawyer, 724 Ninth St., Washington, D. C.

"INVENTORS' Guide" sent free on request; this book contains illustrations of patented inventions and gives valuable information and advice for all who have original ideas or improvements. Frank Ledermann, Registered Attorney and Engineer, Woolworth Bldg., 1712, New York.

PATENTS That protect. Prompt service. Send sketch for free information and opinion. Ehrlich, Garrick Bldg., Chicago.

PATENTS Procured: Trade Marks Registered—A comprehensive, experienced, prompt service for the protection and development of your ideas. Preliminary advice gladly furnished without charge. Booklet of information and form for disclosing idea free on request. Richard B. Owen, 30-Owen Bldg., Washington, D. C., or 41-R Park Row, New York.

PERCY S. WEBSTER, 203 Saving and Loan Building, Stockton, California. Long established organization. Patent booklet free.

LANCASTER and Allwine, 221 Ouray Bldg., Washington, D. C. "Originators of the Form Evidence of Conception." Before disclosing your invention to anyone send for blank form to be signed and witnessed. Form and patent information bulletin free.

MONROE E. MILLER, Ouray Bldg., Washington, D. C., Patent Lawyer; Mechanical, Electrical Expert. Booklet and Priority Record blank gratis.

PATENTS obtained under Cooperative Payment Plan. Write for particulars. W. E. Beck, Registered Patent Lawyer, 951 Jenifer Bldg., Washington, D. C.

RICHARD E. BABCOCK, Patent Lawyer, Washington Loan & Trust Bldg., Washington, D. C. Booklet.

SELL your invention before patenting. Write for free particulars. W. T. Green, 801 Jenifer Bldg., Washington, D. C.

PATENTS—Write for Instructions. Carl Miller, Registered Patent Attorney (former Patent Office examiner), McGill Building, Washington, D. C.

INVENTIONS Patented. Send sketch or model for advice and costs. M. Miller, 910 Gee Street, Washington, D. C.

PATENTS, Trade-Marks, Designs. This firm has 27 years' experience and gives expert personal service at reasonable rates. We properly protect your invention. Write for free information and exact cost of procuring patent before proceeding. John B. Thomas & Co., 902 F St., N. W., Washington, D. C.

UNPATENTED Ideas Can Be Sold. I tell you how and help you make the sale. Free particulars (Copyrighted). Write W. T. Greene, 805 Jenifer Building, Washington, D. C.

FOR INVENTORS

PATENTS. If you have an invention which you wish to patent you can write fully and freely to Munn & Co., for advice in regard to the best way of obtaining protection. Please send sketches, or a model of your invention and a description of the device, explaining its operation. All communications are strictly confidential. Our Hand-Book on Patents is sent free on request. This explains our methods, terms, etc., in regard to Patents, Trade Marks, Foreign Patents, etc. "Scientific American" contains Patent Office Notes, Decisions of interest to inventors and particulars of recently patented inventions. Munn & Company, Solicitors of Patents, 1523 Scientific American Building, 24 W. 40th St., New York City; 524 Scientific American Bldg., Washington, D. C.; 1313 Tower Bldg., Chicago, Ill.; 666 Hobart Bldg., San Francisco, Calif.; 521 Van Nuys Bldg., Los Angeles, Calif.

PATENTS—Write to B. P. Fishburne (a South Carolinian). Registered Patent Lawyer, 525-E McGill Bldg., Washington, D. C.

PATENTS obtained under Cooperative Payment Plan. Write for particulars. W. E. Beck, Registered Patent Lawyer, 950 Jenifer Bldg., Washington, D. C.

INVENTIONS Developed—Your crude ideas developed into practical form for your patent application. Model not necessary. Send rough sketch and description for estimate of cost and advice. 27 years' experience. Albert E. Dietrich, Engineer and Registered Patent Attorney, 621½ Ouray Building, Washington, D. C.

I AM in touch with hundreds of moneyed men and manufacturers who wish to buy good inventions. Write Hartley, 38 Court St., Bangor, Me.

SELL your invention before patenting. Write for free particulars. W. T. Greene, 802 Jenifer Bldg., Washington, D. C.

UNPATENTED Ideas Can Be Sold. I tell you how and help you make the sale. Free particulars (Copyrighted). Write W. T. Greene, 807 Jenifer Building, Washington, D. C.

INVENTORS' Advisory Service; Experienced Patent and Marketing Assistance Rendered. Correspondence Invited. Clarence J. Williams, Engineer, American Bank Bldg., Oakland, Calif.

PATENTS wanted by manufacturers. Send description, Box 126, Dowagiac, Mich.

YOUR Patent—Let me put it over! I will consider the purchase, manufacture, or selling of any article of merit. Wire specialties, radio, and automotive lines preferred. Leo J. Schlitzer, P. O. Box 1280, Paterson, N. J.

WE will buy suitable inventions. Write Martin Laboratories, Gap, Penn.

WANTED—Inventions. Will buy Out-right or Manufacture on a Royalty Basis. Dunn Manufacturing Company, Clarinda, Iowa.

PATENTS. Time counts in applying for patents. Don't risk delay in protecting your ideas. Send sketch or model for instruction or write for free book "How to Obtain a Patent" and "Record of Invention" form. No charge for information on how to proceed. Communications strictly confidential. Prompt, careful, efficient service. Clarence A. O'Brien, Registered Patent Attorney, Security Bank Building (directly across street from Patent Office), Washington, D. C. See pages 156 and 157.

INVENTORS—Write for our free book, "How To Obtain A Patent" and Record of Invention Blank. Send model or sketch of inventions for inspection and instructions free. Terms Reasonable. See advertisement on page 159. Victor J. Evans & Co., 157 Ninth, Washington, D. C.

LACEY'S Patent Sense. Valuable book free. See ad page 160.

I SELL Patents. Established in 1906. A personal Service in your interests, not a set of "Club Breakfast" plans. Charles A. Scott, 773PM Garson Ave., Rochester, N. Y.

INVENTORS: \$2.00 connects you with big manufacturers who may buy your invention. Particulars free. Inventors Service Bureau, Box 1966, Chicago.

WANTED—Well equipped steel specialty plant, Pittsburgh district, desires correspondence with concern or individual, having device to manufacture (preferably patented device used by railroads or traction lines), who could utilize part of our facilities under agreeable arrangement. Address P. O., Box 917, Pittsburgh, Pa.

PATENTS Procured; Trade Marks Registered—A comprehensive, experienced, prompt service for the protection and development of your ideas. Preliminary advice gladly furnished without charge. Booklet of information and form for disclosing idea free on request. Richard B. Owen, 30-Owen Bldg., Washington, D. C., or 41-B Park Row, New York.

INVENTORS Universal Educator—contains 900 mechanical movements; 50 perpetual motions. Tells how to obtain and sell patents. Suggests new ideas. Explains how to select your attorney and avoid patent sharks. Price (revised edition) \$1.00 postpaid. Albert E. Dieterich, 621-Ouray Bldg., Washington, D. C.

GET your own patents. Legal blanks, complete instructions \$1. Cutting Sons, Campbell, Calif.

PATENTS FOR SALE

OUTRIGHT Or royalty—Patent Carrier for Hospitals or laboratories. Can be cheaply manufactured of aluminum. Frank Tulay, Red Cross House, Jefferson Barracks, Mo.

IMPROVED Thermometer; adjustable to correct temperature. All metal, cheaply made, quantity production. Simple useful advertising novelty for office or home. C. H. Schultz, 20 West Superior St., Chicago.

SPONGE Automobile Washer. Attaches to garden hose. Wonderful Mail Order Article. Sell Outright. Box RGT, Popular Mechanics.

PATENT pending on Complete Valve Stem for inner tube. John Rhodes, Le Grand, Iowa.

OUTRIGHT or Royalty—Spring Clip Binding Post. One Operation Manufacture. All wires and tips inserted with one hand without cutting or bending. Height one-eighth inch. United States and Canadian Patents. B. Parrott, 73 Orchard Park Blvd., Toronto, Canada.

OUTRIGHT—Brake for car trucks. Fluid pressure against piston associated with axle causes cushion action. Geo. Gates, 1733 So. Broad St., Trenton, N. J.

OUTRIGHT—Metal hand punch. Unsurpassed cutting edge; serviceable and economical. Charles Pohanz, Geneseo, Ill.

PATENT 1,487,924 chain Belt puller. Best offer. D. Doyle, Box 1231 Sacramento, Calif.

GLARELESS headlight for automobiles. U. S. Patent No. 1,628,545. Price reasonable, outright. Write F. Kinkead, 414 Mass. Ave., Boston, Mass.

CANOPY Holder.—Of the collapsible type, which may be conveniently transported in very small space, and easily placed in operative position to support a mosquito netting. Patent 1625673. V. P. Nelson, 264 Lexington Ave., New York, N. Y.

OUTRIGHT—Anti-skid chains for motor vehicles; cross chain structure prevents skidding snow, ice or mud. H. A. Moulton, Plymouth, N. H.

OUTRIGHT—Comb-brush-mirror-file kit. Compact, and manufactured at very low cost. A. R. Betancourt, 3002-12th St. N. E., Washington, D. C.

OUTRIGHT—holder for pens and pencils. Uniform writing and lines regardless of up or down strokes. E. Shaw, 1803 N. Delaware, Indianapolis, Ind.

PATENT for Sale—Automatic Rocking Chair; fortune in Porch chairs. Stransky, 200 Greenway Ave., Darby, Pa.

PAT. 1,626,503—Power-operated Hand-saws. Cash or royalty. Write to Felix Bjorklund, 224—4th St., Fairport Harb., Ohio.

WANT patented safety razor blade sharpener. Send details. Kyger, 5741 Holmes, Kansas City, Mo.

OUTRIGHT, reasonable, pipe joint for bath tubs, basins, toilets, sinks. Robert Dawson, Fairview Cottage, Skillman, N. J.

WILL Sell very valuable patent your terms. Elizabeth Smith, 3634 Suitland Road, Washington, D. C.

WHY let your patents lie idle? Tell our two million five hundred thousand readers about it! The majority of our readers are especially interested in new ideas and inventions. Ask me to tell you how other inventors successfully sold their patents. M. L. Rund, Mgr., Classified Advertising, Popular Mechanics Magazine, Chicago.

PATENT Just granted on interesting new mathematical toy. Novelty manufacturers write. Joseph H. Jacobs, Vida, Mont.

ELECTRICAL

ELECTRICAL Helpers; I will send 50 Answers and Questions required by most States to Obtain Electrician's License. \$1.00. Harry Hinman, 2938 Hancock Ave., Detroit, Mich.

FOR MECHANICS

WHAT Every Toolmaker or Machinist Needs. The Koch Universal Test Indicator. High Magnifying Power, Compact and Convenient. Shop and Factory Representative Wanted. Henry Koch, Nyack, N. Y.

A HANDY steel protractor for determining angles. Snaps on any zig-zag rule. Home craftsmen and mechanics all interested. Send 50c for prepaid sample. Agents wanted. General Necessities Co., 790 33rd St., Milwaukee, Wis.

SURVEYING INSTRUMENTS

LARGEST stock of new and used surveying instruments in the country direct from factory. Satisfaction guaranteed or money refunded. Wissler, 619 N. Broadway, St. Louis, Mo.

MODELS AND MODEL SUPPLIES

PATENTS. Time counts in applying for patents. Don't risk delay in protecting your ideas. Send sketch or model for instruction or write for free book "How to Obtain a Patent" and "Record of Invention" form. No charge for information on how to proceed. Communications strictly confidential. Prompt, careful, efficient service. Clarence A. O'Brien, Registered Patent Attorney, Security Bank Building (directly across street from Patent Office), Washington, D. C. See pages 156 and 157.

SHIP Models: Complete Parts and Blueprints for Chinese Junk, Venetian Sailboat, Nile Boat, or Viking Galley, 60c Postpaid. Casson-Craft, Dept. B, Framingham, Mass.

SHIP Model Supplies. Circular for stamp. Chas. Schneider, 1811 Sedgwick, Chicago, Ill.

MODEL Steam Engines, Boilers and Model Pipe line fittings. Model Making Supplies. Send 20c for this year's illustrated catalogue and hand book. Bathe Mfg. Co., Dept. D, 5214 Woodland Ave., Philadelphia.

WE make models, dies, manufacture your invention, help perfect it. Do experimental work. Free information. Strand Mfg. Co., 644 West Randolph, Chicago.

SHIP Model Fittings: Send stamp for booklet. A. J. Fisher, 1002 Etowah Ave., Royal Oak, Mich.

SPECIAL machine builders, tool and die makers, inventor's models production work of all kinds. Dept. L. Quality Hardware & Machine Co. Ravenswood and Thorndale Avenues, Chicago, Ill.

WE make working models for inventors and do experimental work and carry a complete stock of brass gears and model supplies. Send for catalogue. The Pierce Model Works, Tinley Park, Ill.

MODELS, Tools, Dies and General manufacturing. Logan Machine Co., 652 W. Lake, Chicago, Ill.

EVERYTHING for Ship Models. Catalog, dime. Roy Hancock, 323 Douglas Ave., Portsmouth, Va.

WOODS for Models, Scroll Work and inlaying. George Wild, 510 East 11th St., New York.

THE Modelmaker, a magazine for all interested in making working models, boats, etc. Sample 10c. Modelmaker, 122 Liberty St., New York.

MODEL steam engines and boilers. Boat and boiler fittings. Send 10c stamp for catalog. Refunded with first order. Model Machine Shop, 212 Price St., Rahway, N. J.

LET our experience be your guide. Models that are models; tools and equipment for economic manfg. Patterns of all types; manufacturing in all branches. Satisfaction guaranteed. United Machinery Company, Cincinnati, U. S. A.

MANUFACTURING

COMPLETE Manufacturing. Dies and stampings and Special Machinery. Our Engineering department will design and perfect your article; our tool room will tool it for production. Our shop will make any quantity you may need. Models made if necessary. Barth Stamping & Machine Company, 3816 West 34th St., Cleveland, Ohio.

MODELS, Dies, Manufacturing, Ideas developed, screw machine products, metal stampings, and contract manufacturing of metal parts. Schror Manufacturing Company, 2221 Campbell Street, Kansas City, Mo.

INVENTIONS developed, manufactured and packed ready for market. Sales campaigns planned. Models, dies, special machinery. Established 20 years. Swanberg, 5124 N. Kildare Ave., Chicago.

AN Organization forming to manufacture small wooden specialties. Want additional products to fill in for capacity production. Give full proposition in first letter. G. W. Bonn, Box 881, Marysville, Mich.

DRAWINGS Made!—any kind, 25 years in the General Drafting business in the Chicago loop. Inventions Developed, and Designed, Working Drawings, Patent Drawings, etc. Accurate Drafting Service, 53 W. Jackson, Chicago.

CONTRACT Manufacturers—Dies, Stampings, Models, Castings and Forgings Machined. Automatic Screw Machine Product. Screw Machine Specialty, Susquehanna Street, Pittsburgh, Pa.

SPECIAL Machinery or parts, dies, tools, metal specialties, models, special gears, stock gears and model supplies. Send for Catalogue. The Pierce Model Works, Tinley Park, Ill.

WANTED to manufacture on royalty basis, some Mechanical Appliance or Automobile Accessory. Cincinnati Automatic Machine Co., Cincinnati, Ohio.

MANUFACTURING Models, Dies, Stampings, Brass Work, one or thousands. Baum's Metal Specialties, Kansas City, Mo.

WIRE goods made to order. Cooley Mfg. Co., 530 N. Western Ave., Chicago.

STAMPING and light manufacturing. Acme Tool Co., Mason City, Ia.

MACHINERY, TOOLS AND SUPPLIES

MARVEL Cylinder Boring Machine, \$125.00. 14x6" Willard engine lathe, \$165.00. 24x10" Davis engine lathe, quick change, \$475.00. No. 60 Heald Cylinder Grinder, \$575.00. 10" Drill Press, \$19.00. Terms if desired. Send for catalogue. Cincinnati Machinery & Supply Company, 27 West Second St., Cincinnati, Ohio.

SLIGHTLY Used 6"x18" Baby Grand lathe, all attachments. George Heine, Orwigeburg, Pa.

HERE is your opportunity to obtain a real good buy on electric grinders and buffers, which are, full 1/4 HP, 110 volt, 60 cycle, single phase, AC, enclosed dust-proof motor with cord and plug, emery wheel on one side and buffer on the other, at a low price of \$19.75 each. General Distributing Co., Duluth, Minn.

NEW 1/8 H.P. 110 V., 1800 R.P.M., Alternating Current Motors \$6.00 cash with order. Elle & Co., 1018 W. Lake St., Chicago, Ill.

HYDRAULIC Garage Press easily made; for particulars address Box 134, Ft. Collins, Colo.

60 HEALD Cylinder Grinder; Nice condition, \$350.00. Lucas & Son, Bridgeport, Conn.

SPEED Lathe \$10.50 complete, 7 inch swing, 3 speed cone. Jefferson Mfg. Co., Fairfield, Iowa.

START Business of your own, small investment required, doing nickel, copper and silver plating. This work is in big demand. Full information free. Electro Platers Supply Co., 547 Considine Ave., Cincinnati, Ohio.

OTHERS have successfully sold their machinery through our columns—so can you. Ask me for proof. M. L. Rund, Manager, Classified Advertising, Popular Mechanics Magazine, Chicago.

CONCRETE Building Block Machine and Molds. Catalogue free. Concrete Machine Co., 5 N. Main St., St. Louis, Mo.

LATHES, Drill Presses, Shapers, Milling Machines, Planers, Screw Machines, Small Tools and Surplus Machinery. Cincinnati Automatic Machine Co., Cincinnati, Ohio.

ENGINES, MOTORS AND DYNAMOS

NEW 1/4 horse 110-volt alternating motors \$5.50 each. Also other bargains all sizes direct and alternating. Write for prices stating size and kind of current. Queen City Electric Co., 1736 Grand Ave., Chicago.

BARGAINS—Motors, machinery, 1/4 H.P., \$6.00; 1/2 H.P., \$18.75; 1 H.P., \$25.00; electric drills, \$14.95. 100 other bargains. Send for "Bargain Sheet No. 630." Acme Tool Co., 627 Washington St., Chicago.

GUARANTEED Alternating and direct current motor bargains. All kinds, all sizes from 1-10 H.P. to 50 H.P. Tell us your needs. Send for price list. Motors repaired and exchanged. Hyre Electric Company, 615 PM, So. Dearborn St., Chicago.

A. C. INDUCTION motor model shows winding connections plain sight. Quick easy way. Gaines Bros., Box 481, Gainesville, Texas.

GOVERNORS for all auto engines where used for power plants. Send for circulars. A. C-S Governor Co., Springville, N. Y. or 215 W. Manchester, Los Angeles.

FOR Sale—4 K.W., 32 Volt, Robbins & Myers D. C. generators at 1500 R.P.M. with pulley, \$20.00 each. A. H. Nimmo Electric Co., 856 Michigan Ave., Detroit.

WRITE for bargain catalogs on electric motors, generators, electric drills, etc. Do not buy, consult us first. General Distributing Co., Security Bldg., Duluth, Minn.

STEAM Engines—One H. P. \$18.00; 1/2, \$12.00. James Chamless, Bessemer, Ala.

MOTORS—New GE 110 or 220 volt 60 cycle Single Phase 1/4 HP, \$11.90; 1/2 HP, \$23.53; 1 HP, \$38.50. Mail \$3 check or money order. We will ship COD anywhere. Motor Specialties Co., Crafton, Penna.

BLACKSMITHS

BE a Master Mechanic Blacksmith and Expert Tool Maker and Dresser with colored tempering charts. Price \$1.00. Valuable samples free. W. M. Toy, Sidney, Ohio.

BENDING MACHINES

THE Famous Hossfeld "Wrenchless" Universal Iron Bender is the last word in bending machines. Bends metal, cold or hot, into most any conceivable shape, including Eye Bolts and Automobile Spring Eyes. Bends up to 1" bars or 1 1/2" pipe cold. Thousands in use by all classes of trade, from the smallest shops to the largest railway systems. Write for circular and prices. Hossfeld Mfg. Co., Winona, Minn.

FOR SALE—MISCELLANEOUS

SALE or trade for multigraph, Alexander Hamilton Institute books. Gaines Bros., Gainesville, Texas.

ADDRESSOGRAPHS, Letter Folders, Multigraphs, Envelope Sealers, Duplicators, less than half price. Guaranteed. Pruitt Co., 117 No. Market, Chicago.

WANTED—MISCELLANEOUS

MAIL us your discarded Jewelry, Gold, Crowns and Bridges, Watches, Diamonds, Silver, Platinum and old False Teeth. Money promptly mailed. Goods returned if offer refused. United States Smelting Works (The Old Reliable), Dept. 71, Chicago.

FALSE Teeth pay high as \$10.00 for full sets, broken or perfect crowns, bridges. Bank References. Dushkind, 138 Delancey St., New York City.

REAL ESTATE, FARM AND ORCHARD LANDS

100 ACRE good Michigan farm, \$100 per acre. Also have Florida lots and land for sale. For further particulars, Address Box 314, Coldwater, Michigan.

CALIFORNIA small farms for dairy, poultry or fruit. Irrigated land. \$10.00 cash, balance monthly. Bomberger Bros., Modesto, Calif.

FARM—Ozarks, 40 Acres; House, Spring, Fruit, Fencing; \$500, \$50 Down, \$10 Month. Box 198, Mt. Vernon, Ill.

LAND free if planted to bananas. Bananas bear a full crop the second year. \$5.00 monthly will plant five acres, which should pay \$1,500 profit annually. Reliable Companies will cultivate and market your bananas for 1/2. Bananas ripen every day and you get your check every 90 days. For particulars address Jantha Plantation Co., Empire Building, Block 949, Pittsburgh, Pa.

80 ACRES and Beautiful Views Among Splendid Fishing Streams, on hard road; 6-room house, all needed bldgs., apple orchard, \$1800, and horses, cattle, implements, crops included; easy terms. Details pg. 88 illus. Catalog. Free. Strout Agency, 255-P, 4th Ave., New York City.

COME to Virginia where seasons are right. Buy farm direct from owner. Write for list. Chamber of Commerce, Emporia, Va.

ATTENTION! "Get acquainted." Cash for your property. Farm, Hotel or Retail Store, no matter where located; confidential service. Hayes Business Agency, Cincinnati, Ohio.

OKLAHOMA—160 acres, near Oil wells, \$5.00 acre. Rollison, 711 Grand, Oklahoma City, Okla.

SELL your property quickly for cash, no matter where located. Don't pay big commission. Particulars free. Real Estate Salesmen Co., Desk B, Lincoln, Nebr.

PECAN-Orange-Fig Groves "On the Gulf" Monthly payments. Guaranteed care. Big, quick returns. Suburban Orchards, Dept. M, Biloxi, Miss.

OZARKS—10 acres near White River and proposed power dam, \$100, \$5 monthly. Alvin Zimmerman, 1802 N. 5th, Kansas City, Kans.

FLORIDA Gulf Coast—We have a few 5 acre tracts inside city limits suitable for poultry and small fruits, Hills Fruit Farm, Panama City, Florida.

SEEDS, PLANTS, TREES, ETC.

BIG money growing Ginseng. Booklet on Golden Seal 10 cts. W. N. Long, Florence, Ky.

GINSENG Seed Stratified, 1000 \$2.50. Roots 100 \$3.00. Vol Bashears, Combs, Ark.

TREE KILLERS

CONDENSED Bo-Ko, enough to kill 100 Trees, \$2.00. Bo-Ko Co., Jenestown, Miss.

SAVE Money. Make your own Tree, Grass, Weed Killer. Particulars free. Miller P. Agency, Kensett, Ark.

ROOTS AND HERBS

HERB Doctor and Medicine Man Book, 10c. (Worth dollars.) Contains over 250 valuable herb medicine recipes for home use. Shawnee, 145 West 112 St., Chicago.

HERB Doctor Book—10 cents. 250 receipts for making herb medicine. Hazzard Company, Box 1, Vanderveer Park, Brooklyn, N. Y.

DOGS AND PETS

FOR Sale, My four year old bluetick coonhound, deposit money anywhere, I pay all express. Bob Sanderson, D28, Mryfield, Ky.

PAIR 2 1/2 Year-old Rabbit Hounds—Mead and Kate—COD, \$35.00 One, 15 days' trial. J. M. Erwin, Murray, Ky.

ST. BERNARD Puppies!!! Champion registered stock; popular prices; photos free. Brockington, 181 McKenna, Montreal, Canada.

FRYE'S Kennels, Finger, Tenn., offers for sale perfectly trained Coonhounds; sent on trial. Get catalog and how I pay express.

FOR Sale, Minks, squirrels, raccoons, foxes, ferrets, muskrats, ginseng, rabbits, skunks, wolf pups, opossums. B. Tippman, Caledonia, Minn.

HUNTING Hounds Cheap; Trial, Dixie Kennels, C2, Herrick, Ill.

COONHOUNDS—Riverbottom Trained. Red-bones, Black and Blueticks. Combination Hunters. Champion Rabbit hounds. Reasonable Prices. Catalog, Photos, Free. Riverview Kennels, L. J. Adams, Mgr., Ramsey, Ill.

RABBITS

MAKE big profits with Chinchilla Rabbits, Real Money-makers. Write for facts, 852 Conrad's Ranch, Denver, Colo.

PERSONAL

TOBACCO or Snuff Habit Cured or no pay. \$1.50 if cured. Remedy sent on trial. Superba Co., N3, Baltimore, Md.

SPARETIME Employment at home. Details stamp. Gluco, 507 Aetna Bldg., Rochester, N. Y.

WE answer your questions, 25c coin. Fred Klotz, Reading, Pa.

THE "Sanatory Physician" an 80 page book teaching natural laws of health, also suggests reliable self-treatment of disease. Appreciated by every reader. Mrs. S. Denver, Colo., says: "I owe my regained health to that dear little book." Post-paid 20c, address, Author, Box 437, Seattle, Wash.

ASTROLOGY—Stars Tell Life's Story. Send Birthdate and 25c for character reading. M. Klemm, 90 Adelaide St., Winnipeg, Man.

STOP! Fingernail biting habit. Copy-righted recipe \$1.00 guaranteed cure or money refunded. No trick dope or chemicals. M. W. McIntire, Wilmington, N. C.

SPIRIT life known from recorded speech. A new study. Free literature. R. C. Hill, 602 W. Jefferson, Detroit, Mich.

DANCING—Full Instructions—\$1.00. Stewart's, 3446 North Third Street, Philadelphia, Penna.

TELL Fortunes With Cards—Become popular. Mystify, entertain others. Easy to learn; easy to do. New book of complete, easy instructions—also Dream Dictionary—all for 10c. G. Elsea, Bowling Green, Ohio.

BOOK of Luck, lucky numbers, superstitions, etc., 25c. Circulars. F. & R. Co., Dept. 30, Hoboken, N. J.

FREE: Valuable book telling the uses of roots and herbs. Box 29, Station L, New York.

MISCELLANEOUS

ROLLING Toy: Leaping Rabbit. Natural Movement. Latest invention. Children delighted. Send 75c to Weikels' Novelty Shop, 310 Mahoning St., Milton, Pa.

ARE Your Keys Worth 25c? Your Name and Address Engraved in Art Metal Key Check 25c Silver. No Stamps. S. Altman, 93 Franklin, Albany, N. Y.

LOCKSMITH—Codes 25 cents and up. Schade Repair Shop, Twin Falls, Idaho.

WRITE for bargain circular on outing clothing, new, below manufacturer's cost. General Distributing Co., Duluth, Minn.

YOU Are Wanted to Resilver Mirrors at Home. Immense profits plating autoparts, tableware, etc. Write for information. Sprinkle, Plater, 288, Marion, Ind.

SURPLUS government tent poles 6 ft. long, 1 1/2" diameter, new, at 10c each. Same in 4 ft. lengths 8c each, in quantities of 100 or more. Cash with order. General Distributing Co., Duluth, Minn.

CASH Paid for Butterflies, Insects. See Sinclair Display Advertisement on page 26.

GREAT! "Gunn's Lightning" exterminates roaches in 24 hours, nothing like it. Send \$1 now, for quick delivery; money back if it fails. E. F. Gunn, 3730 No. 16th St., Philadelphia, Pa.

MUSIC Stamps, printing toys, pecan nut samples 45c. W. Karstaedt, Dayton, Ohio.

YOU can emboss your stationery as needed. Perfect work guaranteed. Simple—inexpensive. Miller Sales Company, Dept. E, Lexington, Ky.

PRINT 250 Signs or pictures an hour without press, type or machinery. Sample and particulars 10c. Straco, 1013, Springfield, Ohio.

LOOK! Fly balloons anywhere. Inflator \$1.00 and \$6.00. Guaranteed. Balloon Inflator Co., Box 853, Providence, R. I.

HOMOEOPATHIC and Biochemic preparations sent postpaid to all parts of the world. Manual and booklets free. Halsey Bros. Co., 645 St. Clair St., Chicago, Ill. Established 1855.

WEEDS—Cut them with cutter bar on Shaw Garden Tractor. Also plows, cultivators and runs belt machinery. Low prices. Immediate delivery. Shaw Manufacturing Company, Department C, Galesburg, Kans.

CUTS anybody can make. Simple, cheap process. \$1. Specimens, particulars. 2c stamp. M. Day, Windfall, Ind.

TELL an army of 3,000,000 live readers all about your offer! If you have anything to sell, buy or exchange, or if you have any reasonable proposition, tell our readers all about it—they'll respond quickly. Our booklet "How to Create More Business" contains some very interesting, helpful facts. Write today for your copy—it's free. M. L. Rund, Manager Classified Advertising, Popular Mechanics Magazine, 200 E. Ontario St., Chicago, Ill.

Are You Hungry For... Adventure... Popularity... Big Pay?



THEN CHOOSE AVIATION!

ARE you a red blooded, daring he-man?

Are you eager for a life of constant thrills, constant excitement and fascinating events? Do you crave adventure, popularity, admiration, and the applause of great crowds? Then why not get into the Aviation Industry—the greatest adventure since time began—the greatest thrill ever offered to man?

Think what Aviation offers you. Thrills such as you never had before! The praise and plaudits of the multitude. Ordinary salaries from \$75 to better than \$400 a week! And a chance to get in on the ground floor where rewards will be unlimited!

Aviation is growing so swiftly that one can hardly keep track of all the astonishing new developments. Air mail routes have just been extended to form a vast aerial network over the entire U. S. Airlines and airplane factories are springing up all over the country. Men like Henry Ford are investing millions in the future of commercial Aeronautics in America! The possibilities are so tremendous that they stagger imagination!

Everything is set for the greatest boom in history. The fortunes that came out of the automobile industry and out of motion pictures will be nothing compared to the fortunes that will come out of Aviation! There is just one thing holding it up—lack of trained men! Even in the beginning thousands will be needed—and generously paid. The opportunities open to them cannot be over-estimated. Those who qualify quickly will find themselves on the road to undreamed of money—success—popularity—and prominence!

Easy to Become an Aviation Expert

Get into this thrilling profession at once while the field is new and uncrowded. Now—by a new unique plan—you can quickly secure the basic training for one of these wonderful high salaried jobs, at home, in spare time. Experts will teach you the secrets—give you all the inside facts that are essential to your success. And, the study of Aviation is almost as fascinating as the actual work itself. Every lesson is chock full of interest—and so absorbing that you actually forget you are studying. But best of all are the ultimate rewards you are fitting yourself to gain!

Pick Your Job!

Airplane Instructor
Airplane Engineer
Airplane Repairman
Airplane Assembler
Airplane Mechanician
Airplane Inspector
Airplane Builder
Airplane Salesman
Exhibition Manager
Airplane Contractor
Airplane Motor Expert
Airplane Designer



Send for FREE Book

Send the coupon for our new, free book, just out—"Opportunities in the Airplane Industry".

It is vitally interesting, reads like a romance and tells you things about this astonishing profession you never even dreamed of. This book is so fascinating it could easily sell for a dollar. We offer a limited number FREE. Write for yours today.

American School of Aviation

Dept. 1347, 3601 Michigan Ave., Chicago, Ill.

AMERICAN SCHOOL OF AVIATION

Dept. 1347, 3601 Michigan Ave., Chicago, Ill.

Without any obligation please send me FREE book "Opportunities in the Airplane Industry." Also information about your course in Practical Aeronautics.

Age.....

Name.....

Address.....

City.....State.....



Travel for "Uncle Sam"

\$158 TO \$225 MONTH

Mail Coupon Before You Lose It

FRANKLIN INSTITUTE, Dept. P-175, Rochester, N. Y.

Sirs: Rush to me, without charge, (1) Full particulars, telling how to become a Railway Postal Clerk; (2) send copy of 32-page book, "How to Get U. S. Government Jobs," with list of many positions obtainable.

Many Other Government Jobs Obtainable
Steady Work—No Layoffs—Paid Vacations
Common Education Sufficient
MEN—WOMEN 18UP

Name.....

Address.....



DRAW CARTOONS

TURN YOUR TALENT INTO MONEY



Cartoonists earn from \$50 to \$150 per week—some even more. Remarkable *Circle System of Drawing* teaches you in half the usual time. Students from all parts of the world are enrolling for this exceptional instruction. *Personal* criticism service and up-to-the-minute instruction make it easy for National students to attain success. Send for interesting **BOOKLET** and **SAMPLE LESSON PLATE** explaining full details of the Course and what National students are accomplishing. No salesman will call.

The National School of Cartooning, 623 Penton Bldg., Cleveland, Ohio

EARN PROMOTION AND COLLEGE CREDIT

through the
HOME-STUDY COURSES

In 40 different subjects given by
The University of Chicago
207 Ellis Hall, University of Chicago, Chicago, Ill.



STEEL BLUE Elite Diamond
IF YOU CAN TELL IT FROM A DIAMOND
SEND IT BACK!

1 Carat Elite Diamonds. Matchless for their dazzling rainbow brilliancy. You'll be delighted. *Elite Rings* surpass all others. Stand acid and other tests. Handsomely Engraved Ring, sterling Guaranteed. Looks like \$250.00. Proud owner offered \$85.00 5 minutes after buying one.

COLLAR AND CUFF LINKS GIVEN

With each ring order, we give free beautiful Combination Set. Set with small *Elite Diamonds*. **SEND NO MONEY.** Just send name, address and finger size. On arrival pay postman \$3.89 and postage. Satisfaction Guaranteed. Write today. Cash with Canadian or foreign orders.

ELITE JEWELRY HOUSE, Dept. 374, 609 S. Paulina St. CHICAGO, ILLINOIS

Information on any book free. Write Popular Mechanics Press, Chicago, Ill.

REMINGTON PORTABLE TYPEWRITER Dealers and Branches Everywhere

LEARN AUTOS IN LOS ANGELES

Jobs Open Now—\$40 to \$100 a Week

You are urgently needed to help repair the one and a half million autos in California. Trained auto repair men are also needed badly in every other state. The rapidly increasing number of cars means prosperity and big pay for auto men—more garages, tire shops, battery stations are needed. You can be one of the highly paid men in this fastest growing industry—if you get the right training.

YOU CAN BE An Auto Expert!



National Automotive special, practical Shop Training makes it easy for you to become an Auto Expert. In a quarter century this great institution has trained

16,000 men for bigger pay. It will help YOU make more money by giving you individual instruction on repairing Packards, Buicks, Cadillacs, Fords, etc., all types of electrical equipment, machine shop equipment, etc. You learn **everything RIGHT** at National.

Paul Briggs Earns \$4000 a Year

"I want to thank you for the big part National has played in helping me to succeed in auto work. I am now assistant sales manager and made \$4,000 this year—which is more than I would have made in three years at my former work."—Paul Briggs, Portland, Ore.

Money-Making Book



Earn While You Learn

Free employment service. Spare time jobs help pay expenses while training. All tools included. No extras. Send for big free illustrated catalog explaining how National trains you for bigger pay. Learn the opportunities for you in California. Mail coupon now.

Million Dollar Training Headquarters for Auto Experts



NATIONAL AUTOMOTIVE, Dept. 703, 4006 Figueroa St., Los Angeles, Calif.

Send me, absolutely free, your big illustrated catalog of Automotive Opportunities.

Name.....

Address.....

Age..... City..... State.....

A FRANTIC CALL FOR MEN WHO CAN READ BLUE PRINTS OF BUILDINGS

Leads Quickly to Jobs Paying \$4,000 to \$12,000 a Year

See how easy it is to get in the building game. Nowhere else does such simple training count for so much. Nowhere else can a man make \$4,000 to \$12,000 a year so quickly and so easily. Nowhere else are there so many countless thousands of openings as there are with contractors, builders, and real estate firms, who are constantly calling for men who can read blue prints. Six billion dollars a year is spent for building. Trained men are at a premium in this gigantic industry. Untold thousands are needed at steady salaries far above the scale wage.

90

DAYS EASY TRAINING PUTS YOU IN THE 6 BILLION DOLLAR BUILDING FIELD

NO longer is it necessary to start at the bottom of the building trades and spend years to work up. Now you can get three years' training in three months. There are no barriers to your success in the great outdoor building field. You do not need more than a common school education. We train you at home, in spare time, by the fascinating blue-print method with lessons that are as easy to read as your newspaper.

These tested plans come to you from one of the oldest and largest schools of building construction and superintendence in the country. This course is endorsed by leading contractors and master builders. These tested, practical plans and lessons are the kind of training that puts men in \$5,000 to \$15,000 jobs and in profitable building and contracting businesses of their own. You learn from actual blue print plans—from practical building experts—you learn how to read all the plans, estimate the costs and supervise the entire construction of a building—you learn everything a contractor has to know when he undertakes the construction of a building.

Amazing opportunities are open to you when you know blue prints, plans, estimating and construction. There is building superintending—the best outdoor profession on earth—that pays handsome salaries and often a bonus for efficient work. Clifford Scholl went from clerk to Asst. Superintendent at 49% increase in salary in 8 months.

Thousands of builders and contractors need men like Clifford Scholl.

IF YOU LIVE IN OR NEAR CHICAGO

Visit our School for Builders, open day or evening. Thousand men attend each year. Enter any time. You can get the same training at home, by mail. Same plans; same lessons; same instructors. The Coupon brings all facts FREE.

Every Job Must Have a Contractor

The building field is wide open for men who want to go into business for themselves. Henry Mehl, Pa., a policeman, now owns his own contracting business. Burgert, Ill., stepped into a foremanship at 200% increase in salary. Busch, Kan., writes, "I have been offered \$300 a month several times." Boyes, Can., writes, "Your school has increased my wages 40% already." Patrick, Mich., says, "My salary has been increased 92%." Marchand, La., writes, "I am getting along fine. My salary is now increased 196%."

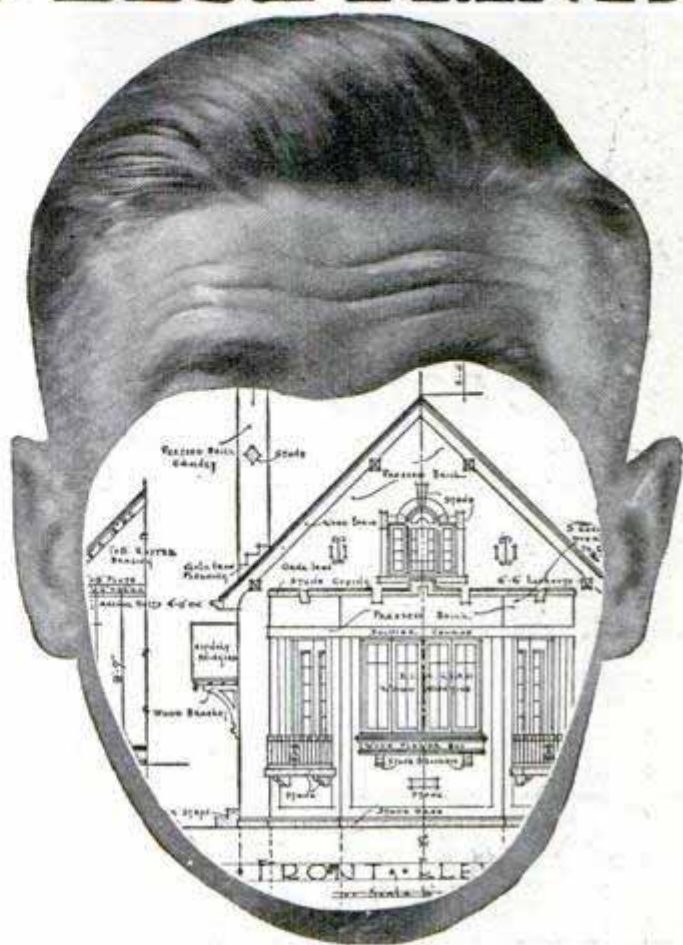

If you really want more money—if you hope to own a business of your own—get into the building business . . . no matter what your job is now. No overcrowding in this tremendous field—room for thousands every day. Why buck competition in crowded industries where only a few men can succeed?

Clerk or carpenter—office man or bricklayer—salesman or superintendent—it makes no difference. You can get into the building business quickly . . . easily. Or if you are in it at present, get this training now, that you must have for success.

FREE Trial Lesson

Simply mail the coupon below for an intensely interesting free book "How to Read Blue Prints," and full information. See what fascinating fun this first trial lesson is. Get these facts before you. See what amazing opportunities open up for you in the Six Billion Dollar Building Field. Don't wait or delay. Act now. Simply mail the coupon below.

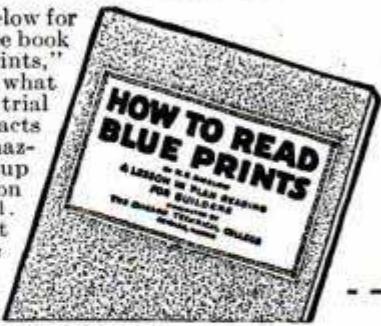

Chicago Technical School for Builders, Dept. N-140, 118 E. 26th Street, Chicago, Ill.

Send me, without obligation, your free book, "How to Read Blue Prints" and full details of the course and the opportunities in the Building Field. It is understood that no salesman will call on me.

Name.....

Address.....

City..... State.....

Age..... Occupation.....

Chicago Technical SCHOOL for BUILDERS

Dept. N-140, 118 E. 26th Street, Chicago, Ill.



"We can't get married until—"

"WE CAN'T get married until I earn more money." Thousands of young men are saying that today. Thousands of girls are giving that as the reason the marriage date is being put off and off. Sometimes it gets a little embarrassing, too, to have to keep on giving that excuse. For no girl likes to admit that the man she is going to marry is a failure!

It takes money to support a home these days. And you're right in waiting. But don't wait too long. The years of youth are precious years. They will never return.

Thousands of men have happy prosperous homes because they had the foresight to prepare themselves for advancement through the home-study courses of the International Correspondence Schools. Hundreds of them report salary increases of \$10, \$15 and \$25 a week. Many are earning \$75, \$100 and \$150 a week. Some have doubled and even tripled their salaries. Some are earning \$10,000 and \$15,000 a year. Others have become owners of businesses of their own.

If the I. C. S. can help other men to raise their salaries, it can help you. At least find out how. It won't obligate you to ask for our Free Booklets, but that one simple act may change your entire life. Do it now. Do it for HER!

Mail the Coupon for Free Booklet

INTERNATIONAL CORRESPONDENCE SCHOOLS

"The Universal University"
Box 5679-E, Scranton, Penna.

Without cost or obligation, please send me a copy of your booklet, "Who Wins and Why," and full particulars about the course before which I have marked X in the list below:

BUSINESS TRAINING COURSES

- | | |
|--|---|
| <input type="checkbox"/> Business Management | <input type="checkbox"/> Salesmanship |
| <input type="checkbox"/> Industrial Management | <input type="checkbox"/> Advertising |
| <input type="checkbox"/> Personnel Organization | <input type="checkbox"/> Better Letters |
| <input type="checkbox"/> Traffic Management | <input type="checkbox"/> Show Card Lettering |
| <input type="checkbox"/> Business Law | <input type="checkbox"/> Stenography and Typing |
| <input type="checkbox"/> Banking and Finance Management | <input type="checkbox"/> English |
| <input type="checkbox"/> Accountancy (Including C.P.A.) | <input type="checkbox"/> Civil Service |
| <input type="checkbox"/> Nicholson Cost Accounting | <input type="checkbox"/> Railway Mail Clerk |
| <input type="checkbox"/> Bookkeeping | <input type="checkbox"/> Common School Subjects |
| <input type="checkbox"/> Private Secretary | <input type="checkbox"/> High School Subjects |
| <input type="checkbox"/> Spanish <input type="checkbox"/> French | <input type="checkbox"/> Illustrating <input type="checkbox"/> Cartooning |

TECHNICAL AND INDUSTRIAL COURSES

- | | |
|---|--|
| <input type="checkbox"/> Electrical Engineering | <input type="checkbox"/> Architect |
| <input type="checkbox"/> Electric Lighting | <input type="checkbox"/> Architects' Blueprints |
| <input type="checkbox"/> Mechanical Engineer | <input type="checkbox"/> Contractor and Builder |
| <input type="checkbox"/> Mechanical Draftsman | <input type="checkbox"/> Architectural Draftsman |
| <input type="checkbox"/> Machine Shop Practice | <input type="checkbox"/> Concrete Builder |
| <input type="checkbox"/> Railroad Positions | <input type="checkbox"/> Structural Engineer |
| <input type="checkbox"/> Gas Engine Operating | <input type="checkbox"/> Chemistry <input type="checkbox"/> Pharmacy |
| <input type="checkbox"/> Civil Engineer | <input type="checkbox"/> Automobile Work |
| <input type="checkbox"/> Surveying and Mapping | <input type="checkbox"/> Airplane Engines |
| <input type="checkbox"/> Metallurgy <input type="checkbox"/> Mining | <input type="checkbox"/> Agriculture <input type="checkbox"/> Navigation |
| <input type="checkbox"/> Steam Engineering | <input type="checkbox"/> Mathematics <input type="checkbox"/> Radio |

Name.....

Street Address.....

City..... State.....

Occupation.....

Persons residing in Canada should send this coupon to the International Correspondence Schools Canadian, Limited, Montreal, Canada

BE A RAILWAY TRAFFIC INSPECTOR



EARN UP TO

\$250

Per Month
SALARY
and Expenses

A Position Promotion and Satisfaction awaited Graduate **JOE ETTLE**



Gentlemen: I am writing this letter in appreciation for what the course in Traffic Inspection has done for me.

I graduated January 25th, 1927, was offered and accepted a position as agreed by you February 4th, 1927, at a salary of \$120 per month, April 10th

I was raised to \$135 per month and June first I accepted a position paying \$175 per month, with one of the largest and best Railway companies in U. S. A. Thanking you very kindly for what you have done for me and the personal interest shown me, from the day the first lesson arrived to the present hour, I am, Yours very truly, Joe Ettle.

For nine years our graduates have been offered positions as Traffic Inspectors at definite salaries, plus expenses, a few days after completing their studies. Traffic Inspectors start at \$120 or more per month and rise rapidly to \$175, \$200 or \$250 per month.

As a Railway Traffic Inspector, you are practically your own boss, see new faces and places each minute, report only to high officials, are rapidly advanced. It's healthful, outdoor work, with regular hours.

Hundreds of Satisfied Graduates

Write today for booklet D-2, giving full details and contract agreeing to refund your money if position is not offered after graduation.

Standard Business Training Inst.
BUFFALO, NEW YORK

A GREAT BOOK FREE WITH THIS LIBRARY!

For a short time only we will give every subscriber to the New Library of Machine Shop Practice a copy of French's Engineering Drawing—the greatest book on mechanical drawing ever written. This book makes drawing as plain as day—tells you all about instruments, plans and methods—and prepares you to handle any drawing job you will ever have to do. It comes to you absolutely free with

Machine Shop Practice

9 volumes—3065 pages—3608 illustrations
(A combined home-study course and reference library)

The New Machine Shop Library is written for practical men. It gives you the best methods for every kind of machine shop work. It explains machine tools and their operation, drawing and design, tool work, gears and grinding, jigs and fixtures, automatic screw machines and their tools and all of the mathematics you will ever have to use. It is plainly written, completely illustrated—the very best kind of help to the machine-shop man who wants to advance himself.

Sent

FREE



No money down—
only 7c
a day

FREE EXAMINATION COUPON

McGraw-Hill Book Co., Inc., 370 Seventh Ave., New York

Send me for 10 days' free examination the New Library of Machine Shop Practice. If satisfactory, I will send you \$1.50 in 10 days and \$2 monthly until the special price of \$19.50 is paid. If not wanted, I will return the books at your expense.

On receipt of my first payment of \$1.50, it is understood that I am to receive, free of charge, a copy of French's Engineering Drawing.

Signed.....

Address.....

City and State.....

Position.....

Employer..... P.M.10-1-27

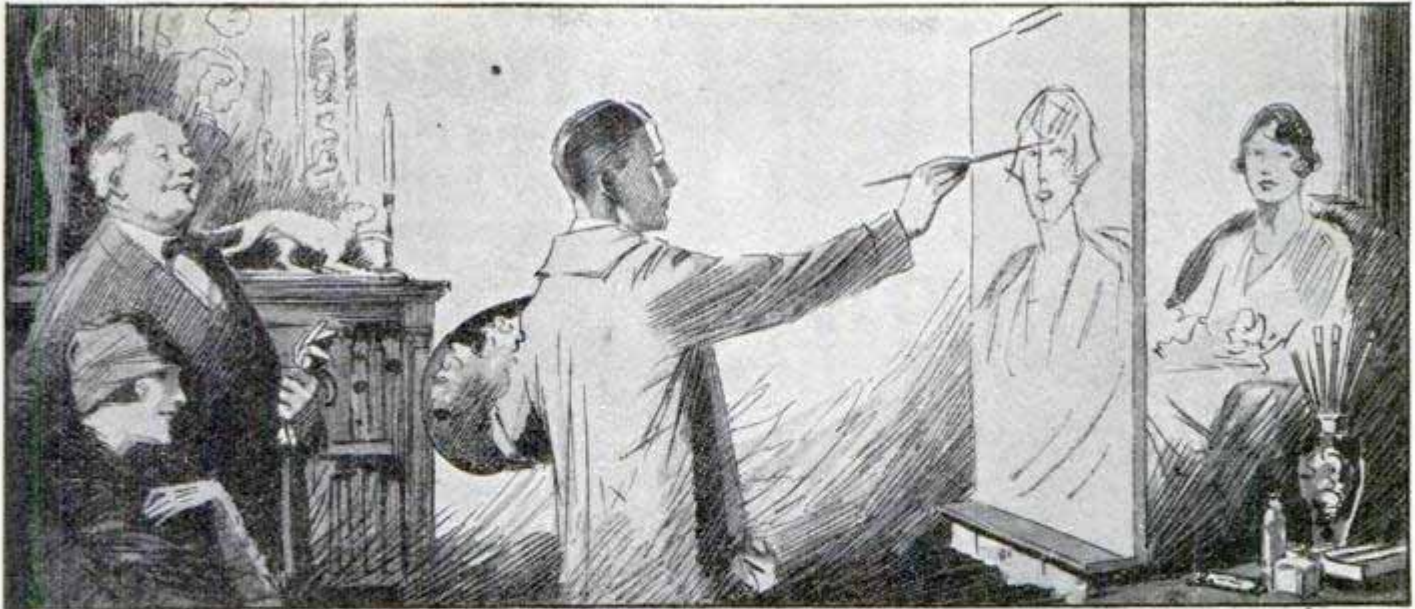

Simple Lines Earn Fame and Fortune

"YOU certainly make your money easily," remarked the heavy-set publisher. "My, such speed," interrupted his lady business associate. "How do you get such a true likeness in so few lines?" They had dropped in to purchase illustrations from the young artist whose masterful drawings in

magazines and newspapers had started him on the road to fame.

"I never thought it was possible myself," he replied as he added a few telling strokes with his brush. "But I liked to draw. I knew it was fascinating and that it offered opportunities. So I decided to study. Through proper training I have learned to form simple lines into finished illustrations."

It was only a short time ago that this young artist filled out a coupon like the one below and mailed it to the Federal School of Illustrating. "And now," he continued, "each time I make a simple stroke with my brush it means money in my pocket."

This story illustrates the success of hundreds of Federal School graduates. Careful, conscientious training by members of our faculty has put thousands of students on the "Road to Bigger Things."

Over fifty famous artists have contributed lessons and drawings exclusively to the Federal Course of Illustrating. You are undoubtedly acquainted with the work of many of these masters. A few of their pictures appear on this page. They teach you their "tricks of the trade" about illustrating, cartooning, lettering, poster designing, window card illustrating, etc. Every subject is covered thoroughly. No one is competent to give instructions in all these branches. For this reason each subject in the course is covered by a famous artist who has made a suc-

cess in his particular field. You profit by their experience. Their instructions prepare you for any problem or emergency that may arise.

If you like to draw, why plod along at some tedious work? Opportunities for artists have never been better. Thousands are wanted every year by magazines and newspapers that spend millions of dollars for illustrations. Drawing is easy to learn the "Federal Way." Study at home in your spare time. Earn while you learn, if you wish. Many students find a market for their work after a comparatively short time of study. Others earn the price of the course several times before they finish.

Every mail brings news of the success of students. Charles Phil Hexom of Decorah, Iowa, writes, "My cover work brings from \$50.00 to \$150.00 per painting." A letter from Sam Nash reads, "I sometimes make as high as \$30.00 a day doing bulletins and have averaged \$150.00 a month outside of school hours." These are only two typical examples of the success that hundreds of young people are enjoying because of Federal training.

If you like to draw, opportunity lies no further away than the lower corner of this page. Write your name and address on the coupon and get our free book, "A Road to Bigger Things," which is illustrated below. With this book we will send our free Vocational Art Test to find out your ability. Hundreds of successful artists got their start by sending for these. This is your opportunity —grasp it. Mail the coupon now.



Federal School of Illustrating

FEDERAL SCHOOL OF ILLUSTRATING,
10137 Federal School Bldg., Minneapolis, Minn.

Gentlemen: Please send your free book, "A Road to Bigger Things," together with Vocational Art Test.

Name.....Age.....

Occupation.....

Address.....

A Few Famous Federal Authors



SIDNEY SMITH



HERB JOHNSON



CLARE BRIGGS



NORM ROCKWELL



FONTAINE FOX



BART



NEYSA MCMEIN



FAY KING



CHARLES L. BULL



FRANK KING



CHAS. M. RUSSELL



W. J. W. LWERDING

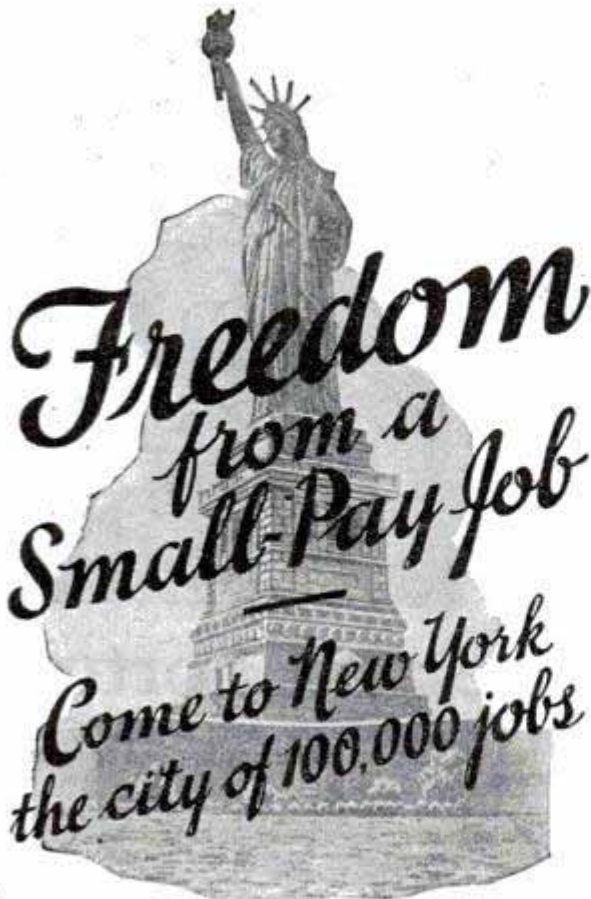

ANY MAN who can read and write and use a pair of pliers can become an electrical expert and free himself forever from the long hours and drudgery of a small pay job.

And you can learn the **BIG PAY** profession of electricity right in New York City—the heart of the electrical world—the city of 100,000 jobs. At the same time you are learning the **BIG PAY** profession you can be enjoying the sights and wonders of New York, the modern Bagdad.

Be An Electrical Expert

Graduates of the **NEW YORK ELECTRICAL SCHOOL** are in demand by all the big electrical companies. Or, if you prefer the independence of a business of your own, there are thousands of opportunities for efficient, dependable men to become electrical contractors. When you are your own boss the money you can make is limited only by your own energy and ability.

Personal Instruction

The **NEW YORK ELECTRICAL SCHOOL** is not a correspondence school. You learn by doing—by personal instruction on full size standard electrical equipment under the personal supervision of trained instructors.

At **N. Y. E. S.** you train your hands and mind at the same time. You learn the theories of electricity—and then you are shown how to put the theories into actual practice by solving the problems with your own hands.

The man who has learned electricity by actually doing electrical work under intelligent personal instructors can go to any part of the world and be sure of a good living. There are **N. Y. E. S.** graduates in all the countries of the world.

Write today for the 48-page booklet giving full information about the **N. Y. E. S.** Course and showing pictures of the equipment available for your personal use in our two seven-story buildings. Mail coupon now! The New York Electrical School, 44 W. 17th Street, New York.

The New York Electrical School
44 W. 17th Street, New York

Please send me **FREE** your 48-page booklet. It is understood that this request puts me under no obligation.

Name.....

Address.....

Win a Buick
or \$1500.00 In Cash

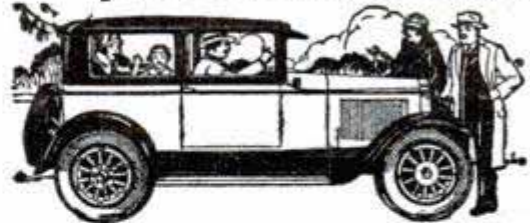

I am going to give away a brand new, latest model Buick Sedan to someone who answers this adv. We have already given away many autos. This is the most liberal offer ever made. It is your chance to win this ideal car. You can win it; why not try? The Sedan will be delivered to the winner, or winner may have the full cash value (\$1,195.00)!

SOLVE THIS PUZZLE

2	21	93	11	7	9	22	5	14
---	----	----	----	---	---	----	---	----

Can you make out the two words spelled by the numbers in the squares above? The alphabet is numbered, A is 1, B is 2, etc. What are the two words? Send your answer today—not a cent of cost to you now or later.

\$305 for Promptness

I will also give away a Chevrolet Coach, Orthophonic Victrola and many other valuable Prizes—besides hundreds of dollars in Cash—and \$305.00 Special Extra Prize for Promptness. First Prize winner will receive \$1,500.00 cash or Buick Sedan and \$305.00 cash. All who answer can share in cash and prizes. In case of ties the prizes will be duplicated. **EVERYBODY REWARDED.** Now, get out your pencil and solve the puzzle—send your answer today with name and address plainly written.
WILLIAM LEROY,
Dept. 1777 315 So. Peoria St., Chicago, Ill.

HIGH SCHOOL EDUCATION *Only \$15.85* **Increase Your Brain Power**
at Home Acquire the essentials of a complete four year high school education this new easy way. Every subject covered by fascinating question and answer method—used in thousands of high schools. Certificate awarded. Write for **FREE FOLDER.**
HIGH SCHOOL HOME STUDY BUREAU (Dept. 2510)
31 Union Square New York City

BE AN ARTIST
WE CAN TEACH YOU DRAWING in your own home during your spare time. Twenty-five years of successful teaching proves our ability. Artists receive large salaries. Write Today for Art Year Book
SCHOOL OF APPLIED ART
ROOM NO. 2 BATTLE CREEK MICH.

BECOME A RAILWAY POSTAL CLERK
Men—Boys 18 up—Examinations coming.
\$1900 to \$2700 a year. Steady life-time job. Common education sufficient. No "pull" necessary. Mail coupon for Catalog.

A. R. PATTERSON
Civil Service Expert
PATTERSON SCHOOL
Dept. 810, ROCHESTER, N. Y.
SIRS: Send me without charge your Catalog, describing this and other U. S. Government positions.

A. R. PATTERSON
Civil Service Expert
Patterson School
Dept. 810
Rochester,
N. Y.

Name.....
Address.....



\$2500 Reward!

For the Capture of an Unknown Man

Twice he had entered the St. Clair Mansion. What was he after? Who? What was in danger?

Berteau, the famous detective, had warned St. Clair that the mysterious marauder would come again. And now—a noise in the passage! The creak of an opening door. A shot in the dark! A capture!

Is this wounded stranger the mysterious intruder? Who could tell? Yet Berteau identified the man without hesitation and won the \$2500 reward.

How did he do it? Easy enough for the Finger Print Expert. He is the specialist, the leader, the *cream* of detectives. Every day's paper tells their wonderful exploits in solving mysterious crimes and convicting dangerous criminals.

Course in Secret Service

For a limited time we are making a special offer of a professional Finger Print Outfit, and Course in Secret Service Intelligence without extra cost. Mastery of these two kindred professions will open a brilliant career for you.

Write quickly for fully illustrated free book on Finger Prints which explains this wonderful training in detail. Don't wait until this offer has expired—mail the coupon now. You may never see this announcement again! You assume no obligation—you have everything to gain and nothing to lose. Write at once—address

University of Applied Science

Dept. 13-57 1920 Sunnyside Avenue, Chicago, Illinois

More Trained Men Needed

The demand for trained men by governments, states, cities, detective agencies, corporations, and private bureaus is becoming greater every day. Here is a real opportunity for YOU. Can you imagine a more fascinating line of work than this? Often life and death depend upon finger print evidence—and big rewards go to the expert. Many experts can earn regularly from \$3,000 to \$10,000 per year.

Learn at Home in Spare Time

And now you can learn the secrets of this science at home in your spare time. Any man with common school education and average ability can become a Finger Print Detective in a surprisingly short time.

FREE

UNIVERSITY OF APPLIED SCIENCE

Dept. 13-57 1920 Sunnyside Ave., Chicago, Illinois

Gentlemen:—Without any obligation whatever, send me your new, fully illustrated, FREE book on Finger Prints and your offer of a course in Secret Service Intelligence and the Professional Finger Print Outfit.

Name

Street Address

City and State

See the World FREE!



Taste Romance and Adventure In the Far Lands of the Earth.

How often you've longed to see for yourself the awe of Egypt's pyramids—the beauties of the gorgeous Mediterranean sunset—the squalor of China's ancient cities!

Spend a few years, or the rest of your life, tasting high adventure on the seven seas and in all the world's great ports—roving the earth's highways and byways! You can do it FREE—all your expenses paid—and earn a good salary besides!

Only one profession will carry you around the world at will, travelling like a gentleman, but that's the most interesting and pleasant work there is—Radio Operating! Easily and quickly learned, there's no other profession like it for the man who wants the experiences and pleasures of world-travel. Radio operators are needed—all sea-going ships like the one shown here must carry from one to half a dozen or more.

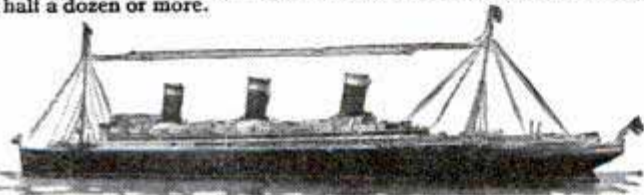

Take a Look Beyond the Skyline Without a Penny's Expense

Radio operators aboard ocean liners live luxuriously—they rank as officers of the ship. Meals, a private cabin, all other living needs are furnished free, and besides the operator draws a good salary. You can learn quickly and easily at home in your spare time to be a Radio operator through our practical training methods. Take a look at the FREE BOOK which tells how—mail coupon below.

This U. S. Government-recognized school has been training successful operators since 1914. Our graduates are all over the world. We maintain an Employment Department to help put you on your own ship. The world-famous NATROMETER, our own patented invention, obtainable only by students of this Institute, is recognized as the best and easiest way to learn the Radio code. A few short months, with the aid of the famous Natrometer and our quick home training, and you too can be a fully qualified Radio operator, sitting in your cabin like the one shown above, bound out for Liverpool or Nagasaki!

Read the Free Book that tells all about this fascinating profession and our practical Government-recognized methods of training you for it. Send coupon TODAY—no obligation. Special tuition offer now on, includes world-famous Natrometer free of extra cost with your course! Act at once.

**NATIONAL RADIO INSTITUTE
WASHINGTON, D. C.**

SPECIAL OFFER COUPON

National Radio Institute,
Dept. MM-85, Washington, D. C.

Gentlemen: Without obligating me in any way send me your free book and information about your offer of Natrometer with course.



World-Famous Natrometer

Name

Address

Popular
because
he can
Play
and
earn
\$75.00
to
\$200.00
each week



LEARN AT HOME

With a nationally famous artist as your teacher you can learn to play classical or popular music. We guarantee our personal teaching method. Both advanced and elementary courses.

Write for catalogue
NATIONAL SCHOOL OF MUSIC, Inc.
506 So. Wabash Ave., Dept. 516, Chicago



NOW

ONLY \$2.00

Grow strong and healthy this quick new way. The Giant Chest Expander and Progressive Exerciser will keep you fit and full of pep and vitality. Only \$2 for 5 cables or \$4 for 10 cables. Why pay more? Complete instructions for scientific progressive exercising sent with each exerciser.

Send no money. Simply pay the postman, plus a few cents postage, on delivery. Every exerciser fully guaranteed. Money back in five days if dissatisfied. Write

**PROGRESSIVE EXERCISER CO., Dept. 4010
Langdon Bldg., Duane St. & Broadway, New York City**

LAW Free Book

Write today for FREE 128-page book, "THE LAW-TRAINED MAN," which shows how to learn law in spare time through the Blackstone home-study course prepared by 80 prominent legal authorities, including law school deans, lawyers, and U. S. Supreme Court justices. Combination text and case method of instruction used. All material necessary furnished with the course, including elaborate 25-volume law library, which is delivered immediately upon enrollment. Many successful attorneys among our graduates. LL. B. degree conferred. Moderate tuition, low monthly terms. Money-Back Agreement.

Write for free book today

**BLACKSTONE INSTITUTE, 4753 Grand Boulevard
Dept. 57 Chicago**



\$50 to \$100 a Week AT HOME OR TRAVELING

Making raised letter SHOW CARDS and NOVELTIES
NEW and ORIGINAL

Learn in a few weeks by mail.

No tiresome brush work. Complete outfit with course.

Write for special inducement to men and women enrolling at once.

**MAILKO, INC., Department 24
8-10-12-14 West 125th Street, New York, N. Y.**



LEARN TO FLY

Billions of dollars will be created and spent through the development of aviation. Thousands of positions will be open for those who are prepared.

Prepare now! Complete Home Study Course in Aviation arranged by America's foremost aeronautical society. Authentic yet inexpensive.

Write for further information

THE AMERICAN SOCIETY FOR PROMOTION OF AVIATION, 522 Fifth Ave., Dept. X, New York

Like to fool with Electric Juice?

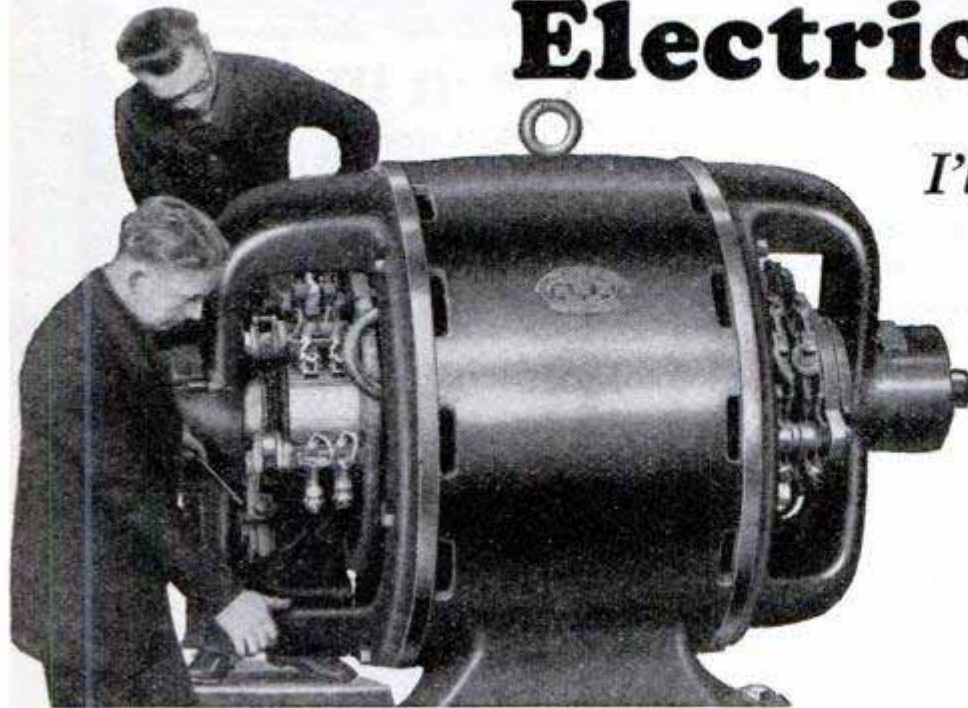

I'll train you to earn
\$100 per hour
to **\$25,000⁰⁰**
per year

I Pay Your Fare to Chicago

You wouldn't turn down a chance at \$5,000 or \$10,000 a year, with the prospect of income even bigger in the future. That's what men today are making in electricity. That's what you can make, if you have the pluck to start right now training for these big pay jobs.

I'm not telling you to read a lot of text books. The men at Greer College work right with equipment that costs thousands of dollars. You take motors and dynamometers apart and put them together till you can do it in your sleep. You work on delicate instruments, learn how to wire them, connect them up, and shoot trouble when it comes. Competent, friendly instructors show you how to do these things.

Then, after only 12 weeks you're ready for a better job than you ever held before. All the luxuries and happy living you can get with a larger pay check are yours.

Grasp Your Chance While It's Here

I believe every man is entitled to a good income and money enough for a rainy day. Those things aren't hard to get if you go after them. I've seen over 60,000 men started on the right road through my help.

But you've got to start or you'll never get there. We'll help you. When you get to Chicago we'll first find you a place to live. Then if you need we'll help get a job for you. In every way we'll take mighty good care of you.

How to Start

I can't tell you much in this short ad, but in an illustrated book I'll send you free you'll find the whole story. Simply send the coupon at the right for the marvelous story of the GREER OPPORTUNITY. It doesn't obligate you at all. And it doesn't cost a cent.

Greer COLLEGE OF
ELECTRICAL
ENGINEERING
Dept. 1001, 2024 S. Wabash Ave., CHICAGO

The way I've succeeded is to do things as soon as I've seen a chance for profit. That is the way to success. Get this book and read just how to grasp it. Mail the coupon right now. Today.

Learn Automobiles Too

If you like automobiles you can learn them here as well as electricity. Auto experts make big money too. They always have a good job. Whether you want electricity or automobile, or both, we train you to know more about these and get that Big Pay Job you have longed for. Just mark on the coupon which you are interested in. We'll tell you at once how little it will cost and how easily you can afford the training you need. Mail coupon direct to us. Do it right now. Then you can decide for yourself what course you want after you see exactly what the GREER OPPORTUNITY affords.

53 Branch Offices to Help You

CLEVELAND, OHIO, Rm. 355, Hippodrome Bldg.
HAMILTON, OHIO, Rm. 5, 204 High St.
SPRINGFIELD, OHIO, Tecumseh Bldg.
LIMA, OHIO, Rm. 25, Metropolitan Bldg.
GRAND RAPIDS, MICH., 250 Pearl St., Weiss Bldg.
FLINT, MICH., 510 P. P. Smith Bldg.
LANSING, MICH., 401 American State Bank Bldg.
BUFFALO, N. Y., 716 Walbridge Bldg.
ROCHESTER, N. Y., 259 Monroe Ave.
RANDOLPH, ME., 51 Water St.
DES MOINES, IOWA, 410 Security Bldg.
BURLINGTON, IOWA, 202 American Bank Bldg.
SIOUX FALLS, S. D., 650 E. 20th St.
ST. LOUIS, MO., 4151 West Pine Bldg.
DULUTH, MINN., Rm. 228, Ferguson Bldg.
MINNEAPOLIS, MINN., 725 Plymouth Bldg.
ELGIN, ILL., 19 Douglas Ave.
QUINCY, ILL., 414 Majestic Bldg.
ROCKFORD, ILL., 124 S. Main St.
LA SALLE, ILL., 128 N. 5th St.
OSKALOOSA, IOWA, 418 North D St.
GALENA, ILL., 400 Park Ave.
DECATUR, ILL., Rm. 754, Orchard Bldg.
PROBIA, ILL., 705 Main St.
JOLIET, ILL., 658 Van Buren St.
MARION, ILL., 400 West Main St.
GARY, IND., 416 Washington St.
SOUTH BEND, IND., 910 Blaine Ave.
MILWAUKEE, WIS., 105 Casswell Bldg.
OMAHA, NEB., 415 Karbach Block
EVANSVILLE, IND., 1016 S. 8th St.
LOUISVILLE, KY., 505 E. Breckinridge St.
LOS ANGELES, 400 So. Kenmore Ave.
CEDAR RAPIDS, IOWA
SIOUX CITY, IOWA
MASON CITY, IOWA
SANDWICH, ILL.
JACKSONVILLE, ILL.
DANVILLE, ILL.
DAVENPORT, IOWA
KALAMAZOO, MICH.
RUSSELL, MINN.
PADUCAH, KY.
SCHENECTADY, N. Y.
NEW YORK CITY, N. Y.
PHILADELPHIA, PA.
ARISTES, PA.
ALEXANDRIA BAY, N. Y.
SLATER, MD.
TORONTO, CANADA
WORCESTER, MASS.
LEXINGTON, KY.
DETROIT, MICH.

ERWIN GREER, President, Greer College
Dept. 1001, 2024 S. Wabash Ave., CHICAGO.

Please send me your FREE BOOK and offer for
It is understood I am not obligated in any way

Electrical course
Automotive course

Name

Address

Will You Accept a 1927 ATLAS

Given to readers of this magazine who take advantage of this offer now made in connection with

Webster's New International Dictionary The Merriam Webster The "Supreme Authority"

A complete reference library in dictionary form, with 3000 pages and type matter equivalent to a 15-volume encyclopaedia, all in a single volume, can now be yours on the following remarkably easy terms:

The entire work (with 1927 ATLAS)

Delivered for \$1.00

and easy monthly payments thereafter (on approved orders in United States and Canada). You will probably prefer the beautiful India-Paper Edition which is

**Reduced About One-half
in thickness and weight as compared
with the Regular Paper Edition**

Over 408,000 Vocabulary Terms and in addition, 12,000 Biographical Names, nearly 32,000 Geographical Subjects, 3000 pages, 6000 illustrations. Constantly improved and kept up to date. "To have this work in the home is like sending the whole family to college." To have it in the office is to supply the answers to countless daily questions.

To Those Who
Send This
Coupon
NOW!



G. & C.
MERRIAM CO.
Dept. S., Springfield, Mass.

Please send me free of all obligation or expense, complete information including "125 Interesting Questions" with references to their answers, striking "Facsimile Color Plate" of the new bindings. Specimen pages of India and regular paper with terms of your Special Atlas Offer on Webster's New International Dictionary to readers of Popular Mechanics. 10-27

Name.....

Address.....

Learn to Write

I Teach by Mail

I CAN make a good penman of you at your home during spare time, no matter where you live or how poorly you now write. My simplified system has shown thousands of others the way to good penmanship during the past twenty years — it can and will do the same for YOU!

Beautifully Illustrated Book
"How to Become
a Good Penman"

It contains general information, with testimonials and beautiful specimens of penmanship showing what others have accomplished by the Tambllyn System. (Your name elegantly written on a card if you enclose stamp for postage.) **FREE!** WRITE TODAY. Address

F. W. TAMBLYN
418 Ridge Bldg., Kansas City, Mo., U. S. A.

F. W. Tambllyn

Learn to Mount Birds



Learn at home by mail, to mount birds, animals, game heads; tan furs, make rugs and robes. Complete lessons. Easily and quickly learned by men, boys and women.

FREE Write today for Free Taxidermy Book. Tells all about it. Every Sportsman, Hunter, Trapper and Nature lover should know this wonderful fascinating art. Save your trophies. Big profits. Success guaranteed. Our school is 20 years old — 100,000 graduates. Investigate today. Write for Free Book.

Northwestern School of Taxidermy 9377 Elwood Bldg., Omaha, Neb.

WANT WORK AT HOME?

Earn \$18 to \$60 a week RETOUCHING photos. Men or women. No selling or canvassing. We teach you and furnish WORKING OUTFIT given with each enrollment. Limited offer. Write today. Artcraft Studios, Dept. 60, 3900 Sheridan Rd., Chicago

\$75 A WEEK BUILDING RADIO SETS

now being made

Join the Radio Association of America. Let it train you to build and repair sets, to be the "radio doctor" of your community. \$3.00 an hour easily made in spare time.

\$500 Earned in Spare Hours

Lyle Follick, Lansing, Mich., writes: "Have already made over \$500 in spare time." He is just one of many. Our members are starting radio stores, securing better positions, passing radio operator examinations, qualifying as big-pay Radio Experts, as well as making money spare time.

Join the Association Now! By our Special Plan your membership need not cost you a cent. Number of these memberships limited. Write for details NOW!

RADIO ASSOCIATION OF AMERICA, 4513 Ravenswood Ave. Dept. PM-10, Chicago, Ill.

A MARVELOUS INVENTION!

SENT FREE

For 10 days' trial in your own home or office. Simply mail the coupon below!

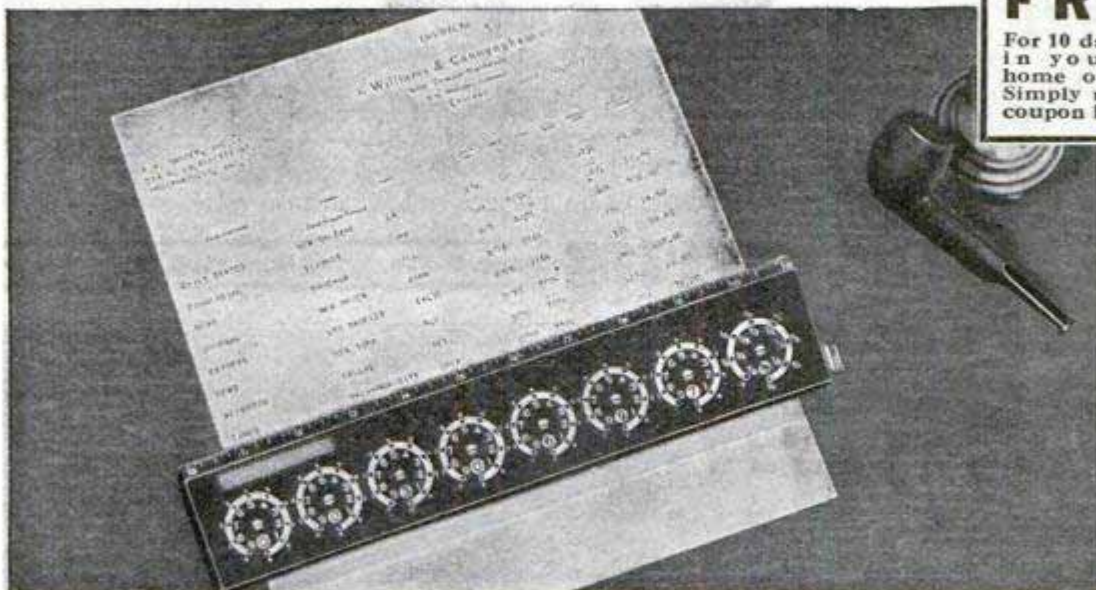

Revolutionary New Kind of ADDING MACHINE!

...Does all the work of bulky \$300 machines, yet costs only \$10

10 COMPLETE

Here's a startling invention worth twenty times its cost to everybody who works with figures! A **new kind** of adding machine, called the **ADDOMETER**, that's truly a wonder! A thoroughly practical and efficient machine that does every kind of figuring swiftly and with perfect accuracy—**at a price of only \$10!**

Just think! A real honest-to-goodness adding machine capable of doing all the work of bulky, expensive \$300 machines, at no more than the cost of a good fountain pen! Why, it seems almost impossible! But it's not—it's a **FACT!** And we're ready to prove it by sending you a machine **FREE** for 10 days' trial without the payment of a single penny!

A Mechanical Marvel

Undoubtedly the most ingenious invention in 25 years, **ADDOMETER** is much more than just an adding machine.

It **ADDS**—clear up to \$99,999.99— $\frac{3}{4}$ quick as a flash! **SUBTRACTS** instantly with the same speed, agility and ease of operation as it adds! Even adds and subtracts **FRACTIONS** in units down to $\frac{1}{8}$! And it **MULTIPLIES** and **DIVIDES** just as easily and quickly as the most costly machines! You can use it to total invoices, take inventory, balance ledger accounts, figure discounts or perform 1001 other useful everyday computations. **ADDOMETER** always gives you the right answer every time—in a jiffy!

Operates on New Principle

Revolutionary in principle as well as in price, **ADDOMETER** has been acclaimed by experts as the neatest, most compact and remarkable adding machine ever invented. It

works entirely without the use of keys or awkward levers. Yet it is lightning fast and never makes a mistake. Shows the total visible at all times. Clears by a flick of the finger. Every action is simple—direct—positive. But that's not all! **ADDOMETER** is also radically new and different in design. It is made entirely of metal—and guaranteed for 2 years! Embodies a host of features that have long baffled the best mechanical designers. Only $11\frac{1}{2}$ " long, $2\frac{1}{2}$ " wide, and $\frac{3}{4}$ " thick, and weighing but 14 oz., it can be

carried anywhere right in your coat pocket—the only adding machine made that really "goes to the work." Being flat, it fits right over the sheet of figures being computed, keeping your place, preventing troublesome eyestrain, and speeding up your work. And the upper edge of the machine is cleverly formed into a handy graduated rule!

A Machine Everybody Needs

ADDOMETER performs a useful, practical, necessary service in the daily life of almost everybody. Does all your figuring for you quickly and accurately. Eliminates mental strain, prevents costly errors, saves you time and money every hour of

the day. Even if it sold for \$100 or more you shouldn't be without it! At only \$10 you

couldn't buy anything that would be such a handy helper. Yet that's all **ADDOMETER** costs—and you don't pay a single cent until you've had a chance to use it for 10 days!

10 Days' FREE TRIAL!

Here's Our Plan

We want you to have an **ADDOMETER** for 10 days' **FREE TRIAL** in your home or office. So we are offering it to anyone on our famous "No Risk" Plan. We ask **NO** money in advance—**NOTHING** on delivery—**NO** deposit of any kind. Simply fill out and mail the coupon and we'll send you a machine postpaid. Try it! Test it! Use it for 10 days! Then if satisfied, remit only \$10 in full payment. Otherwise return the machine. That's all we ask. By all means mail the coupon for your machine **NOW—TODAY!**

AMAZING TEST

In a recent demonstration an inexperienced boy totaled 22 items on the **ADDOMETER** in 29 seconds. It required 28 seconds for an expert operator to get the same answer on a \$350 electric adding machine! **THAT'S SPEED!**

SALESMEN — DEALERS!

ADDOMETER is the biggest selling sensation in years! Sells on sight to everyone who uses figures! Every territory jammed with buyers! Write **TODAY** for details of our astounding Money Making Plan whereby you can easily make profits of \$26 TO \$45 A DAY!

ADDOMETER SALES CO., Dept. 47,
(Div. Reliable Adding Machine Corp.)
184 W. Washington St., Chicago, Ill.

Gentlemen: Please send me an **ADDOMETER** for 10 days' **FREE TRIAL** on your special "No Risk" Plan.

Name.....

Address.....

Clip and mail this coupon **NOW**. Please accompany coupon with your business card or letterhead, or give name of one reference. This is important. **THANK YOU!**

(P. M. 10-27)

ADDOMETER SALES CO. Dept. 47 184 W. Washington St. **Chicago, Ill.**

From "Puny" to PANTHER-MAN

My FREE Book

tells how you can get a body like I gave this lad. Why delay? The book only costs you a postage stamp and there are no strings to that!

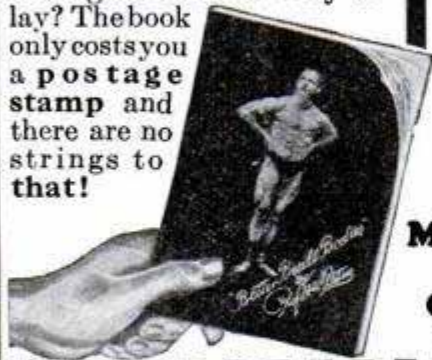

Mail the Coupon NOW

LOOK at these two pictures! to himself and came to me! LOOK at them!! Then go peek In thirty days I built that man in your mirror and see which one of from the sparrow-armed boy in the them is more like you. Never mind first picture. I loaded him with blushing! Don't waste time being muscles. I can do as much—may- ashamed! There's no need of stay- be more—for you! If you want ing that way! a real body mail the coupon be- The chap in the picture got next fore you go to bed TONIGHT!

TITUS Dept. P-119 105 East 13th St., New York City

Titus, Dept. P-119
105 E. 13th Street,
New York City.

Dear Sir:

Mail my copy of your big new illustrated book, Better Built Bodies, absolutely FREE and without obligation.

Name.....
Address.....
City..... State.....



BEFORE

This lad looked pretty hopeless when he came to me. His arms looked like sparrow wings with the feathers removed. His ribs stood out and his bones tried to poke through his skin all over his body. His chest was hollow, his neck scrawny. He had sluggish blood circulation and jumpy nerves. He couldn't sleep. Then he took my course!



30 DAYS AFTER

What a man! In thirty days I built the fellow you see above. I loaded his bones with muscles! I gave him a body that laughs at hardships and illness. He says: "No other apparatus and instruction can touch yours! When the human body will hold another muscle—Titus will put it there!"



mail this coupon today

TOUCHDOWN, BOYS!

You can score the greatest touchdown of your life. It will be fun—easy work—and you need no experience to start.

The Crowell Publishing Company offers you the chance to become a Crowell Junior Salesman. Every week hundreds of fellows, like yourself, are giving a few minutes of their spare time delivering three of the best known magazines in America to regular customers. They earn their own spending money and win splendid prizes.

Send today for the Big Book of over 300 prizes telling how easily you can have any of them.

Jim Thayer, Dept. 35,
The Crowell Publishing Co.,
Springfield, Ohio.

Tell me how to make a touchdown.

My Name.....
Address.....
Town..... State.....

Wake Up Your Lazy Muscles!

Fill Your Body With Manly Vigor
-STRONGFORT Tells How



STRONGFORT
 Builder of Men

new red blood; strengthens the vital organs; brings back health, strength, vigor, vitality—the ability both to do things worth while and to enjoy to the fullest the good things of life.

I Want To Send You MY FREE BOOK

This book of many pages and dozens of pictures tells of my wonderful experience. It tells what I have done for others, what I can do for you. It doesn't mince words. It tells plain truths. "Promotion and Conservation of Health, Strength and Mental Energy," points the way from disease and weakness to health and strength. It is priceless. I'll send it to you on request—FREE. Write for your copy today.

STRONGFORT INSTITUTE

LIONEL STRONGFORT, DIRECTOR.

Physical and Health Specialist
 DEPT. 386 NEWARK, NEW JERSEY, U. S. A.

Your body is full of lazy muscles—you're asleep in most of your anatomy—you're not exerting half the power that you can arouse by stirring up those flabby worthless muscles—you haven't half the vigor and pep and stamina you could have if you sounded the alarm clock and awakened those sleepy muscles and put them to work! No, man—you, perhaps, like thousands of others, are not more than half a man—you're not a full functioning physical machine—you're not the powerful fellow you ought to be, and can be if you'll listen to me and wake up.

You Can Be Strong

You can be a man who will command the admiration of women for your physique and of men for your powerful muscular ability. You can be a man to be feared in combat—a winner in sports. I know what I am talking about—I can prove by tens of thousands of delighted pupils that my methods of body development are beyond any ordinary gymnasium or physical culture course.

It was through my experience in developing my own body to a perfect physical condition—building up a body at once **symmetrical, perfectly proportioned and full-functioning**—and afterwards training and conditioning boxers, wrestlers, and other athletes—and particularly in restoring thousands of weak men to vigorous health and manly strength—that I evolved the science of

STRONGFORTISM

For Building Up Bodies

STRONGFORTISM works wonders with run-down, weakly, skinny fellows. It builds them up to health through internal muscular development, then rounds them out into robust physical specimens, by bringing into play every muscle and making every muscle **do its work** as Nature intended. You'll be astonished how quickly you'll feel the benefits of this wonderful health and strength course.

You'll feel like a new man almost from the first day you start under my instructions—and you'll look like a new man! You'll be surprised at the lazy muscles you wake-up when you begin, and they'll wake you up in turn. You'll quickly realize that a new day has dawned for you as you feel the red blood coursing through your whole body like a bounding mountain stream. The old, stupid, sluggish feeling will disappear like magic. That gloomy outlook will vanish as though a heavenly hand had brushed it away. Oh, it's a great feeling! **Great to feel like a man!** And you surely will when you adopt Strongfort as your instructor and guide—Strongfort, "the builder of men."

Strongfortism Restores Power

by ridding the human organism of distressing ailments and irregularities that have clogged its normal action and thrown its delicate machinery out of gear. The heart, lungs, liver, stomach, brain, all act in harmony in health. Strongfortism restores this harmony; helps to create

Send this FREE Consultation Coupon ABSOLUTELY CONFIDENTIAL

Mr. Lionel Strongfort, Strongfort Institute, Dept. 386, Newark, N. J.—Please send me absolutely free my copy of your book, "PROMOTION AND CONSERVATION OF HEALTH, STRENGTH AND MENTAL ENERGY." I have marked (x) before the subjects in which I am most interested.

- | | | |
|-------------|-----------------|-------------------------|
| .. Catarrh | .. Overweight | .. Great Strength |
| .. Colds | .. Constipation | .. Lung Troubles |
| .. Asthma | .. Weak Back | .. Round Shoulders |
| .. Headache | .. Weak Eyes | .. Stomach Disorders |
| .. Rupture | .. Rheumatism | .. Increased Height |
| .. Thinness | .. Nervousness | .. Muscular Development |
| .. Pimples | .. Short Breath | |
| .. Insomnia | .. Weak Heart | |

Other Ailments.....

Name.....

Age..... Occupation.....

Street.....

City..... State.....



Men Needed in Electricity

ONE of the best ways to prepare for a good position in the Electrical field or to have a business of your own is through the home-study courses of the International Correspondence Schools.

Nearly \$200,000 has been spent in the preparation of these courses and they have been endorsed by Thomas A. Edison and Charles P. Steinmetz—the late “electrical wizard” of the General Electric Co.

Here are just a few of the men who have contributed to these courses:

- EDGAR KNOWLTON—Electrical Engineer, Alternating Current Engineering Department, General Electric Co.
- J. LESTER WOODBRIDGE, E.D. and M.E.—Chief Engineer of the Electric Storage Battery Co.
- S. A. FLETCHER—Electrical Engineer, Superintendent of Service, Alabama Power Co.
- H. B. GEAR, A.B., M.E.—Engineer of Distribution, Commonwealth Edison Co., Chicago.
- C. E. KNOX—Consulting Engineer on the Woolworth Building, New York. Author of “Electric Light Wiring.”
- S. H. MORTENSON—Designer of Alternating Current Motors and Generators, Allis-Chalmers Manufacturing Co.

When you read over a list like that, you know why these I. C. S. Electrical Courses have been endorsed by Edison and Steinmetz . . . you can see why they will help you.

Mail Coupon for Free Booklet

INTERNATIONAL CORRESPONDENCE SCHOOLS
“The Universal University”
Box 5677-E, Scranton, Penna.

Without cost or obligation on my part, please tell me how I can qualify for the position or in the subject before which I have marked an X:

- | | |
|--|---|
| <input type="checkbox"/> Electrical Engineer | <input type="checkbox"/> Electric Draftsman |
| <input type="checkbox"/> Electrician | <input type="checkbox"/> Electric Car Running |
| <input type="checkbox"/> Electric Wiring | <input type="checkbox"/> Electric Machine Designer |
| <input type="checkbox"/> Electric Lighting | <input type="checkbox"/> Radio |
| <input type="checkbox"/> Architect | <input type="checkbox"/> Mathematics |
| <input type="checkbox"/> Architects' Blueprints | <input type="checkbox"/> Mechanical Engineer |
| <input type="checkbox"/> Contractor and Builder | <input type="checkbox"/> Mechanical Draftsman |
| <input type="checkbox"/> Architectural Draftsman | <input type="checkbox"/> Machine Shop Practice |
| <input type="checkbox"/> Concrete Builder | <input type="checkbox"/> Railroad Positions |
| <input type="checkbox"/> Structural Engineer | <input type="checkbox"/> Gas Engine Operating |
| <input type="checkbox"/> Chemistry <input type="checkbox"/> Pharmacy | <input type="checkbox"/> Civil Engineer |
| <input type="checkbox"/> Automobile Work | <input type="checkbox"/> Surveying and Mapping |
| <input type="checkbox"/> Airplane Engines | <input type="checkbox"/> Metallurgy <input type="checkbox"/> Mining |
| <input type="checkbox"/> Agriculture and Poultry | <input type="checkbox"/> Steam Engineering |

BUSINESS TRAINING COURSES

- | | |
|---|--|
| <input type="checkbox"/> Salesmanship | <input type="checkbox"/> Business Management |
| <input type="checkbox"/> Advertising | <input type="checkbox"/> Industrial Management |
| <input type="checkbox"/> Better Letters | <input type="checkbox"/> Personnel Organization |
| <input type="checkbox"/> Show Card Lettering | <input type="checkbox"/> Traffic Management |
| <input type="checkbox"/> Stenography and Typing | <input type="checkbox"/> Business Law |
| <input type="checkbox"/> Business English | <input type="checkbox"/> Banking and Banking Law |
| <input type="checkbox"/> Civil Service | <input type="checkbox"/> Accountancy (including C. P. A.) |
| <input type="checkbox"/> Railway Mail Clerk | <input type="checkbox"/> Nicholson Cost Accounting |
| <input type="checkbox"/> Common School Subjects | <input type="checkbox"/> Bookkeeping |
| <input type="checkbox"/> High School Subjects | <input type="checkbox"/> Private Secretary |
| <input type="checkbox"/> Illustrating | <input type="checkbox"/> Spanish <input type="checkbox"/> French |

Name.....
Street.....
Address.....

City..... State.....

Occupation.....
Persons residing in Canada should send this coupon to the International Correspondence Schools Canadian, Limited, Montreal, Canada.



\$1900 to \$2700 a year



Long vacations with pay. Work easy. Travel on fast trains with all expenses paid, including hotel. No worries about the future. Ex-service men get preference.

MY FREE BOOK TELLS HOW

Get my big free book about the Civil Service which tells all about the Railway Postal Service, and other positions, and how I can help you. Write today.

PATTERSON SCHOOL

Arthur R. Patterson, Civil Service Expert
810A Wisner Bldg. Rochester, N. Y.

GIVEN



\$20 Musical Instruments

Your choice of a Violin, Tenor Banjo, Hawaiian Guitar, Banjo, Cornet, Ukulele, Banjo Ukulele, Guitar, Mandolin or Banjo Mandolin. You will be proud to own any one of these instruments and we will give you one without cost. A few cents a day for lessons is your only expense. Our system of teaching is so easy that you can play several pieces by note with the first four lessons. We guarantee success or no charge. Instrument and lessons sent on one week's free trial. Write for booklet today, no obligation. Over 200,000 satisfied pupils.

CHICAGO CORRESPONDENCE SCHOOL OF MUSIC, INC.
1632 North Halsted Street, Dept. 354, Chicago, Illinois.

FOREST RANGERS

MEN, become Forest Rangers; \$125—\$200 mo. and home furnished; permanent; hunt, fish, trap, etc.

FOR DETAILS, WRITE

NORTON, 2530 McMANN BUILDING, DENVER, COLORADO

WHAT IS A BAR BELL?

A BAR BELL is simply a long-handled dumb-bell. It has many advantages over a pair of dumb-bells. For instance, it is far easier to handle a 50-lb. bar bell than two 25-lb. dumb-bells. Again, with a bar bell you can do certain back and leg exercises where it would be awkward to handle a pair of dumb-bells. The bar bell became



One of the Milo Bar Bell Sets

The Greatest of All Body Builders

when the adjustable feature was added—for then it became possible to employ the progressive method of exercise which has proven to be the only way in which a man of below average physique can gradually but steadily improve his build, his muscular development, and his stock of organic vitality until he becomes a physical superman—the very pattern of health and beauty.

USE COUPON FOR FREE BOOKLET

THE MILO BAR BELL CO., DEPT. P.M. 601
2747 N. PALETHORP ST., Philadelphia, Pa.
Gentlemen: Please mail me, without charge or obligation on my part, your free booklet, "Health, Strength and Development and How to Obtain Them."

Name.....

Address.....

City..... State.....



Learn MIND READING!

**At Home
By Mail**

Make \$250 to \$1000 a month

Magichas always been and *will be* the most popular form of entertainment. Magicians are in great demand not only for the professional stage but by clubs, churches, lodges, schools and for social affairs! **HIGH SALARIES ARE PAID!**

Plenty of opportunity to make \$25 to \$100 a performance as a side-line—*without* neglecting your regular business. All this NOW within your grasp! The great Tarbell course will fit you for this. It was designed for beginners, but the profession has also adopted and endorsed it for the new "kinks" and basic principles it teaches so clearly.

Write for Special Offer!

Special Offer for a Limited Time Only! You can get this fascinating course . . . endorsed by the world's *greatest* magicians, NOW . . . at a Special Price. But you have to act quick! Mail the Coupon NOW!

Amazing "Physic" Acts
Taught as a Part of the
Great Tarbell Course in

MAGIC

For the first time you are offered the opportunity to learn the real secret trick of Mind Reading. Amaze and astonish your friends! You can become an expert "Super-Mentalist Magician" easily, quickly. Mind Reading is a vital part of the amateur or professional Magician's training. The great Dr. Tarbell teaches you the most astounding acts and the principles on which all stage Mind Reading is based. But besides this, you also get a complete course covering the whole realm of Magic—assuring you tremendous returns both in money profits and social prestige.

Tarbell System, Inc., Studio 13-57, 1926 Sunnyside Ave., Chicago, Ill.

Tarbell System, Inc., Studio 13-57

1926 Sunnyside Avenue, Chicago, Illinois

Please send me your big FREE illustrated booklet giving full information on "Psychic Mind-Reading Powers" and the great Tarbell System of Magic. No obligation on my part whatever.

Name

Address

City and State Age

Learn Electricity IN LOS ANGELES

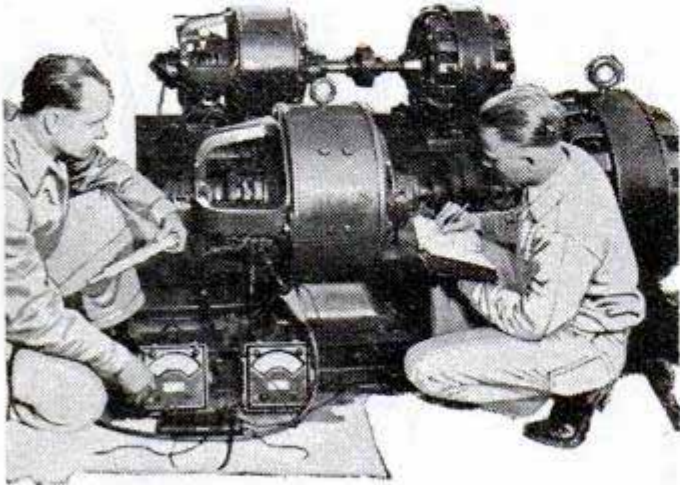

FREE Employment Service!

There are more calls for "National-Trained-Electrical-Men" than we can supply. Jobs are open now paying \$50 to \$200 a week—but you must first get the right training. Get it at National—a world-famous institution with a quarter century record of success in training big pay men.

All These Advantages:

1. Unlimited Training Until Competent.
2. Free Employment and Welfare Service.
3. Million Dollar Training Shops.
4. Personal, individual Training guaranteed.
5. You actually perform work that employers pay big money for.
6. Official Diploma and certified record of work performed.

FREE

Read how National insures your success. Send for this free Electrical catalog—illustrated by actual photos of students training under instructors on a half million dollars' worth of new electrical equipment. Mail coupon now.



Electricity - YOUR Opportunity!

This Big, Free Book Shows You How to Quickly Make BIG PAY



National Electrical School

Dept. 511, 4006 Figueroa St., Los Angeles, California.

Send me your big free illustrated catalog of Electrical Opportunities.

Name.....
 Address.....
 Age..... City..... State.....

Learn How to BOX

JIMMY DeFOREST BOXING COURSE

Teaches by mail the Same System he taught Champion JACK DEMPSEY

In 20 weeks, under the System of Jimmy DeForest, **WORLD'S GREATEST TRAINER AND MAKER OF CHAMPIONS**, you will master the priceless knowledge that made Jack Dempsey his millions, and fortunes for a host of other Jimmy DeForest-trained ring stars. Boys who were once rank amateurs are today earning big money; weaklings have been made strong, courageous; men have learned the art of self-defense. Send today for the now famous book, "THE GOLDEN AGE OF BOXING," greatest book of its kind ever written; full of valuable information, photos of great fighters and pupils who became successes over night. Enclose 10c to cover cost of mailing, etc. **WRITE NOW.**



JIMMY DeFOREST BOXING COURSE

347 Madison Avenue, Box 123, New York City

WANTED!

Ornamental Iron Draftsmen at BIG PAY

Our students are getting positions before they finish our course of instruction. The demand for trained men is greater than the supply. Learn at home, in spare time. No books, higher mathematics or experience necessary. Free Employment Service to qualified students.



Get this FREE BOOK!

It gives full information. We have no agents or salesmen. Write today.

American Inst. of Ornamental Iron & Bronze
 13047 Hennepin Avenue
 Minneapolis, Minnesota

Better Handwriting

A wonderful asset in teaching writing. Aluminum guides. Highly recommended. 2 qualities, at 35c and \$1 a set post-paid. **VIC. HANSEN, WALLACE, IDAHO**

Keynote To Popularity

Popularity is yours. Everyone will seek your company if you play tenor banjo. Enroll for our course. We start you with an \$18 professional tenor banjo. Prof. Six was director of Glee and Instrumental Clubs at N. Y. University. His picture, diagram and phonograph record method is so simple you play immediately.

Don't Send a Single Cent

Write for particulars about our course and we will reserve an \$18 tenor banjo for you. Write now for book and free first lesson. **New York Academy of Music, Studio 110, 100 Fifth Ave., N. Y. C.**



Learn MECHANICAL DENTISTRY



In 3 Months Earn \$5000 A Year

WHY spend the best years of your life at uncertain jobs at small pay? You can **EARN WHILE LEARNING** this NEW money-making profession and become independent. Age no barrier, and no previous training required. You **LEARN BY DOING PRACTICAL** work. Day or night sessions. **INDIVIDUAL INSTRUCTION.** Easy terms. Railroad Fare allowed—no extra cost. Address **SECRETARY N. Y. SCHOOL OF MECHANICAL DENTISTRY, 147 West 33 St., NEW YORK.**

SEND FOR FREE BOOK



Clip and Mail Name..... Street..... City..... State.....

PAIN and Disease Now Quickly Conquered by VIOLET RAY

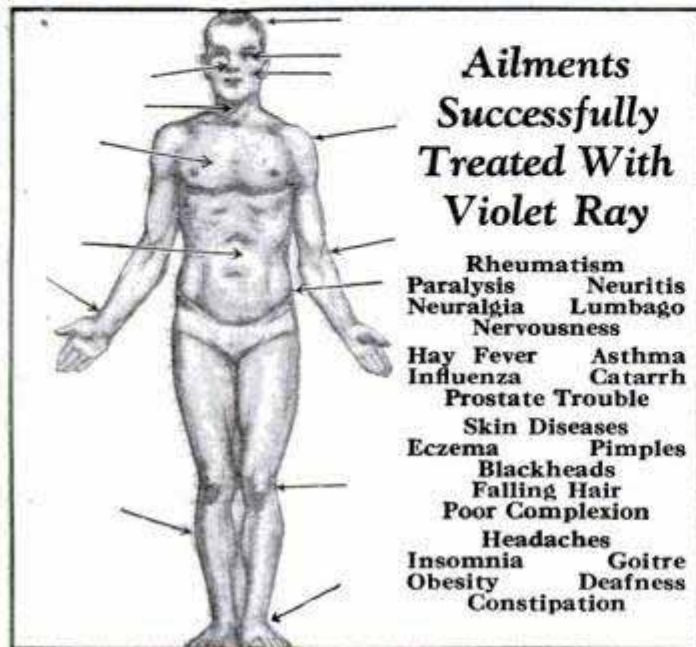

Ailments Successfully Treated With Violet Ray

Rheumatism
Paralysis Neuritis
Neuralgia Lumbago
Nervousness
Hay Fever Asthma
Influenza Catarrh
Prostate Trouble
Skin Diseases
Eczema Pimples
Blackheads
Falling Hair
Poor Complexion
Headaches
Insomnia Goitre
Obesity Deafness
Constipation

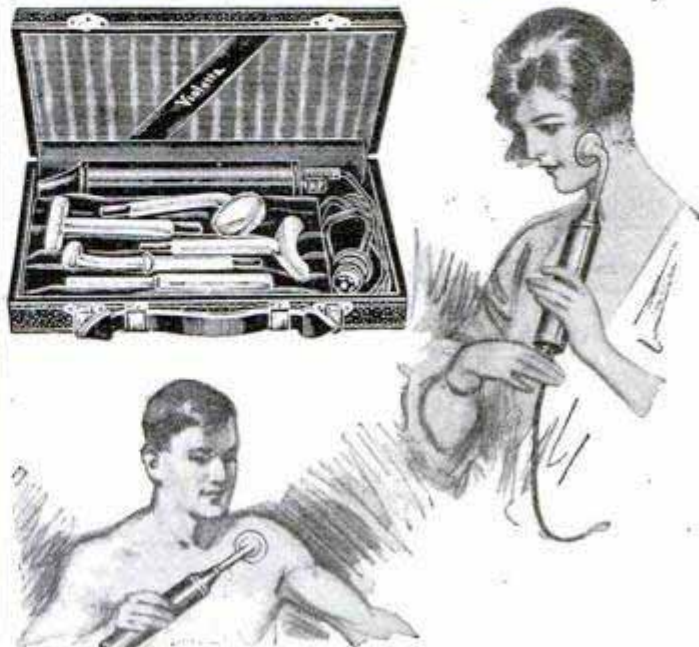

Scientific, Painless Treatment Used by Doctors, Hospitals, Sanitariums Now Offered to Every Home

The mysterious, baffling, supernatural powers of Violet Rays, discovered by Nikola Tesla, the electrical genius, are as phenomenal as the marvels of radio. Why Violet Rays should possess such miraculous curative powers over pain and disease is as much a mystery as the ether wave's ability to transmit a whisper through miles of space.

Let us tell you how thousands of men and women suffering from rheumatism, nervousness, skin diseases, headaches, constipation, sprains, falling hair, obesity and many other ailments, have found quick relief—new health and vitality—with this marvelous scientific invention. We also have many positively astounding letters from former sufferers of paralysis. Pains vanish almost instantly.

Science has proved that the tissues, blood, bones, nerves, hair, nails and other parts of the human anatomy are composed of billions of cells. When these cells function improperly, become inactive, fail to absorb and burn up oxygen and throw off waste products caused by this combustion, the result is pain, disease, and often death.

Violet Rays go direct to the source of the trouble. They

stimulate human cells to healthy activity as positively as an electric current revives a run-down battery.

Violetta is an invention for making genuine violet rays from any electric current. It has long been used and endorsed by hospitals, sanitariums and physicians everywhere. It's a demonstrated success. Every home should have a Violetta outfit. Saves hours, days, months of suffering. No medicine. Painless, pleasant, ever-ready treatment. Only the Violet Ray can penetrate to every cell and nerve affected. Simple, safe, painless—anyone can use Violetta.

Violetta

10 Days FREE TRIAL

For Health—Beauty—Vigor

This Book FREE

Tells all about Violet Rays and the long list of ailments successfully treated—how this marvelous invention now brings this mysterious curative power to all. Why suffer pain and poor health when you can try a Violetta Outfit in your own home 10 days FREE?

Send for this book now. Read some of the many

astounding testimonials it contains from users who have tried this new way to health, beauty, vigor.

Mailing the coupon places you under no obligation. Send for all the facts and our liberal free trial offer today.



HUNDREDS REPORT ASTOUNDING RESULTS

Rheumatism "The Violetta is everything it is claimed to be."

Lumbago "Drugs cannot compete with it for Lumbago and Rheumatism; or when a general toning up of the system is desired."—A. J. Albert, Minnesota.

Neuritis "The Violetta which I received worked wonders on the neuritis of eight years' standing. I had taken all kinds of medicine, tried osteopathic and chiropractic treatments without benefit. Now I am able to sleep nights as I did before the trouble came on. Am gaining right along."—J. T. Blackman, Calif.

Asthma "Your Violetta has completely cured asthma that I had for 25 years. I am a booster for your Violet Ray in every way."—W. E. Hopson, Texas.

Headaches "I am tickled pink over it. Beats medicines every way. Suffered with headaches and have never used anything that gives as quick relief. Wouldn't take \$100 for my Violetta if I couldn't get another."—Mrs. Ora Gallon, Michigan.

Acne "I used the Violetta for a severe case of Acne. It helped me considerably, for the Acne is gone."—H. J. Kobber, Chicago.

VI-REX COMPANY, 2304 Warren Ave., Dept. 1031, Chicago, Ill.

VI-REX COMPANY

2304 Warren Ave.
Dept. 1031, Chicago

Please send me your free book on Violet Rays and details of your 10-day free trial offer.

Name.....

Address.....

City..... State.....

Allment.....

Science Discovers the Secret of CARUSO'S Wonderful Voice

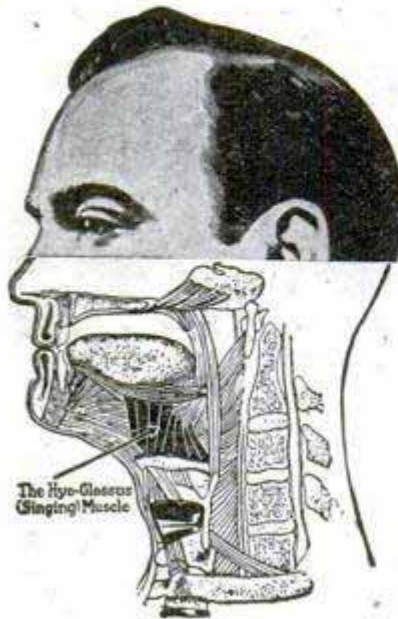

Why is it that the humble peasant boy of Italy became the greatest singer of all time? This diagram of his throat will show you. Caruso's marvelous voice was due to a superb development of his Hyo-Glossus muscle. Your Hyo-Glossus muscle can be developed, too! A good voice can be made better—a weak voice become strong—a lost voice restored—stammering and stuttering cured. Science will help you.

Your voice can be improved 100%

A few very fortunate persons—like the late Caruso—are born with the ability to sing well. But even Caruso had to develop his Hyo-Glossus muscle before his voice was perfect. You can develop a beautiful singing or speaking voice if your Hyo-Glossus muscle is strengthened by correct training. Professor Feuchtinger, A. M.—famous in the music centers of Europe for his success in training famous Opera Singers—discovered the secret of the Hyo-Glossus muscle. He devoted years of his life to scientific research and finally perfected a system of voice training that will develop your Hyo-Glossus muscle by simple, silent exercises right in your own home. The Perfect Voice Institute guarantees that Professor Feuchtinger's method will improve your voice 100%. You are to be your own judge—if your voice is not improved 100% in your own opinion, we will refund your money.

Grand Opera Stars His Students

Hundreds of famous singers have studied Physical Voice Culture. Over 10,000 happy pupils have received the benefits of his wonderful training. You do not know the possibilities of your voice. If you want to sing—but lack the proper training because you have not the time nor means to study—here is your chance. You can now train your voice at a very small cost in the privacy of your own home. If you want to improve your speaking voice—if you stammer or stutter—Prof. Feuchtinger will help you.

Inspiring New Book FREE!

You will do yourself a great and lasting good, by studying the new book, "Physical Voice Culture." It may be the first step in your career. Do not delay. Mail the coupon today.

Perfect Voice Institute

1922 Sunnyside Avenue Studio 13-57 CHICAGO

Perfect Voice Institute

1922 Sunnyside Avenue Studio 13-57 CHICAGO

Please send me FREE your new book, "Physical Voice Culture." I have put X opposite the subject that interests me most. I assume no obligations whatever.

..... Singing..... Speaking..... Stammering..... Weak Voice

Name.....

Address.....

Age.....

Wrestling Book

Learn at Home

10c



Men, Boys be perfect physically. Learn right in your own home from **WORLD'S CHAMPIONS** how to be an expert **WRESTLER**. Learn secret trick holds, blocks, breaks and pinning holds. Learn how to defend yourself against bigger, stronger men. Learn **Jiu-jitsu**. Also most wonderful course in **PHYSICAL CULTURE** ever discovered. The world renowned **FARMER BURNS** and **FRANK GOTCH** are authors of these splendid lessons. Learn to be a real athlete. You can if you'll try. Have a beautiful attractive body that all will admire. Surprise your friends, and the "bully" with your great ability. Learn to protect yourself, your mother, sister or sweetheart. Have perfect health, ability.

Only 10c Send only 10c coin or stamps, for 32 page book, **ILLUSTRATED**, giving full particulars. Tell the secrets of the big Champions; gives many tricks, holds and other valuable information. A costly book which we send for only 10c—the cost of packing and postage. Don't miss it. Don't delay. **SEND TODAY—THIS MOMENT.** State your age.
Farmer Burns School, 3377 Railway Exchange Bldg., Omaha, Neb.

FREE to BOYS!



Sample copy of **OPEN ROAD** for **BOYS** magazine, 50 pages of Thrilling stories, pictures, sports, mystery, etc. Also free membership in the **WINNIT CLUB**, badge button, big outfit, catalogue and brand new plan for making lots of easy money and swell prizes. **ALL FREE!** No obligation. Send name and address at once to **WINNIT CLUB**, 210 Open Road for Boys, 248 Boylston St., Boston, Mass.

FREE A 5-CABLE EXERCISER FREE

and Instructions

WITH ONE YEAR'S SUBSCRIPTION TO "STRENGTH" AT THE REGULAR PRICE

Here's a proposition, fellow, you can't equal—12 big issues of this magazine "Strength," sent to your home each month free of mailing charges and a 5 elastic cable exerciser with instructions on how to use it for developing your physical strength and bodily proportions as well as for improving your general health.

12 BIG ISSUES and the EXERCISER ONLY \$2.50

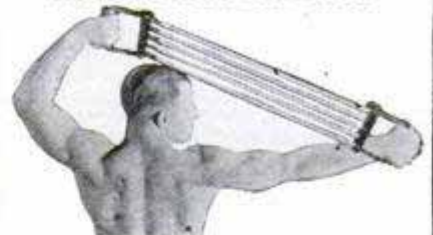

The cables are all of the best rubber and are the strongest made. The grips are finely finished and strong. The instruction will give you exercises.

"STRENGTH"

THE MAGAZINE FOR THE HEALTH, STRENGTH AND MUSCLE SEEKER

"Strength" is a he-man's magazine which contains articles and pictures upon all branches of the health, strength and muscular development subject. It shows you how to become healthier; how to increase your physical strength and how to improve your development and proportions. There are loads of pictures each month of men who have acquired marvelous physiques and great strength through the methods outlined in this Magazine. There are pictures of beautifully formed women who have obtained their shapes through physical training methods. There are fight, base-ball, hold sports articles, etc. in each issue.

SEND YOUR NAME, ADDRESS and \$2.50 NOW—We Pay All Charges



MILO PUB. CO., P. M. 10-27 2747 N. Palethorp Street, Philadelphia, Pa.

Gentlemen: Please find enclosed \$2.50 for which send me immediately a 5-cable exerciser and course free and enter my name on your mailing list for a year's subscription to "Strength."

Name.....

Address.....

City..... State.....

NOW GET into FLYING

you can

**Be a King
of the Air**



With planes, equipment and instructors under U. S. Govt. inspection, the million dollar Sweeney School, with its 150 acre private flying field, club house, hangar and thousands of dollars worth of latest tools, machinery and equipment for aviation, offers young men the most efficient, economical and practical method of getting into this great business.

MONTECALMO

**Safe
Quick
Easy**

The Sweeney School

bases all its work on practical experience. Learn to fly by flying. Learn to make, repair and condition planes by actual work. The record of Sweeney graduates in the air and on the ground as expert mechanics gives this school world wide reputation.

Rich Rewards

Lindbergh, Chamberlin, Byrd, hundreds of others flew to fame and wealth and every day a new hero appears. There is a boom in aviation such as the world never saw in any business. Thousands of ambitious young men are wanted. If you have the heart we will supply the practical training. There's big money in aviation now and simply unlimited possibilities.

YOU can select either the pilot course or ground mechanics course or combine the two courses. All the flying with dual controls and later solos to qualify you. All the ground work in motors, ignition, wings and construction to qualify you as an expert and five men are needed on the ground for one man in the air. The cost of tuition is extremely low and living conditions are pleasant and economical. Many men just out of the army come here to take up this work. Student body very high class. No previous experience required. We use tools, not books.

FREE Send name today for full details. Illustrated catalog shows pictures of students at work in shops and in the air. Everything you want to know about aviation. Lists of jobs and high pay offered aviators and mechanics. No colored students accepted.

LEARN TO FLY BY FLYING
Sweeney
SCHOOL of AVIATION
4206 SWEENEY BLDG., KANSAS CITY, MO.

SEND THIS NOW

EMORY J. SWEENEY, President
4206 Sweeney Bldg., KANSAS CITY, MO.

Please send me full information about your Aviation Course.

Name.....Age.....

Address.....

Town.....State.....



Big Salaries Paid Automobile Experts

**Fastest growing industry in U. S. A.
offers unusual opportunities to
trained men**

THE automobile industry is one of the biggest and fastest growing industries in the United States. There are more than 18,000,000 cars registered in this country and the number is increasing every day.

The best way to prepare for success in the automobile field is to study, and there is no better way to do this than through a home-study course with the International Correspondence Schools.

We say this because many of the leading figures in the automobile world today are former I. C. S. students. The list includes Jesse G. Vincent, Vice-President of the Packard Motor Car Co.; Walter P. Chrysler, President of the Chrysler Motor Corporation; E. V. ("Eddie") Rickenbacker; Hiram Walker, Chief Engineer of the Chandler Motor Car Co.; J. V. Whitbeck, President of the Cleveland Automobile Co., and other men equally as famous.

Just mark and mail the coupon and we'll send you information about the I. C. S. Automobile Courses or any other course in which you are interested.

INTERNATIONAL CORRESPONDENCE SCHOOLS

"The Universal University"

Box 5675-E, Scranton, Penna.

Without cost or obligation on my part, tell me how I can qualify for the position or in the subject before which I have marked an X:

- | | |
|---|--|
| <input type="checkbox"/> Complete Automobile Course | <input type="checkbox"/> Gas Engine Operating |
| <input type="checkbox"/> Automobile Electric Equipment | <input type="checkbox"/> Complete Gas Engine Course |
| <input type="checkbox"/> Electrical Engineering | <input type="checkbox"/> Architect |
| <input type="checkbox"/> Electric Lighting | <input type="checkbox"/> Architects' Blueprints |
| <input type="checkbox"/> Mechanical Engineer | <input type="checkbox"/> Contractor and Builder |
| <input type="checkbox"/> Mechanical Draftsman | <input type="checkbox"/> Architectural Draftsman |
| <input type="checkbox"/> Machine Shop Practice | <input type="checkbox"/> Concrete Builder |
| <input type="checkbox"/> Railroad Positions | <input type="checkbox"/> Structural Engineer |
| <input type="checkbox"/> Civil Engineer | <input type="checkbox"/> Chemistry <input type="checkbox"/> Pharmacy |
| <input type="checkbox"/> Surveying and Mapping | <input type="checkbox"/> Airplane Engines |
| <input type="checkbox"/> Metallurgy <input type="checkbox"/> Mining | <input type="checkbox"/> Agriculture and Poultry |
| <input type="checkbox"/> Steam Engineering <input type="checkbox"/> Radio | <input type="checkbox"/> Mathematics |

BUSINESS TRAINING COURSES

- | | |
|--|---|
| <input type="checkbox"/> Business Management | <input type="checkbox"/> Salesmanship |
| <input type="checkbox"/> Industrial Management | <input type="checkbox"/> Advertising |
| <input type="checkbox"/> Personnel Organization | <input type="checkbox"/> Better Letters |
| <input type="checkbox"/> Traffic Management | <input type="checkbox"/> Show Card Lettering |
| <input type="checkbox"/> Business Law | <input type="checkbox"/> Stenography and Typing |
| <input type="checkbox"/> Banking and Banking Law | <input type="checkbox"/> English |
| <input type="checkbox"/> Accountancy (including C. P. A.) | <input type="checkbox"/> Civil Service |
| <input type="checkbox"/> Nicholson Cost Accounting | <input type="checkbox"/> Railway Mail Clerk |
| <input type="checkbox"/> Bookkeeping | <input type="checkbox"/> Common School Subjects |
| <input type="checkbox"/> Private Secretary | <input type="checkbox"/> High School Subjects |
| <input type="checkbox"/> Spanish <input type="checkbox"/> French | <input type="checkbox"/> Illustrating |

Name.....
Street.....
Address.....

City..... State.....

Occupation.....

If you reside in Canada, send this coupon to the International Correspondence Schools Canadian, Limited, Montreal

Want a good Electrical Job?



Here's the easiest, quickest way to get an Electrical Expert's job, paying all the way from \$50 to \$100 a week—borrow this great American Library of Electrical Engineering for 15 days FREE. Look over the 4000 pages, the 3200 illustrations in the 8 big volumes. And you'll see how other men JUST LIKE YOU have mastered Electricity at home in spare time—without studying or memorizing, without lessons or examinations—at one-fourth the cost of trade courses! If not wanted, return, charges collect. If kept, pay only \$2.00 after 15 days, then \$3.00 a month until \$34.80 is paid.

Want a well-paid Auto Job?

If you are ambitious to be an Auto Expert—or if you are an auto owner and seek to know your car for greater pleasure and economy—or if you are a Service Station Superintendent and want an instant answer to the toughest problems in the day's work, borrow a set of "Auto Engineering" and see how the JIFY INDEX brings to your fingers' ends every needed fact and explanation about autos. 5 DeLuxe volumes, flexible gold-stamped bindings, 2400 pages, over 2000 illustrations. \$2.00 after 15 days free loan, then only \$3.00 a month until \$24.80 is paid.



Pick the job—We'll help you land it!



"READ YOUR WAY to bigger pay" with these great vocational libraries. Don't try to keep thousands of facts and figures in your head. But know where to put your finger on the right one—instantly. The wonderful JIFY INDEX in these volumes does the trick.

"Civil Engineering"—Written so you can understand it. Includes Steel Structures, Surveying, Railroads, Public Works. New 9-volume edition, \$2 after 15 days, then \$3 a month until \$34.80 is paid.

Pay-Raising Books Loaned Free!

Modern Shop Practice—Machine Shop, Foundry and Factory Practice and Management, Production, Drafting, etc. 6 volumes, 2300 pages, 2500 illustrations, \$2 after 15 days, then \$3 a month until \$24.80 is paid.

American Law Library—With reading course of 24 texts, 13 volumes, intended for the business man as well as for the prospective lawyer. \$2 after 15 days, then \$3 a month until \$49.80 is paid.

Drafting—Mechanical and Architectural—4 volumes, 1578 pages, 1000 pictures, blueprints, etc. \$2 after 15 days, then \$3 a month until \$14.80 is paid.

Steam and Gas Engineering—7 volumes, 3300 pages, 2500 illustrations, only \$2 after 15 days, then \$3 a month until \$24.80 is paid.

Fire Prevention and Insurance—4 volumes, 1500 pages, 600 illustrations, \$2 after 15 days, then \$3 a month until \$14.80 is paid.

Employment Management and Safety Engineering—7 volumes, 1800 pages, 540 charts and pictures. \$2 after 15 days, then \$3 a month until \$24.80 is paid.

Sanitation, Heating and Ventilating—4 volumes, 1454 pages, 1450 pictures. \$2 after 15 days, then \$3 a month until \$14.80 is paid.

Business Management and Commercial Law! Here's the quick way to PROMOTION for men eager to win success in business. The "last word" in Accounting, Finance, Production, Sales, Advertising, Commercial Law. 9 great volumes by Bell, McKinsey, Simons, Gauss, Chamberlain and others. A reference work for executives, a complete reading course for the student, \$2 after 15 days free loan, then \$3 a month until \$29.80 is paid.

AMERICAN TECHNICAL SOCIETY

Dept. X-719, Drexel Ave., & 58th St., CHICAGO

Send No Money Coupon

- No C. O. D.—Send no money.
American Technical Society,
Dept. X-719, Chicago, Ill.
- Please loan me FREE set marked X below. In return for this favor, I agree to pay the few cents express on same and to look them over carefully. If I decide to keep them I will pay \$2 after 15 days and then \$2 a month until special price is paid. But I may return them at your expense if I wish and owe you nothing.
- | | |
|--|---|
| <input type="checkbox"/> Architecture, Building & Carpentry, 5 vol. \$24.80. | <input type="checkbox"/> Fire Prevention and Insurance, 4 volumes, \$14.80. |
| <input type="checkbox"/> Civil Engineering, 9 volumes, \$34.80. | <input type="checkbox"/> Sanitation, Heating & Ventilating, 4 volumes, \$14.80. |
| <input type="checkbox"/> Electrical Engineering, 8 volumes, \$34.80. | <input type="checkbox"/> Employment Management, etc., 7 volumes, \$24.80. |
| <input type="checkbox"/> Auto Engineering, 5 volumes, \$24.80. | |
| <input type="checkbox"/> Business Management, 9 volumes, \$29.80. | |
| <input type="checkbox"/> Modern Shop Practice, 6 volumes, \$24.80. | |
| <input type="checkbox"/> Law, 13 volumes, \$49.80. | |
| <input type="checkbox"/> Drafting, 4 volumes, \$14.80. | |
| <input type="checkbox"/> Steam and Gas Engineering, 7 volumes, \$24.80. | |
| <input type="checkbox"/> Civil Engineering, 9 volumes, \$34.80. | |

Name.....

Address.....

(Attach letter stating references' and employer's names and addresses, or write same in margin plainly.)

DO YOU LIKE TO DRAW?

HAVE you a liking for drawing, for sketching people and scenery and putting your thoughts upon paper? Would you like to turn your talent for drawing into money? It is a fascinating and immensely profitable hobby to be able to sketch quickly and easily the people you see about you, pretty scenery, trees and old houses.

DID YOU EVER THINK what a pleasant and profitable profession is open before anyone with a talent for drawing? Commercial Artists and Illustrators make big incomes, the work is extremely interesting and enjoyable and is exceptionally well paid. Many artists engaged in this work make from \$5,000 to \$10,000 a year and more drawing for newspapers and advertisers. Huge prices are paid for Illustrations, Cartoons and Designs for Advertisements and Posters. Editors, publishers and advertisers are always looking for new and interesting drawings and are willing to pay good prices for them.

OPPORTUNITIES ABOUND in this wonderful profession for anyone who has a liking for drawing. No profession offers such opportunities today as does Commercial Art and Illustrating. The tremendous increase in advertising and illustrated publications has created such a demand for competent artists that the field of commercial art and illustrating is a real gold mine for the man or woman who likes to draw.

LEARN AT HOME There is no need for you to leave your home in order to study this delightful and absorbingly interesting art. You can study anywhere under our resultful system of correspondence instruction with which you have the help and guidance of artists high in their profession.

ILLUSTRATED BOOK FREE

This book has a message for you. It is unique and inspiring. It brings you news that no matter where you live, or what you are doing, your talent for drawing can be developed in the privacy of your own home surely and simply and without drudgery. It contains deeply interesting literature dealing with Commercial Art and Illustrating, and discusses various kinds of drawings, the prices paid for them,

and the opportunities which are open to you. You need this book. You can have it for the asking. A request for it does not place you under any obligation whatever. Kindly enclose 4¢ in stamps to cover cost of postage.

THIS BOOK FREE



NORTH AMERICAN SCHOOL OF DRAWING
527 HENKEL BLDG. BUFFALO, N. Y.

Please send me your booklet, "Drawing for Pleasure and Profit." I enclose 4¢ in stamps to cover cost of postage, etc.

NAME.....

ADDRESS.....

Hawaiian Guitar

GIVEN

Worth
\$18

When You Enroll

This Hawaiian Guitar expert and professor wants the opportunity to welcome you as a student so you will quickly learn how to play a Hawaiian Guitar—yes, you will be able to play just like the native Hawaiians. To get you started and help your musical success, which will bring you popularity, you will receive a beautiful Hawaiian Guitar, the same as the one pictured, when you enroll. Our short cut method of instruction will enable you to play a piece almost from the first lesson. Rush coupon for full particulars today and we will reserve a Hawaiian Guitar for you.



Play Quickly

With our short cut method of instruction you will quickly learn how to play Hawaiian Guitar, which will bring you popularity and social success. You will learn to play from notes. If you never had any musical training, you will quickly get on, because our nine experts have perfected a course of home instruction which is as simple as learning A, B, C's.

Picture and Photograph Record Method Easy

We don't depend upon printed lessons only for your success, but we also furnish pictures of our professors playing, diagrams, charts and phonograph records for each lesson. This practically brings our professors from our studio to your own home and enables you to listen to their playing just as if they were actually in front of you. To prove this is easy, we will send you your first lesson free. Rush coupon now.

HAWAIIAN STUDIO No. 5210
of New York Academy of Music
100 Fifth Avenue, New York, N. Y.

Please rush your Free book, "How to Learn Hawaiian Guitar," and my first free lesson. Also reserve a Hawaiian Guitar for me. This obligates me in no way whatever.

Name.....
Address.....
City..... State.....

Do You Like to Draw?



It's Easy To Learn When Shown In The Right Way

Some of the cleverest cartoonists and comic artists in America today learned how to draw quickly—by following **CARTOONIST EVANS' SIMPLE AND EASY METHOD**. This school is recommended by foremost cartoonists because they know the students are handled right. If you like to draw, send 6c in stamps for **portfolio of cartoons and full details**. The course is **NOT EXPENSIVE**.

The W. L. EVANS SCHOOL of CARTOONING
521 Leader Building
Cleveland, Ohio

He Mailed a Postal

and made \$14,400 in 6 months

H. G. Stewart sent for my free book—learned my money-making system of selling real estate. He made big money right away, same as many others I've taught. You can too. Get their secret. Start your own big profit business—at home—in spare time. No capital or experience needed. My big free book tells you how. Write for it today.

President, American Business Builders, Inc.
Dept. 44KK, 18 East 18 Street, New York.



Why not FLY TO FAME AND FORTUNE?

TODAY—a World on Wheels! Tomorrow — a World on Wings!! A marvelous age is that now being ushered in by spectacular advances in the airplane industry. Are you ready to claim your place in the new scheme of things? If not, we can help you!

Trans-continental flights are being made or planned daily. And every step in aviation progress means new opportunities for fame and fortune are opening up for men equipped to take their places in this great uncrowded field.

Trained men are in demand and receive from \$3,000 to \$10,000 a year in aviation enterprises. We teach you the fundamentals of flying in a modern Home Study Course that you can master in your spare time. Our staff of experts is made up of qualified pilots and graduates of U. S. Army Schools.

REMEMBER! Students enrolling now have the opportunity of qualifying for a **scholarship award** that entitles the successful candidate to a special flying instruction course **FREE OF COST!**

Time Is Precious—Don't Wait!

NATIONAL INSTITUTE OF AVIATION
Department E,
Louisville, Ky.

Send me free of all cost information concerning your Home Study Course and Application for Flight Training Scholarship.

Name..... Age.....
Street or R. F. D.....
City..... State.....

-takes only 8 weeks to get a big job

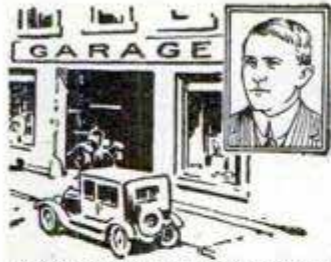

George Smith owns an agency and repair shop in West Alexandria, Ohio. He makes \$200 a week.



D. M. Collins, Williams-ville, West Virginia, writes, "After finishing McSweeney training, I started as manager of a garage at \$300 a month."

and Earn \$75 to \$125 a Week As Auto Expert

Learn the auto and tractor business by the McSweeney method, then step out and get a good job at \$75 to \$125 a week or open your own repair shop and make up to \$10,000 a year. Trained men are needed everywhere. Opportunities galore! Eight weeks training fits you to open repair shop or go with one of the big firms waiting for trained men. Read what George Smith, D. M. Collins and C. E. Gillespie have done. Hundreds of other McSweeney trained men can tell as interesting facts. Every month, McSweeney men who complete their training are taking the place of half-trained and incompletely self-trained men.

Learn in 8 Weeks

Simple, thorough, practical shop methods. You learn the "why" of everything you do, then learn to do it right. You do real work with real tools and real equipment. No book studying. Very little schooling necessary. Any man from 16 to 60 can learn. Write today for Big Special Limited Time Tuition Offer, including

R. R. FARE PAID and BOARD PAID While Learning

Also FREE ELECTRICAL COURSE to those who enroll soon. Don't delay—write at once for complete details and BIG AUTO BOOK FREE. Mail coupon to nearest school—NOW!

FREE

Course in Electrical Work to those who enroll soon. Not a cent extra to pay. No extras to buy. Get my big special offer today.

Money Back Guarantee

If, after completing my training, you are not satisfied, if you are not qualified to accept a big-pay job, your tuition will be refunded. Don't miss this remarkable opportunity. Save by enrolling at once. The sooner you start, the sooner you will be ready to earn big pay or go into business for yourself.

(Mail coupon to school nearest you)



C. E. Gillespie has charge of a fleet of trucks and tractors for the State Highway Commission, due to McSweeney training.

MC SWEENEY

AUTO, TRACTOR and ELECTRICAL SCHOOLS
Dept. YF-302 CINCINNATI, OHIO CLEVELAND, OHIO



McSweeney Auto, Tractor and Electrical Schools, Dept. YF-302, Cincinnati, O. Cleveland, O. Without cost or obligation, send me your big FREE book on Autos; also, full details of your big offer including R. R. Fare and Board Paid, and FREE electrical course.

Name.....
Street.....
Town..... State.....



It's Fun Making Money in Photography

Get one of these big pay jobs at \$50 to \$250 a week-or start your own business

Hundreds of wonderful opportunities await you in Professional Photography. Right now men and women are needed everywhere—in the motion picture studios—in portrait and commercial studios—on the staffs of newspapers.

opportunities than Professional Photography offers and the work is like play. Right where you live you can start making money with a camera almost AT ONCE. Turn your spare hours into dollars. Open your studio; very little capital required. Chances to travel, too.

NO EXPERIENCE NEEDED

Even if you have never taken a picture in your life, you can quickly qualify for one of these fascinating positions. The field is unlimited and growing daily. Nowhere will you find greater

Find out how you can become a Professional Photographer in spare time at home, or learn in our great New York Studios. We have started hundreds on profitable careers. Get the facts about YOUR opportunity in this interesting, thrilling profession.

FREE Illustrated Book and Job Chart

Just send your name and address on coupon or write for beautiful book describing positions and salaries in all branches of Photography. Tells how to make money in spare time, how our FREE EMPLOYMENT SERVICE helps you to the job you want; how to start your own business. This wonderful book is FREE. Job Chart included. Tear out the coupon NOW. Mail it TODAY.



New York Institute of Photography

Dept. 49, 10 West 33rd St., New York, N. Y.

New York Institute of Photography, Dept. 49, 10 West 33rd St., New York, N. Y.

Gentlemen: You may send me your FREE book on Professional Photography. No obligation on my part.

Name.....

Address.....

City.....State.....

Automobile Mechanics are Needed!

Prepare Yourself now for a big-pay Auto Job!

THE demand for trained men in the automobile field is far greater than the supply.

More than 15,000,000 automobiles are in use in this country now, and every week the figures grow larger.

There are not enough trained automobile service and repair men to keep up with this steady growth.

If you are not satisfied with your present earnings, look into this proposition NOW.

Just Published!

PRACTICAL AUTOMOBILE LIBRARY

Four Books—\$1.50 in 10 days and \$2 monthly for 6 months—only \$13.50 in all!

These four practical books, written by five well known teachers of automobile practice, will teach you, right in your own home during your leisure time, just what you need to know about automobile troubles and repair. They will teach you automobile construction, maintenance and repair as experts know them and will help you to earn an expert's pay.

Your Big Chance—Get Ready for it!

Hundreds of question-answering diagrams—hundreds of clearly-marked illustrations—make the books plain and readily understandable to any man with the mechanical instinct. All the explanations and descriptions are clear, simple, direct. Every chapter is packed with definite, step-by-step, how-to-do-it information.

Examine This New Library Free

No money down Small monthly payments

These books were written specially for self-instruction by men who have trained thousands of automobile operators and garage men. Examine the library for 10 days free. Just fill in and mail the attached coupon.

If you find the books what we say they are, send us \$1.50 in ten days and \$2 monthly for only six months. If you do not want the books, send them back at our expense. It costs you only a postage stamp to take a look at the books. Act now!

7c a day pays for these books!

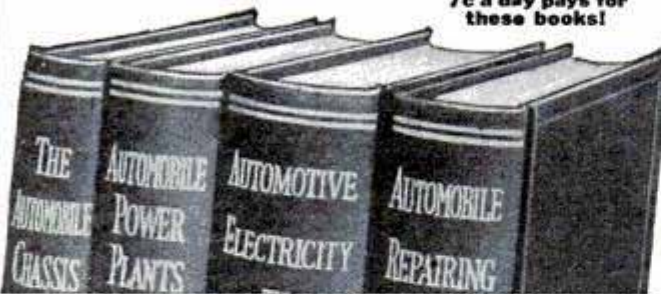

FREE EXAMINATION COUPON

McGraw-Hill Book Co., Inc., 370 Seventh Ave., New York
Send me for 10 days' free examination the New Practical Automobile Library. If satisfactory, I will send you \$1.50 in 10 days and \$2 monthly until the special price of \$13.50 is paid. If not wanted, I will return the books at your expense.

Signed

Address

City and State

Position

Employer P. M. 10-1-27

Hair Test FREE



Pres. Roosevelt

One of Prof. Scholder's many famous patients

IF YOU ARE TROUBLED with falling hair, dandruff or itching scalp, send a sample of your hair (ordinary combings will do) to Professor Maurice Scholder for FREE test. You may also add any details which you think will help Professor Scholder with your case. He will then send you a personal report with recommendations for your individual case. There is no charge for this analysis. It places you under no obligation whatever. Thousands of men and women have been cured of scalp ailments and baldness by following the advice of this famous specialist.

FREE ANALYSIS COUPON:

Mail today, enclosing samples of your hair to
PROFESSOR MAURICE SCHOLDER, D. G.
The Professor Scholder Institute, Inc.
101 West 42nd St., New York, N. Y.

PM10

Name.....Age.....

Address.....

City.....State.....



Air Commerce Needs Men!

Don't envy the Highly Paid Air Man—Be One! Air Men are in demand. Beat the other fellow to the High Salaried Jobs in Aviation. Western training will qualify you to enter Aviation. Learn how through our catalog, sent on request.

Write for Free Catalog
"Airplanes and Flying"
Aeronautical Training Division

WESTERN AIRPLANE CORPORATION
Dept. M-10 Monadnock Block Chicago, Ill.



HEAT Without Coal!

Amazing new invention does away with coal or wood. The new International Oil Burner, with automatic features, simply sets in fire box of any stove, range, or hot air, steam, or hot water furnace. The new International is the first inexpensive oil burning device for homes with low operating cost. Burns without waste 96% air and 4% oil, which it transforms into Instant-Gas, the cheapest and safest fuel known. Gives three times the heat of coal if desired. Better cooking and baking. Absolutely safe. Quickly installed without damage to stove or furnace. Easily moved, if you move.



Burner with Safety Valve
Approved by Underwriters Laboratories.

30-DAY FREE TRIAL OFFER

The new International is the cheapest to install and operate. No noisy motors, no moving parts, no gas or electricity necessary. Sold on money-back guarantee. Over 60,000 International Burners in use. Write today for free trial offer and Free Book, "Scientific Oil Burning."



Agents We pay \$80 a week. Write immediately for free sample offer.

INTERNATIONAL HEATING CO.
Heat Without Coal Dept. 110-O, 3939 Magnolia, ST. LOUIS, MO.

GENUINE CORONA

Limited
Offer



HERE'S your chance to secure that Corona you've wanted—on the easiest terms ever offered—at ONE-THIRD OFF regular price! Complete in every detail; two color ribbon, back spacer, beautifully re-noved, NEW MACHINE GUARANTEE. Recognized the world over as the finest, strongest, sturdiest portable built. Only a limited number of these splendid machines available. To get one, you must act now!

Yours For 10 Days FREE
Send No Money

Experience the joy this personal writing portable typewriter can give you! Use it 10 days free! See how easy it is to run and the splendidly typed letters it turns out. Ideal for the office desk, home, travelling. Small, compact, light, convenient. Don't send out letters, reports, bills in poor handwriting when you can have this Corona at such a low price or on such easy terms.

Carrying Case Included
—If You Act Now

Leatheroid carrying case, oiler, instructions free on this offer. Send no money—just the coupon. Without delay or red tape we will send you the Corona. Try it 10 days. If you decide to keep it, send us only \$2—then \$3 a month until our special price of \$36.25 is paid (cash price, \$33.10). Now is the time to buy. This offer may never be repeated. Mail coupon now.

\$16 SAVED

by using this coupon

SMITH TYPEWRITER SALES CORP.
84A-360 E. Grand Ave., Chicago.

Ship me the Corona, F. O. B. Chicago. On arrival I'll deposit \$2 with express agent. If I keep machine, I'll send you \$3 a month until the \$34.25 balance of \$36.25 price is paid; the title to remain with you until then. I am to have 10 days to try the typewriter. If I decide not to keep it, I will repack and return to express agent, who will return my \$2. You are to give your standard guarantee.

Name.....
Address.....
Employed by.....

"His Tail Between His Legs"

What most men would see if they could see themselves



MOST men are being whipped every day in the battle of life. Many have already reached the stage where they have THEIR TAILS BETWEEN THEIR LEGS. They are afraid of everything and everybody. They live in a constant fear of being deprived of the pitiful existence they are leading. Vaguely they hope for SOMETHING TO TURN UP that will make them unafraid, courageous, independent. But it never does. They continue to work and sweat and—MAKE OTHERS RICH AND HAPPY.

Some men, however, after years of cringing, turn on life. They CHALLENGE the whipper. They discover, perhaps to their own surprise, that it isn't so difficult as they imagined, TO SET A HIGH GOAL—and reach it! Only a few try—it is true—but that makes it easier for those who DO try.

What about YOU? Are you ready to admit that you are through? Are you satisfied to keep your wife and children—and yourself—enslaved? ARE YOU AFRAID OF LIFE?

Success is a simple thing to acquire when you know its formula. The first ingredient is a grain of COURAGE. The second is a dash of AMBITION. The third is an ounce of MENTAL EFFORT. Mix the whole with your God-given faculties and no power on earth can keep you from your desires, be they what they may.

You can develop these God-given faculties as SIX HUNDRED AND FIFTY THOUSAND other people have done—through Pelmanism.

Pelmanism is the science of applied psychology, which has swept the world with the force of a religion. It has awakened powers in individuals, all over the world, they did not DREAM they possessed.

Famous people all over the world advocate Pelmanism, men and women such as these:

T. P. O'Conner, "Father of the House of Commons."
The late Sir Rider Haggard, Famous Novelist.
General Sir Robert Baden-Powell, Founder of the Boy Scout Movement.
Judge Ben. B. Lindsey, Founder of the Juvenile Court, Denver.
Frank P. Walsh, Former Chairman of National War Labor Board.

Jerome K. Jerome, Novelist.
Gen. Sir Frederick Maurice, Director of Military Operations, Imperial General Staff.
Admiral Lord Beresford, G. C. B., G. C. V. O.
Sir Harry Lauder, Comedian.
W. L. George, Author.
Baroness Orczy, Author.
Prince Charles of Sweden.

—and others, of equal prominence, too numerous to mention here.

A remarkable book called "Scientific Mind-Training," has been written about Pelmanism. IT CAN BE OBTAINED FREE. Yet thousands of people who read this announcement and who NEED this book will not send for it. "It's no use," they will say. "It will do me no good," they will tell themselves. "It's all tommyrot," others will say.

If you are made of the stuff that isn't content to remain a slave—if you have taken your last whipping from life,—if you have a spark of INDEPENDENCE left in your soul, write for this free book. It tells you what Pelmanism is, WHAT IT HAS DONE FOR OTHERS, and what it can do for you.

The first principle of YOUR success is to do something radical in your life. You cannot make just an ordinary move, for you will soon again sink into the mire of discouragement. Let Pelmanism help you FIND YOURSELF. Mail the coupon below now—now while your resolve to DO SOMETHING ABOUT YOURSELF is strong.

THE PELMAN INSTITUTE OF AMERICA
Approved as a correspondence school under
the laws of the State of New York

71 West 45th Street Suite 610 New York City

The Pelman Institute of America,
71 West 45th Street, Suite 610,
New York City.

I want you to show me what Pelmanism has actually done for over 650,000 people. Please send me your free book, "Scientific Mind Training." This places me under no obligation whatever.

Name.....
Address.....
City..... State.....

Make a Six Pointed Star
 Just Draw Six Straight Lines
 With Four Dots on Each Line

I will give away four sedans and 30 other big prizes making a total of \$5,000.00 in prizes. We have already given over \$42,000.00 in prizes to advertise our business—including 9 Buicks and many other cars. Now YOU can get YOUR Buick Sedan or \$1,800.00 in cash. **GET BUSY**

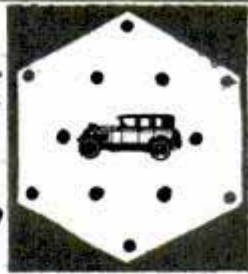

*Puzzle Fans
 Here's a
 Brand
 New One!*

and **WIN NEW 1928 BUICK or \$1800.00 CASH!**

4 New Autos Given!

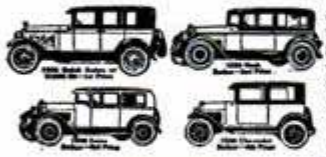

1st prize, Buick Sedan, 2nd prize, Nash Sedan, 3rd prize, Essex Sedan, 4th prize, Chevrolet Sedan. 28 other valuable prizes, total \$5,000.00.

Send No Money Just your answer—it costs nothing! Draw each line making a six-pointed star with a Buick in center. Draw the lines—cut out the ad, send your name and address; that's all and I'll tell you all about this offer. It may mean your winning a Buick Sedan or

You Can Win \$1800.00 Cash

Any winner can have cash instead of prize won. First prize winner can have Buick Sedan worth \$1295.00 and \$505 in cash, total \$1,800. You do not risk one cent, now, later, or ever! Leota I. Markus of Virginia, Minn., received \$2,500.00 check. H. A. Andrews, Horse Creek, Wyo., received Buick Sedan. Big list of former prize winners sent you. Everyone doing good work is rewarded. Act quick.

T. W. KELLY, 500 N. DEARBORN ST. CHICAGO DEPT. 14

\$505 EXTRA for promptness

GASOLINE NOW 11c

A welcome announcement is the fact that gasoline may now cost only 11c. It is estimated that this reduction would effect a saving of millions of dollars for the American Motorists. This amazing reduction is brought about by a mysterious little device that is easily installed on any car in a few minutes time. E. Oliver, 999-494E Third Street, Milwaukee, Wis., is so proud of this invention that for a limited time he is offering the device free to auto owners who will help introduce it. He also needs men everywhere and offers profits of \$75 to \$150 a week to men who will handle local business. Write him at once for his free sample offer and money making proposition.—Adv.

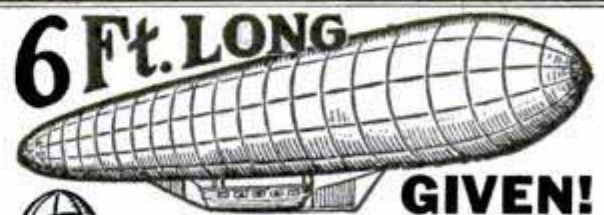

6 Ft. LONG GIVEN!
 Boys! Here's the great Navy model Airship. Large 6-foot air bag with inflators, parachute with automatic release and complete instructions for flying. Will fly for miles at height of 1000 feet. Great chance to study aerial navigation. Send name and we'll send 4 of our new art pictures to dispose of on special 25c offer. Send the \$1 you collect and as a reward for this service we will send this wonderful Airship with full instructions free.
C. M. THOMAS, 337 W. Madison St., 10K91 Chicago.

The man who studies gets ahead. Popular Mechanics Press will advise you what books to read to advance in your trade. 200 East Ontario Street, Chicago, Illinois.

YOU CAN COLLECT A WEEK'S WAGES EVERY DAY

Bigger money every year for auto repairmen! More opportunities! 24 million cars—three-fourths of them over 2 years old, need repairs average once a month. Crying need for trained men. A few weeks in Detroit, the Auto Center does it. Start a little business of your own and soon grow big.



A business of your own makes you the real money. You don't have to start big. If you know your stuff, you will make big money in a little shop. Many of our graduates even start in alley garages, taking in 2 or 3 cars at a time. Their profits and their reputation soon bring a bigger shop. It's training that does it. The man who gives satisfaction by doing his jobs right, is always swamped with business. A nice overhaul job will net you \$50, \$75, \$100. Service jobs from \$5 to \$25 each. The

skilled auto service man is on the way to "easy street" immediately. That means you must have real training—the "Michigan State" kind.

LEARN QUICK

Come to the "Michigan State" at Detroit. Learn right,—in just a few weeks. Then you'll be sitting pretty too.

COME TO DETROIT NOW

Get in this steady, year-round business. It's a big pay business with no strikes, no lay-offs. Get thorough training at this world famous school. Jump on the train for Detroit now. We'll help you to part-time work while learning if you need it. Or write for big illustrated 17th Anniversary Catalog, all about factory-endorsed Detroit-training for real success. Write, or come now!

A. G. Zeller, President,
 Michigan State Automobile School,
 310 Auto Bldg., Detroit, Michigan.

Start Small and Grow Big

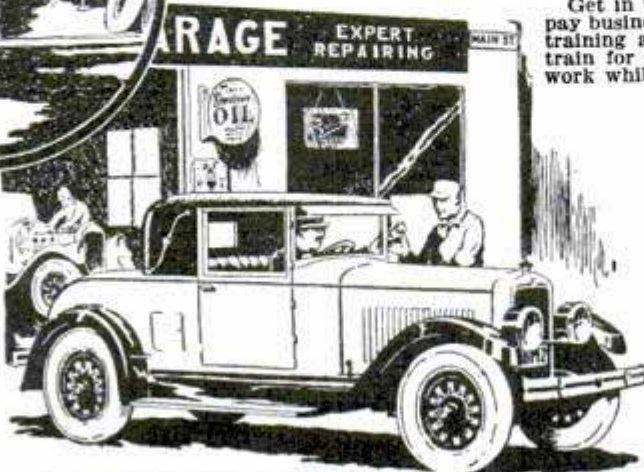

LEARN IN DETROIT—THE AUTO CENTER

Mail Me!

Michigan State Automobile School
 310 Auto Bldg., Detroit, Michigan.

Send me FREE and without obligation full information about Detroit training to make the most money, and your new Automobile Training Book.

Name.....
 Street Number or R. F. D.....
 City.....State.....
 I am interested in
 () 12 weeks' Auto Course
 () 30 weeks' Master Course
 () Home Study Course



The golden glories of the AIR-

Money — Fame — Opportunity — Friends

Opportunities are biggest in new industries. They are more numerous—more easily seized. Aviation is the outstanding new industry of the day. Its doors are open wide to wide-awake, ambitious men and women. Our Free booklet tells how and why.

Aviation is broadcasting for workers—not only for those who have the fire to blaze sky-trails over the world, but for thousands of others in the many fascinating, money-making positions doing ground work. There is no need for you to fly to get rich in Aviation. Pioneers in the automobile field made fortunes without driving racing cars.

But you must have training to get into one of the 53 different lines of interesting work in this thrilling new business. You must understand the fundamentals of Aviation—know the terms, know your way about.

Aviation Institute makes it easy for you to secure training. You do it at home, in your spare time—without interfering with your present occupation—with no loss of time nor money. You need no especial experience, no training in mechanics, the automobile or kindred lines.

The instructions are simple, practical, workable. Under the guidance of Lieut. Walter Hinton, first trans-atlantic Pilot of N.C.4 fame, and his staff you are home-trained to take your place in Aviation. You are ready to become a pioneer in a rich new field filled with golden glories—and to pioneers go the plums.

Think of the thousands of openings just crying for you in the liveliest business of the

AVIATION INSTITUTE OF U. S. A.



Lieut. Walter Hinton, President
1115 Conn. Ave., N. W., Suite 410, Wash., D. C.



Lieut. Walter Hinton, First Trans-Atlantic Pilot, N. C. 4 fame, President of Aviation Institute of U. S. A., and Prominent in Development of the Industry.

53 Kinds of Jobs

There is endless variety to the different lines of opportunities in Aviation. Not only are pilots, instructors, commercial operators, wireless experts, mechanics needed in the air, but the industry is hungry for wood workers, draftsmen, engineers, riggers, designers, electricians, photographers, salesmen, statisticians, tool makers, executives, accountants, glue experts, chemists, glass workers and other lines, totaling 53. Your chance is all ready and waiting for you. Mail coupon for full information.

age. Think of the 4000 airports in America where riggers, inspectors, mechanics and helpers are needed. Think of all the giant factories, building planes and parts, breathless with energy, crying for men. Already there are 6000 privately owned planes here.

Five railroads are going into air transportation—in which Europe is way ahead of us. (Do we ever let Europe stay in the lead?) The Guggenheim Foundation is financing air passenger lines. There are 16 air mail routes already operating. Ocean steamship lines are testing air mail planes from ship to land. The American Express Air Service is under way.

Now is the time to get into Aviation and expand with its rapid growth. Get a kick out of your work—earn big money—meet the best people—travel—in short, get ahead in the world.

First Flight Free

If you wish to become a pilot, after you graduate, final flying instructions are given at our field in Washington—Hoover Field or at other fields all over the United States in cooperation with the Institute. Five to ten hours with an instructor and you can fly alone. First flight free to graduates. Get all the facts. Do it now.

This book is **FREE**

It tells all



AVIATION INSTITUTE OF U. S. A., Suite 410

1115 Conn. Ave., N.W., Washington, D. C.

You may send me without obligation a Free copy of "Aviation and You."

Send for it

Name.....
Age (Not under 16).....
Street.....
City.....State.....



The only man who could talk to the Superintendent

"SOON after I began studying," a student wrote to us the other day, "we had a change in management at our plant. I certainly was glad then that I had decided to study in my spare time. For, thanks to my I. C. S. course, I was the only man in the organization who could talk to the Superintendent in his own language. As a result, I was promoted over men who had been here from ten to twenty years. My salary has been increased 90% in the last ten months."

THAT'S a true story of what just one I. C. S. student has done. There are thousands of others. Every mail brings letters from men and women telling of promotions and increases in salary due directly to spare-time study.

One hour a day, spent with the I. C. S. in the quiet of your own home, will prepare you for success in the work you like best. *Yes, it will!* Put it up to us to prove it.

Mail the Coupon for Free Booklet

INTERNATIONAL CORRESPONDENCE SCHOOLS

"The Universal University"

Box 5678-E, Scranton, Penna.

Without cost or obligation, please send me a copy of your booklet, "Who Wins and Why," and full particulars about the course before which I have marked X in the list below:

BUSINESS TRAINING COURSES

- | | |
|--|---|
| <input type="checkbox"/> Business Management | <input type="checkbox"/> Salesmanship |
| <input type="checkbox"/> Industrial Management | <input type="checkbox"/> Advertising |
| <input type="checkbox"/> Personnel Organization | <input type="checkbox"/> Better Letters |
| <input type="checkbox"/> Traffic Management | <input type="checkbox"/> Show Card Lettering |
| <input type="checkbox"/> Business Law | <input type="checkbox"/> Stenography and Typing |
| <input type="checkbox"/> Banking and Finance Management | <input type="checkbox"/> English |
| <input type="checkbox"/> Accountancy (including C.P.A.) | <input type="checkbox"/> Civil Service |
| <input type="checkbox"/> Nicholson Cost Accounting | <input type="checkbox"/> Railway Mail Clerk |
| <input type="checkbox"/> Bookkeeping | <input type="checkbox"/> Common School Subjects |
| <input type="checkbox"/> Private Secretary | <input type="checkbox"/> High School Subjects |
| <input type="checkbox"/> Spanish <input type="checkbox"/> French | <input type="checkbox"/> Illustrating <input type="checkbox"/> Cartooning |

TECHNICAL AND INDUSTRIAL COURSES

- | | |
|---|--|
| <input type="checkbox"/> Electrical Engineering | <input type="checkbox"/> Architect |
| <input type="checkbox"/> Electric Lighting | <input type="checkbox"/> Architects' Blueprints |
| <input type="checkbox"/> Mechanical Engineer | <input type="checkbox"/> Contractor and Builder |
| <input type="checkbox"/> Mechanical Draftsman | <input type="checkbox"/> Architectural Draftsman |
| <input type="checkbox"/> Machine Shop Practice | <input type="checkbox"/> Concrete Builder |
| <input type="checkbox"/> Railroad Positions | <input type="checkbox"/> Structural Engineer |
| <input type="checkbox"/> Gas Engine Operating | <input type="checkbox"/> Chemistry <input type="checkbox"/> Pharmacy |
| <input type="checkbox"/> Civil Engineer | <input type="checkbox"/> Automobile Work |
| <input type="checkbox"/> Surveying and Mapping | <input type="checkbox"/> Airplane Engines |
| <input type="checkbox"/> Metallurgy <input type="checkbox"/> Mining | <input type="checkbox"/> Agriculture <input type="checkbox"/> Navigation |
| <input type="checkbox"/> Steam Engineering | <input type="checkbox"/> Mathematics <input type="checkbox"/> Radio |

Name.....

Street Address.....

City..... State.....

Occupation.....

Persons residing in Canada should send this coupon to the International Correspondence Schools Canadian, Limited, Montreal, Canada

THE MAGIC BOX OF A THOUSAND WONDERS GIVEN



Here is Mirth, Magic, Mystery, Instruction and Knowledge. Over 1,000 things to give you pleasure. Knife and Chain, Sailor's Aeroplane, Police Badge, Gold Tooth, XRay Novelty, Moving Picture, Transfer Picture, Har'd Lloyd Goggles, Comic Hat,

Colored Crayons, Japanese Water Flowers, Whistle, Look Back, Magnet, Jumping Frog, Magic Bill Fold, Cow Boy Watch Fob, Matrimonial Thermometer, Magic Mirror, Gauze Nose Mask, Three Ring Puzzle, Magic Flute, Gravity Ball, Trick Cards, 56 Feats of Magic, 15 Tricks with Cards, 73 Toasts, 52 Money Making Secrets, Jokes, Riddles, Comic Poetry, Chemical Magic, and hundreds of other things. ALL GIVEN free as a reward for disposing of only 8 fine pictures on big 25c offer and sending the \$2 you collect. Write today. C. M. THOMAS, 337 W. Madison St., 10R91 Chicago



Be an Artist

Would you like to be an artist—draw cartoons, illustrate ads, make magazine covers, etc.? The famous artist, Joseph Cummings Chase, will teach you how to quickly master the principles of art at home. Let this famous artist train you. Earn money while learning. Land a big pay job. Every step is explained with pictures, charts and diagrams. If you want to develop your artistic ability, send \$1.00 for this complete course. Satisfaction Guaranteed. Bargain Book Catalog FREE.

FRANKLIN PUB. CO., 186 N. LaSalle St., Dept. 9407, CHICAGO

EXTRA MONEY for AUTO MECHANICS

You can make plenty of extra money while you hold your present job. Learn the knack of selling automobiles, trucks and tractors. Our simple easy system quickly teaches you how. Here's your chance to get some of the big money earned by high powered automobile salesmen. Complete Course \$3.00. Send money order, draft or check. Money back guarantee.

AUTOMOBILE PUBLISHING COMPANY
318 West 39th St., NEW YORK, N. Y.

These famous electrical books make promotion sure!

59,000 men are using the Croft books to step ahead in Electrical work. WHY NOT YOU! This 8-volume library covers electrical practice complete, from the simplest principles to the operation of a great central station. The books pave the way to the big-pay job by teaching you Electricity as experts know it.

The Croft Library of Practical Electricity

A combined reference library and home study course—8 volumes, 3000 pages, 2100 illustrations

The man who gets anywhere in any line of endeavor is the man who KNOWS. And generally the more he knows the more he earns.

For the man who wants to know there is nothing better than these eight volumes packed to the covers with sound, helpful information on every phase of electricity from first principles to central station work.

SEE IT FREE—No obligation to Purchase

By just filling out and returning the coupon below you will have at no cost to you whatsoever a practical, useful set of books for 10 days' Free Examination. We take all the risk—pay all charges. You assume no obligation—you pay nothing unless you decide to keep the books. Send the coupon NOW and see the books for yourself.

\$1.50 in 10 days and then only \$2.00 a month



FREE EXAMINATION COUPON

McGraw-Hill Book Co., Inc., 370 Seventh Ave., New York

Send me for 10 days' free examination the library of Practical Electricity. If satisfactory I will send you \$1.50 in 10 days and \$2.00 monthly until the special price of \$19.50 is paid. If not wanted, I will return the books at your expense.

Signed.....

Address.....

City and State.....

Position.....

Employer..... P.M.-10 1-27

50 MORE JOBS NOW \$11 a day



Yes—there is a real demand for men trained in auto trades. This very day I could help 50 more men than I have available at \$11 a day. The future looks even better. There is a shortage of men trained like SWEENEY has trained thousands of men. That's why SO MANY SWEENEY TRAINED MEN get TREMENDOUS PAY and are in BIG DEMAND. Get my Free Book today and see that WELDING is only one of the BIG PAY Branches I get you ready for.

My Employment Department Helps Graduates to Jobs

Yes, my EMPLOYMENT DEPARTMENT helped L. W. Kelley to a job at \$18.00 A DAY—IT helped J. H. Miller to a job at \$10.50 A DAY—IT helped Gordon Shyrook to a job at \$10.50 A DAY, and it, also, is helping dozens of other Sweeney Graduates to fine jobs at \$10 to \$18 a day, IMMEDIATELY after finishing ONLY A SHORT COURSE of SWEENEY TRAINING.

Clip the coupon. Find out about this WONDERFUL JOB SERVICE my EMPLOYMENT DEPARTMENT renders. It will simply astonish you.

Men Wanted in Auto Trades

That's what a REAL, "ON THE JOB" EMPLOYMENT DEPARTMENT SHOULD DO, and that is—help men GET REAL JOBS. Think of it—FIFTY-FIVE WONDERFUL JOBS OPEN TODAY for SWEENEY TRAINED men. I have ONLY FIVE MEN READY so that I can help them to these jobs. And the peculiar thing is—it takes me ONLY FOUR WEEKS to TRAIN some of these men. Now what more do you want? Challenge me. Send for my Big Free 72 Page Book. If you go on depriving yourself—if you WANT TO BE OUT OF A JOB—and don't let me help you—PLEASE DON'T READ ANOTHER SWEENEY AD. If you have—(you know what I mean) in you—you will find out NOW. Just clip the coupon below.

The Sweeney System

Teaches by practical, personal experience. You work with tools, not books. You learn by doing. Million dollar school with complete equipment. You need no previous experience. If you are looking for success in life and working at a trade you like write me today. Drivers, mechanics, repair men, testers, garage owners, painters, welders, demonstrators—thousands more are needed and opportunities are everywhere. If you are mechanically inclined simply send name today for my big free book how to fit yourself for steady high paid employment in the auto business.

FREE CATALOG AND SPECIAL OFFER

Get my big FREE 72-page catalog. It shows hundreds of actual photographs of men at work in my magnificent new school. Tells all about wages, profits, opportunities in auto business. Explains step by step how you learn. Interesting letters from graduates telling how they made good. Shows how men come from all over the world to this big school. Makes you want to join the crowd. Tells everything you want to know. I will gladly send you a copy beautifully illustrated. I'll tell you how to get into business for yourself. No colored students accepted.

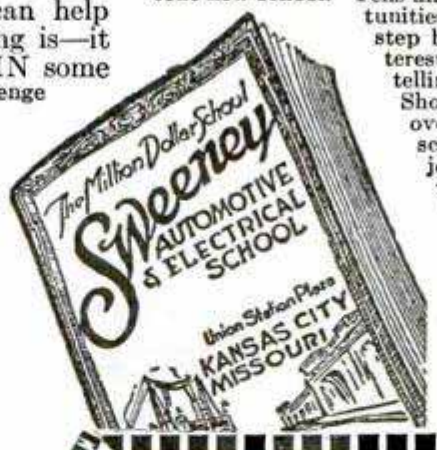

E. J. SWEENEY
President

EMORY J. SWEENEY, President
4231 Sweeney Building, Kansas City, Mo.

Send me free, without any obligation, your catalog and Special Offer!

LEARN A TRADE-
Sweeney
AUTOMOTIVE & ELECTRICAL SCHOOL
4231 SWEENEY BLDG. KANSAS CITY, MO.

NAME.....

P. O.....

STATE.....AGE.....

**10 DAYS' TRIAL
SEND NO
MONEY**



**NO
NEED
FOR A
NEW
PHONOGRAPH**

New PHONIC Reproducer

**makes an up-
to-the-minute
Phonograph out
of your old one!**

\$3⁸⁵ Direct from Factory

Now at last you can say goodbye to the squeaky, nasal, rasping metallic tone of your phonograph. Now you can have the beautiful, natural, full-rounded tone of the expensive new machines which are startling the world. Yet you need not buy a new phonograph if you have an old one. The reproducer is the HEART of any phonograph—and the New PHONIC reproducer makes your old phonograph like an entirely new one. Based on the new PHONIC principle. Makes you think the orchestra or artist is in the same room.

Gives the New Tone and Volume of Latest New Phonographs

Tones never before heard are clearly distinguished when the new PHONIC reproducer is used. Test it on an old record. Hear the difference yourself. Listen to the deep low notes and the delicate high notes. Hear how plainly and clearly the voice sounds. Note the natural tone of the violin and the piano, and the absence of "tinny" music. You will be amazed. The new PHONIC reproducer is ideal for dancing or for home entertainments. Its volume is almost double that of the ordinary reproducer.

10 Days' Trial—Send No Money

You cannot realize how wonderful the New PHONIC is until you hear it. That is why we want to send it to you on 10 days' trial. Send no money now—just the coupon. Pay the postman only \$3.85 plus a few pennies postage when the New PHONIC arrives. Then if you are not delighted, send it back within 10 days and your money will be refunded. If sold in stores the price would be at least \$7.50. Our price only \$3.85. Over 350,000 people have dealt with us by mail. You take no risk. Mail the coupon now for 10 days' trial. **BE SURE TO STATE THE NAME OF PHONOGRAPH YOU OWN.**

**NATIONAL MUSIC LOVERS, Inc., Dept. 5810
327 West 36th Street, New York**

Please send me a New PHONIC reproducer for.....

.....I will pay the postman \$3.85 plus few cents postage. If I am not satisfied after trial, I will return your reproducer within 10 days and you guarantee to refund my money. (Outside U. S. \$4.10, cash with order.)

Name.....

Address.....

City.....State.....

**NEW, Simple, Automatic
FIRE
PROTECTION
at a price that brings
VOLUME SALES**

**easy
\$100
cash
per week**

2 sales instead of 1 at these low prices
1 qt. size \$5
2 qt. size \$7.50



Nothing else can give you Fugo's BIG money-making advantages. Representatives "cleaning up" fast — \$15 and \$20 cash-in-pocket from just one day's work not unusual. Most sales made without demonstration. Fugo is the only instantaneous AUTOMATIC home and life protection—using same chemical all Fire Departments use. America's biggest Fire Chiefs recommend it. It's your opportunity to make good in a BIG WAY.

65%—90% Cash Profit

No investment. No red tape. Full commission same day you take order. Biggest field. **Every** home, factory, church, store, theatre, truck, automobile, etc. wants FUGO! For FUGO outperforms, therefore outsells competition. Easy to make \$100 a week—many doing better. No experience needed—simply ambition and ability to follow instructions. Waiting profits all around you.—Act Quick! Write AT ONCE for full details.

**THE NATIONAL FORMETAL CO.
6535 Metta Ave., N. E. Cleveland, Ohio**

**Distributors!
Write at once
for State
rights.**

\$50 to \$300 Weekly

in Aviation jobs. Learn under actual flying conditions.

Send for **FREE BOOKLET** about Aviation and the opportunities in it for you.

Write **E. E. LA PARLE, Chief Instructor**

CHICAGO AERONAUTICAL SERVICE, INC.

608 S. Dearborn St. Chicago, Ill.

LEARN TO DANCE

You can learn all the modern dances—Charleston, Black Bottom, Valencia, Canter, French Tango, Latest Waltzes, Fox Trots, etc., at home easily and quickly. New chart method makes dancing as simple as A-B-C. No music or partner required. Don't be a wallflower. Learn to dance. Complete Course, 323 pages, 49 illustrations, only \$1.00. Equals \$20 course. Satisfaction Guaranteed. Bargain Book Catalog FREE.

Franklin Pub. Co., 186 N. LaSalle St., Dept. 9406, Chicago



This is the GUITAR

you hear on the radio and records. The Gibson Mastertone Guitar, with its rich tone of such depth beauty and carrying power, embodies finest materials and most expert craftsmanship, acclaimed as *world's finest guitar*. Easy playing qualities make it easy to learn.



Send coupon NOW for **FREE BOOK** and details of Easy Payment plan. Mention which interests you: Guitar; Banjo; Mandolin; Ukulele.

Gibson

GIBSON, Inc. 1003 Parsons St. Kalamazoo, Mich.
Gentlemen: Send Free Book and details of payment plan on

[Instrument]

Name.....

St. or R.F.D.....

City.....State.....

**Sale
Price
NOW!**

\$1.00
Deposit

**Combination
Raincoat
and Warm
Overcoat**

Lamb Collar Dreadnaught Coat

Men! Here is the most practical coat ever made, at a bargain price and only \$1.00 deposit! Broad shawl collar of best quality beaverized lamb skin; and warm plaid blanket body and sleeve lining. Outer fabric is waterproof cloth with a coating of rubber between making coat absolutely stormproof. Smart stylish double breasted belted style with two large patch pockets with flaps and two muff pockets. Length, 44 inches. Brown only. Sizes, 34 to 46.

Order by No. M-1F. Terms \$1.00 with the coupon, then \$1.70 a month. Total price only \$10.95.

6 Months to Pay!

Why pay cash when we offer you this big bargain on such liberal terms? Have this serviceable combination coat and *never miss the money!* Because you send only a little each month, so little you can easily save it out of your everyday expense and not notice it. Six months to pay our bargain price! Send only \$1.00 deposit now and when you get the coat you'll say it's the greatest garment you ever saw. Judge the big value for yourself. Then if perfectly satisfied take six months to pay for it! No risk (see coupon). Send only \$1.00 deposit now while this offer lasts.

**Send Only \$1 Deposit with
Coupon Now!**

Elmer Richards Co.

Dept. 3377, W. 35th St., Chicago

I enclose \$1.00. Send Dreadnaught Coat No. M-1F. If I am not perfectly satisfied I may return it and get my money back. Otherwise I will pay \$1.70 a month until I have paid \$10.95 in all.

Size
Wanted.....

Name.....

Address.....

Post Office..... State.....

No
C.O.D.
to
Pay



COMMAND A LARGE, STEADY INCOME!

The Technical man always wins. Technically trained men are in constant demand. Become independent by using your spare time at home to master any of the crafts listed opposite. The St. Louis Technical Institute is one of the most thorough institutions for Technical home study to-day. Our methods and lesson material are so plainly and clearly defined that you will be astonished at your rapid progress. Underline the subject in which you are interested and write us for complete information. Special drafting courses arranged.



Architectural, Machine, Railway, Electrical, and Structural Steel Drafting. Mathematics and Slide Rule Reading. Steel Ship Laying Off. Steel Ship Plan Reading. Sheet Metal Designing and Drafting. Heating Ventilating Engineering. Steam and Hot Water Heating. Special Warm Air Heating. Plumbing and Sanitary Engineering. Advance Plumbing and Designing. Boiler Making and Laying Out. Steam Boiler Inspection. Contracting and Estimating. Business Administration. Consultation Service.

ST. LOUIS TECHNICAL INSTITUTE

4545 CLAYTON AVE., ST. LOUIS, MO.

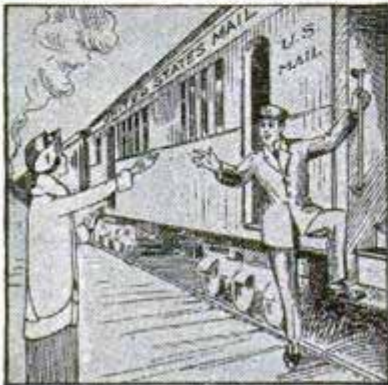

Get on "Uncle Sam's" Payroll

RAILWAY POSTAL CLERKS-MEN-BOYS 18 UP

CARRIERS---POSTOFFICE CLERKS

\$1700 to \$2700 YEAR

Steady Work No Layoffs
Paid Vacations

Common Education Sufficient
MAIL COUPON
IMMEDIATELY

FRANKLIN INSTITUTE,
Dept. P 173, Rochester, N. Y.

Sirs: Rush to me without charge, 32-page book with (1) List of government jobs now open to men and women, 18 up. (2) Full particulars telling how to get them.

Name
Address

TELEGRAPH-RADIO

Operators earn \$150 to \$350 month and up. Learn in Chicago or at home. Chance to work while training. We furnish operators to U. S. Govt., Railroads, Com'l Cos., Broadcasting Stations and Ships.
CHICAGO TELEGRAPH INSTITUTE, Dept. 1-10-7, 1338 So. Michigan Ave., CHICAGO, ILL.

The new Lionel Catalog for 1927 is now ready. Send for it—FREE.

The Lionel Corporation
Dept. G.
15 E. 26th St., New York City



Big Jobs Waiting for McSweeney Trained Men

It Takes Only 8 Weeks with my improved system of practical

training to make any man a competent auto, tractor and electrical mechanic. 8th grade schooling is sufficient—age is no barrier—I train 'em all ages from 16 to 60. Ten thousand men have been qualified by my practical, easy-to-learn shop method of teaching with real tools and real equipment. No tedious book study. You learn by DOING. I tell you WHY, then show you HOW—that's why McSweeney trained men are wanted everywhere, get the biggest jobs and best pay. They "know their stuff." Thousands of big jobs are waiting for rightly trained men. Get ready. Start now. Write at once for my big special offer which includes

R. R. FARE and BOARD PAID While Learning

Accept this amazing offer and you have nothing further to worry about. No extras to buy. After 8 weeks of my skillful training you'll be ready to step out and get a real job with big pay—and I'll help you get one of the very best jobs in the country. If you're just an average man and can read and write, I'll guarantee you can learn by my simple, easy, practical method. Furthermore, I'll refund your tuition if you're not satisfied with what I have done for you.

Auto Mechanics Wanted

in all parts of the U. S. Tractor mechanics and electricians needed, too. Start your McSweeney training at once and qualify for one of the big pay jobs that are begging for trained men. Never in the history of the business have such high wages been paid. Many now earning

\$75 to \$125 Per Week

Electrical Course

of extra cost to those who enroll soon. You get full training in auto and tractor mechanics, plus the electrical course, all for the one amazingly low fee. Hurry! Enroll now! The auto and tractor field is begging for well trained men. Write at once for full details and my big auto book FREE. Send coupon to school nearest you.



McSweeney Auto, Tractor and Electrical Schools,
Dept. YM-302, (Address school nearest you)
Cincinnati, Ohio; Cleveland, Ohio.

Without any obligation send me your big free book on Autos. Also information regarding Special Price Tuition offer.

Name
Address
City State



MAC HIMSELF

McSweeney Schools
AUTO, TRACTOR AND ELECTRICAL

DEPT. YM-302, CINCINNATI, OHIO; CLEVELAND, OHIO

NEW!

Eveready Layerbilt
"B" Battery No.
486, the Heavy-
Duty battery that
should be specified
for all loud-speaker
sets.



The Layerbilt patented construction revealed. Each layer is an electrical cell, making automatic contact with its neighbors, and filling all available space inside the battery case.

DIFFERENT!

For greatest economy all loud speaker sets require the new Eveready Layerbilt "B" Batteries

IT WILL pay you, in convenience and reliability as well as in dollars and cents saved, to use this remarkable battery.

The reason for the Eveready Layerbilt's surprising performance lies in its exclusive, patented construction. No other battery is like it. It is built in flat layers of current-producing elements, making practically a solid block. The layers make connection with each other automatically, and occupy all available space inside the battery case. Layer-building packs more active materials in a given area, and makes those materials produce more electricity.

Every loud-speaker set should use Heavy-Duty batteries, for they alone offer economy on modern receivers. When you buy new "B" batteries be sure to get the Heavy-Duty size, and remember that the Eveready Layerbilt has proved to be the longest lasting, most economical of all Heavy-Duty batteries.

Our laboratories are continually testing batteries and in all our tests we have yet to find a battery that is equal to the new improved and radically different Eveready Layerbilt "B" Battery No. 486. The development and perfecting of this remarkable

battery is an outstanding battery-building achievement. It is the result of many years' experience plus the facilities and resources of the pioneer manufacturers of all dry cell batteries.

NATIONAL CARBON CO., Inc.
New York San Francisco

Unit of
Union Carbide and Carbon Corporation

Tuesday night is Eveready Hour
Night—9 P. M., Eastern Standard
Time

WEAF—New York
WJAR—Providence
WEEI—Boston
WTAG—Worcester
WFI—Philadelphia
WGR—Buffalo
WCAE—Pittsburgh
WSAI—Cincinnati
WTAM—Cleveland
WWJ—Detroit

WGN—Chicago
WOC—Davenport
WCCO—Minneapolis
St. Paul
KSD—St. Louis
WRC—Washington
WGY—Schenectady
WHAS—Louisville
WSB—Atlanta
WSM—Nashville

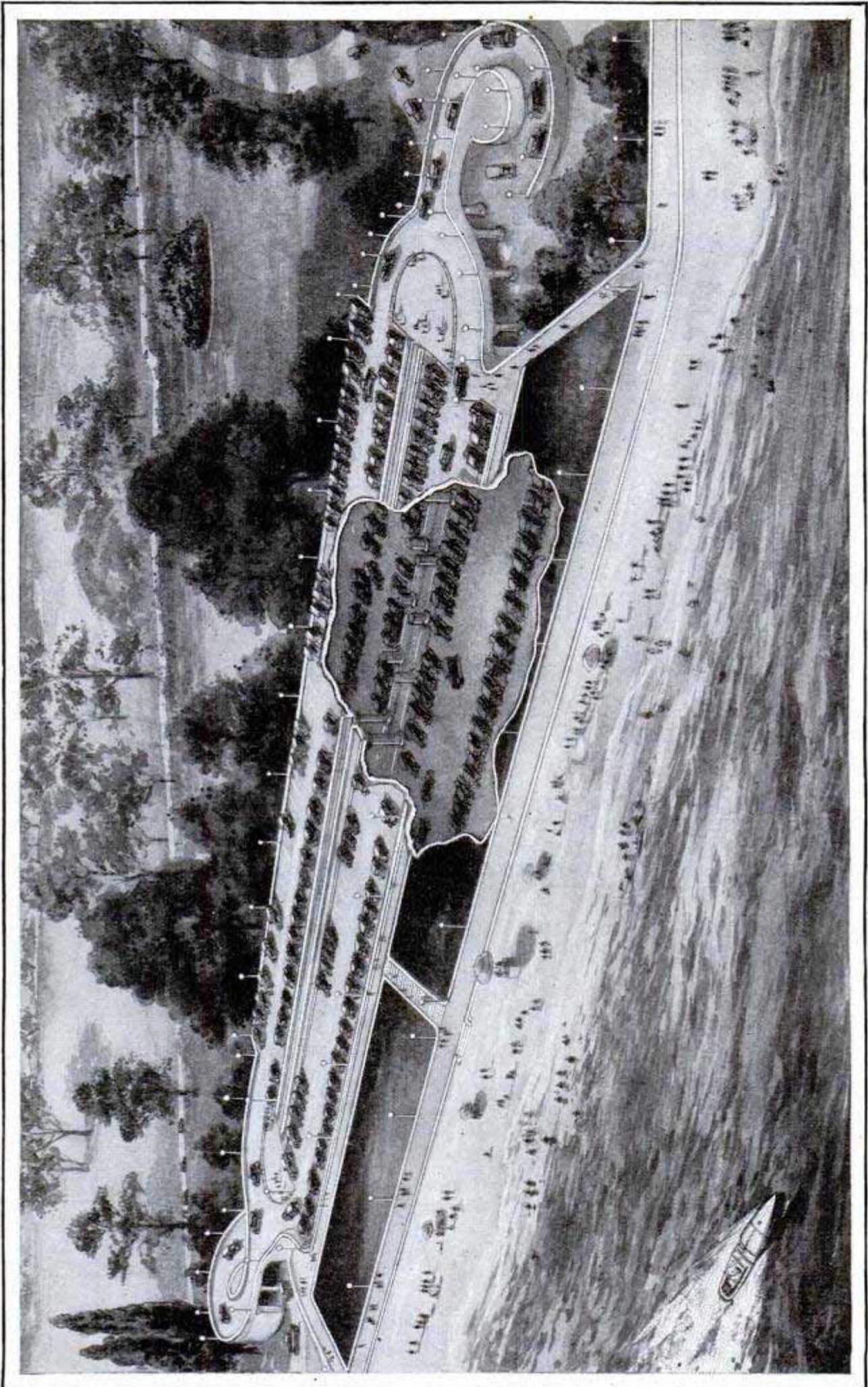

Automobile Parking Congestion in the Neighborhood of Bathing Beaches Has Become So Great in Chicago That Commissioners of Lincoln Park Have Planned This Double-Deck Storage Space to Be Built at a New Beach Being Constructed on Made Land in Lake Michigan—See Page 534

Popular Mechanics Magazine

REGISTERED IN U. S. PATENT OFFICE

WRITTEN SO YOU CAN UNDERSTAND IT

No. 48

OCTOBER, 1927

2841

No. 4

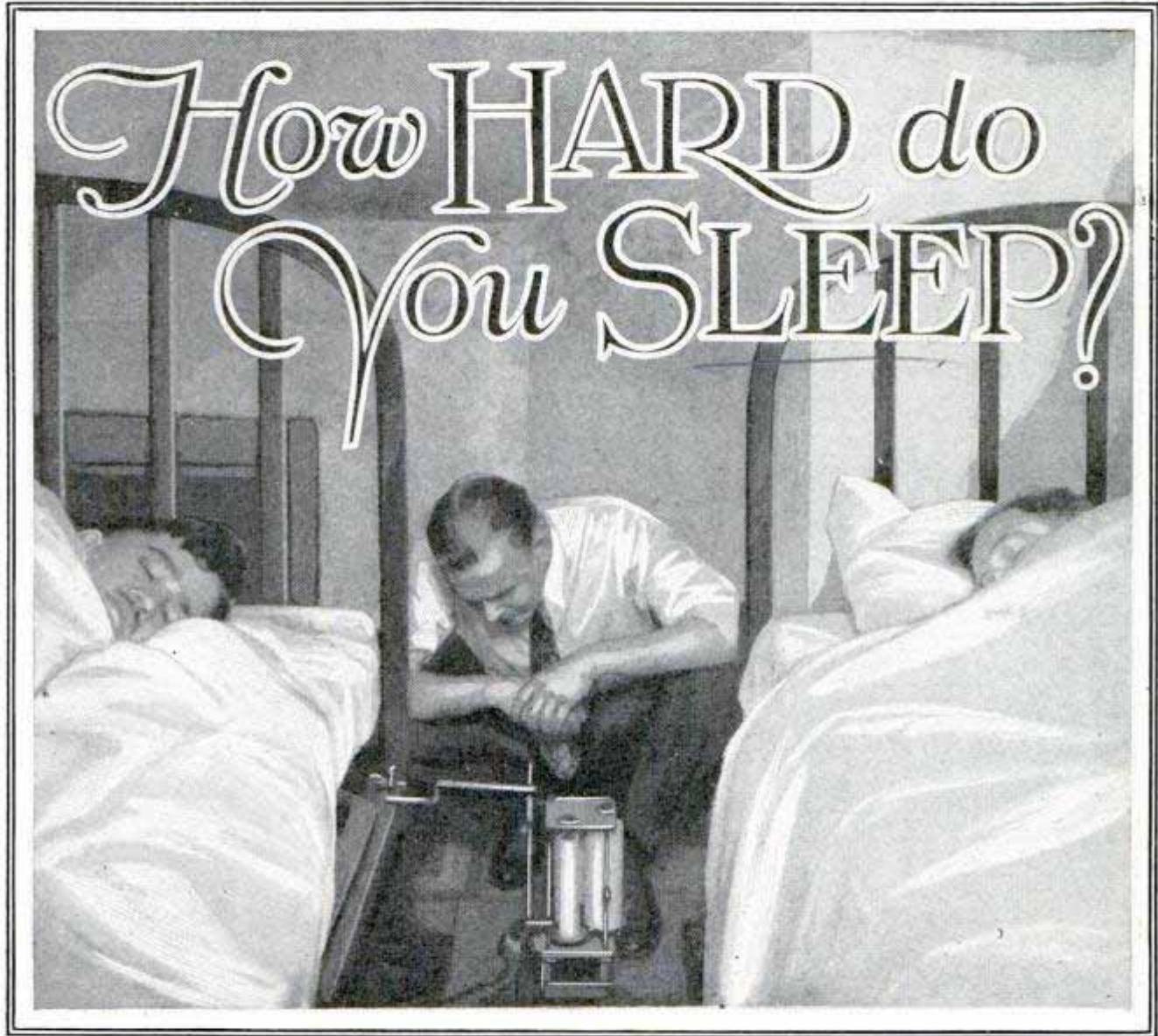

Clockwork-Driven Chart Used to Record Every Restless Movement of Sleepers Undergoing Tests at the Mellon Institute; It Also Charts the Exact Time of Each Movement

SLEEP, instead of being a period of unbroken rest for several hours, is a series of short naps, interspersed with turns and movements, according to investigators of the Mellon institute, Pittsburgh, who have been studying the sleeping habits of twenty-one students for more than a year.

Ten to fifteen minutes of deep sleep proved to be the average for the class, but each one was disclosed to have a certain normal sleep wave or rhythm distinct to himself. Physical or mental strain, finan-

cial or heart worries or disease change the sleep wave, breaking it with more frequent tossing and turning, in some cases, or lengthening it in others.

A special machine invented for the tests by Dr. H. M. Johnson, in charge of the experiments, was attached to each bed in the dormitory. It records, on a moving strip of paper, every movement the occupant makes, and, as the motion of the paper is timed, shows the duration of each deep-sleep period and the recurrence of

Cont. *Whai, Vincent Wilcox* 529
La Honda Park Washington

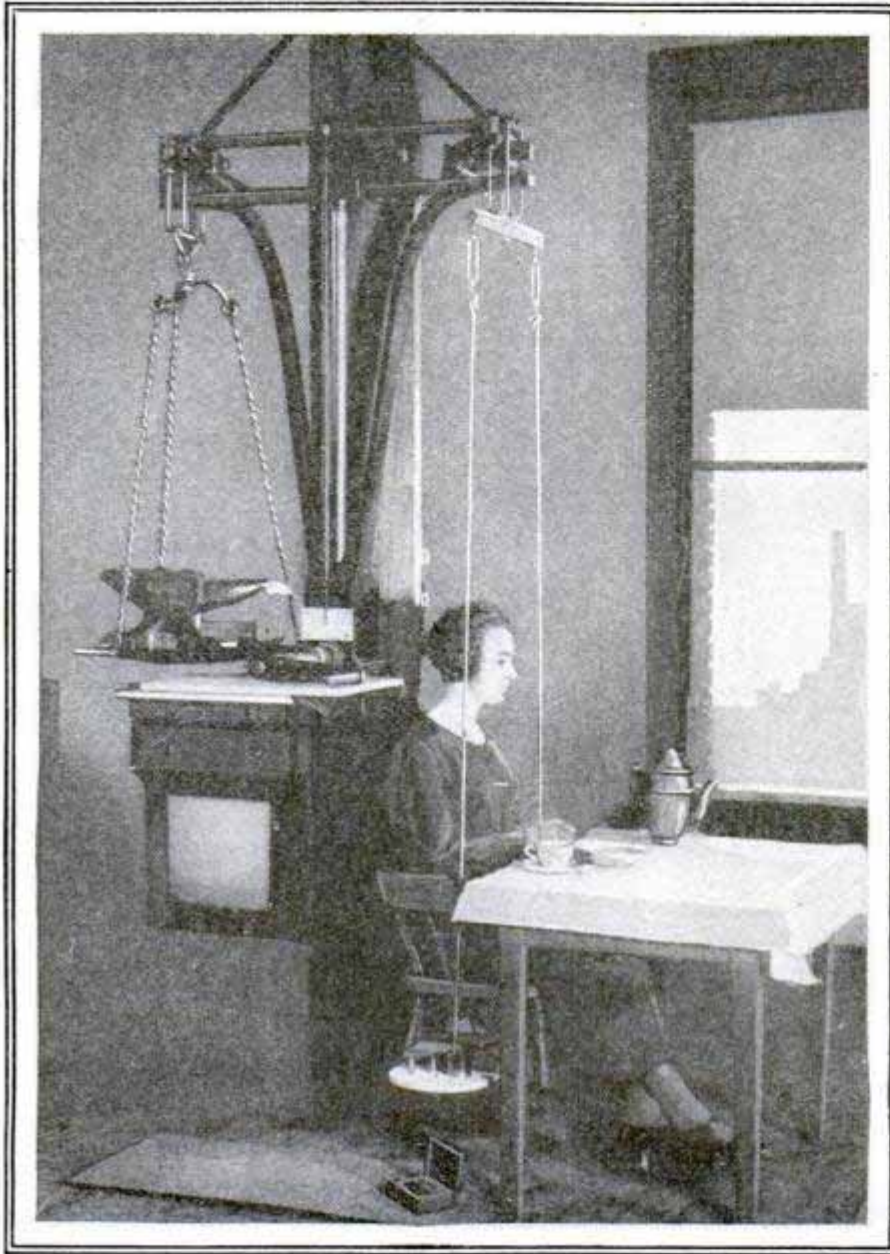

In Nutrition Tests, Subjects Are Seated in Chairs Hung from Balances in Order That Gain in Weight May Be Determined

disturbances. It is expected that the tests may be useful in the study and treatment of disease. Recording machines are being installed in two hospitals to gather data on this phase of sleep alone.

One of the subjects in the experiments contracted influenza. The night before the onslaught of the disease, the average rest period was more than doubled in length, just the opposite of the conditions that German investigators found to be associated with sleeping sickness. The increased periods of still sleep continued throughout the progress of the disease, but after recovery, the subject returned to his normal sleep wave.

"Of course," says Dr. Johnson, "it is well established, as a matter of common

experience, that worry disturbs rest. The discovery of this fact is not the valuable point. What is valuable is that a method has been found which will show in what manner and to what extent the disturbance acts, and which is independent of the personal report and personal impressions of the patient.

"In certain nervous and mental disorders, systematic worries, which are usually ill-founded, and which often persist for weeks, are a characteristic symptom. In fact, they constitute the principal source of unfitness for place in normal society. The treatment consists largely of rest and re-education. An important hindrance to treatment lies in the reticence of the patient or in his actual resort to deception. If a study of his sleep should provide a means of anticipation of the return of a phase of anxiety, the physician might be able to do something to avert it."

In the Mellon institute tests it was discovered that not all people need the same kind of rest. Some of the students worked better after a "warming up" process in the morning, which involved partial tiring of the body. Mental tests were given regularly, and all but one of twenty-one subjects showed more alertness at the end of the day, when well tired, than in the morning.

"When we allow them only seven and three-quarters hours in bed," says Dr. Johnson, "the output at night is about six and a half per cent better than in the morning. When we allow them eight hours in bed they rest more quietly, as well as longer, and their output at night becomes ten per cent higher.

"It looks as though the longer a person

stays in bed—within such limits as these—the more quietly he rests while there and, possibly, the higher the degree of recuperation he attains. By this token, therefore, the less fit for work he will be in the early part of the day, since he must undergo a longer winding-up process to make use of the gain, and the more fit he is by night, since he is not so near the actual exhaustion of his reserve.

“Many people, if they must do detailed thinking in the morning, will find a good preparation to be a good walk, a game of golf, or a half hour’s work in the garden, so that when they attack the day’s task they will be sufficiently fatigued to settle down to it.”

Mild fatigue, Dr. Johnson says, is conducive to effectual work, and is also an important agent of pleasure, through the thrills that attend the discharging of the stored-up energy of the body cells, gained through a night’s sleep.

WHIRLING DISK SHOOTSPARKS OF DIFFERENT COLORS

Showers of colored sparks are produced by a whirling-disk device recently introduced in Germany. The action is accomplished by little pegs that come in contact with an emery disk. The pressure is regulated to produce ample sparks but prevents useless waste. The color effect is gained by the tinted panes in the disk.

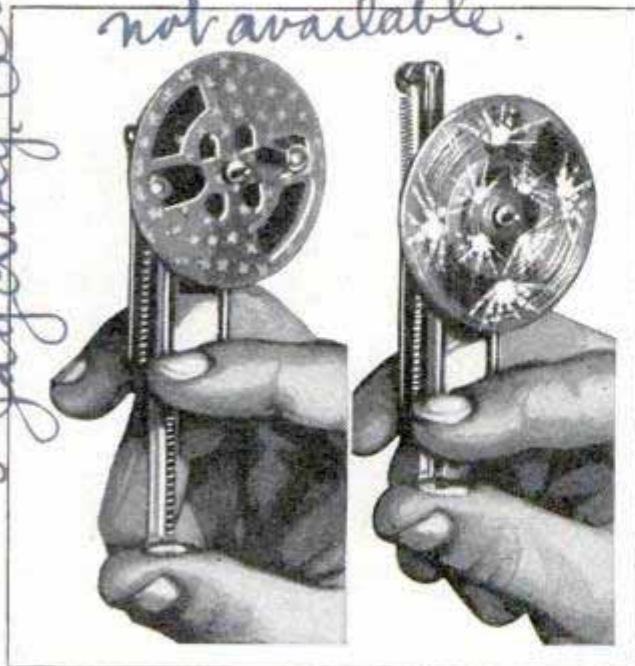

Wheel in Position for Spinning and in Action, Showing How It Is Operated and Sparks Produced



For the Golfer Who Wants to Cultivate the Correct Body Swing: Iron Practice Ring in Use

GOLF PRACTICE IN IRON CIRCLE DEVELOPS PROPER SWING

Control of body sway is said to be an important factor in efficient golf, and to develop this, a Toledo player has introduced an iron practice ring. It rests on firm supports and incloses the user’s waist with sufficient space for freedom of motion but preventing exaggerated effort. According to the inventor, better position and more accurate strokes are cultivated by this aid.

MIX CRUSHED ICE IN CONCRETE TO FORM POROUS BLOCKS

Add crushed ice or snow to cement and sand during the mixing process and obtain concrete units honeycombed with minute pores, says the latest building recipe from Finland. The water from the melting ice soon evaporates, leaving the small holes and forming a cellular structure, especially suited for insulating purposes.

Ed. C. 2 Nagms. 5 Jagdweg. Bonn Germany

U. S. Agent John W. James 7/10 7/2 '17



Battleships of British Navy Decorated with Electric Lights for Recent Maneuvers at Portsmouth; Searchlights and Bursting Star Shells Added Brilliance to the Display

2938

**BATTLE FLEET OF ENGLAND
IN ELECTRIC PAGEANT**

Warships tricked out in vast strings of electric lights were paraded before people on shore at the recent British navy maneuvers at Portsmouth. The lines of lights outlined hulls, conning towers, guns, and masts. Huge searchlights swept the sky, while star shells trailed long streamers of colored light across the darkness.

aca

**ROLLERS FOR PIANO KEYBOARD
HELP IN SCALE PLAYING**

2933

Combinations of sound heretofore impossible on an ordinary keyboard are said to be produced easily with the aid of rollers on the keys, one of the principal features of a grand piano recently introduced. They are intended to assist in the glissando passages where the musician is instructed to produce a brilliant scale by sliding the back of the finger along the keys. The

rollers govern both the white and black keys and are so arranged that chromatic sliding of the fingers singly or in various forms is easily attained.

**DEVELOPMENT OF MARINE RADIO
VICTORY FOR VACUUM TUBE**

3012

How the vacuum tube has revolutionized marine radio is shown by the fact that it was only in 1920 that a chain of coastal broadcasting centers was established using the old system. All were operating on but two wavelengths, and there was a bedlam of interference. It has been no easy matter to discard the hundreds of obsolete transmitters in use on ships, but



Roller Keyboard for Fast Piano Runs

the work of changing from spark to vacuum tube has been going on steadily during the past two years. Already several hundred ships are so equipped, or will be very shortly. Spark signals are becoming a rarity, except for occasional small foreign ships. Vacuum-tube transmission has more than

1538 W. Chicago

The Starr Piano Co. Richmond Ind.

233 Broadway, New York

justified expectations. With the vast increase in distances spanned, ships are now keeping in touch with land stations on the transatlantic course. The static-infested Gulf of Mexico finds vacuum-tube transmitters getting through hundreds of miles of space in broad daylight, with precision and certainty. But the climax of vacuum-tube technique is to be found at the elbow of Cape Cod. Here the visitor is confronted with the busiest scene imaginable, both to the eye and to the ear. There are rows of operating tables, some for the radio circuits that reach out to ships at sea, and others for the telegraph lines stretching to the offices in New York and Boston, the scene suggesting a busy telephone central. The operators are seated before tables with high backs containing the receivers. A supervisor assigns to each ship an operator who tunes in and receives the messages, pounding away the radiograms on his typewriter just as fast as the distant vessels can "shoot" them in.

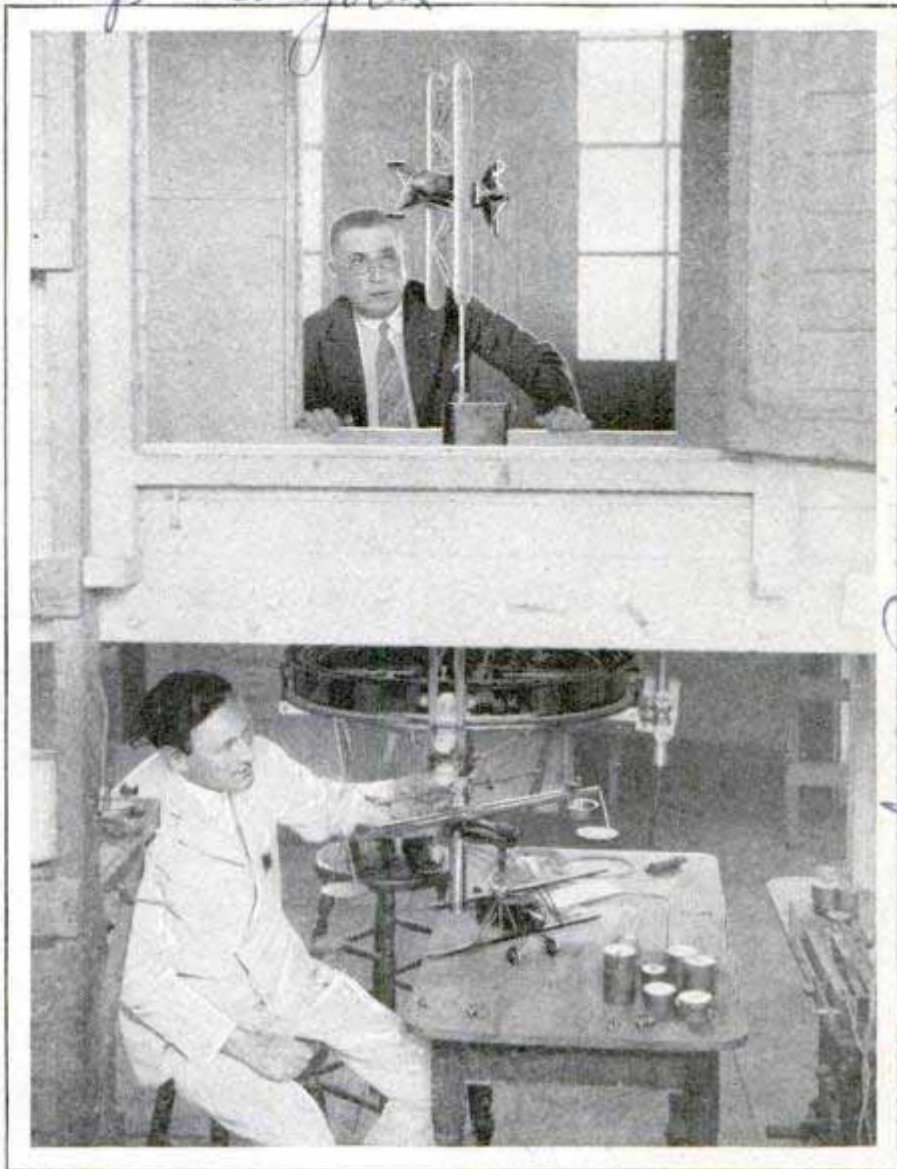

Testing Model Airplanes in Wind Tunnel for Development of Greater Speed in Finished Ships

GREATER SPEED FOR AIRPLANES OBJECT OF TUNNEL TESTS

Successful development of aviation depends, in a great measure, on faster speed for planes, according to officials of a western company, and with that end in view, they have been conducting a series of interesting tests with models in a wind tunnel at the California institute of technology. The miniature ships are carefully constructed to scale, accurately weighed, and their resistance to air currents and behavior in a powerful wind stream noted, so that data may be obtained as to the probable performance of real ships built on those patterns.

In Constantinople, blind and dumb persons wear labels to decrease the likelihood of motor accidents.

BAIT CAN HAS SELF-CLOSING LID AND CLAMP TO FIT BELT



With a strong spring lid that closes tightly of itself, a bait can now on the market is intended to add to the joys of fishing. An additional feature is a steel clamp to be slipped on the belt, pocket

or creel for holding the can in position. Green lacquer protects it against rust.

Practical Novelty Works, Los Angeles

Dr. Harry Ogden Harris, M. D., Director, Western Air Experiment Laboratory, Aerodynamic Laboratory

2948

60 cents by mail 2306

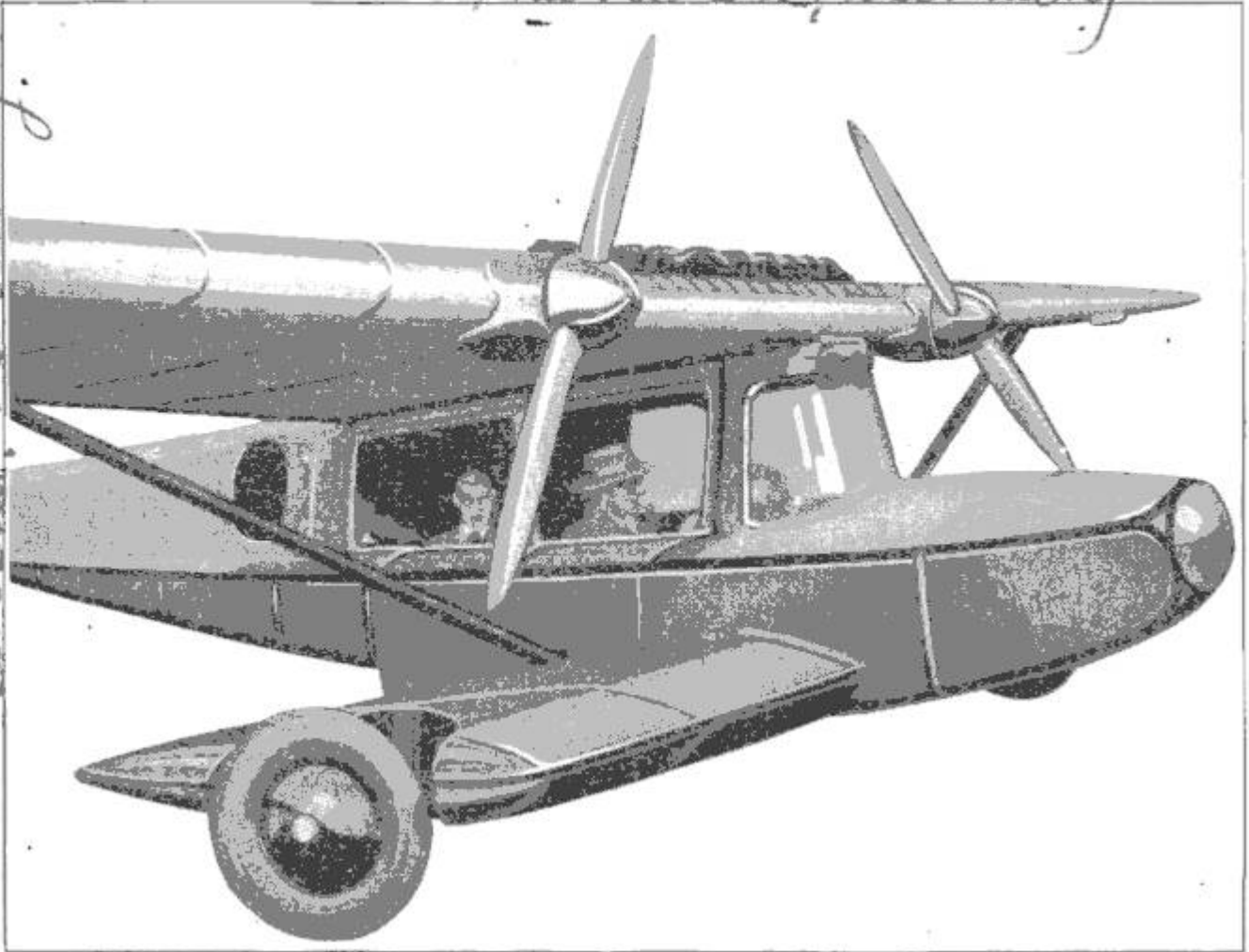

Enter the "Flying Auto"; the Roomy, Glass-Inclosed Cabin Affords a Wide View and Comfortable Riding; Propellers Are Driven through Conical Gears and Wheels Fold into Floats for Water Landings

BODY LIKE AUTO SEDAN MARKS NEW "FLIVVER" PLANE

An airplane which has a cabin inclosed by wide glass windows, affording an all-around view equal to that in an automobile sedan, is being produced in Germany by the famous Junkers works as a personal machine for owner-pilots who want to fly for business or pleasure. The machine is notable for its contrast to the

usual cabin plane, in which the cabin consists mostly of walls with a few very small windows, usually covered by sheets of celluloid instead of plate glass. The Junkers machine has two two-cycle motors, driving the propellers through conical gears. It is an amphibian, and the landing wheels are so arranged that when drawn up at right angles to their normal position they become part of the floats for alighting on water.

DOUBLE-DECK PARKING GARAGE FOR NEW BATHING BEACH

Congestion due to parked automobiles in the vicinity of Chicago bathing beaches has become so great that when commissioners of Lincoln park planned a new beach, to be built on made land in Lake Michigan a half mile from the present municipal bathing house, they provided for a double-decked parking garage with a capacity of hundreds of cars. The city already has many blocks of double-

decked streets, with heavy traffic relegated to the lower levels, and the beach-parking garage will follow the same general design. Circular ramps at either end of the structure, which will be about two city blocks in length, give access to the upper level. By parking cars two deep, considerable space will be saved for baseball diamonds, tennis courts, golf links, a ski slide and other sports. Boulevard lamps around the rim will light the parking space at night, while a row of trees will largely conceal it by day.

Junkers Flugzeugwerke A.G.
 Dessau, Germany.

2887

POPULAR MECHANICS

Cont. J. F. Holingsworth
158
Boston
me

NEW CLOTHING FABRIC PASSES
ULTRAVIOLET RAYS 3021

Full benefit of the sun's rays may now be enjoyed even while wearing clothing, according to reports of a new fabric which is said to permit the ultraviolet rays to pass through and reach the skin. The cloth was tested in New York laboratories with sports costumes, and results showed that the chemically manufactured material allowed the helpful rays to bombard the wearer as though he were totally unclothed. The cloth somewhat resembles silk and is mixed with a small percentage of light wool to create colored patterns. An interesting feature of the tests was the discovery that certain kinds of perfumes obstruct the rays, so that persons wishing to enjoy the full benefit of the sun while wearing the cloth, were cautioned not to use perfume on the fabric.

fabric produced artificial silk
wears better
than Rayon
Celanese

2888

EXERCISER FOR REDUCING FITS
IN SMALL SPACE 2644

Occupying but little floor space, and, when not in use, rolled away in a closet or other convenient room, where it stands upright against the wall, a roller platform for reducing exercises has been introduced. It is a combination rowing and massaging machine, some fifteen different exercises being available from it. While most are intended to reduce the weight, there are stunts for the arms and legs, chest and back, which promote strength and suppleness. A few minutes a day with the outfit is said to be sufficient for desirable results, and, besides, the exercises are a source of enjoyment.

Exerciser Provides Fifteen Stunts for Reducing

Reduce A. Way



Roll a. Way Bed Corp
225 West Ohio St

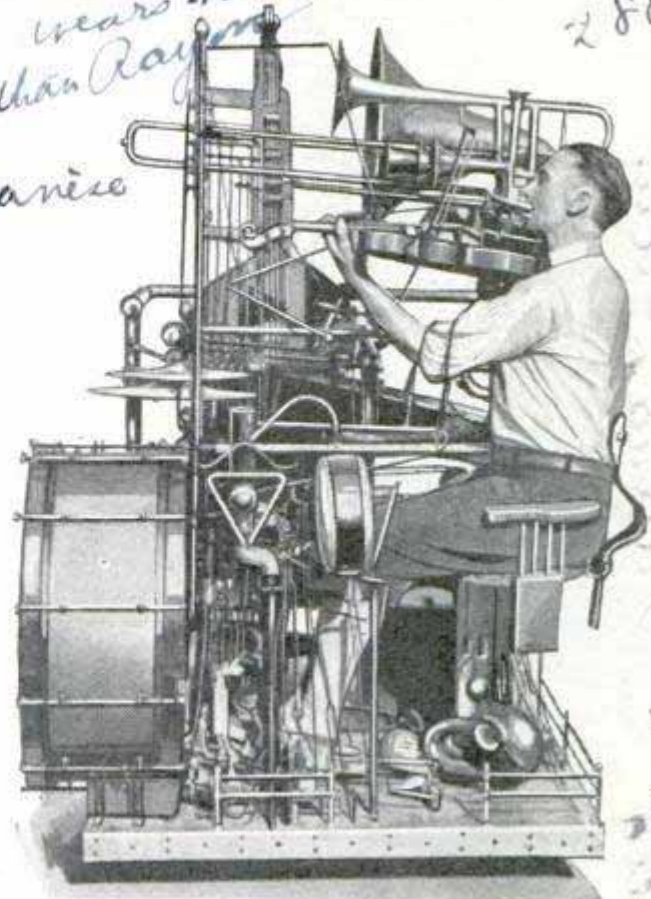

He Plays Twenty-Two Different Instruments, Using His Hands, Feet, Knees and Mouth

ONE MAN PLAYS ORCHESTRA
OF TWENTY-TWO PIECES

Parts salvaged from automobiles and locomotives have been used by a Minneapolis man in the construction of a twenty-two-piece orchestra assembly which he can play alone. It has string, wind and percussion instruments and the operator uses his hands, feet, knees and mouth, simultaneously at times, when playing selections. An amplifier is arranged to increase the volume of the tones from the string instruments so that they will not be drowned out by the brass.

Albert Nelson

AUTOMATIC "SOS" FOR SHIPS
HELPS SEA SAFETY 3006

Even if the wireless operator is not on duty, an SOS signal from another ship would not be missed with special apparatus devised in England. It is so adjusted that reception of the distress signal rings a bell in the wireless room as well as on the captain's bridge, so that attention to the call is summoned at once, even when the radio operator is not at his regular post.

Express 7/18/27

Box 161, Johannesburg S.A.

2935

PORTABLE FRUIT-PICKER TOWER SAVES TIME AND WORK

*A.C. Bigler, Alhambra, California
Patented 9/16/11*



Tower in Operation; Fruit Is Placed in Small Baskets on Endless Belt and Dumped into Box Below

Faster picking and less damage to the fruit are claimed for a portable-tower apparatus a California grower has constructed for gathering oranges, lemons and other crops. It is easily moved about on wheels, and a special feature is the endless-belt conveyor with small boxes, by which the fruit is lowered into larger containers or a hammock at the bottom, saving repeated trips up and down the usual ladder. This conveyor operates by gravity and is made to dump the fruit automatically.

FORTUNE WAITS IN DISCOVERY OF PLATINUM PROCESS

2997

In the shelter of the towering, poisonously white dumps of crushed gold ore that overlook the great African mining city of Johannesburg, stands an unpretentious stone building in which several scientists are seeking a missing ingredient that means extra millions to the mining magnates of the great southern continent

—a way of extracting South Africa's most precious metal, platinum. This metal is found in quantities, but no practical way is known of separating it from the rock in which nature hid it. Like all great discoveries, the principle of extracting platinum is probably very simple—if it can only be found. As one geologist crudely put it: "All they need to add to the stew is a pinch of salt." A tantalizing search indeed, but one that is not being conducted haphazardly. Great masses of statistics are accumulating and gradually—very gradually—some pointers to the unraveling of the mystery are being found, as the facts become tabulated. Thirty years ago, the same problem balked the refining of gold on the Rand. Ten billion dollars' worth of ore lay ready to be dug out as soon as a way was found to separate it from the rock, but not until a battalion of scientists had experimented systematically for a decade did the obvious but essential fact turn up—the simple information that gold combined with cyanide of potassium. And now a fortune again waits a single discovery which will do for platinum what the cyanide process did for gold.

BOWLS OF FIREFLIES CITY'S GIFT TO JAPANESE PRINCESS

Members of the juvenile Red Cross society of Gifu, a city in central Japan, recently captured more than 1,000 fireflies and placed them in two bowls as a gift to the emperor's daughter. In some localities, fireflies are used as a source of illumination and as personal adornment. There are over eighty species of them.

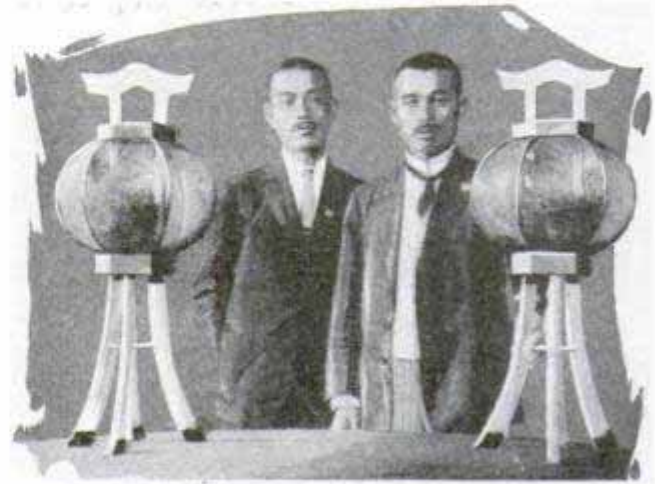

Unique Gift of Japanese Children to the Emperor's Daughter; Bowls Contain More Than 1,000 Fireflies

International

2702
To The News, Detroit
Michigan
Has left this address
Cannal locati

Faster

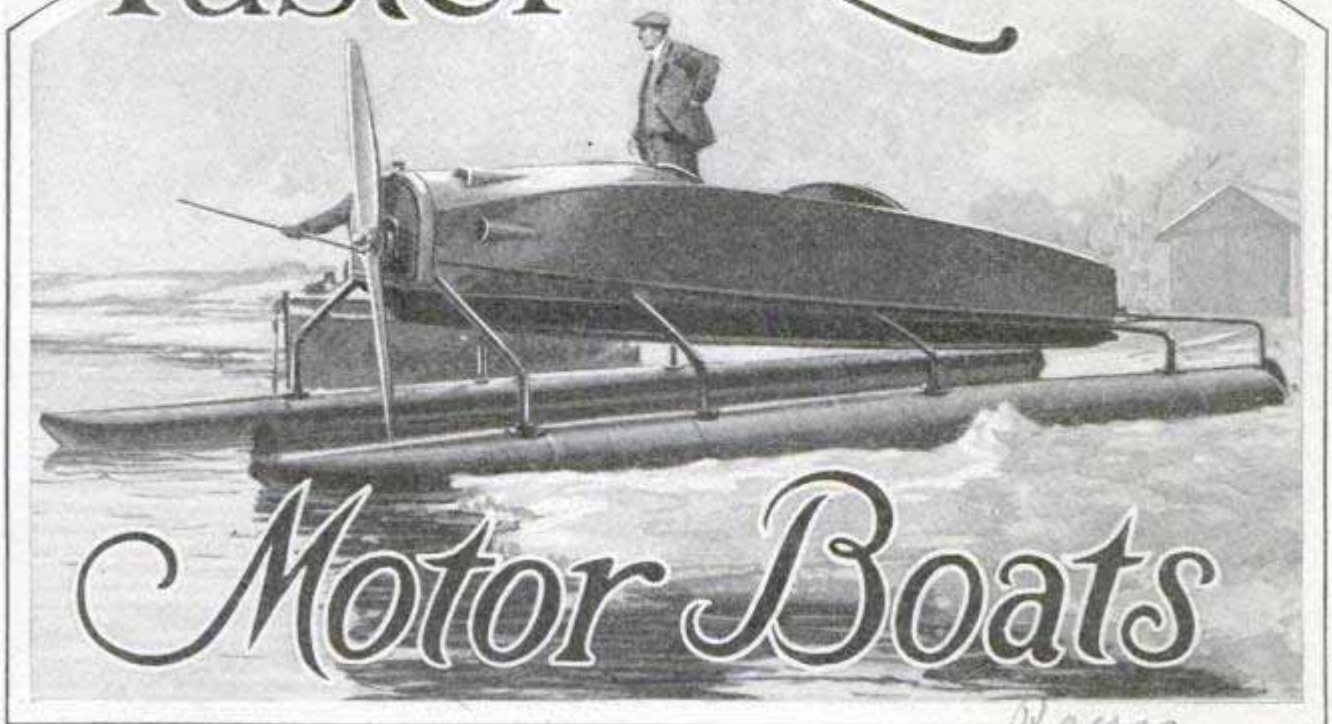

Motor Boats

A Pontoon Boat, Built like an Airplane Body with Two Long Floats, Has Been Tested on the Great Lakes; It Will Run in Four Inches of Water, or Can Skim across Ice in Winter

WITH land and the air conquered by space-devouring speed—209 miles an hour for Maj. Segrave's racing automobile and better than 250 miles an hour for Schneider cup seaplanes—both builders are concentrating on the conquest of the last remaining element, water.

Gar Wood's dream of a 100-mile an hour boat big enough to cross the Atlantic—announced two years ago after his record-breaking dash down the Hudson from Albany to New York—remains unfulfilled, but eighty miles an hour has been attained, and the century mark is in sight.

America, in the years since the war, has become the home of the high-speed boat. When Maj. Segrave came to Daytona with his huge racing machine, to travel faster than man has ever traveled over the ground, Gar Wood and others took him out for trial spins in their high-powered boats and sent him home a convert. He raced his big double-engined car just once when he got back to England, to let the home folks see it in action, and then announced his retirement from the track to devote all his time to high-speed boats.

And, strangely enough, his first entry

in water racing was a pair of little out-board-motor boats, flat-bottomed step hydroplanes of the type that has set up records of better than twenty-eight miles an hour. For the bigger races later in the season, he planned to pilot a craft capable of making forty miles an hour.

Speed on the water, however, is not confined to races, or to professional pilots out for cups and prizes. Thousands of fast but comfortable boats, as easy to handle as an automobile and with many of the automobile's luxuries, from leather seats and sedan tops down to electric cigar lighters on the instrument board, are being turned out in factories on the Great Lakes, around Long Island sound, and in the far west.

They range from fast little day runabouts—corresponding to the sport roadsters of the highways—up to the limousines of the seas, and even on into the camping-coach type, comfortable big cruisers with berths for four to six people, a well-equipped galley and all the comforts of home.

The joys of the open road, which disappeared when automobiles became so

no further information.

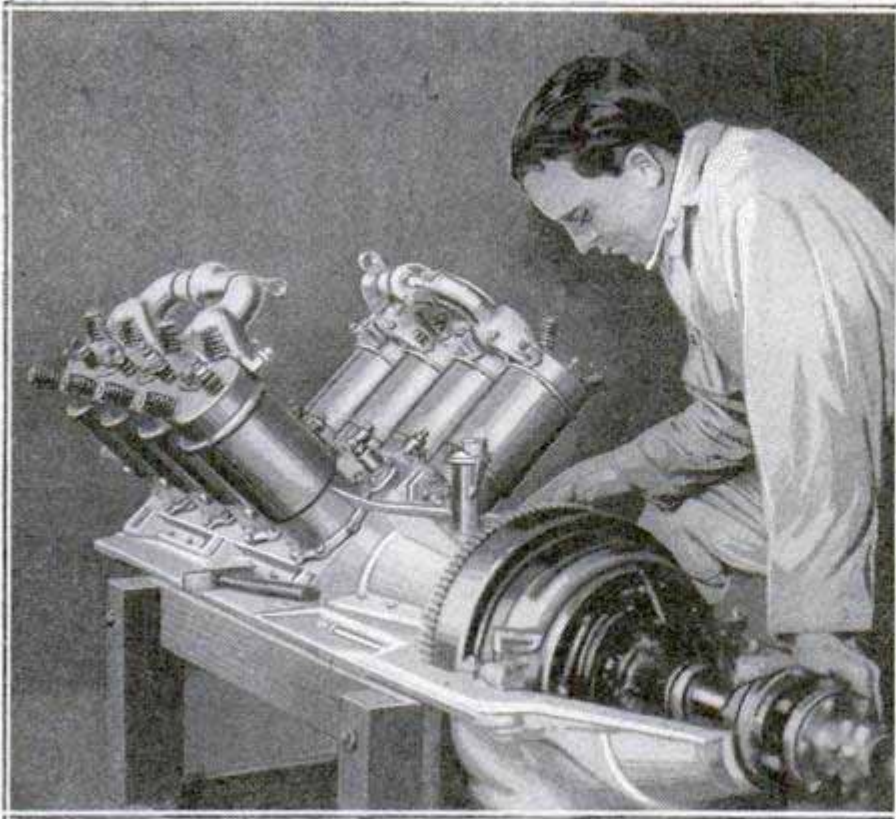

Curtiss Airplane Engine Being Dismantled to Be Rebuilt as a Marine Motor for High-Speed Boat

numerous that it was impossible to move out of any large city faster than a snail's pace on Sundays and holidays, still cling to the water, for there is plenty of space and plenty of changing scenery.

Marine motorists, though, demand the same, or nearly the same, speed they attained with automobiles on land, and it is that demand which has almost revolutionized boat building in the last few years. For speed on the water can only be attained at the cost of economy of operation, so, before the war, practically all power boats, with the exception of a few out-and-out racing machines, were built to chug along at a modest eight to ten miles an hour. Roughly speaking, to jump from ten to fifteen miles an hour about doubles the operating cost of a boat, and to go from fifteen to twenty may double it again, and so on up the scale. A ten-mile cruiser can jog along and conserve gasoline as well as a modestly powered automobile, but the marine motorist who wants high speed pays for it in gasoline consumption.

To get forty or fifty miles an hour out of a twenty-six, twenty-eight or thirty-foot day cruiser, which is the usual seven-passenger car on the water, requires from

200 to 300 horsepower and a gasoline consumption of one-half to one gallon per mile.

The war-time stock of unused aircraft engines left on manufacturers' hands was partly responsible for the development of so many high-speed boats within the space of a few years. One boat maker alone purchased 2,500 Curtiss engines, tore them down and rebuilt them into marine motors for his boats. The rebuilding required considerable change, for a boat engine, subjected to frequent wetting, must be well protected to insure steady operation. Anyone who has watched one of the fast-racing hydroplanes capsize on a

turn, sink to the bottom, while the crew, buoyed by life preservers, floats around waiting to be rescued, and then watched the sunken boat being fished up by a derrick to go back into the race next day, can appreciate the amount of punishment a well-built marine motor will stand. Rust-proof monel-metal jackets and complete coverage of the electrical apparatus are essential.

The search for speed isn't confined to putting bigger motors in standard types of boats. Designers have imitated the airplane by utilizing aerial propellers, by adopting seaplane fuselages and pontoons, and, in at least one case, by producing a hull that looks like an ordinary boat which has been sawn in two down its center line and the two halves put together wrong, the cut surfaces boarded up at the outside and the former outsides stuck together. The result is a curious hull with a tunnel running down its center, and with straight sides that, out of the water, look like runners, so it is called a sea sled. Driven by a 200-horsepower motor, it will ride over the wave tops at forty miles an hour, and without any of the unsteadiness of the usual round or V-bottomed boat. Its unusual construction

makes it safe even in the hands of a novice, as it is immune to tipping and even in rough water skims over the waves instead of plowing through them.

The Great Lakes have produced a new experimental type which looks exactly like an airplane, with somewhat enlarged landing pontoons. The body is high above the water on stiltlike braces, and carries the usual radial airplane engine and tractor propeller. At rest, the boat draws but four inches, and, at high speed, slips along the surface of the water, or, the builder

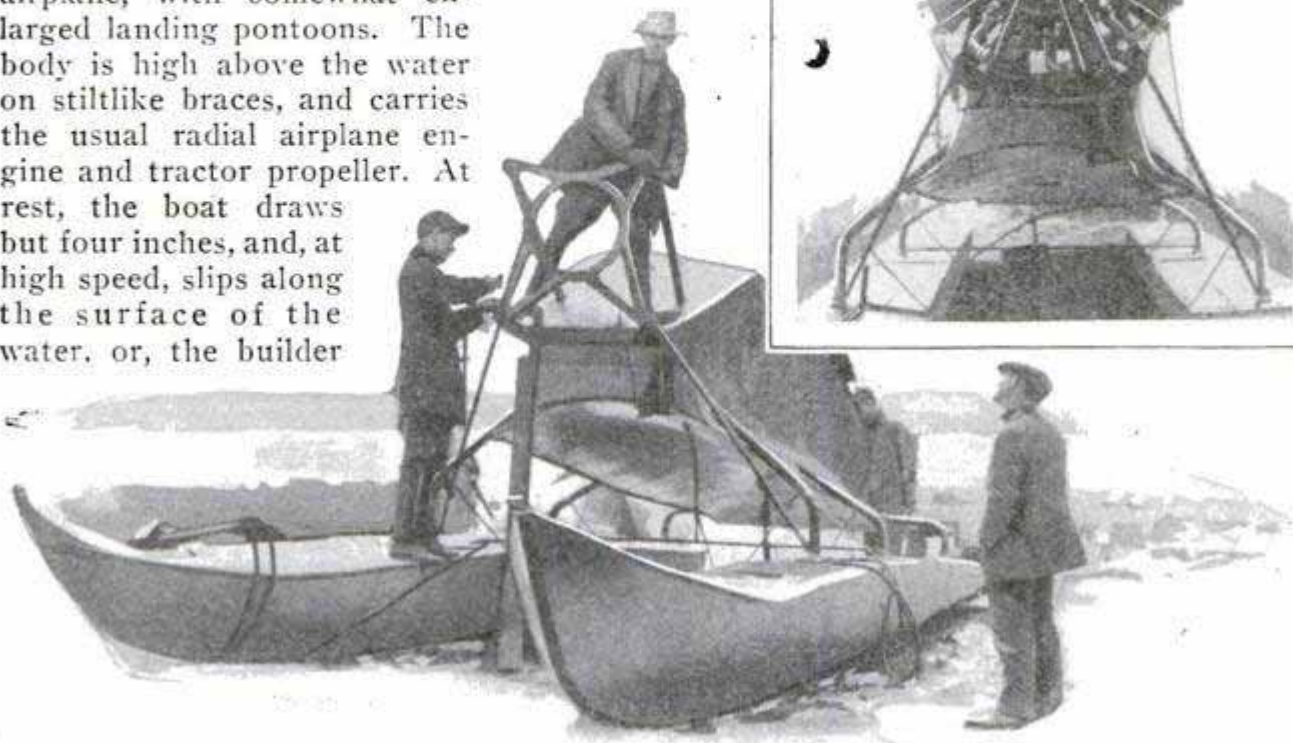
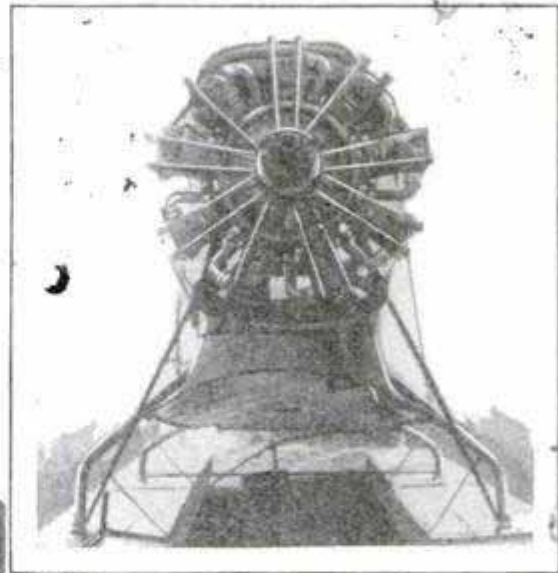

The Radial Aviation Engine of the Pontoon Boat, and the Craft Itself Ready to Have the Power Plant Mounted; It Follows Airplane Design, But Is Much Sturdier

claims, it can be used with equal ease in the winter on the ice.

The airplane-propeller boat has found favor in some localities on inland lakes because it cannot be fouled by water lilies or other marine growth—the chief bug-aboo of the water motorist. And because of its light draft it can be taken into shallow water where boats of more conventional design would be barred.

The demand for reliable marine power plants has grown so much in recent years that several automobile manufacturers have turned out marine editions of their regular engines, to enable them to participate in the business. Also, there are several companies which produce the necessary parts to convert secondhand Ford engines into marine units.

The surplus airplane-engine stock is far from exhausted, but conversions, outside of a well-equipped machine shop or a factory concentrating on the business, is an expensive process. The government has a large stock of new Liberty motors

for sale, but the cost of the necessary changes has kept all but a few Liberties out of boats. Also, the fuel consumption, at the rate of eighteen gallons an hour, makes the Liberty far from an inexpensive power plant outside of its natural habitat in a 150-mile an hour plane. In a boat with a speed of thirty-five to forty miles an hour, the fuel cost becomes an important item.

**EIGHT-WHEELED TOY WAGON
WILL NOT UPSET**

2684

Equipped with eight wheels, so arranged that they prevent overturning, a toy wagon for young children affords amusement and spares floors, as the sides cannot drag and scratch surfaces.



There are four wheels on each side, set to clear the floor when they are not in use.

The Parker
Manufacturing Co.

Toy Tinker Co.
Lowiston Ill.

349 N. Dearborn
POPULAR MECHANICS
Chicago
Allen
Erwin J.
Berrick

Sold by George Borgfeldt & Co
76 N. St. & Irving Place
New York City
286



maker -
Rain-Pak
Corporation
46 W.
40th
St.
New York

normal-food. The secret was revealed through a window that had been cut in "Jessie's" stomach, a small opening through which samples of partly digested food could be taken out and analyzed. It showed that the vitamine was produced in a sort of incubator in one of the cow's stomachs. So far as known, the cow is the only animal that has the ability to thrive on feed lacking this necessary substance. According to Dr. H. C. Sherman, of Columbia university, it would be entirely possible to take cultures of the vitamine from the stomach of "Jessie" or other cows as a source of concentrated material to be used for human consumption in the case of diseases caused by a lack of the vitamine. "Jessie" has been none the worse for her experience.

Paper Raincoats for Emergency Service Have Proved Efficient for Sea Voyages as Well as for Street Wear

PAPER RAINCOAT WEIGHS LITTLE AND KEEPS WEARER COOL

For steamer voyages, and on other occasions when a great amount of walking through heavy traffic is not necessary, raincoats made of waterproof paper have been introduced. As they do not cling so closely as those of rubber, they afford more ventilation and hence are cooler, weigh but little and can be folded up in small space. Modern methods of waterproofing paper have been developed to such a high degree of efficiency that swimming suits have been made of the material.

COW MAKES OWN VITAMINE B FOOD TESTS SHOW

That the cow may be able to serve the human race in an additionally important manner is seen as a result of interesting observations on "Jessie," scientific pet cow of the Pennsylvania State college. "Jessie" has been deprived of vitamine B, an essential material of nutrition, but it was found that her milk contained the substance and she thrived as well as cows with

FOLDING-BRACKET AUTO TABLE FITS ALL CARS

2871
Weighing but five and one-half pounds and easily carried in the hand when collapsed, a folding table, that fits on the back of the front auto seat, has many uses. It can be attached to the robe rail or cord, or to special loops provided for cars not equipped with robe carriers. It is especially serviceable on camping trips for serving meals, playing cards or as a writing table. There are no fixtures to mar or damage the car or upholstery.

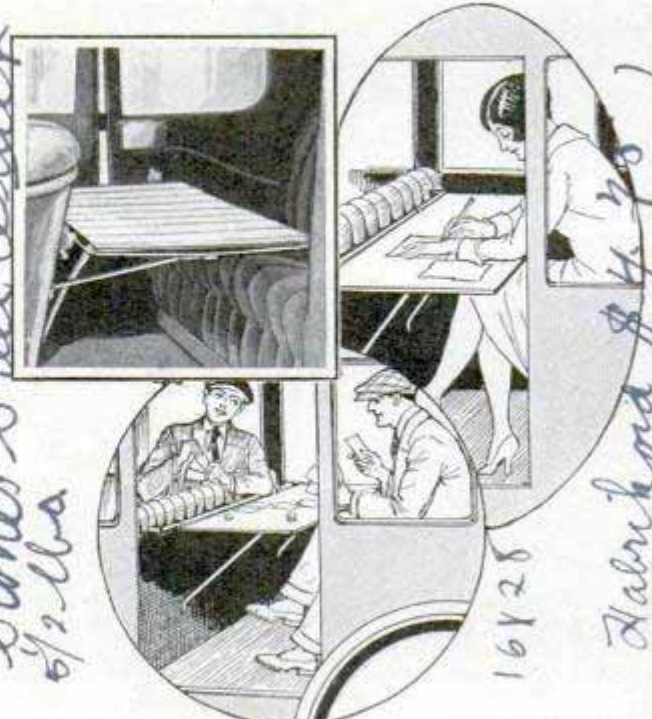

Typical Uses for the Folding Table inside Auto; When Collapsed, It Can Be Held in Hand

2004

Stones Steel Built
6/2 lbs

without bracket \$3.00
2.50

16128
Fabric had \$4.75
\$3.50
No Chicago agent.

Chicago Tribune
7/28/27

New Era Products Co,
La Crosse, Wis.

MYSTERY SOLO WITH ORGAN LATEST MOVIE STUNT



Artist's Drawing, Showing Arrangement of the Amplifying Phonograph, Position of the Loud Speaker and Pitch Control on Organ Console; Dancer and Setting Are Partly Concealed behind Curtain

While the pipe organ played at the Marbro theater in Chicago recently, a beautiful voice sang and a dancer performed behind the transparent "scrim" curtain on which words of the song appeared. "We liked the number, but why didn't the singer come out where we could see her?" patrons asked the theater management. The mysterious voice was that of an electrically operated phonograph and the solo, amplified through a radio unit, was heard through a loud speaker concealed in the stage setting. The slight mechanical sounds were entirely obscured by the organ, and the illusion was so nearly perfect that several musicians in the audience were convinced the voice was that of a real singer hidden in the wings. This musical novelty can be adapted to practically any theater and enables patrons to hear the finest artists while seeing words of the songs on the scrim and enjoying tableaux, dances or other features in the soft lights behind

the curtain. The only equipment needed are the phonograph with radio-amplifying unit, a microphone in place of the regular reproducer, the loud speaker and a simple control on the organ to regulate the speed of the phonograph, so that the pitch will be the same as that of the pipes. This last unit was developed to solve what at first seemed to be a difficult problem. R. Q. Dalton, radio engineer, and Albert F. Brown, organist, who devised the installation, discovered that because of changes in humidity and temperature, organ pipes do not always produce the same pitch. When the combination was first tried, there was a difference of a full tone between the organ and the hidden voice. The speed regulator was installed to correct this difficulty.

More than half of the plate glass used in the United States goes into the manufacture of automobiles.

2908



ment necessary. The big plane carries three gunners, each operating a pair of machine guns, mounted side by side, so that they can be fired simultaneously. One gunner sits in the nose of the ship, another just aft of the wings, with guns pointed upward and backward, and the third is farther back in the tail, with his guns so arranged that they can fire downward and protect the craft against attack from below. The pilots sit just back of the nose cockpit, and the bomber is between the second and third gunners, with his bomb racks beneath the ship.

QUARTZ SURVEY SIGHT AIDS ACCURATE WORK

2996

Fused quartz, which has the peculiar property of transmitting light around corners and



International Lewis
The Nose Cockpit with Its Two Machine Guns, and a Full View of the Army's Flying Fort; Another Pair of Guns Can Be Seen Just Back of the Wing Radiator, and the Arrow Points to the Others

AERIAL BATTLESHIP CARRIES BOMBS AND SIX GUNS

An aerial fort, which carries six machine guns for defense and a huge load of bombs for offense, has recently been completed for the United States army. The slowness of the big bombing craft, as compared with the fast little single-seater attack planes, makes exceptional defensive arma-

with a minimum of absorption, is being used in an interesting way by the coast and geodetic survey to simplify the task of taking observations. In order to avoid the effects of varying temperatures during the daytime when light rays are bent or refracted, some of the most accurate measurements are made at night. A signal lamp of special design is located on a mountain peak or high tower and is so powerful that

airplane

Martin

Encl. Hoag & Ford

205 Union League Bldg
 Los Angeles Calif.

it can be seen for more than 150 miles with the aid of a telescope. The observer, located at a distant point of vantage, makes his measurements by pointing his telescope directly at the signal lamp. This is often difficult to locate through the restricted field of the instrument and accurate pointing is sometimes hard to achieve. To simplify this, a fused-quartz sight has been devised. Two rods of the material are placed against a shielded flashlight bulb on the barrel of the telescope. One extends back toward the eyepiece and the other forward toward the objective. At the outer ends, the rods are bent at right angles so that they extend up from the telescope and the ends are pointed and lightly frosted so that they will glow. Light from the bulb travels along the rods and is seen as two glowing tips, parallel to the barrel of the telescope, and these enable the operator to line his instrument up with the distant signal. The glow of the tips can be regulated.

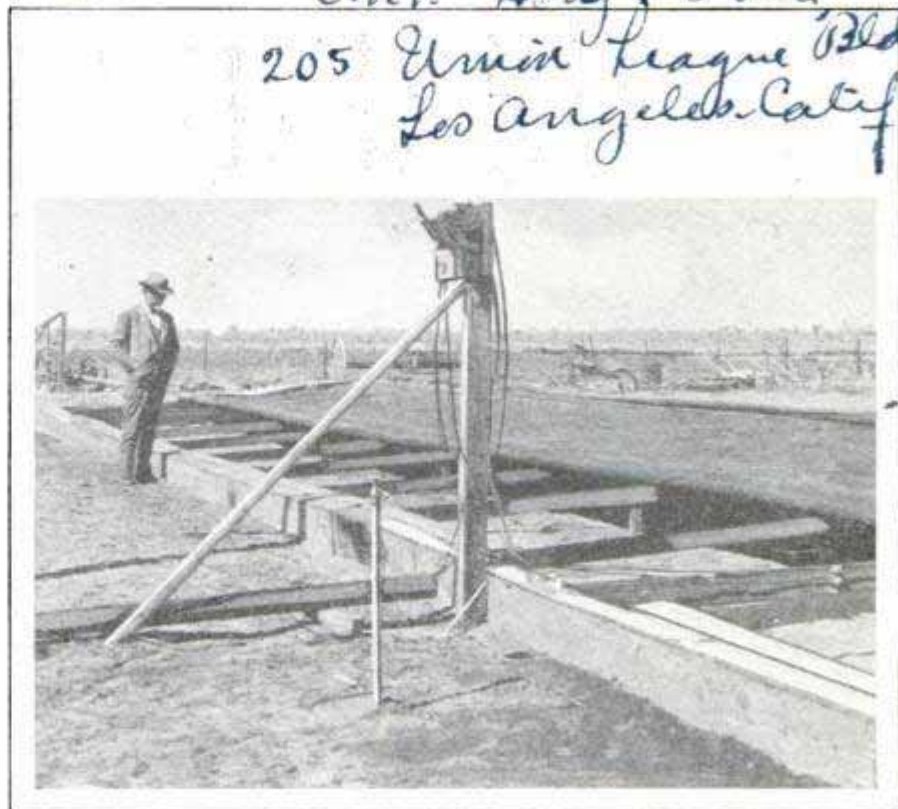

Electric Hotbed on California Farm; Switch Is Seen in Upper Center and Canvas Cover Is Partly Rolled Back

PLANTS IN ELECTRIC-HOTBED MATURED EARLY

Sweet potatoes a full week ahead of the usual season and other produce at unusually early dates, were grown on a California farm with the aid of a hotbed that kept the plants warm by electricity. The bed was supplied with heat through some 4,000 feet of resistance wires, arranged in parallel strands about an inch above the surface. A heavy canvas cover was rolled over the top of the bed when the artificial heat was used. During the season when the young plants were maturing and night temperatures fell below seventy degrees or so, the current was turned on to raise the heat of the bed about fifteen degrees above that of the outside air. The early yields enabled the grower to compete with products shipped in from southern points and enjoy the high prices of the early season.

SELF-OPERATED MARCEL WAVER WON'T BURN HAIR 25764

Women can produce their own marcel waves in a few minutes, it is claimed, with an accessory adapted for convenience and safety. It has a sliding barrel-and-lever arrangement so adjusted that it is said to produce the reverse shadow wave considered essential to a satisfactory dressing. It is made for electric operation or to be heated by gas or otherwise.

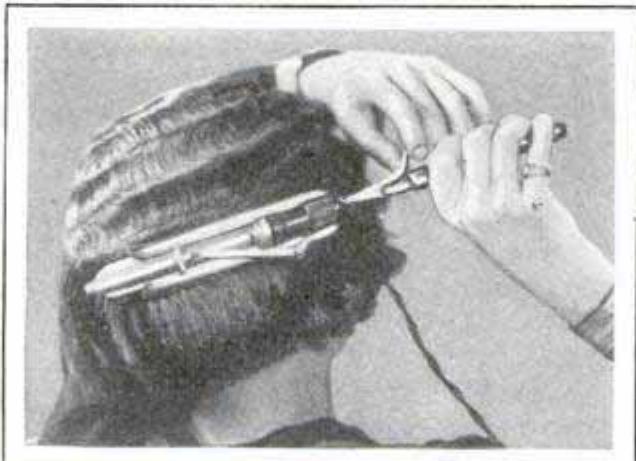

Producing Her Own Marcel Wave; the Iron Is Said Not to Burn the Hair and Has Electric Regulator

Cont. Mrs. J. S. Smith, 730 Beacon St., Los Angeles, Calif.

Developed by manager of agricultural community at Adelanto, near Victorville, Calif.

mp. Marcel Waver 223 Western Mutual Life

78

218 Jessie St. San Armando, Calif.
POPULAR MECHANICS

UNIQUE RAILWAY ACROSS DESERT TAPS RICH MINE

*Ironia Railroad
Ironia, Calif.*

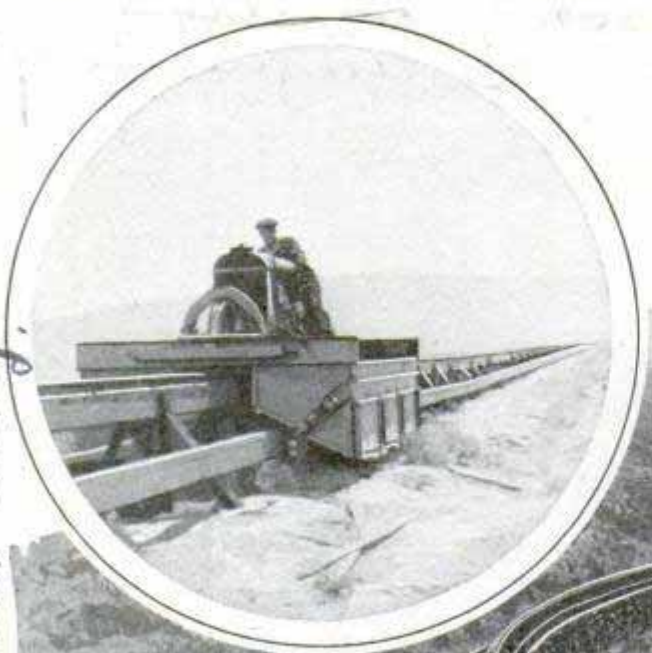

wheels, one front and one rear, fitted to the single rail. Rollers on the sides of the bunkers reduce friction when rounding curves and help balance the load. Each car is a train in itself. A speed of twelve to fifteen miles an hour is maintained with a load of five tons.

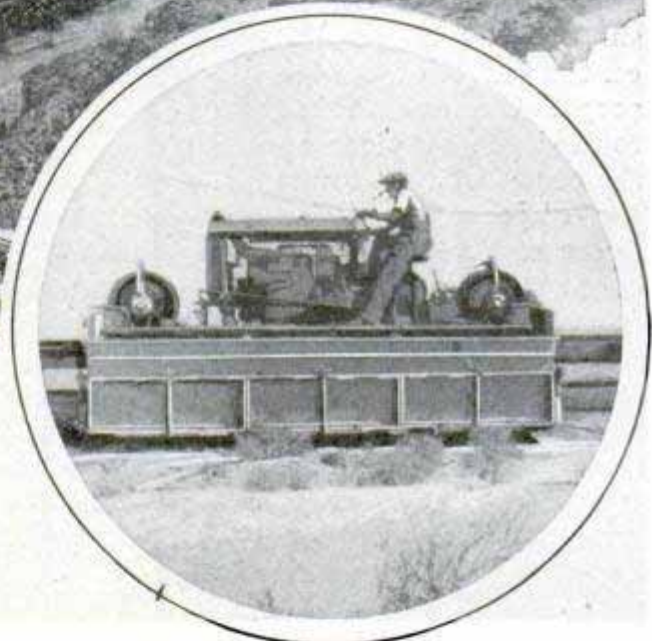
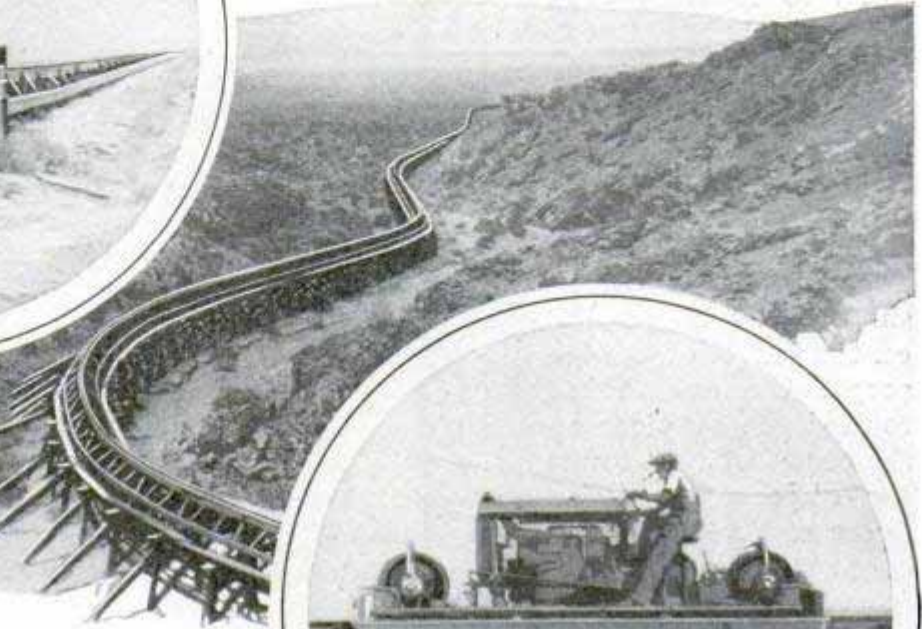

Up steep grades and around sharp curves, an interesting monorail line with gasoline-tractor trains is in operation across a stretch of desert country in California, to bring rich loads of magnesium salts from a mine, nearly thirty miles away, to a main-road shipping point. About forty-five tons of material are hauled daily in bunkers swung on each side of the tractor, which has but two

Front and Side Views of the Monorail Car. Showing Bunkers That Hold the Ore, and a Winding Track

LIFE-SAVING KITE TO DROP LINE OVER WRECKS

231

A life-saving kite, to carry a light line over a ship in distress and drop it on the deck, so that it may be used to haul a heavier line and the breeches buoy from the rescue ship, has been invented by a Florida man. The kite cord is used as a guide for a small traveler, carrying a light parachute and the rescue line. After the kite reaches the necessary height and passes over the wreck, the parachute is released, running up the kite string until it reaches a trip just below the kite, which automatically releases the parachute and

allows it to drift down, carrying the line across the deck. It is only necessary for the rescue ship to maneuver up wind from the vessel in distress, so that the kite will be carried across it, and this is the normal position, as the rescue ship then breaks the waves and forms a more quiet back-water in which the sinking ship can ride. The kite device does away with carrying an expensive life-line gun and is effective over considerably longer distances. If no breeches buoy is available, the line can be used to haul an empty boat down to the wreck, a similar line from the rescue ship steadying the other end and keeping the small boat from being swamped.

*Wm. R. P. Silvertown
Edison Ship*

Kaiser Wilhelm Institute *Free Service* *545*
Manheim **POPULAR MECHANICS** *Westbury Long Island*

**PETROLEUM IS STILL FORMING
 SCIENTIST BELIEVES** *2943*

That the natural formation of petroleum is not wholly a thing of the past, but may be occurring at the present time in nature's underground laboratories, is the theory of Dr. Hans Tropsch, of the Kaiser Wilhelm institute, Germany. He bases his belief on recent discoveries in obtaining synthetic petroleum from fuels of various kinds. Coal, for instance, is liquefied and gases formed are used as a starting point for the preparation of gasoline, naphtha, lubricating oil or paraffin wax. Dr. Tropsch pointed out that in the manufacture of synthetic gasoline, no refining process of any sort is needed.

Auto 2782

**ARMORED FORT FOR PAYROLLS
 GIVES ELECTRIC SHOCKS**

Motor "forts," the armor of which is electrically charged so that persons tampering with them will suffer severe shocks, have appeared in Los Angeles for delivering payrolls and bank shipments. In the top is a revolving turret from which a gunner commands a wide view. From his position there, the guard can throw the car out of gear and stop it at any time, and an automatic rifle is at his hand. Windows of the car are made of bullet-proof glass, and the tires are proof against punctures.

Removing Money from the Armored Fort; Danger Sign on Side Warns against Touching Car, to Avoid Electric Shocks

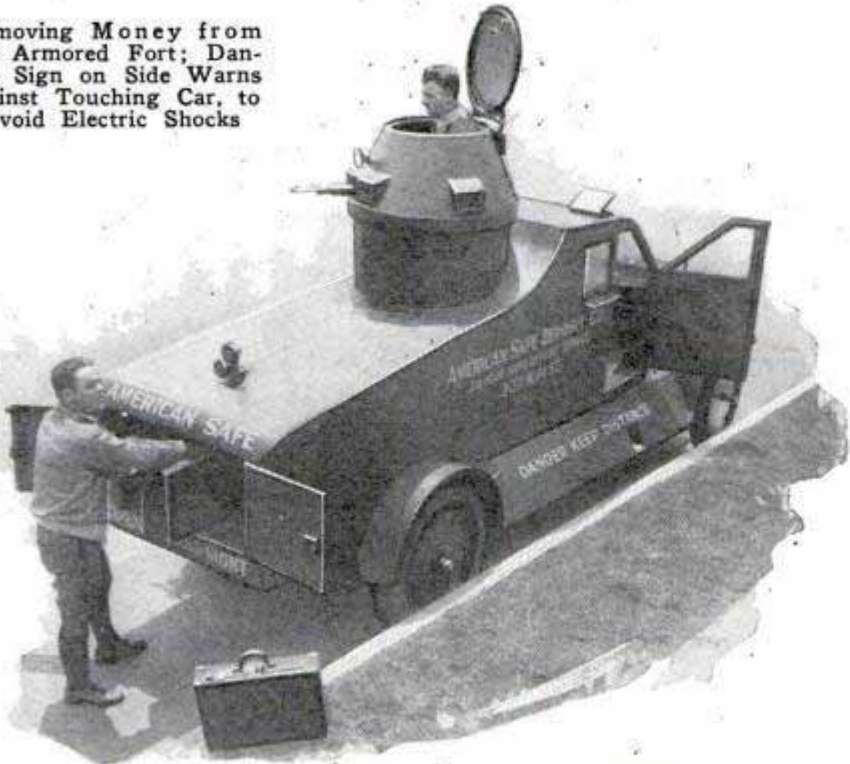

Used by American Safe Deposit Co, Los Angeles Calif.



George Gabres 96 above

Using the Special Wood-Boring Bit to Clean Out Tree Cavity, Preparatory to Filling with Cork

**FILL TREE CAVITIES WITH CORK
 TO PREVENT DECAY**

Blocks of specially prepared cork are being used in a patented process of filling the cavities made in trees, to check decay. The material does not chafe the tree, contains no injurious acids or chemicals, keeps out heat and cold and permits the branches to sway in their natural manner. It also keeps out moisture and allows the bark to heal quickly. Among other aids recently introduced for the treatment of trees are woodboring bits to drill trees for reinforcing and a special unit for cleaning out tree cavities. The bits are said not to clog in green wood and may be run in the full depth and drawn out instantly.

and. M. Kenful + 27, New York City

⌈About four feet is the average height of the pigmy people of New Guinea.

474
Chicago
5370 S. Dearborn
Chicago

MAGIC and

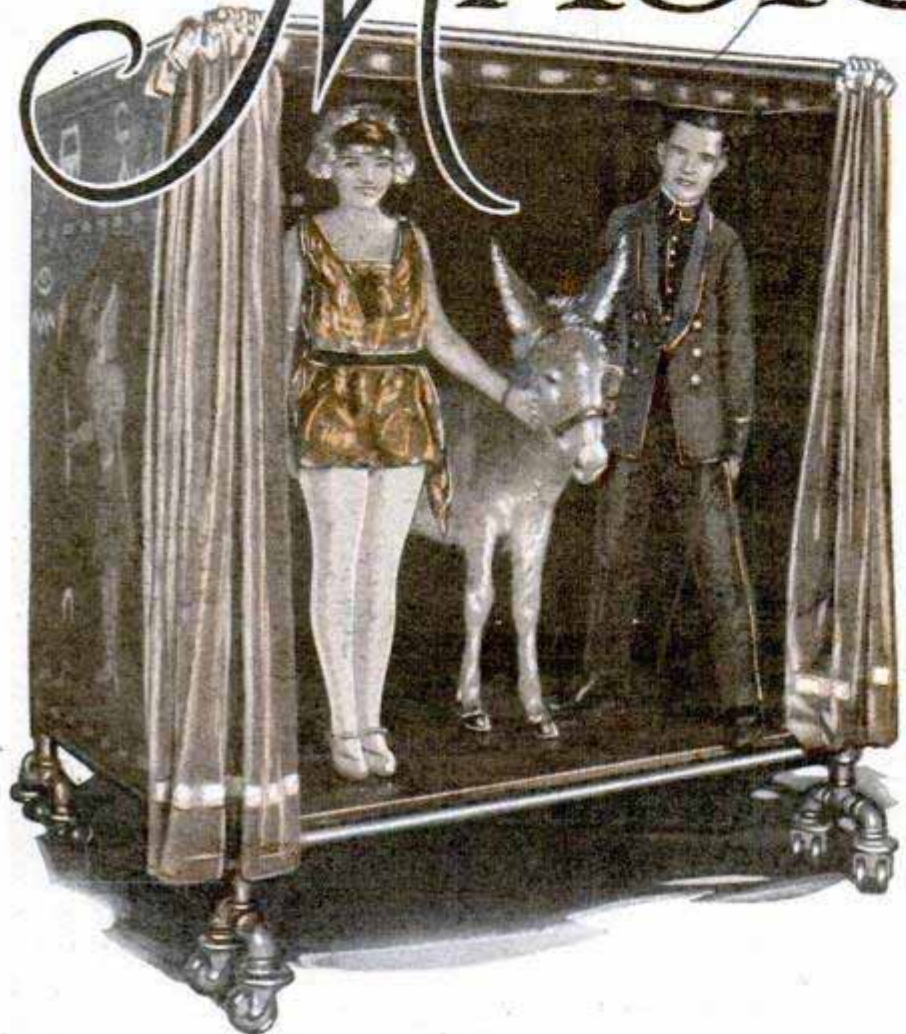

and test new illusions. Mechanics and carpenters are constantly at work. The cost of my "vanishing-horse" illusion was more than \$5,000. The effect can be given in a few words: the disappearance of a horse from a cabinet suspended in mid-air. The method, however, required much thought and more labor. First, a large, firm platform was required, ten feet high, with an incline up which the horse could go. It had to be portable, yet strong. The illusion was finally completed and, had I been an engineer constructing a bridge, I would have known that everything would be satisfactory. But a magical illusion has to meet more than a physical test; it must deceive the minds of the people who see it.

Cabinet Used in a Vanishing Illusion, in Which a Girl, a Boy and a Donkey Accomplish a Seemingly Impossible Disappearance

By HOWARD THURSTON

*Beechhurst
Long Island N.Y.*

THE magician of today must be an artist. But he is more dependent upon mechanical and scientific knowledge than ever before. Years ago, he could present a creditable performance with a few pieces of apparatus, but now the public demands huge illusions and sensational effects.

As a result, the manufacture of magical apparatus has become an active industry. There are several factories in America and others in Europe, where stock tricks are turned out and special apparatus is built to order. But, for my work, I have found it necessary to establish my own factory. At Whitestone, Long Island, near my home, is a large building which was once a motion-picture studio. It has now become my workshop, and there, during the summer months, I experiment, build

the essential step, precision and action. I experimented and tried improvements, but everything seemed to tend toward more complicated details. So I started at the beginning again, and experimented along a new line because of the difficulty of controlling the action of the horse. The heavy platform was discarded. The horse, and the rider with it, marched into a sort of pen mounted on a platform. They were raised in mid-air. A netting and a white curtain dropped in front of the horse and rider, and as the curtain instantly was lowered, the pen fell to the stage empty, the horse and rider having disappeared. In its new form the illusion worked perfectly.

For years I have been experimenting with the "rope trick"—that fabled mystery

How It Is Made



Thurston and His Aids Working on the "Crushing a Lady" Illusion, in Which the Box, Containing Two Girls, Is Lowered into the Cabinet at Left, without Injuring a Girl Who Occupies It

of India in which a boy disappears in mid-air from the top of a magically suspended rope. The problems which confronted me seemed almost insurmountable, but they were gradually solved, and for two or three years the illusion seemed to be on the verge of completion. But every time I was ready to produce it, some complication occurred, and I was forced to delay the first presentation. I carried the apparatus with my show and rehearsed the trick on many an afternoon. I worked on it during the summer, and finally publicly presented it for the first time. While it was a success, yet I still have work to do on it. There are many details which require improvements. To the average spectator, the "vanishing horse" would seem more difficult than the Indian rope trick. On the contrary, the latter has required many more years to evolve and has cost more than twice as much money.

One of the greatest marvels of modern magic is Kellar's "levitation." The mys-

tery of how to make a woman float in mid-air, in the center of a lighted stage, was not solved overnight. Many magicians experimented with it; and many mechanical contrivances were built, only to be discarded. Some years ago, I worked on an old form of the illusion, in which I caused the girl to whirl in the air. My mechanics worked diligently for several months, making changes, but always finding that something would not quite work.

One day I looked at the apparatus, and singled out a ring which the mechanic had spent much time in making. I told him that it was just a trifle too large and that he would have to make a new one. That was the last straw. He felt that he had reached the limit of his endurance. He quit his job and walked out. But the next day he returned, and set to work with new zeal. Within a week the illusion had been completed, and it worked perfectly.

This incident illustrates one of the greatest difficulties experienced by the magi-

cian. He must have mechanical assistants, and they must be the very best. But the tasks which they are required to perform are unlike those of any other occupation. They must not only make fine contrivances that will work perfectly; but they must be able to adapt them to peculiar needs. Imagine building a phonograph that would work, yet could be taken to pieces and examined with no traces of any mechanism! Such a task would be beyond many of the most skillful mechanics, yet it would be no more difficult than some of the requirements of magical illusions.

In my workshop I employ the services of expert carpenters, mechanics and painters. Every one of these men has his work to do in building apparatus that will deceive and mystify. Some of them travel as assistants with my show, because all apparatus must be kept in perfect working order and new tricks are often developed while on tour. A magician's mechanical helpers must not only be skillful, patient and persevering, they must also be reliable and trustworthy, because the ele-

ment of secrecy is quite important. It has been said that "there are tricks in every trade," but magic is a trade that is nothing but tricks.

Years ago, magicians employed cumbersome apparatus and heavily draped tables that were large enough to hide anything. A reaction set in, and sleight-of-hand became popular. A magician's ability was judged according to his lack of paraphernalia. Today the public likes to see apparatus, but it cannot be clumsy or suspicious in appearance. In the building of illusions, there is also the vital factor of safety. Many persons have been injured, and some have been killed because of faulty apparatus. The levitation of a woman in mid-air; my illusion in which a live lion is employed; the raising of a horse and rider above the stage; the projection of a girl into a nest of boxes that hang from the roof of a theater; all of these are illusions which were not completed as soon as a satisfactory method had been determined for their accomplishment.

Although many illusions have cost a

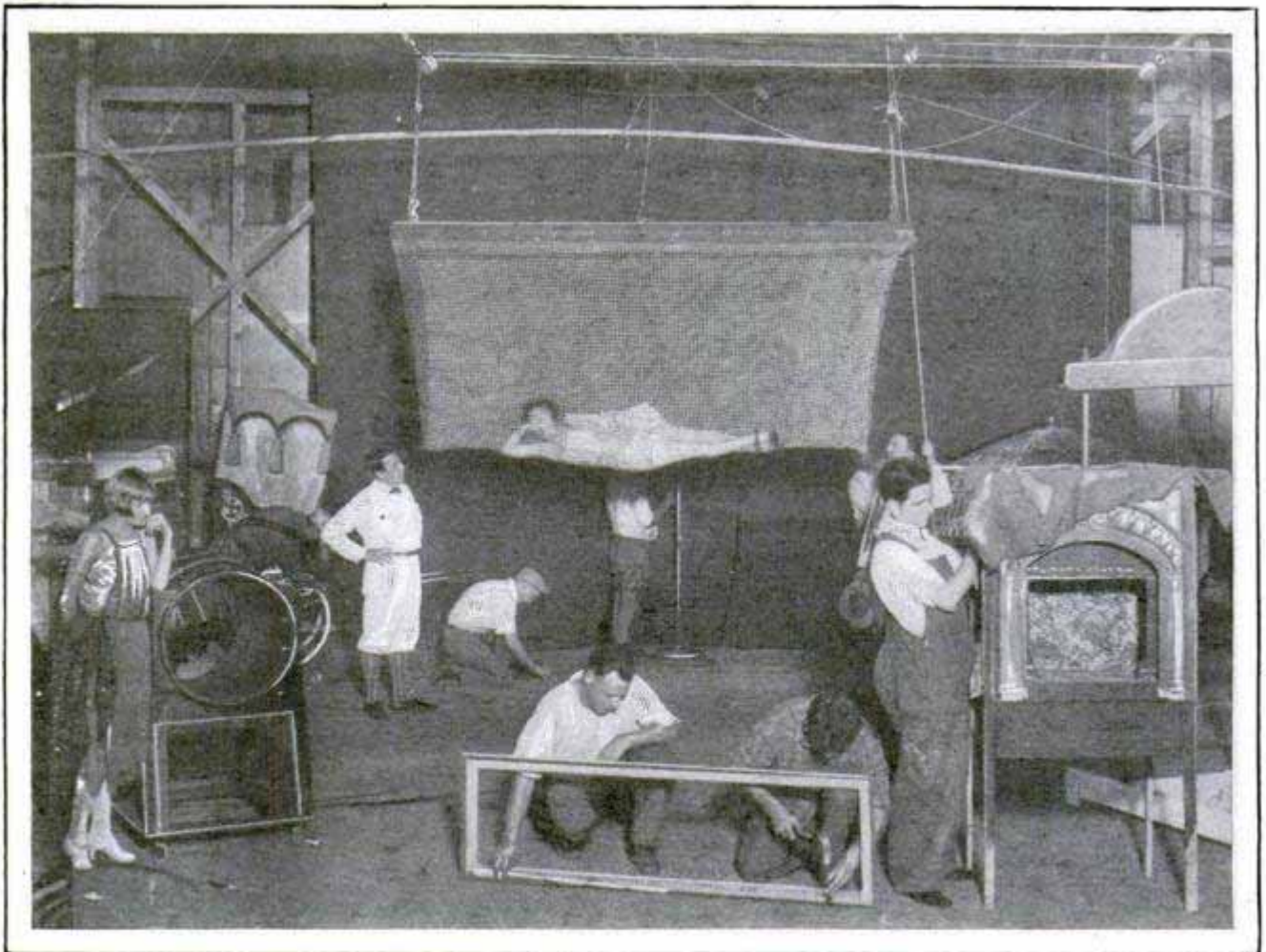

A Work Scene in Thurston's Shop; the Vanishing-Girl Illusion, Being Tested in the Background, Was Finally Developed into Another Trick, in Which a Horse Is Made to Disappear

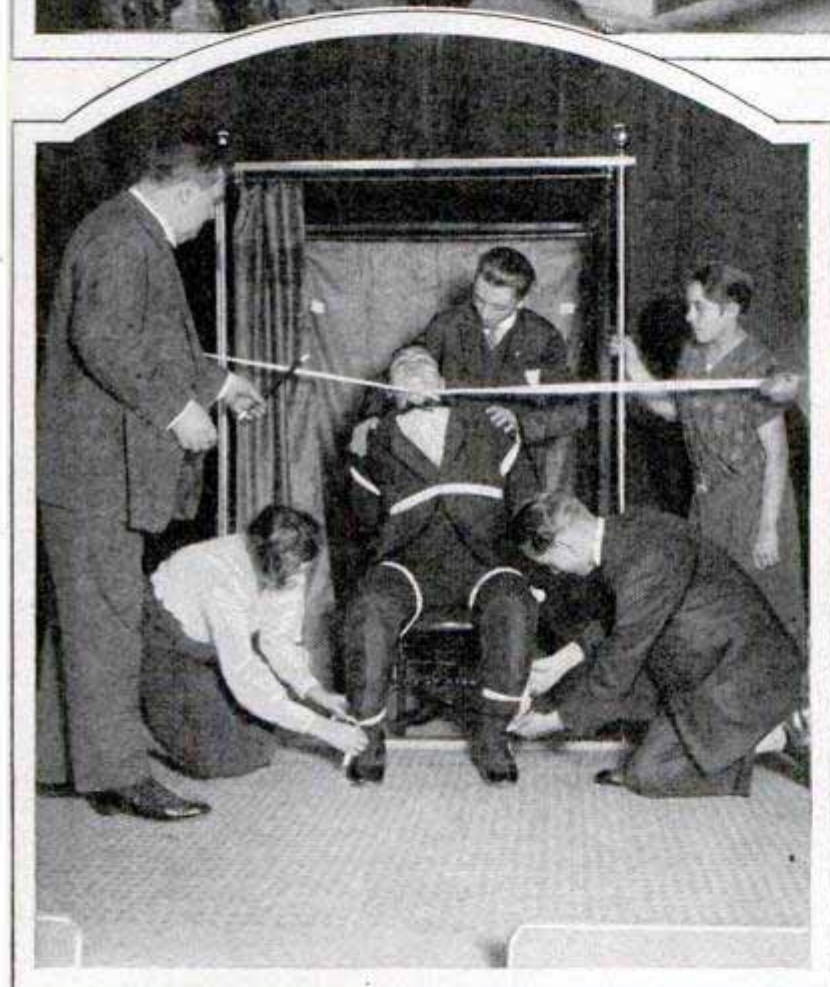
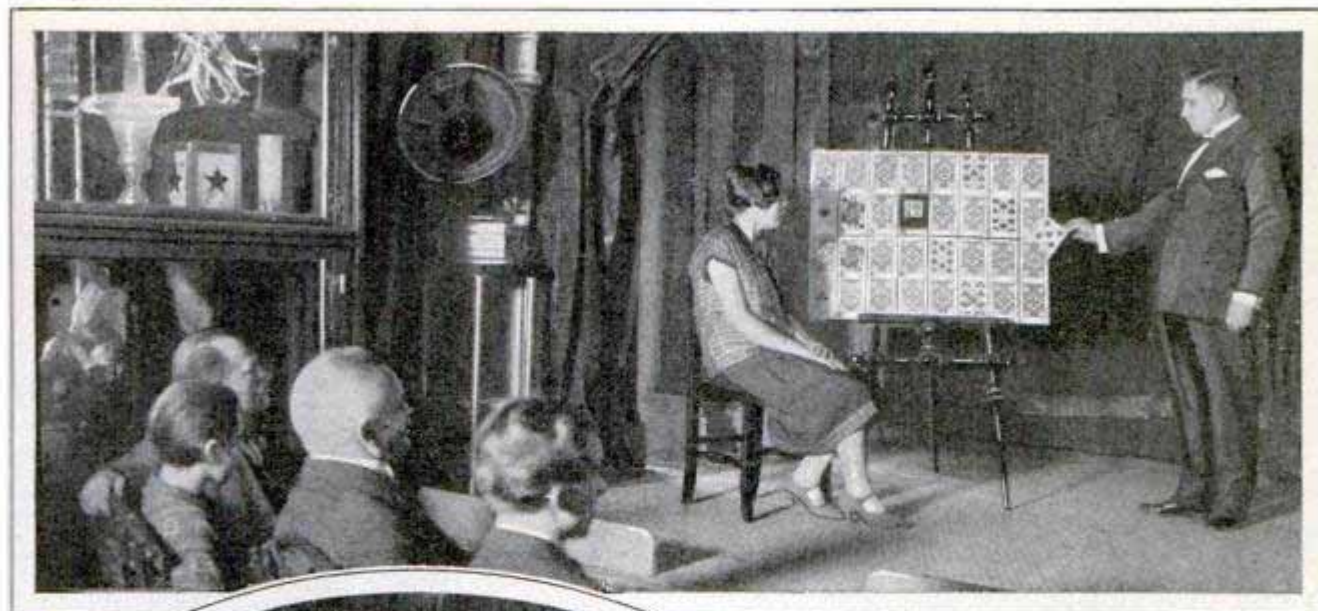

Some Famous Magical Feats as They Appear on the Stage; the Eye Is Deceived by the Ingenious Apparatus; the Trick at the Top Is a Memory Test Performed with Giant Cards

great deal of money, expenditure does not mean success. In many lines of enterprise, results are very closely in proportion to the amount of money spent. But in magic, the situation is different, because, to the audience, a trick is a trick, or an illusion is an illusion. The fine constructive details are not appreciated. Many of the best tricks cost very little.

Nearly every art, science and material

is used in the construction of magical apparatus. Vast and varied knowledge is required. It is an interesting fact that modern scientific discoveries are sometimes employed by magicians before the public has learned of their practical uses. Years ago, electricity was applied by magicians in the operation of certain appliances. Robert Houdini, who flourished seventy-five years ago, employed electro-



A Corner of the Conrad-Horster Magic Factory in Berlin, Which Produced the Houdini Milk Can, the Consad Dollar Staircase, the Wandering Bottle, and Other Mysterious Things

magnetism in his illusions, and before radio became generally known, enterprising magicians were using the wireless telephone in connection with pseudospiritualistic tricks.

A visit to a magical factory shows that the manufacturing of conjuring apparatus is a business which presents peculiar difficulties. The place is an experimental laboratory as well as a factory, for, while a trick is in the course of manufacture, improvements or variations often suggest themselves.

"Good magical mechanics are rare," says Carl Brema, head of a magic factory in Philadelphia, "for the man who possesses the necessary skill that is needed here dislikes the peculiar work that is necessary. We have tried out less skilled workmen who understand the purpose of magical apparatus; but they spoil too many tricks.

"You can't keep a man busy on just one job, because the demand is for a variety of items. As soon as a workman is getting used to one type of metal turning, he has to leave it and start on another, which may be just the opposite to what he has been doing."

In one corner of Brema's workshop is a veritable "morgue" of discarded magical

apparatus. Collapsible tables, with tops of umbrella ribs that slide down into the center leg; odd-shaped metal jars; wooden stands and battered tubes of tin are a few samples. These are the remains of magical "brain waves" that proved to be impractical. Sometimes tricks are salvaged from this junk heap, but for the greater part it consists of apparatus the purpose of which has been forgotten, and an experienced magician can look over the accumulated paraphernalia without being able to identify the bulk of it.

The uninitiated visitor could go through Brema's factory viewing the mechanical parts of tricks without learning a single important fact regarding the operation of any of them. The unassembled parts of tricks seem to have no definite purpose, yet each one has its use.

And so the magician of today testifies to the truth of Goethe's words in "Faust," that he who does not know the powers and properties of the elements cannot be a master over the spirits.

Write our Bureau of Information if you wish to know who makes or sells any article described in this magazine. Send no postage; the service is free.

Chicago Post 7/19/27
COMMERCIAL AIR TRAFFIC IN U. S. INCREASING *294*

Between 3,500 and 5,000 airplanes are now operating on commercial routes in the United States, there are twelve airways under systematic-schedule service and ten transport companies participating, reports of the department of commerce show. There was an increase of more than 100 per cent in the amount of mail carried last year as compared with the year before, and the value of aircraft and air materials was twice that for 1926, or more than \$24,000,000. An outstanding feature of the development of flying is the increasing safety. In 1922, during the first operation of the air mail, there was one death for each 138,600 miles flown. By 1925, this had dropped to one fatality for each 789,110 miles, and in 1926, there was but one death for 2,292,273 miles of flights.

HAT AND COAT RACK HAS LOCK TO PREVENT THEFT *2717*

Hat and overcoat are kept secure from theft, although not in the care of a check-room attendant, on a lock rack recently introduced. It operates on the coin-in-the-slot principle, a nickel giving the user possession of a key with which he may unlock his belongings. The hat is held by a hinged ring that drops over a raised disk mirror and the coat by a chain passed through a sleeve. The unit is adapted to men's or women's clothing.

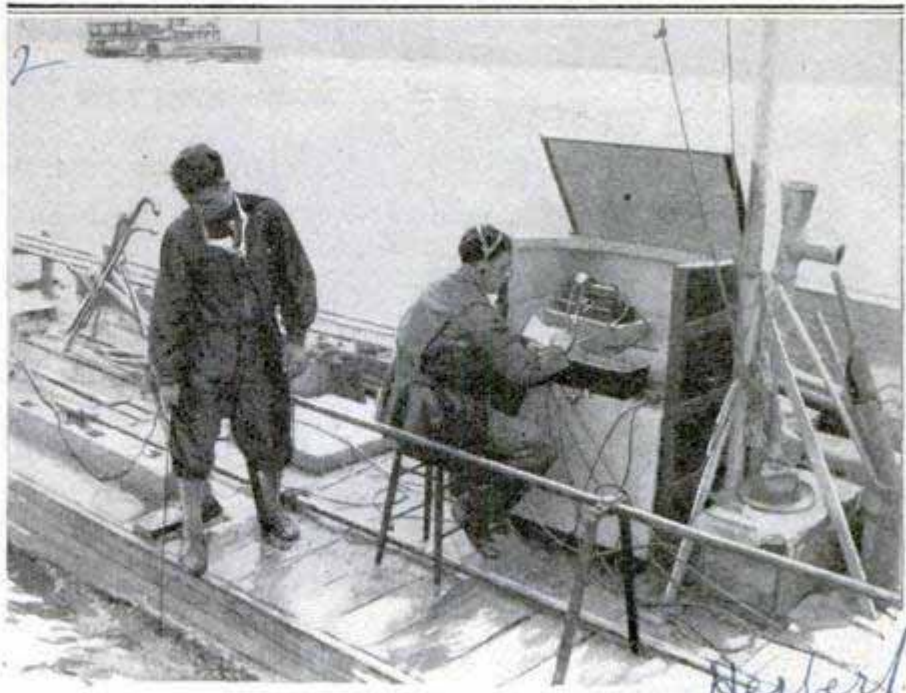

Taking Soundings of New York Harbor; as the Leadsman Makes His Report, His Call Is Registered on Dictaphone

CHART HARBOR BY DICTAPHONE TO INSURE ACCURACY

From daylight to dusk, three barges, lashed together and controlled by a forty-foot launch and outboard motors, make daily trips around New York's harbor, while the men on deck, members of the engineering corps of the United States army, take soundings of the water's depth. So thoroughly is this work conducted, that the charts made on the basis of the observations are said to be models of accuracy. The smallest wreck or other obstruction is noted in order to give ships

a reliable guide. One of the instruments that aids in this task is a dictaphone, much like that used in business offices. As each of the six leadsmen announces his measurements, he is switched to the dictaphone so that a permanent record is made and mistakes avoided. The innovation also saves time, doing a task which formerly required three men.



Locking Hat under Ring on Special Hanger

Minor & Hardin Mfg. Co.

Wally Kalumenas
 552
Essen *Dutch, Germany*
POPULAR MECHANICS
COIN-IN-THE-SLOT CURLING IRON
LATEST TOILET NOVELTY

2573



Enjoying a Home Convenience in Public, the Coin-in-Slot Electric Curling Iron in Use

Electric curling irons supplied with current for about two minutes, after a coin has been dropped in a slot, have been introduced in Germany. The iron is ready for use within thirty seconds and remains hot enough for service for four minutes.

MAIL BOXES FOR MOTORISTS
SAVE LEAVING CARS

2905 As a result of an exasperated motorist's suggestion, a special mail box, in which the occupants of cars can slip their letters or packages without stepping from the auto, will possibly be adopted throughout the country. Tired of seeking a parking place while he mailed his letters, the driver wrote to Postmaster Roy B. Nichols at Houston, Tex., recommending that a box be placed close to the curb so that it could be reached from the car. The idea was tested with an ordinary package box placed at the edge of the cement sidewalk with a ten-inch handle and a chain af-

Richter, experimenter
Engineer Alexander
 fixed to the drop. A "no parking" sign was painted on the pavement. Motorists soon patronized the box, as many as 800 cars stopping at it in one day, and collectors took mail from it on their way to the office, so that it received a minimum of seventeen collections daily.

STUDENT FLYERS' SPRING STICK
TO INCREASE SAFETY

2939

When amateur flyers are up with an instructor, they sometimes become "frozen" with fright and clutch the control stick rigidly so that the teacher has difficulty in getting the management of the plane. To eliminate this hazard, a spring stick has been introduced by a western aircraft company. Its chief feature is a flexible joint, so arranged that the instructor can easily maneuver his own stick even though the student is "glued" to his, thus taking control of the plane away from the pupil.

Alexander Aircraft Co., Denver, Colo.

DRY-LAND SHIPYARD LAUNCHES
BOATS BY MOTOR TRUCK

253

A motor truck plays an important part in the operation of a dry-land shipyard half a mile from San Francisco bay. Forty-foot yachts manufactured at the yard, are hoisted upon the truck, secured with chocks and hauled to the waterside where a derrick lifts them off, holds them in position for the christening ceremonies at the pier and lowers them into the water. Mast, engine and equipment are installed before the yachts are placed on the truck.

Where Motors Aid in Launching Ships; Hauling the Launch to the Water from Inland Yard



United Ship Repair Co.

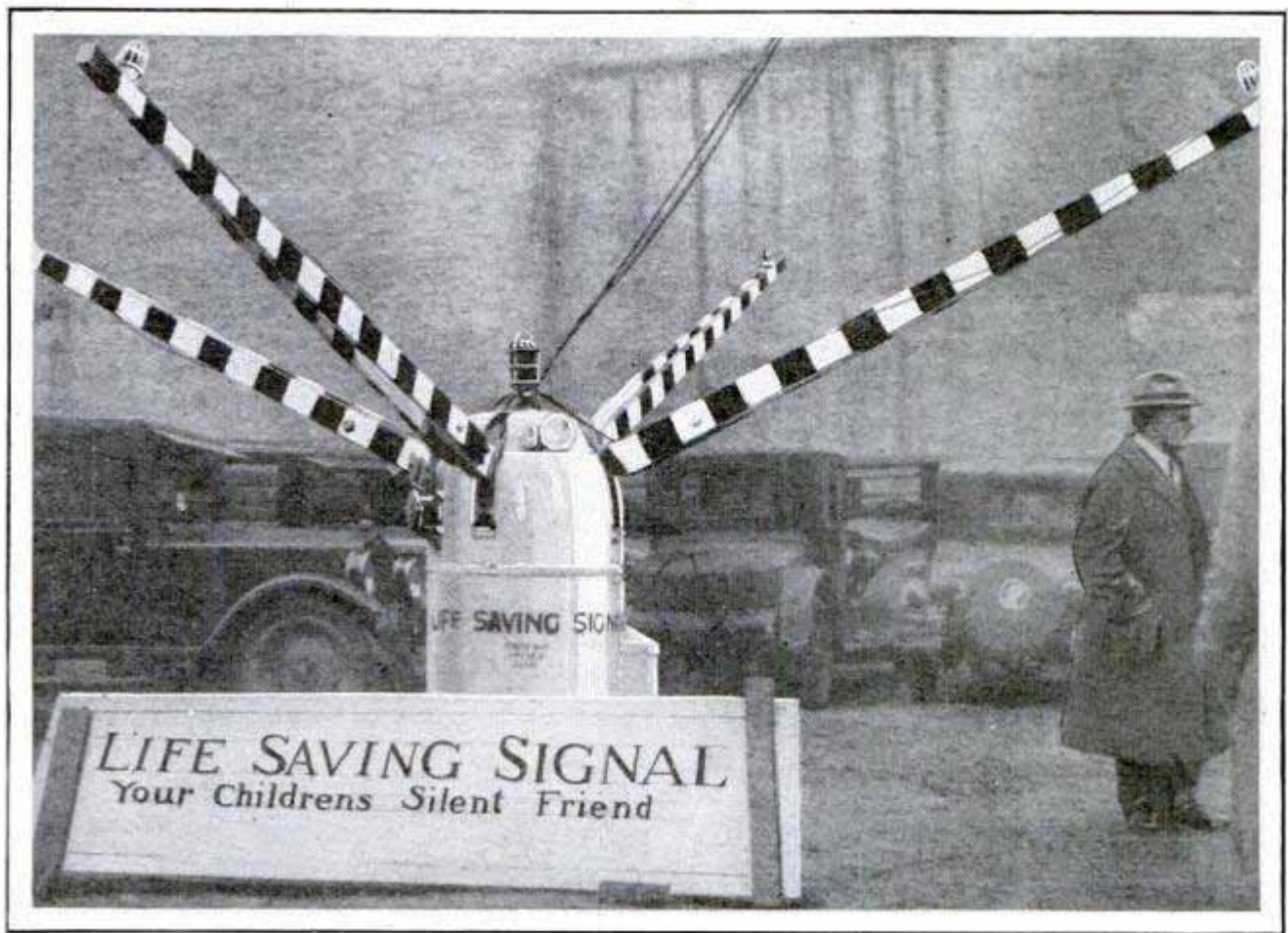

Mechanical Traffic Policeman at Street Intersection; the Arms Are Raised or Lowered Automatically with Stop-and-Go Lights, Affording Signals Visible at Greater Distance

GATES TO GUIDE STREET TRAFFIC PROMOTE SAFETY

George Huine
Automatic gates, somewhat like those at railroad crossings, have been devised by a Detroit inventor for street intersections, to supplement or take the place of traffic policemen. Two of the arms are up in the direction of travel while the other two remain down to denote stops. The gates may be synchronized with stop-and-go lights and operated without the need of an attendant.

SCENERY PAINTED FOR SNAKES SHOWN IN LONDON ZOO

2951
Realistic paintings of scenes from their native haunts feature the cages occupied by reptiles in the new house at the London zoo. Crocodiles have palm-tree and lagoon decorations in their quarters, tropical snakes live in a painted jungle and gila monsters in an alkali desert with lamps that give artificial sunlight. Glass in the windows and roof admits the ultra-violet rays and special heating and venti-

lating equipment has been installed. If the temperature rises above eighty-three degrees, the heat is automatically shut off and, if it falls below seventy-seven, it is turned on again by thermostatic controls, and the keeper is summoned by signals.

1631
GUARDED SASH PULLEY KEEPS CORD FROM JAMMING

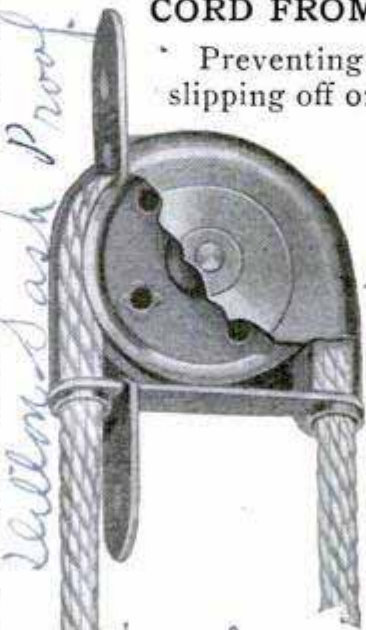

Preventing the weight cord from slipping off or becoming frayed on the edges, a window-sash pulley is fitted with an inclosed guard which keeps the rope in place. It also eliminates wedging of weights between the pulley and the back of the frame, prolongs the life of the cord and presents an improved appearance.

Chicago
61 W. Kings
The Stanley Works
new Detroit Conn.

7/29/23

Cincinnati, Ohio.

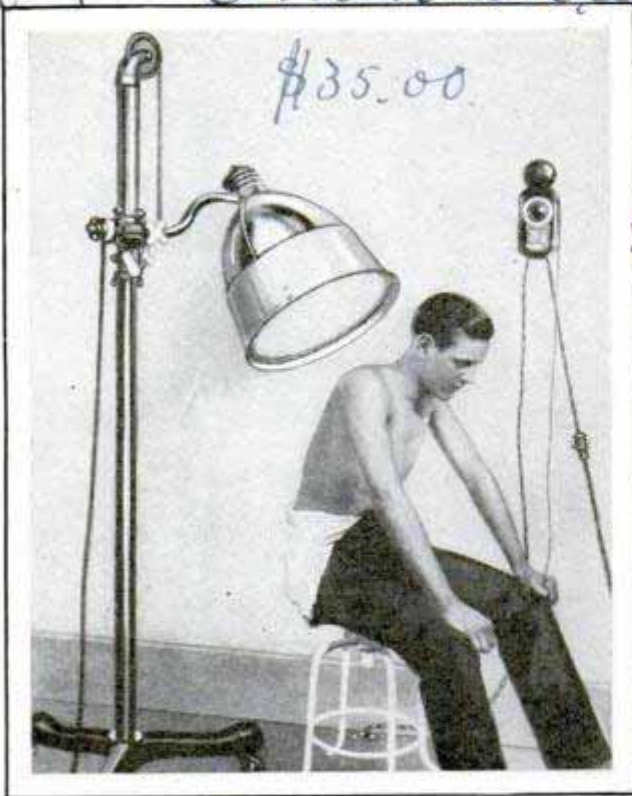

Artificial-Sunlight Lamp with Switch That Automatically Shuts Off Current at Predetermined Time

ELECTRIC TIMER AIDS DOCTORS BY REGULATING CURRENT

An electric timer, developed by a manufacturer of X-ray apparatus, to control the many kinds of electrical apparatus now used by doctors in treating their patients, is also finding a place in other and widely varied lines of work. It is being used to control dough-mixing machines in bakeries, to turn off photographers' arc lights automatically after a predetermined exposure, and even to regulate the electric machines used to impart permanent waves to hair. One of its features, designed to protect the doctor's patient, is proving valuable in the beauty parlors, as the subject controls a cord which will operate the switch independently of the time clock at any time the treatment becomes too warm. The clock is set with a dial, somewhat like those on a radio set, and can be regulated for any given number of minutes up to one hour. Unless the emergency cord is pulled, the clock will operate for the set time, and then open the switch and cut off the current. The timer can be stopped at any point, either by the operator or the patient, and when turned on again will automatically start at the same point and continue for the period originally set. When the emer-

gency cord is pulled by the patient, a gong rings to summon the attendant. The clock is self-winding.

FISH CAN CHANGE THEIR COLORS WHEN SEEKING PREY

Interesting studies of fish in clear waters have been conducted by Alfred C. Weed, of the Field museum of natural history, and have revealed, among other facts, that many species have the power of changing color, some more quickly and completely than the chameleon. Pike and pickerel are among the most skillful at this, the pike, for instance, while lying in wait for prey, being able to change the color of the spots on its back and sides to look like the little specks of sunlight shining on the bottom through the ripples at the surface. Northern pike will often swim into a thick bunch of green weeds, and its spots will change to a color matching that of the growth. In the shallow waters of the Gulf of Mexico is a small fish that can make its markings almost exactly resemble the dancing light spots on the white sandy bottom, due to the sunlight shining through the ripples. This ability not only helps the fish in pursuit of prey but also protects it from larger fish.

FREIGHT CAR DUMPS AT SIDE WHEN LEVER IS PULLED

For handling bulk freight, a side-emptying car has been introduced in Germany. It has a capacity of fifty tons and can be unloaded in a few seconds by pulling a system of levers operated from one end.

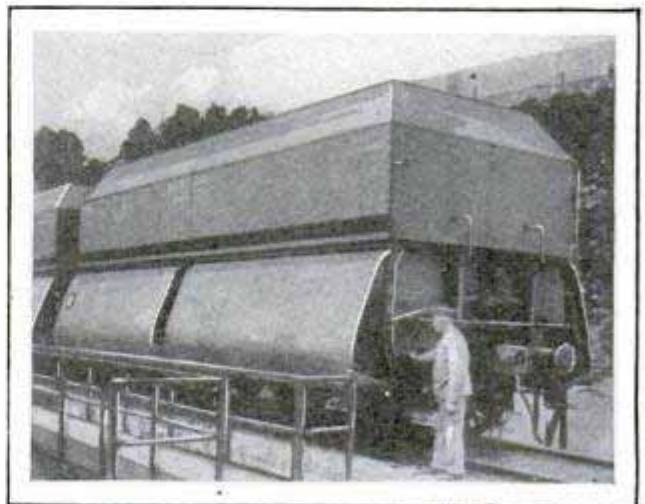

Freight Car, Dumped from Sides by Pulling Levers at End in Few Seconds, Holds Fifty Tons

Cml. Ernest Peterffy
354 Fourth Ave. N.Y.

R-809, 537 S Dearborn
Chicago

Hunting Seals *from the Air*

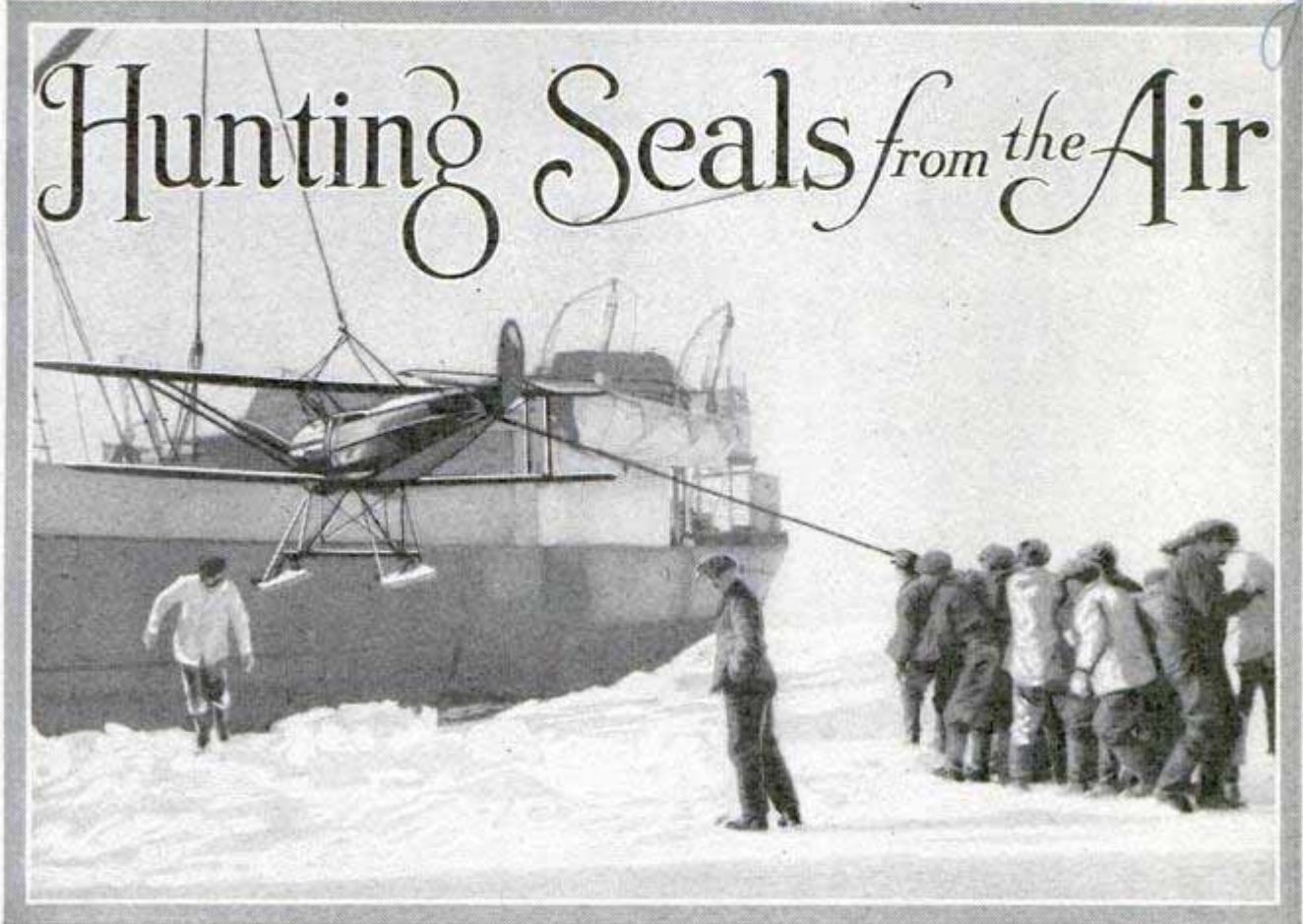

Lowering a Ski-Fitted Plane from a Sealing Ship, to Take the Air and Scout for the Herd; the Aerial Observers Are Able to Guide the Ships to the Hunting Grounds

HUNTING seals from the air? Yes, that's the modern way. Of course this does not mean that all of the operations are carried on from the air—that would be too much of a revolution from the old-time methods that were established back in 1763. But before a seal can be captured, it must be found, and finding seals on floes of hummocky ice in a region that is swept by icy winds and blotted out by sea-blown fogs, often proves the most difficult task that the sealer has to face. He may pass within a few miles of great herds and yet not suspect their presence.

The man on lookout is called the "scunner." He clammers aloft up the shrouds to the trapdoor in the bottom of a barrel on the foretopmast. This man in the scunner's barrel is said to "take charge." And only the captain's word carries more weight than his. The progress, and often the safety and the very life, of the ship depends on his judgment. A good scunner can accomplish the impossible in worming the ship through the most dangerous obstructions. Water and ice are churned to a milky white as giant blocks

leap up and disappear. The ship heels with quivering impacts, yet rides the ice down and vanquishes it. Yet all this battling may prove in vain if, by chance, the vessel is not headed in the right direction. The prosperity of St. John's, Newfoundland, and, in fact, of the whole colony, depends on the animal hunt. Failure spells misery. In the past there has been many a lean year, with its attendant suffering among the hardy islanders.

Naturally the radius of vision of the scunner perched aloft in his barrel is limited. The dazzling sun or the gray mist may mar his keenness. The ship may make but slow progress in bucking the ice and thus the field that is scanned is restricted. Here is where there is a chance for the airman to prove his worth. For him the ice floes are no obstruction. He skims along at an altitude low enough to enable him to detect a patch of seals. He usually employs a light machine that can readily be assembled and transported. It carries sufficient fuel for a two-hour flight only. It is well equipped with wheels, floats and skids, making it possi-

ble to start off ground, water, snow or ice. Such a plane can readily be transported on the specially constructed after deck of a sealing vessel.

When the pilot decides it is time to try a flight for spotting seals, the plane is lowered to the ice floe and all is put in readiness for the trial. Of course, if the ice is hummocky, the crew must be set to work leveling it off. With a small plane such as this it is possible to take off if a runway 100 yards long is prepared.

The experience of C. S. Caldwell, one of the most successful flyers engaged in this service, may be cited to show how the plane helps the sealer. On March 5, the sealing fleet left St. John's with the plane aboard one of the vessels. Six days they made their way through the ice floes advancing northward slowly. Then it was that the lookout spied a solitary seal. It was decided to be merely some stray animal that had drifted far away from the main patches. The captains all agreed that they were much too far south to be in the neighborhood of seals. All were intent on continuing north. The ideal weather for flying appealed to Caldwell, and soon he was in the cockpit of his plane and away on an exploring trip. Within

half an hour he was back. In his flight he had located a floe about five miles square and well covered with seals over most of its expanse. It was shortly after noon when he returned with his glad tidings, but by evening all of the other vessels, which had been notified by wireless, had come up to the vicinity.

The men held themselves in readiness to start the work of hunting, but as the legalized date for starting had not arrived, they were compelled to wait. In the meantime a howling blizzard swept down upon them, driving the vessels and the ice floes a distance of fifty miles before it had spent its fury. At the clearing of the storm, the men from the various vessels, numbering about 150 to each ship, were out with their equipment on the ice, ready for the day's work. On they went, collecting the skins in pans and marking them with the owner's flag, until the patch was exhausted. Then back they started for their ships, picking up the pans and dragging them behind.

If they had not had the plane along, they would have had to start out on a blind search for more seals, but again the aviator took wing and within thirty minutes he was back with the news that not over five miles away was another large patch



The Sealing Vessel Halts alongside a Convenient Ice Floe, Lands Its Plane and the Aviator Flies Away to Locate the Vast Northward-Bound Herds of Fur Seals for the Hunters



of seals. He had noted that much rough ice intervened, but he had also determined the best course for the ship to follow in reaching this herd, and this advice was turned to good advantage.

Any innovation that can be used to lessen the perils of the sealing vessels should prove a boon to these men who risk all every season for wages that, for the whole period of several weeks, do not amount to as much as a harvest hand will receive for a week's work in the wheat fields of Kansas. Just to list these hardships would require a whole page.

Fortunately the ships in use are built of greenheart and oak, massively timbered and with iron-sheathed bows. They grind, crash and shudder through the ice. Often they blast their way through the ice packs with bombs. When they are nipped they drift with the ice, then free themselves and struggle on to take up the fight again. It has happened again and again that the ice has caught a veteran ship in its powerful pincers and nipped it like an eggshell. Shafts and propellers break. Worn-out boilers blow up. Some stray spark may touch off the sea oil and then nothing can stop the tongues of flame that roll up their deadly black smoke, strangling its victims.

If it were not for a peculiar traveling instinct of the seal family, Newfoundland might not see them. When the ice begins to form in Baffin bay, it starts the seals

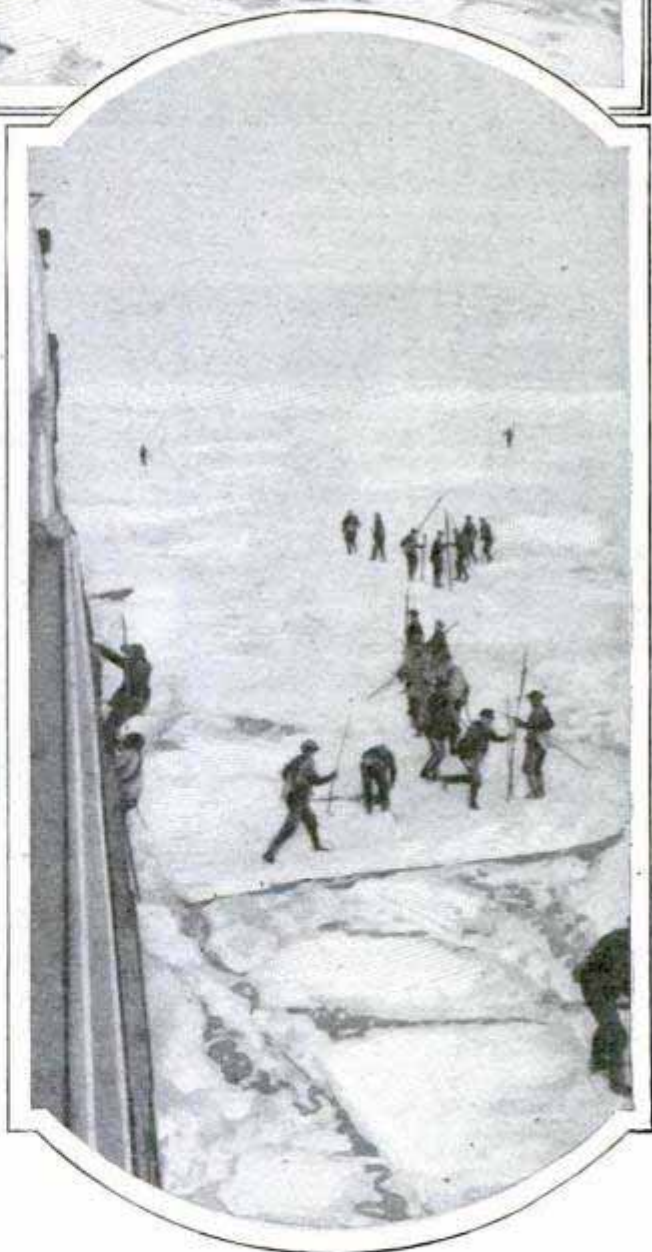

At the Top, the Mother Ship Seen from the Air, and, Below, a Party of Hunters Setting Out for the Kill; They Carry Iron-Shod Poles to Stick in the Ice and Mark the Dead Seals

southward by the thousands. They are told by nature that they must not be caught in solid pack ice, for that would prove fatal. By October 1 they are well under way for the south. The herds migrate at night; they swim from ten to twenty miles a day, following the Labrador coast and coming down in a long string. At the same time the Greenland seals, called "hoods," are moving southward also. About December 20 the hoods turn southwest from Cape Farewell to join the Baffin bay seals, called "harps."

The harps like to cling rather close to shore to escape the heavy ice. At this stage they are lazy and like to bask in the

sun, but the threatening ice follows them closely and they must keep on the move, only pausing long enough to hunt and fish. The rate at which they travel can be well established by the fact that it usually takes the main herd sixty days to cover the 840 miles from Cape Walsingham to Belle Isle.

Theirs is a strange life. Heavy ice would prove fatal to them, and yet they must have ice to suck, as they cannot drink salt water. They make great inroads on the codfish when finally they reach the Great Banks in their long migration. One authority estimates that it takes 3,000,000 codfish a day to satisfy these seals.

WAVE OF HAND STARTS MILL THROUGH RADIO CONTROL

2756 Seated at his office desk in New York city, Judge Elbert H. Gary, chairman of the board of the United States steel corporation, passed his hand over a silver-

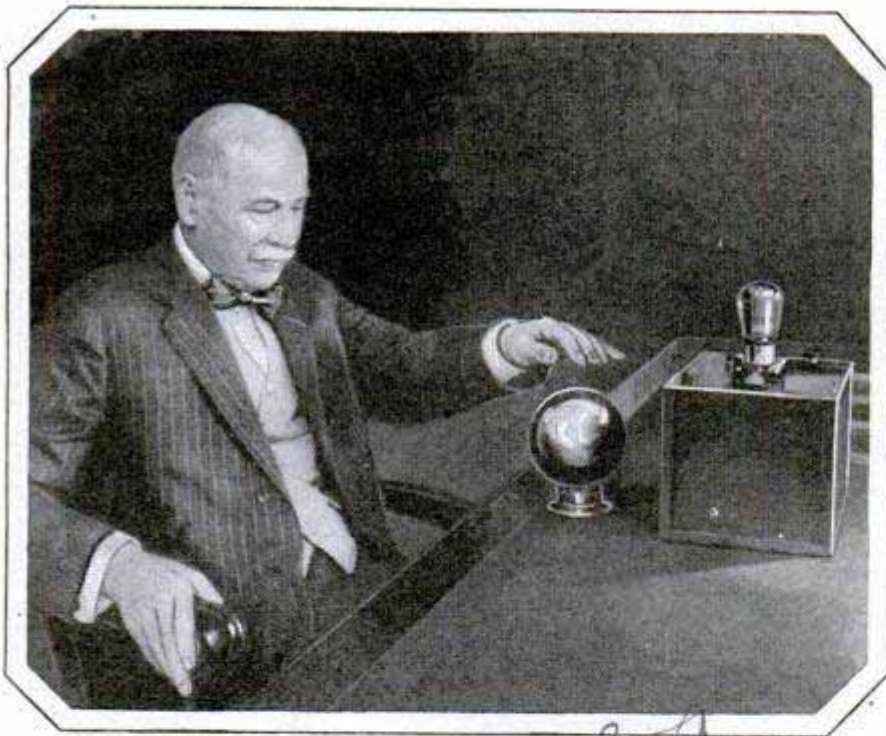

Judge Gary and the Magic Sphere; as His Hand Passed over the Ball, a Steel Mill, 300 Miles Away, Was Set in Operation

lined glass sphere, and the wheels of a mill near Pittsburgh, 300 miles away, leaped into action. It was a demonstration of the magic power of electricity as harnessed through radio waves and a supersensitive current-controlling unit, the Knowles grid-glow tube, which can be

used to release thousands of horsepower by the lift of a finger. The sphere, outwardly much like those with which the wonder workers of the fairy stories were reputed to call up spirits and perform miracles, in reality served as one plate of a condenser. Judge Gary's hand, passing over it for an instant, acted as the other plate, releasing a small electrical charge to the ground, and providing an outlet for the charge on the grid of the tube. This charge, in turn, operated a sensitive relay connected by a telegraph line with the Newark works of the Westinghouse electric company. There, the signal caused a shift in the frequency of a high-power short-wave radio transmitter that was in communication with a receiver, tuned to the same frequency, at the steel mills near Pittsburgh. This variation in frequency caused a zero or "dead spot" during which no current flowed in the receiver, thus setting a switch which started a 6,000-kilowatt motor generator driving a set of large rolls at the mill.

☛ A fish known as the "star gazer" has eyes on the top of its head.



Rustic Garage Fashioned from the Hollowed Trunk of a Giant California Tree; the Front of the Second Car Can Be Dimly Seen in the Background

FALLEN TREE USED AS GARAGE FOR TWO CARS

Centuries were required to make a mountain garage in Tulare county, California. It is the hollowed-out trunk of a giant sequoia tree, which is large enough to accommodate two automobiles at a time, and serves as an efficient shelter from the weather at all times of the year.

AUTO HIGHWAY COLORED GREEN TO REDUCE GLARE

Highway engineers in Texas are planning to color new automobile roads under construction a shade of green, to eliminate the unpleasant glare from white or light-colored roads in the sun. Experiments have been conducted in order to find the most satisfactory coloring material for the work and the best shade. While the plan will probably help in driving by day, some engineers have pointed out that the green road may not be so easy to follow at

night. A border line of contrasting color at the sides of the road as well as a center traffic strip have been suggested to overcome this difficulty.

ODD SHIP UNLOADS ITS CARGO ON ENDLESS BELT

To simplify the disposal of refuse in a Dutch town, a motor craft with steel conveyors in the hold, carries approximately thirty tons and can be emptied in about eight minutes. A hatch at the forward end opens for dumping the load into the sea.



Hatch at Bow of Refuse Boat Raised to Permit Dumping; a Thirty-Ton Load Can Be Dropped in Eight Minutes

Kansas City Times 5/18/27

Cameron County

*Built by - N. V. De Mercede
H. H. Adams Yard.*

Hardins veld.

*2522.
Tacoma, Wash.
R. J. Moore,*



Inventor with Guide That Lines Up Saw and Log Carriage for More Accurate Cuts and Saving of Timber

GUIDE FOR SAW-LOG CARRIAGE HELPS SAVE TIMBER

For his invention of a device to keep the log carriage and saw in alignment, a western lumberman was recently awarded a prize of \$100. It consists chiefly of a target arrangement placed on the head block so that a line can be taken between the carriage and the saw.

by National Lumber Assn
SYNTHETIC STEEL AND FOOD PROMISED BY CHEMISTRY

2963 Artificial rubber, steel and tin, and synthetic foods of various kinds, are plausible in view of recent advances in chemistry, but Dr. Frank C. Whitmore, of Northwestern university, points out that

such products will probably not be made in laboratories, in any quantities at least, until price conditions demand them. As long as food can be furnished at lower costs by natural methods, there is no reason for artificial production, and he believes the same principle applies to other materials. A metal alloy, stronger than steel but only one-fourth as heavy, may come from the chemist's workshop, and steel as it is produced today is far different from that of a few years ago, due to improved processes of refining. There is a monopoly on rubber, but the price is not likely to be advanced beyond a certain point, for, if it is, the chemist will busy himself producing a substitute at lower cost. One of the outstanding accomplishments in the field of chemistry is the cheaper manufacture of helium gas. Before the war, it cost \$1,500 a cubic foot, but government efforts and better ways of handling have reduced this to two and one-half cents a cubic foot.

MOTOR "LINER" OF HIGHWAYS OFFERS MANY LUXURIES

2676 Features of the ocean liner have been adopted in a motor bus recently put in tourist service out of Los Angeles. The driver occupies a "pilot house" high above his usual position, and there is a mezzanine deck for observation. Radio, kitchen and dining facilities and lavatories are other conveniences.

*Chemistry Dept
Dr. Frank C. Whitmore*

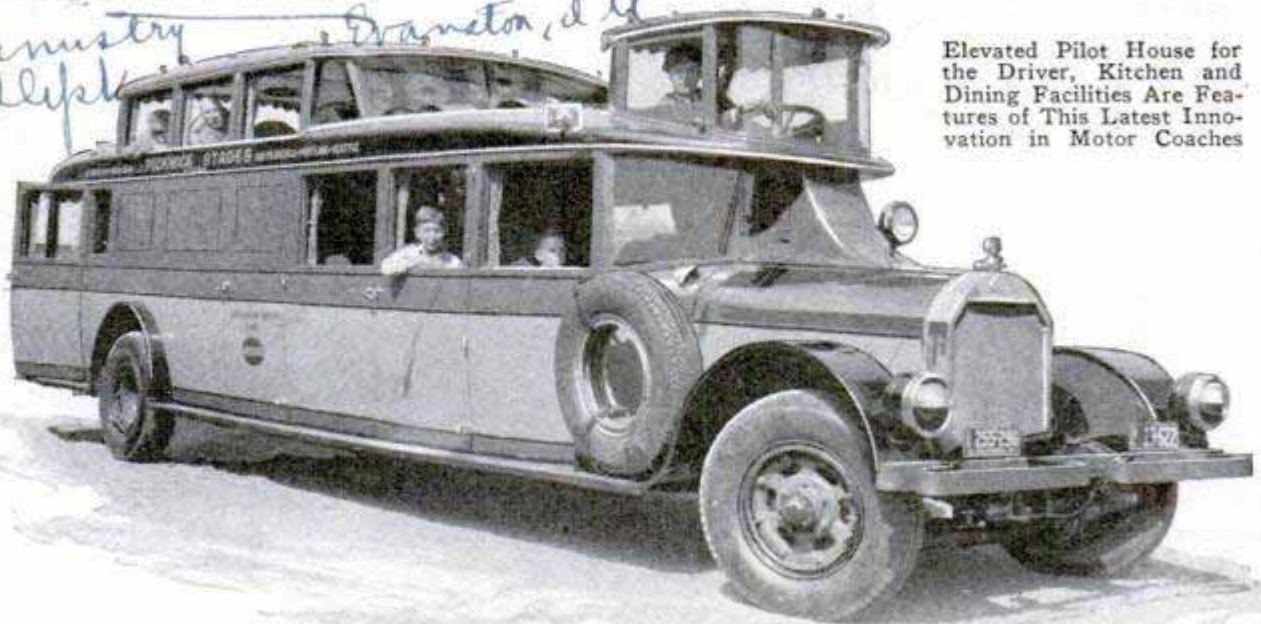

Elevated Pilot House for the Driver, Kitchen and Dining Facilities Are Features of This Latest Innovation in Motor Coaches

*Picknick Stages
Los Angeles, Calif*

RADIO TUBES AID POWER LINES

Developed especially for radio purposes, vacuum tubes are now employed in an entirely different field, that of power transmission. They have been adapted by engineers of the General Electric company for the operation of an instrument that indicates whether or not widely separated power-generating units are "in step," before the output of all the machines may be pooled in a common supply. Throughout the country, isolated plants are consolidating their resources in great central organizations, and before the development of the vacuum-tube synchronizing system, the "timing" of a group of generating stations was accomplished by means of potential transformers. This method was effective, but expensive. The vacuum-tube equipment provides the usual "fast," "slow" and "synchronism" indications, the potential from the lines being obtained from a special transformer and amplified until the indicating unit operates.

2947



Four of the Vehicles Made from the Coaster Set; Parts Are Securely Held Together with Bolts Instead of Nails

SCOOTER, WAGON, SLED IN ONE LATEST CHILD'S VEHICLE

Six different vehicles for children can be constructed from a single assembly lately introduced for practical service as well as sport. The wagon is strong enough to haul groceries and other articles, while the sled, scooter and three-wheeled coaster offer amusement and healthful exercise. There are no nails, the parts being held together with bolts, the entire outfit occupies but little room when knocked down and, besides saving the cost of buying separate units, the rig, or parts of it, can be used the year around. The wheels are of pressed steel with roller bearings and all members are durably constructed.

During a drive on pests in Arizona, more than 400,000 jack rabbits, gophers and prairie dogs were killed.

FLEXIBLE EDGE FOR DUSTPAN AIDS CLEAN SWEEPING

Attached without the use of tools to the dustpan, a flexible edge permits gathering up all the sweepings with a minimum of trouble. It adapts itself to irregularities in the floor surface, covers up the dents in the metal edge of the pan, and has a sharp side with no obstructions where dust can lodge.



1730
Isen Floor Right

The Hummer
2655
The Jordan Novelty Co., Air. Chicago
4236 N. Irving

Isen Mfg. Co.
Bascom, Ohio.

2601

Heroes of an

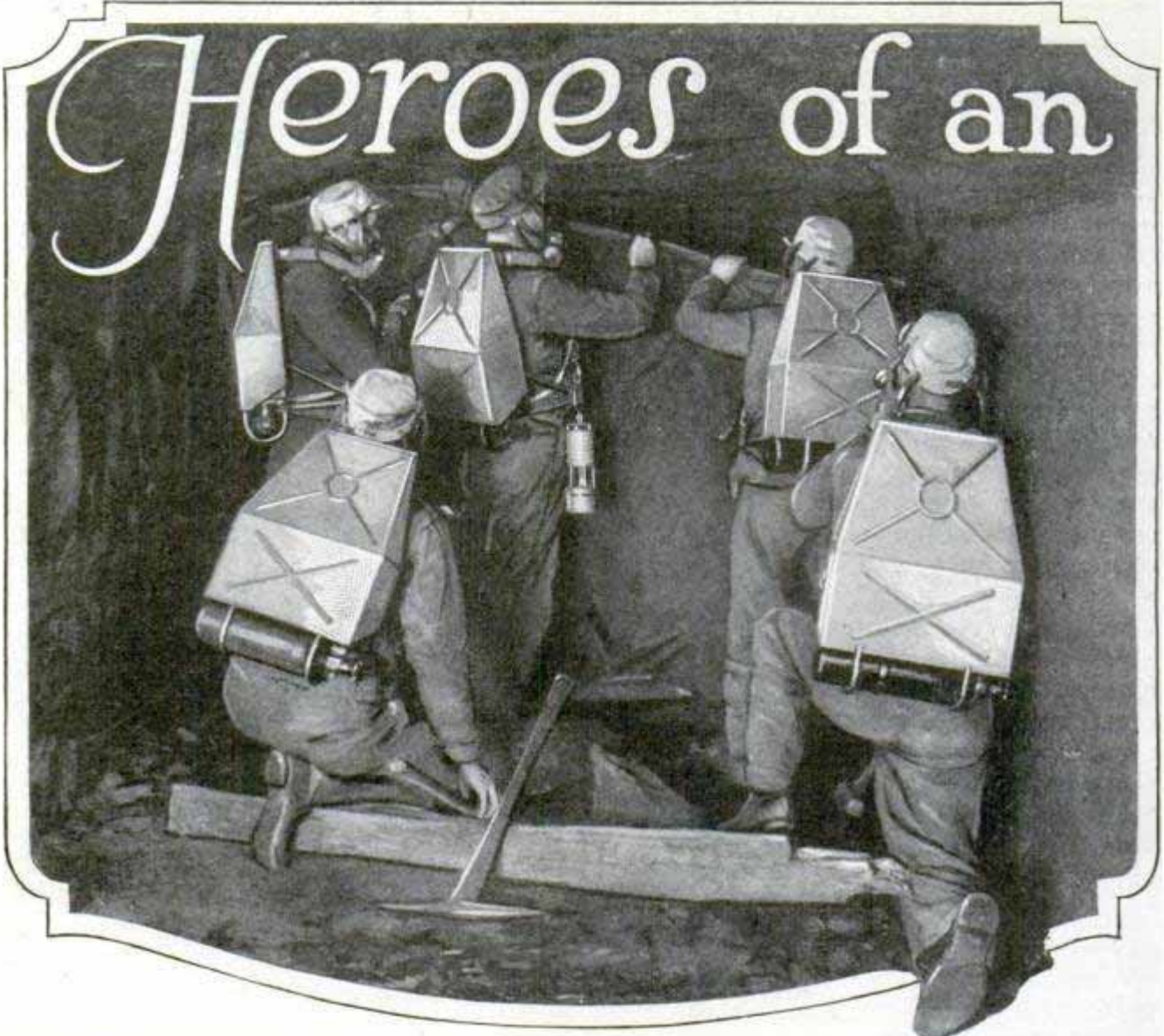

Mine-Rescue Crew Erecting Works to Control and Direct the Fresh-Air Current to Clear a Mine of Dangerous Gases after an Explosion; They Carry Large Oxygen Tanks on Their Backs

By M. E. CLEMENTS, 3829-13th St. N.W. Washington, D.C.

THE art of saving human life has reached perhaps its highest development in the mining industry, where a million men are exposed to a greater variety of hazards than confront almost any other class of workers.

Stirred into action by a long succession of explosions and disastrous fires, the federal and state governments, mine operators and the miners themselves have striven to perfect methods for the rescue of the survivors of these tragedies.

The bureau of mines alone has trained more than 200,000 workers in first aid to the injured and has instructed approximately 50,000 miners in the use and care of oxygen-breathing apparatus, which enables the wearer to penetrate atmospheres that reek with poisonous gas and suffocat-

ing fumes. The mine-rescue courses have reduced to a definite science the whole procedure of saving life underground, from the first steps involved in sounding the alarm, summoning expert assistance, and quieting the crowds at the pit mouth, to the bringing forth of the victims.

It is difficult to imagine a type of disaster more thrillingly dramatic in its progress and consequences than a mine fire or explosion. Far down in the shadowy depths, where men delve for that mineral wealth without which the world would stagnate in a day, a match is dropped carelessly, or perhaps an electric spark goes astray. The scent of smoke or the thunderous boom of an explosion sends scores, perhaps hundreds, of men, trapped in a maze of subterranean rooms and pas-

UNDERGROUND WORLD

sages, groping for the avenues of escape which are only too likely to be blocked by flame, fumes or wreckage. And at the pit mouth above there gathers that mob of bewildered watchers who can only wait the marshalling of grotesquely garbed peace-time heroes, whose duty it is to penetrate the underground murk.

In many mines there are complete telephone systems which, if not put out of commission by the effects of a disaster, may be utilized in notifying scattered underground survivors of the danger, and collecting information to aid in rescue attempts. Thanks to the mine-rescue training, efficient crews of breathing-apparatus men may now be found in practically every district. The telephone and the telegraph may be utilized in summoning the rescue crews of the bureau of mines, ever ready on their ten specially equipped railway cars.

The mine official who takes charge of matters, pending the arrival of the rescue



Using a Geophone, Which Detects Sound through the Rock, to Trace the Development of a Mine Fire

forces, sees to it that all air compressors are kept working, so that fresh air can be forced into the mine workings. Lest those underground may come in contact with electric wires and to prevent further fires and explosions from short-circuiting of wires that may have been blown down, he shuts off all electric power entering the mine, except such as may be needed for operating the ventilating fans. Blueprint copies of the mine map are made available for the rescue crews.

The rescue men work in crews of five, with a captain for each group. The crews are so organized that one will always be in the mine exploring in advance and a second crew held in reserve. The crews should work in shifts of four hours, two hours as advance and two hours as reserve. In addition to the rescue crews on whom the main burden of exploring the mine rests, special crews are organized for the purpose of bringing out the dead.

To complement the weird-looking oxy-

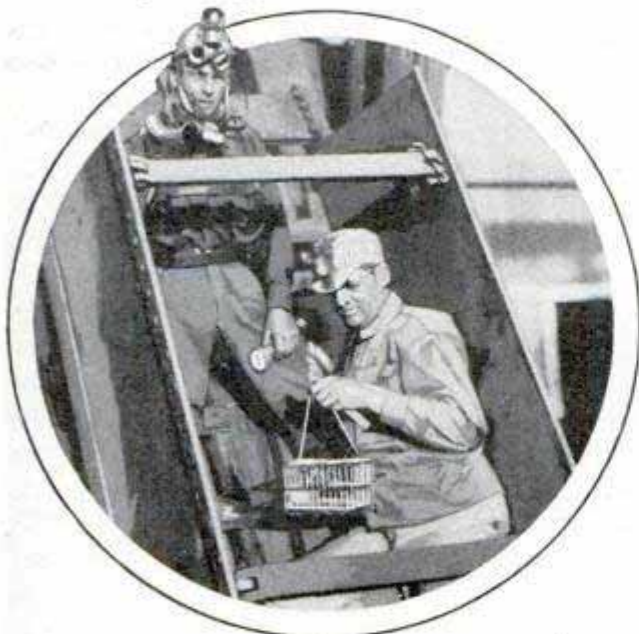

Rescuers Being Lowered into the Argonaut Mine in a Vain Effort to Save Entombed Miners from Death

gen-breathing apparatus, which supplies breathable air to the wearer for at least two hours, the rescue crews take with them various other appliances. The carbon-monoxide self-rescuer, a canisterlike device which can be attached to the belt, will, in a pinch, furnish a half hour's supply of fresh air. The canary, carried in a cage, makes a valuable sentry to warn of the presence of the deadly carbon-monoxide gas. The mine atmosphere may be so clear that the crew will undertake its first exploratory work without putting the cumbersome oxygen-breathing apparatus into actual use, keeping the apparatus in reserve for the time when smoky and gaseous conditions are encountered. Carbon monoxide, the most treacherous of all industrial gases, gives no warning of its presence, however, and the members of the crew might penetrate unknowingly into an atmosphere where they would be overcome suddenly. Here is where the canary contributes its part to the saving of lives by being more susceptible to the effects of carbon monoxide than man. When lighter concentrations of the gas are encountered, the bird will topple from its perch, which is a signal to the crew that the gas area is being reached and that oxygen apparatus must be brought into play. The canaries are revived, after giv-

ing their warning, and are used over and over again in mine-rescue work. The hardened veterans of the rescue cars become quite fond of the birds who travel constantly with them, and have given them pet names such as "Baldy," "Goldy," etc.

Portable electric cap lamps, thoroughly tested against the danger of emitting sparks which might ignite gas, are carried by the rescue crews, as well as flame safety lamps for determining the presence of hazardous gases. A portable telephone also may be taken along. With the types of breathing apparatus now in use, a rescue crew, in the course of one shift, cannot proceed, even along a straightaway unobstructed course, for a distance of more than 2,000 feet. In parts of mines where it is necessary to crawl and to climb over debris, the distance may not exceed 300 or 400 feet. If any one member complains of feeling unwell, or is observed to stagger or breathe unnaturally, the entire crew returns to fresh air. The rescuers keep constantly in mind that the main purpose of exploring a mine with oxygen-breathing apparatus is to rescue the living. When the conditions in any section of the mine are such as to indicate that there is little probability of finding men alive, operations are shifted to other places.

It is often impossible to extinguish a mine fire by the usual fire-fighting methods, and the rescue crews are called on to seal off the fire area, allowing the fire to burn itself out, but preventing its spreading to other parts of the mine. This is effected by erecting concrete barriers or stoppings, through which are inserted metal pipes for the withdrawal of air samples from time to time for determining whether the fire still rages. Mine fires have a way of burning over extremely long periods of time. A fire in a large copper mine has burned continuously for over thirty years, causing the loss of sev-

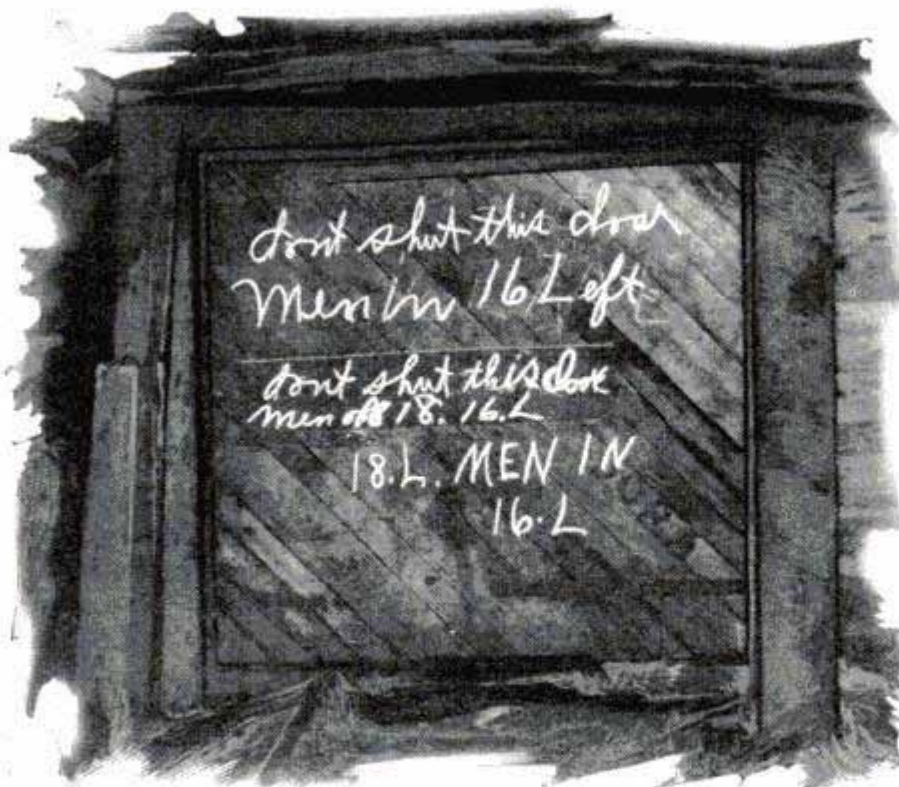

Notice Chalked on Door by Miners Who Barricaded Themselves in One Entry to Escape Deadly Coal Gases in a Tennessee Mine Fire



Fully Equipped Mine Crew and, Below, Inspector, with Methane-Gas Detector, Which Locates the Deadly "Black Damp"

eral lives and of several million dollars in damage to property. Another mine fire, which has been burning about seventeen years, has cost several lives at various times and has tied up more than a million tons of ore. The lives of many miners, who face the horror of being entrapped underground following mine fires or explosions, could be saved by a knowledge of the proper construction of barricades behind which they might seek protection against the deadly fumes and gases that come stealing through the shadowy recesses of their subterranean prison. Barricades of this nature may be built of lumps of coal, slate, or other rock, or ore, stopping the chinks or holes with clay, rags, clothing and similar material. When a fire breaks out or an explosion takes place in a mine, the first impulse of the survivors is, of course, to dash for the nearest exit. But if the smoke and gases are too strong and are advancing on the men, they must retreat rapidly, until they come to a place favorable for barricading



against their deadly pursuers. While retreating, the miners collect tools, timber, canvas, water, dinner buckets and other useful things. The site for the barricade should be near a valve in the compressed-air lines that supply the mine with air for power purposes, if air is so used. If there is no compressed air, the miners should lie down behind the barricade or sit on the floor, as thus they will breathe less of the precious air supply than if exerting themselves. Many mines now are constructed with underground refuge cham-

260
 c/o Bureau of Mines
 Washington, D.C.

bers to which miners might retreat, following fires and explosions, and close themselves in until help arrives. Such chambers are provided with drinking water, canned food and compressed air.

The business of rescuing human life underground has produced its full quota of heroes—and also of martyrs. Quite a number of the bureau of mines rescuers have sacrificed their lives in the course of their careers. As the net result of their work, however, records tell of hundreds of workers saved and many millions of dollars of property preserved. The Joseph A. Holmes Safety association, numbering in its membership thousands of miners, gives annually a number of gold medals in recognition of outstanding instances of courageous and resourceful action on the part of underground workers. The annals of this association hold the stories of deeds as daring as any performed amid the flare and tumult of the battlefield.

These records tell of Louis Pahulo, who groped his way through a gas-filled drift in a Colorado metal mine, where charges

of high explosives were due to cut loose at any moment, and dragged to safety a miner overcome by the gas. They tell the story of Eben W. Jones, section foreman in a Pennsylvania coal mine, who saved the lives of six miners about to be trapped by a cave-in of the mine roof, then lost his own while penetrating farther into the caving area in a desperate effort to warn other men. One page narrates the achievement of William Culp, job superintendent in a Michigan salt mine, who lowered himself in a bucket to the depth of a 550-foot shaft in an effort to save the life of an employe who had previously descended to investigate the breakdown of a pump, and from whom no word had been received, owing to the failure of the signal system. Culp made an almost superhuman, though unsuccessful, effort to rescue his fellow worker, forcing his way through an accumulation of several feet of water and an atmosphere permeated with deadly gases. After having exhausted his energies, he was unable to climb back into the shaft bucket and was drowned.

Lee Fetty and John McNeil, employes of a West Virginia coal mine, were on duty underground when an explosion occurred. At the first sign of danger, they arranged a plan for rounding up twenty-two men working in their section of the mine and collecting them at the entry, where quickly constructed barricades shut out the deadly mine gases and preserved the lives of twenty of the men until the crisis was past. Two of the men, who left the barricade in an effort to escape, lost their lives.

Thomas Hislop, assistant mine foreman in a Pennsylvania anthracite operation, deliberately took the risk of losing his own life when, on the occasion of a roaring mine fire, he tore his way



Bringing Up an Air Sample in a Sealed Glass Tube from a Burning California Mine, to Enable Expert Chemical Analysis to Be Made



Scene Following a Coal Mine Explosion at Eccles, West Virginia; the Railroad Coach in the Foreground Is a Rescue Car of the Bureau of Mines, Manned by Trained Men

through flame-filled underground passages and changed the course of the mine ventilation current, thereby saving the lives of sixty-three entombed men. Hislop was outside when the fire broke out in the timbering, about twenty feet from the mouth of the shaft. He immediately descended, and, realizing that it would be only a matter of minutes before the entire workings were filled with suffocating smoke, he battled his way through dark reeking underground passages until he reached certain mine doors which, on being thrown open, diverted the air current, causing it to carry the smoke back up the shaft and out of the mine.

One of the most notable instances of effective mine-rescue operations was that performed at a disastrous fire at North Butte, Mont., in which 163 men lost their lives. Two bureau of mines rescue cars were rushed to the scene, and during eight days of rescue and recovery work, over 175 persons wore oxygen-breathing apparatus. Many trips of 5,000 to 7,000 feet or over, in poisonous fumes, were made, and in some of these the men climbed over or around strings of ten or more ore cars, and went considerable distances in smoke and steam so dense that a sense of direction was maintained only by feeling the track rails. Working with maps, the rescuers examined every foot of the

thirty miles of drifts and fifteen miles of stopes, raises and manways. Before the work was ended, thirty-one men were rescued from behind barricades, other living miners were helped to safety and 163 bodies recovered.

Approximately 3,000 men lose their lives annually in the United States as the result of accidents in mines. The tragic coal-mine fires and explosions that frequently shock the nation are generally caused by the ignition of explosive gas. The initial blast fires the accumulations of highly explosive coal dust. The system of rock dusting bituminous-coal mines is now being rapidly adopted as a means of limiting and preventing explosions. By rock dusting is meant the thorough spreading of quantities of finely pulverized stone dust in every part of the mine. When a minor or local explosion occurs, the advance air wave, always set in motion by it, will precede by a fraction of a second the onrush of the flames, and will project the rock dust into a cloud or screen, which checks and cools the exploding coal dust, holding within a very small area what otherwise would, in all probability, develop into a mine-wide disaster.

☛ Trees with smooth bark are said to be less susceptible to lightning than those with thick, furrowed bark.

2749



When Liberty's Torch was "Lighted"; the Effect of Fire Was Produced by Smoke from a Special Chemical Regulated by Mechanical Means

FLAMES FROM LIBERTY TORCH ONLY CHEMICAL SMOKE

Smoke pouring from the torch of the statue of liberty and an American flag draped from the figure's upraised arm, were features of Flag Day exercises centering about the statue on Bedloe's island. The smoke was regulated mechanically, giving the torch a realistic appearance.

AIRPLANE HOP FROM BIG LINER POINTS TO FASTER MAILS

Practicability of using airplanes to speed the delivery of ocean mails from liners was demonstrated recently, when Clarence Chamberlin successfully launched his small Fokker plane from an improvised runway on the deck of the "Leviathan" and, less than three hours later, landed at the Teterboro, N. J., air port, where he

2019

Chicago Evening Post
8/1/27

handed a mail pouch to post-office officials. It was estimated that the liner was eighty-two miles off the battery at New York, when the hop-off, the first successful one to be made from a liner at sea, was accomplished, although there was a fourteen-mile breeze blowing. Because of a fog, Chamberlin landed first at Curtiss field, before proceeding to his destination. The runway was made of planks set in front of the ship's forward funnel. The plane left the run about seventy-five feet from the starting point, rose gracefully, dipped in salute over each of three destroyers standing by and headed for New York. The aviator declared that he just as well could have carried passengers, had no trouble at any stage of the take-off and asserted that the whole plan was entirely practical. The test was made to demonstrate that planes could leave

a ship before its arrival, thus cutting off several hours in the delivery time for mails from overseas.

PEA SHELLER THAT FITS ON DISH SAVES TIME AND WORK

294

Pea pods are quickly cut open and their contents removed with a simple unit that

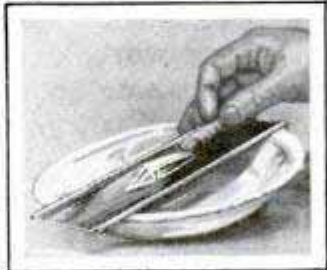

fits over a dish, saving time and work and sparing the fingers. The pod is placed in a grooved guide, moved along until it strikes a small blade which cuts

it open, and the peas are scraped out as the pod is passed on to the other side. The sheller is made of metal and has no parts to get out of order.

Strico Mfg. & Sales Co., 169 Jackson St.

available



One-Car Ferry for Crossing the North River in New York; It Is Steered through the Automobile's Own Steering Gear and Requires Only One Man to Operate It besides the Car Driver

FERRY FOR AUTOS IS GUIDED BY STEERING WHEEL

Autoists are made independent of larger craft in crossing the North river at New York in an individual ferry just large enough for one car. Only two men are required to operate it, and the steering is done through the car's wheel by the driver in his regular position.

OLD RAZOR BLADES SHAVE LAWN IN HOMEMADE MOWER 3005

The question of what to do with old safety-razor blades has been solved by F. M. Durkee, of Brookline, Mass. He shaves his lawn with them. Weakened by illness and unable to push an ordinary mower, Mr. Durkee fashioned an electrically operated one of his own. The motor of an old vacuum cleaner was rigged on toy-cart wheels, connected by an axle. Shafts were mounted in holes bored in the latter and geared to the shaft of the motor with a sewing-machine belt through pulleys. Razor blades were bolted to brass disks at the bottom of the shafts. An extension lamp cord was plugged into a house socket

to supply power to the motor. The machine was light and easily pushed and the cutters proved efficient in giving the lawn a close and even trim.

LETTER DUPLICATOR MAKES FOUR COPIES A SECOND 1649

Letters are duplicated at the rate of more than four a second in an outfit a Berlin inventor has devised. Each copy is said to be free from blurs and the last ones are as legible as the first. The impressions are made from a thin metal-sheet matrix.



© Henry Miller

For Rapid Letter Copying; Impressions Are Made from a Thin Metal-Sheet Matrix and Are Free from Blurs

Dr. Thomas Berlin
Nissen
B. H. Hermann

CODFISH ON CAR-LICENSE PLATE HONORS STATE'S INDUSTRY

2474



How Next Year's Massachusetts Auto-License Plates Will Boost a Home Industry

Massachusetts has introduced a new style in license plates for 1928. The tags are to be marked with the figure of a codfish in recognition of one of the state's leading industries. Other states are expected to follow this idea with decorations of special significance.

RATTLESNAKES BOUGHT BY YARD TO STOCK BIG ZOO

Shopping for kangaroos, kittiwakes, emus and other specimens, to stock Chicago's zoological gardens, is easier for E. H. Bean, director, than a woman's task in selecting a new pair of shoes, for he is in touch with strange-animal markets throughout the world and has a list of professional and amateur dealers who make a specialty of rare animals for exhibition purposes. If anyone wanted an African lion, Mr. Bean could have it shipped and delivered in thirty days. If reptiles are wanted, a letter addressed to "Snake King," Brownsville, Tex., usually brings a reply signed, "rattlingly yours," with a price list of rattlesnakes at so much per yard, with a slightly higher price if the specimen is a self-feeder and need not be coaxed to eat. Sailors, tourists, foreign consuls and even missionaries are relied upon to help stock the zoo, for many

Christian Science Monitor 7/27/27 3011

of them are in the habit of collecting pets from strange countries. Some zoos have animals to trade. For instance, a director may advertise that he has an extra antelope in good condition and is willing to exchange it for a spoonbill duck. Mr. Bean has 170 park men on his lists from whom he may obtain animals at various times. According to the director, stocking the zoo is not nearly as difficult a problem as finding skillful keepers for the animals. Feeding and caring for them require special study and talent that cannot be acquired by reading, Mr. Bean says. Diet has to be varied from day to day in many instances and a thorough understanding of the animals is necessary.

Wick World 2923

CRADLE FOR TELEPHONE POLES SAVES LINEMEN WORK

Telephone poles are raised for framing with a simple unit used in connection with the cant hook or peavey, saving time and work and reducing risk. It is a malleable-steel cradle placed against the pole, which is raised upon the support with the aid of the cant hook, two rockers on the cradle simplifying the task and permitting one man to do what ordinarily takes six or more. After the pole is raised, it may be turned in the saddle of the cradle if the proper face is not in the desired position.

E. J. up



now at present.

Pulling Telephone Pole onto Its "Cradle": One Man Can Safely Do This with a Cant Hook

Harriman + Cunningham 307 S Hill St

525 South 13th, Lincoln

The Sport of PHEASANT TRAPPING

Nebr



IN THE spring of 1912, a few pairs of Chinese ring-neck pheasants were liberated in Nebraska. Under the favorable conditions found there, these birds have so multiplied that last spring 30,000 were trapped in ten days in three central counties and shipped to other sections of the state.

The ring-neck pheasant is a hardy bird and one of the wildest and gamest of all shooting birds. The foundation stock used in Nebraska was imported direct from England, where this species has been bred for several hundred years, but the bird is a native of China. At the same time that the pheasants were introduced into Nebraska, several other states, including Oregon, New York and South Dakota, released them within their boundaries. Hardy and adaptable though they are, they have in no place reproduced so abundantly as in Nebraska, where there is a sandy soil that dries quickly after rains and affords ideal nesting conditions.

Because of these conditions and the year-around protection, these birds have become so numerous and so tame that it is not uncommon for railroad passengers to see them stand calmly near the right of way and watch the trains go by. In fact, they became so tame that some occasionally fed with a farmer's poultry and many complaints resulted. The state was, there-

fore, confronted with the problem of thinning out these thrifty and hardy birds. Accordingly, plans were made to capture and release them in other sections. A trapper, who had hunted jackrabbits by night, hit upon the idea of catching the birds at night while they were blinded by the glare of auto lights. Experimenting with a crude net made from the rim of a buggy wheel, he found that his spotlight dazzled the birds and kept them in place, motionless, but the instant the light missed them they were gone. It was, therefore, necessary to approach places where the birds were likely to be roosting cautiously, and to keep the light full upon them.

When the birds had been located, the car was driven carefully to within ten or fifteen feet of them. A helper stepped out with the net and, judging the distance, carefully tossed it over as many birds as possible. It was then a simple matter to reach under the net and, capturing the pheasants, place them in a specially constructed crate. Various forms of nets were tried, but the best was made by stretching a piece of seine or light wire mesh over a light wooden hoop, about four and one-half or five feet in diameter. Burlap and heavier hoops occasionally injured birds and, being heavier to handle, were soon discarded, as were smaller nets on the ends of long handles.

2657



the Boyce Thompson institute for plant research, where exhaustive experiments have been conducted in speeding up nature by artificial means. It has been found that many plants can use much more light, heat and chemicals than they obtain by natural means. From a human standpoint, nature is enormously inefficient. Only about one per cent of the energy that falls on the plant is utilized. Three factors were essential in achieving the rapid growth: bright illumination, in some cases continued for twenty-four hours, high temperature and increased amounts of carbon dioxide in the atmosphere. The wheat and clover were subjected to arc lights at night and illumination was continued through the twenty-four hours. Tomatoes, however, needed a rest and gave the best results with twelve hours of daylight and six more of artificial sunshine. During the tests, 1,500 kilowatt-hours of electricity were used every day,

Strange as it may seem, those not caught in the net the first time, if within the circle of light, did not fly, so the trapper was almost sure to get all that were roosting in one group. When the complete capture had been made, if his quota was not already filled, he could drive on in search of another group. The pheasants roost huddled together in the grass, not unlike quail. When captured, they were delivered to state officials in pairs and as quickly as possible shipped to the southern and eastern counties to be released.



The Trapper Rides to Work on the Running Board, Dismounting to Cast His Hoop Net When Birds Are Sighted

continued through the twenty-four hours. Tomatoes, however, needed a rest and gave the best results with twelve hours of daylight and six more of artificial sunshine. During the tests, 1,500 kilowatt-hours of electricity were used every day,



indicating that commercial application of the method is not yet practical.

GROWTH OF PLANTS SPEEDED BY ARTIFICIAL LIGHT

Large heads of lettuce grown in three weeks after planting the seed, wheat ready for harvest thirty-five days after sowing, and red clover in flower thirty-eight days after seeding; these suggest impractical fancies but are actual accomplishments at

Report of Gen. John M. Arthur
1914

COAL DUST TRIED IN SHIPS TO LOWER FUEL COSTS

For a number of years, pulverized coal has been used for fuel in various industries, and now, with the ascendancy of oil, it is being investigated for marine uses, in an effort to decrease operating expenses in shipping. The 6,000-ton freighter "Mercer" has been assigned by the fuel-conservation committee of the shipping board for tests, and although definite results have not yet been announced, it is said that experiments so far have been promising. Powdered coal is explosive, and so presents a hazard when stored on a vessel, but this objection is being surmounted, it is believed, by devising a grinder that will crush the fuel just before it is burned, so that it can be kept in the bunkers in lump form. A pulverizer

is said to have been fashioned that reduces the coal to a fine dust that is completely consumed and burns very much like oil, eliminating soot, dust and cinders. These results have been attained with a coal that can be delivered in bunkers for about \$4 a ton, as compared with bunker oil at \$11 a ton and Diesel oil at \$17 a ton. Expenses of firing are said to have been reduced about fifty per cent and the radius of operation of coal-burning vessels increased about fifteen per cent. The first Diesel engine was run on coal dust, and some engineers declare that if as much experimenting had been done with the fuel in the production of high-pressure steam as for internal-combustion purposes, powdered coal and turbines would now be running a close race with the Diesel engine. On the humanitarian side, the use of pulverized coal promises the abolishment of the "black hole gang."



Drawing of Proposed Lindbergh Tower Which Would Serve as Beacon Light and Mooring Mast at Chicago Air Port

TOWER TO HONOR LINDBERGH AND ANCHOR AIRSHIPS

To serve as a beacon for aircraft and a mooring mast for dirigibles, a flood-lighted tower, 1,320 feet high, is being planned in Chicago as a tribute to Col. Charles Lindbergh. It is proposed to be erected in Grant park and serve as a permanent addition to the city's air port. The beacon at the top of the tower would be of 1,200,000 candlepower, visible for 300 miles.

ROLL TOP FOR AUTO PERMITS ENJOYMENT OF SCENERY

Automobiles with tops that roll back somewhat like the lids of old-fashioned desks have appeared in England. They can be shifted entirely to the rear so that occupants of the car may enjoy the scenery and the sunshine if desired.

In charge - C. J. Jefferson,
graduate of Cornell, Chief

Chicago Tribune
7/24/27

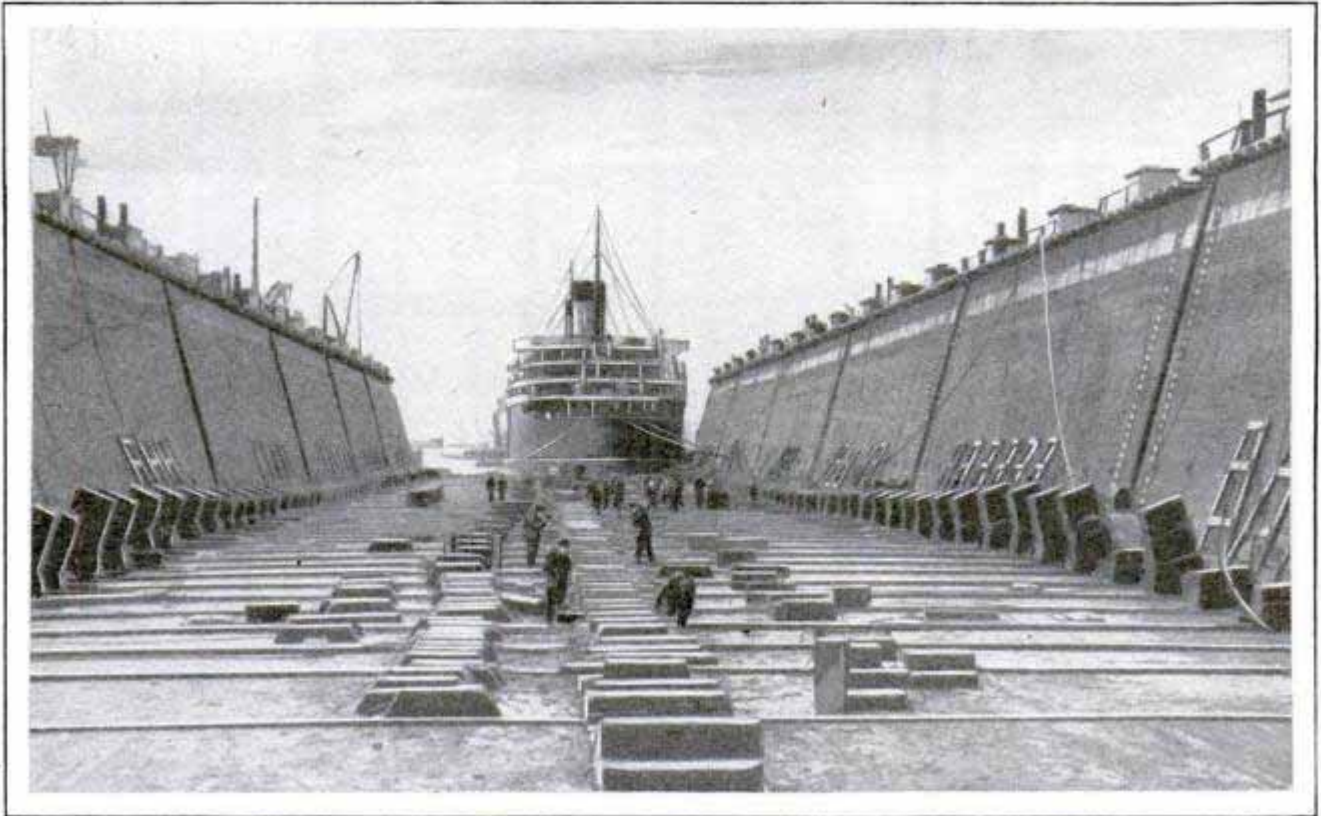
28 14
 "UNSINKABLE" LINER DEFEATS SEA ON FIRST TRIP

Docking the "Malolo," Biggest Passenger Ship Ever Built in the United States; Although the Vessel Was Rammed during a Speed Trip, Its Water-Tight Bulkheads Prevented Sinking

Struck by a blow equal to that of the torpedo that sunk the "Lusitania," and with a gaping hole in her side as large as those which sent the "Titanic" and "Empress of Ireland" to the bottom, the former after collision with an iceberg, the new American liner "Malolo" recently proved her seaworthiness by coming into port with only easily repaired damages. The "Malolo," biggest passenger ship ever built in the United States, was en route to the coast of Maine for her speed trials, carrying a party of officials and newspapermen, when, in a fog off Nantucket lightship, she was rammed by a Norwegian freighter. The bow of the freighter left a hole of more than sixty square feet, allowing the sea to pour into both boiler rooms of the big passenger ship. Within a few moments the engine rooms were flooded, yet so well were her water-tight bulkheads designed that the damage was confined to the sections actually pierced, and the weight of the intruding water was hardly sufficient to change the vessel's normal water line. Actually five full compartments, or up to forty per cent of the entire ship, can be flooded without bringing any portion of the deck line down to

the water level. The twelve water-tight bulkheads of the ship extend nineteen feet above the water line and are equipped with hydraulic connecting doors, which will either close automatically, or can be closed simultaneously from the bridge. The accident to the "Malolo" was unusual in that the freighter struck the liner exactly on the line of the bulkhead separating her two boiler rooms, with the result that both were flooded. Had the blow been five feet to either side, one boiler room would have been saved and the big ship could have reached port under her own power. As it was, she was not only helpless until wrecking tugs arrived to tow her to drydock in New York, but all auxiliary equipment, including the generators that supply electricity for the ranges in the kitchen, were shut down.

 300
 MARS WARM ENOUGH FOR LIFE
 LATEST TESTS DISCLOSE

Temperatures on the planet Mars are high enough to sustain life, late tests by the bureau of standards disclose, but whether life actually exists there or not is still as much of a riddle as ever. In the

7/28/27

2296

Package

summer hemisphere, under a noonday sun, temperatures of eighty degrees Fahrenheit were observed. The morning side is cooler than the afternoon side, the measurements showed. The question as to the presence of water vapor and oxygen in the atmosphere of Mars is still unanswered, but the bureau is continuing its tests. During 1926, the planet was unusually well situated for favorable observations and some of the most complete measurements were made at the observatory in Flagstaff, Ariz., with improved instruments.

**ELECTRIC ICE-MAKING UNIT
FITS ANY REFRIGERATOR** 2690

Simplicity of installation is the chief feature of an electrical refrigerating unit that can be placed in the old ice box and operated simply by connecting it with a lighting socket. To adjust it, the old door is unscrewed and the unit placed within the ice chamber. It is said to keep food at the proper temperature and frozen deserts solid. It also forms ice cubes in the same manner as other apparatus of this kind. In case the machine requires adjustments, "loaner" units are available from a central repair station. The portability of the outfit makes it suitable for temporary installations anywhere, the entire unit weighing less than fifty pounds.

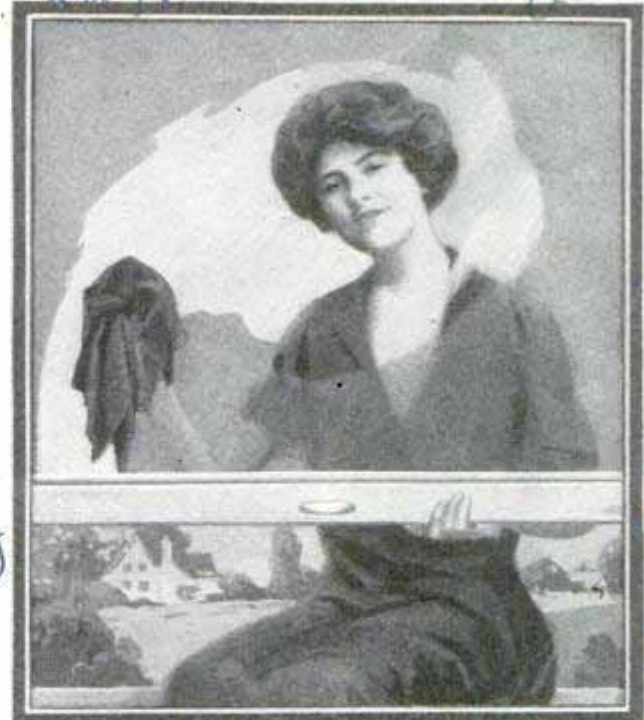

Cleaning Window with the Chemical Rag; No Soap or Water Is Used, and Glass Is Brightly Polished

**CHEMICAL RAG SHINES WINDOW
WITH LITTLE RUBBING**

For keeping auto windshields, house windows, mirrors and other glass surfaces clean and shining, a chemically treated rag now on the market is said to save time and work. It eliminates the use of soap, ammonia and cleaning powders of all kinds, and is intended to leave a cleaner, brighter glass than is possible with ordinary methods. With the chemical cloth comes another for polishing.

**PLATING PROCESS FOR RUBBER
IMPROVES PRODUCTS** 3008

Rubber of greater strength, toughness and resistance to deterioration by age, can now be made by an electrical process at a lower cost than by usual methods, according to reports from an eastern company. Articles are produced in somewhat the same way as metalplating is conducted. An electric current is passed through a mixture of rubber latex, the uncoagulated milk of the rubber tree, with water, sulphur, fillers and other materials, according to the requirements of the article to be produced. The particles of rubber and other ingredients become electrically charged and are deposited on molds of the desired shape, just as copper or nickel is deposited on metal objects.

1862 Monadnock Block
Chicago

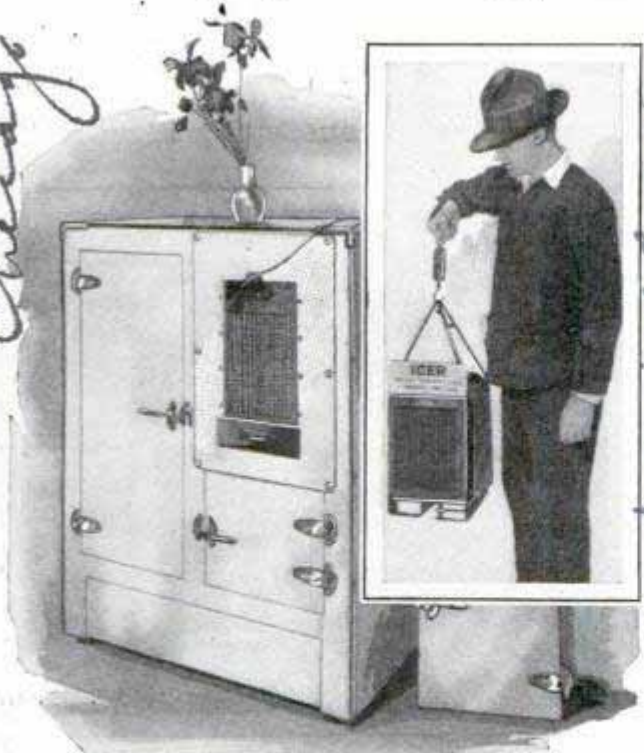

Refrigerating Unit Installed in Ice Box; Insert Shows Its Light Weight and Compact Construction

D. P. Heath & Co.

1815 1862 Monadnock Block

Howard 493 C. St. Boston Mass
Shepard 512
Eastman Kodak Co. Rochester, N.Y.

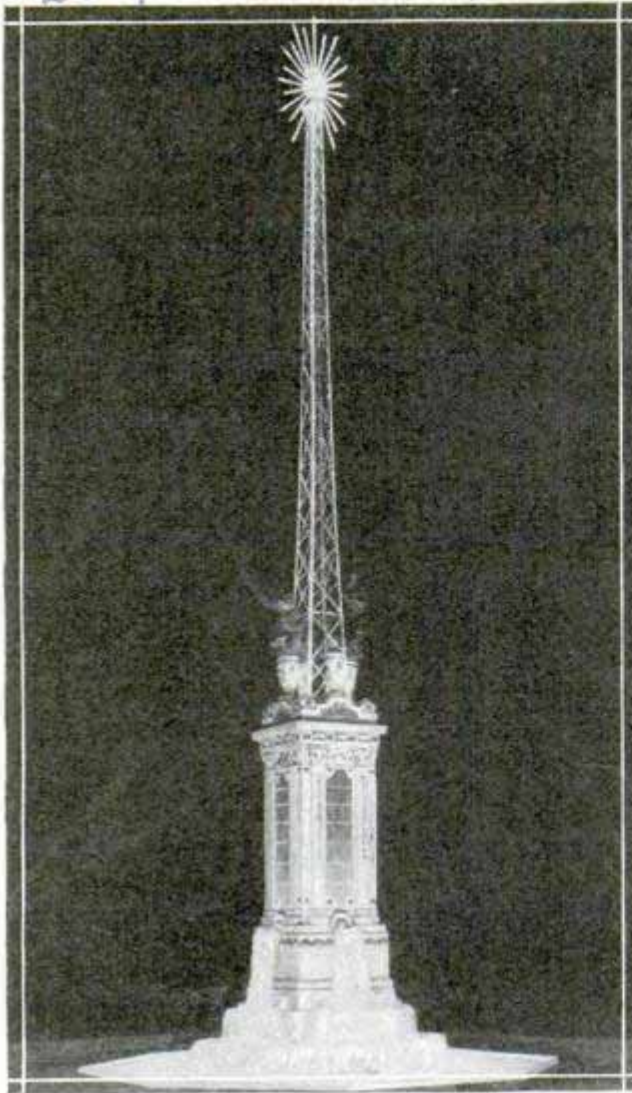

Courtesy General Electric Co.

Illuminated Tower of Jewels at Cleveland Exhibition;
Music Was Played through Concealed Amplifiers

MUSICAL TOWER OF JEWELS FEATURE OF EXHIBIT

An outstanding spectacle of Cleveland's industrial exposition was a 200-foot tower, decorated with 20,000 glass jewels illuminated at night by the colored rays from thirty-six 8,000,000-candlepower searchlights. Within an ornamental cascade and concealed behind panels of fine netting were six special phonographs with amplifying equipment made by the General Electric company, so powerful that the music could be enjoyed at a distance of half a mile. Above the water basin were four large urns, from which steam, also illuminated by the changing colors of the lights, was rising. The jewels were each about two inches in diameter and were first used in the lighting effects at the Panama-Pacific exposition.

SIX-INCH BUTTERFLY TONGUES MARVEL OF INSECT WORLD

2885

How various parts of insects and other creatures are adapted to the needs of the organism, constitutes one of the wonders of nature, aptly illustrated in the tongues of some species of moths and butterflies. Tongues of the sphinx moths may be as much as six inches long, two or three times the length of the insects' bodies. They are hollow so that the nectar may be drawn up from the blossom and, when not in use, are coiled up like the hair-springs of watches and concealed under tippets projecting on either side. In some of the butterflies and moths, the period of adult existence is so short that they never eat. Consequently, most of the mouth parts have disappeared.

MUSCLE TEST FOR CAB DRIVERS 2499 ELIMINATES UNFIT

Endurance is an essential requirement in driving a taxicab and to determine whether candidates for positions have the quality, a Chicago cab company subjects them to various physical and mental tests. One involves a strength trial for the arms. The applicant stands erect at a certain position in relation to a spring which is pushed back by the outstretched arm. A scale indicates the degree of compression and the object of the test is to determine how long the spring can be held exactly at that point without letting it slip back.

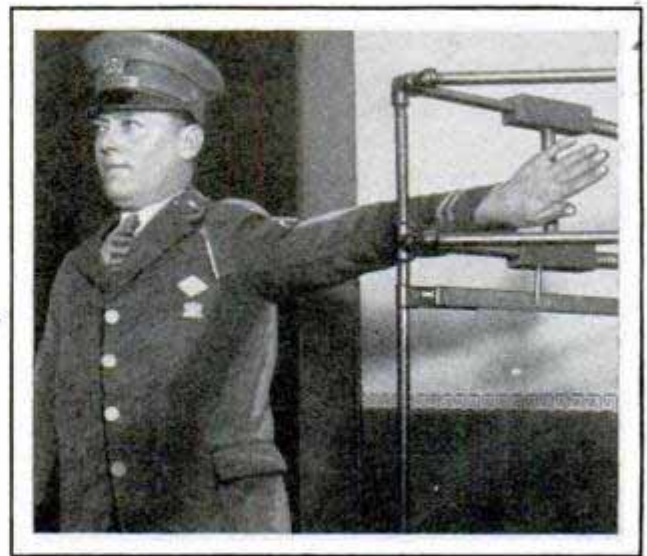

Trying to Hold the Spring Back, One of the Tests for Cab Drivers to Determine Physical Fitness

6-250 driver's manual 6-25

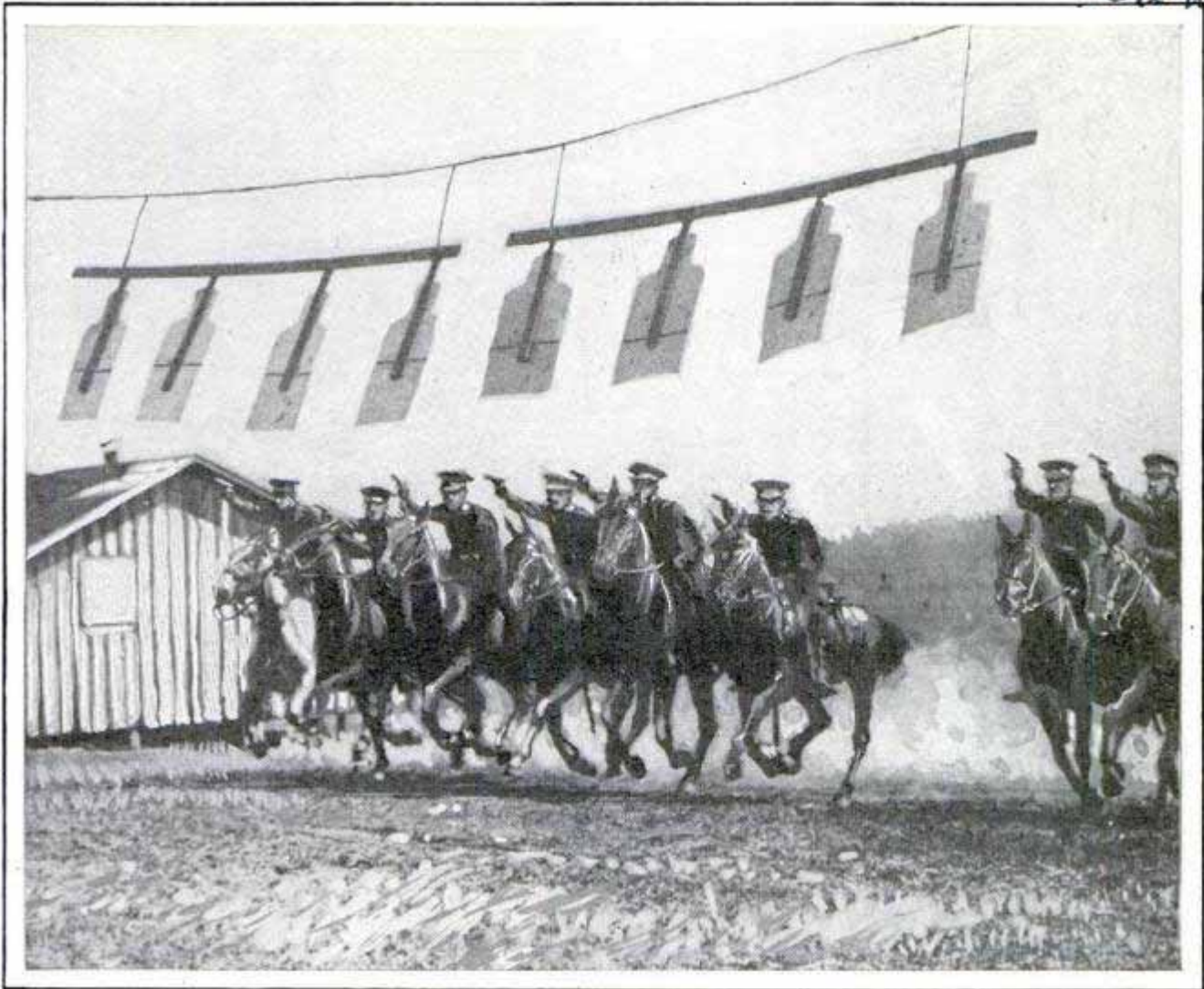

Cavalrymen at Pistol Practice; While the Principal Object of the Drill Is to Hit the Overhead Targets, the Riders Endeavor to Keep a Straight Line as They Approach

CAVALRYMEN'S PISTOL CHARGE DEVELOPS MARKSMANSHIP

Cavalry officers in the United States army are required to be skillful marksmen with the pistol as well as with the saber, and to receive the proper training under conditions as nearly like those in action as possible, target practices during charges are held. As a line dashes toward a string of overhead targets, the student officers draw their weapons and fire at a specified signal. The stunt develops quickness of eye, accuracy of aim and ease in firing from galloping horses.

MAKING MILLION PHONE CALLS REQUIRES TON OF COAL

Only a small amount of electric current is consumed in making a single phone call, but a day's messages for the entire country represent a formidable amount of power expended. One telephone com-

pany has estimated that a million calls can be handled with a consumption of 900 kilowatt-hours, approximately the amount of electrical energy that can be generated from a little more than a ton of coal in a power house.

AUTO GAS-TANK CAP HAS CHAIN TO PREVENT LOSS



In place of the usual cap for the automobile gasoline tank, a cover with a chain attached, to keep it from getting lost, is said to be secure against rattling and leaks. It can be installed

on any tank by the addition of a disk spring, and only one-eighth of a turn is required to put on or remove it.

*Int. Trade Journal,
The Engineer*

*Innovative Products Co,
882 E. 12th St.*

2633



Mrs. Thomas A. Edison, Wife of the Famous Inventor, in Her Kitchen; Note the Electric Plate and the Ventilating Fan Mounted in the Window to Exhaust the Hot Air

Easy Ways to Save Work in the Home

How Uncle Sam, Inventor, Is Constantly Devising Little Things to Help Women

By RENE BACHE

1823 2 St
Washington D.C.

QUITE a number of novel and useful inventions, designed to contribute to the comfort and happiness of women in suburban homes, in rural communities and on farms, owe their origin to the activities of Uncle Sam.

Nearly all of them represent the ideas of women. The bureau of home economics, of the department of agriculture, is run by women, whose attention is devoted largely to contriving helps for housewives. Another branch of the department, the extension service, makes a business of spreading information and worth-while suggestions along such lines.

Time was when alarm was expressed lest the government become too paternal. But today Uncle Sam is father, mother, elder brother and maiden aunt to the peo-

ple. The department teaches folks how to mend broken china, take grease and ink spots out of clothes, make forms for fitting dresses, and ever so many other things, even including the proper method of setting a hen.

The extension service sends lecturers to all parts of the country. It maintains in Washington a first-class motion-picture plant, from which films are distributed, without cost to those who apply for them. Some of the films are plays, meant to be educational but with bits of comedy relief. Agents of the department, in rural regions, travel from village to village, giving movie shows in schoolhouses, the projector operated through a cable by the battery of an automobile or by a generator on the running board.



A Drop Shelf, Hinged to the Wall So It Can Be Hooked Up Out of the Way, Serves as a Kitchen Luncheon Table



Built-In Cupboard above the Sink Holds Soap and Other Accessories



Worktable on Casters and Fitted with Shelves to Carry Extra Utensils; Left, an Iron Ring with Hooks, Which Can Be Hung from the Ceiling to Hold Cooking Tools

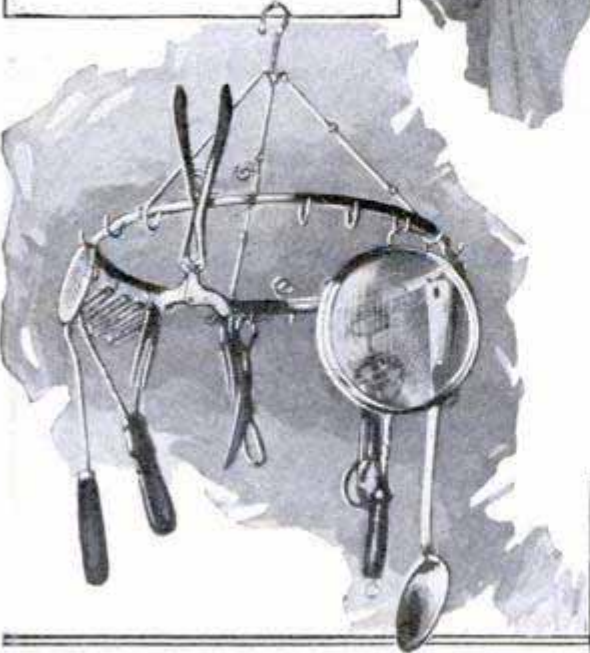

The bureau has concerned itself most particularly with kitchen arrangements. The suburban or rural kitchen lacks not space; indeed, it is often too spacious, making unnecessary steps for the housewife. The range, the sink and the work-

table should not be too far apart; the proper placing of them will save much foot travel. Also, it is important that they be neither too high nor too low.

Much travel may be saved by a judicious location of doors when a house is planned.

Regard should be had for the height of the sink when it is installed. If it is set too low, the consequent necessity of stooping will be a cause of fatigue. The worktable, if too low, may be raised by setting its legs on wooden blocks; if too high, the legs can easily be shortened.

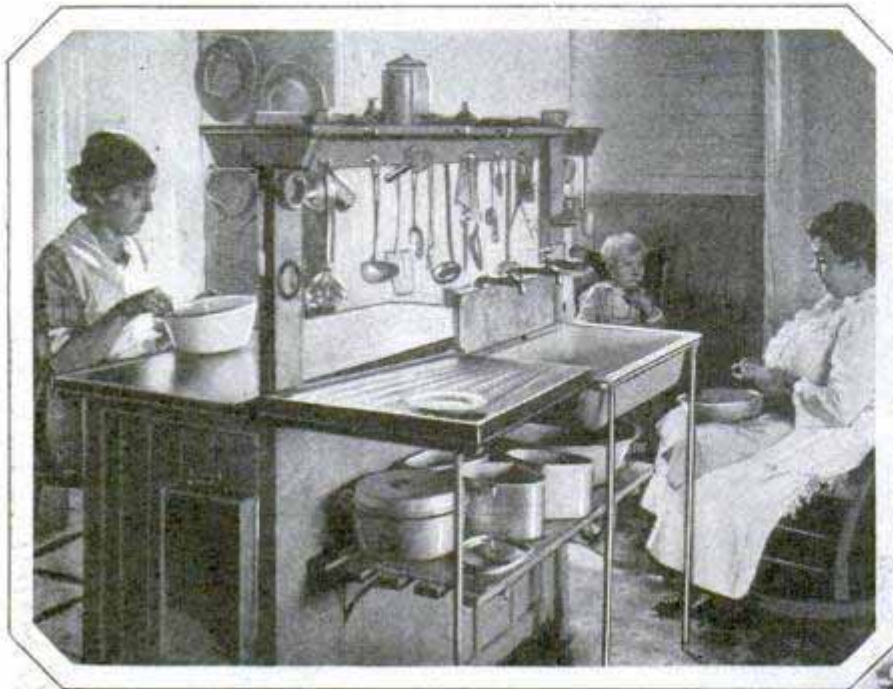

Well-Equipped Double Table and Sink Combination; an Extemporized Water Plant, at Right, and, Below, a Scrubbing Brush Which Is Made of Corn Husks, Easily Discarded and Replaced When Worn Out; the Water Tank Is Kept Filled by Means of a Force Pump



A farm kitchen may have to provide for the feeding of a dozen or more people, including hired hands, and in such a case a systematized economy of labor is particularly desirable. For such a kitchen, necessarily of good size, the bureau of home economics suggests an arrangement whereby the worktable and sink are combined in one piece of furniture, placed in the middle of the room.

The worktable half of it is inclosed, so as to provide convenient cupboards beneath. The other half

is occupied by the sink and drainboard, beneath which is a wide shelf of slats for kettles, bread pan and other large utensils. Erected on two standards from the middle of the duplex affair, is a high lengthwise shelf for odds and ends, with rows of hooks under it to serve for hanging ladles, mops, dish cloths, strainers and other small articles of culinary usefulness.

There are other ways in which the work-

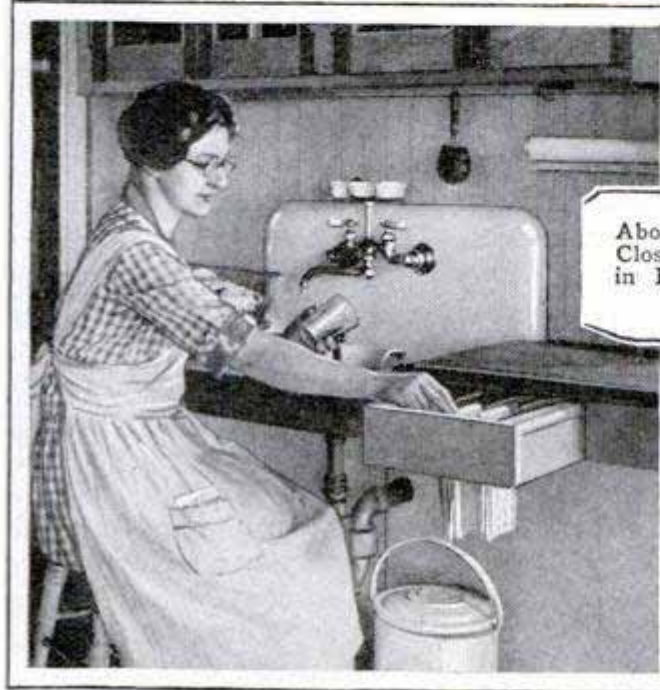

Above, Ironing-Board Closet for the Back Porch in Hot Weather, with a Suitable Seat



table may be modified to advantage. Its operating surface is its top, which should be thirty-three inches high for a woman of average stature. But why not have two shelves beneath, each as long and wide as the table top? They would be very convenient for the temporary stowage of pans and other things.

Another idea, original with a woman expert in the bureau, is that of a small table hinged to the kitchen wall, with two hinged legs to support its free end. Made of suitable size—say, two and a half feet long by a foot and a half wide—it is a great convenience for occasional use. Two persons may seat themselves at it for an impromptu lunch, or it may be employed for such a culinary odd job as making biscuits. When no longer needed, it is turned up and secured by a hook.

A like expedient may be used for getting the ironing board out of the way. With its broad end hinged to the wall and its narrower end fastened with a hook, it is held flat against the wall. A hinged leg



Hinged Drop Shelf, and, Left, a Bottomless Drawer in Which Dish Cloths Are Hung on Metal Rods

provides support for the narrower end when the board is unhooked and turned down for use. As an alternative the ironing board, hinged in the way above described, may be housed in a closet, only a few inches deep, built against the wall. The wall serving as its back, the closet is a very simple piece of construction, requiring only two sides, a top piece and a door. It provides, beneath the hinged end of the board, a shallow cupboard with a couple of shelves for flatirons, etc.

A notably clever device is a bottomless drawer adjoining the sink and beneath the drainboard. Across the upper part of it, from front to back, are set half-a-dozen metal rods, on which dish cloths are hung. The drawer having no bottom, the cloths hang down below it. Thus disposed, they are always in readiness, and the housewife, seated at the sink (as she should be, on a stool of proper height, when washing dishes) has only to reach out her hand and take one when she needs it.

Another contrivance suggested, in connection with the sink, is a cupboard di-

rectly over the latter and occupying a space behind the wall. Its door is a lid that opens upward, being hinged to the upper edge of the cupboard. In it may be conveniently kept soap, washing powder and other articles pertaining to the ordinary uses of a sink. When the door is dropped down and fastened with a turn button, it is flush with the wall and entirely conceals the opening.

Most of the inventions of the bureau are of such simplicity that any person who is at all handy with tools can make the devices they represent.

LENS TELLS THE TEMPERATURE INSIDE OF FURNACES

2751

Various metals as well as glass and ceramic materials must be closely watched



Testing the Temperature of the Furnace by Examining Color of Flames through Special Telescope

while they are in a molten or melting state. There is a critical point at which they must be removed from the furnaces in order to best serve their particular purpose. In order to determine this point with greater accuracy, a telescopic instrument has been introduced. It operates on the principle that, as the temperature of incandescent bodies changes, the light from them varies. A tester places the glass where he can see through a peephole into the furnace. Inside the instrument is a tungsten filament supplied with current

from a battery. The operator endeavors to match the color he sees in the furnace fire by varying the current in the filament to make it glow with the hue of the molten material. Red and-green glass screens simplify this matching and also protect the tester's eyes against glare. The telescope weighs only twenty-five ounces, the battery case ten pounds and, as the outfit is readily portable and can be used in reading the highest temperatures known, it is specially adapted to severe tests. The heat can be read, while the observation is being made, by means of a meter on the battery box which is calibrated to register temperatures ranging from 1,400 degrees Fahrenheit upward.

NAIL BRUSH IN CAKE OF SOAP PREVENTS WASTE

2634

Convenience and economy are claimed for a novel toilet accessory consisting of a nail brush around which a cake of soap is molded. When not in use, it is placed bristle-side down, so that it will be protected from the water, easier to pick up and little likely to fall into the basin or tub. With this arrangement, it is not necessary to rub the cake of soap with a brush, a process that consumes the cake faster than is needed.



Ludov Northrup Co 4901 Stenton Ave Philadelphia Pa

3072. Hutchison

Franklin Simon + Co 414 3rd Ave

and Kansas City Southern R.

WRECKING CRANE LIFTS BOAT OVER DAM SPILLWAY

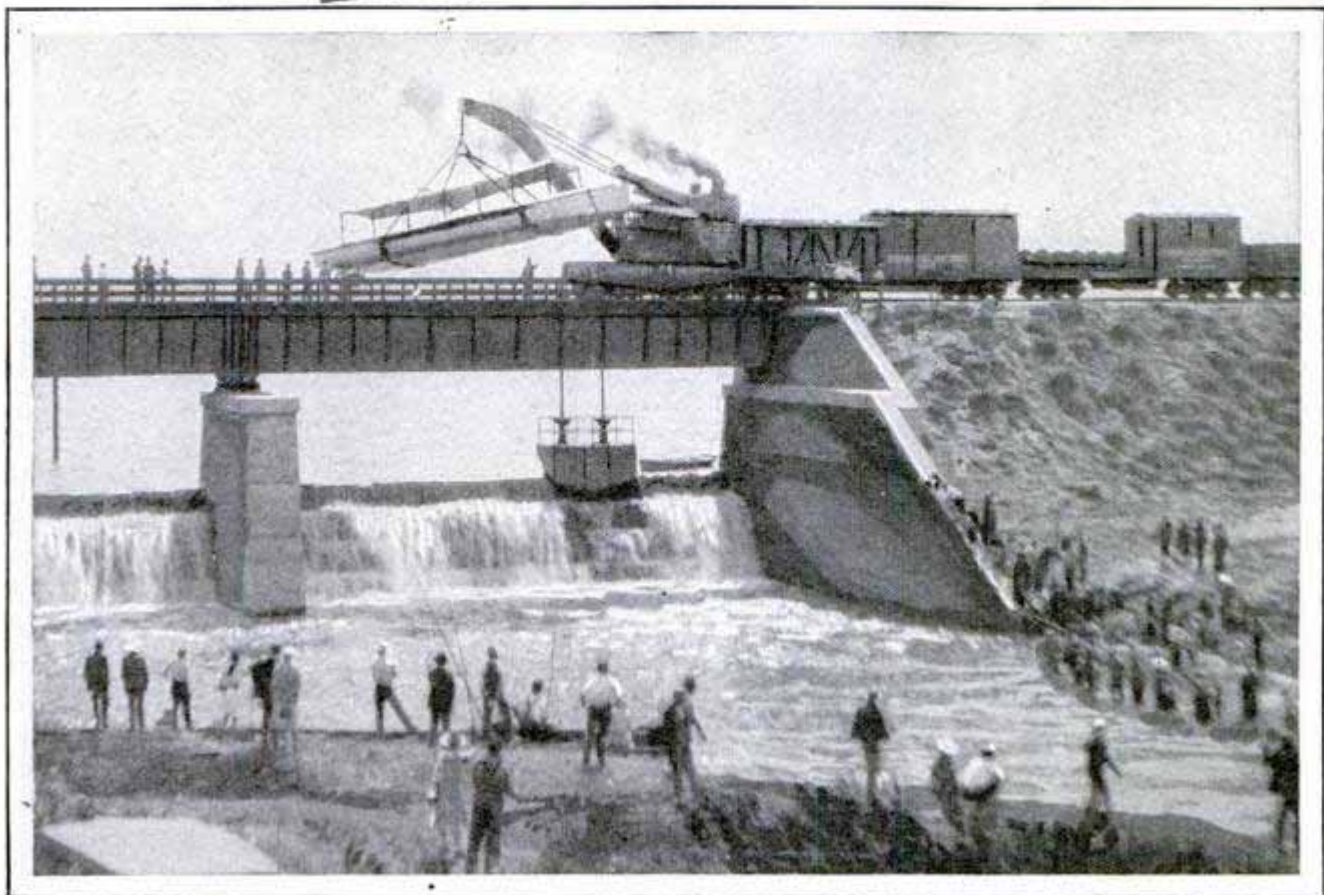

When the Railroad Wrecking Crane Helped a Boat; Lifting Craft from Reservoir to Stream Below for an Emergency Trip to Pipe Lines during a Flood in Louisiana

Rail and water lines met in an unusual situation near Shreveport, La., recently when a wrecking crane lifted a boat from a reservoir and lowered it over the spillway so that it could be sent down the bayou and river to make repairs in oil pipe lines which had been damaged by high water. The craft was forty-five feet long, but was easily swung into position by the powerful crane.

2849

MIX FISH OIL IN TREE SPRAY TO HELP KILL INSECTS

Fish oil, never noted for its fragrance, is being used by scientists of the department of agriculture in their war against insect pests that damage trees. It has been found that the substance, mixed with spray, keeps the poisonous

ingredients from washing away rapidly under rain, so that the spray remains effective for a much longer time. Linseed oil has the same property, but is too expensive to use under ordinary conditions.

AUTOS FOR TRACK INSPECTIONS ALSO AID IN ACCIDENTS

2364

So that track inspectors may cover more territory in shorter time, the German government railroads have put into operation special motor cars for their use. They are driven by ten-horsepower water-cooled engines and develop speeds as high as fifty miles an hour. Besides the ordinary equipment of tools, the autos carry first-aid outfits, and axes and other cutting apparatus so that the crew can be of assistance in wrecks.

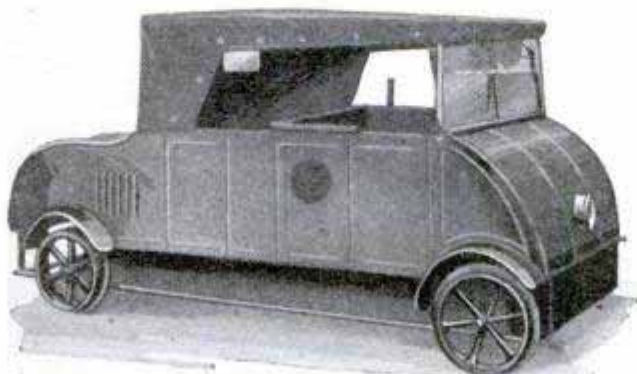

Railroad Track-Inspection Auto on German Lines; Car Has Speed of Fifty Miles an Hour with Load

Clifford & Bureau

Hood from illustrierte Technik Tur Tidemann II 14, 1927

*Science Institute
Toledo Ohio*

*208
Hahnemann Medical College
Philadelphia Pa*

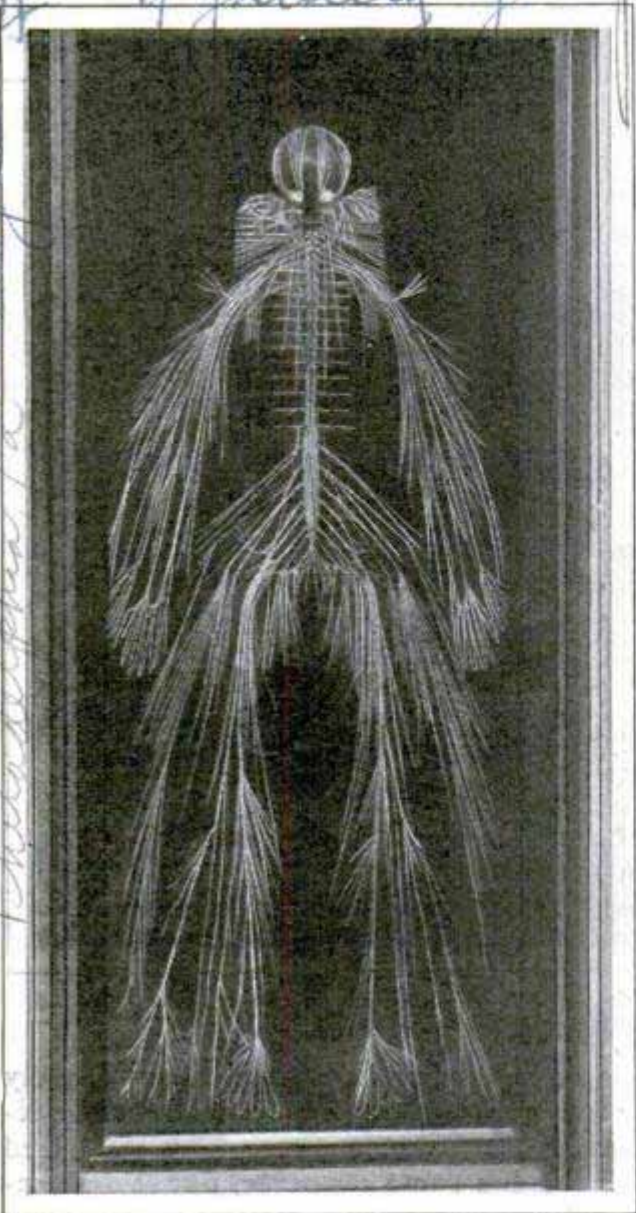

Nerves of the Human Body Represented in Model; Three Months Were Required in the Making

ENTIRE NERVE SYSTEM SHOWN BY MODEL

One of the most intricate models ever made is that of the human nervous system as outlined by an eastern physician. More than three months of intensive work were required to complete the design, which is carefully kept in a vault when it is not being used for study.

WHITE TOPS FOR AUTOMOBILES MAKE DRIVING COOLER

White tops for autos and trains would be effective in decreasing the heat on summer journeys, while a damp burlap or bed sheet, hung as a drape in the car, would add to the comfort of the passengers when the temperature is high. These and other

interesting deductions have been made during ventilation tests conducted by the bureau of mines in co-operation with railroad and automobile engineers. One of the instruments used was a heat meter so delicate that it can record the warmth of a blush. It showed how white deflects heat, while black and other dark colors tend to absorb it. In the laboratory was a drum covered with water-soaked burlap and equipped with thermometers that closely registered the temperature inside and out. Fans were operated to show the humidifying and cooling effect of air motion through water. The cooling effect of evaporation alone was shown to make a difference of eight to twelve degrees in the temperature. Some railroads have installed a sprinkler system on the tops of coaches, and small ventilating fans are used inside to keep the air moving in the right direction and to help remove dust. The tests showed that an ordinary bed-sheet, soaked in water and hung inside the automobile or railroad car, made the occupants more comfortable.

BRICK MOLDED IN ODD SHAPES TO SPEED LAYING

Brick for a new building in New York city have been molded into twenty-nine different shapes to speed up the task of laying. All are marked, according to form, to aid the masons in selecting the proper units for the walls.



Sample Shapes of Brick, Showing Numbers to Guide the Masons

2870

Medicine new Equitable Bldg

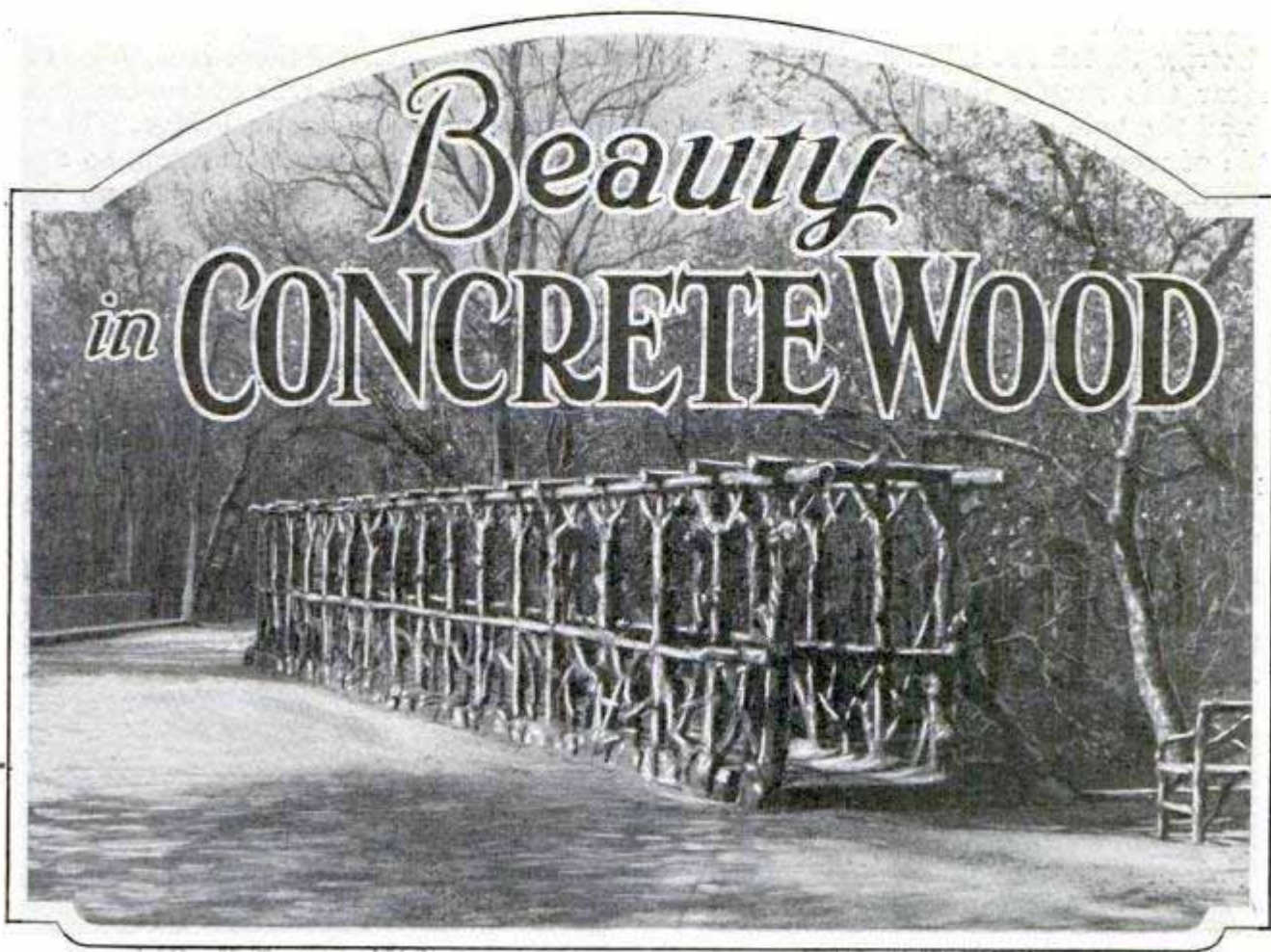

Beauty in CONCRETE WOOD

Rustic Trellis of Concrete Logs, in Faithful Imitation of Wood; the Same Design Also Can Be Adapted for a Garden Bridge across a Small Ravine; the Chair, at Right, Is Also of Cement

By W. E. BARKER *33 W. Spryland Ave Chicago*

PARK and yard furniture made of logs, bark-covered rafters, great trees curved into outdoor seats, tables of timbers roughly smoothed by hand ax and adze and covered roofs with straw thatch or shingles split from a straight-grained block of wood; all are being made of concrete which imitates wood so accurately that words cannot convey its perfection. Even pictures fail, for they do not show the delicate shadings of color which make these imitations look like weathered wood, with bark and knots and growths of lichen so lifelike it requires the sense of touch to tell the difference.

Dionisio Rodriguez, of Mexico City, is the artist who is making concrete wood. At Breckenridge park, in San Antonio, he built a rustic bridge. Concrete logs form the footway, smaller logs make the sides and top. It looks like a log bridge built with primitive tools. The ax marks show; the growth rings can be counted on the ends of the logs; small limbs have been trimmed off, leaving chisel-shaped stubs.

There are knots which growing bark has partly covered; the bark covers some logs and is partly stripped from others. Log ends have been roughly trimmed to fit against other logs and at places nails have cracked the imitation wood—nails, which, by the way, are only concrete nail heads painted a rusty brown. Closer inspection is repaid by the discovery of more clever mimicry: worm holes, a place where stripped bark exposed the channel made by some wood borer, a spot where some industrious woodpecker sought a grub. Park attendants say this bridge even fools the woodpeckers.

In the same park there is a seat carved from a curved log and covered by a straw-thatched roof, supported, like a huge toadstool, by one central log. Around this roof support there is a little table which looks for all the world as though it were built of hand-smoothed wood strips with ends mortised together. There is even a place where some idler whittled the table. He

2635
must have had a sharp knife, for table, seat and straw thatch are all concrete.

Near this shelter there is a seat built around the bole of a tree. It seems to be made of wooden strips, roughly fashioned but fitting together nicely. Because of the difficulty of bending them, the strips are short and have been pieced out with other strips. Countersunk screws hold the strips to sections of plank beneath, roughly cut in short sections to form a circle. This, too, is solid concrete. The lines which seem to mark the edges of the strips are surface lines only; the screws are dents painted a rusty brown. The seemingly uneven surface looks as though the red paint with which it was decorated had worn off in spots. But those splotches were put there exactly as they are today, when the seat was built three years ago.

Simple things are often the most difficult to imitate because there is nothing to aid deception. That is true of two benches that stand near the rustic bridge. They are so colorless, so weatherbeaten, so apparently warped old planks held up by wabby legs, that even one who is looking for deception is surprised when a tapping knuckle discovers that they are concrete.

In Alamo Plaza, a little park in front of the ruins of the famous Alamo, there is another concrete bench and shelter. The bench is made from two stumps and a log (concrete, of course) and is covered by a perfect imitation of split shingles. There is even the sag of age in this roof.

At the entrance to the Mexican hospital grounds there is a similar bench except that it is roofed with concrete straw. At another place what seems to be an enor-

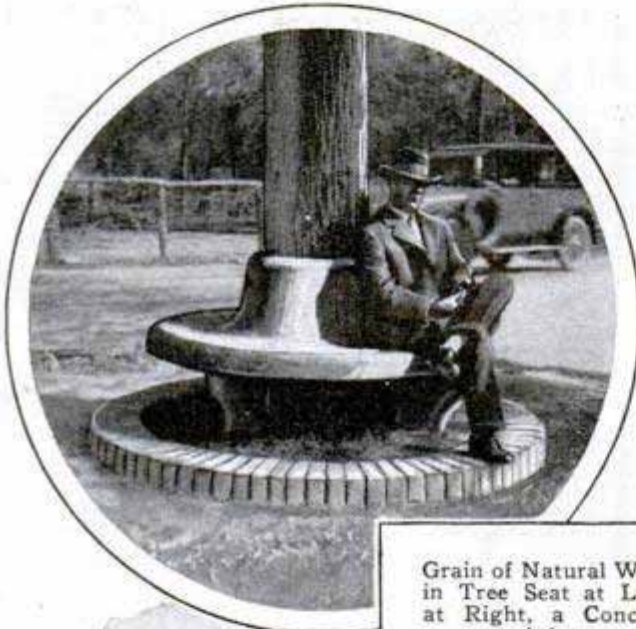

Grain of Natural Wood
in Tree Seat at Left;
at Right, a Concrete
Arbor

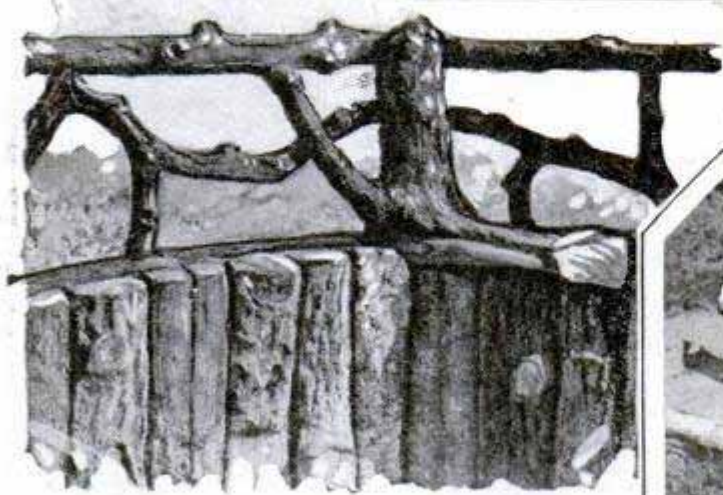

Showing How Bark Is Imitated in Concrete; Note Cement Nail in Third Plank at Left; Right, Rustic Seats of Cement



Director,
587
Theatre
Seattle
Wash

2444

mous stump has been hollowed out to make a bench. The tree of which it is supposed to have been a part was broken off some seven feet above the ground and the sloping, rough break forms the roof.

"How does he make a form to cast such things?" is the inevitable question of those who see these remarkable works. He does not cast them. Every piece of bark, every knot, every worm hole, every ax cut is fashioned by hand.

The first step is the construction of a concrete foundation to support the structure. Then a frame of reinforcing rods or iron pipes, roughly outlining the proposed finished product, is set up. Wire mesh with wires spaced from two to four inches apart each way is placed around the rods in such a manner that it outlines the concrete core of the logs. Then the space between them is filled with concrete.

The bark and surface markings are put on like stucco. Knots are built up from small pieces of brick which are stuck in the soft mortar, then skillfully covered. The tools used are nearly all homemade, though the artist now has a set of ornamental cement finishers' tools. The grain of the wood is made with a brush of straw tied together. A bundle of hay wires, with ends spread apart, makes the worm holes. The coloring is done behind a canvas screen. He uses mineral colors to which neat cement is added to make them stick. First the whole structure, if it represents wood, is painted the buff color of weathered oak denuded of bark. Then the more delicate shadings of bark, moss and other features are put on.

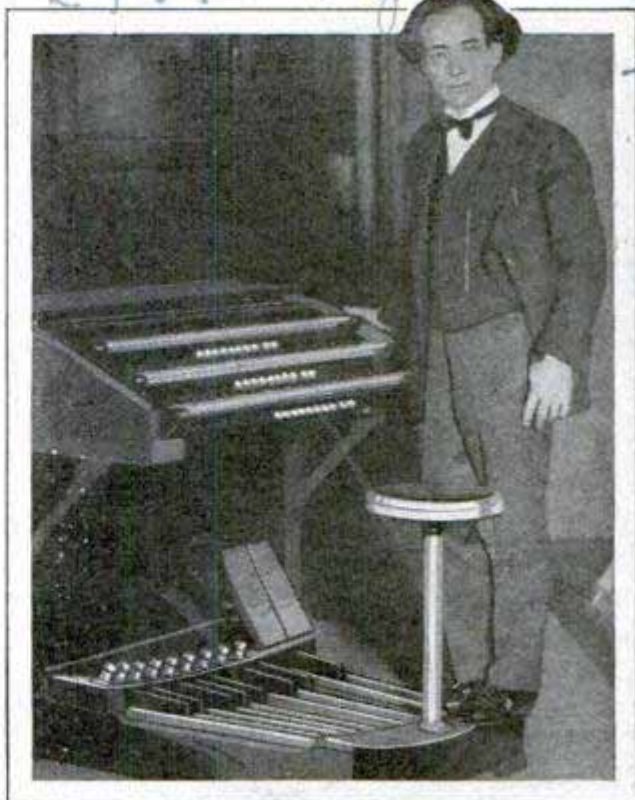

Tiny Pipe-Organ Console Which Can Be Moved to Various Positions on the Theater Stage

ORGAN CONSOLE IS PORTABLE FOR THEATER CHANGES

Weighing but 150 pounds and easily moved to any part of the theater stage, a portable pipe-organ console has been devised by a western concert master. It is electrically controlled and is to be connected to the stationary organ for operation. Its advantages are that it may be treated as any stage property, shifted to best suit the seating arrangement of the theater, or placed so that the player need not have the audience at his back. It has a full keyboard and permits employing the entire capacity of the organ, although it is but a midget in size as compared with the usual console.

see Mar 1928 412

HUM OF PLANES TO LIGHT LAMPS ON LANDING FIELD

Utilization of an airplane's noise is planned in a scheme for turning on the floodlights of the airport at Hartford, Conn., by switches operated by resonance controls. As the planes approach the ground, the sound vibrations from the engines will affect the switch mechanism. According to engineers, the switches can be regulated so that they will not be actuated by vibrations from automobiles.

Suggested by Capt. Clarence in Knox

LION'S HEAD SPOUTS PERFUME TO ADVERTISE STORE

2411

Women passing a perfumery store in Los Angeles may place their handkerchiefs inside a stone lion's mouth near the entrance and enjoy a fragrant scent free. A tiny spout in the mouth drips it from a hidden container.



Connecticut State University
Commenced

Chicago



Mirror and Photograph in One; by Pressing a Button, the Unit Is Transformed into a Lamp

"MYSTERY MIRROR" ALSO SERVES AS TABLE LIGHT

Combined in a single decorative article for the table are a mirror, a photograph and a lamp. Reflections are seen in the glass; when a light is flashed on, a photograph is revealed and another touch on the button again transforms the mirror into a lamp. The photograph has to be treated by a special secret process before it can be used in the glass.

FISH GROWN IN DARKENED TANKS TO DEVELOP BULGING EYES

Many Japanese goldfish fanciers favor the kinds with bulging eyes, like those of a bullfrog. This characteristic is said to be developed by keeping the fish in tanks with only two small holes admitting light. The fish strain the muscles of the eye, turning and seeking the illumination, consequently acquiring the bulging effect through excessive exercise of the muscles controlling the eyes. Among 200 rare specimens recently presented to the United States by Japan in return for a gift of whitefish, were several patterned in delicate red, black, gold and silver colorings and with long, fluttering fins.

PACIFIC HIGHER THAN ATLANTIC COAST SURVEY SHOWS

By taking numerous observations along both coasts and comparing them, engineers of the coast and geodetic survey have found that the Pacific ocean is a foot higher than the Atlantic. Leveling lines were run from Sandy Hook tide gauge across the continent to the Presidio tide gauge and from another point on the south Atlantic to San Diego and San Francisco. A mean of all the levels taken along each coast was obtained and then compared, with the resulting difference of a foot. The error in running the level across the country is said to have been no more than about a tenth of a foot.

TRIANGLE GONG AS FOG SIGNAL PROTECTS FERRYBOATS

Heavy fog sometimes blankets New York harbor and menaces shipping, especially the ferryboats. To help captains find one of the piers, a triangle gong is rung so that the wharf may be located by the sound.

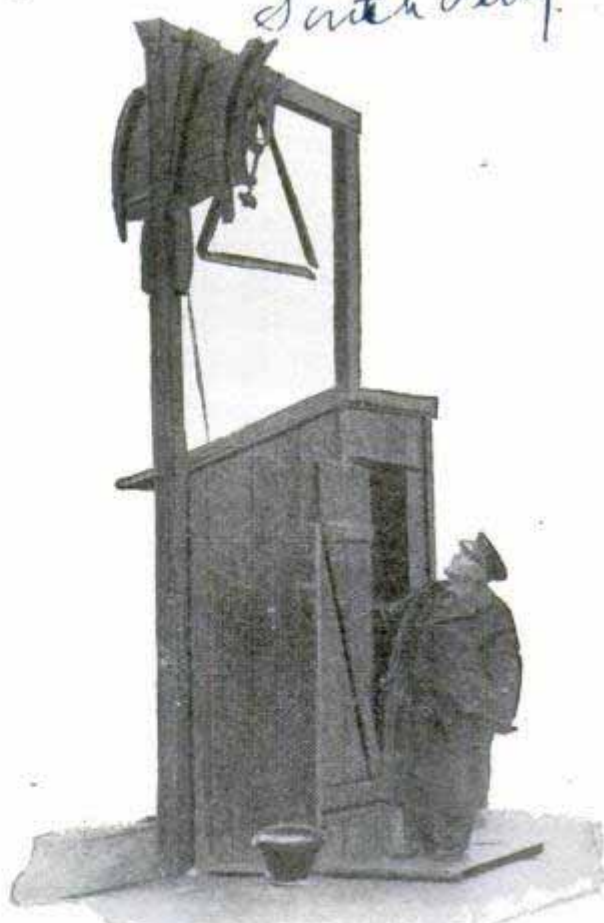

To Guide Ships to the Wharf; Triangle Gong Used as Fog Signal in New York Harbor

Out of Mechanics 9/14/27

*Carl Emmet Longherty
514 Woodward Bldg*

1683

The New Billion Dollar Science



Courtesy Smithsonian Institution

One-Time World's-Record Holder, a Consetoga Wagon Which Traveled from Philadelphia to Pittsburgh in Twenty Days; an Auto Takes Less Than One Day on Modern Roads

By **ARMOUR ARNDELL**

*745 Earle Bldg
Washington D.C.*

TEN great highways spanning the nation from the Atlantic to the Pacific, and more than that number crossing the country from Canada to the gulf or Rio Grande, are included in the program of construction now under way in the United States.

The new science of road building has progressed in direct proportion to the development of the American automobile. Not only has the nation expended \$10,000,000,000 for roads in the past decade, but it contemplates the additional outlay of more than \$14,000,000,000 before the close of 1937. Thus the twenty-year expenditure for highways of the United States will have surpassed the total war debt of the nation. Who builds the mammoth system, and how is it constructed?

The annual construction of approximately 50,000 miles of modern roads is not carried out in a haphazard manner. The exact need of every mile of thoroughfare is scientifically studied to determine the type of surface that is essential for the efficient and economical handling of traffic. The actual building is then carried on under the supervision of carefully schooled scientists or highway engineers.

The modern highway engineer traces his ancestry back to the days of the mighty old king, Sennacherib, who ordered the first city street built through the market places of his royal city, the historic old Nineveh. The Babylonians carefully laid their roads to handle the traffic demands of charioteers, war equipment and equestrians; and later the Romans, inspired by the military advantages accruing from an efficient system of highway transportation, built great stone roads into all corners of their empire. Among them was the famous Appian Way, in many places more than four feet in thickness and built of solid rock by military and slave labor.

From these early days of chariots, light vehicles of war and horsemen developed an even more elaborate system under the great Napoleon, who, sensing the necessity of a transportation system to the integrity of his domains, caused his country to be crisscrossed with the first scientifically constructed roads in the history of civilization.

The present era has offered the most intricate problem of all time. Twenty-two million motor cars are roaring over the public highways. They demand smooth

2683 and dependable surfaces for safe and economical operation. The meeting of that demand has developed a new science which is not only confronted with the gigantic task of expending more than \$1,000,000,000 per year, but shoulders the responsibility for the well-being of one of the nation's greatest assets—highway transportation. Today the construction of a single piece of road involves as much study as a surgical operation or the pleading of a complex case in law.

The most recent development is the traffic-census system for determining the type of road best adapted to a particular thoroughfare. The weights and designs of all vehicles passing over a thoroughfare are carefully tabulated over various periods

of the year and hours of the day. The results are analyzed and, through previous experiences, it is possible to determine exactly the design and materials essential for the construction of the most efficient and economical road that can be laid. On the primary system, better known as the National Federal Aid system because of the government's participation in its construction, the roads are constructed under specifications approved by the United States bureau of public roads. This system includes 182,000 miles of the most widely traveled highways in the country, and particularly the interstate and the transcontinental routes.

When road specifications have been approved by the bureau, the various states

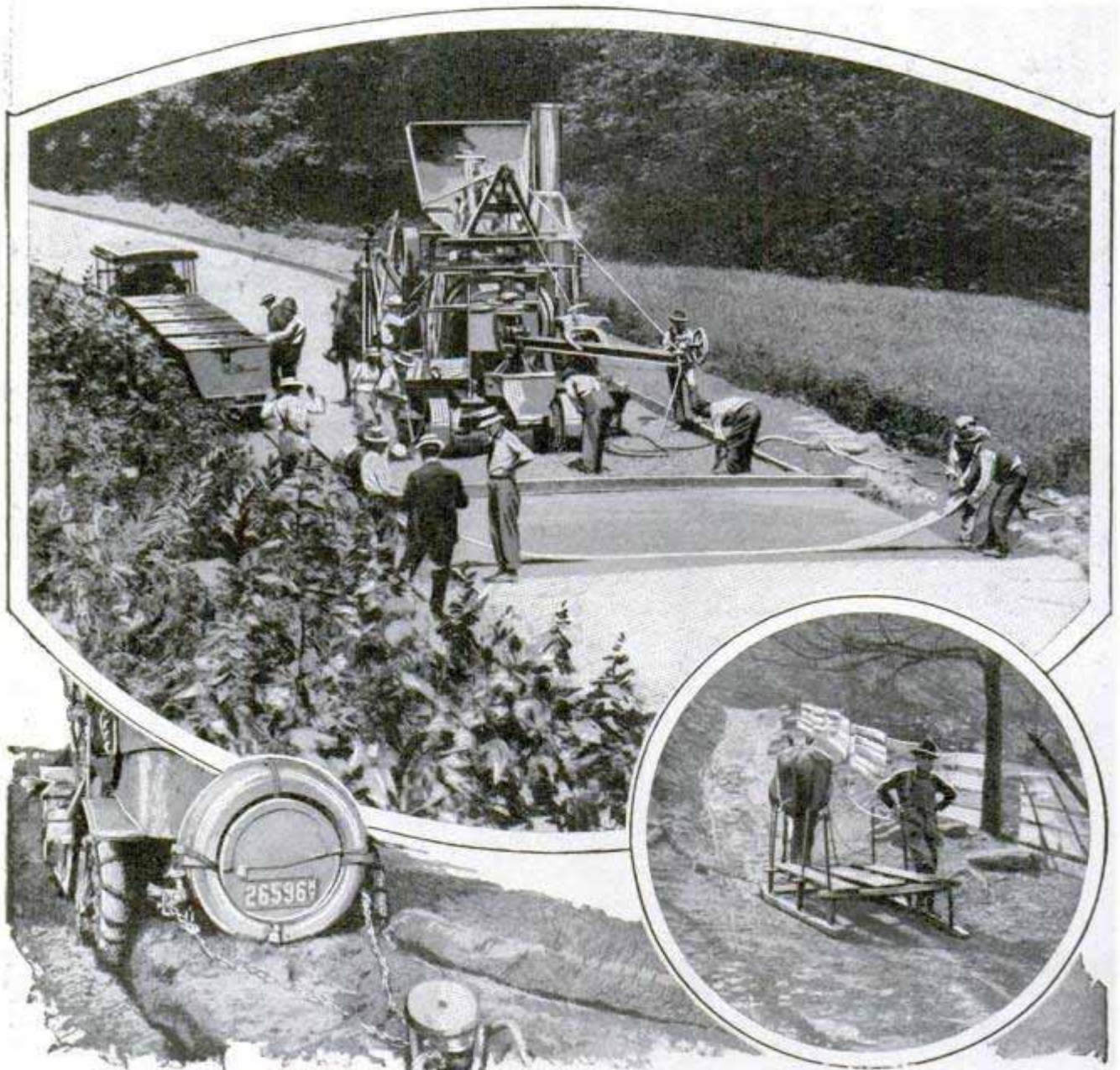

The Old Days When Automobiling Was a Contest with the Mud; Above, a Modern Road-Making Machine at Work in North Carolina, and, in Circle, the Kind of Road It Is Replacing

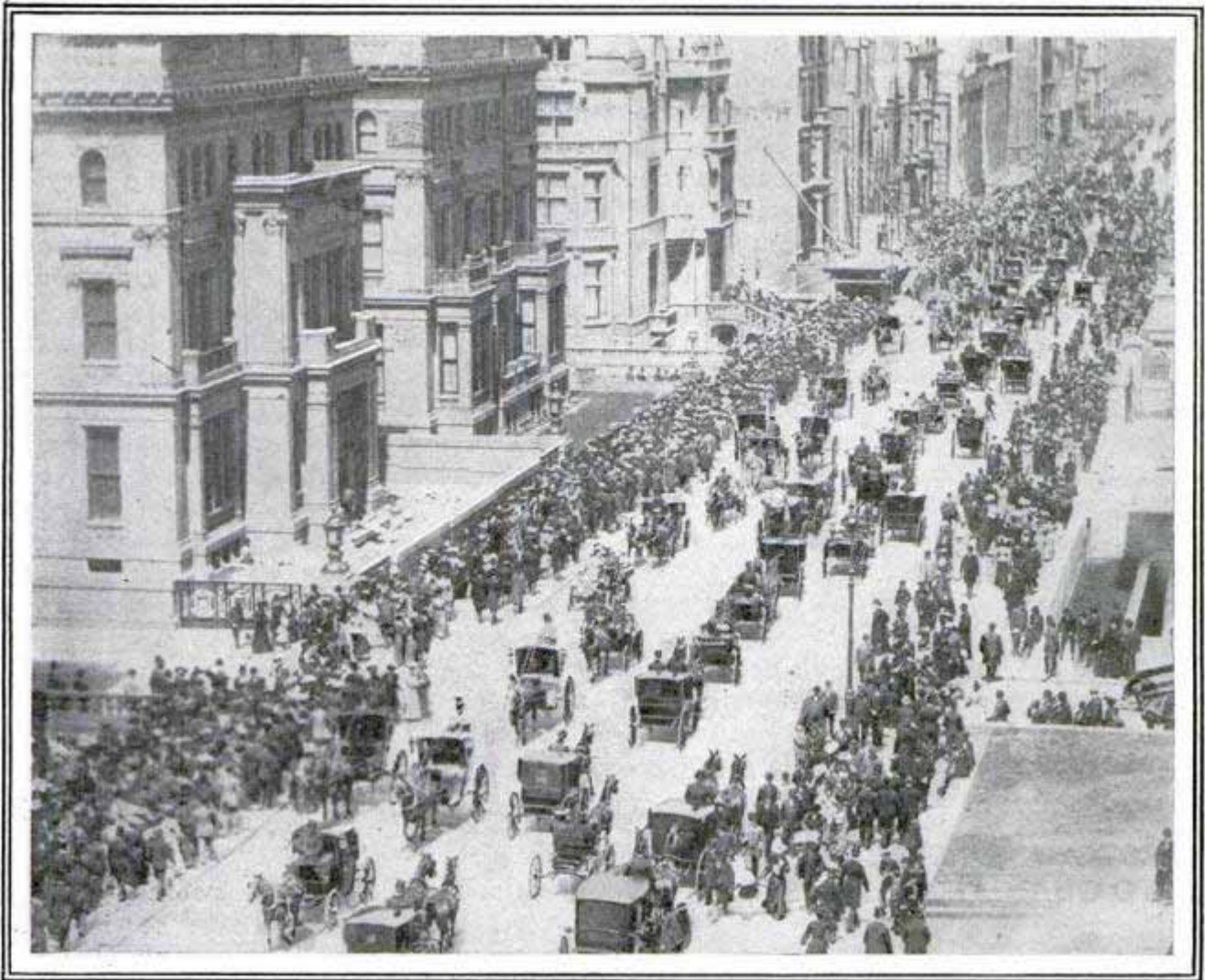

Fifth Avenue, New York, during the Easter Parade in 1900, When the Automobile Was Still an Experimental Toy and the Hansom Cab Hadn't Given Way to Fleets of Taxi Cabs

are permitted to carry out the proposed construction, with the federal government bearing a reasonable portion of the expense, never exceeding fifty per cent. The fifty-per-cent rule is waived only in the case of a few public-land states, where a large acreage is still under control of the national government. The Federal Aid system costs the government approximately \$90,000,000 each year.

The actual laying of our road system is accomplished by a large number of trained engineers, in most cases college graduates in highway-engineering courses. A knowledge of surveying, highway location and economics, reaction of materials to various temperature and weather conditions, traffic stresses and tensions, and many other fundamentals are essential before an engineer is ready to be entrusted with the important task of directing the construction of a modern highway.

One of the most amazing developments in connection with the growth of our gi-

gantic system of highways has been the building of highway-construction equipment. Enormous machines, some of them capable of laying 2,000 feet of concrete road in a single day, have grown out of the crude equipment in use a few years ago. The annual road-machinery exposition held each year by the American Road Builders' association has more than 300 carloads of this equipment on display, and each exposition brings to light new developments that increase the efficiency and economy of highway construction.

Who pays the \$1,250,000,000 annual sum for modern roads, and is this expenditure justified?

Approximately fifty per cent of the total is expended by the various state governments, \$90,000,000 annually by the federal government, and the remainder by county, municipal, township and private agencies. The state funds are raised principally through the mediums of gasoline taxes, motor-vehicle licenses and direct taxation

of property. In 1926, gasoline taxes yielded the states revenue to the amount of \$187,603,231, with the tax ranging from one cent to five cents per gallon, and averaging 2.38 cents per gallon. During the previous year, automobile-license fees contributed \$260,619,000 to the various state treasuries. Thus it may be seen that the motorist, after all, rather than the individual property owner, pays for the highways which make it possible for him to operate his motor vehicle with speed, economy and safety.

The payment of gasoline taxes in 1926 has made it possible to determine the fact that motor vehicles consumed approximately 10,000,000,000 gallons of gasoline. At an average of twelve miles to the gallon, these cars traveled the astonishing distance of 120,000,000,000 miles in a single year. At this rate, the road system is costing the nation but one cent per vehicle-mile, and since research has proved these roads save from two to ten cents per mile, the con-

clusion that they are saving many times their cost is obvious.

The development of America's system of individual transportation has been phenomenal. Where, a few years ago, mud and dust prevailed according to the varying conditions of the weather, today we find a smooth hard highway stretching into any part of the nation. The first transcontinental highway in the history of our country will soon be completed. It is 3,400 miles in length, extending from New York city to San Diego, Calif., via Washington, St. Louis, Texarkana and El Paso, and is already ninety-eight per cent completed. A second great highway, partially completed, is international in nature and extends from Montreal in Canada, through the United States to a point approximately fifty miles south and west of Mexico City.

In fine, the American highway is an achievement that is making history. It is welding an already great nation into a nation of greater internal integrity.

TEST AIR SAMPLES FOR DIRT TO GUARD PUBLIC HEALTH

How much dust and other foreign material are in the air we breathe? At what time of year is the amount likely to be greatest, and how can the hazards of im-

pure air be reduced? These and other questions are being answered by the United States public-health service and other bodies on the basis of facts obtained by testing samples of air from different localities. Carefully measured quantities are taken and subjected to various tests

by which the examiners can compute, with a fair degree of accuracy, the amount of dirt in the air and detect the presence of harmful gases, disease germs and other bodies. In making such a survey in Boston, recently, an outfit mounted on a motor truck was used, saving considerable time and promoting accuracy, as the air could be tested at the spot where it was taken and under a wide variety of conditions.



Gathering Samples of Air for the Pollution Tests; Portable Outfit in Boston, Where Extensive Survey Was Made Recently

German chemists are reported to have discovered a process for making synthetic tobacco.

Mr. John J. Bloomfield

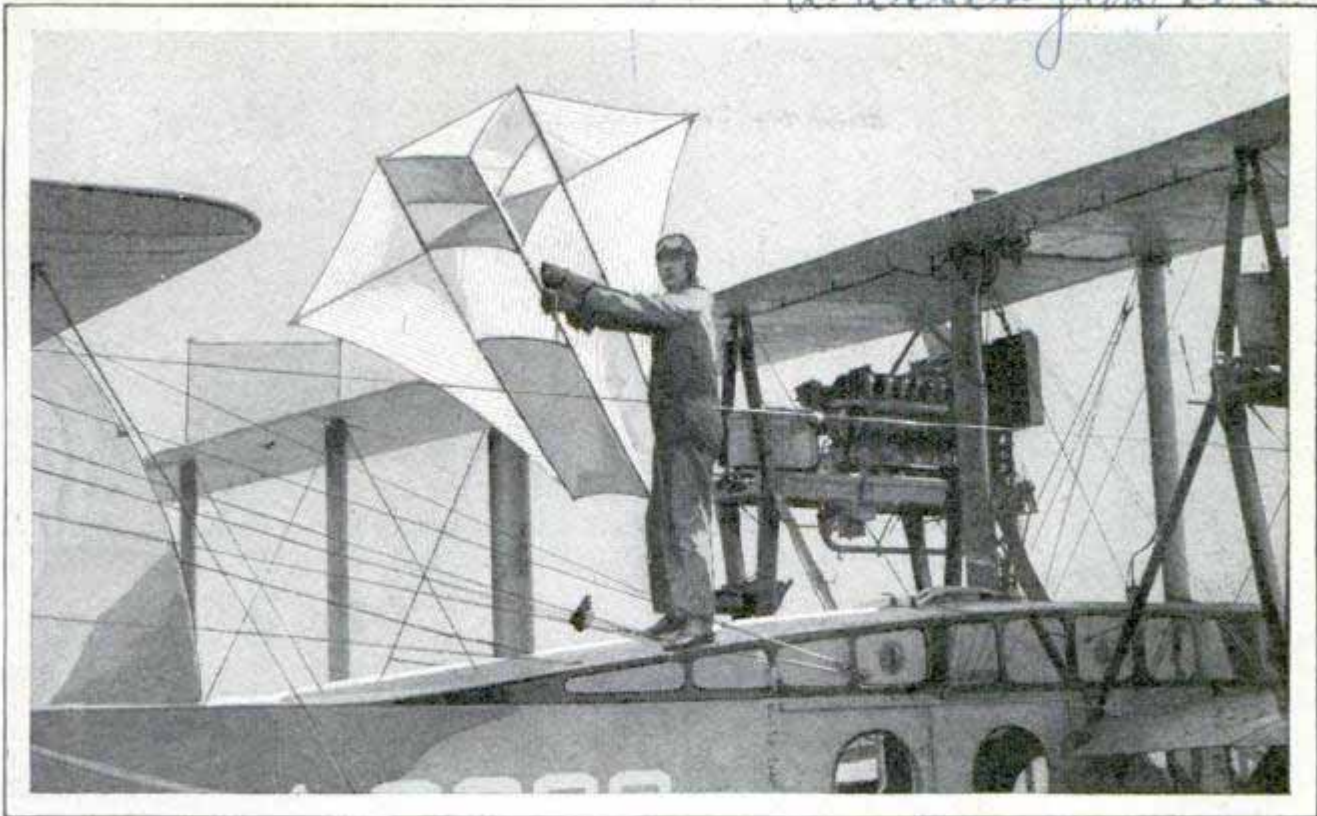

One of the Types of Kites Being Used on Naval Planes to Support Radio Antenna in Case of an Emergency; Besides This Service, the Kite May Be Used as a Visible Signal of Distress

KITES TO HOIST RADIO ANTENNA AID IN AIRPLANE LANDINGS

Kites are proving helpful to aviation as a means of raising radio antenna in case a plane has made a forced landing and emergency communication is necessary. So successful have the kites been performing in naval tests that they may become part of the standard equipment of navy planes on long flights. The antenna wire takes the place of the kite string. Engineers are working on a four-foot kite which is expected to be powerful enough to carry 500 feet of aerial wire and which would also serve as a visible signal of distress. A five-foot man-carrying type of kite, tested at the Anacostia naval station, proved that it could be successfully flown from a plane forced down at sea.

CARING FOR YOUR WATCH

During a sudden cold snap, a watch should not be wound until it has been warmed for at least fifteen minutes. To wind it immediately after exposure to cold may break the spring. During the night, the watch will run better if it is in about the same position it occupies during the day. The timepiece should be wound

in the morning instead of at night. It is directly after winding that a watch works best and can thus stand the vibrations during the day. It should be wound slowly, carefully avoiding jerks. Count the number of turns the spring will allow without undue strain. These hints were recently given by a large watch manufacturer as practical ways to improve the performance of the timekeeper and prolong its life.

KNIFE TO CUT AUTO PATCHES IS ATTACHED TO CAN



cover of the container in which the patches are kept. It is said to cut a fine feather edge, which is necessary to insure the most satisfactory repair.

2598
Cord George H. Holden Esq.
Highfield View Tipton View Road
Chertsey, Surrey, England.

1935
Lockrite Patch Co., 4196 Calhoun Ave
Detroit, Mich.

#24-00 - incl saw - 836.00
2409

2382
New York City

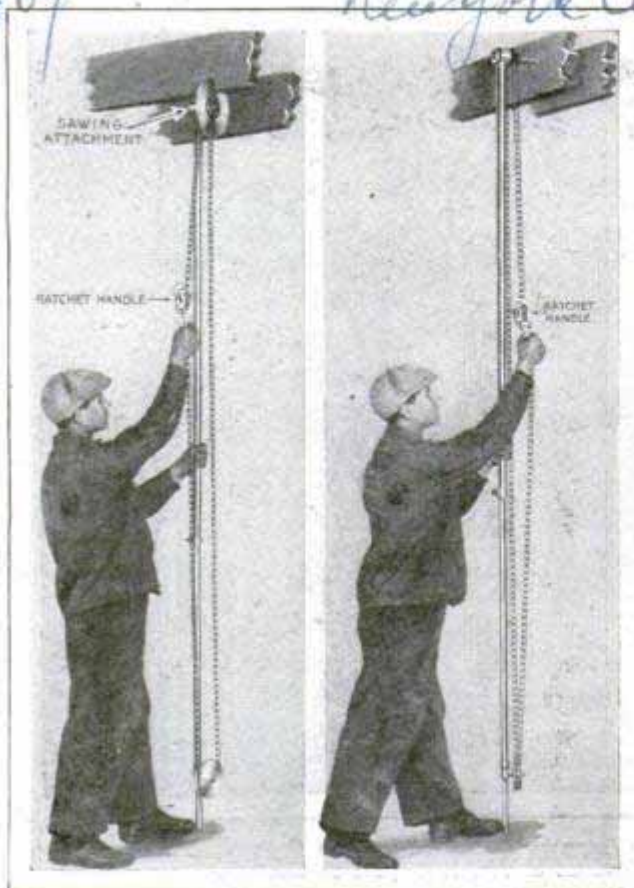

Chain Rig for Sawing and Boring; It Saves Both with a Ladder and Permits Easy Working Position

BORING MACHINE FOR CEILINGS HAS SAW ATTACHMENT

Designed especially for electricians, plumbers and steam fitters, a boring unit for making holes in ceilings or other elevated areas, is operated by a chain and ratchet handle, permitting the user to maintain a comfortable standing position and saving work. The unit is quickly converted into a saw by screwing a circular blade upon the chuck of the machine.

PREDICTING ECLIPSES

2926
As early as 2800 B. C., Chinese astronomers were predicting the coming of eclipses and were receiving rich rewards for their services, but if they made mistakes, their heads were chopped off. The phenomena were attributed to dragons, living in opposite points in the sky, that completely or partly swallowed

the sun or moon. The Chinese observers had found that a "swallowing" was almost certain to occur after so many days, so their predictions came true after a roughly calculated rule, although they were bound to be inaccurate and estimates could be made only for that part of the world. Today, astronomers can foretell eclipses to the second for any part of the globe and can say how long they will last and whether they will be complete or partial, for it is now known that they are due to relative positions of the sun, moon and earth and resulting shadows. There cannot be more than three eclipses of the moon in one year and in some years it is possible for the moon to miss the earth's shadow. In regard to the sun, it cannot undergo more than five eclipses in one year and it is impossible to go a whole year without at least two being visible at some place on the earth.

SMOKESTACK BIG AS TUNNEL HOLDS AUTO TRUCK

219
The size of the smokestacks for the liner "City of Honolulu," being built at a Los Angeles shipyard, was demonstrated recently when an automobile truck was driven into one of the funnels. There was room to spare. The vessel will be equipped with two of the huge stacks.

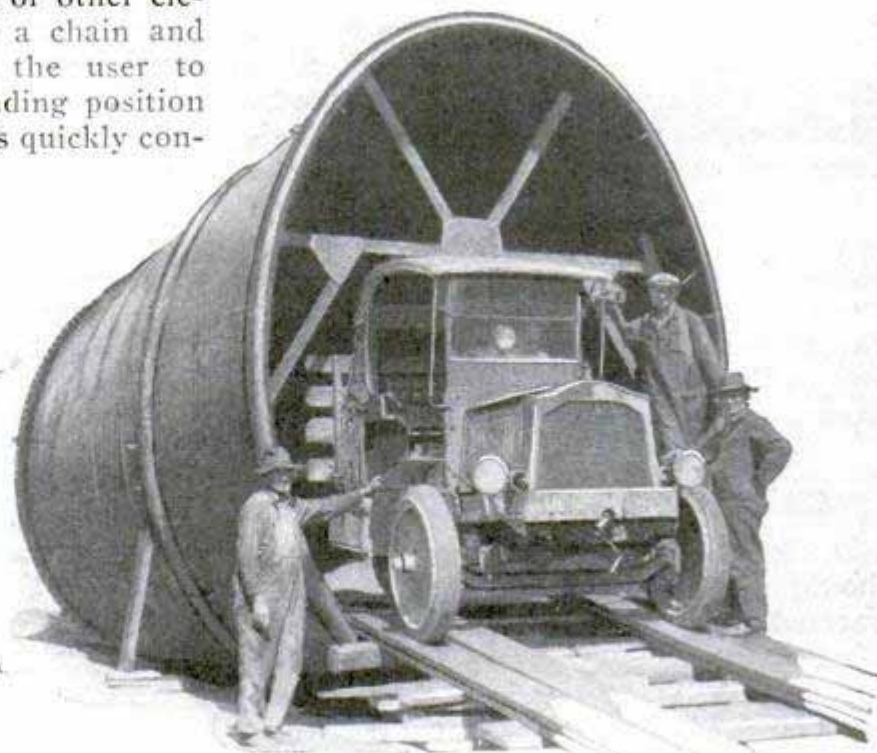

Almost Big Enough to Serve as a Garage; One of the Huge Funnels for the Liner "City of Honolulu," Built in Los Angeles

Winnmore, etc.
Professor of Astronomy
Winnmore

District National Bank Bldg
Washington, D.C.

Uncle Sam's CHICKEN FARM

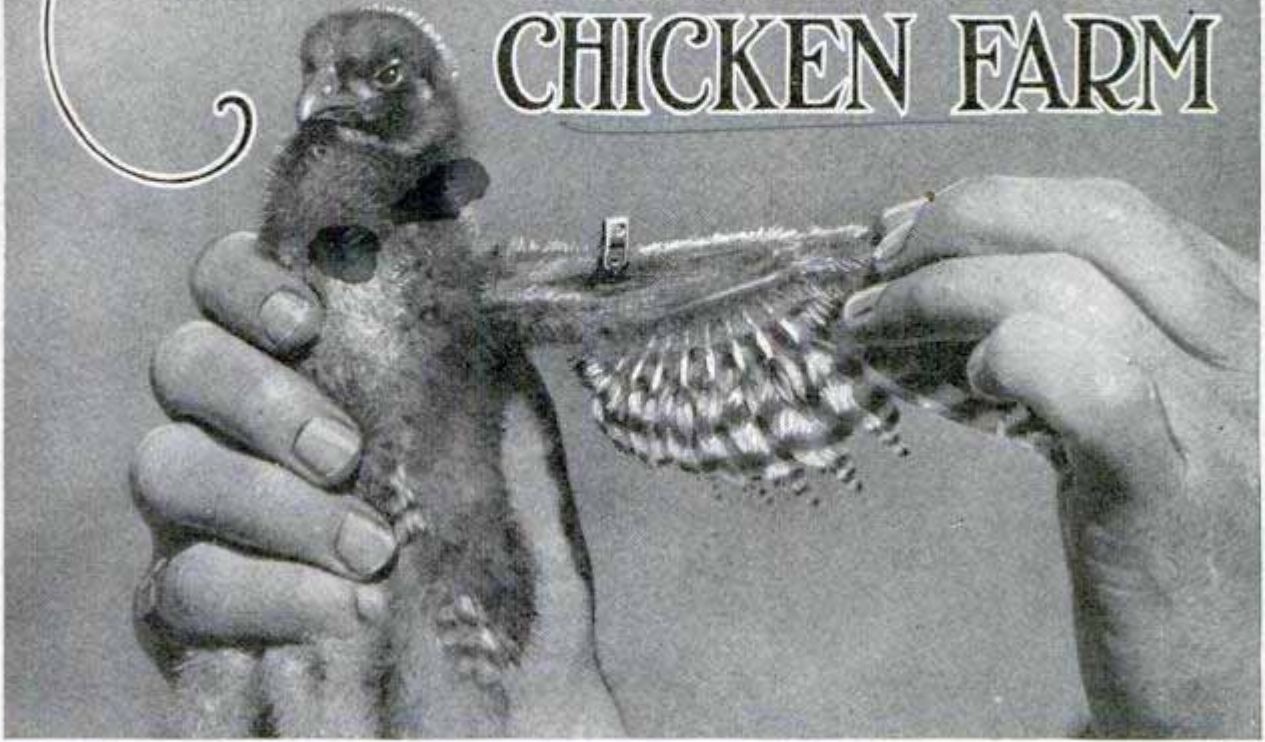

Every Chick Born in the Government Poultry Pens Gets a Wing Band That Identifies It for Life, So That Its History May Be Entered in the Books for Future Comparisons

ON a sixty-acre chicken ranch a dozen miles outside Washington, at Beltsville, Md., the United States government is conducting the world's largest experiment in scientific chicken raising, and every day is learning lessons which can be applied by the thousands of poultry raisers throughout the land.

With from 4,000 to 4,500 fowls, of twelve different breeds, to experiment with, the government scientists are learning things that will improve the egg-laying qualities or the meat value of the nation's 410,060,000 chickens. That is the estimated poultry army, according to the bureau of census—a flock that would provide three fowls for every man, woman and child, with 30,000,000 left over. The hens among them lay approximately 1,654,044,932 dozen eggs each year, and still another three million odd dozen have to be imported from abroad to meet the egg demand.

Half the sailors at sea, it has often been estimated, have an ambition to retire some day and settle on a poultry farm, and thousands of city dwellers, clerks, stenographers and others, hold the same desire,

so poultry raising is one of the country's leading farm pursuits. To supply all the chicken raisers, present and prospective, with adequate scientific information, the corps of the department of agriculture experts at Beltsville are studying the questions of feeding, housing, breeding and raising chickens, as well as how to get more eggs, better eggs, thicker-shelled eggs which will withstand the rigors of transportation, and how to fight the diseases of poultrydom.

Last year alone twenty-seven pens, containing 500 chickens, were used in the scientific study of chicken diet; 1,200 hens and pullets were trap-nested to count their egg yield, and the rest of the experimental flock was used in other studies.

In the government flock there are white Leghorns, Rhode Island reds, barred Plymouth rocks, white Plymouth rocks, buff, partridge and silver rocks, brown Leghorns, Anconas, silver Campines, rose comb, white and black bantams. Eight long poultry houses are set aside for laying hens, while breeding pens, made portable so that they can be dragged to new

Dept. Animal Industry
Washington, D.C.

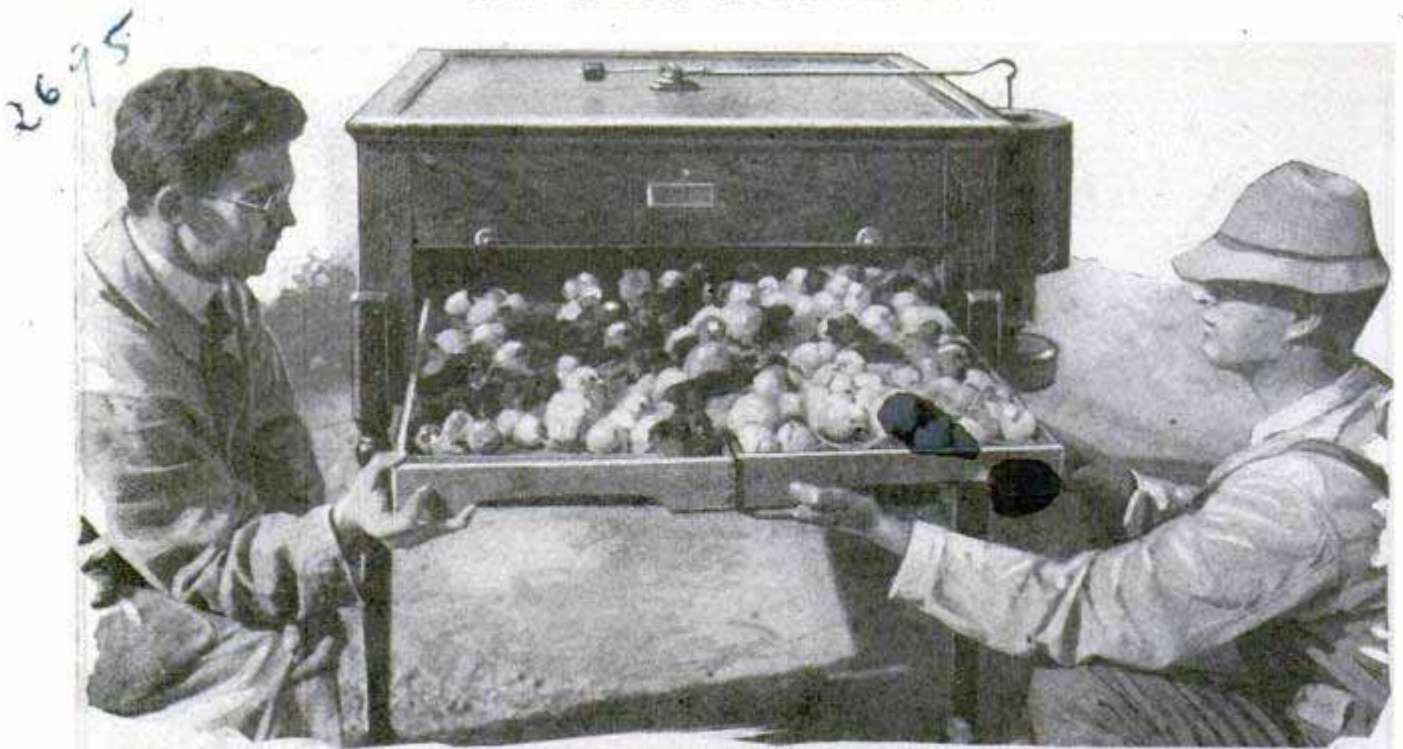

Bringing Off the Incubator Hatch, with Baby Chicks Just Emerging from the Shells; Thousands of Fowls Are Raised and Studied Each Year by the Government Poultry Experts

ranges frequently, are set aside for the breeding stock.

With twenty-seven pens for last year's food tests, each group was given a different sort of food and the results carefully tabulated. Fish meal, tankage, gluten meal, kafir and other foods were tried in various combinations, along with the more familiar articles of diet. All of the results of tests in each line of work are later embodied in the department's poultry pamphlets, and sold for a nickel or a dime through the government's superintendent of documents.

In one test to discover the effect of limestone on eggshells, eleven pens, each containing thirteen pullets, were fed varying amounts of the powdered stone, ranging from none at all in one pen up to twelve per cent in another. The pullets who got no limestone showed a fifty-per-cent drop in egg production, but none of the experiments indicated that limestone caused any appreciable change in the shell texture. The same results were obtained by using gypsum grit. Limestone grit gave fair production, about the same as a two-per-cent limestone diet. Egg production was practically the same in the four to eight-per-cent limestone pens, but dropped off in the pen of those getting twelve per cent stone, just as it did in the pen where no stone was fed.

Tests with varying amounts of protein established that growing chicks made their

maximum gains on a seventeen and a half per cent protein diet. When more was added, the effect was much the same as feeding less than the required amount. Cod-liver oil was used in most of the protein diets, and when it was omitted, there was quite an increase in the number of chickens dying, and much poorer growth among those that lived.

The tests showed that proteins were an absolute necessity. There are both meat and vegetable proteins, and the former were found to be particularly necessary for a poultry farm whose chief reliance is on egg production. Vegetable proteins, such as cottonseed and soy-bean meal may be profitably used when combined with meat scrap.

Semi-solid buttermilk as a drink for laying hens was tested, and found to be a successful substitute for green food. The same vitamins that are necessary for human growth are needed by the chickens.

Feeding experiments with both fish meal and tankage were successful, but the fish diet proved the best. The scientists were especially interested to determine whether a fish diet would affect the taste of either the meat or the eggs, but found it did not.

Gluten meal, a vegetable product, yielded the highest results in egg production. One white Leghorn pullet fed on gluten meal laid 310 eggs in 1926 and another was second with 300.

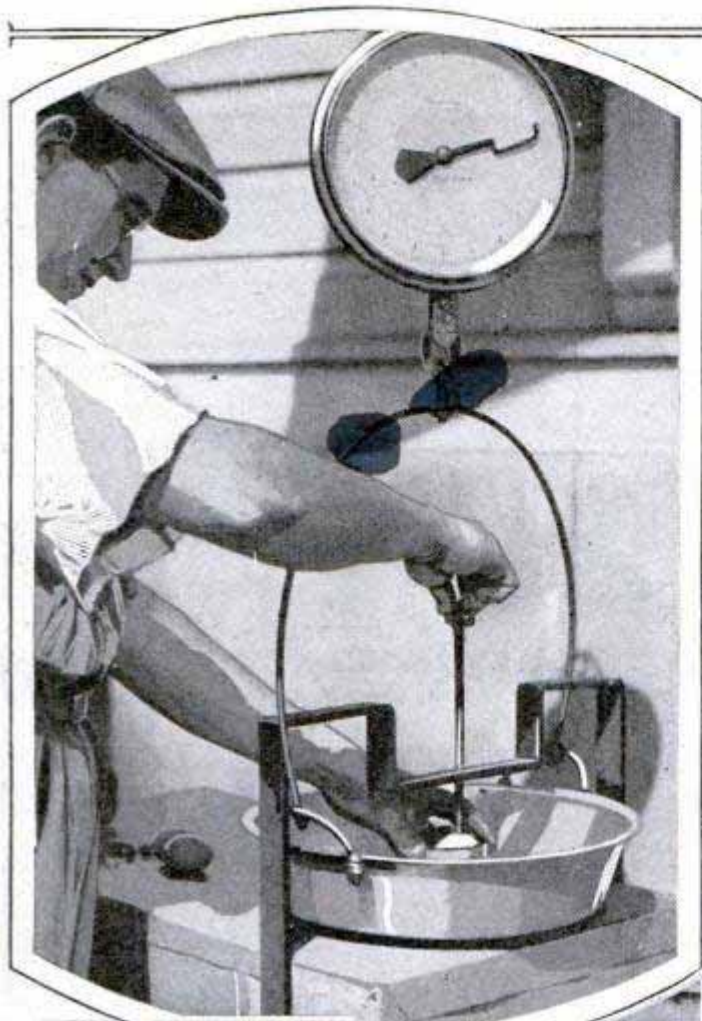

Strong Eggshells Are Necessary to Stand the Rigors of Shipment, and Fowls Are Especially Bred to Produce Them; Above Is the Test by Which the Strength Is Determined



Toe Punching a Chick to Record Its Breeding for All Its Life

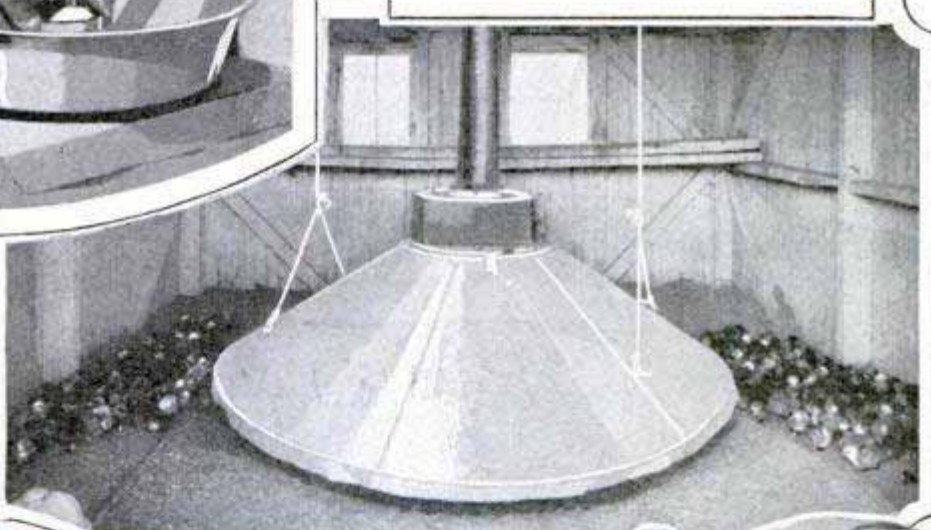

The Tin Mother of the Baby Chicks Is a Vast Metal Brooder under Which They May Gather to Enjoy the Heat of the Stove in Its Center

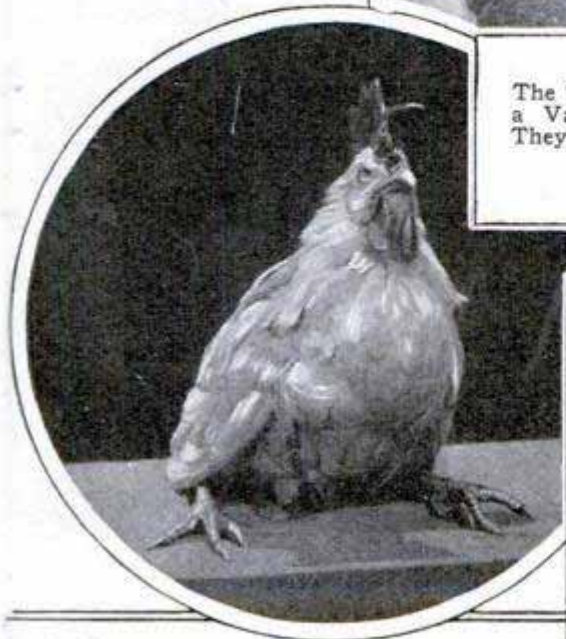

Chicken Diseases Are Studied and Fought; at the Left Is a Sick Hen Waiting for the Doctor to Diagnose Its Ills, While at the Right Is an Attendant Treating a Parasite-Infested Patient to a Dusting in a Tub of Disinfectant to Rid It of Lice; the Studies Have Done Much to Remove the Hazards from Poultry Farming



**CAFETERIA FOR FEEDING RATS
AIDS IN FOOD TESTS**

U. S. Department of Agriculture

2725



Weighing a Rat Subject, and Some of the Special Cages with Automatic Drinking and Feeding Containers

If the reactions of 4,000 rats are any index of what happens to human beings, ham or bacon and eggs may claim their popularity, not by accident, but because they are more nourishing when eaten together than if the meat is eaten alone or the eggs. For the past ten years, Ralph Hoagland, of the bureau of animal industry, has been conducting interesting experiments in feeding albino rats to determine how they thrive on different kinds of food. He has tended 4,000 of the creatures, and has constructed special cages with automatic drinking and eating containers so that the inmates may satisfy their hunger and thirst in cafeteria style. Among other important facts, he learned that lean pork, for instance, is rich in one vitamine but poor in another, hence the desirability of combining the meat with eggs which have a liberal supply of the helpful nutriment. The rats showed a dis-

tinct preference for ham sandwiches over ham or bread alone. They digested pork as easily as chicken. It was found that boiled ham, such as that purchased sliced in the market, is richest in protein, followed in relative proportions by lean smoked ham and medium fat smoked ham. Clean, fat salt pork, on the other hand, contains only a small amount of this food element. The bureau attributes the zest of persons doing manual labor for bacon and salt pork to the fact that either supplies 3,000 food units. From other observations, it was estimated that twenty per cent of the pork cuts are maintained in salty and fresh condition, while eighty per cent are sold as cured products.

**GEOGRAPHY TURNED INTO PLAY
WITH SECTIONAL GLOBE**

2288

Study of geography is made a pleasant game with a sectional globe now on the market. It is so divided that each part represents a continent, and the countries in each section or continent are in blocks which fit together like a jigsaw puzzle. When all the sections are assembled, a complete globe, with a colored map of the world on the outside, is formed. The unit is suited for school or home use, is accurately printed and serviceable as a reference for adults as well as a toy for children. It is manufactured in various sizes.

*Western Union
St. John, N.Y.
C. Stephen matches*

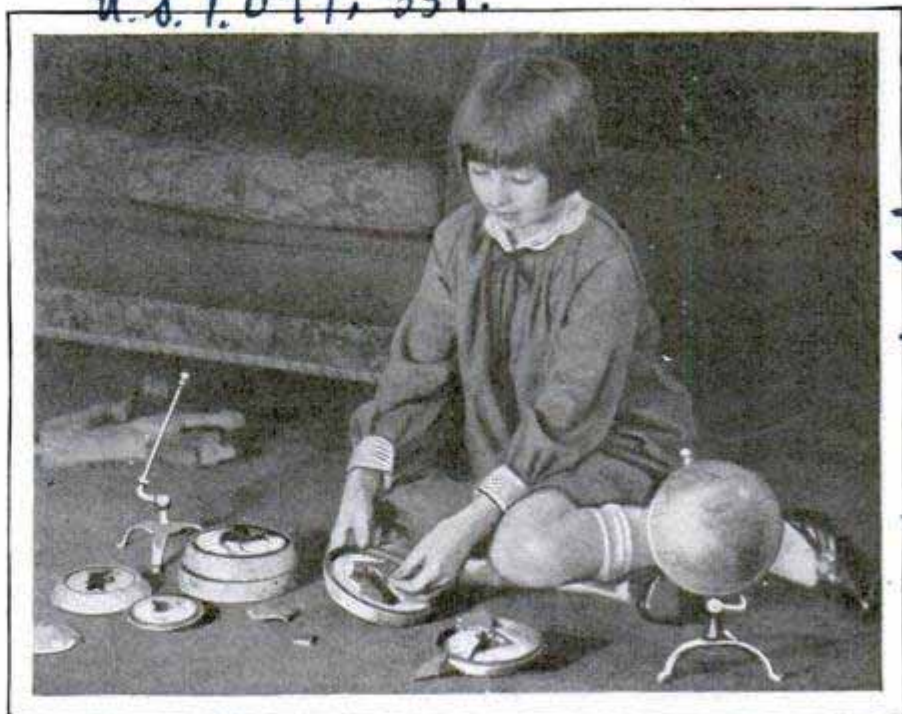

Globe in Sections, Showing How the Puzzle Maps Fit Outside, and the Assembled Sphere on Its Holder; There Is a Section for Each Continent

*Geographic Educator Corp
31 Union Square
New York*

U.S. 1.071, 358.

MINIATURE CITY FOR BIRDS ATTRACTS WARBLERS



"Bird City," Where Feathered Travelers Find Comfortable Homes; the Bath Was Patronized by Eighty-Nine Birds One Hot Afternoon, and Many Return Each Year as Their Bands Indicate

A miniature city for birds, complete even to a church, a cafeteria, a supply house and a bathhouse, to say nothing of modern cabins and houses, has been built in Lawrence, Kans., by Frank L. Hunt. The wren cabins are made of beveled logs and are oiled and painted inside and out. The entrance is seven-eighths of an inch in diameter with no landing to tempt sparrows. There is a miniature chimney which may be used as a handle to open one side of the hinged roof. This enables the nest to be cleaned out in the fall. According to Mr. Hunt, a wren house should not be too large, as the birds will fill it almost to the lid no matter how big it is, before they begin to form their cup-shaped nest. A group of bluebird cabins is occupied every year, as are also the larger cabins for the purple martins. The latter are covered with spools. Martins are colony birds and seem to be more satisfied if several families occupy the same building. Last summer a pair of crested flycatchers took possession of one of the martin houses and raised a brood of four. This season a titmouse family occupied one of the cabins, and two broods of chickadees

have been raised. Little cylindrical houses of rubberoid roofing are made for the woodpeckers. The supply house contains rooms filled with cotton, feathers, scraps of cord, binding twine and bits of fine wire. The upper room is for beef suet and scraps from the table. The bird bath is usually a very interesting corner in "Birdville." It is made of part of an old cooker, twenty by thirty-two inches by six inches deep, with a shallow floating bath for the smaller birds. On one sultry afternoon eighty-nine birds came to the bath for a drink or splash within an hour. One of Mr. Hunt's neighbors has a government license for trapping and banding birds in order to study their migratory habits, and to ascertain whether or not they will return year after year to their old nesting places. So far they have learned that at least fifteen different kinds have returned, proudly wearing their aluminum wristlets. Among them are the robin, wren, catbird, flicker, bluebird, dove, cardinal, brown thrasher, meadowlark, nuthatch, tufted titmouse, chimney swift, bluejay and the downy and red-headed woodpeckers.

311 Johnson Ave

TEACHING TRICKS TO LOBSTERS LATEST TRAINING STUNT

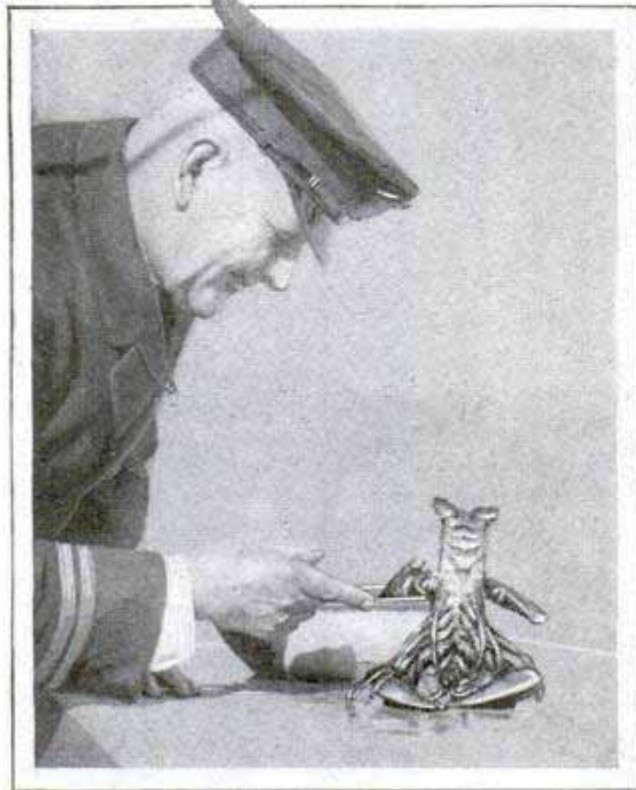

A New Recruit for the Trained-Animal Ranks; Teaching a Lobster to Do Simple Tricks

"Every creature has some degree of intelligence," scientists declare, and the assertion is supported by one of the most recent additions to the ranks of novel tricksters, a collection of trained live lobsters. According to reports, a ship's doctor influences the creatures by a sort of hypnotism and can make them stand on their heads and do other stunts.

END BLASTS ON BATTLESHIPS WITH ELECTRIC FANS

How efficient ventilation has stopped one of the worst horrors of the American navy, powder explosions in gun turrets, is an outstanding triumph of modern engineering. During gun practice, kegs of powder and dynamite are brought into the turret for ammunition. When the breech of a big piece was opened after a shot, air pressure from the outside sometimes whipped down the muzzle, blowing powder smoke and, occasionally, sparks back through the breech and into the turret. If these sparks came in contact with the powder stores, there was instant trouble, with loss of life, injuries and extensive damage the usual penalty. To counteract this out-

side pressure, special ventilating fans have been installed to keep the wind from blowing through the guns into the turrets. In the average installation, the fans were adjusted to pump about 5,000 cubic feet or 385 pounds of air per minute, eliminating the danger of explosions from the returning spark source and keeping out the fumes. In the new airplane carriers, "Lexington" and "Saratoga," each 888 feet long and 106 feet wide, electrical control of air for safety is being used to an extent never before attempted. Cabins and hulls of the ships are conditioned constantly at a temperature of seventy degrees and a relative humidity of forty-five to fifty per cent. There are 370 ventilating fans of various types on each ship, ranging up to a capacity of 40,000 cubic feet per minute, while 352 blowers are used to supply the boiler rooms, cool the main motors driving the ships' propellers and feed fuel to the huge oil-burning boilers.

RADIO ON WHEELS REPLACES THE STREET ORGAN

The traveling radio-concert man is replacing the organ grinder in Berlin. He wheels his set to neighborhoods where there are few receivers in the homes and tunes in a program from the air. The plan has proved more successful with the development of better types of loud speakers.



Giving a Radio Concert Instead of the Usual Hand-Organ Recital; the Traveling Receiving Set in Berlin

Chicago Evening Post
125



One Hundred Varieties of Lilies Are Raised in This and Eleven Similar Spring-Fed Ponds; Mrs. Helen Fowler, Owner of the Water-Lily Garden, Is Shown Gathering Selected Blossoms

Raising Water Lilies by the Millions

Twelve-Acre Water Garden Contains More Than
a Hundred Varieties of Blooms

By G. H. DACY

THE unexpected death of her father plunged Mrs. Helen Fowler, Kenilworth, D. C., into the business of lily raising almost overnight. Today, her twelve-acre water garden, consisting of thirty ponds fed by springs, where she raises some hundred varieties of water lilies, is one of the commercial marvels of modern floriculture. During the peak of the harvest season, from June until the middle of August, she markets from 4,000 to 5,000 cut flowers daily, while she also sells thousands of roots for propagation at from \$1 to \$25 a piece. As a sideline to lily growing, this resourceful producer markets more than twenty-five different kinds of aquatic plants which are in demand for

use in both private and public aquariums.

Mrs. Fowler raises, among other varieties, the "Mrs. Richmond," the finest and largest water lily known to botany, whose roots sell for \$25 a piece. She is the developer of the "Rose Aery," said to be the best commercial lily now offered on the world market, and also has produced the "Suffragette," a pure white lily whose blooms are six to eight inches in diameter. She is a master grower of the exotic night bloomers introduced from South America. These flowers, which sell for \$6 a dozen, open their buds only at night, closing the blooms again the following morning.

The greatest wonders at this record lily garden are the amazing *Victoria Regia*

2687

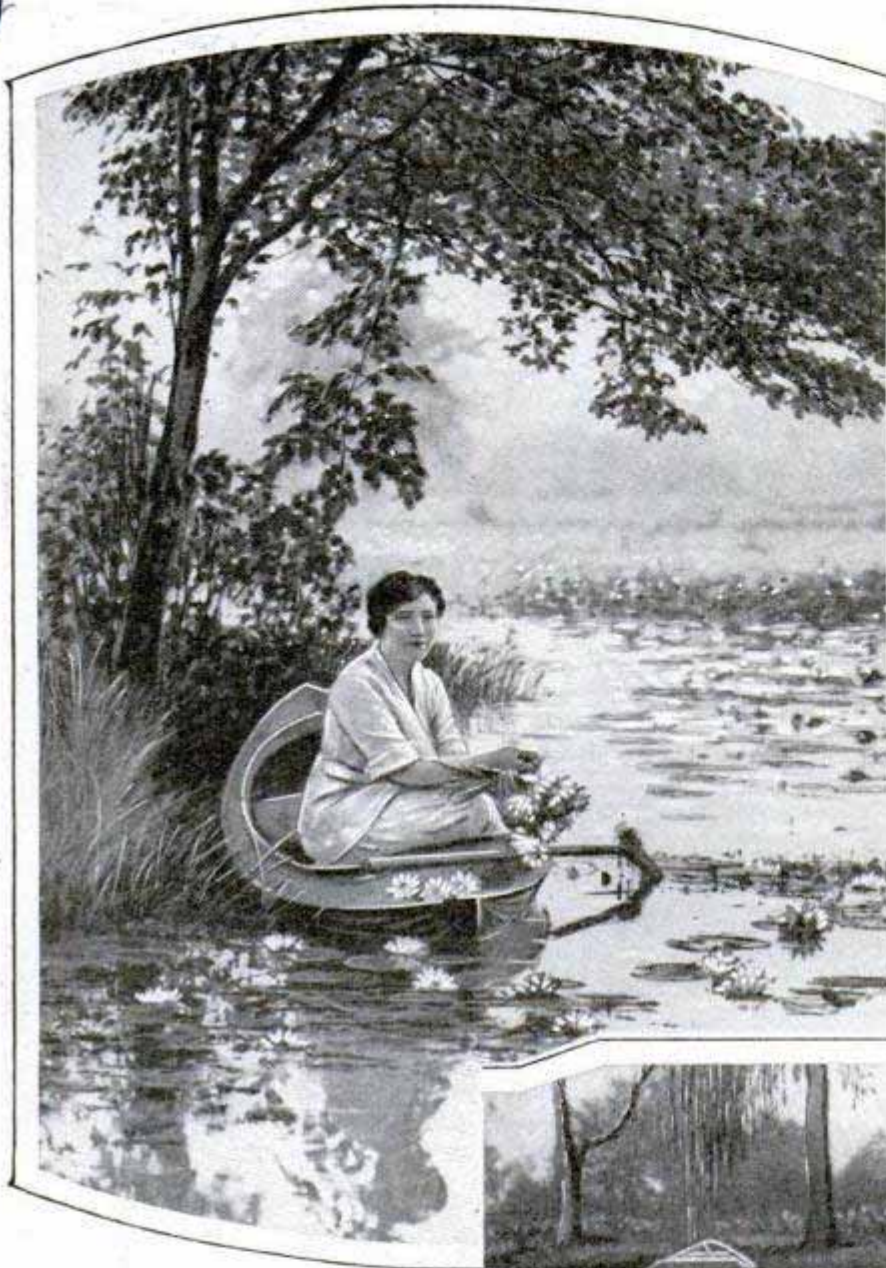

meaning of day and night. The lily imitates man, closing its buds and sleeping at night and not opening its bloom the following day until the sun is high in the heavens. Commercial lily harvest is based on this peculiarity of the aquatic plant. The pickers row about the lily ponds in boats between four and five o'clock in the morning. Rapidly they pick the buds in large quantities, rush them ashore, where they are cut, sorted, washed and packed in moist moss for shipment by parcel post, special delivery.

The cut flowers are distributed as far west as Kansas City, as far north as Portland, Me., and as far south as Atlanta. In all cases, the lilies are

lilies named in honor of Queen Victoria. Mrs. Fowler imported the foundation stock from South America via England. This is the mammoth of all water lilies both in speed of development and size at maturity. The seedlings, raised in greenhouse pots are removed to the pond in the early summer. Sixty days later, the Victoria Regia is fully grown. The plant is then thirty feet square with individual leaves that are six feet wide. This gigantic plant is so strong that it will support the weight of a fifty-pound child.

The water lily is a beautiful flower gifted with almost human intelligence as to the



The Victoria Regia, Giant of the Lily Family, Has Immense Six-Foot Leaves and Enormous Blossoms

shipped in bud so that they are just beginning to open when they arrive at their destinations. These extraordinary flowers will last for seven to eight days if properly handled after delivery. The stems are cut and the buds are floated in shallow dishes of water. Each evening, the buds

Canal State

close and go to rest while, the following morning, they once again open in full magnificence.

A curiosity at the Fowler lily farm is a colony of paradise fish—the famous fighting fish of Siam. These diminutive swimmers, only two to three inches long, are raised to destroy parasites which attack the lily plants. They are more courageous even than the fierce barracuda of southern seas, reputed as one of the most ferocious battlers of the ocean.

Mrs. Fowler also stocks her lily ponds with young fish of the game varieties, six to ten inches long. These fish destroy the colonies of mosquitoes which otherwise would infest the sluggish water.

FISH CAUGHT ON BAITED STONES CENTURIES AGO

2852

Quantities of fish bones found in the cave dwellings of prehistoric man indicate that the art of fishing is at least 200,000 years old, and rude tackle equipment of the times shows that skill was probably even more important in landing a catch than it is now. The fish were speared with sharpened stakes, caught with the bare hands or in nets made out of branches. Hooks of flint came later, and among some of the oldest fishing tackle found are banana-shaped stones with a groove in the center. About this groove was fastened the line, probably a thong of rawhide. The stone was covered with meat and when the fish swallowed it, a quick twist of the wrist turned the "hook" crosswise in the fish's interior so that the catch could easily be pulled out of the water. This same method is used today by French eel fishermen, and by some Indians in catching salmon. The stone hook was supplanted by those of bronze, which were first fashioned without barbs, two being used together at right angles, forming a double hook which could not easily be shaken loose by the fish.



Removing Chicken's Feathers with Electrical Picker; Points on Revolving Arm Save Hand Work

ELECTRICAL CHICKEN PICKER SAVES BUTCHERS' TIME

With a power chicken plucker developed in England, a fowl can be picked clean of feathers in one minute, according to reports. Projecting points on a revolving shaft do the work with little effort on the part of the operator except to handle the bird so that the flesh will not be torn.

PAPER PROOF AGAINST WORMS TO PROTECT BOOKS

2263

Thousands of dollars in damage is the yearly toll of insects that attack library books, but reduction in this destruction is seen as a result of a worm-proof paper a Philadelphia librarian has introduced. He is said to have experimented with 160 species of worms, but all found the paper unpalatable. Most of the damage they do is in boring through the leaves to devour the bindings and paste, etc.

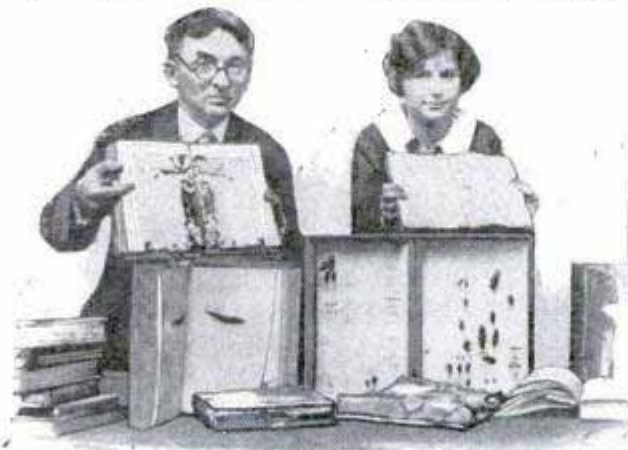

Ravages of the Book-Devouring Insects; Worm-Proof Paper Is Expected to Reduce This Loss

Kansas City Post
6/26/27

William R. Reinicke
Librarian

ELECTRIC KNIFE IS USED TO RESTORE LOST SANITY

*Described by Dr. Harve...
Ward, Howard A. Kelly Hospital, Baltimore, Md.*

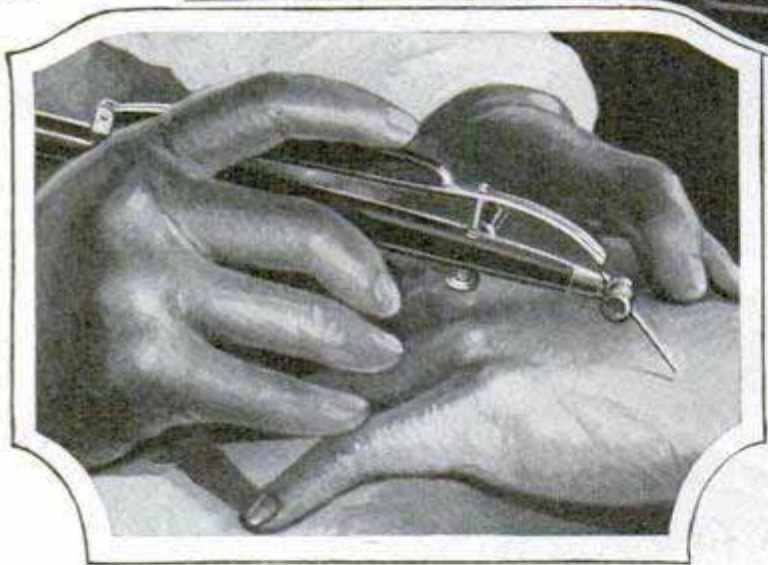
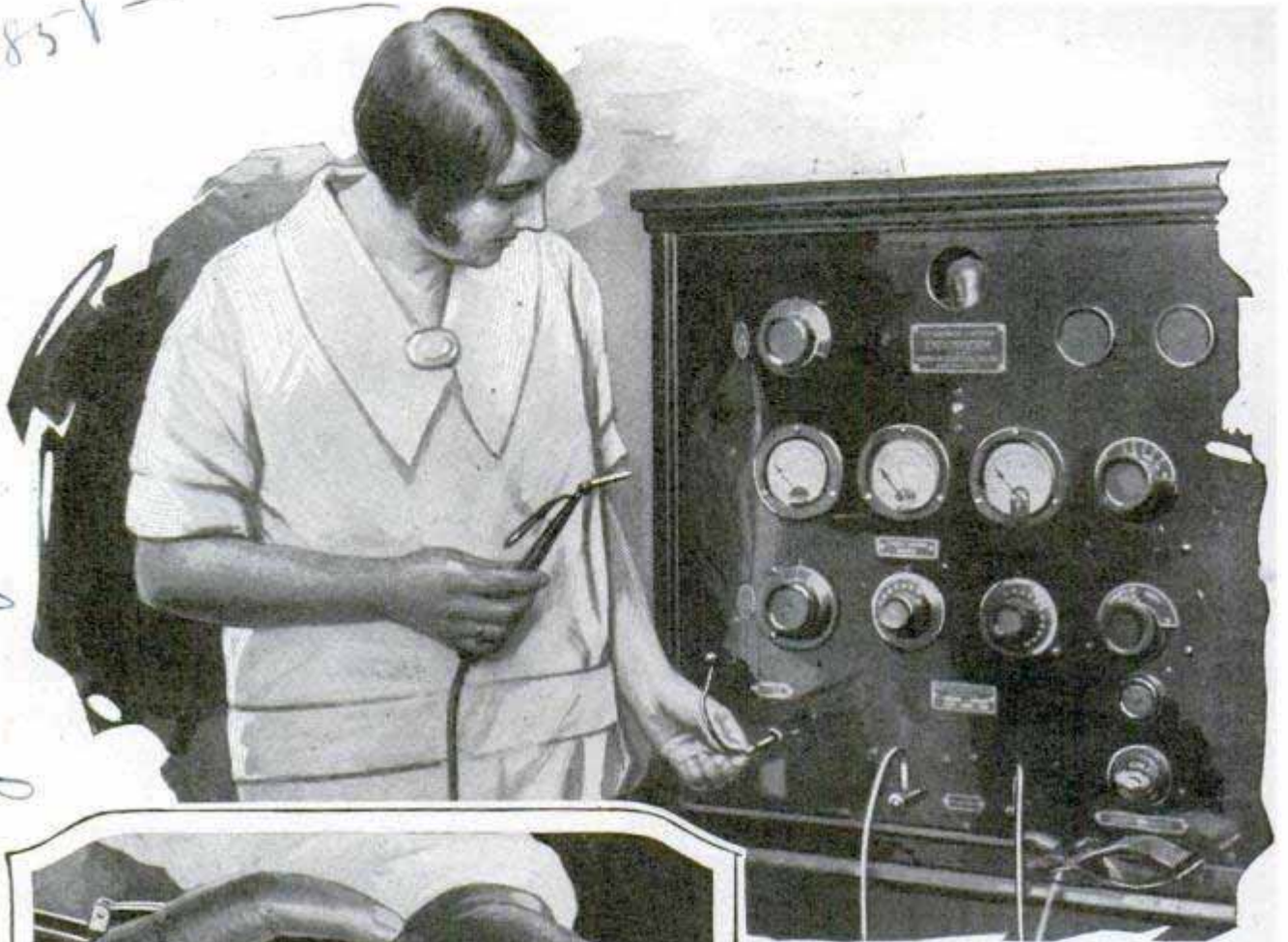

Switchboard of the Electric Knife, Above, and, at Left, the Knife Itself, Which Is Merely a Small Needle

Bloodless surgery, performed with the so-called "radio knife," can restore some insane persons to sanity, as well as make possible operations that have never heretofore been possible without fatal results, latest experiments with this remarkable new tool have disclosed. One of the diseases that has always baffled science, tumors of the brain, has been conquered in more than a score of successful operations by a Boston surgeon. Under former methods of operating with a keen-edged knife, brain tumors could not be removed because the patient would die of loss of

blood. With the electric knife, which is not a knife at all but only a small, needle-pointed electrode, there is no bleeding. Advanced cases of this brain disease cause insanity, and in several of the operations which have been performed at Boston the patients were insane before they went under the electric knife, and came out sane again. The radio knife got its name because it employs the same sort of high-frequency current that is used in wireless. Ordinary house-lighting current is "stepped up" to an enormously high voltage and frequency, but only a minute amount is used. Under such conditions, it is possible to pass the current through the body without feeling it, though the voltage is high enough to jump a gap many inches long. The patient is placed on one electrode and the surgeon uses the other to operate with. An ordinary darning needle, or tool of similar size and

Dr. Harve... Cushing Boston.

*and King Solomon
Pompton Lake, N.J.
605*

**QUOIT GAME WITH OLD TIRES
GIVES GOOD EXERCISE**

2451.

Another Use for
Worn-Out Auto Tires;
Play Quoits with Them

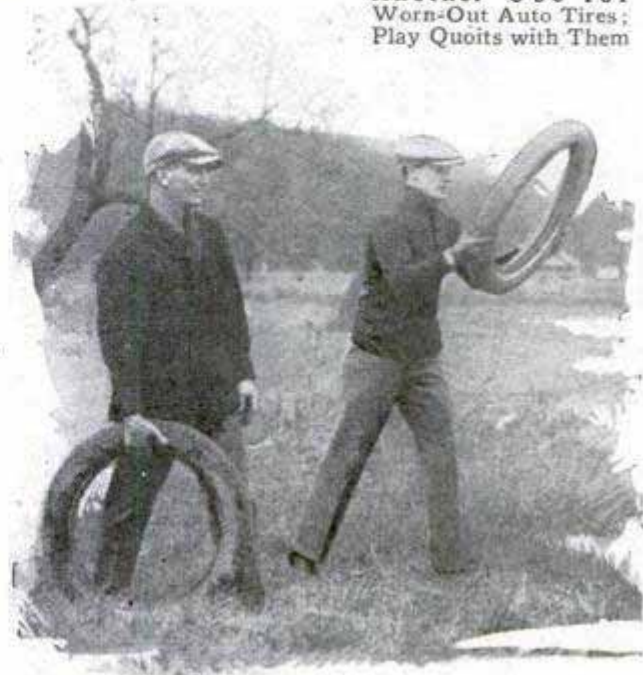

Automobile tires, no longer fit for service on the car, are used for pitching quoits in a variation of the ancient game. Strength and accuracy are both required, especially if the players stand far from the peg.

**POWER STEERING FOR AUTOS
EASES DRIVER'S TASK**

valman gear 292

Driving the automobile in or out of restricted spaces while parking and guiding it under all conditions are relieved of much of their difficulty in a steering gear that functions chiefly by power from the motor. The apparatus is mounted on the steering column just below the footboards and consists chiefly of two brake drums driven slowly in opposite directions. Each drum contains a springy brake band, one end of each being secured to the shaft carrying the worm of the usual steering-gear box mechanism. A turn of the wheel has the effect of expanding the proper brake band which meets the power-driven drum, turning the wheels to a degree corresponding to the steering-wheel movement. The take-up is said to be so rapid that steering seems to be done in the usual way but requires only about one-tenth of the effort. If the motor is not running, the car can still be steered easily, although greater force is required on the wheel.

*Mr. J. M. McManis
Chicago
Bethlehem Steel Co.*

2500 d

shape, is suitable. When the needle approaches the flesh a small arc is formed, and then the current begins cutting its way through the body, coagulating the blood and sealing off the adjacent blood cells as it progresses. By varying the current intensity, it is possible to seal only one thin layer of cells, or seal them to a depth of a quarter inch or more, just as desired. At the same time that it is cutting, it acts as a perfect antiseptic. Even in operations in which large blood vessels must be parted the electric knife provides a seal. The surgeon catches the ends of the severed vessel with small forceps, passes the point of the electric needle over them, and they are sealed as easily as a paper tube could be closed with muciage. Because of its ease of manipulation, and the performance by the knife of work the surgeon formerly had to do by hand, the electric knife has shortened the time of operations materially.

**ANCHOR FOR THEATER CHAIRS
PROVIDES FOOTREST**

2598

One of the latest improvements in theater-seating equipment is a combination anchor and footrest for the chairs. It consists of a concrete ridge, the rear slope of which is inclined at such an angle as to make it suitable for a rest for the feet of persons of different heights. A channel between the anchors simplifies sweeping, allowing rubbish to fall into the center, prevents articles from rolling away and the ridges offer space for ventilators and tend to reduce drafts.

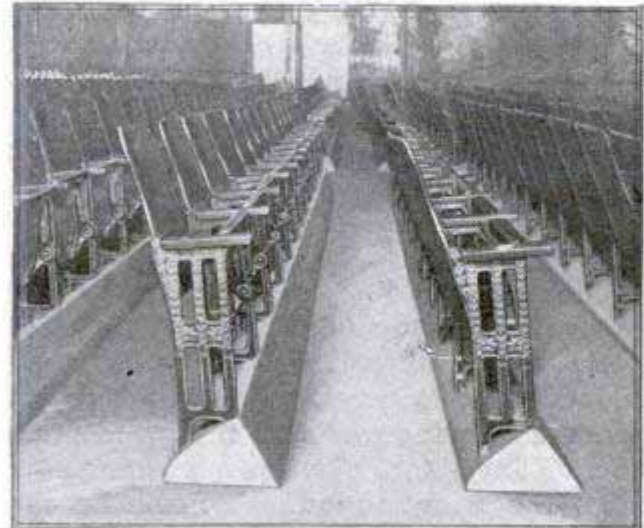

Theater Chairs on Concrete Ridge, Which Serves as Anchor and Footrest and Simplifies Task of Sweeping

*Wm. C. Hodges
4809 E 2nd St.*

*Stutz Motor Car Co.
Cable Car Ave + 10th St.*

1350 E. Jefferson Ave.
Detroit Mich



R. H. Dietrich, Custom Auto-Body Designer, Making His First Sketch of a New-Style Car

90 Dietrich Ave 1331 Holden Ave
By ROLAND MORE *Detroit, Mich*

A LONG, low "slinky"-looking car darts through traffic and speeds away. Lumbering after it comes a short-looking, high-sided, rather ungainly auto. Look up the manufacturers' specifications and you will find the two cars have exactly the same wheelbase. "Cheat" lines is the answer.

The cheat line, in automobile designers' parlance, is anything that is introduced into a body design to fool the eye, to make a car look longer or lower than it really is, thereby giving it that impression of speed and power which some cars have and others miss.

Take the convertible coupe-roadsters which are becoming so popular. Two manufacturers of higher-priced cars have brought out models of the same wheelbase, and one looks a foot or so longer and inches lower than the other. The difference in appearance lies not only in the general outline of the body, but in the molding treatment, color scheme, radiator and hood design, the curve of the fenders, and the size and shape of the windows.

For many years it was standard practice to put three windows in the side of

a sedan, the three being practically square and of equal size. Then an expert in cheat lines discovered that by making the windows of different widths—though the overall width of the three remained the same—he could apparently add several inches to the length of the car.

The science of cheating the eye in designing bodies is exactly the same as that of fooling the eye in designing clothes. Everyone knows that vertical stripes make a person look taller and horizontal stripes add apparent breadth. Fat people, therefore, shouldn't wear horizontal stripes, but automobiles, particularly if they have fairly short wheelbases, need them. The horizontal stripes of an automobile are the long fore-and-aft lines produced by body molding, fender lines, roof top, hood line and window spacing. Vertical lines are made as unobtrusive as possible, and confined to the necessary pillars between doors and windows and the windshield line. Thin pillars play an important part in giving wide vision, particularly the windshield columns, but are equally important in avoiding the sense of height.

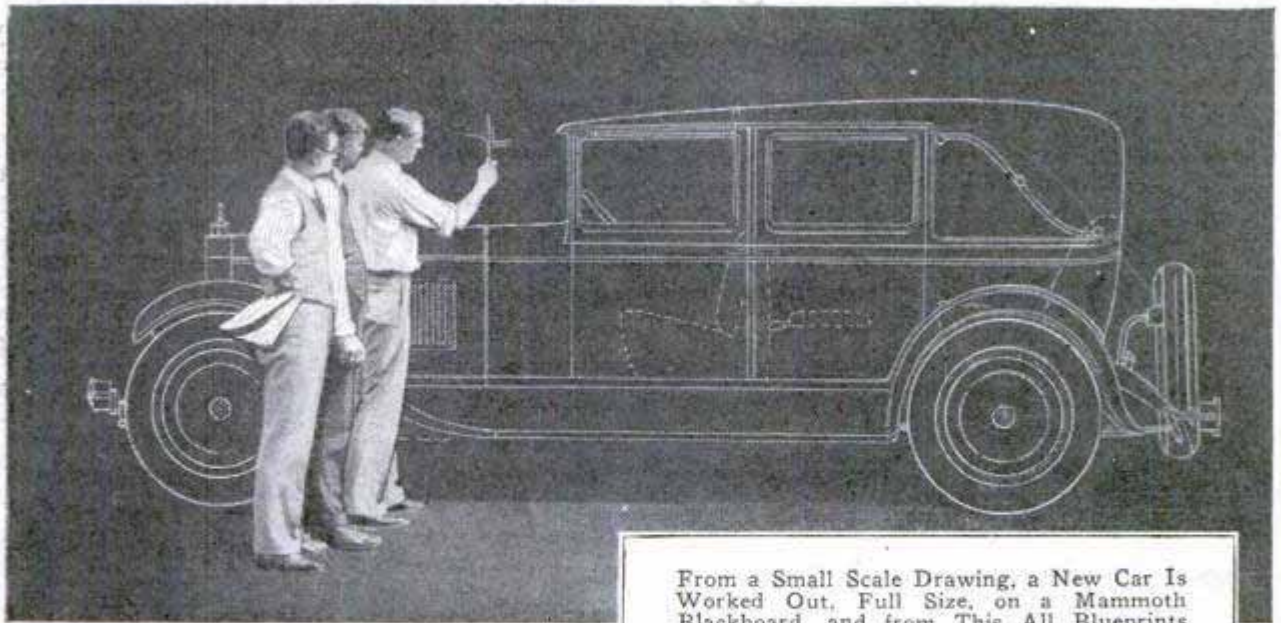

From a Small Scale Drawing, a New Car Is Worked Out, Full Size, on a Mammoth Blackboard, and from This All Blueprints Are Executed

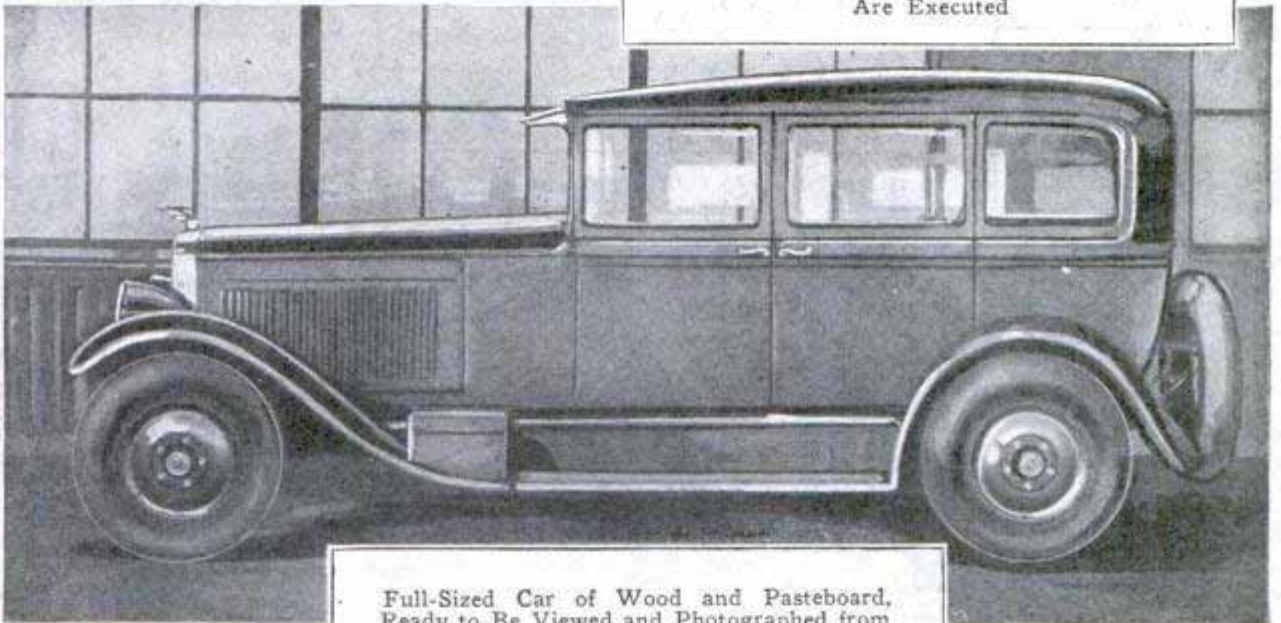

Full-Sized Car of Wood and Pasteboard, Ready to Be Viewed and Photographed from Different Angles to Judge Its Appearance

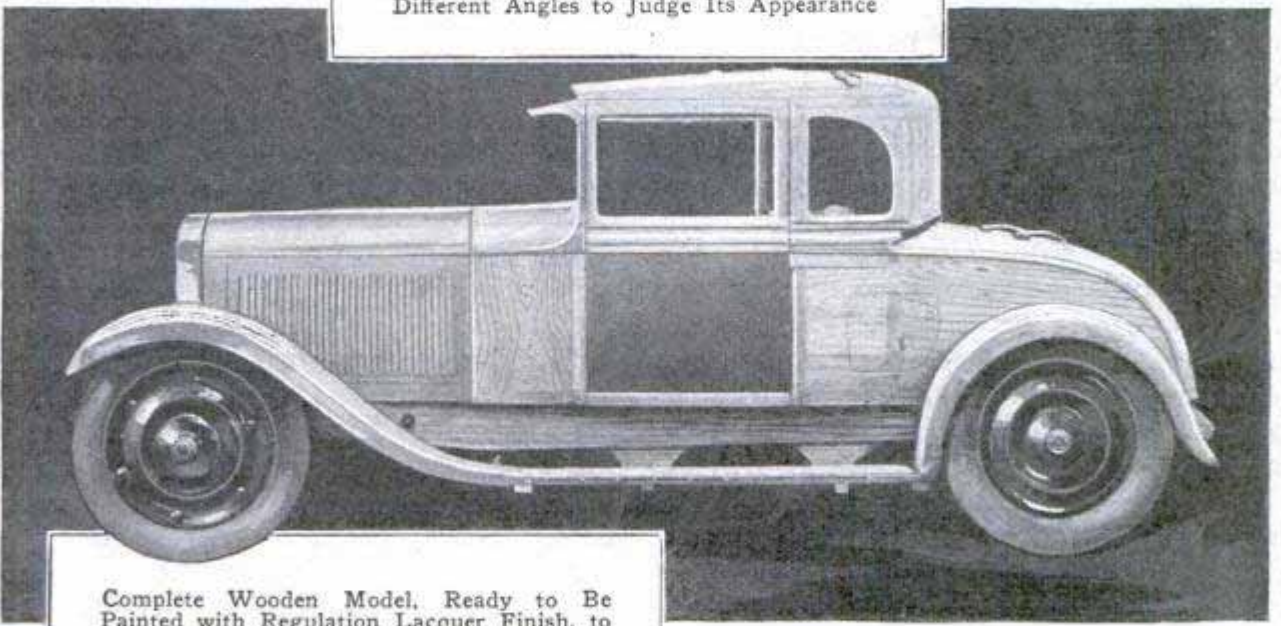

Complete Wooden Model, Ready to Be Painted with Regulation Lacquer Finish, to Give the Maker an Idea How the Design Will Look

The body problem goes back to the chassis design. If a chassis is long, seats may be placed low, with the passengers in a reclining position, plenty of leg room being provided by the long body. If the car is short, however, the seats must be raised to the knee height, the passengers must sit

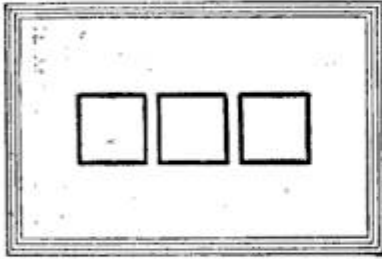

FIG. 1

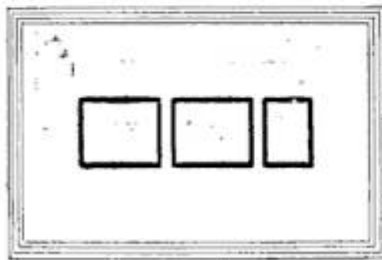

FIG. 2

Above, How Changes in the Width of Windows Alter Appearances, Though in Each Case the Over-All Length Is the Same; Right, Body Molding to Give the Look of Length

body together in a long and narrow rectangle, the tying being accomplished by painting the window columns and a narrow panel above and below them in a contrasting color. A dark color is usually chosen for the upper part because it emphasizes the length of the rectangle.

Below the windows, the designer will have a fairly narrow band of a lighter color, set off from the rest of the body by a narrow stripe or molding, carried the full length of the body and the hood. Sometimes, just above the frame, another dark molding line will run, to still further narrow the light body panel and provide a second long horizontal line to deceive the eye.

The biggest taxicab manufacturer in the country for many years painted his bodies in a bright yellow and hoods in black. The result was a short and dumpy-looking car.

erect, and the body will be much higher. The task of the designer in making such a short body look long is quite apparent.

He starts out by "tying" the windows in the upper part of the

Then he brought out a new model with the hood in the same color as the body, and the result was an apparent lengthening of the machine by many inches.

R. H. Dietrich, one of the leading custom-body builders of the country, who, at thirty-three, not only has his own body plant but is also consulting designer to a half dozen or more of the leading automobile builders, is an expert in the use of cheat lines. Body design, he declares, is far from perfection yet. The structural and mechanical problems have been more or less solved, but the problem now is to build the body around the passenger, giving added comfort, rather than fitting the rider into a car that may be mechanically excellent but uncomfortable to ride in. To solve that problem, designers are studying anatomy to learn where the bones and muscles should rest when at ease.

Many a person who has bought an expensive car, fitted with all the luxury accessories that can be crowded into it, has found himself exhausted after a 100-mile ride, Dietrich says. He tells a story of one of his own failures, when he had designed a fine custom body

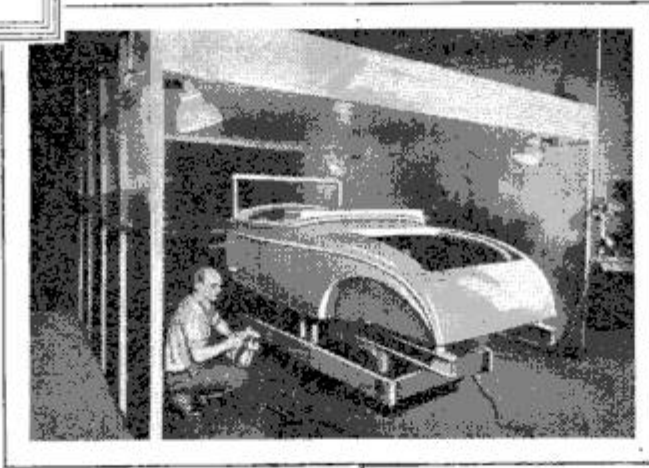

for a millionaire motorist. In a few weeks the owner came back and said the costly new car rode "like an ice wagon." Yet the upholstery was the finest, the seat springs of the deepest, and extra care had been taken to make the car comfortable. A study of its action on the road, however, showed that the owner, riding in the back seat, was subjected to the usual up-and-down bouncing as the car went over

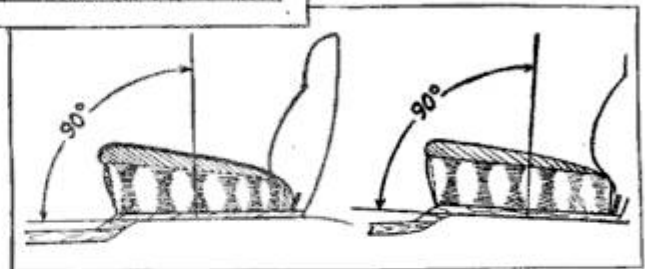

Sloping the "Kick-Up" of the Frame, as at Right, Keeps the Rear-Seat Rider from Being Bounced Forward, as at Left

for a millionaire motorist. In a few weeks the owner came back and said the costly new car rode "like an ice wagon." Yet the upholstery was the finest, the seat springs of the deepest, and extra care had been taken to make the car comfortable.

A study of its action on the road, however, showed that the owner, riding in the back seat, was subjected to the usual up-and-down bouncing as the car went over

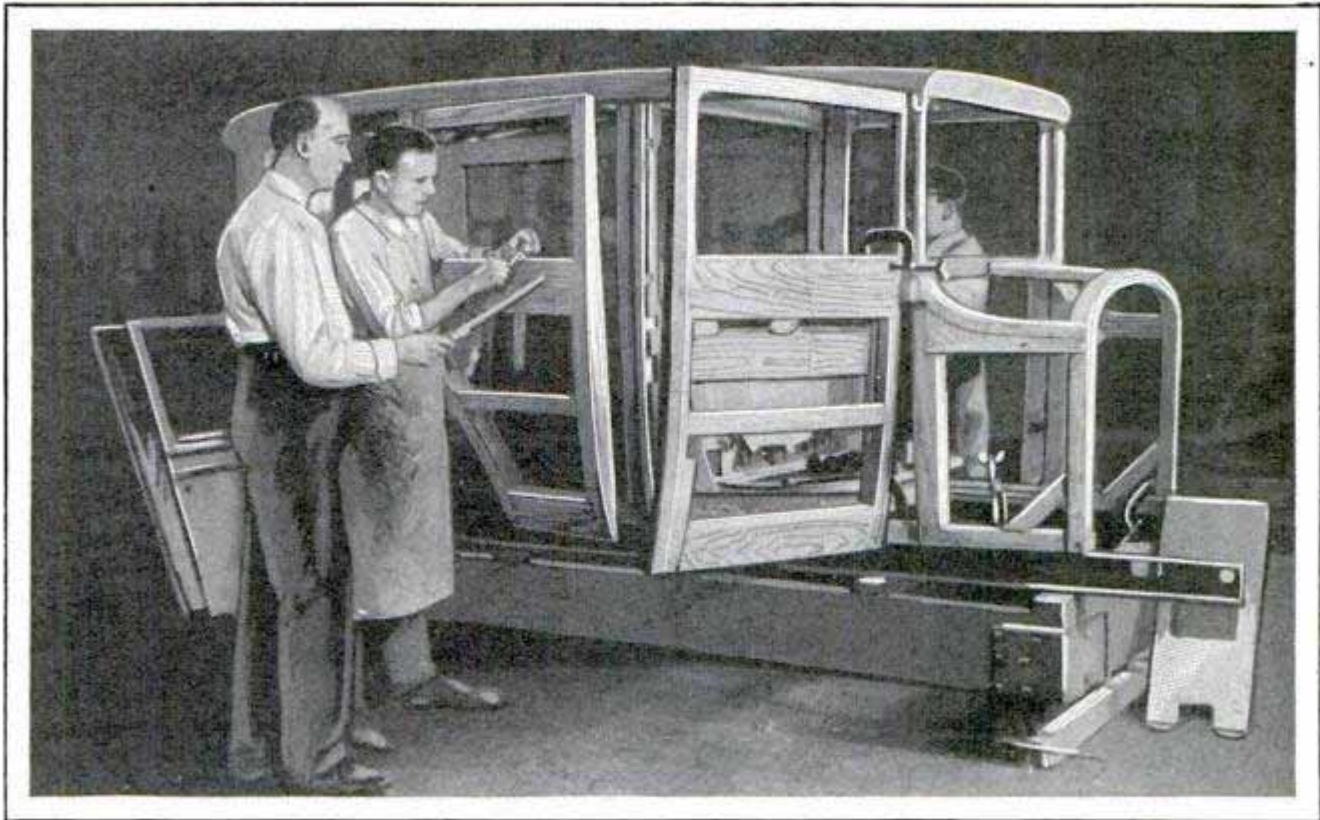

Expert Old-Time Carriage Builders Are in Demand in the Body Departments of Custom-Built Car Plants, to Insure Perfect Joints, Forever Free of Squeaks and Rattles

bumps, and that each bounce slid him a bit farther forward, so that periodically he had to plant himself back in the seat again. Manufacturers had discovered the same fault in back-seat riding long ago, and installed footrails against which the passengers could brace their feet.

"We have now discovered," says Dietrich, "a way to really prevent this forward sliding. One maker has already adopted the change and others will follow. It consists in bending the frame by the rear wheel housing so that it runs parallel to the rear seat, in other words slopes slightly backward. Any bounce then will merely bob the passenger up and down without throwing him forward.

A study of fatigue, he says, has shown that high windows are more tiring than low ones, for the reason that the rear-seat passenger is inclined to focus his eyes on roof and tree tops. By lowering the tops of the windows to limit the angle of vision, the body builders get away from this chance of eye strain.

"I always begin with the interior," Dietrich says, in describing how a body is laid out." He illustrated his point with sketches of a body he was preparing for King Alfonso of Spain. "I draw the seats first. For the front seat the position of

the steering wheel and pedals is the determining factor. After placing my seats, I figure on the necessary headroom and roof line. Here is where knowledge of the human body is necessary. We have found that whether a person is tall or short, the height above the seat will be fairly constant at thirty-three inches.

"For the front seat an angle of 110 degrees has been found the most comfortable—twenty degrees more than a right angle—with a bulge in the back of the seat, of course, to fit the small of the back. Front seats of sport cars are tilted still more, and front seats of town cars are made straight, to force the chauffeur to sit up with rigid dignity."

The first sketch of the body is drawn to a scale of one inch to the foot. Several color sketches are made to the same size to try out various combinations. Then it is copied full size on a blackboard.

In some plants the body is worked out full size in cardboard, like a movie set, supported by a hidden framework and with real tires and wheels attached. It is then viewed from every angle, and changes in lines and colors experimented with. Some factories even build up the cars full size out of wax or clay, waterproof them and then apply regular body lacquers.



Outrigger Sailing Canoe of Sumatra, the Chief Method of Transportation for the Natives in the Malayan Rubberland; They Take Their Frail Craft Far Out to Sea on Fishing Trips

By EMMET DOUGHERTY

ON the top of Mount Kaba, an active volcano on the island of Sumatra, a band of native Malays were going through their religious ceremonies. A sacrifice was offered in the shape of a white pigeon, with pink eyes, for which the Malay chieftain paid \$10 American gold.

The pigeon was turned loose over the crater of the volcano. If it negotiated the flight to safety over the seething mass of red-hot lava, which such birds rarely do, great ill befalls the natives. If the bird falls into the crater, which is generally its fate, all the wishes of the natives come true—rice and fruit will be abundant and the price of rubber bought by American users will continue high.

After a three days' climb through the jungles to the summit of Mount Kaba, this was the unusual scene unfolded before Lieut. Henry C. Kellers, a naval medical officer, who accompanied a recent expedition to Sumatra to witness the solar

eclipse. Kellers spent ten weeks in the Dutch East Indies archipelago, bringing back 9,000 specimens of reptiles, birds, insects and mammals, living and dead.

Among the sixteen living birds brought back are a pair of black-crested hornbills, trapped by Dr. Kellers on the banks of the Musi river, near Kepahiang. Aside from their weird shriek, these birds are distinguished by the habit which the male has of building a mud wall to seal his mate up in her nest. At night, the female sticks her beak through the aperture, effectively plugging it. The purpose of this is to protect the eggs or young from snakes, wandering rats and monkeys.

Marine collections were gathered by Dr. Kellers in the Indian ocean and the Musi river, an outrigger canoe being used in deep-sea fishing and seining. Water reptiles, sea serpents, water snakes six and seven feet long, were collected on the reef off Poeloeticus. The draco, a flying lizard

J. C. Matheson & Co. Ltd. 611

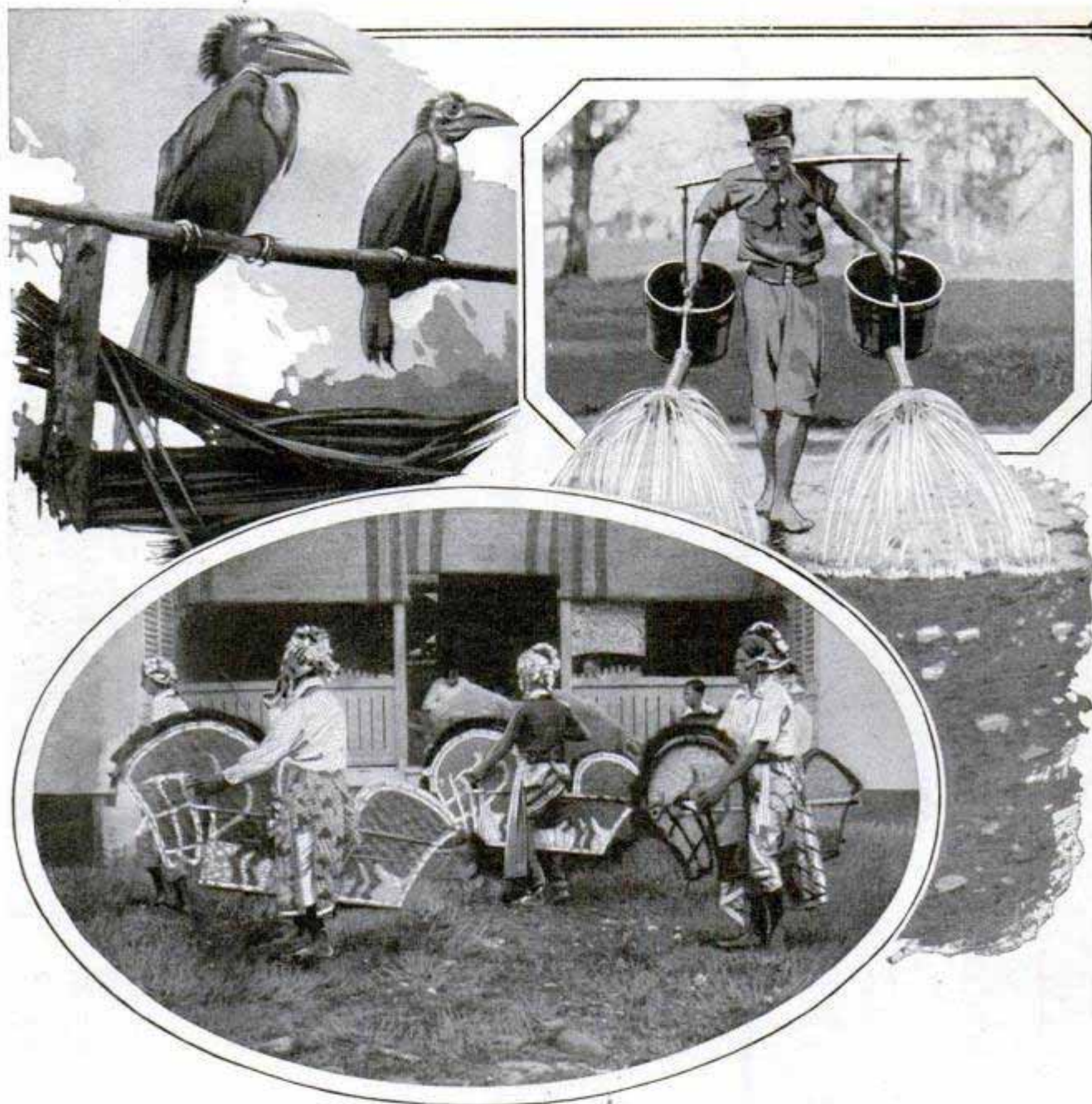

Horse Dance of the Natives; Top, Left, a Pair of Black-Crested Hornbills Captured by Lieut. Kellers, and, Right, a Sumatra Version of the Street-Watering Cart

colored as beautifully as a butterfly, was one of Dr. Kellers' catches. He also caught a coral fish, which is a very rare species. Most of these marine specimens were helpless on land. All are poisonous and live on fish.

A nine-foot cobra, the most vicious snake that frequents the islands of Sumatra and Java, was killed with a gun. It had fangs three-eighths of an inch long, not unlike teeth, and when the mouth was closed they set in sockets in the jaw. Lieut. Kellers also saw a specimen of the diminutive mouse deer, which stands about a foot high, and sought to buy it from its native owner, but failed because the Malay

feared all his family would be desolate if it were sold.

The tiger is the most feared of mammals in Sumatra. It represents the type of ferocity in the native proverbs and folklore. A distinction is drawn, however, between the tiger and the tigress in the way the two kill their prey. The former is said to break the neck, the latter to bite through it. Most of the other mammals do not seem to inspire much terror in the natives, though many are dangerous when hunted. Reptiles arouse great alarm. Crocodiles claim a much larger toll of victims than the tiger, while the more deadly of serpents are feared above all animals

A. Trinton, and Charles A. Becker, 613

because of the suddenness of attack and the certainty of death. The king cobra, because of its great size, is feared the most, although snake bite is of rare occurrence. Among the fables and folklore in Sumatra, the mouse deer is the "King of the Forest" and represents the triumph over the force of the tiger and the elephant.

The houses of the natives reflect another superstition. They are all constructed to keep out the tiger. The Sumatran native religiously believes the myth about the fight between the tiger and the carabao, or water buffalo, with the horned animal triumphing over its adversary. With these two animals in mind, the native builds his house on posts, raising it several feet to keep out the tiger. The horns of the carabao are represented in the shape of the structure, the upper portion being much wider than the ground floor.

The American gold piece is the most sought after trinket of the Malay natives, many of whom have become wealthy through their labors on rubber plantations.

SHIELD FOR AUTO RUMBLE SEAT FOLDS OUT OF SIGHT 1822

For the protection of occupants of the auto rumble seat, a three-piece collapsible windshield has been designed. It swings down out of sight when not wanted, and is quickly elevated for service. It is adjustable for height and when folded does not interfere with the closing of the seat deck.

Pat. Oct 27, 1925. \$115.00

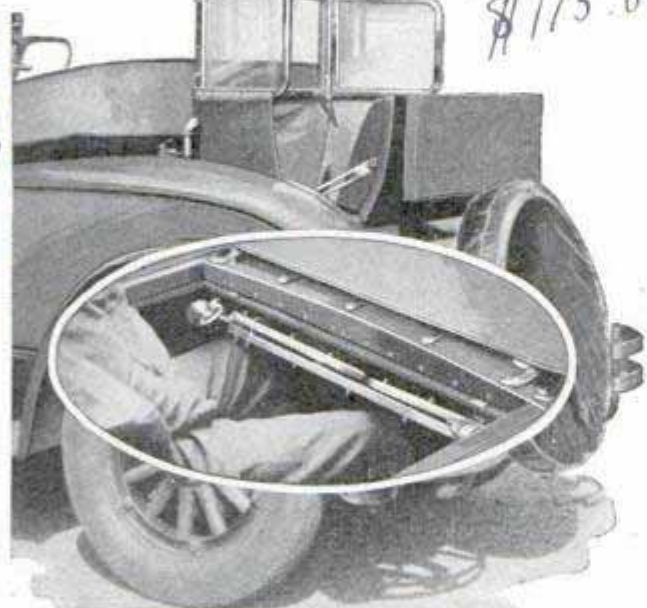

Shield Raised in Front of Rumble Seat, and as It Appears When Folded Up

FIREMAN'S SAFETY HEADLAMP FITS ON HELMET

1896

Astoria, Ld. ny

Designed so that it can be quickly attached to the helmet, a safety light for

Adjusting the Safety Lamp to the Helmet: It Is Controlled by a Switch and Leaves Both Hands Free



firemen has been introduced by a member of the New York city department and an associate. It is turned on and off by a switch, and leaves the hands free while shining where it will most aid the vision.

SCHOOL FOR DINING-CAR MEN TRAINS COOKS AND WAITERS 2613

Dining-car waiters, stewards and cooks of the Pennsylvania railroad are receiving special training in a school at Columbus, Ohio, fitted to resemble a dining car in every particular, so that actual operating conditions on the road will be duplicated as nearly as possible. Waiters learn how to set the tables correctly, how to carry trays and deal with customers, and cooks are taught how to prepare the latest recipes found suitable for dining-car use after tests in the experimental kitchen. The "faculty" is, composed of veteran workers, long in the employ of the railroad, and the course is continuous, constant training being given as new ideas and improvements are introduced in the service. Similar schools are to be established in Chicago and New York.

47 W. 63rd New York City
Joiner's Shield Co. Inc.

Lemouline Carriage Mfg Co
pat. 3,515,425

6/30/27

2002

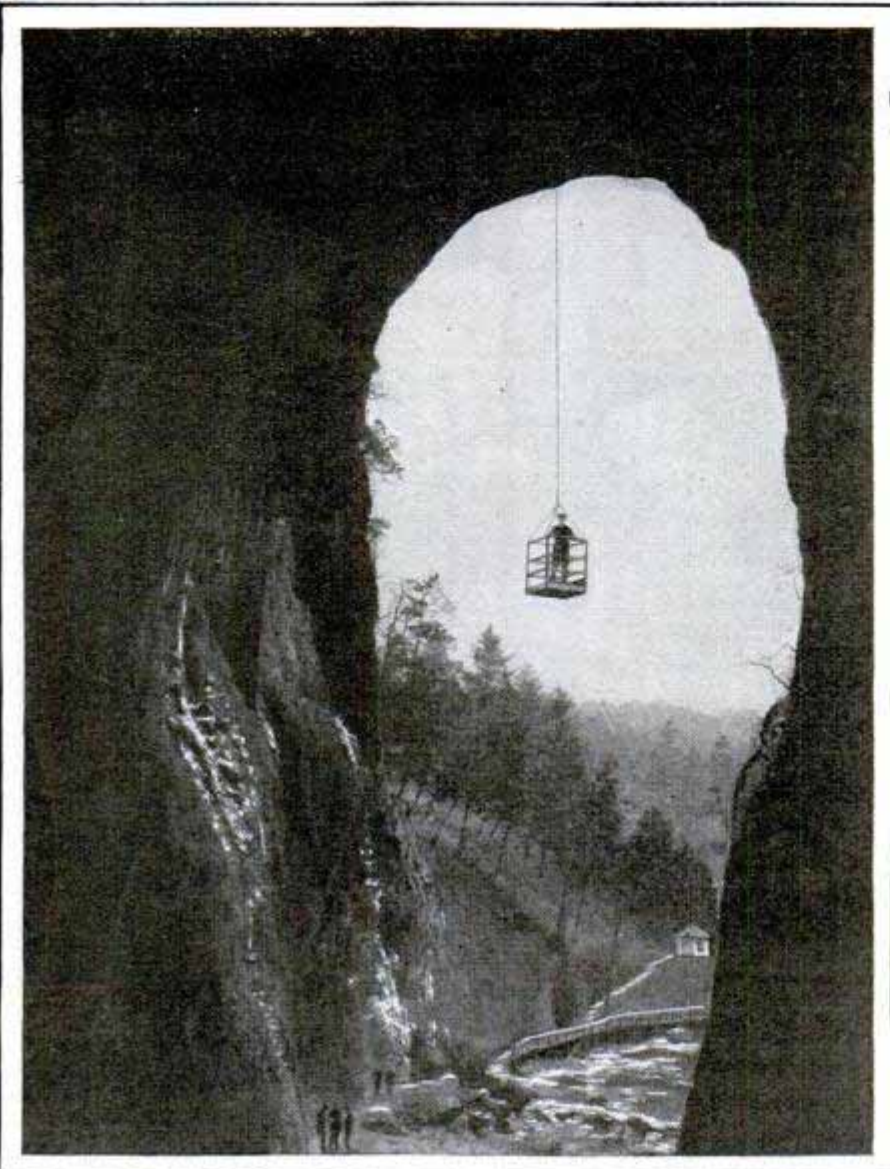

Examining the Underside of Virginia's Natural Bridge, at Staunton, to See if Traffic on Top Is Damaging It

SCIENTIST RIDES IN SWING SEAT TO STUDY NATURAL BRIDGE

Risking his life in a swing basket lowered from the top of the arch, Dr. Chester A. Reed, of the American museum of natural history, recently made a study of the natural bridge at Staunton, Va., to determine if vibrations from traffic over the span had damaged or were likely to injure it. The sling was the most practical way of examining the formation of walls and ceiling for close inspection to locate possible cracks and fissures. The bridge is 251 feet high.

J. M.
Raymond Machlett
with "Hairpin"
Light for Airplane
Landings



*The Rainbow Light Co. Inc.
Long Island City N.Y.*

REMEDY FOR RUST WANTED

299A

A fortune awaits the man who invents a remedy for rust, one that will be as effective on a girder or a boiler as on a knife blade. According to conservative estimates, rust causes four billion dollars in damage throughout the world each year, not counting the costs and suffering resulting from loss of life occasioned by the collapse of rust-worn structures and similar accidents. Rust is responsible for costly depreciation in the value of houses and other buildings, railroad rails and rolling stock. One architect declared that a wise man, owning a house, would do well to build a special reserve fund of one per cent, \$50 a year on a \$5,000 house, to meet renewals made necessary by rust. A railroad expert estimates that the toll of rust on a line would be equivalent to a tax of nearly \$4,000 each

year on every mile of track. The chief problem involved is to put something into the metal which will not reduce its strength or increase its cost beyond a point that would make the process uneconomical.

LIGHT THAT PENETRATES FOGS TO AID AVIATORS

Visible for fifty miles on clear nights and for twenty through fogs, a neon gas light, developed for airplane landing fields and to guide vessels, has been tested by the bureau of standards. It has two tubes, hairpinlike

in shape, the gas inside being electrically agitated and each tube has a reflector of a rare mineral. They glow with a brilliant orange light which has such a long wavelength that it readily penetrates fogs instead of being diffused as is the case with rays from an ordinary incandescent light.

DEAD SEA IS TREASURE CHEST OF RICH CHEMICALS 2989

Enormous quantities of valuable chemicals are held in solution in the waters of the Dead sea, according to Dr. Thomas H. Morton, who regards the historic spot as a potential source of great wealth, capable of supplying the world with important substances for years to come. Magnesium chloride, potassium chloride, common salt, usually pure, and magnesium bromide, serving for the production of various bromides, are among the chemicals found there in great abundance. For their separation, solar evaporation is the chief factor employed. Nearness to ocean transportation is another favorable factor.

INGOT-CASTING MOLD WEIGHS NINETY-ONE TONS 1650

To be used in making large forgings, a huge ingot mold, cast at an eastern steel plant, weighs ninety-one tons, is fifteen and one-half feet long and 108 inches

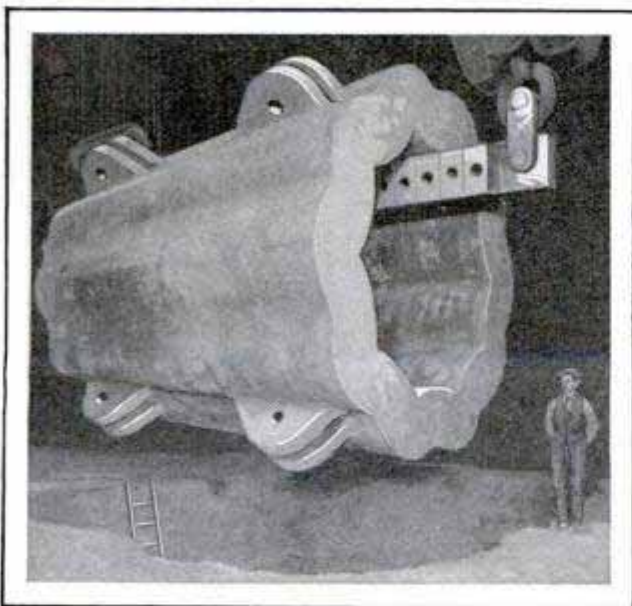

Monster Unit at Eastern Steel Mill; the Mold for Making Ingots That Weigh Over 200 Tons

across at its outside diameter. It will produce an ingot weighing 247 tons.

WIDE VISOR FOR WOMEN'S HATS SHIELDS EYES FROM WIND 2531



Carrying a Windshield on Her Hat; the Transparent Visor Protects Eyes and Face While Motoring

Especially suited to airplane travel or motoring, a woman's hat introduced in Paris has a wide, adjustable visor of transparent material to shield the eyes from the wind. It can be made of colored goods to afford protection from the sun as well and is considered a useful addition to the prevailing style of brimless turbans.

PLANTS TO SERVE AS ANIMALS IN LABORATORY TESTS 2988

In the opinion of Sir Jagadis Chandra Bose, noted Indian scholar, it will be possible to use plants instead of animals for many scientific tests. He explains that plants register reactions to drugs and other stimuli, as do animals, but are not affected by fright as is the case with beasts. Under the influence of fear, normal reactions are often upset so that tests with animals are not always reliable, the scientist believes. With the aid of delicate instruments, he has demonstrated that plants have hearts and pulse and a nervous system akin to that of animals. In his tests, he has shown that various plants manifest definite reactions to stimuli and depressing conditions while making a fight for life.

1) Bethlehem Steel Co
New York Herald Tribune

OVERHEAD CROSSINGS SOLVE TRAFFIC PROBLEM

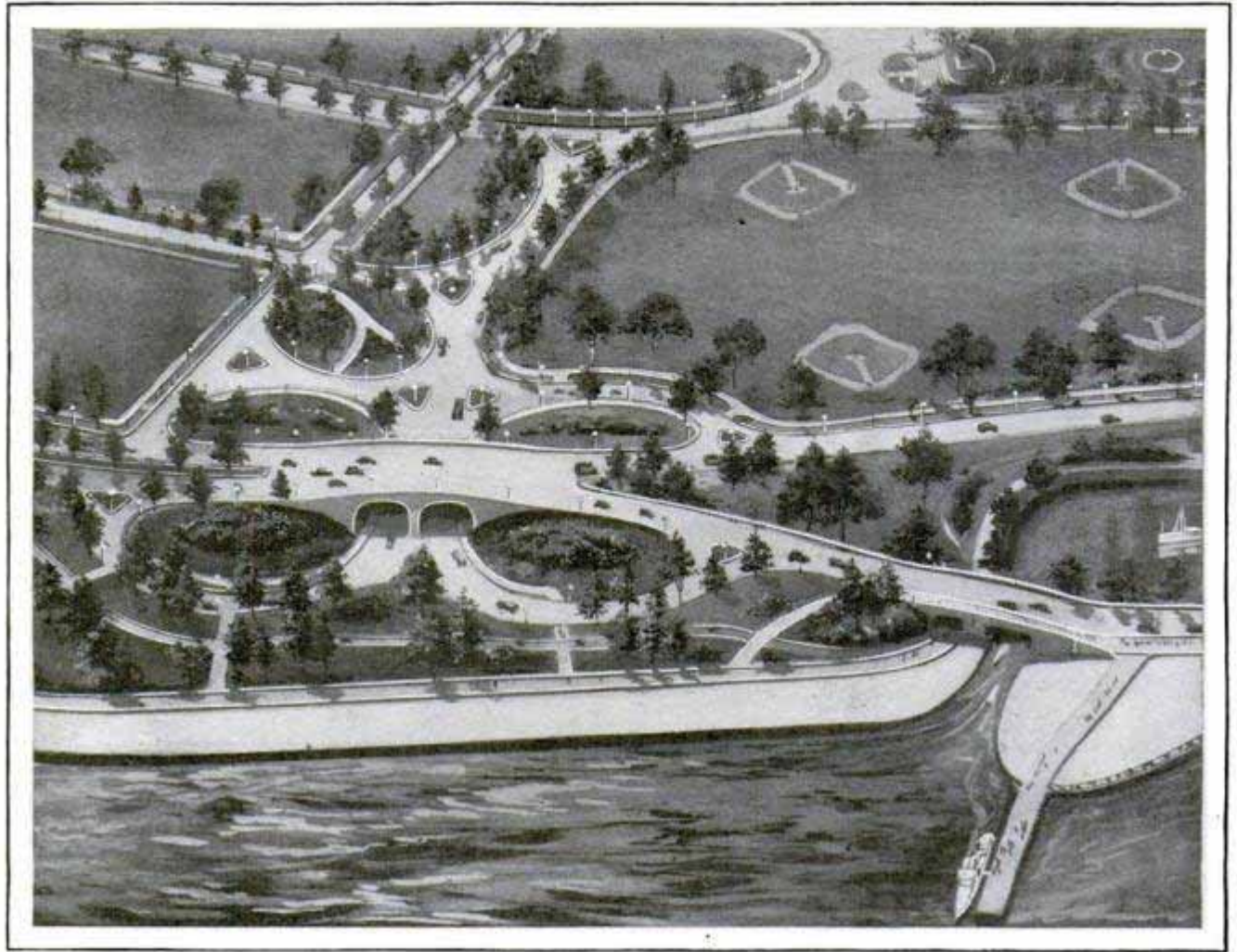

How a Busy Traffic Center at Entrance to Lincoln Park, Chicago, Has Been Arranged to Avoid Congestion by the Construction of Overhead Crossings, Permitting Safe Passages and Eliminating Delays

When commissioners of Lincoln park, Chicago, recently doubled the capacity of Lake Shore drive by adding a second boulevard, making two one-way streets, they faced an unusual problem at the entrance of the drive into the park. With the new street, there were six boulevards meeting at one point, the two parts of the double drive, North avenue, Stockton drive, and the old east and the new outer drive of the park. A bridge was built to carry the traffic of the Lake Shore drive double section into the east and outer park drives. Beneath the bridge four semi-circular drives, leading out from each of the upper highways connected with Stockton drive and

gave access to North avenue. When several hundred acres of new park land, being reclaimed from Lake Michigan farther north, is opened to the public, similar safety crossings will give access to all cross town streets through tunnels under the main through boulevard.

ELECTRIC TRAIN COMES APART TO HELP TEACH BOYS

Taking the Electric Engine Apart; Motor Is Used to Run Other Toys

Amusement and education are afforded in an electric train that may be taken completely apart and put together again without the aid of tools and with little danger of making mistakes. The motor may be disassembled



*The Starfair Co,
137 Jackson St*

bled and the parts studied and, in some models, it may be removed from the engine, placed in another housing and made to run other electric toys.

PORTABLE COOLER FOR FRUIT CARS

Shipments of fruit are often loaded into cars at California producing points in temperatures as high as 130 degrees, and unless special measures are taken, the shipment will not cool properly for several days. To insure rapid and thorough reduction of temperature, a portable blowing outfit has been used with success. It is mounted on an automobile truck, the motor of which furnishes the power to send a strong current of air over the salted ice in the car and throughout the interior, so that effective cooling is attained in a few hours. Hot air is forced out at the same time, through reinforced-canvas exhaust tubes, three feet in diameter. By the use of ethylene gas, fruit can also be pre-ripened as it is being chilled to thirty-eight or thirty-six degrees Fahrenheit. As an average of 700 cars of fruit and vegetables are shipped daily from southern California and the plant travels from one to another of a line of cars, it performs an important service.

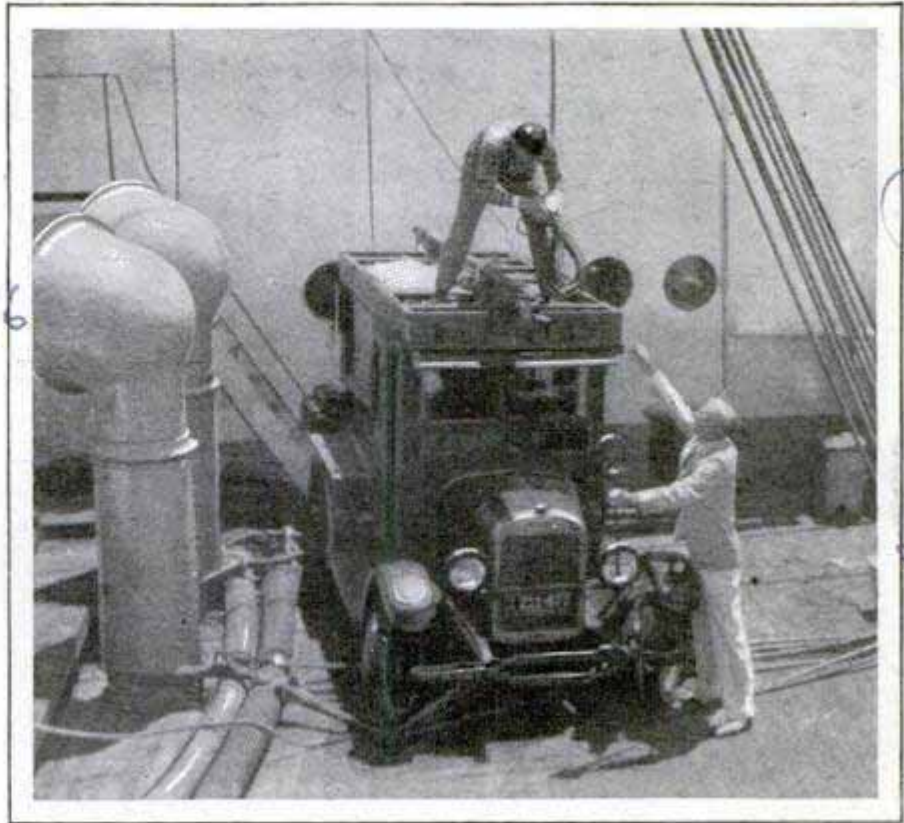

Portable Broadcasting Station on Board "City of Honolulu," for Concerts during Voyage to Hawaii and Return

RADIO STATION GOES TO SEA TO AMUSE TRAVELERS

Radio station KGFO recently went to Hawaii and back aboard the "City of Honolulu," affording passengers on the liner daily programs and giving the captain the unique opportunity of addressing travelers in his charge through a microphone from his cabin. The set, which is mounted on an automobile truck, was taken ashore on the island of Oahu for a tour through Honolulu and near-by territory. Radio experts pronounced the experiment a success in every way and point out that, if such a plan becomes widely adopted, there will be increasing need of an international commission to regulate broadcasting for entertainment purposes while at sea. During the voyage, the auto truck was securely lashed to the deck to prevent mishaps, and the antenna was strung to the crow's nest on the mainmast.

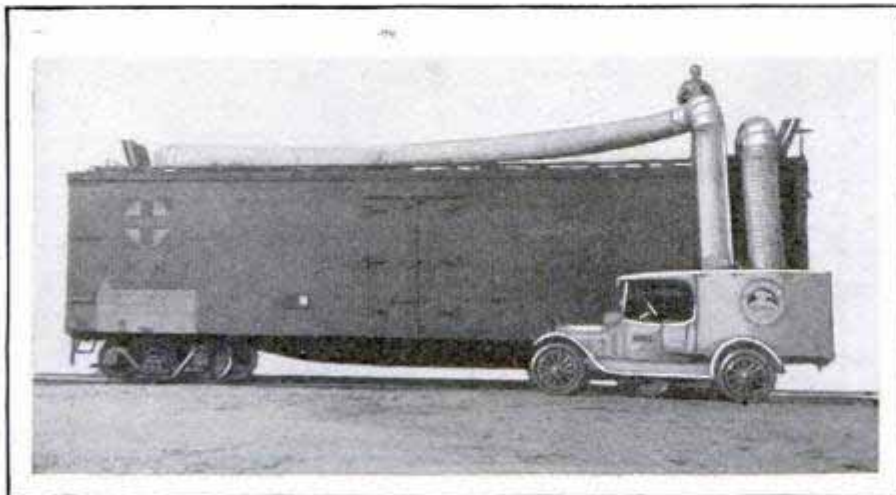

Blowing Air over Ice in Refrigerator Car, to Speed Cooling of Contents; Outfit Is Quickly Set Up at Different Cars

*How Editorial Room, Los Angeles Calif.
 Mr. Frank B. How, Editor, Los Angeles Times, Los Angeles Calif.*

Pre-Cooling Car Service Co., Los Angeles Calif.

The WORLD'S QUEEREST RAILWAY

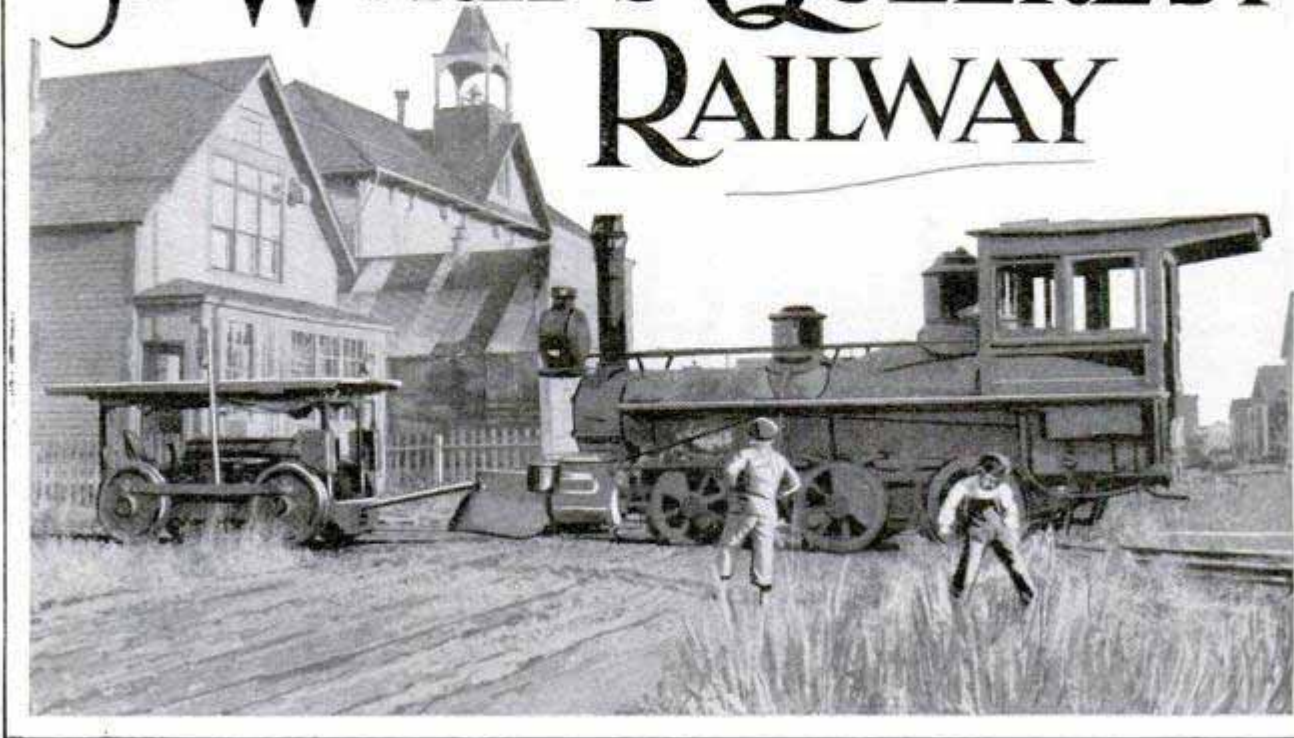

A Railroad Tractor and One of the Ancient Steam Engines of Alaska's "Pupmobile" Road, Where the Customer Furnishes His Own Transportation over the Government-Owned Rails

THERE may be some dissension among railroads as to which is the shortest line in the world, but there can be no controversy as to which is the most curious.

There is no road in the world that can compare with the "Pupmobile" line, a bit of track that was laid in the early days after the gold strike in Alaska, between Nome and Shelton, on which real trains operate, drawn by teams of dogs.

From about 1908 to 1913 it was operated as a steam railroad. The road was abandoned in about 1913 and from that time until it was purchased by the territory of Alaska, no traffic was maintained, several bridges went out and the track fell into disrepair. However, it continued to be used by dog teams drawing light cars and sometimes carrying loads of as much as 1,000 pounds. Where a bridge was out or the track impassable, the car was taken over land across the gap and again placed upon the rails.

In 1923, this line was purchased by the territory of Alaska. It was turned over to the Alaska road commission for improvement and since that time all bridges have been replaced, other gaps in the line have been closed, and the track has been made

suitable for use not only by dog teams but by gasoline speeders—automobiles equipped with flange wheels and Fordson tractors fitted for operation on the line. It is capable of carrying loads not exceeding four tons. The line has been used to a considerable extent by a mining company. It has served especially well in hauling out heavy pieces of equipment to the mine location which is just a few miles from Nome.

One company, organized last year, operates an automobile and a tractor, giving regular service to the end of the line. It is expected that traffic of this sort will largely increase in the future.

The rules of some of the largest railway companies are no more carefully observed than are those of the Pupmobile line. There are sidings and passing tracks and schedules are arranged so that cars meet at certain of these places for passing, but when two cars chance to meet between sidings, it is the rule that the lighter load must give way to the heavier—provided the man with the light load does not happen to be larger than the driver of the other car. The train which must give up the right of way is simply lifted from the

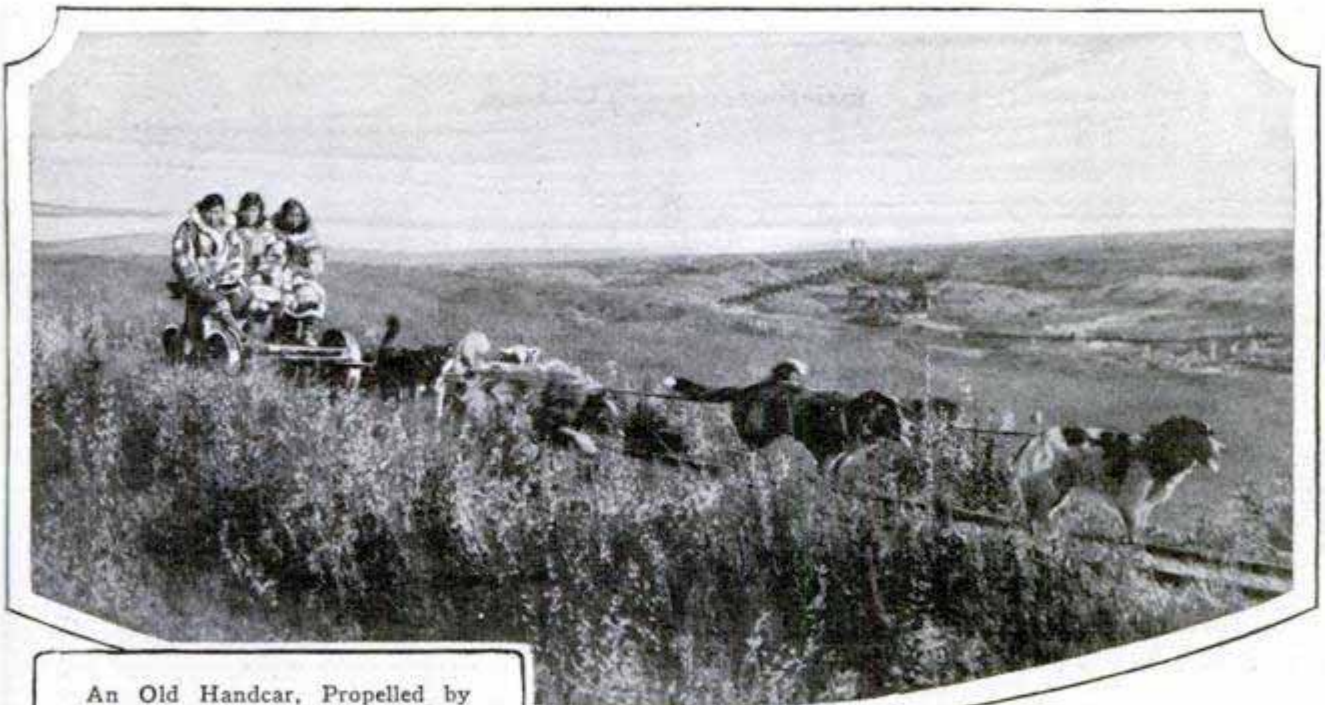

An Old Handcar, Propelled by Six or Eight Dog-Power, Constitutes the Most Usual Equipment When a Party of Eskimo Belles Go for a Ride on the "Pupmobile" Line; Two Native Girls, One Eight and the Other Eleven Years Old, Operated a Regular Dog-Team Train through Forty-Five Miles of Wilderness



Converted Flivvers with Flanged Wheels Are the High-Speed Express Trains of the North; They Also Have Baggage Compartments



A Gasoline Tractor and One Small Flat Car, Doing Repair Work on the Railroad Fill under Jurisdiction of the Alaskan Road Commission

2600
620

Dr. Frances Long

track and when the way is clear again is lifted back and goes on its way.

One train in particular, consisting of four small-wheel flat cars drawn by three dogs and carrying about fifty pounds of baggage, was recently operated by two Eskimo girls, aged eight and eleven years. They attended to the switching and appeared as unconcerned at traveling forty-five miles alone through the woods as any veteran trainman in the States.

The road, though owned by the Alaskan territory and operated by the Alaska railroad commission, is actually open to the public, and anyone may travel over it.

INSECTS DRAWN TO FLOWERS BY COLOR AND ODOR

2904

Flowers attract insects by both color and odor, while form, and such markings as stripes or dots, also help to guide the visitors, in the opinion of investigators for the Carnegie institution, who have conducted a series of tests at the Pikes Peak laboratory for nine years. They discovered that blue is the most popular color among bees and other insects, red the least. Even when blue flowers were turned upside down, the bees eagerly sought them. Many bumblebees were baffled by the new position and found difficulty in mastering the problem of sipping nectar from the inverted blossoms. Bees showed evidence of the best memory, recalling places, odors, shapes and colors and knowing the time of day when the nectar flows. They never touched orange lotus blossoms, seeming to realize that the nectar stopped flowing after the flower had changed from yellow to orange. Fragrance attracted insects of various kinds from a distance, but color only within a radius of about thirty feet. Bees, butterflies and other specimens were not fooled by artificial flowers and disguising blossoms by painting did not prevent them from recognizing their real nature. When bright-colored petals were reduced, the number of visitors fell off.

2848

GIRLS FOR SPECIAL WORK ARE PICKED OUT BY MACHINE

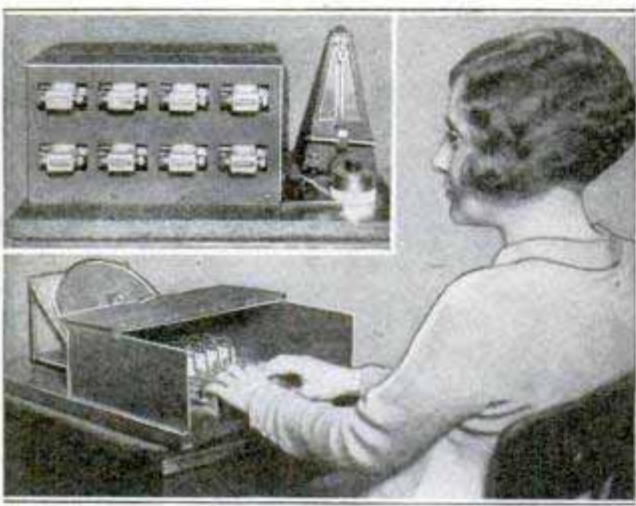

Digitometer

To Test Candidate's Skill at Co-Ordinating Brain and Fingers; Key Apparatus Which Registers Response

Selecting young women to operate a special printing device is simplified by a large company, which hires and trains some 2,000 girls a year, by the use of an instrument that shows how well the candidate can co-ordinate her brain and fingers. There are eight keys, one for each finger. The thumb is not used. Red figures are for the left hand and black for the right. As certain numbers appear on a dial, the operator is required to touch corresponding keys with the proper fingers for each hand. Errors are registered so that, at the end of the test, the examiners have an accurate record of the young woman's performance and can determine whether or not she is likely to prove a success with the instrument she would be hired to operate. An even pace is necessary, and the tester indicates whether the candidate has this.

Western Union Telegraph

HIGH-VOLT LINE UNDERGROUND SHOWS CABLE PROGRESS

2845

Successful transmission of a 132,000-volt electric current underground, is being made over a six-mile stretch in Chicago through the use of a special cable, representing the latest ideas in insulation. Its most interesting feature is its construction. At the center, it carries thin oil that passes around the copper strands of the conductors to impregnate the paper insulation. The oil is under pressure to prevent voids in the insulation, and to limit loss in case of a failure, the line was di-

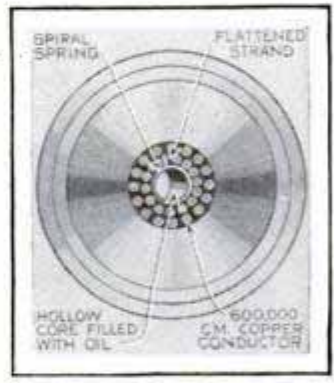

Commonwealth Edison Co

vided into six one-mile sections connected by special joints, in which the oil from the adjacent sections is separated. Reservoirs containing about ninety gallons are mounted forty feet above the ground at one end of each section and connected by pipe lines to the hollow space in the conductor to maintain pressure on the oil. This system of insulation has proved superior to previous use of grease or heavy oil. The cable really consists of three, each a single conductor for one of the three-phase currents, making eighteen miles in all. The protective covering includes two lead sheaths, separated by a few layers of impregnated paper and wrapping of hard-drawn copper ribbon. The latter is applied to assist the lead sheath to withstand the internal pressure of the oil during operation.

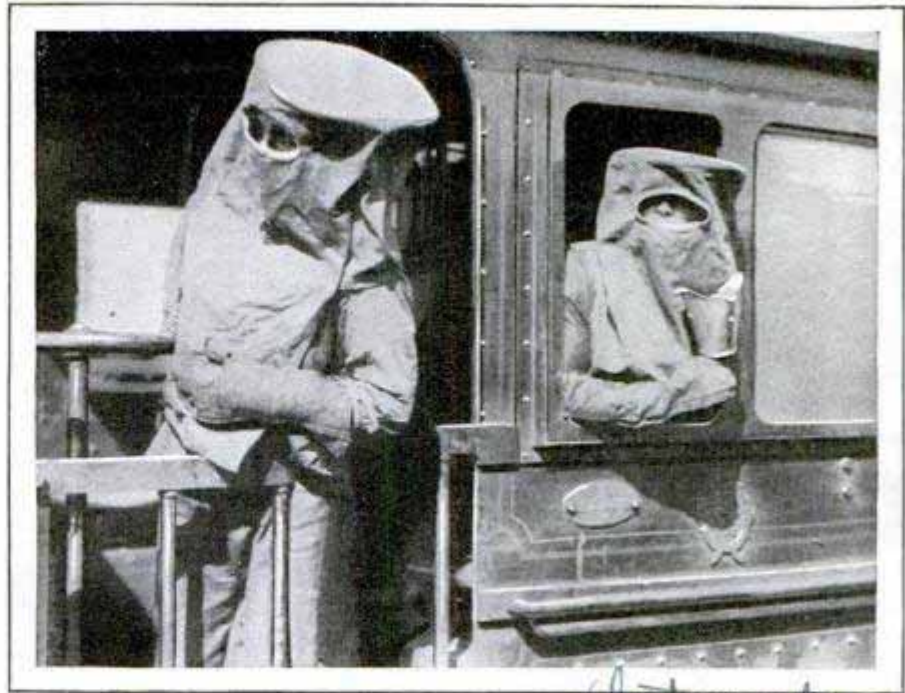

Shielding the Engine Crew from Smoke Fumes While Passing through Tunnels; the Gas Masks Used on Australian Lines

International

**GAS MASKS GUARD ENGINE MEN
- PASSING THROUGH TUNNEL**

To protect them from fumes while passing through tunnels, engineers and firemen on trains in Australia have been wearing a special type of gas mask. It is designed for quick removal or adjustment and, while allowing an unobstructed view, keeps the smoke from entering the lungs.

NEVER TOO OLD TO LEARN ²⁹⁰³

Groups of adults, averaging forty-two and twenty-two years of age, learned more in an hour than did children comparable in brightness, tests at Columbia university showed recently. The older group of adults learned about five-sixths as fast as the younger. According to Prof. E. L. Thorndyke, the common belief that children always learn faster than grown-ups is a delusion. Experiments with adults learning algebra, science, foreign languages and the like in evening classes, or shorthand and typewriting in secretarial schools, support the conclusion that ability to learn rises until twenty.

*see July 1929-1930
see Aug 1929-1930*



Inventor with Model Showing How Motor Can Be Dropped, Leaving Fuselage Free to Glide to Safety

**AIRPLANE CAN DROP ITS MOTOR
FOR EMERGENCY LANDINGS ²⁷⁷³**

To reduce the hazards of landing an airplane under forced conditions, a San Francisco inventor has worked out the model of a ship so arranged that the motor and landing gear can be dropped by simply pulling a trigger, leaving the wings and fuselage free to slide safely down. The plan would practically eliminate the danger of fire and explosion and would increase the gliding radius of the passenger-carrying portion of the ship.

*Hedrick. Newman Co. San Francisco Calif.
2101 Mission St.*

*Joaquín Selveira
Abreau*

THRILLS IN REPAIRING BREAK IN SUBMARINE CABLE

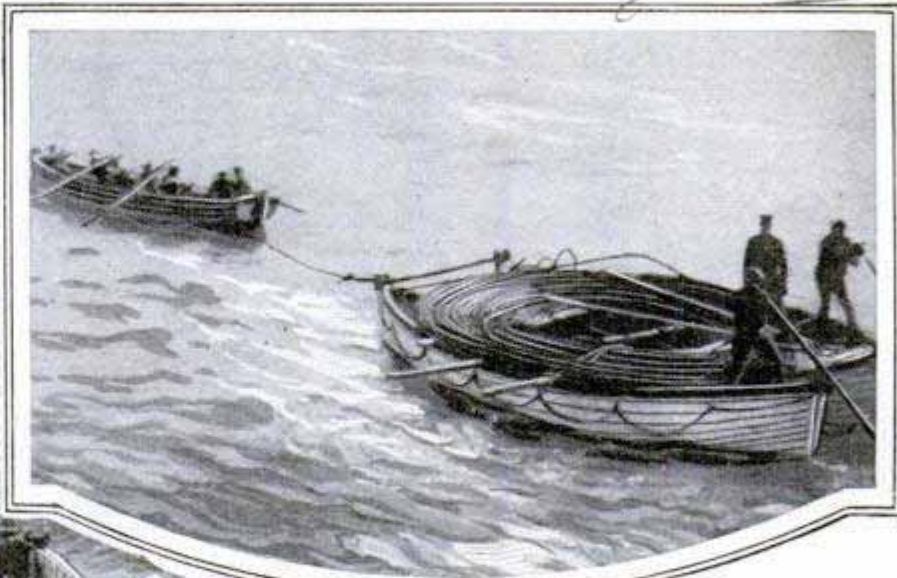
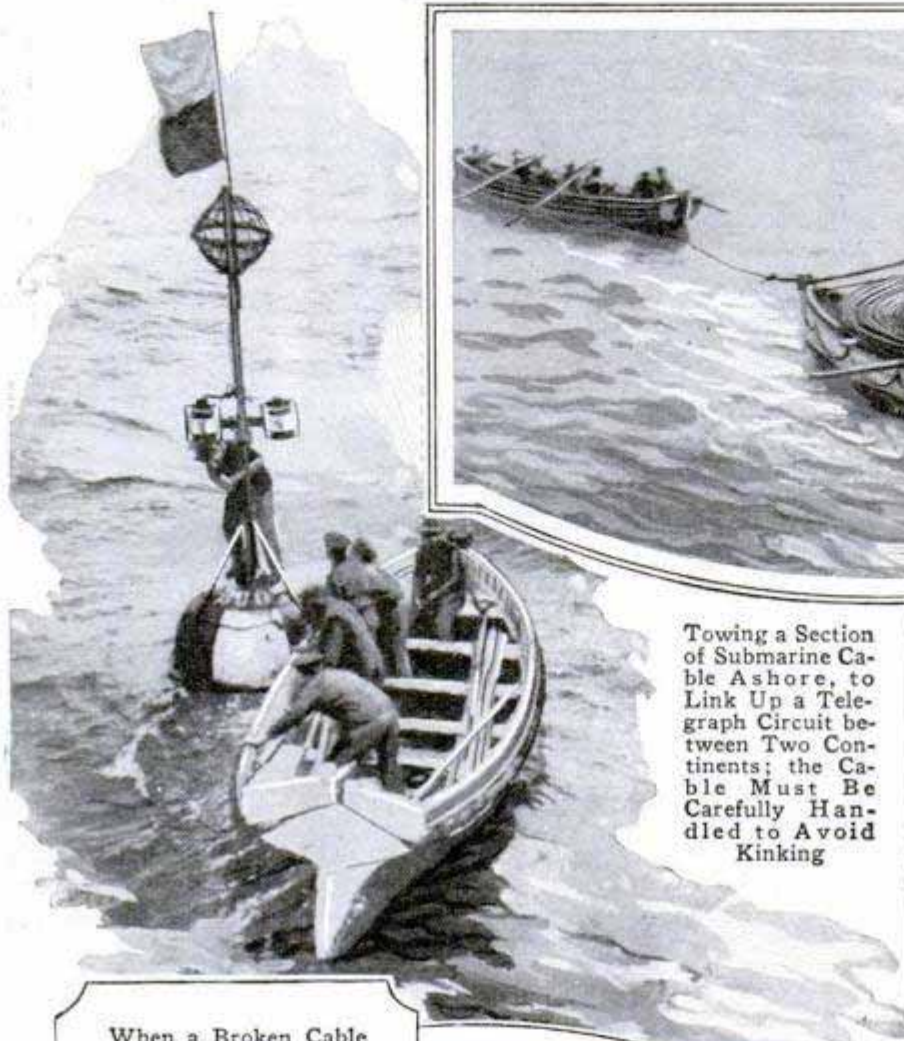

Towing a Section of Submarine Cable Ashore, to Link Up a Telegraph Circuit between Two Continents; the Cable Must Be Carefully Handled to Avoid Kinking

When a Broken Cable End Is Raised, It Is Attached to a Marker Buoy Pending Repairs



Huge Grappling Iron, Above, Which Has Been Broken by Contact with Rocks on the Sea Bottom, While Trying to Find the Cable; at Left, Workmen Repairing the Armored Sheath, the Last Step in Making a Splice in the Cable before Returning It to the Ocean, Ready Again to Transmit Messages

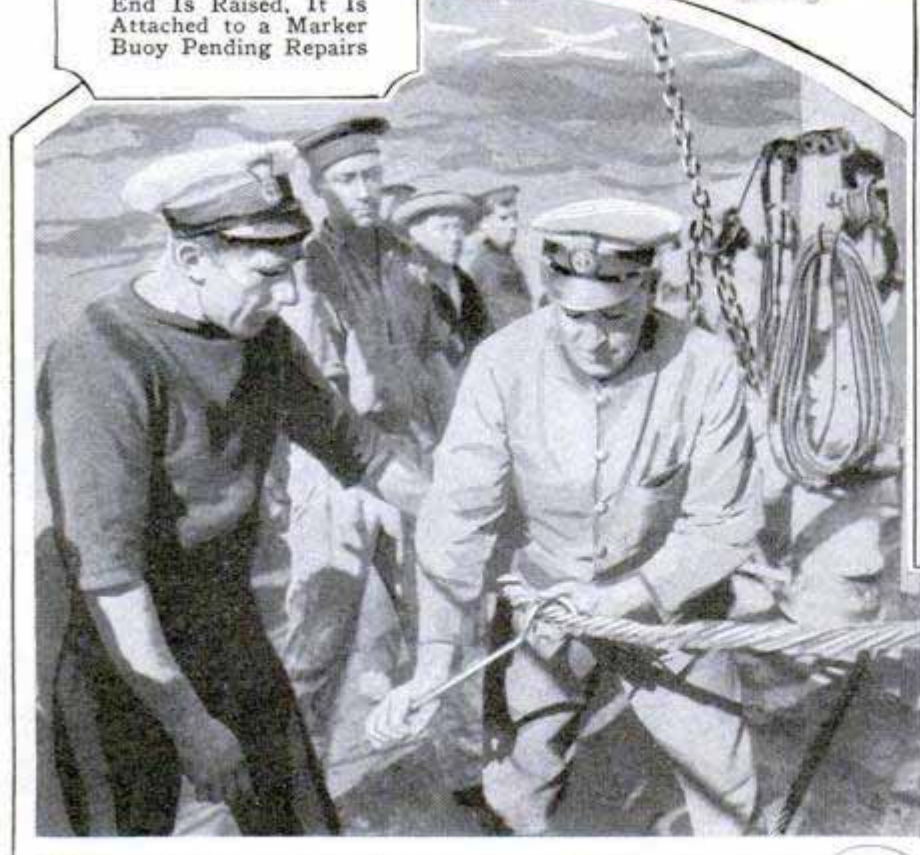

17/23/27

2874.

**SAHARA DESERT ON THE MOVE
BURIES RICH TREASURE**

2969

Since the dawn of civilization, the sands of the Sahara desert have shifted hundreds of miles to the eastward, burying many forgotten cities and centers of population. Some of the ruins on the western side are being found. Not long ago, the body of an ancient queen was discovered beneath the sand. On her arms were eighteen bracelets, nine of gold and nine of silver. Around her neck were five strands of jewels and a diadem of gold starred with gems was on her head. Emeralds, rubies and finely carved furniture were taken from the tomb, which is believed to have been built at least 1,000 years before the Christian era.

Dr. J. M. Gunningham and Mr. J. M. Hansen

**PERFECT SWING FOR GOLFERS
TAUGHT BY MACHINE**

2896

A golf-practice machine, which makes it impossible for the golfer to complete a stroke that is not scientifically correct, has been developed by two Davenport, Iowa, players, one a dentist and the other a manufacturer. The machine has a club shaft with a special head attached to a track in such a way that it can only be swung through the backswing, downstroke and follow-through, when the player is standing correctly and performing properly. Otherwise the club head is automatically locked until the fault has been corrected. Slow-motion movies of several famous players were analyzed to perfect the curves of the track. The manufacturers claim that frequent use of the machine, either to improve one's stroke, or merely as a daily exerciser of the muscles used in golf, will so impress the stroke on the player that he automatically follows the same path in his strokes in actual play. The device has been patented in this and other countries.

Where the Golf Club Runs on a Track to Teach the Correct Stroke



Davenport Mfg Co.



Roller-Skate Shopping Bag, One of the Products of a Detroit High-School Manual Training Department

**ROLLER-SKATE SHOPPING BAG
SIMPLIFIES MARKETING**

Students of the manual-training department of a Detroit high school, have organized their own marketing association to sell their products. They have their own sales manager, and articles made during the summer months are introduced to commercial firms, the profits going to the makers, some of whom have started funds for their college courses. Among things already made by the students is a shopping bag on rollers. With it a woman can easily carry her purchases home with one hand and manage the baby carriage with the other. A speedy egg beater has also been devised. It is placed inside a quart jar, and the eggs are beaten simply by shaking.

Perfect Swing Stroke Reduces

200 211 b ...

ELECTRIC PLOW SPEEDS CROPS AND KILLS WEEDS

By transmitting more than 100,000 volts of electricity into the soil from a tractor plow, an eastern experimenter is reported to have developed an effective way for eradicating weeds and grubs from the ground and hastening the growing of crops. Current is supplied from a special generator on the tractor and is conducted through the blades of the plow. A field of buckwheat treated in this manner grew nearly twice as high as another, which had been given 200 pounds of fertilizer to the acre, and the seeds germinated in eighty hours. In tests with fields of corn, beans and potatoes, it was found that germination occurred in five days under the electrical treatment, whereas sixteen days were needed with nothing but the fertilizer. The sections cultivated with the electric plow were free from weeds.

Plow Wires Electric Blvd.

2978

Used on farm of Herby N.Y. Signal Woodward

2041

*Chicago
1966
Southport Ave
Chicago*



For Easier Pouring from a Barrel; the Tipping Rack in Operation; It Is Made of Metal

TIPPING-RACK TO HOLD BARRELS SIMPLIFIES DRAINING

Quickly assembled from durable metal units, a cradle to hold barrels and drums of liquids makes it easy to draw off the contents. The rack is of convenient height, well balanced and is easily placed in service or disengaged.

SHIP'S ENGINE ROOM IS SO COOL CREW WEAR OVERCOATS

Ordinarily, the engine room is one of the warmest places on a ship, but the Diesel motors in the "Tampa" have been equipped with so efficient a cooling system that but little heat is radiated. Members of the engine crew wore their overcoats during a voyage last winter.

150

Washington

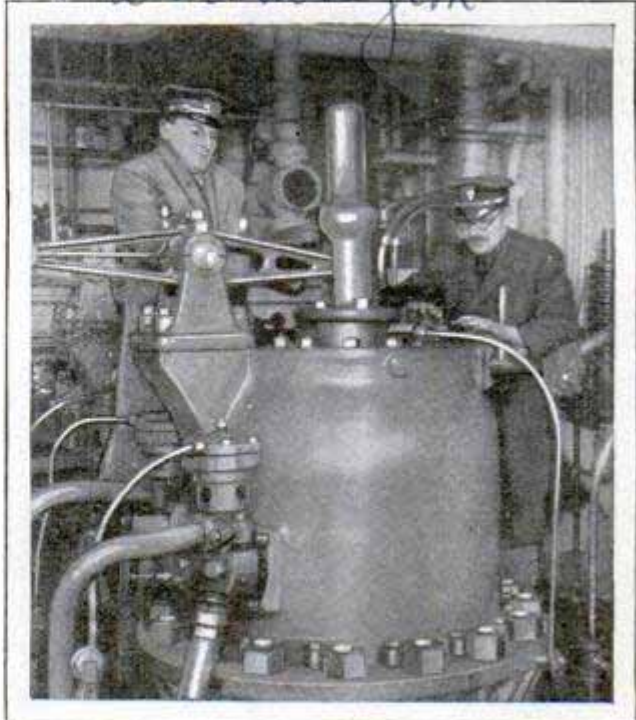

Engine Room of the "Tampa"; So Little Heat Is Radiated, Crew Wear Overcoats in Winter

ROMAN CANDLES ROUT BIRDS

Although the law forbade shooting the birds, people of Newport, Ark., discovered an effective way to drive out a plague of martins by using fire hose, blank cartridges and Roman candles. The last proved especially useful, for the birds were terror-stricken by the balls of fire falling among their roosts at night and quickly sought other quarters. More than 10,000 martins flocked into the town, driving out other birds and causing damage to the trees. Other places in Arkansas, which also were troubled by the pests, used similar means to get rid of them.

2983

Kansas City Times 11/26/27

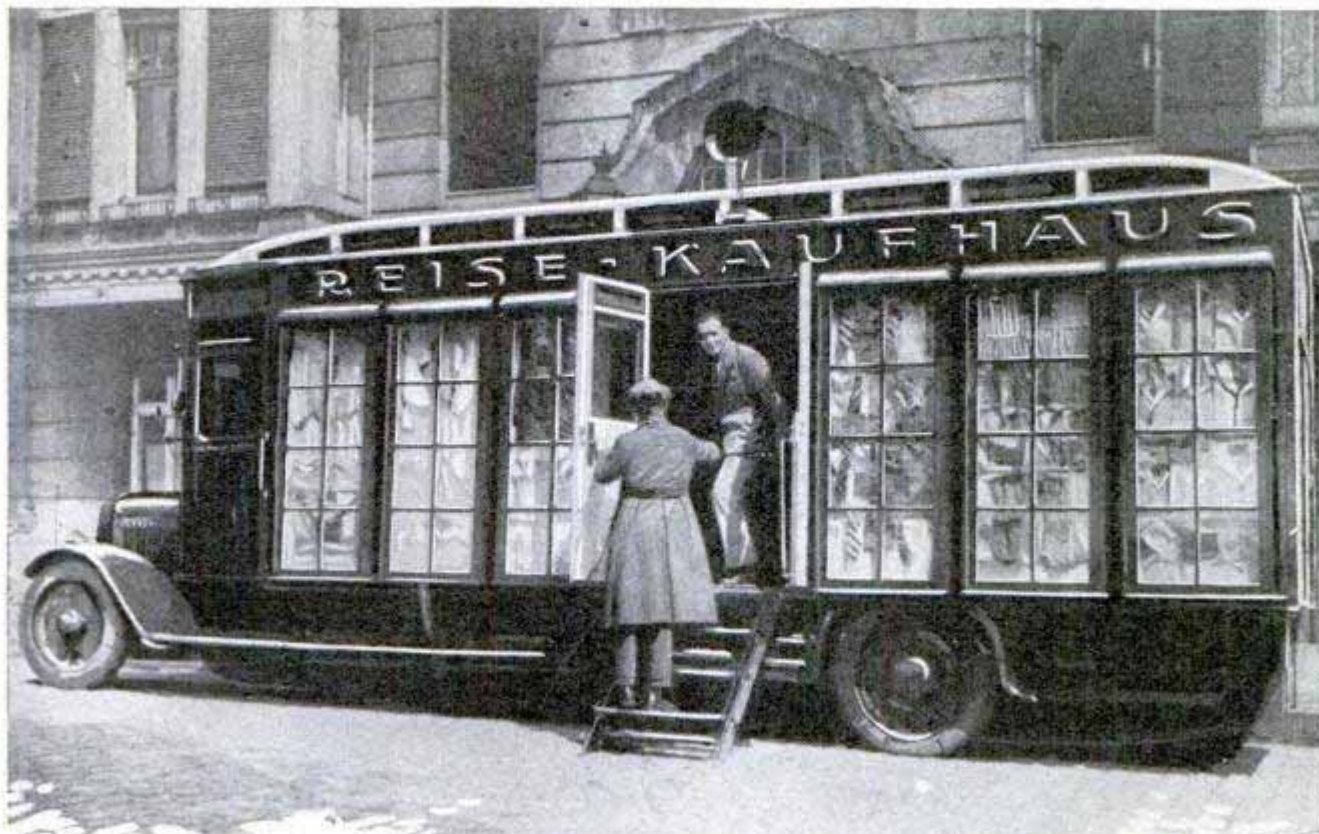

Carrying City Bargains to the Country Buyers; the Traveling Store Now Popular in German Rural Districts; Customers Are Entertained with Radio Concerts Received by Set in Bus

Muller

BIG AUTO AS TRAVELING STORE ALSO GIVES RADIO CONCERTS

Stocks of goods as offered in the city stores are made available to customers in rural districts in Germany by traveling shops, specially built automobile trucks equipped for show and sales purposes. They afford wide display space in outside windows and carry large enough stocks for lengthy tours. An additional feature is the radio set, part of the car's fittings, which gives concerts to the customers while they buy and examine the wares.

MAIL CLERKS MUST REMEMBER THOUSANDS OF NAMES.

Remembering the names of 5,000 different stations is one of the tasks of the average railway mail clerk, who submits to an examination once in six months to test his memory and skill at sorting mail. Besides being an expert in this line, he is trained to decipher difficult handwriting and often displays more skill in this than the person working in the post office, according to J. L. Stockton, newly elected president of the eleventh division of the

railway-mail association. He declares that the most highly educated persons are often guilty of the most illegible mistakes in penmanship and addressing mail, and believes that it will be a long time before airplanes supplant the railways in carrying mail because the volume of the business would require too large a number of aircraft to be practical.

LEATHER CASE TURNS WATCH INTO TRAVELING CLOCK

A leather case that converts any watch into a traveling clock is one of the latest novelties from Europe, which has been specially designed to accommodate the fairly large-size cheap watch of American make. A cloth pocket, drawn tight by an elastic band, holds the watch firmly in place, while the usual bellows extension of the case cover accommodates watches of varying thicknesses when the case is closed.



Kansas City Star

6/12/27

Chicago. Henri Holt, Hotel, York, 4308

*Wm. H. Sprague & Co. 440 40
Chicago, Ill. New York*

...es
learn-
ured
trial
me
the
E.
rr:
1

Designed by E. C. Jordan,
Engineers' Office,
Forestry Dept., Service,
Derry Bl
2515

Calif.



Uprooting and Cutting Brush Likely to Spread Fires; the Plow in Action on California Forest Tract Where Dry-Season Blazes Occur

PERIL OF BRUSH-BLAZES CURBED WITH FIREBREAK CUTTER

Devised especially for cutting through brush, a firebreak plow, demonstrated in California recently, is expected to prove of great aid in preventing the spread of conflagrations starting in dense undergrowth. It operates rapidly, ripping and cutting a swath through the brush, much faster than men can do it. One of the chief troubles in combating fires of this kind has been the time it takes to make a gap through dense thickets.

SAFETY OF AIR TRAVEL SHOWN BY CHANNEL RECORD

Between December, 1924, and July, 1927, planes of the British imperial airways flew 2,000,000 miles and carried 36,500 passengers without a fatality. According to reports, cross-channel flying is becoming more popular. In June this year, 2,460 passengers were carried as compared with 2,098 for the same month last season. The air union reported 1,060 passengers for the month this year as against 852 during the period last year. Between fifty and sixty per cent of the passengers were women, the report stated.

TROUGHS IN AL DRIVEWAY SAVI COST OF PLANKS

One of the longest beach drives in the world is now available to motorists from Corpus Christi, Tex., to Point Isabel, near Brownsville, and an outstanding feature of the route is a double-tracked causeway built across a shallow stretch of water between the mainland and a sandbar. Instead of an ordinary viaduct of planks or other material, this part of the drive is essentially a two-track road of troughs or grooves for auto wheels. In the bottom of each trough is a concave filling of asphalt

so that the wheels are kept in the middle and cannot rub on the sides, and every eighteen inches is a hole to allow water to drain off. The tracks are made of creosoted planks on cross timbers and are securely bound together with heavy iron straps. The plan of construction proved a considerable saving over full planking.

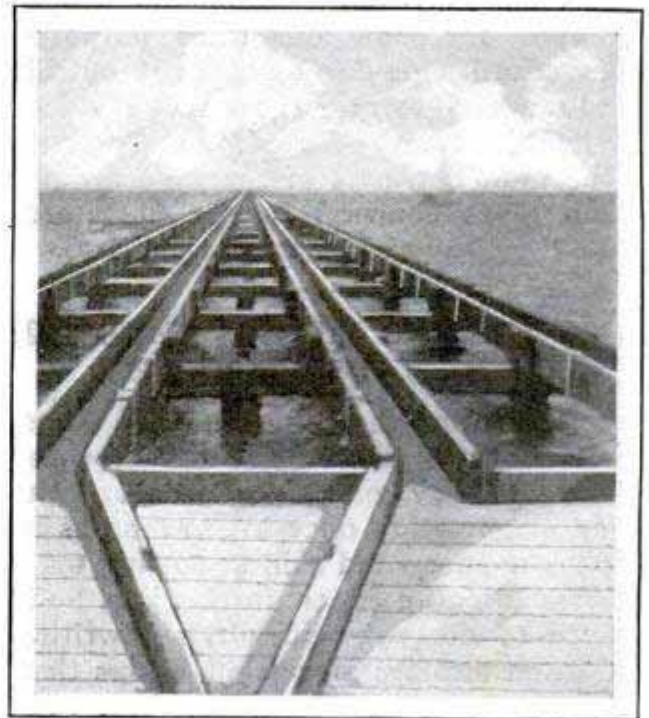

Where Autos Run in Grooves across a Stretch of Sea; Motor Causeway near Corpus Christi, Texas

Chicago Evening Post
7/19/27

Don Patricio

282

Carrying on BURBANK'S WORK

By H. H. DUNN

*2922 Dunsmuir
Berkeley
Calif.*

LUTHER Burbank's spirit is to go marching on, though the hand which developed new forms of beauty in blossoms and new utilities in vegetables, grains and fruits is stilled. Almost on the anniversary of the passing of the plant wizard, his wife announces that all his experiments are to be continued. There are more than 900 of these separate tests. One hundred of them were at the point of successful completion when the aged lover of plants passed on in the spring of 1926; about 400 were well under way on the farm at Santa Rosa, Calif. The remaining 400 are on paper. All will be carried on, just as Burbank would have continued with them.

So quietly that no one knew of it, Mrs. Burbank began last year the distribution of her famous husband's two last-completed gifts to man—a new nectarine and a new asparagus. He considered them his greatest developments, more important even than the Burbank potato, the Burbank plum, or the rust-resisting wheat which is now being grown over hundreds of thousands of acres in northern United States and southern Canada. The nectarine is the result of eighteen years' experiment. Its fruit is nearly twice the size of that of the nectarine now grown, with firmer flesh, and a seed, or stone, less than half the size of that of the present fruit. It endures long shipment, even when picked nearly ripe, and is of a flavor closely resembling that of a ripe strawberry.

The new asparagus produces stalks from

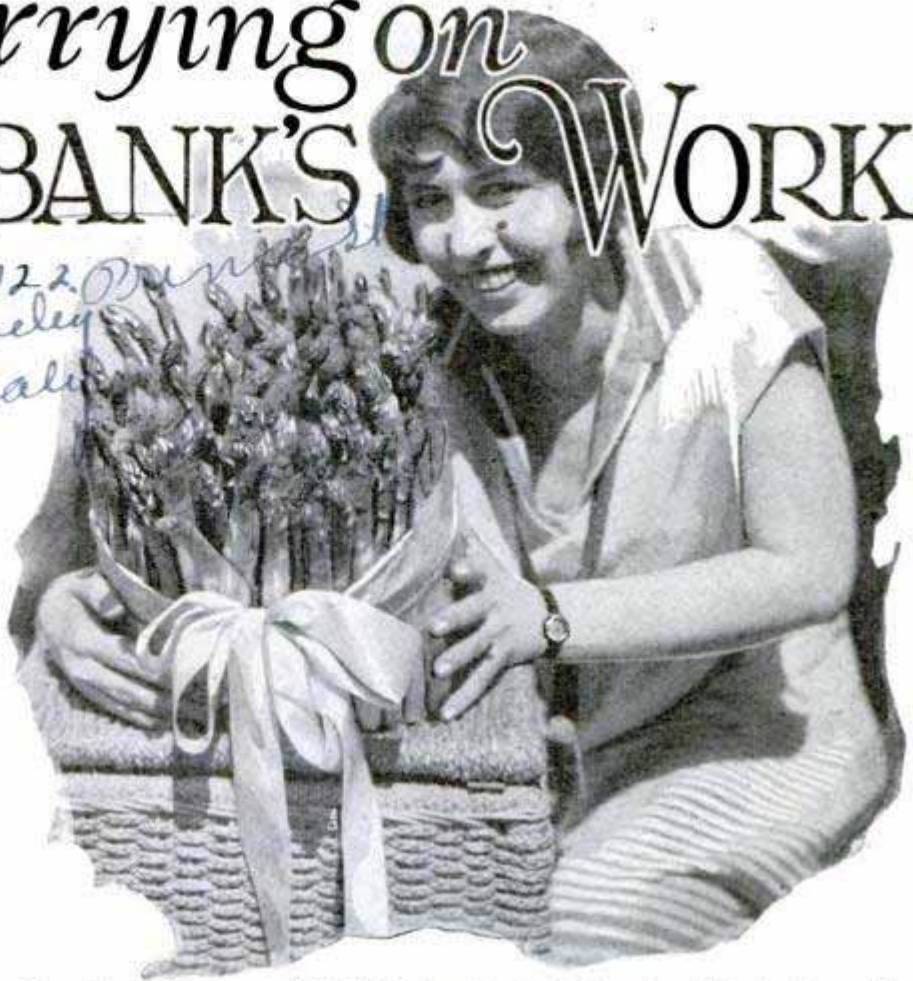

New Giant Asparagus Which Luther Burbank Completed in the Last Year before His Death; the Entire Stalk Is Edible

eighteen to twenty-four inches in length, with the tough, stringy base entirely eliminated, so that the whole stalk is edible. It adds to the production of any area of asparagus soil more than 100 per cent of the present output.

Among the more important of those experiments which were on the point of being given to the world as completed developments when Burbank passed on, are a fast-growing black walnut, maturing in five years, compared with the twenty to twenty-five years required by the wild walnut; a pine which provides a supply of soft wood in less than half the time required by the present white and yellow pines, a development of the tamarisk, well-known in India and Africa and grown largely as a windbreak, and a new form of eucalyptus of much more rapid growth than the blue and red varieties now grown on the Pacific coast. This last is intended in the main for fuel and post supply on interior farms.

In the vegetable world, there is a new

rhubarb with stems from two to three inches in thickness, tender and edible all the way from root to leaf, a distance of about twenty inches. Aside from the new asparagus, already mentioned, there is a radish, a foot in length and three to four inches in diameter, one of which, sliced, will serve as many persons as a dozen or more of the ordinary kind. There is a beet six inches in diameter, a turnip of the same size, out of both of which, as from

the radish. Burbank took that pithiness which spoiled so many of the larger varieties of both vegetables. An artichoke, with a bud six inches in diameter and flower ranging from twelve to twenty inches across, is another. White onions, producing normal bulbs four to six inches in diameter by three inches in thickness, are among the virtually completed developments in vegetables, and a peanut twice as large as any now grown, with greater production per plant, is included.

In the fruits, aside from the new nectarine, which bids fair to rival the famous Burbank plum, there is a mango designed to grow on dry land, and in all the states from Kentucky southward to the Gulf of Mexico and westward to the Pacific coast. There are also two apples of which it may be said that there "ain't no core" and several new berries—developments of the strawberry, raspberry, blackberry and of the celebrated "sunberry," which Burbank produced a few years ago. Heavier production and larger individual fruits are promised from these berries.

Left, Last Picture of Luther Burbank, and, on Opposite Page, the Plant Wizard Discussing Experiments with His Wife

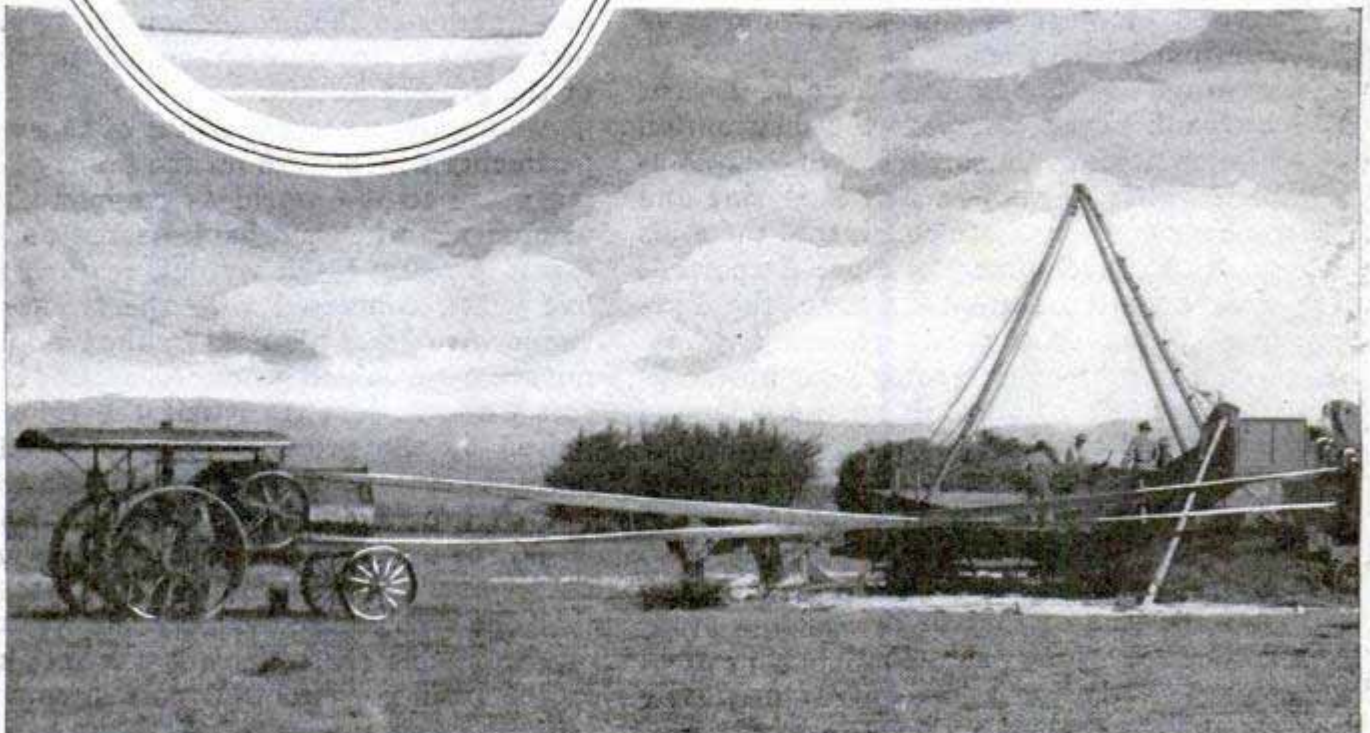
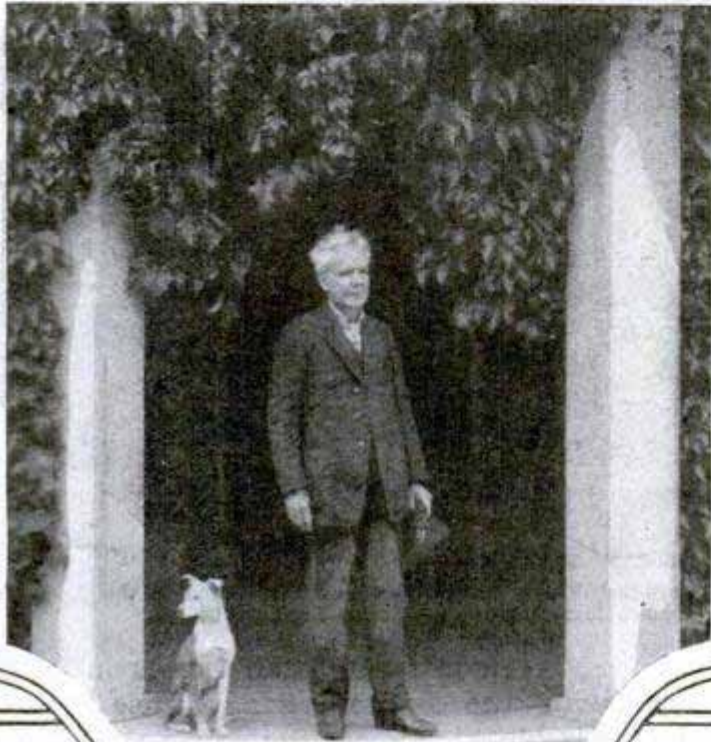

Among flowers, there are a dozen new roses, more vividly colored and with heavier fragrance. New flowering shrubs, some grown from wild plants sent to Burbank from the Himalayas, appear, and there is a pansy whose blossoms are three inches in diameter. Geraniums, whose very large and gorgeously colored bloom makes the present brilliant flowering plants seem tame, are growing in the experimental gardens at Santa Rosa.

Luther Burbank announced, shortly before his death, that he would present to the world, within the succeeding year, at least twenty-five new and commercially valuable trees, fruits and vegetables, with a similar number of flowering plants. While that year has passed, it is Mrs. Burbank's belief that, from the nearly completed experiments he left, she will be able to offer twice this number within the next year.

Among the things Burbank hoped to do was to make the vegetable garden a thing of beauty as well as utility. To this end he already had produced a flowering

leek, an artichoke with large and brilliant blossoms, a mustard with large and heavy golden flower spikes, potatoes with purple, yellow and white flowers, and rhubarb with an ornamental floral offering. He had other similar developments planned, and these, too, will be carried out, without detracting from the value of the plants as producers of food.

During the time since the cessation of the plant wizard's labors, Mrs. Burbank



Below, Threshing Five Acres of Sweet Peas, Just like Wheat or Barley, to Get Seed for Sale and Experimental Work





Part of Burbank's Five-Acre Sweet-Pea Experiment; This Fall Twenty Acres Are to Be Planted to Sweet Peas to Raise the Millions of Flowers Needed in Developing New Species

has kept those new plants which were most nearly completed growing and developing on the experimental farm at Santa Rosa. Now, these farms are to be turned over to plant experts, some of them trained

under Burbank, and all to be led by the woman who had a more intimate knowledge of the marvelous processes by which her husband worked than any other person in the world.

Ward

ELECTRIC WOOD-FILLER RUBBER SAVES WORK BY HAND

For rubbing fillers into wood panels; a motor-driven padded wheel has been devised as a substitute for hand methods. It is said to grind the filler into the surface

much more uniformly than can be done in other ways, makes the work easier and saves time. The one-half horsepower motor is operated with current from a lighting socket, a three-speed counter-shaft is provided, and the wheel, which is reversible, has eighteen sections of rubbing felt pads. The outfit is mounted on a column with swivel base, or on a suspension base with tie-rods, and can be operated with unskilled labor.

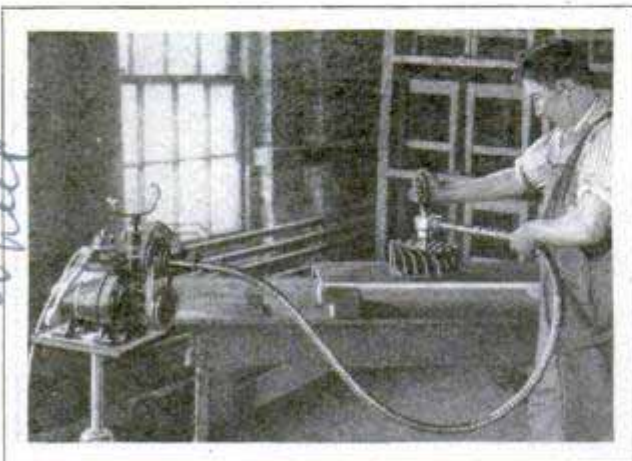

Applying Filler to Wood Panel with the Electric Rubber; It Forces Material into Grain without Damage

PLANES LAND ON SKYSCRAPERS BY REVERSING "PROP" ²⁸⁹⁴

Invention of a propeller-reversing device to permit stopping of an airplane within twice its own length after it touches the ground, has been announced by C. Francis Jenkins, of Washington, D. C. It is expected to make operation of planes within a city practical, as they can land on the tops of skyscrapers and on fields

23 71
Slupper Invention
Wheel

n.a Strand & Co.
500 N. Lincoln

1519 Connecticut

*Stretcher Co. 631
Elmore, Minn*

of restricted area, and will eliminate the costly and time-wasting hauls from air terminals on the outskirts. The attachment is geared so that it cannot be moved while the plane is in the air. At the moment of landing, a spring automatically releases a safety guard on the reversing control, allowing the aviator to bring his plane to rest on ground, deck or sea almost as instantaneously as a bird ceases its flight. Greater success in maneuvers with airplanes in connection with battleships and other vessels is seen as a result of the invention, and it will also prevent disasters in taking off. If the pilot realizes that his ship is not likely to make a successful ascent, he can brake and stop the plane by the reversal of the propeller. It is said, also, that the invention will bring nearer the general use of airplanes for suburb-to-city passenger service.

2274

PROPELLERS TO PLAY "TUNES" FOR MECHANICAL BALLET

Industrial America deserves a special music as well as a special architecture, in the opinion of an eastern composer and, to that end, he has developed an odd assortment of instruments, some of which have never before been used for musical purposes. The equipment includes air-



Some of the Instruments Used in Producing Special Interpretative Music to Describe Modern Industry

plane propellers and apparatus for operating them, two octaves of electric bells and various other units. A demonstration of his "orchestra" was given in Paris and created a sensation among critics.

George Antheil

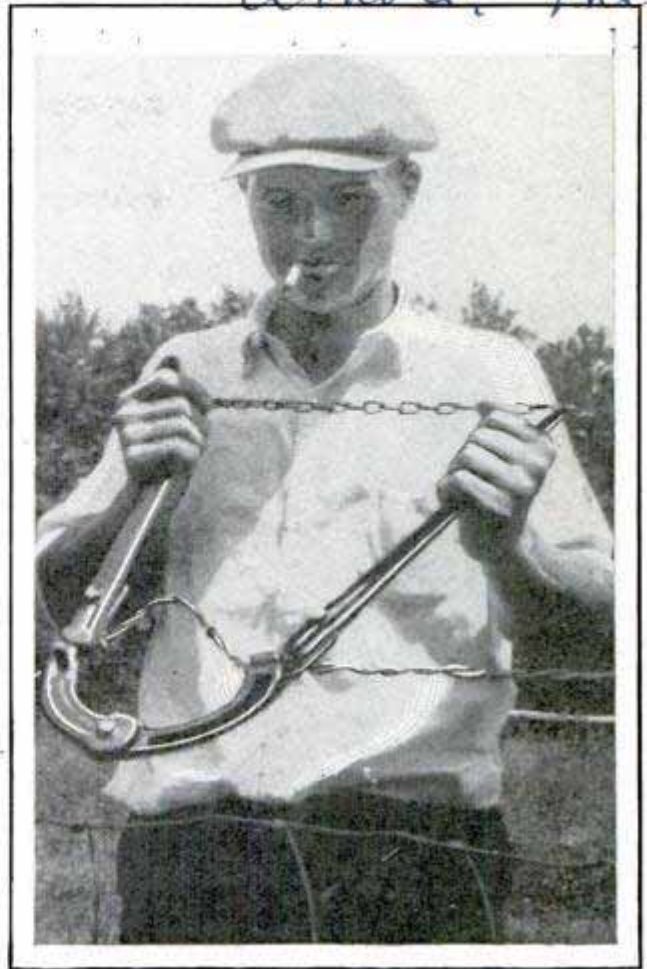

Stretcher in Use; the Chain at Ends of Handles Holds It When Desired Tautness Is Attained

TWO-HANDLED WIRE STRETCHER SIMPLIFIES FENCE REPAIRS

For taking up the slack in barbed, plain or woven-wire fences, or for tightening the wire at the posts, a two-handled stretcher now on the market is easily operated and affords strong leverage. On each handle is an automatic friction clamp and there is a chain at the bottom of the stretcher, the links fitting over the opposite handle to hold the implement in place when the desired tautness has been obtained. To use the stretcher, it is simply spread apart, the clamps attached to the wire and the handles drawn together, pulling the strand up so that it may be tightened by making a loop with a piece of extra wire and twisting it up, or inserting a splice. Keeping the wire taut is of importance, as it is said not only to prolong the life of the fence, but also to maintain it in efficient condition.

☛ Nearly 70,000,000 pounds of artificial silk made from wood is used annually in the United States.

Custom House
six feet long, which will be decorated with more than 1,000 semiprecious stones. The craftsman has his workbench beside his bed where he can carve in quiet.

WILD ELEPHANTS PUT OUT FIRE IN INDIAN JUNGLE

State
How a herd of wild elephants extinguished a forest fire in Travancore, on the southwest coast of India, was related recently by laborers who witnessed the proceeding. A tree had fallen across the road and had been set afire to simplify the task of removing it. The blaze was slowly spreading to the woods near by when the leader of the elephant herd, apparently attracted by the odor of the smoke, appeared, trumpeted loudly to its companions and soon a band of dusky four-footed firemen were squirting streams of water on the blaze from their hoselike trunks. A stream near the road furnished the supply. The wondering natives, who had gone to a house a short distance away, watched the herd put out the fire and then drag the tree into the middle of the road.

SIGHT FOR ANTI-AIRCRAFT GUN LEAVES HANDS FREE

2051
In order to leave the gunner's hands free to keep his piece trained on the target, a special sight has been devised for anti-aircraft purposes. It is set mechanically from a central control station, where all firing data are computed, and is laid to each of the four guns of a battery. When a plane is speeding at 120 miles an hour or so, each second is precious, and if the gunner has to stop to set his sight, the plane may speed out of range.

2745
Mr. Pennock with Some of the Canes Which He Has Carved during His Spare Hours as a Hobby

CARVER HONORS HEROIC DOGS WITH UNIQUE CANE

The memory of a brave collie dog that saved a regiment during the battle of the Argonne by relaying a message, and of other canine heroes, is preserved in a cane carved by A. J. Pennock of Detroit. He worked on the piece for more than 1,600 hours, carving the heads of several other famous dogs, noted for their bravery, as well as a number of prize winners of various breeds. Cane carving is Pennock's hobby, and his collection includes one representing the events occurring during Marshal Joffre's visit to the United States; another tells the story of creation, one represents the life of the frog, and still another Solomon's temple. Some of the designs are so minute that a microscope is needed to see all the details. He is now at work on a larger cane, or staff,

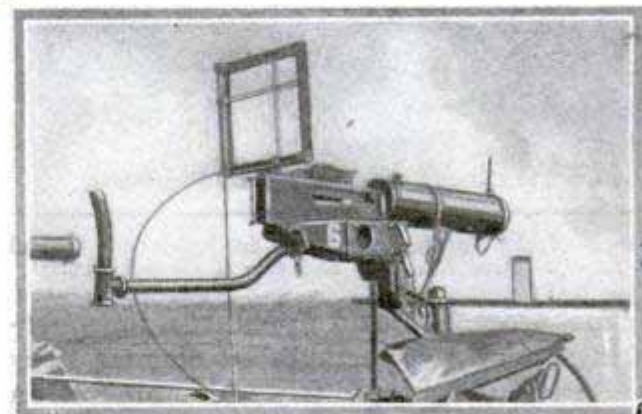

Mechanically Set Sight on Anti-Aircraft Gun, to Improve Accuracy of Fire at Moving Planes

Headquarters, 10th Corps Area
Capt. Lieut. A. M. Isaac,
Presidio, San

1910
 2333 Norwalk Ave
 Eagle Rock, Calif.
 633

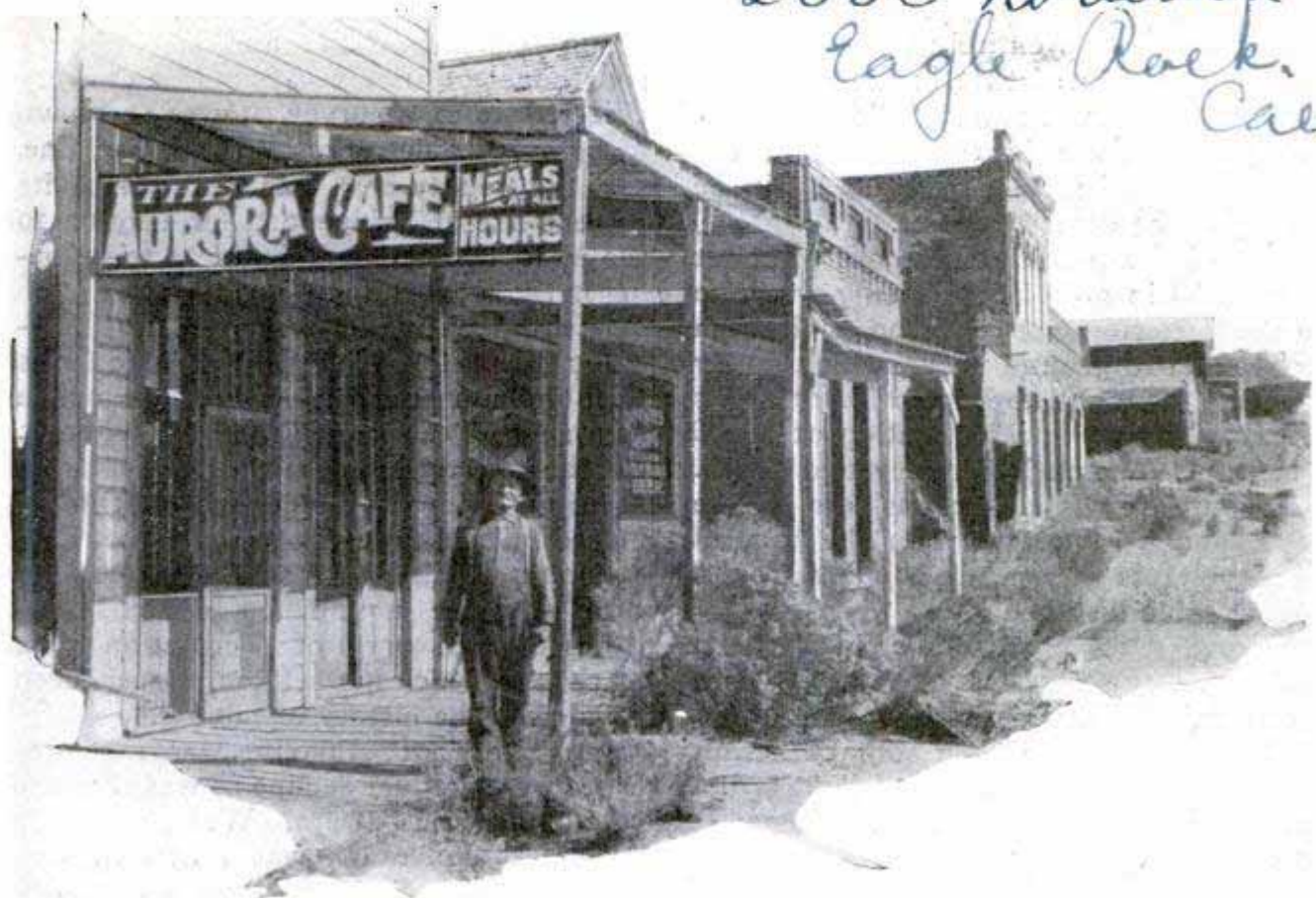

The Hermit of Aurora, Last Living Settler in a Ghost Town That Boasted a Population of 8,000 Back in Civil War Days, and Now Stands Overgrown with Weeds

The Ghost Cities of the West

Gold Towns of Old-Time Rushes Dot the Southwest, Gaunt Reminders of Long Dead and Forgotten Miners

BACK in the little-frequented regions of California and Nevada are found picturesque relics of a colorful past; the skeletons of cities that seethed with life and activity one or two generations ago, but which now are silent and lifeless. It is a far cry from the old west, immortalized by Bret Harte, to the west of today, but only a few miles of dim roads separate trunk lines of tourist travel from some of these ghost cities which stand unchanged since "The days of old, the days of gold."

Mono lake lies at the eastern terminus of Tioga pass which leads over the mighty Sierras to Yosemite. Eighteen miles northeast of Mono lake stands the bulk of once famous Bodie, notable in western lore as the home of "the bad man from Bodie"—a character who, though sleeping under the sagebrush just outside the town, lives even to this day in slang.

The visitor to Bodie who has enjoyed

moving-picture dramas of the old west will find something decidedly familiar in the appearance of its stores with false fronts, two-story frame hotels with full-length balconies and hitching posts conveniently placed. Passing through the broad main street, one looks in vain for signs of activity, the sound of voices or smoke from a chimney. But silence reigns supreme.

Broad plank walks, fast falling to decay, offer an insecure footing. Stepping carefully to avoid knot holes and projecting nails, one may enter the weatherbeaten buildings, inside of which the dust of many years lies thick and masses of cobwebs festoon the walls. Pausing for a moment amid oppressive silence, the question arises: What has happened to the tenants of all these buildings? The answer may be found in the last building on the street, a bank which guarded untold treasure

during the time of prosperity. With an optimism perhaps entirely without precedent, the owner of that bank still waits, hoping the roar of stamp mills may once more reverberate in the hills, and the heavy tread of miners' brogans again be heard on the deserted walks.

Bodie has a production record of about \$50,000,000 in gold. Its passing was due to the "petering out" of some of the rich ledges and to ground water, which finally won the race with the pumps. During its heyday, Bodie had a population of 11,000 which has dwindled to barely two dozen. Not one store is doing business in the town, and it is necessary for the handful of inhabitants to bring in supplies from a considerable distance.

Twelve miles from Bodie, in Virginia Gulch, lie the remains of Aurora, Nev. During the Civil war that city had a population of 8,000; today a solitary hermit makes his abode there. Well-built structures of brick attest the fact that it was at one time a place of considerable importance. Under guidance of the hermit, one may explore the many stores and houses, wherein large numbers of interesting relics may be found—notes and other legal papers, letters, bills, and mining-stock certificates dated in the early sixties. During

that time, Aurora was county seat of Mono county, Calif., and a two-story courthouse of brick was the pride of every citizen. Later, a survey showed the town to be seven miles across the Nevada line, and the county seat was changed to its present site at Bridgeport, far enough to the west to remove all doubt as to its being in the right state.

Situated a few miles east of Death Valley is Rhyolite, a ghost town which was built about twenty years ago, but which has since been completely abandoned. Conflicting stories are told of this district. Some say that there never was gold enough in the hills around the town to pay fair dividends on the stock sold. Others aver that gold in abundance remains untouched. An orgy of speculation took place here which has seldom, if ever, been equaled in the history of mining.

The death of Rhyolite was not preceded by a gradual decline as was the case with Bodie and Aurora. When the stock market broke, death was practically instantaneous. It occurred when the town was in its heyday, boasting a population of 10,000. Hundreds who had reckoned their wealth in stock, found themselves suddenly penniless. A large part of the population did not have sufficient means



Unchanged Since the Days of the Bad Man, Bodie Is a Page from a Picturesque Past, with Its Main Street Lined with Empty Buildings, Their Original Owners Long Since Dead

Avorio, Milan Italy

to purchase tickets to another section of the state, and many were faced with actual starvation. The railroad came to the rescue, and hauled trainload after trainload of penniless families out of the country on flat cars. In a comparatively short time Rhyolite did not have a single inhabitant, and desert vegetation reclaimed the main street.

The disintegration of the town has been hastened by wreckers and vandals, but the walls of the buildings will stand for years to come, monuments to the skill of the stock manipulator, and the faith of the investor. The only intact building in Rhyolite is one which is constructed of bottles. Steps have been taken to keep it in repair, for it is said to be the only one of its kind in the world.

An old smokestack, 175 feet in height, marks the abandoned mining camp of Belmont, near Tonopah, Nev. It was erected from bricks hauled by ox teams from Sacramento, a distance of over 500 miles, and is in as perfect condition today as it was when completed fifty-five years ago, when Belmont was a city of 7,000, made up of frenzied gold seekers. It was for many years the county seat of Nye county and was not entirely abandoned until 1905.

TINFOIL WRAPPING SALVAGED TO DECORATE HATS

Tinfoil and other fancy wrappings on gum and candies are being utilized for trimming hats in England. The pieces are worked into patterns of varying design, pasted to the hat and varnished to give a



lustrous finish.

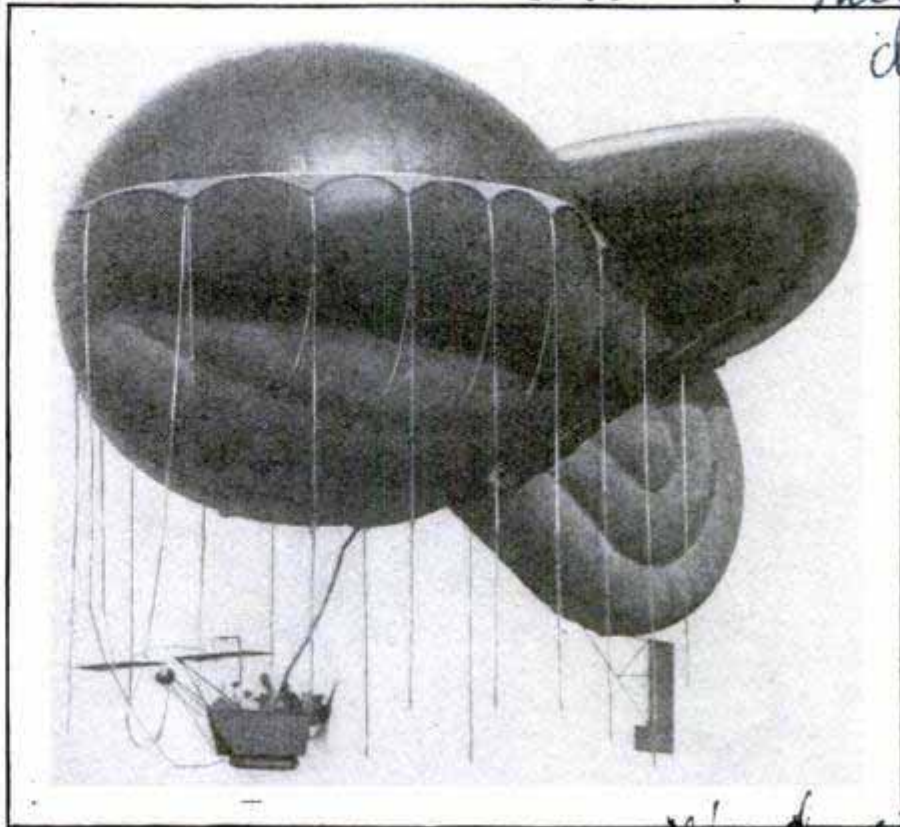

Part Balloon and Part Dirigible. This Odd-Looking Craft Is Used for Observation Purposes by the Italian Army

Wide World

MOTOR BALLOON FOR ARMY USE SIMPLIFIES OBSERVATIONS

Equipped with a small motor and rudder, a balloon designed for the Italian army can easily be moved under its own power for short distances. This simplifies the task of changing positions during maneuvers. The apparatus is attached in place of the regular observation basket.

SUBMARINE DETECTOR IS USED TO TRAP THIEVES

Another instrument of war has been adapted to peace-time usefulness in the submarine detector, a microphone unit that registers vibrations. It is now being used in bank vaults, safes and in other installations. The slightest jar starts an electric current to sound an alarm or operate a visual signal or both, as desired. An advantage of the instrument is that it does not pick up sound waves and is so adjusted that false alarms are almost impossible, vibrations from the outside, such as those caused by trucks passing in the street, having no effect on it. The fact that it is entirely concealed within the vault likewise increases its effectiveness.

2909

*Bell Laboratories
195 Broadway*

2127



Perched on Its Narrow Pinnacle of Earth, After Street Graders Had Excavated Material around It; the Stranded House before Wrecking

HOUSE IS STRANDED IN GRADING TO LOWER STREET LEVEL

Contractors engaged in lowering the grade of a street, to accommodate a new group of homes, were forced to cut around a house which was not removed when the work was started. The result was that the building was stranded on a pillar of earth, high above the new street level.

X-RAYS FIND CRACKS IN WOOD AND HOLES IN CHEESE

British army experts are testing the stanchness of their airplanes by looking for hidden cracks in the wood with the aid of the X-rays. An Ohio dairy farm has employed the same means to locate holes in Swiss cheese and, for some time, prohibition agents have been using a ray apparatus in hunting contraband liquor secreted in packages of merchandise. According to Dr. George L. Clark, founder of the Massachusetts institute of technology X-ray research laboratory, the rays

are industry's latest aid, opening up new fields of invention and fortune and affording short cuts to various tests and findings with far greater accuracy than was possible with other methods. It was shown by X-rays, just recently, that spiders and silkworms spin exactly the same kind of fiber. The discovery has suggested the possibility of spider farms where quantities of the material might be produced and utilized in the manufacture of textiles. Stores are employing the rays to show customers how their feet fit in new shoes and a golf-ball maker is reported to have increased his sales by advertising the fact that he submits the spheres to a close X-ray test to prove the symmetry of the centers. Metallurgists declare they are on the road

to a solution of the mystery of breakage in steel rails with the help of the rays, and the discovery of Illinium, the latest element to be identified, was made possible because X-rays revealed the character of hitherto unknown substances.

LEAKS IN ROOFING PREVENTED BY UMBRELLA-HEAD NAILS

Especially adapted for fastening corrugated or flat sheets of metal roofing, nails that have umbrella-shaped heads tightly seal the hole through which they are driven so that rain cannot enter. They are made of a single piece of metal and are galvanized or bright. Ridges under the head lock the nail.

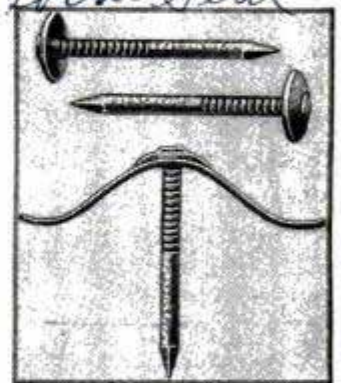

U.S. Steel Products Co.
30 Church St

in address before American Society for Testing Materials

Union Pacific
Los Angeles, Calif



Gates Shut and a Close View of the Electric Unit through Which Train Makes Contact

CROSSING GATES SHUT BY TRAIN SUPPLANT WATCHMAN

Steel safety gates which automatically swing closed across highways on the approach of trains and then swing open again after the train's passing, have been successfully tested in Los Angeles. Watchmen or flagmen are not needed in the operation, which is controlled through electric contact made by the wheels of the train. Lights are flashed to warn drivers that the gates are about to close. The cost of the installation and operation is said to be less than the ordinary wigwag systems, and the gates work satisfactorily should trains approach from different direction on different sets of tracks across the highway.

OLD PANS TURNED INTO MONEY WITH ENAMEL REMOVER

Tons of scrap steel are salvaged each year from worn-out enamel pots and pans cast on city refuse heaps, but the market value of the product has been impaired,

owing to the presence of the enamel which interferes with the resmelting processes. This drawback is said to have been eliminated in a device an English inventor has introduced to remove the enamel. Old pieces are thrown into a hopper and pass through rollers which straighten the scrap into strips. In the operation, the enamel is broken off. It is sold for approximately \$5 a ton for glazing tiles and for making glass and metal polish, while the cleaned steel commands from \$10 to \$20 a ton.

More lumber is used in California than in any other state.

Encl. via W. Builders 5205 Alhambra Ave. Lake View, Calif

The Kahler Co. R. 607 Central Valley 108 W. H. St. P. 11

2311

New Ways to AVOID



To Shield Baby's Eyes, Bassinet Has an Adjustable Top and Is Suited for Use in an Automobile or Outdoors; a Strap across Center Prevents Falling Out



This Glass Teapot, with Tea Ball Fitted in Cover, Has an Insulated Handle Which Remains Cool Although Liquid Is Hot, and Top Permits Expansion and Contraction

At Right, Crankless Ice-Cream Freezer That Also Serves as a Portable Refrigerator on Camping Trips, to Hold Baby Bottles or Keep Milk Cool and Sweet

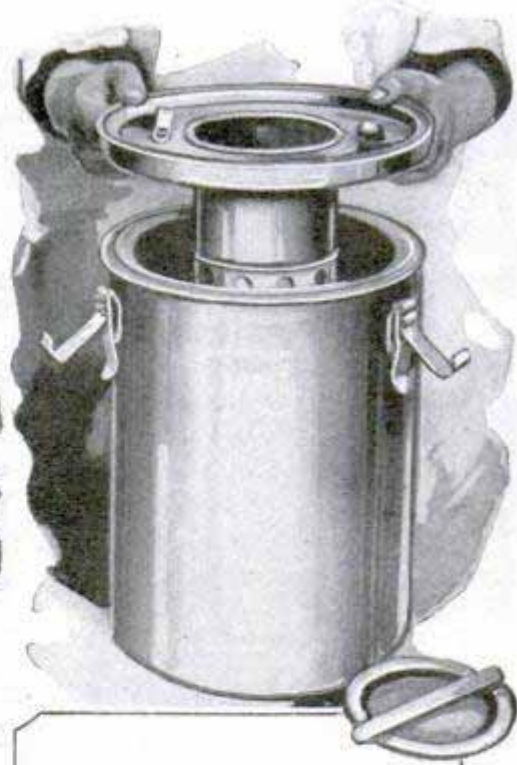

Left, Electric Refrigerator That Fits under Sink Makes Sixteen Pounds of Ice Daily

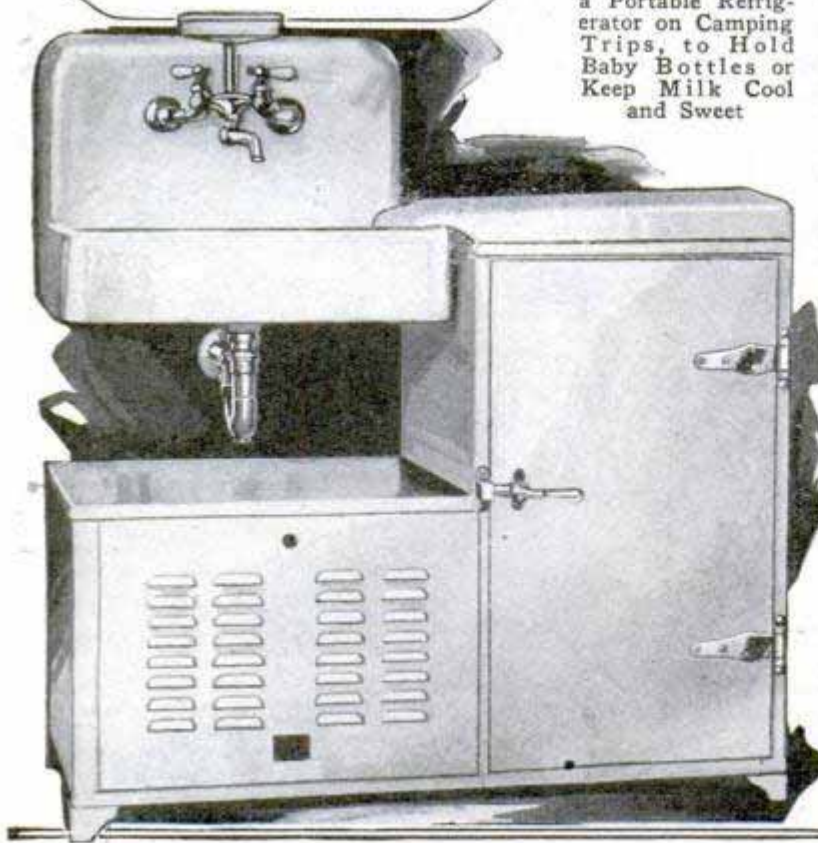

2311 Needle

HOME Drudgery

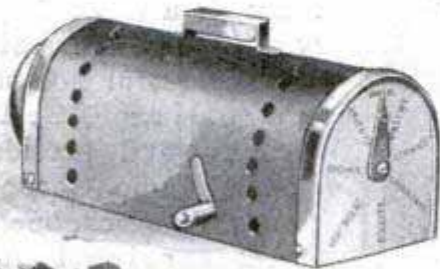

Is Your Oven Hot Enough? This Alarm Can Be Set for Different Foods and Rings When Temperature Reaches Point to Start Cooking

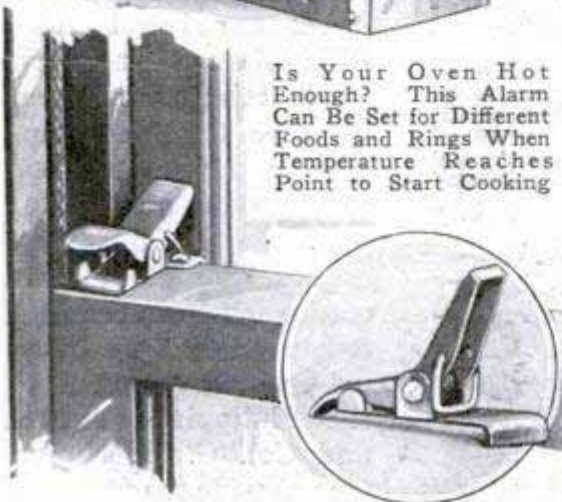

Theft Protection and Reduction of Rattle Are Offered in This Lock, Which Secures the Window in Any Position and Is Easily Attached

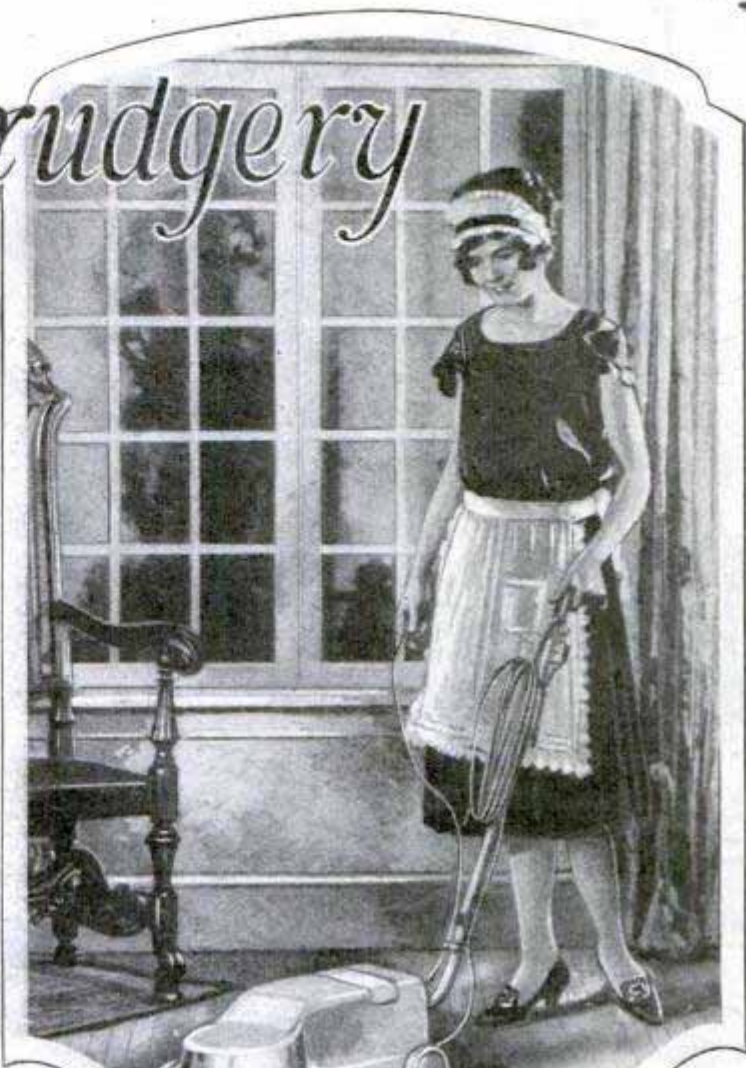

Easier Than Work on Hands and Knees; Electric Floor Machine Which Cleans, Scrubs, Polishes and Removes Old Varnish

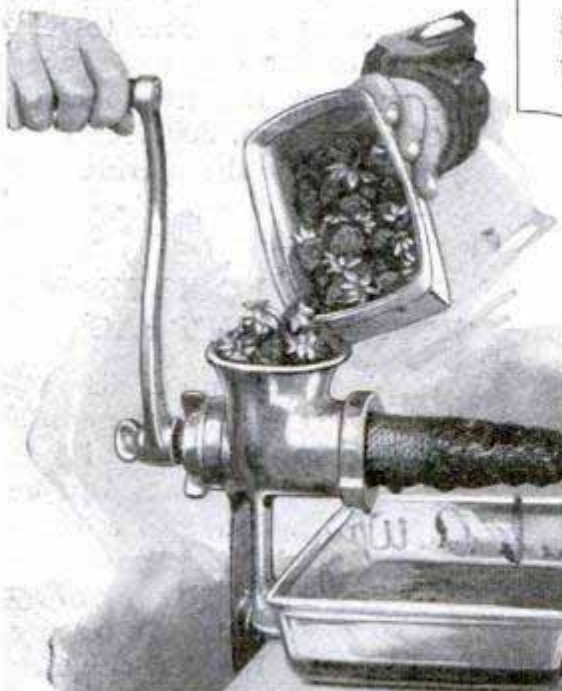

Grinder Which Quickly Separates Pulp from Fruit Juice Also Prepares Meats and Vegetables and Flakes Soap



Transparent Needle Case Simplifies Selection of Right Size for Certain Work and Makes the Remembering of the Proper Numbers Unnecessary

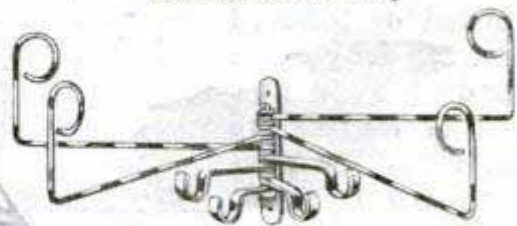

Hanger, That Folds Up in Small Space, Holds Four Hats and Four Coats and Is Attached to the Wall with Two Screws

2854

RADIO SERVICE TO PHILIPPINES

Airplane flights and wireless are connecting the United States to its possessions more firmly so that isolation, in a sense, is a thing of the past. A few hours after the successful non-stop trip to Hawaii, Gen. J. G. Harbord, president of the Radio Corporation of America, opened direct service to the Philippines from New York. His message, sent by wire to San Francisco and thence through the air to Manila, almost halfway around the globe, was read, a few minutes after it had started, by Manuel Quezon, president of the Philippine senate, and Col. C. H. Nance, vice president of the radio corporation of the Philippines. The transmitting station at Manila occupies eight acres. Four steel towers, 165 feet high and spaced

23 Broadway New York

Co. m. d. d.

olding Furniture

Champion 42

mf.

Leipzig, Germany

A. J. Es.

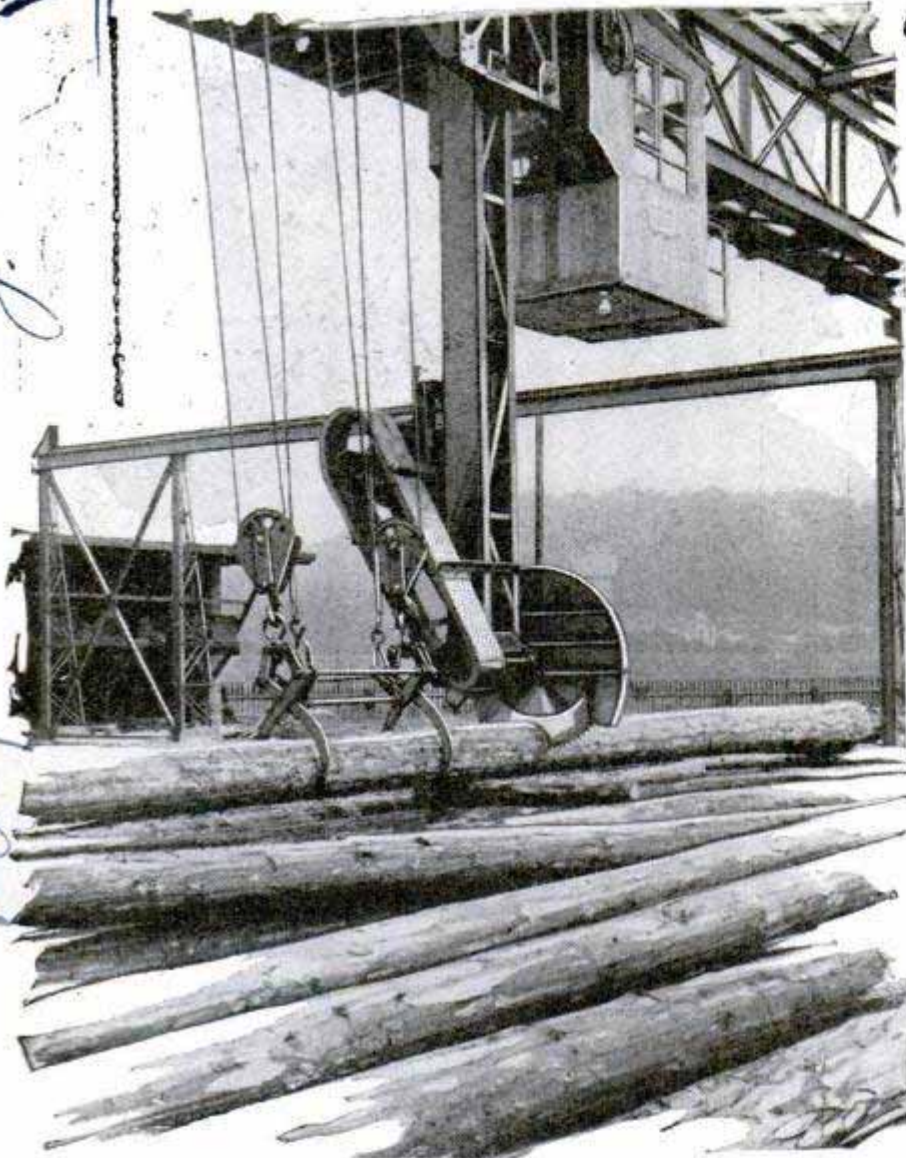

Circular Saw and Lifting Crane, to Speed Cutting and Handling of Logs at a European Lumbering Plant

CRANE AND SAWMILL COMBINED SAVE LABOR

Saving of seventy-five per cent of the labor bill is claimed for a combination electric saw and crane introduced at a European lumbering plant. The circular saw is fitted directly to the traveling crane proper and can be hoisted or lowered at will. Logs are handled by tongs and, as lengths are cut ready for sawing into boards, they are taken, a load at a time, to the saw frames. The crane is also used for loading and unloading cars.

290 feet apart, support the transoceanic antenna, while two others, 300 feet high and 700 feet apart, carry the marine and broadcasting antenna.

FOLDING BED HAS LOCK FRAME AND SPRINGS WON'T SAG

23 29

Setting Up the Folding Bed; the Frame Can Be Locked, to Pull the Springs Taut

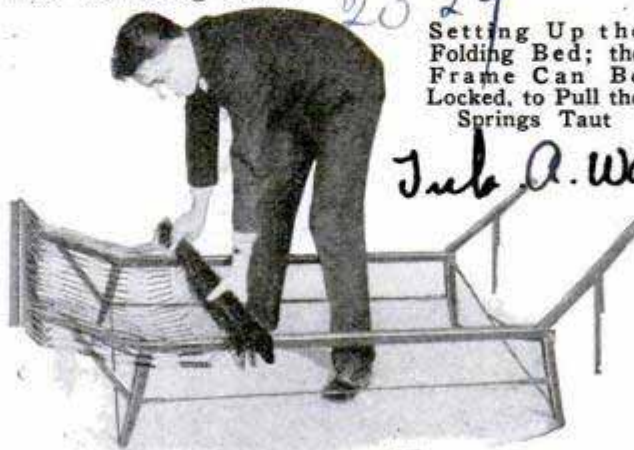

J. A. Way

Set up or dismantled in a minute, a double steel bed and springs can be folded into a compact package weighing but thirty pounds. A feature is the lever which locks the frame and stretches the springs. One pound of pressure on this

Chicago Marshall Field

unit is said to exert a pull of 1,000 pounds. When opened, the bed is forty-eight inches wide and seventy-six inches long. The single size is thirty-two inches wide.

**ANNUAL LOSS BY HAILSTORMS
OVER HUNDRED MILLION**

Weather-bureau records show that more than 250 hailstorms occur in the United States every year, doing approximately \$47,500,000 damage to crops alone. It is estimated that hail does more than \$50,000,000 destruction in foreign countries annually, Germany, France and Italy being the chief sufferers. Tons of ice fell during a severe storm in Dallas, Tex., the damage there being more than \$2,000,000 in broken glass, wrecked roofs and automobile tops. In 1925, hail losses for the state of Iowa were placed at nearly \$8,000,000. Last year, the total premiums paid for hail insurance in this country amounted to more than \$18,000,000 and the losses covered by such insurance were over \$10,000,000.

**HARROW MAKES SHORT TURNS
ON ENDLESS TREAD**

In addition to greater capacity and a saving of labor for the operator, a tread-



For Short Turns in Small Fields, This Tread-Drive Tractor Has Been Found Successful

drive tractor harrow introduced in Germany can make short turns, a great advantage in small fields or on plots where more than one crop is grown. The harrow units can be adjusted to do various grades of work.

Policeman James O'Connell with the Camera Apparatus He Has Rigged to Take Burglars' Pictures



**CAMERA TRAP FOR BURGLARS
LATEST HOME PROTECTOR**

To take a picture of intruders in the act of breaking into a house or other building, a New York policeman has rigged a camera-attachment for a door in such a way that the burglar snaps his own photograph unawares. The instrument is concealed and the apparatus for making the exposure so arranged that it will be set off without fail at the forcing either of the door or of a window.

STRANGE FACTS ABOUT ODORS

While various chemicals, as prepared in the laboratory, have the strongest odors known, certain substances in nature are extremely pungent, the scent of the skunk, for instance, often being detected at a distance of a mile or more. Workers in chemical laboratories have been identified a block away from the odor of the materials clinging to their clothing. Camphor can be detected when diluted as much as one part to 400,000. One one-hundred-and-twenty-thousandth of a grain of oil of rose causes a definite stimulus to the olfactory nerves and one part of musk in 8,000,000 can be detected. Some investigators have launched the theory that odors, like sound and light, might be transmitted by radio, but this is considered impossible in view of the fact that the odor is caused by minute particles of the substance and not by vibrations.

*Stuart Mackenzie
in American Magazine*

*New York Times
7/3/27
Highbridge Police Station
Brooklyn, New York*

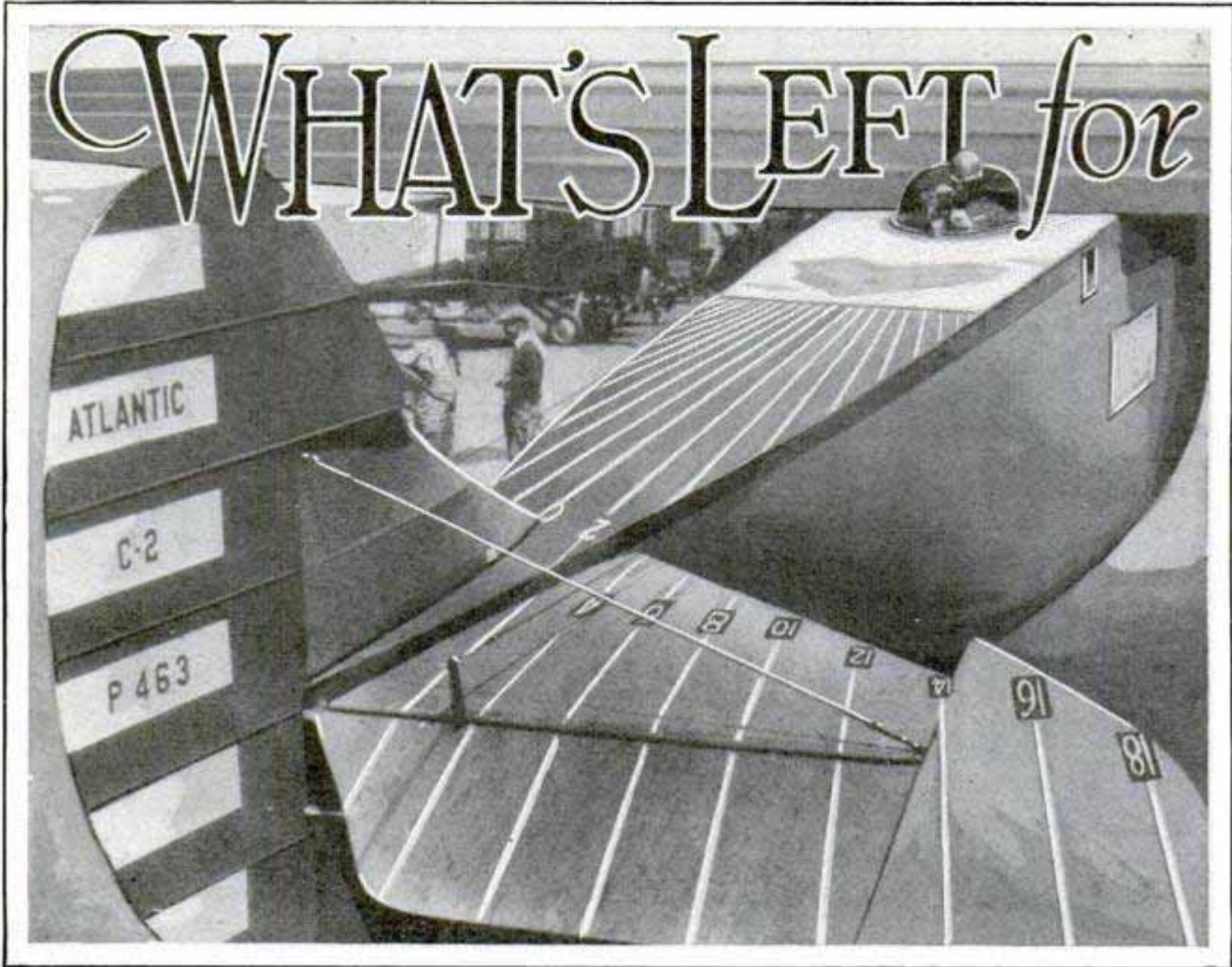

The Army Fokker Which Flew to Hawaii, Showing the Radial Lines Painted on the Ship to Help the Navigator in Dead Reckoning, Aided by the New Sun Compass

By J. OLIN HOWE

*R 2307 130.4
42nd St. New York*

THE fact that stands out in connection with this year's spectacular airplane flights across great sections of the earth's surface is that long-distance non-stop flying over thousands of miles of land and water has only just begun. Aviation has thrills in store for years ahead, until finally some flying genius completely circles the globe without coming down out of the air.

"This flight around the world in one hop is of course the shining mark for pilots to aim at," said Lieut. Leigh Wade, speaking of epic flights yet to come, after discussing with me his and Linton Wells' proposed aerial trip around the world in fifteen days. "Possibly it isn't as far away as you may think," the former war flyer continued, and his partner nodded confident agreement.

Wade was one of three army pilots to make the first air journey around our planet in 1924, by easy stages and taking

altogether about six months; and Wells, a Tokyo press correspondent then, resigned after covering his assignment and stowed away in Wade's plane, where he rode until Washington ordered that he should be dropped.

"Longer air jumps, and still longer," Lieut. Wade said, "are more a matter of motor than of plane design. There is now in the shop an airplane motor for which the inventor claims about twice the duration of any in use. If this will do in a plane what it is said to have done in the laboratory, it will make possible a sustained flight of 12,000 miles.

"That would mean," he went on, "flying clear around the earth if one started far enough north or south of the equator, but not by a practical route; and any flying feats which do not develop commercial practicability cannot possibly advance the cause of aviation.

"In fact, by flying around the earth on

AIR HEROES to Conquer

the Arctic or Antarctic circle you could do it in under 10,000 miles; but to what purpose? You could even go to Spitzbergen, where Byrd took off in his memorable flight to the north pole, 700 miles away, and by some very nice navigation, fly around the globe on its parallel of latitude in about 4,000 miles. Or if it would be possible to take off much nearer the pole, the distance around could be cut away below that. But there is no practical route around the earth much less than 20,000 miles; and any such flight as those mentioned would be but a startling stunt, though it might

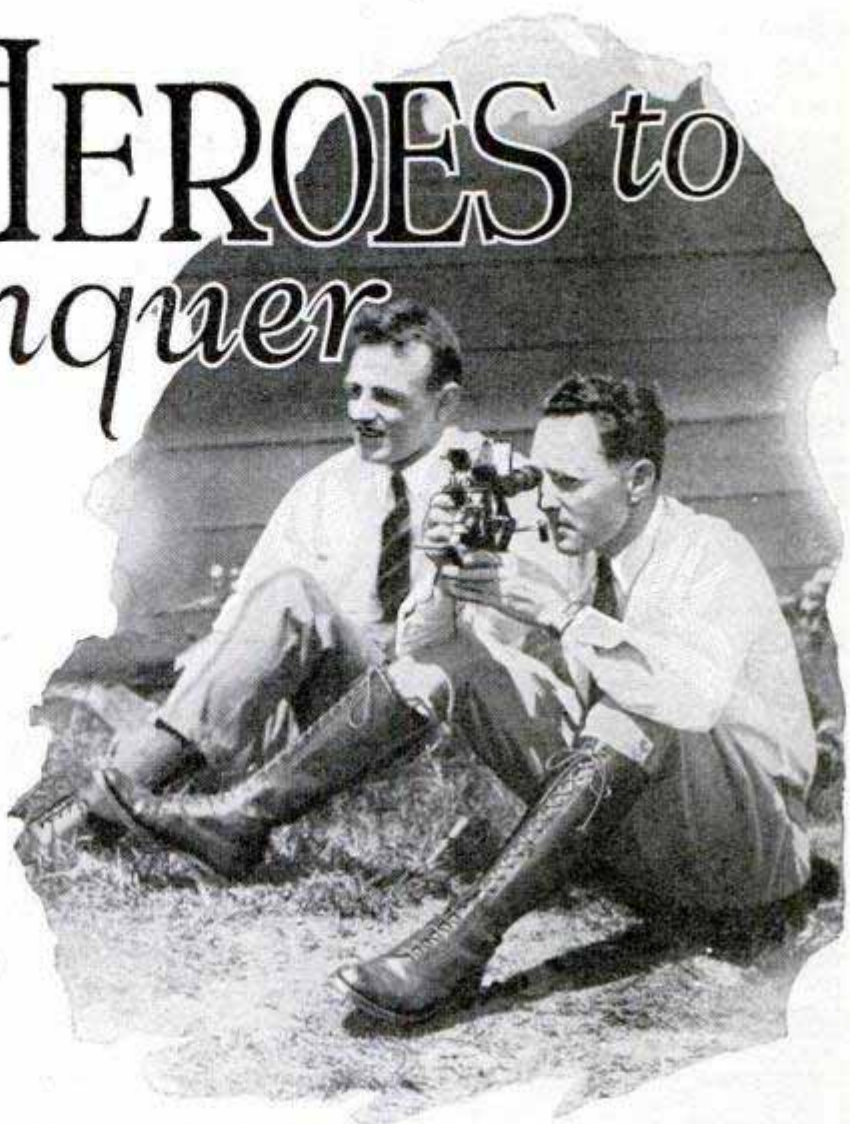

Lieut. Comm. Byrd Testing a Newly Improved Sextant, Which He Himself Designed for Aerial Navigation

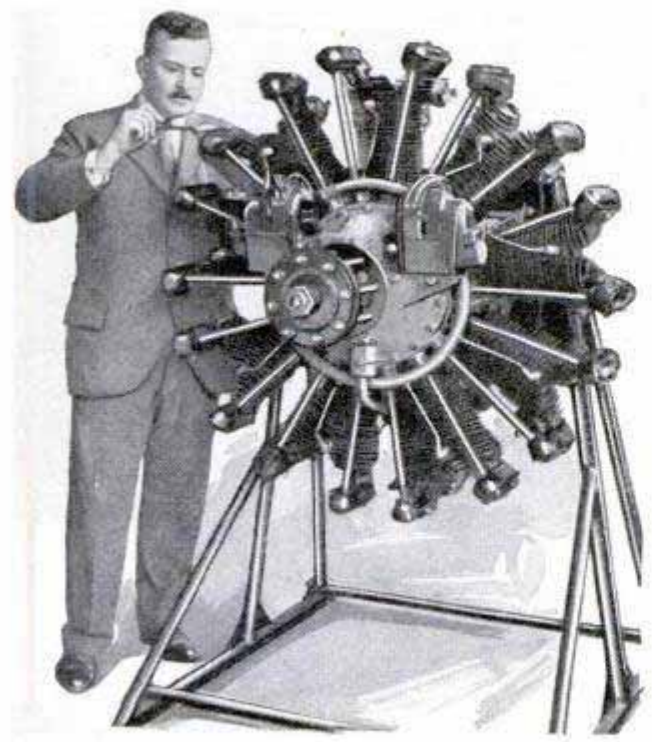

Charles L. Lawrence, with His Famous Ocean-Crossing "Whirlwind" Motor

add something to scientific knowledge. "Such a great flight as Byrd's to the north pole was purely for scientific purposes, as will be that he plans to make to the south pole next year, where there are thousands of square miles of unknown territory, taking off from New Zealand for the polar ice barrier at the beginning of the Antarctic spring in December and later flying from the barrier to the south pole. And one day some adventurous pilot will girdle the globe by way of the two poles, flying over each in turn—just for the sake of doing it!"

Meanwhile many more practical long-distance flights challenge the airman's prowess. At this writing, even the comparatively simple straightaway flight from New York to San Francisco, or Seattle, Spokane or Portland, Oreg., has not been flown, and there are other single hops between distant North American points well worth the flyer's effort—Chicago to Ju-

neau or Nome, Alaska, for instance, or Dallas, Tex., to Ottawa, Toronto or Montreal, Canada.

The possibilities of lengthy jumps across the Atlantic are far from exhausted, moreover. America to Mediterranean points, even to Constantinople, still tempts the capable pilot, as do America to Cairo, America to Sweden, South America to South Africa and so on.

Rene Fonck, French war ace, whose attempt to fly from New York to Paris last year ended in disaster before he got off the ground, was in Europe early in the summer and brought back four Rhone-Gnome-Jupiter motors to be put into a big Sikorsky plane which he has planned to fly across the Atlantic in September—possibly to one of the points mentioned. Besides, European flyers are to be reckoned with in return transatlantic hops—Paris to New York, England to Canada, Rome to America, and over other arcs of the earth's circumference.

And always the Pacific ocean intrigues the daring pilot. The San Francisco-Honolulu hop has been made—2,400 miles over blue water as against 1,700 to 1,800 miles

over the ocean in a transatlantic flight, and without sleet storms—and perhaps some intrepid birdman soon will go on to Tokyo in a second leg across the Pacific.

Or this flight may be from Dallas to San Francisco, then to Honolulu and on to Hongkong with a stop at Guam or Manila, nearly 10,000 miles in four hops; this because of the rich prize hung up by the Texas city. There is also a chance that Leslie Arnold, of Los Angeles, may fly the non-stop round trip he has been planning from that city to Honolulu and return without coming down. And the Japanese may come through with a non-stop from Tokyo to America. Many lengthy transpacific hops beckon the aviator—such as San Francisco to Australia in, at most, three jumps, stopping at Honolulu and Samoa. This could possibly be done in two, for the airline distance from Honolulu to northern Queensland is not much over 4,000 miles, and there are numerous landing places on South Sea islands if the pilot is forced down.

Our present motors can readily do 4,000 to 4,500 miles and, under the most favorable conditions, might stretch this to 5,000.

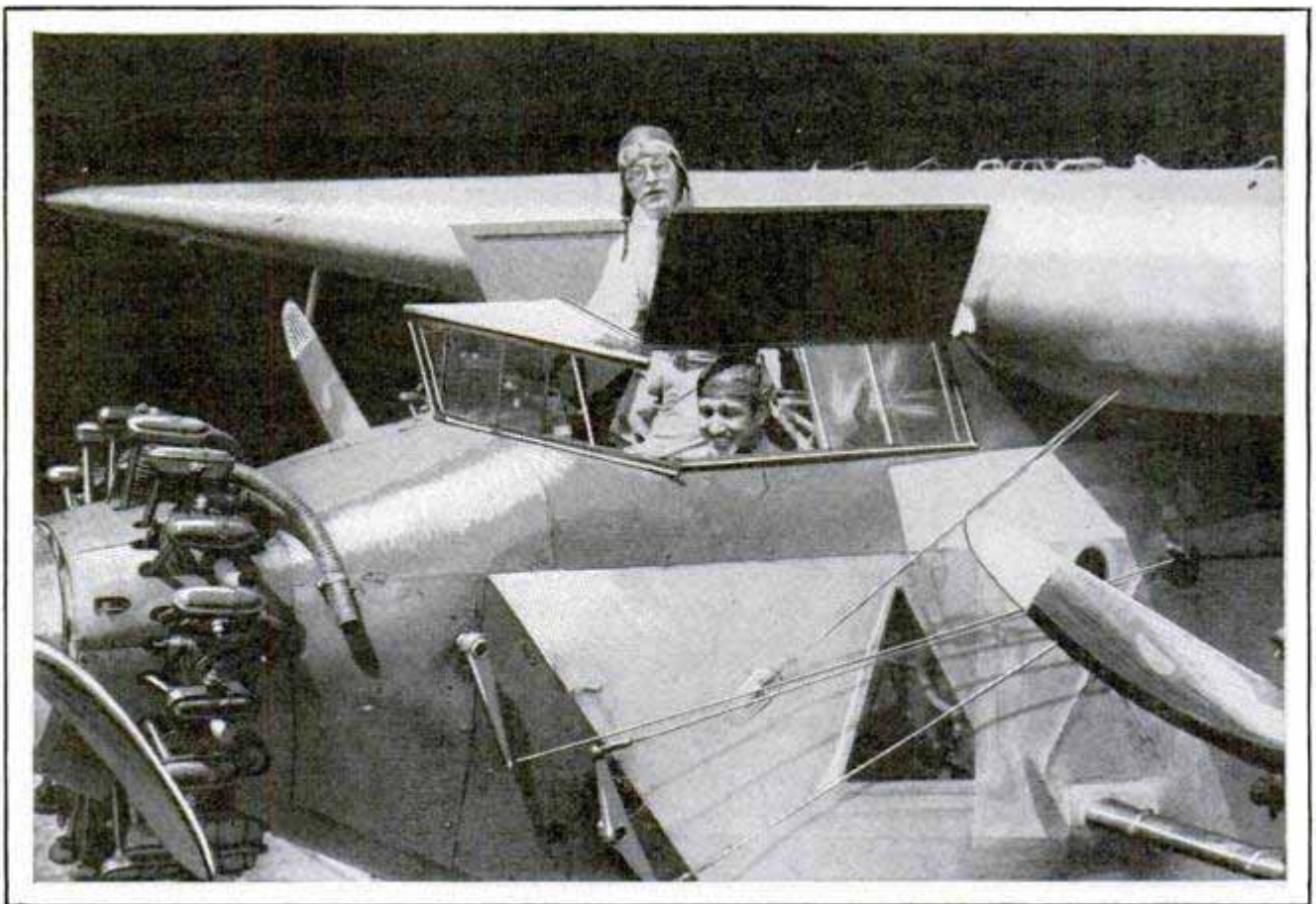

Lieut. George Noville, Radio Officer, Standing, and Bert Acosta, Seated, in the Pilot's Compartment, Just Back of the Center Engine of the "America" and in Front of the One Big Wing

280

15 Schurman St.
New Brunswick, N.J.

Eberhart Aeroplane
Motor Co. Buffalo, N.Y.
New Jersey Indulgent Co.



With This Distress-Signal Gun and the Tubular Water Flare, Above, Byrd Was Prepared to Attract Attention Should His Plane Be Forced to Land in the Sea along Steamship Lanes

The Radio Set That Kept the "America" in Constant Touch with the World throughout Its Long Flight; the Operator Wears a Soundproof Helmet with Built-In Earphones to Eliminate the Roar of the Three Giant Engines



Comm. Adams of the National Aeronautical Society with a Sealed Barograph, One of Which Was Carried by Each Europe-Bound Plane to Record Altitude

Germany claims a motor which will fly sixty hours and a German airman plans to use it on a non-stop flight from Berlin over New

information.



Unsinkable Suit and Water Still, Which Converts the Breath into Drinking Water, Above, and the Air-Speed Indicator's Suction Tube in the Circle at the Left

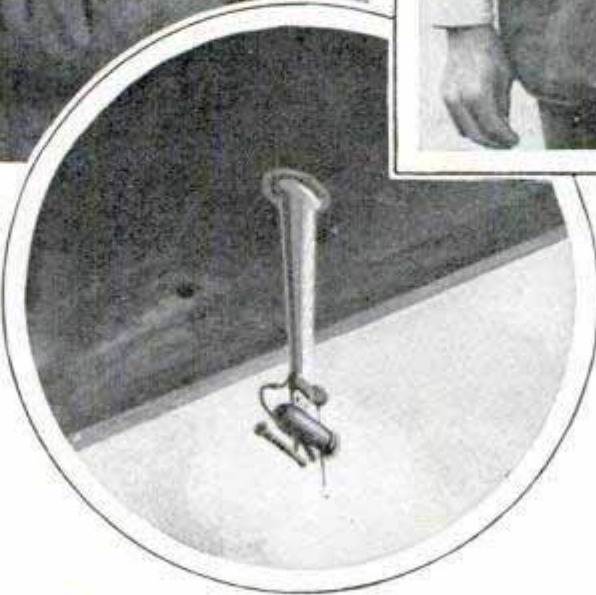

York to San Francisco, a distance of about 6,500 miles.

And, in addition, our western hemisphere has other important flights.

see - see Sept. 1927. 365



Lieut. Comm. Byrd Paddling Ashore from a Navy Plane in a Rubber Life Raft; It Was This Boat That Saved His Entire Crew When They Landed in the Sea 200 Yards off the Coast of Normandy

Noville, Acosta and Byrd Inspecting Some of Their Instruments, Life-Saving Devices and Other Equipment

"If an American pilot—a civilian pilot, not an army or navy flyer; at heart the nations south of us are suspicious even of aviators in uniform—were to fly a non-stop from New York or Chicago to Mexico City, it would go far toward smoothing out relations between Uncle Sam and Mexico," remarked Lieut. Walter Hinton in discussing flights of the future.

Hinton piloted the "NC-4," first plane actually to cross the Atlantic, in 1919, and, since he left the navy, has flown from

New York to Rio Janeiro via South American coast points and has also flown over thousands of miles of Brazilian jungle and wilderness with the Hamilton Rice expedition.

"A solo flight like Lindbergh's from New York to Rio would make a vast difference in the feeling of Latin America for this country," Lieut. Hinton said.

"With the right seaplane, this distance of about 6,000 miles could possibly be flown in two hops, but available landing places for a land plane are very scarce en route."

When Comm. Byrd leaves in the early fall aboard the whaling steamer "Larsen" for the South seas, preparatory to hopping off, about December 1, for the south pole, he will encounter the world's worst flying conditions. Compared with his project of crossing the Antarctic ice barrier by plane, his trip last year over the north pole was

2563

only a joy ride. For one thing, the Antarctic ice barrier is far larger than the northern ice fields, more difficult of crossing and infinitely more difficult of access. On the north pole flight the aviators were able to start from an old-established town, with their floating base lying at anchor off the shore, fly to the pole and come back to the same village again.

There are no towns in the southern hemisphere within striking distance of the pole, and it is difficult even to navigate a ship within a reasonable distance. Instead of the verdant summer vegetation of Eskimo land, the Antarctic is a barren wilderness, devoid of plant life and far colder than the north. It is guarded by a chain of mountains with sentinel peaks rising 10,000 to 15,000 feet into the air. The heavily loaded plane must rise high enough to cross them before it can set off across the vast snow-covered plain.

The north pole is in an ocean and to reach it Byrd simply flew over low and often level ice fields. The south pole is in the center of a vast and almost unknown continent. Here and there are open leads of water, such as those the whalers frequent south of New Zealand. There are nearly 400 miles of this ice barrier to be crossed south of New Zealand before the mountains that rim the plateau are reached. It took Amundsen and his men twenty-seven days to cover the 400 miles, traveling on skis with their supplies on dog sleds.

Amundsen climbed a glacier and crossed the mountains through a pass 10,600 feet high. The pole itself lies back of the mountains on the huge tableland, a perfectly level continent at a height of more than two miles above the sea.

The more intense cold in the southern arctic is due to several causes, principally the high altitude and the absence of warming ocean currents.

Capt. Knight with Eagle Trained as Falcon; the Rack Helps Hold the Bird's Weight



TRAINING EAGLE AS FALCON REQUIRES FACE MASK

Falconry was practiced at least 2,000 years B. C. and is still followed in some sections as a hunting sport. Recently, Capt. C. W. R. Knight, a British naturalist, managed to teach a captured eagle to catch and retrieve game. The bird fought its keeper at first so that a face mask and heavy gloves were needed. In addition, a wooden rest was constructed to help support the eagle's weight.

MOTOR-VALVE SEATS RENEWED WITH SIMPLE CUTTING TOOL 1550

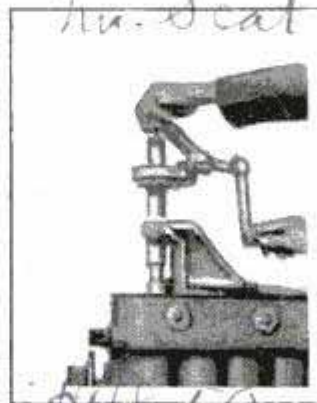

To recondition the valve seats in motor blocks, a hand-operated cutter quickly countersinks the old seat around the top, where it is likely to be worn, cracked or burned, permitting the insertion of a semi-steel ring. The tool is easily adjusted and is provided with five cutters to fit 117 makes of motors.

no seat
848-50
 S. Smith Machine Shop
 917 Main St.

*80 W 40th St
New York*

Steichen, and Typical Pattern Designs Made by the Shadows of Tacks; Strong Lights Are Arranged to Create the Angular Forms

values. This process of creating pattern designs has been developed by Mr. Steichen, who has spent a lifetime in photographic work. After the photographs are completed they are taken to the mills where the cloth is made and stamped with this novel effect which was obtained from a tack or sugar-lump pattern.

MADE-TO-ORDER AIR PROTECTS ART IN MUSEUM

2868 To keep all masterpieces from warping and cracking, the Toledo art museum has been fitted with special heating and ventilating apparatus so that the "weather" inside the building can be kept at the proper temperature and humidity at all times. The importance of these precautions is greatest with respect to many of the most costly paintings, some of which were made on wood backs, subject to buckling and warping that might easily prove

SHADOWS ARE CAUGHT BY LENS FOR NEW DESIGNS

With the ever-changing trend of the present-day fashions new creations are constantly being sought after. The latest development for acquiring distinctive designs is by photographing shadow patterns created by many objects. Tacks furnish many interesting detail effects, while matches, cigarets, moth balls and sugar lumps attain equal honors for variety. These objects are carefully mounted on large white boards and arranged according to the effect desired. Powerful side lights are fixed in various positions until a perfect dark and light shadow effect is obtained. By using lights of varying intensity the shadows acquire different

ruinous to the work. For instance, Raphael's "Madonna of the Chair" is on wood, supposedly the head of a barrel. In summer, it expands in its frame and, in winter, contracts. "Cradling" the backs of paintings on wood has been tried in some museums to protect them. This is accomplished by vertical struts of wood reinforced by horizontal pieces to absorb the various reactions of the picture to the changes in atmospheric conditions. By treating the air that goes into the museum, dust is also extracted, so that there is less damage to the displays. At the Metropolitan museum in New York, installation of weather-making apparatus has been helpful in protecting the large collections of furniture from harmful drying and swelling at different seasons.

*Modern Science
& Institute*

Building a Six-Foot Loud Speaker

By MYRON L. HARMON

THE exponential type of horn, when used with a good loud-speaker unit, leaves little to be desired as regards volume or faithful reproduction. This horn is not a new or revolutionary idea, but represents a well-tried principle. Any good radio store can supply you with factory-made horns of this type, but this article is intended for those who desire to construct their own with the resultant saving in cost.

It may be said without reservation that anyone can build this horn and do a very creditable piece of work without the aid of tools of any kind, and should any mistakes occur, they can easily be corrected with no loss of efficiency.

It is well at this point to pause and picture to oneself the work to be done and

pleted work will be a horn, 6 ft. long, with an opening at the larger end measuring 20 in. in diameter, the horn being wound into a shape much resembling the large tuba of the brass band. Being made of a comparatively vibrationless material, it possesses splendid tonal qualities.

We will now take up the actual construction by laying out the pattern on the cloth. Obtain 2 yd. of a good grade of muslin at least 65 in. wide, or 4 yd. half as wide. By referring to Fig. 1, you will see that the model or core consists of a conical sack which measures $\frac{3}{4}$ in. in diameter at the small end, and tapers to an opening 20 in. in diameter. Of course, in laying out the pattern (see diagram page 651), we are interested in the varying cir-



Completed Core Sack Ready for Filling and Wooden Disk for Closing End

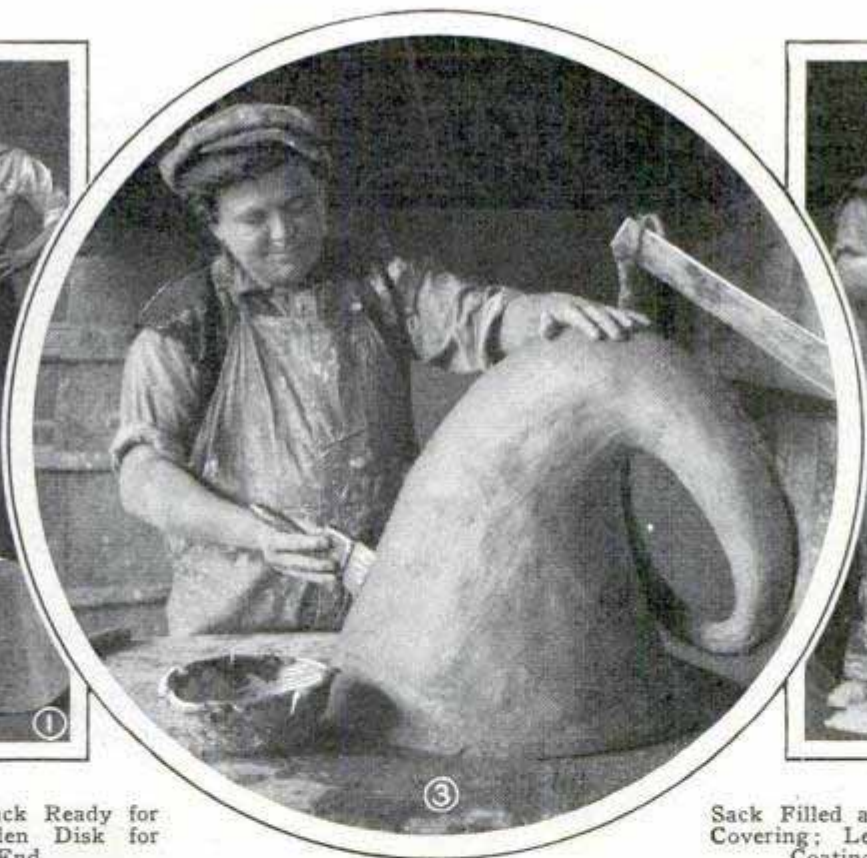

Sack Filled and Ready for Clay Covering; Left, How the Clay Coating Is Applied

the results desired. The work will consist of filling a canvas or muslin bag with sawdust, to serve as a model, and the making of a plaster-of-paris cast from this model, both very simple operations. Various other ideas will occur to the experimenter as to ways and means, but only the one method will be considered. The com-

cumferences rather than the diameters and, since the muslin tube is made in two pieces, the drawing dimensions indicate the half circumferences at points 6 in. apart; the dimensions given, while not mathematically correct, are sufficiently accurate for practical purposes. There may be some who wish to first lay out a paper

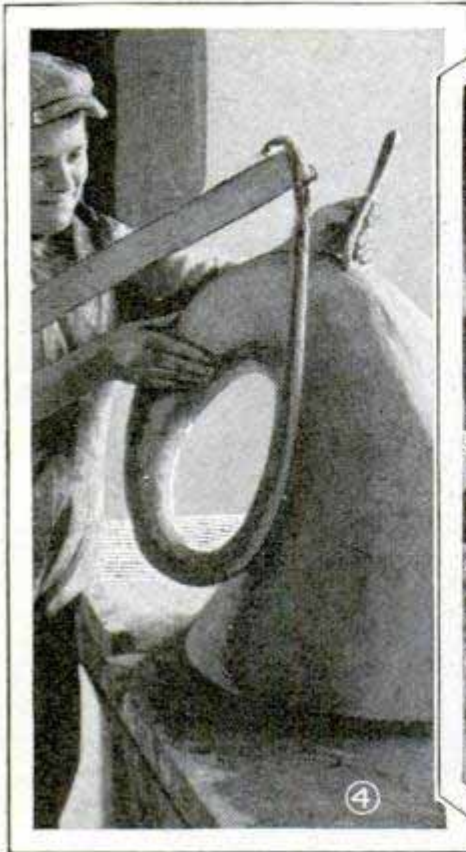

Applying Water with Brush to Obtain Smooth Clay Surface; Note Method Used for Supporting Small End to Prevent Coils from Touching



Applying First Plaster-of-Paris Coating by Throwing Motion of the Hand; the Entire Surface Is Coated in This Manner



Applying Strips of Burlap or Hemp Soaked in Plaster of Paris, to Add Strength and Thickness to the Wall



Completed Casting, Showing Small Coil Joined to Large Section; the Rope Extends beyond Mounting Point for the Loud-Speaker Unit



Removing Wooden Disk and Detaching Core from Plaster Wall; the Sawdust Is Now Loosened and as Much of It as Possible Is Removed



Pulling the Rope to Withdraw the Sack; the Clay Clinging to the Wall Is Then Washed Out with a Hose

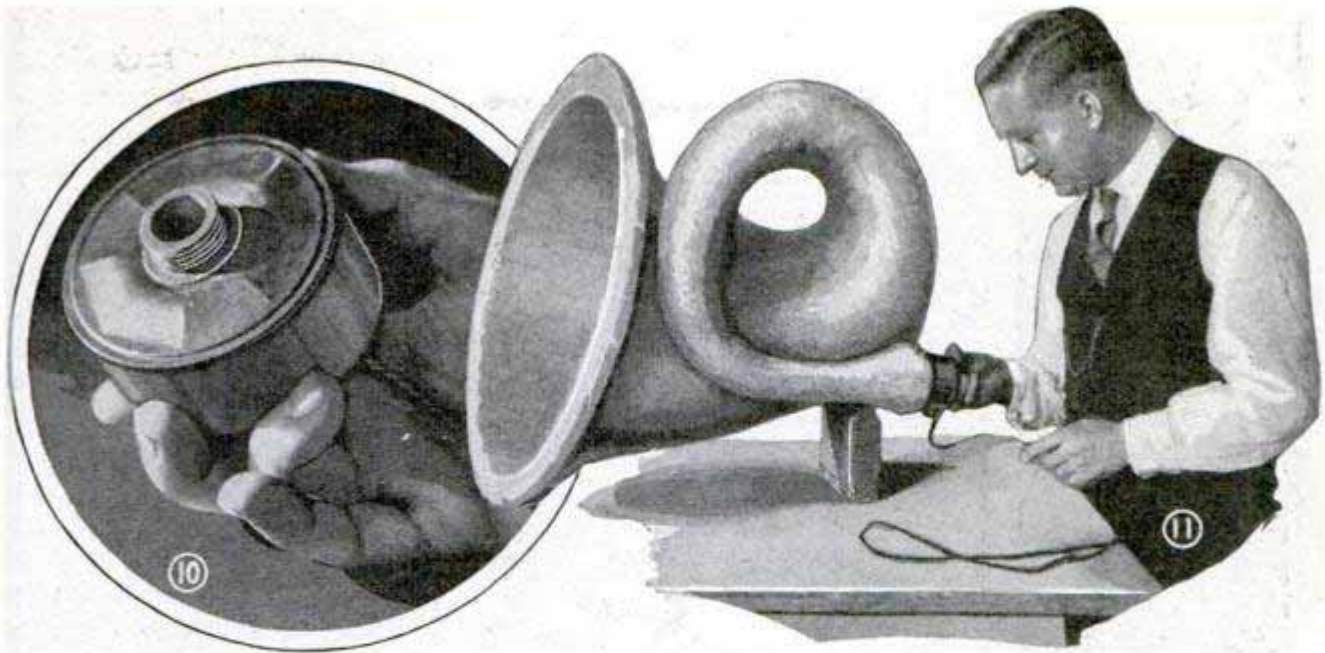

Left, Type of Loud-Speaker Unit Suggested, Which Is Easily Mounted in a Small Brass Bushing, or Sealed in Plaster in the Position Shown in the Photo at Right

pattern and this is not a bad idea, but do not forget to allow enough material for the seams on each side. It would be well also to add about $\frac{1}{2}$ in. to the diameter of the large end for a distance of about 1 in. This will take care of shrinkage and allow a better fit of the front board, which will be mentioned later. Assuming that the cloth has been laid out on a long bench or on the floor, doubled, of course, and securely tacked, the pattern marked and the figures checked, there are only the cutting and sewing to be done, and we have the funnel-shaped sack which, when filled with sawdust, will provide the necessary form for casting. Turn the bag inside out so that the seam edges are on the interior and, in order to prevent the sawdust from becoming water-soaked and to keep the sack from clinging to the plaster, dip the sack into an ordinary cooking pot in which about two bars of paraffin have been melted. As soon as the paraffin has come into contact with all parts of the bag, remove it quickly and with someone's aid pull it back to its original shape, eliminating as many wrinkles as possible and sep-

arating the surfaces which have a tendency to stick. Sometimes the latter may be accomplished by blowing into the small end, thus forcing the bag into shape.

The front board which is used to close the large end of the form to prevent the sawdust from escaping is now fashioned, either from a large single board, about $\frac{7}{8}$ in. thick and 20 in. wide, or from a built up and cleated piece. A circle, 20 in. in diameter, is scribed on the wood and sawed out with a band or scrollsaw. Most lumberyards and mills have bandsaws and they will do this work at a very small expense; of course there is nothing complicated about this operation and the builder can easily do it himself. If the sawing is done on a bandsaw or even otherwise, the edge should be beveled to conform with the contour of the pattern at this point. A large hole is then drilled through the piece for use in pouring the sawdust, and a cork of proper size is provided to close this aperture.

Other materials required are about 20 lb. of plaster of paris, about $\frac{1}{2}$ bbl. of sawdust, a piece of rope, about 8 ft. long and $\frac{1}{2}$ in. in diam-

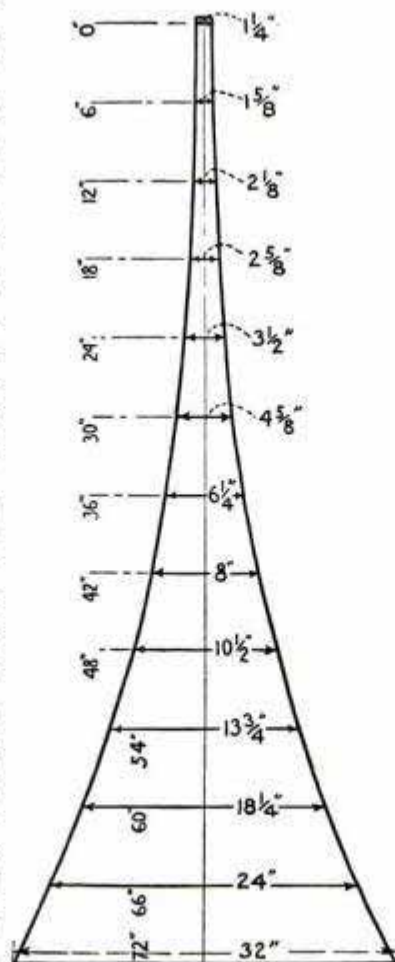

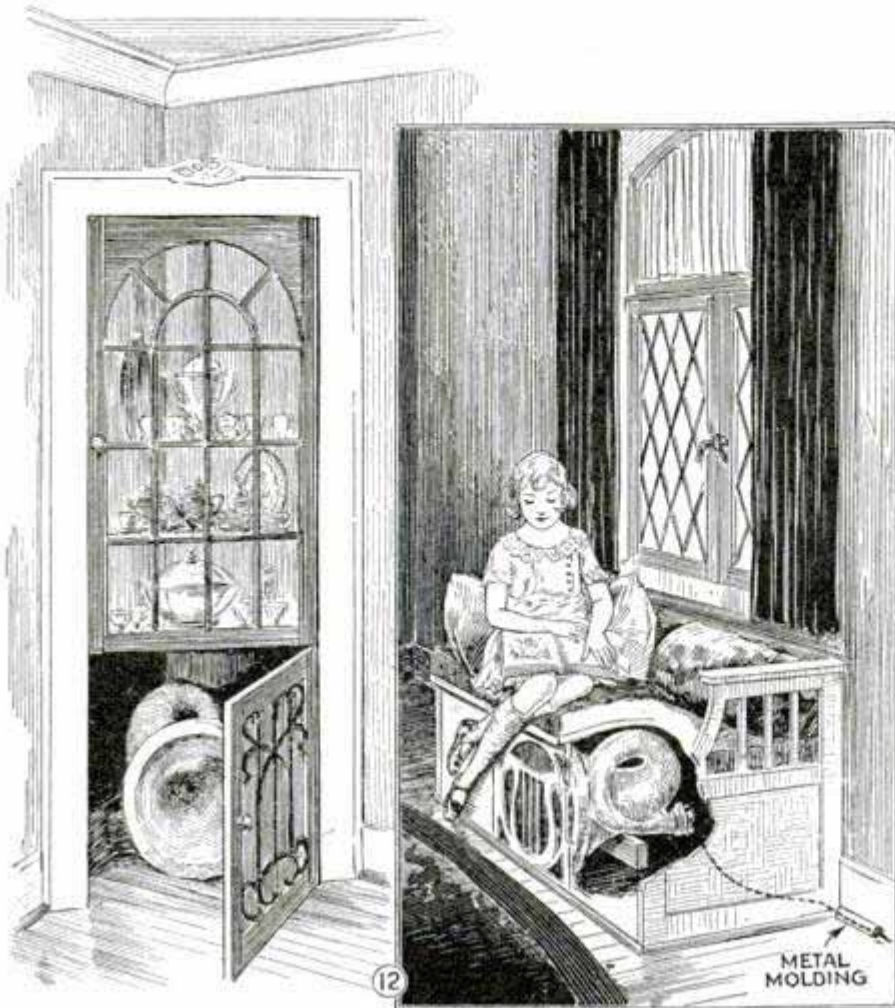

Left, Speaker Installed in Lower Compartment of Colonial Corner Cabinet; the Grill Cut in the Door Is Backed with Gold Cloth; Right, Built-In Window Seat Installation

eter, some pieces of burlap sacking or Philippine hemp, such as is sometimes used for packing glass, and 2 or 3 lb. of clay, such as school children use for making models. It will be noticed that exact quantities are not specified because different individuals will use more or less and it matters little just how much material is used so long as the necessary strength is obtained.

It is well now to call for a little assistance from some one, say, a strong boy. Provide both him and yourself with old clothes, or overalls; not that the work is so terribly dirty but more enjoyment may be had and better results obtained if the builder's mind is not occupied with preventing a few spots on his wearing apparel. Pass the rope through the cone so that it protrudes 1 or 2 in. from the small end and tie the sack securely at this point. Fill the sack with sawdust to a point about halfway up and, by means of a long stick, tamp it down into the small end, being careful not to tear the cloth. If the small end does not fill easily, try

working it down by squeezing the sack along the points where the difficulty appears. The front board is now inserted, with the smooth side out, the edges of the cloth tacked on and the remainder of the form filled. As soon as the bag is reasonably full insert the cork. The result of your labors should now resemble a 6-ft. horn filled with sawdust and closed at both ends.

Place the form with the front board down on a large flat surface and curve the small end around as tight as consistent with the strength of the fabric. Tie the model in this position by running strings to other objects or walls. Care must be exercised here to prevent the different sections from touching, and it is well to separate them by a space of about

2 in. While the paraffin on the bag should prevent the core from sticking, the writer has found that better results are obtained if the whole form is covered with modeling clay, which also will give the interior of the completed horn a smoother finish. One object must be borne in mind and that is to make the bag as easily removable from the cast as possible. Apply a coating of wet clay to the entire surface, about $\frac{1}{8}$ in. thick, fill all wrinkles so that the form presents a smooth, uniform and graceful appearance and eliminate any straight lines in the design. An old soft brush dipped in water will serve to smooth the clay.

Procure an old dish pan and fill it about half full of water; stir the plaster into this, by adding a handful at a time, until the mixture has about the consistency of good cream. There is no better tool for this purpose than the hands and, as the plaster is easily removed, there is no objection to using them. Larger vessels may be used for mixing the plaster, but care must be exercised that it does not harden faster

*465 Broadway St
New York City*

than it can be applied. Several handfuls of the mixture will be required. Apply the mixture to the form in handfuls with a sort of throwing motion, seeing that all surfaces are evenly covered to a depth of about $\frac{1}{2}$ in.

It is here that the pieces of burlap or hemp come into play. Soak them in the mixture and apply to the plaster so that all parts are again covered. A sort of wrapping process can be used on the small parts, still taking care that the sections do not touch on the turns. The burlap adds much to the strength.

A small brass threaded nipple to receive the loud-speaker unit might be set in the tip of the horn at this point, but this can be easily done after the horn is completed and will not be mentioned again.

Add more plaster, until the whole surface is covered by about 1 in. Fill in the space between the turns so that the whole is one solid mass of plaster. With a piece of burlap go over the horn and smooth off. Allow the plaster to set about 10 or 15 minutes, or until, when tapped with the knuckles, it presents a fairly hard surface; of course it will not be entirely dry, but this is not desired at this time.

Get a good grip on the horn and pull out the front board allowing as much sawdust to escape as possible. Pull the rope out of the horn. Some of these operations require considerable force, but the builder will be surprised at the strength of the horn, and unless it is dropped, it will stand a good deal of abuse. Use a long heavy spring or a rod to loosen as much of the filling as possible, and pour it out.

Pull the sack out; this will require considerable force due to the snubbing action on the turns. Do not be alarmed if it does not come out easily, because there is a simple expedient. The binding will probably occur at the turn in one of the smaller sections. Locate this point as nearly as possible and, with an ordinary saw, cut out a section of the horn by V-shaped incisions. Probe around here with the rod or spring, and after the sack is loosened, replace the segment which was sawed out and cover with burlap and plaster as before. No ill effects will be noticed from this operation.

With a garden hose, wash out all remnants of clay that may have lodged in the smaller turns; let the horn dry and attach

a good loud-speaker unit. You will be amazed at the volume and tone that will gush forth and will have an instrument of which you may be justly proud.

1345-R

Tapped Resistance Unit for B-Eliminator

The illustration shows a tapped resistance unit especially designed for B-eliminator use. Fig. 1 shows how the unit is used to regulate detector-tube voltage. When a fixed resistor of 25,000 ohms is connected in series with the tapped unit, and the voltage from the rectifier is 135, then the range covered by the tapped unit will be 14, 15, 24, 27, 33, 37, 41, 45, 48 volts approximately. If the rectifier voltage is 185, the range will be 20, 22, 33, 36, 43, 47, 52, 57, 60 volts. Wherever the rectifier voltage exceeds 200 volts, the fixed resistor used in series should be 50,000 ohms instead of 25,000. Fig. 2 shows two tapped

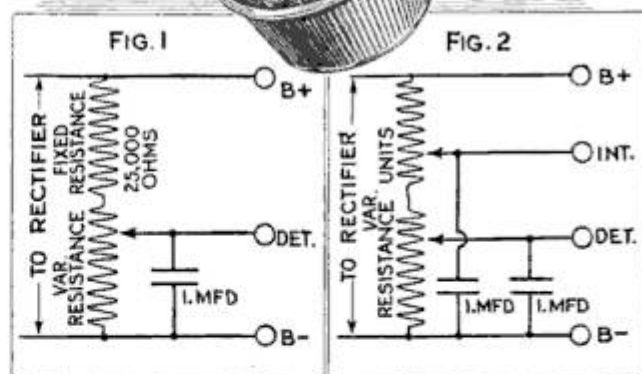
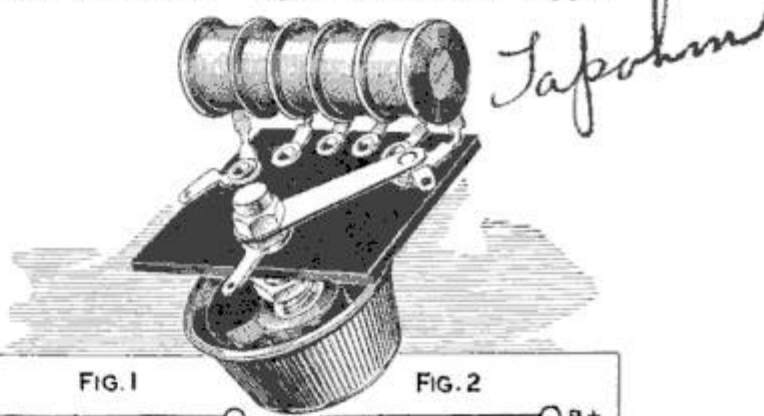

Resistor Having Several Taps to Obtain Various Voltages for B-Eliminators

units used to regulate both detector and intermediate voltages.

Auto-Timer Cable for Battery Leads

A discarded Ford timer cable may be used for battery leads or for bunched leads in receiver construction. A suitable length can be cut and connecting lugs soldered on at convenient points; these lugs will be found on the old cable and may be used again as desired.

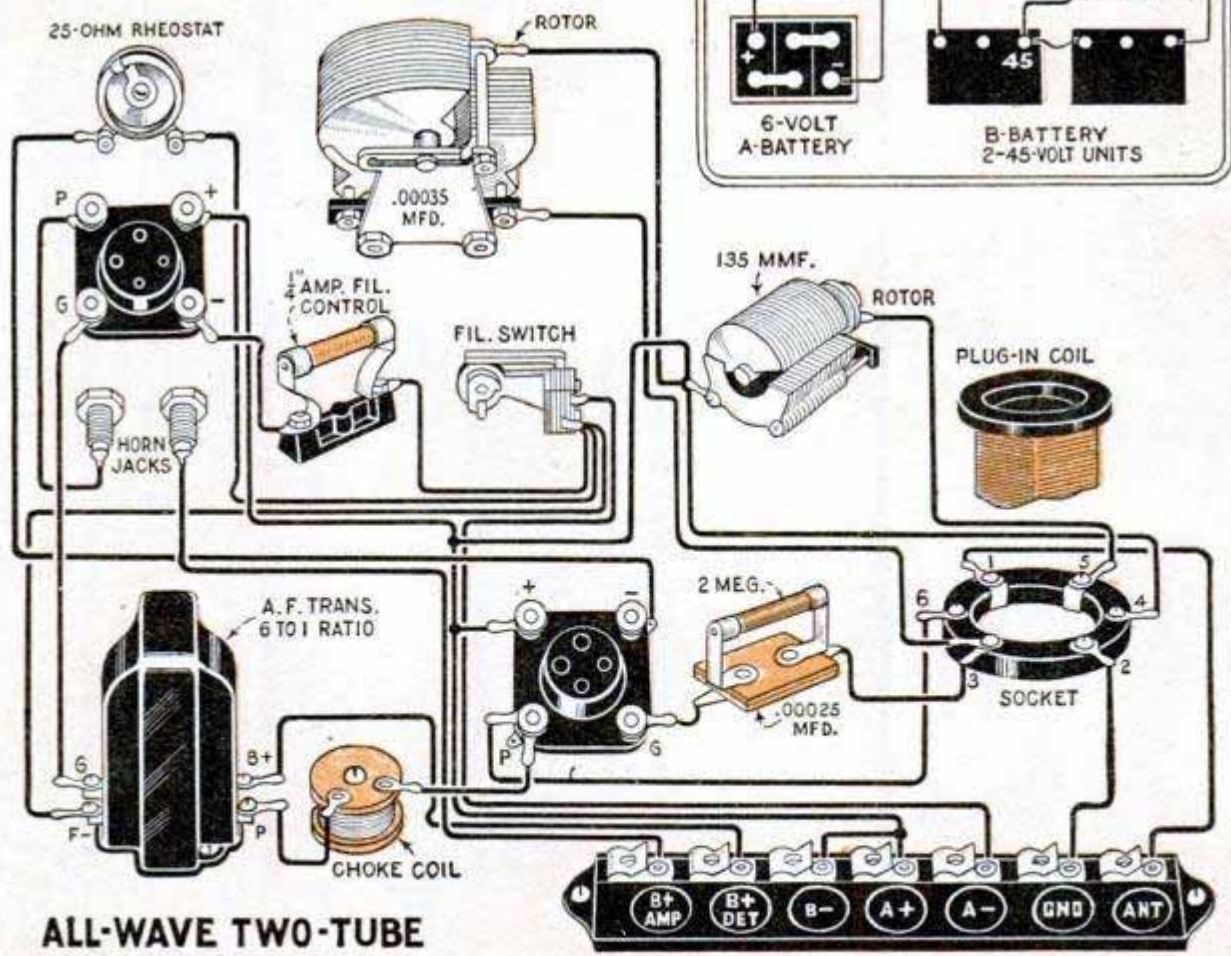
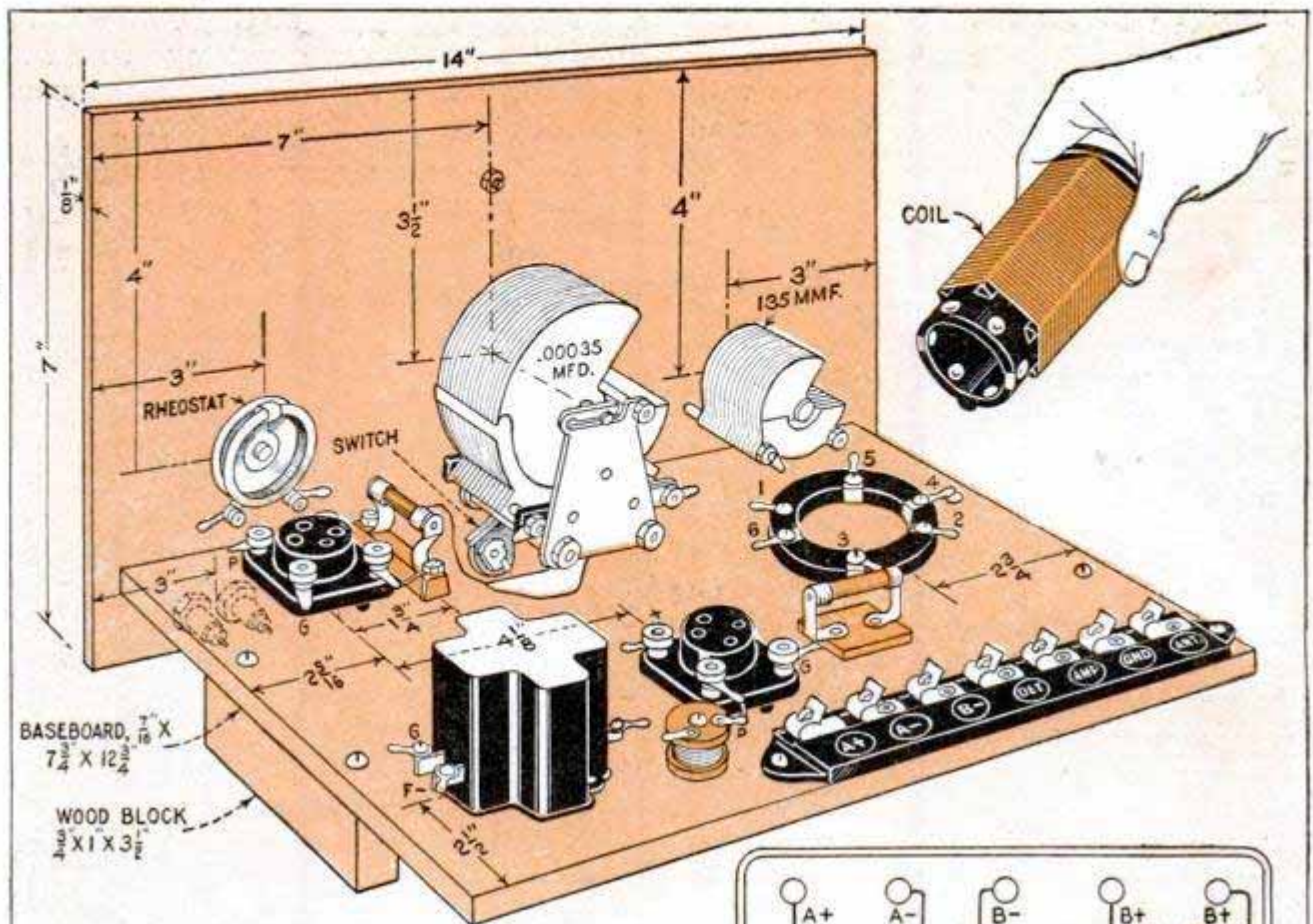

ALL-WAVE TWO-TUBE LOUD SPEAKER SET
 POPULAR MECHANICS MAGAZINE OCT. 1927

Two-Tube Set works LOUD SPEAKER



By FRANK L. BRITTIN

THIS two-tube receiver will not only work a loud speaker but has the additional advantage of covering a range of wavelengths between 30 and 1,500 meters by means of plug-in coils. By its simplicity the set appeals to the beginner, while the wide range possible without change in circuit and the low cost make it attractive to all. As built in Popular Mechanics radio laboratory, the set produces a loud-speaker volume on local stations equal to that obtained with the average three or four-tube set. The parts cost about \$21, allowing \$6 for the a.f. transformer; the plug-in coils are \$2.50 each, additional, and may be selected to cover the wavelengths desired, with the exception of the coil tuning from 550 to 1,500 meters, which costs five dollars.

Either standard or dry-cell tubes may be used, but best results will be obtained with the large tubes. For dry-cell tubes, a filament-control unit suitable for this type and three dry cells connected in series for the A-battery should be used, no other change being necessary. The sockets should be of the new X-type and it is desirable that they should be spring-suspended, especially the one for the detector tube.

The front panel and baseboard layout are shown at the top on the opposite page, the arrangement being very simple. The wooden baseboard is supported by two wood blocks, $\frac{3}{4}$ by 1

by $3\frac{1}{2}$ in. The front panel is screwed to the baseboard at front, the filament switch and the horn jacks being located below the baseboard. A simplified wiring diagram is given below and also a separate diagram showing the battery connections. Flexible rubber-covered hookup wire is used for the circuit, and holes are drilled in the baseboard so that the various leads may be run as direct as possible. The photo giving the rear view of the completed set shows that very little wiring appears above the baseboard. The schematic diagram of the circuit, with the front-panel template, on page 656 also gives a list of the various coils suitable for the set.

Use soldering lugs under each terminal, and solder all connections securely. Note carefully the rotor connections of both

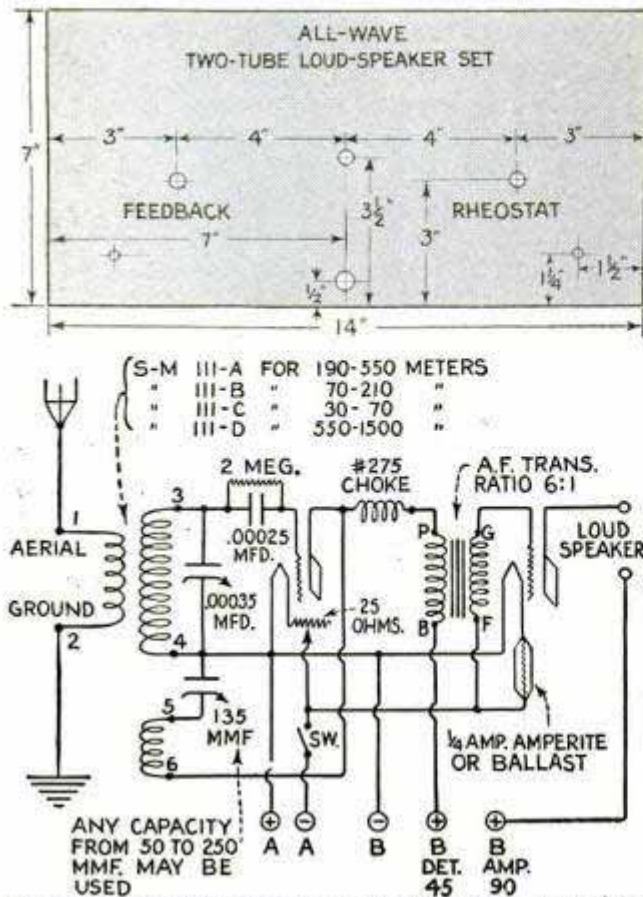

Above, Front-Panel Template; Below, List of Coils for Various Wavelengths, and Diagram of Circuits

variable condensers, and make all grid and plate leads as short as possible, being careful not to run them parallel at any point. The rheostat controls the detector tube only, while the amplifier-tube filament is automatically controlled by a ballast or amperite and a $\frac{1}{4}$ -amp. type is used for the standard 201-A tube. The choke coil

between the plate of the detector tube and the P-post of the a.f. transformer is not absolutely necessary, but is advisable for best results. As a set of this type can be used for the short-wave broadcasts, it should be popular in warm damp localities where heavy static prevails on the longer wavelengths. In such localities, use a grid condenser of the bakelite-covered type and keep the set as dry as possible. A simple method of keeping the set free from moisture is to mount a plain porcelain socket at some convenient point in the cabinet and wire it to the house lighting supply, burning a 60-watt mazda lamp a few hours a day. This idea has been suggested to many of our readers in the Canal Zone with excellent results.

After the wiring has been completed, connect the batteries and place one tube successively in each socket to test the filament circuit; if the tubes light as they should, the set is ready for operation.

Use a one-wire aerial, about 75 ft. long, or not over 100 ft. including lead-in and ground. For the regular broadcast programs between 200 and 550 meters, the 111-A coil is all that is required; plug the coil into the socket provided for it, making sure that all contacts in the socket engage with the metal contact bosses on the base of the coil mounting. Turn on the filament switch and rotate the dial of the large variable condenser, keeping the plates of the small condenser about half

out; then slowly turn up the filament rheostat until a slight hissing is heard. Continue to rotate the large condenser dial until a station is picked up, and finally readjust the small condenser to the point where the volume and clarity of the signal are at maximum. Once the small condenser is adjusted, it will not be necessary to readjust it for every station; merely rotating the large condenser dial will bring in one station after another. Keep the detector rheostat at the lowest point consistent with good re-

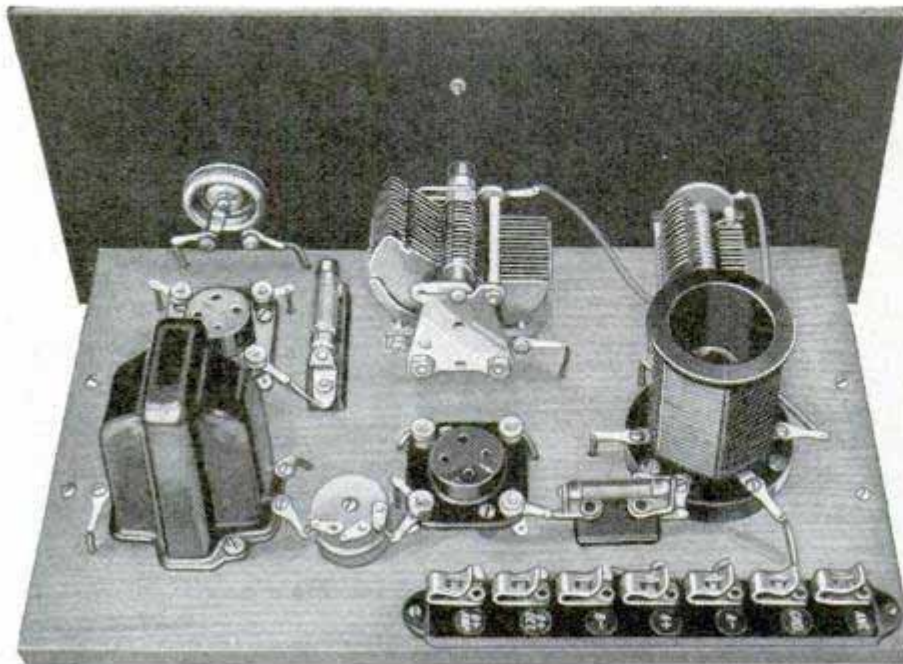

Rear View of the Completed Set, Showing Simple Arrangement of Parts

sults; burning the tube filament higher than necessary does not improve the signal and greatly shortens the effective life of the tube. Stations, once logged, can be found again at the same dialing, and with a little practice distant stations can be brought in, on silent nights when weather conditions are favorable, with remarkable volume for a two-tube set. When select-

ing a loud speaker, do not expect to get first-class results with a small cheap speaker. The better the speaker, the better the results with any type of set.

A large detailed blueprint of the wiring diagram and layout may be obtained from Popular Mechanics radio department, 200 E. Ontario st., Chicago, for 25 cents. Specify blueprint No. 122.

MATERIAL LIST

- 1 front panel, 3-16 by 7 by 14 in.
- 1 baseboard, 7-16 by 7 $\frac{3}{4}$ by 12 $\frac{3}{4}$ in.
- 2 wooden blocks, $\frac{3}{4}$ by 1 by 3 $\frac{1}{2}$ in.
- 1 25-ohm rheostat.
- 1 .00035-mfd. variable condenser.
- 1 135-mmf. variable condenser, or any capacity from 50 to 250 mmf.
- 1 filament switch.
- 1 a.f. transformer, 6 to 1 ratio.
- 2 X-type spring-suspended sockets.

- 2 cord-tip jacks.
- 1 automatic filament control, $\frac{3}{4}$ -amp. type for 201-A tube.
- 1 S-M choke coil, type 275.
- 1 S-M coil, type 111-A, B, C or D.
- 1 S-M universal coil socket.
- 1 grid condenser, .00025 mfd., with gridleak clips.
- 1 2-meg. gridleak.
- 1 spring binding post strip, or single Fahnestock clips.

New Kit for Browning-Drake Set

1392 R

A new kit of tuning units manufactured by the Browning-Drake corporation for the set described in the September issue of Popular Mechanics is now obtainable. Mr. Glenn Browning, the designer, has made a slight change in the antenna coil, which now consists of 56 turns. The National kit may be used in the same manner, provided the corresponding coil is increased to 56 turns. The B-D foundation unit consists of engraved panel and sub-panel, sockets, resistor clips, soldering lugs, machine screws, nuts, bolts and wire; this additional unit makes it very easy for the builder to obtain the correct materials specified by the designer.)

Making Loop Connections

Where it is practical to make a loop connection at a terminal, care should be taken that the loop end of the wire that is placed around the binding post follows the screw thread. Most binding posts are threaded with a right-hand thread, the cap or nut being tightened clockwise. Form the loop over a machine screw or use a small pair of wire-forming pliers, bending the loop in a clockwise direction so that, when the nut or cap is tightened, the wire will not be twisted out from under the nut, as would be the case if the wire and nut turned in opposite directions.

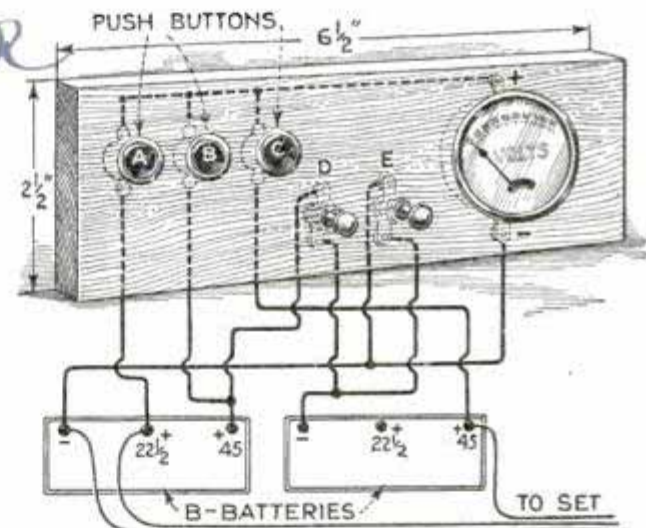

Wiring Diagram Showing Test Board Connected to the B-Batteries and Location of Apparatus

Handy B-Battery Test Board

A handy test board for B-batteries, that may be left connected without interfering with the operation of the set, is shown in the illustration. The materials required are three small push buttons, two push-pull filament switches, a small d.c. voltmeter, reading up to 50 volts, and a board $\frac{1}{2}$ by $2\frac{1}{2}$ by $6\frac{1}{2}$ in. in dimensions. The sketch shows the construction in detail and the board is mounted in the cabinet. For testing the $22\frac{1}{2}$ -volt tap on the first battery, press button A, and button B for the 45-volt tap. To test the second B-battery, close switch E and open D, then press button C. When the set is in operation, close switch D and open E.

*Browning-Drake Corp.
Chicago, Ill.*

1346- *2 auto*
 Bumper Serves as Antenna

Good reception has been obtained by converting the front bumper of an automobile into an aerial. This is done by in-

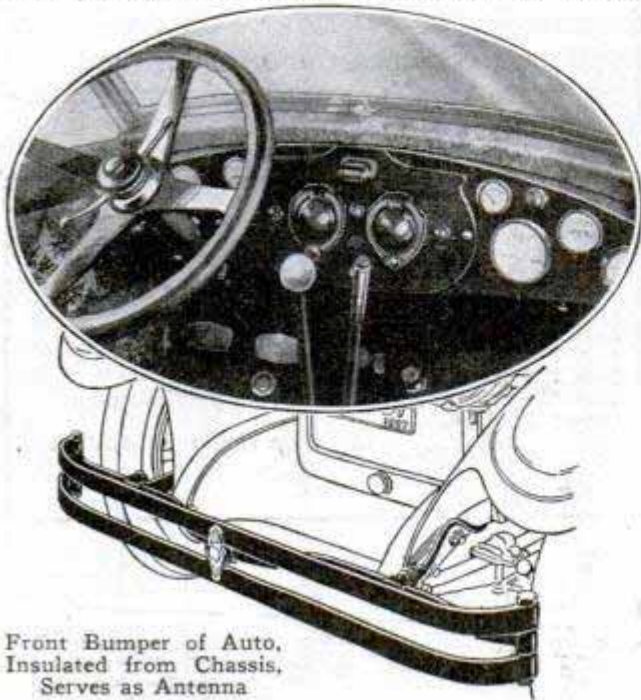

Front Bumper of Auto,
 Insulated from Chassis,
 Serves as Antenna

serting laminated strips of bakelite insulation between the bumper and chassis. The lead-in wire from the bumper runs to a receiving set mounted on the instrument board, as shown in the photo. The loud speaker can be placed in any convenient position. The location of the receiver on the instrument board has been found handy, as the driver can readily tune in.

Selection and Care of Storage Batteries

The lead-acid storage battery is still with us and as far as the radio receiver is concerned it will likely remain for some time. It is necessary to take just as much care in selecting the storage A-battery as any other part of the equipment. There are good and bad types, and a big storage battery will often hide a lot of worthless junk. Therefore, it is usually best to consider the reputation of the manufacturer, as he is just as anxious that you have a good one as you are. In the

average storage battery there are three hard rubber, or glass cells, containing lead plates and diluted acid; the more plates the larger the cell capacity and the longer the charge will last. There are a number of positive and negative plates in each cell, the positive plates being made of lead peroxide and the negative plates of spongy metallic lead. When the cell is charged, the positive plates take on a reddish color. Certain chemical actions taking place inside the battery make possible the use of a graduated, floating gauge, known as a hydrometer, for determining the state of charge, or condition of each cell. During discharge, the active material in the plates is changed to lead sulphate, which gradually covers the surface of the plates and finally the current ceases to flow. It then becomes necessary to reverse the action with the aid of a battery charger, clearing the plates of the sulphate and permitting the acid to again circulate freely. The acid is not lost in this process, but the water evaporates and must be replaced as required to keep the level of the electrolyte at least $\frac{1}{4}$ in. above the top of the plates at all times. The acid content is about 20 per cent of the full volume, and nothing but distilled water need be added. Any acid solution deposited on the top of the cells by spraying during the charging operation should be immediately removed with a cloth dampened with household ammonia. This neutralizes the acid and prevents any leakage paths between the cells due to corrosion. Batteries that have been allowed to remain in a discharged condition will often display an accumulation of greenish corrosion around the positive terminal; this should be carefully

scraped off and the terminal covered with vaseline. It is well, too, to apply vaseline to the terminals of a new battery to prevent corrosion, which is decidedly bad for the battery as well as the connecting

wires from the battery to the set. Before recharging a new battery, see that the vent holes in the top of each cell cap are open.

SIXTY DOLLARS BUILDS NINE-TUBE SUPERHET

A HIGHLY efficient nine-tube superheterodyne receiver of advanced design that can be built for \$60.00, just half the cost of any standard superheterodyne, yet in which nothing has been sacrificed to economy, will be described in next month's Popular Mechanics. Built and thoroughly tested in our radio laboratory, this instrument has proved fully equal to any superheterodyne previously developed, in range, selectivity, volume and tone. Watch for the Economy Nine!

This, of course, also applies to old batteries. When taking a hydrometer reading never hold a lighted match over the battery, as the gas that forms during the charging period is highly explosive. If it is necessary to use a light, provide an electric lamp on an extension cord.

Hints on Variable Resistors

Do not expect a resistor to handle more current than its rating calls for. These instruments are available in a wide range of values to meet all requirements, so, when selecting a resistor for any special job, be sure to provide a sufficiently low as well as high range to meet your needs. All extraneous set noises are not static as many would like to believe, but are often caused by faulty resistors. Large by-pass condensers should be shunted across the variable resistor when it is placed in a circuit handling r.f. current. These condensers should be of 1 or 2-mfd. capacity.

New Coil Requires No Shielding

The coil shown in the photo has been designed so as to eliminate the necessity of shielding and of finding the axis of the coil for insertion in a radio-frequency set. At 8-in. separation, the coupling of coils is claimed at infinity and at 6 in. almost negligible, while a 5-in. separation is said to produce highly efficient results. The

coil is so built that it may be used in a straight r.f. set or in a bridge circuit; it is also suitable for use with either 201-A or 199 tubes, the new 240 tube or the new a.c. tubes. All one needs to do after determining which tube is to be used, is to



bring the B-lead to the proper screw in the base designated for that particular tube. It is also possible to use the coil in a split primary circuit.

A practical crystal receiver of the vest-pocket type, weighing but 4 oz., is now available. This set is tuned by means of a sliding contact fastened to the hard-



Vest-Pocket Set in Use, Showing Simple Connections; Insert Is About One-Fourth Actual Size

rubber knob shown at upper right in the insert. Aerial and ground connections are made at top and bottom, and the phones on the two outer clips at bottom. For the traveler, or where a temporary installation is required, it is an easy matter to throw a length of flexible wire out of the window for an aerial and run a short connection to the radiator for a ground. The set is selective and brings in the local broadcast programs with very satisfactory volume and clarity; the fixed crystal detector requires no adjusting.

High Aerial Not Good for Tube Sets

Radio sets of the vacuum-tube type do not require an extremely high aerial; in fact, there are several reasons why a high aerial should not be used. A low aerial will not pick up as much static as a high one and better selectivity is obtained with short, low single-wire aerials.

Aero Products, Inc.
1772 Walnut Ave

Wall Aerial Resembles Tapestry

1341-2
 To eliminate some of the objectionable features of the usual indoor aerial, which



is strung across the room, an artistic imitation of tapestry, containing an aerial, has been placed on the market. The aerial is more than a number of wires connected together; it is a tuned aerial of low natural period, but of large capacity, which is claimed to make tuning sharp. The wires are held in position by an insulating compound,

which is not only a good dielectric, but is impervious to moisture, thus preventing loss of energy during damp weather.

Specializing the Radio Tube

All devices, to be really efficient, must be designed to do the work they are intended for especially well. This concentration of detail has now been applied to the radio tube; it was a very fine and simple idea to have a standardized tube that may be used in any position in the set, but this convenience was purchased at the sacrifice of good results. The radio set of the past was limited as to sensitivity, volume and tone quality. The reason for this lies in the fact that the old single standard tube might give good satisfactory results on weak signals, but on powerful signals, it became overloaded, which resulted in distortion. The art has now reached a stage where it becomes necessary to have a receiver that will faithfully reproduce the really good programs that are available.

Broadcasting has interested the music lover who will not tolerate distortion, and now, with the special-purpose tubes and better circuit design, the quality of tone obtained puts the radio receiver in the musical-instrument class.

We now have a tube specially designed as a detector possessing greater sensitivity without increasing battery drain or complication of adjustment. This tube is known as the UX-200A or CX-300A type. There are also tubes designed for resistance-coupled stages of amplification and power tubes with ample reserve current-carrying capacity enabling them to reproduce fortissimo passages in full volume. The name power tube is incorrectly applied, however, as it really does not supply its own power to the signal, but merely handles the power, which comes from the increased B-battery voltage.

Advantage of Adjustable Plate Voltage

There is no better method of controlling volume and balancing one tube with the succeeding tube than by controlling the plate voltage of at least the r.f. tubes, and the detector tube also if possible. Variable resistors of proper values are now available for controlling plate voltage and are coming into common use. They are an important part of modern B-eliminators and their use in the set itself is a decided advantage, especially now that new tubes, with plate resistances that vary from the common type of tube, are being introduced.

1324 + R

Tester Aids Radio Service Man

To facilitate testing for short and open circuits, the device shown in the drawing

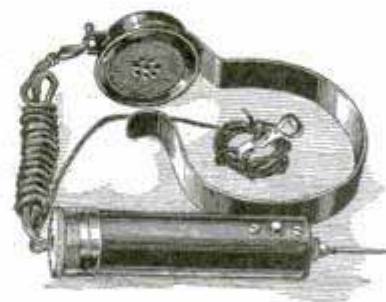

will be found to be of equal usefulness to the radio service man, the electrician, the phone man and to the garage mechanic.

The device consists of a headphone and a flashlight battery, together with the necessary cord, a testing clip and a tip. A button on the battery case closes the circuit.

Leich Electric Co
Essex, Ill

Facts and Fads for Radio Fans

1319-R

1352-R



1244-R

club

English
maker
not known

Upper Left, Lloyd Bertaud and Clarence Chamberlin Examining New Radio Apparatus Designed for Transatlantic Airplane Use; Right, Emil Berliner, Inventor of the Microphone. Displaying a Replica of Original "Mike," Invented in 1877

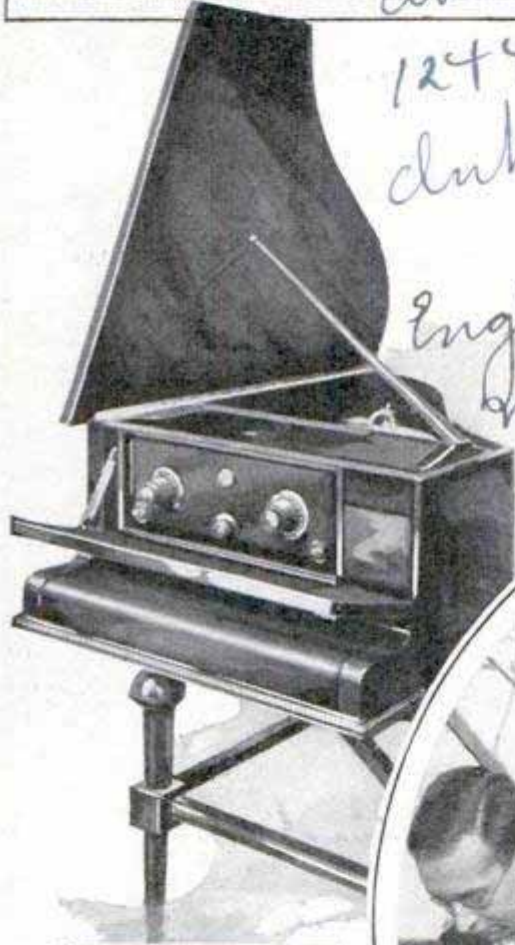

1232-R
254

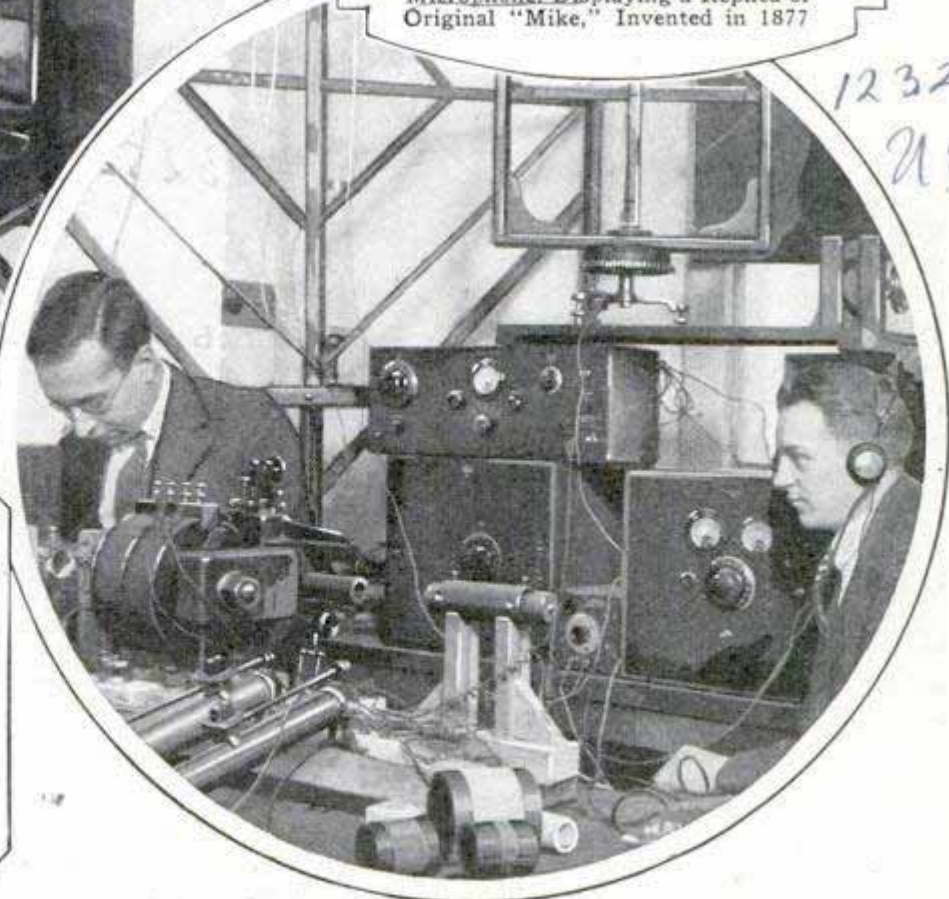

Above, an Attractive Radio Cabinet Copied from the Modern Baby-Grand Piano; Right, Dr. G. Breit and Dr. M. A. Tuve, Research Investigators of the Carnegie Institution at Washington, Conducting Experiments Verifying the Existence of a Layer in the Upper Air Which Bends Radio Waves Back to Earth; Changes in the Layer Are Said to Cause the Phenomenon Known as Fading

Novel Radio Fan

An old suit of clothes, a quantity of straw, a cone-type speaker and a bit of



paint were used to make the novel radio fan shown in the photo. Connected to a receiving set inside of a radio shop, the talking man is placed in front, attracting attention as speeches and music are reproduced. A further novelty originated by the

enterprising dealer is that the dummy may be disconnected from the receiver and the dealer can talk into a microphone through the dummy to persons in the street.—Fred O. Thompson, Long Beach, Calif.

Where to Look for Trouble

When the set goes dead or the signals are not what they should be, make a systematic examination of the entire installation. This may be a process of elimination, and a few suggestions as to where to start and what to expect, will often result in a quick recovery without the expense of calling in a service man. First make sure that all the tubes are lighted at the proper voltage; examine the aerial and ground and see that the connections are all tight and that there is no chance of aerial leakage. Check the B-batteries with a voltmeter and see that the proper B-voltage is supplied to each terminal in the set at its indicated value. Be sure that the C-batteries are fresh. These batteries are often permitted to stay in the set over long periods but should be renewed at least twice a year for best results. See that all tubes are of the type specified and that they are in their proper sockets. In this day of special tubes for special purposes, the set owner must not change the tubes around indiscriminately or the re-

sult may be a power tube in a detector-tube socket or some similar error.

A defective gridleak may often cause trouble, and it is well to have an extra one of the same value or several values that may be substituted. Test for defective fixed condensers and coils with a pair of headphones in series with one or two dry cells in the usual manner. If, after these tests have been made, the trouble is not yet located, examine the loud speaker. These usually have some form of adjustment on the diaphragm and, although they are adjusted at the factory, sometimes require readjustment to obtain best results with the particular set used, or because of jars in shipping. Tighten all loose connections either at the batteries or set terminals, and make sure that the A-battery is fully charged. Test trickle chargers, or any other type used, to determine whether or not they are supplying the output at which they are rated. A run-down A-battery is a very common cause of poor reception, and many set owners who are using trickle chargers with sets of the large multi-tube type never have the battery up to the point where good reception is possible. If your set employs more than five tubes of the 201-A type, use a charger having a 2-amp. output. Some trickle chargers now on the market are built to furnish a higher charging rate than the 1/2-amp. rate of the earlier types and may, of course, be used with larger sets.

1325- R

Resistance-Coupled Power Amplifier

Designed to be added to any two-stage receiver, this resistance-coupled stage of power amplification will provide excellent tone quality and considerable volume without overloading the tubes. The device is entirely self-contained, with



leads to be attached to the batteries and loud speaker, and a variable control for volume. The use of a UX-171 or a CX-371 tube is recommended in this extra stage.

Central Radio
14 Laboratories



AMATEUR MECHANICS

Make Your Own Portraits in Brass

By E. R. HAAN

BRASS silhouettes of friends or members of the family make attractive wall decorations, and anyone who is handy with tools, and will take the trouble to be careful, can make them. All that is necessary to start with is a photo showing the profile of the head, for obviously only profile

views can be used for this purpose. Now clamp the cut-out photo on the surface of the brass sheet from which the silhouette is to be made. Sheet brass, about $\frac{1}{16}$ in. thick, is most satisfactory for the purpose. Using a scribe, trace around the photo on the brass and proceed to cut

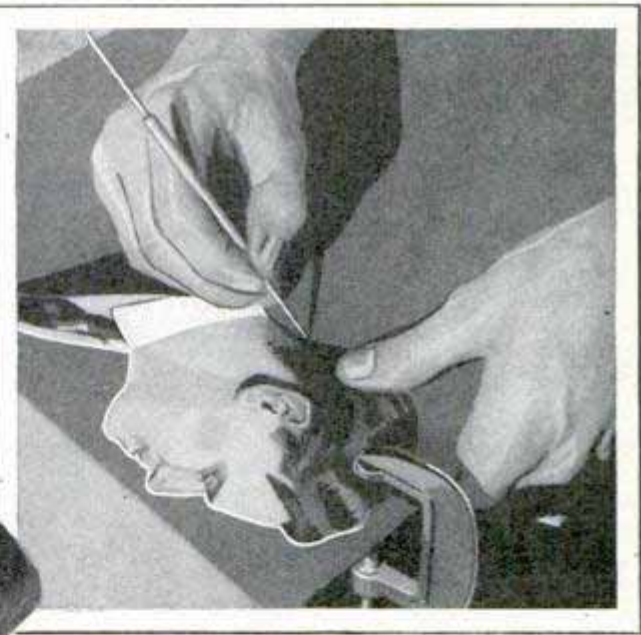
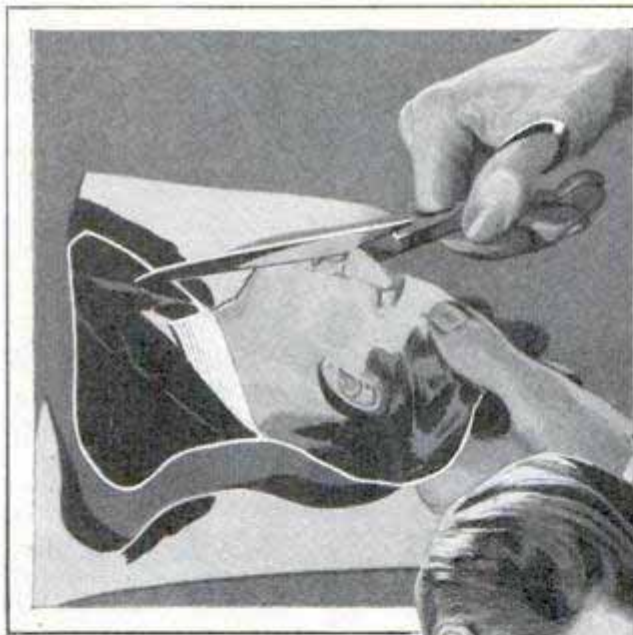

Left, Cutting Out the Photo; Right, Tracing It on a Sheet of Brass; Bottom, Metal-Cutting Cop-

ies can be used for this purpose.

The first operation is to cut out the photo with a pair of scissors exactly along the edge of the face and head, or the silhouette will be ruined, as the likeness, of course, depends en-

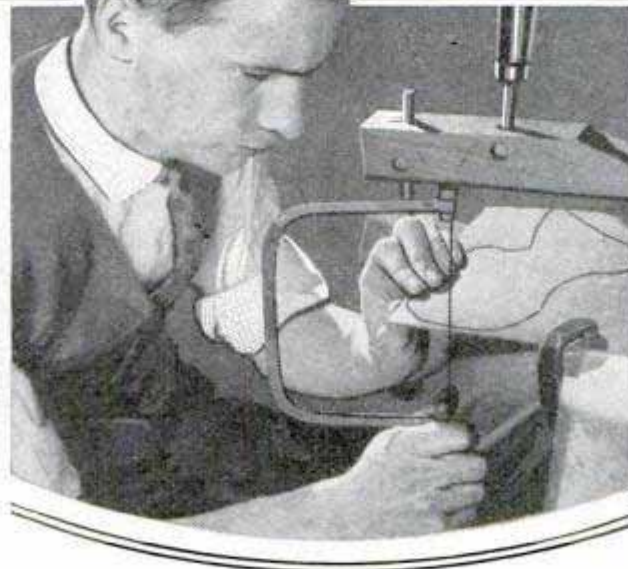

ing Saw Used to Cut Out Silhouette from Brass Sheet; the Saw Should Be One with a Fine Blade

it out with a coping saw, using a fine metal-cutting blade.

While cutting, the sheet of brass can be clamped down to the workbench as indicated in one of the photos, but, as the projecting piece of brass has some spring, which

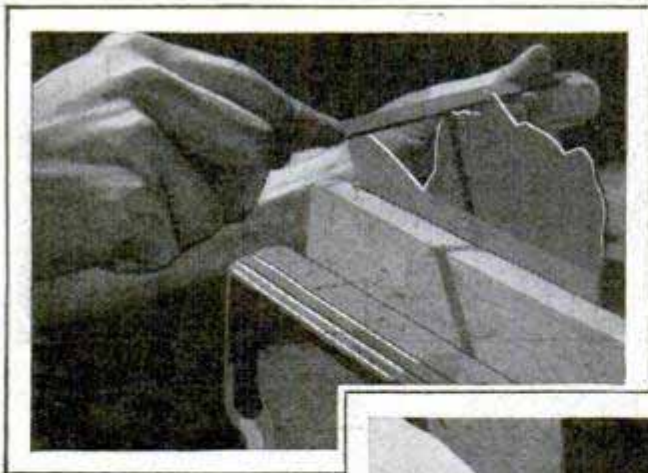

makes cutting more or less difficult, it is better to use a 1-in. board under it, to serve as a support, clamping the board to the bench top. A "V" is cut in this board to allow for sawing, the brass sheet being moved around so that the cutting will be confined in this vee. While cutting the profile be sure to stay just outside of the line, so that the edge can be filed down to the line, which is the next operation. Any fine, triangular file, about 6 in. long, will be handy for this purpose, although occasionally a round file may be useful, depending on the lines of the silhouette. Be very careful in filing, and keep exactly to the line.

After the filing has been finished, a 6-32 flat-head brass screw, about 1 in. long, is soldered onto the reverse side of the plaque, in the center. The screw can be held securely with a pair of pliers while it is being soldered and until after the solder has set.

Polishing the plaque will then improve its appearance. This is done with a piece of No. 000 emery cloth. Always rub in one direction, or else many fine criss-cross scratches will show when the plaque is finished. When this has been done, polish

the surface with a good grade of brass polish, again rubbing in the same direction.

When the plaque is thoroughly dry after polishing, a coat of transparent metal lacquer is applied. As this liquid dries quickly, one cannot go over the same spot twice, but the whole surface must be covered quickly without any laps. Use a soft brush that will not shed any hair, as this would necessitate removing all the lacquer

and doing the job over again. If it becomes necessary to remove the lacquer on account of some mistake, use turpentine, and wash it off immediately. It should be remembered that the surface of the plaque must not be touched after it is polished, as fingerprints and other marks will show up clearly, and they cannot be removed after the lacquer is applied. To prevent dust from getting in the lacquer finish, be sure to wipe off the surface of the plaque before lacquering.

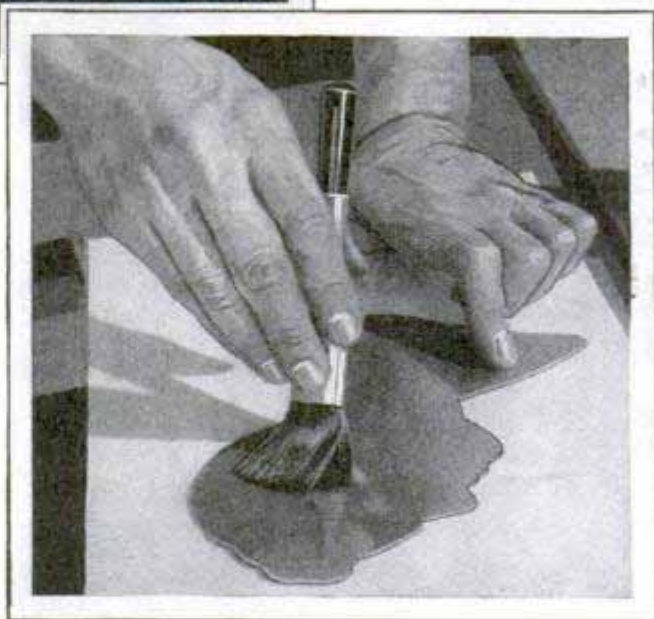
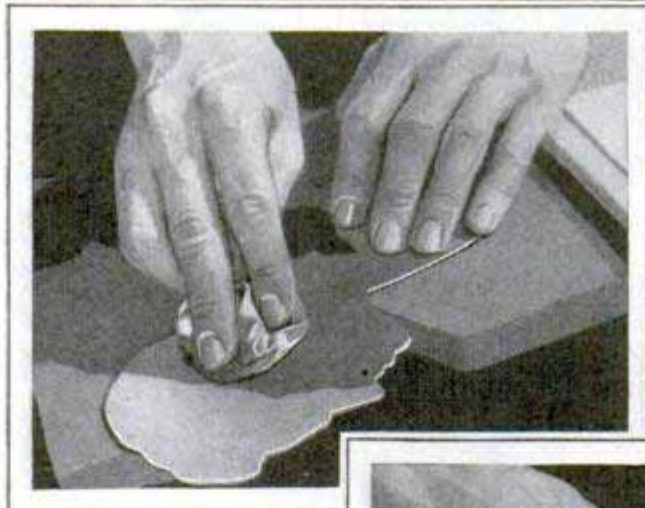
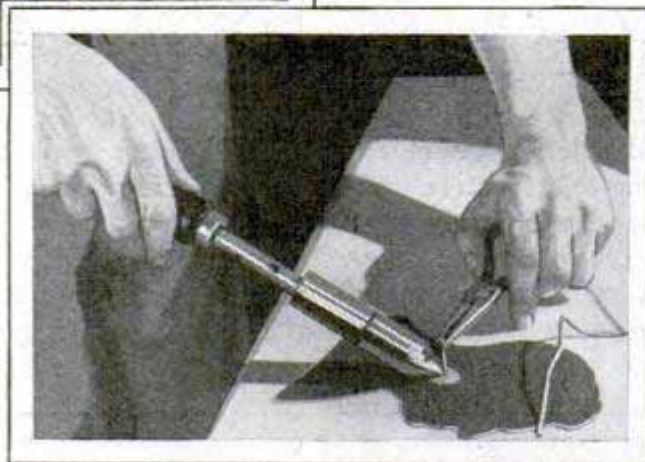

Edges Are Dressed Down with a Small File; Soldering a Brass Screw to the Back; Surface of the Plaque Polished; Dusting Off the Plaque before Lacquering

The plaque, when completed, should be mounted on a beveled base, made of $\frac{3}{4}$ or 1-in. wood, having a very close grain. A hole is drilled and counterbored to receive the screw on the plaque, and a nut and washer run on the end of the screw. A pair of long-nose pliers or a socket wrench, such as is used for hexagon nuts in radio work, can be used to tighten the nut on the screw. The base is, of course, finished before the plaque is attached. Flat black paint or very dark stains, wax-finished, give a good contrast to the work; the plaque is glossy and should have a dull-finished background.

How to Mend Broken Concrete Articles

Contrary to common belief, broken concrete articles can be mended to make the section where the break occurred even stronger than it was originally. In this way garden furniture, sundials, bird baths, and, in fact, almost any damaged cement object can be restored to usefulness. The first step is to soak the pieces in water for at least 12 hours. After this, drill some holes in the broken edges of each piece so that the holes line up opposite each other when the pieces are held together. If the break is a compound one it is best to assemble it piece by piece. The two largest pieces are cemented together the first time and, after the cement has set, the smaller pieces are added. The holes may be made by sharpening the end of an ordinary screwdriver and turning it constantly as it is being tapped with a hammer, although a regular star drill is better. Too violent blows might cause a new break and therefore care must be taken in drilling. After the holes are made, soak the pieces in water again for a few minutes and then fill the holes with soft, freshly mixed pure cement. The largest piece is set securely so

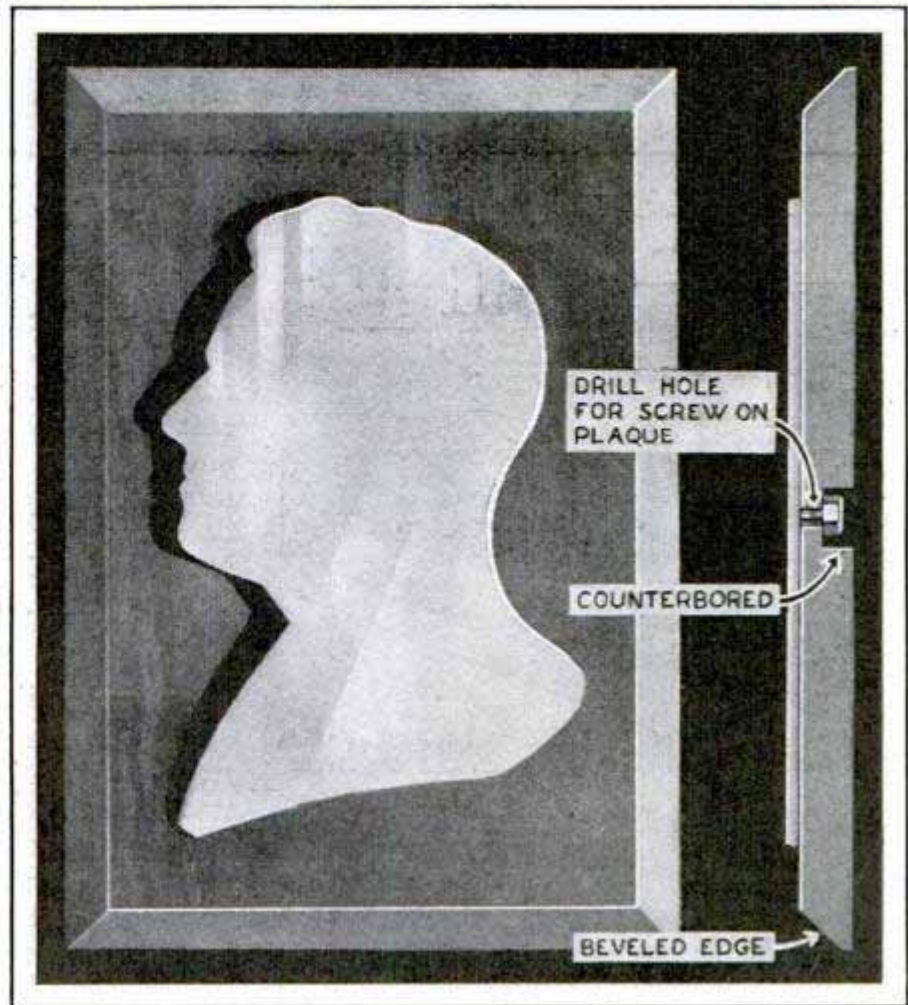

Completed Brass Plaque Fastened to a Beveled Base, Made of One-Inch Wood and Finished in Dull Black

that the fracture is straight up, and supported firmly. A few pieces of No. 12 or 14 iron wire are now cut to a length slightly less than the combined depth of the opposing holes, and inserted into the soft cement of the base piece. The edges of both pieces are again made thoroughly wet and smeared over with a thin coat of neat cement. The pieces are squeezed into place so that the break fits snugly, the surplus cement is carefully removed, and the pieces are covered with wet rags and allowed to set for 24 hours. The pieces should not be disturbed during this time, as the slightest vibration will destroy the crystallization of the concrete in the break. After the first pieces have been cemented together, the process may be repeated in the same way until the whole object is mended. —Oskar J. W. Hansen, Chicago, Ill.

☞ A lighted match held to the outside of a fish-pole joint causes an expansion of the outer ferrule and allows the pole to be readily pulled apart.

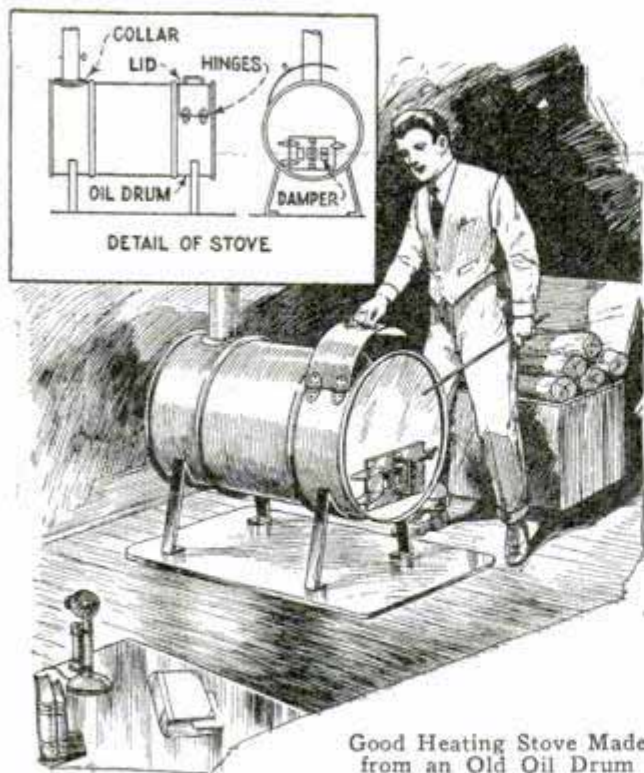

Oil Drum Makes Good Stove

In a general store of a small town, the proprietor uses an empty oil drum as a stove. The drum was first cleaned thoroughly inside and then mounted horizontally on two supports of heavy flat iron. The legs were long enough to support the drum about a foot above the floor and were bent so that they could be bolted to it. A 5-in. round hole was cut in the top, at the rear end, around which a collar was riveted to attach a smoke pipe. Then a section of the top, between the two front ribs, was sawed out about a third way around the circumference. A similar section, but slightly larger, was removed from a second drum, a handle provided in the center and hinges at one end, the latter being riveted to the drum. This made a large lid that fitted snugly over the opening. A small rectangular piece was cut out of the front head near the bottom. A slightly larger door with slide openings was made to hinge over the opening and it was fastened with a metal door latch. The entire cost, including that of the drum and a little work by a tinsmith, was less than five dollars.—L. B. Robbins, Harwich, Mass.

☐ In machine work a way must be provided for removing dowel pins before they are driven in place.

Remedy for Jerky Slide Rules

New slide rules, and old ones that are not often used, are frequently so jerky that it is an exasperation to use them. The surfaces of the tongue-and-groove slide grip together and make a careful adjustment almost impossible. Soap, oil and grease are dirty and ineffective lubricants, but lead-pencil graphite seems to fill the rough pores of the wood and give a permanent sliding surface. Simply rub a soft black lead pencil along the tongue and contact surfaces of the slider until they are well coated. Then work the slider back and forth in the slide until the action is smooth.—C. W. Brockunier, Pittsburgh, Pennsylvania.

Removing Stuck Glass Stoppers

The simple method of removing glass stoppers from bottles, as shown in the illustration, has never failed me no matter how tightly they may stick. I grip the bottle in my left hand with my thumb very firmly pressed against one side of the stopper. Then with the right hand I take a wooden stick of medium weight and strike the cork or stopper on the opposite side, directing the blow toward the thumb with a slight tendency upward. At the same time I resist the blow with the thumb. Two or three taps will loosen the tightest stopper and the thumb pressure will prevent either bottle or stopper from being broken.—Gregor H. Glitzke, Kansas City, Mo.



Test for Lubricating Oils

Place one drop of each oil to be tested on a piece of glass so that the drops will be in a line across one end. The glass should be about 3 in. long and wide enough to hold a number of drops in this way without their mixing. Raise the end on which the drops were placed about 6 or 8 in., to

form an inclined plane, so that the oil will run down slowly. An oil having a light body runs and dries quickly, but an oil that has both a body and a free flow will be readily detected by this test. An oil may have a good body and yet have a tendency to gum badly, which will also be detected on the glass. The oils should be protected from dust while the tests are being made.

Improving Flake Glue

A satisfactory glue, which has greater adhesive qualities than the ordinary article, has no disagreeable odor and is suitable for furniture repairing as well as other purposes, can be prepared by putting a quantity of best-grade flake glue in a bottle nearly filled with carbolic acid, diluted with water, and then heating the whole until the glue is thoroughly dissolved. It is best to allow the glue to soak overnight before heating it. The consistency of the glue is controlled by the addition of either the diluted acid or glue. The best results are obtained with a glue having a fairly heavy consistency.—W. J. Edmonds, Jr., Whitehall, N. Y.

Windshield-Wiper Kink

It frequently happens after a dry spell that the windshield wiper is found practically useless, because it does not wipe clean. This is usually because the rubber has dried out. A good remedy is a long chamois sleeve or bag which fits tightly over the wiper. When the chamois becomes wet it adheres snugly to the glass and wipes it clean.

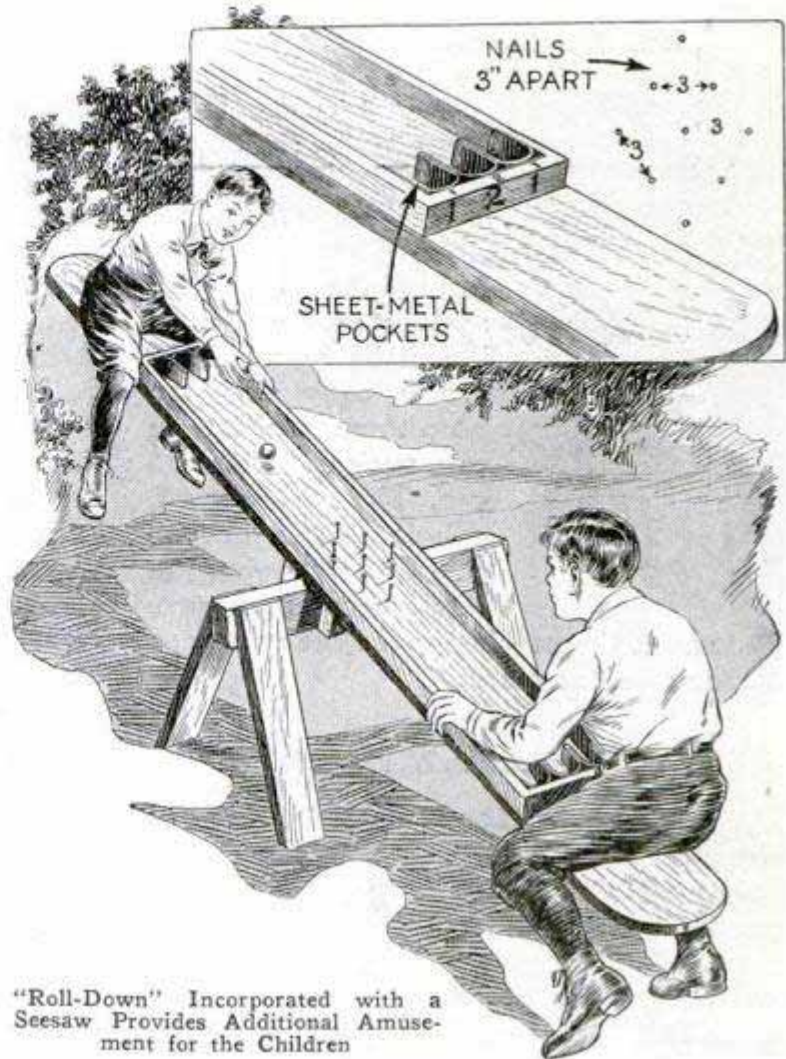

"Roll-Down" Incorporated with a Seesaw Provides Additional Amusement for the Children

Combination "Roll-Down" and Seesaw

To add to the enjoyable exercise of a seesaw, it can be combined with a roll-down game, which will interest children for hours. The seesaw board is removed and a boxlike attachment is built onto it, as shown in the illustration. At each end of the shallow box, sheet-metal strips, bent as indicated in the detail, are nailed, to provide 3-in. pockets. In the middle section of the board rows of nails are driven, spaced about 3 in. apart to produce a diamond-shaped figure. Each pocket is then numbered. With this done, the board is mounted on its support. A small hard-rubber ball is placed on the board and the game begun, the object being to score by rolling the ball into the pockets.

After cleaning a shotgun or a rifle, a cork, large enough to be seen readily, should be placed in the end of the barrel to prevent rusting. The cork should not be pressed into the end deeply as, if it is forgotten, a dangerous explosion results.

Bill File from Tobacco Can



A system for filing is needed by the housewife as well as by the storekeeper, and instead of letting bills accumulate on the shelves of the pantry, it will be found much more convenient to keep them in a flat tin can, such as a tobacco can. The top is cut off, a hole drilled in one side and the opposite side cut out as shown.

The can is then tacked up in the pantry at any convenient place.

Camp Candlestick Made of Wire

A piece of wire, about 18 in. long, makes an excellent candle holder for the camp. Two rings are twisted in the wire, about 2 in. apart, and large enough for the candle to fit into. The lower end of the wire is turned under to make a base on which the bottom of the candle rests, and the other end is bent into a hook so that the candle can be hung from the branch of a tree or the ridgepole of the tent.—Lloyd L. Stewart, Crawfordsville, Ind.

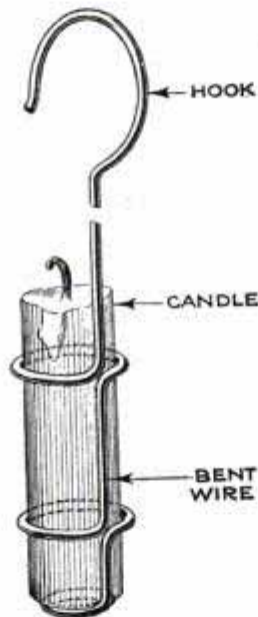

Homemade Paint-Remover Paste

To do a first-class job of painting autos or farm implements, the first thing is to get down through the old paint and grease to a clean surface. Here is a paste that can be made at home at little or no expense and will remove the paint effectively: Dissolve eight heaping tablespoonfuls of cornstarch in a gallon of water in one container, and, in another, one and one-half cans of lye. Then, stirring well all the time, pour the lye solution into the

cornstarch. This will make a thick paste without lumps. The containers should be of porcelain or glass, as the paste will attack tin, copper or aluminum. Remember this paste is a paint remover, so take no chances of its getting on where it is not intended. It is best to remove the fenders from the car before starting, or the enameled parts can be protected by smearing them with grease. With a brush or swab, put the paste on the surface from which the paint is to be removed, in an even, thick coat. Let it stand until it starts to dry and then scrape it off with a putty knife or steel brush. Cover only small areas at one time. If the paint is unusually stubborn, a second coating may be necessary. The paste can also be used in dressing up the tractor and other farm implements. On these, it will speed up the operation to remove all small parts from the machinery and let them soak in a lye solution of one can of lye to a gallon of water. The same solution is also good for removing grease and dirt from the engine. Flush well with water before attempting to repaint and let dry for a few days also. If there is any of the lye water left in the cracks or corners, it will run out after painting and ruin the job.—Ralph W. McPherson, Omaha, Nebr.

Tension Regulator for Tents

The spring attachment shown in the illustration prevents the umbrella type of tent from becoming too tight in damp weather and takes up the slack as it dries out, eliminating the necessity of adjusting it by hand.



The attachment consists of a length of coil spring of sufficient tension to hold the supporting arms in place. It is slipped into position over the center pole and held by a removable pin. It takes no additional space and the weight is negligible.

Repairing Ford Rear Axle

The thread on the right rear axle of my Ford car was stripped. This meant that the nut which held the wheel on could not be tightened, and the wheel was in constant danger of coming off. At first the only way to fix it seemed to be to replace the axle, which would take several hours of labor. I got around this by buying a new nut, sawing through one side with a hacksaw and then pressing the nut together again. This decreased the diameter of the nut by a very slight amount. After welding the joint, making the nut as strong as it was originally, I screwed it onto the axle. It caught the worn thread and held fast as it cut into the threaded axle a little deeper than the original nut. This repair has been perfectly satisfactory.—Edward A. Hine, Hoboken, N. J.

Pocketbooks Make Ammunition Belt

The accompanying photo shows how an inexpensive ammunition belt may be made. Two small pocketbooks were purchased at a 10-cent store and riveted or sewed to a cheap leather belt. Each pocketbook has two compartments. This makes it possible to carry both large and small cartridges at the same time. One of the pocketbooks is used to carry a license card, and the but-



Two Ten-Cent Pocketbooks and a Cheap Belt Make a Good Ammunition Holder

ton is placed on the flap. The capacity of a belt like this may be increased by simply adding more pocketbooks. The belt is especially handy because the license and button are always easily accessible.

☐ A simple method of bracing a screen door is to stretch a stout wire diagonally across the lower portion of it.

Automatic Draft Accelerator for Furnace

Many installations for refreshing the furnace fire in the morning have been

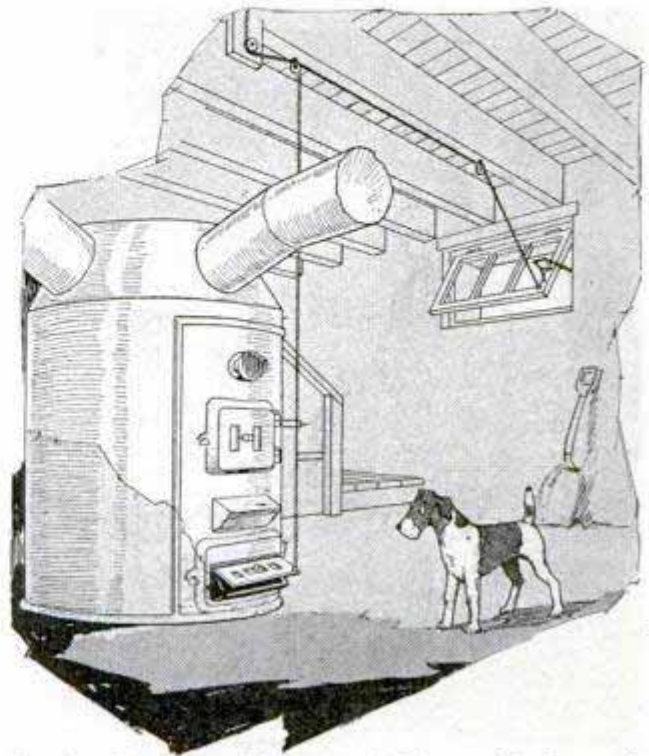

Opening Basement Window and Furnace Draft at the Same Time Brings the Fire Up Quickly

evolved, the most popular, of course, being to attach a chain leading over a pulley up to a convenient place alongside the bed, or connected in some way to an alarm clock. But in many cases, this is not enough. If the furnace is not connected to an outside source of air, the air in the basement may be too still, and it will take a long time to revive the fire. However, this can readily be remedied by attaching an additional chain to the nearest window, as shown in the illustration. This automatically gives you plenty of air circulation, which helps the fire immediately. A coil spring will keep the window closed when the chain is released and there will be no danger of the wind blowing it open.

Damp Spots on Wallpaper

Mold or damp spots on wallpaper are not always easy to remove as all will acknowledge who have tried it. It is, however, not difficult to do this with a mixture consisting of salicylic acid, one part, and alcohol, 90 parts. Use a soft cloth or small sponge to daub the spots. In a few moments they will all disappear.—L. M. Georger, Buffalo, N. Y.

Paper Spindle Holds Flypaper

When sticky flypaper is placed on counters, desks and showcases in stores and of-



Holder for Sticky Flypaper Prevents It from Being Shifted by Breeze

fices, it frequently becomes a source of great annoyance, especially when the electric fans are used, or when a breeze enters through the opened windows. To obviate this trouble, one merchant employs a number of paper spindles, which are securely mounted on wooden blocks, 8 in. square. To attach a sheet of flypaper to the holder, it is rolled into a cylinder, with the ends overlapping about 1 in., and the doubled section is then pushed over the spindle point, as shown in the illustration. When mounted in this manner, the paper cylinders present a full surface for flies and yet remain in their place.

Chemical Windshield Wiper

As every driver knows, even the automatic windshield wipers will leave a blur on the wet glass. To prevent this, sew a piece of felt in the form of a long, narrow bag to fit over the rubber wiper. This should fit tightly so that it will not slip off. A small quantity of denatured alcohol and glycerin is mixed in equal parts, in a bottle, and the felt bag is saturated with this solution. It will remain effective for a long while, so that the solution need not

be added frequently. Nor is it necessary to have the wiper operating constantly. On a wet day, start and let it run for a few seconds, and the rain will then glide off immediately. Repeat about every half hour.—Herman R. Wallin, Brooklyn, N. Y.

Substitute for Bottle Labels

Paper labels pasted on jars and bottles in the laboratory or photo dark room, are often soiled by age or damaged by the chemicals themselves until they are practically illegible. This occasioned one amateur to perform a most disastrous experiment, and therefore he conceived the idea of making permanent labels. This he did in the following way: The surface of each bottle was roughened with emery cloth so that the contents could be indicated by writing. When a bottle was empty and used for some other purpose, the writing was erased for relabeling.—G. E. Hendrickson, Argyle, Wis.

Teaching Dog to Open Door

By using a bone as an inducement a dog can readily be taught to open a swinging door, such as a screen door, without assistance. A large bone is fastened with a wire to a screw-eye, which is driven into the door at the right height. Any dog is curious, and it won't be long before he finds out that he can pull the door open himself by

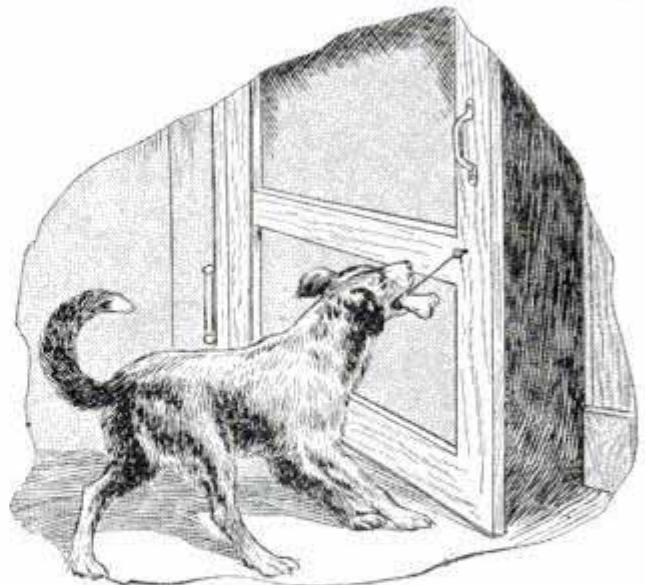

Attaching a Bone on a String to a Swinging Door Teaches Dog to Open It without Assistance

taking hold of the bone and pulling, as he will naturally do.

Varnish Remover

Often we have several old pieces of furniture which, if refinished, would answer our purposes very well. Varnish removers are rather expensive, so when it is absolutely necessary to remove the varnish and get the wood down to its raw state, other means are employed. For instance, when a golden-oak finish is to be changed to an early English, or vice versa, or a fumed-oak piece changed to an early English, take caustic potash, 1 lb., starch, $\frac{1}{2}$ lb., and water, $3\frac{1}{2}$ lb., which is equal to $3\frac{1}{2}$ pints. Add enough of the water to the starch to make a paste and dissolve the potash in the remainder of the water. When both mixtures are cool, stir them together thoroughly. If the mixture is too thick for spreading, thin it with water to the consistency of glue. Cover the entire woodwork of the furniture with the mixture and, when the varnish is softened sufficiently, scrape it off with a putty knife or scraper. After the finish has been removed, it is necessary to thoroughly sponge off the wood with pure water and, in case the remover has been left on too long and is found to have turned the wood to a slight tint of brown, you will find that this will not interfere with any of the colors in fashion these days. The removal by water may raise the grain, but this will only have a tendency to help dispose of the filler and again to open the pores so that they are in better condition to receive the new finish.—H. R. Calhan, San Francisco, Calif.

Handy Storage-Battery Truck

A handy truck for carrying storage batteries, or other heavy loads, can be made from a discarded lawn mower by removing the knife, bolting on a handle and putting on a suitable platform. The handle is, of course, arranged so that the platform will be perfectly horizontal when the handle is at the most convenient position. Such a truck is handy around a battery shop.

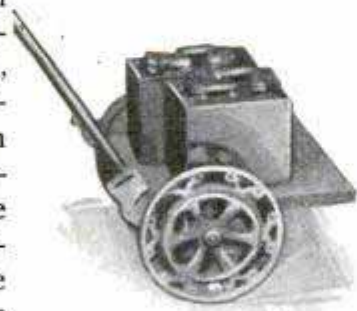

New Use for Old Can Rubbers

Many housewives have noticed that scratches on the bottom of their kitchen sinks are caused by the dishpan and other utensils. To avoid these marks and scratches, one housewife connects her old can rubbers with twine to form a mat for the sink bottom, as shown in the illustration. This can readily be washed and dried so that it is quite sanitary and can either be left in the sink or hung up near by.



Safety-Pin Switch

When experimenting with some home-made solenoids and trying to get them to work a signal apparatus, several light switches were needed. The photo shows how a safety pin was used for this purpose. The catch side of the pin was cut in the middle and the pieces were sharpened to a point where cut. They were then forced into a block of wood. A cork was pushed on the point end for a handle. The spring in the point side kept the contact free when removed from the hook.—Frank W. Bentley, Jr., Missouri Valley, Iowa.

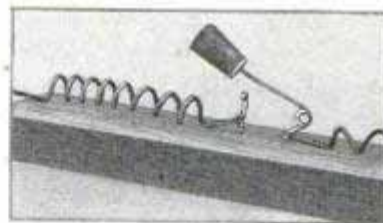

Wood Rot in Flower Boxes

Wooden flower boxes can be made practically free from wood rot by using the following method: Before filling them with earth, coat the inside surface with whitewash. This will prevent insect life to a great extent and will keep the wood in good condition for many years.

How to Build GOOD SHOOTING BLINDS



BLINDS

by

Bob
Becker

the shores. After this comes the necessity of selecting a site according to wind and flyways.

Mallards, pintails, widgeon, teal and shov-

THE art of making blinds, hide-outs or other places of concealment is as old as the sport of hunting. Indian bear hunters of Alaska have, for many decades, constructed blinds along salmon streams from which they could shoot the big brown bears of the north country. South American Indians know the trick of making a hide-out in the low branches of trees from which they can kill the big jaguars, the largest cats in America. In wild-fowl hunting this same art of concealment is practiced, and the successful duck and goose shooter must know something of the craft if he wishes to come home from his hunt with good bag. The wariest the birds the more woodcraft skill is needed, and akin to this requirement is that of decoy location, use of an artificial caller and various other tricks of the trade.

In hunting marsh or puddler ducks, birds that like to frequent, and feed in, shallow ponds, lakes or bayous, one of the first rules in blind making is to take advantage of any natural vegetation along

elers are among the commoner marsh ducks which are usually shot from shore blinds with a stand of wooden or live decoys in front of the place of concealment. These birds come into a stretch of water and to decoys, circle and then swing in to light against the wind. In making your blind for a day's or season's shooting on a body of water try to locate it so that you will have the advantage of prevailing winds and get your shooting at birds facing you as they come in against the breeze (see Fig. 1). For example, in many sections of the

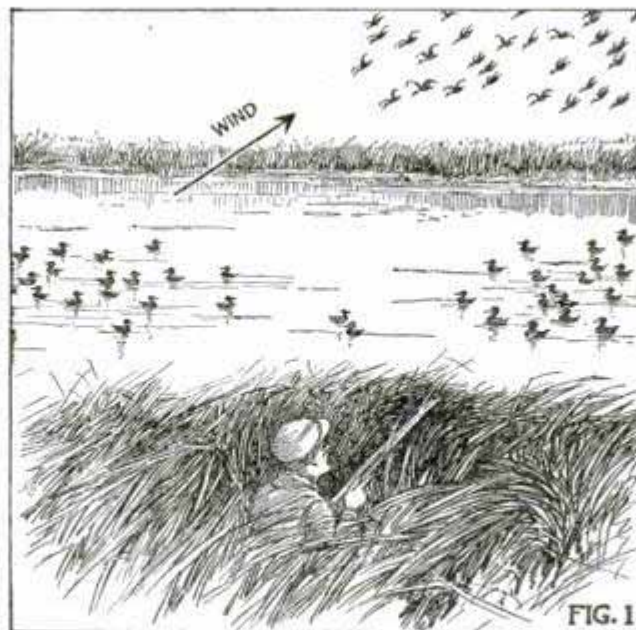

United States the best shooting on waterfowl is had during storms with north and north-west winds blowing, or when a snow flurry and high winds are coming from the east and northeast. If possible, the duck hunter should locate two blinds on the shooting hole so that he can change about when the winds veer. One of the hide-outs on the

bank and at the water's edge should face west or southwest. This blind is for shooting when the wind is in the east or north-

east, as then the birds will swing in to decoys against the wind and facing the hunter. The other blind should be located so that it looks east or southeast.

The site or sites selected, the next step is construction of as "natural-looking" blinds as possible. Ducks, especially mallards and pintails, are quick to size up the appearance of a pond and its surroundings, and if any features look suspicious, away they go. The more they circle, the keener their observations. A piece of white paper carelessly left on the ground near the blind, weeds, cattails, rushes or other vegetation along the shore cut or disturbed too much, or a slight move on the part of the occupant of the blind, often scare the wary birds so that the hunter is not able to get in a single shot.

If there are no weed patches, cattails, tules or other growth along your duck pond, tall enough for concealment purposes, you should get busy before the hunting season and supplement the natural growth with willow branches stuck



Taking Advantage of Small Shrubs and Shore-Line Vegetation; This Is the Famous "Downton Bob" and His Master, Dean Swift; Note the Hole to the Left of the Dog, Made by Him So He Can Mark Fallen Birds

in the shore, or tall weeds of the same kind as grows along the shore line. This "landscaping" should be done early before the



Above, Blind Made of Rushes and Grass Stuck in Chicken Wire; Left, Staking Out a Live-Goose Decoy on a Sandbar



flight begins, so that the birds can get used to it. Be sure to place such a growth also at the point where you intend to make your shooting blind.

If the shore line has a good stand of vegetation, the problem of making a blind is much simpler.

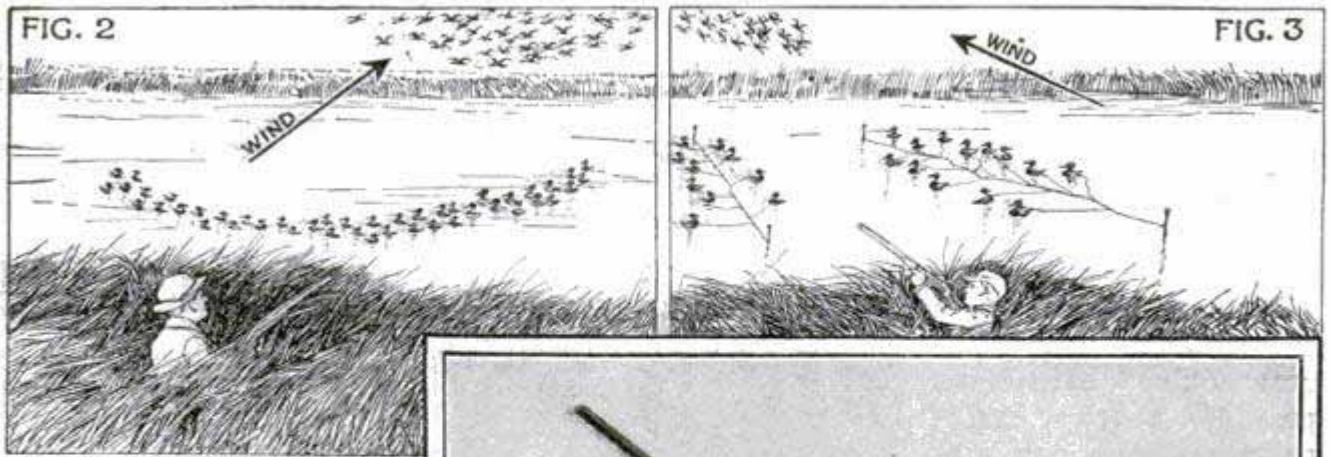

Right, a "Natural" Marsh Blind Made of Standing Rushes at the Edge of the Pond

For a hastily made temporary blind suitable for just a day's shooting, all the tools you will need are a knife and a few pieces of string or old wire. Step into the stand of cattails, weeds, rushes or other growth along the shore and cut out a circle 36 to 48 in. in diameter. As you slash the vegetation, take a handful and tie it together with string and then ram it down in the ground to increase the screen around you. If a few short twigs are handy (you can't always find them in a marsh, however), wedge several around the edge of the blind so that the bundles of weeds can rest against them.

A blind 3 to 4 ft. in diameter is large enough for one person. For two, or one hunter and a retrieving dog, it is a good idea to make them wider, always leaving the vegetation standing at the back of the blind with the exception of a narrow swath through which the hunter can enter. Last fall our permanent duck blinds measured slightly more than 5 ft. in width and about 39 in. in depth with the vegetation sloping inward, as a pitch toward the center furnishes more of a screen for the hunter.

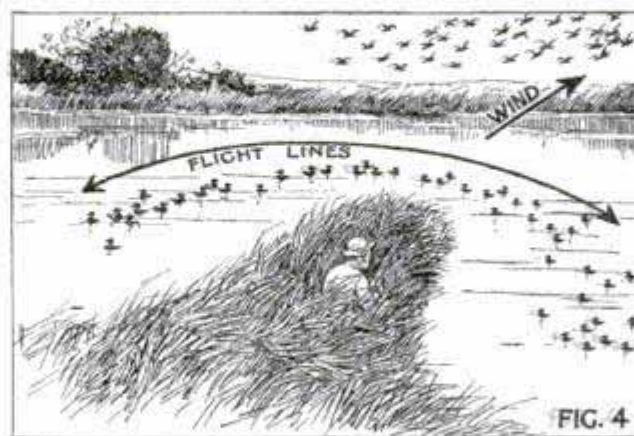

The permanent blind, constructed to last through an entire season of hunting, requires more labor, but even then a good one can be made in the marsh in an hour or two. A band of ordinary chicken wire, 18 to 36 in. wide, three or four roughly made stakes, a few boards, a hammer and sharp knife are the tools and material needed. Locating the blind as close to the water as possible, either in the swamp vegetation, at the edge, or behind a small clump of willows or other shrubs, drive the stakes in the shape of a half circle, and then add two or three to form the back of the blind, the latter being arranged in a straight line. Bend the wire around these stakes and fasten it with small brads. The wire forms the backbone of the blind; into and against it the cattails, tules, tall grass, twigs, or other stuff used to make a screen, can be woven. Last fall we had one blind at



Above, Setting Out Decoys on Louisiana Lake; Center, a Rare Type of Blind, Built in a Cypress



in the Middle of Reelfoot Lake, Tenn.; Below, Setting Out Silhouette Goose Decoys

the edge of a cornfield which was fringed with weeds 5 ft. tall. To make the hide-out blend into the surroundings, we used both dried cornstalks and weeds, the material being cut from a spot several hun-

want for a seat, should be placed at the back of the blind. Inasmuch as duck shooting usually means fairly long hours, it is wise to spend considerable time to make the seat as comfortable as possible. There



dred yards from the blind, so as to leave the surroundings of the blind as natural as possible.

And now for the furnishings of the blind. If the ground is muddy (and most sites for blinds are, as they lie close to the water's edge), it is a good idea to make a rough board floor. A small box painted brown, or whatever you



is no need to punish oneself on a cold, stormy day while waiting for birds to show up. If you can find an old kitchen chair, saw off the legs to get the height desired, paint it dark-brown and use it for

a seat. The backrest means real comfort in a blind.

Now that the blind is located, you're

ready to set out the decoys. If you have a bunch of wooden decoys be sure to set them out so as to give the flying birds some open water between the wooden "foolers";

single-file arrangement works and saves a lot of trouble. Take a slender iron rod of sufficient length to allow you to stick it into the bottom of the pond and still have



otherwise your ducks will come in, circle and then swing to the set and go down at the outer edge of the decoys.

One of the simplest methods of setting out the wooden blocks is to string half of the bunch to the right, the other half to the left, leaving a wide open "parking spot" between them with just one or two decoys in this spot, as in Fig. 1. With such a layout incoming waterfowl are pretty sure to swing and aim for the open water right in front of the blind. Under no circumstances place any of your decoys beyond gun range, as it doesn't give you any shooting to decoy birds and have them settle down out of gun range.

Another effective arrangement of block decoys is the moon-shaped layout shown in Fig. 2, which leaves an open space to which birds will come.

In handling and placing live decoys in front of a blind, one of the simplest arrangements that a hunter can make, is to string 6 to 12 live birds from an iron stake which is rammed into the mud in the bottom of the pond. While this does not permit the scattering of decoys in front of the blind, a layout which many hunters think is most necessary late in the duck season, when it is bitterly cold and getting one's hands wet is real punishment, this

12 to 18 in. of the rod show above the water. Ram it into the mud about 30 ft. from the blind, after fastening to it a stout cord, at least 30 ft. long. At intervals of every 3 or 4 ft. along this cord, tie on short pieces, 18 to 24 in. long. Make these secure so they won't slip. Sew these on and then tape them so that they cannot move an inch. The next step is to provide the smallest metal snap that you can get for the ends of these short pieces.

The rod is in the water, the long cord with shorter lengths attached is in position, and now you are ready to put out your decoys.

Rowing out in your boat, you pick up a live mallard decoy, and put a patented decoy holder (the kind that can be purchased in any sporting-goods store) around its neck. If the short lengths of cord are not provided with small rings at the end, it is no trick to attach these, as the snap on the short decoy line is to be hooked up with the ring on the holder. Just go down the line hooking on your live birds to the "main line" running from the iron stake. When you come to the end, make a loop in the main line, put it over another iron stake and then ram the stake into the mud. You then have a string of 6, 8, 10 or more decoys all on one

cord, as in Fig. 3, each able to swim around a little and make all the fuss they want. Yet all can be put out or picked up with practically no rowing and when you take the birds in at night you release them by just one snap, leaving the stakes and cord in the water.

In hunting the open-water ducks (the diving birds which feed in deep water), several different tricks in decoys and blinds must be practiced. For example, while live mallard decoys are used in hunting the pond ducks, like mallards, pintails, shovellers, widgeon, etc., in gunning for canvasbacks, bluebills, ring necks, redheads and similar open-water ducks, only wooden decoys are suitable. One of the most ideal sites for your blind for such shooting is on a point separating a bay from the main body of water, especially if flying birds are likely to cut close to this point (see Fig. 4). You need large stands of decoys for these birds, especially on fairly good-sized lakes, as the mass of blocks must be large enough to catch the eye of passing birds. As coots or mudhens are often found by the thousands on such bodies of water and invariably feed with the bluebills and canvasbacks, it is a pretty good idea to get some mudhen decoys and mix them with the canvasback, red-head, and bluebill blocks.

Sandbars and cornfields, these are the two locations usually chosen for a goose hunt. Along big rivers like the Mississippi, thousands of wild geese congregate every fall, using the bars and the adjacent cornfields as their rendezvous. To hunt successfully on a sandbar, which observation has shown is the loafing place for geese, one should make a pit. Last fall we found a small growth of willows on a sandbar which could be turned into a blind, but it was only one of this type to dozens of sand pits along the river bars.

Dig a hole in the sandbar, about 4 ft. deep, 6 ft. long and 4 ft. wide. This pit will be large enough for two gunners. Board up the sides to keep the sand from caving in. Across the top, lay at least two 12-in. planks and one narrower in width. The ideal way to use this pit is as follows: When geese appear, the hunters should sit back deep in the pit, keep out of sight and not move. The operations of the birds can be watched by keeping one's face

near the edge of the planks so as to be looking upward.

Putting out decoys is less intricate in goose shooting than in duck hunting. The majority should be set out down wind with no definite arrangement except that live goose decoys must not be staked out too close to each other. Separate them and they "call" better (see Fig. 5). In typical Mississippi river goose sets, silhouette metal decoys are set all around the pit blind, some even being stuck in the sand at the very edge of the pit. These "birds" are always faced into the wind. When a goose is shot, add it to the set by this trick: Find a small willow stick and ram it into the sand. Then take the dead goose, open its mouth and push the head of the bird upon the twig as if it were trying to swallow the twig. This will give a natural curve to the goose's neck and the posture of the bird resting upon the sand produces a very lifelike effect, much as if the goose were sitting on the sand after feeding.

Coil Spring Saves Windmill Pump



Windmill-operated pumps are usually under a severe strain when a strong wind is blowing, which may cause the bolts to become dislodged or broken from the platform. The pump, then loosened, is lifted up and down with each stroke until the rods, pipe and cylinder are more or less damaged. To avoid this, one farmer devised a simple governor. It consists of a stout coil spring placed between the pump head and the mill connection. The

coil spring, partly compressed, is held permanently onto the pump by means of the bolt through the rod, and exerts a downward pressure which prevents lifting of the pump on the upstroke. It also absorbs the shock of the downstroke and a smooth, noiseless operation results.—G. E. Hendrickson, Argyle, Wis.

Canoe Carried on Touring Car

By the provision of a cradle as shown in the drawing, a canoe can easily be trans-

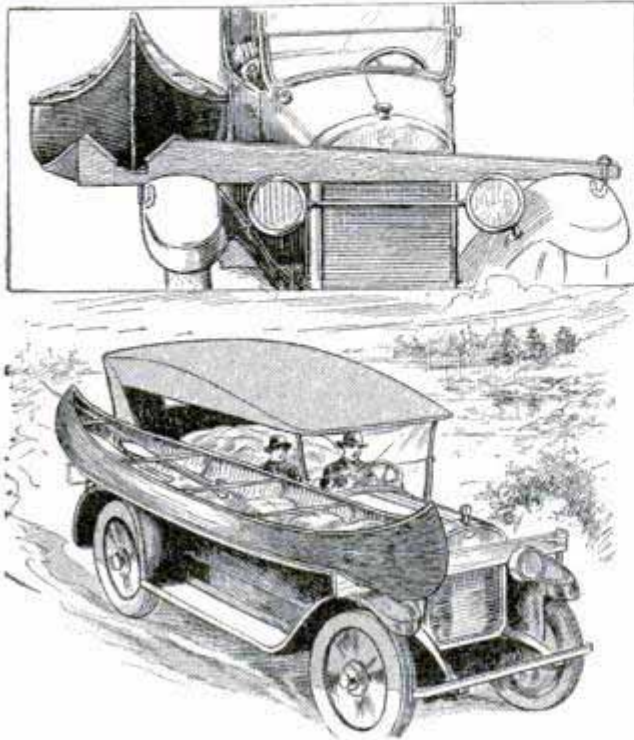

Wooden Cradle for Supporting Canoe Securely on Side of Touring Car

ported on a car. The cradle consists of two 1-in. planks attached to the car in front and behind, and $\frac{3}{8}$ -in. boards extended from the front to the rear brace. The under edges of these boards are cut to conform to the curvature of the fenders, and felt is glued on to prevent scratching. Special hook-shaped bolts are used to attach these boards, as shown in the upper detail. The fore-and-aft planks form a flexible support for the boat, and are nailed or screwed to the end planks after the canoe has been set in place, so that the latter will have sagged as far as they will go. The canoe is then strapped securely.

How to Make Wooden Decoy Ducks

One can buy decoy ducks or one can make them. For the man who likes to build his own, there are a few points to keep in mind. No matter how artistic you may be, practicability and not art is the essential factor in decoy making. Use wood just heavy enough to float easily without bobbing around. Decoys that move too easily may scare away some socially inclined birds rather than attract

them. On the other hand, don't make the decoy so heavy that it is dead and sluggish. Sensitive birds, such as the black duck or the whistler, are much more easily attracted by a decoy showing some signs of life than by a mere floating object. Load or shape the decoys so that they will not capsize easily and balance them so that the heads will not point up, which gives the impression of a take-off attitude. Flying birds will sense this and pass over instead of alighting. In painting decoys, undercolor them. Use colors ground in japan, with turpentine as a thinner. This gives an absolutely flat color and conforms to nature. Keep out details. Viewed from a hundred yards, any bird shows only bands or splotches of color and that is all that is necessary on a good decoy. Paint the underside gray so that, if the decoy capsizes, it will not frighten the flyers.

Sharpening Sewing-Machine Needles

Often the last sewing-machine needle in the house is dull and does poor work. The difficulty can usually be remedied in a few moments by placing a sheet of medium-grade sandpaper, rough side up, under the needle, and running the needle through it several times. This takes only a few moments and will improve the needle.

Right-Handed Telephone for Deaf

Persons who are left-handed and those who are slightly deaf in the left ear, and

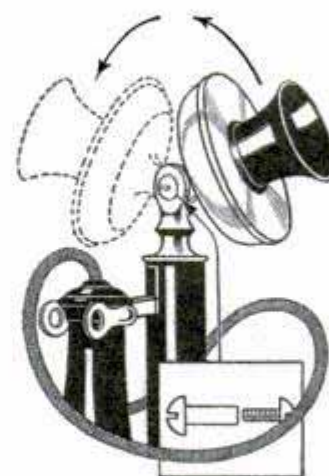

are accustomed to hold the telephone receiver to the right ear, will be better able to use the phone if it is made right-handed. The change is accomplished by removing the screw that holds the transmitter to its base. The transmitter can then be turned

over so that, when the phone is in the speaking position, the receiver hook will be located on the right-hand side.—J. S. Hagans, Chicago, Ill.

How to Make and Keep a Good Lawn

By THE GARDENER

TO most amateur gardeners, fall would seem an unusual time to be thinking about making a lawn, but, as a matter of fact, this is by far the best time to do it. According to Prof. Ralph Curtis, of Cornell, "the best time to seed a lawn in the north is the last of August or the first of September When northern turf grasses, like Kentucky blue grass, redtop, red and Cheving's fescue and the bent grasses are sown in the fall, the seedlings soon produce new shoots from the short, crowded joints at the base of each stem. As the weather grows cool and the days short, these stems do not elongate as they would in the summer, when the grass goes to seed, but they continue to produce an abundance of new shoots from the base. This is called 'stooling,' and it is this stooling habit that makes these grasses good turf-forming grasses.

"When these same grasses are sown in spring, the warmer weather and longer days stimulate the stem into long growth, instead of stooling, and this, under ordinary meadow conditions, will result in a good growth of hay. If the hay is not cut, the grass will go to seed. Of course, the lawn mower prevents seed production, but, even so, the spring seedling will tend to spindle rather than to stool, and will not

produce such vigorous turf as the fall seedling. The spring seedlings are also much less able to hold their own against hot weather and crab grass and other summer weeds. For all these reasons, a good seeding made in late August or early September will give northern grasses a flying start which the weeds can never overcome, provided you keep the grass growing vigorously and normally thereafter."

A good lawn, like a good house, must begin with a good foundation, and it is here that most new lawns fail, especially around new houses. The contractor, when grading around the house, seldom has the lawn very much in mind, and the consequence is that debris of all kinds, bricks, slabs of concrete, timbers, plaster and sticks of all sizes are found an inch or two below the surface, barely covered by the stiff clay excavated from the foundation and with the surface disguised by a bare inch of black soil. Grass will not grow over such stuff, so the first thing the lawn maker should do, around his new house, is to spade up the ground to a depth of at least 2 ft., so as to expose and get rid of the debris. If there is any stiff clay in the grading, spade in a few loads of sand so as to lighten it, for grass will not grow

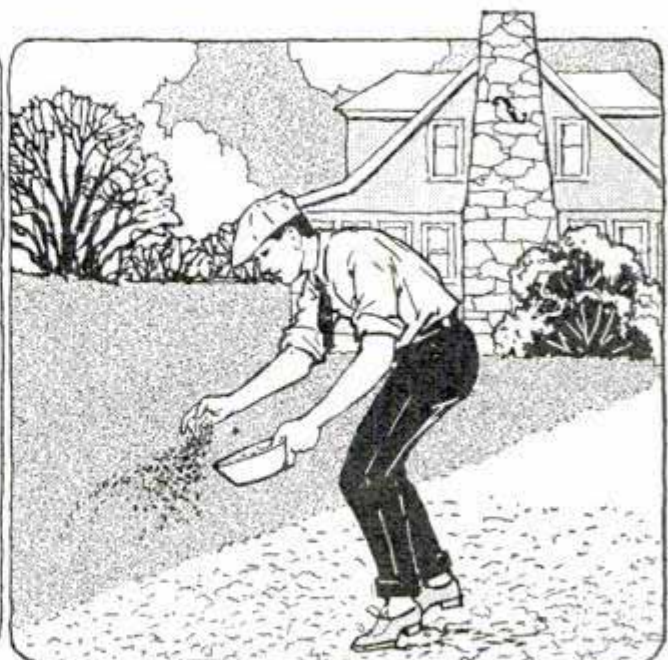

Thorough Preparation of the Soil and Ample Seeding Are Essential in the Making of a Lawn, Especially a New One, and Too Much Care Cannot Be Spent on This

on top of clay. Good drainage is one of the most important features of a good lawn, and a stiff clay subsoil does not permit drainage, consequently the grass, if it

as if it had suffered from an attack of whatever it is that causes baldness, for the annual grasses have not come back and only a few little knots of the perennial grasses grace the lawn.

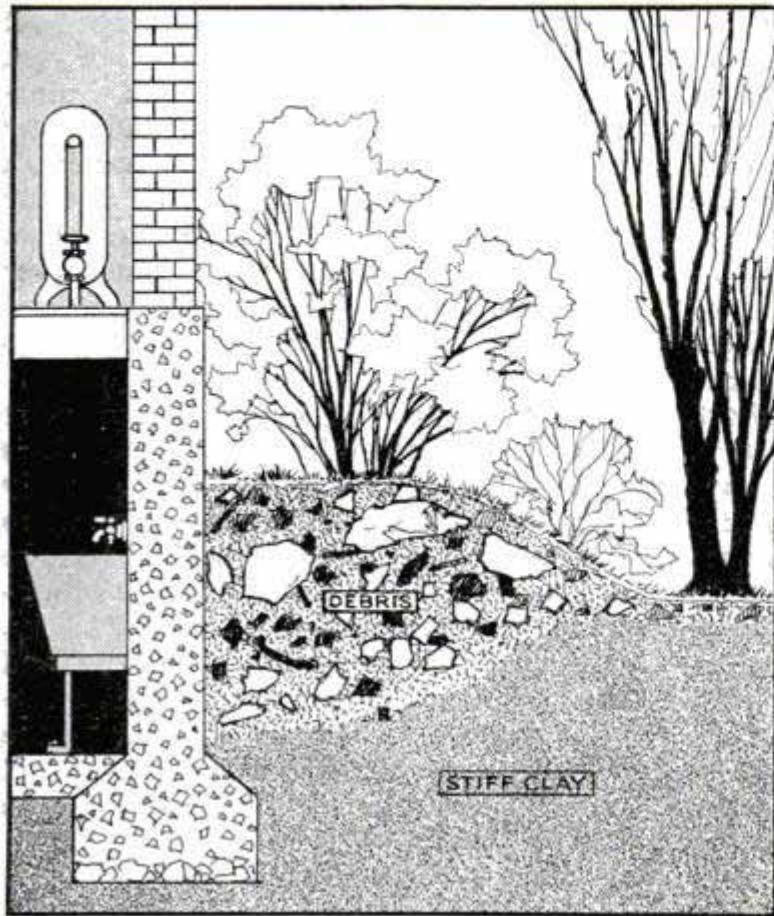

A Picture of the Usual Conditions around the New House; Grass Will Not Grow on Top of Stuff Like This

does get started, gets "wet feet" and dies. In the absence of sand, even coal ashes, well spaded in, will lighten the soil enough to enable drainage to be established. When the ground has been thoroughly spaded and the lumps well broken up, rake the surface fine, level it off and prepare to sow the seed.

To many people grass is grass, and they do not know that there are many different varieties, each with its own preference as to location and soil. To get a good lawn all around the house, it is usually necessary to use a shade grass on the north side, under heavily leaved trees, etc. The first requisite is good seed. Go to a reliable seedsman and pay the very highest price you can afford for seed. Many of the cheaper brands, sold by other than seedsmen, contain large proportions of seeds of annual grasses, and, although these start quickly and make the lawn look fine the first few weeks, the next season it will look

that of Kentucky blue, it is suitable for a lawn where the blue grass is used on the more open spaces. There are many other varieties, but the foregoing are among the most common of good lawn-seed mixtures.

Having obtained good seed, spread it on the prepared ground at the rate of 1 lb. to each 250 or 300 sq. ft. It is best to sow a strip about 10 ft. wide, rake it in one direction and then at right angles to this in order to get the seed well covered, then roll the strip down and proceed with another strip. Do not roll the ground too hard, or you may find that the grass will not come up. On the other hand, the ground should not be left so soft that every dog track on it shows up like a sore thumb. Roll it enough to get the seed into intimate contact with the soil particles. After seeding, raking and rolling, wet the seed down with the hose, using a fine spray so as to avoid washing out the seed, and wet it

down thoroughly every evening or early every morning, until the grass has got a good start. If you like white clover in your lawn, use $\frac{1}{2}$ lb. of clover seed to 1 lb. of grass seed, and sow the clover seed separately, as it is much heavier.

The grass should not be cut until it is about 4 in. high, and the lawn mower should be adjusted so that it does not cut too close for the first few mowings. Most people either rake the lawn clippings off, or else use a grass catcher on the mower. Don't do this; let the clippings lie. Some may object to the appearance of the clippings on the lawn, but this is not a very weighty matter, as they disappear in a day or two, and the advantages of letting them lie far outweigh this slight disadvantage. In the first place, the clippings form a light mulch over the lawn, protecting and shading the roots of the grass from the sun; in the second place, as the clippings decompose, they return to the soil some of the food elements that went into their growth, and thus they actually serve as a very light coat of manure all the year around. If the lawn is cut once or twice a week, the clippings are never heavy enough to be objectionable, and, as mentioned before, they disappear into the grass very quickly.

Rolling is a part of the care of the lawn that is seldom given the attention it deserves. It is said that a visitor, admiring the smooth, velvety lawn on an English estate, once asked the gardener what the

secret of producing such a lawn was. "Well," said the gardener, "there's no secret as I know of, although it do take a bit o' patience, as you might say. You sows your grass, and then waters it, an' cuts it an' rolls it for two or three 'undred years, an' then you 'as a lawn."

We do not need to wait "two or three 'undred years" for a good lawn, but we do need to water it and cut it and roll it. Especially in the spring, after the frosts have been heaving the ground all winter, does the lawn need rolling, to compact the soil about the roots of the grass. Once or twice a month during the summer, the roller should be brought into action, preferably after a shower. In England, many of the lawn mowers are fitted with heavy rollers, so that the lawn is rolled every time it is mowed. As a matter of fact, one can hardly overdo the rolling.

Watering is another thing that is usually done wrong. Don't "sprinkle" your lawn; soak it. When the ground is merely sprinkled, the surface soil only is moistened, and the grass roots occupy this shallow layer. By thoroughly soaking the lawn, the roots are encouraged to go deeper, and are thus better able to stand the hot days of summer.

And now we come to the matter of lawn food. We cannot go on year after year growing grass in one spot and taking the food elements out of the soil without replacing them. Allowing the grass clippings to lie and decompose does return

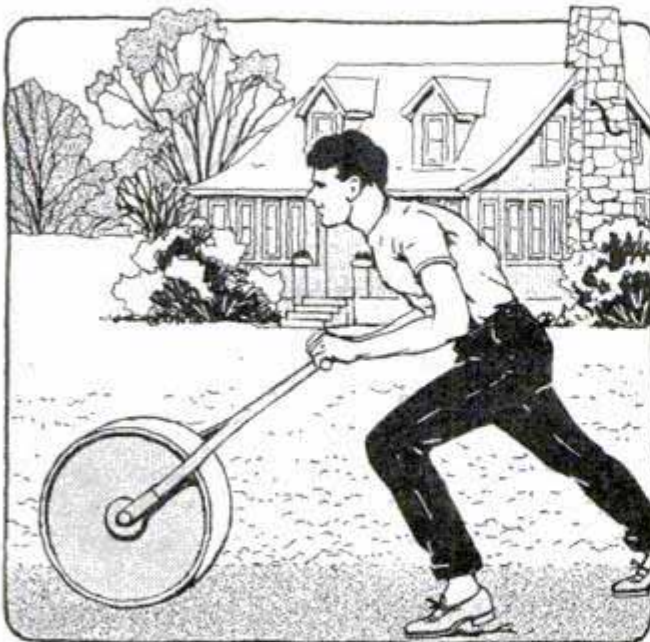

Rolling Is a Much-Neglected Part of Lawn Care, But One That Is as Necessary as Mowing, Especially in the Spring After the Winter Frosts Have Heaved the Ground



When You Water Your Lawn, Don't "Sprinkle" It Lightly; Soak It Thoroughly

some food elements to the soil, but more must be supplied. Many amateurs conscientiously spread lime over their lawns spring after spring and imagine that this is all the grass needs. This is not so; lime is not a fertilizer and very few lawns really need it. If the soil is sour, lime will help to sweeten it, and lime plays a part in unlocking the food stored up in the soil and in making this food available to plants, but the grass needs a complete fertilizer. In addition to this, lime encourages the weeds. Bonemeal is an excellent fertilizer for lawns, as it is a source of potash, which makes for good, stiff growth. It is also a safe fertilizer, for it will not "burn" the grass, even if used excessively, and the excess will simply lie until it is used up. Enough should be spread over the lawn to whiten it. Nitrate of soda is useful in giving the grass a quick start in the spring, but it should be used as a solution not stronger than 1 oz. to 2 gal. of water, sprinkled over the lawn, then washed in with the hose. Sulphate of ammonia is a good fertilizer for the bent grasses, and, as it tends to create an acid soil, it discourages the growth of weeds. It is not especially good for Kentucky blue grass, which prefers a soil not markedly acid. Most seedsmen carry a non-odorless, special lawn fertilizer which contains the

proper proportions of nitrogen, ammonia and potash for the grasses, and the use of one of these is strongly recommended. Some care is necessary in using them, to prevent burning, but the amateur will have no trouble in this respect if he follows the directions accompanying the fertilizer. Hardwood ashes are also good for lawns.

Now as to weeds. There is no easy way to get rid of weeds, but their greatest enemy is a close, vigorous turf, where the seeds can find no lodgment. Sulphate of iron sprayed over the lawn, in solution, will kill dandelions without injuring the grass, but, in the hands of an amateur, this method is a trifle dangerous, so the best advice is, dig 'em out, then fill in the hole with a mixture of good soil and grass seed, press this down firmly, and the new, close grass will keep out the weed seeds. Be sure you get all the roots of the weed, as cutting it off just below the surface only causes two to appear where one grew before. If a lawn is very badly infested with weeds, it will prove simpler, in the end, to plow it up and make a new lawn.

Bottling Beverages

Everyone who has bottled beverages of any kind has experienced the waste caused by having too much in the funnel when the bottle is nearly full, with the result that the surplus liquid runs over. To prevent this, the stopper shown in the illustration



will be found convenient. Get a cork to fit into the spout snugly and run a 4-in. stove bolt through it, washers and nuts being used to keep the cork in place tightly. When a bottle is full the cork is pressed down and the funnel can be transferred to another bottle without spilling the liquid.—L. J. Flugel, Chicago, Ill.

☛ A simple and handy pincushion can be made of a large cork fastened to any support or base with a nail or screw.

How to Remove Sugar and Starch Spots from Silk Fabrics

It sometimes happens that a silk dress of delicate color becomes soiled with a spot of sugar or starch, and as neither of these can be dissolved or removed with the usual dry-cleaning fluids, it is often considered necessary to send the garment to the cleaner. To avoid this expense and at the same time eliminate the trouble of dipping the entire garment in naphtha or gasoline, use the following method: Place the dress on the ironing board with a pad of absorbent material beneath the spot to be removed. Sponge lightly over and around the soiled spot with gasoline, marking the sugar or starch spot with a pin. Before the gasoline has evaporated, daub the stain with a clean cloth pad moistened with water. The gasoline will prevent the water from penetrating the fibers of the silk but the foreign matter of the spot will be dissolved and driven into the pad beneath. After the work has been completed, allow the fabric to dry as quickly as possible and then brush with a fine bristle brush to restore the luster when the spot is removed. A few drops of vinegar added to the water will cause it to work more quickly on sugar spots.

Flashlight Holder Hooks on Belt

Few flashlights have any means of attaching them to a belt, but a holder for that purpose can readily be made. Two slits are cut in the metal cap of the flashlight and the section between the slits is raised sufficiently to allow the metal ring or hook to be slipped under it, as shown in the illustration, the hook being bent to fit over the belt snugly, so that it will hold the flashlight securely.

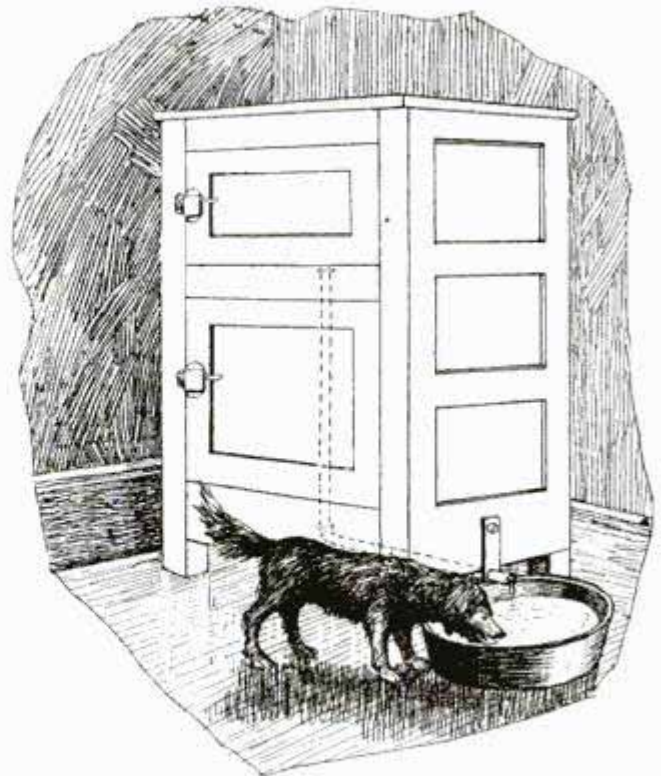
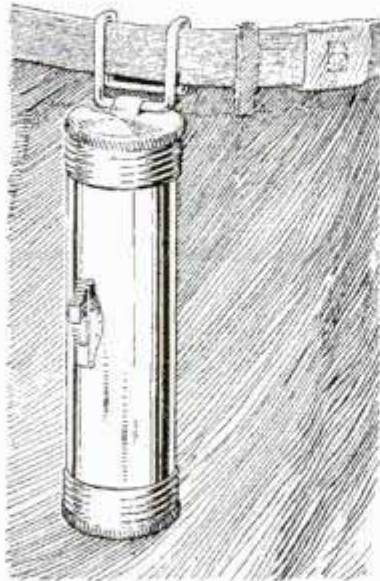

Keeping the Drip Pan of a Refrigerator in Sight, to Prevent It from Overflowing

Refrigerator Drip Pan

Drip pans pushed in under a refrigerator will fill up and overflow if not attended to regularly. By placing the pan at one side of the refrigerator, the water level can always be seen and the contents make good drinking water for dogs and cats about the house. The method of altering the drip pipe for such an installation is simple: Before summer commences, set the refrigerator on end and file the inside of the end of the drip pipe clean. Then get a short length of pipe and an elbow that will just fit inside of the drip pipe and solder them together. Arrange a hanger at the side of the box to hold the added pipe at a slight pitch as shown.

Casters for the Kitchen Table

The home craftsman can do his wife a real service by equipping the kitchen table with tea-cart casters. When this is done, the table becomes one of the most helpful articles in the room, for it can be moved about easily from the stove to the sink, to the ice box, or to the entrance of the dining room. The casters have felt or rubber-covered wheels, and consequently will not mar either polished floors or the surface of linoleum.

Holding Pail Lid Tight

To hold the lid of a small pail in place so that it will not come off while carrying

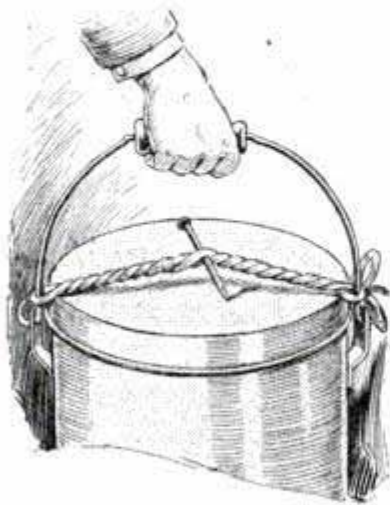

it, take a length of twine, about 2 ft. long, and pass it through the loop at one end of the bail, draw both ends over the top and tie them to the other end of the bail. Next take a nail and twist the twine to tighten it,

as shown in the drawing. When tightened, the nail is left in place to prevent the twine from untwisting again.

Rubber Band Prevents Exposure of Film

While carrying a box or fixed-focus camera in my car, it occasionally happened that the trigger was pushed over and the film exposed, with the result that the photo was ruined. To prevent this, I now snap a rubber band

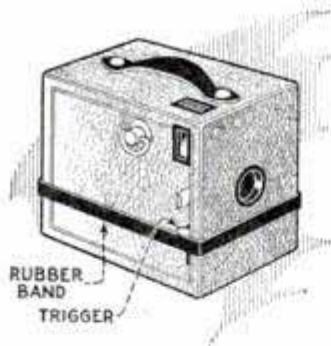

around the camera, as shown in the illustration. This holds the trigger in place securely and prevents it from being pushed over accidentally. When the camera is to be used, the band can readily be removed.
—G. E. Hendrickson, Argyle, Wis.

Protecting the Car Finish

Usually the sun does more to damage the high-gloss finish of an auto than rain, although the latter will check it if the varnish is still "green." An auto should never be left unprotected in the sun or exposed to a high wind, because the latter will drive sand and bits of dirt against it and will have about the same effect as a sand-blast

machine. The heat of the sun will, of course, cause cracking and peeling of the varnish. If the car is kept in a garage, all cracks in the structure should be stopped up so that dust will not settle on the car, and it is best to have the floor of the building concreted. It is really better to keep the car in a cool garage than in a warm one. Sudden changes in temperature have a bad effect on the paint and the varnish. Any bare spots noticed should be touched up with paint to prevent rust from spreading, which it will do quickly, and an unpainted bolt head may furnish the start. Motor cars of today have many nickeled trimmings and these tarnish as easily as a silverplated spoon, so if the auto owner would have his car always looking nice, he must care for this nickel as a housewife cares for her silverplate. This work is irksome, to say the least, but there is no way of getting out of it unless you give the nickel a coat of vaseline, or some other protective compound. In washing the car, do not use soap containing lye, for the latter will quickly ruin the varnished finish. Alcohol will have the same effect, to some extent, and therefore care should be taken when pouring this liquid into the radiator. If you store the car for any length of time, it is advisable to provide it with a paper cover such as may be purchased from any auto-supply store. Sometimes the work of keeping the car shining may seem a thankless one, but, when the time comes for a trade-in, the owner will find that it pays.

Match Scratcher on Steering Wheel

How many times do you look for a place to scratch a match when driving? It is a



simple matter to arrange a suitable scratching spot on the steering wheel, which will scarcely be noticeable and always handy. Cut a strip of emery cloth the width of one spoke of the spider and about

3 in. long. Glue this to the upper surface of the spoke and tie it down until the glue has dried thoroughly.

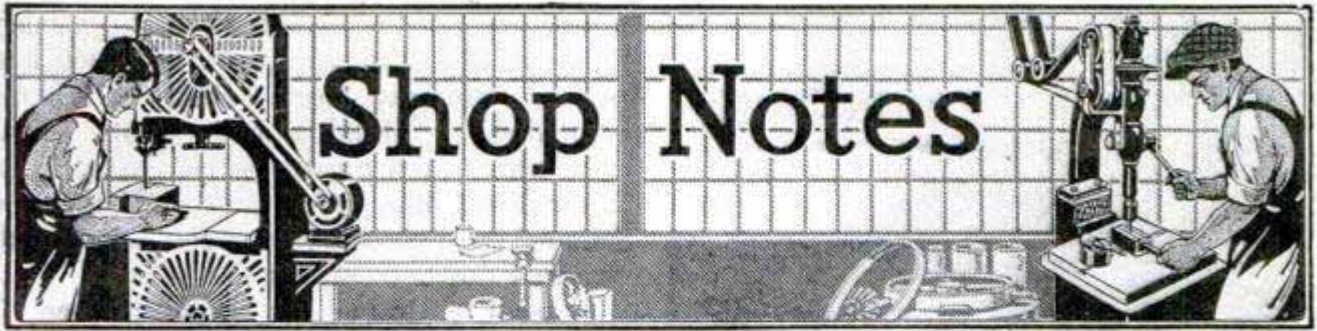

All Shop Notes published in 1926, in book form—Fifty Cents—from our Book Department

Putting In a New Window Glass

By L. B. ROBBINS

SETTING a new pane of glass in a window is one of the most common jobs about the home, yet it is surprising how many men, even "handy men," do the job wrong, from some angle at least. For success in setting a new pane of glass depends more upon the preparation of the sash before the glass is put in than on the finishing of the job. If some, or even one, of the little preparatory essentials are neglected, the glass may crack later without

apparent cause; air may pour in between it and the sash or the putty may drop away and leave the bare wood of the sash exposed to the weather. These possibilities may appear to be trifles, but in a house containing a dozen windows or more they become an important matter. It may mean the saving of considerable fuel during the winter.

The time to repair a broken window is right after the accident happens. Pull out

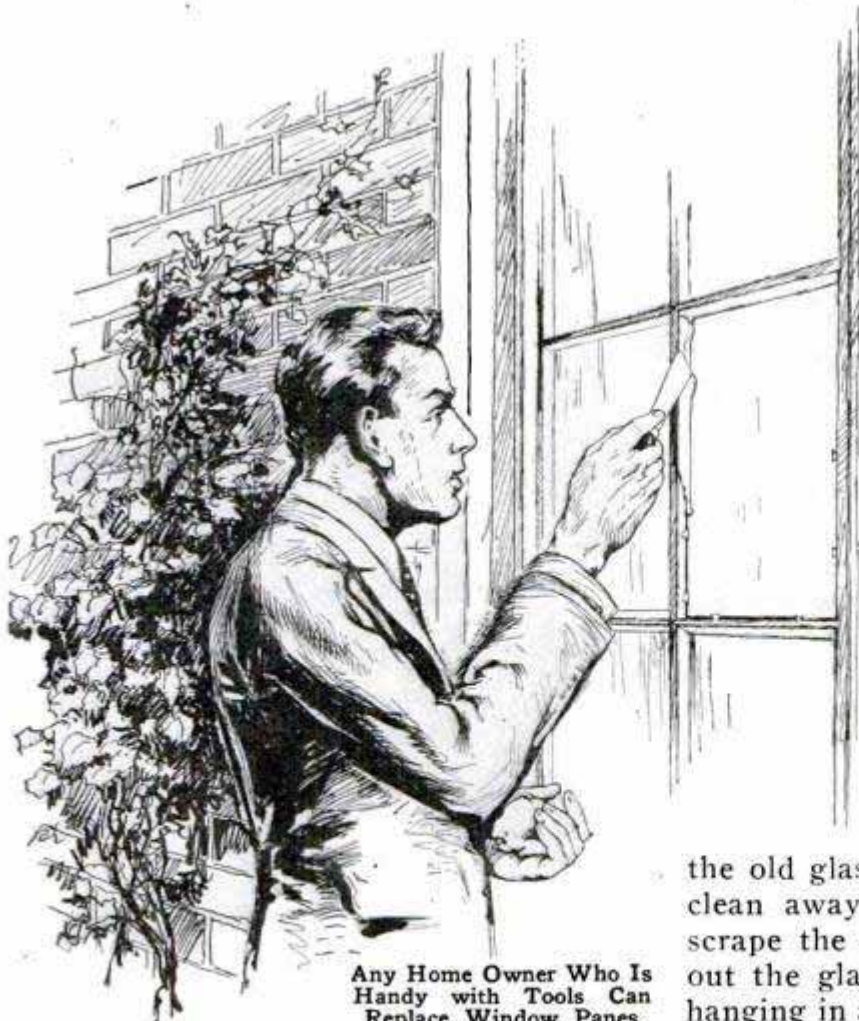

Any Home Owner Who Is Handy with Tools Can Replace Window Panes



How a Cracked Pane Can Be Shattered without Dropping Any of the Glass in Removing It

the old glass fragments and splinters and clean away all the small slivers. Then scrape the wood clean of putty and pull out the glaziers' points. Shattered glass hanging in a sash is dangerous to children



playing about or becomes a menace by dropping out and injuring pedestrians below. Wear old leather gloves when handling the broken glass and put the pieces in a box, or better still, bury them. A few pieces which are large enough and have one or more convex edges, may be saved for scraping paint, but they should be put away safely where children cannot get hold of them. When the window is badly cracked, but not broken out, and the pane is large, it can be safely and easily removed by gluing paper across the broken parts and then smashing them again, which will loosen them and free them from the putty. They can then be pulled out safely and no heavy pieces will fall down.

After the glass is entirely removed and the loose putty picked away from the frame, the latter should be scraped clean with a putty knife to remove all hardened lumps. Glass is far from flexible and if

a new piece has to be forced in, it probably will crack. If the woodwork has been dug out or splintered, these defects should be remedied by filling uneven spots either with putty or a plastic wood paste. The latter dries like wood and can later be finished with woodworking tools and sandpapered down to match the frame.

After the frame has been cleaned, it should be primed with good paint or white lead and oil. This is to fill the pores of the wood as well as to offer a surface for the putty to cling to. If no paint is applied,

the drying putty will eventually pull away from the bare wood. Two coats of paint are better than one, if the time can be taken to allow the first coat to dry. Some glaziers prefer using shellac for the first coat and some use only one coat of shellac.

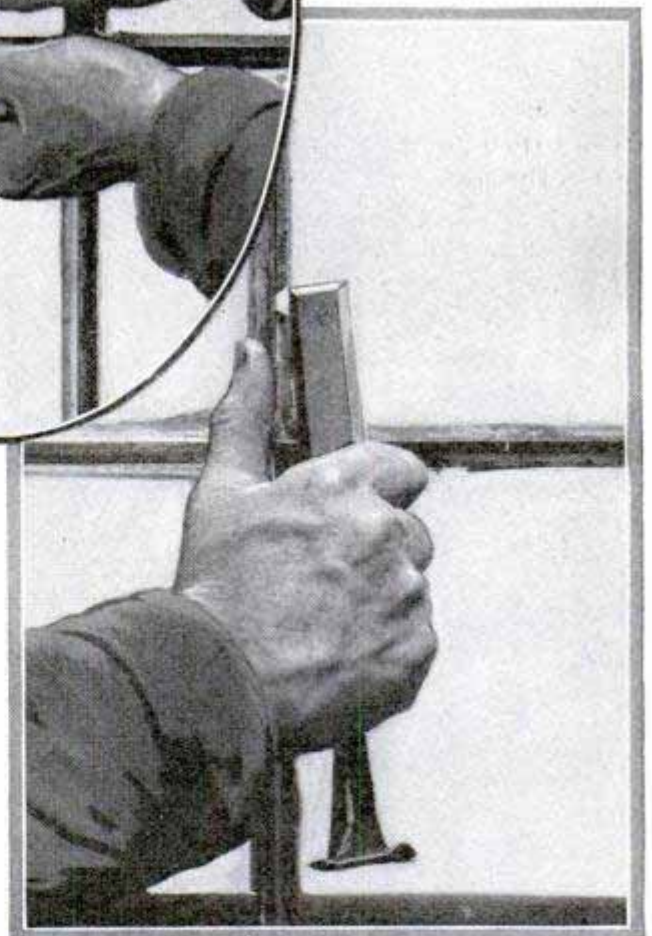
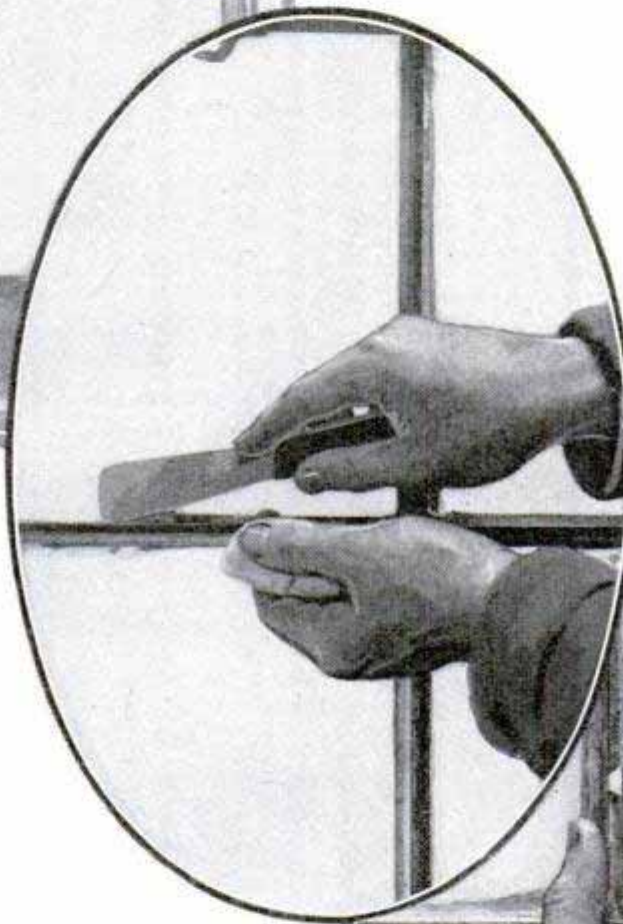

Top, Painting Frame before Setting Pane; Center, Putting On Layer of Bedding Putty; Bottom, Method of Forcing In Glazing Points

If you do not feel competent to measure and cut the glass yourself, have it done at the shop where you buy it. If you cut your own glass, cut it $\frac{1}{8}$ in. smaller than the inside measurements of the sash opening, to allow for uneven breaking of the glass and any bumps in the wood that may have been overlooked. Cut the glass on an absolutely level bench. An old marble slab is ideal for this purpose. Be sure that the surface on which the glass is laid is free from grit or dirt. Little bits of dirt under the glass will almost always cause fractures when pressure is applied.

Before placing the glass in the sash, run a thin backing of very soft putty around the inside of the opening against the stops. This provides a soft bed for the glass to rest on and against, and also prevents water from leaking in as it runs down from the sweating glass. It is amazing how rapidly this moisture will work under the glass if such a putty backing is not provided. This will quickly rot the wood and materially hasten crumbling of the outside putty. Press the glass gently against this putty bed and insert the glaziers' points against the outside of the glass. Do not use too many, and press them firmly into the wood with the thick edge of a flat tool, such as a chisel. Never strike the points if it can be avoided, and be careful not to press the point or the tool against the glass. Just allow the point to clear the glass and press directly down on its top edge with the tool. If glaziers' points cannot be obtained you can use old phonograph needles or even small brads. Regular points, however, are preferable. Force the point well down into the wood to within at least $\frac{1}{8}$ in. of its top, to insure that it will be well covered with putty.

Puttying a window light is an art and not everyone can do a workmanlike job. However, going at it in the right manner helps considerably. A great deal depends on the consistency of the putty and the kind of knife used. The tool preferred by most glaziers is one having a rather long blade, about $1\frac{1}{2}$ in. wide and fairly flexible. One corner should be rounded slightly and the other ground sharp. Thus the putty can be drawn along the glass to a feather edge with the rounded side and the corners molded nicely with the sharp one. The flexible blade is preferable to a stiff one be-

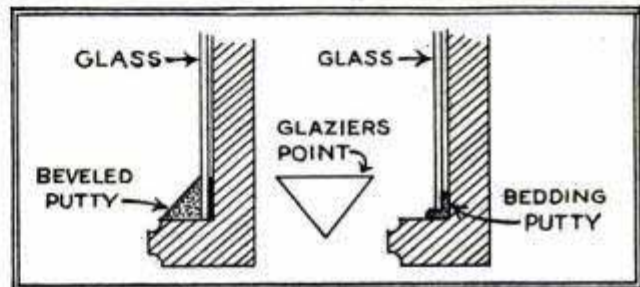
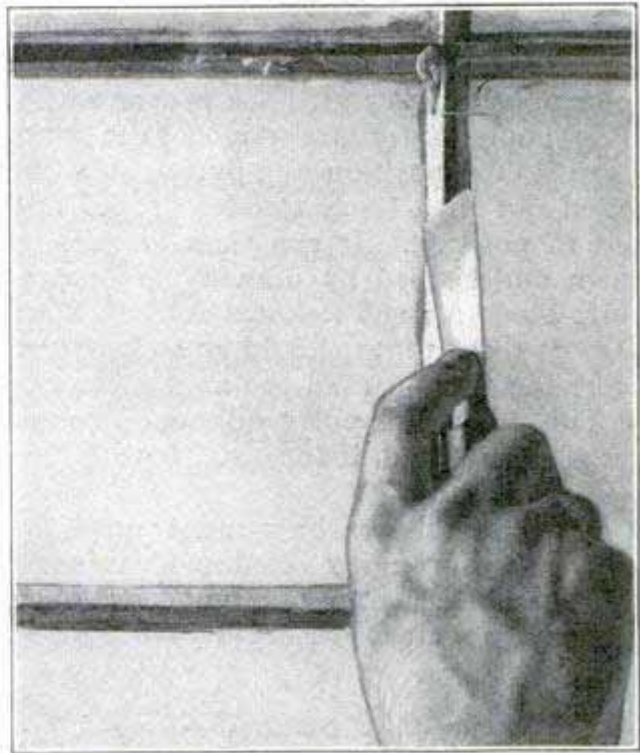

How a Putty Knife Is Used to Smooth Down the Putty "Rope" Evenly

cause the "give" takes up some of the unevenness of the hand pressure when running the putty, and produces a more even surface than a stiff blade.

There are many brands of good putty on the market; most of them consist of a mixture of whiting and linseed oil, ground to a thick paste and kept in air-tight containers. The chief trouble with such putty is that it is short-lived under severe weathering even when protected with sufficient paint. It can be made at home by simply mixing whiting and linseed oil on a sheet of glass with a putty knife. A better putty can be made, however, by using equal parts of whiting and white lead, stirring these parts well together and then adding just enough linseed oil to give the proper consistency. This putty will not crack or crumble like that made of whiting alone and will last from three to four times as long as the latter under similar conditions.

Sometimes, to match the house trim, it is desirable to color the putty. This can be done by the addition of dry coloring mat-

ter: lampblack for black putty, carmine for red putty, and so on. Use only enough coloring matter to give the proper tint.

To apply putty properly to the glass when it is in position, the putty should be rolled out in a long, slender "rope" and laid in position. It can then be pressed down and shaped by drawing the putty-knife blade along as shown in the photo. Two or three times should be sufficient to make the fill and then the next piece can be laid. Too thick putty will bunch up under the knife and, if too thin, it will stick and draw out.

Paint should not be applied until the putty has thoroughly dried and hardened. This may be a matter of a few days, but it will pay to wait. Fresh putty, if painted,

will eventually cause the paint to crack and peel because of shrinkage as it hardens. Give the putty at least two coats of paint, allowing several days for the first coat to dry. Daubs of putty, oil and paint can be removed from the glass by first scraping off the putty with an old razor blade and later scrubbing the remaining smut off with warm vinegar. This will also aid in softening any dried paint, after which the glass can be cleaned with cleaning compound. Paint remover can also be used for the preliminary cleaning, but care should be taken to prevent it from touching the paint, the putty or the woodwork. Any remaining putty should be kept for future use and can be preserved by placing it in a jar of water.

Simple Bridge Permits Overflow

A creek near Floral, Kans., washed away every bridge that was built at one location before the bridge shown in the photo was



Low Concrete Bridge Permits Flood Water to Run over It, to Prevent Washout, While Normal Flow Passes through Openings

constructed. The openings in the concrete are large enough to carry the normal flow of the stream. When the spring rains bring the big flow, which usually lasts but a short time, the surplus water passes over the top.—S. Russell, Winfield, Kans.

Relining Brake Bands

Like many a Ford owner, I repeatedly have to go to the trouble of removing the transmission-case cover, starter, etc., in order to reline the brake band. Two out of

three times, the clutch and reverse bands are still in good condition and all that labor has to be performed just to reline the brake. I would have liked to install a set of quick-change bands but could not afford the initial cost. One day when the brake gave out, I resolved to try using only one of the quick-change bands, already lined, which cost about 80 cents. After purchasing one, I drained the oil out of the transmission and removed the plate. With an old, sharp screwdriver I sliced off the first two rivets on the left-hand ear of the brake band. Removing the nut, slotted washer and spring, I slipped the brake pedal out of the case so

that I was able to turn the band to the right. After a short effort, I succeeded in cutting off the third rivet. With a little prying, the ear left the band and permitted me to slip the band out from the right-hand side. I was all ready now to slip in the new relined brake with its patent removable ear. The band slipped down all right but wouldn't come up again. Finally I pulled the band out, threaded a stout wire through the left-hand side and hooked it on the raised rivet of the band. Again threading the band through

the right-hand side and pulling steadily on the wire from the left, the band adjusted itself nicely and correctly into place. Locking the car and reassembling the brake pedal took only a few minutes. I then flushed the case with kerosene to remove any rivet chips, refilled it with oil, replaced the plate, and found that the work had only taken about $1\frac{1}{2}$ hours, whereas it formerly took fully $3\frac{1}{2}$ hours to reline the brake in the old way. Now, with the patent band already installed, it takes only about 25 minutes to reline it.—Geo. W. Boehmer, Portland, Oreg.

Labor-Saving Filling Device

The filler shown in the illustration has helped a western manufacturer of automobile polish solve the problem of efficient canning. An ordinary gate valve, A, is provided, and to one side of this is fastened a lever for hand control. On the other end of the valve shaft is attached an arm for operating the trap mechanism B. When the valve is completely closed, the steel ball in the bottom of the trap is raised, allowing the liquid to flow through the bottom opening into a container. When the valve is opened, the steel ball drops and closes the opening, so that the trap can be rapidly filled. While this is taking place, the operator is replacing the previously filled container with an empty one, and the process is repeated. The trap is constructed of heavy brass, and is fitted with a screw top, which can readily be removed for cleaning.

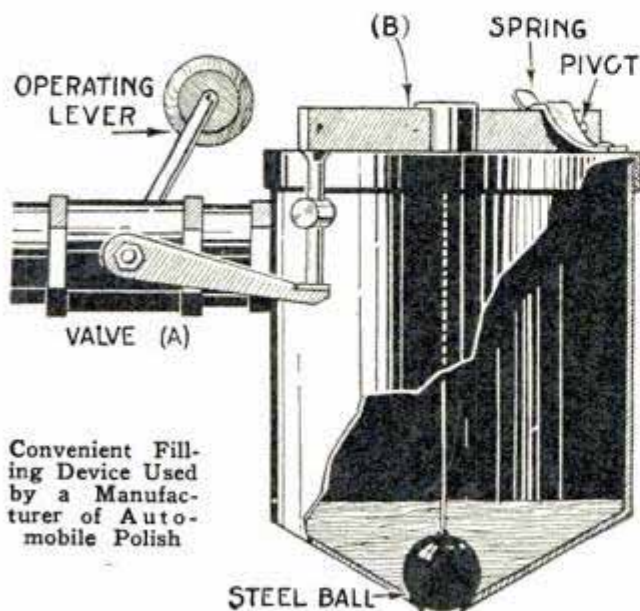

Convenient Filling Device Used by a Manufacturer of Automobile Polish

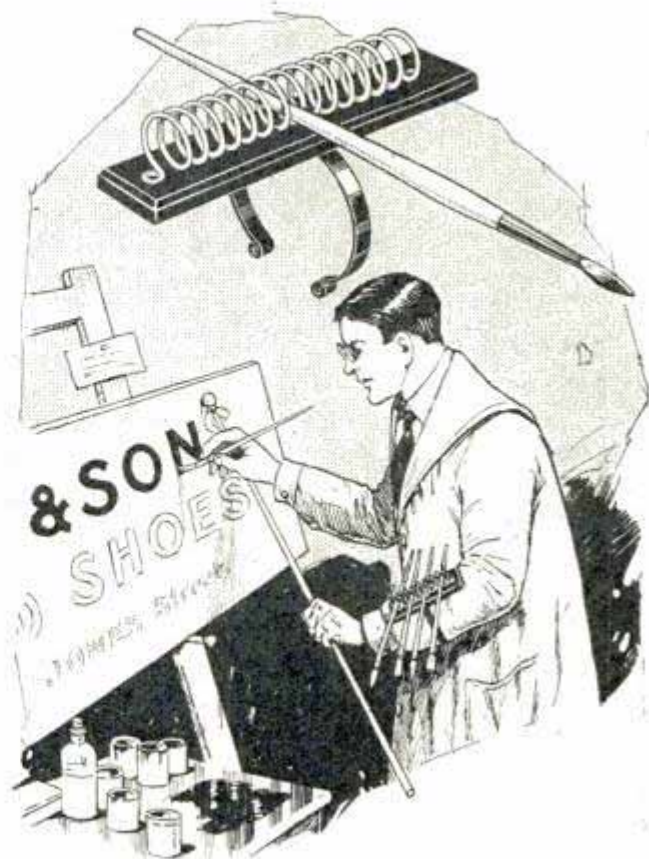

Coil-Spring Pen Rack and Cyclists' Trousers Guard Make Good Brush Holder for the Sign Painter

Holder for Sign Painters' Small Brushes

Sign painters often work in positions where they are much inconvenienced in keeping a selection of small brushes at hand and ready for instant use. This was overcome by a Wisconsin sign writer by soldering a coil-spring pen rack onto a cyclists' trousers guard. This improvised holder can be clamped on the worker's forearm and will hold quite a number of brushes at one time.—G. E. Hendrickson, Argyle, Wis.

Repairing Marble

With a little practice any mechanic can repair holes, cracks or chipped places on marble slabs, so that the patched place cannot be detected from the natural marble. Use the following mixture as a base for the filler: Water glass, 10 parts; calcined magnesite, 2 parts, and powdered marble, 4 parts. These should be mixed thoroughly to a semifluid paste. Fill the crack or hole and smooth off level, then with a camel's-hair brush and colors, made of aniline in alcohol, work out the veins, body colors, etc., as near to the natural marble as possible.

Improved Wood-Steaming Chamber

When pieces of wood have to be bent they should be steamed to make them pliable. A quickly improvised device, which

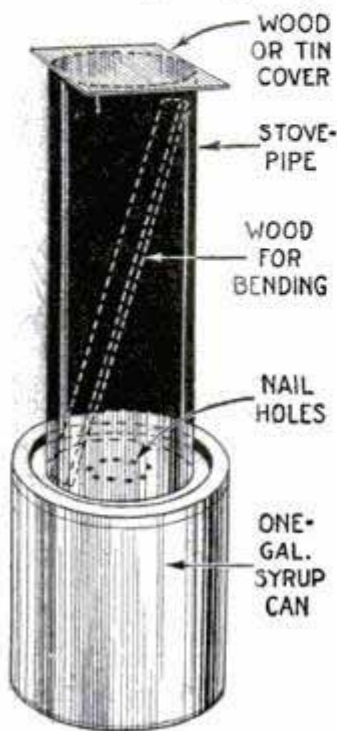

will do the work thoroughly is shown in the illustration. It consists of a 1-gal. sirup can and a section of stove-pipe with a piece of wood or sheet metal for a cover. Holes are punched in the lid of the pail near the center. The stovepipe is set on the lid over the holes, the piece of wood is placed inside of the pipe and the cover put on. The can, partly filled

with water, is placed over a slow, steady fire. Steam rises into the stovepipe and, after the wood has been steamed for about 10 minutes, it is usually as pliable as desired, and can be removed for bending.—O. W. Timm, Eagle Rock, Calif.

Harness Hanger

On my little farm are a number of labor-saving devices, the best of which, I think, is my method of hitching and unhitching, which is similar to that used in fire-engine houses. In the barn, directly over the point where the horse stops, two single pulleys are attached to the ceiling, and one double pulley is attached to the ceiling near the side wall. A sack filled with enough sand to make it a little heavier than the harness and shafts, is tied with two sash cords, which run up to the double pulley, branch out to the two single pulleys, and then drop to the level of a horse's back, where they are fitted with large hooks, one to catch in the saddle on the back band, and the other to catch the harness just in front of the crupper. The buckles on the harness are replaced with snaps. Patent fasteners are placed on the hames and collar. These can be obtained

at any harness shop. The horse is driven under the device and stopped at a point where the front hook is directly over the saddle. The two hooks are attached to the harness, the belly band, hames and lines are unsnapped, and the harness and shafts are lifted from the horse by the weight. The whole operation requires less than two minutes. This method of hitching and unhitching has other advantages. As stated, there are no buckles to unfasten, which is a great convenience, especially on a cold or wet night. The traces, hold and back straps, and lines, all remain fastened to the wagon. The harness is never in the mud or dirt, nor does it become misplaced. To hitch up takes no more time than unhitching. The whole outfit of pulleys, sash cord, snaps, etc., costs less than a dollar.—H. P. Ijams, Knoxville, Tenn.

Protecting Glass When Painting Auto

A spray gun is often used in painting cars, and if the paint comes in contact with the glass, it means a few hours' additional work to clean it. This trouble can be prevented by the use of old newspapers and adhesive or friction tape. The sheets of paper are held against the glass and the tape is used as a binding that fits closely along the edges of the glass, leaving none of it exposed.

When the fenders are to be painted in a color differing from that of the body, the same plan may be used to prevent the paint from getting on the parts that are not to be painted.

Sheets of tin, about 8 by 10 in. in dimensions, are inserted between the running-board shields and the body. This idea is applicable whether you use a brush or spray, and will save quite a bit of labor when painting window frames of any kind.

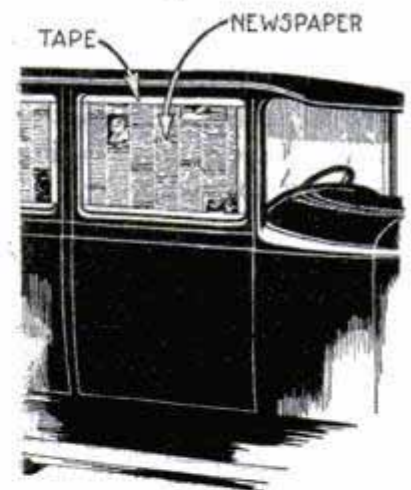

Ⓞ A machine should never be stopped in the midst of a fine cut.

How to Etch Brass and Copper

By H. N. DURHAM

ETCHED brass and copper articles are at present enjoying a wide popularity. The process of making these pieces is very simple and can be carried out by anyone without any special equipment or great outlay of money for material. Briefly, the steps in the process are laying the ground, cutting and biting. The first involves the coating of the object with an acid-proof layer of varnish. This layer is cut with a sharp point to bare the metal in places, according to a selected design, whereupon the object is immersed in an acid bath which eats away the unprotected parts. The metal is then cleaned and the whole process is complete.

The ground or acid-proof varnish is a mixture of rosin and wax, which is soluble in turpentine and can be easily melted. One can either buy it already prepared or make it at home. The following formulas have been found to be very satisfactory: A transparent ground may be made by putting 1 oz. of rosin and 2 oz. of white beeswax in a small dish and heating it over a gentle flame until the rosin and wax simmer and are thor-

oughly mixed. The mass is then allowed to cool, removed from the dish and formed into a small ball, which is tied up in a stout piece of silk cloth. Another ground, slightly more troublesome to make but giving better results, is made by melting



FIG. 2

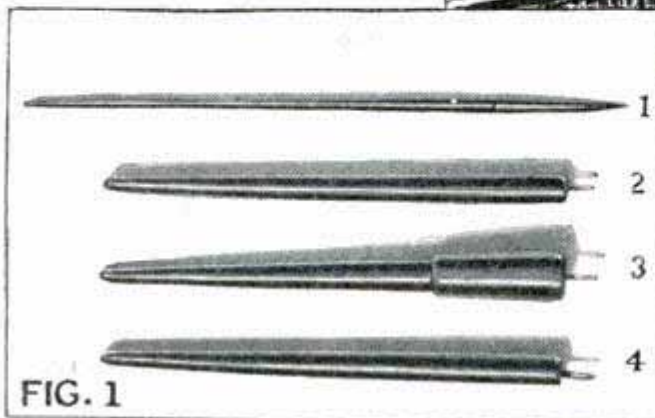

FIG. 1

2 oz. of finely powdered asphaltum over a small flame and adding 1 oz. of Burgundy pitch and 1½ oz. of white beeswax. The whole melted mass is stirred to thoroughly mix the ingredients, then poured into warm water and further mixed by kneading in the hands, after which it is made up into balls as before. Liquid grounds can be made by dissolving either of the

above in turpentine so as to produce a free-flowing solution.

The etching points can be made from phonograph needles, or from a pointed bar of steel. They may be mounted in a piece of wood, shaped like a penholder, by forming a hole in the flat end of the wood and pressing the blunt end of the needle into it. The sharp point of the needle should then be ground off by rubbing on an emery stone or emery paper. The needle should be so held and turned during this operation as to produce a ball-pointed end. Several such needles will be needed and should be ground to different degrees of bluntness, as indicated in Fig. 1, for lines of different widths. A needle with a flat end, like a screw-driver blade, will also be found useful for very wide lines.

The etching solution is made by dissolving 4 oz. of ferric chloride in a pint of water and adding 1 oz. of concentrated hydrochloric (muriatic) acid. This will etch reasonably fast and can be handled without danger. A quicker solution can be made either by substituting nitric acid for the hydrochloric, or by diluting one part of nitric acid with six parts of water and adding a little sal-ammoniac—about a teaspoonful to 1 pt. of diluted acid. Either of the above solutions may be made more vigorous by increasing the proportion of acid, but this must not be overdone, as the ground will break down if the acid is too concentrated.

In addition to the above materials, there will be needed some tailors' wax, turpentine, a small camel's-hair brush, carbon paper, a ruler and a pair of dividers.

The objects to be decorated may be of any shape desired, but they should have a comparatively large smooth surface on

which to place the design so it will show up to advantage and will not be lost in the confusion of the rest of the ornament. They may be either brass or copper, as the procedure with either is the same. The article should first be thoroughly cleaned to remove all traces of grease, by immersing it in a solution

made by dissolving two tablespoonfuls of caustic soda (or lye) in 1 pt. of water. It is then washed in either hot or cold water until all the caustic soda is removed, and dried by rubbing with an absorbent cloth, care being taken not to touch with the fingers the portions to receive the design.

If the ground is to be used as a ball, the article is warmed over a gas flame, holding it with a pair of pliers, until it has become

a little warmer than is just necessary to melt the ground. It is then held with one hand and the ball, tied up in a piece of stout silk (Fig. 2), rubbed over the entire surface, coating it with a thin film. If the film is uneven the object may be again heated, this time a little hotter, to spread out and smooth the coating. If the film is too thick, heat it quite strongly, but not so hot as to make it smoke, and tilt it so the excess ground will run off the edge. Liquid ground is laid in an entirely different manner; a quantity of the ground, considerably more than is needed to coat the surface evenly, is poured from the bottle onto the object while it is held horizontally. It is then tilted from side to side, to cause the ground to run and evenly coat the entire upper surface, taking care that it does not run over the edge. When the object has been completely and evenly coated the surplus liquid is poured back into the bottle. A little practice is needed to effect an even and clean coating in this manner, but once the knack of it is ac-



quired, there will be no difficulty. The object should then be allowed to dry, and when practically all the turpentine has evaporated, it may be heated to hasten and complete drying, thus hardening the coating. As soon as it has cooled, the ground will be hard and ready for proceeding further with the work.

It is usually desirable to transfer the entire design to the surface to be decorated before actual cutting with the point is started. If the design one wishes to use has been recently printed, as, for instance, designs in newspapers, the transfer is easily accomplished by merely placing the printed side of the paper against the waxy coating and rubbing the back of the paper with the finger nail or the bowl of a spoon. This will transfer a clear copy of the design to the ground, which will show very well, especially on transparent ground. If the paper is old and the ink dry, the sheet should first be moistened with turpentine. If it is not practicable to use printed impressions, you can make a tracing of the design and place this on the uncoated side of a sheet of carbon paper, which is then placed over the surface to be etched. The design is traced with a sharp medium-hard pen-

cil to transfer it onto the ground. The entire design may thus be transferred or only the prominent parts of it; in the latter case, the details and fine lines are put in by free-hand work while cutting the ground.

Having transferred the design to the ground, the cutting may be started, using one of the fine points. The hand, during the cutting, should rest on some support at about the same level as, or higher than, the part on which one is working. The point should be grasped as one would hold a pen or pencil and drawn over the ground with just sufficient pressure to cut through the ground. If too great pressure is used,

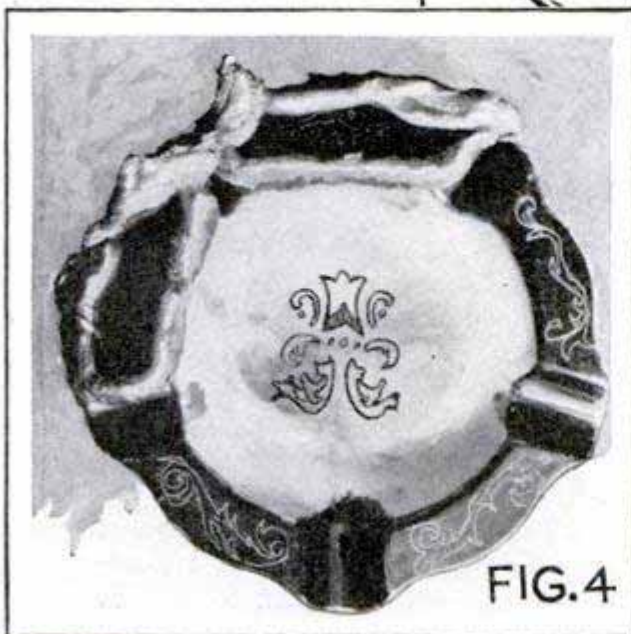
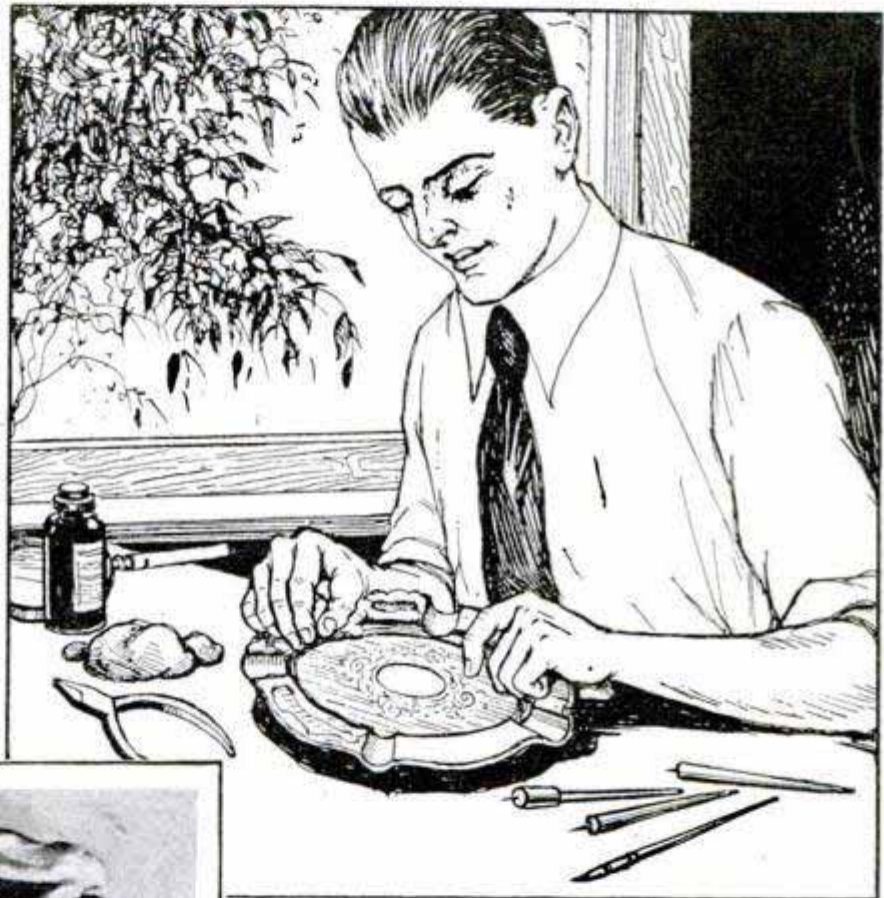
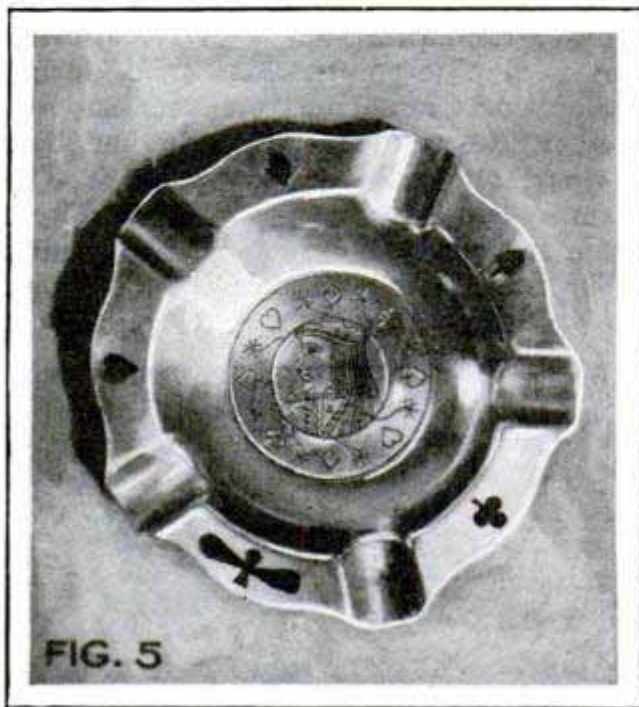

FIG. 4

the point will scratch the metal below, and make corrections more difficult. After all the lines have been put in, the design may be touched up and those lines which are to be wider in the finished design broadened with one of the blunter points. For the widest lines, and those which are to vary from narrow to wide, use the flat-pointed tool held in an upright position. Mistakes are corrected by applying some of the liquid ground over the line with a very fine brush, being careful that the ground does not run into some of the lines

correctly cut. For very fine work, a magnifying glass, Fig. 3, held in the left hand so the movements of the point can be accurately observed, will be helpful.

Small designs on large objects should be built up with a wall or dam of wax



around the part to be etched. (See Fig. 4.) A piece of wax is taken in the hand and worked until it is plastic, and is then drawn out into long strips which are placed around the design and firmly pressed against the ground. This wall should be built up until it is about $\frac{1}{2}$ in. high, so the inclosure will hold an appreciable quantity of acid. The acid is poured over the design until it nearly fills the inclosure and is left while the actual etching is carried out. The time required for the etching will have to be determined for each individual set of conditions, and will usually be somewhere between 30 and 60 minutes. Progress can be observed at any time, however, and after a single trial, the proper time can be accurately determined. If desired, one can pour out the acid, determine the depth of the bite and replace the acid if it is of insufficient depth.

With most designs it is desirable to have certain parts of the design deeper than other parts, or some parts may be etching too rapidly, for some reason or other. If so, the shallowest parts of the design should be etched to their full depth, the acid removed and the surface dried. The fully etched parts are then stopped out

by applying some of the liquid ground with a fine brush. As soon as this has dried, and it must not be heated to hasten the drying, the acid can be poured over the design again and the etching of the metal continued.

As soon as the etching has proceeded far enough the article is washed and the ground removed by wiping it with a rag moistened with turpentine. The turpentine should leave the metal perfectly clean; if one application does not take off all the ground, repeat with a clean piece of rag.

Scratches may be removed or covered by taking the high polish from the object, either by rubbing the surface with an abrasive or by immersing the article in the etching bath for a few minutes. This will produce a fine grain on the surface, dulling it and making it better in appearance. It is well to give this treatment to all articles which are likely to become scratched in use. Fig. 5 shows a completed job.

If certain parts of the design need re-touching, the object should be entirely covered with transparent ground and the lines to be deepened or widened cut through this and the article re-etched.

Additional decoration can be produced in any of the following ways: The engraved lines may be filled with molten metal; they may be filled with a colored substance, or they may be treated with a chemical to turn them dark. The effects can be endlessly varied in this manner and with many designs the addition of a little color lends much to their attractiveness.

To fill the lines of the design with a molten metal, the ground is carefully cleaned off in the usual manner and the whole surface is covered with fine-powdered tin or solder. The object is then tilted and tapped gently to cause the surplus to be removed, or the surplus may be removed by lightly touching the design with a soft brush. Then heat the object to melt the powdered metal remaining in the lines. Dust or powder from filing or similar operations forms a suitable substance to be used in thus filling the lines.

The same general procedure is adopted to fill the lines with colored material and, for this purpose, powdered sealing wax will work well. Brilliant colors may thus be obtained, and even several colors can

be produced on the same piece in the following manner: The entire design is coated with sealing wax of one color and the surplus removed as for single-color work. The wax in those lines which are to be of another color is removed by brushing it from the lines with a fine stiff brush, and the object heated to melt the wax. The remaining lines are filled in the same manner and the object again heated. If the lines are to be merely darkened, the object is not washed after the final etching, and the etching solution is replaced by a solution of a sulphide, such as sodium sulphide. This forms a black compound with the brass or copper and provides a very durable color which is not easily rubbed off.

Etching is not only interesting but very decorative, and useful gifts can be made in this manner. It can also be made a very profitable source of income if one has the time to devote to it.

Rapid Method of Coloring Backgrounds

A southern manufacturer of bas-relief aluminum signs uses a rapid method of coloring the backgrounds neatly without having to "cut in" carefully with a brush around the lettering. He uses brushing lacquer in bright colors, which dries almost immediately. The workmen, who need not be skilled, simply apply the lacquer over lettering and all. Then they quickly wipe a blotter wetted in gasoline over the surface of the raised letters, removing the color there without disturbing



Quick Method of Lacquering Backgrounds of Bas-Relief Cast-Aluminum Signs

the background. This method is not only very fast but also economical.—R. T. Bly, Birmingham, Ala.



Coiling Rope in Washtub Facilitates Carrying It and Prevents Tangling

Coiling Rope in Tub Makes Job Easy

Anyone who has had occasion to use a large coil of rope knows how difficult it is to handle it, due to its bulkiness and tendency to tangle. A sand-blast company, which uses much hemp rope for hoisting scaffolds, has an employe who conceived the idea of coiling the rope in a large galvanized tub. In this way he eliminates the problems of handling and storing it. The tub can be picked up and moved about easily without dropping a portion of the coil, which would invariably result in a tangle.

Keeping Plaster of Paris Soft

For the ordinary repair job around the home and shop, plaster of paris sets too quickly. I have found that, by using equal parts of strong vinegar and water, in which the plaster is mixed, the process of setting can be delayed for 15 to 30 minutes. One teaspoonful of cream of tartar to each quart of water is also effective.—Julion Close, Elmira, N. Y.

*The Anderson Brass Works,
Birmingham Ala. Attn: Mr. Bly*

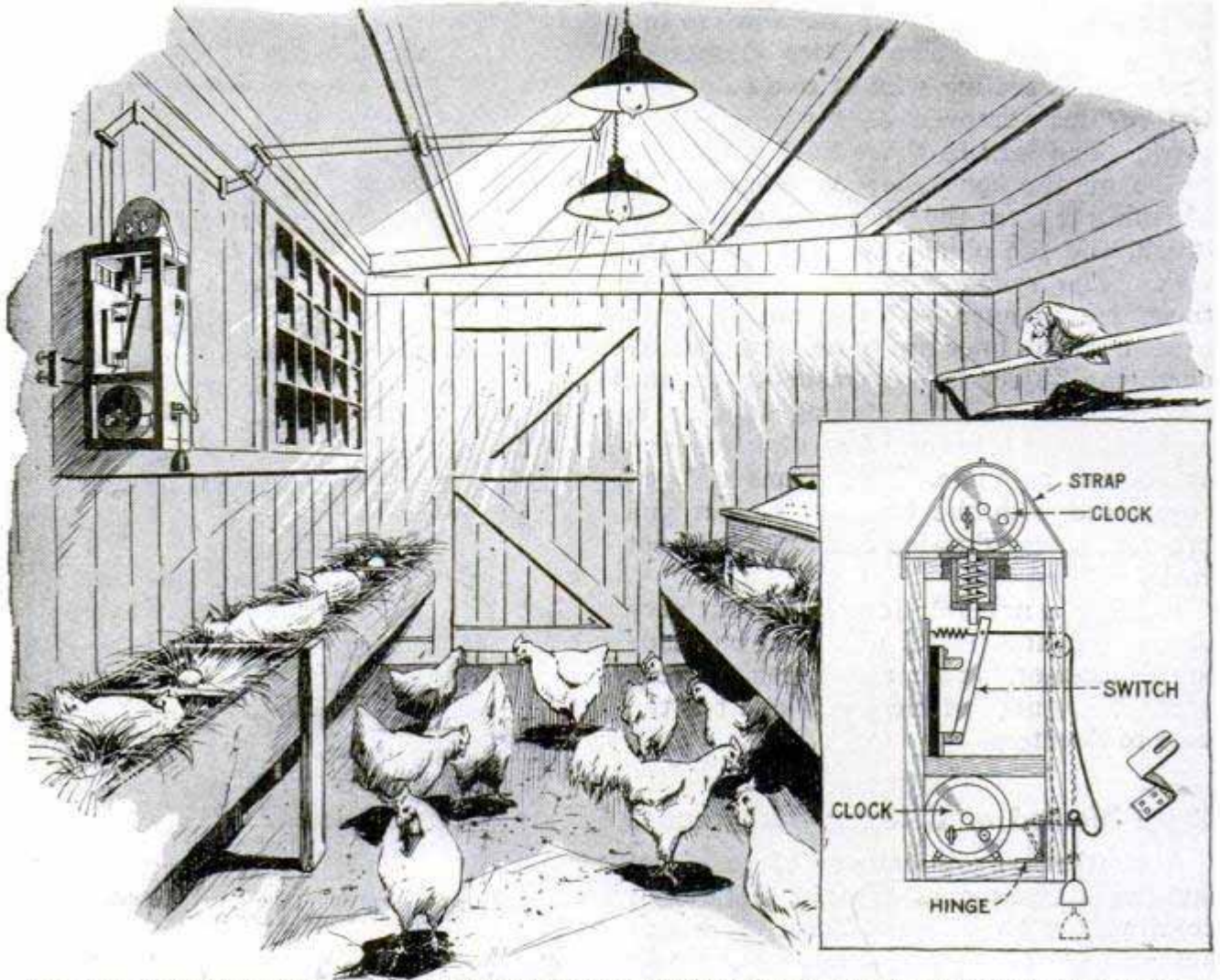

Any Poultryman Who Has Two Extra Alarm Clocks Can Readily Construct This Automatic Switch for Turning the Hen-House Lights On and Off to Increase the Hen's Working Day

Automatic Switch for Poultrymen

Poultrymen have found that using electric lights to lengthen the hen's working day increases profits. To turn the lights on and off automatically, a western man built the simple alarm-clock operated device shown in the illustration. It can be made as follows: Build a two-compartment box of 1-in. stock, of such dimensions that an alarm clock, with its bell and clapper removed, fits snugly in the lower section, with about 1½ in. to spare at one side, while the upper section has a 2-in. clearance above the handle of a s.p.s.t. knife switch. Get a light strap hinge and bend 1½ in. of the end at right angles. Cut a slot, 1 in. long, as shown in the detail. Cut a hole through the side of the case to permit the movement of this forked end, and screw the hinge to the bottom as indicated. Mount the switch vertically in the upper compartment. A 4-in. length of 5/8-in. hardwood dowel stock is pierced

1 in. from the end with a piece of a small nail, against which a washer is placed to take the thrust of a light coil spring. The upper end of this assembly passes through a 7/16-in. hole in the case, suitably placed, and over the lower end a small guide box of ¼-in. stock is slipped, to be nailed to the case. Allow the nail ends to project through saw kerfs in the guide-box sides, both to prevent the plunger from falling out and to prevent twisting. Tie a stout string to the upper end of the hinge, and wind it around the button of the alarm spring of the clock in such a direction that, when this revolves, the string will pull the hinge. Mount another alarm clock on top, fastening it with a leather strap, as shown. Connect the switch plunger with the alarm button by means of a string. Close the switch, and cut a light spring (a curtain spring will do) to hook between the handle and a screwhook in the opposite side of the case. Tie a string to the handle, pass the other end through a hole

in the case and over a small pulley, and tie to it a weight of about $\frac{1}{2}$ lb.

To start the device, set the lower clock for the time of turning off the lights. the fork of the hinge projecting horizontally beyond the case. Set the upper clock for the time that the lights are to be turned on, opening the switch and allowing the plunger to snap down behind the blade and hold it there against the tension of the spring. Tie a nail to the weight string in such a position that, when rested on the fork of the hinge, the string above will hang slack. When the time comes for the lights to go on, the button of the upper clock revolves, lifting the plunger, whereupon the spring closes the switch. At turning-off time, the lower clock operates, withdrawing support from the weight, which drops and pulls open the switch against its spring tension, where it is locked by the plunger. It is, of course, necessary to wind the clocks daily in order to keep the device running.

Spring Opener for Work Vise

After a bench vise has been in use for a considerable length of time there is a certain amount of backlash in the screw, and

the movable jaw does not respond when the vise is opened until the handle has been turned, in some cases, almost twice. To remedy this defect, a spring was made, which presses the jaws apart, so that the vise

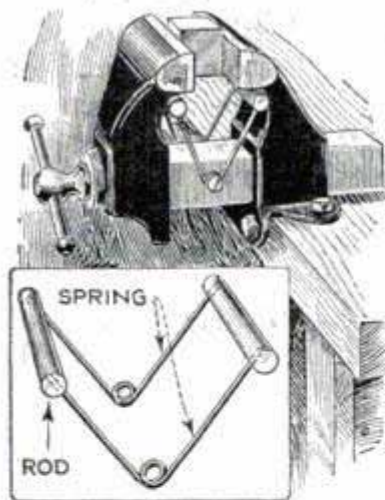

opens immediately the handle is turned. The device consists of two springs, which are driven into two rods, and is fitted between the jaws, as shown in the drawing. The one we made had sufficient pressure to open the jaws 3 in. We found the spring particularly handy when repetition work was done and the vise had to be opened and closed often.—Harry Moore, Montreal, Can.

Pipe Carrier for Drain Tiles

When a large piece of ground is to be drained many tiles have to be carried to



Handy Tile Carrier Made of Pipe and Fittings Eliminates the Necessity of Frequent Stooping

the drain ditches and deposited in position. With the carrier shown in the drawing, this work can be lightened considerably, as with it, the tiles can be picked up, carried and deposited without so much stooping. Connect two lengths of $\frac{1}{2}$ -in. pipe with two elbows and a nipple, as indicated. This can be arranged to suit, but room enough for the hand must be left between the tile and the handle. By making the bottom pipe sufficiently long, two tiles can be carried at a time, if desired. Protect the tile by slipping an old piece of rubber hose over the pipe. A short piece of hose on the handle will also make a better grip.—L. B. Robbins, Harwich, Massachusetts.

Polish for Ferrotypes Plates

Paraffin, dissolved in gasoline is an excellent polish for photographers' ferrotypes plates. A tablespoonful of paraffin in 1 pt. of gasoline is a good proportion.—Philip S. Mentz, Jefferson Barracks, Mo.



BUILDING A "PRISCILLA" SEWING CABINET

By Edwin M. Love

THE usefulness and simplicity of this sewing cabinet especially adapts it to home construction. Built of mahogany, or of red gum stained to imitate either mahogany or walnut, it is a handsome piece of furniture. Only 1-in. stock need be bought, as the thinner wood for lids and tray can be made from this by surfacing down, or by ripping with a handsaw.

The ends of the cabinet are detailed in Fig. 1. Rule a 6 by 26-in. piece of cardboard with lines 1 in. apart, forming squares, by which the curved outline of half the leg can be copied. The straight edges slope $1\frac{1}{4}$ in. in 8 in. of length. The lower end is cut in an arc of $3\frac{1}{4}$ -in. radius, with a smaller circle above of $\frac{3}{4}$ -in. radius, centered $3\frac{3}{4}$ in. above the lower end. Cut out the pattern, and trace on 1 by 12-in. stock, using a center line as a guide.

Shape a cabinet end, using the larger tools where possible, since they cut fast. Smooth the edges carefully, and, if desired, trim the corners of the ends, below the box itself, to give the edges a semicircular profile. On the inner face, centering on

the stock, cut a $\frac{1}{2}$ by $1\frac{1}{4}$ -in. mortise, $\frac{1}{2}$ in. deep, to receive the stretcher tenon. Make the mortise accurately, since the gluing surface is small, and the joint should be as strong as possible.

On the inner face make a groove, $\frac{1}{4}$ in. deep and $\frac{3}{4}$ in. wide, parallel to each edge and $\frac{1}{4}$ in. from it. The shape of the end permits the plow plane to be used with a through stroke, without the end of the joint being exposed to view. Make the other end exactly like the first.

The two sides, detailed in Fig. 2, are rectangles, $8\frac{3}{4}$ by 12 in., cut from 1-in. stock. In one edge of each cut a rabbet $\frac{3}{8}$ by $\frac{1}{2}$ in., tipping the plane to slope the shoulder so that the bottom will make a tight joint with the side inside, when assembled. Since this joint is not depended on for great strength, it may be undercut to insure a tight contact. Size the ends with thin glue to partly seal the pores and lay aside to dry.

Make the stretcher of 1-in. stock, $12\frac{1}{2}$ in. long. Rip and joint it to 2 in. in width, rip a new edge $3\frac{3}{4}$ in. from each end and $\frac{1}{2}$ in. from the upper edge, and curve up to the edge with a radius of $\frac{1}{2}$ in., leaving the raised part 4 in. long. In the same way cut back the lower edge $\frac{1}{4}$ in. for a distance of $4\frac{1}{2}$ in. from each end, finishing with arcs of $\frac{1}{4}$ -in. radius and leaving the raised center 3 in. long. Smooth the edges, and, centering on the ends, with the lower edges flush with the stretcher edge, make tenons, $\frac{1}{4}$ in. thick, $1\frac{1}{4}$ in. wide and $\frac{1}{2}$ in. long. Glue the ends to the sides and stretcher, test for squareness, and put aside to dry while making the lids and bottom.

For the bottom, rip to a thickness of

$\frac{3}{8}$ in. a piece of 1-in. stock, 8 in. wide. The thin piece ripped off, when smoothed up, can be used for building the tray. Square the bottom to the dimensions shown in Fig. 3. The two lids are rectangular pieces of $\frac{1}{2}$ -in. stock, $6\frac{1}{4}$ by 14 in. in size.

Joint the sides of the cabinet flush with the top, taking care to avoid splintering the ends, and glue and nail on the inner faces of the ends, flush with the side rabbets, two lengths of $\frac{3}{8}$ -in. quarter-round, which act as backing cleats for the ends of the bottom. Put the bottom in place, smooth side up, and nail to the sides with four-penny finish nails. Toenail the ends with 1-in. brads.

To support the tray, glue and nail two $\frac{3}{8}$ by $\frac{3}{4}$ by 6-in. cleats to the ends, as shown in Fig. 1, adding small stop blocks at the ends, to keep the tray from sliding forward. Fig. 6 shows the hanging rail, which is a piece of 1-in. stock, $1\frac{1}{2}$ in. wide,

with edges beveled $\frac{1}{8}$ in., and the ends notched $\frac{1}{4}$ in. deep and $1\frac{1}{4}$ in. long. Glue this between the upper ends of the cabinet ends, and when the glue has set, reinforce the joints with triangular brackets, cut

MATERIAL LIST

- 1 piece, 1 by 12 in. by 6 ft., mahogany or red gum.
- 1 piece, 1 by 10 in. by 4 ft., mahogany or red gum.
- 2 pairs, 1 by 1-in. brass fast-pin butts.

from 1-in. stock, glued and nailed underneath. Bevel the upper edges of the lids to fit against the rail edges, and hang with 1 by 1-in. hinges, placed 2 in. from the ends. Mortise the sides into both the rail and the lid edges.

The tray parts are detailed in Fig. 7. Cut two ends from $\frac{1}{4}$ -in. stock, $1\frac{1}{4}$ in. wide and $4\frac{1}{2}$ in. long, with the ends sloped $\frac{1}{4}$

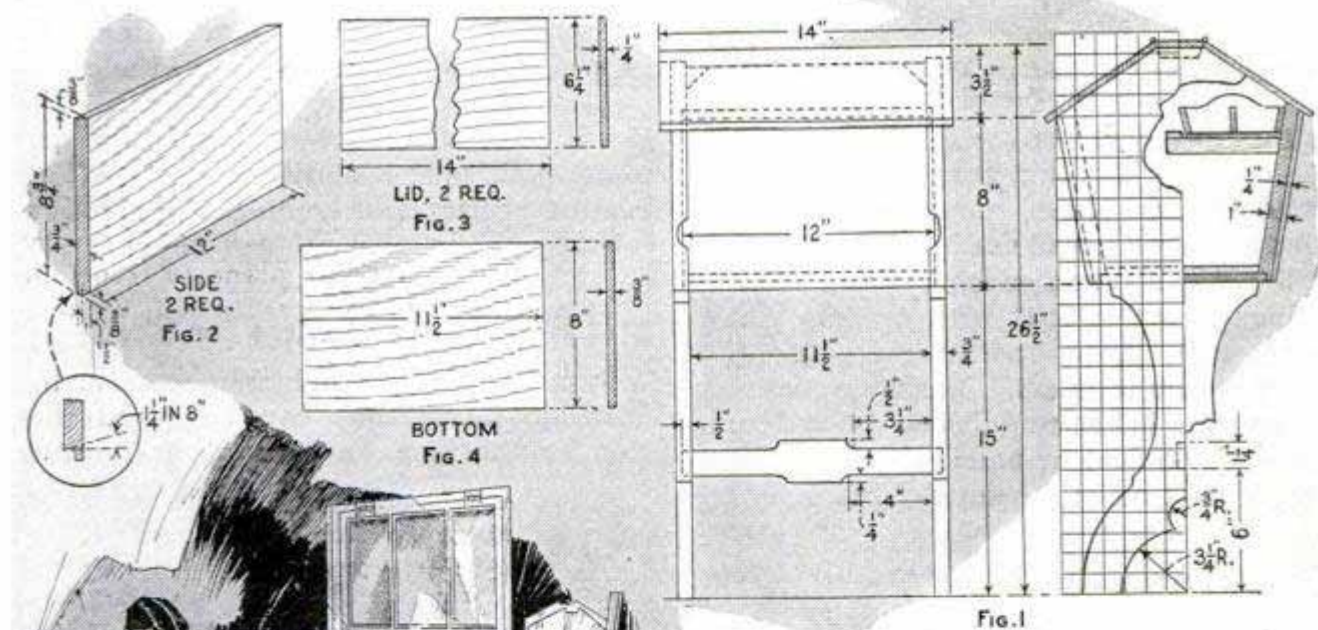

Details of Side, Lid and Bottom of Priscilla Sewing Cabinet; Also Front Elevation, and Layout of End, with Part Section

in. On the inner faces make grooves $\frac{1}{8}$ in. deep and $\frac{1}{4}$ in. wide, as shown. The short partition is similar to it, except that the upper edge is curved up for $\frac{3}{4}$ in. to provide a finger hold and, instead of being grooved, is notched from the bottom $\frac{3}{4}$ in.

The sides are of $\frac{1}{4}$ -in. stock, $15\frac{1}{8}$ in. wide and $11\frac{3}{8}$ in. long, grooved across the grain, $\frac{1}{8}$ in. deep and $\frac{1}{4}$ in. wide. Nail these to the ends, grooves in, and joint the edges flush with the ends. Then put

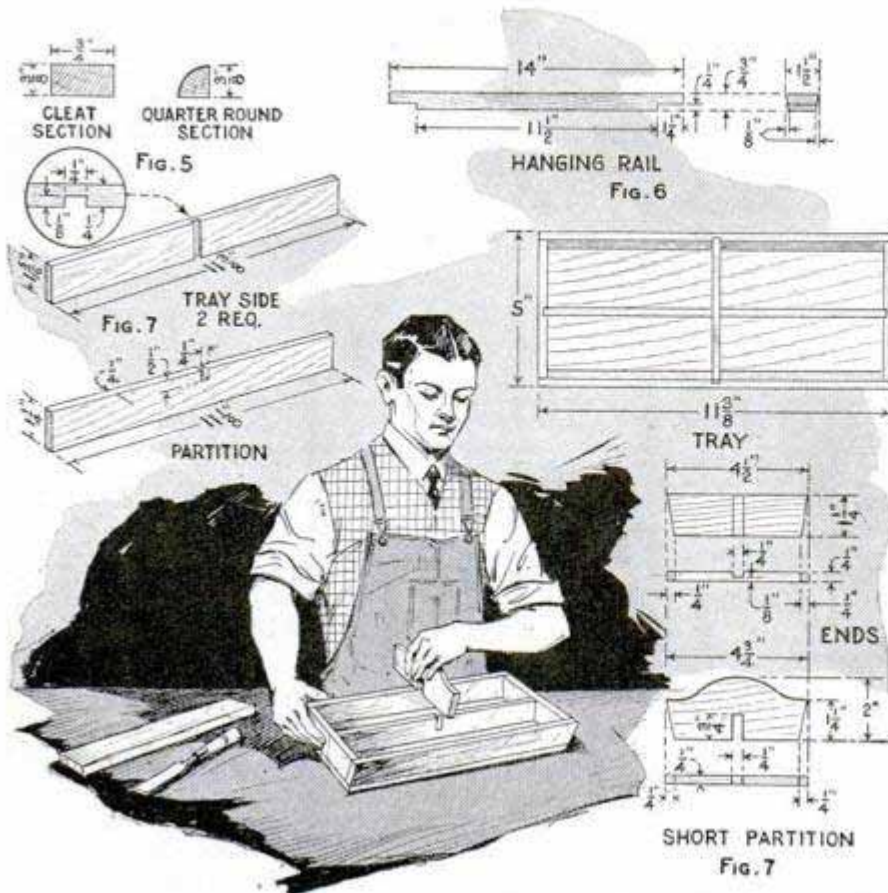

Details of Tray Construction, Cleat and Hanging Rail; the Bottom View Shows How the Tray Is Assembled

in the long partition, which is $\frac{1}{4}$ by $11\frac{1}{8}$ in., notched in the center $\frac{1}{2}$ in. deep. Straddle the short partition over this. Glue all joints. Nail the bottom, and joint flush with sides and ends.

Sponge the cabinet with a damp cloth, to raise the grain, and after drying, sand to glass smoothness. Stain as desired, leaving the inside unfinished. If red gum is used, one coat of boiled linseed oil and two of wax make a beautiful finish.

Fumigating School Books

Many times children are found in school who are suffering from some contagious disease and who are not sick enough to stay at home, and the books and other articles which have been used by them are a source of danger to other pupils. I devised a way to fumigate these articles whereby they can be disinfected at once and at very little cost. A can having a screw top and a place for a candle at the bottom is used for this purpose. A carbide can will do nicely, as it is about $2\frac{1}{2}$ ft. high and about 15 in. in diameter and the top can be screwed down tightly to keep in the gas. Formaldehyde can-

dles are used. They are set in a small tin can about $1\frac{1}{2}$ in. in diameter and $\frac{1}{2}$ in. in height. They can be obtained at a slight cost and each one is sufficient to fumigate 1,000 cu. ft. A hole is cut in the bottom of the large can so that it will admit the upper part of the candle, but the fit must be tight. The books are then placed in the can, so that they are not directly over the hole and the can is raised off the floor enough to permit the lower part of the candle to be inserted in the hole. The top of the can is screwed down firmly as soon as the gas begins to issue forth. The candle is allowed to burn about one minute or until the can is well filled with gas. The

gas is allowed to act on the books and other articles for about 7 hours. This insures perfect and complete fumigation. —George T. Palmer, Springfield, Ill.

Handy Bolt Holders for Shop

By using the bolt holders shown in the drawing, much time can be saved that would otherwise be wasted in hunting

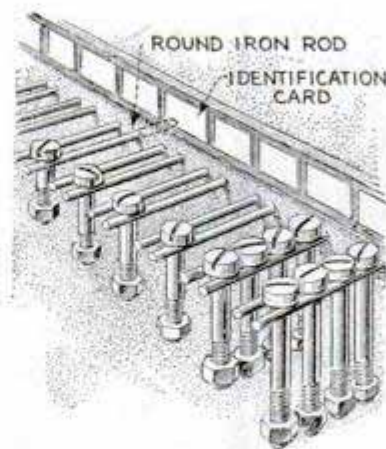

through an accumulation of bolts thrown carelessly in a drawer or box. Hung up on the holders, the bolts will always be in plain sight, being arranged according to size, thread, etc., so that they can readily be found. The holders are made by driving lengths of steel rod into holes drilled in a wall, slightly more than head-high. The rods are spaced in pairs, parallel and just far enough apart to

allow a bolt shank to be slipped between them. The bolts hang down by their heads. A board can be nailed above the holders and cards tacked to it, one above each holder, to indicate the size of the bolts. This method will be found a great convenience near a planer or other similar machine, or in a shop using bolts of various sizes in large quantities.

Non-Slip Drawing Board

I have an uncleated drawing board which I use a great deal on a larger table board. To prevent it from slipping, I got an old piece of rubber-covered extension cord, which is close to $\frac{7}{16}$ in. in diameter, cut two lengths of the cord, still in fair condition, cleaned them off and tacked them to the back of the board with small brads, sinking the heads of the brads below the rubber. These lengths of cord make the board easier to pick up and prevent it from slipping.—Frank W. Bentley, Jr., Missouri Valley, Iowa.

Automatic Shut-Off for Shop Faucet

Often a water faucet in the shop is left running with the result that there is considerable waste. To put a stop to this, one

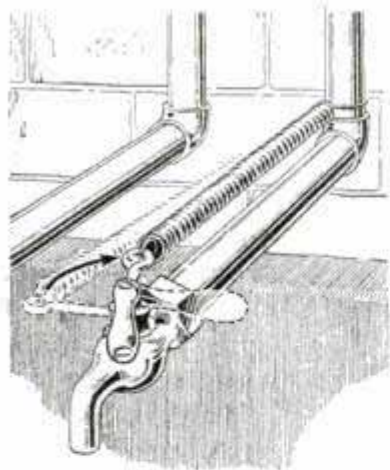

shop owner fixed the faucet so that it would turn off automatically. It was used in connection with a cleaning tank and it stood out from the wall at the end of a short pipe as indicated. The spigot was removed and a small hole drilled through it at right angles to the handle. The hole was tapped for a screw eye with a nut at the end. Then one end of a coil spring was wrapped around the pipe just above the elbow and the other end attached to the screw eye. It is easy to see that the spring will shut the water off with a snap as soon as the handle is released.—Harry Moore, Montreal, Can.

Hanger for Heavy Harness

To care for a heavy work harness in the stable in a proper manner, it must be

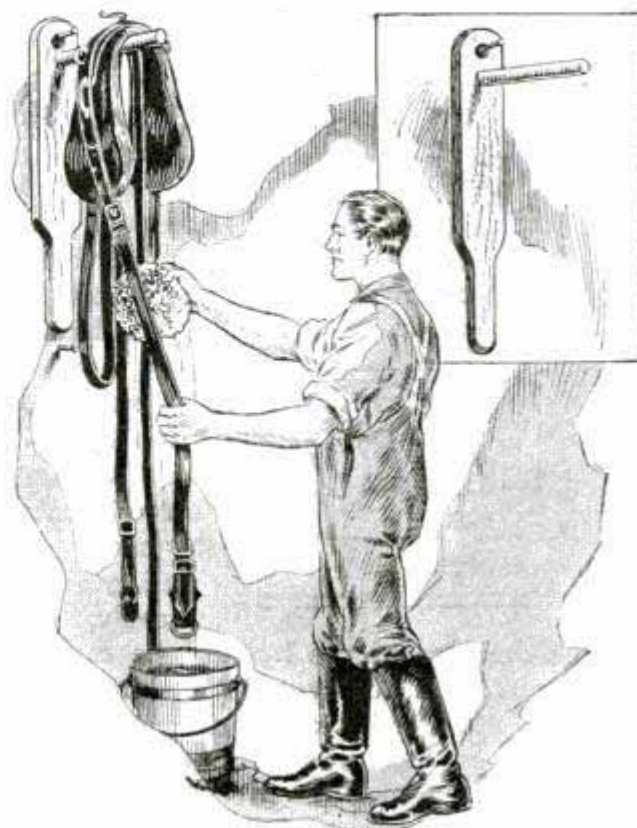

Simple Method of Raising Heavy Harness to Proper Height in Stable

supported on hooks high enough to keep the trailing ends off the damp and usually dirty floor. As it is difficult, however, to lift the heavy pieces to the necessary height and arrange them conveniently, one ingenious farmer resorted to the employment of the holder shown in the drawing. It is made from a length of 2 by 4-in. oak and a discarded fork handle, a hole being drilled through the upper end of the 2 by 4-in. piece. The nails are driven into the wall, one about 4 ft. above the floor and the other several feet higher. In use, the holder is suspended from the lower nail, the harness put on the fork handle, and the whole is then lifted to the second nail.

Old Gaskets Used Over Again

When you are unable to obtain gaskets for your auto, the old ones can perhaps be used, even if they are thin, provided they are not broken. Get some soft string, such as candle wicking, and lay this on the gasket. A little cup grease may be used to hold it in place.

Self-Centering Ring Gauge for Lathe Work

One of the difficulties encountered in the boring of large-diameter rings, flanges, etc., in the lathe, is the gauging of the work as the boring progresses. We used to have end gauges with a handle for this work, but found that considerable time was required to enter the gauge centrally and squarely, owing to the size of the hole. The trouble was overcome, however, in a simple and practical manner by knocking the handles out of the gauges and using an arbor piece in the lathe, turned on the front to enter the hole in the gauge. We made this piece long enough to allow the gauge to be slipped on it before reaching the work. As these gauges were ground to size on the ends using the hole to chuck them on an arbor, it is obvious that the gauge was presented to the work squarely by slipping it on the arbor and sliding it up.—Harry Moore, Montreal, Can.

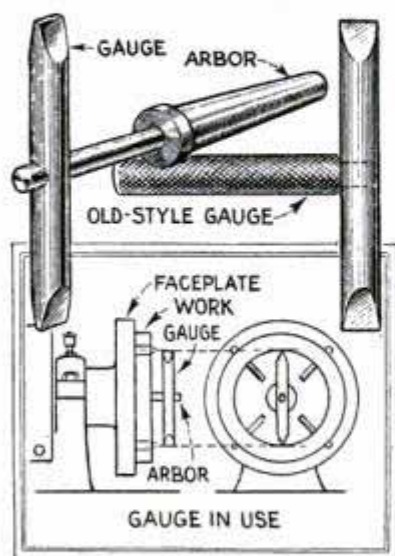

used to have end gauges with a handle for this work, but found that considerable time was required to enter the gauge centrally and squarely, owing to the size of the hole. The trouble was overcome, however, in a simple and practical manner by knocking the handles out of the gauges and using an arbor piece in the lathe, turned on the front to enter the hole in the gauge. We made this piece long enough to allow the gauge to be slipped on it before reaching the work. As these gauges were ground to size on the ends using the hole to chuck them on an arbor, it is obvious that the gauge was presented to the work squarely by slipping it on the arbor and sliding it up.—Harry Moore, Montreal, Can.

As these gauges were ground to size on the ends using the hole to chuck them on an arbor, it is obvious that the gauge was presented to the work squarely by slipping it on the arbor and sliding it up.—Harry Moore, Montreal, Can.

Inexpensive Cuts for the Multigraph

In offices where a multigraph is used for printing forms, announcements and other similar matter, it is often desirable to use a cut if an inexpensive one could be obtained. Simple line cuts, where the design is not too intricate, can be made of cork linoleum, which is used for running boards of automobiles and is easily obtained. It is of the proper thickness for the purpose, as it nearly corresponds to the height of the type. The carving away of the unnecessary cork can be done with small knives made from broken hacksaw blades, ground down on an emery wheel to the proper shape. It should be remembered that only the parts of the design to be reproduced should remain untouched;

all other space must be undercut sufficiently so that it will not take the ink. Also, the design must be drawn in reverse, especially if lettering is included. Designs can be transferred by means of carbon paper or can be drawn by hand directly on the surface of the linoleum. Lines should be fairly broad. When used with type, these cuts can be brought to the proper height by putting sheets of paper under them. The clips used to hold the type in place can also be used to hold the cut in position and, as the linoleum can readily be bent in any direction, no difficulty will be experienced in making it conform to the curve of the printing drum. Two-color effects can be obtained if the designs are carefully matched and properly placed on the drum. This is particularly effective if a solid design is used for a background with the main features of the design brought out in a contrasting ink through the use of a second cut. While these cuts are only intended as cheap substitutes for regular electrotypes, they will stand up for several thousand impressions and will lend variety and charm to otherwise ordinary work.—O. W. Blake, Oakland, Calif.

Handy Ax Holder

Keeping an ax sharp is an easy matter if the head is held in a small wooden box nailed to the wall, as shown in the photo. Besides protecting the ax from becoming dull, due to lying around and getting in contact with other tools, and from being mislaid, which is so often the case, the box can be filled with oil-soaked sawdust to protect the tool against rust. The box is made of 1-in. material and its dimensions should



be such that the ax head can readily be accommodated in it.—J. R. Kuntz, Bremen, Ind.

Uses for Old Emery Wheels

Broken emery wheels should not be thrown away. There are many uses for them about the house or home shop. Take pieces of different grades and grits; have a chunk as coarse as No. 40, a piece of No. 80 and a piece of No. 100 or 120, if possible. Every machine shop has broken wheels that can be had for the asking or at a nominal price, and they will save many a quarter for sharpening pocketknives, table hardware, scissors, pruning shears, hatchets, etc. For carpenters' tools, of course, a piece of grindstone is better than the emery wheel, but soft, fine grades of the latter will do in a pinch. Autoists will find it a handy thing in their tool box for touching up commutator parts while on the road.

Novel Shock Absorbers for the Farm Lumber Wagon

Lumber wagons on the farm are noisy and rough-riding, even when driven over the smoothest roads and fields, and especially when empty. One ingenious farmer devised a pair of simple shock absorbers that eliminate much of the jolting. A discarded auto casing was cut in two and each half slashed as shown so that it could be straightened easily. The halves were nailed onto the bolsters to serve as cushions for the wagon box.—G. E. Hendrickson, Argyle, Wis.

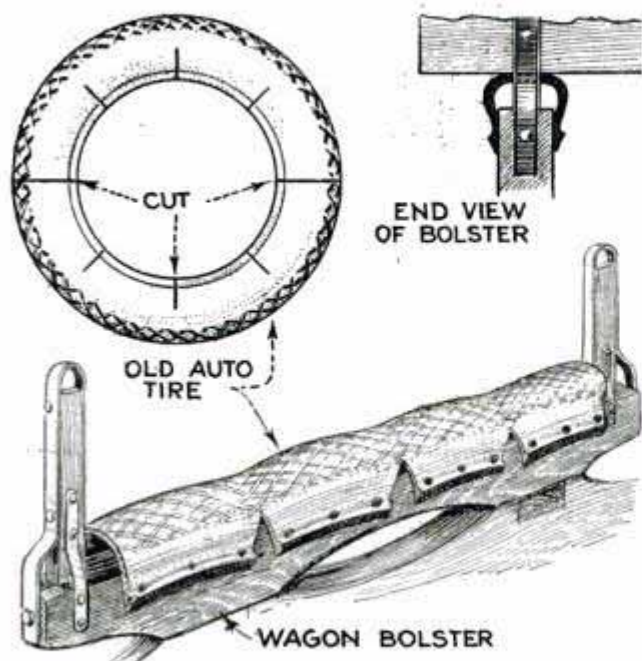

Old Auto Casing Nailed to Bolster Makes a Good Shock Absorber for Wagon

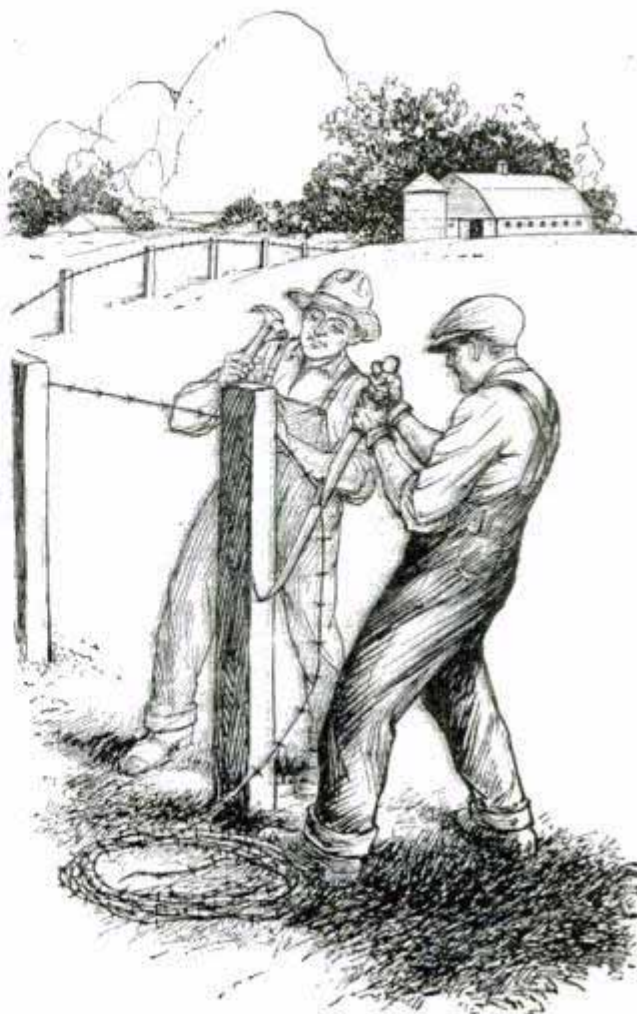

Simple Barbed-Wire Fence Tightener That Is Easily Made from an Old Spring Leaf

Tightener for Barbed-Wire Fences

Barbed wire is usually rather difficult to stretch and many devices for tightening such wire have been made, but the one shown in the drawing has been found to be among the best. It can be made from a large spring leaf, cut off so that it is about 24 in. long, and has a handle ground at the straight end. The curved end should be cut down or ground down to a point. About a third of the way from the point, a long narrow notch is cut in the center of the tool, running down toward the point. Make it similar to a hammer claw. In use, the tool is held vertically and the wire is slipped into the slot so that, when the point is brought against the post and the handle is pulled, the wire can readily be drawn tight, while an assistant staples the wire to the post.—L. B. Robbins, Harwich, Mass.

☛ Vaseline is a good cleaner for commutators while machines are in operation and under load.

2450-OK

Is This Your Home?

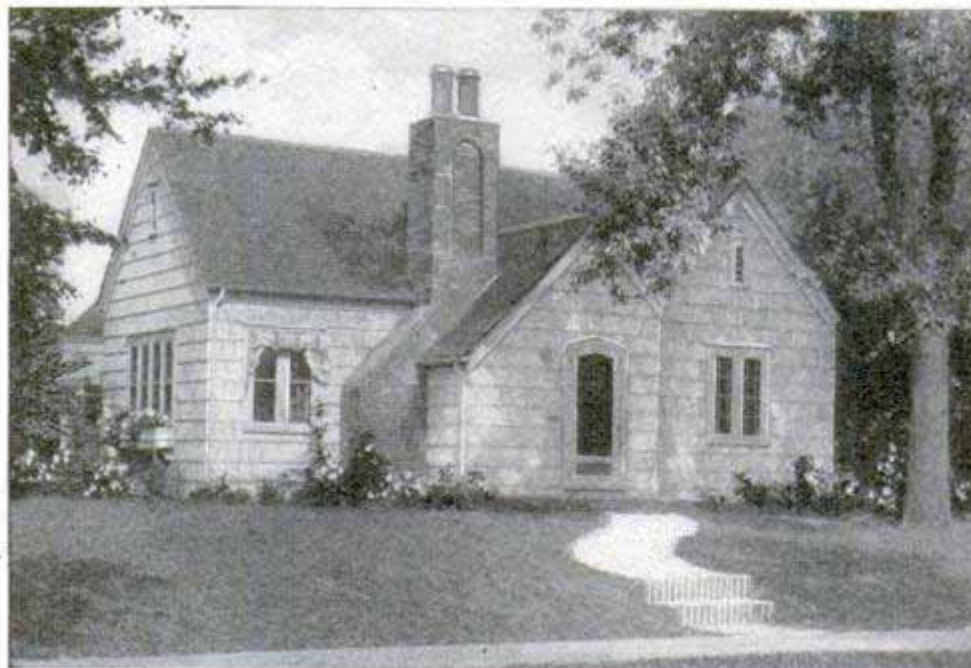

Copyright, Architects' Small House Service Bureau Plan No. 6B30

FORMAL houses of a type following the colonial style are comparatively easy to design. Their orderliness is such that a good many problems about the massing of walls and roofs solve themselves.

But picturesque houses, such as the one illustrated here, are more difficult to design. The organization of these houses follows no definite form. Here the massing of the plan elements greatly influences external appearances. The size and shape of rooms must have such an interrelation that the general exterior effect is fine. Architects call this composition.

Now, if no limitations are placed on the architect as to the way in which he may model the plan, no restrictions as to cost or size, he finds the problem of composition or modeling somewhat easier. But for a small house, such as the one shown here, this liberty does not exist. The plan must be organized so that after all the work is done economy still remains. The house must be of such a type that its con-

struction is not an elaborate matter. View this house then from this point

of view. The plan is straightforward, easy to build, essentially of an economical type. The framing follows a definite procedure. It would necessarily be a little more expensive to construct than a house that had an absolutely rectangular form, yet the difference in cost is not great.

To this six-room house—the sixth room being in the second story, a single one, over the dining room—have been added vestibule, breakfast room, pantry, terrace and a generous fireplace. Going over the plan, one finds countless details of interest. There is abundant closet space, a kitchen lighted on three sides, a breakfast room, which in the morning should be bathed in sunlight. Size of lot required is forty-five to fifty feet, and construction wood.



QUESTIONS regarding home building addressed to this magazine will be answered by The Architects' Small House Service Bureau of the United States, Inc., controlled by the American Institute of Architects and indorsed by the United States department of commerce. Please inclose 10c in stamps or coin. Blueprints, specification forms, and material lists for the house shown here may be obtained from the Architects' Small House Service Bureau for a small fee. If further information is desired, literature describing the plan service and publications of The Architects' Small House Service Bureau will be sent you upon request. A booklet entitled "50 Ways to Lower Home Service Costs," illustrated by ten Bureau homes actually lived in and showing how as much as \$1,000 can be saved on a home, may be obtained for 20c.

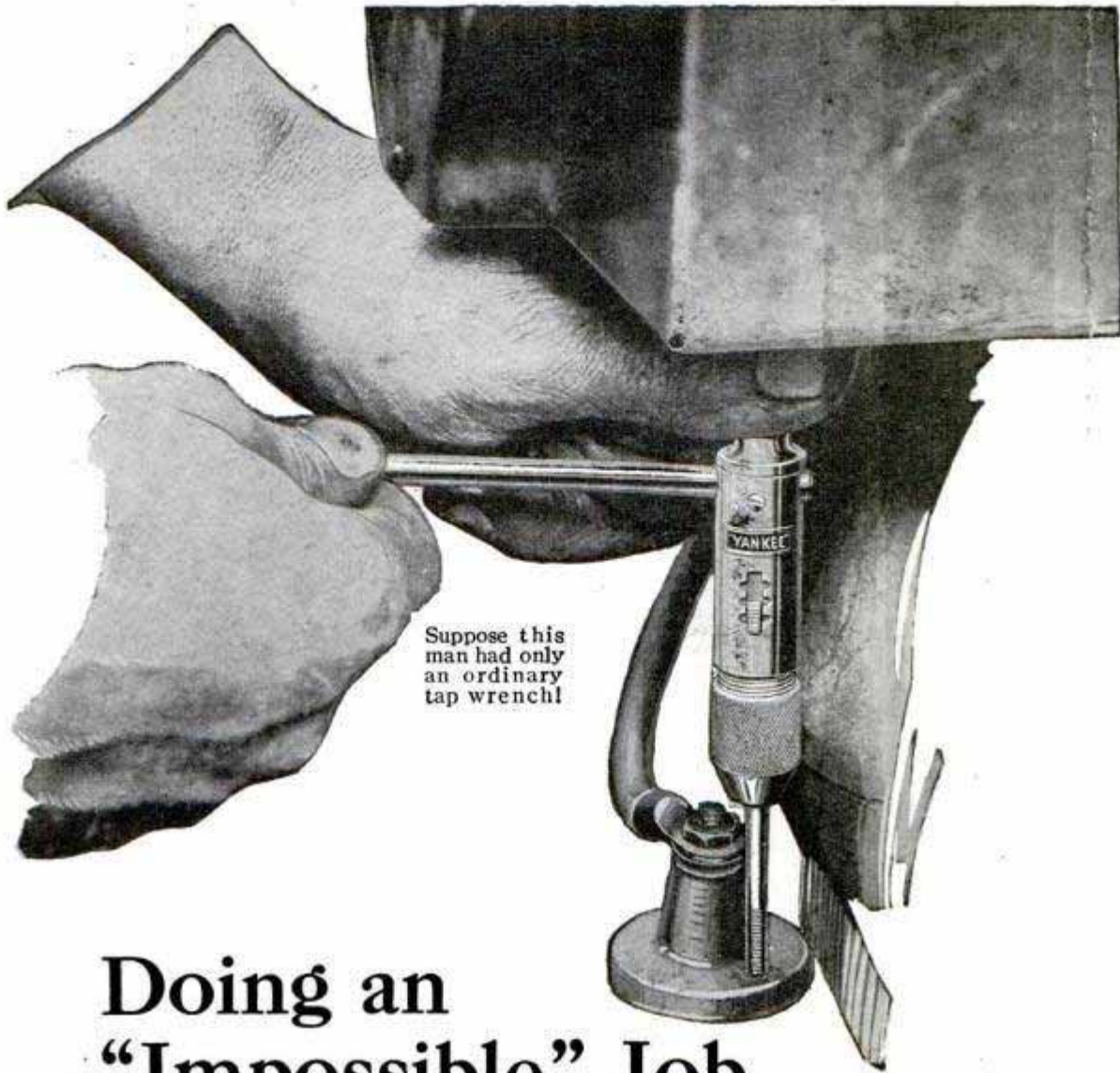

Suppose this man had only an ordinary tap wrench!

Doing an "Impossible" Job with "YANKEE" No. 250

In close quarters where a complete turn cannot be made, there is no need to tear down construction when you have a "Yankee" Ratchet Tap Wrench.

Simply pull the sliding cross-bar out to end position where the hand can move freely, set the ratchet shifter, and tap the hole quickly and easily.

Awkward jobs are found everywhere. Save time and trouble by using this handy "Yankee" Tool.

Three adjustments: Right-hand ratchet, left-hand ratchet, and rigid. Knurled fingerturn at top quickly starts or backs out taps.

No. 250—Length $3\frac{1}{4}$ in. Chuck diam., $\frac{3}{4}$ in. Holds up to $\frac{3}{16}$ in. taps.

No. 251—Length 5 in. Chuck diam., $\frac{7}{8}$ in. Holds up to $\frac{5}{16}$ in. taps.

No. 1251—Length 13 in. For jobs needing long reach. Otherwise same as No. 251.

Some other "Yankee" Tools: Plain Screw-drivers, Ratchet Screw-drivers, Ratchet Breast, Hand, Chain and Bench Drills, Ratchet Bit Braces, Automatic Push Drills, Vises with removable base, etc.

Dealers Everywhere Sell
"Yankee" Tools

"Yankee" on the tool you buy means the utmost in quality, efficiency and durability.



FREE
New "Yankee"
Tool Book

This interesting little book is for all lovers of fine tools. It tells just what you want to know about all the famous "Yankee" Tools for making work easier and quicker.

NORTH BROS. MFG. Co., Philadelphia, U. S. A.

"YANKEE" TOOLS

Make Better mechanics

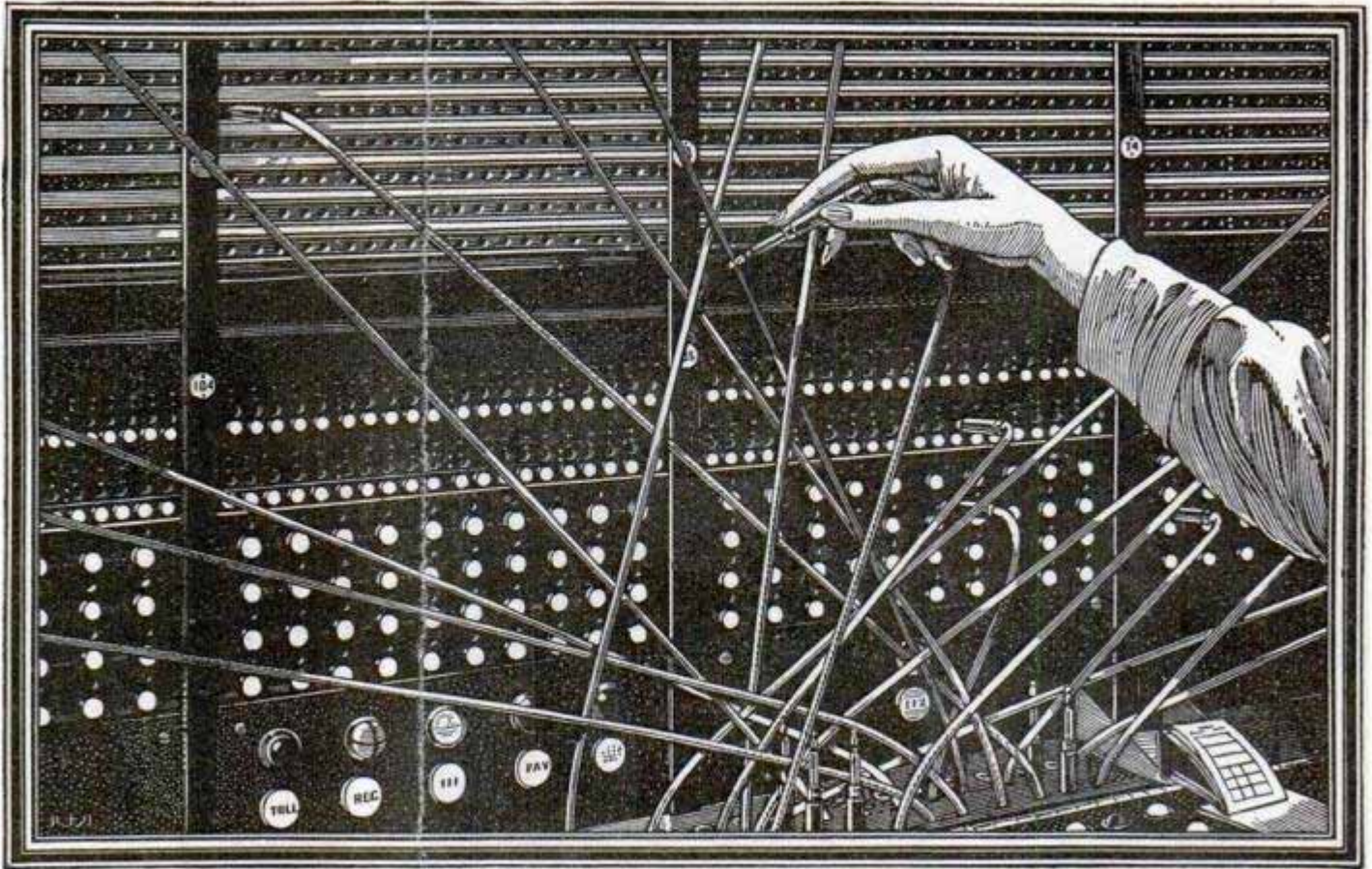

The Switchboard

*An Advertisement of
the American Telephone and Telegraph Company*

A WEB of cords plugged into numbered holes. A hand ready to answer signals which flash from tiny lamps. A mind alert for prompt and accurate performance of a vital service. A devotion to duty inspired by a sense of the public's reliance on that service.

Every section of a telephone switchboard typifies the co-ordination of human effort and mechanism which makes possible America's



far-reaching telephone service. Its cords link for instant speech those who are separated by a few miles or by a continent. Its guardian operators are of the telephone army—men and women vigilant to meet a nation's need for communications.

In plant and personnel, the Bell System is in effect a vast switchboard serving a nation that has been transformed into a neighborhood through telephone growth and development.

Are you using ETHYL GASOLINE ?

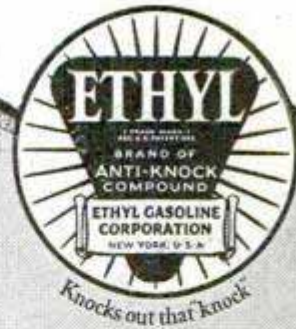

Don't go another day without the benefits of this high compression fuel. ☐ The best proof of its superiority is the fact that its national distribution by leading oil companies has made possible the new high compression automobiles which have just been introduced. ☐ However, no matter what the compression of your car is, Ethyl Gasoline will give it *extra power* . . . quicker acceleration . . . reduced gearshifting . . . better hill climbing . . . in short, a superior car performance in every respect. ☐ Hundreds of thousands of car owners are now driving with Ethyl. It is sold at pumps which bear the "ETHYL" trademark shown above.

Ethyl Gasoline Corporation, 25 Broadway, New York

You pay a lot of money for your car and its maintenance. But you probably use not more than 500 gallons of fuel a year. This means that you can have the advantages of Ethyl Gasoline at an extra cost of only about \$1.25 a month.

ENJOY THE BENEFITS OF HIGH COMPRESSION

Revolutionizing Radio Socket Power!



KUPROX "A" TRANSIFIERS—Batteryless, noiseless, electric "A" power. Dry, dependable, needs no attention. Operates any receiver. 4-volt or 6-volt, \$28.50 and up.



KUPROX A & B TRANSIFIERS—All radio power from a single unit. Controlled from set switch. Absolutely dry, requires no attention. \$57.50 and up.



KUPROX "B" TRANSIFIERS—Dry, permanent, free of hum. Guaranteed voltage at rated output. Models for all sets and circuits, \$14.50 and up.

No acids, liquids,
or charging bulbs....
Dry permanent power
that requires no attention!

KUPROX—the new metallic disc rectifier — has actually revolutionized radio socket power.

For the first time, permanent, dependable power is available for your set without any of the bothersome watering and attention. **KUPROX** Radio Power Devices supply all radio power—A, B, and C constantly, dependably, with no more attention than the snap of a switch.

KUPROX Radio Power Devices make any set truly elec-

tric. They are all metal...dry...they need no watching or watering...they cannot wear out.

Many models are offered from the efficient 1-ampere Trickle Charger to the high-powered Combinations which supply all radio power from a single compact unit. The new **KUPROX** Replacement Unit offers relief from watering and charging troubles, to present owners of electrolytic trickle chargers and power units. Your Radio Dealer has **KUPROX**.

{ FREE BOOKLET FOR YOU: "The Secret of Successful Battery Elimination," describing KUPROX Devices, will be mailed free on request. Write for it. }

THE KODEL RADIO CORPORATION, 517 E. Pearl St., Cincinnati, O.

KUPROX

RADIO POWER DEVICES



KUPROX REPLACEMENT UNIT—For replacing the acid jar on all standard trickle chargers and power units. Eliminates all watering and attention. \$4.50.



KUPROX TRICKLE CHARGERS—Absolutely dry; 1-amp. rate. Large model gives 2½-amp. booster charge. \$10.50 and \$18.50.



This unique invention solves the tool user's greatest problem

Loose handles! How often have you reached for your hammer and found that the head wobbled. Not safe to use. Had to waste time trying to rewedge it in some makeshift way. Then in a few days it was loose again.

Hundreds of wedges were invented to keep tool handles tight. But pounding . . . and shrinkage of the handle loosened them all.

So Plumb discarded old methods of wedging; experimented along entirely new lines.

—and developed a wedge that does away with loose handles for all time.

The Plumb Take-Up Wedge

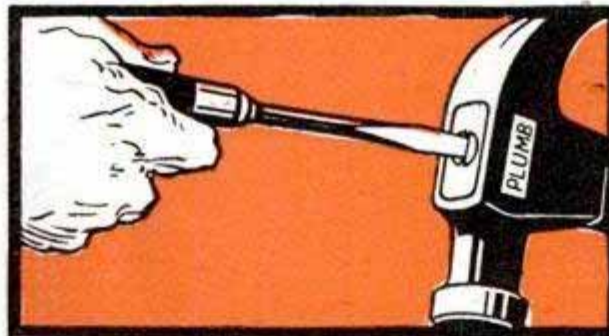

When steady pounding and shrinkage loosen a Plumb Handle you just turn the Screw Wedge and it is tight again

is designed, not to keep the handle tight, (no wedge does that), but to give the user a ready means of retightening it.

Now . . . when hard work and shrinkage loosen a Plumb, you just turn the screw wedge and it is tight as new again.

Always safe! Always tight!
Always ready to work with you.

Own a hammer like that. One you can grip and swing all day without tiring, so well is it balanced. Drive husky nails or smallest brads with accuracy because the weight is placed just right in this head.

Pull headless nails; draw slim brads. The special "Plumb-bend" of the claws gives you powerful leverage. And the split of the claws grips anything.

More in a hammer than you've ever had before. A life-time tool! Yet the price of the HF 81, 1 lb. model is only \$1.50. (Prices slightly higher in Far West and Canada.)

FAYETTE R. PLUMB, Inc., Philadelphia, U. S. A.



You get the same value, Take-Up Wedge included, in the Plumb Half Hatchet and Ball Pein Hammer. Look for the Red Handle and Black Head in your hardware store.

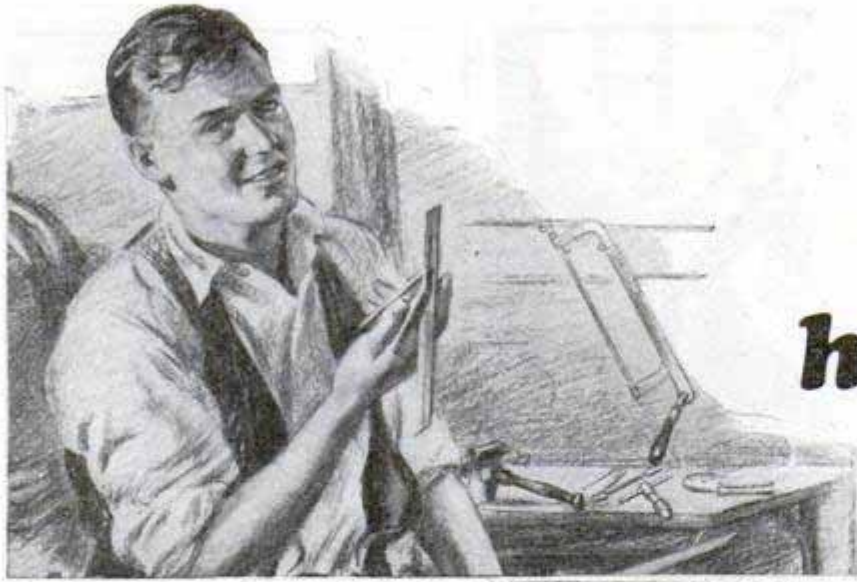

**for
home jobs—**

Use Starrett Tools

for precision work

Just skimming through the pages of the big Starrett Catalog gives you many a suggestion for doing things better and easier.

All the fine precision tools known and accepted as the standard of accuracy by mechanics and artisans the world over are fully described and illustrated in the Starrett Catalog. And you'll find there also many handy tools for work 'round the house or garage,—such as combination squares, steel tapes and rules, hack saws, nail sets, magazine screw drivers, floor scrapers, etc.

THE L. S. STARRETT CO.

World's Greatest Toolmakers
Manufacturers of Hacksaws Unexcelled
Steel Tapes—Standard for Accuracy
ATHOL, MASS., U. S. A.



1104



Starrett Catalog No. 23

Write for free copy of Starrett Catalog No. 23. Then ask your tool dealer to show you the Starrett Tools you need.

**30
DAYS
FREE
TRIAL**

7 Tube Set

Single Dial Radio

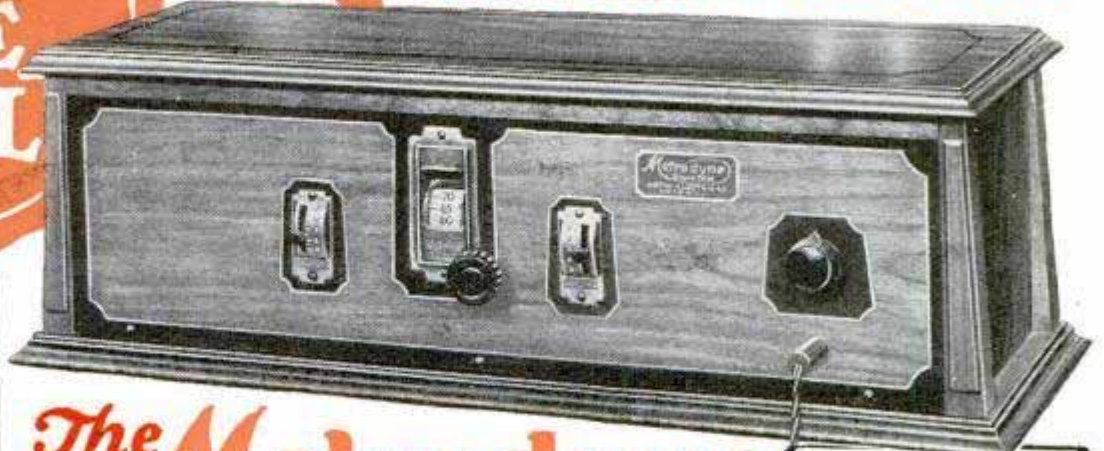

**Metrodyne
Radio Sets**
Are Equipped For
**BATTERY or
ELECTRIC
operation**

The Metrodyne
ONLY ONE DIAL TO TUNE

Retail Price
\$75⁰⁰
**COMPLETELY
ASSEMBLED**
BIG DISCOUNTS to
Agents & Dealers

Wonderful offer direct from the factory! The world's greatest radio! A perfect working, single dial control, 7 tube receiver! And just to prove our claims, we will ship it to your home for 30 days' free trial. Test it under all conditions. Test it for distance, volume and tonal quality—and if you are not convinced that it is the best single dial set you ever heard, return it to the factory. We don't want your money unless you are completely satisfied.

**BIG PROFITS TO
AGENTS AND DEALERS**
Our Agents and Dealers make big money selling Metrodyne Sets. You can work all or part time. Demonstrate the superiority of Metrodynes right in your home. Metrodyne Radios have no competition. Lowest wholesale prices. Demonstrating set on 30 days' free trial. Greatest money-making opportunity. Send coupon, letter or postal for our agent's proposition.

Three Year Guarantee

Metrodyne Super-Seven Radio

A single dial control, 7 tube, tuned radio frequency set. Tested and approved by Popular Science Institute of Standards, Popular Radio Laboratory, Radio News Laboratory and by America's leading Radio Engineers. Designed and built by radio experts. Only the highest quality low loss parts are used. Magnificent, two-tone walnut cabinet with beautiful, gilt metal trimmings. Very newest 1928 model.

Easiest set to operate. Only one small knob tunes in all stations. The dial is electrically lighted so that you can log stations in the dark. The volume control regulates the reception from a faint whisper to thunderous volume, 1,000 to 3,000 miles on loud speaker! The Metrodyne Super-Seven is a beautiful and efficient receiver, and we are so sure that you will be delighted with it, that we make this liberal 30 days' free trial offer. You to be the judge.



30 Days' Free Trial—3 Year Guarantee

Metrodyne Super-Six

New 1928 model Metrodyne 6 tube, two dial, long distance tuned radio frequency receiver. Approved by leading radio engineers. Highest grade low loss parts, completely assembled in a beautiful walnut cabinet. Easy to operate. Dials easily logged. Tune in your favorite station on same dial readings every time—no guessing.

Mr. Howard, of Chicago, said: "While five Chicago broadcasting stations were on the air I tuned in seventeen out-of-town stations, including New York and San Francisco, on loud speaker, loud and clear."

We are one of the pioneers of radio. The success of Metrodyne sets is due to our liberal 30 days' free trial offer, which gives you the opportunity of trying before buying. Thousands of Metrodynes have been bought on our liberal free trial basis.

**6
Tube Set**
\$48⁵⁰
RETAIL PRICE
Completely
Assembled

**MAIL THIS
COUPON**

or send a postal or letter. Get our proposition before buying a radio. Deal direct with manufacturer—SAVE MONEY—WRITE NOW!

Mail COUPON Below!

Let us send you proof of Metrodyne quality—our 30 days' free trial offer and 3 year guarantee

Mrs. Wm. Leffingwell, West-Field, N. J., writes: "The Metrodyne Radio I bought of you is a wow! This is as good as any \$225 machine I have ever seen."
N. M. Greene, Maywood, Ill., writes: "My time is up and the Metrodyne works fine. I got Havana, Cuba, Oakland, Calif., Denver, Colo., Toronto, Canada, all on the loud speaker."

J. W. Woods, Leadville, Colo., writes: "Received the 7-tube Metrodyne in fine condition. Had it up and working same day received. Was soon listening to Los Angeles, San Diego, Oakland and other California points; also St. Louis, Kansas City and other east and south stations—all coming in fine. Am more than pleased. Sure enjoying it."

We will send you hundreds of similar letters from owners who acclaim the Metrodyne as the greatest radio set in the world. A postal, letter or coupon brings complete information, testimonials, wholesale prices and our liberal 30 days' free trial offer.

METRO ELECTRIC COMPANY
2161-71 N. California Ave., Dept. 41, Chicago, Illinois

METRO ELECTRIC COMPANY
2161-71 N. California Ave., Dept. 41, Chicago, Ill.

Gentlemen:
Send me full particulars about Metrodyne 6 tube and 7 tube sets and your 30 days' free trial offer.

Name.....

Address.....

If you are interested in AGENT'S proposition, place an "X" in the square

Buy separately or in assortments

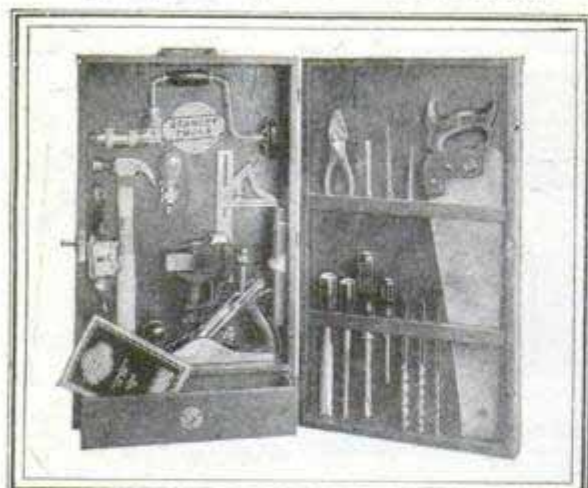

She sews— but how?

Make a sewing cabinet from Plan No. 14d

In comfort with everything in order—or in discomfort with everything scattered? What a tool chest is to a tool user, a sewing cabinet is to one who sews. She would appreciate a sewing cabinet like the one shown above. *You can make it.* Stanley Plan No. 14d gives all details. How is that for a Christmas suggestion?



Of course you realize that to do good work you need good tools. The amateur needs good tools even more than the professional. Most carpenters use Stanley Tools because they know from long experience that the Stanley name promises durability, correct design, and right "feel." And thousands of manual training classes use Stanley Tools.

You can buy Stanley Tools separately and

so collect your own set. For your convenience in buying there are also complete sets of Stanley Tools in chests at a wide variety of prices from \$15 to \$95. Or there are assortments in strong cardboard boxes containing directions for making your own tool chest. Priced from \$5 to \$20.



Your hardware dealer has Plan No. 14d as well as other Stanley Plans for making useful articles, or he can get them for you. The plans cost only 10c each. Ask him also for small Catalog No. Sd50—which shows many useful Stanley Tools. It is free. If he cannot supply you write to The Stanley Works, New Britain, Conn.

The best tools are the cheapest to use
Ask your hardware dealer



STANLEY TOOLS

BIG-NEW SpeedWay Shop

only

\$10⁰⁰ down

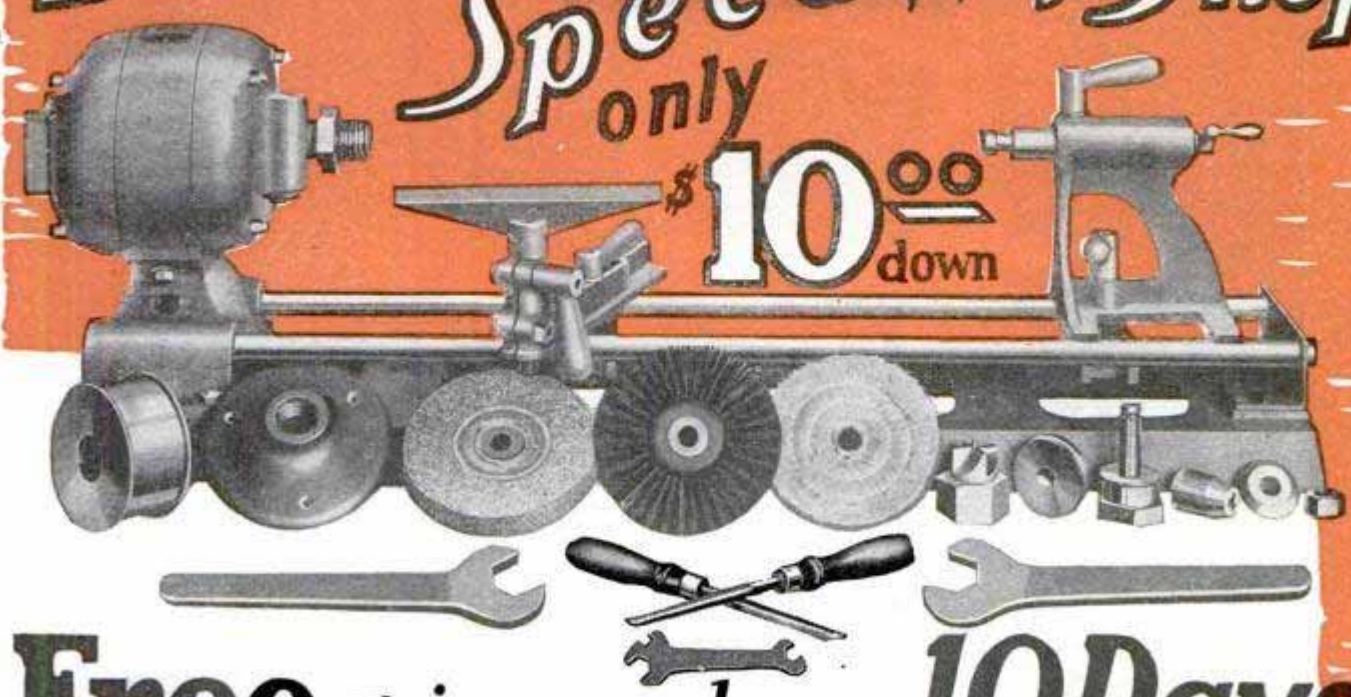

Free - in your home 10 Days



Jig Saw Unit
At right, near bottom
Circular Saw Unit

If You Want It—Use Coupon Today

Everything about this new model Super SpeedWay Shop is big and heavy for regular commercial use yet it operates from any light socket and gives you a complete motor-driven work shop in a jiffy.

Job men, Contractors, Builders, and all sorts of manufacturers are cutting costs and increasing profits with one of the SpeedWay Shops.

A COMBINATION TO SUIT YOU

For the man who wants a Shop for special uses there are various combinations. Even the \$42.50 Shop is built to the same high standards as the one shown above. Send for catalog describing them all.

Have fun or make money with a SpeedWay Shop

The Super SpeedWay Shop, Model No. 265 as pictured above contains—

7 Heavy Motor Driven Tools

- 1—Motor Driven Lathe on heavy cast-iron base, takes up to 10" diameter and 18" length.
 - 2—Speed-Way Bench Drill, 1/4" in steel or 1/2" in wood.
 - 3—Bench Saw with 6" blade for ripping and cross-cutting.
 - 4—Pattern Makers' Jig Saw with capacity for 20" work.
 - 5—Motor drive Grinder—5" emery wheel.
 - 6—This 6" Scratch Brush is quickly attached.
 - 7—Buffer or Polisher, with 6" rag wheel.
- All necessary parts supplied, including two chisels, jig saw blades, etc.

24 FREE Blue Prints
24 working blue-prints of toys, furniture, etc., are furnished free with each SpeedWay Shop.

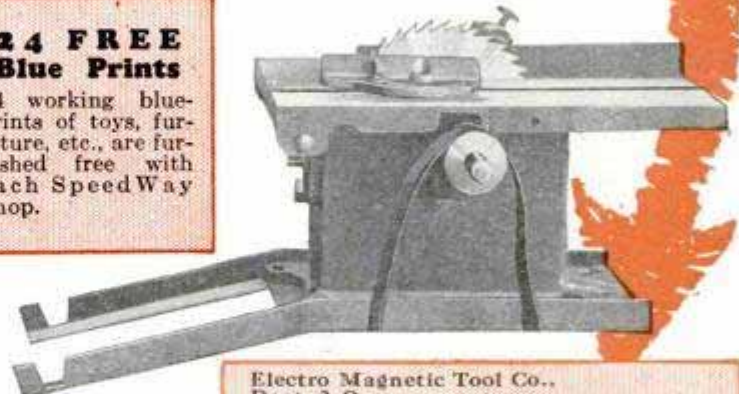

Pay While You Use It

Our terms are very liberal—we want every man who can use a SpeedWay to order it for 10 Days' Free Trial in his own shop. If you like it you pay the balance a little at a time.

Don't delay—write today for special fall offer

Don't waste time—write to this big factory today and benefit by our 15 years' experience in making Electrically Driven tools. We have Sales and Service Stations in 15 of the principal cities—Send the Coupon Today.

ELECTRO MAGNETIC TOOL CO.

Department 2-O, 1830 S. 52nd Ave.
(Adjoining Chicago)

Cicero Illinois

Remember, this is the only Company in the world making a complete line of Portable Electric Saws, Hammers, Drills and Grinders.

Electro Magnetic Tool Co.,
Dept. 2-O,
1830 S. 52nd. Ave., Cicero, Ill.
Gentlemen: Please send me full particulars about 10 Days' Free Trial, Free Blue Prints and your Easy Payment Plan on SpeedWay Shops.

Name.....
Address.....
City..... State.....

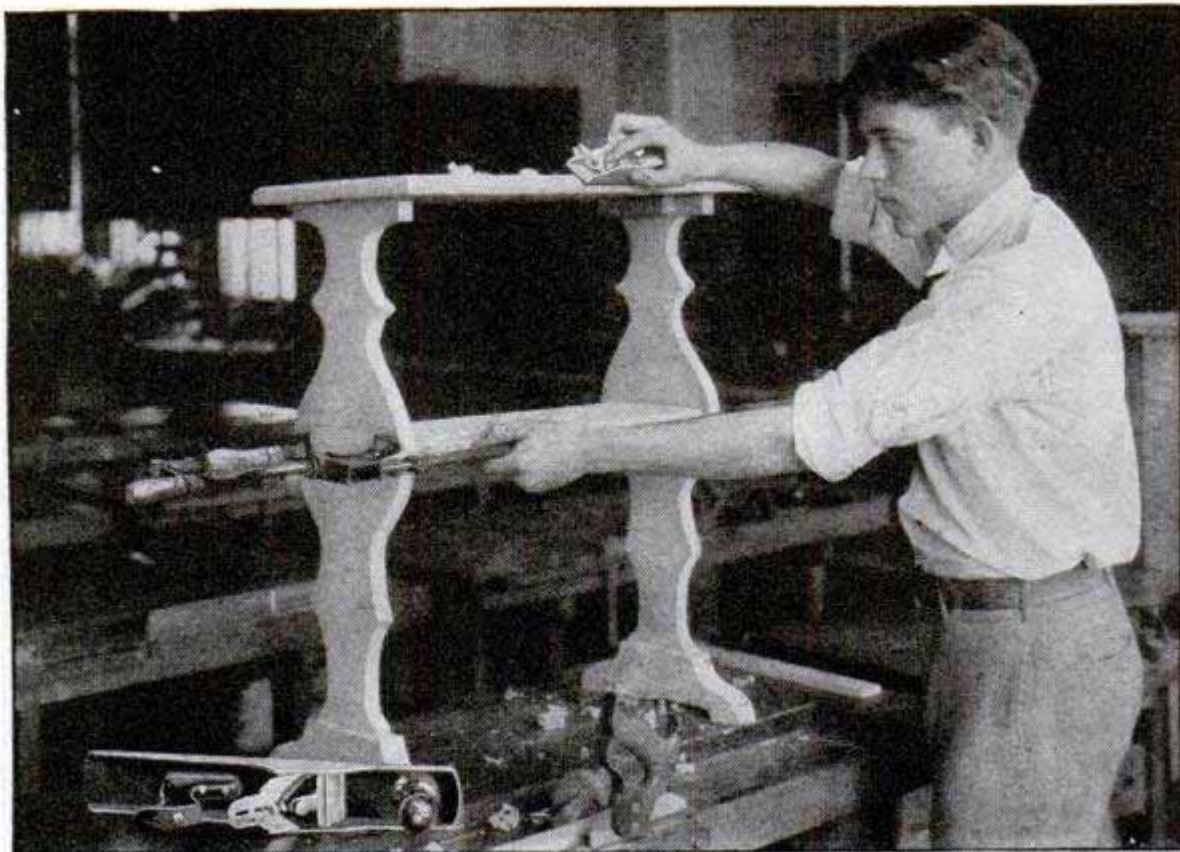

Better tools mean better work

THE Sargent Auto-Set Plane is so strongly made that you should never need to replace it. It is so moderately priced that you cannot afford to be without it. It is so carefully and accurately fitted that the chromium steel cutter seems a solid part of the plane itself, and cuts with, across, or against the grain without chattering. Sargent Auto-Set Planes insure clean, accurate work. They can be quickly and exactly set at any adjustment, *and the cutter*

can be taken out, sharpened and replaced in the original position without disturbing adjustment.

Sargent planes are used by carpenters and wood-workers everywhere. The Auto-Set and the small Steel Block Plane also illustrated here will finish any job. Ask your dealer to show you Sargent planes and write us for catalog and further particulars. Sargent & Company, *Manufacturers*, 49 Water Street, New Haven, Conn.

SARGENT

PLANES

*Sargent Steel Block
Plane No. 5206*

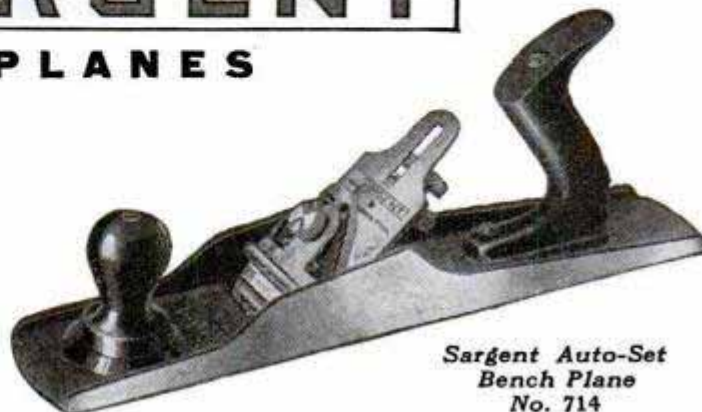

*Sargent Auto-Set
Bench Plane
No. 714*



TABLE DESK
See LePage's Book, page 15

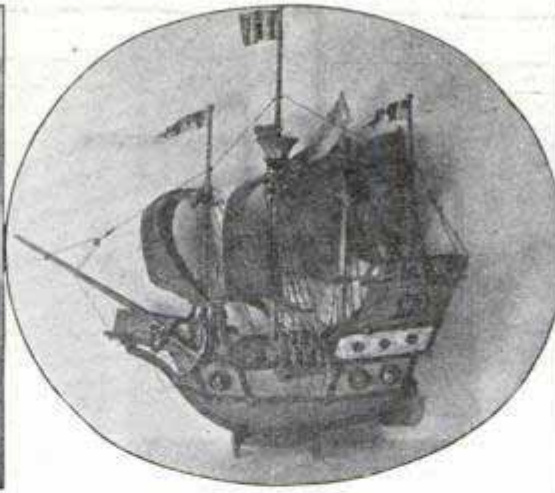

SPANISH SHIP MODEL
See LePage's Book, page 4

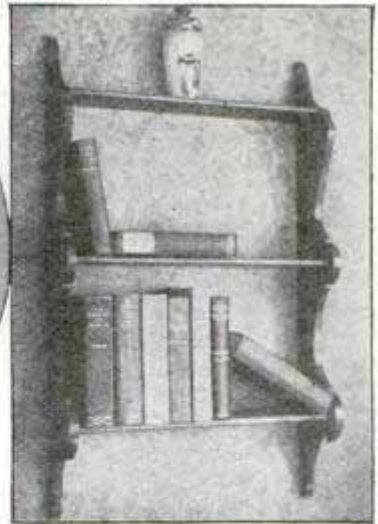

HANGING BOOK SHELVES
See LePage's Book, page 25

How to make Attractive Furniture for Christmas

*LePage's New Home Work Shop Book
will show you how*

WITH the approach of Christmas, comes this NEW LePage's Home Work Shop Book to show you how to make 20 different pieces of gift furniture, designed by an expert—attractive, artistic, useful, practical and easy to make. Each piece is ideally suited to be a Christmas gift.

New Book— greatly improved

THE first LePage's Home Work Shop Book, published a year ago, proved so popular that, though advertised only a few times, over 30,000 copies were sold—an enormous edition for a book of this kind. Now the new book, just off the press, represents a wonderful improvement over the old one. Of its 20 complete projects, 16 are entirely new and never offered before.

Each project is presented in three parts—a photographic illustration of the finished project, a complete dimension drawing of its parts, and simple, easy-to-follow directions, for making, given step by step, from start to finish.

Designed by Expert

FOR each of the 20 gift furniture projects, the design, dimension drawings and photographs, as well as the actual articles, were made by William W. Klenke, Instructor in Woodworking, Central Commercial and Manual Training High School, Newark, New Jersey. Assurance is therefore given

that each project and the directions for making it is perfectly practical.

In addition to the four pieces illustrated above, the book includes the following 16 projects: Occasional Table, Folding Sewing Screen, Fernery Stand, Tilt Top Table, Piano Bench, Priscilla Sewing Box, Cedar Chest, Smoking Cabinet, Desk Chair, Card or Console Table, Book Stand, Turned Bench, Dressing Glass, End Table with Book Trough, Foot Stool and Back Rest. Where else could you get complete directions for making all these things for only 10 cents?

In addition, this new LePage's book contains full information on how to secure plans for making eighteen more new projects, prepared by Frank I. Solar, Teacher of Manual Training in Detroit Public Schools, and widely-known tool craft writer.

Send 10 cents for this NEW LePage's Home Work Shop Book

Just write your name and address on the coupon below, tear it out and mail to us today with 10 cents in coin or stamps, and we will at once send you a copy of LePage's New Home Work Shop Book, postage paid. Address LePage's Craft League, 552 Essex Ave., Gloucester, Mass. Tear out the coupon now so you won't forget it.



Mail this coupon

LEPAGE'S CRAFT LEAGUE,
552 Essex Ave., Gloucester, Mass.

Gentlemen: Enclosed please find 10 cents (coin or stamps) in payment for LePage's New Home Work Shop Book. Please send a copy of this book to:

Name.....

Street.....

City..... State.....



LEPAGE'S LIQUID GLUE

*Handiest Tool in
your Work Shop*

GOODELL-PRATT



High-speed, High-power Bench Grinder—485. Handy for bench and household use. High-grade Abrasive Wheel, 5 x 1". Adjustable Work Rest. Finished in red and black enamel, 6 1/2" high above bench. \$10.00

Goodell-Pratt Electric Drill. Sizes from 3/4 to 3/8". Light and Heavy Duty, for 110 and 220 A. C. or D. C. Steady drilling doesn't overheat these Drills. Vital parts readily accessible. These drills retail from \$36 to \$99

Automatic Drill—185. Mr. Punch, Push, and the tool returns. Drill points carried in handle. Length 10". Beautifully polished and nicked, including 8 drill points from 1/16 to 11/64". \$2.75

All-steel Mitre Box—1285. Cannot bend or break, or become inaccurate. Angles more acute than 45° are secured by side attachment. Gauge can be regulated to saw any desired depth. Equipped with 28 x 5" first quality Back Saw . . . \$27.50

Bench Vise—161. Moderately priced. Cut steel feed screw and guide rods insure rigidity. Jaws machined after assembly, so they meet accurately. Steel parts polished, iron parts enameled. 2" jaws, opening 2". Weight 3 1/4 lbs. \$2.60



GOODELL-PRATT



Ratchet Bit Brace—7010. 10" sweep. Steel clad head on roller bearings. Chuck sockets and shells of malleable iron; forged steel jaws. Square shank bits. Polished and nicked. . . \$3.75

Automatic Screwdriver—111. Reversible, for driving or drawing screws. Can be used ratchet or plain. Handle finished in mahogany. Length, extended, with blade 19". Including 3 tool steel blades \$3.10

Saw Vise—745. Jaws hold saw for their entire length, 10", are self-aligning and can be taken out by removing single screw. Ball and socket gives flexibility in filing positions. Clamps to any bench 3/4 to 2 1/2" thick. Stands 9 1/2" above bench. Weight 5 pounds. \$5.00

Two-speed Hand Drill—51. Black enameled frame. Handle cap unscrews to hold drills. Takes round-shank drills, 0 to 3/8". Steel parts nicked. 14 1/2" long. Without drills \$5.30

Floor Scraper—469. Mahogany finished hardwood handle, 11" long, and set at correct angle. Reversible 3 x 4 1/2" blade of finest tool steel, hardened and tempered to hold good cutting edge. Wing adjusting nut and curved pressure plate. Weight 1 1/4 pounds \$1.65



THE ten carpentry tools pictured here are single examples of the sizes in which each is made. The catalog also features all kinds of tools for machinists, and professional and amateur mechanics.

400 pages of fine tools **FREE**

Select your tools from this catalog—then buy them from your hardware store, mill supply or automotive supply dealer

THIS 400-page catalog is used by carpenters, mechanics, and machinists—who select from its pages the tools they need—and buy them through their local hardware or mill supply man.

You, too, will find this a pleasant and easy way to buy tools. A three-page index helps you find what you want—at once. Clear, easily understood descriptions and good pictures leave nothing for you to guess at.

Whether you make your living with tools

or use them to follow a hobby, you need this catalog, with its 400 pages of pictures and information.

Goodell-Pratt Tools will serve you well for years. No finer tools are made than those that bear the name of Goodell-Pratt.

Select your needs from this catalog; then buy them from your nearest dealer. If he doesn't carry the Goodell-Pratt line, write us for the name of a dealer who can supply you.

For the catalog, address

GOODELL-PRATT COMPANY

Toolsmiths

GREENFIELD, MASS., U. S. A.

MAKERS OF MR. PUNCH

GOODELL-PRATT
1500 GOOD TOOLS



BIG PROFITS

in your own business

No Competition!

Be an exclusive Nestler operator and make money. Modern scientific Nestler Process makes old tires as good as new. Saves car owners ONE-HALF their tire bills. Big demand for Nestler service everywhere.

SOME men spend their lives working for others. They start and quit work when the whistle blows. Their biggest ambition is to "get a raise."

Other men know the thrill of being their own boss. The profits they make belong to themselves, not to an employer. Their hours are their own. There are no dull moments in their days. They enjoy life to the full!

This is the type of man who becomes a Nestler operator. He owns his own business, and he makes money because he furnishes a valuable service to automobile owners that **nobody** else in his locality can offer.

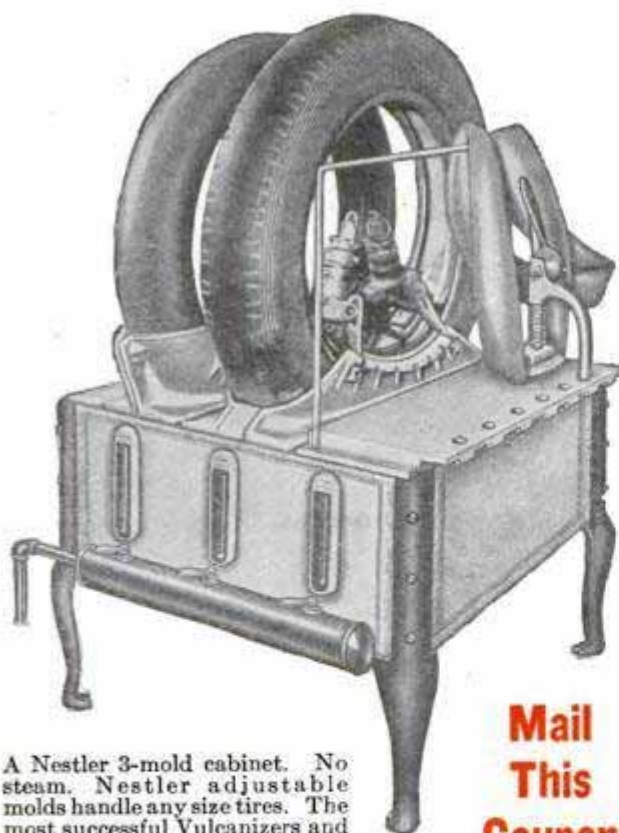

A Nestler 3-mold cabinet. No steam. Nestler adjustable molds handle any size tires. The most successful Vulcanizers and Garages have found the Nestler Process a great advantage because it eliminates all buffing, stripping and cementing.

**Mail
This
Coupon
Today!**

What the Nestler Rubber Fusing Process Is

The Nestler Rubber Fusing Process is the only modern, scientific method of repairing and re-treading automobile tires. A Nestlerized tire will give as much mileage as a new one, at ONE-HALF the cost to the owner, and at a substantial profit to the Nestler operator. There are hundreds of busy, money-making Nestler stations all over the world, with **no competition**, because the Nestler Process is fully protected by patents, and each Nestler operator has his own exclusive territory.

Previous Tire or Garage Experience Not Required

Any red-blooded man with a very little capital can become a successful Nestler operator. Nestler Rubber-Fusing equipment is built for life-time service, and the Nestler Manual, given free to every operator, makes every step in retreading tires and repairing blowouts as simple as A-B-C. Many men have started Nestlerizing tires in a garage or basement in their spare time, and have launched into a full-time business of their own after they could see big profits waiting to be picked up.

Send for an Amazing Book "The Nestler Plan"— It's FREE

How tires are Nestlerized—what Nestler equipment consists of—how the Nestler method will make money for YOU—everything you want to know about Nestler Tire Servicing as a full-time or spare-time business is fully explained and illustrated with photographs in a vitally interesting book "The Nestler Plan." Send coupon below for a Free Copy TODAY. And if you are in New York City, call at Nestler headquarters and ask for a free demonstration of the Nestler Process.

Nestler Rubber Fusing Co., Inc., Dept. 30
245 West 55th Street, New York, N. Y.

Without any obligation on my part, send me your book "The Nestler Plan."

Name.....

Address.....

\$1 Only Down Brings You Either of These Guaranteed Eliminators

Super-Power "A" Eliminator

This eliminator completely replaces "A" Batteries and the bother and expense of chargers with their disappointments. Here is constant, smooth, unvarying, humless current at 6 volts for any radio using 201-A and power tubes.

Not a Battery-Charger Combination

Large capacity rectifier in this super-power "A" Eliminator changes alternating house-lighting current into direct current. Highly efficient heavy duty filter system then changes pulsating direct current from rectifier into smooth, even current for lighting of filament in radio tubes. By simply attaching this "A" Eliminator to your set and plugging in the electric light socket your set is instantly supplied with the correct amount of hum-free current.

Requires no attention, as there are no batteries to be charged. Always reliable whether used once or a thousand times a year. Has no moving parts to wear out. Operates from light socket 110-120 volts, 50-60 cycle A. C., output 6 volts for all sets up to 12 tubes with power tubes.

Test It for 30 Days

Just fill out the coupon below and send it to us with one dollar. We will send you this Super-power "A" Eliminator. Try it for 30 days before you pay another cent. If it fails to make good in any way return it at our expense and your money will be cheerfully refunded. Because of our great buying power we are able to offer you this "A" Eliminator

at $\frac{1}{4}$ less than it is sold for elsewhere. It is offered complete for only **\$31.50** payable in easy installments after you test it.



**NO BATTERY—NO CHARGER
NO BULBS
NO HUM
Nothing to wear out or replace**

ELECTRIFY ANY RADIO

Super-Power "B" Eliminator

This eliminator permanently replaces "B" Batteries and the constant expense of getting new ones. Attached to your radio and plugged into light socket it delivers a steady flow of power. Hum, noise, distortion and all other disturbances are gone. **Used with any good "A" Eliminator it completely electrifies your set.**

Complete with Raytheon Tube

This super-power "B" Eliminator can be used with any set up to 12 tubes. It comes complete with full wave rectifying 85 Mil. Raytheon tube, making possible the delivery of great current at a high voltage. This Raytheon tube has indefinite life as it has no filament to burn out. Delivers up to 180 volts.

The case is beautifully finished in olive green Duco with black panel etched in gold. Equipped with rubber-covered cord and socket plug. High voltage taps and variable adjustments enable the use of new power tubes. Operates from 110-120 A. C., 50-60 cycle current. Has tap for intermediate voltage, on which $67\frac{1}{2}$ to 90 volts may be obtained. The detector tap will supply $22\frac{1}{2}$ to $67\frac{1}{2}$ volts. Variable adjuster will deliver any desired detector voltage. On and off switch and high and low voltage switch are integral parts of the eliminator. No additional switches or cords are necessary.

Test It for 30 Days

We make you the same liberal trial offer with this "B" Eliminator as with the "A" Eliminator described in this advertisement. Ordinarily this "B" Eliminator ordinarily sells for the cash price of \$42.50. You can buy it on easy installments for only **\$29.50** after you have tested it.



**COMPLETELY REPLACES "B" BATTERIES
Easy to attach
Plug into electric light socket**

AT REDUCED PRICES

Mail This Coupon NOW!

ELLIOTT RADIO CORPORATION, Dept. 134
709 West Lake Street, Chicago, Illinois
Attached find \$1.00 for which you agree to send me () "A" Eliminator at \$31.50. () "B" Eliminator at \$29.50. (Send \$2.00 if both are desired as described in ad.) Full particulars will be sent me by return mail and my money refunded if I do not accept your offer.

Name

Address

City State

UP-TO-DATE MACHINE WORKS



UP-TO-DATE HOME-CRAFTSMAN SHOP

**ONLY
\$10
DOWN**

**SENT
ON
TRIAL**

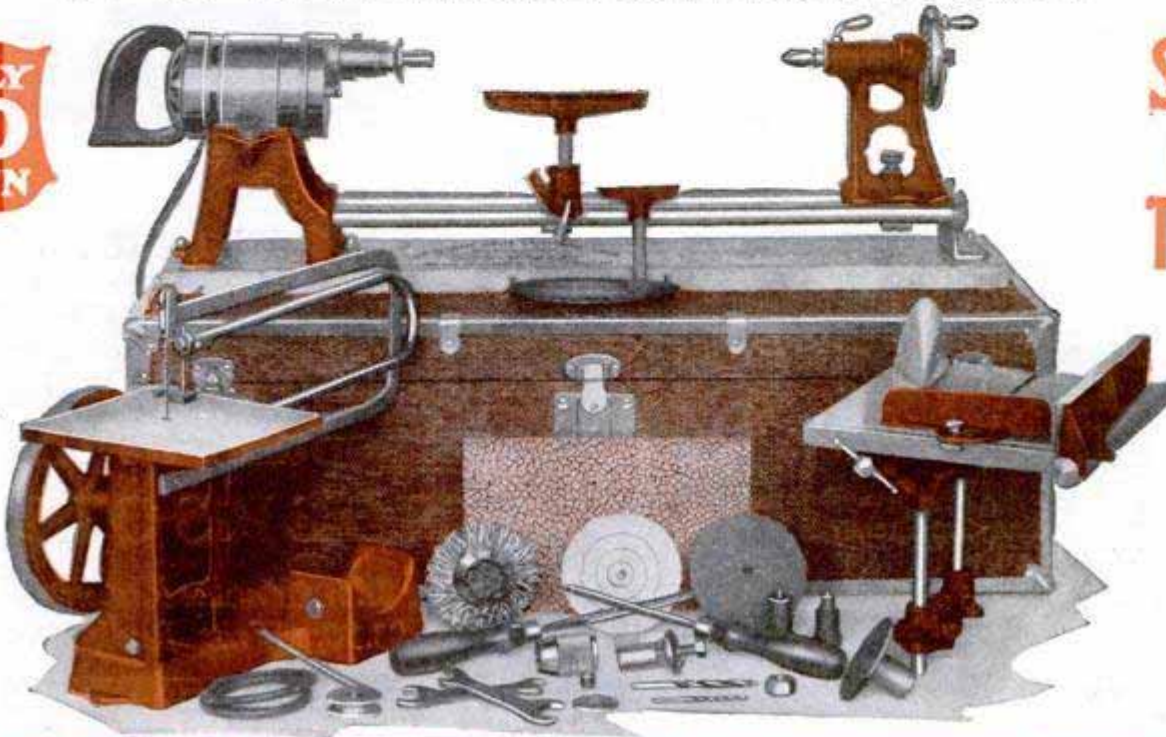

HOME MECHANICS MADE EASY WITH THE NEW UP-TO-DATE HOME-CRAFTSMAN SHOP

If it is your desire to become a craftsman this Home Shop bears your investigation. It has been indorsed, perfect in every mechanical detail by Master Mechanics. Its portability, convenience and precision make it a necessity to efficient home craftsmanship.

The Installation of a complete work shop with all electrical equipment, until now necessitated a big money investment. Now, with only \$10.00 down, it is possible to outfit your bench with the entire equipment pictured above.

GUARANTEE

After receipt of the Up-to-Date Homecraftsman's Shop if you are not satisfied, without question or delay every cent refunded and return express charges paid.

**15' Band Saw
Accessory to
Up-to-Date
Shop**



Our Educational and Blue Print Departments

Under personal Supervision of Master craftsman Eugene E. Maurey offers **FREE** to our users a special correspondence course giving in simple detail, full information on home handicraft. Working blue prints and other items are given free with this course.

Drilling
Turning
Grinding
Sawing
Joining
Painting
Sanding
Carving



Polishing
Buffing
Scroll Sawing
Cabinet Making
and a hundred
other operations
necessary to real
craftsmanship

**NOT A
TOY,
AREAL
MACHINE**

**OUR LITERATURE
GIVES ALL DETAILS**

Your Own Terms on Purchase.
\$10.00 down—balance arranged to your convenience. Liberal discount for cash.

The Up-to-Date Home Craftsman Shop, shown above, can be operated from any home electric light fixture. The shop complete consists of a Super-Power Motor, a Genuine Precision Lathe—(10"x34"), a six-inch Circular Saw, featuring the Tilting Table Bevel, Miter, Side and Depth Gauges, a Superior Jig Saw for scroll work, all accessories for buffing, grinding, etc., and all portable or stationary drilling and sawing.

Volumes of interesting literature explaining the shop in detail have been prepared for your convenience. This literature may be had without any obligation on your part by mailing the corner coupon.

4" Joiner Accessory to Up-to-Date Shop



10 DAY FREE TRIAL

Use our shop for 10 days at our expense. If not satisfied—return—express collect.

MAIL THIS

for full particulars to

Up-to-Date Machine Works
2915 S. Wabash Ave., Chicago, Ill.

MANAGER, Dept. A. Without any obligation, please send me full particulars about your shop, 10-day free trial, free blue prints, free crafts course, also, \$10.00 down payment offer.

NAME.....
ADDRESS.....

It's in This Tube, Men

The supremacy we do not ask you to believe until you've proved it for yourself.

A 10-SHAVE TEST OFFERED FOR THE COUPON



GENTLEMEN:

Ask your druggist, and he will probably tell you Palmolive Shaving Cream is his fastest seller.

Sixty years of soap study stand behind it. 130 formulas were tried before we succeeded in this unique creation. 1000 men had told us what they sought—5 things a shaving cream should accomplish. They set our goal.

Test these 5 improvements

1. Multiplies itself in lather 250 times.
2. Softens the beard in one minute.
3. Maintains its creamy fullness for 10 minutes on the face.
4. Strong bubbles hold the hairs erect for cutting.
5. Fine after-effects due to palm and olive oil content.

Now we offer you a free test. Shave 10 times and *learn* why men adopt it. Words can't win men to quit their former shaving cream for this.

Make this test yourself. Cut out the coupon to remind you.

THE PALMOLIVE-PEET COMPANY, CHICAGO, ILL.

3731

10 SHAVES FREE

and a can of Palmolive After Shaving Talc

Simply insert your name and address and mail to Dept. B-1400, Palmolive, 3702 Iron Street, Chicago, Ill.

Residents of Wisconsin should address Palmolive, Milwaukee, Wis.

(Please print your name and address)



Never before
in all watch history
two watches
as popular as these
INGERSOLLS

Yankee \$1.50; Yankee Radiolite \$2.25;
Wrist \$3.50; Wrist Radiolite \$4.00



BUILD BUSINESS WITH AIR!

Only \$12 monthly for a few months brings the best business builder and advertisement your shop can have if you sell to the car owner. Tire Stores, Garages, Battery Shops, Filling Stations are making big money with the new low-priced HB Automatic Air Compressor — priced \$75 to \$100 less than similar equipment on the market. Ask for bulletin AC 6—Tells all about it. **HOBART BROTHERS CO., Box M1071, Troy, O.**

A waterproof finish—

No umbrella is needed for Valspar. No matter how long you expose it to water and weather, it never turns white. Fine for all wood and metal surfaces indoors and out. Send 20c for 40c sample, clear or in any color. Valentine & Co., 454 Fourth Avenue, New York City.

VALSPAR The Varnish that won't turn white



PIN A DOLLAR BILL TO THIS

and get this genuine leather 5-window-pass case. Holds Railroad Passes, Auto License, Lodge Cards, etc. Masonic or Shrine Emblem stamped on in gold free. Your name or other stamping 35c extra per line. Cash must accompany order.



We carry
EVERYTHING MASONIC

Send for free catalogue No. 10 P. M., of Books, Monitors, Jewelry; No. 11 P. M., of Lodge Supplies.

We Have Been in Business 67 Years!

REDDING & COMPANY

200 Fifth Ave., Desk P. M.

NEW YORK

Follow the Lure of the OPEN ROAD!

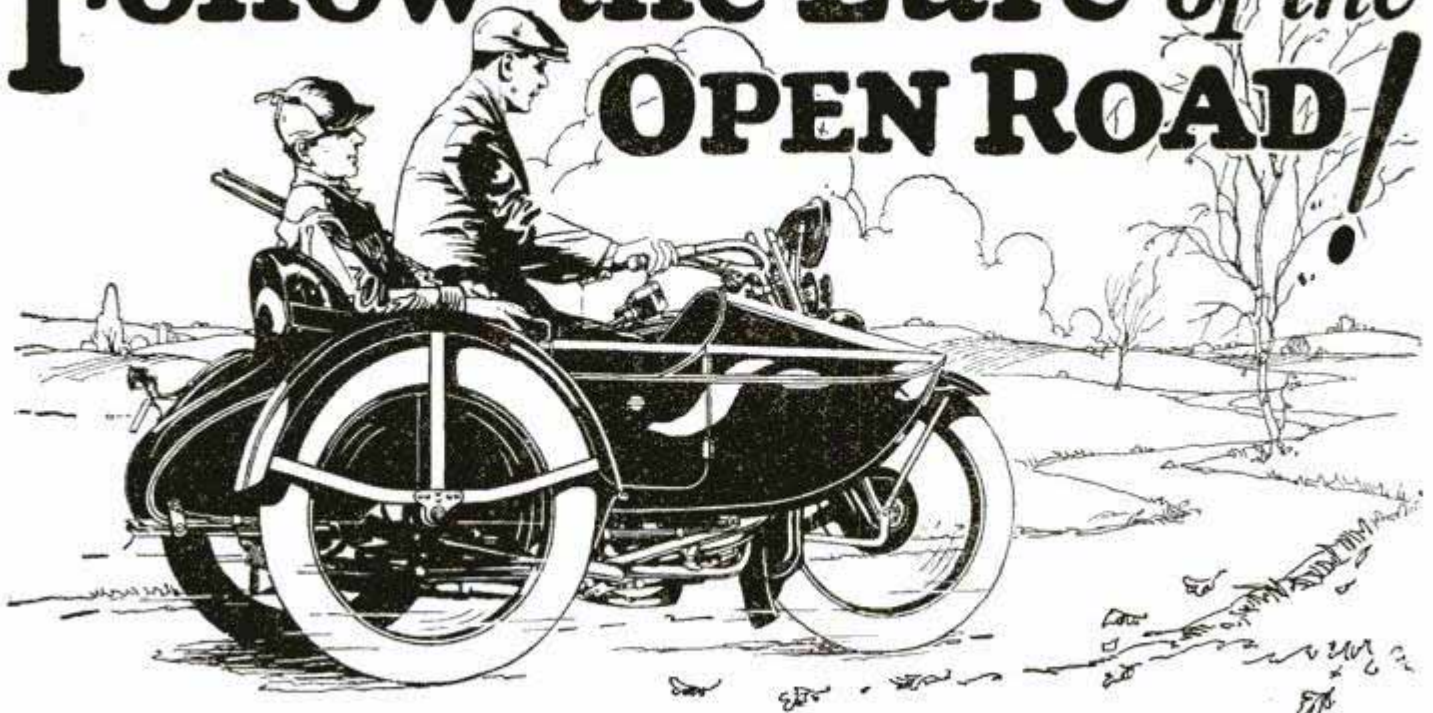

**fore
wheel
brake**

—for doubled safety

This and other new features make the 1928 Harley-Davidson Twin the most advanced mount in the history of the motor-cycle industry.

BID goodbye to everyday scenes. Forget crowded streets and city din. See the things you've longed to see. Visit the places you've read about. Hit the open road that beckons to fun and adventure — for a week — a month — or a year!

A Harley-Davidson Twin gets you there — quickly, comfortably, safely. Upkeep is only a fraction the cost of a car—2¢ a mile for gas, oil, tires and all. Plenty of room in the sidecar for your outfit, or a pal. Prices as low as \$310 f. o. b. factory on easy Pay-As-You-Ride terms. See your dealer. Send coupon for catalog.

HARLEY-DAVIDSON MOTOR CO.
Dept. P Milwaukee, Wis.

HARLEY-DAVIDSON Motorcycles

Twin and Single cylinder models in a wide range of prices. Get our catalog.



New Model Sport Solo Twin

Power and speed aplenty! A real sport mount, smaller wheels — 25" x 3.85 balloon tires — roadster handlebars, Dow-metal pistons, racing type, optional at slight increase in price.



The Single

—our famous solo mount that travels "80 miles per gallon" and is priced at only \$235, complete, f. o. b. factory.

HARLEY-DAVIDSON MOTOR CO.
Dept. P. Milwaukee, Wisconsin
Interested in () Twin () Single.
Send catalog and full details.

Name.....
Address.....



**Make your
LAST change**

Radio Fans spend thousands of dollars every year changing Resistors and Grid Leaks—needlessly! Make your last change now—replace your resistors with

GLASTOR

THE TRANSPARENT RESISTOR

with the complete knowledge and confidence that the resistor will be the value the label says it is—that it will be absolutely noiseless—that it will be permanent. Daven Glastors will not change in value while the glass remains intact. The resistance material is not on the inside of the glass—it is *in* the glass itself.

The DAVEN BALLAST Won't Burn Out

The Daven Ballast, the standard filament control, will not burn out, or change its characteristics no matter what the service.



Replace your filament control devices with Daven Ballasts and forget them—they will perform perfectly, *for the life of the set*. Made in $\frac{1}{4}$, $\frac{1}{2}$, $\frac{3}{4}$, 1 and $1\frac{1}{4}$ amperes. Supplied with or without the special mounting as illustrated.

Free Catalog

The new Daven Catalog describing the complete line of Daven Products, will be sent free upon request. Your copy is ready. Address,

The Sine of Merit

DAVEN RADIO CORPORATION

TRADE MARK

"Resistor Specialists"

REG. U.S. PAT. OFF.

150 SUMMIT STREET

NEWARK, N. J.

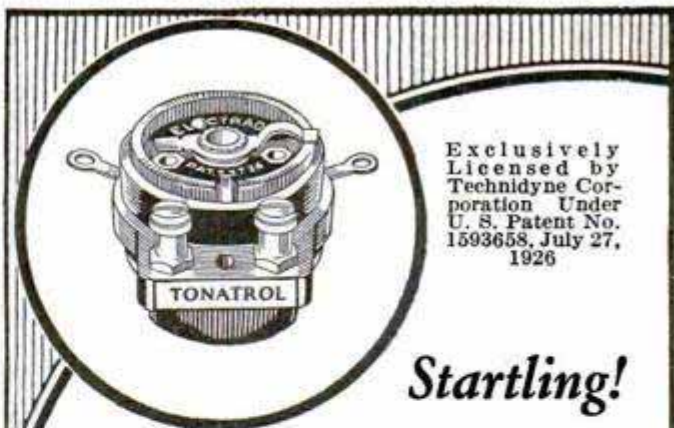

Exclusively Licensed by Technidyne Corporation Under U. S. Patent No. 1593658, July 27, 1926

Startling!

"Tonatrol"

A True Tone and Volume Control

This new and highly perfected Electrad device is amazing users with its smoothness and efficiency in controlling volume. It permits reception of soft music or the most powerful tones with remarkable clarity.

Sturdy Bakelite construction. Very simple to install in any receiver. At your dealers.

Tonatrol—Standard Volume Control \$1.50

Tonatrol—Type W. S. (with filament switch) \$2.00

Write for installation booklet for the proper way to control volume.

Dept. 66B, 175 Varick St., New York, N. Y.

ELECTRAD

BIG NEW CATALOG FOR RADIO BUILDERS

FREE My big 1928 Radio Catalog, Call Book and Trouble Finder. 132 pages about Radio. Chock full of newest circuits—kits, transmitter parts, short wave outfits, eliminators and speakers. Thousands of bargains at lowest wholesale prices. A regular Radio Encyclopedia—Free. Write today.
American Auto & Radio Mfg. Co.
HARRY SCHWARTZBERG, PRES.
Dept. 265 American Radio Bldg., Kansas City, Mo.

LATEST RADIO CIRCUITS



THIS 100 PAGE RADIO CATALOG FREE

Contains 5 Radio "Book Ups" 500 Illustrations Over 1,000 Articles

"Build your own with 'RASCO' Parts"
RADIO SPECIALTY CO., 98 E Park Place, New York, N. Y.

21 JEWEL ~ Extra Thin STUDEBAKER

The Insured Watch.

Sent
for Only
\$1
down

Sold Direct
From the Maker



You save 30% to 50%

An amazing offer! Just \$1.00 down brings you the famous 21-Jewel Studebaker Watch direct from factory. Balance in easy monthly payments. Lowest prices ever named for equal quality. By buying direct you save 30% to 50%. Your choice of 80 magnificent, new Art Beauty cases and dials. Latest designs in yellow, green and white gold effects. Exquisite thin models. 12 Size and 16 Size.

Send coupon for catalog of Advance Watch Styles and full particulars. Studebaker Watches have 21 Jewels, 8 Adjustments—Insured for your lifetime! Insurance Policy FREE! Ladies' Bracelet Watches, Men's Strap Watches, Diamonds and Jewelry also sold at lowest prices and on easy monthly payments. Send coupon for full details.

Mail Coupon For Six-Color Catalog!

The coupon below will bring you a copy of our beautiful new six-color catalog. It contains complete information on watch making. It tells how you can buy a 21-Jewel Studebaker Insured Watch direct from the maker—save big money and pay for it in easy monthly payments.

The Studebaker Watch Company is directed by members of the famous Studebaker family—known for 75 years of honest dealing. Over 100,000 satisfied customers own Studebaker Watches—and saved money by buying them direct. We ship anywhere.

SPECIAL OFFER! Watch Chain FREE!

For a limited time we are offering a magnificent Watch Chain Free. To all who write immediately we will include particulars of this astounding offer. Offer is limited. Send the coupon NOW!

STUDEBAKER WATCH COMPANY

Directed by the Studebaker Family—three-quarters of a century of fair dealing

WATCHES • DIAMONDS • JEWELRY

Dept. W-806 • South Bend, Indiana

Canadian Address: Windsor, Ontario



Mail
Coupon
Today!



STUDEBAKER WATCH COMPANY
Dept. W-806 South Bend, Indiana

Please send me your free catalog of Advance Watch Styles and details of your \$1.00 down offer. Please send me free catalog of Jewelry and Diamonds.

Name.....

Street or R. F. D.....

City..... State.....



An Ace!



\$1.50

New Model Pocket Ben

The New Model Pocket Ben is an ace among watches!

He's steady, reliable and unusually good-looking. That's why he's so popular.

Sold everywhere for \$1.50. With luminous night-and-day dial \$2.25.

WESTERN CLOCK COMPANY
La Salle, Illinois



TELLS ALL ABOUT THE
15 New Features

as well as the many other features of the wonderful Motor that thrilled the world in 1926 by its remarkable speed and power. You will want to know especially about "The Pilot" — a NEW device that steers your boat in any course you choose — straight or curved, without attention from anyone. Leaves you free to cast, or troll or rest. The New—

LOCKWOOD FORMERLY BOAT **LA** MOTOR

also offers you many other advantages—improvements in Power, in Speed, in Ease of Starting, in Stopping, in Convenience and Durability. Find out all about them before you choose any Motor. Get the facts now.

WRITE FOR FREE FOLDER

Just out — See how Lockwood is blazing the way by advanced engineering methods backed by 23 years of marine engine building experience. (24)

LOCKWOOD
MOTOR COMPANY
716 Jackson St. Jackson, Mich.

Own a CORONA

The portable typewriter built like an office machine. Has four-row keyboard and big-machine features throughout. Write to



L. C. Smith and Corona Typewriters, Inc.
1012 E. Washington St., Syracuse, N. Y.

Beautiful HOUSES \$900 and BUNGALOWS

CAN BE BUILT FOR AND UP
This and many others in my new book, Building Plans for Modern Homes, will save you hundreds of dollars. One of the most complete and comprehensive books of plans ever published by any architect. New edition just off the press. Nearly 600 floor plans and photographs of Colonial houses, bungalows, etc., costing from \$200 up; gives sizes and cost to build. Sent postpaid for \$3.00.



FREDERICK H. GOWING
ARCHITECT
101 Tremont St., BOSTON, MASS.

**"203
Miles
an
Hour!"**



Kingsbury
toy Sunbeam
Racer 19 in.
long, \$3.00.

Get the toy sensation of the season—model of the fastest car in the world! The car that made 203 miles an hour in Florida last February. "Speediest toy on wheels." Equipped with spring motor geared to instant swiftness. Dunlop rubber tires. If your toy dealer is not supplied, write us.

KINGSBURY MFG. CO.
83 Myrtle Street KEENE, N. H.

KINGSBURY MOTOR TOYS

Complete Catalog Free. Send 10c for Kingsbury Disc Wheel Eraser.

30 Days FREE TRIAL

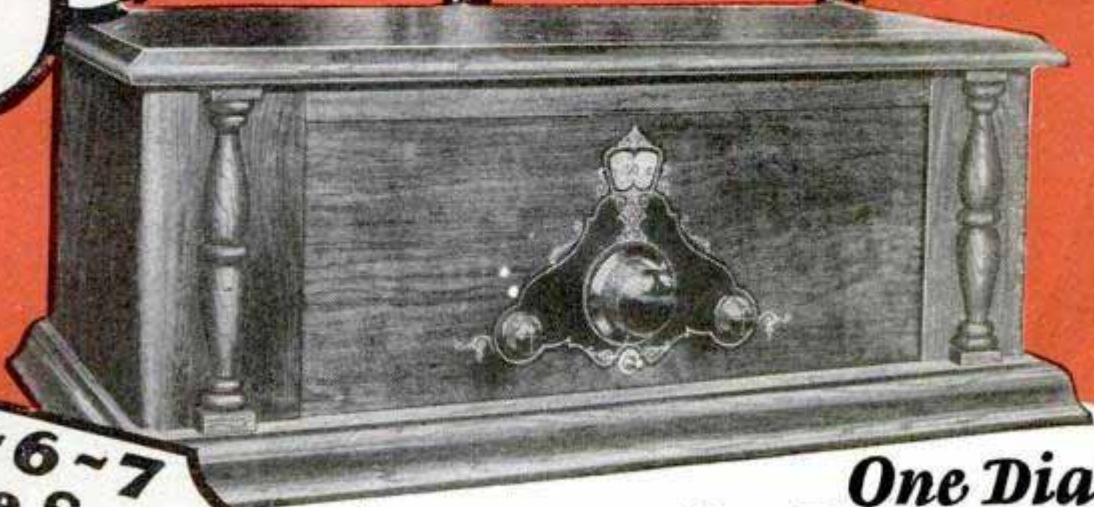

One Dial Westgate Radio Sets

5-6-7
Tube Sets
\$47.00
to
\$72.00
RETAIL PRICES

NOW!—the new 1928 WESTGALE line of Radio Models are ready for you to try. And we stand ready to put any one of our 24 new styles in your home and let you use it to your heart's content on 30 DAYS' TRIAL. Entertain your family and friends. Listen to programs from all over the country. Note the distance, selectivity, and volume. But most of all, hear their amazing deep, mellow tone,—then if you are not convinced that WESTGALE gives you more for your money than you can get elsewhere,—YOU DON'T HAVE TO KEEP IT.

Thousands of Westgate Sets have been sold on this 30 Day Trial Plan. For years we have maintained the reputation of being first with the latest in Radio. These new 1928 models are no exception,—they are the last word in Radio and priced at just about half the usual cost. Why not have the newest Radio? Why pay high prices? Why take chances, when you can test out any Westgate model in your own home on 30 Days Trial.

24 STYLES TO CHOOSE FROM Table Styles—Consoles—De Luxe Cabinets

This season Westgate offers you 5 tube—6 tube—and 7 tube models in your choice of a beautiful array of table styles, consoles and period type Walnut cabinets. Don't buy any radio until you send the coupon for our new catalog which pictures and describes our complete line in almost any size or style you could wish for. Don't wait,—a special introductory discount from retail prices for those who write quick. Mail the coupon today —get posted before you buy.

The Last Word in Guaranteed Radio Sets and the Biggest Values Ever Offered

Why Not Be Our Agent?

Buy at cost. We want Agents and Dealers in every locality to demonstrate and take orders for these amazing new 1928 Westgate Models. This is your chance to get a Westgate Radio at a big discount and make it pay you big money. Millions of radios will be sold this season. Get a Westgate set on 30 Days' Trial—demonstrate to your neighbors and friends and get your share of these big radio profits.

Your Own Radio FREE

Our new Catalog also explains a plan whereby you can put a Westgate Radio in your home on 30 days' Trial—demonstrate it to your neighbors and friends in your spare time and get your own set without cost before the trial period is up.

Special Discounts to Agents and Dealers

To quickly introduce these wonderful new 1928 models we are offering for a limited time a big reduction, way below retail prices on the FIRST Westgate set placed in each community. So get busy now. Be first in your locality to mail the coupon for our FREE catalog and get full particulars of this special discount offer.



Only **\$85.00**
Retail Price
Including Speaker

WESTGALE ELECTRIC CO.

(Formerly Westingale Electric Co.)

Dept. 210

1751 Belmont Ave. Chicago, Ill.

Mail Today - Don't Delay

Westgate Electric Co.,
Dept. 210, 1751 Belmont Ave.,
Chicago, Ill.

Please send me your FREE catalog on the new 1928 Westgate Radio Sets. Also full particulars of your Special Discount Offer on the first outfit placed in each community.

Name.....

Address.....

Quality

To neglect quality in even one of your tubes—the nerve center of your receiver—is to endanger the over-all performance of your set.

Equip throughout with Cunningham Radio Tubes and enjoy the utmost in performance that your set is capable of rendering.

E. T. CUNNINGHAM, Inc.

New York Chicago San Francisco



Twenty types—all in the Orange and Blue Carton

Cunningham
RADIO TUBES

BES

Since 1915—
Standard for all Sets

**30
DAYS
FREE
TRIAL**

7 Tube Set

Single Dial Radio



The **Metrodyne**

ONLY ONE DIAL TO TUNE

Retail Price
\$75
Completely Assembled
Big Discounts to Agents and Dealers

Wonderful offer direct from factory. World's Greatest Radio. Perfect working single dial, 7 tube set. Shipped to your home for 30 day's free trial. If you are not convinced that it is the best single dial set you ever heard return it to the factory. Your satisfaction is guaranteed.

Big Profits to Agents and Dealers!

Home agents and dealers are making big money selling Metrodynes. All or parttime. Metrodyne radios have no competition. Lowest wholesale prices. Demonstrating set on 30 days' free trial.

Metrodyne Super-7 Single Dial Set

Coast to Coast radio set. Tested and approved by Popular Science Institute of Standards, Popular Radio Laboratory and by America's leading radio engineers. **1928 model.** Easiest set to operate. One dial tunes in all stations—1000 to 3000 miles on loud speaker. Tremendous volume. Very selective. Beautiful walnut cabinet. Don't select any radio until you see and hear the Metrodyne in your home on our **30 days' free trial offer**—you to be the judge.

WRITE TODAY! We will send you hundreds of letters from owners who acclaim the Metrodyne as the greatest radio set in the world. A postal or letter brings complete information, testimonials, wholesale prices, and our liberal **30 days' free trial offer.**

METRO ELECTRIC COMPANY
2161-71 N. California Ave., Dept. 40, Chicago, Ill.

RADIO PANELS
BAKELITE—HARD RUBBER

Cut, drilled and engraved to order. Send rough sketch for estimate. Our complete Catalog on Panels, Tubes and Rods—all of genuine Bakelite or Hard Rubber. *Mailed on Request.*

STARRETT MFG. CO. 524 S. Green St. Chicago, Ill.

FREE—NEW CATALOG

DEALERS AND SET BUILDERS—Write today for our new 1928 Catalog. It's FREE. Shows latest and best nationally advertised radio equipment. Complete Kits as specified in articles in leading radio magazines now ready for shipment. No delays in filling orders. Best Prices.

MILLER-WELLES CO., 18-K W. Kinzie St., CHICAGO

BIG RADIO CATALOG

From the "Big, Friendly Radio House"

NEW 1928 Book offers finest, newest well-known sets; parts, eliminators, accessories at lowest prices. Set-builders, dealers, agents—**WRITE for this CATALOG!**

Western Radio Mfg. Co.
132 West Lake St., Dept. 37—CHICAGO

NOW! Make Things At Home

with The New

RED JACKET

HOME Work Shop

SENT ON TRIAL

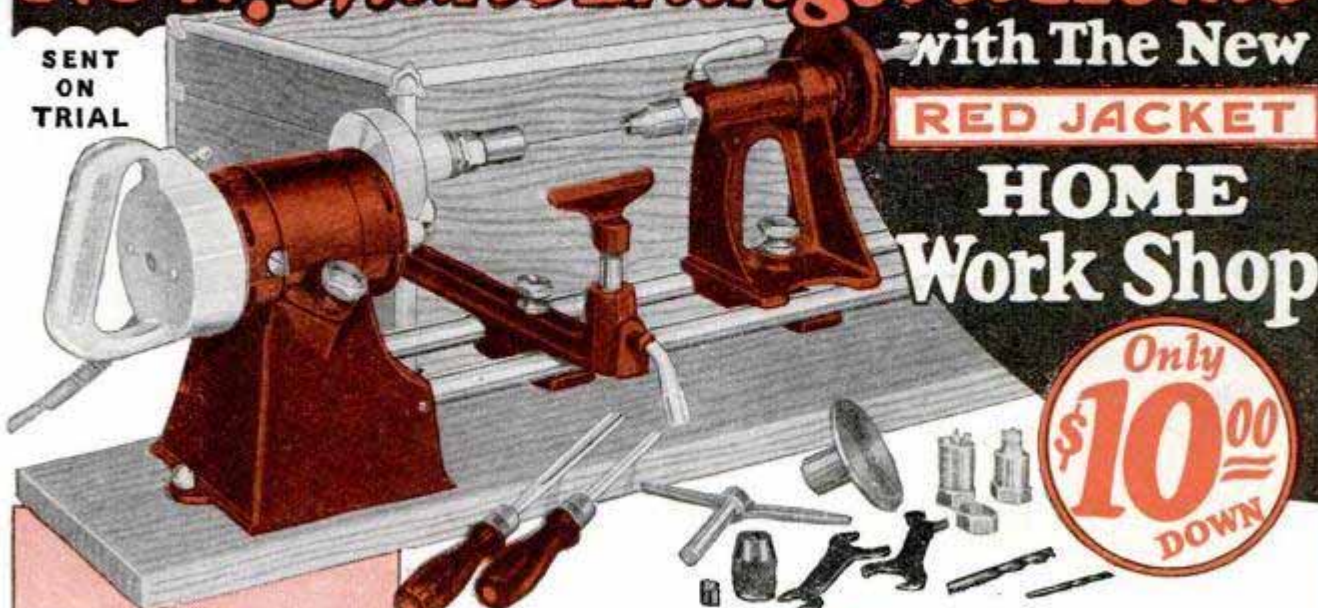

Only \$10.00 DOWN

WACO CRAFTSMAN'S WONDER WORKING LATHE

CRAFTSMANSHIP is now accomplished without labor. Red Jacket electrically driven tools turn out work like magic. Here is a complete made to order workbench equipment of perfect, efficient and powerful craftsman's tools that are small and compact enough for portable use and so inexpensive that any man or boy may have one.

- Turning
- Sawing
- Winding
- Spinning
- Grinding
- Buffing
- Polishing
- Cabinet Making
- Scroll Sawing
- Drilling
- Repairing
- Dove tailing
- Pointing
- Jointing
- Sharpening
- Sanding
- Scratching
- Carving
- Successful Masterpieces



Red Jacket

A chest full of tools designed by a master for the private use of tool lovers and men who want to build, construct, invent and create at home. You will be able to make everything— attractive odd furniture, toys, home and garden improvements, all around manufacturing, repairing.

The Complete Equipment consists of the powerful Red Jacket Motor, with direct drive to the Waco precision wood turning lathe (capacity 9 in. x 34 in.); a bench saw, that has depth and side gauges, scroll and jig saw; and all accessories for both portable and stationary power drilling, buffing, grinding and cleaning. Attaches to any light socket and converts your work bench into a complete private tool and machine shop.

The Waco Guarantee

If It Is Not What You Want When You Get It—Send It Back

Special Crafts Course

And blueprint service is free to Red Jacket Shop owners—all that there is to know about handicraft methods, raw materials, woods, carving, sawing, turning, designing, carpentering, decorating, is taught by special correspondence.

free CRAFTS COURSE

Buy On Your Own Terms Only \$10.00 down. Liberal discounts for cash. Easy monthly payment plans. It is no hardship to own a Red Jacket.

Interesting Literature

Free Send the coupon. You will be surprised with all it contains. Beautiful, Instructive, Fascinating, Interesting.

10 Days' Free Trial Our literature tells you how to start a job of your own. If you are not pleased return the Shop.



WACO TOOL WORKS,
542-4 N. Parkside Ave., Chicago, Ill.
Manager, Dept. 110. Please send me particulars about 10-day free trial, free blueprints, and \$10 down payment.

Name

Address



The "Mountie" isn't lonely any more

WHEN the supply ship steams south from the last outpost of northern civilization in September, not to return until the following July, loneliness will never again beset the lives of the Royal Canadian Mounted Police who patrol that vast, wild area. Radio is now brightening the long winter nights with music, special programs, messages and greetings from their "home folks." And in the receiving sets of the "Mounties" is the best equipment obtainable. The batteries they use *must* be dependable. They must serve until new supplies are brought in a year later.

Ask Any Radio Engineer

BURGESS BATTERY COMPANY

GENERAL SALES OFFICE: CHICAGO

Canadian Factories and Offices:
Niagara Falls and Winnipeg



BURGESS RADIO BATTERIES

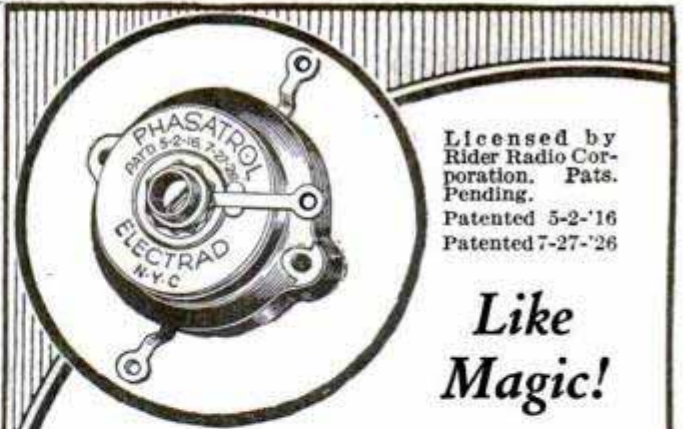

Licensed by
Rider Radio Corporation. Pats.
Pending.
Patented 5-2-'16
Patented 7-27-'26

*Like
Magic!*

Phasatrols

Reg. U. S. Pat. Office

A True Balancing Device for
Radio Frequency Amplifiers

\$2.75

You can't enjoy your radio if you continually hear oscillation noises and squeals. Install Phasatrols—they end oscillations just like magic.

This marvelous device not only checks oscillations but it eliminates distortion and interference to nearby sets as well.

Install Phasatrols yourself — it's easy. Ask your dealer today.

Write for free hook-up circular
for any set or circuit.

Dept. 65B, 175 Varick St., New York, N. Y.

ELECTRAD



CLASS PINS 25¢

NEW CATALOG FREE!

DESIGNS SHOWN—SILVER PLATE 25¢ EA. \$2.75 DOZ. STERLING SILVER 40¢ EA. \$4.00 DOZ. GOLD PLATE 35¢ EA. \$3.50 DOZ. FOR 2 COLORS ENAMEL, ANY LETTERS AND DATE.

3499
BASTIAN BROS. CO., 828 BASTIAN BLDG. ROCHESTER, N.Y.



\$75 to \$125 Weekly

\$5 Down

**Charging Batteries
Starts You**



Let me show you how to make big money right from the start. I've prepared a FREE book explaining all details. First week's profit pays for all equipment. You can get all the battery charging business in your community with my Service Station Charger—it's years ahead of ordinary chargers—handles 50% to 70% more batteries. I explain everything—start you in a business of your own and put you on the way to big money. Write for FREE Book.

C. F. HOLMES, Chief Engineer, Dept. PM
Independent Electric Works, 5116 Ravenswood Ave., Chicago

FREE BOOK—Just Out



I Want to send you a Santa Fe Special Watch

for your
Examination
Approval

21
Jewels



Watch Sent on 30 Days Free Trial

**Send No
Money**

In addition to our New Low Price, I will send for your approval one of these Standard Watches, guaranteed for a lifetime of satisfactory service, not only by the Santa Fe Watch Company, but by the Great Illinois Watch Factory. They are found in the pockets of men in the service on every railroad in this country. Senators, Congressmen and Governors keep their official appointments by "Santa Fe Special" time. Army officers and Privates carried them all through the Greatest War in history—thousands of these splendid watches are in use all over the World. If you want one on my liberal new LOW PRICE PLAN, you had better write for my Free Watch Book today and make your selection without delay. I will send the Watch for you to see WITHOUT ONE PENNY DOWN—I will even allow you to wear the Watch 30 days FREE—then sell it to you on a binding money-back guarantee.

Why Not Own A 21 Jewel Watch

You will never miss the few cents a day that will make you own one of these watches—SEND FOR WATCH BOOK—illustrating in beautiful colors hundreds of designs and combinations in cases in the POCKET WATCH, MEN'S STRAP WATCH and LADIES' WRIST WATCH. You can have your name or monogram and any emblem you may desire engraved in the Case to suit your own ideas.

New Case Designs

I want you to see the new models and wonderful case design in the Santa Fe Special, the Santa Fe Mogul, the Santa Fe Strap Watch and the Petite Santa Fe Princess

Watch. No matter what your choice of a watch may be there is a Santa Fe Watch to please you. Send coupon for our beautiful FREE catalogue showing hundreds of designs and models in watches and newest creations in Diamond Rings and Jewelry.

WRITE FOR SPECIAL CASH OFFER — GOOD FOR 30 DAYS

Mail

SANTA FE WATCH COMPANY
A-6 THOMAS BUILDING TOPEKA, KANSAS
(HOME OF THE GREAT SANTA FE RAILWAY)

Coupon

for Beautiful
FREE Watch
and
Diamond Book

.....
Santa Fe Watch Company,
A-6 Thomas Building, Topeka, Kansas.
Please send prepaid and without obligation your Watch Book Free
explaining your "No Money Down" Offer on the Santa Fe Special
Watch.
Name.....
Address.....
City..... State.....

FREE A limited offer!
With every Santa
Fe Special,
a beautiful gold
chain or strand of exquisite
pearls. Write today.

Furnace Heat Without a Basement



BULLDOG Home Heater

\$10 a Month—at our Rock-Bottom Price

Are YOU struggling along with old-fashioned stoves that heat your home only in spots? Don't do it! Get a Bulldog Seamless Home Heater.

New!—Different!—Better! It looks like a cabinet—heats like a furnace—and needs no basement. It heats your home **evenly!** Burns ANY fuel and LESS of it. Absolutely seamless, dust-tight and gas-tight. Backed by a **Double Guarantee**. Comes completely erected.

Cuts Coal Bill in Half!

"Since installing the Bulldog heater my coal bill has been cut in two! And I have had a more uniform heat and a warmer house."—A. G. Jacobson, Superior, Wis.

No Money Down!

The Bulldog is sent FREE for inspection. Then, if satisfied, you make small monthly payments at our rock-bottom, direct-to-you price.

Write! Get our special limited offer —also our free book telling all about this wonderful Seamless Home Heater. Find out! Mail coupon TODAY!

Babson Bros., Dept. 13-57
2845 W. 19th St., Chicago, Ill. ★

Please send me, without obligating me in any way, your Free Book and Special Limited Offer on the Bulldog Seamless Home Heater.

Name

Address

More than HUMAN

The only automatic self-adjusting filament control, supplying at all times just the current your tubes require. Insures 100% tube performance. Safeguards against damage. Eliminates hand rheostats. Simplifies wiring. Insist on Amperite. Retuse substitutes claimed just as good. Price \$1.10 complete.

RADIALL CO., 50 Franklin St., New York City



Write Dept. P.M. 10 for new "Amperite Book"

AMPERITE

The "SELF-ADJUSTING" Rheostat



Big Money

Selling Ties!

Beautiful Silk and wool ties in scores of live, snappy patterns. Four-in-hands, or new patented SNAP-ON BOWS! Show samples we furnish. See how quick men will buy when you mention the sensational low factory prices. You collect big profits in advance.

\$100 a WEEK

Outfit FREE to You

All you do is take orders. We show you how. You invest nothing to start. No experience necessary. Work spare time if you wish. Send name and address to-day for trial outfit FREE, and special offer whereby you get a full line of samples without cost.

NASH NAWCO NECKWEAR CO., Inc., Dept. 10-2F COVINGTON, KY.

MOTORCYCLES



Price \$10 and up purchased through our Co-Operative Plan for as low as \$1.00 down and \$1.00 per week
Indians Harley-Davidsons Ace Henderson and Clevelands

Send ten cents for Bulletin A. Motorcycles shipped to all parts of the world
WALKER-INDIAN CO., 78 Brookline Ave., BOSTON

Bodies of Rare Beauty for Fords At Factory Prices!

Write for circular A-3 showing Chummy Sportster and others.

\$22.75 and up



SPORT FACTORIES AURORA, ILL.

Line Up With WATKINS and Make Big Money

This ten-million-dollar concern known the world around for fair and honest dealing, offers you a wonderful opportunity. No limit to what you can make. T. Johansen cleared \$385 in one month. L. Roholt's average earnings for the past ten years, \$3,700. Andrew Mitchell frequently makes \$500 in a month. C. Fischer makes \$15 every day. Just write and say you are interested and we will show you how you can turn your time into gold. Address

WATKINS, C. S. 10, Winona, Minn.

TRY IT 30 DAYS FREE
BEFORE YOU BUY

FACTORY PRICES—SAVE 50%
Choice of beautiful cabinets offered

3 Year Guarantee

8 tube one dial MIRACO
TRADE MARK REGISTERED

ALL METAL SHIELDED CHASSIS

only \$69⁷⁵
Retail List Completely Assembled

MAGNIFICENT TONE—SUPER SELECTIVE—POWERFUL DISTANCE GETTER

All Electric or Battery Set Big Discounts to User-Agents

America's big, old, reliable Radio Corporation (8th successful year) **guarantees** in its big, powerful, latest 6, 7 and 8 tube Miraco sets "the finest, most enjoyable performance obtainable in **high grade** radios." Unless 30 days use in your home fully satisfies you a Miraco is unbeatable at any price for beautiful, clear cathedral tone, razor-edge selectivity, powerful distance reception, easy operation, etc.—**don't buy it!** Your verdict final! Save or make lots of money on sets and equipment—write for testimony of nearby users and **Amazing Special Factory Offer.**

Miracos work equally fine on "AC" electric house current or with batteries. Take your choice. Many thousands of Miraco users—who bought after thorough comparisons—enjoy programs Coast to Coast, Canada to Mexico, loud and clear—with the magnificent

cathedral tone quality of costliest sets. Don't confuse Miraco's with cheap, "squawky" radios. Miraco's have finest parts, latest approved shielding, metal chassis, etc.—as used in many \$200 sets.

DEAL DIRECT WITH BIG FACTORY

Your Miraco reaches you completely assembled, rigidly tested, fully guaranteed. Easy to connect and operate. **30 days trial free.** 3 year guarantee if you buy. You take no risk, you insure satisfaction, you enjoy **rock-bottom money-saving prices** by dealing direct with one of radio's oldest, most successful builders of fine sets. 8th successful year.

7 tube one dial METAL SHIELDED CHASSIS \$49⁷⁵ RETAIL LIST

MIRACO "Powerplus" sets—6 and 7 tube models—have magnificently beautiful, clear cathedral tone quality. Turn one dial for stations everywhere. Ultra-selective. Latest all-metal shielded chassis, illuminated dial. Fully guaranteed. Try one free for 30 days! Big selection of beautiful cabinets.

Dealers Write! **USER-AGENTS!** Make big profits showing Miraco to friends. Get Our Special Wholesale Prices! **MID-WEST RADIO CORPORATION, Cincinnati, O.** **BEAUTIFULLY ILLUSTRATED CATALOG AND AMAZING SPECIAL OFFER**

Free! **SEND NO MONEY—30 DAYS' TRIAL, Special Wholesale Price Offer to User-Agents, Bank References, testimony of nearby Miraco users—all the proof you want—sent with catalog.**

mail coupon right now!

ANOTHER BIG BARGAIN! Famous powerful big Miraco Super 6, 1928 model—ultra selective! Thousands find it outperforms sets of much higher price. **30 Days' Trial Free. Fully Guaranteed.**

6 tube Super \$36⁷⁵ RETAIL LIST

Electrify Any Radio with MIDWEST NO-BATTERY AC Light Socket Power Units

"A", "B", and "C" power, direct from light socket, without batteries! Write for Midwest prices and discounts. Units are highest grade—lastingly dependable, quiet in operation, fully guaranteed. Mail coupon!

MIDWEST RADIO CORP'N
Pioneer Builders of Sets
407-C Miraco Bldg., Cincinnati, Ohio.

THIS COUPON IS NOT AN ORDER

WITHOUT OBLIGATION, send me free literature, **AMAZING SPECIAL WHOLESALE PRICE OFFER**, testimony of nearby users, etc.

NAME _____
ADDRESS _____

All Who Love to make things

Model Makers ~ Amateur Mechanics Experimenters, etc. Study the specifications of this ultra-quality line of dependable machine tools, selling at prices you can afford.



KNAPP LATHE No. 930 AND TOOLS

Samples of work done on the Knapp Lathe with Outfit 935, consisting of 12 interesting and useful turning designs, and templates, 43 white pine blocks, 5 in. long, from 1/2 to 1 1/2 in. diameter.

Outfit 935, \$1.25
Shipping Wt. 7 lbs.

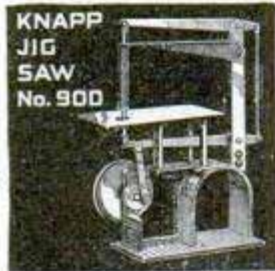

KNAPP JIG SAW No. 900

Knapp Lathe No. 930

Turns wood up to 5 in. length, 2 3/8 in. diameter. Tool rest, head rest, tail stock all fully adjustable. Complete with 3 step pulley, 3 high grade cutting tools, and instruction book.
\$6.00, Denver West \$6.50
Shipping Wt. 4 lbs.



Knapp Jig Saw No. 900

Capacity up to 3/8 in. lumber, also bakelite, celeron, etc. Handy for making radio panels, as well as jig saw and scroll work. Instruction book, wood with design laid out ready for cutting and 3 blades furnished.

\$4.00, Denver West \$4.25
Shipping Wt. 3 1/2 lbs.

Sample of work done on Saw No. 900 from Outfit 902 which consists of 20 boards, 4 1/2 x 12 x 3/16 in. and 12 designs for making everything from toys to practical household articles.

Outfit 902, \$2.00
Shipping Wt. 6 lbs.



KNAPP DRILL PRESS No. 910

Knapp Speed Drill No. 910

Takes 1/16 in. to 3/16 in. dia. drills. Drills wood, iron, copper, brass, aluminum, lead, slate, bakelite. No workshop, whether you work wood or metals, complete without one. Instruction book.

\$4.50, Denver West \$4.75
Shipping Wt. 4 lbs.

Send 10¢ for full color catalogue fully describing Knapp American Industry in Miniature—a real line of miniature machine tools that work.

Go to your dealer and see a Knapp Work Shop with all these tools mounted and assembled \$27.50—at any hardware, sporting goods or department store (toy dep't usually).

If out of stock we will send direct on receipt of price plus forwarding costs.

KNAPP ELECTRIC CORPORATION
Dept. 89 PORT CHESTER, N.Y.

Also manufacturers of Knapp Electric Questioner

In Canada: THE T. EATON CO.
(Canadian prices slightly higher)

32nd Anniversary Specials

Send only \$100 with Order

LATEST STYLE WATCH
2 diamonds
4 sapphires
Value that Defies Comparison

AE1 - Lady's diamond wrist watch; 2 genuine diamonds, 4 French blue sapphires; 14k solid white gold engraved case. Guaranteed 15 jewel movement. \$2.31 a month. Sale Price **\$29.75**



AE2 - Flashing, genuine blue white diamond set in lady's 18k solid white gold newest hand pierced basket design mounting. \$3.87 a month. Anniversary Sale Price **\$48.50**



AE3 - 5 perfectly matched genuine diamonds, four French blue sapphires. Gorgeous new lace design, lady's dinner ring, of 18k solid white gold. \$4.56 a month. Anniversary Sale Price **\$56.75**

Guaranteed Values

A FULL YEAR TO PAY

10 DAY FREE TRIAL

Values unequalled anywhere! 32 years of honest dealing is your guarantee. Send only \$1 with your order and your choice comes to you parcel post prepaid on 10 Days Free Trial. Pay postman just \$1 more on delivery; after free trial period pay balance in 12 equal monthly payments. A written guarantee with each purchase. Your money refunded if you can buy as cheap for cash. Use Your Credit.

Free ROYAL BOOK OF GEMS

Thousands of special values in genuine diamonds, jewelry, watches and silverware. Send for your free copy at once.

ROYAL DIAMOND & WATCH CO.

ESTABLISHED 1895

ADDRESS DEPT. 1860, 170 BROADWAY N.Y.

The man who studies gets ahead. Popular Mechanics Press will advise you what books to read to advance in your trade, 200 East Ontario Street, Chicago, Illinois.

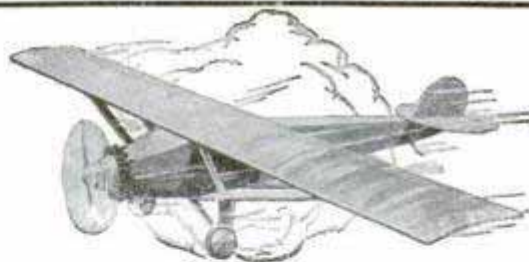

Build and Fly a 3 ft. Model of LINDBERGH'S NEW YORK-PARIS MONOPLANE

Plans for Other Model Airplanes 25c per set.

FOKKER North Pole Plane
CURTISS JN4D-2 Plane
DeHAVILLAND World Flyer
NC-4 Naval Seaplane
Bleriot, Nieuport or Taube Monoplanes
Cecil Peoli Racer Plane

(All 9 Plans for \$2.00)

This IDEAL New York-Paris Monoplane is a perfect copy, 3-ft. size of the "Spirit of St. Louis" in which Lindbergh crossed the Atlantic Ocean. Any bright boy can build this model. The IDEAL Construction Outfit contains everything needed; all parts, fittings, materials and supplies, including careful instructions, plans and diagrams. The model is wonderful; has many features of the original and is guaranteed to fly. Complete Construction Outfit, **\$7.50** (West of Denver, Colo., and in Canada, price is \$8.00)

Ask your dealer or order direct. Plans and Instructions only (No materials included), postpaid 25c.

IDEAL AEROPLANE & SUPPLY CO.
408 West Broadway NEW YORK CITY

Catalog of Model Airplanes, Parts, Supplies, etc., 5c postpaid



30 Days FREE TRIAL

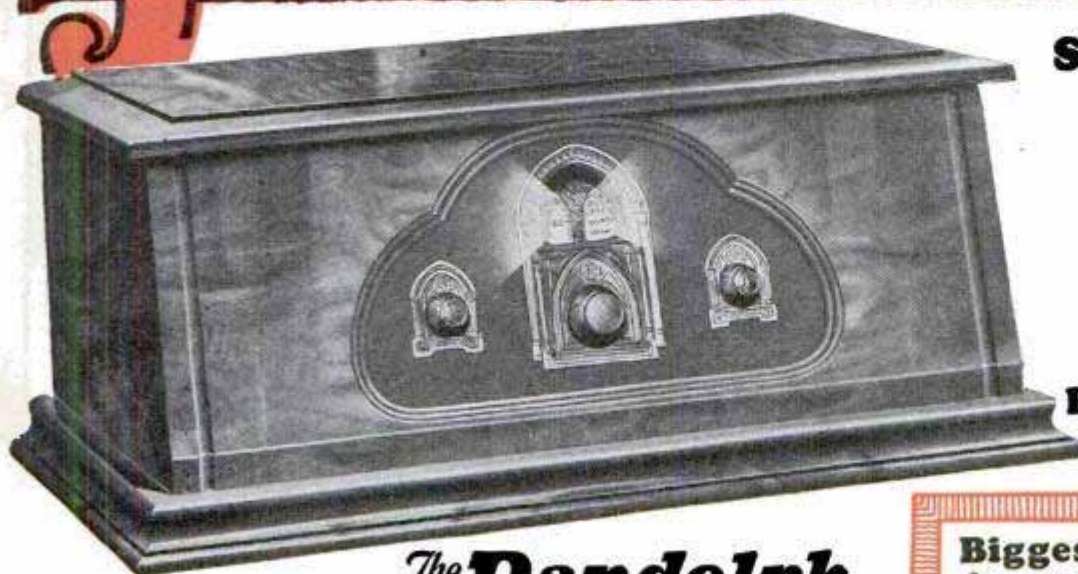

**Single Control
7-Tube**

\$ 77

RETAIL PRICE

**Completely
Assembled**

The **Randolph**

SINGLE CONTROL - ILLUMINATED DRUM

Powerful 7-tube radio at factory price. Test it without spending a cent. We claim the Randolph Seven will out-perform any radio and we want you to satisfy yourself that it will. To do this, we will send you this powerful radio to try for 30 days. Test it for distance, clearness, ease of operation, tone and every other way you can. Unless it more than satisfies you, return it to us. **Every Randolph set must make good before it is sold.**

Battery or **All-Electric Operation**

The Randolph Single Seven is sold for use with batteries or connected for operation direct to electric light socket—absolutely batteryless—no chargers or batteries—just plug in socket and tune in. 100% efficient either way. Its construction and performance have been tested and approved by leading radio engineers and authorities and leading radio and scientific publications.

Single Control—Illuminated Drum

One drum dial operated by one simple vernier control tunes in all stations with easy selectivity to tremendous volume. No overlapping of stations. Illuminated drum permits operation in the dark. Volume control for finer volume modulation. This is a 7-tube tuned radio frequency receiver with power transformers and power amplification. Space wound solenoid coils. Full and completely shielded. A real receiver of the highest quality. Tremendous distance, wonderful tone quality, simple to operate.

The Randolph cabinets are in themselves beautiful pieces of furniture made of carefully selected solid burl walnut. Bas-relief bronze escutcheon plates are mounted on the dial panel. In design and appearance it is a cabinet worthy of the high-quality radio it contains. Solid walnut beautifully shaped surrounds the soft verdi-green panel.

Nothing has been spared to make the Randolph Seven the leading radio receiver. We are so sure that it will surpass even your best hopes that we know how safe we are in making the 30 day free trial offer.

Read What Owners Say

I have logged more than 50 stations from coast to coast.
—Lloyd Davenport, Littlefield, Texas.

I have logged 52 stations from Cuba to Seattle—the set is a world beater.
—J. Lumpkinson, Detroit, Mich.

Your set is a revelation—has all others tied to the post for distance and selectivity.
—Waldo Powers, Vergennes, Vermont.

On strength of its performance sold two more sets this week.
—T. Scanlon, Orlando, Florida.

Beautiful Ampliphonic Console Set

Made of the finest carefully selected solid walnut. Two-tone shaded finish. Has built-in cone loud-speaker that compares with any on the market and accurately reproduces high and low notes. Send for the folder today that shows this beautiful console in full colors and gives complete details. Compares with most table sets in price. For battery or all-electric operation ready to plug in and tune in. Write for complete descriptions.

**RANDOLPH RADIO
CORPORATION**

711 W. Lake St. Dept. 114, Chicago, Ill.

Biggest Discounts to Agents and Dealers

WORK either full or part time and make big money. Tremendous advertising campaign helps you sell. Regardless of whether you have ever sold before, be sure to get our proposition. The Randolph sells on first demonstration. Men and women both can make money this easy way. Get your demonstration set for 30 days **FREE TRIAL.**



The **Randolph**

6-Tube

\$ 55

Retail Price

**Single
Control**

New, modern, single control, 6-tube radio. Do not compare this set with old style 2-dial 6-tube sets selling for same price. The Randolph 1928 Senior Six has been tested and approved by leading radio engineers. Comes in a beautiful solid walnut cabinet of hand-rubbed finish. Single control. Illuminated Drum with space for logging. Absolutely dependable and very selective. Sent for 30 Days Free Trial. You test it before you buy.

MAIL COUPON NOW
The Randolph Radio Corporation are pioneers in the manufacture of radios. All of its vast and unlimited resources have been used in making and perfecting of the Randolph Receivers. We know what it will do. Mail us the coupon now.

Use This Coupon Today!

**Randolph Radio Corporation,
711 West Lake Street, Dept. 114
Chicago, Illinois**

Send me full particulars about the RANDOLPH Six and Seven-Tube Table and Console Sets with details of your 30 Day FREE Trial Offer.

Name.....

Address.....

City..... State.....

Mark here () if interested in Agent's proposition.

The Old Reliable Credit Jewelers

LOFTIS

BROS. & CO. EST'D. 1858

Dept. E-894
108 N. State St.
Chicago Ill.

Genuine Diamonds Guaranteed

Diamonds

CASH OR CREDIT

SEND NO MONEY!

Have one of our beautiful Diamond Rings sent to you today! You don't need to send any money—examine it FREE. **Don't pay a penny until you have convinced yourself it's the biggest value ever offered to you** in such high grade, beautiful merchandise. Our Diamonds are beautiful, blue white gems set in solid 18-k white gold rings, magnificently hand carved and engraved. **Order today—we ship at once. Credit terms to suit your convenience.**

Send for Free Catalog
Big 132-page book, illustrating our Diamonds, Watches, Jewelry, Silverware, and gift articles for all occasions, sent absolutely free. Write today.



No. 849
\$100
\$2.50
a wk.



No. 859
\$125
\$3.25
a wk.



No. 852
\$37.50
\$1.00
a wk.



No. 847
\$150
\$3.75
a wk.

No. 855 Ladies' Wrist Watch
Solid 14-k white gold case, engraved, fancy wing ends, 16-Jewel movement, guaranteed. \$30. **\$3.00** a month \$3 down

19-Jewel Adjusted Waltham No. 846—14-k white gold filled; assorted patterns. \$42.50, \$4.26 down and **\$1.00** a week

Railroad Watches—Guaranteed to Pass Inspection

HAMILTON NO. 992, 21 Jewels, Adjusted to 5 Positions, Gold filled 25-Year Quality Case. **\$55**

ELGIN'S LATEST RAYMOND, 21 Jewels, 8 Adjustments, 40 hours one winding, Gold filled 20-Year Quality Case. **\$55**

ILLINOIS "BUNN SPECIAL", 21 Jewels, Adjusted to 5 Positions, Gold filled 25-Year Quality Case, 60 hours, 1 winding. **\$50**

Credit at Cash Prices

Wedding Rings
No. 824—The "Elite" **\$7.50** solid 18-k white gold
Set with 3 Diamonds, **\$22.50**;
5 Diamonds, **\$32.50**; 7 Diamonds, **\$42.50**; 9 Diamonds, **\$52.50**; 12 Diamonds, **\$67.50**.
All platinum, \$25. With 3 Diamonds, \$50; 5 Diamonds, \$70; 7 Diamonds, \$80; 9 Diamonds, \$100; circled by Diamonds, \$200



\$25 A Day Income For You!

Yes—it is more possible now for you to have this big income, the year 'round than it has been for many other ambitious men for the last ten years. The demand for better floors is steadily increasing, creating more business every day for floor surfacing contractors.

THE AMERICAN UNIVERSAL FLOOR SURFACING MACHINE

is faster and does better work than any other method—therefore makes more money for its owner. It's easy to get into this big paying business. Let us give you the full particulars without obligation. But act now! This is the time of the year when the demand is greatest. Write quick to

The American Floor Surfacing Machine Co.
523 South St. Clair Street Toledo, Ohio

DARCHE "CALL-ME" ELECTRIC ALARM AND LIGHT CLOCK

The only ALARM CLOCK made that is sure to get you out of bed, as the ALARM will not stop ringing until you get up and stop it. No home complete without one. Attractive also as a Mantle Clock. With a little effort on your part you can get one of these Wonderful Clocks

FREE OUR OFFER TELLS YOU HOW
A good punch board proposition. Write today for descriptive literature. It is a money maker. Mahogany finish. Size 10 1/2 x 8 1/2 x 4.

Darche Mfg. Co. 643 Washington Blvd. Chicago

MOVIES AT HOME

Many models of genuine MOVIE MACHINES, some as low as \$3.75, all using standard size big theatre films. Our stock of films is the most complete and lowest in price—with an exchange service. Films of leading stars and religious subjects are available. **DON'T DELAY. WRITE FOR FREE INTERESTING CATALOGUE NOW!**

PARAMOUNT MFG. CO.
Dept. 1371 BOSTON, MASS.

New Sepia Prints

A BEAUTIFUL FINISH
that improves kodak pictures. Send 8¢ and negative for sample and catalog of specialties.
FRANK SCOBIE, 43-S, SLEEPY EYE, MINN.

\$100 to \$125 PROFITS Weekly!

Write Today For THIS



New line of quality toilet goods sells like wildfire. 300% to 500% profits. No experience required. All you do is take orders from this beautiful sample case. Finest perfumes, soaps, facial creams, bath salts, face powders—wonderful products at prices that appeal to all women.

FREE SAMPLE CASE
Just send your name and address. This money-making opportunity is unequalled. Be your own boss. Get paid every day. Write today—we show you how to make BIG money with little work.

THE NATIONAL SOAP & PERFUME CO.
512 W. Huron St. Dept. 55 Chicago, Ill.

LIGHTING FIXTURES

Ready to hang

Direct from the manufacturer. Completely wired, including glassware. Send for new catalogue No. 28. Just Reduced Prices. *Special Proposition to Dealers.*

Erie Fixture Supply Company, Inc.
Station A ERIE, PA.

Make Extra Money This Interesting Way

Make big money showing women our beautiful fabrics. Large repeat sales. 1000 samples furnished. Men and women wanted. Complete details free.

THE NATIONAL IMPORTING CO.
Dept. X-6, 569-573 Broadway, N. Y. C.



Oh, how lovely!



LUMINOUS PAINT

Make Your Watches, Clocks, Etc., Visible by Night

The very latest discovery in the scientific world, Hitherto, practically unobtainable except at an exorbitant price, we have at last succeeded in producing this remarkable LUMINOUS PAINT, which, applied to the surface of any article, emits rays of white light, rendering it perfectly visible in the dark. THE DARKER THE NIGHT, THE MORE BRILLIANT IT SHINES. Quite simple to use. Anyone—you can do it. A little applied to the dial of your watch or clock will enable you to tell the time by night. You can coat the push buttons or switch plates of your electric lights, match boxes, and innumerable other articles; make your own Luminous Crucifixes, Luminous Rosaries, etc. Larger size, 50c and \$1 postpaid. **JOHNSON SMITH & CO., Dept. 814 RACINE, WIS.**



CIGARETTE MAKER

Roll your own and save money. Better and quicker; saves more than half. Use your favorite brand of tobacco. Neat, useful, handy. Pocket size, weighs 1/2 oz. Made entirely of metal, nickel plated. 25c, 3 for 65c postpaid anywhere.



GOOD LUCK RING

Very striking, quaint and uncommon. Silver finish; skull and crossbones design, two brilliant, flashing gems sparkle out of the eyes. Said to bring good luck. Only 25c p.p.d.



Exploding Cigarettes

JUST LIKE ORDINARY CIGARETTES. BUT SUCH REAL STARTLERS! The box contains ten genuine cigarettes of excellent quality. They appear so real, but when each cigarette is about one-third smoked, the victim gets a very great surprise as it goes off with a loud BANG! A great mirth provoker yet entirely harmless. Price 25c box.

NOVELTY BADGES



Kissing Permit 10c Two very novel metal badges, nickel plated, that you can wear giving you fun out of all proportion to their trifling cost. 10c, each badge, 3 for 25c, or 75c per doz. postpaid anywhere.

Garter Inspector 10c

MIDGET BIBLE

GREAT CURIOSITY

Smallest Bible in the World. Size of a postage stamp. 200 Pages. Said to bring good luck to the owner. A genuine work of art. Must be seen to be appreciated. Make good money selling them to friends, church acquaintances, etc. PRICE 15c each, 3 for 40c, 12 for \$1.35, 100 for \$7.50. Also obtainable in Leather Binding, with gold edges. Price 50c each, 3 for \$1.25, \$4.50 per doz. Magnifying Glass for use with Midget Bible. 15c.



STAGE MONEY



With a bunch of these bills, it is easy for each person of limited means to appear prosperous by flashing a roll of these bills at the proper time and peeling off a genuine bill or two from the outside of the roll, the effect created will be found to be all that can be desired. Prices, postpaid: 40 Bills 20c, 120 for 50c, or \$3.50 thousand postpaid.

MAGIC FLUTE



The Magic Flute, or Humanatone, is a unique and novel musical instrument that is played with nose and mouth combined. There is just a little knack in playing it which, when once acquired after a little practice, will enable you to produce very sweet music that somewhat resembles a flute. There is no fingering, and once you have mastered it you can play all kinds of music with facility and ease. When played as an accompaniment to a piano or any other musical instrument, the effect is as charming as it is surprising.

SURPRISE MATCHES

More fun than fighting with your wife. Look just like ordinary matches. Put up in boxes just like regular Safety Matches. As the victim tries to light one he gets quite a surprise. Price 10c per box, 3 boxes for 25c, 12 for 75 cents.



These clever locks cannot be opened unless you know the combination. No key necessary. For your locker, bicycle, tool chest, mail box, thousands of uses. Sturdy and tumblers nickel plated. Weighs trifling over one ounce. Small yet strong. Secret and full instructions with each lock. Price 25c or 3 for 65c postpaid.



Keyless Lock

25c Postpaid

Wonderful X-Ray Tube

A wonderful little instrument producing optical illusions both surprising and startling. With it you can see what is apparently the bones of your fingers, the lead in a lead pencil, the interior opening in a pine stem, and many other similar illusions. A mystery that no one has been able to satisfactorily explain. Price 10c, 3 for 25c, 1 dozen 75c. Johnson Smith & Co.

Every Boy His Own Toy Maker

Greatest boys' book written. Tells how to make a Pinhole Camera, a Canoe, model Railroad, a Telephone, Boomerang, Telegraph Instrument, Box Kite, Talking Machine, Microscope, Electric Motor, Electric Door Bell, Water Wheel, Paddle Raft, a pair of Skis, a Dog Sled, Bird House, Rabbit Yard, etc. 64 pages, 150 illustrations. PRICE, 10c postpaid; 3 for 25c postpaid.

Serpent's Eggs

Box contains 12 eggs. When lit with a match, each one gradually hatches itself into a snake several feet long, which curls and twists about in a most life-like manner. Price per box, 10c postpaid, 3 for 25c.



BLANK CARTRIDGE PISTOL

Protection against Burglars, Tramps, & Dogs



Well made and effective, modeled on latest type of Revolver; appearance alone is enough to scare a burglar. When loaded it may be as effective as a real revolver without danger to life. It takes standard .22 Cal. Blank Cartridge—obtainable everywhere. Special cash with order offer: 1 Superior quality Blank Cartridge Pistol, 100 Blank Cartridges, and our new 550 Page Large Catalog of latest novelties, all for ONLY \$1.50. Shipped by Express only. Cannot go by parcel post. Extra Blank Cartridges 50c per 100. Special Holster (Cowboy Type) for pistol 50c. No C.O.D. shipments.

Special Offer
1 Blank Cartridge Pistol
100 Blank Cartridges
1 550-page Novelty Catalog
ONLY \$1.50

The Lot Shipped by Express Only Cash With Order Only

THROW YOUR VOICE



Into a trunk, under the bed or anywhere. Lots of fun fooling the teacher, policeman or friends.



THE VENTRILO

a little instrument, fits in the mouth out of sight, used with above for Bird Calls, etc. Anyone can use it.

Never Fails. A 16 page course on ventriloquism, the Ventrillo, ALL FOR 10 CENTS



PISTOL, OPERA AND FIELD GLASS

9 In One

It is made in the shape of and looks like a regular Automatic Pistol. No one is likely to stop and ask you whether it is real or not. Thus it is likely to prove itself very handy in an emergency. On pressing the trigger it opens up, as shown in the illustration at the right, revealing nine most useful articles—Opera and Field Glass, Telescope, Mirror, Magnifying Glass and Burning Lens, Reading Glass, Sun Dial, Sun Compass, etc. In the handle of the revolver there is a place for various pocket necessities, such as First Aid Articles, Buttons, Pins, etc. The Pistol is of sheet metal, blued finish, that can be carried comfortably in pocket. PRICE \$1.00 postpaid.

Watch Charm Pistol \$1.75



Exact reproduction of a real pistol; actually fires REAL BLANK CARTRIDGES of miniature size. Illustration is actual size. 1 1/4 inches long, with ring at end for attaching to watch chain. Pistol is break open type; illustration shows position for loading. Made entirely of high grade steel, nickel plated, octagon barrel, handsomely engraved handles, complete in box with cleaning rod. PRICE \$1.75. Also furnished with pearl handles, \$2.50. BLANK CARTRIDGES, 50c per box of 25. JOHNSON SMITH & CO., Dept. 814, RACINE, WIS.

MICROPHONE TRANSMITTER BUTTON



You can easily make a highly sensitive detector-phone by using this Transmitter Button to collect the sound waves. You can build your own outfit without buying expensive equipment. It is simple and inexpensive. You can install an outfit in your home and hear conversations being held all over the house. You can connect up different rooms of a hotel. This outfit was used by secret service operatives during the war. It is being used on the stage. It is ultra-sensitive and is the greatest invention in microphone-phones. You can mount the button almost anywhere—card board boxes, stove pipes, stiff calendars, on the wall behind a picture frame, etc. Button is so light and small it cannot be detected. Persons can be overheard without suspecting it. You can listen in on conversations in another room. A deaf person in the audience can hear the speaker. Connected to phonograph, piano or other musical instrument, music can be heard hundreds of feet away. Button may be used to renew telephone transmitters; often makes an old line "talk up" when nothing else will. The ideal microphone for radio use; carries heavy current and is extremely sensitive. Amplifies radio signals. Countless other similar uses will suggest themselves. Experimenters find the button useful for hundreds of experiments along the lines of telephones, amplifiers, loud speakers, etc. Many fascinating stunts may be devised, such as holding the button against the throat or chest to reproduce speech without sound waves. PRICE \$1.00. JOHNSON SMITH & CO., DEPT. 814, RACINE, WIS.

JOHNSON SMITH & CO.

Dept. 814

RACINE, WIS.

A De Luxe Edition of our new 1928 CATALOG mailed on receipt of 25c. Handsome binding. Bigger and better than ever. Only book of its kind in existence. 550 pages of all the latest tricks in magic, the newest novelties, puzzles, games, sporting goods, rubber stamps, unusual and interesting books, curiosities in seeds and plants, etc., unobtainable elsewhere. Remit by Stamps, Coin, Money Order, Check, etc. Unused U.S., Canadian and Foreign Stamps also accepted.



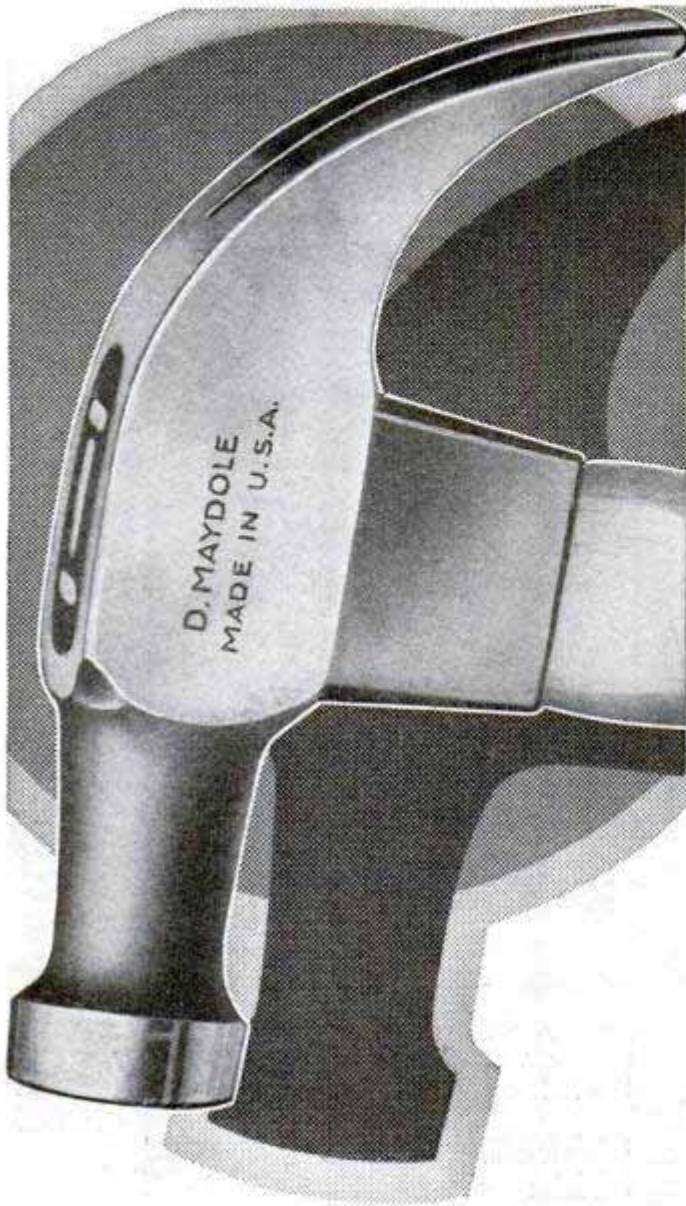

MAYDOLE

for men who appreciate fine tools

Pick up a Maydole Hammer and you will know instinctively that it is worthy of a place among your finest tools.

There is nothing tricky about a Maydole—no fancy colored handle or “patent” features—just the finest hammer that eighty-four years of specialized skill and experience can fashion from press-forged tool steel and clear, second-growth, air-dried hickory—all hammer.

If you really appreciate fine tools, you will be completely satisfied only with the genuine Maydole Hammer. Ask your dealer to show you a Maydole, any style or weight. And ask us to send you a free copy of useful Pocket Handbook 23 “L.”

YOUR HAMMER SINCE 1843
Maydole
Hammers

The David Maydole Hammer Co., Norwich, N.Y.

Auto Bodies, Boats, Blinds, Caskets, Antiques, Doors, Screens, Furniture, Sash, Cabinets, Patterns

If you work with WOOD

you can save, every day, a good many hours of the slow, monotonous work of hand sanding, rubbing, grinding, finishing and polishing—do it accurately and much BETTER with the

TAKE-ABOUT Sander

The only hand belt surfacing machine

It's a little machine—only 13 pounds—but it buys and pays for itself every few days on any kind of wood-working. Bench stand converts it into edge sander or tool grinder. 1001 uses for hard-to-get-at places. Flexible pads. Easy, quick change of belts for every purpose. Carries you over the rough spots and gets your jobs out on time PROFITABLY.

Put it up to us—no obligation—just say “my work is” mail your printed matter. Do it now, before you forget.

PORTER-CABLE MACHINE CO.
 1704-10 N. Salina St.
 Syracuse, N. Y.

Building Contractors, Vocational Schools, Floor Surfacing Contractors, Carpenter shops, Planing mills, Refrigerator manufacturers, All General Repairs, Polishing

Ask for Keds by name
 They are not Keds unless the name Keds is on the shoe

“Interlox” THE SPEEDY RULE

MASTER SLIDE RULE

Quickest, and only direct-reading rule for inside measurements. Fine for outside, too. No annoying folding—it slides. All lengths, 2 to 8 ft., 20¢ per lineal ft. If not at dealers, sent postpaid.

Dealers and Agents: Write for attractive proposition, MASTER RULE MFG. CO., 813 E. 136th Street, New York

For Real

“Woodworking Efficiency”

The QUICKEST and MOST ECONOMICAL RESULTS

You can get them on this

JUNIOR CABINET WORKER

\$156.00 complete with motor

Make just what you want, how you want it and when you want it. Nothing else to buy. This machine does it all.

Write for details

KORNAU MACHINE COMPANY
 Station A, CINCINNATI, OHIO

SIMONDS

BAND SAWS

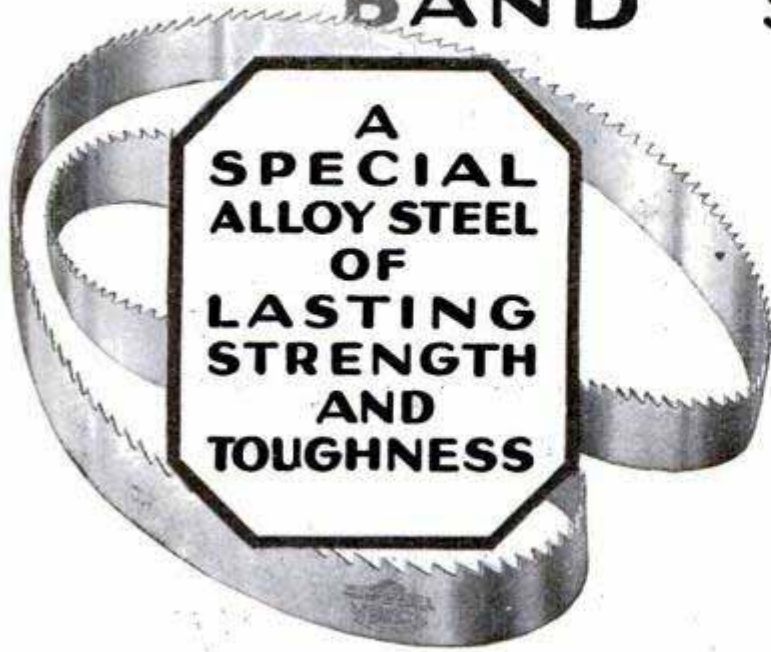

**A
SPECIAL
ALLOY STEEL
OF
LASTING
STRENGTH
AND
TOUGHNESS**

FROM specially tempered and treated alloy steel—with precision that is customarily associated only with fine mechanisms—with a knowledge of band saw requirements that is born of a near-century of experience in making cutting tools—a Simonds Band Saw is made to withstand the strains and stresses of the heaviest jobs. For longer service life, and the highest degree of safety and economy in band saw operation, specify "Simonds" when ordering.

SIMONDS SAW AND STEEL COMPANY, Fitchburg, Mass.

"The Saw Makers"

Branch Stores and Service Shops in Principal Cities

Established 1832



Effective and Positive System is secured by
Gerstner TOOL CASES
for MACHINISTS and TOOL-MAKERS. Avoid lost, mislaid or damaged tools. Catalog free.
Gerstner & Sons
446 Columbia St., DAYTON, OHIO

I made \$250⁰⁰ extra in 3 months with my TORIT handy Torch



THOUSANDS OF MECHANICS in the U. S. and Canada are doing the same—Cashing in on quick, easy profits. One man writes, "I received my Torit Torch in the morning and by night had made an extra \$7.50 on jobs I ordinarily turn down. The Torit has already paid for itself and is now the **HANDIEST TOOL IN THE SHOP.**" Beats anything you ever tried for soldering, lead burning, radiator repairing, etc.

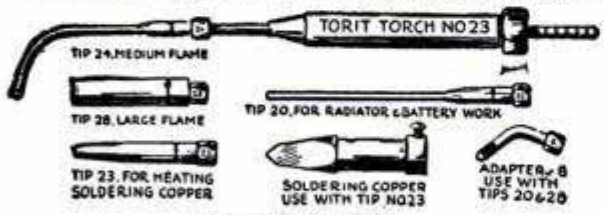

PAT. JAN. 5, 1926

Uses Acetylene Only. No oxygen or air pressure is required. Tips suck in air. Simply connect to Presto auto tank, light gas, and outfit is put to work. Consists of torch, 4 tips, soldering copper, 5 ft. rubber tubing, tank connection and instructions. Price **\$7⁵⁰**
ST. PAUL WELDING & MFG. CO., 177 W. 3rd St., St. Paul, Minn.



The strongest man will find "Cornwell" Tools to answer his most exacting requirements for hard usage. . . . No other tools are like them. . . . They withstand the most severe tests that any tools can be put to. . . . Our money back guarantee is behind every tool that fails in any demonstration.

CORNWELL

Hand Forged Tools

Mechanics in all parts of the country boast about "Cornwell" Tools because they do work that no other tools can do. They are made of the finest Swedish Charcoal Process Molybdenum Steel produced under our famous Cornwell Formula. . . . Forged, heat treated and hardened and tempered in oil. . . . Made by hand. . . . NOT drop forged and case hardened.



Money Back Guarantee
You are protected by our guarantee—if you ever saw tools as good as these, return your order and get your money back.

MAIL THE COUPON TODAY

The Cornwell Quality Tools Co.
Dept. P, Mogadore, Ohio.
(Formerly at Cuyahoga Falls, Ohio.)

Send me new illustrated catalog with prices on full line of Cornwell Hand-Made Tools.

..... Where employed
Name.....
Address.....
City..... State.....

The handy Prest-O-Lite blow torch enables you to work in corners and other places you could not reach with an ordinary torch.

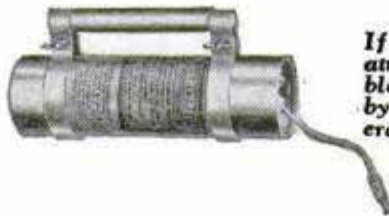

If desired, you may attach the Prest-O-Lite blow torch to a tank by means of a hose. Several sizes of tanks are available.

HOW THIS MODERN BLOW TORCH saves time and money

When you use the Prest-O-Lite Gas blow torch you simply turn on the gas and light it. This means time saved at the start of the job—and between jobs. ◻ Special torch heads, quickly interchanged, give you a flame suited to each specific job. ◻ Write for full details, mentioning the class of work you do with blow torches.

THE PREST-O-LITE COMPANY, Inc.
New York INDIANAPOLIS San Francisco
In Canada, Prest-O-Lite Company of Canada, Ltd., Toronto, Ontario
Unit of Union Carbide and Carbon Corporation



BURN YOUR NAME ON TOOLS

WITH THE
ARKOGRAF

PROTECT YOUR TOOLS FROM THEFT

Write with electricity any name or design on the hardest and finest tools and instruments, or any metal, like writing on paper with pen or pencil.
Complete Outfit \$3.50—Prepaid Anywhere

Interesting illustrated circular free. Write today. Agents wanted.

ARKOGRAF PEN CO., 1171 E. Stark St., Portland, Oregon



\$10⁰⁰

DOWN
Brings
this Lathe
to You

SYPPER MANUFACTURING COMPANY

Dept. D

Toledo, Ohio

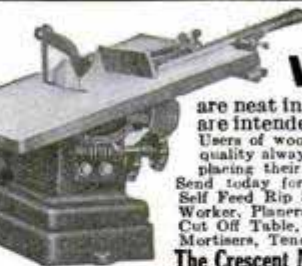

**Crescent Wood
Working Machines**

are neat in design, substantially built and are intended for hard, continuous service.

Users of wood working machinery who appreciate quality always investigate Crescent machines before placing their orders.

Send today for circulars of Band Saws, Saw Tables, Self Feed Rip Saw, Shapers, Jointers, Variety Wood Worker, Planers, Planer and Matcher, Disk Grinders, Cut Off Table, Swing Saws, Borers, Hollow Chisel Mortisers, Tenoners, Universal Wood Workers.

The Crescent Machine Co. 93 Columbia St. Leontia, Ohio, U. S. A.

LIVE SALESMEN WANTED

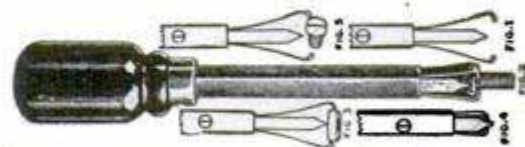

Sell Cox HoldFast Screw Drivers. Self-holding. Self-releasing. For Mechanics, Radio and Auto Work. Proposition and sample, Auto size 50c; Radio 75c. **S. J. COX, Dept. F, Franklin, Pa.**

RAISE BELGIAN HARES

NEW ZEALAND REDS—Chinchillas—Flemish Giants
MAKE BIG MONEY—We supply stock and pay you
following prices for all you raise: Belgian Hares \$2 each—New Zealand \$3 each—Chinchillas \$4 each—Flemish Giants \$5 each. 32-page illustrated book, catalog and contract, also copy of *Fur Farming* magazine, tells how to raise skunk, mink, fox, etc., for big profits, all for 10c. Address

OUTDOOR ENTERPRISE CO., Box 25, Holmes Park, Mo.

**PARKS
Manual Trainer**

\$35⁰⁰

Without
Motor

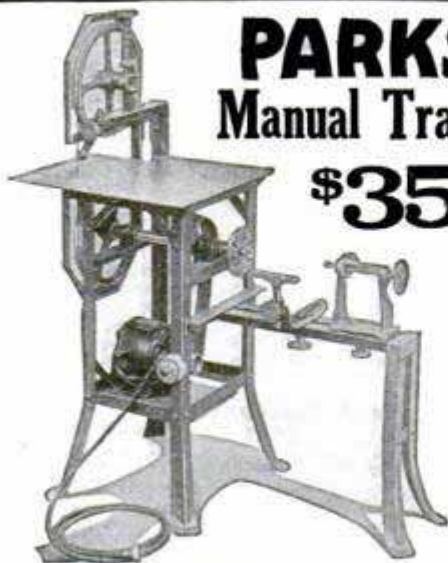

For your home shop! Combination 11-inch band saw and 11-inch wood lathe. If you have a knack for wood working you can turn out first-class bridge lamps, cabinets, furniture, ship models, etc., in fast time. Get one!

Write for specification circular

THE PARKS WOODWORKING MACHINE CO.
1500-40 Knowlton Street Cincinnati, Ohio
CANADIAN FACTORY: 208 Notre Dame East, Montreal, Canada

Plug In and Tune In

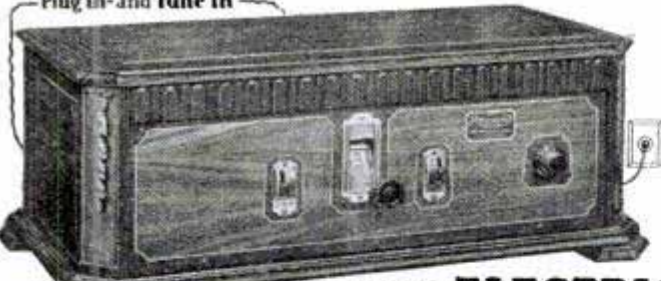

30 Days Free Trial

100% ELECTRIC RADIO SET

Three Year Guarantee
 Shipped direct from our factory at rock bottom prices—cost less than most battery sets. Consumes less than 2¢ worth of electricity a day. No Batteries, Chargers or Eliminators; No Acids; No Liquids—Plug In—Press Button—“Tune In”

Metrodyne
 ALL ELECTRIC RADIO

7 Tubes—Single Dial Set

Agents! Dealers! Big Profits!
 Taking orders for Metrodyne. All or part time. Metrodyne All-Electric Radios are in a class by themselves for quality, performance and price. Demonstrate at home. Lowest wholesale prices. Your demonstrating set on 30 days' free trial.

100% Electric Radio. Only the highest quality low loss parts are used throughout. Solid walnut cabinet, size 28x13x10, beautiful two-tone effect, with handsome gilt metal trimmings. Has electrically lighted dial. Log stations in the dark. Only one dial tunes in all stations. Excellent tone qualities—wonderful volume—very selective.

WRITE TODAY for details of this marvelous all electric radio set and our 30 days' free trial offer.

METRO ELECTRIC COMPANY 2155 N. California Avenue Dept. 618 CHICAGO, ILL.

Radio on Terms

Play While You Pay!

A marvelous set for distance, tone, selectivity. 6 tube—1 dial (illuminated). Beautiful cabinet. Easy monthly payments while you enjoy nation-wide programs. **FREE Log and Call Book** and Big Catalog containing thousands of Radio Bargains. Write today for copy.

\$985
 PUTS IT IN YOUR HOME

AMERICAN AUTO & RADIO MFG. CO.

14501 S. W. 4th St., Miami, Fla.
 Dept. 267 American Radio Bldg., Kansas City, Mo.

AGENTS 500% PROFIT
GENUINE GOLD LEAF LETTERS

S guaranteed to never tarnish. Anyone can put them on stores and office windows. Enormous demand, large profits. Paul Clark says: Smallest day \$28.70. R. L. Reel made \$920 in two months. Write today for free sample and liberal offer to general agents.
METALLIC LETTER CO., 433-B N. Clark St., CHICAGO

BUILD YOUR OWN GRANDFATHER'S CLOCK



We furnish blue prints, finishing material and instructions. Buy the works, dial, weights and pendulum from us at surprisingly low prices. You make a fine profit building artistic clocks for your friends.
 Plain Works as Low As \$5.00. Others with Chimes At All Prices. Ask for Our Free Catalogue and Offer of Blue Prints.

American Chime Clock Company
 1670 Ruffner Street
PHILADELPHIA

WURLITZER
 THE WORLDS LARGEST MUSIC HOUSE



200 Years Ago in the little town of Shoeneck lived Hans Adam Wurlitzer, Master Violin Maker. His shop was a gathering place for musicians of the time, for he was a true craftsman.

When he died his shop passed into the hands of his eldest son, and for seven generations, down to the present day, the descendants of Hans Adam Wurlitzer have carried on his work.

Today in every Wurlitzer instrument you will find a quality, a character, that could not come from mere excellence of manufacture. It is the heritage of these seven generations of music craftsmanship.

Try any Wurlitzer Instrument in your Own Home

YOU may now have any Wurlitzer instrument for a generous free trial in your own home. Examine the instrument, show it to your friends, play it as much as you wish. No obligation to buy—no expense for the trial. We make this liberal offer because we want you to try for yourself these wonderful instruments, the result of 200 years' experience in musical instrument Building. Easy payments are arranged to suit your convenience. This is your opportunity to try a famous Wurlitzer instrument in your own home.

Send for New Catalog

The greatest musical catalogue ever published. Over 3,000 articles—every known instrument described and illustrated; many of them shown in full colors. Gives you lowest prices and all details of Free Trial, Easy Payment plan. All sent FREE—no obligation.

Send this Coupon

THE RUDOLPH WURLITZER CO., Dept. 1777
 120 W. 42nd St., New York 117 E. 4th St., Cincinnati
 329 S. Wabash Ave., Chicago 134 Golden Gate Ave., San Francisco

Send me absolutely free, your new illustrated catalog, with prices and description of every known musical instrument. Also tell me how I may try any instrument in my own home and pay for it in small monthly sums. No obligation.

Name

Address

City

Instrument

(State instrument to which you are interested)

Copyright, 1937, The Rudolph Wurlitzer Co.



Diamonds Here at 60% of Market Price

Never in three quarters of a century have we offered such amazing bargains. Hundreds of money-saving opportunities in latest Diamond Bargain List, equalling those shown here.

Here's why we can offer such remarkable values: This 75 year old firm—rated at over \$1,000,000.00 capital—the largest and oldest diamond banking institution of its kind in the world has made loans on Diamonds, Watches, and other jewels in excess of \$25,000,000.00.

Why Pay Full Prices

Costs Nothing to See
Thousands of unpaid loans. Must sell now. Diamonds, Jewels, Watches and other Gems of unusual qualities—at an entirely different price basis—viz: loan values not market values. At our risk we send you any bargain you wish for absolutely free examination. No red tape. No obligation. Don't buy unless satisfied you can not match the bargain at 60 per cent more. *Diamonds of desirable quality at \$125 per carat. Yes, some even lower priced—also finest gems obtainable at higher per carat—but proportionately low bargain prices. Our bargains have guaranteed loan values also unlimited exchange privilege at full prices.*

Latest List Diamond Loans

Send at once for latest list. Thousands of unpaid loans and other special advantage bargains. Many from big cash deals direct with European diamond cutters. Every gem described in full detail with exact weight, color, quality, etc. Get details of Free Examination Offer. No obligation. List is free.

MAIL COUPON NOW



\$38⁵⁰
1/2-1/6 Ct.
Perfectly Cut



\$186
1-5/32 Ct.
Blue White



\$55
52 Ct. Show Cluster



\$62
1/4 Ct.
White Gold

Only Opposite Post Office
Jos. DeRoy & Sons
1961 DeRoy Bldg., Pittsburgh, Pa.

Without obligation, send me free, your latest Bargain List of Diamonds, Watches and other jewelry.

Name.....
Address.....
City..... State.....

Make \$40 a Day

Introducing MASTERLITE POCKET LIGHTER

Lights On New Marvelous Principle—Without Flint

Attracts crowds everywhere. Works every time in any weather. Sells for only 50c. Equal to \$10 and \$20 lighters. Every smoker instantly appreciates its wonderful convenience. No wind can blow out the flame.

Every Smoker Buys on Sight!
100% CLEAR PROFIT. Repeat Business Guaranteed

Sells instantly to smokers and dealers at big profits. Guaranteed for life. Each sale builds an everlasting repeat business. \$3.00 brings sample dozen in handsome display box with our sure-fire selling plans. Masterlite retails at 50c. **Sells on a Flash Demonstration at over 100% Profit.**



Sample 50c

Radio Gas Lighter

Lights Gas without Flame

No friction, spark, or flame. Lights instantly mantles, gas stoves, jets, and heaters. Held directly over gas flow. Flame appears instantly. Absolutely safe. Banishes danger from matches.

Make \$26 a Day

A big 25c seller, paying 300% clear profit. A gross easily sold in a day for net \$36.00 and costs you \$10.00 — \$26 a day clear. Rush \$10.00 for gross or \$1.00 for sample dozen, with amazing new sure-fire self-selling plans.

Masterlite Mfg. Co., Dept. K-23, 110 East 23 St., New York

Agents: \$2 an Hour

Wonderful new selling plan for prepared cake flour. Jiffykake contains eggs, milk, sugar, shortening, baking powder and flavoring—all ready to bake. We have plan that sells it in every home. Repeat business. Steady income.

\$50 to \$100 a Week

Write now and we will tell you how to make \$2,000 cash and a free automobile in six months. 350 High quality, low price Zanol Products. All fast sellers. No capital or experience required. Write today for territory, free auto offer and details of our new selling plan.

American Products Co., 7532 American Bldg., Cincinnati, Ohio



AUTOMATIC CONCERTINA PLAYED WITH INTERCHANGEABLE ROLLS

Play this most wonderful Musical Instrument on earth, without any knowledge of Music or notes. Simply insert a small roll and start playing. Play the biggest hits in Dance Music, Operas, Songs, etc. Rolls changed in fraction of a minute. Everyone will think you are an artist.

At home, outings, dances and parties, you will be the musical entertainer. Music is always wanted and welcomed everywhere.

You play this Concertina without having to study and practice, just by drawing apart and closing the bellows.

The "Automatic Concertina" will bring you happiness, pleasure and recreation and if you look for it, MONEY beside.

MADE IN THREE MODELS. For Home, Concerts and Paid Entertainers. Interesting descriptive Circular mailed free upon request.

TREASURE SALES COMPANY
1690 Boston Road
NEW YORK CITY



Good Bye Coal

HI-LO OIL BURNER

Does away with coal, ashes, soot and dirt. Performs with amazing efficiency in your heating plant or furnace at home. (Hot water, Steam or Hot Air.) **Noiseless and frees you of all worry. Automatically adjusts temperature under all weather conditions. The low cost, clean, efficient HI-LO way is far the easiest and best.**

LOW COST WAY

Responsible Distributors Wanted
GLORIA LIGHT COMPANY
115-10 N. May Street
CHICAGO



WADE AMATEUR MECHANICS, REPAIR SHOPS, INVENTORS, STUDENTS

BENCH LATHE

A real machine tool for the home work bench—capacity 4" dia. x 12" length. For Metal—Wood—Composition Materials. Turning—Facing—Boring—Drilling—Winding—Thread Cutting. Accurate—Strong—Quiet—Compact. Slide-rest has travel entire length of bed. Lead-screw inside bed. No. 1 Lathe, plain headstock, \$28.00. No. 2 Lathe, back-gear headstock, \$58.00. Extra for lathes with 16 inches between centers, \$7.00. Complete line of accessories at equally low prices. Write for free catalog.

THE GEROLD CO. Dept. P-36 120 Liberty St. New York



\$5.00 Down buys a WITTE Engine

Write Me Today—for new FREE Witte Book telling how you can buy a WITTE Engine for ONLY \$5.00 Down and small EASY Payments. No interest. Absolutely the greatest engine made. Guaranteed for a lifetime. Used all over the world—from the frozen wastes of Alaska to the burning sands of Arabia. Will increase your farm profits \$500.00 to \$1,000.00 a year. Runs on all fuels. Simple, sturdy. Gives most power at least expense. Sizes 1½ to 30 H. P. Engines; also 2-in-1 Saw Rigs and Pump Outfits. Write me today for FREE book and Easy Terms Offer.

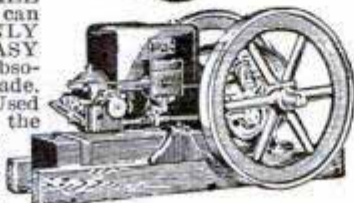

Witte Engine Works
1747 Witte Bldg., Kansas City, Mo.
1747 Empire Bldg., Pittsburg, Pa.

Makes Old Ford a Tractor

Now you can convert that old Ford car into a useful farm tractor without altering any Ford parts. We furnish the traction wheels, drive gears and auxiliary axle and mountings, ready to clamp on to the Ford frame. Pulls 16' plow.

We supply a Belt Pulley also



Write for Free Particulars.
SHAW MFG. CO., Dept. S, Galesburg, Kan.

CHRISTMAS NOVELTY

Salesmen and Agents wanted everywhere to sell our Christmas Novelty. Previous years' experience prove active men make \$25.00 daily, upward. Sold day or evening. Every store, office, and home is a prospect. Easy method of display. Cash sales; no order taking. Send quick for FREE sample and literature.

CONSOLIDATED CO., 65-A West Van Buren St., Chicago, Ill.

save 1/3 to 1/2



New FREE book quotes **Reduced Factory Prices. 5-Year Guarantee Bond** on Stoves, Ranges, Furnaces. 200 styles and sizes. Beautiful porcelain enamel ranges and combination gas and coal ranges. Mahogany porcelain enamel heating stoves. Cash or easy terms. 24-hr. shipments. 30-day free trial. 360-day test. Satisfaction guaranteed. 26 years in business. 650,000 customers. Write today for FREE book.

Kalamazoo Stove Co. Manufacturers
391 Rochester Avenue
Kalamazoo, Mich.

Heating Stoves \$24.95 Up

"A Kalamazoo Direct to You"

Ask the Man Who Mows One

The tougher the beard, the easier it is to shave with Barbasol. . . No brush. No rub-in. No after-smart. Try Barbasol—3 times—according to directions. "Mister, you're next!"



Barbasol

For Modern Shaving

The Barbasol Company
Indianapolis, Ind.

I enclose 10c. Please send trial tube.

Name

Address

P-M-10-27

NEW VEST POCKET ADDING MACHINE

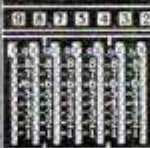

ADDS, SUBTRACTS, MULTIPLIES, DIVIDES
Does work of \$300 machine. Guaranteed 5 years. NOT A TOY. Made of steel and indestructible. Million dollar capacity. Fits in pocket. Will not make mistakes. So simple child can operate it. Instructions furnished. Everybody should carry one for figuring.

FREE TRIAL \$2.50 Total Cost

SEND NO MONEY—Just name and address. We will ship Calculator immediately. On delivery pay postman \$2.50 (Plus few cents Postage). (If outside U. S. send cash). 10c additional in Leatherette Case. If not satisfied after 10 day trial you get your money back. **TROUSANDS OF SATISFIED USERS.**

This is lowest priced practical calculator made. "Why pay more for inferior imitations?" Order from this ad.

----- **Mail Coupon Today** -----

BABY CALCULATOR SALES COMPANY

Dept. 41, P. O. Box 1118, CHICAGO, ILL., U. S. A.

- I am enclosing \$2.50—send adding machine prepaid.
- Send Adding Machine C. O. D. \$2.50 plus postage. (10c additional in Leatherette Case.)

Name

Address

City

State

AGENTS Write for big commission and territory proposition.

CAN YOU SELL HEAT? IN WINTER!

Hot Dollars All Winter!

Man, you don't have to sell heat. Everybody wants it. Everbrite agents cleaning up \$3000 to \$5000—no soliciting—no investment—no risk—just visiting prospects secured by our national advertising and leaving the heater for a night's trial.



When It's 23 Below Zero

The Everbrite Radiant Oil Heater will keep you comfortable. Mrs. Senften, Genoa, Nebraska, writes: "23 below zero, but the Everbrite kept us warm and burned 25 hours on 1 filling." A portable heater for homes, stores, churches. Makes and burns its own gas from common kerosene.

Pours out flood of pure, clean, intense heat at cost of 1 cent an hour.

FREE Just send name for amazing agents' offer. Clean up \$200 a week or more! Get a demonstration heater for your own use. Or if not interested in agency, write for special offer on heater. No wick—burns like city gas. Cleaner, cheaper, more comfortable than wood or coal. Low price.

WRITE TODAY

The EVERBRITE STOVE CO. KANSAS CITY, MO.

4216 Gateway Sta.

The EVERBRITE Radiant Oil Heater \$250 a Week

J. O. Hand, California, made over \$250 a week last year. Knabb and Godwin of Florida both did better than \$200 a week. H. T. Rees of Kansas, averaged \$300 a week. F. W. Hubbel, Iowa, beat \$400 a month. So did Senften and Cassel, Nebr., Richie of Iowa, Shook of New Mexico, Webb of Arkansas, Wilson of Louisiana, and Alfred of Kansas.

Write Like a Business Man

Own a standard remanufactured typewriter—Underwood, Royal, L. C. Smith, Remington—at saving of 40 to 60%. Looks like new. Runs like new. 5 year guarantee. Instruction in rapid touch typing free to purchaser. Express prepaid. EZ terms. 10 days' free trial. Write today for Free catalog of typewriter bargains.



YOUNG TYPEWRITER CO., 654 W. Randolph
Typewriter Headquarters Dept. 110A, Chicago

DO YOU

WANT a new business profession of your own, with all the trade you can attend to? Then become a foot correctionist, and in a few weeks earn big income in service fees,—not medical nor chiropody—easy terms for home training, no further capital needed, no goods to buy, no agency. Address

Stephenson Laboratory, 1 Back Bay, Boston, Mass.

SHIP MODEL PLANS!

Fittings and supplies. Build and sell models. Plans and instructions for Viking Galley 40c; Chinese Junk 45c. Interesting catalog of Sea Things 6c.

SEA ARTS GUILD

730A Winnebago St., Milwaukee, Wis.



ALL FREE

10 year guar. Watch with chain and ring, large Eastman Roll Film Camera or 22 cal. Hamilton Rifle, yours for introducing finest assorted liquid perfume at 15c a bottle. Send for 20 bottles and choose gifts as per offer in our catalog. We trust you—just write to **BELL PERFUME CO., Dep. A153, Chicago, Ill.**



AGENTS!



Science has finally produced it. An instantaneous metal cleaner—neither sloppy liquid nor messy paste. Dry magic floss. Touch it to nickel, copper or brass. The metal shines bright and clean instantly. No hard rubbing! Lightning Silver Cloth does same for Silverware. Lightning Furniture Floss instantly cleans and puts high lustre on Furniture. No liquid! Lightning Polishing Cloth is approved by Good Housekeeping Institute. Agents making up to \$30 a day!

Makes a Sensational Demonstration!

Everybody Buys These Products. Housewives buy the Lightning Silver Cloth and Furniture Floss. Antoinette buy Lightning Polishing Floss. Sell all three to stores and offices in big quantities. Nothing else like them. Sure big, quick MONEY GETTERS.

Sample Free! Exclusive territory. Real cooperation. Triple profit. Answer this ad at once. Make big money. Easy! Quick! Don't delay. Write NOW! FREE test sample and proposition by return mail.

G. T. LIGHTNING PRODUCTS CORP., 1773 Greenleaf Ave., Chicago

EXPERIENCE UNNECESSARY

AMAZING DISCOVERY ABOLISHES METAL AND FURNITURE POLISH

Imagine! Touch tarnished articles with a Lightning Polishing Cloth or Floss and you make them bright as new. Demonstrations positively astonishing! Every one a sale! Agents collect real money on every call.

\$146.75 + \$103.00 = \$249.75

AMAZING NEW ADDING PENCIL

TOTAL SHOWS HERE

Guaranteed Absolutely Accurate. Fountain pen size. Ends all mistakes. Send for yours Today.

Great money maker. Everybody interested. Reserve territory immediately.

AGENTS HOUK ADDING PENCIL CO., Dept. 38 St. Louis, Mo.

\$164.60 - \$64.00 = \$100.60

\$102.00 - \$60.75 = \$41.25

\$20.00

BIG MONEY

Showing shirt samples and writing orders. Many earn \$60 to \$75 a week. We send you all samples and supplies FREE and show you how to make big profits, full or spare time. Apply at once and we will include men's tie line FREE.

HOWARD SHIRT COMPANY
Dept. 60, 1213 W. Van Buren



CHICAGO, ILL.

Direct at Factory Prices

Sample \$1.18 3 for \$3.00 Postpaid

Hand Forged Razor Steel Blades

Send for our 100-page FREE List and "HOW TO USE A RAZOR."

Maher & Grosh Co.
106 A St., Toledo, Ohio



A Genuine \$2 Knife for \$1.18 Postpaid

Handy shaped Blade makes this knife best for mechanics, sportsmen and farmers: light but strong; re-sharpened easily. Stag handle. German silver finish; blades file tested, hand forged from razor steel and warranted.

SOLD 1000 BOXES \$500.00
M. BENJAMIN, CONN. PROFIT

**CHRISTMAS GREETING CARDS
IN BOX ASSORTMENTS**

Clements, N. Y.
—Ship 500
BOXES instead
of 200. Sending
certified check.

Steel, Texas.
Enter order 100
BOXES. Will
more than pass
1000 BOX mark.

Deming, Mass.
— Enter order
1500 **BOXES.**
Enclose check.

Bowser, Pa.—
Ship
100 **BOXES**
every Wednesday
until further
notice.

make great sums of money for Agents in a short time. The season's biggest money-maker. Everybody buys Christmas Greeting Cards. Nothing that an agent sells can possibly compare with the sale of Christmas Greeting Cards in Box Assortments. We publish a magnificent Christmas Box Assortment, containing 21 high grade Christmas Greeting Cards and Folders, Steel Engraved, Colored, Paneled and Bordered, each with an envelope, packed in a beautiful box, lithographed in many colors, which sells for \$1.00 and costs an agent 50c. A value never equaled.

**EACH SALE MEANS 100%
PROFIT**

An agent to be successful must start at once. Now is the time when people buy. Investigate this most extraordinary and profitable business. Write immediately, and we will send full particulars and free samples.

WALTHAM ART PUBLISHERS

7 Water St., Dept. 5-0 Boston, Mass.

**I Offer You
\$250⁰⁰ a Month** ~and a



Write quick for new proposition. \$250 a month. Raincoats. All Colors. Your choice \$2.65. Part time \$2 hour. Complete line 60 patterns, silks, suedes, tweeds, Leather-Lyke. Outfit sent free postage prepaid. Write

COMER MFG. CO., Dept. W-5125, DAYTON, OHIO

Do Your PRINTING

Cards, stationery, circulars, tag, labels, paper. Complete Outfits, \$8.85 up, Job Presses \$11 up, Rotary \$149. Card Cutters, \$3. Save money. Print for others, big profits. All easy rules sent. Write for catalog presses, type, paper, cards, ink etc. **THE KELSEY CO., F-37, Meriden, Conn.**

FREE 1000 Illustrations ELECTRIC FIXTURE CATALOG!

Write today for your copy. Save 50% direct from Manufacturer. No Middleman's Profit. OUR SPECIAL: 8 Room Electric Set, ready to hang, \$24.50—Other bargains.

UNITED LIGHTING FIXTURE CO.
53 Flatbush Ave., Dept. M, Brooklyn, N. Y.

**The One-Profit WITTE Log
and Tree Saw**



**LOW PRICE
EASY TERMS**

COMPLETE OUTFITS—everything you need for working in timber. Saws 15 to 40 cords a day! Change to tree saw in 3 minutes.

FREE Simply send name for NEW CATALOG, new Lower Prices and offers. 3 Hours Shipping Service.

WITTE ENGINE WORKS

7747 Witte Building
7747 Empire Building

**KANSAS CITY, MO.
PITTSBURGH, PA.**

**Play this Pan-American
Clarinet 5 days
FREE!**

**Easy to
Learn on a
Pan-American**

Many high school and amateur bands are completely equipped with Pan-American Clarinets—because they are easy to learn to play and are factory guaranteed. Now is the time to TRY

the world's most popular band instrument with no expense on your part. Just tear out the coupon below and mail today. No obligation. No money. Test a Pan-American at our expense.

Send No Money—Mail This Coupon

THE PAN-AMERICAN BAND INSTRUMENT & CASE CO.,
Dept. G-11, Elkhart, Indiana

YES—I would like to try a PAN-AMERICAN Clarinet for 5 days FREE. Send complete information on other Pan-American instruments.

I would like to learn to play:..... (Instrument)

Name:.....

Address:.....

City:..... State:.....

By local Music Dealer or

Shoot the Best Gun

The NEW BENJAMIN is the finest air rifle ever made. Unlike all others. Has amazing accuracy—shoots hard and far. It's the original American genuine AIR operated rifle. One to six pump strokes compress air to any desired degree of power. Same force as in air drills and air hammers except you control the shooting force. Never loses force—no springs or levers to get out of order. Makes crack shots quickly, inexpensively. Gives years of delightful recreation with utmost safety. At your dealer's, or sent postpaid for \$5.00.

Shoot 5 Days FREE

We give you five days, ammunition supplied, to test the NEW BENJAMIN. If in this time you don't believe it to be the finest air rifle you've ever seen or used, and if you don't believe it is the one and only air rifle for you, return it, postpaid, and your money will be refunded at once.

**The NEW BENJAMIN
AIR RIFLE**

America's Original Air Rifle

\$5 at your dealer's or sent postpaid direct from factory on FREE Trial as above if dealer does not handle it—write for our wonderful offer.

**Get This Book
and Details FREE**



BENJAMIN AIR RIFLE & MFG. CO.
645 N. Broadway, St. Louis, Mo.

Please send your amazing offer and free copy of "The Shooter's Art," telling how to become a crack shot, how to hold, aim, and handle guns and guide others in use of guns.

Name:.....

Address:.....



NOW—
GET MY
GREATEST
Log Saw
Offer



Fastest Cutting

Saws 15 Cords a Day

ONLY \$39

Used by The United States Government

It's easier, now, than ever before to own this fastest-cutting, easiest-moved, most powerful Log Saw. Now, you can make big money sawing firewood, stove-bolts, ice, shingle timber, etc. WRITE TODAY FOR FULL DETAILS.

Try 30 Days

— ONE WHOLE MONTH to use the OTTAWA at your own sawing. Every saw shipped on trial only—

Backed by 10-Year Guarantee

FREE Send me your name and address on a postcard today for my wonderful new edition of the "Wood Sawing Encyclopedia." Be sure to investigate—it will help you to make big money.

HARRY OVERMAN, Pres., OTTAWA MFG. COMPANY
1745-L Wood St., Ottawa, Kans. 1745-L Magee Bldg., Pittsburgh, Penna.

ONLY \$39

Putts the OTTAWA Working For You!

350 Cuts a Minute!

Now you have a log—in a few seconds it's all sawed up—without any hard work!

FREE Wood Sawing Encyclopedia

Wood selling at \$3 a cord brings owner \$45.00 a day. Go into the wood business. Don't let the lack of ready money stop you—Remember, we sell on very easy terms.

To Save You Freight—and get your machine to you a few days after you order. I ship from factory or nearest to you of **NINE BRANCH HOUSES.**

Can Up Sawing



Cuts Down Trees Level With Ground





SHOES

Get Into The Shoe Business Without Investment!

Westart you. Inexperienced worker earn \$5,000 yearly without direct to wear plan. Easy to take orders. Just show the famous Tanners line of shoes and hosiery for Men, Women and Children. We tell how and where to sell. Patented measurement system insures perfect fit. Big facilities guarantee prompt deliveries. You collect your pay daily. We furnish \$40.00 outfit containing actual shoes and actual hosiery—a larger variety of styles and sizes than any store. **Send for free book "Getting Ahead" and full particulars. No obligation. Write now!**

Experience Unnecessary!

Tanners Shoe Manufacturing Co.
1210 South C Street Boston, Mass.

You and This New Machine Can Earn \$500 a Month



Operate a Tire Repair Shop
90,000,000 Tires in use. America's greatest opportunity for men with small capital. We furnish everything—\$100 and up. **Easy payments.** We train you **FREE** right at home. Start making money at once. Write today for **Free Book "Steps to Success."**

Haywood Tire Equipment Co.
1334 South Oakley Chicago, Illinois

Sport Bodies for Fords AT FACTORY PRICES!



This Model in Grey Prime **\$39.50**

Write for Booklet A-2 Showing Other Models.

SPORT FACTORIES, AURORA, ILL.



MOTORCYCLES

WE WILL TRUST YOU
Pay As Low As \$2.00 per Week

Hendersons, Harley-Davidsons, Indians

Slightly used and rebuilt. Hundreds to select from.
Send 10c for list today.

MYEROW BROS. CO., 15 Berkeley St., Boston, Mass., U. S. A.

DENINGER WILL TRUST YOU

SEND 20c IN STAMPS FOR CATALOGUES
BIG MONEY SAVING FOR YOU

Used and rebuilt motorcycles \$25 to \$100, used bicycles \$9.50, tandems \$20. All machines fully guaranteed. New bicycles and motorcycles at factory prices, save dealers' profits. Motorcycle and automobile tires \$3. Complete line frames, engines, supplies.

DENINGER PRICE CUTTER, ROCHESTER, N. Y.

PAY AS YOU RIDE



STOP FORD CRANKSHAFT END-PLAY!

C-A ADJUSTABLE BEARING corrects and prevents end-play without removing motor. Eliminates many troubles. Easy to install—simply drop pan. Only \$3.75. Ask your dealer or sent prepaid by **ADJUSTABLE BEARING CO., Dept. P, 405 Virginia Ave., Indianapolis, Ind.**



WRITE FOR CATALOG!
Address Dept. AA
ELTO OUTBOARD MOTOR CO., MILWAUKEE



No. 6132

\$25

This Reg. Trade Mark guarantees you genuine diamonds.

SEND NO MONEY

Genuine Full Cut Diamonds—No Chips

Terms: 6 Months to Pay

No. 6132. Solid Gold Men's Initial or Emblem Ring. 2 Genuine Diamonds 4-100 each. 14-Kt. White Gold Top. Emblem (any lodge) or any initial (Old English) Yellow or White Gold inlaid in Genuine **Hope Ruby or Black Onyx.** Mention if desired in solid White Gold or Green Gold, same price.

No. 6746. Genuine Double Head Cameo (raised hand carved heads); 1-piece stone. **Heavy Shank** in White Solid Gold or Green Gold. Genuine Stone—onyx, nicely shaded. Send number of ring, size of finger, initial or emblem desired, and ring will be sent for inspection.

"The Mail Order House"
BUFFALO, N. Y.



No. 6746

Exact size of ring.

\$24

Ask for Free Jewelry Catalog

501 Washington St. BUFFALO, N. Y.

EDWARDS WILL SAVE YOU MONEY ON METAL ROOFS

We own our own steel mills, roll our own sheets, make them into high-grade REO METAL SHINGLES, Sidings, Ceilings and Roofings of every type and style for every kind of building. We control every operation from the raw material to the finished roof and we sell direct from our factories to the user. Not a dollar to divide with anybody but the customer! You get better value for less money.

OUTLAST THREE ORDINARY ROOFS

EDWARDS METAL ROOFS are weather-proof, lightning-proof, fire-proof! The galvanizing bends with the metal. No tools required.



LOW-COST ALL-METAL GARAGES

Any size. Any style. Portable. Ready to erect. Complete with frames, doors, sash and hardware. Ornamental,

durable, economical. Blue-prints and complete instructions FREE. Write today. Get our low prices and Free Samples. Ask for Roofing Book No. 150 or for Garage Book No. 150.

THE EDWARDS MFG. CO.
1000-10.0 Butler St. Cincinnati, O.



RADIO AGENTS Make Big Money

EASY to sell American Radios and Supplies. Nationally advertised, high quality merchandise at wholesale. Big profit on every sale. No capital to invest. No stock to carry. Order direct from my huge warehouse as you sell. Get My Liberal Offer and also Big New 152-page Catalog and Guide—"How to Sell Radios"—Free. Full of Bargains—all latest in Radio. Write today. AMERICAN AUTO & RADIO MFG. CO. HARRY SCHWARTZBERG, PRES. Dept. 266 American Radio Bldg., Kansas City, Mo.



30 Days' Free Trial

New Models now ready for delivery direct from our factory. Astonishing low prices and terms. Do not buy until you get them.

RIDER AGENTS WANTED to ride and exhibit sample. Make big money. Many models \$21.50 up.

Guaranteed \$1.50 each. wheels, lamps, horns, equipment at half usual prices. Send No Money. Write for our marvelous prices and terms on RANGER Bicycles.

Mead CYCLE CO. Dept. P110 CHICAGO



LIGHTNING PROFITS TOURISTS PRIDE

Tire Plugs ^{Pat.} Instant INSERTING INSTRUMENT
ENORMOUS DEMAND - EASILY SOLD - SURE REPEATER

FASTEST SELLING NECESSITY KNOWN

Every Vulcanizer, Garage, Repair Shop, etc., is a prospect and can be sold.

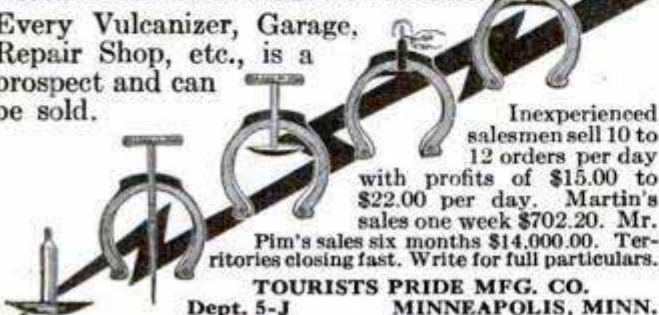

Inexperienced salesmen sell 10 to 12 orders per day with profits of \$15.00 to \$22.00 per day. Martin's sales one week \$702.20. Mr. Pim's sales six months \$14,000.00. Territories closing fast. Write for full particulars.

TOURISTS PRIDE MFG. CO.
Dept. 5-J MINNEAPOLIS, MINN.

START to PLAY Very First Day!

Free Easy Lessons
Show You How



Here at Last is YOUR Magic Key to Fun, Profit, Popularity

YOU'VE often heard Deagan Xylorimbas on the stage and over the radio—most artists use them. You've admired their snap, melody and beautiful tone. Like a million others you've wished you could play.

Your Golden Chance For Lifelong Pleasure and Profit

Now your chance has come. The Deagan Xylorimba—wonderful for the home, in demand at dances and parties, an instant

"hit" wherever you go—is nevertheless the *easiest of all instruments to play*. No teacher is necessary. On the very day you get your instrument you play simple melodies! A few weeks of pleasant practice and a *new life* is opened to you—pleasures you never dreamt of, extra money, new friends, invitations galore. *Xylorimbists regularly earn \$5 to \$25 a night for work that is play.*

Plays in Public in Six Months

Marvin Wood, Brook, Ind., was making big money in public *six months* after purchasing his Xylorimba. L.E. Hallman, Reading, Pa., makes \$65 a week spare time—had never played an instrument before. Ralph Smith, Chicago, played 20 minutes at wedding—got \$20.

Remember, these are not "supermen". They're everyday fellows like yourself who had the gumption to get ahead—to enjoy the pleasure that comes from creating music—to earn the cash and glory the world gladly pays to those who *entertain*.

Five-Day Free Trial—A Year to Pay

And now it's as easy to own a Xylorimba as to play one. Styles to fit every age and pocketbook, with such easy terms that the money it takes to learn to play some other instrument will usually pay for a Xylorimba! Five days' free trial in your own home—an entire year to pay.

Send today for the big FREE Book that tells all about the Deagan Xylorimba, our free trial offer and wonderful easy payment plan. It may be the turning point in your entire career. Don't therefore delay—mail the coupon *today*.



Send Coupon for Big FREE BOOK

J. C. Deagan, Inc., Dept. 1457, 1770 Berneau Ave., Chicago
Please send me full details on the Free Trial offer and easy payment plan of the Deagan Xylorimba.

Name _____
Address _____

CRACKED WALLS—

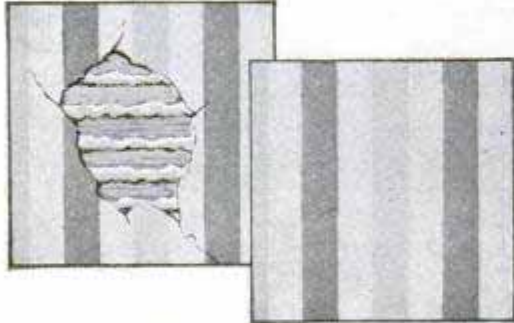

made good
as new!

WHEN you fill a crack or hole with Rutland Patching Plaster, the wall looks as good as new. And the patch is as lasting as the wall itself.

Rutland Patching Plaster will not crack, crumble or fall out. It will not shrink as plaster of paris shrinks. It's easier to use than plaster of paris, because it does not get hard or "set" instantly. Comes in handy cartons. You just add water and apply.

Paint, wall-paper and hardware stores sell it. If your dealer hasn't Rutland, we will mail a package direct and you can pay the postman 30c. plus postage. Rutland Fire Clay Co., Dept. V-4, Rutland, Vermont.



Rutland Patching Plaster

PLUMBING - HEATING WATER SYSTEMS

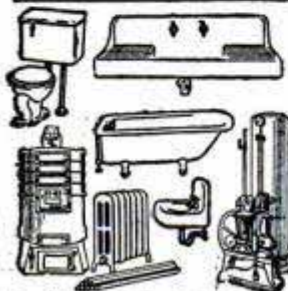

SAVE UP TO 40%

Wonderful bargains—everything guaranteed. Full line of plumbing and heating supplies. Hot water, steam heating plants and fixtures and water systems at big savings.

Install Them Yourself

Finest materials all brand new and perfect. Tell us your wants and mail us a rough sketch of your rooms.

SEND FOR PRICE LIST

B. KAROL & SONS CO. 800 S. KEDZIE AVE. Dept. 20 CHICAGO

\$351⁰⁰ CLEARED IN ONE DAY

So writes W. H. Adams of Ohio. Letter from V. A. Marini of California reports \$11,275 sales in three months. Jacob Gordon of New Jersey "44000 profits in two months." Alexander of Pennsylvania "53000 profits in four months." Ira Shook \$365 sales in one day. Bram bought one outfit April 5 and 7 more by August 28. Iwata, bought one outfit and 10 more within a year. Mrs. Lane of Pennsylvania says "sold 8000 packages in one day." J. R. Bert says "only thing I ever bought that equaled advertisement." John Culp says: "Everything Going Lovely. Crispette wrappers scattered all over town. It's good old world after all." Kellog, \$700 ahead end of second week.



WE START YOU IN BUSINESS

Furnish secret formulas, raw materials, and equipment. Little capital required; no experience needed.

BUILD A BUSINESS OF YOUR OWN

No limit to the sale of Crispettes. Everybody likes them. It's a delicious food confection. Write for facts about a business that will make you independent. Start now in your home town.

Profits \$1000 a Month Easily Possible

Send postal for illustrated book of facts. It contains enthusiastic letters from others—shows their places of business, tells how and when to start, and all information needed. Free. Write now!

LONG-EAKINS COMPANY

1028 High Street

Springfield, Ohio

AUTO PARTS—New and Used Save 30 to 80%

EVERYTHING for your car at prices only Warshawsky can offer. Bargains by the thousand—Timken Axles, Bearings, Brown-Lipe Transmissions, Pistons, Rings, Hayes and Firestone Wheels, Rims, Tires, Tubes and a complete line of accessories—new, except where specified.

FREE—Write for catalog!

WARSHAWSKY & Co.

World's Largest Replacement Parts House
1915-35 S. State St. Dept. PM 10 CHICAGO

Double Action Massage-Shave

Christy SAFETY RAZOR

RAZOR and 10 EXTRA BLADES in CASE \$1.00 POST PAID

The world's most comfortable shave is produced by the double-action massage-shave Christy Safety Razor—absolutely! Users are wildly enthusiastic! The massage bar does the trick! Used like any safety razor.

OH, BOY! WHAT COMFORT!

Yes, your present razor works all right, but wait—just wait till you step up to the shaving mirror with a Christy. You'll grin at yourself. The razor and ten blades in leatherette case with hinged cover for only \$1.00 post paid. Clip this ad and send with your name, address and a dollar bill. Money back if you are not delighted. Home Sales Co., Dept. A., Fremont, Ohio

FOUR MILLION IN DAILY USE

18 Tools In One S & B SAW Money Back Guarantee 8" Combination S.B. SAW 15 DAYS TRIAL

The S&B 8-in. Combination Saw (18 tools in one) is the ideal machine for the shop, factory or the home; will rip, cross cut, bevel, miter, mortise, groove, drill, tenon, grind, rabbet, buff and polish. The greatest machine you ever saw;

\$35

F. O. B. CHICAGO

no other machine so complete and efficient as the S&B—actually 18 tools in one! You will marvel at the wonderful bevel-

ing, grooving, buffing, etc. All attachments are adjusted in a few seconds without any difficulty. Very little space is used and the motor is mounted on a base that is a part of the machine proper, this is an exclusive feature! The motor: 1/4-H.P., 60-cycle, 110-volt A.C., run from any light socket also provides power for other purposes when the saw is not in use. Complete with attachments: 12-in. x 18-in. Table, 8-in. Combination Saw, Iron Pulley for Saw Table, 10-in. Ripping Fence, Adjustable Cut-Off Miter Gauge, Motor 1/4-H.P., 3-in. Iron Pulley, 6-in. Buffing Wheel, 5-in. Emery Wheel, 6-in. Sander, 3/8-in. 3-Jaw Drill Chuck, 1 1/2-in. Endless Leather Belt, 8-foot Cord and Plug, Saw Guard and 2-in. Dado Insert. Price \$35.00, F.O.B. Chicago. Shipping weight 100 lbs. (Planer attachment to fit on table top will smooth pieces up to 2 in. wide, \$12.00 extra. Flexible Shaft Grinder attachment, \$35.00 extra.)

Write for Complete Illustrated Folder

SCOTT-BANSBACH MACHINERY CO.

130 So. Clinton St.

Dept. 56

CHICAGO, ILL.

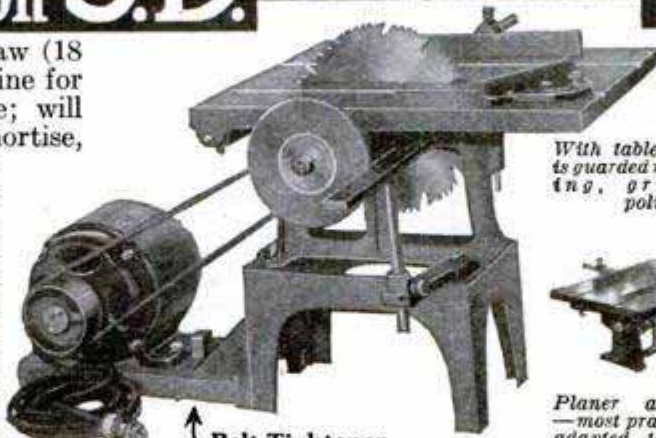

Belt Tightener

With table raised—saw is guarded ready for drilling, grinding or polishing.



Ready for dado or planer head and special molding work—Table is adjustable.

Planer attachment—most practical ever adapted to a saw table.



Flexible shaft grinding attachment—especially good for metal patterns, routing, grinding, die-castings, etc.

The only machine that you can tilt the table to 45° without removing insert. Big advantage on pattern work.



FOY'S BIG PIGEON BOOK
In NATURAL COLORS, a complete guide to successful Squab and Poultry Raising. Tells how to feed, breed, grow and make money raising squabs. Quotes low prices. Write today. **FREE.**
F. FOY Box 18 CLINTON, IOWA



Radium Dial Jeweled Movement

Silveroid. Cushion Shaped Case

This fully guaranteed watch cannot be manufactured in America for less than \$12. Genuine leather strap. Accurate—durable—handsome. **SEND NO MONEY.** Pay on delivery \$3.99 plus postage. "FED CO." U. S. Swiss Agents, 561 Broadway, New York City, Dept. W-10

LEAK

The Proved!
LACO (OIL) GAS Burner of **LOWEST PRICE... HIGHEST PERFORMANCE**

A proved successful wick type oil burner—as simple as the ordinary kerosene lamp. That's LACO!
No (oil) gas burner gives more in heating capacity and none can duplicate its economy for any heating requirement. Five sizes—each the lowest priced on the market—permit adjustment to any size heating plant for any home or building. There's nothing to get out of order; practically noiseless; does not bother radios; electrically controlled flame, operating on high-low principle. It causes no dirt, smoke, soot or odor and the LACO is safer than a gas range for there are no overflows or adjustments to make.
It is sold on a guarantee to heat your home or building to the maximum capacity of your heating plant. Money back if it doesn't do all or more than we claim. Mail the coupon for full details of how it will answer your heating problem.

DEALERS:

LACO sales increased 685% last year over the preceding year. No (oil) gas burner agency has greater profit possibilities. Every installation is a constant working salesman that will sell and continue to sell more LACOS for you. Write for terms, using the coupon below.

LACO Gas Burner Co.
102 Cass St.,
GRISWOLD, IOWA

Gentlemen:
I want to know more about LACO for my home of rooms. Check square if interested in LACO agency.

Name.....

Address.....

City.....State.....

LACO GAS BURNER CO.
102 Cass Street,
GRISWOLD, IOWA

WANTED at once!

700 men for rural localities; 1500 men and women for cities, who are industrious, steady. Let us help you start profitable, permanent business in which thousands who had no previous experience now make

\$50 to \$200 weekly sales year round; in every state and province. 32,000,000 packages sold last year of our 150 necessities. Particulars free. Write today.

The W.T. RAWLEIGH Co.
Dept. 2PPM Freeport, Ill., U.S.A.

PATENT

Protect Your Ideas

Take the First Step Today

If you have a useful, practical, novel idea for any new article or for an improvement on an old one, you should communicate with a competent Registered Patent Attorney AT ONCE. Every year thousands of applications for patents are filed in the U. S. Patent Office. Frequently two or more applications are made for the same or substantially the same idea (even though the inventors may live in different sections of the country and be entirely unknown to one another). In such a case, the burden of proof rests upon the last application filed. Delays of even a few days in filing the application sometimes mean the loss of a patent. So lose no time. Get in touch with me at once by mailing the coupon on the opposite page.

Prompt, Careful, Efficient Service

This large, experienced organization devotes its entire time and attention to patent and trade mark cases. Our offices are directly across the street from the U. S. Patent Office. We understand the technicalities of patent law. We know the rules and requirements of the Patent Office. We can proceed in the quickest, safest and best ways in preparing an application for a patent covering your idea. Our success has been built on the strength of careful, efficient, satisfactory service to inventors and trademark owners located in every state in the Union.

NO CHARGE for Information On How to Proceed

The booklet shown here contains valuable information relating to patent procedure that every inventor should have. And with it I will also send you my "Record of Invention" form on which you can sketch your idea and establish its date before a witness. Such evidence may later prove valuable to you. Simply mail the coupon and I will send you the booklet, and the "Record of Invention" form, together with detailed information on how to proceed and the costs involved. Do this NOW. No need to lose a minute's time. The coupon will bring you complete information entirely without charge or obligation.

My Patent Law Offices
Just Across
Street From
U.S. Pat. Office



Above is a view of my drafting and specification offices where a large staff of experienced experts are in my constant employ. All drawings and specifications are prepared under my personal supervision.

NEWS

Inventors Write for these Free Books

Strict Secrecy Preserved

All communications, sketches, drawings, etc., are held in strictest confidence in strong, steel, fireproof files, which are accessible only to authorized members of my staff. Feel free to write me fully and frankly. Your case will have my personal attention. It is probable that I can help you. Highest references. But **FIRST**—clip the coupon and get my free book. Do **THAT** right now.

Clarence A. O'Brien

Registered Patent Attorney

Member of Bar of: Supreme Court of the United States; Court of Appeals, District of Columbia; Supreme Court, District of Columbia; United States Court of Claims. Practice confined exclusively to Patents, Trade marks and Copyrights

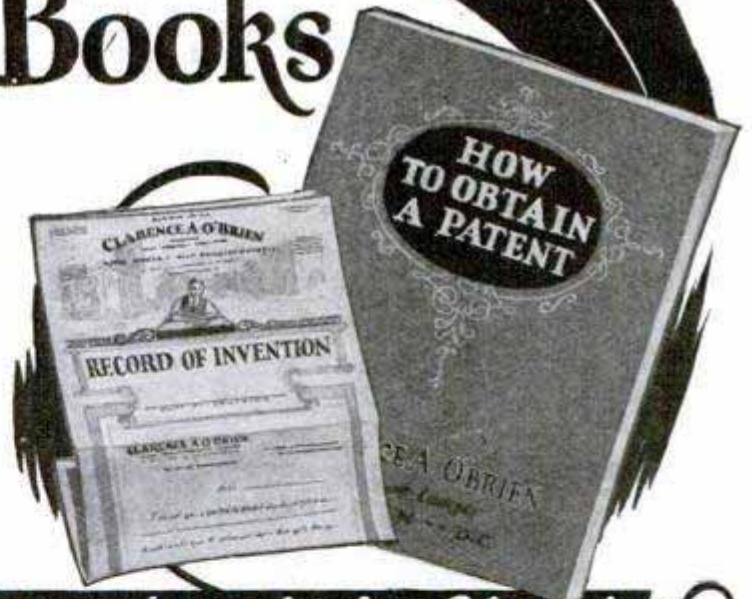

Clip this Coupon and Mail it Now!

CLARENCE A. O'BRIEN, Registered Patent Attorney

70-C Security Savings and Commercial Bank Bldg., Washington, D. C.

Please send me your free book, "How to Obtain a Patent," and your "Record of Invention" form without any cost or obligation on my part.

Name.....
(Important: Write or Print name clearly.)

Address.....

PATENTS

Booklet Free **Highest References**
Promptness Assured **Best Results**

Send drawing or model for preliminary examination of Patent Office records.

ALL BUSINESS GIVEN PROMPT AND PROPER ATTENTION

Listed Patent Lawyer in the latest editions of the Rand-McNally Directory of Bankers and Attorneys, of Chicago, Ill.; The Baggott & Ryall Directory of Attorneys, New York City; The Lawyers Guaranteed Directory, Detroit, Michigan; The Lawyers and Bankers Quarterly, published by the Legal Directory Publishing Company of St. Louis, Mo.; the American Lawyers Annual, Cleveland, Ohio.

WATSON E. COLEMAN,
 REGISTERED PATENT LAWYER

Victor Building, 724 Ninth Street, N. W.
WASHINGTON, D. C.

PATENTS

To the Man with an Idea

I offer a comprehensive, experienced, efficient service for his prompt, legal protection and the development of his proposition.

Send sketch, or model and description, for advice as to cost, search through prior United States patents, etc. Preliminary advice gladly furnished without charge.

My experience and familiarity with various arts frequently enable me to accurately advise clients as to probable patentability before they go to any expense.

Booklet of valuable information and form for properly disclosing your idea free on request. Write today.

Richard B. Owen, Patent Lawyer
 9-303 Owen Bldg., Washington, D. C.
 41-E Park Row, New York City

TRADE-MARKS
 REGISTERED

1000 NEEDED INVENTIONS!

Here is the most remarkable book ever offered to inventors. One Thousand needed inventions listed and described. Arranged as follows: General Problems; Automotive; Mechanical; Electrical; Chemical; Radio; Marine. Separate chapter on the Ten Most Needed Inventions. This book may give you one idea that will win you a fortune. Nothing else like it has ever been published. Compiled at enormous expense. Edited by Raymond Francis Yates, formerly Managing Editor of a leading scientific magazine. Over 100 pages, durably bound. Send no money. Pay postman only \$1.00 plus postage on arrival (*Outside U. S. \$1.20. Cash with Order*). Money back after 10 days' examination if desired. Limited edition. Write NOW.

BUREAU OF INVENTIVE SCIENCE

Dept. 310

Rochester, New York

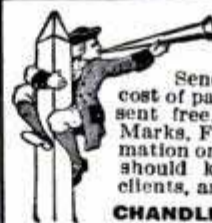

PATENTS

Send us sketch or model for advice and exact cost of patent. Our book "How to Obtain a Patent" sent free. It tells how to apply for Patents, Trade Marks, Foreign Patents, Copyrights, etc.; gives information on Patent Procedure; tells what every inventor should know. Thousands of Inventors, who are our clients, are our reference.

CHANDLEE & CHANDLEE, 25 Years' Experience
 410 Seventh St. Washington, D. C.

PATENTS

Trade Marks, Copyrights, Patent Litigation Handbook with illustrations, 100 mechanical movements. Sent free on request.

ALBERT E. DIETERICH
 formerly member examining corps U. S. Patent Office
PATENT LAWYER and SOLICITOR

621-A, Ouray Bldg.
 27 Years' Experience Washington, D. C.

INVENTORS PROTECT YOUR IDEAS

Send for our Guide Book, **HOW TO GET A PATENT**, and Evidence of Invention Blank, sent Free on request. Tells our terms, methods, etc. Send model or sketch and description of your invention for INSTRUCTIONS. No charge for the above information.

RANDOLPH & CO.
 301 Victor Bldg., WASHINGTON, D. C.

NAME.....
 STREET.....
 CITY..... STATE.....

PATENTS TRADE-MARKS AND COPYRIGHTS



OUR OFFER: FOR THE PROTECTION OF YOUR INVENTION

YOUR FIRST STEP. The inventor should write for our blank form—"RECORD OF INVENTION." This should be signed, witnessed and returned to us together with model or sketch and description of the invention for INSPECTION and INSTRUCTIONS FREE!

Our Four Books Mailed Free to Inventors

Our Illustrated Guide Book

HOW TO OBTAIN A PATENT

Contains full instructions regarding U. S. Patents, Our Methods, Terms, and 100 Mechanical Movements illustrated and described.

OUR TRADE-MARK BOOK

Shows value and necessity of Trade-Mark Protection. Information regarding *Trade-Marks and unfair competition in trade.*

OUR FOREIGN BOOK

We have Direct Agencies in Foreign Countries and secure Foreign Patents in shortest time and at lowest cost.

PROGRESS OF INVENTION

Description of World's Most Pressing Problems by Leading Scientists and Inventors

All Communications and Data Strictly Confidential. Interference and Infringement Suits Prosecuted.

IMPORTANT

TO MAKE YOUR CASE SPECIAL AND AVOID DELAY YOU SHOULD HAVE YOUR CASE MADE SPECIAL IN OUR OFFICE to secure protection, save correspondence and obtain early filing date in Patent Office. To secure special preparation of your case send \$25.00 on account with model or sketch and description of your invention.

Our Lawyers Practice in all U. S. Courts and defend Clients in Suits involving Patents, Trade-Marks and Copyrights

All Communications and Data Strictly Confidential. Interference and Infringement Suits Prosecuted

OUR ORGANIZATION OFFERS PERSONAL SERVICE By Experienced Patent Lawyers, Solicitors and Draftsmen

We Regard a Satisfied Client as our best advertisement, and furnish anyone, upon request, lists of clients in any state for whom we have secured patents.

Highest References—Prompt Attention—Reasonable Terms

WRITE TODAY

VICTOR J. EVANS & CO.

Registered Patent Attorneys

MAIN OFFICES: 792 Ninth St., Washington, D. C.

New York Offices, 1007 Woolworth Bldg.; Philadelphia Offices, 518-519 Liberty Bldg.; Pittsburgh Offices, 514 Empire Bldg.; Chicago Offices, 1114 Tacoma Bldg.; San Francisco Offices, 1010 Hobart Bldg.

Gentlemen: Please send me FREE OF CHARGE your books as described above.

Name.....

Address.....

SHOP BY MAIL FROM THIS WINDOW OF SPECIALS

WHAT YOU DO—

SEND A DOLLAR with Name and Address, number of article desired and brief note telling us something about yourself.

Simply state: (1) how long at address, (2) age, (3) married or single, (4) name and address of employer, (5) nature of work, (6) how long in employ.

All information held strictly confidential—no direct inquiries to employer.

\$1 Brings
Your
Choice
\$37.50
EACH

WHAT WE DO—

Upon arrival of your order, we will open a 10 month Charge Account and send selection for approval and 15 DAY TRIAL. If satisfied, pay \$3.65 monthly; otherwise return and dollar will be refunded.

To Any Adult interested in purchasing Diamonds, Watches or Jewelry, we will send without obligation this complete booklet illustrated in colors.

S-23—Two Diamonds, four blue sapphires; 14K white gold rectangular Wrist Watch; 15 Jewels. Expansion Bracelet.

S-27—Both Watch and Chain are 14K solid green gold. Guaranteed 7-Jewel Elgin movement.

S-24—AA1 blue-white diamond; Ladies' Solitaire; 18K white gold.

S-25—Three AA1 blue-white diamonds adorn this Ladies' Ring wrought in 18K white gold.

S-26—18K white gold Dinner Ring, carved and engraved; set with three AA1 blue-white diamonds

S-28—Elgin Strap Watch for Men; hand carved 14K green gold filled case; 7-Jewel Elgin movement, Radium numerals and hands.

L.W. SWEET, DEPT 1660 BROADWAY
INC. 67-R NEW YORK CITY

PATENTS

Don't Lose Your Rights
To Patent Protection

Before disclosing your invention to anyone send for blank form "EVIDENCE OF CONCEPTION" to be signed and witnessed. As registered patent attorneys we represent hundreds of inventors all over the United States and Canada in the advancement of inventions. The form "Evidence of Conception," sample, instructions relating to obtaining of patents and schedule of fees sent upon request.

LANCASTER & ALLWINE

480 Ouray Bldg. WASHINGTON, D. C.

Originators of forms "Evidence of Conception."

Will Finance Patents

Patents of commercial value financed on royalty basis without expense to inventor. Mail models and copies of patents or full details to

KAMSTONE HOLDING CORP.
41 East 42nd Street N. Y. C.

BLUE BOOK ON PATENTS

AND PRIORITY RECORD BLANK GRATIS

MONROE E. MILLER, PATENT LAWYER
411-2 Ouray Building, WASHINGTON, D. C.

ELECTRICAL AND MECHANICAL EXPERT

PATENTS

As one of the oldest patent firms in America we give inventors at lowest consistent charge, a service noted for results, evidenced by many well known Patents of extraordinary value. Book, Patent-Sense, free. Lacey & Lacey, 646 F St., Wash., D. C. Estab. 1869.

DEAFNESS IS MISERY



Multitudes of persons with defective hearing and Head Noises enjoy conversation, go to Theatre and Church because they use Leonard Invisible Antiseptic Ear Drums. Tiny Megaphones fitting in the Ear entirely out of sight. No wires, batteries or head piece. They are Unseen Comforts and inexpensive. Write for booklet and sworn statement of the inventor who was himself deaf.

A. O. LEONARD, Inc., Suite 699, 70 5th Ave., New York

COOKS BY BURNING AIR

Does Away
With COAL!

Converts any ordinary stove into gas range. Produces clean heat much cheaper and is far more efficient than coal. Burns 96% air and 4% kerosene. Installed in few minutes.

Types for all heating purposes. Reliable distributor wanted. GLORIA LIGHT CO., 111-10 N. May St., CHICAGO

MAKE YOUR FORD Into The "LARK"

\$5.00 Red-i-Kut life size patterns Class—Snap



38-inch Easy Riding Seat

Famous sure-fit RED-I-KUT life-size pattern and picture instructions show how you can easily convert your Ford into this Fast, Saucy, Sport Car as thousands have done, with easily obtained materials. No need to lay up the car. Rear seat folds, making 4-passenger car. Send 10c coin for actual body photo and new manual of other distinctive sport body patterns from \$3.50 up—"RKO" Steel "Swing-Lo" Irons, Tops and Windshields. ORDER RIGHT NOW.

KUEMPEL COMPANY, 89 Kuempel Bldg., GUTTENBERG, IOWA

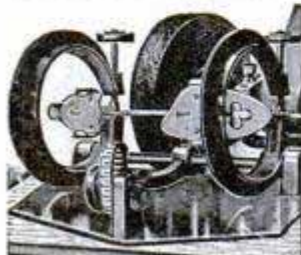
Universal and Keenedge
Skate Grinding Holders

As used for Lengthwise and Cross sharpening of skates. Price \$5.00 and \$3.50 each. Particulars on request. The Original Makers of Skate Grinding Holders. FERODOWILL MFG. CO. 202-214 W. Indiana Ave., St. Paul, Minn.

PATENTS

TRADE-MARKS ·· DESIGNS
FOREIGN PATENTS

MUNN & CO.
PATENT ATTORNEYS

Associated for 81 years with the Scientific American

SCIENTIFIC AMERICAN BUILDING
24 WEST 40th STREET
New York

SCIENTIFIC AMERICAN BUILDING
Washington, D. C.

TOWER BUILDING
Chicago, Ill.

HOBART BUILDING
San Francisco, Cal.

VAN NUYS BUILDING
Los Angeles, Cal.



Books and Information on Patents
and Trade-Marks by Request.
Associates in All Foreign Countries.

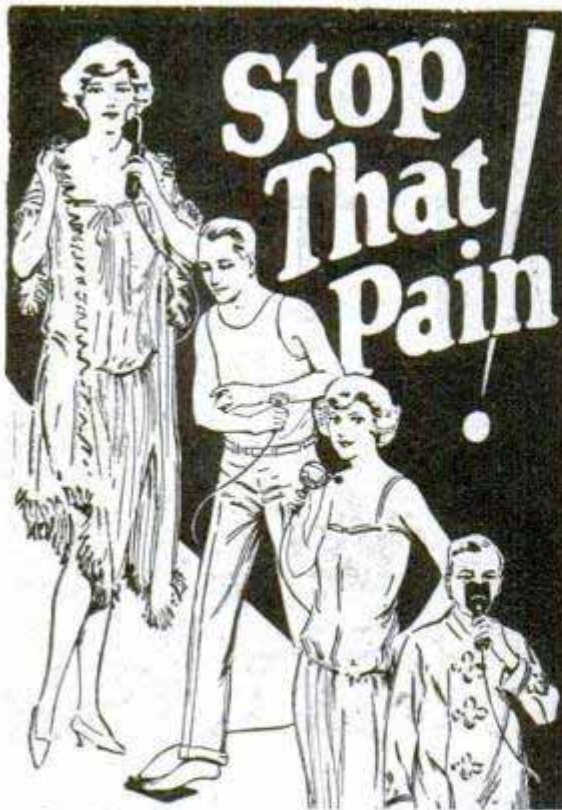

**With Violet Ray Vibration
Ozone Medical Electricity**

*The Four Greatest Curative Powers
Generated by This*

Great New Invention!



Elco Health Generators at last are ready for you! If you want more health—greater power to enjoy the pleasures and delights about you, or if more beauty is your desire—write! Ask for the book on these inventions which has just been prepared. It will be sent to you without cost. It tells you how Elco Health Generators aid you in leaving the lethargy and hopelessness of bad health and weakness behind forever. Re-vitalise yourself. Bring back energy. Be wholly alive. Write today!

Here's What Elco Users Say—

"Wouldn't take \$1000 for my Elco."
"Has done me more good in 2 weeks than doctors did in three years."



"Cured my Rheumatism." "My Eczema gone." "Cured my stomach trouble." "Cured my weakness." "Now I sleep soundly all night." "Thanks to Elco my strength and vigor are back." "No more pain." "Colds never bother me now." "Chronic Constipation banished."

These great new inventions generate Violet Ray, Vibration, Electricity and Ozone—combined or separate. They operate on the electric light in your home or on their own motive power at less than 50 cents per year. Elco Health Generators are positively the only instruments which can give you in one outfit Electricity, Violet Ray—Vibration and Ozone—the four greatest curative agents. Send the coupon below. Get the Free Book NOW!

**MAIL COUPON
for FREE BOOK**

Do not put this paper down without sending the coupon. Don't go on as you are with pains and with almost no life and energy. You owe it to yourself to be a better man or woman. You were put here to enjoy life—not just to drag through it. So do not rest another day until you have put your name on the coupon here. That will bring the whole story of these great new inventions. Do it today—now.



Lindstrom & Company

30 West Lake St. Dept. 1357 Chicago
Please send me your free book, "Health—Power—Beauty" and full information of your 10-day Free Trial Offer.

Name.....
Address.....

"I would not part with it for \$10,000"

So writes an enthusiastic, grateful customer. In like manner testify over 100,000 people who have worn it.

The Natural Body Brace

Comfortable and Easy to Wear

Overcomes Weakness and Organic Ailments of women and men. Develops erect, graceful figure, brings restful relief, comfort, health and strength.

Not Sold in Stores—

Made to Measure—Makes work easy and walking a pleasure; replaces and supports misplaced internal organs; reduces enlarged abdomen; straightens and strengthens the back; corrects stooping shoulders; develops lungs, chest and bust; relieves backache, curvatures, nervousness, ruptures, constipation.

Get Well—Stay Well Write today for illustrated booklet, measurement blank, etc., and read our very liberal proposition.

HOWARD C. RASH, Pres., Natural Body Brace Co.
223 Rash Building - - SALINA, KANSAS



30 Days Free Trial

No Joke to be Bald



Grow New Hair Quick

Let Me PROVE It To You FREE

What I accomplished on my own head, pictured above, I believe I can do for you, provided you are under 45 years of age and loss of hair was not caused by burns or scars. Anyhow, I must succeed or you pay nothing. No apparatus—my home treatment is simple, quick and inexpensive.

Send No Money Just your name and address and I will mail you full information with PHOTOGRAPHS, NAMES and addresses of men and women who have successfully used my treatment for dandruff, falling hair and particularly for baldness. Write Now. A postal will do.

VREELAND'S, 1357 Euclid-Windsor Bldg. CLEVELAND, OHIO

STOP USING A TRUSS



Reduced Fac-Simile Gold Medal

STUART'S PLAPAO-PADS are different from the truss, being mechanico-chemico applicators made self-adhesive purposely to hold the distended muscles securely in place. No straps, buckles or spring attached—cannot slip, so cannot chafe or press against the pubic bone. Thousands have successfully treated themselves at home without hindrance from work—most obstinate cases conquered. Soft as velvet—easy to apply—

inexpensive. Awarded Gold Medal and Grand Prix. Process of recovery is natural, so afterwards no further use for trusses. We prove it by sending Trial of Plapao absolutely

Write name on Coupon and send TODAY. **FREE PLAPAO CO., 733 Stuart Bldg., St. Louis, Mo.**

Name.....
Address.....
Return mail will bring Free Trial Plapao.



Grand Prix

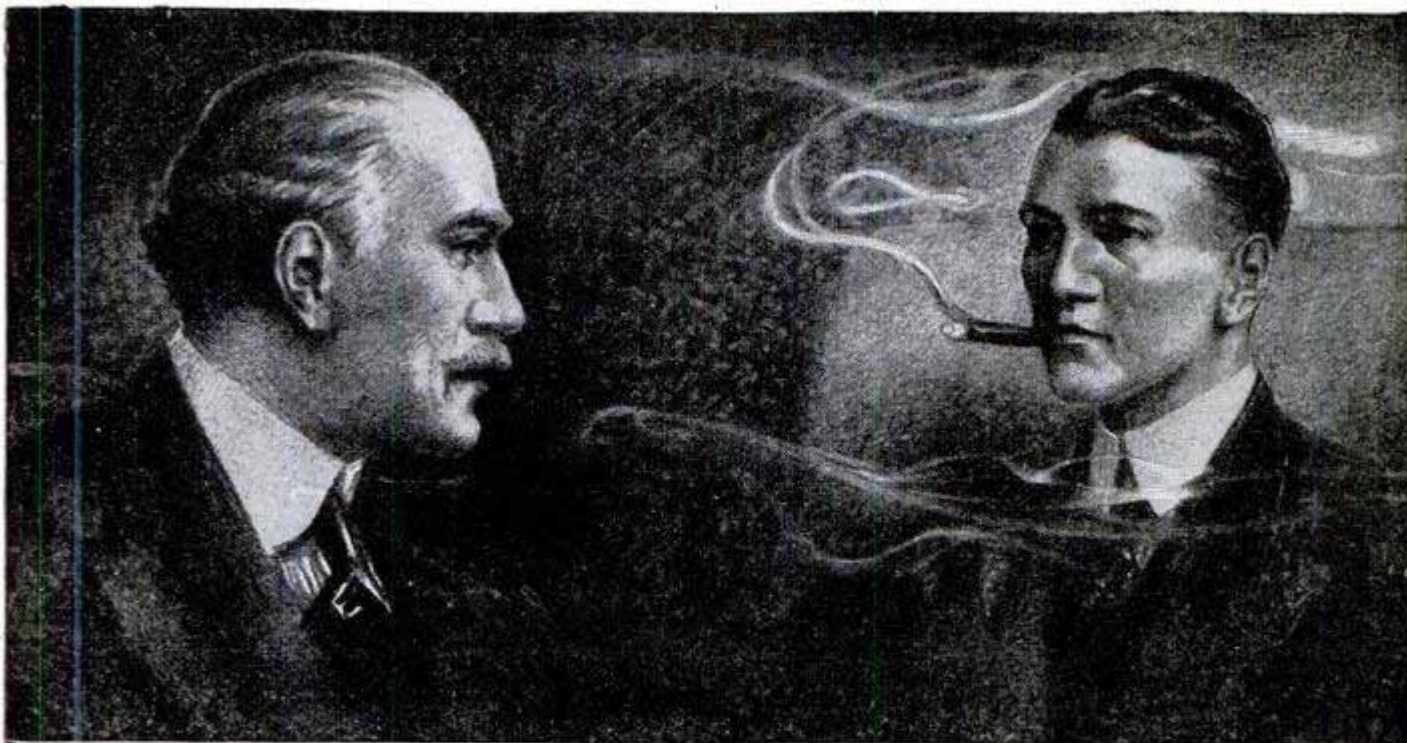

Tobacco Is Hurting You

Look at the facts square in the face, Mr. Tobacco User. You may think tobacco is not hurting you.

That is because you haven't as yet, perhaps, felt the effects of the nicotine poison in YOUR system. For you know that nicotine, as absorbed into the system through smoking and chewing tobacco, is a slow working poison. Slow, yes—but sure.

Tobacco is lowering your efficiency. It slows a man down. Makes it harder for you to concentrate your mind on your work. You haven't near the amount of "pep" and energy you would have if you stopped using it. There's many a man twice as old as you in years who's twice as young in energy, simply because he lets tobacco alone.

Some day you will realize to what an alarming extent tobacco has undermined your system.

When your hands begin to tremble—
and your appetite begins to fail—
and your heart seems to "skip a beat" now and then—
and slight exertion makes you short of breath—
then you have a right to suspect that
TOBACCO is getting the upper hand.

Any well-informed doctor will tell you that these are only a few of many symptoms of tobacco poisoning.

And YOU know that the use of tobacco in any form is an expensive, utterly useless habit. You know you ought to quit.

Tobacco Habit Banished Let Us Help You

It doesn't make a particle of difference whether you've been a user of tobacco for a single month or 50 years, or how much you use, or in what form you use it—whether you smoke cigars, cigarettes, pipe, chew plug or fine cut or use snuff—**Tobacco Redeemer** will positively remove all craving for tobacco in any form in a very few days. Not the slightest shock to the nervous system. Your tobacco craving will usually begin to decrease after the very first dose—there's no long waiting for results.

Tobacco Redeemer contains no habit-forming drugs of any kind and is marvelously quick, scientific and thoroughly reliable.

It is in no sense a substitute for tobacco. After finishing the treatment you have absolutely no desire to use tobacco again or to continue the use of the remedy. It helps to quiet the nerves and make you feel better in every way.

Results Guaranteed A single trial will convince you. Our legal-binding, money-back guarantee goes with each full treatment. We will refund every cent you pay for the treatment if after taking it according to the easy-to-follow directions, it should fail to banish the tobacco habit completely.

SEND Coupon for Free Proof Let us send you our free booklet on the deadly effects of tobacco, together with testimonial letters from men all over the country telling how they have been absolutely freed from the tobacco habit by this simple home treatment. You could not ask for stronger proof that **Tobacco Redeemer** will free you from the habit than the evidence we will gladly send on request. Just mail the coupon—or a postal will do.



Free Book Coupon

NEWELL PHARMACAL CO.

Dept. 300 Clayton Station St. Louis, Mo.

Please send, without obligating me in any way, your free booklet regarding the tobacco habit and proof that **Tobacco Redeemer** will positively free me from the tobacco habit or my money will be refunded.

Name

Street and No.

Town..... State.....

NEWELL PHARMACAL CO.

Dept. 300 Clayton Station St. Louis, Mo.

DEVITT 8" COMBINATION SAW

13 TOOLS IN ONE

Saw table raised, showing Emery wheel, saw guard and drill attachment.



Planer attachment on saw table.

Showing sanding disc attached.



Table tilted for beveling.

Dado head attached for grooving.

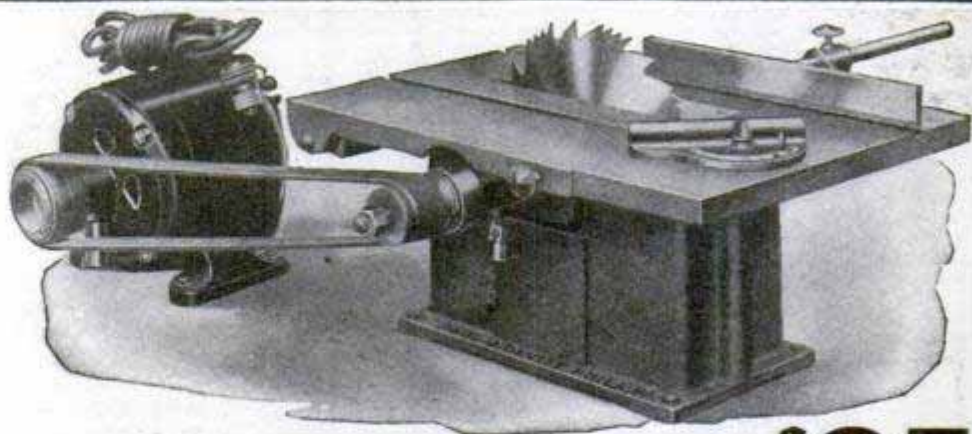

\$35
F. O. B. Phila.

YOU save a great deal of money, time and space by buying a Devitt 8" Combination Saw. Why buy special tools for beveling, grooving, buffing, etc.? The Devitt Combination Saw will rip, cross cut, bevel, miter, groove, mortise, tenon, drill, rabbet, grind, buff and polish. The attachments are easily and quickly adjusted. The saw and motor when set up ready for work occupy very little room. The 1/4 H. P. 60 cycle 110 volt A. C. motor can be run from a light socket and provide power for other purposes when the saw is not in use. A cut up to 2 1/4" can be made with the 8" Combination Saw without planing. The ideal machine for shop, factory or home, complete with attachments: 12"x16" table, 8" Combination Saw, iron pulley for saw table, 10' ripping fence, adjustable cut off miter gauge, motor-specifications as above, 1 1/4" endless leather belt, wood pulley, 8 ft. cord and plug, 6" buffing wheel, 3/4" 3 jaw drill chuck, 5" emery wheel, 6" sander, saw guard, and 2" dado insert. \$35.00 F. O. B. Phila. Height 7 1/2", shipping weight, 100 lbs. (Planer attachment to fit on table top will smooth pieces up to 2 in. wide, \$12.00 extra F. O. B. Phila.)

Write for our beautifully illustrated 4 page circular.

PAUL J. DEVITT 1102 South 2nd Street PHILADELPHIA, PA.

Amazing Violin Value

YOU CAN now purchase a genuine Conn Wonder violin, in either Virtuoso or Symphony model, formerly priced at \$175.00 and at \$200.00, for the amazingly low price of \$50.00, without the bow or the case. Far-reaching economies of production enable this drastic reduction. Famous artists like Heifetz, Elman, Thaddeus Rich and others praise the Conn highly. The Bows range from \$6 to \$12; and the cases \$12.60 to \$14. Six days' free inspection allowed. Send coupon now.



CONN
BAND INSTRUMENTS
WORLD'S LARGEST MANUFACTURERS

C. G. CONN, Ltd., 1031 Conn Bldg., Elkhart, Ind. Send further information about your special violin offer.

Name _____
St. or R. F. D. _____
City, State _____
County _____

GOLFERS

Fellow Golf Bugs! I've discovered it!! I'm over 40 and played a 95 and up game. I nearly lost my happy home trying to cut my score, never made much headway until I made this discovery. Now I'm playing from 75 to 85. Man, woman, boy or girl all can cut 10 or more strokes. A two dollar bill will bring easy simple instructions and GOOD FORM DEVICE. You'll make up this price beating your opponent first game. INVENTOR—

C. J. COONEY 6701 East End Ave., Chicago



FREE CATALOG

Send today for this marvelous catalog of army goods bargains. 52 pages, 100 illustrations, money saving values. Guns, Ammunition, Cutlery, Sport and Army clothing. Full line of Camping needs. Outfitters for 50 years to leading Military, Sports, Theatrical and Society organizations. Satisfied customers all over the world.

W. STOKES KIRK, 1627 P. M. N. 10th St., Philadelphia

I'll Pay Your Bills



and give you a steady income for the rest of your life, if you'll take care of my business in your locality. No experience needed. Full or spare time. You don't invest one cent in stock, just be my local partner. Make \$15.00 a day easy. Ride in a Chrysler Sedan furnished to producers, and distribute teas, coffee, spices, extracts, things people eat. I furnish everything, including world's finest super sales outfit containing 26 full size packages of highest quality products at lowest prices. Big, permanent repeat business. Quality guaranteed by \$25,000.00 bond. With person I select as my partner, I go 50-50. Get my amazing offer for your locality.

Write or Wire

C. W. VAN de MARK

Dept. 101-KK 117 Duane St. Cincinnati, O.

NO MORE BALD HEADS



WHEN our VACUUM CAP is used a few minutes daily. We accept no pay until you have tried the Cap 60 days and are satisfied. The Vacuum Cap is an appliance that draws the blood to the Hair Roots and starts a new healthy crop of hair. It stops Dandruff, stops the hair from falling out.

Bought by Doctors and men who know that it is the only reasonable HAIR GROWER known to science. No Drugs Used. Write for application blank, testimonials and booklet on "HAIR," sent sealed in plain envelope, FREE.

THE MODERN VACUUM CAP CO.
559 Quincy, Denver, Colo.

QUIT TOBACCO



No man or woman can escape the harmful effects of tobacco. Don't try to banish unaided the hold tobacco has upon you. Join the thousands of inveterate tobacco users that have found it easy to quit with the aid of the Keeley Treatment.

KEELEY TREATMENT STOPS Tobacco Habit

Quickly banishes all craving for tobacco. Write today for Free Book telling how to quickly Free yourself from the tobacco habit and our Money Back Guarantee.

THE KEELEY INSTITUTE
Dept. A902 Dwight, Illinois

Correct your NOSE



A shapely nose makes a beautiful face. Improve your good looks with the marvelous ANITA NOSE ADJUSTER. Reshapes any type nose perfectly at home. Quick, painless, permanent results guaranteed. Can be worn night or day. Doctors praise it. Send no money. Write for FREE BOOKLET.



ANITA CO., Dept. L-12, Anita Building, Newark, N. J.

\$10.00 PER MONTH BUYS Fibre-Lite Limbs



NEXT TO NATURE. BRACES MADE TO ORDER. AGENTS WANTED. FREE FIBRE SAMPLE. **WORMAN CO.** 252-P HENNEPIN AVE. MINNEAPOLIS, MINN.

NO JOKE TO BE DEAF



I make myself hear, after being deaf for 25 years, with these Artificial Ear Drums. I wear them day and night. They stop head noises and ringing ears. They are perfectly comfortable. No one sees them. Write me and I will tell you a true story how I got deaf and how I make you hear. Address



GEO. P. WAY, Artificial Ear Drum Co. (Inc.)
80 Hoffman Bldg., 2539 Woodward, Detroit, Mich.

How to Straighten Bow and Knock-kneed Legs!

Improve your personal appearance by using the new patent "Lim-Straitner," Model 18. Corrects now Bow and Knock-kneed legs safely, quickly and permanently at home. No costly operation or discomfort. Is worn at night. Easy to adjust; its result will save you soon from further humiliation and will improve your personal appearance 100 per cent. Write today for copyrighted Physiological and Anatomical book and experience of others without obligation. Enclose a dime for postage.

M. TRILETY, Specialist Dept. 1524L BINGHAMTON, N. Y.

5¢ Gas!



Frank Andrews

I want you to make big money easier and faster than you ever have before in your life. I guarantee \$15.00 a day to any man who becomes my distributor. Use the Coupon NOW.

Cadillac

LaSalle and Delco Light now use as standard equipment Thermostatic Carburetor Control under Blancke license.

More Proof

"Please ship us another 100 controls. Other 100 came yesterday and the writer sold 9 dozen today."

I. J. Phillips, Sr., Ga.

"Send four dozen controls and two demonstrating boards. I ordered two dozen but retail sales have already exceeded that number."

P. I. Cutler, Ore.

"We had a test run Saturday and Sunday through level and hilly country from Washington, D. C., to Martinsburg, W. Va., and back about 208 miles. Made it on 5 gallons of gas. The attachment is a wonder." Charles F. Rougeau, D.C.

Great New Invention

brings gasoline cost down for 8,000,000 Ford Owners. Hundreds of our men are earning more than they ever made before or thought possible introducing the famous Blancke Thermostatic Control. A proved success, backed by over 351,272 public and private tests, which show beyond a doubt that it is possible for Ford Owners to reduce gasoline cost to 5c a gallon. (Affidavits and hundreds of testimonials on file.)

\$15.00 a Day

Guaranteed to Distributors

Can you imagine anything easier to sell than gas at 5c a gallon? No wonder our men are coining money! No wonder we can afford to offer you the most liberal, worth while proposition you could ever dream of. The coupon will bring you full details. Get it into the mail at once!

Nothing Like It

Do not confuse the great Blancke Invention with anything else you've ever heard of. Its principle is entirely scientific — absolutely different. You can easily prove this to your advantage at our risk. All you need to do is mail the coupon. It will cost you nothing and will positively bring you by return mail the biggest surprise and greatest opportunity you've ever known.

Get Free Trial

Act at once if you want to get started with a sure thing. Make real money with the backing of a big, well-known responsible firm. Don't delay. We want to assign men right now to the profitable territories we have left open. Get in with a live proposition. Be independent! Make \$15.00 a day and large commissions. Mail me coupon quick for free trial, proof, and full details of a big proposition that will surprise you.

Frank Andrews, Pres.
Blancke Auto Devices Co.
154 E. Erie Street Dept. 805-N
Chicago, Ill.

Mail Coupon at Once!

Frank Andrews, Pres.
Blancke Auto Devices Co.
154 E. Erie St., Dept. 805-N, Chicago, Ill.

Dear Sir: I am interested in selling gas at 5c per gallon. Send full details and free trial. No obligation to me.

Name

Address

City State

WE PAY OUR DISTRIBUTORS \$15.00 A DAY

A 1/4 Century House, Financially Rated over \$1,000,000.00, offers the following:—

Actual Regular Prices TO DAY \$55 to \$65

21 Jewels \$29⁴⁸

Hamilton '992' ILLINOIS Bunn Special ELGIN B.W. Raymond and Others

Forced Sale for Loan and charges Only

High grade, Hamilton, Illinois, Elgin and other famous railroad makes, perfect conditioned, 21 jewel adjusted movements—each and every watch has gold—sells now—at only \$29.48. Yet offered here at \$55.00 to \$65.00. Why?—Simply because they have been carried in the pocket a short time and used as collateral for loans at this big association of 10 loan firms combined. Of course not all loans are repaid. These, the real opportunities for you to buy at forced sale prices—pay merely the amount loaned plus interest, charges.

Guaranteed to Pass Railroad Inspection
No better running watches—no better timekeepers—than these. Then, why pay full prices for the identical makes and grades of foremost railroad timepieces we offer you here at a fraction of original costs,—

Low as 33c on the \$1 (of original costs)
Of course you wouldn't want to sell your perfectly good watch, keeping perfect time, at any such tremendous loss in price to you—unless you just had to have the money. Well, these watches were never intended to be sold by the individuals who owned them. These represent circumstances where money was borrowed. The owners expected to repay. They failed to meet their obligations. Hence, these watches must be sold to get back the cash loaned and accrued charges only.

Send for Latest List—Examine Watches Free
See one of these 21 jewel, guaranteed perfect condition watches at \$29.48, entire cost. Includes delivery to your very door. Or send for one of our lot No. 47—Elgin "B. W. Raymond" 19 jewel adjusted timepiece at just \$19.80. Or lot No. 63—one of the famous Howard 21 jewel adjusted railroad chronometers, originally cased by factory, priced here at only \$39.50. These and many other unusual offers in latest list. Mail coupon below. Examine any watch on approval—no risk, no expense to you. No obligation to buy if not acceptable.

Don't Delay! Just a limited number in Each Lot. Fill in below for Free List.

JOS. DeROY & SONS. (10 Large Loan Firms Combined)
Opposite Post Office 5961 DeRoy Bldg., Pittsburgh, Pa.

References by permission—
Bank of Pittsburgh
N. A. Marine National Bank—Union Trust Co., Pittsburgh, Pa. Your bank can look us up in mercantile agencies.

Name _____
Address _____

Low as \$60 a Carat for Diamonds

Catch Fish! 

Eels, Mink, Muskrats with our new folding galvanized **STEEL WIRE TRAP**. Write for our **FREE TRAP OFFER** and Bargain Catalog. \$1 Box of our famous Fish Bait **FREE** to introduce our traps. **WALTON SUPPLY CO., 3501 JUNIATA AVE., ST. LOUIS, MO.**

Just Turn This Handle

Make \$12 a Day!

Demonstrate this amazing new **Self-Wringing Mop**. Any man or woman without previous experience can earn at least \$12 daily, just turning handle.

Sells Quickly
Remarkable device wrings mop perfectly dry. Handle on mop wrings out water in a jiffy. No more "back-breaking." No more getting hands into dirty mop water. "Lucky 7" cleans floors in one-fourth the time. Every woman a prospective buyer. Quick demonstration brings easy sales. Big profits for you.

THE DELPHOS MOP CO.
16210 Washington St.
DELPHOS, OHIO

GET SAMPLE MOP—FREE OFFER
Show "Lucky 7" to women. Take orders fast. Hursen made \$7 the first hour. Mrs. B. C. Blyth took 30 orders from neighbors. Others making amazingly big incomes everywhere. Write immediately for full details and **FREE MOP** offer.



FOR FINE WORK

around shop and home

There are a thousand uses for these side cutting, long nose pliers. They reach the awkward places with ease. Their keen wire-cutters are hand sharpened and tempered. **6 INCH**

All Crescent—Smith & Hemenway tools are drop-forged of special analysis steel and are sold with a money-back guarantee. **\$1.50**

YOUR HARDWARE DEALER SELLS CRESCENT TOOLS

CRESCENT TOOL CO. 210 Harrison Street JAMESTOWN, N. Y.

CRESCENT and Smith & Hemenway TOOLS



Motor Head Lathe COMPLETE FOR \$50

8 inch swing, 3 ft. Bed or longer.
Guaranteed Quality.

We build a line of bench woodworking machinery including Band Saws, Rip Saws, Scroll Saws, Jointers and Swing Saws. Ask for circular and prices.

HESTON & ANDERSON, 637 S. W. Depot St., Fairfield, Iowa.



Write today for our 168 page **FREE Book on Deafness**

and learn how Perfect Hearing is now being restored in every condition of deafness or defective hearing. Our "Little Wireless Phones for the Ears" require no medicine but effectively replace what is lacking or defective in the natural ear drums. They are simple devices, which the wearer easily fits into the ears where they are invisible. Soft, safe, and comfortable.

WILSON EAR DRUM CO., Incorporated
663 Inter-Southern Bldg. LOUISVILLE, KY.

\$10⁰⁰ to \$25⁰⁰ a Day!

Selling Freshly Roasted Peanuts

Wherever you find a crowd, hot, savory peanuts and crisp, sweet popcorn are in demand. Set up a Kingery Machine anywhere—in stores, at ball games, races, fairs. Profits 250%. Machines take little room; are easy and inexpensive to operate. Barbecue machines, too. Write now for Free Catalog.

The Kingery Mfg. Co. Dept. P. M. 8, 410 E. Pearl St. CINCINNATI, OHIO



Home Barber Outfit \$1.98



Don't Send 1 Penny

Just send your name and address — no money — and we will send you, postage paid, this complete 5-piece barber outfit for the amazing price of \$1.98. All materials are guaranteed first quality. **CLIPPER** is made of the finest steel. 00 size which cuts almost as close as a razor. Extra spring included. 7-inch barber **SCISSORS** of fine polished steel, and a full size unbreakable barber **COMB**. Famous 10-year guaranteed Ever-Ready **SAFETY RAZOR** which always sells for \$1.00. One blade free. With this complete barber set we will send you, absolutely free, a full size tube of Ever-Ready **SHAVING CREAM**. All of the articles can be used by any barber. This outfit is a necessity in your home for shaving, trimming hair and neck, and cutting children's hair.

35c Tube of Cream FREE



DELIVERY FREE Write us a letter and we will send this 5-piece barber outfit to you. When the postman delivers it at your door pay him **\$1.98**. We have paid the delivery charges. If you do not consider the outfit worth more than \$3.00 return it at our expense and we will cheerfully refund your money. Could anything be fairer?

ORDER BY NO. 16.
WALTER FIELD CO., Dept. B1185 CHICAGO

10 DAYS FREE TRIAL - MONEY BACK IF NOT SATISFIED

THE NEW INKOGRAPH SELF FILLER

IMPROVED GREATEST VALUE EVER OFFERED



The Perfect Writing Instrument

Writes with ink easy as a lead pencil. Won't skip, blot, scratch, leak or soil hands. Its ready uniform flow of ink improves handwriting.

Makes three carbon copies with original in ink. Guaranteed — Send No Money. Pay postman \$1.50 plus postage.

INKOGRAPH CO., Inc.
 199-53 Centre St., New York City

\$1.50

Same size as \$7 and \$8.75 Fountain Pens

A hard, round, smooth ball-like 14-kt. Gold Point.

AGENTS Send for Inkograph or write for Sales plan booklet which tells how to make big money

Boils 50 Gallons In Less Than Hour

No Other Compares With This
Improved Oil Burner
 Use Ordinary Kerosene or Coal Oil

[Burns Outdoors as Well as Indoors]

THE most remarkable Kerosene Burner ever built. Boils down apple cider, maple syrup, molasses, etc., in half the ordinary time. Ideal burner for dairies, butchers, indispensable on the farm.

PRODUCES TERRIFIC HEAT WITH SILENT BLUE FLAME

**NO NOISE
SMELL
SMOKE
SOOT**

So efficient it produces twice the amount of heat of City gas at half the cost. So simple anyone can install and operate. Double generator assures continuous operation without shut-downs. Nothing to wear out, starts in a jiffy, will last a life time. Every burner guaranteed fully. Write for special introductory price and free catalog of outdoor utility and kitchen stove oil burners.

HOME MFG. CO., Dept. 123, 18 E. Kinzie St., CHICAGO



Every Handy Man needs SMOOTH-ON NO. 1



for stopping leaks in steam, water or gas pipes, mending cracks, or leaks in furnaces and boilers, radiators, tanks, sinks, pots and pails, making loose handles tight, tightening loose screws, hooks, locks, door knobs, etc., stopping leaks in automobile engine water jackets, in radiator, hose connections, gas tank and gas, oil and exhaust lines, making a fume-proof joint between exhaust pipe and tonneau heater, keeping grease cups, hub caps and nuts from loosening and falling off, etc. Hardens like iron and stays everlastingly tight.

To Make Wet Cellars Dry Use Smooth-On No. 7

the one practical waterproofing that you can apply yourself, easily, from the inside, to wet or dry surface and with every assurance of thorough watertightness, even in the wettest seasons. Effective in wet boiler pits, at cracks and porous spots and also excellent for patching and waterproofing any concrete, brick or stone surface to keep water out or in.

How to make HOME-AUTOMOBILE REPAIRS



Do it with SMOOTH-ON

About 25 lb. of Smooth-On No. 7 are required for each 100 square feet of surface covered, and no experience is necessary.

To get perfect results, write to us for and use the Smooth-On Repair Book. Free if you return the coupon.

Write for FREE BOOK



Get Smooth-On No. 1 in 7-oz., 1-lb. or 5-lb. tins and Smooth-On No. 7 in 5-lb. tin or 25, 50 or 100-lb. keg at any hardware store, or if necessary, from us direct.

Do it with SMOOTH-ON

SMOOTH-ON MFG. CO., Dept. 37,
 574 Communipaw Ave., Jersey City, N. J.

Please send the free Smooth-On Repair Book.

Name.....

Address.....
 10-27



Expert Knowledge for Professional Radio Set Builders

Leading radio engineers have prepared authoritative design manuals containing much original information of greatest practical value to those interested in improving the operation, bettering the quality of reproduction, or applying power equipment to their sets.

Audio Amplification, Sent upon receipt of 25 cts.

B Eliminator and Power Amplifier Construction. Send 10 cts.

Make-Em-Better Sheet, showing use of RF and AF Chokes in 17 popular circuits or your own receiver. Send 5 cts.

Inductance Units Bulletin, contains RF Amplifier and coil formulae. Send 10 cts.

All four sent on receipt of 50 cts.

Samson Electric Company



MAIN OFFICE: CANTON, MASS.
Manufacturers Since 1882
Factories at Canton and Watertown, Mass.

SOLDERALL

METAL IN PASTE FORM

The only convenient metal solder

Every Electrical Connection needs Solderall for perfect reception

25¢

The SOLDERALL CO., NEWARK, N.J.

CLAROSTAT

—makes your radio set better in many ways by providing micrometric control of delicate currents. As a variable plate voltage control, variable grid leak, regeneration control, oscillation control, stabilizer, amplifier resistance and so on, CLAROSTAT spells radio precision.

—completes your radio power unit by providing accurate and reliable control of the various voltages required by the most critical receiver. The CLAROSTAT is used in majority of good radio power units, whether manufactured or custom-built.

—specified in all leading circuits with the Standard (20-watt) type for moderate power, and the Power (40-watt) type for heavy duty, with necessary range for all purposes, where reliable control is essential.

CAUTION: CLAROSTAT is being imitated. Look for the name stamped on the shell.

Send for descriptive literature on Clarostats and how to use them for better radio results.

AMERICAN MECHANICAL LABORATORIES
285 N. 6th St. Brooklyn, N. Y.

The Famous AERO SHORT WAVE KIT NOW IMPROVED



AERO LOW WAVE TUNER KIT

Code No. L. W. T. 125 Price \$12.50

Always the prime favorite of all experts and amateurs insistent upon the very best in short wave reception, the AERO Low Wave Tuner Kit for this season has been made even better than ever!

Range 13 to 725 Meters

The AERO Low Wave Tuner Kit illustrated above is completely interchangeable. The kit itself includes 3 coils and base mounting covering U. S. bands 20, 40 and 80 meters. You can increase the range of this kit to 725 meters by use of AERO interchangeable coils No. 4 and 5 (Price \$4.00 each) or you can decrease the range to go as low as 13 meters by use of AERO interchangeable coil No. 0 (Price \$4.00).

By all means build the new AERO Short Wave Set. The AERO coils used in its construction can be procured from your dealer or direct from our factory. We have also arranged to furnish the Westinghouse Micarta drilled and engraved panel for this receiver direct from our factory. Write us at once for full information.

AERO PRODUCTS, Inc., Dept. 107
1772 Wilson Avenue CHICAGO, ILL.

5 TUBE RADIO ONLY \$19.98

It's a wonder for power and selectivity. Famous AGL circuit. Coast to coast reception! Finely built of selected, tested parts. Thousands now in use.

FREE Log and Call Book and New 132-p. Catalog with thousands of nationally advertised bargains. Latest in radio at big savings. Write for Free copy.

AMERICAN AUTO & RADIO MFG. CO.
HARRY SCHWARTZBERG, PRES.
Dept. 261 American Radio Bldg., Kansas City, Mo.

AMERICAN RADIO BARGAINS

HOTTER THAN COAL

—and no dirt



Do away forever with the drudgery of wood or coal. The most simple and economical invention on the market is now giving perfect satisfaction to enthusiastic users everywhere. The OKAY Oil Burner fits in the fire box of your furnace or stove. Installed in a few minutes. Burns 96% air and 4% cheap oil (Distillate). No noisy motor or complicated parts. Simply turn one valve and you have all the heat you want. Cleaner and better for heating and cooking.

30 Days FREE Trial Offer

Try this wonderful OKAY Oil Burner right in your own home at our risk. Act quick and get our special low introductory price. Sold under absolute money-back guarantee. Write at once for free booklet on home heating.

AGENTS—Our men are making big money introducing OKAY Oil Burners. The demand is enormous. We want spare or full time workers immediately. If \$300 a month and more interests you, write or wire us for our protected territory offer.

OKAY MANUFACTURING COMPANY
Dept. 207-O, 39th & Magnolia, St. Louis, Mo.

Do You Own a Saw? Let Us File It By Machine!

Then you can see for yourself what perfect filing the Foley Automatic Saw Filer does, and how clean and true saws will cut when they are filed with mechanical precision. Send us your saws—we'll file them on the Foley and reship them in less than a week.—Hand saws 50 cents, hand saws retooled \$1.25, circular saws filed \$1.00, band saws 7 cents a foot.

FOLEY Automatic Saw Filer

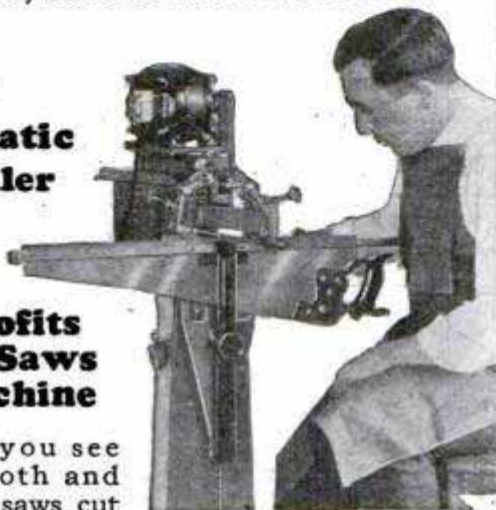

Big Profits Filing Saws By Machine

When you see how smooth and fast your saws cut after being filed on the Foley, you will understand why men like you are making as high as \$15.00 and \$20.00 extra every week with a Foley Saw Filer.

You can easily have a big paying business of your own with a Foley. Hundreds of saws in every town have to be filed many times a month—carpenters, contractors, woodworkers, factories, meat markets, schools. With a Foley you can get all their business because the saws you file will cut faster, truer, cleaner than when filed by hand. You can give quicker service. The Foley files and joints all types of saws in one operation—hand saws "while you wait," band and cross-cut circular saws in less than half hand filing time. Easy to use. You'll make big extra money.

Send us a saw and see for yourself, or mail the coupon for illustrated description of Foley and letters showing the money it is making for others like you. (When sending a saw to be filed, please include return postage with service fee, or, if you wish, we will return your saw C. O. D. for service charge and postage.)

Mail This Coupon!

FOLEY SAW TOOL CO., INC.

220 Foley Bldg., 9 Main St. N. E., Minneapolis, Minn.

Please send me illustrated description of the Foley Automatic Saw Filer and proof of the extra money I can make with it.

Name.....

Street.....

City..... State.....

This Marvelous Wrench Pays \$1000 a Month No Thumb Screw Adjustment

That simple slide motion locks securely, with a better hold than is possible with any other wrench. Does away with the old thumb screw idea that was always a handicap.

First and Only One Hand Monkey Wrench

Any job can be tackled and finished with ONE HAND quicker with the H&E WRENCH than any tool on the market. Fully Patented and the first and only tool of its kind.

Slides Up and Down Locks Automatically

It creates a sensation wherever shown, its simplicity, smooth action, strong grip, and practical value arouses the interest of everyone. Mechanics are wild over it.

Saves Time

As a labor and time saver it simply can't be beat. Any job is done quicker and easier.

Agents Wanted Every- where

Rapid sales with a handsome profit makes this a very attractive proposition for Agents and on account of this increased demand we want Agents everywhere and the opportunity is open to you NOW but you must ACT PROMPTLY.

Pressure 8,000 Inch Pounds

All tests passed Government specifications. Actual service with Railroads assures High-Class Practical Value.

Praised by Big Concerns

C. B. & Q. Railroad and many other large Corporations have acknowledged its value and endorsed it. Factories, Machine Shops, Garages, in fact, wherever tools are used need it. Every home should have one.

MAIL TODAY GET YOURS FREE

H & E WRENCH SALES CORP.
Dept. J, 228 No. LaSalle St., Chicago, Ill.
Dept. J, 285 East 134th St., New York City.
Gentlemen:—Please mail me free particulars. This does not obligate me in any way.

NAME.....

ADDRESS.....

STATE..... R.F.D.....



Bradleyunit-A

PERFECT FIXED RESISTOR

Unaffected by temperature, moisture or atmospheric changes. Does not age or change in resistance.



A solid-molded fixed resistor, baked under high pressure, and accurately calibrated. Can be soldered without affecting accuracy of the unit.

Two Remarkable Radio Resistors

Bradleyunit-A is an outstanding success! It is a fixed resistor for radio circuits of all kinds, and has a capacity of two watts. It is rugged and can be soldered easily, without affecting the rating of the unit.

Bradleyohm-E is widely used by manufacturers of B-eliminators for plate voltage control. Its remarkably wide, noiseless range, accomplished with two columns of graphite discs, accounts for its tremendous popularity.

Use Allen-Bradley resistors in your own hook-ups for superlative results. Follow the example of prominent radio manufacturers. They know!

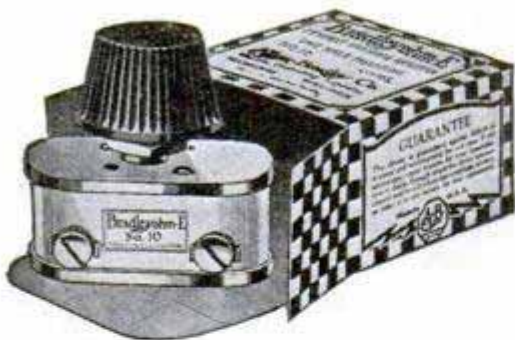

Bradleyohm-E is available in several ranges and ratings. Sold in distinctive checkered cartons. Ask your dealer for Bradleyohm-E.

Allen-Bradley Co.

ELECTRIC CONTROLLING APPARATUS

280 Greenfield Ave.  Milwaukee, Wis.

Like a Long Arm Reach!

Reach across the room, tune out a poor program and bring in a good one, without leaving your easy chair.

The NEW

Thermodyne

REMOTE CONTROL RADIO TUNING UNIT



Only tuning unit of its kind in the world. Attached in a few minutes to any single dial receiver with removable dial. Simply remove old dial and attach adapter plate with Remote Control Unit.

Mechanical Model, \$18.00

Electrical Model, \$60.00

Write today for circular describing radio's newest and most revolutionary development.

ALGONQUIN ELECTRIC COMPANY, Inc.

LEO POTTER, President

245 Fifth Avenue

New York City

Beautiful 136 Page Wholesale Radio Catalog

FREE to Dealers—The greatest book of radio values ever published. Just off the press.

Fully illustrated in colors. **Battery and All-Electric Sets.** New low prices on nationally advertised kits, parts, loud speakers, cabinets, and all accessories. **Sensationally low prices on high quality "A" and "B" Eliminators.** Wholesale only. Write for this book today on your letterhead.

Hamilton-Carr Radio Corp.

711 W. Lake St., Dept. 135 Chicago, Ill.

Set Builders! Dealers!



FREE

Standard parts and equipment at money-saving prices, with discounts that show you a real profit. Electrical Phonograph—pickups—latest kits! New A C tubes and transformers—parts for any circuit—power audio equipment—short wave supplies—they are all in our big new 1928 Catalogue. Write for it today, with discount sheet. 12-hour shipment guaranteed.

Van-Ashe Radio Co.

206 N. 10th St.,

St. Louis, Mo.



Whittling's a lot of fun

PROFESSIONAL carpenters have found that Remington Pocket Knives stand up best under hard service. Their blades are of fine steel, evenly tempered, with lasting, razor-sharp edges.

Amateur carpenters will do well to follow the professionals in choosing a knife. And whether or not you consider yourself an amateur carpenter, you'll find a lot of fun in carving with a knife that is keen enough to do delicate work surely and easily. Remington No. R 4223, illustrated here, is one of many useful patterns that your hardware dealer will show you.

Buy a Remington knife today and learn the fascination of whittling with a knife that cuts.

Write for a circular on Remington Carpenter's Knives.

REMINGTON ARMS COMPANY, INC.

Established 1816

Dept. 10-PM, 25 Broadway New York City

Remington



REMINGTON
UMC

1927 R. A. Co.



Save fuel... save paint

INSTEAD of re-painting, lay Creo-Dipt Stained Shingles right over old side-walls... and cut your annual fuel bill from 15% to 25%. Reduce paint bills, too. In 5 to 7 years Creo-Dipt side-walls save enough paint to pay for themselves.

Find out about these amazing Creo-Dipt savings. Mail the coupon now. Ask about Creo-Dipts — not only for covering old side-walls, but for re-roofing, or for roof and sides of new homes. Or see your lumber dealer... leading lumber dealers everywhere carry genuine Creo-Dipts in stock. Look for the name on each bundle.

CREO-DIPT Stained Shingles

SEND FOR PHOTOS



Creo-Dipt Co., Inc., 1231 Oliver St., No. Tonawanda, N. Y. (In Canada: Creo-Dipt Co., Ltd., 1610 Royal Bank Bldg., Toronto.) Sales offices in principal cities.

Enclosed find 25c for portfolio of large-size photographs of Creo-Dipt homes, booklet of color suggestions, and name of local Creo-Dipt dealer.

Check the use that interests you

- | | |
|--|-------------------------------------|
| <input type="checkbox"/> Covering old side-walls | <input type="checkbox"/> New roof |
| <input type="checkbox"/> Building new | <input type="checkbox"/> Re-roofing |

NAME.....

ADDRESS.....



© C-D Co., Inc., 1927

POWERIZER

Reg. U. S. Pat. Office

Makes Your SET A De Luxe ELECTRIC SET!



POWERIZER will give any set the famous POWERIZER tone and faithful reproduction—obtained by UX 210 for the last stage—PLUS genuine, complete ABC elimination by using UX 226's and 1 UY 227, the new AC tubes. POWERIZER gives a tone to any set that is equal to that in expensive deluxe sets and the finest electric phonographs. POWERIZER strikingly improves the tone quality and when needed, gives ample volume for dancing, concerts, etc.

Model PXY—Radiola—20, illustrated above, is for the Radiola 20. Uses no batteries, liquids or paste. Made complete in a compact, beautifully finished container. Draws between 40 and 50 watts only when set is on. Uses 280 Radiotron as rectifier and 210 as amplifier. List without tubes \$59.00; with UX 280 and UX 210—\$73.00.

3 UX 226's, 1 UX 227—\$15.00.

Model PXY—A. K. is for the Atwater-Kent. List without tubes \$60.00; with UX 280 and UX 210, \$74.00.

There is a POWERIZER for every set—YOUR set. HEAR it TODAY! Your dealer will gladly demonstrate POWERIZER in your home on your own set.

Write for Descriptive
Literature Today.

Jobbers and Dealers:

Write us TODAY for folder 1009-PM, "Real ABC Socket Power with Real Tone." It contains much information that will make money for YOU this season.

Licensed by Radio Corporation of America and Associated Companies

Radio Receptor Co., Inc.
106 Seventh Ave. New York City

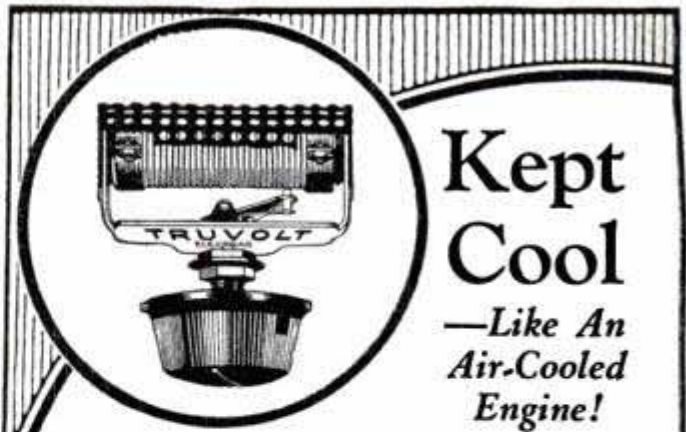

Kept
Cool
—Like An
Air-Cooled
Engine!

TRUVOLT

A Variable All Wire Power Resistor

Truvolt, a wire variable high resistance of special mechanical construction, is air cooled on the same principle as Lindbergh's transatlantic motor. It has therefore a greater radiation area and is adapted especially for B-Eliminators and power devices.

1. Made entirely of wire; permanently accurate; long life.
2. Permits potentiometer control; positive metallic contact at all times.
3. Nichrome wire resistance—very low temperature coefficient. Only heat-resisting materials used.

Type	Ohms Resistance	Milliamperes Current
T-5	0 to 500	224
T-10	0 to 1,000	158
T-20	0 to 2,000	112
T-50	0 to 5,000	71
T-100	0 to 10,000	50
T-200	0 to 20,000	35
T-250	0 to 25,000	32
T-500	0 to 50,000	22.5

Eight stock types with resistances up to 50,000 ohms. All rated at 25 watts. List \$3.50 each. Also full line of fixed wire resistances. Write for FREE resistance booklet.

"This Is An Eliminator Year"

Dept. 17, 175 Varick Street, New York

ELECTRAD

just out!
**GET YOURS
QUICK**



Don't wait! Send today for this wonderful book. See how 14,000 live radio dealers make bigger profits by buying from The Harry Alter Company, America's foremost wholesalers of receiving sets, kits, parts and accessories—the largest stock of standard, nationally advertised radio goods carried anywhere.

RADIO'S GREATEST CATALOG

Compare its low prices with those of any other catalog. You will be amazed. Note: We sell only to radio retailers. Write for your copy NOW.

The Harry Alter Co.

1778 Michigan Avenue CHICAGO

Moist Night Air Improves Auto Engine Performance

New Ways of Improving Running of Auto Engine By Obtaining Moist Atmosphere all the Time Without Waiting for a Damp Evening.

(Reprinted from Ford Owner and Dealer Magazine.)

Your car runs better on a damp evening, but that is not always the most pleasant time for driving. THE WAY AROUND THE DIFFICULTY IS TO PROVIDE YOUR CAR WITH EQUIPMENT WHICH FURNISHES THE FOG AND DAMPNES ALL THE TIME. Whatever your own opinion on the "wet" and "dry" question, your car is definitely on the side of the "wets" and thrives better when things are not too "dry."

Why does "night air" have such a good effect on the performance of a Ford engine? Almost every car owner has noticed how much more smoothly and powerfully a Ford engine seems to run in the cool dampness of the early evening as compared with the heat of the day.

In hilly country, where the fog sometimes collects in pools between the hills, it is interesting to notice how softly and sweetly the Ford engine purrs as it is driven through the fog. Often we have noticed a shower of sparks out of the muffler, when driving uphill with wide open throttle through foggy air. These fireworks are due to incandescent particles of carbon which are loosened by the moist air, and blown out through the exhaust. In tests by the U. S. Government Bureau of Standards, the increase in power of an engine using kerosene and water (as compared with kerosene only) was about 1 horse power or approximately 5 per cent. If an engine is over-heated, carbonized, or otherwise in poor condition, it is quite possible that water vapor (by improving the internal cooling of the engine, reducing the carbon deposits and cooling the oil) might effect a much greater improvement.

In our experiments, the most noticeable improvement was the greater smoothness and softness with which the engine padded along when supplied with moist air. The steam seemed to cushion and absorb the jar, by changing the sharp bang of the explosion into a more even push, thus making the engine run more like a steam engine. The engine seemed to pull hills better when supplied with cool moist air.



JUST LOOK AT THE VAPOR FROM THAT OVERFLOW PIPE

AMAZING AUTO INVENTION

Makes Startling Demonstrations



WHY DON'T YOU MIX IT WITH YOUR GAS AND USE IT FOR FUEL?

\$1,000 A MONTH

and over averaged by one salesman selling the **new VIX**
Vapor Humidifier & Gas Saver

For All Autos, Trucks, Tractors, Busses, Taxis, Engines. Most Amazing Profit-Maker On Market

Never before has there been such a DEMONSTRATOR as VIX. Sells in 5 minutes to any Car Owner by the most amazing, most sensational, most astounding series of demonstrations ever seen. Simply turning on VIX with car standing still increases engine speed 4 to 10 times faster without more gas. Makes any car owner's eyes pop out with amazement. With car running on level under full load, simply opening VIX will double speed without more gas. On steepest hill, running car under full load in gears at slow speed, simply opening VIX will double speed or better without more gas—proving added power in extreme heavy pull. Cars are known to run better in the cool moist night air. VIX mixes moisture from the radiator with the fuel and makes the car run ALL THE TIME with the same wonderful efficiency as on a cool, moist night. Measured tests prove amazing mileage increase. Unbelievable gains reported by thousands of VIX users. Tractors save 4 to 8 gallons a day. Sworn affidavits make this proof convincing. Nothing like VIX on market. No connection with any other Gas Saver or Company. VIX'S sensational demonstrations speak for themselves. Quick sales are made easily—profits are immense.

Moisture Does It

Increases Mileage $\frac{1}{4}$ or MORE. Automatically frees engine from hard carbon, plug and valve troubles. Gives that wonderful smooth running, night-driving effect; with ENORMOUS power, speed and mileage, faster pickup and a snappier, peppier motor. VIX performs wonderful in Winter with all non-freeze and alcohol radiator solutions. If you want to Make BIG Money get into the VIX business now. Sell a high-class worth-while auto mechanical product. Not a jim-crack or 10c store article. Have your own business and reap BIG, QUICK PROFITS.

1 VIX FREE To Introduce. Factory Sales-Distributors wanted everywhere, who can make \$375 to \$1250 per month. Spare or full time. Every Distributor, Salesman, Dealer, Agent, Mechanic, Garageman and Car Owner, should write me at once. Address

WALTER CRITCHLOW

Inventor and Manufacturer

X3-805 St.

Wheaton, Illinois, U. S. A.

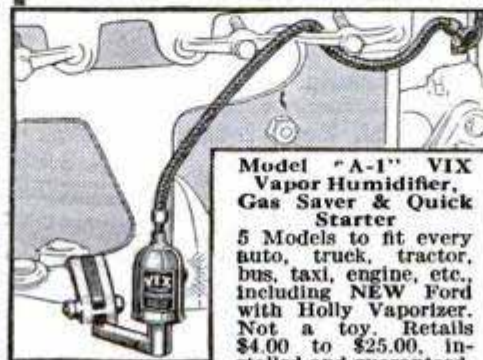

Model "A-1" VIX Vapor Humidifier, Gas Saver & Quick Starter
5 Models to fit every auto, truck, tractor, bus, taxi, engine, etc., including NEW Ford with Holly Vaporizer. Not a toy. Retail \$4.00 to \$25.00, installed and guaranteed.

PROOF of MERIT!

USED by the U. S. Government—
and endorsed by State Highway
Departments—
USED by Entire Municipally Owned
Autos, Trucks, Patrols, Fire-
engines, etc.
USED and Endorsed by Head Officials
of Great Railway Corpora-
tions—
ADOPTED Officially, after Scientific
Tests, by the British Govern-
ment—
USED and Enthusiastically Endorsed
by U. S. Naval Officials—
USED and Endorsed by Consulting En-
gineer of the World Famous
Rolls-Royce Co.

Thousands of unsolicited reports of amazing records and marvelous performances with VIX on all makes of Autos on file from all States and Countries.

Salesmen, Agents Dealers-Distributors WANTED!

QUICK SALES—BIG PROFITS
\$37.00 and UP per week—for
SPARE Time.
\$148.00 and UP per week—for
FULL Time.
1 VIX man drew \$4,939.66 in
3 $\frac{1}{2}$ months. Another \$1,656.40
in 58 days. Still another
\$5,150.00 in 5 months—over
\$1,000.00 a month average.
Thousands of other amazing
BIG PROFIT records.
WRITE ME TODAY for
my FREE VIX Offer.

MAIL this COUPON

Walter Critchlow, Inventor and Mfr.
X3-805 St., Wheaton, Ill., U.S.A.

Send me your Wonderful VIX Moisture
Gas Saver FREE Offer and full particulars
with inside Agency terms.

Name.....

Street.....

Post Office.....

R.....B.....State.....

Victoreen



**Victoreen 112
Audio Transformer Unit**

Designed to handle up to 400 volts of B battery supply, this unit is especially adapted to the Western Electric cone speaker or similar types. The transformer consists of two stages of Audio amplification in one case and is designed for use with two 112 power tubes.

Price, \$22.00

Dependable Standardized Super Parts Accepted as the Best in Radio

If you want the ultimate in radio reception—if you are one of those who demand range, clarity, volume and selectivity, then you will appreciate Victoreen supremacy in the super field! Victoreen has gained the confidence of those whose radio experience is based on scientific knowledge. They accept the new products of Victoreen, knowing that a progressive step has been made in Radio—one that has passed the experimental stage and arrived at the point of the utmost in satisfactory results.

Send today for 1928 Blue Print of Victoreen Circuit

The GEORGE W. WALKER Co.
MERCHANDISERS OF VICTOREEN RADIO PRODUCTS
2825 CHESTER AVENUE CLEVELAND OHIO

Dept. M.



**Victoreen Radio Fre-
quency Transformers**
No. 170—For Storage
Battery Tubes,
No. 171—For Dry Bat-
tery Tubes.

The very heart of the Super Circuit! These units are instruments of great precision, being matched and tuned to within one-third of one per cent and eliminating the necessity of tube matching.

Price, \$7.00

FREE

The Greatest RADIO CATALOG

Send for
This Great Book

**1928
WHOLESALE
CATALOG**
of
**RADIO
Sets, Kits
and
Everything
in Radio**

Compiled exclusively for dealers in radio sets, radio parts, and for set builders. An **Amazing Catalog** containing the newest things in the world of radio. Unbeatable values in **Radio Parts, Kits and Supplies of National Fame.** A complete array of cabinets and consoles, in all the latest styles, finishes and popular sizes, at **Unmatched Prices.**

The high quality of our products eliminates loss. Large stocks offer you large selection. Our speedy shipments insure your customers' good will and **bigger profits for you.**

Wholesale Vest Pocket Price List and Discount Sheet

This wholesale vest pocket price list and discount sheet will be sent with the catalog.

Short Wave Section

Our catalog contains a section devoted to a showing of the highest grade short wave receiving and transmitting apparatus. Also the finest electrical appliances for use in the home.

Shure Service means sure profits. You can take orders direct from our illustrated list price catalog.

Whatever your radio needs may be, you will find them in our **1928 catalog.** Write for a copy **TODAY.** Send your request on your letterhead, write immediately.

Real Bargains to Dealers

SHURE RADIO COMPANY
337-D Madison Street, Chicago, Ill.

RADIO

ACCESSORIES at WHOLESALE

Radio Sets, "B" Eliminators, Chargers, Tubes, Kits, Parts—everything new in Radio at lowest wholesale prices. Thousands of nationally advertised bargains. All listed and illustrated in my Big New Catalog and **FREE Call Book.** 132 Pages of valuable Radio information—trouble finding, set building—Radio knowledge of all kinds. Write today. **HARRY SCHWARTZBERG PRES.**
AMERICAN AUTO & RADIO MFG. CO.
Dept. 264 American Radio Bldg.
Kansas City, Missouri

FREE
BIG BARGAIN CATALOG

\$100 VIOLIN LOUD SPEAKER

~ Make it yourself ~

Last word in radio speakers! The violin that talks! Make it yourself in an hour. Any cheap violin or cigar box will do. Tune it up same as any violin and play to beat the band. Brings in all notes with amazing clearness and sweetness, especially low notes and drums. Improves any receiver; friends marvel at it. Complete directions sent post-paid upon receipt of \$1.00. Write **George T. Hastings, 21 Gorham Pl., Dept. 85, Scarsdale, N.Y.**

RADIO GREATEST RADIO BARGAIN \$18.45

in U. S. 5-Tube Chassis

Coast to coast reception. Certified circuit. Dealers write for special proposition. AGENTS WANTED. Write today for folder.

A. J. MUSSELMAN, Inc.
238 Machinery Hall CHICAGO, ILL.

LATEST SCIENTIFIC MOTOR

Runs 10 Hours on 1 Gallon
Wonderful Gasoline Engine

Operates: Washing Machine, Cream Separators, Lathes, Etc. Also handle Castings for other Engines. Books and Supplies of every kind for **HANDY-MAN, MECHANICS and MODEL MAKERS.**

Complete Catalogue 25c which is allowed on first \$2 order.

AMALGAMATED SALES & SERVICE CORPORATION
327 L So. LaSalle St. Chicago, Ill.

New Improved SPORS Fountain Pen. 60 Day Trial. Money back if not pleased

GUARANTEED 2 YEARS—Improved Point
LADIES' OR MEN'S STYLE

Newest Invention. Rubber sponge keeps point moist. Writes the instant it touches paper.

Agent's Sample **65c** Sells for \$1.25. Writes like a \$7 Pen. Make \$10 Daily Easily

MAKES \$8.40 IN TEN MINUTES
I sold my dozen pens in about 10 minutes. Will order another dozen soon. **TRACY KWENZ, Nebraska.**
Write for **FREE Wholesale Specialty Catalog**
827 Main St. Lesueur Center, Minn.

F. SPORS CO.

THE BIGGEST SELLING HIGH GRADE REEDS IN THE WORLD

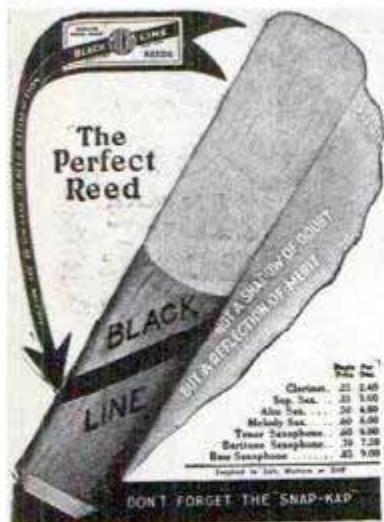

Most widely advertised and internationally known

For sale at all Music Stores
Try a sample dozen today.

J. Schwartz Music Co., Inc.

Dept. No. 600
10 West 19th Street
NEW YORK, N. Y.

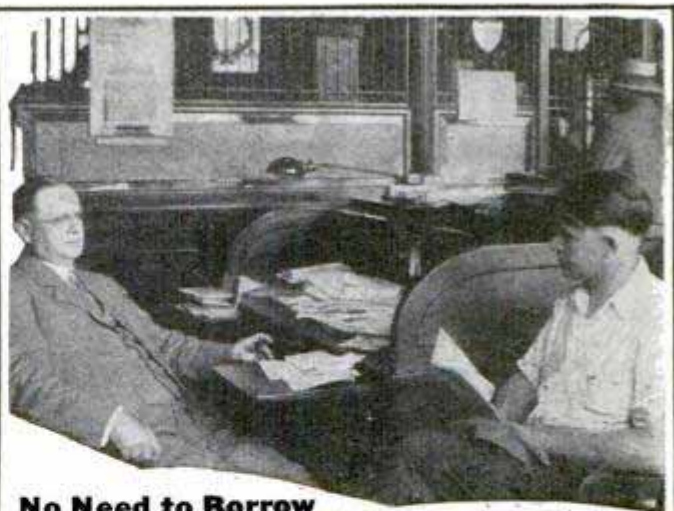

No Need to Borrow Money When You Can Easily Earn

\$150 to \$300 Monthly

With Practically No Investment On Your Part

Your banker will advise installing HB Equipment because it pays for itself without tying up your working capital, brings you big profits from pleasant work, is simple and easy to operate—and comes to you on

30 Days' Trial

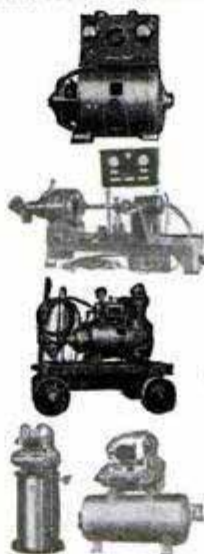

1. 8-Hour Battery Service brings hundreds of new customers. Charges batteries in 1/2 the time and saves 30% to 50% of electric bills over rectifiers. For more information check No. 1 in coupon below.

2. Big profits in auto electrical service with the new **HB Universal Test Bench**. Priced to save you at least \$100 over any similar quality bench on the market. For full details check No. 2 in coupon.

3. Spray Painting with new **HB Portable Paint Spray** does high class work at 1/4 the cost of old time brush methods. You get five men's income for one man's labor. Painting autos, houses, barns, furniture, etc. For information check No. 3 below.

4. Business Building Air Service now available for as low as \$11 monthly for a few months. Brings car owners to your door day and night. Check No. 4 for full details.

You can have the moneymaking advantages of HB Equipment in your shop for as low as

Only \$11 to \$16 Monthly

for a few months—just a small part of the extra profits it will bring you. For full information without obligation, check and mail the coupon below.

HOBART  BROTHERS
Successful manufacturers ~ since 1893 ~

BOX M107

TROY, OHIO

Tear Off Coupon and Mail Today

HOBART BROTHERS CO.
Box M107, Troy, Ohio.

Send me complete information on the items I've checked with your 30 day trial offer, easy payment terms, and information on how HB equipment will increase my earnings.

- 1 One Day Battery Service Profits
- 2 Electrical Test Bench Opportunities
- 3 Portable Paint Spray Business
- 4 Better Automatic Air Compressor

NAME.....

ADDRESS.....



ITALIAN ACCORDEONS

We manufacture and import all kinds of first-class hand-made

ITALIAN ACCORDEONS, the best in the world. Ten year guarantee. Our Prices are lower than any other maker's, Free Accordeon instructions to buyers. Write for FREE catalog.



RUATTA SERENELLI & CO.

1014 Blue Island Ave., Dept. M Chicago, Ill.

PUNCTURE-PROOFS Tires in ONE minute

Agents—Big—Quick Profits

Tires hammered full of nails, leak no air. Amazing new invention banishes puncture trouble forever. Punctures heal instantly. Stops slow leaks. Preserves rubber. Increases tire life. Clean, scientifically correct. *Not a Liquid.*

FREE SAMPLE Immediate—Tremendous profits. No talking—just drive nails in an old tire. **GET THE FACTS.** Territory going fast. Full particulars—Big Book and a **FREE SAMPLE** postpaid by return mail. **Send No Money.** just your name but **ACT NOW.**
C. F. JOHNSON & CO., 19 W. Jackson Blvd., Dept. 866, CHICAGO



Your Coat and Vest Can Be Matched with New Trousers

Save the price of a new suit. We match hundreds of coats and vests satisfactorily every day. Each pair tailored to your measure. 80,000 patterns. We submit sample of cloth for your approval. Just mail your vest or a sample of the suit.

We employ no agents.

ACME PANTS MATCHERS

Dept. BK-14, 20 W. Jackson, Chicago

LEARN TO Mount Birds

We teach you At Home by Mail to mount Birds, Animals, Heads, Tax Furs and Make Eggs. Be a taxidermy artist. Easily, quickly learned by men, women and boys. Tremendously interesting and fascinating. Decorate home and den with beautiful art. **Make Big Profits from Spare Time Selling Specimens and Mounting for Others.**

Free Book— Yes absolutely **Free**—beautiful book telling all about how to learn taxidermy. **Send Today.** You will be delighted. **Don't Delay!**
Northwestern School of Taxidermy 3377 Elwood Bldg. OMAHA, NEB.



Build Your Own ALADDIN GARAGE Save Money!

ALL MATERIALS READI-CUT

A couple of days' time will erect and finish an Aladdin Readi-Cut Garage. You can buy all materials direct from the manufacturer and make substantial savings.

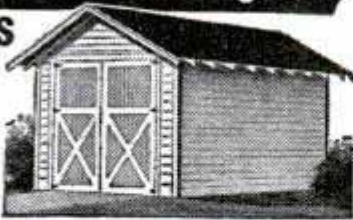

\$87 up

The Aladdin System **WE PAY FREIGHT** prepares all the lumber in our mills, ready to be nailed in place. We pay freight and guarantee safe arrival of materials.

5 ROOM ALADDIN 498



Nine different floor plans of this house are shown in Catalog. 2 and 3 bedroom designs—also 63 other homeplans.

PRICES INCLUDE All lumber cut-to-fit; flooring, windows, doors, glass, paint, hardware, nails, lath, roofing, etc. Blueprints and simple instructions make it easy for anyone to erect an Aladdin Garage, Home, or Summer Cottage.

FREE CATALOG



You will be sure to find in the FREE Illustrated Aladdin Catalog the Garage, Home, or Summer Cottage that you will like. All details of the amazing Aladdin Readi-Cut Money Saving Plan fully explained. Write nearest mill for Catalog No. 519 TODAY.

The ALADDIN Co., BAY CITY MICHIGAN
Wilmington, No. Carolina; Portland, Ore.; Toronto, Ont.

Big Pay - Every Day Earn \$100 a Week

Sell Gibson's better-quality made-to-order all-wool suits, direct to wearer. Our astonishing values sell on sight. My plan pays biggest commissions in this line, in advance, with extra bonus for producers. We deliver and collect. 6x9 cloth samples (over 100 styles) and complete outfit in handsome carrying case, furnished to ambitious men who want to earn \$100 weekly. Ambitious men write at once.



W. Z. GIBSON, Inc., 161 W. Harrison, Dept. K 516 Chicago

Win a NASH Sedan



or **\$1400.00 in cash**

Someone who answers this ad will receive a fully equipped De Luxe Model Nash Sedan, or full value in cash if preferred (\$1,085.00). In addition to this Nash Sedan we give away, a latest model Chevrolet Coach or its cash value (\$595.00), a Brunswick Panatrophe Phonograph, a Six Tube, Single Dial Freshman Radio, a Corona Portable Typewriter—many other valuable prizes and Hundreds of Dollars in Cash.

Solve This Puzzle

The numbers in the squares to the right spell two words. The alphabet is numbered. A is 1, B is 2, C is 3, etc. Can you make out what the two words are? When you do this, send me your answer right away. It may mean winning the Nash Sedan or \$1,400.00 in cash.

\$315.00 Cash For Promptness

In addition to the two automobiles, the many other valuable prizes and Hundreds of Dollars in Cash, we are also offering a Special Prize of \$315.00 in Cash for Promptness. First prize winner will receive \$1,400.00 in cash, or the Nash Sedan and \$315.00 in cash. In case of ties duplicate prizes will be awarded each one tying. Get busy right away. Solve the puzzle and send me your answer together with your name and address written plainly. EVERYBODY REWARDED. Address

M. L. BOEING, Dept. 5771
323 So. Peoria St., Chicago, Ill.

- | |
|----|
| 14 |
| 1 |
| 19 |
| 8 |
| 19 |
| 5 |
| 4 |
| 1 |
| 14 |

MAKES A COMPLETE MACHINE SHOP

EVRY-USE Electric MOTOR ATTACHMENT

Fastens on shaft of small motor in a jiffy. Holds attachments for Grinding, Polishing, Sawing, Drilling, etc. MADE TO FIT 3/8-inch, 1/2-inch and 3/4-inch shafts.

STATE SIZE.



Also Electric Motors at Greatly Reduced Prices.

Write Us YOUR Requirements. **UNITED ELECTRIC MOTOR CO.** 178-C Centre Street, New York

ONLY \$3.95

Oh Boy! See All!

Big 3 1/2 Ft. Telescope

Lend wings to your eyes! People and objects miles away seem close. Wonder telescope brings new pleasures to home, farm, camp, travel, sport. Study the mysterious Sun spots; see Moon and Stars as never before. See people on the beach, on the mountains, etc.

FREE Yes, absolutely free! A handsome leatherette Carrying Case and Shoulder Strap. Also Solar Eye Piece to view the sun—a special feature, found only on expensive instruments.

Beach Views



Thousands Pleased



CLIP THIS AD



Study Heavens

5 Sections 8 Power Lenses

Brass bound; measures 12 in. closed; powerful achromatic lenses protected by dust caps.

Sports

Touring

Study Heavens

Study Heavens

Study Heavens

P. Brush wrote: "Watched submarines three miles off coast." Ed. Foster: "Tall time, on clock five miles away." C. Scribner: "Saw lighthouse 18 miles away." Mrs. Farbrough: "Could tell color of aeroplane four miles away." S. M. Gearhart: "Can see man working seven miles away." A. R. Walker: "Would not take \$10 for it."

SEND NO MONEY

On delivery of Telescope, free Case, Strap and Eye Piece pay Postman only \$1.85, plus postage (2 complete outfits \$3.50). Satisfaction guaranteed or money refunded. Send today, entertain your friends! Be first to have one.

FERRY & CO., Dept. 1779, Chicago, U.S.A.

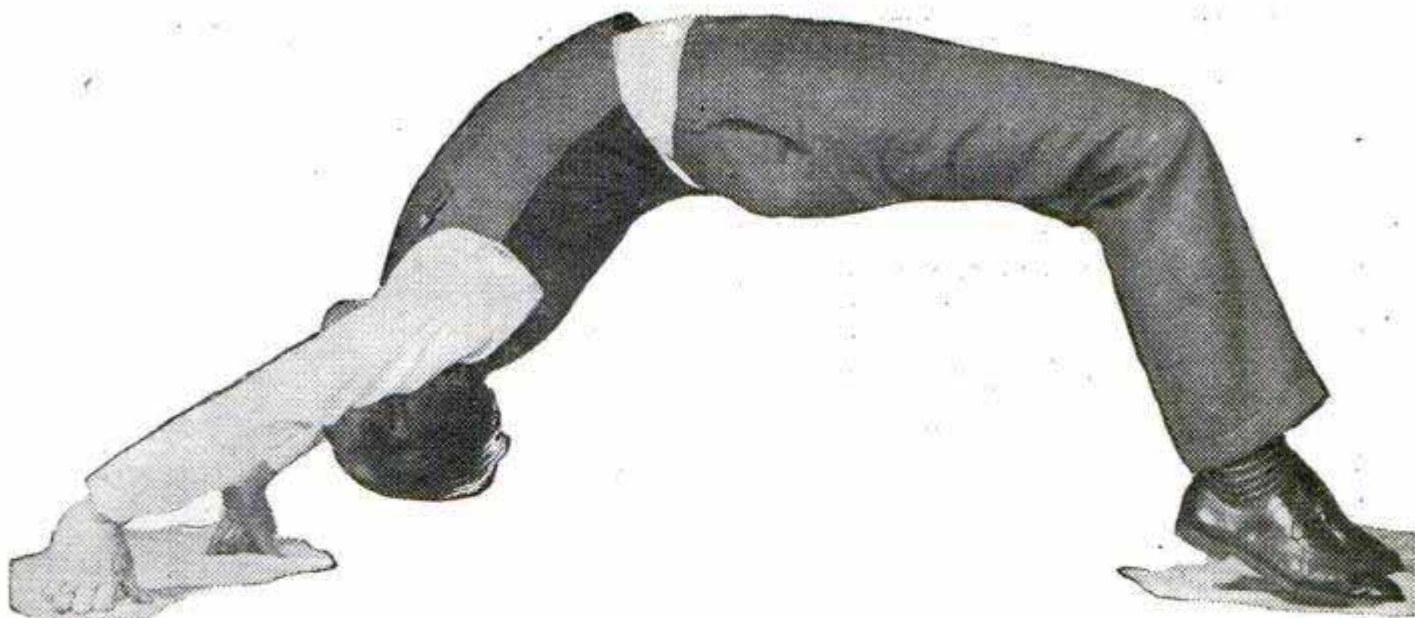

Ruptured 38 Years Is This a Miracle?

A SUDDEN STRAIN AT THE AGE OF TWELVE. . . .
THIRTY-EIGHT YEARS OF PAIN AND DISCOMFORT.
. . . NOW AT FIFTY RELIEF AT LAST.

"I had despaired of ever getting relief from torture, uncomfortable devices, and fear of strangulation. Then came the day that I learned of this remarkable new discovery. It appealed to my common sense, so I sent for it. Almost immediately I felt its wonderful relief. In a few months I was a new man. Today at 50 I enjoy life as a normal man should."

Is this a miracle? No. Thousands of others have also discovered the almost magic power of an amazing new invention which has revolutionized old-fashioned methods of helping hernia. Although only recently announced to the general public, scientific men have been watching with keen interest the tests made within the last eighteen months. The inventor, an American scientist of note, quietly offered it to a limited number of sufferers in every stage of replaceable rupture. The results are of keen interest to medical science.

A New York man who has suffered for 20 years reported it to be the first device he has ever publicly endorsed—a 90-year-old man writes that his hernia has almost disappeared. . . . A Nebraska man says that he has forgotten he is wearing it. . . . Physicians praise it as an entirely new departure. . . . And now it is available to every rupture sufferer in America!

Seals Rupture With a Quarter

Now a queer little device—little larger than a quarter—weighing less than 1-25th of an ounce—reduces rupture by a new method called "sealing," a modern method heretofore impossible with old-fashioned appliances. No longer need hernia sufferers wear awkward steel springs, weighty cushions, unclean leg-straps, and other make-shift devices that were always slipping off the wound.

Magic Dot cannot possibly slip off—for it anchors to the acute point of rupture. More, it allows free blood circulation to tend to knit the tissues over the wound, and heal it much like every other wound is permitted to heal. This exclusive advantage is important, says science. For the old-time "pressing" method with its harsh pressure, common sense warns, prevents free blood circulation and nature's healing process cannot fully operate. Test this fact—press the finger

against the skin and note the white spot remaining. The spot is white because blood can't circulate under harsh pressure.

No More Heavy, Unclean Crotch or Leg Straps

This new modern way is like no other appliance in the world. It is an appliance for human beings. It enables the wearer to bend, cough, run, jump or sleep in any position without fear of the appliance slipping down. For Magic Dot is protected by a flesh-soft, air-porous pad which has no hard corners or harsh surface to grind into the flesh and which flexes with every move of the body. It "breathes." A new kind of comfortable method gently supports the pad. So it is no wonder users say they forget they are wearing it! And no wonder it is healing thousands of rupture cases like those quoted here.

So confident are the inventors that Magic Dot will relieve and delight every sufferer—even cases of many years standing—that they are making an amazing "SEE IT FIRST" offer. Send no money. Be under no obligation. Simply get full description and details of this unusual offer. Learn how easy it is to reduce rupture at home in an amazing short time and banish pain and discomfort forever. Use the coupon.

NEW SCIENCE INSTITUTE

2141 Clay Street STEUBENVILLE, OHIO

New Science Institute,
2141 Clay St., Steubenville, Ohio.

Yes, send me complete details of the Magic Dot that reduces rupture.

Name.....

Address.....

City..... State.....

Create Your Own Music, Too



YOU who find joy in building things—who profit through the work of your brain and hands—create your own music, too! You can do it just as easily and as surely as you now build radio sets, furniture, boat and airplane models.



To build fine things one must have good tools. To make beautiful music one must likewise own a good instrument. You need not ponder over which is best.

There is one name in the Band Instrument field that stands for the best wherever good musicians gather. That name is King. It stands for mechanical precision—for watch-like accuracy in every detail.



King Band Instruments will help you learn faster and play better. But we can't tell you all the reasons here.

Let us send you a full description of the instrument you are most interested in, and a booklet that tells of the joy and profit that can be yours through music.

There is joy in music. Look around you. See how closely music is interwoven with every happy activity. And there is profit in music. In every theatre and dance orchestra, in symphonies and circuses, in churches and auditoriums, musicians are earning worth while incomes.

Write for these booklets Today. Learn of our free-trial plan and our convenient time-payment terms. Learn how easy it is to own a King—how much happier you can make yourself by creating your own music.

"KING" BAND INSTRUMENTS



KING THE H. N. WHITE CO.
5211-92 Superior Ave., Cleveland, Ohio

Please send me free copy of your illustrated magazine "The White Way" and your Handy Reference Catalog. (Check, below, the instrument preferred.)

Name..... Age.....

Address.....

City..... State.....

- Saxophone Trumpet Trombone Alto
- French Horn Baritone Bass Bugle

What Kind of Voice Has Your Loud Speaker?

Does It Sn-a-r-l?

Does It Whine?

or does it register clear, natural Human tones?

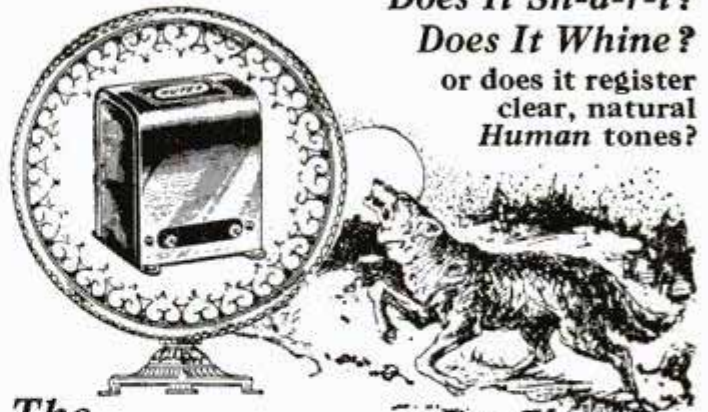

The New Muter Clarifier

(Output Transformer)

on your set will delight you by immediate, almost unbelievable improvement in reception. In nine cases out of ten that weak, distorted voice issuing from the speaker unit is suffering paralysis from high "B" voltage. The Clarifier protects speaker coils from this, assuring longer life as well as strong full tone, clarity and volume. Easily attached in a few seconds without disturbing set.

See Dealer or Send Direct

If you have any difficulty obtaining from your dealer write direct. Prompt shipment will be made postpaid upon receipt of \$5.00, or C. O. D. plus postage if preferred. Try out on our liberal guarantee—you won't recognize your set! Send today.

LESLIE F. MUTER CO.
76th & Greenwood Ave.
Dept. 805-N, Chicago, Ill.



Genuine German Unit Speakers



Choice WITH UNIT \$7.95 while they last

1. 29" Pedestal, Beautiful Crackle Lacquer Finish.
 2. 23" High, Imported German Speaker.
 3. Mantel type Beautiful Crackle Lacquer Finish.
 4. Imported German Demonstrating Speaker.
- all \$16.00 to \$24.00 Values.

Clearer — Louder Radio Amplifying Unit.

GREATER DISTANCE

THE **Mystery** FILTERING UNIT

Will Carry Any Voltage

Attach to console or speaker. No rust—no corrosion—moisture proof, it endures.

\$12.00 Value **\$4.95** Introductory offer

FULLY GUARANTEED Dealers write for prices.

FRANK W. WOOD, U. S. Rep. 416 S. State Chicago, Ill.

Be A Crack Shot Weibly Air Pistol



Guaranteed to group shots within one inch at 10 yards.

Mark No. 1 Calibre .22 or .177 \$15
Mark No. 2 De Luxe Model \$19
Pellets: .177 per 1000, \$1.50; .22 per 1000, \$2.25; 88 Page Illustrated Catalog of Imported Arms 25c in Stamps.

A. F. STOEGER, Inc., 226 E. 42nd St., New York

CUT WINTER FUEL THE EASY WAY



The farmer's best helper for 40 years. Thousands save money and backaches every year. YOU CAN TOO. Send for free catalog showing low prices. Address Dept. 115. FOLDING SAWING MACHINE CO., 300 W. Adams St., CHICAGO, ILL.



**Without Continuous Wiping
Keeps Windshield Clear**

RUBBER wipes off dirt—FELT puts on a chemical that keeps vision-area on windshield clear for hours *without continuous wiping*, in rain, mist, fog, snow.

**CHRISTEN'S
SAFETY WINDSHIELD BLADE
WIPER**

This new wiper blade fits any style of automatic, or hand, windshield wiper—just take out the old blade and insert the Christen blade. Like a new car, or new pair of shoes, it has to be "broken in" before you will get the best results. It comes to you with the Felt slightly higher than the Rubber, because after two or three good storms used as an ordinary wiper blade the Felt squashes down to the level of the Rubber, the excess chemical is worked out and you get results that mean lasting satisfaction. Same good service for life of blade. Guaranteed for one year. Metal part rust-proof because Parkerized.

35¢ standard 7½ in. size. Special 9 in. size, 50c. Ask for it by name wherever auto accessories are sold.

V. H. CHRISTEN MFG. CO.
321 Orleans Street Detroit

Wilcot (Parent) Company, Ltd. Fishponds, Bristol, England. *Distributor for Europe and British Colonies except Canada.*

HOQUIAM (WASH.) U.S.A.

6503 MILES

on loud speaker
with the new

DAVEN BASS NOTE RECEIVER

Although the New Daven Bass Note Receiver brings in enough distance to satisfy any DX hound, we have not talked about it before. Here is but one record: 6503 miles on Loud Speaker. E. A. Johnson, of 249 Eklund Avenue, Hoquiam, Wash., using the new Daven Bass Note hook-up, got 4QG, Brisbane, Australia, and of course had it authenticated.

The New Daven Bass Note Kit, a duplicate of the one used by Mr. Johnson, is now ready. Every part, every wire, even the screws are supplied, drilled and engraved panel, drilled base-board, battery cable, etc., but without cabinet, tubes or batteries.

Complete Kit \$68.50

Quality Reception is synonymous with Daven, but with the Daven Receiver embodying the new coils, you will get greater distance, sensitivity, selectivity and volume than you ever thought possible.

Get the complete kit in its own box to avoid substitutions. If your dealer cannot supply you, write us.

DAVEN RADIO CORP., 150 Summit St., Newark, N.J.

BRISBANE (4QG)
AUSTRALIA

Better Than A Brush

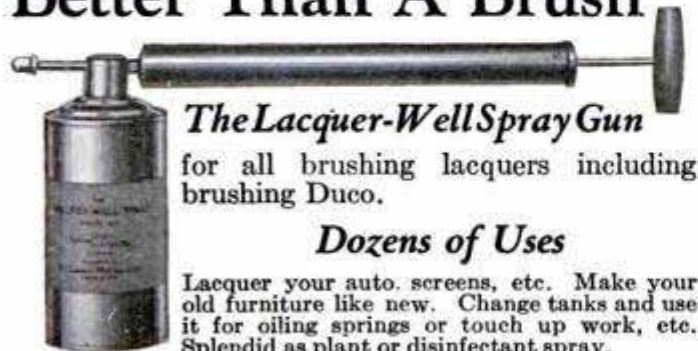

The Lacquer-Well Spray Gun
for all brushing lacquers including brushing Duco.

Dozens of Uses

Lacquer your auto. screens, etc. Make your old furniture like new. Change tanks and use it for oiling springs or touch up work, etc. Splendid as plant or disinfectant spray.

Sturdy, lasting service, quality made—Sent postpaid anywhere in U. S. upon receipt of only \$2.00, extra tanks 25c each.

THE LACQUER-WELL SPRAY COMPANY
Dept. R 2012 East 105th St. Cleveland, Ohio

Free Going Hunting?



Then be sure to write for V L & A's Gun Catalog Sent to you free! Complete information about the finest guns and hunter's equipment. Lowest market prices. Prompt service. Money back guarantee. Write today.

Ask for Catalog No. 71EE

VON LENGERKE & ANTOINE
Sporting Goods Exclusively
33 South Wabash Avenue, Chicago, Ill.

V L & A
Just Sport

Saved Again!

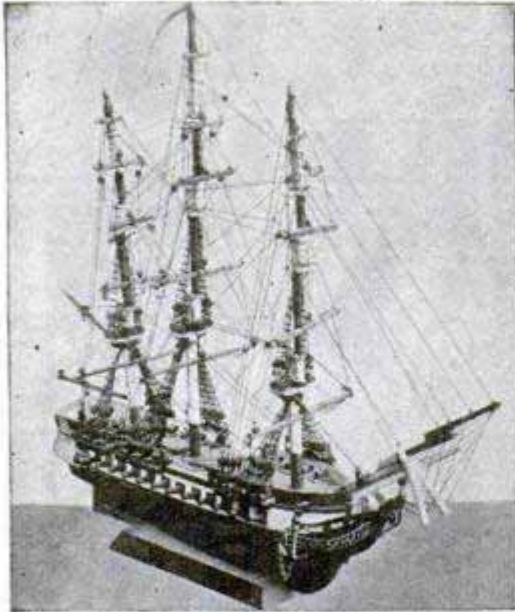

Size: 30" high; 32" long; 10" wide.

Another great victory has been won by Old Ironsides and she will be saved for posterity

While the Frigate Constitution is in dry-dock undergoing rehabilitation the World's Largest Manufacturer of Ship Models has produced a model of the historic ship in knock-down form. The parts are cut-to-fit and ready-to-assemble. So simple is the plan that

You can put these models together in a few hours of pleasant pastime

You need not know anything about ship building to assemble one of these models. As a matter of fact if you have never seen a ship you can put the model of the Constitution together in a few hours by following our diagrams and instruction sheet which is so written that a school boy can understand it. All you need is a small hammer. The parts are numbered on the diagram to make the process even more simple. As long as you can understand such instructions as these (actually taken from assembling chart that is included with every model of the Constitution) you cannot fail: "Take No. 57, place it in front end of No. 56 and tap lightly with hammer. Next take No. 58 and place it up against No. 57 and tap with hammer to bring it into place."

Easy? Nothing simpler. The instructions are just like that from beginning to end. Do this and that—and before you realize it a beautiful model has grown before your eyes.

The model of the Constitution is exact in every detail. The hull, masts, spars, cannons, anchors and rigging correspond to those on the original ship in every way. After you have completed building one of our models from the \$6.98 kit you will be so well satisfied that you would not take \$50.00 or even \$100.00 for the model.

Besides the model of the Constitution we manufacture parts for other historic ships. The Santa Maria and the Mayflower have been the most popular ship models ever built. We have sold these models to people in every part of the world and are shipping a large quantity of them daily to various parts of the United States, Europe, South America and even to Africa.

Send for our beautifully illustrated catalog which contains information and photographs of all our models. Fill in the coupon below today and send it to us and we will set upon it immediately.

Miniature Ship Models, Inc.
 3818 - 20 - 22 - 24 Baring Street
 PHILADELPHIA, PA.

Canadian Branch: 1485 Bleury St., Montreal, Canada

MINIATURE SHIP MODELS, DEPT. P
 3818-20-22-24 Baring St., Phila., Pa.

Please send me the complete parts, cut to fit, and ready to assemble for the model Constitution. I will pay postman \$6.98 plus postage (a few cents).

PLEASE PRINT NAME AND ADDRESS PLAINLY

Name.....

Street or R. F. D.....

City.....

State.....

The NEW 3 Ft. Cone Loud

"ENSCO" Wall Type Speaker

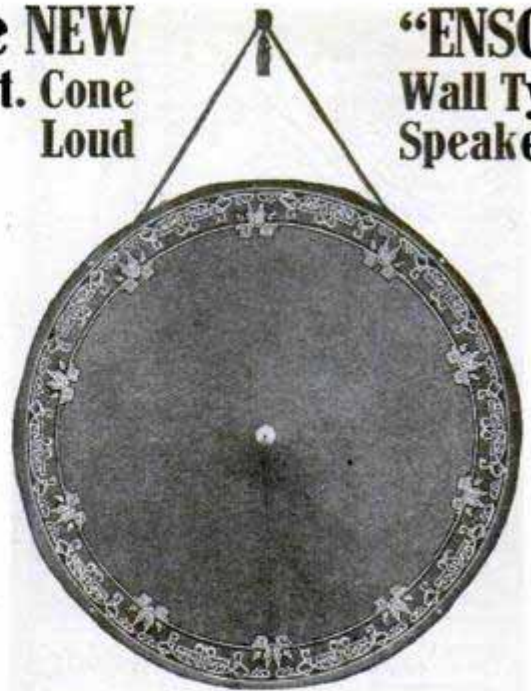

STANDARD "ENSCO" KIT - - - \$10.00
With Hardwood Frame - - - - \$11.00

As described in the July issue of Popular Mechanics
 Anyone can assemble the "World's Finest Loud Speaker" in less than an hour, from the complete "Enesco" Kit. Six styles and 3 sizes to choose from. All described in the illustrated instruction book. Fully patented. At your dealer's or direct from any of the offices listed below. Send check, money order or C. O. D. (Shipping charges paid). In Canada \$11.50 and \$12.50. Absolute money back guarantee.

ENGINEERS' SERVICE COMPANY
 25 Church Street, New York 73 Cornhill, Boston
 28 E. Jackson Blvd., Chicago 331 Bay St., Toronto, Canada

FROST-RADIO DE LUXE APPARATUS

The new Frost-Radio De Luxe Apparatus now is obtainable at your dealers—rheostats, potentiometers, variable high resistances and fixed resistances—all reflecting the supreme quality of our new De Luxe line. Metal parts are nickel plated and hand buffed—resistance windings of rheostats and potentiometers are carried on flexible bakelite winding strips. Bakelite pointer knobs.

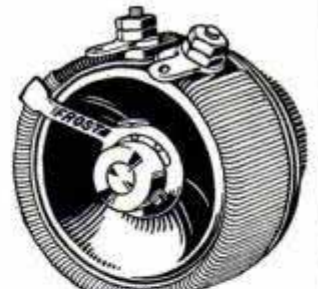

FROST-RADIO



FROST-RADIO

- Metal Frame Rheostats 75c
 - Metal Frame Potentiometers \$1.00
 - Bakelite Rheostats \$1.00
 - Bakelite Potentiometers \$1.25 to \$2.50
 - Variable High Resistances \$1.75
 - Fixed Resistances 15c and 25c
 - Gem Rheostats 75c and \$1.00
- Note: Frost-Radio Rheostats, Potentiometers, and Variable High Resistances may be secured with integrally mounted battery switch at slightly higher prices. See this apparatus today at your local dealer's.

HERBERT H. FROST, INC.

Main Offices and Factory, Elkhart, Ind.
 New York Philadelphia Chicago Los Angeles
 Boston Pittsburgh St. Louis St. Paul

You can now Own a Typewriter!

\$3.00 DOWN
and its
YOURS

guaranteed for 5 years



Be up-to-date—know the pleasure and convenience of having one in your home. You'll be amazed at the uses everyone in your household will find for this real Underwood typewriter. Every member of the family will use and enjoy it! Don't send a cent—but do get our big special offer—our valuable book on typewriters and typewriting—FREE.

Any One Can Learn to Operate a Typewriter!

You can learn to write on this standard-keyboard machine in one day; it's so simple that even a child can use it. A week after the expressman has brought it, you'd feel LOST without it. A trial will PROVE it—and doesn't cost you a penny!

SPECIAL FREE TRIAL OFFER

We don't want a penny now. Nor any money at all unless this proves the typewriter bargain of your life. The trial is FREE. If you buy, our easy terms make it a pleasure to pay. There's no excuse now, for not owning a typewriter—and the finest make!

We include all tools, a cover, etc., all complete, all ready to write. Write us now. Deal direct; we are the largest factory of the kind.

Our plan gives you the opportunity of a thorough trial before you buy. You run no risk whatever. You start to pay for your typewriter AFTER you have found it the only machine for you!

But get the facts before this lot of machines is all in use. Clip the information coupon before you turn the page. It will pay you! Note the very useful book you will receive free! Write for full particulars at once.

The Greatest Typewriter Offer Ever Made

If you know typewriters, you know the perfect work and the ease and speed of a Shipman Ward rebuilt Underwood typewriter.

New machines are guaranteed for only one year; WE GUARANTEE EVERY ONE OF OUR MACHINES FOR FIVE YEARS! If you have never owned a typewriter, start with the finest! You can try this one at our risk. But, the time to act is NOW. Don't miss out on this present bargain offer whereby you can get this genuine Underwood at a big savings. Don't do longer without the convenience of a typewriter.

FREE! Get our catalog free; lowest prices and terms. A manual free, too; valuable instruction for learning rapid typing.

Mail Today!

Shipman Ward Manufacturing Co.,
2127 Shipman Building, Chicago, Ill.

Please send me your Free Trial Plan and Typewriter Book, together with your special offer on prices, terms, free course in Touch Typewriting and also how I can make money with this typewriter, without obligation. This is not an order.

Name.....
Street or R. F. D.....
City.....
State.....

Speed Way Drill & Saw Kit



5 Tools in Case

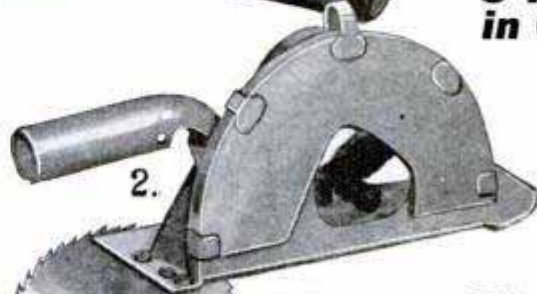

Free Trial

Long before your ten-day free trial is over you will know what a wonder it is. Works from any lamp socket.

Five Tools in Case

Outfit packs into handy steel case (No. 11). Take it to the job. Handy; compact.

HERE THEY ARE

1. SpeedWay Portable Drill, 1/4" in steel; 1/2" in wood.
2. Guard and handle for saw driven by Drill Motor.
3. Saw blade—4-inch.
4. Buffer wheel for polishing.
5. Wire Scratch Brush.
6. Cradle to convert the Portable to a Bench Drill.
7. 2 1/2" Emery Wheel.
- 8, 9, 10. For attaching above.
11. Steel Carrying Case.

Easy to Pay For

We ship on receipt of small down payment. Pay balance in small monthly amounts, while you are using it.

A Money Maker

The electric drill in the Kit is either a portable or stationary drill for 1/4-inch holes in steel or 1/2-inch in wood.

Just attach the blade, with guard, and your drill becomes a handy, husky, portable saw, ready to go to work on any sort of a job. Takes but a moment to put Grinder, Buffer or Polisher in action.

WRITE TODAY

Get our catalog. We are the world's only manufacturers of a complete line of Portable, Electrically Driven Saws, Hammers, Drills, etc.

Send Coupon Today—It Will Pay

Electro Magnetic Tool Co.,
1830 S. 52nd Ave., Cicero, Ill. (Adjoining Chicago).
Manager, Dept. 140. Please send me full particulars about your 10-day free trial on Drill and Saw Kit.
(If interested in other-tools, please check here)

Name.....
Address.....



The First Evening with his Buescher



-and Three Weeks Later Going Strong!

IT'S just a step from the wallflower's corner to the center of popularity ring. Don't let the other fellows capture all the good times, and the smiles of those whose smiles are worth while. Be the whole show with your

BUESCHER

True Tone Saxophone

This is the one instrument you know you can learn to play. If you can whistle a tune you can't fail with a Buescher. You can learn to play quickly, with comparatively little effort.

Join the Home Town Band

With the aid of the 3 lessons given on request with each new Buescher, many learn scales first hour and play tunes first week. You can teach yourself, and in 90 days join the Band, or play with an orchestra, at good pay.

Only Buescher Assures Success

But only with a Buescher is this rapid progress assured. You don't have to fuss and favor for certain notes. Just open the key and blow normally. Every tone full, clear and true.

Six Days' Trial. Easy Terms

Take any Buescher Instrument home for 6 days' trial. If you like it, pay a little each month. Send coupon for beautiful catalog and details of this liberal plan. There will never be a better time to start. Write today.

BUESCHER BAND INSTRUMENT CO.
Everything in Band and Orchestra Instruments
2121 Buescher Block Elkhart, Indiana

All Metal Chassis Completely Shielded

6 TUBE SUPERPHONIC RADIO KIT COMPLETE

Only \$16.95

Can be built in 2 hours

FREE! 6 TUBES UX 201-A TYPE Tested and Matched

Latest 6 tube tuned radio frequency circuit. Extremely selective, marvelous tone quality. 2 stages of radio frequency, detector and 3 stages of low ratio audio frequency amplification for improved tone quality. 2 dial control. All metal chassis completely shielded. Clear and realistic reception guaranteed. Beautiful ornamental design on front panel, crystalline finish. Metal panel and sub panel; all holes drilled making mounting of parts very simple. No special tools needed. Kurz-Kasch bakelite indicator knobs. New type UX sockets. All hook-up wire and colored battery cable included. Value \$60.00, our price, \$16.95.

COAST TO COAST RECEPTION

COMPLETE SET OF SIMPLE PLANS AND DIRECTIONS TO BUILD

Very easy to build this set with the plans and instruction we furnish. No complicated drawings. Can be built in two hours. Instruction for operation also included. Make money by building these sets in your spare time and selling them to your friends.

MAKE MONEY IN YOUR SPARE TIME!

SEND NO MONEY

Just write your name and address on a post card and ask us to send you this great kit together with 6 tubes. We ship them right away. When they arrive, pay only \$16.95 plus a small delivery charge.

RADIO EQUIPMENT CO.
Dept. PF. 549 S. Wells St. CHICAGO, ILL.

Most Amazing INVENTION in 25 Years

"Cleans Up" for Agents!

Men, here is a wonder—the most sensational invention of the age! If you're looking for a sure, rapid-fire seller—one that nets you 100 per cent PROFIT—one that SELLS ITSELF on demonstration to 7 out of 10 men—I've got it in Ve-Po-Ad, the amazing new vest pocket adding machine!

\$90 Weekly in Spare Time!

Yes, you can earn that easily. And here's why: Ve-Po-Ad does all the work of a \$300 adding machine, yet it fits the vest pocket and sells for only \$2.95! It counts up to a billion, clears instantly, is absolutely accurate and lightning fast. Positively sells on sight to storekeepers, business men and everyone who uses figures! And—you make 100% profit on every sale!

SPECIAL FREE OFFER

Live wire salesmen are dropping every thing else and flocking to Ve-Po-Ad. Ve-Po-Ad brings them quick money and lots of it. You can "Clean Up" too! No previous selling experience needed. If you want a steady, substantial income, write at once for full details of my MONEY-MAKING PLAN and FREE VE-PO-AD given to new agents. Do it NOW-TODAY!

You'll need one to add up your profits!

C. M. CLEARY, Dept. 47, 184 W. Washington St., CHICAGO, ILL.

Price only \$10.50

Weight 20 lbs. Write for circular.

THE ADRIAN SPEED LATHE
for wood and light metal turning. 7" swing, 17" centers.

H. G. CRANE, Adrian, Mich.

BUESCHER BAND INSTRUMENT CO. 341C
2121 Buescher Block, Elkhart, Ind.

Gentlemen:--Without obligating me in any way please send me your free literature. Mention instrument interested in.

Age?..... Name instrument.....

Name.....

Address.....

TYPewriter PRICES CUT

Your choice of the World's best typewriters—Underwood, Remington, Oliver—full size, late model, completely rebuilt and refinished brand new. Prices smashed down to half. Act quick.



\$2 and it's yours

Free Trial

Just send your name and address and we will mail you our complete **FREE CATALOG** prepaid, fully describing and showing actual photographs of each beautiful machine in full colors. Tells every detail of our direct-to-you small-payment plan. Write now for tremendous saving. No obligation whatever. Still time if you act now.

International Typewriter Exchange
186-188 W. Lake Street. Department 1094, Chicago, Ill.

SM

Do You Know the Secret of Quality Reproduction?

"The Secret of Quality" tells you simply and concisely how to get the most out of your amplifier—how to get quality. This 96 page booklet is yours for the asking—it's free. Write for your copy.

SILVER-MARSHALL, INC., 840 W. Jackson Blvd., Chicago, U. S. A.

Fansteel Products Company, Inc.
North Chicago, Illinois

Play a Tune in 10 Minutes

Be the "Life" of the Party

10 DAYS FREE TRIAL



Amazing New E-Z Playing UKULELE, BANJO-UKE GUITAR, MANDOLIN, TENOR BANJO

equipped with exclusive patented invention that enables you to play tunes in a few minutes! Simple as A. B. C. Just press the keys and play tunes from the very start. No knowledge of music required with E-Z Playing Instruments. No long months of tiresome practice. No expensive lessons. Play by numbers at first—learn to play by notes **Automatically** while playing tunes. Astonish your friends. Be center of attraction at all parties. Produce real music, rich harmony, old-time favorites, syncopated jazz. Loads of fun! New friends! Money-making chances in dance orchestras, radio, and stage! All yours when you play an instrument. Over 50,000 people have learned to play tunes in a few minutes with E-Z Playing Instruments. Your success guaranteed.

FREE TRIAL—Easy Payments

Choose your favorite instrument on Special 10-Day Free Trial Offer. You be the judge in your own home. Play tunes at once or trial costs you nothing. If you keep instrument—pay on liberal easy terms **At Rate of Few Cents a Day**. Send today for

FREE CATALOG

of E-Z Playing Instruments carrying life-time guarantee. Contains money-saving values in high grade instruments. Also full details of 10-Day Free Trial Offer. You risk nothing. No obligation. (If you have an instrument now, you can secure E-Z Playing Method separately.) For more fun—more popularity—more money—send coupon today.

FERRY & COMPANY, Dept. 8779, CHICAGO

Send me Free Big Catalogue of bargains in patented E-Z Playing Instruments and full details of Special 10-Day FREE TRIAL Offer. No obligations.

Name.....
Address.....
City..... State.....

Heats Home for 25c a Week!

"I can run my Bulldog furnace steady for fourteen days in normal weather conditions on the actual cost of fifty cents." So writes F. R. Redetzke, of Cleveland, North Dakota. He adds: "Hard to believe is it? That's what some of my neighbors thought until I showed them! We have an unlimited amount of grain screenings in this country. That's the fuel I am using."

That's what the Bulldog does with about the lowest grade fuel you can think of! Here's what it does with coal: "There is no heater to compare with the Bulldog. I burned 2½ tons of coal last winter and heated 5 rooms and bath."

—Walter Geary, Gloucester, Mass.



If you are even thinking of a pipeless furnace, or any furnace, write for our free catalog. The Bulldog is one furnace you MUST investigate. Comes completely erected. Fits any height of basement and you install it yourself.

No Money Down

Small Monthly Payments

The Bulldog is sent for free inspection

Then, if satisfied, you make only small monthly payments at our amazingly low price. Factory connections in both East and West. We ship from nearest point. Don't consider buying any furnace until you find out about the Bulldog. Write at once for our special offer and our free catalog together with the wonderful record of Bulldog success. Mail this coupon today.

Bulldog Furnace Co.

Babson Bros. Sole Distributors

19th and California Ave., Dept. 13-57 Chicago

Without obligating me in any way please send me your free catalog and special offer on the Bulldog Pipeless Furnace.

(Print Name and Address plainly)

Have you a basement? Yes No

Name.....

Address.....

As Thin As A Dime

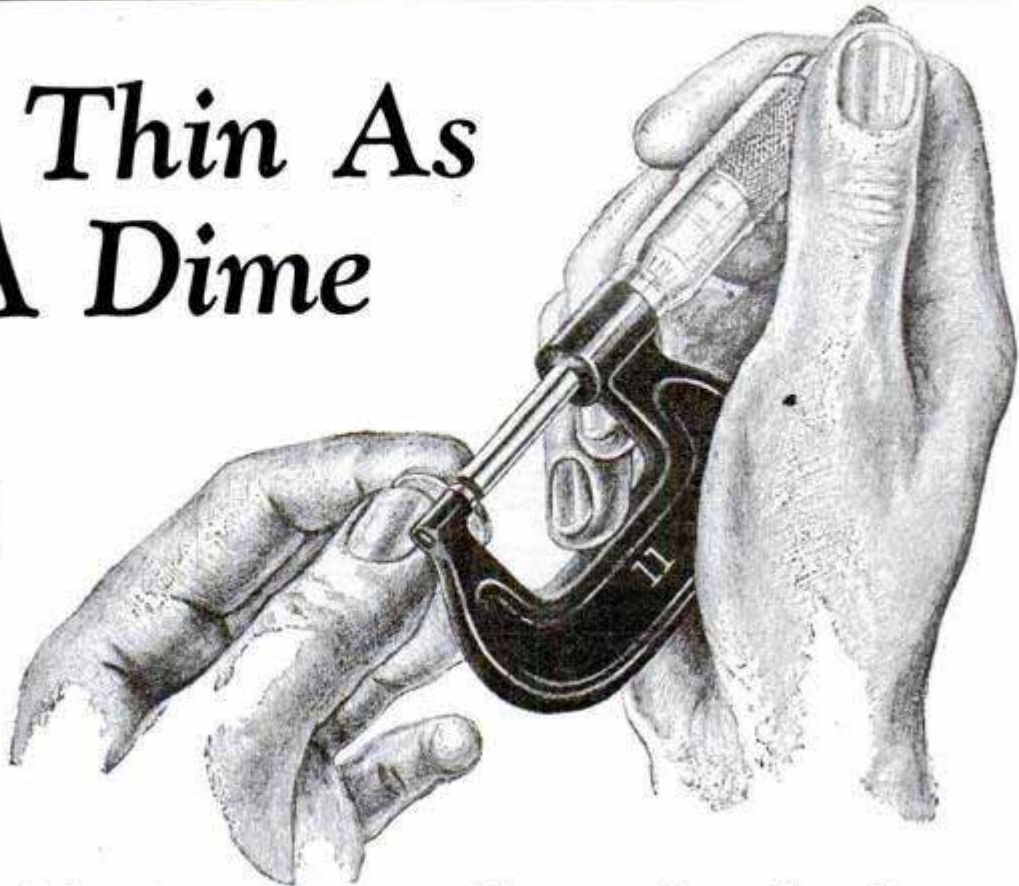
You frequently hear the expression "as thin as a dime" in referring to some unit of measurement.

As it comes from the mint, the average thickness of the edge of a dime is about one thirty-second of an inch.

To many this may seem a small unit of measurement—but not to the hundreds of mechanics who work with Brown & Sharpe precision tools.

These men frequently make measurements daily, accurate to one thousandth of an inch—often to one quarter thousandth of an inch and not infrequently to one ten thousandth of an inch.

The performance of Brown & Sharpe tools sets a standard of accuracy among mechanics everywhere.

Hardware dealers can supply you with Catalog No. 30—or we will be glad to send one free on request.

Dept. P. M.

BROWN & SHARPE MFG. CO.
Providence, Rhode Island, U. S. A.

BROWN & SHARPE TOOLS

"World's Standard of Accuracy"



NEW TIMER FOR FORDS
MARVELOUS INVENTION
FREE OFFER TO USERS **FORDYNA MO**
60,000 MILES WITHOUT TROUBLE
WRITE TODAY FOR FREE OFFER
Agents Wanted Everywhere
Eclipse Timer Co., 2931 Melnecke Av., Milwaukee, Wis.

For Better Filament Control on your radio set use the **NEW Lynch EQUALIZOR** in place of rheostats. \$1 complete with mounting. At your dealer's or post-paid. Money back if dissatisfied. In ordering, state number and types of tubes in your receiver. **ARTHUR H. LYNCH, Inc., Manufacturers of the Lynch Metallized Resistor, 250 West 57th Street, NEW YORK, N. Y.**

Get Boice Prices Before You Buy!

As the world's largest builders of small bench machines, Boice offers greater values at lower prices. Write for 64-page booklet containing

Band Saw shown has 14-in. wheels, uses blades $\frac{3}{8}$ -in. to $\frac{1}{2}$ -in. wide. Saws 7-in. stock. Table 12 in. x 14 in. tilts 45 degrees. Has ball-bearing roller guides, Bronze bearings.

New Boice Saw!

Greatest Saw value ever offered. Boice's latest Universal Handisaw now ready. Combination tilting table saw and jointer. Priced remarkably low. Write for full details before you buy any saw.



Jointer shown has extra long tables, 36 in. over all. Safety head with three knives, $4\frac{1}{2}$ in. wide. Ball bearings. Fence tilts 45 degrees both ways. Does moulding.

W. B. & J. E. BOICE

Dept. P. M. 10-C

TOLEDO, OHIO

Now YOU Can Learn Magic



Dr. Harlan Tarbell, internationally known magician and teacher of some of the world's greatest magicians.

from Europe's

"Miracle Man"

So weird, so mystifying is the magic power of this great Master, Dr. Harlan Tarbell, B. Sc., F. S. D., D. N., that Europe called him "the miracle man."

At Home—By Mail

Think of it! Now YOU have the unique opportunity of learning the Magic Secrets of this great magic wizard, Europe's "Miracle Man"—at home—by mail—quickly and easily—and under his *personal* guidance!

You'll be astonished at how quickly and easily YOU will master—impromptu effects, parlor tricks, and even massive stage illusions. You'll be taught famous mysteries of Europe, China, and of the Ancients. Great secrets will be revealed to you! Your friends will marvel at your magic powers.

Earn \$200 to \$1000 a Month

There's big money in Magic for YOU! Yes, and the best part is that you do not have to give up your present position or business. You can make nice money entertaining on the side, or, under the guidance of this great Magician, you can become a real, professional magician, make big money, enjoy fame and glory.

Write Today—Mail that coupon below NOW and learn of the great, limitless opportunities in store for YOU!

Tarbell System, Inc., Studio 13-57, 1920 Sunnyside Ave., Chicago, Ill

**Tarbell System, Inc., Studio 13-57
1920 Sunnyside Avenue, Chicago, Illinois**

Gentlemen: Without any obligation send me you free literature and information all about your your wonderful "Tarbell Course in Magic" Also tell me about your great Special Price Offer and Easy Payment Plan—offered NOW for limited time only.

Name.....

Address.....

Age.....

Why haven't you clipped this coupon

TEAR OUT HERE

INTERNATIONAL CORRESPONDENCE SCHOOLS

"The Universal University"
Box 5676-E, Scranton, Penna.

Without cost or obligation, please send me a copy of your booklet, "Who Wins and Why," and full particulars about the course before which I have marked X in the list below:

BUSINESS TRAINING COURSES

- | | |
|--|---|
| <input type="checkbox"/> Business Management | <input type="checkbox"/> Salesmanship |
| <input type="checkbox"/> Industrial Management | <input type="checkbox"/> Advertising |
| <input type="checkbox"/> Personnel Organization | <input type="checkbox"/> Better Letters |
| <input type="checkbox"/> Traffic Management | <input type="checkbox"/> Show Card Lettering |
| <input type="checkbox"/> Business Law | <input type="checkbox"/> Stenography and Typing |
| <input type="checkbox"/> Banking and Finance Management | <input type="checkbox"/> English |
| <input type="checkbox"/> Accountancy (including C.P.A.) | <input type="checkbox"/> Civil Service |
| <input type="checkbox"/> Nicholson Cost Accounting | <input type="checkbox"/> Railway Mail Clerk |
| <input type="checkbox"/> Bookkeeping | <input type="checkbox"/> Common School Subjects |
| <input type="checkbox"/> Private Secretary | <input type="checkbox"/> High School Subjects |
| <input type="checkbox"/> Spanish <input type="checkbox"/> French | <input type="checkbox"/> Illustrating <input type="checkbox"/> Cartooning |

TECHNICAL AND INDUSTRIAL COURSES

- | | |
|---|--|
| <input type="checkbox"/> Electrical Engineering | <input type="checkbox"/> Architect |
| <input type="checkbox"/> Electric Lighting | <input type="checkbox"/> Architects' Blueprints |
| <input type="checkbox"/> Mechanical Engineer | <input type="checkbox"/> Contractor and Builder |
| <input type="checkbox"/> Mechanical Draftsman | <input type="checkbox"/> Architectural Draftsman |
| <input type="checkbox"/> Machine Shop Practice | <input type="checkbox"/> Concrete Builder |
| <input type="checkbox"/> Railroad Positions | <input type="checkbox"/> Structural Engineer |
| <input type="checkbox"/> Gas Engine Operating | <input type="checkbox"/> Chemistry <input type="checkbox"/> Pharmacy |
| <input type="checkbox"/> Civil Engineer | <input type="checkbox"/> Automobile Work |
| <input type="checkbox"/> Surveying and Mapping | <input type="checkbox"/> Airplane Engines |
| <input type="checkbox"/> Metallurgy <input type="checkbox"/> Mining | <input type="checkbox"/> Agriculture <input type="checkbox"/> Navigation |
| <input type="checkbox"/> Steam Engineering | <input type="checkbox"/> Mathematics <input type="checkbox"/> Radio |

Name.....

Street Address.....

City..... State.....

Occupation.....

Persons residing in Canada should send this coupon to the International Correspondence Schools Canadian, Limited, Montreal, Canada



Here's an Amazing New Business THAT PAYS UP TO **\$1,000** A **MONTH**

A surprising new profit opportunity is now offered to every ambitious man and woman! A sensational new kind of food business has been invented that can be operated by anyone in either full or spare time. Now, incredible as it may sound, \$400 to \$1,000 a month profit is possible in even the smallest cities! We start you in this business following our proven, time-tested plan. The investment is surprisingly low. You start at once. We supply you with equipment to make, and full plans for selling the already famous Brown Bobby greaseless doughnut. No baker's skill required. Just add water to our prepared "Mix," and our remarkable electrical device does the rest. Brown Bobbys cost less to make and sell four times as fast as old style indigestible grease fried doughnuts. No wonder so many people without one bit of experience are literally cleaning up fortunes with this new money-maker. You can open a shop; rent cheap floor space in a grocery, delicatessen, lunch-counter, drug store, etc. Or start at home—and make up to \$250 your very first week.

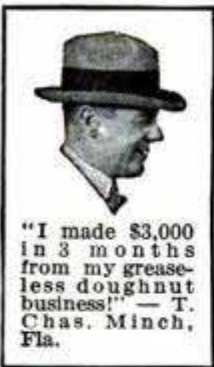

"I made \$3,000 in 3 months from my greaseless doughnut business!" — T. Chas. Minch, Fla.

Big Profits Are Waiting

Men and women everywhere are starting in this business daily! YOU cannot afford to delay! Details will gladly be sent without obligation of any sort. Such an amazing money maker may never come your way again. So fill in and send the coupon at once! TODAY!

MAIL COUPON NOW!

Food Display Machine Corp.,
Dept. 13-57, 350 W. Huron St., Chicago, Ill.

Gentlemen: Please send me the plan by which I can cash in on Brown Bobby, the Greaseless doughnut. It is understood that this obligates me in no way whatever.

Name.....
Address.....
City..... State.....



Big Profits in Tube Repairing

This Improved Shaler 5-Minute Shop Vulcanizer repairs four tubes at a time. And does it in a jiffy—while customers wait. Quick service! Quick profits! Every garage, service and filling station needs it because any one can use it. No steam, no gas, no electric. All you need is a match. A supply of 28 Patch Units brings in twice as much as vulcanizer costs. Write at once!

THE SHALER COMPANY
2711 Fourth Street
WAUPUN WISCONSIN

SHALER

World's Headquarters for Tire Repair Equipment

One
Year

To
Pay



No. CS2 — Price \$62.00
\$2 Down and \$5 a Month

This big cluster of seven best grade sparkling blue white diamonds is set in **SOLID PLATINUM** in this solid white gold ring.

Guaranteed to stand any test.

18 KARAT

No
Red
Tape

10
Days
Trial

YOUR CREDIT IS GOOD

We will give you one whole year to pay for this ring or any other article listed in our catalog shown in this advertisement. There is no red tape. Just send two dollars with your order and tell us your age; the name and address of your employer; how long you've been in his employ and a business reference or two. All of this information will be kept strictly confidential as we make no direct inquiries. Then we will open a 12 month charge account for you and send you the ring for ten days Free Trial. Then if you are satisfied in every way you pay the balance in twelve monthly payments, otherwise you return it and we will refund your money. No articles sold to minors unless order is signed by parent or guardian.

FREE CATALOG

From this catalog you make your selections from over a thousand bargains in diamonds, watches and jewelry. (all sold on convenient terms) just as if you were in our big store. It brings our store right into your home. Sent free to any adult.

STERLING DIAMOND & WATCH COMPANY
(Diamond Importers—\$1,000,000 Stock—Est. 1879)
1540 Broadway Dept. 2346 New York, N. Y.

Radio Static Vanishes!



With a Simple Twist of This Amazing Magic Dial!

Cuts Out Static

"I have just placed your static reducer on my set and must say I am more than pleased with the result. It almost doubled the volume of my set and by properly operating your radio device I could cut out at least 90% of the static."

"I think it is a wonderful thing for a radio and would not be without it even for one night."

Yours truly, D. L. ESMOND

Increases Volume

"To say I am delighted is putting it mildly, for now I have so much volume that I can only tune it down by turning the knob on the Eliminator and cutting down the control dials on my set."

Very truly yours, PAUL M. BEPLER

Brings in Cuba

"Samples received. There are several things I could say that are worth many times the price paid, but the one I am most interested in is being able to reach out and draw in Havana, Cuba, with remarkable clearness and volume, which was impossible before."

Very truly yours, DON FETTER

Saves 35% on Batteries

"I am amazed and delighted with the sample you sent me. If it only did one of the things you say it would, it would be well worth the price. But it actually does all of them. I know that it saves at least 35 per cent on the life of my batteries."

Very truly yours, A. L. SEEBER

Tunes Out Local Stations

"The other night one of the local stations came in no matter where I turned the dials, but when I hooked on your remarkable invention I had no more trouble and was able to pick up stations anywhere. I also notice that it cuts out stations that are crowding each other, which is one point you don't claim for it."

Sincerely yours, C. C. DEPEW

Remarkable new radio invention astounds experts! Users say it presents five major improvements in radio reception. Now offered to radio owners for free test during nationwide advertising campaign. Mail coupon below for details!

HAS radio science at last discovered the solution of static, weak volume and interference? A young genius of Des Moines, Iowa, now answers with an uncanny little device that has worked miracles according to delighted users. Static reduced to a harmless degree . . . volume in full strength and clearness . . . loud nearby stations shut out with ridiculous ease—these and many other striking improvements are now reported.

This announcement was withheld for almost a year. The inventor's theory of controlling static and increasing volume was so revolutionary that he wanted to make a thorough test before public announcement. Now that thousands of radio owners are verifying his theory, he presents this device to every radio owner for free test.

Fits Any Set

This invention is called Geppert's Kleertone. It fits any set—one tube to superhet—home-made model or latest nationally-advertised set. It doesn't matter whether you have an inside or outside aerial. No change in hookup. And anybody can in-

stall it in a few minutes. Just attach it to your set—tune in on nights when interference is at its worst—then believe the evidence of your own ears.

How to Own One Free

Mail the coupon below at once. It will bring you full description of this new scientific contribution to radio reception—tell you how you can test it before buying—and also explains our free sample offer to advertise this invention in every community. There is no obligation. Simply send your name and address. C. H. Geppert, Pres., Geppert Mfg. Co., M-207 Hewitt Bldg., Des Moines, Iowa.

Simply Send Your Name

C. H. Geppert, Pres., Geppert Mfg. Co., M-207 Hewitt Bldg., Des Moines, Iowa

Yes, send full details of your new radio invention. This request does not obligate me.

Name.....

Address.....

City..... State.....

AGENTS

Wonderful new money-making field now yours in the radio industry! This device sells on performance. \$25 to \$75 a week easy. Get details with coupon below.

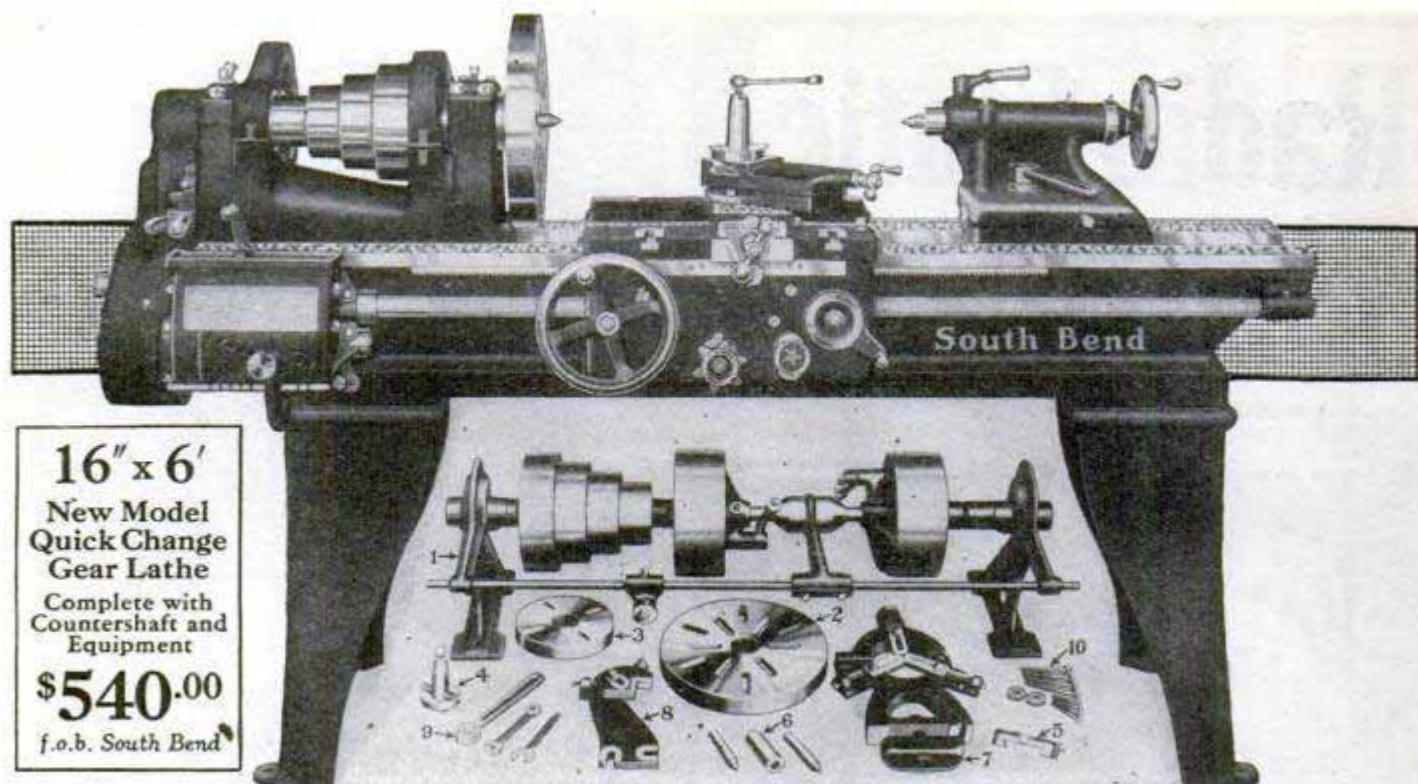

16" x 6'
New Model
Quick Change
Gear Lathe
 Complete with
 Countershaft and
 Equipment
\$540.00
 f.o.b. South Bend

THE NEW, MODEL SOUTH BEND

Screw Cutting, Back Geared Engine Lathe

The New Model South Bend Lathe is made in 210 different sizes, types, and drives, ranging from the 9" swing to 24" swing. These lathes are practical for handling all classes of work that come up in the modern machine shop, manufacturing plant, and service station. Special attachments and equipments are furnished for all sizes South Bend Lathes for service station work, tool room work, and manufacturing.

Popular in Price, High in Quality

The New Model South Bend Lathe is popular because of its low price and high quality. In 21 years, more than 38,000 South Bend Lathes have been shipped to satisfied users in the United States and 64 foreign countries.

The popular sizes New Model South Bend Lathes for all classes of work are listed in the table below, together with the net factory prices, f.o.b. South Bend, Indiana.

Furnished in All Types of Drives

Each size and type New Model South Bend Lathe can be furnished in the Countershaft Drive, Silent Chain Motor Drive, and Simplex Motor Drive. All types are illustrated and priced in Catalog No. 88, free on request.

Time Payments if Desired

Any size or type South Bend Lathe can be purchased on the South Bend Easy Payment Plan. Ask for Booklet No. 28 describing the Easy Payment Plan.

A size and type for every purpose. Below are a few of the most popular sizes:

Size	Quick Change	Standard Change
9" x 3'	\$270	\$235
11" x 4'	335	300
13" x 5'	402	352
15" x 6'	490	430
18" x 8'	700	635

Write for FREE Booklet on each size New Model South Bend Lathe.



New General Catalog No. 88

New General Catalog No. 88 contains complete and up-to-date information on the entire line of South Bend New Model Screw Cutting Engine Lathes of all types and drives, also attachments and tools for all sizes of lathes.

This catalog also gives prices on the entire line. It is a valuable reference book. Mailed upon request, postpaid, no charge. Give street address to insure safe delivery.

SOUTH BEND LATHE WORKS

626 East Madison Street

South Bend, Indiana, U. S. A.

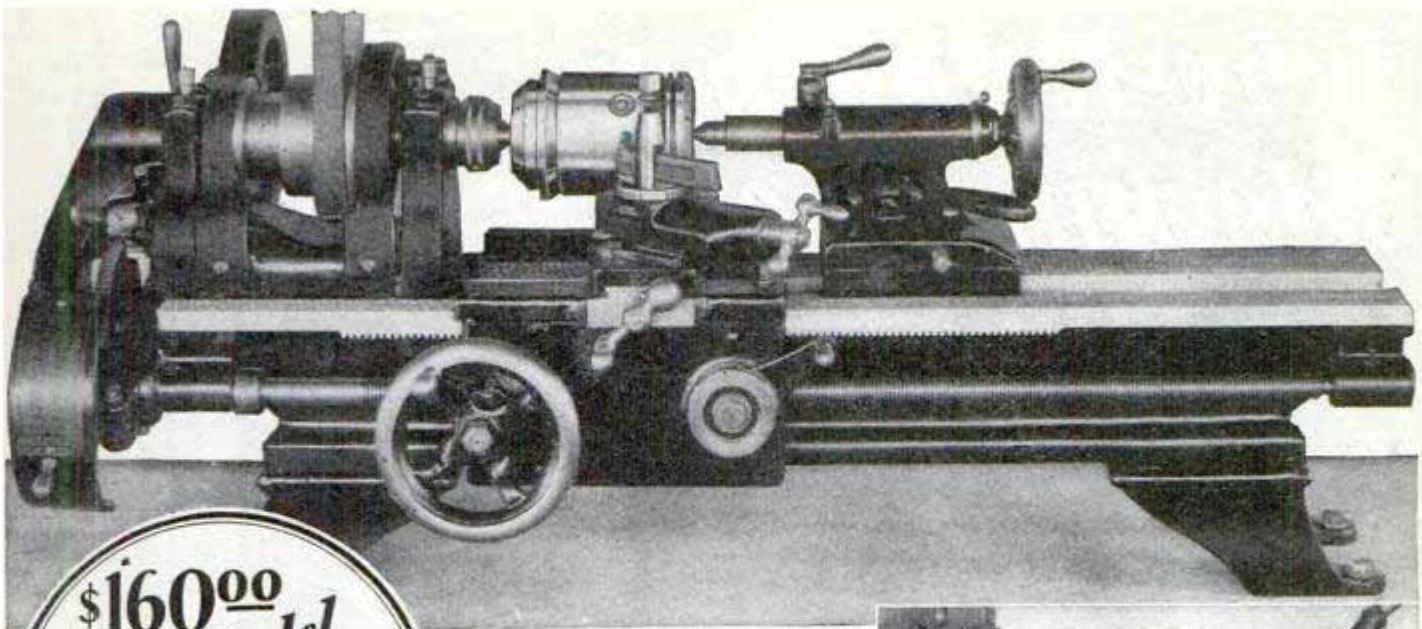

\$160⁰⁰
New Model
9^{INCH} JUNIOR
Back Geared-
Screw Cutting
Bench Lathe
 With Plain Rest, Countershaft
 and Equipment

9" Lathe Finishing Semi-machined Pistons

Both service stations and automobile manufacturers are now turning pistons on a lathe instead of grinding because the job is done equally as well and in one-fourth the time.

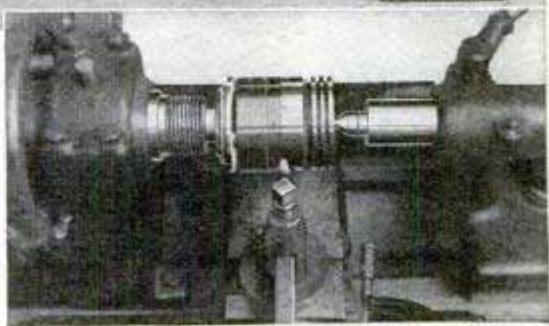

A close-up view of the lathe tool making a finishing cut across the piston

For Accurate Machine Work.

Auto repair shops throughout the country are using the South Bend Junior Lathe for hundreds of precision jobs.

Has All these Practical Features

The South Bend Junior Lathe has all the features of larger lathes and is the ideal tool for all around work. It has six spindle speeds; power feed to carriage; 3/4 inch hole in spindle; plain or graduated compound rest.

It will cut screw threads 4 to 40 per inch. Built in 2 1/2, 3, 3 1/2, 4 and 4 1/2 ft. bed lengths. Weight, 9"x3' Bench Lathe, 375 lbs.

Countershaft or motor drive that plugs into ordinary lamp socket, which has power to drive it at full load.

Time Payment Plan if Desired

FREE BOOKLET 22-K. Just off the press! 24 interesting pages of practical lathe information. 150 photographs completely illustrate the lathe at work and describes all types and drives. A booklet of real interest and value to any mechanic.



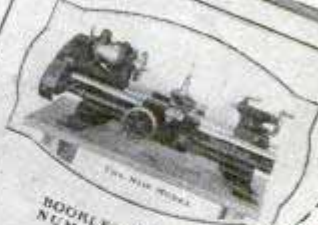

 BOOKLET NUMBER **22-K**
 Describing the
9-INCH JUNIOR L.
 MAY 10, 1927
SOUTH BEND LATHE WORKS, South Bend, Ind.
 630 East Madison Street
 GENTLEMEN: Send me immediately a copy of your new booklet, 22-K. This booklet is Free, postpaid to any address.
 Name.....
 Address.....
 Town.....
 State.....

South Bend Lathe Works

630 East Madison St., South Bend, Indiana
 New York City Salesroom, 183 Centre St. Phone, Canal 9085

USE THE COUPON

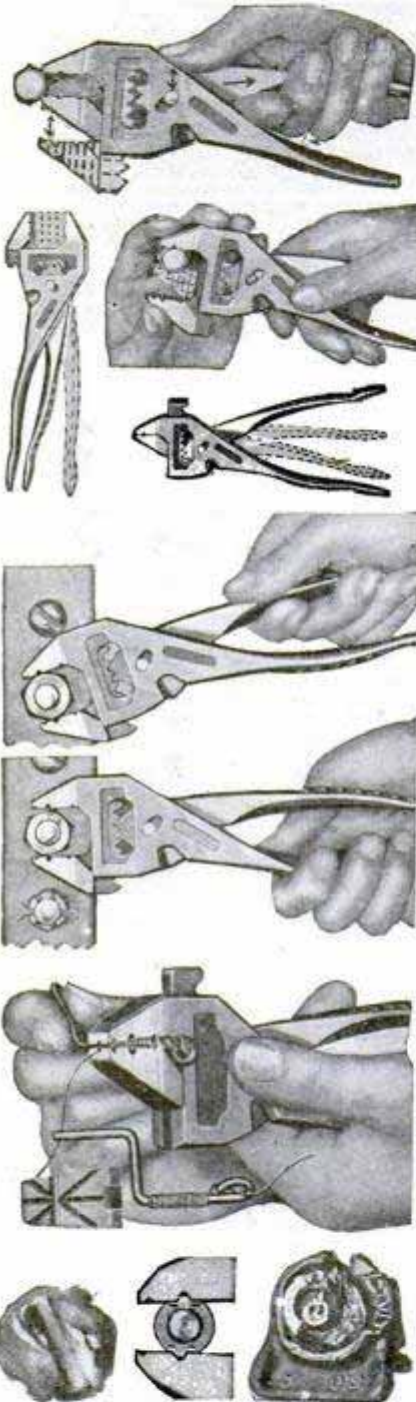
"Why-It's a Whole Machine Shop!"



"A Whole Machine Shop"—
 is what Users call the EIFEL-FLASH PlierWrench KIT, because instead of using a dozen tools on One job they do a thousand jobs with the PlierWrench KIT alone! And if this page could show Popular Mechanics' readers what this Kit can do for them, the Kits reserved for the Special Offer below would not last one day, but—space permits only "a word to the wise."

Helped Win World Flight
 USED BY U. S. World Flyers; on U. S. S. Shenandoah, S. S. Leviathan, U. S. Army, Navy, and Mail Planes. By MAKERS of Buick, Chevrolet, Nash, Packard, Reo, Studebaker, etc.. Automobiles; Fisher Bodies, etc.; each with its employees buying from 200 to 1000 Kits.

Thousands of Housewives are using the PlierWrench too, because it is the only tool giving a woman's hand a 1/2-TON grip and enabling her easily to do mechanical work difficult for a man using other tools!

A SUPER Plier-Wrench-Viser with a 1-TON Power-Gear

The PlierWrench out-speeds, out-works and out-wears, dozens of best other tools in an incomparably superior way. In 1/8 second the Ratchet Gear-shift fits the Jaws to the work and the handles to the size of Your hand. The One-Ton POWER-GEAR automatically LOCKS the grip on the Corners and "flats" of Any shape and in addition applies 1/2 to 1 TON Direct pressure—64 to 128 TONS per square inch! Its automatic grip release makes it a perfect Ratchet Turning Wrench!

The force of the PlierWrench 1-TON Power-Grip is beyond belief—it must be experienced. It actually Out-grips a 40-LB. VISE; twists round heads off 1/4-in. stove bolts and the hexagon heads off 1/2-in. Bolts! It will easily and instantly remove worn, chewed, and chiseled, nuts, broken taps, drills, studs, etc., in tightest places, with next-to-nothing to get hold of—when all other tools fail!

Its smooth Jaws with 4-Way V-Grooves will hold a hair, and all possible shapes from 0-in. to 1 1/2-in. diameter with a rigid, clinching grip that never chews or slips one bit. They coil 1/4-in. to 1-in. diameter springs of fine and heavy spring wire, and—do a thousand other "impossible" things quickly and easily.

All Tools in 1 1/2-lb. Kit
 The PlierWrench Kit is a Guaranteed, Time-perfected, Super-quality Master Tool, having a Universal Utility that defies the Imagination. It takes "The PlierWrench Way" Manual of Mechanics—64 Pages with 145 Pictures—to show only its most valuable uses and advantages!

HUNDREDS OF THOUSANDS of men are using these wonder Kits to make their Homes and Estates more comfortable—Farms, Shops, etc., more profitable; to get more and better service from Automobiles and all mechanical devices, with a big saving in money, time, and energy!

JUST TRY a PlierWrench Kit, and you would no more go back to other tools than you would to the Ox-cart!

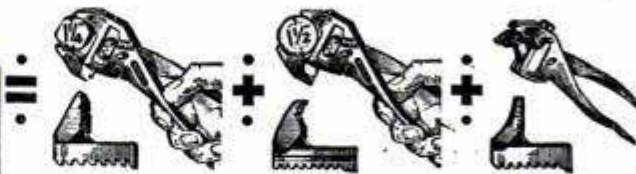
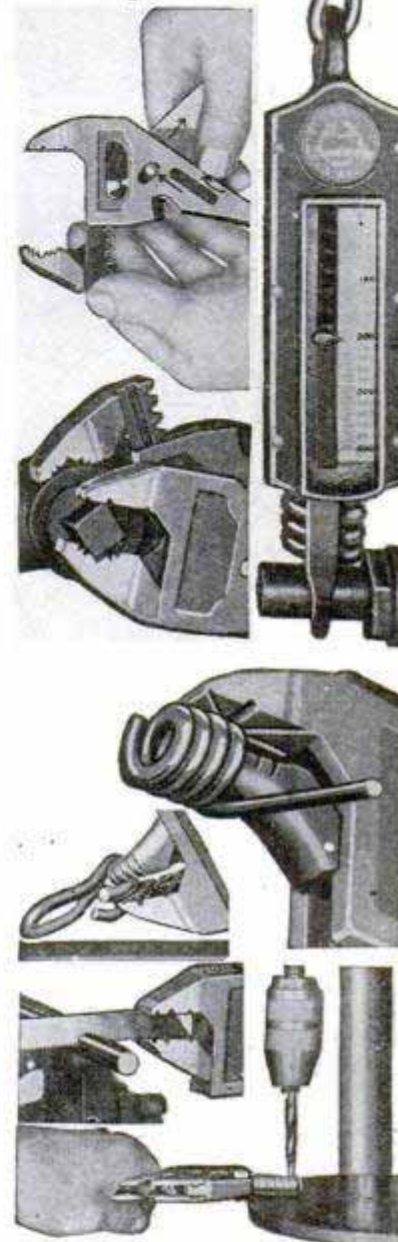

Ltd. Special Introductory PRICE ONLY \$3.75
 (Regular Price \$5.00)

The KIT has 3 Gear-Jaws. In 1/8 Second you convert the Universal PlierWrench into the Pipe-and-Fitting PlierWrench, or into the Wire-Chain-and-Cable PlierWrench—each the Master in its field.

This \$5.00, 1 1/2-Lb., Kit will do the work of 60 Lbs. of other tools costing \$50.00—Quicker, better, easier.

Use the Coupon to get your Kit on the MONEY-BACK 2-Weeks Free Trial Offer—

MAIL TODAY AND SAVE \$1.25

Agents: \$200 a Week
 PlierWrench representatives earn amazing incomes demonstrating this wonderful new tool. One man alone sold nearly 10,000 in just one state. Fastest seller known. Factories buy by hundreds. Every auto and home owner buys. We have wonderful special proposition to agents. Mail coupon for full details. Why not earn \$75 to \$200 and more a week, spare or full time?



THE FLASH SALES CORP'N
 JP-4809 N. Ashland Ave., CHICAGO, ILLINOIS

Plus—
 The Flash Sales Corp'n, JP-4809 N. Ashland Avenue, Chicago, Ill.
 1. Rush E. F. PlierWrench Kit. (With deposit \$3.75 U. S. A. Price) with Postman on arrival. If not delighted I may return within 2 weeks and my deposit will be returned at once.
 2. Send me only user literature.
 3. Am interested in Salesman's Big Proposition.
 Name _____
 R. F. D. _____
 St. _____
 P. O. City _____
 State _____

Plug In-and Tune In

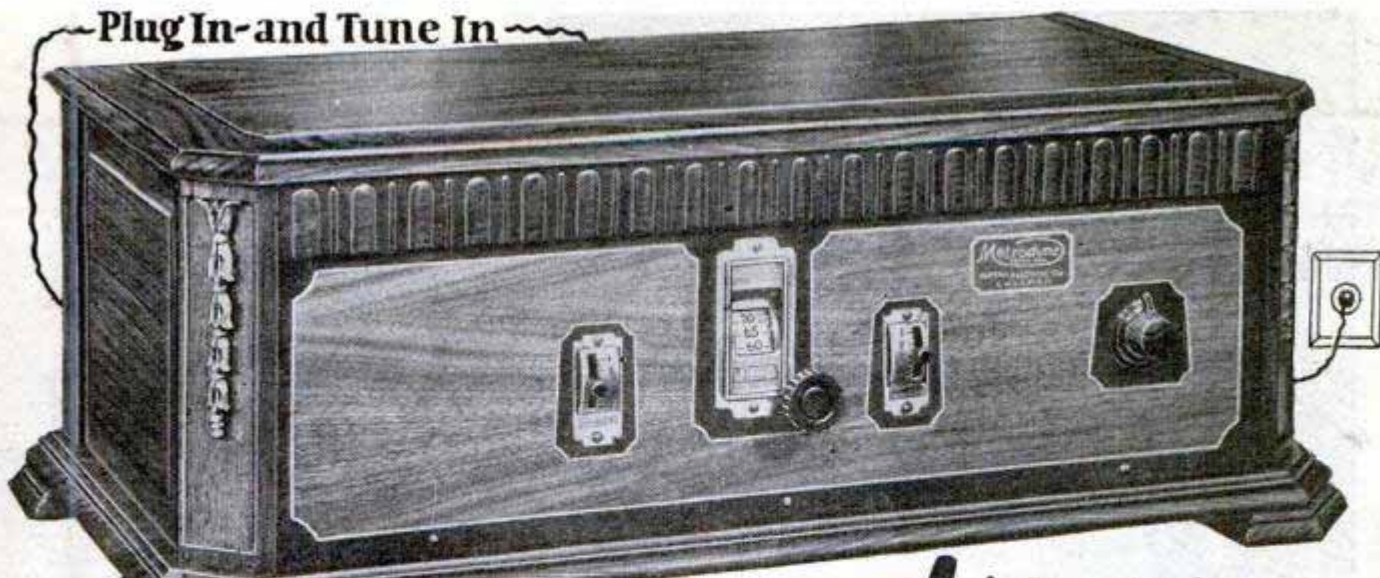

30 Days Free Trial

Now! A Real Electric Radio Set
 Three-Year Guarantee
 Shipped direct from our factory at rock bottom prices—costs less than most battery sets

No Batteries, Chargers or Eliminators
 No Acids; No Liquids—Plug In—Press Button—“Tune In”

Metrodyne
 ALL ELECTRIC RADIO

7 Tubes—Single Dial Set

100% Electric Radio

**BEAUTY—EFFICIENCY
 DEPENDABILITY**

At last! The radio you've dreamed about! If you have electricity in your home you can now really enjoy coast to coast radioreception without the care, bother and muss of batteries, chargers, eliminators, etc. The Metrodyne All Electric is a real, genuine batteryless radio set. Simply insert the plug in the socket, press the switch button and “tune in.” You could not possibly buy a better radio set than the Metrodyne All Electric, no matter what price you paid.

The Metrodyne All Electric Radio is a 7 tube, single dial set. Only the highest quality low loss parts are used throughout. Solid walnut cabinet, beautiful two-tone effect, with handsome gilt metal trimmings. Size of cabinet, 28 inches long, 13 inches deep, 10 inches high. Has electrically lighted dial so that you can log stations in the dark. Only one dial to tune in all stations. Excellent tone qualities—wonderful volume—very selective.

Costs Less Than Most Battery Sets

Do not confuse the Metrodyne electric radio with ordinary light socket sets, because the Metrodyne is truly an all electric radio—consumes less than 2c worth of power a day. Comes to you direct from the factory. Its low cost brings it down to the price of an ordinary battery set. We are so confident that you will be delighted with this wonderful, easy-to-operate batteryless radio that we offer to ship it to your home for thirty days' free trial—you to be the judge.

Mail This Coupon

We are one of the pioneers of radio. The success of Metrodyne sets is due to our liberal 30 days' free trial offer, which gives you the opportunity of trying before buying. Thousands of Metrodynes have been bought on our liberal free trial basis. Write Today!

METRO ELECTRIC COMPANY
 2165 N. California Ave., Dept. 617
 Chicago, Illinois

Gentlemen:

Send me full particulars about Metrodyne All Electric Radio sets and your **thirty days' free trial offer.**

Name.....

Address.....

If you are interested in AGENT'S proposition place an "X" in the square.

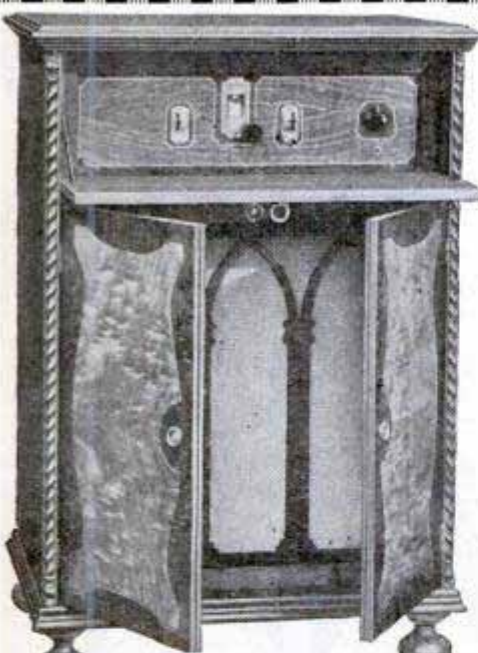

Gorgeous Console All Electric Radio

Genuine walnut cabinet, in a beautiful two-tone finish. Has a built-in genuine Metro-Cone large size speaker. Brings in programs with great volume, reproducing the entire range from the lowest to the highest notes with remarkable clearness and distinction. All metal parts finished in old gold. Wonderful electric radio, in a cabinet that will beautify any home.

METRO ELECTRIC COMPANY
 2165 N. California Ave., Dept. 617, Chicago, Illinois

~when the crown stands or falls....

“~You're there with a Crosley...”

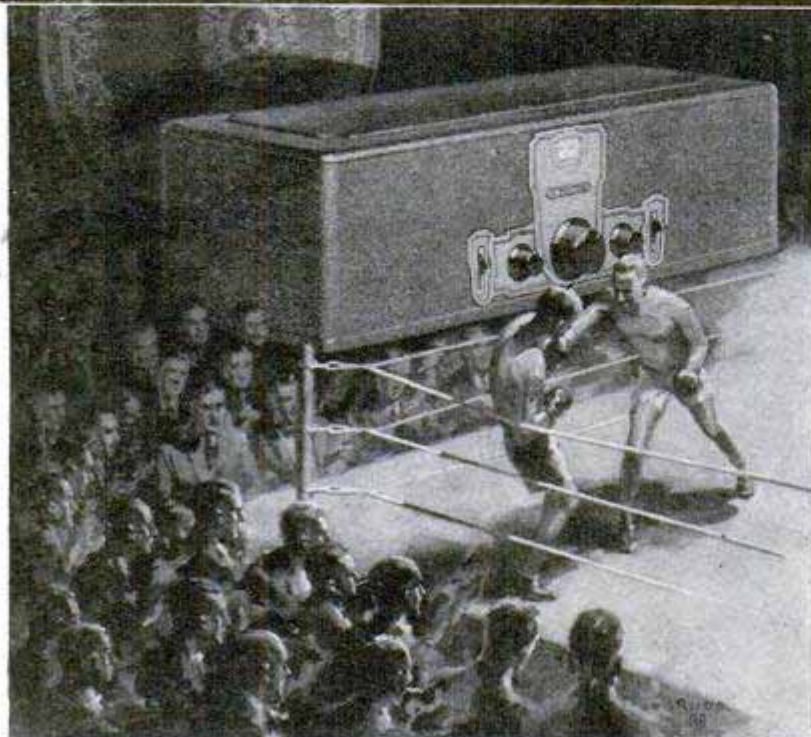

The Crosley Radio Corporation:
Why don't you radio manufacturers stop talking like a lot of doctors and tell us what it's all about in oney-linder words? What's this "shielding" business anyway? Yours truly,
Wellmore Savage Elec. Supply Co.,
Boston, Mass.

Shielding is necessary in a modern radio receiver. The more sensitive the set is, the more you need it. Some sets



are merely housed in a metal case. This helps to keep strong local signals from breaking through, but it is even more important to keep them where they belong after you get them the proper way from the antenna.



A set has tubes, condensers and coils. Here is a coil. The lines around it are the magnetic field.

You know the earth's magnetic field will work a compass down in a mine, or up in a plane (it certainly worked for Lindbergh) and the fields around unshielded coils get all mixed up and the set howls and squeals and has to be choked off by turning down the filaments in the tubes.

Now if the coils are housed in copper shields the fields can't mess each other up, and the tubes can do a real job of amplifying. The coils in Crosley sets have these copper shields, and there isn't anything better.



Then there are the condensers, and if it wasn't for the shield around them the fields would set like those in the coils, and the results would be just as bad, or worse.



It isn't enough to shield the coils and the condensers, because even the wiring of the set has fields around it. This too is shielded, as it is in all really high grade sets. Of course, it's all in knowing how to do it, but that's why Crosley sets can be as good as the best without costing half as much.



APPROVED CONSOLES

Selected by Powel Crosley, Jr., as ideal, acoustically and mechanically for the installation of the Crosley "Bandbox" Genuine Musicone built in. Crosley dealers secure them from their jobbers through

H. T. ROBERTS CO.
814 S. Michigan Ave.,
Chicago, Ill.

Sales Agents for
Approved Console
Factories
Showers Brothers
Company
The Wolf Mfg.
Industries



The BANDBOX

A 6 Tube Receiver of unmatched quality at \$55

Many features of this set have been found heretofore only in the most expensive radio. Since Crosley is licensed to manufacture under nearly all important radio patents, this combination with Crosley leadership and experience, naturally produced an amazing radio, the remarkable value of which can be judged by the following features incorporated and by seeing it and hearing it at your dealers.

1. Completely shielded coils, condensers and wiring.
2. Acuminators for sharper tuning.
3. Completely balanced genuine neutrodyne.
4. Volume control.
5. Single tuning knob.
6. Illuminated dial.
7. Single cable outside connections.
8. Designed for easy installation in consoles.
9. Beautiful frosted brown crystalline finished cabinet.

AC model using new R.C.A. AC tubes and working directly from electric light socket through Crosley Power Converter is \$65. Power Converter \$60 extra. Hear this wonderful new contribution to the enjoyment of radio. If you cannot find one of the 16,000 Crosley dealers near you, write Dept. 15 for his name and literature.

Crosley is licensed to manufacture under patents of the Radio Corporation of America and associate companies, also the Hazeltine Corporation and La Tour Corporation.



IMPROVED MUSICONES

Musicones improve the reception of any radio set. They are perfect affinities in beauty and reproductive effectiveness for Crosley Radios. A tilt-table model, with brown mahogany finish stands 36 inches high, \$27.50 — 16-inch Super-Musicone as pictured above with "Bandbox," \$12.75 — 12-inch Ultra-Musicone, \$9.75.

CROSLLEY RADIO

The Crosley Radio Corporation,
Powel Crosley, Jr.,
Pres.
Cincinnati, Ohio

Crosley Radio is licensed only for Radio Amateur, Experimental and Broadcast Reception.

Prices slightly higher west of the Rocky Mountains

Over 50 years satisfactory service
-DIRECT TO CONSUMER-

**NOW
 IS THE
 TIME TO
 BUY**

**Pay Later
 on
 Easy
 Payments**

**"New Low" WHOLESALE PRICES
 on "New Easy" Method
 PLUMBING and HEATING SYSTEMS
 AND SUPPLIES**

MILLION DOLLAR Bonded Guarantee PROTECTS YOU

The Hardin-Lavin Company founded over 50 years ago has from the beginning specialized in Highest Grade Plumbing and Heating TO THE CONSUMER DIRECT AT WHOLESALE. Our latest catalog (just off the press) is brim full of BIGGER BARGAINS than ever before. Send for your copy TODAY. Our vast buying power and centrally located plant and complete shipping facilities gives you the advantage of ROCK BOTTOM PRICES on HIGHEST QUALITY GOODS. Every Plumbing Outfit or Heating Plant you buy from us is backed by our Bonded Guarantee, our Million Dollar Plant and our reputation of over 50 years ECONOMY service to experienced buyers. The famous Hardin-Lavin New Easy Method of self-installing means TIME and MONEY SAVED.



Royal Bathroom Outfit

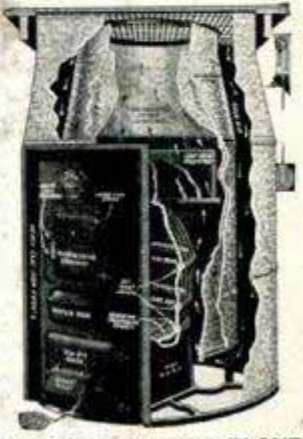

PIPELESS HEATING PLANT

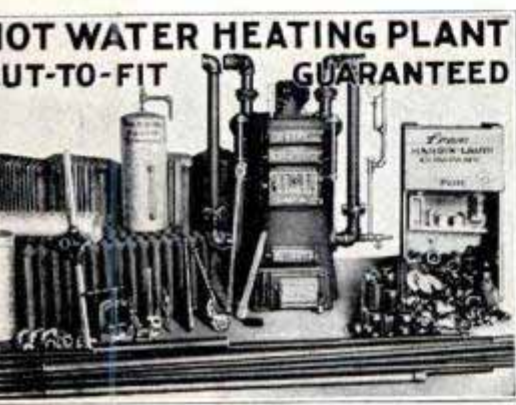

**HOT WATER HEATING PLANT
 CUT-TO-FIT GUARANTEED**

Complete Hot Water Heating Plant ready for shipment with set of installing tools, diagrams, and New Easy Method of self-installing instructions.

**Cut-To-Fit
 Hot Water Plant**

In our latest catalog you will find everything in latest designs of Plumbing Fixtures and Heating Supplies:—Built-In-Tubs, Pedestal Lavatories, Deep Apron Sinks, Laundry Tubs, Hot Water, Steam and Vapor Heating Plants, Pipeless and Warm Air Heating Plants, Supplies, etc. Hardin-Lavin New Easy Method of self-installing enables you to put in your own Plumbing or Heating. No experience needed, we show you how: clear diagrams and instructions guide you accurately.

All materials come to you factory-fitted ready for easy assembly. There is no guess work—when the job is finished an expert will approve it.

Special! Deferred Payments

In addition to quality goods at wholesale prices, new easy installing method, free plans, and all the other Hardin-Lavin advantages, we have now arranged so that you can BUY ON EASY TERMS. Nowhere else can you find so unusual and complete a combination of merchandise, service and accommodation. Added to all this—without charge—is the co-operation of our corps of Engineering Experts.

Read: What Others Say!

SAVED \$300

I am more than pleased with my heating plant. I saved about \$300 comparing with local quotations. A. L. Langley, Gary, Ind.

AS REPRESENTED

The plumbing fixtures arrived in first rate shape. We are very much pleased. Exactly as represented. F. C. Phillipson, Battle Creek, Mich.

VISIT OUR PLANT

When in Chicago, we will be pleased to show you thru our Big Modern Plant, whether you buy or not. We want you to know us.

WELL PLEASED
 I received our furnace and it operating with perfect satisfaction. We are well pleased. Mrs. W. Maceland, Waterbury, Conn.

FINEST EVER SEEN

The heating plant I purchased from you is a peach, the real thing. I am a satisfied customer. Dr. J. C. Branch, White Cloud, Mich.

Thousands of customers testify to the fact that we have saved them money, time, expense and dissatisfaction. You take risk when you buy a Heating Plant or Plumbing Outfit from us because our engineering staff has okayed everything before it leaves our plant. **ASK FOR FREE ESTIMATE.** Let this trained group of Plumbing and Heating Engineers help you. Write them freely for advice and information. Ask for estimate without obligation. Send a rough sketch of arrangement of your rooms if possible and they will design an outfit exactly for your home that will meet all of your individual needs. Thousands of home owners, contractors, farmers, mechanics and nationally known institutions have fitted from these made-to-order Hardin-Lavin designs. This help from our engineering staff is free and backed by 50 years of knowing how. They will show you many trade secrets, kinks and wrinkles that will surprise you with big savings of money, time and labor. **WRITE TODAY.**

FREE ESTIMATE
 Mail Your Plan or Rough Sketch

This Label Your Protection



Send for Your **FREE** Copy Today

FULL OF BIG BARGAINS!

**Hardin-Lavin Company,
 107-17 W. Pershing Road,
 Chicago, Illinois.**

P. M.-10-27

Gentlemen: Please send me your free bargain catalog with special wholesale prices and easy terms. I am interested in:

- Hot Water Heating Plants
- Steam Heating Plants
- Pipeless Heating Plant
- Warm Air Furnaces
- Water Supply Systems
- Bathroom Outfits

NAME.....
 ADDRESS.....
 CITY..... STATE.....

You can buy on Easy Terms

Highest Quality HARDIN-LAVIN CO. Lowest Prices

107-17 W. PERSHING ROAD, EST. 1876 CHICAGO, ILLINOIS

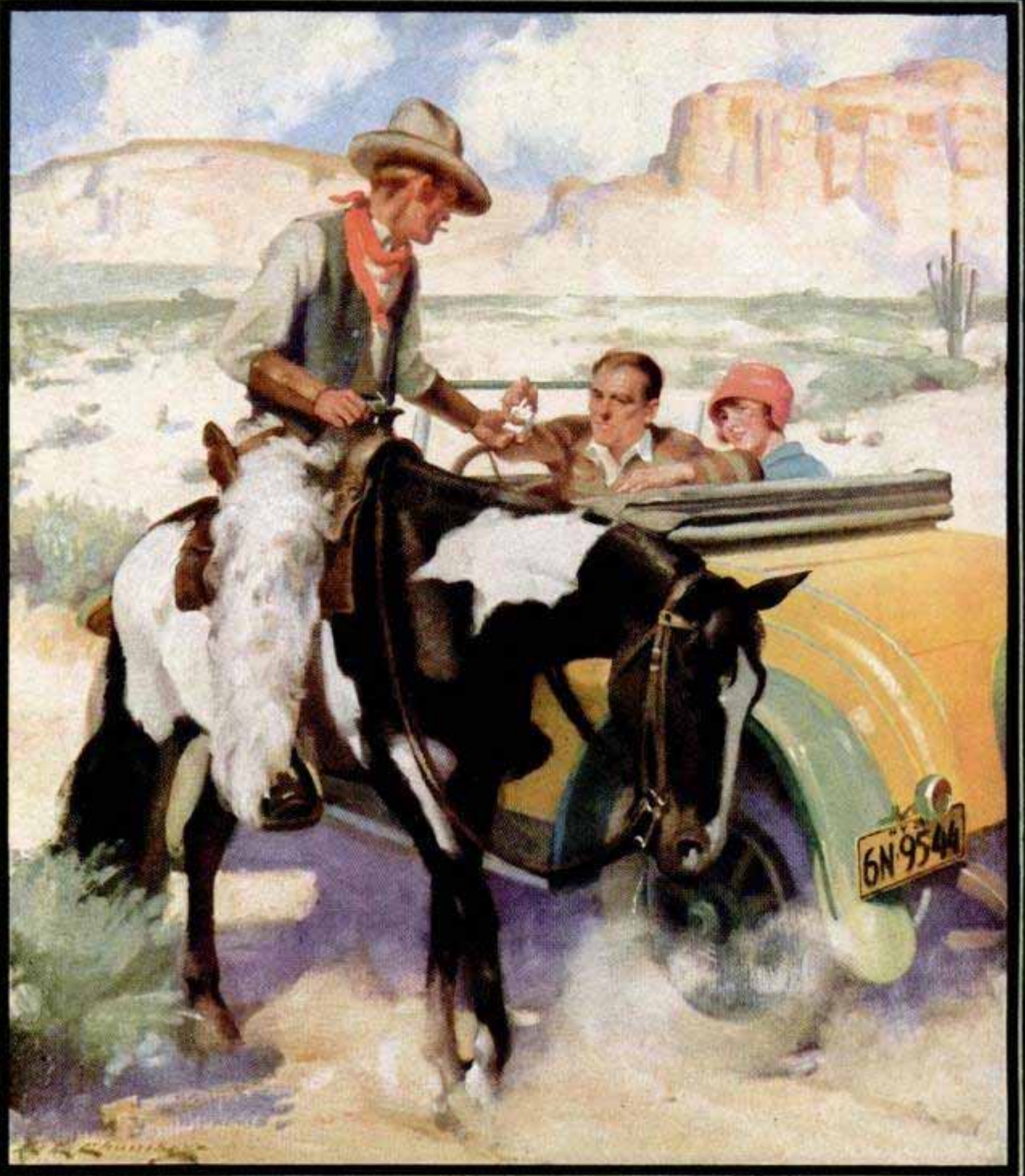

Make yourself at home!



*Right across the country
NATURAL TOBACCO TASTE
is winning a welcome
unparalleled in all
cigarette history . . .*