

SEPTEMBER

25 CENTS

# POPULAR MECHANICS

## MAGAZINE

WRITTEN SO YOU CAN UNDERSTAND IT

REG'D. TRADE MARK, GREAT BRITAIN, NO. 41042D

REG. U.S. PAT. OFF.



SEE PAGE 268



# ATKINS

## SILVER STEEL

# SAWS

*Mr.  
Happy  
Man Says*

*"Your Hardware  
Dealer  
Sells  
Them"*

## SILVER STEEL Hack Saw Blades

*Cut SIX Times More Metal*

ATKINS "Silver Steel" Hack Saw Blades for hand use will cut twice as fast, and last at least six times as long, as any other hack saw blade you ever used.

Think what a saving of time, money and effort this means! What it means to do a metal-cutting job in *half* the usual time—to have a hack saw blade that will outlast six ordinary blades! "Silver Steel" blades keep their teeth and will not snap.

You should be using these wonderful new blades NOW. Ask your hardware dealer for them. If he cannot supply you, write and tell us what kind of metal you are cutting, enclosing 25c, and we will send you a sample "SILVER STEEL" blade.

E. C. ATKINS & CO., Est. 1857  
426 S. Illinois St., Indianapolis, Ind.

*Leading Manufacturers of Highest  
Grade Saws for Every Use; Saw Tools,  
Saw Specialties, Plastering Trowels,  
Machine Knives, Grinding  
Wheels and Files.*



98H  
CATOWELL



# Organize a Band

## *Conn Makes it Easy*



Dodge Brothers, Inc., Concert Band of Detroit, Mich., Eugene LaBarre, conductor. This is one of the famous industrial bands completely equipped with CONN instruments.

ONE interested person can start a band, and with Conn's help, carry it through to success. Our Band Service Department will help you organize a band or orchestra now, among your associates.

In industries, schools, scout troops, legion posts, lodges, communities, wherever there is a group of fellows, there is an opportunity for a band. Our easy payment plan provides complete equipment of instruments at a small outlay per month.

Summer time is band time. Get started now by writing the Conn Band Service Department for complete details—no obligation.

### *Exclusive Conn Features*

The world's largest plant devoted to band instruments, with exclusive machinery and processes, enables Conn to produce the world's finest instruments; easiest to play, beautiful in tone, perfect in mechanism.

One Conn process, the famous hydraulic expansion of tapering tubes, called for an investment of a half million dollars. Unlimited resources in capital, machinery and expert skill are at the base of Conn quality.

### **FREE TRIAL, Easy Payments.**

Send coupon now for free literature and details of trial offer on cornet, trumpet, trombone, saxophone, clarinet, flute, drums—any instrument for band or orchestra. No obligation, send TODAY.

*Mail This*

# CONN

**BAND INSTRUMENTS**  
WORLD'S LARGEST MANUFACTURERS

C. G. CONN, *Ltd.*  
931 Conn Bldg., Elkhart, Ind.

Gentlemen: Please send literature and details of trial offer on the instrument I have indicated.

I am interested in organizing a  band, or  orchestra. Please have your Band Service Department advise me.

{Instrument} \_\_\_\_\_

Name \_\_\_\_\_

St. or R. F. D. \_\_\_\_\_

City, State \_\_\_\_\_

County \_\_\_\_\_



---

---

IT'S THE **YOUNGER CROWD** THAT SETS THE STANDARD!

**G**O to the younger crowd if you want the *right* word on what to wear or drive or smoke. And notice, please, that the particular cigarette they call their own today is one that you've known very well for a very long time.

**F A T I M A**



*What a whale of a difference just a few cents make!*

---

---



# Popular Mechanics Magazine

200 E. Ontario Street, Chicago, U. S. A.

H. H. WINDSOR, Founder

H. H. WINDSOR, Jr., Editor and Publisher

London: Hachette & Cie.,  
16-17 King William Street, Charing Cross, W. C. 2

Paris: Hachette & Cie.,  
111 Rue Reaumur

Melbourne: Gordon & Gotch  
509-513 Little Collins St.

ISSUED MONTHLY

SUBSCRIPTION:

SINGLE COPY, 25 CENTS

In United States and its possessions, also Canada, Cuba, and Mexico, per year, postpaid - \$2.50

To all other countries in the Postal Union - 3.00

All subscriptions are discontinued at expiration. Please examine the date printed on your wrapper.

Entered as Second Class Matter Sept. 15, 1903, at the Post Office at Chicago, Illinois, under Act of March 3rd, 1879.

Entered as Second Class Matter at the Post Office Department, Canada.

Published monthly by POPULAR MECHANICS CO.

Copyright, 1927, by Popular Mechanics Co.

Copyright in Australia. Copyright in France

Vol. 48

Contents for September, 1927

*Joy Furniture* 433  
No. 3

Acid—fumes benefit respiratory diseases	442	Dogs—how to train your pup	403
Advertising		Dogwood—has many uses	445
door made into showcase to increase photo sales	430	Door Closer—invisible spring hidden in frame	413
peanut-shaped auto body	429	Electricity—cheap power transmission promised with new type condenser	471
Agricultural Implements—dusting apparatus spreads insecticide on plants	384	Electric Pad—protects feet of auto passengers	450
Airships		Fertilizer—applied with hose from faucet holder	450
mooring mast on rails simplifies placing in hangar to carry five planes	441	Pipe—square, has better tone and more power	369
Alarm—contact cable sounds at pinch of finger	439	Fish and Fishing	
Animals—treating the world's biggest aches and pains	415	cafe patrons catch own trout	447
Army—runs own railway at infantry camp	378	houses built on runners for smelt fishing	417
Automobiles		rubber ball on fish hooks protects from weeds	432
cleaned with spray mixture from steam boiler	458	Flowers—unusual colors and fragrance produced by cross pollination	465
filling station shaped like umbrella	382	Flute—of gold has improved tone	461
luxurious auto camp for sheep herders	465	Foods—searching the world for new	435
Automobiles—Accessories		Fountain—colored lights reveal beauty	363
beach umbrella as auto top	377	Frogs—eighteen tons shipped from ten-mile area	448
rim remover simplifies puncture repairs	359	Fumigation—small pocket size stove	456
Automobiles—Driving—handle for steering wheel leaves one hand free	373	Gambling—games you can't beat	451
Automobiles—Equipment and Supplies		Garage Accessories—portable oil cleaner substitute for pit	360
aromatic upholstery is germ-proof	402	Gardening	
jack permanently attached to axle	464	long handled weeder saves stooping	460
Automobiles—Repairs—roller press irons out bumps	356	vegetables grown in tiers to save space	431
Aviation		Geography—sectional globe aids in teaching	448
airplane motor strength tested in Dresden	378	Goats—Himalayan mountain, have twisted horns	369
glider with propeller a substitute for parachute	461	Gold Mines—Queen of Sheba's found in Arabia	460
New York-Chicago air express to save a day	366	Golf—home movie lessons aid players	401
plan to fly by air yacht from California to Paris	365	Grand Canyon—bridge across will aid traffic	449
planes planned for transatlantic service	368	Grotto—cavelike, catches old-world charm	392
soldiers form living signs to guide airplanes	430	Guitar—all metal, produces loud sweet tone	360
Bakers—boys in public schools learn to become	407	Gun—hidden in cane handle to fight bandits	442
Banjo—two-tone has damper to regulate sound	418	Hay Fever—air filter helps against	385
Bathing Suits—balloons in serve as life preservers	355	Horses—Arabian, raised on farms in United States	374
Bathtub—huge stone in India	455	Hose—protected by detachable reel on faucet	383
Birds		Household Devices	462
plate glass punctured by force of flight	465	House Plan	528
that live at sea	375	Ice Cream	
Blueberry—substance from, valuable in treating diabetes	441	electric freezer eliminates salt and ice	406
Boats and Boating		flavor coat for cone latest sundae novelty	393
electric for children, runs on batteries	385	Inventions	
one-armed fisherman's steers with wheel	414	developed out of hobbies	379
Bricks		how to sell your	419
made from rubbish used for building	472	Inventors—Major General Squier of the army	410
T-shaped concrete are easily molded	402	Ironing Pad—that won't burn, has soft springy surface	440
Bridge		Jewels—tales of the gems in Tower of London	466
double spiral ramp for, reduces cost	399	Key—two part safe-deposit, gives extra protection	431
moved while in use	446	Knitting—holder prevents ball of yarn from dropping	375
Building Construction—hot air pumped into building for drying	424	Language—fragments of Sinai, found in Arabia	434
Butterflies—in picture frames are art novelty	377	Lawn—trimming shears guard knuckles	442
Carbon Paper—inserts saves time in office work	377	Lawn Mower—changeable blades simplify trimming	423
Carnival—Leipzig's industrial fair	376	Light Rays—determine kinds of rock in the moon	373
Chair—folding, fits in pocket	447	Locomotive—tires kept true without removing wheel	448
Chandelier—ten foot glass, contains 1,000 pieces	448	Mining—electric indicator detects presence of methane gas	418
Check Protector—chemical impervious to ink removers	471	Models	
Church—and shrine, miniature on city street	359	glass skyscraper hints new building age	409
Clocks—queer French, celebrate World War	391	miniature reproduction of cities, harbors, etc., new industry	426
Clothes—teakettle steam used to renovate	390	Motor Coaches—luxurious European with kitchenette	383
Colors—machine that matches, eliminates guesswork	407	Motors—musical test detects defective brushes	378
Corn Borer—\$10,000,000 to fight	386	Mountains—how made, shown by models	358
Cotton—mechanical picker now used	458	Moving Pictures	
Crystal Sphere—fortune telling, fashioned by Japanese	373	earthquakes may take their own pictures	377
Dam		filmed from tree	361
built around railroad without stopping traffic	439	Museum—on balancing rock	457
concrete arch is 1,000 feet long	460		

[Continued on Page 4]

*Joy Furniture* 433  
353



## [Contents—Continued]

Musical Instruments—serpent of old-time bands produces sweet music	367	Traffic—dummy policeman directs tourists	472
Nutrition—why you can fast for weeks and still live	408	Tree Felling—axmen in tree-felling race furnish many thrills	401
Oil Well—courage of workers tested in taming wild well	402	Trees	
Paper—speed tree growth for making	357	braced by grafting to resist wind	465
Photography		protected from insects by chemical injections	375
color pictures reveal sea wonders	442	Tree Stumps—removed with acid	42
pocket arc lamp substitute for flash	355	Tricycle—seagoing, speeds 10 miles an hour	35
Piano—lights on keys guide students	365	Trolley Lines—poles of flexible concrete for use on	40
Planter—improved, saves seed and increases crops	359	Wallpaper—rare old, moved on plaster to new house	36
Police—rapid revolver reloader aids	434	Watchmen—night, school for	35
Prisons—old, serve as schools in Porto Rico	425	Water	
Pruning Shears—double-edged, make clean cut	449	cup turns breath into, for airmen	36
Puzzle—toy furniture set from single block	433	supply kept pure by alternate rain and drought	31
Radio		Whistle—worn as ring always ready for use	407
desert automobile has receiving and sending equipment	440	White House—putting new roof on	357
switching plug	486	Women—fitting to right career	459
Radio Aerial—adapting three tube loop set to aerial	485	Wonders—age of, still in future	353
Radio Applications—power transmission by radio demonstrated	429	Woodworking—toy shop is designed for practical use	451
Radio Batteries		X-Rays	
automatic switch controls B-eliminator and trickle charger	477	aid identification in crime detection	42
cartridge rectifier for A-eliminator	476	discover liquor hidden in hay bale	41
chargers	476		
eliminating charger hum	486		
installing storage battery in console	477		
new unit recharges B-batteries	483		
trickle charger assembled at home	485		
Radio Broadcasting—special environments in studios to aid performers	433		
Radio Construction			
compact gridleak mounting	485		
copper tubing for wiring	476		
Radio Pictorial	484		
Radio Receivers			
building latest Browning-Drake	479		
new motor-driven	483		
Radio Reception			
bather hears program by phones in suit	393		
better selectivity kink	475		
Radio Tubes—overheated filament common trouble	482		
Railroads			
crossing Australia to replace caravans	413		
eight-mile model serves English ports	398		
Rats—eliminated from ocean liners	456		
Rays—"grenz" ray for treating skin diseases	383		
Red Cross—rescues animals during flood	457		
Rubber			
possible new source from African tree	464		
replaces metal in many fields	356		
Rugs—Persian rug of "Lost Prince" takes fifty years to weave	432		
Safety Devices and Measures			
chemical bomb on wall smothers blaze	445		
luminous coat protects police	434		
Saw			
portable air driven saves time	416		
portable electric handsaw weighs ten pounds	384		
Sculpture			
huge statues of Washington mark entrances to state	375		
woman helps carve Washington head	417		
Searchlight—disappearing tower helps guard coast	461		
Seismograph—finds place in industry	384		
Shipping Boxes			
protected by safety clamp	413		
unspillable for liquids	412		
Ships and Shipping			
basin for oil tankers has fireproof door	423		
first turbine cut in two	357		
working the last windjammers	370		
Smokers' Accessories—automatic cigar lighter has large gas fount	385		
Soda Dispenser—coin-in-slot fountain insures sanitary drink	445		
Soldering—how to use rosin core solder	473		
Sports—somersault sled introduced in England	464		
Steeple—twisted and leaning, rivals Pisa's tower	413		
Stop Watch—improved, accurate for timing races	431		
Sundial—shadow in St. Peter's square tells time	416		
Sunshine—what is it?	394		
Tent—poleless, easily and quickly put up	456		
Throne—valuable Persian in public exhibit	458		
Tile			
handle for carrying, reduces breakage	361		
more cement in, reduces cost	367		
Tools			
Japanese woodworking	414		
motor-driven plane for carpenters	441		
Top—fastest is spun with air	424		
Tractor—lightweight for farm reduces cost	433		
		AMATEUR MECHANICS	
		Advertising—ball-bearing crankshaft makes window display	49
		Automobiles	
		carrying oilcan on long trip	494
		water-pressure outfit for washing cars	491
		Automobiles—Batteries—adding distilled water to	497
		Bed—simple rail for child's	490
		Bookcase—rabbit, for children's room	487
		Calf Weaner—made from lard pail	499
		Camping—Tricks of camping out, Part II	493
		Chair, Rocking—sections of garden hose on rockers eliminate noise	491
		Clamp—improvised quick-acting	497
		Coaster Wagon—backrests for	508
		Cream Separator—improving	498
		Electric Light Fixtures—making copper or brass fixture chain	492
		Fish and Fishing—effective homemade lures	489
		Humidifier—for the incubator	490
		Hunting—anchoring decoys	508
		Models—slinging the model ship yards	501
		Motor Trucks—getting out of a mud hole	507
		Photography	
		dark room for the camp	498
		how to make a radium photograph	488
		Plaster Casts—make your own	502
		Sack—to empty large heavy, roll over a barrel	489
		Screens	
		how to stretch tightly	501
		tacks for copper	497
		Signs—how to make porcelain letters stick	499
		Table—combined library and dining	500
		Trapping	
		link makes trap safe	507
		skinning small animals	499
		Vise—model maker's	489
		Water Tank—emergency built on roof	492
		SHOP NOTES	
		Apples—homemade wiper for	525
		Automobiles—Tires—support for buffing heavy	515
		Blowtorch—damper aids in lighting	523
		Boiler—steam trap for	512
		Cement Sacks—tile used to turn	524
		Dies—thread-cutting	524
		Drainboard—homemade for kitchen sink	522
		Envelopes—quick method of moistening	513
		Felloe Bands—cabinet for heating	527
		Floors—to refinish old soft wood	509
		Gate—lattice for stable door	513
		Gauge—clothespin makes marking	523
		Guy Wires—device holds ends of cut	524
		Hay Rake—non-clogging	515
		Lathe—depth cutting in	512
		Miter Box—improved	514
		Paints and Painting—killing alkali spots in plaster walls	515
		Pirate Chest—easily made	516
		Power Plant—made from Ford engine	527
		Rivets—clinching split	523
		Safety Measures and Devices—rail prevents accidents from guy wires	526
		Signs—handling gold leaf letters	522
		Silo—chute facilitates feeding cattle	521
		Tools—drawer chest on truck holds	526
		Wood Trimmings—platform for loading	514

Revolvers, Reloader 434

Toy furniture from 433



# DRAKE'S PRACTICAL MECHANICAL BOOKS

## THEY WILL RAISE YOUR PAY—

### ORDER ON 5-DAY TRIAL

The books listed below will perfect you in your chosen trade—pave the way to the big positions. Written in non-technical language—easy to read and understand. Every book covers its subject completely. An entire course of instruction condensed into one volume. Your choice sent postpaid—your benefit 5 days—money refunded in full if not entirely satisfactory. Order direct from this page.

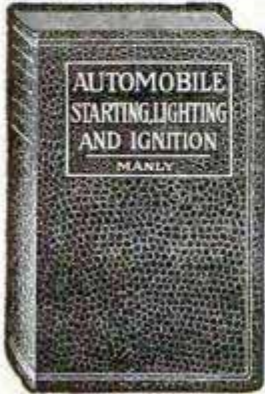

#### Automobile Books

- Automobile Starting, Lighting and Ignition, by Manly... 700 pp. \$3.00
- Automobile Handbook... \$2.00
- Motor Car, Truck and Tractor, by Manly... Cloth \$1.50
- Automobile Battery, Care and Repair, by Manly... Leatherette \$2.00
- Wrecker Handbook, by Manly... \$1.50

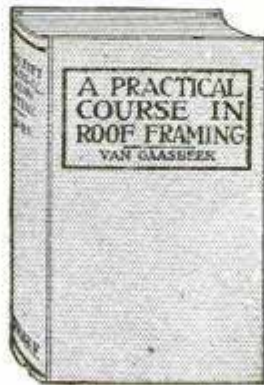

#### Carpentry Books

- Cloth Binding
- Modern Carpentry, 2 vols. \$3.00
  - The Steel Square, 2 vols. \$3.00
  - Modern Estimator \$1.50
  - Timber Framing \$2.00
  - Builders' Architectural Drawing \$2.00
  - Concretes \$1.50
  - Practical Bungalows \$1.00
  - Roof Framing, by Van Gaasbeek \$1.50



#### Painting and Decorating

- Furniture, Furniture Finishing, Decoration and Patching... \$5.00
- Ross Crane Book of Home Furnishing and Decoration... Cloth \$3.00
- House Painting Methods with the Brush and Spray Gun, by Vanderwalker... Cloth \$2.00
- Interior Wall Decoration, by Vanderwalker... Leatherette \$4.00
- The Mixing of Colors and Paints, by Vanderwalker... Cloth \$2.00
- Studio Handbook—Letter and Design... \$3.00
- A Show at Sho' Cards... Cloth \$4.00
- Sign Painting, by Atkinson... Cloth \$4.00
- Strong's Book of Designs, Leatherette \$4.00
- Modern Painters' Cyclopedic... Cloth \$2.00
- Automobile Painting... Cloth \$1.50
- New Hardwood Finishing... Cloth \$1.50
- Wood Finishing, Plain and Decorative... Cloth \$2.00
- Owen's Paint Guide... Cloth \$1.00



#### Shop Practice Books

- Heating Systems, Trouble and Ventilation... \$4.00
- Workers' Manual... \$2.00
- Welding and Cutting... Cloth \$1.25
- Logarithmic Tables... \$2.00
- For Millwrights... Cloth \$2.00
- Shop Practice... Cloth \$2.00
- Architectural Drawing and Machine... Cloth \$2.00

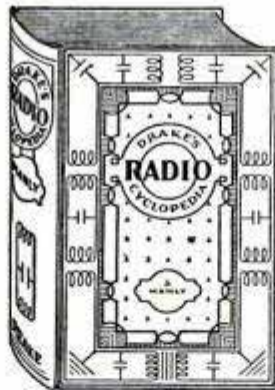

#### Drake's Radio Cyclopedia

By H. P. Manly

870 Pages, 985 Illustrations, 1700 Subjects, arranged alphabetically. For Service and Repair Men, Dealers, Salesmen, Experimenters and Designers. Bound in Art Buckram. Price... \$6.00

#### Steam Engineering

- Swingle's Handbook for Steam Engineers and Electricians... Leatherette \$4.00
- Examination Questions and Answers for Marine and Stationary Engineers... Leatherette \$2.00
- Steam Boilers... Leatherette \$2.00
- Swingle's Catechism of Steam, Gas and Electrical Engineering... Leatherette \$1.50

#### Modern Languages

- By Prof. P. S. Allen, U. of Chicago
- French without a Teacher... Cloth \$1.25
  - Spanish without a Teacher... Cloth \$1.25
  - German without a Teacher... Cloth \$1.25
  - Everyday French... \$1.25
  - Everyday Spanish... \$1.25

### ORDER DIRECT FROM THIS PAGE OUR MONEY-BACK PLAN

Books listed above are only a few of the many in our catalog, which you will receive promptly after filling out and mailing us the attached coupon. For quick action order on this page—cross name of each book wanted and with price quoted. We prepay postage and send the books on our money-back plan.

## FREDERICK J. DRAKE & CO.

Publishers

Michigan Ave. CHICAGO

Drake Books Are For Sale at All Book Stores

**FREDERICK J. DRAKE & CO.**  
1008 Michigan Avenue  
Chicago, Ill.

GENTLEMEN:—Please send me free, postage paid, your illustrated catalogue which lists and describes 200 Practical Mechanical Books for Home Study.

My name is .....

and my address .....

Mail Coupon For Free Catalogue  
Your Guide to Home Study



# Would you turn down an added \$5000 a year?

—just because you're afraid to make  
the move that spells SUCCESS?



**O**F course you'd take it—that \$5,000 check!  
And if—then—your employer said to you,  
"All I ask in return is that you devote a few  
spare hours each week, at home, to training for the  
'job ahead'"—why, you'd jump at the chance.

But—that's not the question—

The point is—have you the vision to start *right now* to get the training, knowing that the "raise" and the bigger job will almost inevitably follow?

**Dryden rose from \$150 a Month  
to \$11,000 a Year**

E. J. Dryden, of Laredo, Texas, grasped his opportunity. He was earning \$150 a month when he started training with LaSalle.

After his first lesson in the Sales Section of Business Management, he tried out his newly acquired knowledge. In six weeks he made \$750 in commissions, working after hours.

He has since followed thru with other courses, and for two years past his earnings have been better than \$11,000 a year.

**At 47 Whitney was Clerk—4 Years  
Later, Treasurer of Big Corporation**

For more than twenty years lack of training had kept R. M. Whitney from climbing higher than a clerkship. He was 47 when he enrolled with LaSalle for home-study training in Higher Accountancy.

Within four years, however, he made up for twenty years of lost opportunity.

He completed his training with LaSalle in only five months. Almost immediately came the offer of a better job.

Less than three years later, the Davenport Machine Tool Company of Rochester, N. Y.—*the very company he had worked for as a clerk*—invited him to come back on his own terms. He returned as Auditor, at a salary-increase of better than 300 per cent. He has since been made Treasurer.

**How You Can Win That Extra \$5000 a Year**

"Exceptional cases," you say—that of Dryden and Whitney—  
*But—don't you think an extra \$5,000 a year looked just as impossible to them when they started, as it does right now, perhaps, to you?*

Of course it did!

These men, however, recognized their chance—they "stuck to their guns"—they got the training!

And just as sure as the sun will rise tomorrow, the same practical home-study training which lifted them to high positions will increase the salaries of thousands of men—men who are now learning of this opportunity for perhaps the very first time in their lives—

Will you be one of them?

Only you can decide—

But one thing is absolutely certain. Before you turn this page—before you swing your thought away from this pressing problem of your future—you should send to LaSalle and get the facts.

The coupon will bring you, without cost or obligation, two books—one a 64-page book outlining the opportunities in the field that most appeals to you and showing you exactly how to meet them—the other, "Ten Years' Promotion in One," the story of how one man, after many wanderings, found the path to responsibility and power.

As you value your future, fill in, clip and mail the coupon NOW!

— — — Find Yourself Thru LaSalle — — —

## LaSalle Extension University

The World's Largest Business Training Institution

Dept. 964-R

Chicago

I would welcome an outline of the LaSalle plan, together with a copy of "Ten Years' Promotion in One," all without obligation.

- Business Management
- Modern Salesmanship
- Higher Accountancy
- Traffic Management
- Railway Station Management
- Law: Degree of LL. B.
- Commercial Law
- Industrial Management Efficiency
- Modern Business Correspondence and Practice

- Banking and Finance
- Modern Foremanship
- Personnel Management
- Expert Bookkeeping
- Business English
- Commercial Spanish
- Effective Speaking
- C. P. A. Coaching
- Stenotypy



Name.....

Present Position.....

Address.....



AUDELS BUILDERS TRADE GUIDES—COMPLETE SET NOW OFFERED ON EASY TERMS

# AUDELS BUILDERS LIBRARY

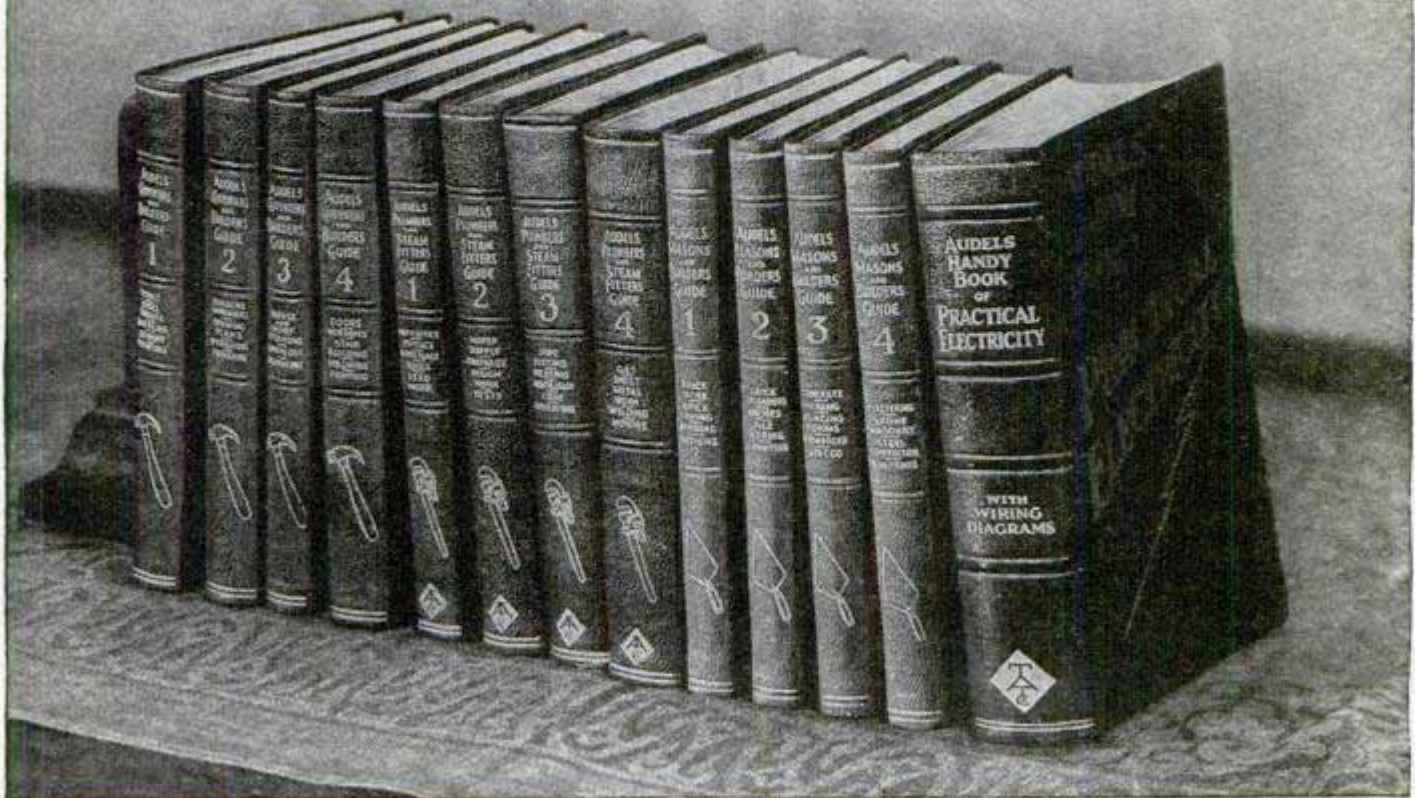

## Practical Helping Hand Guides for All Builders

READY REFERENCE AND INSIDE INFORMATION IN HANDY FORM FOR

**Contractors  
Architects**

**Builders  
Draftsmen**

**Engineers  
Designers**

**Estimators  
All Building Trade Workers**

Quick advancement comes to the steady, daily reader of these books. Increased knowledge gives him an increasing vision of the scope of his work, increasing responsibilities and increasing rewards in profits or pay. If the worker or student will read 15 minutes a day—right through the course—he will, in a year have stored in his mind the wealth of knowledge, that has taken hundreds of years of hard experience to acquire and develop.

These practical, concise, pocket-size educators are an accepted reference work of the trade. Thousands of practical workers use them as a daily guide—contractors depend on the facts, tables, figures and estimating advice—architects and draftsmen use them in planning and laying out work.

Audels clear and comprehensive answers to building problems will save you time and money. The job that worries you has probably all been worked out before. Why worry about it? Turn to the indexes—there you will be directed to the wealth of information that solves your problem. Best of all, Audels Guides give you an answer that you can understand and follow—the diagram, the table, the rule, the picture—with the brief text.

**Thousands of building problems are solved in this set. Some of the more important subjects covered are:—**

MODERN CARPENTRY, Steel Square, Furniture, Mathematics, Plans, Specifications, Laying Out, Framing, Foundations, Millwork, Painting. MASONRY, Brick Work, Foundations, Bonds, Arches, Tile, Concrete Work, Stucco, Plastering, Stone Work, Steel Construction, Blue Prints, Estimating. PLUMBING, Steamfitting, Physics, Water Supply, Drainage, Heating, Ventilation, Sheet Metal Work, Refrigeration, Tests, Estimating, Code, Regulations. ELECTRICITY, Wiring, Batteries, DC & AC Work, Generators, Transmission, Transportation, Radio.

Under each of these main chapter headings are hundreds of sub-headings. Now the best way to find out what a gold mine of valuable help is contained in these pocket-guides, is to examine the actual books. This you can do by mailing coupon and \$1. If not satisfied after careful examination, return the books and we will refund the dollar.

**\$1** Down with ORDER    **\$2** Monthly UNTIL PAID    **\$22** Complete and DELIVERED

In this well known trade library there are 13 pocket-size, flexibly bound, gold edge, guides—5,410 Pages, 12,009 Illustrations. Highly endorsed by the trade, by schools and thousands of subscribers. This great opportunity—to own these standard helpers on easy terms—is one you can't afford to miss. Send coupon now! Then decide for yourself.

**Theo. Audel & Co., 65 W. 23rd St., New York, N.Y.**

I enclose \$1. Ship me Audels Builders Library, 13 pocket vols., postpaid. After 7 days examination, I will send you \$2, then \$2 a month until \$22 is paid, or, I will return the books and you are to refund my \$1.

Name .....

Address .....

Occupation .....

Employed by ..... 9T30



# \$50-\$75- Even \$100 a Week Now Possible for You in Auto Business!

**I**F you're earning a cent less than \$60 a week, clip coupon now! Get my big new Auto Book—it's Free! Learn about the wonderful money-making opportunities in the Auto Business—Opportunities waiting for YOU!

See how men's salaries are raised, doubled, even tripled, in amazingly Quick time! Get all the facts about "JOB-WAY," the training that boosted Yancy of Perla, Ark., from \$30 a week to \$90 a week!—raised the pay of J. Siemens of Shafter, Calif., \$36 a week in a few months—and put Gentry of Superior, Wyo., in a \$65 a week Job!

## LEARN HOW I TRAIN YOU for a BIG PAY JOB AT HOME!

Coupon brings full details of this remarkable new training method. Shows how you can master every branch of Auto work quickly and easily, right in your own home! Includes all Mechanical and Electrical work—Starting, Lighting, Ignition — also, Welding, Brazing, Vulcanizing—everything you need to get in line for a Big Job as an Electrical and Mechanical Auto Expert!

### Experience, Higher Education Not Needed

No matter how much or how little Auto experience you've had, send for my Free Book! Yancy never touched a car before writing for this same book, and he had only 7th grade schooling—but he's making \$90 a week now! On the other hand, S. B. Dillard

**B. W. COOKE** Directing Engineer  
Chicago Motor Training Corporation  
1916 Sunnyside Avenue  
Dept. 616 CHICAGO

of Ovalo, Texas, worked 14 years in the Auto Business, and "JOB-WAY" boosted his pay up to as high as \$90 a day! If you can read and write plain English—it is all you need with this new practical method!



Offer includes: Tools, Tool Bag, Portable Electrical Test Bench — all equipment, Electrical Experimental Outfit, and 500 Wiring Diagram Charts. Coupon brings full details.

**Go Into Business!** Cooke "JOB-WAY" Trained Men are making good in their own businesses all over the country. The industry needs garages that are run by men who know their business.

## Be An Electrical and Mechanical AUTO EXPERT

*The World's Biggest Business Needs You!*

Get into the Auto Business! It's the business where big pay is made—QUICK! Never before so many big opportunities! Five thousand million dollars are paid to Auto men every year for upkeep alone! More cars on the roads than ever before in history—and fewer trained Auto men to each hundred cars! No wonder so many trained Electrical and Mechanical Auto Experts are making the BIG MONEY! Find out how YOU can get your share. Send coupon now!

C. Albertson of Hartington, Ont., was making only \$10 a week when he wrote for this book, but now he's making as high as \$12 a day! H. F. Owen of Watertown, N. Y., is averaging \$214 a month. These are only two out of scores of "JOB-WAY" trained men who are making real money in their own businesses! Practically no capital is needed. It's knowing that counts!

### Earn While You Learn!

"JOB-WAY" trained men are actually "cleaning up" in their spare time, while training! J. M. Dye of Ziegler, Ill., is just one out of hundreds! If you want to add real money on your pay check, and do it Quick, find out what this training can do for you! Send coupon now!

### Get All the Facts!

Learn how you can put yourself in the same position as those men whose pictures are shown above—how you can get in line for a real Job—for a good Raise in pay—for Extra Spare Time Money—or an Auto business of your own! My book is Free. Send for it now.

## MAIL THIS COUPON

**FREE!** B. W. Cooke, Directing Engineer, Chicago Motor Training Corporation, Dept. 616, 1916 Sunnyside Ave., Chicago, Ill.

**AUTO BOOK** Send me your Book, "Auto Facts." Free of charge. Also full particulars of your 4 working outfits offer and of "JOB-WAY" Training. This obligates me in no way whatever.

Name.....

Address.....



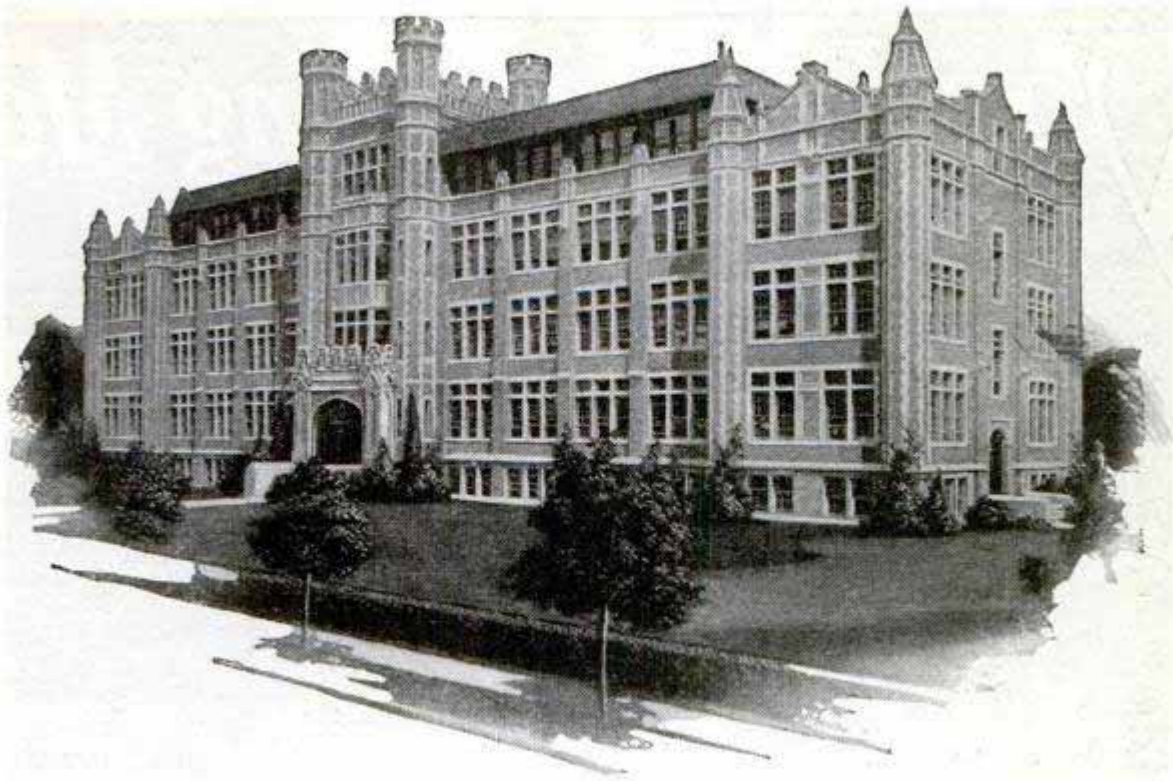

## Go to High School at Home

You can secure a high school education right at home by studying the splendid new courses recently prepared by the International Correspondence Schools.

These courses are equivalent to the courses given in resident high schools. They have been specially arranged for men and women who wish to meet college entrance examinations, to qualify for a business position, or to make up the education they missed when forced to leave school too soon.

The College Preparatory Course, the High School Commercial Course and the High School English Course include English, algebra, ancient, medieval, modern and U. S. History, physiology, literature, geography, Latin, book-keeping, drawing, geometry, shorthand, physics, chemistry, salesmanship, advertising, civics, trigonometry, economics, American business law, corporation finance, money and banking, business and trade economics, etc. A diploma is given at graduation.

The lessons are easy to understand and you will make rapid progress because you will be *in a class by yourself* and you will study under the guidance of instructors who are sincerely interested in helping you to get ahead and achieve the bigger things in life.

Just mark and mail the coupon and we will gladly send you interesting free booklets

describing the High School Courses of the International Correspondence Schools or any other subject in which you are interested.

---

### INTERNATIONAL CORRESPONDENCE SCHOOLS

Box 5667-E, Scranton, Penna.

Without cost or obligation, please send me one of your booklets and tell me how I can qualify for the position or in the subject before which I have marked an X:

- |   |   |
|---|---|
| <input type="checkbox"/> College Preparatory Course       | <input type="checkbox"/> Salesmanship           |
| <input type="checkbox"/> College School Commercial Course | <input type="checkbox"/> Advertising            |
| <input type="checkbox"/> High School English Course       | <input type="checkbox"/> Better Letters         |
| <input type="checkbox"/> High School Vocational Course    | <input type="checkbox"/> Show Card Lettering    |
| <input type="checkbox"/> High School Agricultural Course  | <input type="checkbox"/> Stenography and Typing |
| <input type="checkbox"/> Business Management              | <input type="checkbox"/> English                |
| <input type="checkbox"/> Industrial Management            | <input type="checkbox"/> Civil Service          |
| <input type="checkbox"/> Traffic Management               | <input type="checkbox"/> Railway Mail Clerk     |
| <input type="checkbox"/> Business Law                     | <input type="checkbox"/> Common School Subjects |
| <input type="checkbox"/> Banking and Banking Law          | <input type="checkbox"/> Illustrating           |
| <input type="checkbox"/> Accountancy (Including C.P.A.)   | <input type="checkbox"/> Cartooning             |
| <input type="checkbox"/> Nicholson Cost Accounting        |   |
| <input type="checkbox"/> Bookkeeping                      |   |
| <input type="checkbox"/> Private Secretary                |   |
| <input type="checkbox"/> Spanish                          | <input type="checkbox"/> French                 |

### TECHNICAL AND INDUSTRIAL COURSES

- |   |  |
|---|--|
| <input type="checkbox"/> Electrical Engineering | <input type="checkbox"/> Architect               |
| <input type="checkbox"/> Electric Lighting      | <input type="checkbox"/> Architects' Blueprints  |
| <input type="checkbox"/> Mechanical Engineer    | <input type="checkbox"/> Contractor and Builder  |
| <input type="checkbox"/> Mechanical Draftsman   | <input type="checkbox"/> Architectural Draftsman |
| <input type="checkbox"/> Machine Shop Practice  | <input type="checkbox"/> Concrete Builder        |
| <input type="checkbox"/> Railroad Positions     | <input type="checkbox"/> Structural Engineer     |
| <input type="checkbox"/> Gas Engine Operating   | <input type="checkbox"/> Chemistry               |
| <input type="checkbox"/> Civil Engineer         | <input type="checkbox"/> Pharmacy                |
| <input type="checkbox"/> Surveying and Mapping  | <input type="checkbox"/> Automobile Work         |
| <input type="checkbox"/> Metallurgy             | <input type="checkbox"/> Airplane Engines        |
| <input type="checkbox"/> Steam Engineering      | <input type="checkbox"/> Navigation              |
| <input type="checkbox"/> Radio                  | <input type="checkbox"/> Agriculture and Poultry |
|   | <input type="checkbox"/> Mathematics             |

Name.....

Street Address.....

City..... State.....

Occupation.....

Persons residing in Canada should send this coupon to the International Correspondence Schools Canadian, Limited, Montreal, Canada.





# You Daring Young Men Seize Life's Biggest Thrill!



The famous "Spirit of St. Louis" which flew from New York to Paris in the memorable non-stop flight May 20-31. Wide World Photo

## Get into Aviation

**W**HAT thrill could compare with this—what sport could bring you the tingling, breath-taking adventure of this fascinating, new occupation—the game for men with sporting blood! See life—win applause—thrills—big money—step into a field of excitement and daring—away from the monotony of tame, narrow humdrum everyday life!

Think what Aviation offers you. Thrills such as you never had before! The praise and plaudits of the multitude. And a chance to get in on the ground floor where rewards may be unlimited!

### Amazing Opportunities

Aviation is growing so swiftly that one can hardly keep track of all the astonishing new developments. Air mail routes have just been extended to form a vast aerial network over the entire U. S. Airlines and airplane factories are springing up all over the country. Men like Henry Ford are investing millions in the future of commercial Aviation in America! The possibilities are so tremendous that they stagger imagination!

Everything is set for one of the greatest booms in history. Big fortunes came out of the automobile industry and out of motion pictures. Big fortunes will also come out of Aviation. The development of Aviation as an industry is bringing with it a call for trained men. Those who qualify quickly should find themselves on the road to unusual earnings—success—popularity—and prominence.

### Easy to Become an Aviation Expert

Get into this thrilling business at once while the field is new and uncrowded. Now—by a unique

new plan—you can quickly secure at home, during spare time, the preliminary training necessary to get a start in the Aviation Industry. Experts will teach you the secrets—give you the inside facts that are essential to your success. And the study of Aviation by our method is almost as fascinating as the actual work itself. Every lesson is chockful of interest—and so absorbing that you actually forget you are studying. But best of all are the ultimate rewards you are fitting yourself to gain.

### Send for FREE Book

Send the coupon for our new, free booklet—**Opportunities in the Airplane Industry**. It is unusually interesting, reads like a romance, and gives vital facts about Aviation you probably never even dreamed of. You owe it to yourself to at least read it. We offer you a free copy now. No obligation. Mail the coupon for yours today.

### NOW FREE

**American School  
of Aviation**  
Dept. 1356  
3601 Michigan Ave.  
Chicago, Ill.



### PICK YOUR JOB

Airplane Repairman  
Airplane Mechanician  
Airplane Inspector  
Airplane Salesman  
Airplane Assembler  
Airplane Builder  
Airplane Pilot  
Airplane Instructor  
Airplane Contractor  
Airplane Engineer  
Aerial Photography  
Aerial Advertising

American School of Aviation,  
Dept. 1356, 3601 Michigan Ave.,  
Chicago, Ill.

Without any obligation please send me your FREE book, **Opportunities in the Airplane Industry**. Also information about your course in Practical Aviation.

Name.....Age.....

Address.....

City.....State.....





None of This!

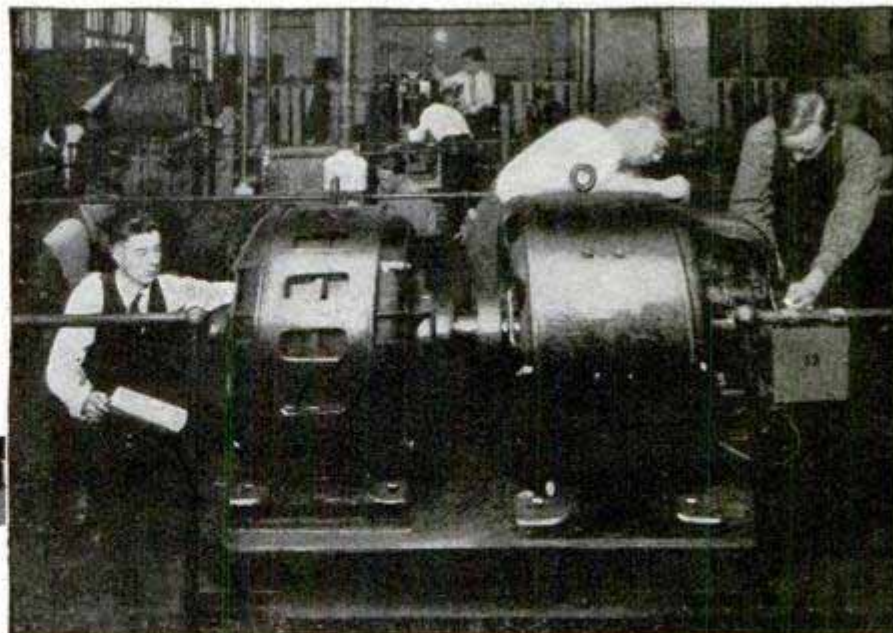

# ELECTRICITY Becomes Amazingly Easy When Taught Without Books or Lessons **IN 90 DAYS**

**W**HY work at dull, uninteresting jobs that will never pay you more than \$35, \$40 or perhaps \$50 a week? Make up your mind *now* to become a master of electricity! Train in 12 easy weeks to hold down the kind of a job that pays \$60 and up a week, and which creates a constant demand for your services nearly any place in the world!

## No Books—No Classes

Electricity, as taught in the Great Shops of Coyne, is surprisingly easy to grasp. That's because we use no books. You learn by doing actual, *practical* experimenting on big, electrical machinery—one of the finest outlays in the country. You learn by *doing*—and you learn from the ground up.

## Not a Correspondence School

Experts work right along with you every step of the way. You get personal attention—you are trained not by books but on actual electrical machinery. The **Coyne Way** gives you real, *sound* knowledge that fits you to do *practical* electrical work in all its branches.

## Now In Our New Home

This is our new, fireproof, modern home wherein is installed thousands of dollars' worth of the newest and most modern Electrical

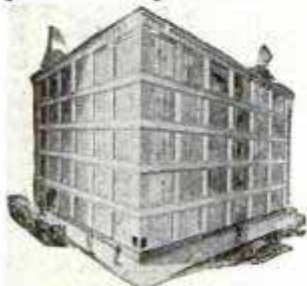

# COYNE ELECTRICAL SCHOOL

Dept. 67-72

H. C. Lewis, Pres.

500-524 S. Paulina St., Chicago, Ill.

Equipment of all kinds. We now have the largest amount of floor space devoted to the exclusive teaching of practical electricity in the world. Every comfort and convenience has been arranged to make you happy and contented during your training.

## No Experience or Advanced Education Needed

You don't need one day's previous electrical experience or any advanced education to learn electricity the Coyne way. Some of our most successful graduates never went farther than the 8th grade.

## Earn While You Learn

By special arrangement, our employment department helps students locate part-time work, if they want to earn while they learn. And after graduation we give them the benefit of our **FREE EMPLOYMENT Service for Life**. Every week we secure positions for Coyne men.

## Get FREE Book

Write today for my big book on electricity with over 150 photographs. Learn what great opportunity Coyne Training opens up for you. Also get full details of my Big-3 Special Offer. No obligation. Mail the coupon now.

## INCLUDED If You Act Now

**1 R. R. Fare** will be refunded upon enrollment from any point in the U. S. to Chicago.

**2 Radio** course included absolutely without any extra charge. Covers new developments in this fascinating field.

**3 Auto** course, covering truck and tractor electricity—especially valuable if you ever want to start an electrical business of your own.

SEE COUPON!

## FREE BOOK Coupon

H. C. LEWIS, Pres.  
COYNE ELECTRICAL SCHOOL, Dept. 67-72  
500-524 S. Paulina St., Chicago, Ill.

Please send me your free catalog on electricity and details of your railroad fare allowance and two extra courses. No obligation on my part.

Name.....

Address.....

City.....

State.....



# You can make the BIG Money



## in Auto Painting

—Because here is the biggest uncrowded field in the world today. Prove it to yourself by the next 20 cars you see. Yes Sir, 17 out of 20 need painting.



**G. KING FRANKLIN**  
Famous Auto  
Painting Authority

**I will have you ready  
in a few months**

NOW—how many auto painters do you know? . . . I thought so. Well, who's going to do the work? You are—after you get the right training and you're going to make more money than you ever dreamed of! The world is looking for trained auto painters. Cash in on this big demand!

## You Can Own Your Own Business!

In auto painting it's no trick to be your own boss—own your own business and be independent!

You don't have to start out with the biggest building on the busiest corner. You can begin small with little or no capital, but I don't know of another business where you can get big so fast. We show you how to open your own shop.

## You Can Make from \$60 to \$90 a Week

After you get my training you can get a job anywhere. You can travel and know at your destination there will be a job waiting for you that pays big money. Remember—I don't forget you when you complete the course. I help you get a real job. You also get a life consultation service without extra charge.

## 17,000,000 Cars Need Painting

Just imagine! There are t-w-e-n-t-y m-i-l-l-i-o-n cars in the U. S. alone—and 17 million need priming, surfacing, painting, ducoing, varnishing, striping and the whole works—and take it from me, I teach you the whole works so you can get in on the Big Money—or I'll refund every penny of the small price you pay.

I realize that you are up against quite a problem in deciding what field to enter, but on my say-so, and my guarantee to you, just come into auto painting with me and you'll be glad of it all your life.

Men like yourself who have taken my advice are now making \$5,000 to \$10,000 a year.

## MAIL the COUPON

G. King Franklin, Supt.,  
American Auto Painting School,  
Dept. 601, 425 S. Ashland Ave., Chicago.

Send sample shop-tickets free and information on how I may learn auto painting and Duco at home in spare time.

Name.....

Street No.....

City.....

State.....

### PROOF

Chicago Duco says: "Skilled Duco men are scarce. We can place many at \$1.00 to \$1.25 an hour." Binks, one of the largest auto equipment manufacturers says "The big auto manufacturers are insisting that their dealers repaint all used cars." Stockton, Illinois, says "No shop here. All work must go to Freeport. Believe plenty of work to make paying business." Nash says "This is a big field and splendid opportunities for your graduates in repainting cars." Many, many more like these.

## LEARN at HOME!

And the beauty of my proposition is that you can learn at home in your spare time—evenings—and keep your present job while learning.

By my Shop Type Method you learn quickly and easily—the greatest advance in home study training assures you success—no car needed—work on wood and metal panels. 13 big outfits given without extra charge—

Get information now! Don't wait. Get my big illustrated booklet Free—you will not be obligated—

**G. KING FRANKLIN, Supt.**

**American Auto Painting School**  
Dept. 601, 425 South Ashland Avenue, CHICAGO



# Pick the JOB You Want!

**Loaned FREE!**

**to Ambitious Men!**

Amazing offer enables you to **START** right NOW, building a real future for yourself in an industry where "the sky's the limit." We've made it mighty EASY for you to begin. Just mail the coupon—don't send a penny! We'll ship any library you select on 15 days' FREE LOAN—and with it we'll tell you how we have helped thousands of men JUST LIKE YOU to get away from the wrong kind of work, and to get into the RIGHT LINE with the training and equipment necessary for success.

We supply a plan of systematic reading which does away with studying and memorizing and we furnish a remarkable Consulting Service, which makes these volumes equivalent in benefit to regular trade courses costing three and four times as much. And we have a plan to give Employment Service—all FREE.

- 13 "Lucky" Libraries**
1. *New 5-Volume Library of Auto Engineering.* 2400 pages, over 2000 illustrations, described above. \$24.80. \$2 after 15 days' loan, then \$3 a month.
  2. *New 5-Volume Library of Electrical Engineering* as described at right. \$34.80. \$2 after 15 days' loan, then \$3 a month.
  3. *A-B-C Library of Architecture, Building and Carpentry* as described at right. 5 volumes. \$24.80. \$2 after 15 days' loan, then \$3 a month.
  4. *Library of Civil Engineering.* 9 volumes as described at right, \$34.80. \$2 after 15 days' loan, then \$3 a month.
  5. *Modern Shop Practice* Machine Shop Foundry and Factory Practice and Management. Production, Drafting, etc. 6 volumes, 2300 pages, 2500 illustrations, \$24.80. \$2 after 15 days' loan, then \$3 a month.
  6. *American Law Library* With reading course of 24 texts. 13 volumes, intended for the business man as well as for the prospective lawyer, \$49.80. \$2 after 15 days' loan, then \$3 a month.
  7. *Drafting* Mechanical and Architectural. 4 volumes, 1578 pages, 1000 pictures, blueprints, etc., \$14.80. \$2 after 15 days' loan, then \$3 a month.
  8. *Steam and Gas Engineering* 7 volumes, 3300 pages, 2500 illustrations, only \$24.80. \$2 after 15 days' loan, then \$3 a month.
  9. *Fire Protection and Insurance* 4 volumes, 1500 pages, 600 illustrations, \$14.80. \$2 after 15 days' loan, then \$3 a month.
  10. *Employment Management and Safety Engineering* 7 volumes, 1800 pages, 540 charts and pictures, \$24.80. \$2 after 15 days' loan, then \$3 a month.
  11. *Business Management and Commercial Law* Here's the quick way to PROMOTION for men eager to win success in business. The "last word" in Accounting, Finance, Production, Sales, Advertising, Commercial Law. 9 great volumes. \$2 after 15 days' loan, then \$3 a month until \$29.80 is paid.
    12. *Sanitation, Heating and Ventilating*—4 volumes, 1454 pages, 1450 pictures, \$14.80. \$2 after 15 days' loan, then \$3 a month.
    13. *Telephony and Telegraphy*—4 volumes, 1728 pages, 2000 pictures, \$14.80. \$2 after 15 days' loan, then \$3 a month.

**1. Be An Auto Expert**



Auto Engineering Library. This is the one chapter on the one book on the one subject. The most complete work of every branch of automotive engineering we have put out. Prepare you for a five billion dollar position in the auto maintenance field. For Garages and auto owners.

**2. Be An Electrical Expert**



Library of Electrical Engineering. Thousands of men with only common schooling have prepared themselves for good electrical jobs. New revised 8-volume edition. Borrow a set free. See No. 2 listed below.

**3. Be a Building Expert**



A-B-C Library. A for Architectural. B for Building. C for Carpentry and Contracting. Here's the easy, quick road to success in the great building industry. 5 volumes, thousands of illustrations, portfolios of 58 architectural plates of the Order FREE for a limited time. See No. 3 listed at left.

**4. Be a Civil Engineer**



Civil Engineering Library. Written so you can understand it. Includes Steel Structures, Surveying, Railroads, Public Works. New 9-volume edition. See No. 4 listed at left.

—here's the **EASIEST** way to get it!

If you're UNDER-PAID and over-worked get into a different line! Where salaries are big, opportunities plentiful and the work interesting. Other men have made the jump—without quitting their jobs or leaving home. You can, too. We'll tell you how they did it—how they prepared for better-paid positions in spare-time, without loss of a dollar in pay, or an hour in time.

**No "Studying" —No Memorizing**

The American Technical Society offers you Reading Courses in Electricity, Civil Engineering, Building Construction, Auto Engineering, and other well paid lines. Home-training texts prepared by the greatest engineers and executives in America. Instruction made so easy to understand that no conscious effort to memorize and study is needed. Built especially for men with LIMITED EDUCATION. And tested by hundreds of thousands of men in the past 30 years—who found the QUICK way to advancement in these pay-raising volumes.

**READ**  
Your Way to Bigger Pay!

So few men are willing to pay the price by acquiring SPECIALIZED TRAINING, that any man who half-tries is sure to succeed. Here then, is your opportunity. Let us prove it to you, at our expense and risk. We'll LOAN you any library you want to see, without cost or obligation. **Just mail the coupon!**

**Don't Send a Penny**

AMERICAN TECHNICAL SOCIETY  
Dept. X-619, Chicago, Ill.

Please loan me FREE set No. . . . . as listed at left,

entitled . . . . .  
In return for this favor, I agree to pay the few cents delivery charges on same and to look them over carefully. If I decide to keep them I will pay \$2 after 15 days and then \$3 a month until special price \$ . . . . . is paid. But I may return them at your expense if I wish and owe you nothing.

Name . . . . .

Address . . . . .  
(Attach letter stating references' and employer's names and addresses, or write same in margin plainly.)



**THE AMERICAN TECHNICAL SOCIETY**  
Dept. X-619, Drexel Ave. and 58th St., CHICAGO

**FREE!** A year's membership in the American Technical Society and the privilege of consulting our staff of Engineers and Experts free to Library Owners.



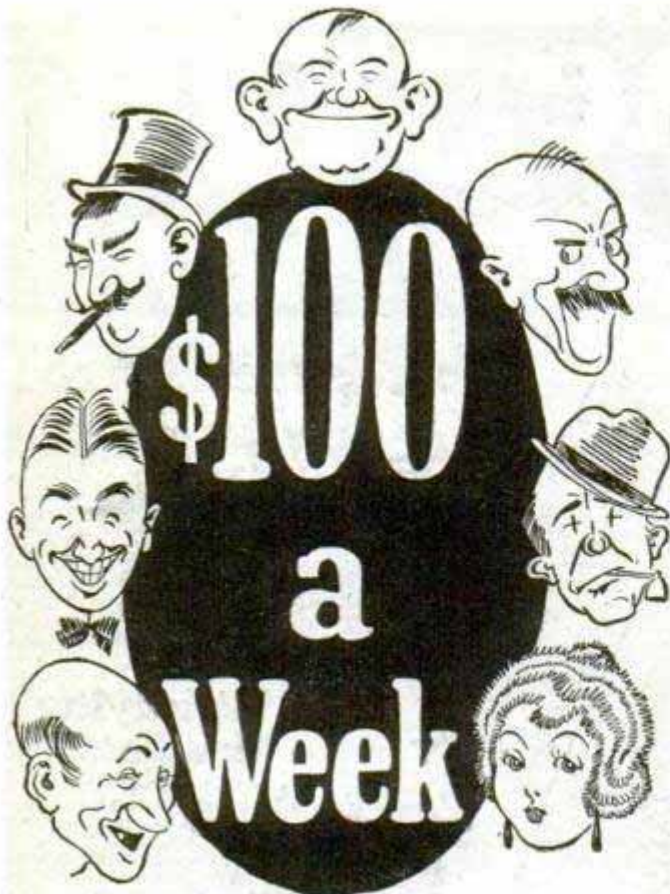

# IN DRAWING CARTOONS

Why spend your time doing work that is drudgery, and get little money for it when you may be able to draw cartoons for Big Pay? You can now learn cartooning at home with this simple, tested method. Many students earn money while learning.

Become a high-salaried cartoonist—one of the easiest, most pleasant, and best paid of all businesses. Millions of dollars spent last year on serious, comic, sport and animated cartoons—and the demand for cartoons increases every day! Hundreds of cartoons now used by big national advertisers.

## Learn Cartooning at Home In Spare Time—Simple, Tested Method

There is a knack about learning cartooning which you can master in your spare time with this simple home study method. It starts you at the very beginning—on simple fundamental principles—then takes you through every branch of humorous and serious cartooning. You will be surprised how quickly you can draw cartoons that will sell. Many earn even while learning.

### Send for Free Book

Get this handsomely illustrated booklet which gives the details of this remarkable home study course in Cartooning. Gives thorough outline of the cartooning field and market for cartoons. Shows how to become a cartoonist. No obligation. Send for it today. (No salesman will call.)

**Washington School of Cartooning**  
Room 309E, 1113—15th St., N. W., Washington, D. C.

Washington School of Cartooning  
Room 309E, 1113—15th St., N. W., Washington, D. C.

Please send me without obligation, your Free Booklet on Cartooning and full details of your home study method of teaching Cartooning.

Name.....  
(Write Name Plainly.) (State whether Mr., Miss or Mrs.)

Address.....

City..... State.....

# AVIATORS WANTED!

The World Over—  
The Biggest Chance for  
Ambitious Men Today!

Fame! Fortune! The  
quick and easy way  
today is only through  
aviation! Are you  
ready? Then act!

The way to the respect and admiration of your whole town! The way to permanent big-paying jobs—open, calling to men of action! Get facts now!

Learn Aviation by U. S. Gov't Methods with U. S. Licensed Pilots—the kind that are Lindbergh's pals. Mechanical and business end well covered.

Big capital ready to back trained men. Big-pay ground jobs open as mechanics and repairmen, flying jobs as pilots, navigators, photographers. 5-year FREE Employment Service.

Big Air Transport Company will train you with hangars, shops and flying field at Chicago Municipal Air Port. New 1927 planes now carrying freight and passengers by air, and making aerial photos.

Ground work at home. Flying in Chicago Moderate cost so you can start now. EARN while you learn. Quick, thorough, safe, practical. When ready for flying, we help you get spare time job in Chicago. For real men who wish to succeed. Get details today—FREE.

Aviation Service & Transport, Inc.  
Dept. 301 22 W. Monroe St., Chicago, Ill.

Learn to PAINT  
SIGN and SHOW CARDS

We quickly teach you by mail, or at school, in spare time. Enormous demand. Big future. Interesting work. Oldest, foremost school.

EARN \$50 TO \$200 WEEKLY

John Vassos, N. Y., gets \$25 for single show card. Crawford, B. C., says: 'Earned \$200 while taking course'. Send today for free information, samples and guarantee.

**DETROIT SCHOOL OF LETTERING**  
154 Stimson Ave. Est. 1899 Detroit, Mich.

# GOV'T. POSITIONS

Forest rangers, start \$125 a month; cabin and vacation; patrol forests; protect game. Railway mail clerks, postoffice clerks-carriers, rural carriers, prohibition agents and internal revenue agents. For list of positions and how to qualify, write Mokane, Dept. 315, Denver, Colo.

# LAW

THIS BOOK

FREE!

Study at Home

Become a lawyer. Legally trained men win high positions and big success in business and public life. Greater opportunities now than ever before. Earn \$5,000 to \$10,000 Annually! We guide you step by step. Degree of LL.B. LaSalle law graduates practicing in every state. We furnish all text material, including 14-volume Law Library. Low cost. Easy terms. Valuable, interesting 96-page book free. Send for it NOW.



LaSalle Extension University, Dept. 964-L, Chicago



# How Strong Are You?

## Can You Do These Things?

*Lift 200 lbs. or more overhead with one arm; bend and break a horseshoe; tear two decks of playing cards; bend spikes; chin yourself with one hand.*

**C**AN you do any of them? I can and many of my pupils can. It is remarkable the things a man really can do if he will make up his mind to be strong. It is natural for the human body to be strong. It is unnatural to be weak. I have taken men who were ridiculed because of their frail make-up and developed them into the strongest men of their locality.

### I Want You for 90 Days

These are the days that call for speed. It once took four weeks to cross the ocean—now it takes less than one. In olden days it took years to develop a strong, healthy body. I can completely transform you in 90 days. Yes, make a complete change in your entire physical make-up. In 30 days I guarantee to increase your biceps one full inch. I also guarantee to increase your chest two inches. But I don't quit there. I don't stop till you're a finished athlete—a real strong man. I will broaden your shoulders, deepen your chest, strengthen your neck. I will give you the arms and legs of a Hercules. I will put an armor plate of muscle over your entire body. But with it come the strong, powerful lungs which enrich the blood, putting new life into your entire being. You will be bubbling over with strength, pep and vitality.

### A Doctor Who Takes His Own Medicine

Many say that any form of exercise is good, but this is not true. I have seen men working in the factories and mills who literally killed themselves with exercise. They ruined their hearts or other vital organs, ruptured themselves or killed off what little vitality they possessed.

I was a frail weakling myself in search of health and strength. I spent years in study and research, analyzing my own defects to find what I needed. After many tests and experiments, I discovered a secret of progressive exercising. I increased my own arms over six and a half inches, my neck three inches and other parts of my body in proportion. I decided to become a public benefactor and impart this knowledge to others. Physicians and the highest authorities on physical culture have tested my system and pronounced it to be the surest means of acquiring perfect manhood. Do you crave a strong, well-proportioned body and the abundance of health that goes with it? Are you true to yourself? If so, spend a pleasant half hour in learning how to attain it. The knowledge is yours for the asking.

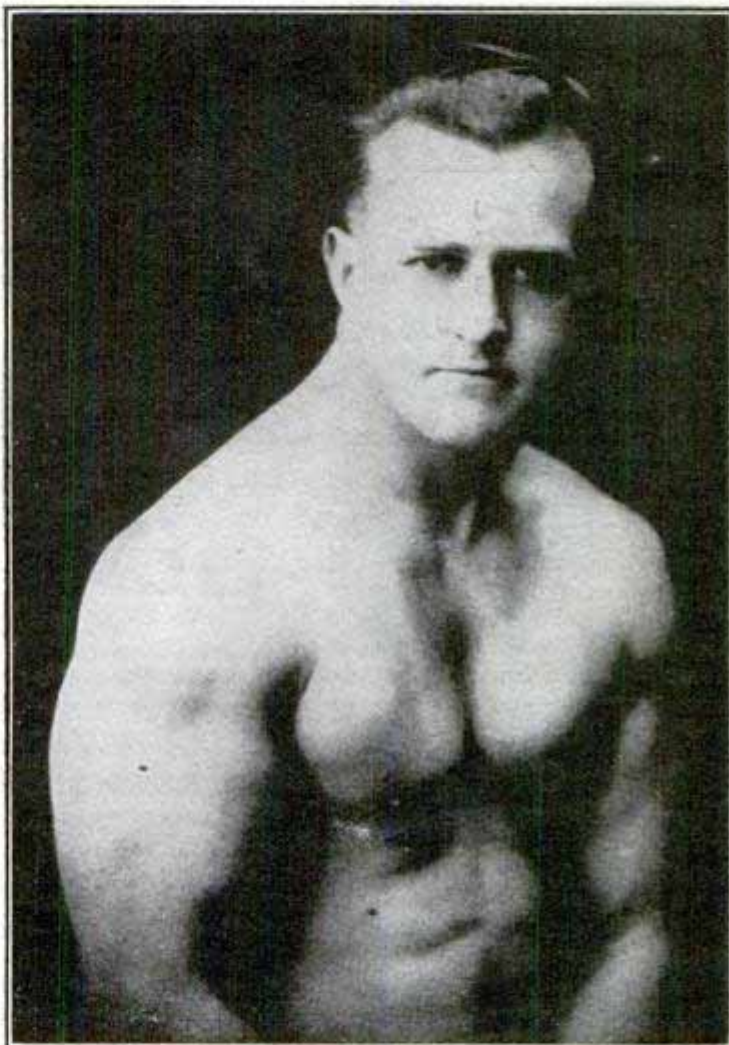

**EARLE E. LIEDERMAN, The Muscle Builder**  
*Author of "Science of Wrestling," "Muscle Building," "Secrets of Strength," "Here's Health," "Endurance," etc.*

Send For My New  
 64 Page Book

# "Muscular Development"

**IT IS FREE**

It contains forty-eight full-page photographs of myself and some of the many prize-winning pupils I have trained. Some of these came to me as pitiful weaklings, imploring me to help them. Look them over now and you will marvel at their present physiques. This book will prove an impetus and a real inspiration to you. It will thrill you through and through. This will not obligate you at all, but, for the sake of your future health and happiness, do not put it off. Send today—right now, before you turn this page.

**EARLE E. LIEDERMAN**

**Dept. 2009, 305 Broadway, New York City**

**DON'T  
 SEND ONE  
 PENNY**

**YOUR  
 NAME AND  
 ADDRESS  
 ON A  
 POSTAL  
 WILL DO**

**EARLE E. LIEDERMAN**

Dept. 2009, 305 Broadway, New York City

Dear Sir: Please send me, without any obligation on my part whatever, a copy of your latest book, "Muscular Development."  
 (Please write or print plainly.)

Name.....

Street.....

City..... State.....





**George Larson and His Dental Laboratory**  
**64,000 Dentists Need Laboratory Work**

Mechanical Dentistry is the laboratory bench work which the dentist turns over to the laboratory worker. Master this profession and help meet the demand of 64,000 dentists for laboratory work. Every city and every town where dentists are located offers work to the mechanical dentist. We train you in a few months in day or night school for this uncrowded field—no classes—no books—no special educational requirements.

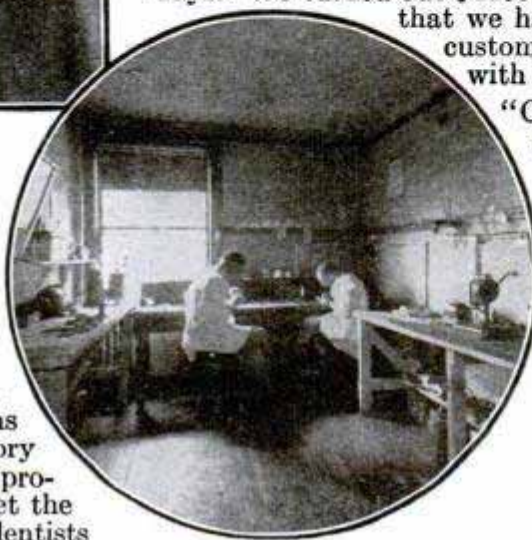

**\$800% PROFIT In One Month!**

**Read This Fascinating, True Success Story of Two McCarrie Graduates Who Have Been in Business Only a Year**

"I have been very busy and don't get much time to write letters these days. We turned out \$1100.00 worth of work in April, so you can realize that we have developed speed. We are getting more customers right along and we keep them satisfied with first class work and service.

"Our expense, including materials for April, runs about \$300.00, which leaves a profit of approximately \$800.00 for the two of us. This has been about the average since the first of the year, and it's not bad for two of your boys who have been in business only about a year. I think Dental Laboratory Work is better than anything else to make a quick, permanent success, if one can turn out first class work.

"I think I am making the training you gave me pay big profits."  
 Yours truly,  
**GEORGE LARSON.**

**You Have This Man's Opportunity in Mechanical Dentistry**

Larson's letter is only one of many such letters we have received. "No trick for me to make \$20.00 a day," writes one McCarrie graduate, and another says, "I was a \$30.00 a week bookkeeper and have built a dental laboratory business netting me \$150.00 a week and growing all the time."

**You Can Do What Larson Did**

It's a big jump from a \$35 a week factory worker to half owner of a laboratory paying \$800 a month profit. That's what Larson did! And what he did, you may do! Leave your blind alley job—enter this big-paying profession—live in affluence—enjoy a dignified, pleasant occupation—be your own boss—go and come as you please. Master the art of Mechanical Dentistry and when you complete your course you may either get a job as a laboratory worker or go in business

for yourself. It takes but very little capital to equip a small laboratory and you can build up a big paying business in a short time. Think what that would mean to you—a car, a fine home, trips whenever you like—all the thousand and one luxuries you crave but can't gratify. And think: the coupon on this page may open the way to the gratification of your every ambition. Follow Larson's example—mail the coupon. It's your one-way ticket to success!

**We Teach You in a Few Months to Make Rubber Plates:**

Partial upper or lower plates with soldered, cast, or wire clasps, palatal bars, lingual bars, etc. McCarrie students learn to make full rubber plates of every type, including Vulcanite base-plates, butted gums, carved gums, etc.

**Crowns:**

Two-piece, seamless, open-face, Richmond, cast-base porcelain, Carmichael, split-pin, carved (swaged) cusp, cast cusp, etc.

**Bridge Work**

Fixed and removable bridge-work. Interchangeable teeth, gold dummy, sanitary porcelain dummy jobs—Roach, Gilmore, Bischoff and all forms of cast-clasp work.

**Metal Base Dentures**

Cast bases of aluminum, gold, Watt's metal, etc. Both centrifugal and air pressure casting machines used. Free catalog tells all about the course. **WRITE TODAY!**

**INTERESTING BOOK FREE**

Our illustrated, free book on Mechanical Dentistry will acquaint you with some surprisingly interesting facts. It tells about the thriving profession of Mechanical Dentistry—the way to swift and certain success. And it tells about the progress of many of our graduates—men who have succeeded beyond their expectations, also full details of our liberal offers. Mail the coupon and find out more about this fascinating opportunity.

**MAIL COUPON**  
**McCarrie School of Mechanical Dentistry**

**1338 S. Michigan Ave. Dept. 133 Chicago, Ill.**

**Work Your Way Through School**

We will assist you in finding a spare-time job to meet part of your expenses while taking McCarrie training. And we will help you find satisfactory living quarters when you arrive.

**McCarrie Schools are located in CHICAGO, DETROIT, CLEVELAND, BOSTON, PHILADELPHIA. DAY and NIGHT SCHOOLS**

**FREE BOOK**

McCarrie School of Mechanical Dentistry, 1338 S. Michigan Ave., Dept. 133, Chicago, Ill.

Without obligation, please send me your free Book with complete information about how I may become a Mechanical Dentist, how you will help me open a Laboratory, how you will help me find a job while I take my training, etc.

Name.....

St. No. or R. F. D.....

City.....State.....





# Raised My Pay 700%

## This Amazing Book Showed Me How

This is Perhaps the Most Remarkable Book Ever Printed. It Has Proved the Turning Point in the Careers of Thousands Who Were Ambitious for Bigger Pay! If You Ever Aspired to Earn \$10,000 a Year or More—Read It Without Fail!

CAN you imagine how a man feels when his earning capacity quickly jumps 700% in a few months? Can you imagine how you would feel if your salary suddenly became seven times greater than ever before?

That is exactly what happened to O. A. Jones of Charleston-Missouri, after reading the amazing book pictured above. Between its covers, he discovered something he had never even dreamed of before—a certain force that lifted him out of the routine rut and set him on the road to \$10,000 a year!

Unusual? Not at all. This surprising book has done the same for hundreds of others. For example, F. N. Hiatt of California read it and quickly saw the way to raise his earnings 625%! It led Robert Ellis of Massachusetts into three promotions and trebled his former salary. Sending for this remarkable book was the first step that elevated M. J. Ebeling of St. Louis from a clerkship to the presidency of a large manufacturing company!

### THE SECRET OF BIG EARNINGS

How did they do it? What did the book show them? Just this: Every one of these men realized that a knowledge of salesmanship and the ability to sell brings bigger rewards than anything else in modern business today! But until they saw the contents of this book—"Modern Salesmanship"—they had no idea that they, too, could win quick success through salesmanship. They believed that this golden field of endeavor was forever barred to them. But they were wrong—and this unusual book opened the way to the success that they had formerly despaired of attaining!

### SALESMEN ARE MADE—NOT BORN!

Yes! Any man of ordinary intelligence can become a successful salesman! Just as you learned the alphabet, you can master the secrets of selling as taught by the National Salesmen's Training Association.

Reason it out for yourself. Salesmanship is governed by rules and laws. There are certain ways of saying and doing things to make men act as you want them to: certain ways of getting exactly what you go after! Once you have mastered these fundamental rules, your success is governed only by your energy and ambition!

### BIG DEMAND FOR TRAINED SALESMEN

City and traveling sales positions are open in every line all over the country. For years, thousands of leading firms have

called on the N. S. T. A. to supply them with salesmen. Employment service is free to both employers and members and thousands have secured positions through this service.

### FREE TO EVERY MAN

If we were asking two or three dollars a copy for "Modern Salesmanship," you might hesitate. But it is now FREE. We cannot urge you too strongly to take advantage of this opportunity to see for yourself what salesmanship has done for others—and what the National Salesmen's Training Association stands ready and willing to do for you. No matter what your opinion is now, "Modern Salesmanship" will give you a new insight into this fascinating and highly-paid profession.

Mail the coupon now!



Dept. M-100, N. S. T. A. Bldg.  
Chicago, Ill.

National Salesmen's Training Association  
Dept. M-100, N. S. T. A. Bldg., Chicago, Ill., U. S.  
Please mail me FREE your illustrated book, "Modern Salesmanship" and particulars of membership in your association and its Free Employment Service.

Name.....  
Address.....  
City..... State.....  
Age..... Occupation.....





# LICKED!

YES, licked! Twenty-five years old and still working in a small job at a small salary.

Why? Well, chiefly because he felt he didn't need special training. And now that he realizes the need, he still keeps putting it off—and off—and off. He'd rather shoot pool or stand around the corner than spend an hour each night in money-making spare-time study.

And the pity of it is that he has just as much natural ability as most of the men who have gone ahead of him. He could be earning three times his present salary if he only had special training.

Are you like that? Are you going to work for a small salary all your life? Or are you going to get the special training that employers everywhere are looking for? It is for you to decide.

Nobody can force you to mail this coupon to the International Correspondence Schools. That's a matter entirely in your own hands. But remember this—the sooner you send it in, the sooner you are going to get a better job and a better salary.

## INTERNATIONAL CORRESPONDENCE SCHOOLS Box 5668-E, Scranton, Penna.

Without cost or obligation, please send me one of your booklets and tell me how I can qualify for the position or in the subject before which I have marked an X:

### BUSINESS TRAINING COURSES

- |   |   |
|---|---|
| <input type="checkbox"/> Business Management            | <input type="checkbox"/> Salesmanship           |
| <input type="checkbox"/> Industrial Management          | <input type="checkbox"/> Advertising            |
| <input type="checkbox"/> Personnel Organization         | <input type="checkbox"/> Better Letters         |
| <input type="checkbox"/> Traffic Management             | <input type="checkbox"/> Show Card Lettering    |
| <input type="checkbox"/> Business Law                   | <input type="checkbox"/> Stenography and Typing |
| <input type="checkbox"/> Banking and Banking Law        | <input type="checkbox"/> Business English       |
| <input type="checkbox"/> Accountancy (including C.P.A.) | <input type="checkbox"/> Civil Service          |
| <input type="checkbox"/> Nicholson Cost Accounting      | <input type="checkbox"/> Railway Mail Clerk     |
| <input type="checkbox"/> Bookkeeping                    | <input type="checkbox"/> Common School Subjects |
| <input type="checkbox"/> Private Secretary              | <input type="checkbox"/> High School Subjects   |
| <input type="checkbox"/> Spanish                        | <input type="checkbox"/> Illustrating           |
| <input type="checkbox"/> French                         | <input type="checkbox"/> Cartooning             |

### TECHNICAL AND INDUSTRIAL COURSES

- |   |  |
|---|--|
| <input type="checkbox"/> Electrical Engineering | <input type="checkbox"/> Architect               |
| <input type="checkbox"/> Electric Lighting      | <input type="checkbox"/> Architects' Blueprints  |
| <input type="checkbox"/> Mechanical Engineer    | <input type="checkbox"/> Contractor and Builder  |
| <input type="checkbox"/> Mechanical Draftsman   | <input type="checkbox"/> Architectural Draftsman |
| <input type="checkbox"/> Machine Shop Practices | <input type="checkbox"/> Concrete Builder        |
| <input type="checkbox"/> Railroad Positions     | <input type="checkbox"/> Structural Engineer     |
| <input type="checkbox"/> Gas Engine Operating   | <input type="checkbox"/> Chemistry               |
| <input type="checkbox"/> Civil Engineer         | <input type="checkbox"/> Pharmacy                |
| <input type="checkbox"/> Surveying and Mapping  | <input type="checkbox"/> Automobile Work         |
| <input type="checkbox"/> Metallurgy             | <input type="checkbox"/> Airplane Engines        |
| <input type="checkbox"/> Mining                 | <input type="checkbox"/> Agriculture             |
| <input type="checkbox"/> Steam Engineering      | <input type="checkbox"/> Navigation              |
|   | <input type="checkbox"/> Mathematics             |
|   | <input type="checkbox"/> Radio                   |

Name.....  
Street.....  
Address.....

City..... State.....

Occupation.....

Persons residing in Canada should send this coupon to the International Correspondence Schools (Canadian, Limited, Montreal, Canada.

## PREPARE FOR AN ART CAREER

—thru the only school operated as a department of a large art organization. Commercial Artists trained the "Meyer Both Way" earn as high as \$10,000 per year. We today have hundreds of students who had previously studied art elsewhere. Why? Because your instruction is based upon our everyday experience in meeting the art needs of leading advertisers. Home study instruction. Write for illustrated book telling of the success of our students.

### MEYER BOTH COMPANY

Michigan Ave. at 20th St., Dept. 16, Chicago, Ill.

## Stop Making Mistakes in English

Wonderful new way to improve your English. No rules to learn. No hard study. Grammar, spelling, punctuation, and expression, taught in 15 minutes a day—at home. Self-correcting feature makes it fascinating as a game. Write today for Free Book "How to Speak and Write Masterly English." Address

**SHERWIN CODY SCHOOL OF ENGLISH**  
59 Searle Building Rochester, N. Y.



## MUSIC LESSONS IN YOUR HOME



Write today for our **FREE** booklet. It tells how to learn to play Piano, Organ, Violin, Mandolin, Guitar, Banjo, etc. Beginners or advanced players. Your only expense about 2c per day for music and postage used. **American School of Music, 51 Manhattan Bldg., Chicago**

## LEARN WATCH REPAIRING



You can learn by our modern and original system of instruction every part of the **Watch Repairing Trade** at home as good or better than at a shop. You can earn money while learning and secure a well paying position or start in business after completing our course of instruction. Good watch repairers are always in demand and earn from \$50 to \$75 per week. For particulars apply to the **Wisconsin School of Watch Repairing** 166 Mason St., MILWAUKEE, WIS.

## IF YOU STAMMER

Write for my free book "Millard's Advanced Natural Corrective Course" and a free copy of my speech magazine. 10,000 cases successfully treated. Est. 24 years. Largest school for stammerers in world. **Millard Inst. of Normal Speech, 2317 Millard Bldg., Milwaukee, Wis.**

## Learn Watchwork, Jewelrywork and Engraving

A fine trade commanding a good salary, and your services always in demand. Address **Horological, Dept. P, Bradley Institute, PEORIA, ILLINOIS**, for our latest catalog.

## WANT THIS JOB?

\$1700 to \$2300 a Year

**MAIL CARRIERS—POSTAL CLERKS**

Men 18 up

**Steady Work**

**Paid Vacation**

Write immediately for **FREE** list of positions and full particulars telling how to get a position.

**FRANKLIN INSTITUTE**

(Not connected with U. S. Government)

Dept. N-305

Rochester, N. Y.







# Two Years Ago A Coal Miner ~ Now in the \$5,000 Yearly Class!

## He Got Into a Field That's Rich in Opportunity ~

Two years ago a coal miner, doing the hardest, dirtiest kind of work possible—today State Sales executive making upwards of \$5,000 yearly, with a big future ahead. That's the record of William H. Wilson!

Wilson looked ahead and trained himself for the new, live-wire Radio industry. He saw the *great need* for trained men in Radio. And after he had got a thorough training his success came quickly, because he was in a *NEW* field that's teeming with opportunities. Where advancement comes quickly for the few men who have got a real Radio training, and understand all the "hows" and "whys."



**J. E. SMITH**  
President

### Bigger Pay Waiting for You in Radio

There are even bigger opportunities waiting for you right now—**TODAY**—in Radio than there were when Wilson got in. The reason is: television accomplished, trans-Atlantic Radio telephony in use, many wonderful inventions and developments being made constantly which are widening the field of Radio opportunities.

Salaries from \$50 all the way up to \$250 a week are not unusual in this field. Radio needs you! With N. R. I. training behind you, there's no telling how far you may go in this business of *almost unlimited opportunity*. You may do as well or better than Wilson.

You learn right at home in your spare hours—you can do it easily. Clip the free book coupon below—the same one that Wilson clipped two years ago—and get all the facts and proof before you.

### 64-Page Book Sent Free

When I receive your coupon filled in I'll send you my 64-page book free. It's filled with photos and facts about the opportunities in Radio; tells about the 6 big Practice Outfits I give you—you can build 100 real Radio circuits with them; this book gives you all the pay-raising facts you want to know. No previous Radio experience is needed to take advantage of this offer, and no special schooling is required. Mail the coupon today for the big Free Book—no obligation.

Address **J. E. SMITH, President**

**NATIONAL RADIO INSTITUTE**  
Dept. K-85, Washington, D. C.

## Read This Letter From William H. Wilson!

1429 S. Michigan Ave.  
Chicago, Ill.

Dear Mr. Smith:

I take pleasure in dropping you a line in regard to my success as a direct result of your course, less than two years since I enrolled as your student—a coal miner by trade. I finished your course in eleven months and in the thirteen months since then I have kept climbing. My present position is just the sort of place I have been aiming to reach. I am in the capacity of manager for the entire State of Michigan for the National Lead Battery Company. My income is \$3,480 a year and added to that I get \$360 a year for bonus, also a nice commission on all sales to the dealers and jobbers in the state, which will run my income past the \$5,000 mark. To say that I am perfectly satisfied would be putting it mildly, because I have got now just exactly what I always wanted, and you and your training get the credit.

WILLIAM H. WILSON



**WM. H. WILSON**

### World-Famous Practical Training That "Pays for Itself"

Think of making \$15, \$20, \$30 extra a week "on the side," without interfering with your regular job! That's what I enable you to do, almost at once after you get started with me. My practical training is world-famous as the "Course That Pays For Itself." I show you how to make these extra dollars in your spare hours—while all the time I'm getting you ready for the bigger Radio jobs ahead. I'll show you how you can pay for your course and put money in the bank, while all the time you're studying and holding down your regular job, too. **SEND COUPON TODAY FOR BIG BOOK OF PROOF!**



### SIX OUTFITS OF PRACTICE MATERIAL WITHOUT EXTRA COST-MAIL THIS COUPON

**J. E. SMITH, President**  
**National Radio Institute**  
Dept. K-85, Washington, D. C.

Dear Mr. Smith: Please send me your 64-page Free Book which gives me all information on learning Radio for bigger pay; also information on your offer of 6 Practice Outfits free of extra cost. I understand this places me under no obligation.

Name.....

Address.....

Town.....State.....



# \$100 for One Good Commercial Drawing



## Become An Artist This Tested Way

Thousands who never dreamed they could draw can now become artists at home, in spare time, by amazingly simple way. Students write telling us they never realized that learning to draw could be so easy. Many are able to earn good money making drawings before completing our training. Miss Hartleigh made \$235 after 12 lessons; David Gould made \$225 on one job while still just a student. E. V. Fritsch wrote, "I earn \$10 to \$15 a day."

### Big Money in Commercial Art

Millions of dollars are being spent this year on advertising and story illustrations, commercial designs, and cartoons. And even more will be spent next year. Commercial art is a tremendous field—and a field where very big money is gladly paid anyone who can produce good art work. Advertisers, magazines, newspapers, printing houses, business concerns all need trained artists. Competent artists easily earn from \$50 to over \$250 a week. Why don't you too enter this fascinating, big pay business?

### Learn to Draw by This Simple Method

You will be amazed at the ease with which you learn—amazed too at your rapid progress. You start at the very simplest fundamentals, yet almost before you realize it, you are taught how to produce salable work. It's actual fun learning to draw this way. You learn at home yet your work receives the personal attention and criticism of competent Art Instructors. Many students actually sell enough work during their training to pay for it many times over!

### Mail Coupon for FREE BOOK

A new handsomely illustrated book has just been printed, which gives all the most up-to-date information on the thousands of wonderful opportunities in Commercial Art and shows how this startling, simple method enables you to enter this field. It tells about our students—their successes—what they say—actual reproductions of their work—how they made big money while studying. This attractive book will be sent without cost or obligation. Send for it. Mail coupon NOW. (No salesman will call).

WASHINGTON SCHOOL OF ART, Inc.

Room 309E, 1115-15th Street, N. W., Washington, D. C.

Washington School of Art, Inc.

Room 309E, 1115-15th St., N. W., Washington, D. C.

Please send me without cost or obligation your new book on "How to Become an Artist" and details of your offer to new Students.

Name.....  
(Write name plainly and state whether Mr., Mrs., or Miss)

Address.....

City..... State.....

Age.....

24th Year



## CHICAGO TECHNICAL COLLEGE

### LEARN DRAFTING IN 4 MONTHS

Trained Draftsmen earn \$60 to \$100 a week. 4 months' interesting study at Chicago Tech. fits you to earn big money in drafting's fertile field. Common schooling all you need. Expert instructors. Opportunities for self-support while studying. Free Employment Service. Day or Evening Classes. Athletics. Enter any time. Also intensive courses in Engineering, Electricity and Building. Write for free 84-page "Blue Book" and facts about how to qualify for a high-pay drafting job in 4 months.

Dept. M-400  
118 East 26th St. Chicago Technical College  
Chicago

If you can't come to Chicago, study at home.  
Write for Free Trial Lesson in Drafting.

## Don't Envy The Plumber BE ONE!

\$11.00-\$16.00 PER DAY and work EVERY day, is the Plumber's wage.

Every skilled workman will tell you that Plumbers have the best of it. WINTER and SUMMER the Plumber is busy at top wages. No skilled Plumber is ever out of a job—compare his opportunities with any trade, plus the opportunities of having your own shop.

We teach you Plumbing with TOOLS (not books) under Licensed Master PLUMBERS in one of the finest equipped schools in America. We make you a Plumber, every branch is taught thoroughly—Lead Work—Blue Print for plan reading—all other tricks.

LEARN IN 8 to 12 WEEKS without previous experience.

If you are making less than \$20.00 a week you owe it to yourself to investigate. Get FREE catalog that tells in pictures and words how we teach this trade. Special rates now.

UNIVERSAL PLUMBING SCHOOL  
2030 Troost Ave. KANSAS CITY, MO.

## Keynote To Popularity

Popularity is yours. Everyone will seek your company if you play tenor banjo. Enroll for our course. We start you with an \$18 professional tenor banjo. Prof. Six was director of Glee and Instrumental Clubs at N. Y. University. His picture, diagram and phonograph record method is so simple you play immediately.

Don't Send a Single Cent  
Write for particulars about our course and we will reserve an \$18 tenor banjo for you. Write now for book and free first lesson.  
New York Academy of Music, Studio 109, 100 Fifth Ave., N. Y. C.



## "STAMMERING

### Its Cause and Cure"

You can be quickly cured if you stammer. Send 10 cents, coin or stamps, for 288 page cloth bound book on Stammering and Stuttering. It tells how I cured myself after Stammering and Stuttering for 20 years. BENJAMIN N. BOGUE  
6947 Bogue Building, 1147 N. III. St. Indianapolis

## GOV'T. POSITIONS

\$35 TO \$75 WEEKLY

- |                        |                                  |
|------------------------|----------------------------------|
| ( ) Railway Mail Clerk | ( ) Meat Inspector               |
| ( ) P. O. Clerk        | ( ) Special Agent (Investigator) |
| ( ) Forest Ranger      | ( ) Stenographer-Typist          |
| ( ) File Clerk         | ( ) Immigration Inspector        |
| ( ) Matron             | ( ) City Mail Carrier            |
| ( ) General Clerk      | ( ) U. S. Border Patrol          |
| ( ) Chauffeur-Carrier  | ( ) Typist                       |
| ( ) Skilled Laborer    | ( ) Seamstress                   |
| ( ) Watchman           | ( ) Steno-Secretary              |
| ( ) Postmaster         | ( ) Auditor                      |
| ( ) RFD Carrier        |                                  |

Mr. Oment, Dept. 111, St. Louis, Mo.

Send me particulars about positions marked "X"—salaries, locations, opportunities, etc.

NAME.....

ADDRESS.....





# See How Easy it is to Quickly Become a Powerful Speaker

THERE is no magic, no trick, no mystery about becoming a powerful and convincing public speaker. I will prove that you can quickly become a powerful speaker. By an amazing five-minute test I will show you how to discover whether you are one of the 7 men out of every 9 who have this "hidden knack" and do not know it.

## Why Powerful Speakers Are Always Leaders

It is the man who can put his ideas into convincing speech—the man who can sway others at his will and dominate one man or a thousand who is sought out and asked to fill big, important, high-salaried positions. He is a leader; he stands head and shoulders above the mass. I am going to prove that you can be such a man by simply bringing out your "hidden personality."

### What 20 Minutes a Day Will Show You

- How to talk before your club or lodge.
- How to address board meetings.
- How to propose and respond to toasts.
- How to make a political speech.
- How to tell entertaining stories.
- How to make after-dinner speeches.
- How to converse interestingly.
- How to write better letters.
- How to sell more goods.
- How to train your memory.
- How to enlarge your vocabulary.
- How to develop self-confidence.
- How to acquire a winning personality.
- How to strengthen your will-power and ambition.
- How to become a clear, accurate thinker.
- How to develop your power of concentration.
- How to be master of any situation.

### It Is Amazingly Easy to Quickly Become a Powerful Speaker

You do not need a college education nor any previous voice training to become a powerful speaker. I will show you the secret that causes one man to rise from an obscure position to the head of a great corporation; another from the rank and file of political workers to national prominence; an ordinary trades-union member to the national leadership of great labor unions; a timid and retiring man to change suddenly into a popular and much applauded after-dinner and banquet speaker. Thousands have accomplished just such amazing things, due to this simple, easy, yet effective training.

## You Become a Good Speaker—or I Don't Want a Penny

I will guarantee to make you a powerful, convincing, and easy speaker within a few weeks if you will give me 20 minutes a day in the privacy of your own home. I know what I have done for thousands of others, therefore if I cannot make you a powerful speaker, your training will not cost you a penny.

## Amazing Book Free—Mail Coupon

If you will fill in and mail the coupon at once, you will receive a remarkable new book called *How to Work Wonders With Words*. This book gives you an amazing test, by which you can determine for yourself in five minutes whether you are one of the seven men out of every nine who possess the "hidden knack" of powerful speech, but do not know it. Decide for yourself if you are going to allow 20 minutes a day to stand between you and success. Thousands have found this to be the biggest step forward in their lives. It has played such an important part in the lives of many big men, may it not in yours? Then mail the coupon at once.

Now Sent Free



**North American Institute**  
3601 Michigan Ave., Dept. 1356, Chicago, Ill.

North American Institute,  
3601 Michigan Ave., Dept. 1356  
Chicago, Ill.

Please send me FREE and without obligation my copy of your inspiring booklet, *How to Work Wonders With Words*, and full information regarding your Course in Effective Speaking.

Name .....

Address .....

City..... State.....





# Here's FUN and SPENDING MONEY

How'd you like to have a pocketful of spending money all the time—\$5 or \$10 or even \$15 every week—all your own—and a lot of real fun at the same time! It would be great, wouldn't it? Well, you can have it! Hundreds of boys still in school are getting it! And they're no different from you except that they are "Cooke" Trained—they know how to do little electrical jobs in their spare time, after school hours, for which they get real money. I showed them how. And I'll show you, too, just as easily!

### I Will Train You at Home

With my easily learned, fascinating Electrical Course, I'll train you at home like I've trained hundreds of other boys who are now successful men with jobs paying \$70 to \$200 a week! It's all done after school hours, without interfering with your school work or with your regular job if you're working. And it's more like play than study. But it's practical. It's sound. It's up-to-the-minute. It fits you thoroughly to land a Big-Pay job when school days are over. And it pays for itself as you learn and gives you plenty spending money, besides, through the spare-time work I tell you how to get, how to do and what to charge for.

### Tools, Apparatus and Radio Course—Given Without Extra Charge

You'll need tools to do Electrical work with, so I give them to you—six big outfits of instruments and apparatus, and a real electric motor—a dandy layout that you can do any kind of spare-time work with—and it's all yours for "keeps". And not only that, but I also give you a brand new Course in Radio! All without extra cost!

#### Makes \$200 a Month

"Dear Mr. Cooke: When I began with you I was a sophomore in High School. Was making \$40 a month as grocery clerk. Now I am a \$200 a month electrician. Not so bad for a 17 year old boy, eh? Oliver P. Cooper 1131 Middle St. Ashland, Pa.

#### Mail Coupon Now!

You want lots of spending money! You want a Big-Pay job when you're through school! Sure, you do! Then don't wait a minute—don't hesitate a second—act right this instant to get into this Big-Pay field where you can make \$2 or \$3 or more spare-time money every day while learning. Mail coupon at once and I'll send you my big 72-page book and a sample lesson, too—All FREE. See for yourself how easy it is. Fill in and mail coupon this minute!

**6 BIG WORKING OUTFITS**  
**NO EXTRA CHARGE**

### Use this FREE BOOK COUPON

L. L. COOKE, Chief Instruction Engineer,  
L. L. COOKE School of Electricity,  
Dept. 016, 2150 Lawrence Ave., Chicago, Ill.

Send me your big Electrical Book, Sample Lesson and particulars about your Electrical Course and extra Radio Course. This does not obligate me in any way.

Name.....  
Address.....  
(This Coupon only for boys 15 years old or more)

**\$50. to \$250. a Week in Photography**  
**FREE BOOK Tells How**

You can quickly qualify for big-paying positions in Motion Picture, Portrait, Commercial or News Photography, or start your own business. No experience needed.

**CAMERA GIVEN WITHOUT EXTRA CHARGE** Learn at home or in our great New York Studios. Earn while learning. Write today for Free Book, Job Chart and Camera offer.  
**NEW YORK INSTITUTE OF PHOTOGRAPHY**  
Dept. 49 10 West 33rd St. New York

*Learn to Write*  
**I Teach by Mail**  
Begin Today—Write for My FREE Book. I can make a good penman of you at home during spare time. Write for my FREE BOOK, "How to Become a Good Penman." It contains specimens and tells how others mastered penmanship by the Tamblin System. Your name will be elegantly written on a card if you enclose stamp to pay postage. Write today for book.  
F. W. Tamblin, 418 Ridge Bldg., Kansas City, U.S.A.

**BE AN ARTIST**  
**WE CAN TEACH YOU DRAWING** in your own home during your spare time. Twenty-five years of successful teaching proves our ability. Artists receive large salaries.  
Write Today for Art Year Book  
**SCHOOL OF APPLIED ART**  
ROOM NO. 2 BATTLE CREEK MICH.

**Learn Advertising at HOME**  
Many of the highest paid men in the world are advertising men. You can learn easily and quickly at home during your spare time. We guarantee satisfaction. Bigger opportunities now in advertising than ever before. Constant demand for our graduates at splendid pay.  
Send for FREE Book. Giving interesting information and vital facts—just what you want to know about advertising. Write today.  
**PAGE-DAVIS SCHOOL OF ADVERTISING**  
Dept. 1356 3601 S. Michigan Ave., Chicago, U. S. A.

**Strength** is not so much muscle as skill. Police Captain Wallander's illustrated "Physical Training Manual" explains fine points of Jiu Jitsu, Boxing and Wrestling. Makes you invincible. A complete course in physical culture, astounding police secrets and simple health rules. Sent C. O. D. for \$1.97 plus postage. Siebel Press, 34-L W. 20 St., New York, N. Y.

**BE A JAZZ MUSIC MASTER**  
**Play Piano By Ear**  
Play popular song hits perfectly. Hum the tune, play it by ear. No teacher—self-instruction. No tedious ding-dong daily practice—just 20 brief, entertaining lessons, easily mastered.  
**At Home in Your Spare Time** Send for FREE BOOK. Learn many styles of bass and syncopation—trick endings. If 10c (coin or stamp) is enclosed, you also receive wonderful booklet "How to Entertain at Piano"—and many new tricks, stunts, etc.  
**Niagara School of Music**  
Dept. 206, Niagara Falls, N. Y.  
**Send for this Free Book**



# ELECTRICITY

**Complete Study Course and Pocket Library \$10**



**SHIPPED FREE**

A set of **HAWKINS GUIDES** is a true friend to the electrical worker. It tells you how to do any job the right way—without guessing or taking chances.

Hawkins Guides put all the facts about modern electrical engineering at your finger tips. Therefore your chances for advancement in the electrical field are unlimited.

**HAWKINS GUIDES DOUBLE YOUR VALUE**



Electricity is king! It is the ruling force of today—transportation, communication, light, heat, power—indeed every modern activity is dependent on electricity. Industry is crying for electrical men that know their jobs!

Hawkins Guides teach you all you need to know about electricity in easy, step-by-step lessons. Daily spare time reading of the Guides will greatly increase your value to yourself and your employer in a few weeks. Hundreds of our friends have written us and told us this!

**READERS OF HAWKINS GUIDES KNOW HOW**



"You can't stump him on an electrical job." "He certainly knows his business." "Certainly have to hand it to him for knowing how."—These are the things employers say about our friends who are readers of **Hawkins Guides**. No matter what question or problem comes up the Ready Reference Index enables you to give an expert answer at once.

**HAWKINS STARTS YOU WHERE OTHERS LEFT OFF**

Why should you work at low wages when easy reading of **HAWKINS GUIDES** will give you the money-making knowledge of the expert? Easy daily reading of the Guides will teach you in a few months what it has taken the expert a lifetime to learn!

With **HAWKINS GUIDES** in hand you have a running start to success in the electrical field. You will actually begin where others left off!



**NOW!**

This coupon is your golden opportunity. Tear it out—send it now!

**FOR EXAMINATION!**

**REAL ELECTRICAL EDUCATORS**

"Hawkins Guides at \$10 is the best investment I have ever made. Am able to take up almost any electrical job and have never gone to an electrical school."—**B. Roessler, Oenaville, Texas.**

**AS EASY AS A. B. C.**

"Everything in Hawkins Guides is very plain and anybody can read and understand them as easy as A. B. C."—**J. Knight, Tobyhanna, Pa.**

**OTHER ENTHUSIASTIC READERS SAY**

"Worth ten times their price." "Helped me to two raises in four months." "Better than a school of instruction." "Studied them when I was laid up and got further ahead than if I had been on the job."

**Hawkins Guides Explain These Points So You Can Easily Understand:—**

Magnetism—Induction—Experiments—Dynamos—Electric Machinery—Motors—Armatures—Armature Windings—Installing of Dynamos—Electrical Instrument Testing—Practical Management of Dynamos and Motors—Distribution Systems—Wiring—Wiring Diagrams—Sign Flashers—Storage Batteries—Principles of Alternating Currents and Alternators—Alternating Current Motors—Transformers—Converters—Rectifiers—Alternating Current Systems—Circuit Breakers—Measuring Instruments—Switch Boards—Wiring—Power Stations—Installing—Telephone—Telegraph—Wireless—Bells—Lighting—Railways. Also many Modern Practical Applications of Electricity and Ready Reference Index.

**Hawkins Guides—10 POCKET SIZE NUMBERS**

Each number easy to carry around and read in spare time. Big type and clear diagrams. Easy to study and learn. Durable, flexible binding—gold edges. 3,500 pages—4,700 illustrations. **Shipped free for examination.** Pay only \$1 a month if satisfied. Price of set, complete, \$10.

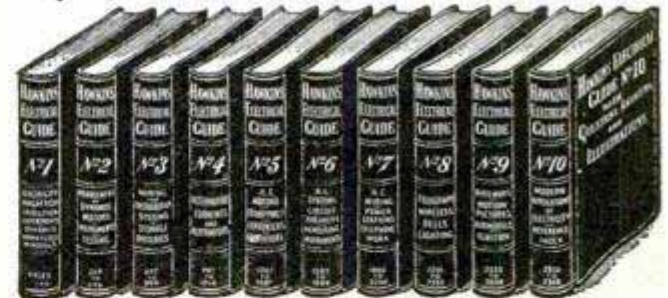

**EXAMINE GUIDES FREE!**

Let the Guides themselves demonstrate their practical value to you—as a study course, reference work and complete electrical library. You are the judge. Simply send this coupon. No obligation unless you are entirely satisfied. Tear out on dotted line—fill in—mail it NOW!

**\$1 PER MO.**

**FREE EXAMINATION COUPON**

**Theo. Audel & Co., 65 W. 23rd St., New York City**

Please send me (postpaid) for my approval **Hawkins Electrical Guides**, 10 numbers (price \$1 each). If satisfactory I will mail you \$1 in 7 days and further mail \$1 monthly until purchase price of \$10 is paid.

Name.....  
 Address.....  
 Occupation.....  
 Employed by..... 9T30



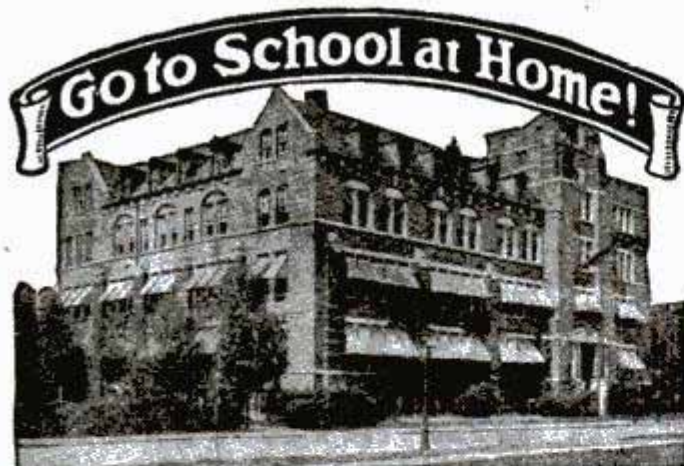

# High School Course in Two Years!

## You Want to Earn Big Money!

And you will not be satisfied unless you earn steady promotion. But are you prepared for the job ahead of you? Do you measure up to the standard that insures success? For a more responsible position a fairly good education is necessary. To write a sensible business letter, to prepare estimates, to figure cost and to compute interest, you must have a certain amount of preparation. All this you must be able to do before you will earn promotion. Many business houses hire no men whose general knowledge is not equal to a high school course. Why? Because big business refuses to burden itself with men who are barred from promotion by the lack of elementary education.

### Can You Qualify for a Better Position

We have a plan whereby you can. We can give you a complete but simplified high school course in two years, giving you all the essentials that form the foundation of practical business. It will prepare you to hold your own where competition is keen and exacting. Do not doubt your ability, but make up your mind to it and you will soon have the requirements that will bring you success and big money. **YOU CAN DO IT.**

Let us show you how to get on the road to success. It will not cost you a single working hour. Write today. It costs you nothing but a stamp.

## American School

Dept. H-674, Drexel Ave. and 58th St., Chicago

### American School

Dept. H-674, Drexel Ave. and 58th St., Chicago

Send me full information on the subject checked and how you will help me win success.

- |                             |                           |
|-----------------------------|---------------------------|
| ....Architect               | ....Business Law          |
| ....Building Contractor     | ....Lawyer                |
| ....Automobile Engineer     | ....Machine Shop Practice |
| ....Automobile Repairman    | ....Mechanical Engineer   |
| ....Civil Engineer          | ....Shop Superintendent   |
| ....Structural Engineer     | ....Employment Manager    |
| ....Business Manager        | ....Steam Engineer        |
| ....Cert. Public Accountant | ....Foremanship           |
| ....Accountant and Auditor  | ....Sanitary Engineer     |
| ....Bookkeeper              | ....Surveyor (& Mapping)  |
| ....Draftsman and Designer  | ....Telephone Engineer    |
| ....Electrical Engineer     | ....Telegraph Engineer    |
| ....Electric Light & Power  | ....High School Graduate  |
| ....General Education       | ....Wireless Radio        |
| ....Vocational Guidance     | ....Undecided             |

Name.....

Address.....

## Electrical Engineering

Course for men of ambition and limited time. Over 5000 men trained. Condensed course in Theoretical and Practical Electrical Engineering including the closely related subjects of Mathematics and Mechanical Drawing.

Students construct motors, install wiring, test electrical machinery. Course designed to be completed in one college year. Prepare for your profession in the most interesting city in the world. Est. 1893. Catalog on request.



## Bliss Electrical School

119 Takoma Ave., Washington, D. C.

## OPPORTUNITIES IN TRAFFIC MANAGEMENT

Conditions point to an unusual demand for trained traffic men, by transportation companies and industrial organizations. Men with scientific traffic training effect big savings for their firms—command big salaries.

### Three Detroit Firms Pay Their Traffic Managers Over \$20,000 a Year

Prepare at home in your spare time, under supervision of traffic experts. Low cost; easy terms. "I would not take \$50,000 for my knowledge of traffic management," writes H. E. Stiffler, Traffic Manager, Marion Steam Shovel Co., Marion, Ohio. Send now for 64-page book—**FREE!**

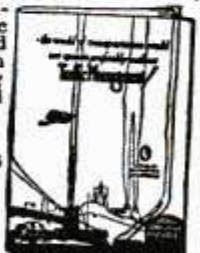

LaSalle Extension University, Dept. 964-T Chicago

## LAW Personal Instruction By Mail Be a lawyer or law trained business man. Quality to earn \$2,500.00 to \$15,000.00 a year.

University Methods. TUITION LOW. EASY TERMS. Textbooks furnished. Practical and authoritative non-resident course. Endorsed by bench and bar. Prepares for bar or business. Over 60,000 students. PERSONAL INSTRUCTION. Guarantee to coach free any graduate failing to pass bar exam. Write today for particulars of low tuition offer now in force and book on law FREE. No obligation.

AMERICAN CORRESPONDENCE SCHOOL OF LAW  
3601 Michigan Avenue, Dept. 1356, CHICAGO, ILL.

## LEARN MECHANICAL DENTISTRY



making crowns, plates, bridges, etc. for dentists. Unusual demand now and always will be—a human necessity. Steady, dignified Professional Trade. Three to six months training. Easily learned by actual practice. R. R. Fare to nearest school included. Regular arrangement for part time positions to help pay expenses. Ask for Catalog No. 2.

### BODEE DENTAL INSTITUTE

New York  
1755 Broadway

Philadelphia  
1305 North Broad Street

Brooklyn  
85 Court Street

## LEARN PIANO TUNING AT HOME

DURING SPARE TIME AND EARN \$50 TO \$100 A WEEK.



Our Tune-A-Phone Makes It Easy. With it any one who has ordinary hearing can acquire the knack quickly and accurately. Esmay, Long Beach, Cal., says: "never dreamed there was so much money in Piano Tuning. I earned \$265 in ten days." He is but one of many. Write for Free copy of our book "Winning Independence" and Guarantee Plan.

BRYANT SCHOOL, 71 BRYANT BLDG., AUGUSTA, MICH.

## LEARN WATCHMAKING AND ENGRAVING



BY OUR PROFIT-SHARING PLAN  
**OUR GRADUATES SUCCEED**

One of our Iowa students started in a very small way—now doing over \$30,000 a year. Another in Wisconsin, over \$10,000 the first year. Day or night classes. Call or write for FREE BOOK

Chicago School of Watchmaking, Dept. 3201, 4844 Lincoln Avenue, CHICAGO



## RAISE POULTRY MAKE BIG MONEY

### Results Quick—Part or Full Time

Take up poultry raising. It's interesting, healthful, PROFITABLE. Easy to sell all you can produce at big prices. Our new course by Henry M. Lamon, former gov't expert, gives short cuts to success. Write for free book, "How to Raise Poultry for Profit."

NATIONAL POULTRY INSTITUTE, Dept. 411, Washington, D. C.







# Two Years' Engineering Course With Diploma and Degree

Civil Mechanical Electrical Chemical

Compact courses of essentials. Rich in higher mathematics, higher science, mechanical drawing and field work. Planned for those short in time and money, but strong in purpose. Courses distinguished alike for what is embraced and what is omitted. Adapted to

**Engineers with Practical Experience desiring a Degree**

**No Entrance Examination or High School Diploma Required**

Indispensable preliminary work provided for students with only elementary school education. Modern laboratories. Students may begin a course in Sept., Jan., Mar., or June. EXPENSES LOW. For catalog address

**TRI-STATE COLLEGE OF ENGINEERING**  
 Box M-97 **Angola, Indiana**

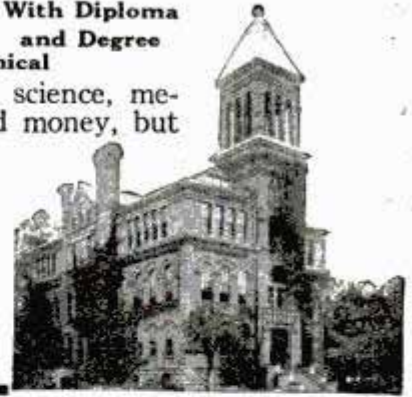

**SAFE!** MAKE PULLETS LAY EARLY. Knowledge is Power! Eliminate guess work. Let world's greatest poultry school show you quickly by mail how to get more EGGS-- make more money. Write for free book. State kind of poultry you like. **AMERICAN POULTRY SCHOOL** Dept. 70 Kansas City, Mo. *free book*

**ENCYCLOPÆDIA BRITANNICA**  
 in the New Form—at a saving of 40%  
 Write for full details. Address Dept. PM8  
**THE ENCYCLOPÆDIA BRITANNICA, INC.**  
 342 Madison Ave., New York City

# LEARN CARTOONING

## AT HOME DURING SPARE TIME



from the School that has trained hundreds of successful cartoonists of today. The Landon Picture Chart Method of teaching ORIGINAL drawing by mail makes cartooning easy to learn. Write today for sample picture chart to test your ability and examples of the work of successful students now earning from \$75 to \$200 and more per week. Please state your age.

**THE LANDON SCHOOL, 2838 National Bldg., Cleveland, Ohio**



Wonderful, new device, guides your hand; correct your writing in few days. Big improvement in three hours. No failures. Complete outline FREE. Write C. J. Ozment, D-34, St. Louis, Mo.

## 30 Days' Free Trial

New Models now ready for delivery direct from our factory. Astonishing low prices and terms. Do not buy until you get them.

**RIDER AGENTS WANTED** to ride and exhibit sample. Make big money. Many models \$21.50 up.

**Tires** Guaranteed \$1.50 each, wheels, lamps, horns, equipment at half usual prices. Send No Money. Write for our marvelous prices and terms on RANGER Bicycles.

**Mead CYCLE CO. Dept. M110 CHICAGO**



# AT HOME LEARN TELEGRAPHY AT HOME



**TEACH YOURSELF**

in half usual time, at trifling cost, with the wonderful Automatic Transmitter, **THE OMNIGRAPH**. Sends unlimited Morse or Continental messages, at any speed, just as an expert operator would. Adopted by U. S. Government, and leading Universities, Colleges and Telegraph Schools. Catalog 6 cents.

**OMNIGRAPH MFG. CO., 13-19 Hudson St., NEW YORK**

## MEN WANTED

TO LEARN

### Motion Picture Projection

\$2,000 to \$4,000 a Year

Quickly learned. Short hours, big pay. Best equipped school in Michigan. Projectionists for Movie Houses and Road Shows.

**MOVIE OPERATORS SCHOOL**

61 Sproat Street, **DETROIT, MICHIGAN**

## PIANO JAZZ

By Note or Ear. With or without music. Short Course. Adult beginners taught by mail. No teacher required. Self-instruction Course for Advanced Pianists. Learn 259 styles of Bass, 684 Syncopated Effects. Blue Harmony, Oriental, Chime, Movie and Café Jazz, Trick Endings, Clever Breaks, Space Fillers, Sax Slurs, Triple Bass, Wicked Harmony, Blue Obligato, and 247 other Subjects, including Ear Playing. 133 pages of REAL Jazz, 25,000 words. A Postal brings our FREE Special Offer.

**Waterman Piano School, 1826 W. Adams St. Los Angeles, Cal.**

# TRAVEL—for 'UNCLE SAM'

**RAILWAY POSTAL CLERKS**  
**MAIL CARRIERS—POSTOFFICE CLERKS**  
**\$1700 to \$2700 a Year for Life**

No "lay-offs" because of strikes, poor business, etc.—sure pay—rapid advancement. City and country residents stand same chance. Common sense education sufficient—no political influence.

**STEADY WORK**

Cut coupon and mail it before turning the page.

**MEN—BOYS**  
**18 to 45**

Use Coupon Before You Lose It

**COUPON**

**FRANKLIN INSTITUTE, Dept. N173, Rochester, N. Y.** Rush to me, entirely free of charge, (1) A full description of the position checked below; (2) 32-page book, with list of positions obtainable; (3) Free Sample coaching.

- Railway Postal Clerk (\$1900 to \$2700)
- Customs Positions (\$1140 to \$1860)
- Postoffice Clerk (\$1700 to \$2300)
- Prohibition Agent (\$1800 to \$3000)
- City Mail Carrier (\$1700 to \$2100)
- Rural Mail Carrier (\$2100 to \$3300)

Name .....

Address .....





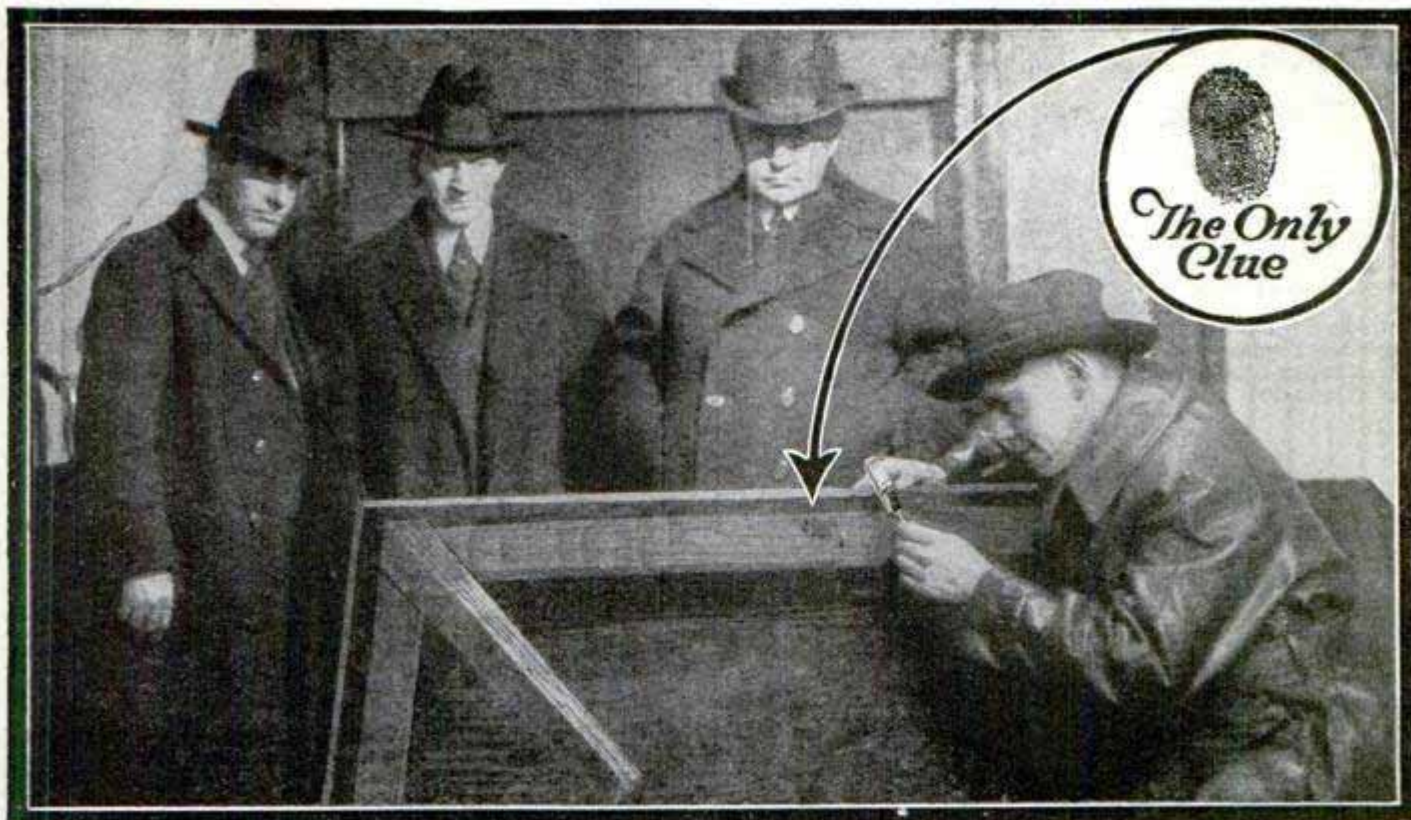

# \$500 REWARD for TWO HOURS WORK

**WARREN BIGELOW**, the Finger Print Expert, was making his usual review in the morning newspapers. He had just finished reading the press reports of the daring robbery of the offices of the T—O— Company when the telephone on his desk rang. Central Office was calling, asking him to come immediately to the scene of the robbery.

Although he drove his high powered roadster rapidly and arrived very shortly at his destination, he had plenty of time to consider the main features of the case as reported by the press. The job had undoubtedly been done by skilled cracksmen and robbers of uncommon nerve. Sixty-five hundred dollars in currency—the company pay-roll—were gone. Not a single, apparent clue had been found by the police.

## Finger Print Expert Solves Mystery

On his arrival, Bigelow was greeted by Nick Austin, Chief of Detectives, who had gone over the ground thoroughly.

"Hello, Warren. Here's a job that has us stumped. I hope you can unravel it for us."

By this time, the district officers and the operatives from Central Office had almost given up the investigation. After hours of fruitless efforts, their work was at a standstill. They were completely baffled.

With lively interest and a feeling of relief they stepped back to await the results of the Finger Print Expert's findings. They were plainly awed at his quiet, assured manner. The adroit old Chief himself was manifestly impressed at the quick, sure way in which Bigelow made his investigation.

Almost immediately Bigelow turned his attention to a heavy table which had been tipped up on its side. Examination of the glossy mahogany showed an excellent set of finger prints. The thief might just as well have left his calling card.

To make a long story short his prints were photographed and taken to Central Office, where they were matched with those of "Big Joe" Moran, a safe blower well known to the police. Moran was subsequently caught and convicted on Bigelow's testimony and finger print proof. Most of the money was recovered. In the meantime the T—O— Company had offered a \$500.00 reward, which was given to Bigelow—his pay for two hours' work.

## Learn At Home in Spare Time

Could you imagine more fascinating work than this? Often life and death depend upon decisions of finger print evidence—and big rewards go to the **Expert**. Many more trained men are now needed in this great field. The finger print work of governments, corporations, police departments, detective agencies and individuals has created a new profession. Many experts regularly earn from \$3,000 to \$10,000 a year in this fascinating game. And now you can easily learn the secrets of this new Science in your spare time—at home. Any man with common school education and average ability can become a Finger Print Expert in a surprisingly short time.

## Free Course in Secret Service

For a limited time we are making a special offer of a **Professional Finger Print Outfit and Course in Secret Service Intelligence** without extra cost. Mastery of these two kindred professions will open a brilliant career for you.

Write quickly for fully illustrated free book on Finger Prints which explains this wonderful training in detail. Don't wait until this offer has expired—mail the coupon now. You may never see this announcement again! You assume no obligation—you have everything to gain and nothing to lose. Address

**UNIVERSITY OF APPLIED SCIENCE**  
Dept. 13-56, 1920 Sunnyside Avenue, Chicago, Illinois

UNIVERSITY of APPLIED SCIENCE,  
Dept. 13-56, 1920 Sunnyside Ave., Chicago, Ill.

Gentlemen: Without any obligation whatever send me your new, fully illustrated, FREE book on Finger Prints and your offer of a FREE course in Secret Service Intelligence and the Free Professional Finger Print Outfit.

Name .....

Address .....

Age .....

# Why don't You be a Finger Print Expert?



## Make That Dream Come True!

Haven't you often pictured yourself playing the Hawaiian Guitar, a happy crowd around you, everybody enjoying and admiring your playing? Now you can reach your goal—and play all the latest hits just as the Hawaiians do!



You can play the  
**HAWAIIAN GUITAR**  
just like the Hawaiians!

**\$15**  
**HAWAIIAN GUITAR**  
with Genuine Seal Grain  
**Fabrikoid Cover**  
**GIVEN**  
when you enroll

### Complete Conservatory Course

52 complete lessons. Pictures explain every move. Our method is simple, practical and interesting—only 4 motions to learn. No tiresome scales and exercises—you play a real piece your very first lesson.

### Expert Instruction by Native Hawaiians

Get the advantage of expert instruction by Kolomoku, Kalaluki, Ferera and Seville—every one famous as both player and teacher. Even if you never touched a musical instrument in your life, under their direction you make rapid headway—you will be astonished when you see how easy it is!

### This Sweet Toned Hawaiian Guitar

in genuine Fabrikoid Case—and complete playing outfit including picks, steel playing bar, etc.; given you when you enroll. Retailers ask \$15 or more for a similar outfit without the case. Remember, there are no extra—we furnish everything with the course.

### Learn in Spare Time

Pick up your guitar at any time and play. Your lessons are always handy—you can always refer to them. You are never hurried or forced. And no waiting for a class to form—start now—go ahead as fast as you like.

### Pay as You Play

Small first payment starts you. And the entire 52-lesson course comes to just a few cents a lesson! Begin now.

### We Guarantee

in writing to teach you. And after graduation we coach and advise you without charge. Over 45,000 successful graduates.

**Tenor Banjo** and other courses—Violin, Tiple, Tenor Guitar, Banjo Ukulele, Ukulele—under well-known instructors. Write for information.

### FIRST HAWAIIAN CONSERVATORY OF MUSIC, INC.

9th Fl., Woolworth Bldg., Dept. 348, New York, N. Y.

Approved as a Correspondence School Under the Laws of the State of New York

### SEND THIS COUPON FOR LIBERAL OFFER!

First Hawaiian Conservatory of Music, Inc.  
9th Fl., Woolworth Bldg., Dept. 348, New York, N. Y.

Please mail full information about your 52-lesson Hawaiian Guitar Course. I am not obliged to enroll unless I want to.

Name \_\_\_\_\_  
Address \_\_\_\_\_  
City \_\_\_\_\_ State \_\_\_\_\_



## Double Your Pay This Easy Way

SCORES of ambitious fellows earn more than their regular salaries simply by using a few pleasant hours a week of their spare time making show cards for local stores. Every retailer in your neighborhood will pay big money for clever sales-producing display cards. Learn at home through easy professional method. Earn \$25 to \$50 a week spare time—\$50 to \$100 a week in full time. Business of your own. Wonderful future. Earn even while you learn.

Send for new illustrated booklet, "Quick Success in Show Card Making." Also for details on Show Card Outfit—given to new students. No obligation. Write now to

### WASHINGTON SHOW CARD SCHOOL

Dept. 309E, 1117—15th St., N. W., WASHINGTON, D. C.



## 1,000 Hotel Positions Open!

HOTELS, restaurants, clubs, apartments, hospitals, institutions, schools and colleges everywhere need trained men and women. Over 70,000 high-class positions paying \$2,500 to \$10,000 a year open annually in the hotels of the United States. Nearly one and three-quarter billions of dollars' worth of NEW HOTELS, CLUBS AND INSTITUTIONS, being built this year will need over 200,000 trained men and women. Hotels start you at salaries up to \$3,500 a year, with living usually included. At any time there are over 1,000 hotel positions open.

### Previous Experience Unnecessary

You can have one of these fascinating, big-pay positions. The Lewis Schools guarantee to give you the valuable knowledge that it has taken some of the most successful hotel men years to obtain. Age is no obstacle—young and old alike have equal chance for success. Past experience absolutely unnecessary. A common school education is all you need. We train you in your spare time with the Lewis Simplified Study Plan and put you in touch with big opportunities. All of your training under the personal supervision of Clifford Lewis, Managing Consultant for over 225 hotels thruout the United States. Our students employed by leading hotels everywhere. Send coupon today for Free Book, "Your Big Opportunity," showing how we can train you for one of these splendid positions and explaining our Money-Back Agreement.

### FREE BOOK COUPON

LEWIS HOTEL TRAINING SCHOOLS,  
Room AK-385, Washington, D. C.

Send me without obligation the Free Book "Your Big Opportunity."

Name.....

Address.....

City..... State.....



# He Clipped This Coupon



CHARLES F. WORTHEN

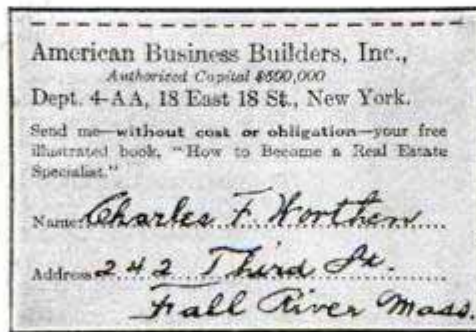

## And Made \$8,500 in 17 Weeks!

C. F. Worthen deserves success. When he read our ad in the *American Magazine* he was wise enough to answer it.

He clipped the coupon. He got our free book. He followed its instructions. Now he is out of the rut of routine work and poor pay. Now he has a splendid business of his own. Now he is making more money than he ever thought possible.

If you want to *do what Worthen did*, send for this remarkable book of business success. Learn the secret of his success. Use our money-making system. Begin at home. In your spare time. No capital—no experience—no special ability needed. Start now. Free book tells how.

### Success Without Capital, Experience or Education

C. F. Worthen is not the only one we have put on the high road to real estate success.

Hundreds of ambitious men and women—young and old—have followed our instructions and are now reaping rich rewards—in business for themselves—independent—prosperous—happy.



Own a new business of your own. Be a Real Estate Specialist. Begin now—in your spare time. Our new book giving full information and positive proof of amazing success, mailed free.

Mrs. Evalynn Balster, a widowed Chicago school teacher, with three children to support, made \$5,500 HER FIRST DEAL, using our amazingly successful real estate sales system.

"Bill" Dakin, of Buffalo, N. Y., worked in a steel mill before he got his copy of this free book. Now he is a successful Real Estate Specialist. Owns his own business. Has a new automobile. Making more money than he ever dreamed he could.

E. G. Baum, ill and discouraged, past 50, lost his job as a bookkeeper. Sent for our free book. Made \$8,000 his FIRST YEAR in real estate.

H. D. Van Houten, Passaic, N. J., formerly a grocery clerk, got our free book, followed our advice, and did a gross business of over \$100,000 his FIRST YEAR in real estate.

But we have no more room here to tell you about the many remarkable stories of amazing business success that are coming to us from readers of our free book. So, send for a copy of it today. Don't be skeptical. Don't say, "It's too good to be true." Don't cheat yourself. It costs nothing to learn the truth. So mail the coupon *now!*

### Our Book Costs You Nothing

If you had to pay \$10 for this book, and take a whole day off to read it, it would pay you to do so. But you don't have to do that. You get the book for nothing if you mail the coupon promptly. And you can read it in thirty minutes. And we guarantee that you will find it the most fascinating book of business opportunity and business success you ever read.

Get this book at once. Learn what it has done for others. Learn what it can do for you in the way of business success—independence—big earnings—cash profits.

Others who have sent for this book have revolutionized their business lives—climbed out of the rut of obscurity—built substantial business of their own—made more money in a WEEK or a MONTH than they formerly made in a WHOLE YEAR of hard work.

Perhaps this book will do as much for YOU.

It costs you NOTHING to find out! AMERICAN BUSINESS BUILDERS, INC., Dept. 44-JJ, 18 East 18 St., New York.



Real Estate is the biggest thing on earth. More than half the nation's wealth is invested in it. Ten million properties are now for sale, rent or exchange.

## Mail this for Free Book!

American Business Builders, Inc.  
(Authorized Capital \$500,000.00)  
Dept. 44-JJ, 18 East 18 St., New York.

Please send me—without cost or obligation—a copy of your book which shows me how to get into real estate, without capital or experience, and make more money than I ever made before.

Name.....

Address.....  
(Get this Free Book! Blame Yourself if You Don't)





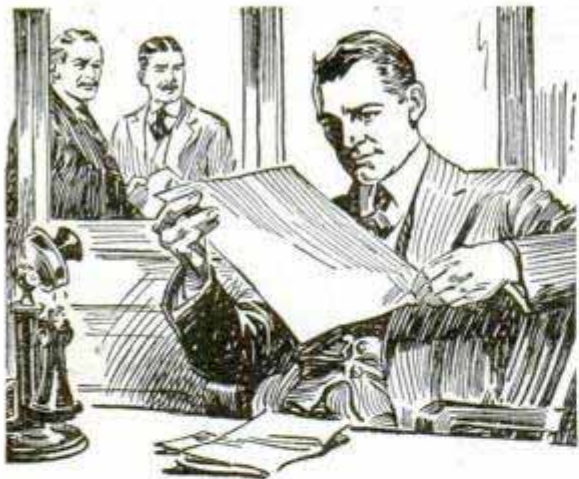

## "I wish we had more men like him"

"I've given him two promotions in the last year and he's made good each time.

"I always feel safe in moving him up because I know that he's preparing himself to handle bigger work.

"The International Correspondence Schools keep me advised of the progress he is making and I've encouraged him to keep on. His spare-time studying certainly has made him a valuable man to this firm."

Why don't *you* study and get ready for promotion too? We'll be glad to help you if you will only make the start. And the way to do that is easy.

Choose the work you like best in the coupon below; then mark and mail it to the International Correspondence Schools today. This doesn't obligate you in the least, but it will bring you information that will help to start you on a successful career. This is your opportunity. Don't let it slip by.

**Mail the Coupon for Free Booklet**

### INTERNATIONAL CORRESPONDENCE SCHOOLS Box 5670-E, Scranton, Penna.

Without cost or obligation, please send me a copy of your booklet, "Who Wins and Why," and full particulars about the course before which I have marked X in the list below:

#### BUSINESS TRAINING COURSES

- |  |   |
|--|---|
| <input type="checkbox"/> Business Management                     | <input type="checkbox"/> Salesmanship                                     |
| <input type="checkbox"/> Industrial Management                   | <input type="checkbox"/> Advertising                                      |
| <input type="checkbox"/> Personnel Organization                  | <input type="checkbox"/> Better Letters                                   |
| <input type="checkbox"/> Traffic Management                      | <input type="checkbox"/> Show Card Lettering                              |
| <input type="checkbox"/> Business Law                            | <input type="checkbox"/> Stenography and Typing                           |
| <input type="checkbox"/> Banking and Banking Law                 | <input type="checkbox"/> English  |
| <input type="checkbox"/> Accountancy (including C.P.A.)          | <input type="checkbox"/> Civil Service                                    |
| <input type="checkbox"/> Nicholson Cost Accounting               | <input type="checkbox"/> Railway Mail Clerk                               |
| <input type="checkbox"/> Bookkeeping                             | <input type="checkbox"/> Common School Subjects                           |
| <input type="checkbox"/> Private Secretary                       | <input type="checkbox"/> High School Subjects                             |
| <input type="checkbox"/> Spanish <input type="checkbox"/> French | <input type="checkbox"/> Illustrating <input type="checkbox"/> Cartooning |

#### TECHNICAL AND INDUSTRIAL COURSES

- |   |  |
|---|--|
| <input type="checkbox"/> Electrical Engineering                     | <input type="checkbox"/> Architect                                       |
| <input type="checkbox"/> Electric Lighting                          | <input type="checkbox"/> Architects' Blueprints                          |
| <input type="checkbox"/> Mechanical Engineer                        | <input type="checkbox"/> Contractor and Builder                          |
| <input type="checkbox"/> Mechanical Draftsman                       | <input type="checkbox"/> Architectural Draftsman                         |
| <input type="checkbox"/> Machine Shop Practice                      | <input type="checkbox"/> Concrete Builder                                |
| <input type="checkbox"/> Railroad Positions                         | <input type="checkbox"/> Structural Engineer                             |
| <input type="checkbox"/> Gas Engine Operating                       | <input type="checkbox"/> Chemistry <input type="checkbox"/> Pharmacy     |
| <input type="checkbox"/> Civil Engineer                             | <input type="checkbox"/> Automobile Work                                 |
| <input type="checkbox"/> Surveying and Mapping                      | <input type="checkbox"/> Airplane Engines                                |
| <input type="checkbox"/> Metallurgy <input type="checkbox"/> Mining | <input type="checkbox"/> Agriculture <input type="checkbox"/> Navigation |
| <input type="checkbox"/> Steam Engineering                          | <input type="checkbox"/> Mathematics <input type="checkbox"/> Radio      |

Name.....

Street Address.....

City..... State.....

Occupation.....

Persons residing in Canada should send this coupon to the International Correspondence Schools Canadian, Limited, Montreal, Canada



**ALL-WOOL Suit Only \$23.50**

Think of being able to offer a suit or topcoat made of the finest quality of pure Virgin Wool; fit, fabric and fashion guaranteed, at the powerfully attractive price of \$23.50! Can you sell such values? You can, if the experience of 2,500 other salesmen means anything. And you don't have to know anything about selling clothing. We'll take you, train and equip you to go out and make a success of this work if you are honest, ambitious and willing to work. If you are, write us. You'll hear from us promptly with the full facts. Address Dept. 550.

**William C. Bartlett, Inc., 850 Adams St., Chicago**

Gentlemen: I'm interested in the opportunity you offer. Please send the facts without obligation to me. 550

Name.....

Address.....

Town..... State.....



**GIVEN FINE TONE**

**\$20 Musical Instruments**  
Your choice of a Violin, Tenor Banjo, Hawaiian Guitar, Banjo, Cornet, Ukulele, Banjo Ukulele, Guitar, Mandolin or Banjo Mandolin. You will be proud to own any one of these instruments and we will give you one without cost. A few cents a day for lessons is your only expense. Our system of teaching is so easy that you can play several pieces by note with the first four lessons. We guarantee success or no charge. Instrument and lessons sent on one week's free trial. Write for booklet today, no obligation. Over 200,000 satisfied pupils.  
**CHICAGO CORRESPONDENCE SCHOOL OF MUSIC, INC.**  
1632 North Halsted Street, Dept. 348, Chicago, Illinois.

## Learn Photography at HOME

Earn \$3000 to \$10,000 a year. Prepare quickly during spare time. Also earn while you learn. New easy method. Nothing else like it. Send at once for free book, "Opportunities in Modern Photography" and full particulars. Special offer open now.

**AMERICAN SCHOOL OF PHOTOGRAPHY**  
Dept. 1356 3601 Michigan Ave. Chicago, U. S. A.

## STAMMERING

...easily, permanently corrected. Win happiness and success. Ask for full information and special photograph record. Send dime for postage 153 Stinson Ave., The LEWIS INSTITUTE, Detroit

**"BECOME A LIGHTNING TRICK CARTOONIST"**  
Send \$1.00 for Laugh Producing Program of 23 Trick Drawings with Instructions. Catalog of Chalk Talk Supplies Free. **BALDA ART SERVICE, Dept. 1, Oshkosh, Wis.**

**WHY NOT** spend Spring, Summer and Fall gathering butterflies, insects? I buy hundreds of kinds for collections. Some worth \$1 to \$7 each. Simple outdoor work with my instructions, pictures, price-list. Send 10 cents (not stamps) for my illustrated Prospectus before sending butterflies.  
**MR. SINCLAIR, DEALER IN INSECTS,**  
Dept. 6, Box 1424, San Diego, Calif.

# Skin Troubles

Cleared up—often in 24 hours. To prove you can be rid of Pimples, Blackheads, Acne Eruptions on the face or body, Barbers' Itch, Eczema, Enlarged Pores, Oily or Shiny Skin, simply send me your name and address today—no cost—no obligation. **CLEAR-TONE** tried and tested in over 100,000 cases—used like toilet water—is simply magical in prompt results. You can repay the favor by telling your friends; if not, the loss is mine. **WRITE TODAY.**  
**E. S. GIVENS, 428 Chemical Bldg., Kansas City, Mo.**



# Beck Makes \$8000 a Year!

**"I make \$1000 a month!"**  
*A.H. Bowen*

**"I make \$350 a month!"**  
*R. G. Foster*

**"Making \$300 a month — haven't finished course yet!"**  
*L. V. Broughton*

**"I make \$130 a Week!"**  
*B. E. Bernack*

**"Averaging over \$400 monthly"**  
*Edwin Libardt*

*Lewis Beck.*  
**\$60 weekly — and 50% construction profits!"**  
*Philgaroy*

**"I refused \$600 a month offer!"**  
*Earl G. Dupree*

**"I make \$475 a month!"**  
*S. C. Stroop*

**"They Pay Me \$350 a Month"**  
*John Saradge*

**"If it wasn't for you and the training you gave me, Mr. Dobe, I wouldn't be making \$8000 a year now."**  
*Lewis Beck.*

Beck jumped from \$12.00 a week to \$8,000 a year! He answered my advertisement and got my Free Book on Draftsmanship. So did these other 9 men. And that's what I want you to do now! They all took my simple, easily understood and quickly learned course in drafting at home without giving up their bread-and-butter jobs. You can do the same thing. Will you?

## Learned Drafting At Home— So Can You!

Before Dobe's "Easy Drafting at Home" it was almost necessary to go away to college to learn drafting. But now you stay home, hold down the job you've got, keep on earning money and easily and quickly equip yourself to enter the drafting profession. All the men you see pictured here did just that.

Get into drafting! It is a big, appealing field. Drafting is growing bigger and more important every year. Before any house or machine or factory can be built there must be a PLAN. That plan *must* be DRAWN. A draftsman must DRAW it. Learn how at home. Get into this fundamental basic and necessary profession! NOW!

Write for FREE Book! Send Coupon TODAY!



**Successful Draftsmanship!**  
Read this book! After you have read it, make up your mind whether you want to be a draftsman! But write for it today. Certainly reading the book can't hurt you. Mr. Dobe will tell you about other men besides these pictured above who have been successful — many — many of them. No matter what you are making now ask for the book today.

**DOBE EASY DRAFTING**  
1951 Lawrence Ave., Div. 13-56 Chicago

**DOBE EASY DRAFTING**  
1951 Lawrence Ave., Div. 13-56 Chicago

Please send me free your book, "Successful Draftsmanship", and names of other big money earning draftsman you have trained.

Name..... Age.....

Address.....

Post Office..... State.....



# See the World FREE!



## Taste Romance and Adventure— In the Far Lands of the Earth

How often you've longed to see for yourself the awe of Egypt's pyramids—the beauties of the gorgeous Mediterranean sunset—the squalor of China's ancient cities!

Spend a few years, or the rest of your life, tasting high adventure on the seven seas and in all the world's great ports—roving the earth's highways and byways! You can do it FREE—all your expenses paid—and earn a good salary besides!

Only one profession will carry you around the world at will, traveling like a gentleman, but that's the most interesting and pleasant work there is—Radio Operating! Easily and quickly learned, there's no other profession like it for the man who wants the experiences and pleasures of world-travel. Radio operators are needed—all sea-going ships like the one shown here must carry from one to half a dozen or more.

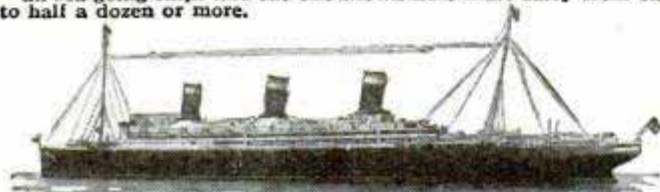

## Take a Look Beyond the Skyline— Without a Penny's Expense

Radio operators aboard ocean liners live luxuriously—they rank as officers of the ship. Meals, a private cabin, all other living needs are furnished free, and besides the operator draws a good salary. You can learn quickly and easily at home in your spare time to be a Radio operator through our practical training methods. Take a look at the FREE BOOK which tells how—mail coupon below

This U. S. Government-recognized school has been training successful operators since 1914. Our graduates are all over the world. We maintain an Employment Department to help put you on your own ship. The world-famous NATROMETER, our own patented invention, obtainable only by students of this Institute, is recognized as the best and easiest way to learn the Radio code. A few short months, with the aid of the famous Natrometer and our quick home training, and you too can be a fully qualified Radio operator, sitting in your cabin like the one shown above, bound out for Liverpool or Nagasaki!

Read the Free Book that tells all about this fascinating profession and our practical Government-recognized methods of training you for it. Send coupon TODAY—no obligation. Special tuition offer now on, includes world-famous Natrometer free of extra cost with your course! Act at once.

**NATIONAL RADIO INSTITUTE  
WASHINGTON, D. C.**

### SPECIAL OFFER COUPON

National Radio Institute,  
Dept. KK-85, Washington, D. C.

Gentlemen: Without obligating me in any way send me your free book and information about your offer of Natrometer with course.



World-Famous  
Natrometer

Name.....

Address.....

# BE A RAILWAY TRAFFIC INSPECTOR



Earn up to  
**\$250**  
per month  
**SALARY**  
plus expenses

**NO HUNTING**  
for a Position After  
Completing Your  
Training

Read what Dan'l M.  
Mack says :

"I received my certificate on April 15, was on my way to take a position on the evening of April 16, and started to work on April 17. If this is not quick work, I don't know what it is. I found the school very thorough."

Our students never worry about a position as one will be offered them within a few days after completing the Traffic Inspection course. You start at \$120 or more per month plus expenses. Our contract shows why you take no risk. As a Railway Traffic Inspector, you are practically your own boss, see new faces and places each minute, report only to high officials, are rapidly advanced. It's healthful outdoor work with regular hours.

### Hundreds of Satisfied Graduates

Write today for Booklet Div. 2, giving full details and contract agreeing to refund your money if position is not offered after graduation.

**Standard Business Training Inst.**  
BUFFALO, NEW YORK

# OPPORTUNITIES IN Salesmanship

## Become a Salesman

Every phase of business revolves around selling. The trained salesman is in demand—he can fix his own hours, choose his own field, control his own pay. His income depends only upon his results—there is no limit to what he can earn. We train you to sell successfully thru the LaSalle problem method under supervision of expert salesmen. Train in your spare time. Low cost; easy terms. 64-page booklet, "The Modern Salesman, Ambassador of Progress," free. Send for it today. LaSalle Extension University, Dept. 964-S Chicago



**FREE**

# LAW Free Book

Write today for FREE 128-page book, "THE LAW TRAINED MAN," which shows how to learn law in your spare time and earn more money. Qualify for a high salaried executive position or prepare to enter the practice of law. Study at home through the Blackstone Course prepared by 80 prominent legal authorities including CHIEF JUSTICE WILLIAM HOWARD TAFT. Blackstone graduates practicing law everywhere. LL. B. degree conferred. Magnificent 25 volume law library furnished immediately upon enrollment. Moderate tuition fee. Low monthly terms. Money Back agreement. Write for book today.

**Blackstone Institute, Inc.,**  
4753 Grand Blvd. Dept. 56 Chicago



# NOW YOU CAN STUDY MUSIC AT HOME

**NO**  
earn  
**\$75.00**  
to  
**\$200.00**  
each week

With a nationally famous artist as your teacher you can learn to play classical or popular music on your favorite instrument. We guarantee our personal teaching method. Both advanced and elementary courses.

**CONN** Write for catalogue  
NATIONAL SCHOOL OF MUSIC, INC.  
506 S. Wabash Ave., Dept. 516, Chicago



*I'll Pay Your Railroad Fare to Chicago Without Extra Cost*

# This funny juice—

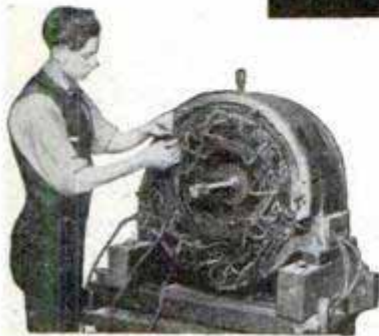

A 25 H. P. Motor for student practice

- helps to run automobiles
  - makes radio possible
  - makes your telephone work
  - makes the wheels go round in thousands of factories
  - illuminates homes, factories, office buildings and city streets
  - toasts bread, percolates coffee and heats flat-irons
  - runs street cars and fast trains
- No one knows what it really is—it is called Electricity—but you can learn how to handle it.

**—AND IT WILL PAY YOU**

**\$1<sup>00</sup> per Hour to \$25,000<sup>00</sup> per Year**

If you get a real "kick" out of this subject of Electricity you're *crazy* if you don't make it earn you real money. Pretty plain speaking—but I want to make you *think*. The world's greatest, most successful men were men who worked at things *they liked*. Work is fun if you like your job. If YOU like electricity, *make it pay you real money*.

## Here's Your Chance

To get somewhere you've got to start, haven't you? It'll mean breaking away from home for about 12 weeks—but you and the family will be mighty glad you *started and finished* something. Especially something that pays so big. We'll take mighty good care of you here in the big Greer Electrical Shops. You'll be in company with hundreds of men temporarily away from home, like yourself. And you'll learn Electricity—*oh man*—how you'll learn it! You'll marvel at the way a subject apparently so mysterious is made so easy to understand. Just wait till we turn you loose among our hundreds of motors, rotary converters, generators, telephone and radio equipments. Competent, friendly instructors will show you

how to take 'em apart and put 'em together till you can do it in your sleep.

## How to Get This Training

The coupon at the bottom of this page is the open door to pleasant work and big money in the Electrical Profession. We can't tell the whole story here because it takes a Book to tell it. The book is free. Mail the coupon, and be thankful the rest of your life for doing it. Delayed action never put money in the bank. DO IT NOW.

## What About Automobiles?

Maybe automobiles interest you as much as electricity—or more. There's a lot of money in fixing autos, too. The well trained auto man is never out of a job. He's ready to go in business for himself. Would you like that kind of work? \$6 a day to \$20,000 a year is what it pays you. Then mark the coupon for the free book on our Automotive Course. We've helped make automobile experts out of thousands of men who didn't know a carburetor from a universal joint when they came to our big training shops. How much does it cost? You'll be surprised to learn *how easily you can afford it*. Mail the coupon NOW for complete information.

**Greer College of Electrical Engineering**  
Dept. 901 2024 S. Wabash Ave. CHICAGO

## FREE

### Employment Service

Our employment department is ready to help you—while in training and for life. Day and evening classes. Low cost. Easy terms.

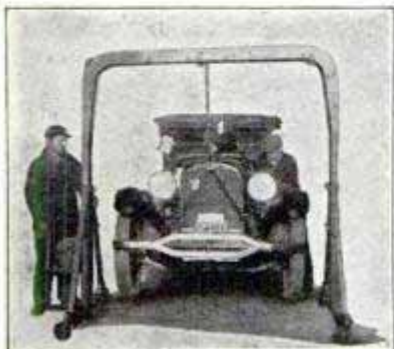

Using the "Wrecker Crane" in the Automobile repair department. Here you learn about all up-to-date auto equipment—by actually using it. Real experience on all makes of cars, under supervision of an expert.

ERWIN GREER, President, Greer College  
Dept. 901, 2024 S. Wabash Ave., CHICAGO.

Please send me your FREE BOOK and offer for  Electrical course  Automotive course  
It is understood I am not obligated in any way.

Name .....

Address .....





**O. C. MILLER**  
 Director  
 Extension  
 Work  
 American  
 School



## The American School

A million Dollar *No-Profit* Educational Institution, now offers men a *double* service—training for a specific job, then help in finding the job. For one small price, on terms of only \$5.00 a month, you are now assured of definite benefits, both in position and salary. Write for complete information—*today!*

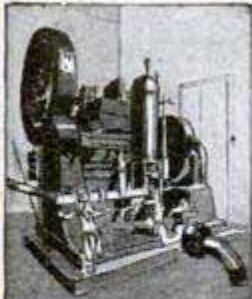

No machine can be built until the Draftsman first builds it on paper. My training prepares you for this work.



Never has the world seen anything like the building boom of today. This has created enormous demand for real Draftsmen.

# 5 BIG-PAY Branches

The big money in Drafting goes to men who specialize in Machine Design, or Electrical Drafting, or Architectural Drafting, or Structural, or Automotive. It is not enough merely to know *general* Drafting practice. You must know how to calculate and design and plan original work. You need many Engineering subjects to fill the kind of a Drafting position that pays \$60 to \$125 a week. The American School now includes this *specialized* training in its *Drafting* course.

## Costly Drafting Outfit Given!

Fine, imported instruments like these help you learn Drafting quickly and easily. These standard quality, full size instruments, board, table, triangles, T square, ink, protractor, etc., given to every student without extra cost.

O. C. Miller, Director Extension Work



*The American School*

Dept. D-674  
 Drexel Avenue and  
 58th St., CHICAGO

# 3 Drafting

*to prove you can*

We have invented a new, simplified way to teach Drafting—the first real improvement in Drafting home instruction in history. We want you to see a few of these new Job-lessons, try them, test your own ability to master them—without one penny of cost or obligation. For instance, you will see how we get away from the “copying” methods used in the past, so you develop into a DRAFTSMAN, instead of a “tracer.” See for yourself the ingenious new method which compels you to think, to solve problems, to do actual Drafting-room jobs from the very first lesson!

## A New, Rapid, Simplified Training

Copying drafting lessons prepares you to be only a “tracer.” This new “Job-Method” gives you actual drafting-room jobs in a new one-step-at-a-time way. With pictures which you can understand almost without reading the “lessons.” And that is why the American School-trained Draftsmen can qualify for a good job at big pay when they graduate.

## Win Success Thru Drafting

Drafting is easy, fascinating work. Short hours. Big pay. And the Draftsman is always in line for promotion to executive positions. This training is *complete*. It includes high school subjects (if you need them) and all the Engineering and Mathematics Drafting experts require.

## FREE Job Service!

The American School now offers its students and graduates, without cost, the services of an efficient employment department keeping in constant touch with employers of Draftsmen all over the U. S. We have placed hundreds of men in good, big-pay Drafting positions. We've made this training so complete, so practical, so easy to master, that our students are **bound to make good**. And so, because the demand for real Draftsmen continues to exceed the supply and because this training actually prepares men for good Drafting positions we back it with a **Free Employment Service**.



# Lessons *Actually* FREE

Learn at home in spare time!  
**Draftsmen Wanted!**  
**\$60 to \$125 a Week!**

70,000 fine jobs advertised last year. Get ready to fill one. Get out of the rut. Make something of

yourself. Plan your future in Drafting. Even if you have only common schooling, even if you know nothing of Drafting, we guarantee to make you a real Draftsman or to refund your money! Special surprise offer right now to the first 500 men who answer this ad—reduced price, easy terms. Coupon brings complete information.

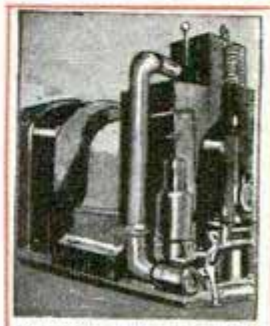

Electricity needs Draftsmen who know Electrical principles as well as general Drafting practice. I give you this training.



The demand for Draftsmen experienced in concrete and structural steel work is enormous. Many big-pay positions open.



Every great Auto factory employs Draftsmen who specialize in Automotive work — men who design bodies, plan engines, etc.

**I Will Make This Contract With You**



American School  
 —the Million Dollar  
 Educational Institution



- WHEN you enroll for our home-training in Drafting, we agree to give you:
1. Complete Drafting training, by the new Practice-Method.
  2. Professional Drafting Outfit, as illustrated.
  3. We will help you get a good Drafting position at a substantial increase in pay,

4. or we'll refund every cent of your money.

*O. C. Miller*  
 Director Extension Work

**Coupon Brings 3 Lessons FREE!**

Get them. Test your own ability to learn Drafting and get ready for a fine job and big pay. Coupon also brings surprise offer, and complete information about your opportunities for success in Drafting. Mail It Today!

**Read These Letters!**

**City of Chicago**  
 Department of Buildings  
 Gentlemen: The same day I received my diploma I got word that I was one of the two candidates who had successfully passed the examination for Deputy Commissioner of Buildings of the City of Chicago, a position paying \$3600 per year.

There were eight applicants examined besides myself, all men well known to the architectural and engineering profession. Seven of these failed to obtain a passing grade of 70%. My grade was 84.69. Inasmuch as I failed to pass this same examination three years before, my present success is mainly due to the knowledge gained through your School.

Yours very truly,  
**ROBERT KNIGHT**

**Got His Draftsman's Job**  
 "I wanted to let you know how I came out in getting that job at the Brownell Co., Dayton, Ohio. I was to start and have a trial at Drawing, and I am still in the Drawing room. The engineer seems to like the work I make, and also the other draftsmen. I thank the school very much for getting me in at this place, because your letter of recommendation helped me a whole lot to get the job."  
**BERNARD WEBER,**  
 730 St. Nicholas Ave., Dayton, O.

**Liberty High School**  
 Bethlehem, Pa.  
 Dear Sirs:—This is to thank the American School for all that you have done for me since I signed up for the Drafting and Design Course.

In the eight years since then, I have gradually climbed from the position of tracer to that of Head of the Department of Machine Drawing and Design in our magnificent new \$2,000,000 High School here, at many times the salary which I received at that time.

The officials of the Pennsylvania State Department, and Dr. Wm. C. Ash of the University of Pennsylvania, all claim that our Course in Drafting and Design is the best now being taught in this state. Every drafting graduate that we have turned out has proved successful, and one is now Chief Draftsman in a local steel concern. Yours sincerely,  
**J. S. LEAR**

**Has Charge of Large Jobs**  
 "Even before I had finished my course, I was put in charge of large construction jobs in different cities. I have been doing that ever since, and the jobs are getting larger all the time. I owe my success to the American School because of the knowledge I gained in mathematics and calculations."  
**ELMER L. LAMB,**  
 1306 Smith St., Peoria, Ill.

## 3 Drafting Lessons *Actually* FREE

**O. C. MILLER, Director Extension Work**  
**AMERICAN SCHOOL**  
 Dept. D-674, Drexel Ave. and 58th St., Chicago.  
 Rush 3 Free Drafting Lessons, Job and Raise Offer, complete information, money-back guarantee, etc., to prove I can become a real Draftsman at home in spare time.

Name.....  
 Street No.....  
 City..... State.....



# The Mysterious Masked Singer Who Was He?

Surely that glorious, golden voice must mean long years of training under some foreign master. And who would have dreamed that The Man Behind The Mask was one of their own crowd and who six months before could scarcely sing a note! How did he do it? How could he possibly, in so short a time, have developed this magnificent voice now that thrilled and amazed his friends?

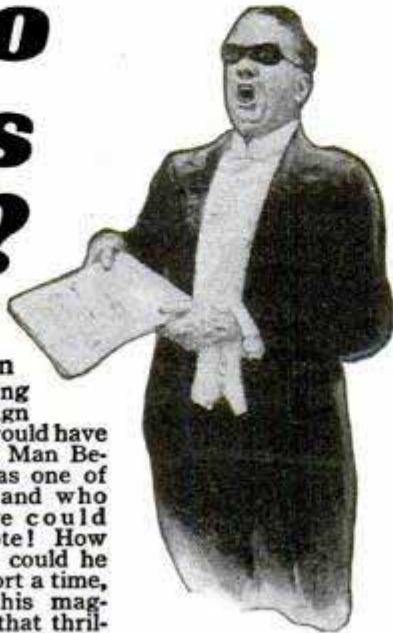

## I Guarantee to Improve Your Voice 100%

There is only one answer—Physical Voice Culture! Your vocal chords are the same in construction as those of Caruso, Garden or Martinelli. But YOURS are under-developed. Your Hyo-Glossus throat muscle has probably never been used. No amount of scale singing will ever develop this muscle. But scientific muscular exercise will. And only Physical Voice Culture—the amazing discovery of Prof. Eugene Feuchtinger can show you how. Now you can build a strong, magnetic, compelling voice that will be the marvel of your friends and open the door to Success and Fame.

## Scientific Voice Training

Prof. Feuchtinger accomplishes his surprising results by silent, muscular exercises that quickly bring strength and control of certain vital vocal organs, heretofore almost unknown to voice culture. No tiresome scale-singing! Practice these marvelous silent exercises in privacy. Soon you find your voice becoming stronger, richer, with ever increasing range. Thousands have done it. You can, too.

## Mail Coupon for "Physical Voice Culture" Free

Your voice has marvelous possibilities that you may not even suspect. "Physical Voice Culture" will reveal them to you. Send at once for this valuable, beautifully illustrated book. Read the astounding true stories of what others have done. Send Today! The Book is FREE!

**Perfect Voice Institute** 1922 Sunnyside Ave., Studio 13-56, Chicago

**Perfect Voice Institute, Studio 13-56**  
1922 Sunnyside Ave., Chicago

Please send me, FREE, and without obligation, Prof. Feuchtinger's new Book, "Physical Voice Culture." I have checked subject in which I am most interested.

Weak Voice  Singing  Stammering  Speaking

Name.....

Address.....

City..... State.....

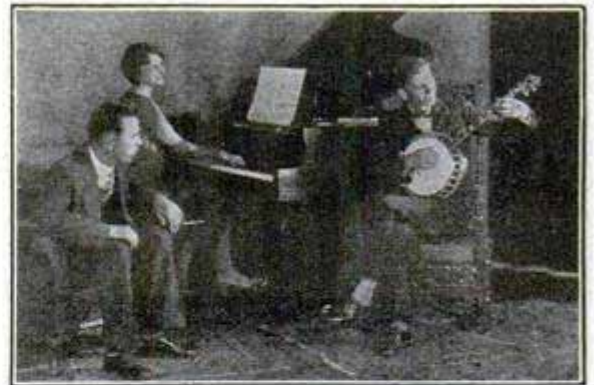

## You, Too, Can Easily Learn to Play

You need not sit on the sidelines and envy the popularity of others. You, too, can be sought after, popular, welcome everywhere. A few short months of fascinating study, right at home, in your spare time, with the wonderful National Academy Courses will give you the finest of all social accomplishments—the ability to play beautifully.

### Easy as A B C

You need know nothing about music to begin. We give you personal, individual instruction right from the start. You will be surprised and delighted to find that music can be made so easy and interesting. Over 200,000 successful Students, Musicians and Teachers endorse and recommend our methods. Courses in Piano, Violin, Trumpet, Voice, Banjo, Tenor Banjo, Spanish Guitar, Hawaiian Guitar, Organ, Mandolin.

### Send for Our Beautiful New Catalog, FREE

It will tell you all about this great School—now in its 25th successful year; our exceptionally low prices and easy terms, and how you can quickly and easily gain the pleasure, popularity and earning opportunities that Music will bring to you. Send for this wonderful book NOW—TODAY.

### NATIONAL ACADEMY OF MUSIC

Dept. 418 702 East 41st Street Chicago

## LEARN WATCHMAKING

and become independent. We help you secure a position.

Easy to learn. Send for FREE CATALOG.

ST. LOUIS WATCHMAKING SCHOOL, Dept. 5, ST. LOUIS, MO.

## FREE

### MUSCLE BUILDING BOOK

Illustrated book—64 pages, by world-famous physical director. Priceless secrets of health and strength. Become a muscular marvel. Have the body of a PANTHER-MAN. Rush name and address, TITUS, 105 East 13th St., Dept. 159, New York City



## Electrical Trades/Need Men

**LEARN** Automobile Starting, Lighting, Ignition, Storage Batteries, Armature Winding, House Wiring, Farm Lighting, Electric Welding, Electric Refrigeration, A. C. and D. C. Motors, Power and Light Switchboards, Radio.

**EARN** \$200 to \$400 monthly. \$320,000,000 paid in wages to electrical workers in U. S. last year. Get your name on the payroll this year. Easy to learn by actual work on real equipment.

FREE BOOK—Write today for book which explains the Coleman System of ten week courses.

WM. H. COLEMAN, President

**Coleman Electrical School**  
1628F MAIN ST., KANSAS CITY, MO.





HOMER H. MCKEE  
President  
Detroit Fidelity & Surety Co.



RALPH J. DALY  
Secretary-Treasurer  
Detroit Fidelity & Surety Co.



Home Office  
Detroit Fidelity  
& Surety Co.

# LaSalle Training Helps College Man to C. P. A. Degree

Ralph J. Daly was an engineer, and an excellent one. Graduated from the University of Michigan, he joined the engineering staff of the Central Union Telephone Co.—then for three years he taught engineering at the University of Pennsylvania.

But business attracted him—and he gave up teaching to enter the Detroit Trust Company. Here, however, he found himself a little more than marking time.

Mr. Daly saw that he needed a grasp of business principles and methods which his college training had not supplied. He recognized the ability of LaSalle to help him—as evidenced by the fact that LaSalle has trained more executive accountants, including Certified Public Accountants, than any other business training institution. He enrolled with LaSalle for home-study training in Higher Accountancy.

With the completion of his training, Mr. Daly obtained the C. P. A. degree—and thus at once identified himself

as a man fitted to do unusual things in business, and to do them well.

His progress, since his enrollment with LaSalle, has been marked—and rapid. Today he is Secretary-Treasurer of the Detroit Fidelity & Surety Company—a position which he credits largely to the practical training he got from LaSalle. "I feel that it was the one great factor," he writes, "which enabled me to find myself in the business world."

Send for Free Book "Accountancy, the Profession That Pays"

The man who has caught the vision of what Accountancy means in the business world—who would seriously fit himself for a high-salaried position—will not turn the page until he has clipped and mailed the coupon for complete information.

For men of this character LaSalle has prepared a 64-page book entitled "Accountancy, the Profession that Pays." It will pay you well to read it. —And LaSalle will send it to you free.

Balance the two minutes that it takes to fill out the coupon against the rewards of a successful career—then clip and mail the coupon—NOW.

A Valuable Service—  
Both to Employer  
and Employee

"In our business of guaranteeing the fidelity of trusted employees I am always favorably impressed with the man whose application shows his ambition to better equip himself by home study. Any educational institution designed to afford a practical business training and broaden the mental horizon is of immeasurable value. LaSalle Extension University, in offering such educational facilities, is performing a valuable service alike to the individual and his employer."

(Signed) Homer H. McKee, Pres.  
Detroit Fidelity & Surety Co.

LaSalle Training  
Yields Big Returns

"It is indeed a pleasure to recommend your Higher Accountancy course of study to young men and women entering business or to those desiring to obtain the degree of Certified Public Accountant. From my own experience and progress, as the result of your training, I feel I can assure any student who will faithfully pursue the course, that his returns for the expense and effort involved, will be many fold."

(Signed) Ralph J. Daly, C. P. A.  
Secretary-Treasurer  
Detroit Fidelity & Surety Co.

## LASALLE EXTENSION UNIVERSITY

THE WORLD'S LARGEST BUSINESS TRAINING INSTITUTION

FIND YOURSELF THRU LASALLE!

### LASALLE EXTENSION UNIVERSITY

Other LaSalle Opportunities: LaSalle opens the way to success in every important field of business.

If more interested in one of the fields indicated below, check here:

- Business Management: Training for Official, Managerial, Sales and Departmental Executive positions.
- Modern Foremanship and Production Methods.
- Personnel and Employment Management.
- Modern Salesmanship.
- Railway Station Management
- Commercial Law.
- Traffic Management—Foreign and Domestic.
- Expert Bookkeeping.
- Business English.
- Industrial Management.
- Commercial Spanish.
- Effective Speaking.
- Law: Training for Bar; LL.B. Degree.
- C. P. A. Coaching for Advanced Accountants.
- Modern Business Correspondence and Practice.
- Banking and Finance.

Dept. 964-HR

CHICAGO

Opportunities in Accountancy—Check below and we will send you a copy of "Accountancy, the Profession that Pays," also copy of "Ten Years' Promotion in One," all without obligation.

Higher Accountancy: Leading to position as Auditor, Comptroller, Certified Public Accountant, Cost Accountant, etc.

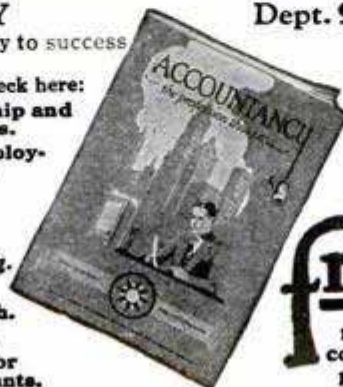

free!  
mail coupon NOW

Name.....  
Age..... Present Position.....  
Street.....  
City or Town.....





# DRAFTING ENGINEERING, ELECTRICITY and ARCHITECTURE

## CHICAGO TECHNICAL COLLEGE

One of "America's oldest and largest schools of specialized engineering" offers you a maximum of practical training in a minimum of time, here at Chicago, the country's building and engineering center. Technical training of college standard for men who have neither the time, money nor preliminary education to attend a university. Each year more than 1000 men and women enroll in day and evening classes.

### Short, Intensive Training

practical in every respect, puts you quickly into a high salaried position. Many of our students are assisted to responsible positions before graduation . . . they earn while they learn.

#### In Spare Time At Home

If you can't come to Chicago, learn Drafting at home. Your spare time is enough. Same practical course. Quick, easy—yet thorough.

#### Trial Lesson FREE

Test yourself and see how easy you can learn Drafting by the Chicago Tech. method. Trial lesson sent free if interested in homestudy. Address Dept. M-200.

COURSES are arranged to suit your needs—2 year diploma; 3 year B. S. degree; special 3 and 4 months' short courses adapted to the individual. Expert instructors actively at work in the very professions they teach.

Tuition low, terms easy. Enter any time. Day and Evening Classes.

## Write for FREE 84 Page Blue Book

It tells about all the courses . . . fully describes them; about the great demand for Chicago Technical College trained men; about college athletics and other interesting facts you'll want to know. Gives you a vivid picture of what you may expect at this leading technical college. There is no obligation. Send for this free Blue Book today . . . now!

Address Registrar M-75

**Chicago TECHNICAL College**  
Dept. M-75 118 East 26th St., Chicago

## Get More Money and Get it Faster!

It isn't so hard - if you really try. For 20 years, The B. E. I., operated by Bedford Branch Y. M. C. A., has been helping men to win promotion, to earn more money, to get ahead in business and in life. Surely we can do for you what we have done for so many others.

Put the great forces of this organization behind your ambition to succeed, and you can break down every obstacle that can stand between you and success.

## Learn AUTO MECHANICS or other IMPORTANT TRADES at BROOKLYN ENGINEERING INSTITUTE

The B. E. I. affords superior training at minimum cost, in addition to privileges not easy to duplicate anywhere in America. At this school you get—

Small classes, permitting individual instruction from teachers with a life-time of experience in their respective fields.

Practical work in \$200,000 plant.

Free use of gymnasium, swimming pool, etc., and use of billiard room, bowling alleys.

Attractively furnished private sleeping quarters for out of town students.

Position secured through placement bureau.

Lower cost per week than at any school of the same calibre and easiest payment plan.

If you have a leaning toward motor cars, our auto mechanics course, at small outlay, will equip you to live a successful life. If other courses are more in your line, observe the wide choice of careers at this school.

BATTERY REPAIR - ELECTRICITY - BRICK-LAYING - PLUMBING - WELDING - SHOE-CARD WRITING - WINDOW DRESSING - REAL ESTATE - INSURANCE - RADIO MECHANICS - TILE SETTING - PLASTERING - FINE AND COMMERCIAL ART - ARCHITECTURAL AND MECHANICAL DRAWING



Insure your own financial progress - now. Write post-card, phone or call for free catalogue. Bedford Branch Y. M. C. A. - 1115 to 1125 Bedford Avenue, Brooklyn, New York City.

**LIVE, LEARN, WORK and PLAY  
in BROOKLYN-The Heart of New York City**

## A Great Book Free with this pay-raising library!

For a short time only we will give every subscriber to the New Library of Machine Shop Practice a copy of French's Engineering Drawing—the greatest book on mechanical drawing ever written. This book makes drawing as plain as day—tells you all about instruments, plans and methods—and prepares you to handle any drawing job you will ever have to do. It comes to you absolutely free with

## Machine Shop Practice

9 volumes — 3065 pages — 3608 illustrations  
(A combined home study course and reference library)

The New Machine Shop Library is written for practical men. It gives you the best methods for every kind of machine shop work. It explains machine tools and their operation, drawing and design, tool work, gears and grinding, jigs and fixtures, automatic screw machines and their tools and all of the mathematics you will ever have to use. It is plainly written, completely illustrated—the very best kind of help to the machine-shop man who wants to advance himself.

Sent

**F  
R  
E  
E**



**No money down—  
only 7c  
a day**

### FREE EXAMINATION COUPON

McGraw-Hill Book Co., Inc., 370 Seventh Ave., New York

Send me for 10 days' free examination the New Library of Machine Shop Practice. If satisfactory, I will send you \$1.50 in 10 days and \$2 monthly until the special price of \$19.50 is paid. If not wanted, I will return the books at your expense.

On receipt of my first payment of \$1.50, it is understood that I am to receive, free of charge, a copy of French's Engineering Drawing.

Signed.....

Address.....

City and State.....

Position.....

Employer..... P.M. 9-1-27





Mr. M. T. Main, of Kenosha, Wis., whose astonishing experience with KRISS-KROSS appears below.

Improved Model July 1917



An Amazing Record of Keen Shaves

Rhodes Mfg. Co., St. Louis, Mo. Gentlemen:

I am pleased to inform you that I have been using one of your KRISS-KROSS Stropplers for the past five years. So far I am still on the same blade, and by the looks of things this blade will outlast me, as it is still the same as when I started using it.

Wishing you continued success, I am Yours very truly, (Signature) M. T. Main.

I Shaved 5 YEARS With This One Blade!

Now Comes the Most Astonishing Record in the History of Shaving! Mr. M. T. Main, a Business Man of Kenosha, Wisconsin, Bought a KRISS-KROSS Stroppler Five Years Ago. Today He Reveals the Fact That He Is Still on His First Blade, KRISS-KROSS Having Kept It Sharp and Keen for More Than 1500 Cool, Slick Shaves! Get Details and Generous Offer That Solves Your Shaving Problem Forever!

THE amazing experience of Mr. M. T. Main, who used but one blade for five years with the aid of KRISS-KROSS, is merely the climax of a series of phenomenal revelations made unsolicited by KRISS-KROSS users from all parts of the U. S. A. What is this sensational device that prolongs the life of any blade for months and years—that eliminates 83% of shaving costs—that gives men the coolest, slickest shaves they ever experienced and ends raking and scraping forever?

the diagonal. Pressure decreases automatically to feather-like finishing stroke. Eleven seconds and you are ready for the finest shave of your life.

New Kind of Razor FREE

Why not let KRISS-KROSS serve you as it is serving over 1,000,000 delighted American shavers today? No need to hesitate, especially since by acting at once you can get free a new kind of razor that will surprise and delight you. Instantly adjustable to any one of three shaving positions—straight, T-shape, or diagonal (new way). The diagonal stroke, exclusive with KRISS-KROSS, cuts beard resistance 45%. This razor comes with five ultra-keen, hollow-ground blades that will last indefinitely. Get yours while this generous offer still holds good. The coupon brings illustrated description and full details without obligation. Mail it today!

The Most Amazing Shaving Invention Ever Patented!

KRISS-KROSS marks such a radical advance in shaving comfort and economy that thousands refer to it as a "Blade Rejuvenator." And no wonder, since it almost literally makes a new blade out of an old one. Operates on an entirely new principle. Actually duplicates the stropping stroke of a master barber. Eight magic leather grooves strop your blade (any make except Durham Duplex) on

\$30-\$40 a Day Made by Agents!

KRISS-KROSS offers astonishing rewards to men who become authorized agents under our new plan. Big commissions and generous bonuses make it easy to earn upwards from \$100 a week. Emil Ham of California made \$200 his first four days—H. King of Massachusetts cleared \$66 in a day! Jas. E. Tillotson of Nebraska paid for a 30-day motor trip vacation out of KRISS-KROSS orders taken enroute. In one day his profits amounted to \$114! Even spare time workers, office and factorymen make \$8-\$12 a day extra just showing KRISS-KROSS to friends and fellow-workers. W. S. Benson made over \$50 in three evenings. Bradford \$40 on a Saturday afternoon. Get details of permanent, dignified position. Check bottom line of coupon and mail it now for quick results.

Rhodes Mfg. Co. Dept. M-372 1418 Pendleton Ave., St. Louis, Mo.

Without obligating me in any way, please send complete illustrated description of KRISS-KROSS Stroppler and details of your introductory offer which gives me a 3-Way Razor Free.

Name.....  
Address.....  
City..... State.....  
( ) Check here if interested in making money as an Authorized KRISS-KROSS Representative.

Rhodes KRISS KROSS STROPPER Rhodes Manufacturing Co. Dept. M-372 1418 Pendleton Ave. St. Louis, Mo. World's Largest Mfr. of Mechanical Stropplers





## Ben Dale received \$200 for this drawing

*You might have made it*

BEN DALE is one of the best known commercial artists in New York. You see his work in all the leading magazines. You perhaps know that his income is "more than \$15,000 a year."

Ben Dale always had a natural talent for drawing, yet he has not always been the great artist that he is today. Time was when he scarcely could draw a straight line—when he knew less about the correct handling of line and wash and color than you do right now.

But he worked and studied, and "drew and drew" as he puts it, until he trained his hand to put down on paper the dream pictures that he saw so clearly in his mind.

All of his great creative ability might have been wasted without the right kind of training—without hard work.

If you have a natural talent for drawing, you have a priceless gift that is given to but few men and women. By all means take steps to develop it before the years fly by and it is too late.

Write today for the new illustrated catalog describing the art courses of the International Correspondence Schools. You will find the booklet interesting and helpful. It may, perhaps, be the means of changing your whole life.

**International Correspondence Schools**  
Box 5669-E, Scranton, Penna.

Without cost or obligation, please send me your new illustrated Art Catalog. I am checking the subject in which I am most interested:

<input type="checkbox"/> Magazine and Book Illustrating	<input type="checkbox"/> Show Card Lettering
<input type="checkbox"/> Commercial Art	<input type="checkbox"/> Handicrafts Designing
<input type="checkbox"/> Cartooning and Caricature	<input type="checkbox"/> Industrial Designing
<input type="checkbox"/> Newspaper Illustrating	<input type="checkbox"/> Interior Decoration
<input type="checkbox"/> Cover Designing	

Name.....

Address.....

# ELECTRICITY

## Practical-Technical TRAINING

Great demand for practical-technical electricians and engineers. A brilliant future awaits you. A high salaried position or a profitable business of your own; these may be yours through our PRACTICAL-TECHNICAL courses. Opportunities unlimited.

Finlay condensed method now in 25th successful year trains head and hand. Thousands of high salaried graduates throughout the world testify to the success of Finlay training. Extensively equipped laboratories and shops. Faculty of recognized experts. One and Two Year courses in Electrical Engineering open in September; 12 Weeks courses in Practical Electricity and Power Plant Operation open at any time. Degrees, diplomas and certificates of efficiency awarded. Students assisted to positions.

SEND FOR FREE CATALOG

**FINLAY ENGINEERING COLLEGE** Fall term starts September 15th  
123 Finlay Bldg. Kansas City, Mo.

**Learn to PAINT SIGNS and SHOW CARDS**

We quickly teach you by mail, or at school, in spare time. Enormous demand. Big future. Interesting work. Oldest and foremost school.

**EARN \$50 TO \$200 WEEKLY**

John Vasson, N. Y., gets \$25 for single show card. Crawford, H. C., writes: "Earned \$200 while taking course." Don't delay. Send today for complete information, samples and guarantee.

**DETROIT SCHOOL OF LETTERING**  
150 Stimson Ave. Est. 1899 DETROIT, MICH.





## A Milo Bar Bell Will Bring True Your Dreams of Physical Perfection

You can't tell us you haven't dreamed more than once of being physically powerful and beautifully built. You can't tell us you don't believe physical strength and stamina are as important as brains in making a success of your life. But you could tell us, if you cared to, why in the world you haven't tried our Bar Bells as a means of making your ambitions of physical power come true. We can't understand this, for the MILO BAR BELLS and the MILO COMPLETE COURSE on how to use them compose the surest and most logical means of getting rapid and life-lasting results.

Don't take our word for this. Ask any one who knows; ask any one who has ever seen or used a Milo Bar Bell. Our long experience, the thousands of physically perfect men we have already produced, and the additional hundreds we are producing right along are a few of the reasons that make us positively sure of our methods and make you doubly sure of Enormous Strength and Superior Physical Proportion. Your results will equal your wildest dreams.

### Get Away From the Idea That Bar Bells Mean Hundreds of Pounds to Be Lifted

It is true that our Bells do run into the hundreds of pounds. This is so because you will eventually need greater weight to cope with your ever-increasing strength. But the Milo Bells are adjustable also. This means that no matter how puny you are now, a weight well within your present strength can be had. Furthermore, your physical condition is taken into consideration and you are started off on the correct weight and exercises by one of, if not the best authority on physical training with a Bar Bell. He personally assigns you your exercises, weights to start with, and any other special information that pertains to your individual case, which he is exceedingly capable of giving you.

#### OUR GUARANTEE IS BROAD

If our Bells, Course and personal service to you are not what we say they should be, your money will be refunded within ninety days of purchase.

#### SEND FOR OUR BIG FREE BOOKLET

THE MILO BAR BELL CO., DEPT. PM600  
2747 N. PALETHORP ST., Philadelphia, Pa.  
Gentlemen: Please mail me, without charge or obligation on my part your free booklet, "Health, Strength and Development and How to Obtain Them."

Name.....  
Address.....  
City.....  
State.....





# “Every 3,000 Miles This Amazing Little Device Buys Me a New Tire...**FREE**”

“THE money I save on gasoline more than keeps me in new tires. Figure it out . . . I was getting 13 miles per gallon on my Nash. With gas at 18c plus 2c tax it cost me \$46 to drive, 3,000 miles. Now I'm getting better than 26 miles per gallon. It takes just half the gas and I save \$23 to \$25 every 3,000 miles—more than the price of a new tire.”

No matter what make of car you drive, the Stransky Vaporizer is unconditionally guaranteed to give you 50% to 100% more miles per gallon or it costs you nothing. As a matter of fact, it is not uncommon for the Stransky Vaporizer to more than double gasoline mileage!

## Note These Records

Forty-three miles per gallon from a Chevrolet, reported by F. S. Carroll. Fifty-seven miles on one gallon in a Ford, reported by J. T. Jackson, Michigan. Forty miles per gallon in a Dodge from Brownsville, Tex., to Tampico, Mex., reported by T. L. Brown.

## Proved by Two Million Owners

Records like these are reported in every mail for every make and model car . . . from 72 different



### 43.8 Miles Per Gallon

Mr. M. E. Miller, Kansas City, writes: “You people claim a saving of 25 to 50% of Gasoline. I have subjected the Vaporizer to a severe and thorough test. After installing one on a Chevrolet, I found I was obtaining 43.8 miles to a gallon whereas formerly I had been getting only 19.5. That is not a saving of 25 or 50% but 124%, so you see that the actual test surpasses your claim.”



### FITS ANY CAR IN 5 MINUTES

Anyone can install this device in 5 minutes. Simply loosen one connection to the intake manifold with a wrench. You can do the rest with your fingers!

countries . . . the world over. More than two million Stransky Vaporizers have been installed.

### Easily Installed

No bigger than a dollar coin—no more expensive than a good wrench—no more trouble to attach than a fan belt! Attaches to the intake manifold of any car in five minutes. Anyone can do it.

### Less Gasoline—More Power

The vaporizer supercharges your gasoline after it leaves the carburetor. Completely vaporizes the gasoline. Under this ideal condition you get more compression out of less gasoline and a more complete explosion. Both power, pickup and speed are noticeably increased. Starting is not interfered with as the Vaporizer automatically shuts itself off when the motor is idle.

### Make This Test

Test the Stransky Vaporizer on your car—and expect results that will amaze you! Double your mileage—get flashing pickup and power—forget carbon troubles, sluggish motor and fouled spark plugs from over-rich mixture—and save enough on your gasoline to more than keep you in tires. These results are guaranteed or the test costs you nothing.

Mail the coupon below for full details, guarantee, and amazing trial offer, which is even more remarkable than we can tell you here. There is no obligation whatever.

## \$4 an Hour for Salesmen, Agents, and Spare Time Workers

Men are making wonderful earnings showing the Stransky Vaporizer to car owners in spare time and full time. Sells fast under our guarantee. Foster made \$357 in two weeks. G. F. Fuller earned \$114 in 5 days. Eberlein sold 23 Vaporizers in 35 minutes! J. W. Cronk actually earned \$51 in an hour. You should be able to earn at least \$3 every hour you put in. We offer demonstrators one Vaporizer FREE, under our unusual offer. Get full details. Simply mail coupon at once.

**J. A. STRANSKY MFG. CO.**  
L-10 Stransky Block, Pukwana, So. Dakota

J. A. Stransky Mfg. Co., L-10 Stransky Block, Pukwana, So. Dakota.

Without obligation send me full details of your free trial offer.

Name.....

Address.....

City..... State.....

( ) Check here for Distributor's Sample Offer and the selling plan.



# PAIN and DISEASE

Quickly Conquered by

## VIOLET RAY



Let us tell you how thousands of men and women suffering from rheumatism, neuritis, paralysis, nervousness, skin diseases, headaches, constipation, sprains, prostate trouble, goitre and many other ailments, even hay fever and asthma, have found quick relief—new health and vitality with this marvelous, scientific invention. Pains vanish almost instantly.

# Violetta

For Health—Beauty—Vigor

Endorsed and used by hospitals, sanitariums and physicians. Every home can now have one. Saves hours, days, months of suffering. No medicine. Painless, pleasant treatment. Only the violet ray can penetrate to every nerve affected. Simple, safe, painless—anyone can use VIOLETTA. Why suffer pain and poor health when you can try VIOLETTA 10 days FREE.

### This Book FREE

Tells all about violet rays—how this marvelous discovery by Nikola Tesla, the electrical wizard, now brings this mysterious curative power to all. Contains many astounding testimonials from our thousands of satisfied users. Send for the facts and our liberal trial offer today. Mail the coupon now.

VI-REX CO., Dept. 931  
2304 Warren Avenue, Chicago



VI-REX CO., 2304 Warren Ave., Dept. 931 Chicago

Please send me your free book on Violet Rays and details of your 10 days' free trial offer.

Name.....

Address.....

City.....State.....

Ailment.....

# Why Good Dancers Are Popular

EVERYONE admires and wants to dance with the person who knows the latest steps. There is no need of being a wallflower! By my remarkable new easy method anyone can learn the newest dances at home in a few hours. Much less expensive than from a personal teacher. No music or partner needed. So simple even a child can learn quickly. **Almost one half million have learned dancing by mail.** Your own success is guaranteed.

To prove I can quickly and easily make you an accomplished dancer, I will send you FREE my 32 page book and TEST LESSON. To pay the cost of mailing, handling, etc., send 10c. Learn in private—surprise your friends. Act now and be a good dancer soon!

ARTHUR MURRAY, Studio 728, 7 East 43rd St., NEW YORK



Posed by Edna Murphy and Arthur Murray

# Learn to Mount Birds



Learn at home by mail, to mount birds, animals, game heads; tax furs, make rugs and robes. Complete lessons. Easily and quickly learned by men, boys and women.

**FREE** Write today for Free Taxidermy Book. Tells all about it. Every Sportsman, Hunter, Trapper and Nature lover should know this wonderful fascinating art. Save your trophies. Big profits. Success guaranteed. Our school is 20 years old—100,000 graduates. Investigate today. Write for Free Book.

Northwestern School of Taxidermy

9376 Elwood Bldg., Omaha, Neb.

# LEARN MECHANICAL DENTISTRY



In 3 months Earn up to \$5000 a year

FREE EMPLOYMENT SERVICE enables you to earn while learning this new money making Profession. Age no barrier and no previous training required. You learn by doing actual work in rubber and gold. Easy terms. Individual instructions. Day or night sessions. Railroad FARE allowed—no extra cost. Write Secretary.

NEW YORK SCHOOL OF MECHANICAL DENTISTRY  
147 W. 33rd Street New York

SEND FOR FREE BOOK



# Earn \$75 Weekly Building Radio Sets

Join the Association! We train you to build and repair radio sets—start you in business—enable you to earn \$3 an hour upwards. **Free 5-Tube Radio Set to Members.** Write for special limited-time plan whereby your membership need not cost you a cent. Write today!

RADIO ASSOCIATION OF AMERICA

Dept. PM-9

4513 Ravenswood Ave., Chicago, Ill.



# CAN'T PUNCTURE IT!

NO WONDER AGENTS MAKE \$61 A DAY

Just imagine driving 987 nails into an ordinary air-filled tire without a single leak! An amazing new tire fluid now heals punctures while driving—and brings agents \$75 to \$150 a week. Outheart made \$157 in two days. Every auto owner wants to buy on sight. And no wonder!

**FREE SAMPLE**—The inventor wants agents to help him introduce his discovery and offers to send you test samples at his own risk. And if you are not amazed and delighted, he will actually pay you for your time and trouble in testing them. Get details at once. Drop a postal tonight!

AIR-STOP MFG. CO.  
1526 Hewitt Bldg., Des Moines, Ia.



# FREE BLUE PRINTS

AND FREE BOOK "HOW TO READ BLUE PRINTS"

SHOW YOU THE WAY TO

# 9 BIG PAY JOBS

- |  |   |
|--|---|
| <b>1</b> Building Superintendent—\$5,000 to \$12,000 | <b>6</b> Building Estimator—\$6,000 to \$10,000                               |
| <b>2</b> Building Inspector—\$4,800 to \$8,000       | <b>7</b> Real Estate Expert—\$5,500 to \$12,000                               |
| <b>3</b> Appraiser—\$6,000 to \$10,000               | <b>8</b> Construction Foreman—\$4,500 to \$8,500                              |
| <b>4</b> Material Buyer—\$5,000 to \$7,500           | <b>9</b> CONTRACTOR AND BUILDER IN A BUSINESS OF YOUR OWN—\$5,000 to \$12,000 |
| <b>5</b> Material Salesman—\$5,000 to \$12,000       |   |

**FIND OUT HOW**  
Easy it is to Make  
**\$4,500 to \$12,000 a Year**

Learn to read Blue Prints this amazing new way! Get into the world's richest industry—Building! See how quickly and easily you can train to make \$4,500 to \$12,000 a year! My FREE Book "How to Read Blue Prints" discloses all the so-called "mysteries" of Blue Print Reading—also gives some startling facts about the nine best jobs in America. Don't send one penny—just mail the coupon!

**N**O longer need you spend years trying to pick up the "mysteries" of Blue Print Plan Reading. For now a quick, sure practical method has been perfected that has made thousands of men Blue Print Experts in a surprisingly short time.

This is no ordinary "school course." It is practical from start to finish. It is based on many sets of real Blue Prints—plans that would cost thousands of dollars if purchased from architects. Twenty famous experts in all lines of construction work talk over these Blue Prints with you in plain simple language. Show you every detail. Explain every short cut. Tell you the "secrets" of quick, accurate estimating. Explain Superintending. Give you for the first time many inside facts and money-making methods used by the "Giants" of the Building Industry.

This is the kind of training that quickly puts men into \$4,500 to \$12,000 a year jobs—or into profitable contracting businesses of their own. Yet now you get it right at home in only 2 or 3 months. It requires no extensive education. If you can read and understand what is written here you can easily master it.

See what this training has done for others: Bartholomew, Calif., became a contractor at an in-

crease of over 300% his first year; Blair, Okla., stepped up to Superintendent at 100% increase; Dickerson, R. I., increased his salary 700% in 12 months; Marchand, La., says "My income has increased 200% and I now have more contracting work than I can do."

Over seven billion dollars will be spent this year in new construction! No wonder then, such tremendous opportunities are open to you when you have this "head-work" training in Blue Prints.

If you want more money—real big money! Print" job in Building, Clerk or Salesman, Carpenter or Bricklayer, here is the one field where there are unlimited opportunities for advancement.

So accept my FREE gift of a complete set of real working Blue Prints, and my fascinating Book "How to Read Blue Prints" that tells all the interesting and instructive facts about Blue Print Plans. Don't send one penny—pay no C. O. D.—It's all FREE. Just fill out and mail the coupon today—NOW!

Then choose a "Blue

Chicago Technical College



**TWO BOOKS also**

**FREE**

#### IF YOU LIVE NEARBY

Visit our big day or evening school attended by over 1000 Builders. You can get the same training at home by mail—same plans, lessons and instructor. Your spare time is enough.

**Chicago Technical School for Builders—Dept. M-140, Chicago Tech. Building, 118 East 26th Street, Chicago, Ill.**

Please send me your free book, "How to Read Blue Prints," and complete set of real Blue Prints. I understand these are mine to keep without obligation. It is also understood that no salesman will call on me.

Name.....

Address.....

City.....State.....

Age.....Occupation.....

**Chicago Technical SCHOOL for BUILDERS**

Dept. M-140, 118 East 26th St., Chicago, Ill.







# Switch

If you are now earning less than \$40 a week, if you're short of schooling, you'll have to face these questions, sooner or later:

What are your chances in your present line of work? How much more will your job pay you next year? Can you overcome the handicaps of neglected education? Will you get "fired" when times get bad?

You may not like your own answers to these questions. And if you don't, my advice is, GET INTO A DIFFERENT

FIELD where there are plenty jobs, big salaries and real opportunities for advancement.

**ELECTRICITY**—the wonder-industry offers you such unlimited opportunities. I'll prove that to you here. And I'll tell you how you can SWITCH TO ELECTRICITY without losing a day's time or a dollar's pay.

## Electricity Offers You Amazing Opportunities

The map on the next page shows 112,000 miles of electric trunk lines, but that's just to carry the "juice" from the power plants to the homes and factories and shops and skyscrapers and farms of the U. S. The map can't show the million USES of electricity, the millions of men already employed at high wages in this fascinating industry, nor can it even suggest the future of Electricity. Marconi, Edison, Insull and other leaders say Electricity is still in its infancy! And that men who enter the field TODAY have a bigger chance, even, than the "pioneers" of 30 years ago.

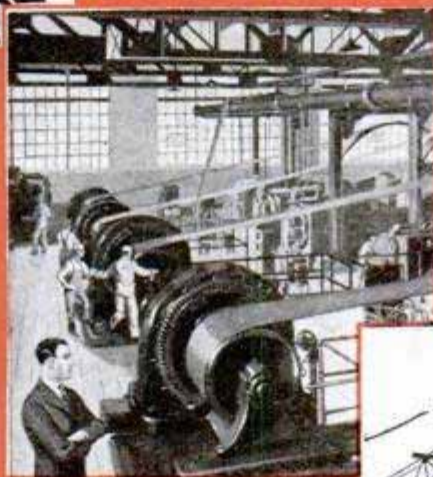

Great power-plants like these don't run themselves. It takes men, trained men, highly paid men to design and install, to manufacture and operate, to repair and manage the thousands of central stations or privately owned electrical power plants in America.



## I will help you get a well-paid job — or money refunded

You don't need to be a high-school or college graduate to succeed in Electricity. I have placed hundreds of men in fine electrical jobs and I'll be glad to tell you how I can help you to get a well-paid electrical position. Mail coupon for the most remarkable offer ever made to ambitious men.

## 29 Executives

—men from Westinghouse, Allis-Chalmers, Western Electric, General Electric, Commonwealth Edison and other great corporations and the leading Universities of the U. S.—helped us develop a remarkable service for preparing and placing ambitious men in fine electrical positions. It will pay you to get all the facts of this startling service. Coupon on next page brings them.

The railroads are turning from steam to electricity. Notable installations are on the C. M. & St. P. in the "Rockies" and in New York City terminals. The Rubber industry is 80% electrified—machinery is 81% and the steel industry 54% electrified. 14 million homes in the U. S. are wired for electric light. Radio is a billion dollar "baby" of the industry, only 6 or 7 years old commercially. Even this entire magazine is not big enough to contain all the interesting facts of the importance of the electrical industry.

**Chief Engineer Dunlap, Electrical Division,**



# to Electricity

— World's Greatest, Fastest Growing Industry

Even electricians and skilled electrical mechanics are earning \$15 to \$20 a day in the big cities. And the EXPERTS are getting more than that. In no other line is there the tremendous need for men. No other great industry continues to grow so rapidly. *Come into electricity* and your future is SECURE!

**Many \$60 to \$125 a Week Jobs!**

Chief Electricians, Superintendents of Electric Power Plants, Electrical Construction and Installation Experts, Electrical Contractors, Electrical Engineers—are sitting on top of the world these days. The demand is bigger than the supply. That is why I am urging men to come into Electricity. Here they can have their chance of many fine positions. Here they are sure of big pay. Here they can bank on rapid promotion.

The Electrical industry has ridden through wars and panics without a backward step. You never hear of the men in an Electrical plant getting "laid off." That's because the use of Electric current is growing every minute. Whether times are good or bad we continue to light our homes and ride in street cars and turn over machinery with Electric power motors.

This is the ELECTRICAL AGE. And you'll be wise to hook-up with its basic industry.



Radio, telegraph, telephone. Now pictures come over the air electrically. Much transportation, all communication, over half of all industry is Electrical.

**112,000 miles** of Electrical trunk-lines in the U. S. Super-power in voltage is carried hundreds of miles. Giant hydro-electric plants are dotting the map too. Get my free book and get more fascinating facts about this most interesting industry.



**Confidential Surprise Offer**

to men earning less than \$40<sup>00</sup> a week

I am prepared to enter into a written contract with any ambitious man who seeks a fine, well-paid Electrical job. To help him get ready AND TO HELP HIM GET PLACED.

We are now bound by similar agreements to deliver this pay-raising JOB-SERVICE to over 15,000 men. Backed by our entire resources of over a million and a half dollars.

I will show YOU how YOU can break into the giant electrical industry, how to qualify for and GET a wonderful position, paying at least 50% more than you earn today. And offering opportunities for advancement that are simply dazzling.

All without a penny's risk to you—I promise you that.

This offer is for ambitious men only. Lack of schooling will not bar you. Lack of ready money will not bar you. Send me the coupon and I'll give you the chance to cash in, too.

Chief Engineer Dunlap,  
Electrical Division  
The American School,  
Dept. E-674,  
Drexel Avenue & 58th Street,  
Chicago.

I may want to SWITCH to Electricity.

I am ambitious. Send Confidential Surprise offer, to.....

Address.....

Age..... Occupation.....

**The American School** Dept. E-674, Drexel Ave. and 58th St., Chicago, Ill.



# This Home \$28<sup>00</sup> a Month!



## Pay Like Rent

Now you can build your Liberty Home and pay for it like rent—less than rent! Liberty just perfected an amazingly thrifty time payment plan by which you can get complete materials for this beautiful home for only \$207 down and \$28.00 a month. Cash price \$796. 5 large rooms, bathroom, 2 closets, roomy porch. 43 other homes from \$14.00 to \$45.00 a month.

## No Red Tape—No Mortgage—No Delay

No extra charges beyond monthly payments. Price includes all highest quality lumber cut to fit, doors, windows, stairs, high grade interior woodwork, lath, shingles, hardware, glass, paints, nails, etc., complete. Working plans, instructions Free. All materials fully guaranteed. Freight paid to your station.

*We pay Freight*

Freight paid east of Mississippi and north of Mason-Dixon line, also Minnesota, Iowa and Mo.



## FREE HANDSOME BIG BOOK OF HOMES—FULL COLOR—WRITE

Describes 44 home plans from the cozy 4, 5 and 6-room bungalows to the 9-room 2-story. Shows how skyscraper system of building will give you solid, substantial, permanent home at 30 to 40% saving. No waste, no worry. *Your rent will pay for your home.*

**Owners Save \$200 to \$1500**  
No middlemen—you deal direct with mill and save 4 big profits. Mrs. Coombs saved \$1000. B. A. Anderson saved \$500. F. E. Davis saved \$1000 to \$1500 the Liberty way. You can do as well. 30 years of square dealing behind our guarantee. Write or send coupon for Free Book Today.

**Lewis Mfg. Co.,**  
Dept. 129, Bay City, Mich.  
Please send me Free your new Book of Homes, illustrated in color. I understand that this puts me under no obligation whatever.

**LEWIS MANUFACTURING CO.** Dept. 129 BAY CITY, MICH.

**Learn Watchwork, Jewelrywork and Engraving** A fine trade commanding a good salary, and your services always in demand. Address **Horological Institute, PEORIA, ILLINOIS**, for our latest catalog.

## YOU CAN OIL PAINT

Amazing new method teaches men or women to earn after first lesson. OIL PAINT photos—portraits, landscapes or art subjects. Earn \$18 to \$50 and more a week. OIL PAINT OUT-FIT GIVEN. Send now for free illustrated book. PICTORIAL ART STUDIOS Inc. Dept. MP, 2926 Broadway, Chicago, Ill.

# Want Some Money?

*Here's a wonderful way to get it*

Our beautifully illustrated book tells how. It tells all about our new methods of art decoration, art treatment and how anybody can learn without previous training or experience. It contains page after page of handsome color illustrations of what you can make and sell. You can make good money and this book is **FREE**. All supplies are sent by us with the instructions and many have made \$25 the first week. Some society women have taken up this work for their own amusement.—Either way, pleasure or profit. It's the most delightful home work you can imagine. Write Now for your copy of this valuable book: it's FREE.



## Fireside Industries

DEPT. 66-M, - ADRIAN, MICH.

# Travel on "Uncle Sam's" Payroll \$158 TO \$225 MONTH

Mail Coupon Before You Lose It

**FRANKLIN INSTITUTE, Dept. N-174, Rochester, N. Y.**

Sirs: Rush to me, without charge, (1) Full particulars, telling how to become a Railway Postal Clerk; (2) send copy of 32-page book, "How to Get U. S. Government Jobs," with list of many positions obtainable.

Name.....

Address.....



Many Other Government Jobs Obtainable  
Steady Work—No Layoffs—Paid Vacations  
Common Education Sufficient  
**MEN—WOMEN 18UP**



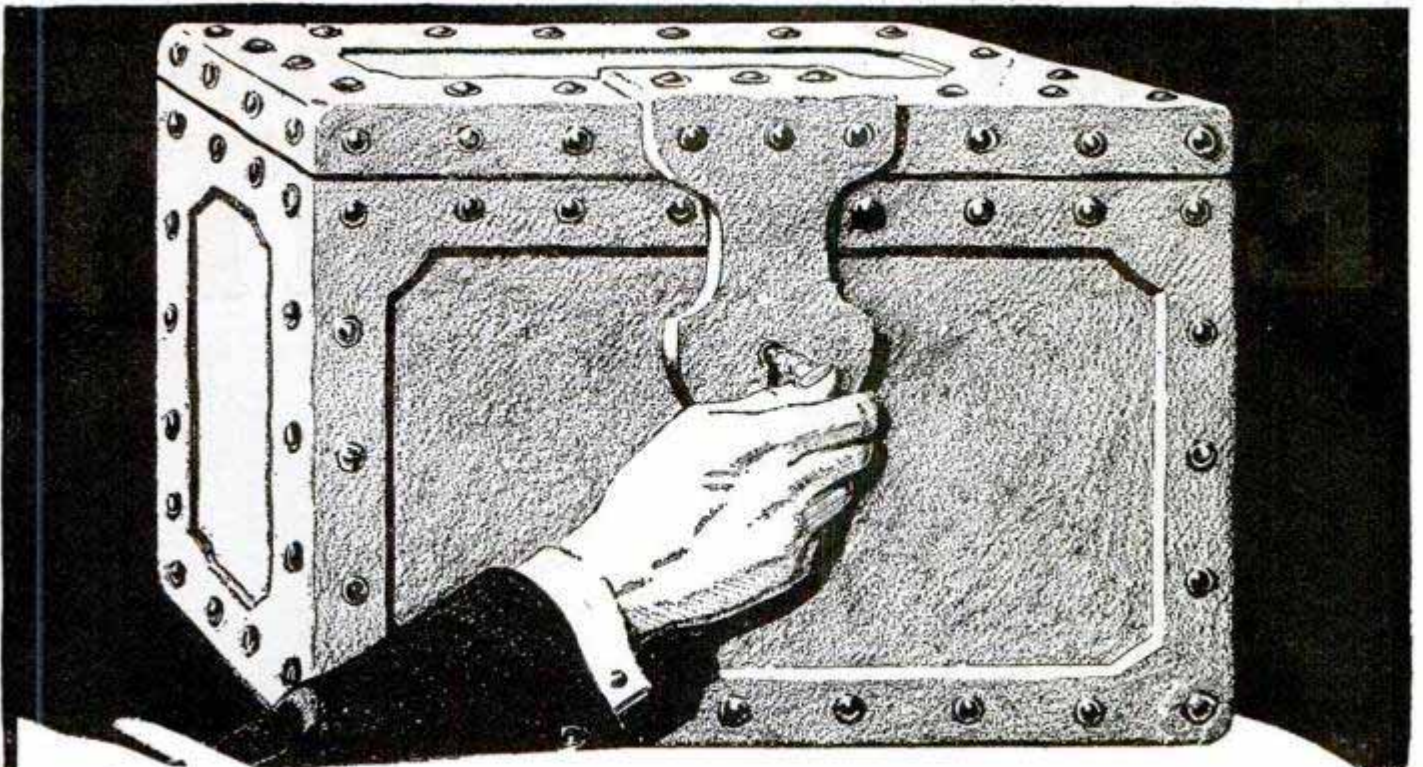

# Unlocking For You the Age-Old Secrets of Magic

Baffling secrets of the world's greatest magicians—mysteries never before divulged—supernatural effects of the Orient—massive stage illusions—the most priceless, most treasured Secrets of the Magic Profession now—*for the first time*—disclosed to YOU in the great Tarbell Course in Magic. Learn to perform like a real magician in a short time—in your spare time—at home. Be the life of every party—the center of every crowd, wherever you go. Business and social success are YOURS when you know Magic. And it's EASY with the Tarbell System!

**Earn \$350 to \$1000  
a Month!**

From Impromptu Tricks through Sleight of Hand to Great Stage Illusions—EVERYTHING is taught to you so that you can go right out and MAKE BIG MONEY WITH MAGIC. There is a tremendous demand for Magic Entertainment. Clubs, churches, schools, conventions, theaters are on the lookout for Magicians—and they pay \$25 to \$100 for perhaps half an hour's program. Keep your job and make a lot of EXTRA MONEY on the side. Just master a few easy tricks. Salesmen—business men—professional men—all can use Magic to gain popularity and profits. Easy for YOU to make \$250 to \$1000 a month!

## Mail Coupon

You can now get this great course, endorsed by the world's greatest magicians, at a special low price. But you have to *act quickly* to get in on this offer. Write today SURE!

**Tarbell System, Inc., Studio 13-56  
1926 Sunnyside Avenue, Chicago, Ill.**

## Astonish Your Friends

Study the first lesson and your friends will be amazed at your wonderful Magical powers. You will have that Magnetic power that gives you instant popularity in any crowd. Everyone will marvel at your apparently supernatural, psychic power. YOU possess this talent now! Surprisingly *easy* to bring it out. Send the coupon below now—and find out how easily you can do it.

**Tarbell System, Inc., Studio 13-56**

1926 Sunnyside Avenue, Chicago, Illinois

Please send me your big FREE illustrated and colored booklet giving full information on the Tarbell System of Magic. No obligation on my part whatever.

Name .....

Address .....

City and State..... Age.....



# Let me-L.L.Cooke-teach you ELECTRICITY

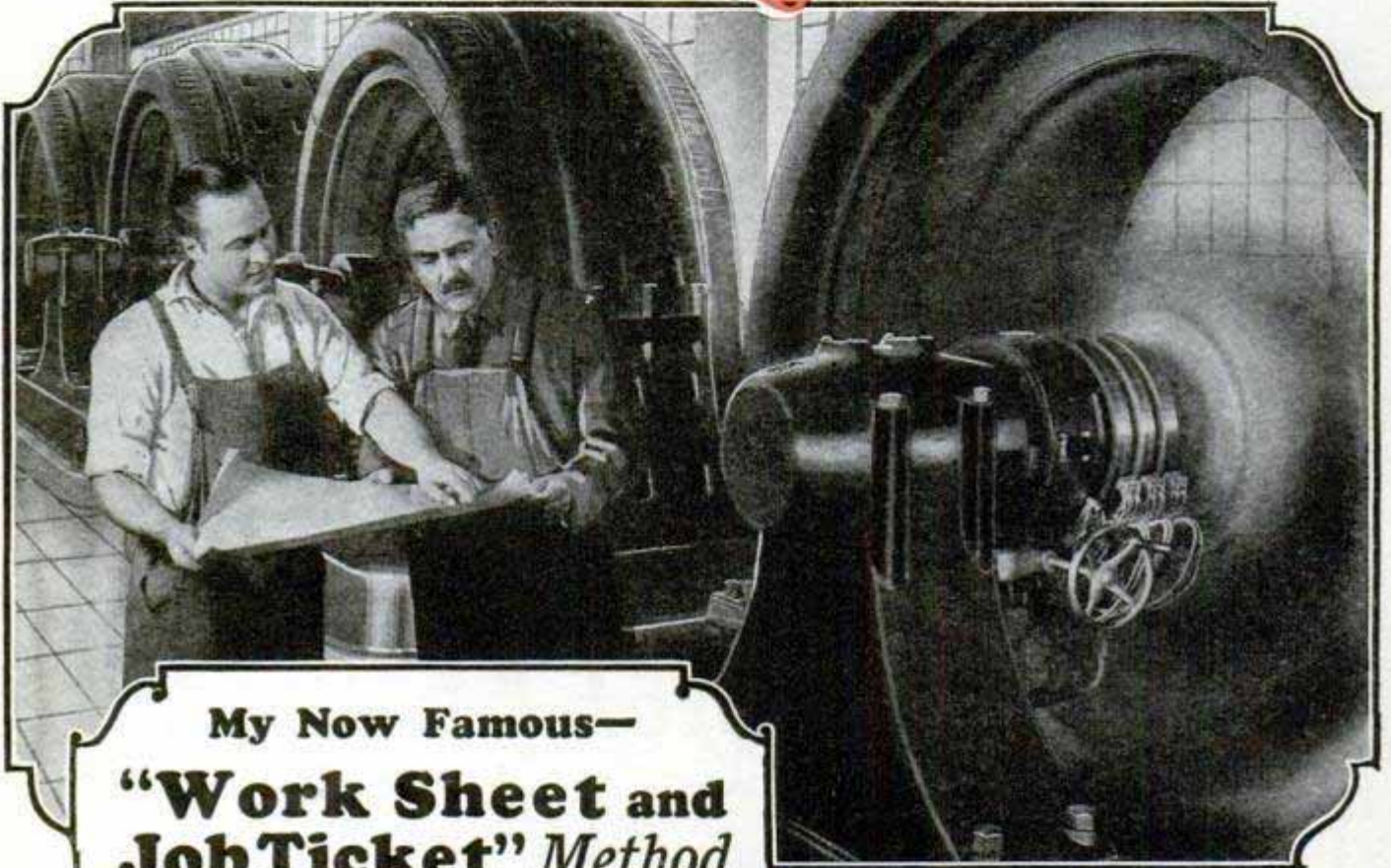

My Now Famous—

## “Work Sheet and Job Ticket” Method

guarantees you simplified, practical instruction along work-shop lines. You learn at home, but it's just like having me at your side every minute. And that means you learn Electricity—right.

Thousands of my “boys” are now making

**\$3500 to  
\$10,000 a year**

Why don't you get into this Big-Pay Field too? No experience necessary. Lack of education no drawback. You can read. You can write. That's enough.

## Investigate!

Look before you buy. Get the best.

Send coupon for my big free book “How to Make Big Money in Electricity.” It won't cost you a cent. It won't obligate you in any way. But it may be the means of jumping your pay hundreds of dollars a month, just as it has done for so many others.

## Tools and Electrical Apparatus to Work With

Six Big Outfits in all. Not toys, but honest-to-Pete tools and apparatus. I give you these so that you can do with your hands what I teach you to do in my Work Sheets. You learn by doing. That's why L. L. Cooke Training is practical. That's why “The L. L. Cooke Trained man is the Big-Pay Man”—he knows how and does it. Make Big Money in Electricity —Be an L. L. Cooke Trained man yourself.

**DON'T WAIT**  
If you are making less than \$70 a week, you owe it to yourself to investigate. Just mail coupon. But do it now—today

L. L. Cooke,  
Chief Instruction Engineer,  
L. L. Cooke School of Electricity, Dept. 16,  
2159 Lawrence Ave.,  
Chicago.

Please send me, without obligation, your big free book, “How to Make Big Money in Electricity,” telling me all about your famous “Work Sheet and Job Ticket” Method.

Name.....

Address.....

City..... State.....



# Classified Advertisements

## WORLD'S BEST WANT AD MEDIUM

Advertisements in this section, 30 cents per word, each insertion, minimum 10 words, payable in advance. To be inserted under proper classification in October issue; copy should be in our office August 18th

### ADVERTISING AGENCIES

**SECURE** and Increase Your Business by going after out of town trade. Our Service department guides you on every detail. Copy and literature composed free. Your 24-word ad (4 lines) inserted in the following 10 leading Sunday papers for only \$10.00. Circulation 1,500,000. Gazette, Little Rock; American, Atlanta; Star, Indianapolis; Journal, Minneapolis; Star, Kansas City; World Herald, Omaha; Courier, Buffalo; Enquirer, Cincinnati; Gazette Times, Pittsburgh; Banner, Nashville. Proof of insertion guaranteed or money refunded. 52 page rate Book sent free. Frank W. Lenhoff Advertising Agency, 600 North Michigan Blvd., Chicago. (Established 1897.) Chicago's Most Progressive Advertising Agency.

A TEN Dollar Ad may put your proposition over. \$10 pays for a 4 line 24 word classified ad one Sunday in 8 of the largest newspapers. Reach over 6 million readers. Minneapolis Tribune, Buffalo Courier, Detroit Free Press, Kansas City Star, Pittsburgh Press, Indianapolis Star, Atlanta Journal, Cincinnati Enquirer. Free catalogue showing other lists of newspapers and magazines sent on request. Ankrum Advertising Agency, 22 West Jackson Blvd., Chicago. Largest classified advertising agency in the world.

"BRINCKERHOFF Directory for Advertisers" Free, 66 pages; complete information regarding newspapers, magazines, classified and display rates and circulations. Many bargain list combinations. Brinckerhoff, Inc., 37 W. VanBuren, Chicago. 17 years' experience.

ADVERTISE in 24 Big Sunday Newspapers, 24 words \$15.00. Excellent for securing Agents, Salesmen, and Business Opportunities. Catalog listing 1,000 leading Dailies, Weeklies, Mail Order Magazines. Everything. Free. Wade Advertising, Baltimore Bldg., Chicago.

ADVERTISERS: 24 words; 39 Sundays. Dailies \$15.00. \$3.00 with order, \$3.00 week. Booklet free. Waring Advertising Agency, Dundee, Mich.

LOWEST Rates. New Catalog. Owl Agency, Times Bldg., New York.

NEWSPAPER — Magazine advertising—Classified, mailorder, Catalog. Martin, 276B West 43rd, New York.

SIX Word Line—355 rural weeklies \$3.55. Admeyer, 4112-M Hartford, St. Louis.

### FOR ADVERTISERS

POSTCARDS, Club-Mailings. Best, cheapest direct-mail method. Reaches 25,000,000 one million agents or mail-order buyers. Original inquiry letters used. \$2.00 thousand. Columbia Postal Group-Mailing, 203 East 12th St., New York City.

I WRITE letters, folders, booklets, complete followup for manufacturers, mail order dealers. Long experience. Write for details. L. Taylor, 201 S. Day, Rockford, Ill.

ADVERTISE 30 words 439 Rural News papers \$12.65; Inch \$35.12. Thompson Service, 818 Oak St., Cincinnati.

ADVERTISE in 275 country newspapers, 28 words, \$10. Keator, Hartford Bldg., Chicago.

CUTS, Drawings \$1.50. Window Cartoons, 6, \$1.50. GPO, Bx471, New York.

40 WORDS insert 70 magazines \$2.00. Empire Agency, Shawano, Wis.

### SALES PROMOTION

\$50 TO \$50,000 Daily Sales Developed During 28 years for clients by our direct mail plans, copy, campaigns. One product, 1923, an idea; this year \$100,000 orders booked. Fifty year old concern desired 50 national representatives in 1925; we produced 40 in three months. 700 dealers in 10 months at \$3 each, for another. Ten years Sales Promotion Manager Larkin Co. Submit sales problems for Free diagnosis. James C. Johnson, 118A Woodbridge Ave., Buffalo.

**DIRECT-BY-MAIL** Advertising for small manufacturers is quickest, surest, and best. I furnish copy, art work, printing, and mailing of catalogs, booklets, and sales letters. Dudley Bunn, Advertising Service, Savannah, Okla.

### LETTER SPECIALISTS

INVESTIGATE Finkel! Recognized reputation! His crackerjack letters-folders-advertisements campaigns insure positive success. Reasonable rates. 15M-Fairview, Jersey City, N. J.

### AUTOMOBILE SUPPLIES

NOB-URN, the Beautiful and Useful Gear Shift Ball, not just another ball, but a combination Ash Receiver, Cigar Holder and Gear Shift Ball, all in one. Finished in the following colors: scarlet, maroon, green, blue, orange, and cream. This Nobby Ash Tray can be installed, in place of ordinary ball, in a few seconds. Postpaid \$1.00. Send make and year of car, also color wanted. Agents Wanted. Fisher & Rockwell, 7740 South Chicago Ave., Chicago, Ill.

AUTO Tourists—Here are 133 practical plans for making touring easier, less expensive and more enjoyable. With these we supply a Touring Atlas of the U. S. showing road maps of every state. All this information for the small price of 98 cents plus the postage. Pay postman when he delivers the package. Popular Mechanics Press, Room 908, 200 E. Ontario St., Chicago, Ill.

JUST Out! Electric Puncture Preventer. Install yourself. Any car. No operating costs. Complete information \$1.00. R. Hancock, 323 Douglas, Portsmouth, Va.

TIRE and Battery Shop Equipment at wholesale. Send for our complete catalog and state what business you are interested in. Adams-Barr, Columbus, Ohio.

YOU Are Wanted to Resilver Mirrors at Home. Immense profits plating autoparts, tableware, etc. Write for information. Sprinkle, Plater, 77, Marion, Ind.

A TELL-TALE Calculator; tells time and speed on any given trip; carry in pocket; every motorist should carry one. 25c each; 5 for \$1.00. P. O. Box 293, DeKalb, Ill.

AT Last! Reasonably priced Auto Emblems for every Lodge. Sells for only \$1.25. Write for attractive selling proposition and free Sample Case offer. North Central Distributors, Dept. 9, Ashland, Ohio.

VULCANIZING Auto Tires is a Paying Business. We have plants near you from \$50 up. Catalog Free. Instruction Book \$1. Equipment Exchange, 108 East 11th, Los Angeles, Calif.

FAST selling Auto-Accessory! County Distributors and Agents wanted. Write Valley Mfg. Co., No. 435, Chino, Calif.

"ALABAM" Boat Whistle, three tone, independent, for car or canoe. \$3.50 postpaid. Alabam, Box 992, Van Nuys, Calif.

42.8 MILES on 1 Gallon. Wonderful Moisture Gas Saver. All autos. 1 free. Critchlow, D1-805, Wheaton, Ill.

DYKE'S Automobile Encyclopedia. Latest 14th edition. Information on repairing and adjusting every part of all motor cars. How to find trouble and fix it. Send no money. Pay postman the postage and \$6. Popular Mechanics Press, Room 908, 200 E. Ontario St., Chicago, Ill.

### AUTOMOBILES

PATENTS. Time counts in applying for patents. Don't risk delay in protecting your ideas. Send sketch or model for instruction or write for free book "How to Obtain a Patent" and "Record of Invention" form. No charge for information on how to proceed. Communications strictly confidential. Prompt, careful, efficient service. Clarence A. O'Brien, Registered Patent Attorney, Security Bank Building (directly across street from Patent Office), Washington, D. C. See pages 138 and 139.

AUTOMOBILE—Make your own motor car, toy size, operated with motorcycle engine. Any boy can make it. Costs little aside from engine. Full directions with drawings an dimensions in The Boy Mechanic, Book 3. Send no money. Pay postman postage and \$2. Popular Mechanics Press, Room 908, 200 E. Ontario St., Chicago, Ill.

### AUTOMOBILE ARMATURES

FORD armatures rewound—Made same as new—\$1.40 each, plus postage. Satisfaction guaranteed. Southern Armature Works, Charlotte, N. C.

### AUTOMOBILE SERVICE EQUIPMENT

BARGAINS in repossessed battery chargers. Rectifiers of all kinds and a few Constant Potential 8-Hour Chargers, two of them practically new. Very low prices and terms arranged while they last. I. C. Helmick, Box M-972, Troy, Ohio.

STARTING, Lighting, Ignition Service most profitable in automobile field. Small investment, big profits, pleasant work. New HB test bench brings you this business. Low price, easy terms, 30 days trial. Write for new bulletin TB. HB Test Bench Division, Box M-974, Troy, Ohio.

AUTOMATIC Air Compressors, paint spray outfits in sizes to suit the smallest and largest business. Only equipment of this kind on market using the Silent Spiral, Bevel Transmission. Low prices, easy terms. Automatic Compressor Co., Box M-973, Troy, Ohio.

### FOR FORD OWNERS

WELCO Fan Stops Fords Overheating. Easily installed, \$1 postpaid. Good Agents' proposition. Welco Products, 3344A Altamont, Cleveland, O.

42.8 MILES on 1 gallon. Wonderful Moisture Gas Saver. All autos. 1 free. Critchlow, D2-805, Wheaton, Ill.

DELIVERY Bodies for Ford Model T. Chassis with inclosed cab, suitable for Contractors, Grocers and Farmers. Three Styles. Price \$39.50. Write Daniel Zimmerman, Cragville, Ind.

UNDERSLUNG with "RKO" Swing L0 Irons. See "Red-i-Kut" ad page 135.

FORD Electrical Equipment Troubles—Locate and remedy them easily yourself with the aid of our book "Ford Standard Electrical Equipment." Why pay big garage bills? Battery, ignition, starting and lighting covered. Order today. When postman hands you the package pay him \$1.98 and the postage. Popular Mechanics Press, Room 908, 200 E. Ontario St., Chicago, Ill.

### MOTORCYCLES, BICYCLES AND SUPPLIES

MONEY Saving Motorcycle Bargains—Large stock of Used Harley-Davidson—\$50 and up. Send for Free bargain bulletin—Now! Motorcycle Parts, accessories, repairs. Knuth's Harley-Davidson Agency, 2525 Fond Du Lac Ave., Milwaukee, Wis.

MOTORCYCLES at Reduced prices. Save 25% to 50%. Send for our Bargain Bulletin. American Motor Cycle Company, 2041-2047 Chicago Ave., Chicago.

GOOD Second Hand Parts for Indian, Harley, Henderson, Ace and Excelsior Motorcycles. No Junk. Ship C. O. D. No Lists. J. B. Dahl, 3661-63 Archer Ave., Chicago, Ill.

MOTORCYCLE Bargains. Used, rebuilt. Guaranteed. Shipped on approval. Catalog free. Floyd Clymer, 810 Broadway, Denver, Colo.

MOTORCYCLES \$50.00 each. All makes; they run; send cash; ride. Others \$75, \$100, \$150, \$200. Rebuilt Hendersons \$300. Look like new. List 5c. John F. Ballak & Co., 100 N. 12th, St. Louis, Mo.

### AVIATION

SPORT Plane builders. Send one dollar for booklet on Nomenclature, Stability, Controllability, Design, Charts, Illustrations, etc. Donald Smith, 1247 Loma Vista Drive, Long Beach, Calif.



**LEARN to Fly;** \$100.00 including Solo. We guarantee to solo you regardless of the number of flying hours required. Our instructors are ex-army aviators and air-mail pilots with wide experience. Our training equipment is the best obtainable. Our course requires about two weeks, depending on the individual. No bond required, no charge for breakage. Eight years without an accident. 76 students graduated in 1925. Commercial aviation is a rapid growing industry. Don't delay! Enroll now in one of the oldest and best known flying schools in America. Write for booklet. Robertson Aircraft Corporation, operators of the United States Air Mail, St. Louis-Chicago, Lambert-St. Louis Airport, Anglum, Mo.

**PREPARE** with us and make sure of a pilot's license. Ten lessons in the air of twenty minutes each will make you a pilot by our advanced method of training. This, together with our five weeks shop course, at \$100.00 makes America's oldest aircraft factory the most popular flying school. Work after class hours guaranteed. Special evening courses, including shop work, field and flying, \$185.00. Employment assistance on jobs paying \$18.00 to \$40.00 per week. Heath Airplane Company, Chicago, Ill.

**LEARN to fly** in Chicago—the world's greatest Aviation Center. Now is the time to get in on this big new enterprise. We teach you to fly in a few weeks and make you a competent pilot. Licensed instructors—modern planes—all equipment furnished. Special money saving proposition to those who answer this advertisement. Room 1357A, 122 South Michigan Ave., Chicago, Illinois.

**A JOB** for you while you learn to fly. We can arrange employment for fifteen young men in an aircraft factory which will pay enough for room and board while taking their course. Permanent employment if you make good. 15-hour course \$250. Porterfield Flying School, 2330 Harrison Street, Kansas City, Mo.

**AERONAUTICS!** "Aeroplane engines in Theory and Practice," by Rathbun, describes engines fully. Includes all makes. For mechanic, builder and flyer. Send no money. Just order on a postal. When postman hands you book, pay him \$2.50 and postage charges. Popular Mechanics Press, Room 908, 200 E. Ontario St., Chicago, Ill.

**HEATH** propellers represent the most efficient method of aerial drive. Each propeller individually designed for the particular work to be done, as laid out by America's oldest aeronautical engineers. Propeller circular 4c. Heath Airplane Company, Chicago, Ill.

**SET** Absolutely new wings for Heath monoplane crated for shipment \$20.00. If you are building one save money. Curtiss Jenny new wings used engine ready to assemble \$450.00. Time payments. New Curtiss propeller tipped boxed \$3.00. Midway Aero Co., Box 283, St. Paul, Minn.

**EAGLEROCK**, government certified safety airplane at \$2,475. Denver or may be purchased on time payments. Pilots pay as they earn. Low charge for student instruction. Alexander Aircraft Company, 3333 S. Broadway, Denver, Colo.

**THE American School of Aviation** announces a new correspondence course in Mechanics of Aviation. A thorough training in Practical Aeronautics. American School of Aviation, Dept. 1861, 3601 Michigan Ave., Chicago, Ill.

**DICTIONARY of Aviation**, \$3.90. Languages Publishing Company, 15 W. 18th Street, New York.

**BLUEPRINTS**, Prices reduced. "Aerodrome" boats, sleds. Blueprints only 50c each. Ostergaard Aircraft, 4305 No. Narragansett, Chicago.

**SEND** dime for 12 inch mounted propeller and circulars on free three foot model aeroplane. No selling. Aero Shop, 3050 Hurbit Ave., Detroit, Mich.

**BIGGEST**, Best Catalog Model Airplanes, Parts Supplies; 5c postpaid. Ideal Company, 165½ Spring Street, New York.

**AIRPLANE** Propellers, Brand New, 8' Diameter; Cost Government \$75.00; Sacrificed at \$3.50. Equipment Company, Carle Place, New York.

**THE Age of the Air is Here.** For reliable information on both airplane building and flying we recommend "Aeroplane Construction and Operation," by Rathbun. All features of construction treated. Send no money. Pay postman \$2.50 and postage. Popular Mechanics Press, Room 908, 200 E. Ontario St., Chicago, Ill.

**BUILD** your own Sport Monoplane. Blueprints and Instructions, \$2.50. Allison Airplane Co., Lawrence, Kans.

**PATENTS.** Time counts in applying for patents. Don't risk delay in protecting your ideas. Send sketch or model for instruction or write for free book "How to Obtain a Patent" and "Record of Invention" form. No charge for information on how to proceed. Communications strictly confidential. Prompt, careful, efficient service. Clarence A. O'Brien, Registered Patent Attorney, Security Bank Building (directly across street from Patent Office), Washington, D. C. See pages 138 and 139.

**AIRPLANE** and 599 other prizes given away to purchasers of Nelson's Aero Dope Sheets. Only \$1.00, postpaid! Send Stamp for particulars. Nelson Aero Service—H., Box 2186, Seattle, Wash.

**DURALUMIN** sheets, strongest, lightest metal known, 2' by 6' by 1/16" \$7.50. Equipment, Carle Place, N. Y.

**IF** you would get into the game of our new way to fly, write F. O. Parsons, Indianola, Iowa.

### BOOKS AND PERIODICALS

1927, **THIRD** edition revised. "Radio Theory and Operating," by Mary Texanna Loomis, President Loomis Radio College; member Institute Radio Engineers, 886 pages, 700 illustrations. Used in all Government and private radio schools, many colleges and high schools. Comprehensive, up to date, the standard on radio. Price \$3.50, postage paid. At your book store, or order direct from Loomis Publishing Company, Dept. M., 405 Ninth, Washington, D. C.

**WHAT Subject** interests you? Select from this list of helpful worth-while books. Social Letters Made Easy, Spelling Made Easy, How to Develop Your Will Power, Tricks and Magic Made Easy, Bookkeeping Made Easy, Chemistry for Beginners, How to Work Your Way Through College, Confidential Chats with Boys. Price \$1.25 per volume. Pay postman price and postage when he hands you the package. Address Popular Mechanics Press, Room 908, 200 E. Ontario St., Chicago.

**PAINTERS, Decorators, Artists—Books** 10c up. Circulars free. King, Box 1482, Indianapolis, Ind.

**SELF-INSTRUCTION** Books. Pitman Light Line Shorthand and Simplified Bookkeeping, 50c. Marr, Teacher, B605, Nashville, Tenn.

**SEND** for our unique catalog of 5000 books listed alphabetically under subject headings. Free on request. Popular Mechanics Press, 200 E. Ontario St., Room 908, Chicago, Ill.

**HYPNOTISM** wins Health, Wealth, Fame, etc. 25 Easy Lessons and 248-page illustrated reference guide \$2.00. Popular Institute, 430-PS Milwaukee Ave., Chicago.

**PROSPERITY, Health, Happiness—Make** them yours. Concise, inspiring booklet telling how—10c. Carl Masson, 11 Hubbard St., Jamaica Plain, Mass.

**ANSWERS** to mathematical problems of office, store, shop, bank, farm, or factory. Explains and simplifies every principle of arithmetic, mechanics and mensuration. Send No Money. Just ask for Ropp's Calculator." Pay postman \$1.00 and postage. Popular Mechanics Press, 200 E. Ontario St., Room 908, Chicago, Ill.

**SEND** for our unique catalog of 5,000 books listed alphabetically under subject headings. Free on request. Popular Mechanics Press, 200 E. Ontario St., Chicago.

**WHERE'D Cain** Get Wife? 15 pages, 20c. Jabe Studio, Kansas City, Mo.

**AUTHORS**, write for circular "Cooperative Book Publishing." Meador Publishing Company, 27 Beach, Boston, Mass.

**INDUSTRIAL Alcohol**, Wright's book. Full directions for making, fully illustrated. \$2.50. Spon & Chamberlain, 120 P.M. Liberty Street, New York, N. Y.

**QUESTION and Answer** had sweeps country. Send for a copy of the best book on this popular pastime "Ask Me Another." 2000 Questions and Answers, forty information tests with the scores of 69 people you know from all walks of life. Pay postman \$1.60 and the postage when he hands you the package. Popular Mechanics Press, Room 908, 200 E. Ontario St., Chicago, Ill.

### PICTURES AND POSTCARDS

**SPECIAL—Genuine Hand Painted Landscapes** 79c. By real artist. C. C. Dry, 1112½ 21st N. W., Canton, Ohio.

**20 CEYLONESE** Girl models, Dollar Bill, Art Photo Galleries, 10, Temple Road, Colombo, Ceylon.

**ART** Pictures, Books and Novelties. Catalog 10c. Howard Sales Co., Dent. 15, 1188 Folsom St., San Francisco, Calif.

**FREE—True-Blue Book.** Exchange postcards, stamps. Ericson, Elroy, Wis.

### MAGIC TRICKS, BOOKS AND JOKER NOVELTIES

**NEW 1927 "Fun—Magic—Mystery"** now ready. 100 Pages, profusely illustrated. Over 750 Tricks—Illusions—Jokes—Puzzles—Books—European Novelties, at Reduced Prices. Postpaid 10c. Lyle Douglas, Station A, Dallas, Texas.

**MAGIC—Tricks, Books and Supplies.** For Amateurs as well as the great professionals. Anyone can learn through our instructions. Feature Acts in Mind-Reading, Spiritualism, Rope Ties, etc. Large illustrated Professional Catalog, 20c. Chicago Magic Co., 140 So. Dearborn St., Dept. B, Chicago, Ill.

**CARD** tricks. Coin tricks. Hypnotism. Ventriloquism. 64 page books. Complete guides 10c each. Geo. Fenner, 2401 Jefferson, Louisville, Ky.

**TWO** Trick Novelties, Trick Magic Catalog, 10c. Bagdad, 716 Pine, St. Louis, Mo.

**COMPLETE** Book on Magic, 563 pages, 318 illustrations. Hundreds of tricks. The standard book for years. Make money giving magic entertainments. Send no money. Just ask for Prof. Huffman's "Modern Magic." Pay postman postal charges and \$2.00. Popular Mechanics Press, Room 908, 200 E. Ontario St., Chicago, Ill.

**MAGIC** Trick Cards That Are Absolutely guaranteed. Free samples. Write me today. C. D. Blankenship, Adrian, W. Va.

**FREE** with \$25 order die box. Send 20c for our large catalogue of tricks, wigs, sensational escapes. Oaks Magical Co., Dept. 548, Oshkosh, Wis.

**ELECTRIC** Fun! Seventy stunts, 110 volts, \$1. Tacutting, Campbell, Calif.

**ILLUSION** Catalog 10c. Trick Catalog Co., Lynn's, 105 Beach, Jersey City, N. J.

**READ** Sealed Messages in Dark; messages retained by audience; burned message appears on blank slate; spirit message appears on slate in sitter's presence; spirit rappings; spirits appear in the dark; answer questions written on folded papers while blindfolded. All this you can do with directions in "Behind the Scenes with The Mediums." 69 best secrets of mediums fully exposed. The best because most baffling, yet all easy to do. Send no money. Just write a postal. Pay postman \$1.50 and postal charges. Popular Mechanics Press, Room 908, 200 E. Ontario St., Chicago, Ill.

### GAMES, ENTERTAINMENTS AND PLAYS

**VENTRILLOQUISM** taught almost anyone at home. Small cost. Send 2c stamp today for particulars and proof. George W. Smith, Room S-195, 125 N. Jefferson Ave., Peoria, Ill.

**PUZZLES!** If you like them we recommend an illustrated book containing 122 of the best Mechanical Puzzles. You can have loads of fun working out the solutions as enough hints are given in the text matter to enable one to do so. Pay postman \$1.00 and postage when he hands you the package. Address Popular Mechanics Press, Room 908, 200 E. Ontario St., Chicago.

### NOVELTIES, CURIOS, ETC.

**YOUR** Name in Gold on One Good Lead Pencil, 10c. Arthur Carlander, South Yarmouth, Mass.

### STAMP COLLECTING

**NBODY** Knows what is happening in China; but we know that Scott Seald Packet No. 277 will certainly please you, for it has in it the Dragon stamps of Imperial China, the Junk and Reaper stamps of the later Republic issues, many surcharges and interesting postage dues. This bargain packet contains 25 guaranteed genuine stamps for only 25c. Other fine Scott Seald packets to pep up your album pages: No. 68, 100 Diff. from Fifty Different countries, 25c. No. 8, 1,000 diff. (general collection), \$1.00. No. 152, 100 different from Europe, 10c. No. 67, 100 diff. of the beautiful French Colonials, 40c. No. 146, 200 diff. from Austria, only 25c. No. 202, 50 different from Wurtemberg, 25c. The Scott price list which is free contains hundreds of sets, dime sets, packets, illustrating Scott albums, hinges, tongs, magnifying glasses, watermark detectors and other accessories. Ask us to send it to you when we fill your packet order. International Junior Postage Stamp Album, 1927 Edition. Spaces for 21,000 stamps. Fully illustrated. No. 1, Attractive blue cover, red corners, \$4.00. No. 2, Bound in cloth, gilt lettering, \$5.00. Forwarding extra; weight 6 lbs. Scott Stamp & Coin Co., 1 West 47th Street, New York, N. Y.



500 DIFFERENT Stamps for 25c! Big Collection 500 Different Stamps from Bosnia-Herzegovina, Crete, Epirus, Hong Kong, Iceland, Kenya and Uganda, Liberia, Malta, Nyassa, Tanganyika, Wallis, and Futuna, Zanzibar, and other "hard" countries. Catalogue value \$10.00. Price only 25c to Approval Applicants! Special Bargains: 1,000 different 7c; 15 triangle stamps 4c; 100 Africa 5c; 100 Asia 6c; 100 Balkan States 35c; 100 British Colonies 25c; 100 French Colonies, 30c; 100 Portuguese Colonies 50c; All 8 packets for \$3.00! Illustrated Lists Free. Loma Stamp Co., 2221 Madison Ave., San Diego, Calif.

MYSTIC'S "Queer Country" Packet! Contains scarce stamps from the following strange lands: San Marino, Antioquia, Congo, Cyprus, Fiji Islands, Gwalior Hyderabad, Iceland, Jhind, Kenya, Uganda, Lebanon, Monaco, North Borneo, Nyassa, St. Thomas Prince, Port. Guinea, Siam, Sierra Leone, Tanganyika, Trinidad Tobago, Ubangi, Upper Volta, Wallis Futuna, Zanzibar. Get this wonderful packet of "freak countries" and make your friends envious! Price only 10c to approval applicants! Write today. Mystic Stamp Company (Dept. 8), Camden, New York.

\$1.00 FREE. Black U. S. Postage, Given Away with each order. Pioneer Stamp Album with 500 illustrations. 150 different stamps from 40 countries. Syria, Lebanon, Hejaz, Liberia, New French Colonies, British, Portuguese Colonies, South Africa, Australia, 500 hinges, 36 page illustrated catalogue. All for 15c. Big Commission to Agents for the Best approval sheets of stamps ever offered. Write for sample outfit. Hussman Stamp Co., Dept. M, 620 Olive St., St. Louis, Mo.

ANCHERS \$\$\$ Outfit—only 12c! Fine triangle stamp; set German stamps with (pre-war) value forty million dollars (interesting!); perforation gauge, mme. scale; small album; airmail set; scarce stamp from smallest republic on earth; newspaper set; packet good stamps from Travancore, Malay, Dutch Indies, etc. Entire outfit for 12c to approval applicants! (Nice pocket stock book, value 25c, with every order!) Ancher Stamp Co., 148½ Clerk St., Jersey City, N. J.

A SNAP—300 Different Foreign and 60 Different U. S. Stamps, including \$1 and \$2 revenues, all for only 25c. Free, with each order, our pamphlet which tells "How To Make a Stamp Collection Properly," together with our price lists of albums, supplies and hundreds of bargains in sets, packets, etc. Queen City Stamp & Coin Co., Room 36, 604 Race Street, Cincinnati, Ohio.

MOST Sensational values; over 140 diff. Algeria, Airplanes, Azerbaijan, Barbadoes, Cameroun, Gabon, Guyane, Irish set, large French Colony packet, largest stamp, 40 year old U. S., gauge, etc., for 10c to approval applicants. List free. 100 diff. U. S. 25c—1,000 hinges 9c—50 Bavaria 7c. Hawkeye Stamp Co., Cedar Rapids, 39, Iowa.

CANADIAN—25 different only 10c and asking to see our Excellent Approvals; receive Beautiful Confederation Jubilee stamp, 5 Newfoundland and Bargain Lists free. Victoria Stamp Co., London, Canada.

DANZIG Stamps Free—Interesting packet from Danzig with big catalogues free for 2c. Midland Stamp Company, Toronto, Can.

THOUSAND Foreign Stamps, 50c; catalog free. Prof. McCreery, Chatham, Ontario.

ONLY 5c! 10 Airmail stamps, including scarce Esthonia triangle; Greece Red Cross set; packet fifty different stamps—all unused—from Guyane, Ubangi, etc. All for 5c! Approvals and free lists with each order. Curhan Stamp Company, Gloucester, Mass.

PREMIUM List and new offers for Stamp and References. Marney's, 400 Broadway, East St. Louis, Ills.

BRITISH Colonials. Startling prices. Approvals for reference. Stamp Drawer, Rockville, Conn.

BEAUTIFUL Stamps Free! Bargain Approvals. Van's Stamp Co., Walla Walla, Wash.

1000 MIXED Foreign Stamps 25c. Phil Lundstedt, Cape Cottage, Maine.

300—300 ALL different stamps (\$6.00 catalogue); 300 hinges; 5 approval sheets; duplicate stamp album; perforation gauge; millimeter scale and ruler to approval applicants for only 20c. Edgewood Stamp Co., Milford, Conn.

1,000 DIFFERENT Fine Stamps, 69 cents. Approvals. Kenilworth Stamp Co., Ridge-wood, N. J.

20 DANZIG free to applicants for my 60% approvals. Reference required. Ask for illustrated bargain lists. A. Frisch, 83-47 Vietor Place, Elmhurst, L. I., N. Y.

FREE! 5 rare Siam to approval applicants. Winthrop Smith, 3611M Cedardale Rd., Baltimore, Md.

MARTINIQUE—10 var. 15c, postpaid. Lists free. Allion, Angola, Ind.

APPROVAL applicants sending 2c for postage will receive five stock transfer slips containing United States and New York State Revenue Stamps. Herbert Keigwin, 192, Middletown, N. Y.

PRECANCELS—1,000 Bulk, \$1.50. Good Foreign approvals, nice first premium. Pet-tet Bros., 962 S. Boulevard, Atlanta, Ga.

FREE: Dandy Surprise Packet to approval applicants. Postage 2c. Commonwealth Stamp Co., Box 1507, Boston, Mass.

FREE! Special Bargain Bulletin. Stamps at ½-¼ catalog. Penna. Stamp Co., Greensburg, Pa.

50 STAMPS, 2c postage, Approval Applicants. H. Hunziker, Jordan, Minn.

100 FOREIGN Stamps for four cents postage; approvals with each order; references necessary. Low price stamp lists, free. Palmer Stamp Co., 8221 Linwood Ave., Detroit, Mich.

50 DIFFERENT United States 10c. 60% approvals. Reference please. Seidenberg, Baroda, Mich.

FRENCH Colonies Free—Jungles, Tigers, Native Chief. 2c postage. Empire Stamp Co., Toronto, Canada.

YOUR Government has over 100 different unused United States stamps for sale to collectors at face value. List and pamphlet about Government Philatelic Agency, only 10c. C. E. Nickles, 212 Seaton, N. E., Washington, D. C.

FREE Premium to those requesting our approvals. Pine Tree Stamp Co., Box 159, Lewiston, Maine.

150 GOOD mixed foreign stamps, 3 cents. Stanton, Niantic, Conn.

BEST one-cent approvals in America. F. P. Hand, 1117 So. 60th St., Philadelphia, Pa.

SWEDEN Packet, Attractive Stamps 5c to Approval Applicants. Harvey Teeple, De-catur, Ind.

FREE—True-Blue Book. Exchange stamps, postcards. Erickson, Elroy, Wis.

PENNY Approvals that Satisfy. Neil Gronberg, Box 5441, Philadelphia, Pa.

AIRMAIL First Flight covers 17c. Stra-ser, 910m Lakeview, Cleveland, Ohio.

SPECIAL! 50 diff. Soviet Russia, 23c; 50 British Col. 20c; 25 French Col. 10c; 50 Greece, 40c, or all Four Packets, 75c. To Approval Applicants only. The Cleveland Stamp Co., Caxton Bldg., Cleveland, Ohio.

1000 NICELY mixed stamps, 25c postfree; 1000 hinges 10c; 2000 17c. Approvals. Price lists. Sunshine Stamp Co., 549 East Maryland St., St. Paul, Minn.

STAMPS, 100 all different, Postage 2c. Lists free. P. M. Quaker Stamp Co., Toledo, Ohio.

STAMPS sent on approval at 70% discount. Reference required. Emory Renoll, Hanover, Pa.

FREE 40 Czecho Slovakia Stamps to approval applicants 2c Stamp. Lightbown's, Osborne Rd., Southsea, England.

FREE, 12 Diff. large, showy picture stamps for a request for my popular approvals. Premiums with every purchase. A. Bauer, Palmyra, N. J.

ANNIVERSARY Offer! Seven following sets: "Anniversary," "Jubilee," "Charity," "Airmail," "Eagles," "Prisoners," "Pic-torials." Four following packets: (British, French, Dutch Colonies), (Precancels), (Bulgaria), (International) 15c to approval applicants. Deering, Fairmount, Marlborough, Mass.

PACKETS, Sets, Albums. List Free. Open 9 a. m. to 5:30 p. m. Carl Young, 202 So. Eleventh St., Philadelphia.

24 VARIETIES Cuban stamps, 10 cents. List of 6,000 low-priced stamps free. Ad-dress Chambers Stamp Co., 111P, Nassau St., New York City, N. Y.

110 DIFFERENT Stamps, many unused, high values, free to collectors requesting our Net Approvals. Postage 2 cents. Christen-son, Milwaukee, Wis.

1,000 DIFFERENT, \$0.80; 2,000, \$3.50. Fred Onken, 630 79th Street, Brooklyn.

105 CHINA, etc. 2c. Album (500 illus-trations) 3c. Bullard, Sta. A. Boston.

100 DIFFERENT Stamps Free to Ap-proval Buyers. Postage 3c. Write now. Wineholt Stamp Co., Woodbine, 26, Penna.

FOREIGN Revenues, Telegraphs, Locals, envelopes, rails, etc. pretty, different, cheap. Stamped Marine Policy free to applicants with references. Vanderhoof, 1114 Logan, Denver, Colo.

200 DIFFERENT stamps 10c; 1,000 Hinges 10c. R. H. Carlton, 380 W. So. Temple, Salt Lake, Utah.

110 NEW Europe All Different, a won-derful collection cataloguing several dollars, free to collectors requesting our Net Ap-provals. Postage 2 cents. Badger Stamp Co., Milwaukee, Wis.

FREE Hungary Charity No. 565 to 567 and a surprise packet given to those re-questing for my 1, 2, and 3c approvals, and also my 50% discount. Chas. W. Schmidt, P. O. Box 4832, Frankford Station, Phila-delphia, Pa.

BORNEO, Malay, Liberia, large U. S. revenue, commemoratives, with 105 other dif-ferent U. S. and foreign stamps for only 9c. Fennell Stamp Co., Dept. M, St. Louis, Mo.

109 DIFFERENT, Arabia, Azerbaijan, Zanzibar, etc., 10c to approval applicants. Floyd Marsh, 524 Hamilton Ave., Indian-apolis, Ind.

FRENCH Colonies, 25 different, 5 cents. Big lists free. Challenge Stamp Company, 425 McDonough Street, Brooklyn, N. Y.

OUR Latest 20-page U. S. and Canadian price list free. Stanley Gibbons, Inc., 37 Ann St., New York City.

STAMPS, 100 varieties, Africa, Brazil, Peru, Cuba, Mexico, etc., 10c; 25 different U. S., 25c; 1,000 mixed, 40c; 1,000 hinges, 10c. List free. C. Stegman, 5941 Coto Brillante, St. Louis Mo.

LIBERIA Snake Triangle and two other triangles in our packet of 53 genuine foreign stamps for five cents. Crowder Company, Waverly, Baltimore, Md.

COVERTCO Packet, 250 varieties unused and used stamps 15 cents. Covert Stamp, 39 State, Rochester, N. Y.

BEAUTIFUL Picture Stamps Sent Free. Paul Cornish, Schenectady, N. Y.

#### RARE COINS

COINS, 3 different foreign coins, 4 dif-ferent foreign Notes and Catalog 10c. Geo. Best, Cedar Rapids, Iowa.

UNITED STATES, Large Cent, two-cent bronze, three-cent nickel and Bargain List, 25c. Fifteen dates large cents, \$1.00. George Coffin, Greenwood Mountain, Me.

40 OLD Coins, all different, \$1.00, 100 different coins \$3.00, 200 different coins \$5.00. Monroe Half-Dollar, Unc., \$1.00. Stone Mountain Half-Dollar, Unc., 90c. Lexington Half-Dollar, Unc., \$1.00, 10 dif-ferent dates Half-Dimes \$1.25. Claud Den-ney, Box 315, Dallas, Texas.

HUNDREDS, Bills, Coins, never sold in America. Catalogue 2 war Coins 10c. Wacker-Dickman, Minster, Ohio.

\$5, \$20 CONFEDERATE 1861 Bills, 15c. 100,000 German Marks, 10c. 5 Different Copper Coins and Price Lists, 10c. Califor-nia Gold ¼, 27c; ½, 53c. Al E. Bonsall, Richmond, Ind.

OLD Money Wanted. Will pay \$100.00 for 1894 Dime, S. Mint. \$50.00 for 1913 Liberty Head Nickel (not Buffalo). Big premiums paid for all rare coins. Send 4c for Large Coin Folder. May mean much profit to you. Numismatic Co., Dept. H, Fort Worth, Tex.

AMERICAN Coins, Relics Bought. Coin Value Booklet 12c. Frank Saco, 735 45th St., Brooklyn, N. Y.

OLD Coins Bought and Sold. Rare Coin Book 65c. 700 illustrations. Send 10c for Coin collecting booklet. Gutttag Bros., 16 Exchange Place, New York.

UNITED STATES and Foreign Money; Military Decorations Catalogue and Greek coin 10c. Alexis Mengelle, Colorado Springs, Colo.

UNITED STATES, Large Cent, two-cent bronze, three-cent nickel and Bargain List, 25c. Fifteen dates large cents, \$1.00. George Coffin, Greenwood Mountain, Me.

GET Profit and Pleasure in collecting Old Coins. Send 10c for Large Illustrated Coin Catalogue. You'll be delighted with it. Send for it right now. B. Max Mehl, Numis-matist, Mehl Bldg., Dept. P, Fort Worth, Texas. Largest Rare Coin Firm in the U. S.

OLD Coins, Large full Selling catalogue of coins for sale free. Catalogue quoting prices paid for coins, ten cents. William Hesselein, 101A Tremont Street, Boston, Mass.

CALIFORNIA Gold—Quarter Size, 27c; ½ size, 53c; 3c Piece and Catalogue, 10c. Norman Shultz, Box 746, Salt Lake, Utah.



## FOR BOYS

**BOYS!** 600 prizes, including airplane, given to purchasers of Nelson's Aero Dope Sheets. Particulars for stamps. Nelson Aero Service—1, Box 2186, Seattle, Wash.

**EARN Christmas Money.** Order 50 Sets Christmas Seals. Sell for 10c set. When sold return \$3.00, you keeping \$2.00. No Work—Just Fun. St. Nicholas Seal Co., Dept. 43PM, Brooklyn, N. Y.

**DRAFTING.** Learn Mechanical Drawing. Big demand for men. Pocket size. Start at beginning and learn by a series of simple lessons. Send no money. Just write postal for "Practical Course in Mechanical Drawing." Pay postman postage and \$1. Popular Mechanics Press, Room 908, 200 E. Ontario St., Chicago, Ill.

**SHALL I Become an Engineer?** You can decide this all-important question better by reading a book called "Engineering as a Career," written by a group of eminent engineers. It costs only \$1.00. You will find the advice of these successful men to be of the greatest value. Pay postman price and postage when he hands you the package. Address Popular Mechanics Press, Room 908, 200 E. Ontario St., Chicago, Ill.

## CAMERAS AND PHOTO SUPPLIES

**PHOTOGRAPHIC** equipment and accessories of every description are listed and illustrated in our 228-page catalog. It will pay you to secure a copy which is issued free, as our prices are low. We also deal in used goods which are sold under the same guarantee as new goods. Ask for our Bargain Book, Central Camera Co., Dept. E-121, 112 S. Wabash Ave., Chicago, Ill.

**DON'T waste film.** Take good pictures every time. Use the Amateur Photographer's Guide. Postpaid, 30c. Exemplar Society, 16 Virginia Bldg., Avondale, Cincinnati, Ohio.

**EARN big money** with your camera in your spare time, using Halldorson Home Portrait Lamp. Write for booklet "Home Portrait Photography" and catalog—both free. The Halldorson Company, 4747 N. Western Ave., Chicago.

**NO. 2 Goodwin Box Cameras** (Anso made), \$2.50 each postpaid. Roll films developed 5c. Prints 3c up. 10x12 enlargement 50c. H. P. Weaver, 907 W. 17th St., Los Angeles, Calif.

**KODAK Film—Special Trial Offer—**Your next roll developed 5c, prints 3c each. Beautiful 6x10 mounted Enlargement 40c. Fleet Photo Service, 425 G St., N. W., Washington, D. C.

**MAKE money in Photography.** Learn quickly at home, spare or full time. New plan. Nothing like it. Experience unnecessary. American School of Photography, Dept. 3432, 3601 Michigan Ave., Chicago.

**BIG Money Saved on Photographic Lenses and Apparatus—**goods exchanged; repairing done. Ralph J. Golsen, 1128 Argyle St., Chicago, Dept. P.

**FILMS Developed.** Special Trial Offer. Any Size Kodak film developed 5c, prints 3c each. Trial 6x10 Enlargement in handsome folder 40c. Overnight Service. Roanoke Photo Finishing Co., 209 Bell Ave., Roanoke, Va.

**AMATEUR Photographs Profitable.** Booklet describing One Hundred Best Magazine Markets 10c. Snyder Publishing Co., Guilford, Conn.

**HAVE You a Camera?** Write for Free sample of our big magazine, showing how to make better pictures and earn money. American Photography, 116 Camera House, Boston, 17, Mass.

## MOTION PICTURES

**\$1,250.00 FOR a Photoplay Story** by an unknown writer and sold through our Sales Dept. We revise, copyright and market. Located in the heart of Motion Picture Industry, we know the demand. Established 1917. Send Manuscript for free criticism. Booklet on request. Universal Scenario Company, 206 Western and Santa Monica Bldg., Hollywood, Calif.

**WANTED to Buy—**Second-Hand Power's, Simplex and Motograph Machines. Also extra mechanisms and stands. Must be bargains. P. O. Box 202, Birmingham, Ala.

**SEND 10c in stamps** for the 1928 edition of the famous Bass Book of Cinema Apparatus, greater than ever. Send \$2.00 for catalog and new book on "How to Make Motion Pictures," by Cameron. Bass Camera Company, 179 West Madison St., Chicago.

**NEW and Rebuilt Projectors for Theaters, Schools, Churches, Traveling Shows.** Supplies and Complete Theater Equipments. Bargain Prices. Free Catalog. Monarch Theatre Supply Co., Memphis, Tenn.

**FILMS:** \$3.00 per reel up. Comedy, Western, Cartoon, Drama, Serial, Educational, Special Features. Best Movie Stars. Free List. Toy Film 200 Feet Postpaid \$1.50. Dixie Film Co., Box 2042, Memphis, Tenn.

**NEW 100-foot Spring Motor Camera \$120.** New 14½ Spring Motor Camera \$37.50. New Home Projector \$40. Negative Film 2½ cents foot. 5-reel drama \$10. Comedy \$5. 16M Cameras and Projectors reduced. Ray, 296 5th Ave., New York.

**COMEDIES, Westerns, \$2.50.** Professional Camera \$80.00. Stewart Marshall, Rome, Ga.

**MOVIE Films, 1,000 ft. reels, \$2.50 each;** shipped anywhere on receipt of remittance. Particulars on request. Independent Films, 177 Golden Gate Ave., San Francisco, Calif.

**1000 FEET of Comedy, \$2.00.** No Hits. Sunset Film Exchange, 298 Turk St., San Francisco, Calif.

**BARGAINS:** Machines, Films, Supplies, Stereopticons, National Equipment Company, Duluth, Minn.

## SCENERY TO RENT

**WORLD'S Most Beautiful Settings** for operas, plays, minstrels. Amelia Grain, Philadelphia.

## EDUCATIONAL AND INSTRUCTION

**STORY Ideas Wanted** for photoplays, magazines. Big demand. Accepted any form for revision, development and submission to markets. Established 1917. Send manuscripts for free criticism. Booklet mailed on request. Universal Scenario Company, 403 Western and Santa Monica Bldg., Hollywood, Calif.

**FAMOUS Bailey Handbook—**The book that prepares you to pass the examination for any grade of license for stationery, marine and Diesel engineers, firemen and boiler inspector in any state of the union or any province of Canada. Flexible cover. Handy pocket size. Pay postman \$2.00 plus the postage when he hands you the package. Popular Mechanics Press, Room 908, 200 E. Ontario St., Chicago, Ill.

**CARTOONEX** Makes anyone draw cartoons. Complete sample 12c. Cartoonist Longeway, Wabasha, Minn.

**HANDBOOK of Useful Facts and Information,** containing Key to High School Home Study Course, memory, fasting, heredity, will power, magnetic personality, sleeplessness, etc. Single copies 25 cents; wholesale prices to mail-order dealers. Eugene Fenn, Box 473, St. Louis, Mo.

**EARN \$25 weekly,** spare time, writing for newspapers, magazines. Experience unnecessary. Details Free. Press Syndicate, 981, St. Louis, Mo.

**USED educational matter** sold on re-purchase basis. Also rented and exchanged. Money-back guarantee. Catalog free. (Books, etc. bought.) Lee Mountain, Pisgah, Ala.

**DOUBLE Entry Bookkeeping** mastered in 60 hours with 8 keys; guaranteed; diploma. International Bookkeeping Institute, Dept. 8, Springfield, Mo.

**WORLD-ROMIC System.** Masterkey 5,000 languages. Primers, \$1.98; Arabic, Chinese, French, German, Italian, Japanese, Russian, Spanish. Languages, 15 W. 18th St., New York.

**INSTRUCTION books,** all kinds. Catalogue free. Winebolt Book Co., Woodbine, 4, Penna.

**FUN Making Things.** Four large profusely illustrated books telling how to make almost everything from a sail boat to a toy automobile propelled by a motorcycle engine. Now \$2 per book or \$7 for the four if ordered at once. Send no money. Just write a postal saying, "Send the Boy Mechanic Library." Pay postman \$7 and postage. For single books, specify either Book 1, Book 2, Book 3, or Book 4. Popular Mechanics Press, Room 908, 200 E. Ontario St., Chicago, Ill.

**AMATEUR Cartoonists:** Make money in spare time with new cartoon selling plan. Write Smith's Service, PM1194, Wenatchee, Wash.

**PROFESSIONAL Bookkeeping Taught** for \$9.85 by simpler, speedier, more practical method. "Different"—that describes it! All papers. Write for folder. Kinman Morris Co., CPA's. Old National Bldg., Spokane, Wash.

**YOU Need a better grip on mathematics?** Tell us to send you a copy of "Mathematics for the Practical Man," only \$1.50. By common sense methods it removes the mystery and difficulties so algebra and calculus are made simple. Assuming your knowledge is limited to arithmetic you quickly and easily gain a working knowledge of algebra, geometry, trigonometry and calculus. Simply pay postman when he hands you the package. Address Popular Mechanics Press, Room 908, 200 E. Ontario St., Chicago, Ill.

## RADIO OUTFITS AND SUPPLIES

**RADIO Receiver:** All stations—American and overseas; all wave lengths—200 to 4,000 meters. This 6 tube Gnome Polyphase, the latest development in modern radio. Agents wanted. 100% profit—\$100—per week easy. Radio Exchange, 925 Broadway, New York.

**RADIO Up-to-the-Minute.** Telegraphy, radio reception, vacuum tubes, telephony, how to build receivers, broadcasting, all treated in new book. Send no money. Pay postman \$1.25 and postage. Just write postal for "Radio Up-to-the-Minute." Popular Mechanics Press, Room 908, 200 E. Ontario St., Chicago, Ill.

**CATALOG listing Radio Supplies** on request. Arthur Dombrowski, 4341 So. Campbell Av., Chicago, Ill.

**GUARANTEED X201A Tubes—75c.** Five Tube DX Receivers, \$16.50. Literature free. Radio, C427 E. 16th St., New York.

**BARGAINS.** New-used receivers, chargers, eliminators. Radioman, Lake, New York.

**BEST Radio Book—**New Third Edition, 1927, Revised—Radio Theory and Operating by M. T. Loomis of the Loomis Radio College is America's Standard Radio Text-Book. Used by the various gov't depts. and schools and leading radio schools. 885 pages, 700 illus., flexible krafty leather binding. Sent C. O. D. Pay postman \$3.50 and the postage when package is delivered. Popular Mechanics Press, Room 908, 200 E. Ontario St., Chicago.

## TRADE AND TECHNICAL SCHOOLS

**LEARN Bricklaying** and earn \$1 to \$1.75 an hour. Wm. M. Woods, who has trained 500 men will teach you bricklaying in our school run by 800 builders interested in giving jobs to Mr. Woods' students. Tuition \$60.00 per month. Time required 3 to 6 months. Board and room \$8.00 to \$10.00. Work is actual bricklaying; you become a master in the craft, in line for highest wages and promotion. Ample space and material. Catalog free. Associated Building Employers, R-400, A. B. E. Bldg., Grand Rapids, Mich.

**INTERNATIONALLY recognized** as world's leading radio institution. Investigate through Department of Commerce. Fall Term September 5th. Large staff expert instructors. All graduates placed at splendid salaries to start. Students may earn all expenses while taking course. Write today for catalogue and full particulars. Address Secretary, Loomis Radio College, Washington, D. C.

**GET a Foreman's job** in any trade. You will earn more money. Become an expert Blue Print Reader. You can do it in spare time. My training will advance you quickly. Write now—tell me what trade you want—I will send my plan at once. Carroll Rumsey, 265 Drexel Building, Philadelphia, Penna.

**TELEGRAPHY—**Both Morse and Wireless—taught thoroughly and quickly. Tremendous demand. Big salaries. Wonderful opportunities. Expenses low; chance to earn part. School established fifty years. Catalog free. Dodge's Institute, Fern St., Valparaiso, Ind.

**LEARN Barbering** at home. Practice on the family. Complete barber college instructions, home study, for \$1 bill or money order. Foster, Expert Barber, 6128 Michigan Blvd., Chicago, Ill.

**AUTOMOBILE Radiator** repairing. Complete instructions. Learn by doing actual work at home or in our school. Bixler Radiator Institute, Frankfort, Ky.

## BUSINESS OPPORTUNITIES

**READ The Mail Order News—**America's Pioneer Mail Trade Journal. Quarter Century Old. Approximately 600 pages yearly of valuable information for beginners and established mail-order houses. Analyzes mail-order business, its opportunities. Practical mail-order ideas, legitimate money-making schemes, instructive articles. Tells how to start, what to sell. Published monthly. Subscription \$3.00 yearly. Send 25c for sample copy. None free. Mail Order News, 360 Bristol Bldg., New York.



**PRIVATE Brand:** perfumes, cosmetics, soaps, disinfectants, cattle and chicken specialties, etc., manufactured for Agents, Salesmen and Mail Order Operators. Wholesalers of Foreign and domestic herbs and raw materials for perfumers. Wholesalers in bottles, jars, boxes, etc., any quantity, small or large. Formulas furnished for any purpose—not "book" formulas, but those resulting from years of experience as chemists abroad. Lor-El Scientific Laboratories is in constant communication with all foreign countries and sources of supply. New inventions purchased. 32-page booklet, just published, containing many things you have probably never thought of. 10c coin, postpaid. Correspondence in German, Holland, French, Esperanto, Italian, etc. Drs. Lorraine and VonKlein, Lor-El Scientific Laboratories, Room 316, Los Angeles Warehouse, 316 Commercial St., Los Angeles, Calif.

**NOTHING** on earth offers bigger opportunity for building wonderful business this summer than manufacturing these popular profitable, big-selling specialties. Start small—watch business grow. Write today for valuable formula literature relative to making: Sealatite, guaranteed puncture proof liquid; Ducopol, automobile polish; Cellulac, Duco finishes in color, quick drying; Solvit; powdered hand cleaner; Miracle, non-thermic ice cloths, mendit, fabric patching liquid; Liquid-Seal, radiator cement; Vanil-Ozone, "million-dollar" vanilla flavor; Fruitina; concentrated summer drinks; and a hundred other real honest-to-goodness, money-making propositions. 30 years headquarters for best formula service. Miller, Chemist, 1706-B Jetton, Tampa, Fla.

**PATENTS.** Time counts in applying for patents. Don't risk delay in protecting your ideas. Send sketch or model for instruction or write for free book "How to Obtain a Patent" and "Record of Invention" form. No charge for information on how to proceed. Communications strictly confidential. Prompt, careful, efficient service. Clarence A. O'Brien, Registered Patent Attorney, Security Bank Building (directly across street from Patent Office), Washington, D. C. See pages 138 and 139.

**LEARN Dry Cleaning.** My Book used by millions, housewives, cleaners, tailors. Formulas for spotting, pressing, pleating, repairing. Send 50c. W. Hoffmann's Laboratories, Capitol Hill Sta., Denver, Colo.

**CLASSIFIED** list fifty German manufacturers. \$1.00. Maywell, 1110A Washington, Chicago.

**MAKE** and sell something every mechanic needs, write Champion Sales Co., Box 604, Minneapolis, Minn.

**NEW System** mail order; big profits, instructions free. Evans P. King Company, Wilmington, Del.

**I EARNED \$30 weekly**—Home-making wood toys. My 36 patterns and instructions \$1. Money back guarantee. Morton, 3937 Tracy, Kansas City, Mo.

**MANUFACTURE** new fast-selling novelties, toys, preparations, agent's goods. Free list of plans, patterns, processes. Manufacturer's Bureau, R39, 1127 East 31, Kansas City, Mo.

**GET** behind the scenes of Mail Order business via our new, complete course of instructions, 100 plans, 15 years research. Pulliam, No. 712, Brady, Nebr.

**MAIL-ORDER** plans, complete—10c. Leyendecker, 163 Johnson Ave., Brooklyn.

**MAKE** money, get pleasure. Learn new art in few days. Complete directions \$1. Weidner, 5025 Annandale Blvd., Los Angeles.

**MAKE** toys, novelties, furniture; assorted patterns and instructions, \$1.00. Scroll saw free with order. Wm. Bogren, 2264 Hermany Ave., New York.

**MAIL-DEALERS**—Start Right, Grow, Succeed. Sensational Money Maker. Write Ellis, Route 3, Box 31A, Stockton, Calif.

**MAKE** money; Ideas, Plans, Opportunities. Read The Solicitor, copy 10c. 1130-H, East End, Chicago.

**ESTABLISH** a Sales Agency of Your Own. Unlimited field. Let us show you our interesting money-making proposition for exclusive agency in your territory. A dignified, independent career can be yours. Allen Typewriter Mfg. Co., Allentown, Pa.

**ARTIFICIAL** marble sanitary flooring instructions, covering wood or cement flooring 1/2 inch thick, fireproof, waterproof, all colors, low cost. Ornamental casting, concrete, plaster, papier-mache decorations, garden furniture, statuary, flexible molds. 18 years instructing the public; particulars and illustrations free. Chris. Mahler, Huntington, N. Y.

**\$8,500 IN 17 weeks!** That's what Charles F. Worthen made after reading my free book. Do as he did. Be a Real Estate Specialist. Use my successful system. Start at home in spare time. No capital or experience needed. Free book shows how. Address President, American Business Builders, Room 41-3, 18 East 18th St., New York.

**PRODUCE** Perfect Products yourself. Thaxly Formulas, Processes, Trade-Secrets show the way. All lines. Modern master methods. Catalog, circulars free. B. Thaxly Co., Washington, D. C.

**EARN \$12.00 Daily.** Learn Interior Home Refinishing, Redecorating, Repaint, retrim old cars like new. Manufacture auto specialties; unlimited demand. Profit by the World's Best Trade Experience. DeWilde, Sheboygan, Wis.

**SPLENDID** Sideline. Excellent profits selling to trade finest complete line vending machines, etc. No samples, sell from catalog. Specialty Mfg. Co., N724 N. Racine, Chicago.

**BIG** bunch mail, Year 15c. Magazines, catalogues. Kentucky Agency, Covington, Ky.

**MANUFACTURING** Pays Big Profits. Latest, dependable Formulas, Processes, Trade-Secrets. Best sellers. Valuable information free. Specialty Mfg. Service, 801 So. Farragut, Bay City, Mich.

**CAN** you stand prosperity? Are you ready to make yours? We can show you the way to make big money. No peddling. No competition. F. D. Gibson Co., 209 Bell Block, Cincinnati, Ohio.

**MIRRORS** Resilvered at Home. Costs less 5 cents per square foot; you charge 75 cents. Immense profits plating like new; brass, worn-off autoparts, reflectors, tableware, stoves, etc. Outfits furnished. Details Free. Sprinkle, Plater, 127, Marion, Ind.

**CAPITAL** Seekers—Put your project before 250 live-wire brokers. Cost trifling. Details free. Amster Leonard, East Orange, N. J.

**AGENTS:** Greatest Joke Novelty in years; pack of fun; everybody bites; some drop it and run; sells on sight; absolutely harmless; carry in vest pocket. Sample 25 cents. Buns, Oregon, Ill.

**501 SPARETIME** money-making opportunities. Write today, enclosing stamp. J. P. Bailey, Q 1109 Manhattan Ave., Brooklyn, N. Y.

**BECOME** a Hat Renovator. Learn how to clean and dye felt hats, bleach panamas and straw hats. Uncrowded field. Fascinating work. Learn this profitable trade in a few weeks. Write for particulars. Walter A. Hugo, Dept. 23, 703 McAllister St., San Francisco.

**REFINISH** and decorate furniture. Rub, polish, burn in, antique polychrome, etc. Easy to learn. Instructions \$1.00. Stamp brings circular. Bairs System, P. O. Box 2327, Cleveland, O.

**\$750,000,000 MAIL** order business last year. Many grew rich in this great trade. Sell merchandise, information, patented articles various preparations. Brenner's Famous Mail Order Handbooks tell how. Eleven brochures \$3. One book with complete catalog, 25c; none free. Brenner (Established 1900), 1007 Sansom, Philadelphia.

**EARN \$70 a week** at home silvering Mirrors. French mirror expert is giving a \$25 guaranteed formula in English or Spanish postpaid for \$1.85. Eduardo Halberto, Gasometro 32, Santiago de Cuba.

**SELL** By Mail wonderful opportunity. Particulars Free. Mason, 3902 Broadway, Room. 5, Chicago.

**150% PROFIT.** Spare-time business of your own. Article needed every home. Particulars, 2c stamp. Hughes Sales Co., 501 E. South St., South Bend, Ind.

**BUSINESS** profession of your own and earn big income in service fees. See Stephenson Laboratories, display ad, page 145.

**RESPONSIBLE** manufacturer wants competent men to manage office and salesmen. \$300 to \$1,500 necessary; will allow expenses to Baltimore if you qualify. Address Manager, 601 N. Eutaw St., Baltimore, Md.

**SIGNS** and Showcards Easily painted with Letter Patterns. Large variety of Styles and Sizes. Samples for stamp. John Rahn, a2120 Neva Ave., Chicago.

**TASTE** flavor of real money selling Annie Blain Flavors, wholesale, retail; new system, samples; other unique methods. Geo. S. Parker, New Brunswick, N. J.

**PATENTS** Procured; Trade Marks Registered—A Comprehensive, experienced, prompt service for the protection and development of your ideas. Preliminary advice gladly furnished without charge. Booklet of information and form for disclosing idea free on request. Richard B. Owen, 30-Owen Bldg., Washington, D. C., or 41-R Park Row, New York.

**UNPATENTED** Ideas Can Be Sold. I tell you how and help you make the sale. Free particulars (Copyrighted). Write W. T. Greene, 810 Jenifer Building, Washington, D. C.

**START** Mail Order Business of your own at home. We supply catalogues with your address on. Winebolt Sales Co., Box 4, Woodbine, Penna.

**"SCHEMER,"** Alliance, Ohio, 36 p. monthly, prints Schemes, Tips, Formulas. Subscriber reports \$25,000 from three; another \$10,000 from one. Try it! Year, \$1.00; 3 months, 30c.

**CHARTERS:** Delaware; best, cheapest; free forms. Colonial Charter Co., Wilmington, Del.

**YOU** can have an independent business of your own, and I am here to show you the way. Write at once! Wm. E. Heinemann, 2415 Montrose Ave., Chicago, Ill.

**GET** into the mail order business. Unlimited opportunities for ambitious persons. Write today for our big "free" offer. Publisher, 6652-J Gravois, St. Louis, Mo.

**WE** Start You in Business, furnishing everything; men and women, \$30.00 to \$100.00 weekly operating our "New System Specialty Candy Factories" anywhere. Opportunity lifetime; booklet free. W. Hillyer Ragsdale, Drawer 4, East Orange, N. J.

**MECHANICS,** painters, carpenters, start furniture refinishing, painting, handyman shop on nearly nothing; winning plan brings customers quickly. John Bracland, 1439 So. Ninth, Philadelphia, Pa.

**MAIL** Order Business Positively Your Big Opportunity. Start Right. Grow. Win. Free Circular. Send Today. Macrae, Publisher, 402M, Oregonian Building, Portland, Ore.

**CHEMICAL** Expert furnishes Manufacturing Formulas and Processes with complete working directions. Reliable individual service only. No list. Charges reasonable. Correspondence invited. Dr. Arthur Van-Heeden, 508 South Oakley, Chicago.

**CHEMICAL** Expert will furnish Formulas and Trade Secrets. All lines. Lists Free. W. L. Cummings, Ph. D., 228 Gordon Ave., Syracuse, N. Y.

**SELL** by Mail! Books, novelties, bargains! Large profits! Particulars Free! B-Elco, 525 South Dearborn, Chicago.

**EARN \$10** daily silvering mirrors, plating, refinishing metalware, chandeliers, head-lights, bedsteads. Outfits furnished. E. Deele Laboratories, 152 E. 23d St., New York.

**DELAWARE** Incorporator. Charters; Fees Small; forms. Chas. G. Guyer, 901 Market St., Wilmington, Del.

**LEARN** the collection business. Good income, quick results. Interesting booklet, "Skillful Collecting" free. National Collectors Assn., Long St., Newark, Ohio.

## TELEGRAPHY

**TELEGRAPHY**—Both Morse and Wireless—taught thoroughly and quickly. Tremendous demand. Big salaries. Wonderful opportunities. Expenses low; chance to earn part. School established fifty years. Catalog free. Dodge's Institute, H St., Valparaiso, Ind.

## CHEMISTRY

**YOUR** chemical problem solved and working formula or process furnished for \$5.00. Write me. W. Stedman Richard, Industrial Chemist, Box 2402, Boston, Mass.

**CHEMICAL** Analysis, Processes, Technical Information. Robert Henderson, Laboratory, Madison, Maine.

## FORMULAS AND TRADE SECRETS

**FORMULAS:** Absolutely guaranteed. Best chemical science has devised. Don't risk your money till you've investigated these wonderful processes for all lines. Get my valuable "eye-opening" literature. Highest references. 30 years supplying the best. Miller, Chemist, 1706-P Jetton, Tampa, Fla.



**10,000 FORMULAS.** A real gold mine of money-making ideas. Tells how to make almost everything under the sun. You can make and sell cosmetics, muckilage, anti-freeze solutions, battery solutions, beverages, cheese, chewing gum, cleaning preparations, extracts, hair preparations, inks, blueing, leather polish, mirrors, perfumes, polishes, typewriter ribbons, carbon paper, washing powders, liquid soap, and hundreds of other profitable articles. Send no money. Just write a postal for "Henley's 20th Century Book of Formulas." Pay postman postage and \$4. Popular Mechanics Press, Room 908, 200 E. Ontario St., Chicago, Ill.

**PRODUCE** Perfect Products yourself. Thaxly Formulas, Processes, Trade-Secrets show the way. All lines. Modern master methods. Catalog, circulars free. B. Thaxly Co., Washington, D. C.

**TOMBSTONE** Renewing: We will send amazing money getting process to 2 Men. Women or Boys to go partners working cemeteries; spare time or steady; lonesome work but dollars jingle. Sterling Specialty Co., 231 Federal, Denver, Colo.

**500 FORMULAS** and Big Catalog 20c Ideal Book Shop, Park Ridge, Ill.

**TATTOO** Remover Formula \$1.00. Supply Catalogue, "Waters," 965 Puttman, Detroit.

**15,000 FORMULAS** in "Scientific American Encyclopedia of Formulas." Includes following and many others: Accidents and emergencies, agriculture, alloys and amalgams, artist's materials, beverages, cements, glues, pastes, muckilages, bleaching, renovating, coloring metals, dyeing, glass, heat treatment of metals, household formulas, ice cream, confectionery, chewing gum, lapidary work, exterminating vermin, lubricants, paints, varnishes, photography, condiments, canning formulas, rubber, soap, candles, soldering, toilet preparations, perfumes, waterproofing, fireproofing, writing materials. Send no money. Just write a postal. When postman hands you book pay \$5.50 and postal charges. Popular Mechanics Press, Room 908, 200 E. Ontario St., Chicago, Ill.

#### AGENTS WANTED

**100% PROFIT** on Every Sale selling Christmas Greeting Cards in Box Assortments. Our wonderful Box Assortment is the finest published. Agents earn \$2 to \$4 per hour. We have a magnificent Box Assortment containing 21 high-grade Christmas Greeting Cards and Folders, each with envelope, Steel Engraved, Colored, Paneled, and Bordered. Sells for \$1.00; costs 50 cents. Nothing ever sold begins to compare with the sale of Christmas Box Assortments. Write immediately for particulars and free samples. Waltham Art Publishers, 7 Water St., Dept. B-26, Boston, Mass.

**WHY Not Sell Us Your Spare Time.** \$2.00 an hour, \$19.70 daily easy full time—(In Advance) ? Send for sworn proof, Introducing New Style Guaranteed Hosiery—57 styles, 39 colors, for Men, Women, Children; including latest "Silk to the Top" Ladies' Hose. No capital or experience needed. You simply take orders. We deliver and collect (or you can deliver—suit yourself); Credit given. Pay you daily. We furnish samples. Silk hose for your own use free. New Plan. Milton Mathews, Road 5869, Cincinnati, Ohio.

**AGENTS:** Make \$100 Weekly selling "Gray Seal." Automatically, Instantly and Permanently seals all tire punctures. Gives longer life to tires and tubes. Demonstration closes sale every time, with \$1.50 to \$3.00 profit for you. Exclusive territory given. Money-back guarantee. Write today for our Very Liberal Offer. Gray Seal Products Corp., 200 Rutger St., St. Louis, Mo.

**TAILORING** Agents. Earn \$35.00 to \$75.00 weekly, showing fine 100% Pure Virgin Wool \$23.50 suits, union hand-tailored to measure. Equal usual \$35 to \$40 suits. Old reliable \$4,000,000.00 firm offers pay in advance, exclusive territory, generous backing and big outfit of hundreds of large samples free. Write J. B. Simpson, 843 Adams St., Dept. 1281, Chicago.

**AGENTS** make \$3.00 an hour taking orders for our 40 fascinating Kitchen Specialties. No competition. Write quick. General Products Co., Dept. H 207, Newark, N. J.

**LAMB'SWOOL** Polishing Mittens, Brush. Newhall, 358 Broad, Lynn, Mass.

**WANT \$15 a Day?** New way to make quick cash profits selling fine shirts. Actual samples sent free. Write Fashionwear Shirt Co., L-943 Jackson St., Cincinnati, O.

**PRIVATE** brand Toilet Articles, Household Specialties, Perfumes, Soaps, Extracts, etc. We pack these goods for you under your private label. With your name on the goods you get all the repeat business. Highest quality merchandise. Extremely low prices. Immediate shipments on both large and small orders. Write at once for lowest wholesale prices and complete information regarding our amazing offer. Address Supply Department, National Scientific Laboratories, 1904 W. Broad, Richmond, Va.

**THANCO** Flavors—Bottle Yourself! Concentrated—add water! Free labels. Whirlwind Sellers! 500% profit! Lifetime opportunity! Write Thomas Manufacturing Company, Indianapolis, Ind.

**AMAZING** new device, Sharpens everything, even scissors. Over 100 big uses in every home. Also sells fast to Garages, Shops, etc. Many now making \$3-\$9 an hour. Everything furnished. Write for Free Outfit Offer, Central States Mfg. Co., Dept. L-930, St. Louis, Mo.

**100 MORE** active men to Introduce Chief-tain Guaranteed Tailored Shirts, 3 for \$4.95. Latest Novelties, colors. Dickman, Illinois, in 3 weeks made \$589; Sinton, Texas, in 12 days, \$324.80; Bend, Iowa, in 16 days, \$334.80. Why not you? No experience or capital needed. We deliver and collect. Full working outfit free. Cincinnati Shirt Company, Lane 1589, Cincinnati, Ohio.

**AGENTS—**Make \$15 Daily. Show samples and distribute teas, coffee, spices, extracts; 200 products; things people eat. I go 50-50 and furnish Chrysler closed car. Offer made to first person answering in your locality. Write or wire Health-O Quality Products Company, Dept. 101-J, Cincinnati, Ohio.

**MAKE \$25.00** daily selling colored Rain-coats and Slickers; Red, Blue, Green, Etc., \$2.95. Hat Free. Commissions daily. Outfit free. Elliott Bradley, 241 VanBuren, Dept. AB-9, Chicago.

**IF I** Send You a Suit made in latest style from finest goods, will you keep it, wear it, and show it to your friends as a sample of my sensational \$19.50 suits guaranteed regular \$40.00 values? Could you use \$3.00 an hour for a little spare time? If so, write me at once for my wonderful new proposition. Just write your name and address on a card and mail to Salesmanager, Peoria and Adams, Dept. 768, Chicago.

**42.8 MILES** on 1 gallon. Wonderful Moisture Gas Saver. All autos. 1 free. Critchlow, D5-805, Wheaton, Ill.

**COUNTY** Representatives With Cars to demonstrate Webb's Tube Seal. Seals punctures, slow leaks and porous tubes. Reduces the cause of Rim Cuts and Blow-outs. Increases Tire Mileage. Positively not-injurious to Rubber. Webb's Gasoline Intensifier reduces Carbon deposits, increases Gasoline Mileage. "A regular Monkey Gland for Automobiles." Write for County Rights, Pgh. Puncture Proof Products Co., 209 Anderson St., N. S., Pittsburgh, Penna.

**REPRESENTATIVES** wanted by over 500 manufacturers, offering real money making propositions. No need of being out of work. Write for Free Copy. Opportunity Magazine, 750 N. Michigan, Service Dept., Desk 2, Chicago.

**OUR** Agents average better than \$75 a week; Rich's pure fruit soft drink powders. Every home, store, drink dealer buys. Samples Free. Sol P. Rich Co., 622 S. Sangamon, Chicago.

**AGENTS** you want to earn money without interfering with your regular work. Write for free dress, slicker catalogue. Superbuilt, Box 453-A, Chicago.

**"LIQUID-LEATHER"** Fills Holes in Shoes, Rubbers, Tires. Dries Instantly. Pliable, Waterproof. Just Imported from France. Tube Retalls 75c—Cost 35c. Sells Housewives. Sub-Agents. Nullife Leather, Hartford, Conn.

**PITCHMEN** wanted sell eight pair men's fancy socks \$1.00, imperfect \$0.00 gross, \$10.00 gross, \$11.00 gross, \$12.00 gross. send \$42.00 for four gross pairs or \$10.50 one gross pairs assorted. Lewis Hosiery Co., 12 No. Third St., Philadelphia, Pa.

**BIG** money easily made without peddling or outfits. Free particulars, Elite, 38 Elizabeth St., New York.

**75c PROFIT** on \$1.00 sale. Auto, furniture and glass cleaner. Your name on label. Exclusive rights; free sample. Mfg. E, 213 Griswold, Detroit, Mich.

**NATIONALLY** Known Organization now selling to retail trades is seeking men and women agents for profitable full or part time canvassing in every city. The product is a high grade refrigerator accessory, with a tremendous appeal to the housewife. Fully guaranteed and highly endorsed. Sells for One Dollar. Every refrigerator owner a prospect. 100 per cent profit on each sale. Exclusive territory for aggressive workers. Kanak Company, Inc., 18 East 41st St., New York City.

**AGENTS—**\$13.80 Daily in advance, Introducing New Insured Hosiery for men, women, children. Must wear or replaced free. 57 styles, 39 colors, including latest "Silk to the Top" Ladies' Hose. Nyland made \$595 in one month. Edwards, \$460.60. Mrs. Bone, \$425.45. Why not you? Even spare time should pay you \$3.00 an hour. No experience needed. We furnish samples. Silk hose for your own use free. New Plan. School line now ready. Write quick. Milton Mathews, Road 2569, Cincinnati, Ohio.

**AGENTS** start a permanent business of your own selling guaranteed hosiery and underwear worn all over the world. No capital or experience needed; many representatives make \$3,000 to \$5,000 per year. Become our district manager—get others working for you. Write for details to Malloch Knitting Mills, 579 Grant St., Grand Rapids, Mich.

**HOOPER** sold 830 in 90 days, King 450 in 6 weeks. Improved Hydrostatic Gage shows gasoline supply on dash of all cars. No cutting or drilling, quick installation. Guaranteed 3 years. Lowest price ever made on dash gage. Big commission to salesmen. Write Kirstin, Box 1001, Escanaba, Mich.

**QUICK** Money. Our agents selling 2-3 dozen daily Vanhix garage-door holders. Every private garage owner instantly buys. Retail \$2.50 pair. Big proposition, whole or part time. Experience unnecessary. Exclusive territory. Write today. Vanhix Metal Products, 352 Mulberry St., Newark, N. J.

**AGENTS:** No investment necessary to handle new high-class advertising novelty with unusual motion-picture angle. Yearly repeat order feature. Both you and your salesmen build a large solid permanent business quickly. Just ready. Will close fast with capable men. Dept. C, Star & Studio Picture Co., 116 West 39th Street, New York.

**SELL** Surety, the Original, Genuine, powdered Hand Soap, and make \$5,000 yearly. We furnish sales plans, advertising, free samples. Write quick. Surety Mfg. Co., Dept. H9, 26 W. Washington, Chicago.

**BIG** pay every day! Complete guaranteed line direct to wearer—Dress Shirts, Work Shirts, Flannels, Overalls, Pants, Leather Coats, Sweaters, Playsuits. \$10-\$25 daily! Experience unnecessary. Big outfit free! Nimrod Co., Dept. 8, 4922-28 Lincoln Ave., Chicago.

**MEN—**Women, \$1.80 an hour—no less. Large mfg. Co., estab. 30 years. Starting new medallion dept. Amazing new sales plan. First 22 agents averaged \$1.80 an hour steady. Only one agent wanted in locality. Your own photo free as sample. Art Medallion Co., Chicago, Ill., Campbell Ave., at Jackson, Dept. 42.

**75c PROFIT** on \$1.00 sale. Auto, furniture and glass cleaner. Your name on label. Exclusive rights; free sample. Mfg. E, 213 Griswold, Detroit, Mich.

**MEN** and women. Establish paying business, spare time at home. \$1 starts or particulars free. Greene Laboratories, 198, Falmouth, Mass.

**ATTRACTIVE** proposition and exclusive territory to crew organizers. The V-W Window Ventilators are easily installed and removed by any person. Write now giving references. The V-W Ventilator Co., A. I. U. Bldg., Columbus, Ohio.

**AGENTS—**Valuable information for your address. "Master," 816-20 Chestnut, St. Louis.

**GOLD-LEAF** Sign Letters; copyrighted Manufacturing Instructions; profits 1,000%. Johnston Co., Quincy, Ill.

**\$16 A DAY** Easy—I start you in auto accessory business; no investment; no experience necessary. Landin, 4206 Montrose Ave., Chicago.

**ARVEO** Polishing Cloths do the job the way it should be done. Write for our remarkable introductory selling plan to new agents. Arveo Industries, Box F 147, Grosse Ile, Mich.



**AGENTS**—Fred Chaplain made \$70.00 one week. Start your own business. Make 100% profit. New magic powdered hand cleaner. Entirely different. Washes hands cleaner and in half the old time. A man's job. Big repeater. Free samples furnished to be given away. Write for free trial package. H. Magnus Chemical Co., 728 Atlantic Ave., Brooklyn.

**EMBOSSER**, Engraved lodge emblems for Autos. L. Belle Mfg. Co., 96 Friendship, Providence, R. I.

**EVERY Woman Wants a Sewing Set.** Home Sewing Sets contain 142 useful sewing articles. \$4 an hour easily made with this 50c seller. Lee Bros., 128 E. 23rd St., New York.

**AGENTS and Canvassers Wanted to sell five self-selling Auto Accessories** direct to consumer. 100% profit. Write Anderregg Brothers, Mfrs., Algoma, Wis.

**MAN Between 25 and 65 to Act as Manufacturer's agent.** No investment necessary. A man with selling experience or willing to learn, who can command respect and who is willing to work, will find this a permanent business with a steady income of from \$175 to \$425 a month. Write to Thomas M. Judy, Box 966, Dayton, Ohio.

**WILLIAMS' Powdered Hand Soap** has taken auto owners by storm. Cleans dirtiest hands instantly. Easy demonstration sells on sight. Free Sample and particulars. W. B. Williams, Inc., Dept. 266, Montclair, N. J.

**MAKE Big Money; supply tremendous demand.** Everybody buys; profits big. Get your free sample. Magic Products, Dept. 200, Oak and 31st, Kansas City, Mo.

**AGENTS take orders for orthophonic portable phonographs.** Sells \$19. Commission \$8. Sample free. Orthophonola Mfg. Co., 157-F Broadway, N. Y.

**MANUFACTURE Chipped Glass Name and Number Plates, Mirrors, Signs, etc.** Investigate! Radiant Signs, 15905 Alden, Detroit, Mich.

**BIG Money and Fast Sales.** Every owner buys Gold Initials for his auto. You charge \$1.50; make \$1.35. Ten orders a day easy. Write for particulars and free samples. American Monogram Co., Dept. 40, East Orange, N. J.

**AGENTS—\$6.00 hour earnings making four sales hour.** Tremendous demand \$3.50 article; powerful selling plan. Fagley & Halpen, Dept. 40, Philadelphia, Pa.

**AGENTS—Best Seller; Jem Rubber Repair** for tires and tubes; supersedes vulcanization at a saving of over 800 per cent; put it on cold, it vulcanizes itself in two minutes, and is guaranteed to last the life of the tire or tube; sells to every auto owner and accessory dealer. For particulars how to make big money and free sample, address Amazon Rubber Co., Philadelphia, Pa., Dept. 595.

**AGENTS—Men and Women making remarkable records with our Empress Quality Line of Household Specialties.** Full or Spare Time. Hess Mfg. Co., Dept. C, Freeport, Ill.

**AGENTS and distributors wanted to sell Acto Foot Salve.** 200% profit. It makes good. Write for particulars. Trial box 25c. Audrey Agent Supply Co., Louisville, Ky., Box 2102.

**WRITE for Opportunity List.** Guaranteed high-class specialties. Every one "Leader." Miller Sales Company, Dept. P, Lexington, Ky.

**AGENTS: Earn \$25.00 daily selling La Fleurette Solid Perfume.** Full or spare time. Sales guaranteed. Write, Quality Laboratories, 296 Broadway, New York.

**EXCELLENT popular priced, self-feed automatic pencil—generous commission; particulars free; sample 75c.** A. N. D., 317 Broadway, New York.

**AUTO Fountain Sponge and Auto Mitten Dusters** going over big. Send for circulars and free sample offer. National Dible Broom Co., St. Louis, Mo.

**ARE You Old at Forty?** See our advertisement on page 144 of this issue. The Electro Thermal Company, 2173 Main St., Steubenville, Ohio.

**CASH Paid for Butterflies, Insects.** See Sinclair Display Advertisement on page 30.

**42.8 MILLS on 1 gallon.** Wonderful Moisture Gas Saver. All autos. 1 free. Critchlow, D6-805, Wheaton, Ill.

**MIRRORS Resilvered at Home.** Costs Less 5 cents per square foot; you charge 75 cents. Immense profits plating autoparts, reflectors, tableware, stoves, refinishing metalware, etc. Outfits furnished. Details Free. Write Sprinkle, Plater, 128, Marion, Ind.

**PARTNER** wanted to introduce beautiful fit-to-measure Style-Arch shoes for women. No capital required. We furnish everything, including sample shoes. Amazing values at \$3.95 and \$4.95. Can make \$60 to \$135 in cash, plus semi-yearly share of company's profits. Write at once for full details. No experience necessary. Style-Arch Shoe Co., Desk V-102, Cincinnati, Ohio.

**AGENTS: Make \$500.00 monthly.** Pay daily. No investment. Rhinestone Initial buckles and Novelties. Sell easy everywhere. Exclusive territory. Chaton Novelty Co., 606 Blue Island, Chicago.

**AGENTS, \$14 daily in advance.** Bonus besides. Write orders for finest line guaranteed hosiery you ever saw. 126 styles, colors. We deliver or you deliver, suit yourself. Auto furnished. No experience needed. Spare time satisfactory. Credit given. Samples furnished. Wilknit Hosiery Co., Dept. 3031, Greenfield, Ohio.

**EARN Dollar an hour selling pearl necklaces: Liberal profits.** Hanover Trading, 925 Broadway, New York.

**RELIABLE aggressive agents** needed to sell Holley Suction and Force Pumps. Used in clearing plugged plumbing fixtures. Sizes for every need. Readily salable, and show good profit to consistent workers. The Holley is priced below competition and offers, at the same time, exceptional quality. Worthwhile for worth-while men. Alert Products, Inc., Dept. 50, Holley, N. Y.

**AGENTS, \$300 month.** Sell guaranteed silk hosiery. Must wear 7 months or replaced. New selling plan. We furnish auto. Silk hosiery for your own use. Write for samples. Betterknit Textile Co., Silk 831, Greenfield, Ohio.

**AGENTS: 90c an hour to advertise and distribute samples to consumers.** Write quick for territory and particulars. American Products Company, 9212 Monmouth, Cincinnati, Ohio.

**RADIO Agents—Make Big Money—Easy!** selling Marvelous New Sets and accessories. Buy from factory at lowest prices. Get Big New Catalog with thousands of nationally advertised bargains. Free Call Book. Write today. American Auto and Radio Co., Dept. 268, Radio Bldg., Kansas City, Mo.

**\$100.00 WEEKLY! Two Suits or Suit and Overcoat \$33.50.** All Wool—Made to measure. Commission \$6.00-\$7.50. Outfit Free. Garfield Tailors, 111557 Milwaukee, Chicago.

**GOOD money made in handling our new crumblers breadknife.** Never before offered. New Patent. Fast Seller. Send 50 cents today for sample and proposition. Lindsay Sales Co., 515 Case Bldg., 82 St. Paul St., Rochester, N. Y.

**AGENTS: Sensational profits taking orders for Taylor made-to-measure caps for men, and women's Bobbette hats with purse to match.** \$75 to \$150 every week. Pay in advance. We deliver. Outfit free. Write quick. Taylor Cap Manufacturers, Desk R-11, Cincinnati, Ohio.

**AGENTS—Make a dollar an hour.** Sell new kind of sharpeners. Sharpens all knives and tools quickly. Demonstrating sample free. Premier Mfg. Company, Dept. 71, Detroit, Mich.

**\$50.000. PICTURE Man Friedman** made canvassing. Beginners can make \$100.00 weekly with my sales talk. Experienced men make more. Free book. "Profits in Portraits" explains. Samples Free. Picture Man Friedman, Dept. 8-L, 541 W. Lake, Chicago.

**AGENTS—New Plan,** makes it easy to earn \$50.00 to \$100.00 weekly, selling shirts direct to wearer. No capital or experience needed. Represent a real manufacturer. Write now for Free Samples. Madison Company, 566 Broadway, New York.

**MAKE \$100 weekly** supplying demand for new invention. Makes autos run on 7¢ gasoline. Free sample. Write Whirlwind Co., 1041-360 Winnebago, Milwaukee, Wis.

**JUST Out—New Patented Apron.** No strings or straps—\$20.00 a day every day; over 100% profit; commissions daily. Write for free offer. Sta-Put Co., Dept. 209, St. Louis, Mo.

**AGENTS, portraits, photo-pillow tops, frames, sheet pictures, medallions, photo-jewelry, guaranteed hose, laundry tablets, food products, toilet requisites, luminous crucifixes.** Catalog 50 specialties free. 30 days' credit. Jas. C. Bailey, Dept. C-9, Chicago.

**WILL you wear a pair of genuine tailor-made shoes at my expense? Will you show them to your friends and take their orders? I will also send you free our big selling outfit showing 70 shoe styles and 60 actual leather samples.** I pay my agents \$8.00 daily. Write quick. Tailor-Made Shoe System, 932 Wrightwood, Dept. AA-9, Chicago.

**BIG Winner for Agents.** New patented cigarette case. Holds package cigarettes and box safety matches; beautiful, compact, flexible container; large profits; write for liberal proposition. All-in-One, Dept. A-9, 2810 Portland Ave., Minneapolis, Minn.

**CAN You Sell Gas at 5c a Gallon? If so, write us.** We guarantee distributors \$15 a day. Blanche Co., 154 E. Erie Street, Dept. 805 M-X, Chicago.

**\$8 TO \$12 a day.** Man or Woman Wanted. Part or full time. To distribute well known line of cosmetics and toilet preparations in their locality. No experience necessary. We train you. Big profits. Large repeat sales. Free sample offer. Write Franco-American Hygienic Company, 123 E. 13th Street, Chicago, Ill.

**PRODUCE Perfect Products yourself.** Thaxly Formulas, Processes, Trade-Secrets show the way. All lines. Modern master methods. Catalog, circulars free. B. Thaxly Co., Washington, D. C.

**WE Start You in Business,** furnishing everything; men and women. \$35.00 to \$100.00 weekly operating our "New System Specialty Candy Factories." Few dollars start you home or small room anywhere. Booklet free. W. Hillyer Ragsdale, Drawer 350, East Orange, N. J.

**MAKE \$18 a Day and More.** Everyone needs shoes. Sell Mason's all-leather shoes below store prices. 85 styles—men's, women's, children's. No experience needed. Big outfit free. Mason Shoe Mfg. Co., Dept. 259, Chippewa Falls, Wis.

**NEW Dynamo Timer** guaranteed life of car. 12,000,000 prospects. Earn \$100 weekly. Write today. Free sample. Dynamo Co., 426-1111 Eleventh St., Milwaukee, Wis.

**\$30.00 A DAY** Guaranteed to Workers taking orders for Goodwear tailored-to-measure clothes at sensational new low price. Tremendous assortment Virgin Wool fabrics. Biggest cash commissions paid daily and special cash bonus besides, makes our best paying line in America. \$25.00 Sales Outfit Free. Exclusive Territory. Write at once to Dept. 167, Goodwear Chicago, Inc., 844 West Adams, Chicago.

**\$25 DAILY** showing \$2.98 slickers. \$1.25 gift to customer makes sales easy. Outfit free. American, 724P, Roosevelt, Chicago.

**\$18 TO \$25 daily.** Biggest selling line of 2-piece suits, \$9.95 and \$12.50; 3-piece wool suit, \$17.95 (regular \$28.00 value). All-wool overcoat, \$18.50. Splendid raincoats, slickers and boys' suits. Biggest commissions. Free outfit. "Jim" Foster, Inc., Dept. 29, 2250 S. Spaulding Ave., Chicago, Ill.

**MAKE \$12 a day** from start and liberal bonus selling Pioneer \$23.50 all-wool tailoring. Commissions paid in advance. Striking leather brief case and 100 large cloth samples furnished. We train the inexperienced. Write now to Pioneer Tailoring Co., 159 W. Harrison, Dept. G-1117, Chicago.

**MAKE \$1,000 before Christmas** selling exclusive personal Christmas cards in distinctive steel engraved designs. Expensive Sample Book free. Wetmore, Jones and Sugden, Rochester, N. Y.

**MEN—Women—Sell beautiful household linens; wholesale prices.** Big commissions. Everybody buys. Full-spare time. Milton Linens, 354 Fourth Avenue, Dept. 20, New York.

**IF you are a man worthy of the name and not afraid to work, I'll bet you \$50.00 you can't work for us thirty days and earn less than \$200.00.** Think I'm bluffing? Then answer this ad and show me up. Openings for managers. Wonder Box sells on sight. The best selling proposition in America today. Write Tom Walker, Dept. 120, Pittsburgh, Pa.

**REAL Whirlwind Seller—Nopolout Custom Shirt.** Every man buys them. Patented—no competition. Liberal commission. Free selling kit. Make \$15 up daily taking orders direct from consumer at manufacturer's prices. District or local agents. Write Nopolout Shirt Co., Dept. Y, Hazleton, Pa.

**\$60-\$200 A WEEK.** Genuine Gold Letters for store windows. Easily applied. Free samples. Liberal offer to general agents. Metallic Letter Co., 438-B North Clark, Chicago.



**AGENTS:** both sexes, we manufacture and control new household article. Fast seller. Big profits. Exclusive territory. Write now. Connolly, 123 Liberty St., New York.

**SEND** name, address on postcard. Free introductory copy Salesology Magazine; contains 1,000 money-making opportunities. Offered by big reliable firms; no obligations. Salesology Magazine, Desk B-38, 500 No. Dearborn, Chicago.

**32 SECONDS** complete tire change by Detmer, Ohio, with Morey Quick Action Rim Tool. Sold, singly, 49 three days, cleared \$100. Anderson, Mont., sold 1400 in 14 weeks. Get details for good territory. Harvest time Now. M. Morey Rim Tool, Buffalo, N. Y.

**AT Last! Diamond Rival Discovered!** Amazing blue white Rajah Gem astounds jewelry world and deceives experts. Beautiful sample case free! \$100 weekly. Quick! Rajah Diamond Co., Dept. F20, Salisbury, N. C.

**\$31.00 PROFIT—**with \$1.50 Outfit—Big Money—Easy Work. Selling Gold Monograms for Automobiles, Luggage, Windows, Wagons. No Experience. No License. "Samples Free." NuLife Monograms, Hartford, Conn.

**SELL** men's neckwear; wonderful proposition. Astor, 318-M Broadway, New York.

**DO** you want good live agents—fellows who can get the business? Ask me how others are doing it. I'll gladly render the necessary assistance without cost to you. Address, M. L. Rund, Mgr. Classified Advertising, Popular Mechanics Magazine, Chicago.

**AGENTS.** Get our prices on Coffee, Tea, Desserts, Soaps, Perfumes, etc. Endless variety, superb quality, quick service. Sample display free. Address Blair Laboratories, Lynchburg, Va.

**AGENTS:** Our gold-eyed Needle Cases are wonderful sellers; immense profits; \$50 to \$300 weekly; proof and particulars free; sample outfit 10c; factory prices. Paty Needle Co., 231 Davis Square, Somerville, Mass.

**CALIFORNIA** perfumed beads selling like hot cakes. Agents coining money. Big profits. Catalog free. Mission Factory P. 2328 W. Pico, Los Angeles, Calif.

**HUNDREDS** of manufacturers, formerly agents selling other goods now owe their success to Miller's Guaranteed Formulas for making biggest-selling, advertised specialties in all lines. Investment small. No machinery needed. Profits great. Make your own goods—get the profit you're entitled to. Write today for my "eye-opening" literature. It's free and tells all. Miller, Chemist, 1706-W Jetton, Tampa, Fla.

**ATLAS** Sign Works for Beautiful Gold Window Letters. Penny Each! Why pay 8c? Write for Free Samples. F1032 E. 55th St., Chicago.

**42.8 MILES** on 1 gallon. Wonderful Moisture Gas Saver. All autos. 1 free. Critchlow, D3-805, Wheaton, Ill.

**WE** Start You Without a Dollar. Soaps, Extracts, Perfumes, Toilet Goods. Experience unnecessary. Carnation Co., Dept 2480, St. Louis.

**AGENTS—**Make a dollar an hour. Sell Mendets, a patent patch for instantly mending leaks in all utensils. Sample package free. Collette Mfg. Co., Dept. 404, Amsterdam, N. Y.

**AGENTS** make \$100 week placing advertising Cigar Lighters with glass front. Every dealer wants one. Write for free plan. Drake Mfg. Co., Dept. M, Milwaukee, Wis.

**NO** Dull Times Selling Food. People must eat. Federal distributors make big money; \$3,000 yearly and up. No capital or experience needed; guaranteed sales; unsold goods may be returned. We furnish you with sample case, license and Free Samples for customers—Sure repeat orders. Exclusive territory. Ask now! Federal Pure Food Co., A2307 Archer, Chicago.

**POLMET—**The Wonderful Polishing Cloth that cleans all metals without liquid, paste or powder. Approved by "Good Housekeeping" and "Modern Priscilla"—sells fast at 25c. Sample free. Gale & Co., Inc., 15 Edinboro St., Boston.

**PHOTO** Medallion Men and Women, the largest line of Photo Novelties in the world. Lowest prices, quickest service. Send for catalogue showing over 200 money makers. Photo medallions, photo medallion clocks, photo mirrors, photo fountain pens, photo powder compacts, photo jewelry and photo buttons. Gibson Photo Jewelry Co., 608-614 Gravesend Ave., Brooklyn, N. Y.

**AUTO** owner tire agent wanted each locality to use and take orders for hand made Mellinger cord and balloon tires; guarantee bond 15,000 miles; shipped prepaid on approval; get your tires free; no capital or experience required; make \$100 to \$300 weekly. Write for wholesale prices and sample kit. Address Mellinger Tire Co., Dept. 400, Kansas City, Mo., or Dept. 400, Philadelphia, Pa., or Dept. 400, Oakland, Calif.

**GENUINE** Gold Leaf Letters anyone can put on store windows. Guaranteed to never tarnish. Large Profits. Enormous Demand. Free Samples. Write today. Metallic Letter Co., 438-D North Clark, Chicago.

**AGENTS—N-R-G** Laundry Tablets, the old reliable moneymaker for live agents. Millions sold—200% profit—sales waiting for you. Clothes washed spotlessly clean in 10 minutes without rubbing. Free samples. N-R-G Company, 230 W. Superior, Chicago.

**\$50.00 WEEKLY** easy, Applying Gold Initials on Automobiles. No experience needed. \$1.45 profit every \$1.50 job. Free Samples. "Ralco Monograms," 1043 Washington, Boston, Mass.

**AGENTS:** 500% profit. "Happy Home Make Shampoo" builds your own big business. Martin of Indiana made \$75.00 in one day. Missouri man made \$750.00 one month. Exclusive territory. Geo. A. Schmidt & Co., Dept. P, 236 W. North Ave., Chicago.

**REPLATE** brassy worn-off Automobile parts. Reflectors, Bath Room Fixtures, Worn Spoons, Forks, etc., with pure silver. Looks like new. Use U-Kan-Plate Polish. Positively no mercury. \$1.00 half pints. Post Paid. Satisfaction Guaranteed. Agents wanted. Dept. A, U-Kan-Plate Co., Philadelphia.

**ATLAS** Sign Works for Beautiful Gold Window Letters. Penny Each! Why pay 8c? Write for Free Samples. G1032 E. 55th St., Chicago.

**AGENTS!** \$5.00 to \$10.00 profit each sale with our New Octagon Portraits and Frames. \$50 to \$75 weekly easy. Catalog free. Write Linder Art Company, 551 W. Washington St., Chicago.

**AGENTS** make \$10.00 Daily selling Non-Splash Water Filters on sight. Best canvasser's article on market. Investigate. Write for particulars. Desk 14, Seed Filter Company, 73 Franklin Street, New York.

**AGENTS—**Mosco Corn and Callous Remover will build you a steady repeat business. Send today for pocket size trial outfit. The Moss Company, 380 Searle Bldg., Rochester, N. Y.

**100% PROFIT.** Every home buys "The Home Patrol" Burglar Alarm. Automatically sounds alarm and locks window. Agents coining money. Particulars free. Tuerk Mfg. Co., 32 No. Jefferson St., Chicago.

**FIBRE** Brooms—detachable handles, fine finish. Good profits, repeat sales. The Fibre Broom People, 147-C New Jersey Ave., Brooklyn, N. Y.

**AGENTS.** Hosiery NuLife, positively prevents run in silk hosiery, lingerie, etc. Every woman buys. Enormous profits. Write today. Wright Supply Co., Box 42, W. Orange, N. J.

**\$1,000.00 CLEARED** in 30 days by one agent. New Amazing Cleaner. Sample Free. Bestever Products Company, 4317-P, Irving Park, Chicago.

**AUTOMOBILE** Specialties. Guaranteed formulas for all latest money makers. Lowest prices. Write for free lists. Murphy, Chemist, Tujunga, Calif.

**BIG** profits distributing 5c candy specialties to dealers. Fast sellers. Exclusive territory. Universal Sales Company, 631-B Wilson Ave., Brooklyn, N. Y.

**AGENTS—**250% profit selling exclusive new process Artistic Signs. Finest selection of stock signs in the country, barring none. Details free. Sample 10c. Artistic Signs, 799-R Broadway, New York, N. Y.

**SEND** 25 cents for a one dollar Cigar Lighter, and learn how to make \$10 a day. Particulars free. Rapid Mfg. Co., 799 Broadway, New York City.

**300% PROFIT.** Fast seller. Cleaner Polish for autos, furniture, metal, glass. Particulars and sample free. Deal Laboratories, Springport, Mich.

**GOLD** Sign Letters. \$9.75 for Thousand! Non-Tarnishable. Free samples. Catalogue. Atlas Sign Works, A1032 E. 55th St., Chicago.

**SELL** Our Handy Wire Stretcher, a simple, practical fence-repairing device. Hawbaker Stretcher Co., Elmore, Minn.

**MONOGRAM** Automobiles. \$1.35 Profit ten minutes' work; every owner wants them; millions without; particulars free. Motorists Accessories Co., Mansfield, Ohio.

**TOMBSTONE** Cleaning; lonesome work, but dollars jingle. See under classification (Formulas).

**AGENTS** Wanted for fast, easy seller—Marvel pipe cleaner; literature free. Costick Products, 400 West 23rd, New York.

**NEW.** Fast Seller; 150% profit; "Best-ever Powdered Hand Soap"; removes grease, paint, ink, dirt; great repeater. Sample Free. Bestever Prod. Co., 4319-P, Irving Park, Chicago.

**PORTRAIT** Agents—Write for new Catalogue—Enlargements, Frames, Medallions, Sheet Pictures, Luminous Crucifixes. Adam J. Kroll & Co., 2539 So. State St., Chicago, Ill.

**WANT** Distributing Agent for Handslick, powdered hand soap; removes anything from hands; everybody a customer; sample free. Solar Products Co., J-2142 S. Troy, Chicago.

**ALL-YEAR-ROUND** profitable business selling wonderful new water softener and cleaner. Removes grease, oil, ink and dirt quickly. Every home and business place a live prospect. 100% profit. Big repeat orders. Exclusive territory. Write for free sample. Seacoast Laboratories, Sea Bright, N. J.

**GOLD** Leaf window letters and script signs. No experience; 500% profit. Samples free. Consolidated, 69-U West VanBuren, Chicago.

**REMNANT** Store, Bethel, Ohio. Greatest Dry Goods Bargains on Earth. Agents and Dealers.

**AGENTS—**Clever Invention! Inkspoon makes every pen a fountain pen. Fast office seller; big profit, demand increasing everywhere. Exclusive territory offered. Sample free. H. Marui Company, Tribune Bldg., New York, N. Y.

**GET** Our Free Sample Case—Toilet articles, perfumes and specialties. Wonderfully profitable. La Derma Co., Dept. A, St. Louis, Mo.

**BIG** Profits: Steady Income our line food products, toilet articles, soaps. No cash or experience needed. Sample case free. Write Linro Co., Dept. 242, St. Louis, Mo.

**OVER 100% Profit.** Self Lighting Gas and Cigar Lighters; Everybody interested, repeat business. Sell individuals, dealers, subagents. Particulars Free. P. Bernhardt, 127 West 30th St., New York.

**UNDER** Your Name or Brand, Sell Our Laundry Tablets. Amazing profits. Samples, circulars free with order. Costick Products, 400 West 23rd, New York.

**EARN** \$10 daily silvering mirrors, plating, refinishing metalware, chandeliers, head-lights, beadsteads. Outfits furnished. E. Decie Laboratories, 152 E. 23d St., New York.

**ONE** of the biggest mails on earth. Sent to any address for 10c. Louisiana Distributing Service, Dept. PM, Harmon, La.

**MAN** in each town to plate auto parts, reflectors, bathroom fixtures, refinish beds, mirrors, chandeliers; by new method. No capital or experience required. Simple plan of manufacturing at home starts you in big money-making business. Outfit furnished. Free particulars and proofs. Gun Metal Co., Ave. H, Decatur, Ill.

**OUR** Luminous Crucifix Shines in the Dark. Every one amazed at the wonderful effect. Easily demonstrated. Easily sold. W. G. Hannan Co., Dept. B, 2539 So. State St., Chicago.

**A BUSINESS** of Your Own—Making Sparkling Glass Name and Number Plates, Checkerboards, Signs. Big Book and Sample Free. E. Palmer, 512 Wooster, Ohio.

**THREAD-CUTTING** Thimble 25c. Seller Sample 15c. Irvel, 3973 Elston, Chicago.

**WHERE** to Buy Half Million Articles Wholesale. 72-page Directory—1927 Edition. Distributors wanted. Pruitt System, Brookfield, Ill.

**PATENTS.** Time counts in applying for patents. Don't risk delay in protecting your ideas. Send sketch or model for instruction or write for free book "How to Obtain a Patent" and "Record of Invention" form. No charge for information on how to proceed. Communications strictly confidential. Prompt, careful, efficient service. Clarence A. O'Brien, Registered Patent Attorney, Security Bank Building (directly across street from Patent Office), Washington, D. C. See pages 138 and 139.



**AGENTS** wanted to sell Velvet Hand Soap, a very fine mechanics' hand soap; this soap is a good seller with unusual merits. One giving their entire time can make a very fine commission. However, we would like some to take as side line. Territory rights given. Velvet Chemical Company, 30 N. Michigan Ave., Chicago.

**SOMETHING** New. Every motorist a buyer of our electro-magnetic-emergency Wenderlamp; takes only one minute to demonstrate and make a sale; no experience necessary; \$5.00 an hour easily made; full time or evenings. Write for sample. Wenderlamp Co., 926 Fisk Bldg., Dept. 10-A, New York.

**TEST** Big Money-Maker at our risk. Will send sample patented wringer mop on approval. Many eager buyers. Kleanzey Mop Co., Dept. G9, Delphos, Ohio.

**MAKE** \$20 daily selling \$1.00 changeable-letter store window display sign. Experience unnecessary. Get free sample offer. Mase Company, 544 W. Washington Street, Chicago.

#### HIGH-GRADE SALESMEN WANTED

**\$75.00 TO \$150.00** per week is what our salesmen make steadily selling our Made-to-Measure Clothes. Highest commissions paid daily. Free \$40.00 selling equipment, including 200 all-wool fabrics and all sales helps in beautiful leather carrying case. Our prices save customers \$15.00-\$25.00 over local stores. Six-day delivery schedule. Fall lines now ready. Write for full particulars and free equipment today. Experience unnecessary. Tell us all about yourself. Edward E. Strauss & Co., Inc., 400 S. Market St., Chicago, Dept. 102.

**\$20.00 DAY** extra! Newly discovered warm, heavy, all-wool cloth. We call it Motortex. Tailored into dressy, serviceable, latest suit. Shower-proof. Spot-proof. Worth \$35.00. Only \$19.95. Pays \$3.00 and \$4.00 commissions. Add to your line. Two suits in one. Lawyers, Bankers, Doctors, Office Workers, Factory Men, Outdoor Workers—they all buy. Has 37 features. No competition. Expensive outfit free. Harrison Bros., Dept. 565, 133 West 21st St., New York.

**DEMAND** for Electric Window Displays is Established. Our Hustlers easily hitting \$100 weekly with the Leader—Magic Window Salesman—Color, Light, Motion, High-class. Buyers fall quick on demonstration. Greatest quick-change Letter System known, and new, snappy, Two-color Poster Service the answer. Live salesmen getting protected territory now. Display Products Co., A467-9 East 31st, Kansas City, Mo.

**TRAVELING** Salesmen Calling on Retail Stores wanted by large manufacturer of fast-selling specialties entirely different from the average. Year-round sales, main or sideline. Big commission paid immediately on original and repeat business. Opportunity for well paid and permanent connection with old-established firm. If not making \$150 weekly, write today. Union Specialty Works, Dept. 222, Boonville, N. Y.

**ONE** sale daily means \$300 monthly. Smallwood sold twenty in three hours. Improved 3-lb. Calculator. Retail \$15.00. Work equals costly machines. Fully guaranteed. For details, Trial Offer and protected territory, address Lightning Calculator Co., Dept. F, Grand Rapids, Mich.

**SALESMEN, \$2 In Your Pocket Every 15 Minutes.** Just out, sensational advertising novelty with fast-selling movie angle. New. No competition. Sells to stores on sight. Big cash commissions in advance. Full or spare time. Free illustrated pamphlet and sales plan. Be first in your territory. Write today or you lose money. Star & Studio Picture Co., Dept. D., 1400 B'dway, New York.

**HUNDRED** dollars up weekly guaranteed selling necessities every business must buy. Experience unnecessary. Opportunity unlimited. Going big, Coast to Coast. Rush reply. Dept. 5, Kaeser & Blair, Inc., Cincinnati, Ohio.

**EARN \$20 a Day.** Establish income for life selling for \$1 a year \$1,500 accident policy. Write W. C. Stone, All So. La Salle, Chicago.

**\$40.00 SUITS** for \$23.50! All one price. Union made of finest quality Virgin Wool. You don't have to know anything about selling clothing. We guarantee your success if you are honest and willing to work. Write at once. William C. Bartlett, 850 Adams, Dept. 549, Chicago.

**DISTRICT** Salesman—All wool, Union Made suits, overcoats, \$23.50. Liberal advance commission, bonus. Write for expensive Free outfit. Harvey Bros., Dept. 513, Box 60, Chicago, Ill.

**FIFTEEN** Dollars a Day. Sell Harrison's "New York Style" suits and overcoats. Tailored 100% virgin woolsens. Priced \$19.75 to \$34.75. Highest commissions paid daily. Experience unnecessary. Valuable exclusive territory now open. Send for expensive sales portfolio with many selling features. It's free to men who mean business. De Luxe Harrison raincoat line included if you write now. Harrison Bros., Inc., Dept. 866, 135 West 21st St., New York, N. Y.

**TO** market 3A garage Door Holders. Simple Automatic action; Easy, Quick installation instantly attracts Private Garage Owners, Builders and Dealers. Write for attractive, exclusive territory proposition. Knowlson-Stevenson Company, 1118 Packard, Ann Arbor, Mich.

**DOUBLE** Spark Plug—Two spark gaps; Bigger, hotter spark on weaker current and leaner mixture. Guaranteed to be better than other plugs or money refunded. 50% Commission. Agents and side-line men wanted. Affinity Spark Plug Co., Box P329, Omaha, Neb.

**SALESMEN**—Become Independent. Own Your business, experience unnecessary selling our \$7,500.00 Accidental Death; \$50 Accident; \$25 Sick Weekly Benefits—\$12.50 Yearly. Other Amounts proportionate. Guaranteed steady income from renewals. \$250,000 Deposited Insurance Department. Universal Policy, Dept. A, 30 Clinton St., Newark, N. J.

**GUARANTEED** Permanent Repair Section for Blown-Out Tires. For Owners and Garages. Big Profits. Small Investment. Freight Paid. Distributors Wanted. Fla. Rubber Products Co., Tampa, Fla.

**SELL** Stay-Froze Ice Blanket: Saves 40 to 60%. Satisfaction or money refunded; mail \$1 for sample and full particulars. All Florida Chemical Co., Box 255, Lemon City Station, Miami, Fla.

**A GUARANTEED** salary and commissions selling new specialty among all retailers. Enormous opportunity. New Specialty Corp., Cedar Rapids, Iowa.

**OFFICE** specialty salesmen wanted. Exclusive agencies. Dibb Manufacturing Company, Minneapolis.

**MR. BRUSH** Salesmen—Old Established New York brush manufacturers require services of men in all territories to sell their extensive line of Sanitary Twisted in Wire Brushes. We pay larger commission than any other brush house in the country. Write immediately for our proposition. Wire Grip Sanitary Brush Corporation, 15 Mercer St., New York.

**\$18 TO \$25** daily. Biggest selling line of 2-piece suits, \$9.95 and \$12.50; 3-piece wool suit, \$17.95 (regular \$28.00 value). All-wool overcoat, \$18.50. Splendid raincoats, slickers and boys' suits. Biggest commissions. Free outfits. "Jim" Foster, Inc., Dept. 29-A, 2250 S. Soaulding Ave., Chicago, Ill.

**BIG** Season Just Ahead. Advertising pencils most popular every day—every business prospect. Our line repeats. Big commissions. Established in 1902. North American Pencil Works, 126 So. Clinton, Dept. 55-C, Chicago.

**MEN**—Sell dependable shrubbery, fruit trees, etc. Steady demand. Complete co-operation. Commissions paid weekly. We deliver and collect. Write Perry Nurseries, Dept. R-9, Rochester, N. Y.

**SHOES!** We specialize in workmen's shoes and furnish equipment free to responsible agents. Write today. J. C. Moench Shoe Company, Boston, Mass.

**FILLING** Station Salesmen: Convenient sample 25c. Sales Large. Commission Liberal. Mideard Printery, Stoughton, Wis.

**I WILL** Pay You \$2 an Hour to take orders for Carlton dresses and coats. Women in every home, store, factory and office eager to save a third on our stunning Paris styles. Everything supplied Free but only applications stating territory, experience and references will be considered. Carlton, Inc., 206 So. Wabash, Dept. 1053-A, Chicago.

**MAKE** \$25.00 daily selling colored Raincoats and Slickers; Red, Blue, Green, Etc., \$2.95. Hat Free. Commissions daily. Outfit free. Elliott Bradley, 241 VanBuren, Dept. AB9-S, Chicago.

**REPRESENTATIVES** wanted by over 500 manufacturers, offering real money making propositions. No need of being out of work. Write for Free Copy. Opportunity Magazine, 750 N. Michigan, Service Dept., Desk 1, Chicago.

**FOUR** \$7.50 sales to merchants net you \$20.00 daily. Savers Systems, 2803 Sheffield Ave., Chicago, Ill.

**ANY** Salesmen Can Sell Them! Merchants everywhere use punchboards. Someone sells them, why not you? Collect big commissions daily. Newest, largest, elaborate catalog sent upon request. Lincoln Sales Co., 9 So. Clinton, Chicago, Dept. D.

**PUNCHBOARD** Salesmen, making small towns. One sale a day nets you \$105 weekly. Full commission on repeats. K. & S. Sales Co., 4395 Ravenswood Av., Chicago.

**75c PROFIT** on \$1.00 sale. Auto, furniture and glass cleaner. Your name on label. Exclusive rights; free sample. Mfg. E. 213 Griswold, Detroit, Mich.

**\$60-\$200 A WEEK.** Genuine Gold Letters for store windows. Easily applied. Free samples. Liberal offer to general agents. Metallic Letter Co., 438-A North Clark, Chicago.

**COLLECTS** Money from the Dead-Beats. Retail \$5.00—Cost \$1.00—Profit \$4.00. "New Method." Every Storekeeper, Doctor buys quickly. Wonderful Money Getter. Federal Association, Hartford Conn.

**DISTRICT** Managers: 16 hosiery styles, 10 lingerie styles; over 60 colors. We deliver. \$10.00 sample outfit furnished to representatives (no deposit); 10% bonus. Premium to customer. Advertising and office allowance. Send three references, stating experience, to see Samples Dept. G, S. Q. S., Lexington, Ky.

**ATLAS** Sign Works for Beautiful Gold Window Letters. Penny Each! Why pay 8c? Write for Free Samples. H1032 E. 55th St., Chicago.

**WALKER** Made \$165.00 First Day selling Collection System to Doctors and Merchants. Retail \$6.50, Collects \$65.00. Costs \$1.50. Adjustment Bureau, Mobile, Ala.

**SALESMEN** and Salesladies: Take orders for rugs, damask. Novelty designed bedspreads and draperies. Liberal territory and commission. Rainbow Novelty Mills, Grover, N. C.

**SEND** name, address on postcard. Free introductory copy Salesology Magazine; contains 1,000 money making opportunities. Offered by big reliable firms; no obligations. Salesology Magazine, Desk B-39, 500 No. Dearborn, Chicago.

**TAKE** orders for coffee, flour, dried fruits, canned goods, staple groceries, toilet articles, paints, radio sets, auto and tractor oils. No capital or bond required. We deliver and collect. Permanent business. Big pay. Write at once. Hitchcock-Hill Co., Dept. 50, Chicago.

**GOLD** Leaf window letters and script signs. No experience; 500% profit. Samples free. Consolidated, 69-V West Van Buren, Chicago.

**SALESMAN**—Get exclusive selling rights of a scientific drugless health product needed in every home. Unlimited possibilities. Write Radiumed Applicator Co., 1303-P Fillmore, Buffalo, N. Y.

**\$20.00 DAILY** Selling guaranteed all wool made to measure Suits and Overcoats at \$23.50, regular \$35.00 values. Large and attractive Fall Sample Outfit Free to men with selling ability. Jay Rose & Company, 411 S. Wells Street, Desk 13, Chicago.

#### HELP WANTED

**U. S. GOVERNMENT** Jobs. Become Railway Postal Clerks (\$150-\$225 month)—City Carriers—Postoffice Clerks (\$142-\$192 month). Rural Carriers (\$175-\$255 month). Men 18 up. Steady work. Life positions. Paid vacation. Common education sufficient. Sample coaching and full particulars free. Write today sure. Franklin Institute, Dept. N3, Rochester, N. Y.

**MEN** wanting outdoor work, qualify for forest ranger position. Start \$125 month; cabin and vacation; patrol the forests, protect the game; give tourists information. Write Mokane, Dept. M-21, Denver, Colo.

**FIREMEN, Brakemen, Baggage men** (white or colored), sleeping car, train porters (colored), \$150-\$250 monthly. Experience unnecessary. 810 Railway Bureau, East St. Louis, Ill.

**DO** you need more money? Let me add \$30 a week to your pay without interfering with your present occupation. Interesting, pleasant work. Particulars free. Albert Mills, 9450 Monmouth, Cincinnati, Ohio.

**MAKE** \$25.00 daily selling colored Raincoats and Slickers; Red, Blue, Green, Etc., \$2.95. Hat Free. Commissions daily. Outfit free. Elliott Bradley, 241 VanBuren, Dept. AB9-M, Chicago.



**LEARN** Telegraphy. Pleasant, steady work; big pay. Operators earning \$250 monthly. Always in demand. Previous experience unnecessary. Write chief operator, Illinois Telegraph, 1608 W. Madison, Chicago.

**SEND** name, address on postcard. Free introductory copy Salesology Magazine; contains 1,000 money-making opportunities. Offered by big reliable firms; no obligations. Salesology Magazine, Desk B-40, 500 No. Dearborn, Chicago.

**U. S. GOVERNMENT** wants men. \$1,700-\$1,900 and up at start. Railway Mail clerk examination coming. Let our expert (former Government examiner) prepare you for this and also Rural Carrier, Post Office, Customs, Internal Revenue, and other branches. Write today for free booklet. Dept. 8, Patterson School, Rochester, N. Y.

**BECOME** a Landscape Architect. Uncrowded profession of wonderful opportunity for money-making. Easily mastered by mail. Earn while you learn. Write for book. American Landscape School, 56-E, Newark, N. Y.

**SILVERING** Mirrors, French Plate. Easily learned; immense profits. Plans free. Wear Mirror Works, Excelsior Springs, Mo.

**RAILWAY** Postal Clerks. Men 18 up. \$1900-\$2700 year. Common education. 25 coached free. Write immediately for particulars. Franklin Institute, Dept. N14, Rochester, N. Y.

**MEN**, become Forest Rangers: \$125-\$200 mo. and home furnished; permanent, hunt, fish, trap, etc. For details, write Norton, 253 McManis Bldg., Denver, Colo.

**CASH** Paid for Butterflies, Insects. See Sinclair Display Advertisement on page 30.

**ARE** You Old at Forty? See our advertisement on page 144 of this issue. The Electro Thermal Company, 2173 Main St., Steubenville, Ohio.

**MEN** to train for locomotive firemen on railroads nearest their homes—everywhere; beginners \$150-\$250 monthly; promoted, locomotive engineer, \$3,000-\$4,000 yearly. Best paying positions on railroads. Railway Association, Desk M1, Brooklyn, N. Y.

**EARN** Increased Income while you learn Landscape Architecture. Profitable profession easily acquired by correspondence. Write today free literature. National School of Landscape Design, 504½ Equitable Bldg., Des Moines, Iowa.

**STEAMSHIP** Positions. Europe, orient, etc. Good pay; experience unnecessary. We help you to secure them. Write for free application form. Box 30-A, Mount Vernon, N. Y.

**COUNTY** Representatives for Credit Bureau. Liberal Drawing Account. Western Credit Index, Ltd., Lankershim Building, Los Angeles.

**BOYS**—Men, 16 Up. Become Auto Mechanics. Particulars free. Franklin Institute, Dept. N400, Rochester, N. Y.

**REPRESENTATIVES** wanted by over 500 manufacturers, offering real money making propositions. No need of being out of work. Write for Free Copy. Opportunity Magazine, 750 N. Michigan, Service Dept., Desk 3, Chicago.

**GET** a job! 70 offered one person! "How To Obtain Employment" must get you work within 30 days or money returned. 50 cents, postpaid. Better Yourself! New Idea Service, Box 39-A, Station K, New York.

**TAILORING** Salesmen: Best proposition. Our men making big money. Commissions advanced, plus bonus. Large samples. Outfit free. Brighton Tailoring Co., 640 Broadway, New York, Dept. PM.

**DO** oiling, greasing and mechanical upkeep service at the home garages of automobile owners in your town. Write for free folio "How to Build a Big Monthly Income." National Auto Maintenance Co., 2604 Geary St., San Francisco, Calif.

**RAILWAY** Postal Clerks. Men 18 up. \$1,900-\$2,700 year. 25 coached free. Franklin Institute, Dept. N14, Rochester, N. Y.

**GOVERNMENT** positions pay \$35 to \$75 weekly. We help you get them. Big List Free. Write, Mr. Ozment, 101, St. Louis, Mo.

**EARN** \$10 daily silvering mirrors, plating, refinishing metalware, chandeliers, headlights, bedsteads. Outfits furnished. E. Dele Laboratories, 152 E. 23d St., New York.

**DON'T** prepare for any Civil Service Examination without seeing our catalogue. Free. Columbian Correspondence College, Washington, D. C.

### MAILING LISTS

**NAME** Lists for sale 50c hundred, \$5.00 thousand. All live names. Bessie Berg, Mt. Pleasant, Pa.

### INFORMATION

**PUZZLES!** If you like them we recommend an illustrated book containing 122 of the best mechanical puzzles. You can have loads of fun working out the solutions as enough hints are given in the text matter to enable one to do so. Pay postman \$1.00 and postage when he hands you the package. Address Popular Mechanics Press, Room 908, 200 E. Ontario St., Chicago.

**WHAT** Subjects Interest You? Select from this list of helpful worth while books. Social Letters Made Easy, Spelling Made Easy, How to Develop Your Will Power, Tricks and Magic Made Easy, Bookkeeping Made Easy, Chemistry for Beginners, How to Work Your Way Through College, Confidential Chats with Boys. Price \$1.25 per volume. Pay postman price and postage when he hands you the package. Address Popular Mechanics Press, Room 908, 200 E. Ontario St., Chicago.

### BUSINESS SERVICE

**ATLANTA**—South's Headquarters—\$3.00 Month. Daily mail forwarding; Also offer complete sales service; sample display; Sales Supervision; Inquiry followup; Interview applicants, act or report. Experienced. Successful. Responsible. Confidential. References. Write, Commercial Service Bureau, 523 Forsyth Bldg.

**SOUTH DAKOTA**—liberalst laws—lowest expense. Free forms. Wren & Chapman, Billings, Mo.

**RAISE** necessary capital. Incorporate! And sell shares in your business. 27 years organizing and raising money for businesses of merit. Terms reasonable. Prompt and confidential service. W. Harrison Cole, 507 Fifth Avenue, Suite 310, New York.

**WHO** Owes You? We Locate. Collections Anywhere. Western Credit Index, Lankershim Building, Los Angeles.

**NEW YORK** address. \$5.00. Broadway Service Co., 42 Broadway.

### TYPEWRITERS AND SUPPLIES

**100** TYPEWRITERS Free. Overstocked. Rent Rebuilt Underwood or Remington \$3.00 month. If you pay its value in rental, we give machine free. Particulars free. Pittsburgh Typewriter Exchange, 945 Hersch Bldg., Pittsburgh, Pa.

**TYPEWRITERS**, all standard makes, thoroughly re-manufactured by the famous "Young Process" and shipped direct from factory to you on 10 days' trial. Guaranteed 5 years. Easy monthly payments. Write today for free catalog. Young Typewriter Company, Dept. 5749, 654 W. Randolph St., Chicago.

**UNDERWOOD** Typewriters — only \$3.00 down. Easy monthly payments. Low prices at less than manufacturers, 16 days' free trial. Rebuilt, all worn parts replaced. Just like a new machine. 5-year guarantee. Write for a big free catalog. A-151, Shipman-Ward Mfg. Co., 1516 Shipman Bldg., Chicago, Ill.

**TYPEWRITERS**, all standard makes. \$10 up. Fully guaranteed. Free trial. Write for complete illustrated lists. Northwestern Typewriter Exchange, 121 N. Francisco Ave., Chicago.

### PRINTING, ENGRAVING AND MULTIGRAPHING

**PUBLISH** Your Own Magazine or House Organ. Our standardized service at one-fifth ordinary prices. Samples and particulars free. Evans Printing Company, Grand Rapids, Mich.

**"NEARGRAVURE"** Process. ("Stationery simply wonderful."—Gonzalez.) Samples, stamp appreciated—state business. Solldays, Knox, Ind.

**1,000** LETTERHEADS or Envelopes, \$3.00. Sent Prepaid. Samples Free. Monitor Press, Morrisville, Pa.

**3,000** ENVELOPES \$7.00, 10,000, \$22.00; Prepaid. Foote, 5706 Haltnorth, Cleveland.

**PRINTING**—Stationery, Circulars, Booklets. Fine work; prices right. Battlefield Press, Gettysburg, Pa. Free battlefield souvenir.

**5,000** 3½x5½ AD Slips, \$5.00; 5¼x6½ Circulars, \$7.75; 5¼x8½ Circulars, \$10.00; 3¼x6 4-page Folders, \$13.75. Samples. Goo's Printery, Harrisonburg, Va.

**200** SHEETS and 100 Envelopes printed, \$1.00. Write for samples. J. Brooks, Printer, Glasgow, Ky.

**DISTINCTIVE**—Artistic Business Stationery that Creates Confidence. 1,000 Letterheads or Envelopes \$3.00. Samples. Moulton Printing Company, 1410-P East 8th, Kansas City, Mo.

**200** LETTERHEADS and 100 Envelopes, \$1.00, postpaid. Oberman Company, Box 1268, Chicago.

**WE** print Stationery, Booklets, Catalogs, Circulars. Samples. Commercial Press, Batavia, Ohio.

**MULTIGRAPHING** business correspondence, two dollars thousand. Hammermill letterheads, four dollars. Miscellaneous printing. Mayera Corporation, Monmouth, Ill.

**250** BOND Letterheads, Envelopes, Billheads, Cards, \$1.35 each. Economic Press, Lenia, N. J.

**GUMMED** Labels—The Better kind, with name, business and address, 500—40c; 1,000—60c; 2,000—\$1.00. P. Wetzel, Valhalla, N. Y.

**QUALITY** Printing! Reasonable Prices! Send for Free Standardized samples and prices. Folders, Circulars, Catalogs our specialty. Earnest Fantus, 525 South Dearborn, Chicago.

**IMITATION** Typewritten Letters. (mimeographed); 500—\$3.00; 1,000—\$4.00; printed heads, 20 lb. bond, prepaid; samples, price-list, red stamp. Letter Service, 620P Woodland, Kansas City, Mo.

### PRINTING, OUTFITS AND SUPPLIES

**PRINTING** Presses, type, supplies. List 2c stamp. Bargains. Geo. Foster, 4312 North Robey, Chicago.

**PRINT** Your Own Stationery, cards, bookplate, Christmas cards, circulars, book, pamphlets, etc.; complete outfits, \$8.85; larger, \$11, \$29; rotary \$140. Print for others. Easy and interesting; rules sent. Write for catalogue presses, type, paper, etc. Kelsey Company, K-11, Meriden, Conn.

**PRINTING** Outfits—Presses, type supplies, type novelties. Send stamp for catalogue. Model Press, York, Penna.

### RUBBER STAMPS

**RUBBER** Stamps! Name, Address, two lines 25c. Three lines 35c. Brush & Co., Auburn, Nebr.

### DUPLICATORS AND DEVICES

**YOU** can make 50 to 100 copies of a letter, notice, etc., at a cost of three cents on a Heyer Quality Duplicator. Write for free trial offer. The Heyer Duplicator Co., 909 Jackson Blvd., Chicago, Ill.

### ADDING MACHINES

**FREE** trial. Marvelous Calculator. Adds, Subtracts, Multiplies, Divides automatically. Work equals \$300.00 machines. Five year guarantee. Price only \$15.00. Write today for free trial offer. Special: \$3.00 Pocket Calculator, only \$2.00 cash. Lightning Calculator Co., Dept. E, Grand Rapids, Mich.

**NEW** \$3.50 Automatic Adding Machine. Adds, subtracts, multiplies absolutely accurate. Capacity \$999,999.99. Fully guaranteed. 75,000 pleased users. Makes adding easy, positive, quick. Eliminates mistakes. Saves time. Postpaid \$3.50. Bassett Co., 1458 G Hollywood Ave., Chicago.

### FOR SMOKERS

**NEW** Self Starting Cigar Lighter Selling for 50c. Self Starting Gas Lighter, 25c means a sale a minute. Write for details. New Method Mfg. Co., Box P. M. 9, Bradford, Penna.

**GUARANTEED** Homespun Tobacco—Chewing, 5 pounds \$1.00; 10, \$1.75. Smoking, 10, \$1.50. Pipe Free. Pay when received! United Farmers, Bardwell, Ky.

**BETTER** Tobacco! Fragrant, mellow! Ten pounds smoking, \$1.50. Four pounds chewing, \$1.00. Farmers' Club, 57, Hazel, Ky.

### FOR THE HOME

**THIS** is the season for making repairs about the home. Easily done with instructions in our new book. Tells exactly how to use tools, sharpen tools and cutlery, repair furniture and cabinets, upholster, work metal, solder, work glass, paint, stain, varnish, hang paper, repair plumbing, furnace, electrical equipment, shoes, harness, gloves and concrete work. Send no money. Just write and ask for "The Practical Book of Home Repairs." When postman hands you the book, pay him \$2.50 and the postal charges. Popular Mechanics Press, Room 908, 200 E. Ontario St., Chicago, Ill.



**GRANDFATHER'S Clock Works, \$5.00.** Build your own case; Instructions free; make good profits selling your friends. Clock works with chimes for old or new cases. Write for full particulars. Clock Co., Ruffner St., Philadelphia.

**CEDAR chests only \$11.65—"Red-i-Kut"** complete with rich copper trim—you assemble and save half—send for pictures. Kuempel Furniture Company, Guttenberg, Iowa.

**HOW to Make and How to Mend.** 1000 articles telling how to repair almost everything in use or needed about a home or farm. Many illustrations; formulas and trade secrets. Send no money. Just ask for "How to Make and How to Mend." Pay postman postal charges and \$1.00. Popular Mechanics Press, Room 908, 200 E. Ontario St., Chicago, Ill.

**HOME Redecoration Time is here.** Get newest ideas and methods from books just published for sale by Popular Mechanics Press. Interior Wall Decoration, Plain and Decorative Finishes, Practical Working Methods. 450 pages. Price \$4. Mixing of Colors and Paints, 292 pages \$2. Wood Finishing, Plain and Decorative, 360 pages, \$2. House Painting Methods, Brush and Spray Gun, 386 pages, \$2. Books will be sent C. O. D. Pay postman price plus postage when he hands you the package. Popular Mechanics Press, Room 908, 200 E. Ontario St., Chicago.

### RAZORS AND BLADES

**USED blades wanted,** any standard make, from private parties. We pay 1c for each clean blade. No rusty, broken, fake blades, no agents wanted. Given away free, clean trial blades to prove that individually reconditioned blades shave better than new factory blades. We hollow grind, hone and stop any style—25c six blades, 50c a dozen. All blades inspected, hair-tested, guaranteed to shave like "Velvet." Send your blades; we buy or recondition them; ask for samples. We manufacture commercial blade sharpening machines. Established 1916. Velvet Edger Mfg. Co., 6001 Gramercy, Los Angeles, Calif.

**"PERFECTEDGER" safety razor blade sharpener.** Agents wanted—commission \$50.00. Horton Manufacturing Company, Minneapolis, Minn.

### BOATS AND LAUNCHES

**BUILD Your Own Boat** using our Knock-Down ready cut materials. 55 models, outboard motor speedsters, runabouts, cruisers, sail, or row. Send 25c for catalog. Brooks Boat Co., Inc., Rust Ave., Saginaw West Side, Mich.

**NEW Boat Book** telling how to make 21 kinds of boats. Also many other helpful ideas on boating. Profusely illustrated. With this we include the big book, "Outdoor Sports the Year Round." Directions for making all sorts of devices for outdoor recreation. Send no money. Simply pay the postman \$1.98, plus postage when books are delivered. Popular Mechanics Press, Room 908, 200 E. Ontario St., Chicago, Ill.

**THE world's record holding Outboard Motor boat.** Plans 25c. Free boat building catalog. The Rudder, 15 Murray Street, New York.

**HUBBEL Marine Coolers** convert Ford engines into marine motors. Booklet free. Ford speedboat easily built, blueprint and directions, sixty cents. C. C. Hubbell, Perry Ave., Norwalk, Conn.

**SHIP Models—Worth while.** Easy to make. Decorative Ships Picturesque Barbary Pirate Felucca and Beautiful Spanish Treasure Galleon (both 17th century). Instructions so simplified that any handy person can make these models with a few household tools almost without expense. No personal knowledge of ships or naval architecture required. New book only one of its kind. Pay postman \$2.50 plus postage when book is delivered. Popular Mechanics Press, Room 908, 200 E. Ontario St., Chicago, Ill.

### WATCH REPAIRING

**ALL makes of Watches** repaired by experts. Write International Watch Service, Box 5P, Fordham Station, New York.

### ANTIQUES, WAR RELICS AND INDIAN GOODS

**100 GENUINE Indian arrowheads** from Arkansas \$4.00 postpaid. H. Daniel, Lamar, Ark.

**SEND 5c** for fine new Hist Indian relics, antique firearms. F. E. Ellis, Webster Groves, Mo.

### PHONOGRAPHS AND RECORDS

**RECORDS,** latest selections thirty cents each. Write for catalogue. Pleading Sound Phonograph Company, 204 East 113th Street, New York, N. Y.

**BUILD your own Phonograph.** Parts catalog free. American Phonograph Company, 4116 West 24th Place, Chicago.

### MUSIC AND MUSICAL INSTRUMENTS

**MUSIC** composed and arranged: Art Melody Co., Art Theatre Bldg., Kansas City, Kans.

**SONG-POEM Writers:** Address Monarch, 236 W. 55th, Dept. 104, New York.

**SONG Poem Writers,** Write Sequoia Songwriters' Service, Sherman Branch, Los Angeles, Calif.

**SONG Writers** with poems or melodies: Send for bona fide proposition. Hibbeler, 11, 2104 N. Keystone Ave., Chicago.

**YOUR Victrola** or any phonograph given that orthophonic tone. Circular free. C. M. Mahood, Warren, Pa.

**I BUY, Sell, Publish Songs.** Chester Escher, 455 Wayne St., Jersey City, N. J.

**VIOLINS, Deep, Mellow, Soulful—on credit.** Easy terms for wonderful instrument. Get details today. Gustav F. Henning, 2424 Gaylord St., Denver, Colo.

**"MUSIC Composed" to words.** Bauer Bros., (formerly of Sousa's Band), Oshkosh, Wis.

**I WANT Song Poems.** Casper Nathan, 3544 N. Racine, Chicago.

**CORNETISTS—Trombonists—Saxophonists—Clarinetists.** Get "Free Pointers." Name instrument. Virtuosi School, Buffalo, N. Y.

**RUDY WIEDOEFT'S "Talks to Saxophonists,"** Free. Valuable advice on playing by America's Premier Saxophonist. Selmer, Elkhart, Ind.

**FREE-Song Writers' Guide.** Beaver, 1239 Elm, Green Bay, Wis.

**SHEET-MUSIC, 10 for \$1.00.** For Amateur Teacher or Student. Catalog free. Ferd. Zarb, P. O. B. 18, Sta. D., New York.

**WRITE Songs.** Big money and reputation. Write for information. J. Gordon Pub. Co., 201 N. Hoyne Ave., Chicago.

**SONG Writers!** Cooperative publishing plan. McDaniel Music Co., Newbern, N. C.

### PATENT ATTORNEYS

**PATENTS.** Time counts in applying for patents. Don't risk delay in protecting your ideas. Send sketch or model for instruction or write for free book "How to Obtain a Patent" and "Record of Invention" form. No charge for information on how to proceed. Communications strictly confidential. Prompt, careful, efficient service. Clarence A. O'Brien, Registered Patent Attorney, Security Bank Building (directly across street from Patent Office), Washington, D. C. See pages 138 and 139.

**PATENTS Procured:** Trade Marks Registered—A comprehensive, experienced, prompt service for the protection and development of your ideas. Preliminary advice gladly furnished without charge. Booklet of information and form for disclosing idea free on request. Richard B. Owen, 30-Owen Bldg., Washington, D. C., or 41-R Park Row, New York.

**PERCY S. WEBSTER,** 203 Saving and Loan Building, Stockton, California. Long established organization. Patent booklet free.

**PATENTS—Write for our free book, "How to Obtain a Patent" and Record of Invention Blank.** Send model or sketch of inventions for inspection and Instructions Free. Terms Reasonable. See advertisements on pages 140 and 141. Victor J. Evans & Co., 934 Ninth, Washington, D. C.

**LANCASTER and Allwine,** 221 Ouray Bldg., Washington, D. C. "Originators of the Form Evidence of Conception." Before disclosing your invention to anyone send for blank form to be signed and witnessed. Form and patent information bulletin free.

**EDWARD C. SASNETT,** Formerly a Principal Examiner U. S. Patent Office, Attorney at Law. Strictly personal service. Correspondence invited. McGill Building, Washington, D. C.

**MONROE E. MILLER,** Ouray Bldg., Washington, D. C., Patent Lawyer; Mechanical, Electrical Expert. Booklet and Priority Record blank gratis.

**PATENTS** obtained under Cooperative Payment Plan. Write for particulars. W. E. Beck, Registered Patent Lawyer, 951 Jenifer Bldg., Washington, D. C.

**PATENTS, Trade-Marks, Designs.** This firm has 27 years' experience and gives expert personal service at reasonable rates. We properly protect your invention. Write for free information and exact cost of procuring patent before proceeding. John B. Thomas & Co., 902 F St., N. W., Washington, D. C.

**UNPATENTED Ideas Can Be Sold.** I tell you how and help you make the sale. Free particulars (Copyrighted). Write W. T. Greene, 807 Jenifer Building, Washington, D. C.

**RICHARD E. BABCOCK,** Patent Lawyer, Washington Loan & Trust Bldg., Washington, D. C. Booklet.

**SELL your invention** before patenting. Write for free particulars. W. T. Green, 801 Jenifer Bldg., Washington, D. C.

**PATENTS—Write for Instructions.** Carl Miller, Registered Patent Attorney (former Patent Office examiner), McGill Building, Washington, D. C.

**INVENTIONS Patented.** Send sketch or model for advice and costs. M. Miller, 910 Gee Street, Washington, D. C.

**LACEY'S Patent Sense.** Valuable book free. See ad page 143.

**PATENTS.** Ordinary mechanical inventions including search, Government fees and one-sheet drawings \$85.00. Inquiries promptly answered. Milton G. Carver, Patent Solicitor, 212 McLaughlin Bldg., Washington, D. C.

**PATENTS Procured.** Prompt service. Personal, careful and efficient service. Highest references. Moderate fees. Send sketch or model for actual search and advice. George P. Kimmell, Master of Patent Law, 54-K Legal Bldg., Washington, D. C.

**UNPATENTED Ideas Can Be Sold.** I tell you how and help you make the sale. Free particulars (Copyrighted). Write W. T. Greene, 806 Jenifer Building, Washington, D. C.

**INVENTOR'S Advice,** valuable patent book, sent free. Labinere, 3 Parkrow, New York.

**INVENTORS:** Send sketch or model for advice and exact cost of patent. Ask for our Free book: "How to Obtain a Patent." Tells what every inventor should know. Established twenty-eight years. Highest references. Prompt service. Reasonable charges. Chandler & Chandler, 474 Seventh, Washington, D. C.

**PATENTS.** Booklet free. Highest references. Best results. Promptness assured. Send model or drawing for preliminary examination. Watson E. Coleman, Patent Lawyer, 724 Ninth St., Washington, D. C.

**"INVENTORS' Guide"** sent free on request; this book contains illustrations of patented inventions and gives valuable information and advice for all who have original ideas or improvements. Frank Ledermann, Registered Attorney and Engineer, Woolworth Bldg., 1712, New York.

**PATENTS—Free preliminary advice.** Confidential, prompt. Registered Patent Attorney, formerly Examiner United States Patent Office. Albert Jacobs, Barrister Building, Washington.

**INVENTORS** having ideas to patent: Write for Booklet explaining Co-operative Plan for handling your applications. Tells how to sell and safeguard your inventions at lowest cost. Ralph Burch, Patent Lawyer, Jenifer Bldg., Washington, D. C.

**MILLIONS** spent annually for ideas! Hundreds now wanted! Patent yours and profit! Write today for free book—tells how to protect yourself, how to invent, ideas wanted, how we help you sell, etc. American Industries, Inc., 500-Victor Bldg., Washington, D. C.

**INVENTORS—Write for our Guide Book, "How to Get Your Patent" and Evidence of Invention Blank.** Send model or sketch of your invention for our prompt examination and instructions free. Randolph & Co., Dept. 450, Washington, D. C.

**PATENTS, Trade-marks, Copyrights.** Reliable services by an experienced practitioner devoting personal attention to each case. Inquiries invited. References furnished. B. P. Fishburne, Patent Lawyer, 525-A McGill Bldg., Washington, D. C.

**UNITED STATES and Foreign Patents** and Trade Marks; Low rates; easy terms. H. Sanders, Registered Patent Attorney, 7 Rand McNally Building, Chicago.

**ESTABLISHED 1864.** Milo D. Stevens Company. Free Booklet. Patents, Trade-Marks, Copyrights. Offices, Monarch Block, Chicago; Barrister Building, Washington, D. C.



## FOR INVENTORS

**PATENTS.** If you have an invention which you wish to patent you can write fully and freely to Munn & Co., for advice in regard to the best way of obtaining protection. Please send sketches, or a model of your invention and a description of the device, explaining its operation. All communications are strictly confidential. Our Hand-Book on Patents is sent free on request. This explains our methods, terms, etc., in regard to Patents, Trade Marks, Foreign Patents, etc. "Scientific American" contains Patent Office Notes. Decisions of interest to inventors and particulars of recently patented inventions. Munn & Company, Solicitors of Patents, 1523 Scientific American Building, 24 W. 40th St., New York City; 524 Scientific American Bldg., Washington, D. C.; 1313 Tower Bldg., Chicago, Ill.; 666 Hobart Bldg., San Francisco, Calif.; 521 Van Nuys Bldg., Los Angeles, Calif.

**PATENTS.** Time counts in applying for patents. Don't risk delay in protecting your ideas. Send sketch or model for instruction or write for free book "How to Obtain a Patent" and "Record of Invention" form. No charge for information on how to proceed. Communications strictly confidential. Prompt, careful, efficient service. Clarence A. O'Brien, Registered Patent Attorney, Security Bank Building (directly across street from Patent Office), Washington, D. C. See pages 138 and 139.

**PATENTS**—Write to B. P. Fishburne (a South Carolinian), Registered Patent Lawyer, 525-E McGill Bldg., Washington, D. C.

**PATENTS** obtained under Cooperative Payment Plan. Write for particulars. W. E. Beck, Registered Patent Lawyer, 950 Jenifer Bldg., Washington, D. C.

**INVENTIONS** Developed—Your crude ideas developed into practical form for your patent application. Model not necessary. Send rough sketch and description for estimate of cost and advice. 27 years' experience. Albert E. Dietrich, Engineer and Registered Patent Attorney, 621½ Ouray Building, Washington, D. C.

**UNPATENTED** Ideas Can Be Sold. I tell you how and help you make the sale. Free particulars (Copyrighted). Write W. T. Greene, 806 Jenifer Building, Washington, D. C.

I AM in touch with hundreds of moneyed men and manufacturers who wish to buy good inventions. Write Hartley, 38 Court St., Bangor, Me.

**SELL** your invention before patenting. Write for free particulars. W. T. Greene, 802 Jenifer Bldg., Washington, D. C.

**PENDING** patents successfully marketed through cooperation. Booklet free. Chartered Association American Inventors, Barrister Building, Washington, D. C.

**LACEY'S** Patent Sense. Valuable book free. See ad page 143.

**INVENTIONS** Developed, Protected and Marketed. Prompt Service. Twenty years' experience. Write for information. C. J. Williams, American Bank Building, Oakland, Calif.

**UNPATENTED** Ideas Can Be Sold. I tell you how and help you make the sale. Free particulars (Copyrighted). Write W. T. Greene, 807 Jenifer Building, Washington, D. C.

**FREE** information, advice on inventions, patents: immediate personal service. J. E. Trabucco, Hobart Bldg., San Francisco.

**WANTED**—Well equipped steel specialty plant, Pittsburgh district, desires correspondence with concern or individual, having device to manufacture (preferably patented device used by railroads or traction lines), who could utilize part of our facilities under agreeable arrangement. Address P. O., Box 917, Pittsburgh, Pa.

I **SELL** Patents. Been at it 27 years exclusively. Experience has been known to be valuable in every other line of endeavor. Send Patent copy. Charles A. Scott, 773PM Garson Ave., Rochester, N. Y.

**PATENTS** Procured: Trade Marks Registered—A comprehensive, experienced, prompt service for the protection and development of your ideas. Preliminary advice gladly furnished without charge. Booklet of information and form for disclosing idea free on request. Richard B. Owen, 30-Owen Bldg., Washington, D. C., or 41-R Park Row, New York.

**INVENTORS**—Write for our free book, "How To Obtain A Patent" and Record of Invention Blank. Send model or sketch of inventions for inspection and instructions free. Terms Reasonable. See advertisements on pages 140 and 141. Victor J. Evans & Co., 157 Ninth, Washington, D. C.

**INVENTORS** Universal Educator—contains 900 mechanical movements; 50 perpetual motions. Tells how to obtain and sell patents. Suggests new ideas. Explains how to select your attorney and avoid patent sharks. Price (revised edition) \$1.00 post-paid. Albert E. Dieterich, 621-Ouray Bldg., Washington, D. C.

**GET** your own patents. Legal blanks, complete instructions \$1. Cutting Sons, Campbell, Calif.

## PATENTS FOR SALE

**FOR** Sale: for cash, or cash and royalty basis. Patent No. 1535262 Steel Railroad Tie (reinforced), and Rail Fastener. For City and Suburban Railroad lines; also Steam Railroad lines. Tie approved by competent engineers as simple in construction, durable and economical. Will supplant wood ties most anywhere. George W. Slade, Forest Hill, Md.

**OUTRIGHT** or Royalty—Device for Packing Bananas. One Bunch Packed and Sealed in ½ Minute. J. M. Scarborough, Chattanooga, Tenn.

**OUTRIGHT** or Royalty basis. Automobile turning signal. Best out to-day. Max Barton, Winchester, Ida.

**PATENTED** Jewelry Novelty. U. S. and France. Big Demand, Big Profits. Write for Particulars. Kathryn Connolly, 5319 Kenmore Avenue, Chicago, Ill.

**ROYALTY** Basis—fly escape on window screens permits flies or insects on inside to escape. Viola D. Muzzy, R. F. D. No. 1, Spring Creek, Warren Co., Pa.

**FOR** Sale—patent on Sanitary sugar dispenser. Reasonable. Particulars, inquire Andy Thanos, Stanley Hotel, La Porte, Ind.

**OUTRIGHT**, State Rights or Royalty. Worth millions. Enameled Concrete. V. A. Clark, 643 3rd St., Santa Rosa, Calif.

**NOVELTY** children's Blocks, first steps in music for Teaching notes. Outright or Royalty. Hopkin, 90, Grays Inn Rd., London, W. C. 1, England.

**OUTRIGHT**, reasonable, pipe joint for bath tubs, basins, toilets, sinks. Robert Dawson, Fairview Cottage, Skillman, N. J.

**CANADIAN** patent No. 268,459—Automatic Water Gauge for Steam Boilers. United States patent pending. Rhodes & Dunham, LeGrand, Iowa.

**FOR** Sale—Life-saving device for submarines. Patent Pending. Leguen, 127 Hobart Ave., Bayonne, N. J.

**OUTRIGHT** or royalty—newly patented pocketbook fastening device, a death-blow to pocket-book pickers. David N. Gray, Box A 9741, North Side Station, Pittsburgh, Pa.

**OUTRIGHT** or Royalty—U. S. and Canadian rights; a locked device protects automobile license plates from loss or theft. Thirteen thousand duplicate plates issued in N. J. State 1926. C. W. Hartman, 300 Pershing Ave., Carteret, N. J.

**OUTRIGHT** Canadian patents for new motor vehicle traffic signal device operated from steering wheel. Arthur D. Roberts, 276 Bourgenis St., Montreal, Canada.

**PATENT** pending on Independent Valve Stem for Inner Tube. John Rhodes, Le Grand, Iowa.

**FOR** Sale—Printers Furniture Cabinet, patent No. 1,609,816. Printer can grasp one or more blocks as desired: saving time. Valuable improvement. Address Bela R. Haldeman, Franklin Grove, Ills.

**WILL** Sell very valuable patent your terms. Elizabeth Smith, 3634 Suitland Road, Washington, D. C.

**OUTRIGHT** or Royalty—music stand; sheet music pages turned without interfering with playing. W. S. Lucas, 1635 W. Division St., Chicago, Ill.

**WHY** let your patents lie idle? Tell our two million five hundred thousand readers about it! The majority of our readers are especially interested in new ideas and inventions. Ask me to tell you how other inventors successfully sold their patents. M. L. Rund, Mer., Classified Advertising, Popular Mechanics Magazine, Chicago.

## ELECTRICAL

**POWERFUL** Electro-magnets, six volts, lift 150 lbs., \$6.50; 300 lbs., \$12.00; 500 lbs., \$20.00 all post-paid. We make electromagnetic devices for any purpose; write your wants. Nauta Products Co., 385 No. 11th St., Paterson, N. J.

"**BLUEPRINT** Reading" is a compact book telling how to read machine blueprints. Send no money. Just pay postman postal charges and \$1. Popular Mechanics Press, Room 908, 200 E. Ontario St., Chicago, Ill.

**MAKE** Things Electrical. Complete instructions for making medical coil, buzzer, rheostat, sign flasher, electric toaster, heater, electric grill, soldering copper, crystal receiver, transformer, Tungar rectifier, Duram receiver, motor and other things in fine illustrated book costing \$1.25. Pay postman price and postage when he hands you the package. Address Popular Mechanics Press, Room 908, 200 E. Ontario St., Chicago, Ill.

## FOR MECHANICS

**KINKS** on Metal Work. 419 discoveries for anyone who works with metal. For mechanic, machinist or the man who tinkers at home. 287 illustrations. Send no money. Just write a postal asking for "Machinist's Kinks." When postman hands you book pay postage and price of book, \$1.50. Popular Mechanics Press, Room 908, 200 E. Ontario St., Chicago, Ill.

**SHOP** Notes for 1927. Get your copy now. Only a limited edition. Contains all the articles published in the Shop Notes department of Popular Mechanics Magazine during 1926. Send no money. Just write a postal and we'll send 1927 Shop Notes and any one of the other following numbers, 1908, 1912, 1913, 1914, 1915, 1916, 1917, 1919, 1920, 1921, 1922, 1923, 1924, 1925, 1926. Pay the postman 98 cents and the postage when he hands you the two books. Popular Mechanics Press, Room 908, 200 E. Ontario St., Chicago, Ill.

## SURVEYING INSTRUMENTS

**LARGEST** stock of new and used surveying instruments in the country direct from factory. Satisfaction guaranteed or money refunded. Wissler, 619 N. Broadway, St. Louis, Mo.

## MODELS AND MODEL SUPPLIES

**PATENTS.** Time counts in applying for patents. Don't risk delay in protecting your ideas. Send sketch or model for instruction or write for free book "How to Obtain a Patent" and "Record of Invention" form. No charge for information on how to proceed. Communications strictly confidential. Prompt, careful, efficient service. Clarence A. O'Brien, Registered Patent Attorney, Security Bank Building (directly across street from Patent Office), Washington, D. C. See pages 138 and 139.

**WE** make models, dies, manufacture your invention, help perfect it. Do experimental work. Free information. Strand Mfg. Co., 644 West Randolph, Chicago.

**SHIP** Model Fittings: Send stamp for booklet. A. J. Fisher, 1002 Etowah Ave., Royal Oak, Mich.

**SPECIAL** machine builders, tool and die makers, inventor's models production work of all kinds. Dept. L. Quality Hardware & Machine Co. Ravenswood and Thorndale Avenues, Chicago, Ill.

**WE** make working models for inventors and do experimental work and carry a complete stock of brass gears and model supplies. Send for catalogue. The Pierce Model Works, Tinley Park, Ill.

**MODELS, Tools, Dies** and General manufacturing. Logan Machine Co., 652 W. Lake, Chicago, Ill.

**EVERYTHING** for Ship Models. Catalog, dime. Roy Hancock, 323 Douglas Ave., Portsmouth, Va.

**WOODS** for Models, Scroll Work and inlaying. George Wild, 510 East 11th St., New York.

**THE** Modelmaker, a magazine for all interested in making working models, boats, etc. Sample 10c. Modelmaker, 122 Liberty St., New York.

**MODEL** steam engines and boilers. Boat and boiler fittings. Send 10c stamp for catalog. Refunded with first order. Model Machine Shop, 212 Price St., Rahway, N. J.



## MANUFACTURING

**COMPLETE Manufacturing.** Dies and stampings and Special Machinery. Our Engineering department will design and perfect your article; our tool room will tool it for production. Our shop will make any quantity you may need. Models made if necessary. Barth Stamping & Machine Company, 3816 West 34th St., Cleveland, Ohio.

**DIES, Tools, Production Machine Work, Models and Contract Manufacturing.** Let Kansas City's Largest and Best Equipped Combination Die and Machine Shop figure with you on your requirements. Bank and Commercial Agency References. Schroer Bros. Machine Works, 23rd and Holmes St., Kansas City, Mo.

**LET us figure on your requirements for special machine work and manufacturing.** Automatic machines developed to reduce production costs. York Electric & Machine Co., York, Pa.

**WANTED:** Mechanical work, all branches. Ideas developed. Quantity Production. Parma Engineering Co., Brooklyn Station, Cleveland, Ohio.

**MODELS, Dies, Manufacturing, Ideas developed, screw machine products, metal stampings, and contract manufacturing of metal parts.** Schroer Manufacturing Company, 2221 Campbell Street, Kansas City, Mo.

**CONTRACT Manufacturers—Dies, Stampings, Models, Castings and Forgings Machined.** Automatic Screw Machine Product. Screw Machine Specialty. Susquehanna Street, Pittsburgh, Pa.

**MECHANICAL Designing and Working Drawings.** J. Platt, 474 Lincoln Ave., Grantwood, N. J.

**SPECIAL Machinery or parts, dies, tools, metal specialties, models, special gears, stock gears and model supplies.** Send for Catalogue. The Pierce Model Works, Tinley Park, Ill.

**WANTED to manufacture on royalty basis, some Mechanical Appliance or Automobile Accessory.** Cincinnati Automatic Machine Co., Cincinnati, Ohio.

**MANUFACTURING Models, Dies, Stampings, Brass Work, one or thousands.** Baum's Metal Specialties, Kansas City, Mo.

**WIRE goods made to order.** Cooley Mfg. Co., 530 N. Western Ave., Chicago.

**STAMPING and light manufacturing.** Acme Tool Co., Mason City, Ia.

## MACHINERY, TOOLS AND SUPPLIES

**MARVEL Cylinder Boring Machine,** \$125.00. 14x6" Willard engine lathe, \$165.00. 24x10" Davis engine lathe, quick change, \$475.00. No. 60 Head Cylinder Grinder, \$575.00. 10" Drill Press, \$19.00. Terms if desired. Send for catalogue. Cincinnati Machinery & Supply Company, 27 West Second St., Cincinnati, Ohio.

**PUNCH Presses—Small power bench type.** \$65.00. Circular free. Alva F. Allen Company, Manufacturers, Independence, Mo.

**WANTED—Bargain.** Accurate, first-class, medium or small lathe motors to rewind. E flat saxophone. 260 High St., Eugene, Ore.

**60 HEALD Cylinder Grinder;** Nice condition, \$350.00. Lucas & Son, Bridgeport, Conn.

**LESTER four-spindle Automatic Screw Machines,** \$200.00 each. Pratt & Whitney Automatic Screw Machines, \$125.00 each. No. 2 Pratt & Whitney Hand Screw Machine, \$125.00. Lincoln type Milling Machine, \$125.00 each. 5-B Becker Milling Machine, \$400.00. Also lathes and drill presses. Machinery & Supply Corporation, Joplin, Mo.

**CONCRETE Building Block Machine and Molds.** Catalogue free. Concrete Machine Co., 5 N. Main St., St. Louis, Mo.

**LATHES, Drill Presses, Shapers, Milling Machines, Planers, Screw Machines, Small Tools and Surplus Machinery.** Cincinnati Automatic Machine Co., Cincinnati, Ohio.

**SPEED Lathe \$10.50 complete.** 7 inch swing, 3 speed cone. Jefferson Mfg. Co., Fairfield, Iowa.

**START Business of your own, small investment required, doing nickel, copper and silver plating.** This work is in big demand. Full information free. Electro Platers Supply Co., 547 Considine Ave., Cincinnati, Ohio.

**OTHERS have successfully sold their machinery through our columns—so can you.** Ask me for proof. M. L. Rund, Manager, Classified Advertising, Popular Mechanics Magazine, Chicago.

## ENGINES, MOTORS AND DYNAMOS

**NEW 1/4 horse 110-volt alternating motors \$5.50 each.** Also other bargains all sizes direct and alternating. Write for prices stating size and kind of current. Queen City Electric Co., 1736 Grand Ave., Chicago.

**ALTERNATING current bargains.** 1/4 H. P. Holtzer-Cabot \$7.00. Westinghouse or General Electric 16-inch oscillating fan \$18.00. These special prices for a few weeks only. Send your order now. Hyre Electric Company, 615TF, So. Dearborn St., Chicago.

**STEAM Engines—One H. P. \$18.00; 1/2, \$12.00.** James Chambliss, Bessemer, Ala.

**A. C. INDUCTION motor model shows winding connections plain sight.** Quick easy way. Gaines Bros., Box 481, Gainesville, Texas.

**MOTORS—New GE 110 or 220 volt 60 cycle Single Phase 1/4 HP, \$11.90; 1/2 HP, \$28.53; 1 HP, \$38.50.** Mail \$3 check or money order. We will ship COD anywhere. Motor Specialties Co., Crafton, Penna.

**A. C. 1/4 H. P. Washing Machine Motors \$5.00.** Other bargains. Elle & Co., 1018 W. Lake, Chicago, Ill.

**753 TIME, Labor and Money Saving Ideas for all who own, drive or repair autos.** These practical kinks are based upon the actual experiences of hundreds of owners and repairmen. Three books, Auto Owners, Auto Repairman's and Auto Tourist's Handbooks, regular \$1.50 value from Popular Mechanics Press will be supplied at 98c, plus the postage C. O. D. for a limited time only. Send your order today to Popular Mechanics Press, Room 908, 200 E. Ontario St., Chicago.

## BLACKSMITHS

**BE a Master Mechanic Blacksmith and Expert Tool Maker and Dresser with colored tempering charts.** Price \$1.00. Valuable samples free. W. M. Toy, Sidney, Ohio.

## BENDING MACHINES

**THE Famous Hossfeld "Wrenchless" Universal Iron Bender is the last word in bending machines.** Bends metal, cold or hot, into most any conceivable shape, including Eye Bolts and Automobile Spring Eyes. Bends up to 1" bars or 1 1/2" pipe cold. Thousands in use by all classes of trade, from the smallest shops to the largest railway systems. Write for circular and prices. Hossfeld Mfg. Co., Winona, Minn.

## FOR SALE—MISCELLANEOUS

**\$160.00 MODEL Hammond typewriter, \$50, \$65.00 Dietzgen engineers level, \$37.50; bargains in cameras, lenses.** Cash paid for firearms, microscopes. National Camera Exchange, 5 South Fifth, Minneapolis, Minn.

**PUNCHBOARD Contains 12 Fine Pocket Knives, Two Blades, Transparent Handles showing bathing beauties.** 600—5c Punches, retails \$30. Shipped Prepaid for \$11. Moneyorder. Moneyback Guarantee. Avery Graham, 51 West Cedar, Denver, Colorado.

**PUBLIC Correspondence Association Monthly Magazine, 15c per copy, (90c) six issues.** Box 326, 601 E. 36th St., Chicago, Ill.

**ADDRESSOGRAPHS, Letter Folders, Multigraphs, Envelope Sealers, Duplicators, less than half price. Guaranteed.** Pruitt Co., 117 No. Market, Chicago.

**VACATION Reading.** Ask us to send you lists of books that are 100% entertaining—such books as Beau Geste, Old Ironsides, One Minute to Play, The Nervous Wreck, etc., prices of most of these books not over 75 cents. You will receive at once attractive lists to choose from and from time to time thereafter lists of the newest and best stories as soon as the publishers' announcements are made. Popular Mechanics Press, 200 E. Ontario St., Chicago.

## WANTED—MISCELLANEOUS

**MAIL us your discarded Jewelry, Gold, Crowns and Bridges, Watches, Diamonds, Silver, Platinum and old False Teeth.** Money promptly mailed. Goods returned if offer refused. United States Smelting Works (The Old Reliable), Dept. 71, Chicago.

## REAL ESTATE, FARM AND ORCHARD LANDS

**PREPARE for Old Age—120 acre Northern Minnesota, \$1,200—\$100 down, \$10 per month.** R. Ring, Palace Bldg., Minneapolis, Minn.

**CALIFORNIA—Thirty acre Fruit Farm ideally located.** Terms. F. E. Carmichael, Modesto, Calif.

**LAND free if planted to bananas.** Bananas bear a full crop the second year. \$5.00 monthly will plant five acres, which should pay \$1,500 profit annually. Reliable Companies will cultivate and market your bananas for 1/2. Bananas ripen every day and you get your check every 90 days. For particulars address Jantha Plantation Co., Empire Building, Block 949, Pittsburgh, Pa.

**\$10 IS all I ask down on 20 acres in Mich. Potato Belt.** Very easy terms. Near markets, lakes and streams. Write for particulars now. G. W. Swigart, P1276 First Nat'l Bank Bldg., Chicago.

**SELL your property quickly for cash, no matter where located.** Don't pay big commission. Particulars free. Real Estate Salesmen Co., Desk B, Lincoln, Nebr.

**PECAN-Orange-Fig Groves "On the Gulf" Monthly payments.** Guaranteed care. Big, quick returns. Suburban Orchards, Dept. M, Biloxi, Miss.

**OZARKS—10 acres near White River and proposed power dam, \$100, \$5 monthly.** Alvin Zimmerman, 1802 N. 5th, Kansas City, Kans.

**FLORIDA Gulf Coast—We have a few 5 acre tracts inside city limits suitable for poultry and small fruits, Hills Fruit Farm, Panama City, Florida.**

**KEY to Real Estate Success.** The Real Estate Educator, new, 1927 edition. Most valuable work on real estate selling, buying, advertising, appraising, investigating, leasing, sub-letting, transferring, insuring, mortgaging, etc., in simple, practical, usable form. Based on the experience of leading realtors. Pay postman \$2 and postage when he delivers the book. Popular Mechanics Press, Room 908, 200 E. Ontario St., Chicago.

## SEEDS, PLANTS, TREES, ETC.

**WRITE Today for Prices on 1928 Ginseng Seed Booklet on Golden Seal Growing, 10c.** W. N. Long, Florence, Ky.

## TREE KILLERS

**CONDENSED Bo-Ko, enough to kill 100 Trees, \$2.00.** Bo-Ko Co., Jonestown, Miss.

## ROOTS AND HERBS

**HERB Doctor and Medicine Man Book, 10c.** (Worth dollars.) Contains over 250 valuable herb medicine recipes for home use. Shawnee, 145 West 112th Street, Chicago.

**HERB Doctor Book—10 cents.** 250 receipts for making herb medicine. Hazzard Company, Box 1, Vanderveer Park, Brooklyn, N. Y.

## DOGS AND PETS

**THE World's Largest Kennel offers for sale Oorang Airedale watch dogs, automobile companions, children's playmates, hunters, retrievers, stock-drivers.** Also Big Game Hounds, Coonhounds, Foxhounds, Rabbit Hounds. All dogs individually schooled and trained by canine specialists and shipped on trial, Price \$50.00 to \$150.00 each. Thoroughbred puppies \$25.00 to \$35.00 each. Catalog ten cents. Oorang Kennels, Box 14, La Rue, Ohio.

**FRYE'S Kennels, Finger, Tenn., offers for sale perfectly trained Coonhounds; sent on trial.** Get catalog and how I pay express.

**HUNDRED Hunting Hounds Cheap.** Trial Catalogue. Kaskaskennels, M40, Herrick, Ill.

**COONHOUNDS—Riverbottom Trained.** Red-bones, Black and Blueticks. Combination Hunters, Champion Rabbit hounds. Reasonable Prices. Catalog, Photos, Free. Riverview Kennels, L. J. Adams, Mgr., Ramsey, Ill.

**RAT Terrier Pups.** Bred for ratters. Also trained dogs. Satisfaction Guaranteed. Crusader Kennels, Stafford, Kans.

**FOR Sale.** Minks, squirrels, raccoons, foxes, ferrets, muskrats, ginseng, rabbit, skunks, wolf pups, opossums. B. Tippman, Caledonia, Minn.

**BEAUTIFUL Fox Terriers, Collies, Shepherds.** Barnes Farm, Clay Center, Neb.

## PERSONAL

**TOBACCO or Snuff Habit Cured or no pay.** \$1.50 if cured. Remedy sent on trial. Superba Co., N3, Baltimore, Md.

**SPARETIME Employment at home.** Details stamp. Gluco, 507 Aetna Bldg., Rochester, N. Y.

**WE answer your questions, 25c coin.** Fred Klotz, Reading, Pa.



**ASTROLOGY**—Stars Tell Life's Story. Send Birthdate and 25c for character reading. M. Kleman, 90 Adelaide St., Winnipeg, Man.

**BILLIE Boy**—We are well. Write again. All right to give address.

**POSITIVE** evidence of higher spirit life and power. Free descriptive literature. R. C. Hill, 692 W. Jefferson, Detroit, Mich.

**FREE:** Valuable book telling the uses of roots and herbs. Box 29, Station L, New York.

**CARTOONING** and Commercial Art Work easily learned with new book. Complete art course beginning with simplest drawings and leading through higher branches of illustration. Profusely illustrated. Send no money. Just write a postal for "Commercial Art and Cartooning." Pay postman postal charges and \$1.25. Popular Mechanics Press, Room 908, 200 E. Ontario St., Chicago, Ill.

**FOODS** from Twenty Lands. Popular Mechanics new cook book made up of recipes sent by our readers from 20 countries. Many delightful foreign dishes, and many American ones, too. Only a few copies for sale. Send no money. Just order on a postal. When postman hands you book, pay \$1.50 and postal charges. Popular Mechanics Press, Room 908, 200 E. Ontario St., Chicago, Ill.

#### MISCELLANEOUS

**YOU** can emboss your stationery as needed. Perfect work guaranteed. Simple—inexpensive. Miller Sales Company, Dept. E, Lexington, Ky.

**CASH** Paid for Butterflies, Insects. See Sinclair Display Advertisement on page 39.

**MAKE** Extra Money Evenings Mfg. 24 good sellers. Instructions 50c. Steffey, 3924 Fairmount, Philadelphia.

**SURPLUS** government tent poles 6 ft. long, 1 1/2" diameter, new, at 10c each. Same in 4 ft. lengths 8c each, in quantities of 100 or more. Cash with order. General Distributing Co., Duluth, Minn.

**SHORTCUTS** in figures. The quickest ways of working all problems. Instructions for drilling yourself to become rapid with figures. Complete, yet simplicity itself. Send No Money. Just write a postal for "Shortcuts in Figures." Pay postman \$1.25 and postage. Popular Mechanics Press, Room 908, 200 E. Ontario St., Chicago, Ill.

**MIRRORS** Resilvered at Home. Costs Less 5 cents per square foot; you charge 75 cents. Immense profits plating autoparts, reflectors, tableware, stoves, refinishing metalware, etc. Outfits furnished. Details Free. Write Sprinkle, Plater, 288, Marion, Ind.

**PRINT** 250 Signs or pictures an hour without press, type or machinery. Sample and particulars 10c. Straco, 1013, Springfield, Ohio.

**SPEECHES.** No matter where you must speak, here is help. 366 pages of instruction and anecdotes, toasts and complete speeches for the amateur or professional. Send No Money. Simply write a postal for "Speeches, Their Preparation and Delivery." Pay postman postal charges and \$1.25. Popular Mechanics Press, Room 908, 200 E. Ontario St., Chicago, Ill.

**MEXICAN** Made pistol holsters, cartridge belts, lariats, horse hair articles; rattlesnake belts; list free. Tex-Mex Leather Co., 309 Esperson Bldg., Houston, Texas.

**MAKE** a Telescope; Join ranks of enthusiastic group of amateur astronomers. Fascinating subject treated in new book, only one published in America. "Amateur Telescope Making." Pay postman \$2 and few cents postage on delivery. Popular Mechanics Press, Room 908, 200 E. Ontario St., Chicago, Ill.

**DISTRIBUTORS:** No canvassing; free samples; stamp appreciated. Honery, Roseto, Pa.

**861 PRACTICAL** Ways to Reduce Farm Labor and Expense and Increase Income. One farmer writes he would not part with this information for \$100, if he could not duplicate it. Nothing experimental. These ideas have all been put to test and proven practical. Send today for a copy of our Handbook for Farmers and get ready to put these ideas into operation for your own benefit. Pay postman only 98 cents and the postage when he hands you the package. Popular Mechanics Press, Room 908, 200 E. Ontario St., Chicago, Ill.

**LOOK!** Fly balloons anywhere. Inflator \$1.00 and \$6.00. Guaranteed. Balloon Inflator Co., Box 853, Providence, R. I.

**GOLD, Silver, Copper, Lead, Zinc Ores,** 10c each. Minerals identified \$1.00. Buskett, Joplin, Mo.

**POST-CARD** views of the Panama Canal during Construction days, 25 assorted for \$1.00. W. Ramey, Box 571, Cristobal, Canal Zone.

**HOMEOPATHIC** and Biochemic preparations sent postpaid to all parts of the world. Manual and booklets free. Halsey Bros. Co., 645 St. Clair St., Chicago, Ill. Established 1855.

**CANE** Becomes Ukulele by Removing Secret Cover, \$3.50. Broadway Music Co., Bayonne, N. J.

**FUN** making things. Four large profusely illustrated books telling how to make almost everything from a sail boat to a toy automobile propelled by a motorcycle engine. Now \$2 per book or \$7 for the four if ordered at once. Send No Money. Just write a postal saying, "Send the Boy Mechanic Library." Pay postman \$7 and postage. For single books, specify either Book 1, Book 2, Book 3, or Book 4. Popular Mechanics Press, Room 908, 200 E. Ontario St., Chicago, Ill.

**COMMERCIAL** Poultry Raising can be made a profitable venture, yet certain well established rules must be followed. Avoid pitfalls by getting our reliable 572 page book of the latest and best practice. It will increase your profits. Order today and pay postman \$3 plus the postage when he hands you the book. Money back if not satisfied. Popular Mechanics Press, Room 908, 200 E. Ontario St., Chicago, Ill.

**WEEDS**—Cut them with cutter bar on Shaw Garden Tractor. Also plows, cultivates and runs belt machinery. Low prices. Immediate delivery. Shaw Manufacturing Company, Department C, Galesburg, Kans.

**CUTS** anybody can make. Simple, cheap process. \$1. Specimens, particulars. 2c stamp. M. Day, Windfall, Ind.

**TELL** an army of 3,000,000 live readers all about your offer! If you have anything to sell, buy or exchange, or if you have any reasonable proposition, tell our readers all about it—they'll respond quickly. Our booklet "How to Create More Business" contains some very interesting, helpful facts. Write today for your copy—it's free. M. L. Rund, Manager Classified Advertising, Popular Mechanics Magazine, 200 E. Ontario St., Chicago, Ill.

## YOU CAN COLLECT A Week's Wages Every Day — START SMALL and GROW BIG

Bigger money every year for auto repairmen! More opportunities! 24 million cars—three-fourths of them over 2 years' old, need repairs average once a month. Crying need for trained men. A few weeks in Detroit, the Auto Center does it. Start a little business of your own and grow big.



Start Small and Grow Big



LEARN IN DETROIT—THE AUTO CENTER

A business of your own makes you the real money. You don't have to start big. If you know your stuff, you will make big money in a little shop. Many of our graduates even start in alley garages, taking in 2 or 3 cars at a time. Their profits and their reputation soon bring a bigger shop. It's training that does it. The man who gives satisfaction by doing his jobs right, is always swamped with business. A nice overhaul job will net you \$50, \$75, \$100. Service jobs from \$5 to \$25 each. The

skilled auto service man is on the way to "easy street" immediately. That means you must have real training—the "Michigan State" kind.

### LEARN QUICK

Come to the "Michigan State" at Detroit. Learn right.—in just a few weeks. Then you'll be sitting pretty too.

### COME TO DETROIT NOW

Get in this steady, year-round business. It's a big pay business with no strikes, no lay-offs. Get thorough training at this world famous school. Jump on the train for Detroit now. We'll help you to part-time work while learning if you need it. Or write for big illustrated 17th Anniversary Catalog, all about factory-endorsed Detroit-training for real success. Write, or come now! A. G. Zeller, President, Michigan State Automobile School, 309 Auto Bldg., Detroit, Michigan.

### Mail Me!

Michigan State Automobile School  
309 Auto Bldg., Detroit, Michigan.

Send me free and without obligation full information about Detroit training to make the most money. Also send me FREE your big new illustrated Catalog and Automobile Training Book.

Name.....

Street Number or R. F. D.....

City.....State.....

I am interested in  
 12 weeks' Auto Course  
 30 weeks' Master Course  
 Home Study Course



One of the 4000 Airports in America

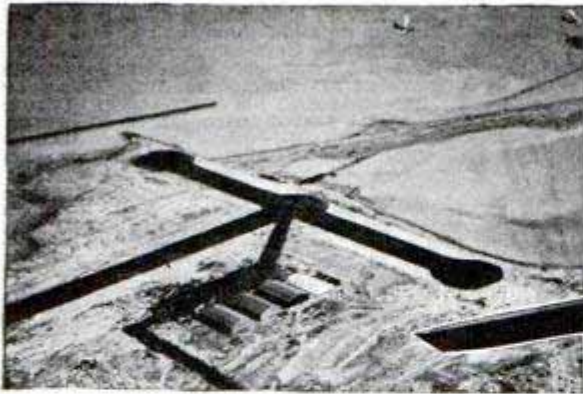

# The Sun Rises offering a great, new Opportunity



One of the Busy Factories

Make big money in Aviation. Thousands of opportunities are opening every day. It's the business of the hour—the gold mine of the future. Just as in the automobile field when it was new, men who learned the fundamentals climbed to the top—just as in electricity, radio—so it will be in Aviation.



Lieut. Walter Hinton  
President  
First Transatlantic  
Pilot—N. C. 4.

Walter Hinton, first Trans-Atlantic flyer, and his staff of experts will guide your instruction from beginning to end.

The Aviation Institute Course teaches you everything you need to know, right up to the point of actual flight instruction in the air. All the principal ground work, so absolutely necessary to qualify, is secured in a comparatively short time at home. When you have graduated from the Institute and receive your credentials, you are ready to take your place in Aviation.

If you wish to become a pilot, final flying instructions are given in all parts of the United States in cooperation with the Institute. Five to ten hours with an instructor and you can fly alone.

This great, new field is open to every ambitious young man. There are 53 different trades in the industry, many ground jobs. The business is humming. Manufacturing of machines and parts is growing by leaps and bounds. There are now 4,000 air ports operating in America—6,000 privately owned planes. Men in Aviation earn up to \$100.00 weekly and more.

Wide awake men are needed as mail pilots, commercial flyers, instructors, inspectors, riggers, mechanics at flying fields, besides the thousands of positions in factories.

At home in your spare time, you can learn the fundamentals of Aviation. Lieut.

**AVIATION INSTITUTE of U. S. A.**



WALTER HINTON, President

1115 Connecticut Ave., N. W., WASHINGTON, D. C.

**FREE** This Book  
Tells  
All.



Aviation  
Institute  
of U. S. A.  
Suite 49

1115 Connecticut  
Ave., N. W.,  
WASHINGTON, D. C.

You may send me with-  
out obligation a Free  
copy of "Aviation and You."

Name.....

Age (Not under 16).....

Street.....

City.....State.....





## "Real Money in the Bank"

"Think of it, Nell—\$460! And to think that just a few months ago we couldn't save a cent.

"Remember the night we talked it over and you persuaded me to send in that I. C. S. coupon? It was the best investment we ever made.

"The boss says there will be a still better position open for me soon if I keep on showing the same interest in my work. It certainly does pay to study in spare time."

Thousands of men now know the joy of happy, prosperous homes because they let the International Correspondence Schools prepare them in spare time for bigger work.

One hour after supper each night, spent with the I. C. S. in the quiet of your home, will prepare you for the position you want in the work you like best.

This is all we ask: Without cost or obligation, put it up to us to prove how we can help you.

### Mail the Coupon for Free Booklet

INTERNATIONAL CORRESPONDENCE SCHOOLS  
Box 5672-E, Scranton, Penna.

Without cost or obligation, please send me a copy of your booklet, "Who Wins and Why," and full particulars about the course before which I have marked X in the list below:

#### BUSINESS TRAINING COURSES

- |  |   |
|--|---|
| <input type="checkbox"/> Business Management                     | <input type="checkbox"/> Salesmanship                                     |
| <input type="checkbox"/> Industrial Management                   | <input type="checkbox"/> Advertising                                      |
| <input type="checkbox"/> Personnel Organization                  | <input type="checkbox"/> Better Letters                                   |
| <input type="checkbox"/> Traffic Management                      | <input type="checkbox"/> Show Card Lettering                              |
| <input type="checkbox"/> Business Law                            | <input type="checkbox"/> Stenography and Typing                           |
| <input type="checkbox"/> Banking and Finance Management          | <input type="checkbox"/> English  |
| <input type="checkbox"/> Accountancy (including C.P.A.)          | <input type="checkbox"/> Civil Service                                    |
| <input type="checkbox"/> Nicholson-Prouty Cost Accounting        | <input type="checkbox"/> Railway Mail Clerk                               |
| <input type="checkbox"/> Bookkeeping                             | <input type="checkbox"/> Common School Subjects                           |
| <input type="checkbox"/> Private Secretary                       | <input type="checkbox"/> High School Subjects                             |
| <input type="checkbox"/> Spanish <input type="checkbox"/> French | <input type="checkbox"/> Illustrating <input type="checkbox"/> Cartooning |

#### TECHNICAL AND INDUSTRIAL COURSES

- |   |  |
|---|--|
| <input type="checkbox"/> Electrical Engineering                     | <input type="checkbox"/> Architect                                       |
| <input type="checkbox"/> Electric Lighting                          | <input type="checkbox"/> Architects' Blueprints                          |
| <input type="checkbox"/> Mechanical Engineer                        | <input type="checkbox"/> Contractor and Builder                          |
| <input type="checkbox"/> Mechanical Draftsman                       | <input type="checkbox"/> Architectural Draftsman                         |
| <input type="checkbox"/> Machine Shop Practice                      | <input type="checkbox"/> Concrete Builder                                |
| <input type="checkbox"/> Railroad Positions                         | <input type="checkbox"/> Structural Engineer                             |
| <input type="checkbox"/> Gas Engine Operating                       | <input type="checkbox"/> Chemistry <input type="checkbox"/> Pharmacy     |
| <input type="checkbox"/> Civil Engineer                             | <input type="checkbox"/> Automobile Work                                 |
| <input type="checkbox"/> Surveying and Mapping                      | <input type="checkbox"/> Airplane Engines                                |
| <input type="checkbox"/> Metallurgy <input type="checkbox"/> Mining | <input type="checkbox"/> Agriculture <input type="checkbox"/> Navigation |
| <input type="checkbox"/> Steam Engineering                          | <input type="checkbox"/> Mathematics <input type="checkbox"/> Radio      |

Name.....

Street Address.....

City..... State.....

Occupation.....

Persons residing in Canada should send this coupon to the International Correspondence Schools Canadian, Limited, Montreal, Canada

## \$2500 DRAWING COURSE for \$298



Haven't you often wished that you could draw cartoons, illustrate some idea, sketch some pretty face, etc.? You can do all of these things. One of America's most famous Cartoonists and Illustrators has developed a great, simple system for success in all branches of Commercial Art. This system has revolutionized the entire theory of drawing. It means that drawing can be as easy for you as writing—much simpler than learning shorthand, bookkeeping or typewriting. We are now placing this original system for learning Drawing, Art and Cartooning, consisting of 34 lessons with over 500 illustrations, within reach of every one. If you will devote a few hours each week to the Course WE ABSOLUTELY GUARANTEE that you will learn to draw and draw well before you have half finished the Course. If we fail to make this claim good, we will refund every cent paid us. By eliminating a large office force for answering correspondence, expensive catalogs, etc., we are enabled to make a price of \$2.98, the cheapest price ever known for a high-grade, home study course. Many have sent us letters similar to that of Rob't P. Davis of Detroit, who wrote: "I can't see how you ask so little. It is more than I expected." Learn to draw. It is a big asset, no matter what field you are in.

### Send No Money

Just order the course and on arrival pay postman \$2.98 plus a few cents postage, payment in full for the entire Course and Drawing Outfit. If not entirely satisfied, return within five days and we will Refund Money. Address:

If you order the course at once, we will include a drawing outfit, consisting of artist's pencil, pens, paper, erasers, thumb tacks, etc., enabling you to go to work without any additional cost.

LEDERER SCHOOL of DRAWING, Dept. 4400-U, Chattanooga, Tenn. Orders from outside the U. S. A. are payable \$3.28 cash with order.



## LEARN TO FLY

Billions of dollars will be created and spent through the development of aviation. Thousands of positions will be open for those who are prepared.

Prepare now! Complete Home Study Course in Aviation arranged by America's foremost aeronautical society. Authentic yet inexpensive. Write for further information. THE AMERICAN SOCIETY FOR PROMOTION OF AVIATION, 522 Fifth Ave., Dept. X, New York

## FOREST RANGERS

MEN, become Forest Rangers; \$125—\$200 mo. and home furnished; permanent; hunt, fish, trap, etc.

FOR DETAILS, WRITE

NORTON, 2530 McMANN BUILDING, DENVER, COLORADO

### LEARN PHOTO-ENGRAVING!

Earn \$200 to \$500 monthly. Photography and Photo-Engraving taught in few months by largest college of its kind. Established 1893. Big demand for graduates.

Write for free book.

Illinois College of Photography, Box 497, Effingham, Ill.

## Better Handwriting

A wonderful asset in teaching writing. Aluminum guides. Highly recommended. 2 qualities, at 35c and \$1 a set post-paid. VIC. HANSEN, WALLACE, IDAHO



## \$1900 to \$2700 a year

Long vacations with pay. Work easy. Travel on fast trains with all expenses paid, including hotel. No worries about the future.

### MY FREE BOOK TELLS HOW

Get my big free book about the Civil Service which tells all about the Railway Postal Service, and other positions, and how I can help you. Write today.

### PATTERSON SCHOOL

Arthur R. Patterson, Civil Service Expert  
89 Wisner Bldg. Rochester, N. Y.





# 50 MORE JOBS NOW \$11 a day



Yes—there is a real demand for men trained in auto trades. This very day I could help 50 more men than I have available at \$11 a day. The future looks even better. There is a shortage of men trained like SWEENEY has trained thousands of men. That's why SO MANY SWEENEY TRAINED MEN get TREMENDOUS PAY and are in BIG DEMAND. Get my Free Book today and see that WELDING is only one of the BIG PAY Branches I get you ready for.

## My Employment Department Helps Graduates to Jobs

Yes, my EMPLOYMENT DEPARTMENT helped L. W. Kelley to a job at \$18.00 A DAY—IT helped J. H. Miller to a job at \$10.50 A DAY—IT helped Gordon Shyroock to a job at \$10.50 A DAY, and it, also, is helping dozens of other Sweeney Graduates to fine jobs at \$10 to \$18 a day, IMMEDIATELY after finishing ONLY A SHORT COURSE of SWEENEY TRAINING.

Clip the coupon. Find out about this WONDERFUL JOB SERVICE my EMPLOYMENT DEPARTMENT renders. It will simply astonish you.

# Men Wanted in Auto Trades

That's what a REAL, "ON THE JOB" EMPLOYMENT DEPARTMENT SHOULD DO, and that is—help men GET REAL JOBS. Think of it—FIFTY-FIVE WONDERFUL JOBS OPEN TODAY for SWEENEY TRAINED men. I have ONLY FIVE MEN READY so that I can help them to these jobs. And the peculiar thing is—it takes me ONLY FOUR WEEKS to TRAIN some of these men. Now what more do you want? Challenge me. Send for my Big Free 72 Page Book. If you go on depriving yourself—if you WANT TO BE OUT OF A JOB—and don't let me help you—PLEASE DON'T READ ANOTHER SWEENEY AD. If you have—(you know what I mean) in you—you will find out NOW. Just clip the coupon below.

### The Sweeney System

Teaches by practical, personal experience. You work with tools, not books. You learn by doing. Million dollar school with complete equipment. You need no previous experience. If you are looking for success in life and working at a trade you like write me today. Drivers, mechanics, repair men, testers, garage owners, painters, welders, demonstrators—thousands more are needed and opportunities are everywhere. If you are mechanically inclined simply send name today for my big free book how to fit yourself for steady high paid employment in the auto business.

## FREE CATALOG AND SPECIAL OFFER

Get my big FREE 72-page catalog. It shows hundreds of actual photographs of men at work in my magnificent new school. Tells all about wages, profits, opportunities in auto business. Explains step by step how you learn. Interesting letters from graduates telling how they made good. Shows how men come from all over the world to this big school. Makes you want to join the crowd. Tells everything you want to know. I will gladly send you a copy beautifully illustrated. I'll tell you how to get into business for yourself. No colored students accepted.

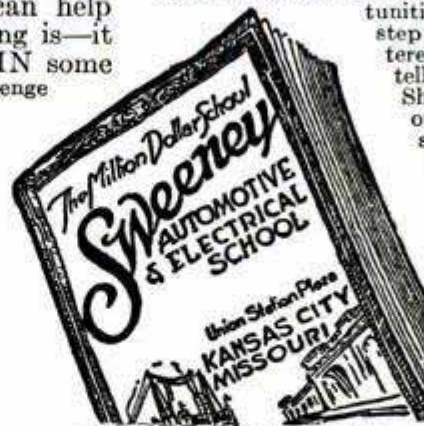

E. J. SWEENEY  
President

EMORY J. SWEENEY, President  
4131 Sweeney Building, Kansas City, Mo.

Send me free, without any obligation, your catalog and Special Offer!

LEARN A TRADE—  
**Sweeney**  
AUTOMOTIVE & ELECTRICAL SCHOOL  
4131 SWEENEY BLDG. KANSAS CITY, MO.

NAME.....

P. O.....

STATE..... AGE.....





If You  
Want a Job

or a  
Hobby



Where You  
can be Your  
Own Boss



learn  
Illustrating

Our new catalog "A Road to Bigger Things" tells you how. You will also be interested in the illustrations and comments by Neysa McMein, Leyendecker and other nationally known artists who are among the Federal authors and contributors. Just write your name and address on the margin of this page. Tear it out and mail it to us and we will send you your copy.

**Federal  
School  
of Illustrating**

9137 Federal School Bldg., Minneapolis, Minn.



that Pays  
Well



and Keep Your  
Own Hours



**Win a Buick**  
or **\$1500.00** In Cash



I am going to give away a brand new, latest model Buick Sedan to someone who answers this adv. We have already given away many autos. This is the most liberal offer ever made. It is your chance to win this ideal car. You can win it; why not try? The Sedan will be delivered to the winner, or winner may have the full cash value (\$1,195.00)!

**SOLVE THIS PUZZLE**

2 21 9 3 11 | 7 9 22 5 14

Can you make out the two words spelled by the numbers in the squares above? The alphabet is numbered, A is 1, B is 2, etc. What are the two words? Send your answer today—not a cent of cost to you now or later.

**\$305 for Promptness**

I will also give away a Chevrolet Coach, Orthophonic Victrola and many other valuable Prizes—besides hundreds of dollars in Cash—and \$305.00 Special Extra Prize for Promptness. First Prize winner will receive \$1,500.00 cash or Buick Sedan and \$305.00 cash. All who answer can share in cash and prizes. In case of ties the prizes will be duplicated. EVERYBODY REWARDED. Now, get out your pencil and solve the puzzle—send your answer today with name and address plainly written.

**WILLIAM LEROY,**  
Dept. 1776 315 So. Peoria St., Chicago, Ill.

**LEARN WATCH REPAIRING**

Be a watchmaker—you can learn this profitable trade by correspondence in a few weeks in your own home by the DeSelms Chart System. After you complete the course you will know a watch from A to Z. You will know just what the matter is and how to repair one. When you graduate you will be a practical watchmaker and repairer and competent to fill any position. Positions for our graduates. Ask for our Free Book. It explains our system and terms.

**THE DeSELMS WATCH SCHOOL**  
LOGANSPORT, INDIANA



**RADIO AGENTS AND  
DEALERS—BIG MONEY**

Our Agents and Dealers make big money selling Metrodyne Sets. You can work all or part time. Demonstrate superiority of Metrodynes in your home. Metrodyne Radios have no competition. Lowest wholesale prices. Demonstrating set on 30 days' free trial. Greatest money making opportunity. Write today for proposition.

**METRO ELECTRIC CO.**

2161 N. California Ave.

Dept. A

CHICAGO, ILL.



**Learn How to  
WRESTLE**

In Your Own Home  
By Mail

Yes, learn to become an expert wrestler right in your own home, by mail, from the greatest wrestlers the world has ever known. Be an athlete, be strong, be healthy. Learn how to throw and handle big men with ease. Learn to defend yourself. All taught in our course of lessons, and illustrated with hundreds of charts and actual photographs by

**Farmer Burns and Frank Gotch**

Farmer Burns, "the grand old man of the mat," taught Frank Gotch, the World's Champion, all he knew about wrestling, so Gotch said. He will now teach you Scientific Wrestling—Physical Culture—Jiu-Jitsu—Self Defense. Every man and boy in America, no difference what age, needs this wonderful course of lessons. Write today—your name, age and address on a postcard or letter brings you our fine book absolutely free, — no obligation of any kind. A splendid book on wrestling and physical culture. Write today stating your age.

**Farmer Burns School of Wrestling** 3376 Range Bldg., Omaha

This  
Wrestling  
Book  
FREE



# Learn How to BOX



## JIMMY DeFOREST BOXING COURSE DEVELOPS CHAMPIONS BY MAIL

**DeForest Boys are on the Road to Fame and Fortune!**  
**The World's Most Famous Trainer Will Make You a Finished Boxer!**



Read What Tasker Says

Under the wonderful System of Jimmy DeForest, World's Leading Trainer and Developer of Champions, you will master the priceless knowledge that has made champions and started hundreds of boys on the road to Fame and Fortune.

Jimmy DeForest teaches you all the fundamentals of boxing—right from the very ground up. His 35 years' experience is embodied in this marvelous System of Instruction—the identical methods which made more champions and real contenders for ring honors than any other trainer, either living or dead, ever created!

Every trick, every blow, every defense, every new angle in ring strategy that DeForest taught Dempsey, Firpo, Joe Gans, Kid McCoy and a host of others, is explained and illustrated in this one and only Complete Course in Boxing. Students testify that anyone can readily understand and master these simple as A B C instructions.

### 20 Weeks is All It Takes

20 weeks will make you a finished DeForest-trained boxer—ready to take your place along with the best of the lads who are real drawing cards for bouts at big fights. Soon thereafter, by applying the principles you have been taught, your name will rank as one of the clever boxers in your locality. DeForest-trained boys who were unheard of a year ago, are now fast approaching championship titles, and several of them are actual contenders. Novices in the beginning, they are top-notchers now!

### Opportunities Simply Unlimited

See what Geo. Tasker, of Rumford, Me., did. Until he took the DeForest Course he never won a contest in his life. "Since then," he writes, "I have engaged in nine contests, winning all

but one, which I lost on a close newspaper decision." Tasker is only one of scores whom the DeForest Course has put on the road to Fame and Fortune. The same opportunity is knocking at YOUR door. Grasp it NOW, on the eve of the biggest boom in the history of Boxing. Promoters all over America are clamoring for new material. They are constantly asking us to recommend good boys—boys with fighting hearts. Are you that kind of a lad?

Weaklings have been made strong and men physically rebuilt, energy, strength and courage developed. Prominent men and leaders in all walks of life, including Prof. T. W. Seeley, famous Physical Culturist, box regularly to keep themselves fit. It will be a revelation to you.

**Send for This Gripping Book** Send today for this new famous book, "The Golden Age of Boxing," the most remarkable volume of its kind ever written, full of valuable information, photos of great boxers and pupils who became successes overnight. It contains a complete outline of the DeForest Course, week by week, with special picture charts used in most of the lessons. This book will thrill you and open your eyes to the marvelous opportunity that lies before you. Who knows but what your life's fortune is right in the signing of that coupon below? Enclose 10c to cover mailing cost, etc.



**Jimmy DeForest Boxing Course**  
347 Madison Ave., Box 122, New York City

**Jimmy DeForest Boxing Course,**  
347 Madison Ave., Box 122, New York City

Enclosed find 10c to cover cost of mailing, etc., of your book, "The Golden Age of Boxing."

Name.....

Street No.....

City..... State.....

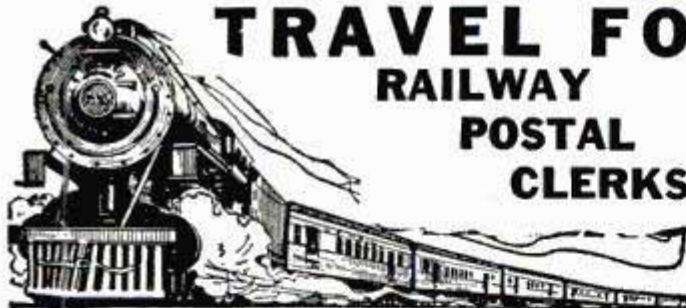

## TRAVEL FOR "UNCLE SAM"

**RAILWAY  
POSTAL  
CLERKS**

**\$158 to \$225 Month**  
**Mail Coupon Before You Lose It**

FRANKLIN INSTITUTE, Dept. N-176, Rochester, N. Y.

Sirs: Rush to me without charge—(1) Specimen Railway Mail Clerk Coaching; (2) tell me how to get a U. S. Government Job; (3) send copy of 32-page book, "How to get U. S. Government Jobs," with list of positions obtainable.

Name.....

Address.....

**Steady Work—No Layoffs—Paid Vacations**  
**Travel—See Your Country Common Education Sufficient**  
**MEN—BOYS 18 UP**

## Learn Watchwork, Jewelrywork and Engraving

A fine trade commanding a good salary, and your services always in demand. Address: **HOROLOGICAL**, Dept. P. Bradley Institute, PEORIA, ILLINOIS, for our latest catalog.

## TELEGRAPHY

(Morse and Wireless) and RAILWAY ACCOUNTING taught thoroughly. Big salaries; great opportunities. Oldest, largest school. Endorsed by Telegraph, Railway, Radio, and Government officials. Expenses low—opportunities to earn large portion. Catalog free. **DODGE'S INSTITUTE**, Jones St., Valparaiso, Ind.

## CHEMISTRY—Learn at home

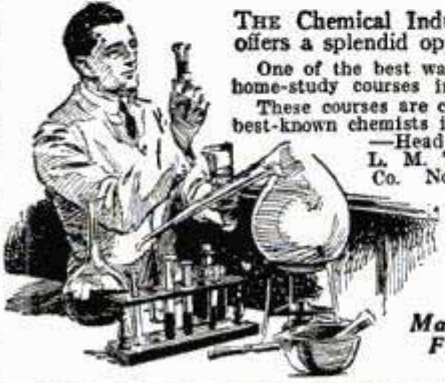

THE Chemical Industry now ranks fourth among the industries of the United States and it offers a splendid opportunity for ambitious men.

One of the best ways to prepare for a good position in this fascinating field is through the home-study courses in Chemistry offered by the International Correspondence Schools.

These courses are complete and practical because they were prepared by some of the best-known chemists in this country, including ALLEN ROGERS, B.S., M.S., Ph.D.

—Head of Department of Industrial Chemistry, Pratt Institute;

L. M. TOLMAN, Ph.D.—Formerly Chief Chemist, Wilson &

Co. Now Vice-president, United Chemical and Organic

Products Co.; BRADLEY STOUGHTON, B.S.

—Head of the Department of Metallurgy,

Lehigh University, and OWEN L.

SHINN, Ph.D.—Professor of Applied

Chemistry, University of Pennsylvania.

### INTERNATIONAL SCHOOL OF CHEMISTRY

Associated with the International Correspondence Schools  
Dept. 5673-E, Scranton, Penna.

Without cost or obligation, please send me full details of your home-study course in

### CHEMISTRY

Name.....

Address.....

Mail coupon for Free Booklet



# Learn Electricity in Los Angeles

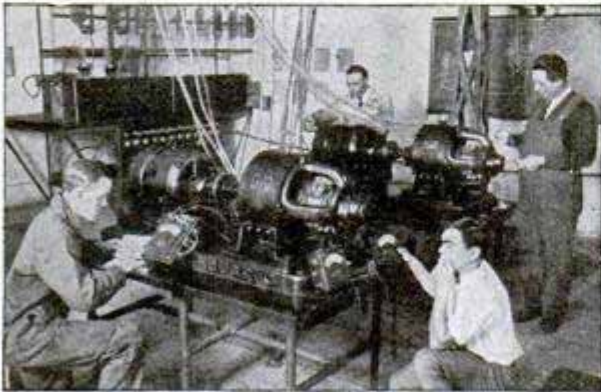

## Earn \$50 to \$200 Week As Electrical Expert

Train at National, Los Angeles, in the center of California's \$100,000,000 electrical development program.

The tremendous increase in development of enormous electrical projects has created a big demand for trained men with practical knowledge. YOU can quickly get into this fascinating industry and earn \$50 to \$200 a week.

### L. W. Bell Gets Two Promotions in 19 Days

"After leaving National Electrical School, I obtained employment with the So. Cal. Edison Co. as apprentice operator, and after working at this job for 10 days was promoted to assist foreman at the Laguna Bell Sub. I worked here for 9 days and was transferred to Saticoy Sub, a switching center, as assistant operator."  
(Signed) L. W. Bell,  
Saticoy, Calif.

National training will qualify you. Actual work on modern electrical equipment helps make you a skilled expert in Power House Operation, Motors and Controls, Central and Sub-Station Operation, Armature Winding, Motor Building, Electrical Fundamentals, Drafting, Illumination, Commercial Radio, Radio Construction, Battery Manufacture, Automotive Electricity, etc. Expert instructors; million-dollar shops; liberal "no-time-limit" training plan assure success. Over 17,000 successful graduates of this quarter-century-old institution.

### Free Employment Service

National graduates are preferred by many big electrical employers. We help you get the kind of job you want upon your graduation. We also assist you to get part-time jobs to pay living expenses while training. Mail the coupon now for big free electrical book. Explains everything. Make your start to win success today.

# NATIONAL ELECTRICAL SCHOOL



Dept. 510 4006 Figueroa St., Los Angeles, California

Please send me your Free, illustrated National Electrical Book describing opportunities in the electrical industry and illustrating National training methods.

Name \_\_\_\_\_

Address \_\_\_\_\_

City \_\_\_\_\_

State \_\_\_\_\_



## FREE BOOK ON MIND TRAINING

An instructive book which explains an amazing system of mind training already used by more than 600,000 people.

Secure your copy of the book which will show you how and why Pelmanism is the *only* system of teaching for developing *all* the mental powers at the same time. Write TODAY to

**THE PELMAN INSTITUTE OF AMERICA**  
71 West 45th St. Dept. 69 N. Y. C.

### DECIDE NOW TO BE THE 437th!

Up to July 15 we have 436 Students actively enrolled in our Aviation course—well on the road to FAME—POPULARITY and BIG PAY. We will teach YOU to fly.

Our written guarantee protects YOU.

Ground training given in specially prepared home course packed full of interesting data and facts of the industry. Actual flying and final instructions are taken at our huge airport in Chicago. Write TODAY for FREE BOOKLET on AVIATION and the OPPORTUNITIES in it FOR YOU.

**CHICAGO AERONAUTICAL SERVICE Inc.**  
Agents for WACO and AMERICAN EAGLE Planes  
Dept. S. 608 So. Dearborn St. Chicago, Ill.



## Learn Tenor Banjo

**BANJOISTS!** Earn big money through Charles McNeil's famous Home Study Banjo Course. Simple as A B C—yet has all technical requirements. Includes phonograph record demonstrating jazz strokes, "breaks" and chords, played by Charles McNeil, 5 years with Isham Jones-Brunswick Records. Easy payments. Send for Free Book.

**CHICAGO BANJO INSTITUTE**  
Dept. 1356 3345 N. Lincoln Street CHICAGO, ILL.

## BE A MAGICIAN

Entertain and amuse your friends with magic. Earn money at fairs, bazaars, and clubs. Win new popularity. Be in demand everywhere. Thurston, the World's Master Magician, has written a Big Book that explains the secrets of 200 Mystifying Tricks with cards, coins, matches, eggs, dice, dominoes, handkerchiefs, etc. Everything explained so clearly you can perform these tricks in a few minutes. Well illustrated. This amazing book, \$1.00. Satisfaction Guaranteed. Bargain Book Catalog FREE.

**FRANKLIN PUBLISHING CO.**  
186 N. LaSalle St., Dept. 9403, Chicago



## LEARN to PITCH

Lessons by "MATTY" ED. WALSH, "DOC" WHITE, WALTER JOHNSON, "NAP" RUCKER, "SMOKY JOE" WOOD, PITCH THE FADE-A-WAY, SPITTER, KNUCKLER, SMOKE BALL, etc. Clearly described and illustrated by 55 Pictures. Entire COURSE OF LESSONS SENT POSTPAID for 50 cents.

**BENEDEK, 2300 N. Mason Avenue, CHICAGO, ILLINOIS**

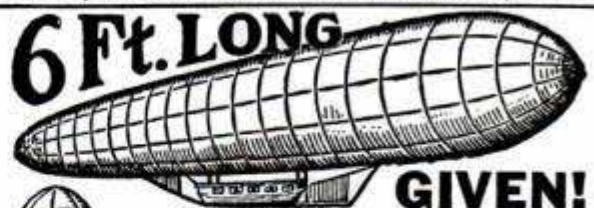

**Boys! Here's the great Navy model Airship.** Large 6-foot air bag with inflators, parachute with automatic release and complete instructions for flying. Will fly for miles at height of 1000 feet. Great chance to study aerial navigation. Send name and we'll send 4 of our new art pictures to dispose of on special 25c offer. Send the \$1 you collect and as a reward for this service we will send this wonderful Airship with full instructions free.

**C. M. THOMAS, 337 W. Madison St., 9K91 Chicago.**

## WANT WORK AT HOME?

Earn \$15 to \$50 a week **RETOUCHING** photos. Men or women. No selling or canvassing. We teach you and furnish **WORKING OUTFIT** given with each enrollment. Limited offer. Write today. Artcraft Studios, Dept. 50, 3900 Sheridan Rd., Chicago



## Be an Artist

Would you like to be an artist—draw cartoons, illustrate ads, make magazine covers, etc.? The famous artist, Joseph Cummings Chase, will teach you how to quickly master the principles of art at home. Let this famous artist train you. Earn money while learning. Land a big pay job. Every step is explained with pictures, charts and diagrams. If you want to develop your artistic ability, send \$1.00 for this complete course. Satisfaction Guaranteed. Bargain Book Catalog F.R.E.

**FRANKLIN PUB. CO., 186 N. LaSalle St., Dept. 9400, CHICAGO**



# Strongfort Puts Pep Into the Weakling



**STRONGFORT**  
Builder of Men

## I Want To Send You MY FREE BOOK

This book of many pages and dozens of pictures tells of my wonderful experience—how I became the outstanding athlete of the world, performing feats others dared not attempt; how I turned the knowledge gained through developing my own body to the benefit of others, and then how STRONGFORTISM was evolved. It tells what I have done for others, what I can do for you. It doesn't mince words. It tells plain truths. "Promotion and Conservation of Health, Strength and Mental Energy," points the way from disease and weakness to health and strength. It is priceless. I'll send it to you on request—FREE. Write for your copy today.

**STRONGFORT INSTITUTE**  
LIONEL STRONGFORT, DIRECTOR.  
Physical and Health Specialist  
DEPT. 369 NEWARK, NEW JERSEY, U. S. A.

It's the man with the punch who battles his way to the front in life—he's the chap who gets on, is sought for the good jobs and is respected and admired wherever he goes. You needn't be a pugilist, or a wrestler, or a professional athlete. You can be just an every-day fellow like Lindbergh and young men of his type, with plenty of sand and courage and manly strength and vigor to stand out in the crowd and carry off life's prizes.

**Muscular strength and perfect health go together.** You can attain strength through Lionel Strongfort's scientific muscular development—internally and externally—and vigor and health and a full-functioning body comes as sure as sunrise.

I've taken thousands of young fellows, skinny as a lath, and built them up into strapping, powerful men who commanded respect and admiration wherever they went. Some of these chaps had set too fast a pace for themselves, others had wasted their vitality and broken down their manhood, others had gone stale from neglect of their bodies. No matter how despondent their state of mind or how physically broken they were, they quickly came back when they adopted

## STRONGFORTISM

### The Science of Health and Strength

STRONGFORTISM works wonders with run-down, weakly, skinny men. It builds them up to health through internal muscular development, then rounds them out into robust physical specimens, by bringing into play every muscle and making every muscle do its work as Nature intended. You'll be astonished how quickly you'll feel the benefits of this best of all health and strength Courses. You'll feel like a new man almost from the first day you start under my instructions. You'll be surprised at the lazy muscles you wake up when you begin, and they'll wake you up in turn. You'll quickly realize that a new day has dawned for you as you feel the red blood coursing through your whole body like a bounding mountain stream. That old, stupid, sluggish feeling will disappear like magic. That gloomy outlook will vanish as though a heavenly hand had brushed it away. Oh, it's a great feeling! Great to feel like a man! And you surely will when you adopt Strongfort as your instructor and guide — Strongfort, "the builder of men."

### Send this FREE Consultation Coupon

#### ABSOLUTELY CONFIDENTIAL

Mr. Lionel Strongfort, Strongfort Institute, Dept. 369, Newark, N. J.—Please send me absolutely free my copy of your book, "PROMOTION AND CONSERVATION OF HEALTH, STRENGTH AND MENTAL ENERGY." I have marked (x) before the subjects in which I am most interested.

- |             |                 |                         |
|-------------|-----------------|-------------------------|
| .. Catarrh  | .. Overweight   | .. Great Strength       |
| .. Colds    | .. Constipation | .. Lung Troubles        |
| .. Asthma   | .. Weak Back    | .. Round Shoulders      |
| .. Headache | .. Weak Eyes    | .. Stomach Disorders    |
| .. Rupture  | .. Rheumatism   | .. Increased Height     |
| .. Thinness | .. Nervousness  | .. Muscular Development |
| .. Pimples  | .. Short Breath |                         |
| .. Insomnia | .. Weak Heart   |                         |

Other Ailments.....

Name.....

Age..... Occupation.....

Street.....

City..... State.....



# GENUINE CORONA

Limited  
Offer



**\$2.00**  
DOWN  
BALANCE  
EASY  
TERMS

**H**ERE'S your chance to secure that Corona you've wanted —on the easiest terms ever offered —at **ONE-THIRD OFF** regular price! Complete in every detail; two color ribbon, back spacer, beautifully re-newed, **NEW MACHINE GUARANTEE**. Recognized the world over as the finest, strongest, sturdiest portable built. Only a limited number of these splendid machines available. To get one, you must act now!

**Yours For 10 Days FREE  
Send No Money**

Experience the joy this personal writing portable typewriter can give you! Use it 10 days free! See how easy it is to run and the splendidly typed letters it turns out. Ideal for the office desk, home, travelling. Small, compact, light, convenient. Don't send out letters, reports, bills in poor handwriting when you can have this Corona at such a low price or on such easy terms.

**Carrying Case Included  
—If You Act Now**

Leatheroid carrying case, oiler, instructions free on this offer. Send no money—just the coupon. Without delay or red tape we will send you the Corona. Try it 10 days. If you decide to keep it, send us only \$2—then \$3 a month until our special price of \$36.25 is paid (cash price, \$33.10). Now is the time to buy. This offer may never be repeated. Mail coupon now.

**\$16 SAVED**  
by using this coupon

SMITH TYPEWRITER SALES CORP.  
849-360 E. Grand Ave., Chicago.

Ship me the Corona, F. O. B. Chicago. On arrival I'll deposit \$2 with express agent. If I keep machine, I'll send you \$3 a month until the \$34.25 balance of \$36.25 price is paid; the title to remain with you until then. I am to have 10 days to try the typewriter. If I decide not to keep it, I will repack and return to express agent, who will return my \$2. You are to give your standard guarantee.

Name.....

Address.....

Employed by.....



## Young outdoor men wanted

Interesting, vigorous outdoor work in a growing organization where merit wins advancement. Good starting wages. Permanent positions and a real future for men who make good. Our present field force of Davey Tree Experts cannot meet the increasing demand. So we are selecting now, to enter our employ, a few sturdy, clean young men, thorough Americans, single, between 20 and 30 years old, free to travel, industrious, with good practical education, and able to give good references. Write for qualification blank to serve in place of personal interview.

The Davey Tree Expert Co., Inc.,  
838 Federal Bldg., Kent, Ohio

## Big Money for You as an Automobile Mechanic

These four practical books, written by five well known teachers of automobile practice, will teach you right in your own home during your leisure time just what you need to know about automobile troubles and repair. They will teach you automobile construction, maintenance and repair as experts know them and will help you to earn an expert's pay.

**Practical Automobile Library: Four Books—\$1.50 in 10 days and \$2 monthly for 6 months—only \$13.50 in all!**

Hundreds of question-answering diagrams—hundreds of clearly-marked illustrations—make the books plain and readily understandable. All the explanations and descriptions are clear, simple, direct. Every chapter is packed with definite, step-by-step, how-to-do-it information. Here is your opportunity to enter a big-pay field.

Sent FREE

Send No Money  
Mail the Coupon



### FREE EXAMINATION COUPON

McGraw-Hill Book Co., Inc., 370 Seventh Ave., New York

Send me for 10 days' free examination the New Practical Automobile Library. If satisfactory, I will send you \$1.50 in 10 days and \$2 monthly until the special price of \$13.50 is paid. If not wanted, I will return the books at your expense.

Signed.....

Address.....

City and State.....

Position.....

Employer..... P. M. 9-1-27



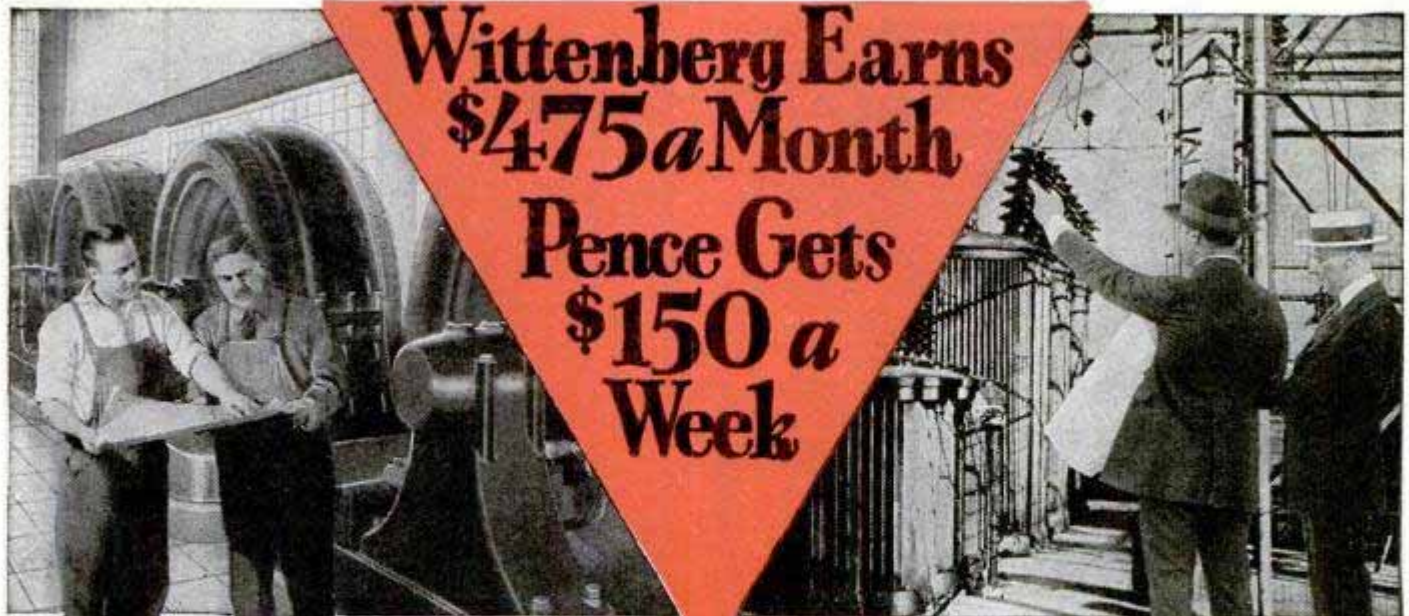

**\$475 a Month**

Dear Chief: I just bought a 5-passenger sedan and my income now amounts to about \$475.00 a month. Before I took your Course I never made over \$50 a month. Herman Wittenberg, 1930 Grand Concourse, Bronx, New York.

**\$150 a Week**

Dear Mr. Cooke: I must thank you again for my success, because it was your wonderful Course that put me where I am. I am making over \$600 a month. W. E. Pence, Albany, Oregon.

# Cooke Training Did It

**There's a Place for You Too, in This Big Pay Field. Electrical Experts Needed Everywhere. Let Chief Engineer Cooke Train You at Home.**

CALL it luck—Call it “bunk”—Call it anything you like—But these two and many thousands of other Cooke Trained Electrical Men *are* earning this big pay. They earn from \$3500 to \$10,000 a year and the same road they took is open to you—Now!

Why stick to your no-future \$25 to \$30 a week job when these thousands of men no smarter than you and with no previous experience are jumping ahead of you—easily earning two to four times what you earn, year in and year out?

Electricity needs you. It has a place for you and thousands of other red-blooded, honest-to-goodness young fellows who want a real job and REAL MONEY and who have gumption enough to trade a little of their spare time for a chance to get it. Electricity is the world's greatest business. Over 750 million dollars are being invested in it every year. In the power house end of the industry alone, 15 thousand new and additional jobs were created last year. Electricity is an opportunity—a future—“Success”—for thousands of men. Will you risk two pennies

for a stamp to find out what it will do for you?

Chief Engineer Cooke has written a wonderful book about electricity, its opportunities for young men, and what these opportunities mean to you. It is printed in colors, has 64 pages and more than 100 pictures. It's the same book that started ten thousand other men on the road to big pay. It's free—and it may help you like it helped them. Anyway send for the book and decide for yourself. You won't be obligated in any way. What you do in the next minute may mark the turning point in your life. Mail the Coupon Now, to—

L. L. COOKE, Chief Instruction Engineer  
**L. L. Cooke School of Electricity**

2150 Lawrence Ave. Dept. 516 Chicago, Illinois

L. L. Cooke, Chief Instruction Engineer  
 Dept. 516, 2150 Lawrence Ave., Chicago, Illinois

I want the proof. Send me your free book on Electricity and other information regarding your training and employment service so I can decide for myself.

Name.....

Address.....

City.....State.....



**Chief Engineer Cooke — The man who has trained and helped many thousands of other men into big pay electrical jobs in all parts of the world.**

**Mail Coupon for his big free “Book of Facts”**



# Learn Autos in Los Angeles



## \$50 to \$125 a Week for Trained Auto Men

Don't you be satisfied with small wages, when you have the ambition to earn big money. You can learn \$50 to \$125 a week as an auto expert, and all you need is practical training at National where you learn easily and quickly by the job-experience method.

You can, on this training plan which has proved successful with 17,000 men, gain the actual auto experience in a few months time which would ordinarily take years to half-learn as an apprentice. National training helps make you a big-pay expert.

### Jobs Open Now in California

In the motor metropolis of America, auto jobs at \$50 to \$125 a week are open now for trained men. There's an active demand for experts who have mastered auto mechanics, who can make good "on the job." That's why National men win success quickly. They "know how," and they prove it.

### HIS BATTERY STATION NETS \$200 A MONTH

"After leaving National, in December, 1926, and opening the S. & S. Battery Service Station, I will say that this shop has never made less than \$200 a month, net profit, and I feel that anyone going to National with the determination to make good, should be able to do at least as well as I have done."—A. M. Stroble, Los Angeles.

### National Men Favored by Motor Industry

Because National training is so complete and so practical, big auto employers favor National men. You get actual experience on all types of motors, transmissions, batteries, etc.—more than half-million dollars' worth of motor equipment for practice and job-experience work. Expert instructors. No books—you learn by doing.

**FREE Earn While You Learn**  
**AUTO** You want to earn more money, so make  
**BOOK** your start today. Write for big auto  
book—mailed free postpaid—which tells  
complete story. Earn while you learn. We help  
you get part-time job to pay living expenses while  
training. Mail coupon now.

# NATIONAL AUTOMOTIVE & ELECTRICAL SCHOOL

Dept. 702 4006 Figueroa St., Los Angeles, California

Send me the big, FREE National Auto Book that explains how I can get a big-pay Auto Job.

Name \_\_\_\_\_

Address \_\_\_\_\_

City \_\_\_\_\_

State \_\_\_\_\_

**FREE  
AUTO  
BOOK**

# Electricity

**A Practical Training**  
in this great profession will make your successful future a certainty.

The School of Engineering of Milwaukee has specialized for 23 years in training young men for

## ELECTRICAL ENGINEERING

With a B. S. Degree in 3 years

**Junior Electrical Engineering**—12 months to 18 months, depending upon previous education. Graduates are technically trained electrical experts. **Commercial Electrical Engineering**—1 year for high school graduates. **Electrical Refrigeration**—3 months. **Automotive Electricity**—a 3 to 6 months' course will make you a highly paid specialist on all types of starting, lighting and ignition systems. **Armature Winding**—and Motor Generator Repair—thorough 3 months' course. **Practical Electricity**—6 to 12 months' course to become a Master Electrician.

We will Aid You Earn Your Way Partly through College, through our practical plan of co-operative employment. Board and room at cost. Student activities, orchestra, daily broadcasting WSOE. **NEW TERM NOW ORGANIZING.** Write NOW for latest catalog and full details. Mention age, education and course of interest.

## SCHOOL of ENGINEERING of Milwaukee

P. M. 927-163 East Wells Street

Milwaukee, Wis.

## TELEGRAPH—RADIO

\$18 to \$35 a week while training for Radio and Telegraph Operator jobs at \$150 to \$300 per month. Write for particulars.

CHICAGO TELEGRAPH INSTITUTE

Dept. 1-9-7

1338 S. Michigan Avenue, CHICAGO

## Single Dial—7 Tube Set on 30 Days' Free Trial

Judge the wonders of the marvelous Metrodyne radio by taking advantage of our liberal offer. Write at once for details and for money making proposition to agents and dealers.

METRO ELECTRIC CO.

2161 N. California Ave.

Dept. A.

CHICAGO, ILL.

## FREE A 5-CABLE EXERCISER FREE

and Instructions

WITH ONE YEAR'S SUBSCRIPTION TO "STRENGTH"  
AT THE REGULAR PRICE

Here's a proposition, fellow, you can't equal—12 big issues of this magazine "Strength" sent to your home each month free of mailing charges and a 5 elastic cable exerciser with instructions on how to use it for developing your physical strength and bodily proportions as well as for improving your general health.

**12 BIG ISSUES  
and the EXERCISER  
ONLY \$2.50**



The cables are all of the best rubber and are the strongest made. The grips are finely finished and strong. The instruction will give you exercises.

### "STRENGTH"

THE MAGAZINE FOR THE HEALTH,  
STRENGTH AND MUSCLE SEEKER

"Strength" is a he-man's magazine which contains articles and pictures upon all branches of the health, strength and muscular development subject. It shows you how to become healthier; how to increase your physical strength and how to improve your development and proportions. There are loads of pictures each month of men who have acquired marvelous physiques and great strength through the methods outlined in this Magazine. There are pictures of beautifully formed women who have obtained their shapes through physical training methods. There are fight, base-ball, field sports articles, etc. in each issue.

**SEND YOUR NAME, ADDRESS and \$2.50 NOW—We Pay All Charges**

MELO PUB. CO., P. M. 9-27  
2747 N. Palmetto Street, Philadelphia, Pa.

Gentlemen:

Please find enclosed \$2.50 for which send me immediately a 5-cable exerciser and course free and enter my name on your mailing list for a year's subscription to "Strength."

Name.....

Address.....

City.....

State.....



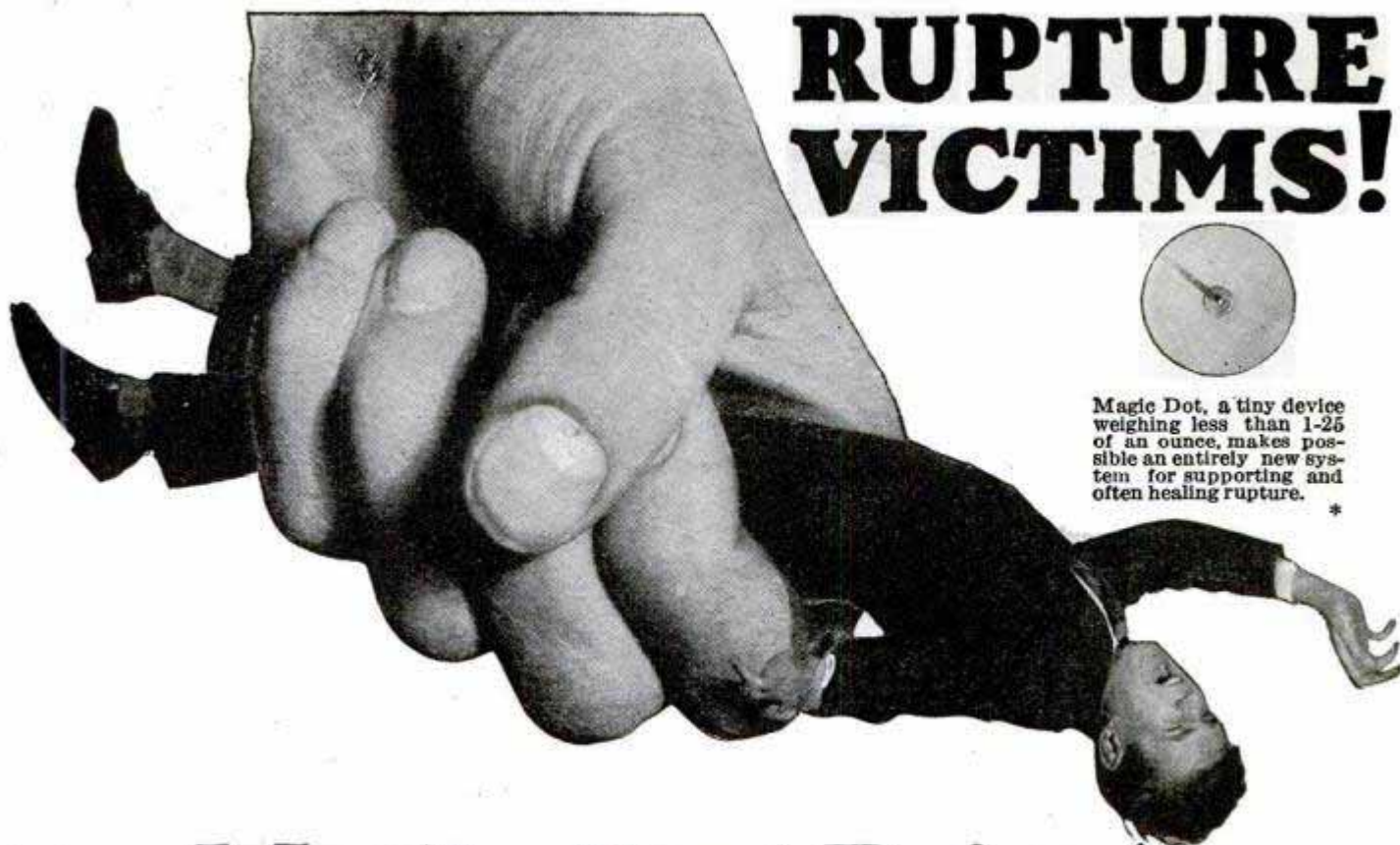

# RUPTURE VICTIMS!

Magic Dot, a tiny device weighing less than 1-25 of an ounce, makes possible an entirely new system for supporting and often healing rupture. \*

## Magic Dot Brings Magic Relief



**N**OW—a great scientific achievement revolutionizes rupture treatment. No longer are ruptured men and women doomed to the eternal torture and discomfort of harnesslike trusses with their gouging knobs, steel springs and unsanitary leg straps! An astonishing simple little device that weighs only  $1/25$  of an ounce offers you glorious new freedom—freedom such as you never dreamed would ever be yours again!

This surprising invention has won the praise of physicians and rupture sufferers from coast to coast. It is such a radical departure from the old-fashioned, painful, *dangerous* appliances it renders obsolete that one cannot help but wonder why scientists have never stumbled upon its secret before! It is simplicity itself—but the results it accomplishes are little short of remarkable! Only when you have tested its feather-lightness by holding it in the palm of your own hand, can you realize how startling it really is!

### Weights Less Than a Penny!

A remarkable little circle called Magic Dot anchors and makes possible the lightest, flesh-soft padlet you can imagine. Composed of a newly-discovered substance (named Airtex) it is honey-combed with tiny cells that actually *breathe air* with every movement of your body. It expands and contracts as easily as your own flesh. When you walk, run, bend or exercise it squeezes *itself*—not the tender part of the body it rests against.

The Airtex-Magic Dot combination is so little and light that the wearer hardly knows he has it on. Its myriad air-cells keep it air-cooled at all times—so that it does not produce that "hot spot" feeling that is so uncomfortable. Besides this, the padlet can be washed out sweet and clean in a jiffy. Just dip it into clear water and squeeze with your hand. Every bit of perspiration odor is easily removed in an instant—leaving it as fresh and sanitary as new!

### Absolutely Dependable and Safe!

And yet with all its yielding softness, Airtex holds the rupture securely in place at all times—whether you are standing, sitting, lying or exercising and moving about. No slipping or skidding; no constant readjusting, no danger of strangulation or "coming down."

### —And Hernia Often Disappears!

Magic Dot not only offers you amazing new comfort from the very first day, but something of far greater importance—the possibility of ultimate **FREEDOM!!** The New Science System is even more than a feather-light, pressureless support. Its big purpose is to cause a disappearance of the protrusion and eventually free you from the necessity of any kind of support. This is because its inventor has found proof that Nature will often *heal* if given a certain kind of aid, which is now made available in 100% practical form for the first time! A record of amazing results in numerous cases, together with common sense diagrammatic explanation, has just been published in book form—a copy of which will be sent you on request without obligation.

### Clever Sample FREE!

Write at once for a sample of remarkable washable, *air-breathing* Airtex! It will be sent you absolutely without charge, together with our "See it First" offer on the complete New Science System and a book describing exactly how this new rupture relief works. It is one of the biggest things that has ever been offered to those afflicted with hernia, or rupture—and will open your eyes to the dawn of a new day of freedom from the rigorous limitations your trouble has saddled upon you! Don't delay! This generous offer is limited to 30 days. Mail the coupon at once!

### NEW SCIENCE INSTITUTE

2140 Clay Street STEUBENVILLE, OHIO

New Science Institute,  
2140 Clay Street, Steubenville, Ohio.

Without obligation send me a no-cost Airtex sample with illustrated explanation of Magic Dot and full details of the New Science System of rupture and hernia relief.

Name.....

Address.....

City..... State.....



**Be the BOSS!**

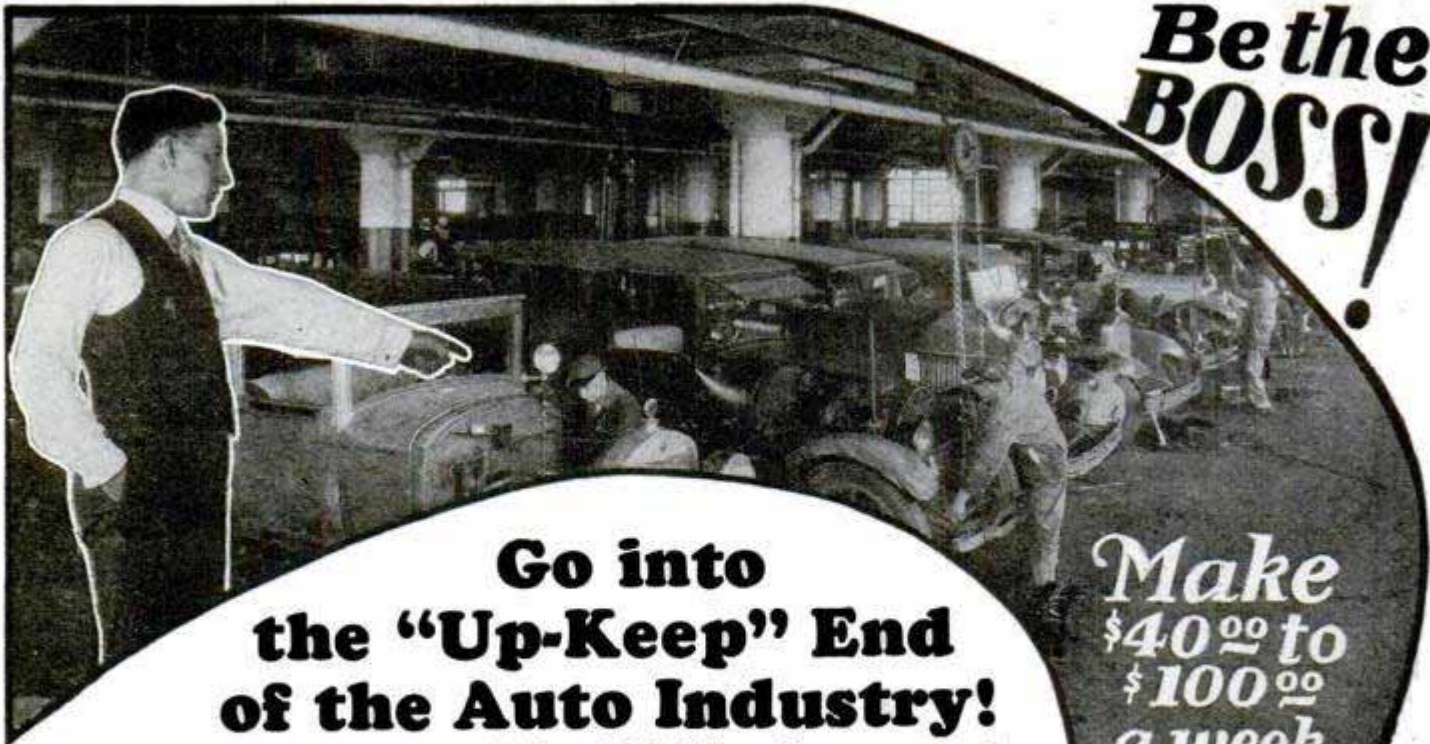

**Go into the "Up-Keep" End of the Auto Industry!**

**Make \$40<sup>00</sup> to \$100<sup>00</sup> a week**

If you want to be sure of a good job—ALWAYS—if you want real opportunities to get ahead—if you're looking for a line of work that pays **BIG MONEY**—just remember the repair and "Up-Keep" of autos is now a ten billion dollar industry, **four times as big as the manufacture of new cars!** Mechanical and Electrical Auto **EXPERTS** are urgently needed—by garages, service stations, repair shops, electrical stations. Men who **KNOW** autos, who can locate trouble and tell the mechanics how to **FIX IT**, can almost name their own salary.

**Maintenance — Now the BIG MONEY End!**

They build less than 3 million new cars a year, but there are 22 million autos, trucks, tractors, busses, and taxis to **SERVICE**—to keep going. And the day of the tinkerer and dub is over. Dealers must have **EXPERTS** for their service stations, the public insists on **EXPERTS**. And so any man who will take the trouble to really learn the mechanical and electrical end of autos is "setting pretty." The demand will exceed the supply for many years to come.

**But get away from the grease—be the SUPERINTENDENT**

Men who have a little practical experience, who can do what the **BOSS** tells them to do, are always sure of a \$35 to \$50 a week job. **But \$50 is just about the limit for mere mechanics.** And there's not much joy to a life-time of hard, dirty, greasy work. And so I urge you to aim for the job **HIGHER UP**. Be the foreman, manager or superintendent. Or go into business for yourself. **YOU CAN**, if you'll pay the price—which is simply **LEARNING** every branch of Automotive Engineering work. **You can** prepare yourself for the **BIG MONEY** and tremendous opportunities in automotive work. No matter if your education is limited, and even if you

have no practical auto experience, we'll show you the quick, easy, sure way other men **LIKE YOU** have found to get into auto work—**RIGHT**—with the training and equipment needed to succeed.

**11 Famous Auto Engineers Guide You to Success!**

—men from **STROMBERG, STANDARD OIL, STUDEBAKER, BUICK** and leading Universities, members of noted Engineering Societies, men who employ Auto Experts and know the requirements for holding down a well paid job speak to you from the pages of this **great Reading Course.**

**Don't Send a Penny**

**Learn**

**AT HOME — the QUICK, Sure Way!**

You don't have to keep a million facts and figures "in your head"—when you know where to find them **INSTANTLY**. Here is a home training service which brings you **real help** in your search for the **QUICK**, sure way to advancement. We have made it so simple, so easy to understand, that any man, even with only grammar schooling can master the work without hard studying or memorizing. A hundred thousand men have taken this way to a better job, and you need only follow their example.

**Question and Answer Service**

No examinations, no "lessons," no costly outfits, no \$100 or more to pay out, by our method. We send you the 5 volume Library containing the entire material, for 15 days free loan. 2400 pages, over 2,000 charts, wiring diagrams and tables. **Coupon brings it.** You can keep it or return it, as you please. The total price is only \$24.80, and the terms are \$2 down and \$3 a month. You can go as fast or as slow as you please. And you can get any questions answered, any problem solved, **simply by writing in for the answer.**

**Start with the Coupon!**

Here is the pay-raising service you have been looking for. All the auto facts you can ever need—literally at your finger-tips in the **JIFFY INDEX**. We'll guarantee it contains the answers to any problem you'll encounter in your daily work—or our staff of engineers will supply it. **Don't risk a penny!** Don't take our word alone. See for yourself. Let us prove the opportunities in Auto Work and the **reading way** to qualify for them. Just mail the coupon, send no money—that's all.

**LOANED FREE!**

American Technical Society, Dept. A-619, Drexel Ave. at 58th St., Chicago, Ill.

Please loan me for 15 days, free, the new 5 volume library of "Auto Engineering". I will pay the few cents delivery charges when books are received, and I have the privilege of returning them at your expense within 15 days, in which case I will owe you nothing. If I decide to keep them, I will send you \$2, after 15 days, then \$3 a month until your special advertising price of \$24.80 is paid. This includes a year's Consulting Membership in the American Technical Society **FREE**.

Name.....

Address.....

Attach a letter stating employer's and reference's names and addresses, or write same plainly on margin.

**AMERICAN TECHNICAL SOCIETY**

Dept. A-619

Drexel Ave. at 58th St.

Chicago, Ill.



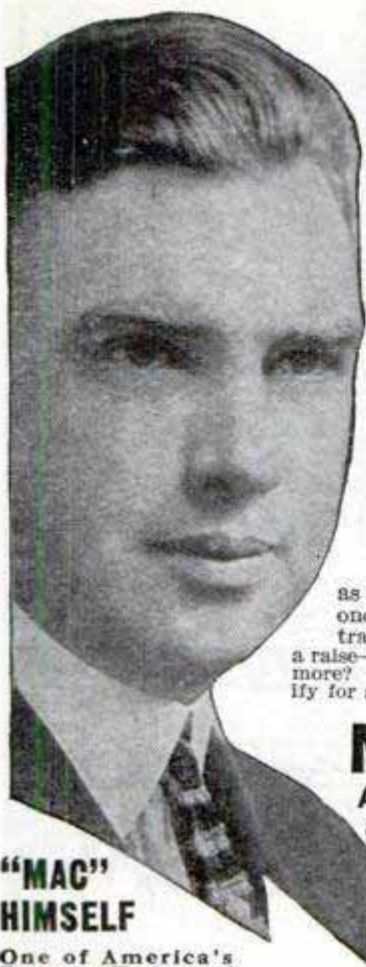

"MAC" HIMSELF

One of America's Foremost Trainers of Auto and Tractor Mechanics.

# HELP! HELP! HELP!

## Thousands of BIG PAY JOBS CRYING FOR TRAINED AUTO MECHANICS

Opportunities everywhere in cities and rural communities. McSweeney men are constantly stepping into fine big-pay jobs and are opening their own repair shops and earning 2 to 5 times as much as before. Millions of jobs and only a few thousand properly trained men to fill them. If my great schools were twenty times as big I couldn't turn out mechanics fast enough to meet the demand for well trained men.

**YOU LEARN 8 WEEKS IN ONLY 8 WEEKS**

Thorough methods based on long experience. Mac has trained thousands of the best auto, tractor and electrical experts in this country. You get actual shop practice as well as theory. Easy to understand. Anyone can learn. Age is no barrier. I train men from 16 to 60. Why beg for a raise—why complain because you don't earn more? Learn more—that's the answer! Qualify for a real big-pay job.

**FREE Course in Electrical Work**

to those who enroll soon. Not a cent extra. This offer is for a limited time only.

**\$75 to \$125 Weekly WAGES**

being paid to hundreds of McSweeney graduates as garage managers and chief mechanics. Those who go into business make up to \$10,000 a year. You can, too! Write at once for my big special tuition offer including **R. R. Fare and Board Paid While Learning**

No extras to pay for. No book study; very little previous schooling necessary. Complete practical training easily learned in 8 weeks. Tuition refunded if not satisfied. (Mail coupon to school nearest you.)

## McSWEENEY Auto, Tractor and Electrical SCHOOLS

Dept. Z-302 Cincinnati, Ohio Cleveland, Ohio

Write Nearest School for details of big offer, FREE electrical course and big auto book FREE. Just mail coupon.

McSWEENEY AUTO, TRACTOR AND ELECTRICAL SCHOOLS, Dept. Z-302, Cincinnati, O., Cleveland, O.

Without cost or obligation, send me your big FREE book on Autos; also, full details of your big offer including R. R. Fare and Board Paid, and FREE electrical course.

Name.....  
Street.....  
Town..... State.....



### PUBLIC SPEAKING MADE EASY

Learn to speak in public. Our Big 186-page Course shows how to become a powerful speaker, how to address meetings, propose and respond to toasts, talk convincingly, make more sales, become a leader. The ability to speak effectively in public wins new friends, greater opportunities, BIG MONEY. Don't allow your ability to go undeveloped. Master the secrets of public speaking at home. Complete Course, \$1.00. Satisfaction Guaranteed. Bargain Book Catalog FREE. Franklin Pub. Co., 186 N. LaSalle St., Dept. 9401, CHICAGO



### A PERFECT LOOKING NOSE Can Easily Be Yours

Trados Model No. 25 corrects now ill-shaped noses quickly, painlessly, permanently and comfortably at home (excepting cases caused by improper bone structure). It is a safe and guaranteed patent device of precise adjustment that will actually give you a perfect looking nose. Over 90,000 satisfied users. For years recommended by physicians. 16 years of experience in manufacturing Nose Shapers is at your service. Model 25 Junior for children. Write for testimonials and free booklet, which tells you how to obtain a perfect looking nose.

M. TRILETY, Pioneer Noseshaping Specialist  
Dept. 2792 Binghamton, N. Y.



### Learn Quick at Home

A large, beautiful \$20.00 Hawaiian Guitar comes to you with the very first lesson of our remarkable, interesting, easy-to-follow course of fifty-five simple lessons. Also included are FOURTEEN standard size phonograph records, reproducing every selection in the course. Our students having wonderful success and "beats" of fun.

It's Easy Now to Be Popular. You, too, can become "dover" on this fascinating, delightful instrument in ONLY 1 to 3 months. Bid good-bye forever to dull, lonely evenings. Course, outfit, everything to insure quick social and professional success—costs only a few cents a day. Write

right now—for FREE book and FREE sample lesson. Address—HAWAIIAN STUDIO, Dept. 5509 New York Academy of Music, 100 Fifth Avenue, New York City.



## WANTED!

Ornamental Iron and Bronze Draftsmen at \$50.00 to \$65.00 a week for beginners. Experienced men as high as \$500.00 a month. Opportunities to become executives. Put yourself in line for a better job. We place you free when you're ready. Write today.

American Institute of Ornamental Iron & Bronze  
3045 Hennepin Avenue MINNEAPOLIS, MINN.

## EARN PROMOTION AND COLLEGE CREDIT

Through the HOME-STUDY COURSES

in 40 different subjects given by The University of Chicago

207 Ellis Hall, University of Chicago, Chicago, Ill.



### 1,038 NEW JOKES

Everybody laughs right out loud at the hundreds of new, snappy, well selected jokes in our big 198-page book, "Jokes for all Occasions." The ability to tell good jokes is a social and business asset. Have a supply of new jokes for the next banquet, lodge meeting, or gathering. Be popular. This book will make you the life of any party. Cloth bound, only \$1.00. Satisfaction Guaranteed. Bargain Book Catalog FREE.

Franklin Pub. Co., 186 N. LaSalle St., Dept. 9404, Chicago

## DO YOU LIKE TO DRAW?

It's Easy To Learn When Shown In The Right Way

Some of cleverest cartoonists and comic artists in America today learned how to draw quickly—by following CARTOONIST EVANS' SIMPLE AND EASY METHOD. This school is recommended by foremost cartoonists because they know the students are handled right. If you like to draw, send 6c in stamps for portfolio of cartoons and full details. The course is NOT EXPENSIVE.

The W. L. Evans School of Cartooning

821 Leader Building CLEVELAND, OHIO







# FREE

## FOUR Dance Hits

Latest Broadway  
on Two 10-Inch Double-Face Records

DO not send a penny. Just mail the coupon below. Here is an offer you cannot afford to miss. The four biggest dance hits of today—the most popular tunes on Broadway, on the radio, and in ballrooms—FREE. These records are electrically recorded, played by wonderful jazz orchestras. Brand new ten-inch records. Why we make this offer: We offer these four latest dance selections free in order to introduce and popularize our new PHONIC Reproducer. Millions of National records have already been purchased; users say they are equal in every way to 75c records. The

**HERE THEY ARE**

- HALLELUJAH**  
(from "Hit the Deck")  
Fox Trot, Vocal Chorus
- SO BLUE**  
Waltz, Vocal Chorus
- MY BABY and ME**  
Fox Trot, Vocal Chorus
- CRAZY WORDS,  
CRAZY TUNE**  
Fox Trot, Vocal Chorus

## NEW PHONIC REPRODUCER

Makes an up-to-date phonograph out of your old one

**Try it 10 days FREE**  
**Send No Money**

buy a new phonograph if you have an old one. The reproducer is the HEART of any phonograph—and the new PHONIC reproducer makes your old phonograph like an entirely new one. Based on the new PHONIC principle. Makes you think the orchestra or artist is in the same room.

With each new Phonic Reproducer we will include the four latest dance hits described above. The new Phonic is only \$3.85. Over 25,000 of them sold at that price, so the free records really mean a big discount. Satisfaction absolutely guaranteed—money back if you want it. Mail coupon now, before this offer is withdrawn. Send no money. Address NATIONAL MUSIC LOVERS, Inc., Dept. 589, 327 West 36th Street, New York.

**Send No Money**



**Mail Coupon**

**NATIONAL MUSIC LOVERS, Inc.**  
Dept. 589  
327 West 36 St.  
New York

Please send me a New PHONIC reproducer for.....  
(give name of Phonograph)  
I will pay the postman \$3.85 plus few cents postage. Also include the four Latest Dance Hits FREE, as advertised. If I am not satisfied after trial, I will return your reproducer and records within ten days and you guarantee to refund my money.

Name.....  
Address.....  
City..... State.....

Outside U.S. \$4.40. Cash with order.

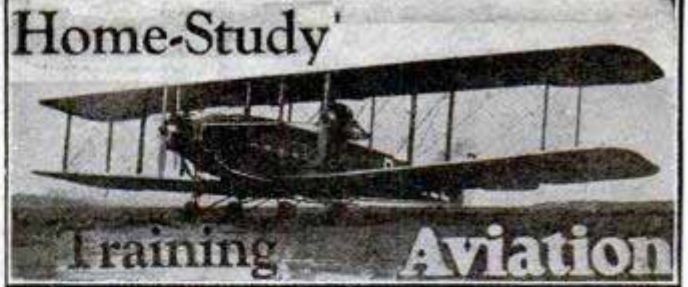

## Air Commerce Needs Men!

Don't envy the Highly Paid Air Man—Be One! Air Men are in demand. Beat the other fellow to the High Salaried Jobs in Aviation. Western training will qualify you to enter Aviation. Learn how through our catalog, sent on request.

**Write for Free Catalog**  
**"Airplanes and Flying"**

Aeronautical Training Division

**WESTERN AIRPLANE CORPORATION**  
Dept. M-9 Monadnock Block Chicago, Ill.



**BART SUPPLIES**

Quality art materials at lowest prices. Save on everything you need. Convince yourself—send today for latest 96-page 2-color catalog.

BART SUPPLIES, 443 Eustis Bldg., Minneapolis, Minn.

25 EASY LESSONS IN

## HYPNOTISM

Learn the secrets of Hypnotism—that strange, subtle power which enables you to make others love you; overcome bashfulness; strengthen your memory, mind and will power; realize your ambitions; develop a strong, magnetic personality, and gain control over others. These magic secrets explained in 25 easy lessons. Complete Course, \$1.00. Satisfaction Guaranteed. Bargain Book Catalog FREE.

**FRANKLIN PUB. CO., 186 N. LaSalle St., Dept. 9402 CHICAGO**

**FREE if You Act Now**

Braymer and Roe's Rewinding Small Motors

## Get into the electric wiring field—big money for you

Great demand in wiring field. These books prepare you. **KINKS**; helps; short cuts; practical, on-the-job electrical data, written particularly to help wiremen, trouble shooters, maintenance men, armature winders, electrical contractors and students. The whole wiring field covered; concrete and usable details about new and better ways for doing the kind of work you have to do.

**American Electricians' Library**  
6 volumes, 2000 pages, illustrated, \$16.00 payable \$2.00 in ten days and \$2.00 a month

The books tell you all you must know about conduit wiring, armature winding, wiring for lighting circuits and switches, wiring for machinery, circuit troubles, circuit testing, or electrical machinery erection. Through a study of this great set you can push yourself into a big-pay job for life.

**See it FREE—Send no money—ACT**

**FREE EXAMINATION COUPON**

**McGRAW-HILL BOOK CO., Inc.**  
370 Seventh Avenue, New York

Send me the American Electricians' Library for 10 days' free examination. If satisfactory, I will send you \$2 in 10 days and \$2 monthly until the full price, \$16, is paid. If not wanted, I will return the books at your expense. Upon receipt of my first payment of \$2.00, I am to receive a copy of Braymer and Roe's REWINDING SMALL MOTORS free of charge.

Name.....  
Address.....  
Position.....  
Company..... P. M. 9-1-27



# A Million Dollar Can Opening Machine

## BRAND NEW INVENTION BRINGS FORTUNES TO AGENTS!

Here's Something Brand New! An Amazingly Simple Invention—Yet, Absolutely Revolutionary! For Now, At One Sweep, Millions Of Old Style Can Openers Are Doomed To The Scrap Heap! Think Of It, Men! A Tremendous New Opportunity For Quick Profits In Every Home In America! No Wonder Agents Are Making Astonishing, Almost Incredible Sums—\$75, \$100, \$150 A Week Easily Right Along. So Mail The Coupon For All The Facts And Full Details Of My Remarkable FREE TEST OFFER!

ABOUT once in a "Blue moon" some genius pops up with a new invention that everyone has been waiting for. Then, presto! Almost like magic, agents' profits go soaring overnight to tremendous heights! And now the cold, hard-boiled facts about this amazing new can opener bear convincing proof!

### More Than a Can Opener

This queer new device doesn't just cut a ragged hole around the edge of the can. It lifts the entire top completely out, clean as a whistle! The machine grips the can—holds it—opens it—flips up the lid so you can grab it—and gives you back the can without a drop spilled, without any jagged edges to hack your fingers—all in a couple of seconds! You just put the can in the machine—turn the handle—and almost instantly the job is done! Built to do the job better than anything ever devised! Will last a lifetime! It's far more than just a can opener, it's a real can-opening machine!

### The Secret of Big Money

Women hate the old style can opener—and with good reason, too. It's the last relic of barbarism in the modern kitchen. Yet every day millions of women have to open cans the dangerous, laborious old-fashioned way. Food is spilled and wasted. Fingers are cut and torn—often followed by infections and blood poisoning that result in expensive doctor bills. Opening cans the old way is a job nasty enough to make most any man swear—this amazing new way—it's so easy a ten year old child can do it with perfect safety! No wonder women—and men, too—simply go wild over it!

### A Spectacular New Sales Plan

I want you to see this surprising new invention with your own eyes. I want you to know why everyone, man or woman, falls for it the instant they see it. Whether you are an experienced salesman, or never sold a penny's worth of anything in your life—I want to tell you about a remarkable new sales plan that wins you a profit on every call you make. This plan is made possible by another spectacular money maker in the Speedo line and guarantees you a steady income of up to \$150 a week!



**AVERAGES \$16.53 A DAY!**

R. A. Stewart writes, "Made 20 sales in 23 calls. Between the 13th and 28th this month I have made \$248. Speedo has them all beat for real money."

#### \$72 HIS FIRST WEEK

J. F. Riley says, "I made \$72 my first week only working 4½ days. Since then my commissions have been bigger each week."

#### 12 SALES IN 2 HOURS

J. C. Reister writes, "Rush 96 Speedos to me via express. Sold my trial order of 12 in 2 hours spare time."



### Free Trial—Act Quickly!

If you are ambitious—if a new, but tested and proved opportunity to make \$75 to \$150 a week interests you—act at once before some other live wire beats you to this lifetime opportunity. Without obligation, learn about these amazing new patented inventions, and get my FREE TRIAL OFFER. Just mail the coupon today—NOW!

## → SPEEDO →

~PATENTED HOUSEHOLD SPECIALTIES

**CENTRAL STATES MFG. CO.**

4500 Mary Ave. Dept. L-700 St. Louis, Mo.

Central States Mfg. Co.,  
4500 Mary Ave., Dept. L-700,  
St. Louis, Mo.

Yes, rush me the facts and details of your FREE OFFER.

Name.....

Address.....

City..... State.....



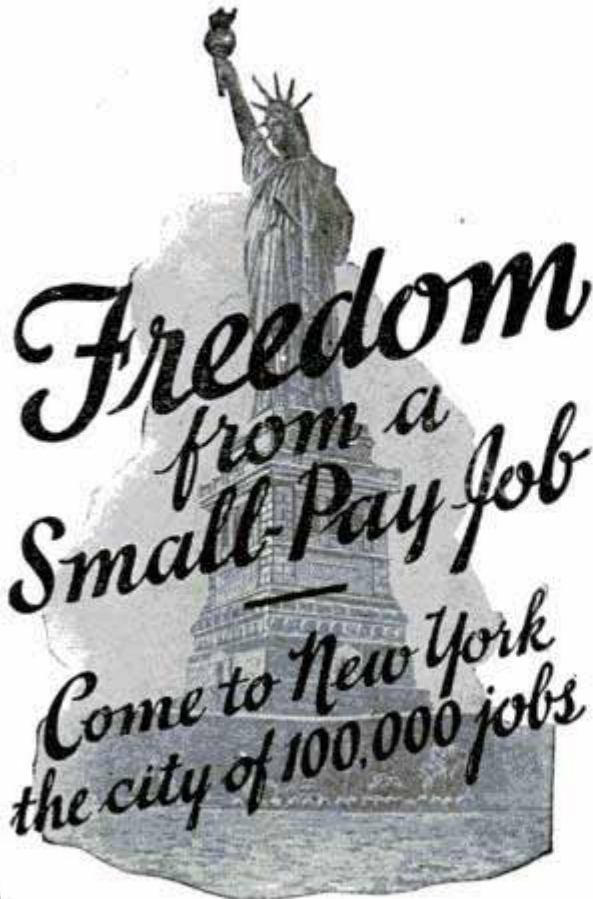

**A**NY MAN who can read and write and use a pair of pliers can become an electrical expert and free himself forever from the long hours and drudgery of a small pay job.

And you can learn the BIG PAY profession of electricity right in New York City—the heart of the electrical world—the city of 100,000 jobs. At the same time you are learning the BIG PAY profession you can be enjoying the sights and wonders of New York, the modern Bagdad.

**Be An Electrical Expert**

Graduates of the NEW YORK ELECTRICAL SCHOOL are in demand by all the big electrical companies. Or, if you prefer the independence of a business of your own, there are thousands of opportunities for efficient, dependable men to become electrical contractors. When you are your own boss the money you can make is limited only by your own energy and ability.

**Personal Instruction**

The NEW YORK ELECTRICAL SCHOOL is not a correspondence school. You learn by doing—by personal instruction on full size standard electrical equipment under the personal supervision of trained instructors.

At N. Y. E. S. you train your hands and mind at the same time. You learn the theories of electricity—and then you are shown how to put the theories into actual practice by solving the problems with your own hands.

The man who has learned electricity by actually doing electrical work under intelligent personal instructors can go to any part of the world and be sure of a good living. There are N. Y. E. S. graduates in all the countries of the world.

Write today for the 48-page booklet giving full information about the N. Y. E. S. Course and showing pictures of the equipment available for your personal use in our two seven-story buildings. Mail coupon now! The New York Electrical School, 44 W. 17th Street, New York.

The New York Electrical School  
44 W. 17th Street, New York

Please send me FREE your 48-page booklet. It is understood that this request puts me under no obligation.

Name.....

Address.....

**DRAW CARTOONS**

**Turn Your Talent Into Money**

Cartoonists earn from \$50 to \$300 per week—some even more. Remarkable new Circle System of Drawing teaches you in half the usual time. Send for booklet and sample lesson plate explaining full details of the Course.

THE NATIONAL SCHOOL OF CARTOONING  
623 Penton Building Cleveland, Ohio



**Be a drummer!**



Trap Drumming made easy in a short time. Our free instruction course furnished with genuine Ludwig Trap-Drum Outfit. Develop your natural sense of rhythm. Go to your nearest dealer or write for full details.

LUDWIG & LUDWIG, 1611 North Lincoln Street, Chicago

**100% ELECTRIC RADIO**

The Metrodyne All Electric Radio does away with all batteries, eliminators, chargers, acids, etc. World's Greatest Electric Radio. Shipped on 30 days' free trial. Write!

METRO ELECTRIC CO.

2161 N. California Ave. Dept. A. CHICAGO, ILL.

**LEARN TO DANCE**

You can learn all the modern dances—Charleston, Black Bottom, Valencia, Canter, French Tango, Latest Waltzes, Fox Trots, etc., at home easily and quickly. New chart method makes dancing as simple as A-B-C. No music or partner required. Don't be a wallflower. Learn to dance. Complete Course, 323 pages, 49 illustrations, only \$1.00. Equals \$20 course. Satisfaction Guaranteed. Bargain Book Catalog FREE.



Franklin Pub. Co., 186 N. LaSalle St., Dept. 9405, Chicago

**Get Strong QUICKLY and Stay So!**

**D**EVELOP your muscles this quick way. Get big broad shoulders. Fill out your chest. Become the strongest man in your town by using the famous GIBALTAR EXERCISER—the strongest tensioned apparatus made! Many famous athletes and strong men use it.

Can be adjusted to from 10 lbs. to 200 lbs. resistance. Every man, woman and child should have one. Made of finest quality, genuine para rubber elastic cables. Guaranteed 50 rubber strands

to each cable. Do not compare this apparatus with cheap imitations.

We have made arrangements with a prominent author and publisher, who is an authority on physical culture, to present you with 16 complete booklets on every subject pertaining to your muscles and organs.

It is only by special arrangement and additional expense to us that we are able to offer you this wonderful premium ABSOLUTELY FREE OF CHARGE with each exerciser.

ONLY \$1.50 For 5 Cables | 10 ONLY \$2.50 For 10 Double Strength Cables

**SEND NO MONEY**

All 16 booklets will be shipped free to your home with the exerciser, and you simply pay the postman the price of the exerciser, plus a few cents postage. When ordering, mention that you want a five cabled or ten cabled exerciser. If you live outside the U. S. send cash with order.



FREE INSTRUCTIONS

**Remember!**

The name Gibraltar on an Exerciser means as much as Sterling on silver.

GIBALTAR EXERCISER COMPANY  
Dept. 309, 225 W. 34th St., New York City  
Please send me your [10 cable] EXERCISER, [5 cable]

It is understood that I am to get the 16 booklets on the body absolutely free with this order.

NAME.....  
ADDRESS.....  
CITY..... STATE.....



# NOW GET into FLYING

you can

## Be a King of the Air



With planes, equipment and instructors under U. S. Govt. inspection, the million dollar Sweeney School, with its 150 acre private flying field, club house, hangar and thousands of dollars worth of latest tools, machinery and equipment for aviation, offers young men the most efficient, economical and practical method of getting into this great business.

## The Sweeney School

bases all its work on practical experience. Learn to fly by flying. Learn to make, repair and condition planes by actual work. The record of Sweeney graduates in the air and on the ground as expert mechanics gives this school world wide reputation.

## Rich Rewards

Lindbergh, Chamberlin, Byrd, hundreds of others flew to fame and wealth and every day a new hero appears. There is a boom in aviation such as the world never saw in any business. Thousands of ambitious young men are wanted. If you have the heart we will supply the practical training. There's big money in aviation now and simply unlimited possibilities.

Safe  
Quick  
Easy

YOU can select either the pilot course or ground mechanics course or combine the two courses. All the flying with dual controls and later solos to qualify you. All the ground work in motors, ignition, wings and construction to qualify you as an expert and five men are needed on the ground for one man in the air. The cost of tuition is extremely low and living conditions are pleasant and economical. Many men just out of the army come here to take up this work. Student body very high class. No previous experience required. We use tools, not books.

**FREE** Send name today for full details. Illustrated catalog shows pictures of students at work in shops and in the air. Everything you want to know about aviation. Lists of jobs and high pay offered aviators and mechanics. No colored students accepted.

LEARN TO FLY BY FLYING  
**Sweeney**  
SCHOOL OF AVIATION  
4106 SWEENEY BLDG, KANSAS CITY, MO.

— SEND THIS NOW —

EMORY J. SWEENEY, President  
4106 Sweeney Bldg., KANSAS CITY, MO.

Please send me full information about your Aviation Course.

Name.....Age.....

Address.....

Town.....State.....



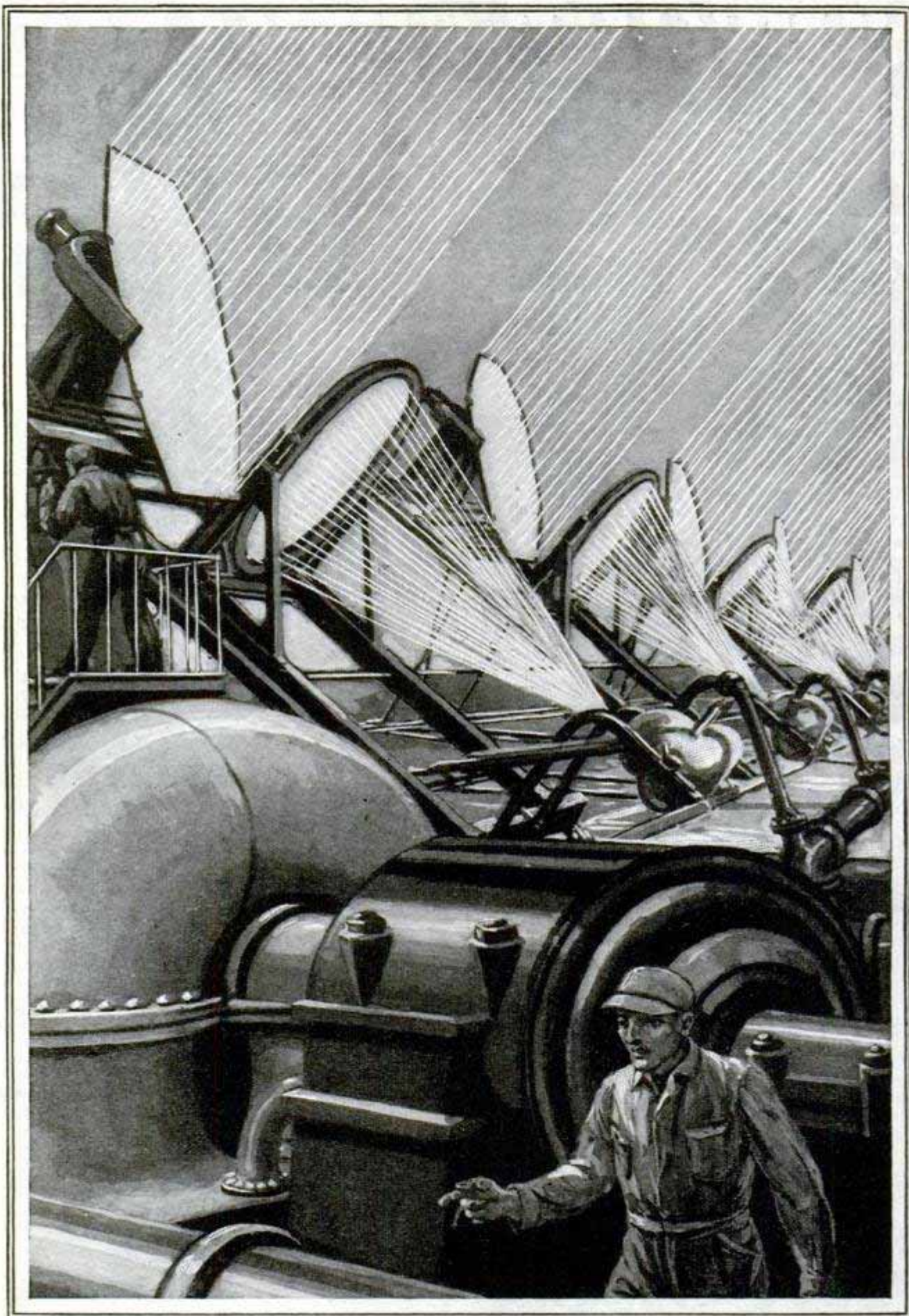

A German Plan for Utilizing the Concentrated Heat of the Sun to Generate Steam and Operate Turbines Driving Electric Generators; Similar Apparatus Has Met with Some Success



# Popular Mechanics Magazine

REGISTERED IN U. S. PATENT OFFICE

WRITTEN SO YOU CAN UNDERSTAND IT

Vol. 48

SEPTEMBER, 1927

No. 3

## Age of Wonders Still in Future 2667

### Inventor of Automobile Self-Starter Sees Time When Power Will Be Supplied Directly by the Sun

**W**ILL sun energy supply the power of the future, when coal, water forces and gasoline have been exhausted?

"Why the future?" said Charles F. Kettering, inventor of the self-starter for automobiles and many other things that have advanced the science of motoring. "Isn't sun power our main power today?" he asked. "We are but using up the energy the sun stored away for us during countless centuries prior to the time when man first learned the uses of steam and gasoline."

"The time will come, however, when we must use the sun power given us every day. The world will use more and more power, and gradually our natural resources will give out. Not in our lifetime, certainly, but, geologically speaking, just a short time ahead. Then we must turn to the sun and to the spots on earth where the sun is most active."

Mr. Kettering

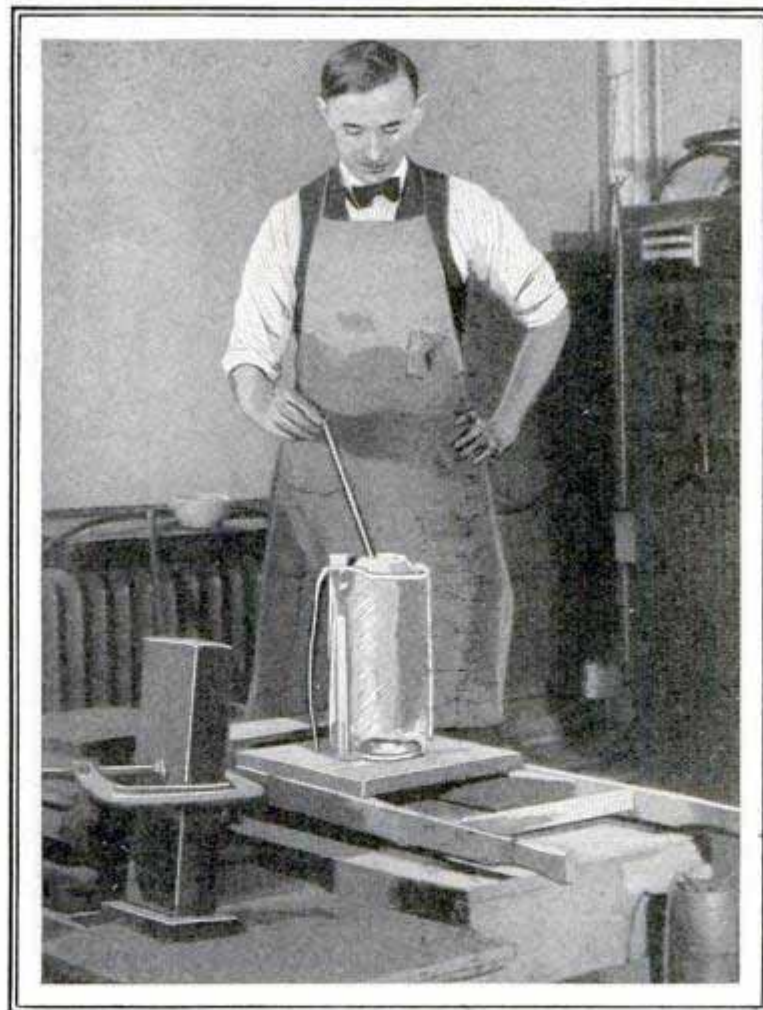

The Small Electric Furnace with Which Mr. Kettering Demonstrates How to Fry an Egg in a Skillet Set on a Cake of Ice

says the world is interested generally in sun machines that are being invented with a certain degree of success, but he doesn't believe a sun machine in itself will be the method to be adopted for the use of sun energy. Coal fields, he points out, came as the result of vegetation brought forth by sun power.

"A learned scientist is now experimenting in Cuba, where it is possible to raise eleven tons of sugar to the acre," he said. "In these temperate zones we may do our own experimenting—that of making fuel from vegetation—but the method is too slow for this swiftly moving world. We must plant our corn in the spring, wait for the sun to develop it to maturity and harvest it in the fall—all before we are ready to make commercial use of what the sun has accomplished."

"Now, in the tropics, this process is shortened by months."

*Emb. E. O. McLaughlin's feature Sept. Detroit News, Detroit, Mich.*

*General Director, General Motors Research Laboratories*



And so, when the time comes for us to turn our eyes toward the sun, we must take to the tropics." Visions of the world of tomorrow have been painted by other scientists, following the success of sun-power machines, operated during the sunlight hours by means of great lenses to generate steam. Predictions have been made that the generations that will follow a gasless and coalless age, will people the great deserts. But the engineer, who made it possible to start an automobile without cranking and who heads one of the greatest research laboratories in the world, asks why bother with engines at all, when the sun is at work constantly to produce man's greatest necessity—fuel.

"Who knows but that the time may come," he suggested, "when man will learn to use directly the sun power; that, instead of waiting for the sun to place its energy into a grain of corn which man can remove in the shape of alcohol, such energy may not be put to work at once as a slave to the ingenuity of man?"

In stressing the importance of fuel, Mr. Kettering emphasizes that mankind is merely taking its first toddling steps in science and cites the case of J. W. Mettler, of Great Falls, Mont., who in 1888 received a suit and overcoat for dumping 20,000 barrels of gasoline into a creek and not getting caught at it. Gasoline was the white elephant to the refiner, for, when

too much of it was left in kerosene, lamps exploded. He gladly paid anyone to get rid of the dangerous stuff. Today, as Mr. Kettering says, more than one-half of the horsepower produced in the United States is developed by gasoline.

"When our crude oil is gone, we must learn how to cause the sun to make us more, not in the process that requires ages, but quickly," he says.

Mr. Kettering believes the greatest danger in the world today is the belief generally held that this is a wonderful age.

"When man first learned to fashion knives and hatchets of flint, he thought that he lived in a wonderful age," he illustrated. "Next, when a smarter generation fashioned their implements of bronze, they too considered themselves wonderful, and so on through the ages. Now we have automobiles, radio, steam engines, airplanes and radium and we go around boasting about our wonderful age. But we are just learning to walk!"

Mr. Kettering often lectures in his laboratory and loves to illustrate. His favorite is the small electric furnace in his laboratory. "In the furnace we'll take a piece of

Small Unit of a Sun Motor Constructed by Prof. Marcuse, a German Scientist, to Determine the Heat Available for Conversion into Power

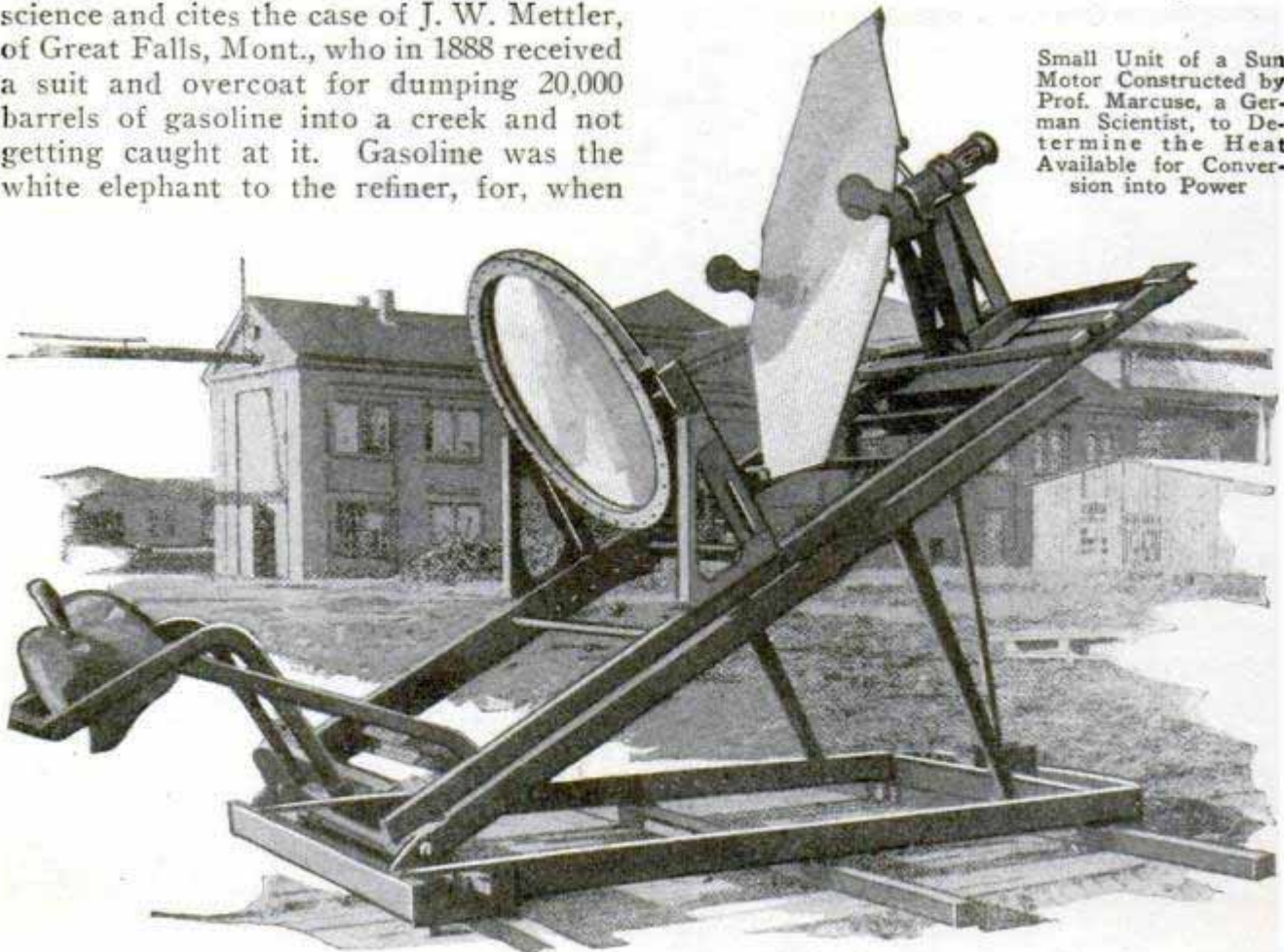



iron bar and heat it red-hot," he said. "Over the furnace, while the iron is red-hot, we'll place this piece of ice and notice that it doesn't melt. On top of the ice we'll put this skillet and in it drop an egg. You notice the egg fries, while the ice does not melt.

"That is all very simple, because all we have is a transformer that sends out electric radiations. When we place in the furnace a piece of metal, these radiations induce electric currents in the metal which make it hot. We all know that electric currents will not flow into ice, so the ice does not get hot. We get all our heat from the sun, whose rays pass through space that is absolute zero, and it is only when they strike something that they are converted into heat. The heat was generated in the bar but not in the ice."

Gasoline, as the important fuel, says the engineer, is being made better today than ever before and yet, he affirms, scientists have just taken their first steps in getting all the power out of gasoline.

"The world must accept new things or die," he declared. "We all know that every civilized country that became satisfied with its old things, passed away. We must quit saying we are living in a wonderful age, for the wonderful age is yet to come."

### BALLOONS IN BATHING SUITS SERVE AS LIFE PRESERVERS

Weighing but two ounces, and tied to the shoulder strap of the swimming suit, a life preserver devised by a Los Angeles man consists of three balloons that may be used for play when not needed as supports. They are inflated by a tiny gas bomb which is broken by simply squeezing two small handlelike pieces of steel with prongs which puncture the gas container and allow the gas to escape into the balloons. The preserver will support a 250-pound man for from three to six hours.



Balloons on Suit and One Broken Open to Show the Inner Holder That Contains Inflating Gas

### POCKET ARC LAMP FOR PHOTOS SUBSTITUTE FOR FLASH



Using the Arc Light to Take a Picture, and Close View of Its Construction and Connections

For taking interior photographs, a German concern has introduced a pocket-size electric arc light that closes flat like a cigaret case, when not in use, and is about the size of an ordinary wallet. It is designed for all types of current and is a substitute for flashlight powder, with its noise, smoke and the scared looks it often produces on the faces of the subjects. It is said to be suitable for large groups when a time exposure is given. In such a case the group is "painted" with light by moving the arc about over the field to kill the shadows. The lamp may either be attached to the camera tripod or it can be held in the hand without danger.

*Maher - Safety & Boat Products Co  
 Allied Crafts Bldg, Los Angeles, Calif.*

*269  
 known  
 H. Frank, 56 Brennerstrasse  
 Munich, Germany*

*Price - \$1.00  
 Eyre Powell  
 913 Chamber of Commerce Bldg, Calif.*



### SEAGOING TRICYCLE HAS SPEED OF TEN MILES AN HOUR

When he wants an ocean ride, a New York inventor is independent of boats, for

Motor Tricycle That Rides the Ocean Waves; Securely Balanced on Three Floats, the Rig Can Make Ten Miles an Hour, under Favorable Conditions



Herbert photo

he pedals out on his seagoing tricycle. It is sturdily constructed and well balanced on floats. At the time the accompanying photograph was taken, the rider was making about ten miles an hour without great effort off Atlantic City, N. J.

### RUBBER IS REPLACING METAL IN MANY FIELDS

Rubber is proving a durable substitute for iron, steel and other metals in various industrial processes. One of its increasing uses is in linings for grinding mills. In a cement plant where one-inch rubber sheets were used in a mill charged with 45,000 pounds of steel balls, not even the cloth on the rubber's surface had been worn off after ninety days' use, and the rubber was not worn more than one sixty-fourth of an inch after fourteen months of service. One explanation of this is that rubber absorbs the impact. In various ceramic processes, rubber is preferred to metal for linings, as it reduces the risk of contaminating the product, is more easily cleaned and in certain chemical processes, insures

protection against erosion. Rubber linings have also been used successfully in flues built to carry off abrasive dust and gases. A rubber sheet on a river dredge was found to outlast ten steel plates. It was placed at the mouth of the discharge conveyor, to receive the impact of rock and sand. Rubber bearings on a power tug showed no visible signs of wear after ten months' service, and speeds of 5,000 revolutions per minute have been attained with bearings of this kind, without any difficulties. Grit and sand injure the material less than they do metal, for the particles imbed themselves in the rubber and gradually work out through the grooves in bearings where they are washed away by water, the only lubricant needed. Reduction of vibrations

and noises commends the use of rubber bearings in passenger craft.

### ROLLER PRESS FOR FENDERS IRONS OUT BUMPS

To simplify the task of straightening bent automobile fenders, an efficient roller press has been designed. It literally "irons out" the dents and can be adjusted to many angles and positions according to the requirements of the job.

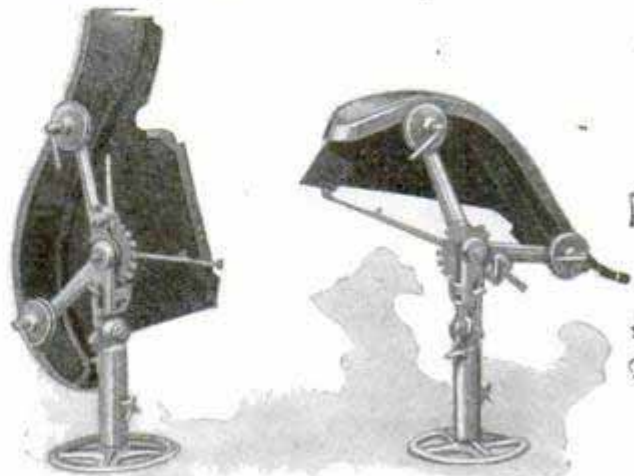

Two Views of the Fender Press, Showing How the Rollers Can Be Adjusted to Iron Out Dents

2426

28 27

New York Times

Patterson Laundry Machinery Co.

City Fender Works, 626 E. 74th St. N.Y.

Poughkeepsie N.Y.

Long Beach, Calif. 74th St. N.Y.



## WHITE HOUSE LOSES ITS CENTURY-OLD COVERING

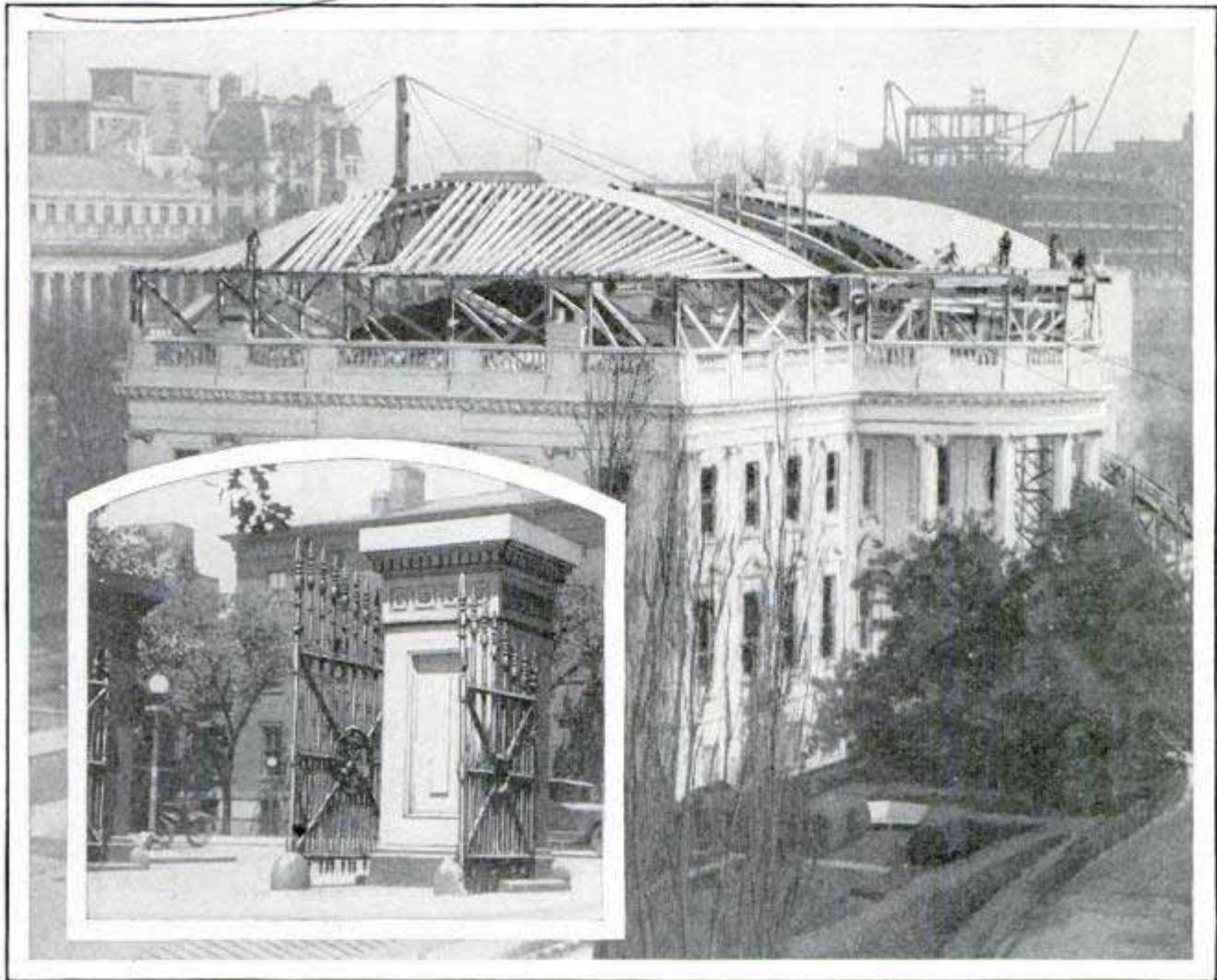

© Harris &amp; Ewing

Building a Temporary Roof over the White House to Protect It While the Real Roof Is Being Laid, and, Insert, the Famous Executive Avenue Gates, Which Are Being Removed

The roof that has sheltered the presidents of the United States for more than a century has finally given way for more modern construction. The ancient wooden trusses that spanned the building from wall to wall have come out, and on 200 tons of new steel beams a new roof has been laid. A bill for \$300,000 for a new roof looks large, but the changes made required the rebuilding of the entire attic floor and the reconstruction of some of the massive brick chimneys down to the second floor. To protect the valuable furnishings from inclement weather, it also was necessary to cover the entire White House with an elaborate false roof, raised high enough to permit construction being carried on under its shelter. At the same time another improvement was started with the removal of the historic old gates of West Executive avenue, the narrow street between the

White House offices and the old State, War and Navy building. The gates were erected between 1872 and 1875, during President Grant's term.

### FIRST TURBINE SHIP CUT IN TWO

The "Turbinia," a 100-foot steamer that astonished the world thirty years ago with its speed of more than thirty-two knots by turbine drive, has been cut in two and sent to the South Kensington museum to be housed among other notable exhibits. It was this ship, the invention of Sir Charles Parsons, that paved the way for the modern ocean greyhounds and their speedy schedules. Since quarters large enough to accommodate the entire vessel could not be found in the museum, the "Turbinia" was cut in half. The after part has been placed on exhibition.

*Owner - Mess. Parsons & Turbine Co. Ltd.*

*Shipping World 6/22/27*



*University of Chicago*

HOW MOUNTAINS WERE MADE SHOWN BY MODELS

2753



Dr. Link Applying Lateral Pressure to Model Mountains in Laboratory, to Illustrate How Appalachians Were Probably Formed; Right, Sawing a Block for Better Examination of the Strata



Pointing to Dark Layer of Grease, Which Represents a Lava Flow

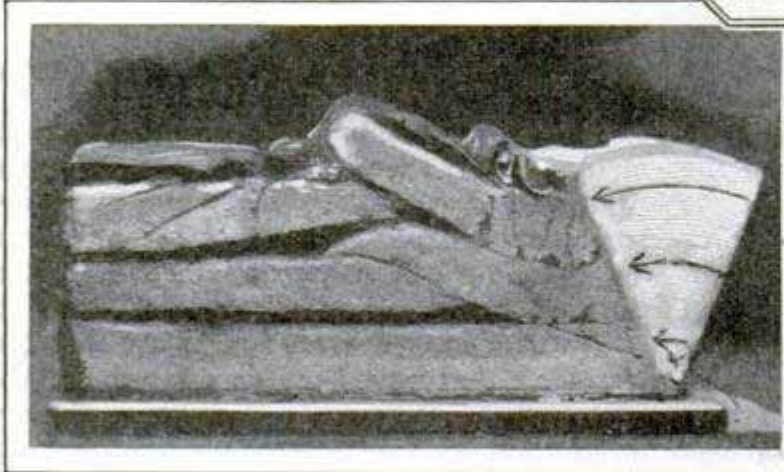

One of the Best Specimens, Showing the Folding and Slipping That Often Occurs to Form Ridges; Arrows on White Block Show How the Pressure Was Applied

Grease as Lava, Forced between Layers of Concrete and Plaster, to Illustrate Ridge Formation



Surrounding Material Cleared Away, to Reveal How Lava, in This Case Represented by Grease, Spreads in Being Forced into Rock



**ROCKIES WERE MADE BY PUSH FROM THE WEST** *2753*

By making miniature mountains, bending and squeezing them with jack screws, Dr. Theodore A. Link, of the University of Chicago, has given interesting laboratory demonstrations of the possible manner in which the Rockies and other ranges were formed. His general method is to use wet layers of sand mixed with cementing material, such as plaster of paris, and alternate layers of wax, grease, paraffin and other substances, to represent the different strata. The mass is placed in a pressure box and subjected to the action of the screws from various angles. By regulating the pressure, its speed and the period of application, different effects are obtained. The "mountains" can be cut open to study the folds, faults and other features of the strata. Similar experiments were made to show how volcanoes operate. Hot paraffin, representing lava, was forced into and through artificial rocks by upward pressure of the jacks. Dr. Link suggests that the Rocky mountains were formed by a severe push of the earth's surface from the west and that the great American desert is evidence of a vast inland sea which formed when the upward fold of the world's crust imprisoned part of the ocean and in the course of time has dried up.

**AUTO-RIM REMOVER SIMPLIFIES PUNCTURE REPAIRS** *2586*

Punctures have less terror for the motorist equipped with a recently introduced lever unit for removing the tire rim and replacing it. The task requires but a few minutes, with this aid, and is easily performed. The lever operates on a ratchet gear, essentially like a jack, is quickly clamped on and "breaks" the rim apart at the joint so that it can be removed. To put it back, the lever is used in a reverse way.



*Douglas Rim Tool Co.,  
Attn: Mr. T. J. Sharpe,*

*2694*  
Teresa Losonszky before the Wayside Shrine Which She and Her Sister Care For; It Is Situated near a Hospital in the Bronx

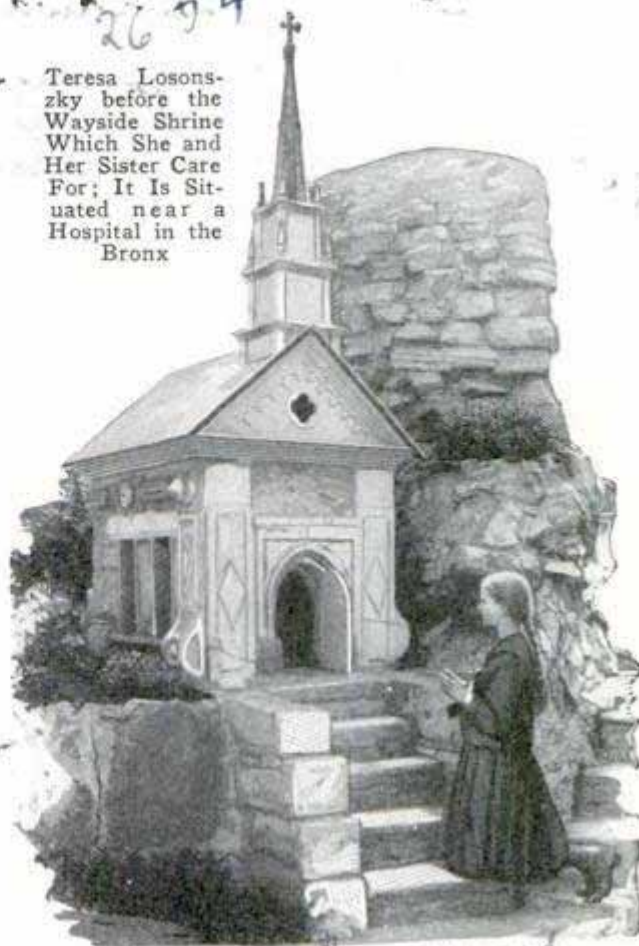

**MINIATURE CHURCH AND SHRINE ON CITY STREET**

Persons passing St. Joseph's hospital for consumptives at 143rd street and St. Anne's avenue, the Bronx, come unexpectedly upon a little wayside shrine, built on a terrace of the institution's grounds. A miniature church, realistic in detail, has been constructed, and the shrine, which has become known as one of the novel beauty spots of that part of the city, is in the care of two young girls.

**IMPROVED PLANTER SAVES SEED AND INCREASES CROPS** *2842*

Marked savings in the quantity of seed required and increased yields, varying from 100 to 200 per cent, are claimed for a planter an Austrian has devised for use with small crops. An important feature is that seeds are placed at exact intervals which can be carefully regulated according to the kind. It is reported that grains and other produce sown with this outfit sprouted two to three weeks earlier than those planted with ordinary rigs or by hand, were deeper green, longer, and that the stalks were of greater diameter.

*name unknown.  
Reported by John P.*

*Consul at Vienna  
Director of Commerce*



Proof against Warping; the Metal Guitar and Its Inventor

2569



**ALL-METAL GUITAR PRODUCES LOUD, SWEET TONE**

Besides being proof against warping and checking, an all-metal guitar devised by a Los Angeles inventor is said to possess great volume, making it adaptable to more efficient use in an orchestra, and yet maintains the sweet tone of the wooden instrument. German silver was the material used in manufacturing the guitar shown in the accompanying illustration.

**WATER SUPPLY IS KEPT PURE BY RAIN AND DROUGHT**

Periods of rainy weather, then days of drought may be unpleasant to all and particularly annoying to the farmer, but it is this alternating wet and dry weather that keeps the great supply of well water pure, insuring the health of millions and preventing the spread of harmful microbes. This hitherto unrealized law of nature, the rise and fall of ground water due to rain and drought, giving the soil a chance to filter out the impurities, has recently been revealed as the result of investigations in water pollution. Foreign material sinks with the water as it passes into the earth and will not flow far to the sides until a large area of moist ground is encountered. Then it tends to spread out over a wider

territory in a lateral direction. If a constant rainfall kept this moist section at a permanent level, harmful substances would thus travel much farther and might easily trickle into wells and springs. But as the wet strata keep moving up and down, due to the rainy and dry spells, a continual filtering process is going on, keeping the great ground supply of water pure. During tests at army camps, it was found that chemical pollution in water traveled as much as 450 feet and bacterial impurities over 200 feet from the trenches in which they were placed.

**PORTABLE AUTO OIL CLEANER SUBSTITUTE FOR PIT**

One of the latest units for servicing automobiles is a portable motor outfit to clean the oil. It insures a thoroughly flushed crankcase, prevents pollution of new oil and eliminates the use of the pit for draining. In operation, it pumps a cleaning lubricant through the running motor at the oil intake into a pan underneath the engine. Then the oil is filtered and pumped back again. The process is continued until the lubricant clears up in color. The refiltered cleaning lubricant is pumped through the motor at the rate

Filtering the Auto Oil with Portable Unit That Eliminates Need of Pit

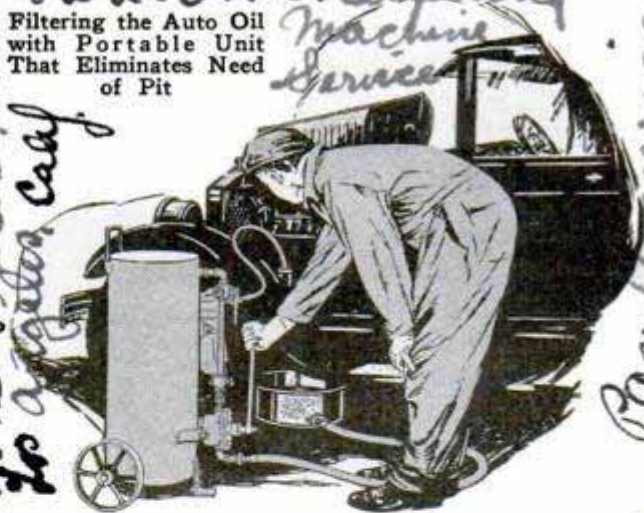

of ten gallons a minute. With this apparatus, oil in the entire system is given a thorough washing.

U.S. Pat. # 1,627,282  
We want all our readers to write us freely and often whenever they wish additional information on articles published in this magazine. Address Bureau of Information, Popular Mechanics, Chicago.

Public Health

Can. # 271,272  
Patent attorney  
1014

George A. Deaneham  
5006 d Broadway  
Los Angeles  
Calif

2442  
Deaneham Process, Inc., 121 W. Pico St  
Los Angeles, Calif

Washing ton  
Pan. American Petroleum Co., 1851 E. Washington  
Los Angeles, Calif.  
Pan. Am. Cleaning Machine Service  
Bank Bldg, Chicago



6/29/29

**AIRSHIP TO CARRY FIVE PLANES**

2851

*an* Dreams of a dreadnaught of the skies are promised realization in a monster dirigible planned for the United States navy. It will be two and one-half times as large as the "Los Angeles" in volume, will carry five airplanes that can be launched, while the ship is in motion, down inclined runways within the bag, a battery of guns, and will have a cruising radius equivalent to nearly half the distance around the world at a speed of about sixty miles when filled with non-inflammable helium. Round-trip flights from New York to Honolulu or two round-trip voyages to Europe on one fueling would thus be possible. The maximum speed will be approximately eighty miles an hour. A crew of forty-five men and officers will be carried. The bag will have a gas capacity of 6,500,000 cubic feet. Construction of the ship is authorized by action of congress. The Goodyear Rubber company won first prize for its plans for such a dirigible.



Lofty "Tripod" for Motion-Picture Camera in Filming Outdoor Scenes; the Ladder and Platform Built on Tall Fir Tree

**MOVIE IS FILMED FROM TREE THAT SERVES AS TRIPOD**

A "tripod" more than 100 feet high was used in taking an outdoor motion picture recently. It was a tall fir tree to which a ladder and platform were attached so that a wide view could be obtained.

*Richard B. Arthurs, The Patent Leather Kid, Camp Lewis, Tacoma, Wash.*

**CARRIER FOR HANDLING TILE REDUCES BREAKAGE**

Adaptable to building or drain tile of different sizes, a hand carrier speeds work and reduces the risk of breakage. It is adjusted for rapid picking up, holds the pieces securely and is well balanced.

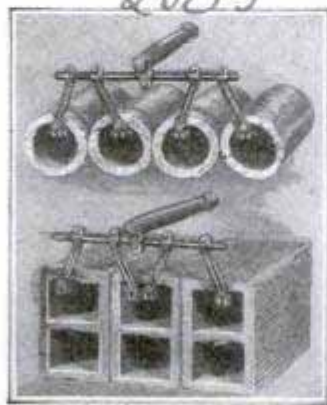

**SILK FROM REDWOOD BARK**

Artificial silk, suitable for the manufacture of stockings and other articles, is now being made from the bark of giant redwood trees. The discovery of the process makes it possible to utilize practically every fiber of the tree, the bark alone being considered a waste product until the silk-producing method was developed. Other trees have furnished material for artificial silk, but not the redwood.

*Wm. H. Smith, 730 Beacon St., Los Angeles, Calif.*

*Miller Tilghamer*

*The Builders Material Co., Cedar Rapids, Iowa.*



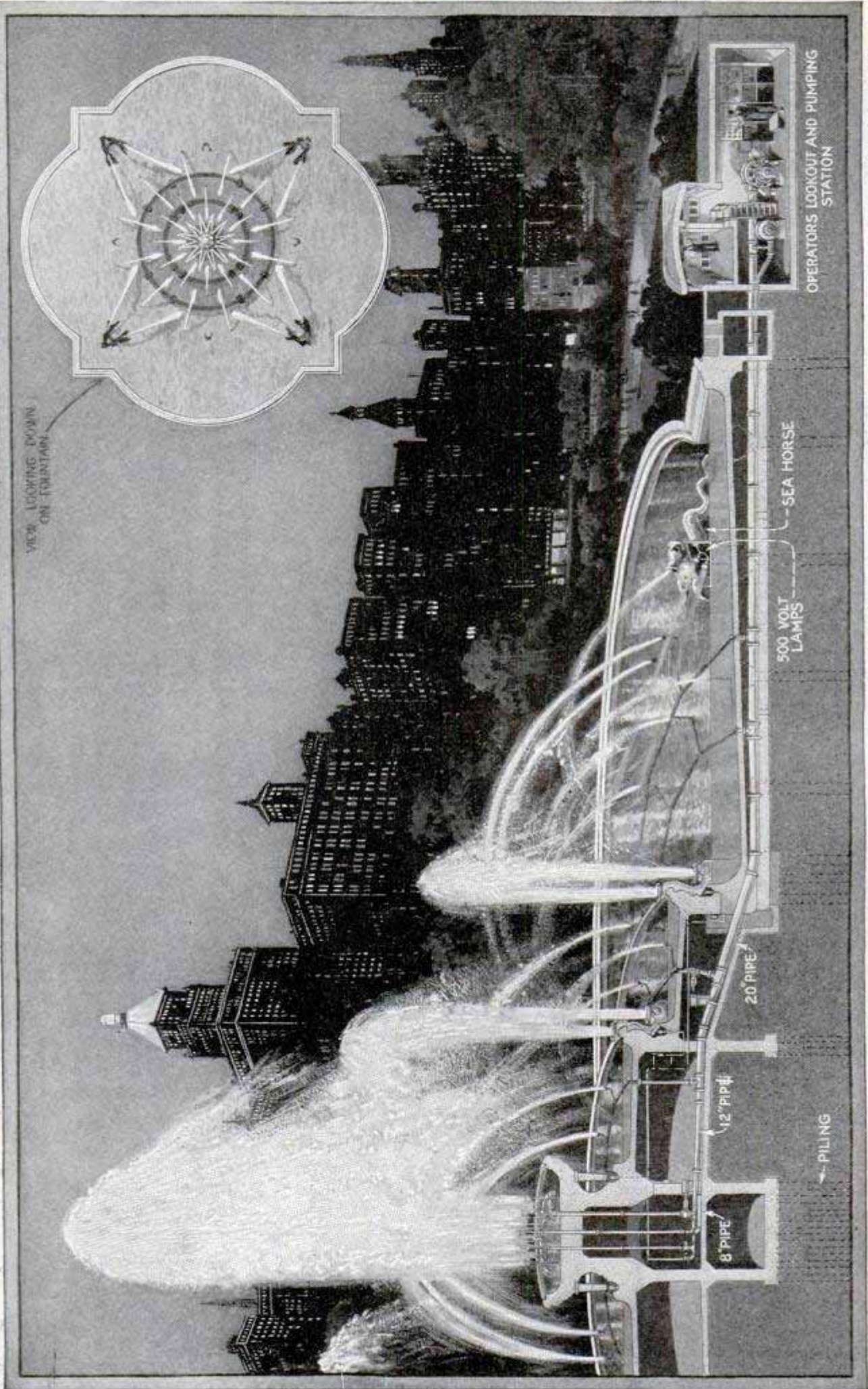

Against the Background of Towering Skyscrapers with Their Myriad Lights, Gleaming Columns of Spray Are Thrown More Than 100 Feet in the Air, Lit by Concealed and Ever-Changing Lights in Chicago's New Memorial Fountain



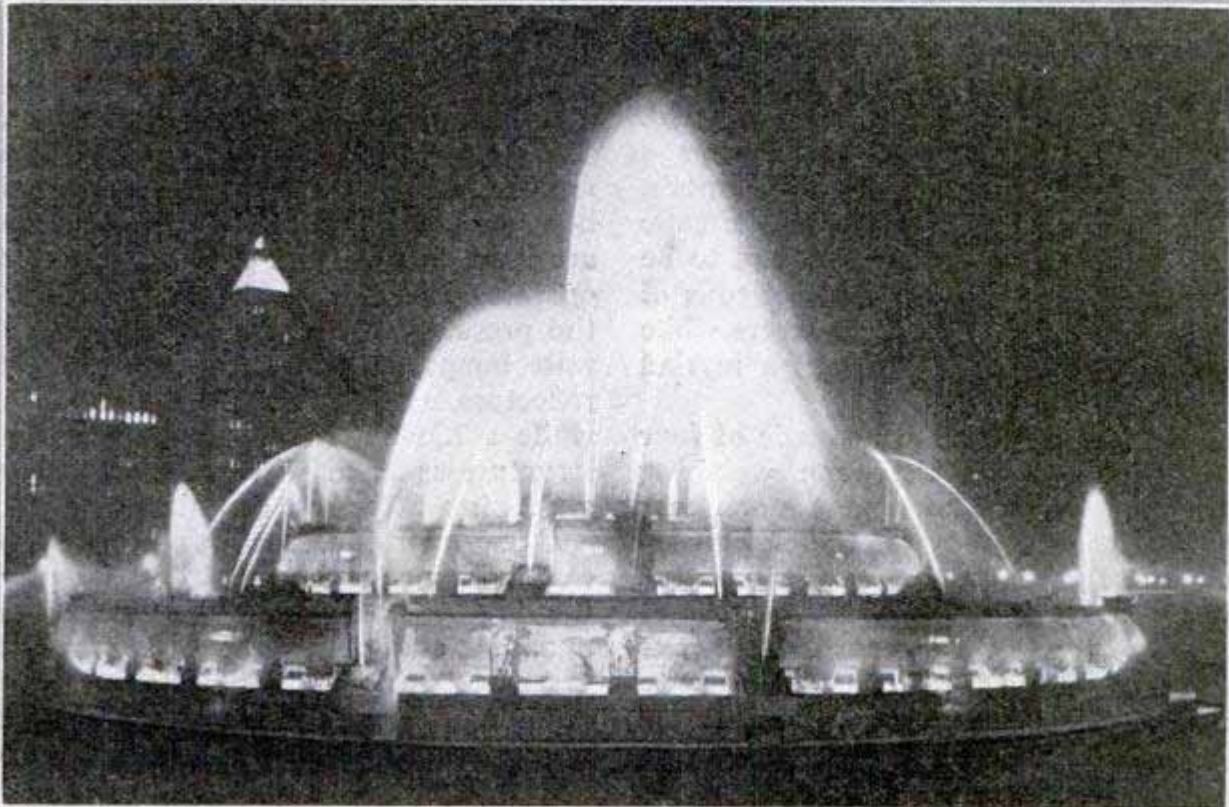

A Night Photograph of the Buckingham Fountain at the First Test of the Pumps; the Pyramid of Light in the Background Is the Tower of a Michigan Boulevard Office Building

## Colored Lights Reveal Fountain's Beauty

Play of Water and Colors in Giant Memorial Basin Outshines Historic Pageant Created by French Monarch Long Ago

A FOUNTAIN that has cost more than \$600,000, and that is to be supported by a perpetual endowment fund of \$200,000 more, has recently been completed in Chicago and hailed by artists and architects as the greatest feat of hydraulic architecture in history. It is conceived on so vast a scale that it outshines the historic fountains of Versailles, which draw tourists from all parts of the world.

The new fountain, a memorial to Lieut. Clarence Buckingham, who lost his life in France, was given to the city by his sister, and erected in Grant park, opposite the famous skyscraper-lined Michigan boulevard. Into a basin, 300 feet across, a myriad water jets, some rising 110 feet into the air, pour ten and a half million gallons daily, when the fountain is operating at full capacity. Clusters and rows of electric lights, hidden beneath the water, shine through the clouds of spray, while an operator in a

concealed control plant plays a giant switchboard, resembling a mammoth pipe-organ console, to produce the continuous changes in the water display and the color of the lights.

Hundreds of tons of concrete and marble, a forest of enormous wooden piling, and eight huge bronze sea horses, besides miles of electric wiring and a prodigious amount of big water mains, went into the construction. Nine hundred piles, each seventy-five feet long, were driven down to bedrock to carry the weight. They are topped by concrete columns, which in turn carry the entire weight of the fountain, cast as a monolith, 300 feet across, and faced with pink Georgia marble. The reinforced-concrete monolith was poured on a bed of loose cinders, so that the bed would settle and leave the fountain suspended on the piling stilts, permitting the earth to expand and contract with alter-



2711  
 nate freezing and thawing, without damaging the superstructure.

The combination of concrete and Georgia marble, having different rates of expansion and contraction in heat and cold, added to the difficulty of water seepage getting between them, made the fountain construction an unusual problem. Elastic joints and expansion chambers had to be provided, so that the hundreds of tons of marble could move over the concrete, while water seepage drained through a myriad of concealed ducts.

The top of the fountain is made of four huge blocks of marble, each weighing eighty-four tons. The largest stone ever quarried, it is claimed, was the eighty-six-ton block for the statue of Civic Virtue in New York, so each of these four comes within two tons of the record. The four blocks were so big that it was necessary to cut them down practically to a finished size on the quarry bed. Enormous ramps, like those used in the construction of the pyramids, were built up, and on these modern tractors hauled the stones to the surface, for final polishing and finishing. Four special steel flat cars brought the

blocks from the quarry to Chicago, and other ramps were built to unload and convey them to the fountain.

The interior of the fountain is a hollow chamber, criss-crossed by big water mains and insulated electric ducts which lead in a network from the control and pumping house to the fountain. All the water valves are shut and opened electrically, so the operator can play the streams of water at the pressure of a button. Series of 500-watt lamps, backed by chromium-plated reflectors, shine through the larger jets, while a hidden recess under the superstructure is lined with rows of 100-watt globes in water-tight containers.

Eight enormous sea horses of bronze, cast in France at a cost of \$100,000, play in the big water basin. The control and pumping station is practically all underground, save for a long and narrow window facing the fountain, from which the operator watches the display. Shrubbery will conceal the window from visitors.

The water in the fountain is used over and over again, only enough being pumped from near-by Lake Michigan to take care of evaporation.

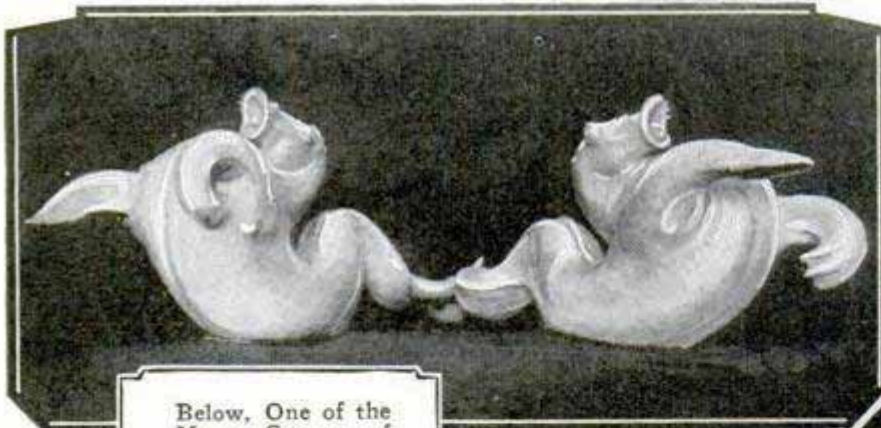

Below, One of the Many Groups of Spray Nozzles



Eight Huge Sea Horses of Bronze, Like the Models at the Left, and a Central Group, Below, Furnish Ornament; the Huge Bronze Pieces Were Cast in France and Cost \$100,000





Los Angeles, Calif. 365

PLAN TO TRAVEL BY AIR YACHT FROM CALIFORNIA TO PARIS

Development of regular passenger travel from Los Angeles to London and Paris by way of New York in a yacht of the air,

may easily be encountered elsewhere. The cup produces from twelve to sixteen ounces of water per day while only eight ounces are necessary for life. The construction of the device is said to enable any one to breathe through it without fa-



Model of the Aerial Yacht Which Is Planned to Carry Ten Persons at a Time from Los Angeles to Paris; It Will Have Five Motors of 300 Horsepower Each, Two to Be Kept in Reserve

capable of carrying forty persons on short cruises and ten across the ocean, is under way, according to reports from the California city. A model of the proposed craft showed that it is to be a monoplane with a wing spread of 110 feet and will measure nearly seventy feet from nose to tail. Five 300-horsepower motors will be installed, a speed of ninety miles an hour being available from only three of the engines, the other two to be kept in reserve. A cruising radius of 4,000 miles is expected. The plane will carry a total load of sixteen tons.

tigue and it is made of non-corrosive material. Col. Charles A. Lindbergh and others have carried them on their trips.

LIGHTS ON PIANO KEYS GUIDE STUDENT IN PLAYING

To help pupils in learning to play the piano, a light system has been introduced in New York. The instructor guides the beginner from an adjacent piano which causes lights to flash over the keys at the pupil's instrument as the teacher strikes the proper notes. The plan is said to develop the capacity for reading music rapidly and correctly.

CUP TURNS BREATH INTO WATER TO PRESERVE AIRMEN

Drinking water condensed from the breath is now afforded flyers, travelers and others in a simple cup apparatus that hangs from the neck, is attached to the life-preserver jacket and weighs but six ounces empty. To produce water with the unit, the wearer simply breathes through it when the cup is subjected to a temperature lower than that of the breath. Such conditions would prevail during shipwrecks or other accidents at sea, or



As Instructor Plays, Lights Appear above the Keys on the Student's Piano, Aiding Correct Fingering and Reading of Notes

Dr. E. W. Ambrose

Com. Chester S. Harrison, 1026 O'Connell Av. Oceanside, Calif.

International Life Saving Water Making Cup Corp. 2014 ...



24.78



Plaster and Wallpaper in This Room Were Removed Intact from House in Maine and Installed in New Dwelling in Massachusetts

**RARE OLD WALLPAPER MOVED ON PLASTER TO NEW HOUSE**

*Shepard Janew Bath*

Removal of the plaster, with its imported wallpaper, from a dwelling in Maine, and its replacement in rooms of the same dimensions in a house in Massachusetts, were accomplished recently. A special facing was used to prevent the paper from tearing while the plaster was carefully cut away. With the woodwork, the wall decorations are valued at \$4,000. The paper was put on in 1804. It was brought from Italy and depicts views of the Vatican and other Italian scenes.

**NEW YORK-CHICAGO AIRPLANE EXPRESS TO SAVE A DAY**

2827

Day and night air-express service between New York and Chicago and Chicago and Dallas will be inaugurated by the American Railway express in conjunction with the National Air Transport, Inc., on or about the first of September, saving a

business day on package shipments between the points named and speeding them to other intermediate points and to cities which make a close connection with the air line by rail. Between New York and Chicago, the only intermediate stopping place will be Cleveland, Ohio, and between Dallas and Chicago, stops will be made at Fort Worth, Oklahoma City, Ponca City, Wichita, Kansas City, St. Joseph, Davenport, Rock Island and Moline. Two trips will be made each way daily, between New York and Chicago. Packages leaving New York at 8:00 o'clock at night will reach Chicago at 5:35 the next morning. East-bound planes leaving Chicago at 8:00 a. m. will get their load into the Pennsylvania station at New York at 7:00 in the evening.

The New York landing field will be at New Brunswick, N. J. Flying equipment for the service will include eighteen Douglas planes, seven Curtiss "Carrier Pigeons" and eight "Travel Air" monoplanes. The Douglas and Curtiss planes are powered with 400-horsepower Liberty motors. The monoplanes will have Wright "Whirlwind" 200-horsepower air-cooled motors of the same type used in the recent transatlantic flights. The planes will carry from 750 to 1,000 pounds pay load. In addition to express, air mail will be carried between these points by the National Air Transport under contract with the post office department. Since May, 1926, the company has flown about 1,000,000 miles between Dallas and Chicago without injury to any of its personnel or the loss of a letter or package.

By filtering the water in which workers wash their hands, a Kansas City jewelry company reclaims about \$3,000 in precious metals yearly.

*Owned by Mr. Dudley A. Pickering Boston Mass.*

*506 S. Wabash Chicago*



**KEROSENE AS LOBSTER BAIT INCREASES CATCH** 2836

Bricks soaked in kerosene and placed in the lobster traps have proved successful as bait for shellfish along the Maine coast. Fishermen are employing it instead of other smelly lures as the bricks keep their odor for several days, are easy to handle, and a gallon of oil will treat a number of bricks. Brick-baited traps contained more lobsters than those using mixed fish.

**SEEK TO SPEED TREE GROWTH FOR PAPER MAKING** 2469

Greater speed in the growth of poplar trees for pulpwood is the object of experimental work recently conducted by the New York botanical garden, Columbia university and a paper-manufacturing company. The work is based on selective breeding of seeds in order to isolate the strains possessing unusual merit. The seeds selected are those growing high up in trees. The female catkins are inclosed in paper bags before the flowers are ready for pollination. Those in close touch with the work state that many of the hybrids that have been obtained are showing growth of an inch a year, indicating that trees may be harvested when not much more than ten years old. A Carolina poplar, thus bred, has reached a height of ten feet one inch in its third summer.



Selecting Tree Seeds for Faster Growth and So Speeding Paper Making; Inclosing Female Catkins in Paper Bags

Father of the Saxophone? The "Serpent" of the Old-Time Bands



**"SERPENT" OF OLD-TIME BANDS PRODUCES SWEET MUSIC**

That the use of queer-looking musical instruments is not wholly a feature of the modern "jazz" age, is seen in the odd "serpent" piece which was said to be an essential part of most military bands up to 1800. It fell into discard about that time, its distant "cousin" being found today in the saxophone. The instrument was made of wood and produced a baritone note of pleasing quality.

**MORE CEMENT IN TILE REDUCES COST** 2870

Reducing the cost of a building material by increasing the quantity of cement used in its manufacture sounds paradoxical, but that is what a Los Angeles producer has done with a special hollow building block. Because of the greater strength of the unit, there is less loss from breakage during handling, and a load can be dumped from the trucks without damage, saving time and labor expense involved in unloading by the hand method.

*Fillmore-Wiley Corp.  
2002 21 Glasgow St.*

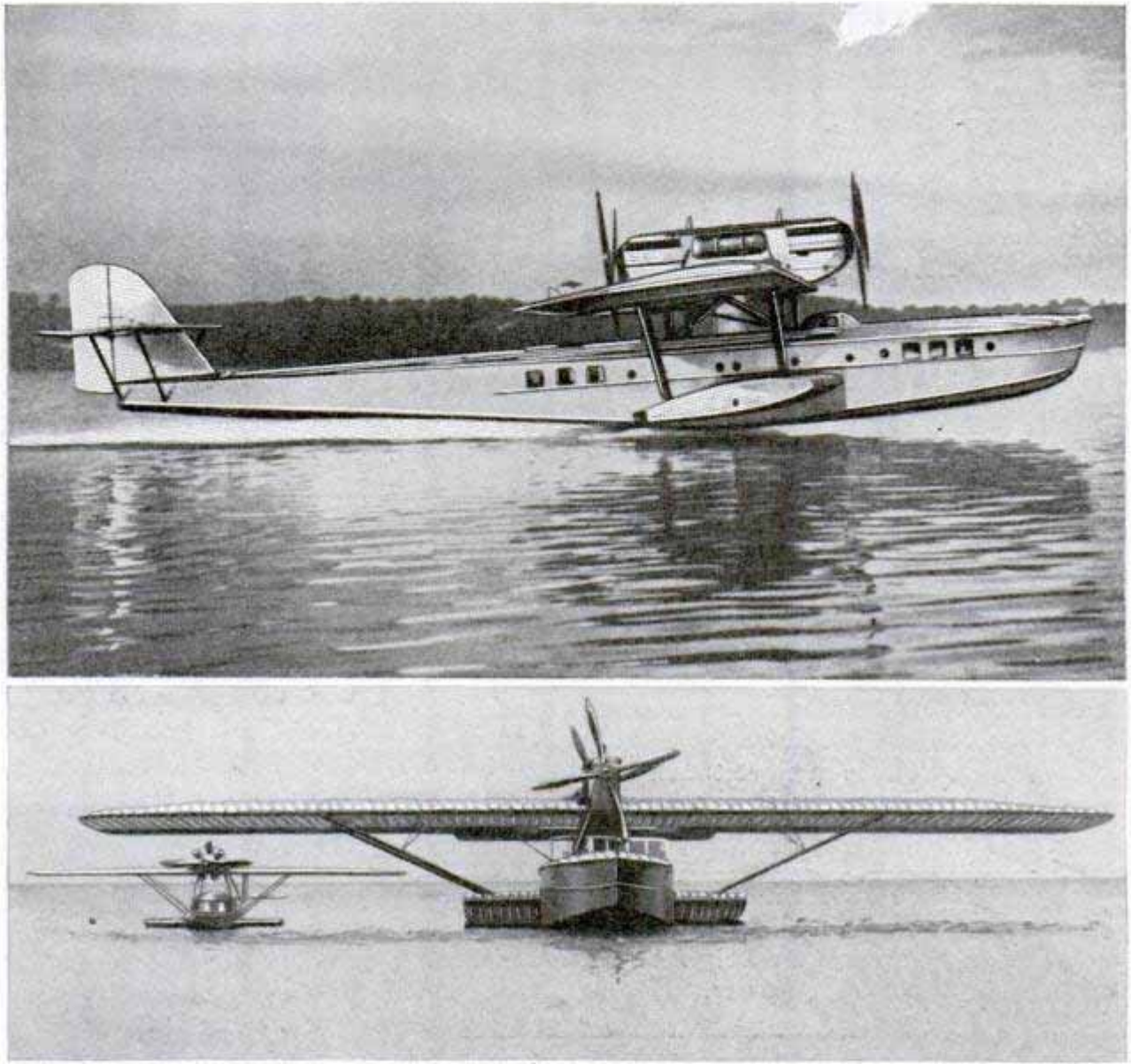

2636  
 PLANES PLANNED FOR TRANSATLANTIC SERVICE

Sixty-Passenger Flying Boat Produced in Germany for Transatlantic Service, and the Same Ship, with One of the Standard Half-Dozen-Passenger Kind beneath Its Enormous Wing

Instead of being ten or twenty years in the future, regular transatlantic airplane service may be just around the corner, if new planes now under construction or planned measure up to their builders' hopes. In Germany two designers, Prof. Junkers and Dr. Dornier, are laying plans to be first in the Europe-America air service. The Dornier factory, whose Dornierwals have set many records in size and weight-carrying ability, has already produced a flying giant with room for sixty passengers, driven by two 1,000-horsepower engines and with a cruising radius of 4,000 miles.

Prof. Junkers, the designer of the Junkers planes used on a number of the longer

commercial air routes abroad, is working on plans for an enormous ship with room for 100 passengers. It really will be an immense flying wing, 400 feet in length, with cabins and whole suites contained within the wing, as well as the engines, for which he proposes to use four Diesel motors. Beneath the wing, twin fuselages would carry crew and operating rooms, and provide the floats for alighting on water.

Government officials at Washington are equally interested, and the aviation section of the department of commerce has prepared figures to show that a profitable air line could be operated with ordinary small planes by building a series of floating islands at 500-mile intervals across the

Company Friedrichshafen, Germany.



2540  
Walcott Ave  
Newport, R.I. 369

ocean. The proposed islands would be horseshoe-shaped, anchored at the nose so they would swing with the wind and always present a basin of calm water between the two wings. Flying into the basin against the wind, seaplanes could alight easily. The wings would be topped by shops, hangars, storage warehouses and hotels for storm-bound passengers.

With these refueling depots at 500-mile intervals, planes could be operated across the ocean with the minimum of risk. The floating-island plan contemplates two aerial routes to Europe. The northern and shorter route would require only three of the sea bases, while the southern route, for winter flying, would necessitate four or five. The advantage of the island plan over non-stop flights is that a plane, since it must necessarily carry all its fuel while in the air, is more profitable on short flights than long ones. The difference between the fuel needed for 500 miles and that needed for 3,600 miles is considerable, and if that difference is saved for pay load, the air line stands considerably better chance of making a profit.

**SQUARE FIFE HAS BETTER TONE AND MORE POWER** 2424

Improved tone and increased carrying power are claimed for a fife that has a square instead of a round body. According to the inventor, it is the result of some forty years' testing and experimenting, and its greater power has been gauged by actual sound measurements.



Built with a Square Tube Instead of Round, This Fife Is Claimed to Have Better Tones

Myr. Noah Skinner described in Russian



Hunted for Its Queer Horns, a Sheep from the Almost Inaccessible Mountain Peaks of the Himalayas

**SHEEP FROM ROOF OF WORLD PRIZED FOR QUEER HORNS**

One of the species of wild goats found among the lofty peaks of the Himalayas, is notable for its twisted horns. They somewhat resemble huge screws, are three feet long and are set on the head to form a "V." The home ranges of the animals are nearly inaccessible to hunters.

**SUNFLOWER LIFE PRESERVERS LIGHTER THAN CORK** 2489

Life preservers are being made in Germany from the pith of the sunflower. The material is said to be four times lighter than the hair of the reindeer and eight times lighter than cork.



2498  
Sailing ship

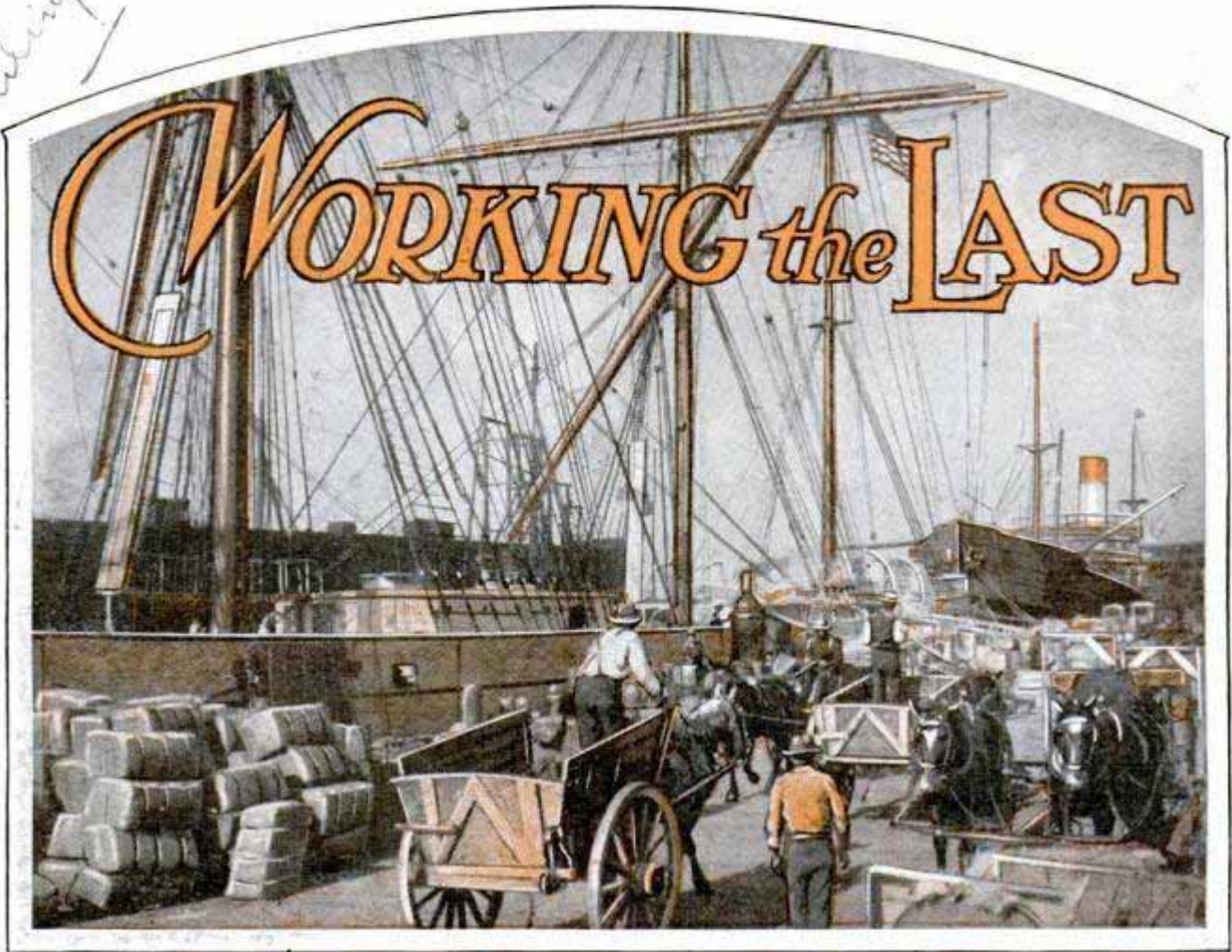

Loading Tinplate and Box Shooks on the "Star of India," at Alameda, Calif.; a Donkey Boiler on the Dock and the Catted Yard of the Mizzenmast Serve as Cargo-Handling Crane

By H. H. DUNN, 2722 Bruna St  
Berkeley Calif

**R**OMPING up and down the Pacific coast as swiftly as they sailed the seven seas half a century or more ago, the last fleet of windjammers in the world each year links the Golden Gate with the Aleutian isles. "Through fog to fog, by luck and log, they sail where Bering sailed," bearing the Stars and Stripes with that same daring which characterized the square-riggers of the seventies. Modern mechanical devices, ranging from radio to refrigerating plants, have made them able competitors of steam, and they bring to your grocer the annual crop of canned salmon, taken where Alaska's coast bends toward the pole.

They are the fleet of the Alaska Packers' association, a co-operative organization of fishing companies operating in Alaska, and almost as old as some of these famous ships themselves. There are fifteen of the sailers, twelve of steel and three of iron, ranging from the "Star of India," built in 1863, in

Ramsay, Scotland, to the "Star of Lapland," largest sailing vessel under the American flag, built at Bath, Me., only twenty-five years ago. They are known in all the ports of the world, where, under various names, they have fluttered their starry pennons in the passenger, freight and mail services. Coming to their present owners, they were renamed "Stars" of various countries, so that they are known and recognized as the "Star Fleet."

In April of each year, they leave their mooring place in the estuary, at Alameda, Calif., bound for Bristol bay, Alaska, whence they return in October, once more to lie snug in the estuary until April calls them northward like migrating swans. During the winter they are overhauled thoroughly, and then, in the spring, huge tugs pick them from their moorings, tow them through the Golden Gate and turn them loose. Topsails, gallants and royals are broken out to the time of the last deep-

111 California St  
San Francisco Calif.



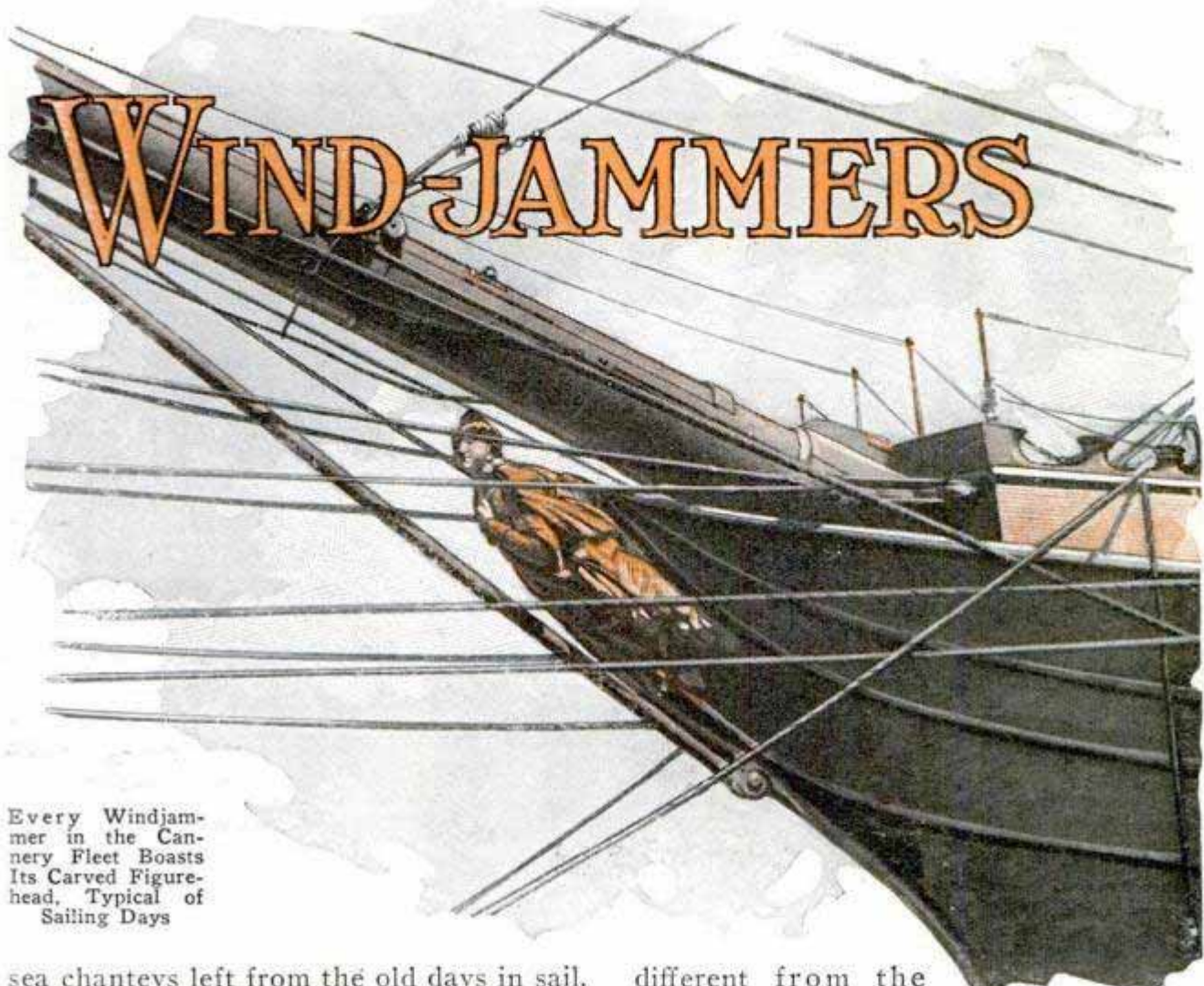

# WIND-JAMMERS

Every Windjammer in the Cannery Fleet Boasts Its Carved Figure-head, Typical of Sailing Days

sea chanteys left from the old days in sail. Dripping toelines are hauled in through the chocks; towering blankets of canvas covering the naked spars are flung out, the wind fills them, the long swells of the Pacific catch the hulls, the great ships heel to the power of wind and wave, and once more a fleet of windjammers foats the seas.

In the holds are cargoes of tinplate for cans, shooks for cases, supplies for the canneries, and food for 200 to 240 men a ship for five and one-half months. One might think this a tremendous crew for a wind-powered vessel, and so it would be were they all sailors. Instead, they are the fishermen who will take tons of salmon during the short season on Bristol bay. On the way up and back, all of them work ship, but, once arrived at the anchorage in Alaskan waters, all take to small boats for the fishing, leaving only the captain, the cook and the latter's assistants on board. They are fishermen first, and sailors afterward, though each ship's company is sprinkled with old-time sea dogs.

Each ship, though still a sailer, is vastly

different from the windjammers which carried the American flag to every port in the world in the last half of the nineteenth century. Steam engines on deck and below give power for handling the sails, loading the cargo, sheeting home the anchor, and catting the yards to serve as cranes for the movement of heavy packages to and from the ship.

Radio, refrigerating plants and refrigerators, typewriters, motion pictures, and the best and freshest of food, not to mention distilled water, make pleasant the modern sailor's life. Light, roomy quarters, equipped with electricity and other conveniences, have replaced the "cockroach heaven" of the forecandle of the old-time sailing ship, while the rooms of the captains and officers compare favorably with those on any steamers, except the very largest liners.

Leader of this last sailing fleet is the "Star of Lapland," largest vessel of her kind flying the Stars and Stripes. She is a four-masted, steel-hulled bark, a thing



2498

of beauty as ships go, her masts rising better than 200 feet, trimmed with a cobweb tracery of backstays, braces, lifts, halyards and clewlines. She is double and topgallant-royal rigged. She has the high-reaching flare and the overhang of a yacht, a saucy "rake" to her masts, and such perfect balanced proportions as to bring back memories of the clippers of the sixties and seventies.

Attached to every one of these ships is a chapter of maritime history, but many of them are passing to the ports of missing ships, due to the encroachments of steam, and the fact that one steamer will carry as much cargo as three of the windjammers, and make the passage in one-third of the time. The "Star of India," built at Ramsay, Scotland, in 1863—sixty-four years ago—has gone to San Diego, to be converted into a marine museum. The "Star of Peru," launched in the same year at Sunderland, England, is ending her days, sans masts and spars, as a coal barge at Noumea,

where, whenever she moves, it will be at the mercy of a tug, instead of the free will of her once swanlike wings. She has been rechristened "Bougainville."

The real reason for the sale of these older ships is that their cargo-carrying capacity proved too small alongside the larger sailers, such as the "Stars" of Lapland, Shetland, Zealand, Scotland, and others. When these largest and last of windjammers arrive in Bristol bay, they unload thousands of flat sheets of tin, millions of printed labels, hundreds of tons of box wood, nails, and other cannery equipment. On the way up, their sails have been worked largely by power supplied from donkey engines on deck, and, tied up at the piers of the Alaskan port, these same engines, with a catted spar for a crane, discharge the ship, so that the great majority of the sailor-fishermen may get to their fish-

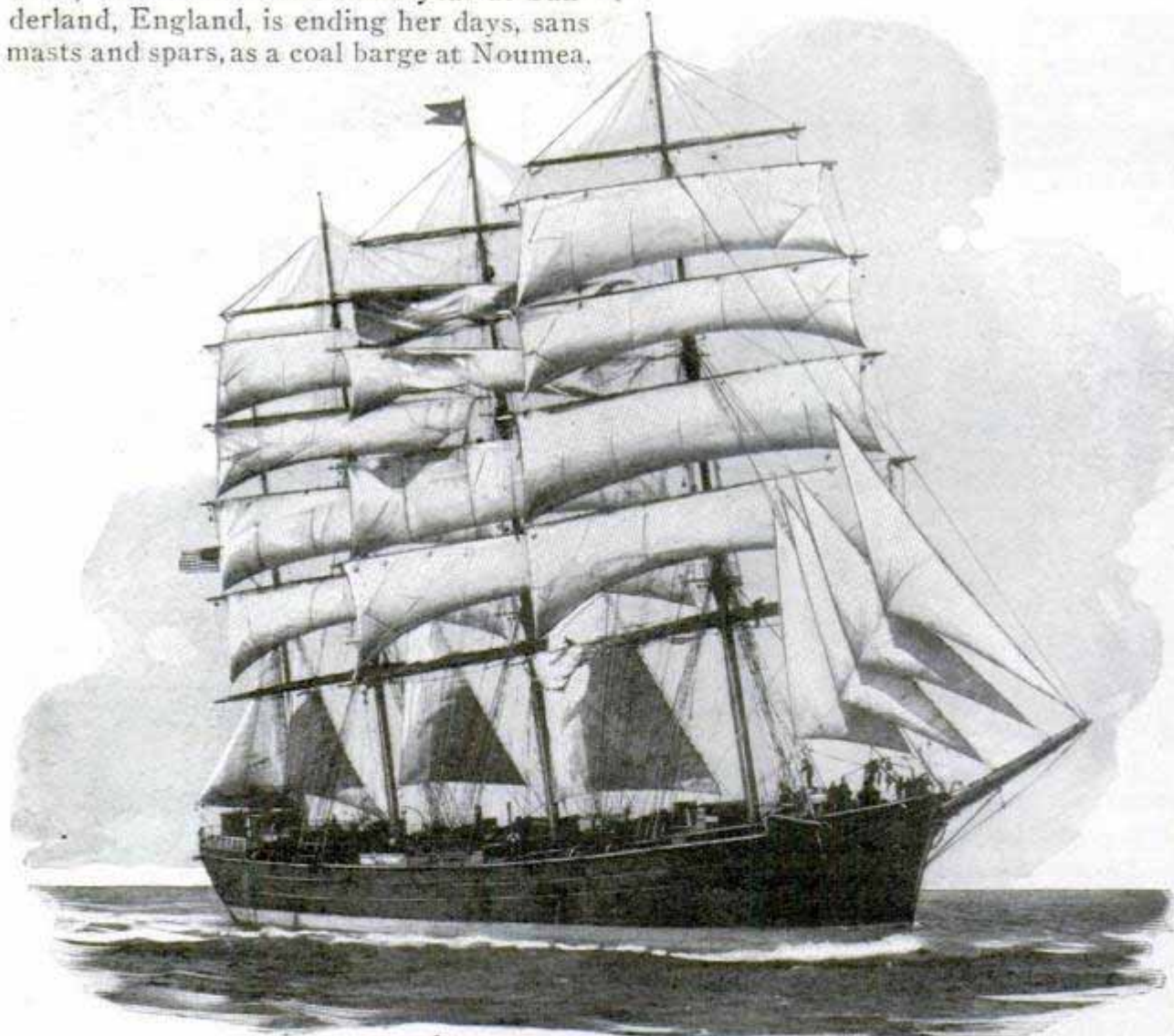

Folding Her White Wings as She Comes About, to Enter the Golden Gate, "The Star of Lapland," Largest Sailing Ship under the U. S. Flag, Scorns a Tug to Help Her up San Francisco Bay



2591

ing. When the pack is finished, late in September, the tinplate has been made into cans and filled with salmon, thousands of tons of it. The wood is converted into boxes and crates. The catted yards again are called into use, and the holds piled to their limit with the crates. The crews pile back on board, and, with the exception of the watchman, the canneries are deserted. The last ropeslingful of cases comes inboard. On fore, main and mizzen yards, the men loosen sail, gaskets are let go, buntlines are freed, steam winches hooked up, and donkey engines put to the jobs at which sailors once wore out their hands.

Topsails are broken out, fore-and-afters, topgallants, royals and courses spread to the wind from off the pole. The old-timers, still sound and sturdy as the day they slid down the ways, heel gently, come into the breeze enough to lift the weather clews, fill their sails with the wind, and the race to the Golden Gate is on.

They clear the rugged and dangerous Alaskan coast; they stand out a bit farther; they begin to draw apart, the faster and better-sailed square-riggers leaving their fleet mates behind, and the Star fleet comes bowling down the sunset side of the continent, the only place in the world where such a sight can be seen.

Last year, the "Star of Shetland" led the fleet, a snow-white bone in her teeth, every sheet drawing taut, her helmsman steering "full an' by," her crew laughing over the rail as the squadron faded into distance.

**HANDLE FOR STEERING WHEEL LEAVES ONE HAND FREE**

With the aid of a knob grip that is easily attached to the auto steering wheel, one hand can guide the car while the other is left free to change gears. It is of convenient size and shape and fastens securely to the wheel rim.

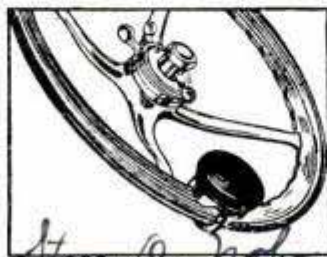

*Whipple Mfg Co  
337 W 60th St*



Japanese Craftsmen Are Experts in the Art of Cutting Crystal Balls like This, Using But Two Simple Tools

**CRYSTAL SPHERE OF FORTUNES SHOWS CRAFTSMAN'S ART**

Quartz balls, fashioned by Japanese artisans, are prized for their beauty, symmetry and clearness even if there is doubt as to their revelations. Some of the best specimens are cut with two simple tools as the chief instruments, a piece of steel to round the angular quartz block into a sphere and a bamboo joint to give the final polish. The art of cutting the crystals is handed down from father to son, the skill of the craftsmen being manifest in the mountings prepared for the spheres and in shaping them.

**KINDS OF ROCK IN THE MOON SHOWN BY LIGHT RAYS**

By examination of the light reflected from the moon, Dr. F. E. Wright of the Carnegie Institution has determined that there is pumice and granite on its surface. Light reflected from these substances was used as a basis for the study.

*Eschphysical Laboratory*

*2591  
Cmt. H. Beardsley Wolcott  
Newport, R.I.*

*added to Morgan Isen  
collection. New York*



ORIENTAL DESERT STEEDS ARE RAISED ON RANCH

There are three large farms in the United States devoted to the raising of Arab horses. The latest is a four-hundred-acre estate thirty miles from Los Angeles. It is a modern Garden of Allah, rather than a

present high standard. History is replete with accounts of the wonderful achievements of Arabian horses, their swiftness, beauty and docility.

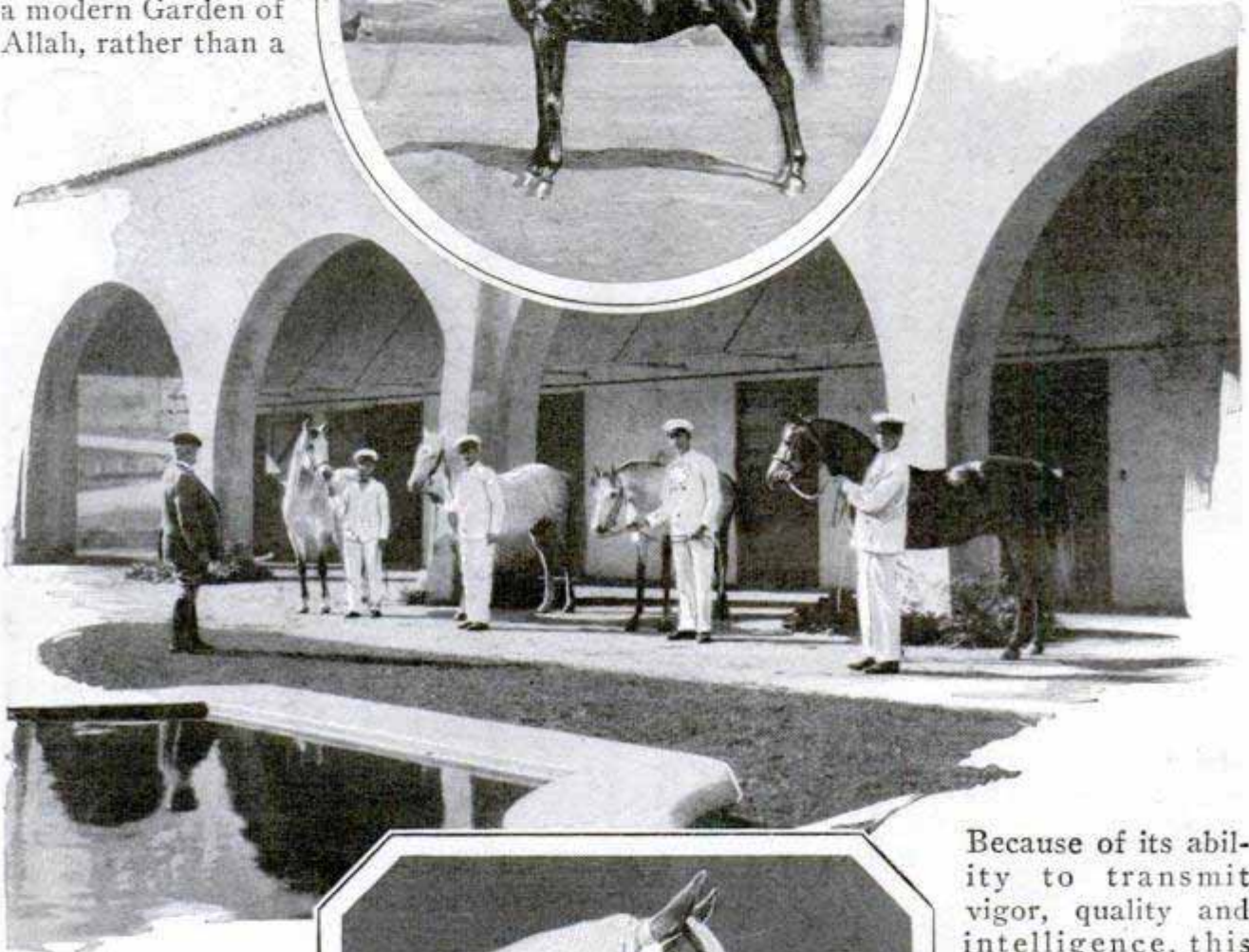

Center, W. K. Kellogg inspecting his Arabians at Pomona, Calif.; Above, "Raseyn," Champion Four-Year-Old; Below, "Autez," a Six-Year-Old Beauty

mere horse farm set down in the center of the southland's great citrus belt. Although its origin is steeped in mystery, the Arabian breed of horses is said to be found at its best in Arabia proper, and in the Syrian desert, and perhaps found in its greatest perfection along the Euphrates river, where the Bedouin tribes have developed them to their

Because of its ability to transmit vigor, quality and intelligence, this breed has always been regarded very highly as an improver of other breeds. Invariably, the Arabian is both gentle and affectionate, yet notably fearless, this latter trait being particularly noticeable in the young colts. In color the Arabian

may be gray, bay, chestnut, brown, sometimes white, but very rarely black. It weighs from 900 to 1,000 pounds. The

*Cmd. Robert S. Lyman, 377 W. Milford St. Escondido, Calif.*



gaits are the walk, trot, canter and gallop. They are easy to control and seldom become hot-headed. The Bedouins ride without a bit, doing their controlling with a rein attached to the noseband. Furthermore, they use only a pad without stirrups instead of the ordinary saddle, thus practically riding bareback. Primarily a saddler, the Arabian horse has been plentifully used for centuries in molding other prominent types and breeds.

**THE STORY OF CORK** 279

Green oak trees of a certain variety are literally skinned alive to furnish the world's supply of cork. The stripping is not begun until the trees are twenty years old, the first crop being practically worthless, and eight or nine years are required to grow another. The trees will live and thrive until they are 150 years old or more. About \$6,000,000 worth is imported into the United States every year. When metal caps came into use for stopping bottles, cork growers feared a big slump in their business, but new uses for the material have been found. Cork is now widely employed in the manufacture of refrigerating outfits for homes, artificial limbs, hat linings, inner soles for shoes, cigaret tips, and in the making of linoleum.

**KNITTING BALL HELD ON WRIST TO PREVENT DROPPING** 25 94

One of the latest aids to the knitter is a holder for the ball of yarn. It fits on the wrist, permits the thread to roll off easily yet keeps the ball securely in place so that it cannot drop or become snarled. For

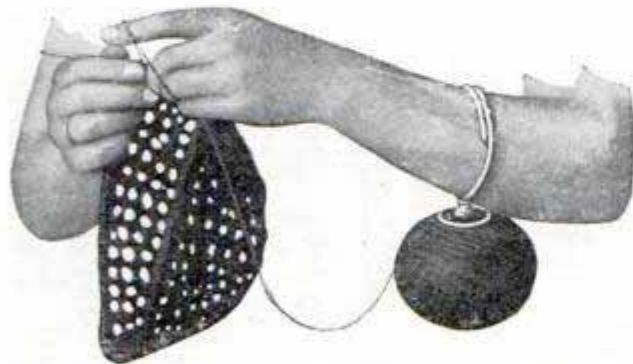

Dropping the Yarn Ball While Knitting Is Nearly Impossible with This Holder That Fits on Arm

large balls, the unit has a spring inside the shaft that can be extended.

*Karl Duttig, Milwaukee, Wis. Germany*



*Alonzo Victor*  
Sculptor Lewis at Work on One of the Washington Heads for Monuments to Mark Auto Roads

**HUGE STATUES OF WASHINGTON MARK ENTRANCES TO STATE**

Tourists entering the state of Washington through any one of the four principal roads leading to the commonwealth, will be welcomed by a huge statue of the first president, mounted on a pedestal forty feet high. Officially, Washington is the only state in the union entitled to use such an emblem. The model illustrated here is being prepared by Alonzo Victor Lewis, a Seattle sculptor.

**BIRDS THAT LIVE AT SEA** 277

When Col. Lindbergh was on his airplane flight to Paris, he noticed birds in mid-ocean and wondered how far they could fly from land and what they lived on. They probably were not seagulls, in the opinion of scholars, but might have been any one of several varieties of birds that commonly spend all of their time over or on the ocean, from the day they leave their breeding grounds in the early spring until they return again the next year. Seasnipes, phalarope and petrels are among these kinds, and one of the greatest sea flyers is the frigate bird. These species feed on small forms of ocean life, ride the waves like corks and survive the most violent gales with their heads tucked under their wings.

*Kansas City Star 6/13/29*



226 LEIPZIG'S TRADE FAIR IS AN INDUSTRIAL CARNIVAL



The Annual Fair at Leipzig, Germany, Which Draws Exhibitors from All Parts of the World and Buyers from All Europe, Is Really a Street Carnival of Gay Booths, like the Huge Vacuum Cleaner Above



SCHERZ-SCHUTZ-U-SPORTBRILLEN!  
Bienen- u. Rollaugenbrillen!  
Monstrel-Lorgnetten, etc. D.R.G.M.  
MODELLE-BLECHSPIELW.  
FRANZ RICHTER  
ZSCHOPAU Ss  
UNTERGÜNDIG-MESSHALLE-MAKRT  
ROYAL



Sandwich Men Parade the Streets Showing Enormous Alarm Clocks and Giant Spectacles, While Manufacturers Lavish Ingenuity on Such Oddities as Huge Chairs

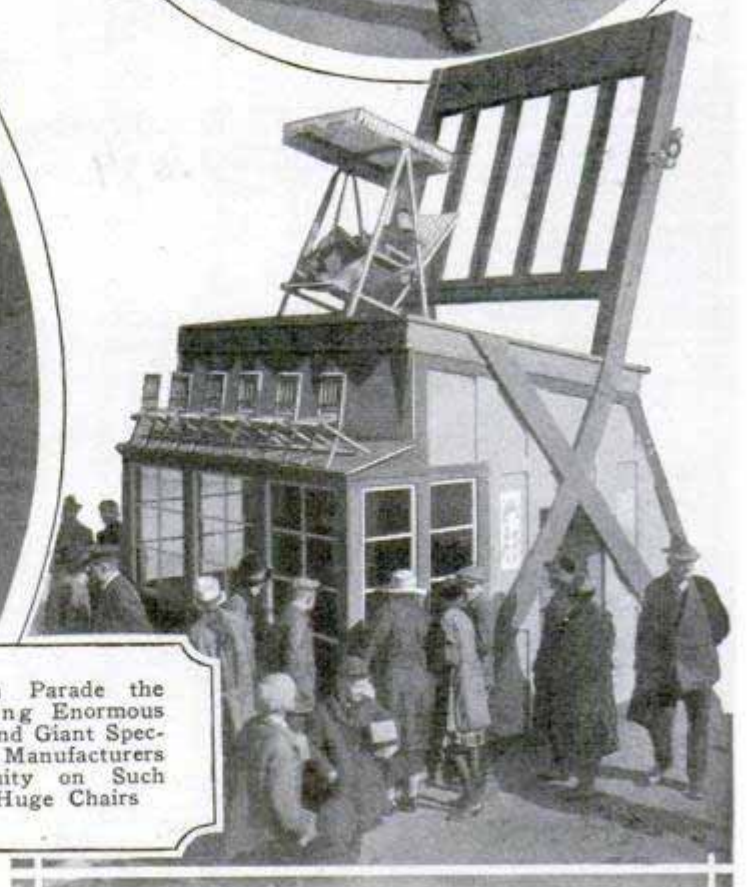



*Clarke*

**EARTHQUAKE MOVIE WITH CAMERA PREDICTED** 277

Earthquakes may take their own motion pictures with cameras placed at strategic points and set in operation by the tremor, in the opinion of Comm. N. H. Heck, of the coast and geodetic survey, who points out that such a record of the disturbances would be of great value in studying how buildings stand the strain of collapse and how the ground waves actually travel. The cameras would have to be left in position in open spaces and arrangements made for changing the film to keep it fresh, but these details could be managed with little trouble, he believes. During the earthquake in Tokyo, scientists calmly remained at the seismograph while buildings were falling around them or taking fire, and Heck suggests that a motion-picture operator would have no more hazardous task in obtaining his film record.

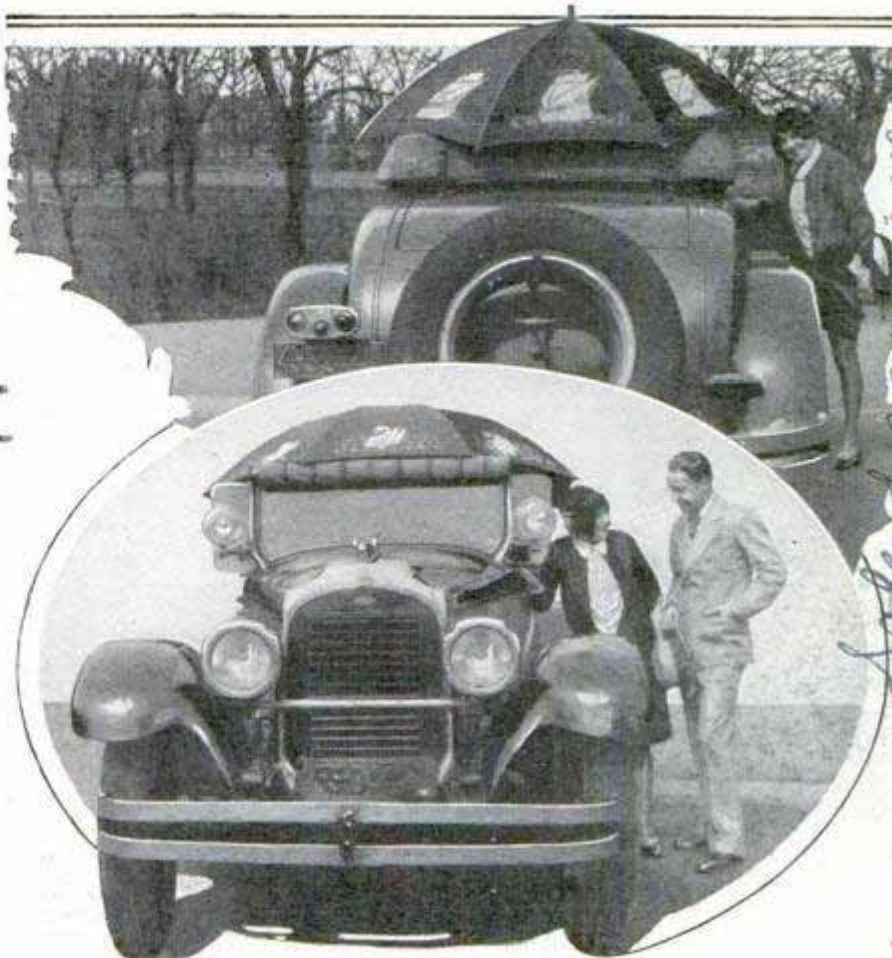

Front and Rear Views of the Sunshade Auto Top Installed; There Is a Small Window in the Back for Looking Behind

**BEACH UMBRELLA AS AUTO TOP NEW MOTOR ACCESSORY**

Colored beach umbrellas are being used as tops for open roadsters, special attachments making the installation a matter of a few moments. There is an open space in the rear to promote safety, and both pole and ribs are strongly constructed.

**BUTTERFLY IN PICTURE FRAMES LATEST ART NOVELTY** 276

Butterflies of various kinds are mounted in picture frames by a New York dealer to form novel decorations, and suggest a practical use for collections of the insects. On some of the frames, pussy-willow twigs are introduced and the butterflies mounted at different angles to increase the realistic impression of the work.

**CARBON-PAPER INSERTER SAVES TIME IN OFFICE WORK** 1672

To simplify the task of inserting a sheet of carbon paper between printed forms and receipts, an insurance company has devised an apparatus which does the work at the rate of 4,000 sets an hour, equivalent to the performance of six girls. The carbon is fed from a roll, automatically cut to the required size and inserted between the forms. Varying thicknesses of stock can be used, and the outfit is adaptable to work on different weights and sizes of paper. A feed device prevents clogging.

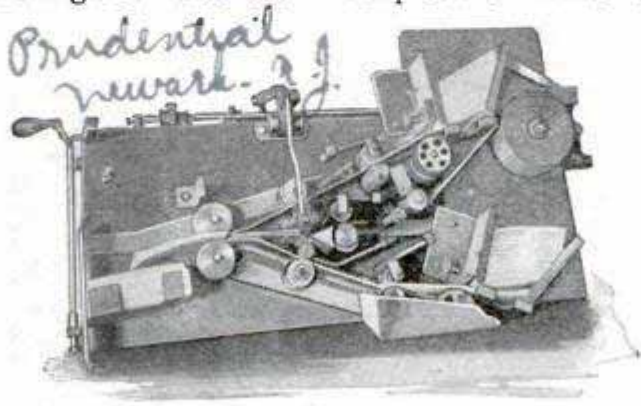

Side View of the Carbon-Paper Inserter

*Sale discontinued  
Dixie Umbrella Top Works  
2958 N. Oakley Ave Chicago*

*Designed by Emil Mueller  
Prudential Newark  
mechanical  
molder*

*Conceived by W.A. Meddetyre  
Supervisor Prudential Newark N.J.*

*The Butterfly Store  
300 10th Ave. New York City*



2534. "VACCINE" INJECTED IN TREES  
SUBSTITUTE FOR SPRAYING



Doctoring a Tree by Pouring Its Medicine into the Container Renders the Tree Immune to Pests

Injecting chemicals into trees through a specially constructed spigot has been found an improvement over spraying to make the trees immune to various insects, according to a German landscape gardener. He bases his conclusions on results from experiments with 1,200 trees. The chemical preparation is applied from time to time and is absorbed by the trunk, spreading to the upper limbs and twigs.

2656 MUSICAL TEST FOR MOTORS

By applying the principle of the xylophone to the brushes of electric motors, Dr. G. M. Little, research engineer of the Westinghouse electric manufacturing company, has developed a method for detecting defective units and thus averting accidents that might do extensive damage. A brush is worth about fifty cents when made of carbon, but might put an armature, valued at half the entire motor, out of commission if it failed. Dr. Little constructs a sort of xylophone, using the carbon brushes as keys. Then, employing one as a tuning fork and striking the keys with an ordinary drumstick, he determines by the pitch

which are of good material and which are not. A standard note is G sharp. Brushes of a lower pitch are found to be defective. An A-pitch denotes satisfactory ones.

2587 ARMY RUNS ITS OWN RAILWAY  
AT INFANTRY CAMP

One of the few narrow-gauge railroads now in active service in the United States is run by the army at the infantry-school reservation at Fort Benning, Ga. The road was constructed in 1920 to handle passengers, supplies and material over the 99,000-acre reservation. At that time, the roadbed was rough and unsettled, the equipment and motive power were in crude condition and wrecks and engine failures were frequent. Improvements have been steadily made until now the system has the latest type of equipment and is efficiently operated under the direction of the fort's quartermaster department.

1506 AERIAL MOTOR PULLS WEIGHT  
TO DETERMINE POWER

The strength of an airplane motor and the stability of the craft are tested at the Dresden technical university in a stationary frame with weights and gauges. The outfit is so adjusted that when the propeller exerts a horizontal pull, it lifts a weight at the rear. Different types and sizes of propellers can be used and the frame is also rigged to show the approximate reaction of a real airplane in flight during the test.

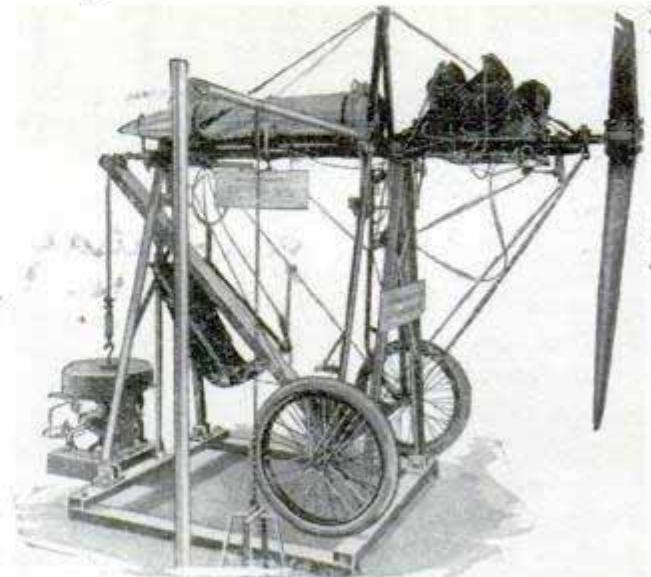

Testing Outfit Used in Germany to Measure the Actual Forward Pull of an Airplane Motor and Propeller

Water Clliché see later folder in muse. Feb under Agriculture

all these things are in the folder...



Mr. ...  
1823 2 St.  
Washington, D. C.

2543

# Hobbies that LED to INVENTIONS

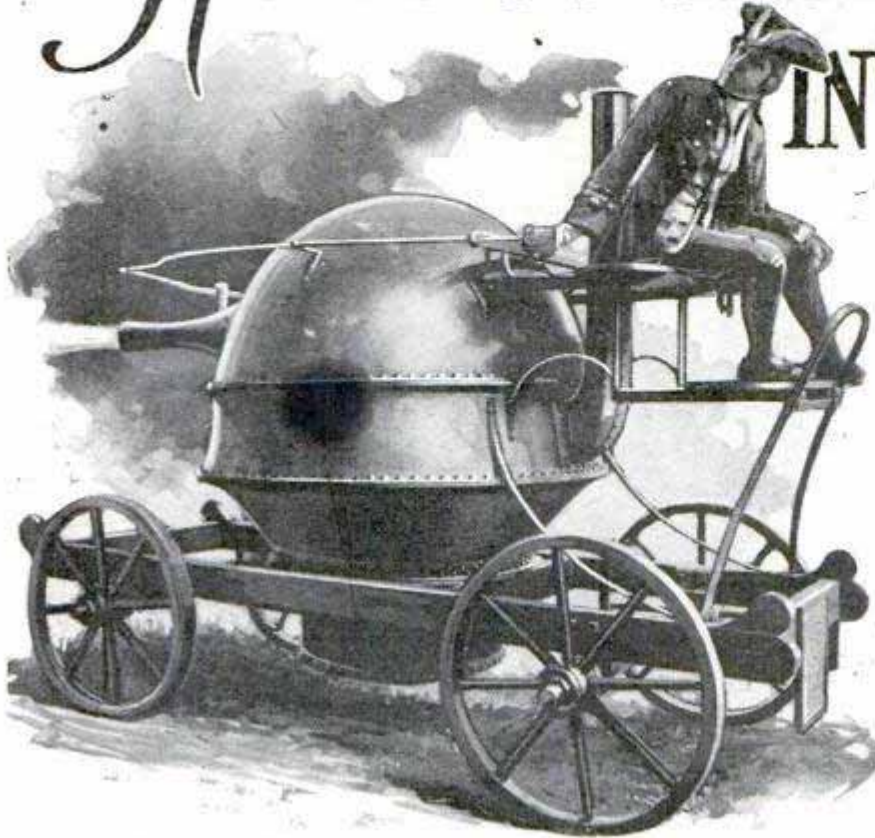

Sir Isaac Newton Designed This Locomotive in 1690, but Never Built It; an American Railroad Constructed the Model from His Drawings

By C. FRANCIS JENKINS

**N**EARLY all important inventions have developed out of hobbies. A man wants something to play with, outside of his workaday occupation. Taking it up in his leisure hours, he may be led to the finding of a new and useful idea.

Fifty years ago Emile Berliner was a clerk in a dry-goods store. For amusement, he took up the study of electricity. In textbooks on physics he found interesting the chapters relating to sound. When the invention of the telephone was first made known, in 1876, he was struck with the notion that it might be possible to transmit sound by electricity. For an experiment, he bought a toy drum and cut it in halves. One of the halves provided him with the means he needed. To the center of the drumhead, inside, he glued a small disk of wood, and through it stuck a sewing needle far enough to make its point protrude a very little way at the front of the drumhead. Then, from the rim of the head he suspended, by a metal string, a steel-ball button, so that it hung against

and in loose contact with the point of the needle.

With a simple arrangement of wires he caused a current of electricity to pass through the point of contact, by which means the current was thrown into vibrations at the point of contact and onward over a line wire to a distant Bell telephone receiver. When, thereupon, he spoke against the drumhead, a listener at the other end of the wire caught his words.

It was the first telephonic microphone, which rendered practicable the subsequent great development of the telephone. With the original Bell instrument it

was necessary to speak loud and very distinctly, putting one's mouth into the transmitter, while the receiver, conical in shape, was inserted into the ear. The Berliner invention supplied a battery transmitter which threw the voice into electric waves corresponding to sound waves, by means of a loose contact.

Alexander Graham Bell was a school-teacher. Study of sound became his hobby, and led to his becoming an instructor of the deaf. He taught classes of deaf persons with the help of a contrivance of his own, which was an arrangement of multiple rubber tubes, through which he could speak to a number of pupils at once.

It is said—whether truly or not—that the idea of the telephone was first suggested to Mr. Bell by a toy that was popular with boys fifty years and more ago. When two topless tin cans were connected together, by a long string fastened to their bottoms, words spoken into one of them were audible at a considerable distance by a listener who held the other can to his ear, the voice



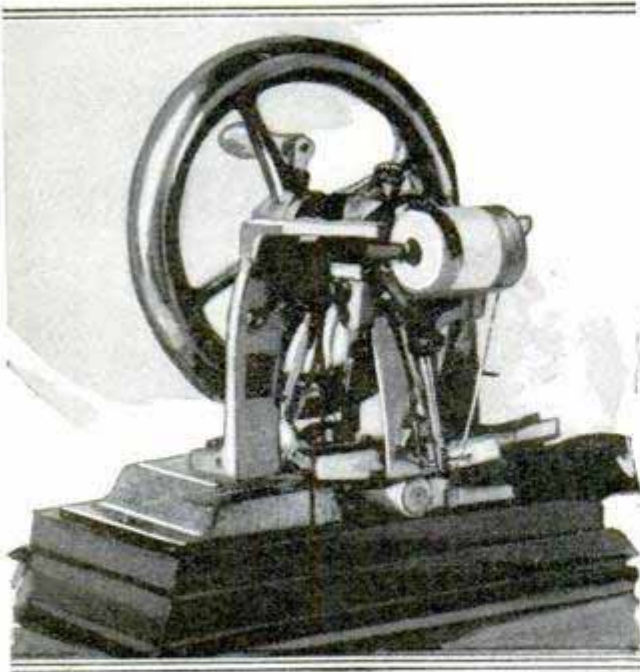

vibrations being transmitted along the string.

I understand it to be a fact that Bell took his first working model of the telephone to a government official, hoping to interest him in the invention; but the official could see in it nothing of practical usefulness, and said: "I dare say your contrivance works excellently, but who would want to talk through a thing like that?"

Nearly all great inventions have been products of poor men's imagination and ingenuity. Money develops but does not originate. Edison was of humble birth, his father a maker of shingles at a period when all shingles were made by hand labor. His first job was that of a train boy, selling newspapers and candy. At risk of his life, he saved a small child from being run over by a freight car, and the father of the child, in gratitude for the service, taught the boy the rudiments of telegraphy.

Young Edison made telegraphy his job, and became a remarkably speedy operator, earning high wages. But he wanted something else, outside of the day's work, to occupy his mind, and so, before long, he

developed an ingenious telegraphic device, which he offered to a company on Broadway, New York City.

This invention, as the result of a test, proved valuable, and Edison was summoned to an interview with the president of the company. As the story goes, the president said to him, "You inventors have a way of setting fabulous values on your ideas. I will pay you \$36,000 for your contrivance, if you care to accept that. You can take it or leave it."

The young man had trouble to conceal his surprise and delight. He had expected to get not more than a few hundred dollars. When a check for the amount was

handed to him, he could hardly believe that it was real money; and he felt convinced that it was only a joke when the teller at the bank on which the check was drawn refused to cash it for him. The difficulty, however, proved to be merely a matter of identification.

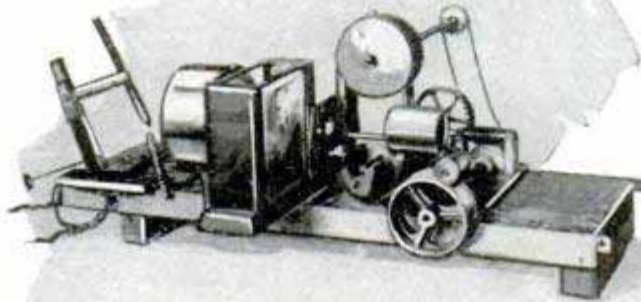

Three Original Models, Elias Howe's Sewing Machine, the First Movie Projector, and Emile Berliner's Telephone Microphone



George M. Westinghouse learned the trade of a machinist in Schenectady. Mechanical things possessed for him an extraordinary fascination and, when nineteen years of age, he invented a "frog" to put back derailed cars on railroad tracks. He was only twenty-one when he invented the airbrake, which is said to have been suggested to his mind by a railroad wreck he chanced to witness and by an article on pneumatics in a discarded magazine that he happened to pick up while traveling.

The story is that he offered the airbrake to an official who was at that period one of the foremost among American railroad men.

"Do you mean to tell me," said the official, "that you can stop a railroad train with wind?"

"Well, yes, if you choose to put it that way," replied young Westinghouse.

"I have no time to waste on fools," said the magnate, terminating the interview.

Nevertheless, the first train experimentally equipped with the airbrake stopped so suddenly

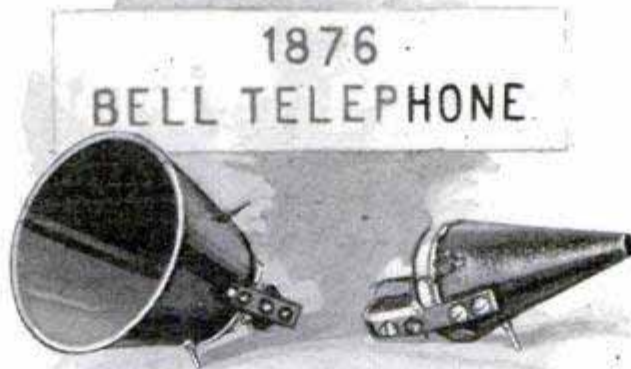

that it was wrecked. The airbrake made high-speed railroad-ing possible, and is reckoned to have saved more lives than Napoleon lost in all his battles.

The Wright brothers, Wilbur and Orville, were earning a livelihood by repairing bicycles at Dayton when they took up flying as a hobby. Neighbors were accustomed to speak of them as "those crazy

Wright boys." Their early experiments were "gliders." At that time the patent office itself looked upon flying machines as pretty nearly in the same class with perpetual-motion contrivances. The rest of the story tells itself.

Mergenthaler, who invented the mechanical typesetter, was a maker of telescopes and other scientific apparatus. The famous astronomer Herschel built his wonderful telescopes and astonished the world by his discoveries while earning a living playing the fiddle at dances, concerts and other entertainments.

Morse, inventor of the telegraph, was a portrait painter. Stephenson, who developed the locomotive, was a Welsh coal miner. Corliss, inventor of steam engines,

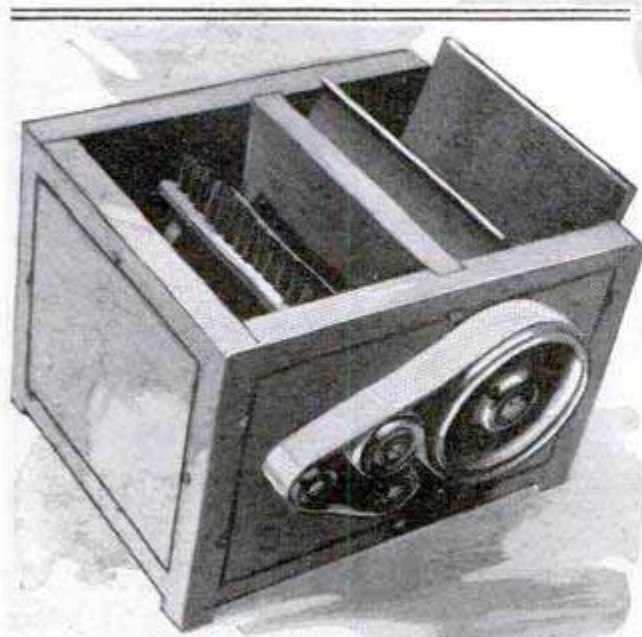

Mrs. Nancy Johnson's Original Ice-Cream Freezer of 1843; Bell's First Telephone Model, and Eli Whitney's Original Cotton Gin





German Cartoon of 1830, Making Fun of Illuminating Gas; the Covered Buckets Were Supposed to Contain Gas for the Walking Street Light

made his experiments after working twelve hours a day as a meat cutter. Eli Whitney, a Connecticut Yankee, was a cabinet-maker by trade. On a visit in the south, he saw negroes separating cotton from the seed with their fingers, a slow and laborious operation. It occurred to him that the work might be done by a machine, and hence his invention of the cotton gin.

William Murdoch, a poor mechanic at Redruth, in Wales, was struck with the idea that gas from coal might be used for lighting. That was 1796. He lighted his own humble home by that means, and his neighbors became convinced that he was in league with the devil. When Murdoch's invention was first considered by a committee of parliament, a member said to him, "Do you mean to tell me that it is possible to have a light without a wick? Ah, my friend, you are trying to prove altogether too much."

It was supposed at that time that living flame passed through the pipes, and, when illuminating gas was first experimentally introduced in the house of commons, fire engines were at hand with hose laid ready.

The first motion-picture projecting machine was my own invention. I was then a stenographer. I took delight in mechanical things, working at them in my leisure time. My projector was the outcome of a hobby, but eventually proved to be the

prototype of the projecting machine in every theater the world over to this very day.

Thomas Jefferson's pet hobby was mechanics, for which he had a "flair," as evidenced by his invention of the swivel chair and the copying press. The former is in universal use today, while the latter, until superseded within recent years by other devices, was deemed indispensable to the equipment of all business offices.

It pays to have a hobby. A hobby makes life more interesting, and there is always a possibility that pursuit of it may lead to

something worth while in the way of invention or discovery.

### GAS STATION LIKE UMBRELLA SERVES MANY CARS

2347 Besides being ornamental, an umbrella-shaped gasoline filling station in Portland, Oreg., has practical advantages in that cars can arrive and depart at all angles and there are no posts or obstructions.

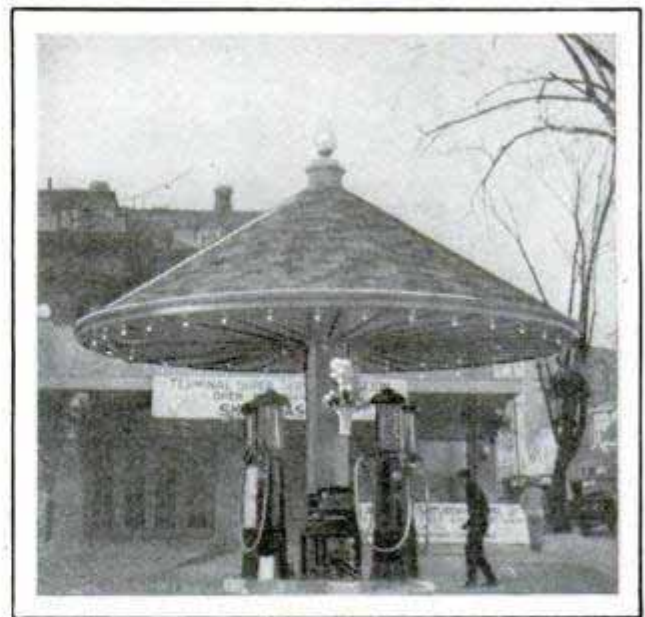

Unique Shelter for the Gasoline Pumps of a Filling Station Provides Protection without Bulky Columns

Five pumps are provided. The umbrella roof is attractively lighted at night.

Carl Carlton Isroak  
of Empress Theatre The



2496 C.C. Crane  
 Castiglione, Paris,  
 POPULAR MECHANICS  
 Castiglione  
 23 Haymarket, London, S.W.1

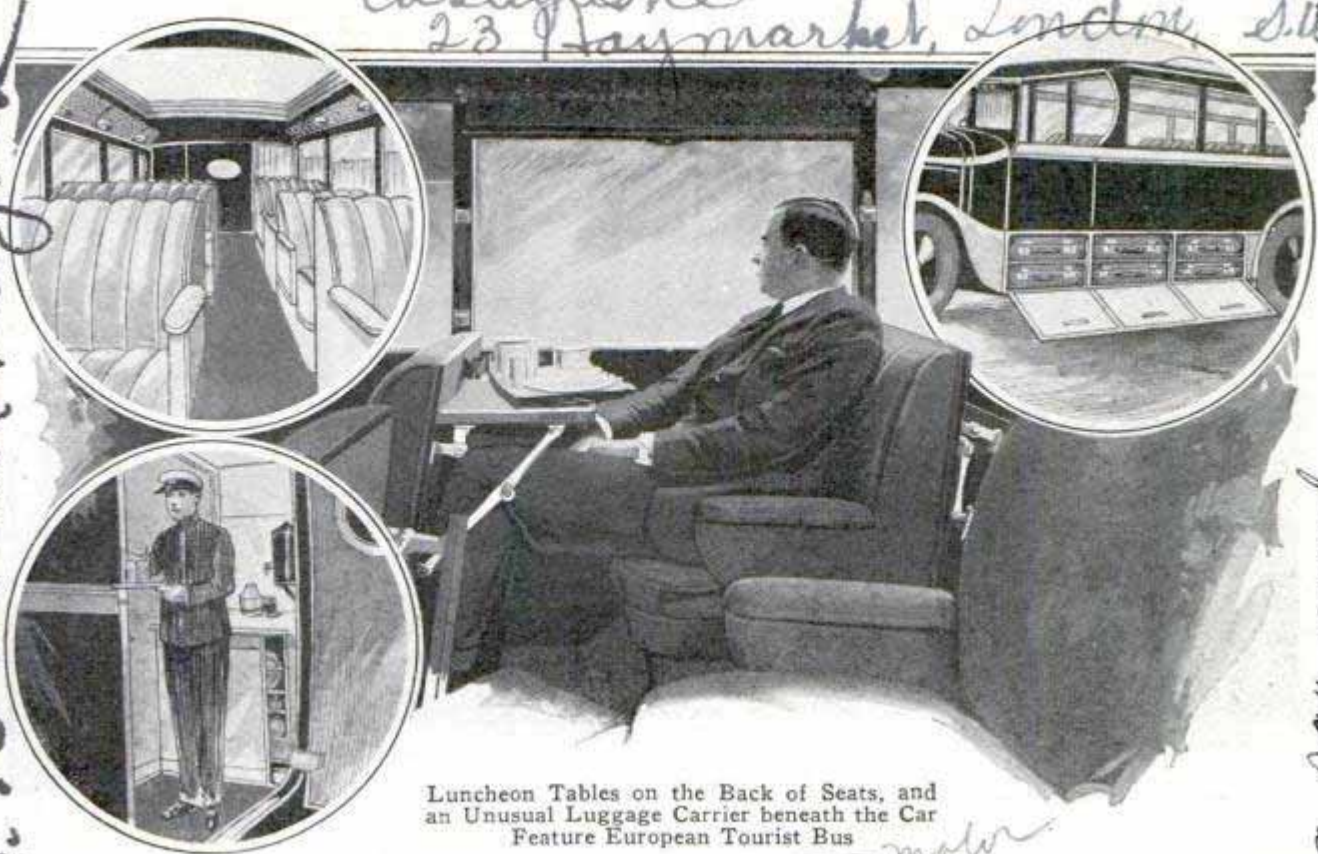

Luncheon Tables on the Back of Seats, and an Unusual Luggage Carrier beneath the Car Feature European Tourist Bus

**MOTOR COACH WITH KITCHEN  
 NEWEST TRAVEL LUXURY**

2496

Conveniences generally found only in the most luxurious railroad cars are afforded travelers in motor coaches built for a tourist line in Europe. There is a kitchenette from which afternoon tea is served daily. Each seat has a folding table under the glass top of which is a map of the day's run, and passengers are given luggage cases that fit under the bus in a dustproof compartment. The grips become theirs after the journey. The coaches have sliding tops that can be pushed back to afford an unobstructed view above. Toilet facilities, wide aisles and armchair seats are other comforts.

*to be used only under care of physician.*

**NEW RAY FOR SKIN TREATMENTS  
 LATEST MEDICAL AID**

2604

Reports of successful treatments of skin diseases with the "grenz ray," a form of radiation shorter in length than the ultra-violet light and longer than X-rays, were made before the American medical association recently. Since the new ray is not so penetrating as the X-rays, it is believed that it may be used with little injury to the skin. Favorable results have been obtained with it on twenty-seven kinds of

skin diseases upon eighty-seven patients it was claimed. Another medical aid is heparin, a substance obtained from the liver of dogs to keep the blood from clotting during transfusion operations.

**DETACHABLE REEL ON FAUCET  
 PROTECTS HOSE**

2398

Hose is kept from kinking and knotting when wound on a detachable reel that may

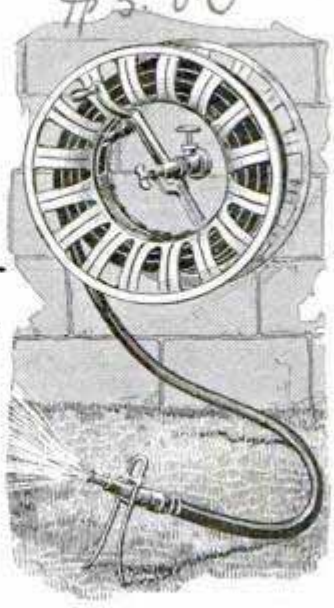

be quickly clamped to the faucet or removed and hung on the wall when not in use. It has a capacity of 125 feet of five-eighth-inch hose, is made of galvanized iron and weighs but little. A nickel-plated faucet is furnished with it. The reel protects the hands, saves time and work, and, as it can be easily moved from

one outlet to another, considerably less hose is required, and the absence of kinking prolongs its life.

Discovered by Dr. J. J. Allen and Dr. E. J. ...  
 173 E 80th Street, New York  
 173 E 87th Street, New York  
 173 E 87th Street, New York

Castiglione Ray machine made by  
 Castiglione, Paris  
 23 Haymarket, London, S.W.1

Kansas City Star

The Specialty Mfg. Co.



Emb. C. Moran, 3025-13th St. N.W., Washington, D.C.  
Dynamite Co., Exchange St., N.Y.  
Porter, Cable Machine Co., Salina, Exchange St., N.Y.

Review of 1007335  
more  
no. 2  
no. 1  
no. 1



Killing Insects on Two Rows of Plants at Once, the "Spider" Fumigator in Operation; the Canvas Tents Keep the Dust from Blowing Away Too Soon and Help Expose the Branches

### "SPIDER" MOUNTED ON TRACTOR FUMIGATES PLANTS

Resembling a huge spider, a dusting apparatus, mounted on a tractor, spreads insect-killing preparations on plants at the rate of twenty-five acres a day. The dust is distributed through four nozzles and is kept from blowing away by a canvas covering, one on each side of the machine. These have flaps that closely surround the plants and give each one an intensive dusting for about eight seconds. The outfit is adaptable to different field crops and to rows of various widths.

### PORTABLE ELECTRIC HANDSAW WEIGHS TEN POUNDS

A portable electric handsaw, which weighs but ten pounds and has the saw blade mounted directly on the armature shaft, eliminating all gears, embraces several novel features. A cooling fan on the motor is arranged to exhaust inside the saw guard so that it blows the sawdust away. Most of the parts are made of

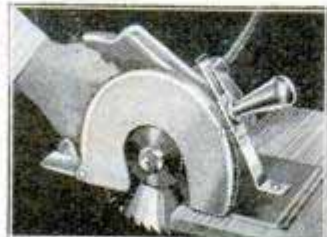

aluminum or duralumin, which accounts for its light weight. A seven-inch combination saw, for either crosscutting or ripping, is standard equipment, but hollow-ground saws for particularly fine cutting, or other special types, can be furnished. Motors for either 110 or 220-volt direct or alternating current, of 25 to 60 cycles, are supplied with the outfit.

### EARTHQUAKE RECORDER IS AID TO INDUSTRY AND COURTS

The seismograph, the delicate instrument used in recording earthquakes, is finding a place in industry as an aid to the location of oil domes, helping to solve railroad claims and to determine whether the vibrations due to blasting in large constructive undertakings are detrimental to surrounding property. Its service to the oil hunter lies in the fact that the earth waves set up by the explosion of dynamite, travel from two to four times faster through the salt domes where oil is more likely to be found. Hence, by setting off charges about a seismograph as a center, the prospectors can gain a fairly accurate idea of the character of the ground below the surface and be guided in sinking their shafts. Recently, when residents near a cement-block factory in the neighborhood



of New York city objected because they believed the vibrations from the heavy machinery cracked the plaster in their homes, a seismograph was set up to measure the jars and showed that they were no greater than those caused by a man walking across the floor of a house. The suit, started by property owners, was thrown out of court as a result of the instrument's evidence. Seismographs were used in measuring the force of the explosions while blasting out the East river tunnel in New York to prevent breaking water mains and causing other damage. When a greenhouse owner asserted that moving a railroad line fifty feet nearer the glass structure caused breakage of the panes due to the vibration from the trains, a seismograph proved that the closer location had increased the force of the vibrations hardly a millionth part. In another case, it was shown that heavy quarry blasts did as little damage to houses a quarter of a mile away as a person walking in them.

**AUTOMATIC CIGAR LIGHTER HAS LARGE GAS FOUNT** 25 70

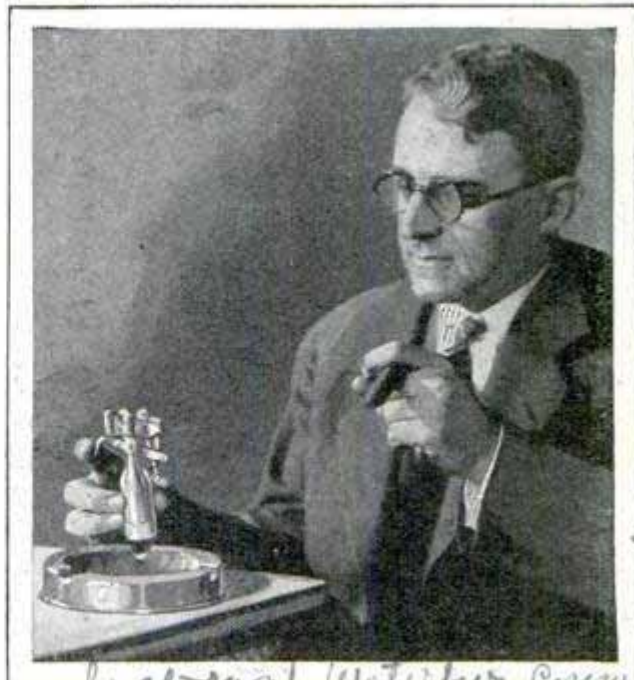

How Cigar Lighter Is Used and Base That Holds It to Ash Tray; It Has Large Container for Benzine

An automatic cigar lighter with an unusually large fount for the benzine is being manufactured. Besides the extra-size gas supply, which removes one objection to previous lighters, the mechanism has several novel improvements. It is being manufactured as an individual unit on its own base, without a base to fit in a small cup attached to the ash tray, instead of the usual match-box holder, and in the same form is being placed on lamp-stand trays.

**ELECTRIC BOAT FOR CHILDREN RUNS ON BATTERIES** 26 93

Started or stopped simply by turning a switch, an eight-foot boat is run with current from two storage batteries and develops a speed of seven miles an hour. It will go for about fourteen hours continuously on one charging. The motor used is a common type of automobile starter and is rewound so that it will reverse the drive shaft whenever it is necessary to stop the boat or back it out of the docking place. The craft is especially suited for fishing, as it is silent, and the same feature makes it suitable for use in duck hunting.

**AIR FILTER HELPS HAY FEVER BY KEEPING OUT POLLEN** 27 08

Persons suffering with hay fever, asthma and similar ills are said to receive marked relief in rooms where the air is specially filtered to keep out the pollen of weed and plant blossoms, often at least partly responsible for the ailment. It is arranged to suck air in at the rate of 150 to 200 cubic feet per minute, sufficient to change the air in the average bedroom in five or ten minutes and is operated by a fan run by an electric motor.



Easy to Operate and Steer, the Electric Boat Is a Source of Fun for Children and Is Good on Fishing Trips, as It Is Silent

*Steel & Johnson Mfg. Co. 174 W. Wabash  
 Chicago  
 280 Madison Ave. New York  
 Ohio  
 Dr. J. J. Johnson,  
 4063 E. 176 St. Cleveland*

*Visited in designing boat. Mr. Bushel called to Wagon*

*Agent for Western New York  
 Alfred J. Lawrence  
 7063 E. 176 St. Cleveland  
 Warren, Pa.*

*at number 6621 in Ocean, sed*



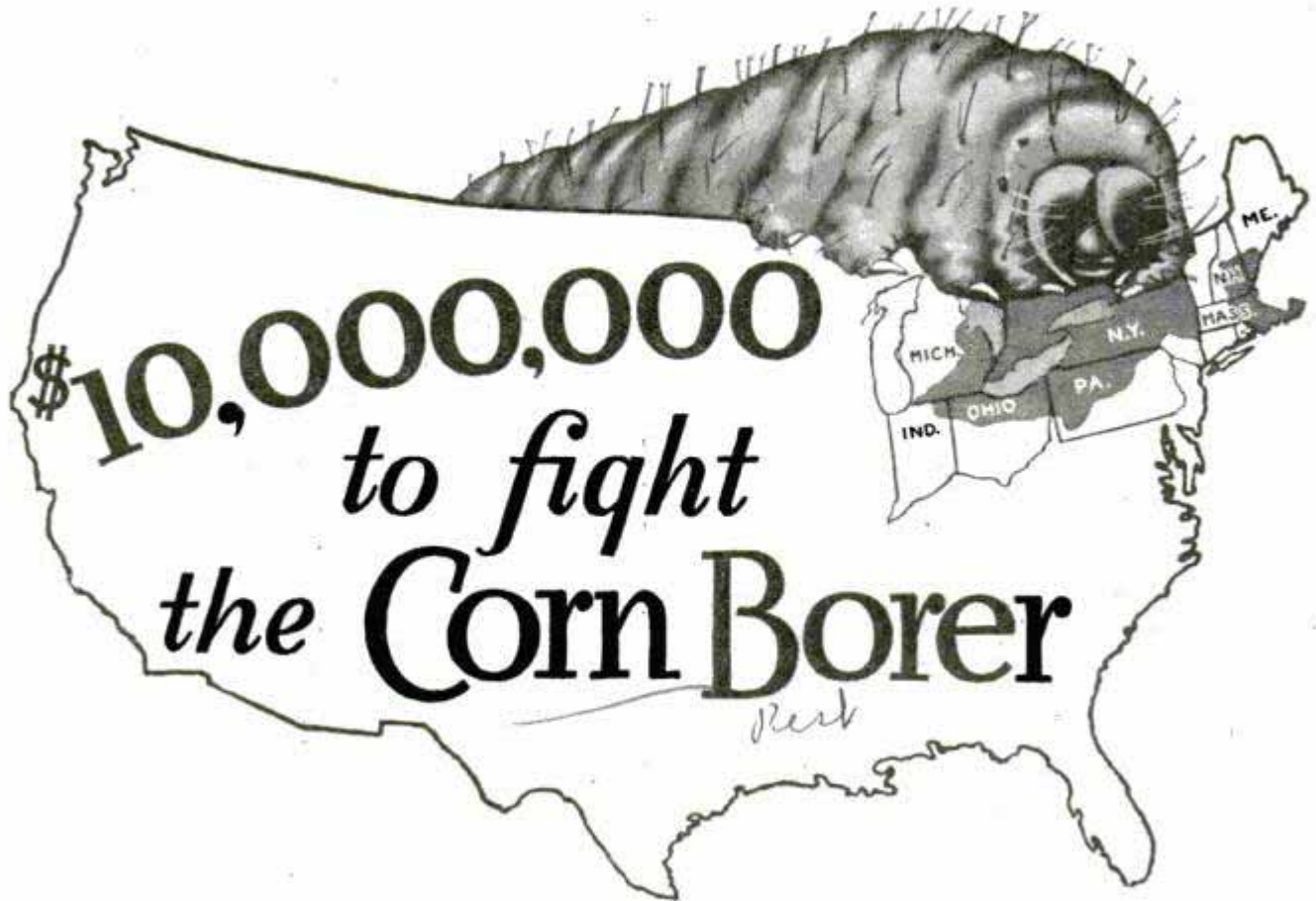

### Government Spending Huge Sum to Wipe Out the European Pest, Which Threatens Great Staple Crop

TEN million dollars is the price that has been placed on the head of an insect by the United States government—the largest reward ever offered for the extinction of any living thing. The millions, however, are considered but a small price to pay if the European corn borer, an imported pest from overseas, can be wiped out in time to save the \$2,000,000,000 annual corn crop.

The borer is believed to have come to America in broom corn imported from Italy and Hungary. From broom plants in New York and Massachusetts it spread to the fields, and then began a western march which has already reached at least one county in eastern Illinois. With the exception of parts of Indiana, it has not as yet penetrated the heart of the corn-producing country, and with ten millions to spend fighting it, experts of the department of agriculture hope to hold the pest in check until some means of eradicating it can be found.

Though corn is its favorite diet, the borer will eat almost any kind of vegetation, being particularly inclined toward

beans, beets, potatoes, hops, celery, cow-peas, rhubarb and garden flowers, such as the aster, chrysanthemum, gladiolus, dahlia and sunflower. Even weeds can support it, and heavily weeded patches have been found to contain as many as 400,000 borers to the acre.

To meet the attack, the federal government, besides providing ten million for equipment, has enlisted the aid of the individual states, not only financially, but through special legislation to enforce the co-operation of the farmers. Heavy fines have been provided to back up the quarantine regulations, which prohibit the transportation of any plant in which a borer may be concealed. Warning signs are posted at the limits of infected territory, forbidding the carrying of green corn beyond that point, and last year several hundred thousand automobiles were stopped by patrols and immense quantities of green corn confiscated and destroyed.

Unless carried into new territory by moving of corn, the normal advance of the borer, all in the summer moth-flying season, has been about twenty miles a year,





Wiping Out the Larvæ of the Corn Borer by Burning the Stubble and Surface of a Corn Field; the Nozzles Generate a Heat of 1,400 Degrees as They Are Dragged Along

though last year, because of high winds, it leaped about fifty miles ahead. The only practical method of wiping it out is destruction of everything in which it may be lodged, since it resists all known poisons. Five species of corn-borer parasites found in France, however, have been imported, and this year 500,000 of the parasites, hatched from cocoons in special incubators, are to be liberated in Ohio to test their ability to wipe out the borers.

The main attack, however, will be made on more than 400,000 farms, having 2,500,000 acres of corn land. Train loads of tractors have been purchased by the government, to be used in plowing up the land and destroying every vestige of corn stalks and cobs. Farmers who do the work voluntarily will be paid \$2 an acre by the government, and those who refuse will have their premises cleaned up by government crews and will be charged the bill, in the form of special taxes. Unless the campaign succeeds in checking the pest, it may be necessary to restrain planting of corn for a year or two in the infested regions.

The borer does its worst damage in the

larva stage, before it turns into a moth and takes to the air. The eggs are laid in the corn stalk by the previous generation, hatch out into the larvæ, and the latter begin to eat. They bore through the corn stalk until it is only a hollow shell, easily broken off by the wind.

Many of the worst insect pests we have, have been imported from abroad. Ships and cargoes from overseas, or produce and cattle imported over the Mexican border have brought in the corn borer, the Japanese beetle, the San Jose scale, gypsy moth and browntail moth, cotton boll weevil and pink bollworm, alfalfa weevil in the west and the Mexican bean beetle which has reached eastern bean fields.

Despite the work being done not only here but abroad to combat injurious pests, these classes of insects are actually on the increase, according to L. O. Howard, chief of the bureau of entomology. Insects annually cause a loss in the United States of \$2,000,000,000, he says.

Where the insect pests come from, and why and how they become so closely associated with one particular crop that they



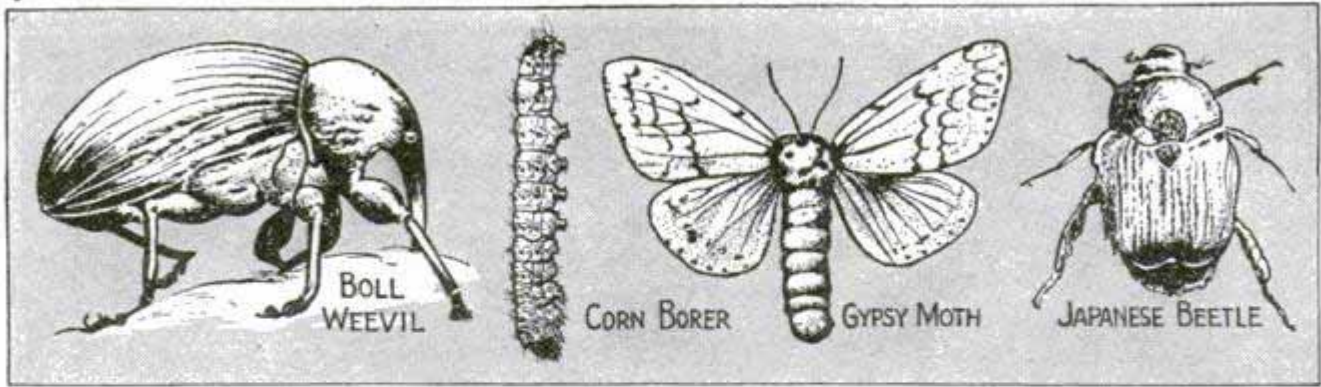

Some of America's Imported Pests, against Which the Agricultural Department Wages a Steady Fight to Prevent Their Turning American Farms into an Unproductive Desert

threaten to destroy it, is an interesting story. The early pioneers in the west found that what the drouth did not destroy often would be eaten up by the native grasshoppers or chinch bugs, while the Hessian fly would destroy the wheat over large areas. When they turned to fruit, the native borers, or curculio, and the imported codling moth took a hand. As commerce abroad grew, more pests kept coming in, and other native insects which had been raised on wild plants developed a taste for cultivated fields.

Mr. Howard traces the advent of the corn borer back twelve years. His bureau has been working ever since it first appeared to find a means of controlling and eventually eradicating it. Because it feeds within the stalk and ears, it cannot be reached by the usual sprayed poisons. The only satisfactory method yet found is a change in farming practice. For seven months of the year, the borer lives in the caterpillar stage in the corn stalk. Farmers have been in the habit of cutting the stalks some distance above the ground, or leaving them in the field all winter after picking the corn, the stalks to be plowed under in the spring to enrich the ground.

If all stalks are destroyed in the fall, by gathering and burning them, all the borers they contain will be effectively wiped out, Mr. Howard says. As an alternative they can be cut off at the ground level and placed in silos to be used as cattle feed.

The insects of the world present an enormous problem for study. Entomologists estimate that there probably are at least 5,000,000 different species, of which only 600,000 kinds have been classified and studied. Many of them are harmless, and

many can be turned to good account by being used to prey on the harmful species. Experts of the government are continually searching the world for new species which are harmless in themselves but can be used to attack others that are not wanted. It was in this way that the parasitic enemy of the corn borer was found in France.

Fascinating stories of the lives of minute insects are constantly being unearthed in the studies of entomologists all over the world. Prof. J. Arthur Thompson, regius professor of natural history at Aberdeen university, in Scotland, tells of the common house gnat, which has been using a short-wave broadcasting set and a very sensitive directional receiver for ages before men invented radio and the loop aerial.

Mrs. Gnat, though only a fifth of an inch in length, can broadcast signals for Mr. Gnat to pick up. She employs tiny and tightly stretched membranes over some of her breathing tubes, vibrating them at a very high rate so that they emit a shrill sound, entirely distinct from the usual buzzing sound made by the rapid vibration of the gnat's wings. The male gnat has a pair of sensitive antennæ which act as a directional loop. He maneuvers until the sound made by his mate comes in with equal distinctness on both antennæ, and then flies directly toward the sound. If he gets off his course, he has only to hover for an instant while he "tunes in" again.

Experiments made with a tuning fork adjusted to the exact pitch of the female gnat's signal showed that the males were attracted in swarms, proving it is the sound and not any sight of the mate that guides them.

The insect world is full of marvels even



more interesting. People have to learn nearly everything in life, for only the most elemental cravings are born in them, but the insects, animals and birds are born as master builders, engineers, weavers, often producing structures so mathematically perfect—as is the bee's honeycomb cell—that it taxes the ingenuity of man even to duplicate it. Yet their knowledge is wholly instinctive, for all members of a given species are inclined to build their homes exactly alike, regardless of whether the design is suited to the surroundings to which they may be transplanted. It is only in the higher animals, like the fox, that an ability to adjust the plan to the surroundings is developed.

In British Guiana, on the northeast coast of South America, there is a whole cycle of life concentrated in the stem of the leaf of a tree, three kinds of insects living there in harmony, and all dependent on each other for success.

First a queen ant gnaws her way into the stem to find a nest for her eggs in the dried-up, fluffy pith inside. The worker ants hatch out and open the door, which the queen has made, so they can go and come about their business. Then a brood of mealy bugs appear, attracted by the dried pith, which is their favorite food. Whether the mealy bugs come of their own ac-

cord or are brought in by the ants, scientists have never been able to learn, but the latter is quite possible, for the bug eats more than it needs, and the ants proceed to use it as a cow, "milking" the bug to get the excess. The milking process is unusual. The ants gather around the overfed beetle and begin to thump it on the back, according to Prof. J. Arthur Thompson, who has

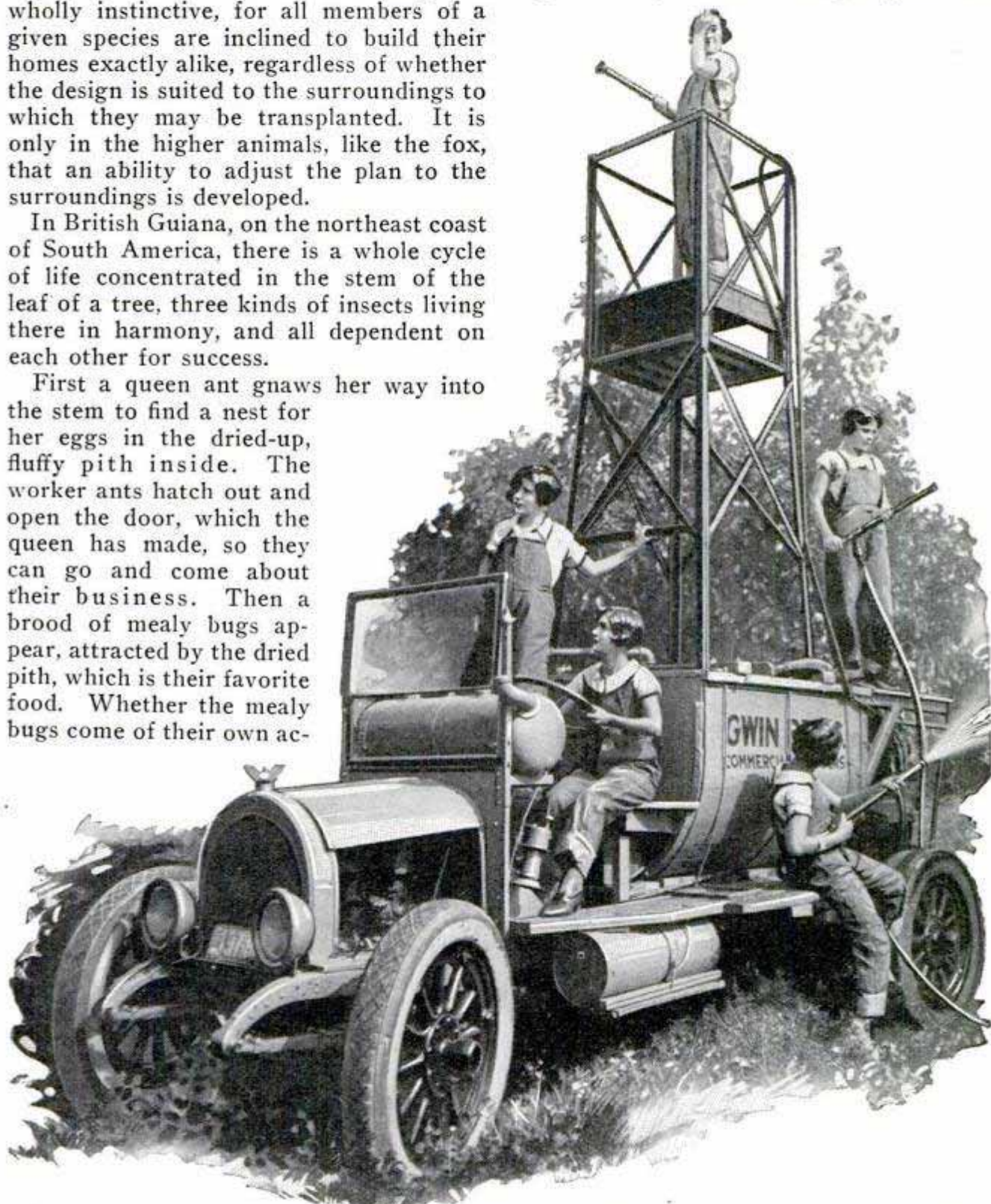

Automobile Spraying Apparatus Developed to Save the Orchards of California from the Inroads of Destructive Parasites That Have Been Brought Here from Abroad



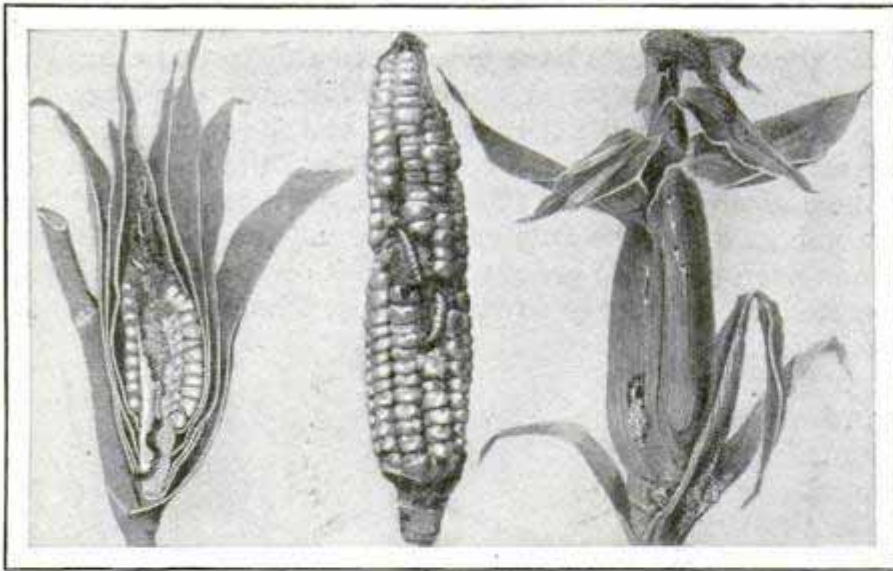

Three Examples of What the Corn Borer Does to One of America's Great Staple Crops if Left Alone

described the process in his book "The New Natural History." As the pounding continues, the bug gives up a drop of sap, which is eaten by the ants. Then the thumping is resumed until another drop is obtained, a process that may take as much as half an hour.

Pretty soon a third boarder arrives in the leaf stem, a pair of small, slender, dark-brown beetles. They set up house-keeping and join the ants in milking the cow bugs. To earn their keep, the beetles erect a small round tower at the entrance to the leaf stalk, and here one is always on guard duty, ready to repel invasion or sound the alarm. As the beetles multiply, the mealy bugs increase in about the same ratio, so that there is usually a cow for every young beetle. Everybody appears to get something out of the apartment-house crowding except the mealy bug, but, as a matter of fact, it is one of the chief beneficiaries, for it has to get to the food inside to live, and, being unable to make an entry for itself, it is dependent on the ants and beetles whose slave it afterward becomes.

Another insect nature has fitted, in an unusual way, to cope with the problems of life, is the ant lion, which is really the larva stage of a rather large-winged and night-flying fly. When full-grown, the ant lion is about half an inch in length. As it emerges from the egg, however, it is a much smaller edition of what it eventually will be, just a little creature a twelfth of an inch in length. Despite its smallness, it immediately proceeds to earn its name

of lion, for it sets to work to burrow a pit and then sits down in the bottom to wait for a much larger ant to tumble in and furnish a meal.

The burrowing process is unusual. The ant lion always moves backward in a spiral course. When it finds a dry sandy place suitable for a home it starts to burrow, moving backward in concentric circles. The earth plowed up by its tail is shifted on top of its head, and then thrown clear by a

series of explosive upward jerks. Going round and round, the ant gradually digs a deep and steeply walled cone and takes its place at the bottom.

When food tumbles in and tries to claw its way out, the ant lion begins to throw particles of sand at the invader until it is swept off its feet and carried to the bottom—seemingly a case of unusual intelligence. As a matter of fact, scientists, according to Prof. Thompson, have decided that whenever a particle of sand lights on the ant lion's head it automatically gives an explosive jerk and hurls it upward and away, just as it does in digging its trap. So when the intruder tries to climb out and knocks sand particles down on the ant's head, the latter hurls them upward—not at the insect trying to escape but all around the cone—and some of the sand eventually sweeps the "meal" off its feet and down to the waiting ant lion.

### TEAKETTLE STEAM IS USED TO RENOVATE CLOTHES

Easily attached to the spout of the teakettle, a flat-topped chamber makes use of the steam to renovate and iron ties, dresses and other articles. The gar-



ment to be treated is drawn over the steamer with slight pressure to crease it, the vapor reaching all parts of the fabric.

*J. R. Horton*  
1214 Clay Ave.



2500

# QUEER FRENCH CLOCKS CELEBRATE WORLD WAR

Three of M. Boulat's Unusual Clocks; That of the Allies, at Left, the Branch Clock, at Right, and the Fantastic Heaven Below

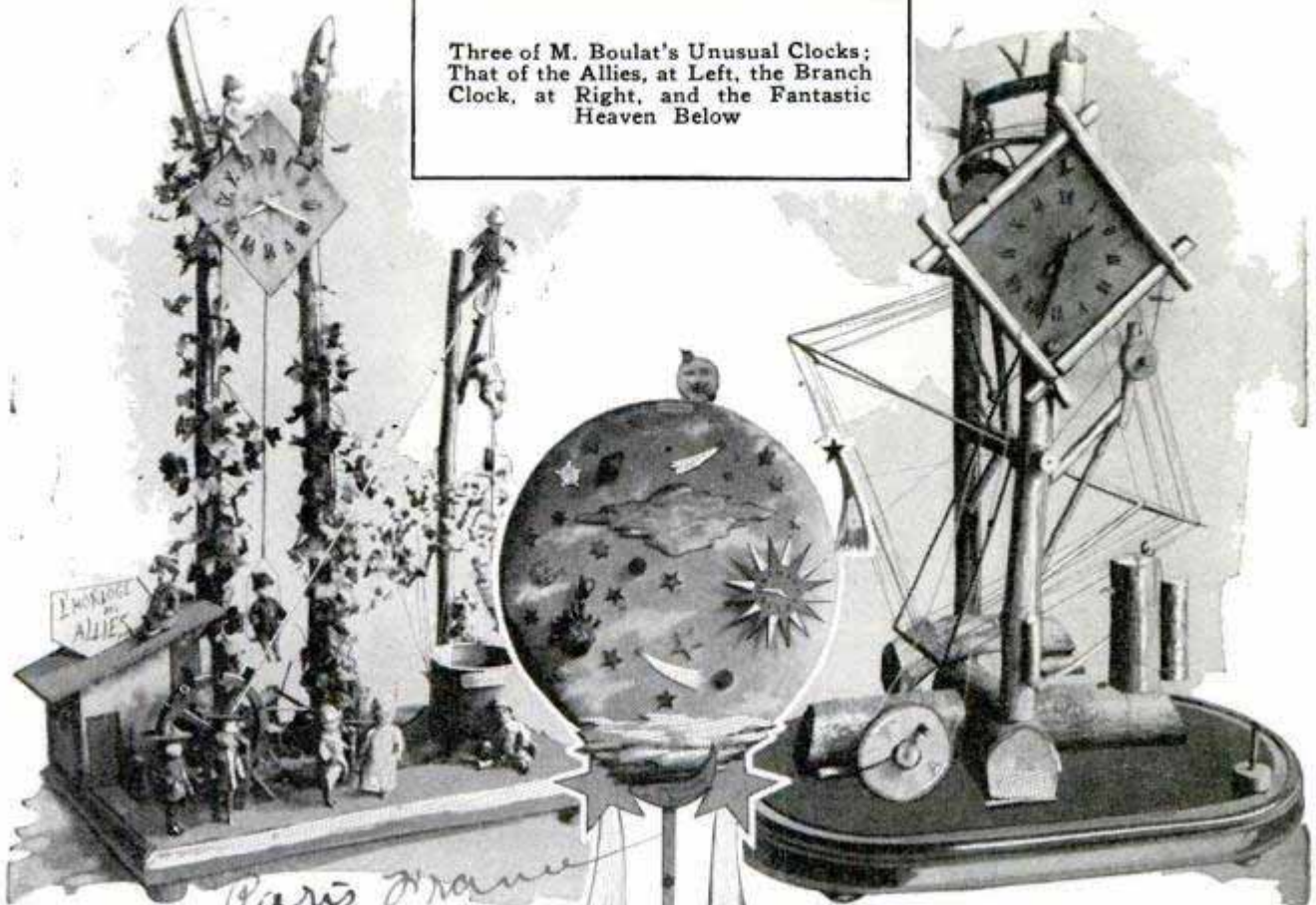

*Paris, France*

M. Boulat, a French clockmaker with a taste for the fantastic, has become noted for his unusual timepieces. One, which he calls "L'Horloge des Allies," or the "Clock of the Allies," has a small figure representing a German soldier, caught by the seat of his trousers. Once an hour, while figures representing the allied generals look on, the mechanism winds up a string attached to the German, and then releases him, to fall into a vat labeled "sauerkraut." Another queer clock conception shows a globe studded with stars, and a large sun, the latter bearing the clock face. At the top of the globe is a happy-faced moon representing the German ex-kaiser. A comet, which represents Marshal Foch and is traveling around the rim of the globe, knocks the kaiser off his perch, and he disappears behind the clock, to reappear at the bottom as a sad-faced moon, when the operation is repeated. Still a third one, which he has named the "Branch clock," is constructed

of parts made from a single tree branch and a spool of thread, wound up around a framework so that it resembles a loop aerial for a radio receiver. Even the gong on which the hours are struck by a wooden

mallet is carved out of the same kind of material.

## HUNT MYSTERIOUS BLUE GOOSE IN NORTHERN WATERS

Search for the little-known blue goose, and study of other birds that frequent the north, are objectives of an expedition of scientists who have fitted up a fifty-three-foot schooner for a stay of several months among the fastnesses of northern Labrador and Baffin bay. The explorers hope to find specimens for further observation and study. Among other things, they have taken 10,000 non-rusting tags or bands to place on birds captured, so that their wanderings may be recorded.

*Boston Traveler 5/21/27*

*Headed by Dr. Ulmer  
of Austin Superior*



## 2651 CAVELIKE GROTTO CATCHES OLD-WORLD CHARM

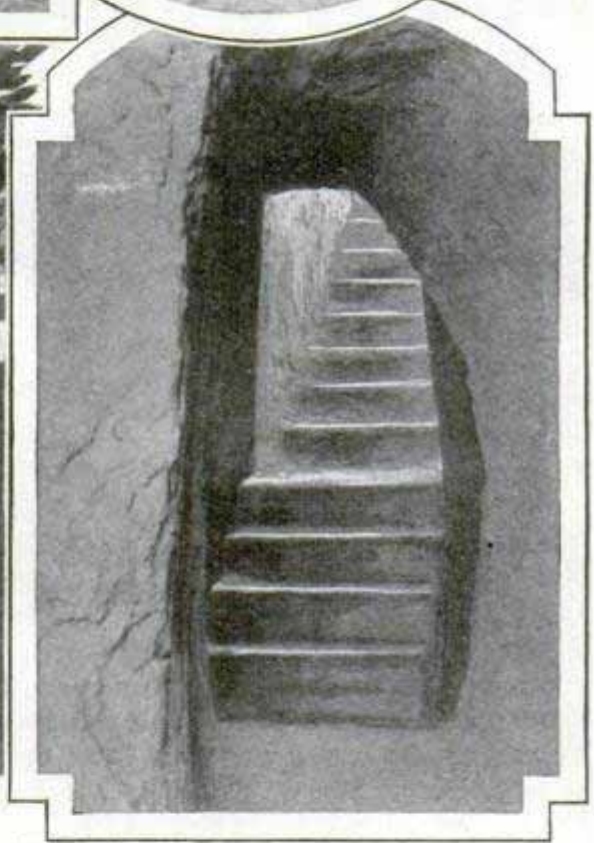
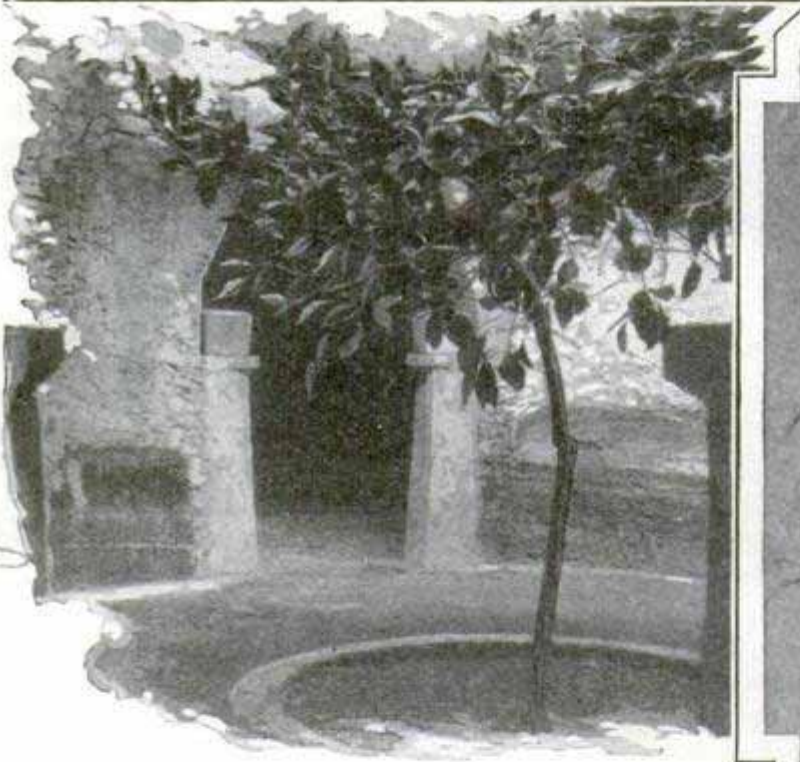
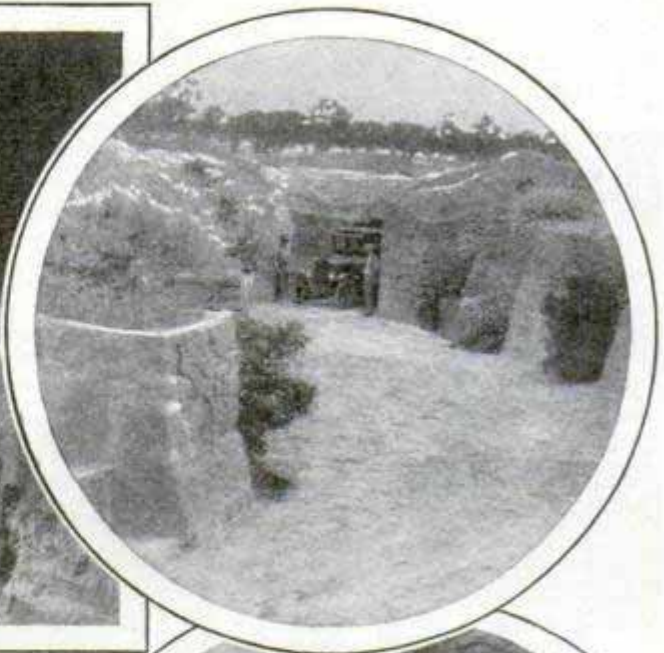
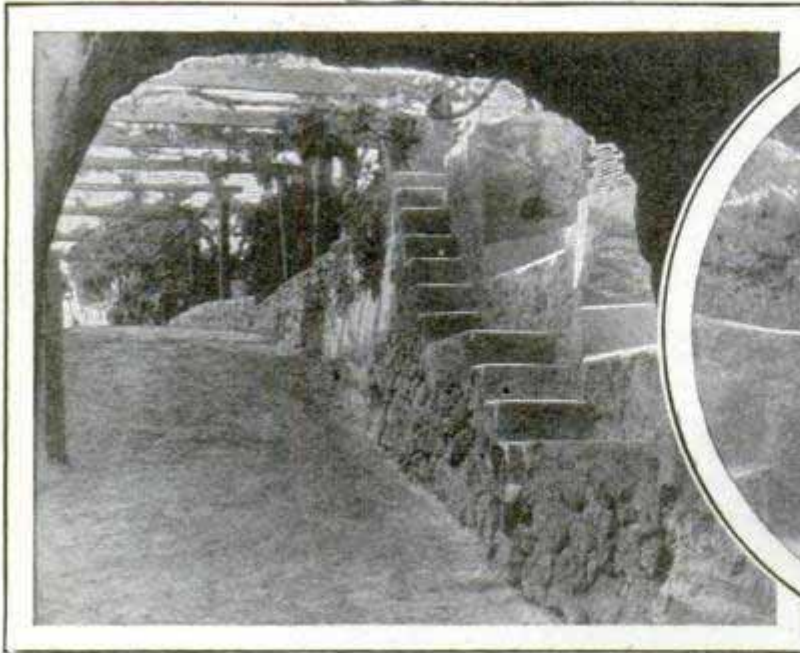

One of the Rock Stairways, Upper Left; the Entrance Drive with Its Orange-Tree Bays, Right; a Courtyard, Two Stories Underground, with a Lemon Tree in the Center, and One of the Stairways

A sixty-room underground grotto, modeled after the semi-cave dwellings of southern Italian hillsides, has been constructed by a transplanted Italian in southern California. A portion of the structure is used as a public cafe and the rest as a residence, while the builder's plans call for an eventual addition of over 100 more rooms. The semi-cave construction lends itself to endless expansion, since there is no exterior form to be pre-

served and chambers can be added indefinitely without spoiling the appearance. Rock and cement stairways, arched doorways, quaint courtyards, in which lemon and orange trees grow far below the normal surface, pools and fountains, are among the features. The sloping entrance way, down which automobiles can drive, is flanked by a series of bays, in each of which an orange tree flourishes. The bays are cut back fifteen feet from the drive-

Baldysan Dorestore, near Fresno.



way and so sloped that they will absorb all the water that enters the drive even in the hardest storm, preventing the streams from running down into the apartments.

**SCHOOL FOR NIGHT WATCHMEN TO HELP PREVENT FIRES** 282

More than sixty per cent of the time, or about eight months of the year, millions of dollars worth of property in the United States is under the sole care of watchmen. Surveys have shown that many of these men do not know how to turn in fire alarms, do not know the location of stand pipes and valves and have little knowledge of what to do in case of a fire or theft emergency. To improve these conditions, a training school for watchmen is to be opened in Chicago this September under the supervision of the fire underwriters and Frank C. McAuliffe, chief of the fire-insurance patrols. It will be of six weeks' duration, the courses given including special instruction on fire prevention, sprinkler equipment, automatic and other fire-alarm apparatus and general duties of a watchman. One morning each week will be devoted to the lessons, and at the end of the training, students will be given diplomas certifying to their preparation, provided they pass the final examination. The instruction is free. Already more than 100 men have been enrolled for the school and a corps of experts enlisted as teachers.

**FLAVOR COAT FOR CREAM CONE LATEST SUNDAE NOVELTY** 2549

Ice-cream cones are converted into sundaes with the aid of a simple unit that spreads a coating of fruit or other flavor inside the cone before the cream is introduced. The machine holds two quarts of liquid flavoring, is simple to operate and, when not in use, is tightly covered to protect the contents. The sirup is thick enough to prevent saturating and breaking the cone.



National Cone Sundae Co,  
1615  
Spiermont Ave.  
1921



Earphones in This Rubber Suit Permitted the Swimmer to Listen to Programs While under Water

**BATHER HEARS RADIO PROGRAM BY EARPHONES IN SUIT**

Radio fans who want to enjoy programs while swimming, may be able to do so while under the water, with the aid of an earphone-equipped rubber suit recently tested. A swimmer wearing it, listened in as a radio dialogue was in progress between a diver and an occupant of an airplane not long ago. The earphones of the suit were plugged into the diver's receiving set, and a long extension cord permitted the wearer free movements.

**ALUMINUM STREET CAR QUIETER AND SAVES POWER** 2821

Following a test of six months, Cleveland traction officials have reported that the aluminum street car is quieter than the usual kind and operates at a saving of about twenty per cent in power. It weighs but fifteen tons as compared with the twenty-one tons of the usual steel type. The decrease in noise is due to the fact that aluminum is not as good a conductor of sound as steel. Resistance to wear also was satisfactory, officials reported.

Cleveland Railway Co. and Aluminum Company of America.

no data available



# Sunshine

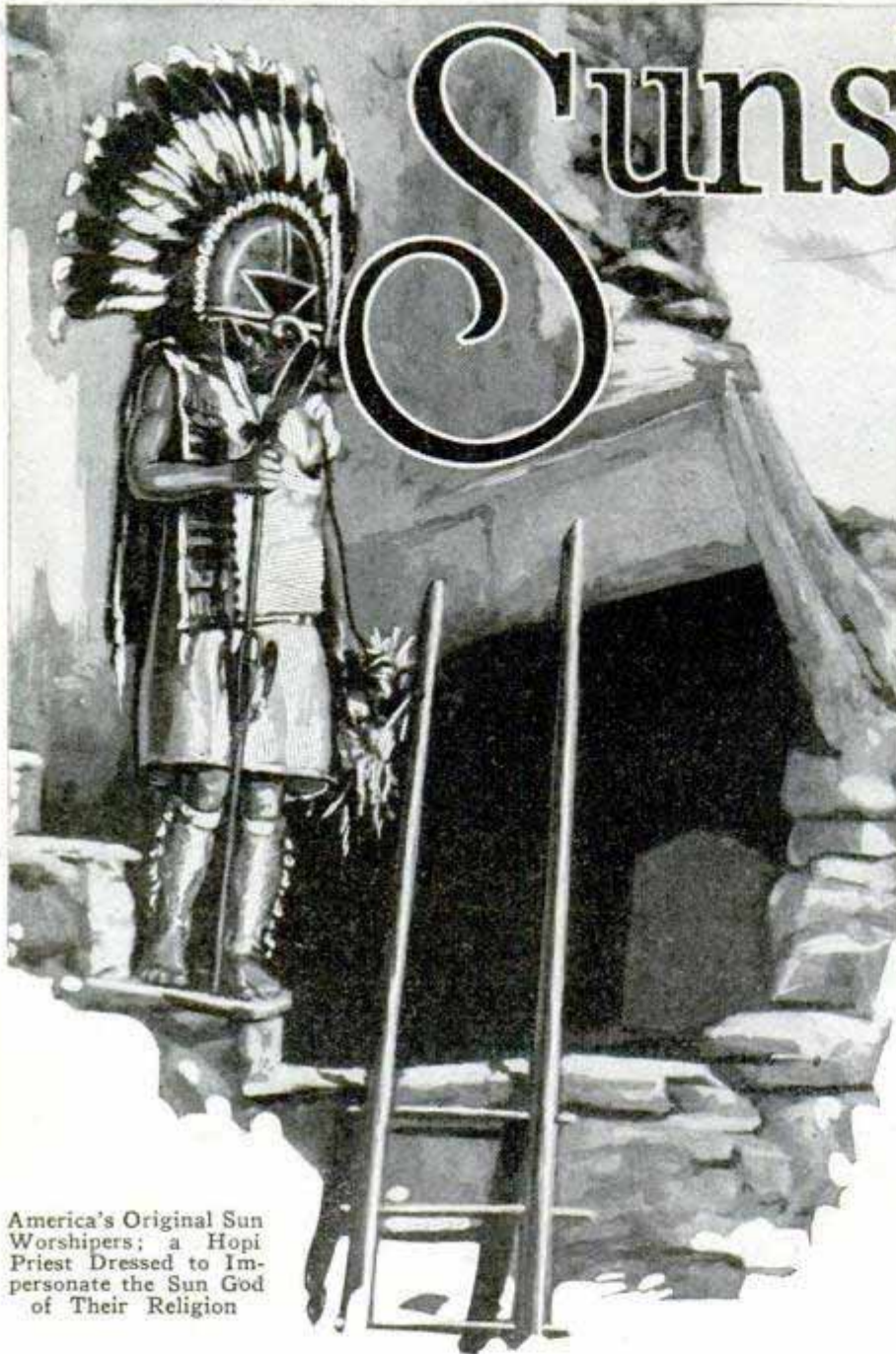

America's Original Sun Worshipers; a Hopi Priest Dressed to Impersonate the Sun God of Their Religion

ONE of the world's oldest religions, sun worship, is being revived again, not as a religious belief, but because of new discoveries of the part the sun plays in maintaining health, life and happiness.

Without sunlight children would waste away with the bone disease rickets, followed by tuberculosis; adults would be pale and weak and subject to colds and pneumonia, animal life could not be maintained and even the plants would turn sickly-pale and wither away.

It is remarkable that it took so many centuries to interest men in the light that protects them against so many evils. What is sunlight? From sunrise to sunset the earth is being bombarded by a limitless

stream of invisible waves. They cover a wide range of sizes, just as their companion radio waves vary in size. A small part of the sunlight waves, when they enter the earth's atmosphere, become visible to the eye. Below the visible band, and also above it, shading off into ultraviolet at one end and infrared or heat waves at the other, are other waves which the eye, unaided, cannot see. All of them are moving through space at the same rate, roughly 186,000 miles a second, so the very short waves of ultraviolet are much more frequent than the long infrared waves.

The discovery by science that some of the visible waves at the violet end of the spectrum and more of the invisible ultraviolet rays beyond the realm that the eye can see are capable of making the bones develop, furnishing the green in grow-

ing plants, causing tan, and also sunburn, and protecting against colds and the weaknesses that make one susceptible to many diseases, is responsible for the growing popularity of the sun. Once the therapeutic or healing waves were isolated, science soon produced an artificial light to provide them whether the sun shines or not, and from that it was but a step to the latest-model lights, the power of which can be varied at will to give sunlight or double or triple sunlight, so that the equivalent to an hour or an hour and a half on the beach can be had in thirty minutes or less under the light.

The discovery that ordinary window glass stops practically all of the health-



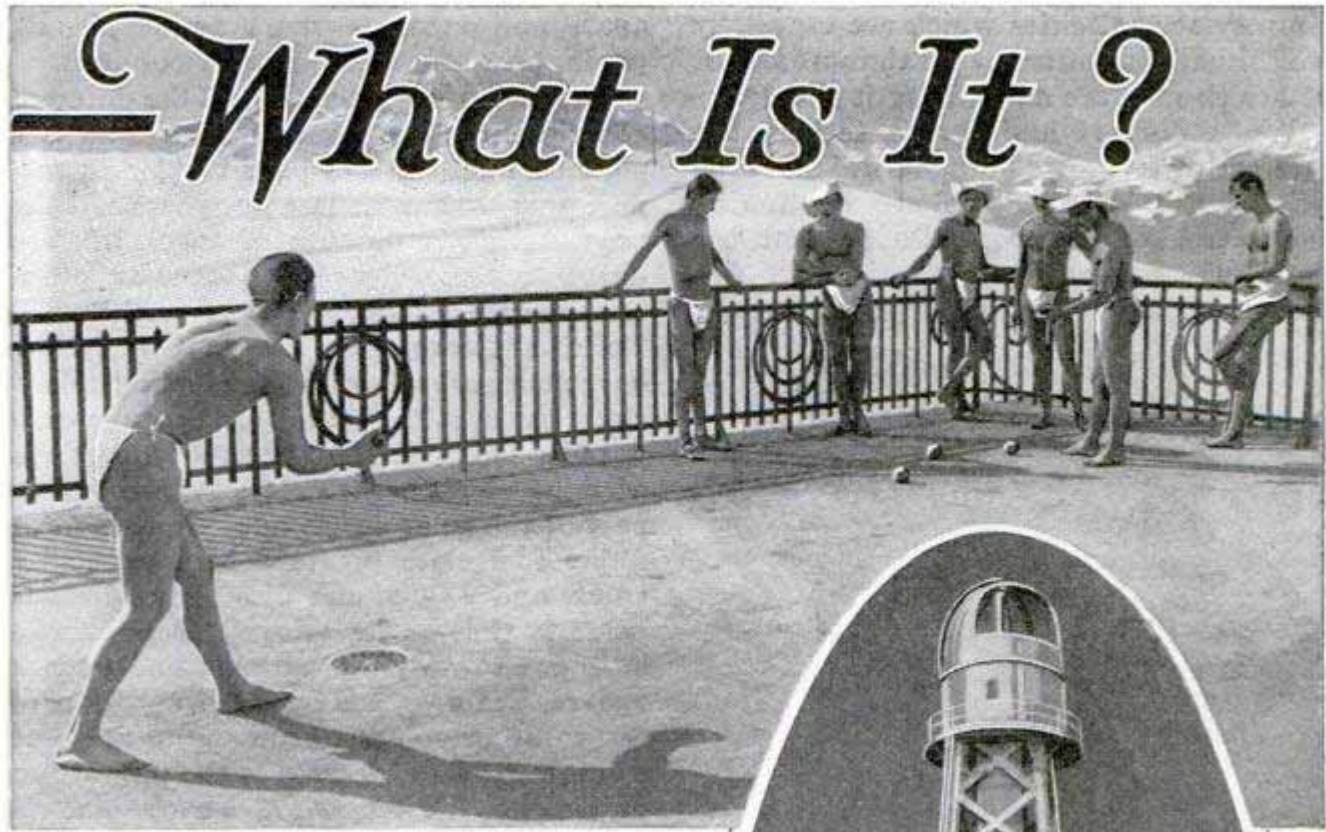

# What Is It?

Sun Bathers Getting Tanned amid the Snow of the High Alps, and Solar Telescope at Mount Wilson, Calif.

giving rays and passes only the visible light, was one of the biggest scientific surprises in many years. The electric-furnace production of quartz glass, however, solved the difficulty, by making quartz windows and quartz globes for mercury-vapor lights possible. One drawback, however, of the quartz lamps has been that the powerful ultraviolet rays emitted from the mercury lights were so strong that they could only be administered under medical supervision to patients with their eyes carefully shielded by goggles, to prevent blindness and excessive sunburn.

A new type of light has been developed, however, and is now in the experimental stage, which produces the healing rays with practically none of the burning ones, so that long exposure will give a coat of tan without bad sunburn, and will not endanger the eyes.

The growing sunshine worship has led to keen rivalry between cities with the maximum amount of annual bright days. In England daily measurements of the ultraviolet radiation are made and published in the newspapers of several cities, along with the more familiar weather statistics, such as rain and temperature. In this

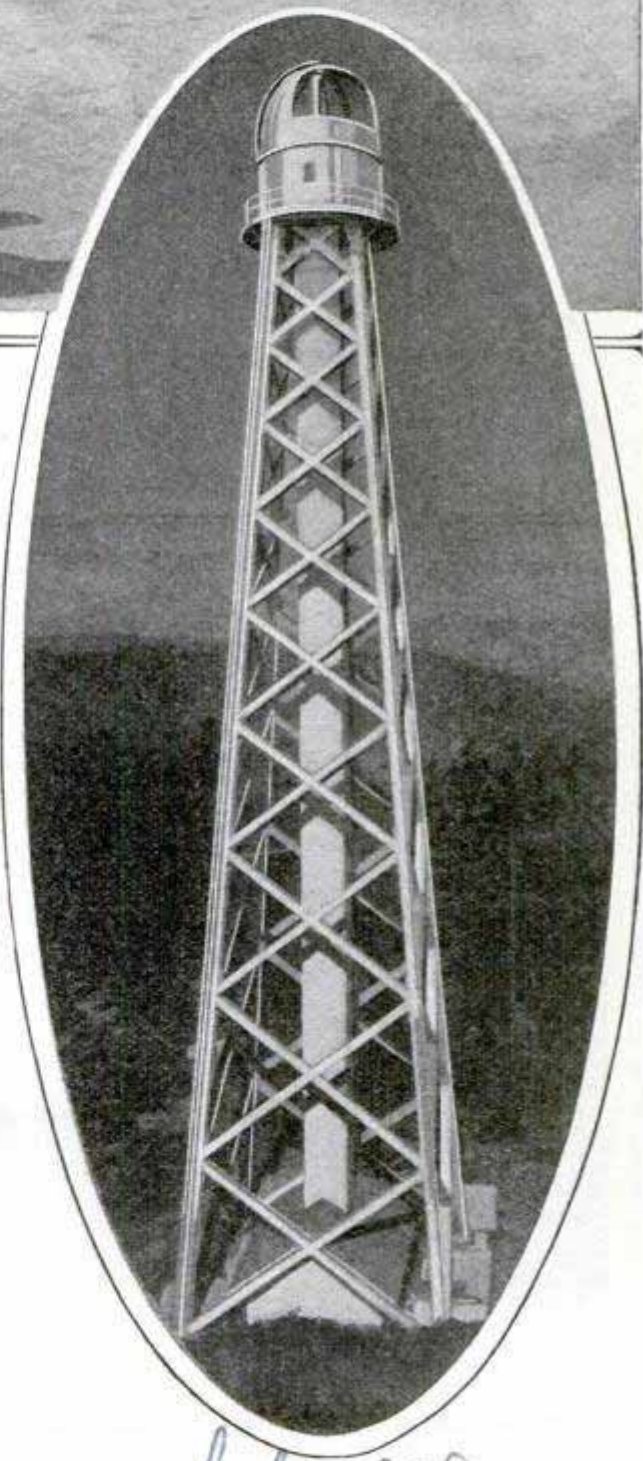

*Will be put on market 1928  
Lieber-Glarsheim Co  
410 Howe St*



country several cities which are especially well situated to offer the maximum amount of health rays are advertising it widely.

While doctors and health seekers are attempting to utilize both natural and artificial sunshine, scientists are continuing the search of its properties so that the world will know all possible about it. Instruments have been developed to take it

apart and measure the amount of red, green, blue and violet light it contains.

The task of investigating all the different constituents and phases of sunshine is a gigantic one, and has been tackled in earnest only within the last few years. At the present time a number of specialists are devoting themselves to particular problems in this field. Thus a well-known Polish meteorologist, Dr. L. Gorczynski, has spent several years in traveling to various parts of the world for the sole purpose of studying the relative proportions of light of different colors in the visible part of the solar spectrum. He uses glass filters to isolate the rays of a particular color, and one of the discoveries he has made is that as one travels from middle latitudes toward the equator one finds a progressive decrease in the proportion of red to other colors in the composition of sunlight, and an increase in the proportion of violet. We may have here a clue to some of the effects of tropical climate on human health. These effects cannot be due to heat alone, since the highest temperatures in the world do not occur in the tropics, but in parts of the temperate zone.

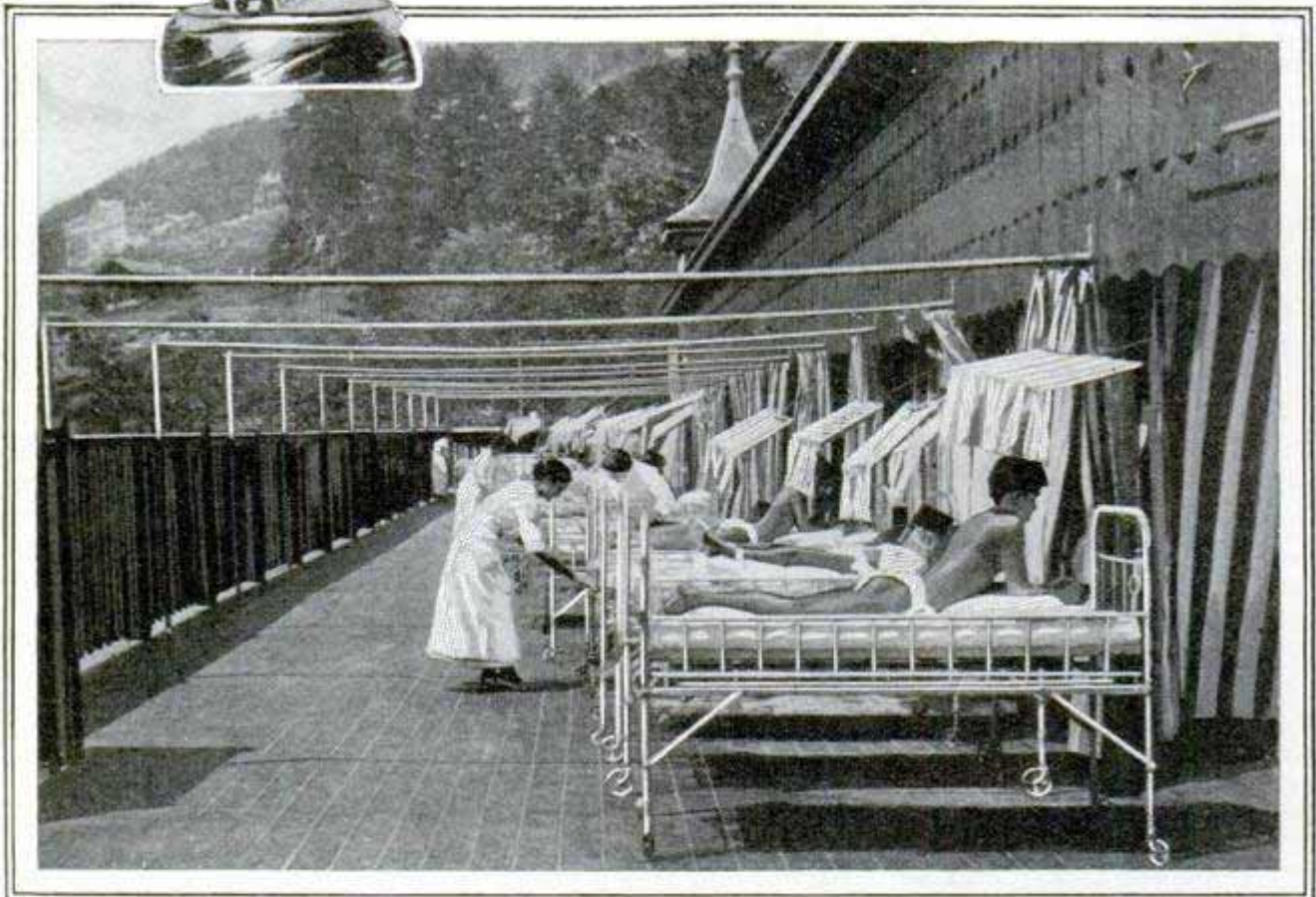

Tubercular Patients Taking the Sun Cure in the Alps, and, Above, a Model Showing the Amount of Soot That Falls Each Minute in London, in Comparison with a Man on the Same Scale





Weather Bureau Observer at the American University, Washington, D. C., Measuring Solar Radiation, as Well as the Ultraviolet Rays That Reach the Earth from the Sun

The study of ultraviolet radiation has attracted a great deal of attention, on account of the effects of such radiation in curing various ailments. The sun cure, as carried out with great success at Davos, Leysin and other places in the Alps, depends chiefly upon the richness of the sunshine at these high mountain resorts in ultraviolet rays. Even at places near sea level, the proportion of these rays in sunlight and daylight is supposed by many authorities to be an important factor in promoting health. The campaign that has been waged so long against the smoke nuisance has received a new impetus from the desire to secure an atmosphere more transparent to ultraviolet.

The measurements made have disclosed a number of interesting facts. It is found, for example, that the amount of ultraviolet received from the sun does not run parallel with the annual variation of temperature. Far less ultraviolet is received in the spring than in the autumn. It has even been suggested that the deficiency of spring sunshine in these rays may account for "spring fever." Another curious fact about ultraviolet is that a much larger proportion of it is found in the light reflected from the sky than in direct sunlight. Hence heliotherapy, which depends upon these rays, can be carried out in the shade on

sunny days, and even on cloudy days in the atmosphere of the Alpine health resorts. Lastly, the Mount Wilson observers report an increase in ultraviolet with an increase in the number of spots on the sun.

In the United States, the latest practical development in the study of solar radiation is the campaign of daylight measurements undertaken in several cities under the auspices of the public health service. This service has adopted an elaborate form of daylight recorder, which traces on a moving sheet of paper a complete record of the intensity of daylight minute by minute throughout the day. The record for each day is from three to four feet long. The recording pen is controlled by a varying electric current generated by a photo-electric cell exposed out of doors to sunlight and daylight. This cell is a highly exhausted vacuum tube within which are two electrodes, one of these being an aluminum plate coated with a form of barium that is peculiarly sensitive to the action of light. The service has one of these instruments in operation in Washington and two in New York; one of the latter being on top of the U. S. marine hospital in the lower part of Manhattan, where there is usually much smoke and dust, while the other is at the quarantine station on Hoffman island in the lower bay, where the air



2497



Artificial Ultraviolet Rays Have Increased the Laying Capacity of Hens. So These Experimenters Are Trying the Same System on Queen Honey Bees

the earth's surface, as affected by varying conditions in the atmosphere, is the fundamental problem of measuring the actual amount of radiation sent to us across the gulfs of space from the sun. This is the great task with which the astrophysical observatory of the Smithsonian Institution has been identified for many years. The director of that observatory, Dr. C. G. Abbot, recently returned from a 30,000-mile journey taken for the purpose of selecting a site for a new "solar constant" station. This station has now been opened on the

is normally clear. The national conference board on sanitation is installing similar instruments in other parts of New York City, so that a comprehensive survey of New York's daylight will soon be in progress.

In the background of all these undertakings in the measurement of sunshine at

summit of Mount Brukkaros, in arid southwest Africa, and is one of three stations maintained by the Smithsonian for making daily measures of the misnamed solar constant of radiation, which is actually subject to marked fluctuations. The other two are located on mountain tops in California and Chile.

### EIGHT-MILE MODEL RAILWAY SERVES ENGLISH PORTS

2551

Nearing completion in the south of England is an interesting miniature railway, eight and one-half miles long, between the old towns of Romney and Hythe. It is double-tracked, has a gauge of fifteen inches and, while much smaller than the standard lines, will be operated in up-to-date fashion with a system of block-signaling and other methods typical of the modern railroad. The engines are four and one-half feet high and weigh, with water and coal, about seven

and one-half tons each. They can develop a speed of twenty-five miles an hour. Eight in all are required for the line, five passenger, two freight and one switching locomotive, together with sixty cars.

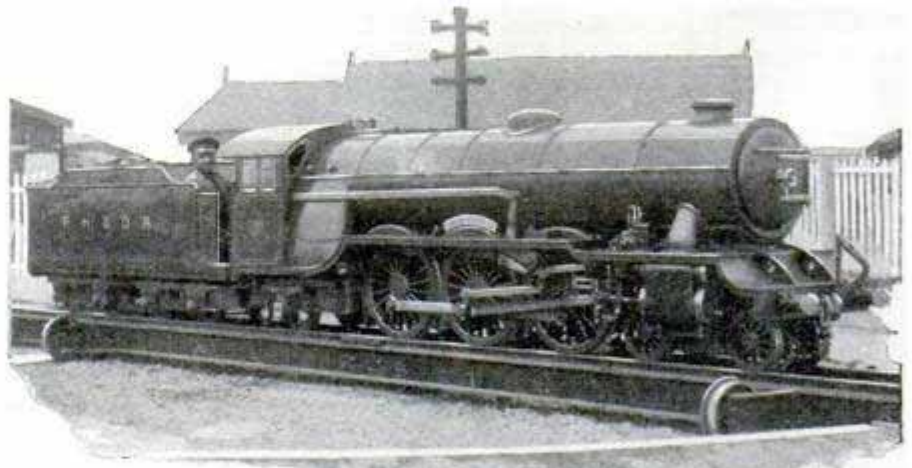

Nearly as Small as a Toy, but Built for Service; One of the Locomotives of Model Railway on Turntable

Cont. A. A. Bell, 3 Amen Corner, London. E. C. 4. England.



*Agricultural Engineer,  
Agricultural and  
Mechanical College of Texas  
College Station  
Texas*

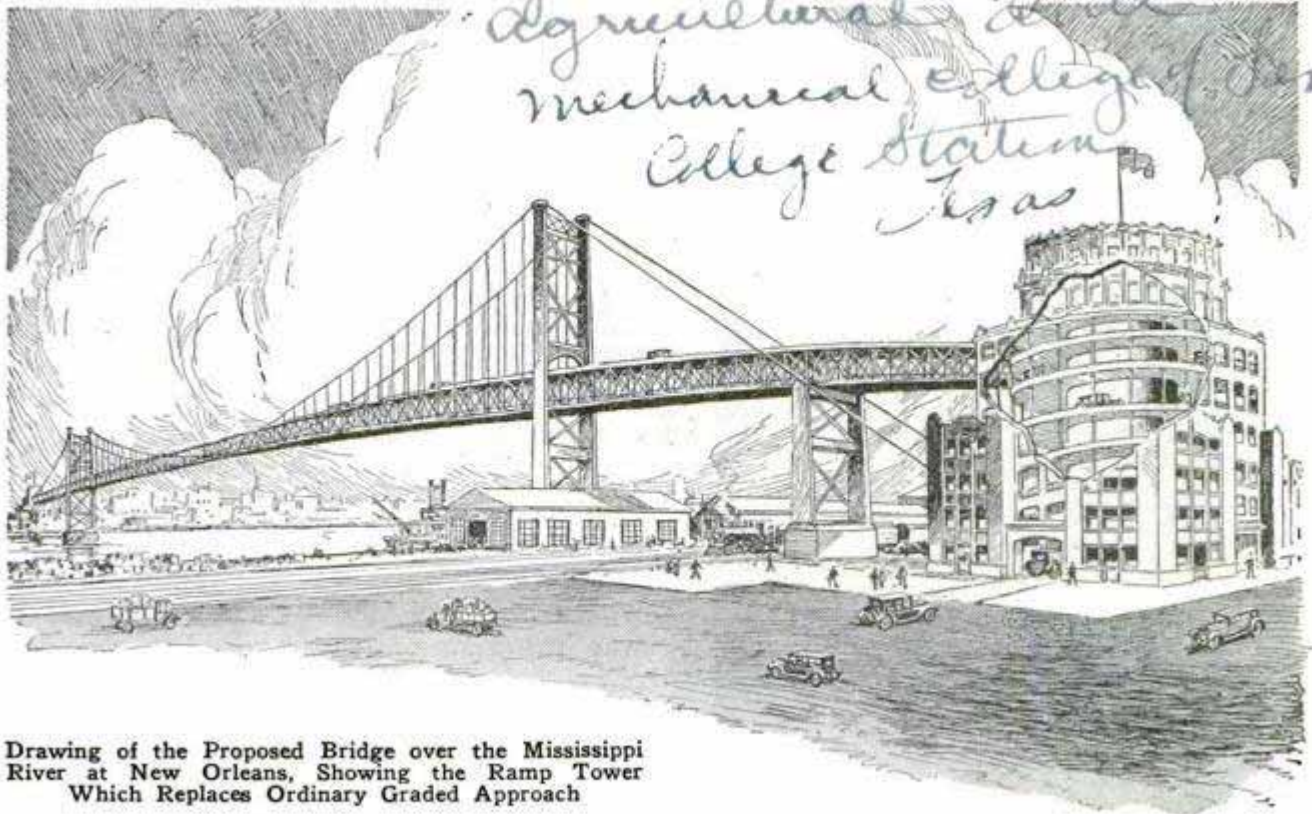

Drawing of the Proposed Bridge over the Mississippi River at New Orleans, Showing the Ramp Tower Which Replaces Ordinary Graded Approach

### DOUBLE-SPIRAL BRIDGE RAMP TO REDUCE COST

Solution of the approach problem for the proposed bridge over the Mississippi river at New Orleans has been offered in double-spiral ramps at each end of the structure. They will save space and greatly reduce the expense of the bridge, engineers estimate, each being about 300 feet in diameter and about 120 feet high. The ramp roadways will be twenty-five feet wide and have a three and one-half per cent grade. Different ways will be provided for vehicles going on or off the bridge. It is expected that the entire structure will cost approximately \$10,000,000. The main span will be 1,650 feet long with two approaching spans, each of 800 feet. Several thousand automobiles will be accommodated each hour.

### RACING IN EGGSHELLS 2825

Eight of the strongest athletes, more than half a ton of them, usually are picked for the rowing crews who race in craft so fragile they could be punctured with a finger thrust. Speeds are made that were considered impossible a few years ago, due to improved training methods, and better craft and oars. Harvard beat Yale re-

*Paddock*

cently largely because of a second's loss of time by Yale's crew near the finish, when a stroke was missed. Every instant counts in this exciting four-mile race, which requires twenty minutes or more of the most strenuous physical exertion the human body is capable of. Latest training stunts involve measuring the actual force of a stroke in terms of pounds and horsepower, and timing the strokes with clocklike precision at so many per minute.

### VAPORIZER FITS LIGHT BULB TO KILL MOTHS 2631



43.50  
Easily installed in the wardrobe or closet, a vaporizing outfit, operated with current from a lighting socket, is said to be effective in eradicating moths. A chemical, placed in a small basin, is vaporized by the heated bulb and permeates the clothing so that six hours' treatment assures thorough work, no matter how deeply the eggs or larvæ may be imbedded in the fabrics.

*J. L. Friedel Co,  
215 Wallace St*

*Moth X. Thermo.*



## FORTY-FIVE-DAY MASTER CLOCK CORRECTS OWN ERRORS



Where the Time Is Controlled for a Big City Building, the Master Clock in the Metropolitan Life Offices

Nearly 250 small electrical clocks and a number of larger ones in the Metropolitan Life Insurance company building in New York are controlled by a single master instrument. It, in turn, is regulated by telegraphy and automatically rectifies itself. It will run for forty-five days without adjustments of any description.

## FIRST HANDKERCHIEFS IN CHINA WERE MADE OF PAPER

Silk and paper handkerchiefs were common in China long before the Christian era and, from this beginning, the article has had an interesting history. It first appeared among Anglo Saxons as a cloth worn at the belt to remove perspiration. Churchmen were the first to use handkerchiefs in Europe and, for a time, only priests were allowed to carry them. In the sixteenth century, it was not uncommon to mention the handkerchief in wills,

as the article had become highly prized, those of Holland, for instance, being fringed with gold and silver and made of costly silks. Lace trimmings also became fashionable although, for a time, the handkerchief was considered vulgar in French court circles until the Empress Josephine brought it again into favor. It is said that she habitually raised a lace-bordered kerchief to her lips when smiling to conceal her unsightly teeth. In the days of chivalry, the handkerchief was worn as a favor, and sometimes attached to the lance from which was derived the banneret or guidon now in common usage. Few accessories of dress have undergone so little change since early times as the handkerchief, which is essentially the same today as it was hundreds of years ago. In European cities, manufacture of the article is still a skilled handicraft, some handkerchiefs bringing large sums because of their excellent workmanship and materials. On the island of Malta, genuine Maltese silk handkerchiefs fringed with a deep border of lace can be purchased for \$5 each.

## 2095 FRICTION DRIVE GIVES DRILL EIGHTEEN SPEED CHANGES

A drilling machine with eighteen different speeds, made possible by the substitution of friction-drive disks for the usual belts and gears, is a distinct departure from the usual design. A direct-reading speed dial shows at a glance the speed at which the machine is operating. The drive is transmitted through a pile of fiber disks, tapered at eighteen degrees. The motor is mounted on the head of the column and furnishes the power through a single disk to the first pile, in the shape of an inverted cone. An intermediate disk, supported by an arm which also carries the speed counter, moves between the inverted cone and an upright one on the spindle head.



Joseph S. Myers & Son,  
16th & Rockwell,  
Chicago



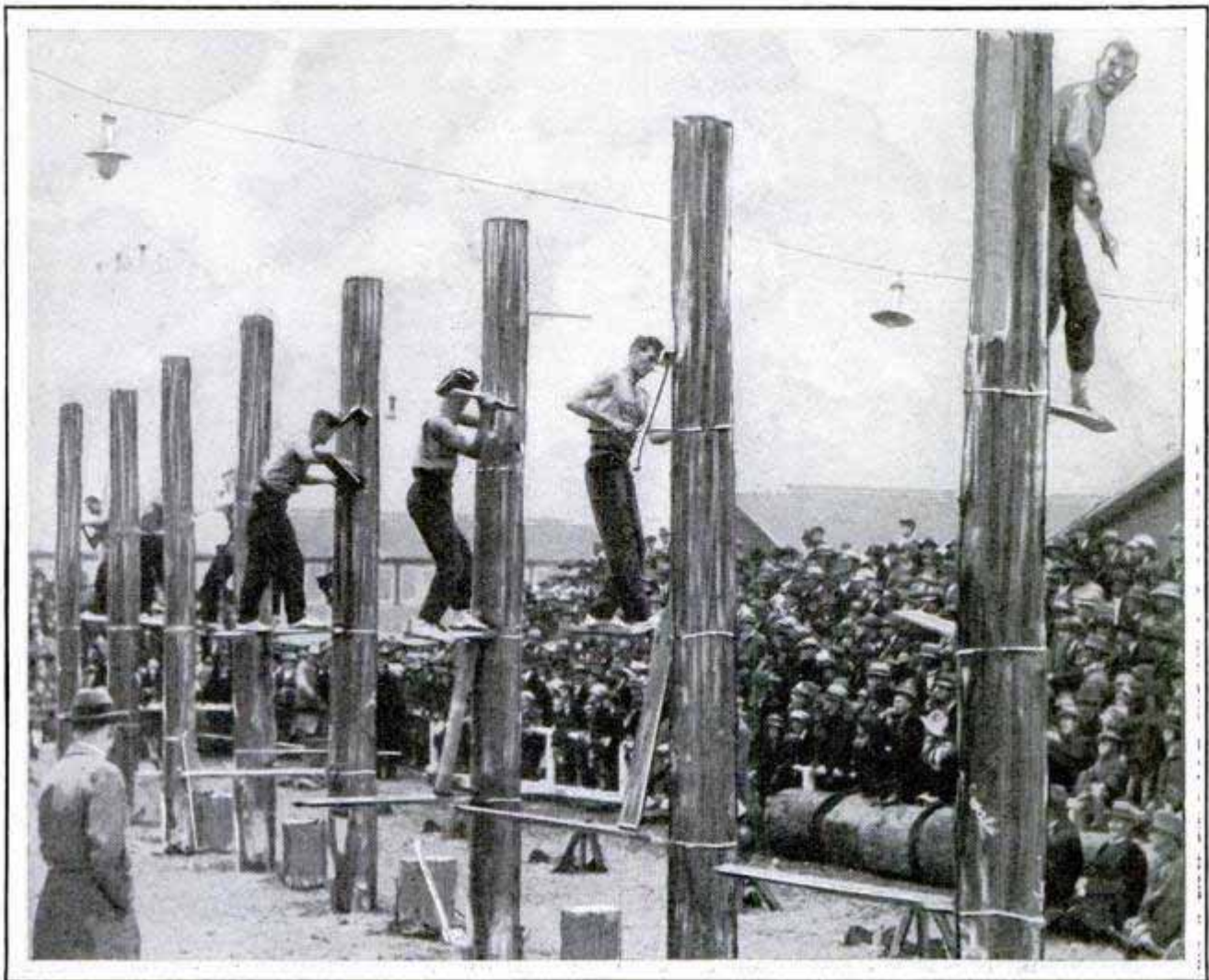

Tree-Felling Contest in Australia; Each Ax Expert Was Required to Erect His Own Platform and the Cut Had to Be Made at Least Ten Feet from the Ground

### AXMEN IN TREE-FELLING RACE FURNISH MANY THRILLS

Australia is known, among other things, for its skilled woodsmen and one of the features of an exhibition for the Duke and Duchess of York, during their recent visit to that country, was a race between axmen at Sydney. The men worked from platforms, planks braced against upright logs of the same size, and were each required to make the cut at least ten feet above the ground. The victor in the event illustrated here was the man at the left, farthest from the cam-

era. In addition to making the cuts in the shortest possible time, the contestants were also required to erect the platforms.

### HOME MOVIE LESSONS IN GOLF LATEST AID TO PLAYER

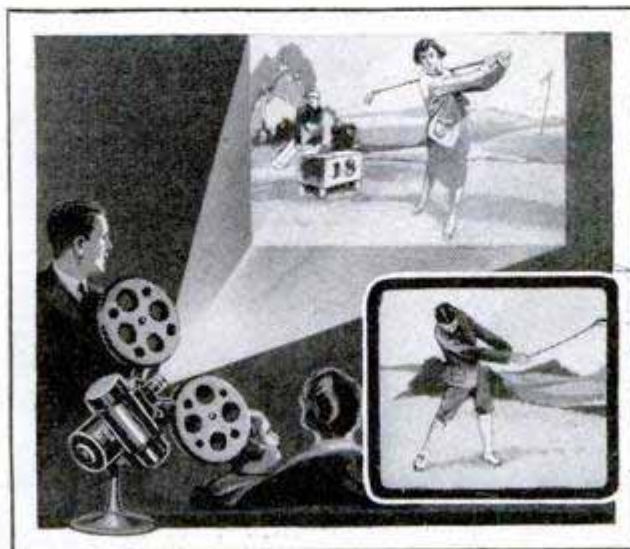

Golf Lessons from the Home Movie

Slow-motion films of golf experts demonstrating a wide variety of strokes have been made for display on the home projectors. The pictures show how to hold the club correctly and make the proper swing. The student may follow the lesson with his own club, comparing his own performance with the expert's.

*2535*  
*220. Regent St. London E.C. 1*  
*per lesson 1/3*  
*2535*  
*U.S. Bell & Howell Co., 189-1*  
*Larchmont Ave., Chicago.*



2596  
402

H-42

*Wardson View Isardes*  
POPULAR MECHANICS  
*New York City*



Before the "Wild" Well Was Tamed; View of the Derrick as Reflected in Pool of Oil

### TAMING WILD OIL WELL TESTS COURAGE OF WORKERS

Battling against gas fumes and deluges of flowing oil, workers replaced a valve that had blown off an oil well in Mexico, recently, after a week of strenuous effort. The difficulty of the undertaking may be imagined by comparing it with the task of putting on a water faucet knocked off a kitchen pipe, while all the gas jets in the stove are pouring forth gas. Multiplied several hundred times, the job might approach that involved in stopping the wild well. The valve weighed 500 pounds, there was an eight-inch geyser of tarlike liquid and it was shooting out under several hundred pounds' pressure with asphyxiating gases. For a time, anchored airplanes were used in an effort to blow away the deadly flames, but, because of the fire hazard, they were abandoned.

Crews worked in relays, with doctors in attendance to revive those who were overcome, until the valve was replaced and the big flow could be controlled.

### AROMATIC UPHOLSTERY IN CAR 2704 IS GERM-PROOF

*no data.*  
Odors of such common plants as cloves, thyme, wild verbena, geranium and cinnamon will protect automobile upholstery against germs, an English expert has discovered. Upholstery in which quantities of the plants have been mixed remains germ-proof for eighteen months to two years. He found that the odor of cloves would kill microbes in thirty-five minutes, while cinnamon killed some species in twelve minutes. The essence of cinnamon was fatal, he claims, to typhoid-fever bacteria after twelve minutes.

### T-SHAPED BRICKS OF CONCRETE 2561 ARE EASILY MOLDED

Strong bricks of concrete that closely resemble the usual variety are made in a recently patented molding machine, simple to operate and adaptable to large or small jobs. The units are shaped for quick and efficient laying and, when the materials are properly mixed, each brick has a compressive strength of more than 2,000 pounds to the square inch before crushing. Molds are automatically filled and the press is so arranged that ordinary-shaped brick, the T-forms for nine or thirteen-inch hollow walls, or a combination of the sizes may be produced at each operation of the press.

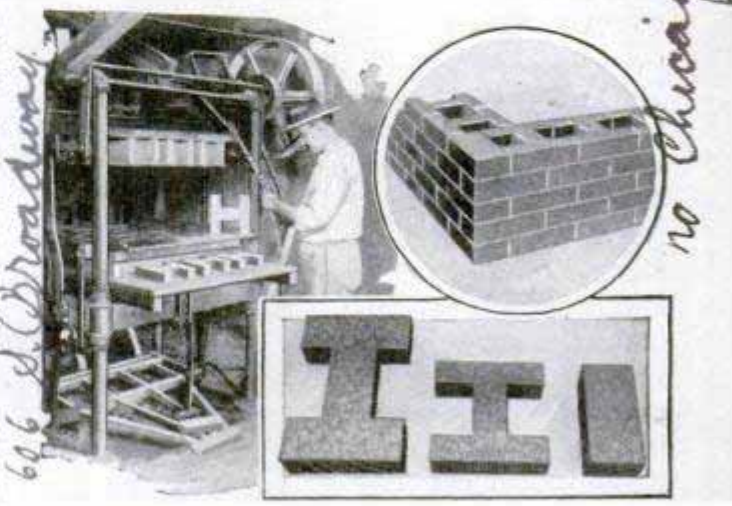

Brick Mold, Sample Wall Construction, and Three of the Bricks, Showing Shapes for Easy Laying

*Haydenite Brick*  
*Co. 403*



# How to TRAIN your PUP

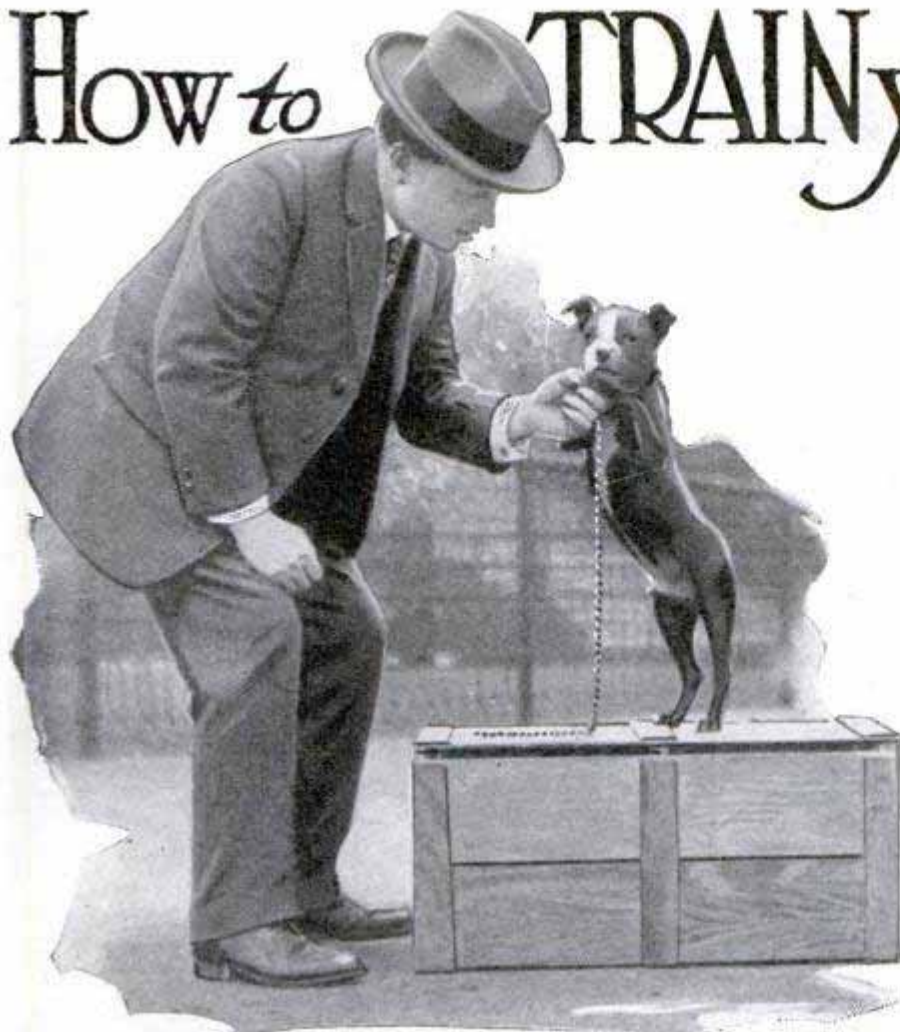

Albert Parker, Superintendent of the Lincoln Park Zoo, with a Bull Pup Getting Its First Lesson in Walking on Its Hind Legs

By J. EARLE MILLER

**C**CAREFUL statistics have been kept in recent years of the thousands of people killed annually by automobiles, but how many pet dogs lose their lives through running out to bark and snap at passing cars no one knows.

A hunter who lost a valuable setter in this way, propounded the question of how to train a dog to break it of the habit. He received scores of answers. An English dog trainer described his method, which consists in tying the dog with a short leash attached to the radiator cap of a car, and then driving some distance, continually bumping the dog and forcing it to exert greater effort to keep ahead of the machine. Another suggestion was to take the dog out on a soft country road, have some one hold it down, with the tail outstretched, and then run over the tail with the car. The weight, on an unpaved road, will not hurt the dog much, but the fright, which can be accented by running the en-

gine in low gear, blowing the horn and making as much noise as possible, is sufficient to break the habit of chasing cars. The cure seems rather cruel, but it is better than letting the dog be killed or maimed for life. It is limited, however, to dogs with long tails.

Another suggestion, which has been successfully tried and which is suitable for any kind of dog, is to fill a garden syringe, used for spraying plants, with a mixture of water and ammonia and have a friend drive past in his car. As the dog runs out to snap at the machine the ammonia-water mixture is sprayed in its face. A couple of such experiences are suf-

ficient to effect a permanent cure, without injury to the pet. The owner's car should not be used, for the dog may associate it with its experience and be afraid to ride in it thereafter.

Training dogs is not a hard task, even to teach them complicated trick stunts. Albert E. Parker, superintendent of the Lincoln Park Zoo, in Chicago, and an old-time circus and vaudeville trainer, declares that any bright dog can be taught to sit up in twenty minutes, and to stand up in not much longer. Long-legged wolfhounds and other large dogs, of course, are not very suitable for trick training, the best type being the short-legged and close-coupled little terriers, small bulldogs and similar species. In his zoo, where no particular effort is made to teach tricks, since the animals are there for exhibition purposes only, he has a deer that can stand up and even walk a bit on its hind legs, though it is then about seven feet tall; a goat that stands up at will, and several other animals equally gifted. Compared



2483



Parker with "Blossom," a Trained Deer Which Stands Well Over Six Feet High, and, at Right, "Medina," a Year-Old Camel, Born in the Coliseum at Chicago, with Its Trainer

to them, the training of a pup is a simple matter.

A corner of a room is a good place to start teaching a dog stunts, though a regular training bracket, such as is used by professional trainers, is still better. The bracket is simply two boards fastened together at right angles to form an angle in which the animal can sit up. They should be attached to the floor to prevent their being shoved around. The dog is backed into the corner, taught to sit down, and then, by lifting its front feet, is shown how to sit up. The teaching should only be carried out in a quiet place, where there is nothing to distract the dog's attention, and it goes better before a meal than after the dog is well fed, for then the brain is sluggish and the animal prefers to lie down in a warm spot and nap.

To succeed, the trainer must keep his temper, not shout, never grow angry, but gently and firmly make the dog do the de-

sired things. After the dog is backed into the corner or the angle of the training bracket, a hand is placed on its back and pressure applied, accompanied by the order to "sit down," emphasizing the last word until the pup associates it with the action. No further step should be attempted until the dog has mastered the order to sit down and will do it on command without the hand being applied.

Once that is learned, the front paws are lifted and the pup raised to a sitting position. Watch the back legs to see that they are drawn up in the proper position for balancing, and not sprawled out so that the dog is resting only on its tail. Each time the dog is lifted, the movement is accompanied by the order to "sit up," again emphasizing the second word. A few trials should be sufficient to teach the dog to keep the position, provided the back feet are properly placed to afford balance. The bracket is then discarded and the free



hand used behind the dog's back, and after the balance is attained, the hand is removed so that the dog can sit alone.

From sitting up to standing up and walking is the next step, and one that is not much more difficult to teach, though it requires plenty of patience. A training ring, which may be a spare leather strap, is fitted around the dog's body just back of the front legs, and to the underside of the ring a leash is attached and led between the front legs, through the collar under the throat, and the end held in the right hand. Order the dog to sit up, then, pulling on the leash and accompanying the pull with the words, "stand up," draw the leash upward to raise the dog to its feet.

The animal's weight is supported by the ring around the body, and not by the collar, so there is no danger of partial choking, while the leash, passing through the collar, controls the head and keeps the dog from getting it down or turning it about from side to



Using a Band around the Body with Leash under the Collar to Teach a Dog to Sit Up and to Walk on Its Hind Legs, and, in the Center, a Trained Goat

side. A small whip, a ruler or a light stick in the free hand is tapped under the front paws to keep them up, or to provide a temporary rest, if necessary. The chief difficulty to be overcome is the tendency of the dog to keep its hind feet firmly planted in one place and drag them rather than take forward steps.

Don't pull the body forward and out of balance, but, speaking quietly and soothingly, urge the dog to walk, and at the same time tap one foot or the other with the whip or ruler to emphasize the command. Even the brightest dog doesn't learn the trick of balancing itself on the first attempt.

A supply of bits of candy or cubes of meat should be on hand so that, after each attempt, the dog can be rewarded, and learn to associate food with obeying or-



2483  
406



One Way of Breaking a Dog of the Automobile-Chasing Habit, Only to Be Tried on a Soft Unpaved Road

has begun to waver. They should always be given in a quiet place, with no other animals or people about, and if possible with no disturbing sounds outside. A professional trainer never starves an animal into submission, for that only breaks its spirit, but he does exercise judgment in feeding periods so that they follow, and do not precede, the daily lessons. Similarly he teaches the animal to associate a reward with obedience."

ders. The dog should never be slapped, whipped or shouted at, for the first two will make it fear training rather than enjoy it, and the last will only rattle it and keep its mind off the work.

All dog tricks are taught in essentially the same way. Only one thing is attempted at a time and no others started until that one is thoroughly learned; the dog is always rewarded with food or petted and praised after each attempt. The first step is always to force the dog through the trick, at the same time repeating the command over and over until the animal learns to associate the two. The second is to put it through the trick without force, but with assistance in lifting or balancing, if needed, until the dog learns to do the thing unaided, and finally it is put through the trick unaided until it has learned to do it on command.

Harness is used in many tricks as in standing on either the front or hind legs, but is always designed carefully so that it supports the weight without binding or alarming the animal.

"The chief thing," Parker declares, "is to train yourself first and the animal second. Before you can hope to master an animal you have to be master of your own temper, so that you never lose it, never become impatient, never try to hurry things along too fast. Any animal with an undeveloped mind can no more concentrate for a long period than a baby can. Lessons should always be brief, and should stop at the first sign that the animal's attention

Sitting, walking and other stunts should not be taught until the dog is old enough to keep its attention centered on the task.

**ELECTRIC ICE-CREAM FREEZER ELIMINATES SALT AND ICE**

One of the latest additions to the lunch-counter or refreshment stand is an electric ice-cream freezer which employs a circulating brine system and beater instead of salt and ice. It is said to have a

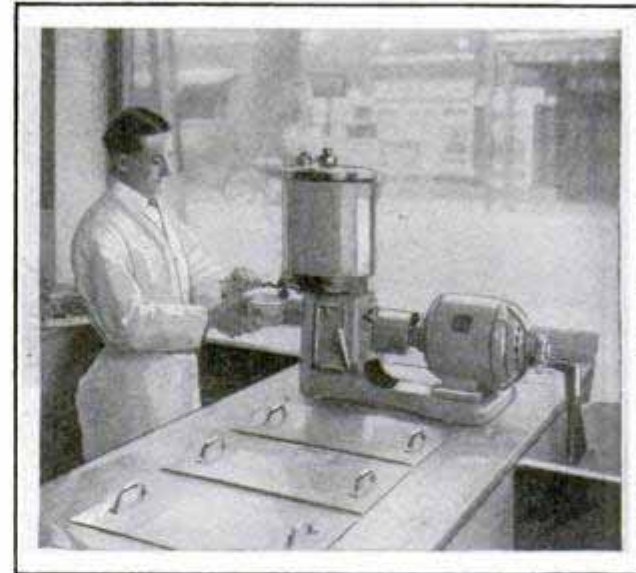

Freezing Ice Cream While You Wait; the Counter Outfit in Operation Showing Its Compact Size

capacity equal to freezers three times its size, is noiseless and can also be operated as a drink mixer. Space is provided in its cabinet for storing creams and fruits as well as for hardening ice cream to be taken away.

Taylor Freezer Corp.  
11111 Broadway St.

Corpo.  
General Refrigeration  
Buffalo, N.Y.  
Beloit, Wis.





Class of School Boys Qualifying to Become Professional Bakers; Schools in Several Cities Have Added Cooking Courses for Boys to the More Usual Types of Training

**BOYS LEARN TO BAKE CAKES IN PUBLIC COOK SCHOOL**

Cooking classes for boys are given in one of the public schools in Baltimore. Hundreds of boys are taught essential points in baking at a Chicago school and similar instruction is given in several others. Most pupils take the course with a view to becoming professional bakers.

**MACHINE THAT MATCHES COLOR ELIMINATES GUESSWORK**

Matching the delicate shades of fabrics and flowers has been reduced to an exact science in an apparatus developed at the Massachusetts institute of technology, promising great benefit to textile and other industries that make important use of color, and eliminating the factor of error when the task is left entirely to the human eye. The method involves the use of a photo-electric cell, a tungsten-filament lamp fifty times as bright as sunlight and a recording apparatus that makes a visible analysis of the color specimen. The sample is placed in a special holder and illuminated. Water filters are adjusted to prevent the sample from catching fire. Light

is alternately reflected from the specimen, and a portion of magnesium carbonate, the whitest substance known, is used as a standard of comparison. This reflected light acts upon a photo-electric cell in such a way that an alternating current is induced, is magnified through vacuum-tube amplifiers, and a record of the wavelengths produced on a moving drum by a pencil. The result is a description of the color which may be telegraphed across the country, if desired, for matching with another sample or for reproduction.

**WHISTLE IS WORN AS A RING FOR INSTANT SERVICE**

Slipped on the finger like a ring, a whistle is always in position for use, is less likely to be lost and eliminates bothersome chains. It is intended especially for postmen, policemen and referees, but is also useful to scoutmasters and teachers, as a plaything for children and would be serviceable to almost anyone in emergencies for summoning aid.



*Prof. Arthur P. Hardy & C. Petre, 15 Moore  
and Frederick Cunningham St. New York*



WHY YOU CAN FAST FOR WEEKS AND STILL LIVE

2592

Why the human body can be deprived of food for days or weeks without serious or permanent injury is being studied at the Carnegie Institution in Washington in

health and then restored to good marketing condition by liberal feeding.

The tests with steers showed that the so-called "hunger feeling" was merely a temporary sensation caused by physical contraction of the alimentary tract to meet the requirements of a diminished bulk. In no sense, it was said, does it represent distress due to lack of nourishment or tissue, and, in fact, after the second day, the steers showed no particular craving for food.

In the experiments, the subjects were placed in airtight boxes, with a measured flow of air admitted through a blower,

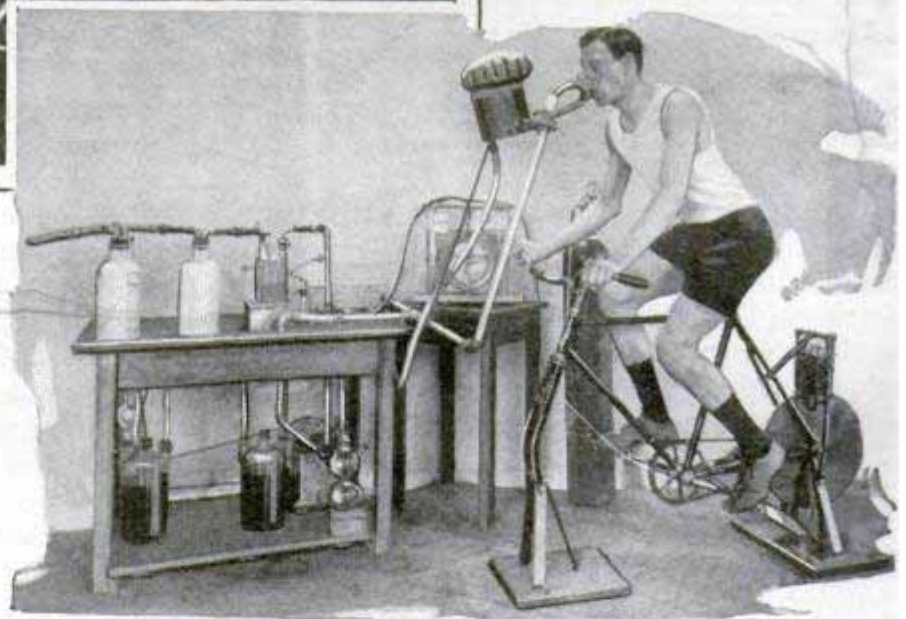
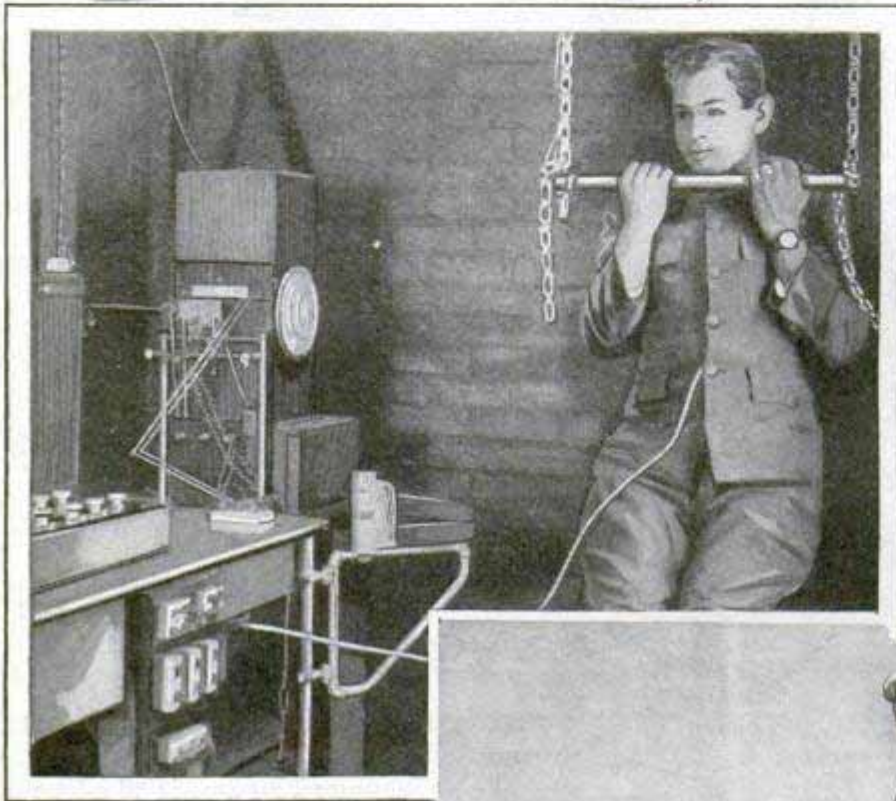

Measuring the Energy Consumed and Body Changes of a Man Chinning Himself and One Riding a Stationary Bicycle

experiments on men and animals, with the result that new facts about the problem of human nutrition have been disclosed.

Steers, dogs, white rats and men and women were subjected to the most exhaustive tests ever made, to discover exactly what the body does with the food consumed, and how it functions when food is withheld. Tests on 136 men and 103 women showed that every twenty-four hours the body of a man produced 925 calories of basal heat for each square meter of body surface, while the women averaged 850 calories each. Under practically the same conditions, the average steer burned up 1,300 calories a day, while the white rats were at the foot of the list with only 600 calories. It was demonstrated that steers can be carried through a period of several months on extraordinarily low rations without affecting their general

while the used air, containing the chemicals, exuded both in the breath and through the body pores, was exhausted through a second blower and passed through chemicals to extract and measure the products of energy consumption.

SKINLESS FRANKFURTERS

"Hot dogs" without casings are being produced by a Maryland sausage maker who is said to have experimented fifteen years on the problem.

The Laffer Sausage Co  
Piquette, Md



### SAVINGS FROM RAILROAD JUNK TOTAL MILLIONS YEARLY

Once scorned by the American railroads, the junk pile is proving an important source of economy to the carriers, the intensive work of recovering, reclaiming and repairing discarded materials involving millions of dollars annually. A railroad needs practically everything from pins to locomotives. Purchasing agents buy approximately 60,000 separate and distinct items. The railways use twenty-five per cent of the steel produced in this country, twenty per cent of the lumber and twenty-eight per cent of the coal. The total purchase of materials and supplies approximates several billion dollars every year.

### POLES OF FLEXIBLE CONCRETE FOR TROLLEY LINES

For use on trolley and electric transmission lines, concrete poles with a high degree of flexibility have been made by an interesting process developed at the Westinghouse plant in Milwaukee. The poles are spun in a horizontal position, a wet mixture of concrete being placed in a steel mold and the mold revolved at high speed. The centrifugal force throws the concrete against the mold and packs it well around the reinforcement, leaving a hollow opening extending the full length of the pole. Excess water and dust come to the center and are drained out through this opening, leaving an extremely well-packed and strong unit. Tests showed that, below the elastic limit of the steel reinforcing bars, the poles will return, upon release of the load, to within an inch of their original position. There was no break in the pole at the ultimate load, only a refusal of the pole to take further load and a slight opening of tension cracks as the steel is stressed beyond the elastic limit. Even after failure, the pole will take the same load in the opposite direction.

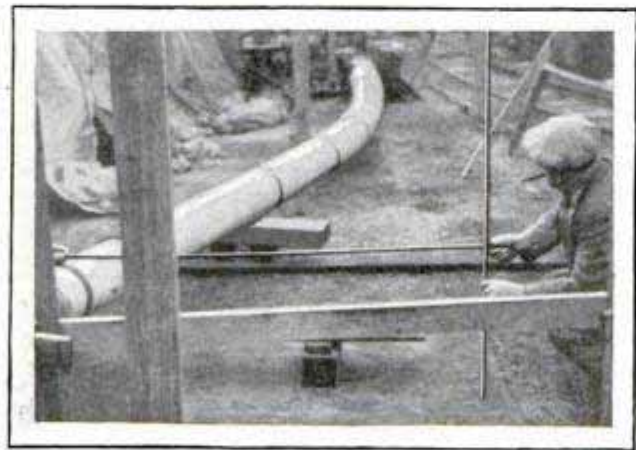

Reinforced-Concrete Telegraph Pole Bending in Tests from Which It Straightened Again

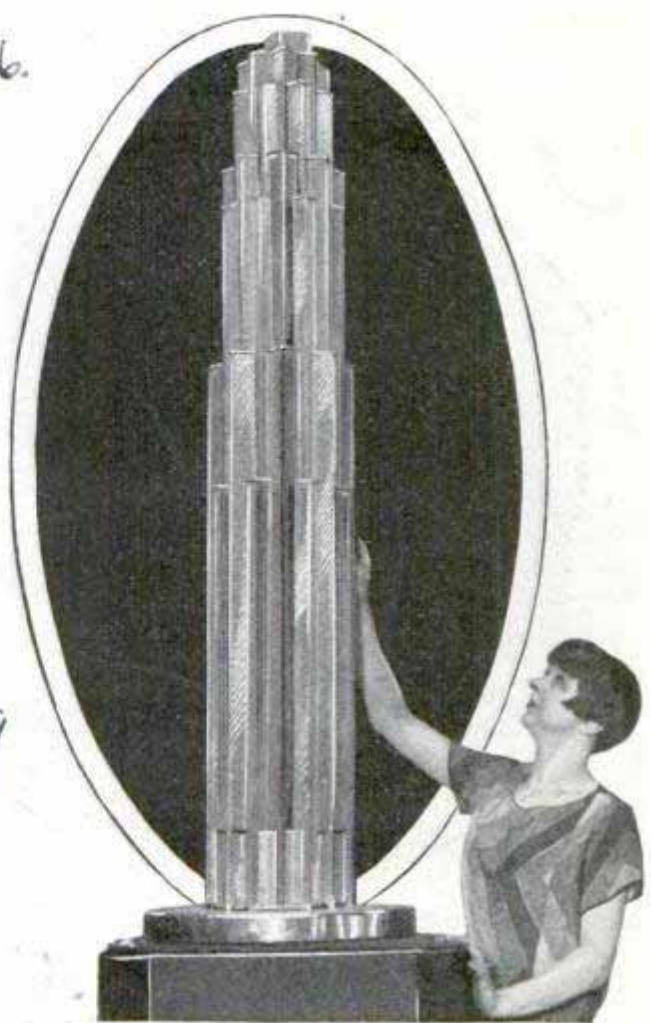

Model of a Skyscraper of the Future, Built Almost Entirely of Glass Sides and Steel Beams

### MODEL OF GLASS SKYSCRAPER HINTS NEW BUILDING AGE

Not long ago, Hugh Ferriss, a New York architect, presented drawings to show the appearance of a skyscraper built of glass and steel. At a recent exhibition, he displayed a model based on his sketches. It showed a structure with walls almost entirely of glass and the weight supported

mainly by steel girders at the center. Improved and cheaper methods of manufacture, the need of light in city streets and offices and the fact that glass can be made to admit the healthful rays of the sun, are factors favoring the use of the material for structural purposes, engineers say.

*Machine Age Show*

*Westinghouse Electric & Mfg. Co*



2239

# The Army's GREATEST

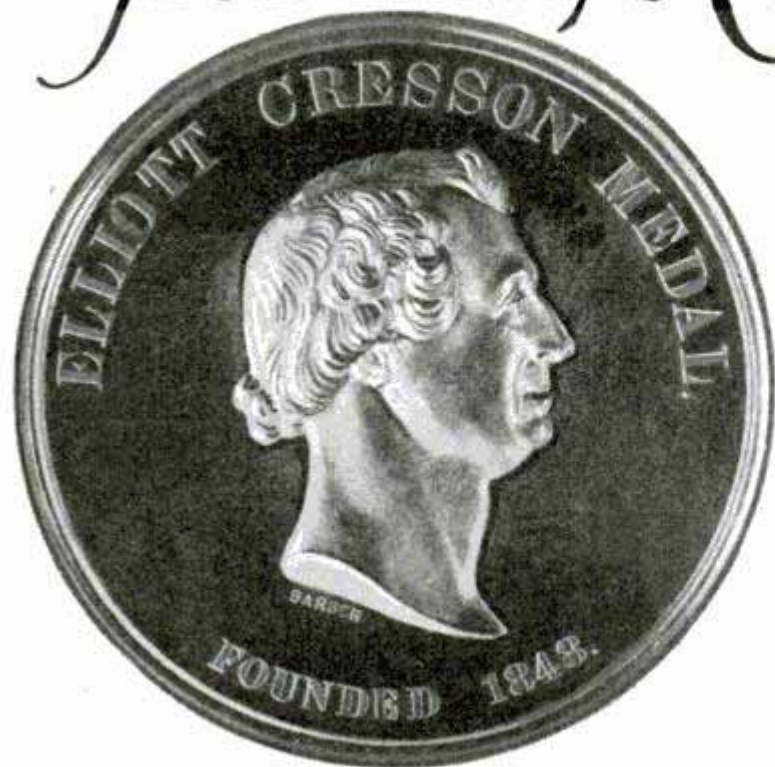

One of the Many Medals Awarded Gen. Squier for His Inventive Work Improving Army Communications

By EMMET DOUGHERTY

*Washington*  
*514 Woodward Bldg*

A DOZEN empty spools plus a hundred feet of twine in the hands of a lad in Dryden, Mich., fifty years ago, were converted into complicated devices which operated with the slightest human urge.

Ten years thereafter, the deft hands and active mind of that youth had won him a commission in the United States army in which he had a distinguished career and from which he retired not long ago at his own request with the thanks of the government.

The man is Maj. Gen. George Owen Squier, war-time commander of the signal corps and air service of the government, the only American soldier who was ever made a member of the National Academy of Sciences, holder of two awards from the Franklin Institute for scientific discoveries, and distinguished by four governments for special praise.

"I was always tinkering around with spools and twine and a piece or two of wire if I could find any," Gen. Squier explained. "If I could turn a crank and see something that I made with my own hands

move, twist or vibrate or show the slightest animation, I felt I had invented something and was happy."

Gen. Squier has easily the most unusual record of any of the hundreds of skilled and expert men in the official personnel of the American army. His name is inseparably connected with the transmission of intelligence on land, under the sea and in the air. He was at the birth of two of the greatest inventions or discoveries of the world—the radio and the airplane—and during his active career in the army had charge of both and is responsible for improvements in each.

As a young officer in the artillery school at Fort Monroe, he was the instructor of future military geniuses of the army. During the Spanish-American war, he was press censor of the Haytian cable at New York, the connecting link between McKinley in the White House and Sampson at the front. He laid the cable connecting the west coast with the Philippines, commanding a ship at sea for two years in this task, which took him before the Sultan of Sulu and other notables to whom he described the magic of his "talking wires."

Gen. Squier attributes most of his inventive activity to the days he spent in the classroom at Johns Hopkins university at Baltimore, taking a post-graduate course in physics. His inventive mind found expression first while a second lieutenant as head of the department of electricity and mines at the artillery school at Fort Monroe. While studying the velocity of projectiles in 1894, Squier invented the polarizing photo-chronograph, an instrument of remarkable recording power. In measuring the velocity of projectiles, the time is recorded by sending the missile through screens which operate the device. This was followed by the synchronograph, a device for increasing the capacity of land



# INVENTOR

telegraph wires. This invention marked a great step forward in the rapid transmission of intelligence. The active mind of young Squier then turned to conquering the mysteries of undersea transmission, inventing a dynamo that sent an unbroken alternating current over ocean cables, thus permitting uninterrupted use of the submerged telegraph line and almost doubling its capacity. One of Squier's first discoveries applied during the World war was the "tree wireless," a method of transmitting and receiving wireless messages by the use of growing trees as antennæ. In studying the absorption of electromagnetic waves by living vegetable organisms, Squier found that a metal rod driven into a tree is intimately connected with the earth and is subject to change of electrical tension representing the innumerable frequencies required by the modern radio telephone and telegraph, as well as other electrical disturbances. Applying his principle, American signal-corps officers at the front in France, by the simple device of driving a nail into a tree to which to connect the radio set that wireless operators use to magnify the dots and dashes, found it possible to "listen in" on wireless communications between flying German airplanes and instruments on the ground.

These inventions, however, were merely the beginning of a series of achievements by which he improved and advanced the methods of telegraphy and telephony, which won him that place in science where the Franklin Institute declared him entitled to the awards which it bestows. The

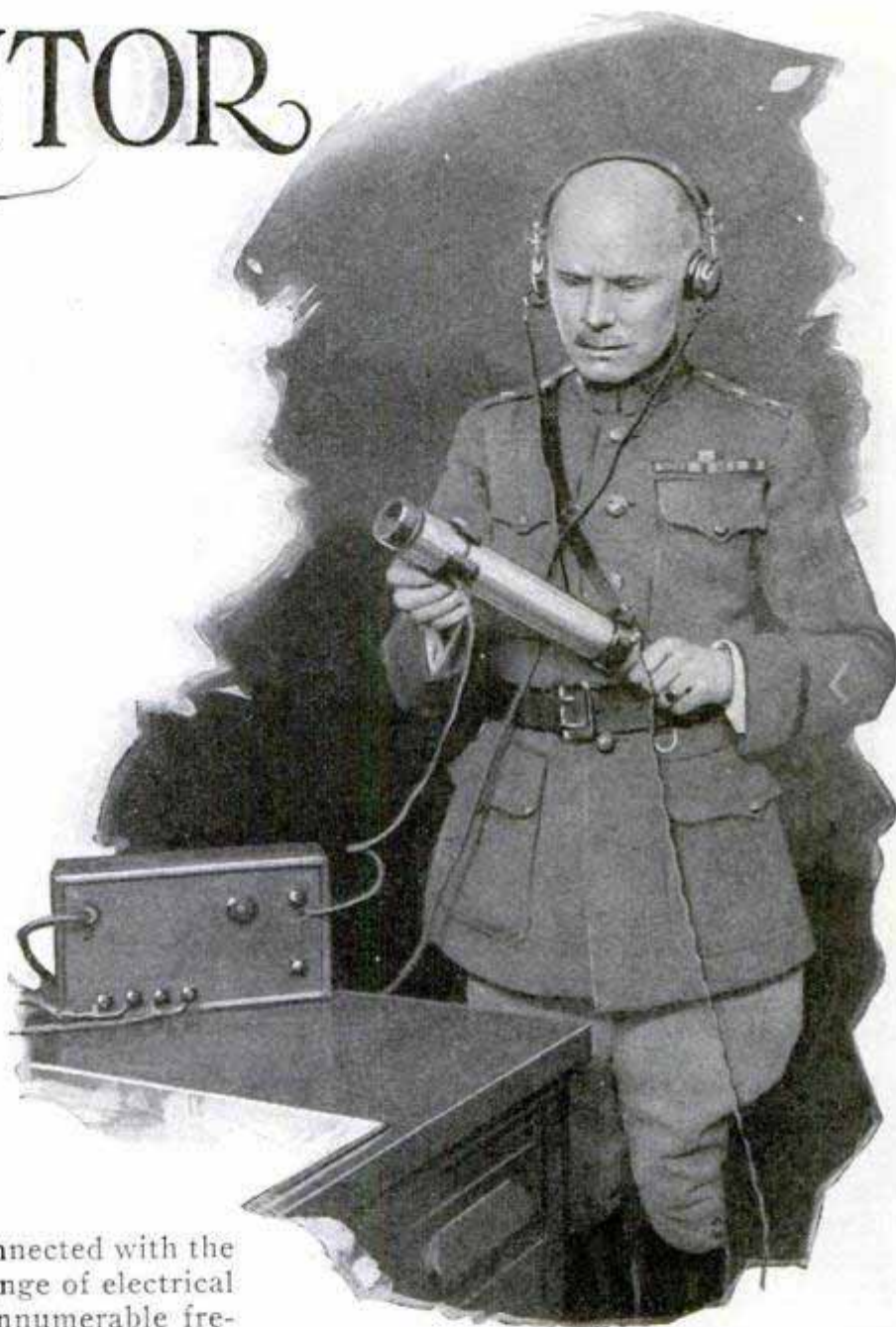

Gen. Squier in His Laboratory with Some of the Electrical Apparatus Which He Has Produced

capstone of his achievements, figured from the standpoint of the Franklin Institute, was declared to be "wired wireless" or multiplex telephony and telegraphy. On the occasion of presenting Gen. Squier with the Franklin medal, the institute made this reference to his discovery:

"The 'wired wireless,' first proposed by him in 1911, has proved, especially in military field operations during the war, to be invaluable as a means of sending intelligence and commands. As the name implies, it is a method of telegraphing or telephoning by means of electrical waves guided by wires. In this way as many as a half dozen messages may be sent along



2239  
412

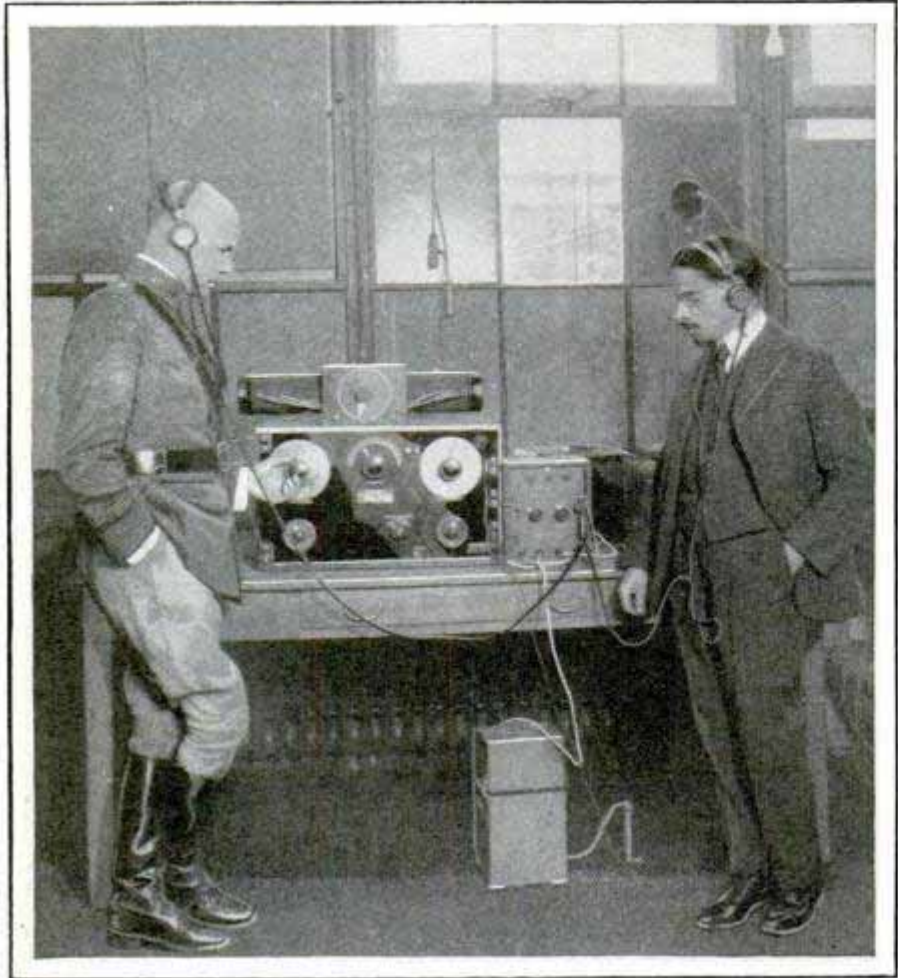

The Army's Inventor with Louis Cohen, Consulting Radio Engineer, in His Private Laboratory in Washington, Where He Does Much of His Work

velous thing. Later Gen. Allen, then chief signal officer of the army, assigned me to the task of collaborating with Wright in designing the first heavier-than-air airplane for military use."

Gen. Squier therefore enjoys the distinction of being at the birth of two of the most creative things in the world—wireless or radio communication, and flying machines that actually did fly.

In addition to the Distinguished Service Medal bestowed on him by the United States government for his services, Gen. Squier possesses many decorations from foreign governments.

**UNSPILLABLE BOX FOR LIQUIDS**

2284

a telephone wire, but outside of it, at the same time, and without interfering with the use of the wire for ordinary service. The message, however, must be tuned to different frequencies and be received by separate receivers. One great advantage of this system is that the waves will still travel along the wire when it is broken and jump gaps in it of fifty feet and more."

Gen. Squier cannot be brought into a discussion of his part in the strenuous days of American war preparations, but he frankly boasts of that day in 1906 when Orville Wright came into his office in Washington with plans for an airplane.

"Orville Wright came in with his airplane all planned," he said, "and I was skeptical. 'Where is the gas bag to hold it up?' I asked. 'You can't stay up in that without gas.' Wright offered to demonstrate and we went over to Fort Myer, across the river from Washington, and the thing actually stayed in the air. I was the first passenger to ride in the ship, the flights of which caused congress to adjourn, to let the legislators see the mar-

One of the aids to international standardization tests of electric force is a special shipping container for a cell used in the grading work. It is a double box, the inner chamber being arranged so that it swings right side up at all times and the liquid content of the cell will not spill.

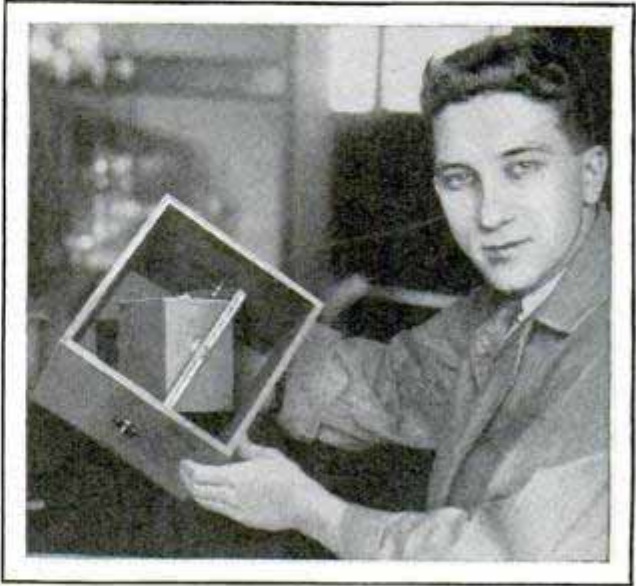

Built like the Mount of a Gyroscope, the Inner Box Remains Right Side Up All the Time

*Bureau of Standards*



**RAILROAD TO CROSS AUSTRALIA  
REPLACING CARAVANS** 2602

One of the most ambitious railway projects now under way in the world has been started in the construction of a line to close the gap between north and south Australia. It involves the building of about 1,000 miles of railroad and, when completed, will open up a wide territory as yet but little developed. It is now crossed only by a telegraph line and costly camel caravans that transport freight at an expense of about \$350 a ton on the 900-mile journey from Oodnadatta, the present northern terminal of the southern line. The finished railway, according to the National geographic society, will link Adelaide, in a latitude comparable to that of Memphis or Little Rock, with Darwin, Australia's tropical port, and is expected to stimulate agriculture, stock raising, mining and other industries.

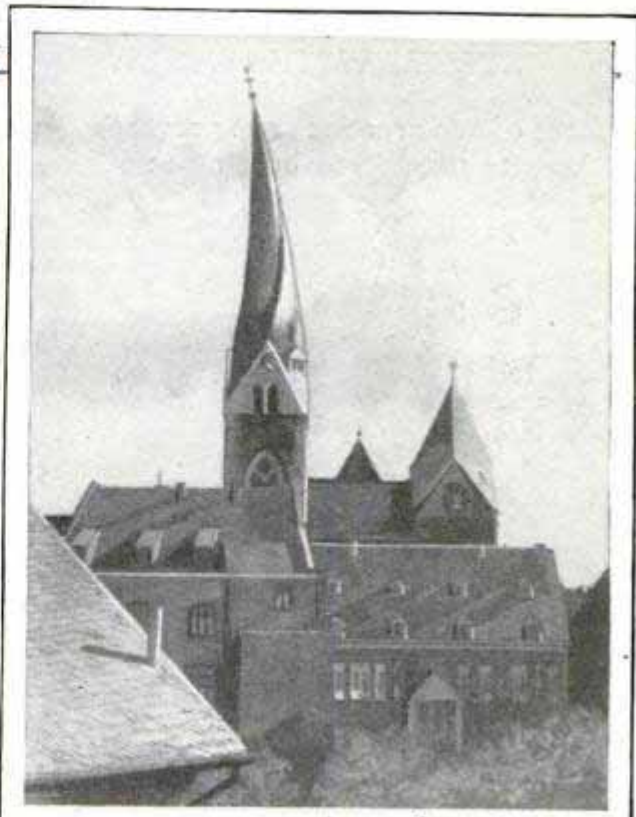

Leaning and Twisted like a Corkscrew, This German Church Steeple Still Stands

**INVISIBLE SPRING DOOR CLOSER  
HIDDEN IN FRAME** 2486

Unightly arms and brackets are eliminated in a door closer contained in a housing within the frame so that it cannot be seen when the door is shut. Two strong compression springs are the chief operating units of the device and speed control is afforded in a regulating valve.

The closer is not difficult to install and is especially adapted to use where schemes of interior decoration and other effects are marred by conspicuous door attachments.

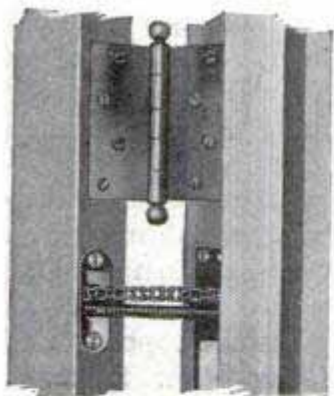

**TWISTED AND LEANING STEEPLE  
RIVALS PISA'S TOWER**

Lightning is believed to be responsible for the shape of a church steeple in Coblenz, Germany. It has been twisted like a corkscrew and also leans at a decided angle, but appears to be sturdy in spite of the displacement.

**BOXES PROTECTED IN SHIPPING  
WITH SAFETY CLAMP** 2430

Safe delivery of goods shipped in wooden containers is made more certain by using a special clamp for the lid of the box. It cannot be removed without permanent mutilation, while the receiver of the case can take off the clamps and not destroy the container. It is essentially a lock, a nail being driven through a hole in the clasp at the top and securing a bottom portion. A spiked flap of the clasp is then bent over and fixed into a slot to seal the nailhead.

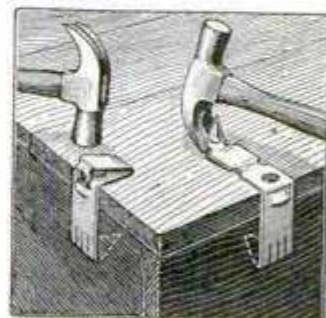

**WOOL FROM RABBITS** 2660

Prized as pets in America, Angora rabbits are an important item of industry in France. They are raised on more than 1,000 farms for their wool, which, in some seasons, brings as much as \$8 a pound. In one year, the value of the total amount produced in France was \$190,000.

C. W. Newton & Co., 261 Franklin St. Boston

New York City

C. A. Israhram, 170 Broadway



### ONE-ARMED FISHERMAN'S BOAT STEERS WITH WHEEL

Loss of one arm does not prevent a Massachusetts man from boating and fishing.

Novel Fishing Boat with Paddle Wheels Operated by Hand Lever, for Use of One-Armed Man



He has designed a special craft for his own use with a wheel at the side that operates the rudder, and paddles manipulated by levers within easy reach.

### JAPANESE STILL USING SAWS THAT CUT ON UPSTROKE

Saws and planes that are pulled toward the carpenter on the cutting stroke, instead of being pushed, continue to be used almost universally in Japan, despite the adoption by wood and metal workers of practically all other forms of American and European tools. Hammers, augers, bit braces, files, screwdrivers, twist drills, hacksaws, pliers, wrenches, taps and dies as well as other imported tools are sold throughout the islands by hardware dealers, but every attempt to introduce saws and planes has been a

failure. The Japanese saw is about the size and shape of a meat cleaver, and is unusual also because there are two saws combined in one, a rip saw on one edge and a crosscut saw on the other. The workman ordinarily stands on his work and uses the back muscles to pull the blade upward. The ordinary Japanese plane is a simple wooden block, with the blade held in place by a wedge. The blades usually are of soft iron. Japanese carpenters have several unusual tools in their kits. One is the "sumitsubo," which takes the place of the American chalk line, and in many ways is quite an improvement over the latter. It consists of a beautifully carved wooden reel, containing a silk line, which

is wound up by a small handle. When the line is drawn out it passes over an ink pad in a recess, so that, when it is snapped, it leaves a black mark. To use the sumitsubo, the carpenter draws out a few inches of line, sticks a pin through a loop in the end, pushes the pin into place in the plank to be marked, walks to the other end, allowing the line to reel out, and then snaps the line, making his mark. A companion piece to the sumitsubo is the "sumisashi," a piece of bamboo about seven

inches long. One end is cut to a rounded point and the other flattened to a thin chisel-like edge, about three-eighths of an inch wide. The thin edge is then split back with a dozen or more fine knife marks, so that it will hold a quantity of ink. The carpenter rubs the split end on the ink pad of the sumitsubo and uses it in lieu of a carpenters' pencil.

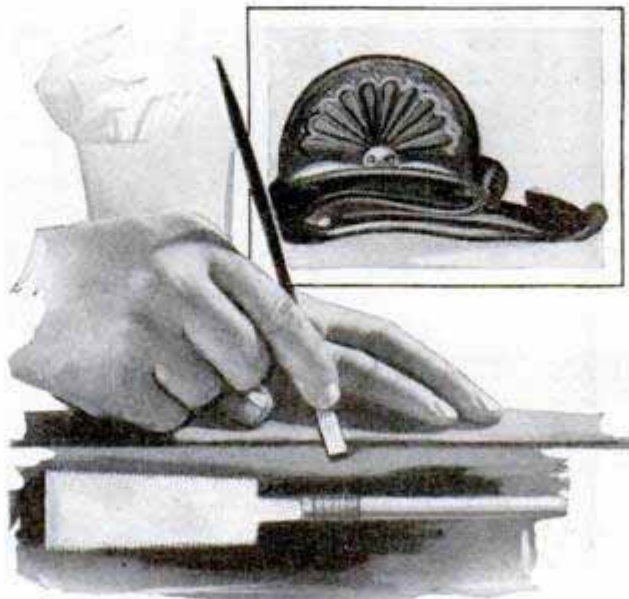

Three Japanese Tools; a Chalk-Line Substitute, a Bamboo Marking Pencil, and a Double-Edged Saw

*James G. Harville*  
*Ware*  
*Mass*  
*226*  
*Mr. Hanjuro Hoshino*  
*7 Higashi Morichitacho*  
*Fujigawaku, Tokyo, Japan*



# TREATING THE WORLD'S BIGGEST ACHES AND PAINS

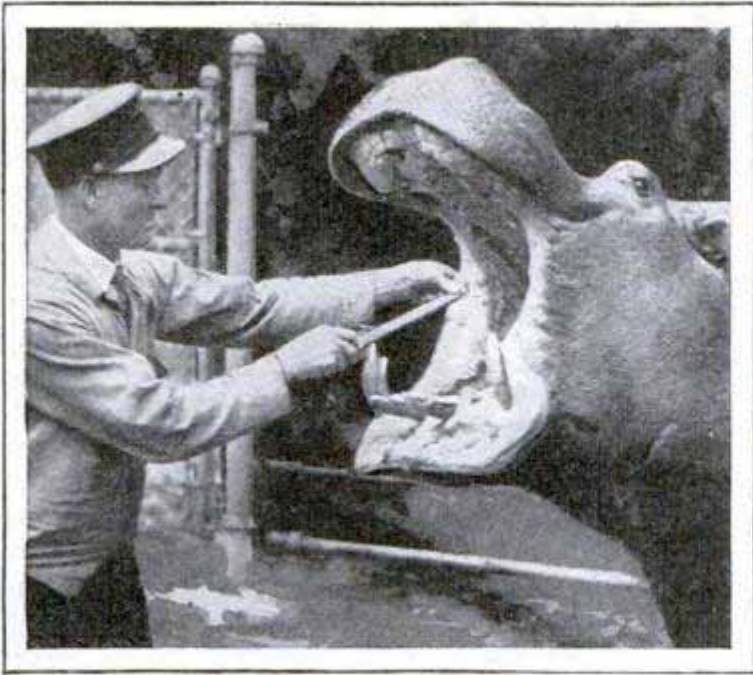

The Dentist's Drill Is Bad Enough, but the Zoo Tooth Doctor Uses a Large File on the Hippo's Tusks

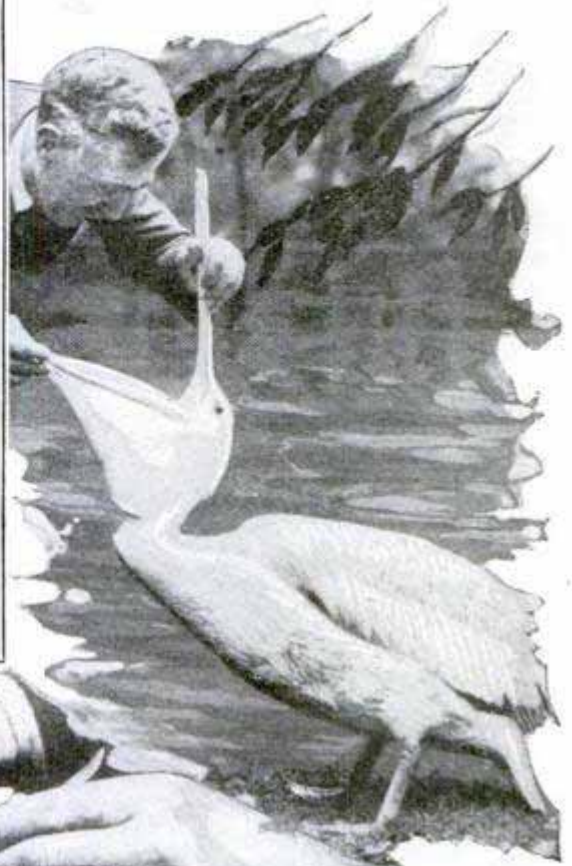

Some Doctors Render Big Bills and Others Treat Them; Meet the Pelican, Above, and the Toucan, Left, Taking Their Medicine

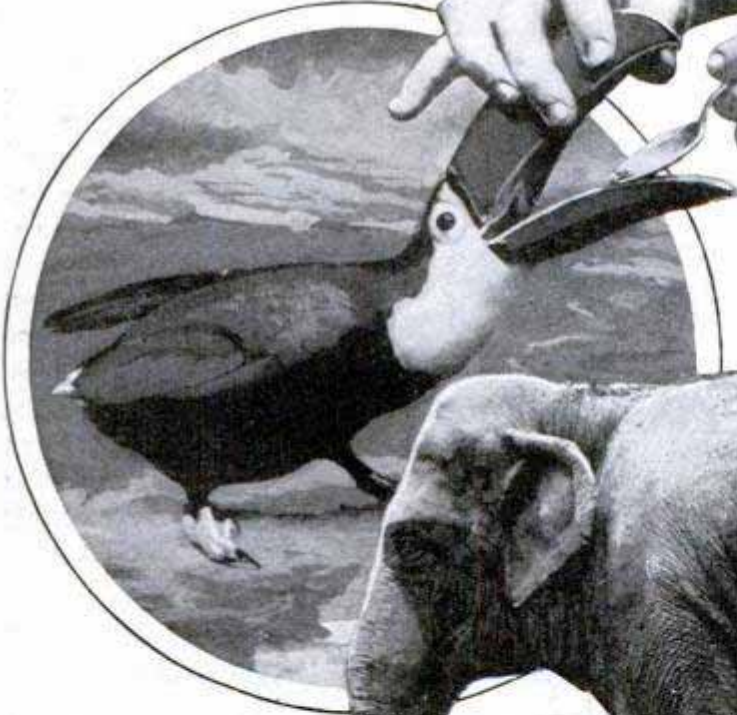

It Takes All Kinds of Manicurists to Make a World, Including the One Who Trims the Elephant's Toe Nails to Get It Ready to Be Admired by the Sunday Visitors to the Zoo

*Photo*





6/19/27

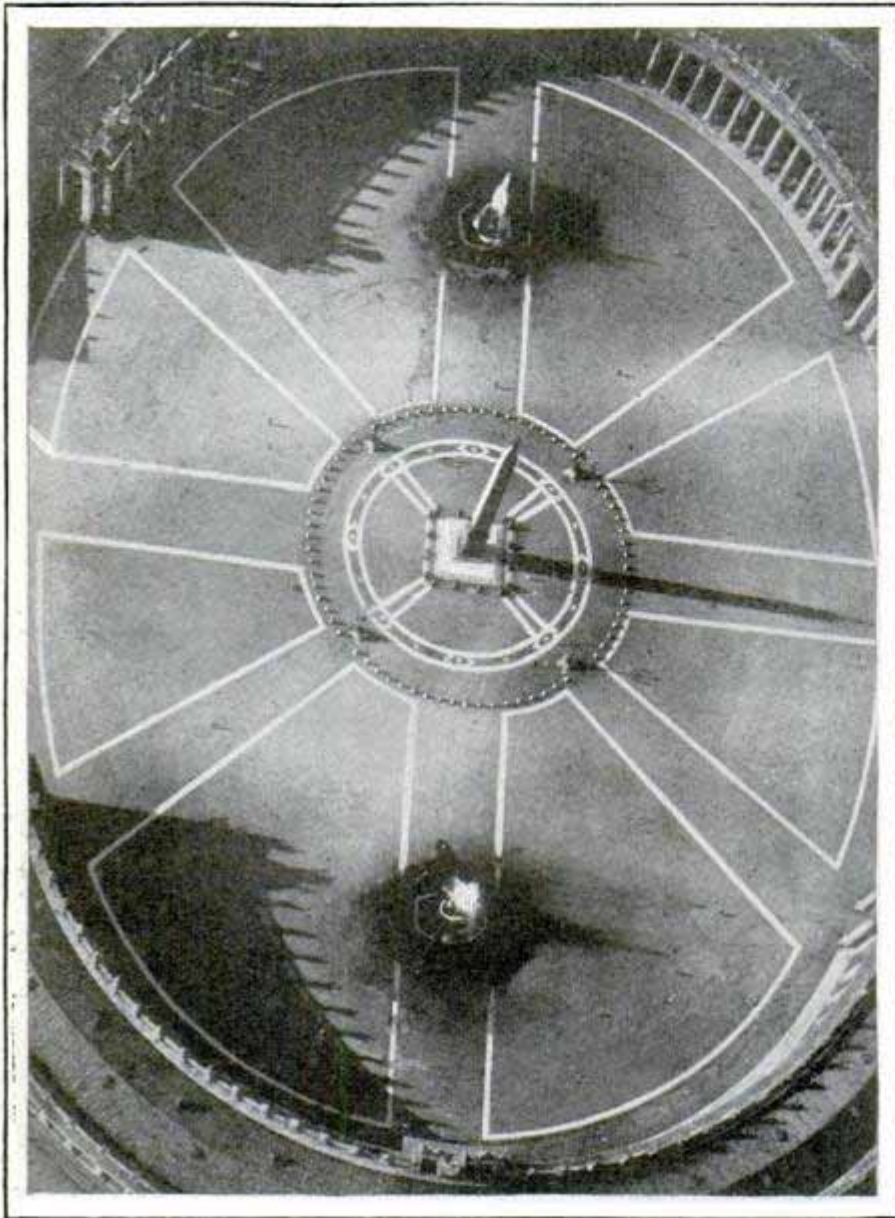

Giant Sundial of St. Peter's Square Registering the Time in Mid-Afternoon

### SHADOW IN ST. PETER'S SQUARE TELLS TIME OF DAY

One of the most famous, and perhaps the largest, sundial in the world is that formed by St. Peter's square in Rome. The obelisk's shadow, falling on the marked circle, indicates the hours when the sun is sufficiently bright. When the accompanying photograph was taken, the time was a few minutes past three.

### AIR PATROL OVER FOREST FIRES REDUCES TIMBER LOSSES

Army airplanes, playing much the same role in the warfare against forest fires as they do in military tactics, are patrolling the national timber stands this summer, enabling observers to guard large sections

and affording a means for quick action in case fires break out. Reserve officers, temporarily in the employ of the forest service, make special flights from several bases established in California, Oregon and Washington, especially after electrical storms, when there is a likelihood that fires may have been started from lightning. One of the interesting results of the air patrol is the effect it has on campers. Knowing that their fires are likely to be seen from the planes, they are displaying greater care in extinguishing their camp fires when they move, and there has been a marked falling off in the number of cases of incendiarism. Congress has appropriated \$50,000 for the patrol work and the planes cover huge territories in the national forests of the west. Besides gaining early knowledge of the fires, the flying patrolmen carry messages to forest rangers, food supplies to fire

fighters when they are combating blazes in otherwise inaccessible places, and the planes have been found useful in making timber surveys and studies of forest areas.

### PORTABLE SAW DRIVEN BY AIR SAVES TIME AND WORK



Adapted to a wide variety of tasks where speed is essential, a portable air-driven saw now on the market has been found useful. It has replaceable blades for crosscut or rip work and special saws for cutting materials other than wood. A feature is the safety guard which

*Safety first*  
Ingersoll-Rand Co.,  
11 Broadway,



automatically covers the blade when the saw is lifted out, and there is also a convenient adjustment for regulating the depth of the cut.

**HOUSES ARE BUILT ON RUNNERS FOR SMELT-FISHING** 2640

Because a Boston man froze his ears and one foot while fishing for smelt in Maine one winter, sportsmen now have learned to tend their lines in comparative comfort, sheltered by little huts constructed on runners for quick and easy moving over the ice. Before the Bostonian's experience, the fishermen stayed in the open air, enduring the intense cold as best they could. But he had a heavy wooden frame constructed, covered it with sail canvas, leaving an opening for the door, placed the "house" over a hole in the ice and fished in luxury, warmed by a wood fire in a small stove. The idea was soon adopted and, before many seasons, similar huts appeared on nearly every estuary and tidal river where the fishing was conducted. When the day is right and the season good, an expert fisherman can catch sixty pounds in a day, and there is always a ready market. The tackle required is simple, a linen cord about four feet long, sinker, a small hook at the end of a two-foot snell attached to a swivel, and clam worms for bait. Usually four lines are operated to a hole. During the fishing season, whole villages may be seen on the ice.

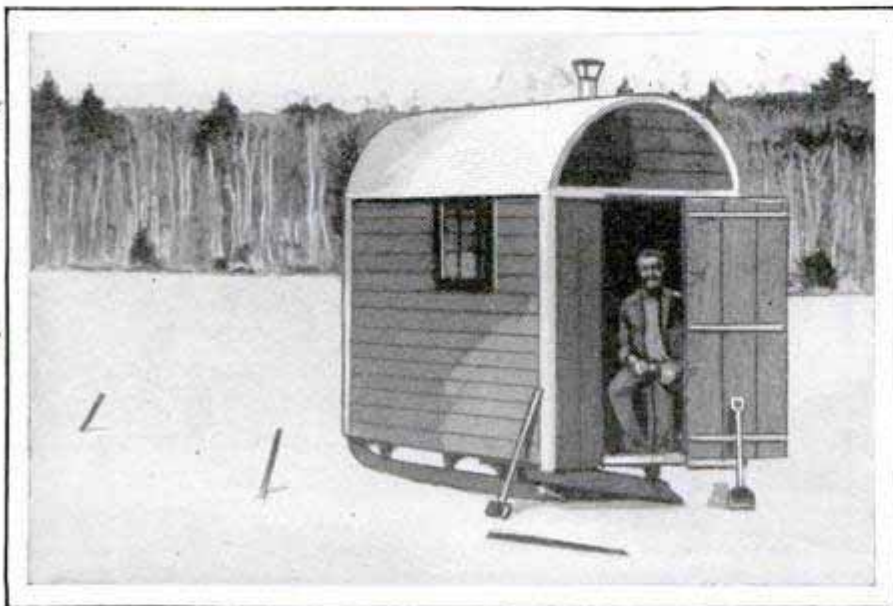

Fishing Shed Mounted on Runners, So Horse Can Pull It to New Scenes, Is Used by Winter Smelt Fishermen

*Bureau of Fisheries*

**WOMAN DARES DIZZY HEIGHTS CARVING WASHINGTON HEAD** 2607

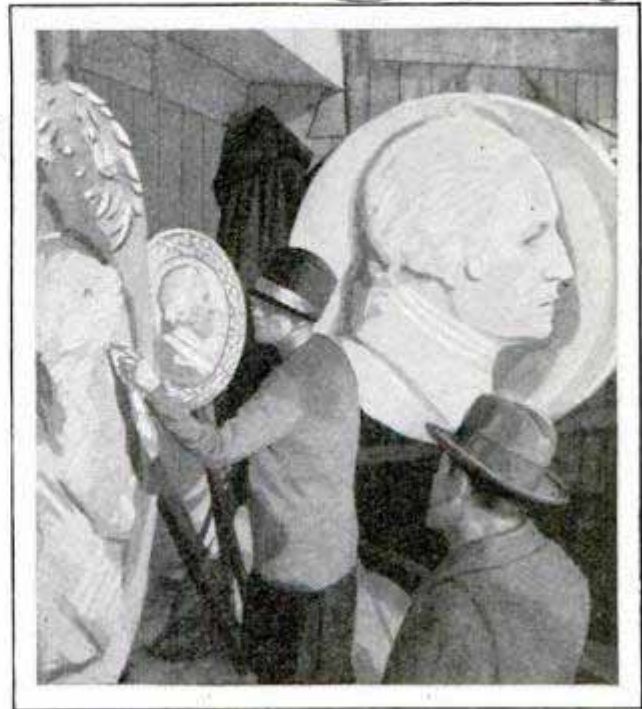

Woman Sculptress at Work, High above the Ground, on Head of George Washington

Perched perilously on a scaffold, eighty feet high, Mrs. Harvey Wiley Corbett, a New York sculptress, assisted in finishing the massive bas-relief of Washington on the masonic national memorial at Alexandria, Va. The carving was made on a huge block of stone weighing seventeen tons, the head itself being four feet six inches from neck to crown. Mrs. Corbett rode on an improvised ladder and pulley hoist to reach the work, preferring that means

of ascent to the temporary stairway. The actual chiseling was done by G. Fred Coles, who executed the statue in the Lincoln memorial, from a plaster plaque molded by Mrs. Corbett. The task was slow, for many pauses had to be made to allow the stone to weather in order to judge the proper delineation of lines and shadows, while the cutting tools had to be renewed frequently because of the hardness of the material, Conway pink granite, in which the bas-relief was cut.

*Washington*



2472  
418

*W. H. Milligan  
X-Ray Specialist*  
*Prohibition Agents X-Raying Bale of Hay, to Reveal Bottles of Liquor Hidden in Its Center*  
*POPULAR MECHANICS*  
*FIRE DAMP FOILED BY ELECTRIC COIL*  
*2688*  
*Central Terminal, New York*  
*W. H. Milligan, X-Ray Specialist*



### X-RAYS DISCOVER LIQUOR HIDDEN IN HAY BALE

X-rays have come to the aid of the dry sleuths in the form of a portable outfit for locating contraband hidden in shipments of various kinds. Not long ago, the apparatus led to the discovery of several cases of whiskey which had been concealed in bales of hay. The machine affords a fluoroscopic record of the materials inside.

### TOMATO-CANNERY WASTE CUTS 2905 LAUNDRY BILLS

Tomato-cannery waste, formerly discarded, has been discovered to be worth six cents a gallon in Italy, where laundries now utilize it to remove stains from linen, particularly collars. The clothes are soaked in vats of the diluted cannery by-product for an hour, by which time the stains are so thoroughly loosened that they can be washed out with little soap and practically no rubbing.

rise, the increase being recorded on a dial in the mine office. An entire mine can be wired up with the indicators scattered through every passage, and the dials centered at one point, where any increase in the amount of gas can be detected long before it reaches dangerous proportions.

### TWO-TONE BANJO HAS DAMPER 2394 TO REGULATE SOUND

Two distinct tones are said to be produced by a banjo recently introduced. It differs from the usual instrument in its rim construction which has built-in chambers and two sets of sound openings that amplify the tones. In addition to these is a damper arrangement whereby the player can cause the sound to pass through the openings in it and those in the rim, thereby obtaining increased volume, or can restrict it to but one set of openings. This results in a rich tone of different quality, and an intermediate effect may be produced by using the damper.

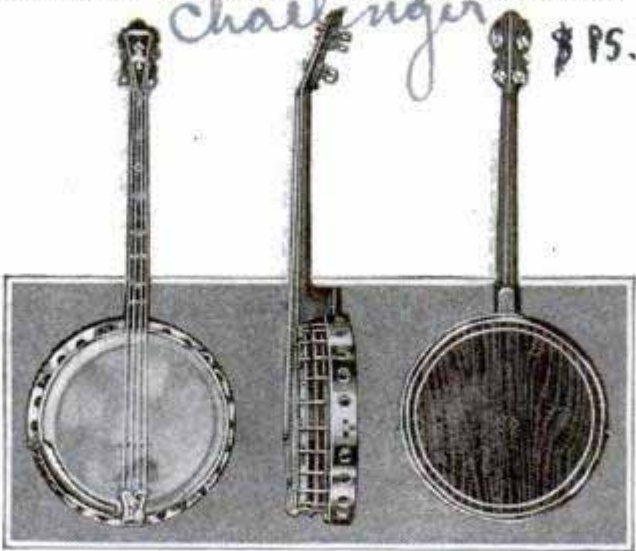

Novel Two-Tone Banjo Which Utilizes Two Sets of Sound Chambers, Either Singly or Together

*Emb. George H. Holden  
Highfield  
W. H. Milligan  
X-Ray Specialist*

*William J. Lange*

*1615460  
Jan. 28, 1927*



2301 Mr. Walter ...  
1922 Florida Ave, Kenmore,  
Ohio

# How to SELL YOUR INVENTION

law  
rec  
an  
de  
ap

HAVE you a patent lying around the house, earning nothing because you could never find a market in which to sell it, or financial backing to put it to use?

Several hundred thousand Americans are in that position, judging from estimates that fully ninety per cent of all patents issued never return a dollar to the fathers of the ideas.

The creator of any new idea (provided it isn't a perpetual-motion machine or hasn't been previously conceived in somewhat similar form by someone else) can get a patent on it at comparatively small cost.

But getting the patent is the least part

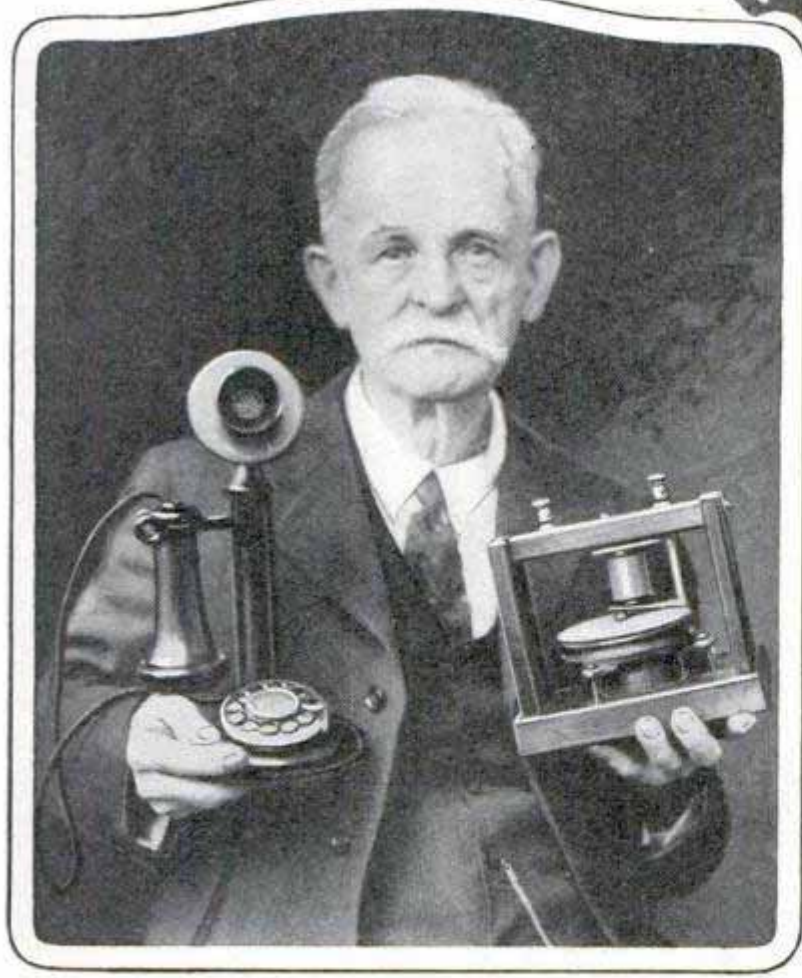
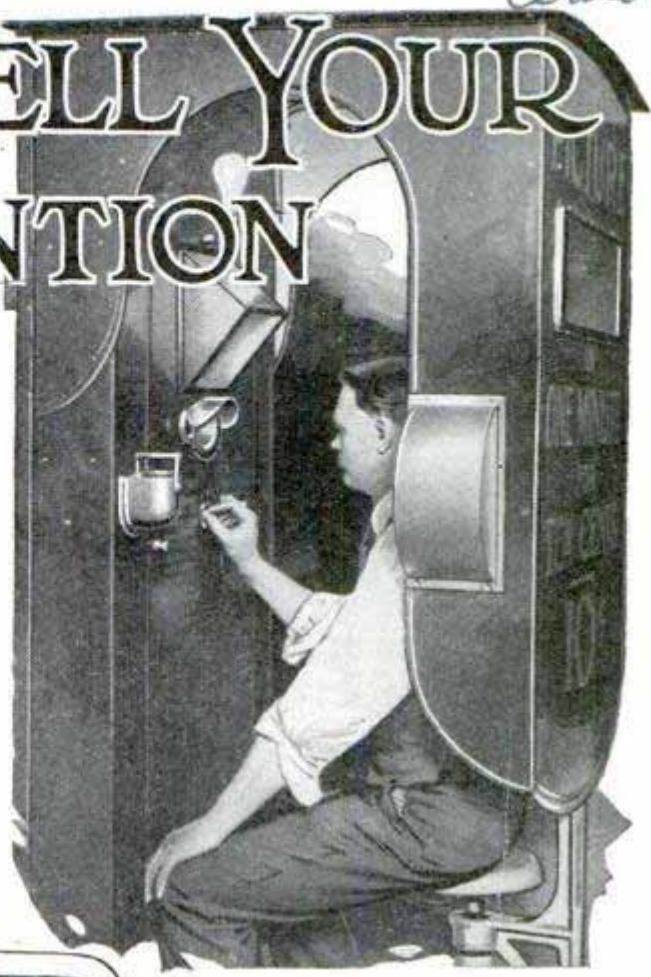

Frederick W. Loehr, Oldest Telephone Craftsman, Who Has Seen the Instrument Grow from Bell's Crude Model, Which He Holds beside the Latest Style; Above, a New Automatic Photo Machine

of the problem. Making it pay is the real task. The question of how to sell an invention really goes back to the old one of what to invent. The product must be, first of all, one for which there will be a demand, in other words one which serves some practical purpose. Secondly, it must be one which can be manufactured, advertised and sold at a price which is not out of proportion to the benefits the user would derive from it.

As an example of what that means, an inventor who has a long list of successful patents to his credit, turned out, as one of his early efforts, a water-motor reel for winding up the hose after the lawn is sprinkled. He went to a manufacturer, who promptly pointed out that, while the motor would eliminate the labor of reeling the hose by hand, the cost of the outfit would be more than any-



one would care to pay for the slight benefit he received.

As a general thing it has been stated that a simple and inexpensive invention with a widespread field will return greater profits than a complicated and highly expensive machine. Can openers—a need in every kitchen—have returned far greater profits than Zeppelin airships. A complicated machine, to earn large profits, must serve a wide field and be a real labor saver. The reaper, binder and threshing machines are good examples.

Given a good idea, the problem of selling it can be tackled after or before patenting, just as desired. Many embryo inventors have an idea that a villain lurks around every corner waiting to steal their ideas. After an inventor has obtained a few patents and discovered how hard it is to practically give them away, his ideas about patent thieves are considerably changed.

Some people have the erroneous idea that letters patent from the government constitutes an exclusive franchise to manufacture the product described for a certain number of years and is a guarantee against infringement. In reality a patent is nothing but a written record that on such and such a date the inventor actually possessed such an idea. It is up to him or his assigns to protect themselves against infringement, for the patent is only useful

in some cases, and the date established by taking the papers to the post office and having them stamped with the official government date stamp. Once witnessed and stamped, the inventor's idea is safely protected for two years, even though someone later has the same idea and actually patents it, for the patent proceedings can be contested, if a prior date can be shown.

After the drawings and description are patented or witnessed, comes the real task of finding either a buyer or financial backer. Suppose the invention is an automobile accessory. Where would you try to market it?

As a general thing, the most likely field would be among existing auto accessory manufacturers who did not have a device for a similar purpose already represented in their lines. The reasons are obvious. Such a manufacturer probably has factory equipment suited for the making of the new product, and is perhaps not engaged to maximum capacity in the making of his existing line. He knows the automotive trade and knows whether the new idea would serve a useful purpose and be a good seller. He already has existing jobber and retailer contacts, and his sales and advertising forces are ready to handle an additional line. His manufacturing, sales, advertising and distribution expenses, therefore, would be a fraction of what they would be if a new company was formed to manufacture the one new device. And, likewise, he has the existing good will of his company behind him, whereas a new company would have to build up its own place in the trade.

If no company already in the field can be persuaded to handle the invention, then, perhaps, a company in some allied trade, or one with plant equipment for the manufacturing problem, can be interested. If not, the inventor's next step may be the formation of a new company.

The best field for that is in your own home town, among friends, neighbors and others who know you. Usually the inventor puts in his patent, plus, perhaps, a small amount of capital, and the other incorporators put up proportionately larger

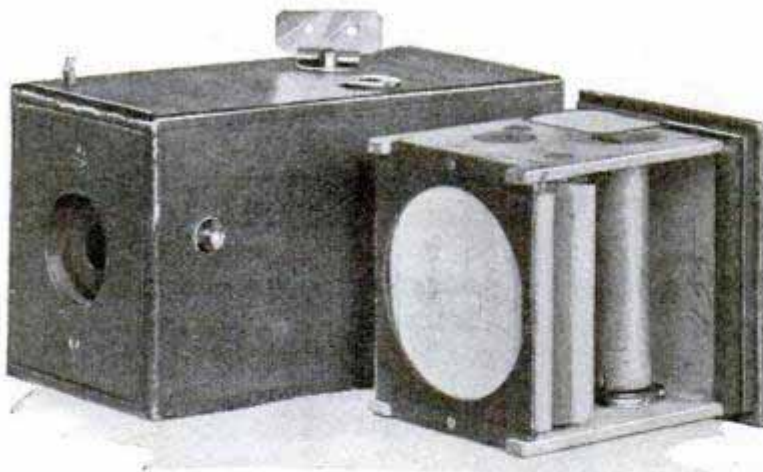

The First Kodak Roll Holder, Invented in 1888, Has Been One of the Biggest Money Makers in History

in that it establishes the priority of his idea. Many inventors establish the same fact by showing their drawings to two friends, having both witness them before a notary, who signs and seals each sheet to attest the date. Even the notary has been elim-



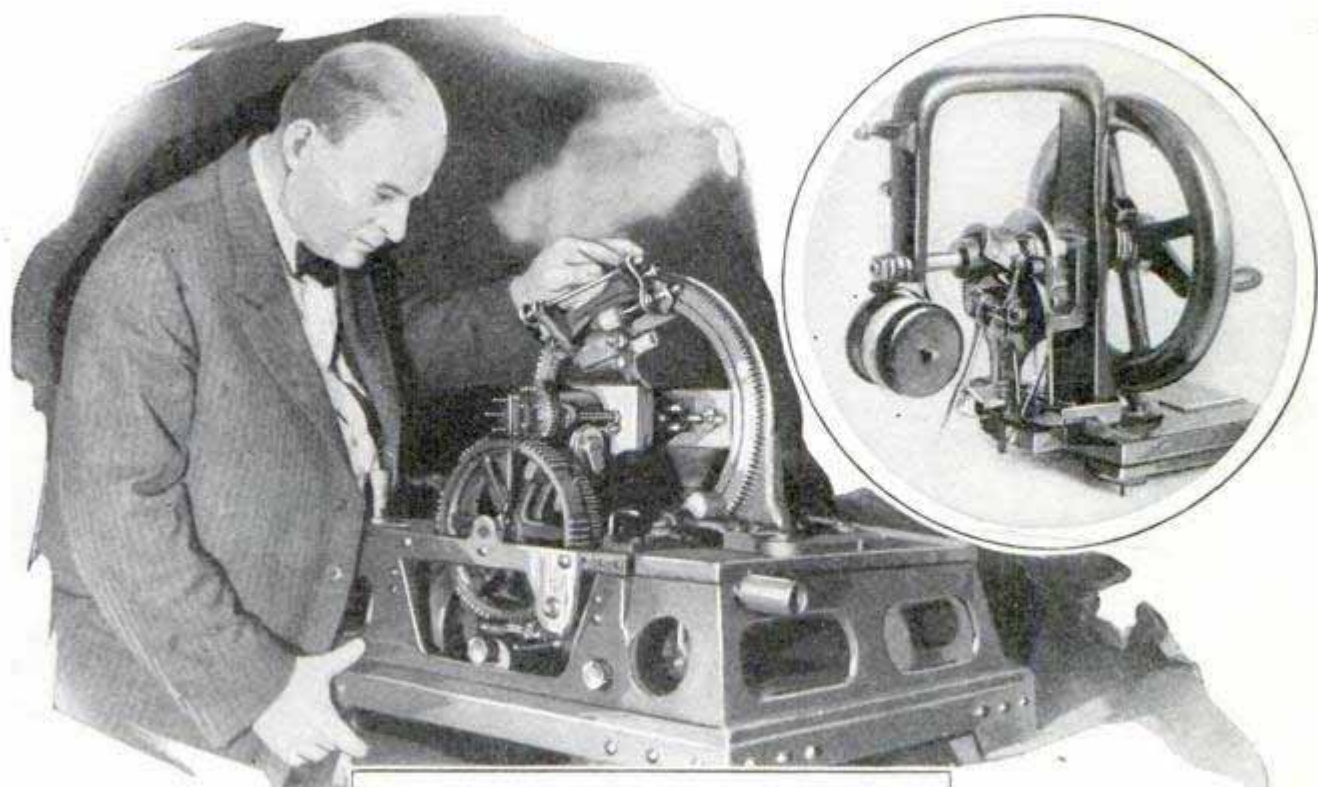

John R. Gammeter, Who Has Devoted Years to Inventing New Machines for the Rubber Industry; at Right Is the First Selden Automobile, Which Started the Famous Selden Patent Litigation; Insert, Howe's Original Sewing Machine



shares. If \$50,000 of paid-up capital is planned, the patent, for example, might be valued at \$5,000, and the inventor assigned a corresponding share in the company.

The inventor doesn't always stay in the company when a new one is organized to manufacture his invention. Sometimes he prefers to sell the patent outright. One experienced inventor says it is easier to sell a half interest in a patent and then give the buyer the other half, than it would be to sell the whole thing. Buyers who would hesitate to assume the full responsibility, he claims, can be persuaded to take a half, and pay as much as they might be asked for the whole, merely because they feel the owner of the other half is going to share the responsibility of establishing a market for the invention.

The man who has a device which will serve a real need, and that can be made and sold at a price within keeping with the service it is to perform, sooner or later is going to find a market for his idea, which

is why the sales problem really goes back to the question of what to invent.

A patent for a chicken roost with a disinfecting feature, after lying idle in its owner's hands for four years, was recently put to use. The owner, living

in Nebraska, had obtained his papers, and then couldn't find a market. A friend of his met an Iowa manufacturer of chicken brooders who casually expressed a desire for such a device to add to his line. The friend introduced the two, and a satisfactory sales agreement was reached. The patent probably will never earn any vast fortune for either inventor or manufacturer, but as a side line, easily marketed with existing factory, sales, advertising and jobber forces, it will earn a certain and fairly steady income.

Recently the inventor of an automatic quarter-in-the-slot camera was reported to have sold his rights to a group of New York capitalists for \$1,000,000. His device was quite complicated, but the field for it was so great that it could earn money on even that large investment. If it was never used for anything but to make the small photographs for chauffeurs' licenses,



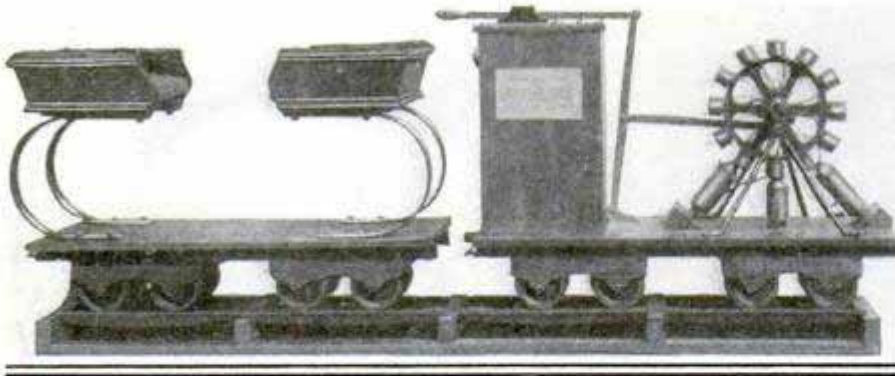

From This Crude Model of the Farmer Electric Motor and Car, the Entire Electric Railway Business Has Grown in One Lifetime

ever, has intrigued countless thousands, for the foreign pastures, for some reason, always look the greenest. The inventor who strays outside his own field is likely either to turn out an impractical device, or reinvent some old idea. Thousands and thousands of inventors every year, after months or years of hard work, are

passports and similar documents, it probably would earn a fortune.

For contrast, consider the bomb-dropping devices used on war planes, several types of which have been patented. All are fairly simple and not particularly expensive to make, but the inventors will never earn any great fortunes for the simple reason that so few people need bomb-dropping machinery.

The often-stated axiom that the simple and inexpensive invention will pay better than the complicated is only partly true. The real test is the number of people who are potential customers.

The revolving cups by which the weather bureau measures the wind velocity is about as simple an invention as one could want, but after all of the possible customers have been supplied, the inventor probably had no great return on his idea. An automobile, on the other hand, is a fairly complicated and highly expensive device, but there are 20,000,000 or so in use and more being made and sold every day.

On the other hand, fortunes have been spent in developing mechanical vote-recording machines, but if every voting district in the country had one, the number probably wouldn't equal one year's output of one auto factory. Compared with that, the hookless fastener is so cheap and simple that it can be placed on billions of articles of various kinds.

Usually the inventors that are the most successful are the ones who stick to their own field. A street-car motorman inventing improvements on street-car mechanisms is apt to succeed, for he knows his subject, but if he turned to household utensils or astronomical instruments, he stands a good chance of being a failure. Inventing things in the other fellow's field, how-

turned down by the patent office because somebody else had the same idea, maybe years ago. One inventor, for example, spent two years laboring to produce a variable eccentric for a machine he was working on, and then learned, after he succeeded, that exactly the same idea had been patented forty years earlier.

If he had had any previous experience, he would have known that a few cents would purchase from the patent office descriptions of patented devices for that purpose, and among them he would have found the very one he wanted. For \$10 a patent attorney will search the records and tell you about everything that has been invented in any given field.

The bugaboo of patent thieves is so great in some inventors' minds that occasionally men are found who do not want even to tell their patent attorney what they want to invent—despite the fact that the lawyer must have drawings and a description prepared before he can file them.

For those who are afraid to confide even in their lawyer, the signed and witnessed drawings and descriptions present the obvious solution. The inventor is then allowed two years' grace to perfect the idea before he need submit his application for the patent papers.

Professional inventors keep notebooks and sign and date each day's notes and sketches, and, if the idea appears particularly important, even have the date and signature witnessed and sealed.

2663

**STUMPS REMOVED WITH ACID**

Removing stumps with acid instead of blowing them out with dynamite is the method used successfully in Germany. A hole is bored in the wood, equal parts of

no other data



2603  
 111 Milwaukee Ave.  
 423  
 Portland, Ore

nitric and sulphuric acid poured in and, in a few weeks, even the hardest wood is said to be so affected by the action of the liquids that it can be crumbled with a pick. Besides being easier, the process is less dangerous.

2625

**SHIP BASIN FOR OIL TANKERS HAS FIREPROOF DOOR**

On an island built of sand, dredged up from the harbor bottom, the port of Havre, where American troops landed during the war, has built the most modern fuel-oil depot in the world. It is unique in many ways, but particularly because the basin in which the oil tankers unload their cargoes from overseas has been fitted with a fireproof door which closes the entrance gap so that, should a carelessly dropped spark set fire to oil floating on the water, the flames cannot spread to the rest of the harbor. The oil depot is operated under a private company, with a sixty-year concession from the government. The 250 acres of land provide room for thirty-three tanks with a capacity of 786,000 barrels of oil, a pump house with pipe lines to all the tanks, a boiler house, electric generating station, chemical laboratory, workshop, a filling station for barreling oil for shipment inland, and shortly a refinery is to be added. The ship basin is big enough to handle the largest tankers afloat at any stage of the tide.



Lawnmower with Interchangeable Blades, Based on the Safety-Razor Principle

**CHANGEABLE BLADES ON MOWER SIMPLIFY TRIMMING LAWN**

Marking a radical departure from the ordinary types, a lawn mower now on the market has interchangeable blades which may be discarded and replaced almost as easily as those of a safety razor. There are thirty-six on the twelve-inch model cutter, each being a small square of stamped steel. They are fastened in six rows, extending around the revolving unit and present a solid cutting surface. Contact is made against a spring bar close to the ground, and it is said to be impossible to destroy the alinement of the blades by catching a stone or stick. The entire cylinder or separate blades may be changed, and by reversing the knives, double service is gained. A close-cut, even trim is obtained with the mower, according to reports.

More than 1,200,000 farms in the United States are now equipped with radio sets.

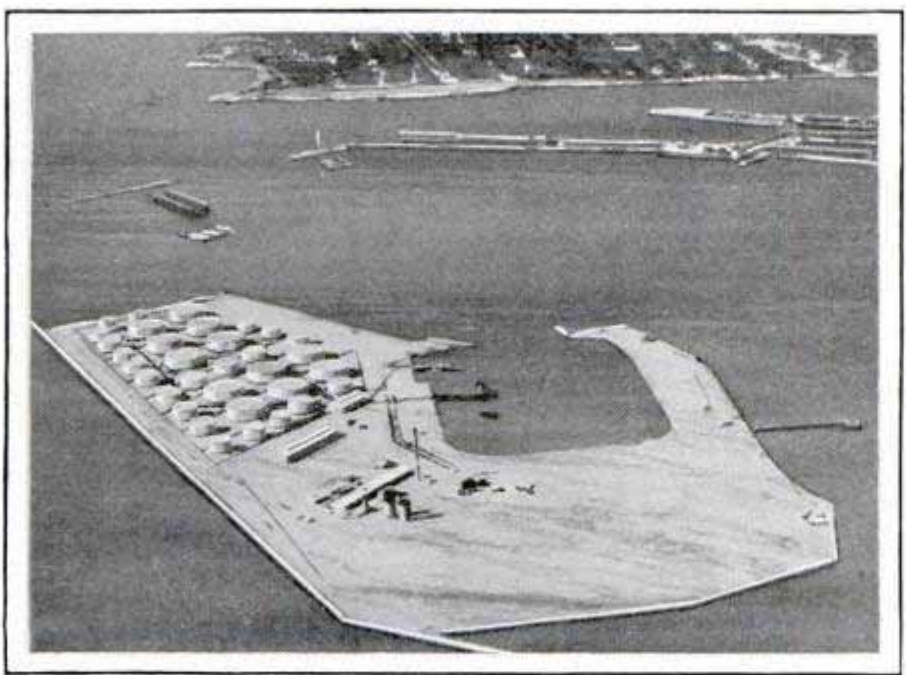

Oil Base at Havre; a Fireproof Door Closes the Entrance to the Ship Basin

Commerce Reports 5/23/27  
 12 1/2



2/27/27

1910

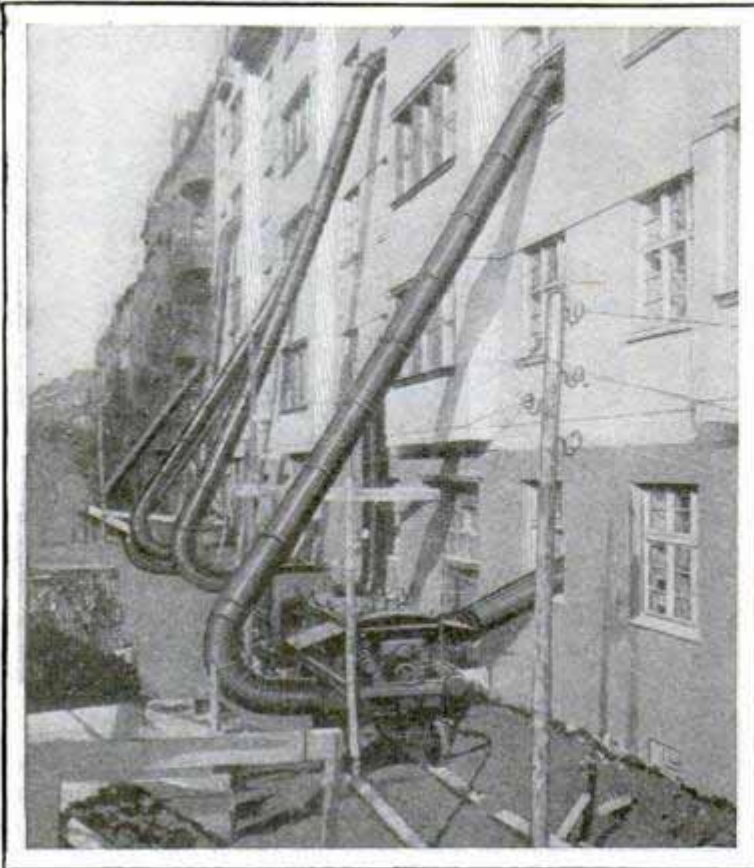

How the Building Was Quickly Dried for Early Occupancy; the Hot-Air Pipes and Pumps Installed and Operating

### PUMP HOT AIR IN NEW BUILDING FOR QUICK DRYING

To make new buildings suited for occupancy within a few days after completion, German engineers are using a system of compressors to force hot air into the interiors. Delivery pipes are rigged to supply all floors, the apparatus being constructed so that it can readily be taken down or set up and hauled from job to job. The plan is said to be especially useful for concrete houses which can be made ready for rental in two to four days by the treatment.

### X-RAYS IN CRIME DETECTION AID IDENTIFICATION

That X-rays may be used like fingerprints to establish identity, is suggested following their successful employment in a case involving a murder victim who had left considerable property. The man had attempted to enter Tibet and had dropped out of sight purposely, shortly before his venture, so that his plans might not be frustrated by his government which forbade entrance into that country. Seventeen days later, the bodies of two white

men, disfigured beyond ready identification, were found seventy miles from the camp where the man had made preparations for his journey. One of them bore a scar such as had been on the victim's head. His physicians, by means of X-ray photographs, taken at the time of the treatment and later, established the identity of the victim beyond all question. This is said to be the first case on record in which the rays were so employed.

### FASTEST TOP IN WORLD IS SPUN WITH AIR

Spinning tops for science is one of the interesting activities of a French investigator who has been studying rotary effects. His tops are quite different from the ordinary toy variety, being accurately constructed rotor units of brass alloy, propelled by compressed air. His fastest one has made 11,000 revolutions a second, by measurement, and its actual speed is believed to be considerably greater, but instruments of sufficient delicacy were not available to check it. The operating principle is unique. The unit is so adjusted and the air so applied that the top literally floats in air as it spins. As yet, little practical use has been made of such speed, although a purpose was found for one of the tops at 75,000 revolutions per minute.

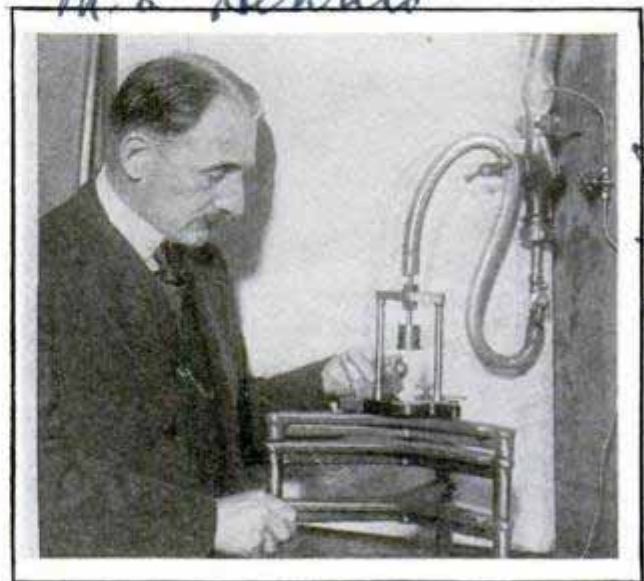

One of the Record-Breaking Tops, and Compressed-Air Apparatus in Which It Is Spun

277

Science News Letter

Laboratory utb and

Paris France  
M. E. Denrator  
Feb. 16, 1910  
Arch. A. M.



OLD PRISONS SERVE AS SCHOOLS IN PORTO RICO

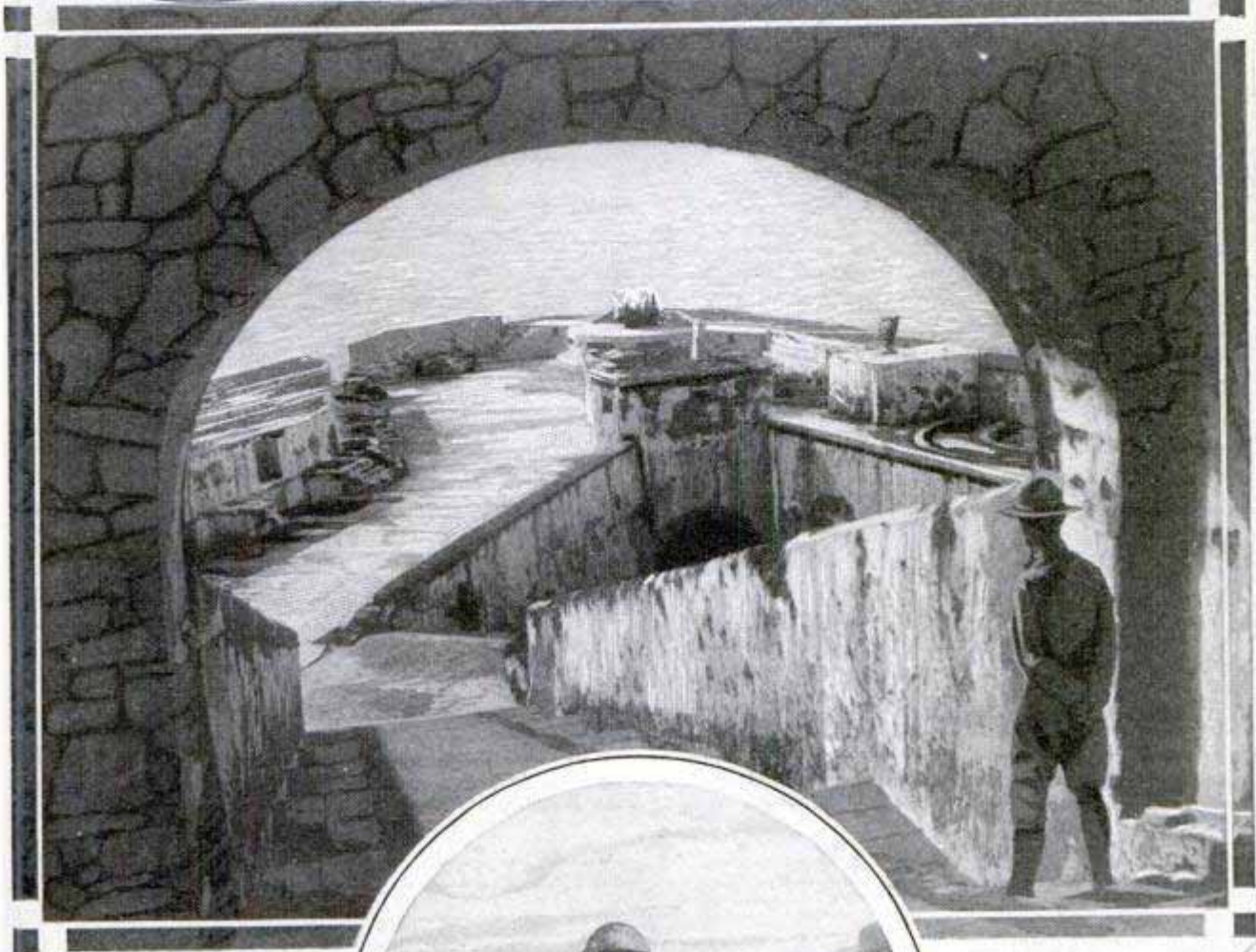

Where Prisons Serve as Schools; Views of Old Spanish Fortresses at San Juan, Porto Rico

Prison cells in old Spanish fortresses have been converted into schoolrooms as the latest step in Americanization processes carried on by the United States army in Porto Rico. American officers are learning to speak Spanish, and Porto

Ricans, who are also enrolled in the 65th infantry regiment stationed at San Juan, are learning English, and many of the classes are conducted behind barred windows and heavily grated doors, installed some 400 years ago. The schools are maintained in El Morro and San Cristobal fortresses. Writing of the transformation that has been made in some of the rooms of the former, Lieut. C. R. Smith, editor of the regimental paper, says: "Doors of heavy steel bars still swing to and fro at

the entrances. Sunshine entering the windows still etches perpendicular parallel lines on the walls. Iron hooks still remain here and there in the masonry to recall the hammocks that had swung therefrom for the repose of all-night lodgers.

And well-worn stone floors remain to bring a mind's picture of former restlessness by day. However, modern school desks, blackboards and chalk dust give a real school atmosphere and, when the machines of the typewriting class click, the teacher must feel as well satisfied with things in his cell room as does any old maid hearing the teakettle singing."

☐ The cost of a radio program may reach from \$5,000 to \$7,000 an hour.



2456  
426

Mr. H. Sibley, 1240 S. Figueroa St  
Los Angeles  
Calif

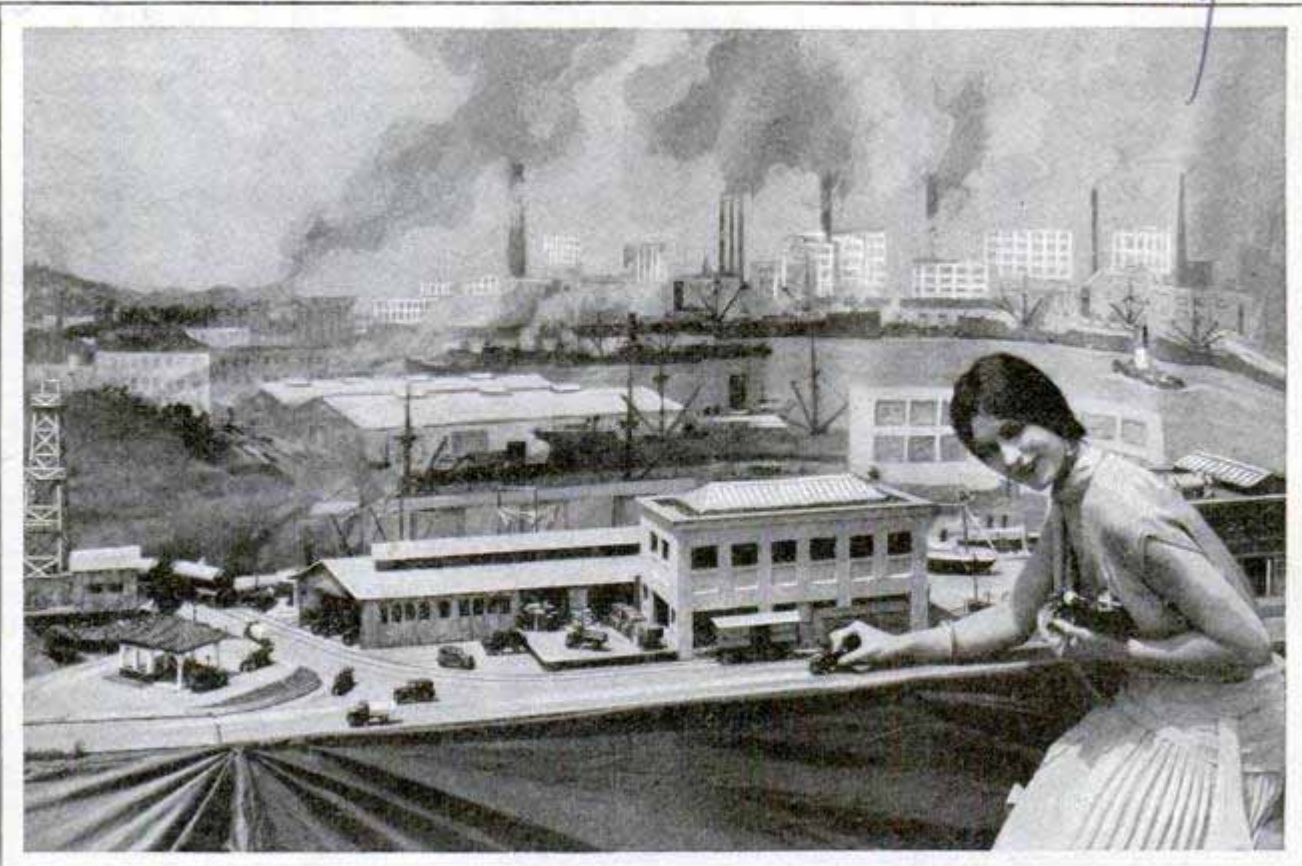

Section of a Vast Harbor-Development Model, with Buildings, Ships, Automobiles and People All Reproduced to Scale; Commercial-Model Making Has Become an Important Industry

## Modeling Whole Towns in Miniature

### Demand for Toy-Size Reproductions of Cities, Harbors and Plants Creates New Industry for Experts in Scale-Model Making

**I**N sixteen years of building miniature models for industrial exhibits, William Fowler, of Los Angeles, has developed his creations to a point approaching perfection. His sets include complete steel plants, potteries, oil, mining, fishing and textile industries, motion-picture studios and all classes of California farm enterprises. Every item, however inconsequential, is worked out in the minutest detail—even to the eyes of fish a quarter of an inch long. Some of his sets have been built on as fine a scale as one-twenty-second of an inch to the foot.

Now under construction is a vast harbor set, thirty feet in length, in which vessels only three-fourths of an inch long will move about on real water. This set will be an exact replica of the Los Angeles harbor district, and to make it accurate, photos were first taken from an airplane of the area to be duplicated. These photos were then thrown upon a large sheet of

drawing paper with a stereopticon lantern, and the outlines of waterways, docks, buildings, railroads, etc., were traced. Upon these tracings the set is being built.

An odd assortment of commodities contributes to the making of the details of other sets. For instance, flower seeds were used for the bodies of the tiny fish in the fishing set; short sections of macaroni were painted to represent the drain tile in the potteries set; scrap iron in the steel mills consisted of slugs, gear wheels and springs from discarded clocks; tile roofs were made from the corrugated paste-board used around mazda bulbs in stock; trees and foliage from kelp, steel wool, sponges, certain mosses and ferns imported from Germany, and the cabbages in a truck garden were made from rosebuds, such as milliners use, and tinted green.

Practically every part of the work is done by hand, except that dies are used for the structural brick and tile and some



2736

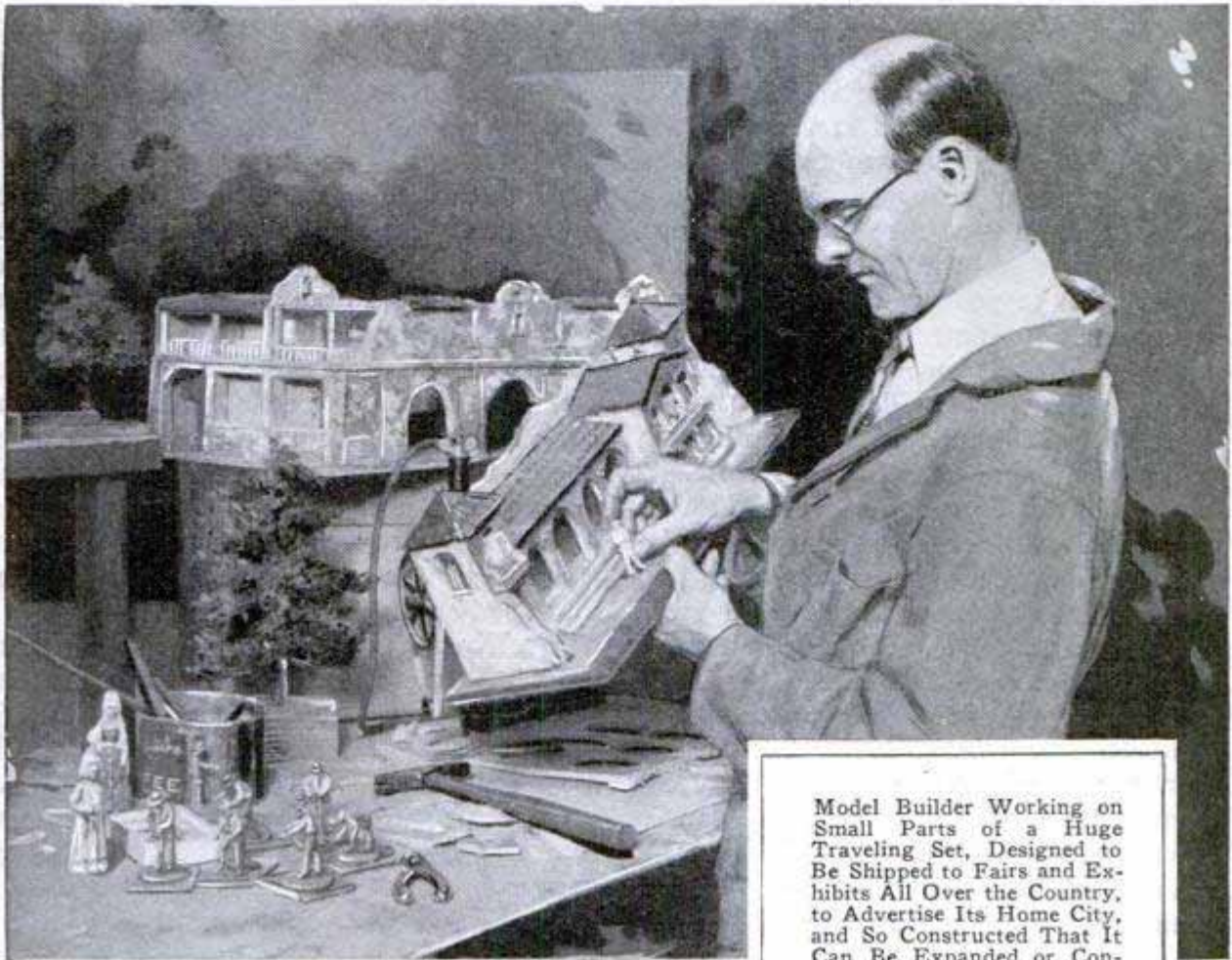

Model Builder Working on Small Parts of a Huge Traveling Set, Designed to Be Shipped to Fairs and Exhibits All Over the Country, to Advertise Its Home City, and So Constructed That It Can Be Expanded or Contracted to Fit Any Size of Exhibit Booth; Below Are William Fowler, at the Left, and Two of His Assistants, Working on an Oil-Well Model, Being Reproduced from the Enlarged Picture in the Background

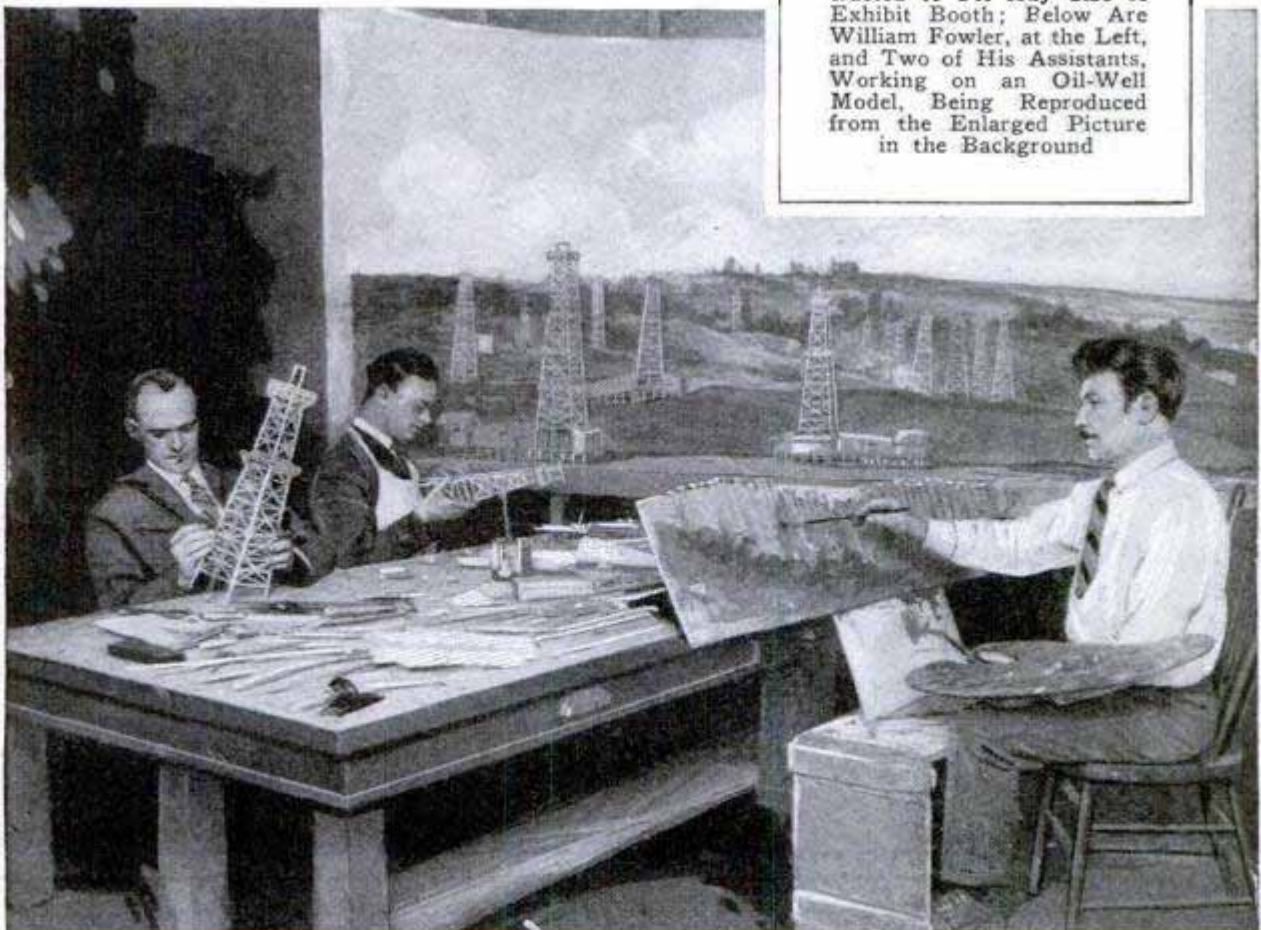



of the architectural decorative effects. The human and animal figures are molded in wax, using a flexible glue mold for such pieces as have undercut parts which could not be drawn from a rigid mold. Shelves are filled with tiny men, women and children in all sorts of postures, waiting to be painted to match the set to which they are called. Cattle and other live stock assume the most lifelike postures and are a startling contrast to some of the cruder type of sets where dolls and toy animals used to take the place of the figures. Some of the chickens in the farm sets are no bigger than the "BB" shot used in an air rifle.

The buildings generally are made of compo-board or heavy cardboard, and in the industrial buildings a covering of corded cloth is applied and treated with aluminum paint. This, with a brown stain here and there to simulate rust, gives them exactly the appearance of corrugated iron.

The trees and foliage are works of art. The larger specimens, such as a sturdy pine tree, are built up branch by branch with evergreen foliage. A fruit tree in bloom is achieved by dipping the branches in glue and then blowing tiny shreds of

pink tissue paper upon them. The effect is true to life even at a short distance. Steel wool, tinted green, does very well for the smaller shrubs, and certain ferns and agar-agar are used for the leaves of small trees.

The building of the sets is pretty much an industry in itself, for several are on the road at one time, with special cars and special crews to take charge of their erection and dismantling during exhibits and fairs. In this way there is a minimum of wear and tear. The construction shop has such a variety of equipment and stock of papier-mache horses, statues, mechanical effects, etc., that it has the appearance of a theatrical-property storeroom. Most of this material is salvaged from year to year and used again in another form.

Mr. Fowler adopted model making more as a pastime than a profession sixteen years ago, after he had been temporarily blinded in a steel plant in the east. His slow recovery forced him to take up creating such things as he could to amuse himself while lying in bed, and the accompanying illustrations show to what a high plane he has developed his art.

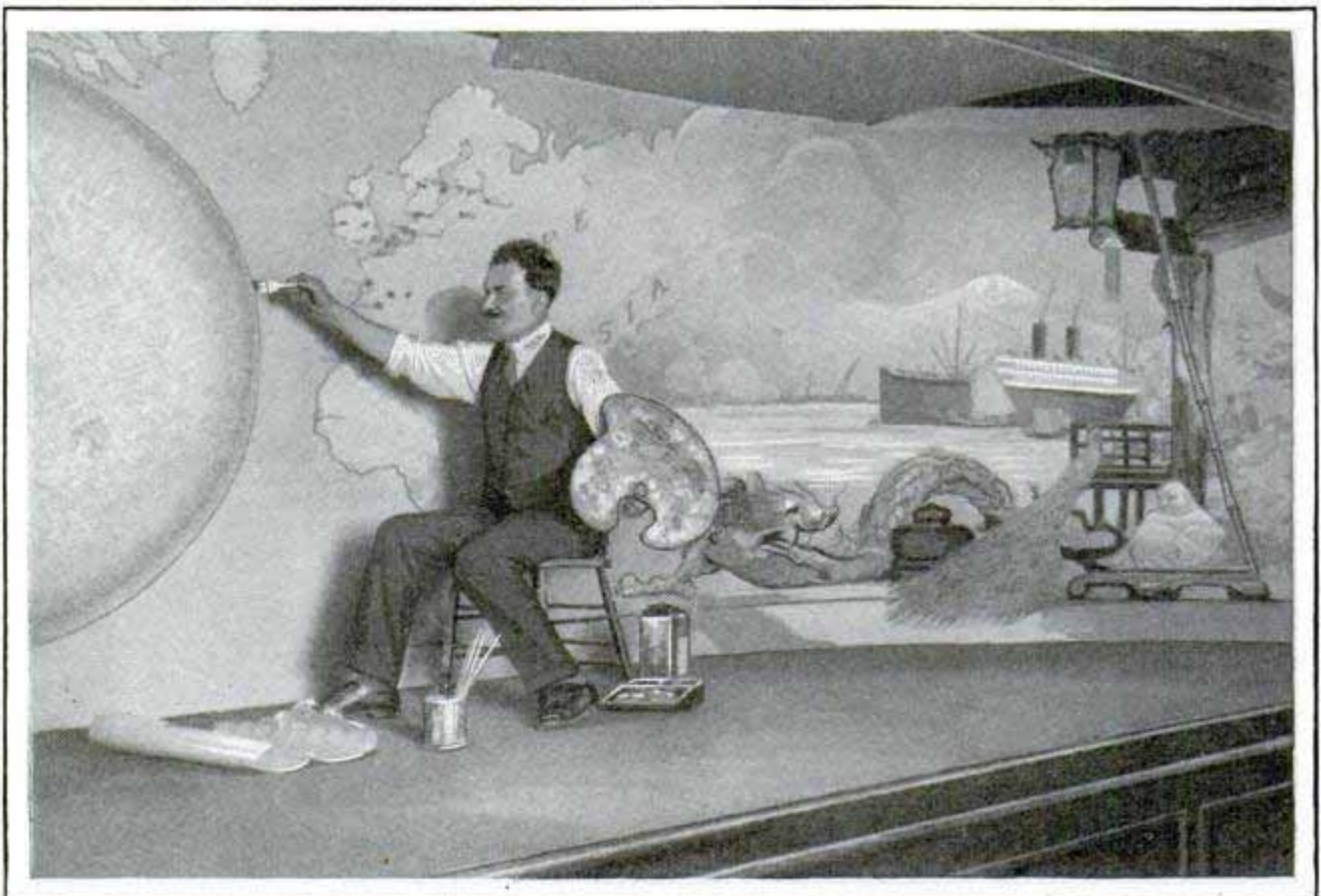

Part of a Background of Harbors of the World, to Be Used behind a Miniature Traveling Model of the Los Angeles Harbor When It Is Exhibited in Other Cities



*Highfield View  
Tipton View Road*

*2377*

**NATIVES OF CONGO  
USE FISH GLUE FOR  
WATERPROOFING**

Natives of the Congo region in Africa waterproof their clothing, as well as their canoes, with a preparation made from fish scales. To facilitate the task of removing the scales, the fish are laid out in the hot sun for an hour or so and then scraped; whitebait, bleak, dace and roach being the species commonly used. The scales are mixed with twigs of various native plants and boiled for several hours, until a thick fish glue is obtained. The glue, when thinned by heat, can be applied to cloth or to the canoes and, after thoroughly drying, forms a waterproof coating that compares with the best products of modern chemistry and besides is considerably cheaper.

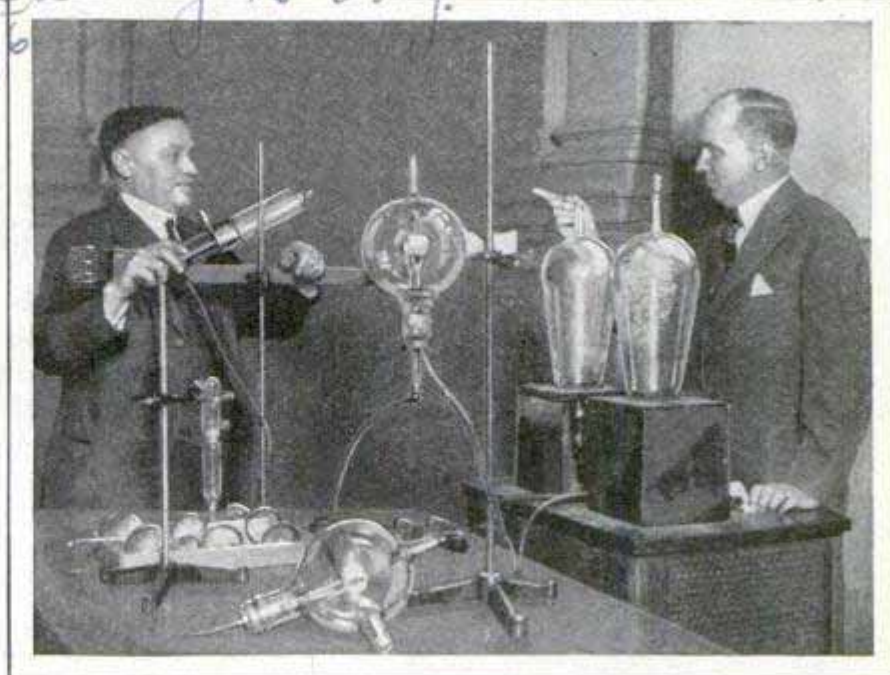

Dr. Harvey C. Rentschler Explaining His Radio Furnace to S. P. Grace, President of the New York Electrical Society

**POWER TRANSMISSION BY RADIO  
DEMONSTRATED IN TESTS**

Electric lamps held in the air, glowed brightly although not connected to wires, during interesting tests in transmitting power by radio, recently. In a "radio furnace," chemical reactions were initiated by wireless waves. A disk of metallic tungsten, among the most infusible of all metals, was heated white-hot on exposure to the rays. In the opinion of many investigators, developments in power transmission by radio promise practical service for the future.

**PEANUT-SHAPED AUTO BODY  
ADVERTISES PRODUCT**

To make an automobile body look like a peanut for advertising purposes, craftsmen of an Indianapolis company had to solve several perplexing problems. One involved the indentations on the "shell." As they were nearly all of different size, all had to be done by hand, and special shading applied with peanut-colored paint to bring out the depth of the grooves and markings. Each spot was heat-treated and hand-drawn. To insure proper ventilation for the radiator, an opening was cut in the front of the steel body and a heavy wire screen welded on. A dummy figure on top of the body was fashioned from sheet steel and hinged so that it could be folded back when needed in passing under viaducts.

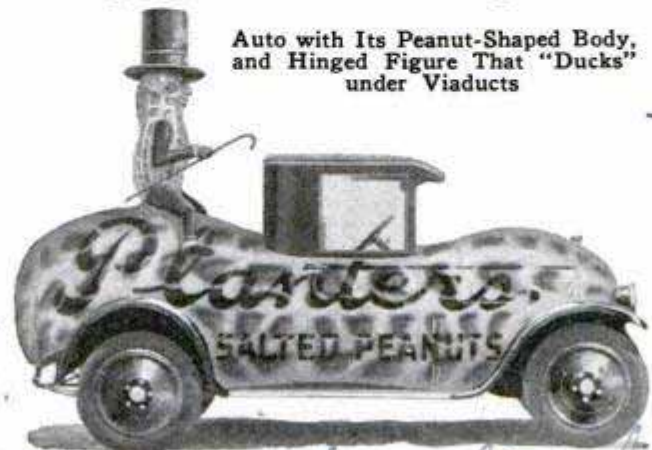

Auto with Its Peanut-Shaped Body, and Hinged Figure That "Ducks" under Viaducts

**RECORD NON-STOP TRAIN RUNS  
OVER TWO HUNDRED MILES**

What is said to be the longest non-stop run in regular railroad service has been inaugurated on an English line from London to Carnforth. The distance is 236 miles, the only delay being to add an extra engine for the pull over a steep grade. One of the purposes of the new train is to afford better connections to Ireland.

*The Milsbaugh & Co. Body Corp.*

*Canashire  
Watm. St. Pancras route*



2370

Paul Muller



Making Use of Waste Space; Upper Part of Door Converted into Photographer's Showcase

### DOOR IS MADE INTO SHOWCASE TO INCREASE PHOTO SALES

By converting a near-by door into a shallow showcase, a Cincinnati photographer increased his exhibit space and obtained a special booth for the display of various kinds of cards. The glass pane in the upper part of the door served as a

window and the rest of the case was easily built. Besides promoting the sale of cards, the plan attracted more patrons for the picture studio.

over 1914

### SOLDIERS FORM LIVING SIGNS TO GUIDE AIRPLANES

2680

Two squads of soldiers are lying prone, the underside of their haversack flaps, painted white and orange, exposed. From an altitude of 4,000 feet or more, an observer looks down from his airplane, reads the code revealed by the little color spots and notes the exact location of the groups and possibly the rest of the infantry position. This interesting maneuver is a development of modern warfare, necessitated by the increasing use of the airplane in scout and defense work. At Fort Benning, Ga., experiments have been made recently, using parts of the doughboys' equipment to give the signals. The meat cans were found effective in attracting attention because of their glitter, but not reliable in relaying messages. Strips of cloth fitted to the inside of the meat-can pouch flap, underneath the haversack flap, the gas-mask satchel, and helmets having a shutter containing three triangular slots and rotated to expose the polished surface of the crown alternately, were tried with varying degrees of success.

Infantry Board

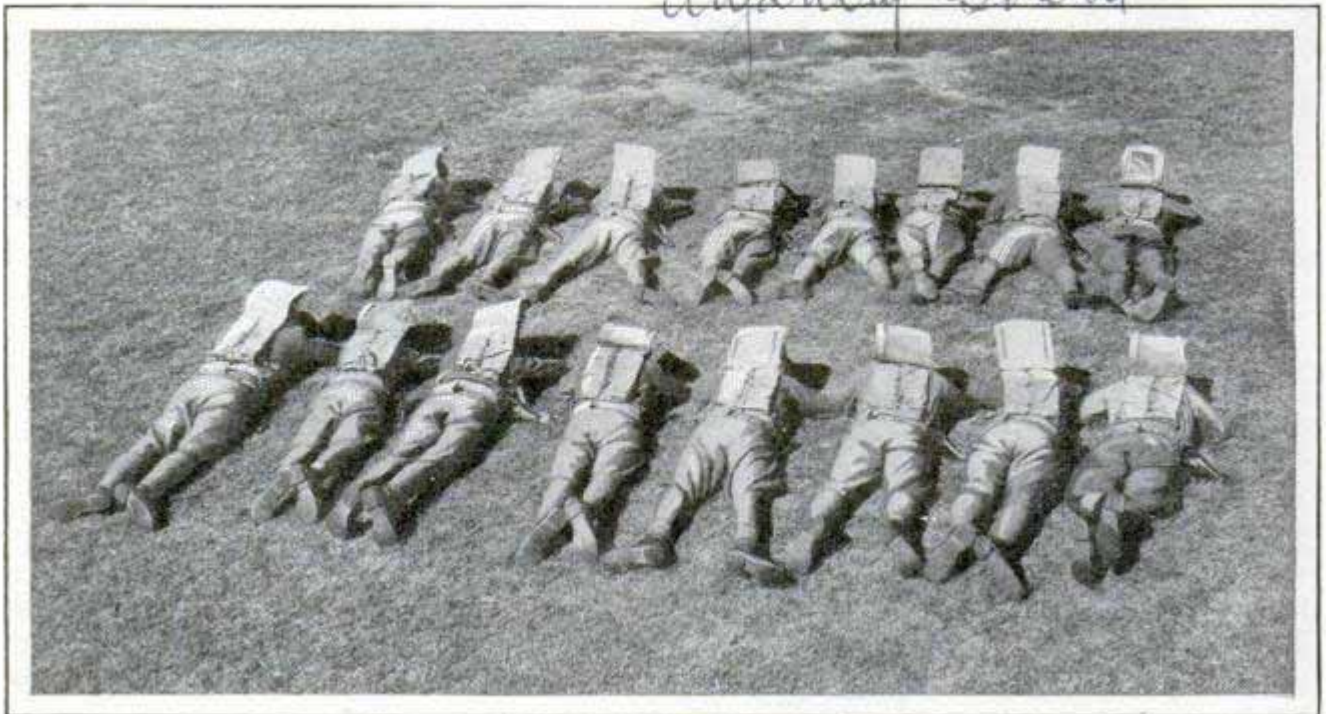

Forming a Signal for the Airman above Them; How Soldiers and Their Accouterments Are Utilized to Communicate with Men in Airplanes, a Development of Modern Warfare

9th Infantry, 2nd Div Sam Houston Texas.



2570  
Cary

**HORSE RACE TIMED BY SHADOW**

Accurate timing of horse and other races with an ordinary stop watch is difficult under most conditions and to simplify this task, a South African inventor has introduced a simple apparatus which utilizes the light-sensitive properties of selenium. Essential parts of the mechanism are a clock, a lamp and a receiver. The clock is started automatically with the beginning of the race and ticks off the seconds and quarter seconds electrically. A beam of light shines across the track into a receiving instrument so connected to the clock that when an object cuts off the illumination, the resulting shadow affects the selenium element in the receiver, with the result that the clock is instantly stopped. Thus the winner's shadow registers the exact time of the race. In case there is more than one lap to the run, the clock can be operated so that it will not stop until the end of the race.

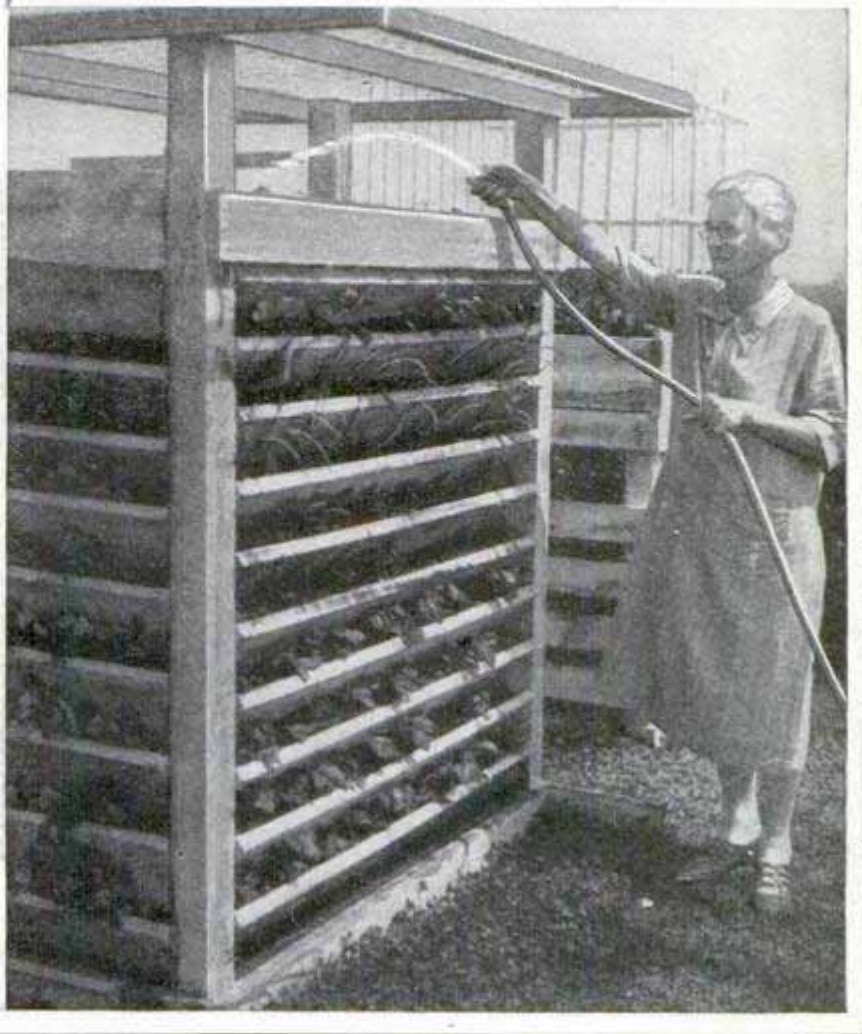

Watering the Terrace Garden Is a Simple Process and the Vegetables Are Easily Tended, Sometimes without Having to Stoop

**VEGETABLES GROWN IN TIERS TO SAVE SPACE**

Quantities of vegetables can be produced on relatively small space by planting them in a rack, as illustrated in the accompanying photograph. Abundant soil is provided in the center and the plants are protected from severe rains and too much sunshine. Strawberries, carrots, onions, spinach and radishes were successfully grown in this compact garden, and the system simplifies the work of tending the plantings considerably.

2565

**CRAB TRAVELS THIRTY MILES**

About a year ago, a crab caught near Lynnhaven Inlet on Chesapeake bay, was tagged with a Lincoln penny and released. Just recently, it was found by fishermen in the York river and identified by the man who had tagged it. The crab had traveled approximately thirty miles.

by J. J. Juggel  
W. J. Juggel

**TWO-PART SAFE-DEPOSIT KEY GIVES EXTRA PROTECTION**

It is sometimes necessary, in matters of trust or corporation management, to place securities under the joint control of two persons. A divided key, designed especially for safe-deposit boxes, solves the problem in a case of this kind. Each person is given half of the key and they both must go to the box together or one must give his half to the other, for both parts are required to open the lock. The parts fit together easily, as shown.



Chila  
St. Philips  
Wittkam  
St. Johns  
3/13

2004

The Mosler Co.





A Rug That Tells Ancient Legend of a Lost Prince; Oriental Masterpiece Counting 600 Knots to the Square Inch

### WEAVING RUG OF "LOST PRINCE" TAKES FIFTY YEARS

One of the finest examples of oriental rug-making is seen in the rug of the "Lost Prince," so called because the figures represent an old eastern legend of that name. There are but six of these in the world. One, now in the possession of a Chicago firm, counts 600 knots to the square inch and took over fifty years to complete. Few of the finest examples of Persian rugs have over 300 knots in that surface space. The designs and figures are worked in soft coloring and with the most minute attention to detail.

### UNSEEN LIFE WITHIN THE SOIL PLAYS BIG PART IN WORLD

Under our feet is a whole swarming world of life, unseen and unknown to almost everyone, but having an important effect on the world of larger plants and

animals. It is the realm of the soil bacteria, fungi and other low forms of life. Certain kinds capture the carbon dioxide from the air, build it into their bodies, and when they die, release their organic substances as humus for the enrichment of the soil. Others utilize nitrogen from the air and it is eventually turned by the higher plants into meat-making materials. One of the greatest services of the bacteria lies in breaking down dead plant and animal bodies, returning them to the dust whence they came. Were it not for these lowly creatures, the earth's surface would soon be littered with carcasses, and the material basis of life locked up beyond recovery. The process is not a simple one and requires more than one class of bacteria, one group of "wreckers" carrying the

work as far as its nature permits and another taking it up until another stage has been reached. By this tearing-down process, the creatures make it possible for themselves and other organisms to find homes.

### 2212 RUBBER BALL ON FISH HOOKS PROTECTS FROM WEEDS



For surface or deep-water fishing, a three-hook tackle unit has a red and white rubber-ball lure that is said to protect the hooks from weeds. It is simple to use, having no wires to bend and nothing to get out of

order, and is said to be effective for bass, pike and muskies.

*12x6*  
Under our feet is a whole swarming world of life, unseen and unknown to almost everyone, but having an important effect on the world of larger plants and

*white.*  
*7-10-50*  
Progressive Tools Mfg. Co.  
*534 W. Duquesne*

*Authored by Sir John Russell*



*wood address worked on street 433*

**SPOTLIGHTS IN RADIO STUDIOS TO AID PERFORMERS**

*2792*

Acting on the psychological principle that many persons do their best work when in an environment that harmonizes with their moods or temperament, officials of a radio-broadcasting company have planned special studios for different performers before the microphones. For instance, the operatic and theatrical stars will stand in the glare of a spotlight while they do their bit for their invisible audience, and the rest of the room will be arranged to give the effect of an actual auditorium filled with listeners. Columns like those of the old Roman forum are the chief features of another studio in which prominent men are expected to feel more at ease while broadcasting; another is designed to stimulate minds to which the mystic carries great appeal. This has the appearance of a Gothic church interior with alternate dark and light sections suggesting arches and aisles and the pattern of a church window thrown on the floor in light. Comic artists will perform in a gay studio fitted in the fashion of Louis XIV, and jazz bands and singers will be made to feel at home in a studio where futuristic designs are predominant.

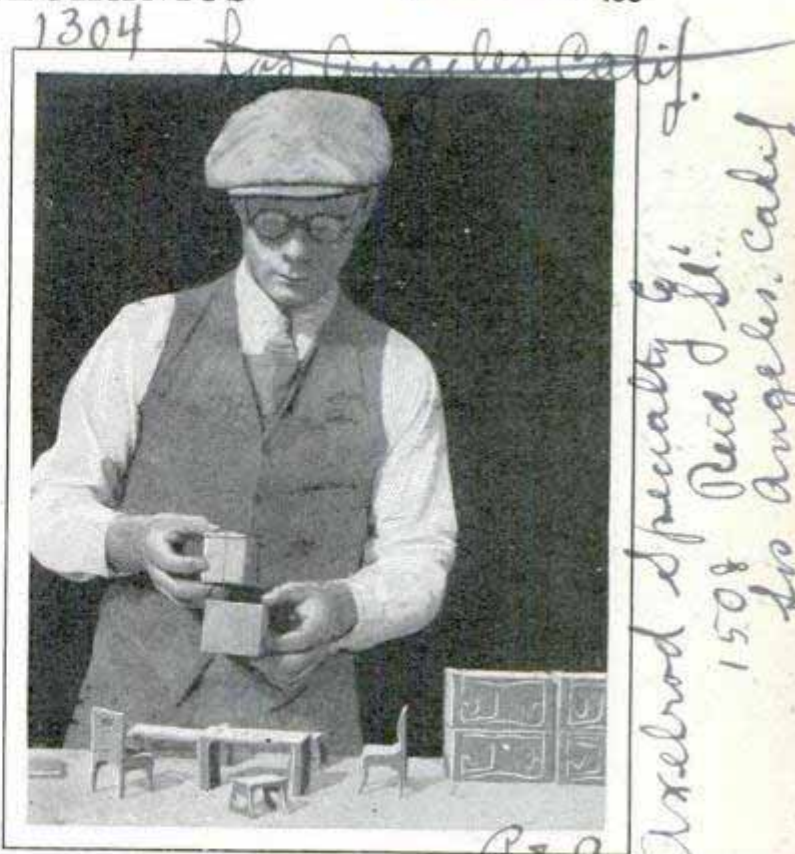

Some of the Furniture Pieces and, at the Right, How the Block Looks When Assembled

**FURNITURE SET AND PUZZLE CUT FROM SINGLE BLOCK**

Ten pieces of toy furniture have been cut from a single block of wood and are so arranged that fitting them together or taking them apart constitutes an entertaining although not difficult puzzle. The pieces are so shaped that they may be used to imitate furnishings of a school, house or lodge room.

**TRACTOR FOR LIGHT FARM JOBS REDUCES WORK AND COST**

*2195*

Intended especially for cultivating corn planting, mowing and other farm tasks usually done by horses, a lightweight tractor now on the market can be easily hitched to various implements and is said to be as simple to operate as an automobile. It develops speeds from one and one-half to six miles an hour, provides more than twenty-two horsepower and is designed to supplement the bigger tractor in such a way that complete motorization of the farm can be accomplished with moderate expense.

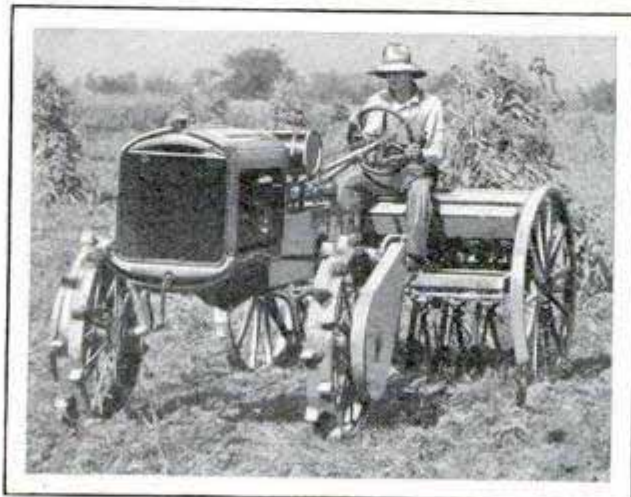

For the Tasks Too Light for the Usual Tractor, This Handy Unit Does Faster Work Than with Horses

**FIREPROOF LIQUID FOR FABRICS ALSO PROTECTS WOOD**

*2739*

Textiles, woodwork and other materials are said to be thoroughly protected against fire by treating them with a special liquid now on the market. It is colorless, odorless and transparent, while harmless even to delicate fabrics, the manufacturers claim. A fireproof disinfectant is also available.

*not yet ready for Continental Cutter Co.*

*Axelrod Specialty Co. 1508 Reid St. Los Angeles, Calif.*  
*Murphy Parib Mfg. Co. Inc. 539 S. Dearborn. Chicago*



1965



What the Amsterdam Policeman Is Wearing for Night Functions; the Coat Is Easily Seen by Motorists

### LUMINOUS COAT SAVES POLICE FROM TRAFFIC ACCIDENTS

Traffic policemen in Amsterdam wear long coats that reflect light from near-by sources at night, so that motorists and pedestrians may see them more clearly and the officers' signals be more easily interpreted. Barred sleeves also aid in directing traffic.

### KEY TO LANGUAGE OF MOSES FOUND ON MT. SINAI?

Fragments of the mysterious Sinai inscriptions which may throw additional light on Moses and Biblical history, have been found in Arabia by Prof. Kirsopp Lake, head of the Harvard-Michigan expedition to Mt. Sinai. Some of the inscriptions were discovered more than twenty years ago, on the mountain where Moses received the tablets of the law, according to the Bible account, but complete trans-

lation of them has not been made, partly due to their odd characters, which are allied both to the Egyptian hieroglyphics and the Semitic alphabet, but are not identical with either. According to one translation, Moses himself was the author of the writings which describe his position as superintendent of the mine workers of Sinai and give thanks to the Egyptian queen, for having rescued him as a child from the Nile. One scholar estimates that the inscriptions date back to some time between 2000 and 1200 B. C., when copper and turquoises were mined near Sinai.

### RAPID RELOADER FOR REVOLVER 2646 AIDS POLICE WORK

Refilling a "six-shooter" can be done in three seconds or less with a loading unit invented by a Kansas City detective. It consists of a nickelplated holder containing six springs, shaped to hold one cartridge each. At the end is a plunger, which, when pressed, causes the springs to push the six bullets into the cylinders of the revolver. In a demonstration, a policeman reloaded his weapon in two seconds with this device. It was inspired by the detective's experience during the World war, when he realized that lives sometimes

Chicago Evening Post 5/27/29



Inventor E. L. Nelson and Three Views of the Revolver Loader; Inserting It, Detached, and How It Is Worn

were lost because of the delay involved in loading revolvers by the ordinary hand methods.



2237

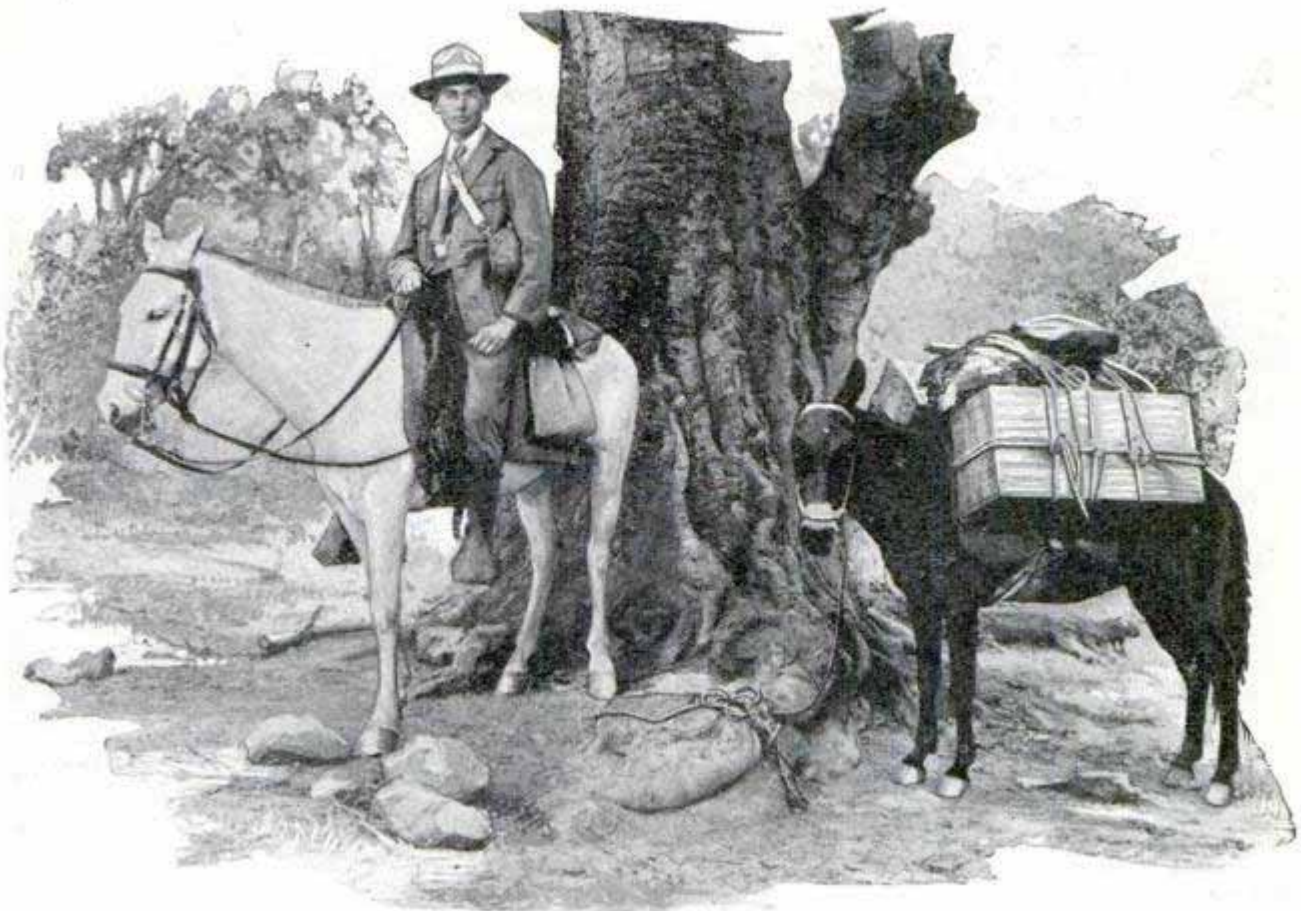

Wilson Popenoe Bringing in a Load Avocado Budwood, One of the Many Fruits Which He Introduced into America; the Government Searches the World for New and Profitable Crops

## Searching the World for New Foods

Plant Explorers Go to Ends of the Earth in Hunt for Delicacies for Our Tables and Gardens

By UTHAI VINCENT WILCOX

*Sukoma Park  
Washington, D.C.*

"A SLICED ilama and cream, waiter."  
"Sorry, sir, but we are all out of ilamas."

"How about a marang, then?"  
"It is out of season for marangs."

Or, if this restaurant of the future is out of mangosteens, it is possible that the patron can get Zarda melons, carabaos, paradisiaca plantains, itzamas, or a dozen other fruits now unknown on the breakfast tables of the United States.

The particular ones mentioned above have been introduced by the department of agriculture, and experiments are under way to determine just what regions of the nation are best adapted for their growth, and just how American people will receive them. They came from the out-of-the-way places of the earth, mostly tropical.

The search that sends plant explorers

into remote regions of Europe, Asia, Africa or South America, is not for undiscovered lands or fabled riches, like the explorers of old, but frequently their efforts are rewarded far in excess of the hardy sailor men who years ago brought home their ingots of gold. There is a touch of romance in the work that turns a few handfuls of seeds, a dozen or so of cuttings from plants heretofore uncultivated in the United States, into a great contribution to the country's wealth.

There is the case of durum wheat, used extensively for macaroni making. It was brought to the United States for cultivation in the northern states, where the climate is cold and unfavorable for a wheat which matures earlier than that species. Today this crop has a value far in excess of \$50,000,000.



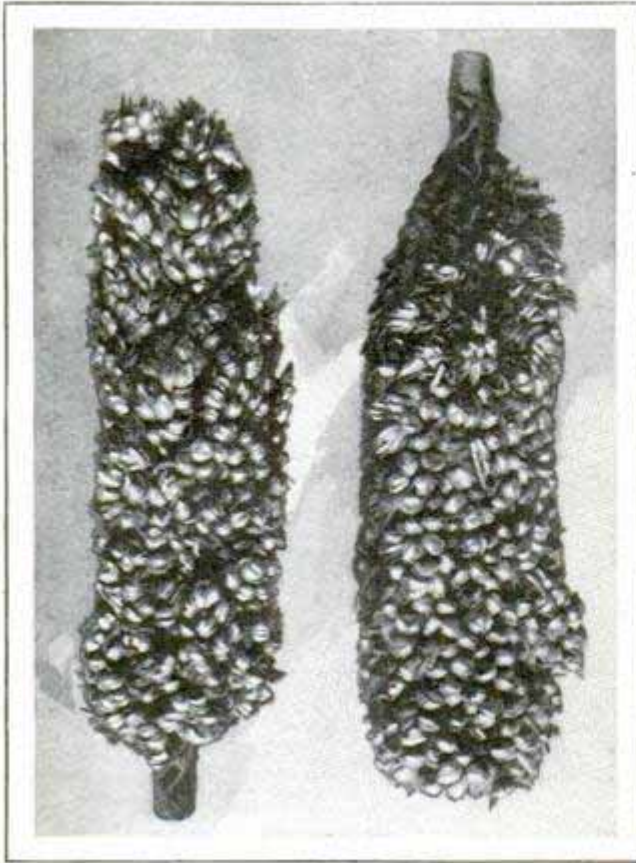

Nearly 50,000 separate introductions have been made by the plant explorers and many of these are a most important part of our agriculture. Durum wheat is not the only notable example of plant immigrants that have since become thoroughly naturalized. There are a number of regions in the United States that owe their prosperity, and in some cases the very existence of their agriculture, to one of these plants brought in or sent in by a government plant explorer from some distant corner of the world. This is true of the date trees of California and Arizona; the feterita, Kafir and Sudan grass fields of the west; the dasheen patches of the south; the Panariti currant vineyards of California, and the rice fields of Texas and California.

It might seem that the reservoir of the world's flora would soon be drained of all possibilities and that a few years would tell us the limitations nature has set for our enjoyment of flowers, fruits and seeds. But explorers are still busily searching in distant places, and the lists of their findings show that we are nowhere near the end of the possibilities of the plant world.

One of the hardest tasks that the food-plant explorer has to meet is the gathering of accurate information from ignorant natives. Dr. Wilson Popenoe, who found the avocado, or alligator pear, in Guatemala, was warned again and again not to pick the fruit except when the moon was full. To do otherwise was dangerous, the natives claimed. Besides, they were certain that the avocado would be unfit to eat.

Dr. Popenoe went through India, Arabia, where he spent a year, and also northern Africa. He has spent six months in Brazil and a year and a half in Guatemala, a year in Mexico and six months in the West Indies. His work was concerned largely, in his later travels, with the avocado, giving attention also to the Andes berry and giant blackberry of Colombia. While he never was attacked by wild beasts, he was five times jailed during his travels. He was accused of being a German spy, a

thief, suspected of inciting rebellion, and held for a short while over a difficulty about a hotel bill. Frank Meyer,

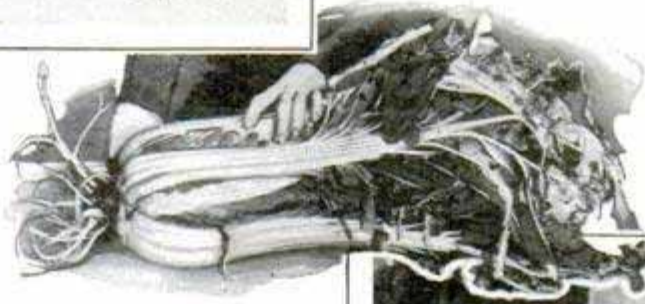

Head of Sorghum Cane, Some Chinese Cabbage Grown Outside Washington, and a Fruiting Branch of the Chaulmoogra Tree



another plant explorer, was time and again robbed and molested by robber bands in the eastern countries through which he passed. He finally lost his life by drowning in a river in China which he was attempting to cross. Another, J. F. Rock, recently spent much time in out-of-the-way places of Tibet. While there he had a nearly deadly encounter with a man-eating tiger.

Dr. David Fairchild says that those who live in the north may wonder at the seeming preference for plants of the hot countries, but he explains that the plants which grow in the colder regions are those which have slowly crept out of the tropics, adapting themselves to the changes. Furthermore, there are ten times as many undiscovered plants remaining in the tropics today as are to be found in the colder regions of the globe.

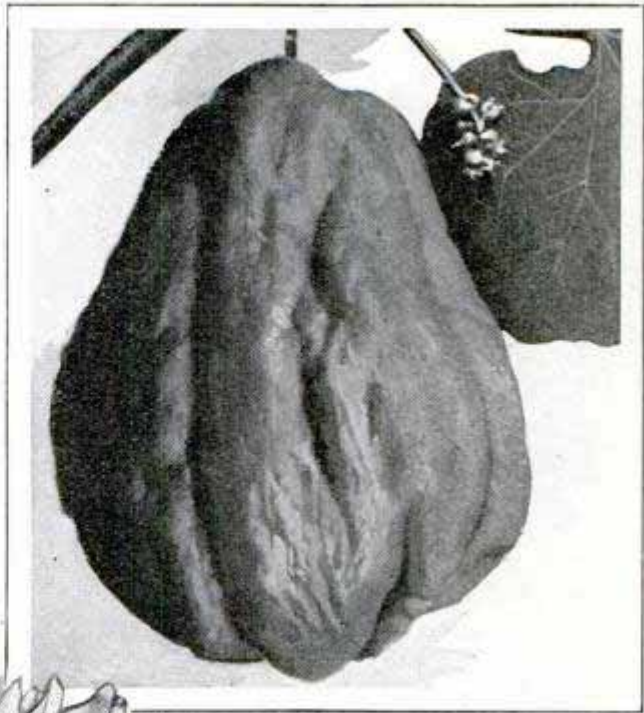

The inventories containing the descriptions and some of the history of these strange exotic plants read like a romance in serial form. One paragraph may take you to Mexico where some inquiring traveler has discovered a plant, related

to one of our common weeds, whose seeds once filled the granaries of the Aztecs. The scene shifts to Africa, the source of a number of crops now important to American agriculture, or to China, a veritable wonder garden of fruits and nuts, vegetables and flowers. Then there are the queer plants of New Zealand or Australia which may have possibilities as a provider of wood, food, shade, or beauty to our future generations.

The explorers have found a blight-resistant pear that grows in China which may save our future orchards of this fruit from a devastating disease. Some of these may be used as stocks on which to graft more luscious varieties. From the same country have come chestnuts, the yang-tao, a fruit said to "combine the flavors of the gooseberry, strawberry, pineapple, guava and rhubarb," and the jujube, an odd fruit now being grown in California.

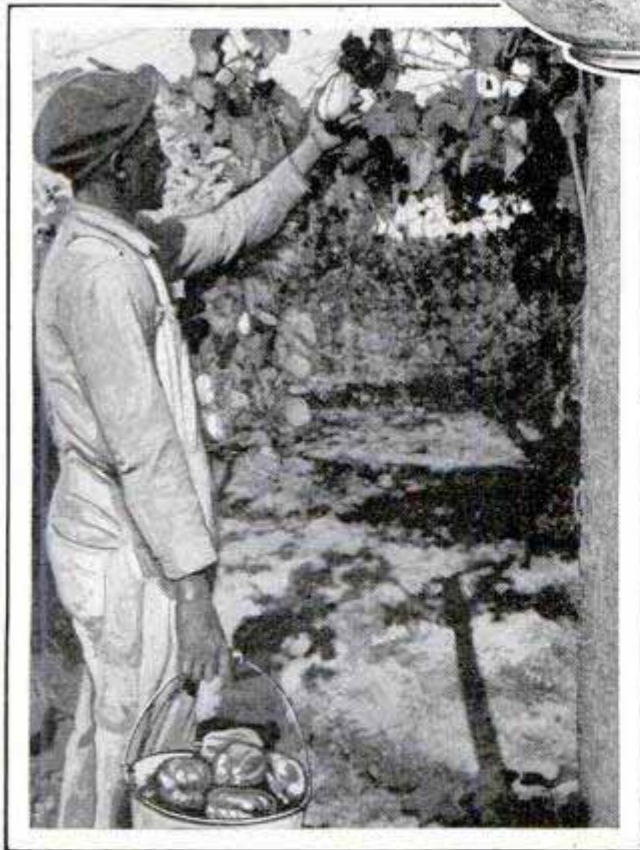

Close-Up of the Chayote, Top; an Artichoke, Center, and a Farm Hand Picking Chayotes at the Plant-Introduction Garden

The great variety of plants found by



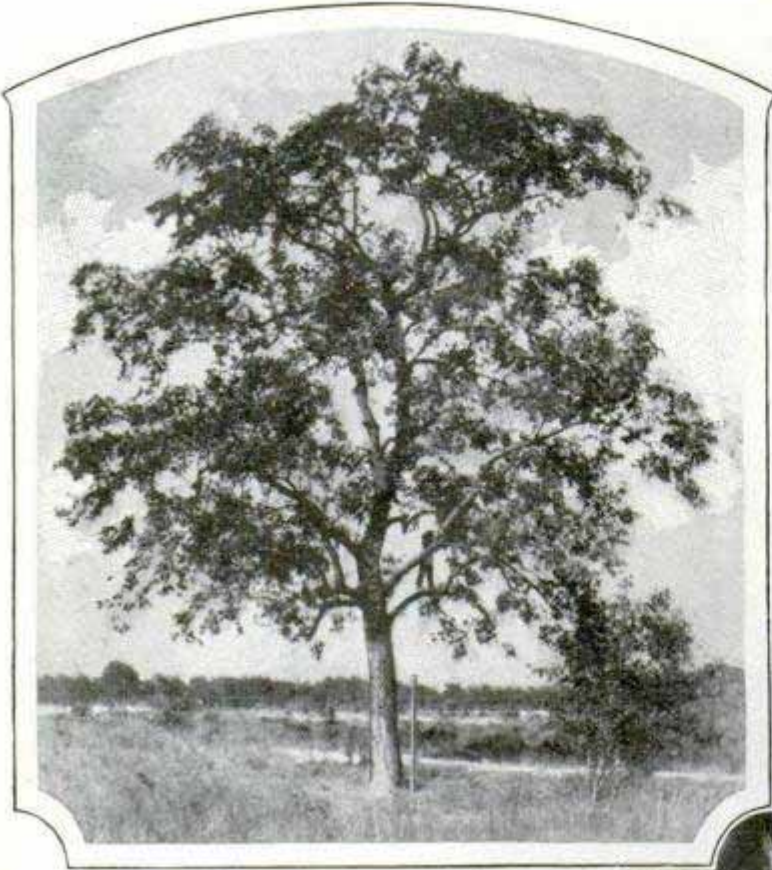

Persimmon Tree Which Produces a Non-Astringent Fruit, and Some of Its Product

these scouts for the tables of America seems almost endless. There is the neem tree from India with wood like mahogany, fruit that yields a medicinal oil, and sap that may be made into a cooling drink; the giant lilies from the Himalayas; the mitsuba, a common vegetable from Japan that resembles some of our native plants found growing all the way from Nova Scotia to Texas; high-yielding wheats from England and Australia; from Colombia a night-blooming cereus with blood-red flowers like saucers; the New Zealand corkwood tree with wood half the weight of cork; from Yucatan a dooryard tree whose leaves provide delicious greens; a wild rice from west Africa that may be used for marsh pasture; a citrus fruit from India with a concentrated peach flavor; Australian elephant grass which yields thirty tons of hay to the acre, and from the same continent an edible canna, a single plant of which, in Florida, has produced eighty pounds of tubers.

Most interesting of the introductions from nearer home is the "haauhtli" of Mexico, resembling pigweed. It was culti-

vated by the Aztecs before Columbus discovered America. The Spaniards made a flour of the grain which they used in making cakes. The plant is being given close study as it may be most valuable for growth in regions that are too dry to grow corn. Other plants from our neighbors include a large number from Guatemala and other countries of Central America—chayotes, the inga, a tropical walnut, a hitherto neglected tropical fruit called the coyo, a grape and a brilliant flower suggestive of the poinsettia.

"The many generations that will

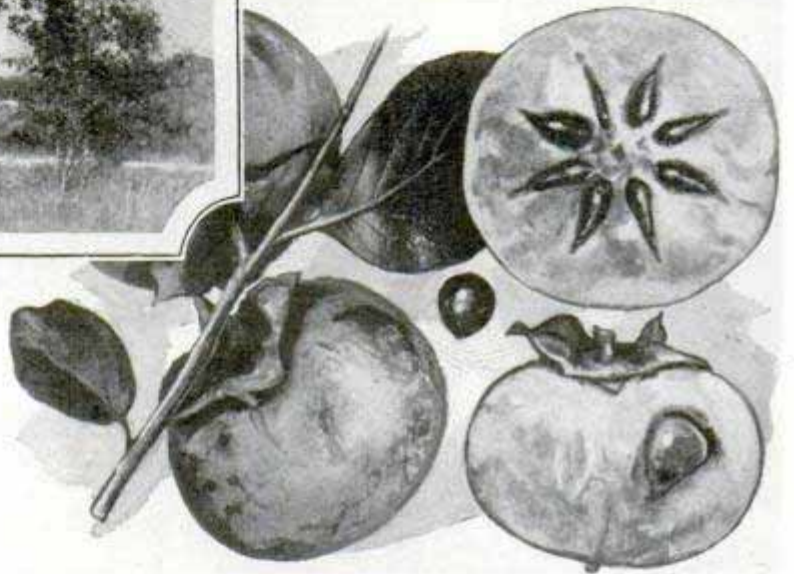

inherit the hills and valleys and prairies we now call ours may complain that we have wasted some of their rightful inheritance, but we may feel sure that they will bless us for making it possible for them to enjoy in increasing measure the fruits of all the earth," said Dr. Fairchild in commenting on the work of his food explorers and scouts. "Because of the efforts of these men, they will have in their gardens, fields, forests and dooryards hundreds and even thousands of plants that were unknown here when the Indian girdled trees to provide a sunny spot for his corn patch."

¶The Popular Mechanics Bureau of Information offers its free service to all readers of this magazine. Names and addresses of manufacturers and dealers in articles described, and any other details will be promptly furnished by the Bureau.



**WATCH RUNS FOR THREE YEARS AND NEEDS NO WINDING** *2765*

Movements of the wearer's wrist are sufficient to keep a watch, introduced by an English craftsman, running satisfactorily without winding. As the arm and hand are moved, a small weight or balance inside the watch is swung, keeping the spring coiled. Before introducing his invention to the public, the watchmaker is said to have worn one of the pieces for three years, during which it kept accurate time without winding.

*2780*

**DAM BUILT AROUND RAILROAD WITHOUT STOPPING TRAFFIC**

So that railway operations could be carried on without interruption, the Exchequer dam on the Merced river in California was literally built around the tracks of the road, which followed the river canyon. When the dam was done and a new course had been constructed for the railway line, the tunnel hole through the barrier was plugged with concrete. Another feature of the task was the use of a steel tower, 475 feet high, for distributing the concrete. The completed dam is 330 feet high and has a top length of 955 feet.

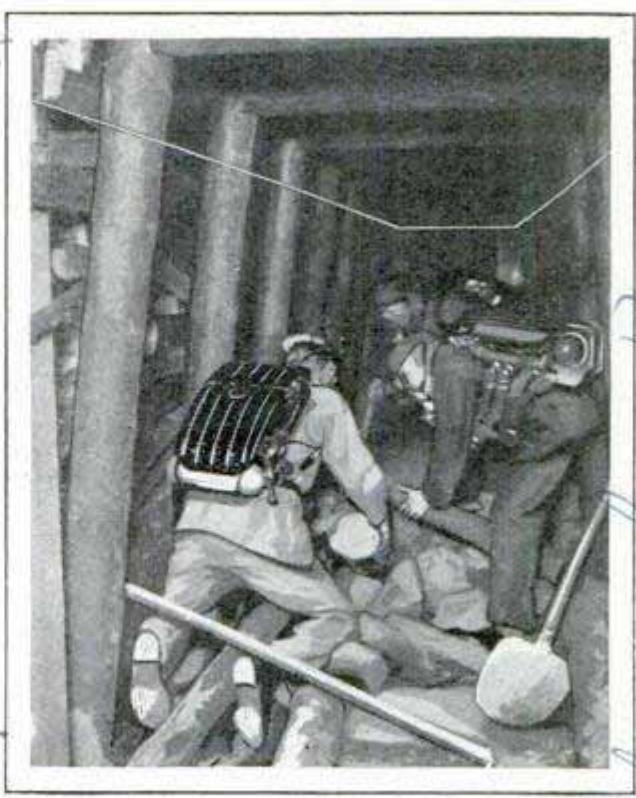

Demonstrating the Use of the Contact Cable in a Mine Shaft; an Alarm Is Sent Simply by Pinching the Wire

**CONTACT CABLE GIVES ALARM AT PINCH OF FINGER**

Inclosed in a flexible tube, conductive wires have been devised by a Hungarian engineer so that pinching of the outside of the "jacket" causes a contact and the sounding of an alarm. The cables are especially suited for use in mines, in homes and offices as burglar signals, in police and hospital quarters for communication, and in connection with machinery for cutting out the current. Installed under a carpet, for instance, an alarm would be sounded simply by stepping upon the tube. The covering protects the wires against moisture and eliminates the danger of fire. In a test, as many as 63,000 contacts were made at one point, without damaging the wires. As a fire alarm, the cable has proved efficient since the two wires are fused at a high temperature.

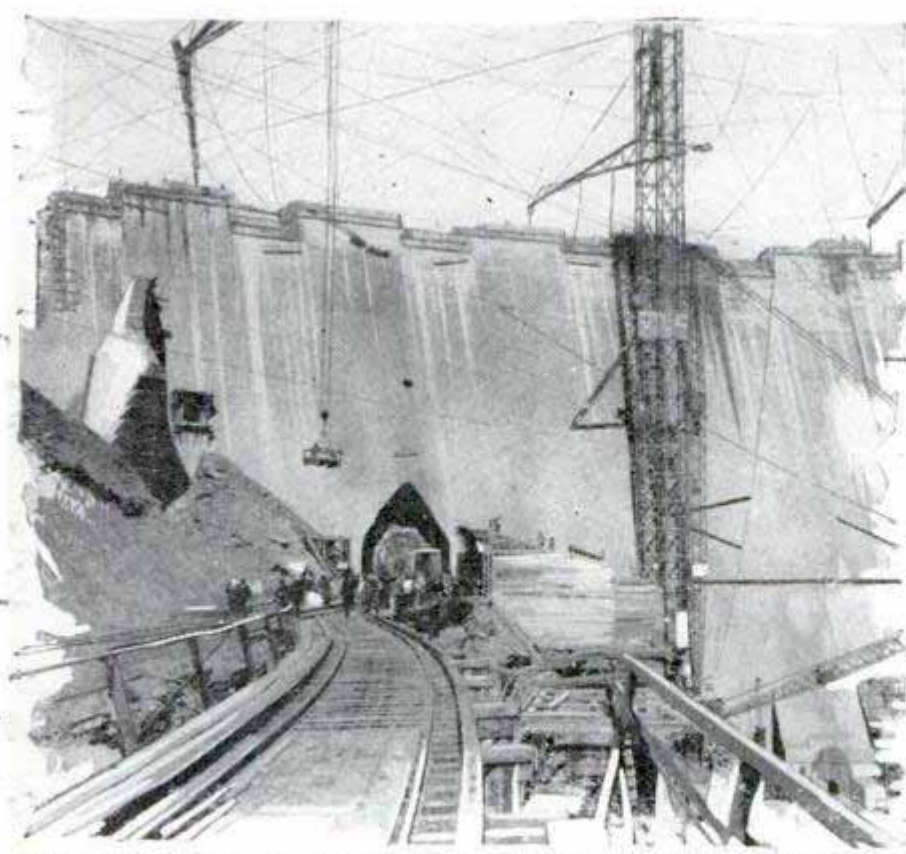

Exchequer Dam near Completion, Showing the Tunnel through Which Trains Were Run Until New Line Was Finished; Hole Was Then Stopped Up

*Telephonwerke & Kabelindustrie  
A. G., Berlin, Germany.  
Dr. Hungarian engineer. G. Nagy.*



180 Wacker Drive Chicago



Ironing Pad Exposed; It Gives an Effective Surface to the Board and Will Not Burn

IRONING PAD THAT WON'T BURN MAKES WORK EASIER

To give a springy surface to the ironing board, a soft hair pad that is guaranteed not to burn has been introduced. It is said not to curl or wrinkle, lies flat and is designed to fit all popular-sized boards, being fifty-four inches long. It is reversible and stoutly edged.

SPECIAL NURSE CARES FOR FISH ON RAILROAD JOURNEY

Successful shipment of sixty-five live fish, three king crabs and one lobster from New York to San Francisco was accomplished recently, marking what experts declare is a record for a long-distance journey without a special fish car. The specimens, including a number of salt-water fish, were carried in tanks and were constantly cared for by a trained aquarium keeper. Out of the total number starting the trip, all but nine arrived at the end of the 3,169-mile ride in good condition. A special water filter was employed, oxygen was supplied to the tanks in carefully regulated quantities, and a temperature of seventy-two degrees was maintained until warm territory was reached. Water in the

Steinhart Aquarium San Francisco

cans had to be filtered from five to seven times a day, each filtering requiring two hours and thirty-five minutes, including the time consumed in washing the filter. On long train journeys, fish are subject to car sickness; coal dust and dirt accumulating on the water are not good for them; on sharp curves, they are likely to be dashed out of the buckets, and the changing temperature of a baggage car is harmful. Before the successful journey, an attempt was made to send live specimens to New York from the Steinhart aquarium in San Francisco, but only one, a leopard shark, lived to reach the city and it gasped out its last as the train was pulling into the terminal. A singing fish lasted but eight hours.

RADIO ON DESERT AUTO AIDS EXPLORING PARTY

2572

Remote parts of the Sahara desert are being explored by automobile, and one of the latest units in this work is a special car equipped with radio receiving and sending apparatus for both long and short-wave service. An advantage of the latter installation is that messages can be easily received while the car is running, less power is required in sending and adequate antennae are provided in three insulated metal bars on the car's roof. When the auto is stopped, a mast and wire are unwound from a drum and rigged for reception from all stations. The generating equipment for operating the radio is also used for providing electric lights when camping. Like other types of autos designed especially for travel across the sands, this one has an endless tread at the rear.

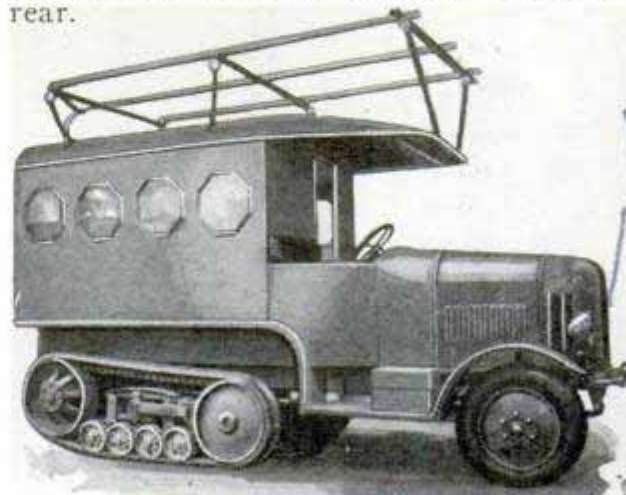

Desert Auto Equipped with Radio Outfit; Both Long and Short-Wave Apparatus Were Carried

Paris, H. P. France

Societe Anonyme Andre Citroen 14 3



*Cleveland Ohio*

**MOORING MAST ON RAILS DOES WORK OF FIVE HUNDRED MEN**

To simplify the task of running dirigibles in or out of a hangar, a locomotive

and insulin has been too costly to allow wide use. In the belief that nature has secreted a substance which may be as effective in the treatment of the disease, the tests on holly are being conducted,

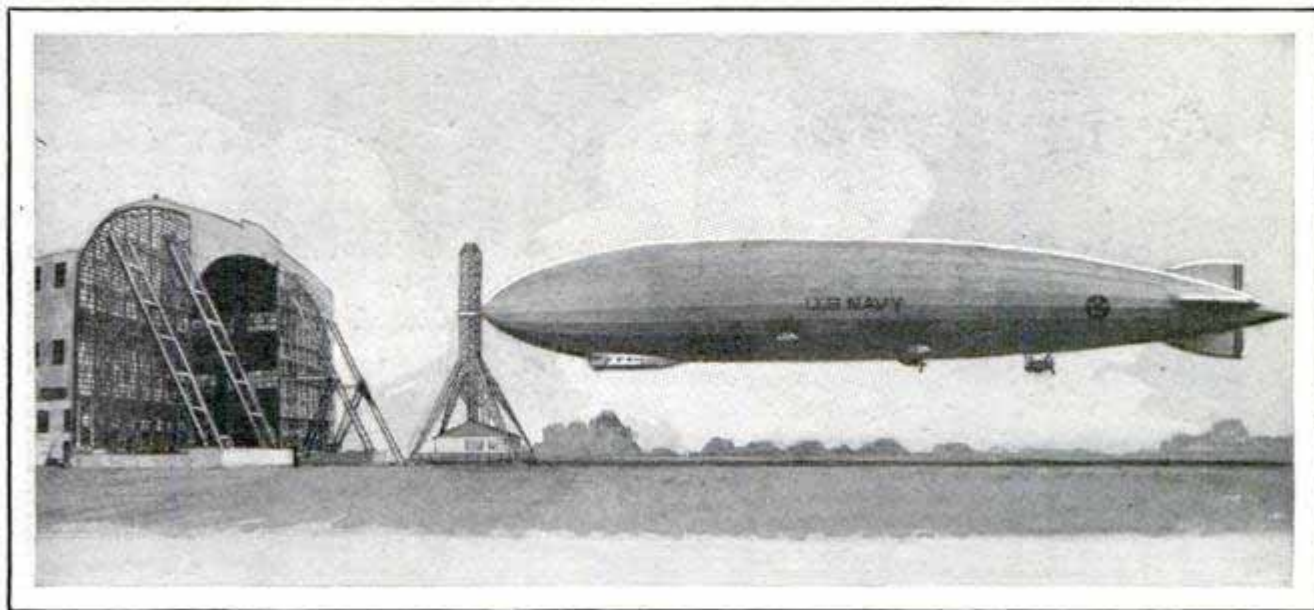

Illustrating How the Motor Mooring Mast Would Appear While Pulling the "Los Angeles" into Its Hangar at Lakehurst; It Has Its Own Motor and Runs on Track

mooring mast has been designed. It operates on a wide track, carries its own machinery and has a passenger elevator inside and mooring ring elevator on the outside, the ship being attached to this ring with a ball-bearing socket. In case an adverse wind blows, the tail of the dirigible can be hauled around with tractors. Sometimes as many as 500 men are required to place a large ship, such as the "Los Angeles," in its hangar. It is said that only a few men would be needed with the motor mooring mast and there would be less danger of damaging the dirigible.

**MEDICINE FOUND IN BLUEBERRY RELIEVES DIABETES**

Discovery of a substance in the blueberry, which is said to be a valuable aid in the treatment of diabetes, has encouraged the department of agriculture to investigate holly leaves as a possible source of a like material. Dr. Frederick M. Allen, of Morristown, N. J., who found the blueberry element, employed it on some fifty diabetic patients with relatively satisfactory results. Its effects are said to be somewhat the same as those of insulin, but it has the advantage of being applicable as a hypodermic injection or through the mouth,

and experiments will be made with other plants. George F. Mitchell, of the bureau of chemistry, who has manufactured tea from holly, is co-operating with a medical-research company in the investigation. The chief function of insulin and the blueberry substance in treating diabetes lies in lowering the sugar content of the patient's blood.

**HAND PLANE DRIVEN BY MOTOR SPEEDS CARPENTERS' WORK**

Designed especially for smoothing the edges of doors and similar surfaces, a motor-driven hand plane now on the market is capable of fine adjustments, works rapidly and operates on either direct or alternating current. An apron at the side holds it for planing at right angles or angles of lesser degree. Boards as much as four inches wide can be planed by smoothing first from one side and then from the other. On door edges, the side guide insures accurate planing.

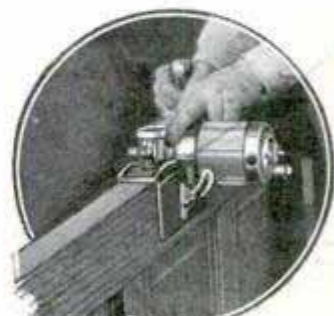

*Dept. of Agriculture Washington*  
*2476*  
*Chicago '642*  
*W. W. Washington*  
*871206*  
*R. L. Carter Co.*  
*Phenix 114*



2358



Handle of Cane Pulled Back to Expose the Gun; Weapon Is Quickly Made Ready for Firing

**GUN HIDDEN IN CANE HANDLE TO FIGHT BANDITS**

To discourage the Paris apaches in attacks on citizens, a French inventor has introduced a combination gun and cane. By pulling the handle out a few inches, the weapon is made ready for inserting the shell, and the trigger is released by twisting a ring on the cane. Aside from its weight, it can scarcely be told from an ordinary walking stick when the firing mechanism is concealed.

**ACID GAS FOR LUNG TROUBLES HELPS CURE COLDS**

Mild cases of tuberculosis, hay fever and colds are reported to have been benefited by exposing the patients to fumes from a special acid preparation developed in Germany. The substance is merely placed in an evaporating dish at the side of the sufferer, who inhales the helpful vapors with each breath. The discovery was the result of an odd happening in a factory. Workmen in a certain department, where the acid was used, noticed an exceptional feeling of well-being and employees in other sections made it a habit to eat their lunches in these rooms. Further investigation showed that workers near the acid had remarkably sound respiratory organs and were free from grip and colds even

during epidemics. Experiments were then made with animals. Guinea pigs, exposed to the acidified air, were not made sick when inoculated with tuberculosis bacilli, although others, not placed in contact with the vapors, died shortly after being subjected to the germs. The acid appeared to slightly irritate and then harden the bronchial tubes and the lung passages. The tests were repeated with human beings, over a period of several years. It was found that vapors from the acid, distributed in living and sleeping rooms, protected the inmates from respiratory infections and facilitated recovery.

**LAWN SHEARS GUARD KNUCKLES AND REDUCE STRAIN**

2008

For trimming the grass close to sidewalks, and for similar tasks, a pair of shears now on the market differs from others in that it enables the user to employ the natural gripping movement of the entire hand, an up-and-down toggle action being applied to the blades. The grips are designed to fit the natural lines of the hands and are so arranged that the knuckles do not come in close contact with the ground.

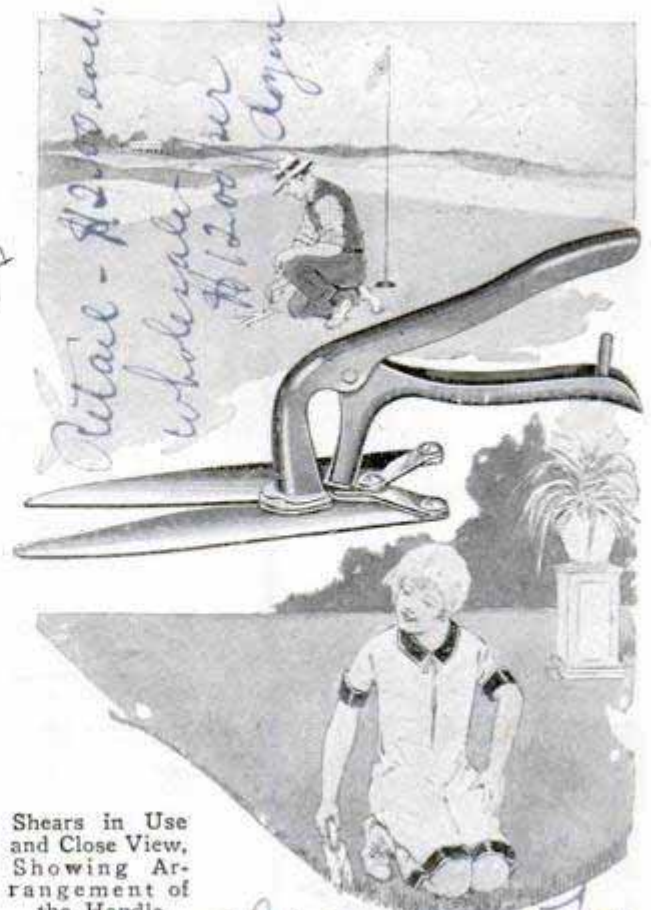

Shears in Use and Close View, Showing Arrangement of the Handle

Distributor / Kapf Acid Agency / 172 W. Washington St. / Chicago  
Retail - \$2.00 each  
Wholesale - \$1.20 per dozen  
Distributor / Kapf Acid Agency / 172 W. Washington St. / Chicago  
Retail - \$2.00 each  
Wholesale - \$1.20 per dozen

Dr. W. von Kapf

The Alliance Toy Specialty Co., Chicago



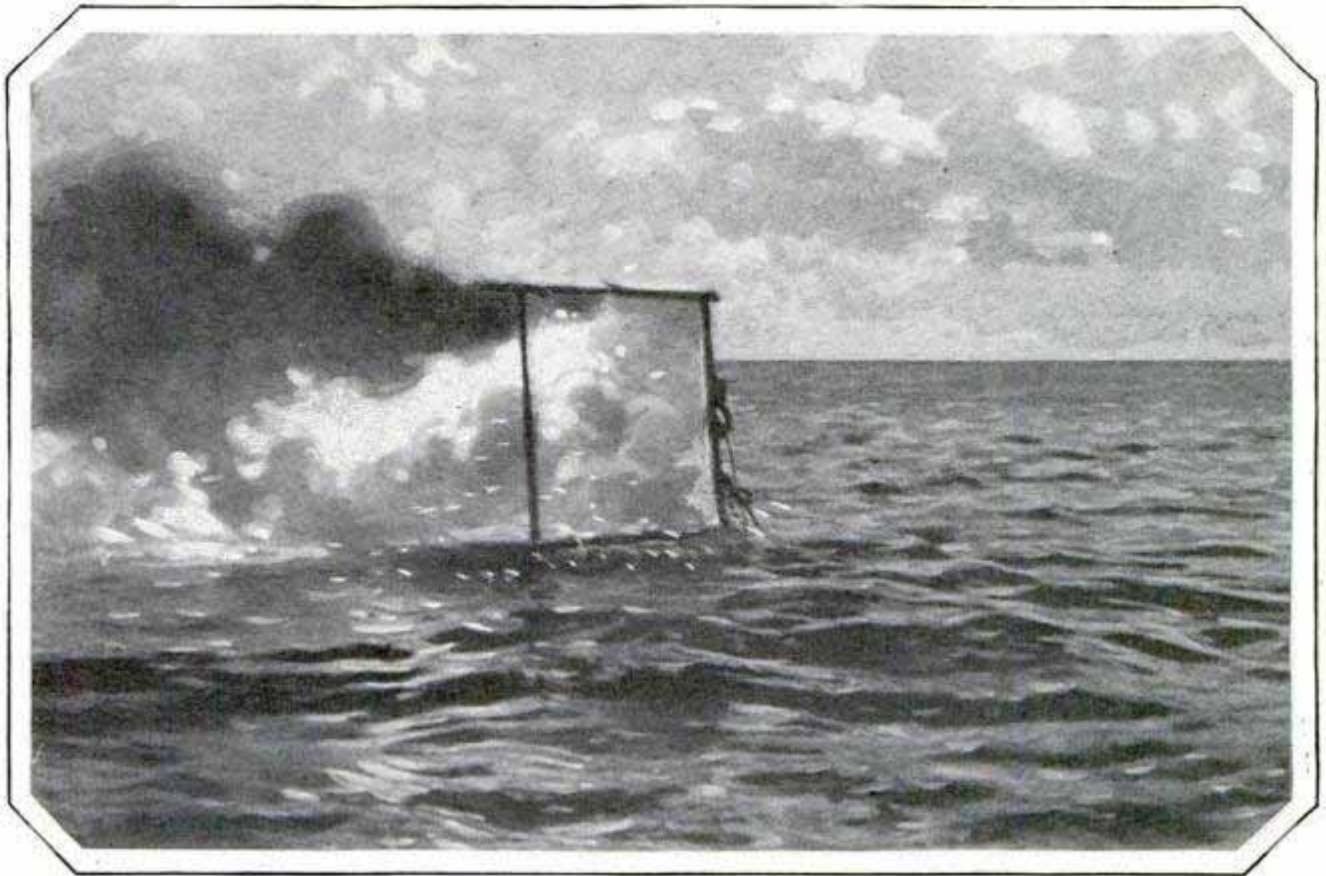

Exploding a Pound of Flashlight Powder in a Single Charge, to Assist the Sunlight in the Taking of Color Photographs of Fish on the Coral Bottom of the Gulf of Mexico

## Color Photos Reveal Submarine Wonders

### How Autochromes of the Ocean Bottom Are Obtained with the Aid of Huge Flashlight Charges

**S**ITTING on the bottom of the sea and popping off a pound of flashlight powder at a time, Dr. W. H. Longley, of Goucher college, and Charles Martin, of the National geographic society, recently obtained successful natural-color photographs of life under the ocean. This interesting camera conquest was made off Dry Tortugas in the Florida Keys and was accomplished only after many months of experimenting and considerable risk. Dr. Longley was seriously burned by a premature explosion of a large flashlight charge.

Their early attempts at color pictures were made with supersensitive plates but even at a depth of only fifteen feet, the natural light was so greatly reduced that satisfactory results could not be obtained. The flash apparatus was therefore arranged and proved so efficient that supersensitive plates were not needed.

The powder was first set off on the dory in which rode the men who worked the air

pumps, but this was not a success, as the flash and the camera shutter could not be accurately synchronized and the strain of waiting for the explosion proved trying to the occupants of the boat. Consequently, a pontoon that could be controlled by the diver was constructed to carry the powder, the dry battery that furnished the spark for firing and a reflector for directing the rays of light downward into the sea over the field of operations. The photographers could wait until the fish were in the best pose before taking the picture. The camera was inclosed in a brass case with a glass window in front of the lens and, with the aid of a mirror set at an acute angle, the operator was able to focus the instrument without bending over, a task that would have been rather difficult in a divers' helmet.

Another scientist who has contributed much to man's knowledge of the under-sea world through his camera is Dr. Paul



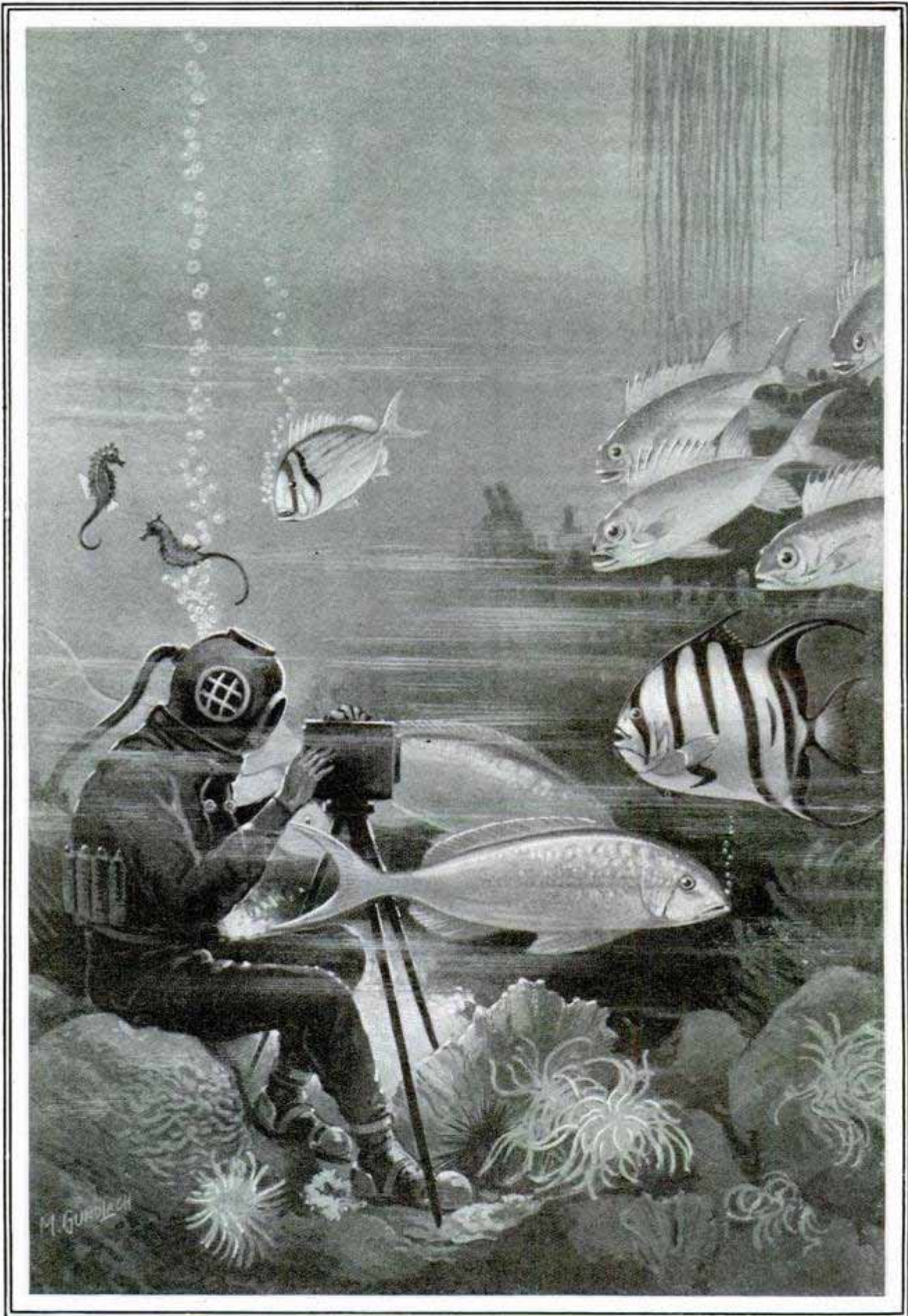

The Diver, with His Camera Inclosed in a Watertight Metal Case, Often Sat for Hours Waiting for a Fish to Get in Just the Right Position to Have Its Picture Taken



Enterprises 535  
445  
of the New York

Bartsch of the National museum. He has visited the creatures of several oceans in their natural haunts and describes the realm under the surface as an enchanting one, dimly lighted with a soft silvery "atmosphere," suggesting the effect of sunlight streaming through stained-glass windows upon clouds of incense. The fish do not seem to be annoyed by an intruder when he is actually among them, Dr. Bartsch says.

There are several tricks to submarine photography, he declares, one of them being proper focus of the camera to allow for the distortion caused by the water. For instance, if the object is six feet away, the camera has to be set with a focal length of three feet. An improved instrument has recently been devised for under-water photography. It rests on a tripod, can be tilted, used for panoramic views and is focused as easily as the land instruments. Another trick Dr. Bartsch has found valuable is learning how to guard against the cold. By rubbing his body with olive oil before submerging, he is able to remain in the water for five and one-half hours at a stretch without discomfort.

*Estay 2042*  
**SILENT FIREMAN KEPT ON WALL SMOTHERS BLAZE WITH GAS**

Added protection from fire is afforded by a chemical bomb attached to the wall, which falls automatically and bursts when the temperature rises high enough to melt a soldered sleeve that holds it. The substance released is a smothering gas, said to be sufficient to blanket an average fire under all but the most unusual conditions in a room of 1,500 cubic feet. The liquid does not injure persons or furnishings. The grenade falls when the temperature slightly exceeds the highest summer heat.

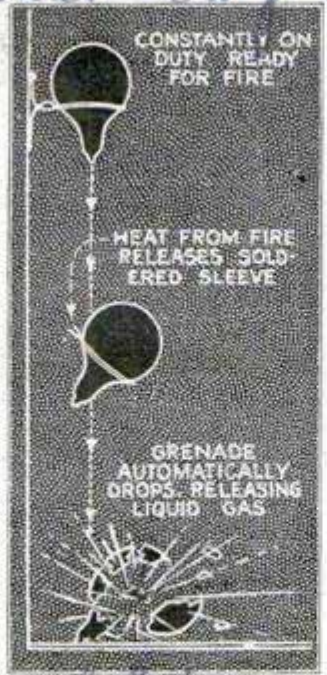

*Shur Stop*  
International Fire Equipment Corp.



Getting a Soda Mixed to Order by Dropping a Coin in the Slot of a New Machine

**COIN-IN-SLOT SODA FOUNTAIN INSURES CLEAN DRINK**

Soft drinks are now served in a sanitary manner simply by inserting a five-cent piece in a slot and pulling a lever. The dispenser may be used as a single unit or as part of an installation to furnish a variety of flavors. Only a few minutes are needed to replenish the machine. Proper proportions of flavoring sirup and carbonated water are measured and mixed by specially constructed valves. The materials are not touched by hand and each drink is served in a clean cup that never has been used before.

**DOGWOOD HAS MANY USES**

Flowering dogwood is widely enjoyed because of its beautiful blossoms, yet comparatively few persons realize that the tree has considerable commercial importance. The wood is used for making golf-club heads, shuttles, bobbins, brush backs, small handles and many novelties. For shuttles and shuttle blocks, the dogwood, persimmon and boxwood are the only kinds used and large quantities are exported. Because of the increasing scarcity of dogwood for manufacturing purposes, improved methods of sawing it are being devised, and its conservation is being urged by appealing to native lovers not to break the branches for the flowers.

International Fire Equipment Corp.

*Low Frederick & Son, Phila.*

*2591*

*6/21/19*



2730

were done by ...

# STEEL BRIDGE IS MOVED WHILE IN CONSTANT USE

In the moving intact of a four-span steel highway bridge, over 400 feet in total

*Enl. Charles Alma Myers 912 California Bldg. Los Angeles, Calif.*

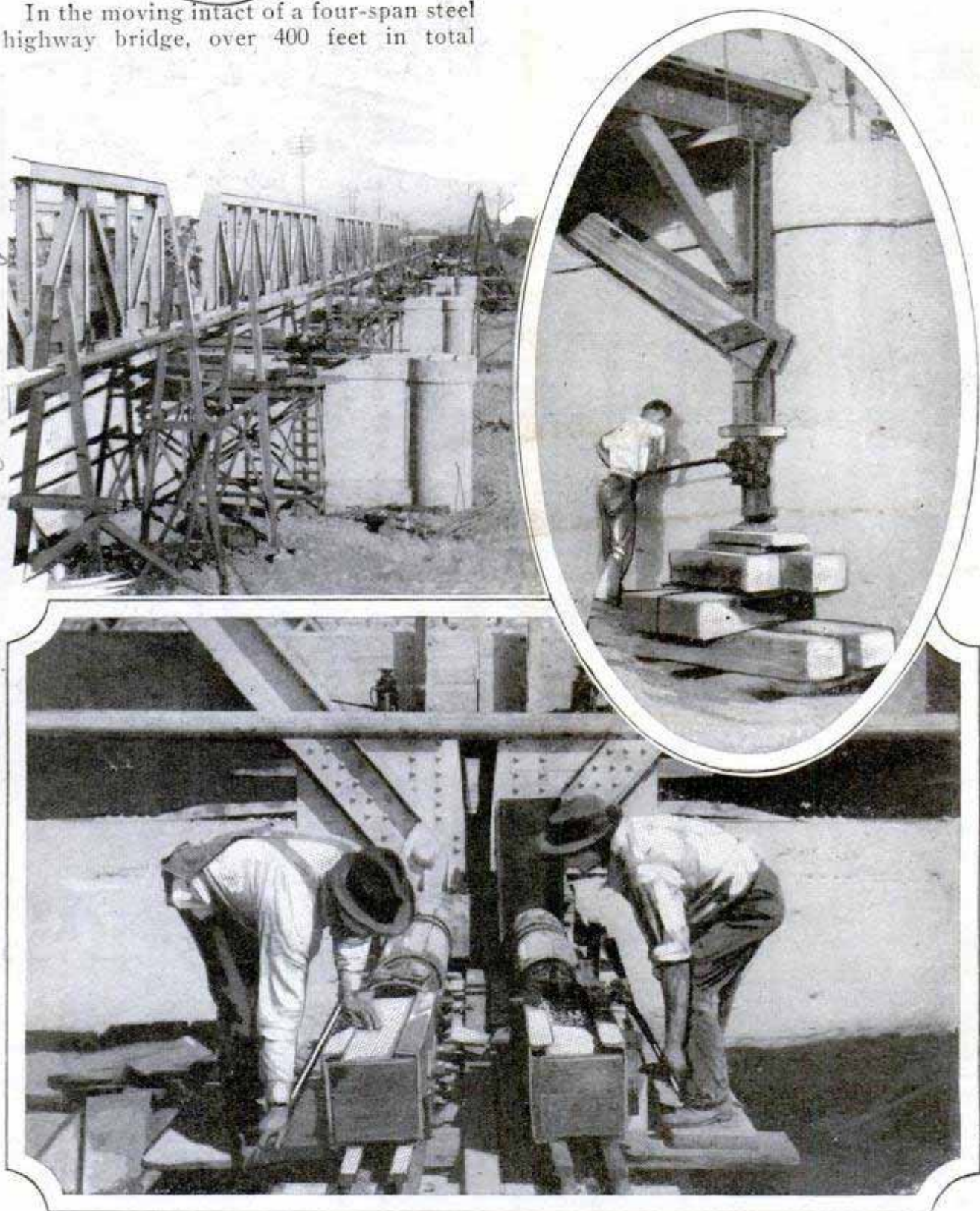

When Steel Bridge, Weighing 258 Tons, Was Moved Fifteen Feet upon New Piers without Halting Auto Traffic; View of the New Supports and Raising Legs on Jacks

length, while automobiles, motor trucks and other vehicles constantly passed over it uninterrupted, there has recently been completed, near Los Angeles, Calif., an engineering feat of unusual interest. This bridge spans the Hondo river. From

careful check made upon traffic before starting work on the undertaking, it was found that approximately 15,000 vehicles crossed the bridge daily, and, since the work required ten days to complete, it is estimated that about 150,000 automobiles,

*Ans.*



*and J. H. Kenyon*

motor trucks, and so forth, passed over it while the moving was in progress. The bridge consists of four steel-truss spans, each 102 feet in length, and carries a twenty-four-foot roadway. The weight of each span, including the roadway, was calculated to be 258 tons, to which was further added, to take care of the traffic, an estimated live load of forty-two tons. Before starting the actual moving, fifteen-foot extensions were built onto each end of the old concrete piers. These extensions, together with the old piers to which they were added, were to give room both for the old bridge, in its new position, and for the new one to parallel it. The trusses were raised on structural-steel lifting legs, to a height of about nine inches, and then two lines of sixty-pound steel rails were run under each end of the spans. These rails were continued out over the pier extensions on the upstream side for the full fifteen feet which the bridge was to be moved.

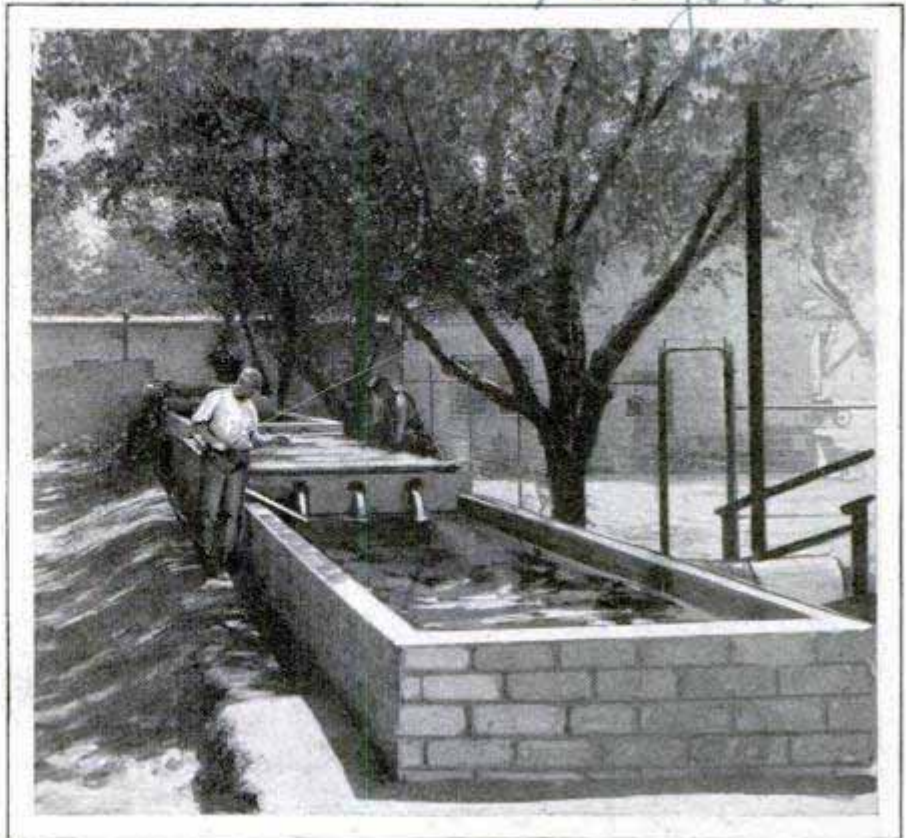

Fishing for His Dinner in the Cafe Pool; Guests Are Permitted to Catch Their Own Trout from Irrigating Stream

**CAFE PATRONS CATCH OWN FISH IN POOL ON GROUNDS**

Persons visiting a roadside cafe near Pomona, Calif., may catch the trout for their meal in a brook that runs through the restaurant grounds. While the fish are frying, they may enjoy a walk through the small farm operated in connection with the cafe. Chickens, special game fowl, frogs, squabs, rabbits and other animals are raised to supply food for the patrons. At night, gas jets are lighted over the fish pools so that insects will be attracted and fall into the water where the fish may get them. The stream is also used for irrigating purposes.

**FOLDING SEAT FITS IN POCKET FOR CAMPING TRIPS**

2505

A chair that can be carried in your pocket has been devised for campers, auto tourists and others. It is a collapsible seat that weighs only two pounds and is but two inches in diameter and ten inches long when folded in its convenient carrying bag. It is strongly constructed, strains are evenly distributed and when set up, it is the height of an ordinary chair. Folding or setting it up takes only a few moments.



**POLISH TO MATCH AUTO COLOR PRESERVES PAINT'S SHINE**

Preservation of the automobile's "show-room complexion" is sought in a polish that can be had in colors to match those of the car. It follows the principle of face powder and shoe polishes to correspond to the hues of surfaces to which they are to be applied, and is said to be more effective in keeping the original luster of the auto than ordinary polishes.

*in Chicago*

*220 N. Dearborn, Chicago. The Pocket Co.*

*Henry Labass, New York*



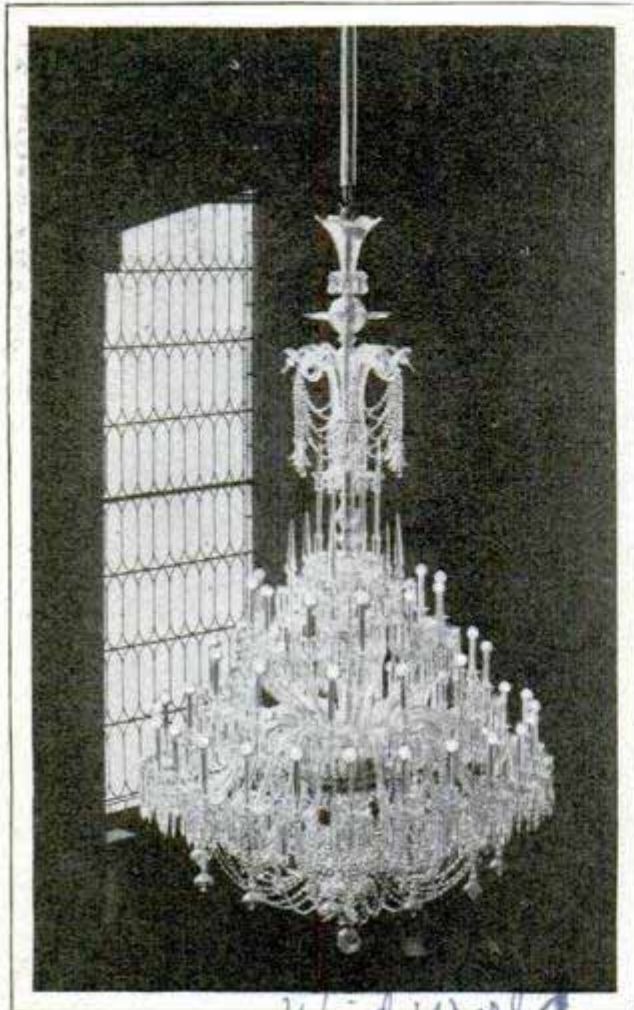

Magnificent Crystal Chandelier Built in Czechoslovakia as a Gift for New York's New Cathedral

**TEN-FOOT GLASS CHANDELIER CONTAINS THOUSAND PIECES**

One of the finest examples of the glass-makers' art is seen in the ten-foot chandelier presented to the Cathedral of St. John the Divine in New York on behalf of the Czechoslovakian government by Dr. Jaroslav Novak, the consul-general. The assembly contains 1,000 pieces, and forty men worked a year to complete it.

**SHIP EIGHTEEN TONS OF FROGS FROM TEN-MILE FARM**

More than 36,000 pounds of frogs were caught and sent to Chicago from an Indiana town last season, the "crop" proving a record, partly on account of the long period of wet weather. Lee Myres, the "big frog-leg man" of the district, employed expert frog gatherers who worked a ten-mile area of swamp land. Their pay was based on the pound wholesale rate. In one shipment, a ton of frogs was sent.

*Parr, Inc.*

**LOCOMOTIVE TIRES ARE TRUED WITHOUT REMOVING WHEEL**

2581 Keeping the tires of the huge locomotive wheels true is an important task of the mechanical departments of the nation's railroads. This work, which usually takes about six days for each engine when the wheels are removed, can now be done in ten hours on an eight-drivewheel freight locomotive by a method the Pennsylvania railroad has adopted. This is accomplished with the help of a lathe, placed so that it can pull the engine on its transfer table, and a steel cutter set in a block on the brake head. Ten pounds of air pressure placed on the brake causes the cutter to dig in and plane the tire as required. One man can handle the apparatus, controlling the air by means of a cord.

**GLOBE MADE WITHOUT PASTE HELPS TEACH GEOGRAPHY**

1915 Geography pupils are afforded amusement and helpful instruction in learning to form their own globes from carefully cut-out sections, joined on the equator line, and ready for adjustment to a wire form. No pasting or gluing is necessary as there are holes in the ends of the sections for inserting the support. The globe is four inches in diameter, accurately printed in five colors, and can be assembled or taken apart in a few seconds.

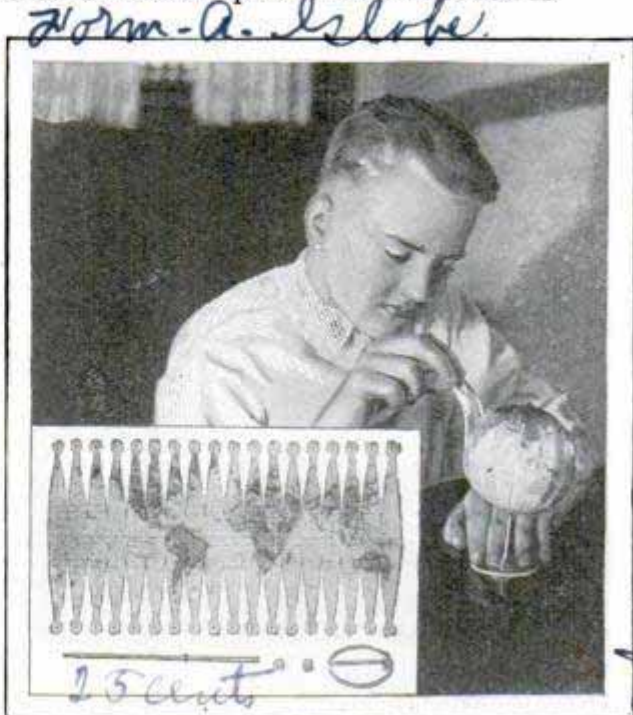

Cut-Out Globe Which Can Be Assembled on a Wire

*U. J. Kystrom Co.*  
22 W. LaSalle Ave.

*Chicago*



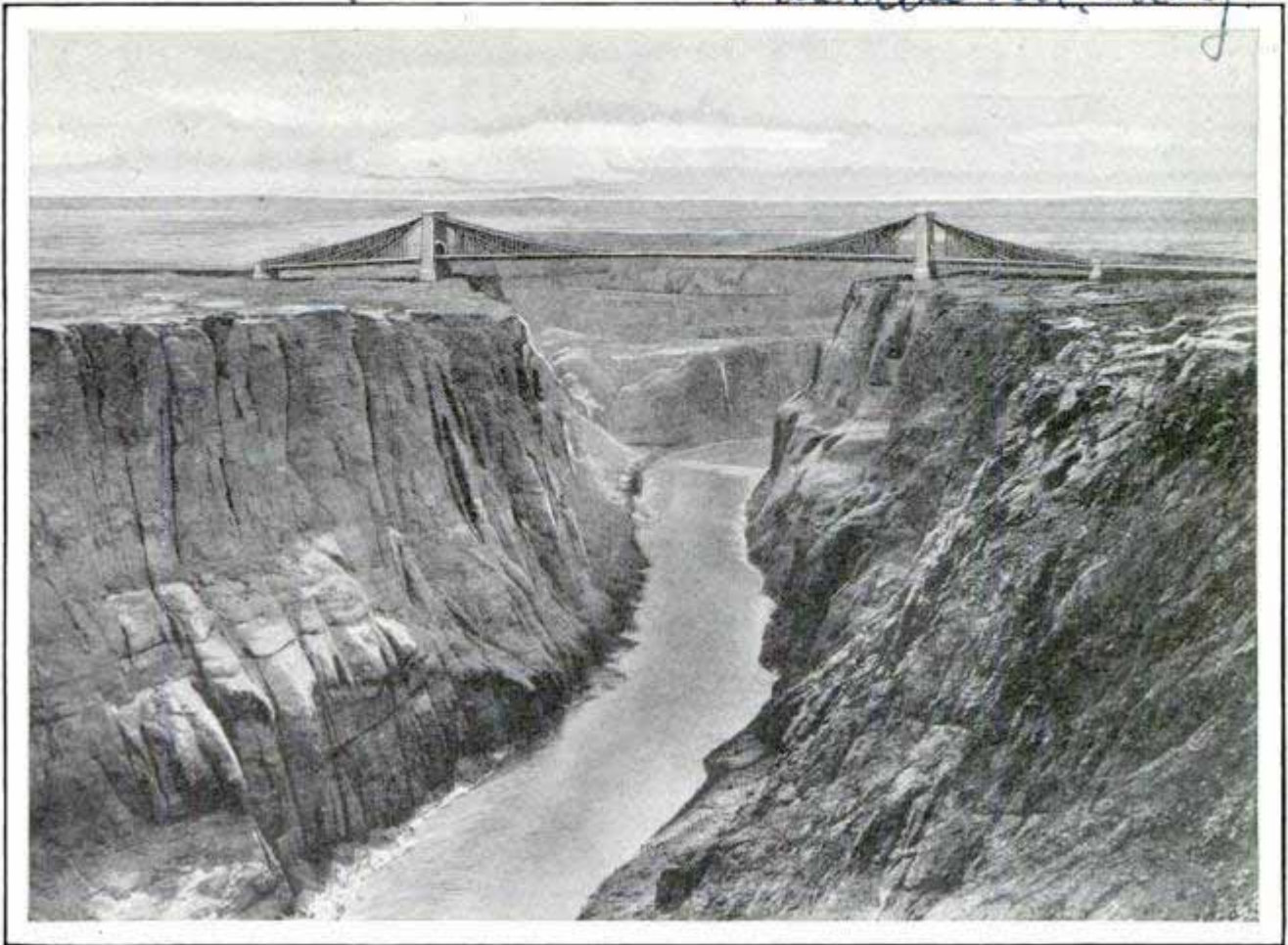

Northern and Southern Arizona Are to Be United by This Huge Bridge, to Be Flung across the Grand Canyon of the Colorado, Hitherto an Unconquered Barrier across the State

### BRIDGE ACROSS GRAND CANYON — TO AID AUTO TRAFFIC

Northern and southern Arizona will be linked more closely together and a new automobile through route will be possible as a result of the bridge soon to be erected over the gorge of the Grand canyon at the mouth of the Paria river, not far from the Utah line. The structure will be one of the highest in the world and will bridge a gap which has remained a dividing barrier since the canyon was discovered in 1540. The river, hitherto, has had the longest unbridged stretch of any major stream in the United States, a slender suspension bridge being the only one over a distance of nearly 700 miles of continuous canyon. Because of the chasm, points in northern and southern Arizona, almost in actual sight of each other, have been more widely separated in point of time than New York and London, for, at certain seasons of the year, the desert roads leading to the crossing of Lee Ferry are unfit for wagon or automobile traffic. The

bridge is expected to cost \$200,000. The money has been furnished by the state of Arizona and from oil-royalty funds of the Navajo Indian reservation. At the point where the bridge will be built, the canyon is nearly 600 feet wide and 400 feet deep.

### DOUBLE-EDGED PRUNING SHEAR MAKES CLEAN CUT 1123

Severing branches with pithy centers is sometimes a difficult task with ordinary pruning shears, as the twigs are likely to be bent and bruised without being cut.



This feature is said to have been eliminated in a pair of shears which has two cutting edges, the upper blade sliding while it works, to produce a clean cut. There is also a hook on this blade to prevent the branch from slipping out. The cutters are easily removed for changing, and powerful leverage can be exerted by the strong spring grips.

*Hu. Aly Specialty Co.,  
712 Western Ave.*



2431

### ELECTRIC PAD PROTECTS FEET OF AUTO PASSENGERS



Electric Heating Pad Built with Drawstring and Designed to Fit Snugly about an Autoist's Feet

An electric heating pad, specially shaped to inclose the feet and fastened with a drawstring, has been brought out to protect automobile passengers from the cold. The pad is provided with a short extension cord, which plugs into a receptacle installed in the car just beneath the seat, the wiring from the storage battery being entirely concealed beneath the car. The pad is furnished with thermostatic control to prevent overheating, and a variable switch giving the choice of two temperatures. The same manufacturer also makes electrically heated driving gloves, which can be equipped either with a long extension cord, or permanently attached to the steering wheel, so that the driver can slip his hands into them or remove them at will.

### CRAWFISH HELP CAUSE FLOODS BURROWING IN LEVEES

2614

Investigation of the recent floods in the Mississippi valley by weather-bureau men has developed the fact that crawfish were a contributing cause to the disasters. Not

all the breaks in the levees were caused by high water running over the tops. Many were occasioned by seepage which is often increased by the burrowings of the crawfish. They dig straight through thick banks, water flows out, slowly at first, but with constantly greater volume as pressure inside increases, and before long, the small fissure has widened into a large crevasse. Patrols are maintained to guard against the breaks, but occasionally the crawfish win. Another contributing factor in the destruction of the levees was found in sand boils. In effect, these are merely springs where the land is sufficiently porous to allow the water to run through and boil out on the landward side. It is usually impossible to stop them by plugging, so circular dikes are built around them to trap the water. When it reaches the level of the river, it will cease to flow out, but the action undermines the levee so that it is less efficient under great strain.

### FERTILIZER APPLIED WITH HOSE FROM FAUCET HOLDER

2396

Watering and fertilizing the lawn or garden at the same time can now be done with a simple attachment connected to the supply faucet and to the hose. A fertilizer containing plant food in the form of various chemicals is held in the unit, which is simply a metal cylinder with two openings. As water rushes through, it washes the material with it. This is in the shape of a stick that drops down of its own weight as it dissolves, insuring a constant supply. An adjustable disk controls the strength of the solution and the speed at which it is dissolved. The sticks are odorless, and one pound of the material is said to be equal to about five pounds of ordinary fertilizer applied in the old way.



\$15.00

Ⓜ A Portuguese is said to have invented the ukulele about forty years ago.

Chicago Daily News  
5/15/17

Terride Specialty Co.  
104 E. 14th Ave. St. Paul, Minn.

*new York*



119 1/2  
New York City  
Herald Tribune  
Greatest Show on Earth

# Games you CAN'T BEAT

THREE little walnut shells and a pea or two spot cards and a queen have done more to convince many thousands of people that the hand is quicker than the eye than any two games ever invented. For the shell game and three-card monte are two pastimes in which the "sucker" never has a chance.

The only time the player can beat either is when the professional deliberately lets him win to encourage others to try their luck, or to lead them on to making bigger and more reckless bets.

For those that have never seen it performed, the shell game is supposedly a contest in which the player matches his eyes against the shell man's nimble fingers. A small pea is placed on the table, one of three half walnut shells placed over it, and the shell man then moves the three shells about, changing their positions apparently aimlessly, and invites the player to point out the shell that covers the pea.

If a bet is made and the gambler wants to win it, the player always loses, for the pea is not under either of the three shells, so there is no chance of locating it. The pea itself is made of soft rubber and after a shell has been placed over it the gambler starts to move the shell by placing the forefinger on top of the shell and the thumb and middle finger behind it. As he moves it, the shell is tilted slightly at

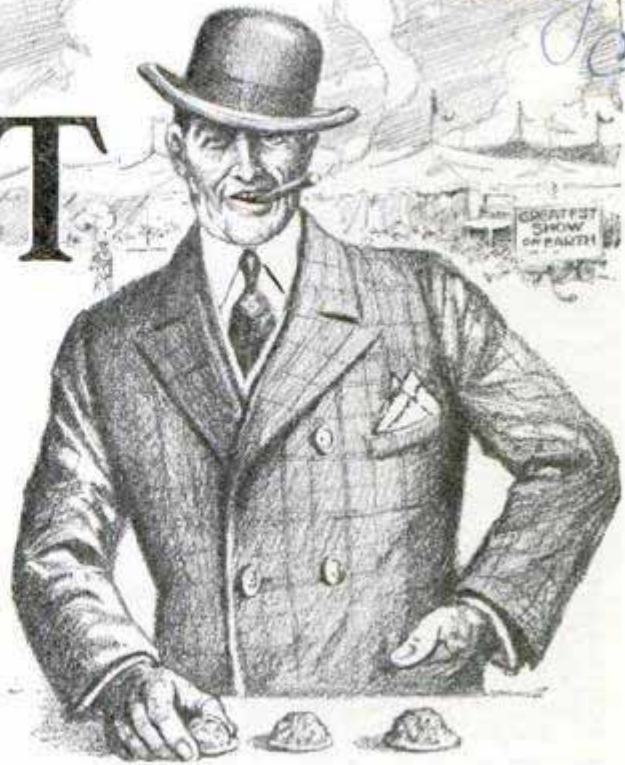

the back, the flattened pea rolls under the edge and is caught between the thumb and middle finger and, as the hand is withdrawn, transferred out of sight between the first and middle fingers. From that time on until it is necessary to disclose it again, the pea remains there.

After the victim has turned up his chosen shell and found nothing under it, the gambler reaches for either of the other two, draws it slightly toward him, at the same time pressing the rubber pea flat, so that it will pass under the edge, and then lifts the shell and discloses the pellet.

If you play the game the shell man's way it can't be beat, though two ways of

winning have been discovered, neither of which meets the approval of the shell man, so, if you try them, he will quickly pack up his portable table and move on. One of the two was introduced by an expert shell man who once was picked for a victim by another pea artist. Having a rubber pea of his own in his pocket,

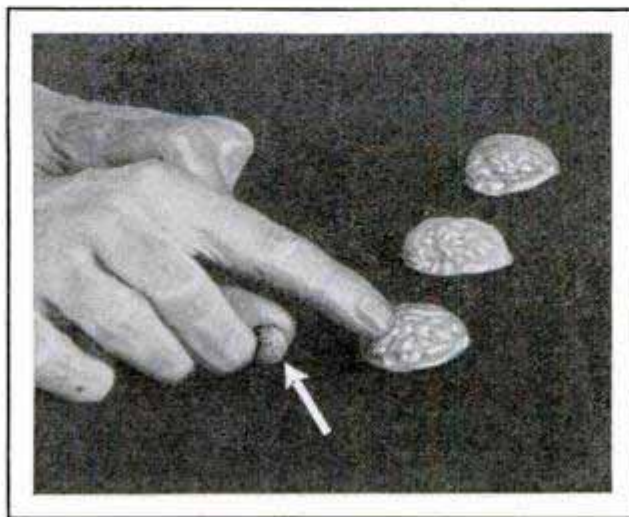

Why the Pea Is Never under the Shell; the Little Rubber Ball Is Snapped Back between the Fingers



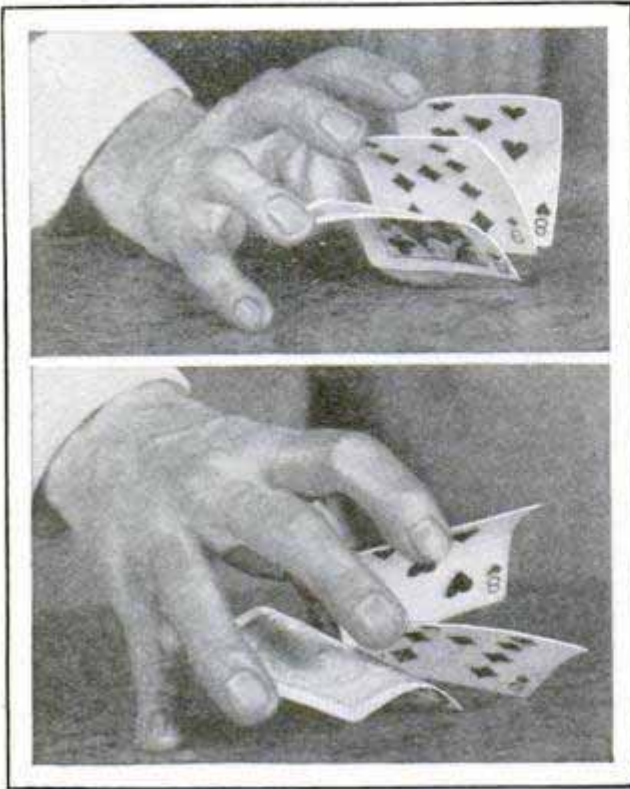

One Monte Deal; the Queen, Bottom Card in the Top Picture, Is Held Back and the Nine Falls in Its Place

the potential victim slipped it under the shell as he picked it up, and the surprised gambler paid rather than expose the fact he had been tricked. The other method, which anybody can try, but which will only work once, is to clap your hand over two shells and announce the pea is under the third, forcing the gambler to lift it. His only recourse is to slip the pea under it and pay the bet, or else the two empty shells you have covered will expose the fact that the pea was not under either of the three.

Three-card monte requires more skill and better nerves on the part of the gambler, and for that very reason often will trap people who wouldn't fall for the rubber pea. It is played in numberless different ways, but practically all of the variations employ one face card, usually a queen, and two spot cards, usually of the opposite color from the queen, to make it look easier for the victim.

The trick is to point out the queen after the gambler has exposed the three cards and then thrown them on the table. It looks easy, but anyone with well-trained hands can defeat the eye every time. Every monte man has his own favorite way of dealing, or throwing the three cards face downward on the table. Some use one

hand, some use both, and others will lay the cards face up and then flip them over, using the edge of one of the other cards to do the turning. But regardless of the method used, the trick is always the same—the queen is replaced with another card by a method so simple that the onlooker doesn't see the substitution.

Take the "two-hand throw," for example. One of the spot cards is held in the left hand (which is called the blind) and the other two in the right hand, both slightly cupped and separated so that both are visible, the queen being lowest, or nearest the finger tips. Now, if a card is dropped from the right hand, then the one from the left, and finally the third card from the right hand, it stands to reason that the queen will be lowest, or at the bottom of the pile. The monte man repeats this performance a few times to show how easy it is.

Then the bets are made—and the bottom card turns out to be a spot, and the queen is on top! The reason is that the monte man has released the spot card from the right hand while keeping the queen between the finger tips, but has done it so quickly that the eye doesn't catch the move. At the same time the throw is made, the queen, which has been held between the thumb and second finger, is shifted to the first finger, replacing the spot card, and even examination of the hand fails to show anything wrong.

The "one-hand throw," which eliminates the "blind," is much more difficult to do, but more popular with the gamblers, because it is harder to detect. The three cards are held in the right hand, one end of all three against the thumb, and the other ends pressed against the first, second and third fingers, the queen being the lowest card, or the one against the third finger. The hand is drawn across the board in a quick sweep, dropping the three cards in a row. Apparently the queen should be the first card dropped, but actually is in the center, for the middle card is the first to fall.

The method is popular with the monte men because it can be varied at will, making the queen fall in any position. All that is necessary to drop a card is to lift the finger off its top edge, whereupon it is removed from the hands by the sweeping



motion across the board. In addition to letting the cards fall in any order desired, the monte man also has the advantage of changing the position of the queen in the hand, which helps mix up the victims.

One of the trickiest methods of confusing the betters is used with this same throw, the queen being held as top card with the two spots below it. The first spot card is dropped, and the gambler then, apparently by accident, lets the players get a quick flash at the middle card, which they see is a spot card, but he drops the queen instead, and then gives another quick flash of the spot card still in the hand. Having seen the glimpse of spots on the second and third falls, the players naturally assume the queen must have been the first card dropped, so they pick it, much to their sorrow.

The most deceptive form of three-card monte is performed on the table with the queen being face up at the start and the other two cards face down. All three cards are bent so that they are quite concave, and the two end cards are held by each hand. The card in the right hand is used

An Old Card Superstition That People Standing behind One's Back during Play Bring Bad Luck Is Well Founded



as a lever to turn over the center card, the queen, which falls against the left forefinger. Then the hands are drawn apart, and the end cards are laid on the table. Naturally the queen is in the center. But after the dealer has done the trick a few times and is ready for bets, a change takes place. As the queen falls on the left forefinger the right hand moves slightly to the left, the thumb and third finger catch the queen, draw it out and at the same time the right-hand spot card is released, to fall into the queen's place in the center. The movement is so natural and is accomplished so rapidly that the eye is completely fooled.

A variation, called "Mexican monte," is equally deceptive. The three cards are all laid face up, one of the spots then being used as a lever to turn the other spot face down, and then the queen, after which it is laid with

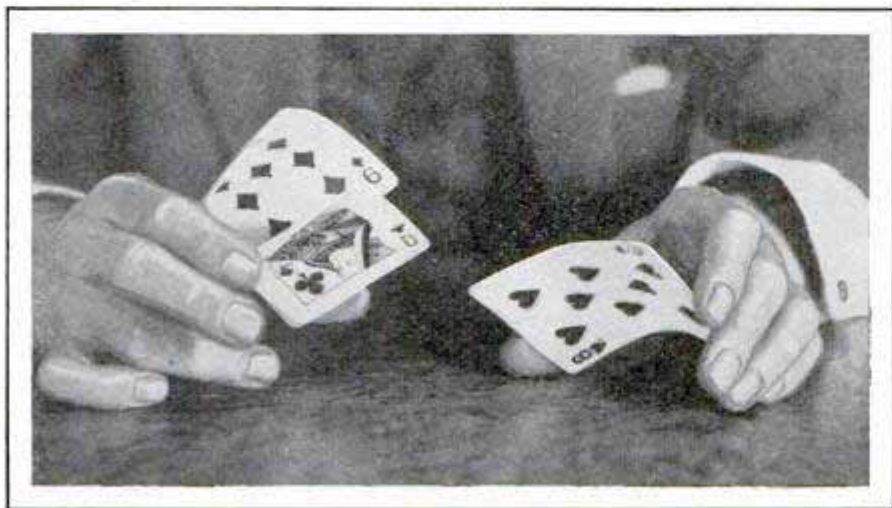

Dealing Two-Handed Monte, Showing How It Is Possible to Trick the Spectator by Changing the Order in Which the Cards Are Thrown



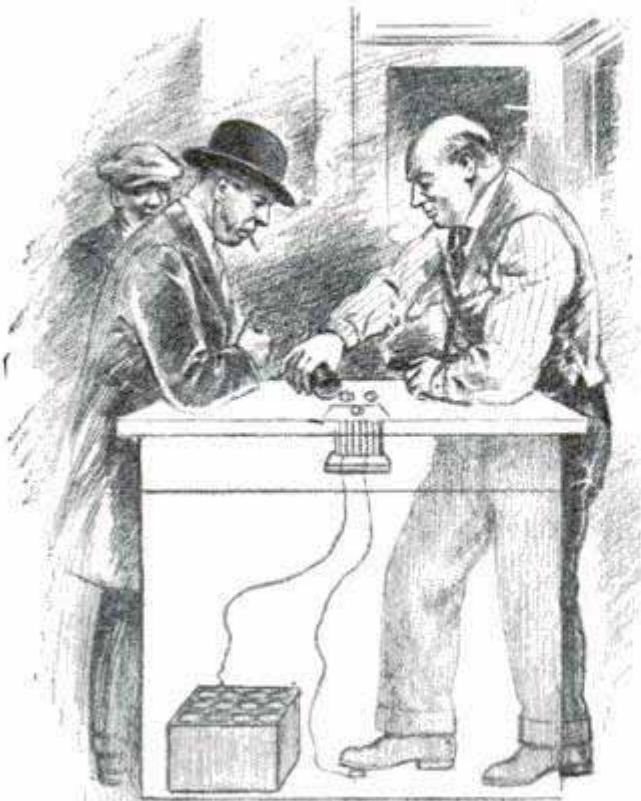

Dice Boards Which Can't Be Picked Up and Examined Are Always Open to Suspicion of Being Wired

the other two. But the supposed queen turns out to be a spot card, for the simple act of turning over the queen enables the monte man to switch cards. As the queen is tilted up, with the spot card held between the thumb and forefinger, the second finger is placed under the lower corner of the face card, and, just as it is about to fall, the queen is caught between the thumb and finger, while the extended first finger turns the spot card face down.

Should a suspicious player actually point out the queen, the monte man picks up a face card, uses it as a lever to turn the queen up, and works the same substitution, so that the spot card falls face up on the table.

Sometimes monte is played with three trick cards, though only the veriest amateurs use them. Instead of one queen, all three are spot cards, usually the ace, deuce and trey of the same suit. The deuce is a normal card, and is held at the bottom, but the other two, while having one and three spots respectively, have a fake pip at one end. The ace will have the usual "A" at one end and a figure three at the other, and the trey is arranged in the same way. Fanned and exposed in the usual way, held only by one corner, the fake

piPs are covered, while the correct ones and all the spots are shown. By simply reversing the cards in the hand the trey and ace apparently have changed positions.

Shell and monte men seldom work alone, usually having anywhere from one to six "cappers" to round up victims and start the play (in which the capper always wins).

There is no such thing as an honest professional card gambler, no matter what the game is. Despite the ban on gambling throughout the country, "mobs" of professionals work the cities and even small towns, while others ride the through trains and try to lure fellow travelers into a game. They are so numerous that the Pullman company has been forced to post warnings in each of its cars, with a realistic photograph showing one simple hold-out trick by which the gambler can fill his hand with aces at any time he desires.

One of the most used devices for cheating at cards is a "combination machine" which will supply the gambler either with holdouts or an entire new stacked deck. It is only necessary to hold the hands near the body to dispose of the old deck in the machine and have a new one pop into the hands, and in the same way three aces, previously extracted while shuffling another hand, can be brought into the hand whenever a pair is caught on the draw, and the betting by the victims makes an ace-full worth having.

The combination machine is a belt affair, worn about the waist beneath the trouser band, and carrying a sack for the holdouts and a thread arrangement worked by spreading the legs, which raises the new deck or the cards previously held out, into the hand.

Another common gambling device is a "ring shiner," which looks like an ordinary finger ring with a brilliant set, only the set is really a tiny mirror. The ring is worn backward on the middle finger of the left hand, with the set turned inward. The deck is held in the left hand, so that it does not cover the mirror, and as each card is lifted off the dealer can catch a glimpse of its face, so he knows exactly what each player has.

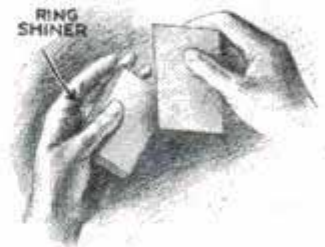



The same company that makes the ring shiner also produces a white ink for marking cards, the ink matching the white finish of a card so perfectly that it escapes detection, while the gambler's carefully sandpapered forefinger can feel the raised surface of the ink and recognize the card from the touch.

Even dice games played over the cigar-store counter may be corrupted with crooked dice which fall only in one way when the proprietor steps on an electric button on the floor. A magnet hidden beneath the counter does the work.



Not all card sharps use marked decks, "cold decks" or holdouts. Work-

ing usually in pairs—always appearing as strangers when they meet in the Pullman smoking room—they have intricate systems of signals by which they can communicate to each other the contents of their hands, or, after one has dropped out of a hand, can overlook the victim's cards and flash their value across the table. The index finger of the right hand may be used, for example. When it touches the tip of the first finger of the left hand it means an ace, tip of the second finger a king, third a queen, fourth a jack, first knuckle of the first finger a ten, and so on. A cigaret held between the lips is often used in a bridge game to signal the best suit, meaning, in the left side of the mouth, clubs; center, diamonds; right, hearts, and in the fingers, spades.

### LIFE DISCOVERED IN GEYSERS

Although they are always in hot water and likely to be incased in chalky material almost any time, various forms of animal life are found in the geysers and hot springs of the Yellowstone and other parts of

the world, according to Prof. Charles T. Brues. He found water beetles in ponds with temperatures of ninety to 100 degrees Fahrenheit, the larvæ of a species of horsefly at ninety-one degrees, a water bug at ninety-six degrees, snails at the same temperature, and certain kinds of worms at 120 to 124 degrees. In waters where the temperature reaches 200 degrees or over no life was found. Besides the question of heat, the animals have to solve the problem of chemical content in the water, the decreased supply of oxygen and the danger of the liquid becoming solid suddenly due to a drop in temperature and the high proportion of limestone and silica in solution.

2495

### STONE BATHTUB FIVE FEET HIGH SHOWS STYLE CHANGES

Stone, instead of porcelain and metal, was the material favored for bathtubs in the days of the old Indian rulers and the basins were huge affairs with a crude stairway chiseled in one side so that the bather could get in and out of the tub safely. At Agra, India, is a specimen of "plumbing" as known in the time of Jahangir, one of the great moguls. The tub is five feet high, eight feet in diameter and twenty-five feet in circumference. It is fashioned from a single block of porphyry.

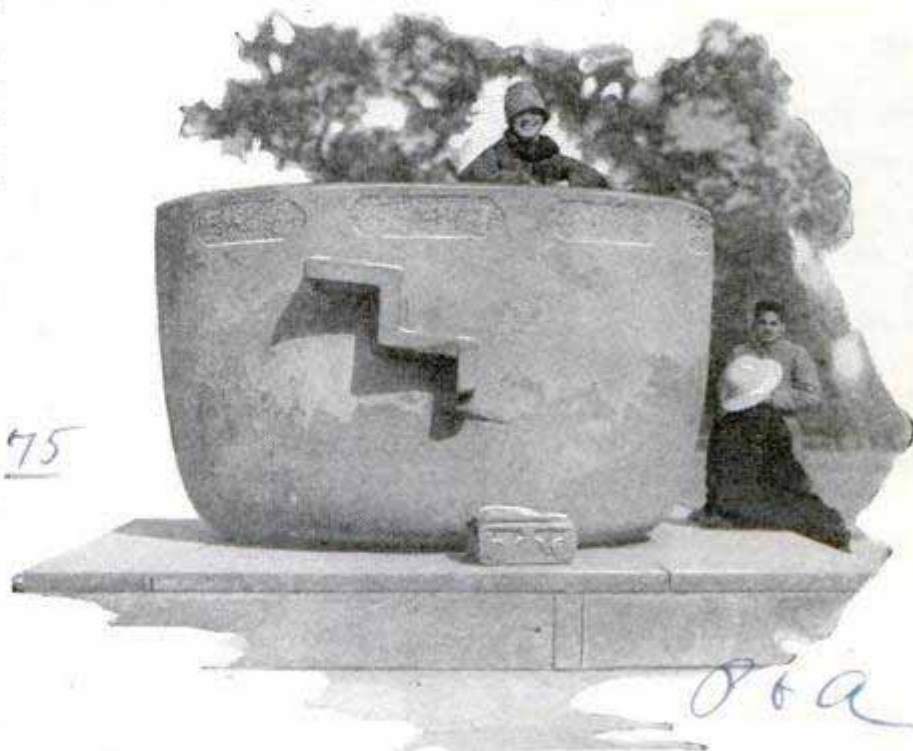

Huge Stone Bathtub Used in India Several Centuries Ago; It Is Made from a Single Piece of Porphyry



2392

Electro Mech.

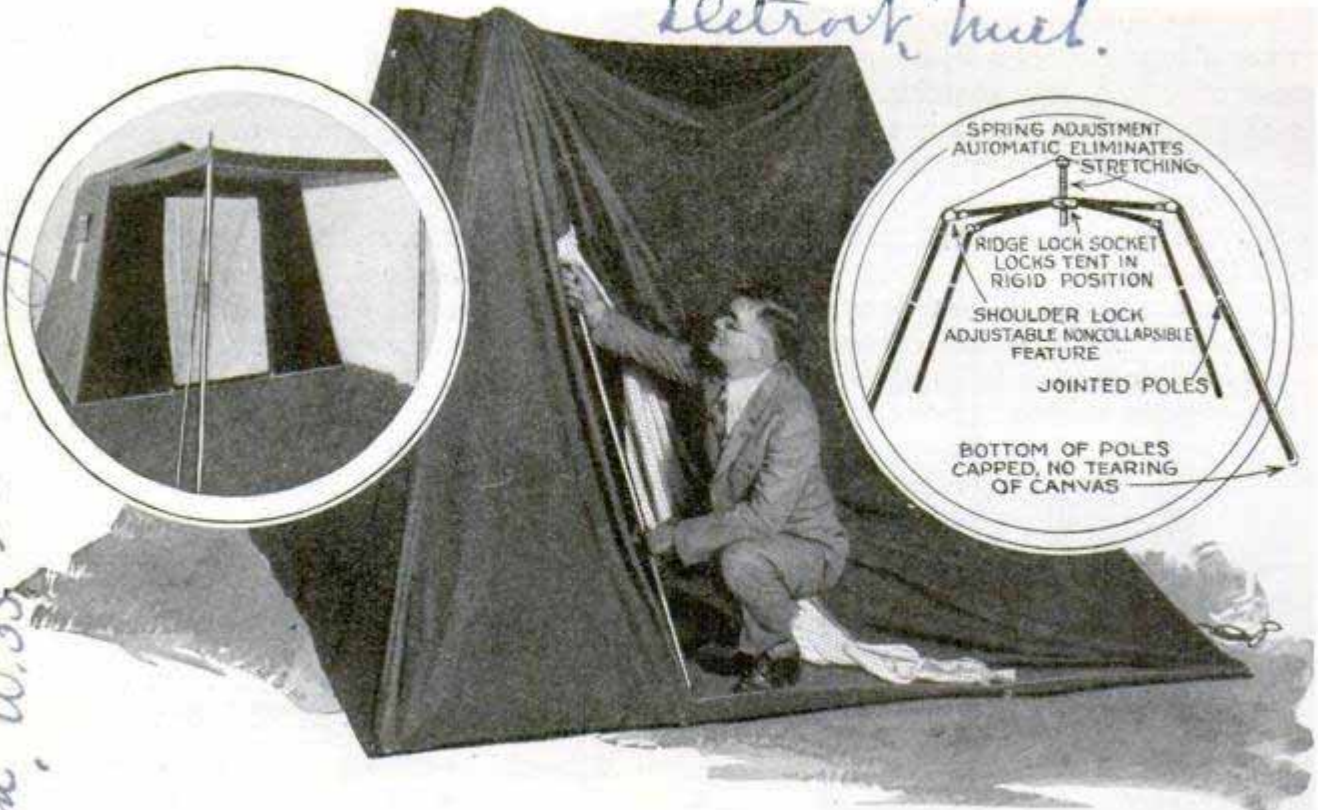

Tent Erected with Canopy Adjusted in Front; Setting Up the Frame inside the Canvas; the Diagram of the "Skeleton," Showing How It Looks in Rigid Position

### POLELESS TENT EASILY PUT UP IN FOUR MINUTES

Supported by an easily adjusted frame instead of poles, a tent can be erected by one man in four minutes and is said not to stretch out of shape. The only poles used in the outfit are for the awning in front. The frame and tent are carried in separate bags to prevent damaging the cloth.

### STOVE THAT FITS THE POCKET HELPS KILL MOTHS

What is believed to be the smallest stove in the world has been introduced in Germany in the form of a pocket-size unit for fumigating and deodorizing rooms. It burns gasoline, which is poured into wadding within an inner receptacle. Heat is transferred from a wire netting at the top to a safety cover and tube outside. Drops of perfume or chemicals are added to the fuel



for removing unpleasant odors or killing moths and other insects. To extinguish the stove, the inner chamber is simply turned upside down.

### RAT-PROOFING OCEAN LINERS IS CALLED SUCCESS

About two years ago, eighteen steamship companies started renewed warfare against rats on seventy-three vessels. The government foreman of rat-proofing, one of the officials of the New York quarantine station, was called in, the plans of the ships were studied and extensive measures taken to combat the pests. So effective were the steps that ships which formerly trapped twenty or more rats on every voyage, now catch one in fifteen months or so, and on others, it was found that almost no rats were caught even before the protective measures were finished. The time to do rat-proofing is when the vessel is being constructed. Each compartment, section and room is designed so far as possible to be an isolated unit, but ships already built have been made practically proof against rats by careful alterations. The habits and movements of the rodents were studied and charted; then the work of eliminating their hiding places

NY Times 5/29/27

Mr. Kalischer & Co., City of Berlin, W. 35 Germany, 27, Lützowstr.



2233

began. All dead spaces were blocked off or done away with, flooring over bilges was made tight, metal casings placed around pipes, and metal collars or flanges at places where pipes entered walls. Metal cupboards and bins replaced wooden ones, double walls were removed for solid ones or, where this was impossible, metal screens were installed to block off spaces at frequent intervals. Rat-proof covers were placed on all food containers. Although the pests sometimes boarded the ships after they had been thus protected, they were soon exterminated as they could find few places to hide.

**TOY WORK SHOP IS DESIGNED FOR PRACTICAL USE** 2544.

A toy-sized woodworking shop, which actually runs and produces practical work, is one of the latest things for the boy, or, for that matter, for the model builder or others who need only comparatively small-capacity machine tools. It includes a wood-turning lathe, drill press and jig saw, all mounted on one wooden base and ready equipped with an electric motor, line shafting and the necessary belts, as well as several extra pulleys from which other tools can be operated. Despite its toy size, all the machines are well made and do excellent work within their limits. The lathe takes material up to five inches long and an inch and a half in diameter. The drill press will handle drills up to three-six-

\$25.00

Turning on Practical Toy Lathe

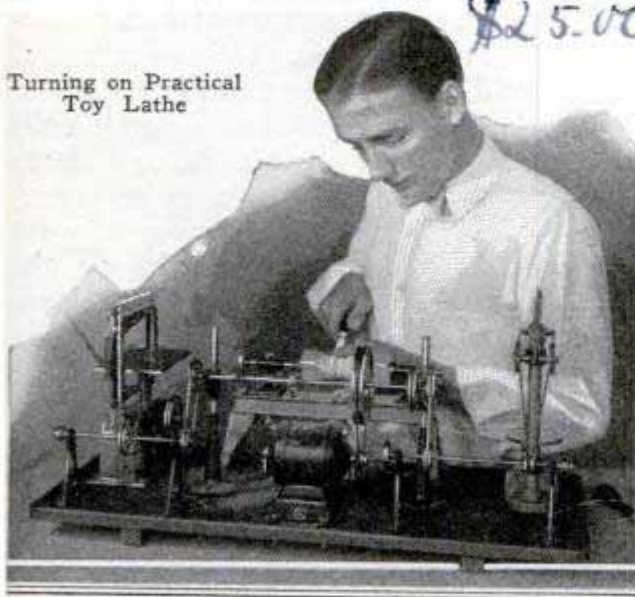

teenths of an inch, and the jig saw will cut boards up to three-eighths of an inch thick.

*Knapp Electric Corp. n*  
*Pat. Oct. 11, 1911*

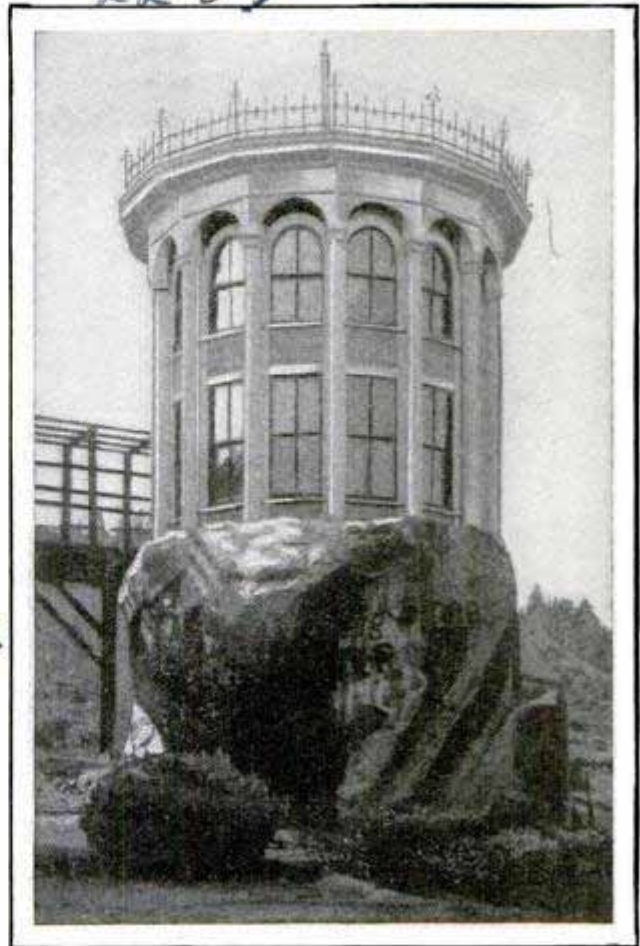

Museum Built on Balanced Rock, Which Can Be Moved by the Pressure of One's Hand

**MUSEUM ON BALANCING ROCK IS MOVED WITH HAND**

*Structure*

A push of the hand is sufficient to move a house foundation and all, in a California town. The structure is a small museum for Indian relics built on a balanced boulder which can be tipped back and forth by slight pressure against it.

**POULTRY VICTIMS OF FLOOD RESCUED BY RED CROSS** 2612

Human beings, generally, are the chief recipients of aid from the Red Cross in times of disaster, but in the recent floods on the Mississippi, animals were rescued and cared for in great numbers. At Opelousas, St. Landry parish, La., the largest temporary hen yard in the United States was constructed to feed 100,000 chickens driven from their roosts by the flood waters. The feathered refugees were fed by the Red Cross, as were 30,000 hogs, 10,000 mules and some 30,000 head of cattle. One of the problems arising from this work was to find the owners.



Chicago 8/26/27

44th annual report of Comptroller General of Patents, Designs and Trade Marks for Great Britain

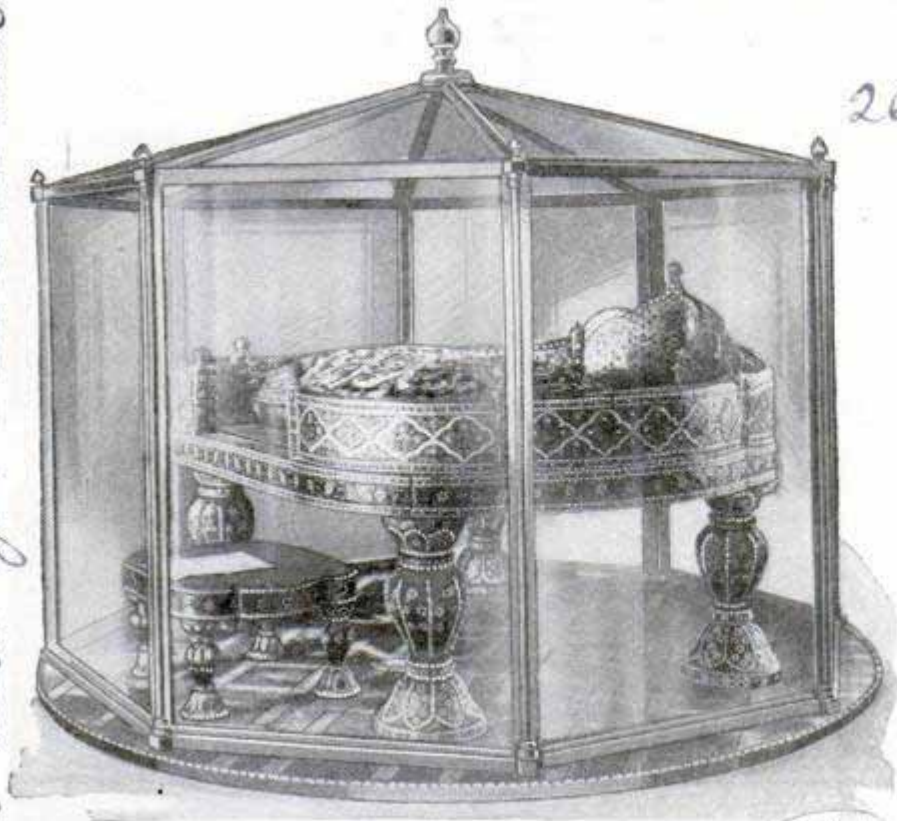

Gold Throne Once Used by a Persian Shah. Now Valued at \$15,000,000, as It Appears in Display Case

**GOLD THRONE WORTH FORTUNE NOW IN PUBLIC EXHIBIT**

Fairy stories of Oriental splendor do not seem so far-fetched in view of the rich relics that have finally been exhibited to the public from a treasure house long kept guarded by the Turkish government. One of the most striking objects is a gold and jewel-encrusted throne of one of the shahs of Persia. It is valued at \$15,000,000.

**INCREASE IN BRITISH PATENTS OVER SEVENTY PER CENT**

More than 33,000 applications for patents, trade-marks or designs were filed in Great Britain last year, according to the annual report, an increase of seventy-seven per cent as compared with the number received in 1925. There were seventy-one fewer applications from women inventors. Receipts from the office totaled \$2,440,760, an increase of \$60,540 over 1925.

**COTTON IS PICKED WITH SLEDS**

Old-time negro cotton pickers with their baskets are giving way in Texas and other sections to a mechanical picker that is mounted on a sled. It has long "fingers" which reach out and strip the bolls from the stalks, passing them back to a wooden trough where they are drawn into a rear compartment as the sled moves forward, for gathering and carrying to the scales. Although cotton picked by this method does not bring as high a price as that picked in the old way, improvements in the outfit are being made, and with it one man can

gather as much cotton as twenty pickers working by hand. This saving in labor more than makes up for the difference in market price, growers believe.

**STEAM BOILER CLEANS AUTOS WITH SPRAY MIXTURE**

To simplify the cleaning of automobiles, an automatic steam generator, recently introduced, has safety and automatic features intended to insure a high quality of performance and operation at a minimum of expense and trouble. It is so arranged that should the water get too low, the fire under the boiler is shut off, small coils prevent danger of an explosion and steam

is said to be generated a few minutes after lighting the fire. To aid in cleaning, a soap solution is mixed with the steam and delivered with it from a separate tank. Pressure and temperature are accurately controlled to prevent damage to the automobile finish and insure a thorough job.



Steam-Cleaning an Automobile

Harley Boiler Works



FITTING WOMEN TO RIGHT NICHES FOR A CAREER

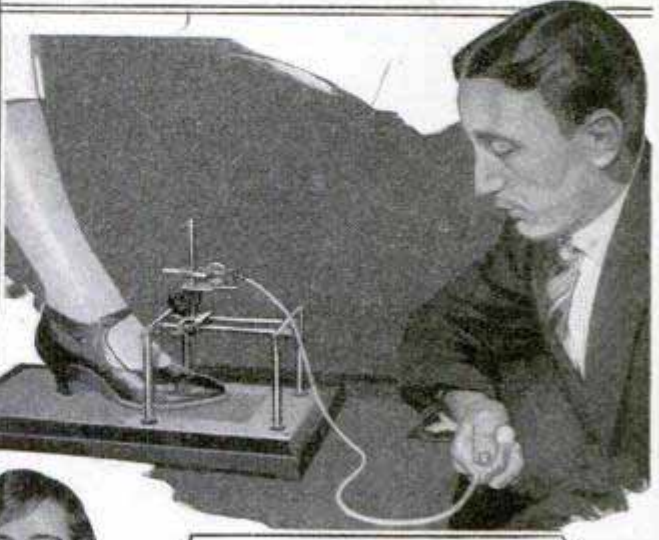

The Machine Above Determines One's Capacity for Work, Carefulness and Willingness

German Scientists Have Perfected a Number of Machines to Test the Abilities of Women to Fill Various Positions; the Outfit Above, Which Tests the Sensitivity of the Foot, Is Used in Several Industries Which Employ Large Numbers of Women at Tasks Requiring Quickness and Agility; at the Left Is a Test for Sensitivity of the Fingers



The Nerve Drain of Doing Monotonous Work Over and Over Again Is Measured by This Apparatus

Henry Miller



*Comm. James W. Ray, San Sebastian, Calderwood, Tenn*

2627



Like Some Weird Metropolis of the Future, the Towering Concrete Forms of This Huge Dam Stand Out under the Floodlights Which Illuminate the Work at Night

### BIG ARCH DAM OF CONCRETE THOUSAND FEET LONG

Nearly 1,000 feet long on top and 196 feet high, the Santeetlah dam in North Carolina will contain 195,000 cubic yards of concrete when completed. The central portion is an arch design, five feet thick at the top and about forty at the bottom. Adopting this form of construction saved nearly 40,000 cubic yards of material, in the opinion of engineers, although it is a little longer than a straight dam would have been. During the building, as much as 20,000 cubic yards of concrete were placed in the forms in one month.

### QUEEN OF SHEBA'S GOLD MINES FOUND IN ARABIA?

The lost lands of Ophir, where the queen of Sheba obtained the thirty-three tons of gold and jewels she gave to King Solomon, have been found in southern Arabia, 400 miles east of Aden, according to Comm. C. Crauford, a British naval officer who has searched for them twenty years. He reports that gold mines and precious stones are in the ground there, a veritable Transvaal of wealth, and that identification of the territory was made by means of inscriptions and the ruins of a temple. The city has a harbor to the north and a river

which gave wharfage to the seaport, but a thin ribbon of coral sand, drawn across the harbor mouth, apparently was one of the factors that strangled the life of Ophir. In recent years, the land of mystery was believed to have been located in East Africa, as popularized in "King Solomon's Mines" by Rider Haggard. But research showed that the ruins of what were supposed to have been temples of the queen's day were but 300 or 400 years old.

### LONG-HANDLE GARDEN WEEDER SAVES STOOPING

2326 Puller in Working Position and Close View of Blades with Hole between Them

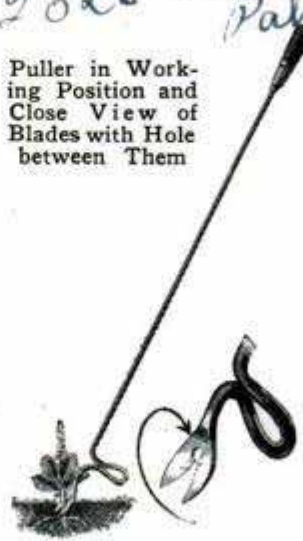

Dandelions and other weeds are said to be easily removed from lawns and gardens with a combination puller and cutter now on the market. It has sharp, pronged blades with a hole between them to help catch the small weeds. The handle is forty-two inches

long, so that the user need not stoop. The tool is also suitable for pruning bushes and may be employed in difficult places.

*Daily Mail 5/12/27*

9599

*Before Royal United Service Institution sold by Deep Service Box 253, Highland Station, Mr. John W. Young, Holyoke, Mass.*



2577 Mrs. Jones  
 Leblanc 461  
 France

**FLUTE MADE OF GOLD YIELDS IMPROVED TONE** 2621

When special effects are desired in certain passages of their selections, the Boston symphony orchestra sends to Cincinnati to borrow a golden flute, belonging to Prof. Dayton C. Miller, experimenter on ether and sound problems. The instrument has a curious, rich tone, not equaled by any other. The explanation, according to Prof. Miller, is that the density of the metal in the tube improves the tone quality, and the relative nature of the golden flute's sound and that of other flutes has been determined by motion pictures of the waves produced. Prof. Miller has a collection of more than 700 flutes and is thinking of having one made of platinum to determine if it will produce a still finer note.

**LIGHT TOWER THAT DISAPPEARS HELPS GUARD COAST** 1956

For use along the seacoasts, a disappearing searchlight tower has been adopted by the government. In two minutes it can be raised from a nearly horizontal position to a height of 200 feet, and, when not in service, is lowered and concealed within a portable shed on rollers. With electrical equipment, it weighs about 8,000 pounds. The towers will not only be of service in case of military necessity, engineers believe, but will also aid in determining the location of vessels in distress.

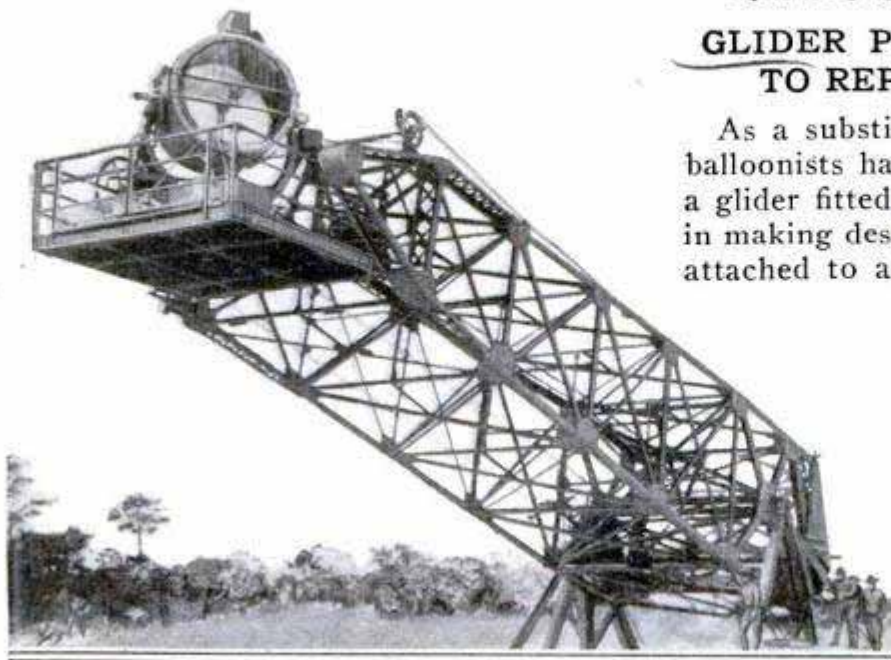

Disappearing Searchlight to Aid Coast-Defense Ports

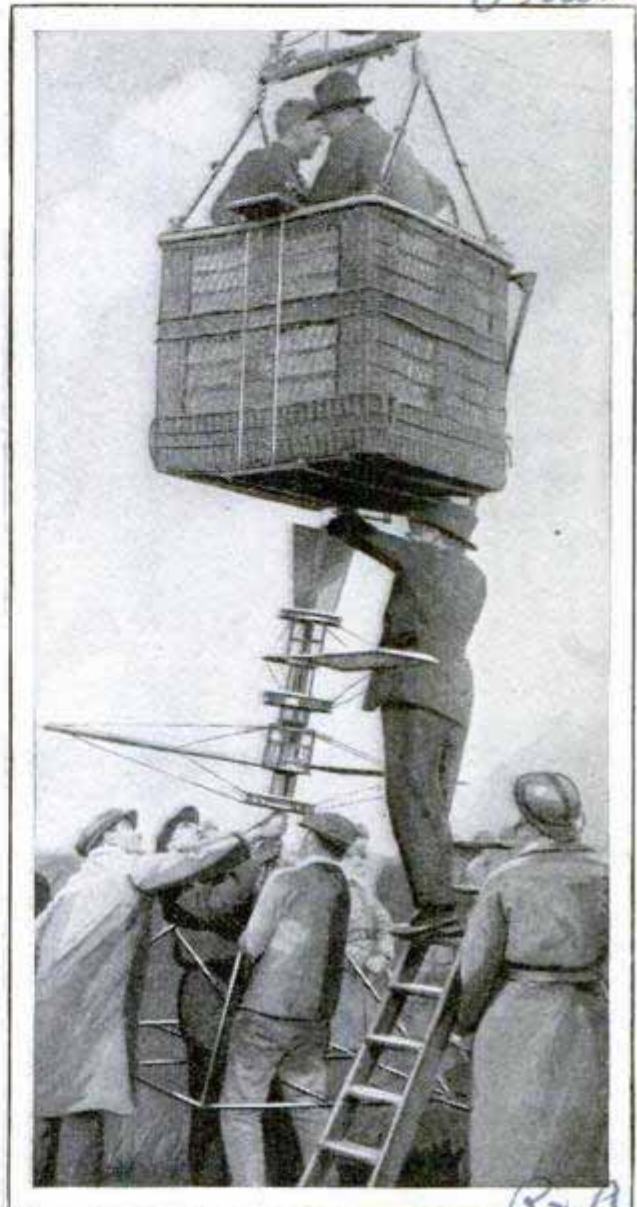

Attaching the "Parachute Propeller"; It Is Intended to Spin, Keeping the Flyer from Abrupt Descent

**GLIDER PROPELLER PLANNED TO REPLACE PARACHUTE**

As a substitute for parachutes, French balloonists have been experimenting with a glider fitted with a horizontal propeller in making descents. The arrangement was attached to a balloon basket in one test and then released at a height of 1,300 feet. The blades revolved rapidly during the downward course, helping to break the force of the fall just as a parachute supports the weight fastened to it. It fell at about the same speed as an equivalent load with a parachute would have done.

Capt. E. E. Purson, Bloomington, Ill



2/45-

# TIME and things



Added Service Is Derived from This Vacuum Cleaner, Which Has Revolving Brush for Polishing Floors

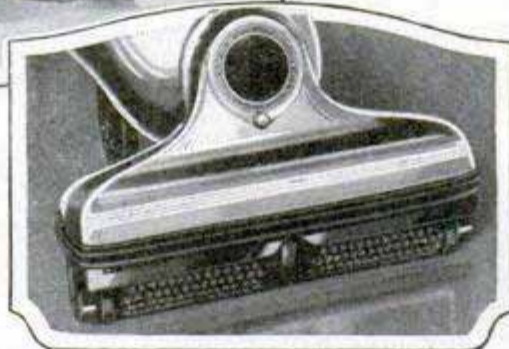

Bottom for Kettles to Keep Food from Scorching; Turn of Center Ring Makes It Larger or Smaller



Safety Plug for Electric Iron; It Automatically Shuts Off Current at Danger Point and Has Button Heat Control



Mop Wringer without Roller, Adjustable to Different-Sized Pails; the Net in Center Holds Rag for Squeezing Out Water



No More Rocker Scratches on Baseboards; the Rubber Tips Protect the Wood, and the Ankles, Too



# MONEY SAVING for Your Home

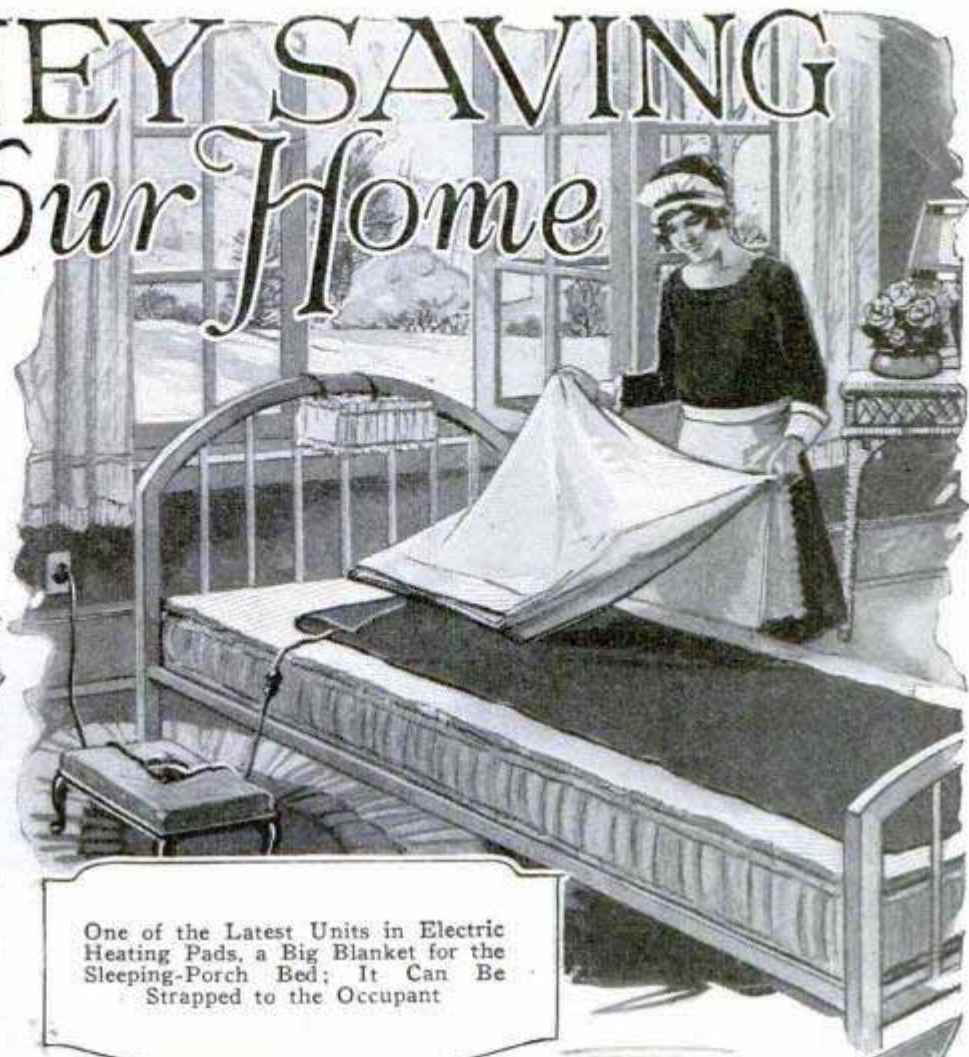

One of the Latest Units in Electric Heating Pads, a Big Blanket for the Sleeping-Porch Bed; It Can Be Strapped to the Occupant



Metal Ring for Gas Stoves Focuses Flame Where It Will Do the Most Good, Speeding Up Cooking and Saving Gas; It Also Protects the Sides of Kettles



Large-Toothed Kitchen Knife Cuts Bread and Cake Easily; Old Blades May Be Shaped in This Manner, to Make Them More Useful

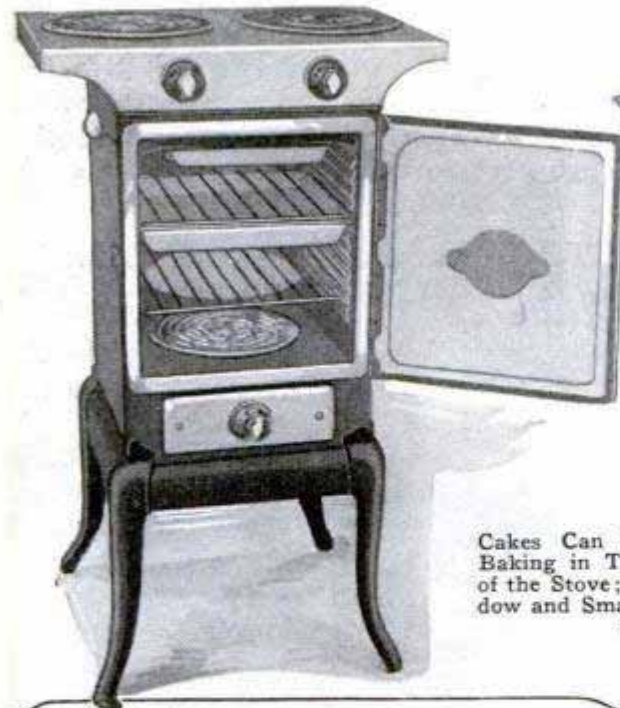

Special Wiring Is Not Required for This Compact Electric Range with Roomy Oven, Racks and Grid for Frying and Broiling besides Place for Percolator; Current Is Supplied through a Convenient Wall Socket



Cakes Can Be Watched While Baking in This Pan for the Top of the Stove; It Has a Mica Window and Small Hole for Inserting a Straw

E  
N  
R  
L  
S  
C  
53

R  
370

M  
M.

G  
C.

E  
W.



Shooting the Chute, Leaping the Gap and Looping the Loop, Are All Three Combined in a Thrilling New Sled Ride Which Has Been Introduced in England, Where Women as Well as Men Try It

*Amusement*

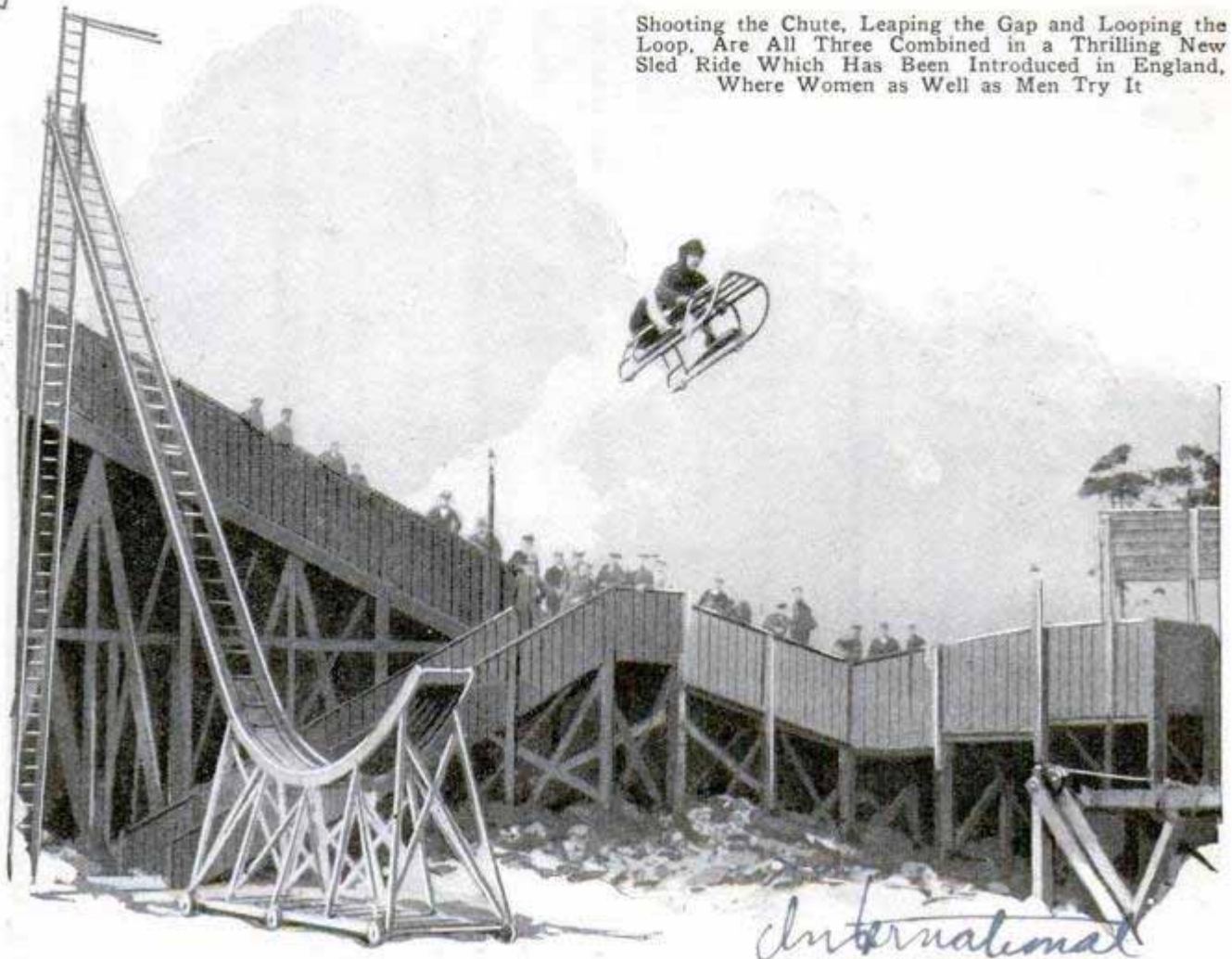

**RIDING ON SOMERSAULT SLED  
LATEST THRILL IN SPORT**

*London.*  
"Shooting the chute" on a sled that turns a somersault in mid-air and lands upright on a large net, is the latest outdoor sport introduced in England. The sled and rider start from the top of a steep incline. At the base, is an abrupt tip-up that turns them over as they shoot up and forward into the net, which is placed the correct distance from the bottom of the slide.

**NEW SOURCE OF RUBBER SEEN  
IN AFRICAN TREE**

Renewed interest in the possibilities of the euphorbia tree, which grows in great abundance in southern Africa, as a source of rubber, is reported from that district. For forty years or more, the species has been known as a producer of latex and resins, but active cultivation, contemplated shortly before the war, was halted and little has been done until recently, when samples were sent to London, New York

and the bureau of standards. According to a German chemist, about three gallons of latex of pure-white color were extracted from twenty trees in two hours. It proved to have a high rubber content and the resins were suitable for varnishes.

**AUTO JACK IS ALWAYS IN PLACE  
1936 ON THE AXLES**

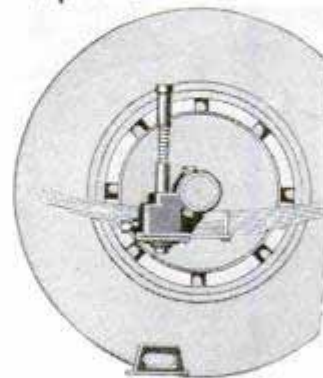

*pend.*  
Permanently attached to the automobile axle, a jack operated by a small handle, is always ready for duty and saves the work of adjusting. A special base is provided, but this is not needed on hard-surfaced roads. The jack may be fixed to either front or rear axle, and spares the motorist soiling of his clothing and the usual difficulty encountered, particularly in placing a jack under the rear.

2672

*option obtained by  
Premier Rubber Corp.*

*Draver Infy. Co.*



John H. Cross  
York, Pa 465

**BIRD PUNCTURES PLATE GLASS  
IN FLIGHT OVER POOL** 2645

Mistaking a large plate-glass window in front of a swimming pool at Banff, Alberta, for an open passage, a partridge flew into it, breaking the huge pane and killing itself. The force of the flight was shown by the fact that the bird passed entirely through the glass and partly across the large room within before it fell. It cost \$400 to repair the damage.

**PALACE CAMP OF SHEEP RANGE  
HAS LATEST LUXURIES** 2664

Auto camps with radio, electric lights, comfortable disappearing beds and other furniture, have come to replace the horse-drawn wagon used by sheep herders. It is built on a small auto truck, specially rigged for climbing steep hills or wallowing through creeks and can go almost anywhere a team can go. To a degree, it has replaced horses, which are now used in some camps merely for the actual herding. The body is fitted with bins for water, gasoline and grain, and when new supplies are needed, the truck is quickly driven to the nearest station and back again, in much less time than was required for the journey with horses. Some cars have glass windows in front so that the driver can sit comfortably inside to steer, and others have front and side doors with special steps, for use when stops are made for a day or more at a time.



Cross Braces Grafted into a Tree, to Give the Limbs Added Resistance to the Wind

**TREE IS BRACED BY GRAFTING  
TO RESIST WINDS**

Interwoven at six different points by grafts, the three main limbs of an apple tree have been strongly braced to prevent breaking in storms. The supports are said to be more effective than props and also to help hold up the branches when they are loaded with fruit. It is suggested that the method might profitably be adopted in other orchards.

**COLORS "PAINTED" IN FLOWERS  
WITH CAMEL'S-HAIR BRUSH** 2670

By transferring grains of pollen from one flower to another with a camel's-hair brush, Alois Frey, a California naturalist, has produced many blossoms of unusual colors and fragrance. He has been doing the work for more than twenty years and already has classified 1,200 separate creations, besides twenty-odd distinct shades. He has a freesia bed containing 10,000,000 plants and maintains a glass-enclosed workshop where thousands of bulbous plants are specially cultivated from selected seed. The new varieties are the result of careful study of the colors, plant size and foliage of different specimens.

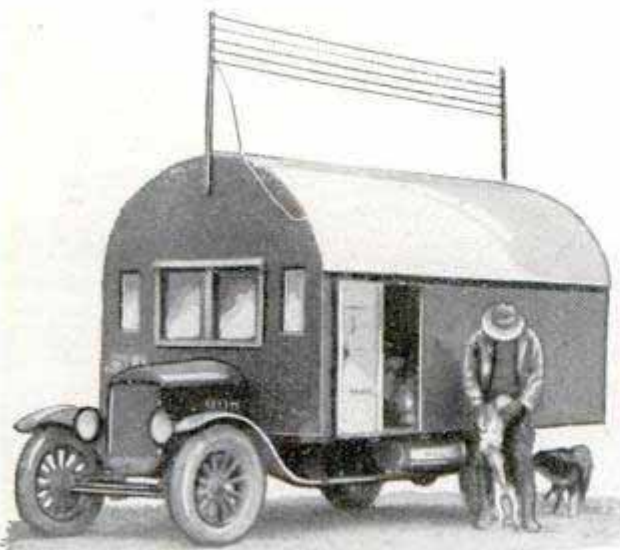

Modern Sheep Tenders' Camp in the West Complete with Electric Lights and Radio

Cont. Harrison C. Merrill San Francisco  
386 N. Fourth East

an  
bin  
bec  
The  
art  
so  
is  
dri  
und  
us  
d  
r



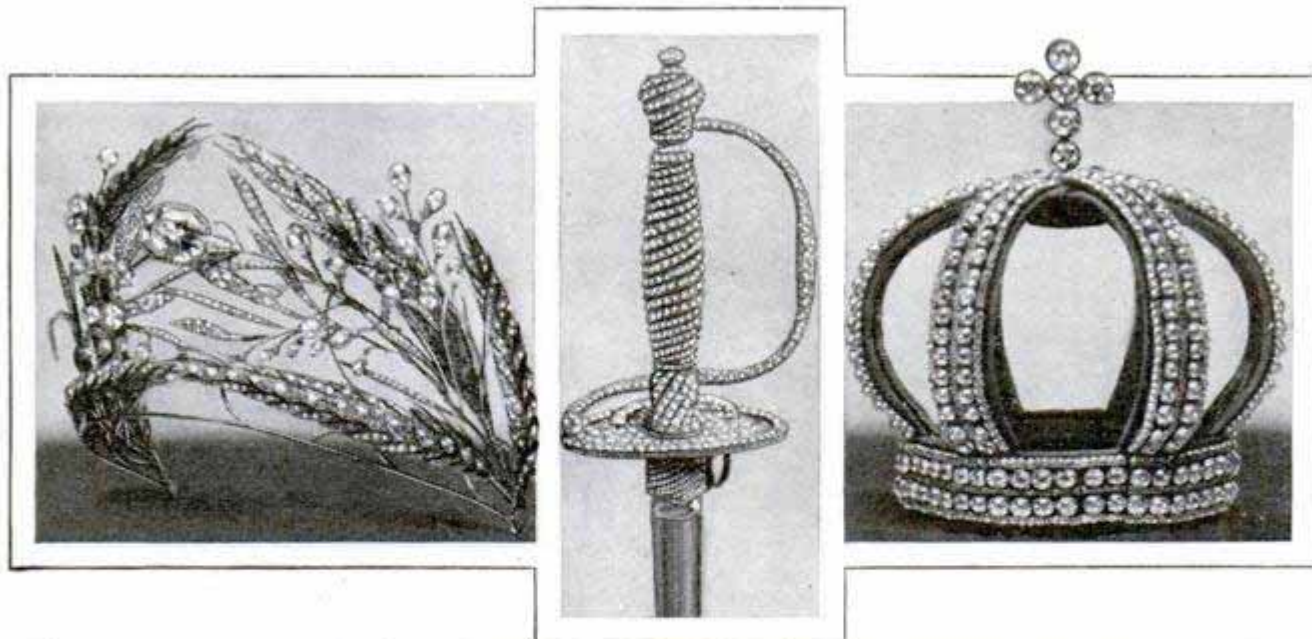

Three of the Former Russian Crown Jewels, Recently Auctioned in London by the Soviet Agents; the Tiara Was Designed for the Wife of Paul I, and the Jeweled Sword Likewise Was His

## Secrets of a King's Jewel Safe

### Strange Tales of World-Famous Gems in the Tower of London, Which Baffles Cracksmen

By HAROLD T. WILKINS, *Esq.*

EVERY night, inside the gray stone walls of the 900-year-old Tower of London, an interesting ceremony takes place. It has been performed without a break for the last seven centuries. A yeoman of the guard, wearing a picturesque uniform as old as the days of Henry VIII of England and carrying a bunch of massive keys, goes round the castle, escorted by a detachment of the soldiers of the tower garrison.

Before him walks a bugler carrying a lantern, behind him an officer of the guard. The outer gates are locked one by one, and then the chief warder approaches the massive tower in which are kept King George's crown jewels. A sentry on duty, outside this jewel house, stops pacing up and down and lowers his bayonet.

"Halt, who goes there?"

"The keys," answers the chief warder.

"Whose keys?" replies the sentry.

"King George's keys," says the warder.

"Pass, King George's keys!" The guard shoulders his bayonet, and continues his sentry-go. Inside is an amazing collection of blazing diamonds, glowing blood-red rubies and jewels set with sapphires and

emeralds, the cunning work of centuries of long-dead goldsmiths of Europe and the east, who were masters in the art of creating beautiful things of gold and silver.

Next to the vaults of the federal reserve bank, at New York, and the nightly submerged bullion room of the bank of England, the jewel house in the tower is probably one of the most strongly guarded places in the world. Its walls are eight feet thick, the windows are heavily barred and there is only one exit. Sentries mount double guard all night outside, and police, soldiers, detectives and yeomen of the guard watch all the day. The crown jewels are kept inside an octagonal glass case, protected by slender steel bars and built around a circular base. After the jewels of St. Patrick were stolen from the royal castle at Dublin, Edward VII called in locksmiths, and they invented this burglar-proof casement of steel and glass.

Burglars and crooks, watched by detectives, have come inside the jewel house, along with honest visitors, and have flattened their noses against the grille in the circular cell, but they have had to give up the idea with a sigh. At the slightest tam-



1948

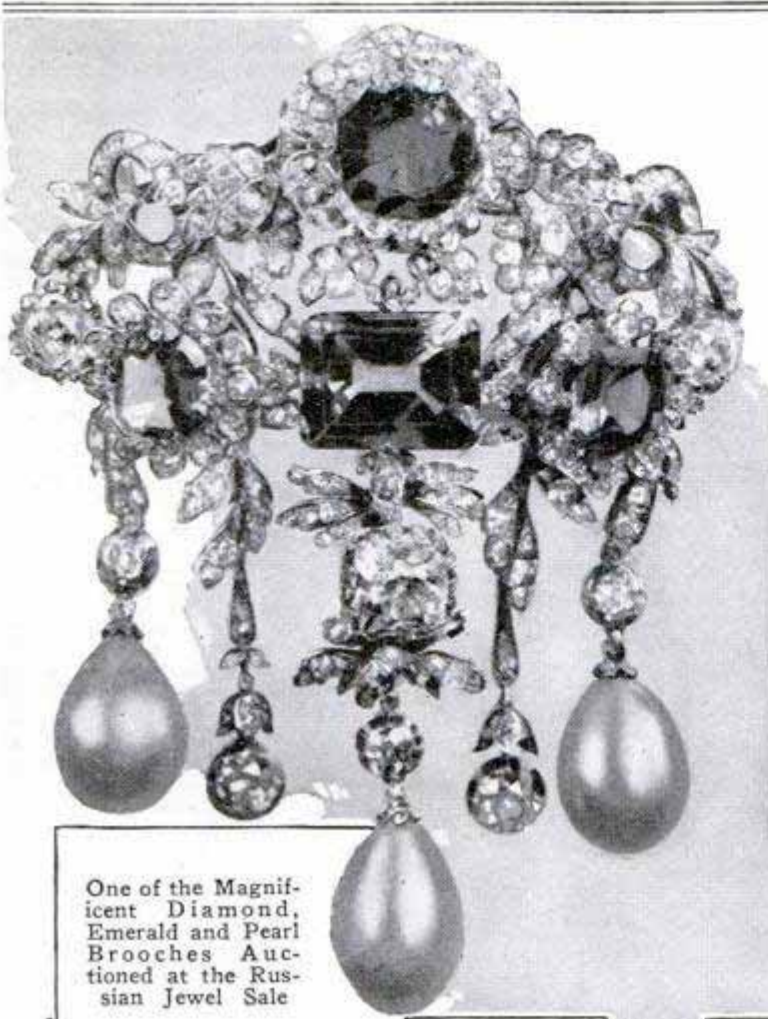

One of the Magnificent Diamond, Emerald and Pearl Brooches Auctioned at the Russian Jewel Sale

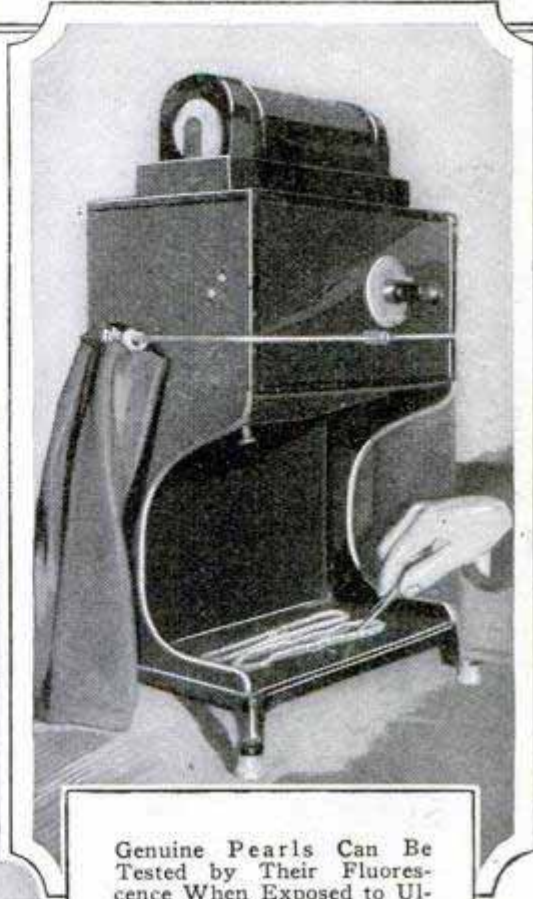

Genuine Pearls Can Be Tested by Their Fluorescence When Exposed to Ultraviolet Light from the Machine Shown Above

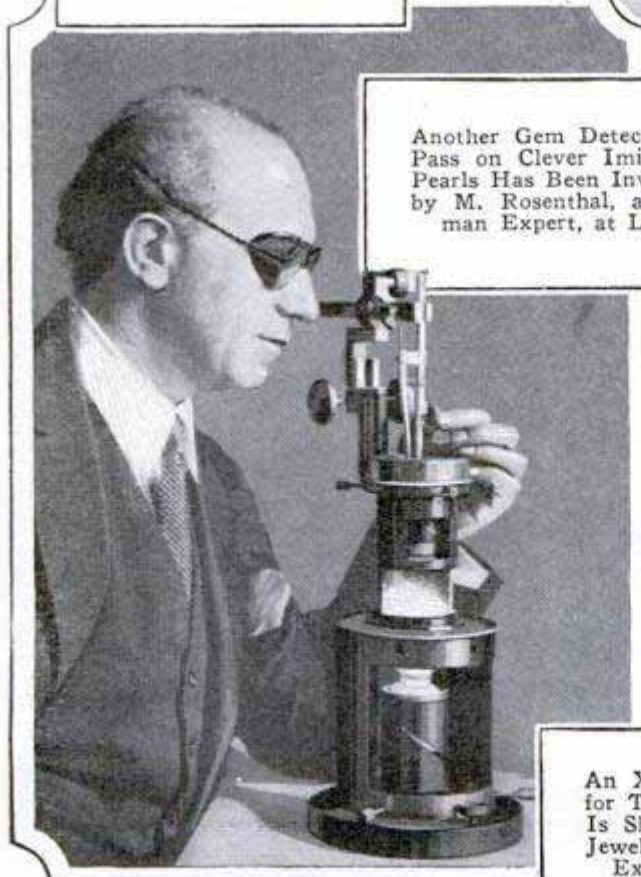

Another Gem Detector to Pass on Clever Imitation Pearls Has Been Invented by M. Rosenthal, a German Expert, at Left



An X-Ray Outfit Designed for Testing Precious Stones Is Shown Above; Artificial Jewel Makers Are So Clever Experts May Be Misled



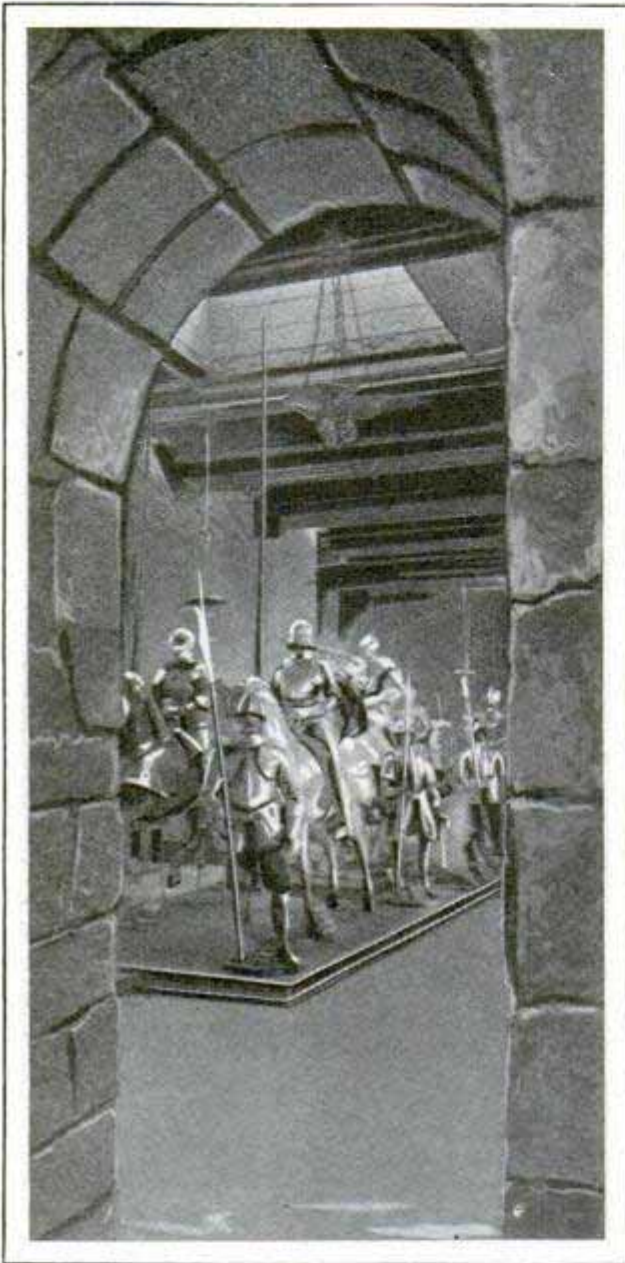

England's Jewel House in the Tower of London Is Barred to Photographers, but Resembles This Armory in the Near-By White Tower

pering with the grille of the casement, alarm bells would ring all over the tower, and the outer gates of the fortress would automatically clang to and shut fast. Simultaneously, the thieves would find themselves imprisoned by the mechanical closing of the doors, and steel shutters, invisible to the ordinary sight-seer, would automatically close over the grille of the glass casement and convert it into a great octagonal steel safe.

Many of the wonderful gems in the jewel house of the tower have a romantic past more thrilling than fiction. No jeweler, living or dead, could give the value of the crown jewels and the regalia, which have been kept in the Wakefield tower since the

seventeenth century. Thirty million dollars would be a low estimate. There is a ruby as large as an egg, which belonged to the Black Prince in 1367, and was worn in the coroneted helmet of Henry V at the battle of Agincourt.

The first thing to dazzle your eyes, as you enter the jewel house, is Queen Mary's crown, lying on its white satin bed. Set in it is the famous Koh-i-Noor, a thousand-year-old diamond burning in the jeweled turbans of princes of the orient.

This crown is the personal property of Queen Mary, and is studded with hundreds of diamonds set by the court jewelers. One big square diamond blazes in an arch, and at the top glitters a large drop-shaped stone. These gems are called the "Lesser Stars of Africa," and are part of the great Cullinan diamond given to Edward VII by the Transvaal government.

The Black Prince's ruby, now in the crown of King George, and worn at his coronation in Westminster Abbey, has a strange history. It is truly blood-red. Don Pedro, of Spain, killed the Moorish king of Granada to get this jewel, and then, frightened by its influence, gave it to the Black Prince of England for help in his wars. A hole bored through the top shows that, in ages long past, it was worn as a pendant hanging from the neck of some eastern potentate who got it from the mines of Burma. This ruby saved the life of King Henry V at Agincourt, when he wore it as a diadem. It deflected a smashing sword cut aimed at his head by the Duc d'Alencon.

When Charles I was beheaded at Whitehall, London, the British republican government of Cromwell ordered the insignia of royalty to be destroyed and the gems to be sold. The Black Prince's ruby was purchased for \$20 by some unknown buyer who sold it back to Charles II, when that monarch came to the throne. The ruby has a gold backing, so ancient that no modern jeweler will undertake to remove it, as that would ruin the gem.

The famous Koh-i-Noor (Mountain of Light) was picked up on the diamond fields of Golconda (southern India) about 250 years ago. The great mogul emperor of Delhi, Shah Jehan, heard of it, and got it by bribery from the king of Golconda. Then the cavalry of a Persian shah swept



through the Khyber pass on to the plains of India, in 1739, captured Delhi, and tried hard but in vain to find the Koh-i-Noor. One of the Mogul's wives, however, betrayed the hiding place of the jewel.

But the Persian was murdered by an Afghan of his bodyguard, who fled with the diamond to the wild and inaccessible mountains of Afghanistan, where he founded a dynasty. One of the Afghan's descendants lost his throne and fled to Lahore in India, where the Indian maharajah, Runjeet Singh, demanded the Koh-i-Noor as the price of shelter. Then the British invaded his country and captured the Koh-i-Noor in battle with the Punjabi army. So it came into the hands of Queen Victoria. This gem is worth about \$800,000 and weighs 106½ carats, although it was originally 1,000 carats. The spell of

its evil luck is broken if a woman wears it, runs the legend, so the Koh-i-Noor is Queen Mary's stone.

One-half of the well-known Cullinan diamond, or "Star of Africa," burns as a cushion-shaped brilliant just under the Black Prince's ruby in King George's crown. The Cullinan diamond, called after its finder, and originally one and a third pounds in weight, four inches long and two and a half inches deep, was picked up by chance in 1905 in a South African mine. The finder dug it out with a pocket-knife. A tremendous volcanic upheaval had sliced it in half. For fourteen years, search was made for the missing half, which was found in October, 1919, in the Premier mine, Johannesburg, but the crusher smashed in pieces what was originally a 1,500-carat gem.

The other half of the great diamond was divided into two parts—the "Stars of Africa"—and set in the crowns of King



London's Famous "Beefeaters," or Yeomen of the Guard, Protect the Crown Jewels with These Ancient Weapons

George and Queen Mary. Before being sold, the Cullinan stone was insured for \$7,500,000, but nobody could or would buy it, so the Transvaal government bought it for a tenth of that sum and presented it to King Edward VII. Lying on a bed of satin, under the octagonal casement in the crown-jewel house, is a model of this diamond, looking like a big rock crystal.

Diamond cutters told the king that it was impossible to cut and shape a gem of this size into a single brilliant. They said it would have to be cut along the lines of natural cleavage into four parts—two big gems, and two smaller brilliants. Costers, the famous diamond cutters of Amsterdam, did the work at the tower, and the steel chisel and mallet used by them are still preserved there. One slip of the chisel would have ruined the great diamond and shattered it into fragments with a total loss of millions of dollars.

The largest piece was made into a pear-



shaped brilliant and set in the king's scepter. The next largest, a cushion-shaped brilliant, is now in King George's state crown, under the big ruby. They are both bigger gems than the famous Koh-i-Noor. Queen Mary's crown has the other parts of the Cullinan diamond. The king's stones cut from the Cullinan weigh 516 carats and 309 carats, respectively, and the queen's stones weigh ninety-six carats and sixty-four carats.

Lying by King George's crown is that of Queen Victoria, worth \$1,500,000. Silver hoops and a brilliant band, sparkling with 3,000 diamonds, 341 pearls and great sapphires and emeralds, arch over a cap of purple velvet in the crown. On the summit of the arch is a mound of 548 diamonds and a cross formed of four very large sapphires and four diamonds of similar size. This crown weighs two pounds.

Every king of England must have the archbishop of Canterbury place on his head, at his coronation, the crown of England, which weighs five pounds. It stops on his head for a second, and is replaced by the state crown, weighing nineteen ounces. The crown of England is of mas-

sive gold, jeweled with diamonds, rubies and sapphires, and is used only once in a king's or queen's lifetime.

A very valuable jeweled state sword, of which one gem alone (an emerald), is worth \$15,000, was lost after the coronation of Queen Victoria. Years after, it accidentally turned up in a gun case, at the back of an old cupboard in the tower. This sword is a blade of real Damascus steel, so finely tempered that it can be tied up into a knot without snapping. Its golden scabbard is set with rich gems and it has a hilt studded with sapphires, rubies and diamonds, and a very rare and costly yellow sapphire.

Have the crown jewels ever been stolen?

The famous Col. Blood headed a band of thieves who broke into the jewel house and got away with the crown jewels. They slipped the royal crown of England into a bag, battered and bent the gold rims and arches, and broke the gems out of their settings. Diamonds, emeralds and rubies fell out of the crowns and rolled about on the floor of the jewel house, and when the thieves were captured, the big ruby of the Black Prince was found at the bottom of



The Tower of London from the Air, with London Bridge in the Foreground; the Jewel Tower Is the One Behind and Slightly to the Left of the Right End of the Bridge



*San Francisco Calif*

the pocket of one of them. King Charles II, who was on the British throne at the time, rewarded Col. Blood for his theft with a pension of \$2,000 a year.

Once the crown jewels were kept in Westminster Abbey, but one of the Edwards found that they were being stolen, so he shifted them to the tower, appointed a keeper of the regalia, and surrounded them with soldiers and battlements. The old-time jewel house was in the haunted Martin house. It was guarded by a single sentry, but he refused to go on duty one night because he said he had seen a ghost.

The old jewel house was a strong cage with bars through which the jewels could be seen under the light of dim lanterns by folk who had passes and paid a fee to look at them. It was set on fire and burnt to the ground in 1843, and the crown jewels were saved by a sergeant and yeoman who threw the jewels onto the parade ground without useless ceremony.

During the late war, the tower was a target for the bombs of German airplanes flying over London. Bombs hit the walls, the river and places all around the fortress. One bomb fell into the tower moat, another missed the crown-jewel house by a few yards and fell into the Thames, close to which the present jewel room is located.

Just before, the crown jewels had been quietly taken in one of King George's private autos and deposited in Windsor castle, whence they came back after the war was over.

**LONGER POWER LINES PROMISED THROUGH CONDENSER SYSTEM**

Cheap transmission of electric power over long distances is promised through

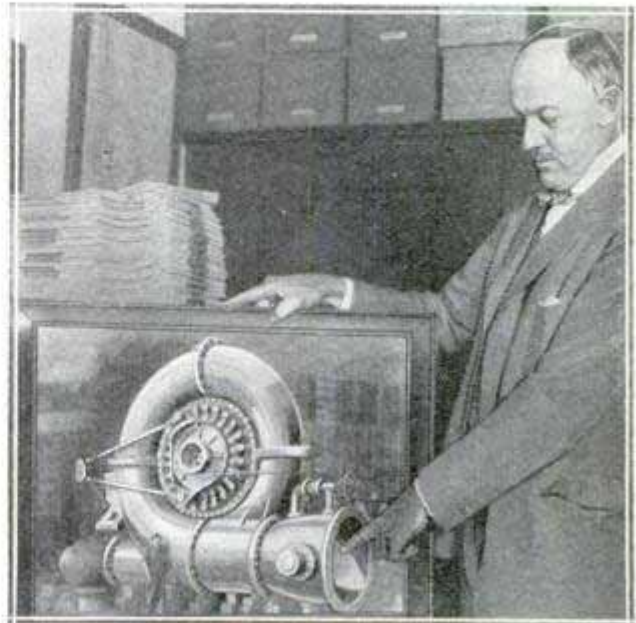

Inventor with Picture of His Rotary Condenser, Designed to Keep Power-Line Voltages at Maximum Peak

the invention of a new type of rotary condenser, the manufacturing rights to which have been taken over by one of the largest electrical plants in the world. Transmission of power across the continent without loss of voltage is possible through the device, engineers say. Line losses have been the most serious drawback to the growth of super-power systems, since, even with tremendous voltages at the generating plant, it was only possible to cover a few hundred miles before the energy losses became so great as to threaten the profits. The new converter is designed somewhat like the gyroscope used on ships for steering and stabilization, the revolving rotor, which is air-cooled, keeping the line voltage up to a constant point.

*Patents acquired by Westinghouse Electric & Mfg Co.*

**CHEMICAL AS CHECK PROTECTOR FOILS INK REMOVERS**

Altering checks by means of ink eradicators is sometimes successful, but this method, as well as others, is said to be unavailing after the paper has been rubbed with a little stick of chemical which resembles paraffin. It is reported to coat the paper with a substance impervious to ink removers and may be used also for safeguarding legal documents.

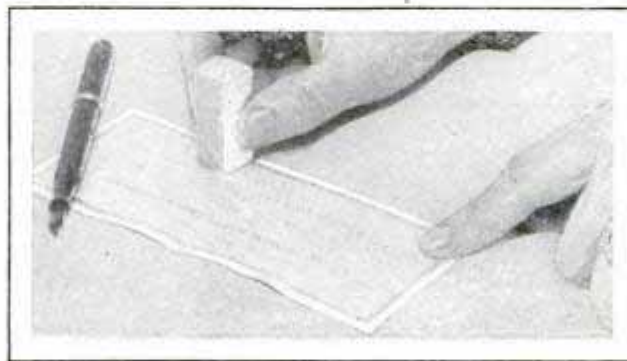

New Check Protector Which Is Rubbed over the Paper After the Check Is Written

Popular Mechanics magazine does not publish the name of the maker or seller of any device described in its pages, but this information is kept on file and will be furnished, free, by addressing our Bureau of Information.

*Soldstein Bros, Santa Cruz, Calif*





Sidewalk in Berlin Made of Bricks Formed of the Slag Left When Refuse Is Burned

### BRICKS MADE FROM RUBBISH USED FOR PAVING

Refuse that cannot be reclaimed is burned in Berlin and the slag resulting is formed into bricks. These have been found excellent for building, paving and other purposes, as they are durable and readily worked.

### MILLION DOLLARS IN WHALE OIL CAUGHT IN THREE MONTHS

*2628* Last February, Popular Mechanics described the Norwegian steamship "C. A. Larsen," the boat that "swallows whales." It is fitted with a big drag tunnel through which the whale is drawn directly into the ship where it can be cut up, saving delays and extra handling. Recently, the steamer arrived in New York with a cargo of oil in her hold valued at \$1,000,000, the result of a three months' expedition in the Ross sea, about 700 miles from the south pole. The "Larsen" and her sister ship, the "Sir James Clark Ross," are said to be able to do in three months what the old-time

fleets did in three years, each of the vessels being equal to about 100 of the old-fashioned type. Six 200-ton "killer" boats joined the "Larsen" south of New Zealand for the whaling. These craft carry harpoon cannon and are sometimes dragged along by the whales for miles. Skippers of the killer boats are paid on commission, occasionally making as much as \$18,000 in three months. The prize pay on the recent trip was \$10,000. The crews work night and day, since, at the whaling season, there is no real night at that extreme southern locality. Most of the whale oil is used for the manufacture of fine soaps and similar products, and the bone is now ground up for oil, its use for corsets and whips having practically vanished, owing to the gradual disappearance of horse-drawn vehicles and to changing fashions.

### DUMMY AS TRAFFIC POLICEMAN DIRECTS AUTO TOURISTS

*195* On the supposition that automobile drivers will pay attention to a policeman when a sign would be unnoticed, officials of Iron Bridge in Ontario, Can., have erected a dummy traffic supervisor at the intersection of two busy highways. Directions are indicated by the outstretched arms, and the humorous make-up of the figure seldom fails to amuse the traveler.



Dummy Traffic Policeman Used as a Road Guide in an Ontario Town



# How to Use Rosin-Core Solder

By P. C. RIPLEY

**E**XHAUSTIVE research on the part of radio engineers and manufacturers covering the entire field of fluxing agents has resulted in the endorsing of rosin as a

efficient heat for the lightest soldering operations. Lack of capacity in the iron will be disastrous to good soldering and this also applies to the plain copper. "Rosin

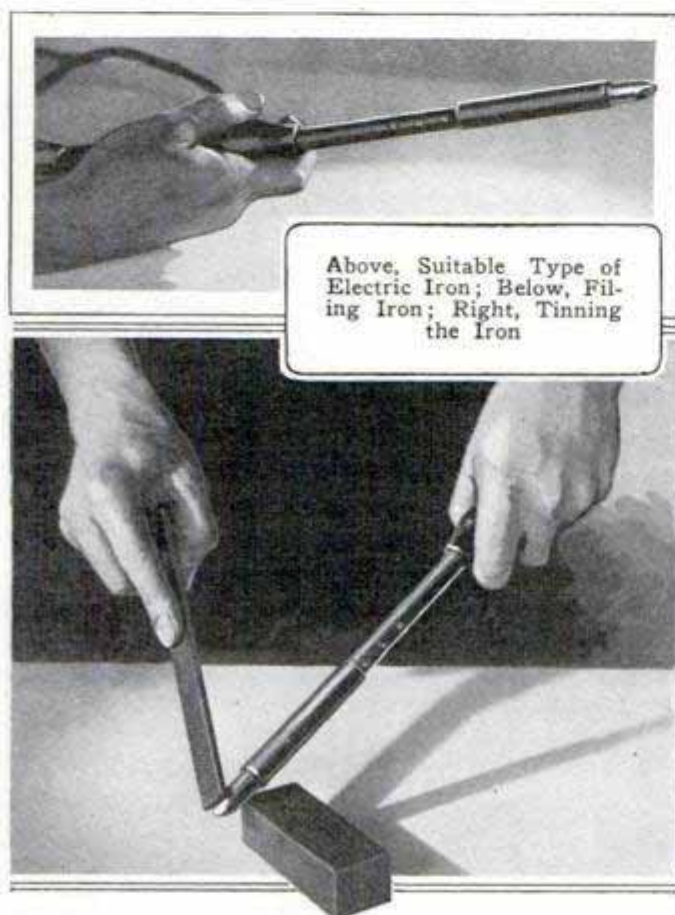

Above, Suitable Type of Electric Iron; Below, Filing Iron; Right, Tinning the Iron



deoxidizer for radio soldering, when properly used. When improperly used, however, it is apt to show rather discouraging results, and the worker then condemns the solder, instead of placing the blame where it really belongs, on his own lack of knowledge of how to use it.

The first important thing is the selection of the soldering iron, and there are two types to consider: the conventional copper which is heated in a fire or stove, and the electrically heated iron. Each type has advantages that recommend it, but the latter possesses the distinct advantage of maintaining a more or less constant heat, eliminating loss of time required for reheating the ordinary copper. The purchaser of an electric iron should exercise caution, however, as many irons of this type now on the market only generate suf-

icient heat for the lightest soldering operations. Lack of capacity in the iron will be disastrous to good soldering and this also applies to the plain copper. "Rosin joints" and insecurely soldered connections are often traced to this source. The only motive in the employment of a soldering iron is to convey heat to the parts to be soldered, and not until these reach a solder-melting temperature can they be successfully soldered. A good standard iron of the electrical type is shown in the photo at the upper left (on this page). Long and slender points on the soldering tool have a great appeal to the uninitiated, as having a very efficient appearance, but the use of such points will likely lead to trouble. When using such a point conduction and radiation in the parts to be soldered may be so rapid that heat cannot be delivered speedily enough through the slender point to keep the parts at the proper temperature.

Before any effort is made to use the iron



we must coat the working faces with solder. This process is commonly called tinning, and affords a means of utilizing the force of capillary adhesion, which is of material assistance in heat conduction. This tinning of the iron retards the formation of oxides on its working faces, and, as oxides are poor conductors, the value of this coating is apparent. To secure this surface on the iron we first heat it, and, after filing away all oxides, take a piece of bright tin and with the clean and heated iron melt some rosin-core solder on its surface, moving the iron back and forth in the molten pool of solder and rosin, as shown in the photo on page 473, until the working faces present a uniformly coated appearance. Frequent reapplications of the iron to this tin sheet will assist in the preservation of the coating. Overheating the iron will tend to destroy the surface, and the iron should immediately be tinned again, if best results are to be expected in continuous use.

Poor handling of the iron, even though it be of sufficient capacity, properly shaped, well tinned and correctly heated, may be the cause of solder failures. Obviously we must have the work suitably prepared to receive the solder and apply the iron intelligently. At the upper left, on page 475, two wires are shown properly connected preparatory to soldering; where stresses are likely to occur, it is highly important that a good mechanical connection be made to insure a good electrical contact of the surfaces before applying the solder. It is obvious that such surfaces must be clean and bright. In the past, and unfortunately still in the present, many amateurs and some manufacturers persisted in butting wires together and depending on the solder alone to hold the connection in place; such an error is shown in the inset at the upper right. The connection will not only break, but the result will be a high-resistance joint that invariably will produce poor results even if it holds. The correct method of soldering a good mechanically formed connection is shown in the photo at left; note that the iron is held on the work in such a manner that both wires are heated, and the rosin-core solder held on the opposite side of the joint until the heated surfaces melt it, flowing the solder in and over the joint; when this occurs,

the iron is immediately removed. The work should either be clamped in position or held immovable with pliers until the solder sets; this condition is evidenced by a quick turn to a light-gray color. Moving the work while the solder is cooling will result in a fractured joint that will give trouble later. Never carry rosin-core solder on the point of the iron, as the active fluxing element of the rosin is driven into the atmosphere in the form of a blue-white smoke at a very rapid rate when subjected to the direct heat of the iron. This is illustrated in the photo at left, where the solder is being applied directly to the hot iron instead of the heated material to be soldered. Close-up insert drawings show the right and wrong methods clearly. When the joint has absorbed sufficient heat to melt the solder the rosin is liberated where required in just the right quantity, thoroughly cleaning the surface and permitting the molten metal and heated surface of the work to form what to all intents and purposes is a welded joint. To heat surfaces to be soldered properly, the working face of the iron must be brought in contact with the work in such a manner that a maximum of surface is presented to hasten the transmission of heat. The lower left-hand photo, page 475, shows the correct method of applying the iron to the work to obtain this result, while the photo at the right shows the tip of the iron applied instead, resulting in poor heat transmission to the surfaces to be soldered.

Insulated wires of the enameled type must be cleaned of all enamel at the point to be soldered, before any attempt is made to connect them. This is best done mechanically, with a knife or sandpaper, rubbing or scraping until the bright copper surface is exposed. Cotton, rubber or shellac-covered conductors must also be mechanically cleaned before soldering, and in the case of some rubber-covered wire it will be found that a sulphate has formed that has practically destroyed the tinning on the strands. It is then best to clean down to the raw copper, as rosin cannot remove this material in the quantities that will be experienced. Exercise care in soldering rubber-insulated hookup wire, as this insulation may melt and run into your joint. Heavily oxidized or dirty metal sur-



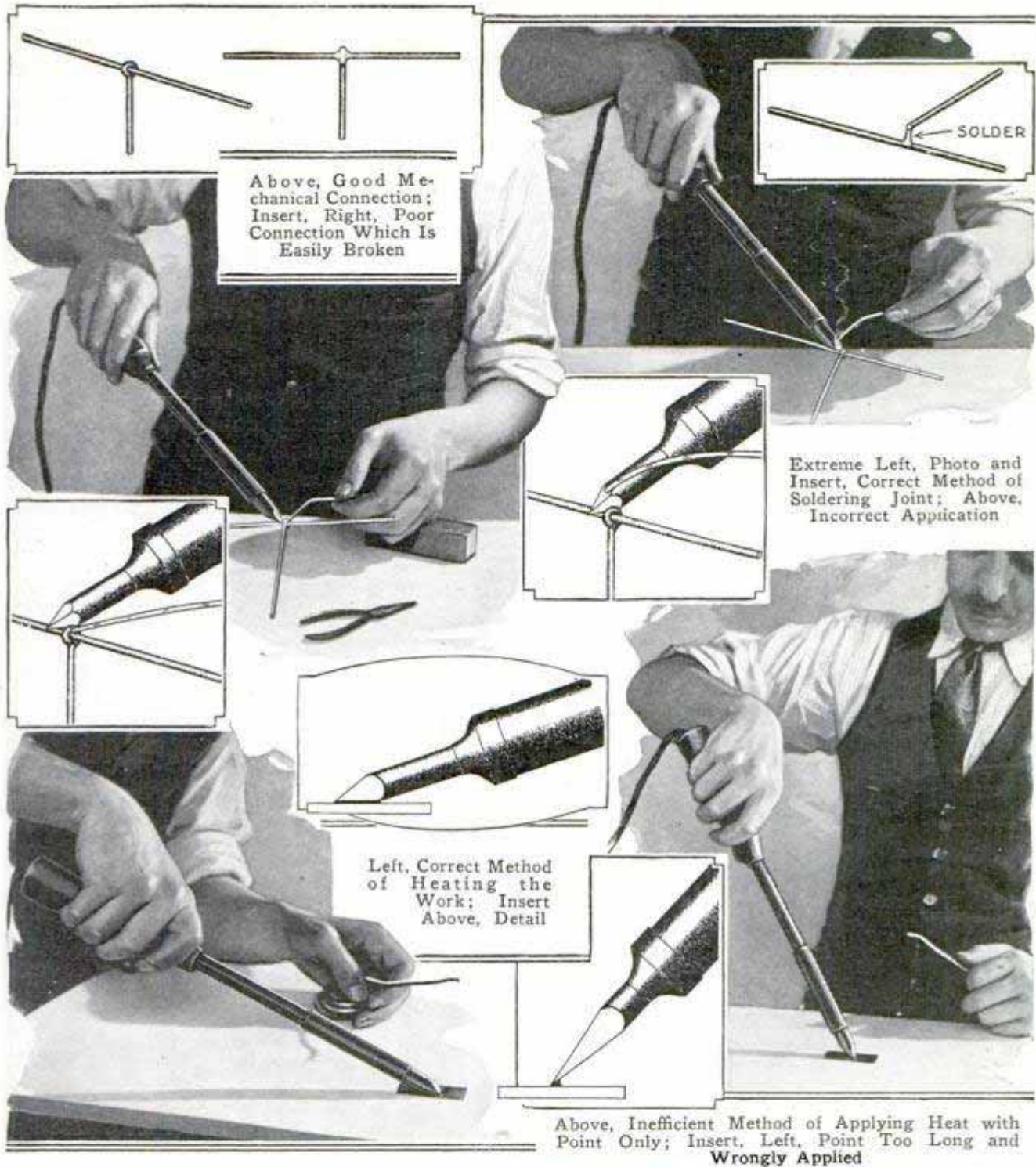

faces should be cleaned thoroughly with a file, sandpaper or scraper before attempting to make a soldered connection, and the same thing applies to nicked surfaces. By following these simple instructions pertaining to the use of rosin-core solder, you will eliminate all possibility of rosin joints and be agreeably surprised at the ease with which good joints are made.

### Better-Selectivity Kink

Strong local broadcasting stations and the use of sensitive detector tubes are the

cause of apparent broadness of tuning in the average receiver. This may be remedied in a measure by the use of gridleaks of lower resistance value. If the leak in the set is the usual 2 or 3-meg. type and the detector is of the hypersensitive variety, the result will be a set that is too sensitive for local reception. By substituting a  $\frac{1}{2}$  or  $\frac{1}{4}$ -meg. leak the set will be found to tune much more sharply. Extra leaks of various values should be kept on hand and used when local stations are inclined to spread out over the dials.



1323- B

New A-Rectifier in Cartridge Form

With an entirely new principle as a basis, a highly efficient, non-breakable and fool-proof rectifier has been placed on the

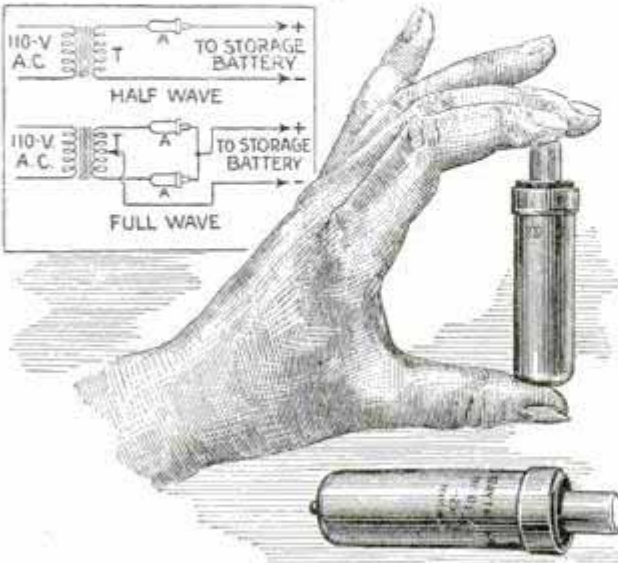
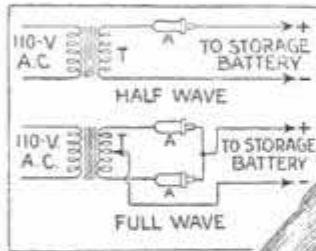

New A-Rectifier Cartridge Which Is Capable of Passing 2½ Amperes at 6 Volts

market. It is designed for use in A-eliminators, but also serves the purpose of charging batteries, being capable of passing 2½ amp. or less of direct current at a potential of 6 volts. It is about the size of a man's thumb and is contained in a strong metal cartridge. It has no delicate filament, chemicals or moving parts to cause trouble, and is merely snapped into a clip holder.

Copper Tubing for Wiring

Minimum r.f. loss is claimed for a tinned-copper tubing made in England for wiring of radio sets, as its conducting surface is much greater than that of ordinary busbar wire. The tubing is rolled from a narrow strip of copper, the two ends meeting in an open joint. Both inside and outside surfaces are burnished, to reduce resistance as much as possible. The tubing is easily bent and manipulated with the fingers, and the ends can be flattened out with a pair of pliers so that it can readily be soldered to a lug, giving

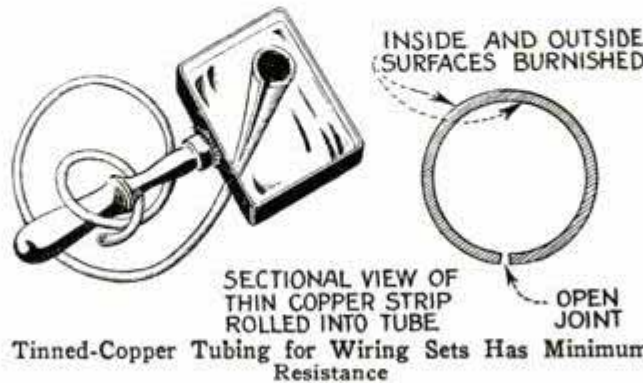

Tinned-Copper Tubing for Wiring Sets Has Minimum Resistance

more actual surface contact and making a better joint than ordinary busbar wire.— C. A. Oldroyd, Barrow-in-Furness, Eng.

Battery Chargers

There are three types of battery chargers in common use for recharging radio storage batteries, the mechanical type, bulb type and chemical charger. The choice lies largely with the individual. All have their good points, but under certain conditions one type is better suited than the other. The bulb or "tungar" charger makes use of a glass bulb containing a hot and a cold electrode, and is filled with a gas. In operation, the electric current is conducted in but one direction through the gas between the electrodes. This type of charger is comparatively quiet, and, if placed on a large book or magazine that will take up the slight vibration, cannot be heard a few feet away. There is no chemical to spill and the unit is very compact. The current supplied to the battery is steadier than that supplied by mechanical chargers, and there are no movable parts to wear out. The bulbs last several years if carefully handled, making this type of charger very reliable.

The mechanical type of charger depends for its action on a vibrating switch which alternately connects the battery in one direction, and then in another direction in regard to the source of supply. This switching is done in phase with the fluctuations of the alternating current, so that the current always flows through the battery in one direction. Good mechanical chargers are ruggedly built and give very good service, although they are not so quiet as some of the other types, and sometimes cause interference to other radio listeners in the neighborhood. However, as one usually charges the battery in the daytime, this objection is not a serious one. The contact points wear out after some time's use, but are easily renewed by

Antonyeros, Ltd 82, Victoria St. London, S.W.1. England. 12 ft. about 50 cent. 867-R



the factory or electrical repair shop. The chemical chargers are simple and require very little attention, but they cannot be carried about like the other types referred to. They are especially suitable where but small current delivery is required, as with sets using the 4-volt storage battery for the 199-tubes, and for sets using not more than six of the 201A-type tubes on a 6-volt storage battery. They are also ideal for recharging storage B-batteries. They depend for their action on a chemical solution and suitable electrodes; when the electrodes are placed in the solution the electrical current is permitted to flow in one direction only, through the solution between the electrodes. The objection to the electrolyte, which is usually of a corrosive nature and if spilled will damage rugs and furniture, is not a serious one, as the same objection applies to all kinds of storage batteries.

**Installing Storage Battery in Console**

Some consoles have so little space above the battery, which is set in the lower compartment, that it is impossible to take a



False Bottom in Console Holds Battery, and Slides Out to Facilitate Testing

**Automatic Switch Controls B-Eliminator and Trickle Charger**

Radio owners frequently forget to switch off the current to the B-eliminator when not in use. This is apt to burn out a rectifying tube, if one is used, or a condenser. To eliminate this risk, an automatic switch is now available. It is connected in series with the set and the storage battery. When the switch on the set is snapped on, it automatically turns on the B-eliminator and cuts off the trickle charger, and when the set is turned off, the B-eliminator is disconnected and the trickle charger again connected. As fire underwriters require that all A-battery-circuits must be fused, a 10-amp. fuse is provided on the switch to make its use perfectly safe.

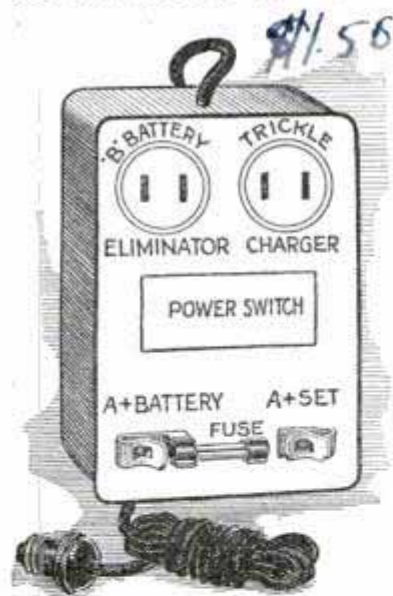

snapped on, it automatically turns on the B-eliminator and cuts off the trickle charger, and when the set is turned off, the B-eliminator is disconnected and the trickle charger again connected. As fire underwriters require that all A-battery-circuits must be fused, a 10-amp. fuse is provided on the switch to make its use perfectly safe.

hydrometer reading, unless the battery is removed, and this is rather inconvenient. However, by providing an outward-sliding false bottom, as shown in the drawing, one can get at the battery without any trouble. Lengths of Z-bar are used for slides, or two wooden strips, as shown in the lower detail. It is a good idea to provide some kind of stop to prevent the board from being pulled out too far, which might upset the storage battery and spill the electrolyte over the floor.—Michael Duzmal, Chicago.

**Trouble in B-Battery Leads**

A frequent source of trouble lies in improperly placed B-battery leads; never run such leads near the storage A-battery, particularly if they are cotton-insulated. The fine acid spray from the A-battery when being charged will quickly destroy the insulation and any wires in contact will immediately cause a short circuit that will quickly ruin the B-battery. The leads should be of the rubber-covered type and kept well away from the A-battery. Also, keep all B-battery leads as short as possible and in no case longer than 6 ft.

*Liberty Bell Mfg Co.*







# Building Latest Browning-Drake Receiver

by  
Glenn H. Browning



**T**HIS latest model of the Browning-Drake receiver is the result of constant work on the set since its introduction to our readers about a year ago. A few improvements have been incorporated, one of which is a balancing system, having the advantage of being more nearly constant over a band of wavelengths from 200 to 500 meters. Control has been simplified, reproduction improved, and last, but decidedly not least, better selectivity has been obtained, making the new model very attractive. It incorporates a low-frequency amplifier with excellent tone quality and the circuit is built around an efficient tuned high-frequency transformer developed at Harvard university by the author and his associates.

One stage of tuned high-frequency amplification is used in conjunction with a regenerative detector unit. The condensers and coils have been improved from both an electrical and mechanical standpoint, and the construction details worked out in a very simple and practical manner. The combination low-

frequency amplifier consists of one stage of impedance-coupled amplification, one stage of resistance-coupled amplification and a final stage of resistance-coupled amplification with an impedance leak, a combination finally selected

after many experiments. This type of audio amplifier not only preserves all the qualities of resistance and impedance amplification, but it seems to be more stable in its operation with B-eliminators and is therefore better suited for a.c. operation. The parts have been laid out in such a manner that interaction troubles have been reduced to a minimum, and the builder is advised to follow the blueprint diagram closely so as to obtain best possible results. It will be noted that ample space has been left between the two tuning units for the high-frequency amplifier tube, permitting short connections to be used for the high-frequency circuits. The detector is placed at right of the 2d tuning condenser; the r.f. transformer and the audio-frequency amplifier are in the rear. Care

has been taken in the layout not to place any of the apparatus too close to the coils, as this tends to increase their resistance and makes the tuning less sharp, and the builder must remember this. Two



Completed Set in Cabinet Showing Tuning Controls

tuning dials, a filament switch, a 30-ohm rheostat knob for controlling volume and the knob which rotates the tickler coil, are the only controls on the front panel. No jack has been provided for phones, but



the builder may easily put one in if he desires, mounting it directly under the rheostat. The list of parts includes the exact

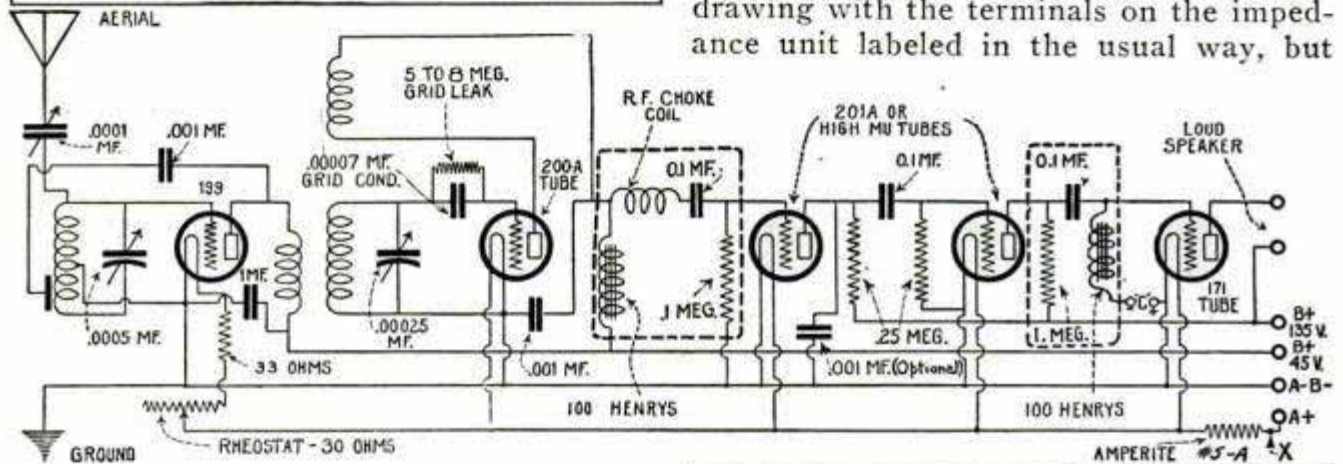
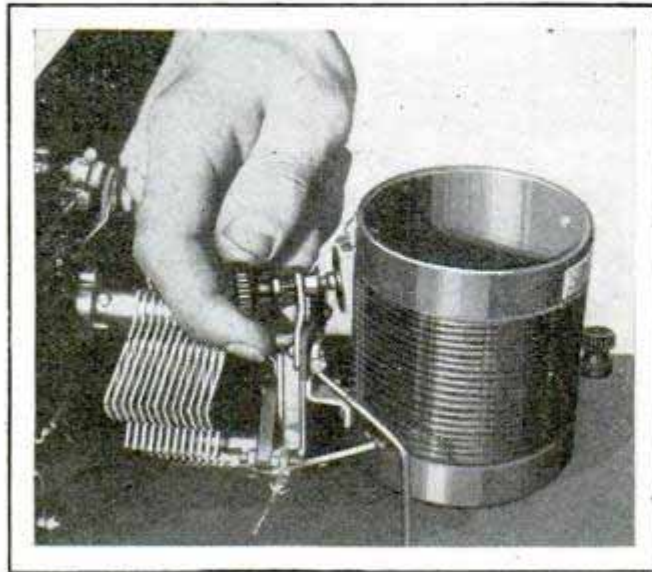

Upper Left, Balancing or Neutralizing Device; Center, Schematic Diagram; Impedafomers Are Shown within the Dotted Lines; X Indicates Position of Filament Switch; Lower Right, Under View of Subpanel

instruments used in the laboratory set, from which these specifications are drawn; if instruments other than those specified are used, care should be taken in their selection so that they meet the requirements of the circuit. A drilled and engraved front panel, as well as subpanel, are obtainable already made up, the subpanel being equipped with sockets, resistor clips and soldering lugs. Few constructional data are necessary, as the detailed drawing and blueprint, as well as the photos and schematic diagram, give all the information necessary to the builder. It might be well, however, to enumerate the most important connections, those which should be run as directly as possible and kept well away from all other leads: Connection from the antenna binding post to the mid-gate variable .0001-mfd. series condenser,

and the connection from the rotor plates of this condenser to the stator plates of the first tuning condenser; connections between the coils and condensers, as these carry more r.f. current than any other leads in the set; the connection between the stator plates of the first condenser and the grid; the connection between the plate of the r.f. tube and the primary of the r.f. transformer; the connection between the stator plates of the second tuning condenser and the gridleak and condenser; and, finally, the connection between the gridleak and condenser, and the grid of the detector tube.

It will be noted that the specifications for the third audio stage call for an impedance in reversed position. This instrument is shown in the large detailed circuit drawing with the terminals on the impedance unit labeled in the usual way, but

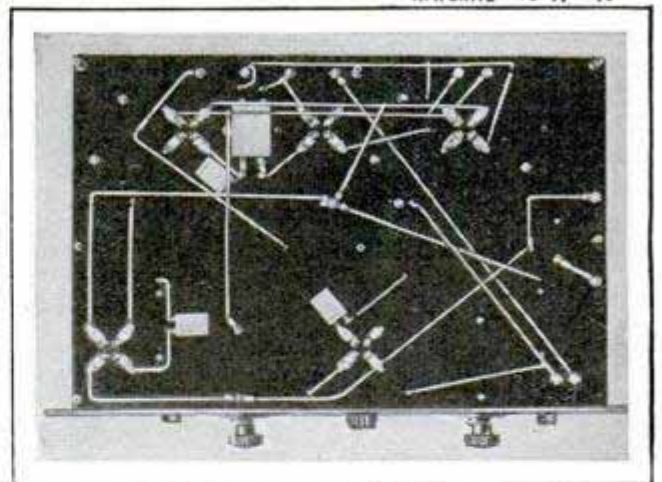

connected in the circuit in a reversed manner. New impedance units, labeled 3rd stage, which have terminals designed to eliminate the reversed connections are now available, but those having the old type will connect them exactly as shown.

Great care should be taken to see that the ends of the wire on the two tuning coils are scraped and well tinned before



soldering, to insure good connections between the condensers and coils, which is most important. The receiver is primarily intended for operation with large tubes, except in the r.f. stage, where a CX-299 or UX-199 tube should be used. The resistance of 33 ohms in series with its filament, reduces the 5 volts across the filaments of the other tubes to 3 volts for the small tube. The 30-ohm rheostat then becomes solely a volume control and may be turned completely on when full volume is required. For detector, use either a CX-300A, or UX-200A tube, as the author has found it to be more sensitive on weak signals than a 201A type. The grid return on this tube is run to the negative side of the filament, as shown in the diagrams. For the first two stages of the audio amplifier, use either "High Mu" or 201A tubes, or one of each, as desired. In the last stage of the amplifier it is essential to have some type of semi-power tube, such as the 171 type, for best undistorted volume.

The output unit consists of an audio choke, combined with a 4-mfd. condenser, keeping the direct current flowing in the plate circuit of this tube from passing through the windings of the loud speaker. This is optional but is very desirable in most cases as it improves the tone quality slightly and at the same time protects the speaker. This output unit is shown connected in the circuit in the full-page diagram, but not in the schematic drawing.

When the set has been constructed according to the diagrams, it is ready to be balanced. Connect the batteries, as shown in the sketch at the right of the large detailed diagram, turn on the switch and try one tube in the sockets successively, to be sure the filament circuit is as it should be; if the tube lights, put all tubes in, and connect the set to aerial and ground. If the set is performing as it should, turning the rotor coil to a certain position should give a slight "plop," and upon touching the finger to the grid side of the r.f. transformer, or the stator plates of the second

tuning condenser, the plop should be repeated; this is the test for oscillation in the secondary of the r.f. transformer. With the tickler coil set in the position just back of the point at which the plop occurs, station whistles should be heard upon rotat-

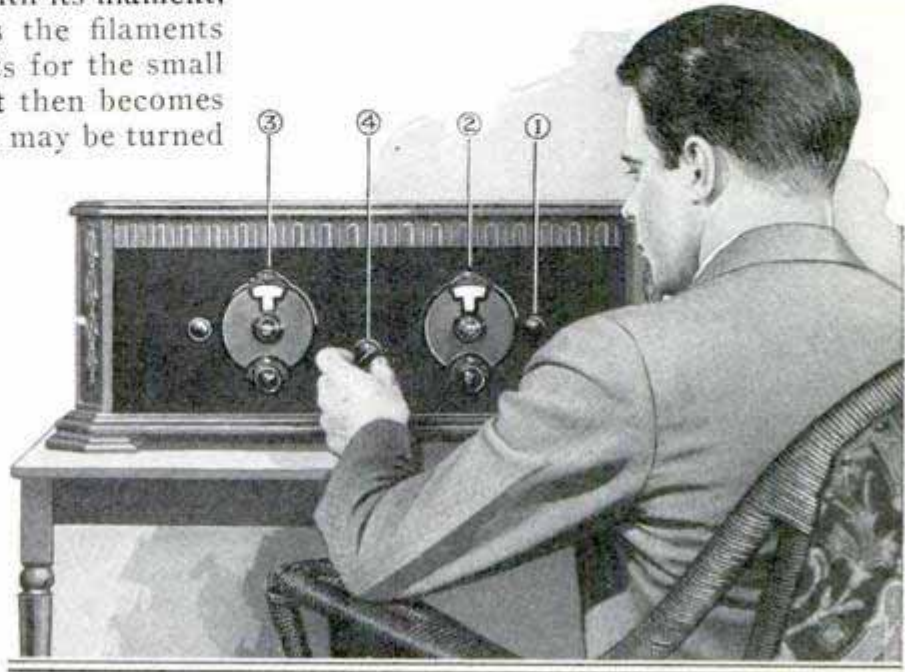

Adjusting Rheostat to Control Volume; Numbers Above Show Sequence Employed When Tuning

ing the second or right-hand condenser, if a station is operating. The receiver, now operating normally, should next be so balanced that no radiation is sent out and maximum signal strength and selectivity are obtained. Tune in a local station by means of the two dials indicated at 2 and 3 in the photo on this page, and then turn off the rheostat labeled 4. Probably the local station will still be audible, or can be made so by adjusting the tickler coil indicated by 1, or the second tuning condenser. Now set the balancing disk signal shown in the upper photo on page 480 in such a position that a minimum signal is obtained; the receiver is then balanced or neutralized.

In case of several local stations, the one chosen for balancing should be the one operating on the lowest wavelength. Where there are no local stations, the set may be balanced by tuning in the whistle from semidistant stations, then setting the balancing disk so that a change of the dial 3 does not alter the pitch of the whistle. Of course, the intensity or loudness of the whistle will always be affected by the setting of the first condenser at left, so do



not confuse this with the pitch of the whistle. A little experience in tuning on the part of the operator is better than a whole book on the subject although a few suggestions may be useful. Referring to the photo on page 481, you will find the controls numbered in the order in which they are manipulated. First, set the rotor coil 1 on the B-D transformer in such a position that the secondary circuit is oscillating; next rotate the second dial 2 until a whistle is heard; this is the carrier wave of the transmitting station beating with the oscillations the set is producing and will be heard if a station is within range. Turn back rotor coil 1 so that the whistle disappears and, at the same time, turn the left-hand dial 3 until the signals are loudest. Readjust both dials and rotor coil until satisfactory volume is obtained. It will be found that rheostat 4 makes an excellent volume control for tuning it down, regulating the signals received without detuning the set.

This receiver, being more selective than previous Browning-Drake sets, it is necessary to tune the circuits to exact resonance in order to obtain the best quality. Always regulate the volume by the rheostat and tickler coil, never by setting the

dials off resonance. In case the builder is located in a district where there are a number of high-powered local stations, a metal panel and metal cabinet will stop any pick-up from these stations on the coils and wires of the set, so that outside stations may be picked up through the locals; ordinarily this is not necessary. Do not expect distant reception every night. Static and other interference will not permit it on any set, regardless of design. A vertical aerial, 50 to 75 ft. high, is suggested by the author, although the set will work well on a short indoor aerial, 15 or 20 ft. long, in the same room with the receiver. The wire, however, should be placed as high above the set as possible, and should be well insulated. A good ground connection made with an efficient ground clamp on a near-by water pipe is superior to other types of grounds used by the average amateur; radiator grounds are sometimes suitable, especially if the heating system is hot water, although they cannot always be relied upon.

A large blueprint of the detailed wiring diagram may be obtained from Popular Mechanics Radio department, 200 E. Ontario st., Chicago, for 25 cents. Specify blueprint No. 121.

#### MATERIAL LIST

- |  |   |
|--|---|
| 1 set National tuning units for new B-D receiver, complete with dials.   | 1 Yaxley, or similar type, filament switch.   |
| 1 foundation unit, consisting of front and base panels, drilled and engraved, with mounted sockets, resistor clips and soldering lugs. | 1 Yaxley, or similar type, 30-ohm rheostat.   |
| 1 National Impedaformer, 1st stage.  | 8 Eby, or similar type, binding posts with engraved tops.                           |
| 1 National Impedaformer, 2nd or 3rd stage.   | 1 Precise midget variable condenser, .0001 mfd.                                     |
| 1 Tobe condenser, .1 mfd.  | 1 B-D 33-ohm resistance cartridge.  |
| 3 Tinytobe fixed condensers, .001 mfd.   | 3 resistors, Electrad, Lynch or similar type, one .1 meg., one .05 meg., one 8 meg. |
| 1 Tinytobe, fixed grid condenser, .00007 mfd.  | 1 Amperite, type 5-A.   |
| 1 National tone filter, optional.  | 1 B-D balancing or neutralizing device.   |

#### Overheated Filament Common Trouble

If tube filaments are subjected to continuous overheating, the electron emission will drop to a point where the tube will become inoperative. Most of the tubes now in common use are of the thoriated-tungsten type. This type depends upon a surface layer of thorium oxide for its electronic emission, and this active layer is automatically deposited or formed on the filament when the tube is operated at a certain temperature. Overheating will

quickly destroy the active surface coating and the result is a poor tube. For best results, it is evident that the tube must be kept at the voltage specified by the tube manufacturer. This may be checked with a voltmeter or controlled by the use of any filament-control device.

☞ Interference traced to fan motors may be greatly reduced by placing two 2-mfd. fixed condensers in series across the supply line and grounding the center point between them.



350 Dayton Ohio

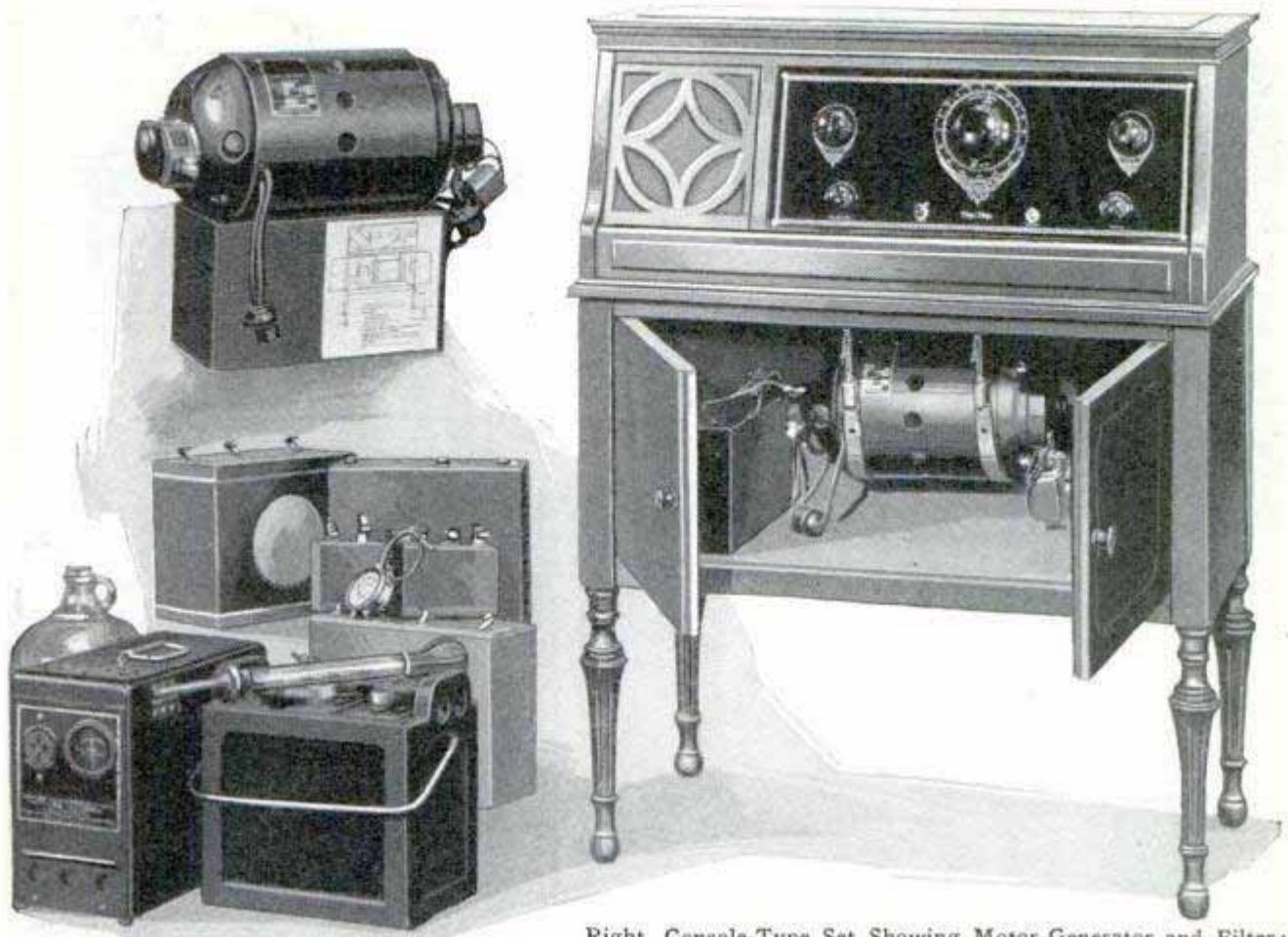

Right, Console-Type Set Showing Motor-Generator and Filter; Lower Left, Equipment Eliminated by Their Use

### New Receiver Is Motor-Driven

A complete receiver, which has no batteries or eliminators and employs standard tubes, turns on like a light and gets its power from a silent motor driving a small generator. Its outstanding feature is, of course, its freedom from the inconvenience of run-down or deteriorating batteries and the absence of even such attention as must be given to battery eliminators. The motor-generator receiver illustrated is a single-dial control model with self-contained loud speaker. It cannot be used with batteries, but will operate wherever electric current is available in 25 or 60 cycles, or on direct current. The motor-generator and filter require no servicing and may be installed in the basement, or in any out-of-the-way place, such as a store-room or closet.

### Cleaning Bakelite Panels

Panels will gather dust and fingerprints easily, and rubbing with a damp rag will not greatly improve the matter. However, a little alcohol on a piece of cheesecloth,

that has been wrung out in warm water, will clean the panel thoroughly. Wring the cloth out dry and then add a few drops of alcohol, being careful not to get the alcohol on the woodwork. Wipe the panel dry with a soft cloth or chamois skin.

### New Unit Recharges Dry B-Batteries

A new charging unit of the trickle type employing the recently introduced metallic element in which the atoms have been re-arranged so that it passes current in only one direction, makes possible the recharging of dry B-batteries of any standard voltage. The batteries are left connected



in series and the charging unit is merely connected across them from the negative post of the first battery to the positive post

of the last. The dimensions of the unit are 3 1/8 in. wide by 5 3/4 in. long and 6 in. high.  
Kodak Radio Corp.  
512 1/2 East St.

1357 R

Cincinnati, Ohio.



# Facts and Fads for Radio Fans

1245.0  
Pia

1280.0  
Inter national

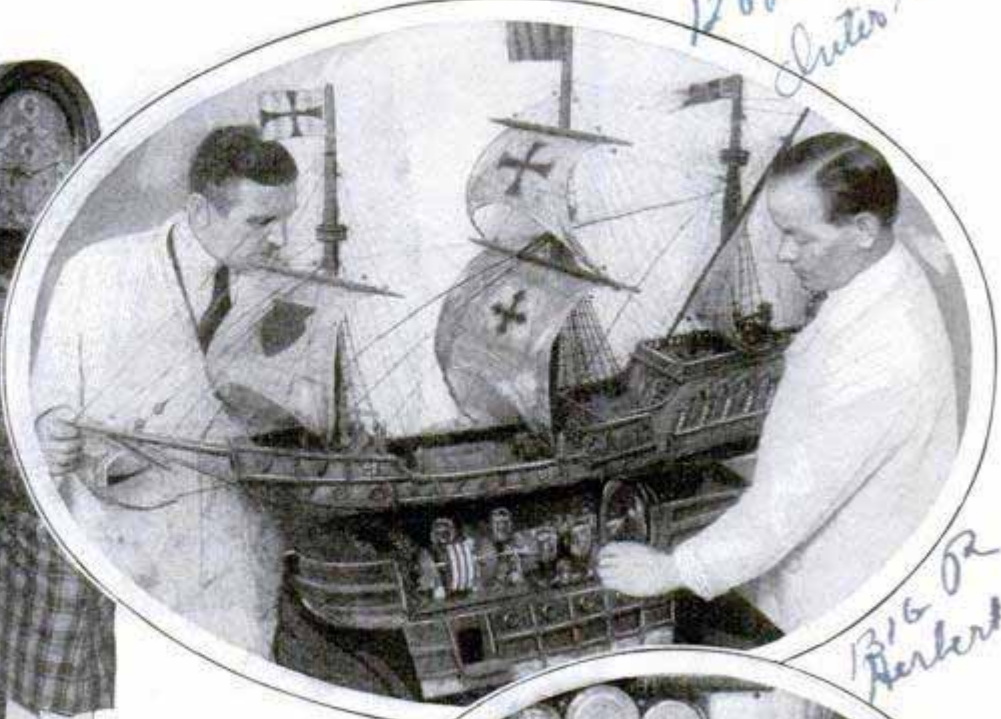

1316.0  
Herbert

Above, Complete Five-Tube Receiver Built into Ship Model, a Novel Combination of the Past and Present

An Idea from England Employing a Clock of the Grandfather Type

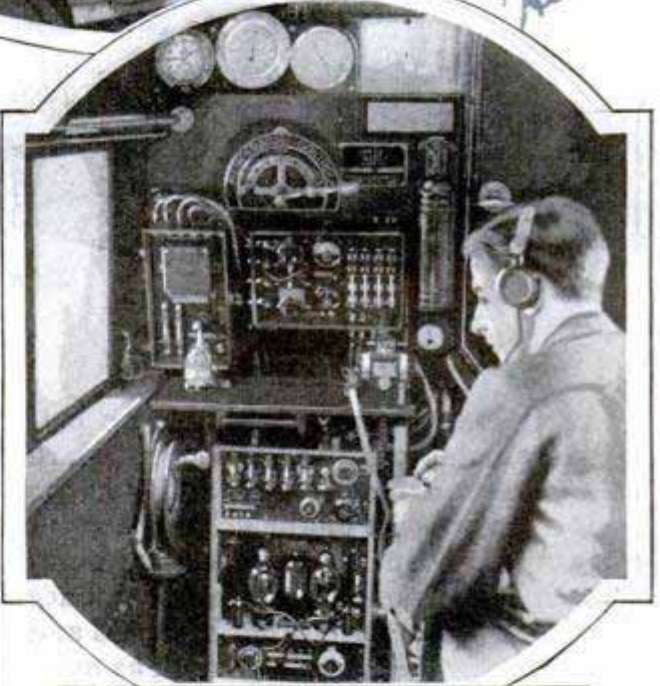

Wireless Cabin in Plane Operating between England, Egypt and India; the Winch Serves to Raise and Lower the Aerial beneath the Plane



Herbert  
1317.0

Left, Miss Harriette Quick, Brooklyn, Who Designs and Builds Her Own Sets; Right, New Loud Speaker Employs Diaphragm of Central American Balsa Wood, Seven Times Lighter Than Cork and Which Has Remarkable Reproducing Qualities

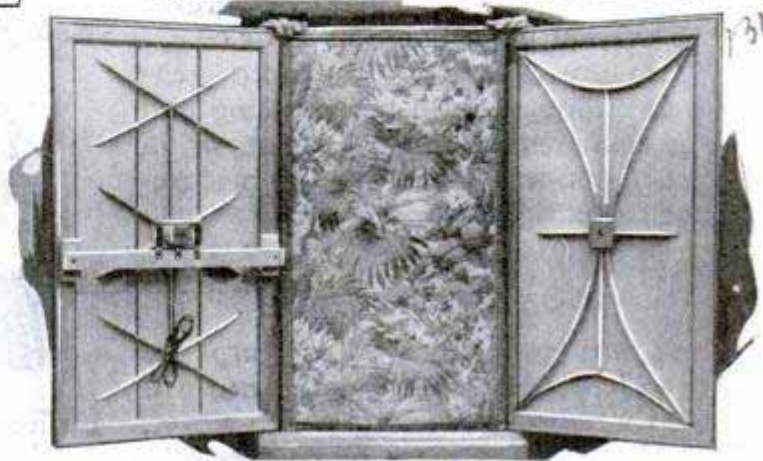

1318.0

non



**Testing B-Batteries**

Poor reception is often due to run-down B-batteries, and quite often the owner will attribute the trouble to the set without giving a thought to the B-battery. The A-battery is, of course, watched more carefully, owing to the need of frequent charging. Another reason for neglecting to test the B-battery is the common use of trickle chargers for the A-battery, resulting in less attention being given to the battery compartment. It is a good plan to test the B-batteries about once a month. Provide a small voltmeter of the pocket type, reading from 0 to 50 volts for this purpose. Test each 45-volt unit separately, and when the voltage has dropped to 35 volts or less, discard the battery for a new one. It is not recommended to mix new and old batteries, as new ones soon fall to the level of the old cells. Have them all new to begin with. The large heavy-duty units now on the market are cheapest in the long run and do not change in voltage perceptibly except over fairly long periods of time. As the batteries grow older, place the one having the highest voltage reading at the negative end of the series to compensate for the extra drain of the detector-plate voltage.

**Compact Gridleak Mounting**

It is usually an advantage, when building radio receivers, to have the parts mounted as compactly as possible without longer leads than necessary, especially in the grid and plate circuits. A gridleak may be mounted in this manner, as shown in the illustration. Take two strips of  $\frac{1}{64}$ -in. sheet brass and make two brackets as indicated in the detail. A hole is drilled so that they can be slipped over the terminals on the tube socket, and after the gridleak is inserted, the nuts are turned down tight, holding the assembly securely.

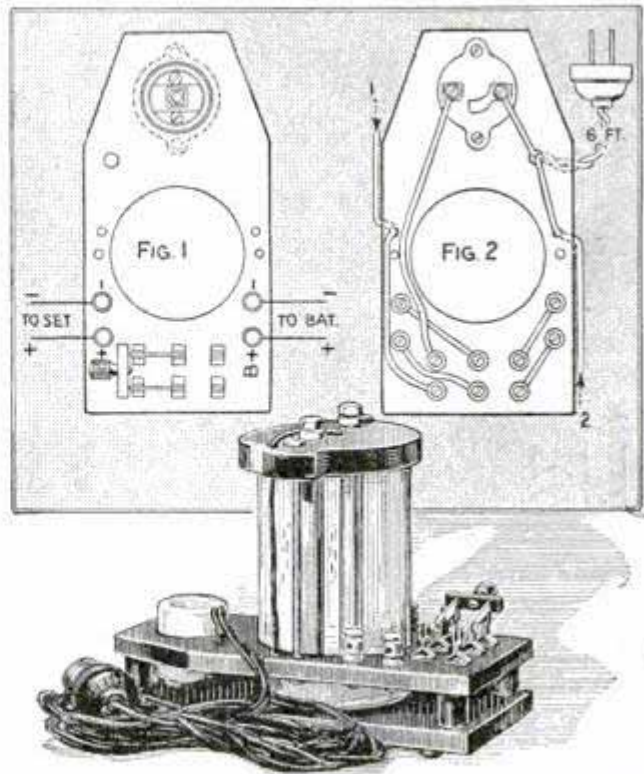
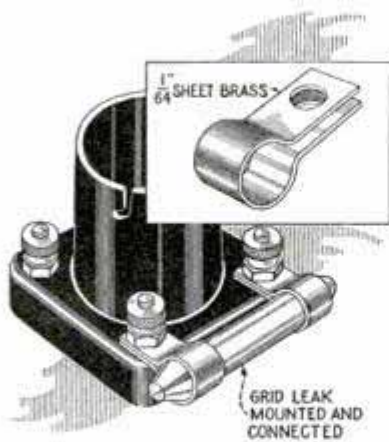

Trickle Charger Sold in Kit Form Can Be Assembled by Any Radio Fan

**Trickle Charger Assembled at Home**

The trickle charger shown in the drawing can be assembled by anyone, and the parts are sold in kits with complete instructions for assembling. The total cost of the outfit is only a few dollars, and it has an adjustable charging rate from  $\frac{1}{4}$  to  $\frac{1}{2}$  amp., depending on the size lamp used in the socket. Besides, it has a d.p.d.t. knife switch, which, when thrown over on one side, connects the charger to the battery, and, when thrown to the other side disconnects the charger from the battery and connects the latter to the receiver. Fig. 1 shows the arrangement of the parts on the base and Fig. 2 the wiring diagram.

**Adapting Three-Tube Loop Set to Aerial**

Readers of Popular Mechanics magazine who built the three-tube loop set described in the December, 1926, issue, can extend the range of the set by using the antenna adapter described on page 306 of the February, 1927, issue. This coupler consists of a plug-in coil mounted in a universal socket, and is connected to an aerial and ground. It gives the set wider range but tuning is also broadened; therefore it is advisable to have temporary connections so that the loop can be used on strong local stations in crowded localities.

1342-52.  
 Radio Sales  
 2424 Lincoln Ave Chicago



### Eliminating Charger Hum

Some chargers have a tendency to hum considerably, especially when set on the

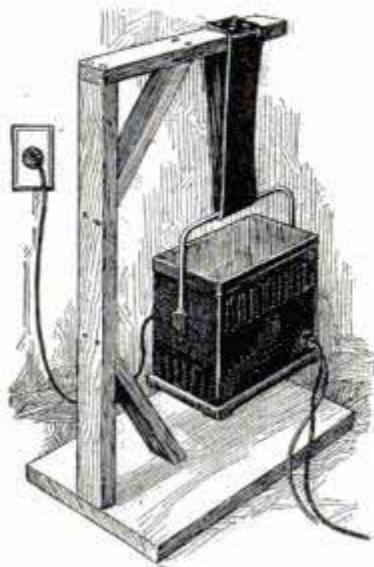

floor, table or similar surface, which acts as a resonator. Most of this hum can readily be eliminated by suspending the charger on a length of inner tube, as shown. It is passed under the handle of the charger, the ends are

fastened together, and it is then slipped over a specially made wooden frame.

### Locating B-Eliminator Troubles

The search for trouble in a B-eliminator should be a systematic process of elimination; the first step is to make sure that the 110-volt current is turned on. This may seem to be a needless caution, but is given for the same reason that the auto owner should look after his gas supply before examining the engine when the car stops. The next step is to make sure the trouble is in the B-eliminator and not in the receiver. A common trouble in the former is the absence of voltage at a given tap, and can usually be traced to an open-circuited or burnt-out resistor. For example, if the fixed resistor is open, the detector-plate voltage will be increased to a point where the signal strength will be appreciably diminished, or constant uncontrollable oscillation will be present. Trouble of this nature may be located by testing each tap with a special high-resistance voltmeter designed for use with B-eliminators. The reading should be about that for which the post is labeled. In case a voltmeter of the required type is not available, a 15-watt, 220-volt lamp may be used for the test. It should glow a dull red on the full output and on the intermediate tap of the eliminator. If the detector tap

shows a glow of the same brilliancy, it is an indication that the fixed resistor, or other type of resistor used, is open. In this case, not knowing the value of the resistance, it is advisable to get in touch with the manufacturer. However, a temporary repair may be made with a Clarostat connected between the amplifier binding post and the dead tap. The Clarostat is then adjusted until the correct voltage is obtained. If all voltage taps are found faultless and the set still fails to function as it should, the trouble may be located in a defective by-pass condenser. A short-circuited by-pass condenser will act in the same manner as a short-circuited resistor. A short-circuited condenser may be located by testing the condenser terminals with a pair of headphones in series with one or two dry cells or a small B-battery unit. A loud click should be heard at the contact, and a weaker click at each successive tapping of the terminals, but if the clicks are equally loud, a defective condenser is clearly indicated. Check all the wiring for broken connections, and use the phone-and-battery test on the choke coils and transformer secondary to be sure there is no opening in any of these windings. The presence of a click upon completing the circuit in any of these coils indicates an uninterrupted path, and the lack of a click a defective unit. If, after these checks, the trouble has not been located, the fault may lie in a defective rectifier tube; the best and quickest method of determining the trouble here would, of course, be to try out a new tube.

### Radio Switching Plug

Designed for the tandem use of horn and cone speakers, a recently marketed switching plug is inserted into the speaker jack as shown in the photo,



permitting two speakers to be connected in parallel or in series, the use of horn or cone alone, or shutting both off. There are six positions,

two for parallel connections, and one for each of the others.

*maker unknown.*



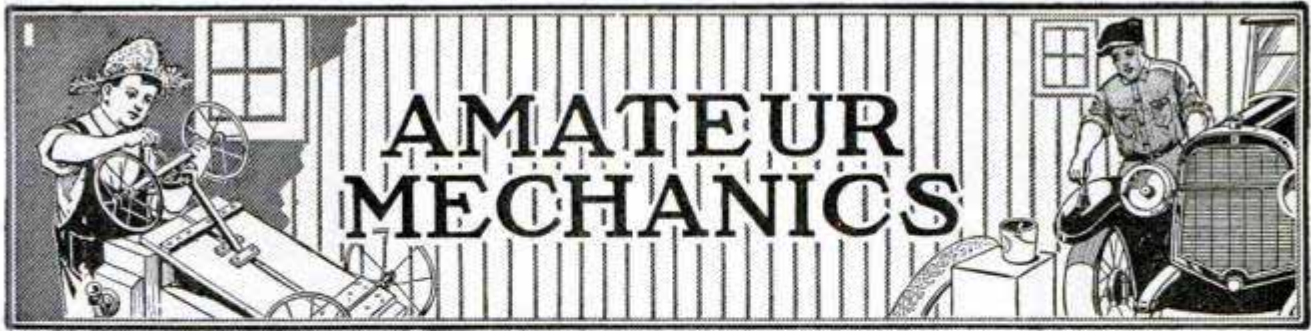

## Rabbit Bookcase for Children's Room

By HERBERT C. McKAY

*B.P. 612*

WHEN juvenile books are kept in the family bookcase children do not feel free to take them out when they want to, for the adult members of the family usually object to having their books disturbed. For this reason a bookcase will be found a pleasing addition to the nursery. The books are kept with the other toys, are always accessible for bedtime stories and the child can take them out at any time.

Such a bookcase should be of an appropriate design. The bunny case shown in

the illustration has been found very satisfactory both in shape and appeal to the child. The stock used for making it is the home workers' favorite—three-ply paneling. Two sides are cut out with a scroll or jigsaw, as shown in the layout, the squares being 2 by 2 in. The sides are slightly over 3 ft. high. In addition to the sides, one stop brace or back piece is required for the top shelf. This part is cut from a piece of the same material, 4 by 18 in. in dimensions. The curve can be laid out with a pair of dividers, as indicated, the central curve having a radius of 6 in. and the end curves a 3-in. radius, using the bottom corners of the piece as centers. These curves are connected with two reverse curves of  $3\frac{1}{8}$ -in. radius, as shown.

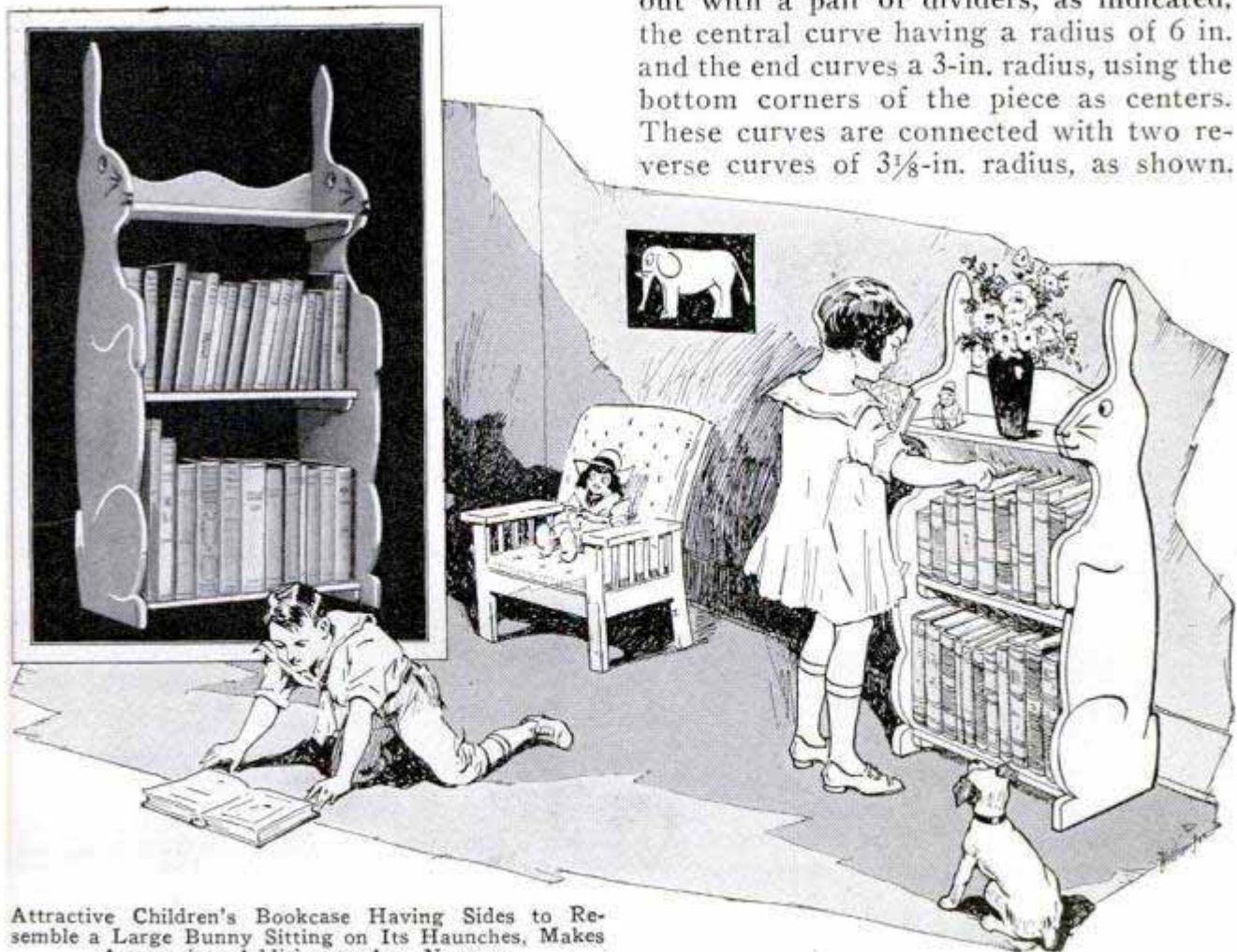

Attractive Children's Bookcase Having Sides to Resemble a Large Bunny Sitting on Its Haunches, Makes Appropriate Addition to Any Nursery



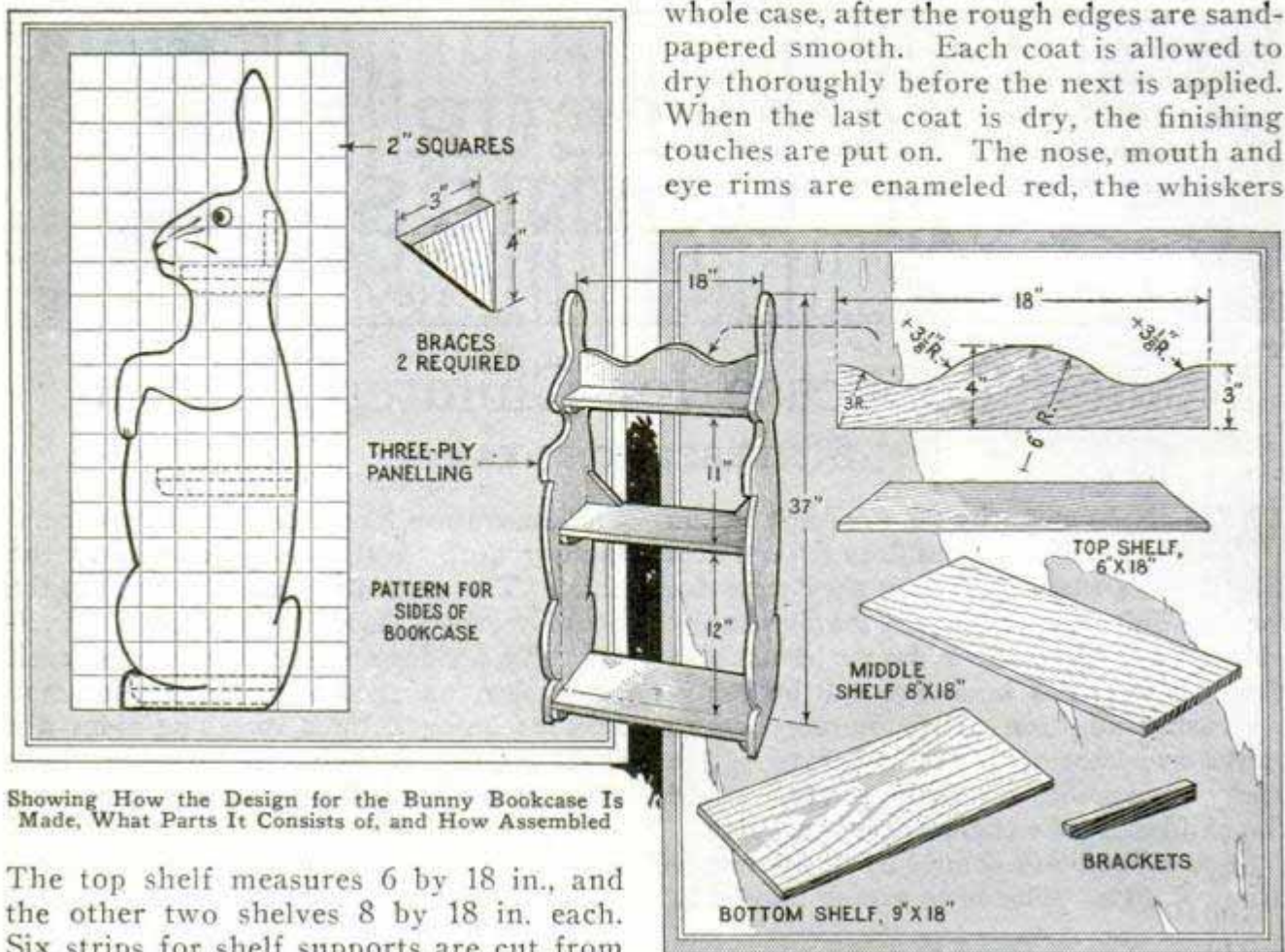

Showing How the Design for the Bunny Bookcase Is Made, What Parts It Consists of, and How Assembled

The top shelf measures 6 by 18 in., and the other two shelves 8 by 18 in. each. Six strips for shelf supports are cut from paneling; these are 1 in. wide and 1 in. shorter than the width of the shelves. The front ends of these strips are rounded off. Finally, two triangular braces are cut from a piece of the same material, 4 by 4 in. in dimensions. The shelf cleats are screwed to the sides; the lower edge of the first one is  $1\frac{1}{2}$  in., the second one  $13\frac{7}{8}$  in., and the third one  $25\frac{1}{4}$  in. from the bottom. The clearance of 12 in. between the two lower shelves provides ample space for large folio-type books. After all the cleats have been screwed in place, the shelves are laid on them and screwed to the cleats and then the sides are screwed to the shelves. It is a good idea to drill holes for the screws before driving them in, the holes being just a little smaller than the thickness of the screw shank. This prevents splitting the wood. The stop brace is put in place at the back of the top shelf, screws being driven into it through the sides and into the edge of the top shelf. The two corner braces are attached at the ends of the middle shelf as shown in the drawing of the assembled case.

All is now ready for painting. Three coats of ivory enamel are applied to the

whole case, after the rough edges are sand-papered smooth. Each coat is allowed to dry thoroughly before the next is applied. When the last coat is dry, the finishing touches are put on. The nose, mouth and eye rims are enameled red, the whiskers

and pupil are black, while the outlines of the legs are pearl-gray with the edges carefully blended into the ivory of the body. The rest of the eye and the tip of the tail are white, while the claws are black.

### How to Make a Radium Photograph

That radium rays, like X-rays, affect photographic plates, is well known, but it would naturally be supposed that the enormous cost of radium would prevent the making of such a photograph by the amateur. However, a radium photograph can be made at home at practically no cost at all, provided the amateur has patience enough to gather the necessary material, which is nothing else but broken gas mantles. These contain a salt of the rare metal thorium, which is slightly radioactive. Collect a sufficient quantity of broken mantles to cover the bottom of a small cardboard box, a dry-plate box, for instance, with a layer of powdered mantle substance. Upon this layer, and pressed tightly against it, is placed a piece of cardboard; then some metal article to be photographed is laid on



the cardboard box, and covered with sensitized paper. This is again covered with a piece of cardboard and the box is filled with crumpled paper to the top. The cover is then put on, the box is tied up with a piece of string and set in some place where it is sure to be left undisturbed. The radium rays from the powdered mantles penetrate the cardboard and paper, but not the metal article. As the rays are very weak, they must be given four weeks to accomplish their work. After that time, however, a picture of the metal object in white on a dark background will be found on the sensitive paper. Such pictures will not be so sharp as ordinary photographs, because the rays are not focused, but they fairly represent the originals and the experiment is an interesting one.

### Effective Fish Lure

A bit of pine wood, a piece of tin and three pins make a good lure for game fish. The photo shows how these floating wood lures are designed, striped with blue-black paint and varnished. The two gangs of treble hooks give it a crawling action, while the hornlike piece on the head is bent to make the bug dip and wobble in the water. The tailpiece is loose and adds to the lifelike appearance by giving the lure a swinging motion. The pins are pushed through, looped and soldered. A pin through the head makes the eyes, a bit of solder being applied at each end. If luminous paint is applied to the under-

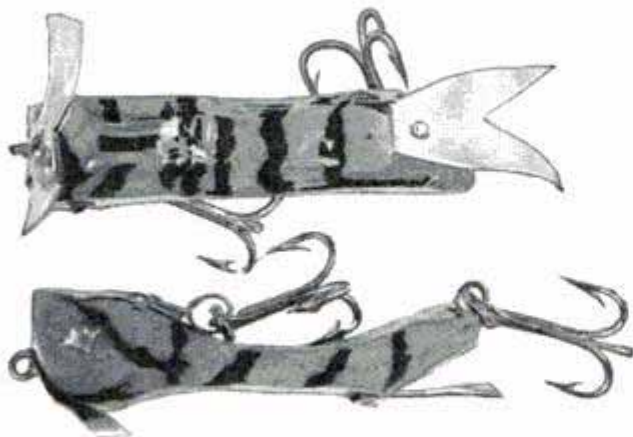

Simple Homemade Lures Which Attract Game Fish side, game fish will strike this bug at night.—L. S. Landmichl, Riverton, Wyo.

☞ To empty a large sack filled with heavy material, roll it over a barrel.

### Model Makers' Vise

In model shipbuilding, and other similar work, there are many small pieces to be sawed, drilled, etc., that are difficult to



Wooden Device with Notches of Different Shapes and Sizes Helps Model Makers

hold solidly. They are apt to be bruised or crushed in a vise and considerable time is lost in operating the vise. With the simple fixture shown in the illustration this trouble can readily be overcome. It consists of two pieces of 1-in. wood, nailed together as indicated, the narrow piece having notches of various shapes and sizes cut along its top to take the different pieces that are to be shaped.

### Repair for Cracked Vacuum Bottle

I was going to start the next morning on a 1,000-mile train trip and had to have my quart vacuum bottle for the baby food. Somehow or other it got badly cracked at the last minute, so I thought of mending it with ordinary adhesive tape. I wrapped a 1-in. strip around the bottle twice, then crisscrossed the tape over the cracked spot. There were a dozen or more little cracks besides the big one. I intended to get a new bottle the next day when changing trains, but this was not convenient. The cracked bottle held up well and is still in use.—Mrs. V. S. Martin, Detroit, Mich.



### Simple Rail for Child's Bed

Children often fall out of bed while sleeping, bruising themselves and waking the household during the night. One way

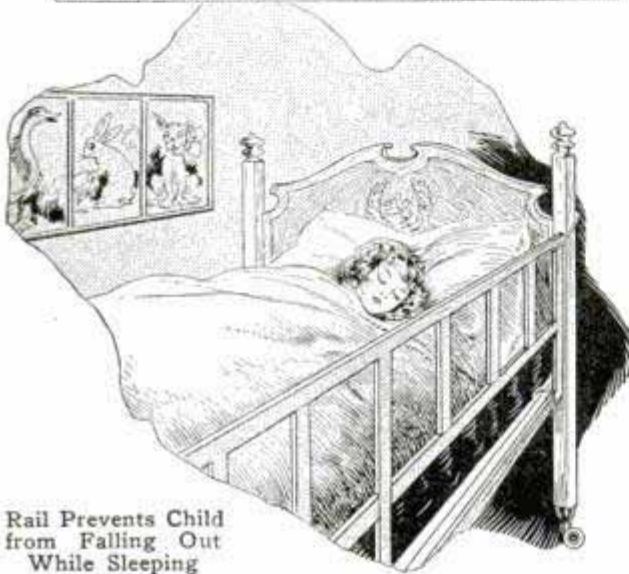
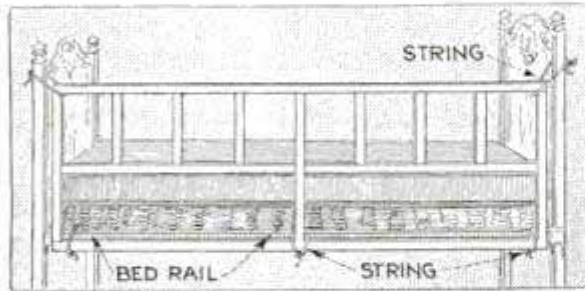

Rail Prevents Child from Falling Out While Sleeping

to prevent this is to provide a rail as shown in the drawing, tying this to the bedposts and frame of the bed so that it can readily be removed when not needed.—F. A. Inman, Grand Haven, Mich.

### Making a Humidifier for the Incubator

Incubator manufacturers and poultry experts have for many years agreed that a careful regulation of moisture within the incubator is an aid to perfect incubation, and there has been a wide range of opinion concerning the method of applying the moisture for best results. Increasing or decreasing the ventilation has been recommended, but atmospheric conditions are variable, and the amateur therefore has considerable difficulty in adjusting the ventilators correctly. Placing pans of water within the machine has also been tried, but usually this results in an oversupply of moisture and a loss of chicks.

A Wisconsin poultryman who has tried several types of incubators employs a system of his own, which allows him to gov-

ern the moisture within the machine regardless of outside conditions, and he claims that he has been rewarded by more uniform hatches of sturdy and healthy chicks. The ventilation is regulated according to the instructions furnished by the manufacturer, but the moisture problem is solved by the self-feeding device shown in the illustration. In the front of each machine, between the doors, a hole is drilled to admit the insertion of a 12-in. length of  $\frac{3}{4}$ -in. gas pipe, with an elbow at the outer end. This is turned so that the open end of the elbow is on the upper side. On top of the machine is a can of water with a faucet, arranged directly over the open elbow. A fine sponge is wired over the end inside of the incubator.

No moisture is applied until the end of the third day after the eggs have been placed in the incubator, and then the faucet of the can is opened so that the water drips very slowly into the elbow. As it passes along the pipe and is distributed over the sponge, it readily evaporates due to the warm air inside of the machine. Every two days a few of the eggs are tested, to determine the exact regulation of the moisture as provided by the faucet. From a standard chart, which shows the approximate size of the air cells in the eggs under natural incubation, it can readily be determined whether the eggs in the machine require more or less moisture. If the air cells of the tested eggs are larger than they should be according to the chart, too little moisture is being provided, and if they are smaller, the moisture supply should be reduced.—G. E. Hendrickson, Argyle, Wis.

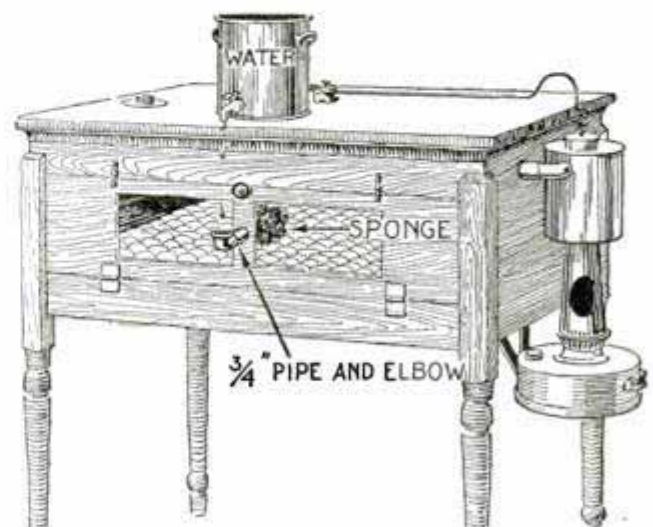

Simple and Effective Method of Getting Correct Humidity Inside of Incubator



### Water-Pressure Outfit for Washing Cars

In rural sections where a water supply under pressure is unavailable, it is a long and tiresome task to wash the car or the house windows with a bucket and sponge. The simple water-pressure system shown in the illustra-

lead at the joints, as they must be air-tight. Screw an auto-tire valve into the top of the barrel and drive the bung in so that it will not blow out, or else thread in a pipe cap to close the hole. Mount the barrel on skids so that the pipe lines will clear the floor. Connect the check end of the line to the spout of a hand force pump with a strong rubber hose capable of withstanding considerable pressure.

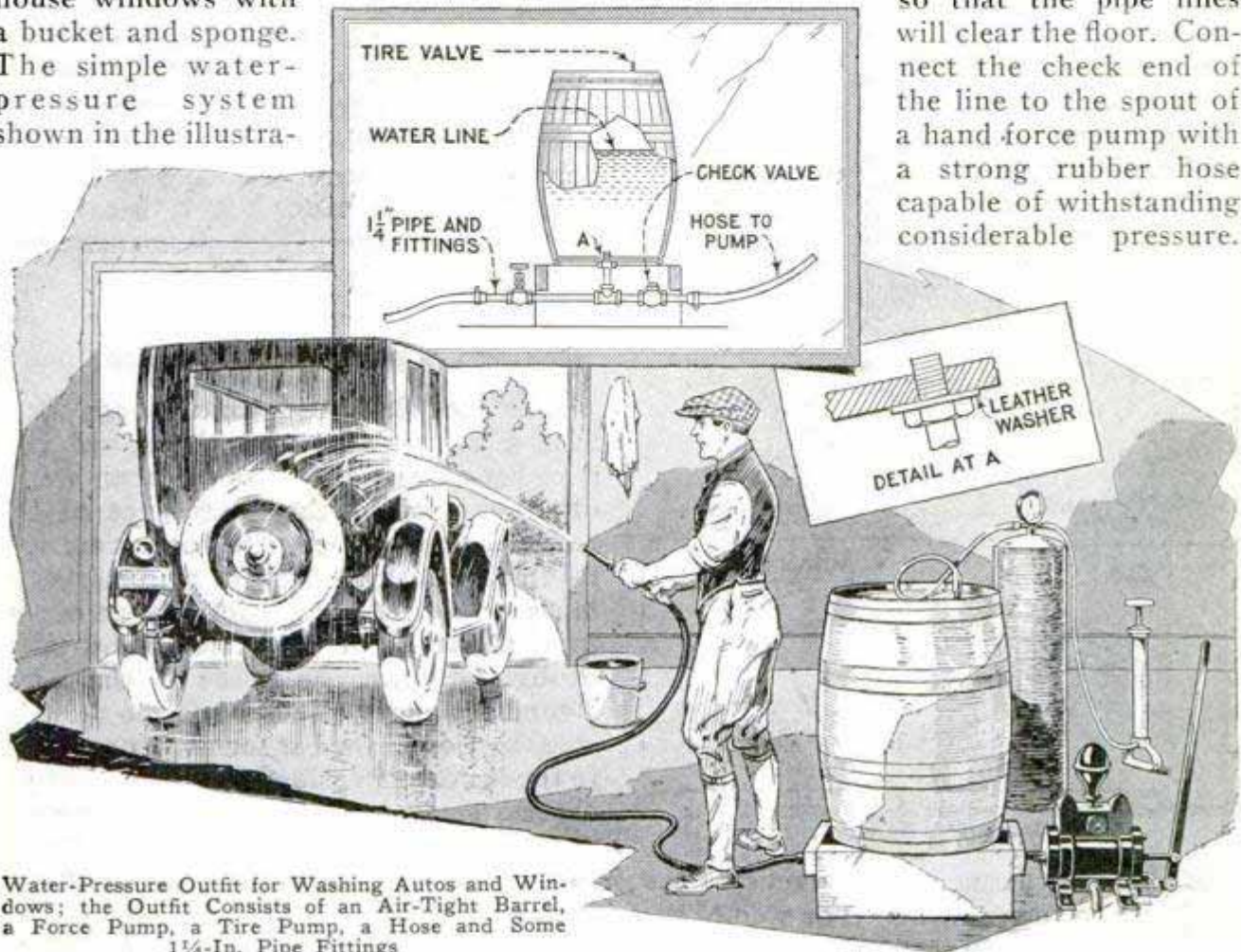

Water-Pressure Outfit for Washing Autos and Windows; the Outfit Consists of an Air-Tight Barrel, a Force Pump, a Tire Pump, a Hose and Some 1 1/4-In. Pipe Fittings

tion is designed to facilitate such work. It can be made from an old air-tight barrel and some pipe fittings. Drill a 1 1/4-in. hole in the center of the bottom of the barrel and thread in a short 1 1/4-in. nipple, placing a leather washer and locknut against the underside and drawing it up tight to make a water-tight joint. The hole should be small enough so that the nipple will have to be threaded in with a wrench. Run a 1 1/4-in. tee on the bottom end of the nipple and thread a short 1 1/4-in. nipple in one end and a piece of 1 1/4-in. pipe in the other end that will just reach out beyond the bottom of the barrel. On the short nipple, provide a check valve and a length of 1 1/4-in. pipe to project just beyond the edge of the barrel, as indicated. On the other end of the pipe connected to the tee, fasten a valve and a short pipe nipple. Be sure to use plenty of white or red

Use hose clamps to prevent it from blowing off at the connections. A length of common garden hose can be attached to the other nipple as indicated. Close the valve and pump water into the barrel until it is about two-thirds full. This should produce considerable pressure, but if not enough, simply pump in air through the tire valve with the automobile pump. If the installation is in a rural garage, the air supply can be obtained directly from the compressed-air tank. When ready to use the water, turn on the valve.—L. B. Robbins, Harwich, Mass.

☐ The annoyance of a chair rocking on a bare floor, especially a child's rocking chair, may be overcome by tacking sections of garden hose along the curved rockers. If properly done, this also adds to the comfort of the chair.



### Emergency Water Tank Built on Roof

A farmer whose water supply was limited, and who did not care to erect an additional tank, utilized a portion of the barn

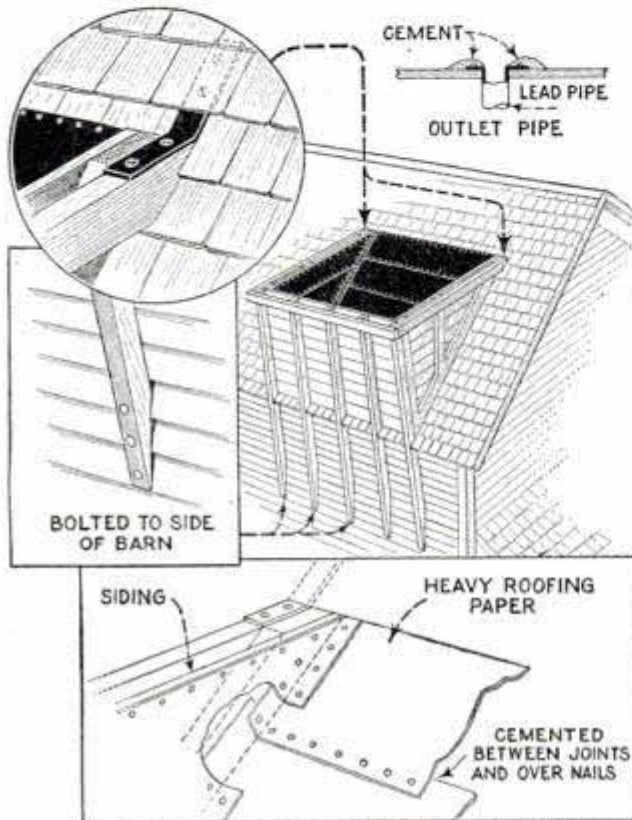

Emergency Water Reservoir for Farmer Having an Inadequate Supply

roof in constructing an emergency tank, as shown in the drawing. The side of the roof facing the direction of the prevailing rainfall was chosen for the purpose. Several lengths of 2 by 4-in. wood were erected vertically, mortised into the eaves of the roof and bolted to the side of the barn below, the ends being beveled to match the angle at which the two met. Then pieces of the same material were laid on the roof, being fastened to it at the top end by means of short pieces of flat iron, as shown in the circular detail, while the lower ends were bolted to the uprights. A few shingles were removed so that the piece of flat iron could be securely fastened to the roof board, and were then replaced. Pieces of 2 by 4-in. wood were bolted from the top of the uprights to the upper ends of the pieces attached to the roof. The framework was boarded up from the inside and formed a wedge-shaped wooden tank. The inside was lined with three-ply roofing paper, laid with wide laps, the nails being driven fairly close to-

gether. Roofing cement was spread plentifully between and over the laps and also over the nail heads. A round opening was cut through the tank close to one of the bottom corners for a length of lead pipe, which was held in place by means of a flange on the inside, formed by tapping the edge of the pipe outward with a hammer. The flange thus formed was connected to suitable piping which led to the necessary points. Rains were the sole source of supply for this tank, but it proved its worth and has been kept permanently in position on the barn roof.

### Making Copper or Brass Fixture Chain

Most electric-lighting fixtures are fitted with a brass-plated iron chain, and this is rather unsatisfactory as the brass wears off, thus spoiling the appearance of the entire fixture. The writer overcame this trouble by making a chain of either solid brass or copper wire. Get a piece of flat iron, about 12 or 18 in. long and large enough to form the inside of the links. Round the edges off with a file so that the cross section of the bar forms an oval equal to the inside dimensions of the links. Purchase a small quantity of brass or copper wire the same size as the wire of the chain to be replaced. Clamp the bar in a vise,

inserting one end of the wire between the bar and the vise jaw. Then coil the wire around the bar as shown in the drawing, tapping it down with a lead hammer and driving it tight against the bar. When the wire is all wound up in this way, take a cold chisel or a hacksaw and cut the wire along the upper edge as indicated. Remove the links thus formed, file the ends smooth and force them together.—Dick Hutchinson, Ithaca, N. Y.

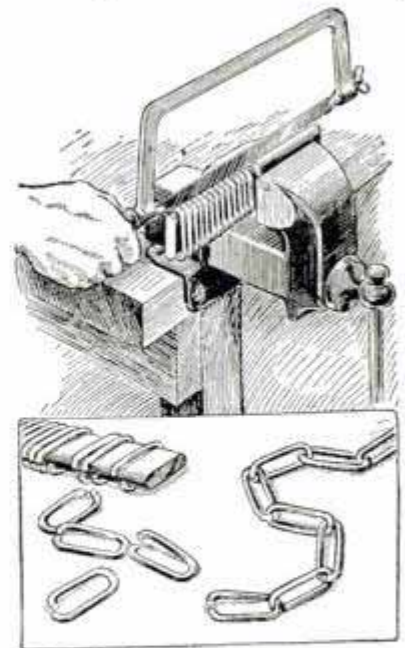



# TRICKS of CAMPING OUT

by Earle W. Gage

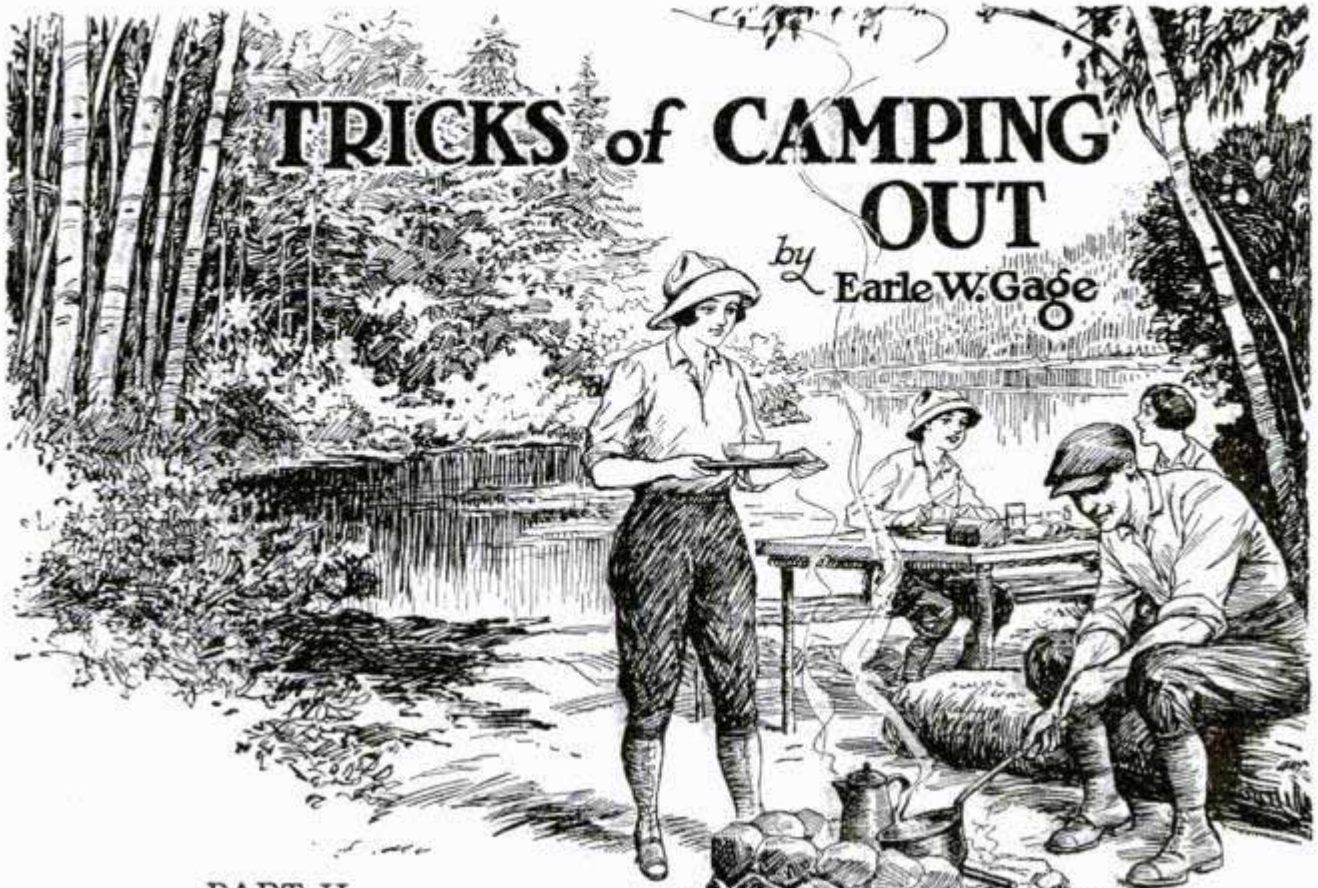

## PART II

THE camp fire plays one of the biggest parts in the outing, as all the cooking and baking depend on it. It is best to take a camp stove whenever one can be transported, as it is safer to use than open fires, more convenient, requires less fuel, and does not blacken the cooking utensils so much. Collapsible sheet-iron stoves will be found useful for this purpose.

In the absence of a stove, however, an open hearth may be built. A safe and serviceable fireplace can be made of rocks placed in a small circle and a few iron rods to support the utensils, according to the accompanying illustrations. Where rocks are not obtainable, poles may be used. For permanent camps, it pays to build a stone fireplace over which is laid a piece of sheet iron; this will prevent the blackening of the pans and also give a better draft. For temporary camps, the fire should be built as follows: Excavate a hole, about 1 ft. deep and about 3 or 4 ft. in diameter. Shovel away the side toward the wind and lay green poles across the hole to support the pans and other utensils. Fire irons are often convenient. A 4-ft. length of  $\frac{3}{8}$ -in. iron rod is bent at

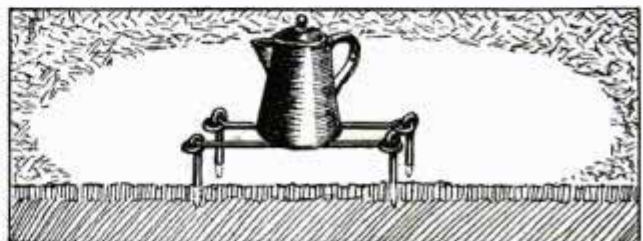
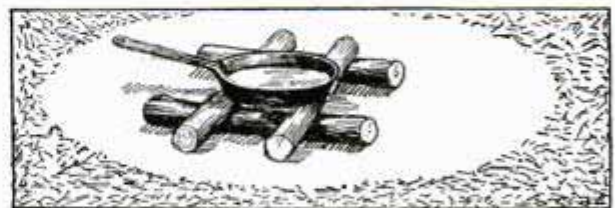
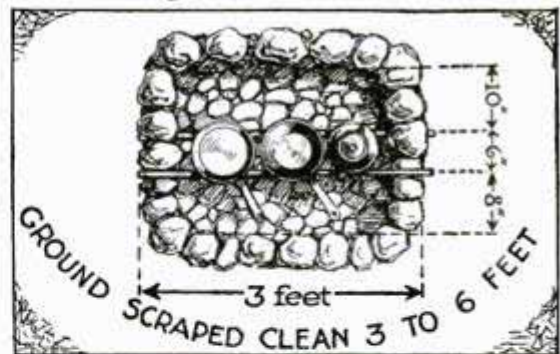
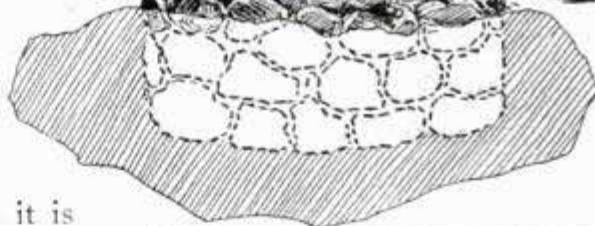



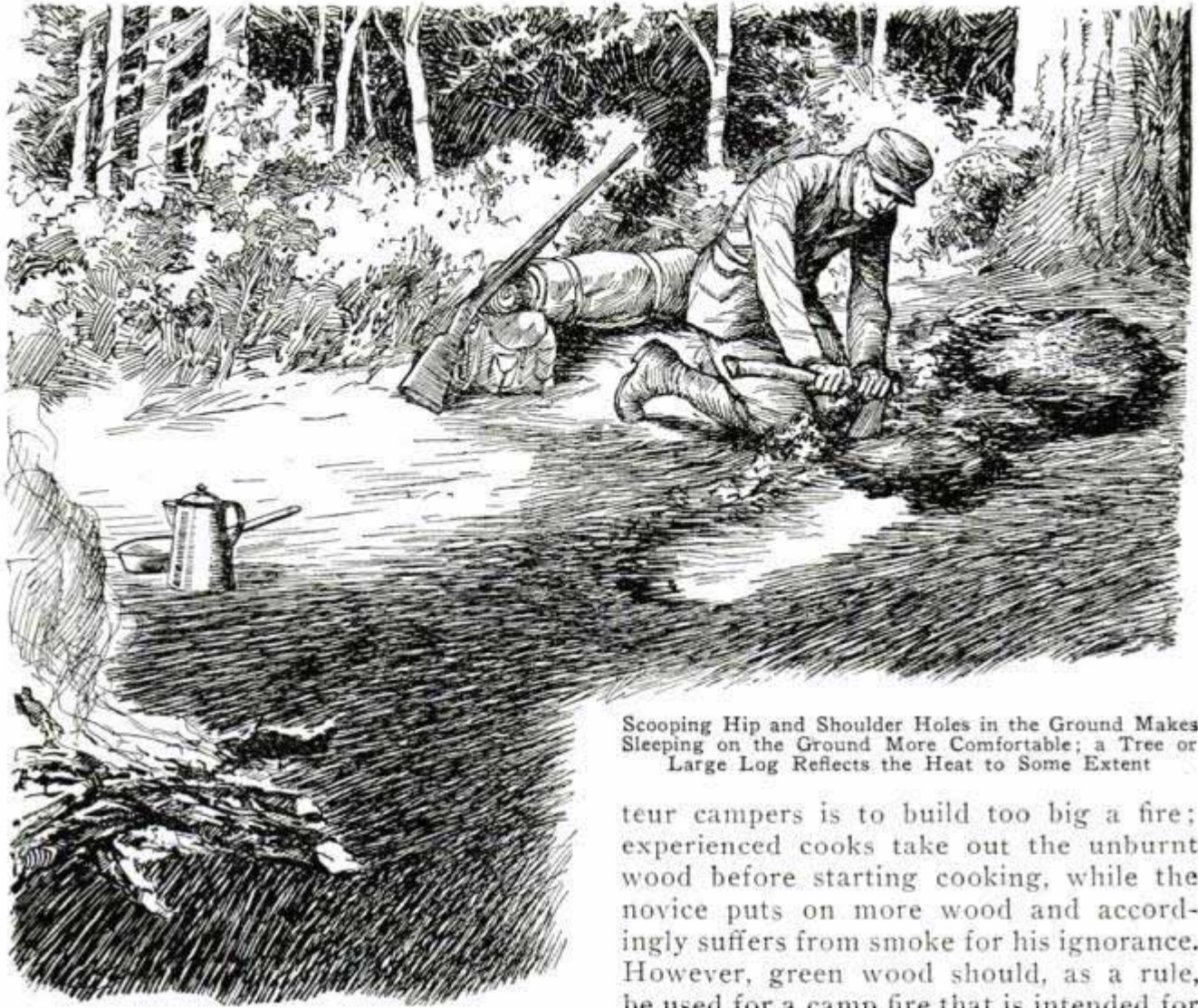

Scooping Hip and Shoulder Holes in the Ground Makes Sleeping on the Ground More Comfortable; a Tree or Large Log Reflects the Heat to Some Extent

right angles, about 1 ft. from each end, and the ends are sharpened. Two of these irons, placed side by side, with the ends driven into the ground, and the fire kindled beneath them, make a good fireplace. Instead of being made of one piece, the pegs and crossbars may be connected by rings at the ends. These can then be folded and will be easier to pack. Another good way to prepare the camp fire is to select two short medium-thick green logs and level down one side with an ax. Set and brace these logs a few inches apart, so that they will form a support on which the bottom of the cooking utensils will rest safely. Scrape a little trench underneath and, with a few additional logs, form the wind guard on one side. The two logs which are to form the sides of this improved cooking range should be arranged so that they are about 6 in. apart at one end and about 2 ft. apart at the other end, at which the baker may be placed, facing the glowing coals. The common error of ama-

teur campers is to build too big a fire; experienced cooks take out the unburnt wood before starting cooking, while the novice puts on more wood and accordingly suffers from smoke for his ignorance. However, green wood should, as a rule, be used for a camp fire that is intended for all-night service.

The Indians made camp fires long before matches were invented and therefore campers who are caught without matches can make use of the same primitive methods, of which a number are shown in the drawing on page 496. One of these uses a bow of stout oak or hickory, about 2 ft. long and strung with a loose leather thong. Make a drill of balsam, cottonwood, cedar or basswood, and of the same wood make a firestick, split flat with an ax. Notch this firestick with a penknife and start a small drill cup at the point of the notch. Make a pressure block for the upper end of the fire drill from a piece of hardwood, and you will have all the tools necessary for making fire.

You must also get some tinder ready, which will ignite easily. The best is birch or cedar bark. String it into fine shreds between two stones. To make a fire, pass the leather thong around the drill once, enough for the bow to run taut on it. Put



the drill point in the small cup-shaped depression at the end of the notch. Draw the bow back and forth steadily, with even strokes, its full length. You will grind out filings which are brown, but after two or three seconds you have a pile of black shredded wood dust, and presently smoke will come from the pile which forms on the top of a chip placed under the notch. A glowing coal will form in this as you blow on it gently; add some of the tinder and capsize the coal into it. Breathe gently on the flame.

Another method is to take a piece of bamboo, split it in half, and, after starting a notch, rub rapidly across with a sliver of bamboo. This forms a pile of dust from which will presently come smoke and a glowing coal, to which tinder is added and the flame started. Still another method is to knock the ball out of your rifle cartridge, take out all the powder, placing some in a pile of tinder, discharge the rifle or receiver into this, using only the primer and a few grains of powder strewn down the barrel. This is the easiest method of making fire in the woods, aside from the

use of matches. If there is sunlight, a magnifying lens or a watch crystal filled with water will serve to concentrate enough of the sun's rays to start a fire. Unless you have tinder, it is impossible to get a fire with flint or steel.

Good bedding is important because nothing takes more from endurance and enjoyment than loss of sleep. Where light weight is the object, nothing surpasses a sleeping bag. The best ones have an outer bag or canvas, tanalite or balloon silk, with two inner bags of eiderdown or other good blanket or quilting. According to the weather, the sleeper has more of the coverings over him to keep warm or beneath him for softness. Any blankets or quilts can be made into sleeping bags by folding them lengthwise and sewing or fastening the edges with horse-blanket safety pins. Of course, these are not water and wind-proof. Without a sleeping bag and without having bedding enough to improvise one, most warmth can be had by lying down and drawing the blankets over you as a coverlet; then lifting the legs without bending at the knees, and tucking the cov-



Proper Method of Tucking a Blanket under One's Legs for the Greatest Comfort When Sleeping in the Open; Always Sleep with Your Feet toward the Camp Fire



ering smoothly under them from both sides, folding the ends under the feet; lifting the hips and tucking the covering under similarly and finally following the same procedure at the shoulders, so that the edges are overlapped for the full length beneath you. Two light blankets are

scoop hip and shoulder holes. If the fire must be kept up all night for warmth or safety, have your head toward a log or tree to reflect the heat and stop the wind, for you should be windward of the fire to avoid smoke and sparks. The fire should be 5 or 6 ft. from your feet and in an open

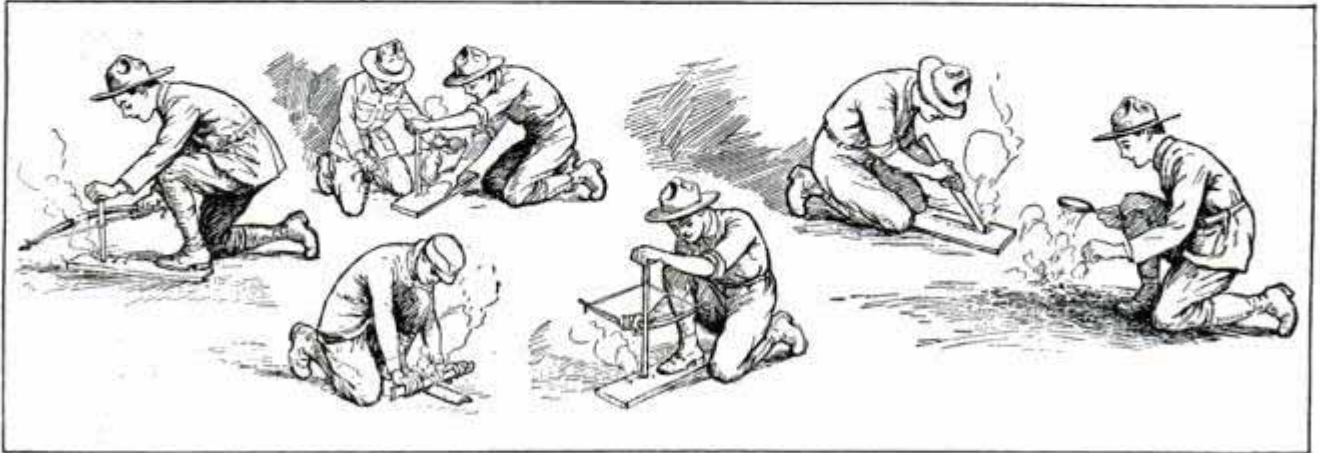

Various Methods of Making Fire When No Matches Are Available; the Use of a Wooden Drill Rotated by a Bow Has Been Found Especially Satisfactory

warmer than one heavy one. Better than blankets are quilts of eiderdown or wool, with extra covering of denim or more weatherproof material. A 7 by 7-ft. sheet of 10-oz. canvas, folded, makes a good ground cloth and extra cover, while it is also useful as a pack cover when traveling or for a rain shelter.

Folding cots and pneumatic mattresses are practical for auto and pack-horse trips, although too heavy to carry when hiking. Brush beds are easily made from feathery coniferous boughs. Other boughs are useless. Use none that are larger at their butt than your thumb, and these only well covered by smaller tips. Collect a good supply first. If possible, confine the entire bed by 4 or 6-in. logs pegged in place, before the brush laying is begun, and with foot logs resting on the side logs. Lay the largest boughs in courses, "bow" up and overlapping, so that the butts are toward the foot end of the bed and, except at the very foot, covered by tops of other courses. Keep pushing in smaller boughs the same way; always lengthwise of the bed, bowed ends up, and butts down and covered by tops. Finally sift the smaller ones evenly over the whole. Try the bed and build up the weak spots.

If you have to sleep on the ground, choose a level place (so that you won't slide) and one that is free from roots; then

place, where you can walk around it and where no log, tree or rotten wood can catch fire from it. Before dark, drag up a good supply of the biggest logs and chunks you can find. Also locate more so that you can go out in the dark to get it if necessary. Sit up late, burning your smallest stuff. Save the biggest to keep the fire longest without replenishing during the night. Keep your shoes away from the fire even if they are wet.

While permissible on horse and auto trips, tents are inconvenient to carry when hiking. If taken at all, they should be small and of oiled silk. They are unnecessary unless it rains, and then shelter is provided by lighter ponchos, tarpaulins or like covers, elsewhere suggested as part of the bedding equipment and better adapted for this in good weather. They can be stretched, lean-to fashion, facing the fire and with the back to the wind.

Always provide drainage around the tents and shelter, especially on slopes, or the floor and the bedding may be flooded. Tent poles need not be taken in the woods. For an A-tent, have a rope long enough to serve as a ridgepole, knotted inside of each end grommet of the tent and having at least 10 ft. to spare at each end, to be tied around an improvised pole and then guyed to a ground peg. Often a tree serves for the end away from the fire.



### Nails for Copper Screen

When making copper-wire screens it is advisable to attach the screen to the frames with copper tacks. If iron tacks are used, an electrolytic action will take place in the presence of moisture and this will destroy either the tacks or the screen at the point of contact, allowing the screen to come loose and sag, which in turn makes a repair necessary. Only pure copper tacks, not copperplated ones, should be used for this purpose. To determine whether or not the tack is solid copper, scrape it with a file or cut off the end with a pair of pliers. If the tacks are of pure copper, they will show the characteristic copper color throughout. They are also much softer than iron tacks.

### Adding Distilled Water to Battery

Most auto owners have experienced some inconvenience when adding distilled water to storage batteries. However, the difficulty can readily be overcome by using the handy filling device shown in the drawing. It consists of a bottle, two lengths of small glass tubing and a short piece of rubber tubing. Two holes are drilled through the cork for the glass tubes, but

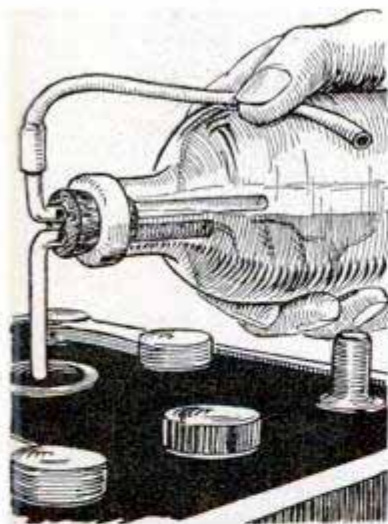

before they are inserted, they are heated and bent to the shape shown. The rubber tubing is then slipped over the end of one as shown. Pressing this tube shuts off the air from the bottle and prevents the distilled water from flowing out. By using this filler, there will be no water spilled over the top of the battery.

☞ A No. 10 gauge shotgun cartridge shell, telescoped with a No. 12 gauge shell, forms a convenient match safe for campers, or other persons out of doors, and is moisture-proof.

Holding Small Parts Is an Easy Matter with This Improved Quick-Acting Clamp



### Improved Quick-Acting Clamp

In an electrical shop, it was necessary to solder and fit a large number of small pieces. To loosen and tighten the vise each time a piece was removed and reinserted, was found inconvenient, so the method of holding the parts by means of a pair of heavy pliers, as shown in the illustration, was used and found entirely satisfactory. One handle of the pliers was caught in the vise, while a length of pipe, with a weight on the end, was slipped over the free handle. The work, held in the jaws of the pliers, can be instantly released by merely lifting up the weighted handle.—G. A. Luers, Washington, D. C.

### How to Clean Celluloid Side Curtains

After the auto side curtains have been lying in a tool compartment for some time it is often necessary to clean the celluloid "lights," as they have become scratched and dirty, making them more or less opaque. This can readily be remedied by applying liquid metal polish or furniture polish. The cleaning should be done with a rotary movement, starting in the center and gradually increasing the diameter of the circles.



### Improving the Cream Separator

The efficiency of the cream separator shown in the photos was increased considerably by two little devices that anyone

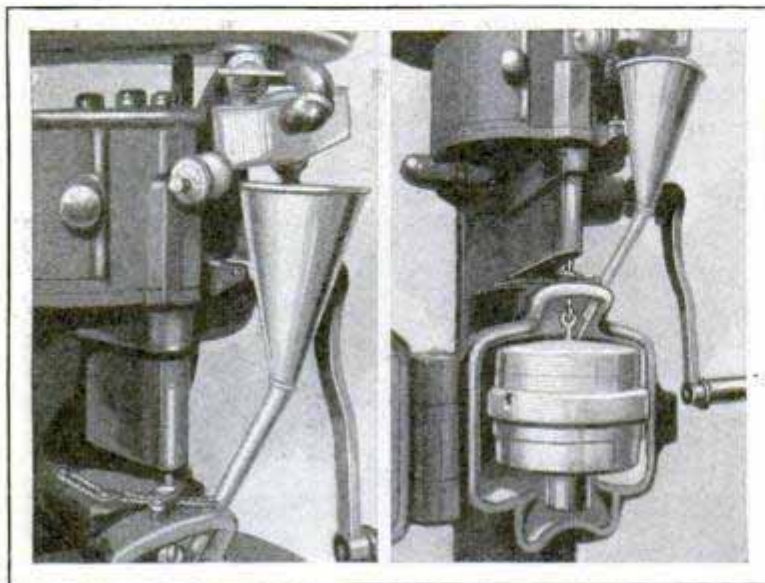

A Few Changes in the Cream Separator That Make It More Efficient and Sanitary

able to use a soldering iron can make. The left-hand photo shows the milk regulator in position for use. It operates on two pivots, one on each side, which rest in V-shaped notches in the frame. A slight rap was sufficient to put it out of position, so that enough milk did not enter the bowl, resulting in a clogged machine. To remedy this, a partition made of galvanized iron was placed in the outside notch of the frame, with supporting strips encircling the hanger, and soldered together at the ends. A drop of solder was also placed in the notch, and attached to the partition to serve as a brace. After this was done, the machine separated perfectly. The right-hand photo shows the same machine with a funnel in position for use. While the full flow of milk was entering the bowl, this worked very well, but the tube of the funnel was made so short that the drippings would fall outside of the bowl en-

trance, run down onto the bowl-clamping ring and onto the floor when the bowl was removed for washing. A little spout of galvanized iron, soldered to the outside of the tube at the bottom and extending down just  $\frac{3}{4}$  in. to the bowl entrance, remedied this. The machine now was entirely sanitary.

### Ball-Bearing Crankshaft Makes Window Display

An auto dealer used a novel method of demonstrating the ease with which a ball-bearing crankshaft would turn. The crankshaft was suspended from the ceiling of a show-room window by means of two small wires attached to the bearings. Much to the amazement of the passers-by the crankshaft revolved continuously without any apparent drive. The secret of the drive was a strong blast of air from a small blower concealed in the display. The air was directed into a small cardboard outlet, concealed next to one of the counterbalances on the crankshaft. The crankshaft would continue to revolve until the air supply was shut off. All articles that would be affected by the air were removed.

### Darkroom for the Camp

When you wish to develop photos in camp, take a piece of dark-red celluloid along and use it to make a shade. It should be about  $1\frac{1}{4}$  in. wide and 6 in. long. After bending it to a cylindrical shape so that it will just slip over the dash light, wrap a narrow strip of tape around each end. The same idea can be used with a flashlight. When developing in the car, spread a robe or blanket from the dash over the back of the front seat, and the darkroom is ready.—L. S. Christison, Disman, Wash.

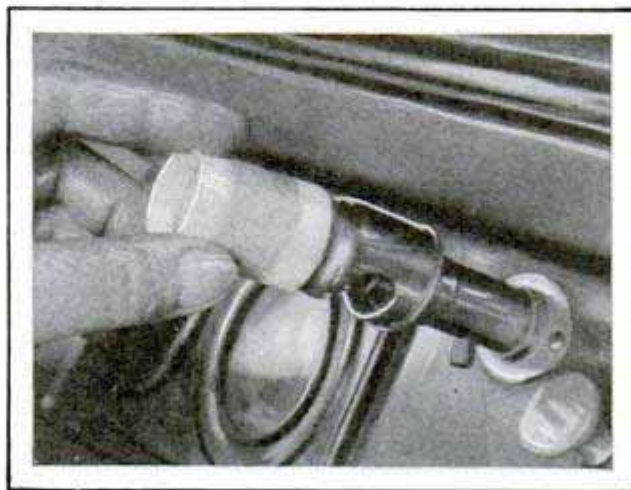

Red-Celluloid Shield over Dash Lamp Gives Ruby Light for Developing at Camp



### How to Make Porcelain Letters Stick

Trouble is often experienced with porcelain and glass letters coming off windows to which they are cemented. A good method of eliminating this trouble is to clean the window thoroughly where the sign is to be located. This should be done with soap and water so that every trace of grease will disappear. Then apply a coating of white paint, covering a space about 4 in. larger than the space to be occupied by the letters. Let this coating dry for 24 hours, or longer, and then apply the letters in the usual way. After the cement has dried thoroughly, remove all the surplus paint around the letters with a scraper or a razor blade. Be careful, however, not to get under the letters as this will make a crack, permitting the entrance of water, which will loosen them. By applying paint as just described, the appearance of the letters from the inside will be improved considerably.

### Lard Pail Makes Calf Weaner

Calf weaners can be made from 5-lb. lard pails and will be found entirely satisfactory. About two-thirds of the bucket is used for the weaner, as shown. Bend the bottom out a little to fit over the nose.



Attach straps to the two corners at the rim. The straps must reach back to the calf's neck and have loops at the end so that a third strap can be slipped through to go around the

neck. A length of wire fastened to the lower edge prevents the calf from raising the weaner beyond the nose but not from grazing. It is advisable, of course, to remove the burr from the sharp edge of the tin with a file, or double it back to form a bead and then solder it.

☐ A column of water 27.6 in. high will have a pressure of 1 lb. per square inch.

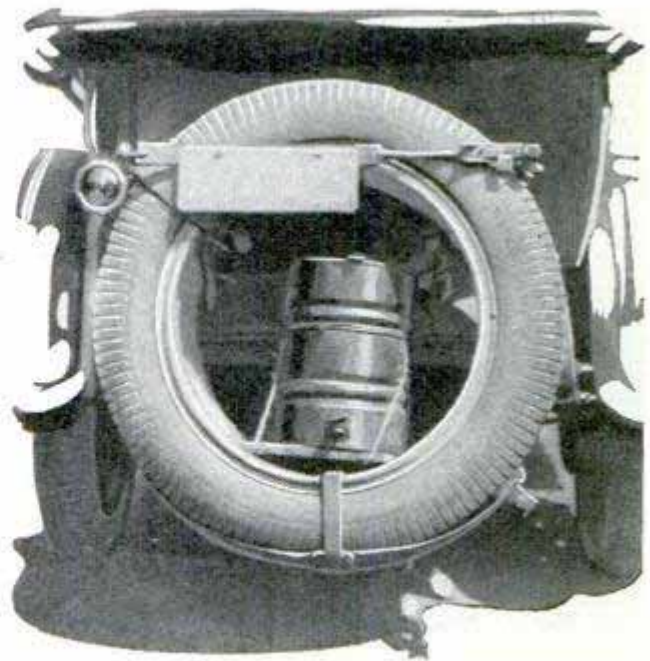

Mounting a Small Oilcan on Spare Tire Saves Space When on a Long Trip

### Carrying Oilcan on Long Trip

When motoring through some sections of the country it is impossible to get oil when necessary, or to get the particular kind of oil desired. By placing an oil drum on a short board and setting it on the spare tire, as shown in the photo, it will be out of the way and will not make a mess on the running board. The spigot projects at the back far enough to allow the oil to be drawn out without spilling any on the tire.—Carlton Groat, The Dalles, Oreg.

### Skinning Small Animals

Some trappers use a trick in skinning small animals that is not generally known. They carry a small metal pipe 6 or 8 in. long, and, on killing a mink, weasel or other small fur-bearing animal, and while the body is still warm, they make a small slit on the inside of the hind leg, large enough to admit the tip of the metal pipe. By holding the skin about the pipe to make an air-tight joint, the skin can literally be blown free from the animal, clear out to the tip of the nose, with a little assistance in loosening it, making the task of skinning simpler and quicker. A pocket bicycle pump could readily be adapted for this purpose, and carried along on the trap-line route.—Harold E. Benson, Denver, Colorado.





Folding Table Leaves That Are Stored in the Drawers Make an Ordinary Double-Drawer Library Table Serve as a Dining Table

### Combined Library and Dining Table

In small apartments, it is often necessary for one piece of furniture to meet several requirements, and library tables must sometimes also be used for other purposes than that for which they are really intended. If a library table has a drawer on each side, it can readily be converted into

### Application for Small Wounds

Pure wintergreen oil makes a good local application for all small wounds, bites, scratches, abrasions, etc. There is no germ or microbe that can withstand this oil, and at the same time it is not injurious to the tissues. A few drops gently rubbed in where there is apt to be any infection is sufficient. An infection always follows the wound of a bullet or the scratch of a brass pin, with irritation extending up the

a dining table. Pull out the drawers and build a folding leaf to fit inside of each when collapsed, and over the drawers when in use, as indicated in the drawing. Each leaf consists of two equal pieces, hinged together, and one of these pieces is in turn arranged to pivot at its end, inside of the drawer. When in use, the leaf rests on the top of the drawer

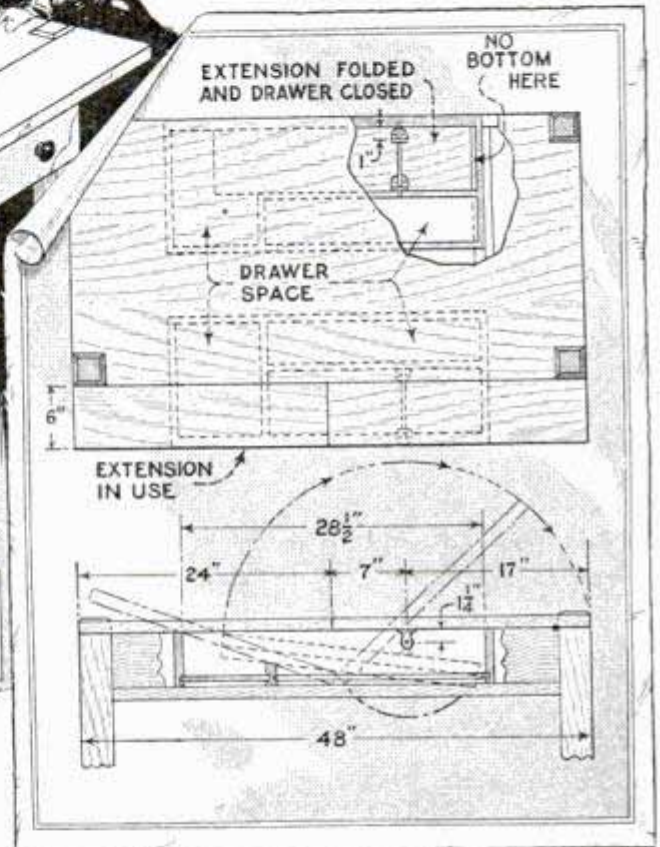

and also on the rod to which one piece is pivoted. Each leaf should be about 1 ft. wide and just as long as the table. The bottom of the drawer below the leaf is removed so that the end of the leaf can swing down when unfolded.

injured member, threatening tetanus or lockjaw. These symptoms are manifested by spasmodic pains which shoot upward, but are quickly subdued if the oil is applied along the track of the pain or infection. This oil is equally effective when locally applied to tendons or ligaments which have been unduly strained. An ounce of pure oil does not cost much and should be kept in every shop and household. If 5 or 10 per cent of olive oil is added, the oil will have more body and last longer.



### Patching Inner Tube without Cement

While on a country tour last summer, we had the misfortune to have a flat tire, and an examination of the repair kit revealed the fact that the liquid cement had evaporated beyond the point of usefulness. As a repair of some kind was necessary, one of the party suggested a simple method of vulcanizing. The punctured portion of the tube was roughed and cleaned, and a few drops of gasoline were poured upon it. This was ignited with a match and allowed to burn until consumed. The cold patch was then immediately applied, pressed firmly in place, and the repair was completed. The patch held until the tube was later removed for the repair of another puncture.—G. E. Hendrickson, Argyle, Wis.

### How to Stretch Screens Tightly

Stretching screens tightly is an easy task if one goes about it in the right way. Place two frames end to end as shown in the drawing and pull the screen over the frames as indicated. Then, after tacking down the piece of screen at the far ends, drive small wooden wedges between the frames, or raise the tacked ends enough to permit the insertion of a  $\frac{1}{2}$ -in. strip of wood, after which the frames are pushed down again. Either method will stretch the screen tightly and it can then be tacked down in the middle and trimmed off.

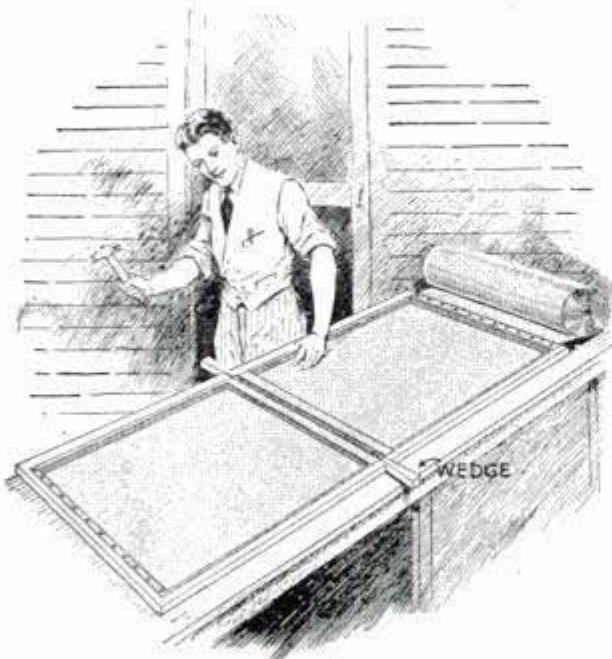

Practical and Easy Way of Stretching Screens Tightly over Frames

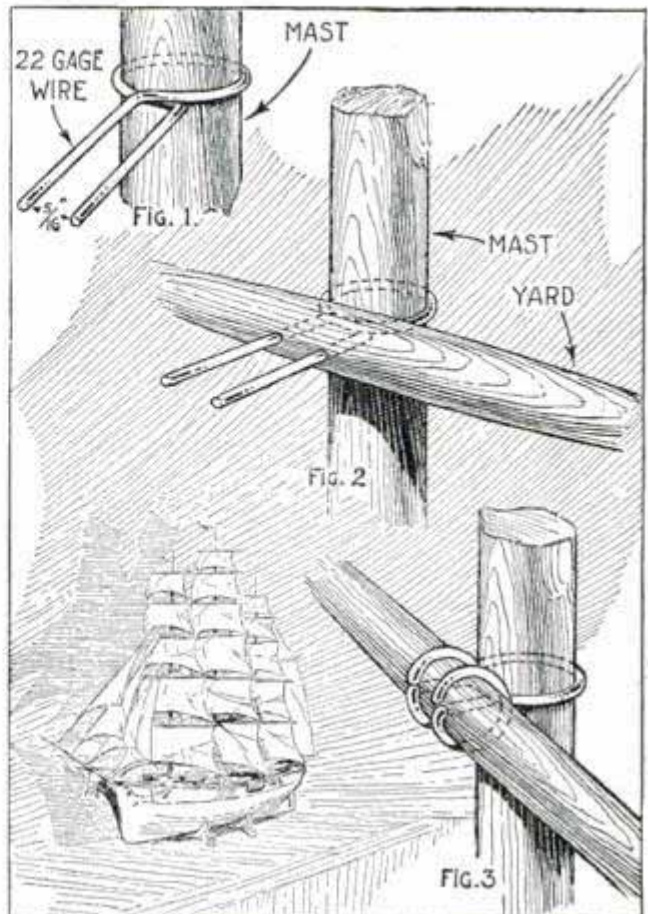

Simple Method of Slinging the Yards to the Masts in Making Model Ships

### Slinging the Model-Ship Yards

When slinging yards to masts of model ships, the method of attaching them shown in the drawing will be found convenient. Get a piece of No. 22 gauge brass wire, about 3 in. long, form a ring around the mast and shape the ends as shown in Fig. 1. The parallel ends should be about  $\frac{5}{16}$  in. apart. Drill two holes through the center part of the yard, using a No. 60 drill, spaced so that the yard will slide on the straight ends, as indicated in Fig. 2. To hold the yard securely to the mast, turn the straight ends of the wire completely around the yard and clip off the surplus wire. The yard is then slung to the mast correctly, as shown in Fig. 3, and should be attached so that it can be slid up or down when pulling on the halyards after the yard has been rigged. This method makes it easy to rig the yard with sails, etc., before slinging to the mast.—L. Edgar Davis, Syracuse, N. Y.

☞ Cover the top and side of ice in a refrigerator with a piece of canton flannel, and the ice will last longer.



*These casts can be made weatherproof by sealing weatherproof  
coating or dull white flat paint.*

# Make Your Own Plaster Casts

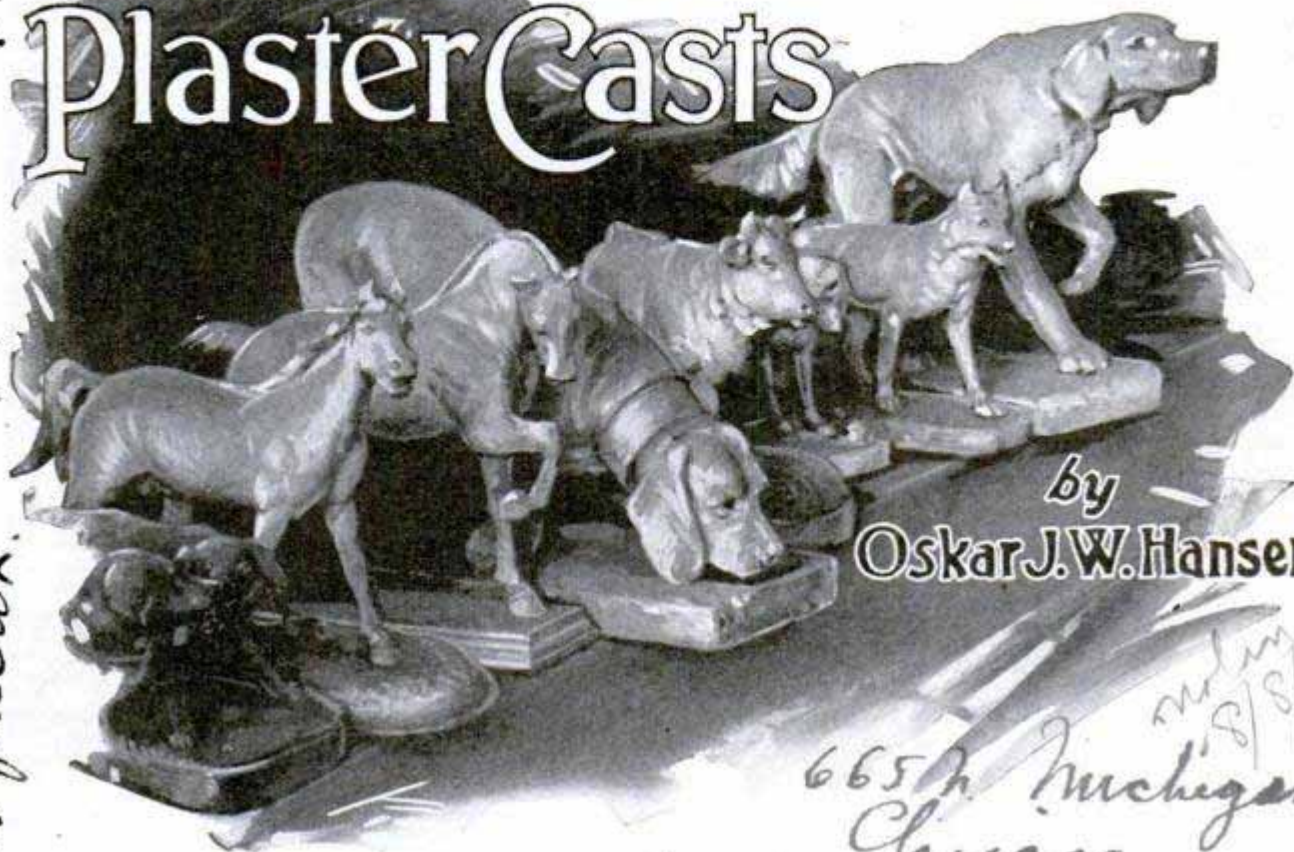

by  
**Oskar J. W. Hansen**

*665 N. Michigan  
Chicago*

THE art of plaster casting combines the practical and the beautiful. Its fundamental mechanics are simple, and the materials needed are few and inexpensive. The child can model animals and toy soldiers for the play house, and the older members of the family can beautify the home with artistic lamp bases, book ends, wall brackets and candlesticks. Copies can be made of beautiful art objects possessed by others. Molds can be made for concrete garden furniture, bird baths and sundials.

Those about to build a home can make a small model of their new house exactly to scale and paint it in the proper colors. This model can be constructed on a plot representing the lot, and the proper location of the building, sidewalks,

flower garden and service yard determined. A model of this kind will enable you to visualize the practical details much better than a blueprint and will eliminate costly and unsightly mistakes. These are only a few suggestions. The variety of things that can be made is practically unlimited.

It might be thought that a description of how to model in wax is unnecessary in this connection, but the first step in making

an original plaster cast is always a model in wax, and, since the making of the mold is exactly the same either for the original or for copying another object, we can combine both the artistic and the practical. Not only this, but a little practice with this fascinating work will develop in many people artistic talents which they

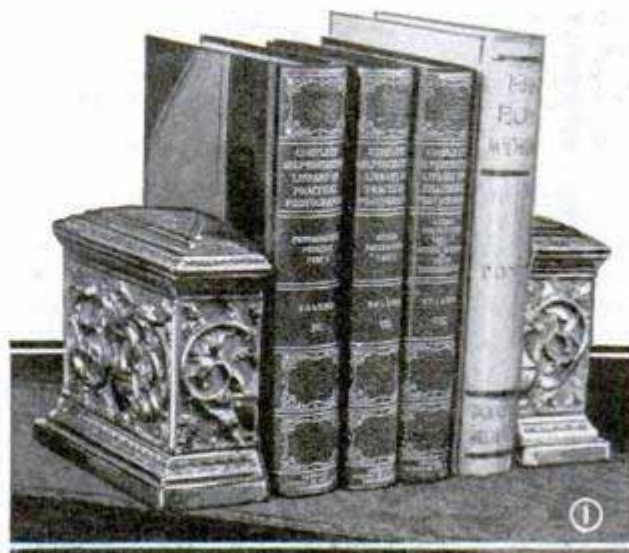

Book Ends of This Type Can Be Made and Reproduced in any Quantity at Home



*Clover Rock N. C. ...  
 Bloomfield, N.J. #860 J. Halsted  
 POPULAR MECHANICS  
 396 S. Columbus Chicago 503*

never knew they possessed, and in this way provide a most unusual form of profitable recreation.

In order to tell you in a simple way how to become familiar with the materials and their uses, I have selected the making of the pair of book ends, shown in Fig 1, as an example. The method illustrated is, of course, also used in the making of any of the other objects which you may wish to make, except, perhaps, for very large objects, where special reinforcing and bracing are necessary on account of the bulk and weight of the article.

The first model, as mentioned previously, is usually done either in modeling wax or in wet clay. A plaster mold is made from this model and from this a plaster or artificial-stone cast is taken. I will tell you how to make the modeling-wax model, and the plaster mold from it, and then how to make a "clover-rock" model from this mold, which will be the finished product. Clover rock is a very hard composition stone now used by dentists in making fine casts of teeth, and I have found that it is a very tough and beautiful material, which

can be used as an almost perfect imitation of marble. Also, when colored and finished suitably it makes a realistic substitute for bronze.

As a modeling wax I recommend either domestic or imported "plastiline." This is a specially prepared compound which always remains soft and pliable. If it seems a little hard as it comes out of the box, knead it between the palms of your hands. The heat and friction will soon bring it to the proper flexibility. This wax can be used over and over again and is a permanent investment.

For modeling tools, one or two small orange-wood sticks, like those used in manicuring, which can be cut into various shapes on the ends, are all that is needed.

Now take a smooth piece of board, or better still, a piece of plate glass, and begin making the wax model for your book ends. If the design is to be the same for both ends you need only make one model. This can be duplicated again and again. First you build up and form the main shape and then you model in the design.

You can always find many attractive de-

*Imported by - E. L. Soltmann  
 202 E 42nd St  
 New York  
 Solly  
 29  
 Wabrad  
 Chicago*

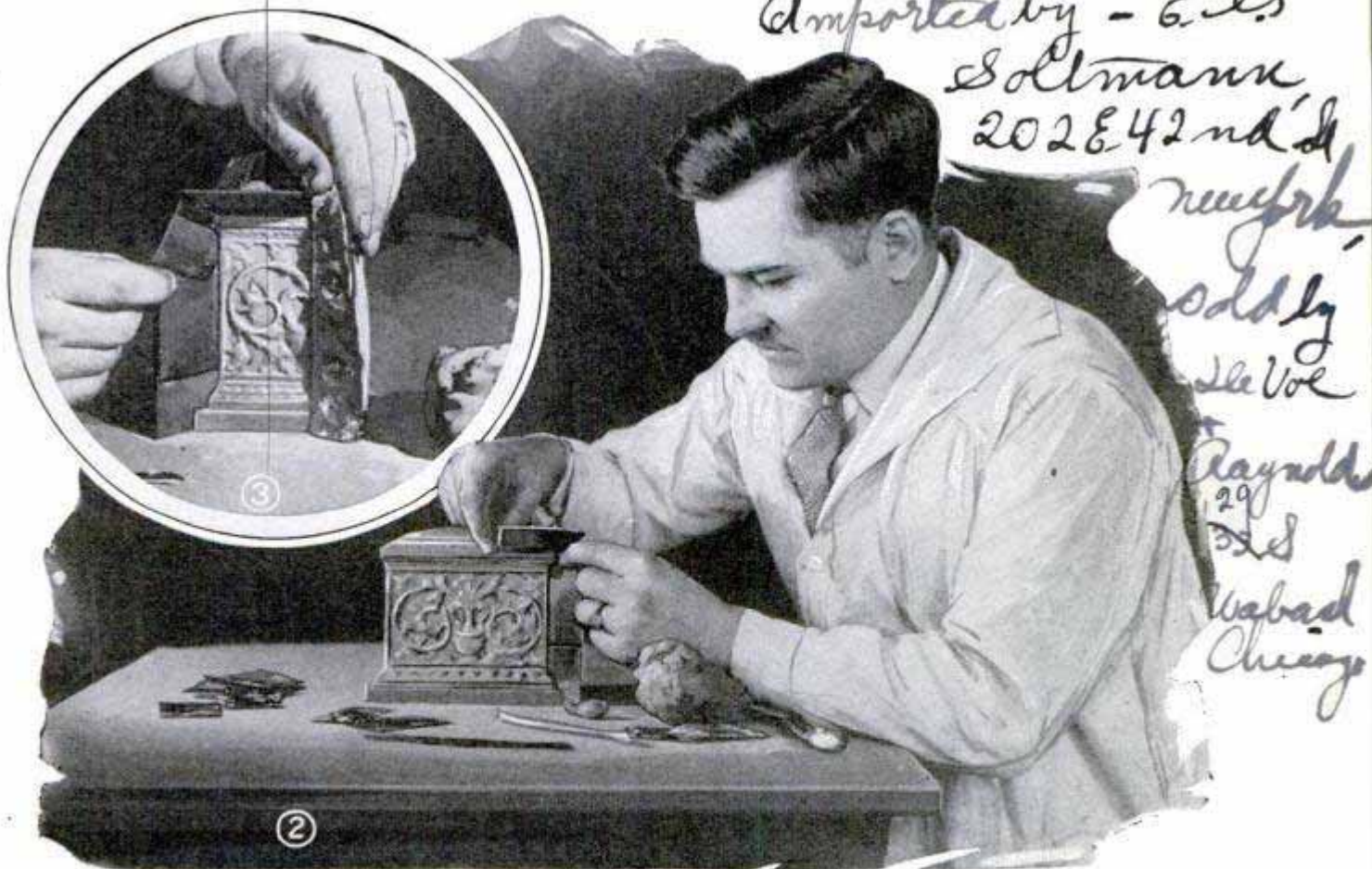

Fig. 2. Sticking the Brass Shim Stock into the Edges of the Model; Fig. 3. One Side of the Mold Completed, Commencing Another Side

*see letter - Hardite used instead  
 of Clover Rock*



signs in the public libraries in old books and illustrations. These you can copy by tracing and transfer lightly to

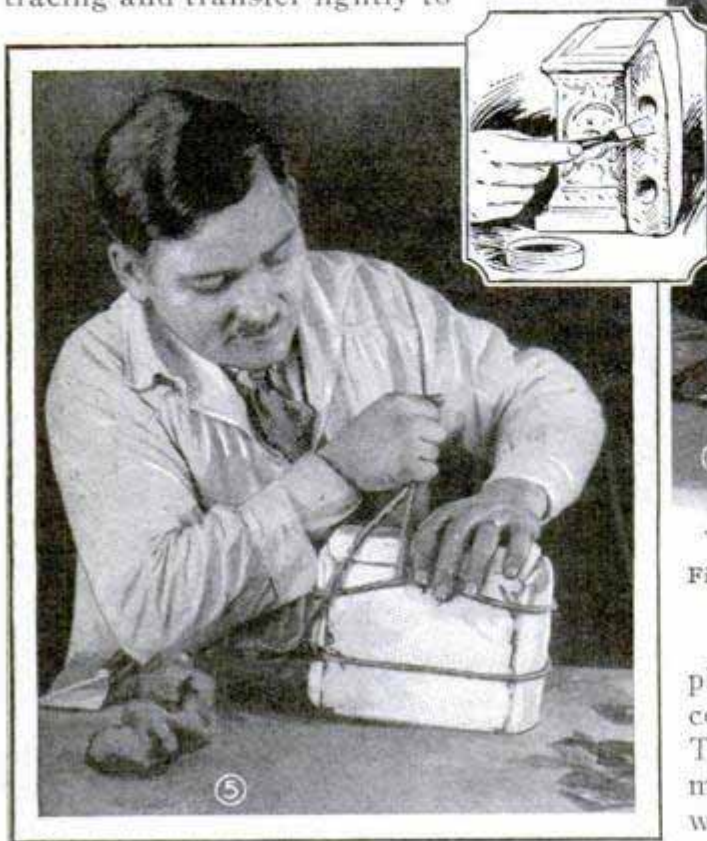

Fig. 4. Separating the Pieces of the Mold; Fig. 5. Tying Mold for Casting; Insert, Varnishing Mold Edges

your wax models. Then use these lines and, with your modeling tools and small pieces of soft wax, make them stand out in low relief. One way of heightening the relief effect without cutting into the model too deeply is to make the depression a little rougher than the higher parts. This catches and breaks up the light and gives a deeper shadow. You work carefully with the wax until it represents exactly the form you wish your finished work to have. Your model is then ready for the making of the mold.

The first thing to do in making a mold is to divide the wax model into several parts by making dividing walls with a very thin brass called "shim stock." This metal is carried by every automobile-repair shop. It is ordinarily used in the adjusting of connecting-rod bearings, etc. Cut this brass into small squares and make dividing walls by pushing the square about  $\frac{1}{4}$  in. into the wax model. The purpose of these dividing walls is to enable you to make your mold in several pieces so that it can be taken apart without destroying either the original wax model or the finished cast which you will pour into it later. Locate the walls as in Figs. 2 and 3.

Next, mix a small quantity of fine dental plaster of paris with water, until it is of the consistency of cream and free from lumps. Then cover one of the sections you have made by the metal dividing walls on your wax model with the wet plaster. A good way is to make a sort of screen with some newspapers around the three sides of your model and then, with a large spoon, throw the thin plaster against the model. This gives the plaster a chance to get into the details of your modeling. It is also helpful to blow hard against the plaster and drive it into every crack and hole. As the plaster hardens, keep adding to the thickness of the mold until it is about 1 in. thick. It should then be allowed to harden.

Now remove the brass pieces from the sides of the pieces of plaster mold, taking care not to injure the wax model. Carefully dig a few half-spherical holes into the edges of the plaster mold. Then, with a fine camel's-hair brush, give the edges of the piece of mold a coat of sandarac varnish. This varnish is obtainable from any dental-supply house, and will act as a separating medium between the different pieces of the completed mold. The varnish dries in five minutes and then, to assure greater ease in taking the pieces apart later, you may go over the varnished surface with a thin coat of melted butter. Now take the pieces of brass and build another wall, as shown in Fig. 3, so as to enable you to build up another side of the mold, and repeat the process until every

Chicago Dental Supply Co.  
240 N. Wabash



side of the wax model is covered except the bottom which rests upon the board or the glass. It is not necessary, of course, to form brass walls for the top piece, since the four sides of the mold serve as walls. Each of these sections should be put in with freshly mixed plaster, and the edge of each section should be varnished and greased before casting the next. The whole mold is now allowed to dry for fifteen minutes, after which it is opened.

To open the mold, carefully remove it piece by piece, beginning with the piece last completed. If you have done your work carefully and divided the mold right, it should come off without any appreciable damage to the wax model. The pieces can be carefully loosened with a putty knife; see Fig. 4. The mold is now cleaned carefully from any small pieces of clinging wax and then it is varnished on the inside with the sandarac varnish and greased with butter like the edges. The mold is then reassembled and tied together securely with a strong cord, as in Fig. 5, and it is then ready to be filled with the clover rock for the final cast.

This material comes in the form of a fine white powder. Measure out enough to fill your mold and to this add water to make a thin paste. Mix this thoroughly until it is entirely free from lumps. You may take your time about this work, as the clover rock will not set for about three-quarters of an hour. Turn your mold upside down and with your finger tips shake a small quantity of the paste into the bottom of the mold, as in Fig. 6. This work should be done slowly and deliberately, as the shaking prevents any air holes from forming and also gives a finer and harder surface to the finished cast.

When the mold is completely filled, let it set for three hours. At the end of this time, you should make the bottom of the cast smooth and square with a sharp knife. The cast is then allowed to set for a total of twenty-four hours. Do not try to force the setting by drying the cast, or by placing it in the sun; that would destroy the material. Let it set naturally in a cold, moist place. On the following day, the mold is opened. This is done by tapping it lightly all over the surface with a piece

of wood so as to loosen it completely from the cast. Then, taking it apart by removing it piece by piece, in the same manner as it was removed from the wax model, you can preserve the mold intact, and by applying another coat of the melted butter, it is ready to be filled again. In this way you can make a great number of book ends, depending upon the care with which you handle the mold.

In making a copy of an existing art object, the procedure may be slightly different. It is obvious that an object with a fine finish cannot be subjected to greasing and a direct contact with the plaster, although many commoner objects can. The best method is to make an impression in wax. The modeling wax repels water, since it is oily, and because of this a slight moistening of the surface of the object to be copied will prevent the wax from sticking and will give you a firm, clean impression. The main problem is to remove the wax from the object without pulling the impression out of shape. It is therefore best to arrange it so that it can be removed

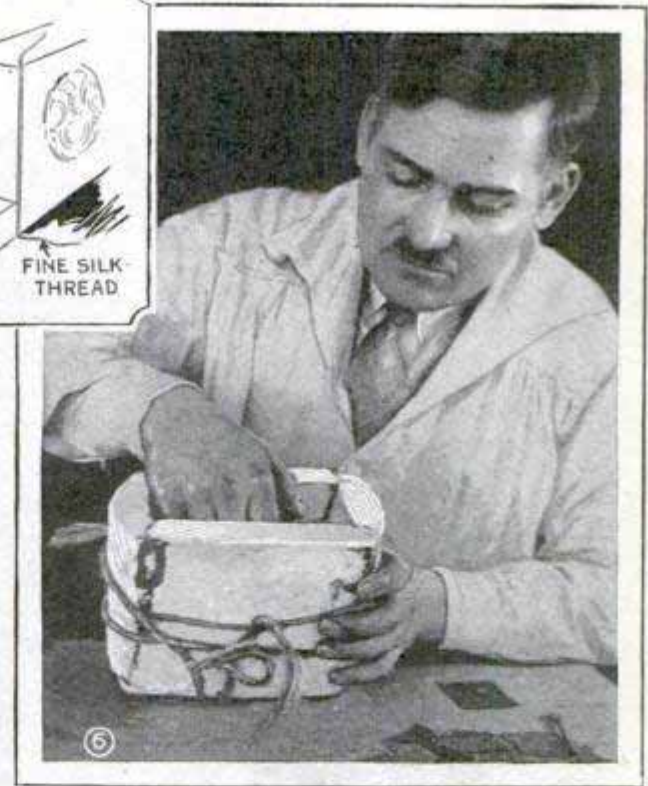

Shaking In the First Material; Insert Shows How Wax Is Separated When Taking Off Wax Mold

in comparatively small pieces and fitted together afterward. This is done in the following manner: Take some fine silk thread and, by moistening it, make it ad-



here to the surface of the object to be copied exactly along the lines where you will want the wax to separate. Then, after moistening the entire surface of the object to be copied, press the soft wax firmly against it until it is entirely covered. In placing the silk threads, you should leave the ends sticking out of the wax, as indicated above, Fig. 6, and, after the wax covers the model, you cut it in sections by pulling gently at both ends of the silk threads. The threads will cut the wax and allow it to be removed.

You now have a wax mold from which a clover-rock model can be made in the same manner as from a plaster mold. Only one cast should be taken from this wax mold as it is very hard to keep it in shape. For large objects, a wax mold should be given a backing by applying an outside casing of plaster of paris.

It is often desirable to use the first-finished cast as a master pattern for the making of new molds. In this way many more reproductions can be made. The master cast is varnished and greased as described for the molds. Fresh piece molds can then be continuously made in the same manner as from the wax model, with the exception of the substituting of a wall of model-

ing wax for the shim stock. This completes the directions for the making of simple molds, and having made finished casts of your book ends, we will now take up the matter of finishes.

Of course, no matter how carefully you prepare your molds, there will be fine hair-lines in the cast where the mold was joined. Carefully smooth these places with a sharp knife and a piece of fine sandpaper. If, by any chance, through lack of care and experience, your cast shows any small air holes, these can quickly be filled with some freshly dissolved clover rock and made smooth. A good way to do this is to make the mix very thin and apply it to the defective place with a small water-color brush. Your cast should now be a smooth velvet-white with a texture like a piece of Vermont marble. It can be used in this way, or finished to imitate bronze.

To give a fine imitation of bronze, purchase some dark-gold satin-finish bronze powder. Mix a small quantity with half shellac and half denatured alcohol and apply to your cast with a fine camel's-hair brush. You can now tone this finish with any colors you may desire, to imitate aged bronze, the principal shades being dark brown or dark and light greens. To a

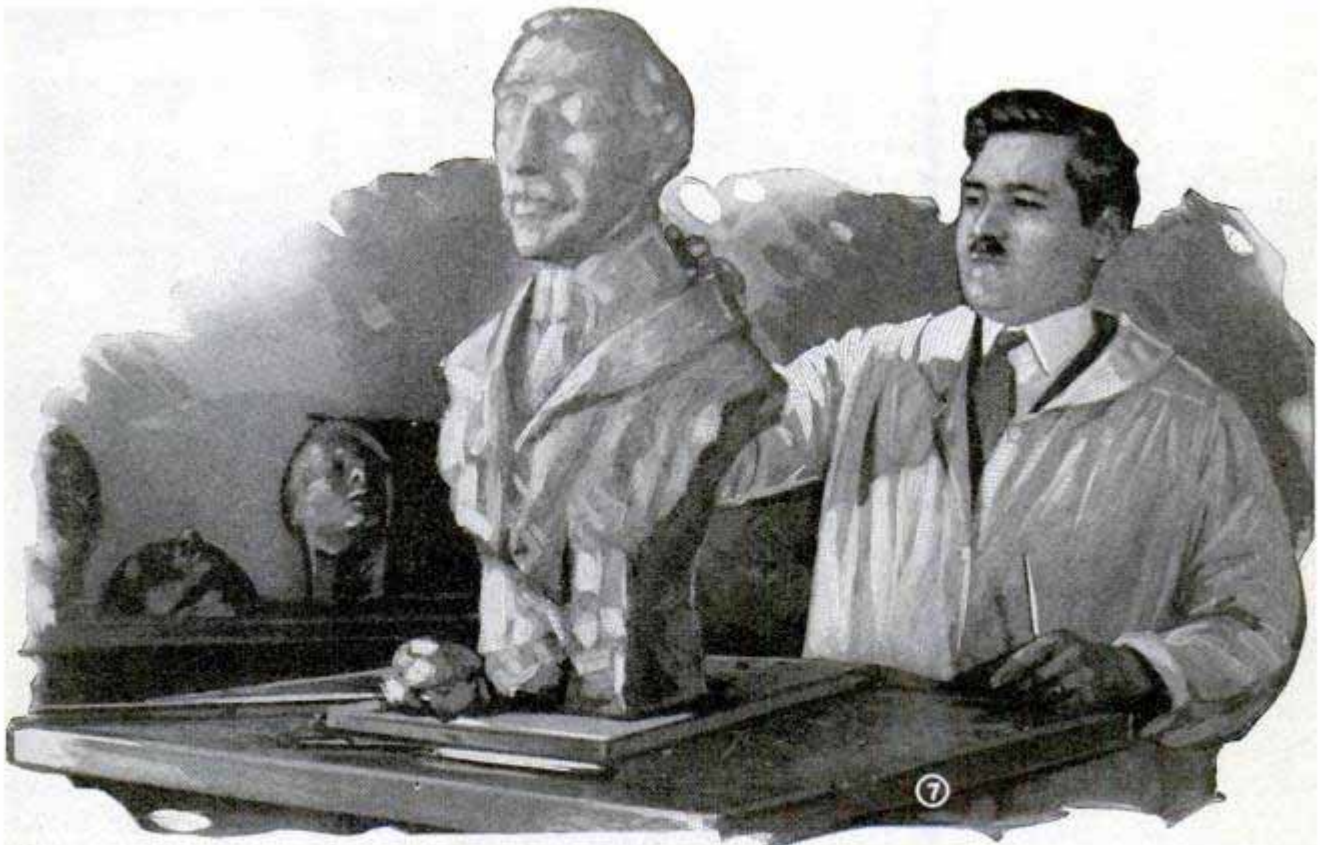

The Methods Described Here Are Exactly Those Used by the Sculptor in Making Plaster Copies of Fine Busts, Such as the One Shown Above



small quantity of turpentine add some dry color of the shade desired and give a very even wash over the metal-finished surface. Now let this dry, after which you can apply a very thin coat of ordinary floor wax. The wax should be rubbed on with your hands, which will cause some of the colored wash to be carried off the high places and the metal coating to show through. The finished effect will be that of aged bronze. If your design is architectural, like the book ends shown in the illustrations, you can heighten the effect by a touch of color in the depressions and the moldings. The shadings and finishes obtained in this manner are only dependent upon your ingenuity in coloring. A little cleverness and patience will give you a product that will have all the appearance and wearing qualities of a real bronze.

The final step is to glue a piece of felt to the bottom and back of your book ends. This will save your furniture from being scratched. You can now pride yourself upon having made an original contribution to usefulness and to art. The experience gained will enable you to give your home those touches of artistic individuality which create an atmosphere that is the distinctive result of the efforts of your own genius.

### Link Makes Trap Safe

Many trappers of wild game have suffered the unpleasant experience of having one or more fingers nipped while setting or baiting steel traps. A safety device used by a Wisconsin trapper to avoid such accidents is shown in the illustration. A sliding link, made of stout steel wire, is slipped over the chain so that it may be drawn down over the compressed spring where it will prevent the jaws from closing accidentally while the bait pan is being adjusted or baited. After the trap has been set and placed in the desired position, the link is slid back.—G. E. Hendrickson, Argyle, Wis.

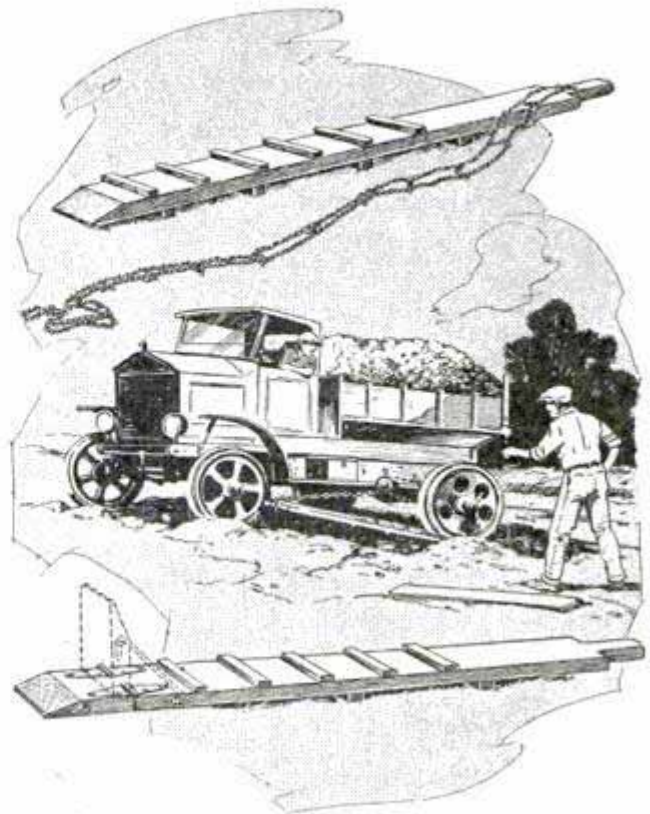

Cleated Boards Effectively Help the Truck Driver Out of a Mud Hole

### Getting the Truck Out of a Mud Hole

Much time and energy are wasted by motorists in trying to remove automobiles and trucks from mud holes or ruts, especially when the automobile or truck carries a heavy load. One truck operator found that this can easily be done by means of two cleated boards of suitable length and width, as shown, placed at the foot of each rear wheel. The other end of the board is raised to about the same height as the rear axle, and a chain tied to the raised end and the rear axle. The board should be forced under the front part of the rear wheel to get the necessary traction. When the roads are exceedingly muddy, a second type of board, as shown below, which has a hinged piece to prevent the wheel from slipping off again after it is once on, will be found more serviceable. The boards can be conveniently carried on the running boards.—A. Bereskin, Winnipeg, Can.

☞ An excellent method of closing a crack in a wall before papering is to paste a thin strip of linen over the crack. This not only makes a smooth job, but prevents the paper from being torn if the crack should widen.



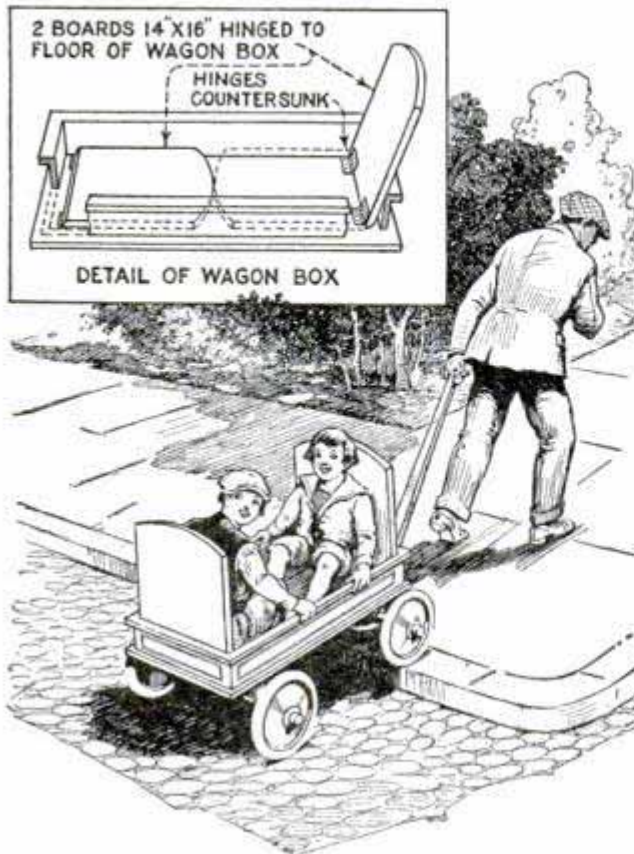

Backrests on Coaster Wagon Prevent Children from Falling Out Easily

### Backrests for Coaster Wagon

When giving small children a ride in a coaster wagon, they sometimes find it hard to maintain their balance and the provision of simple boards to serve as backrests will be of considerable aid. These may be attached permanently to the coaster, in such a way that they will not interfere with the use of the wagon for other purposes. They are hinged to the bottom, as shown in the detail, and can be folded to lie on the bottom when not in use.—Harry C. Jackson, Chicago, Ill.

### Magnetic Suspension Pendulum

When a pendulum is not periodically supplied with energy its amplitude grows smaller and finally the motion ceases, due to the resistance of the air and the friction at the point of suspension. Usually the suspension is in the form of a knife-edge bearing against plates of agate. Sometimes the pendulum rod is simply attached to a very slender and flexible spring without any bearings. But the minimum of friction is obtained by means of magnetic suspension, as the following experiment will prove. If the rod of a pendulum about

12 in. long, beating half seconds, is sharpened to a needle point and suspended from one of the poles of a magnet, it will be found that, if set into motion, it will continue to swing fifteen times as long as the ordinary knife-edge suspended pendulum, and it will not stop until after about 16 hours, while one working on agate plates will stop in from 50 to 60 minutes. Similarly a top, provided with a fine-pointed axis of iron, will spin much longer when suspended from a magnet. Magnetic suspension is used in precision instruments; for example, the small mirrors which are used in certain telegraph systems to register writing photographically.

### Anchoring Decoys

One of the problems of the duck hunter is the anchoring of his decoys. Rocks can be used for this purpose but it will be found much more convenient to use one of the anchors shown in the illustration. A discarded auto-wheel hub can be used by running a long eyebolt through the bearing and fastening it with a nut on the bottom. Sash weights also make good

anchors, but owe their holding power more to weight than shape. A short length of twisted wire cable, turned into an eye at one end and with a few strands at the other untwisted and bent up as flukes, makes a very good anchor. Small

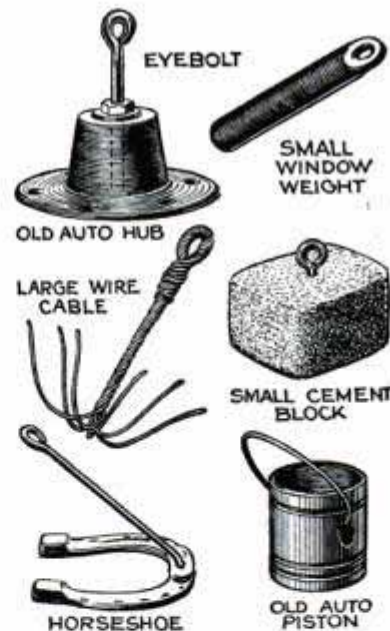

concrete blocks are good weights and can be quickly and easily made. Dig several small, square holes in clay ground and place an eyebolt in each. Then pour in concrete and let it harden for a week or more. Horseshoes with a long eyebolt clamped angularly to each and old automobile pistons with a wire bail also are serviceable anchors.



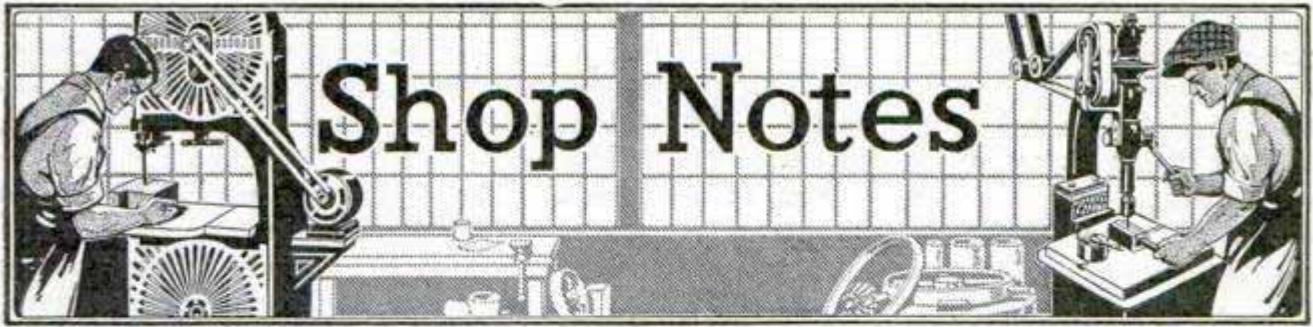

All Shop Notes published in 1926, in book form—Fifty Cents—from our Book Department

## How to Refinish Old Soft-Wood Floors

By C. M. OWENS

**O**LD floors that are worn or have been painted can readily be refinished by anyone who carefully follows the instructions contained in this article. First of all, see that the surface of the floor is clean, free from wax, polish, grease or dirt, and is thoroughly dry. If there is wax or polish on the floor, the best method of removing it is to use benzine or gasoline. Washing the floor with water and strong soap will also help considerably. However, be sure to rinse it well, for soap water is as harmful as wax or grease in preventing the paint or varnish from drying.

Then give the floor a coat of ground color. This can be purchased at any paint store or can be made by mixing white lead

with turpentine and a small amount of japan drier.

In order to obtain the proper color, add 1 lb. of yellow ocher to 10 lb. of white lead, using about  $\frac{1}{2}$  gal. of turpentine for this amount of lead. It should be about as thick as cream after it is thoroughly mixed. Strain it through a piece of cheesecloth or fine screen wire. If the wood has no paint or finish on it, apply one coat and let it dry for about 24 hours.

If there are cracks to be filled, this must be done after the first coat of ground color

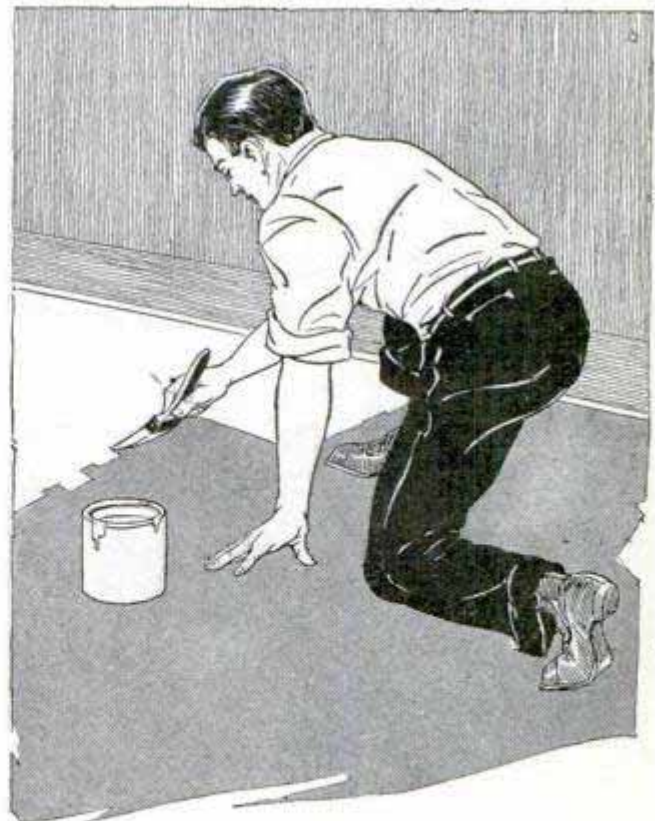

Left, Cleaning Off Dirt, Wax and Grease from an Old Floor with Benzine; Right, Applying the Ground Color on the Cleaned Floor



is applied and is thoroughly dry. Never put crack filler or putty on bare wood, as the dry wood will draw the oil out of the filler and leave only the dry pigment, which will shrink and come out. There are several crack fillers that can be bought at the paint stores, but a good one can be made by mixing white lead and putty, equal parts, and adding whiting to make it thick enough to use with a putty knife. Force it into the cracks and wipe the surplus off on the edge of the boards. Let the filler dry four or five hours before applying the second coat of color. This coat should be allowed to dry longer than the first coat, for if one coat of any kind of paint or varnish is applied over another coat before it is dry, the lower coat, upon drying, will cause the top coat to crack or "alligator." If the floor has paint or varnish on it and you do not wish to remove it, clean it thoroughly as explained above. If there are worn or bare places, give them a coat of the ground color, let it dry, fill the cracks and then apply a coat of ground color over the entire floor. If you get a uniform coat on with the one coat, that is all that

is necessary, but if this is not the case, apply a second coat.

The graining color can also be purchased, but only in one color—light oak. However, you can make it yourself in any shade. The colors are sold in powdered form and the pigments used to imitate different kinds of wood are as follows: Light oak, raw sienna; dark oak, burnt umber; walnut, Van Dyke brown or burnt umber and drop black; light mahogany, rose lake; dark mahogany, rose lake and drop black; cherry or redwood, burnt sienna and raw sienna.

You should use 1 lb. of dry color to each  $\frac{1}{2}$  gal. of any kind of ordinary vinegar to make a graining color or compound. The thinner the liquid is, the lighter the color of the finish will be, and so you can add as much vinegar as you want until the desired shade is obtained. Put the powder into a pail, add a small amount of vinegar at first to make a sort of paste, which will facilitate mixing the powder with the rest of the vinegar. When the color is wet, it is about the shade it will be when the varnish is applied over it.

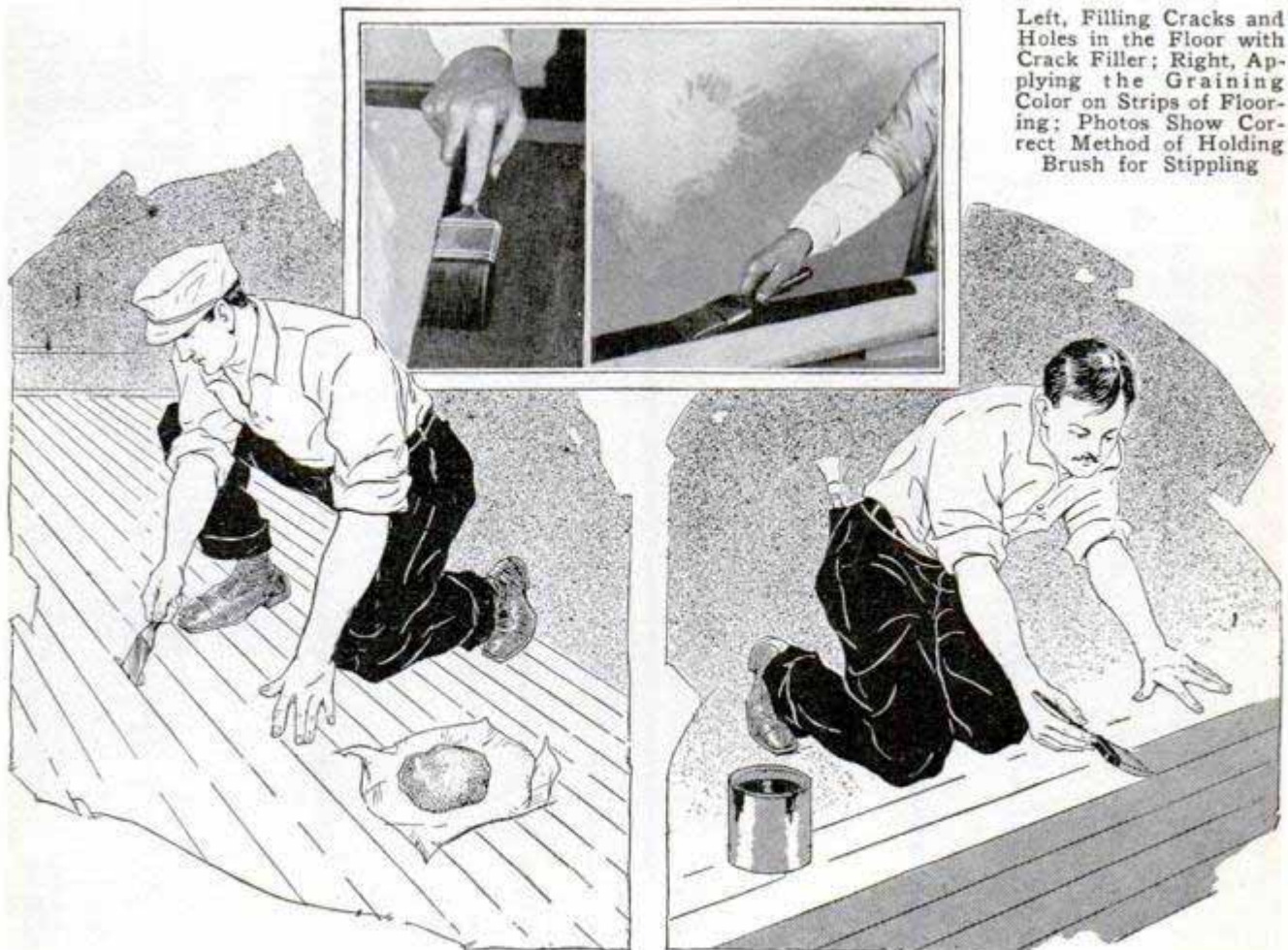

Left, Filling Cracks and Holes in the Floor with Crack Filler; Right, Applying the Graining Color on Strips of Flooring; Photos Show Correct Method of Holding Brush for Stippling



When applying the graining

boards. If you are not satisfied after you have done some of the flooring, wash it off with water and try again. This can only be done before the varnish is applied. It is a good idea to first practice on some boards or a small floor.

After the graining color has dried, which only takes a few minutes, it is ready for a coat of varnish. You must be careful not to mar

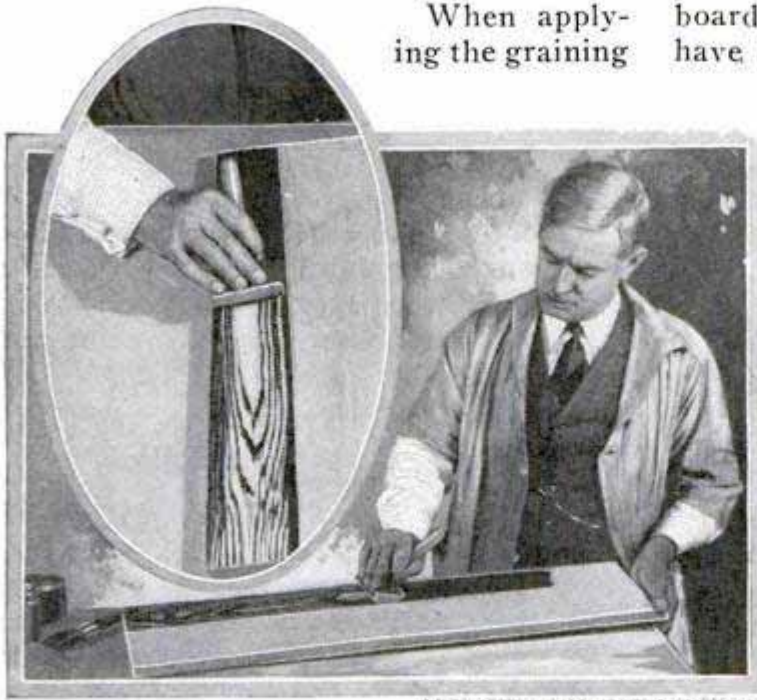

Upper Left, How the Roller Is Used to Imitate Natural Wood; Right, Drawing a Line Lengthwise over Center of Wide Floor Boards Produces Effect of Narrow Flooring

compound, it is better for two persons to do the work, for one can do the painting while the other does the stippling or graining. Only paint two or three boards, the full length of the room, at a time, as the graining compound dries quickly. Brush it out very thin, for if too much is applied on the surface, it cannot be stippled. After you have done about 3 or 4 ft., use a long-bristle brush to do the stippling. There is a brush made for this purpose, called a walnut stippler, but any long-bristle brush, as an ordinary calcimine brush, can be used for the purpose. The stippling is done by tapping the wet graining color with the flat side of the brush, always pushing it away from you. Try to use the same force in tapping and also the same amount of tapping all the time, for if you tap more in some places than in others the former places will be lighter. After you have done the entire length of the painted boards, take a damp cloth or sponge and make a clean edge along the boards you have just finished. When applying the color to the next stretch you must only come up to this edge or there will be a "lap," that will show up plainly when the varnish is applied. Also be careful, when stippling the remainder, not to get over on the dried

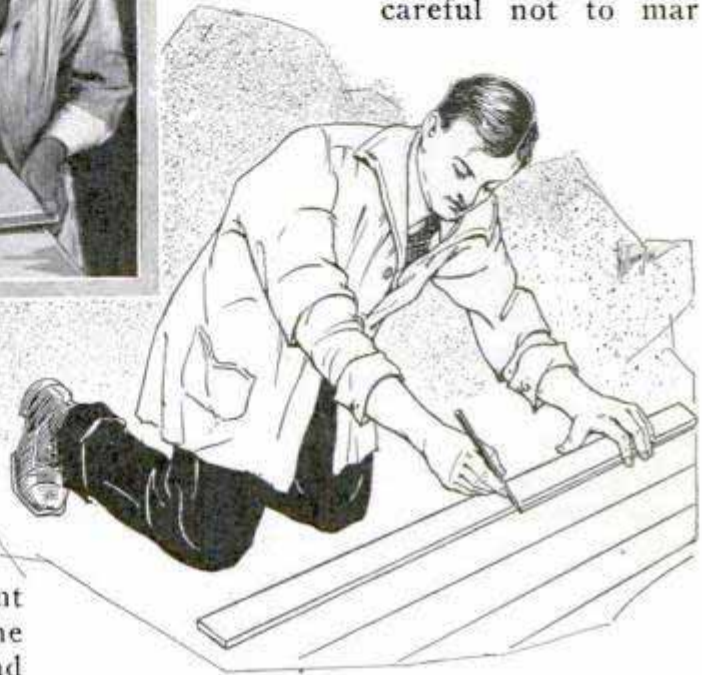

this coat. You can walk on it, but it is well to take off your shoes, or pull an old pair of heavy socks over them, if you do so. If the floor consists of wide boards, you can make a wonderful improvement by taking a carpenter's lead pencil and drawing a line lengthwise down the center of each board before applying the varnish, as this will give the appearance of narrow oak flooring to some extent. Now give the floor a coat of floor varnish, let it dry for 48 hours and then apply another coat. The second coat adds to the wearing quality, for as soon as you wear through the varnish, the graining color will begin to be scuffed off. Remember that you have to apply an additional coat of varnish occasionally, to replace that which wears off. With a little practice, you will be able to make a very nice finish, not only on your floors but also on other woodwork and furniture. This stippled finish is exactly the same as that often seen on the interior of railroad coaches and street cars, on cash registers, elevators, lockers, etc.



There is another effect to be had with the same materials. It is called graining, and the object is to imitate the natural wood. This is often thought to be a job for only the professional painter, but there

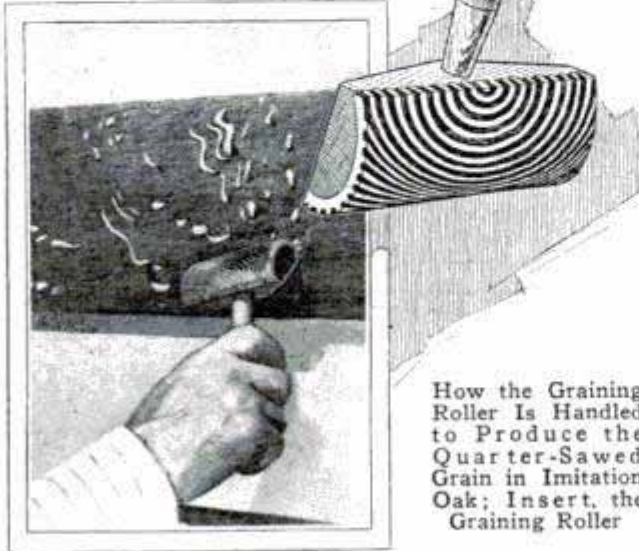

is a tool on the market called the graining roller, which anyone can handle, and which gives good results in the hands of the amateur. You can produce a grained effect by merely drawing this roller over the graining color while it is wet, in the manner shown in the illustrations, and it will make a good imitation of natural wood. The same method of preparing the surface and finishing is used as in the stippled work, only the roller is used instead of the stippler. A coat of good prepared floor wax, applied every few weeks to the varnished floor, will add to its wear considerably. A good method of applying the wax is to use a piece of muslin, not too thin and about 18 in. square. Put about  $\frac{1}{2}$  lb. of wax in the center, gather up the corners and tie a string around it forming a ball of wax. Rub this over the surface and you will find that the wax will seep out in just the right amount, for you must not put it on too thick. After it has dried for about half an hour, polish it with a brush or a woolen rag. If the wax in the ball gets hard when not in use, put it in a warm place for a few minutes.

If you do not care to use the methods described above, there is still another way of finishing floors. If you have a dark floor and want to make it lighter, apply the ground color as directed, then give a coat of varnish stain, which can be pur-

chased at any paint or hardware store. When dry, apply a coat of floor varnish. Another method is the application of ordinary floor paint, which can be had in almost any color. A great many of the floor paints are made with varnish, which is much better than ordinary paint. One or two coats of a good floor paint will make a great difference in an old floor. You can varnish and wax over floor paint just as over any other varnished finish.

### Steam Trap for a Boiler

Many years ago, before molded-lead traps came into general use, plumbers made sheet-lead box traps for use on waste pipes from baths, sinks, etc. I used the same method with success as a trap to prevent steam from entering the hollow copper spring of a pressure gauge on a steam boiler. It is much easier to make a box trap than it is to make the bent-pipe traps often used. The illustration shows how it is constructed. It consists of a  $1\frac{1}{2}$ -in. pipe nipple, 4 in. long, fitted with a cap at each end. The caps are drilled and tapped for lengths of  $\frac{1}{4}$  or  $\frac{3}{8}$ -in. pipe, which are installed as shown, the top one connecting with the pressure gauge and the other to the water column, or elsewhere, as desired. Steam coming in through the lower pipe into the chamber forces water up the top pipe. A box trap can be cleaned much more easily than one made of bent pipe.—James E. Noble, Toronto, Can.

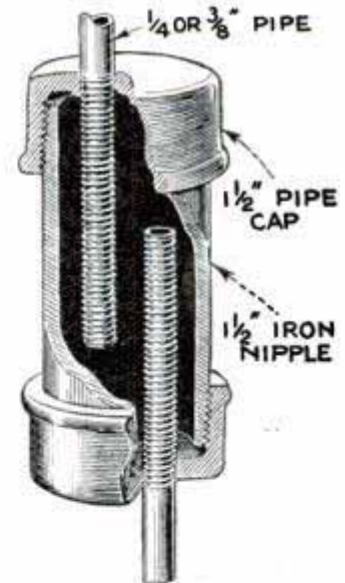

### Depth Cutting in a Lathe

There are numerous other methods of cutting to a certain depth in the lathe than that of using a depth gauge. The gauge process of finding the proper depth requires cutting and trying several times before the result is obtained. Sometimes the compound rest is set at an angle of



30° for thread cutting, and is left in that position, unless some other angle is required. Where the compound rest is graduated on the lathe, the depth can be obtained by simply multiplying the required depth by 2. The sine of 30° being .5, the compound rest would have to move 1 in. in order to make the tool move in ½ in. Take for a more comprehensive illustration an equilateral triangle, the sides of which are 1 in. long, the angle being 60°. One-half of this would be 30°, hypotenuse 1 in. and the opposite side ½ in. The hypotenuse represents the center line of the compound rest. Another method is to set the compound rest at zero (any angle) and run the carriage up until the tool just touches the work, lock the carriage and run the compound rest out until you can "feel" with a piece of cold-rolled steel of the required size. Then unlock the carriage and run it up until it touches and locks again. Feed the compound rest in toward the zero point and note the revolutions.

Still another method is to clamp a piece of stock with the square end on the lathe, where it will come against a clean, smooth surface of the carriage, put a piece the right size between them, lock the carriage and feed the compound rest up until it touches. Take out the piece and run the carriage to the stop. These methods have been used with success and have been found handy and simple.—John Home-wood, Chicago, Ill.

☞The word "diameter" when applied to gears is always understood to mean the pitch diameter.

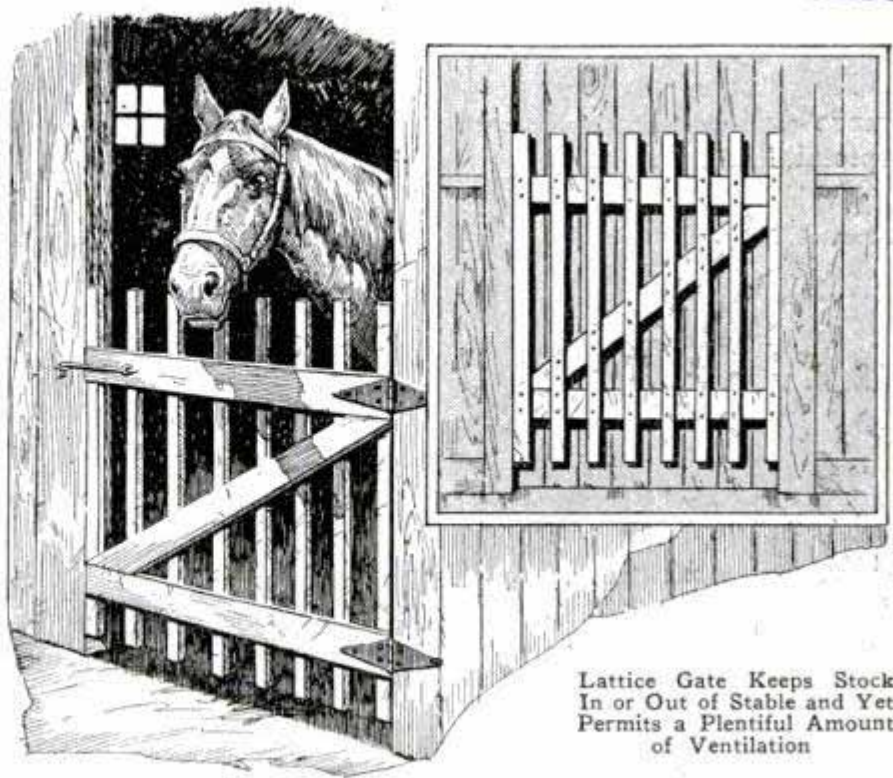

Lattice Gate Keeps Stock In or Out of Stable and Yet Permits a Plentiful Amount of Ventilation

### Lattice Gate for Stock Door

The drawing shows how an ordinary lattice gate, hinged to one edge of the stock door, will permit ventilation on hot days and yet keep the stock either in or out. The gate is made of 1 by 4-in. pieces for the horizontal members and also for the diagonal brace, and the vertical strips are 1½ in. wide and ½ in. thick.—Dale R. Van Horn, Walton, Nebr.

### Quick Method of Moistening Envelopes



Quick and Easy Method of Moistening and Sealing a Large Number of Envelopes

Many small firms who send out a large amount of mail will appreciate the quick method of moistening envelopes shown in the illustration. Lay all the envelopes, face down, with the flaps thrown back, one envelope overlapping the next as shown. Then take a lath or yardstick and use this to hold the envelopes down securely while running a moist brush over the gummed sections. It is then easy to seal the envelopes.



**Platform for Wood Trimmings**

Every sawmill or planer mill produces more or less trimmings, and these make splendid fuel for cookstoves and fireplaces.

the illustration. It is 5 ft. high and has two sides to prevent the wood from falling off. A runway leads to it from the trim saws so that wheelbarrows can be rolled up on the platform. The wagons are

Elevated Platform Where Wood Cuttings of Planer Mill Are Dumped and Raked into Wagons with Little Waste of Time and Effort

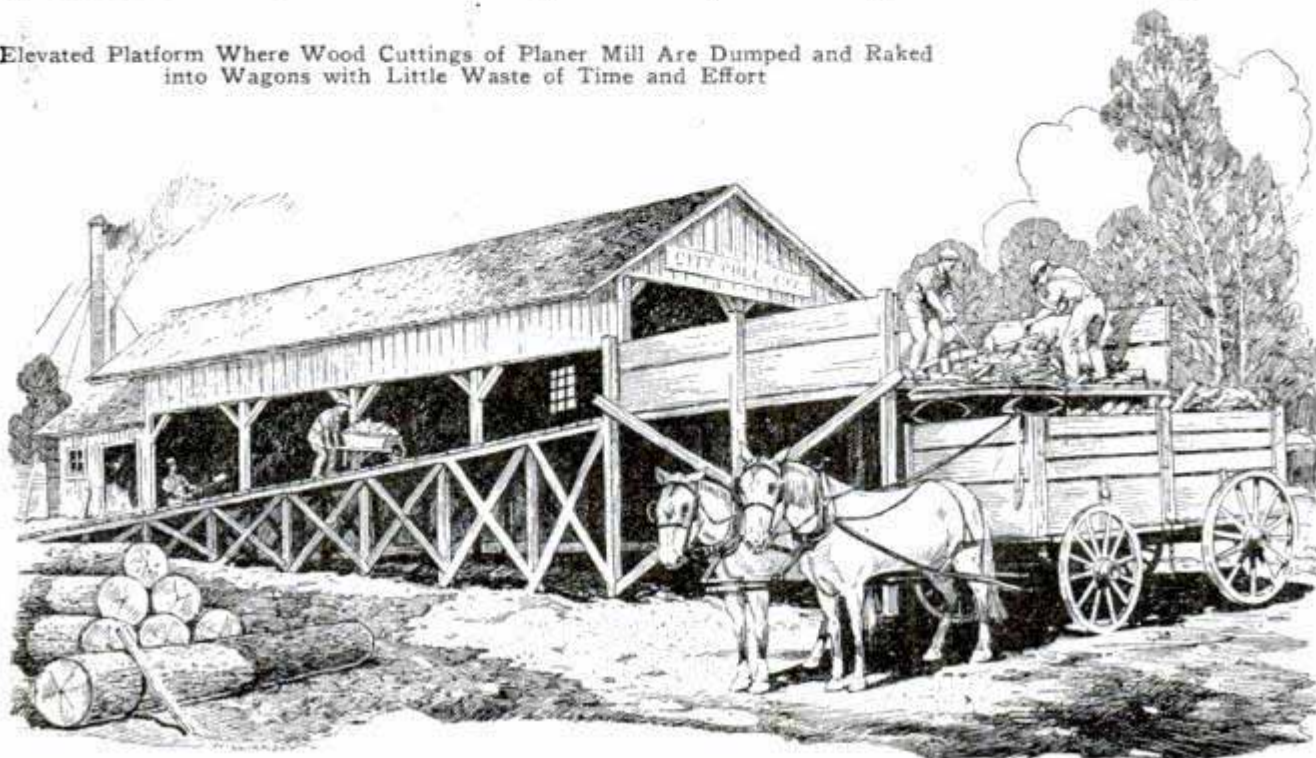

Most mills sell this by-product, but loading it into wagons for distribution is tedious and slow. To speed this work, one mill arranged a loading platform as shown in

driven under the open end of the platform, and a raker is used to push the wood into the wagon, which takes very little time and effort.—L. M. Jordan, Vredenburgh, Ala.

**Improving the Miter Box**

For over fifty years I have been making miter boxes in the usual way and have been annoyed at their getting out of true due to the sides warping or a piece splitting off, which makes the boxes useless. It occurred to me to make the sides with the grain of the wood vertical instead of horizontal. Such a box was made from cuttings of flooring and has remained in perfect condition for a long time. Also, it was usual to make the miter cuts opposite each other near one

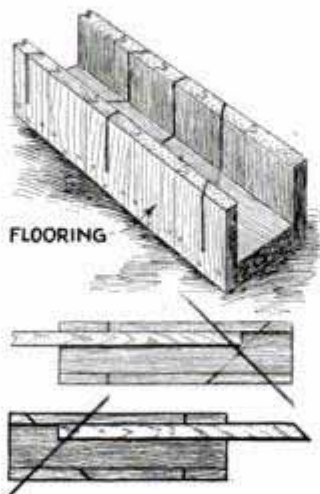

end, and the square cut near the other end, as in the lower view. This involved reversing the box for cutting the two ends of the same stick. In the improved box, shown in the upper drawing, I made one miter cut in each end so that the box is right for all cuts without reversing, and the square cut was placed in the center.—G. M. Beerbower, Hollywood, Fla.

**Threshing Wet Oats**

When trying to thresh a field of oats that had stood in mud for about two months of continual rain and fog, trouble was experienced, as the wet straw would clog up the separator and cause delay. The difficulty was overcome by sawing off the heads of wet bundles of oats with a buzz saw located near the separator. The cut-off heads were then thrown into the separator and the wet, rotted butts were thrown on a near-by pile.



**"Killing" Alkali Spots in Plaster Walls**

It is discouraging to the amateur painter, when working on plastered walls, to find spots that bleach out. This has driven many to papering when painting would otherwise be the best procedure. The condition can be overcome in the following way: Go to a drug store and get 1/2 oz. of phenolphthalein. Put this substance in about 4 oz. of alcohol, either wood or grain. Shake the mixture well and, when dissolved, put about 20 or 30 drops in a gallon of glue size or water; it does not make any difference which of these two is used. Now coat the wall with the mixture. If there are any bad alkali spots in the wall, they will turn red under this application. Next, prepare a mixture consisting of 1 pt. of acetic acid and 4 pt. of water. When mixed, apply this to the spots, and if one application does not kill them, go over them again.

**Non-Clogging Hay Rake**

The average automatic-trip hay rake often clogs up with hay at the wheel hubs, fouling the cogs and ratchets and causing the teeth to trip unexpectedly. The photo shows a simple remedy. Two sheet-iron disks are fitted over the hub axle, and are fastened to the spokes with wire, threaded through holes punched in the disks.

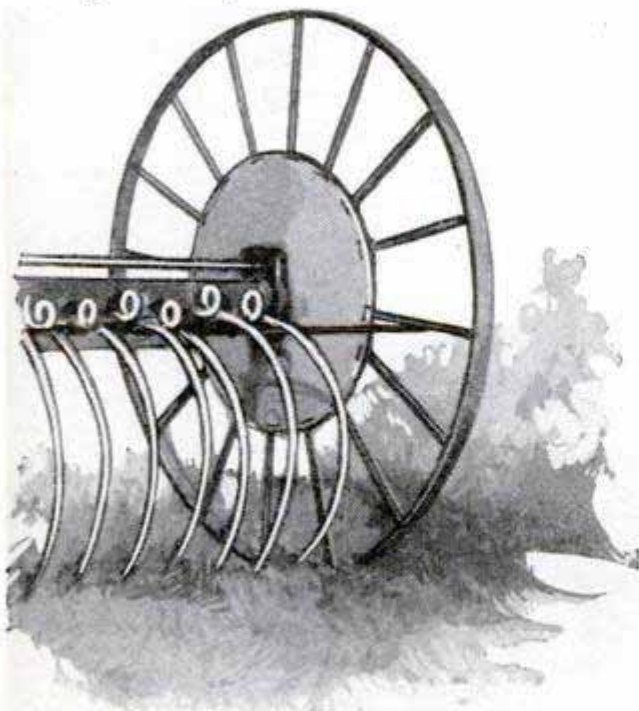

Disks Prevent the Wheel Hubs of the Automatic-Trip Hay Rake from Clogging

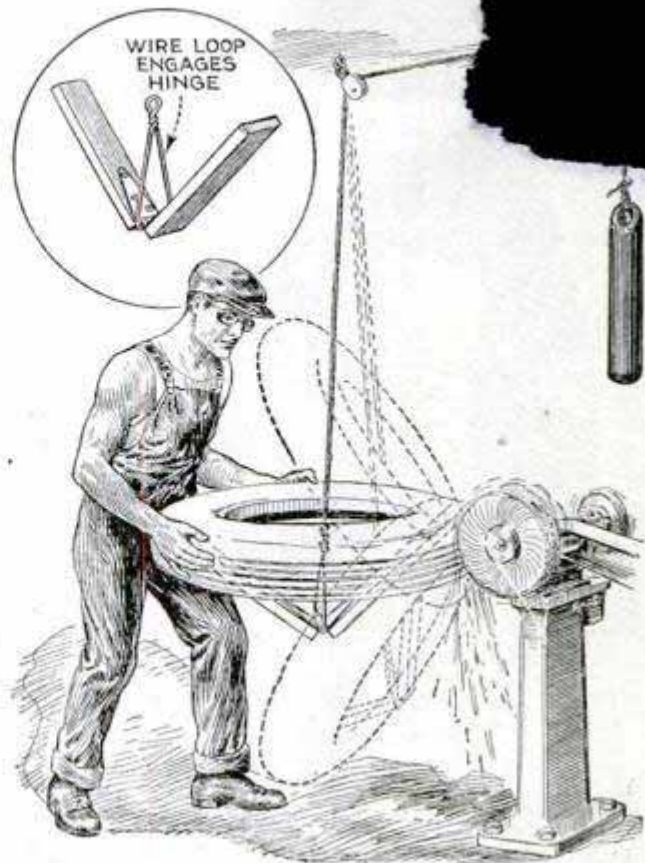

Handy Support for Holding Heavy Tires against Buffing Wheel Eliminates Unnecessary Work

**Support for Buffing Heavy Tires**

In vulcanizing shops where many large heavy tires are repaired, the labor of buffing and cleaning the damaged fabric is extremely difficult, as each tire not only must be supported at several different angles against the buffing wheel but must often be held in one position for a considerable length of time. To simplify the task, a Wisconsin repairman devised an adjustable support which accommodates itself instantly to any-size tire. The clamp that holds the tire is made from two short pieces of 2 by 4-in. material, hinged to open one way only, and this is suspended, as shown, from a pulley in the ceiling by means of a counterbalanced rope. In operation, the clamp is drawn down to the floor and the hinged clamp partly closed so that the ends of the legs may be inserted into the tire. When the rope is released, the counterweight draws the clamp upward, opening the hinge so that the tire is held firmly, and may be easily supported at any height desired. Thus the operator is free to direct his entire energy and attention to the buffing and cleaning without undue fatigue.—G. E. Hendrickson, Argyle, Wis.



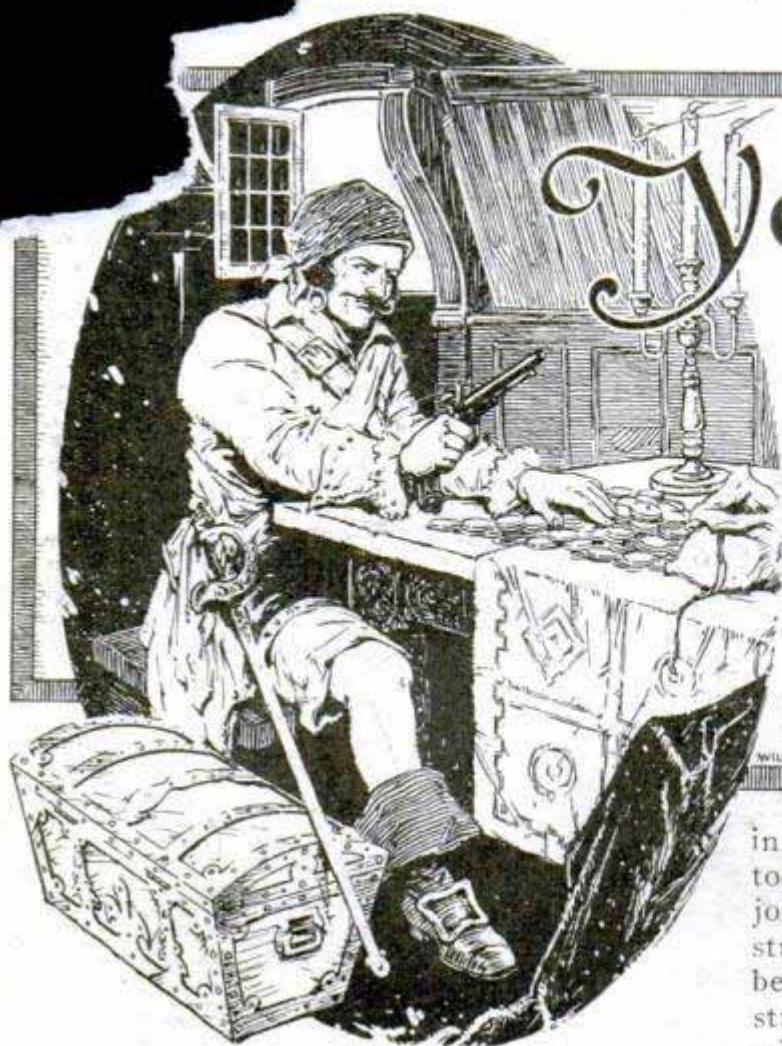

# You Can Make This PIRATE CHEST

By Edwin M. Love

SHIP models on mantels and in wall niches suggest pirate chests as companion pieces—weathered treasure boxes strengthened by well-riveted straps and ornate hinges of iron. Such a chest, today, would cost the purchaser a sum almost rivaling the fortunes guarded by the strongboxes of old, and to make one would tax the ability of an expert. However, with linoleum for “iron,” upholsterers’ tacks for “rivets,” and a few carpenters’ tools, the home mechanic can build a chest in the most approved pirate manner, as a glance at the photographs shows. The materials required are listed at the end of this article. The linoleum may be scraps obtained from the nearest furniture dealer.

Since the corner straps hide the joints, poor joints

in the wood are concealed. The arched top, instead of being formed with well-joined strips, is simplified to four straight boards nailed on with spaces between, into which wedge-shaped strips are glued. It is difficult to get wide enough stock for the parts to be made of a single width, so it is necessary to glue up. From each of the two 10-in. and 8-in. boards cut two 4-ft. lengths and one 2-ft. piece. Group these in pairs of a wide and narrow board, marking crosses on the faces with a pencil to identify the mates and the face sides. The old tradition among workers is to alternate heart and sap sides to provide for warping in opposite directions, that is, toward the sap side, thus preserving a flatter surface, but modern methods of milling and seasoning

leave an open question as to whether the sap side contains more moisture than the heart. A good rule is to match the better surfaces.

The edges to be glued are jointed straight. They need not be square, provided the bevel on each matches the other, to make a

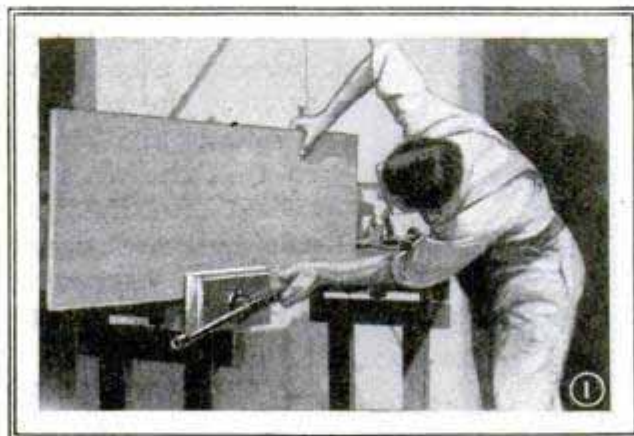

Jointing the Edges of the Stock for the Sides of the Pirate Chest



flat surface when one board is fitted on the other. Press first one end, as in Fig. 1, and then the other, looking at the far end to detect any opening that would indicate a high spot between. Then take out a "shrinkage shaving" from each, beginning and ending about 3 in. from the ends. The clamps will close the middle, and the extra compression of the ends will

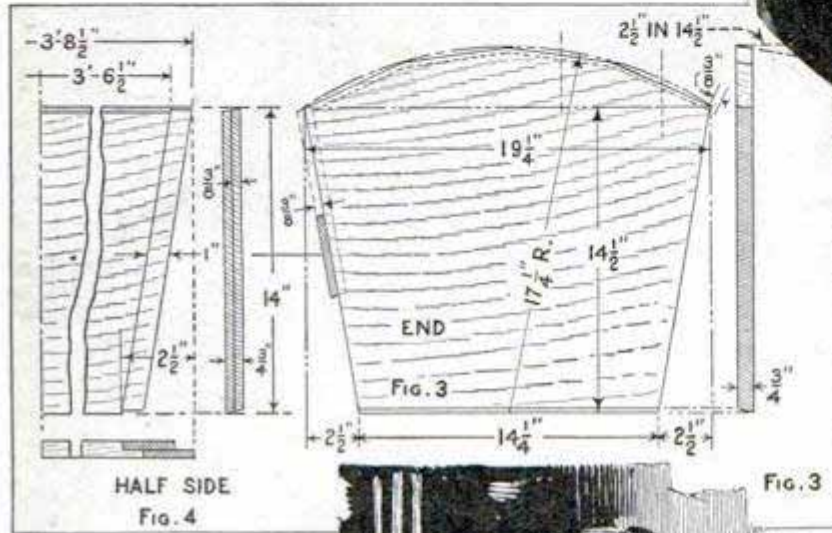

compensate for rapid shrinking of the ends because of ready evaporation from the open pores. Fold the boards together with faces out, and square across both at the center and 6 in. from the ends,



Fig. 2, Squaring across the Ends; Figs. 5 and 6, Cutting the Rabbits on the Endpieces

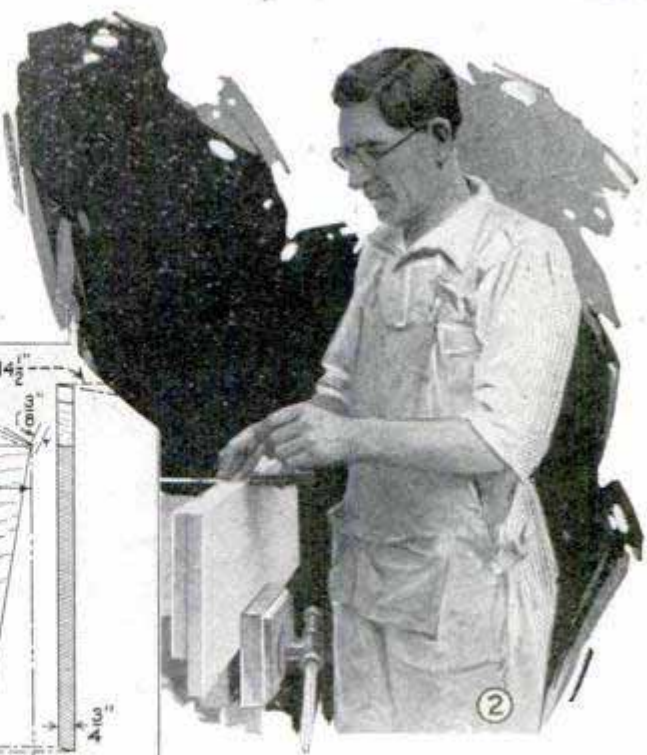

as in Fig. 2. With a marking gauge set for  $\frac{3}{8}$  in., and working from the faces, scratch through each line, centering the  $\frac{3}{8}$ -in. dowel holes, which are bored to a depth of  $1\frac{1}{4}$  in.

Cut the dowel pins  $2\frac{1}{4}$  in. long. The extra length of the holes provides space for surplus glue, which otherwise either would prevent the joint from closing, or would split the boards. Apply glue to all joining surfaces, and clamp up. If using hot glue, warm the wood and work rapidly; but if liquid glue is used, allow it to soak into the wood for two or three minutes, and apply more where

none remains. Many poor joints with liquid glue result from so much glue sinking into the wood that none is left between the pieces to unite them. Two dowels are enough for the endpieces. The stock thus





Fig. 7. Marking off Bottom; Fig. 8, Fitting Lining in Ends.



Fig. 9 Starting Cut for Lid; Fig. 10, Detail of the Corner Joint

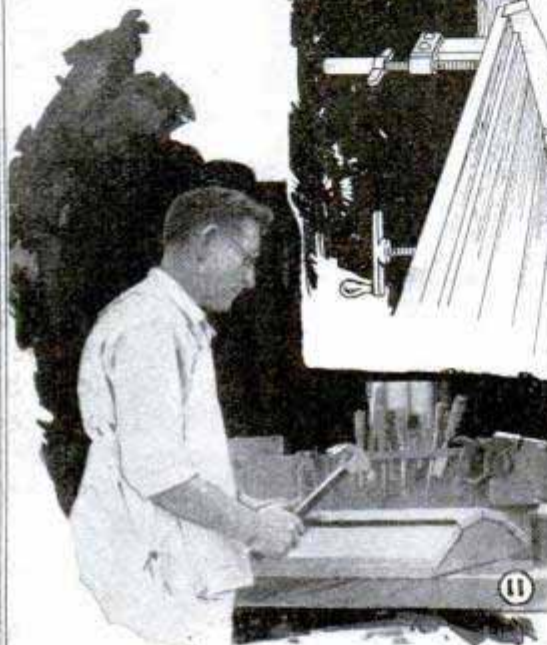
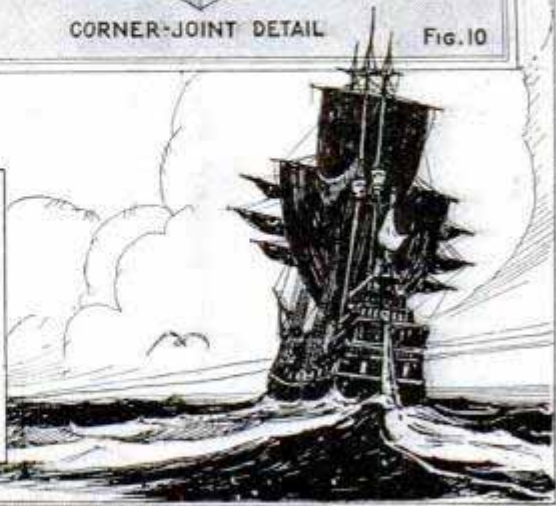
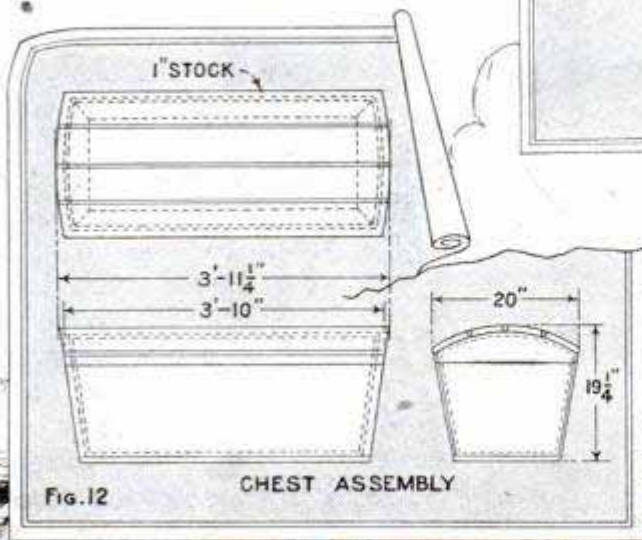
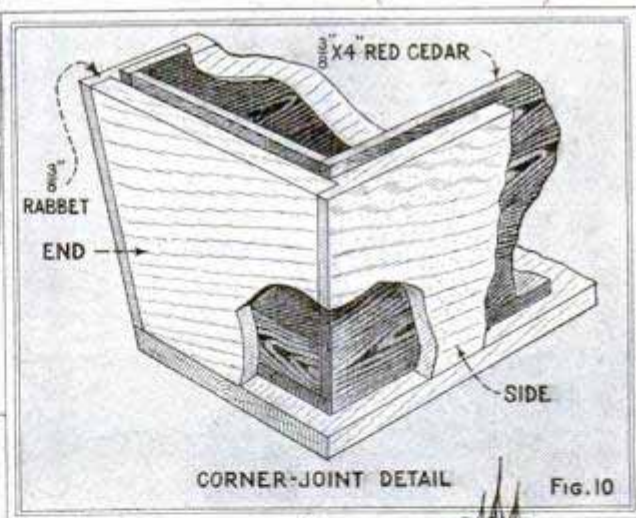

Fig. 11, Driving the Glued Strips between the Boards Forming the Top of the Chest; Fig. 12, Assembly



WILLIAMS



obtained is roughly 17 in. in width, so that narrow additional pieces must be glued to the lower edges of them to allow for the curve.

Fig. 3 illustrates an endpiece. Straighten one edge, square a line across the center of the outer face, and from a point  $7\frac{1}{8}$  in. to the right, on the lower edge, to a point  $15\frac{1}{2}$  in. above and  $9\frac{5}{8}$  in. from the center, draw a line. In the same way lay out the other end. Set a bevel square to the obtuse angle indicated and bevel the lower edge to fit. With the base of the center line as a pivot and a radius of 1 ft.  $5\frac{1}{4}$  in., describe an arc extending  $\frac{3}{8}$  in. beyond each end line, and divide it into four equal parts, across which chords are drawn. Saw out the end, set the bevel for the acute angle, and, holding the handle parallel to the center line for tests, bevel the chords toward the inner face. Trace the other

width by comparison with the endpieces. On the inner face gauge lines 1 in. from the ends, and on the ends,  $\frac{3}{8}$  in. from the outer faces. Saw the shoulders of the rabbets, guiding by a strip of wood tacked along the mark, as in Fig 5. Remove the waste and trim to depth with a chisel, as shown in Fig. 6. Lay out the second piece from the first.

Tack the ends to the sides, and set them on the bottom. Square, and trace around the inside with a pencil, as in Fig. 7. Guiding on this line, nail on the cedar bottom lining, toenailing through the tongue every 6 or 8 in. with four-penny finish nails, sloped enough to prevent the points from coming through the bottom. Then scrape and sandpaper the lining.

Line the sides with cedar, cutting the ends flush with the rabbets. Start  $\frac{3}{8}$  in. from the bottom with a strip of such width that the last board will be 2 in. from the upper edge. Again assemble temporarily with the ends, and nail the bottom to the sides, driving the nails at various angles to increase their grip. Then, piece by piece, fit the cedar strips in the ends, as shown in Fig. 8, bringing them to the height of the side linings. Remove the ends for smoothing, and brace the sides with strips. With a rip saw cut 6 in. into each side, guiding on a line parallel to the bottom and located at a distance of 1 in. below the upper corners of the endpieces. (See Fig. 9.)

Nail the chest together with eight-penny finish

Fig. 13, Ripping Off the Lid; Fig. 14, Scratch-Brushing the Wood before Putting On the Linoleum "Ironwork"

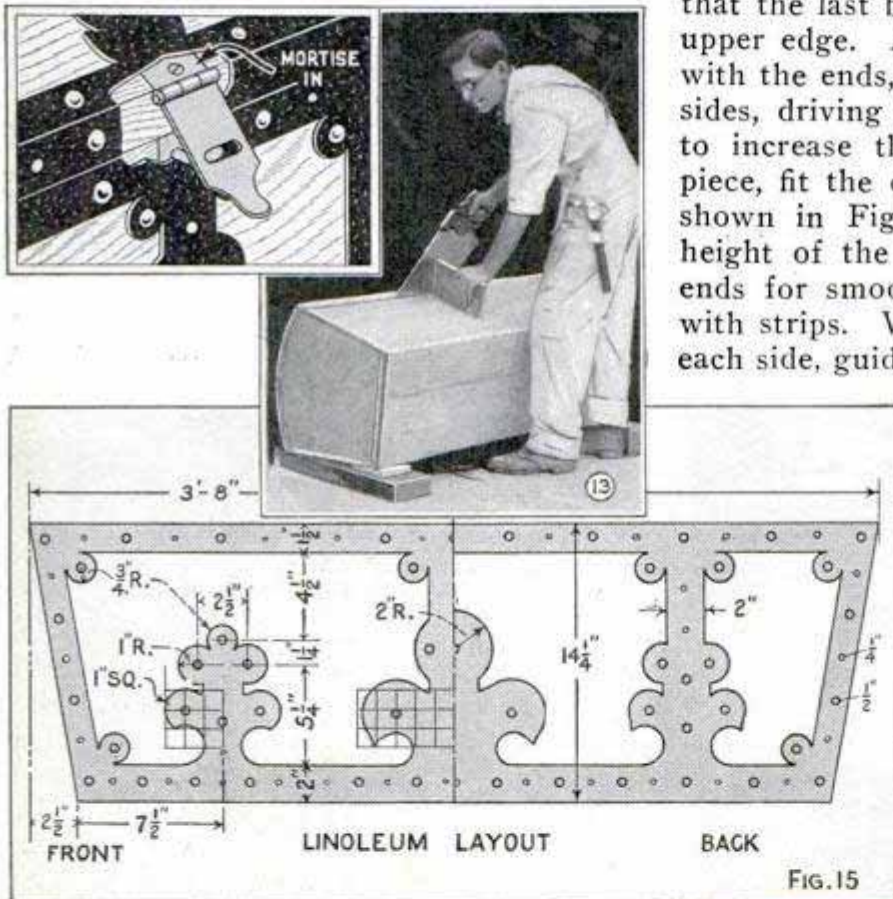

end from the first. If the upper edges are not alike, when the lid is sawed off the box, the top boards will be sure to twist it out of shape.

The sidepieces are beveled on the lower edges and cut to a length of 3 ft.  $8\frac{1}{2}$  in. on the upper edge, the ends, of course, sloping. (See Fig. 4.) Obtain the exact

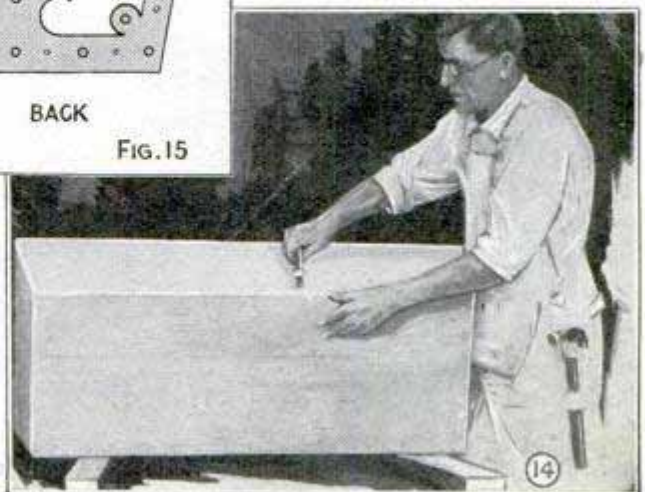



nails driven at various angles through both sides of the corners, while clamped together, forming the joint illustrated in Fig. 10. Bevel the upper edges of the sides, and nail on the four previously jointed pieces of 1 by 6 in. stock, that form the top, slanting the nails so that they will not interfere with the cutting off of the lid. Make three wedge-shaped strips, coat with glue and drive them into the cracks, as in Fig. 11. When dry, round off the surface to fit a cardboard template of a radius of 1 ft. 5 3/4 in. Trim the projecting ends of top and side, completing the assembly as indicated in Fig. 12.

Finish sawing off the top, using a guide



Fig. 17, "Peening" the Linoleum; Fig. 18, Mortising for the Hinges; Fig. 19, Staining the Finished Chest

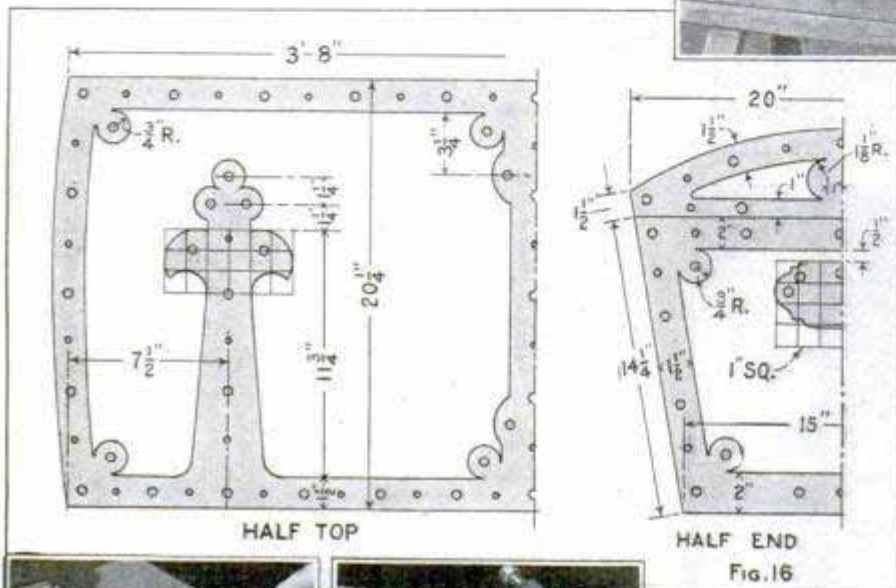

at the bottom. In each corner scribe a circle of 3/4-in. radius, the edge being 1/8 in. from the border, and joined to it with a curve. The lock-plate strap is 2 1/2 in. wide, with 1 1/2-in. circles in the upper corners. Centering on the strap, 6 in. from the lower border, draw arcs

of 2-in. radius terminating in the strap edges, and draw the leaf forms below from a paper pattern developed from 1-in. squares, as shown in Fig. 15. The two side ornaments are based on straps 2 1/2 in. wide, centered 7 1/2 in. from the ends of the bottom, finished at the top by a circle of 3/4-in. radius, centered 6 1/2 in. above the low border, with curves of 1-in. radius 1 1/4 in. below, centered on the edges, and leaves drawn as for the center.

block, if necessary, to insure the correct angle, as in Fig. 13. Joint the edges smooth, and mark the back edge. Line the top with cedar, gluing it as well as nailing.

With a wire brush, scrub the box lengthwise of the grain, as in Fig. 14, leaving a 1 1/4-in. border around the edges, until the soft wood is scratched out, leaving the hard grain in low relief. Mortise in the hasp and staple, as indicated above, Fig. 13, wedging the staple solid if it is of the loose type.

Lay a piece of plain inlaid linoleum over the lock side, tack it down, and trim the edges with a saw. Draw a border line 1 1/2 in. from the edge at the top and ends, and 2 in.

The back linoleum, when cut to size, can be laid out almost entirely by tracing from the front piece. The center strap, instead of reaching to the top, finishes with the 2-in. circle, while the hinge straps go to the top, as shown in Fig. 15. Trace the outlines on the box and paint on glue. Apply glue to the linoleum, and nail in place with 3/4-in. brads driven every 1 1/2 in., 1/4 in. from the edges. Set them all in. The end and lid patterns are easily ob-



tained in the same way as the others, from Fig. 16. The ends lap past the sides, and the top past sides and ends. Place the handle plates  $\frac{1}{2}$  in. below the upper strap of the box ends.

Surface the linoleum with a  $\frac{1}{2}$ -in. gouge, as shown in Fig. 17, to imitate the hammer marks of the iron. Drive in the "rivets," centering on the straps and spacing them as evenly as possible. First drive the  $\frac{1}{2}$ -in. tacks, and then the others. Put the lid in place, and,  $1\frac{3}{4}$  in. from the center of each hinge strap, mark lid and box together at the joint with a knife

point. Remove the lid, take the hinges apart, and use one-half to mark the mortises. Make crosscuts with a chisel, Fig. 18, before trimming to depth.

Stain the wood fairly dark oak, applying with a brush, and wiping off the surplus with a cloth. Since the stain will not "take" over glue, any squeezed from under the linoleum must be removed. Paint the linoleum with lampblack, as it comes from the can, mixed with a little litharge to hasten drying. A coat of boiled linseed oil on the wood completes the finish. Last, attach the handles and the lid chain.

#### MATERIAL LIST

2 pieces, 1 by 10 in. by 10 ft., fir, S4S, vertical-grained, if possible.  
2 pieces, 1 by 8 in. by 10 ft., fir, S4S.  
2 pieces, 1 by 6 in. by 8 ft., fir, S4S.  
28 sq. ft.  $\frac{3}{8}$  by 4-in. red-cedar lining.  
15 doz. upholsterers' tacks,  $\frac{1}{2}$ -in. heads.  
200 upholsterers' tacks,  $\frac{1}{4}$ -in. heads.  
1 iron hasp and padlock.

1 pair heavy iron chest handles.  
1 pair 2 by  $2\frac{1}{2}$ -in. loose-pin butts.  
1 lid chain.  
2 lb.  $\frac{3}{4}$ -in. brads.  
1 lb. 1-in. brads.  
 $\frac{1}{2}$  lb. each of six-penny and eight-penny finish nails.  
 $1\frac{1}{2}$  pt. liquid glue.  
Small can each of lampblack and oak oil stain.

Linoleum enough to cover the chest.

#### Cleaning Rubberized Garments

Rubberized garments cannot be cleaned with gasoline or dry cleaning, as the cemented seams will loosen. When cuffs and collars of such garments become soiled, they should be sponged with a solution of water, ammonia and baking soda in the following proportions: one glass of water, one level teaspoonful of baking soda and one tablespoonful of household ammonia. This will clean and brighten the rubber without injuring it.

#### Silo Chute Facilitates Feeding

To facilitate feeding his cattle from the silo, one farmer built the chute shown in the photo. The feeding trough was placed directly underneath the chute, and when it is desired to feed the cattle, it is only necessary to toss the silage into the chute. A ladder is arranged inside of the chute to enable the worker to climb into the silo and a trapdoor is provided to close the chute at the point

where the spout is located, so that all silage will be diverted through the spout and will drop into the feeding trough. The trapdoor is hinged so that the worker can push it up when climbing up or down the chute, and locks in a vertical position.

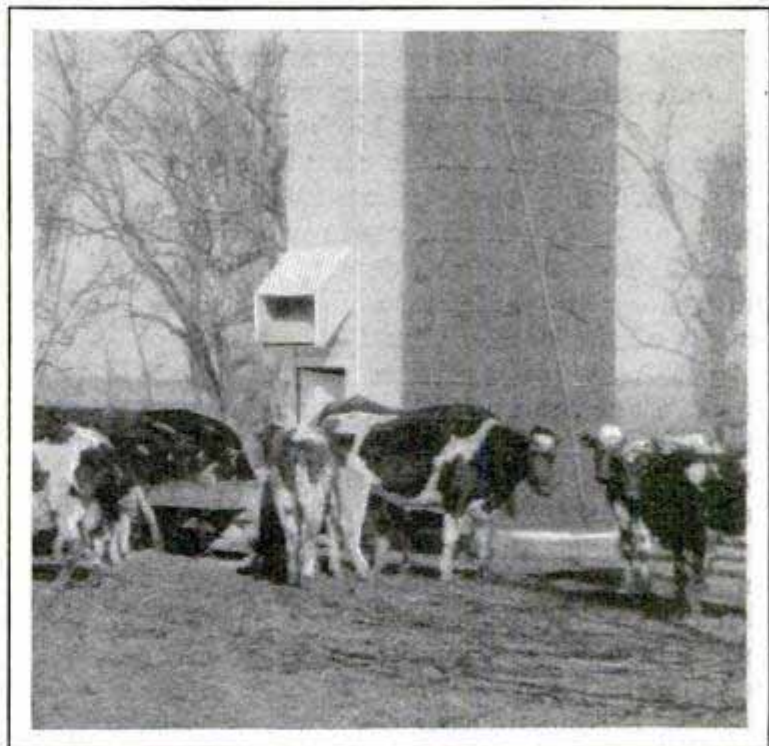

The Wooden Chute on the Silo Conveys the Ensilage into the Feeding Trough Below



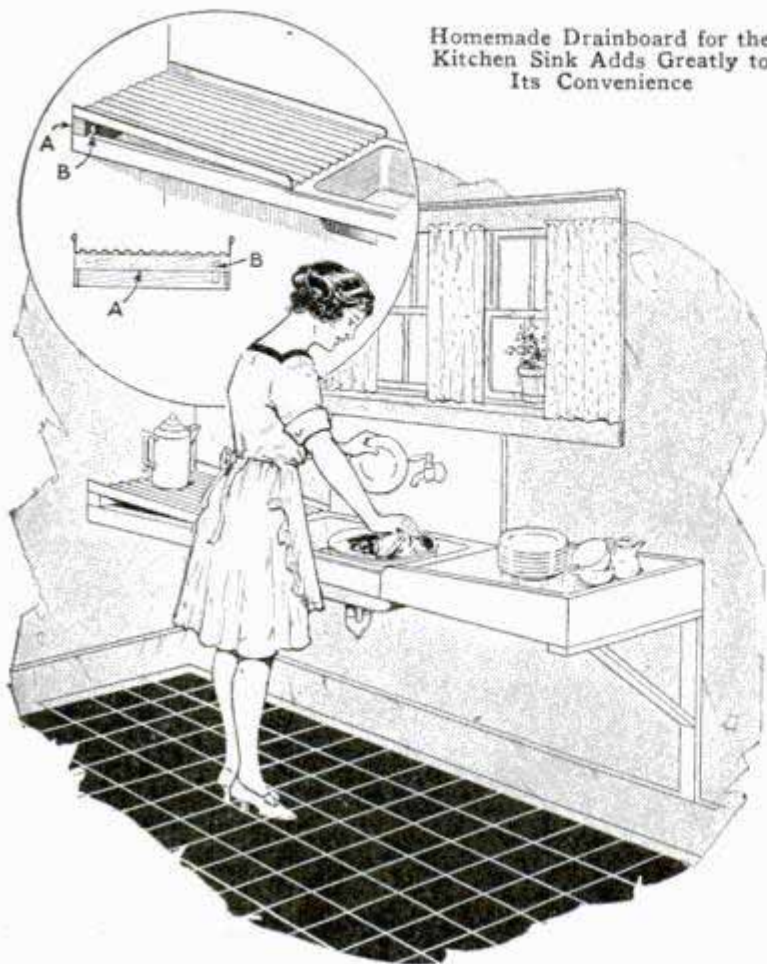

Homemade Drainboard for the Kitchen Sink Adds Greatly to Its Convenience

### Homemade Drainboard for Kitchen Sink

In most small houses in outlying districts, the plumbing usually consists of the mere essentials. This applies particularly to the kitchen sink, which will be found against the wall, bare of any refinements. A housewife who is familiar with the fittings in a well-equipped kitchen will appreciate drainboards. A simple method of constructing these is as follows: A frame of light wood is made around the sink, the size, of course, depending on the dimensions of the sink and the desired length of the draining surface. Strips of 1 by 2-in. wood are used to make this frame. Each drainboard is cut from a sheet of corrugated-iron roofing, a sheet having the smallest size corrugations being most practical for this purpose. The sheet is bent up about an inch on each side and the edges are hammered over to make a bead. Next, strips of wood are nailed to the ends farthest from the sink to raise the board and give the necessary slope. A slope of one inch to the foot, or even less, is sufficient. Strips of wood are nailed to the blocks on the main supporting

brackets, with edges projecting upward. This is to prevent the drainboards from sliding forward into the sink. The piece of roofing will be found very rigid and, although only supported at each end, will take considerable weight. However, if the board is more than 2 ft. long, it may be advisable to provide an extra support. A neat finish is given to the whole job by nailing a light board to the front of the frame, as shown at the right in the drawing. This will also support the front edge of the iron. There is no need to fasten the drainboards in any way. In fact, it is an advantage to leave them free so they can be lifted off at any time for cleaning or other purposes.—Stanton Chapman, Sevanee, Tenn.

### Handling Gold-Leaf Sign Letters

Handling and applying small gold-leaf sign letters is a somewhat difficult and tedious task.

However, the use of a dentists' air syringe will be found to eliminate much of the trouble. This is fitted at the nozzle end with a short length of small rubber tubing, as shown in the illustration. The air is forced out of the syringe and the nozzle pressed against the piece of gold leaf,



Holding Gold-Leaf Letters with a Small Air Syringe



which is to be applied to the sign; the bulb is then slightly released so that the leaf is held and lifted by means of the vacuum created in the nozzle. Any small letter or decorative piece may be safely handled in this manner.—G. E. Hendrickson, Argyle, Wis.

### Polarity of D. C. Electric Wires

The polarity of wires can be determined by placing the ends of the wires in a common white potato cut in halves. The wires should be stuck in a small distance apart, the distance depending on the voltage. The positive wire of a direct current will turn the potato green and the negative side will remain uncolored. This method can be used in finding the polarities of current from one dry cell up to 500 volts, the only difference being that with very low voltages the wires should be stuck in the potato closer together than with higher voltages. In the case of 110-volt lines, the time necessary to determine the polarity is about 10 seconds, and with a current of, say, 2 volts and upward to 10 volts, it will require about one minute. If electrical workers carry a potato in their tool bag, they will always have a reliable polarity indicator.—Geo. H. Davie, Erie, Pa.

### Clothespin Makes Marking Gauge

A clothespin can quickly be made into a very practical marking gauge for running a straight line parallel to the edge of a board, as shown below. One leg of the pin is cut off squarely and a nick made in the edge of the other leg to catch the point of the pencil at the desired distance from the edge. This method will be found handy when the regular gauge is not at hand, and, in fact, the pin can be used in many places where the regular tool is too large for convenient use.—Frank W. Bentley, Jr., Missouri Valley, Iowa.

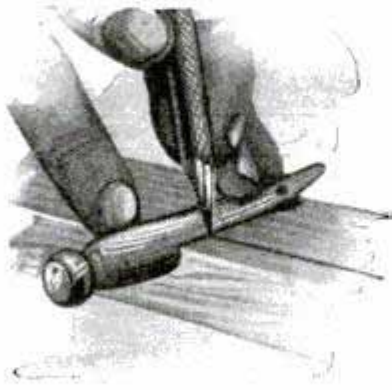

### Clinching Split Rivets

I was trying to fasten the hinges and locks on a case with split rivets, and as these were not long enough to clinch they would pull out. To overcome the trouble, I drilled the holes about halfway through the board and dropped a single No. BB shot in the hole. When the rivet was driven against it, the points were spread into the wood as shown, and the rivets did not come loose.—Robert A. Fansher, Cambridge City, Ind.

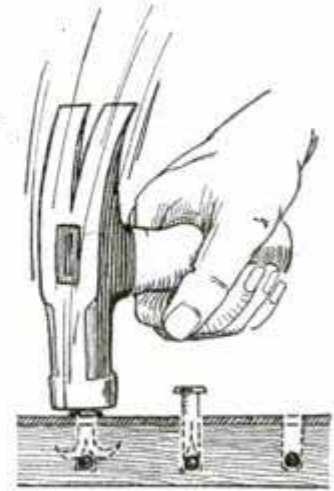

### Damper in Blowtorch Aids in Lighting

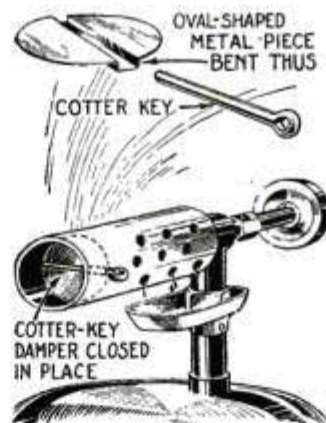

When starting a blowtorch, the stream of gasoline from the jet must be regulated very carefully to prevent it from spraying wastefully out of the nozzle. For this purpose, a Wisconsin tinsmith devised a simple damper from a piece of sheet metal and a cotter key. The metal disk was cut oval and bent, as indicated in the drawing, to fit within the mouth of the torch. Holes were drilled to permit the insertion of a cotter pin, which held the damper, the outer ends of the key being spread to hold the damper firmly in place. When desired to pre-heat the torch, the loop of the key is turned with a pair of pliers to close the damper. After the generating pan has filled with gasoline, the damper may be opened so that it will not interfere with the flame. In cold weather, when the torch operates sullenly, the damper may be partly closed so that the flame will transfer more heat to the generating system and thus bring aid in generating gas.



Quick Method of Turning Empty Cement Sacks Inside Out over a Section of Eight-Inch Tile



### Using Tile to Turn Cement Sacks

Before empty cement sacks may be returned to the dealer for credit, the contractor must see that they are turned inside out to show that no crust or lumps of cement are left clinging to them to damage the fabric. This is usually a slow and disagreeable task, but one Wisconsin builder simplified the process by the use of an ordinary 8-in. tile. The tile is set on end beside the pile of sacks and the workman performs the labor by lowering each sack into the tile as shown in detail 1, opening the end of the sack as shown at 2 and giving a downward pull. The movement turns the sack in a fraction of a second, leaving it inverted over the tile.—G. E. Hendrickson, Argyle, Wis.

### Thread-Cutting Dies

Thread-cutting dies cannot be expected to cut cleanly and well without rake. This rake or lack of it makes quite a difference between a cutting die and one that only scrapes the metal off. The cutting edge of each "land" of the die should be made an acute angle with a line passing through the center of the work and through the extreme point of the cutting edge. Avoid

dies that cut both ways. Such dies do not cut cleanly or easily when either face is to the work, and they must of necessity drag the idle cutting edges over the work and dull them. A set of bolt dies that had the cutting edges parallel to the center line, or rather if continued would form the center line, never cut so well as might have been expected. They were ground out so that the cutting edge had rake, and after that they always cut nicely.

### Device Holds Ends of Cut Wires

If a suspended wire is not held securely before cutting it, the ends will drop and whip around in a most dangerous manner. Guy wires are often used on experimental work or temporary constructions, and when the need is ended, it is usual to cut all wires to hasten dismantling operations. A wrecking contractor engaged in tearing down an exhibition building, constructed a little device for holding the cut ends of flag, guy and all other wires, which, if allowed to drop, might injure workmen. The device is made of two short lengths of heavy wire looped at one end into each other, the other ends being bent, as shown, to slip over the wires to be cut. The important feature of these bends is that they must be a spring fit on the wire. Before cutting a wire the gripper is snapped over it on each side of where the cut is to be made. When the wire is cut, the weight of it pulls the gripper out straight and it tightens as shown in the photo, the sudden jerk bending up the cut ends, which are then held securely. To bring the long end of the wire safely to the ground the

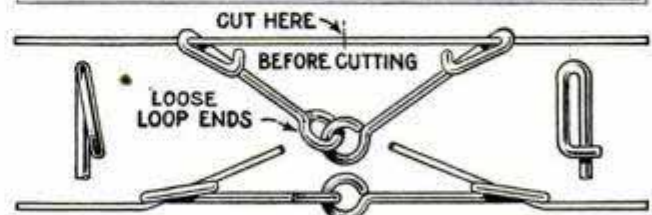

Simple Device for Holding the Cut Ends of Wires under Tension

gripper is pulled at one end and the short end of the wire removed.



# A Homemade Apple Wiper

By H. R. MERRILL

WHEN the edict was issued from the U. S. department of agriculture that all Utah apples must be wiped before they were placed on the market, a loud wail went up from the fruit growers of the

the same direction, by a  $\frac{1}{8}$ -hp. motor. While the rollers run in the same direction, one is driven a little faster than the other, due to the difference in the number of teeth on the sprockets. At the top of the frame was mounted a feed chute for the apples, and a heavy cloth top was fastened to a frame



Above, Packing the Wiped Apples, Using the Cone; Right, the Homemade Wiper in Operation

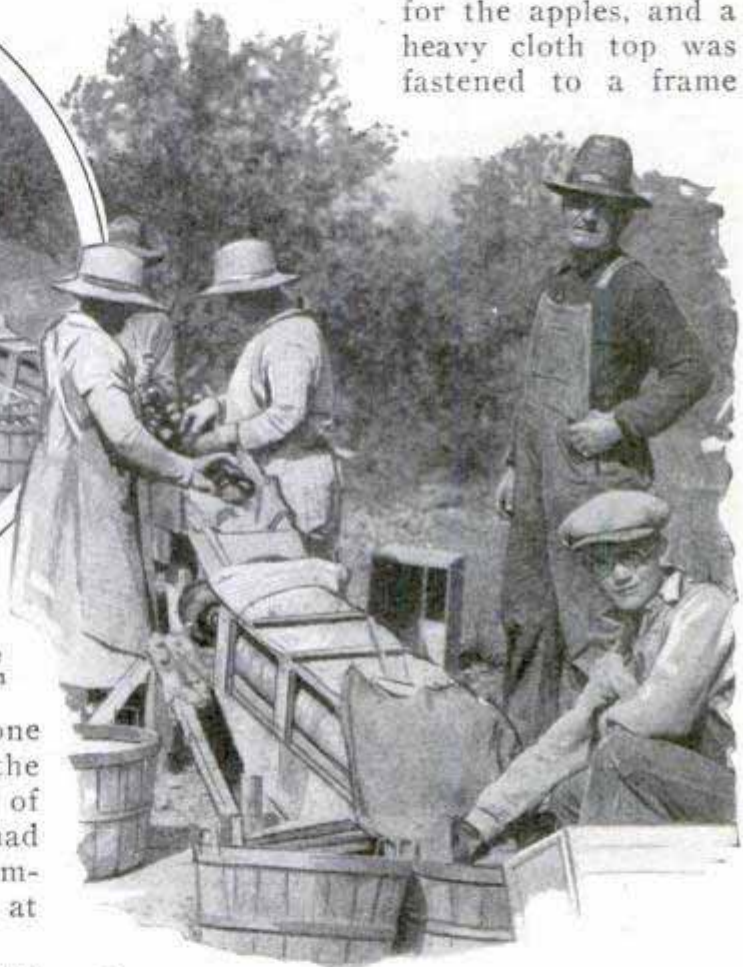

state. Brigham Young university, one of the largest private institutions in the west, found itself with an apple crop of 4,000 bu., on a piece of ground that had been bought as an addition to the campus, and the problem of wiping them at first seemed a hopeless one.

It happened that the custodian of one of the buildings was a real handy man, and had shown his ingenuity in the past by constructing such devices as a feeder for his stoker, a bell ringer for the school clock and an automatic sprinkling device which turned the water for the grounds on and off at the required times, and, in this emergency, he was set to work on the problem. The machine he evolved is shown in the accompanying illustrations.

He first obtained two sprocket wheels from the bicycle shop, fastened them to the ends of two rollers, about 3 ft. long, covered the rollers first with padding, and then with sheepskin, wool-side out. These were mounted in a wooden frame, with the sprocket ends elevated, and driven, in

over the rollers, the cloth being left loose enough to sag down on the apples, as they passed along the rollers, and thus do a share of the wiping. Since a commercial machine had later been introduced in which a fan was incorporated, the constructor of this machine, Mr. J. W. Sauls, obtained a blower similar to those used on blacksmiths' forges, and mounted this in a box under the rollers, in such a manner that a constant current of air was driven over the apples. This completed the machine, which met with the entire approval of the inspector.

The machine worked successfully for the entire crop of apples, handling an average of 1 bu. a minute. In fact, the



wiper was fast enough to keep the packers busy every minute.

The upper picture shows the method used to pack the apples in round bushel baskets, in such a manner as to have the top layer in perfect concentric circles. The apples are first placed in a sheet-metal

cone, constructed to hold a bushel, the first layer being carefully laid by hand, and the remainder of the bushel poured in. A basket is then placed over the packing cone, bottom side up, the whole inverted and the cone removed, leaving the top layer in perfect order.

### Drawer Chest for Tools on Truck

After he had frequently forgotten some of his tools and material, a plumber built



Plumber's Handy Tool Chest and Workbench Fitted at the Back of His Car

a large drawer chest on the back of his car. The sides of the chest was hinged and could be dropped down to form a sort of workbench, as shown in the illustration. Besides being handy to work at, this improvised bench eliminated much of the usual mess on customers' premises, and therefore quickly won the approval of his customers.

### Nickel and Silverplating by Friction

To nickelplate iron by friction, a thin coating of copper is first produced on it by rubbing on a solution of 20 parts sulphate of copper, 5 parts sulphuric acid and 100 parts of water. After the copper coating has been formed, rub over it, with a rag, a solution of 3 parts tin, 6 parts nickel and 1 part iron in 100 parts of hydrochloric acid and 3 parts of sulphuric acid. If finally the object is rubbed with a rag that has been dipped in finely pulverized zinc, a nickel deposit will be formed on the copper. The thickness of the deposit of

nickel can be increased by repeating the two last operations. A silver coating can be produced by dissolving freshly precipitated chloride of silver in a solution of hyposulphite of soda, 1.1 parts to 10 parts of water, and adding to this solution 180 parts of spirits of sal ammoniac and then stirring in 800 parts of finely washed chalk. This mixture is applied and rubbed until it dries on the object.

### Rail Prevents Accidents from Guy Wires

In a factory yard where a number of guy wires are anchored to support several high steel smoke stacks, many accidents resulted when workers stumbled over the wires, or loaded trucks and wagons were driven beneath them. To avoid this trouble in a cheap and effective manner, the superintendent ordered frames of wood erected at each anchor as shown, the highest post being set at a point which would direct the highest-loaded truck out of the

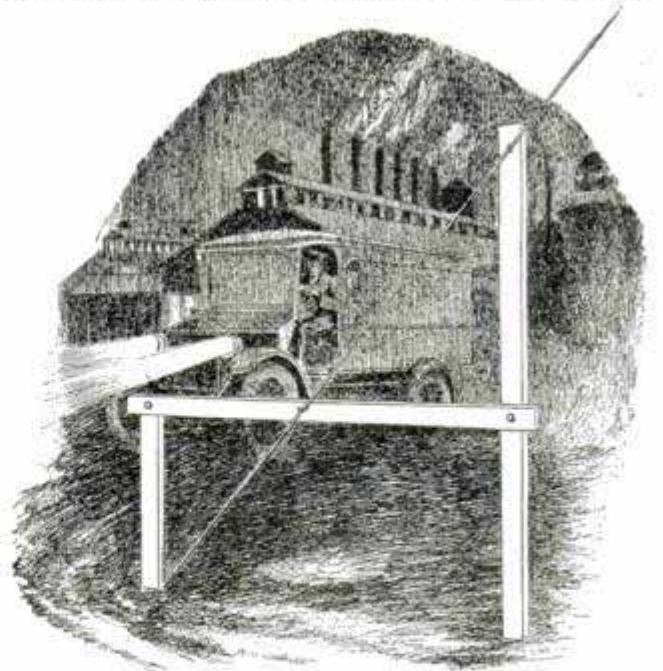

Wooden Frames on Guy-Wire Anchors Effectively Prevent Accidents

danger zone. The frames were painted white to insure visibility at night.



### Ford Engine Used as Power Plant

There are thousands of old Ford engines that are still useful for occasional duty to run a workshop power plant, a generator for lighting purposes and the like. One difficulty that the amateur encounters in such an installation is the attachment of a pulley to the shaft. The detail in the upper right-hand corner shows how this can readily be done, and the photo in the lower

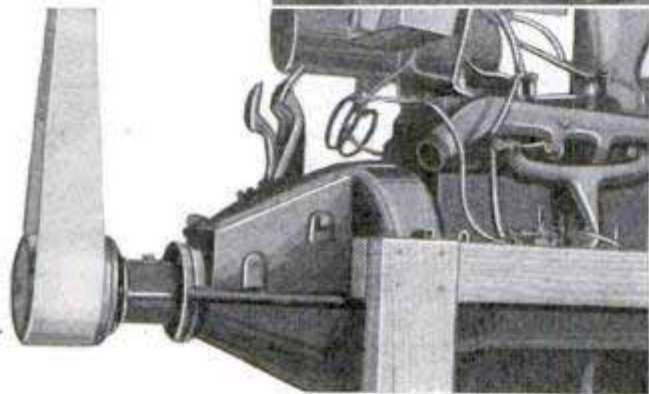
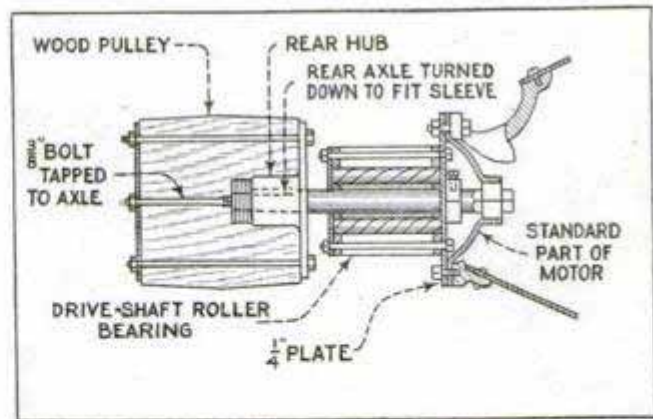

Wooden Pulley, Securely Attached to the End of the Crankshaft, Makes Ford Engine into Power Plant

left-hand corner shows the pulley completely installed. All parts are standard and can be obtained from any Ford dealer. —Geo. C. Plummer, Huntsville, Ohio.

### How to Remove Broken Key in Auto Gear Shift

When a key breaks in the gear shift the owner often has to remove the entire lock, and as it is usually riveted in place it is then ruined. A better method of getting the broken end of the key out is to solder a short length of copper wire to it. The storage-battery current can be used for this purpose. The procedure is simple: First tin the end of the wire, about No. 22 or No. 24 gauge, so that there is a small drop of solder adhering to it. Then attach a length of fairly heavy wire, about No. 10 or No. 12 gauge, and preferably stranded, to the other end of the small wire. Apply some flux or soldering salts

to the edge of the broken key. Try not to get any flux on the sides of the slot, for the solder might then stick to them, which is, of course, undesirable. Insert the small wire and while holding the end against the

edge of the key, carefully touch the free end of the heavier wire to the live side of the battery current, the other side being grounded. A touch or two is sufficient, as the small wire immediately gets hot and sticks to the key. —Guy L. Anthony, Honolulu, T. H.

### Cabinet for Heating Felloe Bands

In a Denver auto repair shop, felloe bands are heated in a perpendicular cabinet of sheet metal, which saves space and makes the operation much more satisfactory than the usual method of heating them flat on the floor. The cabinet closes up like a kitchen cupboard with two large

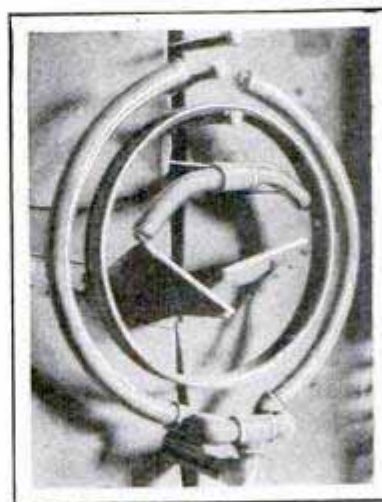

doors. Large bolts in the back of the cabinet serve to hold the bands while the 2-in. perforated pipes supply the gas flame.



2367

# Is This Your Home?

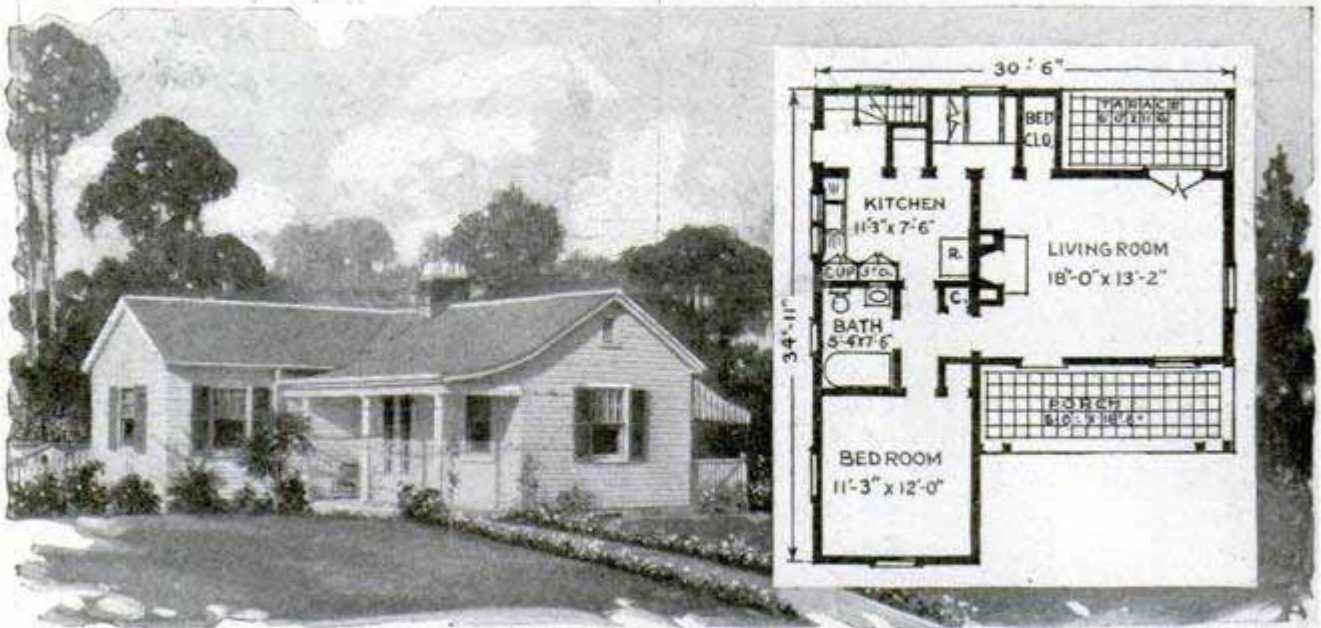

Copyright, Architects' Small House Service Bureau

Plan No. 3B1

**Q**UESTIONS regarding home building addressed to this magazine will be answered by The Architects' Small House Service Bureau of the United States, Inc., controlled by the American Institute of Architects and endorsed by the United States Department of Commerce. Please inclose 10c in stamps or coin. Blueprints, specification forms, and material lists for the house shown here may be obtained from The Architects' Small House Service Bureau for a small fee. If further information is desired, literature describing the plan service and publications of The Architects' Small House Service Bureau will be sent you upon request. A booklet entitled "50 Ways to Lower Home Building Costs," illustrated by ten Bureau homes actually lived in and showing how as much as \$1,000 can be saved on a home, may be obtained for 20c.

**T**HIS little house presents an opportunity of combining luxury with economy. It is something more than the bare bones of a house, for it is cram full of the kind of things home builders want. It has a fine plan and fine exterior, because it was arranged by a group of architects who knew how to make use of ordinary materials and forms so as to get the most out of them.

People are beginning to see more and more the futility of wanting large houses and to realize that nearly everything they want can be had, anyway, in the smaller house. This is well worth thinking about. Why do people build six rooms when they need only three? Take this plan as an example of what can be done with three rooms. By the inclusion of space for a closet bed and a dining alcove there is living accommodation here for at least three.

The omission of the dining room is a major stroke in effecting economies. For all ordinary purposes the dining alcove serves admirably.

Look over this plan and see the luxuries it affords. The living room is replete with

them. There is a fine fireplace at one end and at the other a window seat. This is flanked on both sides by built-in bookcases. A French door leads to the terrace.

In the dining alcove are arranged built-in seats with hinged tops, a dining table and an attractive china cabinet. The kitchen has broad spaces for working under a strong light. The refrigerator is reached through a door off the rear entry, where also are the stairs that lead to the basement.

The bathroom has a recessed tub and a medicine cabinet. Just opposite the bathroom is a closet for coats or linens. The bedroom is of good size and has a closet arranged where the door will not interfere with the room space, and has windows on two sides. In the basement is a long, well-lighted laundry, a storage pantry, and the usual heater and fuel rooms.

Construction: Wood frame, exterior finish, siding, roof of shingles. Lot size: About a forty-foot lot is required. Facing: The house should be faced west or north, or it may be built reversed.



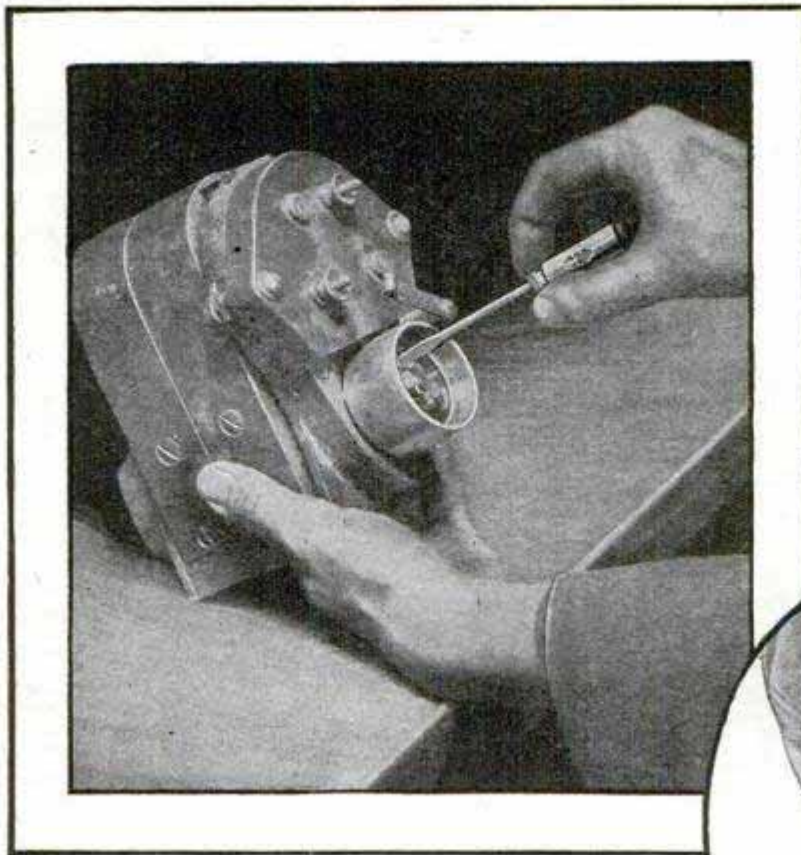

While left hand holds work, and right hand holds driver steady, you start screw with thumb-turn on blade.



*Pesky little screws  
are easy with*  
**“YANKEE” No. 15**

For with this handy Ratchet Screw-driver you can start wobbly screws quickly by revolving Knurled Washer with thumb and forefinger.

Then you send screw home in a jiffy by Ratchet Movement. How simple—how useful!

Right and Left Ratchet, and Rigid. Saves time and strength. Ask your dealer to show you the “Yankee” Ratchet Screw-driver.

**No. 15** — With “Yankee” thumb-turn on blade. Ratchet shifter moves lengthwise. Six sizes: 2 to 8-inch blades.

**No. 10** — Without thumb-turn  
Eight sizes: 2 to 12-inch blades.

**No. 11** — Same as No. 10, except ratchet shifter moves across tool.

**Some Other “Yankee” Tools**

Plain Screw-drivers	Automatic Push Drills
Spiral Screw-drivers	Automatic Feed Bench Drills
Ratchet Bit Braces	Ratchet Tap Wrenches
Ratchet Breast and Hand Drills	Vises—Removable Base

Dealers Everywhere Sell “Yankee” Tools

*“Yankee” on the tool you buy means the utmost in quality, efficiency and durability.*

**FREE**—“Yankee” Tool Book for all lovers of fine Tools. Write for it.

NORTH BROS. MFG. Co.

Philadelphia, U. S. A.

**“YANKEE” TOOLS**  
*Make Better Mechanics*





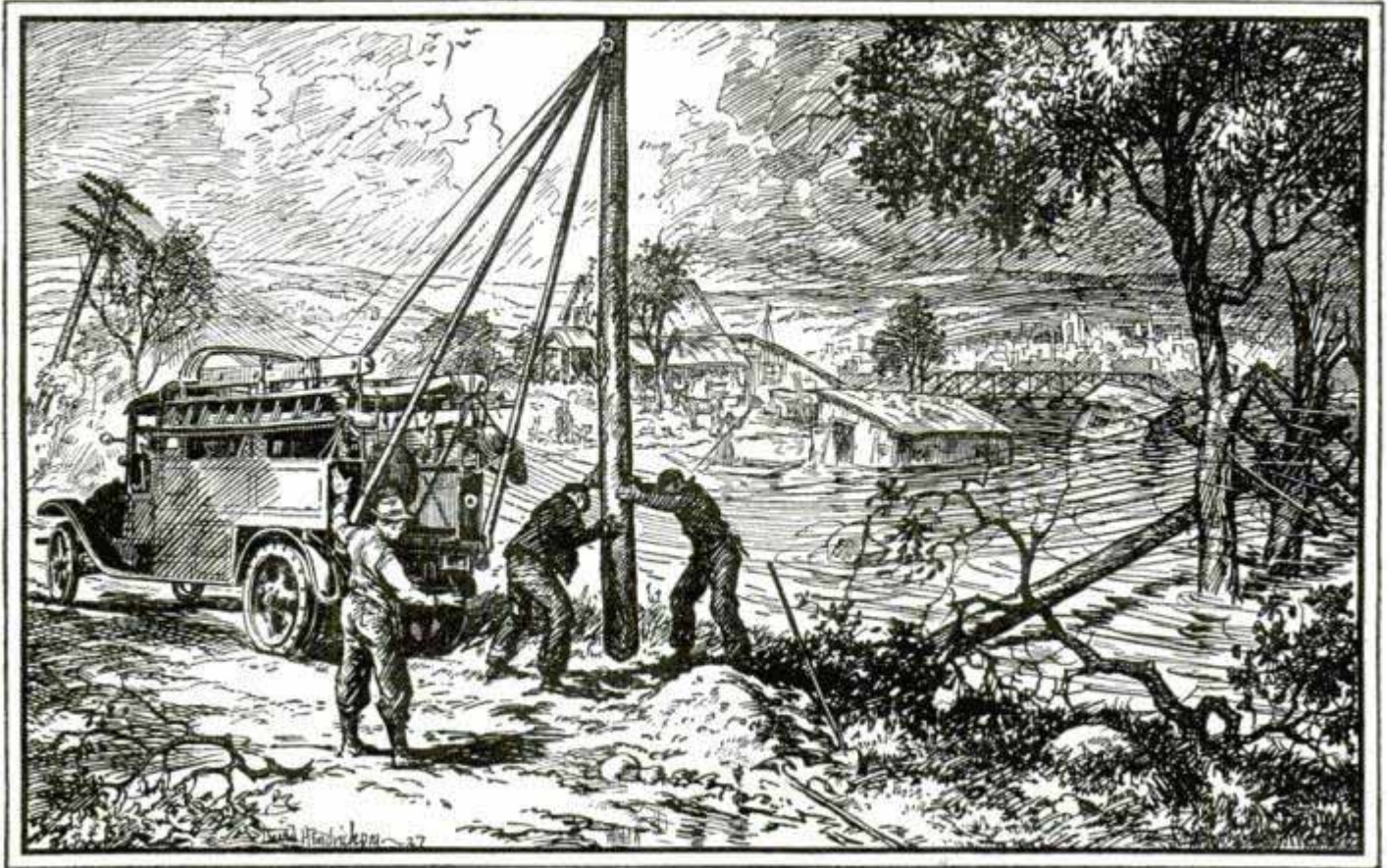

## All for One

*An Advertisement of  
the American Telephone and Telegraph Company*

A SLEET storm descends, carrying down trees and wires. A wind turns outlaw and blows down a pole line. Or some swollen river rampages through a circuit of destruction.

But wherever angry nature attacks the Bell Telephone System there are repairmen trained to meet the emergency, and everywhere trained in the same schools to the use of the same efficient tools. Supplies of surplus equipment and materials are kept at strategic points whence they may be rushed by train or truck to the devastated area.

Throughout the Bell System, all



construction and practice are standard, so that men and supplies, when necessary, may be sent from one state or company to another.

There are twenty-five Bell Companies, but only one Bell System—and but one Bell aim and ideal; stated by President Walter S. Gifford as:

“A telephone service for this nation, so far as humanly possible free from imperfections, errors and delays, and enabling anyone anywhere at any time to pick up a telephone and talk to anyone else anywhere else in this country, clearly, quickly and at a reasonable cost.”



*Ride with*

# ETHYL

and get the benefits of  
*High  
Compression*

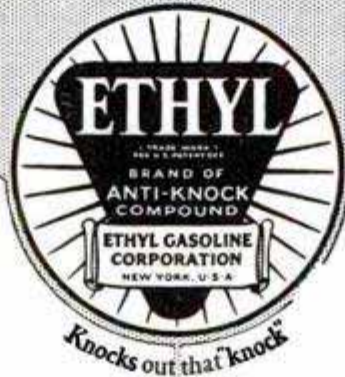
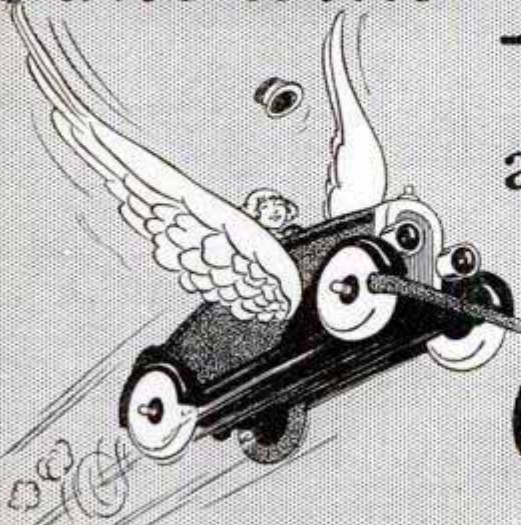

**M**ORE than a million motorists are now enjoying the benefits of high compression through Ethyl Gasoline. In two ways:

**1** *Through high compression automobiles.* The advent of Ethyl Gasoline has at last given car manufacturers the opportunity mechanically to raise the compression of their engines. For cars now in use they can offer special high compression cylinder heads which greatly increase performance.

**2** *Through carbon formation.* By letting carbon form in the cylinders of a car of ordinary compression, you automatically increase compression. And since Ethyl Gasoline is a high compression fuel, those deposits which heretofore have meant "knocking" and power loss become a source of *extra* power and driving satisfaction.

Ethyl Gasoline is motor gasoline

containing Ethyl brand of anti-knock compound, the ingredient which eliminates the "knocking" characteristics of ordinary gasoline and makes it a high compression fuel.

*In terms of you and your car, high compression and Ethyl Gasoline mean a more powerful and flexible car, less gear-shifting, faster pick-up, less vibration and lessened depreciation. In short, a performance and economy impossible with ordinary compression and ordinary gasoline.*

Ethyl Gasoline is distributed in the United States and Canada by responsible oil companies. *It has absolutely no ill effect on the motor or its parts.*

The first tankful will prove every claim. On sale at pumps which bear the "ETHYL" trademark shown on this page. There's one near you.

ETHYL GASOLINE CORPORATION  
25 Broadway, New York City

# ETHYL GASOLINE



Buy separately or  
in assortments

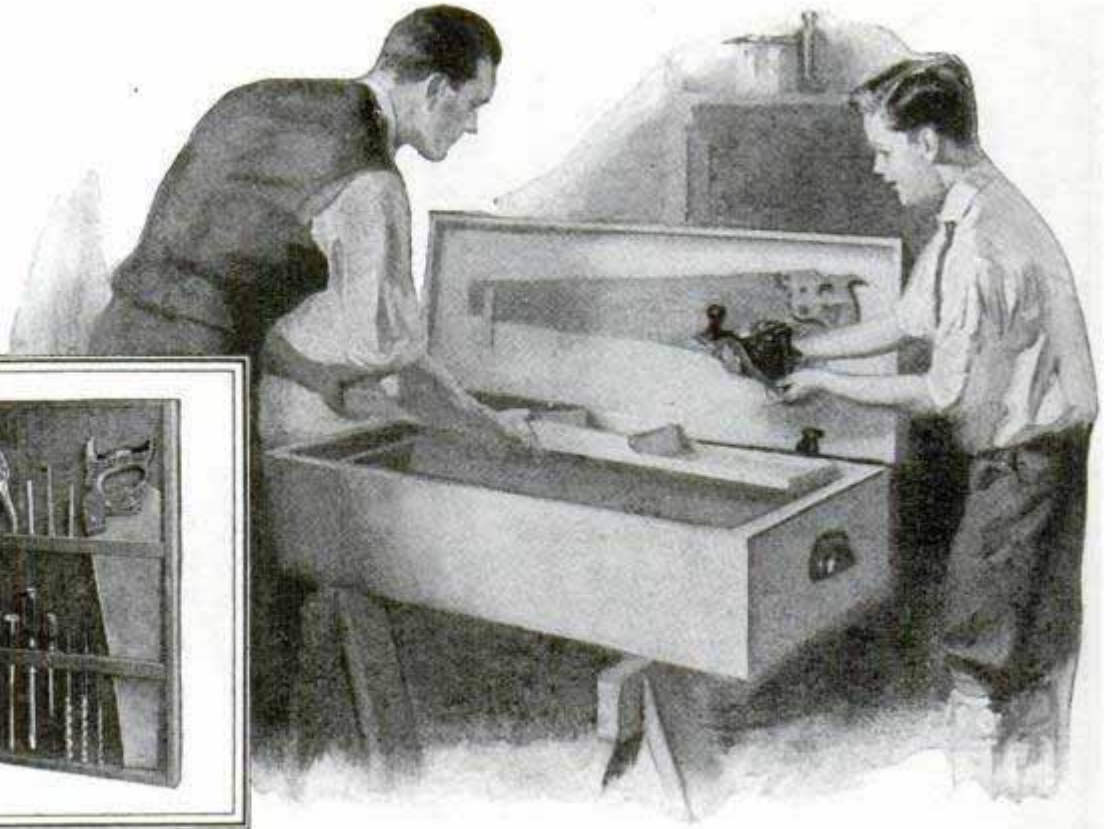
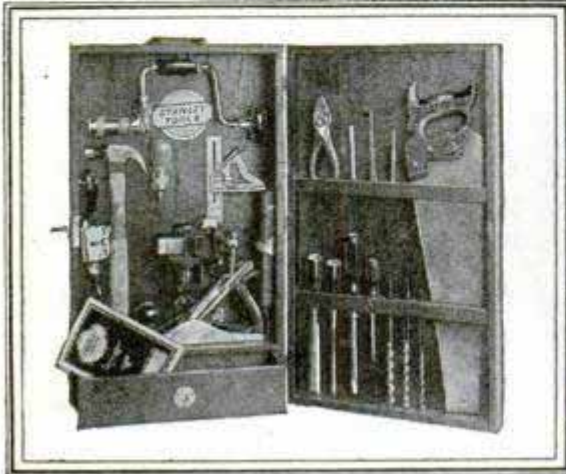

# No more lost tools!

*Make a Tool Chest from Plan No. Sd70*

A chest keeps tool-edges sharp and surfaces free from rust. It guards against loss. Here's good news: Stanley Plan No. Sd71 gives detailed instructions for making a large sized tool chest. Plan No. Sd70 is for a smaller chest.



Of course, you realize the savings that come from using *good* tools. The amateur needs good tools even more than the professional. Most carpenters and manual training instructors use Stanley Tools. They know from first hand experience that the Stanley name stands for durability, correct design, and right "feel."

You can buy Stanley Tools separately and so collect your own set. For your convenience

in buying there are also complete sets of Stanley Tools in chests at a wide variety of prices from \$15 to \$95. Or there are assortments in strong cardboard boxes containing directions for making your own tool chest. Priced from \$5 to \$20.



Your hardware dealer has Plan No. Sd71 and Sd70 as well as other Stanley Plans for making useful articles, or he can get them for you. The plans cost only 10c each. Ask him also for small Catalog No. Sd50—which shows many useful Stanley Tools. It is free. If he cannot supply you write to The Stanley Works, New Britain, Conn.

The best tools are the cheapest to use  
Ask your hardware dealer



# STANLEY TOOLS



# Fore-wheel brake

## 1st time in America!

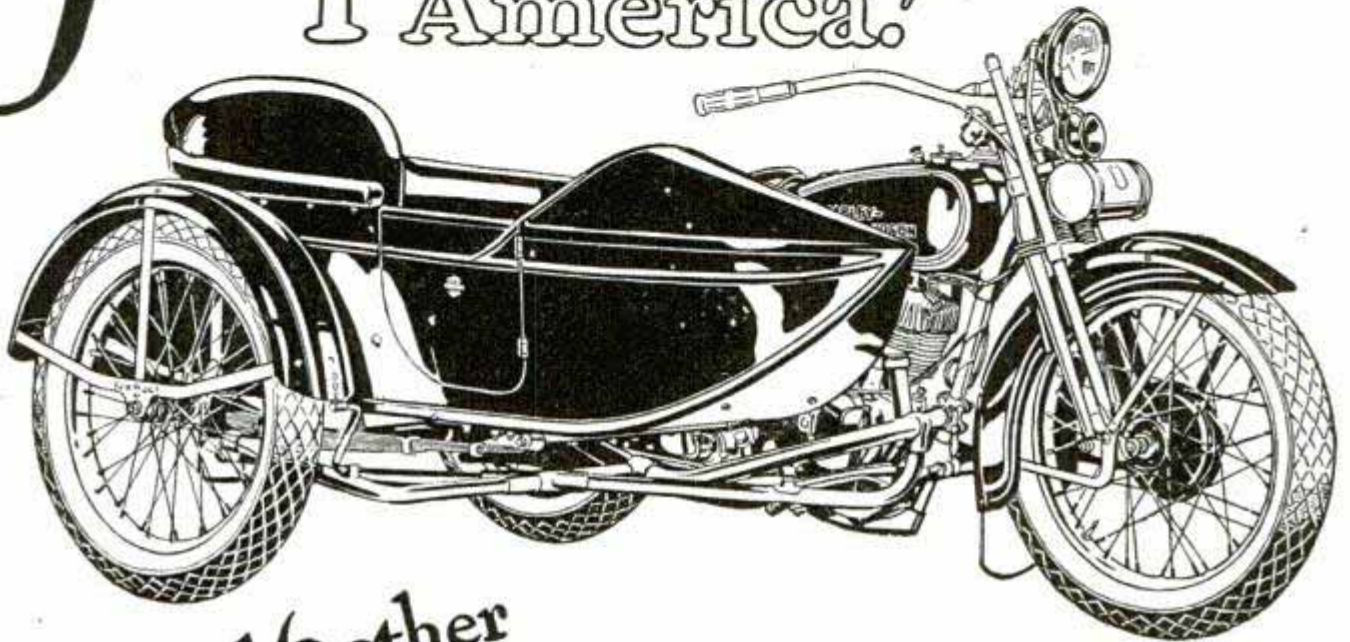

and 6 other  
new features  
in the  
**1928  
MODEL**



### New Model Sport-Solo Twin

Face-setter for 1928! Open 'er up wide and see what she'll do! Has all the new features of standard Twin and in addition has smaller wheels — 25" x 3.85" balloon tires — roadster handlebars. Dow-metal pistons, racing type, optional at slight increase in price. The ideal solo mount — wonderfully smooth acceleration and even flow of power.

**T**HE most advanced models in the history of the motorcycle industry, with improvements that are being talked about from coast to coast.

Outstanding feature for 1928 is the Fore-Wheel Brake — *doubled safety*. Other improvements are — throttle controlled motor oiler — air cleaner — positive gear shift lock gate.

Greater stability! Increased safety! Longer life! Streamlines that make each model a beauty! Five minutes in the saddle will convince you that this is the mount you have been looking for.

No increase in prices. Solo Twins as low as \$310 f.o.b. factory. See your local dealer. Send coupon for catalog.

HARLEY-DAVIDSON MOTOR COMPANY  
Department P. Milwaukee, Wis.

# HARLEY-DAVIDSON

## Motorcycles

HARLEY-DAVIDSON MOTOR COMPANY  
Department P., Milwaukee, Wis.

I want to know all about the new 1928 Harley-Davidson Twins. Send catalog and full details.

Name.....

Address.....

City..... State.....



# In Queensland—too Starrett Tools mean more to a man!

Read the letter reproduced below. It contains a more powerful and sincere argument in favor of a full kit of Starrett Tools than anything we can say.

The catalog which Mr. Hannah requests is the Starrett Catalog No. 23 "AP" It contains illustrations, descriptions and prices of more than 2500 fine tools. We will gladly mail you a copy on request.

THE L. S. STARRETT CO.  
World's Greatest Toolmakers  
Manufacturers of Hacksaws Unexcelled  
Steel Tapes—Standard for Accuracy  
ATHOL, MASS., U. S. A.

Peeramon  
North Queensland  
Australia  
21/12/26

The L. S. Starrett Co.  
Could you send me a catalogue of  
small machinists tools?

I work in a local shop with a pal  
who has a complete range of tools bearing  
your name. It is disappointing when the  
boss sends him out on special jobs remarking  
that he can make a better job with the tools  
of his than I can, when I feel confident of  
doing the work myself.

So seeing your ad in Popular  
Mechanics I took the liberty to write.  
I remain,

Yours truly,

*Geo Hannah, Jr.*



# Use Starrett Tools



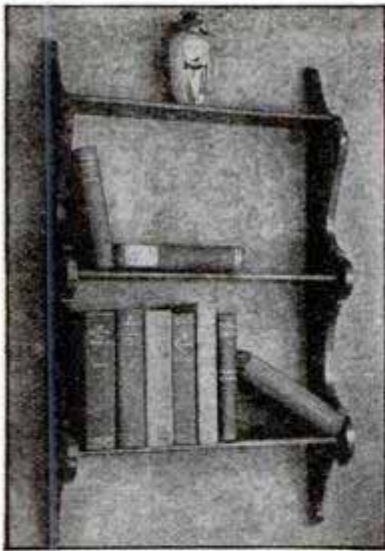

HANGING BOOK SHELVES  
See LePage's Book, page 25.

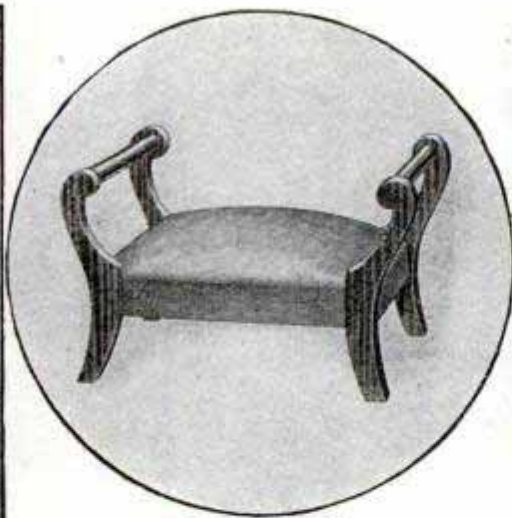

FOOT STOOL  
See LePage's Book, page 23.

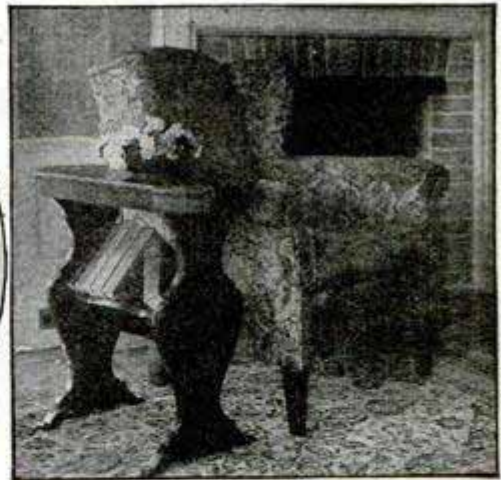

END TABLE WITH BOOK TROUGH  
See LePage's Book, page 22.



BACK REST  
See LePage's Book, page 24.



### Handiest tool in your shop

PERHAPS you have never thought of the special advantages of using LePage's Liquid Glue. It is always ready for immediate use. No weighing, soaking or heating is required. The quality is always the same. It "sets" slowly enough so that you have plenty of time to place the joints together exactly as they should go. Slow setting also allows LePage's to penetrate the wood, increasing the strength of the joint. LePage's Liquid Glue is equal in strength to any animal glue. Buy a can for your work shop. It is the easiest, quickest, handiest form of glue. Insist on LePage's.

## How to make attractive Gift Furniture

LePage's NEW Home Work Shop Book will show you how

NOW with the coming of fall and the home work shop season, comes this NEW LePage's Home Work Shop Book to show you how to make 20 different pieces of gift furniture, designed by an expert—attractive, artistic, useful, practical and easy to make.

### New Book—greatly improved

THE first LePage's Home Work Shop Book, published a year ago, proved so popular that, though advertised only a few times, over 30,000 copies were sold—an enormous edition for a book of this kind. Now the new book, just off the press, represents a wonderful improvement over the old one. Of its 20 complete projects, 16 are entirely new and never offered before.

Each project is presented in three parts—a photographic illustration of the finished project, a complete dimension drawing of its parts, and simple, easy-to-follow directions, for making, given step by step from start to finish.

### Designed by Expert

FOR each of the 20 gift furniture projects, the design, dimension drawings and photographs, as well as the actual

articles, were made by William W. Klenke, Instructor in Woodworking, Central Commercial and Manual Training High School, Newark, New Jersey. Assurance is therefore given that each project and the directions for making it are perfectly practical.

In addition to the four pieces illustrated above, the projects include the following: Table with side flaps and two drawers, Spanish Ship model, folding sewing screen, fernery stand, tilt top table, piano bench, costumer, Priscilla sewing box, Cedar Chest, Smoking Cabinet, table desk, desk chair, card or console table, book stand, turned bench, dressing glass. Where else could you get complete directions for making all these things for only 10 cents?

This new LePage's book also shows you how to make strong joints with glue in its most convenient form—LePage's Liquid Glue. It also tells you a lot of craftsmanship possibilities with a new product, Gesso, in making joints, covering up small defects, etc.

### Send 10 cents for this NEW LePage's Home Work Shop Book

JUST write your name and address on the coupon below, tear it out and mail to us today with 10 cents in coin or stamps, and we will at once send you a copy of LePage's New Home Work Shop Book, postage paid. Address LePage's Craft League, 551 Essex Ave., Gloucester, Mass. Tear out the coupon now so you won't forget it.

### MAIL THE COUPON

LEPAGE'S CRAFT LEAGUE  
551 Essex Ave., Gloucester, Mass.

Gentlemen: Enclosed please find 10 cents (coin or stamps) in payment for LePage's New Home Work Shop Book. Please send a copy of this book to:

Name.....

Street.....

City..... State.....

**LEPAGE'S**  
**LIQUID**  
**GLUE**  
BOTTLES, TUBES, CANS



# Like to use GOOD tools?

Then you need this  
400-page Free catalog

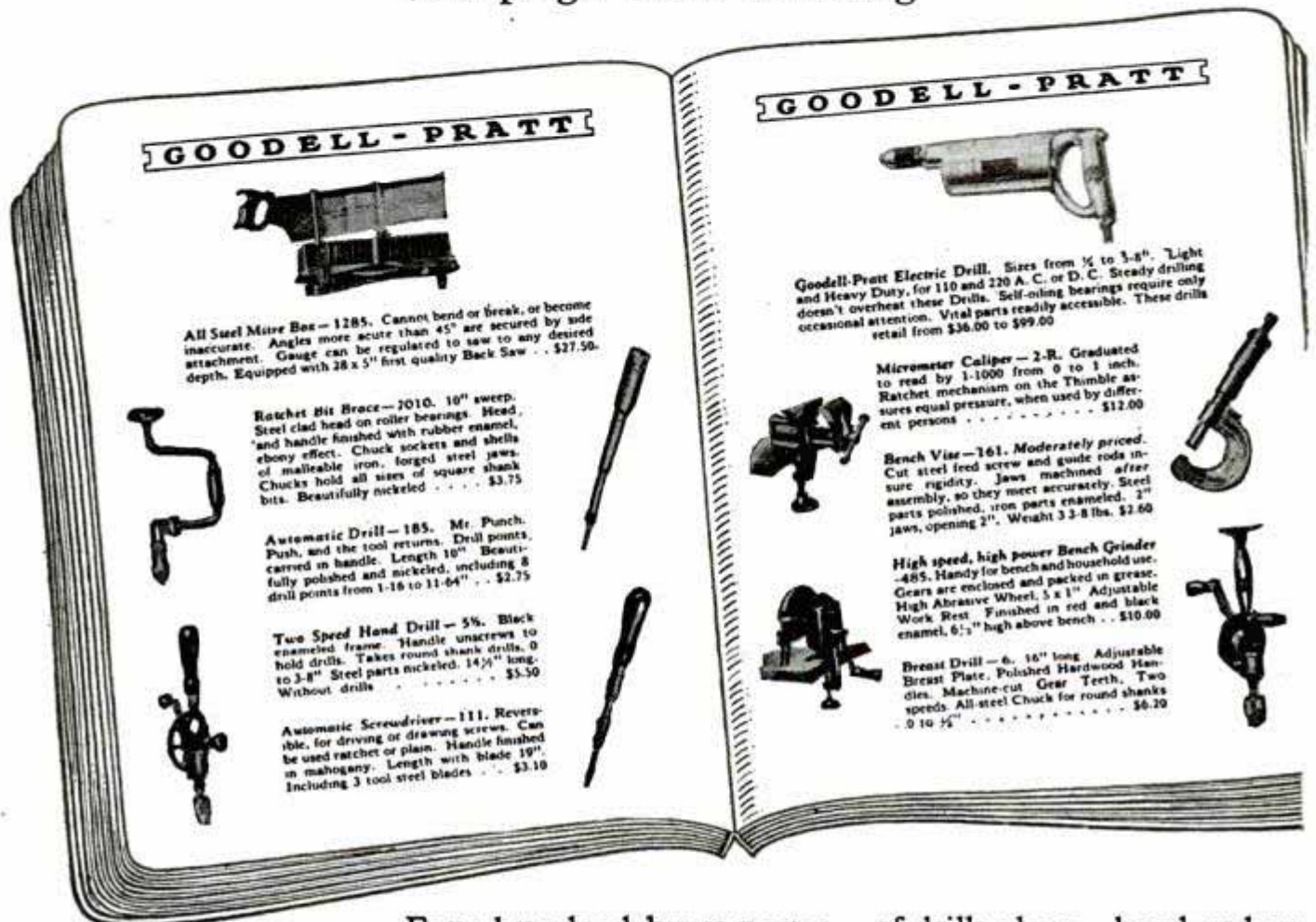

## GOODELL-PRATT



**All Steel Miter Box—1285.** Cannot bend or break, or become inaccurate. Angles more acute than 45° are secured by side attachment. Gauge can be regulated to saw to any desired depth. Equipped with 28 x 5" first quality Back Saw . . . \$27.50.



**Ratchet Bit Brace—2010.** 10" sweep. Steel clad head on roller bearings. Head, and handle finished with rubber enamel, ebony effect. Chuck sockets and shells of malleable iron, forged steel jaws. Chucks hold all sizes of square shank bits. Beautifully nicked . . . \$3.75.



**Automatic Drill—185.** Mr. Punch. Push, and the tool returns. Drill points, carried in handle. Length 10". Beautifully polished and nicked, including 8 drill points from 1-16 to 11-64" . . . \$2.75.

**Two Speed Hand Drill—56.** Black enameled frame. Handle unscrews to hold drills. Takes round shank drills, 0 to 3-8". Steel parts nicked. 14 1/2" long. Without drills . . . \$5.50.

**Automatic Screwdriver—111.** Reversible, for driving or drawing screws. Can be used ratchet or plain. Handle finished in mahogany. Length with blade 19". Including 3 tool steel blades . . . \$3.10.



**Goodell-Pratt Electric Drill.** Sizes from 1/4 to 3-8". Light and Heavy Duty, for 110 and 220 A. C. or D. C. Steady drilling doesn't overheat these Drills. Self-oiling bearings require only occasional attention. Vital parts readily accessible. These drills retail from \$36.00 to \$99.00.



**Micrometer Caliper—2-R.** Graduated to read by 1-1000 from 0 to 1 inch. Ratchet mechanism on the Thimble assures equal pressure, when used by different persons . . . \$12.00.

**Bench Vice—161.** Moderately priced. Cut steel feed screw and guide rods insure rigidity. Jaws machined after assembly, so they meet accurately. Steel parts polished; iron parts enameled. 2" jaws, opening 2". Weight 33-8 lbs. \$2.60.

**High speed, high power Bench Grinder—485.** Handy for bench and household use. Gears are enclosed and packed in grease. High Abrasive Wheel, 5 x 1" Adjustable Work Rest. Finished in red and black enamel. 6 1/2" high above bench . . . \$10.00.



**Breast Drill—6.** 16" long. Adjustable Breast Plate. Polished Hardwood Handles. Machine-cut Gear Teeth. Two speeds. All steel Chuck for round shanks . . . \$6.20.



Four hundred busy pages, showing the 1500 Good Tools—tools for carpentry, automotive and electrical work—machinists' and builders' tools—in fact, pretty nearly every kind of good tool—for professional and amateur use.

The pages above show only one tool in each line. The catalog shows a complete range of each—65 pages, for instance,

of drills alone—hand and automatic drills, breast and chain drills, electric and foot power drills, in every size and capacity.

With this catalog you can select leisurely the tools that will exactly suit your purpose and your pocketbook—then go to your hardware store and buy them.

Write for the catalog—today.

GOODELL-PRATT COMPANY, GREENFIELD, MASS., U. S. A.

MAKERS OF *Toolsmiths* MR. PUNCH

# GOODELL-PRATT

## 1500 GOOD TOOLS

Goodell-Pratt make a complete line of fine tools for carpenters, mechanics and machinists. No better are to be had at any price.



# 7 Tube Set

## Single Dial Radio



**The Metrodyne**  
ONLY ONE DIAL TO TUNE

**30 DAYS FREE TRIAL**

**Metrodyne Radio Sets**  
Are Equipped For **BATTERY or ELECTRIC** operation

**Retail Price**  
**\$75<sup>00</sup>**  
**COMPLETELY ASSEMBLED**  
BIG DISCOUNTS to Agents and Dealers

Wonderful offer direct from the factory! The world's greatest radio! A perfect working, single dial control, 7 tube receiver! And just to prove our claims, we will ship it to your home for 30 days' free trial. Test it under all conditions. Test it for distance, volume and tonal quality—and if you are not convinced that it is the best single dial set you ever heard, return it to the factory. We don't want your money unless you are completely satisfied.

**BIG PROFITS TO AGENTS AND DEALERS**  
Our Agents and Dealers make big money selling Metrodyne Sets. You can work all or part time. Demonstrate the superiority of Metrodynes right in your home. Metrodyne Radios have no competition. Lowest wholesale prices. Demonstrating set on 30 days' free trial. Greatest money-making opportunity. Send coupon, letter or postal for our agent's proposition.

### Three Year Guarantee

## Metrodyne Super-Seven Radio

A single dial control, 7 tube, tuned radio frequency set. Tested and approved by Popular Science Institute of Standards, Popular Radio Laboratory, Radio News Laboratory and by America's leading Radio Engineers. Designed and built by radio experts. Only the highest quality low loss parts are used. Magnificent, two-tone walnut cabinet with beautiful, gilt metal trimmings. Very newest 1928 model.

Easiest set to operate. Only one small knob tunes in all stations. The dial is electrically lighted so that you can log stations in the dark. The volume control regulates the reception from a faint whisper to thunderous volume, 1,000 to 3,000 miles on loud speaker! The Metrodyne Super-Seven is a beautiful and efficient receiver, and we are so sure that you will be delighted with it, that we make this liberal 30 days' free trial offer. You to be the judge.



30 Days' Free Trial—3 Year Guarantee

### Metrodyne Super-Six

New 1928 model Metrodyne 6 tube, two dial, long distance tuned radio frequency receiver. Approved by leading radio engineers. Highest grade low loss parts, completely assembled in a beautiful walnut cabinet. Easy to operate. Dials easily logged. Tune in your favorite station on same dial readings every time—no guessing.

Mr. Howard, of Chicago, said: "While five Chicago broadcasting stations were on the air I tuned in seventeen out-of-town stations, including New York and San Francisco, on loud speaker, loud and clear."

We are one of the pioneers of radio. The success of Metrodyne sets is due to our liberal 30 days' free trial offer, which gives you the opportunity of trying before buying. Thousands of Metrodynes have been bought on our liberal free trial basis.

**6 Tube Set**  
**\$48<sup>50</sup>**  
RETAIL PRICE  
Completely Assembled

**MAIL THIS COUPON**  
  
or send a postal or letter. Get our proposition before buying a radio. Deal direct with manufacturer—SAVE MONEY—WRITE NOW!

### Mail COUPON Below!

Let us send you proof of Metrodyne quality—our 30 days' free trial offer and 3 year guarantee

Mrs. Wm. Leffingwell, Westfield, N. J., writes: "The Metrodyne Radio I bought of you is a wow! This is as good as any \$225 machine I have ever seen."  
N. M. Greene, Maywood, Ill., writes: "My time is up and the Metrodyne works fine. I got Havana, Cuba, Oakland, Calif., Denver, Colo., Toronto, Canada, all on the loud speaker."

J. W. Woods, Leadville, Colo., writes: "Received the 7-tube Metrodyne in fine condition. Had it up and working same day received. Was soon listening to Los Angeles, San Diego, Oakland and other California points; also St. Louis, Kansas City and other east and south stations—all coming in fine. Am more than pleased. Sure enjoying it."

We will send you hundreds of similar letters from owners who acclaim the Metrodyne as the greatest radio set in the world. A postal, letter or coupon brings complete information, testimonials, wholesale prices and our liberal 30 days' free trial offer.

METRO ELECTRIC COMPANY  
 2161-71 N. California Ave., Dept. 39, Chicago, Ill.  
 Gentlemen:  
 Send me full particulars about Metrodyne 6 tube and 7 tube sets and your 30 days' free trial offer.  
 Name.....  
 Address.....

**METRO ELECTRIC COMPANY**  
2161-71 N. California Ave., Dept. 39, Chicago, Illinois

If you are interested in AGENT'S proposition, place an "X" in the square



# for Precision Construction Mechanics use BROWN & SHARPE TOOLS

The moderate priced motor car could not roll on the roads today were it not for the precision tools which make quantity production possible.

Precision construction plays just as important a part throughout hundreds of industries as it does in the manufacture of automobiles.

Mechanics in all of these industries place complete reliance in the performance of Brown & Sharpe Tools. They know that this performance sets a standard of accuracy throughout the mechanical world.



**B.S.**

Hardware dealers can supply you with catalog No. 30 or, we will send you one direct.

DEPT. P M

**BROWN & SHARPE MFG. CO.**  
Providence, R. I., U. S. A.

# **BROWN & SHARPE TOOLS**

*"World's Standard of Accuracy"*

## What Do You Want?

Think of the things you would have if you only had the money—a new car, the best radio, that musical instrument, those new tools, or money to start in for yourself!

### Here's the Way to Get It

Cash in on the big demand everywhere for expert saw filing. You can do it with the Foley Automatic Saw Filer. You can turn out better work than expert hand filers, in less than half their time. Carpenters, contractors, woodworking plants, factories and schools will be your regular customers. Steady year around business. As high as \$20.00 a week extra cash. Why not find out how easy it is to have the things you want? No obligation if you write. Address—

**Foley Saw Tool Co., 219 Foley Bldg., 9 Main St. N.E., Minneapolis, Minn.**





# 21 JEWEL ~ Extra Thin STUDEBAKER The Insured Watch

Sent  
for Only  
\$1 down

Sold Direct  
From the Maker



## You save 30% to 50%

An amazing offer! Just \$1.00 down brings you the famous 21-Jewel Studebaker Watch direct from factory. Balance in easy monthly payments. Lowest prices ever named for equal quality. By buying direct you save 30% to 50%. Your choice of 80 magnificent, new Art Beauty cases and dials. Latest designs in yellow, green and white gold effects. Exquisite thin models. 12 Size and 16 Size.

Send coupon for catalog of Advance Watch Styles and full particulars. Studebaker Watches have 21 Jewels, 8 Adjustments—Insured for your lifetime! Insurance Policy FREE! Ladies' Bracelet Watches, Men's Strap Watches, Diamonds and Jewelry also sold at lowest prices and on easy monthly payments. Send coupon for full details.

### Mail Coupon For Six-Color Catalog!

The coupon below will bring you a copy of our beautiful new six-color catalog. It contains complete information on watch making. It tells how you can buy a 21-Jewel Studebaker Insured Watch direct from the maker—save big money and pay for it in easy monthly payments.

The Studebaker Watch Company is directed by members of the famous Studebaker family—known for 75 years of honest dealing. Over 100,000 satisfied customers own Studebaker Watches—and saved money by buying them direct. We ship anywhere.

### SPECIAL OFFER! Watch Chain FREE!

For a limited time we are offering a magnificent Watch Chain Free. To all who write immediately we will include particulars of this astounding offer. Offer is limited. Send the coupon NOW!

### STUDEBAKER WATCH COMPANY

*Directed by the Studebaker Family—three-quarters of a century of fair dealing*

WATCHES • DIAMONDS • JEWELRY

Dept. V-806 • South Bend, Indiana

Canadian Address: Windsor, Ontario

STUDEBAKER WATCH COMPANY  
Dept. V-806 South Bend, Indiana

Please send me your free catalog of Advance Watch Styles and details of your \$1.00 down offer.  Please send me free catalog of Jewelry and Diamonds.

Name.....

Street or R. F. D.....

City..... State.....

Mail  
Coupon  
Today!







*New Model*

## *Pocket Ben*

Hundreds of thousands of men and boys have put their "O. K." on the New Model Pocket Ben.

Good looks, faithful service and low price—it is everything you need in a watch.

Sold everywhere for \$1.50. With luminous night-and-day dial \$2.25.

WESTERN CLOCK COMPANY  
La Salle, Illinois

## BIG PROFITS

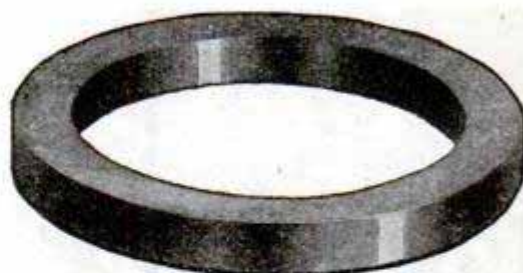

## TO DEMONSTRATORS

This is the WASCO Inserted Valve Seat, for all cars. A set may be inserted in a car in from 40 to 60 minutes by our special tool (patent applied for). Has approval of big auto factories and is listed in manufacturers' "approved" shop equipment catalogs.

You can make big money demonstrating to car dealers, garages and service stations. Has instant approval. 3 out of 4 want it. Low in price. Earns big money for dealer. We want several men who can earn \$5,000 a year, clear, and upwards. Write for full information, special proposition and literature. No obligation. State territory wanted.

Inserted Valve Seat and Tool Co.  
512 Morgan Bldg.,  
Detroit

Fansteel Products Company, Inc.  
North Chicago, Illinois

## RADIO AGENTS

Make Big Money

EASY to sell American Radios and Supplies. Nationally advertised, high quality merchandise at wholesale. Big profit on every sale. No capital to invest. No stock to carry. Order direct from my huge warehouse as you sell. Get My Liberal Offer and also Big New 122-page Catalog and Guide—"How to Sell Radios"—Free. Full of Bargains—all latest in Radio. Write today!

AMERICAN AUTO & RADIO MFG. CO.

HARRY SCHWARTZBERG, PRES.  
Dept. 266 American Radio Bldg., Kansas City, Mo.



## SET BUILDERS!

Before you build get our special prices on the parts you are planning to use. We'll save you money. Largest and most complete stock in U. S. A.

CHICAGO SALVAGE STOCK STORE  
Dept. P. M. 509 S. State St., Chicago, Ill.

## A SHIP MODEL FOR \$4.98



Build an exact replica of the historic Santa Maria or the Mayflower with your own hands. We will furnish the parts cut to fit and ready to assemble complete for only \$4.98 plus a few cents for postage. No tools needed except a small hammer.

Write for our illustrated catalog.

MINIATURE SHIP MODELS  
Dept. O, 3818-20-22-24 Baring St., PHILADELPHIA, PA.



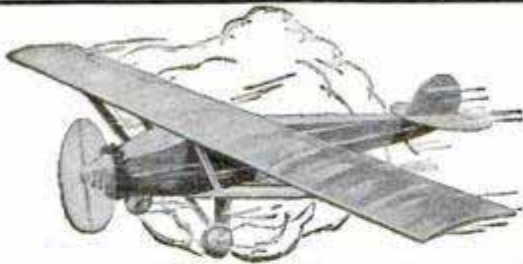

## Build and Fly a 3 ft. Model of LINDBERGH'S NEW YORK-PARIS MONOPLANE

Plans for Other Model  
Airplanes 25c per set.

**FOKKER North Pole**

**Plane**

**CURTISS JN4D-2**

**Plane**

**DeHAVILLAND World**

**Flyer**

**NC-4 Naval Seaplane**

**Bleriot, Nieuport or**

**Taube Monoplanes**

**Cecil Peell Racer Plane**

(All 9 Plans  
for \$2.00)

This IDEAL New York-Paris Mono-  
plane is a perfect copy, 3-ft. size of  
the "Spirit of St. Louis" in which  
Lindbergh crossed the Atlantic  
Ocean. Any bright boy can build this  
model. The IDEAL Construction  
Outfit contains everything needed;  
all parts, fittings, materials and sup-  
plies, including careful instructions,  
plans and diagrams. The model is  
wonderful; has many features of the  
original and is guaranteed to fly.  
Complete Construction Outfit, **\$7.50**  
(West of Denver, Colo., and in Canada,  
price is \$8.00)

Ask your dealer or order direct.  
Plans and instructions only (No  
materials included), postpaid 25c.

IDEAL AEROPLANE & SUPPLY CO.  
408 West Broadway NEW YORK CITY

Catalog of Model  
Airplanes, Parts,  
Supplies, etc.,  
5c postpaid



## Own a CORONA

The portable typewriter  
built like an office ma-  
chine. Has four-row key-  
board and big-machine  
features throughout.  
Write to



L. C. Smith and Corona Typewriters, Inc.  
912 E. Washington St., Syracuse, N. Y.



## Motor Head Lathe COMPLETE FOR \$50

8 Inch swing, 3 ft.  
Bed or longer.

Guaranteed Quality.

We build a line of  
bench woodworking  
machinery including Band Saws, Rip Saws, Scroll Saws, Jointers  
and Swing Saws. Ask for circular and prices.

HESTON & ANDERSON, 637 S. W. Depot St., Fairfield, Iowa.

## MOVIES AT HOME

Many models of genuine MOVIE MACHINES, some  
as low as \$3.75, all using standard size big theatre films.  
Our stock of films is the most complete and lowest in  
price—with an exchange service. Films of leading stars  
and religious subjects are available. DON'T DELAY.  
WRITE FOR FREE INTERESTING CATALOGUE  
NOW!



PARAMOUNT MFG. CO.  
Dept. 1371 BOSTON, MASS.

## COOKS BY BURNING AIR



### Does Away With COAL!

Converts any ordinary  
stove into gas range. Pro-  
duces clean heat much  
cheaper and is far more effi-  
cient than coal. Burns 96% air  
and 4% kerosene. Installed in few minutes.

Types for all heating purposes. Reliable distributor wanted.  
GLORIA LIGHT CO., 111-9N. May St., CHICAGO

## Made for You, Sir

Do us the kindness  
to try it



GENTLEMEN:

One thousand men were consulted as to what they  
sought in a shaving cream. From them we learned  
four things in which they said others had failed.

With these as our goal our laboratories started in.  
Time after time they failed, only to try again. The  
130th formula brought success. Brought, too, a  
fifth feature to assure still greater shaving joy.

Now we ask you to try this shaving cream we've  
made for you. In simple fairness let us send a 10-  
day tube to try. We believe we'll win you.

### We know how

Our laboratories are competent, superlatively equipped. For  
60 years they have studied soap chemistry. The leading toilet  
soap of the world—Palmolive—is one of our creations.

### These 5 advantages

1. Multiplies itself in lather 250 times.
2. Softens the beard in one minute.
3. Maintains its creamy fullness for 10 minutes on the face.
4. Strong bubbles hold the hairs erect for cutting.
5. Fine after-effects due to palm and olive oil content.

### Don't buy—yet

Now we ask that for 10 days you shave our way. At our  
expense. If we have excelled, you will want to know. If we  
have not, you will know that, too. You can't fool men about  
shaving.

Do us the courtesy of a 10-day test. Cut out the coupon now.

THE PALMOLIVE-PET COMPANY,  
CHICAGO, ILLINOIS

3730

## 10 SHAVES FREE

and a can of Palmolive After Shaving Talc

Simply insert your name and address and mail to Dept.  
B-1382, Palmolive, 3702 Iron Street, Chicago, Ill.  
Residents of Wisconsin should address Palmolive, Mil-  
waukee, Wis.

(Please print your name and address)





## The "Mountie" isn't lonely any more

**W**HEN the supply ship steams south from the last outpost of northern civilization in September, not to return until the following July, loneliness will never again beset the lives of the Royal Canadian Mounted Police who patrol that vast, wild area. Radio is now brightening the long winter nights with music, special programs, messages and greetings from their "home folks." And in the receiving sets of the "Mounties" is the best equipment obtainable. The batteries they use *must* be dependable. They must serve until new supplies are brought in a year later.

*Ask Any Radio Engineer*

**BURGESS BATTERY COMPANY**

GENERAL SALES OFFICE: CHICAGO

*Canadian Factories and Offices:*  
Niagara Falls and Winnipeg



# BURGESS RADIO BATTERIES

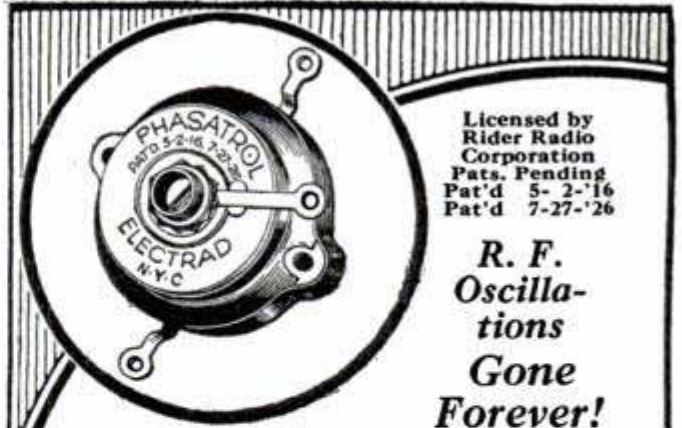

Licensed by  
Rider Radio  
Corporation  
Pats. Pending  
Pat'd 5-2-'16  
Pat'd 7-27-'26

**R. F.  
Oscilla-  
tions  
Gone  
Forever!**

## Phasatrols

A True Balancing Device for All  
Radio Frequency Amplifiers

**Price \$2.75**

Imagine your set without the squeals caused by radio frequency oscillations! You can stop the oscillations and assure perfect, even reception by installing PHASATROLS.

This new Electrad device simplifies tuning and lets distance come in clear. Easily installed in any R. F. set—tuned, untuned or reflex.

**At Good Dealers**

Write for free hook-up circular for any set  
or circuit

Dept. 65A, 175 Varick St., New York, N. Y.

# ELECTRAD

## RADIO PANELS OF GENUINE BAKELITE

Cut, drilled and engraved to order. Send rough sketch for estimate. Our complete Catalog on Panels, Tubes and Rods—all genuine Bakelite—mailed on request.

**STARRETT MFG. CO.** 524 S. Green St.  
Chicago, Ill.

Information on any book free. Write Popular  
Mechanics Press, Chicago, Ill.



THIS 100 PAGE  
**RADIO  
CATALOG  
FREE**

Contains "Hook Ups"  
5 Radio Illustrations  
500 Illustrations  
Over 1,000  
Articles

"Build your own with 'RASCOS' Parts"  
RADIO SPECIALTY CO., 98 E Park Place, New York, N. Y.





# HOT Dollars all Winter

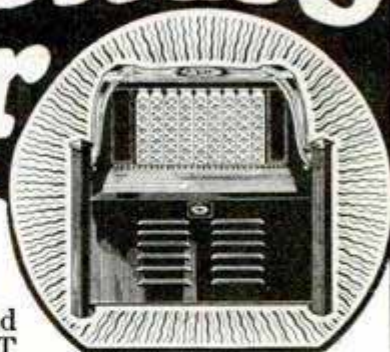

Man—you don't have to sell heat! Everybody wants it. Millions of farm and town homes demanding convenient, cheap GAS heat for cold weather. Here's a 100% EFFICIENT HEATER that will keep the house warm at 23° below zero.

EVERBRITE men making \$3000 to \$5000 a season—no high pressure, no soliciting, just visiting prospects and leaving the heater for a night's trial. In the morning call and get your money. No argument—the man who can supply a UNIVERSAL NECESSITY at LOWER COST is the man who piles up the dollars.

NOW I'm going to smash all sales records—pay more money to representatives—double my

Just sold seven Everbrites. They look like a gold mine to me. Secured three extra salesmen and have several more ready to start. Kindly keep the Everbrites rolling in by twos daily by express until large freight shipment can reach me."

Willet Arnquist,  
Union City, N. J.

When it's 23 below zero, the EVERBRITE Radiant Oil Heater will keep you comfortable. Mrs. Senften, Genoa, Nebr., writes: "Last Sunday it was 23 below zero, but the Everbrite kept us warm and burned 25 hours on one filling."

national advertising campaign—HEAT UP THE WHOLE COUNTRY with EVERBRITES. If you WANT MONEY write me QUICK.

## The EVERBRITE IMPROVED Radiant Oil Heater

*Harry M. Washington*  
President

**\$200 A Week Easy  
We're Choosing Men Now**

A portable heater for homes, stores, churches, offices, making and burning its own gas from common kerosene—the greatest household comfort ever offered—and the greatest money making proposition for agents in the world. 10,000 sold last winter—revolutionizing heating in districts where there is no natural gas! Pours out floods of intense, pure, healthy heat without fuss or bother. Looks like a million dollars and lasts forever. Sold at low price. Just the thing for your home—heats a cold room like an August Sun. You can get one now for your own use.

Elegant Nickel trimmed baked enamel finish. Cleaner, cheaper, more comfortable than wood or coal fire. Generates its own heat from common coal oil and combines with 96 per cent air to burn clean and smoke free through lava disc burners and fire clay radiants. No wick. Turn up or down at will, like city gas. Burns 8 to 10 hours on gallon at cost of less than 1 cent an hour. Move from room to room while burning. Will heat whole house or single room. 23 in. high—shipping weight, 40 lbs.

### Amazing New Sales Plan

We make the sale by national advertising, furnish you names, and you get the profit. District agents clean up; local agents work for you. Local agents promoted into big money class. Gave one Texas agent 291 leads; Oklahoma man found it a cinch to close 247 names we gave him in his district. Sales manuals and splendid mailing literature furnished. A real business and valuable franchise.

### A Hot Proposition

"Send 6 Heaters. Yesterday was the first cool day so I fitted up an Everbrite in a window of a downtown office. It created a great deal of excitement and I booked 5 orders with several prospects." J. E. Downen, Durant, Okla.  
"I have already sold 135 Everbrite Heaters. Daily increasing my sales force and dealers and I hope to place a total of 500 before the season closes." J. O. Hand, Sacramento, California.  
"Sold 89 stoves here in Tarrant County last year, and expect to more than double that this year." J. D. Bule, Fort Worth, Texas.

Mail me coupon today.

HARRY M. WASHINGTON, Pres.

The EVERBRITE STOVE CO.

3211 Gateway Station, Kansas City, Mo.

J. O. Hand, California, made over \$250 a week last year. Knabb and Godwin of Florida both did better than \$200 a week. F. W. Hubbel, Iowa, beat \$400 a month. So did Senften and Cassell, Nebr., Richie of Iowa, Shook of New Mexico, Webb of Arkansas, Wilson of Louisiana and Alfred of Kansas. You can do as well. Local agent averages \$11.20 on each sale. Two to five sales a day easy. We supply everything, give you pick of open territory free—start you in business for yourself.

**FREE** Just send coupon now for amazing agent's offer and full information how to get your own heater and make big money.



Mr. Harry M. Washington, Pres.  
Everbrite Stove Company, 3211 Gateway Sta.,  
Kansas City, Missouri.

Dear Mr. Washington—Send me Agent's offer. Tell me how to get a free demonstrator heater.

Name.....

Address.....

Territory Desired.....



SEAEVER-WILLIAMS **SW** BOSTON - MASS.



Thousands are Discovering  
New Joys—New Worlds!  
with these Powerful

# BINOCULARS



See miles away! Bring people, ships, wild game, sports... right to YOUR FEET! Keep a pair in YOUR car! Enjoy glorious vistas of nature. You'll find these Binoculars a never-ending pleasure. Great for vacations, hunting, camping, races, boxing bouts, football games, bird and nature study. We are selling thousands to Explorers, Yachtsmen, Big Game Hunters, Naturalists, men all over the world! Usual price \$50.00. Our "Direct-by-Mail" price while LIMITED Importation lasts... **\$23.50**

### Tested by the GOVERNMENT

Bureau of Standards at Washington. Used by Army and Navy Officers and Commanders! These are Genuine Imported French and German makes. 8-Power Magnifications, Genuine Prisms. Send NO Money Famous PREMIERE QUALITE—brilliant illumination, exquisite definition. Wide field of vision, many times area of Field Glass. Individual eye strength and width adjustment. Leather Case, neck and shoulder Straps!

**Our Plan 10 Days' Trial Absolutely FREE**

*is Different!* We ask for NO money in advance! NOTHING on Delivery. See, Try, Test, Enjoy BINOCULARS for 10-days' trial, ABSOLUTELY FREE. If pleased you may pay on Budget Plan: **\$5.00 MONTHLY**

or if you prefer to pay cash at end of 10 DAYS, deduct \$1.75 and send Check or Money Order for **\$21.75** in FULL SETTLEMENT. Otherwise return them. Order NOW at this Special Price! Send NO Money! Pay NOTHING on Delivery.

**SEAEVER-WILLIAMS CO.**  
Importers, Exporters, International Mail Order House  
"2 Generations of Honorable Dealings"  
**365 WASHINGTON ST., BOSTON, MASS.**  
Largest Retailers of Binoculars in the World.

Gentlemen:—Send me the 8-POWER BINOCULARS for 10 days' FREE Trial on your "NO Money in Advance—NO Money on Delivery" Plan.

Name.....

Address.....

Clip and mail coupon NOW! If a new customer please tell us something about yourself. We will appreciate and respect the information. THANK YOU. Pop. M. 9-27

# RADIO DEALERS' CATALOG—FREE!

A most complete catalog of everything in Radio. All the latest hook-ups. Sets, Parts and Kits of every description. Live Dealers need this book. Write on your business stationery.  
COLUMBIA RADIO CORP., 711 W. Lake St., Dept. 247, CHICAGO, ILL.

# INDISPENSIBLE

for 100%  
**Tube Efficiency**

Only Amperite supplies automatically the self-adjusting filament current your tubes require. Eliminates hand rheostats. Simplifies wiring. Insist on Amperite. Accept nothing else. Price \$1.10 complete. Sold everywhere. Write for Free Hook-Ups and construction data to Dept. P. M.-9.

**RADIALL COMPANY**  
50 Franklin St., NEW YORK CITY

# AMPERITE

REG. U.S. PAT. OFF.

The "SELF-ADJUSTING" Rheostat

# PARKS Manual Trainer

## \$35.00

Without Motor

For your home shop! Combination 11-inch band saw and 11-inch wood lathe. If you have a knack for wood working you can turn out first-class bridge lumps, cabinets, furniture, ship models, etc., in fast time. Get one!

Write for specification circular

**THE PARKS WOODWORKING MACHINE CO.**  
1500-40 Knowlton Street Cincinnati, Ohio  
CANADIAN FACTORY: 208 Notre Dame East, Montreal, Canada

# BIG RADIO CATALOG

From the "Big, Friendly Radio House"

NEW 1928 Book offers finest, newest well-known sets; parts, eliminators, accessories at lowest prices. Set-builders, dealers, agents—WRITE for this CATALOG!

# Western Radio Mfg. Co.

132 West Lake Street—CHICAGO, ILL.

# SOLDERALL

METAL IN PASTE FORM

The Only convenient metal solder

Every Electrical Connection needs Solderall for perfect reception

**25¢**

The SOLDERALL CO., NEWARK, N.J.

# They Give Permanent Satisfaction

Frost-Radio De Luxe Super Variable High Resistance Units and Rheostats and Potentiometers, both Bakelite and Metal Frame Type must give permanent satisfaction or they would not be used by more than 60 leading set manufacturers. You will like their dependability, their design and fine construction. Ask your dealer to show you the complete line of these parts.

**HERBERT H. FROST, Inc.,** Main Offices and Factory: ELKHART, IND.



# NOW! MAKE THINGS AT HOME WITH THE NEW **RED JACKET** HOME WORK SHOP

SENT ON TRIAL

only \$10.00 down

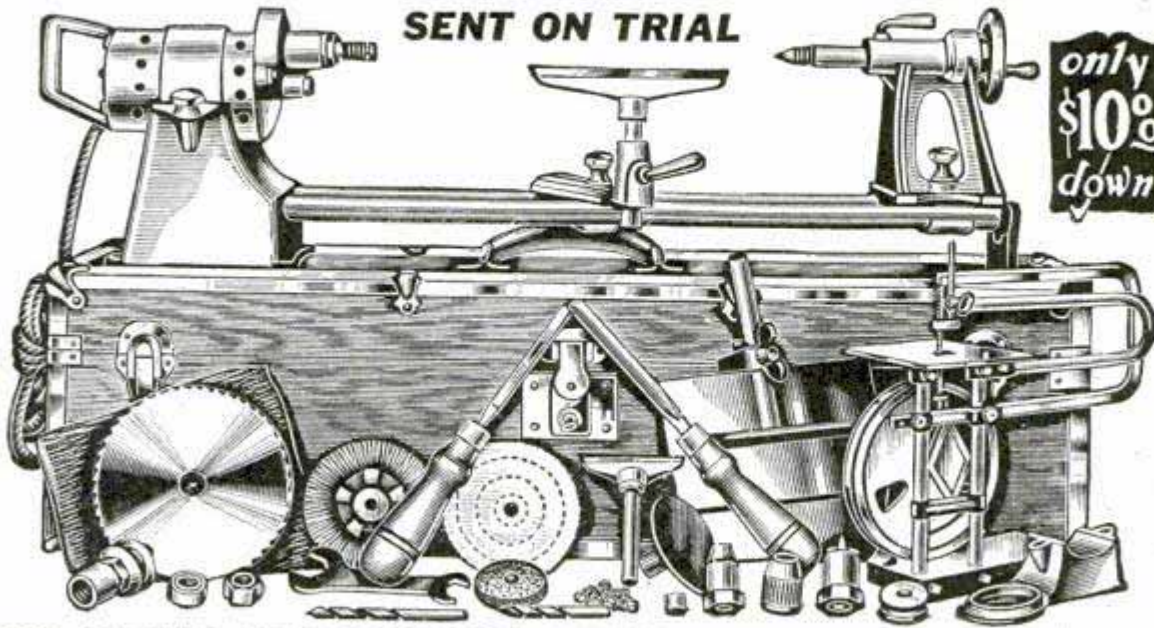

## THE HOME CRAFTSMAN'S LATHE Will Make You a Craftsman

**A COMPLETE SET OF PRECISION TOOLS** electrically driven that will make you an accomplished workman. It is a chest full of tools that has been designed by a master for the private use of tool lovers and men who want to build, construct, invent and create at home. You will be able to make everything — attractive odd furniture, toys, home and garden improvements, all-around manufacturing, repairing.

**free CRAFTS COURSE**

**free BLUE PRINTS**

The complete equipment consists of the powerful Red Jacket Motor, with direct drive to an accurate wood turning lathe (capacity 9 in. x 34 in.); a bench saw, that has depth and side gauges; scroll and jig saw; and all accessories for both portable and stationary power drilling, buffing, grinding and cleaning. Attaches to any light socket and converts your work bench into a complete private tool and machine shop.

**THE WACO GUARANTEE IF IT IS NOT WHAT YOU WANT When You Get It—SEND IT BACK**

**A SPECIAL CRAFTS COURSE** And blueprint service is free to Red Jacket Shop owners—all that there is to know about handicraft methods, raw materials, woods, carving, sawing, turning, designing, carpentering, decorating, is taught by special correspondence.

**BUY ON YOUR OWN TERMS** Only \$10.00 down. Liberal discounts for cash. Easy monthly payment plans. It is no hardship to own a Red Jacket.

**INTERESTING LITERATURE FREE** Just send the coupon. You will be surprised with all it contains. Beautiful, Instructive, Fascinating, Interesting.

**Everything Explained in Our Literature**

**WACO TOOL WORKS, Inc., 542 N. Parkside Av. Chicago, Illinois.**

Manager, Dept. 109: Please send me particulars about 10-day free trial, free blue-prints and \$10 down payment.

Name.....  
Address.....

### When You Want a **BLOTORCH**

That gives 400° more heat—That's 100% safe—send for

**TURNER MASTER No. 45**  
Only \$7.75, postpaid

TURNER BRASS WORKS, Industry Ave., Sycamore, Ill.

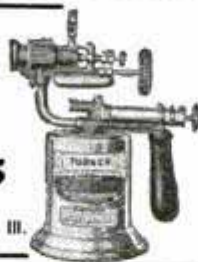

### DRIES IN MINUTES!

Valspar Lacquer gives chairs, tables, cabinets, woodwork a beautiful satin finish in any color. Easy to apply—dries in minutes. Send 20c for sample! Red, Blue, Green, Yellow, Orange, Lilac, Brown, Ivory, Coral, Gray, Black, White. Valentine & Co., 450 Fourth Avenue, New York, N.Y.



## VALSPAR BRUSHING LACQUER

### Better Than A Brush



#### The Lacquer-Well Spray Gun

for all brushing lacquers including brushing Duco.

#### Anyone Can Work It

Lacquer your auto, screens, etc. Make your old furniture like new. Every garage should have one.

Sent postpaid anywhere in U. S. upon receipt of \$2.50, extra tanks 25c.

**THE LACQUER-WELL SPRAY COMPANY**  
Dept. R 2014 East 105th St. Cleveland, Ohio

**Relieve the Pain Prevent Infection**

Use Absorbine, Jr. to heal cuts, bruises, burns, rash, skin eruptions and to reduce swelling. It's a safe and powerful liniment—a dependable antiseptic.

\$1.25 a bottle at your druggist's  
W. F. YOUNG, Inc., Springfield, Mass.

**Absorbine Jr.**  
THE ANTISEPTIC LINIMENT



# 18 Tools In One S&B SAW Money Back Guarantee 8" Combination S.B. SAW 15 DAYS TRIAL

The S&B 8-in. Combination Saw (18 tools in one) is the ideal machine for the shop, factory or the home; will rip, cross cut, bevel, miter, mortise, groove, drill, tenon, grind, rabbet, buff and polish. The greatest machine you ever saw;

**\$35**

F. O. B. CHICAGO

no other machines complete and efficient as the S&B—actually 18 tools in one! You will marvel at the wonderful bevel-

ing, grooving, buffing, etc. All attachments are adjusted in a few seconds without any difficulty. Very little space is used and the motor is mounted on a base that is a part of the machine proper, this is an exclusive feature! The motor: ¼-H.P., 60-cycle, 110-volt A.C., run from any light socket also provides power for other purposes when the saw is not in use. Complete with attachments: 12-in. x 16-in. Table, 8-in. Combination Saw, Iron Pulley for Saw Table, 10-in. Ripping Fence, Adjustable Cut-Off Miter Gauge, Motor ¼-H.P., 3-in. Iron Pulley, 6-in. Buffing Wheel, 5-in. Emery Wheel, 6-in. Sander, ¾-in. 3-Jaw Drill Chuck, 1 ¼-in. Endless Leather Belt, 8-foot Cord and Plug, Saw Guard and 2-in. Dado Insert. Price \$35.00, F.O.B. Chicago. Shipping weight 100 lbs. (Planer attachment to fit on table top will smooth pieces up to 2 in. wide, \$12.00 extra. Flexible Shaft Grinder attachment, \$35.00 extra.)

Write for Complete Illustrated Folder

**SCOTT-BANSBACH MACHINERY CO.**

130 So. Clinton St.

Dept. 55

CHICAGO, ILL.



Belt Tightener

With table raised—saw is guarded ready for drilling, grinding or polishing.

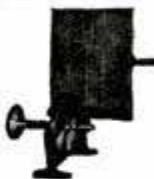

Ready for dado or planer head and special molding work—table is adjustable.

Planer attachment—most practical ever adapted to a saw table.



Flexible shaft grinding attachment—especially good for metal patterns, routing, grinding, die-castings, etc.



The only machine that you can tilt the table to 45° without removing insert. Big advantage on pattern work.

## Here is Wood That You Can Mould!

It's as soft and workable as clay or putty and it hardens to the toughest kind of solid wood.

## PLASTIC WOOD



corrects mistakes in wood working; repairs bicycle grips; fixes up toy boats or big boats; fills screw or nail holes to use again; holds loose casters, tiles, or handles; repairs broken furniture, fills up cracks; takes paint, varnish or lacquer—yes, it's mighty useful as well as lots of fun.

¼ lb., 35c.; one pound \$1.00  
Sold by Hardware and Paint Stores.  
Send coupon if they cannot supply you

**ADDISON-LESLIE COMPANY**  
45 Bolivar Street, Canton, Mass.  
Please send me ¼ lb. can of PLASTIC WOOD for which I enclose 35c.

Name.....  
Address.....

## BURN YOUR NAME ON TOOLS WITH THE ARKOGRAF

### PROTECT YOUR TOOLS FROM THEFT

Write with electricity any name or design on the hardest and finest tools and instruments, or any metal, like writing on paper with pen or pencil. Complete Outfit \$3.50—Prepaid Anywhere. Interesting illustrated circular free. Write today. Agents wanted. ARKOGRAF PEN CO., 1171 E. Stark St., Portland, Oregon

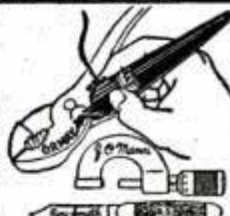

## I made \$250<sup>00</sup> extra in 3 months with my TORIT handy Torch



### THOUSANDS OF MECHANICS

in the U. S. and Canada are doing the same—Cashing in on quick, easy profits. One man writes, "I received my Torit Torch in the morning and by night had made an extra \$7.50 on jobs I ordinarily turn down. The Torit has already paid for itself and is now the **HANDIEST TOOL IN THE SHOP.**" Beats anything you ever tried for soldering, lead burning, radiator repairing, etc.

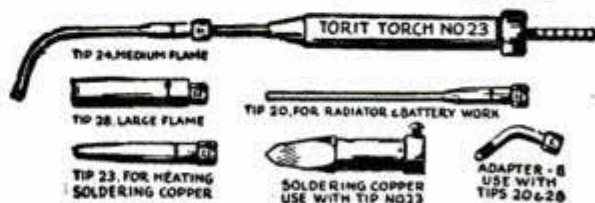

PAT. JAN. 5, 1926

Uses Acetylene Only. No oxygen or air pressure is required. Tips suck in air. Simply connect to Presto auto tank, light gas, and outfit is put to work. Consists of torch, 4 tips, soldering copper, 5 ft. rubber tubing, tank connection and instructions. Price **\$7.50**

**ST. PAUL WELDING & MFG. CO., 177 W. 3rd St., St. Paul, Minn.**



**VERSATILE!**

Does everything  
a novelty saw can  
do—but does  
it better.

# SIMONDS PLANER SAW

This saw will produce quickly and economically with either soft or hard wood. Whether ripping, cutting off or mitering, it will stand fast hand feed without rubbing or overheating. The successful performance of Simonds Saws, Knives and Files is due to the fact that they are made of scientifically tempered steel and that behind them is Simonds' near-century of experience in making the finest cutting edges. When buying cutting tools, specify "Simonds"!

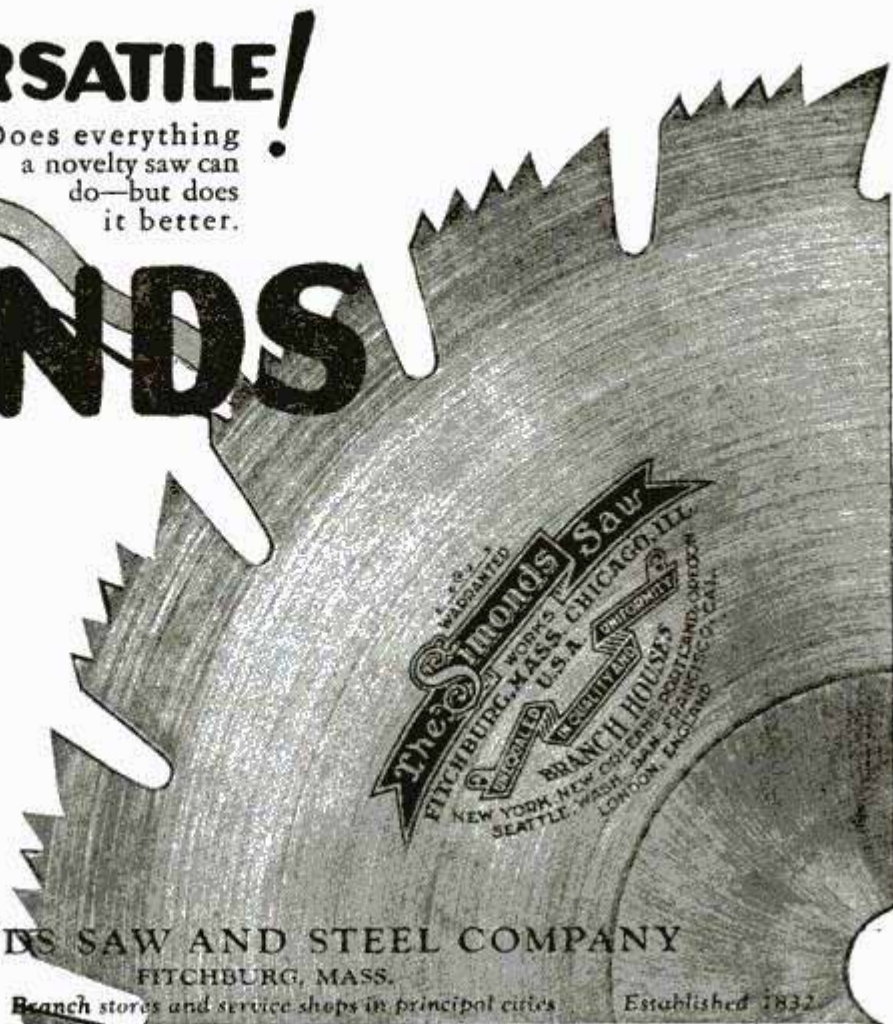

**SIMONDS SAW AND STEEL COMPANY**  
FITCHBURG, MASS.

"The Saw Makers"

Branch stores and service shops in principal cities

Established 1832



## Crescent Wood Working Machines

are neat in design, substantially built and are intended for hard, continuous service. Users of wood working machinery who appreciate quality always investigate Crescent machines before placing their orders. Send today for circulars of Band Saws, Saw Tables, Self Feed Rip Saw, Shapers, Jointers, Variety Wood Worker, Planers, Planer and Matcher, Disk Grinders, Cut Off Table, Swing Saws, Boreers, Hollow Chisel Mortisers, Tenoners, Universal Wood Workers. **The Crescent Machine Co.** 93 Columbia St., Leostonia, Ohio, U. S. A.



## A Gerstner CHEST

is the right Chest for your needs. Toolmakers and Machinists—select your Cases and Chests from our free catalog.

*Gerstner & Sons*

445 Columbia St., DAYTON, OHIO

## YOU NEED SARGENT PLANES

See them at your hardware dealer's. For booklet write **Sargent & Company, Manufacturers** 49 Water Street New Haven, Conn.

## "A GOOD RULE THAT WORKS BOTH WAYS"

### THE SPEEDY RULE

For accurate inside and outside measurements. Quickest, handiest, strongest. It slides—no folding. All lengths, 2 to 8 ft., 20c per lineal ft. If not at dealers, sent postpaid.



**Master Rule Mfg. Co.**  
813 E. 138th St.  
New York

Dealers and Agents: Write for attractive proposition.

## You can do it better with a Crescent Wrench

Your "shop" may be in the attic or the basement; maybe it's in the garage, but at any rate you need a dependable wrench—a Crescent.

Crescent wrenches are made of special analysis steel—they are easily adjusted and they hold when set. They'll do the job easier and better.

The CRESCENT—Smith & Hemenway line includes a wide range of small tools, many with exclusive features, but all identified by their quality and workmanship. Crescent Tools are always sold under a satisfaction or money back guarantee.

## CRESCENT TOOL CO.

210 Harrison St., JAMESTOWN, N. Y.

Wrenches Chisels Snips  
Pliers Punches Hackaws  
Screw Drivers Auger Bits  
Nippers Electricians' Tools



# CRESCENT and Smith & Hemenway TOOLS





## You can tell by his hammer

The man who isn't satisfied with anything he builds or "fixes" unless it's absolutely right is the kind that gets real satisfaction and pleasure out of owning and using Maydole Hammers.

If you're that kind of man, there's only one make of hammer for you—the genuine Maydole. Grip one in your fist. Feel its superb "hang." Remember that the head is *press-forged* of selected tool steel and the handle is of clear, second-growth hickory, air-dried for years and put on "for keeps." You'll recognize it for what it is—the finest hammer that specialists in hammers for over eighty years can produce.

Ask your hardware dealer to show you a Maydole in whatever style or weight you need.

Write us for a free copy of our valuable and interesting Pocket Handbook No. 23 "L." You'll find it useful.

YOUR HAMMER SINCE 1843  
**Maydole  
Hammers**

The David Maydole Hammer Co., Norwich, NY

942

Please Mention Popular Mechanics

# \$5.00 DOWN buys a WITTE Engine

**Write Me Today**—for new FREE Witte Book telling how you can buy a WITTE Engine for ONLY \$5.00 Down and small EASY Payments. No interest. Absolutely the greatest engine made. Guaranteed for a lifetime. Used all over the world—from the frozen wastes of Alaska to the burning sands of Arabia. Will increase your farm profits \$500.00 to \$1,000.00 a year. Runs on all fuels. Simple, sturdy. Gives most power at least expense. Sizes 1½ to 30 H. P. Engines; also 3-in-1 Saw Rigs and Pump Outfits. Write me today for FREE book and Easy Terms Offer.

**Witte Engine Works**

1746 Witte Bldg., Kansas City, Mo.  
1746 Empire Bldg., Pittsburg, Pa.

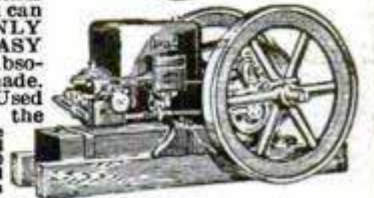

### BUILD SHIP MODELS!

Easy to build and sell. Plans and instructions: "Santa Maria" \$1.00—Viking Galley, 40c—Pirate Ship, 50c—or all for \$1.75. Catalog 6c.

**SEA ARTS GUILD**

405-A Eleventh Ave. Milwaukee, Wis.



## Makes Old Ford a Tractor

Now you can convert that old Ford car into a useful farm tractor without altering any Ford parts. We furnish the traction wheels, drive gears and auxiliary axle and mountings, ready to clamp on to the Ford frame. Pulls 16' plow.

Write for Free Particulars.  
**SHAW MFG. CO., Dept. S, Galesburg, Kan.**



## For Real "Woodworking Efficiency"

is your woodworking ability lying dormant? **Wake it up!** With this new

### JUNIOR CABINET WORKER

at your service

**\$156.00**  
complete

From raw material to finished product all on this complete woodworker.

An ideal outfit for special furniture jobs. Indispensable to the home shop.

Carry it on the job.

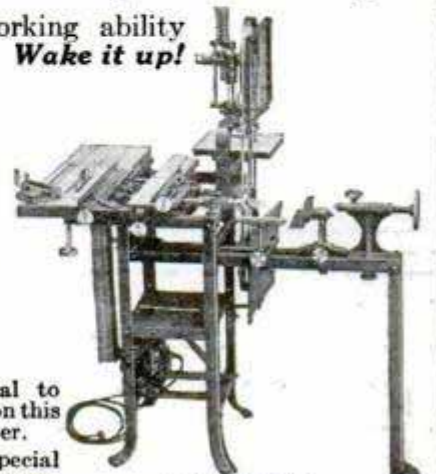

Write for details

Mfg. by **KORNAU MACHINE COMPANY**  
Station A Cincinnati, Ohio





**Save more than ever**

This 6 Room Bungalow **\$1493** NOW FREIGHT PAID

Price includes everything complete—lumber cut-to-fit, FREIGHT PAID to your station.

**New Low Prices** Our customers claim average savings of 47% over local prices. This year reduced prices make possible still greater savings.

**We Loan You Money to Build**

We ship you any home you select, ready to erect, and ADVANCE YOU CASH to help you build. You pay us in small amounts monthly, just as you pay your rent—and your rent money is saved instead of spent. Send 25c in coin today for beautiful Color Book of Sterling Home Plans and you can be living in a home of your own a month from now.



**INTERNATIONAL MILL & TIMBER CO.**  
794 S. Wenona Ave. BAY CITY, MICH.

**Try in Your Own Home**

Any Wurlitzer Instrument

See for yourself the superior quality of these famous instruments, the result of 200 years' experience. Every known instrument. No expense for trial. Easy terms if desired.

Send for New Catalog—Free

**Rudolph Wurlitzer Co., Dept. 1776**

Cincinnati Chicago  
New York San Francisco

Address city nearest where you live.

**Beautiful HOUSES \$900 and BUNGALOWS**

CAN BE BUILT FOR AND UP

This and many others in my new book, Building Plans for Modern Homes, will save you hundreds of dollars. One of the most complete and comprehensive books of plans ever published by any architect. New edition just off the press. Nearly 600 floor plans and photographs of Colonial houses, bungalows, etc., costing from \$200 up; gives sizes and cost to build. Sent postpaid for \$3.00.

**FREDERICK H. GOWING ARCHITECT**  
101 Tremont St., BOSTON, MASS.

**PLUMBING-HEATING**

Install Your Own—Save Half

Lowest wholesale prices on highest quality Grade A goods. Any Handy Man can install his own Plumbing and Heating BY OUR NEW EASY METHOD. Get the best and pay only a little each month.

**Send for FREE Book**

New bargain catalog just issued. With our cut-to-fit systems you save waste material and high labor cost. 50 years of economical service to home owners, farmers, builders and mechanics. Million Dollar Plants back up our Bonded Guarantee. FREE book gives you the whole story. Write for your copy today.

**HARDIN-LAVIN CO. EST. 1876**  
107-17 West Pershing Road, Chicago, Ill.

**Suppose You Were Offered Diamonds at 60% of Market Price**

Suppose a reason you rarely think of makes possible here radically low prices, even for finest quality diamonds. Thousands of representative people, bankers, lawyers, merchants, others—continually reap this real advantage. Everything sent for Free Examination. This 3/4 century, oldest, largest diamond banking institution in the world, rated over \$1,000,000.00,—converts into cash the diamonds on which money was loaned and not repaid. Loan values, a fraction of market values, are the price basis. Diamonds too from big cash deals direct with European cutters. Must sell now

**Why Pay Full Prices**

When Much Less Buys the Same

See this 3/4 less 1/16 ct., snappy solitaire for \$69.50. Try to match at \$115.00. Examine free any bargain at our risk. Startling, legitimate offers here of diamonds at 60% of market price. Send now for full details. Diamonds of unusual qualities (also watches) from unpaid loans, offered at radically low prices based on mere loan values. Then, too, we have hundreds of diamonds from big, cash, European deals with diamond cutters, who sacrificed these gems away under the market. Send now for our latest offers of this internationally known cash headquarters.

**Unpaid Loan Listings Ready**

**As low as \$60 a Carat**

Radically different from a catalog. List accurately describes every diamond in full detail with guaranteed exact weight, color, quality, etc. Explains Guaranteed Cash—like Insurance Policy Loan guarantee. Also Unlimited Exchange privilege at price paid us. Gives full details of free examination offers. Don't wait, the very diamond you want may be in this very list at a price that will amaze you. Costs nothing to see. Write today a postal will do, or—

**Mail Coupon NOW!**

**JOS. DE ROY & SONS**  
Only Opposite Postoffice  
1960 De Roy Bldg., Pittsburgh, Pa.

Without obligation to buy, send me free, in plain envelope, your Latest Bargain List of Diamonds, Watches, and other Jewels.

Name \_\_\_\_\_  
Address \_\_\_\_\_  
City \_\_\_\_\_ State \_\_\_\_\_

References by Permission:—Bank of Pittsburgh, N. A.; Marine National Bank; Union Trust Co., Pittsburgh, Pa. Your bank can look us up in the mercantile agencies.

**NEW VEST POCKET ADDING MACHINE**

ADDS, SUBTRACTS, MULTIPLIES, DIVIDES

Does work of \$300 machine. Guaranteed 5 years. NOT A TOY.

Made of steel and indestructible. Million dollar capacity. Fits in pocket. Will not make mistakes. So simple child can operate it. Instructions furnished. Everybody should carry one for figuring.

**FREE TRIAL \$2.50 Total Cost**

**SEND NO MONEY**—Just name and address. We will ship Calculator immediately. On delivery pay postman \$2.50 (Plus few cents Postage). (If outside U. S. send cash). 10c additional in Leatherette Case. If not satisfied after 10 day trial you get your money back. THOUSANDS OF SATISFIED USERS.

This is lowest priced practical calculator made. "Why pay more for inferior imitations?" Order from this ad.

**Guaranteed**

**Mail Coupon Today**

**BABY CALCULATOR SALES COMPANY**  
Dept. 41, P. O. Box 1118, CHICAGO, ILL., U. S. A.

I am enclosing \$2.50—send adding machine prepaid.  
 Send Adding Machine C. O. D. \$2.50 plus postage. (10c additional in Leatherette Case)

Name \_\_\_\_\_  
Address \_\_\_\_\_  
City \_\_\_\_\_ State \_\_\_\_\_

**AGENTS** Write for big commission and territory proposition.



**NOW—**  
GET MY  
GREATEST  
**Log Saw**  
Offer



**Fastest Cutting**

**Saws 15 Cords a Day**

**ONLY \$39**

**Used by The United States Government**

It's easier, now, than ever before to own this fastest-cutting, easiest-moved, most powerful Log Saw. Now, you can make big money sawing firewood, stove-bolts, ice, shingle timber, etc. **WRITE TODAY FOR FULL DETAILS.**

**Try 30 Days** **OTTAWA** **Make Big Money**—Wood selling at \$3 a cord brings owner \$45.00 a day. Go into the wood business. Don't let the lack of ready money stop you—Remember, we sell on very easy terms.

**Backed by 10-Year Guarantee**

**FREE** Send me your name and address on a postcard today for my wonderful new edition of the "Wood Sawing Encyclopedia." Be sure to investigate—it will help you to make big money.

**HARRY OVERMAN, Pres., OTTAWA MFG. COMPANY**  
1745-L Wood St., Ottawa, Kans. 1745-L Magee Bldg., Pittsburgh, Penna.

**ONLY**  
**\$39**

**Putts the OTTAWA Working For You!**

**350 Cuts a Minute!**  
Now you have a log—in a few seconds it's all sawed up—without any hard work!

**FREE**  
Wood Sawing Encyclopedia

**Putts the OTTAWA Working For You!**

**350 Cuts a Minute!**  
Now you have a log—in a few seconds it's all sawed up—without any hard work!

**FREE**  
Wood Sawing Encyclopedia

# Shoot the Best Gun

The **NEW BENJAMIN** is the finest air rifle ever made. Unlike all others. Has amazing accuracy—shoots hard and far. It's the original American genuine **AIR** operated rifle. One to six pump strokes compress air to any desired degree of power. Same force as in air drills and air hammers except you control the shooting force. Never loses force—no springs or levers to get out of order. Makes crack shots quickly, inexpensively. Gives years of delightful recreation with utmost safety. At your dealer's, or sent postpaid for \$5.00.

## Shoot 5 Days FREE

We give you five days, ammunition supplied, to test the **NEW BENJAMIN**. If in this time you don't believe it to be the finest air rifle you've ever seen or used, and if you don't believe it is the one and only air rifle for you, return it, postpaid, and your money will be refunded at once.

# The NEW BENJAMIN AIR RIFLE

America's Original Air Rifle

**\$5** at your dealer's or sent postpaid direct from factory on **FREE Trial** as above if dealer does not handle it—write for our wonderful offer.

## Get This Book and Details FREE

**BENJAMIN AIR RIFLE & MFG. CO.**  
845 N. Broadway, St. Louis, Mo.

Please send your amazing offer and free copy of "The Shooter's Art," telling how to become a crack shot, how to hold, aim, and handle guns and guide others in use of guns.



Name \_\_\_\_\_

Address \_\_\_\_\_

**Ask for Keds by name**  
They are not Keds unless the name Keds is on the shoe

# Part-Time Men Get This Suit FREE

**Make \$45 a Week and up**  
**Cash profits paid in advance**  
No question about it, any man can easily earn \$45 a week and up, just showing our wonderful outfit and taking orders for our high-grade tailoring. Never before such low prices and beautiful styles.

## Your Own Clothes FREE

To introduce our unbeatable values, classy styles and perfect tailoring, we make this introductory free suit offer to those who qualify—something different, better, bigger, more liberal than any offer ever made. **Handsome Carrying Case Outfit** of large real cloth samples—everything furnished free. Write today for free suit and big money-making offer.



**SPENCER MEAD CO., Wholesale Tailors, Dept. J816, Chicago**

# WANTED 1500 MEN AND WOMEN

With ambition and industry, to distribute Rawleigh's Household Products to steady users. Fine openings near you. We train and help you so you can sell up to \$200 a week or more. No experience necessary. **Write today** Pleasant, profitable, dignified work.

**W. T. RAWLEIGH CO.**  
Dept. IL8267 Freeport, Ill.

# AGENTS AND SIGN MEN

Now Making \$50.00 to \$100.00 and Up Per Week Selling Our **GOLD LEAF SIGN LETTERS**

**R** For store and office windows, board signs, trucks and glass signs. We also make to order script signs and business emblems singly or by the thousands. A permanent business. No capital or experience required. **Big demand in every city. Samples and Literature Free.**  
**CONSOLIDATED SIGN LETTER CO. 89X W. Van Buren CHICAGO, ILL.**



**A Genuine \$2 Knife for \$1.18 Postpaid**  
Handy shaped Blade makes this knife best for mechanics, sportsmen and farmers; light but strong; re-sharpened easily. Stag handle. German silver finish; blades file tested, hand forged from razor steel and warranted.

**Direct at Factory Prices**

Sample \$1.18 3 for \$3.00 Postpaid

**Hand Forged Razor Steel Blades**

Send for our 100-page **FREE** List and "HOW TO USE A RAZOR."

**Maher & Grosh Co.**  
106 A St., Toledo, Ohio



# EDWARDS WILL SAVE YOU MONEY ON METAL ROOFS

We own our own steel mills, roll our own sheets, make them into high-grade REO METAL SHINGLES, Sidings, Ceilings and Roofings of every type and style for every kind of building. We control every operation from the raw material to the finished roof and we sell direct from our factories to the user. Not a dollar to divide with anybody but the customer! You get better value for less money.

## OUTLAST THREE ORDINARY ROOFS

EDWARDS METAL ROOFS are weather-proof, lightning-proof, fire-proof! The galvanizing bends with the metal. No tools required.



## LOW-COST ALL-METAL GARAGES

Any size. Any style. Portable. Ready to erect. Complete with frames, doors, sash and hardware. Ornamental, durable, economical. Blue-prints and complete instructions FREE.

Write today. Get our low prices and Free Samples. Ask for Roofing Book No.150 or for Garage Book No. 150.

THE EDWARDS MFG. CO.  
900-950 Butler St. Cincinnati, O.



## \$45 Buys This Motor Cycle

It's a Harley-Davidson, 16 H. P., twin chain drive, magneto and clutch. It has power and can get up and go on the open road at a speed which thrills. This is only one of hundreds of bargains in used motor cycles which you can get. Send for Free Catalog. It tells of big bargains and tremendous values in used motor cycles. Repairs quickly done. Motor cycles exchanged. Send us your machine to be overhauled.



Oliver Cycle & Motor Co., 1045 N. Grand Ave., St. Louis, Mo.

## MAKE YOUR FORD Into The "LARK"

\$5- Red-I-Kut life size patterns Class-Snap



Famous sure-fit RED-I-KUT life-size patterns and picture instructions show how you can easily convert your Ford into this Fast, Seamy, Sport Car as thousands have done, with easily obtained materials. No need to lay up the car. Rear seat folds, making 4-passenger car. Send 10c coin for actual body photo and new manual of other distinctive sport body patterns from \$5.50 up—'RKO' Ste 1 'Spring-Le' Irons, Tops and Windshields. ORDER RIGHT NOW.

KUEMPEL COMPANY, 88 Kuempel Bldg., GUTTENBERG, IOWA

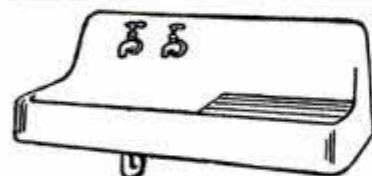

## SPECIAL

Porcelain Enameled SINK \$28.25

One of many bargains Write for Plumbing and Heating Catalog. Save 40%

B. KAROL & SONS CO., Dept. 20, 800 So. Kedzie, CHICAGO

## AGENTS 500% PROFIT GENUINE GOLD LEAF LETTERS

guaranteed to never tarnish. Anyone can put them on stores and office windows. Enormous demand, large profits. Paul Clark says: Smallest day \$28.70. R. L. Reel made \$920 in two months. Write today for free sample and liberal offer to general agents. METALLIC LETTER CO., 433-B N. Clark St., CHICAGO

## It soothes as it smooths as it gleans

Barbasol takes all the trouble out of shaving—all the pull and sting and smart. No brush. No rub-in. Use Barbasol—3 times—according to directions.

"Mister, you're next!"



# Barbasol

For Modern Shaving

The Barbasol Company  
Indianapolis, Ind.

I enclose 10c. Please send trial tube.

Name.....

Address.....

P-M-9-27

## FOY'S BIG PIGEON BOOK

In NATURAL COLORS, a complete guide to successful Squab and Poultry Raising. Tells how to feed, breed, grow and make money raising squabs. Quotes low prices. Write today. FREE.

F. FOY Box 5 CLINTON, IOWA



## WANT MORE MONEY?

### Easy to Earn with a TYPEWRITER

Write like a business man and turn spare time hours into dollars—right at home. Own a standard remanufactured typewriter—Underwood, L. C. Smith, Royal, Remington



10 Days' Free Trial

—at saving of 40 to 60%. Latest models. Look like new. Run like new. 5-year guarantee. Express prepaid. Instructions in rapid touch typewriting Free to purchaser. Easy to learn.

### REAL TYPEWRITER BARGAINS.

Write today for free catalog and learn of our EZ pay-like-rent plan.

YOUNG TYPEWRITER CO., 654 West Randolph St. Typewriter Headquarters Dept. 1109 CHICAGO



**LOFTIS BROS. & CO.**  
108 N. State St. Chicago, Ill.  
Dept. D-894

**Diamonds** (CASH OR CREDIT)  
Genuine — GUARANTEED

Diamond Catalog Free: 132 Pages of bargains in Diamonds, Watches, Silverware, Clocks, Ivory Goods, and gift articles for all occasions.

**Quality Gifts**

The Quality Diamond Gift is the most prized of all. Every article we sell is of finest grade. You always get the best value from Loftis. Satisfaction guaranteed or money back. The Diamond Rings shown here are exquisite creations in Solid 18-karat White Gold, set with sparkling blue white Diamonds of fiery radiance. Any ring sent for your free examination on request.

**Credit Terms:** Pay one-tenth down balance in weekly, semi-monthly, or monthly terms at your convenience. All goods delivered on first payment. Our References: Any Bank in the U. S. A.

No. 31 \$200 **\$5.00** A Week  
No. 852 \$37.50 **\$1.00** A Week  
No. 849 \$97.50 **\$2.50** A Week  
No. 27 \$75.00 **\$1.75** A Week  
No. 12 \$150 **\$3.75** A Week

**Railroad Watches — Guaranteed to Pass Inspection**

**HAMILTON NO. 992.** 21 Jewels, Adjusted to 5 Positions. Gold filled 25-Year Case. **\$55**

**ELGIN'S LATEST RAYMOND.** 21 Jewels, 8 Adjustments. Runs 40 hours one winding. Gold filled 20-Year Case. **\$55**

**ILLINOIS "BUNN SPECIAL."** 21 Jewels, Adjusted to 6 Positions. Gold filled 25-Year Case, 60 hrs. 1 winding. **\$50**

**19-Jewel Adjusted Waltham No. 846**—14-k white gold filled; assorted patterns, \$42.50 \$4.25 down and **\$1.00 a week**

We carry all standard makes of Railroad Watches—guaranteed to pass inspection. Credit at Cash Prices.



**Wrist Watch No. 16**—14-k white gold. High grade 15-Jewel movement, \$14.85. **\$1.48** a month down and . . . . .

**Cushion Strap Watch, nickel, 6 Jewels**—high grade Leatherstrap. Special **\$9.95**



**Wedding Rings**

No. 624—The "Elite" 18-k white gold. . . . . **\$750**

Set with 3 Diamonds, **\$22.50**; 5 Diamonds, **\$32.50**; 7 Diamonds, **\$42.50**; 9 Dia's, **\$52.50**; 12 Dia's, **\$67.50**. All platinum, \$25. With 3 Diamonds, \$50; 5 Diamonds \$70; 7 Diamonds \$80; 9 Diamonds, \$100; circled by Diamonds, \$200.



**How Fast Can You Take Orders?**

Many average \$75 a week showing women our eye-catching, money-saving line of imported and domestic fabrics. Large repeat sales. 1000 samples and selling instructions furnished. Men and women wanted on either part or full time. Complete details free. Write THE NATIONAL IMPORTING CO., Dept. W-6, 573 Broadway, N. Y. C.



**LIGHTNING PROFITS TOURISTS PRIDE** (Sell Dealers)

Tire Plugs <sup>with</sup> Instant INSERTING INSTRUMENT  
ENORMOUS DEMAND — EASILY SOLD — SURE REPEATER

**FASTEST SELLING NECESSITY KNOWN**

Every Vulcanizer, Garage, Repair Shop, etc., is a prospect and can be sold.

Inexperienced salesmen sell 10 to 12 orders per day with profits of \$15.00 to \$22.00 per day. Martin's sales one week \$702.20. Mr. Pim's sales six months \$14,000.00. Territories closing fast. Write for full particulars.

**TOURISTS PRIDE MFG. CO.**  
Dept. 5-1 MINNEAPOLIS, MINN.

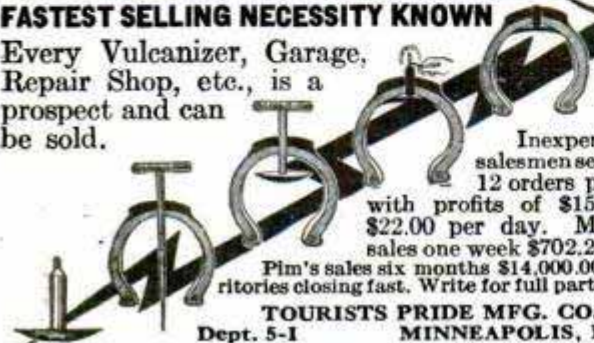

Ready for you

**FREE FOLDER**

TELLS ALL ABOUT THE 15 New Features

as well as the many other features of the wonderful Motor that thrilled the world in 1926 by its remarkable speed and power. You will want to know especially about "The Pilot" — a NEW device that steers your boat in any course you choose — straight or curved, without attention from anyone. Leaves you free to cast, or troll or rest. The New—

**LOCKWOOD BOAT MOTOR**  
FORMERLY LA

also offers you many other advantages—improvements in Power, in Speed, in Ease of Starting, in Stopping, in Convenience and Durability. Find out all about them before you choose any Motor. Get the facts now.

**WRITE FOR FREE FOLDER**

Just out — See how Lockwood is blazing the way by advanced engineering methods backed by 23 years of marine engine building experience. (24)

**LOCKWOOD MOTOR COMPANY**  
716 Jackson St. Jackson, Mich.

**Catch Fish!** 

Eels, Mink, Muskrats with our new folding galvanized STEEL WIRE TRAP. Write for our FREE TRAP OFFER and Bargain Catalog. \$1 Box of our famous Fish Bait FREE to introduce our traps. WALTON SUPPLY CO., 3501 JUNIATA AVE., ST. LOUIS, MO.

**MAKE A MOTORCYCLE OUT OF YOUR BICYCLE** with a STEFFEY MOTOR ATTACHMENT. RELIABLE—ECONOMICAL—EFFICIENT. Easy to attach. Fits any wheel. Send stamp for circulars.

**STEFFEY MFG. CO.,** Dept. P, 3924 Fairmount Ave., Phila., Pa.

**\$10.00 DOWN**  
Brings this Lathe to You

Lathes \$6.00 to \$75.00. Largest line of small lathes in America. Send four cents for 24 page catalog of lathes, drill presses, bench saws, jig saws, band saws, etc.

**SYPHYER MANUFACTURING COMPANY**  
Dept. D Toledo, Ohio

**AGENTS: \$14 a DAY**

Here's your chance for bigger profits. H. T. Pearl made \$750 in one month. Marshall made \$80 in 5 hrs. Webster made \$6 in 1½ hrs. Hundreds of others are making big money. You can become agent for Zanol Products—pure foods, toilet preparations, soaps, perfumes, etc. Over 350 articles. Fast sellers. Orders in every home. Repeat business. Big, steady income.

**American Products Co.**  
7531 American Building, Cincinnati, Ohio







## Make \$40 a Day

Introducing **MASTERLITE POCKET LIGHTER**

**Lights On New Marvelous Principle—Without Flint**

Attracts crowds everywhere. Works every time in any weather. Sells for only 50c. Equal to \$10 and \$20 lighters. Every smoker instantly appreciates its wonderful convenience. No wind can blow out the flame.

**Every Smoker Buys on Sight!**

**100% CLEAR PROFIT. Repeat Business Guaranteed**

Sells instantly to smokers and dealers at big profits. Guaranteed for life. Each sale builds an everlasting repeat business. \$3.00 brings sample dozen in handsome display box with our sure-fire selling plans. Masterlite retails at 50c. **Sells on a Flash Demonstration at over 100% Profit.**



**Sample 50c**

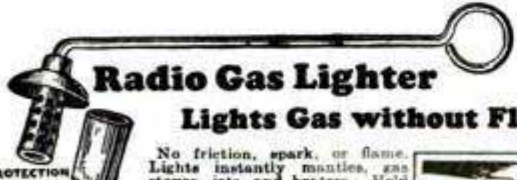

## Radio Gas Lighter

**Lights Gas without Flame**

No friction, spark, or flame. Lights instantly, mangles, gas stoves, jets, and heaters. Held directly over gas flow. Flame appears instantly. Absolutely safe. Banishes danger from matches.

**Make \$26 a Day**

A big 25c seller, paying 300% clear profit. A gross easily sold in a day brings \$36.00 and costs you \$10.00—\$26 a day clear. Rush \$10.00 for gross or \$1.00 for sample dozen, with amazing new sure-fire self-selling plans.



**Masterlite Mfg. Co., Dept. J-23, 110 East 23 St., New York**

## SELL PIONEER \$23.50 TAILORING

**Full or Part Time**

**MEN/DOUBLE YOUR INCOME**

**Cash Paid Daily**

Make \$12 a day from start—part time men \$5 an hour selling famous Pioneer tailored-to-measure, all-wool suits at \$23.50. Commissions paid in advance. Striking leather brief case containing 100 large swatch samples furnished—other equally remarkable values at \$29.50 and \$34.50. We train the inexperienced. Men with determination and willingness to work for success write for this big money-making opportunity—today!

**PIONEER TAILORING CO., 159 W. Harrison St., Dept. J1116, Chicago**



## SQUAB BOOK FREE

Breed squabs and make money. Sold by millions at higher prices than chickens. Write at once for free 40-page book beautifully printed in colors telling how to do it. *You will be surprised.*

**PLYMOUTH ROCK SQUAB CO.**  
634 H Street Melrose Highlands, Mass.

## BUILD YOUR OWN GRANDFATHER'S CLOCK



We furnish blue prints, finishing material and instructions. Buy the works, dial, weights and pendulum from us at surprisingly low prices. You make a fine profit building artistic clocks for your friends.

Plain Works as Low As \$5.00. Others with Chimes At All Prices. Ask for Our Free Catalogue and Offer of Blue Prints.

**American Chime Clock Company**  
1670 Ruffner Street  
PHILADELPHIA

Auto Bodies. Boats. Blinds. Caskets. Antiques. Doors. Screens. Furniture. Sash. Cabinets. Patterns.

## If you work with WOOD

you can save, every day, a good many hours of the slow, monotonous work of hand sanding, rubbing, grinding, finishing and polishing—do it accurately and much BETTER with the

# TAKE-ABOUT Sander

The only hand belt surfacing machine

It's a little machine—only 13 pounds—but it buys and pays for itself every few days on any kind of wood-working. Bench stand converts it into edge sander or tool grinder. 1001 uses for hard-to-get-at places. Flexible pads. Easy, quick change of belts for every purpose. Carries you over the rough spots and gets your jobs out on time PROFITABLY.

Put it up to us—no obligation—just say "my work is . . . . . mail your printed matter." Do it now, before you forget.

**PORTER-CABLE MACHINE CO.**  
1704-10 N. Salina St. Syracuse, N. Y.

Polishing. All General Finishing. Repair.



## Here's Happiness With a Pan-American Saxophone



Pleasure, Pride, Popularity, Profit—all these wonderful advantages and more are yours when you've learned to play a PAN-AMERICAN Saxophone. Here's an instrument you'll treasure highly for the real pleasure it will bring. Made as only PAN-AMERICAN knows how to make really fine saxophones, with clear, sweet, beautiful tones—handsomely finished, mechanically perfect.

**AS EASY TO OWN AS IT IS TO PLAY**

No other saxophone—not one—can possibly give you such fine quality—such real satisfaction, plus an iron-clad factory guarantee, at a cost so surprisingly low. And it's easy to learn how to play this splendid instrument. Decide now to get full particulars about our free trial offer and easy payment plan on Saxophones and the full line of better PAN-AMERICAN band and orchestra instruments. You'll be glad you did.

## FREE TRIAL

**Send No Money Just Mail Coupon**

The Pan-American Band Instrument & Case Co., Dept. G-10, Elkhart, Indiana

Send Along full information and low prices on Pan-American Saxophones and other band instruments. I want to learn to play . . . . . (instrument).

Name . . . . .

Address . . . . . City . . . . . State . . . . .

My local music dealer is . . . . .



# PATENT

## Protect Your Ideas

### Take the First Step Today

If you have a useful, practical, novel idea for any new article or for an improvement on an old one, you should communicate with a competent Registered Patent Attorney AT ONCE. Every year thousands of applications for patents are filed in the U. S. Patent Office. Frequently two or more applications are made for the same or substantially the same idea (even though the inventors may live in different sections of the country and be entirely unknown to one another). In such a case, the burden of proof rests upon the last application filed. Delays of even a few days in filing the application sometimes mean the loss of a patent. So lose no time. Get in touch with me at once by mailing the coupon on the opposite page.

### Prompt, Careful, Efficient Service

This large, experienced organization devotes its entire time and attention to patent and trade mark cases. Our offices are directly across the street from the U. S. Patent Office. We understand the technicalities of patent law. We know the rules and requirements of the Patent Office. We can proceed in the quickest, safest and best ways in preparing an application for a patent covering your idea. Our success has been built on the strength of careful, efficient, satisfactory service to inventors and trademark owners located in every state in the Union.

### NO CHARGE for Information On How to Proceed

The booklet shown here contains valuable information relating to patent procedure that every inventor should have. And with it I will also send you my "Record of Invention" form on which you can sketch your idea and establish its date before a witness. Such evidence may later prove valuable to you. Simply mail the coupon and I will send you the booklet, and the "Record of Invention" form, together with detailed information on how to proceed and the costs involved. Do this NOW. No need to lose a minute's time. The coupon will bring you complete information entirely without charge or obligation.



My Patent Law Offices  
Just Across  
Street From  
U.S. Pat. Office

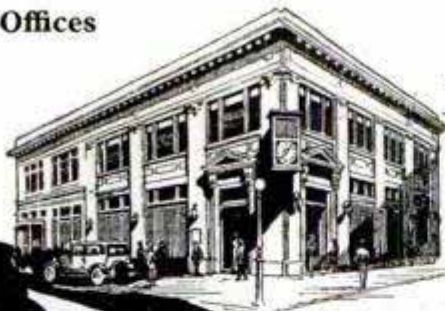

Above is a view of my drafting and specification offices where a large staff of experienced experts are in my constant employ. All drawings and specifications are prepared under my personal supervision.

# NEWS

## Inventors Write for these Free Books

### Strict Secrecy Preserved

All communications, sketches, drawings, etc., are held in strictest confidence in strong, steel, fireproof files, which are accessible only to authorized members of my staff. Feel free to write me fully and frankly. Your case will have my personal attention. It is probable that I can help you. Highest references. But **FIRST**—clip the coupon and get my free book. Do **THAT** right now.

### Clarence A. O'Brien

*Registered Patent Attorney*

Member of Bar of: Supreme Court of the United States; Court of Appeals, District of Columbia; Supreme Court, District of Columbia; United States Court of Claims.

Practice confined exclusively to Patents, Trade marks and Copyrights

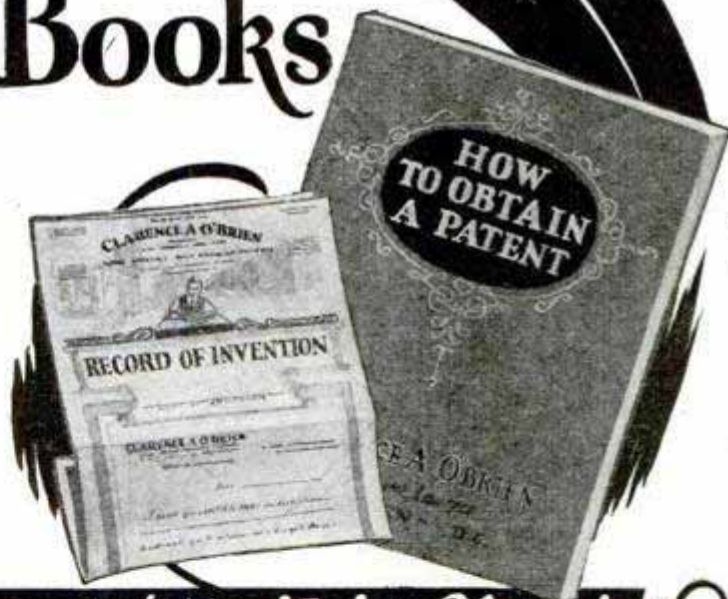

**Clip this Coupon and Mail it Now!**

**CLARENCE A. O'BRIEN, Registered Patent Attorney**

70-B Security Savings and Commercial Bank Bldg., Washington, D. C.

Please send me your free book, "How to Obtain a Patent," and your "Record of Invention" form without any cost or obligation on my part.

Name.....  
(Important: Write or Print name clearly.)

Address.....



# PATENTS TRADE-MARKS AND COPYRIGHTS

## Have You An Idea?

**Our Offer:** FOR THE PROTECTION  
OF YOUR INVENTION  
**YOUR FIRST STEP**

Before disclosing an invention the inventor should write for our blank form

### "RECORD OF INVENTION"

This should be signed and witnessed and returned to us together with model or sketch and description of the invention for **INSPECTION and INSTRUCTIONS**

*No Charge for the Above Information*

**Our Four Books Mailed  
Free to Inventors**

*Our Illustrated Guide BOOK*

### HowtoObtain a Patent

Contains full instructions regarding U. S. Patents. Our Methods, Terms, and 100 Mechanical Movements illustrated and described.

### Our Trade Mark Book

Shows value and necessity of Trade Mark Protection. Information regarding *Trade Marks and unfair competition in trade.*

### Our Foreign Book

We have Direct Agencies in Foreign Countries, and secure Foreign Patents in shortest time and lowest cost.

### Progress of Invention

Description of World's Most Pressing Problems by Leading Scientists and Inventors.

*We Regard a Satisfied Client* as our best advertisement, and furnish anyone, upon request, lists of clients in any state for whom we have secured patents.

**Highest References—Prompt Attention  
—Reasonable Terms**

**VICTOR J. EVANS & CO.**  
**PATENT ATTORNEYS**

Main Offices: 956 9th St., N. W., Washington, D. C.

*Opposite U. S. Patent Office*

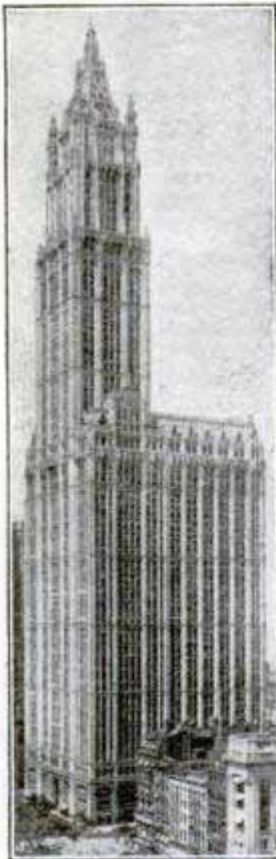

Our New York Office  
Suite 1007 Woolworth Bldg.



Our Philadelphia Office  
Suite 714-15 Liberty Bldg.



Our Washington Office  
Victor Building





# PATENTS TRADE-MARKS AND COPYRIGHTS

## IMPORTANT

TO HAVE YOUR CASE MADE SPECIAL AND AVOID DELAY YOU SHOULD HAVE YOUR CASE MADE SPECIAL IN OUR OFFICE to secure protection, save correspondence and secure early filing date in Patent Office. To secure special preparation of your case send \$25.00 on account with model or sketch and description of invention.



MAIN OFFICE, VICTOR J. EVANS & CO.—VICTOR BUILDING, WASHINGTON, D. C.

*Our Lawyers Practice in all U. S. Courts and defend Clients in Suits involving Patents, Trademarks and Copyrights*

All Communications and Data Strictly Confidential. Interference and Infringement Suits Prosecuted

OUR ORGANIZATION OFFERS PERSONAL SERVICE By Experienced Patent Lawyers, Solicitors and Draftsmen

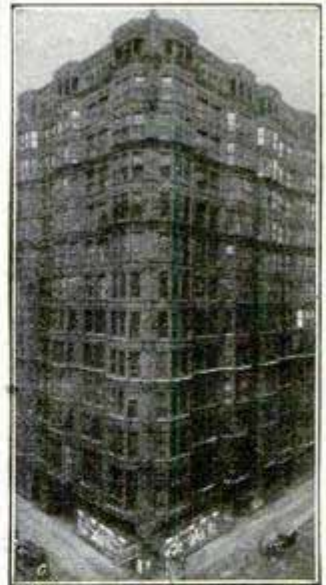

Our Chicago Office Suite 1114 Tacoma Building



Our Pittsburgh Office Suite 514 Empire Building



Our San Francisco Office Suite 1010 Hobart Building

**FREE COUPON** **VICTOR J. EVANS & CO. PATENT ATTORNEYS**

NEW YORK OFFICES 1007 Woolworth Bldg.	CHICAGO OFFICES 1114 Tacoma Bldg.
PHILADELPHIA OFFICES 714-715 Liberty Bldg.	PITTSBURGH OFFICES 514 Empire Bldg.
SAN FRANCISCO OFFICES Hobart Bldg.	

**MAIN OFFICES: 956 9th Street, N. W., WASHINGTON, D. C.**

Gentlemen: Please send me *Free of Charge* your books as described on preceding page.

Name .....

Address .....



# PATENTS

Just as it is important that you protect your idea with a patent, so it is imperative that your patent covers your invention completely. The one best way to assure this is to retain a reliable, experienced patent attorney

**MUNN & CO.**  
**PATENT ATTORNEYS**  
*Associated for 81 years with the Scientific American*

1572 SCIENTIFIC AMERICAN BLDG.  
*24 West 40th Street, New York*

523 SCIENTIFIC AMERICAN BLDG.  
*Washington, D. C.*

1312 TOWER BUILDING  
*Chicago, Ill.*

520 VAN NUYS BUILDING  
*Los Angeles, Cal.*

655 HOBART BUILDING  
*San Francisco, Cal.*

*Ask for free copy of "Patents—A Book of Facts Every Inventor Should Know" and for "Inventor's Diary." Send for them NOW.*



# PATENTS

Booklet Free Highest References  
Promptness Assured Best Results

Send drawing or model for preliminary examination of Patent Office records.

## ALL BUSINESS GIVEN PROMPT AND PROPER ATTENTION

Listed Patent Lawyer in the latest editions of the Rand-McNally Directory of Bankers and Attorneys, of Chicago, Ill.; The Baggott & Ryall Directory of Attorneys, New York City; The Lawyers Guaranteed Directory, Detroit, Michigan; The Lawyers and Bankers Quarterly, published by the Legal Directory Publishing Company of St. Louis, Mo.; the American Lawyers Annual, Cleveland, Ohio.

**WATSON E. COLEMAN,**  
REGISTERED PATENT LAWYER

Victor Building, 724 Ninth Street, N. W.  
**WASHINGTON, D. C.**



## RAISE BELGIAN HARES

NEW ZEALAND REDS—Chinchillas—Flemish Giants  
**MAKE BIG MONEY**—We supply stock and pay you  
following prices for all you raise: Belgian Hares \$2 each—  
New Zealand \$3 each—Chinchillas \$4 each—Flemish Giants  
\$5 each. \$2-page illustrated book, catalog and contract, also  
copy of *Fur Farming* magazine, tells how to raise skunk,  
mink, fox, etc., for big profits, all for 10c. Address

**OUTDOOR ENTERPRISE CO.,** Box 25, Holmes Park, Mo.

## DEAFNESS IS MISERY

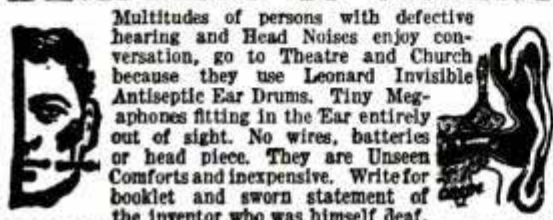

Multitudes of persons with defective hearing and Head Noises enjoy conversation, go to Theatre and Church because they use Leonard Invisible Antiseptic Ear Drums. Tiny Megaphones fitting in the Ear entirely out of sight. No wires, batteries or head piece. They are Unseen Comforts and inexpensive. Write for booklet and sworn statement of the inventor who was himself deaf.

**A. G. LEONARD, Inc.,** Suite 699, 70 5th Ave., New York

## SKIN-TROUBLES

**ANDRE'S ACNE CREAM** is Excellent for all Skin Troubles no matter how severe or chronic. Quickly ends Pimples, Blackheads, Eruptions on face or body. Eczema, Barbers' Itch, Sores, Crusts, Pustules, Enlarged Pores, Oily, Shiny or Itching Skin. Lightens Freckles, softens and whitens the skin. Immediate Results. Full Particulars **FREE**. Write at once.

**Andre & Co.,** 4029 Cottage Grove Av., Suite 430, Chicago, Ill.

## INVENTORS

who derive largest profits know and heed certain simple but vital facts before applying for Patents. Our book *Patent-Sense* gives those facts; sent free. Write **LACEY & LACEY,** 646 F St., Washington, D. C. Established 1869.



**Inventors and Mechanics**  
Send 10 cents in stamps for  
**Material Catalog**

**COLBURN GEAR & MFG. CO.**  
98 Holmes St., Quincy, Mass.

## 1000 NEEDED INVENTIONS!

Here is the most remarkable book ever offered to inventors. One Thousand needed inventions listed and described. Arranged as follows: General Problems; Automotive; Mechanical; Electrical; Chemical; Radio; Marine. Separate chapter on the Ten Most Needed Inventions. This book may give you one idea that will win you a fortune. Nothing else like it has ever been published. Compiled at enormous expense. Edited by Raymond Francis Yates, formerly Managing Editor of a leading scientific magazine. Over 100 pages, durably bound. Send no money. Pay postman only \$1.00 plus postage on arrival. Money back after 10 days' examination if desired. Limited edition. Write NOW.

**BUREAU OF INVENTIVE SCIENCE**

DEPT 39

ROCHESTER, NEW YORK

## Will Finance Patents

Patents of commercial value financed on royalty basis without expense to inventor. Mail models and copies of patents or full details to

**KAMSTONE HOLDING CORP.**

41 East 42nd Street

N. Y. C.



## PATENTS

Send us sketch or model for advice and exact cost of patent. Our book "**How to Obtain a Patent**" sent free. It tells how to apply for Patents, Trade Marks, Foreign Patents, Copyrights, etc.; gives information on Patent Procedure; tells what every inventor should know. Thousands of Inventors, who are our clients, are our reference.

**CHANDLEE & CHANDLEE,** 25 Years' Experience  
473 7th St. Washington, D. C.

# INVENTORS PROTECT YOUR IDEAS

Send for our Guide Book, **HOW TO GET A PATENT**, and Evidence of Invention Blank, sent Free on request. Tells our terms, methods, etc. Send model or sketch and description of your invention for **INSTRUCTIONS**. No charge for the above information.

**RANDOLPH & CO.**  
301 Victor Bldg., WASHINGTON, D. C.

NAME.....

STREET.....

CITY.....

STATE.....



## Buy a BULOVA WATCH —the Modern Way

### WHAT YOU DO—

SEND A DOLLAR with Name and Address, and brief note telling us something about yourself.

Simply state: (1) how long at address, (2) age, (3) married or single, (4) name and address of employer, (5) nature of work, (6) how long in employ.

All information held strictly confidential—no direct inquiries to employer.

### WHAT WE DO—

Upon arrival of your order, we will open a 10 month Charge Account and send selection for approval and 15 DAY TRIAL. If satisfied, pay \$2.75 monthly; otherwise return and dollar will be refunded.

You pay the Nationally Advertised Cash Price—  
**No More \$28.50**

\$1 with order,  
\$2.75 a month



14K Green or white gold filled case; guaranteed 15 Jewel Bulova Movement; radium numerals and hands; genuine leather strap.

Flexible transparent cap, which protects the movement.

# L.W.SWEET Inc

To Any Adult interested in the purchase of Diamonds, Watches or Jewelry we will send without obligation our beautiful booklet illustrated in colors.



DEPT. 67-P  
1660 Broadway  
NEW YORK

## AGENTS! EXPERIENCE UNNECESSARY



Science has finally produced it. An instantaneous metal cleaner—neither sloppy liquid nor messy paste. Dry magic floss. Touch it to nickel, copper or brass. The metal shines bright and clean instantly. No hard rubbing! Lightning Silver Cloth does same for Silverware. Lightning Furniture Floss instantly cleans and puts high lustre on Furniture. No liquid! Lightning Polishing Cloth is approved by Good Housekeeping Institute. Agents making up to \$30 a day!

## AMAZING DISCOVERY ABOLISHES METAL AND FURNITURE POLISH

Imagine! Touch tarnished articles with a Lightning Polishing Cloth or Floss and you make them bright as new. Demonstrations positively astonishing! Every one a sale! Agents collect real money on every call.

### Makes a Sensational Demonstration!

Everybody Buys These Products. Housewives buy the Lightning Silver Cloth and Furniture Floss. Autoists buy Lightning Polishing Floss. Sell all three to stores and offices in big quantities. Nothing else like them. Sure big, quick MONEY GETTERS.

Sample Free! Exclusive territory. Real cooperation. Triple profit. Answer this ad at once. Make big money. Easy! Quick! Don't delay. Write NOW! FREE test sample and proposition by return mail. G. L. LIGHTNING PRODUCTS CORP., 1773 Greenleaf Ave., Chicago

# PATENTS

## Don't Lose Your Rights To Patent Protection

Before disclosing your invention to anyone send for blank form "EVIDENCE OF CONCEPTION" to be signed and witnessed. As registered patent attorneys we represent hundreds of inventors all over the United States and Canada in the advancement of inventions. The form "Evidence of Conception," sample, instructions relating to obtaining of patents and schedule of fees sent upon request.

### LANCASTER & ALLWINE

480 Ouray Bldg. WASHINGTON, D. C.  
Originators of forms "Evidence of Conception."

# PATENTS

## To the Man with an Idea

I offer a comprehensive, experienced, efficient service for his prompt, legal protection and the development of his proposition.

Send sketch, or model and description, for advice as to cost, search through prior United States patents, etc. Preliminary advice gladly furnished without charge.

My experience and familiarity with various arts frequently enable me to accurately advise clients as to probable patentability before they go to any expense.

Booklet of valuable information and form for properly disclosing your idea free on request. Write today.

Richard B. Owen, Patent Lawyer  
9-303 Owen Bldg., Washington, D. C.  
41-E Park Row, New York City

## TRADE-MARKS REGISTERED

## PATENTS

Trade Marks, Copyrights, Patent Litigation Handbook with illustrations, 100 mechanical movements. Sent free on request.

**ALBERT E. DIETERICH**  
formerly member examining corps U. S. Patent Office  
**PATENT LAWYER and SOLICITOR**

621-A, Ouray Bldg.  
27 Years' Experience Washington, D. C.

## BLUE BOOK ON PATENTS AND PRIORITY RECORD BLANK GRATIS.

**MONROE E. MILLER, PATENT LAWYER**  
411-2 Ouray Building, WASHINGTON, D. C.  
ELECTRICAL AND MECHANICAL EXPERT

## SCIENCE FINDS NEW DRUGLESS GLAND STIMULANT

Science has discovered a new method of applying a positive-nature force. The method is wholly different—a tremendous step forward in regaining prostate gland health. Amazing effects produced in thousands of men, many beyond sixty.

"A hundred years ahead of modern medicine," writes a New York physician. Doctors and osteopaths are using and prescribing it. No drugs, medicine, massage or violet rays. Absolutely safe.

Does what gland tablets can never do. Directly stimulates prostate gland and often restores it to normal size and functioning in six days! Also tones up entire system, usually routs constipation and piles. Bladder weakness and frequent painful urination relieved in most cases. These results are unconditionally guaranteed.

Scientist's FREE Book, "Why Many Men Are Old at Forty," explains these amazing facts. This book is now FREE. No obligation at all. Simply ask for FREE book.

The Electro-Thermal Co., 2173 Main St., Steubenville, Ohio  
Western Address: Suite 21-S, 303 Van Nuys Bldg., Los Angeles, Calif.





## Gas, 5c per Gallon

Any Ford Owner who wants to cut his gas cost down to 5c per gallon should write at once to Frank Andrews, President, Blancke Auto Devices

Co., Dept. 805-M, 154 E. Erie St., Chicago. A simple little thermostatic device put on in two minutes without drilling or bother has made this possible for thousands of Ford Owners. Results of 351,272 public and private tests show astounding gas mileages up to 43.8 miles per gal. Agents make as high as \$3000.00 a month just taking orders for this marvellous device. \$15.00 a day is guaranteed to Distributors.

Frank Andrews will send a Blancke Control Free to Ford Owners who will introduce it in their communities. Get their Free offer. Write him today.

**RADIO WHOLESALE**

Write for my Big 1928 Radio Catalog —just off the press. Thousands of marvelous bargains in nationally advertised goods. All the LATEST IN RADIOS and equipment. Lowest wholesale prices. Agents Wanted.

**FREE**

It's a regular encyclopedia on Radio. All about trouble finding. **FREE Log and Call Book** and Catalog. Get your copy today. Send postcard now!

**DEALERS NEW 1928 CATALOG**

American Auto & Radio Mfg. Co.  
HARRY SCHWARTZBERG, PRES.  
Dept. 263 American Radio Bldg., Kansas City, Mo. 3

## MOTORCYCLES



Price \$10 and up purchased through our Co-Operative Plan for as low as \$1.00 down and \$1.00 per week

Indians Harley-Davidsons Ace Henderson and Clevelands

Send ten cents for Bulletin A.

*Motorcycles shipped to all parts of the world*

**WALKER-INDIAN CO., 188 Mass. Ave., BOSTON**

## World's Greatest Radios

Thousands of homes are enjoying coast to coast programs on Metrodyne receivers. None better at any price. Shipped on 30 days' free trial. Write for details before you buy any radio set.

**METRO ELECTRIC CO.**

2161 N. California Ave. Dept. A CHICAGO, ILL.

## DO YOU

WANT a new business profession of your own, with all the trade you can attend to? Then become a foot correctionist, and in a few weeks earn big income in service fees,—not medical nor chiropody—easy terms for home training, no further capital needed, no goods to buy, no agency. Address

Stephenson Laboratory, 1 Back Bay, Boston, Mass.

**Materials For Handy Men**

Bearings, Belting, Blue Prints, Books on Mechanical and Scientific Subjects, Brass Castings, Compressors, Gears, Lathes, Motors, Saws, Shafting, and Supplies of every kind for MODEL MAKERS and HANDY MEN.

Complete Catalogue 25c which is allowed on first \$2 order.

Amalgamated Sales and Service Corporation  
327-G South La Salle St., Chicago, Ill., U. S. A.

# Heats Home for 25c a Week!

"I can run my Bulldog furnace steady for fourteen days in normal weather conditions on the actual cost of fifty cents." So writes F. R. Redetzke, of Cleveland, North Dakota. He adds: "Hard to believe is it? That's what some of my neighbors thought until I showed them! We have an unlimited amount of grain screenings in this country. That's the fuel I am using."

That's what the Bulldog does with about the lowest grade fuel you can think of! Here's what it does with coal: "There is no heater to compare with the Bulldog. I burned 2½ tons of coal last winter and heated 5 rooms and bath."

—Walter Geary, Gloucester, Mass.



If you are even thinking of a pipeless furnace, or any furnace, write for our free catalog. The Bulldog is one furnace you MUST investigate. Comes completely erected. Fits any height of basement and you install it yourself.

# No Money Down

Small Monthly Payments

The Bulldog is sent for free inspection. Then, if satisfied, you make only small monthly payments at our amazingly low price. Factory connections in both East and West. We ship from nearest point. Don't consider buying any furnace until you find out about the Bulldog. Write at once for our special offer and our free catalog together with the wonderful record of Bulldog success. Mail this coupon today.

**Babson Bros.**

19th and California Ave., Dept. 13-56 Chicago

Without obligating me in any way please send me your free catalog and special offer on the Bulldog pipeless Furnace.

Have you a basement? Yes  No

Name .....

Address .....



# LUMINOUS PAINT



**Make Your Watches, Clocks, Etc., Visible by Night**

The very latest discovery in the scientific world, Hitherto, practically unobtainable except at an exorbitant price, we have at last succeeded in producing this remarkable LUMINOUS PAINT, which, applied to the surface of any article, emits rays of white light, rendering it perfectly visible in the dark. THE DARKER THE NIGHT, THE MORE BRILLIANT IT SHINES. Quite simple to use. Anyone—you can do it. A little applied to the dial of your watch or clock will enable you to tell the time by night. You can coat the push buttons or switch plates of your electric lights, match boxes, and innumerable other articles; make your own Luminous Crucifixes, Luminous Rosaries, etc. Small bottle, price 25c. Larger sizes, 50c and \$1 postpaid. JOHNSON SMITH & CO., Dept. 813 RACINE, WIS.



## CIGARETTE MAKER

Roll your own and save money. Better and quicker; saves more than half. Use your favorite brand of tobacco. Neat, useful, handy. Pocket size, weighs 1/2 oz. Made entirely of metal, nickel plated. 25c, 3 for 65c postpaid anywhere.



## GOOD LUCK RING

Very striking, quaint and uncommon. Silver finish; skull and crossbones design, two brilliant, flashing gems sparkle out of the eyes. Said to bring good luck. Only 25c ppd.



## Exploding Cigarettes

JUST LIKE ORDINARY CIGARETTES. BUT SUCH REAL STARTLERS! The box contains ten genuine cigarettes of excellent quality. They appear so real, but when each cigarette is about one-third smoked, the victim gets a very great surprise as it goes off with a loud BANG! A great mirth provoker yet entirely harmless. Price 25c box.

## NOVELTY BADGES



**Kissing Permit 10c** Two very novel metal badges, nickel plated, that you can wear, giving you fun out of all proportion to their trifling cost. 10c, each badge, 3 for 25c, or 75c per doz. postpaid anywhere.

**Garter Inspector 10c**

## MIDGET BIBLE

**GREAT CURIOSITY** Smallest Bible in the World. Size of a postage stamp. 200 Pages. Said to bring good luck to the owner. A genuine work of art. Must be seen to be appreciated. Make good money selling them to friends, church acquaintances, etc. PRICE 15c each, 3 for 40c, 12 for \$1.35, 100 for \$7.50. Also obtainable in Leather Binding with gold edges. Price 50c each, 3 for \$1.25, \$4.50 per doz. Magnifying Glass for use with Midget Bible, 15c.



## STAGE MONEY

With a bunch of these bills, it is easy for each person of limited means to appear prosperous by flashing a roll of these bills at the proper time and peeling off a genuine bill or two from the outside of the roll, the effect created will be found to be all that can be desired. Prices, postpaid: 40 Bills 20c, 120 for 50c, or \$3.50 thousand postpaid.

## MAGIC FLUTE

The Magic Flute, or Humantone, is a unique and novel musical instrument that is played with nose and mouth combined. There is just a little knack in playing it which, when once acquired after a little practice, will enable you to produce very sweet music that somewhat resembles a flute. There is no fingering, and once you have mastered it you can play all kinds of music with facility and ease. When played as an accompaniment to a piano or any other musical instrument, the effect is as charming as it is surprising.

Post Paid 25c

# JOHNSON SMITH & CO.

Dept. 813 RACINE, WIS.

A De Luxe Edition of our new 1928 CATALOG mailed on receipt of 25c. Handsome binding. Bigger and better than ever. Only book of its kind in existence. 550 pages of all the latest tricks in magic, the newest novelties, puzzles, games, sporting goods, rubber stamps, unusual and interesting books, curiosities in seeds and plants, etc., unobtainable elsewhere. Remit by Stamps, Coin, Money Order, Check, etc. Unused U. S., Canadian and Foreign Stamps also accepted.

# BLANK CARTRIDGE PISTOL

Protection against Burglars, Tramps, & Dogs. Special Offer 1 Blank Cartridge Pistol 100 Blank Cartridges 1 550-page Novelty Catalog ONLY \$1.50 The Lot Shipped by Express Only Cash With Order Only

Well made and effective, modelled on latest type of Revolver; appearance alone is enough to scare a burglar. When loaded it may be as effective as a real revolver without danger to life. It takes standard .22 Cal. Blank Cartridge—obtainable everywhere. Special cash with order offer: 1 Superior quality Blank Cartridge Pistol, 100 Blank Cartridges, and our new 550 page De Luxe Catalog of latest novelties; all for ONLY \$1.50. Shipped by Express only. Cannot go by parcel post. Extra Blank Cartridges 50c per 100. Special Holster (Cowboy Type) for pistol 50c. No C. O. D. shipments.

# THROW YOUR VOICE

Into a trunk, under the bed or anywhere. Lots of fun fooling the teacher, policeman or friends.

**THE VENTRILO** a little instrument, fits in the mouth out of sight, used with above for Bird Calls, etc. Anyone can use it.

Never Fails. A 16 page course on ventriloquism, the Ventrillo, ALL FOR 10 CENTS



**9 In One**

It is made in the shape of and looks like a regular Automatic Pistol. No one is likely to stop and ask you whether it is real or not. Thus it is likely to prove itself very handy in an emergency. On pressing the trigger it opens up, as shown in the illustration at the right, revealing nine most useful articles—Opera and Field Glass, Telescope, Mirror, Magnifying Glass and Burning Lens, Reading Glass, Sun Dial, Sun Compass, etc. In the handle of the revolver there is a place for various pocket necessities, such as First Aid Articles, Buttons, Pins, etc. The Pistol is of sheet metal, blued finish, that can be carried comfortably in pocket. PRICE \$1.00 postpaid.

**Watch Charm Pistol \$1.75**

Exact reproduction of a real pistol; actually fires REAL BLANK CARTRIDGES miniature size. Illustration is actual size. 1 1/4 inches long, with ring at end for attaching to watch chain. Pistol is break open type; illustration shows position for loading. Made entirely of high grade steel, nickel plated, octagon barrel, handsomely engraved handles, complete in box with cleaning rod. PRICE \$1.75. Also furnished with pearl handles, \$2.50. BLANK CARTRIDGES, 50c per box of 25. JOHNSON SMITH & CO., DEPT. 813, RACINE, WIS.

## MICROPHONE TRANSMITTER BUTTON



You can easily make a highly sensitive detector-phone by using this Transmitter Button to collect the sound waves. You can build your own outfit without buying expensive equipment. It is simple and inexpensive. You can install an outfit in your home and hear conversations being held all over the house. This outfit was used by secret service operatives during the war. It is being used on the stage. It is ultra-sensitive and is the greatest invention in micro-phones. You can mount the button almost anywhere—card board boxes, stove pipes, stiff calendars, on the wall behind a picture frame, etc. Button is so light and small it cannot be detected. Persons can be overheard without suspecting it. You can listen in on conversations in another room. A deaf person in the audience can hear the speaker. Connected to phonograph, piano or other musical instrument, music can be heard hundreds of feet away. Button may be used to renew telephone transmitters; often makes an old line "talk up" when nothing else will. The ideal microphone for radio use; carries heavy current and is extremely sensitive. Amplifies radio signals. Countless other similar uses will suggest themselves. Experimenters find the button useful for hundreds of experiments along the lines of telephones, amplifiers, loud speakers, etc. Many fascinating stunts may be devised, such as holding the button against the throat or chest to reproduce speech without sound waves. PRICE \$1.00. JOHNSON SMITH & CO., DEPT. 813, RACINE, WIS.

## SURPRISE MATCHES

More fun than fighting with your wife. Look just like ordinary matches. Put up in boxes just like regular Safety Matches. As the victim tries to light one he gets quite a surprise. Price 10c per box, 3 boxes for 25c, 12 for 75 cents.

**Keyless Lock 25c**

These clever locks cannot be opened unless you know the combination. No key necessary. For your locker, bicycle, tool chest, mail box, thousands of uses. Shackle and tumblers nickel plated. Weighs trifling over one ounce. Secret and full instructions with each lock. Price 25c or 3 for 65c postpaid.



## Wonderful X-Ray Tube

A wonderful little instrument producing optical illusions both surprising and startling. With it you can see what is apparently the bones of your fingers, the lead in a lead pencil, the interior opening in a pipe stem, and many other similar illusions. A mystery that no one has been able to satisfactorily explain. Price 10c, 3 for 25c, 1 dozen 75c. Johnson Smith & Co.

## Every Boy His Own Toy Maker

Greatest boys' book written. Tells how to make a Pinhole Camera, a Canoe, model Railroad, a Telephone, Boomerang, Telegraph Instrument, Box Kite, Talking Machine, Microscope, Electric Motor, Electric Door Bell, Water Wheel, Paddle Raft, a pair of Skis, a Dog Sled, Bird House, Rabbit Yard, etc. 64 pages, 150 illustrations. PRICE, 10c postpaid; 3 for 25c postpaid.

## Serpent's Eggs

Box contains 12 eggs. When lit with a match, each one gradually hatches itself into a snake several feet long, which curls and twists about in a most life-like manner. Price per box, 10c postpaid, 3 for 25c.





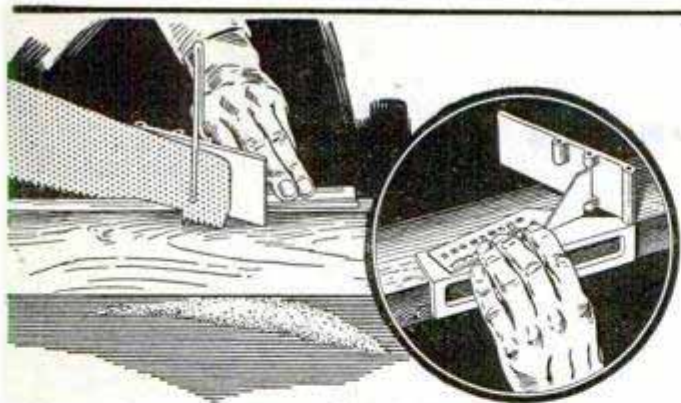

# SAW STRAIGHT AND TRUE

The Harmak mitre saw guide makes it easy. Everyone can now do their own carpentry work—picture framing, garden seats and ornaments, shelving, cabinets, all the jobs around the house that require a neat true angle.

Don't ruin good lumber. Use a Harmak guide. Operates anywhere, and cuts any angle, simple or irregular. Popular priced.

Ask for it at your hardware or department store. Or write us for special folders.

**HARMAK MFG. CO. ST. LOUIS, MO.**

# STANLEY Plumbing Supply Co., Inc.

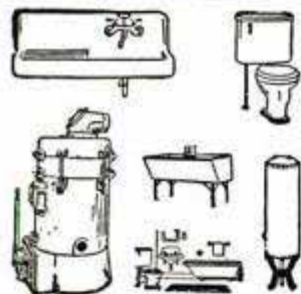

Save **one-half**

We sell everything in plumbing, heating, hardware, paint, roofing and millwork supplies. Due to large-quantity buying, we are able to offer you Grade A merchandise at enormous savings. Satisfied customers in every State. Send for our elaborate catalog—over 95 pages of surprising bargains.

**STANLEY PLUMBING SUPPLY CO., Inc.**  
400 N. 12th Street, PHILADELPHIA, PA.

## A SHIP MODEL FOR \$4 98



Build an exact replica of the historic Santa Maria or the Mayflower with your own hands. We will furnish the parts cut to fit and ready to assemble complete for only \$4.98 plus a few cents for postage. No tools needed except a small hammer.

Write for our illustrated catalog.

**MINIATURE SHIP MODELS**  
Dept. O, 3818-20-22-24 Baring St., PHILADELPHIA, PA.

## REMINGTON PORTABLE TYPEWRITER

Dealers and Branches Everywhere

## PUNCTURE-PROOFS Tires in ONE minute

Agents—Big—Quick Profits

Tires hammered full of nails, leak no air. Amazing new invention banishes puncture trouble forever. Punctures heal instantly. Stops slow leaks. Preserves rubber. Increases tire life. Clean, scientifically correct. *Not a Liquid.*

**FREE SAMPLE** Immediate—Tremendous profits. No talking—just drive nails in an old tire. **GET THE FACTS.** Territory going fast. Full particulars—Big Book and a **FREE SAMPLE** postpaid by return mail. **Send No Money.** just your name but **ACT NOW.**  
**C. F. JOHNSON & CO., 19 W. Jackson Blvd., Dept. 662, CHICAGO**



# I Want to Send You a Santa Fe Special Watch

for You to see and examine

Our 21 Jewel Santa Fe Special Guaranteed for Life

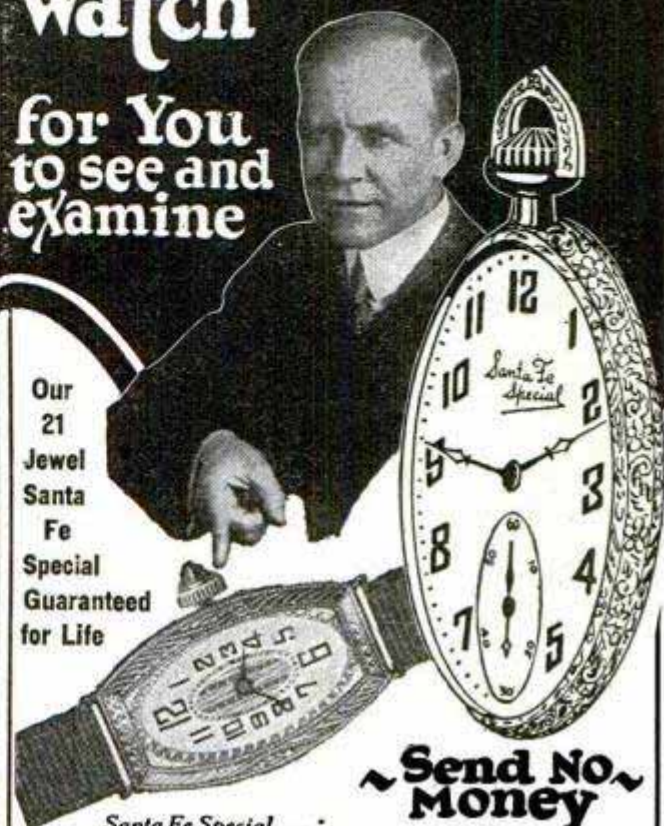

Send No Money

**Watch Sent on 30 Day Free Trial**

*Santa Fe Special Watches are today being shipped to every civilized country in the world, and are probably the best and most favorably known watch in both Army and Navy.*

In addition to our NEW LOW PRICE, I will send for your approval one of these Standard Watches, guaranteed for a lifetime of satisfactory service, not only by the Santa Fe Watch Company, but by the Great Illinois Watch Factory. So accurate, Government officials carry them; so perfect and beautiful, jewelers say they are worth 1-3 to 1-2 more than we ask for them. I will send you one to wear it 30 days FREE—then sell it to you on easy payments.

### WHY NOT OWN A 21 JEWEL SANTA FE SPECIAL WATCH ?

You will never miss the few cents a day that will make you own one of these watches—SEND FOR WATCH BOOK—illustrating in beautiful colors hundreds of designs and combinations in cases in the POCKET WATCH, MEN'S STRAP WATCH and LADIES' WRIST WATCH. You can have your name or monogram and any emblem you may desire engraved in the Case to suit your own ideas. Write today for Free Watch Book, and make your selection at once, while this offer lasts.

**FREE** A limited offer! With every Santa Fe Special, beautiful gold chain or strand of exquisite pearls. Write today. Mail coupon for both Watch and Diamond Catalog

**SANTA FE WATCH COMPANY**  
96 Thomas Building Topeka, Kans.  
*(Home of the Great Santa Fe Railway)*

Mail coupon to-day!

**SANTA FE WATCH COMPANY**  
96 Thomas Building, Topeka, Kansas

Please send prepaid and without obligation your Watch Book Free, explaining your "No Money Down" Offer on the Santa Fe Special Watch.

Name.....

Address.....

City..... State.....



# DEVITT 8" COMBINATION SAW

## 13 TOOLS IN ONE

Saw table raised, showing Emery wheel, saw guard and drill attachment.



Planer attachment on saw table.

Showing Sanding disc attached.



Table tilted for beveling.

Dado head attached for grooving.

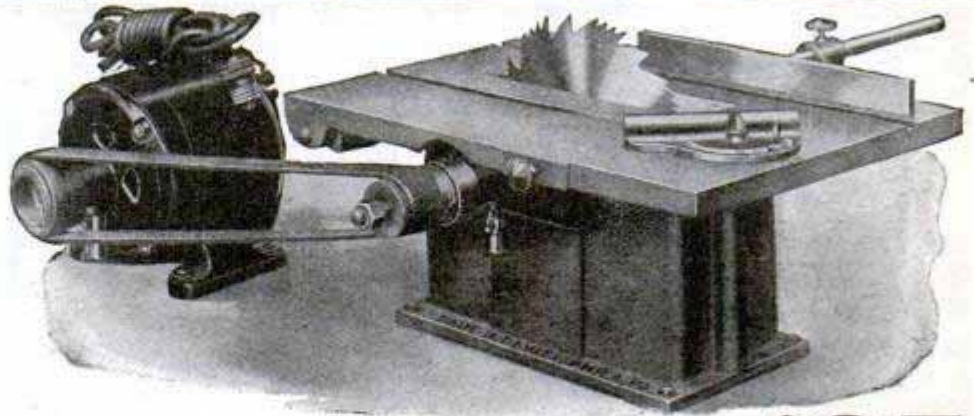

**YOU** save a great deal of money, time and space by buying a Devitt 8" Combination Saw. Why buy special tools for beveling, grooving, buffing, etc.? The Devitt Combination Saw will rip, cross cut, bevel, miter, groove, mortise, tenon, drill, rabbet, grind, buff and polish. The attachments are easily and quickly adjusted. The saw and motor when set up ready for work occupy very little room. The 1/4 H. P. 60 cycle 110 volt A. C. motor can be run from a light socket and provide power for other purposes when the saw is not in use. A cut up to 2 3/4" can be made with the 8" Combination Saw without planing. The ideal machine for shop, factory or home, complete with attachments: 12"x16" table, 8" Combination Saw, iron pulley for saw table, 10" ripping fence, adjustable cut off miter gauge, motor-specifications as above, 1 1/4" endless leather belt, wood pulley, 8 ft. cord and plug, 6" buffing wheel, 3/4" 3 jaw drill chuck, 5" emery wheel, 6" sander, saw guard, and 2" dado insert. \$35.00 F. O. B. Phila. Height 7 1/2", shipping weight, 100 lbs. (Planer attachment to fit on table top will smooth pieces up to 2 in. wide, \$12.00 extra F. O. B. Phila.)

**\$35**  
F. O. B. Phila.

Write for our beautifully illustrated 4 page circular.

**PAUL J. DEVITT** 1102 South 2nd Street PHILADELPHIA, PA.

### THE BIGGEST SELLING HIGH GRADE REEDS IN THE WORLD

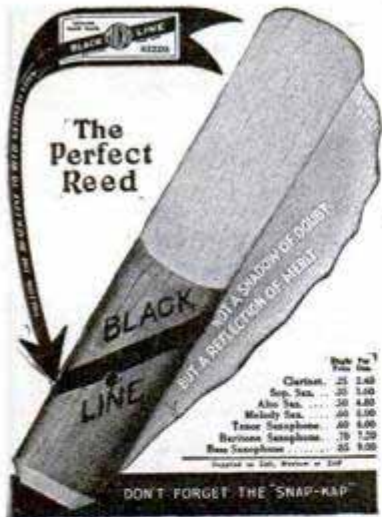

Most widely advertised and internationally known

For sale at all Music Stores

Try a sample dozen today.

**J. Schwartz Music Co., Inc.**

Dept. No. 600  
10 West 19th Street  
NEW YORK, N. Y.

### AGENTS MEN BUY THIS COOKER ON SIGHT

Merely show the DUO-COOKER (condensing), explain its features and use, and a quick sale results. Easy to use. No failures. Wonderful to cook meats, etc. Fastest selling item ever known through agents. Every American household a good prospect. Write for details.

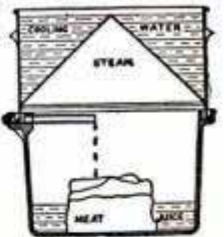

**DUO-COOKER CO.**  
[condensing]  
4306 Duncan Ave. St. Louis, Mo.

### FREE CATALOG

Send today for this marvelous catalog of army goods bargains. 52 pages, 100 illustrations, money saving values, Guns, Ammunition, Cutlery, Sport and Army clothing. Full line of Camping needs. Outfitters for 50 years to leading Military, Sports, Theatrical and Society organizations. Satisfied customers all over the world.

**W. STOKES KIRK, 1627 P. M. N. 10th St., Philadelphia**

### LIGHTING FIXTURES

Ready to hang

Direct from the manufacturer. Completely wired, including glassware. Send for new catalogue No. 28. Just Reduced Prices. Special Proposition to Dealers.

**Erie Fixture Supply Company, Inc.**  
Station A ERIE, PA.

### Marvelous Book Sent FREE

Be a Taxidermy Artist

You can now learn Taxidermy, the wonderful art of mounting birds, animals, tanning skins, etc. Learn at home, by mail. The free book tells how. Mount your own trophies. Decorate home and den. Hunters, trappers, nature lovers, you need taxidermy. Interesting, fascinating, big profits. Join our school. 100,000 students. Success guaranteed. Get our free book without delay. Send right now—today.

**N. W. School of Taxidermy, 3376 Elwood Bldg., Omaha, Neb.**

### WADE AMATEUR MECHANICS, REPAIR SHOPS, INVENTORS, STUDENTS

## BENCH LATHE

A real machine tool for the home work bench—capacity 4" dia. x 12" length. For Metal—Wood—Composition Materials. Turning—Facing—Boring—Drilling—Winding—Thread Cutting. Accurate—Strong—Quiet—Compact. Slide-rest has travel entire length of bed. Leadscrew inside bed. No. 1 Lathe, plain headstock, \$28.00. No. 2 Lathe, back-gear headstock, \$58.00. Extra for lathes with 18 inches between centers, \$7.00. Complete line of accessories at equally low prices. Write for free catalog.

**THE GEROLD CO.** Dept. P-35 120 Liberty St. New York



# An Opportunity for YOU

*if you really want a big income*

Men in every section of the country are making amazing profits with the American Universal floor surfacing machine. You work for yourself—and you do the work of six men, easier, quicker and better. Floor Surfacing work is plentiful and very profitable. We help you get started and let you pay for the machine as you work—twelve months, if you wish. The least you can do is investigate what the American Universal offers you.



**Accept this opportunity Today!**

American Floor Surfacing Machine Co.,  
523 So. St. Clair St., Toledo, Ohio.

I want to make a big income and work for myself. Tell me more about the American Universal. No obligations, on my part, of course.

Name.....

Address.....

Town.....

## Bodies of Rare Beauty for Fords At Factory Prices!

Write for circular  
A-3 showing  
Chummy Sportster  
and others.

\$22.75 and up

SPORT FACTORIES



AURORA, ILL.



## Your Coat and Vest Can Be Matched with New Trousers

Save the price of a new suit. We match hundreds of coats and vests satisfactorily every day. Each pair tailored to your measure. 80,000 patterns. We submit sample of cloth for your approval. Just mail your vest or a sample of the suit.

*We employ no agents.*

**ACME PANTS MATCHERS**

Dept. BH 14, 20 W. Jackson, Chicago

Enclose  
return  
postage  
if vest  
is sent.

## Hand Made TOOLS of Amazing Strength

THE amazing strength and service of Cornwell Quality Tools is attested by more than 100,000 mechanics throughout every state in the Union. You can do things with Cornwell Tools that cannot be accomplished with any other tools because of their high quality and phenomenal strength.

## CORNWELL Quality Tools

Only the finest Swedish Charcoal Process Molybdenum Steel, produced under our famous Cornwell Formula, enters into these hand-made tools. Forged, heat treated, hardened and tempered in oil. NOT drop forged and case-hardened.

**Let Us  
Demonstrate**

Ask for salesman to call and show you many startling demonstrations that no other tools in the world will stand. Or send for free descriptive booklet, order tools, and make these tests at our risk.

### Money-Back Guarantee

If you ever saw tools as good as these, return your order and get your money back. This is the strongest guarantee for any tools on the market and shows our complete faith in our product.



## HERE'S THE BIGGEST MONEY-MAKING OPPORTUNITY OF THE YEAR!

Show Leeding Auto Seat Covers for all makes of cars. Made-to-Measure—Guaranteed to fit. Beats all competition. Undersell stores! 4 out of 5 auto owners buy. Wide selection of patterns—leather trimmed. Made with Glove Fasteners—easy to attach. Quick delivery. Commissions paid in advance. Beginners make \$10.00 and up daily. Old timers make \$100.00 weekly and more.

### FINE SELLING OUTFIT FREE!

Most beautiful, pocket size, order pulling outfit FREE! Colored illustrations, samples, etc. You'll make BIG MONEY quick, if you send for this Outfit NOW!

**THE JOHN LEEDING CO.**

70 E. 18th St. Dept. 130 Chicago, Ill.

Mail this  
Coupon  
for New  
Free Book

The Cornwell Quality Tools Co.  
Dept. O, Mogadore, Ohio.  
(Formerly at Cuyahoga Falls, Ohio.)

Send me new illustrated catalog with prices on full line of Cornwell Hand-Made Tools.

..... Where employed

Name.....

Address.....

City..... State.....



**START to PLAY Very First Day!**



**YOU CAN PLAY THE XYLOIMBA**

**Extra Money—Hosts of Friends—Loads of Fun Within Your Reach**



Fame and Money Broadcasting



Center of Attraction at Gatherings



Big Money at Dances

**HAPPY DAYS** are in store for you if you will only act on this suggestion! Cheery evenings, playing catchy music alone or with sweetheart, wife or sister; proud moments as center of interest at gatherings; nights of joy making \$5 to \$25 for work that is "play."

The Deagan Xylorimba is your Opportunity! Wonderful for home, in demand at dances and entertainments, yet easiest of all instruments to play. No teacher necessary—you actually play simple melodies the very first day even if you cannot read a note of music right now! **Earns \$60 a Week**—Ralph Smith, Chicago, says: "Played 20 minutes at wedding. Received \$20." L. E. Hallmann, Reading, Pa., writes: "Made \$300 in 5 weeks, spare time. Had never played instrument before."

**SEND FOR BIG FREE BOOK!** Our new book tells all about the delightful lessons, furnished with each instrument; the five-day trial that removes risk; the wonderful Deagan, easy-payment plan. No obligation—simply fill in and mail the coupon.

**J. C. Deagan, Inc., Dept. 1456, 1770 Berceau Ave., Chicago**  
Send me, without obligation, full details of Free Trial offer and easy-payment plan on the Deagan Xylorimba.

Name \_\_\_\_\_  
Address \_\_\_\_\_



**90 to 125 a week**

**Selling Amazing New 3-1 Battery Tester**

Men—here's a wonder—it's the most sensational selling invention of the age. If you're looking for something new; without competition; that sells 8 out of 10 on sight; an item that nets you 100% profit—the TTT 3 in 1 Battery Tester is the answer.

**Sells for \$1.50—Yours Without Cost**

TTT Battery Testers are guaranteed accurate and non-breakable. Sure-fire seller to 38,000,000 car owners and radio fans. One-minute demonstration closes sale. \$15 to \$25 profit a day easy. Get started NOW. To save time, send \$1 for complete demonstrating outfit. Money-back guarantee if not satisfactory. Write at once.

**N. & N. MANUFACTURING CO.**  
Dept. 9-5, 3715 West Grand Ave., Chicago, Ill.

**100% PROFIT ON EVERY SALE**  
SELLING CHRISTMAS GREETING CARDS

In **Box Assortments**. Our Christmas Box Assortment is the finest published. Agents earn \$2.00 to \$4.00 per hour. We have a magnificent **Box Assortment** containing 21 high-grade Christmas Greeting Cards and folders, each with an envelope. Steel Engraved, Colored, Fancied and Bordered. Sells for \$1.00; costs 50 cts. Nothing ever sold begins to compare with the sale of Christmas Box Assortments. Write immediately for particulars and free samples.

**WALTHAM ART PUBLISHERS**  
7 Water St., Dept. 5-S Boston, Mass.



**Zentola Radios—1928 Zenith Super-Power Head for Fords**  
**Make \$75 to \$300 a Week selling Radios and Motor Devices. Distributors and Agents Wanted**

Lowest-priced high quality radio receiving sets. Unusual selectivity, coast to coast reception, great tonal volume. Cabinet models, 6 and 7 tube, \$29.50 up. Console models \$42.00 up. Highest grade walnut cabinet consoles only \$19.50 up. Zenith A Batteries, \$6.95.

This new Zenith Head, with Over-Head valves, is first choice of all. Permits 75 miles per hour—gives 50% to 100% more power—big saving on gasoline. Fits all Ford cars and trucks. Only \$35.00 cash payment—balance \$4.00 weekly. Also for Dodge.

Write for free circulars and for agent's or distributor's money-making proposition on our radios and motor devices.

**ZENITH AUTOMOTIVE MFG. CO., A. S. Sinclair, Mgr., 4416 Olive St., St. Louis, Mo.**

**Cabinet Model \$29.50 up**

**KINGSBURY TAXIPLANE No. 766**  
Length 15 in. Wingspread 12 in.  
Price \$2.00  
Prices slightly higher west of Miss. and in Canada



**BE A U. S. AIR MAIL PILOT**

Here, boys, is one of the season's most popular toys! A lifelike U. S. mail plane, painted in beautiful colors and equipped with a swift, strong motor that sends it dashing round and round the floor, the propeller spinning. "Banks" on the curves like real planes do. Go to your favorite toy dealer and ask to see this Kingsbury Taxiplane. If he doesn't carry it, write us for free catalog. **KINGSBURY MFG. COMPANY, 83 Myrtle St., Keene, N. H.**

**KINGSBURY MOTOR TOYS**  
DISC DRIVEN

Dealers—Kingsbury toys are always "best sellers." Write for our proposition.



Send 10c for this Kingsbury Disc Wheel Eraser

**AUTOMATIC OIL HEAT**

**Good Bye Coal**



**HI-LO OIL BURNER**

Does away with coal, ashes, soot and dirt. Performs with amazing efficiency in your heating plant or furnace at home. (Hot water, Steam or Hot Air.) **Noiseless and frees you of all worry. Automatically adjusts temperature under all weather conditions. The low cost, clean, efficient HI-LO way is far the easiest and best.**

**LOW COST WAY**

Responsible Distributors Wanted  
**GLADIA LIGHT COMPANY**  
115-9 N. May Street CHICAGO



**MOTORCYCLES**

**WE WILL TRUST YOU**  
Pay As Low As \$2.00 per Week  
Hendersons, Harley-Davidsons, Indians

Slightly used and rebuilt. Hundreds to select from.  
Send 10c for list today.

**MYEROW BROS. CO., 15 Berkeley St., Boston, Mass., U. S. A.**

**Save Your Feet**

When all else fails, end your suffering with the **Heefner Arch Support**

**No Metal**  
Fully patented. It re-adjusts the entire foot. Write for free book and statements from doctors and users.



Heefner Arch Support Co. 655 M. E. Taylor Bldg. Louisville, Ky.

**BUCHSTEIN'S FIBRE LIMB**

is soothing to your stump—strong, pool, neat, light. Easy payments. Braces for all deformities.



**D. BUCHSTEIN CO.**  
610 3rd Ave., So. MINNEAPOLIS, MINN.

Send for Catalog Today



**For New and Old Fords**



Plug In—and Tune In

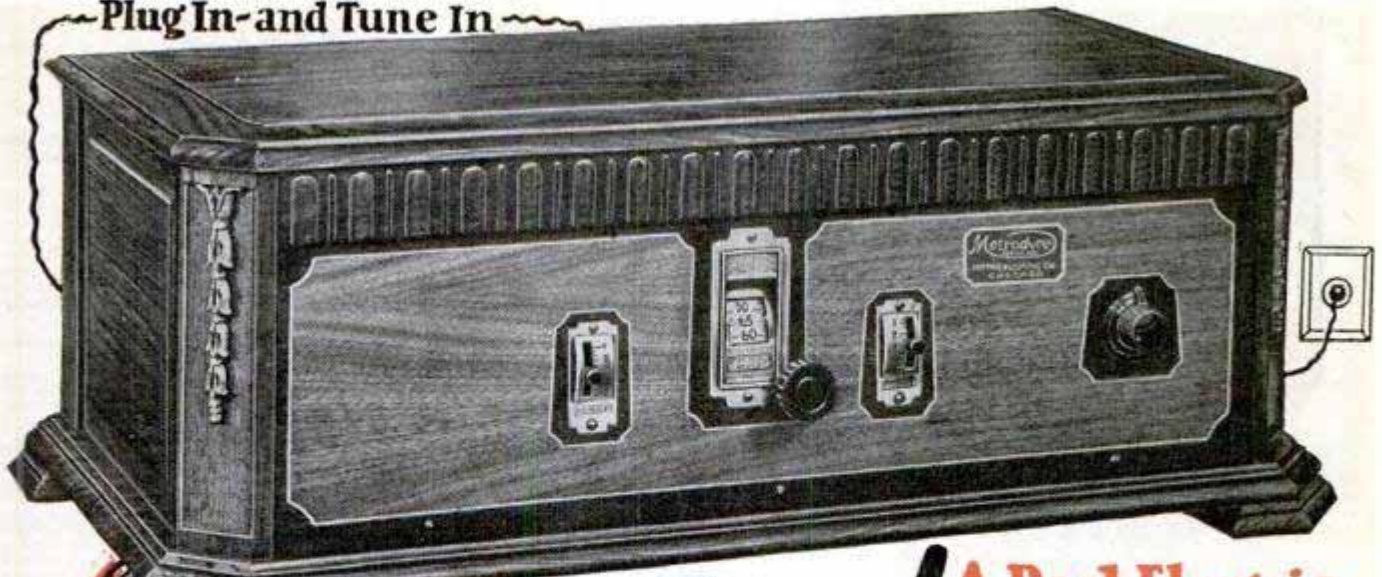

**30 Days Free Trial**

**Now!** **A Real Electric Radio Set**  
 Three-Year Guarantee  
 Shipped direct from our factory at rock bottom prices—costs less than most battery sets  
**No Batteries, Chargers or Eliminators**  
 No Acids; No Liquids—Plug In—Press Button—“Tune In”

**Metrodyne**  
**ALL ELECTRIC RADIO**

**7 Tubes—Single Dial Set**

**100% Electric Radio**

**BEAUTY—EFFICIENCY  
 DEPENDABILITY**

At last! The radio you've dreamed about! If you have electricity in your home you can now really enjoy coast to coast radio reception without the care, bother and muss of batteries, chargers, eliminators, etc. The Metrodyne All Electric is a real, genuine batteryless radio set. Simply insert the plug in the socket, press the switch button and “tune in.” You could not possibly buy a better radio set than the Metrodyne All Electric, no matter what price you paid.

The Metrodyne All Electric Radio is a 7 tube, single dial set. Only the highest quality low loss parts are used throughout. Solid walnut cabinet, beautiful two-tone effect, with handsome gilt metal trimmings. Size of cabinet, 28 inches long, 13 inches deep, 10 inches high. Has electrically lighted dial so that you can log stations in the dark. Only one dial to tune in all stations. Excellent tone qualities—wonderful volume—very selective.

**Costs Less Than Most Battery Sets**

Do not confuse the Metrodyne electric radio with ordinary light socket sets, because the Metrodyne is truly an all electric radio—consumes less than 2c worth of power a day. Comes to you direct from the factory. Its low cost brings it down to the price of an ordinary battery set. We are so confident that you will be delighted with this wonderful, easy-to-operate batteryless radio that we offer to ship it to your home for thirty days' free trial—you to be the judge.

**Mail This Coupon**

We are one of the pioneers of radio. The success of Metrodyne sets is due to our liberal 30 days' free trial offer, which gives you the opportunity of trying before buying. Thousands of Metrodynes have been bought on our liberal free trial basis. Write Today!



**METRO ELECTRIC COMPANY**  
 2165 N. California Ave., Dept. 616  
 Chicago, Illinois

Gentlemen:

Send me full particulars about Metrodyne All Electric Radio sets and your **thirty days' free trial offer.**

Name.....

Address.....

If you are interested in AGENT'S proposition place an "X" in the square.

**Agents! Dealers—Big Profits!**  
 Make big money taking orders for Metrodynes. All or part time. Metrodyne All Electric Radios are in a class by themselves. Unequaled for quality, performance and price. Demonstrate at home and take orders. Lowest wholesale prices. Your demonstrating set on 30 days' free trial. Mail coupon below for details.

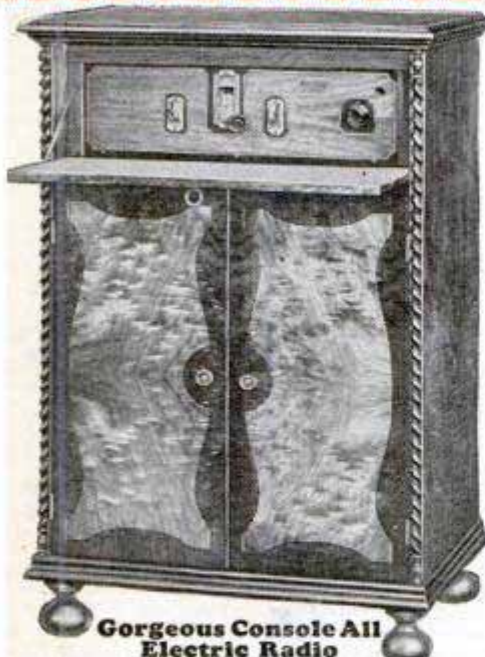

**Gorgeous Console All Electric Radio**

Genuine walnut cabinet, in a beautiful two-tone finish. Has a built-in genuine Metro-Cone large size speaker. Brings in programs with great volume, reproducing the entire range from the lowest to the highest notes with remarkable clearness and distinction. All metal parts finished in old gold. Wonderful electric radio, in a cabinet that will beautify any home.

**METRO ELECTRIC COMPANY**  
 2165 N. California Ave., Dept. 616, Chicago, Illinois





**Stop  
That  
Pain!**

**With Violet Ray Vibration  
Ozone Medical Electricity**

*The Four Greatest Curative Powers  
Generated by This*

**Great New Invention!**



Elco Health Generators at last are ready for you! If you want more health—greater power to enjoy the pleasures and delights about you, or if more beauty is your desire—write! Ask for the book on these inventions which has just been prepared. It will be sent to you without cost. It tells you how Elco Health Generators aid you in leaving the lethargy and hopelessness of bad health and weakness behind forever. Re-vitalize yourself. Bring back energy. Be wholly alive. Write today!

**Here's What Elco Users Say—**

"Wouldn't take \$1000 for my Elco."  
"Has done me more good in 2 weeks than doctors did in three years."



"Cured my Rheumatism." "My Eczema gone." "Cured my stomach trouble." "Cured my weakness." "Now I sleep soundly all night." "Thanks to Elco my strength and vigor are back." "No more pain." "Colds never bother me now." "Chronic Constipation banished."  
These great new inventions generate Violet Ray, Vibration, Electricity and Ozone—combined or separate. They operate on the electric light in your home or on their own motive power at less than 50 cents per year. Elco Health Generators are positively the only instruments which can give you in one outfit Electricity, Violet Ray—Vibration and Ozone—the four greatest curative agents. Send the coupon below. Get the Free Book NOW!

**Free Trial**

**MAIL COUPON  
for FREE BOOK**

Do not put this paper down without sending the coupon. Don't go on as you are with pains and with almost no life and energy. You owe it to yourself to be a better man or woman. You were put here to enjoy life—not just to drag through it. So do not rest another day until you have put your name on the coupon here. That will bring the whole story of these great new inventions. Do it today—now.



**Lindstrom & Company**

30 West Lake St. Dept. 13-56 Chicago  
Please send me your free book, "Health—Power—Beauty" and full information of your 10-day Free Trial Offer.

Name.....  
Address.....

**No Joke to be Bald**



**Grow  
New  
Hair  
Quick**

**Let Me PROVE It To You FREE**

What I accomplished on my own head, pictured above, I believe I can do for you, provided you are under 45 years of age and loss of hair was not caused by burns or scars. Anyhow, I must succeed or you pay nothing. No apparatus—my home treatment is simple, quick and inexpensive.

**Send No Money** Just your name and address and I will mail you full information with PHOTOGRAPHS, NAMES and addresses of men and women who have successfully used my treatment for dandruff, falling hair and particularly for baldness. Write Now. A postal will do.

**VREELAND'S,** 1356 Euclid-Windsor Bldg. CLEVELAND, OHIO

**QUIT  
TOBACCO**



No man or woman can escape the harmful effects of tobacco. Don't try to banish unaided the hold tobacco has upon you. Join the thousands of inveterate tobacco users that have found it easy to quit with the aid of the Keeley Treatment.

**KEELEY TREATMENT  
STOPS  
Tobacco Habit**

Quickly banishes all craving for tobacco. Write today for Free Book telling how to quickly Free yourself from the tobacco habit and our Money Back Guarantee.

**THE KEELEY INSTITUTE**  
Dept. A901 Dwight, Illinois

Write today for our 168 page **Deafness** FREE Book on

and learn how Perfect Hearing is now being restored in every condition of deafness or defective hearing. Our "Little Wireless Phones for the Ears" require no medicine but effectively replace what is lacking or defective in the natural ear drums. They are simple devices, which the wearer easily fits into the ears where they are invisible. Soft, safe, and comfortable.

**WILSON EAR DRUM CO., Incorporated**  
662 Inter-Southern Bldg. LOUISVILLE, KY.

**STOP USING A TRUSS**



Reduced  
Fac-Simile  
Gold Medal

**STUART'S PLAPAO-PADS** are different from the truss, being mechanico-chemico applicators made self-adhesive purposely to hold the distended muscles securely in place. No straps, buckles or spring attached—cannot slip, so cannot chafe or press against the pubic bone. Thousands have successfully treated themselves at home without hindrance from work—most obstinate cases conquered. Soft as velvet—easy to apply—



Grand Prix

inexpensive. Awarded Gold Medal and Grand Prix. Process of recovery is natural, so afterwards no further use for trusses. We prove it by sending Trial of Plapao absolutely **FREE**

Write name on Coupon and send TODAY. **PLAPAO CO., 733 Stuart Bldg., St. Louis, Mo.**

Name.....

Address.....

Return mail will bring Free Trial Plapao.



# Swear Off Tobacco

## Tobacco Habit Banished Let Us Help You

### Quick Results

Trying to quit the tobacco habit unaided is often a losing fight against heavy odds, and may mean a serious shock to your nervous system. So don't try it! Make the tobacco habit quit you. It will quit you if you will just take **Tobacco Redeemer** according to directions.

It doesn't make a particle of difference whether you've been a user of tobacco for a single month or 50 years, or how much you use, or in what form you use it. Whether you smoke cigars, cigarettes, pipe, chew plug or fine cut or use snuff—**Tobacco Redeemer** will positively remove all craving for tobacco in any form in a few days. Your tobacco craving will usually begin to decrease after the very first dose—there's no long waiting for results.

**Tobacco Redeemer** contains no habit-forming drugs of any kind and is marvelously quick, scientific and thoroughly reliable.

### Not a Substitute

**Tobacco Redeemer** is in no sense a substitute for tobacco, but is a radical, efficient treatment. After finishing the treatment you have absolutely no desire to use tobacco again or to continue the use of the remedy. It helps to quiet the nerves, and will make you feel better in every way. If you really want to quit the tobacco habit—get rid of it so completely that when you see others using it, it will not awaken the slightest desire in you—you should at once begin a course of **Tobacco Redeemer** treatment for the habit.

### Results Absolutely Guaranteed

A single trial will convince the most skeptical. Our legal, binding, money-back guarantee goes with each full treatment. If **Tobacco Redeemer** fails to banish the tobacco habit when taken according to the plain and easy directions, your money will be cheerfully refunded upon demand.

### Let Us Send You Convincing Proof

If you are a slave of the tobacco habit and want to find a sure, quick way of quitting "for keeps" you owe it to yourself and to your family to mail the coupon below or send your name and address on a postal and receive our free booklet on the deadly effect of tobacco on the human system, and positive proof that **Tobacco Redeemer** will quickly free you from the habit.

**Newell Pharmacal Company**  
Dept. 300, Clayton Station, St. Louis, Mo.



### Free Book Coupon

**NEWELL PHARMACAL CO.,**  
Dept. 300, Clayton Station, St. Louis, Mo.

Please send, without obligating me in any way, your free booklet regarding the tobacco habit and proof that **Tobacco Redeemer** will positively free me from the tobacco habit or my money will be refunded.

Name.....

Street and No.....

Town..... State.....



Tobacco Tells on Nervous System

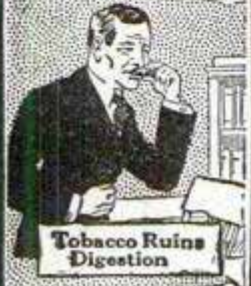

Tobacco Ruins Digestion



Tobacco Stunts Boy's Growth



Tobacco Robs Man of Vitality

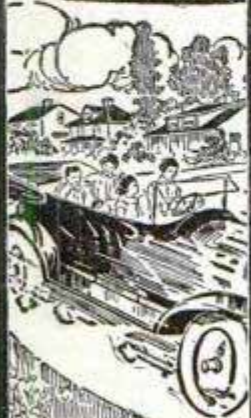

Tobacco Steals from You the Pleasures, Comforts, Luxuries of Life



**Book of 100 Homes FREE!**  
Tells how you can build yourself

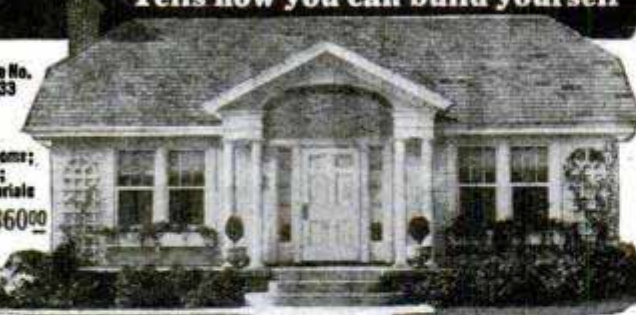

Home No. 633

5 Rooms;  
Bath;  
Materials  
\$1860.00

**Buy at Special Discount During September!**

Right now you can buy your home, barn, garage, summer cottage or poultry house at amazing savings. Write at once for *September Discount Prices!* Top quality material, Plan-Cut at Mill according to architects' plans; built-in convenience features; no extras, 20 year guarantee! Mail Coupon today for Free Book and Special Discount from our low Wholesale Prices!



**Gordon-Van Tine Company**  
1000 Case St., Davenport, Iowa  
Please send catalogs.  
I expect to build.....

Name.....  
Address.....



**Music Opens The Door**

INSIDE that closed door there is joy and good-fellowship. Outside there is loneliness, long evenings that seem never to pass. You can play better on King instruments. They are in tune because they are tested to the largest set of tuning bells in the world.

Let us tell you more about your favorite instrument. We will send our brand new handy reference catalog with full particulars on request. Our easy payment plan puts King band instruments within easy reach of all. Clip the coupon now.

**KING Band Instruments**

THE H. N. WHITE CO.  
5211-91 Superior Ave., Cleveland, Ohio  
Kindly send me your Handy Reference Catalog. I am interested in a \_\_\_\_\_ Instrument

Name \_\_\_\_\_  
Address \_\_\_\_\_  
City \_\_\_\_\_ State \_\_\_\_\_

**DIAMONDS WATCHES-JEWELRY**

10-Day Free Trial - Biggest Values - Easiest Terms  
Money Back Guarantee - A Whole Year to Pay!

No. 2335A257 **\$75**

Biggest Diamond Value Ever Seen!

Large flashing blue-white diamond, 2 oblong emeralds! Very smart new ring!

Artistic Mounting of 18 Karat Solid White Gold!

PAY ONLY \$2 DOWN - THEN \$1.50 A WEEK  
Order Today on 10-Day Free Trial!

No. 2335V42 **\$22**

Only \$1 DOWN 50c A WEEK

14 Kt. solid white gold wrist watch, with 2 sapphires! Adjusted, regulated, guaranteed accurate! Real bargain!

**CREDIT DEALINGS STRICTLY CONFIDENTIAL**

No one will know WHAT or FROM WHOM you are buying. When ordering, give a little information about yourself and a few business references to assure prompt delivery.

**WRITE FOR BIG FREE CATALOGUE!**

**STERLING DIAMOND & WATCH CO.**  
Diamond Importers - \$1,000,000 Stock - Established 1879  
1540 Broadway Dept. 2341 New York

**The One-Profit WITTE Log and Tree Saw**



**LOW PRICE EASY TERMS**

COMPLETE OUTFITS—everything you need for working in timber. Saws 15 to 40 cords a day! Change to tree saw in 3 minutes.

**FREE** Simply send name for NEW CATALOG, new Lower Prices and offers. 3 Hours Shipping Service.

**WITTE ENGINE WORKS**

7746 Witte Building KANSAS CITY, MO.  
7746 Empire Building PITTSBURGH, PA.  
7746 Witte Building SAN FRANCISCO, CALIF.

**Do Your PRINTING**

Cards, stationery, circulars, tag, labels, paper. Complete Outfits, \$8.85 up, Job Presses \$11 up, Rotary \$149. Card Cutters, \$3. Save money. Print for others, big profits. All easy rules sent. Write for catalog presses, type, paper, cards, ink etc. **THE KELSEY CO., E-37, Meriden, Conn.**

**E-Z WIRE STRIPPER \$3.00**

INSTANTLY STRIPS INSULATION from ELECTRIC WIRES. Guaranteed.

The ONLY TOOL in the world for this purpose—Works Clean—Quick—Easy—Handy. Used by General Electric Co.

**PYRAMID PRODUCTS CO., Dept. E., 2311 So. State St., CHICAGO, ILL.**

**NEW TIMER FOR FORDS**

MARVELOUS INVENTION FREE OFFER TO USERS **FORD DYNAMO**

60,000 MILES WITHOUT TROUBLE

WRITE TODAY FOR FREE OFFER  
Agents Wanted Everywhere

Eclipse Timer Co., 2930 Meinecke Av., Milwaukee, Wis.





**AGENTS MEN and WOMEN**  
**Make \$16 A Day**  
*everyday you show*  
*this marvelous new*  
**Steaming Iron**



**No More Sprinkling!**

Millions of eager American Women are waiting for you to demonstrate the amazing new ELDEC Electric STEAMING Iron...the startling new invention that takes the sting and drudgery out of washday. Eldec Iron does away with sprinkling, because it steams as it irons; prevents scorching; does pressing without cloth and

sponge, and does it all quicker, better and more uniformly. Best of all, ELDEC costs no more than the old fashioned electric iron—AND SAVES ITS COST from eight weeks' pressing alone.

**Send for Whirlwind Sales Plan!**

Be the first to show the Eldec in your community, and you'll be the chap who banks the big money. Every sale leads to two or three more. Don't let a day go by. Drop a postal before you turn this page and get the new whirlwind sales plan which is helping Eldec men wind up their week's sales on Saturday in a blaze of glorious commissions.

**ELDEC CO., Inc., Dept. D-9, 501 Fifth Ave., N. Y. City**



**Beautify your NOSE**

to shapely proportions—while you sleep!



**ANITA NOSE ADJUSTER** is SAFE, painless, comfortable. Speedy, permanent results guaranteed. Doctors praise it. No metal to harm you. Small cost.



Write for **FREE BOOKLET**  
**ANITA CO., Dept. K-12 ANITA Bldg., NEWARK, N. J.**

**NO JOKE TO BE DEAF**

—EVERY DEAF PERSON KNOWS THAT



I make myself hear, after being deaf for 25 years, with these Artificial Ear Drums. I wear them day and night. They stop head noises and ringing ears. They are perfectly comfortable. No one sees them. Write me and I will tell you a true story how I got deaf and how I make you hear. Address



**GEO. P. WAY, Artificial Ear Drum Co. (Inc.)**  
 80 Hoffman Bldg., 2539 Woodward, Detroit, Mich.

**NO MORE BALD HEADS**



**WHEN** our VACUUM CAP is used a few minutes daily. We accept no pay until you have tried the Cap 60 days and are satisfied. The Vacuum Cap is an appliance that draws the blood to the Hair Roots and starts a new healthy crop of hair. It stops Dandruff, stops the hair from falling out.

Bought by Doctors and men who know that it is the only reasonable HAIR GROWER known to science. No Drugs Used. Write for application blank, testimonials and booklet on "HAIR," sent sealed in plain envelope, FREE.

**THE MODERN VACUUM CAP CO.**  
 559 Quincy, Denver, Colo.

**You can now Own a Typewriter!**



*Guaranteed for 5 years*



Be up-to-date—know the pleasure and convenience of having one in your home. You'll be amazed at the uses everyone in your household will find for this real Underwood typewriter. Every member of the family will use and enjoy it! Don't send a cent—but do get our big special offer—our valuable book on typewriters and typewriting—FREE.

**Any One Can Learn to Operate a Typewriter!**

You can learn to write on this standard-keyboard machine in one day; it's so simple that even a child can use it. A week after the expressman has brought it, you'd feel LOST without it. A trial will PROVE it—and doesn't cost you a penny!

**SPECIAL FREE TRIAL OFFER**

We don't want a penny now. Nor any money at all unless this proves the typewriter bargain of your life. The trial is FREE. If you buy, our easy terms make it a pleasure to pay. There's no excuse now, for not owning a typewriter—and the finest make!

We include all tools, a cover, etc., all complete, all ready to write. Write us now. Deal direct; we are the largest factory of the kind.

Our plan gives you the opportunity of a thorough trial before you buy. You run no risk whatever. You start to pay for your typewriter AFTER you have found it the only machine for you!

But get the facts before this lot of machines is all in use. Clip the information coupon before you turn the page. It will pay you! Note the very useful book you will receive free! Write for full particulars at once.

**The Greatest Typewriter Offer Ever Made**

If you know typewriters, you know the perfect work and the ease and speed of a Shipman Ward rebuilt Underwood typewriter.

New machines are guaranteed for only one year; WE GUARANTEE EVERY ONE OF OUR MACHINES FOR FIVE YEARS! If you have never owned a typewriter, start with the finest! You can try this one at our risk. But, the time to act is NOW. Don't miss out on this present bargain offer whereby you can get this genuine Underwood at a big savings. Don't do longer without the convenience of a typewriter.

**FREE!** Get our catalog free; lowest prices and terms. A manual free, too; valuable instruction for learning rapid typing.

**Mail Today!**

Shipman Ward Manufacturing Co.,  
 2126 Shipman Building, Chicago, Ill.

Please send me your Free Trial Plan and Typewriter Book, together with your special offer on prices, terms, free course in Touch Typewriting and also how I can make money with this typewriter, without obligation. This is not an order.

Name.....  
 Street or R. F. D.....  
 City.....  
 State.....





Exclusively Licensed by Technidyne Corporation Under U. S. Patent 1593658, July 27, 1926.

**At Last!**

# "Tonatrol"

*A True Tone and Volume Control*

Electrad, Inc., has scored another triumph with this new and improved volume control. Tonatrol controls volume smoothly from a whisper to full power.

A smart addition to any set. Very easy to install. At your dealer's.

"Tonatrol"—Standard Volume Control \$1.50.

"Tonatrol"—Type W. S. (with filament switch attached) \$2.00.

Write for free installation booklet for the correct way to control volume.

Dept. 66A, 175 Varick St., New York, N. Y.

# ELECTRAD



## 5 TUBE RADIO ONLY \$19.98

It's a wonder for power and selectivity. Famous ARL circuit. Coast to coast reception! Finely built of selected, tested parts. Thousands now in use.

**FREE Log and Call Book and New 132-p. Catalog** with thousands of nationally advertised bargains. Latest in radio at big savings. Write for Free copy.

**AMERICAN AUTO & RADIO MFG. CO.**  
HARRY SCHWARTZBERG, PRES.  
Dept. 261 American Radio Bldg., Kansas City, Mo.



# Set Builders! Dealers!



**FREE**

Standard parts and equipment at money-saving prices, with discounts that show you a real profit. Electrical Phonograph—pickups—latest kits! New A C tubes and transformers—parts for any circuit—power audio equipment—short wave supplies—they are all in our big new 1928 Catalogue. Write for it today, with discount sheet. 12-hour shipment guaranteed.

## Van-Ashe Radio Co.

206 N. 10th St., St. Louis, Mo.

### Enjoy a Big Powerful Radio: 30 Days FREE!



**MIRACO Ultra**

Users everywhere report it gets Coast to Coast, Canada to Mexico, loud and clear on speaker; outperforms \$100 to \$200 sets. Some hear Europe. Marvelous bargain! Don't buy unless 30 Days Trial proves it. Most Selective, Clearest and Most Powerful Distance-Getter among big, fine 6-tube radios. Retail LIST price, now \$49.75.

**Factory Prices—SAVE Up to 1/2**

Every set completely assembled, rigidly tested, fully guaranteed. Single Dial Sets, Speakers, batteries, tubes, etc., at big savings. literature, user's testimony and BIG SPECIAL OFFER

**Free**

**MIDWEST RADIO CORPORATION**  
Pioneer Builders of Sets  
Send for Proof 407-C Miraco Bldg., Cincinnati, O.

**USER-AGENTS WANTED**  
Write for discounts

## AGENTS! DEALERS! BIG MONEY IN RADIO

Demonstrate Metrodynes at home. Big profits. Demonstrating set on 30 days' free trial. Write for money making proposition.

**METRO ELECTRIC CO.**  
2161 N. California Ave. Dept. A, Chicago, Ill.

### 5 TUBE RADIO KIT COMPLETE—\$16.95

Genuine Blue Ribbon Neodyne Kit—2 dial control gets real distance. Simple plans, instructions furnished. Can be built in 2 hours. **FREE** 21 inch Eria Cone Speaker. 5 tubes included. Kit sent C. O. D. Order today.

**RADIO EQUIPMENT CO., Dept. P. E., 549 S. Wells St., Chicago, Ill.**

**FREE** New Daven Radio Catalog now ready. Send for it today.

**Daven Radio Corporation**  
150 Summit Street Newark, N. J.

**For Better Filament Control** on your radio set use the **NEW Lynch EQUALIZOR** in place of rheostats. \$1 complete with mounting. At your dealer's or post-paid. Money back if dissatisfied. In ordering, state number and types of tubes in your receiver. **ARTHUR H. LYNCH, Inc., Manufacturers of the Lynch Metallized Resistor, 250 West 57th Street, NEW YORK, N. Y.**



### DIE CUT OVAL PRINTS

Something new for kodakers. Send negative with dime for sample and catalog of specialties for kodakers.

**FRANK SCOBIE, 43-O, Sleepy Eye, Minn.**



## LeDet "B" POWER

*A New Scientific Discovery that Provides Perfect "B" Power For your Radio*

### Direct from Factory at Half its Retail Price

Guaranteed to be equal to, or better than the highest price B Eliminators on the market. Equipped with the famous LeDet Condenser and Transformer, made to last a lifetime, has no tube to wear out, years ahead of the ordinary B Battery Eliminator. Eliminates foreign sounds and gives your radio a tone as smooth as velvet. We offer a limited number of "LeDets" at \$12.50 each, postage paid. Send \$1 pay balance on delivery. 5 day trial guaranteed with money refunded if returned within that time.

**LEDET LABORATORIES, Detroit 12th St., Terminal Bldg. Detroit, Michigan**

Send \$1 Pay Balance ON DELIVERY TOTAL **\$12.50**



**3 Greatest SPECIALS \$29.75**  
Your Choice at

**A Full Year To Pay**

The greatest genuine jewelry bargains ever offered! Credit values which defy cash store competition. Pin only \$1 to your order and your choice comes to you parcel post prepaid on **10 Days Free Trial**. Then pay postman only \$1 more on delivery; after free trial period pay balance in 12 equal monthly payments of **\$2.32 each**. Satisfaction absolutely guaranteed or your money refunded—our policy for 32 years

**FREE—Royal Book of Gems**

Thousands of special values in genuine diamonds, jewelry and watches. Send for your copy at once. **Wear while paying.**

**AA1 -** Gorgeously pierced, lace design dinner ring; 18K white gold set with 5 perfectly matched genuine diamonds. Special **\$29.75**

**AA2 -** Spectacular value! Lady's wrist watch, 14K solid white gold engraved case set with 2 genuine diamonds and 4 French Blue Sapphires; guaranteed 15 jewel movement. Special **\$29.75**

**AA3 -** Never before offered at so low a price! Gents strap watch; 20 year guaranteed, largest Olympic octagon case, white or green gold filled. Fitted with 15 jewel nationally advertised Waltham or Elgin movement. Special **\$29.75**

**15 JEWELS** Elgin or Waltham

**ROYAL DIAMOND & WATCH CO**  
ESTABLISHED 1895  
ADDRESS DEPT 1848 170 BROADWAY NY

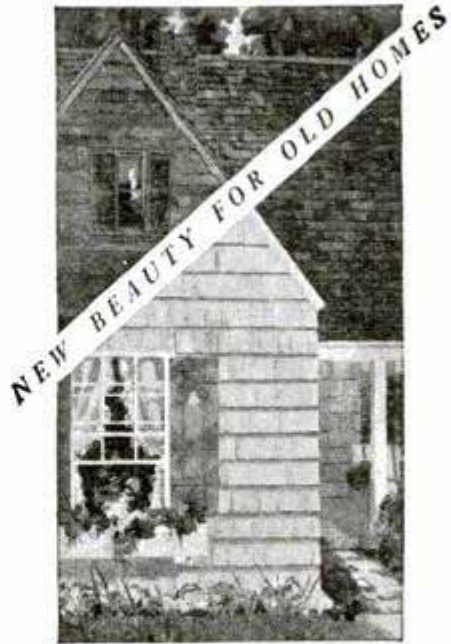

**Lay Creo-Dipts over old side-walls ... save paint ... save fuel**

Do you want to rebeautify your present home—make it more livable—more valuable? Lay Creo-Dipt Stained Shingles right over the old side-walls. Costs only 1/3 more than re-painting; saves its entire cost in paint-bills alone in the first 5 to 7 years.

Saves fuel, too. Most owners estimate from 15% to 25% each year. Side-walls of Creo-Dipts add another protection against winter-cold and summer-heat.

Mail the coupon today for photographs showing this new way of making old homes new. Ask about Creo-Dipts for new homes, new roofs, re-roofing, too. Get the facts now—before you turn the page.

Genuine Creo-Dipts are carried in stock by leading lumber dealers everywhere.

**CREO-DIPT Stained Shingles**

MAIL THIS COUPON

Creo-Dipt Co., Inc., 1230 Oliver St., No. Tonawanda, N. Y. (In Canada: Creo-Dipt Co., Ltd., 1610 Royal Bank Bldg., Toronto.) Sales offices in principal cities.

Enclosed find 25c for portfolio of large-size photographs of Creo-Dipt homes, booklet of color suggestions, and name of local Creo-Dipt dealer.

Check the use that interests you

- Covering old side-walls
- Building new
- New roof
- Re-roofing

NAME.....

ADDRESS.....

**Oh Boy! See All!**  
**Big 3 1/2 Ft. Telescope**

Lend wings to your eyes! People and objects miles away seem close. Wonder telescope brings new pleasures to home, farm, camp, travel, sport. Study the mysterious Sun spots; see Moon and Stars as never before. See people on the beach, on the mountains, etc.

**FREE** Yes, absolutely free! A handsome leatherette Carrying Case and Shoulder Strap. Also Solar Eye Piece to view the sun—a special feature, found only on expensive instruments.

**5 Sections**  
**8 Power Lenses**

Brass bound; measures 12 in. closed; powerful achromatic lenses protected by dust caps.

**Thousands Pleased**

P. Brush wrote: "Watched submarines three miles off coast." Ed. Foster: "Tall time on clock five miles away." C. Scribner: "See lighthouse 18 miles away." Mrs. Yarbrough: "Could tell color of airplane four miles away." S. M. Gearhart: "Can see men working seven miles away."

**CLIP THIS AD**

**SEND NO MONEY**

On delivery of Telescope, free Case, Strap and Eye Piece pay Postman only \$1.85, plus postage (2 complete outfits \$3.50). Satisfaction guaranteed or money refunded. Send today, entertain your friends! Be first to have one.

**FERRY & CO., Dept. 1778, Chicago, U.S.A.**

**Sports**  
**Touring**  
**Beach Views**



# Cunningham RADIO TUBES



The tube that out-performed and out-sold all other makes and types

The same quality that is responsible for the overwhelming popularity of the CX-301A tube is found in each of the other nineteen types of Cunningham Radio Tubes.

Remember, that in the final analysis it is the tube that makes or mars the reception of the finest receiver. One inferior tube can mar its over-all performance. Equip throughout with Cunningham Radio Tubes and you will enjoy to the utmost all that your set can offer.

Consult your radio dealer for the correct combination of Cunningham Radio Tubes to use for improving your radio reception.

**E. T. CUNNINGHAM, Inc.**  
NEW YORK CHICAGO SAN FRANCISCO

**Write quick** FOR HARRY ALTER'S  
**New Wholesale RADIO BOOK**



"Minute-Man" shipping service means quicker turnover for radio dealers

—bigger business and more profits without increasing your capital investment.

## EVERYTHING IN RADIO AT BED-ROCK PRICES

made possible by cash buying and cash selling. If it is used in radio and is a reputable product, we have it. Send now for catalog.

*Note: We sell radio retailers only*

**The Harry Alter Co.**

1776 MICHIGAN AVENUE CHICAGO

## METRODYNE RADIOS 1928 MODELS

Completely assembled 6 and 7 tube sets, equipped for battery or electric operation. Also a wonderful line of 100% electric sets. Don't buy any radio until you get our 30 days' free trial offer. Write Today!

**METRO ELECTRIC CO.**

2161 N. California Ave. Dept. A. CHICAGO, ILL.



## CLAROSTAT

When you build a radio set, B eliminator, ABC power unit or amplifier, go to your dealer and ask for CLAROSTAT, the greatest variable resistor. He'll recommend it highly.

There's a Clarostat for every resistor purpose. Illustrated (top) Standard Type, Universal range, carrying capacity 20 watts; (below) Power Clarostat, Universal range, carrying capacity 40 watts.

**AMERICAN MECHANICAL LABORATORIES**

285 N. 6th St. Brooklyn, N. Y.

## Five Tube Radio



**\$25.00**

**AGENTS WANTED**

EXCLUSIVE TERRITORY DEMONSTRATING AGENT IN EVERY COUNTY

5-Tube, Single-Dial Control, Loud Speaker Radio. "Gets everything." What the public wants. New low price—\$25 retail, liberal agent's discount. Take orders in spare time—no radio experience necessary. 100-page Radio Book FREE. Territory going fast—Write TODAY.

**K. B. FISCHER, 122 W. Austin Ave., Chicago**



## His Bank Account Is Growing!

He is one of the many men who have sent for a remarkable book, "The Nestler Plan." It tells how you too can establish a money-making business all your own, servicing tires by the patented Nestler Rubber Fusing Process. You can easily learn this scientific, modern rebuilding and repairing method in your spare time. Big profits; protected territory; little capital required; no experience necessary.



Send for FREE illustrated book of facts, "The Nestler Plan." Write TODAY to Dept. 39

NESTLER RUBBER FUSING CO., Inc.  
245 West 55th St., New York, N. Y.

## You-and This New Machine Can Earn \$500 a Month

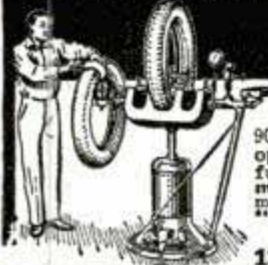

### Operate a Tire Repair Shop

90,000,000 Tires in use. America's greatest opportunity for men with small capital. We furnish everything—\$100 and up. Easy payments. We train you FREE right at home. Start making money at once. Write today for Free Book "Steps to Success."

Haywood Tire Equipment Co.  
1334 South Oakley Chicago, Illinois



**AMAZING INVENTION**  
Appeals to every motorist. Gets any car out of mud or sand. Nothing like it.  
**GETS-U-OUT TIRE LUG**  
Special offer to agents. Ask for details and territory. Chicago Tire Lug Co., 860-336 W. 47th St., Chicago



## STOP FORD CRANKSHAFT END-PLAY!

**C-A ADJUSTABLE BEARING** corrects and prevents end-play without removing motor. Eliminates many troubles. Easy to install—simply drop pan. Only \$3.75. Ask your dealer or sent prepaid by ADJUSTABLE BEARING CO., Dept. P, 405 Virginia Ave., Indianapolis, Ind.

**\$500 DIAMOND RING REPRODUCTION FOR LESS THAN 1/2 PRICE 2.98**

Marvelous Mex. Blu-Flash Gem

This beautiful fiery gem, the Sensation of the age is astounding experts everywhere. Its the ONLY gem POSITIVELY MATCHES the finest genuine Diamond side-by-side. Same perfect cut and dazzling play of rainbow fire, guaranteed for life. Delighted customers write: "Can't be told from finest Diamond"; "Most beautiful gem I've ever seen"; "One expert offered me \$95.; another \$110 for my Blu-Flash Gem". Best people wear them.

## AMAZING OFFER TO INTRODUCE

Rings shown above latest 1928 chased and filagree styles in finest platinum (No. 11 in gold if preferred). Set with perfect selected first-water Gems. Match \$500 Diamond-platinum rings. Catalogue price \$7.50 each. **SEND NO MONEY** just your name, address, number of ring desired, and paper strip that meets around ring finger. On receipt deposit with post-man only \$2.98, or \$5.50 for both rings. Wear 3 days; if not delighted return for prompt, cheerful refund. **NO RISK**: no more to pay. Only one of each ring under this offer.

**FREE** with rings a \$1.00 1 3/4 inch silver bar or scarf pin set with flaming Sea Opal from depths of Monterey Bay. **WRITE TODAY**. Agents Wanted. Mexican Gem Importing Co., Dept. US, MONTEREY, Calif. Dealers in Fine Gems for over 21 years.

# Have you a Wet Cellar?

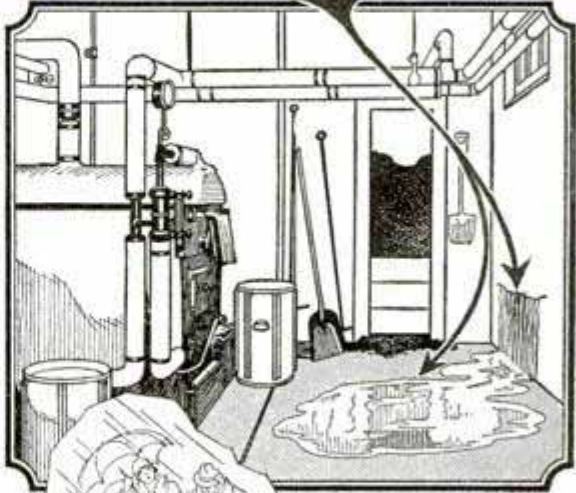

Dampness and flooding from ground water getting in is easily stopped by filling the cracks and painting over the porous spots in concrete or brick walls and floor with

## SMOOTH-ON NO. 7

—the only effective waterproofing material that can be applied from inside and to wet or dry surface.

Excellent also for waterproofing boiler pits, cisterns, tanks, ponds, wash-room, garage and stable floors, etc. About 25 lbs. required for each 100 sq. ft. of surface.

## You should also know SMOOTH-ON NO. 1

—The good old standby for stopping leaks in pressure joints, mending cracks, making loose handles, screws, etc., tight, stopping leaks in automobile radiators and hose connections, keeping lubricators, hub caps and nuts from loosening, etc.

## The Free Smooth-On Repair Book

will show you how, and by doing the work yourself you make big savings. Mail the coupon for free copy.

Get Smooth-On No. 7 in 1 or 5-lb. can, or 25, 50 or 100-lb. keg and Smooth-On No. 1 in 7-oz. or 1 or 5-lb. can. At any hardware store, or from us direct.



# Do it with SMOOTH-ON

SMOOTH-ON MFG. CO., Dept. 37,  
574 Communipaw Ave., Jersey City, N. J.

Please send the free Smooth-On Repair Book.

Name.....

Address.....

9-27



# Learn to Play This for Real Fun-Money

Have fun. Be Popular. Make real money in your spare time. Easy! When you learn to play a

**BUESCHER**

*True Tone Saxophone*

If you can whistle a tune you can learn to play a Buescher. 3 lessons given on request with each Buescher Sax' give you quick, easy start. Many learn scales first hour, play tunes first week, with their Bueschers.

*Easy to Play - Easy to Pay*

Take any Buescher Instrument home for six days' trial. See what you can do. If you decide to keep it, pay a little each month. Send for Beautiful Catalog and details of this liberal plan. No obligation. Mail the coupon today.

**BUESCHER BAND INSTRUMENT CO.**  
*Everything in Band and Orchestra Instruments*  
2116 Buescher Block Elkhart, Indiana



BUESCHER BAND INSTRUMENT CO. 383  
2116 Buescher Block, Elkhart, Ind.  
Gentlemen: Without obligating me in any way please send me your free literature. Mention instrument interested in.  
Age?.....Name instrument.....  
Name.....  
Address.....

SEND FOR  
FREE BOOK

# \$240<sup>00</sup> A Week

## Riding In Your Car

Making startling demonstrations. Wonderful New VIX Moisture Humidifier and Gas Saver. For all autos, trucks, tractors, busses, engines, taxis. Makes engines run all the time with same wonderful efficiency they do on a cool damp moist night. Startling demonstrations prove



### Amazing Mileage Increase

**42.8 Miles 1 Gallon—No Carbon**  
SWORN AFFIDAVIT—H. G. Flymate of Ariz. says: "My Ford 18 to 18 miles per gallon, with VIX on 42.8 miles. Took off head and instead of using putty knife and emery paper to clean carbon I could wipe it off with cloth."

**Oldsmobile 360% Gain**  
SWORN AFFIDAVIT—Wilson T. Jarboe, Minister, Baltimore, says "on my 1926 Oldsmobile, with VIX on 43.3 miles per gallon, 12 to 14 before."  
**ALSO Thousands of Other Remarkable Records.** Sworn affidavits make this proof convincing.

**Moisture in engine does it.** Smoother running; more mileage; added power; faster pickup; more pep; stronger on hills; increased top speed; frees engine from hard carbon troubles.

**1 Free to Introduce QUICK SALES BIG PROFITS!**  
One man \$4939.66 in 3 1/2 months. Another \$1656.40 in 58 days. Factory Sales-Distributors wanted everywhere. Spare or full time. \$375 to \$1250 monthly. **WRITE ME TODAY.** Address, **WALTER CRITCHLOW, Inventor, J3-805, Wheaton, Ill.**

## Sport Bodies for Fords AT FACTORY PRICES!



This Model in Grey Prime **\$39.50**

Write for Booklet A-2 Showing Other Models.

**SPORT FACTORIES, AURORA, ILL.**

### New Improved SPORS Fountain Pen. 60 Day Trial. Money back if not pleased GUARANTEED 2 YEARS—Improved Point LADIES' OR MEN'S STYLE

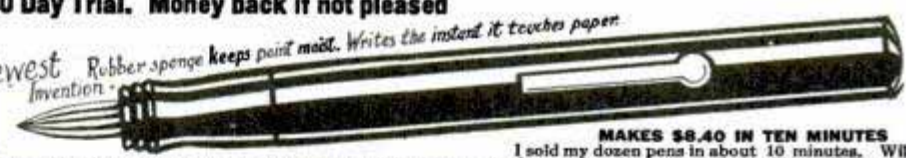

Agent's Sample **65c** Sells for \$1.25. Writes like a \$7 Pen Make \$10 Daily Easily

**MAKES \$8.40 IN TEN MINUTES**  
I sold my dozen pens in about 10 minutes. Will order another dozen soon. TRACY KRENS, Nebraska.  
Write for FREE Wholesale Specialty Catalog

Comes in Red or Green

F. SPORS CO.

727 Main St. Lesueur Center, Minn.

## Just five minutes of your time on each Ford means \$1.75 profit on a \$2.50 sale

To a man with vision—an "up and at 'em" fellow—one who will say—"I'll make your car ride 100% smoother, without spring rattles or spring squeaks, or give you a set of RIDE AIR Cushions Free!"—that chap can easily earn \$8.75 in less than an hour! And I'll prove it to you absolutely if you write to me NOW! Sample Free.

**C. F. HAMILTON, Sales Manager, Desk PM-9  
530 W. 27th Street Los Angeles, Calif.**

# 6 TUBE RADIO ONE DIAL Only \$32.50

Latest advanced circuit. All steel chassis totally shielded. Balanced parts of best quality. Marvelous power and selectivity. Gets the long range stations as clear as a bell. One dial single control. An unsurpassed value—just one of our many mighty bargains.  
**FREE Log and Call Book and Big New Catalog—**just off the press. Full of Radio Bargains. Send for your free copy now!  
**American Auto & Radio Mfg. Co.**  
HARRY SCHWARTZBERG, Pres.  
Dept. 262 American Radio Bldg., Kansas City, Mo.



## HANDY TOOLS FOR HANDY MEN!

Better work with bigger volume can be easily had with amazing speed and accuracy on

### Boice-Crane Bench Machines

Do ripping, mitering, grooving, rabbeting, sanding, grinding and other operations better, quicker and easier. Driven by any 1/2 to 3/4 h. p. motor; portable; attached to any light socket. Sold with or without motor. Greatest values at lowest prices.

Send 10c today for descriptive catalog of Bench Saws, Lathes, Jointers, Drills and Band Saws.

**W. B. & J. E. BOICE, DEPT. F. M. 9-C, TOLEDO, OHIO**





**\$100 to \$125 PROFITS Weekly!** Write Today For THIS



New line of quality toilet goods sells like wildfire. 300% to 500% profits. No experience required. All you do is take orders from this beautiful sample case. Finest perfumes, soaps, facial creams, bath salts, face powders—wonderful products at prices that appeal to all women.

**FREE SAMPLE CASE**

Just send your name and address. This money-making opportunity is unequalled. Be your own boss. Get paid every day. Write today—we show you how to make BIG money with little work.

**THE NATIONAL SOAP & PERFUME CO.**  
512 W. Huron St. Dept. 54 Chicago, Ill.

**TYPewriter PRICES CUT**



Your choice of the World's best typewriters—Underwood, Remington, Oliver—full size, late model, completely rebuilt and refinished brand new. Prices smashed down to half. Act quick.

**\$2 and it's yours** Free Trial

Just send your name and address and we will mail you our complete **FREE CATALOG** prepaid, fully describing and showing actual photographs of each beautiful machine in full colors. Tells every detail of our direct-to-you small-payment plan. Write now for tremendous saving. No obligation whatever. Still time if you act now.

**International Typewriter Exchange**  
386-188 W. Lake Street. Department 994, Chicago, Ill.

**FREE Wholesale Radio Catalog**

Our new 1928 catalog is jammed full of the newest offerings of nationally known radio parts, kits, sets, accessories, table and console cabinets, etc. Whatever your radio needs may be it's in our 1928 catalog. Write for it—and for our confidential discount sheet. Send your request on your letterhead—but write immediately.

**SHURE RADIO COMPANY**  
835 D Madison St., Chicago, Ill.



**Boils 50 Gallons In Less Than Hour**

No Other Compares With This

**Improved Oil Burner**

Use Ordinary Kerosene or Coal Oil

**[Burns Outdoors as Well as Indoors]**

THE most remarkable Kerosene Burner ever built. Boils down apple cider, maple syrup, molasses, etc., in half the ordinary time. Ideal burner for dairies, butchers, indispensable on the farm.

**PRODUCES TERRIFIC HEAT WITH SILENT BLUE FLAME**

**NO NOISE  
SMELL  
SMOKE  
SOOT**



So efficient it produces twice the amount of heat of City gas at half the cost. So simple anyone can install and operate. Double generator assures continuous operation without shut-downs. Nothing to wear out, starts in a jiffy, will last a life time. Every burner guaranteed fully. Write for special introductory price. Free descriptive catalog.

**HOME MANUFACTURING CO.**  
Dept. 113, 16 E. Kinzie Street, Chicago

**This Marvelous Wrench Pays \$1000 a Month**  
**No Thumb Screw Adjustment**

That simple slide motion locks securely, with a better hold than is possible with any other wrench. Does away with the old thumb screw idea that was always a handicap.

**First and Only One Hand Monkey Wrench**

Any job can be tackled and finished with ONE HAND quicker with the H&E WRENCH than any tool on the market. Fully Patented and the first and only tool of its kind.

**Slides Up and Down Locks Automatically**

It creates a sensation wherever shown, its simplicity, smooth action, strong grip, and practical value arouses the interest of everyone. Mechanics are wild over it.

**Saves Time**

As a labor and time saver it simply can't be beat. Any job is done quicker and easier.

**Agents Wanted Everywhere**

Rapid sales with a handsome profit makes this a very attractive proposition for Agents and on account of this increased demand we want Agents everywhere and the opportunity is open to you NOW but you must ACT PROMPTLY.

**Pressure 8,000 Inch Pounds**

All tests passed Government specifications. Actual service with Railroad assures High-Class Practical Value.

**Praised by Big Concerns**

C. B. & Q. Railroad and many other large Corporations have acknowledged its value and endorsed it. Factories, Machine Shops, Garages, in fact, wherever tools are used need it. Every home should have one.

**MAIL TODAY GET YOURS FREE**

H & E WRENCH SALES CORP.  
Dept. E, 228 No. LaSalle St., Chicago, Ill.  
Dept. E, 285 East 134th St., New York City.  
Gentlemen:—Please mail me free particulars. This does not obligate me in any way.

NAME.....  
ADDRESS.....  
STATE..... R.F.D.....





# Big Money in "Red Hots" Roasted

## The New Better Automatic Electric Way

If you are already in the good business—OR, if you are ambitious to start in a business that brings tremendous profits on a small investment—

Find out at once all about this new automatic electric way of roasting "Red Hots" that makes them twice as appetizing as before.

With the demand for "Red Hots" growing by millions a month what an opportunity for big profits this wonderful new Wee-Nee Machine opens up to you! It not only roasts them by electricity, but it also avoids watching and handling 'em—takes 'em out when done to a turn—and stores 'em in a heated compartment until served.

## \$5000 to \$15000 a Year From Roasted "Red Hots"

Fortunes are being made everywhere. Even bigger profits await you with the Wee-Nee Machine.

Once a man tastes a roasted Red Hot, he is done forever with the old soggy, boiled "dog"—or the dried-up, fried kind. Crowds flock to the place where Roasted Red Hots are served, hot, deliciously browned, chock full of appetizing juiciness, as only the Wee-Nee Machine can cook them. They'll pass by the old "boiled dog" stands and toss down their money before this flashing white, electric, automatic roaster.

### MAIL COUPON QUICK!

Be the first to have the Wee-Nee Machine and Monopolize the Red Hot business of your locality! You can do it with this machine whether you are now in the business or wish to start into one of the sweetest profit producing lines imaginable. Coupon brings the full details that will open your eyes to what is in store for you. Mail it today!

### Food Display Machine Corp. 350 W. Huron St. Dept. 13-56 Chicago

FOOD DISPLAY MACHINE CORP.,  
350 W. Huron Street,  
Dept. 13-56, Chicago, Illinois.

Send me, without obligation, full details of your new Wee-Nee Machine and facts concerning the big money to be made.

Name.....

Address.....

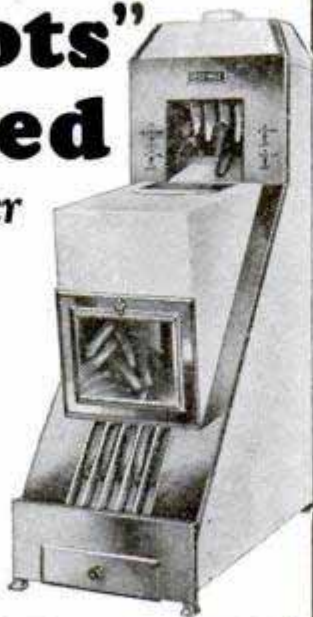

### Wee-Nee

Approved by Health Authorities for its Sanitary Features. Crowds attracted by beautiful white display and moving parts. The greatest moneymaker in the food line. Capacity 300 Red Hots an hour. Costs almost nothing to run. Get all the facts. No obligation.

# How to Start a Tire REPAIR SHOP

*With only a few dollars investment*

MAKE more money. No experience necessary. All you need is a few dollars for a Shaler 5-Minute Shop Vulcanizer for speedy tube repairs (see photo). Big profits soon pay for a Shaler Balloon tire Vulcanizer for casing repairs.



With this tube Vulcanizer you get 28 patches free. Even at 50c a repair these 28 patches bring \$14.00—far more than you pay for the Vulcanizer. Additional patches cost little. Write at once for particulars.

**THE SHALER COMPANY**  
2710 Fourth St. WAUPUN, WIS.

# SHALER

*World's Headquarters for Tire Repair Equipment*

## ALL TOOLS IN ONE = 10 to 1 LEVERAGE POWER GEAR TRANSMISSION

In the EIFEL-FLASH Plie Rench Kit—weighing only 1½ lbs.—you get a complete UNIVERSAL Tool Service that beats any number of other hand tools weighing 60 lbs. and costing \$50.00. Creates a sensation everywhere. It's astounding. 1-Ton Grip makes it worth ten times its cost.



**THE FLASH SALES CORP'N**  
IP-4809 N. Ashland Avenue, Chicago, Ill.

### GET YOURS FREE

We want distributors everywhere and for introductory purposes offer 1 Plie-Rench Kit FREE to the first interested person in each locality—Here is a real opportunity!

*The Super-Elto*  
*Starts with a revolution*  
**WRITE FOR CATALOG!**  
Address Dept. AA  
**ELTO OUTBOARD MOTOR CO., MILWAUKEE**

## AUTO PARTS—New and Used Save 30 to 80%

EVERYTHING for your car at prices only Warshawsky can offer. Bargains by the thousand—Timken Axles, Bearings, Brown-Lipe Transmissions, Pistons, Rings, Hayes and Firestone Wheels, Rims, Tires, Tubes and a complete line of accessories—new, except where specified.

FREE—Write for catalog!

# WARSHAWSKY & Co.

World's Largest Replacement Parts House  
1915-35 S. State St. Dept. PM 9 CHICAGO



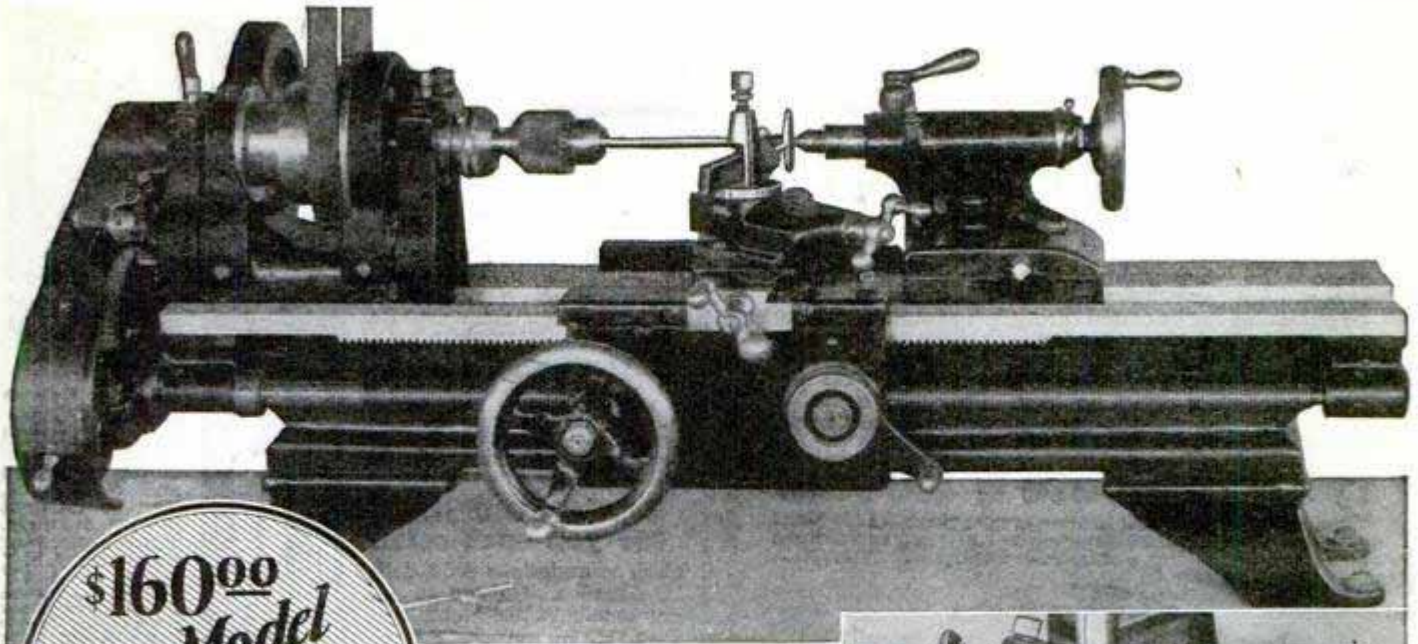

Motor Drive if Desired

The 9 in. Junior South Bend Lathe is ideal for refacing valves. Using the compound rest set at the proper angle, one or two light cuts with a turning tool will true the valve face with utmost accuracy in five minutes. Refacing valves by turning in a lathe is now universal practice in larger shops.

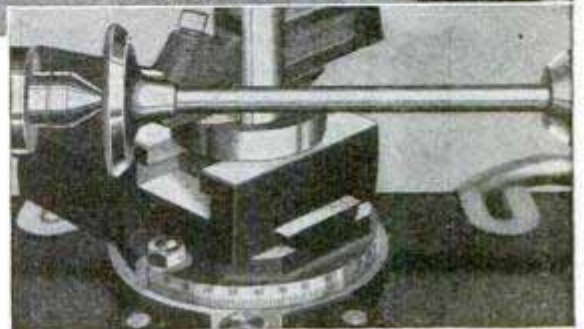

Rear view of compound rest of lathe set at 45 degree angle for refacing valves.

**\$160<sup>00</sup>**  
**New Model**  
**9 INCH JUNIOR**  
**Back Geared -**  
**Screw Cutting**  
**Bench Lathe**  
 With Plain Rest, Countershaft and Equipment

## For Auto Repair Work

There is one outstanding tool for the auto repair shop of today—used and recommended by thousands of the larger shops and recommended by all automobile manufacturers. It is the back geared screw cutting lathe. It is the one master tool that does the same work with a greater degree of accuracy and speed of scores of other tools combined—and in addition, there are hundreds of jobs that it alone can do.

## and Thousands of Machine Jobs

But auto repair work is only one small part of the work done by the 9 in. Junior South Bend Lathe. It is the ideal tool for metal work, regardless of it being auto repair work or any other kind of repair work. The Junior lathe has all the features of the larger lathes, cuts screw threads 4 to 40 per inch and is built in 2½, 3, 3½, 4 and 4½ ft. bed lengths, either bench or floor legs. Weight, complete, 375 lbs.

**FREE** BOOKLET 22-K. Just off the press! 24 interesting pages of practical lathe information. 150 photographs completely illustrates the lathe at work and describes all types and drives. A booklet of real interest and value to any mechanic.

**South Bend Lathe Works**  
 624 E. Madison St. South Bend, Indiana  
 New York City Salesroom—183 Centre St.  
 Phone. Canal 9085.

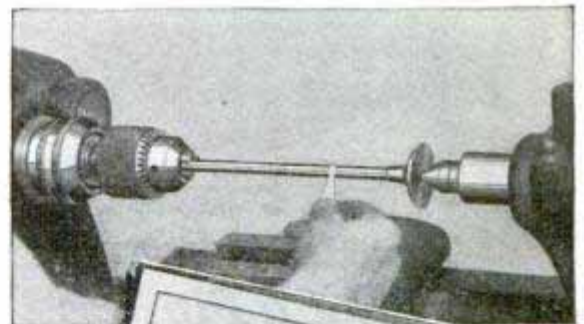

Testing a bent valve stem in the lathe.



Time  
 Payment  
 Plan  
 if desired

**SOUTH BEND LATHE WORKS, South Bend, Ind.**  
 624 East Madison Street  
 Gentlemen: Send me immediately a copy of your new booklet, 22-K. This booklet is FREE, post paid to any inquirer.  
 Name .....  
 Address .....  
 Town .....  
 State .....

**USE THE COUPON**



# New - Better Furnace!

Here is the latest and greatest advance in heating. It circulates fresh, warm air through your home, just as hot water is circulated through a radiator. There is an individual air supply for each principal room, so that no room is either over or under heated. The circulating grills are so located that there are no disagreeable drafts along the floor. Positively no other heating method affords such economy, comfort and safety as does Air-Line.

## 4 Tons Heats 8 Rooms

"The Air-Line is the best heating system there is! It heats my 8-room house perfectly and saves fuel, too, as I burned only 4 tons of coal."—F. Faber, 37 Center St., Little Ferry, N. J.



## AIR-LINE Heating System Not a Pipeless

The Air-Line firepot burns almost any kind of fuel—hard or soft coal—coke—or wood and all with the greatest possible economy; because it is lined with Power Plant Fire Brick and has oxidizers that get the entire heat value out of any fuel. Keeps even a wood fire over night!

**Comes Completely Erected!** Send us no plans! Just write us and we will send you the Air-Line for FREE INSPECTION. You will promptly receive the completely welded heater, together with necessary piping, and within a few hours you will have the Air-Line System completely installed, a roaring fire going, and your house as warm as toast.

## No Money Down!

You do not pay us a cent until after you have received the heater and are absolutely satisfied that you want it. Then you make only small monthly payments at a remarkably low price. To find out ALL about this marvelous heating system just SEND US THE COUPON BY RETURN MAIL.

### Air-line Furnace Co.

2845 W. 19th Street, Dept. 93-56 Chicago

Without obligating me in any way please send me your free catalog and special offer on the Air-Line Heating System.

Have you a basement? Yes  No

Name .....

Address .....

## They can't say NO to the "Wright" man

### Laugh at Competition!

You make SALES while other salesmen are making CALLS. When you sell WRIGHT made to measure suits and overcoats, you show \$35.00 woolsens, workmanship, fit and style AT ONLY \$23.75! Our one and only low price gets 'em all! You make big money when you deliver such fine tailored to measure suits and overcoats for our sensational low price. For one man tells another.

### \$4.00 to \$5.25 for you each sale!

Cash commissions paid daily in advance. Only 2 sales a day means \$250.00 a month easy! And we have men who are doing twice that. Here's a line good enough to justify your full-time. If you have any selling experience get the WRIGHT line and we'll prove record-breaking earnings to you.



Tailored to Measure  
**ALL WOOL**  
Over a hundred smart new all-wool fabrics in the Fall and Winter line. And 30 different fashion models. You can offer your customers A N Y fabric, in A N Y style and any size—no extra charge whatsoever—real union-tailored to individual measure clothes at a saving of \$11.25 per garment! If you can sell anything you can make a killing with the "Wright line."

We supply big outfit including 139 swatches and everything needed to make money—FREE. To qualify state in first letter territory wanted, age, experience in full and references.

**WRIGHT & CO., Quality Tailors since 1884**  
Dept. 405 2300 Wabansia Ave., Chicago



## Will you wear these Shoes and Show them to your Friends?

Men! Women! Here's your chance to get your own shoes without cost, and to make the easiest money of your life. Take orders for genuine Tailor-Made Shoes from your friends and neighbors. Shoes Tailor-made to fit six actual foot measures. Choice of 70 different leathers—made in 70 styles in men's, women's and children's shoes. Unlimited market. Amazing value because sold direct from makers. Every pair guaranteed to fit perfectly and give comfort and satisfaction.

### GET FREE OUTFIT

No capital—no investment necessary. Big commissions for you in advance. I do the collecting and delivering. Send for FREE outfit immediately and get genuine Tailor-Made Sample shoes to wear without one penny of c. st. TAILOR-MADE SHOE SYSTEM, Dept. C.K.9, 932 Wrightwood Ave., Chicago, Ill. Act at once. Mail Name and Address—Today

**MAKE MORE MONEY This Easy Way!**

Experience unnecessary. Just show samples and take orders. **Make \$100.00 weekly.** Beautiful "Style Tailored" shirts and neckties direct to wearer under store prices. We deliver and collect. No investment. Everything furnished. Write Quick.

**HOWARD SHIRT CO., Dept. 40**  
1213 Van Buren Street Chicago

\$146.75 + \$103.00 - \$7.00 x 3 + \$78.40 = \$800.65

**AMAZING NEW ADDING PENCIL**

TOTAL SHOWS HERE

Guaranteed Absolutely Accurate. Fountain pen size. Ends all mistakes. Send for yours Today.

AGENTS Great money maker. Everybody interested. Reserve territory immediately.

**HOUK ADDING PENCIL CO., Dept. 38 St. Louis, Mo.**

154 60 - \$64 00 - \$678 75 - \$102 00 - \$60 75 - \$820 00



**Lucky!**

*if  
you own  
a new Indian Motorcycle*

Indian owners are masters — of the open road, for Indian power and stamina bow to none — masters of secluded beauty spots, for an Indian will carry you *anywhere* — masters of long hours of delightful health building recreation, for an Indian makes the beach, the ball game, the camping ground, golf, or your best girl right around the corner, for its lucky owner.

Now Ready

For 1928 **Five New Models**

Over

**Forty Important Improvements**

**PICK** the one that's built for you from the world's most complete cycle line. It is transforming motorcycle history.



For demonstration call on the nearest Indian dealer. Generous pay-as-you-ride plan. Write for catalog.



Indian Motorcycle Co.  
Dept. P-200, Springfield, Mass.  
Send me your new Catalog.

Name .....

Address .....

City.....State.....

**Indian Motorcycle Co.**  
SPRINGFIELD, MASS.



# Many Well-Known Men Have Helped To Prepare These ELECTRICAL COURSES

Endorsed  
by  
THOMAS A.  
EDISON

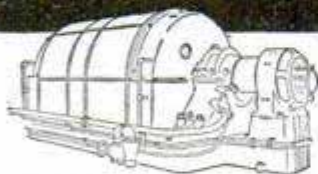

Endorsed  
by  
CHARLES P.  
STEINMETZ

NEARLY \$200,000 has been spent in the preparation of the Electrical Courses of the International Correspondence Schools.

They have helped thousands of men to get good positions in this fascinating profession for two reasons. (1) They are specially designed to meet the needs of the student who studies at home. (2) They are written by *practical men*.

Here are just a few of the men who have contributed to these courses:

EDGAR KNOWLTON — Electrical Engineer, Alternating Current Engineering Department, General Electric Co.

J. LESTER WOODBRIDGE, E.D. and M.E.—Chief Engineer of the Electric Storage Battery Co.

O. J. BUSHNELL—Superintendent of the Meter Department, Commonwealth Edison Co.

S. A. FLETCHER—Electrical Engineer, Superintendent of Service, Alabama Power Co.

H. B. GEAR, A.B., M.E.—Engineer of Distribution, Assistant to Vice-president, Commonwealth Edison Co., Chicago.

C. E. KNOX—Consulting Engineer on the Woolworth Building, New York. Author of "Electric Light Wiring."

G. E. PARHAM, M.E.—Electrical Engineer, General Foreman, the Brooklyn-Manhattan Transit Corporation.

S. H. MORTENSON—Designer of Alternating Current Motors and Generators, Allis-Chalmers Manufacturing Co.

When you read over a list like that, you know why these I. C. S. Electrical Courses have been endorsed by Edison and Steinmetz . . . you can see why we say they will help you.

Just mark and mail the coupon printed below and we'll gladly send you a Free Booklet telling all about these I. C. S. Electrical Courses or any other course in which you are interested.

**INTERNATIONAL CORRESPONDENCE SCHOOLS**  
Box 5671-E, Scranton, Penna.

Without cost or obligation, please send me one of your booklets and tell me how I can qualify for the position or in the subject before which I have marked X:

- |  |  |
|--|--|
| <input type="checkbox"/> Electrical Engineer                         | <input type="checkbox"/> Electric Draftsman        |
| <input type="checkbox"/> Electrician                                 | <input type="checkbox"/> Electric Car Running      |
| <input type="checkbox"/> Electric Wiring                             | <input type="checkbox"/> Electric Machine Designer |
| <input type="checkbox"/> Electric Lighting                           | <input type="checkbox"/> Radio                     |
| <input type="checkbox"/> Telegraph Expert                            | <input type="checkbox"/> Salesmanship              |
| <input type="checkbox"/> Practical Telephony                         | <input type="checkbox"/> Show Card and Sign        |
| <input type="checkbox"/> Mechanical Engineer                         | <input type="checkbox"/> Painting                  |
| <input type="checkbox"/> Mechanical Draftsman                        | <input type="checkbox"/> Railroad Positions        |
| <input type="checkbox"/> Toolmaker                                   | <input type="checkbox"/> Illustrator               |
| <input type="checkbox"/> Machine Shop Practice                       | <input type="checkbox"/> Business Management       |
| <input type="checkbox"/> Gas Engineer                                | <input type="checkbox"/> Private Secretary         |
| <input type="checkbox"/> Diesel Engineer                             | <input type="checkbox"/> Business Correspondent    |
| <input type="checkbox"/> Civil Engineer                              | <input type="checkbox"/> Bookkeeper                |
| <input type="checkbox"/> Surveying and Mapping                       | <input type="checkbox"/> Stenographer and Typist   |
| <input type="checkbox"/> Reading Architects' Blueprints              | <input type="checkbox"/> Accountancy               |
| <input type="checkbox"/> Metallurgy                                  | <input type="checkbox"/> Traffic Management        |
| <input type="checkbox"/> Architect                                   | <input type="checkbox"/> Commercial Law            |
| <input type="checkbox"/> Architectural Draftsman                     | <input type="checkbox"/> English                   |
| <input type="checkbox"/> Plumbing and Heating                        | <input type="checkbox"/> Common School Subjects    |
| <input type="checkbox"/> Sheet Metal Worker                          | <input type="checkbox"/> Civil Service             |
| <input type="checkbox"/> Automobiles                                 | <input type="checkbox"/> Railway Mail Clerk        |
| <input type="checkbox"/> Chemistry <input type="checkbox"/> Pharmacy | <input type="checkbox"/> Stationary Engineer       |
|  | <input type="checkbox"/> Mathematics               |

Name.....

Address.....

Persons residing in Canada should send this coupon to the International Correspondence Schools Canadian, Limited, Montreal, Canada.

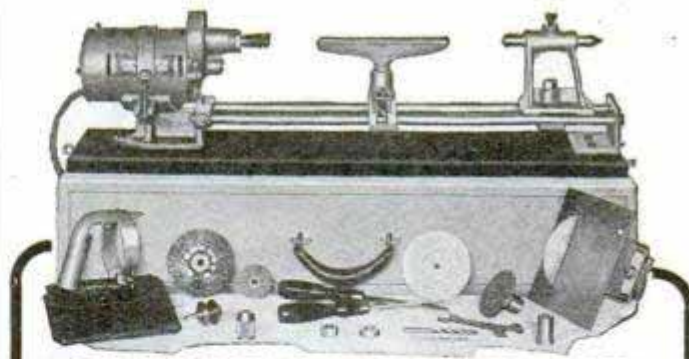

## MAKE MONEY—HAVE FUN! with *SpeedWay Shop!*

COMPACT and efficient! That's what users say about this new electric workshop powered by world famous SpeedWay motor. Super SpeedWay Shop is equipped with—

### 8 Motor Driven Tools

Super SpeedWay Shop gives you privately owned machine shop right in your home. This sturdy combination of tools gives you a complete Lathe—a Bench Saw—a Jig Saw—a Portable Electric Hand Saw—a Portable or Stationary Power Drill, especially equipped for buffing, grinding and cleaning. Works from any lamp socket.

### Only \$10.00 Down

We make it easy for you to own a Super SpeedWay Shop. You can buy on a small down payment. The balance in easy monthly payments puts one of these sturdy, efficient Super SpeedWay Shops in your home.

### 10 Days' Free Trial

Take advantage of our 10 days' free trial offer! Test the Super SpeedWay Shop in your own home! If it fails to do what we claim for it, send it back. We will cheerfully refund your money.

### Free Blue Prints

We furnish 26 working blue prints free with each SpeedWay Shop. Enables you to make attractive furniture, novelties, toys, radio work, bric-a-brac, etc.

### Write Today For Full Information

Every tool in the "Shop" is high grade, for regular work. A money maker for the small job man. Write today. Just sign your name on the margin.

**Electro-Magnetic Tool Company**  
Dept. 2-S, 1830 S. 52nd Ave., Cicero, Ill.  
Adjoining Chicago

**Locked from inside without pad-lock**

**Protect Yourself**

from burglars and sneak-thiefs. KEELOCK makes every mortise lock PICK-PROOF. It slides through keyhole. Safeguards homes, rooming houses, hotel rooms, offices, lockers, closets, etc., where valuables are stored. JIMMY PROOF. Sample 25c. Special proposition for agents and wholesalers from distributors. Sells at night.

**KEELOCK MFG. CO.**  
Dept. P. M., 415 West 50th Street  
NEW YORK, N. Y.

**Note Lock-Prongs gripping door-plate**

**FREE**

1000 illustrations

**ELECTRIC FIXTURE CATALOG!**

Write today for your copy. Save 50% direct from Manufacturer. No Middleman's Profit. OUR SPECIAL: 8 Room Electric Set, ready to hang, \$24.50—Other bargains.

**UNITED LIGHTING FIXTURE CO.**  
83 Flatbush Ave., Dept. M, Brooklyn, N. Y.

**SM**

**Do You Know the Secret of Quality Reproduction?**

"The Secret of Quality" tells you simply and concisely how to get the most out of your amplifier—how to get quality. This 96 page booklet is yours for the asking—it's free. Write for your copy.

**SILVER-MARSHALL, INC., 840 W. Jackson Blvd., Chicago, U.S.A.**

## CUT WINTER FUEL THE EASY WAY



RUNS EASY NO BACKACHES  
WEIGHT ONLY 45 LBS  
EASILY CARRIED  
SAWS DOWN TREES

The farmer's best helper for 40 years. Thousands save money and backaches every year. **YOU CAN TOO.** Send for free catalog showing low prices. Address Dept. 115.  
**FOLDING SAWING MACHINE CO., 2633 S. State St., CHICAGO, ILL.**



# 30 Days Trial

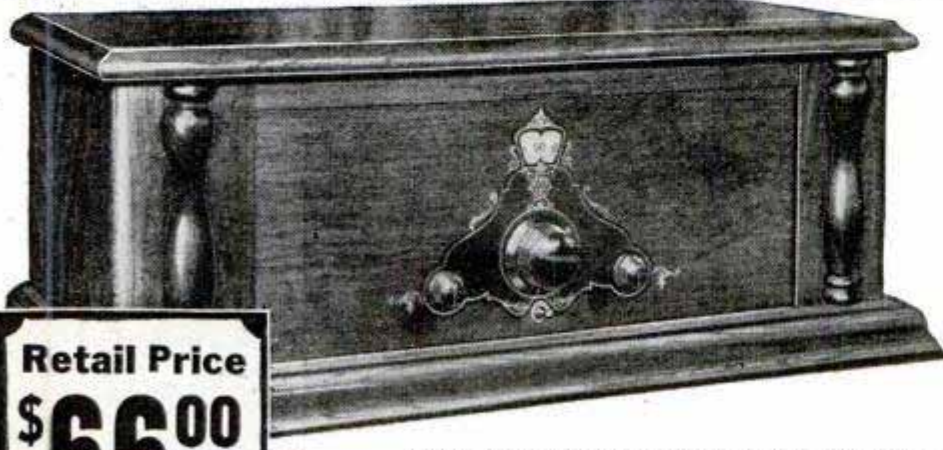

**New 1928 Models**  
**6 Tubes**  
**Shielded Set**  
**ONE DIAL**  
*Westgale*  
**RADIO**

Retail Price  
**\$66<sup>00</sup>**  
**6 Tubes**  
**ONE DIAL**

NOW—the new 1928 Westgale Radio Models are ready for you to try. And we stand ready to put any one of our ten new models in your home and let you use it to your heart's content on 30 DAYS' TRIAL. Entertain your family and friends. Listen to programs from all over the country—see the latest style period type cabinets—note the selectivity, distance and volume—hear the rich, deep, mellow tone—then if you are not convinced that Westgale gives you more for your money than you can get elsewhere—YOU DON'T HAVE TO KEEP IT.

Don't buy any Radio until you send the coupon for our catalog which pictures and describes these new 1928 models in 5-tube, 6-tube, and 7-tube sizes offered in a beautiful array of table models, consoles and DeLuxe Baby Grand styles. Why take chances when you can take your choice of these last minute models and put them in your home on 30 Days Trial?

*The Last Word in Guaranteed Radio Sets and the Biggest Values Ever Offered*

**The Utmost in Distance, in Volume and in Lifelike Tone**

Thousands of Westgale sets have been sold. For years we have maintained a reputation of being first with the latest in Radio. These new 1928 models are no exception. Every late feature—every new, worthwhile idea is embodied in their make-up—the last word in every way, and priced at just about half the usual cost. Send for our catalog and find out all about their many superior features at once. Don't wait—a



**SPECIAL Introductory DISCOUNT**

**Our De Luxe Baby Grand**

for those who write quick. Mail the coupon today. Get posted before you buy.

**Why Not Be Our Agent—Buy at Cost**

We want Agents and Dealers in every locality to demonstrate and take orders for these amazing new 1928 Westgale Models. This is your chance to get a Westgale Radio at a big discount and make it pay you big money. Millions of radios will be sold this season. Get a Westgale set on 30 Days' Trial—demonstrate to your neighbors and friends and get your share of these big radio profits.

**Your Radio FREE**

Our new Catalog also explains a plan whereby you can put a Westgale Radio in your home on 30 Days' Trial—demonstrate it to your neighbors in spare time and get your own set without cost before the trial period is up.

**Special Discount to Agents**

To quickly introduce these wonderful new 1928 models we are offering for a limited time a big reduction, way below retail prices on the FIRST Westgale set placed in each community. So get busy now. Be first in your locality to mail the coupon for our FREE catalog and get full particulars of this special discount offer.

**Westgale Electric Company**  
 (Formerly Westingale Electric Co.)

Dept. 19, 1751-57 Belmont Ave., CHICAGO, ILL.

**Mail Today - Don't Delay**

**WESTGALE ELECTRIC CO.,**  
 Dept. 19—1751 Belmont Ave.,  
 Chicago, Illinois

Please send me your FREE Catalog on the new 1928 Westgale Radio sets. Also full particulars of your Special Discount offer on the first outfit placed in each community.

Name.....

Address.....





When the  
Greatest  
Show in  
History thrills  
the World

“...You’re there with a Crosley”



\$35



\$85

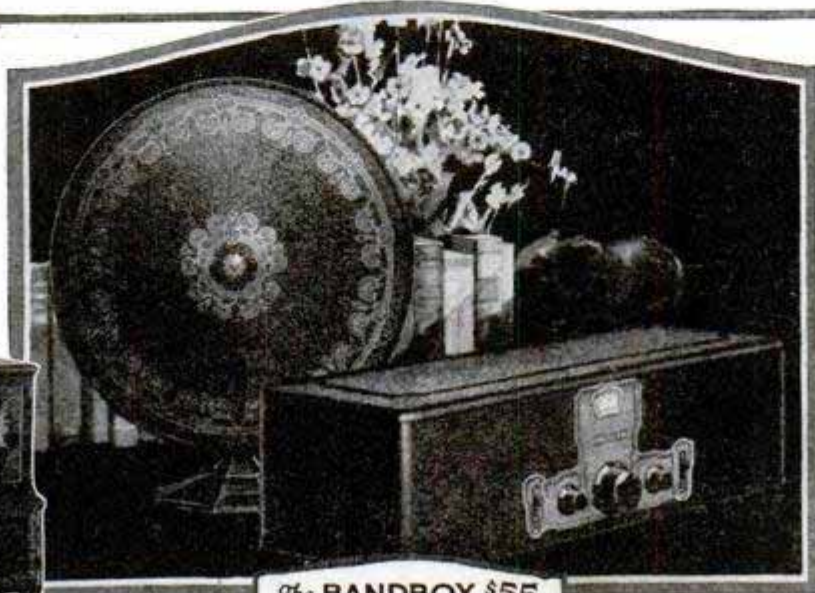

The **BANDBOX** \$55  
A 6 tube Receiver  
Brown frosted Crystalline Finish—  
Bronze Escutcheons.

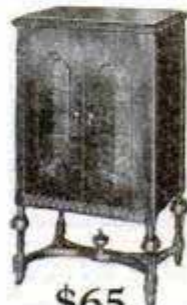

\$65

These approved cabinets have been selected by Powell Crosley, Jr., as ideal consoles, acoustically and mechanically, for the installation of the Crosley "BAND-BOX." Genuine Musicones built in. Crosley dealers secure them from their jobbers through

H. T. ROBERTS CO.,  
914 S. Michigan Ave., Chicago, Ill.

Sales Agents for  
Approved Console Factories:  
**SHOWERS BROTHERS  
COMPANY**  
**THE WOLF MFG.  
INDUSTRIES**

## A tremendous Crosley radio achievement 1927-28

RECENT court decisions which clarified the radio patent situation have paved the way for still greater Crosley triumphs. Now—completely available to Crosley—and amplifying Crosley supremacy in fullest measure, are the enormous resources, great discoveries and ideas embodied in patents of

- 1—The Crosley Radio Corporation.
- 2—The Radio Corp. of America.
- 3—The Westinghouse Co.
- 4—The General Electric Co.
- 5—The American Telephone & Telegraph Co.
- 6—The Hazeltine Corporation.
- 7—The Latour Corporation.

under which Crosley is now licensed to manufacture.

Here are the seven big things which represent radio's greatest advancement, brought together by Crosley and combined with the experience, mass production method and leadership of the Crosley organization. No wonder a waiting radio world pronounces the "Bandbox" at the unprecedented price of \$55, Crosley's paramount achievement.

### The Bandbox is Shielded

Radio coils are surrounded by magnetic fields similar in every respect to the magnetic field around the earth that moves the needle of a compass but around radio coils these fields make nuisances of themselves by feeding back on each other. Heretofore it has been customary to make inefficient coils with inefficient fields to prevent such feeding back. The Crosley Bandbox incorporates copper shields around each coil to prevent such feeding back. The coils consequently can be made and are very

much more efficient. The amplification of the receiver is, therefore, much higher—the sensitivity is greatly increased. Condensers are also completely shielded from each other in separate metal compartments. Hitherto, only high priced sets have enjoyed this super radio advantage.

### There Is No Oscillation

The Bandbox employs completely balanced or neutralized radio frequency stages to prevent oscillation, instead of the common form of lossier method. More costly, to be sure, but extremely necessary in achieving such results as are obtained by this marvel of radio reception.

### For Sharpness—The Acuminators

"Bandbox" acuminators enable "fishers" for distant stations to bring them in loud and clear. As powerful telescopes magnify distant scenes, acuminators increase

the volume of far-away signals so they seem like local programs.

### Volume Control

This is another big "Bandbox" feature which permits full brass band power for those who want their dance notes strong and loud. For others, it cuts volume down to a soft and gentle murmur, without distortion.

### Illuminated Dial

A Master Station Selector has an illuminated dial for easy reading in shadowy corners. A single knob permits full tuning for ordinary reception of local, nearby and super-powered stations.

### Installation Simplified

A woven cable, containing vari-colored rubber covered leads makes installation and hook-up easy for the veriest novice. No waiting for the radio service man, should the batteries be changed.

### Easily Adapted to Consoles

Simply remove screws in escutcheon and in base of set. Lift off metal case. Chassis now stands ready for installation in console cabinet. Opening in console cabinet permits control shafts to protrude. Escutcheon screws in place and—Presto! the console radio is complete.



**IMPROVED  
MUSICONES**

Although Musicones improve the reception of any radio set, they are perfect affiliates in finish, beauty and reproductive effectiveness for Crosley Radios. A new model built in the form of a Colonial Tilt-Table with brown mahogany finish, stands 3 feet high. Price \$27.50.

16-Inch Super Musicone (As pictured with Bandbox) \$12.75  
12-Inch Ultra Musicone \$9.75

For AC Operation a special Bandbox is available at \$65, wired especially for use with the Crosley Power Converter at \$60. This special Bandbox utilizes the new R. C. A. AC tubes which have made the operation of radio receivers direct from house current so simple, efficient and dependable. The first three tubes employed in the AC model are UX226. These go into the radio frequency sockets. The detector tube is UY 227, with indirectly heated emitter. Another UX226 is used in the first audio stage. Raw A C current heats the filament of all UX 226 tubes. Power tube UX 171 is in the last audio socket. This makes the "dog houses" rumble sonorously and the bass drums deeply boom.

### The Power Converter

The power converter which smooths the alternating current is a marvel of engineering ingenuity. Only half the size of an ordinary "A" storage battery, it supplies the required A, B, and C currents, without hum. Finished in brown frosted crystalline. There are models for 25 and 60 cycle current. A snap switch shuts down the set and power converter completely.

### Price of Power Converter—\$60

You owe it to yourself to see the "Bandbox" and listen to its remarkable performance. If you cannot easily locate the nearest Crosley dealer, his name and address will be supplied on request. Write Dept. 15.

# CROSLEY RADIO

Crosley Radio is licensed only for Radio Amateur, Experimental and Broadcast Reception

Crosley recommends the use of five power tube, or Cunningham equivalent prices, with each Bandbox. While gives a superior performance for 135-



201-A Radiotrons and one UX171 lens which are furnished at standard Radiotron UX-171 is 180-volt tube, it volt "B" batteries.

**THE CROSLEY RADIO CORPORATION**  
Powell Crosley, Jr., Pres. **CINCINNATI, O.**  
Prices slightly higher west of the Rocky Mountains



# 650,000 Satisfied Customers

W.S. DEWING  
President



## Have Saved 1/3 to 1/2 by buying Direct from Kalamazoo

Gas Stoves  
\$25.80 up



Send for this *New* FREE Book

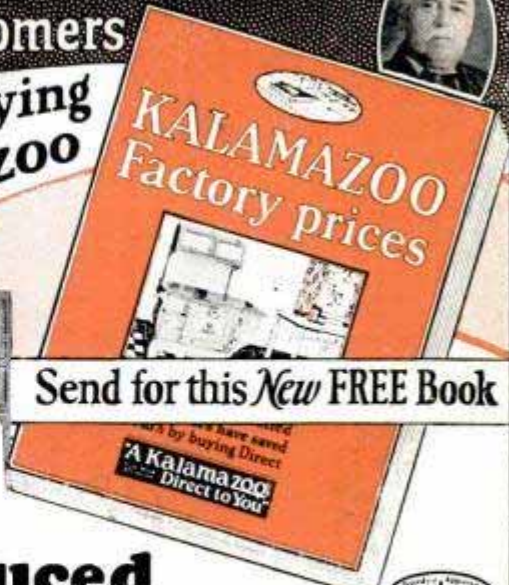

Heating Stoves  
\$24.95 up



### Reduced Factory Prices

#### Five Year Guarantee of Quality

650,000 customers—one out of every 35 families in the United States. They are not only Kalamazoo customers—they are *satisfied Kalamazoo customers*. That's the important thing—*satisfied customers*. And think of this: they are increasing at the tremendous rate of more than 50,000 *new* customers a year. Could anything more clearly or concisely prove Kalamazoo quality! Could anything more convincingly or conclusively prove that Kalamazoo is saving customers 1/3 to 1/2 by selling direct from factory to user.

### Get Your Copy of this New FREE Book

#### 30 Days FREE Trial

Send for this new book *now*. Learn how Kalamazoo gives you 30 days FREE trial in your own home and 360 days approval test on anything you purchase. Read how Kalamazoo is saving over \$1,000,000 yearly for Kalamazoo customers.

#### 24-Hour Service—Safe Delivery Guaranteed

Send for this book! See how close Kalamazoo is to you—24 hours shipping service saves you time. Kalamazoo goods are carefully packed to arrive safely. Safe delivery is absolutely guaranteed.

#### Cash or Easy Terms

This FREE book quotes you easy terms that are truly amazing—many as low as \$3 down and \$3 monthly. Nowhere in the world can you get such value, such service as Kalamazoo now offers. This new book shows you why this big 13-acre factory, now in its 26th year, is a national institution.

#### Free Furnace Plans

This new FREE book tells you how you make a double saving on Kalamazoo furnaces. First it saves you 1/3 to 1/2 on the price of the furnace itself. Secondly, it illustrates how you save the cost of installation by following Kalamazoo FREE plans and FREE service. Thousands of Kalamazoo owners have put up their furnaces themselves.

#### Beautiful Porcelain Enamel Ranges

Everywhere now porcelain enamel ranges are in demand. See these Kalamazoo ranges in delft blue and pearl gray—bright, colorful, glistening clean—as easy to clean as a china dish. *Check and Mail Coupon Today!*

**KALAMAZOO STOVE CO., Mfrs.**  
391 Rochester Av. Kalamazoo, Mich.

Combination Gas & Coal Ranges  
\$71.50 up



Your FREE book is ready—alive with interest, full of new features. Reduced prices are in effect! A new 5-year quality guarantee is in force! See the Beautiful Porcelain Enamel Ranges in beautiful delft blue and pearl gray—the very latest and most popular of all ranges. Look for the Mahogany Porcelain Enamel Heating stoves—the most popular of all heating stoves. Read about the new Hot Blast, improved fire box—more heat from less fuel, a clean fire without smoke or soot. See the latest improvements in warm air furnaces—pipe and pipeless.

#### 200 Styles and Sizes

No matter what you are interested in—gas stoves, coal and wood ranges, combination gas and coal ranges, oil stoves, heating stoves or furnaces (pipe or one-register type)—you will find here exactly what you want. Mail coupon today.

#### Quality First—Values Unexcelled

Kalamazoo values cannot be equalled anywhere. When you buy from Kalamazoo you buy direct from manufacturer. There is nothing between you and our factory—but the railroad tracks. We are not a mail order house that collects a variety of merchandise from scores of factories to sell by mail—we are *specialized* manufacturers, making Kalamazoo stoves, ranges and furnaces complete in our own highly modernized factory and shipping direct to you, thus eliminating any other manufacturer or middleman of any kind. We build in large quantities. You get better quality at lower prices from a factory whose sole interest is making stoves, ranges and furnaces than elsewhere. This new catalog proves it. Fill out coupon for your copy.

#### Saved \$80 to \$100

I put up the furnace in a very short time. I saved from \$80 to \$100 on what it would cost me here. Am more than satisfied.  
John Fischer, Warren, Pa.

Pipe or Pipeless Furnaces  
\$59.95 up

Quality Baker Stove works perfectly. Stoves costing \$175 could not begin to compare with it in fuel economy, baking quality and in heating performance.  
William Hook, Rochester, Minn.

**"A Kalamazoo Direct to You"**  
Trade Mark Registered

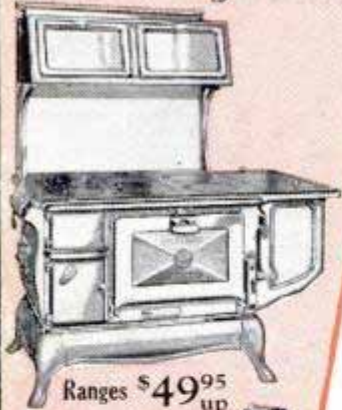

Ranges \$49.95 up



- Coal and Wood Ranges
- Gas Ranges
- Combination Ranges
- Furnaces
- Heating Stoves
- Parlor Furnace
- Oil Ranges

#### Mail this Coupon Today for FREE Book

*Important: Be sure to put an (X) in column at left to indicate articles in which you are interested.*

Kalamazoo Stove Co., Mfrs.  
391 Rochester Av., Kalamazoo, Mich.  
Dear Sirs: Please send me immediately without obligation, your FREE catalog of stoves, ranges and furnaces.

Name.....  
Address.....  
City.....State.....



H A V E A C A M E L

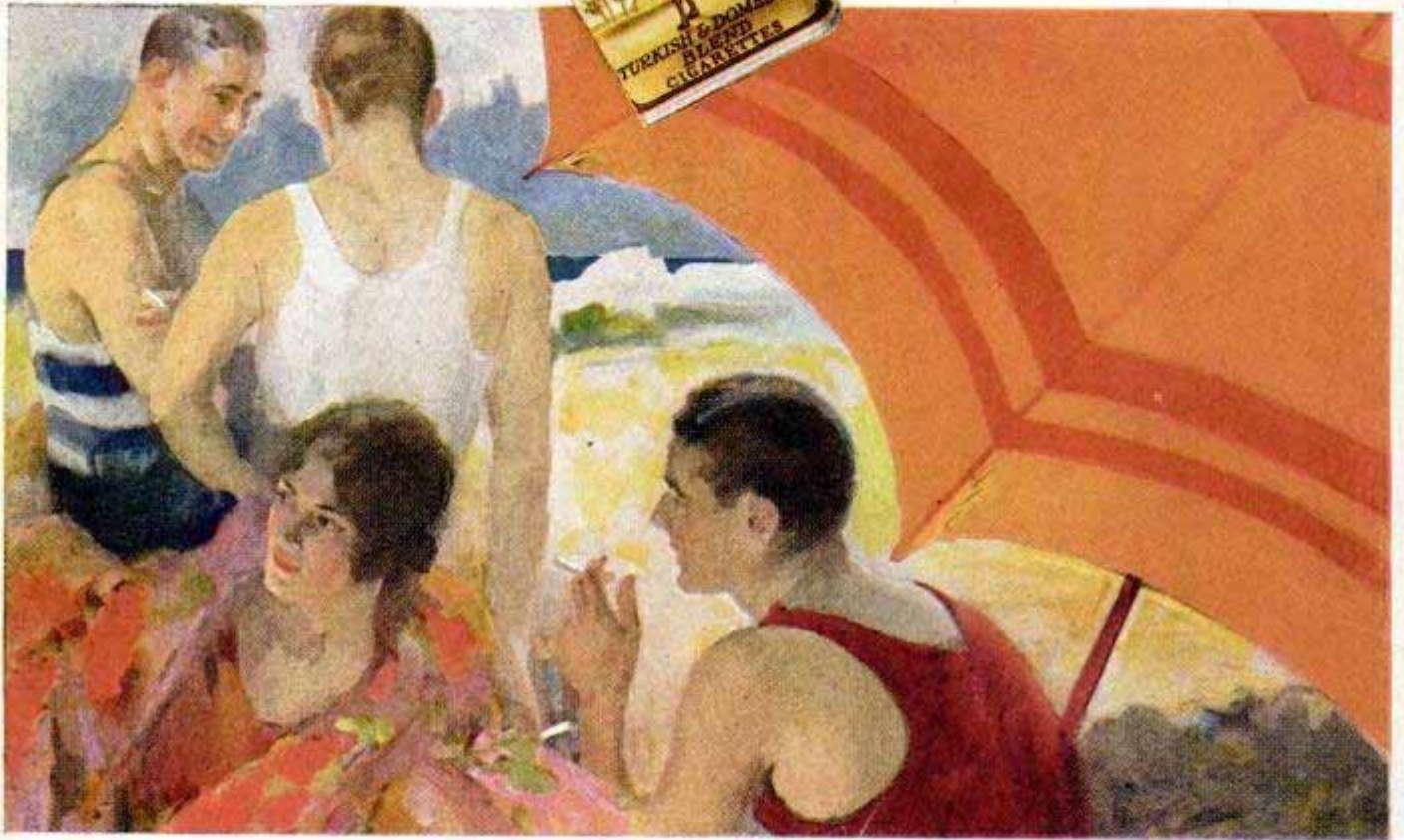

## *Camel is as good as the sea is wide*

BOUNDLESSLY deep is the quality of Camel. Its cool, smooth smoke is as tasty and fragrant, as restful and friendly as an ocean plunge. Modern smokers, educated by experience to the quality of tobaccos, have made Camel their favorite. In worktime and playtime, Camel is the most loyal smoking companion anyone ever had.

The choicest Turkish and Domestic tobaccos tell in the smoking. Expert

blending has its part in making Camel the finished masterpiece of cigarettes. In creating Camels no cost or care is too great to make them the fittest and finest, regardless of price.

If you don't yet know Camels, you are invited to complete taste satisfaction. Camel is the smoking friend that will never fail. It's first in this modern, particular age.

*"Have a Camel!"*

R. J. REYNOLDS TOBACCO COMPANY, WINSTON-SALEM, N. C.