

# POPULAR MECHANICS

## MAGAZINE

WRITTEN SO YOU CAN UNDERSTAND IT

REGD. TRADE MARK GREAT BRITAIN No. 410468



A KITCHEN  
KABINET BAND  
Page 235

# ATKINS SILVER STEEL SAWS



*Mr. Happy-Man Says—*

“ATKINS 401 Ship Point Saw  
Makes Easy Sawing  
and Saving!”

**A**N easy push—an easy pull—and it cuts fast, free and quick! Let YOUR ATKINS Saw do most of the work. Save you time, labor and money.

Only genuine ATKINS Saws are made of “Silver Steel” to outlast many “ordinary” saws. Only ATKINS Saws are two-way Taper Ground to cut faster and easier—with the famous Perfection handle. Look for the ATKINS name on the blade.

YOUR Hardware Dealer can show you a better ATKINS Saw for every use, in cutting wood or metal. Ask him, or write us, for interesting booklets showing savings on any kind of sawing.

**E. C. ATKINS & CO. Est. 1857 426 S. Ills. St., Indianapolis, Ind.**

Branch Houses: Atlanta, Ga.; Chicago, Ill.; Memphis, Tenn.; Minneapolis, Minn.;  
New Orleans, La.; New York City; Portland, Ore.; San Francisco, Cal.; Seattle, Wash.;  
Hamilton, Ont.; Vancouver, B. C.; Paris, France

*Leading Manufacturers of Highest Grade Saws for Every Use; Saw Tools,  
Saw Specialties, Plastering Trowels, Machine Knives, Grinding Wheels and Files*

# Conn Saxophone Superiority

is based upon *Exclusive Features*



This photograph of Dreschers Saxophone Boys, Houston, Tex., is typical of many saxophone bands, completely equipped with Conns. Membership in such a band gives both pleasure and profit.

**E**VER since Conn built the first saxophone ever produced in America—under the supervision of that great artist, E. A. Lefebre—Conn leadership in this important field has been maintained.

Exclusive features, improving quality and making easier playing, have caused a great host of the foremost saxophonists to use the Conn saxophone exclusively.

The accompanying view shows a section of the final assembly and padding department at the Conn factory—only about one-third of the entire department. Here skilled padders and adjusters work under the supervision of two experts, one of whom has been with Conn for 40 years and was the first padder and adjuster, and the other was with the Sousa band for a number of years. Both supervisors pass upon every saxophone before shipment.



*Start now to cultivate your musical "bump" with a Conn. Play solos, in orchestra or saxophone club like the one illustrated—win pleasure, popularity, increased income.*

**FREE TRIAL, EASY PAYMENTS**  
on any Conn instrument for band or orchestra. Send coupon for literature and details.

VIEW of a section of the Saxophone final assembly and padding department of C. G. Conn, Ltd.

**CONN**  
BAND  
INSTRUMENTS  
WORLD'S LARGEST MANUFACTURERS

C. G. CONN, Ltd.,  
831 Conn Bldg., Elkhart, Ind.  
Gentlemen: Please send literature and information about trial offer on  
(Instrument) \_\_\_\_\_  
Name \_\_\_\_\_  
St. or R. F. D. \_\_\_\_\_  
City, State \_\_\_\_\_  
County \_\_\_\_\_

**CULTIVATE YOUR MUSICAL 'BUMP'**

# Pore-Dirt hides from surface washing



*but this cream fetches  
it from a twice-washed face*

**I**T seems queer to say that a twice-washed face is still dirty. But you can easily prove that this is true.

The skin of your face, for instance, appears as a solid layer. It is really porous—like a sponge—filled with thousands of open pores. In these pores dirt lodges, gets worked in, gets ground down tight.

When you wash your face the surface dirt is removed. The pore-dirt, however, is left in the pores, hiding from the wash cloth, causing what cosmeticians term "grey skin." If pore-dirt is allowed to remain too long, blackheads result.

Washing *can't* dislodge pore-dirt. Pompeian Massage Cream *can*. This remarkable cream goes into pores and brings out hiding dirt. It opens up the pores; lets them function normally.

The result? Your skin is restored to a normal, athletic

flush. Your friends remark, "How well you look . . . Been on a vacation lately?"

**Goes in PINK, rolls out dingy GREY! Try it!!**

Prove to yourself that Pompeian Massage Cream begins to clean where ordinary cleansing leaves off. First wash your face and hands as clean as you can. Then scoop a little cream

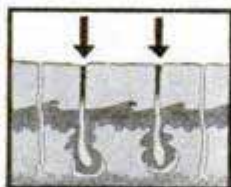

Highly magnified cross-section of the skin showing how pore-dirt becomes imbedded in the pores. Surface washing cannot remove it.

The pores after Pompeian Massage Cream has cleansed them. The cream first loosens pore-dirt and then rolls the dirt out on the face.

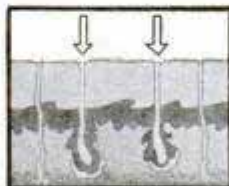

from the jar and massage it into your face. Keep on rubbing until the cream rolls out of your skin in tiny pellets.

Note this amazing thing—the cream that went into the skin a clean pink rolls out a dingy grey. The grimed-in dirt is now removed. Your pores can once more fully breathe. Your skin quickly responds to the invigorating massage. Your face looks, feels, and *is* clean!

**Free test convinces thousands**

We'd like you to test the benefits of Pompeian Massage Cream on your face—FREE. Fill in this coupon and mail it to us—right now while you are reading this magazine.

POMPEIAN LABORATORIE, Dept. 303 H  
595 Fifth Avenue, New York City

Gentlemen:

Please send me a generous trial tube of Pompeian Massage Cream . . . enough for three facial massages.

Name \_\_\_\_\_

Address \_\_\_\_\_

City \_\_\_\_\_ State \_\_\_\_\_

**POMPEIAN  
MASSAGE  
CREAM**

# Popular Mechanics Magazine

200 E. Ontario Street, Chicago, U. S. A.

H. H. WINDSOR, Founder

H. H. WINDSOR, Jr., Editor and Publisher

London: Hachette & Cie.,  
16-17 King William Street, Charing Cross, W. C. 2

Paris: Hachette & Cie.,  
111 Rue Reaumur

Melbourne: Gordon & Gotch  
509-513 Little Collins St.

ISSUED MONTHLY

SUBSCRIPTION:

SINGLE COPY, 25 CENTS

In United States and its possessions, also Canada, Cuba, and Mexico, per year, postpaid - \$2.50

To all other countries in the Postal Union - 3.00

All subscriptions are discontinued at expiration. Please examine the date printed on your wrapper.

Entered as Second Class Matter Sept. 15, 1903, at the Post Office at Chicago, Illinois, under Act of March 3rd, 1879.

Entered as Second Class Matter at the Post Office Department, Canada.

Published monthly by POPULAR MECHANICS CO.

Copyright, 1927, by Popular Mechanics Co.

Copyright in Australia. Copyright in France

Vol. 48

Contents for August, 1927

No. 2

Advertising		
huge chair boosts town's industry	253	
switch outside show window saves electricity	264	
Agriculture—see better seeds and crops by use of cleaner and grader	234	
Airplanes—propeller blades of canvas resist corrosion	232	
Airship—strength of girder tested by squeezing	210	
Anchor—for guy ropes screws into ground	253	
Archæology		
mystery temple found in Yucatan jungle	255	
secrets of the mounds	243	
Architecture—insurance union building high as Washington monument	262	
Army—cavalry kitchen mounted on a horse	193	
Athletics—energy tests on athletes	224	
Automobiles—Accessories—battery winds clock on steering post	233	
Automobiles—Design		
air blowers increase "lung" power	278	
comfort of car seat measured	181	
Automobiles—Driving		
drivers' steering skill tested with perforated tape	209	
stop sign tells cost of violating law	242	
Automobiles—Equipment and Supplies		
awning and shade runs on spring roller	272	
car-step plate carries luggage	248	
water and oil pump	288	
Automobiles—Lighting—headlight set in bumper	280	
Automobiles—Tires—ride with punctured tire on extension ring	277	
Automobiles—Wheels		
shimmying stopped by friction plates	216	
spring to end tire troubles	208	
Aviation		
air train of plane and glider in successful test	218	
electric airplane signals replace canvas strips	239	
hundred-foot tunnel helps in studying airplane	271	
landing field electrically cleared of fog	272	
parachute is carried in tube to insure opening	202	
Paris flight shows need for speed indicator	183	
record flights with gliders	257	
Balloon Record—Eight miles—straight up!	177	
Banjo—holder rests player and improves tone	242	
Barber—mirror set for chair aids better hair cuts	232	
Basket Ball—roller skate, latest army game	182	
Beauty Treatment—electric manicure set saves time	193	
Bed—folds up as knapsack for hiker's comfort	254	
Birds—when canaries go to school	256	
Botany—light tests show plants' need of sleep	281	
Building Construction		
clamp for concrete columns cuts cost	295	
endless steel-joint bridging substitute for wood	283	
fabric resembling stone makes wall covering	202	
Burglars		
"breath current" gives alarm to foil	253	
poison crystals in safe wall to defeat	247	
Canal, Suez—split light ends glare danger in	225	
Circus—with candy butchers	275	
Cleaning		
seam cleaner for trousers prolongs their life	279	
window squeegee and spray saves time and work	273	
Clock—alarm plays music	181	
Clocks—man makes profession of winding	222	
Cornstalks—yield silk and explosives	232	
Deafness		
hearing through the teeth	257	
relieved by work of leagues for hard of hearing	201	
Diagnosis—electric doctor tests heart to diagnose disease	285	
Disease—quicker diagnosis with new staining method	242	
Dishes—unwashed may break	296	
Diving—swimming pool swings give thrills in	241	
Dogs		
beauty parlor for	187	
heroes of world war honored in cemetery	224	
thrills in racing	267	
Electric Lights		
as bug traps guard rice fields	253	
safety lamp prevents shock and danger of fire	256	
turn night into day to finish steel job	216	
Electricity—exposition shows development in Japan	296	
Education		
machine talks, prints and serves as teacher	282	
pupils are taught to spell by block machine	285	
Eggs—quality judged by measuring air space	274	
Fish and Fishing		
terrapin growing on farms profitable	273	
winding leveler prevents backlash in casting	254	
Flood—Can the Mississippi be tamed?	188	
Floor Finisher—fits corners	296	
Flowers—new tulip wins gold medal at flower show	207	
Fossils—bones found in Kansas river bed	209	
Fruit Jar—cap straightener reduces spoilage	200	
Fur Store—roadside solves high rent problems	241	
Geodetic Survey—light keepers of the mountain peaks	249	
Geology—submarine circles globe to study earth's crust	265	
Glaciers—affected by weather hundred years ago	279	
Gold—mine yields eight cents to ton of sand	201	
Goldfish—kerosene treatment for their ills	193	
Golf—match and tee holder easy to carry	241	
Gun—mounted on flashlight gives double protection	225	
Hats		
kept in shape by brace under sweat band	261	
waterproof straw keep shape	192	
Heating—steam sold by meter in New York buildings	295	
Horseradish—fumeless grater	217	
Horses		
tester for eyesight to curb disease	201	
wear rubber armor during bull fights	288	
House Plan	352	
Household Devices	286	
Ice Cream—delivery truck has refrigerating plant	207	
Kangaroo—beats race horse in speed test	238	
Lawn Mower—vacuum motor saves time and work	247	
Leather—artificial made from scraps	215	
Librarians—face mask shields from dust	201	
Life Belt—inflated with gas	191	
Light Waves—much unseen to the eyes in ray of sunlight	288	
Linen—"super-flax seed" developed to make cheaper	247	
Linoleum—on curved molding protects baseboard	289	
Lumber—knot remover for boards also plugs holes	230	
Magic—Houdini's books in Library of Congress	240	
Mail Boxes—merry-go-round simplify deliveries	277	
Mail Delivery—cable lines as substitute for airplanes	209	
Malaya—adventures in topsy-turvy land	194	
Mammoths—hunt in America for fossil collection	200	
Manicure Set—in small tube	191	
Map Making—binocular on drawing board aids surveyor	186	
Marble—the romance of cutting	226	
Meat Packing—scraping hogs by electricity	289	
Medical Treatment—electric vapor inhaler aids treatment of colds	283	
Memorials—earth mound in Polish city honors Kosciusko	200	

[Continued on Page 4]

*Benoculars on ... 196 193*

[Contents—Continued]

Preserved 240

Milk—treated with steam to prevent souring . . . . . 254  
 Mining—prospecting from air . . . . . 182  
 Models—cork model of Pantheon shows artist's skill . . . 247  
 Motorboat  
     defeats plane in rescue of crew . . . . . 233  
     tiny steel speeds twenty-two miles an hour . . . . . 234  
 Motor Bus—danger in "gassing" reduced by grounding 218  
 Motorcycle—has inclosed passenger compartment . . . . . 202  
 Moving Pictures  
     compressed air outfit for administering make-up . . . 209  
     doing the impossible in the movies . . . . . 290  
     movie makers defy weather on indoor stages . . . . . 216  
     ship inclosed in cloth screen for taking fog pictures 231  
     "wrestling" camera registers fighting face . . . . . 277  
 Music—kitchen kabinet band . . . . . 235  
 Navy—hospital ship gives service to U. S. fleet . . . . . 254  
 Oil—extracted from coal in improved retort . . . . . 265  
 Orange Grove—century-old flourishes in Florida . . . . . 233  
 Owls—to kill rats in South Australia . . . . . 274  
 Paints and Painting  
     how China's war affects U. S. paint market . . . . . 202  
     paint gun to reduce waste works in any position . . . . . 238  
     paint still ground by stones . . . . . 283  
 Phonograph—Edison's greatest invention is half century old . . . . . 203  
 Photography—filming of county records saves time and work . . . . . 223  
 Photography—Aerial—cannon sized camera has 200-mile range . . . . . 265  
 Physical Culture  
     handhold merry-go-round aids chest development . . . 238  
     wrists and arms developed with spring gripper . . . . . 217  
 Picture—of scenic wonders framed by window . . . . . 256  
 Pipe Line—large defies coast storm without support . . . . . 257  
 Plow—tractor needs no driver . . . . . 231  
 Power—revolving funnel to generate . . . . . 187  
 Radio  
     facts and fads for radio fans . . . . . 309  
     to improve appearance of set . . . . . 307  
 Radio—Aerials  
     adjustable aerial from old Ford part . . . . . 307  
     umbrella . . . . . 308  
 Radio—Applications—radio eyes help to find new mineral fields . . . . . 240  
 Radio—Batteries  
     bottle makes battery filler . . . . . 310  
     charging . . . . . 299  
     handy markers for leads . . . . . 301  
     solderless cable terminals . . . . . 301  
     three-barreled hydrometer easy to read . . . . . 308  
 Radio—Cabinets—repairing defects in . . . . . 306  
 Radio—Condensers—twin rotor condensers in gang form 310  
 Radio—Construction  
     reamer is a useful tool . . . . . 299  
     small clamp used as a vise . . . . . 301  
 Radio—Installation  
     adjustable ground clamp fits any pipe . . . . . 307  
     filament-control units simplify wiring . . . . . 301  
 Radio—Loud Speakers  
     built from cigar boxes . . . . . 297  
     cabinet speaker has eighty-six inch tone chamber . . . . . 299  
     push-button plug corrects polarity . . . . . 301  
 Radio—Receivers  
     aluminum shields for standard sets . . . . . 307  
     safety first in installation . . . . . 302  
 Radio—Reception—time chart for daily programs . . . . . 306  
 Radio—Tubes  
     adapting short-prong tubes to X-sockets . . . . . 308  
     multiple simplify receivers . . . . . 300  
 Railroad  
     gas-electric train has small crew . . . . . 225  
     train for Mexican president has many luxuries . . . . . 211  
     two-man serves Kansas farmers . . . . . 288  
 Ranching—where the west is still wild . . . . . 212  
 Razor—magnet keeps blades keen . . . . . 265  
 Respiration—loss of weight in breath . . . . . 277  
 Road Building—asphalt-pouring pot helps in patching . . . . . 283  
 Saddle—making revived as art in far west . . . . . 263  
 Salvage—old railroad rails make ties . . . . . 295  
 Sculpture—saints carved in concrete for church steeple 279  
 Ship  
     control for propellers prevents racing . . . . . 264  
     glory of sailing days still seen in fish fleet . . . . . 274  
     guarded from Chinese bullets by rope armor . . . . . 248  
 Ships and Shipping—tank ship with double hull keeps cargo hot . . . . . 199  
 Silver—seek tarnish-proof . . . . . 224  
 Sleds—run by motor-driven propellers . . . . . 273  
 Snow Fence—portable canvas substitute for boards . . . . . 256  
 Soldering—replaced by connector for electric wire . . . . . 271  
 Sound Waves—harness music to relieve illness . . . . . 210  
 Spark Plugs—rock found in bed leads to better . . . . . 210

Sports—winter, played all year in palace . . . . . 192  
 Street Cars—retired Topeka used as stores and cottages 289  
 Street Cleaning—armored car reduces dust . . . . . 182  
 Suitcase—holder in, keeps garments pressed . . . . . 295  
 Tattooing—experts find new demands for their art . . . . . 246  
 Taxicab—tricycle cab cuts cost . . . . . 262  
 Telephone—cable like spiral cord . . . . . 186  
 Testing—how science guards the things you use daily . . . . . 284  
 Toys—child's horse and buggy run by pulling bridle . . . . . 272  
 Transportation—east meets west in traffic in India . . . . . 264  
 Tree—old stump as giant umbrella shelters garden seat 217  
 Tree Trimmer—insulated against electric shocks . . . . . 223  
 Ultraviolet Rays—pass through permeable clothing . . . . . 257  
 Violin Bow—has ball bearings for easier tightening . . . . . 217  
 Weather—the mystery of unbearable cold . . . . . 219  
 Whale—cuts Alaskan cable . . . . . 193  
 Wheels—tests show what size should be . . . . . 280

*Wall covering resembles stone* 202  
 AMATEUR MECHANICS

Birds—"filling station" for . . . . . 325  
 Boats—dolly aids in landing . . . . . 317  
 Book Ends—Japanese effect . . . . . 327  
 Camping—tricks of . . . . . 311  
 Clocks—repairing worn escapement wheel . . . . . 323  
 Clothesline—non-sagging for beating rugs . . . . . 318  
 Diving Board—improved . . . . . 323  
 Electric Light—telltale light on basement circuit . . . . . 327  
 Electric Light—Fixtures—assembling and hanging . . . . . 318  
 Ferrule—how to make tapered . . . . . 322  
 Firewood—carrier for . . . . . 316  
 Flypaper—handling sticky . . . . . 325  
 Garage—novel door installation . . . . . 324  
 Gates  
     automatically closing farm . . . . . 325  
     better garden . . . . . 319  
 Gauge—Depth—spring clip for . . . . . 318  
 Glue—casein . . . . . 316  
 Humidity—homemade indicator . . . . . 325  
 Ice—to carry on running board . . . . . 331  
 Ladder—combined with wheelbarrow . . . . . 331  
 Meters—handy place for gas and electric . . . . . 323  
 Milk Can—floating frame to hold . . . . . 332  
 Milk House—screened shelf for . . . . . 329  
 Motors—outboard are not baggage . . . . . 317  
 Paints and Painting  
     striping in white on furniture . . . . . 329  
     to paint shingles quickly . . . . . 332  
 Silhouettes—how to make typewritten . . . . . 328  
 Stains—removing vegetable . . . . . 329  
 Stump Puller—effective one-man . . . . . 326  
 Telegraph—electric light . . . . . 316  
 Toys—cycling clown amuses the youngsters . . . . . 330  
 Wagon Wheel—how to lift . . . . . 327  
 Wall—protection for behind gas stove . . . . . 329  
 Woodworking—wedge fastener for portable equipment. 324

SHOP NOTES

Automobiles—Repairing  
     clamp for holding brake or clutch pedal . . . . . 335  
     replacing Ford crank spring . . . . . 336  
 Barbed Wire—tongs for handling spools . . . . . 336  
 Blackboard—self-erasing . . . . . 351  
 Blowtorch—non-slip base for . . . . . 348  
 Brass Letters—inlaying in steel . . . . . 334  
 Building Construction  
     better sifters for the builder . . . . . 350  
     building paper kept on sawhorse . . . . . 347  
     hints for the builder . . . . . 337  
     safety hints for the builder . . . . . 349  
 Cable—held to wall by staggered screws . . . . . 348  
 Caterpillars—killing tent . . . . . 338  
 Concrete—mixtures for various uses . . . . . 347  
 Cornstalk—homemade cutter . . . . . 335  
 File—point handle for, aids in filing . . . . . 338  
 Flagstone Walk—make your own . . . . . 333  
 Forge  
     improving the small shop . . . . . 348  
     portable carries rivets . . . . . 340  
 Garage—concrete bumpers for . . . . . 338  
 Gasoline Engines—moving stationary . . . . . 351  
 Gauge—handy method of setting surface . . . . . 336  
 Grain—binding short grain evenly . . . . . 340  
 Hay—hoist for saves work . . . . . 339  
 Needle—holder for shop . . . . . 334  
 Oil Engine—cooling system for . . . . . 339  
 Paints and Painting—producing marble effects with paint . . . . . 340  
 Plaque—attractive ship easy to make . . . . . 341  
 Stone Boat—handy improvised . . . . . 351  
 Wagons—dumping boxes aid loading of . . . . . 351

Radio - Construction  
disposing of the hot sold  
Wood -- antique finish for new secur  
with solution

Handwritten text on a strip of paper, likely a page from a book or manuscript. The text is written in a cursive script and is mostly illegible due to fading and the angle of the strip. Some faint words are visible, including "THE" and "OF".



# DRAKE'S PRACTICAL MECHANICAL BOOKS

## THEY WILL RAISE YOUR PAY—

### ORDER ON 5-DAY TRIAL

The books listed below will perfect you in your chosen trade—pave the way to the big positions. Written in non-technical language—easy to read and understand. Every book covers its subject completely. An entire course of instruction condensed into one volume. Your choice sent postpaid—you benefit 5 days—money refunded in full if not entirely satisfactory. Order direct from this page.

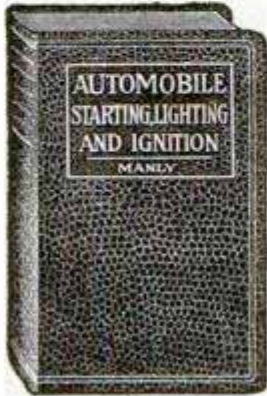

#### Automobile Books

- Automobile Starting, Lighting and Ignition, by Manly... 700 pp. \$3.00  
 Brookes' Automobile Handbook... \$2.00  
 Ford Motor Car, Truck and Tractor, by Manly... Cloth \$1.50  
 Automobile Battery, Care and Repair, by Manly... Leatherette \$2.00  
 Motorcycle Handbook, by Manly... \$1.50



#### Shop Practice Books

- Practical Heating Systems, Trouble Jobs and Ventilation... \$4.00  
 Sheet Metal Workers' Manual... \$2.00  
 Oxy-Acetylene Welding and Cutting... Cloth \$1.25  
 Slide Rule and Logarithmic Tables... \$2.00  
 Handbook for Millwrights... Cloth \$2.00  
 Machine Shop Practice... Cloth \$2.00  
 Mechanical Drawing and Machine Design... Cloth \$2.00

#### ORDER DIRECT FROM THIS PAGE—ON OUR MONEY-BACK PLAN

The books listed above are only a few of the many in our catalogue, which you will receive promptly after filling out and mailing us the attached coupon. For quick action order direct from this page—cross name of each book wanted and send in with price quoted. We prepay postage and send the books on our money-back plan.

### FREDERICK J. DRAKE & CO.

Publishers

1008 Michigan Ave. CHICAGO  
 Drake Books Are For Sale at All Book Stores

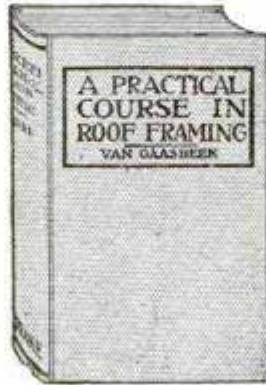

#### Carpentry Books

Cloth Binding

- Modern Carpentry, 2 vols... \$3.00  
 The Steel Square, 2 vols... \$3.00  
 Modern Estimator... \$1.50  
 Timber Framing... \$2.00  
 Builders' Architectural Drawing... \$2.00  
 Concretes... \$1.50  
 Practical Bungalows... \$1.00  
 Roof Framing, by Van Gaasbeek... \$1.50

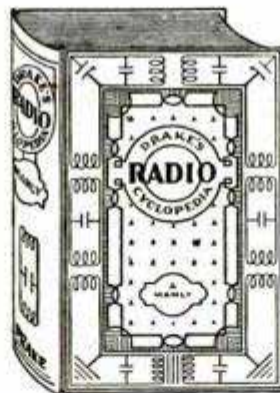

#### Drake's Radio Cyclopeda

By H. P. Manly

870 Pages, 985 Illustrations, 1700 Subjects, arranged alphabetically. For Service and Repair Men, Dealers, Salesmen, Experimenters and Designers. Bound in Art Buckram. Price... \$6.00



#### Painting and Decorating

- Furniture, Furniture Finishing, Decoration and Patching... \$5.00  
 Ross Crane Book of Home Furnishing and Decoration... Cloth \$3.00  
 House Painting Methods with the Brush and Spray Gun, by Vanderwalker... Cloth \$2.00  
 Interior Wall Decoration, by Vanderwalker... Leatherette \$4.00  
 The Mixing of Colors and Paints, by Vanderwalker... Cloth \$2.00  
 Studio Handbook—Letter and Design... \$3.00  
 A Show at Sho' Cards... Cloth \$4.00  
 Sign Painting, by Atkinson... Cloth \$4.00  
 Strong's Book of Designs, Leatherette \$4.00  
 Modern Painters' Cyclopeda, Cloth \$2.00  
 Automobile Painting... Cloth \$1.50  
 New Hardwood Finishing... Cloth \$1.50  
 Wood Finishing, Plain and Decorative... Cloth \$2.00  
 Owen's Paint Guide... Cloth \$1.00

#### Steam Engineering

- Swingle's Handbook for Steam Engineers and Electricians... Leatherette \$4.00  
 Examination Questions and Answers for Marine and Stationary Engineers... Leatherette \$2.00  
 Steam Boilers... Leatherette \$2.00  
 Swingle's Catechism of Steam, Gas and Electrical Engineering... Leatherette \$1.50

#### Modern Languages

- By Prof. P. S. Allen, U. of Chicago  
 French without a Teacher... Cloth \$1.25  
 Spanish without a Teacher... Cloth \$1.25  
 German without a Teacher... Cloth \$1.25  
 Everyday French... \$1.25  
 Everyday Spanish... \$1.25

Mail Coupon For Free Catalogue  
 Your Guide to Home Study

FREDERICK J. DRAKE & CO.  
 1008 Michigan Avenue  
 Chicago, Ill.

GENTLEMEN:—Please send me free, postage paid, your illustrated catalogue which lists and describes 200 Practical Mechanical Books for Home Study.

My name is .....

and my address .....



6C10-IAV-EXCB

1928 1929 1930 1931 1932 1933 1934 1935 1936 1937



# Will You Be Clerk or Manager Ten Years from Now?

**S**URELY, this could never happen to *me*," you say—"that I should be sitting at the same desk—be doing the same work, *for ten straight years!*"

But wait a minute—

Exactly the same thing is happening to thousands upon thousands of men thruout the country. It has probably happened to men right in the company you now are working for. *And—unless you deliberately fit yourself for a better job—there is a very good chance that it will happen to you!*

Unthinkable? That's what R. M. Whitney, of Rochester, N. Y., said to himself. Yet lack of training kept him slaving away at low wages for more than twenty years . . .

## Trebled His Salary in Three Years

—For more than twenty years, till finally, at the age of 47, and still receiving only thirty dollars a week, R. M. Whitney resolved to be a bookkeeper no longer. He enrolled with LaSalle for training in Higher Accountancy, and completed the course. Almost immediately came the offer of a bigger job.

Less than three years later, the Davenport Machine Tool Company—the very company he had worked for as a clerk—invited him to come back. He returned as Auditor, at a salary-increase of better than 300 per cent.

Today, he is Treasurer of this great company; and in a letter to LaSalle, after commenting on the opportunities LaSalle affords to men in their forties or early fifties, he adds, "And for the young man, who is just getting a foothold in the business world, LaSalle Extension University training is the most profitable investment he could make."

## Says Good-bye to Clerkship— Now Heads Successful Firm

We have told you about a man who *waited*—at a cost to himself of probably not less than \$100,000. Now consider the experience of a younger man—G. Roy Eshelman, of Decatur, Illinois—

Eshelman was occupying a subordinate position in the purchasing department of a manufacturing concern—salary \$16 a week. Visualizing the opportunities for skilled accountants, he enrolled with LaSalle for training in Higher Accountancy.

"Thru this training," writes Mr. Eshelman, "I became interested in the Auditing Department and often remained after working hours watching the Auditor at his work. Observing my interest, he soon placed me in his department at a 50% increase in pay, and as I progressed with my LaSalle work, I was shortly rewarded with an additional 40% increase.

"My studies rapidly equipped me to strike out for myself, and at present I have an extensive practice as a Public Accountant, employing four accountants. It is sufficient to say that my present income is many, many times greater than when I enrolled."

## Send For These Two Books and Start Toward Real Success

Need you hear more before you investigate the opportunities in Accountancy? Shall we tell you about Pentland—or Gray—or McDuffie—all of them commanding incomes better than \$10,000 a year and all of them still in their thirties?

Or will you face the problem of your future NOW—and send to LaSalle and get further facts and particulars?

Without cost or obligation, the coupon will bring you two books—one a 64-page book entitled, "Accountancy, the Profession that Pays;" the other, "Ten Years' Promotion in One."

How about those next ten years—will you wait, or will you START TODAY to realize the opportunities that lie ahead of you thru sound and practical home-study business training?

Measure your grit and ambition by what you do with this coupon—NOW.

— — — Find Yourself Thru LaSalle — — —

## LaSalle Extension University

The World's Largest Business Training Institution

Dept. 864-HR

Chicago

Opportunities in Accountancy—Check below and we will send you copy of "Accountancy, the Profession that Pays," also copy of "Ten Years' Promotion in One," all without obligation.

### Higher Accountancy:

Leading to position as Auditor, Comptroller, Certified Public Accountant, Cost Accountant, etc.

Other LaSalle Opportunities: If more interested in one of the other fields of business indicated below, check here:

- |  |   |
|--|---|
| <input type="checkbox"/> Business Management         | <input type="checkbox"/> Banking and Finance  |
| <input type="checkbox"/> Modern Salesmanship         | <input type="checkbox"/> Modern Foremanship   |
| <input type="checkbox"/> Traffic Management          | <input type="checkbox"/> Personnel Management |
| <input type="checkbox"/> Railway Station Management. | <input type="checkbox"/> Expert Bookkeeping   |
| <input type="checkbox"/> Law: Degree of LL.B.        | <input type="checkbox"/> C. P. A. Coaching    |
| <input type="checkbox"/> Commercial Law              | <input type="checkbox"/> Business English     |
| <input type="checkbox"/> Industrial Management       | <input type="checkbox"/> Commercial Spanish   |
| <input type="checkbox"/> Business Correspondence     | <input type="checkbox"/> Effective Speaking   |
|  | <input type="checkbox"/> Stenotypy            |



Name .....

Present Position .....

Address .....

AUDELS BUILDERS TRADE GUIDES—COMPLETE SET NOW OFFERED ON EASY TERMS

# AUDELS BUILDERS LIBRARY

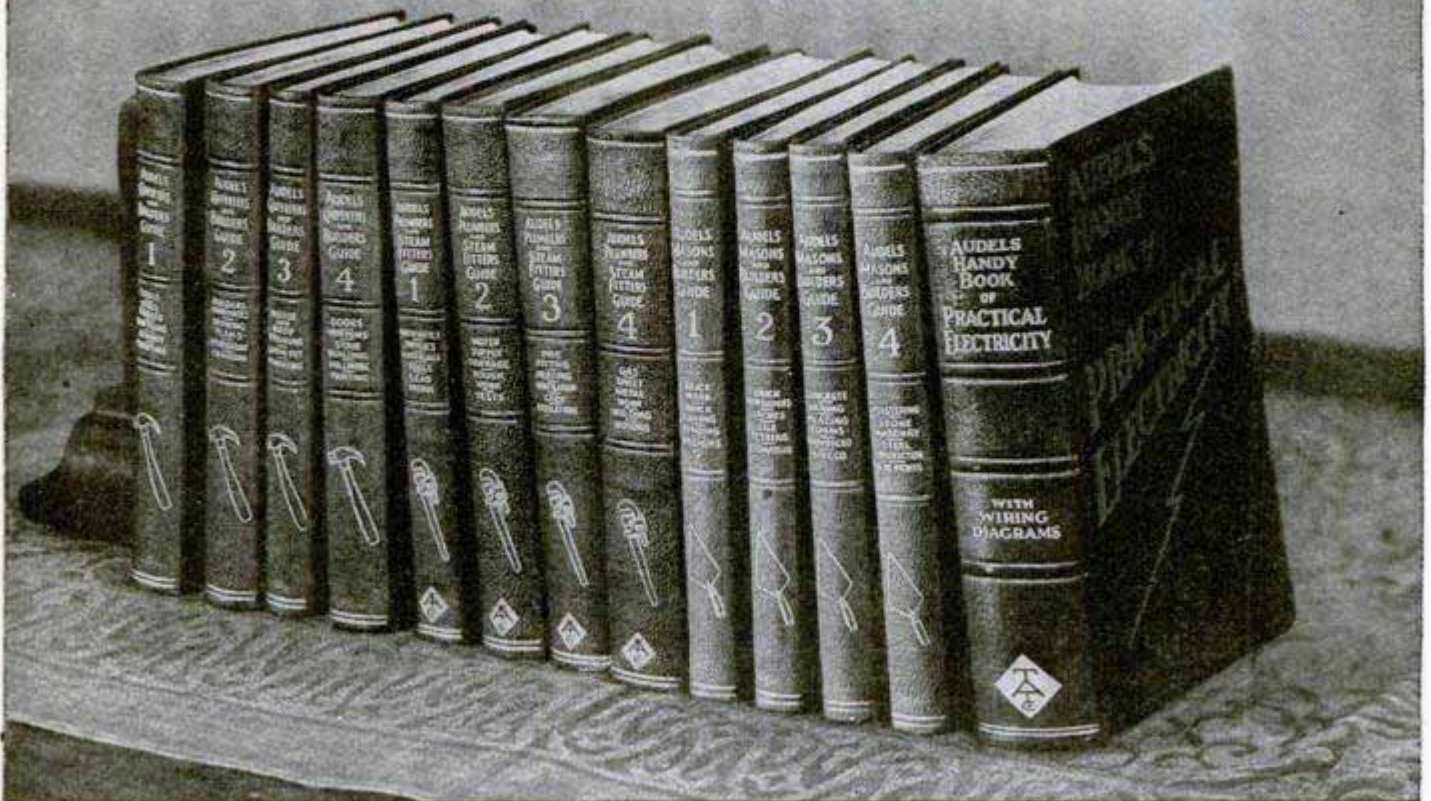

## Practical Helping Hand Guides for All Builders

READY REFERENCE AND INSIDE INFORMATION IN HANDY FORM FOR

**Contractors  
Architects**

**Builders  
Draftsmen**

**Engineers  
Designers**

**Estimators**

**All Building Trade Workers**

Quick advancement comes to the steady, daily reader of these books. Increased knowledge gives him an increasing vision of the scope of his work, increasing responsibilities and increasing rewards in profits or pay. If the worker or student will read 15 minutes a day—right through the course—he will, in a year have stored in his mind the wealth of knowledge, that has taken hundreds of years of hard experience to acquire and develop.

These practical, concise, pocket-size educators are an accepted reference work of the trade. Thousands of practical workers use them as a daily guide—contractors depend on the facts, tables, figures and estimating advice—architects and draftsmen use them in planning and laying out work.

Audels clear and comprehensive answers to building problems will save you time and money. The job that worries you has probably all been worked out before. Why worry about it? Turn to the indexes—there you will be directed to the wealth of information that solves your problem. Best of all, Audels Guides give you an answer that you can understand and follow—the diagram, the table, the rule, the picture—with the brief text.

**Thousands of building problems are solved in this set. Some of the more important subjects covered are:—**

**MODERN CARPENTRY.** Steel Square, Furniture, Mathematics, Plans, Specifications, Laying Out, Framing, Foundations, Millwork, Painting. **MASONRY.** Brick Work, Foundations, Bonds, Arches, Tile, Concrete Work, Stucco, Plastering, Stone Work, Steel Construction, Blue Prints, Estimating. **PLUMBING.** Steamfitting, Physics, Water Supply, Drainage, Heating, Ventilation, Sheet Metal Work, Refrigeration, Tests, Estimating, Code, Regulations. **ELECTRICITY.** Wiring, Batteries, DC & AC Work, Generators, Transmission, Transportation, Radio.

Under each of these main chapter headings are hundreds of sub-headings. Now the best way to find out what a gold mine of valuable help is contained in these pocket-guides, is to examine the actual books. This you can do by mailing coupon and \$1. If not satisfied after careful examination, return the books and we will refund the dollar.

**\$1** Down with ORDER **\$2** Monthly UNTIL PAID **\$22** Complete and DELIVERED

In this well known trade library there are 13 pocket-size, flexibly bound, gold edge, guides—5,410 Pages, 12,009 Illustrations. Highly endorsed by the trade, by schools and thousands of subscribers. This great opportunity—to own these standard helpers on easy terms—is one you can't afford to miss. Send coupon now! Then decide for yourself.

**Theo. Audel & Co., 65 W. 23rd St., New York, N. Y.**

I enclose \$1. Ship me Audels Builders Library, 13 pocket vols., postpaid. After 7 days examination, I will send you \$2, then \$2 a month until \$22 is paid, or, I will return the books and you are to refund my \$1.

Name .....

Address .....

Occupation .....

Employed by ..... ST30



# Bear ELECTRICAL AND MECHANICAL AUTO EXPERT

Now! Send only \$2.00 AND YOU START FOR QUICK SUCCESS!

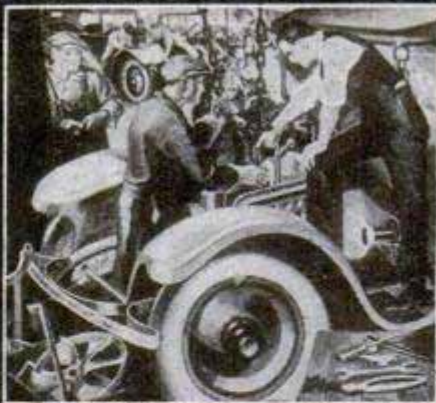

## Earn up to \$100 a week

Now only \$2 starts you for success in the World's Biggest Business—the Auto Business! Think of it!—only \$2 starts you for a Big Pay Job, paying up to \$100 a week—for Extra money in your spare time—or a money-making Auto Business of your own paying up to \$6000 a year or more. If you're earning a cent less than \$60 a week, take advantage of this remarkable offer! It's your big chance!

## I TRAIN YOU AT HOME!

### CLIP COUPON NOW!

Before enrolling for this "Job-Way" Auto Training, J. T. Summers never made over \$25 a week—now it's \$50 to \$75 a week! George Deal's salary was boosted from \$10 a week up to \$100 a week as Foreman. Y. S. Yancy made \$30 a week—now it's \$90 a week! These are the kinds of opportunities that the Auto Business offers YOU when you are a trained Auto Man! Get out of the low pay class. Get into the business where Six thousand million Dollars are paid to Auto Men every year! Act Now!

### FILL IN AND MAIL THIS

B. W. Cooke, Directing Engineer, Chicago Motor Training Corporation, Dept. C16, 1916 Sunnyside Ave., Chicago, Ill.

I enclose \$2.00 as first payment. Enter my name as your student

on and after this date.....

.....19..... for your complete Electrical and Mechanical Automobile course, including training on Trucks, Tractors and Aeroplanes. It is understood that I am to receive each and every feature and service listed in this announcement and that my signing this coupon makes my agreement legal and binding to refund all my money upon graduation if I am not satisfied in every way. It is also understood that under no circumstances am I to pay more than the low price of \$112.50 which I agree to pay as follows: only \$2 with this enrollment and only \$5 a month thereafter. My first lessons are to be sent to me immediately upon receipt of this enrollment.

Name..... Address..... Town..... State..... Age.....

### 4 TESTING AND REPAIR OUTFITS

Act quick and you get all of this equipment free of extra charge! Tools include S. A. E. Wrenches, Adjustable Wrench, Pliers, Hammer, Screw Driver, Cold Chisel, Punch, File and Tool Bag. Also Portable Electrical Test Bench Equipment, Also Electrical Experimental Outfit, Also 360 Wiring Diagram Charts. Send Coupon Now!



### Money-Back Agreement Your Full Protection!

Send your enrollment direct from this announcement today! You cannot take the slightest risk! The coupon in itself is an agreement that you must be absolutely satisfied in every way or my training does not cost you a penny! You must be absolutely satisfied with every one of the 14 "Job-Way" Features shown in the panel to the right—you must be satisfied that every claim I make is true—you must be satisfied with the service I give, with the success you have, with the earnings you make—OR MY TRAINING IS FREE TO YOU! This is the broadest Agreement I could possibly make! You alone are the judge! You cannot risk a cent! So if you want Big Pay, and want it QUICK—send that coupon NOW!

### Earn While You Learn!

a week in their spare time, while training. These same opportunities are open to you! And when you have completed your training, my Employment Department will help you get a good JOB! With hundreds making almost as much in spare time only as their regular jobs pay, why can't you?

Scores of men earn up to \$30

### Common Schooling All You Need!

Men between 16 and 50 with little education, easily finish my training. Gust Alevras, a foreigner, with little education was boosted from \$18 a week to \$50 a week in only 6 months! If he can do it, it should be easy for you! My Lifetime Consultation Service helps you with all Auto Problems. My agreement protects you. Now it's up to you. ACT!

## B. W. COOKE DIRECTING ENGINEER

### CHICAGO MOTOR TRAINING CORPORATION

1916 Sunnyside Ave., Dept. C16, Chicago

### Stayhome—

keep your job. I bring the Automotive world to you! Not a thing is left out! You get complete Training in Electricity—Starting, Lighting, Ignition, Batteries, etc.—all Mechanical work—also Welding, Brazing, Vulcanizing—also Trucks, Tractors, Steam Cars, Motorcycles, Farm Light Plants, Stationary Engines, also Business Training, also Inventive Science and other Special Lessons—Everything you need to put you in line for a Big Job as an ELECTRICAL and MECHANICAL AUTO EXPERT IS MADE EASY FOR YOU!

### 14 "JOB-WAY" Features You Get!

**Complete Training**  
The exclusive "Job-Way." You learn with Lessons, Job Tickets, Tools and actual Money-making Jobs!

**Personal Training**  
Individual help and instruction.

**Practical Training**  
15,731 letters from my students, all telling of actual Auto Experience while learning proves how practical this training is.

**Simplified Training**  
All the snags and stumbling blockstaken out for you. You glide along over my Course quickly and easily. You learn without realizing that you are learning.

**4 Testing & Repair Outfits**  
Master mechanics Tools, Tool Bag, portable Electrical Test Bench, Special Electrical Experimental Outfit and 360 Wiring Diagram Charts all yours FREE of extra cost.

**Extra Lessons**  
I give you Business Training, also Aeroplanes, Farm Lighting, Inventive Science, Trucks, Tractors, Motorcycles, Electric Autos, Steam Cars, Stationary Engines and Radio.

**No Extra Expense**  
One small sum, payable a little at a time brings you everything.

**No Time Limit**  
No classes. You can take all the time you want, or go as fast as you like.

**Job Service**  
My Employment Department helps you find a good Auto Job.

**Consultation Service**  
To help you with any or all of your Auto Problems.

**Auto News**  
Free subscription to my monthly magazine that gives you all the latest auto dope.

**Home Training**  
You needn't give up your job or go to a big expense to become a trained Auto man. I train you at home.

**Earn While Learning**  
Hundreds make big extra money in spare time while learning. My training shows you how.

**MoneyBack Agreement**  
Absolute legal agreement that if you are not entirely satisfied with "Job-Way" Training in every way, your money refunded. (Send Coupon Now)



## Salary Increased 300% in few months

*Chief draftsman of big company received big increase even before he had completed his course with the I.C.S.*

"AT THE time I started my I. C. S. course I was working in a paper mill," writes A. J. Hutchins, Chief Draftsman of the American Strawboard Co.

"Before I had completed the course I was called upon to make drawings in one of the company's largest mills and was appointed Superintendent of Construction at a 300% increase in salary."

Every mail brings letters from students of the International Correspondence Schools telling of increases in salary due to spare-time study.

Jesse G. Vincent was a toolmaker before he enrolled with the I. C. S. He is now Vice-president of the Packard Motor Car Company. Walter Chrysler, President of the Chrysler Motor Corporation, is also a former I. C. S. student. So is "Eddie" Rickenbacker, the famous flying ace, who is now President of the Rickenbacker Motor Company.

An I. C. S. course enabled Fred W. Southworth to leave a poorly paying job that he had held for *twenty years* and get a position as a salesman. In six months he also had increased his salary more than 300 per cent.

George A. Griebel is another man who lifted himself out of the rut by spare-time study. He was a stone cutter earning \$15 a week when he enrolled with the I. C. S. He now has his own architectural and engineering business in Cleveland and his income is "between \$10,000 and \$15,000 a year."

If the I. C. S. can help these men to get out of the rut and make good, it can help you too. If it

can raise the salaries of other men, it can raise yours! At least find out how.

### Mail the Coupon for Free Booklet

INTERNATIONAL CORRESPONDENCE SCHOOLS  
Box 5661-E, Scranton, Penna.

Without cost or obligation, please send me a copy of your booklet, "Who Wins and Why," and full particulars about the course before which I have marked X in the list below:

#### BUSINESS TRAINING COURSES

- |  |   |
|--|---|
| <input type="checkbox"/> Business Management                     | <input type="checkbox"/> Salesmanship                                     |
| <input type="checkbox"/> Industrial Management                   | <input type="checkbox"/> Advertising                                      |
| <input type="checkbox"/> Personnel Organization                  | <input type="checkbox"/> Better Letters                                   |
| <input type="checkbox"/> Traffic Management                      | <input type="checkbox"/> Show Card Lettering                              |
| <input type="checkbox"/> Business Law                            | <input type="checkbox"/> Stenography and Typing                           |
| <input type="checkbox"/> Banking and Finance Management          | <input type="checkbox"/> English  |
| <input type="checkbox"/> Accountancy (including C.P.A.)          | <input type="checkbox"/> Civil Service                                    |
| <input type="checkbox"/> Cost Accounting                         | <input type="checkbox"/> Railway Mail Clerk                               |
| <input type="checkbox"/> Bookkeeping                             | <input type="checkbox"/> Common School Subjects                           |
| <input type="checkbox"/> Private Secretary                       | <input type="checkbox"/> High School Subjects                             |
| <input type="checkbox"/> Spanish <input type="checkbox"/> French | <input type="checkbox"/> Illustrating <input type="checkbox"/> Cartooning |

#### TECHNICAL AND INDUSTRIAL COURSES

- |   |  |
|---|--|
| <input type="checkbox"/> Electrical Engineering                     | <input type="checkbox"/> Architect                                       |
| <input type="checkbox"/> Electric Lighting                          | <input type="checkbox"/> Architects' Blueprints                          |
| <input type="checkbox"/> Mechanical Engineer                        | <input type="checkbox"/> Contractor and Builder                          |
| <input type="checkbox"/> Mechanical Draftsman                       | <input type="checkbox"/> Architectural Draftsman                         |
| <input type="checkbox"/> Machine Shop Practice                      | <input type="checkbox"/> Concrete Builder                                |
| <input type="checkbox"/> Railroad Positions                         | <input type="checkbox"/> Structural Engineer                             |
| <input type="checkbox"/> Gas Engine Operating                       | <input type="checkbox"/> Chemistry <input type="checkbox"/> Pharmacy     |
| <input type="checkbox"/> Civil Engineer                             | <input type="checkbox"/> Automobile Work                                 |
| <input type="checkbox"/> Surveying and Mapping                      | <input type="checkbox"/> Airplane Engines                                |
| <input type="checkbox"/> Metallurgy <input type="checkbox"/> Mining | <input type="checkbox"/> Agriculture <input type="checkbox"/> Navigation |
| <input type="checkbox"/> Steam Engineering                          | <input type="checkbox"/> Mathematics <input type="checkbox"/> Radio      |

Name.....

Street Address.....

City.....State.....

Occupation.....

Persons residing in Canada should send this coupon to the International Correspondence Schools Canadian, Limited, Montreal, Canada

# See Life

Win Applause...Thrills  
Big Money

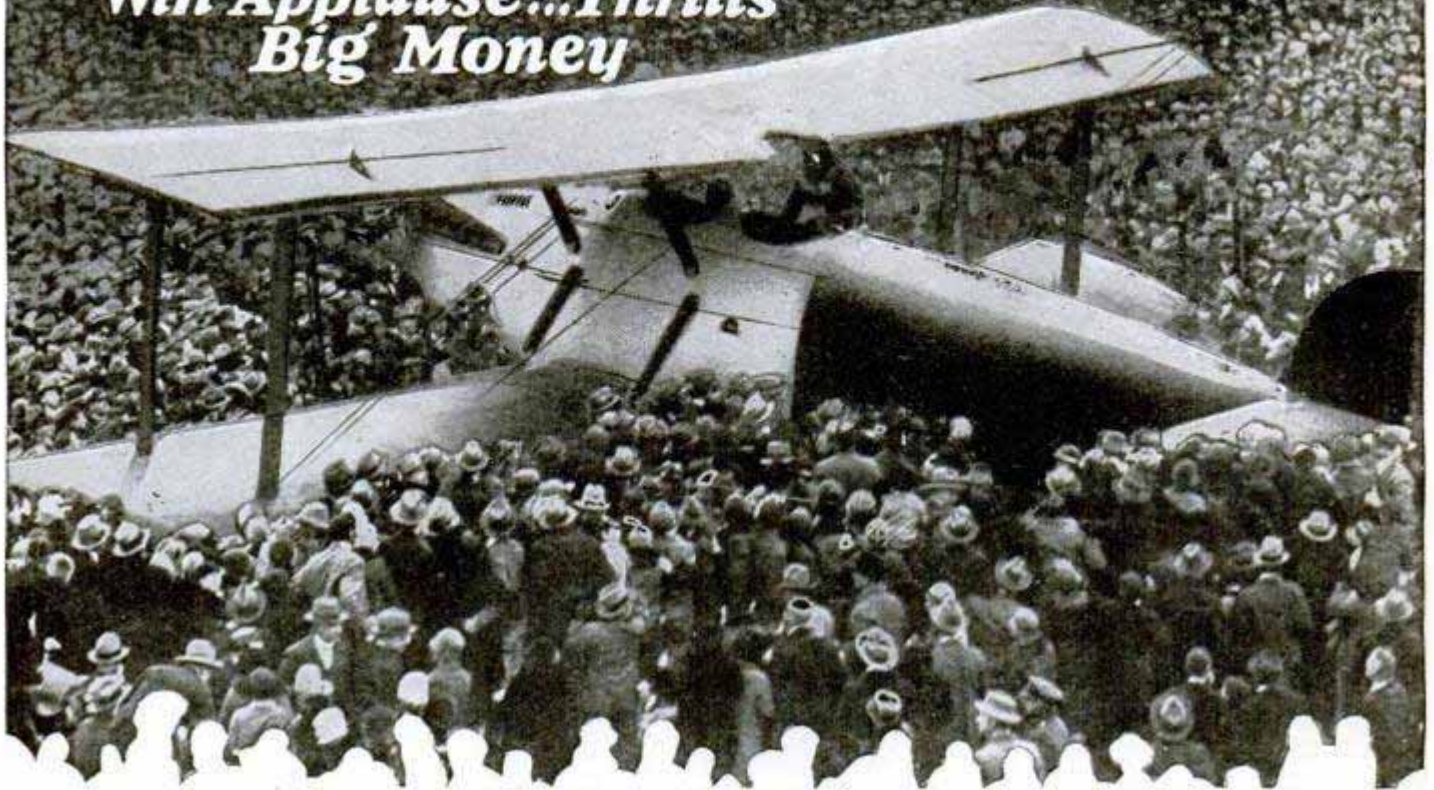

# Get Into Aviation!

**S**EIZE the biggest thrill ever offered to man—the biggest adventure since time began—smash into Aviation—the game for men with sporting blood! Step into a life of excitement, daring and big money—away from a tame, narrow, humdrum existence.

Think what Aviation offers you, Thrills such as you never had before! The praise and plaudits of the multitude. And a chance to get in on the ground floor where rewards will be unlimited!

### Amazing Opportunities

Aviation is growing so swiftly that one can hardly keep track of all the astonishing new developments. Air mail routes have just been extended to form a vast aerial network over the entire U. S. Airlines and airplane factories are springing up all over the country. Men like Henry Ford are investing millions in the future of commercial Aviation in America! The possibilities are so tremendous that they stagger imagination!

Everything is set for the greatest boom in history. Big fortunes came out of the automobile industry and out of motion pictures. Big fortunes will also come out of Aviation. The development of Aviation as an industry is bringing with it a call for trained men. The opportunities open cannot be overestimated. Those who qualify quickly should find themselves on the road to undreamed of money—success—popularity—and prominence.

### Easy to Become an Aviation Expert

Get into this thrilling business at once while the field is new and uncrowded. Now—by a unique new plan—you can quickly secure at home, during spare time, the preliminary training necessary to get a start in the Aviation Industry. Experts will teach you the secrets—give you the inside facts that are essential to your success. And the study of Aviation

by our method is almost as fascinating as the actual work itself. Every lesson is chockful of interest—and so absorbing that you actually forget you are studying. But best of all are the ultimate rewards you are fitting yourself to gain.

### Send for FREE Book

Send the coupon for our new, free book, just out—"Opportunities in the Airplane Industry." It is unusually interesting, reads like a romance, and gives vital facts about Aviation you never even dreamed of. You owe it to yourself to at least read it. We offer you a free copy now. No obligation. Mail the coupon for yours today.

free—

**AMERICAN  
SCHOOL OF  
AVIATION**

Dept. 135- C  
3601 Michigan Ave.  
Chicago, Ill.



### BIG PAYING JOBS

Get Ready Now for One  
of These Positions

Airplane Repairman  
Airplane Mechanician  
Airplane Inspector  
Airplane Salesman  
Airplane Assembler  
Airplane Builder  
Airplane Pilot  
Airplane Instructor  
Airplane Contractor  
Airplane Engineer  
Aerial Photography  
Aerial Advertising

American School of Aviation,  
Dept. 135-C, 3601 Michigan Ave.,  
Chicago, Ill.

Without any obligation please send me your FREE book, "Opportunities in the Airplane Industry." Also information about your course in Practical Aviation.

Name..... Age.....

Address.....

City..... State.....

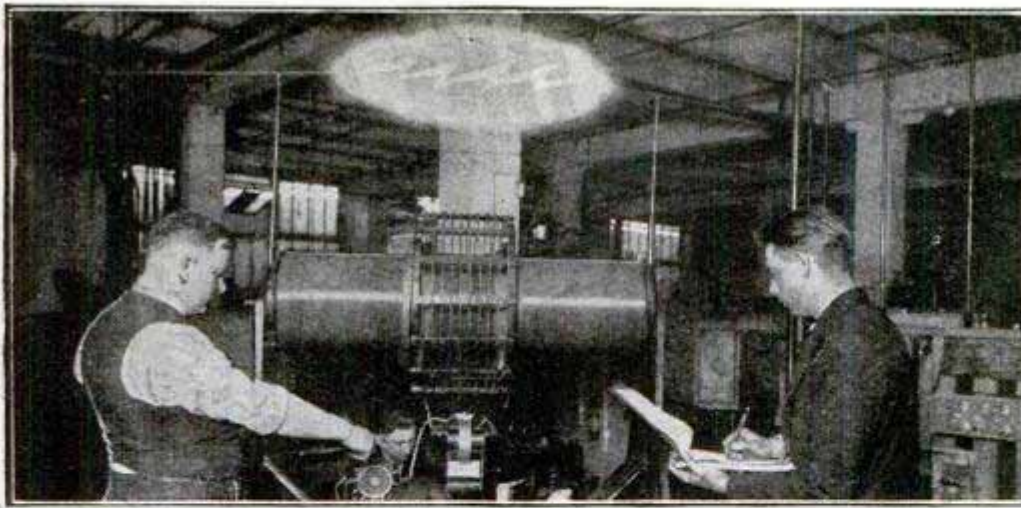

# 500,000 VOLTS

"Artificial lightning" being developed in Coyne School. Spark of 500,000 volts is shown jumping 30 inches. This gigantic Tesla Coil is the same as that used by Steinmetz, absolutely harmless, because of high frequency.

# LEARN ELECTRICITY Without Books or Lessons *in 12 Weeks!*

## By Actual Work — In the Great Shops of Coyne



ANYONE who can see and understand the English language can master electricity in 90 days. I teach you with as complete an outlay of electrical apparatus as was ever assembled in any institution—30-foot control board—2-story transmitting stations—skeleton houses, huge motors of all kinds—dynamos—sub-stations—

automobiles—switchboards—In one department we generate enough electricity to supply a small city!

### No Books—No Lessons—No Classes

Enter anytime. Experts teach you without books or classes. They guide you every step of the way with individual attention. You do the actual work on real full-size machinery in full operation. Take motors for instance. Instead of learning from books and charts—you actually build motors. You can't help but know all about them. Anyone can learn this fascinating way.

### No Experience Necessary

That's how my methods make men master electricity in 12 wonderful weeks. You don't need experience—Coyne training starts from the very beginning. You don't need advanced education—you learn by doing. Age is no handicap—Coyne students range from 16 to 40.

### Triple Your Earning Power

I don't need to tell you about the opportunities in electricity. They are too many and too amazing to mention. Ordinary jobs run \$50—\$75—\$150 a week. And Coyne training leads to the biggest positions.

## COYNE ELECTRICAL SCHOOL

H. C. LEWIS, President, Founded 1899

1300 W. Harrison St., Dept. C7-72, Chicago, Ill.

Many Coyne men are making up to \$600 a month. Our employment bureau helps place men in wonderful jobs.

### Earn While You Learn

We help many students to secure part-time jobs to earn a good part of living expenses while studying.

### I Pay R. R. Fare to Chicago

Right now I am including railroad fare to Chicago and complete courses in Radio and Automotive Electricity without extra charge.

### All Details Sent Free

This school is 28 years old—Coyne training is tested—proven beyond all doubt—endorsed by electrical industry. You can find out everything absolutely free. Simply mail the coupon and let me send you the big, free Coyne book of 150 photographs—facts—jobs—salaries—opportunities. See what Coyne training can do for you in just 90 days! This does not obligate you. So act at once. Just mail coupon.



## GET THIS FREE BOOK

Mr. H. C. Lewis, Pres.,  
COYNE ELECTRICAL SCHOOL,  
Dept. C7-72  
1300 W. Harrison St., Chicago, Ill.

Dear Mr. Lewis:

Without obligation send me your big free catalog and all details of Free Railroad Fare to Chicago, Free Employment Service, Free Radio and Free Automotive Courses and how many "earn while learning." I understand I will not be bothered by any salesman.

Name.....

Address.....

City.....State.....

# You can make the BIG Money



## in Auto Painting

—Because here is the biggest uncrowded field in the world today. Prove it to yourself by the next 20 cars you see. Yes Sir, 17 out of 20 need painting.



**G. KING FRANKLIN**  
Famous Auto  
Painting Authority

**I will have you ready  
in a few months**

NOW—how many auto painters do you know? . . . I thought so. Well, who's going to do the work? You are—after you get the right training and you're going to make more money than you ever dreamed of! The world is looking for trained auto painters. Cash in on this big demand!

## You Can Own Your Own Business!

In auto painting it's no trick to be your own boss—own your own business and be independent!

You don't have to start out with the biggest building on the busiest corner. You can begin small with little or no capital, but I don't know of another business where you can get big so fast.

## You Can Make from \$60 to \$125 a Week

After you get my training you can get a job anywhere. You can travel and know at your destination there will be a job waiting for you that pays big money. Remember—I don't forget you when you complete the course. I help you get a real job. You also get a life consultation service without extra charge.

## 17,000,000 Cars Need Painting

Just imagine! There are t-w-e-n-t-y m-i-l-l-i-o-n cars in the U. S. alone—and 17 million need priming, surfacing, painting, ducoing, varnishing, striping and the whole works—and take it from me, I teach you the whole works so you can get in on the Big Money—or I'll refund every penny of the small price you pay.

I realize that you are up against quite a problem in deciding what field to enter, but on my say-so, and my guarantee to you, just come into auto painting with me and you'll be glad of it all your life.

Men like yourself who have taken my advice are now making \$5,000 to \$10,000 a year.

## MAIL the COUPON

G. King Franklin, Supt.,  
American Auto Painting School,  
Dept. 501, 425 S. Ashland Ave., Chicago.

Send sample shop-tickets free and information on how I may learn auto painting and Duco at home in spare time.

Name.....

Street No.....

City.....

State.....

### TESTIMONIALS

Chicago Duco says: "Skilled Duco men are scarce. We can place many at \$1.00 to \$1.25 an hour." Binks, one of the largest auto equipment manufacturers says "The big auto manufacturers are insisting that their dealers repaint all used cars." Stockton, Illinois, says "No shop here. All work must go to Freeport. Believe plenty of work to make paying business." Nash says "This is a big field and splendid opportunities for your graduates in repainting cars." Many, many more like these.

## LEARN at HOME!

And the beauty of my proposition is that you can learn at home—in your spare time—in the evenings—and keep your present job while learning.

A few pennies a day puts you in line for a job in this big uncrowded industry. It doesn't obligate you or cost you a penny, to clip the coupon.

So get this information now—while Byrd and Chamberlin were talking about flying the Atlantic, Lindbergh did it. Nuff said! Act now!

**G. KING FRANKLIN, Supt.**

**American Auto Painting School**  
Dept. 501, 425 South Ashland Avenue, CHICAGO



# Read your way to Bigger Pay!

Great Men Who Borrowed Books!



ABRAHAM LINCOLN

For about a fourth the usual cost of trade-courses, you can now systematically read your way to a mastery of every branch of Automotive "up-keep." This ten-billion-dollar industry offers rich rewards to any man who will go to the trouble of really learning auto engineering and maintenance. Send no money—just mail the coupon. We will trust any man who seeks to get ahead through self-improvement.



*"I will study and prepare myself, and some day my chance will come"*



This Big "Library of Automobile Engineering"



**Auto Owners!**  
**FIX IT YOURSELF**  
and Save Money!

Know your car—know how to keep it tuned, how to adjust ignition and carburetor, how to make emergency repairs on the road, how to "shoot trouble" and get started and keep her going. "AUTO ENGINEERING" pays for itself many times over, in repair bills saved and lost time avoided.

**For Garagemen ~ Auto Mechanics**  
You don't have to study or memorize "AUTO ENGINEERING." Thousands use it as a REFERENCE WORK—to look up any fact, any problem in their daily work. For these, the JIFFY INDEX places the right answer—instantly—at their finger tips.

AMERICAN TECHNICAL SOCIETY

Dept. A-C19 Drexel Ave. and 58th St., Chicago



# Loaned Free!

to Ambitious Men

NEW  
5 Volume Edition  
—just off the press!

2320 pages, over 2000 illustrations, charts and wiring diagrams. Flexible, de Luxe binding, gold stamped. Revised and up to the minute. A reference library for the auto owner, a hand-book for the auto expert, and a simplified, complete reading course for men who want to learn. Men who have mastered a single subject, like IGNITION, Starting and Lighting systems, have jumped to \$50 and up to \$100 a week.

**3 Valuable Services FREE**

- To emphasize the benefits you will find in these books, we offer without extra charge:
  1. Home Study Guidance.
  2. A year's membership in the American Technical Society and privilege of consulting our Automotive Engineers.
  3. Employment Service.

If you want a better job and BIGGER PAY—borrow a set of "Auto Engineering" and you'll find the quick road to both! Even a glance through the pages will explain why a hundred thousand auto mechanics, garagemen, foremen and Auto OWNERS study it and refer to it constantly. Built by eleven of America's greatest automotive engineers. But written so men with limited education can understand it.

**Be an Auto Expert**  
**Learn at Home!**

They only build three million new cars a year, but there are twenty-two million to service, on the highways! 22,000,000 autos, trucks, tractors, taxis and busses to keep going. That's the BIG MONEY end of the world's greatest industry today. That's the kind of work to get into. But get into it RIGHT. Learn it.

*Don't send a penny...No C.O.D.*

AMERICAN TECHNICAL SOCIETY,  
Dept. A-C19, Drexel Ave. & 58th St., Chicago  
I want to borrow FREE for 15 days' use, a brand-new set of "AUTO ENGINEERING," the latest 5 volume edition. I will pay only the few cents delivery charges when books are delivered, but not one penny for the use of the library itself. In return for this, I agree to look them over very carefully, and determine for myself if I wish to keep them. If I do, I will pay you \$2.00 after 15 days, then \$3.00 a month until \$24.80 is paid, your special advertising price. If not wanted, I will return charges collect, and owe you nothing.

NAME.....  
ADDRESS.....  
Attach letter stating references' and employer's names and addresses, or write same plainly in margin.

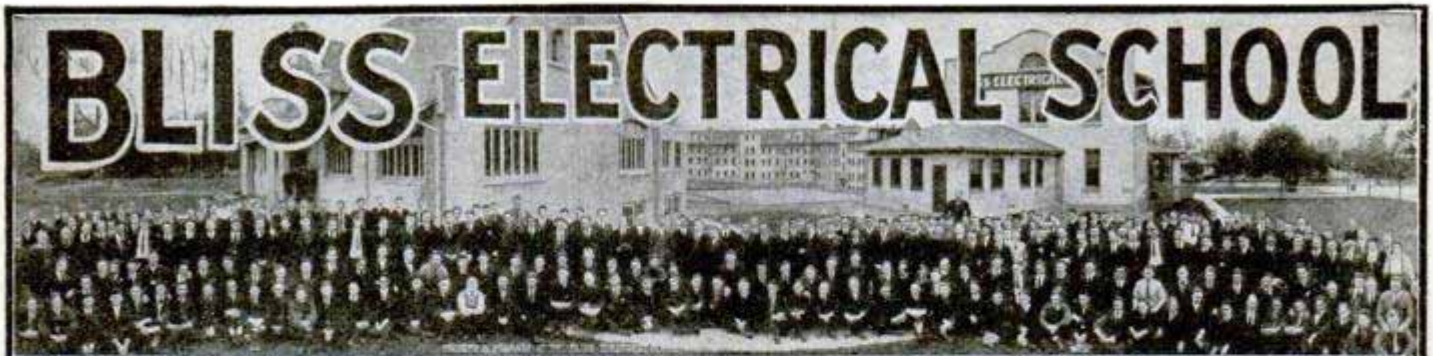

# BLISS ELECTRICAL SCHOOL

A special technical school with concise but comprehensive course in Electrical Engineering designed to be completed in ONE COLLEGE YEAR. Thorough knowledge of underlying principles emphasized.

## ELECTRICAL ENGINEERING



The course is designed for earnest, ambitious young men of limited time and means. Curriculum includes mathematics, mechanical drawing and intensive shop work. Students construct motors, install wiring, test electrical machines. Graduates are qualified to enter the electrical field at once.

Bliss men hold responsible positions throughout the world. Thoroughly equipped fireproof dormitories, dining hall, laboratories and shops. Prepare for your profession in the most interesting city in the world. School established 1893. Catalog on request. Address

BLISS ELECTRICAL SCHOOL, 118 Takoma Avenue

Washington, D. C.

## A Great Book Free with this pay-raising library

For a short time only we will give every subscriber to the New Library of Machine Shop Practice a copy of French's Engineering Drawing—the greatest book on mechanical drawing ever written. This book makes drawing as plain as day—tells you all about instruments, plans and methods—and prepares you to handle any drawing job you will ever have to do. It comes to you absolutely free with

## Machine Shop Practice

9 volumes — 3065 pages — 3608 illustrations  
(A combined home study course and reference library)

The New Machine Shop Library is written for practical men. It gives you the best methods for every kind of machine shop work. It explains machine tools and their operation, drawing and design, tool work, gears and grinding, jigs and fixtures, automatic screw machines and their tools and all of the mathematics you will ever have to use. It is plainly written, completely illustrated—the very best kind of help to the machine-shop man who wants to advance himself.



Sent FREE

No money down—only 7c a day

### FREE EXAMINATION COUPON

McGraw-Hill Book Co., Inc., 370 Seventh Ave., New York  
Send me for 10 days' free examination the New Library of Machine Shop Practice. If satisfactory, I will send you \$1.50 in 10 days and \$2 monthly until the special price of \$19.50 is paid. If not wanted, I will return the books at your expense.  
On receipt of my first payment of \$1.50, it is understood that I am to receive, free of charge, a copy of French's Engineering Drawing.

Signed.....  
Address.....  
City and State.....  
Position.....  
Employer..... P.M. 8-1-27

## ACCOUNTING

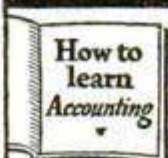

THOUSANDS of ambitious men are earning more money today because they know Accounting. Send for our 80-page book, "How to Learn Accounting," and the first lesson. Both will be sent free.

International Accountants Society, Inc.  
A Division of the Alexander Hamilton Institute  
3411-F South Michigan Avenue Chicago, Illinois

## LEARN PIANO TUNING AT HOME

DURING SPARE TIME AND EARN \$50 TO \$100 A WEEK.



Our Tune-A-Phone Makes It Easy. With it any one who has ordinary hearing can acquire the knack quickly and accurately. Esmay, Long Beach, Cal., says: "never dreamed there was so much money in Piano Tuning. I earned \$265 in ten days." He is but one of many. Write for Free copy of our book "Winning Independence" and Guarantee Plan.  
BRYANT SCHOOL, 71 BRYANT BLDG., AUGUSTA, MICH.

## Learn to PAINT SIGNS and SHOW CARDS

We quickly teach you by mail, or at school, in spare time. Enormous demand. Big future. Interesting work. Oldest, foremost school.  
EARN \$50 TO \$200 WEEKLY  
John Vassos, N. Y., gets \$25 for single show card. Crawford, H. C., says: "Earned \$200 while taking course". Send today for free information, samples and guarantee.  
DETROIT SCHOOL OF LETTERING  
154 Stimson Ave. Est. 1899 Detroit, Mich.



## Learn Watchwork, Jewelrywork and Engraving

A fine trade commanding a good salary, and your services always in demand. Address Horological, Dept. P, Bradley Institute, PEORIA, ILLINOIS, for our latest catalog.



RAILWAY MAIL CLERKS  
FRANKLIN INSTITUTE  
Dept. M176, Rochester, N. Y.  
Sir: Rush to me without charge (1) Specimen Railway Postal Clerk and Mail Carrier coaching. (2) FREE 32 page book with list of U. S. Government positions now obtainable.  
Name.....  
Address.....



"Due to your well prepared training, I received my appointment eight days after my name was placed on the register. David W. Tucker."

## WORK FOR "UNCLE SAM" \$1700 to \$3000 Year

## RAILWAY POSTAL CLERKS MAIL CARRIERS

TRAVEL—See Your Country  
MEN, BOYS, 17 UP SHOULD MAIL COUPON IMMEDIATELY  
Steady Work No Layoffs Paid Vacations

# How Is Your Bone-Oil?

**C**AN you squat down and sit on your heels without hearing a crack in your knees or a stiffness around the joints? Can you bend over slowly without bending your knees and place the open palms on the ground alongside of your feet? Can you place your hands on the wall behind you and gradually let yourself down backwards till your hands touch the ground? If not, your joints are rusty, your tendons are too tight—you need more *bone-oil*.

## WHAT IS BONE-OIL?

When you were born, nature gave you a lubricating fluid in and around the socket of every joint. This lubricating fluid continued in an abundant supply as long as you kept active. But when you ceased to exercise, this fluid lessened and the tendons shortened, which attached the muscles to your bones. You dried up and stiffened. You became rusty.

When machinery becomes rusty we get the oil can. But you can't squirt Bone-Oil into your joints. What then can you do?

## Come to My Repair Shop

As a regular machinist I'm a first class dub—but when it comes to human framework, I've yet to find the one I can't whip into shape. Yes, I know they call me the Muscle Builder, and I'm proud of the fact that my system will build more muscle in a shorter length of time than hitherto has ever been accomplished. I'm the man who guarantees to add one full inch to your arms and two inches to your chest in the first 30 days. Before I'm through, however, I'll at least triple that. In every case I build up the back and literally cover the abdomen with a ripple of real healthy muscle. I clear the brain and brighten the eye. I add pep and virility to the whole system.

But the finest thing about my system is the type of muscle it creates. My pupils are not only enabled to perform remarkable feats of strength, but, with it all, they have suppleness and grace. I have studied the entire human structure and work around the very joints and cartilages as well. That is why I am now guaranteeing you not only a strong, sturdy, robust body, a virile, muscular body, but actually guarantee to lubricate your joints as well. I guarantee Bone-Oil. And notice I'm not making any idle promises. I guarantee these things. Come on, then, let those stiff-kneed, wobbly, half-animated bodies be a thing of the past. Tomorrow you start on the straight and rapid road to real manhood.

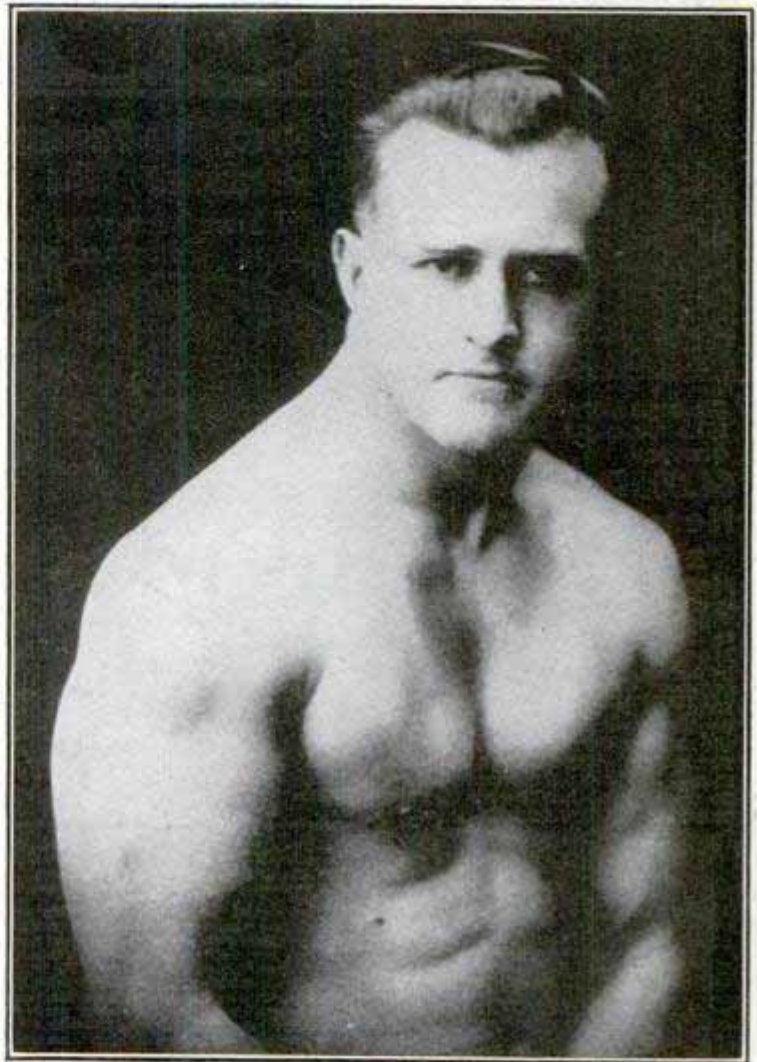

**EARLE E. LIEDERMAN, The Muscle Builder**  
*Author of "Science of Wrestling," "Muscle Building," "Secrets of Strength," "Here's Health," "Endurance," etc.*

Send For My New  
 64 Page Book  
 "Muscular Development"  
 IT IS FREE

I don't ask one cent. And it's the peppiest piece of reading you ever laid your eyes on. I swear you'll never blink an eyelash till you've turned the last cover. And there are over four dozen full-page photos of myself and some of my prize-winning pupils. This is the finest art gallery of strong men ever assembled. And every last one of them is shouting my praises. Look them over. If you don't get a kick out of this book, you had better roll over—you're dead.

Come on, then. Take out the old pencil and sign your name and address to the coupon. Remember, it's something for nothing and no strings attached—no obligation. **GRAB IT!**

**Earle E. Liederman**

Dept. 2008 305 Broadway, New York City

**DON'T  
 SEND ONE  
 PENNY**

**YOUR  
 NAME  
 AND  
 ADDRESS  
 ON A  
 POSTAL  
 WILL DO**

**EARLE E. LIEDERMAN**

Dept. 2008, 305 Broadway, New York City

Dear Sir: Please send me, without any obligation on my part whatever, a copy of your latest book, "Muscular Development." (Please write or print plainly.)

Name.....

Street.....

City..... State.....



**George Larson and His Dental Laboratory**  
**64,000 Dentists Need Laboratory Work**

Mechanical Dentistry is the laboratory bench work which the dentist turns over to the laboratory worker. Master this profession and help meet the demand of 64,000 dentists for laboratory work. Every city and every town where dentists are located offers work to the mechanical dentist. We train you in a few months in day or night school for this uncrowded field—no classes—no books—no special educational requirements.



**\$800% PROFIT In One Month!**

**Read This Fascinating, True Success Story of Two McCarrie Graduates Who Have Been in Business Only a Year**

"I have been very busy and don't get much time to write letters these days. We turned out \$1100.00 worth of work in April, so you can realize that we have developed speed. We are getting more customers right along and we keep them satisfied with first class work and service.

"Our expense, including materials for April, runs about \$300.00, which leaves a profit of approximately \$800.00 for the two of us. This has been about the average since the first of the year, and it's not bad for two of your boys who have been in business only about a year. I think Dental Laboratory Work is better than anything else to make a quick, permanent success, if one can turn out first class work.

"I think I am making the training you gave me pay big profits."

Yours truly,  
 GEORGE LARSON.

**You Have This Man's Opportunity in Mechanical Dentistry**

Larson's letter is only one of many such letters we have received. "No trick for me to make \$20.00 a day," writes one McCarrie graduate, and another says, "I was a \$30.00 a week bookkeeper and have built a dental laboratory business netting me \$150.00 a week and growing all the time."



**We Teach You in a Few Months to Make Rubber Plates:**

Partial upper or lower plates with soldered, cast, or wire clasps, palatal bars, lingual bars, etc. McCarrie students learn to make full rubber plates of every type, including Vulcanite base-plates, butted gums, carved gums, etc.

**Crowns:**

Two-piece, seamless, open-face, Richmond, cast-base porcelain, Carmichael, split-pin, carved (swaged) cusp, cast cusp, etc.

**Bridge Work**

Fixed and removable bridge-work. Interchangeable teeth, gold dummy, sanitary porcelain dummy jobs—Roach, Gilmore, Bischoff and all forms of cast-clasp work.

**Metal Base Dentures**

Cast bases of aluminum, gold, Watt's metal, etc. Both centrifugal and air pressure casting machines used. Free catalog tells all about the course **WRITE TODAY!**

**Read This Extract From a Dental Laboratory Publication**

"The dental laboratory technician earns the money he receives. The very nature of the business—the law of supply and demand assure that. There are not, and never have been, enough competing dental technicians. As long as that condition exists, the dental technician is assured a good wage and satisfactory working conditions. As a matter of fact, statistics prove that the average salary of the dental technician equals or perhaps exceeds the net earning power of the dentist."

**You Can Do What Larson Did**

It's a big jump from a \$35 a week factory worker to half owner of a laboratory paying \$800 a month profit. That's what Larson did! And what he did, you may do! Leave your blind alley job—enter this big-paying profession—live in affluence—enjoy a dignified, pleasant occupation—be your own boss—go and come as you please. Master the art of Mechanical Dentistry and when you complete your course you may either get a job as a laboratory worker or go in business for yourself. It takes but very little capital to equip a small laboratory and you can build up a big paying business in a short time. Think what that would mean to you—a car, a fine home, trips whenever you like—all the thousand and one luxuries you crave but can't gratify. And think: the coupon on this page may open the way to the gratification of your every ambition. Follow Larson's example—mail the coupon. It's your one-way ticket to success!

**Interesting Book FREE**

Our illustrated, free book on Mechanical Dentistry will acquaint you with some surprisingly interesting facts. It tells about the thriving profession of Mechanical Dentistry—the way to swift and certain success. And it tells about the progress of many of our graduates—men who have succeeded beyond their expectations, also full details of our liberal offers. Mail the coupon and find out more about this fascinating opportunity.

**MAIL COUPON**

**McCarrie School of Mechanical Dentistry**

1338 S. Michigan Ave.  
 Dept. 126 Chicago, Ill.

**Work Your Way Through School**

We will assist you in finding a spare-time job to meet part of your expenses while taking McCarrie training. And we will help you find satisfactory living quarters when you arrive.

**McCarrie Schools** are located in **CHICAGO, DETROIT, CLEVELAND, BOSTON, PHILADELPHIA.** DAY and NIGHT SCHOOLS

**FREE BOOK**

McCarrie School of Mechanical Dentistry, 1338 S. Michigan Ave., Dept. 126, Chicago, Ill.

Without obligation, please send me your free Book with complete information about how I may become a Mechanical Dentist, how you will help me open a Laboratory, how you will help me find a job while I take my training, etc.

Name.....  
 St. No. or R. F. D.....  
 City..... State.....

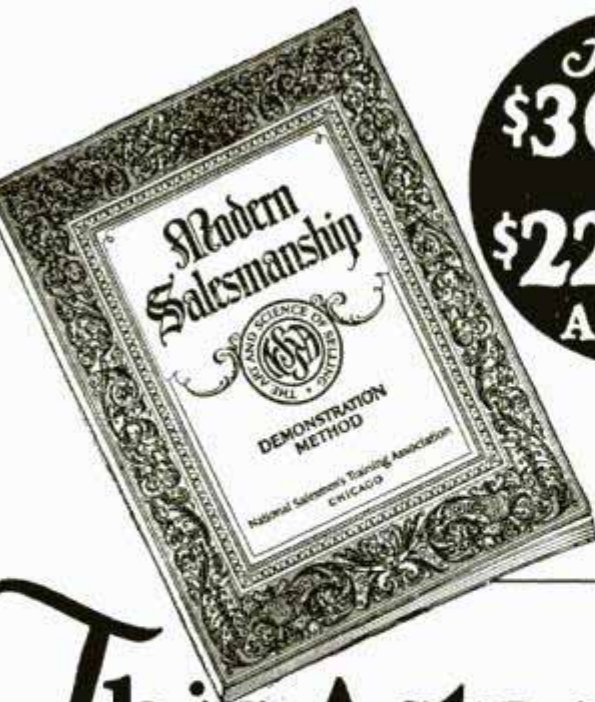

From  
**\$30** A WEEK  
 to  
**\$22,500**  
 A YEAR

\$30 A WEEK

\$5,000 A YEAR

\$7,500 A YEAR

\$22,500 A YEAR

START. 1<sup>ST</sup> YEAR 2<sup>ND</sup> YEAR 3<sup>RD</sup> YEAR

# This Astonishing Book Showed Him How

How One Man Uncovered Hidden Possibilities He Never Suspected Within Himself and Raised His Yearly Income \$20,940! An Illuminating Message of Vital Interest to Every Man Who Ever Aspires to Earn \$10,000—\$20,000—or More a Year! SEE FOR YOURSELF this remarkable Volume That Has Led So Many Men Into the Five-Figure Salary Class!

## Where Shall We Send Your Copy... FREE?

TRUTH is stranger than fiction! And the true story that happened to V. H. Harelson proves it! His experience is not only intensely INTERESTING—but it will prove a revelation and positive inspiration to every ambitious man who reads this page.

Not long ago—three years to be exact—Harelson was working as a clerk in a grocery store. His salary was \$30 a week. (Today he looks back with a laugh and calls it a "paltry sum.") But it was no laughing matter in those days—because it meant scrimping and petty economies that are bound to irk ANY ambitious man. Naturally he was keenly dissatisfied—but like many other men caught in blind-alley jobs, he didn't know how to get out!

And then one day something happened! A certain book fell into his hands. Between its covers he discovered a certain force that eventually led him to rewards beyond his fondest expectation. Inspired to action and with his feet firmly guided to the best rungs of the ladder to Success, Harelson made \$5,000 his first year. The following year he boosted his income to \$7,500! And last year HE CLEARED A TOTAL OF \$22,500!

### SALARY INCREASES—200% TO 900%!

A lucky accident? Not a bit of it! Harelson is not alone in his achievement of success after reading this remarkable book. OTHER men who have increased their salaries amazingly after reading these vital facts are numbered in the thousands! For example, C. W. Birmingham of Ohio read it and his salary increased from \$15 a week to \$7,500 a year. Wm. Shore of California made \$3,000 his first 5 months. R. B. Hansen of Ohio commenced earning over \$10,000 a year. And O. D. Oliver of Oklahoma, who used to earn \$200 a month, now makes as much as \$1000 in a single week!

### THE SECRET OF BIG PAY

How did they do it? What did the book show them? Just this:—Every one of these men realized that Salesmanship offers BIGGER rewards and delivers them QUICKER than any other line of work under the sun. This vital book, "Modern Salesmanship," introduced them to hundreds of surprising and little-known facts about the highest paid of all professions. It revealed to them the real TRUTH about the art of selling. It blasted dozens of old theories, explained the science of selling in simple terms and told them exactly how the great sales records of nationally-known star salesmen have been achieved. And not only that, it outlined a simple plan that will enable almost any man to master scientific salesmanship without spending

years on the road—without losing a day or dollar from his present position.

### A FEW WEEKS—THEN BIGGER PAY

There was nothing "different" about these men when they started. Salesmanship is just like any other profession. It has certain fundamental rules and laws—laws that you can master just as easily as you learned the alphabet. And through the NATIONAL DEMONSTRATION METHOD—an exclusive feature of the N. S. T. A. system of SALESMANSHIP training—you can acquire the equivalent of actual experience while studying. Hundreds of men who never sold goods in their lives credit a large portion of their success to this remarkable training.

### FREE TO EVERY MAN

If we were asking two or three dollars a copy for "Modern Salesmanship" you might hesitate. But it is now FREE. We cannot urge you too strongly to take advantage of this opportunity to see for yourself what salesmanship has done for others—and what the National Salesmen's Training Association stands ready and willing to do for you. Find out exactly what the underlying principles of salesmanship are—and how you can put them to work for you. No matter what your opinion is now, "Modern Salesmanship" will give you a new insight into this fascinating and highly-paid profession. Mail the coupon now!



Dept. K-100 N. S. T. A. Bldg. Chicago, Ill.

NATIONAL SALESMEN'S TRAINING ASS'N.  
 Dept. K-100, N. S. T. A. Bldg.,  
 Chicago, Illinois.  
 Without cost or obligation you may send me your free book  
 "Modern Salesmanship."

Name.....  
 Address.....  
 City..... State.....  
 Age..... Occupation.....



## "Last night I came home with great news"

"I'D TELEPHONED Ruth that I had a surprise for her and she could hardly wait for me to get home. You should have seen her face when I told her the Boss had called me in and given me a \$25 increase in salary.

"It's wonderful," she said. "Now we can pay some of those bills that have been worrying us and even put a little in the bank each week.

"Remember the night we saw that coupon in a magazine and you decided to take up an I. C. S. course? It made a new man of you, Bob, and I knew it wouldn't be long before the firm would notice the difference in your work.

"We certainly owe a lot to the International Correspondence Schools. You would never have received this increase if you hadn't studied at home and prepared yourself for bigger work."

How about *you*? Are you always going to work for a small salary? Or are you going to get ahead in a big way? It all depends on what you do with your spare time.

Don't let another precious hour pass before you find out what the I. C. S. can do for you. It doesn't cost you a penny or obligate you in any way to ask for full particulars, but that one simple, little act may be the means of changing your entire life. *Do it now!*

### INTERNATIONAL CORRESPONDENCE SCHOOLS Box 5662-E, Scranton, Penna.

Without cost or obligation, please send me a copy of your booklet, "Who Wins and Why," and full particulars about the course before which I have marked X in the list below:

#### BUSINESS TRAINING COURSES

- |  |   |
|--|---|
| <input type="checkbox"/> Business Management                     | <input type="checkbox"/> Salesmanship                                     |
| <input type="checkbox"/> Industrial Management                   | <input type="checkbox"/> Advertising                                      |
| <input type="checkbox"/> Personnel Organization                  | <input type="checkbox"/> Better Letters                                   |
| <input type="checkbox"/> Traffic Management                      | <input type="checkbox"/> Show Card Lettering                              |
| <input type="checkbox"/> Business Law                            | <input type="checkbox"/> Stenography and Typing                           |
| <input type="checkbox"/> Banking and Finance Management          | <input type="checkbox"/> English  |
| <input type="checkbox"/> Accountancy (including C.P.A.)          | <input type="checkbox"/> Civil Service                                    |
| <input type="checkbox"/> Cost Accounting                         | <input type="checkbox"/> Railway Mail Clerk                               |
| <input type="checkbox"/> Bookkeeping                             | <input type="checkbox"/> Common School Subjects                           |
| <input type="checkbox"/> Private Secretary                       | <input type="checkbox"/> High School Subjects                             |
| <input type="checkbox"/> Spanish <input type="checkbox"/> French | <input type="checkbox"/> Illustrating <input type="checkbox"/> Cartooning |

#### TECHNICAL AND INDUSTRIAL COURSES

- |   |  |
|---|--|
| <input type="checkbox"/> Electrical Engineering                     | <input type="checkbox"/> Architect                                       |
| <input type="checkbox"/> Electric Lighting                          | <input type="checkbox"/> Architects' Blueprints                          |
| <input type="checkbox"/> Mechanical Engineer                        | <input type="checkbox"/> Contractor and Builder                          |
| <input type="checkbox"/> Mechanical Draftsman                       | <input type="checkbox"/> Architectural Draftsman                         |
| <input type="checkbox"/> Machine Shop Practice                      | <input type="checkbox"/> Concrete Builder                                |
| <input type="checkbox"/> Railroad Positions                         | <input type="checkbox"/> Structural Engineer                             |
| <input type="checkbox"/> Gas Engine Operating                       | <input type="checkbox"/> Chemistry <input type="checkbox"/> Pharmacy     |
| <input type="checkbox"/> Civil Engineer                             | <input type="checkbox"/> Automobile Work                                 |
| <input type="checkbox"/> Surveying and Mapping                      | <input type="checkbox"/> Airplane Engines                                |
| <input type="checkbox"/> Metallurgy <input type="checkbox"/> Mining | <input type="checkbox"/> Agriculture <input type="checkbox"/> Navigation |
| <input type="checkbox"/> Steam Engineering                          | <input type="checkbox"/> Mathematics <input type="checkbox"/> Radio      |

Name.....

Street Address.....

City..... State.....

Occupation.....

Persons residing in Canada should send this coupon to the International Correspondence Schools Canadian, Limited, Montreal, Canada

The Whole World is the Workshop of the Professional Photographer!

**\$50. to \$250. a Week in Photography**

**FREE BOOK Tells How**

You can quickly qualify for big-paying positions in Motion Picture, Portrait, Commercial or News Photography, or start your own business. No experience needed.

**CAMERA GIVEN WITHOUT EXTRA CHARGE** Learn at home or in our great New York Studios. Earn while learning. Write today for Free Book, Job Chart and Camera offer.  
**NEW YORK INSTITUTE OF PHOTOGRAPHY**  
Dept. 49 10 West 33rd St. New York

## Write and Speak MASTERLY ENGLISH



Learn correct English with Sherwin Cody's new invention. No rules to memorize. Like a fascinating game. Spare-time study, 15 minutes each day, quickly gives you mastery command of English. Interesting booklet sent free. Write today. Sherwin Cody School of English, 58 Searle Building, Rochester, N. Y.

## LAW Personal Instruction By Mail Be a lawyer or law trained businessman. Qualify to earn \$2,500.00 to \$15,000.00 a year.

University Methods. TUITION LOW. EASY TERMS. Textbooks furnished. Practical and authoritative non-resident course. Endorsed by bench and bar. Prepares for bar or business. Over 60,000 students. PERSONAL INSTRUCTION. Guarantee to coach free any graduate failing to pass bar exams. Write today for particulars of low tuition offer now in force and book on law FREE. No obligation.

**AMERICAN CORRESPONDENCE SCHOOL OF LAW**  
3601 Michigan Avenue, Dept. 135-C CHICAGO, ILL.

## PIANO JAZZ

By Note or Ear. With or without music. Short Course. Adult beginners taught by mail. No teacher required. Self-Instruction Course for Advanced Pianists. Learn 259 styles of Bass, 684 Syncopated Effects, Blue Harmony, Oriental, Chime, Movie and Café Jazz, Trick Endings, Clever Breaks, Space Fillers, Sax Slurs, Triple Bass, Wicked Harmony, Blue Obligato, and 247 other Subjects, including Ear Playing. 133 pages of REAL Jazz, 25,000 words. A Postal brings our FREE Special Offer.

**Waterman Piano School, 1826 W. Adams St. Los Angeles, Cal.**

## Learn Advertising at HOME

Many of the highest paid men in the world are advertising men. You can learn easily and quickly at home during your spare time. We guarantee satisfaction. Bigger opportunities now in advertising than ever before. Constant demand for our graduates at splendid pay.

Send for FREE Book. Giving interesting information and vital facts—just what you want to know about advertising. Write today.

**PAGE-DAVIS SCHOOL OF ADVERTISING**  
Dept. 135C 3601 S. Michigan Ave., Chicago, U. S. A.

## YMCA

Learn Auto Mechanic, Auto Electrical, Battery, Machine, Electrical, Radio Mechanic, Tiling, Bricklaying, Plastering, Plumbing, Welding, Drawing, Estimating, Show Card, Sign Painting, Window Dressing. Write for Catalog 50.

**BROOKLYN ENGINEERING INSTITUTE**  
(Operated by Bedford Br. Y. M. C. A.)  
1125 Bedford Ave., Brooklyn, New York City.



Wonderful, new device, guides your hand; correct your writing in few days. Big improvement in three hours. No failures. **Complete outline FREE.** Write C. J. Ozment, D-34, St. Louis, Mo.



# CHAINED!

**Are YOU, Too, Chained Down By Low Salary, the Lack of a Fair Chance? If You Are, Read My Message**

Don't let the precious years of your life slide by in a struggle to make both ends meet! Don't be a slave! To your job or to your responsibilities.

Men no smarter or luckier than you are, right now today own nice cars, a real bank account, a comfortable home, and make real money, too, from \$50 all the way up to \$200 a week! Radio is doing it for them. They're N. R. I.—trained Radio men, and you can blame only yourself if you're tied down on a small salary, plodding along in the rut—because you have a chance to do the same as they did! The new, growing, live-wire Radio industry needs men with Radio training, and I can give you this training quickly, in your spare time and in the quiet of your home.

Here's your chance—if you're really in earnest about wanting to throw off your "chains"—if you really want independence, a good salary, and bigger opportunities for the future. Get into Radio—the profession of growth and opportunity. I can train you to grasp Radio's bigger opportunities, just as I've trained these other men, in a few months of your spare time. You learn right in your own home. I teach you in a way that's clear, unforgettable, and simple—you need not even have finished the grade schools to start with me. It's practical—you learn by doing. So practical that almost from the beginning under my instruction you can earn extra cash—doing spare-time Radio jobs. I send you six outfits of Radio material to experiment with—free of extra charge with your course.

Now I'm ready to mail you a free 64-page book telling you all about Radio and its opportunities, and the way I can help you to a fresh start. I gladly send this book free to every man who wants to get somewhere—to break loose from the chains of low salary, no opportunity, discouragement. Mail the coupon for this book and read for yourself of the golden opportunity Radio now offers. Read the stories of scores of other men—how I've helped them to become successful. Sending for this free book will place you under no obligation, so see all the facts for yourself. Mail the coupon today! Address: J. E. Smith, President, National Radio Institute, Washington, D. C.

**Employment Service to all Graduates**  
**Originators of Radio Home Study Training**



J. E. SMITH

J. E. Smith, founder and President of the National Radio Institute, ranks as one of the foremost Radio educators of the world. He has trained more men for the Radio profession than any other man in the world. The National Radio Institute—oldest and largest Radio home-study school in the world—is recognized by the U. S. Government and recommended by Radio men everywhere. N. R. I. students and graduates are to be found in practically every Radio concern of importance.



**Mail Coupon Below for FREE 64 Page Book**

J. E. SMITH, President,  
 National Radio Institute,  
 Dept. H-85, Washington, D. C.

Dear Mr. Smith: Kindly send me your free 64-page book "Rich Rewards in Radio," and all information about learning Radio at home for bigger pay and a bigger future. I understand this request places me under no obligation.

Name .....

Address .....

Town ..... State .....



# DRAFTING ENGINEERING, ELECTRICITY and ARCHITECTURE

## CHICAGO TECHNICAL COLLEGE

One of "America's oldest and largest schools of specialized engineering" offers you a maximum of practical training in a minimum of time, here at Chicago, the country's building and engineering center. Technical training of college standard for men who have neither the time, money nor preliminary education to attend a university. Each year more than 1000 men and women enroll in day and evening classes.

### Short, Intensive Training

practical in every respect, puts you quickly into a high salaried position. Many of our students are assisted to responsible positions before graduation . . . they earn while they learn.

#### In Spare Time At Home

If you can't come to Chicago, learn Drafting at home. Your spare time is enough. Same practical course. Quick, easy—yet thorough.

#### Trial Lesson FREE

Test yourself and see how easy you can learn Drafting by the Chicago Tech. method. Trial lesson sent free if interested in home study. Address Dept. K-200.

COURSES are arranged to suit your needs—2 year diploma; 3 year B. S. degree; special 3 and 4 months' short courses adapted to the individual. Expert instructors actively at work in the very professions they teach.

Tuition low, terms easy. Enter any time. Day and Evening Classes.

## Write for FREE 84 Page Blue Book

It tells about all the courses . . . fully describes them; about the great demand for Chicago Technical College trained men; about college athletics and other interesting facts you'll want to know. Gives you a vivid picture of what you may expect at this leading technical college. There is no obligation. Send for this free Blue Book today . . . now!

Address Registrar K-75

**Chicago TECHNICAL College**  
Dept. K-75 118 East 26th St., Chicago



## \$1900 to \$2700 a year

Long vacations with pay. Work easy. Travel on fast trains with all expenses paid, including hotel. No worries about the future.

#### MY FREE BOOK TELLS HOW

Get my big free book about the Civil Service which tells all about the Railway Postal Service, and other positions, and how I can help you. Write today.

#### PATTERSON SCHOOL

Arthur R. Patterson, Civil Service Expert  
88 Wisner Bldg. Rochester, N. Y.

## LAW Free Book

Write today for FREE 128-page book, "THE LAW TRAINED MAN," which shows how to learn law in your spare time and earn more money. Qualify for a high salaried executive position or prepare to enter the practice of law. Study at home through the Blackstone Course prepared by 80 prominent legal authorities including CHIEF JUSTICE WILLIAM HOWARD TAFT. Blackstone graduates practicing law everywhere. LL. B. degree conferred. Magnificent 25 volume law library furnished immediately upon enrollment. Moderate tuition fee. Low monthly terms. Money Back agreement. Write for book today.

**Blackstone Institute, Inc.,**  
4753 Grand Blvd. Dept. 50-C Chicago



## \$20 Musical Instruments

Your choice of a Violin, Tenor Banjo, Hawaiian Guitar, Banjo, Cornet, Ukulele, Banjo Ukulele, Guitar, Mandolin or Banjo Mandolin. You will be proud to own any one of these instruments and we will give you one without cost. A few cents a day for lessons is your only expense. Our system of teaching is so easy that you can play several pieces by note with the first four lessons. We guarantee success or no charge. Instrument and lessons sent on one week's free trial. Write for booklet today, no obligation. Over 200,000 satisfied pupils.

**CHICAGO CORRESPONDENCE SCHOOL OF MUSIC, INC.**  
1632 North Halsted Street, Dept. 347, Chicago, Illinois.

## WANTED!

Ornamental Iron and Bronze Draftsmen at \$50.00 to \$65.00 a week for beginners. Experienced men as high as \$500.00 a month. Opportunities to become executives. Put yourself in line for a better job. We place you free when you're ready. Write today.

**American Institute of Ornamental Iron & Bronze**  
3043 Hennepin Avenue MINNEAPOLIS, MINN.

### LEARN PHOTO-ENGRAVING!

Earn \$200 to \$500 monthly. Photography and Photo-Engraving taught in few months by largest college of its kind. Established 1893. Big demand for graduates.

Write for free book.

**Illinois College of Photography, Box 487, Effingham, Ill.**



## Learn SIGN AND SHO-CARD Lettering

Fascinating work. Pays \$50 to \$200 weekly. Vassos gets \$25 for a sho-card. Some posters bring \$300. Many earn while learning. Study in spare time. Learn quickly. For facts and guarantee write: **DETROIT SCHOOL OF LETTERING, 173 Stimson, Detroit, Michigan.**

## LEARN TO Mount Birds

We teach you At Home by Mail to mount Birds, Animals, Heads, Tax Furs and Make Rugs. Be a taxidermy artist. Easily, quickly learned by men, women and boys. Tremendously interesting and fascinating. Decorate home and den with beautiful art. Make Big Profits from Spare Time Selling Specimens and Mounting for Others.

**Free Book**—Yes absolutely Free—beautiful book telling all about how to learn taxidermy. Send Today. You will be delighted. Don't Delay!  
**Northwestern School of Taxidermy** C-337 Elwood Bldg. OMAHA, NEB.







# Suddenly I Broke Away and Held Them Spellbound

As I review that tense dramatic moment when I electrified that meeting, it all seems strange and weird to me. How had I changed so miraculously in three months from a shy, diffident "yes" man to a dynamic, vigorous he-man? How had I ever dared give my opinion? Three months before nobody ever knew I held opinions!

ALL my life I had been cursed with a shy, timid, self-conscious nature. With only a grammar school education I could never express ideas in a coherent, self-confident way. But one day my eye fell upon a newspaper article which told about a wonderful free book entitled *How to Work Wonders with Words*, — a book that was causing widespread comment from coast to coast—a book that was being read not only by millionaires, but by thousands of others. It discussed men like me and explained how we could overcome our handicaps.

At first I was skeptical. I thought these defects were a part of my natural makeup—that I would never be able to overcome them. But some subtle instinct kept prodding me to send for that free book. I lost no time in sending for it, as I was positively amazed at being able to get cost free a book that made absolutely plain the secrets that most successful men have used to win popularity, distinction, money and success.

As the weeks wore on, and I absorbed the principles of this remarkable method, I became conscious of new physical and mental energy, a new feeling of aggressiveness, and a resurrected personal power that I never dreamed I possessed. Then came that day in the general meeting when the president called on the assembled department heads and assistants for suggestions on the proposed new policy.

## WHAT 15 MINUTES A DAY WILL SHOW YOU

- How to talk before your club or lodge
- How to address board meetings
- How to propose and respond to toasts
- How to make a political speech
- How to tell entertaining stories
- How to make after-dinner speeches
- How to converse interestingly
- How to write better letters
- How to sell more goods
- How to train your memory
- How to enlarge your vocabulary
- How to develop self-confidence
- How to acquire a winning personality
- How to strengthen your will power and ambition
- How to become a clear, accurate thinker
- How to develop your power of concentration
- How to be the master of any situation

Three months previously, the forces of indecision, timidity, and inability to talk in public would have held me to my seat. But suddenly that new power took possession of me and drove me to my feet. That wonderful 15-minute daily training at home had taught me to forget myself and think only of my subject. Almost automatically the ideas which had heretofore lain dormant in a mental jumble, now issued with a vigor, clearness and enthusiasm that astounded me no less than my

boss and associates. And I noticed with silent exultation the rapt, intent look on my audience as my story unfolded itself smoothly and eloquently.

To-day the men whom I used to greet deferentially I now meet with an air of cool equality. I am asked to conferences, luncheons, banquets, etc., as a popular after-dinner speaker. And my talents are not confined to business matters but have made me an interesting conversationalist at social affairs. I am meeting worth-while people, I own a good job, a good home, a good car. I am the happiest man that ever lived.

And I frankly and candidly admit that I owe all of these blessings to that wonderful little, free book *How to Work Wonders with Words*.

## Send for This Amazing Book

This new method of training is fully described in a very interesting and informative booklet which is now being sent to everyone mailing the coupon below. This book is called *How to Work Wonders with Words*.

Now Sent  
FREE

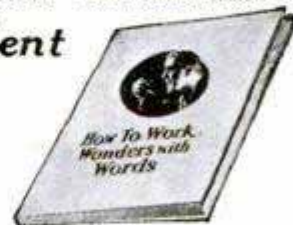

You are told how to bring out and develop your priceless "hidden knack"—the natural gift within you—which will win for you advancement in position and salary, popularity, social standing, power and real success. You can obtain your copy absolutely free by sending the coupon.

North American Institute,  
3601 Michigan Ave., Dept. 135-C  
Chicago, Illinois

NORTH AMERICAN INSTITUTE,  
3601 Michigan Ave., Dept. 135-C, Chicago, Illinois

Please send me FREE and without obligation my copy of your inspiring booklet, *How to Work Wonders with Words*, and full information regarding your course in Effective Speaking.

Name.....

Address.....

City..... State.....



# BOYS

Make Big Spare Time Money  
Surprise your chums

## Learn ELECTRICITY

This Quick Easy Way

Electricity is great fun! And it pays. Lots of my boys still in school are making \$10 to \$15 a week in spare-time—and getting a real training besides for a regular he-man's Big-Pay job in Electricity when school days are over. You can, too! I'll show you how. Begin right now to prepare for a big future in this fascinating field of great opportunity. Your chances of success are simply wonderful!

### Learn Right at Home

With my easily-learned, spare-time Electrical Course I will train you at home like I trained hundreds of other boys who are now big successful men. It won't interfere with your school work. And you'll find it so enjoyable it will be more like play than study. It's just the thing for you fellows who are ambitious to get somewhere and be somebody after you have finished school.

### I Train You RIGHT!

My training is practical—you learn along work-shop lines by doing. I furnish you with all necessary equipment to work with. And it doesn't cost you a penny extra! Six Big Outfits of tools, material and apparatus, including a real electric motor—not toys, but the real thing. And they're yours to keep—to learn right with, and to help you do the spare-time work I tell you how to get and how to do.

### Mail Coupon for Book

If you want lots of spending money—if you want to be ready to jump into a Big-Pay Electrical Job when you're through school—my Big Book will show you how. Get it—you'll like it—it's full of "dope," data and pictures that will thrill you. And it's FREE—won't cost you a penny—mail coupon for it right now!

**L. L. COOKE**

Chief Instruction Engineer  
Dept. 01C, CHICAGO, ILL.

**RADIO COURSE NO EXTRA CHARGE**

Every fellow wants to learn radio. And this Course is a dandy. It's simple—it's thorough. You'll be surprised what it will teach you about Radio. And it's yours without a penny of extra cost!

**6 BIG OUTFITS given including a REAL MOTOR**

What a thrill you'll get from these Six Big Outfits of tools and apparatus! There's enough equipment in this fine layout for you to tackle any kind of spare-time work. Imagine saving all this for "keeps."



### Use this SPECIAL OFFER Coupon

L. L. COOKE, Chief Instruction Engineer,  
L. L. Cooke School Of Electricity  
Dept. 01C, 2150 Lawrence Ave., Chicago, Ill.

Send me free and fully prepaid your Big Book about Electricity, and full particulars about your Electrical Course and extra Radio Course. This does not obligate me.

Name.....  
Address.....  
City..... State.....  
(This coupon only for use of boys 15 years old or more)



# Double Your Pay This Easy Way

SCORES of ambitious fellows earn more than their regular salaries simply by using a few pleasant hours a week of their spare time making show cards for local stores. Every retailer in your neighborhood will pay big money for clever sales-producing display cards. Learn at home through easy professional method. Earn \$25 to \$50 a week spare time—\$50 to \$100 a week in full time. Business of your own. Wonderful future. Earn even while you learn.

Send for new illustrated booklet, "Quick Success in Show Card Making." Also for details on Show Card Outfit given to new students. No obligation. Write now to

### WASHINGTON SHOW CARD SCHOOL

Dept. 308E, 1117—15th St., N. W., WASHINGTON, D. C.



# 1,000 Hotel Positions Open!

HOTELS, restaurants, clubs, apartments, hospitals, institutions, schools and colleges everywhere need trained men and women. Over 70,000 high-class positions paying \$2,500 to \$10,000 a year open annually in the hotels of the United States. Nearly one and three-quarter billions of dollars' worth of NEW HOTELS, CLUBS AND INSTITUTIONS, being built this year will need over 200,000 trained men and women. Hotels start you at salaries up to \$3,500 a year, with living usually included. At any time there are over 1,000 hotel positions open.

Previous Experience Unnecessary  
You can have one of these fascinating, big-pay positions. The Lewis Schools guarantee to give you the valuable knowledge that it has taken some of the most successful hotel men years to obtain. Age is no obstacle—young and old alike have equal chance for success. Past experience absolutely unnecessary. A common school education is all you need.

We train you in your spare time with the Lewis Simplified Study Plan and put you in touch with big opportunities. All of your training under the personal supervision of Clifford Lewis, Managing Consultant for over 225 hotels throughout the United States. Our students employed by leading hotels everywhere. Send coupon today for Free Book, "Your Big Opportunity," showing how we can train you for one of these splendid positions and explaining our Money-Back Agreement.

### FREE BOOK COUPON

LEWIS HOTEL TRAINING SCHOOLS,  
Room AJ-385, Washington, D. C.

Send me without obligation the Free Book "Your Big Opportunity."

Name.....  
Address.....  
City..... State.....

# Dick! You're a Regular Grandpa

## A Month Ago They Razzed My Dancing—Yet Almost Overnight I Became a Popular Dancer

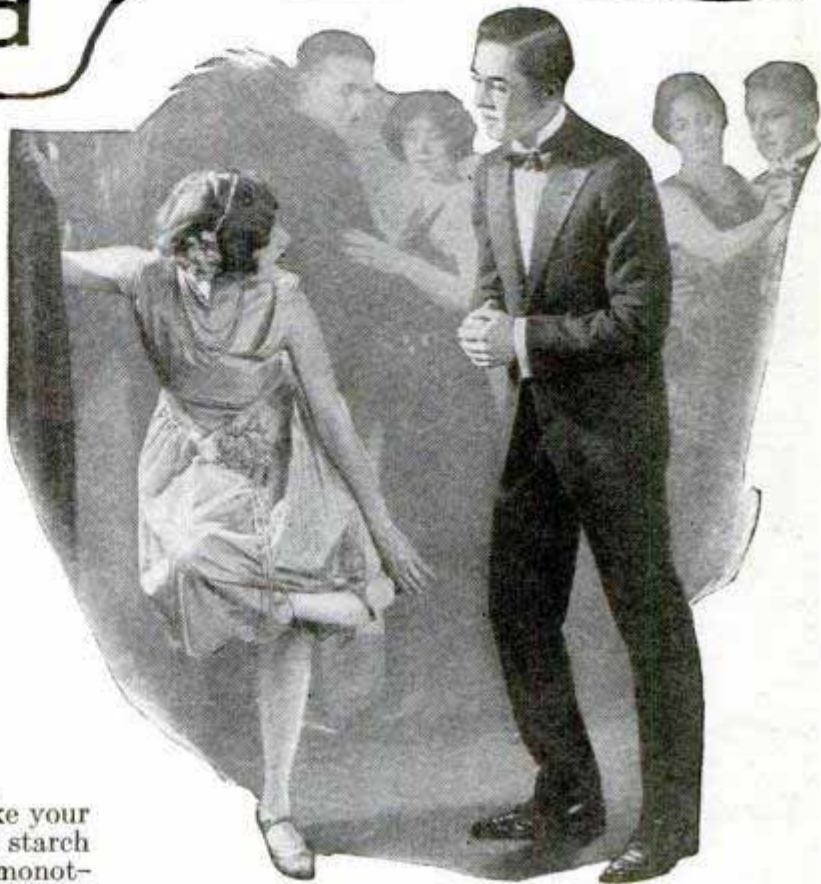

"DICK, will you ever learn to dance the late steps—will you ever learn to hold me properly—will you ever learn to act at home on a dance floor and keep off my feet?"

"I'm awfully sorry I . . ."

Anne kept up the bombardment. "Honestly you're worse than an old grandpa when it comes to dancing. You never take your eyes off your feet. You hold yourself stiff as starch and walk in a straight line until it becomes monotonous. When you do attempt to turn, you hop—then stumble over me and bump into every one else near you. It's so tiresome and embarrassing. Please don't ask me to dance again."

### The Bitter Truth

What could I say? It was not the first time that I had bluffed. Yet it was always such a temptation to mingle with the good dancers that I watched the steps they did and then foolishly tried to imitate them. I never realized that my clumsy, old-fashioned methods made me a "laughing stock" each time I stepped on the floor—*until Anne opened up and spoke her mind.*

#### IF YOU CAN DO THIS STEP

Arthur Murray will make you a finished dancer in 10 days.



### A Short-Cut to Popularity

In a flash I realized that if anyone could correct my faults and make me a polished, up-to-date dancer it was Arthur Murray, the famous dancing instructor, whom I had so often read about. Oh, if I had only written to him before. But it wasn't too late, I hoped. The very next day I sent for his "Learn At Home" course. The simple instructions worked marvels for me. In a few short evenings I had learned many of the very late steps and within a month every one admitted that I was as finished a dancer as the best of them.

### Learn to Dance at Home

This story is typical and it shows you just the chance you've been looking for—a chance to become an accomplished dancer right in your own home at a small cost.

No matter how poorly you dance now—no matter if you've never been on a dance floor in your life—Arthur Murray's new method makes you a finished dancer in ten days or you don't have to pay a penny for the lessons. You can learn right in your own room without music or partner.

Just think! In ten days' time you'll be able to do the Charleston, the Valencia, the French Tango, the Ritz Fox Trot, the Debutante Waltz, and all the other smart new steps.

### Five Lessons FREE

To prove that Arthur Murray can make you a finished dancer in ten days' time, he is willing to send you five lessons from his remarkable course absolutely free. Just send the coupon (with 10c to cover cost of printing and mailing) and these valuable lessons will be forwarded at once. Also a free copy of his new book, "The Short Cut to Popularity."

Don't wait. Mail this coupon NOW. Arthur Murray, Studio 724, 7 East 43rd Street, New York City.

Arthur Murray, Studio 724,  
7 East 43rd Street, New York City.

To prove that I can learn to dance at home in ten days you may send the FIVE FREE LESSONS. I enclose 10c (stamps or coin) to pay for the postage, printing, etc. You are to include free "The Short Cut to Popularity."

Name .....

Address .....

City ..... State .....

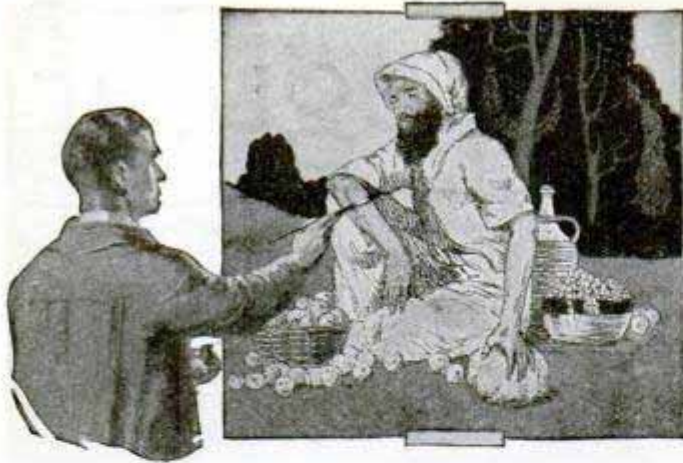

# DRAWING is a way to FORTUNE

ALI HAFED, a Persian farmer, sold his acres to go out and seek his fortune. He who bought the farm found it contained a diamond mine which made him fabulously rich. Ali Hafed overlooked the great opportunity at his door to go far afield in search of wealth—which illustrates a great truth.

## Do You Like to Draw?

If you do, it is almost certain that you have talent, a talent which few possess. Then don't follow Ali Hafed's example and look further for fortune. Develop your talent—your fortune lies in your hand!

## Earn \$200 to \$500 a Month and More

Present splendid opportunities in the field of illustrating never excelled. Publishers buy millions of dollars' worth of illustrations every year. Illustrating is the highest type of art and it is fascinating as well as profitable.

The Federal Course includes illustrating, cartooning, lettering, poster designing, window card illustrating, etc. No one artist is competent to give instruction in all these branches. That's why the Federal School has established its "Master Course," in which every subject is written by a specialist. No other School can offer a course nearly comparable. No other institution in the country has such an array of artists as are on the Federal Staff.

## Federal Course Gets Results

Its authors include such nationally known artists as Sid Smith, Neysa McMein, Fontaine Fox, Charles Livingston Bull, Clare Briggs, Norman Rockwell and over fifty others. Exclusive lessons and drawings especially prepared by them are included in the Federal Home Study Course. They guide you from simple sketches to complex illustrations having a high market value.

Mail in the coupon below today and we will send you our free illustrated booklet, "A Road to Bigger Things."



# Federal School of Illustrating

Federal School of Illustrating,  
8137 Federal School Bldg., Minneapolis, Minn.

Name.....Age.....  
Occupation.....  
Address.....

# OPPORTUNITIES IN Traffic Management

## Become a Traffic Expert

The opportunities in traffic management are limited only by the boundaries of the business world. The trained traffic man is in demand by transportation systems and by industrial organizations.

## Three Detroit Firms Pay Their Traffic Managers Over \$20,000 a Year

Prepare for this growing, profitable profession at home in your spare time under supervision of traffic experts. Low cost; easy terms. Thru the LaSalle Problem Method you learn by doing. Valuable 64-page booklet free. Send for it Now.

LaSalle Extension University, Dept. 864-T Chicago



This Book  
**FREE!**

## Write for this FREE SERVICE

### Before Choosing a School

Help—guidance—counsel. Anything and everything you want to know about schools in any part of the country is now made available to you without cost by the educational department of a great national magazine.

Advantages . . . special features . . . ratings . . . that show you why one school is better fitted to meet your individual requirements than another. Free information . . . facts that solve for you the perplexing problem of choosing a school. Write today, giving past education, type of school desired, location, etc. There is absolutely no cost to you. Address

The Director, Educational Dept.  
The Red Book Magazine A-420 Lexington Ave.  
NEW YORK CITY

# LEARN MECHANICAL DENTISTRY



making crowns, plates, bridges, etc. for dentists. Unusual demand now and always will be—a human necessity. Steady, dignified Professional Trade. Three to six months training. Easily learned by actual practice. R. R. Fare to nearest school included. Regular arrangement for part time positions to help pay expenses. Ask for Catalog No. 2.

**BODEE DENTAL INSTITUTE**  
New York 1755 Broadway Philadelphia 1305 North Broad Street Brooklyn 85 Court Street

# LEARN WATCH REPAIRING

Be a watchmaker—you can learn this profitable trade by correspondence in a few weeks in your own home by the DeSelms Chart System. After you complete the course you will know a watch from A to Z. You will know just what the matter is and how to repair one. When you graduate you will be a practical watchmaker and repairer and competent to fill any position. Positions for our graduates. Ask for our Free Book. It explains our system and terms.



**THE DeSELMS WATCH SCHOOL**  
LOGANSFORT, INDIANA

# GOV'T. POSITIONS

\$35 TO \$75 WEEKLY

- ( ) Railway Mail Clerk ( ) Meat Inspector
- ( ) P. O. Clerk ( ) Special Agent (Investigator)
- ( ) Forest Ranger ( ) Stenographer-Typist
- ( ) File Clerk ( ) Immigrant Inspector
- ( ) Matron ( ) City Mail Carrier
- ( ) General Clerk ( ) U. S. Border Patrol
- ( ) Chauffeur-Carrier ( ) Typist
- ( ) Skilled Laborer ( ) Seamstress
- ( ) Watchman ( ) Steno-Secretary
- ( ) Postmaster ( ) Auditor
- ( ) RFD Carrier

Mr. Ozment, Dept. 111, St. Louis, Mo.  
Send me particulars about positions marked "X"—salaries, locations, opportunities, etc.

NAME.....  
ADDRESS.....

# Easy as A-B-C !

**You Can Play Any Instrument  
In a Few Months  
This Delightful  
New Easy Way!**

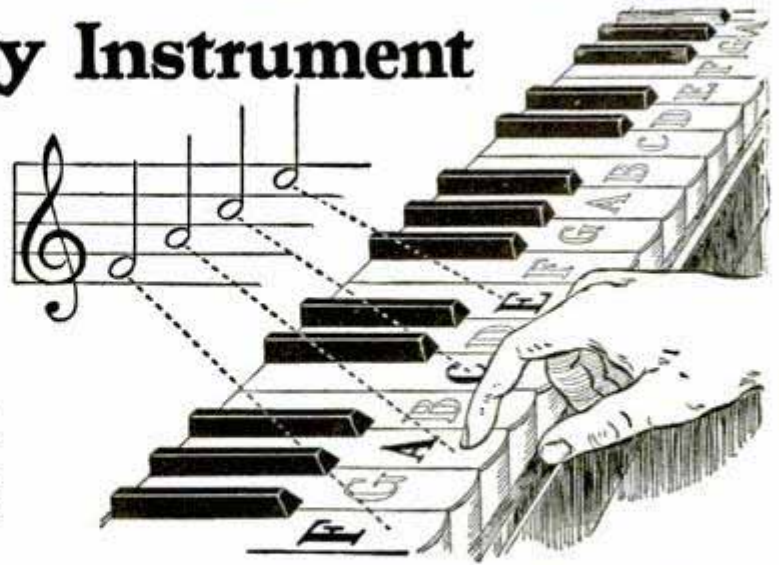

**Quickest because natural and pleasant. Grateful students say they learn in a fraction of the time old dull methods required. You play direct from the notes. And the cost averages only a few cents a lesson!**

Learning music is no longer a difficult task. If you can read the alphabet, you can now quickly learn to play your favorite instrument! A delightful new method has made it positively easy to become a capable performer within just a few months. And the cost is only a *fraction* of what people used to spend on the old, slow methods!

You don't need a private teacher, this new way. You study entirely at home, in the privacy of your own room, with no one to interrupt or embarrass you. And, strange as it may seem, you'll enjoy every minute of it—because the new method is *agreeable* as well as *rapid!*

### No Tricks or Stunts—You Learn from "Regular" Music

You don't have to know the first thing about music in order to begin. You learn to play from actual notes, just like the best musicians do. And almost before you realize your progress, you begin playing real tunes and melodies instead of just scales. There are no "trick numbers," no "memory stunts." When you finish the U. S. School of Music course you can pick up any piece of regular printed music and understand it! You'll be able to read music, popular and classic, and play it from the notes. You'll acquire a life-long ability to please your friends, amuse yourself, and, if you like, make money (musicians are highly paid for their pleasant work).

Whether you like the piano, violin, 'cello, organ, saxophone, or any other instrument, you can now learn to play it in an amazingly short time. By means of this wonderful newly perfected method reading and playing music is made almost as simple as reading aloud from a book. You simply can't go wrong. First, you are told how a thing is done, then a picture shows you how, then you do it yourself and hear it. No private teacher could make it any clearer. The lessons come to you by mail at regular intervals. They consist of complete printed instructions, diagrams, all the music you need, and music paper for writing out test exercises. And if anything comes up which is not *entirely plain*, you can write to your instructor and get a full, prompt, personal reply!

### The Surest Way To Be Popular and Have a Good Time

Do you sit "on the sidelines" at a party? Are you out of it because you can't play? Many, many people are! It's the musician who claims attention. If you play you are always in demand. Many invitations come to you. Amateur orchestras offer you wonderful afternoons and evenings. And you meet the kind of people you have always wanted to know. So don't miss this exceptional opportunity.

Learn to Play by Note	
Piano	'Cello
Organ	Harmony and Composition
Violin	Sight Singing
Drums and Traps	Guitar
Banjo	Ukulele
Plectrum (5-String or Tenor)	Hawaiian Steel Guitar
Mandolin	Harp
Clarinet	Cornet
Flute	Piccolo
	Trombone
	Saxophone
	Voice and Speech Culture
	Automatic Finger Control
	Piano Accordion

### Free Book Explains All Get This Special Offer

The whole interesting story about the U. S. School course cannot be told on this page. So a booklet has been printed—"Music Lessons in Your Own Home." You can have a copy absolutely free by mailing the coupon below. In the booklet you will find an offer that makes the U. S. course available to you at a very low price. With it will be sent a demonstration lesson which shows better than words how delightfully quick and easy this wonderful Method is. If you are really anxious to become a good player on your favorite instrument, mail the coupon now—today. Instruments supplied when needed, cash or credit. U. S. School of Music, 78 Brunswick Bldg., New York City.

U. S. SCHOOL OF MUSIC,  
78 Brunswick Building, New York City.

Please send me your free book, "Music Lessons in Your Own Home," with introduction by Dr. Frank Crane, Demonstration Lesson, and particulars of your offer. I am interested in the following course:

Have you  
..... Instr? .....

Name.....

Address.....

City..... State.....



# High School Course in Two Years!

## You Want to Earn Big Money!

And you will not be satisfied unless you earn steady promotion. But are you prepared for the job ahead of you? Do you measure up to the standard that insures success? For a more responsible position a fairly good education is necessary. To write a sensible business letter, to prepare estimates, to figure cost and to compute interest, you must have a certain amount of preparation. All this you must be able to do before you will earn promotion. Many business houses hire no men whose general knowledge is not equal to a high school course. Why? Because big business refuses to burden itself with men who are barred from promotion by the lack of elementary education.

### Can You Qualify for a Better Position

We have a plan whereby you can. We can give you a complete but simplified high school course in two years, giving you all the essentials that form the foundation of practical business. It will prepare you to hold your own where competition is keen and exacting. Do not doubt your ability, but make up your mind to it and you will soon have the requirements that will bring you success and big money. **YOU CAN DO IT.**

Let us show you how to get on the road to success. It will not cost you a single working hour. Write today. It costs you nothing but a stamp.

### American School

Dept. HC-74, Drexel Ave. and 58th St., Chicago

### American School

Dept. HC-74, Drexel Ave. and 58th St., Chicago

Send me full information on the subject checked and how you will help me win success.

- |                             |                           |
|-----------------------------|---------------------------|
| ....Architect               | ....Business Law          |
| ....Building Contractor     | ....Lawyer                |
| ....Automobile Engineer     | ....Machine Shop Practice |
| ....Automobile Repairman    | ....Mechanical Engineer   |
| ....Civil Engineer          | ....Shop Superintendent   |
| ....Structural Engineer     | ....Employment Manager    |
| ....Business Manager        | ....Steam Engineer        |
| ....Cert. Public Accountant | ....Foremanship           |
| ....Accountant and Auditor  | ....Sanitary Engineer     |
| ....Bookkeeper              | ....Surveyor (& Mapping)  |
| ....Draftsman and Designer  | ....Telephone Engineer    |
| ....Electrical Engineer     | ....Telegraph Engineer    |
| ....Electric Light & Power  | ....High School Graduate  |
| ....General Education       | ....Wireless Radio        |
| ....Vocational Guidance     | ....Undecided             |

Name.....

Address.....

## Don't Envy The Plumber BE ONE!

**\$11.00-\$16.00 PER DAY** and work **EVERY day**, is the Plumber's wage.

Every skilled workman will tell you that Plumbers have the best of it. WINTER and SUMMER the Plumber is busy at top wages. No skilled Plumber is ever out of a job—compare his opportunities with any trade, plus the opportunities of having your own shop.

We teach you Plumbing with **TOOLS** (not books) under Licensed Master **PLUMBERS** in one of the finest equipped schools in America. We make you a Plumber, every branch is taught thoroughly—Lead Work—Blue Print for plan reading—all other tricks.

**LEARN IN 8 to 12 WEEKS** without previous experience.

If you are making less than \$50.00 a week you owe it to yourself to investigate. Get **FREE** catalog that tells in pictures and words how we teach this trade. Special rates now.

**UNIVERSAL PLUMBING SCHOOL**  
2030 Troost Ave. KANSAS CITY, MO.

## Learn to PAINT SIGNS and SHOW CARDS

We quickly teach you by mail, or at school, in spare time. Enormous demand. Big future. Interesting work. Oldest, foremost school. **EARN \$50 TO \$200 WEEKLY**  
John Vassos, N. Y., gets \$25 for single show card. Crawford, B. C., says: "Earned \$200 while taking course." Send today for free information, samples and guarantee.



**DETROIT SCHOOL OF LETTERING**  
150 Stinson Ave. Est. 1899 Detroit, Mich.

## LEARN WATCH REPAIRING



You can learn by our modern and original system of instruction every part of the **Watch Repairing Trade** at home as good or better than at a shop. You can earn money while learning and secure a well paying position or start in business after completing our course of instruction. Good watch repairers are always in demand and earn from \$50 to \$75 per week. For particulars apply to the **Wisconsin School of Watch Repairing** 166 Mason St. MILWAUKEE, WIS.

## MUSIC LESSONS IN YOUR HOME



Write today for our **FREE booklet**. It tells how to learn to play Piano, Organ, Violin, Mandolin, Guitar, Banjo, etc. Beginners or advanced players. Your only expense about 2c per day for music and postage used. **American School of Music** 51 Manhattan Bldg., Chicago

## BE AN ARTIST

WE CAN TEACH YOU DRAWING in your own home during your spare time. Twenty-five years of successful teaching proves our ability. Artists receive large salaries. Write Today for Art Year Book



**SCHOOL OF APPLIED ART**  
ROOM NO. 2 BATTLE CREEK MICH.

## IF YOU STAMMER

Write for my free book "Millard's Advanced Natural Corrective Course" and a free copy of my speech magazine. 10,000 cases successfully treated. Est. 24 years. Largest school for stammerers in world. Millard Inst. of Normal Speech, 2317 Millard Bldg., Milwaukee, Wis.

## Learn Photography at HOME

Earn \$3000 to \$10,000 a year. Prepare quickly during spare time. Also earn while you learn. New easy method. Nothing else like it. Send at once for free book, "Opportunities in Modern Photography" and full particulars. Special offer open now.

**AMERICAN SCHOOL OF PHOTOGRAPHY**  
Dept. 135-C 3601 Michigan Ave. Chicago, U. S. A.



# Blue Print Plans

## and 24 Page Book

### "How to Read Blue Prints"

## Sent FREE

Our gift to every man in the building game. Sent absolutely free. For we want you to see for yourself . . . at our expense how easily and quickly you learn to read blue prints . . . and can get the knowledge that will make you more money. Don't send a penny. Just mail the coupon.

### The Book Tells How

"How to Read Blue Prints" is written in plain, every day English. It is easy to understand . . . and will prove to you immediately how quickly you can get the training that has given other men the chance to work with their heads . . . and to make more money than just the wage scale.

We know this is true. For 22 years we have been training men . . . in their spare time, at home . . . to advance and succeed in the building field. Many have now got good contracting or building businesses of their own. Many are salaried men, foremen or superintendents.

This book is really a Free Trial Lesson in Plan Reading . . . written by a practical building expert. It costs you nothing . . . will teach you how to read Blue Prints . . . and may point the way for you to big money. It will show you how easy our instruction is . . . how quickly you can become an expert . . . can get the practical knowledge that you must have to get ahead quick.

### Another Book FREE

We will send you also a book about the Chicago Technical School for Builders. It is free, too. It tells you all about our method of training by correspondence. It shows you how you can make your spare time pay you a handsome profit in a very short while. It tells all about our practical instructors . . . shows every branch and department of our Builder's Courses . . . gives you photo-

graphs of our men and departments . . . tells what others have done and what you can expect to do.

Chicago Technical School for Builders is one of the oldest and best equipped schools of its kind in America. Many big builders owe their first steps to success to our training. Hundreds of practical men from the building trades attend our day and evening classes at our school for builders here in Chicago. You get this same training . . . from the same practical instructors . . . in your own home by mail.

### Train by Mail

Go right on with your work. Your spare time . . . as little or as much as you wish . . . is all you need. Our practical lessons and actual blue print building plans come to you by mail. And the cost is little.

Send the coupon . . . today. It will bring you, with the free Blue Print Plans and the two books, full information about the Chicago Technical School for Builders. Shows what we have done for hundreds of other men, gives the facts about their success. Tells how some became superintendents in a few months. How others established contracting businesses of their own. Gives all details of this practical builder's course with descriptions, photographs and illustrations.

Start now. It costs you nothing to find out what this practical builder's course is . . . and what it can do for you. If you want to make more money in the building game . . . get the facts about the Chicago Technical School for Builders.

### Mail the Coupon—NOW

#### CHICAGO TECHNICAL SCHOOL FOR BUILDERS

Dept. K-140 Chicago Tech. Bldg.,  
116 East 26th St., Chicago, Ill.

Please send me your Free Books and Blue Prints for men in the Building Trades. Send postpaid to my address below. It is understood that no salesman will call on me.

Name.....

Address.....

City.....State.....

### You Can Become a Building Expert

**Plan Reading.** Every man who has got very far ahead in any building trade can read blue prints. No man can expect to be a first rate foreman or superintendent until he knows what every line on a plan means and how to lay out and direct work from the architect's plans. By the Chicago Tech. method you quickly learn to read any plan as easily as you read these words.

**Estimating.** Of course a man who wants to be a contractor or to hold a big job in a contracting organization must know how to figure costs of labor, material, and everything else that goes into any kind of building. The Chicago Tech. Course covers every detail of this important branch—shows you just how it is done from actual blue print plans.

**Superintending.** How to hire and direct men, how to keep track of every detail of construction as it goes on, how to get the work done in the least time at the lowest cost is also fully covered in the Chicago Tech. Builders' Course.

Also special courses in Architectural Drafting for builders, taught by practical men. These explained in Special Catalog "D" sent on request.

## CHICAGO TECHNICAL SCHOOL FOR BUILDERS

CHICAGO TECH. BUILDING

Dept. K-140, 116 E. 26th St., CHICAGO, ILL.

# Make That Dream Come True!

Haven't you often pictured yourself playing the Hawaiian Guitar, a happy crowd around you, everybody enjoying and admiring your playing? Now you can reach your goal—and play all the latest hits just as the Hawaiians do!



You can play the **HAWAIIAN GUITAR** just like the Hawaiians!

**\$15**  
**HAWAIIAN GUITAR**  
with Genuine Seal Grain  
**Fabrikoid Cover**  
**GIVEN**

when you enroll



Get the advantage of expert instruction by Kolomoku, Kalaluki, Ferera and Seville—every one famous as both player and teacher. Even if you never touched a musical instrument in your life, under their direction you make rapid headway—you will be astonished when you see how easy it is!

**This Sweet Toned Hawaiian Guitar**

in genuine Fabrikoid Case—and complete playing outfit including picks, steel playing bar, etc.; given you when you enroll. Retailers ask \$15 or more for a similar outfit without the case. Remember, there are no extra—we furnish everything with the course.

**Learn in Spare Time**

Pick up your guitar at any time and play. Your lessons are always handy—you can always refer to them. You are never hurried or forced. And no waiting for a class to form—start now—go ahead as fast as you like.

**Pay as You Play**

Small first payment starts you. And the entire 52-lesson course comes to just a few cents a lesson! Begin now.

**We Guarantee**

in writing to teach you. And after graduation we coach and advise you without charge. Over 45,000 successful graduates.

**Tenor Banjo** and other courses—Violin, Tiple, Tenor Guitar, Banjo Ukulele, Ukulele—under well-known instructors. Write for information.

**FIRST HAWAIIAN CONSERVATORY OF MUSIC, INC.**  
9th Fl., Woolworth Bldg., Dept. 348, New York, N. Y.

Approved as a Correspondence School Under the Laws of the State of New York

**SEND THIS COUPON FOR LIBERAL OFFER!**

First Hawaiian Conservatory of Music, Inc.  
9th Fl., Woolworth Bldg., Dept. 348, New York, N. Y.

Please mail full information about your 52-lesson Hawaiian Guitar Course. I am not obliged to enroll unless I want to.

Name \_\_\_\_\_  
Address \_\_\_\_\_  
City \_\_\_\_\_ State \_\_\_\_\_

**Complete Conservatory Course**

52 complete lessons. Pictures explain every move. Our method is simple, practical and interesting—only 4 motions to learn. No tiresome scales and exercises—you play a real piece your very first lesson.

**Expert Instruction by Native Hawaiians**



# PREPARE FOR AN ART CAREER

—thru the only school operated as a department of a large art organization. Commercial Artists trained the "Meyer Both Way" earn as high as \$10,000 per year. We today have hundreds of students who had previously studied art elsewhere. Why? Because your instruction is based upon our everyday experience in meeting the art needs of leading advertisers. Home study instruction. Write for illustrated book telling of the success of our students.

**MEYER BOTH COMPANY**  
Michigan Ave. at 20th St., Dept. 16, Chicago, Ill.

*Learn to Write*



**I Teach by Mail**

Begin Today — Write for My FREE Book. I can make a good penman of you at home during spare time. Write for my FREE BOOK, "How to Become a Good Penman." It contains specimens and tells how others mastered penmanship by the Tamblin System. Your name will be elegantly written on a card if you enclose stamp to pay postage. Write today for book.  
F. W. Tamblin, 418 Ridge Bldg., Kansas City, U.S.A.

**MEN WANTED TO LEARN**

**Motion Picture Projection**

\$2,000 to \$4,000 a Year

Quickly learned. Short hours, big pay. Best equipped school in Michigan. Projectionists for Movie Houses and Road Shows.

**MOVIE OPERATORS SCHOOL**

61 Sproat Street, DETROIT, MICHIGAN

*Raise Poultry* **MAKE BIG MONEY**

**Results Quick—Part or Full Time**

Take up poultry raising. It's interesting, healthful, PROFITABLE. Easy to sell all you can produce at big prices. Our new course by Henry M. Lamon, former gov't expert, gives short cuts to success. Write for free book, "How to Raise Poultry for Profit."

NATIONAL POULTRY INSTITUTE, Dept. 411, Washington, D. C.

**LAW High-Grade Instruction By Correspondence Prepares You for the Bar—Est. 1892**

University Methods. Standard Text-Books. Approved by Bench and Bar. Graduates practicing in every state. Send today for Free Catalog and Rules for Admission to the Bar. CHICAGO SCHOOL OF LAW, 802 Reaper Block, Chicago, Ill.



**Learn Watchwork, Jewelrywork and Engraving**

A fine trade commanding a good salary, and your services always in demand. Address **Horological**, Dept. P, Bradley Institute, PEORIA, ILLINOIS, for our latest catalog.

No Joke to **STAMMER**  
Be successful. Master perfect speech. Win happiness. Send for full information and special phonograph record. Dime covers postage.  
153 Stimson, The Lewis Institute, Detroit





# NOW Boys <sup>earn</sup> Men's Wages

\$75<sup>00</sup> to \$125<sup>00</sup> Weekly, Paid to

# AUTO MECHANICS

Why go on begging for a raise? Why growl and complain because you don't get it? Why, when every city, town and farming community is pleading for more auto and tractor mechanics — trained as McSweeney students are trained, to know cars of every make and to know them "inside out"?

Every month my men are taking fine jobs formerly filled by half-trained students or half-baked, self-trained mechanical tinkers.

## I Train You in 8 Weeks

Think of it! Working with real tools on real equipment you become in only EIGHT WEEKS a better auto mechanic than men who have "fiddled" around an ordinary garage

for years trying to learn. Let me send you the proof, letters from former McSweeney students now earning up to \$10,000 a year. "Mac's SHOP WAY Means Bigger Pay."

## Your Money Back Guaranteed

If, when you have finished your training, you are not perfectly satisfied; if you are not qualified to fill a big pay job, I will re-

fund every cent of your tuition. There is a reason for my making such a convincing offer. Ask yourself why. Then write quick for my remarkable SPECIAL TUITION OFFER. Save one-third now. See what you yet:

## Special Offer Your Board for 8 Weeks and Your Railroad Fare

For a limited time only, and when you enroll, I will pay your railroad fare to Cincinnati or Cleveland and give you your board for 8 weeks. Send the coupon NOW—before it is too late—for full particulars of this amazing offer. Don't delay.



**McSWEENEY**  
AUTO, TRACTOR AND ELECTRICAL SCHOOLS  
CINCINNATI, OHIO CLEVELAND, OHIO

McSWEENEY Auto, Tractor and Dept. 14 TH Electrical SCHOOLS  
Cincinnati, Ohio, 654 McMillan St.  
Cleveland, Ohio

Please send your Special Offer and Big Illustrated Book.

Name .....

Address .....

City..... State.....

# AT HOME LEARN TELEGRAPHY AT HOME



TEACH YOURSELF in half usual time, at trifling cost, with the wonderful Automatic Transmitter, THE OMNIGRAPH. Sends unlimited Morse or Continental messages, at any speed, just as an expert operator would. Adopted by U. S. Government, and leading Universities, Colleges and Telegraph Schools. Catalog 6 cents. OMNIGRAPH MFG. CO., 13-19 Hudson St., NEW YORK



"BECOME A LIGHTNING TRICK CARTOONIST"  
Send \$1.00 for Laugh Producing Program of 23 Trick Drawings with Instructions. Catalog of Chalk Talk Supplies Free. BALDA ART SERVICE, Dept. 1, Oshkosh, Wis.

**NOW YOU CAN STUDY MUSIC AT HOME**

**earn \$75.00 to \$200.00 each week**

With a nationally famous artist as your teacher you can learn to play classical or popular music on your favorite instrument. We guarantee our personal teaching method. Both advanced and elementary courses.

Write for catalogue  
**CONN** NATIONAL SCHOOL OF MUSIC, INC.  
506 S. Wabash Ave., Dept. 516, Chicago

**FOREST RANGERS**  
Men wanting forest ranger, mail clerk, or other government positions, write for particulars.  
MOKANE, 236, DENVER, COLO.

# TRAVEL - for 'UNCLE SAM'

**RAILWAY POSTAL CLERKS**  
**MAIL CARRIERS—POSTOFFICE CLERKS**  
**\$1700 to \$2700 a Year for Life**

No "lay-offs" because of strikes, poor business, etc.—sure pay—rapid advancement. City and country residents stand same chance. Common sense education sufficient—no political influence.

**STEADY WORK**  
Cut coupon and mail it before turning the page.



**MEN—BOYS**  
**18 to 45**

Use Coupon Before You Lose It

**COUPON**

FRANKLIN INSTITUTE, Dept. M-173, Rochester, N. Y.  
Rush to me, entirely free of charge, (1) A full description of the position checked below; (2) 32-page book, with list of positions obtainable; (3) Free Sample coaching.

Railway Postal Clerk (\$1900 to \$2700)  Customs Positions (\$1140 to \$1860)  
 Postoffice Clerk (\$1700 to \$2300)  Prohibition Agent (\$1000 to \$3000)  
 City Mail Carrier (\$1700 to \$2100)  Rural Mail Carrier (\$2100 to \$3300)

Name .....

Address .....



## "Four Raises in Two Years"

"AND it hasn't been hard to get them, either. Why, it seems only yesterday that I was wondering if I would ever make as much as \$45 a week. And now I'm making \$75.

"Tom Dawson was speaking about it today. 'Gee,' he said, 'I wish I had started studying with the I. C. S. when you did. Here I am plugging away at the same old job and the same old salary while you've gone 'way up.'

"I told him it wasn't too late and he said he was going to send in the I. C. S. coupon right away.

"I hope he does, because an I. C. S. course is the very thing he needs to get out of the rut. I wouldn't be making anywhere near \$75 a week if I hadn't started to study just when I did."

How much longer are you going to wait before you take the step that will bring you advancement and more money? To earn more you've got to learn more. And to learn more you've got to study in that hour after supper that most men throw away.

One hour a day, spent with the International Correspondence Schools in the quiet of your own home, will prepare you for the position you want in the work you like best.

### Mail the Coupon for Free Booklet

INTERNATIONAL CORRESPONDENCE SCHOOLS  
Box 5665-E, Scranton, Penna.

Without cost or obligation, please send me a copy of your booklet, "Who Wins and Why," and full particulars about the course before which I have marked X in the list below:

#### BUSINESS TRAINING COURSES

- |  |   |
|--|---|
| <input type="checkbox"/> Business Management                     | <input type="checkbox"/> Salesmanship                                     |
| <input type="checkbox"/> Industrial Management                   | <input type="checkbox"/> Advertising                                      |
| <input type="checkbox"/> Personnel Organization                  | <input type="checkbox"/> Better Letters                                   |
| <input type="checkbox"/> Traffic Management                      | <input type="checkbox"/> Show Card Lettering                              |
| <input type="checkbox"/> Business Law                            | <input type="checkbox"/> Stenography and Typing                           |
| <input type="checkbox"/> Banking and Finance Management          | <input type="checkbox"/> English  |
| <input type="checkbox"/> Accountancy (including C.P.A.)          | <input type="checkbox"/> Civil Service                                    |
| <input type="checkbox"/> Cost Accounting                         | <input type="checkbox"/> Railway Mail Clerk                               |
| <input type="checkbox"/> Bookkeeping                             | <input type="checkbox"/> Common School Subjects                           |
| <input type="checkbox"/> Private Secretary                       | <input type="checkbox"/> High School Subjects                             |
| <input type="checkbox"/> Spanish <input type="checkbox"/> French | <input type="checkbox"/> Illustrating <input type="checkbox"/> Cartooning |

#### TECHNICAL AND INDUSTRIAL COURSES

- |   |  |
|---|--|
| <input type="checkbox"/> Electrical Engineering                     | <input type="checkbox"/> Architect                                       |
| <input type="checkbox"/> Electric Lighting                          | <input type="checkbox"/> Architects' Blueprints                          |
| <input type="checkbox"/> Mechanical Engineer                        | <input type="checkbox"/> Contractor and Builder                          |
| <input type="checkbox"/> Mechanical Draftsman                       | <input type="checkbox"/> Architectural Draftsman                         |
| <input type="checkbox"/> Machine Shop Practice                      | <input type="checkbox"/> Concrete Builder                                |
| <input type="checkbox"/> Railroad Positions                         | <input type="checkbox"/> Structural Engineer                             |
| <input type="checkbox"/> Gas Engine Operating                       | <input type="checkbox"/> Chemistry <input type="checkbox"/> Pharmacy     |
| <input type="checkbox"/> Civil Engineer                             | <input type="checkbox"/> Automobile Work                                 |
| <input type="checkbox"/> Surveying and Mapping                      | <input type="checkbox"/> Airplane Engines                                |
| <input type="checkbox"/> Metallurgy <input type="checkbox"/> Mining | <input type="checkbox"/> Agriculture <input type="checkbox"/> Navigation |
| <input type="checkbox"/> Steam Engineering                          | <input type="checkbox"/> Mathematics <input type="checkbox"/> Radio      |

Name.....

Street Address.....

City..... State.....

Occupation.....

Persons residing in Canada should send this coupon to the International Correspondence Schools Canadian, Limited, Montreal, Canada



## Electrical Trades/ Need Men

**LEARN** Automobile Starting, Lighting, Ignition; Storage Batteries, Armature Winding, House Wiring, Farm Lighting, Electric Welding, Electric Refrigeration, A. C. and D. C. Motors, Power and Light Switchboards, Radio.

**EARN** \$200 to \$400 monthly. \$320,000,-000 paid in wages to electrical workers in U. S. last year. Get your name on the payroll this year. Easy to learn by actual work on real equipment.

**FREE BOOK**--Write today for book which explains the Coleman System of ten week courses.

**WM. H. COLEMAN, President**

**Coleman Electrical School**  
1628E MAIN ST., KANSAS CITY, MO.

# LAW

STUDY AT HOME  
Become a lawyer. Legally trained men win high positions and big success in business and public life. Be Independent. Greater opportunities now than ever before. Big corporations are headed by men with legal training. Earn \$5,000 to \$10,000 Annually. We guide you step by step. You can train at home during spare time. Degree of LL.B. conferred. LaSalle students found among practicing attorneys of every state. We furnish all text material, including fourteen-volume Law Library. Low cost, easy terms. Get our valuable 108-page "Law Guide" and "Evidence" books FREE. Send for them NOW. LaSalle Extension University, Dept 864-L, Chicago. The World's Largest Business Training Institution

## "STAMMERING Its Cause and Cure"

You can be quickly cured if you stammer. Send 10 cents, coin or stamps, for 288 page cloth bound book on Stammering and Stuttering. It tells how I cured myself after Stammering and Stuttering for 20 years. BENJAMIN N. BOGUE  
6946 Bogue Building, 1147 N. Ill. St. Indianapolis

## Earn \$75 Weekly Building Radio Sets

Join the Association! We train you to build and repair radio sets--start you in business--enable you to earn \$3 an hour upwards. **Free 5-Tube Radio Set to Members.** Write for special limited-time plan whereby your membership need not cost you a cent. Write today!

**RADIO ASSOCIATION OF AMERICA**  
Dept. PM-8 4513 Ravenswood Ave., Chicago, Ill.



### PLAY PIANO BY EAR

Master Jazz or Ragtime in 90 days by famous Niagara Method. 35,000 pupils. Big, established school. Certificate given on graduation. Send dime Today for booklets: "Entertaining at Piano" and "The Niagara Secret" Niagara School of Music, Dept. D, Niagara Falls, N.Y.

## 30 Days' Free Trial

New Models now ready for delivery direct from our factory. Astonishing low prices and terms. Do not buy until you get them.

**RIDER AGENTS WANTED** to ride and exhibit sample. Make big money. Many models \$21.50 up. Guaranteed \$1.50 each, wheels, lamps, horns, equipment at half usual prices. Send No Money. Write for our marvelous prices and terms on RANGER Bicycles.

**Mead CYCLE CO. Dept. L110 CHICAGO**



# Skin Troubles

Cleared up--often in 24 hours. To prove you can be rid of Pimples, Blackheads, Acne Eruptions on the face or body, Barbers' Itch, Eczema, Enlarged Pores, Oily or Shiny Skin, simply send me your name and address today--no cost--no obligation. **CLEAR-TONE** tried and tested in over 100,000 cases--used like toilet water--is simply magical in prompt results. You can repay the favor by telling your friends; if not, the loss is mine. **WRITE TODAY.**

**E. S. GIVENS, 428 Chemical Bldg., Kansas City, Mo.**

# Oh You Skinny!

## Are You Laughed At On The Beach ?



**STRONGFORT**  
**Builder of Men**

### I Want To Send You MY FREE BOOK

This book of many pages and dozens of pictures tells of my wonderful experience—how I became the outstanding athlete of the world, performing feats others dared not attempt; how I turned the knowledge gained through developing my own body to the benefit of others, and then how STRONGFORTISM was evolved. It tells what I have done for others, what I can do for you. It doesn't mince words. It tells plain truths. "Promotion and Conservation of Health, Strength and Mental Energy," points the way from disease and weakness to health and strength. It is priceless. I'll send it to you on request—FREE. Write for your copy today.

**STRONGFORT INSTITUTE**  
**LIONEL STRONGFORT, DIRECTOR.**  
*Physical and Health Specialist*  
DEPT. 360 NEWARK, NEW JERSEY, U. S. A.

Are you a puny, bony, skinny outfit at whom everybody laughs? Are you a curiosity on the beach, inviting all sorts of ridicule? Do girls titter as you pass them? Do they shun your society? If this is your sorry plight, young fellow, just take a hunch from me—snap out of your skinniness—put on flesh and muscle, build up strength and straighten up your back. **YOU CAN DO IT.** You can be a duplicate of that bronzed and much admired life-guard over whom the girls rave. You can develop a symmetrical form, rounded out chest, rippling muscles on your arms and legs. You can be a powerful swimmer, a graceful dancer, a peppy boxer, a swift runner—just what you'd like to be.

### Let **STRONGFORT** Make a Man of You

I've taken thousands of young fellows, skinny as a lath, and built them up into strapping, powerful men who commanded respect and admiration wherever they went. Some of these chaps had set too fast a pace for themselves, others had wasted their vitality and broken down their health, and others had gone stale from neglect of their bodies. No matter how despondent their state of mind or how physically broken they were, they quickly came back when they adopted

## STRONGFORTISM

### The Science of Health and Strength

STRONGFORTISM works wonders with run-down, weakly, skinny men. It builds them up to health through internal muscular development, then rounds them out into robust physical specimens, by bringing into play every muscle and making every muscle do its work as Nature intended. You'll be astonished how quickly you'll feel the benefits of this best of all health and strength Courses. You'll feel like a new man almost from the first day you start under my instructions. You'll be surprised at the lazy muscles you wake-up when you begin, and they'll wake you up in turn. You'll quickly realize that a new day has dawned for you as you feel the red blood coursing through your whole body like a bounding mountain stream. That old, stupid, sluggish feeling will disappear like magic. That gloomy outlook will vanish as though a heavenly hand had brushed it away. Oh, it's a great feeling! Great to feel like a man! And you surely will when you adopt Strongfort as your instructor and guide—Strongfort, "the builder of men."

#### Send this **FREE Consultation Coupon** **ABSOLUTELY CONFIDENTIAL**

Mr. Lionel Strongfort, Strongfort Institute, Dept. 360, Newark, N. J.—Please send me absolutely free my copy of your book, "PROMOTION AND CONSERVATION OF HEALTH, STRENGTH AND MENTAL ENERGY." I am enclosing 10c (one dime) to help cover mailing expense, etc., and have marked (x) before the subjects in which I am most interested.

- |             |                 |                     |
|-------------|-----------------|---------------------|
| .. Catarrh  | .. Overweight   | .. Great Strength   |
| .. Colds    | .. Constipation | .. Lung Troubles    |
| .. Asthma   | .. Weak Back    | .. Round Shoulders  |
| .. Headache | .. Weak Eyes    | .. Stomach          |
| .. Rupture  | .. Rheumatism   | .. Disorders        |
| .. Thinness | .. Nervousness  | .. Increased Height |
| .. Pimples  | .. Short Breath | .. Muscular         |
| .. Insomnia | .. Weak Heart   | .. Development      |

Other Ailments.....

Name.....

Age..... Occupation.....

Street.....

City..... State.....



# IN DRAWING CARTOONS

Why spend your time doing work that is drudgery, and get little money for it when you may be able to draw cartoons for Big Pay? You can now learn cartooning at home with this simple, tested method. Many students earn money while learning.

Become a high-salaried cartoonist—one of the easiest, most pleasant, and best paid of all businesses. Millions of dollars spent last year on serious, comic, sport and animated cartoons—and the demand for cartoons increases every day! Hundreds of cartoons now used by big national advertisers.

## Learn Cartooning at Home In Spare Time—Simple, Tested Method

There is a knack about learning cartooning which you can master in your spare time with this simple home study method. It starts you at the very beginning—on simple fundamental principles—then takes you through every branch of humorous and serious cartooning. You will be surprised how quickly you can draw cartoons that will sell. Many earn even while learning.

### Send for Free Book

Get this handsomely illustrated booklet which gives the details of this remarkable home study course in Cartooning. Gives thorough outline of the cartooning field and market for cartoons. Shows how to become a cartoonist. No obligation. Send for it today. (No salesman will call.)

**Washington School of Cartooning**  
Room 308E, 1113—15th St., N. W., Washington, D. C.

Washington School of Cartooning  
Room 308E, 1113—15th St., N. W., Washington, D. C.

Please send me without obligation, your Free Booklet on Cartooning and full details of your home study method of teaching Cartooning.

Name.....  
(Write Name Plainly.) (State whether Mr., Miss or Mrs.)

Address.....

City..... State.....

# Win a Buick or \$1500.00 In Cash

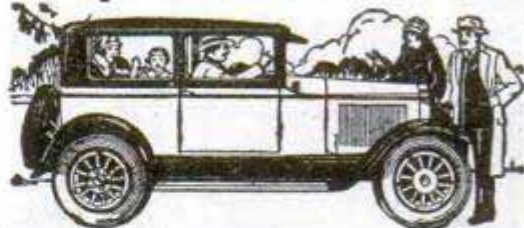

I am going to give away a brand new, latest model Buick Sedan to someone who answers this adv. We have already given away many autos. This is the most liberal offer ever made. It is your chance to win this ideal car. You can win it; why not try? The Sedan will be delivered to the winner, or winner may have the full cash value (\$1,195.00)!

## SOLVE THIS PUZZLE

2	21	93	11	79	22	5	14
---	----	----	----	----	----	---	----

Can you make out the two words spelled by the numbers in the squares above? The alphabet is numbered, A is 1, B is 2, etc. What are the two words? Send your answer today—not a cent of cost to you now or later.

## \$305 for Promptness

I will also give away a Chevrolet Coach, Orthophonic Victrola and many other valuable Prizes—besides hundreds of dollars in Cash—and \$305.00 Special Extra Prize for Promptness. First Prize winner will receive \$1,500.00 cash or Buick Sedan and \$305.00 cash. All who answer can share in cash and prizes. In case of ties the prizes will be duplicated. EVERYBODY REWARDED. Now, get out your pencil and solve the puzzle—send your answer today with name and address plainly written.

**WILLIAM LEROY,**  
Dept. C-177 315 So. Peoria St., Chicago, Ill.

## Be a Civil Engineer!

Learn  
at  
Home!



### Cyclopedia of Civil Engineering

9 great volumes.  
4000 pages.  
3000 illustrations.  
New edition just off the press, by twelve of America's greatest engineers. Includes: Surveying, bridges, railroads, steel structures, municipal engineering, water supply, road building, etc.

Earn  
\$5000  
a Year—and Up!

"CIVIL ENGINEERING"—in plain English written so you can understand it, even if you have only a limited education. Prepares you for a well-paid railroad structural or public works position. Covers every branch of Civil Engineering practice. At once a reading course for the ambitious student and an authoritative reference work for the experienced engineer. Borrow a set—free. Look over the test questions which help you master each subject quickly. Mail the coupon without obligation today!

**American Technical Society**  
Dept. C-C19 Chicago

## Loaned Free!

to prove you can learn Civil Engineering at home in your spare time. And because no description here could do it justice, to let you see for yourself the scope and simplicity, the authority and quality of this great home reading course. Cost and terms are within your reach. Send no money—just mail the coupon.

American Technical Society,  
Dept. C-C19, Chicago.

I want to BORROW the CIVIL ENGINEERING Cyclopedia for 15 days FREE. I will gladly pay the few cents express, but I am to pay nothing for the loan of the 9 big volumes if I return them within 15 days. If I wish to keep them I will send you \$2 after the 15 days, then \$3 a month until special advertising price, \$34.80, is paid.

Name.....

Address.....

(Attach letter stating age, occupation, employer's and references' names and addresses.)



# 30 Miles of BATHING BEACHES in CHICAGO

## Learn **ELECTRICITY** Here at GREER COLLEGE

### Railroad fare allowed—no extra cost

Why not enjoy life while you train for life's biggest job? Learn Electricity. Learn it now. Learn it here—at Greer College—in Chicago, the world's greatest vacation city.

Thirty miles of bathing beaches to take the edge off your day's electrical work among our hundreds of motors, rotary converters, generators, telephone and radio equipments. Combine pleasure with educational profit. Leave here after twelve weeks equipped to start after the \$1 per hour to \$25,000 per year that electricity pays trained men.

We take mighty good care of you—help you find a place to live—help find a part-time job if you need one—and in other ways keep you from feeling like a stranger in a big city. Hundreds of fine men, all ages, already enrolled. You'll find them excellent companions, and perhaps lifetime friends or business associates.

Act fast if you want to get full information in time to enroll for new summer class. Your

name on coupon brings a big Free Book that answers all questions. Tells

how to get an allowance of railroad fare—how to save 37½% of regular cost by taking our Automobile Course along with Electricity. Greer Shops have trained over 60,000 men for better jobs. Come here for good training and fair treatment. And while you learn, enjoy life at Chicago's many summer playgrounds. Mail the coupon and learn all about our School, courses and Greer opportunity Now.

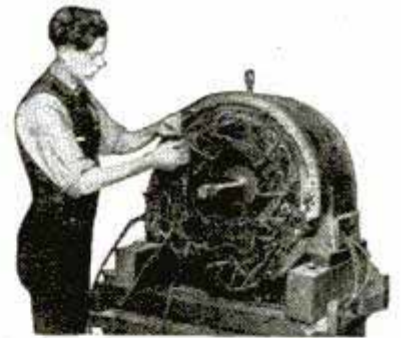

A 25 H. P. Motor for student practice

#### FREE Employment Service

Our employment department is ready to help you—while in training and for life. Day and evening classes. Low cost. Easy terms.

If unable to come to Chicago now for resident course, write for information about Home Study Course!

# GREER

## College of Electrical Engineering

Dept. 801

2024 S. Wabash Avenue

## CHICAGO, ILLINOIS

ERWIN GREER, President, Greer College  
Dept. 801, 2024 S. Wabash Ave., CHICAGO.

Please send me your FREE BOOK and offer for  Electrical  Automotive course  
It is understood I am not obligated in any way

Name .....

Address .....



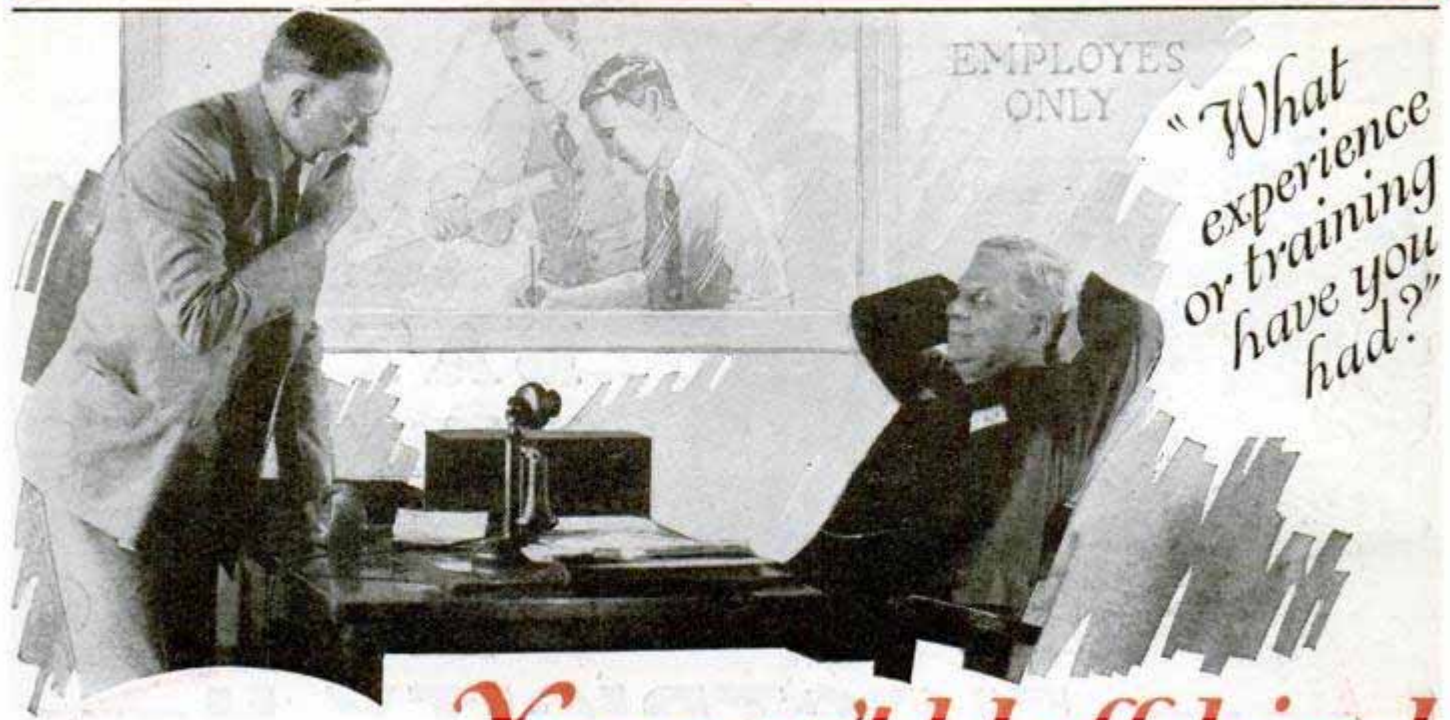

## Go Into DRAFTING!

Drafting has become a fundamental, ESSENTIAL profession. It is the motive-power underlying all building construction, all engineering, all manufacturing, all public-works. No man can get very far in any of these fields without knowing how to make and read PLANS. Destroy all blue prints, and you will throw thirty million men out of work and stop all the wheels of commerce and transportation — until new plans could be made.

Drafting is fascinating work that grips you in a way no other work can. And you'll like the good-natured atmosphere of a Drafting office, and you'll enjoy the friendship of the fine class of men employed there.

## Learn at Home, In Spare Time!

Drafting is easy to learn by our one - step - at - a - time JOB METHOD. We give you actual Drafting-room jobs to do. And we've figured out how to present them so you can't merely COPY them. For "copying" makes TRACERS and our system develops REAL DRAFTSMEN.

There's a tremendous demand for expert Draftsmen today in the booming building field. In the great automotive industry. In the ten-billion dollar electrical business. In all mechanical and manufacturing lines. By railroads, municipal, state and federal governments.

Drafting offers you the QUICK-EST WAY TO BIG PAY. It guarantees you rapid promotion, and a happy, prosperous and successful future.

# You can't bluff him!

The man who does the HIRING is usually a wise old bird. He's trained to buy EXPERT SERVICE and you can't sell him anything "just as good." He can spot a bluff a mile away and around the corner. He asks you FACTS, not fancies. "What experience have you had? Just what specialized training have you for this job? What proof can you show me of your fitness for this opportunity?"

## Face the Truth!

Compare what you have to offer the Employment Manager with what he demands. If you find you're short of the specialized skill he requires, better set about to get it, and then you'll find a warm welcome—for employers are always as eager to land a good man, as you are now to land a good job. And don't forget that men aren't hired on the "general education" they may claim. It's what you

have done to improve yourself after you left school that COUNTS MOST!

## That "June Terror"

Conditions are different than they were a few years ago. It's true enough that men you know were able to "get by" in the past with little education. But today you must fight better educated men in your battle for success. Remember this—each June you are shoved back half a million places! For each June the high-schools and the colleges of the U. S. are turning loose an army of 565,000 graduates. These men are pushing their way into the offices, factories and drafting rooms. They are elbowing men with LESS EDUCATION AND NO TRAINING out of the way. They will grab off the jobs and the promotions you hoped for. And where in the past it didn't matter—much—whether you improved yourself or not, NOW IT'S BECOME ALMOST A MATTER OF LIFE AND DEATH. And if you doubt it, just ask any employment manager what your chances are today—with neither education or training.

O. C. MILLER, Director Extension Work

*The* **American**

Dept. DC-74, Drexel Ave. & 58th St., CHICAGO

*"That's a fine bunch of Working Drawings"*

*"Start work tomorrow morning"*



**O. C. Miller**

IT'S no trick to get a good job and a salary of \$60 to \$125 a week, when you can calculate and design bridges or buildings or machinery. When you can invent the

plans and draft them. It's funny to see what a pleasant, good-natured fellow the employment man becomes when he sees the proof that you can fill the bill. You know when the Chief Draftsman needs a good draftsman quick, he NEEDS him! **Learn Drafting**, learn it the way we teach it, learn the **engineering** end of drawing plans, and getting the job you'd give most anything for today, will take care of itself, almost.

**First, Training!**

The American School has been teaching men Drafting, at home, in their spare time, for over 30 years. Sixteen of America's most noted Engineers have built 'this Drafting instruction. It starts you off Drafting—the way they do it in the big architects' and engi-

neers' offices, and it leads you along by easy stages until you get every branch of the advanced work. Every job you practice, every lesson you do, has been built so men with little education can understand them. One of our graduates is Deputy Building Commissioner of Chicago. Another is Chief Draftsman of the oldest architectural firm on the Coast. Thousands of others are holding down important positions at **BIG SALARIES**. If you are wise, you will go after that kind of training with no urging from us or anyone else.

**Then, Employment**

Don't worry about "selling" yourself to the hiring-boss when you have that kind of training and practice tucked away in your head and finger-tips. Your "samples" will sell you, **OR WE WILL HELP YOU TO!** For it's part of our course, part of the service you pay for, to help you get **placed**, as well as trained. To help you get the **JOB** as well as the **preparation** for the job. The American School has included a real, national employment service in its training contract for the past 3 years. **UNDER PENALTY OF MONEY REFUNDED.**

**\$60 to \$125 a Week**

Over a period of 30 years, our students averaged \$25 a week when they began their training. And after finishing this course, they report salaries ranging from \$40 to \$125 a week and more. A few have gone into the \$10,000 to \$15,000 class. Most of them are earning \$75 to \$100 a week.

This pay-raising training may be secured on small monthly payments, which we agree to refund if your pay is not increased at least 50%—if you do not secure a good drafting position after you finish.

**START! with the Coupon**

Get our training and employment service agreement. Get the facts about your opportunities in Drafting. Find out how easily you can learn it. Look into the "JUNE TERROR"—a booklet we'll send you which tells about conditions today, and the dangers now facing the untrained man. Coupon brings **ALL**—Mail it today!

**O. C. MILLER, Director Extension Work**



**Dept. DC-74, Drexel Ave. & 58th St., CHICAGO**

**O. C. Miller, Director Extension Work**  
**THE AMERICAN SCHOOL**  
 Dept. DC-74, Drexel Ave. and 58th St., Chicago.

Send Free  
 Facts about Drafting opportunities and training.  
 Booklet "THE JUNE TERROR."

To.....  
 Address.....  
 Age..... Occupation.....  
 without cost or obligation.

# PAIN and DISEASE

Quickly Conquered by

## VIOLET RAY

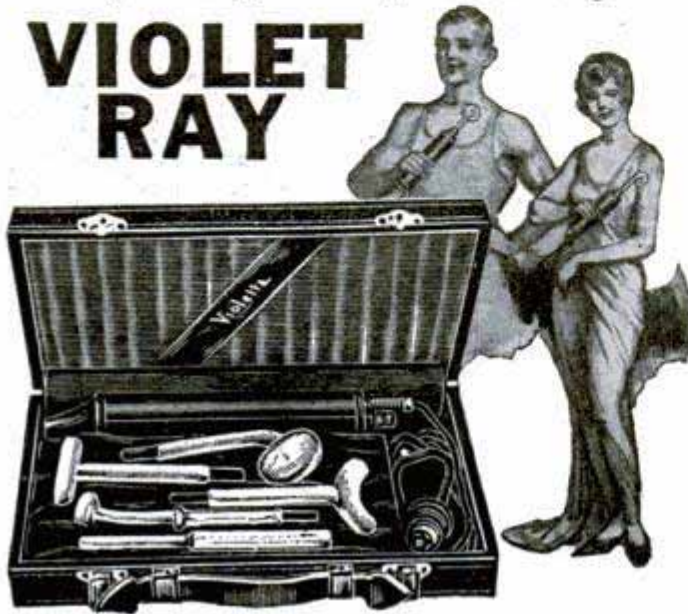

Let us tell you how thousands of men and women suffering from rheumatism, neuritis, paralysis, nervousness, skin diseases, headaches, constipation, sprains, prostate trouble, goitre and many other ailments, even hay fever and asthma, have found quick relief—new health and vitality with this marvelous, scientific invention. Pains vanish almost instantly.

# Violetta

Ten Days FREE Trial

For Health—Beauty—Vigor

Endorsed and used by hospitals, sanitariums and physicians. Every home can now have one. Saves hours, days, months of suffering. No medicine. Painless, pleasant treatment. Only the violet ray can penetrate to every nerve affected. Simple, safe, painless—anyone can use VIOLETTA. Why suffer pain and poor health when you can try VIOLETTA 10 days FREE.

## This Book FREE

Tells all about violet rays—how this marvelous discovery by Nikola Tesla, the electrical wizard, now brings this mysterious curative power to all. Contains many astounding testimonials from our thousands of satisfied users. Send for the facts and our liberal trial offer today. Mail the coupon now.



VL-REX CO., Dept. 831  
2304 Warren Avenue, Chicago

VL-REX CO., 2304 Warren Ave., Dept. 831 Chicago  
Please send me your free book on Violet Rays and details of your 10 days' free trial offer.

Name.....  
Address.....  
City.....State.....  
Ailment.....

# ELECTRICITY

## Practical-Technical TRAINING

Great demand for practical-technical electricians and engineers. A brilliant future awaits you. A high salaried position or a profitable business of your own; these may be yours through our PRACTICAL-TECHNICAL courses. Opportunities unlimited.

Finlay condensed method now in 25th successful year trains head and hand. Thousands of high salaried graduates throughout the world testify to the success of Finlay training. Extensively equipped laboratories and shops. Faculty of recognized experts. One and Two Year courses in Electrical Engineering open in September; 12 Weeks courses in Practical Electricity and Power Plant Operation open at any time. Degrees, diplomas and certificates of efficiency awarded. Students assisted to positions.

SEND FOR FREE CATALOG

**FINLAY ENGINEERING COLLEGE** Fall term starts September 15th  
122 Finlay Bldg. Kansas City, Mo.

## NO JOKE TO BE DEAF

—EVERY DEAF PERSON KNOWS THAT



I make myself hear, after being deaf for 25 years, with these Artificial Ear Drums. I wear them day and night. They stop head noises and ringing ears. They are perfectly comfortable. No one sees them. Write me and I will tell you a true story, how I got deaf and how I make you hear. Address



**GEO. P. WAY, Artificial Ear Drum Co. (Inc.)**  
80 Hoffman Bldg., 2539 Woodward, Detroit, Mich.

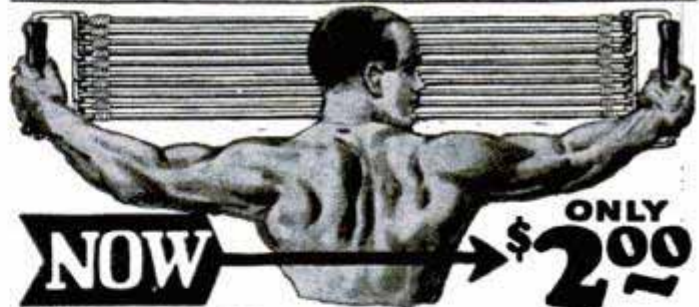

## Giant Chest Expander

and Progressive Exerciser

Be a muscular Marvel. Have the muscles of a super-man. Become strong for your health's sake or to astound your friends with extraordinary feats which only men of giant strength can do.



**Free instructions.**  
The Giant Chest Expander and Progressive Exerciser is made with new, live springy rubber so as to give it long wear and great resisting qualities. Sold with a guarantee to give entire satisfaction or money back. Made two ways, either

**5 Cables or double strength 10 Cables**  
for The double for  
**\$2** strength exerciser has resistance of **\$4**  
over 200 lbs.

**Send No Money** Send at once and get your Giant Exerciser at the present low introductory price. Deal with a long established, reliable firm. Don't pay more—order from us—get the most for your money. Use coupon now.

**PROGRESSIVE EXERCISER CO.,**  
4008 Langdon Bldg.,  
Broadway and Duane Street, New York  
Please send } your 10 cable { Progressive  
} your 5 cable { Exerciser.  
(Check the Exerciser you want.) It is understood that if I am not satisfied with this Exerciser, I will return it within 5 days and get my money back.  
Name.....  
Address.....  
City.....State.....



# A Million Dollar CAN OPENER

**Patented!**



## Will You Make This Free Test?

Men, this is something absolutely novel and unique. It's a queer new kind of can opener that is radically different. Needed in every home! No wonder the dollars simply pour in for Speedo representatives everywhere!

**\$75 TO \$150 A WEEK—EASY!**

Imagine an almost magical little device—so small that you can easily slip it into your coat pocket—that ends forever all the stabbing and hacking, all the danger and bother of old-style can openers! It takes hold of the can—opens it—flips up the top so you can grab it—and gives you back the can in a couple of seconds with the entire lid completely cut out, slick, smooth and clean!

### Sells on Sight

Everyone knows that women all hate the awkward, dangerous old-style can opener. Imagine, then, how they welcome this startling new method—this automatic way of doing their most distasteful kitchen task!

And men, here's the best part of it. We have worked out a sure-fire demonstration for you that opens every door for you instantly—closes sales in 10 seconds by the clock, and gives you 4 orders out of every five calls!

### No Cost or Obligation

There is not space here to go into all the sensational details of this new money maker. But every wide-awake, ambitious man will see the possibilities instantly. So accept my offer. Test your profits absolutely without cost or obligation. Territories are closing fast. Get the facts about \$75 to \$150 a week, today. Mail the coupon at once.

### CENTRAL STATES MFG. CO.

Dept. K-700, 4500 Mary Ave., St. Louis, Mo. Est. Over 20 Years

Central States Mfg. Co., Dept. K-700,  
4500 Mary Ave., St. Louis, Mo.  
Rush me details of your free Test Offer. This does not obligate me in any way.  
Name.....  
Address.....  
Town..... State.....

# DANCE to real music!



for **\$3.85**  
only **3** Direct from Factory

—make your old machine  
like the expensive new  
phonographs

Now at last you can say goodbye to the squeaky, metallic tone of your old phonograph. You can have the beautiful, natural, full-rounded tone of the expensive new machines. The New PHONIC reproducer makes your old phonograph like an entirely new one. Based on the New PHONIC principle. Makes you think the orchestra or artist is in the same room.

## The New PHONIC Reproducer

gives the new tone and immense volume of the latest new phonograph. Tones never before heard are clearly distinguished. Test it on an old record. Hear the difference yourself. Listen to the deep low notes and the delicate high notes. You'll be amazed. Ideal for dancing or for home entertainment. Its volume is almost double that of the ordinary reproducer.

### 10 Days' Trial—Without Risk

Send no money now—just the coupon. Pay the postman only \$3.85 plus a few pennies postage when the new PHONIC arrives. Then if you are not delighted, send it back within 10 days and your money will be refunded. If sold in stores the price would be at least \$7.50. Our price only \$3.85. Over 350,000 people have dealt with us by mail. You take no risk. Mail the Coupon now for 10 days' trial. BE SURE TO STATE THE NAME OF PHONOGRAPH YOU OWN.

NATIONAL MUSIC LOVERS, Inc., Dept. 588  
327 West 36th Street, New York

Please send me a New PHONIC reproducer for.....  
I will pay the postman \$3.85 plus few cents postage. (give name of Phonograph)  
If I am not satisfied after trial, I will return your reproducer within 10 days and you guarantee to refund my money. (Outside U. S. \$4.10, cash with order)

Name.....  
Address.....  
City..... State.....

# Get In on the Ground Floor of ELECTRIC REFRIGERATION

YOU have seen the fortunes that have been made by the men who got in on the ground floor of the automobile . . . movies . . . radio. Electric Refrigeration is going to be another tremendous money maker for the men who get in on it early in the game.

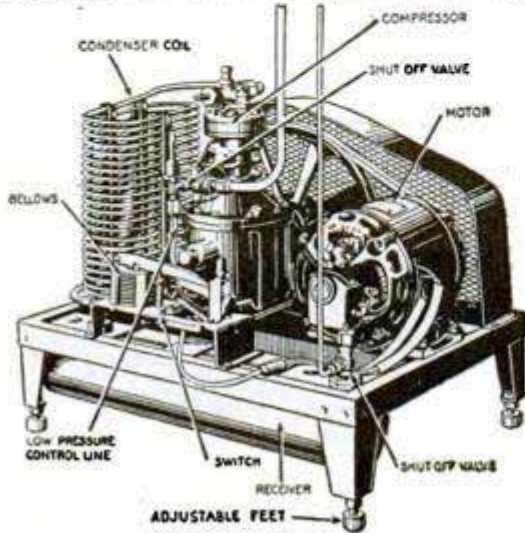

N  
O  
W  
i  
s  
t  
h  
e  
T  
i  
m  
e  
!

## Electric Refrigeration Offers You a Brilliant Future

**3 MONTHS** LEARNED IN In 3 months only—just 90 days you can be one of the new group of trained experts who will guide and develop the most lucrative and newest of America's gigantic industries.

**Experts Needed** Electrical refrigeration needs men, men and more men—with positions—big, responsible, well-paid positions open—waiting for them.

**Special Training Essential** Trained mechanics cannot service these new machines—they need refrigeration experts of which there are but a pitiful few.

### A Complete, Practical, Electrical Education

Learn by the thorough, approved scientific methods which our twenty-three years of specializing enable us to give you. In addition to Electrical Refrigeration, the following complete courses are given: A. C. and D. C. Armature Winding, Wiring and Testing, Junior Electrical Engineering, Electro-technics, Commercial Electrical Engineering, Electrical Engineering (B. S. Degree in 3 years), Automotive Electricity, Radio Broadcasting Transmitters, Receivers and Code.



### FREE BOOKLETS

Don't miss this fortune-making opportunity. Let us prove what we say. Let us send you our literature on the course you are most interested in. It's free—no obligation—the coupon will bring it to you—no fuss—no trouble. Be sure to mention course interested in, age and education.

**New Class Organizing Sept. 1st—Act at Once**

## SCHOOL of ENGINEERING

of Milwaukee

Founded 1905

163 East Wells Street Milwaukee, Wis.

School of Engineering of Milwaukee,  
PM827, 163 East Wells St., Milwaukee, Wisconsin.

Send me FREE, with no obligations, more details on your course in . . . . .

Name . . . . . Age . . . . .

Address . . . . .

City . . . . . State . . . . .

Education . . . . .

# Magic

## Learned Easily At Home

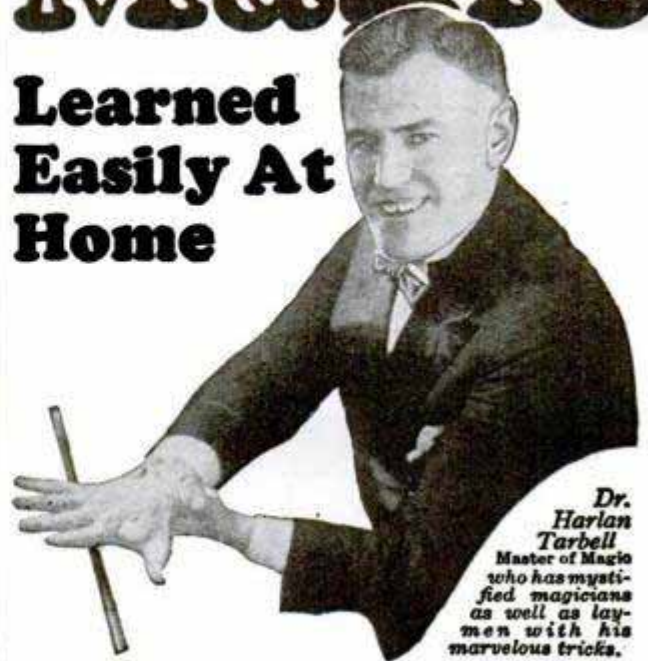

**Dr. Harlan Tarbell**  
Master of Magic  
who has mystified magicians as well as laymen with his marvelous tricks.

## Astonish Your Friends

Gain that magnetic popularity that makes you the center of any crowd. Business and social success is assured the man who can perform mystifying tricks. You can earn big money either on the side or as a professional, as well as being the most popular person in your crowd. Why envy others' skill? You can learn Magic yourself, quick and easy.

## Earn \$250 to \$1000 a Month

Even sleight-of-hand, generally supposed to require long practice, is NOW made simple to learn. For Dr. Harlan Tarbell, one of the really Great Magicians, has finally opened up the secrets of his profession in a completely illustrated course offered at a merely nominal cost. Through the wonderful Tarbell System you will be able to mystify and entertain your friends with simple tricks taught in your very first lesson. After that Dr. Harlan Tarbell takes you through the entire maze of sleight-of-hand, card tricks and elaborate stage diversions. The apparently superhuman doings of the accomplished magician become as simple as ABC when you just know how.

## Mail Coupon for Special Offer

There is a tremendous demand for magic entertainment. Clubs, Lodges, Charity and Social affairs—all will pay high fees to the man who knows Magic. Dr. Harlan Tarbell really gets as high as \$250 for an half hours work right now. Opportunity everywhere to make money aside from your regular occupation. Salesmen find it a tremendous asset. Find out all about this unprecedented opportunity to learn Magic. The coupon brings full details without any obligation. Mail it TODAY.

### Tarbell System, Inc.

1926 Sunnyside Ave., Studio C-935 Chicago

Tarbell System, Inc.

1926 Sunnyside Ave., Studio C-935 Chicago

Tell me all about Dr. Tarbell's new and simple system by which I can learn the secrets of MAGIC. No obligation on my part.

Name . . . . .

Address . . . . .

# Learn How to BOX



## JIMMY DeFOREST BOXING COURSE DEVELOPS CHAMPIONS BY MAIL

DeForest Boys are on the Road to Fame and Fortune!

The World's Most Famous Trainer Will Make You a Finished Boxer!

### Opportunities Galore

From every nook and corner in the land Boxing Promoters are clamoring for Jimmy DeForest-trained boys. They know they make good. Money is no object—they want fighters. The demand far exceeds the supply.

### A Remarkable Physical Training System!

The DeForest Course has demonstrated its efficiency as a physical training system. Weaklings have been made strong, and men physically rebuilt, energy, strength and courage developed. It will be a revelation to you.

**Send for This Gripping Book** It's the most remarkable volume of the kind ever written, full of valuable information, photos of great boxers and pupils who became successes over night. It contains a complete outline of the Jimmy DeForest Course, with special picture charts used in most of the lessons. This book will thrill you and open your eyes to the marvelous opportunity that lies before you. Enclose 10c to cover cost of mailing, etc. **DO IT NOW!**



**Jimmy DeForest Boxing Course**  
347 Madison Ave., Box 121, New York City

**Jimmy DeForest Boxing Course,**  
347 Madison Ave., Box 121, New York City  
Enclosed find 10c to cover cost of mailing, etc., of your book, "The Golden Age of Boxing."

Name.....

Street No.....

City..... State.....



Arthur de Champlain

DeForest Training changed this boy from a mediocre fighter in Wallingford, Conn., to a star attraction at Madison Square Garden, New York City, immediately after graduation, and today he is a contender for the Bantam Championship of the World!

The list of champions, real contenders and fast-approaching contenders developed by the Jimmy DeForest Boxing Course is growing longer every month. Boys who knew nothing of boxing, making only a bare living, found themselves on the way to fame and fortune in almost no time.

What they have done under the System of Jimmy DeForest, World's Leading Developer of Champions and Master Ring General of All Time, so you can do, too—right in your own home, and without interfering with your work.

Everything the Great Master knows about boxing—every trick, blow, defence, and new angle in ring strategy which he taught Dempsey, Firpo, Gans, McCoy and a host of other famous battlers—is taught to you in this marvelous and Complete Course in Boxing. Arthur de Champlain, whose picture you see at the left, is an example. He knew nothing about boxing. Look at him today—a contender for the Bantam Championship of the World! From obscurity in Wallingford, Conn., to a world figure and a fortune! Would he take \$50,000 for what the DeForest System taught him? **HE WOULD NOT!**

### 20 Weeks and You're Ready!

20 weeks is all the time it takes to complete this wonderful Course and step into the ring, a finished boxer. Against any self-trained boxer of equal experience, you will bewilder him with your speed and science, and have the fight sewed up in the first round.



**WHY NOT** spend Spring, Summer and Fall gathering butterflies, insects? I buy hundreds of kinds for collections. Some worth \$1 to \$7 each. Simple outdoor work with my instructions, pictures, price-list. Send 10 cents (not stamps) for my illustrated Prospectus before sending butterfly. **MR. SINCLAIR, DEALER IN INSECTS,** Dept. 6. Box 1424. San Diego, Calif.

**YOU CAN OIL PAINT**  
Amazing new method teaches men or women to earn after first lesson. OIL PAINT photos—portraits, landscapes or art subjects. Earn \$18 to \$50 and more a week. OIL PAINT OUT-FIT GIVEN. Send now for free illustrated book. PICTORIAL ART STUDIOS Inc. Dept. MP. 2926 Broadway, Chicago, Ill.

## Two Years' Engineering Course With Diploma and Degree

Civil Mechanical Electrical Chemical

Compact courses of essentials. Rich in higher mathematics, higher science, mechanical drawing and field work. Planned for those short in time and money, but strong in purpose. Courses distinguished alike for what is embraced and what is omitted. Adapted to

**Engineers with Practical Experience desiring a Degree**  
**No Entrance Examination or High School Diploma Required**

Indispensable preliminary work provided for students with only elementary school education. Modern laboratories. Students may begin a course in Sept., Jan., Mar., or June. EXPENSES LOW. For catalog address

**TRI-STATE COLLEGE OF ENGINEERING**

Box M-87

Angola, Indiana

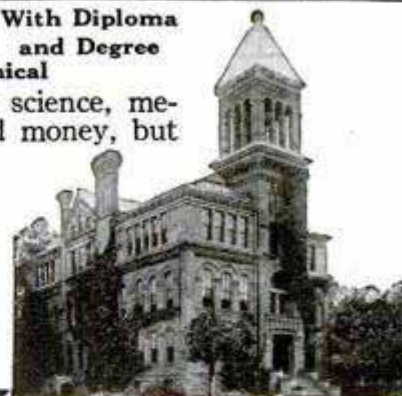

## EARN UP TO \$250 PER MO. SALARY as a Railway Traffic Inspector

I will help place as many men as I can qualify in this dignified, interesting profession where you are practically your own boss, see new sights and places each minute. It's outdoor, healthy work near home or in more distant cities. Promotions are rapid and opportunities numerous.

### No Previous Experience Necessary

For eight years I have trained men for Traffic Inspection and upon completion of 3 months' spare time home study, I helped them get good positions. Any man of normal intelligence can qualify regardless of previous training. I will train you on the same basis and upon completion assist you to a position paying at least \$120 per month salary plus expenses—or refund your money.

Let me show you how Traffic Inspection will increase your income and give you a permanent profession. Send coupon today.

**JAMES T. JARRELL**  
PRES. DIV. 2

Standard Business Training Inst.  
BUFFALO, N. Y.

Standard Business Training Inst. Div. No. 2 Buffalo, N. Y.

Yes, I'd like to know more about Traffic Inspection. Send me your free booklet "A Profession of Protection."

Name.....

Address.....





## “There’s One Man We’re Going to Keep”

“ED WILSON, there, is one of the most ambitious men in the plant. I notice that he never fools away his spare time. He studies his International Correspondence Schools Course every chance he gets.

“It’s been the making of him, too. He hasn’t been here nearly so long as Tom Downey, who was laid off yesterday, but he knows ten times as much about this business.

“I’m going to give him Tom’s job at a raise in salary. He’s the kind of man we want around here.”

How do you stand in your shop or office? Are you an Ed Wilson or a Tom Downey? Are you going up? Or down? No matter where you live, the International Correspondence Schools will come to you. No matter what your handicaps or how small your means, we have a plan to meet your circumstances.

### Mail the Coupon for Free Booklet

INTERNATIONAL CORRESPONDENCE SCHOOLS  
Box 5664-E, Scranton, Penna.

Without cost or obligation, please send me a copy of your booklet, “Who Wins and Why,” and full particulars about the course before which I have marked X in the list below:

#### BUSINESS TRAINING COURSES

- |  |   |
|--|---|
| <input type="checkbox"/> Business Management                     | <input type="checkbox"/> Salesmanship                                     |
| <input type="checkbox"/> Industrial Management                   | <input type="checkbox"/> Advertising                                      |
| <input type="checkbox"/> Personnel Organization                  | <input type="checkbox"/> Better Letters                                   |
| <input type="checkbox"/> Traffic Management                      | <input type="checkbox"/> Show Card Lettering                              |
| <input type="checkbox"/> Business Law                            | <input type="checkbox"/> Stenography and Typing                           |
| <input type="checkbox"/> Banking and Finance Management          | <input type="checkbox"/> English  |
| <input type="checkbox"/> Accountancy (including C.P.A.)          | <input type="checkbox"/> Civil Service                                    |
| <input type="checkbox"/> Cost Accounting                         | <input type="checkbox"/> Railway Mail Clerk                               |
| <input type="checkbox"/> Bookkeeping                             | <input type="checkbox"/> Common School Subjects                           |
| <input type="checkbox"/> Private Secretary                       | <input type="checkbox"/> High School Subjects                             |
| <input type="checkbox"/> Spanish <input type="checkbox"/> French | <input type="checkbox"/> Illustrating <input type="checkbox"/> Cartooning |

#### TECHNICAL AND INDUSTRIAL COURSES

- |   |  |
|---|--|
| <input type="checkbox"/> Electrical Engineering                     | <input type="checkbox"/> Architect                                       |
| <input type="checkbox"/> Electric Lighting                          | <input type="checkbox"/> Architects’ Blueprints                          |
| <input type="checkbox"/> Mechanical Engineer                        | <input type="checkbox"/> Contractor and Builder                          |
| <input type="checkbox"/> Mechanical Draftsman                       | <input type="checkbox"/> Architectural Draftsman                         |
| <input type="checkbox"/> Machine Shop Practice                      | <input type="checkbox"/> Concrete Builder                                |
| <input type="checkbox"/> Railroad Positions                         | <input type="checkbox"/> Structural Engineer                             |
| <input type="checkbox"/> Gas Engine Operating                       | <input type="checkbox"/> Chemistry <input type="checkbox"/> Pharmacy     |
| <input type="checkbox"/> Civil Engineer                             | <input type="checkbox"/> Automobile Work                                 |
| <input type="checkbox"/> Surveying and Mapping                      | <input type="checkbox"/> Airplane Engines                                |
| <input type="checkbox"/> Metallurgy <input type="checkbox"/> Mining | <input type="checkbox"/> Agriculture <input type="checkbox"/> Navigation |
| <input type="checkbox"/> Steam Engineering                          | <input type="checkbox"/> Mathematics <input type="checkbox"/> Radio      |

Name.....

Street Address.....

City..... State.....

Occupation.....

Persons residing in Canada should send this coupon to the International Correspondence Schools Canadian, Limited, Montreal, Canada

# Gets \$500<sup>00</sup> for Set of Drawings

## Learn to Draw at Home Earn While You Learn



W. R. KENT

“I sold \$400.00 worth of drawings to local boxing promoters” writes graduate W. R. Kent, New Jersey. “Have sold a drawing which took less than a day to do for \$100.00.”

P. C. Roberts, Fla., writes: “Earning \$100.00 a week.” Harold A. Allen, R. I., writes: “Have made \$40.00 in a day.”

**EARN WHILE YOU LEARN.** Miss H. H. Hartleigh, Mass., writes: “I made \$235.00. Yet I’ve only sent in 12 lessons.” David Gould, Maine, wrote, while learning: “I made \$225.00 on a single job.” E. V. Fritsch, Texas, wrote: “Making \$10.00 to \$15.00 a day.”

**GET FREE BOOK.** Shows why you can learn to draw at home by THIS method even if you have never shown talent. Shows what graduates earn; how you earn while learning; why artists get \$50, \$75, \$100 and \$200 a week; shows big money opportunities in your own neighborhood. Send for it today. No obligation.

Washington School of Art, Room 308E, 1115-15th Street, N. W., Washington, D. C.



**WASHINGTON SCHOOL OF ART, Inc.**  
1115-15th St., N. W., Room 308E Washington, D. C.  
Send your free book on how to become an artist.  
(Put name and address on separate sheet.)  
Write plainly. State age and whether Mr., Mrs. or Miss.  
(No salesman will call.)

## LINDBERGH Says:

“Physical culture carried me to Paris.” (N. Y. Graphic, May 28.) Bonomo — world’s most perfect strong man says: “Physical culture made me a great Movie Star.” His physical culture training now gives you an opportunity to get in the movies — a trip to Hollywood, all expenses paid — and Screen Test. Write today.

**BONOMO, Movie Star, Box T-5, Hollywood, Calif.**



## TRAVEL for “Uncle Sam”

New Bandit Proof Railway Mail Car

## U. S. GOVERNMENT JOBS \$1140 TO \$3000 YEAR

Men — Boys, 18 Up

Steady Work  
Paid Vacations  
Common Education  
Sufficient

Mail Coupon — Today SURE

**FRANKLIN INSTITUTE**  
Dept. M174, Rochester, N. Y.  
Gentlemen: Rush to me without charge 32-page book with list of U. S. Government big paid positions obtainable. Advise me regarding the salaries, hours, duties, vacation and full particulars.

COUPON Name.....

Address.....



# Inventor Declares War On Gasoline Waste!

## Ford

"I have used one on my 1922 Ford which I have driven over 50,000 miles myself. I am getting 30 miles on a gallon of gas, where before, I got only 12 to 14 miles on a gallon."—H. H. Cummings, Electric and Radio Engineer, California.

## Chevrolet

"I own a Chevrolet roadster. I made a trip of 125 miles and stopped at a filling station. It took only three gallons of gas."—C. Cummings, Mich. Rex Dean, another Chevrolet owner, reports he got 25 miles a gallon with the device. He took it off and mileage dropped to 19. Put it back and mileage moved up again to 25.

## Nash

"I had a large Nash Six that I drove from Los Angeles to San Francisco on 20 gallons of gas, whereas I have usually taken from 50 to 55 gallons. Distance 470 miles."—H. T. McCallon, Calif.

## Chrysler

"I installed it on the Chrysler without any trouble and it increased the mileage from 19 to 32 miles."—A. J. Trodick, Mont.

## International Truck

"I find it better than you recommend it. On the International truck we use we are saving by positive test 41 per cent in gas and our engine uses less oil."—George Bell.

## Sworn Affidavit

I, L. G. Stransky, Vice-President, J. A. Stransky Mfg. Company, being first duly sworn, depose and say that the J. A. Stransky Mfg. Company have in their files thousands of unsolicited testimonials from satisfied users all over the world.  
L. G. STRANSKY,  
Vice-President.

## Over Two Million Car Owners Install New Device to Get More Miles Per Gallon

A SUDDEN new revolt is sweeping America—a fight against the high cost of owning a car! Startling tests revealed by foremost authorities indicate that the average car owner is losing 20% to 30% of his gasoline through inefficient combustion. Think of it! Enough money wasted in a year to pay for a new set of tires!

Stop this waste right now! Join the two million car owners who have installed a tested way to increase gasoline mileage—the amazing invention of J. A. Stransky, former candidate for Governor of South Dakota. Read below how it works—how you can test it free and win a cash forfeit if it fails—and how it will pay you big earnings, full or spare time. Then read the coupon.

The Stransky invention is a simple little device, little larger than a dollar.

## Big Pay Jobs! \$200 in a Week

Men, here is a sensation in money-making opportunities. Eberlein sold 500 in one day. Tammany sold 20 in 45 minutes. No experience required. Work full or spare time. You don't need a car to make money with it. Rush the coupon at the right—without obligation—for full details.

It is easily installed in a few minutes without cutting or boring out holes. It has no delicate parts to get out of order, is ruggedly made and will probably outlive the car itself. It cannot hamper or harm the engine in any way. Its engineering principle of economizing gas has been tested by garage mechanics, automobile dealers, truck operators and thousands of experienced car owners and found to be sound and practical.

## A Challenge

Whether or not you own a car, this coupon below will bring full details of our free test offer and our offer to pay a cash forfeit if the test does not satisfy you that it will save gasoline. If you want to make some real money in your full or spare time, we will also send you a definite plan that shows how to make \$75 to \$200 in a week. Over 20,000,000 car and truck owners need this amazing invention. Send no money. But rush the coupon below for full details, without obligation.

## J. A. STRANSKY MFG. CO. K-10 Stransky Block, Pukwana, S. D.

This Coupon Brings You Introductory Sample Offer, FREE Inventor's Cash Forfeit Offer, And Money-Making Plan for Full or Spare Time.



J. A. Stransky Manufacturing Co.,  
K-10, Stransky Block,  
Pukwana, S. Dak.

Name.....  
Address.....  
City.....State.....



# Switch

If you are now earning less than \$40 a week, if you're short of schooling, you'll have to face these questions, sooner or later:

What are your chances in your present line of work? How much more will your job pay you next year? Can you overcome the handicaps of neglected education? Will you get "fired" when times get bad?

You may not like your own answers to these questions. And if you don't, my advice is, GET INTO A DIFFERENT

FIELD where there are plenty jobs, big salaries and real opportunities for advancement.

**ELECTRICITY**—the wonder-industry offers you such unlimited opportunities. I'll prove that to you here. And I'll tell you how you can SWITCH TO ELECTRICITY without losing a day's time or a dollar a pay.

## Electricity Offers You Amazing Opportunities

The map on the next page shows 112,000 miles of electric trunk lines, but that's just to carry the "juice" from the power plants to the homes and factories and shops and skyscrapers and farms of the U. S. The map can't show the million USES of electricity, the millions of men already employed at high wages in this fascinating industry, nor can it even suggest the future of Electricity. Marconi, Edison, Insull and other leaders say Electricity is still in its infancy! And that men who enter the field TODAY have a bigger chance, even, than the "pioneers" of 30 years ago.

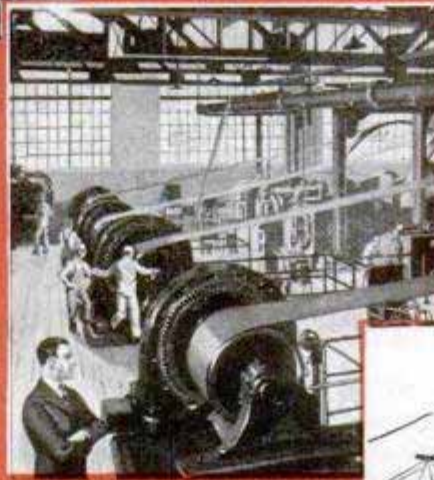

Great power-plants like these don't run themselves. It takes men, trained men, highly paid men to design and install, to manufacture and operate, to repair and manage the thousands of central stations or privately owned electrical power plants in America.

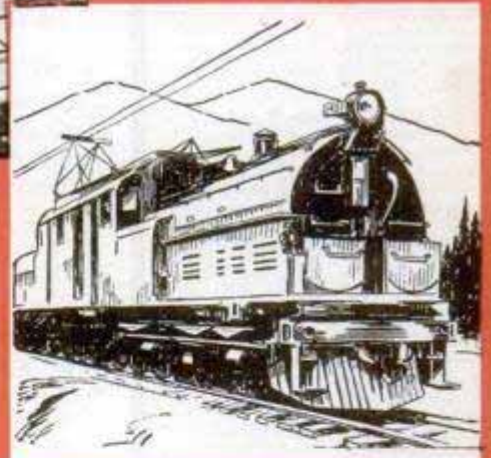

## I will help you get a well-paid job — or money refunded

You don't need to be a high-school or college graduate to succeed in Electricity. I have placed hundreds of men in fine electrical jobs and I'll be glad to tell you how I can help you to get a well-paid electrical position. Mail coupon for the most remarkable offer ever made to ambitious men.

## 29 Executives

—men from Westinghouse, Allis-Chalmers, Western Electric, General Electric, Commonwealth Edison and other great corporations and the leading Universities of the U. S.—helped us develop a remarkable service for preparing and placing ambitious men in fine electrical positions. It will pay you to get all the facts of this startling service. Coupon on next page brings them.

The railroads are turning from steam to electricity. Notable installations are on the C. M. & St. P. in the "Rockies" and in New York City terminals. The Rubber industry is 80% electrified—machinery is 81% and the steel industry 54% electrified. 14 million homes in the U. S. are wired for electric light. Radio is a billion dollar "baby" of the industry, only 6 or 7 years old commercially. Even this entire magazine is not big enough to contain all the interesting facts of the importance of the electrical industry.

**Chief Engineer Dunlap, Electrical Division,**

# to Electricity

— World's Greatest, Fastest Growing Industry

Even electricians and skilled electrical mechanics are earning \$15 to \$20 a day in the big cities. And the EXPERTS are getting more than that. In no other line is there the tremendous need for men. No other great industry continues to grow so rapidly. *Come into electricity and your future is SECURE!*

**Many \$60 to \$125 a Week Jobs!**

Chief Electricians, Superintendents of Electric Power Plants, Electrical Construction and Installation Experts, Electrical Contractors, Electrical Engineers—are sitting on top of the world these days. The demand is bigger than the supply. That is why I am urging men to come into Electricity. Here they can have their chance of many fine positions. Here they are sure of big pay. Here they can bank on rapid promotion.

The Electrical industry has ridden through wars and panics without a backward step. You never hear of the men in an Electrical plant getting "laid off." That's because the use of Electric current is growing every minute. Whether times are good or bad we continue to light our homes and ride in street cars and turn over machinery with Electric power motors.

This is the ELECTRICAL AGE. And you'll be wise to hook-up with its basic industry.



Radio, telegraph, telephone. Now pictures come over the air electrically. Much transportation, all communication, over half of all industry is Electrical.

**112,000 miles** of Electrical trunk-lines in the U. S. Super-power in voltage is carried hundreds of miles. Giant hydro-electric plants are dotting the map too. Get my free book and get more fascinating facts about this most interesting industry.



**Confidential Surprise Offer**

to men earning less than \$40<sup>00</sup> a week

I am prepared to enter into a written contract with any ambitious man who seeks a fine, well-paid Electrical job. To help him get ready AND TO HELP HIM GET PLACED.

We are now bound by similar agreements to deliver this pay-raising JOB-SERVICE to over 15,000 men. Backed by our entire resources of over a million and a half dollars.

I will show YOU how YOU can break into the giant electrical industry, how to qualify for and GET a wonderful position, paying at least 50% more than you earn today. And offering opportunities for advancement that are simply dazzling.

All without a penny's risk to you—I promise you that.

This offer is for ambitious men only. Lack of schooling will not bar you. Lack of ready money will not bar you. Send me the coupon and I'll give you the chance to cash in, too.

Chief Engineer Dunlap,  
Electrical Division  
**The American School,**  
Dept. EC-74,  
Drexel Avenue & 58th Street,  
Chicago.

I may want to SWITCH to Electricity.

I am ambitious. Send Confidential Surprise offer to.....

Address.....

Age..... Occupation.....

**The American School** Dept. EC-74, Drexel Ave. and 58th St., Chicago, Ill.

# Learn Autos in Los Angeles

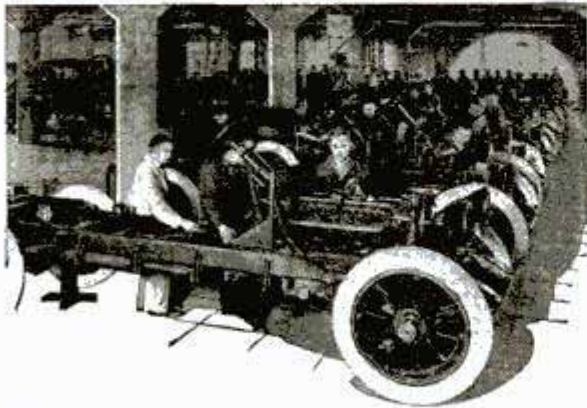

## Free Employment Service \$50 to \$125 a Week Jobs Open Get Practical Training in Big Shop

If you are earning less than \$50 a week and are mechanically inclined, this famous school can quickly train you for bigger pay. Over 17,000 unskilled men like you have come to National during the past quarter century, from all parts of the world. Our expert instructors show them—on a half million dollars' worth of new equipment—how to correct engine trouble, carburetors, ignition, battery—teach them how to repair every part of every automobile. A few months later they graduate with more experience than they would have gained in six years as apprentices. Our free Employment Service helps them find the jobs they want.

### Genuine Need for Skilled Auto Experts

Over 200 National graduates own their own businesses right here in Los Angeles. They are hiring other National men. Employers write us asking for trained men. The auto industry is tired of half-trained "dub" mechanics. For men who "know their stuff" the industry offers big pay, steady work and rapid promotion.

### Big Auto Employers Endorse National

You get thorough, quality training at National. No time limit—work in each department until qualified. No books—you learn by doing. You master everything before you complete National training. This unusual thoroughness gives National students preference with big employers.

**FREE AUTO BOOK** Earn While You Learn  
Write for big Auto Book—mailed free—illustrating National training methods and opportunities for you in auto industry. We help you to get part-time job to pay expenses while training. Mail coupon now.

# NATIONAL AUTOMOTIVE & ELECTRICAL SCHOOL

Dept. 701 4006 Figueroa St., Los Angeles, California

Send me the big, FREE National Auto Book that explains how I can get a big-pay Auto Job.

Name \_\_\_\_\_

Address \_\_\_\_\_

City \_\_\_\_\_ State \_\_\_\_\_



# Lindbergh! Chamberlin!



A few weeks ago, unknown! Today, famous: a fortune in their grasp. Aviation did it, will do it again for others. How about you? The game is young, the rewards big. It takes character, courage—to act without delay.

## Big Air Transport Company Will Train You

Big concern with hangars, shops and flying field at Chicago Municipal Air Port, and new 1927 planes, will train a few men in all phases of aviation. Company is now carrying freight and passengers by air and making aerial photos.

## Ground Work at Home Actual Flying in Chicago

Amazing new combination—homestudy and resident school instruction. Moderate cost, so you can start at once. Quick, safe, thorough, practical. Open to real men with good references. Progress is fast in aviation. Delay may mean opportunities lost. Write for details today. Startling Offer to those who write at once for free information.

## Aviation Service & Transport, Inc. Dept. 201, 22 W. Monroe St., Chicago, Illinois

**LEARN AVIATION**  
by U. S. Gov't Methods  
with U. S. Licensed Pilots  
Air corps methods, taught by the sort of fellows "Lindy" and Chamberlin trained with. Mechanical and business end of aviation covered. Commercial aviation just starting. Big capital ready to back trained men. Now is the time to get in on the ground floor.



JOHN MILLAR  
former U.S. Chief Instructor of Air Corps Technical School, Rantoul, Illinois.

# Get Strong QUICKLY and Stay So!

**D**EVELOP your muscles this quick way. Get big broad shoulders. Fill out your chest. Become the strongest man in your town by using the famous GIBLALTAR EXERCISER—the strongest tensioned apparatus made! Many famous athletes and strong men use it.

Can be adjusted to from 10 lbs. to 200 lbs. resistance. Every man, woman and child should have one. Made of finest quality, genuine para rubber elastic cables. Guaranteed 50 rubber strands

to each cable. Do not compare this apparatus with cheap imitations. We have made arrangements with a prominent author and publisher, who is an authority on physical culture, to present you with 16 complete booklets on every subject pertaining to your muscles and organs.

It is only by special arrangement and additional expense to us that we are able to offer you this wonderful premium ABSOLUTELY FREE OF CHARGE with each exerciser.

ONLY \$1.50 For 5 Cables  
10 ONLY \$2.50 Cables, Double Strength



FREE INSTRUCTIONS

### SEND NO MONEY

All 16 booklets will be shipped free to your home with the exerciser, and you simply pay the postman the price of the exerciser, plus a few cents postage. When ordering, mention that you want a five cabled or ten cabled exerciser. If you live outside the U. S. send cash with order.

### Remember!

The name Gibraltar on an Exerciser means as much as Sterling on silver.

GIBLALTAR EXERCISER COMPANY  
Dept. 308, 225 W. 34th St., New York City  
Please send me your [10 cable] EXERCISER.  
5 cable]

It is understood that I am to get the 16 booklets on the body absolutely free with this order.

NAME.....  
ADDRESS.....  
CITY..... STATE.....





# Beck Makes \$8000 a Year!

"I make  
**\$1000**  
a month!"  
*R.H. Brown*

"I make  
**\$350**  
a month!"  
*R.C. Foster*

*Lewis Beck.*  
**\$60** weekly  
— and  
50% construction  
profits!"  
*Phil Garrison*

"Making  
**\$300**  
a month  
—haven't  
finished  
course yet!"  
*L.V. Broughton*

"If it wasn't for you and the training you gave me, Mr. Dobe, I wouldn't be making \$8000 a year now."  
*Lewis Beck.*

"I refused  
**\$600**  
a month  
offer!"  
*Earl Dupont*

Beck jumped from \$12.00 a week to \$8,000 a year! He answered my advertisement and got my Free Book on Draftsmanship. So did these other 9 men. And that's what I want *you* to do now! They *all* took my simple, easily understood and quickly learned course in drafting at home without giving up their bread-and-butter jobs. You can do the same thing. Will you?

"I make  
**\$130**  
a Week!"  
*P.E. Amwack*

"I make  
**\$475**  
a  
month!"  
*S.C. Stroop*

## Learned Drafting At Home— So Can You!

"Averag-  
ing over  
**\$400**  
monthly"  
*Arthur Libralt*

"They  
Pay Me  
**\$350**  
a Month"  
*John Saradge*

Before Dobe's "Easy Drafting at Home" it was almost necessary to go away to college to learn drafting. But now you stay home, hold down the job you've got, keep on earning money and easily and quickly equip yourself to enter the drafting profession. All the men you see pictured here did just that.

Get into drafting! It is a big, appealing field. Drafting is growing bigger and more important every year. Before any house or machine or factory can be built there must be a PLAN. That plan *must* be DRAWN. A draftsman must DRAW it. Learn how at home. Get into this fundamental basic and *necessary* profession! NOW!

**Write for  
FREE Book! Send Coupon TODAY!**



**Successful Draftsmanship!**  
Read this book! After you have read it, make up your mind whether you want to be a draftsman! But write for it today. Certainly reading the book can't hurt you. Mr. Dobe will tell you about other men besides these pictured above who have been successful—many—many of them. No matter what you are making now ask for the book today.  
**DOBE EASY DRAFTING**  
1951 Lawrence Ave., Div. C-135 Chicago

**DOBE EASY DRAFTING**  
1951 Lawrence Ave., Div. C-135 Chicago  
Please send me free your book, "Successful Draftsmanship", and names of other big money earning draftsman you have trained.

Name.....Age.....  
Address.....  
Post Office.....State.....

# The Mysterious Masked Singer Who Was He?

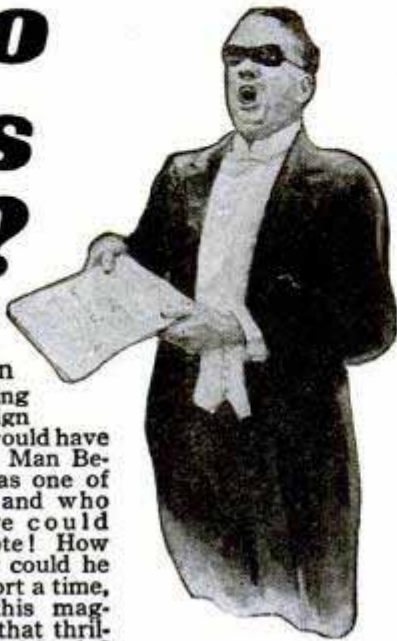

Surely that glorious, golden voice must mean long years of training under some foreign master. And who would have dreamed that The Man Behind The Mask was one of their own crowd and who six months before could scarcely sing a note! How did he do it? How could he possibly, in so short a time, have developed this magnificent voice now that thrilled and amazed his friends?

## I Guarantee to Improve Your Voice 100%

There is only one answer—Physical Voice Culture! Your vocal chords are the same in construction as those of Caruso, Garden or Martinelli. But YOURS are under-developed. Your Hyo-Glossus throat muscle has probably never been used. No amount of scale singing will ever develop this muscle. But scientific muscular exercise will. And only Physical Voice Culture—the amazing discovery of Prof. Eugene Feuchtinger can show you how. Now you can build a strong, magnetic, compelling voice that will be the marvel of your friends and open the door to Success and Fame.

## Scientific Voice Training

Prof. Feuchtinger accomplishes his surprising results by silent, muscular exercises that quickly bring strength and control of certain vital vocal organs, heretofore almost unknown to voice culture. No tiresome scale-singing! Practice these marvelous silent exercises in privacy. Soon you find your voice becoming stronger, richer, with ever increasing range. Thousands have done it. You can, too.

## Mail Coupon for "Physical Voice Culture" Free

Your voice has marvelous possibilities that you may not even suspect. "Physical Voice Culture" will reveal them to you. Send at once for this valuable, beautifully illustrated book. Read the astounding true stories of what others have done. Send Today! The Book is FREE!

**Perfect Voice Institute** 1922 Sunnyside Ave., Studio C-135, Chicago

**Perfect Voice Institute, Studio C-135**  
1922 Sunnyside Ave., Chicago

Please send me, FREE, and without obligation, Prof. Feuchtinger's new Book, "Physical Voice Culture." I have checked subject in which I am most interested.

Weak Voice  Singing  Stammering  Speaking

Name.....

Address.....

City.....State.....

# Fat Men

This new self-massaging belt not only makes you look thinner INSTANTLY — but quickly takes off rolls of excess fat.

DIET is weakening—drugs are dangerous—strenuous reducing exercises are liable to strain your heart. The only safe method of reducing is massage. This method sets up a vigorous circulation that seems to melt away surplus fat. The Weil Reducing Belt, made of special reducing rubber, produces exactly the same results as a skilled masseur, only quicker and cheaper.

Every move you make causes the Weil Belt to gently massage your abdomen. Results are rapid because this belt works for you every second.

## Fat Replaced By Normal Tissue

From 4 to 6 inches of flabby fat usually vanish in a few weeks. Only solid, normal tissue remains. The Weil Reducing Belt is endorsed by physicians because it not only takes off fat, but helps correct stomach disorders, constipation, backache, shortness of breath and puts sagging internal organs back in place.

## Special 10-day Trial Offer

Send no money. Write for detailed description and testimonials from delighted users. If you write at once, you will receive a special 10-day trial offer. The Weil Company, 98 Hill Street, New Haven, Conn.

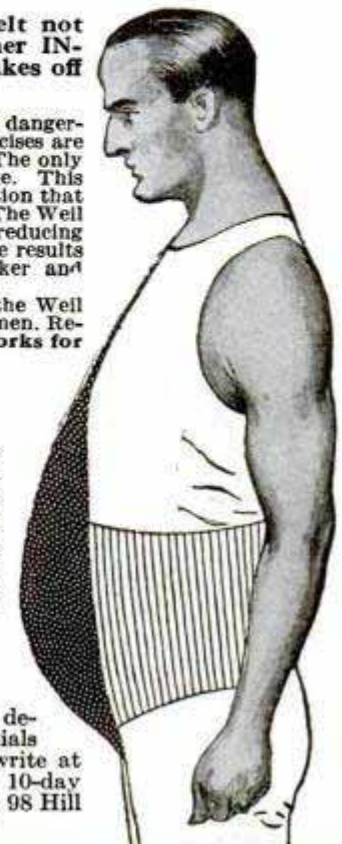

THE WEIL COMPANY, 98 Hill St., New Haven, Conn.

Gentlemen: Please send me complete description of the Weil Scientific Reducing Belt, and also your Special 10-day Trial Offer.

Name.....

Address.....

City.....State.....

**SAFE!** MAKE PULLETS LAY EARLY. Knowledge is Power! Eliminate guess work. Let world's greatest poultry school show you quickly by mail how to get more EGGS—make more money. Write for free book. State kind of poultry you like. **AMERICAN POULTRY SCHOOL** Dept. 70 Kansas City, Mo. *free book*

## Strength

is not so much muscle as skill. Police Captain Wallander's illustrated "Physical Training Manual" explains fine points of Jiu Jitsu, Boxing and Wrestling. Makes you invincible. A complete course in physical culture, astounding police secrets and simple health rules. Sent C. O. D. for \$1.97 plus postage. **Stebel Press, 34-K W. 20 St., New York, N.Y.**

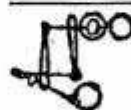

**200**

Kinds of **IRON, WOOD and WIRE PUZZLES.** Leader and Illustrated List **10 cents.**

**WESTERN PUZZLE WORKS, St. Paul, Minn.**

## LEARN WATCHMAKING

and become independent. We help you secure a position. Easy to learn. Send for **FREE CATALOG.** **ST. LOUIS WATCHMAKING SCHOOL, Dept. 5. ST. LOUIS, MO.**

## LEARN AT HOME By Moving Pictures

Sign Painting, Card Writing, Decorating, Paperhanging. We **LOAN** you a movie machine. Write Today for Free Folder.

## LEARN the Movie Way



**National Painters and Decorators School** Room 701, 160 N. Wells St., Chicago, Illinois

# Button Rupture Newest Way [Without Pressure]

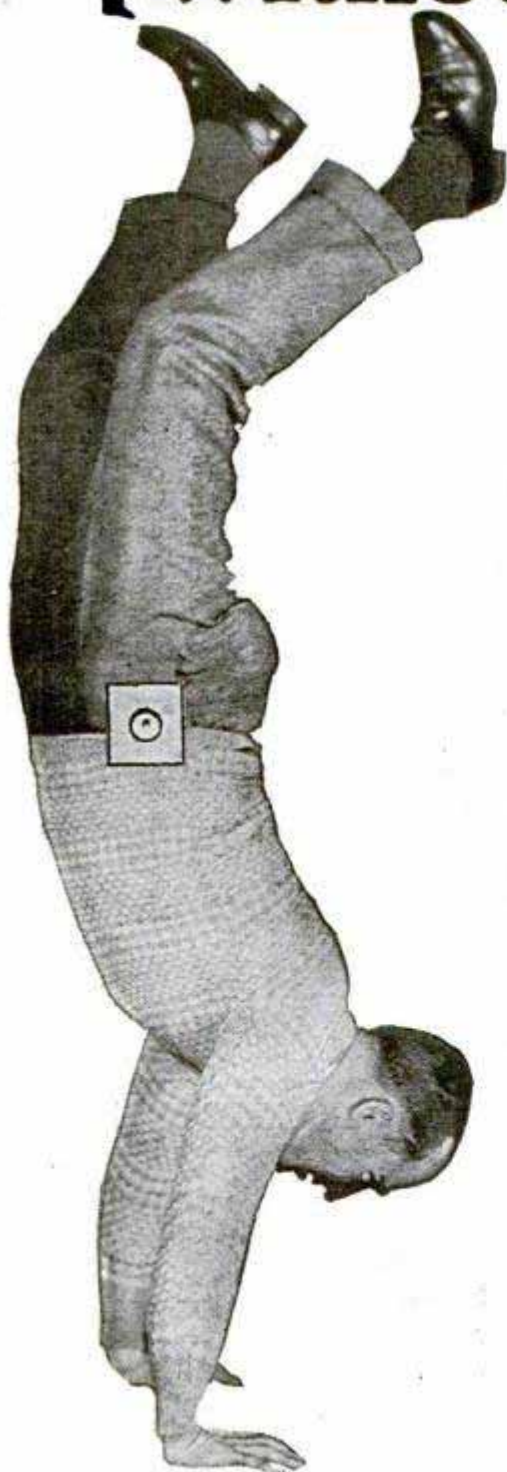

**S**CIENCE now advises discarding cruel steel springs, barbarous leg straps, and other harness that press against the rupture and thus prevent nature from healing it. A new sensible method has been perfected, after thousands of test cases, called Magic Dot—entirely different from any other way. Instead of “pressing” it “seals” rupture, and of course allows users to run, jump, bend and cough in perfect safety.

## Breathes Air

With this 1-25th oz. device is a new kind of pad, air-porous and washable. It actually breathes air, and cannot slip off the rupture—a feature, you’ll frankly admit, that is lacking in your present appliance. In fact, it is so superior and different that it is praised by physicians as “an entirely new departure.” Users report they have forgotten they are wearing it. But don’t buy it yet.

## See It First

By a special arrangement you can now have it sent to your home without obligation to wear it. Don’t send a penny or order it now. Just mail the coupon for full description of “Magic Dot” and details of this unusual offer. Act now for quick relief. Write your name and address on the coupon and mail it today!

### NEW SCIENCE INSTITUTE

2139 Clay St.

Steubenville, O.

New Science Institute,  
2139 Clay St., Steubenville, O.

Please send me free your illustrated book and sample of Airtex. Include also your offer which permits me to see the New Science System without cost or obligation.

Name.....

Address.....

City..... State.....

# ELECTRICITY PAYS -



**I'LL TRAIN YOU AT HOME**

**to EARN BIG MONEY**



**\$300 A MONTH**  
Dear Mr. Cooke: You made me what I am. Working for the Cadillac Motor Co., making over \$300 a month.  
C. L. Stachurski  
2602 Wahlen Street  
Hamtramck, Mich.

**N**OW you make \$20, — \$25, — or \$30 a week. In the same 6 days, as a "Cooke" Trained Electrical Man, you could be making \$70 to \$200 a week, — and do it easier—not work half so hard.



**\$200 A WEEK**  
Dear Mr. Cooke: In two years I have jumped from \$25 a week to \$200 a week, and you get all the credit.  
G. W. Schnupp  
315 E. New Street  
Lancaster, Pa.

Why, then, remain in a small-pay, no-future job? You can't make Big Money there. Get into Electricity. That's where the big money is being made, and that's where the big money always will be made, because Electricity is the biggest and fastest growing industry in the world.

**I'll Train You At Home**

I'll train you at home,—in your spare time. You work just as you are working now—at your same old job. But you learn Electricity every day, in an easy, simple, unforgettable way — **by doing.** And —

**You Earn As You Learn**

That's the way I teach Electricity — so that you can make extra money as you go along. That's why my Training is Practical. That's why my students are successful. That's why the "Cooke trained man is the Big-Pay Man", everywhere,

**L. L. COOKE**  
Chief Instruction Engineer

and always. \$40 a week is just an ordinary salary in Electricity. \$70 to \$200 a week is what thousands of "Cooke" Trained Men are earning.

**SIX BIG OUTFITS AT NO EXTRA COST**

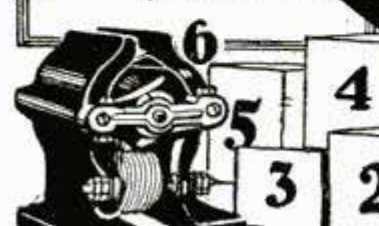

**Money Back if not Satisfied**

That's what I agree to do. And you're to be the judge and jury, all in one. If you're not satisfied you get your money back—every cent of it. And back of me in this agreement stands the Chicago Engineering Works, a \$2,000,000 Illinois Corporation.

**Nothing Like "Cooke" Training**

Don't be satisfied with anything but "Cooke" Training, the Training with 10,000 boosters. There is nothing like it anywhere. It stands by itself—alone in this field. This is the Training that Electrical men are praising — the Training that Electrical concerns recommend to their employees—the Training that a great engineering association has endorsed 100%, after a rigid investigation. It's the Training for you.

**If You're Earning less than \$70 a week — Investigate**

Don't wait a minute! Find out today why "The Cooke Trained Man is the Big-Pay Man", everywhere! Find out how "Cooke" Training will help you boost your pay! Mail coupon right now for my Big, FREE Book of Facts. Read the whole wonderful story. See the Six Big Working-Outfits I give you without extra charge. See the hundreds of pictures, the proofs, the Big-Pay letters of other "Cooke" Trained Men. Get this great free Book. Send for it today. Clip, sign, and mail coupon **right NOW!**

**L. L. COOKE, Chief Instruction Engineer**

**L. L. COOKE SCHOOL OF ELECTRICITY**

Dept. 1-C  
2150 Lawrence Ave., Chicago, Illinois

**FREE BOOK COUPON-Mail It**

**L. L. COOKE, Chief Instruction Engineer,**  
Dept. 1-C, 2150 Lawrence Avenue, Chicago, Illinois  
Send me, FREE and prepaid, your Big Book "Secrets of Success in Electricity," with all details about your Home Study Course in Electricity.

Name \_\_\_\_\_  
Address \_\_\_\_\_  
City \_\_\_\_\_ State \_\_\_\_\_

Residents of Canada send coupon to R. A. Farrow, Special Representative, 7 Medbury Lane, East, Windsor, Ontario, Canada.

**The "Cooke" Trained Man Is The "Big Pay" Man**

# Classified Advertisements

## WORLD'S BEST WANT AD MEDIUM

Advertisements in this section, 30 cents per word, each insertion, minimum 10 words, payable in advance. To be inserted under proper classification in September issue; copy should be in our office July 18th

### ADVERTISING AGENCIES

**SECURE** Business in other cities. Increase your business by going after out of town trade. Manufacturers, jobbers, wholesalers, importers, etc., can open an entirely new avenue for sales by advertising for Agents and Salesmen. Need not interfere with your other business. Many enterprising big concerns now invading direct field. Names on request. Our Service department guides you on every detail. Copy and literature composed free. Your 24 word ad (4 lines) inserted in the following 20 leading Sunday papers for only \$25.00. Four million circulation (20 million readers). Journal, Atlanta; Tribune, Chicago; Star, Indianapolis; Journal, Sioux City; Eagle, Wichita; Sun, Baltimore; Post, Boston; Free Press, Detroit; Tribune, Minneapolis; Post Dispatch, St. Louis; World Herald, Omaha; Courier, Buffalo; Enquirer, Cincinnati; Oklahoman, Oklahoma City; Press, Pittsburgh; Banner, Nashville; News, Dallas; Times Dispatch, Richmond; News, Wheeling; Journal, Milwaukee. Proof of insertion Guaranteed or money refunded. 52 page rate book sent Free. Frank W. Lenhoff Advertising Agency, 600 North Michigan Blvd., Chicago. (Established 1897). Chicago's Most Progressive Advertising Agency.

A TEN Dollar Ad may put your proposition over. \$10 pays for a 4 line 24 word classified ad one Sunday in 8 of the largest newspapers. Reach over 6 million readers. Minneapolis Tribune, Buffalo Courier, Detroit Free Press, Kansas City Star, Pittsburgh Press, Indianapolis Star, Atlanta Journal, Cincinnati Enquirer. Free catalogue showing other lists of newspapers and magazines sent on request. Ankrum Advertising Agency, 22 West Jackson Blvd., Chicago. Largest classified advertising agency in the world.

**ADVERTISE** in the classified section of newspapers and magazines, to secure help, money, or to sell. 24-word advertisement in nine big Metropolitan papers \$10.00. Nearly two million circulation. Many other bargain lists. Write for Free 58-page Directory No. 26. Brinckerhoff Advertising Agency, 37 W. VanBuren, Chicago.

**ADVERTISE** in 24 Big Sunday Newspapers, 24 words \$15.00. Excellent for securing Agents, Salesmen, and Business Opportunities. Catalog listing 1,000 leading Dailies, Weeklies, Mail Order Magazines. Everything Free. Wade Advertising, Baltimore Bldg., Chicago.

**ADVERTISERS:** Your 24 word "ad" in 10 big Metropolitan Dailies \$5.00. Let us help you get results. Booklet 42, listing Dailies, Weeklies, all kinds magazines, Free. Waring Advertising Agency, Dundee, Mich.

**HAVE** your classified ad in our high-class magazine at half cent per word. Quarter page ad (3 1/2 x 4 1/2 inches) \$2.00. Circulates everywhere. Copy 20 cents. International Digest, 21 Dent Road, Shanghai, China.

**LOWEST Rates.** New Catalog. Owl Agency, Times Bldg., New York.

"CONTEST" Magazine, Rates: \$1.00 inch. Beautiful Painted Art Covers. Devoted—Authors, Salesmen, Dealers. Copy 10c. LaBelle, Box 592, St. Paul, Minn.

**NEWSPAPER**—Magazine advertising—Classified, mailorder, Catalog. Martin, 276B West 43rd. New York.

**SIX Word Line**—355 rural weeklies \$3.55. Admeyer, 4112-M Hartford, St. Louis.

### FOR ADVERTISERS

**YOUR** twenty-word advertisement in "Open Road for Boys" magazine \$1.00. Reaches 70,000 responsive boys. Sure-fire puller, agents, novelties, etc. Gleason, 248 Boylston, Boston.

**CUTS,** Drawings \$1.50. Window Cartoons, 6. \$1.50. G.P.O. Bx471, New York.

**40 WORDS** insert 70 magazines \$2.00. Empire Agency, Shawano, Wis.

**ADVERTISE** in 275 country newspapers, 28 words, \$10. Keator, Hartford Bldg., Chicago.

### SALES PROMOTION

**\$50 TO \$50,000 Daily Sales** Developed During 28 years for clients by our direct mail plans, copy, campaigns. One product, 1923, an idea; this year \$100,000 orders booked. Fifty year old concern desired 50 national representatives in 1925; we produced 40 in three months. 700 dealers in 10 months at \$3 each, for another. Ten years Sales Promotion Manager Larkin Co. Submit sales problems for Free diagnosis. James C. Johnson, 118A Woodbridge Ave., Buffalo.

### AUTOMOBILE SUPPLIES

**NO Spare tire** needed if you have a Midget rim tool. Shrinks and expands 20-21-22 inch rims. Weighs one pound. Give size and make of rim. Ratchet wrench free. Postpaid \$1.00. Home Equipment Co., Drawer 923, Butler, Penna.

**AUTO Awnings** For Touring Roadster and all closed cars. Postpaid \$2.50 pair. Send year, make and style of car. Montag & Haggard 1511 Zangs Blvd., Dallas, Tex.

**WE Need Reliable Men** to Demonstrate the Marco Contact Arm for Chevrolets. Prevents back fire, gives smoother performance and more speed. Price \$1.00. Marion Manufacturing Co., Hannibal, Mo.

**THE 1927 New Air Friction Carburetor** will develop far greater speed in your motor than any other carburetor, and will also retain slow idle speed and high mileage. We fit all motors. The New Air Friction Co., 10 Israel Bldg., Dayton, Ohio.

**DYKE'S Automobile Encyclopedia.** Latest 14th edition. Information on repairing and adjusting every part of all motor cars. How to find trouble and fix it. Send no money. Pay postman the postage and \$6. Popular Mechanics Press, Room 908, 200 E. Ontario St., Chicago, Ill.

**VULCANIZING Auto Tires** is a Paying Business. We have plants near you from \$50 up. Catalog Free. Instruction Book \$1. Equipment Exchange, 108 East 11th, Los Angeles, Calif.

**EVERYTHING** for battery and tire shops at wholesale. Send for complete catalog. Adams-Barrs, Columbus, Ohio.

**YOU Are Wanted** to Resilver Mirrors at Home. Immense profits, plating autoparts, headlights, tableware, stoves, etc. Outfits furnished. Write for information. Sprinkle, Plater, 77, Marion, Ind.

**42.8 MILES** on 1 Gallon. Wonderful Moisture Gas Saver. All autos. 1 free. Critchlow, D1-805, Wheaton, Ill.

**SALESMEN** to sell umbrellas that attach conveniently to automobile. Umbrella always safe and handy. Parking restrictions make big demand and sure sales. Wm. Beebler, Baltimore, Md.

**AT Last!** Reasonably priced Auto Emblems for every Lodge. Sells for only \$1.25. Write for attractive selling proposition and free Sample Case offer. North Central Distributors, Dept. 9, Ashland, Ohio.

**HEADLIGHT Telltales** securely attached to lens. No drilling. 25c and 50c a pair. The Handy Dental Specialty Co., Somerville, Mass.

**AUTO TOURISTS**—Here are 133 practical plans for making touring easier, less expensive and more enjoyable. With these we supply a Touring Atlas of the U. S. showing road maps of every state. All this information for the small price of 98 cents plus the postage. Pay postman when he delivers the package. Popular Mechanics Press, Room 908, 200 E. Ontario St., Chicago, Ill.

### AUTOMOBILES

**MAKE \$1.00** on sale of inside visor for automobiles. Retail at \$7.50. Adopted standard equipment on all Stearns Knight cars, for sun and headlight glare. Kilby-Cleveland Co., 407 National City Bank Bldg., Cleveland, Ohio.

**PATENTS.** Time counts in applying for patents. Don't risk delay in protecting your ideas. Send sketch or model for instruction or write for free book "How to Obtain a Patent" and "Record of Invention" form. No charge for information on how to proceed. Communications strictly confidential. Prompt, careful, efficient service. Clarence A. O'Brien, Registered Patent Attorney, Security Bank Building (directly across street from Patent Office), Washington, D. C. See pages 138 and 139.

**AUTOMOBILE**—Make your own motor car, toy size, operated with motorcycle engine. Any boy can make it. Costs little aside from engine. Full directions with drawings an dimensions in The Boy Mechanic, Book 3. Send no money. Pay postman postage and \$2. Popular Mechanics Press, Room 908, 200 E. Ontario St., Chicago, Ill.

### AUTOMOBILE SERVICE EQUIPMENT

**ELEVEN months** to pay for Universal Test Bench used only few weeks. First class condition guaranteed. Shipped on approval. D. W. Baker, Box 872, Troy, Ohio.

**8-HOUR Battery Charger**, used, repossessed, rebuilt. Shipped on approval. Guaranteed. Easy monthly terms. W. E. Jordan, Box M871, Troy, Ohio.

**GARAGE Air Compressor** like new at big saving. Beltless, ball-bearing, automatic. Single unit, electric drive. Small monthly payments accepted. E. C. Galbraeth, Box M873, Troy, Ohio.

### FOR FORD OWNERS

**WELCO Fan Stops** Fords Overheating. Easily installed. \$1 postpaid. Good Agents' proposition. Welco Products, 3344A Altamont, Cleveland, O.

**42.8 MILES** on 1 gallon. Wonderful Moisture Gas Saver. All autos. 1 free. Critchlow, D2-805, Wheaton, Ill.

**DELIVERY Bodies** for Ford Model T. Chassis with inclosed cab, suitable for Contractors, Groccermen and Farmers. Three Styles. Price \$39.50. Write Daniel Zimmerman, Craigville, Ind.

**\$20 "SIMPLEX"** Mechanical truck starter—better than electric—Now \$5. American Simplex Co., Anderson, Ind.

**UNDERSLUNG** with "RKO" Swing Lo Irons. See "Red-i-Kut" ad page 136.

**FORD Electrical Equipment Troubles**—Locate and remedy them easily yourself with the aid of our book "Ford Standard Electrical Equipment." Why pay big garage bills? Battery, ignition, starting and lighting covered. Order today. When postman hands you the package pay him \$1.98 and the postage. Popular Mechanics Press, Room 908, 200 E. Ontario St., Chicago, Ill.

### MOTORCYCLES, BICYCLES AND SUPPLIES

**MONEY Saving Motorcycle Bargains**—Large stock of Used Harley-Davidson—\$50 and up. Send for Free bargain bulletin—Now! Motorcycle Parts, accessories, repairs. Knuth's Harley-Davidson Agency, 2525 Fond Du Lac Ave., Milwaukee, Wis.

**MOTORCYCLES** at Reduced prices. Save 25% to 50%. Send for our Bargain Bulletin. American Motor Cycle Company, 2041-2047 Chicago Ave., Chicago.

**GOOD Second Hand Parts** for Indian, Harley, Henderson, Ace and Excelsior Motorcycles. No Junk. Ship C. O. D. No Lists. J. B. Dahl, 3661-63 Archer Ave., Chicago, Ill.

**MOTORCYCLE Bargains.** Used, rebuilt. Guaranteed. Shipped on approval. Catalog free. Floyd Clymer, 810 Broadway, Denver, Colo.

**INDIAN Motorcycles** \$50. Standard models—\$10 deposit with order, balance C. O. D. Stern Bros., 1790—1st Ave., New York City.

## AVIATION

**LEARN to Fly; \$100.00** including Solo. We guarantee to solo you regardless of the number of flying hours required. Our instructors are ex-army aviators and air-mail pilots with wide experience. Our training equipment is the best obtainable. Our course requires about two weeks, depending on the individual. No bond required, no charge for breakage. Eight years without an accident. 76 students graduated in 1925. Commercial aviation is a rapid growing industry. Don't delay! Enroll now in one of the oldest and best known flying schools in America. Write for booklet, Robertson Aircraft Corporation, operators of the United States Air Mail, St. Louis-Chicago, Lambert-St. Louis Airport, Anglum, Mo.

**PREPARE** with us and make sure of a pilot's license. Ten lessons in the air of twenty minutes each will make you a pilot by our advanced method of training. This, together with our five-weeks shop course, at \$100.00, makes America's oldest aircraft factory the most popular flying school. Work after class hours guaranteed. Special summer evening course, including shop work, field and flying, \$185.00. Employment assistance on jobs paying \$18.00 to \$40.00 per week. Heath Airplane Company, Chicago, Ill.

**PATENTS.** Time counts in applying for patents. Don't risk delay in protecting your ideas. Send sketch or model for instruction or write for free book "How to Obtain a Patent" and "Record of Invention" form. No charge for information on how to proceed. Communications strictly confidential. Prompt, careful, efficient service. Clarence A. O'Brien, Registered Patent Attorney, Security Bank Building (directly across street from Patent Office), Washington, D. C. See pages 138 and 139.

**TO** liquidate affairs of an aero company I will sacrifice following: Thomas Morse fuselage \$25.00, Curtiss \$40.00, Lawrence Motor with propeller \$75.00, Gnome motor \$32.50, LeRhone \$35.00, Propellers \$5.00 up. Photographs furnished with complete description if you mean business. L. E. Waldron, Box 283, St. Paul, Minn.

**AERONAUTICS!** "Aeroplane engines in Theory and Practice," by Rathbun, describes engines fully. Includes all makes. For mechanic, builder and flyer. Send no money. Just order on a postal. When postman hands you book, pay him \$2.50 and postage charges. Popular Mechanics Press, Room 908, 200 E. Ontario St., Chicago, Ill.

**GENUINE 1/2" waterproof Mahogany** plywood, 12" wide, 20c per foot. A-C airplane spark plugs 20c in lots of 100. Other bargains in proportion. Send 2c for bargain list of surplus aircraft material. Heath Airplane Company, Chicago, Ill.

**THE American School of Aviation** announces a new correspondence course in Mechanics of Aviation. A thorough training in Practical Aeronautics. American School of Aviation, Dept. 1861, 3601 Michigan Ave., Chicago, Ill.

**AIRPLANE** and 599 other prizes given away to purchasers of Nelson's Aero Dope Sheets! Only \$1.00, postpaid! Send Stamp for particulars. Nelson Aero Service—H., Box 2186, Seattle, Wash.

**WANTED.** One good used 28 H. P. 2-cyl. Lawrence aviation motor. M. D. S. Box 582, Haines City, Florida.

**AVIATION** positions pay \$2,000 to \$10,000 a year. Prepare for flying and ground positions thru thorough and complete home study training. Write Dept. K-8, Western Airplane Corp., Monadnock Bldg., Chicago.

**SEND** dime for 12 inch mounted propeller and circulars on free three foot model aeroplane. No selling. Aero Shop, 3050 Hurlbut Ave., Detroit, Mich.

**BIGGEST.** Best Catalog Model Airplanes, Parts Supplies; 5c postpaid. Ideal Company, 165 1/2 Spring Street, New York.

**OUR** Protector Goggles Worn by Leading Army, Navy, Air Mail Aviators; \$5.00. Equipment Company, Carle Place, New York.

**THE** Age of the Air is Here. For reliable information on both airplane building and flying we recommend "Aeroplane Construction and Operation," by Rathbun. All features of construction treated. Send no money. Pay postman \$2.50 and postage. Popular Mechanics Press, Room 908, 200 E. Ontario St., Chicago, Ill.

**BUILD** it yourself for \$188.00. The famous "Parasol" sport plane. Safest to fly—simplest to build. Wings come already assembled. Send 4c for "Parasol circular." Heath Airplane Company, Chicago, Ill.

**MAGNETOS**—Splittorf Dixie, Six Cylinders, Brand New, Complete. Fifteen Dollars Equipment, Air Transport Equipment Co., Carle Place, New York.

**NEW** Curtiss JN4D, original crate, less motor, \$650.00. Southern Airplane Company, Knoxville, Tenn.

**DICTIONARY** of Aviation, \$3.90. Languages Publishing Company, 15 W. 18th Street, New York.

**BLUEPRINTS.** Prices reduced. "Aerodrive" boats, sleds. Blueprints only 50c each. Ostergaard Aircraft, 4305 No. Narragansett, Chicago.

**AIRPLANE** Propellers, Brand New, 8' Diameter, Cost Government \$75.00; Sacrificed at \$3.50. Equipment Company, Carle Place, New York.

**NEW** Jenny in original crate, less motor, \$650.00. Southern Airplane Company, Knoxville, Tenn.

## BOOKS AND PERIODICALS

**AMERICA'S** best radio text and reference book. Third edition revised. "Radio Theory and Operating," by Mary Texanna Loomis, member Institute Radio Engineers; President and lecturer on radio, Loomis Radio College. 886 pages, 700 illustrations. Flexible binding. Used by Government Radio Schools, private Radio Schools, Universities and Technical Colleges throughout United States and Canada. Comprehensive with wealth of practical information. For students, practical operators, fans and engineers. Price \$3.50 postage paid. Buy of your book store or send money order or check to Loomis Publishing Company, Dept. M, 405 Ninth, Washington, D. C.

**WHAT** Subject Interests You? Select from this list of helpful worth-while books. Social Letters Made Easy, Spelling Made Easy, How to Develop Your Will Power, Tricks and Magic Made Easy, Bookkeeping Made Easy, Chemistry for Beginners, How to Work Your Way Through College, Confidential Chats with Boys. Price \$1.25 per volume. Pay postman price and postage when he hands you the package. Address Popular Mechanics Press, Room 908, 200 E. Ontario St., Chicago.

**PAINTERS, Decorators, Artists**—Books 10c up. Circulars free. King, Box 1482, Indianapolis, Ind.

**HYPNOTISM** wins Health, Wealth, Fame, etc. 25 Easy Lessons and 248-page illustrated reference guide \$2.00. Popular Institute, 430-PA Milwaukee Ave., Chicago.

**MY** encyclopaedia, Harvard Classics, Book of Knowledge, History, Medical sets, about half price. Dalton Riggs, Crilly Bldg., Chicago.

**ANSWERS** to mathematical problems of office, store, bank, farm, or factory. Explains and simplifies every principle of arithmetic, mechanics and mensuration. Send No Money. Just ask for Bopp's Calculator." Pay postman \$1.00 and postage. Popular Mechanics Press, 200 E. Ontario St., Room 908, Chicago, Ill.

**SELF-INSTRUCTION** Books, Pitman Light Line Shorthand and Simplified Bookkeeping, 50c. Marr, Teacher, B695, Nashville, Tenn.

**AUTHORS,** write for circular "Cooperative Book Publishing." Meador Publishing Company, 27 Beach, Boston, Mass.

**INDUSTRIAL** Alcohol, Wright's book. Full directions for making, fully illustrated. \$2.50. Spon & Chamberlain, 120 P.M. Liberty Street, New York, N. Y.

**FREE**—True-Blue Book. Exchange postcards, stamps. Erickson, Elroy, Wis.

**QUESTION** and Answer fad sweeps country. Send for a copy of the best book on this popular pastime "Ask Me Another." 2000 Questions and Answers, forty information tests with the scores of 69 people you know from all walks of life. Pay postman \$1.60 and the postage when he hands you the package. Popular Mechanics Press, Room 908, 200 E. Ontario St., Chicago, Ill.

**USED** books, educational matter, apparatus, for sale. George Krier, Box 1017, Hibbing, Minnesota.

**BOOKS:** Stock, obtained; used, new. Higene's 978 McAllister, San Francisco.

**SEND** for our unique catalog of 5000 books listed alphabetically under subject headings. Free on request. Popular Mechanics Press, 200 E. Ontario St., Room 908, Chicago, Ill.

## PICTURES AND POSTCARDS

**FOLDER** of thirty views, City of Detroit, 10c; twenty-two views Belle Isle Park, 10c; twenty views Ford plant, world's largest, 10c; twenty-two views, Ford plant and allied industries, 10c; twenty views Detroit's largest industries, hotels, 10c; twenty views, Beautiful Parks, Detroit, 10c; fourteen panoramic views, Detroit, 10c. Six folders, 50c. Folders, 4x6, views in colors. Book 6x9, fifty-six views of Detroit, not in colors, 25c. Mention views wanted. Atlas View Co., Dept. A, Box 681, Detroit, Mich.

**20 CEYLONESE** Girl models, Dollar bill, Art Photo Galleries, 10, Temple Road, Colombo, Ceylon.

**ART** Pictures, Books and Novelties. Catalog 10c. Howard Sales Co., Dept. 15, 1188 Folsom St., San Francisco, Calif.

**FREE**—True-Blue Book. Exchange stamps, postcards. Erickson, Elroy, Wis.

## MAGIC TRICKS, BOOKS AND JOKER NOVELTIES

**NEW** 1927 "Fun—Magic—Mystery" now ready. 100 Pages, profusely illustrated. Over 750 Tricks—Illusions—Jokes—Puzzles—Books—European Novelties, at Reduced Prices. Postpaid 10c. Lyle Douglas, Station A, Dallas, Texas.

**AMUSEMENT?** Party? Send for our list of laugh producers. Sepec Co., 4636 Drake Avenue, Chicago.

**MAGIC**—Tricks, Books and Supplies. For Amateurs as well as the great professional. Anyone can learn through our instructions. Feature Acts in Mind-Reading, Spiritualism, Rope Ties, etc. Large illustrated Professional Catalog, 20c. Chicago Magic Co., 140 So. Dearborn St., Dept. B, Chicago, Ill.

**COMPLETE** Book on Magic. 563 pages, 318 illustrations. Hundreds of tricks. The standard book for years. Make money giving magic entertainments. Send no money. Just ask for Prof. Huffman's "Modern Magic." Pay postman postal charges and \$2.00. Popular Mechanics Press, Room 908, 200 E. Ontario St., Chicago, Ill.

**SEVEN** Magical Delusions and Catalogs—25c. Gilmaglio, Morgan Park, Ill.

**MAGIC** Trick Cards That Are Absolutely guaranteed. Free samples. Write me today. C. D. Blankenship, Adrian, W. Va.

**FREE** with \$25 order die box. Send 20c for our large catalogue of tricks, wigs, sensational escapes. Oaks Magical Co., Dept. 548, Oshkosh, Wis.

**ELECTRIC** Fun! Seventy stunts, 110 volts, \$1. Tatcutting, Campbell, Calif.

**CARD** tricks. Coin tricks. Hypnotism. Ventriloquism. 64-page books. Complete guides 10c each. Geo. Fenner, 2401 Jefferson, Louisville, Ky.

**ILLUSION** Catalog 10c. Trick Catalog Co. Lynn's, 105 Beach, Jersey City, N. J.

**CIGARETTE** vanisher, Card Locator, Handkerchief Vanisher, Multiplying Balls. Each 25c. Catalogue stamp. Swivel, 114 Huntington, New Brunswick, N. J.

**READ** Sealed Messages in Dark; messages retained by audience; burned message appears on blank slate; spirit message appears on slate in sitter's presence; spirit rappings; spirits appear in the dark; answer questions written on folded papers while blindfolded. All this you can do with directions in "Behind the Scenes with the Mediums." 69 best secrets of mediums fully exposed. The best because most baffling, yet all easy to do. Send no money. Just write a postal. Pay postman \$1.50 and postal charges. Popular Mechanics Press, Room 908, 200 E. Ontario St., Chicago, Ill.

## GAMES, ENTERTAINMENTS AND PLAYS

**VENTRILLOQUISM** taught almost anyone at home. Small cost. Send 2c stamp today for particulars and proof. George W. Smith, Room 8-194, 125 N. Jefferson Ave., Peoria, Ill.

**PUZZLES!** If you like them we recommend an illustrated book containing 122 of the best Mechanical Puzzles. You can have loads of fun working out the solutions as enough hints are given in the text matter to enable one to do so. Pay postman \$1.00 and postage when he hands you the package. Address Popular Mechanics Press, Room 908, 200 E. Ontario St., Chicago.

## NOVELTIES

**TWO** Trick Novelties, Trick, (Magic Catalog), 10c. Bagdad, 716 Pine, St. Louis, Mo.

NOVELTIES, Wholesale—retail; circulars; samples, 10c. Housinger, 8236 Cornell, Chicago.

### STAMP COLLECTING

NOBODY Knows what is happening in China: but we know that Scott Seald Packet No. 277 will certainly please you, for it has in it the Dragon stamps of Imperial China, the Junk and Reaper stamps of the later Republic issues, many surcharges and interesting postage dues. This bargain packet contains 25 guaranteed genuine stamps for only 25c. Other fine Scott Seald packets to pep up your album pages: No. 68, 100 Diff. from Fifty Different countries, 25c. No. 8, 1,000 diff. (general collection), \$1.00. No. 152, 100 different from Europe, 10c. No. 67, 100 diff. of the beautiful French Colonials, 40c. No. 146, 200 diff. from Austria, only 25c. No. 202, 50 different from Wurtemberg, 25c. The Scott price list which is free contains hundreds of sets, dime sets, packets, illustrates Scott albums, hinges, tongs, magnifying glasses, watermark detectors and other accessories. Ask us to send it to you when we fill your packet order. International Junior Postage Stamp Album, 1927 Edition. Spaces for 21,000 stamps. Fully illustrated. No. 1, Attractive blue cover, red corners, \$4.00. No. 2, Bound in cloth, gilt lettering, \$5.00. Forwarding extra; weight 6 lbs. Scott Stamp & Coin Co., 1 West 47th Street, New York, N. Y.

500 DIFFERENT Stamps for 25c! Big Collection 500 Different Stamps from Bosnia-Herzegovina, Crete, Epirus, Hong Kong, Iceland, Kenya and Uganda, Liberia, Malta, Nyassa, Tanganyika, Wallis and Futuna, Zanzibar, and other "hard" countries. Catalogue value \$10.00. Price only 25c to Approval Applicants! Special Bargains: 1,000 different 79c; 15 triangle stamps 49c; 100 Africa 50c; 100 Asia 60c; 100 Balkan States 35c; 100 British Colonies 25c; 100 French Colonies, 30c; 100 Portuguese Colonies 50c; All 8 packets for \$3.00! Illustrated Lists Free. Loma Stamp Co., 2221 Madison Ave., San Diego, Calif.

MYSTIC'S "Queer Country" Packet! Contains scarce stamps from the following strange lands: San Marino, Antioquia, Congo, Cyprus, Fiji Islands, Gwalior Hyderabad, Iceland, Jhnd, Kenya, Uganda, Lebanon, Monaco, North Borneo, Nyassa, St. Thomas Prince, Port. Guinea, Siam, Sierra Leone, Tanganyika, Trinidad Tobago, Ubangi, Upper Volta, Wallis Futuna, Zanzibar. Get this wonderful packet of "freak countries" and make your friends envious! Price only 10c to approval applicants! Write today. Mystic Stamp Company (Dept. 8), Camden, New York.

\$1.00 FREE Black U. S. Postage. Given Away with each order. Pioneer Stamp Album with 500 illustrations. 150 different stamps from 40 countries, Syria, Lebanon, Hejaz, Liberia, New French Colonies, British, Portuguese Colonies, South Africa, Australia, 500 hinges, 36 page illustrated catalogue. All for 15c. Big Commission to Agents for the Best approval sheets of stamps ever offered. Write for sample outfit. Hussman Stamp Co., Dept. M, 620 Olive St., St. Louis, Mo.

ANCHERS \$\$\$ Outfit—only 12c! Fine triangle stamp; set German stamps with (pre-war) value forty million dollars (interesting!); perforation gauge, mme. scale; small album; airmail set; scarce stamp from smallest republic on earth; newspaper set; packet good stamps from Travancore, Malay, Dutch Indies, etc. Entire outfit for 12c to approval applicants! (Nice pocket stock book, value 25c, with every order!) Ancher Stamp Co., 148½ Clerk St., Jersey City, N. J.

FREE—200 different stamps to collectors desiring approvals. Lee, 539 S. Salina, Syracuse, N. Y.

PACKETS, Sets, Albums. List Free. Open 9 a. m. to 5:30 p. m. Carl Young, 202 So. Eleventh St., Philadelphia.

24 VARIETIES Cuban stamps, 10 cents. List of 6,000 low-priced stamps free. Address Chambers Stamp Co., 111P, Nassau St., New York City, N. Y.

110 DIFFERENT Stamps, many unused, high values, free to collectors requesting our Net Approvals. Postage 2 cents. Christensen, Milwaukee, Wis.

TO approval applicants enclosing 10c for our Marvel Packet of 55 different from Gabon, Togo, etc., we will send—absolutely free—a genuine scarce South African triangle stamp! Curhan Stamp Co., Gloucester, Mass.

FREE 40 Czecho Slovakia Stamps to approval applicants. 2c Stamp. Lightbown's, Osborne Rd., Southsea, England.

70 DIFFERENT Foreign Stamps from 70 Different Foreign Countries, including Africa, Asia, Australia, Europe, West Indies, etc., for only 16c. Free with each order, our pamphlet which tells "How to Make a Stamp Collection Properly," together with our price lists of albums, supplies, and hundreds of bargains in sets, packets, etc. Queen City Stamp & Coin Co., Room 36, 604 Race Street, Cincinnati, Ohio.

FOREIGN stamps on approval. Reference necessary. Stolt, 2135 Cleveland, Chicago.

1000 NICELY mixed stamps, 25c postfree; 1000 hinges 10c; 2000 17c. Approvals. Price lists. Sunshine Stamp Co., 549 East Maryland St., St. Paul, Minn.

STAMPS, 100 all different. Postage 2c. Lists free. P. M. Quaker Stamp Co., Toledo, Ohio.

STAMPS 60% disc. Fernand Sabater, Box 314, Mayaguez, Porto-Rico.

150 GOOD mixed foreign stamps, 3 cents. Stanton, Niantic, Conn.

FREE 40 Czecho Slovakia Stamps to approval applicants 2c Stamp. Lightbown's, Osborne Rd., Southsea, England.

100 AFRICAN, China, etc., 4c to approval applicants. E. L. Gericke, Lake Mills, Wis.

FREE Premium to those requesting our approvals. Pine Tree Stamp Co., Box 150, Lewiston, Maine.

STAMPS sent on approval at 70% discount. Reference required. Emory Renoll, Hanover, Pa.

3 NORTHERN, 3 Southern Rhodesia, 10c postpaid. Allien, Angola, Ind.

100 FOREIGN postage stamps for 4 cents postage to those requesting our approvals and lists. Free premium offer. Palmer Stamp Co., 8221 Linwood Ave., Detroit, Mich.

300-300-300—ALL different stamps (\$6.00 catalogue); 300 hinges, 5 approval sheets; duplicate stamp album; perforation gauge, millimeter scale and ruler to approval applicants for only 20c. Edgewood Stamp Co., Milford, Conn.

BEST one-cent approvals in America. F. P. Hand, 1117 So. 60th St., Philadelphia, Pa.

FREE—100 all different and many premiums to approval applicants. Albums, hinges, sets, packets, etc. John Cooley, Fishers Island, N. Y.

FREE! Germany 280-293 and price list. Brooklyn Stamp Co., Box 149, Times Plaza Station, Brooklyn, N. Y.

1000 DIFFERENT foreign postage stamps, cataloging \$25.00 for 69c, together with a selection of pretty approvals. 500 different cataloging \$10.00 for 19c. Rotnem Stamp Co., 809 N. W. Bldg., Minneapolis, Minn.

MAGNIFICAROCIOUS Packet foreign stamps, beauties from distant lands. (Many richly colored, unusual designs) free for 2c. Gray Stamp Company, Toronto, Can.

STAMPS One cent each, 13 Azerbaijan 13c, 13 Algeria 13c, 13 Cameroons 13c, 7 Chad 7c, 9 Dahomey 9c, 15 Togo 15c, 8 Ubangi 8c. Charles Townsend, Akron, Ohio.

85—DIFF. U. S. Stamps—25c; 10 Nyassa—10c; 10 Wurtemberg—10c. Mountain City Stamp Co., Box-335, Mannington, West Va.

SPECIAL! All Four of These Packets 75c. (50 diff. Soviet Russia, 25c; 50 British Col. 20c; 25 French Col. 10c; 50 Greece, 40c.) Ask for Approvals. The Cleveland Stamp Co., Caxton Bldg., Cleveland, Ohio.

DANDY packet of free stamps for application for our net approvals. Send reference please, and postage. H. S. Federal, 33 Pine St., Granville, N. Y.

OUR Surprise Packet at 25c includes items such as Rare Stamps, Coins, Shells, Arrow Points, Quills, Lists, etc. Ye Olde Hobbie Shoppe, Port Huron, Mich.

FREE, 12 Diff. large, showy picture stamps for a request for my popular approvals. Premiums with every purchase. A. Bauer, Palmyra, N. J.

SEND Dime—Modern Approvals. Free Premiums! Sets—Packets and Supplies. Marney's, 400 Broadway, East St. Louis, Ill.

COLLECTORS! 100 Stamps Free to Approval, Sets Applicants. Welshaar's, 5813 North Artesian Ave., Chicago, Ill.

ANNIVERSARY Offer! Seven following sets: "Anniversary," "Jubilee," "Charity," "Airmail," "Eagles," "Prisoners," "Pictorials." Four following packets: (British, French, Dutch Colonies), (Precancels), (Bulgaria), (International) 15c to approval applicants. Deering, Fairmount, Marlborough, Mass.

MOST Sensational values; over 140 diff. Algeria, Airplanes, Azerbaijan, Barbadoes, Cameroun, Gabon, Guyane, Irish set, large French Colony packet, largest stamp, 40 year old U. S. gauge, etc., for 10c to approval applicants. List free, 100 diff. U. S. 25c—1,000 hinges 9c—50 Bavaria 7c. Hawkeye Stamp Co., Cedar Rapids, 39, Iowa.

CANADIAN—25 different only 10c and asking to see our Excellent Approvals; receive Beautiful Confederation Jubilee stamp, 5 Newfoundland and Bargain Lists free. Victoria Stamp Co., London, Canada.

DANZIG Stamps Free—Interesting packet from Danzig with big catalogues free for 2c. Midland Stamp Company, Toronto, Can.

300 DIFFERENT Stamps and Premium, 10c. Central News, Watertown, S. Dak.

THOUSAND Foreign Stamps, 50c; catalog free. Prof. McCreery, Chatham, Ontario.

200 DIFFERENT Stamps, Zanzibar; Album, 12c. Liberty, 3974 Arsenal, St. Louis, Mo.

1,000 DIFFERENT, \$0.80; 2,000, \$3.50. Fred Onken, 630 79th Street, Brooklyn.

105 CHINA, etc. 2c. Album (500 illustrations) 3c. Bullard, Sta. A. Boston.

FOREIGN Revenues, Telegraphs, Locals, envelopes, rails, etc. pretty, different, cheap. Stamped Marine Policy free to applicants with references. Vanderhoof, 1114 Logan, Denver, Colo.

200 DIFFERENT stamps 10c; 1,000 Hinges 10c. R. H. Carlton, 380 W. So. Temple, Salt Lake, Utah.

110 NEW Europe All Different, a wonderful collection cataloging several dollars, free to collectors requesting our Net Approvals. Postage 2 cents. Badger Stamp Co., Milwaukee, Wis.

FREE Hungary Charity No. 565 to 567 and a surprise packet given to those requesting for my 1, 2, and 3c approvals, and also my 50% discount. Chas. W. Schmidt, P. O. Box 4832, Frankford Station, Philadelphia, Pa.

BORNEO, Malay, Liberia, large U. S. revenue, commemoratives, with 105 other different U. S. and foreign stamps for only 9c. Fennell Stamp Co., Dept. M, St. Louis, Mo.

109 DIFFERENT, Arabia, Azerbaijan, Zanzibar, etc., 10c to approval applicants. Floyd Marsh, 524 Hamilton Ave., Indianapolis, Ind.

FRENCH Colonies, 25 different, 5 cents. Big lists free. Challenge Stamp Company, 425 McDonough Street, Brooklyn, N. Y.

BUY collections without purchasing duplicates. Write Farley Stamp Co., Auburn-dale, Mass.

OUR Latest 20-page U. S. and Canadian price list free. Stanley Gibbons, Inc., 37 Ann St., New York City.

STAMPS, 100 varieties, Africa, Brazil, Peru, Cuba, Mexico, etc., 10c; 25 different U. S., 25c; 1,000 mixed, 40c; 1,000 hinges, 10c. List free. C. Stegman, 5941 Cote Brillante, St. Louis Mo.

LIBERIA Snake Triangle and two other triangles in our packet of 53 genuine foreign stamps for five cents. Crowder Company, Waverly, Baltimore, Md.

COVERTCO Packet, 250 varieties unused and used stamps 15 cents. Covert Stamp, 39 State, Rochester, N. Y.

TRIANGLES! 75% discount—Special approval sheets with each 5c packet containing set triangles. 2 sets war tax, set airplane, U. S. stamp before 1880, etc.; over 100 different stamps. Murray Stamp Co., 515A Tower Bldg., St. Louis.

PENNY Approvals that Satisfy. Neil Gronberg, Box 5441, Philadelphia, Pa.

BEAUTIFUL Picture Stamps Sent Free. Paul Cornish, Schenectady, N. Y.

### RARE COINS

40 OLD coins, all different, \$1.00, 100 different coins \$3.00. 200 different coins \$5.00. 300 different Germany City Bills \$1.00. 50 different Germany Banknotes 50c. Claud Denney, Box 315, Dallas, Tex.

COIN Magnifier reveals all details and markings. Send \$3.00 subject to return if not satisfied. Optical Specialties, Box WW, Waterloo, Iowa.

OLD Coins, Large fall Selling catalogue of coins for sale free. Catalogue quoting prices paid for coins, ten cents. William Hesselein, 101A Tremont Street, Boston, Mass.

AMERICAN Eagle Cent, 4 Foreign Notes, 10c. 2c Bronze, Russian Note and Catalog 10c. Geo. Best, Cedar Rapids, Iowa.

**GET Profit and Pleasure** in collecting Old Coins. Send 10c for Large Illustrated Coin Catalogue. You'll be delighted with it. Send for it right now. B. Max Mehl, Numismatist, Mehl Bldg., Dept. P, Fort Worth, Texas. Largest Rare Coin Firm in the U. S.

**OLD Money Wanted.** Do you know that Coin Collectors pay up to \$100.00 for certain U. S. Coins? And high premiums for all rare coins? We buy all kinds. Send 4c for Large Coin Folder. May mean much profit to you. Numismatic Co., Dept. H, Ft. Worth, Tex.

**OLD Coins Bought and Sold.** Rare Coin Book 65c. 700 Illustrations. Send 10c for Coin collecting booklet. Guttag Bros., 16 Exchange Place, New York.

**UNITED STATES and Foreign Money;** Military Decorations Catalogue and Greek coin 10c. Alexis Mengelle, Colorado Springs, Colo.

**UNITED STATES, Large Cent, two-cent bronze, three-cent nickel and Bargain List, 25c. Fifteen dates large cents, \$1.00. George Coffin, Greenwood Mountain, Me.**

**\$2 TO \$500 Each Paid** for hundreds of old and odd coins. Keep all old money. It may be very valuable. Send 10 cents for illustrated coin value book, 4x6. Get posted. Guaranteed prices. We buy and sell. Clarke Coin Office, LeRoy, N. Y.

**CALIFORNIA Gold—Quarter Size, 27c; 3/4 size, 53c; 3c Piece and Catalogue, 10c** Norman Shultz, Box 746, Salt Lake, Utah.

#### FOR BOYS

**BOYS! 600 prizes,** including airplane, given to purchasers of Nelson's Aero Dope Sheets. Particulars for stamps. Nelson Aero Service—L, Box 2186, Seattle, Wash.

**DRAFTING.** Learn Mechanical Drawing. Big demand for men. Pocket size. Start at beginning and learn by a series of simple lessons. Send no money. Just write postal for "Practical Course in Mechanical Drawing." Pay postman postage and \$1. Popular Mechanics Press, Room 908, 200 E. Ontario St., Chicago, Ill.

**SHALL I Become an Engineer?** You can decide this all-important question better by reading a book called "Engineering as a Career," written by a group of eminent engineers. It costs only \$1.00. You will find the advice of these successful men to be of the greatest value. Pay postman price and postage when he hands you the package. Address Popular Mechanics Press, Room 908, 200 E. Ontario St., Chicago, Ill.

#### CAMERAS AND PHOTO SUPPLIES

**COLORING** photographs is a profitable and pleasant profession; the field is big—expert colorists are in demand everywhere, at all times—not many know how. We teach you by mail. You can color photographs, lantern slides, greeting cards, etc., in your spare time or steady employment. Write today for free booklet. Japanese Water Color Co., 11 Diamond Place, Rochester, N. Y.

**HAVE You a Camera?** Write for Free sample of our big magazine, showing how to make better pictures and earn money. American Photography, 116 Camera House, Boston, 17, Mass.

**PHOTOGRAPHS** for sale: California, Panama Canal, Havana, Hudson River, others. Albums, Cameras. Write for price list. Kenneth Sales Co., Dept. C, Box 893, Poughkeepsie, N. Y.

**KODAK Film—Special Trial Offer—Your** next roll developed 5c, prints 3c each. Beautiful 6x10 mounted Enlargement 40c. Prompt Service. Fleet Photo Service, 425 G St., N. W., Washington, D. C.

**PHOTOGRAPHIC** equipment and accessories of every description are listed and illustrated in our 228-page catalog. It will pay you to secure a copy which is issued free, as our prices are low. We also deal in used goods which are sold under the same guarantee as new goods. Ask for our Bargain Book. Central Camera Co., Dept. E 120, 112 S. Wabash Ave., Chicago, Ill.

**MAKE money** in Photography. Learn quickly at home. Spare or full time. New plan. Nothing like it. Experience unnecessary. American School of Photography, Dept. 3432, 3601 Michigan Ave., Chicago.

**BIG Money Saved** on Photographic Lenses and Apparatus—goods exchanged; repairing done. Ralph J. Golsen, 1128 Argyle St., Chicago, Dept. P.

**FILMS** Developed. Special Trial Offer. Any Size Kodak film developed 5c, prints 3c each. Trial 6x10 Enlargement in handsome folder 40c. Overnight Service. Roanoke Photo Finishing Co., 209 Bell Ave., Roanoke, Va.

**AMATEUR Photographs Profitable.** Booklet describing One Hundred Best Magazine Markets 10c. Snyder Publishing Co., Guilford, Conn.

**\$150 GRAFLEX** Camera \$75. R. Schlegel, 1118 N. Negley, Pittsburgh, Pa.

**SPECIAL Trial Offer.** Any size Kodak film developed 5c. Prints 3c each. 8x10 enlargement beautifully mounted 40c. 24-hour service. Young Photo Service, 405 Bertha St., Albany, N. Y.

**WE Sell** Photographs, snapshots, short feature articles. Write for circulars. Snyder Publishing Co., Guilford, Conn.

#### MOTION PICTURES

**\$1,250.00 FOR** a Photoplay Story by an unknown writer and sold through our Sales Dept. We revise, copyright and market. Located in the heart of Motion Picture Industry, we know the demand. Established 1917. Send Manuscript for free criticism. Booklet on request. Universal Scenario Company, 206 Western and Santa Monica Bldg., Hollywood, Calif.

**SEND 10c** in stamps for the 1928 edition of the famous Bass Book of Cinema Apparatus, greater than ever. Send \$2.00 for catalog and new book on "How to Make Motion Pictures," by Cameron. Bass Camera Company, 179 West Madison St., Chicago.

**NEW and Rebuilt Projectors** for Theaters, Schools, Churches, Traveling Shows. Supplies and Complete Theater Equipments. Bargain Prices. Free Catalog. Monarch Theatre Supply Co., Memphis, Tenn.

**FILMS:** \$3.00 per reel up. Comedy, Western, Cartoon, Drama, Serial, Educational, Special Features. Best Movie Stars. Free List. Toy Film 200 Feet Postpaid \$1.50. Dixie Film Co., Box 2042, Memphis, Tenn.

**MAKE Movies!** Make Money! with the Real Professional Institute Standard Motion Picture Camera—the kind used by largest studios. 200 and 400 feet film capacity. F3.5 lens. Ideal for educational, Industrial and News film. Free Booklet sent. New York Institute of Photography, Dept. 9, 14 West 33rd St., New York.

**NEW 100-foot Spring Motor Camera,** \$120. New \$150 leather case Spring Motor Camera, \$37.50. Eastman Negative Film 3 cents a foot. Motor Driven Suit Case Projector \$50. Movie Printer \$25. 50-foot Developing Outfit \$30. Films \$2 reel. 5 Mazda lamps, 25 volts, 30 amperes, \$5. Ray, 296 5th Avenue, New York.

**COMEDIES, Westerns,** \$2.50. Professional Camera \$80.00. Stewart Marshall, Rome, Ga.

**MOVIE Films,** 1,000 ft. reels, \$2.50 each; shipped anywhere on receipt of remittance. Particulars on request. Independent Films, 177 Golden Gate Ave., San Francisco, Calif.

**1000 FEET** of Comedy, \$2.00. No lists. Sunset Film Exchange, 298 Turk St., San Francisco, Calif.

#### SCENERY TO RENT

**WORLD'S Most Beautiful Settings** for operas, plays, minstrels. Amelia Grain, Philadelphia.

#### EDUCATIONAL AND INSTRUCTION

**STORY Ideas** Wanted for photoplays, magazines. Big demand. Accepted any form for revision, development and submission to markets. Established 1917. Send manuscripts for free criticism. Booklet mailed on request. Universal Scenario Company, 403 Western and Santa Monica Bldg., Hollywood, Calif.

**AAA, learn** auto driving by mail. Results guaranteed; for Ladies and Gentlemen; only method in the world; gold medal won in Europe. For \$1.50 you will learn to drive any car; no instructor needed. You will be surprised. Send for your manual to-day. 235 W. 37th Place, Los Angeles, Cal.

**FAMOUS Bailey Handbook—The** book that prepares you to pass the examination for any grade of license for stationery, marine and Diesel engineers, firemen and boiler inspector in any state of the union or any province of Canada. Flexible cover. Handy pocket size. Pay postman \$2.00 plus the postage when he hands you the package. Popular Mechanics Press, Room 908, 200 E. Ontario St., Chicago, Ill.

**WE will publish** any story, article or poem you wish to see in print, in our high-class magazine. Send us 20 cents per hundred words. Circulates everywhere. Copy 20 cents. International Digest, 21 Dent Road, Shanghai, China.

**SONG Poem Writers—address** Hibbeler, D15X, 2104 N. Keystone Ave., Chicago.

**DON'T speak** incorrectly. Our self-explanatory chart corrects you, \$1. Psychological Publishing Co., 579 Yondota, Toledo, Ohio.

**FUN Making Things.** Four large profusely illustrated books telling how to make almost everything from a sail boat to a toy automobile propelled by a motorcycle engine. New \$2 per book or \$7 for the four if ordered at once. Send no money. Just write a postal saying, "Send the Boy Mechanic Library." Pay postman \$7 and postage. For single books, specify either Book 1, Book 2, Book 3, or Book 4. Popular Mechanics Press, Room 908, 200 E. Ontario St., Chicago, Ill.

**WORLD-ROMIC System, Masterkey** 5,000 languages. Primers, \$1.98; Arabic, Chinese, French, German, Italian, Japanese, Russian, Spanish. Languages, 15 W. 18th St., New York.

**SHOWCARD Course,** 90 Alphabets, 100 examples, \$1.00 complete. Satisfaction guaranteed. Stamps accepted. Educator Press, 19 Park Row, New York, Dept. 120.

**PROFESSIONAL Bookkeeping** Taught for \$9.85 by simpler, speedier more practical method. "Different"—that describes it! All phases. Write for folder. Kinman Morris Co., CPA's, Old National Bldg., Spokane, Wash.

**"COLOR Chart"** (actual colors) 10c prepaid. King, Box 1482, Indianapolis, Ind.

**EARN \$25 weekly,** spare time, writing for newspapers, magazines. Experience unnecessary. Details Free. Press Syndicate, 981, St. Louis, Mo.

**USED educational matter** sold on repurchase basis. Also rented and exchanged. Money-back guarantee. Catalog free. (Books, etc. bought.) Lee Mountain, Pisgah, Ala.

**DOUBLE Entry Bookkeeping** mastered in 60 hours with 8 keys; guaranteed; diploma. International Bookkeeping Institute, Dept. 8, Springfield, Mo.

**YOU Need** a better grip on mathematics? Tell us to send you a copy of "Mathematics for the Practical Man," only \$1.50. By common sense methods it removes the mystery and difficulties so algebra and calculus are made simple. Assuming your knowledge is limited to arithmetic you quickly and easily gain a working knowledge of algebra, geometry, trigonometry and calculus. Simply pay postman when he hands you the package. Address Popular Mechanics Press, Room 908, 200 E. Ontario St., Chicago, Ill.

#### RADIO OUTFITS AND SUPPLIES

**RADIO Receiver;** All stations—American and overseas; all wave lengths—200 to 4,000 meters. This 6 tube Gnome Polyphase, the latest development in modern radio. Agents wanted. 100% profit—\$100—per week easy. Radio Exchange, 925 Broadway, New York.

**CHOKE Coils—100H., 125 M. A., \$5.75;** 50 H., 85 M. A., \$2.75. Write for lists. Radio Parts Sales Co., Orange, N. J.

**RADIO Up-to-the-Minute.** Telegraphy, radio reception, vacuum tubes, telephony, how to build receivers, broadcasting, all treated in new book. Send no money. Pay postman \$1.25 and postage. Just write postal for "Radio Up-to-the-Minute." Popular Mechanics Press, Room 908, 200 E. Ontario St., Chicago, Ill.

**BEST Radio Book—New Third Edition,** 1927. Revised—Radio Theory and Operating by M. T. Loomis of the Loomis Radio College is America's Standard Radio Text-Book. Used by the various gov't depts. and schools and leading radio schools. 885 pages, 700 illus., flexible krafty leather binding. Sent C. O. D. Pay postman \$3.50 and the postage when package is delivered. Popular Mechanics Press, Room 908, 200 E. Ontario St., Chicago.

#### TRADE AND TECHNICAL SCHOOLS

**LEARN** barbering at home. Practice on the family. Complete barber college instructions, home study, for \$1 bill or money order. Foster, Expert Barber, 6128 Michigan Blvd., Chicago, Ill.

**AUTOMOBILE Radiator** repairing. Complete instructions. Learn by doing actual work at home or in our school. Bixler Radiator Institute, Frankfort, Ky.



**LEARN** Bricklaying and earn \$1 to \$1.75 an hour. Wm. M. Woods, who has trained 500 men will teach you bricklaying in our school run by 800 builders interested in giving jobs to Mr. Woods' students. Tuition \$60.00 per month. Time required 3 to 6 months. Board and room \$8.00 to \$10.00. Work is actual bricklaying; you become master in the craft, in line for highest wages and promotion. Ample space and material. Catalog free. Associated Building Employers, R-400, A. B. E. Bldg., Grand Rapids, Mich.

**INTERNATIONALLY** recognized as world's leading radio institution. Investigate through Department of Commerce. Fall Term September 5th. Large staff expert instructors. All graduates placed at splendid salaries to start. Students may earn all expenses while taking course. Write today for catalogue and full particulars. Address Secretary, Loomis Radio College, Washington, D. C.

**GET** a Foreman's job in any trade. You will earn more money. Become an expert Blue Print Reader. You can do it in spare time. My training will advance you quickly. Write now—tell me what trade you want—I will send my plan at once. Carroll Rumsey, 265 Drexel Building, Philadelphia, Penna.

**TELEGRAPHY**—Both Morse and Wireless—taught thoroughly and quickly. Tremendous demand. Big salaries. Wonderful opportunities. Expenses low; chance to earn part. School established fifty years. Catalog free. Dodge's Institute, Fern St., Valparaiso, Ind.

**BIG** Pay Jobs. Learn Sign Painting, Decorating, Paperhanging, Show Card Writing, Graining and Marbling by practical training in a few weeks. Chicago Painting School, 148 West Austin Ave., Chicago.

**BUSINESS OPPORTUNITIES**

**NOTHING** on earth offers bigger opportunity for building wonderful business this summer than manufacturing these popular profitable, big-selling specialties. Start small—watch business grow. Write today for valuable formula literature relative to making: Sealate, guaranteed puncture proof liquid; Ducooil, automobile polish; Cellulac. Duco finishes in color, quick drying; Solvit; powdered hand cleaner; Miracle, non-thermic ice cloths, mendit, fabric patching liquid; Liquid-Seal, radiator cement; Vanil-Ozone, "million-dollar" vanilla flavor; Fruitina; concentrated summer drinks; and a hundred other real honest-to-goodness, money-making propositions. 30 years headquarters for best formula service. Miller, Chemist, 1706-B Jetton, Tampa, Fla.

**GO** into the manufacturing business. Make your own products. Almost no immediate capital required. Orr's Formulas, Trade-secrets, Processes and Sales methods assure easy, big selling products. Free complete catalog includes listing of processes for manufacture of beverages, bleaches, cosmetics, confectionery, cements, dyes, soaps, exterminators, lubricants, household preparations, perfumes, liniments, proprietary medicines and countless other specialties always in great demand. Write for this catalog. Orr Industrial Laboratories, 1356 N. Wells St., Chicago.

**READ** The Mail Order News—America's Pioneer Mail Trade Journal. Quarter Century Old. Approximately 600 pages yearly of valuable information for beginners and established mail-order houses. Analyzes mail-order business, its opportunities. Practicable mail-order ideas, legitimate money-making schemes, instructive articles. Tells how to start, what to sell. Published monthly. Subscription \$3.00 yearly. Send 25c for sample copy. None free. Mail Order News, 360 Bristol Bldg., New York.

**MAKE** chili bricks in your community Mfg., in your kitchen, sell to Stores, Restaurants, Hotels, Housewives. 200% Profit. 5-ounce brick makes 12 dishes fine chili Con Carne, delicious, appetizing, easy to make. Materials easy to obtain. Sells itself. Full size \$.35 brick, secret formula, complete instructions for making and selling, all for \$1.35. Send no money, just pay postman when package arrives. Address Mexican Chili Company, Centralia, Wash.

**\$750,000,000** MAIL order business in 1925. Many grow rich in this great trade. Sell merchandise, information, patented articles, various preparations. Breniser's Famous Mail Order Handbooks tell how. Eleven brochures \$3. One book with complete catalog, 25c; none free. Breniser, (Established 1900), 1607 Sansom, Philadelphia.

**START** a manufacturing business of your own. Earn \$100 weekly. Make your own products. Formulas, Toilet Articles, Perfumes, Soaps, Extracts, etc. We furnish everything and show you how. Valuable catalog free. National Scientific Laboratories, 1987W Broad, Richmond, Va.

**PATENTS** Procured; Trade Marks Registered—A Comprehensive, experienced, prompt service for the protection and development of your ideas. Preliminary advice gladly furnished without charge. Booklet of information and form for disclosing idea free on request. Richard B. Owen, 30-Owen Bldg., Washington, D. C., or 41-R Park Row, New York.

**THAXLY** Formulas, Processes, Trade-Secrets produce perfect products. Make them yourself. All lines. Send for catalog, circulars free. B. Thaxly Co., Washington, D. C.

**501 SPARETIME** money-making opportunities. Write today, enclosing stamp. J. P. Bailey, 1109 Manhattan Ave., Brooklyn, N. Y.

**DELAWARE** Incorporator. Charters; Fees Small; forms. Chas. G. Guyer, 901 Market St., Wilmington, Del.

**A BUSINESS** of Your Own Making—Sparkling Glass Name and Number plates, Checkerboards, Signs. Big book and sample free. E. Palmer, 540, Wooster, Ohio.

**MIRRORS** Resilvered at Home. Costs Less 5 cents per square foot; you charge 75 cents. Immense profits plating like new; brassy, worn-off autotaps, reflectors, tableware, stoves, etc. Outfits furnished. Details Free. Sprinkle, Plater, 127, Marion, Ind.

**CHEMICAL** Expert furnishes Manufacturing Formulas and Processes with complete working directions. Reliable individual service only. No lists. Charges reasonable. Correspondence invited. Dr. Arthur Van-Heeden, 508 South Oakley, Chicago.

**IMMENSE** Sales, Greatest Profits. The biggest star sellers from all over the world. \$1.00 brings proposition, six assorted samples. Details, Circulars and Price list 20c. Miller, Specialty Wholesaler, Box 596 Pasadena, Cal.

**MAKE** \$25.00, glass or flashing electric signs for \$3.50. Big demand. Full instructions—samples work, etc., \$1.50. R. Harris, Grimes, Calif.

**EARN** \$10 daily silvering mirrors, plating, refinishing metalware, chandeliers, head-lights, bedsteads. Outfits furnished. E. Decie Laboratories, 152 E. 23d St., New York.

**I EARN** big money weekly for my home. An auto my only equipment. No canvassing or selling. You can do the same in towns over 25,000. Quickly learned. Feasible for men or women. \$5 for complete instructions or \$1 for description and first lesson. O. B. H., 14724 Clifton Blvd., Cleveland, O.

**BUSINESS** profession of your own and earn big income in service fees. See Stephenson Laboratories, display ad, page 145.

**PAINT** Manufactured for less than 50c per gallon. Without machinery. Not a formula scheme. Free Literature. Illinois Business Service, Room 708, 72 E. Madison St., Chicago.

**IF** required capital for business or patent, write Mr. O'Sullivan, Drawer D973, Sault Ste Marie, Ontario.

**FREE** information small article, sell by mail or personally, popular as cigarettes; 15,000,000,000 sold annually. Necessity, nationally advertised. 100% Profit. Great sideline for salesmen. Velvet Products Co., 47 South Park Lake Ave., Orlando, Fla.

**MAIL** Dealers—Our books are sure winners. Powerful circular brings home the bacon; send for sample. Bestyet Products, 129 Church St., New York City.

**MAKE** big money opening Safe and Setting Combinations. Wayne Strong, 3706 1/2 Lan Franco St., Los Angeles.

**CHEMICAL** Expert will furnish Formulas and Trade Secrets. All lines. Lists Free. W. L. Cummings, Ph. D., 228 Gordon Ave., Syracuse, N. Y.

**SELL** by Mail! Books, novelties, bargains! Large profits! Particulars Free! R-Elfec, 525 South Dearborn, Chicago.

**BECOME** a Hat Renovator. Learn how to clean and dye felt hats, bleach panamas and straw hats. Uncrowded field. Fascinating work. Learn this profitable trade in a few weeks. Write for particulars. Walter A. Hugo, Dept. 24, 703 McAllister St., San Francisco.

**CAPITAL**—For copy of "The Promoters' Hand Book," a leaflet on financing, send \$1.00 to Amster Leonard, East Orange, N. J.

**PATENTS.** Time counts in applying for patents. Don't risk delay in protecting your ideas. Send sketch or model for instruction or write for free book "How to Obtain a Patent" and "Record of Invention" form. No charge for information on how to proceed. Communications strictly confidential. Prompt, careful, efficient service. Clarence A. O'Brien, Registered Patent Attorney, Security Bank Building (directly across street from Patent Office), Washington, D. C. See pages 138 and 139.

**ARTIFICIAL** marble sanitary flooring instructions, covering wood or cement flooring 1/2 inch thick, fireproof, waterproof, all colors, low cost. Ornamental casting, concrete, plaster, papier-mache decorations, garden furniture, statuary, flexible molds. 17 years instructing the public; particulars and illustrations free. Chris. Mahler, Huntington, N. Y.

**BIG** mail, magazines, circulars. Year 15c. Kentucky Agency, Covington, Ky.

**EARN** \$2,000 to \$6,000 yearly in your own business with our new collection course. Particulars for stamp. Tri-State Agency, 12 Doyle Bldg., Akron, Ohio.

**YOU** Need Porter's Magazine containing mail order articles for beginners and dealers. Copy 5c; year 25c. Porter's Publications, 941a 115th St., Richmond Hill, N. Y.

**MECHANICS,** painters, carpenters, start furniture refinishing, painting, handyman shop on nearly nothing; winning plan brings customers quickly. John Braceland, 1439 So. Ninth, Philadelphia, Pa.

**MAIL** Order Business Positively Your Big Opportunity. Start Right. Grow. Win. Free Circular. Send Today. Macrae, Publisher, 402M, Oregonian Building, Portland, Ore.

**INCOME** Increaser—newly enlarged 32 page monthly magazine of best, latest ideas, plans, schemes, tips, pointers, starters. Sample copy dime. Buckman, publisher, 63-A Court St., Boston, Mass.

**SELL** by mail. Wonderful opportunity. Particulars Free. Mason, 3902 Broadway, Room 5, Chicago.

**YOU** can have an independent business of your own, and I am here to show you the way. Write at once! Wm. E. Heinemann, 2415 Montrose Ave., Chicago, Ill.

**GET** into the mail order business. Unlimited opportunities for ambitious persons. Write today for our big "free" offer. Publisher, 6652-J Gravois, St. Louis, Mo.

**WE** Start You in Business, furnishing everything; men and women, \$30.00 to \$100.00 weekly operating our "New System Specialty Candy Factories" anywhere. Opportunity lifetime; booklet free. W. Hillyer Ragsdale, Drawer 4, East Orange, N. J.

**I MADE** \$30 a Week Home. French Breadmaking. 15 years' experience; Free Booklet tells. Ashbrook 67, Marengo, Ohio.

**UNPATENTED** Ideas Can Be Sold. I tell you how and help you make the sale. Free particulars (Copyrighted). Write W. T. Greene, 810 Jenifer Building, Washington, D. C.

**"SCHEMER,"** Alliance, Ohio, 36 p. monthly, prints Schemes, Tips, Formulas. Subscriber reports \$25,000 from three; another \$10,000 from one. Try it! Year, \$1.00; 3 months, 30c.

**CHARTERS:** Delaware; best, cheapest; free forms. Colonial Charter Co., Wilmington, Del.

**MAIL** Order Information, where to buy goods, Specialties, imprint circulars, everything for mail order business 25c. Harvey Teeple, Decatur, Ind.

**LEARN** the collection business. Good income, quick results. Interesting booklet, "Skillful Collecting" free. National Collectors Assn., Long St., Newark, Ohio.

**MAIL** Order offers unlimited opportunities. Get free offer today. Messenger, Dept. 62, Stillwater, N. Y.

**RESPONSIBLE** manufacturer wants competent men to manage office and salesmen. \$300 to \$1,500 necessary; will allow expenses to Baltimore if you qualify. Address Manager, 601 N. Eutaw St., Baltimore, Md.

**SIGNS** and Showcards Easily painted with Letter Patterns. Large variety of Styles and Sizes. Samples for stamp. John Rahn, a2120 Neva Ave., Chicago.

**TASTE** flavor of real money selling Annie Blain Flavors, wholesale, retail; new system, samples; other unique methods. Geo. S. Parker, New Brunswick, N. J.

## TELEGRAPHY

**TELEGRAPHY**—Both Morse and Wireless—taught thoroughly and quickly. Tremendous demand. Big salaries. Wonderful opportunities. Expenses low; chance to earn part. School established fifty years. Catalog free. Dodge's Institute, H St., Valparaiso, Ind.

## CHEMISTRY

**CHEMISTRY**—YOUR chemical problem solved and working formula or process furnished for \$5.00. Write me. W. Stedman Richard, Industrial Chemist, Box 2402, Boston, Mass.

## FORMULAS AND TRADE SECRETS

**CHEMICAL** Consultation. Manufacturing ideas made practical. Guaranteed economic formulas prepared, \$5.00. With sample, \$6.00. Associated Chemists, Indianapolis, Indiana.

**START** a manufacturing business of your own. Earn \$100 weekly. Make your own products. Formulas, Toilet Articles, Perfumes, Soaps, Extracts, etc. We furnish everything and show you how. Valuable catalog free. National Scientific Laboratories, 1987W Broad, Richmond, Va.

**THAXLY** Formulas, Processes, Trade-Secrets produce perfect products. Make them yourself. All lines. Send for catalog, circulars free. B. Thaxly Co., Washington, D. C.

**TATTOO** Remover Formula \$1.00. Supply Catalogue, "Waters," 965 Putnam, Detroit.

**CURE** Chafing. Instant relief. Recipe for 50c (Stamps). J. Albert Young, Bellevue, Iowa.

**10,000 FORMULAS.** A real gold mine of money-making ideas. Tells how to make almost everything under the sun. You can make and sell cosmetics, mucilage, anti-freeze solutions, battery solutions, beverages, cheese, chewing gum, cleaning preparations, extracts, hair preparations, inks, blueing, leather polish, mirrors, perfumes, polishes, typewriter ribbons, carbon paper, washing powders, liquid soap, and hundreds of other profitable articles. Send no money. Just write a postal for "Henley's 20th Century Book of Formulas." Pay postman postage and \$4. Popular Mechanics Press, Room 908, 200 E. Ontario St., Chicago, Ill.

**500 FORMULAS** and Big Catalog 20c Ideal Book Shop, Park Ridge, Ill.

**DUCO,** Lacquer, and Baked-Enamel Polish. A remarkable formula. Easiest, quickest, best. Result of one year laboratory experiment. Easy made. Only \$1. C. F. Roll, 1127 N. Main St., Tulsa, Oklahoma.

**FORMULAS:** Absolutely guaranteed. Best chemical science has devised. Don't risk your money till you've investigated these wonderful processes for all lines. Get my valuable "eye-opening" literature. Highest references. 30 years supplying the best. Miller, Chemist, 1706-P Jetton, Tampa, Fla.

**TOMBSTONE** Renewing: We will send amazing money getting process to 2 Men, Women or Boys to go partners working cemeteries; spare time or steady; lonesome work but dollars jingle. Sterling Specialty Co., 231 Federal, Denver, Colo.

**SAWDUST**—Chemicals makes Sanitary Flooring. Guaranteed directions \$1.00. Universal Supply Co., Auburn, N. Y.

**15,000 FORMULAS** in "Scientific American Cyclopedia of Formulas." Includes following and many others: Accidents and emergencies, agriculture, alloys and amalgams, artist's materials, beverages, cements, glues, pastes, mucilages, bleaching, renovating, coloring metals, dyeing, glass, heat treatment of metals, household formulas, ice cream, confectionery, chewing gum, lapidary work, exterminating vermin, lubricants, paints, varnishes, photography, condiments, canning formulas, rubber, soap, candles, soldering, toilet preparations, perfumes, waterproofing, fireproofing, writing materials. Send no money. Just write a postal. When postman hands you book pay \$5.50 and postal charges. Popular Mechanics Press, Room 908, 200 E. Ontario St., Chicago, Ill.

## AGENTS WANTED

**START** a manufacturing business of your own. Earn \$100 weekly. Make your own products. Formulas, Toilet Articles, Perfumes, Soaps, Extracts, etc. We furnish everything and show you how. Valuable catalog free. National Scientific Laboratories, 1987W Broad, Richmond, Va.

**MAKE \$100** weekly supplying demand for new invention. Makes autos run on 7% gasoline. Free sample. Write Whirlwind Co., 1041-359 Winnebago, Milwaukee, Wis.

**AGENTS**—\$13.80 Daily in advance. Introducing New Insured Hosiery for men, women, children. Must wear or replaced free. 57 styles, 39 colors, including latest "Silk to the Top" Ladies' Hose. Nyland made \$595 in one month. Edwards, \$460.60. Mrs. Bone, \$425.45. Why not you? Even spare time should pay you \$3.00 an hour. No experience needed. We furnish samples. Silk hose for your own use Free. New Plan. School line now ready—Write quick. Maccohee Company, Road 2568, Cincinnati, Ohio.

**AGENTS:** Lindbergh's air exploits. Tremendous demand. Big book; profusely illustrated, \$1.50, \$25.00 daily. Credit given. Outfit 10c, stamps accepted. Wilmore Book Co., Como Bldg., Chicago.

**\$25 DAILY** showing \$2.98 slickers, \$1.25 gift to customer makes sales easy. Outfit free. American, 724P, Roosevelt, Chicago.

**AGENTS** become a regular established McConnon Dealer; buy on credit, sell for cash or credit. 185 absolute household necessities; all repeaters. Enjoy a sure income 52 weeks per year, year after year. City or country trade. Capital, experience unnecessary. McConnon & Co., Dept. S10, Winona, Minn.

**WOMEN**—\$2 an hour spare time; 100% commission, new idea sanitary necessity; sells on sight; every woman buys; new feature never before used; designed by physician; revolutionizes old uncomfortable methods; pay every day; no deliveries, no collections; no experience or capital required. Particulars mailed in plain envelope. Write Mrs. Mary P. Coleman, Meriden, Conn.

**NEW** Dynamo Timer guaranteed life of car. 12,000,000 prospects. Earn \$100 weekly. Write today. Free sample. Dynamo Co., 426-1110 Eleventh St., Milwaukee, Wis.

**AGENTS,** portraits, photo-pillow tops, frames, sheet pictures, medallions, photo-jewelry, guaranteed hose, laundry tablets, food products, toilet requisites, luminous crucifixes. Catalog 50 specialties free. 30 days' credit. Jas. C. Bailey, Dept. C-8, Chicago.

**HERE** it is, something different, a new adjustable, waterproof apron everybody wants; over one hundred percent profit. B. & G. Rubber Co., Dept. 240, Pittsburgh, Pa.

**COUNTY** Representatives With Cars to demonstrate Webb's Tube Seal. Seals punctures, slow leaks and porous tubes. Reduces the cause of Rim Cuts and Blow-outs. Increases Tire Mileage. Positively not-injurious to Rubber. Webb's Gasoline Intensifier reduces Carbon deposits, increases Gasoline Mileage. "A regular Monkey Gland for Automobiles." Write for County Rights, Pgh. Puncture Proof Products Co., 209 Anderson St., N. S., Pittsburgh, Penna.

**\$40.00 SUITS** for \$23.50! All one price. Union made of finest quality Virgin Wool. You don't have to know anything about selling clothing. We guarantee your success if you are honest and willing to work. Write at once. William C. Bartlett, 850 Adams, Dept. 505, Chicago.

**TEST** big money-maker at our risk. Will send sample patented wringer mop on approval. Many eager buyers. Kleanezy Mop Co., Dept. G8, Delphos, Ohio.

**AGENTS**—Sensational new adjustable cap fits everybody. Sells at sight. Make \$50 to \$75 weekly writing orders. Commissions in advance. Complete outfit free. Fits-U Cap Co., Dept. CH-75, Cincinnati, Ohio.

**AGENTS** Sell Gas 3c Gallon. 300% Profit. Your address on cans. No Fake. Guaranteed product. Free Particulars and proof. LeFebvre Company, Alexandria, Ont., Canada.

**BRAND** New Plan. Make \$45 and up weekly. Profits paid in advance. Free suit to each agent. Just show our wonderful new style outfit and take orders for our high-grade tailoring. Handsome carrying case outfit of large real cloth samples—everything furnished free. Spencer Mead Company, Sherman and Harrison, Dept. H-817, Chicago.

**\$50,000.** PICTURE Man Friedman made canvassing. Beginners can make \$100.00 weekly with my sales talk. Experienced men make more. Free book. "Profits in Portraits" explains. Samples Free. Picture Man Friedman, Dept. 8-K, 541 W. Lake, Chicago.

**AGENTS,** make \$3.00 an hour taking orders for our 40 fascinating Kitchen Specialties. No competition. Write quick. General Products Co., Dept. G-207, Newark, N. J.

**PRIVATE** Brand Toilet Articles, Household Specialties, Perfumes, Soaps, Extracts, etc. We pack these goods for you under your private label. With your name on the goods you get all the repeat business. Don't sell for others but build up a profitable business for yourself. Highest quality merchandise, extremely low prices. Immediate shipments on both small and large orders. Write at once for low wholesale prices and complete information regarding our amazing offer. Address Supply Department, National Scientific Laboratories, 1904W Broad, Richmond, Va.

**AGENTS,** Salesmen, Crewmen—You'll have the Devil's-own-time finding a better seller than "Zippo." Splendid profit on snappy 50c "Go-Getter" repeat article that sells on a ten-second demonstration. Works while you watch it! Demonstrates value while others waste time making claims. New development! Greatest scientific triumph of the age! It's the berries! Write immediately for complete proposition. Karam-Smith Company, 608 Bozen Street, Fort Wayne, Ind.

**MAKE \$18** A Day And More. Everyone needs shoes. Sell Mason's all-leather shoes below store prices. 85 styles—men's, women's, children's. No experience needed. Big outfit free. Mason Shoe Mfg. Co., Dept. 227, Chippewa Falls, Wis.

**MAKE \$100** a week up, selling better-quality, all-wool made-to-measure suits and overcoats. Biggest values. Highest Commissions, paid in advance, and extra bonus for producers. Large swatch samples furnished free. Write W. Z. Gibson, Inc., 161 West Harrison, Dept. H-517, Chicago.

**AGENTS**—Make a dollar an hour. Sell new kind of sharpeners. Sharpens all knives and tools quickly. Demonstrating sample free. Premier Mfg. Company, Dept. 70, Detroit, Mich.

**SCARY** women buy my new "Lookout" invention on sight. The Lookout permits women to see who is outside their door without the caller knowing it. A \$1.50 seller that pays you 85c profit! Sells quickly to every home, private clubs and hardware stores. Easy to sell 20 a day and earn \$17 daily. Send one dollar for sample and particulars about free kit and special sales plan. Write To-day! New Invention Factories, 25 Governor Place, Long Island City, New York.

**GENUINE** Gillette Razor. To introduce other specialties. Your name and thirty cents. Miller Sales Company, Lexington, Ky.

**BIGGEST** Summer Seller out: Reduces ice bills one-half; Sells on sight; Big profits. Magic Products, Room 200, 332 E. 31st, Kansas City, Mo.

**IF** you are a man worthy of the name and not afraid to work, I'll bet you \$50.00 you can't work for us thirty days and earn less than \$200.00. Think I'm bluffing? Then answer this ad and show me up. Openings for managers. Wonder Box sells on sight. The best selling proposition in America today. Write Tom Walker, Dept. 120, Pittsburgh, Pa.

**AGENTS:** Sensational profits taking orders for Taylor made-to-measure caps for men, and women's Bobette hats with purse to match. \$75 to \$150 every week. Pay in advance. We deliver. Outfit free. Write quick. Taylor Cap Manufacturers, Desk 8-6, Cincinnati, Ohio.

**THAXLY** Formulas, Processes, Trade-Secrets produce perfect products. Make them yourself. All lines. Send for catalog, circulars free. B. Thaxly Co., Washington, D. C.

**EARN \$15.** Daily pay advanced with our fast sellers. Guaranteed slickers \$2.95. Selling outfit and slicker free. Fisk Warner, 443 So. Dearborn, Chicago, Dept. AA.

**\$5,000 A YEAR**—Selling Perry Photo Medallions. Big demand. Ready sales. 400% to 600% profits. Any photo copied perfectly on Medallions, Mirrors, Compacts, Jewelry, etc. Guaranteed likeness. Investigate. Free catalog, full details on request. Write Today. P.M. Perry Photo Novelty Corp., 1793 Jerome Ave., New York.

**REAL** Whirlwind Seller—Nopolout Custom Shirt. Every man buys them. Patented—no competition. Liberal commission. Free selling kit. Make \$15 up daily taking orders direct from consumer at manufacturer's prices. District or local agents. Write Nopolout Shirt Co., Dept. Y, Hazleton, Pa.

**A PAYING** Position Open to representative of character. Take orders shoes-hosiery direct to wearer. Good income. Permanent. Write now. Tanners Shoe Mfg. Co., 8-90 C St., Boston, Mass.

**42.8 MILES** on 1 gallon. Wonderful Moisture Gas Saver. All autos. 1 free. Critchlow, D6-805, Wheaton, Ill.

**\$2,731.00. THAT'S** what Chas. Hickey's Commissions amounted to for only 60 days work this spring selling Face-A-Lites. This amazing device needed by every car. Wonderful tourist line. Good distributors wanted in open territory. Either sex. Short hours. Big commissions. Experience not a requirement. Write or wire to W. M. Willy, President, 331 Logan Bldg., Mitchell, So. Dakota.

**AGENTS, Hosiery Nulife**, positively prevents run in silk hosiery, lingerie, etc. Every woman buys. Enormous profits. Write today. Wright Supply Co., Box 42, W. Orange, N. J.

**\$1,000.00 CLEARED** in 30 days by one agent. New Amazing Cleaner. Sample Free. Bestever Products Company, 4317-P, Irving Park, Chicago.

**WE Start You Without a Dollar.** Soaps, Extracts, Perfumes, Toilet Goods. Experience unnecessary. Carnation Co., Dept 2480, St. Louis.

**AGENTS—Make a dollar an hour.** Sell Mendets, a patent patch for instantly mending leaks in all utensils. Sample package free. Collette Mfg. Co., Dept. 404, Amsterdam, N. Y.

**AGENTS make \$100 week** placing advertising Cigar Lighters with glass front. Every dealer wants one. Write for free plan. Drake Mfg. Co., Dept. M, Milwaukee, Wis.

**NO Dull Times Selling Food.** People must eat. Federal distributors make big money; \$3,000 yearly and up. No capital or experience needed; guaranteed sales; unsold goods may be returned. We furnish you with sample case, license and Free Samples for customers—Sure repeat orders. Exclusive territory. Ask now! Federal Pure Food Co., A2307 Archer, Chicago.

**POLMET—The Wonderful Polishing Cloth** that cleans all metals without liquid, paste or powder. Approved by "Good Housekeeping" and "Modern Priscilla"—sells fast at 25c. Sample free. Gale & Co., Inc., 15 Edinboro St., Boston.

**PHOTO Medallion Men and Women**, the largest line of Photo Novelties in the world. Lowest prices, quickest service. Send for catalogue showing over 200 money makers. Photo medallions, photo medallion clocks, photo mirrors, photo fountain pens, photo powder compacts, photo jewelry and photo buttons. Gibson Photo Jewelry Co., 608-614 Gravesend Ave., Brooklyn, N. Y.

**AGENTS—Stamping names on Pocket Key Protectors:** sample Cheek with your name and address, 25c. Stamping Outfits. Emblem Checks, Check Fobs, Name Plates. Hart Mfg. Co., Desk 2, 303 Degraw St., Brooklyn, N. Y.

**AUTO owner tire agent** wanted each locality to use and take orders for hand made Mellinger cord and balloon tires; guarantee bond 15,000 miles; shipped prepaid on approval; get your tires free; no capital or experience required; make \$100 to \$300 weekly. Write for wholesale prices and sample kit. Address Mellinger Tire Co., Dept. 400, Kansas City, Mo., or Dept. 400, Philadelphia, Pa., or Dept. 400, Oakland, Calif.

**GENUINE Gold Leaf Letters** anyone can put on store windows. Guaranteed to never tarnish. Large Profits. Enormous Demand. Free Samples. Write today. Metallic Letter Co., 438-D North Clark, Chicago.

**AGENTS—N-R-G Laundry Tablets**, the old reliable moneymaker for live agents. Millions sold—200% profit—sales waiting for you. Clothes washed spotlessly clean in 10 minutes without rubbing. Free samples. N-R-G Company, 230 W. Superior, Chicago.

**\$50.00 WEEKLY** easy. Applying Gold Initials on Automobiles. No experience needed. \$1.45 profit every \$1.50 job. Free Samples. "Ralco Monograms," 1043 Washington, Boston, Mass.

**AGENTS: 500% profit.** "Happy Home Make Shampoo" builds your own big business. Martin of Indiana made \$75.00 in one day. Missouri man made \$750.00 one month. Exclusive territory. Geo. A. Schmidt & Co., Dept. P, 236 W. North Ave., Chicago.

**REPLATE** brassy worn-off Automobile parts, Reflectors, Bath Room Fixtures, Worn Spoons, Forks, etc., with pure silver. Looks like new. Use U-Kan-Plate Polish. Positively no mercury. \$1.00 half pints. Post Paid. Satisfaction Guaranteed. Agents wanted. Dept. A, U-Kan-Plate Co., Philadelphia.

**AGENTS Make 200% Profit Direct Sales:** 100% selling retailers, 50% selling jobbers Regular and Pleasant medicated gums. Fast sellers; permanent repeats. Exclusive territory to producers. Pleasant Products, 134-P, Mt. Pleasant, Newark, N. J.

**CASH Paid for Butterflies, Insects.** See Sinclair Display Advertisement on page 39.

**WHY not sell us your spare time?** \$2.00 an hour. \$19.70 daily easy full time. Introduce 12 months Guaranteed Hosiery—47 styles, 39 colors, for men, women, children, including latest "Silk to the Top" Ladies' Hose. No capital or experience needed. We furnish samples. Silk hose for your own use Free. New Plan. M. H. Mathews, Road 5868, Cincinnati, Ohio.

**CHICAGO Diamond Expert** overvalued our Mexican Blu-Flash Gem 3,000%! The Diamond's Only Guaranteed rival! Greatest spare-time, side-line agent's article known! Amazing profits! \$5 pocket sample case Free! Write quick! Mexican Gem Company, Box P7C, Monterey, Calif.

**FREE Samples and Details!** Something New! Just Out! Write Immediately. Samuel Berman, 417 N. Eutaw, Baltimore, Md.

**START a manufacturing business of your own.** Earn \$100 weekly. Make your own products. Formulas, Toilet Articles, Perfumes, Soaps, Extracts, etc. We furnish everything and show you how. Valuable catalog free. National Scientific Laboratories, 1987W Broad, Richmond, Va.

**42.8 MILES on 1 gallon.** Wonderful Moisture Gas Saver. All autos. 1 free. Critchlow, D5-805, Wheaton, Ill.

**AGENTS: It's a winner.** Combined cigarette and match case. Beautiful compact, flexible container. Holds package cigarettes and box matches. Sells on sight. Big profits. Write for details. All-In-One, Dept. A-8, 2810 Portland Ave., Minneapolis, Minn.

**MEN-WOMEN sell hand loomed rugs,** big profits, beautiful sample about 27x54 inches, \$1.60. Write today. Coruwa Co., 103 Tillson Ave., Rockland, Maine.

**75c PROFIT on \$1.00 sale.** Auto, furniture and glass cleaner. Your name on label. Exclusive rights; free sample. Mfg. E. 213 Griswold, Detroit, Mich.

**SELL New Ford** necessity to garages and Ford owners. Retail for \$1.00. Big profits. Write Lamb Mfg. Co., 2629 LaSalle St., St. Louis, Mo.

**COLONEL Lindbergh's Story—Your opportunity** to make big money quickly; illustrated book \$1.50; best terms, outfit free. Landberg Co., 20 East Lake St., Chicago.

**AGENTS and Distributors.** If you are looking for an article on which you can make a good profit and give satisfaction to your customers, sell the all steel wire brush to auto owners, garages, shops or hardware stores. C. S. Brush Works, 18 E. 16th St., Chicago, Ill.

**AGENTS \$1.50 hourly** guaranteed selling our new glass pointed unbreakable self filling fountain pens. Agents' sample pen \$1. Write for confidential wholesale prices. Address, Julius Parker, Ashburn, Ga.

**TAKE orders for Orthophonic Portables.** Sample Free. Orthophonica Mfg. Co., 757-F, Broadway, New York.

**\$10 DAILY** Selling California Marvelline, "Nature's Wonderful Medicine." Experience unnecessary. Particulars free. Marvelline Co., 1456 Dunsmuir Ave., Los Angeles, Calif.

**ONE of the quickest fire killers in America** selling for \$3.50, cost \$12.00 dozen. Sample, \$1.50. Reliance Sales Company, 942 15th Ave., Columbus, Ohio.

**MAKE** chipped glass name and number plates, mirrors, signs, etc. Investigate! Radiant Signs, 15905 Alden, Detroit, Mich.

**AGENTS—\$6.00 hour** earnings making four sales hour. Tremendous demand \$3.50 article; powerful selling plan. Fasley & Halpen, Dept. 40, Philadelphia, Pa.

**AGENTS—Best seller:** Jem Rubber Repair for tires and tubes; supersedes vulcanization at a saving of over 800 per cent.; put it on cold, it vulcanizes itself in two minutes, and is guaranteed to last the life of the tire or tube; sells to every auto owner and accessory dealer. For particulars how to make big money and free sample, address Amazon Rubber Co., Philadelphia, Pa., Dept. 505.

**AGENTS—Quick profits assured:** \$200 per week possible selling improved vacuum cleaner; no waiting for electricity or connections to demonstrate; does same work as most expensive electric machines; housewives convinced by single demonstration; best seller in years. Write for profit-making plan. The Marvel Co., Dept. PM, 3450 Archer Ave., Chicago, Ill.

**\$18 TO \$25 daily.** Biggest selling line of 2-piece suits, \$9.95 and \$12.50; 3-piece wool suit, \$17.95 (regular 28.00 value). All-wool overcoat, \$18.50. Splendid raincoats, slickers and boys' suits. Biggest commissions. Free outfit. "Jim" Foster, Inc., Dept. 28, 2250 S. Spaulding Ave., Chicago, Ill.

**AGENTS: Make \$100 Weekly** selling "Gray Seal." Automatically, Instantly and Permanently seals all tire punctures. Gives longer life to tires and tubes. Demonstration closes sale every time, with \$1.50 to \$3.00 profit for you. Exclusive territory given. Money-back guarantee. Write today for our Very Liberal Offer. Gray Seal Products Corp., 200 Rutger St., St. Louis, Mo.

**TAILORING Agents.** Earn \$35.00 to \$75.00 weekly, showing fine 100% Pure Virgin Wool \$23.50 suits, union hand-tailored to measure. Equal usual \$35 to \$40 suits. Old reliable \$4,000,000.00 firm offers pay in advance, exclusive territory, generous backing and big outfit of hundreds of large samples Free. Write J. B. Simpson, 843 Adams St., Dept. 1381, Chicago.

**AGENTS: Make \$500.00 monthly.** Pay daily. No investment. Rhinestone Initial buckles and novelties. Sell easy everywhere. Exclusive territory. Chaton Novelty Co., 606 Blue Island, Chicago.

**JUST Patented.** Red, White and blue spinning light used anywhere on automobile. Beats flags. Sample \$2.00. Box 202, Midland Park, N. J. Agents wanted.

**INVESTIGATE** our unique sales plans—250 Household favorites—quick sales 100% profit—steady business. E. M. Davis Co., Dept. 56, 451 E. Ohio, Chicago.

**150% PROFIT.** Spare-time business of your own. Article needed every home. Particulars, 2c stamp. Hughes Sales Co., 501 E. South St., South Bend, Ind.

**WANTED, Agents** either sex, for fastest selling article in America. Valuable territory open if you act quickly. Students making \$5 to \$15 daily. Write for free sample to Fred L. Viel, Salmon, Idaho.

**GOLD Sign Letters, \$9.75 for Thousand!** Non-Tarnishable. Free samples. Catalogue. Atlas Sign Works, A1032 E. 55th St., Chicago.

**SELL Our Handy Wire Stretcher,** a simple, practical fence-repairing device. Hawbaker Stretcher Co., Elmore, Minn.

**UNDER Your Name or Brand,** Sell Our Laundry Tablets. Amazing profits. Samples, circulars free with order. Costick Products, 400 West 23rd, New York.

**CHRISTMAS Cards—Start** selling early. 133 in our sample book. Everyone buys them. The Windermere, 6702 Dorchester, Chicago.

**AGENTS, \$240 month.** Bonus besides. Dri-Klean-it makes car look like new. Slickest thing you ever saw. Removes dirt, grease, road oil, all one operation. No soap or water used. Clean any car for 10c. Wonderful seller. Exclusive territory. Write for sample. American Accessories Co., Desk 1431, Cincinnati, Ohio.

**THANCO Vanilla—Bottle Yourself!** Concentrated; add water! Free labels. Whirlwind seller! 500% profit. Crushes competition! Other Moneymakers. Write Thomas Manufacturing Company, Indianapolis, Ind.

**THREAD-CUTTING Thimble** 25c. Seller Sample 15c. Irvel, 3973 Elston, Chicago.

**HOSIERY Free and \$12 daily.** Sell nationally known Pure Silk Hosiery. Amazing values. Experience unnecessary Free sample outfit mailed immediately. Pure Silk Hosiery Co., 208 W. Monroe, Dept. P180, Chicago.

**AGENTS, Sell Fragrant Bathroom Deodorizer;** Big Profits. Brown Laboratories, 11 Park Place, New York.

**MONEY Talks—You can have plenty of it** selling Amazing New Moth Bag. Absolutely air-tight. Never on market before. Sells on sight. Write today. S. & P. Products Co., Dept. 1, St. Louis, Mo.

**100 MORE active men to introduce** Chieftain Guaranteed Tailored Shirts 3 for \$4.95. Latest novelties, colors. Dickman, Illinois, in 3 weeks made \$589; Sinton, Texas, in 12 days, \$219.60; Bend, Iowa, in 16 days, \$334.80. Why not you. No experience or capital needed. We deliver and collect. Full working outfit Free. Cincinnati Shirt Company, Lane 1588, Cincinnati, Ohio.

**SELL every motorist a flag-signal outfit.** Dearman, Box 183, Tulsa, Okla.

**AUTOMATIC Card Printing Presses—** print 100 cards per minute. "Master," 816½ Chestnut, St. Louis.

**OUR Agents average better than \$75 a week;** Rich's pure fruit soft drink powders. Every home, store, drink dealer buys. Sample Free. Sol P. Rich Co., 622 S. Sangamon, Chicago.

**NEW Invention—400% profit.** Liquid Quick Mend for Fabrics and Hosiery. Stops runs. Every woman buys. Hundred other fast sellers. J. E. Johnson, Co., Dept. 456, 6129 Wentworth Ave., Chicago.

**AGENTS: Salesmen—Sell New Thermo-static Automatic Carburetor Control Attachment for Fords. Big profit, full or part time. Increases mileage 50-100%. Cadillac now using Thermo-static Carburetor Control under Blanche license. Sales guarantee. \$15.00 a day Guaranteed to Distributors. Write today. Blanche Auto Device Co., Dept. 805-L-X, 157 E. Erie St., Chicago.**

**MEN—Women, \$1.80 an hour—no less. Large mfg. Co., estab. 30 years. Starting new medallion dept. Amazing new sales plan. First 22 agents averaged \$1.80 an hour steady. Only one agent wanted in locality. Your own photo free as sample. Art Medallion Co., Chicago, Ill., Campbell Ave., at Jackson, Dept. 36.**

**AGENTS Wanted—Rab-O-Gun described on page 117 July issue Popular Mechanics, sells for \$2.00. Rab-O Mfg. Co., St. Louis, Missouri.**

**DOUBLE Your Income. Read Opportunity, the Magazine that offers thousands of openings to double your income. Sent Free. Just send name and address. Opportunity Magazine, 750 N. Michigan, Dept. D-2, Chicago.**

**WILL you wear a pair of genuine tailor-made shoes at my expense? Will you show them to your friends and take their orders? I will also send you Free our big selling Outfit showing 70 shoe styles and 60 actual leather samples. I pay my agents \$8.00 daily. Write quick. Tailor-Made Shoe System, 932 Wrightwood, Dept. 1, Chicago.**

**SALESMEN: How and where I found a wonderful side line. Without leaving my car I sold thousands, gas stations, stores, individuals. Customers say come back again. Also sell by mail. Good money maker and dignified. Information \$1. no answers otherwise. Money back if dissatisfied. P. P. Hutcheson, Mt. Plymouth, Fla.**

**INVESTIGATE our unique sales plans—250 Household favorites—quick sales—100% profit—steady business. E. M. Davis Co., Dept. 56, 451 E. Ohio, Chicago.**

**SOMETHING New. Every motorist a buyer of our electro-magnetic-emergency Wonderlamp; takes only one minute to demonstrate and make a sale; no experience necessary; \$5.00 an hour easily made; full time or evenings. Write for sample. Wonderlamp Co., 926 Fisk Bldg., Dept. 10-A, New York.**

**SELL Bright Silver Window Letters. Sent C. O. D. Samples Free. Standard, Box 54R2, West Chester, Pa.**

**STATE Distributors to complete expansion program by quality Twister-In Wire brush manufacturer. Low prices. High Commission. Jarvis Brush Co., Inc., 13316 Hamilton, Detroit, Mich.**

**ATLAS Sign Works for Beautiful Gold Window Letters. Penny Each! Why pay 8c? Write for Free Samples. F1032 E. 55th St., Chicago.**

**75c PROFIT on \$1.00 sale. Auto, furniture and glass cleaner. Your name on label. Exclusive rights; free sample. Mfg. E. 213 Griswold, Detroit, Mich.**

**Big Pay Every Day! Complete guaranteed line direct to wearer—Dress Shirts, Work Shirts, Flannels, Overalls, Pants, Leather Coats, Sweaters, Playsuits, \$10-\$25 daily! Experience unnecessary. Big Outfit Free! Nimrod Co., Dept. 8, 4922-28 Lincoln Ave., Chicago.**

**LOOK, Listen—hats off to this one! Much needed auto hat hangers—sells everywhere, anywhere. Special prices to representatives. Write Auto Hat Hanger Co., 90 E. 45th, So. Portland, Oregon.**

**Big money easily made without peddling our outfits. Free particulars. Elite, 38 Elizabeth St., New York.**

**EARN \$10 daily silvering mirrors, plating, refinishing metalware, chandeliers, head-lights, beadsteads. Outfits furnished. E. Decie Laboratories, 152 E. 23d St., New York.**

**ONE of the biggest mails on earth. Sent to any address for 10c. Louisiana Distributing Service, Dept. PM, Harmon, La.**

**START a manufacturing business of your own. Earn \$100 weekly. Make your own products. Formulas, Toilet Articles, Perfumes, Soaps, Extracts, etc. We furnish everything and show you how. Valuable catalog free. National Scientific Laboratories, 1987W Broad, Richmond, Va.**

**42.8 MILES on 1 gallon. Wonderful Moisture Gas Saver. All autos. 1 free. Critchlow, D3-805, Wheaton, Ill.**

**GOLD-LEAF Sign Letters; copyrighted Manufacturing Instructions; profits 1,000%. Johnston Co., Quincy, Ill.**

**AGENTS—Sworn Proof \$12.85 Daily in Advance. Bonus besides, introduce finest line New Guaranteed hosiery you ever saw. Beats store prices. 126 styles, colors. Amazing new sales plan a wonder. You deliver or we deliver—as you like. Make \$25 a week in spare time. Auto furnished. No capital or experience necessary. Selling like wild-fire. Samples furnished. Write quickly. Wilkmit Hosiery Co., Dept. 2831, Greenfield, Ohio.**

**MOCCASIN Manufacturer Wants Agents Everywhere to sell a complete line of moccasins to wearers. Entire new line. No competition, repeat orders. Get details. Daley Moccasin Co., Fort Covington, N. Y.**

**AGENTS Wanted To Advertise Our Goods and distribute free samples to consumers; 90c an hour; write for full particulars. American Products Co., 9211 Monmouth, Cincinnati, Ohio.**

**JUST Out—New Patented Apron. No strings or straps—\$20.00 a day every day; over 100% profit; commissions daily. Write for free offer. Sta-Put Co., Dept. 207, St. Louis, Mo.**

**MIRRORS Resilvered At Home. Costs Less 5 cents per square foot; you charge 75 cents. Immense profits plating autoparts, reflectors, tableware, stoves, refinishing metalware, etc. Outfits furnished. Details Free. Write Sprinkle, Plater, 128, Marion, Ind.**

**AGENTS—Make \$15 Daily, show samples and distribute teas, coffee, spices, extracts; 200 products; things people eat. I go 50-50 and furnish Chrysler closed car. Offer made to first person answering in your locality. Write or wire Health-O Quality Products Company, Dept. 101-H, Cincinnati, Ohio.**

**WONDERFUL opportunity; establish yourself in business; a new idea; needs only small income. Send stamps for particulars. Box 428, Middletown, N. Y.**

**NEW: Just invented; Comb fastens anywhere. Send 10c for a 25c value. Never Lose Comb Mfg. Co., Lesueur Center, Minn.**

**MANUFACTURING Pays Big Profits. Latest, dependable Formulas, Processes, Trade-Secrets. Best sellers. Valuable information free. Specialty Mfg. Service, 801 So. Farragut, Bay City, Mich.**

**NO difference what you are selling, you can increase your sales 500% by giving our \$1000 policies as free premiums. Costs you nothing. Name your line and write. National American Benefit Association, B201M, Willow Hill, Ill.**

**WHERE to Buy Half Million Articles Wholesale. 72-page Directory—1927 Edition. Distributors wanted. Pruitt System, Brookfield, Ill.**

**AGENTS \$240 month. Bonus besides. Sell finest line silk hosiery. Guaranteed 7 months or new hose free. New selling plan. Auto furnished. Write quick. Betterknit Textile Co., Silk 631, Greenfield, Ohio.**

**AGENTS—Mosco Corn and Callous Remover will build you a steady repeat business. Send today for pocket size trial outfit. The Moss Company, 380 Searle Bldg., Rochester, N. Y.**

**"JUST Out!" No-Glare Spectacles. No Lenses. Green Shade Over Each Eye. Prevent Auto Accidents. Sells Like Wild Fire. Beaches, Fairs, Carnivals. (Retail 75c—Costs 25c.) Sample 50c. Nulife Specs, Hartford, Conn.**

**AUTOMOBILE Specialties. Guaranteed formulas for all latest money makers. Lowest prices. Write for free lists. Murphy, Chemist, Tujunga, Calif.**

**Big profits distributing 5c candy specialties to dealers. Fast sellers. Exclusive territory. Universal Sales Company, 631-B Wilson Ave., Brooklyn, N. Y.**

**AGENTS—250% profit selling exclusive new process Artistic Signs. Finest selection of stock signs in the country, harring none. Details free. Sample 10c. Artistic Signs, 799-R Broadway, New York, N. Y.**

**SEND 25 cents for a one dollar Cigar Lighter, and learn how to make \$10 a day. Particulars free. Rapid Mfg. Co., 799 Broadway, New York City.**

**300% PROFIT. Fast seller. Cleaner Polish for autos, furniture, metal, glass. Particulars and sample free. Deal Laboratories, Springfield, Mich.**

**DISTRIBUTORS: No canvassing; free samples; stamp appreciated. Honery, Roseto, Pa.**

**FREE: Large wholesale Specialty catalog, showing latest best sellers from many parts of the world. Spors Co., Lesueur Center, Minn.**

**PATENTS. Time counts in applying for patents. Don't risk delay in protecting your ideas. Send sketch or model for instruction or write for free book "How to Obtain a Patent" and "Record of Invention" form. No charge for information on how to proceed. Communications strictly confidential. Prompt, careful, efficient service. Clarence A. O'Brien, Registered Patent Attorney, Security Bank Building (directly across street from Patent Office), Washington, D. C. See pages 138 and 139.**

**AGENTS wanted to sell Velvet Hand Soap, a very fine mechanics' hand soap; this soap is a good seller with unusual merits. One giving their entire time can make a very fine commission. However, we would like some to take as side line. Territorial rights given. Velvet Chemical Company, 30 N. Michigan Ave., Chicago.**

**JUST Landed. New, imported double-edged safety-razor blades. Retail 50 cents dozen. Big seller and money maker. Write. Suburban, Mt. Washington, Ohio.**

**ATLAS Sign Works for Beautiful Gold Window Letters. Penny Each! Why pay 8c? Write for Free Samples. G1032 E. 55th St., Chicago.**

**AGENTS! \$5.00 to \$10.00 profit each sale with our New Octagon Portraits and Frames. \$50 to \$75 weekly easy. Catalog free. Write Linder Art Company, 551 W. Washington St., Chicago.**

**AGENTS make \$10.00 Daily selling Non-Splash Water Filters on sight. Best canvasser's article on market. Investigate. Write for particulars, Desk 14, Seed Filter Company, 73 Franklin Street, New York.**

**\$60-\$200 A WEEK. Genuine Gold Letters for store windows. Easily applied. Free samples. Liberal offer to general agents. Metallic Letter Co., 438-B North Clark, Chicago.**

**100% PROFIT. Every home buys "The Home Patrol" Burglar Alarm. Automatically sounds alarm and locks window. Agents coinng money. Particulars free. Turck Mfg. Co., 32 No. Jefferson St., Chicago.**

**FIBRE Brooms—detachable handles, fine finish. Good profits, repeat sales. The Fibre Broom People, 147-C New Jersey Ave., Brooklyn, N. Y.**

**MAN with auto; one day weekly; \$35. Bens. Woodside, N. Y.**

**SIMPLEX Vaporizer. 25 to 60% increased mileage guaranteed. Retail \$1. Thirty Days Free trial. Exclusive territory. American Fixture Co., 234 West Water, Milwaukee, Wis.**

**MONOGRAM Automobiles, \$1.35 Profit ten minutes' work; every owner wants them; millions without; particulars free. Motorists Accessories Co., Mansfield, Ohio.**

**TOMBSTONE Cleaning; lonesome work, but dollars jingle. See under classification (Formulas).**

**AGENTS Wanted for fast, easy seller—Marvel pipe cleaner; literature free. Costick Products, 400 West 23rd, New York.**

**NEW, Fast Seller; 150% profit; "Best-ever Powdered Hand Soap"; removes grease, paint, ink, dirt; great repeater. Sample Free. Bestever Prod. Co., 4319-P, Irving Park, Chicago.**

**PORTRAIT Agents—Write for new Catalogue—Enlargements, Frames, Medallions, Sheet Pictures, Luminous Crucifixes. Adam J. Kroll & Co., 2539 So. State St., Chicago, Ill.**

**WANT Distributing Agent for Handslick, powdered hand soap; removes anything from hands; everybody a customer; sample free. Solar Products Co., J-2142 S. Troy, Chicago.**

**ALL-YEAR-ROUND profitable business selling wonderful new water softener and cleaner. Removes grease, oil, ink and dirt quickly. Every home and business place a live prospect. 100% profit. Big repeat orders. Exclusive territory. Write for free sample. Seacoast Laboratories, Sea Bright, N. J.**

**GOLD Leaf window letters and script signs. No experience; 500% profit. Samples free. Consolidated, 69-U West VanBuren, Chicago.**

**REMNANT Store, Bethel, Ohio. Greatest Dry Goods Bargains on Earth. Agents and Dealers.**

**AGENTS—Clever Invention! Inkspoon makes every pen a fountain pen. Fast office seller; big profit, demand increasing everywhere. Exclusive territory offered. Sample free. H. Marul Company, Tribune Bldg., New York, N. Y.**

START a manufacturing business of your own. Earn \$100 weekly. Make your own products. Formulas, Toilet Articles, Perfumes, Soaps, Extracts, etc. We furnish everything and show you how. Valuable catalog free. National Scientific Laboratories, 1987W Broad, Richmond, Va.

AGENTS: both sexes, we manufacture and control new household article. Fast seller. Big profits. Exclusive territory. Write now. Connolly, 123 Liberty St., New York.

SEND name, address on postcard. Free introductory copy Salesology Magazine; contains 1,000 money-making opportunities. Offered by big reliable firms; no obligations. Salesology Magazine, Desk B-38, 500 No. Dearborn, Chicago.

32 SECONDS complete tire change by Detmer, Ohio, with Morey Quick Action Rim Tool. Sold singly 49 three days, cleared \$100. Anderson, Mont., sold 1400 in 14 weeks. Get details for good territory. Harvest time Now. M. Morey Rim Tool, Buffalo, N. Y.

AT Last! Diamond Rival Discovered! Amazing blue white Rajah Gem astounds jewelry world and deceives experts. Beautiful sample case free! \$100 weekly. Quick! Rajah Diamond Co., Dept. F20, Salisbury, N. C.

\$31.00 PROFIT—with \$1.50 Outfit—Big Money—Easy Work. Selling Gold Monograms for Automobiles, Luggage, Windows, Wagons. No Experience. No License. "Samples Free." NuLife Monograms, Hartford, Conn.

SELL men's neckwear; wonderful proposition. Astor, 318-M Broadway, New York.

DO you want good live agents—fellows who can get the business? Ask me how others are doing it. I'll gladly render the necessary assistance without cost to you. Address, M. L. Rund, Mgr. Classified Advertising, Popular Mechanics Magazine, Chicago.

AGENTS, Get our prices on Coffee, Tea, Desserts, Soaps, Perfumes, etc. Endless variety, superb quality, quick service. Sample display free. Address Blair Laboratories, Lynchburg, Va.

AGENTS: Our gold-eyed Needle Cases are wonderful sellers; immense profits; \$50 to \$300 weekly; proof and particulars free; sample outfit 10c; factory prices. Paty Needle Co., 231 Davis Square, Somerville, Mass.

CALIFORNIA perfumed beads selling like hot cakes. Agents coin money. Big profits. Catalog free. Mission Factory P, 2328 W. Pico, Los Angeles, Calif.

HUNDREDS of manufacturers, formerly agents selling other goods now owe their success to Miller's Guaranteed Formulas for making biggest-selling, advertised specialties in all lines. Investment small. No machinery needed. Profits great. Make your own goods—get the profit you're entitled to. Write today for my "eye-opening" literature. It's free and tells all. Miller, Chemist, 1706-W Jetton, Tampa, Fla.

WILLIAMS' Powdered Hand Soap has taken auto owners by storm. Cleans dirtiest hands instantly. Easy demonstration sells B. Williams, Inc., Dept. 266, Montclair, on sight. Free Sample and particulars. W. N. J.

IT'S the cat's meow. Brand new novelty. Biggest seller on earth. Write today for particulars. Novelties, Box 10, Mt. Washington, Ohio.

OUR Luminous Crucifix Shines in the Dark. Every one amazed at the wonderful effect. Easily demonstrated. Easily sold. W. G. Hannan Co., Dept. B, 2539 So. State St., Chicago.

A BUSINESS of Your Own—Making Sparking Glass Name and Number Plates, Checkerboards, Signs. Big Book and Sample Free.—E. Palmer, 512 Wooster, Ohio.

BIG Money and Fast Sales. Every owner buys Gold Initials for his auto. You charge \$1.50; make \$1.35. Ten orders a day easy. Write for particulars and free samples. American Monogram Co., Dept. 40, East Orange, N. J.

MAN in each town to plate auto parts, reflectors, bathroom fixtures, refinish beds, mirrors, chandeliers; by new method. No capital or experience required. Simple plan of manufacturing at home starts you in big money-making business. Outfit furnished. Free particulars and proofs. Gun Metal Co., Ave. H, Decatur, Ill.

EVERY Woman Wants a Sewing Set. Home Sewing Sets contain 142 useful sewing articles. \$4 an hour easily made with this 50c seller. Prentice-Lee, 145 East 23rd St., New York.

GET Our Free Sample Case—Toilet articles, perfumes and specialties. Wonderfully profitable. La Derma Co., Dept. A, St. Louis, Mo.

BIG Profits: Steady Income our line food products, toilet articles, soaps. No cash or experience needed. Sample case free. Write Linro Co., Dept. 242, St. Louis, Mo.

OVER 100% Profit. Self Lighting Gas and Cigar Lighters; Everybody interested, repeat business. Sell individuals, dealers, subagents. Particulars Free. P. Bernhardt, 127 West 30th St., New York.

AGENTS: 500% profit. "Happy Home Make Shampoo" builds your own big business. Martin of Indiana made \$75.00 in one day. Missouri man made \$750.00 in one month. Exclusive territory. Geo. A. Schmidt & Co., Dept. P, 236 W. North Ave., Chicago.

### HIGH-GRADE SALESMEN WANTED

DEMAND for Electric Window Displays is Established. Our Hustlers easily hitting \$100 weekly with the Leader—Magic Window Salesman—Color, Light, Motion. High-class. Buyers fall quick on demonstration. Greatest quick-change Letter System known, and new, snappy, Two-color Poster Service the answer. Live salesmen getting protected territory Now. Display Products Co., A407-9 East 31st, Kansas City, Mo.

IF You call on Garages, Tire or Battery Shops get our liberal proposition. Nothing to carry. \$20 to \$60 on each sale. Cash paid for live leads. Haywood Tire Equipment Co., 1337 So. Oakley Ave., Chicago.

\$60-\$200 A WEEK. Genuine Gold Letters for store windows. Easily applied. Free samples. Liberal offer to general agents. Metallic Letter Co., 438-A North Clark, Chicago.

TRAVELING Salesmen Calling on Retail Stores wanted by large manufacturer of fast-selling specialties entirely different from the average. Year-round sales, main or sideline. Big commission paid immediately on original and repeat business. Opportunity for well paid and permanent connection with old-established firm. If not making \$150 weekly, write today. Union Specialty Works, Dept. 222, Boonville, N. Y.

ONE sale daily means \$300 monthly. Smallwood sold twenty in three hours. Improved 3-lb. Calculator. Retail \$15.00. Work equals costly machines. Fully guaranteed. For details, Trial Offer and protected territory, address Lightning Calculator Co., Dept. F, Grand Rapids, Mich.

75c PROFIT on \$1.00 sale. Auto, furniture and glass cleaner. Your name on label. Exclusive rights; free sample. Mfg. E, 213 Griswold, Detroit, Mich.

\$10.00 PROFIT on Every \$15.00 Sale. A Real necessity for every business and professional man. Big repeat business. Western Credit Protection Association, PM-Washington Building, Los Angeles, Calif.

START a manufacturing business of your own. Earn \$100 weekly. Make your own products. Formulas, Toilet Articles, Perfumes, Soaps, Extracts, etc. We furnish everything and show you how. Valuable catalog free. National Scientific Laboratories, 1987W Broad, Richmond, Va.

ADVERTISING Blotters—2-color illustrations. Every business a prospect. Selling outfit free. Windermere Press, 6702 Dorchester Avenue, Chicago.

\$20.00 DAILY Selling guaranteed all wool made to measure Suits and Overcoats at \$23.50, regular \$35.00 values. Large and attractive Fall Sample Outfit Free to men with selling ability. Jay Rose & Company, 411 S. Wells Street, Desk 13, Chicago.

A SPLENDID, New, Complete line of Duplicating and Triplicating Salesbooks and Cafe Checks at prices that sell. Compact Samples Free to real Sideline Men. Kansas City Salesbook Co., 1003 Walnut, Kansas City, Mo.

SALESMAN—Get exclusive selling rights of a scientific drugless health product needed in every home. Unlimited possibilities. Write Radiumized Applicator Co., 1303-P Fillmore, Buffalo, N. Y.

AMERICA'S Greatest Tailoring Line Free. 130 large Swatch Samples—All Wool—Tailored-to-Order—Union Made. Sensational low price. Get outfit at once. Address Dept. 107, Goodwear, 844 Adams, Chicago.

MEN—Sell dependable shrubbery, fruit trees, etc. Steady demand. Complete co-operation. Commissions paid weekly. We deliver and collect. Write Perry Nurseries, Dept. R-8, Rochester, N. Y.

WANTED—Openings for territorial Salesmen in every state. We are the largest made-to-measure tailoring house in the country. Our full time men earn \$60 to \$125 per week. Spare time workers earn \$35 to \$60 per week. Complete \$40 selling outfit sent free—150 all-wool fabrics—featured to sell at \$23.50-\$29.50-\$34.50-\$43.50. Large commissions paid daily. Our prices save customers \$15-\$20 on their garments. Absolute Satisfaction Guaranteed or money refunded. 6-day delivery service. Write for line today and full particulars. Edward E. Strauss & Co., Inc., Dept. 101, 400-416 S. Market St., Chicago.

BIG Season Just Ahead. Advertising pencils more popular every day—every business prospect. Our line repeats. Big commissions. Established 1902. North American Pencil Works, 126 So. Clinton, Dept. 55-B, Chicago.

COLLECTS Money from the Dead-Beats. Retail \$5.00—Cost \$1.00—Profit \$4.00. "New Method." Every Storekeeper, Doctor buys quickly. Wonderful Money Getter. Federal Association, Hartford Conn.

DISTRICT Managers: 16 hosiery styles, 10 lingerie styles; over 60 colors. We deliver. \$10.00 sample outfit furnished to representatives (no deposit); 10% bonus. Premium to customer. Advertising and office allowance. Send three references, stating experience, to see Samples Dept. G, S. Q. S., Lexington, Ky.

PRINTING Salesmen—36-hour service, most complete line, best Cuts, attractive samples, every co-operation. Wonderful Outfit free. Atlas Co., 2622G East Tenth, Indianapolis, Ind.

DUST Mittens at \$2.00 doz. Newest, best-looking on market. Sell 50c each, 300% profit. No matter what else you sell, carry one in pocket. Sells on sight to every housewife and autolst. Samples 25c. Midway Co., 3650 Jasper St., Chicago.

SALESMEN Wanted for novelty that sells on sight. Sells to Department Stores, Drug Stores, Gift and Luggage Shops, etc. Exclusive territories with liberal commissions. Write for further particulars. Novelty Sales Co., Box 859, Binghamton, N. Y.

\$18 To \$25 daily. Biggest selling line of 2-piece suits, \$9.95 and \$12.50; 3-piece wool suit, \$17.95 (regular 28.00 value). All-wool overcoat, \$18.50. Splendid raincoats, slickers and boys' suits. Biggest commissions. Free outfits. "Jim" Foster, Inc., Dept. 28, 2250 S. Spaulding Ave., Chicago, Ill.

SALESMEN—You can make \$130 extra each month selling only one policy a day. Policy pays \$5,000. Death; \$25 weekly benefit for injury or sickness. Entire cost \$10 yearly. Salary and commission. Permanent income from renewals. \$100,000 Deposit with State. Address Underwriters, 702 Bonnell Bldg., Newark, N. J.

DOUBLE Your Income. Read Opportunity, the Magazine that offers thousands of openings to double your income. Sent Free. Just send name and address. Opportunity Magazine, 750 N. Michigan, Dept. D-2, Chicago.

I WILL Pay You \$2 an Hour to take orders for Carlton dresses and coats. Women in every home, store, factory and office eager to save a third on our stunning Paris styles. Everything supplied Free but only applications stating territory, experience and references will be considered. Carlton, Inc., 296 So. Wabash, Dept. 953-A, Chicago.

SALESMEN with Housefurnishing experience. Profitable territory open. Commission checks mailed weekly. Write P. O. Box 1017, Milwaukee, Wis.

SALESMEN Wanted—Specialty Salesmen; experience with grocery and drug trade of direct selling. Main or sideline. New proposition. Pennsylvania Soap Co., Lancaster, Pa.

ATLAS Sign Works for Beautiful Gold Window Letters. Penny Each! Why pay 8c? Write for Free Samples. H1032 E. 55th St., Chicago.

WALKER Made \$165.00 First Day selling Collection System to Doctors and Merchants. Retail \$6.50. Collects \$65.00. Costs \$1.50. Adjustment Bureau, Mobile, Ala.

SALESMEN and Salesladies: Take orders for rugs, damask, Novelty designed bedspreads and draperies. Liberal territory and commission. Rainbow Novelty Mills, Grover, N. C.

SEND name, address on postcard. Free introductory copy Salesology Magazine; contains 1,000 money making opportunities. Offered by big reliable firms; no obligations. Salesology Magazine, Desk B-39, 500 No. Dearborn, Chicago.

**SALESMEN—Become Independent.** Own Your business, experience unnecessary selling our \$7,500.00 Accidental Death; \$50 Accident; \$25 Sick Weekly Benefits—\$12.50 Yearly. Other Amounts proportionate. Guaranteed steady income from renewals. \$250,000 Deposited Insurance Department. Universal Policy. Dept. A. 30 Clinton St., Newark, N. J.

**SPECIALTY Salesman** wanted. Big commissions being earned selling Ever-Ready cans. Write for particulars. Ever-Ready Can Company, Greenfield, Ohio.

**TAKE orders** for coffee, flour, dried fruits, canned goods, staple groceries, toilet articles, paints, radio sets, auto and tractor oils. No capital or bond required. We deliver and collect. Permanent business. Big pay. Write at once. Hitchcock-Hill Co., Dept. 50, Chicago.

**GOLD Leaf window letters** and script signs. No experience; 500% profit. Samples free. Consolidated, 69-V West Van Buren, Chicago.

**IF You Think in Terms of \$6,000 This Year**, write us now. Strong line for retail stores. Nationally advertised. Established concern. Best season now starting. Liberal weekly advance to producer. Continental Co., 2010 Euclid, Dept. 1300, Cleveland, Ohio.

**FOUR \$7.50 sales** to merchants net you \$20.00 daily. Sayers Systems, 2803 Sheffield Ave., Chicago, Ill.

**ANY Salesmen Can Sell Them!** Merchants everywhere use punchboards. Someone sells them, why not you? Collect big commissions daily. Newest, largest, elaborate catalog sent upon request. Lincoln Sales Co., 9 So. Clinton, Chicago, Dept. D.

### HELP WANTED

**AGENTS—\$13.80 Daily** in advance. Introducing New Insured Hostelry for men, women, children. Must wear or replaced free. 57 styles, 39 colors, including latest "Silk to the Top" Ladies' Hose. Nyland made \$595 in one month. Edwards, \$460.60. Mrs. Bone, \$425.45. Why not you? Even spare time should pay you \$3.00 an hour. No experience needed. We furnish samples. Silk hose for your own use Free. New Plan. School line now ready—Write quick. Maccoche Company, Road 2608, Cincinnati, Ohio.

**MR. BRUSH Salesmen—Old Established** New York brush manufacturers require services of men in all territories to sell their extensive line of Sanitary Twisted Wire Brushes. We pay larger commission than any other brush house in the country. Write immediately for our proposition. Wire Grip Sanitary Brush Corporation, 15 Mercer St., New York.

**\$95.00 TO \$225.00 Month.** Men-women 18 up. Get U. S. Government Jobs. Railway Postal Clerks—Mail Carriers—Postoffice Clerks and Clerical Positions. Steady. Paid vacation. Experience unnecessary. Common education sufficient. 32-page book with sample examination coaching and full particulars Free. Write today sure. Franklin Institute, Dept. M3, Rochester, N. Y.

**SOUTH AMERICA:** How to obtain Positions. Booklet. Lists prospective employers. \$1.00. Box 342, South Bend, Ind.

**WANTED—Man with Car.** Make fortune as Real Estate Specialist. I made \$100,000. Cooperate with me. Learn the secret of my success. Use my remarkable system. Start at home in spare time. Build wonderful business without capital or experience. Write at once for my amazing money-making offer. Address Ostrander, Room 44-2, 18 East 18th St., New York.

**\$158 MONTH.** Men 18 up. Railway Postal Clerks, 25 coached Free. Write immediately. Franklin Institute, Dept. M14, Rochester, N. Y.

**MEN to train** for locomotive firemen on railroads nearest their homes—everywhere; beginners \$150-\$250 monthly; promoted, locomotive engineer, \$3,000-\$4,000 yearly. Best paying positions on railroads. Railway Association, Desk M1, Brooklyn, N. Y.

**GOVERNMENT positions** pay \$35 to \$75 weekly. We help you get them. Big List Free. Write, Mr. Ozment, 101, St. Louis, Mo.

**WANTED—Boys—Men.** \$35.00 Week. Become Automobile Electricians. Sample lessons Free. Franklin Institute, Dept. M-400, Rochester, N. Y.

**MEN, qualify** as Forest Rangers; \$125-\$200 mo. and home furnished; permanent; hunt, fish, trap. For details, write Norton, 253 McMann Bldg., Denver, Colo.

**CASH Paid** for Butterflies, Insects. See Sinclair Display Advertisement on page 39.

**DOUBLE Your Income.** Read Opportunity, the Magazine that offers thousands of openings to double your income. Sent Free. Just send your name and address Opportunity Magazine, 750 N. Michigan, Dept. D-1, Chicago.

**GOVERNMENT Jobs.** Mail Carriers—Clerks, Railway Postal Clerks. \$1,700-\$3,000. Men 18 up. Steady. Sample coaching free. Write today sure. Franklin Institute, Dept. M14, Rochester, N. Y.

**\$2.00 AN hour** for special advertising work among local families. Exceptional opportunity; pay starts immediately. American Products Co., 9354 Monmouth, Cincinnati, Ohio.

**BEGINNERS** for hotels. Carolinas, Bermuda, Florida. Instruction. Fares paid. Write Lee Hotel Institute, Drawer 1508, Boston.

**EARN \$10 daily** silvering mirrors, plating, refinishing metalware, chandeliers, headlights, bedsteads. Outfits furnished. E. Decie Laboratories, 152 E. 23d St., New York.

**STEAMSHIP Positions.** Europe, orient, etc. Good pay; experience unnecessary. We help you to secure them. Write for free application form. Box 30-A, Mount Vernon, N. Y.

**DON'T prepare** for any Civil Service Examination without seeing our catalogue. Free. Columbian Correspondence College, Washington, D. C.

**MEN wanting** to prepare for forest ranger job; \$125-\$200 month; nice cabin. Hunt, trap and patrol. Nat'l Forest list free. Write, Rayson, Dept. B-46, Denver, Colo.

**SEND name,** address on postcard. Free introductory copy Salesology Magazine; contains 1,000 money-making opportunities. Offered by big reliable firms; no obligations. Salesology Magazine, Desk B-40, 500 No. Dearborn, Chicago.

**U. S. GOVERNMENT** wants men. \$1,700-\$1,900 and up at start. Railway Mail clerk examination coming. Let our expert (former Government examiner) prepare you for this and also Rural Carrier, Post Office, Customs, Internal Revenue, and other branches. Write today for free booklet. Dept. 8, Patterson School, Rochester, N. Y.

**BECOME a Landscape Architect.** Uncrowded profession of wonderful opportunity for money-making. Easily mastered by mail. Earn while you learn. Write for book. American Landscape School, 56-E, Newark, N. Y.

**SILVERING Mirrors, French Plate.** Easily learned; immense profits. Plans free. Wear Mirror Works, Excelsior Springs, Mo.

### INFORMATION

**RESEARCH Expert** will supply dependable formula, information, advice, any subject. \$2. H. Newman, Box 343, Madison Square Station, New York.

**PUZZLES!** If you like them we recommend an illustrated book containing 122 of the best mechanical puzzles. You can have loads of fun working out the solutions as enough hints are given in the text matter to enable one to do so. Pay postman \$1.00 and postage when he hands you the package. Address Popular Mechanics Press, Room 908, 200 E. Ontario St., Chicago.

**WHAT Subjects Interest You?** Select from this list of helpful worth while books. Social Letters Made Easy, Spelling Made Easy, How to Develop Your Will Power, Tricks and Magic Made Easy, Bookkeeping Made Easy, Chemistry for Beginners, How to Work Your Way Through College, Confidential Chats with Boys. Price \$1.25 per volume. Pay postman price and postage when he hands you the package. Address Popular Mechanics Press, Room 908, 200 E. Ontario St., Chicago.

### MAILING LISTS

**GUARANTEED Lists—Agents, Mail Order Buyers.** Opportunity Seekers, others. \$1.00 thousand. Price List free. Demuth Company, Englewood, N. J.

### BUSINESS SERVICE

**REPRESENTATION** in Washington, D. C. Information. Anything, Anytime. Service, Victor Bldg.

**NEW YORK address.** \$5.00. Broadway Service Co., 42 Broadway.

### TYPEWRITERS AND SUPPLIES

**TYPEWRITERS,** all standard makes. \$10 up. Fully guaranteed. Free trial. Write for complete illustrated lists. Northwestern Typewriter Exchange, 121 N. Francisco Ave., Chicago.

**TYPEWRITERS,** all standard makes, thoroughly re-manufactured by the famous "Young Process" and shipped direct from factory to you on 10 days' trial. Guaranteed 5 years. Easy monthly payments. Write today for free catalog. Young Typewriter Company, Dept. 5748, 654 W. Randolph St. Chicago.

**UNDERWOOD Typewriters—only \$3.00 down.** Easy monthly payments. Low prices at less than manufacturers, 10 days' free trial. Rebuilt, all worn parts replaced. Just like a new machine. 5-year guarantee. Write for a big free catalog. A-151, Shipman-Ward Mfg. Co., C-151 Shipman Bldg., Chicago, Ill.

**TYPEWRITERS;** Business equipment; World's Lowest Prices. National Typewriter Exchange, 729 Clark, Cincinnati, O.

**FREE—Lindbergh's Picture** with Typewriter Ribbon 75c. PJH—1937 No. Hoynes, Chicago.

### PRINTING, ENGRAVING AND MULTIGRAPHING

**100 LETTERHEADS,** envelopes, labels or cards \$1 delivered. Samples and prices other printing free. C. E. Patton Company, 409 Arthur Bldg., Omaha, Neb.

**250 STANDARD Business Cards.** \$1.00; 1,000, \$2.50. Acorn Printery, Newport, Ky.

**GUMMED Labels—The Better kind,** with name, business and address. 500—40c; 1,000—60c; 2,000—\$1.00. P. Wetzel, Valhalla, N. Y.

**"NEARGRAVUREMBOSSO" (type embossing)—distinctive.** 250 Letterheads \$3.75. ("Stationery work of art."—Doctor Bittner.) Samples. Solldays, Knox, Ind.

**500 HAMMERMILL Bond Letterheads,** Noteheads, Billheads, \$1.95. Two-color Checkbook Blotters, 500, \$2.75. Easton Press, Lohrville, Iowa.

**GUMMED labels,** 500 name, address. 2 lines 35c. 3—55c. Catalogue. Eastern Label Co., B., Clintonville, Conn.

**500 ENVELOPES** or letterheads, \$2.00; 1000, \$2.95, delivered. 4605 Wells St., Milwaukee.

**5000 3½x5½ AD. slips,** \$5.00; 5½x6½ circulars, \$7.75; 5½x8½ circulars, \$10.00; 3½x6 4-page folders, \$13.75. Samples. Good's Printery, Harrisonburg, Va.

**COMMERCIAL Prints 8x10" 12 cents** each in hundred lots. Photo Retouching, Drawing, Photo Engraving. Commercial Art Engravers, Cedar Rapids, Iowa.

**CUTS, etchings, halftones; your copy;** any style, size; right prices. Write for information. Halco, 143, South Erie, Penna.

**QUALITY Printing!** Reasonable Prices! Send for Free Standardized samples and prices. Folders, Circulars. Catalogs our specialty. Earnest Fantus, 525 South Dearborn, Chicago.

**STATIONERY:** 200 lettersheets \$1.00; envelopes \$1.00. P. Loffin, Coshocton, Ohio.

**IMITATION Typewritten Letters,** (mimeographed); 500—\$3.00; 1,000—\$4.00; printed heads, 20 lb. bond, prepaid; samples, price-list, red stamp. Letter Service, 620P Woodland, Kansas City, Mo.

**BUSINESS Cards—200 for \$1.00 prepaid.** Samples for Stamp, Business Card Specialty Shop, Box B-552, Jackson, Mich.

**150 BUSINESS Cards \$1.00,** 100 letterheads, 100 Envelopes \$1.00. Jean McLane, 1215 Russell Ave., Bethlehem, Pa.

**"PRICE-LESS" Business Stationery.** Since 1904. Samples. Bulletin Press, Fergus Falls, Minn.

**SELL Printing** for house established thirty years. Largest Commissions. Low Prices guarantee permanent business. Repeat orders. Not seasonal. Pocket Sample outfit free. Secretary Kaeser & Blair, Inc., Murdock Bldg., Cincinnati, Ohio.

**200 SHEETS** and 100 Envelopes printed, \$1.00. Write for samples. J. Brooks, Printer, Glasgow, Ky.

**200 LETTERHEADS** and 100 Envelopes, \$1.00, postpaid. Oberman Company, Box 1268, Chicago.

**PRINTING — Specialists** Hammermill Bond envelopes, Letterheads, Billheads, cards, etc. Low prices. Dime for samples. State your business. Hall Printing House, Meadville, Pa.

**GOOD Printing cheap.** 24-page list free. Clarence Herr, Mountrille, Pa.

**PRINTING prepaid — \$3.50 thousand.** Samples for stamp. 2805 Kellogg, Wichita, Kan.

**LETTERHEADS, Envelopes,** 1,000 \$2.95; 2,000 \$5.60, Delivered. Free Samples. Freeman, Box 384, Eureka Springs, Ark.

200 HAMMERMILL Bond Letterheads or Envelopes \$1.00. Other printings. Samples free. De Toledo Printing Co., 455 N. 51st Street, Philadelphia, Penna.

\$3.00 DELIVERED, 500 watermarked bond letterheads 8 1/2 x 11 and 250 envelopes. Cash. Catalog free. Printing bargains. National Printing, Goshen, Ind.

COMMERCIAL Printing. Prices Right. Samples Free. The Fox Press, Frankfort, N. Y.

DISTINCTIVE — Artistic Business Stationery that Creates Confidence. 1,000 Letterheads or Envelopes \$3.00. Samples. Moulton Printing Company, 1410-P East 8th, Kansas City, Mo.

WE print Stationery, Booklets, Catalogs, Circulars. Samples. Commercial Press, Batavia, Ohio.

MULTIGRAPHING business correspondence, two dollars thousand. Hammerrill letterheads, four dollars. Miscellaneous printing. Mayera Corporation, Monmouth, Ill.

1,000—6 1/2 WHITE envelopes printed, \$2.35; 5,000—\$8.85. Letterheads, 1,000—\$2.95. Spors Printery, Lesueur Center, Minn.

EMBOSS your Stationery with Hand Embosser. Circular free. Midwest, Box 47, Springfield, Ill.

250 BOND Letterheads, Envelopes, Billheads, Cards, \$1.35 each. Economic Press, Leonia, N. J.

**PRINTING, OUTFITS AND SUPPLIES**

PRINTING Presses, type, supplies. List 2c stamp. Bargains. Geo. Foster, 4342 North Robey, Chicago.

PRINT your own cards, stationery, circulars, paper, etc. Complete outfits, \$8.85; Job presses, \$11, \$29; rotary, \$149. Print for others, big profit. All easy, rules sent. Write for catalog presses, type, paper, etc. Kelsey Company, F-11, Meriden, Conn.

PRINTING Outfits—Presses, type supplies, type novelties. Send stamp for catalogue. Model Press, York, Penna.

**DUPLICATORS AND DEVICES**

YOU can make 50 to 100 copies of a letter, notice, etc., at a cost of three cents on a Heyer Quality Duplicator. Write for free trial offer. The Heyer Duplicator Co., 909 Jackson Blvd., Chicago, Ill.

**ADDING MACHINES**

FREE trial. Marvelous Calculator, Adds, Subtracts, Multiplies, Divides automatically. Work equals \$300.00 machines. Five year guarantee. Price only \$15.00. Write today for free trial offer. Special: \$3.00 Pocket Calculator, only \$2.00 cash. Lightning Calculator Co., Dept. E, Grand Rapids, Mich.

NEW \$3.50 Automatic Adding Machine. Adds, subtracts, multiplies absolutely accurate. Capacity \$999,999.99. Fully guaranteed. 75,000 pleased users. Makes adding easy, positive, quick. Eliminates mistakes. Saves time. Postpaid \$3.50. Bassett Co., 1458 G Hollywood Ave., Chicago.

**FOR SMOKERS**

SEND 10c, Silver or Stamps, for sample package 20 finest quality cigarettes. Large tin Special smoking tobacco sent for 10c. Direct-to-Smoker. French Tobacco Company, Dept. 32, Statesville, N. C.

BETTER Tobacco! Fragrant, mellow! Ten pounds smoking, \$1.50. Four pounds chewing, \$1.00. Farmers' Club, 57, Hazel, Ky.

**FOR THE HOME**

WANTED—Hundreds of users for an amazing new finish which dries hard in 30 minutes and is extremely durable—Valspar Brushing Lacquer. Resists hard wear and is not injured by water (even boiling water), oil, grease, tar, mud, acid, soap, or any of those things which usually ruin ordinary finishes. You can easily prove these remarkable qualities by trying Valspar Lacquer in your home, shop, office or on the farm. Comes in Java Brown, Coral Sand, India Ivory, Nile Green, Palm Green, Italian Blue, Cardinal Red, Peacock Blue, Jonquil Yellow, Persian Lilac, Chinese Red, Oriental Green, French Gray, Holland Blue, Argentine Orange, also White, Black and Clear. Ideal for all surfaces, wood, metal or composition. Try it on furniture, floors, woodwork, walls, bicycles, fixtures, radio apparatus, tools, etc. Send 25c for 45c sample, stating color. Valentine & Company, Dept. 2, 456 Fourth Avenue, New York, N. Y.

BEAUTIFUL Sea Shells from Florida, Bahamas, Cuba. Make attractive novelties for Home, Gifts and Sale. Fine collection sent Post Free, \$1.00 (bill). Blumer (imported), Melbourne, Fla.

THAT Concrete Job. Don't be afraid to tackle it. With the instructions found in Popular Mechanics Concrete Handbook you can make 173 articles of utility and beauty ranging from ordinary steps to garden furniture. This book with our Home Mechanics Handbook that contains 329 helps about jobs that come up about the home will be sent for only 98c plus postage C. O. D. Send your order today to Popular Mechanics Press, Room 908, 200 E. Ontario St., Chicago, Ill.

CEDAR chests only \$11.65—"Red-i-Kut" complete with rich copper trim—you assemble and save half—send for pictures. Kuempel Furniture Company, Guttenberg, Iowa.

HOME Redecoration Time is here. Get newest ideas and methods from books just published for sale by Popular Mechanics Press. Interior Wall Decoration, Plain and Decorative Finishes, Practical Working Methods, 450 pages. Price \$4. Mixing of Colors and Paints, 292 pages \$2. Wood Finishing, Plain and Decorative, 360 pages, \$2. House Painting Methods, Brush and Spray Gun, 386 pages, \$2. Books will be sent C. O. D. Pay postman price plus postage when he hands you the package. Popular Mechanics Press, Room 908, 200 E. Ontario St., Chicago.

GRANDFATHER'S Clock Works. \$5.00. Build your own case; Instructions free; make good profits selling your friends. Clock works with chimes for old or new cases. Write for full particulars. Clock Co., Ruffner St., Philadelphia.

HOW to Make and How to Mend. 1000 articles telling how to repair almost everything in use or needed about a home or farm. Many illustrations; formulas and trade secrets. Send no money. Just ask for "How to Make and How to Mend." Pay postman postal charges and \$1.00. Popular Mechanics Press, Room 908, 200 E. Ontario St., Chicago, Ill.

"ARISTOCRAT" Portable Gang Lawn Sprinkling System, send for circular. Lawn Supply Co., Newport, Ky.

THIS is the season for making repairs about the home. Easily done with instructions in our new book. Tells exactly how to use tools, sharpen tools and cutlery, repair furniture and cabinets, upholster, work metal, solder, work glass, paint, stain, varnish, hang paper, repair plumbing, furnace, electrical equipment, shoes, harness, gloves and concrete work. Send no money. Just write and ask for "The Practical Book of Home Repairs." When postman hands you the book, pay him \$2.50 and the postal charges. Popular Mechanics Press, Room 908, 200 E. Ontario St., Chicago, Ill.

**BOATS AND LAUNCHES**

BUILD Your Own Boat using our Knock-Down ready cut materials. 55 models, outboard motor speedsters, runabouts, cruisers, sail, or row. Send 25c for catalog. Brooks Boat Co., Inc., Rust Ave., Saginaw West Side, Mich.

SIXTEEN foot outboard cabin cruiser. Complete plans 50 cents. Free boat building catalog. The Rudder 15 Murray Street, New York.

NEW Boat Book telling how to make 21 kinds of boats. Also many other helpful ideas on boating. Profusely illustrated. With this we include the big book, "Outdoor Sports the Year Round." Directions for making all sorts of devices for outdoor recreation. Send no money. Simply pay the postman \$1.98, plus postage when books are delivered. Popular Mechanics Press, Room 908, 200 E. Ontario St., Chicago, Ill.

HUBBELL Marine Coolers convert Ford engines into marine motors. Booklet free. Ford speedboat, easily built, blueprint and directions, sixty cents. C. C. Hubbell, 14B Cottage St., East Norwalk, Conn.

PROPELLERS, stuffing boxes, bearings, etc. Used reverse gears bought, sold. Wm. H. Baker, Pond St., Quincy, Mass.

SHIP Models—Worth while. Easy to make. Decorative Ships Picturesque Barbary Pirate Felucca and Beautiful Spanish Treasure Galleon (both 17th century). Instructions so simplified that any handy person can make these models with a few household tools almost without expense. No personal knowledge of ships or naval architecture required. New book only one of its kind. Pay postman \$2.50 plus postage when book is delivered. Popular Mechanics Press, Room 908, 200 E. Ontario St., Chicago, Ill.

**WATCH REPAIRING**

WATCH and general repairing; Work guaranteed. Lewis, Lothair, Ky.

ALL makes of Watches repaired by experts. Write International Watch Service, Box 5P, Fordham Station, New York.

**ANTIQUES, WAR RELICS AND INDIAN GOODS**

100 GENUINE Indian arrowheads from Arkansas \$4.00 postpaid. H. Daniel, Lamar, Ark.

SEND 5c for fine new list Indian relics, antique firearms. F. E. Ellis, Webster Groves, Mo.

**PHONOGRAPHS AND RECORDS**

BUILD your own Phonograph. Parts catalog free. American Phonograph Company, 4116 West 24th Place, Chicago.

**MUSIC AND MUSICAL INSTRUMENTS**

PLAY an Instrument? Like to laugh? Send ten cents for sample copy of The Music Jester. The Music Jester Co., Dept. P, 246 Fifth Ave., New York City.

SONG Poem Writers—Submit poems. Expert professional service. Diamond Music Company, Suite EHS, 790 Seventh Avenue, New York.

WRITE Songs. Big money and reputation. Write for information, J. Gordon Pub. Co., 201 N. Hoyne Ave., Chicago.

VIOLINS—Hand-made masterpieces. Get details. John Lehto, 935 14th, San Pedro, Cal.

SHEET-MUSIC, 10 for \$1.00. For Amateur Teacher or Student. Catalog free. Ferd. Zarb, P. O. B. 18, Sta. D., New York.

SONG-WRITERS—Original melodies to your words Publication guaranteed. Raymond H. Clark, Presque Isle, Maine.

SONG writers with poems or melodies, send for bona fide proposition. Ray Hibeler, D1, 2104 N. Keystone Ave., Chicago.

RUDY WIEDOEFT'S "Talks to Saxophonists." Free. Valuable advice on playing by America's Premier Saxophonist. Selmer, Elkhart, Ind.

FREE-Song Writers' Guide. Beaver, 1239 Elm, Green Bay, Wis.

SONG Poem Writers Address Monarch Music Co., 236W-55th, New York.

I BUY, Sell, Publish Songs. Chester Escher, 455 Wayne St., Jersey City, N. J.

VIOLINS, Deep, Mellow, Soulful — on credit. Easy terms for wonderful instrument. Get details today. Gustav F. Henning, 2424 Gaylord St., Denver, Colo.

"MUSIC Composed" to words. Bauer Bros., (formerly of Sousa's Band), Oshkosh, Wis.

I WANT Song Poems. Casper Nathan, 3544 N. Racine, Chicago.

CORNETISTS—Trombonists—Saxophonists—Clarinetists. Get "Free Pointers." Name instrument. Virtuosi School, Buffalo, N. Y.

**PATENT ATTORNEYS**

PATENTS. Time counts in applying for patents. Don't risk delay in protecting your ideas. Send sketch or model for instruction or write for free book "How to Obtain a Patent" and "Record of Invention" form. No charge for information on how to proceed. Communications strictly confidential. Prompt, careful, efficient service. Clarence A. O'Brien, Registered Patent Attorney, Security Bank Building (directly across street from Patent Office), Washington, D. C. See pages 138 and 139.

PATENTS Procured, Trade-Marks Registered. Over 25 years' experience, devoting our entire time exclusively to Patent practice. Highest references. Preliminary advice gladly furnished without charge upon receipt of sketch or model. Communications kept strictly confidential. Get in touch with us immediately. Your case will receive our prompt personal attention. Terms reasonable. Bryant-Lowry, Registered Patent Attorneys, 315-A Victor Building, Washington, D. C.

PATENTS Procured. Advice Free. Careful, Efficient Service by Attorney of 25 years Experience. Mechanical Experts. Chester Brown, 510 Van Buren Street, Chicago.

SELL your invention before patenting. Write for free particulars. W. T. Green, 901 Jenifer Bldg., Washington, D. C.

LACEY'S Patent Sense. Valuable book free. See ad page 144.

PATENTS—Write for our free book, "How to Obtain A Patent" and Record of Invention Blank. Send model or sketch of inventions for inspection and instructions Free. Terms Reasonable. See advertisements on pages 140 and 141. Victor J. Evans & Co., 934 Ninth, Washington, D. C.

**PATENTS Procured:** Trade Marks Registered—A comprehensive, experienced, prompt service for the protection and development of your ideas. Preliminary advice gladly furnished without charge. Booklet of information and form for disclosing idea free on request. Richard B. Owen, 30-Owen Bldg., Washington, D. C., or 41-B Park Row, New York.

**PERCY S. WEBSTER,** 203 Saving and Loan Building, Stockton, California. Long established organization. Patent booklet free.

**PATENTS.** Ordinary mechanical application including search, one sheet drawings and Government fees, \$85.00. Milton G. Carver, 1825 New Hampshire Avenue, Northwest, Washington.

**PATENTS—Write for Instructions.** Carl Miller, Registered Patent Attorney, (former member Examining Corps United States Patent Office), McGill Building, Washington, D. C.

**PATENTS Procured.** Prompt service. Personal, careful and efficient service. Highest references. Moderate fees. Send sketch or model for actual search and advice. George P. Kimmell, Master of Patent Law, 54-J, Legal Bldg., Washington, D. C.

**INVENTOR'S Advice,** valuable patent book, sent free. Labinere, 3 Parkrow, New York.

**INVENTORS:** Send sketch or model for advice and exact cost of patent. Ask for our Free book: "How to Obtain a Patent." Tells what every inventor should know. Established twenty-eight years. Highest references. Prompt service. Reasonable charges. Chandlee & Chandlee, 474 Seventh, Washington, D. C.

**PATENTS.** Booklet free. Highest references. Best results. Promptness assured. Send model or drawing for preliminary examination. Watson E. Coleman, Patent Lawyer, 724 Ninth St., Washington, D. C.

**"INVENTORS' Guide"** sent free on request; this book contains illustrations of patented inventions and gives valuable information and advice for all who have original ideas or improvements. Frank Leder-mann, Registered Attorney and Engineer, Woolworth Bldg., 1712, New York.

**PATENTS—Free preliminary advice.** Confidential, prompt. Registered Patent Attorney, formerly Examiner United States Patent Office. Albert Jacobs, Barrister Building, Washington.

**INVENTORS** having ideas to patent: Write for Booklet explaining Co-operative Plan for handling your applications. Tells how to sell and safeguard your inventions at lowest cost. Ralph Burch, Patent Lawyer, Jenifer Bldg., Washington, D. C.

**MILLIONS** spent annually for ideas! Hundreds now wanted! Patent yours and profit! Write today for free book—tells how to protect yourself, how to invent, ideas wanted, how we help you sell, etc. American Industries, Inc., 500-Victor Bldg., Washington, D. C.

**INVENTORS—Write for our Guide Book.** "How to Get Your Patent" and Evidence of Invention Blank. Send model or sketch of your invention for our prompt examination and instructions free. Randolph & Co., Dept. 430, Washington, D. C.

**PATENTS, Trade-marks, Copyrights.** Reliable services by an experienced practitioner devoting personal attention to each case. Inquiries invited. References furnished. B. P. Fishburne, Patent Lawyer, 525-A McGill Bldg., Washington, D. C.

**UNITED STATES and Foreign Patents** and Trade Marks; Low rates; easy terms. H. Sanders, Registered Patent Attorney, 7 Rand McNally Building, Chicago.

**ESTABLISHED 1864.** Milo D. Stevens Company. Free Booklet. Patents, Trade-Marks, Copyrights. Offices, Monadnock Block, Chicago; Barrister Building, Washington, D. C.

**PATENTS, Trade-Marks, Designs.** This firm has 27 years' experience and gives expert personal service at reasonable rates. We properly protect your invention. Write for free information and exact cost of procuring patent before proceeding. John B. Thomas & Co., 902 F St., N. W., Washington, D. C.

**UNPATENTED Ideas Can Be Sold.** I tell you how and help you make the sale. Free particulars (Copyrighted). Write W. T. Greene, 807 Jenifer Building, Washington, D. C.

**RICHARD E. BABCOCK,** Patent Lawyer, Washington Loan & Trust Bldg., Washington, D. C. Booklet.

**LANCASTER and Allwine,** 221 Ouray Bldg., Washington, D. C. "Originators of the Form Evidence of Conception." Before disclosing your invention to anyone send for blank form to be signed and witnessed. Form and patent information bulletin free.

**EDWARD C. SASNETT,** Formerly a Principal Examiner U. S. Patent Office, Attorney at Law. Strictly personal service. Correspondence invited. McGill Building, Washington, D. C.

**MONROE E. MILLER,** Ouray Bldg., Washington, D. C., Patent Lawyer; Mechanical, Electrical Expert. Booklet and Priority Record blank gratis.

**PATENTS** obtained under Cooperative Payment Plan. Write for particulars. W. E. Beck, Registered Patent Lawyer, 951 Jenifer Bldg., Washington, D. C.

#### FOR INVENTORS

**PATENTS.** If you have an invention which you wish to patent you can write fully and freely to Munn & Co., for advice in regard to the best way of obtaining protection. Please send sketches, or a model of your invention and a description of the device, explaining its operation. All communications are strictly confidential. Our Hand-Book on Patents is sent free on request. This explains our methods, terms, etc., in regard to Patents, Trade Marks, Foreign Patents, etc. "Scientific American" contains Patent Office Notes, Decisions of interest to inventors and particulars of recently patented inventions. Munn & Company, Solicitors of Patents, 1523 Scientific American Building, 24 W. 40th St., New York City; 524 Scientific American Bldg., Washington, D. C.; 1313 Tower Bldg., Chicago, Ill.; 666 Hobart Bldg., San Francisco, Calif.; 521 Van Nuys Bldg., Los Angeles, Calif.

**PATENTS** wanted by manufacturers. Send description, Box 126, Dowagiac, Mich.

**I SELL Patents.** Established in 1900. The service you will eventually employ, if you wish to sell your patent or know why. Send Patent copy, Charles A. Scott, 773PM Garson Avenue, Rochester, N. Y.

**PATENTS Procured:** Trade Marks Registered—A comprehensive, experienced, prompt service for the protection and development of your ideas. Preliminary advice gladly furnished without charge. Booklet of information and form for disclosing idea free on request. Richard B. Owen, 30-Owen Bldg., Washington, D. C., or 41-B Park Row, New York.

**INVENTIONS** Developed and Marketed. Twenty Years' Experience. C. J. Williams, American Bank Building, Oakland, Calif.

**PENDING Patents** marketed through co-operation. Booklet free. Chartered Association American Inventors, Barrister Building, Washington, D. C.

**IF** you can't afford to throw money away, get inventor's experience before you apply for a patent; cost you one dollar. May save you hundreds. C. P. Bronson, Corning, N. Y.

**I BUY** meritorious inventions, write, George Ross, 159 N. Queen St., Lancaster, Pa.

**INVENTORS:** \$2.00 connects you with big manufacturers who may buy your invention. Particulars free. Inventors Service Bureau, Box 1968, Chicago.

**SELL** your invention before patenting. Write for free particulars. W. T. Greene, 902 Jenifer Bldg., Washington, D. C.

**LACEY'S Patent Sense,** Valuable book free. See ad page 144.

**INVENTORS—Write for our free book.** "How To Obtain A Patent" and Record of Invention Blank. Send model or sketch of inventions for inspection and Instructions Free. Terms Reasonable. See advertisements on pages 140 and 141. Victor J. Evans & Co., 157 Ninth, Washington, D. C.

**INVENTORS** Universal Educator—contains 900 mechanical movements; 50 perpetual motions. Tells how to obtain and sell patents. Suggests new ideas. Explains how to select your attorney and avoid patent sharks. Price (revised edition) \$1.00 postpaid. Albert E. Dieterich, 621-Ouray Bldg., Washington, D. C.

**GET** your own patents. Legal blanks, complete instructions \$1. Cutting Sons, Cambell, Calif.

**INVENTORS:** Manufacturers' names in the line of your invention \$1.00. W. D. Schwenk, Box 133, Ferndale, Mich.

**PATENTS.** Time counts in applying for patents. Don't risk delay in protecting your ideas. Send sketch or model for instruction or write for free book "How to Obtain a Patent" and "Record of Invention" form. No charge for information on how to proceed. Communications strictly confidential. Prompt, careful, efficient service. Clarence A. O'Brien, Registered Patent Attorney, Security Bank Building (directly across street from Patent Office), Washington, D. C. See pages 138 and 139.

**PATENTS—Write to B. P. Fishburne** (a South Carolinian). Registered Patent Lawyer, 525-E McGill Bldg., Washington, D. C.

**PATENTS** obtained under Cooperative Payment Plan. Write for particulars. W. E. Beck, Registered Patent Lawyer, 950 Jenifer Bldg., Washington, D. C.

**INVENTIONS** Developed—Your crude ideas developed into practical form for your patent application. Model not necessary. Send rough sketch and description for estimate of cost and advice. 27 years' experience. Albert E. Dieterich, Engineer and Registered Patent Attorney, 621½ Ouray Building, Washington, D. C.

**UNPATENTED Ideas Can Be Sold.** I tell you how and help you make the sale. Free particulars (Copyrighted). Write W. T. Greene, 807 Jenifer Building, Washington, D. C.

**I AM** in touch with hundreds of moneyed men and manufacturers who wish to buy good inventions. Write Hartley, 38 Court St., Bangor, Me.

#### PATENTS FOR SALE

**OUTRIGHT,** Rack, displays mattresses on edge. Meets dealers needs, 15x56 floor space. Inexpensive made of wood, new, nothing like it. Jennings, Winnsboro, Texas.

**PATENT:** The tired woman's work bench, Sink, etc. Three lengths, seven by two and half floor space. Ideas never before assembled. Efficiency. Proposition direct. Brack, 314 Lake Cliff Drive, Dallas, Texas.

**COMBINATION** Schock Absorber and Air Compressor. Patent Pending. Wm. Luoma, Box 804, New Smyrna, Fla.

**COMBINATION** Window Shade and Drapery bracket. Number 1,611,088. Outright. Joshua Thomas, 304 Stevens, Joliet, Ill.

**FOR Sale,** outright or royalty, Patent No. 1,597,140, a "Toy Fly Killer," simulates a pistol. Also, financing wanted for new Harvester invention. W. Bargo, B. R. No. 6, Box 113-A, Wichita, Kansas.

**FOR Sale,** Patent No. 1,468,908, Safety Cover for Cooking Vessels, prevents boiling over of any liquids. Simple in construction. Easy to manufacture. Complete details. Write, A. Kraft, 2364 Funston Ave., San Francisco, Calif.

**OUTRIGHT,** or part Royalty, combined weatherstrip and antirattler for windows and doors in buildings and autos. Absolutely tight at all times. C. E. Reyburn, Peru, Ind.

**PATENT** oars for canoes. Made to order by the American Boy and Propeller Co., Box 34, Cathay, No. Dak.

**FOR Sale,** Cash or Royalty Basis. Patented Geared Roller Skates. Wonderful Amusement Park Device. Stetson, Post Office Box 2243, Station B, San Francisco, Calif.

**FOR Sale—Key Ring Holder.** Patent Pending. Box 506, Ind. Harbor, Ind.

**FOR Sale—Patent Dynamic Balance** for Four-cylinder Motors. Cheap. For particulars address M. Schaffer, 1023 Pear St., Reading, Pa.

**OUTRIGHT** or royalty basis, patent 1,620,272, Improved Jar Holder. Low cost to manufacture; good seller. Charles J. May, 534 W. Lawrence St., Mishawaka, Ind.

**PATENTED** Construction, fireproof; cheaper than frame. Territory. Gibbins, Lancaster, Calif.

**PAT.** 1,569,690, self-cleaning Berry-picker. Cash or royalty. Write to Wester Walno, Box 81, Watton, Mich.

**MINIATURE** Bowling Alley—a proven winner. Write for illustrated literature. Shears Amusement Company, Oklahoma City, Okla.

**U. S. and Canada** Patent, outright or royalty; double-faced Name and Emblem Displaying Device for automobiles. George Hortick, 39 Shultz St., Danville, Ill.



**FOR Sale**—Patent on Tractor Hitch for Horse-Drawn Gang Plow. Fred H. Bergborn, Latimer, Iowa.

**WILL** Sell very valuable patent your terms. Elizabeth Smith, 3634 Suitland Road, Washington, D. C.

**OUTRIGHT**, newly patented fruit gatherer. Great cherry and fruit picker. M. Blum, 5332 North Lovejoy Ave., Chicago.

**FOR Sale** or lease used Everywhere. H. Malbauer, 622 Howard, Detroit.

**SEED** Potato cutter. Wood, Practical. Mailable. L. E. Purkey, Pocatello, Idaho.

**SALE** or Royalty. Hair curler and waver. Automatically lifts hot end when laid down. No unscrewing from socket. Nollie Simmons, Statler Hotel, Detroit, Mich.

**OUTRIGHT** or Royalty—music stand; sheet music pages turned without interfering with playing. W. S. Lucas, 1635 W. Division St., Chicago, Ill.

**DEVICE** protects bottled milk from burglars, enemies when left at door un-protected. No key. Manufactured at very low cost. J. Mammals, 58 St. Marks Pl., New York City.

**OUTRIGHT**—Newly patented process for briquetting coal dust—Smokeless Binder. Prof. Rudolph Kratochwill, Greenville Tenn.

**WHY** let your patents lie idle? Tell our two million five hundred thousand readers about it! The majority of our readers are especially interested in new ideas and inventions. Ask me to tell you how other inventors successfully sold their patents. M. L. Rund, Mgr., Classified Advertising, Popular Mechanics Magazine, Chicago.

### ELECTRICAL

**POWERFUL** Electro-magnets, six volts, lift 150 lbs., \$6.50; 300 lbs., \$12.00; 500 lbs., \$20.00 all post-paid. We make electro-magnetic devices for any purpose; write your wants. Nauta Products Co., 385 No. 11th St., Paterson, N. J.

**MAKE** Things Electrical. Complete instructions for making medical coil, buzzer, rheostat, sign flasher, electric toaster, heater, electric grill, soldering copper, crystal receiver, transformer, Tungar rectifier, Duram receiver, motor and other things in fine illustrated book costing \$1.25. Pay postman price and postage when he hands you the package. Address Popular Mechanics Press, Room 908, 200 E. Ontario St., Chicago, Ill.

### FOR MECHANICS

**RAFTER** chart, an accurate and time-saving method of cutting roof rafters. Price \$1.00. T. W. Martin, 714 E. 4th St., Charlotte, N. C.

**"BLUEPRINT** Reading" is a compact book telling how to read machine blueprints. Send no money. Just pay postman postal charges and \$1. Popular Mechanics Press, Room 908, 200 E. Ontario St., Chicago, Ill.

**KINKS** on Metal Work. 419 discoveries for anyone who works with metal. For mechanic, machinist or the man who tinkers at home. 287 illustrations. Send no money. Just write a postal asking for "Machinist's Kinks." When postman hands you book pay postage and price of book, \$1.50. Popular Mechanics Press, Room 908, 200 E. Ontario St., Chicago, Ill.

### SURVEYING INSTRUMENTS

**LARGEST** stock of new and used surveying instruments in the country direct from factory. Satisfaction guaranteed or money refunded. Wissler, 619 N. Broadway, St. Louis, Mo.

### MODELS AND MODEL SUPPLIES

**PATENTS.** Time counts in applying for patents. Don't risk delay in protecting your ideas. Send sketch or model for instruction or write for free book "How to Obtain a Patent" and "Record of Invention" form. No charge for information on how to proceed. Communications strictly confidential. Prompt, careful, efficient service. Clarence A. O'Brien, Registered Patent Attorney, Security Bank Building (directly across street from Patent Office), Washington, D. C. See pages 138 and 139.

**WE** make models, dies, manufacture your invention, help perfect it. Do experimental work. Free information. Strand Mfg. Co., 644 West Randolph, Chicago.

**LET** our experience be your guide. Models that are models; tools and equipment for economic manfg. Patterns of all types; manufacturing in all branches. Satisfaction guaranteed. United Machinery Company, Cincinnati, U. S. A.

**MODELS, Tools, Dies and General** manufacturing. Logan Machine Co., 652 W. Lake St., Chicago, Ill.

**CLIPPER** Ship. Fullrigged, 20" overall. Spars, sails, dead-eyes, Blocks, bits, anchor, chains, Steering wheel, Rigging, Cabins. Everything for this beautiful model \$5.00. Catalogue, Dime. Roy Hancock, 323 Douglas Ave., Portsmouth, Va.

**THE Modelmaker**, a magazine for all interested in making working models, boats, etc. Sample 10c. Modelmaker, 122 Liberty St., New York.

**MODEL** steam engines and boilers. Boat and boiler fittings. Send 10c stamp for catalog. Refunded with first order. Model Machine Shop, 212 Price St., Rahway, N. J.

**WHEELS** for toys, models, Disk and Spike. One inch up. Few cents a dozen. Circular Free. Santicraft Studio, Lovelock, Nev.

**SHIP** Model Fittings: Send stamp for booklet. A. J. Fisher, 1002 Etowah Ave., Royal Oak, Mich.

**SPECIAL** machine builders, tool and die makers, inventor's models production work of all kinds. Dept. L. Quality Hardware & Machine Co. Ravenswood and Thorndale Avenues, Chicago, Ill.

**WE** make working models for inventors and do experimental work and carry a complete stock of brass gears and model supplies. Send for catalogue. The Pierce Model Works, Tinley Park, Ill.

**MODEL** and Experimental Work at lowest cost. Wagar Model & Machine Works, 115 So. Clinton Street, Chicago.

### MANUFACTURING

**COMPLETE** Manufacturing. Dies and stampings and Special Machinery. Our Engineering department will design and perfect your article; our tool room will tool it for production. Our shop will make any quantity you may need. Models made if necessary. Barth Stamping & Machine Company, 3816 West 34th St., Cleveland, Ohio.

**DIES, Tools, Production Machine Work, Models and Contract Manufacturing.** Let Kansas City's Largest and Best Equipped Combination Die and Machine Shop figure with you on your requirements. Bank and Commercial Agency References. Schroer Bros. Machine Works, 23rd and Holmes St., Kansas City, Mo.

**WIRE** goods made to order. Cooley Mfg. Co., 530 N. Western Ave., Chicago.

**SPECIAL** Machinery or parts, dies, tools, metal specialties, models, special gears, stock gears and model supplies. Send for Catalogue. The Pierce Model Works, Tinley Park, Ill.

**WANTED** to manufacture on royalty basis, some Mechanical Appliance or Automobile Accessory. Cincinnati Automatic Machine Co., Cincinnati, Ohio.

**MACHINE** work and manufacturing. Automatic Machines developed to reduce cost of production. Wide experience and reasonable prices. York Electric & Machine Company, York, Pa.

**MANUFACTURING** Models, Dies, Stampings, Brass Work, one or thousands. Baum's Metal Specialties, Kansas City, Mo.

**WIRE** goods made to order. Cooley Mfg. Co., 530 N. Western Ave., Chicago.

**STAMPING** and light manufacturing. Acme Tool Co., Mason City, Ia.

### FOR MANUFACTURERS

**WANTED**—Manufacturer to handle patented auto headlight dimmer and grease cup on royalty basis. G. V. Heidt, R. P. B., Governors Island, N. Y.

### MACHINERY, TOOLS AND SUPPLIES

16"x6" PRENTICE engine lathe, \$175.00. 20"x10" Davis engine lathe—quick change, \$550.00. No. 60 Heald Cylinder Grinder, \$750.00. 10x32" Landis Universal Piston and General Grinder, \$375.00. 20" Drill Press, \$75.00. 14" Drill Press \$40.00. Complete line of machinery and small tools. Write for catalog. Cincinnati Machinery & Supply Co., 218 East Pearl St., Cincinnati, Ohio.

**CONCRETE** Building Block Machine and Molds. Catalogue free. Concrete Machine Co., 5 N. Main St., St. Louis, Mo.

**LATHES, Drill Presses, Shapers, Milling** Machines, Planers, Screw Machines, Small Tools and Surplus Machinery. Cincinnati Automatic Machine Co., Cincinnati, Ohio.

**SPEED** Lathe \$10.50 complete. 7 inch swing, 3 speed cone. Jefferson Mfg. Co., Fairfield, Iowa.

**PIPE** second hand, guaranteed suitable for all practical purposes with new threads and couplings, sixteen feet and over; cut to your requirements, also Boiler Tubes, New Fittings. Pfaff & Kendall, 102 Waydell St., Newark, N. J.

**WOODWORKING** Machinery: Scroll Saw with motor \$28.50. Motor Head Lathe \$50.00. Our catalog shows complete line. Heston & Anderson, 637 Depot Ave., Fairfield, Iowa.

**START** Business of your own, small investment required, doing nickel, copper and silver plating. This work is in big demand. Full information free. Electro Platers Supply Co., 547 Considine Ave., Cincinnati, Ohio.

**OTHERS** have successfully sold their machinery through our columns—so can you. Ask me for proof. M. L. Rund, Manager, Classified Advertising, Popular Mechanics Magazine, Chicago.

**SHOP** Notes for 1927. Get your copy now. Only a limited edition. Contains all the articles published in the Shop Notes department of Popular Mechanics Magazine during 1926. Send no money. Just write a postal and we'll send 1927 Shop Notes and any one of the other following numbers, 1908, 1912, 1913, 1914, 1915, 1916, 1917, 1919, 1920, 1921, 1922, 1923, 1924, 1925, 1926. Pay the postman 98 cents and the postage when he hands you the two books. Popular Mechanics Press, Room 908, 200 E. Ontario St., Chicago, Ill.

### ENGINES, MOTORS AND DYNAMOS

**ANOTHER** lot new 110-volt alternating washing machine motors \$5.50 each, cash with order. Also other bargains direct and alternating. Write for prices stating size and kind of current. Queen City Electric Co., 1736 Grand Av., Chicago, Ill.

**ALTERNATING** current bargains. ¼ H.P. Holtzer-Cabot \$7.00. Westinghouse or General Electric 16-inch oscillating fan \$20.00. These special prices for a few weeks only. Send your order now. Hyre Electric Company, 615 TF, So. Dearborn St., Chicago.

**GUARANTEED** A.C. ¼ H. P. 110 V. Washing Machine Motors \$5.00. Other bargains. 25% required, balance C. O. D. Elle & Co., 1018 W. Lake, Chicago.

**WRITE** for bargain catalogs on electric motors, generators, electric drills, etc. Do not buy, consult us first. General Distributing Co., Security Bldg., Duluth, Minn.

**MOTORS**—New GE 110 or 220 volt 60 cycle Single Phase ¼ HP, \$11.90; ½ HP, \$28.50; 1 HP, \$38.50. Mail \$3 check or money order. We will ship COD anywhere. Motor Specialties Co., Crafton, Penna.

**753 TIME, Labor and Money Saving Ideas** for all who own, drive or repair autos. These practical kinks are based upon the actual experiences of hundreds of owners and repairmen. Three books, Auto Owners, Auto Repairman's and Auto Tourists Handbooks, regular \$1.50 value from Popular Mechanics Press will be supplied at 98c, plus the postage C. O. D. for a limited time only. Send your order today to Popular Mechanics Press, Room 908, 200 E. Ontario St., Chicago.

**18" EXHAUST** Fans \$50.00. Complete stock of other sizes. Elle & Co., 1018 W. Lake St., Chicago.

### BLACKSMITHS

**BE** a Master Mechanic Blacksmith and Expert Tool Maker and Dresser with colored tempering charts. Price \$1.00. Valuable samples free. W. M. Toy, Sidney, Ohio.

### BENDING MACHINES

**THE** Famous Hossfeld "Wrenchless" Universal Iron Bender is the last word in bending machines. Bends metal cold or hot into most any conceivable shape, including Eye Bolts and Automobile Spring Eyes. Bends up to 1" bars or 1½" pipe cold. Used by all classes of trade, from the smallest shops to the largest railway systems. Write for circular and prices. Hossfeld Mfg. Co., Winoona, Minn.

### FOR SALE—MISCELLANEOUS

**HAIR** Grows when our Vacuum Cap is used a few minutes daily. 60 days' free trial. No drugs or electricity. 20 years success. Stops falling hair and dandruff. Booklet free. Modern Vacuum Cap Co., 555 Quincy, Denver, Colo.

**IMPORTER** buys goods for you from all countries. Miller, 55 E. Wacker Drive, Chicago, Ill.

\$160.00 MODEL Hammond typewriter, \$50.  
\$65.00 Dietzgen engineers level, \$37.50; bargains in cameras, lenses. Cash paid for firearms, microphones. National Camera Exchange, 5 South Fifth, Minneapolis, Minn.

**ADDRESSGRAPHS.** Letter Folders. Multigraphs, Envelope Sealers, Duplicators, less than half price. Guaranteed. Pruitt Co., 117 No. Market, Chicago.

**WIRELESS** Station Complete, \$10.00. Printing outfit, \$35.00. Nelson Huff, Confluence, Ky.

SEND for our unique catalog of 5,000 books listed alphabetically under subject headings. Free on request. Popular Mechanics Press, 200 E. Ontario St., Chicago.

**VACATION** Reading. Ask us to send you lists of books that are 100% entertaining—such books as Beau Geste, Old Ironsides, One Minute to Play, The Nervous Wreck, etc.; prices of most of these books not over 75 cents. You will receive at once attractive lists to choose from and from time to time thereafter lists of the newest and best stories as soon as the publishers' announcements are made. Popular Mechanics Press, 200 E. Ontario St., Chicago.

#### WANTED—MISCELLANEOUS

**WANTED**—Old Books, Prints, Autographs, Photographs. Describe; Price, Ralph Hadley, Lowry City, Mo.

**MAIL** us your discarded Jewelry, Gold, Crowns and Bridges, Watches, Diamonds, Silver, Platinum and old False Teeth. Money promptly mailed. Goods returned if offer refused. United States Smelting Works (The Old Reliable), Dept. 71, Chicago.

#### REAL ESTATE, FARM AND ORCHARD LANDS

**ATTENTION!** "Get acquainted." Cash for your property. Farm, Hotel, or Retail Store, no matter where located; confidential service. Hayes Business Agency, Cincinnati, Ohio.

**WANTED**—Cash price from owners. Land for sale. D. Bush, Minneapolis, Minn.

**OZARKS**—10 acres near White River and proposed power dam, \$100, \$5 monthly. Alvin Zimmerman, 1802 N. 5th, Kansas City, Kans.

**FLORIDA** Gulf Coast—We have a few 5 acre tracts inside city limits suitable for poultry and small fruits, Hills Fruit Farm, Panama City, Florida.

**FORTY** Acres unimproved in Beautiful Ozarks. \$150.00. Box 127, Houston, Mo.

**SEND** For Free List of farms, prices, description, say in what state; buy direct from owner. Home-Pilot, Douglas, Wash.

**OZARKS**, 40 acres, House, Spring, Fruit, Fencing, \$500, \$50, down, \$10 month. Box 198, Mt. Vernon, Ill.

**\$10** IS all I ask down on 20 acres in Mich. Potato Belt. Very easy terms. Near markets, lakes and streams. Write for particulars now. G. W. Swigart, P1276 First Nat'l Bank Bldg., Chicago.

**SELL** your property quickly for cash, no matter where located. Don't pay big commission. Particulars free. Real Estate Salesmen Co., Desk B, Lincoln, Nebr.

**PECAN**-Orange-Fig Groves "On the Gulf" Monthly payments. Guaranteed care. Big, quick returns. Suburban Orchards, Dept. M, Biloxi, Miss.

#### SEEDS, PLANTS, TREES, ETC.

**WRITE** Today for Prices on 1926 Ginseng Seed Booklet on Golden Seal Growing, 10c. W. N. Long, Florence, Ky.

#### ROOTS AND HERBS

**SAVE** Doctor bills. Read Herb Doctor book. 250 valuable herb medicine recipes for home use. 10c postpaid. Worth many dollars. Shawnee, 145 West 112th, Chicago.

**HERB** Doctor Book—10 cents. 250 receipts for making herb medicine. Hazzard Company, Box 1, Vanderveer Park, Brooklyn, N. Y.

#### POULTRY

**SHEPARD'S** Strain Anconas. Several hundred 8-12 weeks old pullets now ready, 75c, \$1.00 each. Homer Cline, Canton, Ga.

**COMMERCIAL** Poultry Raising can be made a profitable venture, yet certain well established rules must be followed. Avoid pitfalls by getting our reliable 572 page book of the latest and best practice. It will increase your profits. Order today and pay postman \$3 plus the postage when he hands you the book. Money back if not satisfied. Popular Mechanics Press, Room 908, 200 E. Ontario St., Chicago, Ill.

#### RABBITS

**MAKE** big profits with Chinchilla Rabbits. Real Money-makers. Write for facts, 852 Conrad's Ranch, Denver, Colo.

#### DOGS AND PETS

**THE** World's Largest Kennel offers for sale Orang Alredale watch dogs, automobile companions, children's playmates, hunters, retrievers, stock-drivers. Also Big Game Hounds, Coonhounds, Foxhounds, Rabbit Hounds. All dogs individually schooled and trained by canine specialists and shipped on trial. Price \$50.00 to \$150.00 each. Thoroughbred puppies \$25.00 to \$35.00 each. Catalog ten cents. Orang Kennels, Box 14, La Rue, Ohio.

**HUNDRED** Hunting Hounds Cheap. Trial. Catalogue. Kaskaskennels, CA17, Herrick, Ill.

**A. K. C. SMOOTH** Fox Terriers, all ages. Puppies for sale. Free photos. Shipped on approval anywhere; if not satisfactory return at my expense. References exchanged. Order now. Mrs. Carmen D. Welch, Ramsey, Ill. R. R. No. 1.

**RACING** Homers, pedigreed. Old Birds \$10.00, pair. Young Birds \$5.00, pair. R. L. Zimmerman, Lexington, Ky.

**HUNDRED** Hunting Hounds. Hunting Supplies. Catalogue. Kaskaskennels, C115, Herrick, Ill.

**BEAUTIFUL** White Spitz Puppies. Prices, Photographs. H. Maloy, Temple, Texas.

**HIGH**-Class Collie Puppies. Type—Intelligence—Health. Iola Kennels, Farmersville, Ohio.

**FOR** Sale. Minks, squirrels, raccoons, foxes, ferrets, muskrats, ginseng, rabbits, skunks, wolf pups, opossums. B. Tippman, Caledonia, Minn.

**BEAUTIFUL** Fox Terriers, Collies, Shepherds. Barnes Farm, Clay Center, Neb.

#### PERSONAL

**TOBACCO** or Snuff Habit Cured or no pay. \$1.50 if cured. Remedy sent on trial. Superba Co., N3, Baltimore, Md.

**SPARETIME** Employment at home. Details stamp. Gluco, 507 Aetna Bldg., Rochester, N. Y.

**FREE:** Valuable book telling the uses of roots and herbs. Box 29, Station L, New York.

**GET** a better grip on mathematics. Write for "Mathematics for the Practical Man." "Common sense methods remove mystery and difficulties. Algebra and calculus made simple. Assuming knowledge limited to arithmetic you quickly and easily gain working knowledge of algebra, geometry, trigonometry and calculus. Pay postman \$1.50 and postage when he delivers package. Popular Mechanics Press, Room 908, 200 E. Ontario St., Chicago, Ill.

**WE** answer your questions, 25c coin. Fred Klotz, Reading, Pa.

**861 PRACTICAL** Ways to Reduce Farm Labor and Expense and Increase Income. One farmer writes he would not part with this information for \$100, if he could not duplicate it. Nothing experimental. These ideas have all been put to test and proven practical. Send today for a copy of our Handbook for Farmers and get ready to put these ideas into operation for your own benefit. Pay postman only 98 cents and the postage when he hands you the package. Popular Mechanics Press, Room 908, 200 E. Ontario St., Chicago.

**HOW** to Work with Tools and Wood for the home workshop is an unusually interesting new book just published by the Stanley Rule and Level Plant. 180 pages, illustrated. Cloth bound. Price \$1. Pay postman price and postage when he delivers package, C. O. D. Order from Popular Mechanics Press, Room 908, 200 E. Ontario St., Chicago.

#### MISCELLANEOUS

**"COLOR** Mixing Guide" (paints, inks, dyes) \$1.00 prepaid. King, Box 1482, Indianapolis, Ind.

**MEXICAN-MADE** pistol holsters, cartridge belts, lariats; hand-carved belts and holsters; horse-hair belts, hat bands, fobs; rattlesnake belts, fobs. Tex-Mex Leather Co., 309 Esperson Bldg., Houston, Tex.

**WEEDS**—Cut them with cutter bar on Shaw Garden Tractor. Also plows, cultivators and runs belt machinery. Low prices. Immediate delivery. Shaw Manufacturing Company, Department C, Galesburg, Kans.

**CUTS** anybody can make. Simple, cheap process. \$1. Specimens, particulars, 2c stamp. M. Day, Windfall, Ind.

**TELL** an army of 3,000,000 live readers all about your offer! If you have anything to sell, buy or exchange, or if you have any reasonable proposition, tell our readers all about it—they'll respond quickly. Our booklet "How to Create More Business" contains some very interesting, helpful facts. Write today for your copy—it's free. M. L. Rund, Manager Classified Advertising, Popular Mechanics Magazine, 200 E. Ontario St., Chicago, Ill.

**LOCKSMITHS**—Something new. Write. Also buy, sell and exchange codes. Free list. Locksmith, 1656 Lawrence, Denver, Colo.

**CASH** in on your Artistic Ability. Your home, your office, your spare time, your gold mine. Not a correspondence course. Sample and particulars 10c. Straco, 1013 Mulberry, Springfield, Ohio.

**ELECTROPLATING.** New printing of popular book by H. C. Reetz. Complete instructions for plating with all kinds of metals. Send no money. Just write a postal asking for "Electroplating." Pay postman the postage and \$1.00. Popular Mechanics Press, Room 908, 200 E. Ontario St., Chicago, Ill.

**HOMEOPATHIC** and Biochemic preparations sent postpaid to all parts of the world. Manual and booklets free. Halsey Bros. Co., 645 St. Clair St., Chicago, Ill. Established 1855.

**CANE** Becomes Ukulele by Removing Secret Cover, \$3.50. Broadway Music Co., Bayonne, N. J.

**MAKE** Extra Money Evenings Mfg. 24 good sellers. Instructions \$.50. Steffey, 3924 Fairmount, Philadelphia.

**MAKE** a Telescope; Join ranks of enthusiastic group of amateur astronomers. Fascinating subject treated in new book, only one published in America, "Amateur Telescope Making." Pay postman \$2 and few cents postage on delivery. Popular Mechanics Press, Room 908, 200 E. Ontario St., Chicago, Ill.

**LOOK!** Fly balloons anywhere. Inflator \$1.00 and \$6.00. Balloon Inflator Co., Box 853, Providence, R. I.

**MIRRORS** Resilvered at Home. Costs less 5 cents per square foot; you charge 75 cents. Immense profits plating autoparts, reflectors, tableware, stoves, refinishing metalware, etc. Outfits furnished. Details Free. Write Sprinkle, Plater, 288, Marion, Ind.

**POST-CARD** views of the Panama Canal during Construction days, 25 assorted for \$1.00. W. Ramey, Box 571, Cristobal, Canal Zone.

**WIN** distinction. Use our Individual Stationery Embossers. Inexpensive—Simple—Unique. Miller Sales Company, Lexington, Ky.

**CASH** Paid for Butterflies, Insects. See Sinclair Display Advertisement on page 39.

# LEARN CARTOONING

## AT HOME DURING SPARE TIME

from the School that has trained hundreds of successful cartoonists of today. The Landon Picture Chart Method of teaching ORIGINAL drawing by mail makes cartooning easy to learn. Write today for sample picture chart to test your ability and examples of the work of successful students now earning from \$75 to \$200 and more per week. Please state your age.

**THE LANDON SCHOOL, 2838 National Bldg., Cleveland, Ohio**



# Be a KING of the AIR



Look at Lindbergh. The hero of the whole world. A product of a commercial school. Rode up on his bike and paid \$250 for his first instruction. Flew to Paris in a commercial built ship. Used

Wright whirlwind motor. Just started off by himself with a couple of sandwiches and now the world is at his feet. Proved what energy and independence can accomplish. You might have done it. As a result of Lindbergh's feat commercial aviation receives a new impetus. "Get into flying," says Lou Holland, president of K. C. Chamber of Commerce. "It's the coming great business."

## It's Safe, Quick and Easy

I have taught hundreds of students. Many now doing commercial work at large salaries. World's record of 4000 hours student flying without material damage. All the flying necessary to make you a skilled pilot. Planes under government inspectorship. Learn to fly from men who know. All equipment and instructors examined by U.S. inspectors.

**GROUND SCHOOL.** Mechanics in big demand. Take either flying or ground school course or both. Sweeney students are trained by DOING. Thorough ground school work, under skilled instructors in the construction and repair of planes, recovering wings, tuning motor, etc., learning everything about the mechanical work by actual practice. This fits you as an aviation mechanic. You can build your own plane and do anything required in aviation mechanics and construction and repairing when you have finished this work. You are thoroughly taught motors, etc., and work with thousands of dollars' worth of new material, including all types of engines. Aviation is now playing in commercial activities. Progress is rapid. More men are needed every day. You can qualify as a mechanic, or an engineer, or repair man, or builder; five men on the ground are needed for one man in the air.

**FREE SEND NAME TODAY** for full details of this aviation mechanical course and photographs of planes and equipment actually used; also full information as to the commercial end of flying and opportunities for young men. No colored students accepted.

### BIG MONEY in Flying

- Aviation Mechanics—\$50-\$125 Week
- Riggers—\$50-\$75 Week
- Flyers—\$125-\$225 Week
- Taxi-Service—\$100-\$300 Week
- Aerial Photo Pilot—\$200-\$250 Week
- Special Messenger Service—\$125-\$200 Week
- Aerial Advertising—\$225-\$500 Week
- Crop Dusting—\$125-\$200 Week
- Crop Survey—\$125-\$225 Week

**150 Acre Flying Field**  
**Hangar and Club House**  
**Skilled Instructors**  
**Thorough Construction Course**

LEARN TO FLY BY FLYING  
**Sweeney**  
 SCHOOL OF AVIATION  
 4006 SWEENEY BLDG, KANSAS CITY, MO.

-----**SEND THIS NOW**-----

**EMORY J. SWEENEY, President**  
 4006 Sweeney Bldg., KANSAS CITY, MO.

Please send me full information about your Aviation Course.

Name.....Age.....

Address.....

Town.....State.....



## The Boss Was Afraid to Make Me Foreman

"HE SAID he had always liked me and he thought I could handle men, but he was afraid to make me Foreman until he was sure I knew more about the work.

"Tell you what I'll do," he said. "You take up a course with the I. C. S.—let me see that you really want to prepare yourself for advancement—and I'll promise to keep you in mind the next time there's a good job open."

"That sounded like a good proposition, so I began studying with the International Correspondence Schools. It changed my whole life.

"In three months the Boss called me in and said he was ready to make me Foreman. Just fourteen months after that he went before the Board of Directors to urge my appointment as Superintendent because he said I knew more about the business than anybody else in the plant.

"I'm making five times as much as I did before the Boss woke me up and literally forced me to take up an I. C. S. course and prepare to earn more money."

### Isn't that good advice for you too?

Why don't you take up a home-study course with the International Correspondence Schools and get ready for a real job at a salary that will enable you to give your wife and children the comforts you would like them to have?

Right at home, in the odds and ends of spare time that now go to waste, you can prepare for the position you want in the work you like best. At least find out how.

### Mail the Coupon for Free Booklet

**INTERNATIONAL CORRESPONDENCE SCHOOLS**  
Box 5666-E, Scranton, Penna.

Without cost or obligation, please send me a copy of your booklet, "Who Wins and Why," and full particulars about the course before which I have marked X in the list below:

#### BUSINESS TRAINING COURSES

- |   |   |
|---|---|
| <input type="checkbox"/> Business Management            | <input type="checkbox"/> Salesmanship           |
| <input type="checkbox"/> Industrial Management          | <input type="checkbox"/> Advertising            |
| <input type="checkbox"/> Personnel Organization         | <input type="checkbox"/> Better Letters         |
| <input type="checkbox"/> Traffic Management             | <input type="checkbox"/> Show Card Lettering    |
| <input type="checkbox"/> Business Law                   | <input type="checkbox"/> Stenography and Typing |
| <input type="checkbox"/> Banking and Finance Management | <input type="checkbox"/> English                |
| <input type="checkbox"/> Accountancy (including C.P.A.) | <input type="checkbox"/> Civil Service          |
| <input type="checkbox"/> Cost Accounting                | <input type="checkbox"/> Railway Mail Clerk     |
| <input type="checkbox"/> Bookkeeping                    | <input type="checkbox"/> Common School Subjects |
| <input type="checkbox"/> Private Secretary              | <input type="checkbox"/> High School Subjects   |
| <input type="checkbox"/> Spanish                        | <input type="checkbox"/> Illustrating           |
| <input type="checkbox"/> French                         | <input type="checkbox"/> Cartooning             |

#### TECHNICAL AND INDUSTRIAL COURSES

- |   |  |
|---|--|
| <input type="checkbox"/> Electrical Engineering | <input type="checkbox"/> Architect               |
| <input type="checkbox"/> Electric Lighting      | <input type="checkbox"/> Architects' Blueprints  |
| <input type="checkbox"/> Mechanical Engineer    | <input type="checkbox"/> Contractor and Builder  |
| <input type="checkbox"/> Mechanical Draftsman   | <input type="checkbox"/> Architectural Draftsman |
| <input type="checkbox"/> Machine Shop Practice  | <input type="checkbox"/> Concrete Builder        |
| <input type="checkbox"/> Railroad Positions     | <input type="checkbox"/> Structural Engineer     |
| <input type="checkbox"/> Gas Engine Operating   | <input type="checkbox"/> Chemistry               |
| <input type="checkbox"/> Civil Engineer         | <input type="checkbox"/> Automobile Work         |
| <input type="checkbox"/> Surveying and Mapping  | <input type="checkbox"/> Airplane Engines        |
| <input type="checkbox"/> Metallurgy             | <input type="checkbox"/> Agriculture             |
| <input type="checkbox"/> Mining                 | <input type="checkbox"/> Navigation              |
| <input type="checkbox"/> Steam Engineering      | <input type="checkbox"/> Mathematics             |
|   | <input type="checkbox"/> Radio                   |

Name.....

Street Address.....

City..... State.....

Occupation.....

Persons residing in Canada should send this coupon to the International Correspondence Schools Canadian, Limited, Montreal, Canada

**WE PAY FREIGHT**  
5 ROOMS AND PORCH  
BATH INCLUDED - **\$548<sup>00</sup>**

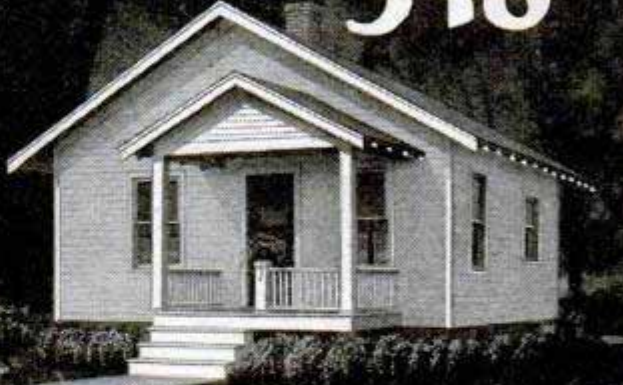

**Others \$379<sup>00</sup> up**  
**BUILD YOUR OWN HOME**  
**Save \$300 to \$800**

**AND MORE**

Buy all materials direct from manufacturer—saving four big profits! Guaranteed materials. Factory-cut. No waste, 40% less labor. Most remarkable money-saving prices ever offered!

**HANDSOME BIG FREE!**  
**CATALOG**

Prices include all lumber, millwork, roofing, lath, hardware, paints, nails. Plans furnished FREE. Freight paid east of Mississippi and North of Mason-Dixon line, also Minnesota, Iowa, Missouri.

Write for catalog now *Send Postcard*  
**LEWIS MFG. CO., Dept. 128 Bay City, Mich.**

## Big Money for You as an Automobile Mechanic

These four practical books, written by five well known teachers of automobile practice, will teach you right in your own home during your leisure time just what you need to know about automobile troubles and repair. They will teach you automobile construction, maintenance and repair as experts know them and will help you to earn an expert's pay.

**Practical Automobile Library: Four Books—\$1.50 in 10 days and \$2 monthly for 6 months—only \$13.50 in all!**

Hundreds of question-answering diagrams—hundreds of clearly-marked illustrations—make the books plain and readily understandable. All the explanations and descriptions are clear, simple, direct. Every chapter is packed with definite, step-by-step, how-to-do-it information. Here is your opportunity to enter a big-pay field.

**Sent FREE**

**Send No Money**  
**Mail the Coupon**



### FREE EXAMINATION COUPON

**McGraw-Hill Book Co., Inc., 370 Seventh Ave., New York**

Send me for 10 days' free examination the New Practical Automobile Library. If satisfactory, I will send you \$1.50 in 10 days and \$2 monthly until the special price of \$13.50 is paid. If not wanted, I will return the Books at your expense.

Signed.....

Address.....

City and State.....

Position.....

Employer..... P. M. 8-1-27

# He Left His Calling Card

—*Telltale Finger Prints!*



**Written In Blood!**



**T**HREE bloody finger prints on the cash register! He might as well have left his calling card—his doom was already written! These silent witnesses told the story—identified him—convicted him! Live through these thrilling adventures right with Detective McDonald as he gets Arizona's first finger print conviction. Mail the coupon below and get this gripping story **FREE**, with 12 others just as exciting!

## 13 True Detective Stories—**FREE!**

Gripping Mysteries! Gruesome Tragedies! Daring Deeds! Hair-Raising Climaxes! Every story will thrill you—grip you! You won't be able to lay it down until you have finished.

Think of it! Real Secret Service Operators give you "inside dope" on real crime cases. They reveal their secret workings—how they solved big crimes that baffled the police all over the country—how they won handsome rewards! These stories are **YOURS FREE!**—if you act quick! You would pay a good sum for them at a bookstore or news-stand. Here they are yours **FREE**—for the asking. Mail the Coupon **NOW!**

**Big Demand for Trained Men**  
**Make \$2500 to \$10,000 a Year**

Finger Print Experts solved every one of these weird, blood-curdling crimes! Finger Print Experts gathered in the great big rewards—were appointed to high official positions for their work! Every day more and more trained men are needed. New Bureaus of Identification, new positions are opening up all the time. The field is uncrowded! Opportunities are unlimited!

**YOU** can learn Finger Print Identification easily, in a short time—in your spare time—at home! **YOU** can make \$2500 to \$10,000 a year as a Finger Print Expert. Find out how you can enter this most thrilling, adventure-some profession and make big money fast!

### The Knock of Opportunity

Is the knock of the postman as he brings this book, "Finger Prints," to you. It brings you fascinating true detective stories. And more! It tells you how **YOU** can become a Finger Print Expert quickly and easily. It offers you a Professional Finger Print Outfit and a Course in Secret Service Intelligence. **Act Quick!**

**University of Applied Science**  
 1920 Sunnyside Ave., Dept. C-135 Chicago, Ill.

**Send for this Free Book!**

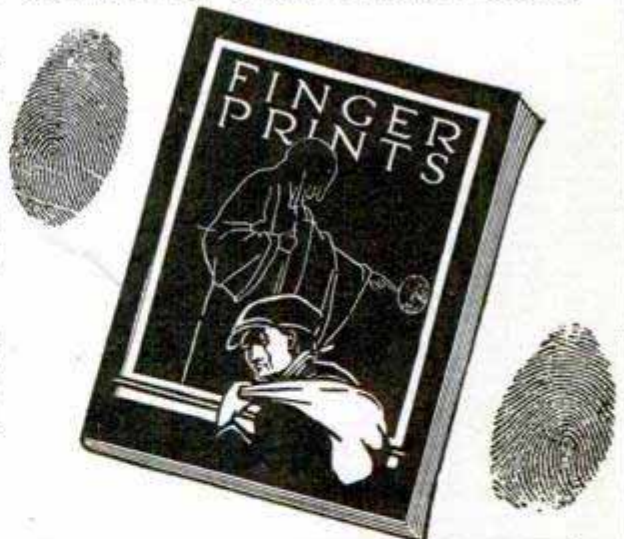

**Mail This NOW for Free Book**

University of Applied Science,  
 1920 Sunnyside Avenue, Dept. C-135 Chicago, Ill.

Without any obligation whatever, send me your new, fully illustrated, **FREE** book of authentic detective tales, "Finger Prints"; also your offer of a Free Professional Finger Print Outfit and Free Course in Secret Service Intelligence.

Name \_\_\_\_\_

Address \_\_\_\_\_

City and State \_\_\_\_\_ Age \_\_\_\_\_



**Freedom**  
from a  
**Small-Pay Job**

**Come to New York**  
the city of 100,000 jobs

**ANY MAN** who can read and write and use a pair of pliers can become an electrical expert and free himself forever from the long hours and drudgery of a small pay job.

And you can learn the **BIG PAY** profession of electricity right in New York City—the heart of the electrical world—the city of 100,000 jobs. At the same time you are learning the **BIG PAY** profession you can be enjoying the sights and wonders of New York, the modern Bagdad.

### Be An Electrical Expert

Graduates of the **NEW YORK ELECTRICAL SCHOOL** are in demand by all the big electrical companies. Or, if you prefer the independence of a business of your own, there are thousands of opportunities for efficient, **dependable** men to become electrical contractors. When you are your own boss the money you can make is limited only by your own energy and ability.

### Personal Instruction

The **NEW YORK ELECTRICAL SCHOOL** is not a correspondence school. You learn by doing—by personal instruction on full size standard electrical equipment under the personal supervision of trained instructors.

At **N. Y. E. S.** you train your hands and mind at the same time. You learn the theories of electricity—and then you are shown how to put the theories into actual practice by solving the problems with **your own hands**.

The man who has learned electricity by actually doing electrical work under intelligent personal instructors can go to any part of the world and be sure of a good living. There are **N. Y. E. S.** graduates in all the countries of the world.

Write today for the 48-page booklet giving full information about the **N. Y. E. S.** Course and showing pictures of the equipment available for your personal use in our two seven-story buildings. Mail coupon **now!** The New York Electrical School, 44 W. 17th Street, New York.

The New York Electrical School  
44 W. 17th Street, New York

Please send me **FREE** your 48-page booklet. It is understood that this request puts me under no obligation.

Name .....

Address .....



## On Top of the World

Auto repair men are sitting pretty! 24,000,000 cars now in use—and every one has to be repaired regularly. Car owners have to pay out all the time, \$15 here, \$100 there.

**TRAINED AUTO REPAIR MEN** get this big money. Steady jobs, big pay, no strikes, no layoffs. Or, open a shop of your own.

**LEARN QUICK!** Let us show you what factory-endorsed Detroit-training can do for you. 25,000 graduates. Send today for big illus. 17th Anniversary Catalog.

**MICHIGAN STATE AUTOMOBILE SCHOOL**  
308 Auto Building Detroit, Mich.

## Be a REAL ESTATE Specialist

Learn my amazingly successful system—right at home—in your spare time. Let me train you for real success. Let me put you in touch with big business. Let me do for you what I have done for other wide-awake men and women. D. H. Garrett says: "Made \$630 in one week before I was half through your training." Mrs. J. H. Hastings says: "Have sold two lots, receiving two hundred and forty-eight dollars in commissions. Have fine business lined up." M. I. Stokes says: "Made \$900 in three months in my spare time." Send your name and address at once for my new, free book, "How to Become a Real Estate Specialist," giving full facts about my remarkable Home-Study Course, my Free Business Service and positive proof of big success. Address **DIRECTOR**, Dept. 44HH, American Business Builders, Inc., 18 East 18 Street, New York, N.Y.



## LEARN TO FLY

Billions of dollars will be created and spent through the development of aviation. Thousands of positions will be open for those who are prepared.

Prepare now! Complete Home Study Course in Aviation arranged by America's foremost aeronautical society. Authentic yet inexpensive.

**Course complete with blueprint of airplane \$5.00**  
Send money order or check or write for further information  
The American Society for Promotion of Aviation, 522 Fifth Ave., Dept. X, New York



## Great Athletic Book 10c

Be strong and athletic. Learn **wrestling**, self defense, **jiu-jitsu**. Let **Farmer Burns**, Mgr. **Frank Gotch**, **World's Champion**, teach you. Great opportunity for young men. Makes you strong, healthy and skillful.

**Send 10c** for 32-page book showing great holds and tricks by Burns and Gotch. Only a few at this price. Write today, giving your age.  
Farmer Burns School of Wrestling, C337 Ramps Bldg., Omaha, Neb.

## FOREST RANGERS

**MEN, QUALIFY AS FOREST RANGERS; \$125-200 MO. AND HOME FURNISHED; PERMANENT; HUNT, FISH, TRAP.**  
**FOR DETAILS, WRITE**  
**NORTON, 2530 McMANN BUILDING, DENVER, COLORADO**

## Keynote To Popularity

Popularity is yours. Everyone will seek your company if you play **tenor banjo**. Enroll for our course. We start you with an \$18 professional tenor banjo. Prof. Six was director of Glee and Instrumental Clubs at N. Y. University. His picture, diagram and phonograph record method is so simple you play immediately.

**Don't Send a Single Cent**  
Write for particulars about our course and we will reserve an \$18 tenor banjo for you. Write now for book and free first lesson.  
**New York Academy of Music, Studio 108, 100 Fifth Ave., N. Y. C.**



# Who Else Wants My Amazing CONTRACT



## TO GROW NEW HAIR in 30 Days — or no cost!

By Alois Merke  
 Founder of the Merke Institute,  
 5th Ave., New York

**M**EN, beware of baldness! Stop falling hair! Grasp this "no risk" way to grow new healthy hair in 30 days!

I don't care how long your hair has been falling out—how many expensive hair treatments you have tried without results—how discouraged you may be. I absolutely GUARANTEE to banish dandruff—stop falling hair—grow new hair in 30 days—or I don't want a penny of your money. That is my iron-clad contract with you!

### Here's My Secret!

Years of training and research—experience in treating thousands of cases of loss of hair—have taught me this vital fact. In most cases of approaching baldness the hair roots are not dead, but *dormant*—asleep. You don't try to make a tree grow by rubbing "growing fluid" on the bark.

You get to the roots. And so it is with the hair. You're wasting your time—throwing away money—on ordinary hair tonics, salves, massages and oils, which fail simply because they treat only the *surface* skin. My scientific treatment goes *beneath* the surface—brings nourishment *direct* to dormant roots—encourages quick and healthy growth of

new hair. That's the simple secret of its astounding success!

At the Merke Institute, 5th Avenue, New York, many people have paid \$100 for results secured. Yet now you can secure equally beneficial results at home—for only a few cents a day—and your money instantly refunded if not delighted with results after a 30-day test.

### New Hair or No Cost!

Many claim seeming miracles for my treatment. I don't. I admit some cases of baldness are hopeless. But these cases are so rare, and so many hundreds have regained luxuriant hair through my method, that I am willing to let you try it for 30 days—at my risk! You MUST be satisfied—or you pay NOTHING! You alone are the judge!

### Here's Your FREE Booklet!

You can easily prove my claims. If you will merely fill in and mail the coupon I will gladly send you without cost or obligation a wonderfully interesting booklet, describing in detail my successful system, which is growing new hair for thousands from coast to coast. In addition, it tells all about my iron-clad guarantee, which enables you to take my treatment without a penny's risk. For new hair, mail coupon TODAY! Allied Merke Institutes, Inc., Dept. 168, 512 Fifth Avenue, New York City.

.....  
**Allied Merke Institutes, Inc.,**  
 Dept. 168, 512 Fifth Avenue,  
 New York City.

Please send me without cost or obligation a copy of your book, "The New Way to Grow Hair," describing the Merke System.

Name.....

Address.....

City..... State.....



# Learn Electricity in Los Angeles

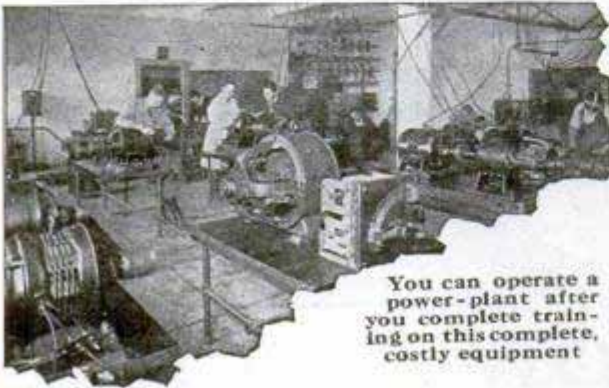

You can operate a power-plant after you complete training on this complete, costly equipment

## You Learn 14 Electrical Trades in these Big Shops

### Unlimited Training Until Competent, in

Power House Operation and Testing  
Motors and Controls  
Central and Sub-Station Operation  
Armature Winding  
Motor Building  
House Wiring  
Electrical Fundamentals  
Drafting  
Illumination  
Commercial Radio  
Radio Construction  
Battery Manufacture  
Automotive Electricity  
Machine Shop

GET practical training in heart of huge electrical projects. Expert instructors help you actually perform work that employers pay big money for. Over 17,000 men have been trained to earn bigger pay in National's million dollar shops. A quarter-century old reputation for quality training brings ambitious men here from every corner of the world. Big electrical employers prefer National Graduates because they know National training is complete, modern and practical. You leave National fully qualified to fill electrical jobs paying \$50 to \$200 a week.

### FREE EMPLOYMENT SERVICE

We assist you to part time job to pay your expenses while training. We help you get work you like after training is completed. Electrical industry now suffering from shortage of skilled workers. You can succeed if you are properly trained.

Write for full information about your opportunities in Electricity. Learn how National quality training starts you towards success. Mail coupon now.

# NATIONAL ELECTRICAL SCHOOL



Dept. 509, 4006 Figueroa St., Los Angeles, California

Please send me your Free, illustrated National Electrical Book describing opportunities in the electrical industry and illustrating National training methods.

Name \_\_\_\_\_

Address \_\_\_\_\_

City \_\_\_\_\_

State \_\_\_\_\_



## Home-Study'



## Air Commerce Needs Men!

Don't envy the Highly Paid Air Man—Be One! Air Men are in demand. Beat the other fellow to the High Salaried Jobs in Aviation. **Western** training will qualify you to enter Aviation. Learn how through our catalog, sent on request.

### Write for Free Catalog "Airplanes and Flying"

Aeronautical Training Division

**WESTERN AIRPLANE CORPORATION**  
Dept. M-8 Monadnock Block Chicago, Ill.



24th Year

**CHICAGO  
TECHNICAL  
COLLEGE**

**LEARN  
DRAFTING  
IN 4 MONTHS**

Trained Draftsmen earn \$60 to \$100 a week. 4 months' interesting study at Chicago Tech. fits you to earn big money in drafting's fertile field. Common schooling all you need. Expert instructors. Opportunities for self-support while studying. Free Employment Service. Day or Evening Classes. Athletics. Enter any time. Also intensive courses in Engineering, Electricity and Building. Write for free 84-page "Blue Book" and facts about how to qualify for a high-pay drafting job in 4 months. Dept. K-600  
118 East 26th St. **Chicago Technical College**  
Chicago  
*If you can't come to Chicago, study at home.  
Write for Free Trial Lesson in Drafting.*

Learn

# Advertising

**\$10,000  
Men  
Needed**

at Home

per year. You can easily master Derek White's famous 20 lesson course in advertising. Short, simple, easy to learn. Written so you can understand it, after 15 years experience as copy writer, advertising manager and head of two advertising agencies. Covers all details of writing advertising and publicity. Full price of complete course including consultation privileges and personal service, only \$10. Send for circular or order now at special temporary \$10 price. Full course sent at once.

**FULL  
PRICE  
\$10**

**DEREK WHITE**

642A San Fernando Bldg.

Los Angeles, Cal.

# FREE

## MUSCLE BUILDING BOOK

Illustrated book—64 pages, by world-famous physical director. Priceless secrets of health and strength. Become a muscular marvel. Have the body of a **PANTHER-MAN**. Both name and address. **TITUS, 105 East 13th St., Dept. 155, New York City**



## ARE YOU BASHFUL?

Nervous? Easily embarrassed in company? Shy among strangers, afraid of your superiors, fearful of the future, or timid with the opposite sex? These faults are easily overcome—when you understand the reasons. Only 25 cents in coin or stamps will bring my explanatory book on Nervous Troubles and information how to overcome your complaint. Write at once to

**RICHARD BLACKSTONE, 478 Flatiron Bldg., New York**



# PATENTED SUBANTENNA!

THE AMAZING, NEW  
UNDERGROUND ANTENNA SYSTEM  
**Eliminates All Interference**  
INCREASES DISTANCE—KILLS STATIC

**SCIENCE!**  
Now offers a  
Positive Means  
to Enjoyable  
Long Distance  
Reception

How often, when for days you have anticipated listening to a certain program from some distant station your set has failed you—because of the condition of the air. And how often "man-made" static, such as leaky power lines, or some other nuisance has spoiled your radio evening. Indeed, there has been a dire need for some means of overcoming these obstacles. SUBANTENNA is the answer, for it not only cleans up the reception before it reaches the set, but it actually gives greater distance, bigger volume to weak signals and finer selectivity. Send coupon for particulars and Trial offer.

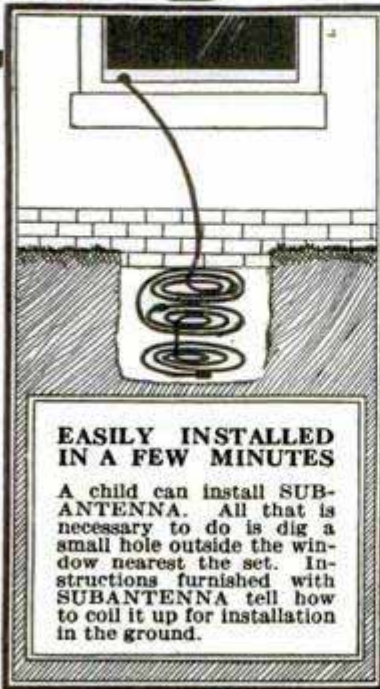

SUBANTENNA positively makes every night a good radio night. No matter what the season, the condition, or the weather, you get clean, clear reception, free of the annoying crackles that make distant reception an impossibility with a regular antenna.

**NOTHING ELSE LIKE IT**  
SUBANTENNA is not just a wire. It is a patented device consisting of a specially treated wire, sheathed in a lead jacket, and containing three specially constructed pick-up or building-up coils. Nothing else will do what SUBANTENNA does.

**DISTANT MUSIC  
CLEAR AS LOCAL**

No longer need static, air noises, arc lamps, leaky power lines, street car trolleys and other disturbances spoil your radio enjoyment. For SUBANTENNA—The new underground pickup system gets nothing but the pure radio waves.

**USE FILTERED GROUND  
WAVES NOT NOISY AIR  
WAVES**

Being buried in the ground and shielded, SUBANTENNA is sensitive only to the continuous broadcast wave. Intermittent impulses, such as static, etc., are filtered out before they reach SUBANTENNA. Hence, you get greater distance because the radio signal is not held back by the interfering noise level.

**MAKE THIS TEST**

Connect your set to your regular aerial. Then connect it to SUB-ANTENNA. If you do not get the results we promise, we agree to promptly refund your money.

**Send Coupon for TRIAL OFFER**  
Right now—decide to tear down your aerial; that unsightly, inefficient combination of sticks and wires that is obsolete. Just send the coupon and we'll mail you full particulars of SUBANTENNA—the first and only really practical system of radio reception. Mail the coupon NOW—for special TRIAL offer. Clip at once!

**CLIP AND MAIL NOW**

Cloverleaf Manufacturing Co.,  
2717-D South Canal Street, Chicago.  
At once—send me full particulars of SUB-ANTENNA, also tell me about your special introductory TRIAL OFFER.

Name.....  
Address.....

**Cloverleaf Mfg. Co.,** 2717-D South Canal Street  
**CHICAGO**

## DO YOU LIKE TO DRAW?

*It's Easy To Learn When Shown In The Right Way*

Some of the cleverest cartoonists and comic artists in America today learned how to draw quickly—by following **CARTOONIST EVANS' SIMPLE AND EASY METHOD**. This school is recommended by foremost cartoonists because they know the students are handled right. If you like to draw, send 6c in stamps for **portfolio of cartoons and full details**. The course is **NOT EXPENSIVE**.



**The W. L. Evans School of Cartooning**

821 Leader Building  
CLEVELAND, OHIO

**396 Students actively enrolled**  
in our course up to June 15

We can teach you also how to fly and prepare you for big pay jobs in **AVIATION**, the fastest growing professions in the world. Special home study course with final training at our huge airport in Chicago. Write today for our Free Booklet.

**CHICAGO AERONAUTICAL SERVICE INC.**  
AGENTS FOR WACO PLANES

Dept. A 608 S. Dearborn St. Chicago, Ill.



### Learn Tenor Banjo

**BANJOISTS!** Earn big money through Charles McNeill's famous Home Study Banjo Course. Simple as A B C—yet has all technical requirements. Includes phonograph record demonstrating jazz strokes, "breaks" and chords, played by Charles McNeill, 5 years with Isham Jones-Brunswick Records. Easy payments. Send for Free Book.

**CHICAGO BANJO INSTITUTE**  
Dept. C-135 3345 N. Lincoln Street CHICAGO, ILL.

# MONEY IN YOUR NEIGHBORHOOD

*Here's a Wonderful Way to Get It*

Our beautifully illustrated book tells how. It tells all about our new methods of art decoration, art treatment and how anybody can learn without previous training or experience. It contains page after page of handsome color illustrations of what you can make and sell. You can make good money and this book is free. Our system is amazingly easy to learn and the profits are larger than in almost any other business. You can produce beau-

tiful finished art objects almost from the beginning. You don't have to know how to draw or have any experience. Begin making money now.

All supplies are sent by us with the instructions and many have made \$25 the first week. Some society women have taken up this work for their own amusement.—Either way, pleasure or profit, it's the most delightful home work you can imagine. Write Now for your copy of this valuable book; it's **FREE**.

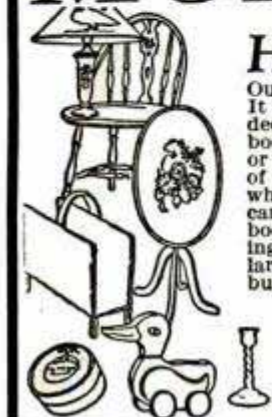

**Fireside Industries**

DEPT. 66-K ADRIAN, MICH.



## 10 Days' Free Trial

An extraordinary offer! Genuine No. 5 L. C. Smith ball-bearing typewriter at a 50% saving—and for only \$4 a month. Here's your chance to own the finest machine made at rental prices. Only a limited number of these superb typewriters available at these low prices and easy terms.

You cannot imagine the perfection of this wonderful ball-bearing typewriter until you have used it. Positively the easiest writing, fastest running, longest wearing typewriter made. Test this magnificent machine in your home or office for 10 days. Then you'll know money cannot buy a better, more beautiful, rebuilt typewriter.

Only  
**\$4**  
a Month

### Guaranteed 5 Years

For over 20 years the L. C. Smith has been recognized as the best typewriter made. The U. S. Government bought 40,000. It is the choice of big corporations like the Standard Oil Co., etc. **IT IS THE WORLD'S ONLY BALL-BEARING TYPEWRITER.**

### SEND NO MONEY

Just mail the coupon—we'll send you the typewriter for a 10 day trial. No one will urge you to buy. Unless the typewriter sells itself to you, return it at our expense. But you'll want to keep it, and you can for only \$3 down and \$4 a month. By using the coupon below, you receive \$3 worth of extras free. Send coupon now before the offer is withdrawn.

**\$50 SAVED BY USING THIS COUPON**

Smith Typewriter Sales Corp.  
118-360 E. Grand Ave., Chicago.

Ship me the No. 5 L. C. Smith F. O. B. Chicago. On arrival I'll deposit \$3 with express agent. If I keep machine, I'll send you \$4 a month until the \$45.50 balance of the special \$48.50 price is paid; the title to remain in you until then. I am to have 10 days to try the typewriter. If I decide not to keep it, I will repack and return to express agent who will return my \$3. You are to give your standard 5-year guarantee.

Name.....  
Address.....  
City.....State.....  
Occupation.....  
Employed by.....



## A Fortune At Your Fingertips

Millions are spent annually for advertising designs and illustrations. If you like to draw, develop your talent—turn your spare hours into money through the practical, result-getting Federal home-study course. It has exclusive lessons from nationally known artists, and gives you individual, personal criticisms of lessons. Send today for "YOUR FUTURE," a beautiful 56 page book with full information and showing students' work. State age and present occupation.

FEDERAL SCHOOL OF COM'L DESIGNING  
629 Federal Schools Bldg., Minneapolis, Minn.

## OPPORTUNITIES IN Salesmanship

### Become a Salesman

Every phase of business revolves around selling. The trained salesman is in demand—he can fix his own hours, choose his own field, control his own pay. His income depends only upon his results—there is no limit to what he can earn. We train you to sell successfully thru the LaSalle problem method under supervision of expert salesmen. Train in your spare time. Low cost; easy terms. 64-page booklet, "The Modern Salesman, Ambassador of Progress," free. Send for it today.



**FREE**

LaSalle Extension University, Dept. 864-S Chicago



## WANT THIS JOB?

\$1700 to \$2300 a Year

MAIL CARRIERS—POSTAL CLERKS  
Men 18 up

Steady Work Paid Vacation  
Write immediately for FREE list of positions and full particulars telling how to get a position.

FRANKLIN INSTITUTE  
(Not connected with U. S. Government)  
Dept. M-305 Rochester, N. Y.

## LEARN WATCHMAKING AND ENGRAVING

BY OUR PROFIT-SHARING PLAN  
OUR GRADUATES SUCCEED

One of our Iowa students started in a very small way—now doing over \$30,000 a year. Another in Wisconsin, over \$10,000 the first year. Day or night classes. Call or write for FREE BOOK

Chicago School of Watchmaking, Dept. 3101, 4844 Lincoln Avenue, CHICAGO

## Learn Watchwork, Jewelrywork and Engraving

A fine trade commanding a good salary, and your services always in demand. Address: **Horological**, Dept. P. Bradley Institute, PEORIA, ILLINOIS, for our latest catalog.

## TELEGRAPH-RADIO

\$18 to \$35 a week while training for Radio and Telegraph Operator jobs at \$150 to \$300 per month. Write for particulars.

CHICAGO TELEGRAPH INSTITUTE  
Dept. 1-8-7 1338 S. Michigan Avenue, CHICAGO

## WANT WORK AT HOME?

Earn \$18 to \$60 a week RETOUCHING photos. Men or women. No selling or canvassing. We teach you and furnish WORKING OUTFIT given with each enrollment. Limited offer. Write today.  
Artcraft Studios, Dept. 50, 3900 Sheridan Rd., Chicago

# Let SWEENEY Help YOU to \$10 to \$18 a day



**My Employment Department Helps My Graduates to Jobs at \$10 to \$18 a Day**

*E. J. Sweeney*

Yes, my EMPLOYMENT DEPARTMENT helped L. W. Kelley to a job at \$18.00 A DAY—IT helped J. H. Miller to a job at \$10.50 A DAY—IT helped Gordon Shyrook to a job at \$10.50 A DAY, and it, also, is helping dozens of other Sweeney Graduates to fine jobs at \$10 to \$18 a day. IMMEDIATELY after finishing, ONLY A SHORT COURSE of SWEENEY TRAINING.

Clip the coupon. Find out about this WONDERFUL JOB SERVICE my EMPLOYMENT DEPARTMENT renders. It will simply astonish you.

## Coupon Brings Full Facts About Valuable Job Service

That's what a REAL, "ON THE JOB" EMPLOYMENT DEPARTMENT SHOULD DO, and that is—help men GET REAL JOBS. Think of it—FIFTY-FIVE WONDERFUL JOBS OPEN TODAY for SWEENEY TRAINED men. I have ONLY FIVE MEN READY so that I can help them to these jobs. And the peculiar thing is—it takes me ONLY FOUR WEEKS to TRAIN some of these men. Now what more do you want? Challenge me. Send for my Big Free 72 Page Book. If you go on depriving yourself—if you WANT TO BE OUT OF A JOB—and don't let me help you—PLEASE DON'T READ ANOTHER SWEENEY AD. If you have—(you know what I mean) in you—you will find out NOW. Just clip the coupon below.

## Today 50 More Jobs at \$11 a Day

This very day, I could help 50 more men than I have available at \$11 a day. The future looks even better. There is a shortage of men trained like SWEENEY has trained thousands of men. That's why SO MANY SWEENEY TRAINED MEN get TREMENDOUS PAY and are in BIG DEMAND.

Get my Free Book today and see that WELDING is only one of BIG PAY Branches I get you ready for.

## CAN YOU DO THESE SIMPLE JOBS?

1. When there is a grinding noise in the differential?  
The Sweeney student IN HIS FIRST WEEK can overhaul the rear end assembly, adjust pinion and crown gear, eliminate noise and turn out a fine job on any car.
2. When the brakes need adjustment?  
The Sweeney student IN HIS FIRST WEEK can set and adjust brakes, old style or 4 wheel, any make of car.
3. When the clutch is slipping?  
The Sweeney student IN HIS FIRST WEEK can quickly correct transmission or clutch trouble in any car.

This shows how quick you learn and the man who knows is the man who gets and holds good jobs.



## COME RIGHT NOW

Never Before Have I Made Such an Amazing Offer. I now make it possible for you to come to this Million Dollar Sweeney School Right Now.

## FREE CATALOG AND SPECIAL OFFER

Get my big FREE 72-page catalog. It shows hundreds of actual photographs of men at work in my magnificent new school. Tells all about wages, profits, opportunities in auto business. Explains step by step how you learn. Interesting letters from graduates telling how they made good. Shows how men come from all over the world to this big school. Makes you want to join the crowd. Tells everything you want to know. I will gladly send you a copy beautifully illustrated. I'll tell you how to get into business for yourself. No colored students accepted.

**E. J. SWEENEY**  
President



**EMORY J. SWEENEY, President**  
4031 Sweeney Building, Kansas City, Mo.

Send me free, without any obligation, your catalog and Special Offer!

**LEARN A TRADE-**  
*Sweeney*  
AUTOMOTIVE & ELECTRICAL SCHOOL  
4031 SWEENEY BLDG. KANSAS CITY, MO.

NAME.....  
P. O.....  
STATE..... AGE.....

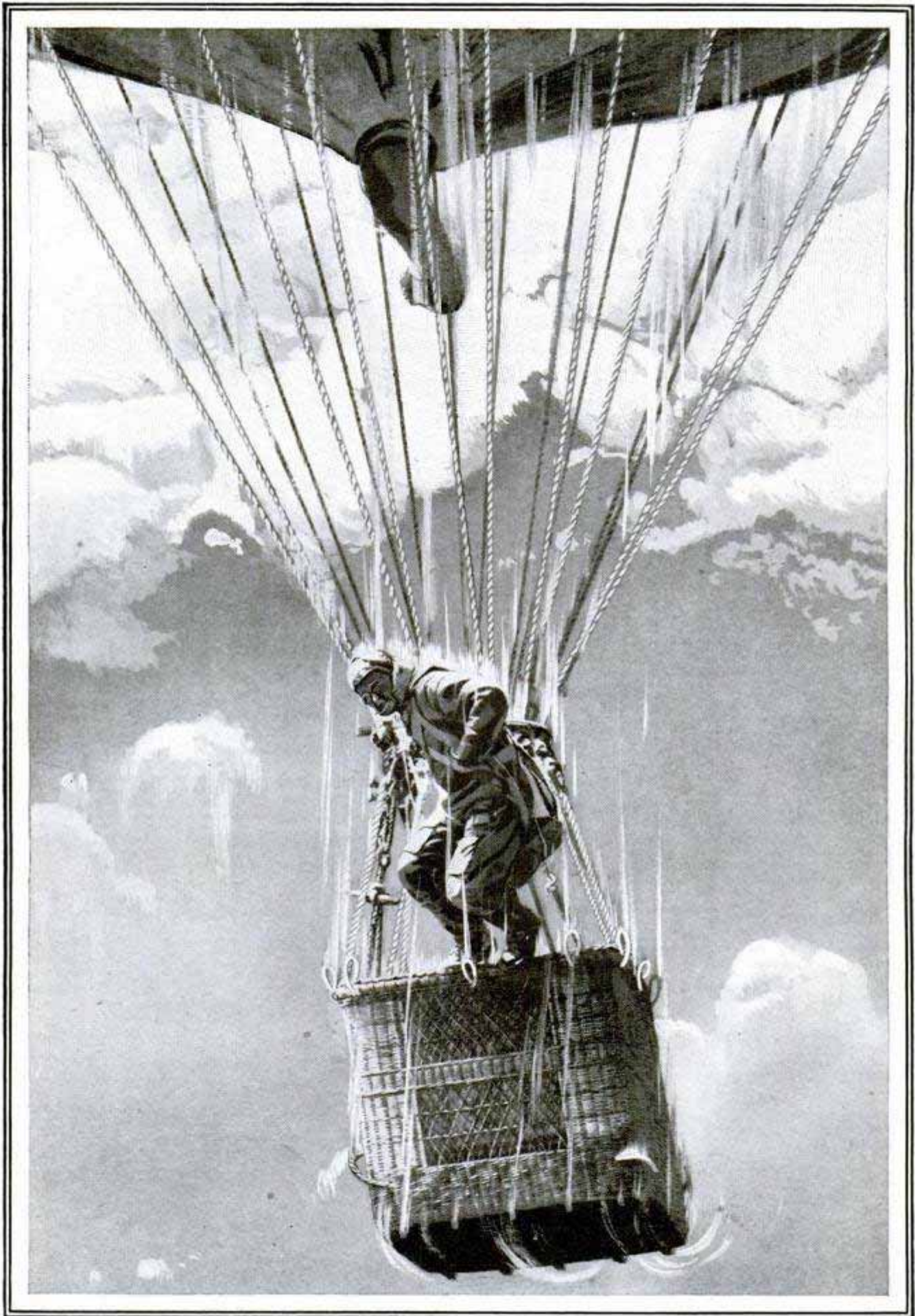

At 8,000 Feet, with His Deflated Balloon Falling Faster and Faster, Capt. Gray, World's Altitude-Record Holder, Climbed to the Basket and Leaped for a Parachute Drop

# Popular Mechanics Magazine

REGISTERED IN U. S. PATENT OFFICE

WRITTEN SO YOU CAN UNDERSTAND IT

Vol. 48

AUGUST, 1927

No. 2

2578

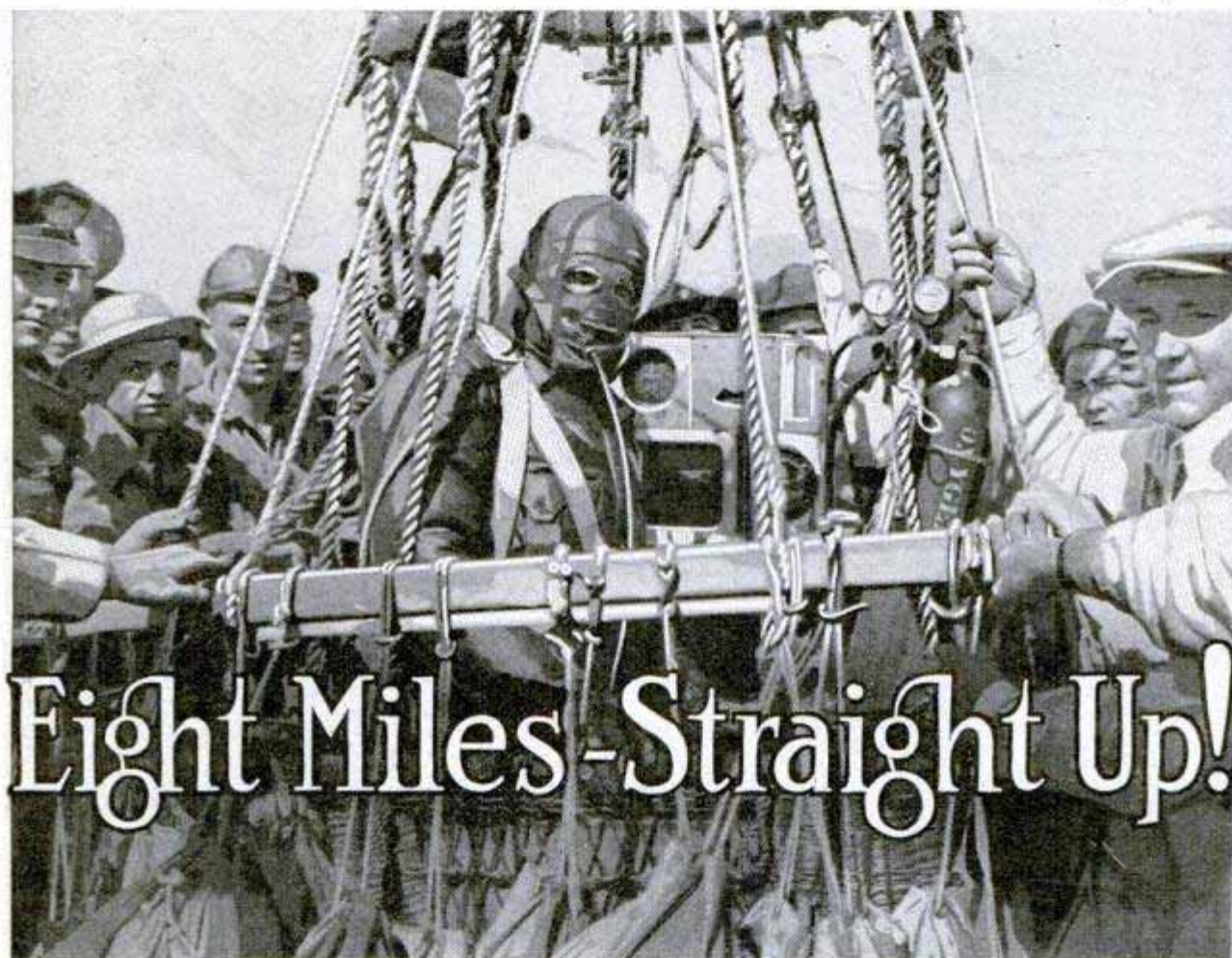

Capt. Hawthorne C. Gray, U. S. A., at the Start of an Attempted Record-Breaking Flight in Which He Lost Consciousness; a Month Later He Broke All World Records for High Flying

By **CAPT. HAWTHORNE C. GRAY, U. S. Air Service**

(As told to J. Earle Miller)

**H**OW does it feel to soar more than eight miles into the air, higher than man has ever gone before, up where the air becomes too thin to support life; where the thermometer, headed for the absolute zero of outer space, has already reached nearly seventy below zero?

A few weeks ago I did it, reached 42,470 feet above sea level, and broke every world's altitude record for any kind of craft—airplane or balloon. Within a few weeks I am going up again, confident of making more than 43,000 feet. An 80,000-

cubic-foot balloon took me up from Scott field, Belleville, Ill., and once I had reached its ceiling, it brought me back so fast that I had to leave it and step off in space with a parachute to check my descent.

At 42,000 feet, having been kept alive by compressed oxygen for the last four miles, I was listening to a jazz orchestra playing in St. Louis, the music coming in clear and loud on my radio, without a single trace of static. That was the only connecting link with the world I had left. Far below, cruising along the top of the cloud



banks at 13,000 feet, two escort planes, one with a movie photographer aboard and the other, with the post surgeon as passenger, hovered and watched me, though I could not pick them out of the mist. Below them, the clouds covered the land, except for an occasional rift. Once, through such a crevasse, I caught a magnificent view of the Mississippi and the Missouri, tracing their winding course for miles and miles to the north and the south.

Up above, the cloudless sky was a deep, almost cobalt, blue. The dust particles that turn sunlight white were all below me and in the thin and rarefied air above, the sky was magnificent in the depth of its coloring.

At 40,000 feet I had released the last of my 4,700 pounds of sand ballast and came to a stop. But I had prepared for that by having special parachutes built to carry the weight of each piece of equipment. One was attached to an oxygen cylinder which had been emptied on the way up,

and the cylinder, a twenty-five-pound steel flask, was dropped over the side. In the rare air, and weakened by breathing oxygen for some time, it seemed to me to weigh at least 150 pounds as I struggled to lift it over the basket rim. The release of its weight was sufficient to send the balloon up another couple of thousand

feet — which broke the last world's record, the airplane mark of slightly over 40,000 feet claimed by a French pilot last fall.

At that height, though still distended, I knew the gas bag above contained less than one-eighth of the gas I had started with. As the balloon had climbed into lighter air and the pressure against it was

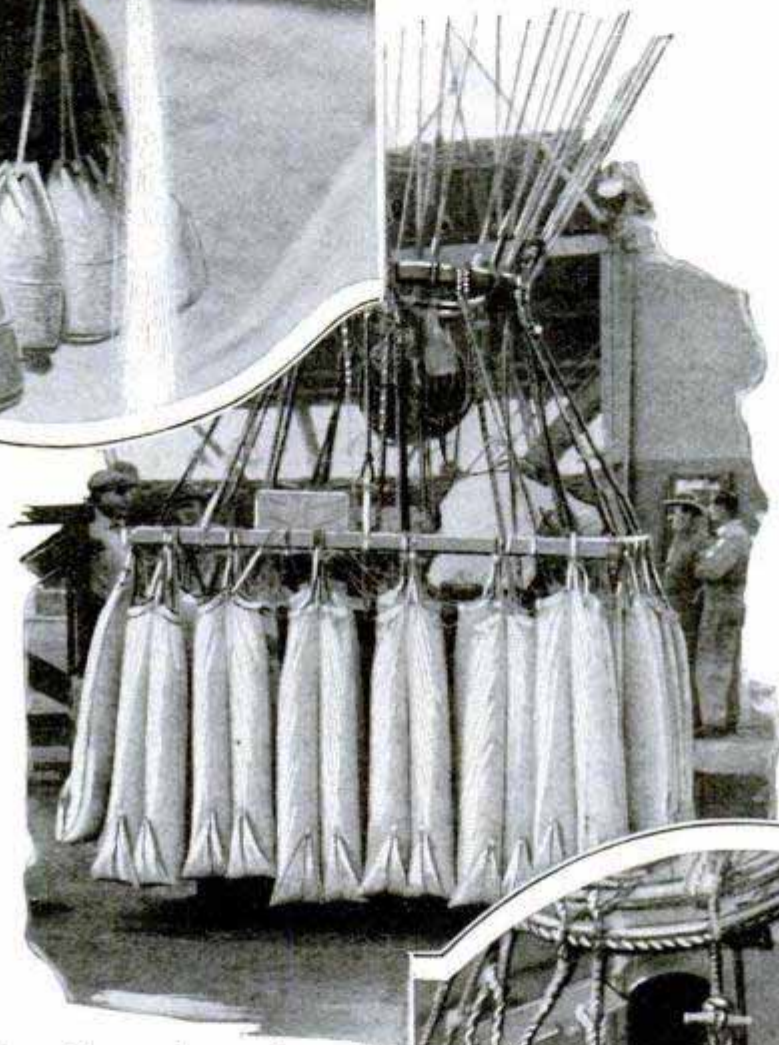

Capt. Gray Demonstrating the Usual Method of Dumping Sand Ballast; His New Sand Bags, Center, and at His Radio, Below

removed, the gas had rushed out through the big appendix in the bottom, keeping the silvered fabric from bursting. So long as I stayed up, the balloon would be full, but once I started down the gas would begin to contract under the increasing air pressure, so that if I could keep all the gas I had, there still would be less than 10,000 cubic feet when I reached the ground.

It was time to start back, and a slight pull on the valve cord, which passes up through the inside of the bag to the valve at the top, was sufficient to start the bag downward, and once started, it began to drop faster and faster, as the statorscope, which records the rate of ascent or descent, indicated. To check it, I began to attach parachutes to other articles of equipment and drop them over the side. The parachutes were designed to fall at sixteen feet a second, the same rate as the large chutes used by flyers, but the bag was falling so much more rapidly that when I dropped things over the side they appeared to fly straight up in the air, because I went past them so fast. It was queer to see twenty-five-pound steel bottles apparently flying upward. Two more oxygen tanks, the storage battery used to run the electric heater in my oxygen mask, my radio batteries and loud speaker, and finally the wooden framework which supported the sand-ballast bags, with all the empty bags still attached, were released to lighten the balloon. They served to check the descent somewhat, but not enough. Ordinarily a badly deflated balloon will flatten out and "parachute" as it comes down, but for some reason mine didn't. At 8,000 feet I got a sight over a tree top on a small marsh beyond, and discovered that the spot I was looking at kept right in line with the tree top, sure proof that my rate of descent and drift before the wind were just right to land me in the swamp. The bag was still falling 1,800 feet a minute, which is twice the safe landing speed in a parachute, so I finally was forced to leave my ship.

Climbing up on the side of the basket, I held onto the load ring above, in which all the rigging is concentrated, reached for the valve line, pulled it down and tied it to the ring, so that the bag, when it reached the ground would deflate itself. Then I jumped and pulled the rip-cord ring of my

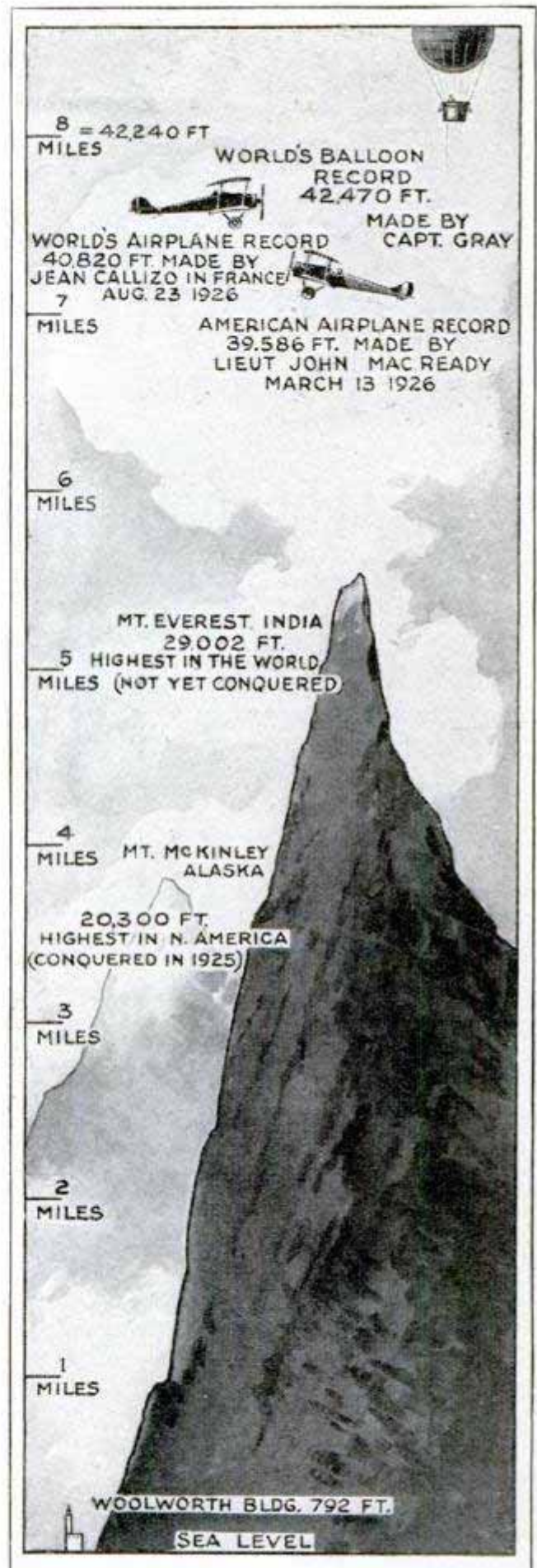

Comparative Records, from the Tallest Building to the Biggest Mountains, and the Highest Airplane and Balloon Flights

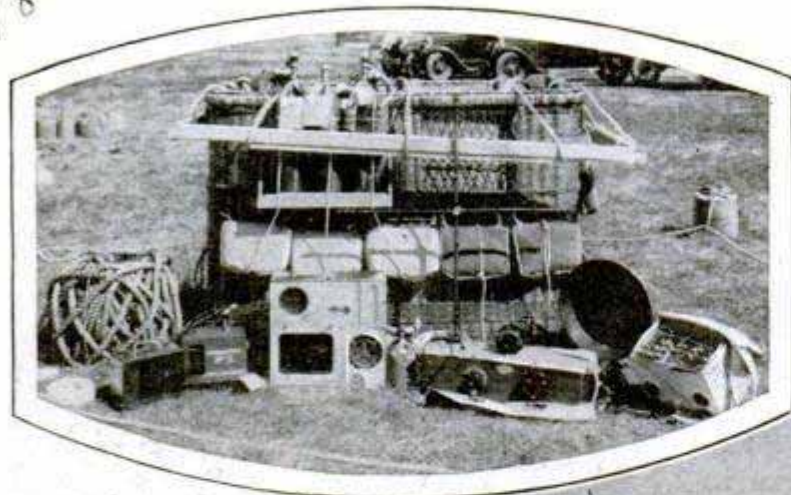

chute, and drifted downward, while the movie plane circled around and filmed the final chapter.

Freed of my weight—some 240 pounds, of which 183 were me, stripped, and the rest flying clothes—the balloon had risen slightly and drifted off before the wind, to come to earth ten miles farther on. I had lit

more than 110 miles from the starting point. Before the start, I had prepared a typewritten slip and an empty envelope, to be attached to each article I planned to drop, with instructions to the finders to fill in the slips and return by mail to me. My faith in human nature was the cause of considerable amusement at the field. But within a few days after the flight, five of the seven articles—all but one oxygen cylinder and the oxygen-heater battery—had been found and notices returned to me.

The successful record-breaking flight, my 107th in a balloon, had been the second within a little more than a month. On the first, worn out by the labor of handling two and a quarter tons of sand, lifting each thirty-three pound bag into the basket, cutting the bottom with a knife, and pouring the ballast over the side, and hampered by defective oxygen equipment, I had passed out at 27,000 feet and for forty-five minutes, the barograph record showed, the balloon had drifted along at that height,

Basket and Equipment for the Altitude Flight, Above, and Capt. Gray, Wearing His Gas Mask; the Canister on His Chest Contained the Electric Heater; His Flying Clothes Alone Weighed More Than Sixty Pounds

until I finally recovered enough to pull the valve cord and release sufficient gas to start the descent.

Warned by that lesson, I had designed a new type of sand bag for the second flight. Instead of the usual squat canvas sack, with a drawstring at the top and a hook on the end of the string to hang it to the rigging, the new bags were long slim pouches, each of fifty pounds' capacity, with a flap door in the bottom, which was opened by pulling a cord, just as the rip cord releases the parachute.

All the bags were hung from a wooden framework suspended outside the basket, and when I got ready to cast them loose on the descent, the whole framework, with the empty bags, was released at one time.

The oxygen apparatus was improved by adding a hollow asbestos-covered cylinder, in which was suspended the electrical heating element, operated by a two-volt cell of a storage battery. The heater warmed the stream of oxygen as it passed and made



breathing much easier. With the canister, the oxygen helmet greatly resembled a war-time gas mask. Inside, however, the helmet was quite different. The oxygen tubes ended in flat metal pipes which projected right up against the glass of the goggles, so that the passing stream of oxygen would keep the glass from frosting when I reached the extremely low temperatures of the upper air. Official calibration of my instrument showed that the lowest point was sixty-seven below zero.

Next time I am going to be prepared to drop additional equipment at the top, instead of on the way down, and thus I hope to pass 43,000 feet. A lot has been said and written in the past about the coming conquest of the 50,000-foot mark, but recent research indicates it may never be realized, at least with any existing type of equipment. The doctors have found in the rebreather tests, in which men breathe oxygen in a partial-vacuum chamber as a test of their ability to withstand high altitudes, that somewhere between 40,000 and 50,000 feet there probably lies a point at which the air pressure becomes so slight that the muscles of the body can no longer function to operate the lungs, so that a man who took in a breath of oxygen could not exert enough muscular action to expel it. At that point he would die.

The action of oxygen is peculiar. I believe I was perfectly normal every minute while at the top, yet I would not swear to it, for I have watched others in the rebreather chamber and seen them try to put a finger on one button to press it and stab at something two or three feet away, yet come out declaring they were perfectly normal throughout the test and did everything correctly.

My tube thermometer was broken on the first flight, and on the second, I had no means of knowing the temperature reached, as the recording thermometer was sealed. It was not uncomfortably cold, however, as I had dressed for the occasion. Over the heaviest of woolen underwear I wore two woolen shirts, a sweater and a winter uniform. On top of that was a flying suit, leather on the outside, reindeer fawn skin on the inside, and two thicknesses of heavy woolen blanket cloth between. My flying boots were built on the same plan.



Measuring the Comfort of an Auto Seat with Instrument Devised by Bureau of Standards

**AUTO COMFORT IS MEASURED TO IMPROVE CARS**

How comfortable are the seats of your automobile? An answer would probably be based largely on guesswork and personal opinion, but the bureau of standards has developed a far more accurate way of telling. A gauge has been devised that registers the movements of the auto seats, at different speeds of the car, and other factors which enable manufacturers and designers to furnish upholstery and springs better adapted to comfort.

**MUSICAL CLOCK PLAYS TUNES TO AWAKE SLEEPERS**



Instead of a strident bell to arouse sleepers, a new alarm clock uses a Swiss music box to play a little tune. The makers claim it wakes without giving nervous people the shock caused by a loud alarm bell.

Popular airs, selections from operas, and old German folk songs are some of the melodies among which a purchaser can make his selection.

Henri Holt 4308  
Sheridan Road.

Dr. H. C. Dickinson, Chief Division of Heat and Power.

2454

maritzburg, natal, South Africa

PROSPECTING FROM THE AIR

2525

Organization of an aerial expedition to hunt for copper and other mineral deposits in northern Rhodesia, close to the Congo border in Africa, is under way. By means of the maps and surveys that can be made from the airplanes, the prospectors can be guided through the dense jungles to places that promise riches in ore. One of the hazards of the work is the absence of favorable landing fields. For this reason, emergency plots will have to be cut out of the forests at fairly close intervals throughout the territory that is to be surveyed and aerodromes will have to be erected for servicing the ships and keeping

Clipping from the Cape Argus 7/6/25



Waiting for the Toss in a Roller-Skate Basket-Ball Game at Camp Normoyle, Tex., Where Sport Was First Introduced

ROLLER-SKATE BASKET BALL LATEST ARMY GAME

Basket ball on roller skates has been introduced by Lieut. Barney L. Meeden at Camp Normoyle, Tex. It was played with slight modifications of the standard game and, contrary to expectations, was not as fast as the usual sport and there were few falls. The players were men who had served on other teams and knew how to skate as well.

supplies. A special airplane has been designed for the project. It is to be fitted with two motors and so constructed that it will be able to fly or even climb with but one of the engines running.

ARMORED CAR FOR STREET DIRT 2376 REDUCES DUST

Removing sweepings from the streets in Hamburg, Germany, is simplified with a special auto truck somewhat like an armored car. It has compartments that close tightly so that dust and dirt cannot escape while the truck is being driven through the city.

manipulated

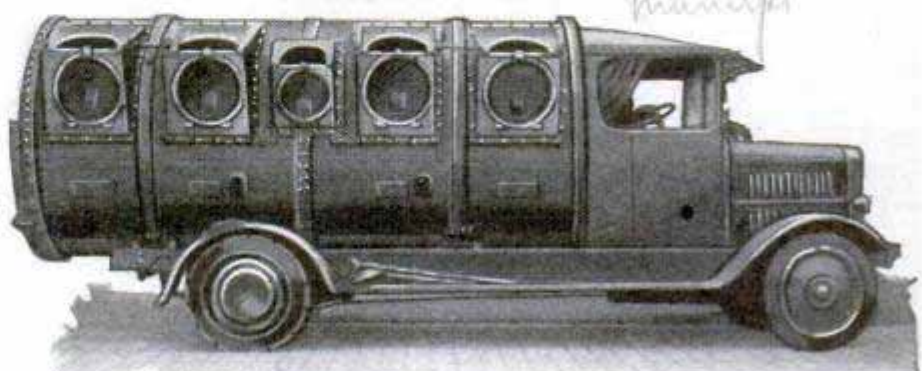

Armored Car for Hauling Street Rubbish; the Compartments Are Tightly Closed, to Prevent Scattering the Contents

OCEAN DEPTH OVER SIX MILES FOUND IN PACIFIC

2508

What is reported to be the deepest spot in the ocean yet recorded was measured recently by sailors on the cruiser "Emden" en route from the Dutch East Indies to Japan. The sounding was 34,416 feet, or close to 2,000 feet deeper than the previous "deepest spot" off the coast of Japan.

German admiralty

Com. George A. Paul 537 S. Dearborn

Le  
Ch  
v

# Paris Flight Shows Need for SPEED INDICATOR

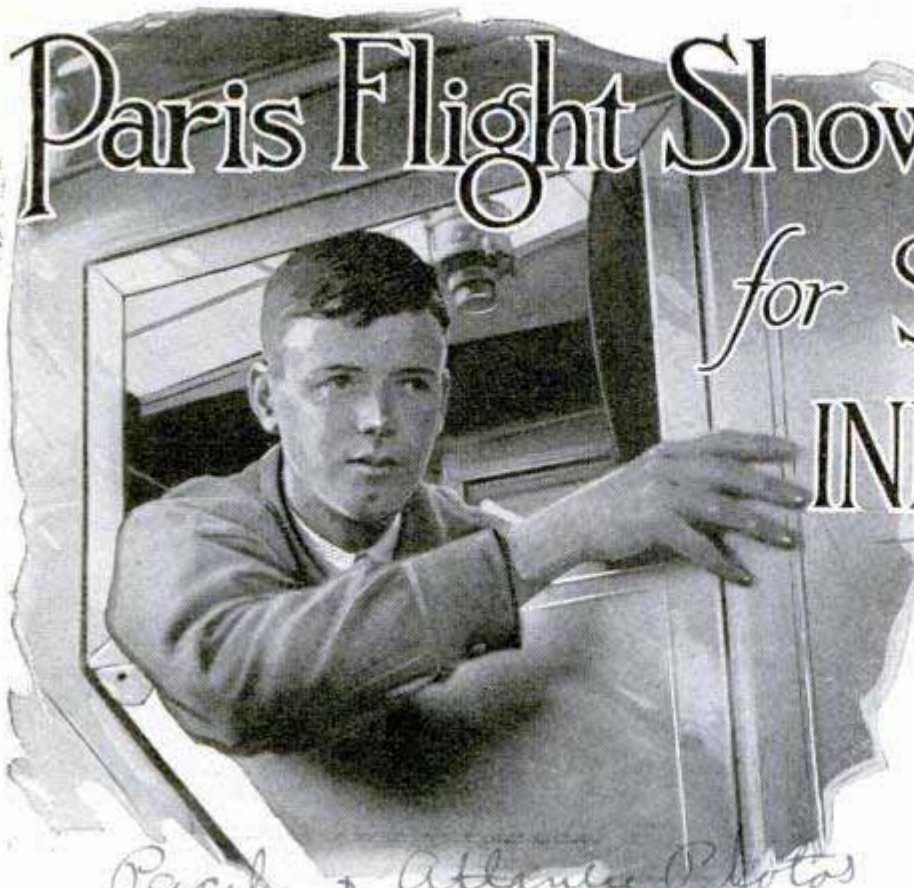

*Pacific & Atlantic Photos*

Ryan monoplane "Spirit of St. Louis" has a speed of 100 miles an hour in still air. With a tail wind that is increased in proportion to the wind's strength, and with a head wind, it is correspondingly decreased.

Inasmuch as Lindbergh averaged about

**C**APTAIN Charles Lindbergh's epochal non-stop flight from New York to Paris emphasized the need, in the opinion of aviation engineers, of one more instrument to make such long journeys across the ocean safe and sure. That is, some device for measuring the speed of an airplane across the surface of the earth, without the necessity of taking complicated sights at sun or stars, which are often impossible because of fog and storms.

Lindbergh reached Paris, 3,600 miles from his starting point, in thirty-three hours and thirty minutes, with nothing but an earth-inductor compass and an air-speed indicator to guide him. Fortunately, for his success, the latter not only indicated his speed through the air, but showed fairly well his actual ground speed, for he had a tail wind most of the way. Had he met head winds, however, which would have slowed down his plane and burned up his precious store of gasoline, he would have had no way of knowing the fact so long as he was flying over the ocean.

It is to offset that one great lack in flying instruments that aerial navigators are cudgeling their brains. At three-quarter throttle, the speed at which Lindbergh operated his engine throughout the flight, the

113 miles an hour for the entire distance, he apparently had a tail wind most, if not all, of the time. So long as the air-speed indicator, which shows the plane's speed through the air, registered better than 100 miles an hour, the pilot had nothing to worry about, for the excess mileage over 100 could only be due to a wind behind him. But if the indicator had dropped to 100 he would not have known whether he was flying in still air or against a head wind, for the head wind, plus the plane's speed, would have continued to register as 100 regardless of the strength of the wind. The latter might have attained a velocity of forty miles an hour and cut the ground speed of the plane to sixty miles, and still the indicator would have shown 100, while the plane could never have reached its destination with the gas it carried. With nothing below, even in daylight, to check his ground speed by, the flyer would have sailed on, ignorant of his danger, whereas with a ground-speed indicator he could have sought safety by turning back.

Centuries of navigation have never produced anything better than the sextant and stellar or solar observations to check the position of a craft at sea. Patent logs, to be trailed through the water, are fairly

reliable, but far from being exact enough even for a surface ship to depend on.

Flying through the air over the ocean, even the trailing log is impossible. If the problem is ever solved, it may possibly come through some new discovery in radio whereby practical instruments may be developed to indicate the distance from a broadcasting station by measuring the amount of power with which the signal reaches the plane.

The Lindbergh flight brought home more forcibly than anything that has happened in aviation the high degree of perfection which planes and aerial motors have attained. That a single motor could operate, without stopping, for more than thirty-three hours, that it could do 6,100

miles without overhaul, and still be ready to continue, proved a revelation to many who have not closely followed the improvements made in flying. Lindbergh's average speed from New York to Paris was 113 miles an hour. A few days later, at Indianapolis, ten of the finest racing creations in the automobile world were worn out in the first half of a 500-mile race while trying to meet the 109-mile-an-hour pace set by the leader.

The air-cooled motor, which Byrd used in his flight over the north pole and which Chamberlin and Acosta used in setting a new world's duration record, has proved ideal for flying. It eliminates the weight of the radiator and its water supply, and also all the manifold possibilities of broken



A Hop of 1,600 Miles to St. Louis, a Skip of 900 Miles to New York, and a Jump of 3,600 Miles to Paris Carried Lindbergh a Third of the Way around the World in Fifty-Five Hours and a Quarter; at Right Is the Pilot Examining His Motor and, Below, His Instrument Board

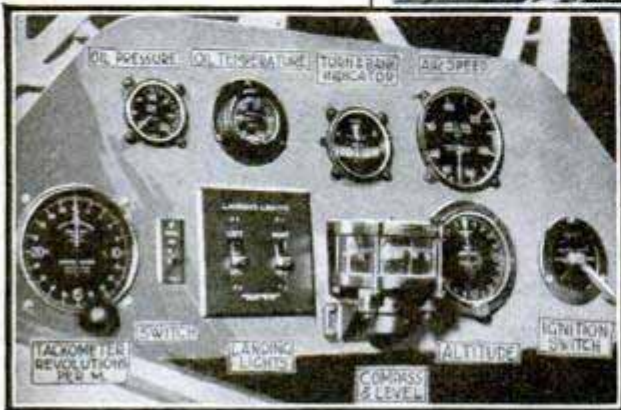
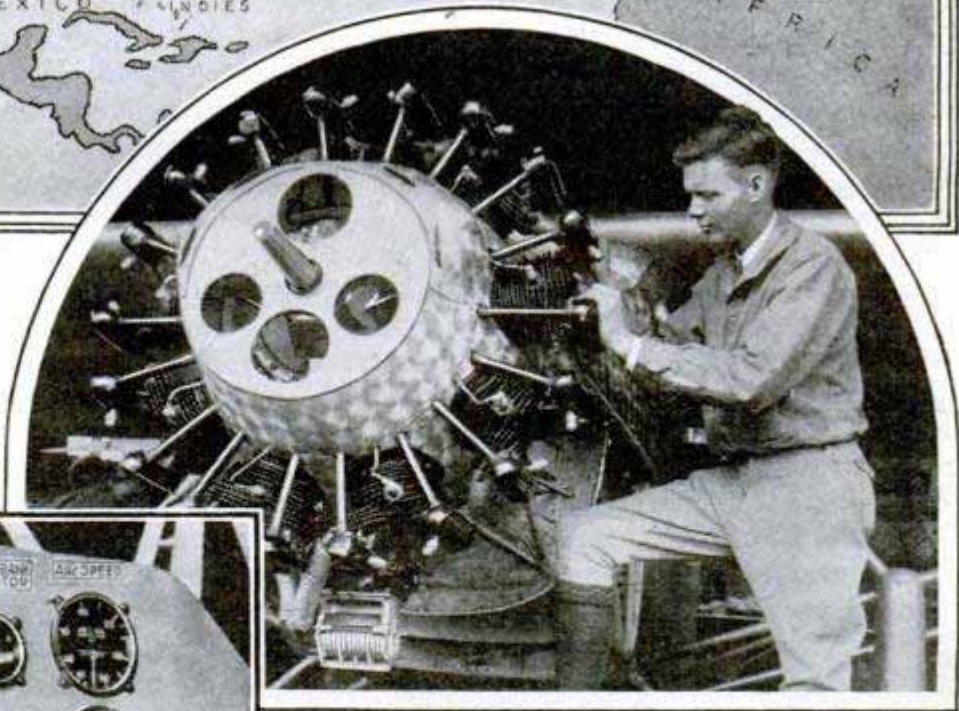

water connections and clogged tubes, or a fractured radiator pipe. Every tube, pipe and joint on a plane is a liability, since the failure of any one of them is usually sufficient to force a flyer down.

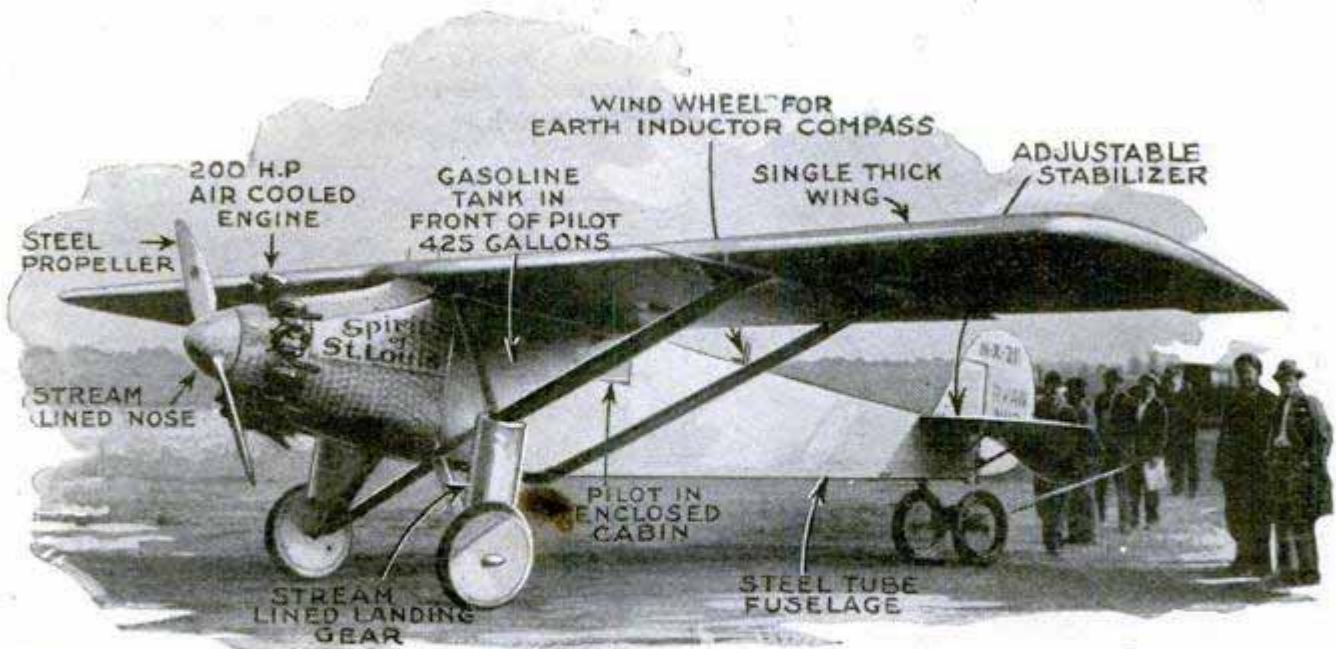

The "Spirit of St. Louis" in New York, and Some of the Principal Features of the First Airplane to Bridge the Gap between Two Great Cities on Opposite Sides of the Atlantic in One Flight

In staking his life on his earth-inductor compass, instead of carrying the excess weight of a companion to act as navigator, Lindbergh likewise was not taking such extreme chances as many might think. Loss of flying speed due to a head wind would have upset all the calculations on which his navigation was based, but, with the exception of that one possibility, his method of flying was fairly safe.

The earth-inductor compass is not a compass at all, in the usual meaning of the term, since it does not employ a floating needle to be attracted toward the magnetic north. He carried a magnetic compass, too, but they are far from being reliable in the air, since the presence of the mass of metal in the engine and the electrical effect of the ignition system make them difficult to correct. The earth inductor is nothing but a small electric generator, driven by a tiny air fan, a "dummy" compass dial by which the electrical field of the generator can be varied, and a galvanometer, which looks like the familiar "charge" and "discharge" ammeter on the automobile instrument board. The generator is placed far back in the tail of the plane, to remove it from the electrical influence of the ignition system. Its vertical shaft projects up through the body of the plane and carries a little two-bladed wind propeller, as the photographs of the "Spirit of St. Louis" show.

In flight, the aviator charts his true course, and then turns the dummy compass

pointer to the route chosen, upsetting the magnetic field of the generator in its relation to the earth. Then he swings his ship until the galvanometer hand rests on the top center of the dial, and is then on his chosen course. Any variation to left or right will cause a corresponding deflection of the needle, just as the ammeter hand on the automobile swings to one side for charge and the other for discharge.

To fly across the Atlantic, Lindbergh plotted his course in advance, basing it on the great circle, which is the shortest distance between two points on the earth's surface. Actually he did not fly a circle, but rather a series of short legs of 100 miles or so each. As plotted, his course required him to fly one hour in a fixed direction, then reset his compass for another hour, and so on. Since all the courses, or one-hour legs, had been calculated in advance, the changes were simple to make.

The feasibility of transatlantic flying was further strengthened only two weeks after Lindbergh's flight when Clarence Chamberlin and Charles A. Levine flew almost to Berlin in their Bellanca monoplane. They remained in the air for forty-two hours, finally running out of gasoline and descending within 110 miles of Berlin, at Eisleben. That was at 5:00 a. m., Berlin time, after nearly two days and nights in the air, yet they immediately regassed and took off again, but, becoming lost, finally descended seven hours later, still 70 miles from the German capital.

2559  
186

kielano 16 (Cite de la Paix)  
Paris, France  
POPULAR MECHANICS



Guiding the Hand through the Binoculars; Profiles Are Easily Copied with Braced Pencil

### BINOCULARS ON DRAWING BOARD AID IN DRAWING MAP

For use in various kinds of topographical work, French engineers have devised a binocular addition to the drawing outfit. It is so adjusted that the contour of distant hills or other objects can be accurately followed by the hand in tracing on the paper. The pencil is braced for greater steadiness and ease in operation.

### UNDERGROUND POLICE TO GUIDE TRAFFIC IN TUNNEL

2582 What is believed to be the first underground police force ever established has been enlisted to supervise traffic through the new vehicular tunnel under the Hudson river in New York City. They will have signal boxes every 400 feet to flash electric signs such as "Stop All Traffic," "Stop Your Motor," "Accident, Halt," and "Fire." Electrical emergency wagons, equipped with powerful jacks, will be stationed at all entrances and exits, ready to respond to calls to haul out disabled vehicles. In case of a fire, the ventilating drafts can be regulated from the signal boxes so that an increased suction can be induced, to draw off the smoke and flames through the outlets. Three hundred men are to

N.Y. Herald 5/16/29

compose the force. They will have a three-foot walk in each tunnel and vehicles will be confined to two ten-foot passages between white lines.

### TIDE FLOATS GIANT GAS PIPE INTO PLACE IN CHANNEL

An interesting engineering feat was accomplished recently when a stretch of eight-inch gas pipe, 600 feet long, was lowered as a single unit into the eastern end of the estuary that separates Alameda, Calif. from Oakland. The pipe, welded into one length, was constructed parallel to the shore and then floated out on pontoons. Ropes were passed underneath the pontoons to support the pipe, and while one end was held fast to the Alameda side, the other was allowed to drift with the incoming tide, which swung it into place.

Pacific Gas & Electric Co.

### PHONE CABLE LIKE SPINAL CORD 2484 PHOTOGRAPHS SHOW

Telephone lines have often been compared to the nerves of the human body, and the analogy is further carried out by cross-section photographs of a cable and those of transverse sections of a human spinal cord. The separate nerves of the

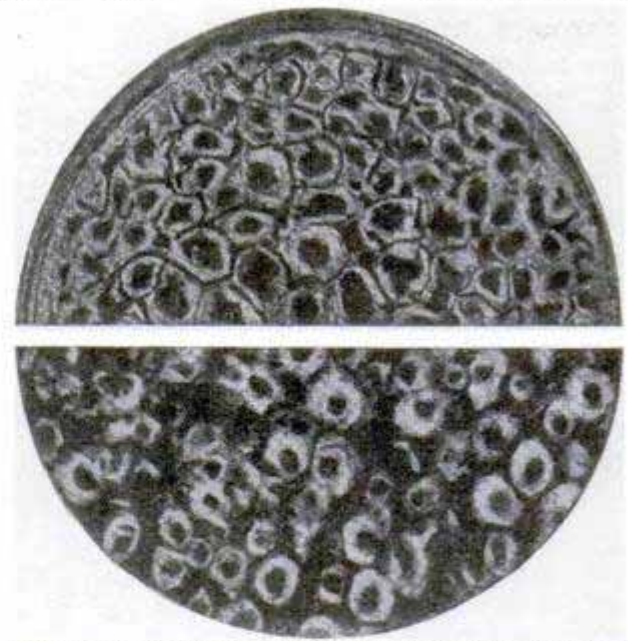

Upper Photo, Section of Telephone Cable; Lower, Cross Section of Human Spinal Cord Magnified

cord are comparable to the individual wires that make up the cable, while the ganglia, or nerve centers, have somewhat the same function as the various "centrals" in a telephone system.

Bell Laboratories Record

Canfield 2233  
Mrs. An. Alameda Calif

POPULAR MECHANICS Pablo Ave 187  
*Wm. O. Co. 6210 S. San*  
*Alhambra*

*Los Angeles, Calif.*  
*Letter returned -*  
*no other address*  
*known.*

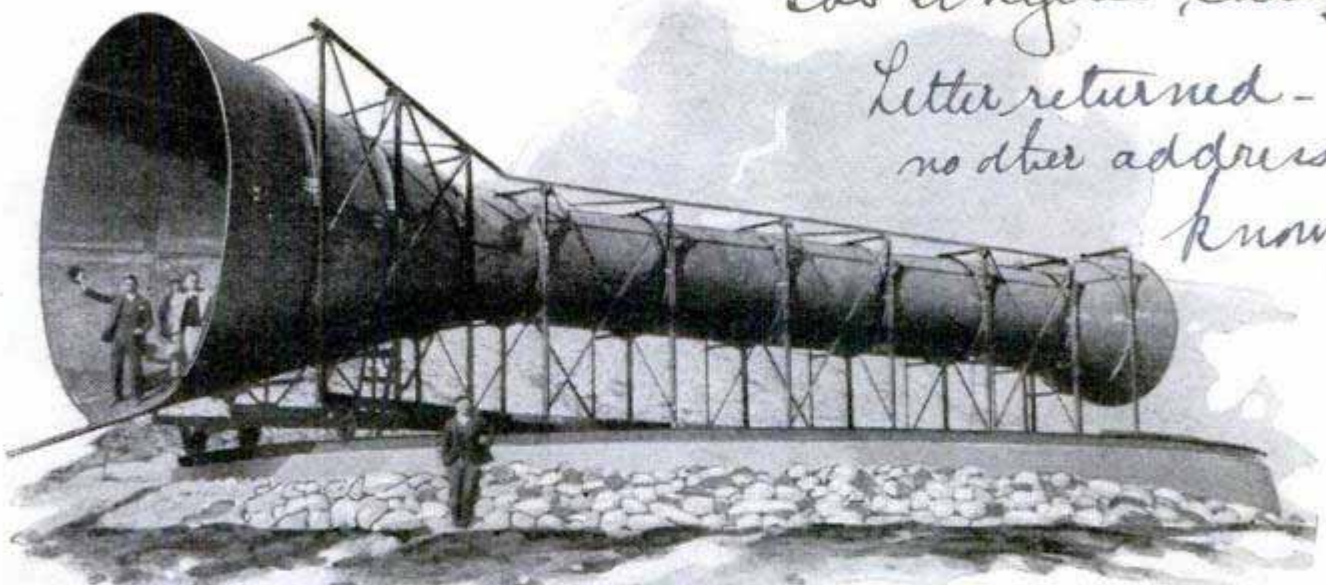

Turntable Funnel to Generate Electric Power from the Wind; It Can Be Swung to Get the Full Benefit of the Breeze, and Is Intended to Operate Ten Turbines

*H. P. Oliver, Los Angeles*  
**REVOLVING FUNNEL TO MAKE WIND GENERATE POWER**

Mounted on a circular track so that it can always be pointed toward the wind, a huge funnel has been constructed by a California inventor for harnessing the breezes to generate electricity. The entire apparatus weighs about eighteen tons and is intended to so compress the wind that it will operate ten turbines as it rushes through the tunnel. These, in turn, would be made to actuate generators for making electricity. The inventor has calculated that as much as 1,445 horsepower can be derived from the wind with this outfit and, if it proves a success, he will erect others in localities where strong winds prevail.

*2577*

**PLAYING TAG WITH WHALES**

To learn more about the habits and travels of whales, Norwegian fishermen are tagging them with metal labels. A specially designed crossbow is used to shoot a small dart, bearing the tag, into them and when a tagged whale is captured, a report is made to the Norwegian fishery headquarters, giving the data appearing on the tag and where and under what conditions the whale was caught. This system of tagging fish is not new. As early as 1653, Izaak Walton made mention of a study of the homing instincts of salmon by tying ribbons to the tails of the young fish, and for more than twenty-

*Cont. J. M. Hollingsworth*  
*168 Hartmuth St*

five years the United States has been tagging cod, mackerel, salmon and other species. Up to April of this year, 3,565 codfish had been tagged and fifty-two of the number had been recaptured.

**BEAUTY PARLOR FOR PET DOGS SAVES OWNERS WORK** *2030*

Dogs have a beauty parlor of their own in Paris where they receive hair cuttings, trimmings and curling, skin treatments and baths to keep their fur glossy. Sickly pets are given ultraviolet ray applications. Each morning, "customers" arrive in the arms of their mistresses or maids and the shop is doing a large business.

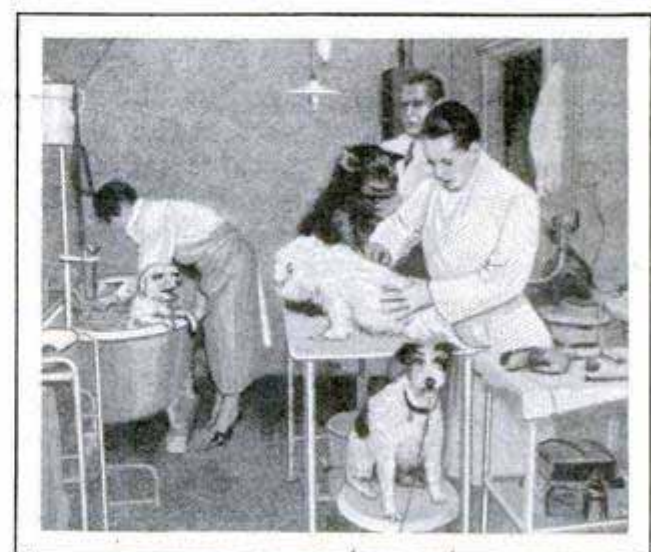

Courtesy L' Illustration *2/26/27*  
 Bathing and Curling the Pet Dogs in the Canine Beauty Shop; "Dressing" Them for Shows Is a Specialty

2567

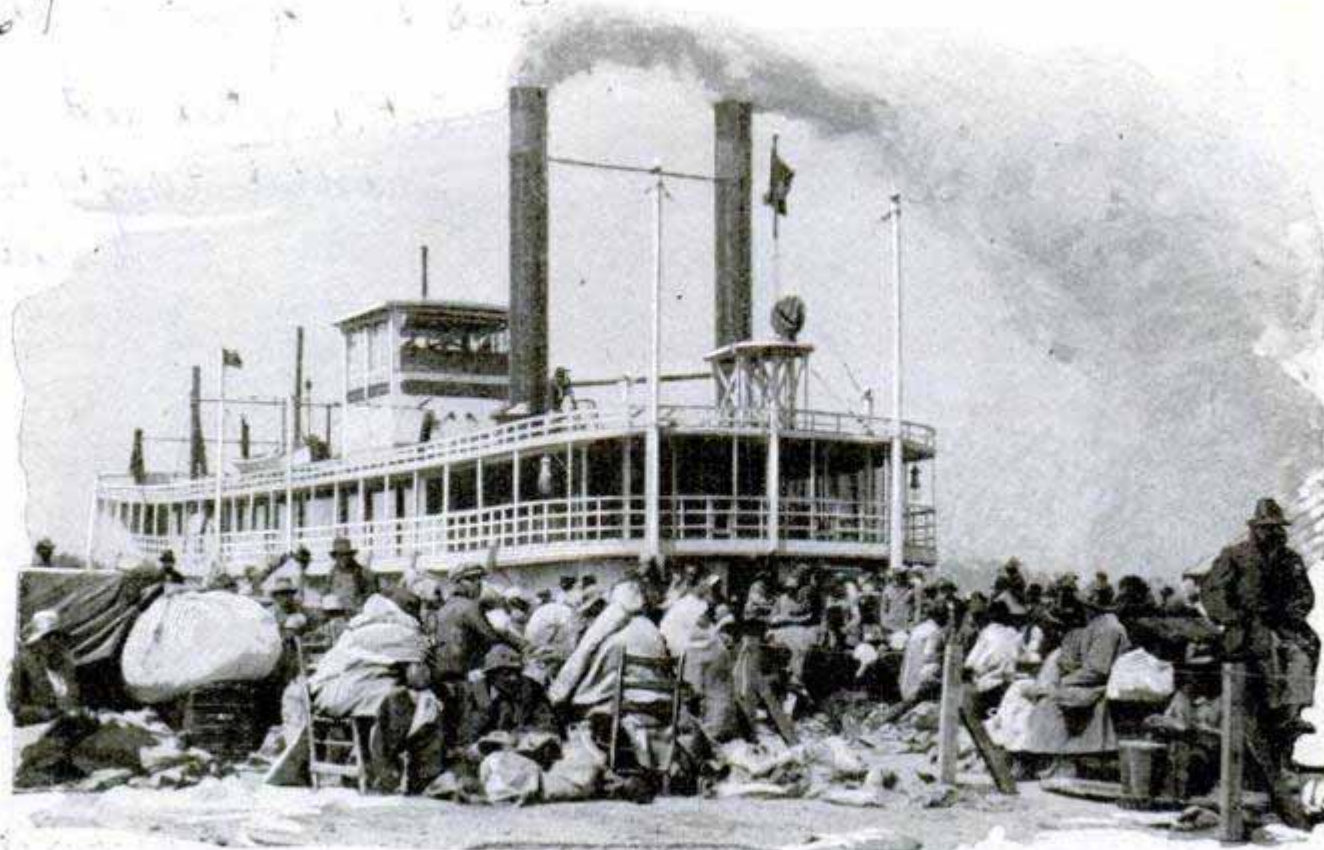

Rescue Steamer at Greenville, Miss., Loading Refugees from the Levee Top to Transport Them to Red Cross Relief Camps; the Flood Victims Clung to Vast Bundles in Their Flight

## Can the Mississippi Be Tamed?

### Engineers Debate Need of Returning Part of Bottom Lands to River to Supplement Levee and Reservoir System

**W**HAT to do with the Mississippi river to prevent disastrous floods in the future is a problem perplexing the engineering brains of the nation as a result of the unparalleled damage done this year.

Three schools of flood prevention have existed for years, so none of the ideas advanced are exactly new, but the widespread failure of the levees in the highest flood in history, due to rains falling for months over practically all of the Mississippi watershed, has emphasized the differences between them. One group has always advocated flood control through the levee system alone. A second favors abolishing all levees except those protecting river-bank cities, allowing the river to take back its former overflow land. The third idea is to combine levees with a series of dams in the upper river and the main tributaries, the dams being designed to hold back the flood water in vast storage pools, releasing it in time of low water to

maintain navigation levels, and at the same time using the storage waterhead to generate electric current.

Old-time river men, who bitterly denounce the levee system, declare that so long as dikes are built to retain the river in its main channel, the river will keep on depositing silt in the bottom, raising itself higher and higher, and force the extension of the levees upward, without end. In the old days, they claim, the river overflowed the bottom lands every two or three years and deposited a rich covering of silt, ranging from a few inches to as much as three or four feet. Always, however, the water drained back into the main channel in time for spring planting, with the result that the river bottoms, enriched by the silt deposit, were the finest cotton plantations in the world.

Then came the levee system, and the bottom lands, deprived of their natural fertilization, were exhausted so that now,





Levee Tops Were the Only Safe Refuge When the Mississippi Poured through the Broken Dikes, and for Hundreds of Miles Thousands of People Pitched Their Tents in the Midst of the Flood



On the Upper Mississippi Cows Were Milked in Water Nearly Knee-Deep, and Horses Had to Swim to Pasture

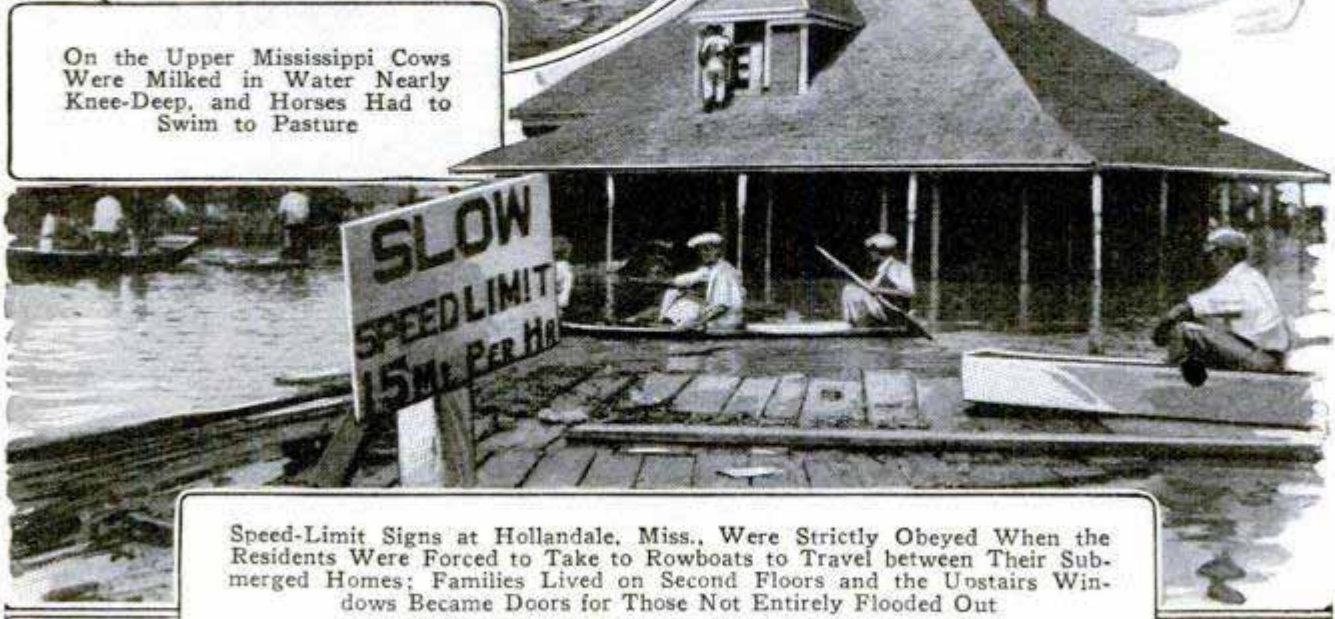

Speed-Limit Signs at Hollandale, Miss., Were Strictly Obeyed When the Residents Were Forced to Take to Rowboats to Travel between Their Submerged Homes; Families Lived on Second Floors and the Upstairs Windows Became Doors for Those Not Entirely Flooded Out

even with artificial fertilizer, they will not produce the cotton they did in the past. And the silt, which formerly enriched the bottoms, drops to the river bed and raises it higher each year, making for worse floods in succeeding seasons.

Col. Robert Isham Randolph, one of the flood engineers who studied the question during the recent high water, declares that many of the hundreds of thousands who were driven from their homes should not be permitted to return, but should be settled elsewhere and provided with farms. The bottom lands should be returned to the river, and used only for grazing or fish and game preserves, he says, leaving them open to absorb the surplus flood water. The trouble with the river, he claims, is that men have attempted to settle the bottom lands before nature finished making them. Left alone, the river would have kept on depositing silt in the bottoms until they were built up in vast savannas as high as the highest flood, and the river would then have dug itself deep in its own channel and stayed there.

The river tributaries with their connecting swamps and marshes in Missouri,

Arkansas and Louisiana, he says, show plainly that they formerly served as an overflow channel to the Gulf of Mexico, and some provision should be made, with artificial connections, to restore them to that use, so that in time of high water part of the stream could be diverted into relief channels, instead of passing the entire burden down the main river. The proposal of controlling the flood at its source through reforestation is impractical, according to Col. Randolph, first because it takes too long to grow the trees, and secondly, because it would take a forest area equal to Montana, the Dakotas, Minnesota, Wisconsin, Ohio, Illinois, Indiana, Iowa, Nebraska, Kansas and Missouri to reduce the flood crest five feet at Cairo, Ill., where the Ohio joins the combined waters of the Mississippi and Missouri.

The increasing damage from the recurrent floods is largely due, engineers admit, to the cutting of the northern forests and the building of cities where they stood. Every paved street, city sewer and every farm drain tile helps make the floods worse by carrying the water rapidly to the river, instead of leaving it on the ground



Courtesy Illinois Central System

Millions of Tons of Water Beat at the Cement Wall Guarding Vicksburg's Lowlands, While Pumps on Freight-Car Tops Returned the Seepage to the River

*John Walter & Sons Ltd  
2222. 913 King St. 1918,  
Chicago*

where it fell. Since the Mississippi drainage basin includes about two-thirds of the area of the United States, the water carried off through these three agencies alone is enormous.

The Mississippi levee system, which failed this year, is one of the greatest engineering feats ever undertaken as a means of flood control. From Cairo to New Orleans, for 2,000 miles, they stretch along both banks of the river at every low spot, and in the southern states arms extend for hundreds of miles up the many tributary streams and bayous. The levees are built of earth, usually dredged up from the river bottom several feet out from the bank. In height and width they conform to specifications laid down by the United States Mississippi river commission, which was created by an act of congress back in 1879, the avowed purpose being to "correct, permanently locate and deepen the channel and protect the banks of the Mississippi river, improve and give safety and ease to the navigation thereof; prevent destructive floods; promote and facilitate commerce, trade and the postal service." The national government has paid two-thirds of the cost of the levees and local levee boards the other third. The standard levee top has been three feet above the crest the 1912 high water would have reached had it been confined to the river channel. The flood this year topped the levees at Vicksburg by six-tenths of a foot, however, even after millions of acres had been flooded. Had all the water been kept within the banks, the flood crest there would have been ten feet or more above the 1912 flood mark.

One effect of this year's flood was the covering of Louisiana's famous muskrat marshes, from which the state each year extracts furs worth millions. The state conservation department built 1,500 rafts of logs covered with marsh grass, stocked them with muskrat food, and turned them loose in the marshes to provide floating homes and provision supplies for the muskrats, whose situation was as serious as that of the 300,000 humans driven from their homes. Trappers were assigned to watch the rafts and keep illicit fur gatherers from killing off the rats. They estimated that half the muskrat population was saved.



Releasing the Gas, the Chamber Filling, and the Preserver Inflated for Service

**LIFE BELT INFLATED WITH GAS ALSO WORN FOR SPORT**

In emergency a life-saver, in ordinary use, a practical belt for sport wear; these are the advantages claimed for a swimmers' safety unit recently introduced. To inflate it, a screw is turned. This releases a buoyant gas which is carried in a small container. The vapor fills the belt, which is folded in such a way that it forms a chamber.

**MANICURE KIT IN SMALL TUBE INVENTED BY WOMAN**

A complete manicure set not much larger than a "compact," has been devised by a woman inventor. In one end of a small cylinder is a removable tube of nail polish, in the other nail white and cotton for its application. A buffer, file, emery board and manicure stick are attached to the cylinder. The kit takes up little room in a handbag and is neat in appearance.



Woman's World's Fair, 64 W. Wabash, Chicago

*Edna Sibley Tipton  
2414 Jackson Heights, L.I.C., N.Y.*

*known as Sparkles Bulbs for 5 cents to 7 cents each*

2429 192

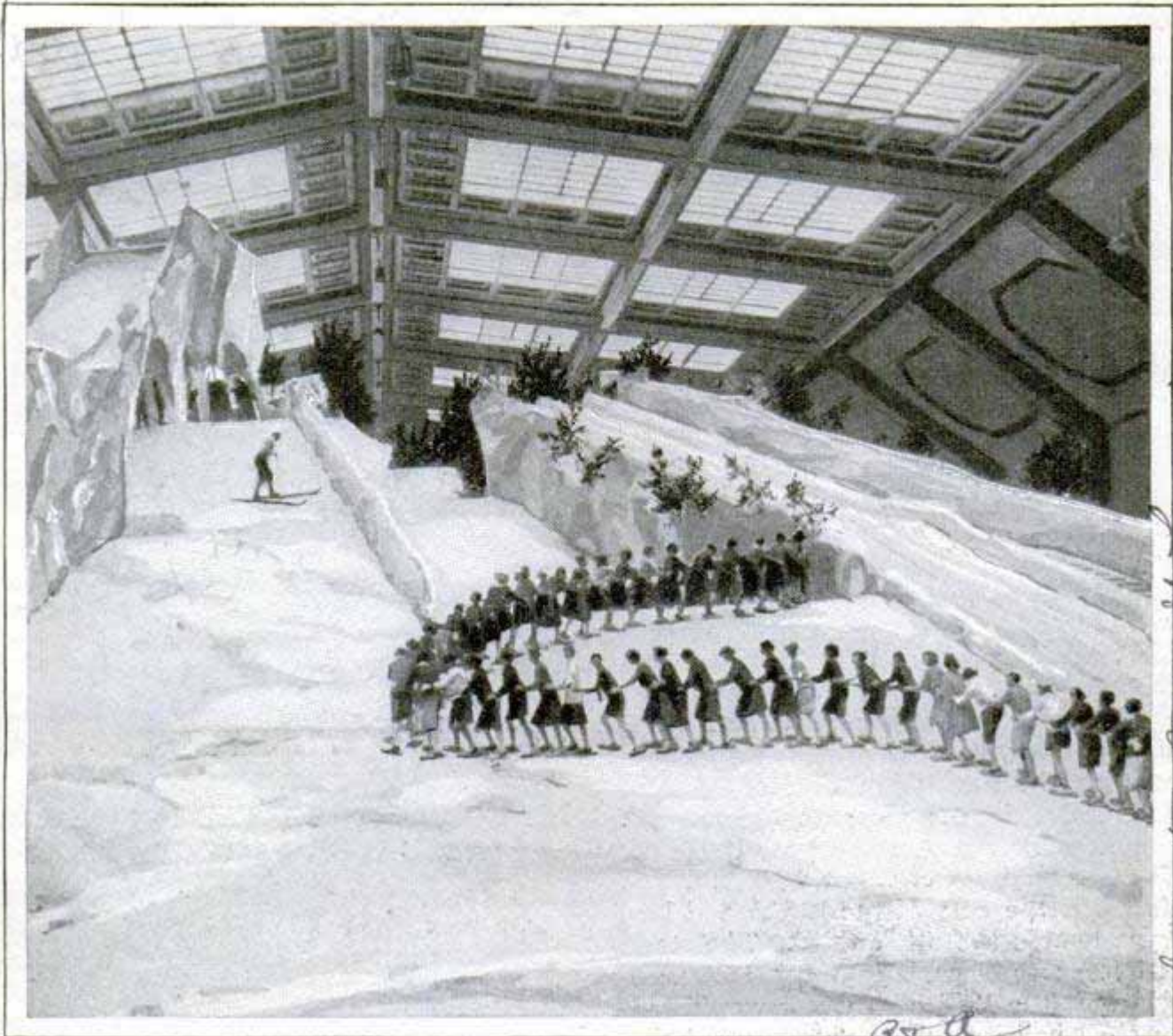

Fun in the Winter-Sports Palace the Year Around; Chemical Snow Is Used, But Proves Satisfactory for Ski and Snowshoe Practice, and There Is Also an Ice Rink

### PLAY WINTER SPORTS ALL YEAR UNDER PALACE ROOF

Winter sports can be enjoyed at all times of the year in a huge building recently opened in Berlin. There are ski runs, toboggan slides and ice rinks. An artificial substitute for snow is used, but proves satisfactory as the grades of the slides are steep. The dimensions of the palace are such as to permit large crowds enjoying it at the same time.

### PAINTING DOME OF U. S. CAPITOL TAKES THOUSAND GALLONS

One thousand gallons of special paint were required recently, to cover the dome of the United States capitol with a protective coat. The liquid was prepared by a formula approved by the bureau of stand-

ards and is expected to withstand several years of exposure. More than a week was required to scrape off the old paint.

### WATERPROOF STRAW HAT HOLDS SHAPE IN ANY WEATHER



Adapted for the beach, hiking or street wear, a straw hat, made waterproof by chemical treatment, has been placed on the market. It is said to maintain its shape

in wet or dry weather, is light and pliable and does not tear. Hand-woven palm fiber is the principal material used in manufacturing the hat.

Washington Ave. St. Louis, Mo.

2564  
Enl. Emmet Dougherty  
514 Woodward Bldg.

The New Way  
Waterproof Hat Co.

*Ida M. Eldredge  
Los Angeles, Calif.*

**KEROSENE BATH FOR GOLDFISH  
CURES THEIR ILLS** 2521

If your goldfish seem listless and ailing, there is hope of a cure for them, although owners are strongly advised against experimenting with treatments just because they have proved successful in some cases. A competent aquarium expert should always be consulted if you value your pets. Miss Ida M. Mellen of the New York aquarium, recently discovered two simple remedies that proved effective in curing some sick goldfish brought to her for treatment, a kerosene bath and a bath in a solution of aluminum sulphate. Twelve large comet goldfish were allowed to stay in a bucket of kerosene for one and a half minutes, one at a time. Then they were placed in a reserve tank of fresh water into which a strong flow of salt water was introduced. The fish recuperated and in ten days were bright and shining. The aluminum-sulphate treatment proved effective in curing thirty common, straight-tailed fish from a park lake. Evidently, they had been poisoned by automobile oil draining into the water. Some were in an almost hopeless condition. They were left in a solution, one ounce of aluminum sulphate to a gallon of water, for one to three minutes. Only two died, the rest improved.

*Wond  
Machin*

*represented  
Eda M.*

**CAVALRY KITCHEN IS MOUNTED  
ON A HORSE** 2182

All necessary equipment for preparing and serving a meal is contained in a kitchen-pack outfit that has recently been designed for cavalry units of the United States army. It is easily carried on one horse, as it weighs only 200 pounds, and can be put together in less than a minute. It is intended for emergency use when the big rolling kitchens find it impossible to maintain contact with the army forces.



Compact Army-Kitchen Outfit Being Adjusted to Horse; It Weighs but 200 Pounds Complete



Manicuring by Electricity; the Motor Is Inclosed in Dome Unit in Front

**ELECTRIC MANICURE SET SAVES  
CUSTOMERS' TIME**

Manicuring by electricity has been introduced in Los Angeles at a reported saving in time and with an improvement in the work. A motor-driven unit occupies but little space on the table. A flexible shaft turns different attachments for polishing and buffing the nails.

*Manicure Co  
Supt. 602  
Ruggell Bldg.*

**ALASKAN CABLE CUT BY WHALE**

Cable communication between Seattle and Alaska was interrupted for a month recently when a whale attacked the submerged line. The cut was repaired by the army cable ship "Dellwood," which brought the cable to the surface along with the whale, which was hopelessly entangled in it. The animal had completely severed the core of the cable by its teeth in eight places. Since the inner covering is made of gutta-percha and heavy iron armor, some idea of the whale's biting strength is obtained. It was a member of the killer species, weighed twenty tons and was twenty-eight feet long with maximum girth of nineteen feet.

*Henry Miller News Picture Service  
819-13th St. N.W.*

# A Adventures *in*

By J. EARLE MILLER

WOULD you believe there is a land where:  
Fish come out of the water and inflate themselves with air like rubber balls?

Deer are so small they can be carried home in the pocket and cooked whole in a frying pan?

Full-grown bears are only fifteen inches high?

Fish climb trees and blink their eyes?

There is such a land, and Charles Darwin, who years ago named it topsy-turvy land, only half described it, according to Carveth Wells, English railroad engineer, who spent six years in the jungles of the Malay peninsula building railroads and surveying roads across its unexplored interior.

Imagine walking along the beach and seeing a fish come up out of the water, cross the sand and climb a tree, "and," says Mr. Wells, "I watched and, after a few moments, it came down and returned to the pond."

Nothing that Sindbad the Sailor told can rival that story, yet there is such a fish and you can see it in museums tagged *Periophthalmus Schlosserii*, and, incidentally, it is the only fish in the world that can wink its eyes and climb trees.

Carveth Wells went to Malaya before the war to spend

Cart in a Rubber Plantation;  
the Queer Top Shields the  
Driver from Burning Sun  
and Almost Daily Rains

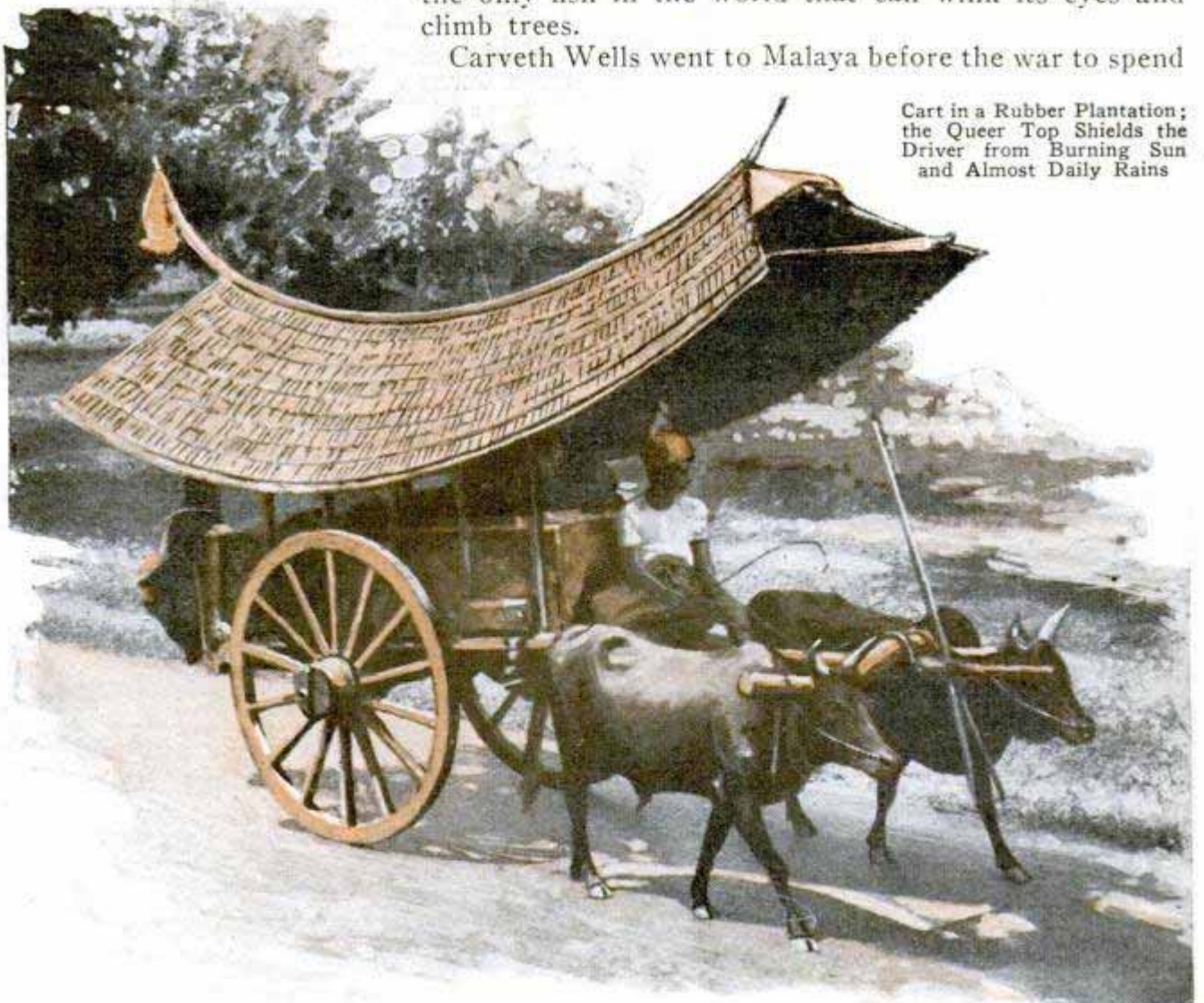

# TOPSY- TURVY Land

two years surveying a railroad up the peninsula toward Siam, but the war came on and it was impossible to relieve him, so he spent six years in the jungles before he was finally invalidated out.

Imagine hunting for deer that are only nine inches high and that can be lured from the forest by beating a rat-a-tat-tat on a palm leaf; killing twenty-foot boa constrictors with the iron-shod end of a surveyors' pole; photographing forest dwarfs so shy even their native neighbors rarely see them; crossing an unmapped wilderness to find a health resort where the wild elephants go to take the mud baths when they think they are about to die; watching fish fights between finny battlers that are trained like fighting cocks, and meeting birds who seal their mates in hollow trees at nesting time and feed them for weeks on a diet of strychnine.

He did all those things and many more.

"One day," Wells relates, "I was walking through the jungle when I became thirsty. One of my natives walked over to a tree and cut off a section of large vine, about three feet long, holding it carefully with both ends level. He told me to kneel and open my mouth, when he poured out of the apparently solid wood a stream of delicious cold water.

"I went to the same vine and cut off a section, but it was dry. 'Of course,' the

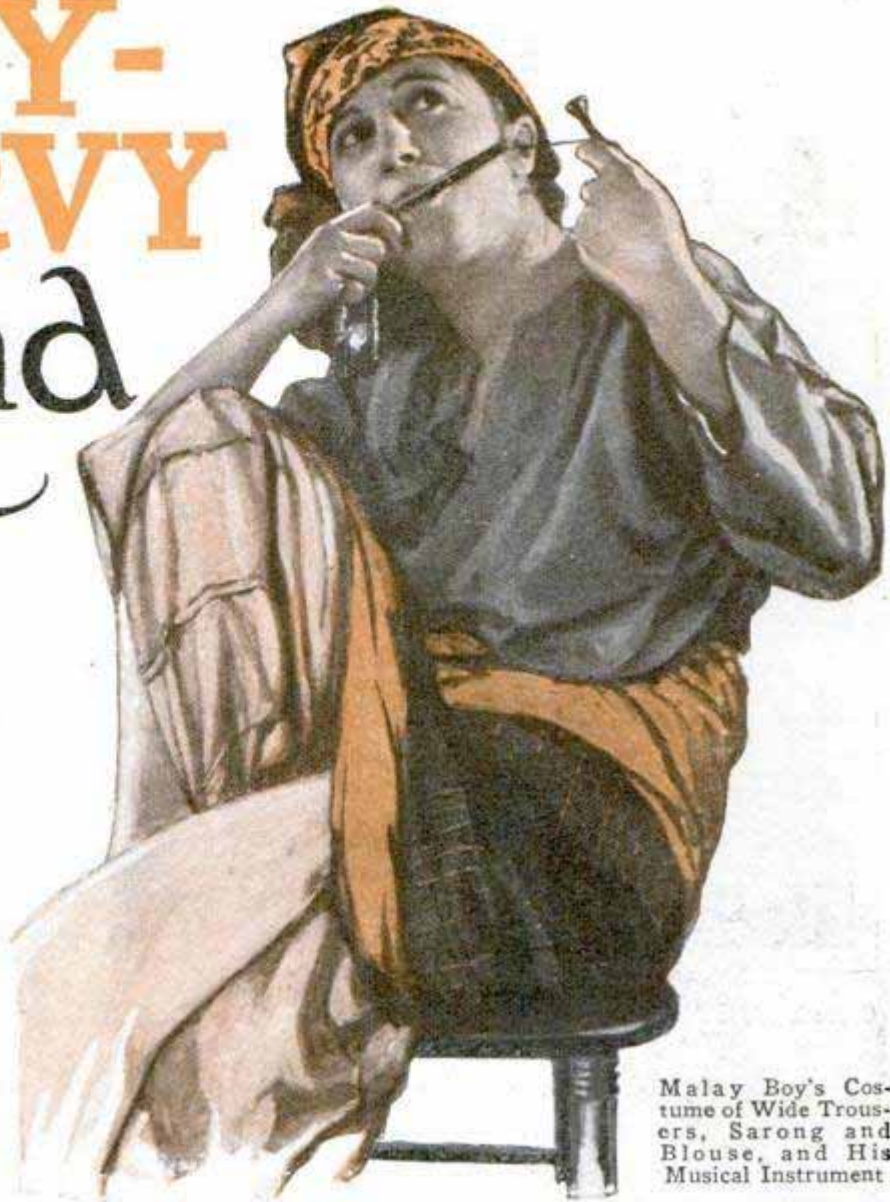

Malay Boy's Costume of Wide Trousers, Sarong and Blouse, and His Musical Instrument

native said, 'you made too much noise so the water all ran down to the roots.' I tried that many times, and always found water if I approached quietly, but a dry vine if I scared it!"

He found a plant in Malaya that folds up its branches, closes its flowers and lies flat on the ground if you touch it or even breathe upon it, though it will stand up in the face of a brisk wind. A buffalo feeding at the edge of a patch will make the whole field lie down.

He met a Malay bird about the size of a hen that lays an egg almost as big as itself, buries it in a shallow hole, covered with twigs, and when the egg hatches, the chick flies out, to a tree top, for its wings and feathers are fully formed within the shell.

Occasionally a little band of wild elephants was met, or, usually when the almost daily rains drowned out the noise of



Carveth Wells with a Malay Fire Maker, Which Employs the Principle Used in the Diesel Engine

approach, some other animal would be seen, but such sights were rare. There is plenty of rain, some 250 inches a year, and a nine-inch shower in three hours is more or less common, while his surveyors' rain gauge, with a ten-inch capacity, frequently overflowed in a single afternoon. The rains, however, usually arrive on schedule at the same time each day, so a morning could be spent surveying and the afternoon inside working on the field notes. It was not unusual to walk away from home in the morning and return in the afternoon by boat, the rivers rising so fast they would overflow the clearings to a depth of two or three feet.

Insects and their neighbors were the worst curse of the jungle. To live in any comfort in one of the palm-thatched native huts, it is necessary to erect a tent inside to keep off the things that live in the roof. Cockroaches arrive first, to eat the palm fronds. Then lizards arrive to eat the roaches, and in turn come scorpions, rats, mice, centipedes, frogs, spiders and other things, each living on the others,

until the snakes come to eat all of them.

Chicken three times a day is the usual diet prepared by the cooks, most of whom are Chinese. Running a household in the jungle, or even in one of the sea-coast cities is no easy task. Each morning the cook inquires how many are expected for dinner and asks for a certain amount of money for his shopping. Rarely is there any change. If the employer objects and tries to do the shopping himself, there is an astonishing increase in prices, so that, in the end, it is cheaper to let the cook get his rake-off. In the jungle, though hundreds of chickens are kept in the coops, there are never any eggs, for they are part of the cook's graft and must be purchased back from him. Sometimes the cook helps out his private income by selling the same chickens several times before they are eventually eaten.

On a fishing trip with a Malay boy, the youngster carried twenty or more small rods, about two feet long, to a rice field and stuck them among the growing grain with the baited hooks in the swamp water below. When all were in place, he began making the rounds, taking little fish, three inches long, from each. After catching a hundred or so, they returned to land, and the boy began stroking the fish across the ground, whereupon they promptly filled themselves with air until they could be bounced like rubber balls.

The Malays are not fond of work, and seldom do any, beyond cultivating a rice field. Most of their food comes ready prepared and nature grows it without assistance. One species of monkeys is trained to climb coconut palms and throw down the fruit. The monkeys know two words of Malay, meaning "ripe" and "green," and will throw down either kind of coconut asked for.

Because of their disinclination for work, the Malays declare one of their favorite fruits, the durian, is not good until nature drops it off the tree; so when the durians begin to ripen, they build a small fence around the tree to keep out animals, and



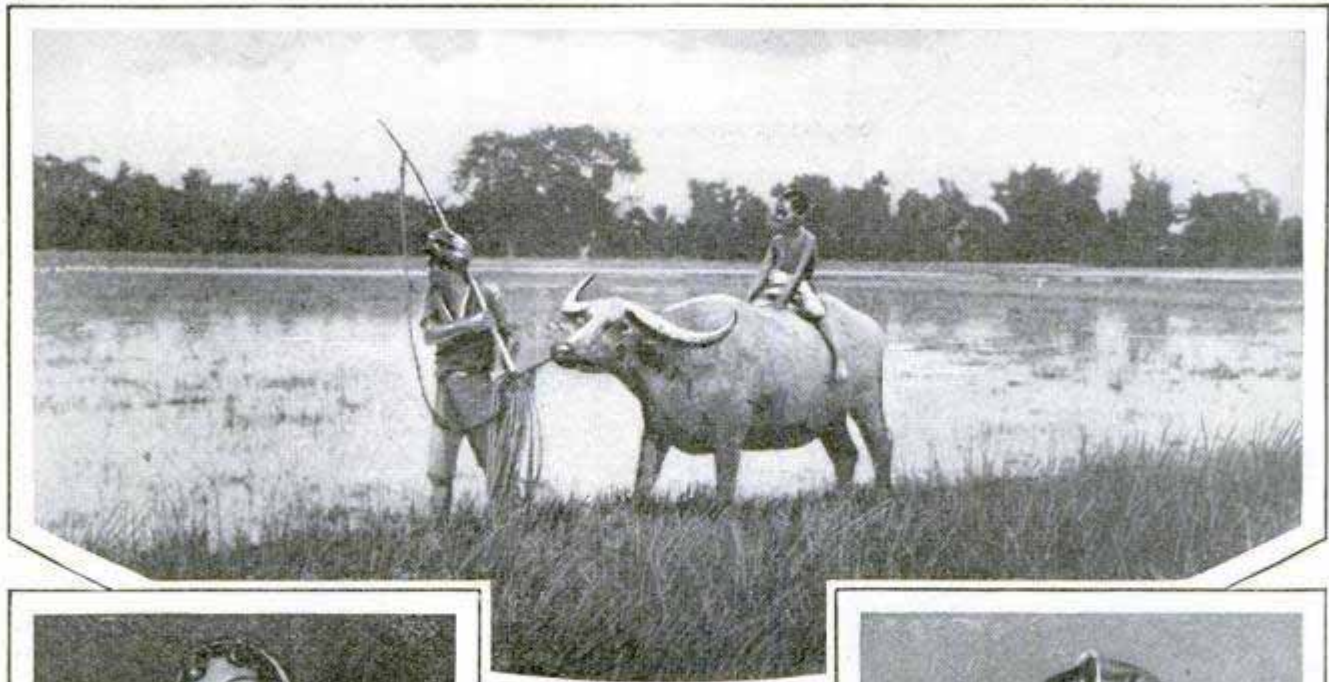

The Water Buffalo, Used in Rice Fields, Can Smell a Foreigner a Mile Away and Charges on Sight



Above and at the Right Are Two Views of a Royal Princess' Costume; the Veil, of Pure Silver Mesh, Weighs Seven Pounds and Covers a Jacket of Gold and Silk

Ready to Draw a Fold of the Veil across the Eyes; the Malays, Being Mohammedans, Require Women to Cover Faces When Abroad; Veil and Sarong Are of Silk Batik

within the inclosure a hut in which they can rest and chew betel nut until the durians drop. A durian, according to Wells, is about the size of a football, tastes like a mixture of custard, turpentine and

overripe onions, but nevertheless is good to eat, after the taste is acquired.

Railroading in the jungles is unlike that anywhere else. On ordinary surveying it is often possible to run lines of a mile or more at a time, and in the western states the government surveyors, working on mountain tops, have run lines more than 150 miles long. But in the jungle, the vegetation is so thick that a sight of a hundred yards is often difficult, and because of the incessant hacking away of vines and bamboo to clear the path, a quarter or half mile is a good day's work.

Malays were used in the surveying party, but when the actual building of the roadbed started, Chinese coolies were imported. Each carried a tool that was a cross between a rake and a hoe, and two baskets suspended on a shoulder rod. When the baskets were filled they were carried up the slope and deposited on the right of way.

The Malayans make most of the things they use, even to guns. When a gun barrel is wanted, a length of iron rod will be buried upright in the ground, a native drill,

Row of Palms in Penang, and a Typical Malay Dugout with Its Small, Crude Sail

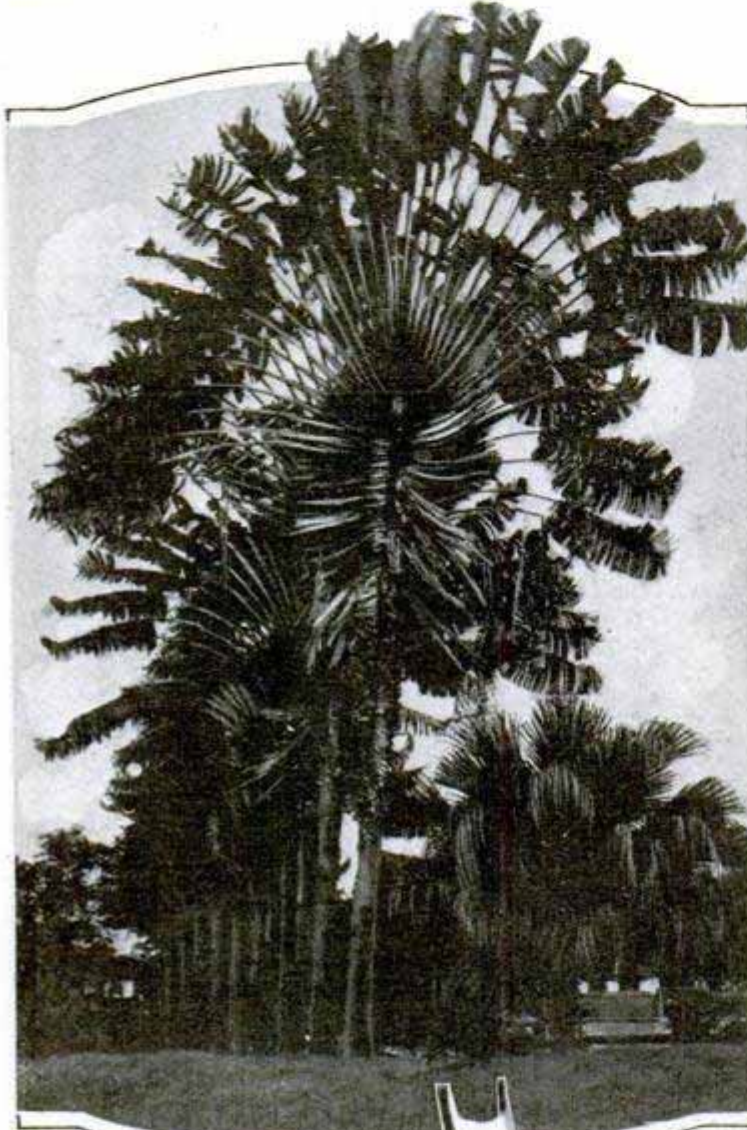

weighted down with a box of stones, placed above it, and with a loose bow string twisted around the drill, a native will sit on the ground and saw away for weeks and months, slowly boring a hole through the rod.

Most of their utensils are crude, yet they often employ scientific principles that are remarkable even in civilized countries. When Diesel invented the engine bearing his name, employing the heating of the air during compression to explode the gas, it was considered a remarkable achievement, yet the Malayan natives have used exactly the same principle in making matches for centuries. On a lathe composed of two tough thorns they mount a piece of buffalo horn, with a bow string around it. One man saws away on the bow, revolving the horn, while another turns out a small cylinder, about three inches long and an inch in diameter. In the cylinder they drill a tapering hole, a quarter of an inch across at the end and slightly less near the bottom, and then turn out a piston an inch and a half long, slightly larger than the bottom of the cylinder hole, and with a button of horn as big as the cylinder on one end.

Around the piston end they wrap some thread, greased, to form a piston ring, and cup the end of the piston slightly to hold a pinch of vegetable fiber. The piston with its fiber is inserted a short way into the cylinder, which is held tightly in one hand. Then the other palm is brought down with considerable force on the horn button, driving the piston in so sharply that the highly and rapidly compressed air becomes so hot it ignites the tinder. The first and middle fingers grasp the horn button at the end of the stroke and jerk the piston out, so that the fire can be kept alive by blowing on it.

Native clothing is worn in the jungle even by the white engineers, except when on actual survey work. The native dress is chiefly a sarong, which means envelope. It is like a sack or tube, about four feet long and as wide, with the bottom left



Even the Foxes Fly in Topsy-Turvy Land; This One Is Notable for Its Immense Wingspread

open. Slipped over the head and under the arms, the surplus is held out to one side while a finger is inserted between the folds and run around to the back, then is quickly withdrawn and the fold caught there, the rest of the cloth being tucked in at the top in front.

The women, being Mohammedans, wear a veil when abroad, and for dress wear a short jacket is sometimes added. The sarongs are made of beautifully colored silk.

#### TANK SHIP WITH DOUBLE HULL 2500 KEEPS CARGO HOT

To keep asphalt warm while being shipped, a California oil company has designed a double-hulled tanker with steam coils in the intervening space. An even distribution of heat is thus assured, preventing the asphalt from solidifying.

*maltha*  
Union Oil Company  
of California



In Memory of a Great Polish Leader, Thaddeus Kosciusko; This Earthen Mound Is One of the Sights of the City of Cracow and Has Been Built in the Midst of a Series of Forts

### EARTH MOUND IN POLISH CITY HONORS KOSCIUSKO

One of the unique modern monuments of the world is that in the city of Cracow, in honor of the great Polish hero, Thaddeus Kosciusko. It takes the form of a large conical earthen mound, rising from the center of a group of fortifications. A pathway leads to the top where a clear view of the city may be enjoyed.

### HUNT ELEPHANTS IN AMERICA FOR FOSSIL COLLECTION

A hunt for remains of mammoths that inhabited this country thousands of years ago, has been conducted in Florida and Oklahoma by Dr. James W. Gidley, of the National museum. An object of the search is that a complete skeleton may be obtained for mounting. The base of a skull, some teeth, ribs and foot bones were found near Alva, Okla., with fossils of parts of other animals including the three-toed horse and a deerlike creature. In Florida, better-preserved relics are hoped for, as the fossil bones are buried deeper. The mammoth passed out of existence in the glacial period; before that it roamed

widely over the continent. It was probably twice the bulk of the present elephant and was a "cousin" of the mastodon.

### FRUIT-JAR CAP STRAIGHTENER REDUCES SPOILAGE

Needless expense in buying new fruit-jar caps by reclaiming the old ones, and greater assurance that the contents of the jars will not spoil, are offered in a simple unit for truing the edges of the caps. It consists of a roller that fits in the grooves of the cover and a crank to turn the cap, which is fitted to a holder. A lever is furnished to press the roller tightly against the edge and "iron" out any irregularities that may have been formed.



☐ Sugar beets furnish about one-half of the world's supply of sugar.

2/19/27 2302 Courtesy The Sphere

*Poland*

2467

*Jm-Kap*

\$ 1.50

*Ames, Iowa  
Hug Mfg. Co.*

*Paleontologist*

2516

*Yuba. Calif*

2415

**EIGHT CENTS TO TON OF SAND IS YIELD OF GOLD MINE**

2606

A yield of but eight cents to the ton of sand and gravel would not tempt the poorest placer miner, but that is all the yellow wealth obtained from a big California working, where \$50,000,000 worth of gold has been extracted in twenty-three years. The explanation lies in modern machinery and enlightened engineering. Huge dredges are employed to sift the sand, enough electricity to supply a city of 60,000 persons is required and 200 men are employed. In twenty-four hours, 100,000 tons of material are handled and during the twenty-three years of operation, the company has moved about 135,000,000 more cubic yards of earth than was excavated to dig the Panama canal.

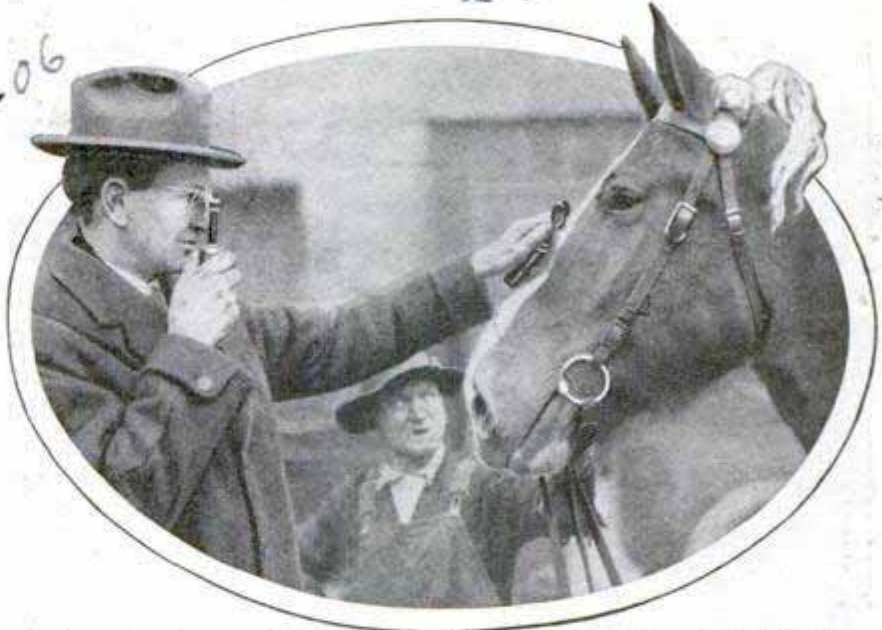

Testing Horse's Eyes for Defective Vision; Most of Their Optical Ills Are Said to Be the Result of Heredity

**TESTER FOR HORSES' EYESIGHT TO CURB DISEASE**

Defective vision in the mounts causes more than ninety per cent of the accidents during horse races, jumps or riding, according to a specialist. He has devised an instrument for testing and recording the vision of the horse, to detect the presence of ailments. Practically all eye trouble in horses is due to hereditary causes, according to this authority.

*Dr. E. G. ...*

**FACE MASK FOR LIBRARIANS SHIELDS THEM FROM DUST**

2154

Keeping the thousands of volumes in the New York public library in repair is a task requiring special workers so that the books will always be in condition for loaning. To protect themselves from dust and germs, a tape mask that guards the face and mouth has been used by some of the repairers. It is especially useful when examining volumes that have been in storage some time.

**CURSE OF DEAFNESS RELIEVED BY HEARING LEAGUES**

2600

Surveys made by the leagues for the hard of hearing in various American cities indicate that there are 3,000,000 children with defective hearing in this country, but that eighty per cent of deafness could have been prevented if recognized early enough and given proper care. Under the direction of the leagues and with the co-operation of school boards, thousands of pupils are given hearing tests by competent ear specialists with accurate instruments; lip-reading classes are held for the deaf, and vocational departments maintained for securing proper employment for those with defective hearing.

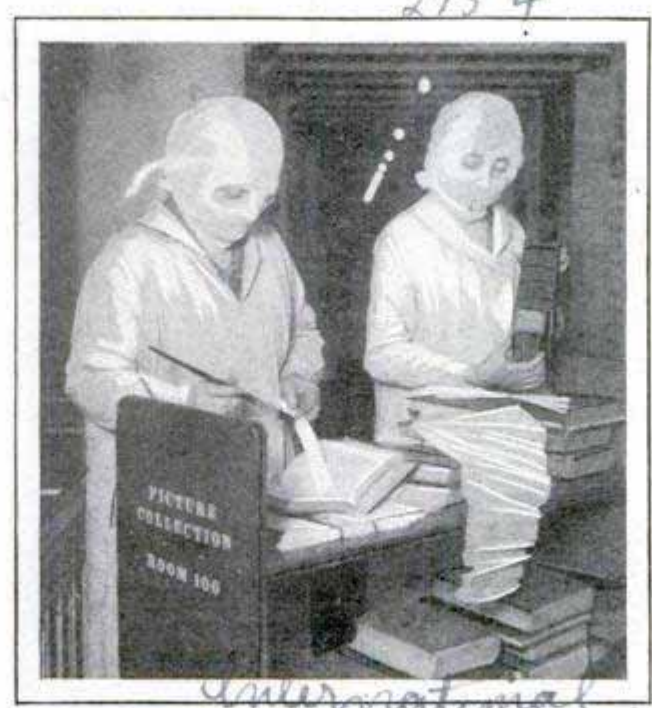

Librarians Wearing Dust and Germ Masks

*Chicago League for Hard of Hearing*

*Union Tail Paper +  
Color Industries, Inc. Hackensack*

tree here. In a few seasons, Florida, Georgia, Mississippi and Louisiana will be producing the oil, but the trees are only saplings now.

**FABRIC THAT RESEMBLES STONE  
MAKES HANDSOME WALL**

Imitation Italian travertine is now furnished in a fabric wall covering that is easily applied and is said to closely resemble the natural material. It is impervious to water and can be washed with soap if it becomes soiled. Different colors are provided and a nonrepeating block design is followed in the pattern to increase the effectiveness of the material for interior decorating. It is easily repaired if damaged and may be removed whole for use on another wall.

**MOTORBIKE HAS AN INCLOSED  
PASSAGE COMPARTMENT**

Many of the conveniences found in a touring car have been fitted to a motorcycle and sidecar a Chicago man has designed. The cycle has reverse gear, a horn and whistle for warning signals, and the passenger compartment is equipped with a top, a seat that can be adjusted for sleeping, a footrest, windows on the driver's side, permitting conversation, and a light for reading. In all, the vehicle has twelve lamps. The sidecar is waterproof and the fender is removable for entrance to the compartment. The outfit is adapted to long trips at lower than auto costs.

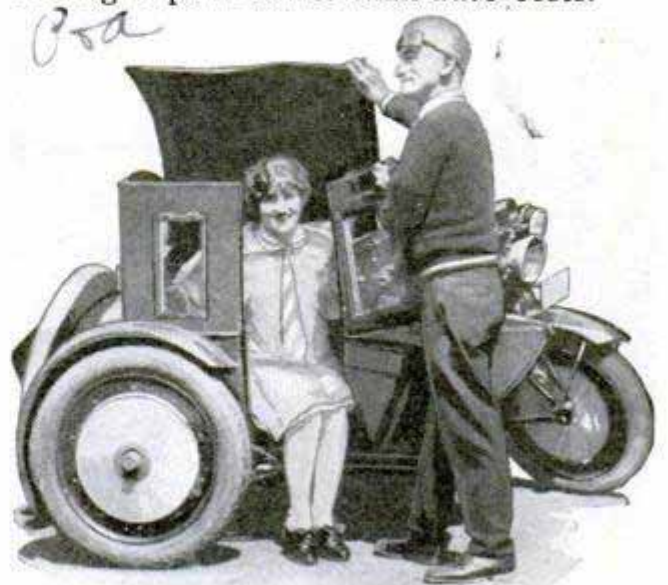

How Sides of Motorcycle Passenger Car Fold Out for Convenience of Occupant and for Loads

*H. Nielsen, Chicago*



Parachute in Container; It Is Pulled Out When Pilot Leaps over Side, Saving Bother with Release Cord

**PARACHUTE IS CARRIED IN TUBE  
TO INSURE OPENING**

Successful tests are reported with a parachute incased in a metal tube, which protrudes through the cockpit floor of the airplane. When the aviator jumps, his weight snaps it out of the carrier by means of a cable attached to the parachute and the flyer's back. This insures quick opening and forestalls any chance of the aviator not being able to pull the release cord.

**HOW CHINA'S WAR AFFECTS U. S.  
SEEN IN PAINT MARKET**

At first thought, a war in China and the price of varnish seem to have no connection but the relationship is direct, for most of the wood oil, extensively used in paints and varnishes of various kinds, is obtained from China. The recent military troubles there have sent the price from twelve to thirty cents a pound. We import more than 12,000,000 gallons yearly. Ten years or so from now, this country may not be so dependent on China for the material, because plant explorers of the department of agriculture have introduced a tung-oil

*Demonstrated at Haerlyn  
Aviation Fields Brussels  
Belgium*

2520

*Geographic News Bulletin  
1340 N.S.*

*American Builder  
Nov. 1927*

*William Boekser*  
*Star-Eagle, Newark, N.J.* 203

**Lincrusta-Walton Co.**

Division Tait Paper and Color Industries, Inc.



Thomas A. Edison with One of His First Phonographs, Which Will Be Fifty Years Old on August 12, and One of His Dictating Machines, Which Grew Out of the Original Invention

## Edison's Greatest Invention Half Century Old

**Inventor, Now Eighty, Picks Phonograph as Contribution He Hopes History Will Remember Him By**

**F**FIFTY years ago, on Aug. 12, 1877, Thomas Edison scrawled four crude little diagrams on a scrap of paper, wrote across the bottom the laconic message, "Kreusi, Make this. Edison," added the date, and—the phonograph was born!

Almost half a century later, on his eightieth birthday, the greatest inventor the world has probably ever known picked up a scrap of paper on which a reporter had written, "By what would you prefer to be remembered?" and, with the same laconical briefness, wrote beneath the question two words—"The phonograph."

The reason why the man who conceived the carbon-filament light, created central-station generating systems, invented the non-acid storage battery, brought out multiplex telegraphy and gave a host of other

inventions to the world, should pick the phonograph, whose greatest development has been in the field of entertainment, as his premier achievement is twofold. First, he believes the surface of its sphere of usefulness has hardly been scratched. Secondly, as probably the most impelling reason, the phonograph was not a discovery but a true invention. No man had ever conceived recording the human voice for mechanical reproduction.

Curiously enough, Edison did not set out to invent "frozen speech and music," but was trying to perfect a telegraph repeater to record incoming messages and later repeat them mechanically to another station. Having started in life as a telegraph operator, his first interests were in that field, and the phonograph was more

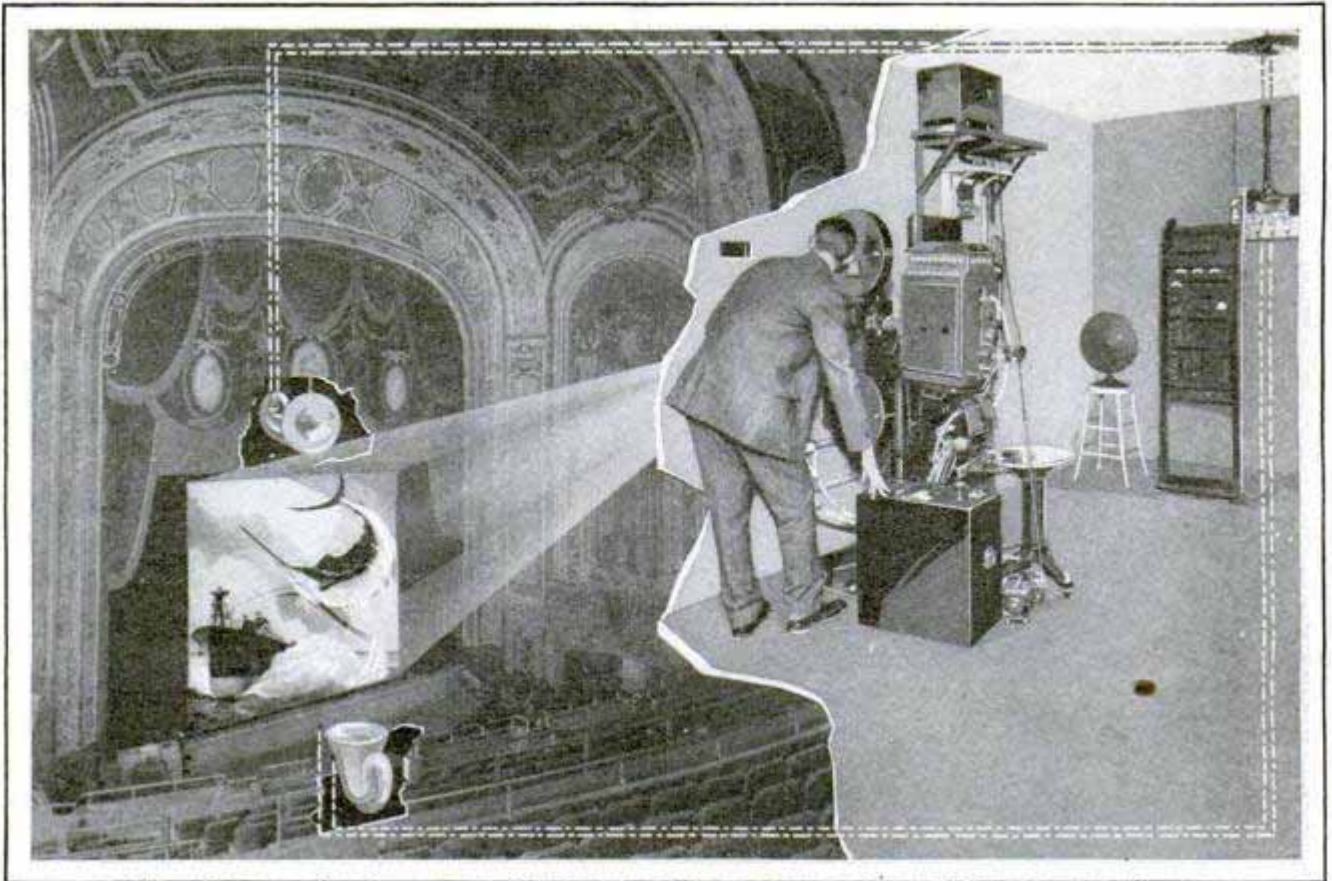

One of the Latest Phonograph Applications, the Talking Movies in Which the Large Record, Shown on a Metal Stand, Furnishes Voice and Music Synchronized with the Film

or less of an accident. The repeater with which he was experimenting bore a remarkable resemblance to the modern disk phonograph. In his notebook for that day he wrote:

"Just tried experiment with diaphragm having an embossing point and held against paraffin paper moving rapidly. The speaking vibrations are indented nicely and there's no doubt that I shall be able to store up and reproduce automatically at any future time the human voice perfectly."

The telegraph repeater was forgotten. In his mind he could see exactly how a phonograph should look. The only question was the best material to use. Paraffin was too soft; the record wore out too quickly. A hard wax would have been ideal, but would require months of research, and he wanted immediate action. Tinfoil suggested itself—something soft and pliable, yet more durable than coated paper. On Aug. 12, the rough diagram was drawn, with a note to John Kreusi, his instrument maker, to "make this." The mechanic also was told he could spend up to \$18 on the model!

The model was completed within a few

days and carried to the "old man," as the thirty-year-old inventor was even then called. The laboratory staff, curious to see the outcome of what Kreusi had freely branded as a "crazy idea," gathered around. Edison turned the crank to test its friction, wrapped a sheet of tinfoil on the cylinder, fastening the ends down with a strip of lead, laid in a groove cut for the purpose, and adjusted the mouthpiece.

He grasped the crank, for the first phonograph was hand-operated, and began to turn, at the same time shouting into the mouthpiece:

"Mary had a little lamb,  
Its fleece was white as snow,  
And everywhere that Mary went  
The lamb was sure to go."

The laboratory wits were convulsed with laughter at the picture of Edison shouting childhood rimes at a revolving piece of tinfoil. Amid their shouts and jokes, Edison calmly substituted the reproducing diaphragm, turned the cylinder back to the starting point, and spun the crank. Back from the tinfoil, in a high, thin voice came the words:

"Mary had a little lamb...."

Straight on to the end it went, not a word missing!





Edison Invented Both the Phonograph and the Movies, and Now They Are Combined; Above Is an Orchestra Recording in the Old Mechanical Days When They Had to Be Grouped Closely around the Horn; at Right, a Record Maker Is Watching the Disk as It Is Engraved with Sounds

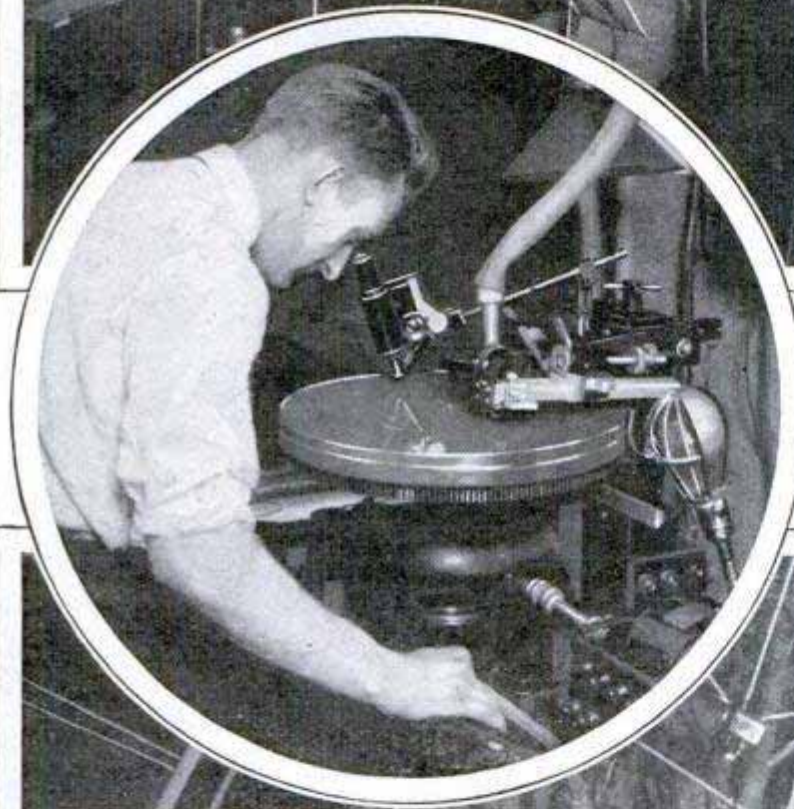

Modern Radio Microphones Have Eliminated Close Grouping and Carry the Sounds to the Recording Laboratory; Here Is a Set Used to Photograph the Singer in Action While the Record Is Being Made



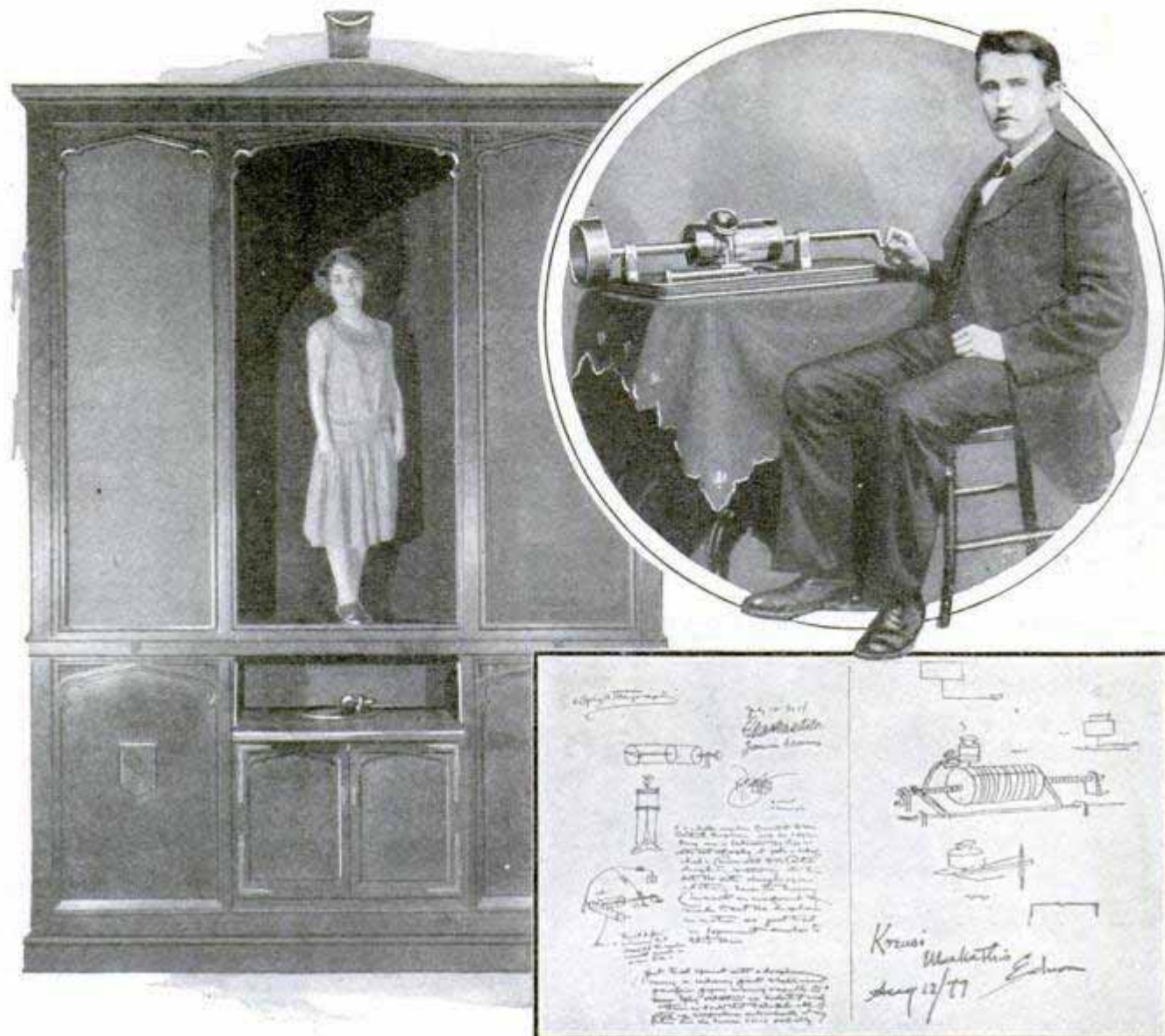

The Horn of the New Victrola for Auditoriums Is So Big a Girl Can Stand in Its Mouth; at Top Is Young Edison with His First Phonograph, and Below It His Original Dated Sketches

It was a memorable day, and night, too, at Menlo Park. Nobody went home. Hour after hour they stood around the machine, taking turns at speaking, laughing, whistling and singing, and then listening to their voices repeated back to them.

The next day Edison carried the first phonograph under his arm to New York and demonstrated it in the office of a friend. The demonstration was a success, and the papers were filled with reports which were cabled all over the world. Orders poured in from every quarter, and Edison, without stopping to perfect and improve, was forced to begin making machines immediately, to supply the demand. The phonographs were used for exhibition purposes. So great was the interest aroused, that one enterprising exhibitor cleared \$1,800 in a single week in Boston.

The craze lasted for a year and a half, then gradually died out. Edison had become interested in the electric light, and for nine years let the phonograph languish. Yet he realized its possibilities and, in an article published a few months after the invention, he listed no less than ten fields of development in which it would prove a boon to mankind.

It wasn't until 1887, ten years after the original invention, that he went back to the phonograph. His first step was to revolutionize the machine, substitute a permanent cylindrical wax record for tinfoil, and a battery-driven electrical motor, which was very shortly replaced by a spring motor.

Until radio came along to challenge its supremacy, the phonograph held the center of the stage as a music and speech re-

producer. Radio made a temporary dent in its prestige, but the various manufacturers, who saw their profits threatened, responded with a series of notable inventions that again revolutionized the canned-music art.

The company which had been founded to develop Berliner's disk inventions produced, in co-operation with the Bell telephone laboratories, an entirely new type of reproducing horn. About the same time radio and the phonograph were combined, using radio tubes and electrical power to pick up and amplify the vibrations of the needle traveling over the record.

Two other notable inventions involving phonographic records quickly followed. The first was the perfection of talking motion pictures, utilizing large phonograph records and radio amplifiers to furnish the sound. Talking pictures were not new. Lee DeForest had brought them out several years before, with the sound photographed on the edge of the film.

The new idea involved using an ordinary phonograph record which should be recorded in perfect synchronization with the movie film, and the projection of the film and the reproduction of the sounds in perfect tune, which is achieved by operating both from the same electric motor, so their speed in relation to each other cannot vary.

The latest application of Edison's original phonograph principle is in the recording of motion pictures on wax disks, from which they can later be reproduced by playing the record on the phonograph. The idea is the invention of an English experimenter with television. The movie scenes are picked up, not by the usual camera, but by a photoelectric cell, which records them as pulsating electric currents, that in turn operate the cutting tool making the record. When the record is played, the reproducing needle is used to create another pulsating current, which operates a neon light to sweep bands of light and dark across the screen, creating the pictures again.

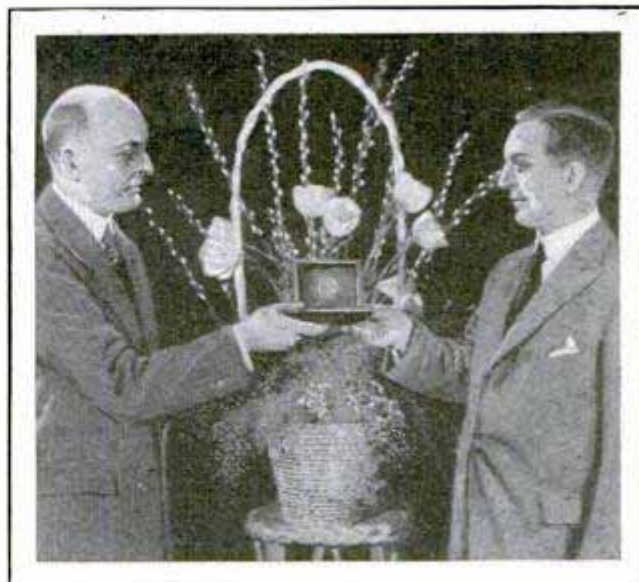

John Sheepers, Right, Receiving Medal for Prize-Winning Tulip from Secretary Jardine

### NEW TULIP WINS GOLD MEDAL AT FLOWER SHOW

A tulip was judged the best of the new flowers shown at a recent New York floral exhibition and was awarded a gold medal by Secretary of Agriculture Jardine. It is named the "Miss Helen Eakin."

### THIS TRUCK MAKES OWN ICE FOR DELIVERING CREAM

For ice-cream storage and delivery, an auto truck now on the market is equipped with an electric refrigerating plant instead of ice. Temperatures of several degrees below zero can be attained, while the coils and other parts of the apparatus are compactly arranged and save transporting hundreds of pounds of ice, brine, tanks, etc.

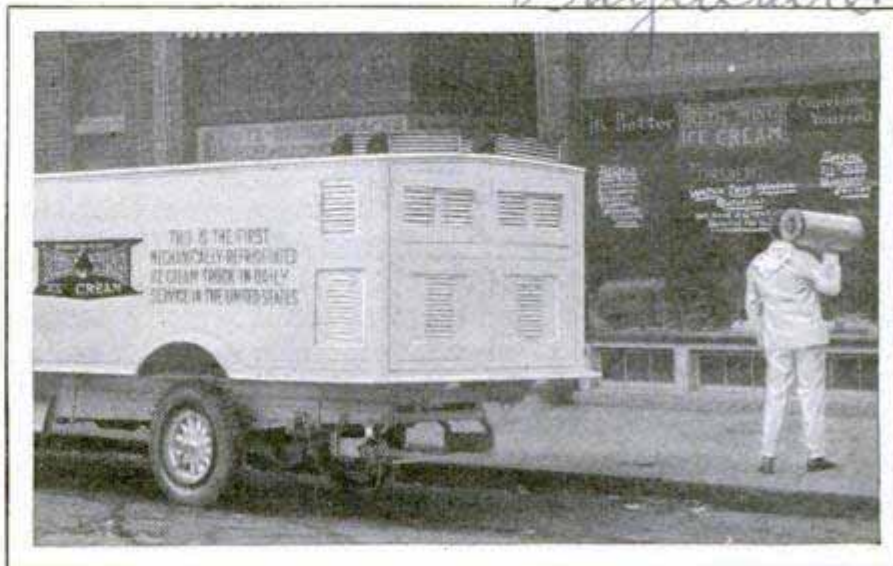

Ice-Cream Delivery Truck with Own Refrigerating Plant

*Used by Red Wing Corp*

*2187  
Delco Light Plant*

2394

# SPRING WHEEL TO END AUTOISTS' TIRE TROUBLES

*Chicago*

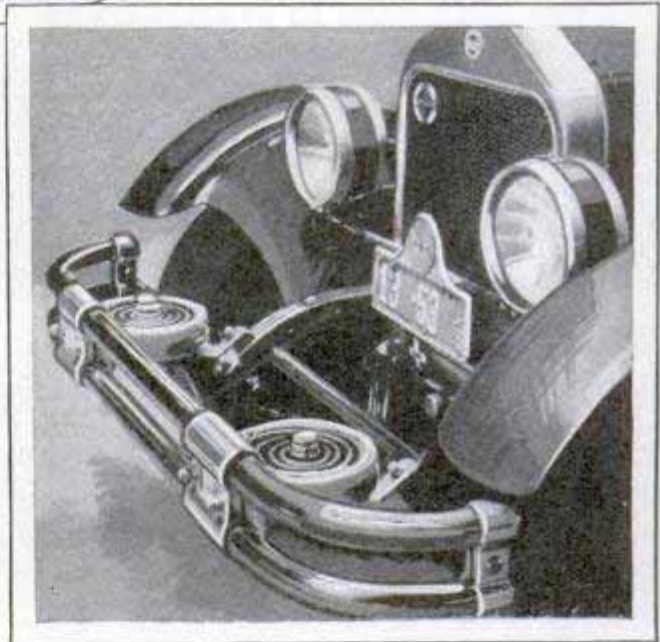
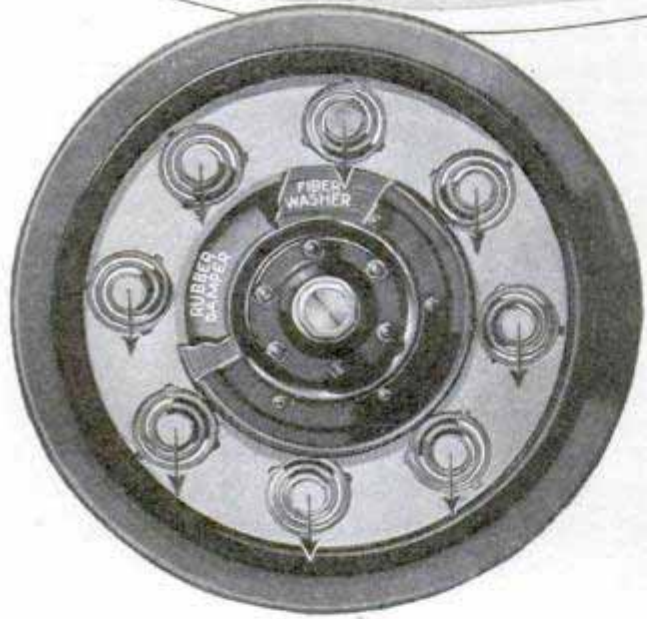
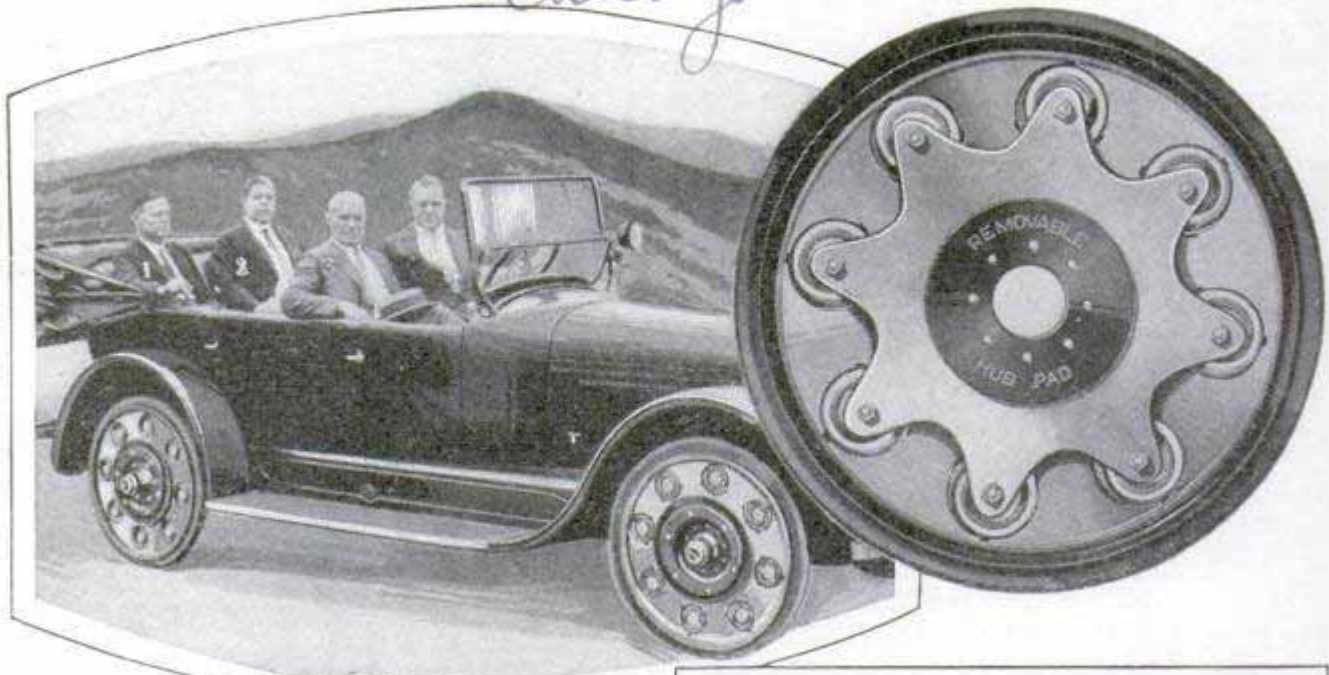

Car Equipped with Spring Wheels, and Another with Spring Bumper; the Inserts Show, Top, the "Spider" Which Distributes the Load to the Springs, and, Bottom, the Outer Side

A spring wheel which permits use of hard-rubber tires even at speeds of seventy miles an hour without excessive road shocks has been developed by a Chicago inventor, who believes it not only will end tire-repair troubles, but reduce the cost of tires through longer life and less material and labor consumed in manufacture. Called by the maker the "resilient wheel," it employs eight flat spiral springs to support the load, the center of each spring being attached to an arm of a cast-metal "spider" which revolves about the hub, where it is cushioned by a heavy rubber pad built into the wheel. Because of its

peculiar construction, the wheel produces an entirely new effect—the load revolving while the wheel rolls forward, due to the fact that the load is carried near the rim, by the springs, instead of in the center of the wheel. Ordinary wheels, unless perfectly balanced, produce increasing vibrations as the speed increases. The spring wheel, however, when it reaches its critical high speed, actually carries the load at a higher point than at low speed, for the springs have a tendency to establish a common center, in doing which they lift the load, and thereby overcome gravity. A similar bumper is also being made.

### CABLE LINES TO CARRY MAILS IN PLACE OF AIRPLANES

As a substitute for airplanes in carrying mails, an eastern engineer has suggested the use of long, slim containers, moving at high speed on an overhead cable suspended between high towers. They would be driven by motors or propellers and might be operated either with or without a pilot. It is estimated that this method would be more economical, faster and less hazardous as well as more regular.

### TEST DRIVERS' STEERING SKILL WITH PERFORATED TAPE

Candidates for automobile drivers' licenses are given numerous tests in Germany, one of them being a trial to determine how skillful they are at steering. A perforated tape is rotated past a marker attached to an automobile steering wheel. The objective of the subject taking the test is to avoid striking the perforations which represent obstacles in an actual road. Turning with the wheel, as the tape passes, the marker leaves an actual record of the candidate's solution of the obstacle problem. A rating is given on the basis of the accuracy shown by the candidates.

Perforated Tape Apparatus for Testing Auto Drivers; Marker Is to Be Steered around the Holes

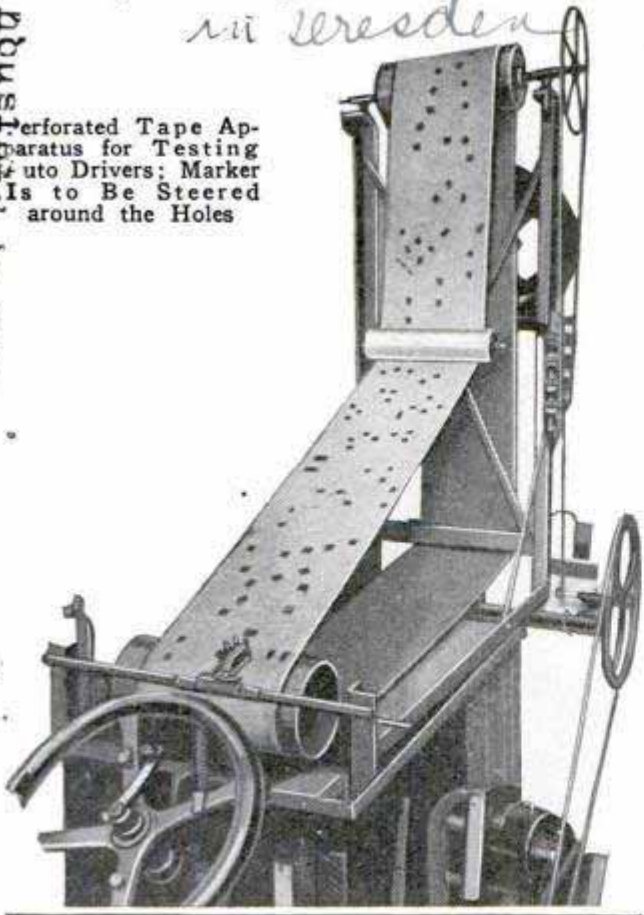

Making Up with the Help of an Air Brush; Applying Whitening to Hide Sunburn on Actress' Arms

### AIR BRUSH IN MAKE-UP SOLVES MOVIE PROBLEM

Extensive alterations in costumes-sometimes have to be made in the motion-picture studios to hide the effects of sunburn. This will no longer be necessary, in the opinion of an inventor who has prepared a flesh-tint spray which is applied to the skin with a compressed-air outfit. An even coating is easily administered and the material is said to cover the darkest shade of burn effectively.

### FOSSILS FOUND IN RIVER BED

It will be necessary to change the course of the Kansas river, at Topeka, to uncover a bed of fossil remains believed to underlie the water, in the opinion of engineers. Three huge fossil teeth have been dredged up by sand companies, two of mastodons and one of a mammoth. Each of the mastodon teeth weighed ten pounds, was seven inches long, four inches wide and three inches high. Other fossil bones have been recovered from time to time.

*Letter ret'd*

*Frank Martin, Hollywood Calif.*  
*24-47*  
*Comdr. Richard Alden*  
*Swallow, 1138, 4th St*

*nickel plated or burnished aluminum spiral with nickel plated or burnished aluminum*

210  
2/80

1350 E. Jefferson Ave  
Detroit, Mich

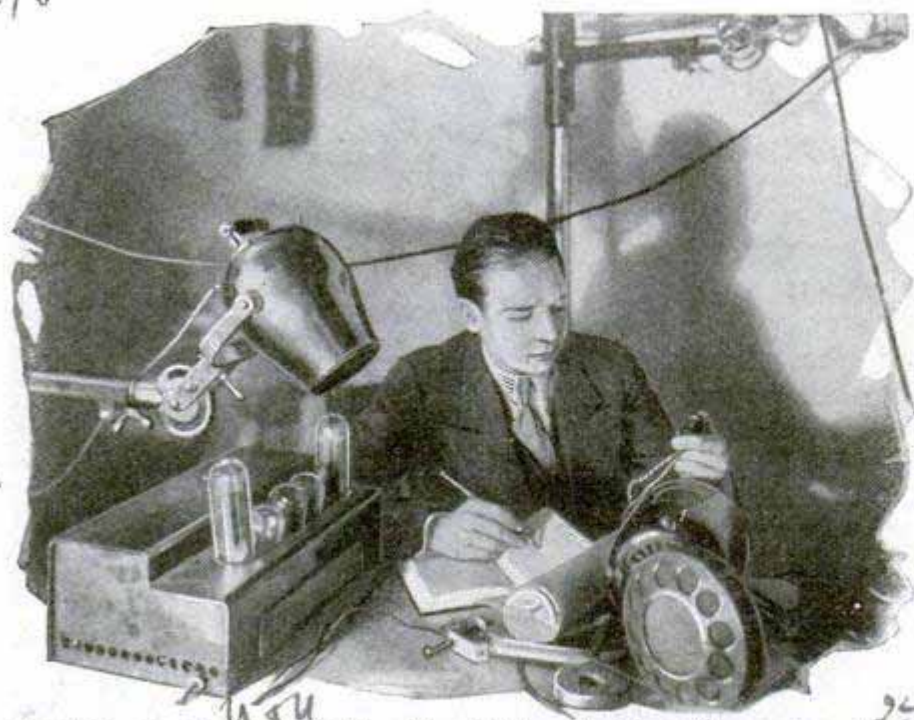

Pondering the Problem of Using Sound Waves to Treat Illness; Inventor with Radio Apparatus Used in Tests

**HARNESS MUSIC SOUND WAVES TO RELIEVE ILLNESS**

Instruments to utilize more effectively the healing power of music have been designed by a concert pianist and a scientific investigator. With their apparatus, the long or audio waves are imposed on rays that penetrate the body, resulting in vibrations which are said to be of great benefit in relieving nervousness, depression and other ills.

**STRENGTH OF AIRSHIP GIRDER TESTED BY SQUEEZING**

How much strain can an airship girder stand? The question is important in building big dirigibles, for costly experience has shown that the duralumin units are sometimes subjected to stresses beyond their strength and disaster follows. Investigators at the bureau of standards have a special apparatus by which

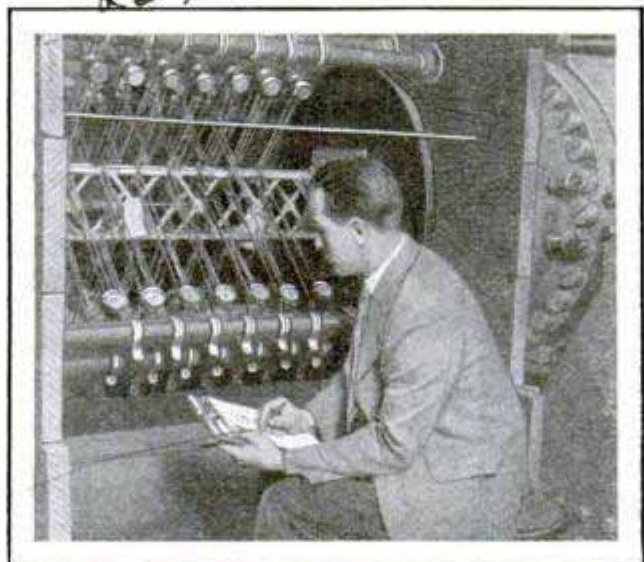

Reading Gauges That Tell Where Duralumin Girder Is Weakening; Piece Being Squeezed by Big Plunger

the parts are given rigid tests, while observers record the performance. The part to be examined is placed in front of a powerful plunger which slowly presses against it, while as many as eighty-five micrometers, connected to the girder, register the slightest reaction to the strain. The test gives a good indication as to how the part would perform in actual service.

**ROCK FOUND IN BED LEADS TO BETTER SPARK PLUGS**

Because a prospector who was sleeping out doors in the mountains of Mono county, Calif., felt a stony lump in his bed, our spark plugs are now better than they used to be. The chance occurrence disclosed to Dr. Joseph A. Jeffery, of Detroit, the only known deposit of sillimanite in the world. During the war, the government felt the need of better spark plugs. A porcelain core was desired that was stronger that had a higher electrical resistance at high temperatures and a greater heat conductivity. Certain spark plugs exhibiting these desirable characteristics were tested and it was found they were better because the cores were composed of sillimanite crystals. However, such great heat was

required to produce this sillimanite artificially that it looked doubtful as a commercial venture. Then a search began for a supply of sillimanite that had been produced in nature's own laboratory. Some specimens were traced to South Dakota and Dr. Jeffery began his geological "detective work" by prospecting there. Again the sub-

Huston Ray

Richard, Mich

2448

Butler 8525

2273

Champion Porcelain

Ray

C. D. Fitchison, Asst. Mechanical Engineer



Courtesy The Pullman Company

Dining Room in the Mexican Presidential Train of Five Cars Recently Built in America; There Are Seats for Fourteen Persons; Special Silverware Was Made for the Car

stance was found only in scattered crystals, located as small pockets in other rocks. His next search was based on a "hunch." If there was any sillimanite, he reasoned, it would be found in regions where great natural convulsions had taken place. He decided that the Inyo mountains in California had come through about the greatest volcanic disturbances. Two prospecting trips in this range merely yielded more of those exasperating little specimens. On the third trip came the episode of the rock in the bed which proved to be sillimanite. Being on a rocky shelf, the chunk must have fallen there from higher up, Dr. Jeffery reasoned. Behind the prospectors loomed a perpendicular cliff 14,250 feet high. One section of this cliff seemed to be more blue than the rest of it. Investigation revealed a deposit of several million tons of the ore.

### TRAIN FOR MEXICAN PRESIDENT HAS MANY LUXURIES

One of the most luxurious trains ever produced was built recently for President Calles of the Republic of Mexico. It cost more than \$500,000 and consists of five steel cars, one for the president's personal use, a dining and smoking car, staff car, escort's car and a special automobile car with space for four machines. The interior decorations and furnishings reflect details representative of Mexican art from Aztec days to the present time, and were chosen to harmonize with the furnishings in the president's palace in Mexico City. Fourteen persons can be seated about the two telescoping walnut tables in the dining car.

☞ Sound and images have been transmitted on the same radio wavelength.

2150

# Where *the* WEST

Little Eagle, One of the Indian Riders on Miller Brothers' Ranch

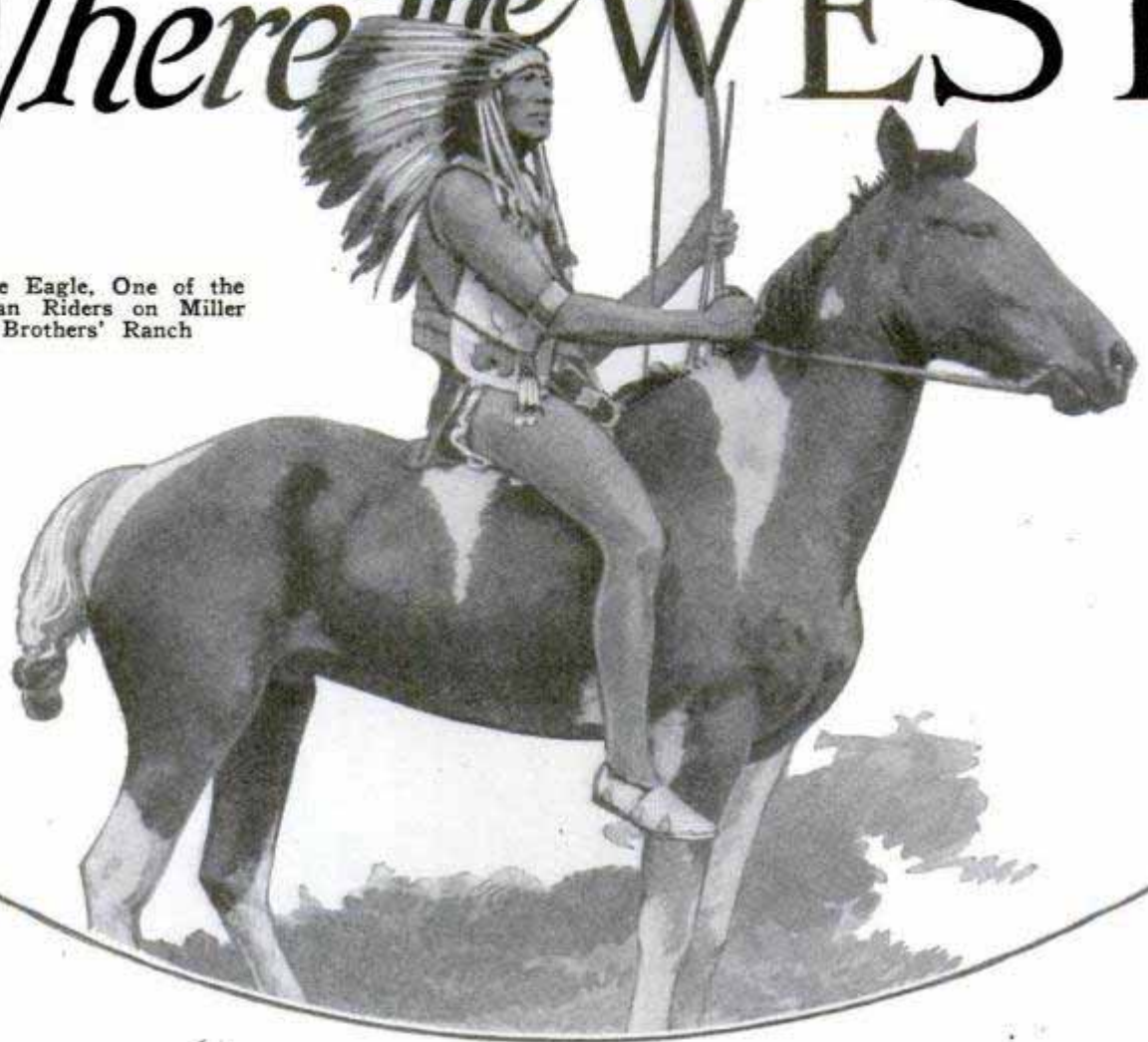

*Miller Brothers' Ranch.*

ON the "101 Ranch," near Ponca City, Okla., the largest food-producing establishment of its kind in the world, you can ride in a few moments from the progressive present to the scenes of the remote pioneering period, for this 110,000-acre project, in addition to fostering modern scientific farming, also preserves the practices and traditions of cowboy days.

Superlatives are drained of their descriptive resources when one visits and attempts to tell about this last of the huge ranches which once speckled western America's map. In all creation, from one end of the earth to another, a counterpart of this vast empire of stock raising, crop growing, fruit production and specialized farming cannot be found.

The largest herd of purebred Duroc Jersey hogs in the world, the biggest herds of registered Holstein and Shorthorn cattle in America, the most extensive band of buffalo under private ownership, the only herd of "cattalo," a new breed of drouth-

resisting cattle, one of the largest apple orchards west of the Mississippi, new types and varieties of corn, barley-rye, pecans, peaches, plums, apples, grapes and other fruits—these are but a few of the various outstanding accomplishments of this Oklahoma ranch.

Col. George W. Miller, a native Kentuckian, deserted the Bluegrass country in 1872 in order to seek a stock-farming fortune in the primitive southwest. Eventually he settled in Oklahoma and leased grazing land from the government for from two to five cents an acre. In the course of time, he became friendly with the Cherokee, Ponca and Otoe Indians, and from then to now, the Millers have annually rented large tracts of grazing land from the redskins. At one time, Col. Miller rented 250,000 acres of Indian land.

When Col. Miller died twenty-four years ago, the ranch covered 110,000 acres, one-half of the property being owned by the Millers. His three sons have managed the



# is Still WILD



An Old-Fashioned "Chuck-Wagon" Still in Use, and a Group of Cowboys Out on a Cattle Roundup on the Vast Miller Range, Where the Old West Is Kept Alive

ranch during recent years, and, fulfilling their father's wishes, have developed it into the finest farming enterprise of its kind. Some years ago, oil was discovered on the property and at present more than 150 wells are in operation, yielding from \$20,000 to \$25,000 in oil daily.

The Miller ranch since its inception has been a training school for cowboys and cowgirls. A rodeo and roundup, one of the big events of the cowpunchers' calendar, is held annually at this ranch which attracts thousands of visitors from all parts of the country and which ranks in the same class with the famous frontier entertainments that take place at Cheyenne and Pendleton.

Three thousand of the best breeding Duroc Jersey swine which money can buy compose the champion hog herd which specializes in the production of valuable parent stock for new stock. In addition, more than 15,000 hogs as well as 20,000 Texas cattle are fattened annually and butchered in the large packing plant which is an important part of the equipment.

The herd of 500 Holstein cows is without equal from the Atlantic to the Pa-

cific, butter and ice cream being the dairy products which are sold, while the skim milk is fed to the hogs. The cows are milked by electricity and the dairy is provided with the most modern labor-saving machinery.

A breeding herd of 2,000 registered Herefords and 3,000 purebred Shorthorns is providing foundation stock which is doing much to improve the cattle of the southwestern states.

The 160-acre apple orchard is the largest in Oklahoma, and last year produced 40,000 bushels of top-quality fruit, all of which was sold directly through the large store on the ranch. Peaches, plums, cherries and other fruits also are produced on an extensive scale.

It is not uncommon for the Miller wheat crop to aggregate 100,000 bushels, the elevators at the ranch being large enough to accommodate the maximum crop of bread grain which can be raised. Ten thousand acres of corn provide feed for the enormous herds and flocks and produce a marketable surplus. Last year, 90,000 bushels of fine seed corn were distributed throughout the southwest. This

2150

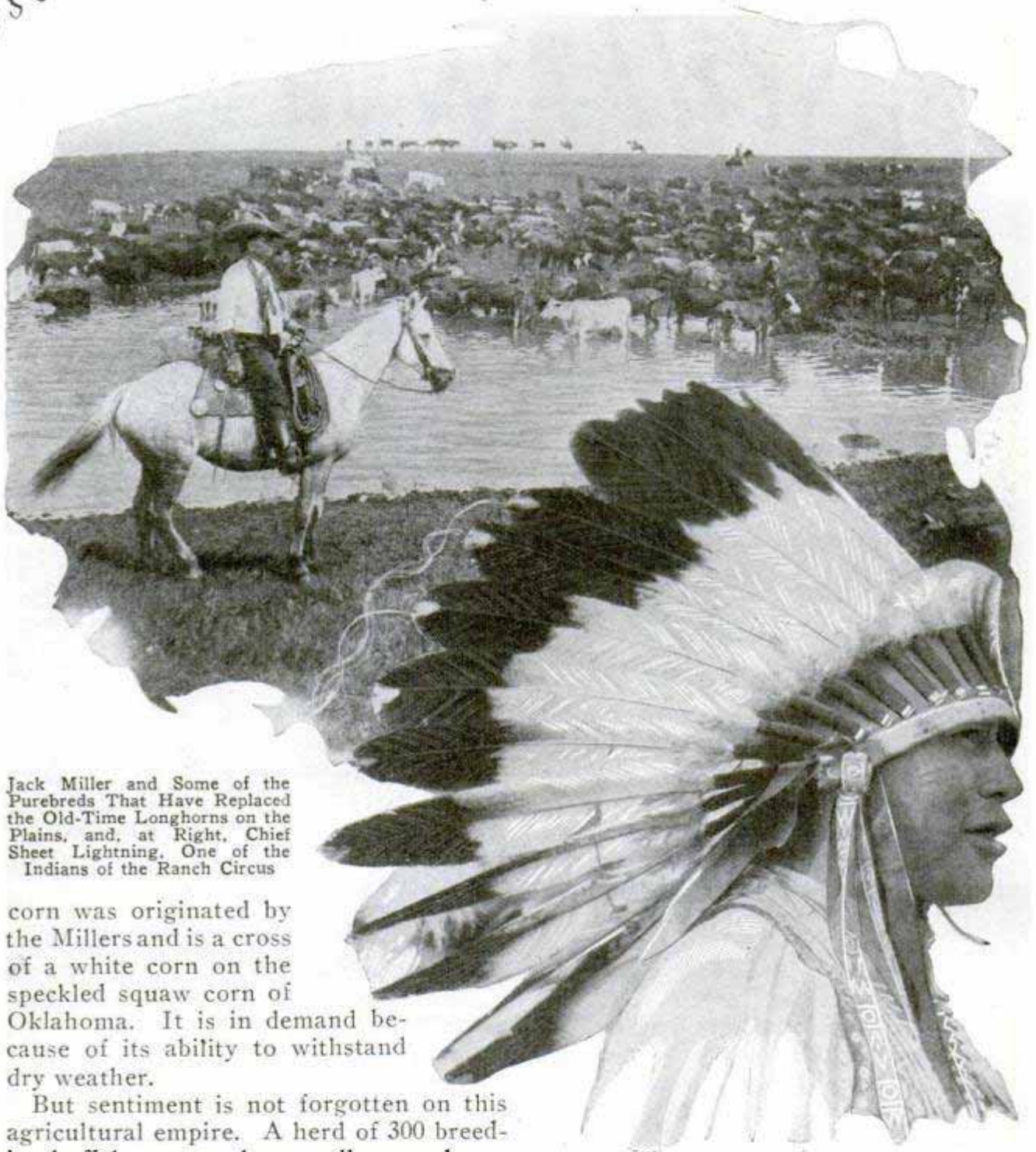

Jack Miller and Some of the Purebreds That Have Replaced the Old-Time Longhorns on the Plains, and, at Right, Chief Sheet Lightning, One of the Indians of the Ranch Circus

corn was originated by the Millers and is a cross of a white corn on the speckled squaw corn of Oklahoma. It is in demand because of its ability to withstand dry weather.

But sentiment is not forgotten on this agricultural empire. A herd of 300 breeding buffalo roams a large well-grassed pasture. It is a heaven and haven for buffalo multiplication. For many years the Miller boys besought Uncle Sam to protect the remnant bison from extinction. The government took no action and finally the Millers established a buffalo preserve of their own where they have provided ideal conditions for the band of bison to live and increase. The surplus buffalo are used for educational and exhibition purposes, and are sold to zoological gardens, public parks, museums, sideshows and circuses.

Scientific farming is in profitable part-

nership with practical agriculture in Kay, Noble and Pawnee counties, Oklahoma, where the 200 miles of Miller fences are stretched. These sons of the cow country, who possess sheepskins from prominent colleges, have hired science to solve some of their riddles. As a result they have developed a combination barley-rye which provides the best of winter pasturage. They have produced a new breed of beefsteak makers by crossing buffalo with ordinary range cows. A herd of 300 of these animals, called "cattalo," is now main-



Two of the Hundred Cowboys Gathered by the Millers to Work Their Ranch and Keep the Old West Alive by Carrying on the Work Started by Col. William (Buffalo Bill) Cody

tained at the ranch. They have also been successful in crossing the Big Brahma, the sacred cattle of India, with Oklahoma cows, thus producing the most drouth-resistant cattle known.

Skill with grafting tools and proficiency in horticultural art have enabled them to graft a Japanese persimmon on the Oklahoma native, the paper-shelled pecan on the Oklahoma variety and finer-quality peaches, plums, grapes and apples on the local varieties. Similar scientific skill has been harnessed to improve the native vegetables and truck crops.

From the covered grandstand, which seats 20,000 spectators, to the special oil refinery, huge blacksmith shop and marble-columned mansion, the ranch is as interesting as a six-ring circus. A 200-horsepower electric engine, which runs by nat-

ural gas, is used in making all the lubricating oil for the fleets of trucks, tractors, gasoline engines and automobiles. Machine power has replaced handwork wherever possible on this huge establishment. It is one farm, at least, which operates on a factory scheme and scale.

**ARTIFICIAL LEATHER IS MADE FROM SCRAPS** 2490

Leather waste, or scraps, is now being shredded and prepared into a paste which is rolled into sheets. To the paste, is added fibrous substances such as hemp, flax, jute, wood and cementing material such as animal or vegetable glue. The product is usually dyed and, as it is easily ornamented or embossed, is especially suited for wall coverings and upholstery.

*Emb. Co. of Wash. D.C. Chicago  
57946 Grandview Ave.  
A. Woodrow & Co. Ltd  
London England.*



off with black paint so that it hid the top of the stage, where the lights came from, and gave the impression of a dark night with plenty of sky. For a day scene, the black mask was painted over with fleecy clouds. In the case of snow-country pictures, the custom now is to take a short location trip to film long shots and then return to the studio and film all the action in medium shots and close-ups.

2462

### FUMELESS HORSERADISH GRATER

Preparing horseradish "without shedding tears" is now possible with a power-driven grater that removes the fumes before they can spread. This is accomplished by the centrifugal force of the rapidly revolving cylinder that does the grating, no fan being needed. Air and odors are discharged at the rate of 150 cubic feet per minute into a pipe leading outside the building. As the horseradish is ground, it falls into a crock of vinegar, saving the trouble of scooping it from a receiving bin. The grater is made entirely of metal and is intended for preparing large quantities.



23370

\$2.00

Trying to Force the Plate into the Socket and Enjoying the Task; Below, Position for Two "Players"

### WRISTS AND ARMS DEVELOPED WITH SPRING GRIPPER

Helpful exercise for the hands, wrists and arms is afforded by a compact unit recently introduced for the home or gymnasium. It consists of a small cylinder, into the top of which a movable plate is to be forced by means of a handle. To do this, a spring must be depressed and considerable strength and steadiness are required, although the task may be made as easy as the user desires by regulating a screw at the bottom of the cylinder. The gripper, with the exception of the cover on the handle, is made of metal that will not rust, and it is intended to last a long time under constant use. Two persons can operate it at the same time, enjoying a contest and game together.

### OLD STUMP AS GIANT UMBRELLA SHELTERS GARDEN SEAT

2060

Instead of removing an old tree, which would have spoiled the appearance of his garden, a California man built a rustic seat about the base and converted the top into



Tree Umbrella Fashioned from an Old Stump for Shelter over Garden Bench

a wide shelter. The result was a natural "umbrella" of very attractive form.

### VIOLIN BOW HAS BALL BEARINGS FOR EASIER TIGHTENING

2439

Children sometimes have difficulty in tightening the hair on violin bows, and adults often experience trouble with cello and bass bows. To eliminate this, a western inventor has introduced a bow with a ball-bearing screw. There are eleven steel balls, each one-sixteenth of an inch in diameter, to permit easy turning of the tightening unit.

Philip E. Anderson

Carl H. Harrington 2122 Ashby Ave

2420 Suite 1100, 72 W. Adams Chicago POPULAR MECHANICS

DANGER IN "GASSING" MOTOR BUS REDUCED BY GROUNDING

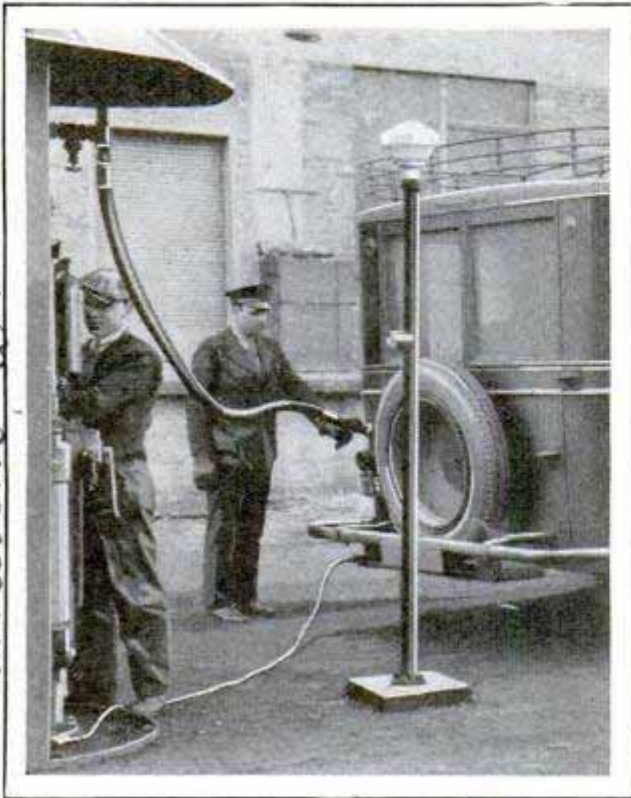

Filling Gasoline Tank on Motor Bus in Safety; Note Cable at Bottom, Making Ground Connection

Filling the gasoline tank on automobile coaches presents a hazard under some conditions, as a spark, occurring between the nozzle of the hose and the tank, may cause a fire or explosion. To eliminate this risk, a western company has devised a means of grounding the car while the tank is being filled so that any static present is carried off. A cable is installed at the gasoline pump, grounded to a water pipe at one end and fitted with a plug at the other. Each coach has a porcelain receptacle, connected by cable to the frame and forming the ground for the entire electrical system of the coach. Before gasoline is pumped in, the operator inserts the plug into the porcelain socket, thereby grounding any static charge that may have accumulated. Where special connections are not provided, a substitute is furnished by grounding the tank to a pipe through

a chain before starting to fill the tank. This plan is not so efficient as the other, but establishes a fair degree of safety.

2443

BUTTERFLIES SAVE WALNUTS

How a recent flight of the "painted lady" butterfly through southern California helped the walnut crop there, is one of the odd adjustments in nature. The insects laid numberless eggs on weeds with the result that the grubs, when hatched, became parasites that attacked the eggs of the codling moth, one of the greatest enemies of the walnut. More than fifty per cent of the moth eggs were attacked by the parasites, it was estimated, to the great benefit of the new walnut crop.

Handwritten note: "Curt. H. Helling's yard 168 Marlborough St Boston Mass"

AIR TRAIN OF PLANE AND GLIDER IN SUCCESSFUL TEST

2230

Enter the train of the air. A big plane glides over a city. In its wake, a row of gliders, connected to each other and to the "locomotive" plane by slender wires. The last glider drops away and skims gently down to a landing field. The rest proceed. The picture suggests a fanciful idea, but recent successful tests in Germany indicate that it may become a reality. The experiment was performed with one glider connected to an airplane by a wire nearly 1,000 feet long. By means of an automatic release, the pilot of the glider cut loose when ready and achieved a separate landing while the plane proceeded.



Glider Used as "Car" behind Airplane in Recent German Test; It Was Detached and Made an Independent Landing with Occupant

Handwritten note: "(Raab. Katzenstein Airplane Works near...)"

Vertical handwritten note: "Wisconsin Light Co. Madison Wis"

national Bank Bldg.  
Washington, D C

# The Mystery of UNBEARABLE COLD



The World's Loftiest Observatory on Monte Rosa, Second Highest Peak in the Alps and 15,000 Feet above Sea Level, Where Perpetual Snow Gives Records of Extreme Cold the Year Around

**W**HETHER any form of life can exist at absolute zero—the point where cold reaches its ultimate limit, as it is believed to do in outer space far beyond the earth's atmosphere—may soon be known. For a scientific laboratory at Leyden, Netherlands, has recently brought cold within one degree of its final limit by solidifying a sample of helium gas received from the United States.

Absolute zero long ago was fixed by intricate calculation at 459.6 degrees below the zero on a Fahrenheit thermometer scale. No one has ever actually produced such a temperature, but the Dutch experiment came within a degree of it, which is twenty-one degrees lower than the record previously made in the United States by the liquefying of hydrogen gas.

At the farthest limit of cold, the movement of atoms which is a part of the creation of various substances ceases and strange phenomena begin to appear. The late Prof. Kamerlingh Onnes, who first reduced helium to a liquid, which occurs at about eight degrees above absolute zero,

or seven degrees above the freezing point of the gas, discovered that all the accepted ideas of electrical resistance were upset there. Metals which because of their high resistance are poor conductors became excellent ones when placed in a bath of liquid helium. A ring of pure lead cooled to that temperature was used in one experiment, and after the current supply had been connected to it and a charge of electricity started traveling around the ring the wires were removed, yet the electricity kept right on going round and round the lead path as long as the ring was kept cold. For six hours the test continued, and it was estimated that, if helium had been available to maintain the temperature, the current could have been kept flowing for at least two years.

Equipment for reproducing this and other experiments through the cooling of helium to its liquid and freezing points is being installed in the low-temperature laboratory of the bureau of standards at Washington. When work gets under way, the results may revolutionize many popu-

There is no reason for believing, however, according to Dr. C. W. Kanolt, of the low-temperature laboratory of the bureau of mines, that some form of life cannot exist at even the final limit in coldness. A fish, he points out, can be frozen and then revived again, provided the freezing and melting processes are carried out slowly enough not to damage the fish through abrupt changes. That being true, there is probably no obstacle to taking the frozen fish and gradually reducing its temperature to that of liquid or even frozen helium, and then as gradually bringing it back to life again.

Any sudden melting, however, would blow the fish to pieces from the strains set up by the expansion.

The production of unusually low temperatures in the laboratory does not differ from the process of making artificial ice out of water, except that better equipment, more delicate care, and the utmost refinement of mate-

Casting a Deep-Sea Thermometer into the Depths to Get Cold Records Miles beneath the Surface, Above, and a Sounding Balloon Starting Aloft to Test the Air

lar conceptions. The common idea of heat and cold as two different things has no place in science, for to the scientist there is only one unit of measurement—from absolute zero upward. Heat and cold are usually reckoned by our sense of touch rather than any scientific basis. Anything colder than blood temperature may be classed as cool, cold or colder, while anything with a higher temperature than that feels warm, warmer or hot, yet when compared to the temperatures attained in the laboratory our coldest cold is hot.

Once, in Siberia, the thermometer is reported to have gone down to ninety-two degrees below zero, and there is a record of sixty-five below zero in northern Montana. Compared with absolute zero, a mark of minus ninety-five Fahrenheit is much hotter than the difference between water at freezing and at the boiling point.



© Harris & Ewing

Testing Thermometers in an Ice Bath to Send the Mercury Down to Zero



1929

rials are necessary. A thousandth part of air in a quantity of hydrogen or helium to be liquefied would ruin the whole experiment, because air would freeze long before the gas was cooled and in freezing would clog the delicate expansion valve of the apparatus.

Like the making of artificial ice through the use of ammonia or other gases, the process is one of alternate compression with resultant heating, and expansion with the accompanying cooling. When air, or any other gas, is compressed in a confined space it contains a certain amount of heat which is distributed through the space it occupies. When the gas is suddenly allowed to expand in a much larger space, there is just so much heat to be spread through the entire space, with the result that the temperature drops enormously. In making liquid hydrogen—the coldest thing yet produced in the United States—the gas is compressed and then cooled in liquid air, which itself has a temperature so low that, if the finger touches it, the skin will be badly burned by the rush of heat from the hand to the air, just as a rush of heat from a hot iron to the hand raises a blister.

After being cooled by the liquid air to

a temperature far below zero, the compressed hydrogen is allowed to expand and spread what little heat it has left over a much larger space, which further reduces its temperature by many degrees. Then a second tank of compressed hydrogen, after first being cooled by liquid air, is cooled by the liquid hydrogen, and it in turn is allowed to expand, bringing a still further drop. The process may be carried on until the gas turns to liquid at twenty-two degrees above absolute zero. The same process, carried farther, will liquefy and eventually freeze helium.

The farther the process is carried, the shorter and more difficult the steps become, until eventually the reductions are so slight that it is useless to continue—at least without better equipment and purer materials.

Liquefied gases at such low temperatures are hard to handle. If a container of liquid or solid hydrogen is left open in a room, air will rush in and freeze as it strikes the hydrogen, settling to the bottom if the gas is a liquid. As the process continues, the hydrogen rises higher and higher, floating on top of the frozen air, and more and more hydrogen is turned into its gaseous state by heat absorbed from the air.

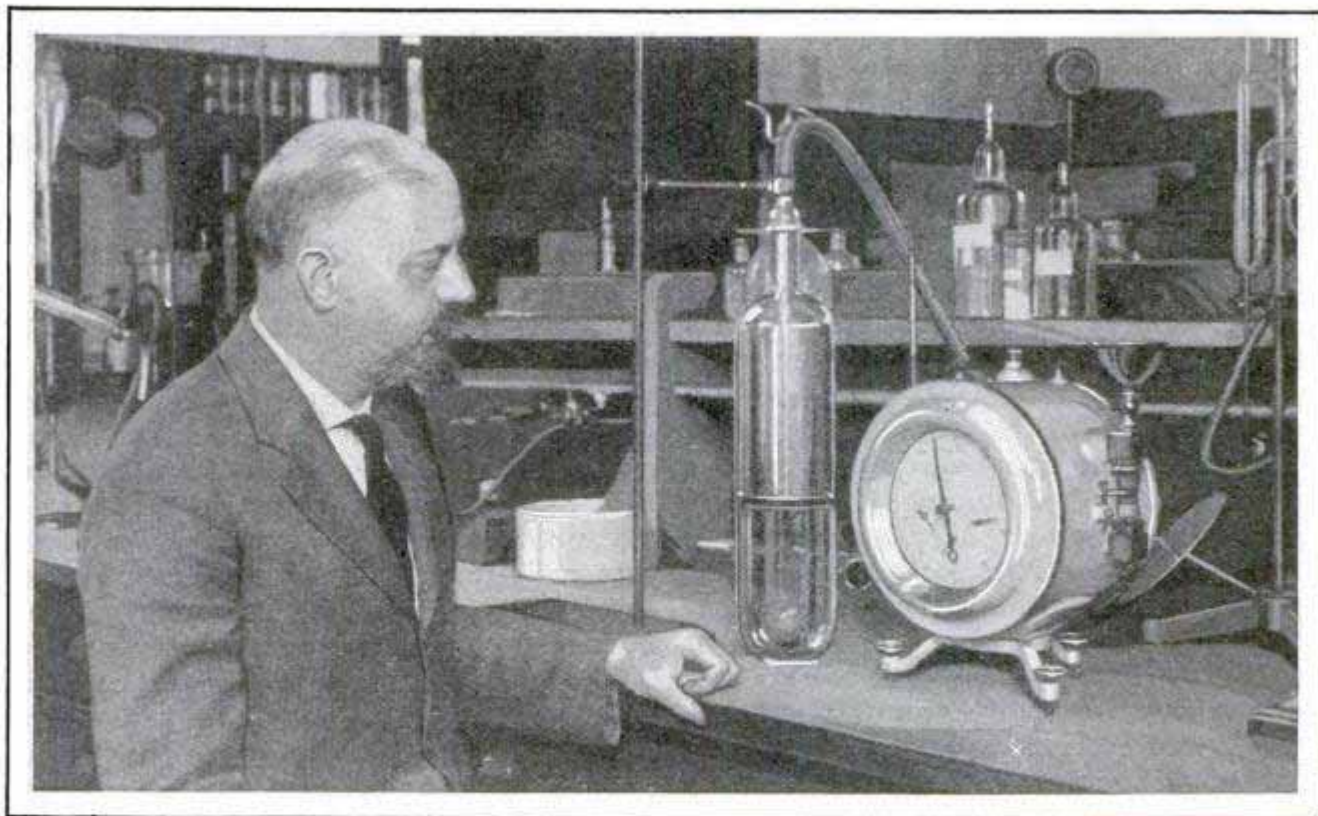

© Harris & Ewing

Dr. C. W. Kanolt, of the Low-Temperature Laboratory, Bureau of Mines, Who Produced the Lowest Temperature Ever Recorded in the U. S., within Twenty-Two Degrees of Absolute Zero

THIS MAN MAKES PROFESSION OF WINDING CLOCKS

222  
38  
c/o Edward J. Beck, 1350 E. Jefferson av. Detroit Mich.

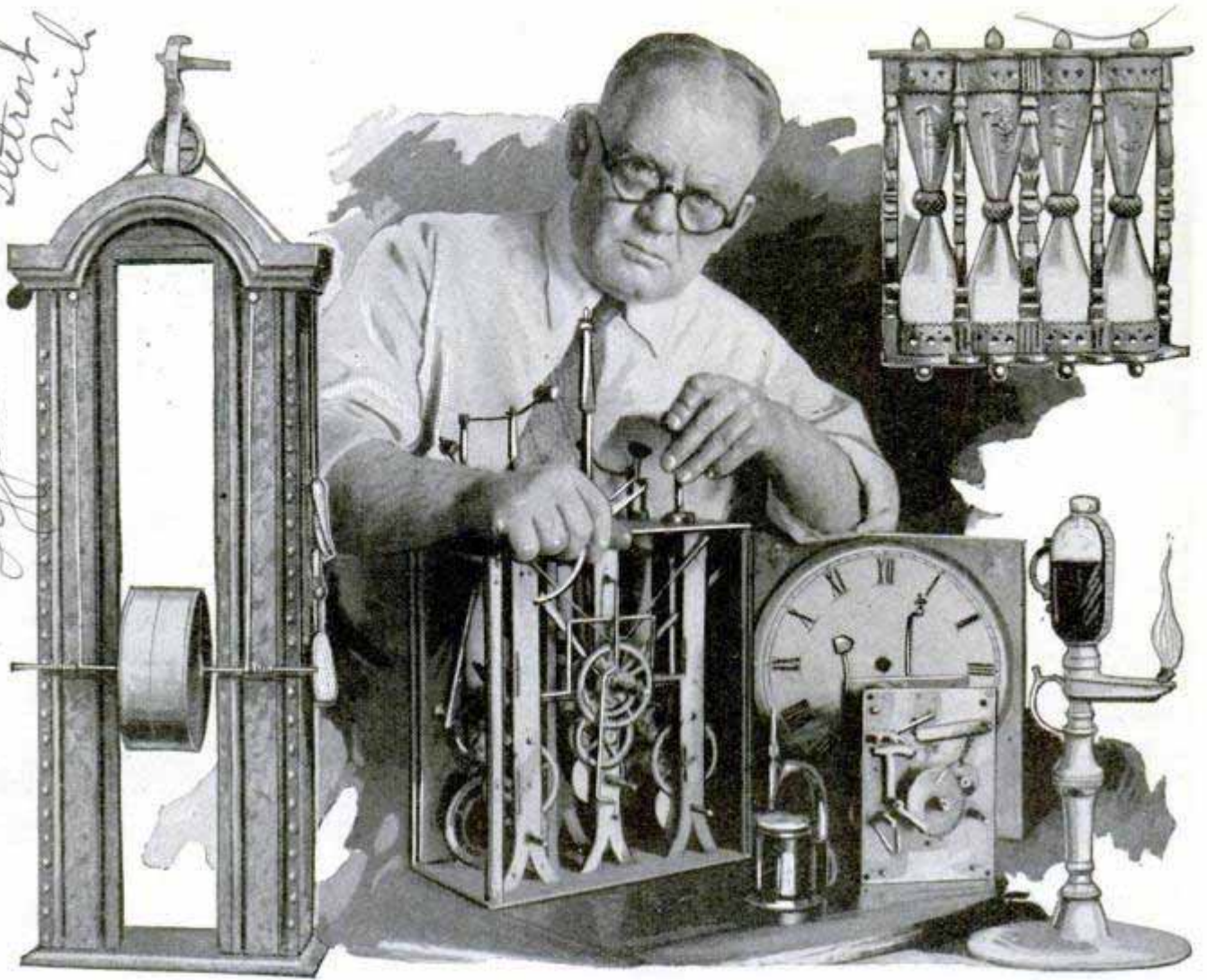

Mr. Schwarz and Old-Clock Specimens; at Left, an Instrument for Measuring Time by Flow of Water; Upper Right, Sand Glass, and, below It, Roman Lamp That Told Time by Oil Level

Horace Greeley Schwarz, of Detroit, has worked up an unusual business which gives him an income that many professional men might envy. He conducts a clock-winding service for private homes. Every week, on the appointed day, he appears at a client's home, passes from room to room where there are clocks and winds and adjusts them. Schwarz has divided his territory into four routes, each serving about twenty-five customers. He charges from \$60 to \$96 a year for his services. The homes he serves all have staffs of servants. Why is not the butler given the responsibility of winding the clocks? The answer is that Schwarz's clients all possess antique, musical or stately grandfather clocks that they do not want to take chances with.

"People expect more of a clock and give it less attention than almost any other piece of machinery," Schwarz said when asked for tips on how to treat a clock. "In

the first place, a clock should be wound regularly. If this is done, the power will be uniform and hence the timekeeping consistent. If winding is delayed past the regular period, a weaker portion of the spring is brought into play and hence the clock cannot run as accurately as it should.

"Temperature changes should be avoided as much as possible. A clock should not be placed near a hot stove or radiator one day and in a cooler spot at other times; or near a source of heat that varies as the steam is turned off or on. Clocks often stop when a room gets unusually cold and unexpectedly start, when it gets warm."

Cheap clocks that have stopped can often be "cleaned" or freed of the inside stickiness that impedes them by dipping in gasoline. Many housewives give silent clocks the "feather and kerosene can" treatment, like cure-all patent medicine. This often seems to correct the trouble. Kerosene

667 W. Hancock Ave.  
Detroit Mich.

will dissolve the dirt and gummy oil. To keep the dial from getting spotty, it is best to remove it during a dipping treatment.

Schwarz rather frowned on these methods for clocks that are valued at all. "Though gasoline and kerosene will cut thick gum," he said, "a film is always left. I always give clocks a cyanide treatment after that to remove the film. If you value your clock highly, don't monkey with it and try such cleaning. Only a clock shop has facilities to clean away the cleaner."

**FILMING OF COUNTY RECORDS SAVES TIME AND WORK**

Official records of court proceedings in King county, Washington, and other legal matters have been photographed on motion-picture film so that, in case the originals are destroyed, duplicates may quickly be obtained. The task required 1,200 reels, and involved 400,000 separate descriptions and 1,600,000 recorded instruments. The work was completed in about seven months. More than three and one-half years would have been needed to do it under old methods. The photographing was done in the vaults of the county auditor, and the projecting and indexing in a building especially fitted for the purpose. For the indexing, a battery of 100 projecting machines was used. The reels are of non-burning film and have been stored.

System invented by Carl E. Lundberg, manager of company



Making an Index of the Records from the Projected Negatives

Work done by King County Title Co,  
 1st Bldg. Second Floor

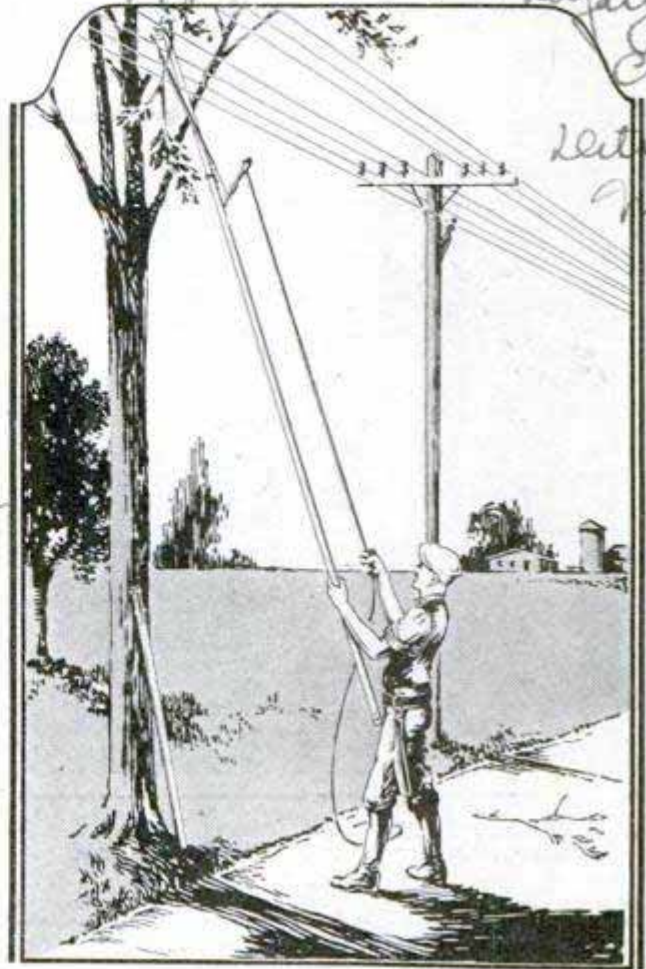

Working the Trimmer with the Rope Where Shock Might Be Received from Electric Wires

**TREE-TRIMMER IS INSULATED AGAINST ELECTRIC SHOCKS**

Keeping cut-away branches of trees from electric wires is a necessary but sometimes hazardous task, especially if the cables carry high voltages. To simplify this work, an insulated tree-trimmer has been devised. It is equipped with an insulator thirty inches long and capable of resisting 105,000 volts, the poles are made of shellac-treated spruce, and the lever that operates the cutting knife is pulled with a rope. The cutter will sever branches up to one and one-fourth inches in diameter, leaving a clean wound that is not likely to damage the tree. Extra sections provide for increasing the length of the pole.

1987 4288 Lafayette Ave Detroit Mich



Racer Wearing Mask Which Collects Expired Air So That the Energy Expended Can Be Measured

### ENERGY TESTS ON FOOT RACERS DEVELOP TRACK TEAM

How much horsepower is represented in the leap of a racer as he starts at the gun? How much speed does he gain in the first twenty yards? How soon does he begin to get tired? These and similar questions are answered by means of special apparatus which a British scientist has developed to aid coaches in training teams and to give the athlete a more definite idea of his own performance. One of the units employed is a mask arrangement which collects expired air so that measurements may be taken as to the amount of energy required for the race.

### SEEK TARNISH-PROOF SILVER

With a view to increasing the use of silver, the bureau of mines is conducting a series of experiments in an effort to find an alloy of the metal that will not tarnish. Although completely satisfactory results have not yet been attained, several kinds have been developed that will not tarnish as readily as sterling. Alloys of cadmium and silver, and zinc and silver are the most highly resistant to tarnish, but they have low tensile strength and therefore are not

suitable for most practical uses. Antimony or tin, added to a mixture of silver and zinc, produced good results, while the introduction of twenty per cent gold in an alloy containing fifteen or twenty per cent of zinc or cadmium, yielded a hard yet workable material that also resists tarnish.

### DOG HEROES OF WORLD WAR HONORED IN CEMETERY

Since the World war, numerous additions have been made to the graves in the pet cemetery at Hartsdale, N. Y. They mark the last resting places of dogs that belonged to various members of the A. E. F., some of whom owe their lives to the faithfulness of their canine pals. A monument at the entrance to the burying ground features the bronze figure of a police dog, and bears an inscription stating that the monument was "erected by public contribution by dog lovers to man's most faithful friend for the valiant services rendered in the World war, 1914 to 1918." Some stones at the head of the graves bear a photograph of the dog, and such epitaphs as "Good Old Pal," "True to the End," "Born a Gentleman—Died a Hero," are to be found. The cemetery was started in 1896. Besides dogs, many other pets are buried there, including monkeys, a lion, sheep and a canary bird.

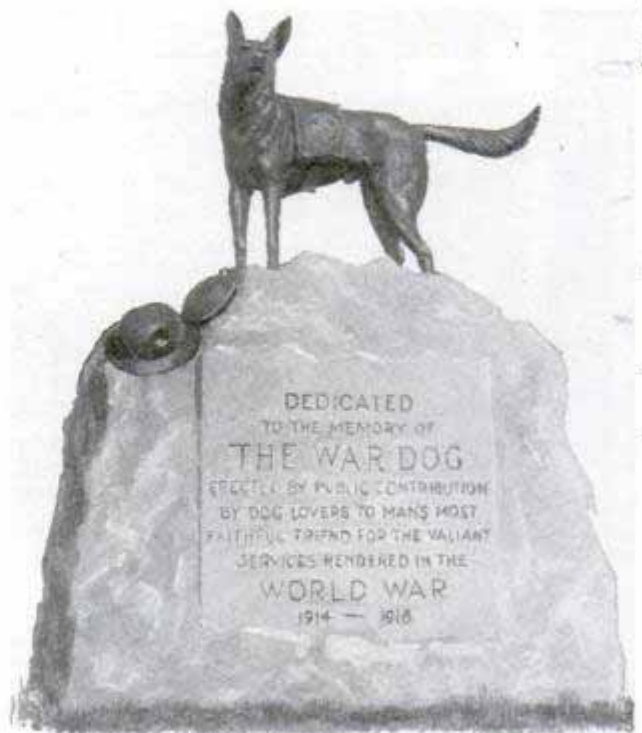

Monument in Honor of Dog Heroes of the World War; It Stands at Entrance to Pet Cemetery

Cemetery founded in  
1896 by Mrs. J. S.

Prof. A. V. Hill

243

2408

*Walker Esate Newcastle-on-Tyne*  
**SPLIT LIGHT ENDS GLARE DANGER IN SUEZ CANAL**  
*England*

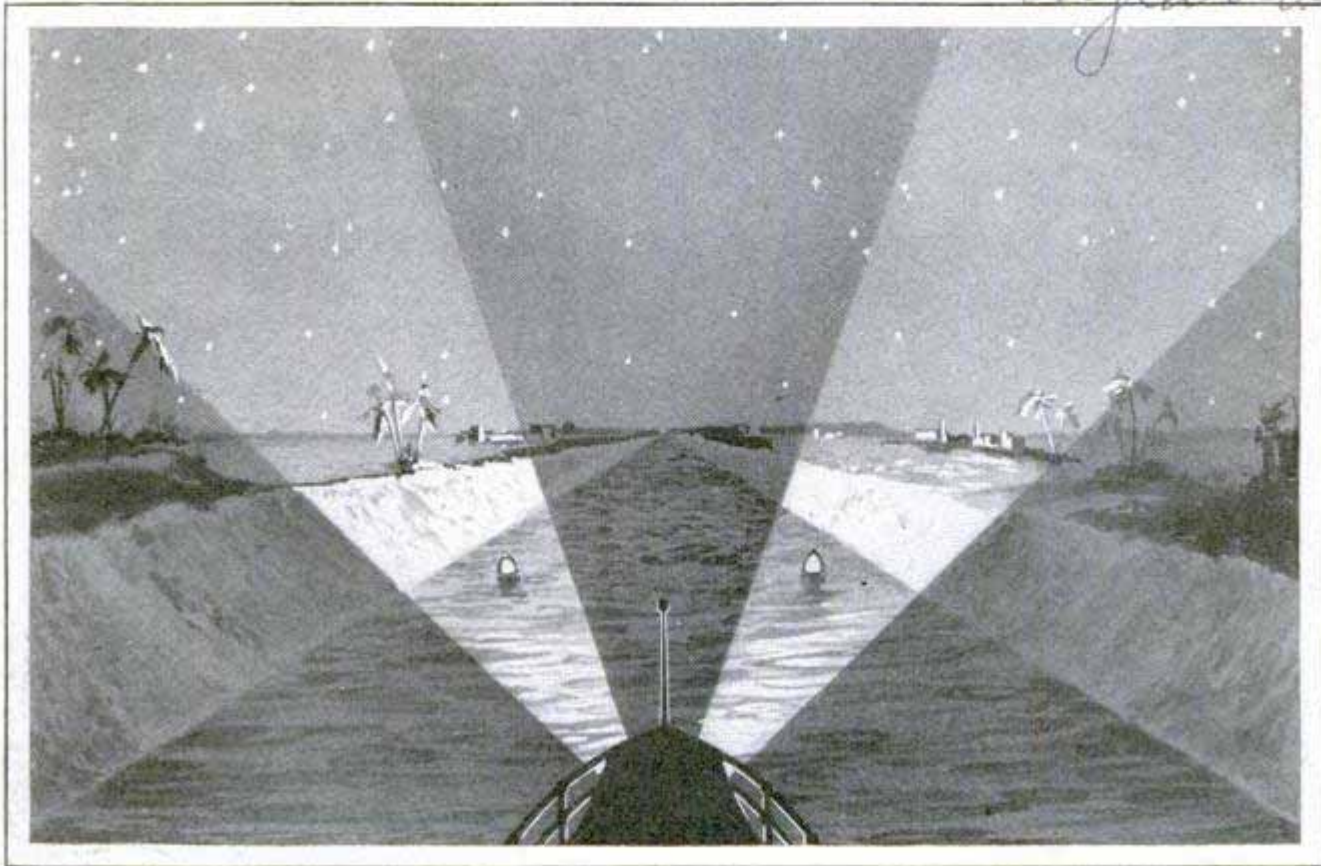

Illustrating the Effect of the "Split-Beam" Headlight for Boats on the Suez Canal, to Eliminate Glare in the Eyes of Approaching Pilots; Guide Buoys Are Plainly Visible

Boat traffic through the Suez canal at night involves lighting problems somewhat like those on automobile highways. The glare from one ship, shining into the eyes of an approaching pilot, has been found objectionable and a menace to safety, so a "split" reflector has been designed. It enables a passing boat to light up the buoys at the sides of the canal but eliminates the beam straight ahead, giving an oncoming navigator an unobstructed view.

enty-two feet long, burns a lighter grade of oil than others, develops high speed and is said to produce little more smoke than an automobile.

2040

**GAS-ELECTRIC RAILROAD TRAIN HAS SMALL CREW**

2470

Locomotive, passenger, baggage and mail cars are combined in one unit in a coach that is now in use on a western railroad. It generates its own power through an engine, burning a light fuel oil to drive generators that supply current to motors geared to the trucks. The cost of operation is said to be about one-third of that for an equivalent unit of steam train. The motor develops 275 horsepower, and is capable of pulling two or three trailer cars. It demands only two men, a conductor and motorman. The car is sev-

**GUN MOUNTED ON FLASHLIGHT GIVES DOUBLE PROTECTION**



\$9.75.

For household protection, for campers, watchmen, railway detectives and others, a combination flashlight and seven-shot revolver has been placed on the market. It directs a powerful beam for a distance of 300 feet and this helps in aiming the

weapon. The trigger that fires the pistol folds tight against the case when not in use, to prevent accidental discharge. The light switch is on the side, and pistol or flash may be used separately.

*Rock Island S. P. Cobrell & Son*  
*2811 Bailey Ave*

2258

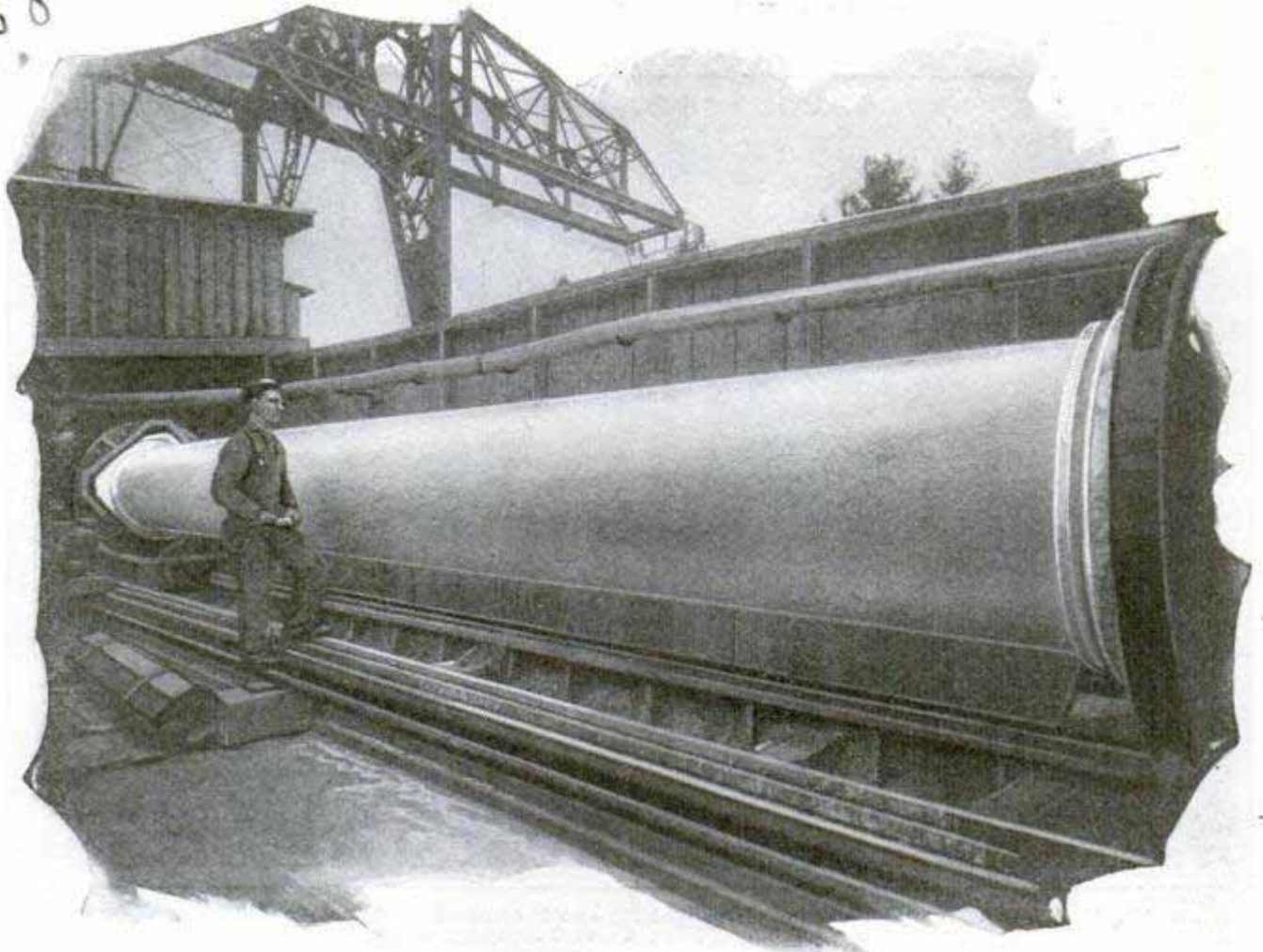

Turning a Marble Column, Thirty Feet Long and Four Feet in Diameter, in a Giant Lathe; Smooth Columns Are Often Made in One Piece, While Large Fluted Ones Are in Sections

## The Romance of Marble Cutting

### Age-Old Methods Still Used in Turning Out Slabs and Columns for Modern Building

By N. C. McCLOUD,

*1717 So Paul St  
Baltimore Md*

**I**F an ancient Egyptian could visit the Vermont or Georgia quarry regions he would find the marble workers cutting stone by the same primitive method that prevailed in the days of antiquity.

But the saw of the marble mill is not a saw in any sense of the word. Accurately described, the blade is a strip of soft iron, fastened in a frame, and moved back and forth along the channel that is being cut through the stone. The saw itself does no cutting. The actual work is performed by sharp particles of sand fed to the blade by a stream of water.

The saws work in "gangs" in a frame, and are set at intervals regulated by the thickness of the slabs to be cut. The use

of these saws dates back many centuries before the dawn of Christianity. There have been changes in the form of application, but modern engineering has discovered no effective substitute for the use of sand and water in the process of converting blocks of stone into slabs. Iron frames are employed for holding the blades, instead of the wooden holders of antiquity, and there has been marked increase in the number of saws placed in a single gang, but the method itself is unchanged. The first saws were moved to and fro by the hand of man; then came water power, steam and electricity.

The casual visitor will be amazed at the quantity of sand required for effective saw-

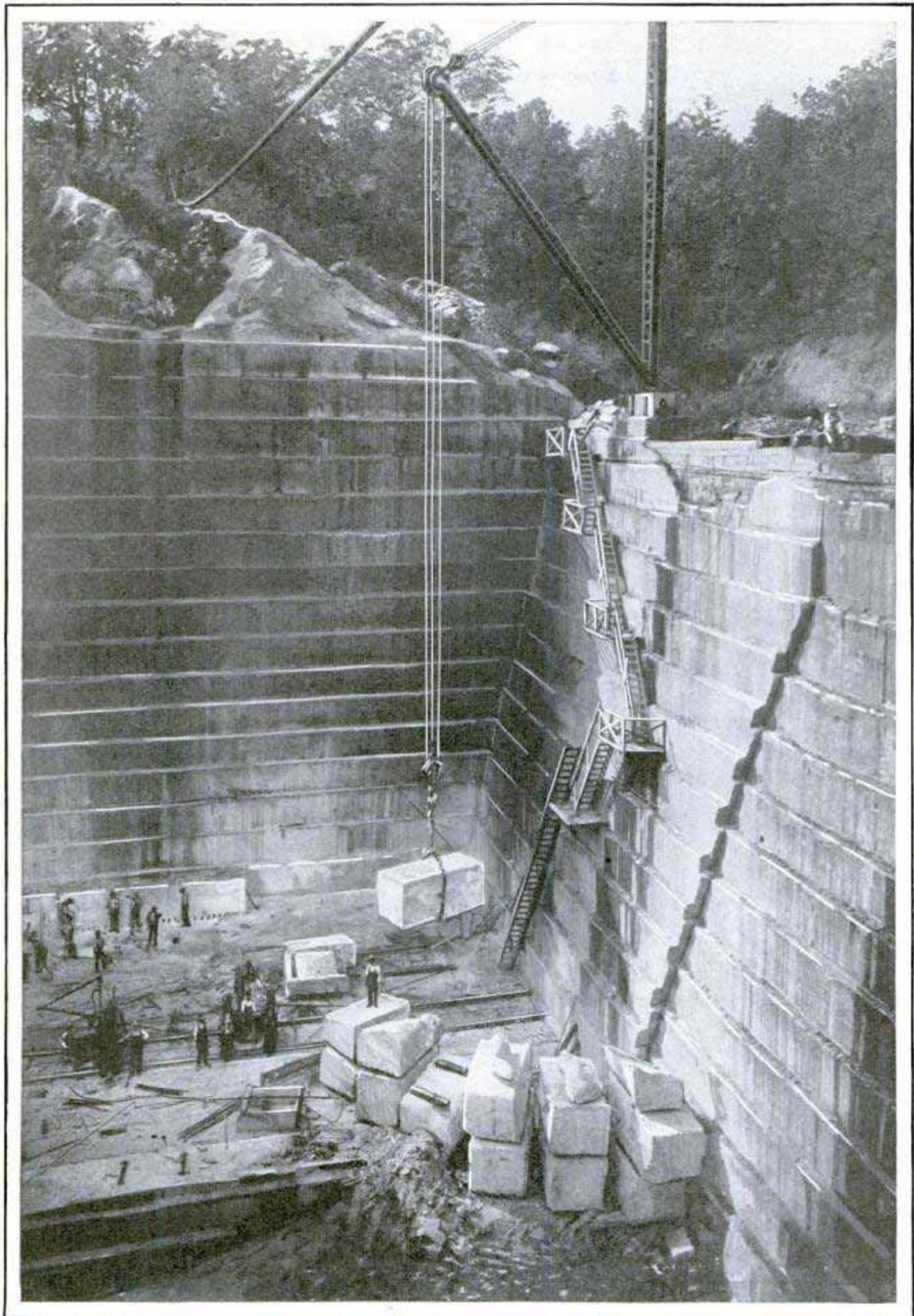

Courtesy Georgia Marble Co.

Modern Cutting Tools Saw Out the Huge Blocks of Marble as the Quarry Level Slowly Sinks, with Almost Perpendicular Sides, the Steps Too High for Climbing

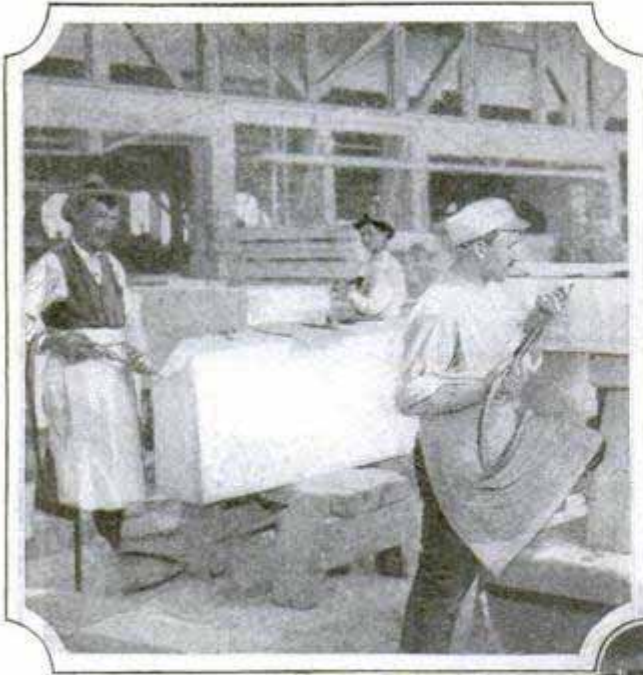

ing operations. For the general run of marble, the volume of abrasive runs close to the size of the block itself. With the harder varieties of stone the weight of the sand is even greater. Marble is sawed at a rate of one and a half to two inches an hour. Hard stone yields less readily. Once started, however, the blades move back and forth twenty-four hours a day until the largest block has been separated.

As received from the quarry, the original blocks vary in size, according to the use for which the stone is intended. The most common dimensions, perhaps, are six by four by four feet, with a weight of several tons.

In the early days of the American industry, the first steps in opening a quarry involved the use of drills and blasting powder, for uncovering the deposits of marble lying beneath the surface. The stone uncovered by the blasts was then split off in great chunks by means of blasting and the use of steel wedges. The employment of explosives, however, was so destructive

that much good stone was spoiled, and for this reason the blasting was abandoned in favor of hand-drilled channels which separated the marble into blocks of convenient size.

In most quarries the stone is taken out from an upright face, offering a wall of solid marble. The first block prepared for removal is known as the key, because it opens the way for general operations. Whether done by derrick or tramway, the hoisting operation demands extreme care to prevent damage to the heavy blocks, and especially is this true in the removal of the great pieces intended for long columns. At the surface the lifting derricks load the

blocks on the cars for the mill. The modern marble mill is an object lesson in efficient arrangement. Stone is heavy and excessive handling adds much to the cost of the finished product. For this reason everything is planned for orderly sequence in the journey of the stone through the plant. The huge blocks are unloaded from the

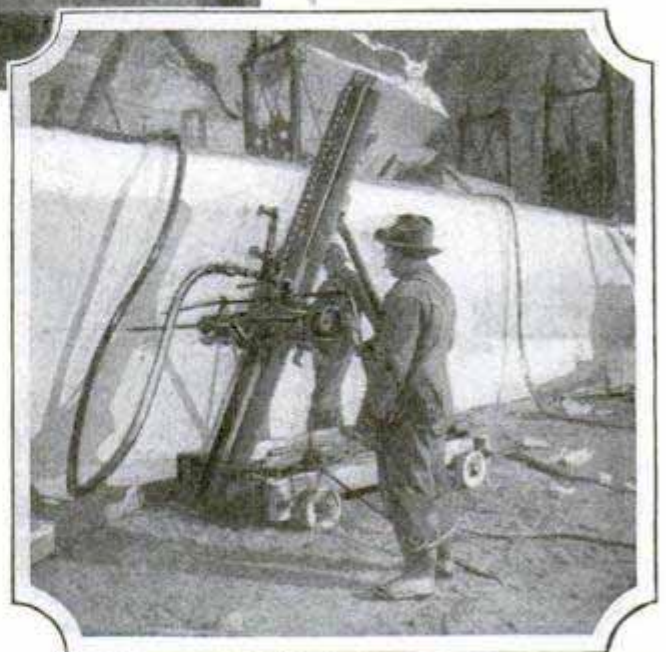
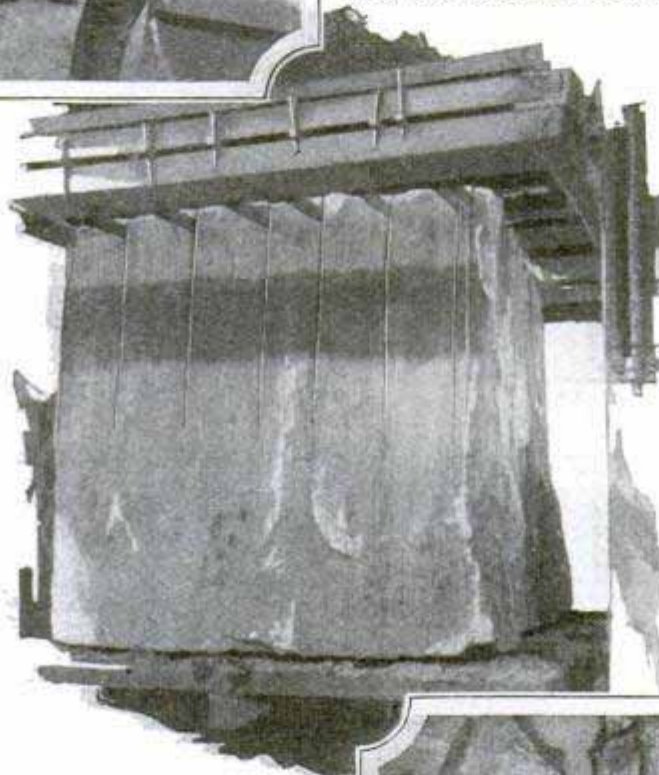

Courtesy Vermont  
Pneumatic Chisels and Electric Drills Do Much of the Work; Center, Gang Saws Cutting Layers



cars by means of traveling cranes, and are piled on transfer cars to be hauled by locomotive cranes to the gang saws within the mill. From the saws the individual slabs proceed to the finishing shop, where they are dressed and polished to the required dimensions.

In its passage through the finishing shop, the marble receives varied treatment. To produce a slab of exact dimensions, the rough material that has been turned out by the saw is trimmed and sent to a rubbing bed, a revolving cast-iron plate on which it is ground true to size and thickness under the abrasive action of sand.

Constant rotation on the true plane of the bed results in giving the slab uniform thickness and properly squared edges. For curved and irregular surfaces the rubbing is done by hand, with a simple instrument made of a marble brick, passed back and forth with sand and water.

Recent years have seen marked improvements in the methods of cutting curved pieces, moldings, cornices and balusters. For this

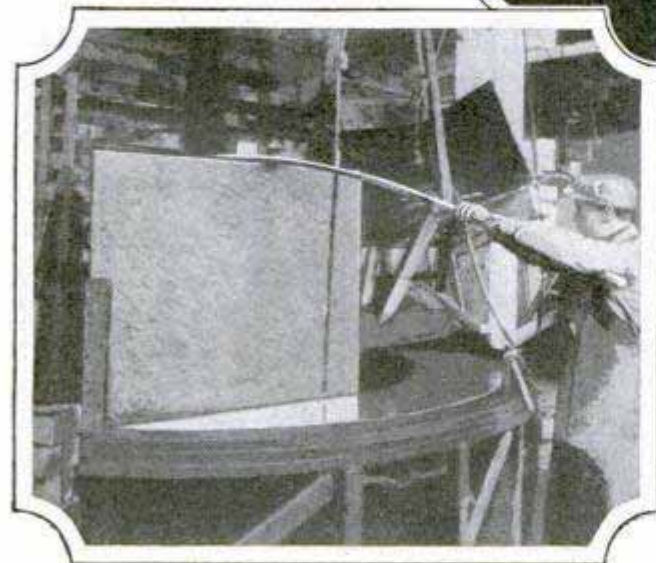

Marble Company

A Rubbing Bed for Polishing, a Figure for a Fountain at Madison, Wis., and a Block Being Hoisted

work a carborundum wheel is set into a lathe, and, by means of a steel tool, is cut into a shape exactly the reverse of the pattern that is to be wrought in the marble. This negative then cuts into the face of the marble block as the latter travels on the machine bed beneath.

The process of fluting large columns involves the use of diamond saws in conjunction with the carborundum wheel. The saw

of this type makes a series of parallel cuts in the places intended for the deepest part of the troughs. The fluting operation is completed with a carborundum wheel.

Most columns are made up of sections known as "drums," because of their shape. Some of the largest sections ever produced are those used in the Lincoln Memorial, recently completed at Washington, D. C. Each drum in the columns of this massive structure has a diameter of eighty-nine inches and a length of fifty-eight.

The solid columns with smooth face, seen in many pretentious buildings and memorials, are produced by means of a

lathe, with the same ease as iron or steel is turned.

To produce ornamental surfaces, the marble carver of today works with pneumatic cutting tools. He still uses the hammer and mallet in places, but his usual chisel is driven by compressed air.

Marble is a form of limestone, of such close structure as to cause it to take a polish of extreme fineness. In point of hardness there is wide variation in marbles of different types. Besides taking a high polish, it has the important characteristic of permitting penetration of light. Some marbles are waxy in appearance, because of this property, while others are milk-white and opaque. The best Pentelic marble, used by the old Greek sculptors, has been found to admit light to a depth of more than half an inch. In Parian marble, from which the Venus de Medici was sculptured, the penetration is more than twice as great. Carrara marble, used by Michelangelo and Canova, is penetrated

to more than an inch and a half. In thin sections, white marbles are almost transparent. Some marble is porous, admitting water and dirt with resultant freezing and discoloration.

The change of limestone into marble, in past geologic ages, came through pressure or heat, or both. The formation has been reproduced experimentally through the application of heat and pressure to calcium carbonate.

### KNOT REMOVER FOR BOARDS

255 <sup>7</sup> ALSO PLUGS HOLES

Savings of lumber are promised by a recently patented electric unit to cut the knots out of boards and fit a threaded plug into the hole. The machine is said to be so simple that a boy can operate it, removing from sixty to ninety knots an hour and plugging the holes. The outfit works on hard or soft lumber and is adapted to boards up to three inches, either rough or

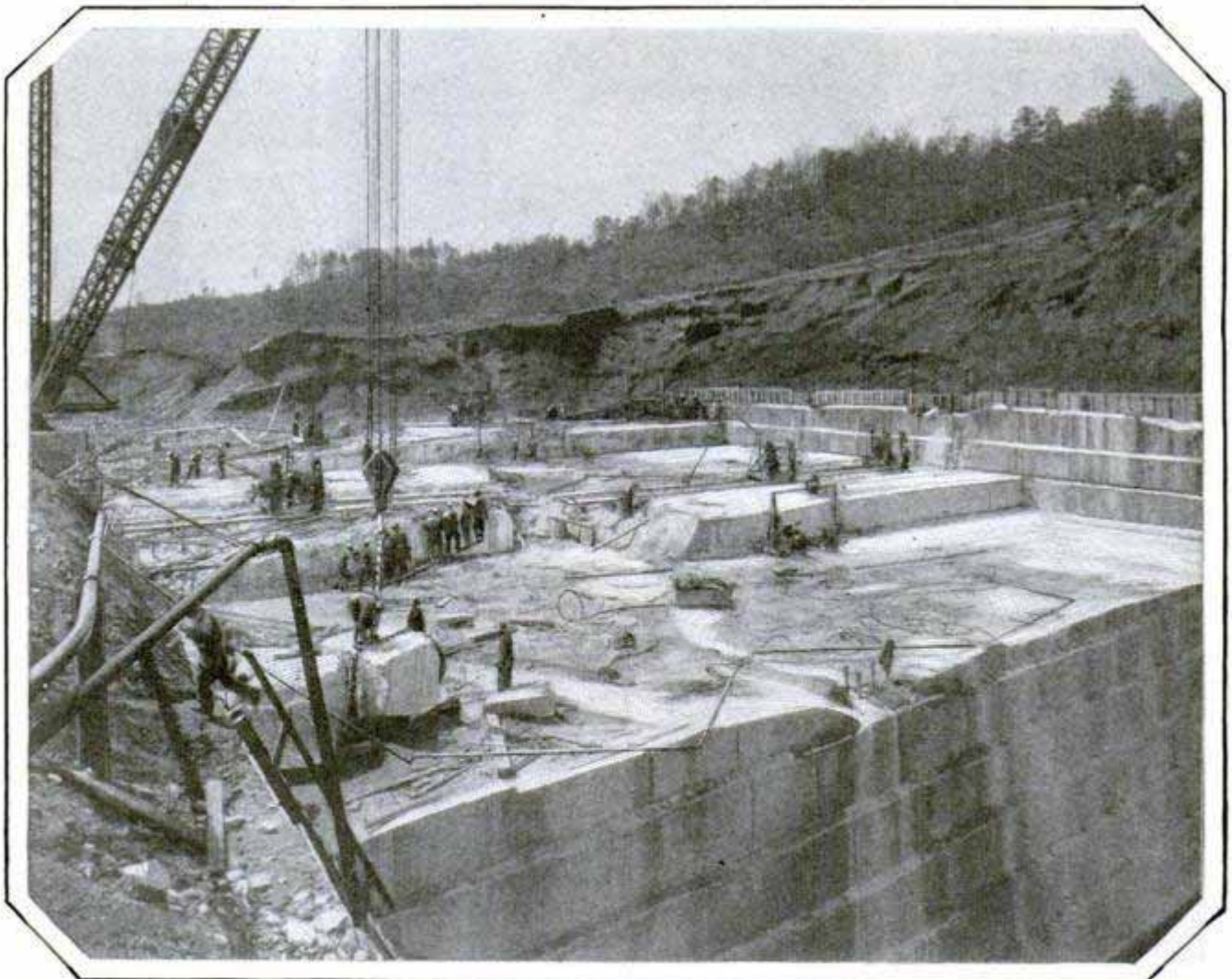

When the Thin Layer of Surface Earth Is Stripped Off, a New Section of the Quarry Can Be Opened alongside the Old, Which Has Grown Too Deep to Be Worked Profitably

124 N. Florence  
231  
Berkeley, Calif.

finished. As the knot is cut out, a thread is formed in the sides of the hole and the plug is threaded to fit this. It is inserted flush with the board and turned so that the grain is in the same direction as that of the timber. No glue is required and it is said that green lumber will dry around a dry plug without splitting. For larger cut-outs two plugs can be utilized.

**PLOW TRACTOR  
NEEDS NO  
DRIVER**

248 7

Farmers will be able to help their neighbors with their work, go to town, or listen to the radio while their fields are being plowed, if the invention of a Nebraska man is generally adopted. It is a self-steering attachment for a tractor, permitting the outfit to work without a driver after the first, or guiding furrow, has been made. If the machine leaves the row, the guider automatically stops it. Essentially, the unit is composed of a piece of aluminum, covering a pipe attaching it to the tractor, and a curved piece of sheet iron that slides along the furrow. It is held in place by a heavy spring which is released should the plow stray out of its course, and the power is automatically shut off. The guiding furrow is made with rounded corners so that the plow can turn them easily. In a demonstration, the driverless tractor plowed a twenty-acre field without guidance from an operator, requiring only replenishment of the gasoline and oil. The attachment can be fitted to any type of tractor.

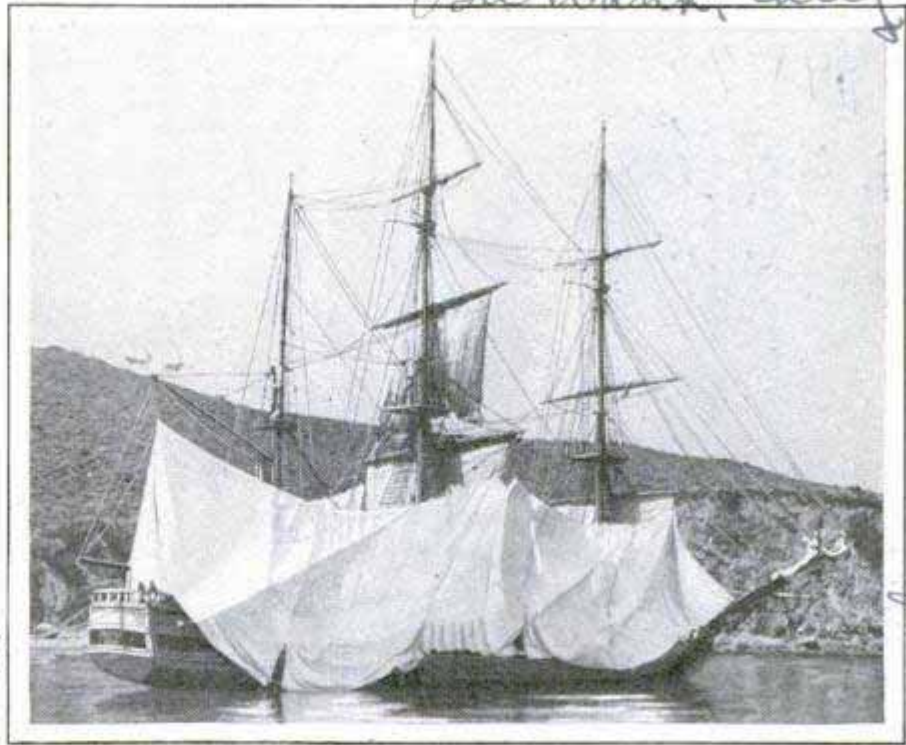

Cloth Trap Inside of Which the Fog Was Produced for the Picture and Held from Blowing Away

**SHIP ENCLOSED IN CLOTH SCREEN  
FOR TAKING FOG PICTURES**

In order to keep smoke, manufactured in smoke pots, on board a ship for producing a fog effect, the vessel was inclosed in a cloth screen to trap the fumes. When enough had been collected, the coverings were removed and the photograph made.

**ANTIQUÉ FINISH FOR NEW WOOD  
SECURED WITH SOLUTION**

New wood can be treated to give it an aged appearance with a mixture of a solution of hydrogen peroxide and hydrochloric acid, four parts of the former to one of the acid. The liquid is painted on, allowed to dry, and the antique coloring develops quickly. The acid may afterward be neutralized with ammonia. Various colors may be produced by additional treatment that causes metallic deposits in the wood.

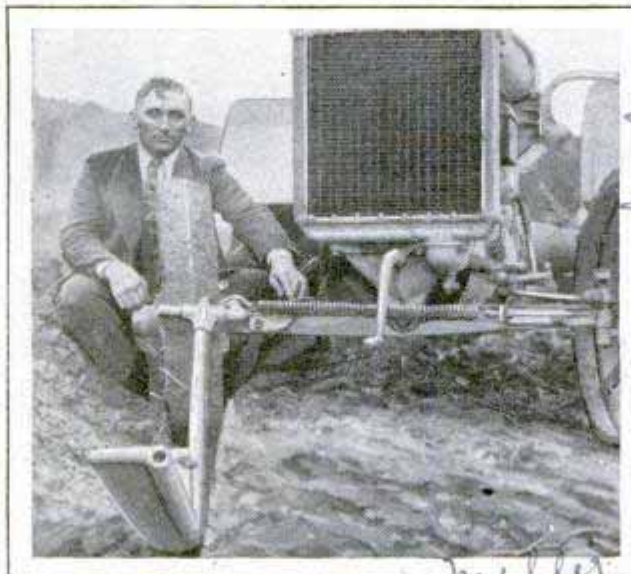

Steering "Foot" That Guides the Tractor

Wm. H. L. Zybach, Island Island, Neb.  
Em. Drechsel  
Formula in Russian Book on Wood Finishing by Constructive Engineer Hoffmann.  
written (?) by Constructive Engineer Hoffmann.

2025 Postland Ore.



Mirror Bracket in Place, Showing How It Affords Person in Chair Front and Rear Views of Head

### MIRROR SET FOR BARBER CHAIR AIDS BETTER HAIR CUTS

Clamped to the barber chair, a double mirror arrangement gives a clear view of the front and back of the patron's head, so that he may be sure of a satisfactory cut. The supports are not in the way and the mirrors always remain in proper position, as they are raised, lowered and revolve with the chair. A pedestal type on rollers has an adjustable spring to obtain any height desired.

### PROPELLER BLADES OF CANVAS RESIST CORROSION

High-powered airplane-propeller blades made from ordinary canvas pressed into a noncorrosive product of metallic strength are to be used on the navy department's training planes. The new material is likewise used for the manufacture of pulleys. Because of its water-resisting and moisture-proof nature, parts manufactured of this material have been accepted as standard equipment by the United States army and navy. This latest propeller is brass-tipped and is of special interest to aviators because of its lighter weight, smoother ac-

tion and absolute absence of corrosion or warping in storage or in service. It is especially adapted to use on seaplanes because the spray does not damage it. The substance is chiefly cotton, layers of canvas being impregnated with chemicals and pressed into material of steel-like hardness.

### CORNSTALKS MADE TO YIELD SILK AND EXPLOSIVES

The problem of commercial utilization of cornstalks is believed to have been solved after many years of effort. The process of Dr. Bela Dorner, a Hungarian chemist, has been brought to the United States, tested by experts and pronounced practicable and economical. By this method artificial silk has been produced from cornstalk pulp. The technical obstacles have been the pith and knuckle of the cornstalk, which could not be removed economically. The Dorner process grinds up the entire stalk, which means that it is possible to convert a waste material into abundant supplies of pulp for making paper, artificial silk, motion-picture films, explosives, celluloid, lacquers, artificial leather, pyralin and other products. Now the corn-belt farms destroy annually more than enough cornstalks to supply the pulp requirements

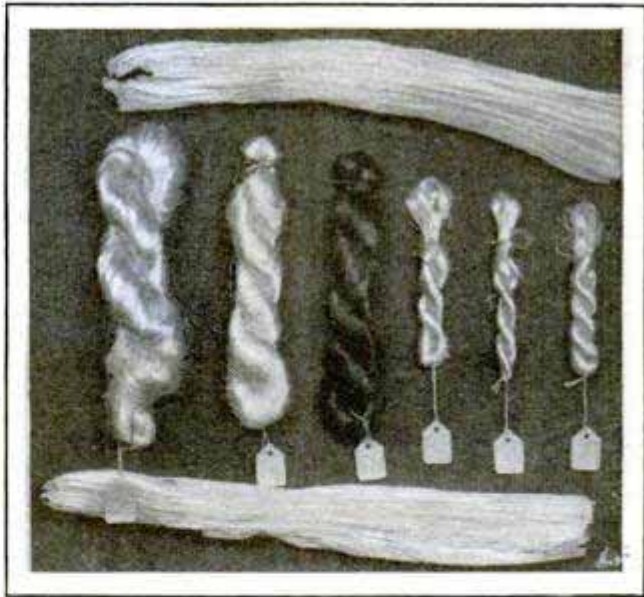

Samples of Artificial Silk Made from Cornstalks through Improved Process Developed by Hungarian Chemist

of the United States. By-products of the Dorner process can be used in the manufacture of alcohol, cattle feed, butanol, furfural, lactic acid, etc. These by-products will be an additional revenue.

Westinghouse Electric & Mfg. Co., East Pittsburgh, Pa.

Carl Utah Vincent Park

24

under command of Capt. Frank Liverpool, Eng. 233



One of the Rescue Attempts That Failed; the Plane, Flying Low, with Rope Suspended, Was Guided over the Stranded Vessel in an Effort to Get the Line Aboard

### MOTORBOAT DEFEATS PLANE IN RESCUE OF CREW

Thirty men, stranded four days without food on the steamer "Collingdale," which went aground off Morocco, were rescued in a small motorboat after unsuccessful attempts were made to get a line to the craft with the aid of a seaplane. When repeated efforts at dropping a cable on the deck of the vessel failed, a veteran Spanish skipper put forth in the motor launch and brought the men to shore in two trips.

### CENTURY-OLD ORANGE GROVE FLOURISHES IN FLORIDA

Budded on native-soil orange stock, from seedlings brought to this country during the Spanish occupation of Florida, an orange grove at Allenhurst is still thriving. Measures have been taken to place it under the protection of the state, national and local interests so that it may be preserved for many years more. The grove is believed to have been planted about 1830. Some fifty of the original trees are still standing and produce about three boxes of fruit each. Some are fifty-

four inches in circumference one foot above the ground, average from twenty-five to thirty feet high and have an average crown spread of sixteen feet. Since 1914, the grove has been better cared for, the application of fertilizers having increased the vigor of the trees.

### AUTO BATTERY WINDS CLOCK ON STEERING POST

To keep accurate time and eliminate the bother of winding by hand, a magnetic clock, attached to the automobile steering post, is kept wound through an electromagnet energized by the car battery. A coil spring is tensioned every thirty seconds, so, being fully wound at all times, the clock is little affected by road shocks or vibrations of the motor. A screwdriver is the only tool that is required to attach it.



\$12.00.

The Magnetic Clock Co.

Chicago - A. J. Shields 358 W. Harrison. Hayschope Ave. 160

Summit

2538  
Dr. Harry A. Warren, 526 W. 18th St. Chicago

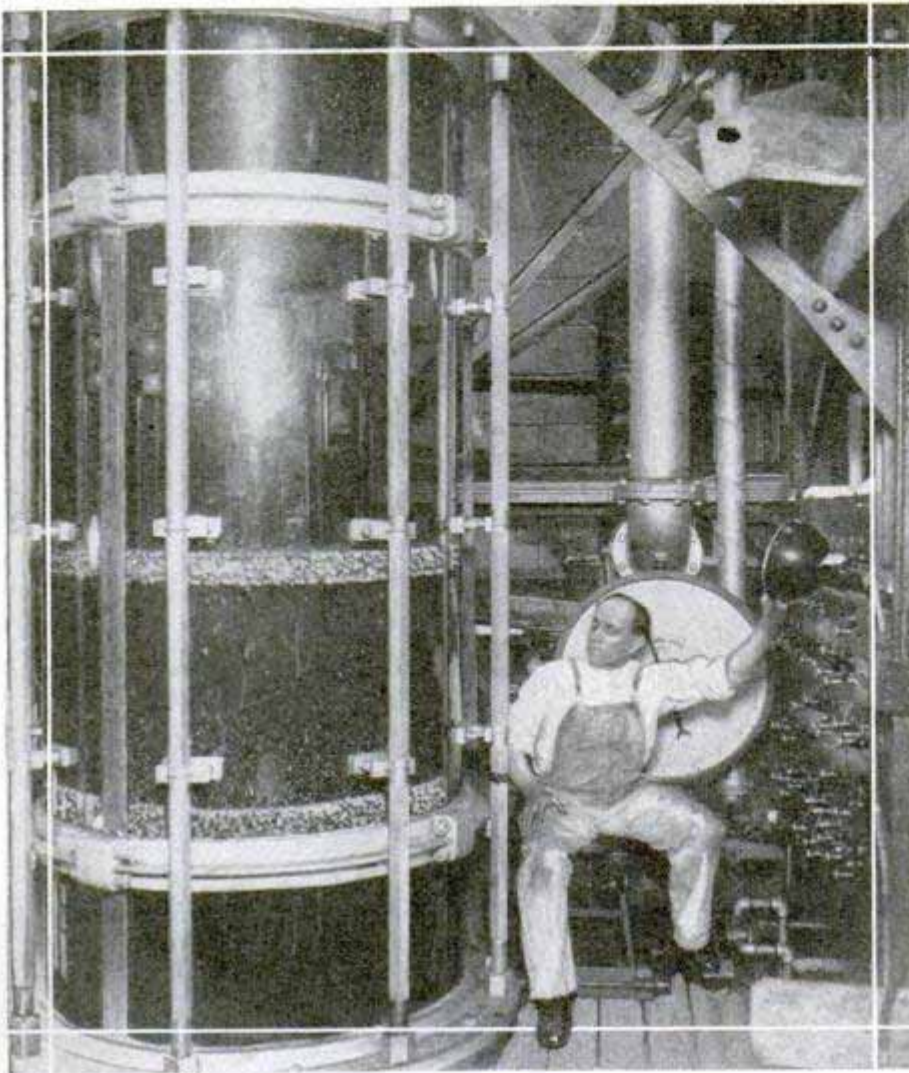

An Important Unit of the Grading Apparatus, the Huge Glass Test Tube Where Grain Is Mixed with Chemical Solutions

### SEE BETTER CROPS AND SEEDS IN CLEANER AND GRADER

Field and garden seeds of practically every kind and variety grown in the world can be cleaned and graded in a new apparatus recently built in Chicago at a cost of \$275,000. Through the use of chemical solutions of different strengths, compressed air and vacuums, seeds are entirely freed from weeds and foreign matter and then separated into strata depending upon the weight of the seeds. The process will make it possible for farmers and gardeners to plant only the finest of the best seeds, increase the number of pounds per bushel and add greatly to the yield per acre. In the handling of corn for

example, this apparatus, eighty-eight feet high, separates the light and diseased kernels into one group and heavy high-quality kernels into another. Almost an unlimited number of grades of grain can be made. The apparatus cleans and grades all of the grains commonly grown in North America, including corn, wheat, rye, oats, barley, clover, alfalfa and soy beans. Vegetable and flower seeds are also cleaned and graded by this new process. Clover seeds contaminated with noxious-weed seeds, which are often of the same size and cannot be removed by any machine now used in cleaning and screening seeds, are easily cleaned and graded by this method. The whole process takes place in a huge glass test tube, nine feet tall and four feet in diameter. A

thousand pounds of grain is separated at a time. The invention makes it possible for farmers to plant seeds which will germinate, develop, bloom and fruit at the same time. It will put the world's seed situation under laboratory control.

1944.  
**TINY STEEL MOTORBOAT SPEEDS TWENTY-TWO MILES AN HOUR**



Tiny Outboard Racer in Full Speed

Weighing less than seventy-five pounds and but three feet wide, a ten-foot outboard-motor boat develops a speed of twenty-two miles an hour. It is made of steel, has a flat bottom and is provided with an air chamber under a waterproof canvas deck, so that it will float even if filled with water and can carry 300 pounds.

Furnished by John L. Kellogg, 2010 Tribune

35 E. Utica St.  
Buffalo, N.Y.

# KITCHEN KABINET BAND



itchen  
set o  
azz ba  
t., Bu  
r, :  
oui  
0.0  
et o

## Cooking-Utensil Bands Get Harmony Out of Tinware in the Latest Scheme to Raise Funds for Charity

**H**AVE you heard the latest recipe from the kitchen?

Take one tin funnel, medium size, a half dozen tin spoons and three or four extension curtain rods, coat the ends with soldering flux, heat slightly with the iron and apply a good grade of solder. Add one of those queer little tin instruments called a

"kazoo" at one end and serve it up in the music band under the nom de plume of a trombone.

That's the basic formula for the dozens of recipes that go to make up Susie's Kitchen Band, the tinware "sinkopaters," who are getting harmony out of the cook's cooking utensils, and making money at it.

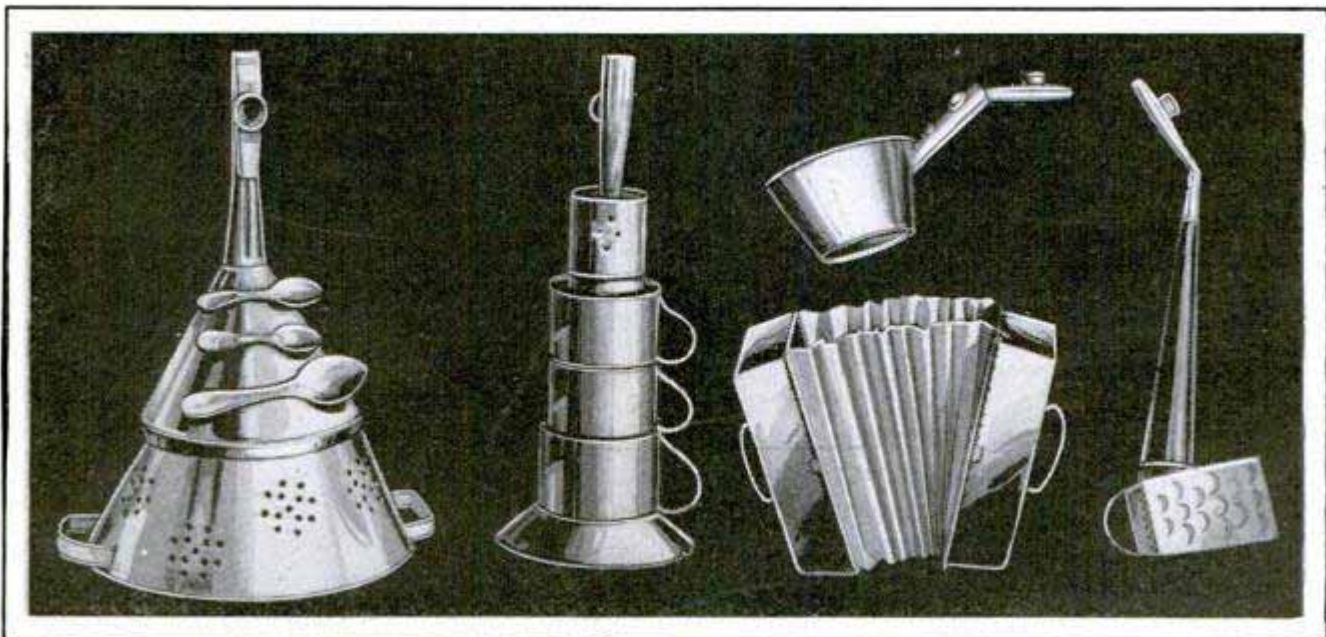

Details of Baby Saxophones, Horns and an Accordion, All Built from Odds and Ends of Kitchen Tinware by a Woman Who Learned to Solder in Order to Help Raise Funds for Charity

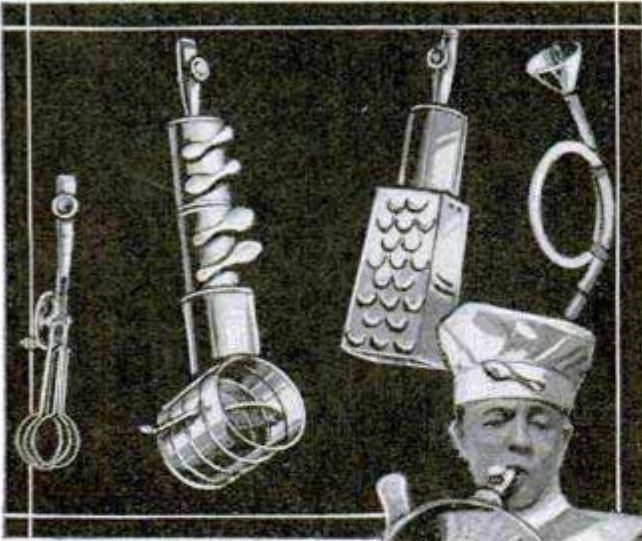

Imagine a large band of fifty pieces, completely equipped from drums to French horn and from clarinets to the strings of the bass viol. Such a band isn't unusual, but if everyone of the instruments is made out of kitchen tinware soldered together, and everyone, regardless of what it looks like, is held to the lips and blown into, you have something decidedly novel.

Where the idea of the kitchen band originated nobody knows for sure, but there is evidence that it came out of the Kentucky mountains by way of southern Illinois. A dentist's wife in East St. Louis, Ill., Mrs. Harvey S. Smith, heard about such a band, and, after a course of soldering lessons under the tutelage of her radio-building husband, proceeded to make a full set of instruments, guided only by a postcard photograph of a similar organization. Mrs. Smith's idea was to create a novel form of entertainment to raise a charity fund for one of her clubs. She succeeded so well that others wanted to

do the same, and a brisk trade in rented band instruments sprang up. A kitchen story in scenario form was written to go with the concert and add hilarity to an already laughable performance.

The instruments themselves are as varied as the ingenuity of the maker. They include about every odd and end that can be culled from the kitchen. Tin cans sol-

dered together, with tinice-cream spoons as keys, a flour sifter at one end and a kazoo at the other, become a moaning saxophone. Frying pans with picture-wire strings and split clothespins for keys are transformed into ukuleles. A washboiler top, fastened to an old mop handle and strung with picture wire, makes a neat-appearing cello. Tomato cans, graduated in size, soldered to form a circle, with a washbasin at the end and tin spoons for keys, make a passable bass horn. The drum is a dishpan covered with oil-cloth. Extension

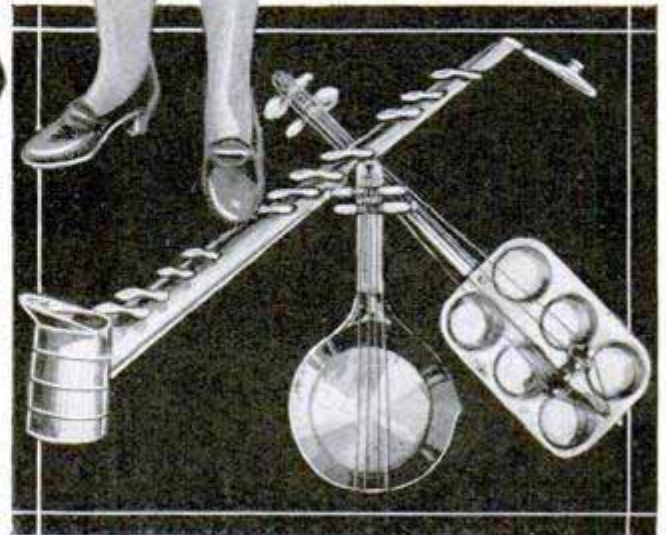

Pair of Soloists from a Los Angeles High-School Faculty Band and Some of the Instruments Made by Mrs. Smith for Her Bands





"Sinkopaters" of a Los Angeles School Faculty, Led by a Drum Major Wielding a Feather Duster for Baton; the Instruments Show the Wide Variety of Utensils Pressed into Service

curtain rods make excellent slides for such things as trombones, or extension coat hangers can be used for the same purpose.

If you want a tom-tom, a worn-out washboard is excellent, particularly when a retired slipper is used as a mallet. Bake tins, with the handles of other pans soldered to their bottoms and connected by cold-starched and pleated muslin, can be converted into accordions. For the director's baton, a curtain rod is excellent, though a kitchen band composed of members of the faculty of a Los Angeles high school is ruled by a feminine drum major armed with a feather duster.

An entire outfit of instruments for a good-sized band costs little more than five dollars, plus several hours' work with a soldering iron.

And for musicians, one need not have a single person in the band who can read one note of music, for the kazoo plays when the player hums, and anybody who can hum a tune is eligible for membership. One kazoo alone doesn't make a band, but when twenty-five or thirty or more are hummed in unison, the result is surprisingly good, with a stirring quality and rhythm that is startling. The history of the kazoo is as shrouded in mystery as the origin of the kitchen band, but one story is that it goes back to the days of

Cleopatra, when a frightened slave, ordered to play on a reed, extemporized with a crude hollowed stalk.

The bands were such a success at the start that, by the time a half dozen sets of instruments were on the road constantly, being rented to organizations all over the country, Mrs. Smith turned to uniforms. Brilliant red caps, scarfs and sashes, garnished with small tin spoons instead of gold frogs, and with toy knives and forks to add a special touch here and there, carried the kitchen band one step further. The demand for instruments and uniforms became so great that it was necessary to design special boxes for packing and shipping them. At that, a full set of instruments and uniforms for a twenty-eight-piece band rent for only \$12.

The maker saves the tin cans that pass through her kitchen and buys the rest of the supplies at a dime store. With constant practice, she has become proficient with tin snips and soldering iron and has reached the point where she not only doesn't cut her hands any more, but is seldom scratched. Her bands, in the last three years, have earned more than \$4,000 for women's organizations, in addition to the profits from others designed in imitation of the originals. The original concert before the Wednesday club netted \$150.

Chicago

1861  
4/21/31



Illustrating How Paint-Spray Gun Is Adapted to Overhead Work and Reaching in Corners

**PAINT GUN TO REDUCE WASTE WORKS IN ANY POSITION**

For the application of paints, varnishes and lacquers, a spray gun recently introduced is so adjusted that it will function in any position, an important advantage for overhead work, reaching under parts and other special uses. It is said to give a continuous spray without sputtering, uses all the material in the supply cup and is easy to control. An additional feature is that it rests comfortably on the side of the hand so that the fingers do not have to stand the full strain of supporting it.

**WETTING BRICK AFTER LAYING NO HELP TO WALL**

Wetting brickwork for a period after laying, does not add to its strength, according to tests by the bureau of standards. For more than six months, walls were built and crushed, brick of different grades used and pressures ranging from 2,500 to 6,500 pounds to the square inch applied. The panels were covered with burlap which was sprinkled at intervals and then removed, allowing the brick to season for about sixty days. While the dampness tended to strengthen the mor-

tar, it weakened the rest of the wall, it was found, and the variation in strength between the walls which had been moistened and those which were not, was considered insufficient to justify the practice of wetting the brick.

**KANGAROO BEATS RACE HORSE 2524 IN SPEED TEST**

One of the fastest Australian race horses, ridden by an expert jockey, was decisively defeated by a kangaroo in a recent trial near Sydney. The contest was described as a "procession" with the horse pounding away and losing at every bound of the big kangaroo. The animal covered more than thirty feet at a jump when at full speed.

**HANDHOLD MERRY-GO-ROUND AIDS CHEST DEVELOPMENT**

Healthful exercise and amusement are provided in a steel unit for the playground. It is constructed on the principle of a merry-go-round, consisting of a revolving rack turning about a center pole set in concrete. Instead of sitting, the riders cling to the rack with their hands. This gives beneficial stretching exercise and promotes chest development as well as strength of arms and fingers. Patents have been asked for the device.

Combining the Merry-Go-Round and Trapeze for Fun and Exercise

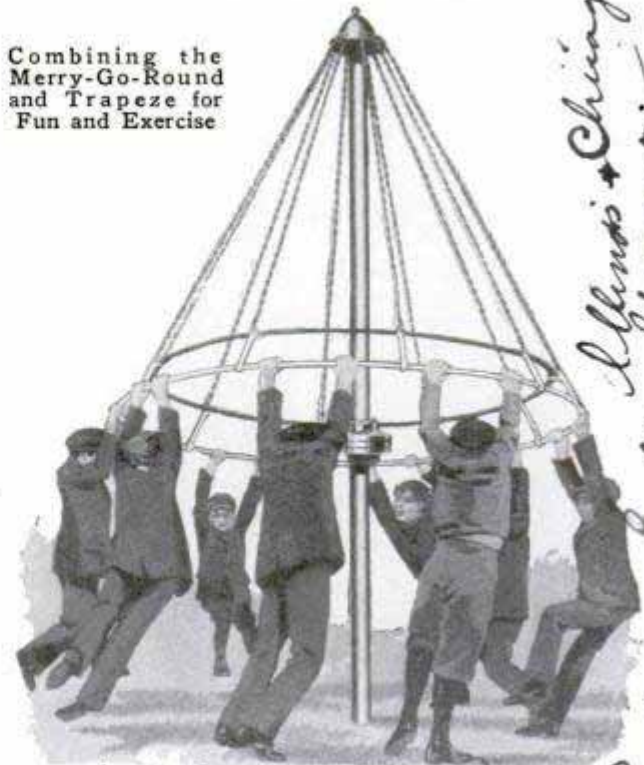

The Everwear Co, Springfield, Ohio

Common Brick Manufacturers Association of America

2537

Illinois Chicago  
Co. Yager Supply Co., 504  
School

M. Plona, U.S.

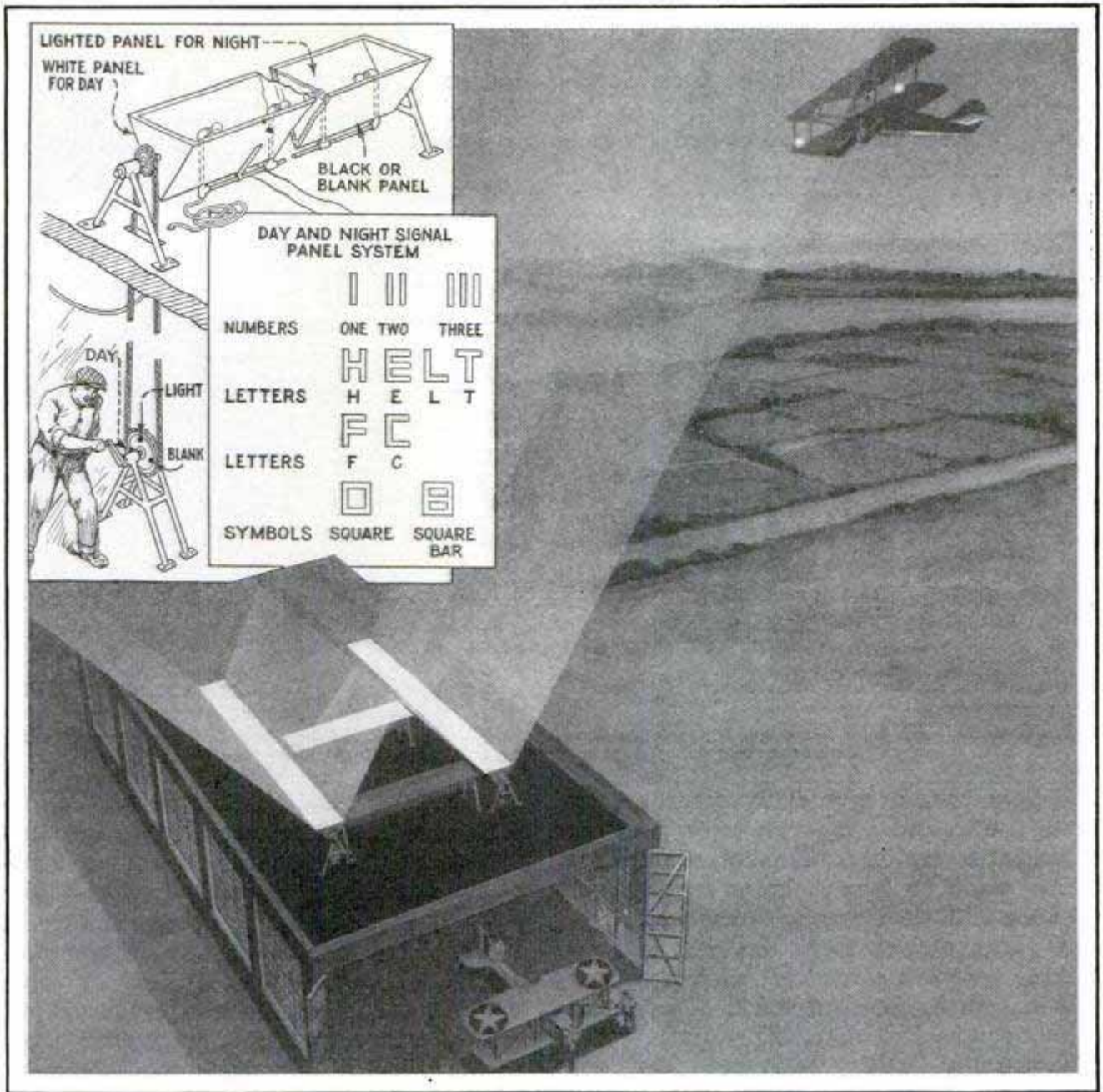

Guiding Airplane Pilots with Troughs of Light; Drawing of the Signal Apparatus as Installed on Top of Hangar, How Signs Are Operated, and Drawings of the Eleven Characters

**ELECTRIC AIRPLANE SIGNALS  
REPLACE CANVAS STRIPS**

A simple electric-signal system, visible both by day and night and designed to replace the cumbersome canvas ground panels invented during the war, has been developed by the aeronautics branch of the department of commerce. Five triangular metal troughs, mounted on top of the hangar so that they can be revolved to show either a white service by day or lights by night, or a black surface when not in use, are employed, and with them it is possible to form three numbers, seven letters and one square, or a total of eleven different signals. The troughs consist of

two sides, three feet in width, joined together to form the sides of a triangle, with a three-foot open face. The inside of the open trough is painted white for day use and fitted with a row of electric lights for night signaling. Two of the troughs, twenty feet long, are mounted parallel to each other, with three shorter ones between them at right angles, the whole forming a twenty-foot square. Each trough is swung between supports and fitted with a sprocket and endless chain, so that it can be revolved from the inside of the hangar, where a simple switchboard enables the operator to turn on the lights in any one or any series of the troughs mounted on the roof.

*Information Bulletin no. 2, from  
Department of Commerce above. by*

*Los Angeles Calif*

*24* **RADIO EYES HELP TO FIND NEW MINERAL FIELDS**

Prospecting by radio is the latest development in the mining world. Ore deposits beneath hard lava-covered ground,

coil to various positions, the location of the axis of the second magnetic field is determined. So far, the process is applica-

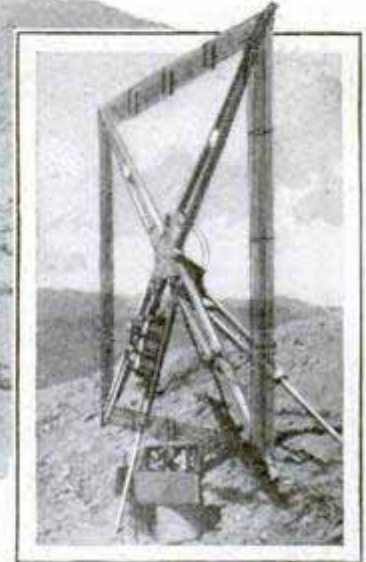
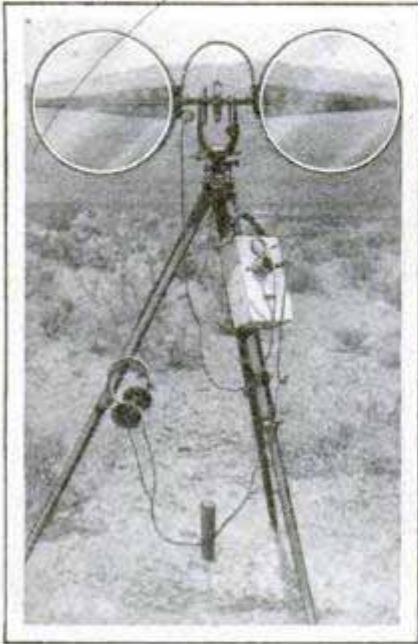

Receiving Set with Loop Direction Finder; the Crew Setting Up the High-Frequency Broadcasting Set and View of the Energizing Apparatus That Causes the Current to Flow

or below rock or gravel formations, may easily be found with this new process. Systematic exploration surveys are now being made in the mineral regions of Arizona and other southwestern states. A high-frequency broadcasting set and a receiving set with direction finder compose the equipment for field work. The entire outfit weighs less than 275 pounds. The broadcasting and receiving sets are mounted on tripods which are set up quickly at desired points about the territory to be surveyed. Four or five men are sufficient to operate the apparatus under average conditions, but when the terrain is very rough, the crew is increased. In order to locate an unknown ore deposit, which may be five or 500 feet below the surface, it is necessary to induce high-frequency alternating currents to pass through conductive ore deposits.

The current sent out from the broadcasting set creates a secondary field when there is some such ore beneath the surface of the ground. A special receiving set is attached to the direction-finding coil. This latter apparatus is mounted on an ordinary surveyors' transit, and is easily carried about the field. By using the ear-phones and revolving the direction-finding

ble only to ores containing metallic sulphides in sufficient quantity to conduct high-frequency electric currents. The sulphides include such minerals as lead, copper and iron. In order to determine the nature of the ore deposit the radio survey is followed by diamond drilling or other methods of reaching the underground mineral. Although the length and depth of the deposit can be found, the total volume cannot be determined with the present apparatus. With the new process the explorations may be conducted in old mines hundreds of feet under ground as readily as on the surface.

**HOUDINI'S BOOKS ABOUT MAGIC**  
**2526 IN LIBRARY OF CONGRESS**

One of the most unique collections of books in the world, 5,147 volumes about magic and psychical research, gathered during the lifetime of the late Harry Houdini, is now in the Library of Congress at Washington, to which it was bequeathed by his will. The assortment was selected from all over the globe, Houdini having searched carefully through many catalogs and having advertised his wants in European and American cities. He considered

*sulphide ores.*

one of his choicest books, "Natural and Unnatural Magic," by Gantzony, dated 1489. It is in the author's script. Another volume is among the pioneer writings on the subject of spiritualism in this country. The authors were John W. Edmonds, a judge in New York, and George T. Dexter, a physician.

**SWIM-POOL SWING GIVES THRILLS IN DIVING**

Safety and added sport are features of a diving-swing apparatus for which patent applications have been filed. It is intended to be placed in water four feet deep, the swing extending out to depths safe for diving. The diver gets on the seat with ease, trips a foot lever when he is ready to start and soars in a wide arc ready to start the actual dive. Parts of the outfit are securely tied together by ground boards, which lie at the bottom of the pool or beach. The frame is sixteen feet above the ground boards, and the stairs are twelve feet high to the top platform. There is a well-braced apparatus to stop sideway, while corrugated hardwood treads on the steps promote safety.

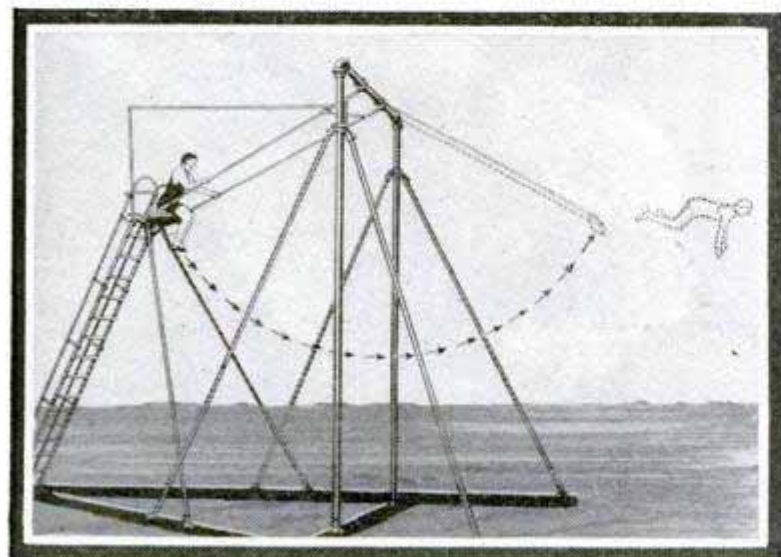
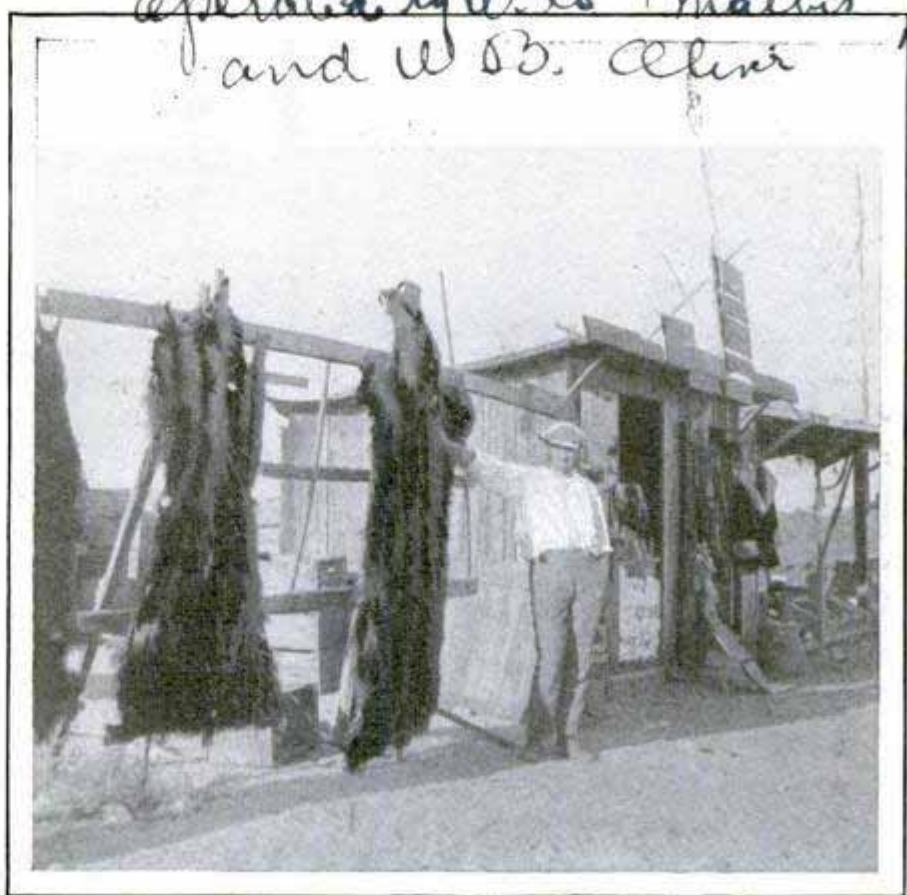

Diagram Drawing of the Diving Swing in Operation; Chief Caution Is to Have the Take-Off in Deep Enough Water



At the Outdoor Fur Store Where Pelts Are Sold to Autoists; the Proprietors Do Their Own Trapping in Alaska

**ROADSIDE FUR STORE SOLVES HIGH-RENT PROBLEMS**

Adopting the plan of the fruit and vegetable grower, a California trapper and his friend have established a fur stand on an automobile road near Los Angeles, where they exhibit and sell furs taken from animals caught each year in Alaska. The wayside store serves automobile patrons directly, saves the expense of rent in the city, and the racks on which the furs are hung afford good display.

**MATCH AND TEE HOLDER EASY TO CARRY**

One of the latest conveniences for the golfer is a pocket holder to carry matches and tees. It keeps the pockets clean and free from holes, simplifies changing from one pair of knickers to another, and the articles are kept where they can easily be reached. Besides the ordinary book of matches, the holder has space for long wooden ones and there is a scratcher on the back.

The Everwear Co

self specialties of a man

*Needle City*

*Forbes man*

*2466*

*\$18.00*

*William L. Lange, 225 E. 24th New York*



Sturdy Rest Keeps Banjo in Position and Away from the Player's Body So That Tone Is Not Muffled

### BANJO HOLDER RESTS PLAYER AND IMPROVES TONE

To relieve a banjo player of the weight of the instrument and to insure freedom and relaxation for rapid execution, an upright holder has been introduced. It is said to improve the tone because the banjo is kept away from the body. The unit is adjustable to different heights and positions, is easily moved out of the way, as it has casters, folds up into compact space, and the bottom is so constructed that it serves as a footrest.

### SHEEP STOP FIRE DANGER AROUND OIL TANKS

*2365*

One of the most feared enemies of the oil company is fire and, to reduce danger from this source, a western concern keeps a herd of sheep grazing in the fields near the tanks. They keep the grass so short that there is little likelihood of a blaze spreading, should it start, and the plan involves practically no expense.

### QUICKER DIAGNOSIS OF DISEASE IN NEW STAINING METHOD

Diseased tissue of the human body may be studied with much less trouble, and quicker diagnosis made, by an improved method of staining the cells, demonstrated by Dr. B. T. Terry of the Mayo clinic. Under former processes, samples had to be cut extremely fine and carefully mounted for microscopic examination, a process that took eight or more minutes, often while the patient was under anæsthetic. By the new system, sections may be cut with an ordinary razor without special regard for thickness. The stain affects only the surface of one cell layer and the light is permitted to pass through the rest as though they were not there. In less than a quarter of a minute, Dr. Terry prepared a specimen so that another physician could diagnose the case as malignant cancer.

*Yankee*

### AUTO STOP SIGN TELLS COST OF VIOLATING LAW

To answer complaints of motorists who declared that they were being fined too heavily, and to give an additional warning at intersections, stop signs in Ann Arbor, Mich., bear figures showing what fine will be imposed if drivers violate the law. The plan removes all grounds for charges of unjust penalties, and is also calculated to make the motorist think before running any risk.

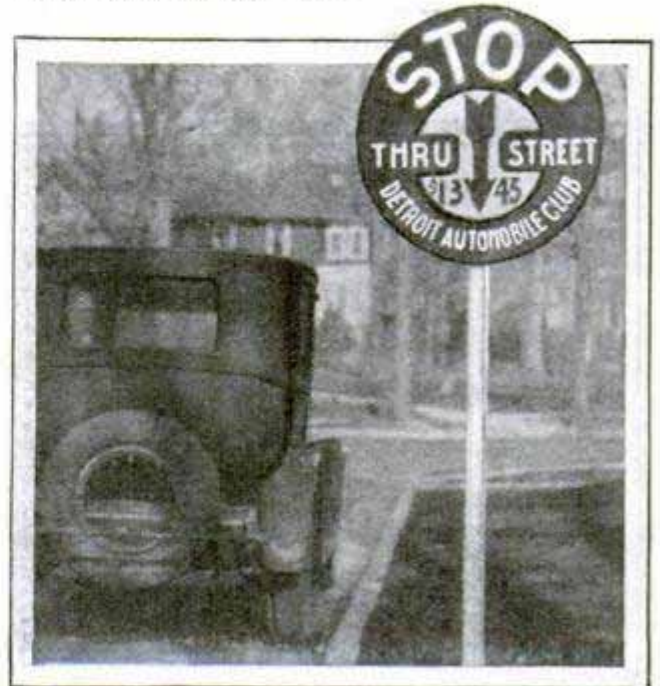

Figures below Words, "Thru Street," Show Amount of Penalty for Failure to Stop

# SECRETS of the Mounds

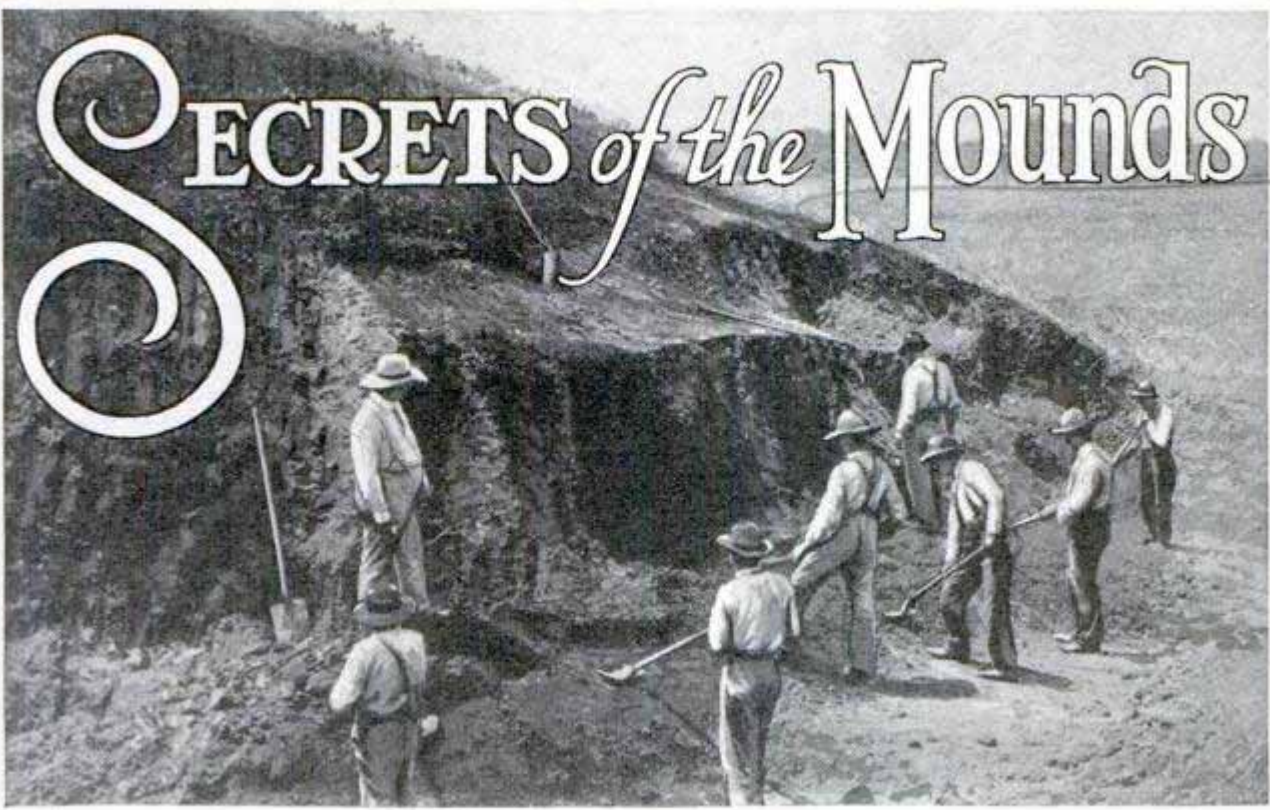

Workers Digging into the Big Serpent Mound in Ohio, to Probe the Secrets of the Oldest Civilization in the Eastern United States, Antedating the Indians, the Explorers Found

By TRUMAN B. MILLS

*The Dayton Journal  
Dayton,  
Ohio*

**E**VER since the discovery of America the secrets of the Indian mounds, thousands of which are to be found throughout the Mississippi valley and adjacent regions, have been sought. Even the Indians found by the first white settlers knew nothing of them. Scientists have attributed them to an early people who occupied these regions centuries before and had been subjugated or driven out by later nomadic or hunting Indians.

The fact is that the custom of mound building was not limited to the American continent. Mounds are to be found the world over, this having been one of the earliest methods of showing respect for the memory of the dead. Civilized man has naturally dug into these structures out of curiosity and for the purpose of study. Few mounds are to be found in the United States that do not show some evidence of molestation. Indeed, the early settler often declared a holiday in slack times to make exploration attempts. Adventurers also dug into them in search of buried treasure, but the pot of gold they sought was ever an elusive one, and the reward was usually only some decayed bones.

The state of Ohio has 5,000 or more ancient monuments of the mound builders, and this region has been the focus of more mound-excavating parties than any other in the Mississippi valley.

But up to 1900, this work had, with one or two exceptions, been carried on under the old system of exploration, that is, shaft sinking and trenching, and most of the "good" mounds had been dug into and messed over. As would naturally be expected, little information of real value was obtained by these methods. About the beginning of the present century or a little before, more thorough and more scientific methods of mound exploration were brought into use. Pioneers in this work were Dr. F. W. Putman, of Harvard university, and Dr. William C. Mills, of Columbus, Ohio.

"The mounds of Ohio, we have found, were erected as monuments to the dead," declared Mr. Mills. "In them were placed the bodies of prominent individuals of the tribes to whom special honors were paid. With the remains were placed objects of stone, bone, shell and copper that were used as implements or ornaments."

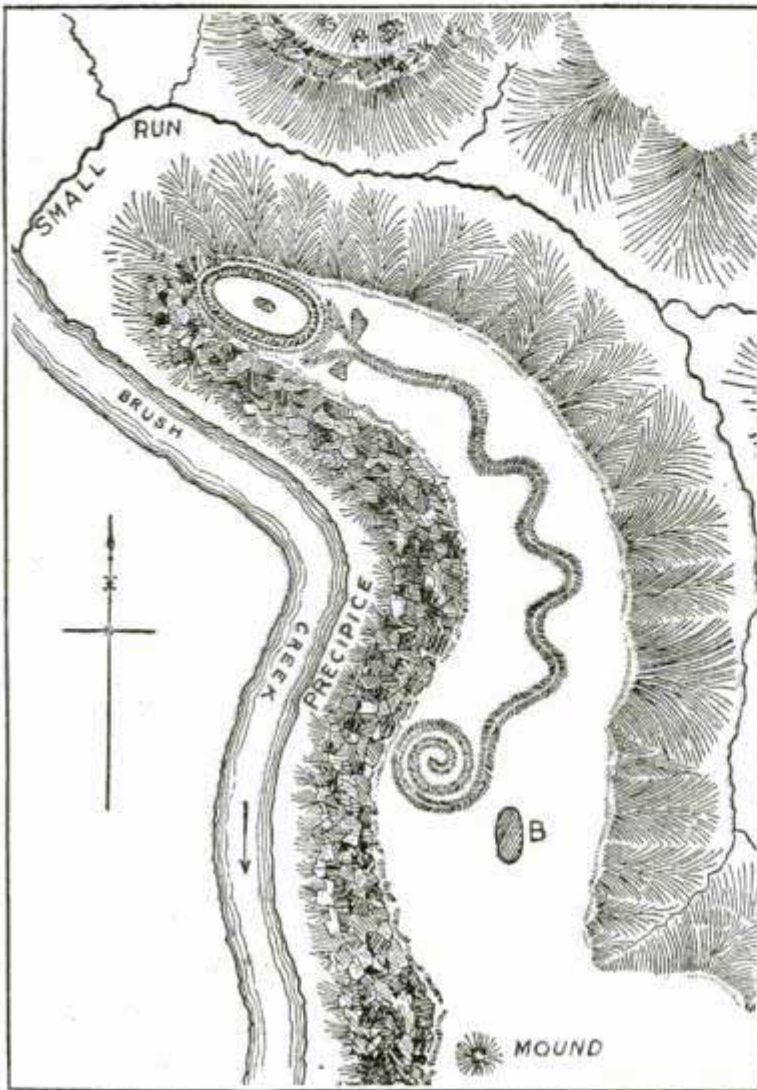

Map of the Great Serpent Mound and Two Smaller Ones, Showing the Coils and Undulations of the Huge Earthwork

Some of the mound builders were adepts in the working of copper into beautiful objects. They possessed rich pearls, wove beautiful fabrics, made artistic objects of bone, stone and shell and carried out elaborate ceremonies in connection with the burial of their dead. Some cremated the

dead and showered upon the remains the most precious of their possessions. One famous grave found in an Ohio mound recently revealed a burial of four mound-builder "princes," lying in beds of pearls and covered with finely woven fabrics bearing the most artistic designs.

Among the more advanced of these ancients, copper was the "precious" metal which was worked up into art objects of rare design and execution. Silver was used in lesser amounts. In addition, they made use of materials from all over the United States and traded or bartered for stone, bone and shell.

"The Ohio Indian or mound builder," says Mr. Mills, "was never any more intent on doing the unnecessary than we are today. Having a suspicion of this, we early doubted whether the mounds that had been examined previously and reported unproductive had been explored thoroughly. We always were inclined to feel that the Indian would not go to all that work of piling up a big heap of dirt over nothing at all.

"One of the first mounds we explored was of small size. In this we began at the edge and moved the entire structure, but we did not find a trace of a burial. When we got all through, the boys asked what we were going to do about it, and I said that we would start right in and go through it again. But this time we went down a little bit deeper, and we

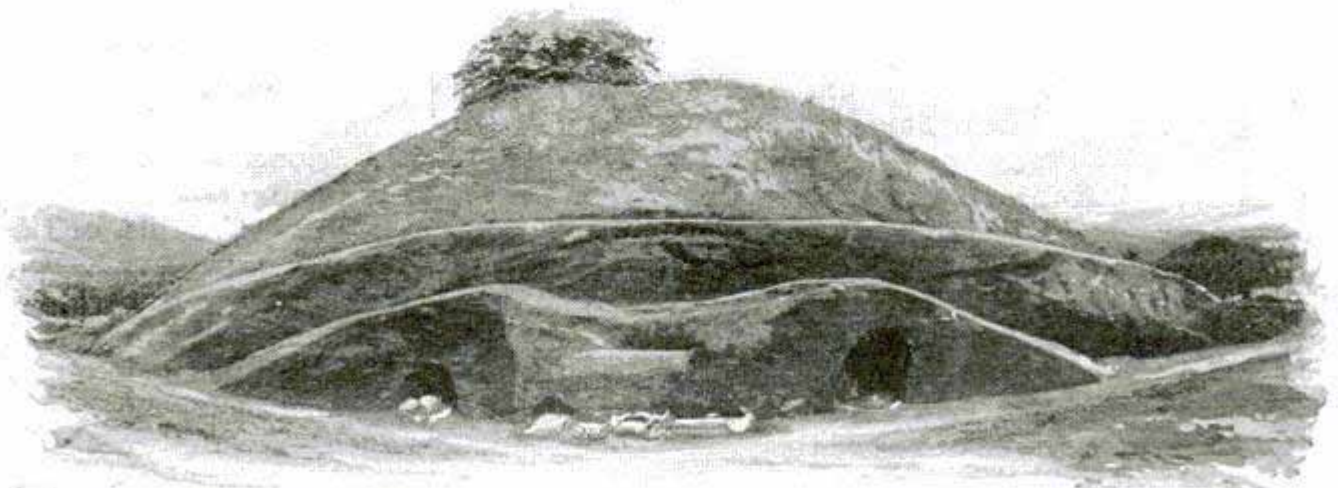

The Seip Mound, in Ross County, Ohio, Showing Graves Which Have Been Uncovered by Shoveling Away Successive Layers of the Earth That Had Been Heaped over Them Long Ago



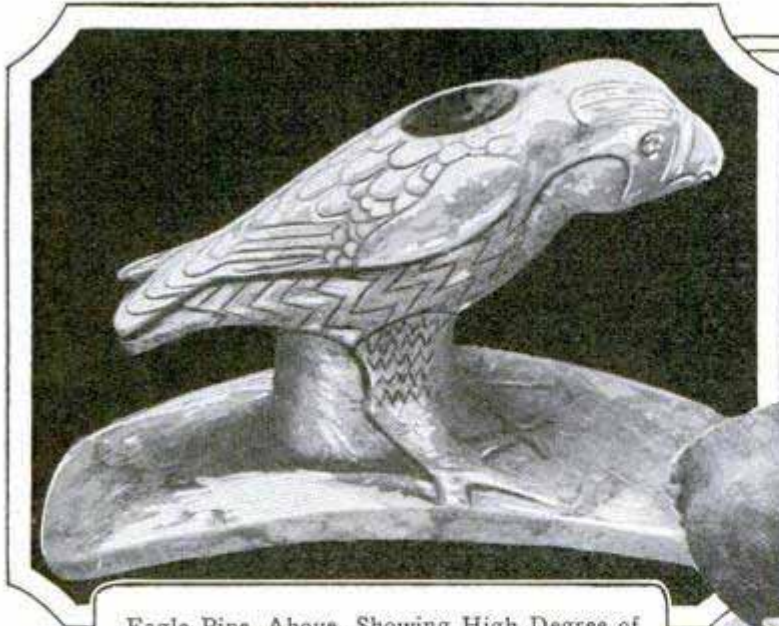

Eagle Pipe, Above, Showing High Degree of Art Developed by the Original Settlers Who Preceded the Nomad Indians



Dr. W. C. Mills, Above, Director of the Ohio Archaeological and Historical Museum, Examining a Specimen of Ancient Pottery Recovered from One of the Burial Mounds Which Are Now Being Investigated by the State

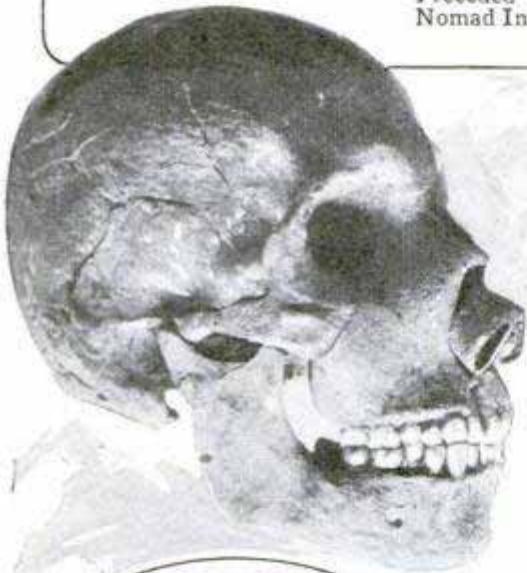

Artificial Noses, Made of Copper, Are Sometimes Found Added to the Skulls in the Burial Mound, Apparently through a Post-Mortem Operation; the Skull at the Left Wears One of These Ornaments, the Purpose or Significance of Which Remains a Mystery; at the Left Is the Claw of an Eagle Sculptured in Mica, One of the Religious Ornaments Found in a Mound Builder's Grave; at the Right Is an Elaborate Effigy Pipe; the Prevalence of Smoking Pipes, Usually of Highly Sculptured Designs, Indicates That the American Indians Got the Tobacco Habit from the Far Earlier Civilization Which Their Nomad Tribes Displaced, Probably Several Centuries before the Arrival of the First White Men



discovered that we hadn't been on the base line the first time. The second exploration of the structure resulted in the finding of five skeletons, all placed in one grave on the original surface of the ground upon which the mound stood."

Although a great many new facts have been learned about the mound builder in recent years, much remains to be revealed. Modern explorers and scientific workers are as yet unable to tell where the mound builder came from and what happened to him. They are hoping that further discoveries may clear up these mysteries.

**TATTOO EXPERTS FIND NEW DEMAND FOR THEIR ART**

Like all other arts and crafts, tattooing must keep abreast of the times in order to survive. The day of sailor trade, with its mermaids, ships' anchors and dragons, is pretty well in the background, but a new field has been opened in applying a

under two layers of skin, which is accomplished with a fine needle actuated by an electric vibrator. The delicate shading required is a test of the operator's skill. Applying photographs to the body is another form of expert work. A single needle is employed, but in the coarser work of the old days, and to a certain extent even today, several needles soldered together and operated by a single vibrator. The inks used are harmless, being made for this purpose in Germany. The predominating colors in the old-time designs were reds, blues and greens, but today a great variety of shades has been achieved. Another profitable field for the tattoo artist, if he is an expert, is the removal of tattoo marks. This is a dangerous process, if not carefully handled, and leaves a scar. To remove the marks, an acid preparation is pricked into the design, which eats away the color. An odd turn of the trade is putting color in a dog's nose to make it a more promising bench-show entry. An

245

*Prof. Harry Lawson  
Los Angeles, Calif.*

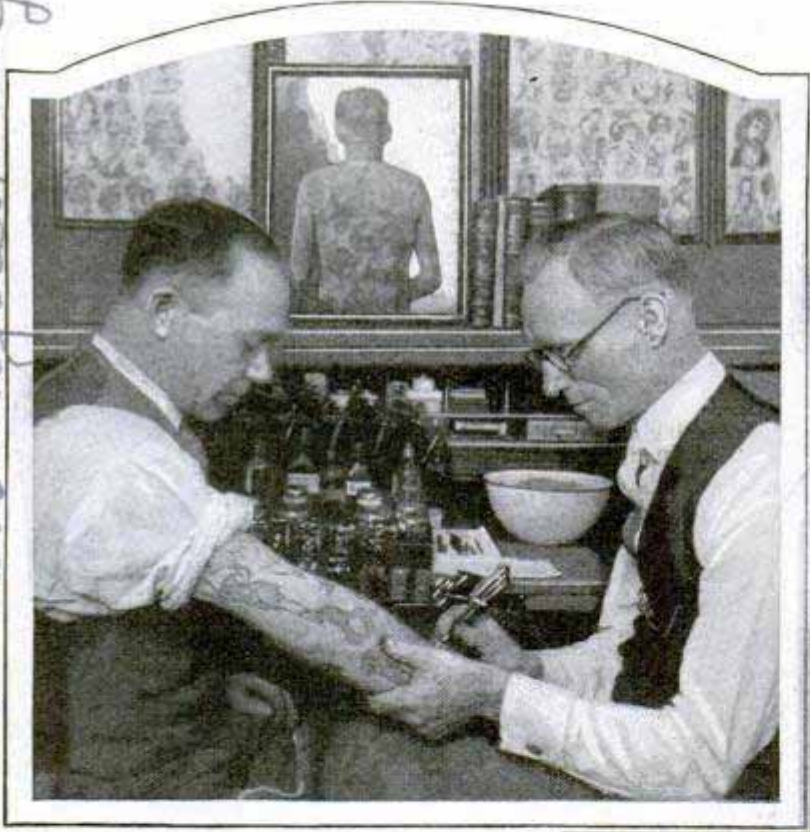

Applying Old-Time Tattoo Designs, and, at Right, a "Permanent Blush" to Young Woman's Cheek; This Work Requires a Delicate Touch and Discriminating Eye

"permanent blush" to women's cheeks, according to an expert who has experimented in this line. The operation consists, simply, of pricking the tint

*Comr. W. Sibley, 1240 E. Figueroa St.  
Los Angeles, Calif.*

239<sup>3</sup>

animal may approach perfection in all other requirements, but a mottled nose may bar it from a prize ribbon. The nose can be made all one color by tattooing. For many years there has been a profitable business in tattooing identification marks on infants, as a protection against kidnaping and getting lost, and emblems of lodges and fraternal organizations in indelible tattoo are in demand. A large number of customers wish tattoo designs to cover up vaccination scars, moles or birthmarks, and a blemish is thus converted into a decorative asset. Some of the more complicated designs cost as much as \$300, but the usual price is much less.

**POISON CRYSTALS IN SAFE WALL TO FOIL ROBBERS** 2492

Volumes of poisonous gas are produced the moment a drill penetrates the steel in a safe a German inventor has devised to defeat robbers. Crystals of deadly chemicals are deposited between the walls in a bed of porous concrete and are converted into gas by heat from the drill or blowtorch. The crystals are a compound of chlorine, carbon monoxide and hydrocyanic acid and the fumes are said to be more deadly than any used during the war and will penetrate any mask yet invented.

*Herald Tribune 5/8/27*

**VACUUM MOTOR LAWN MOWER SAVES TIME AND WORK** 2297

The blades of an electric lawn mower now on the market are so arranged that they are said to suck the grass against the cutting edges, thereby insuring a better trim. There are five rotary cutters and they turn at a speed of 5,000 revolutions per minute, power being supplied from an electric motor through a cord which may be attached to the ordinary 110-volt house current, either alternating or direct. The motor cuts a swath seventeen inches wide and the height of the cut may be adjusted.

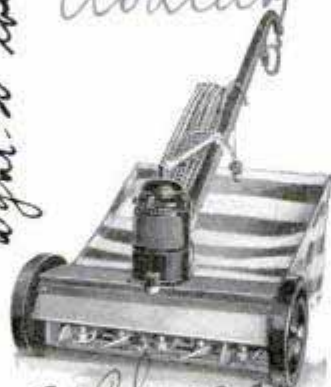

*Wght. 20 lbs. Vacuum Chicago*

*H.C. Lodge, Inc. 39-46 Alder St.*

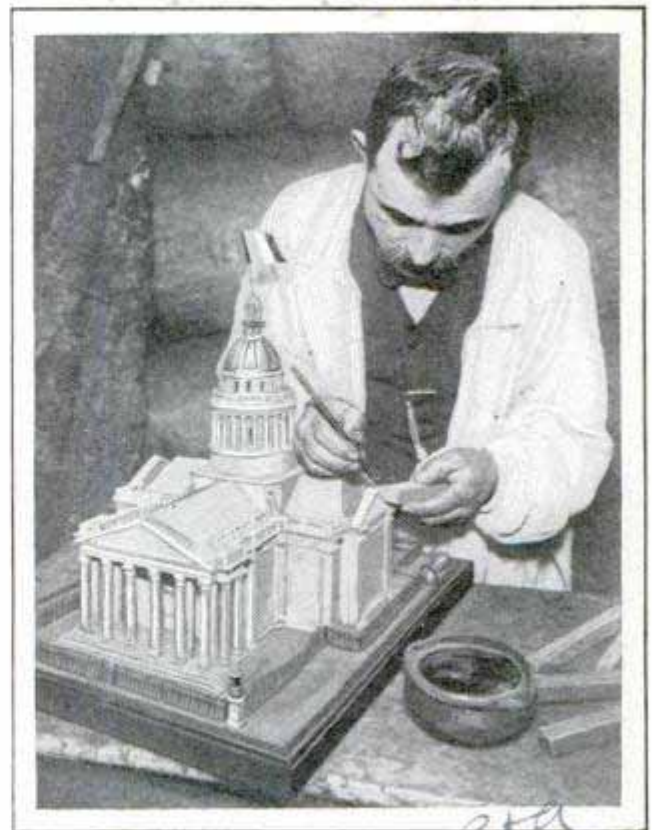

French Artist Finishing Model of the Pantheon in Cork; Material Is Easily Worked from Slabs

**MODEL OF PANTHEON IN CORK SHOWS ARTIST'S SKILL**

Slabs of cork are the principal material used by a French artist in fashioning models and other decorative objects. It is kept moist so that it will be pliable, and a special knife is used in tracing the outlines on the slabs before cutting. A replica of the famous Paris Pantheon, shown here, is typical of the things made from cork. One of the advantages of the material, besides its softness, is that the grain gives the effect of age—a desirable quality in reproducing some structures.

**"SUPER-FLAX SEED" DEVELOPED TO MAKE LINEN CHEAPER** 2511

Linen may become as cheap as cotton goods if experiments with a new flax seed introduced in Ireland produce the results that some of the most optimistic growers anticipate. It yields tow double the length of the ordinary variety and free from the troublesome sticky substances which necessitate expensive hand-cleaning methods. The new flax can be worked by machinery, it is said. Several hundred acres in Ulster and a tract in Somerset, England, are to be planted with the seed.

*Experiments conducted by Ulster Linen Research*

*Whang Poo, one of the largest and swiftest river steamers on the Whang Poo River*

*2434*



Protection from Chinese Bullets for Ships in Whangpoo River; the Rope Armor Is Draped on Vessel's Bridge

### ARMOR OF ROPE GUARDS SHIP FROM CHINESE BULLETS

Heavy ropes and cable, draped over the sides of vessels on the Whangpoo river in China, proved effective in protecting the bridge against bullets during recent anti-foreign demonstrations. The "armor" was necessary because the ships were frequently exposed to fire while on the river.

### WHO GAVE THE MONKEY WRENCH ITS NAME?

Where did the monkey wrench get its name? Some persons have held that it was named after its supposed inventor, James Monckey, but careful search of records has shown that no such name appears in the patent files of any country and the nearest approach is that of a Mr. Monk who was granted a patent for an improvement on pipe wrenches. But the term monkey wrench was used

long before that. One plausible explanation is offered by a foundry proprietor in a letter written to a friend in 1865. He suggested that the wrench was probably so called because you "twisted its tail to make it open its mouth." Another misconception lies in the application of the name. Large buyers prefer the term "screw wrench," while in some sections, "spanner" is used.

### CAR-STEP PLATE ALSO CARRIES LUGGAGE

*2250*

A luggage carrier that folds up and becomes a step plate on the running board of the car is one of the latest novelties for motorists. Fully opened, it has a length of thirty-five inches, sufficient to

hold two or three bags in place, while folded it is only fifteen inches long, and presents an aluminum and rubber tread for the passengers. The extension bars slide into the plate, which is hinged to the running board, and are held in place by a locking system.

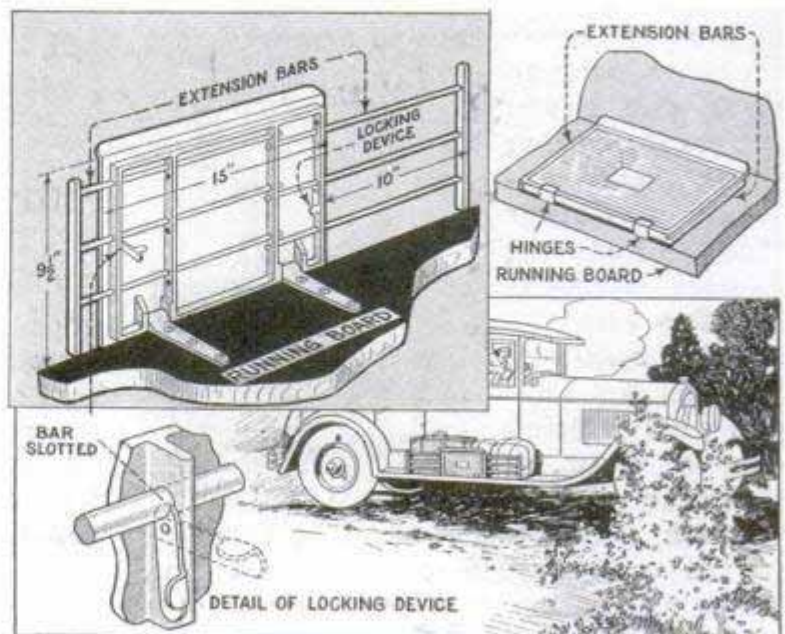

Diagrams of the Luggage Carrier Folded and Extended, and in Use on Auto Running Board

*Contrib. M. M. Swock, F. W. Kircher, 80!*

# Light Keepers *of the* Mountain Peaks



Coast and Geodetic Survey Party Dragging Sledge Load of Equipment across a Glacier Bound for a Mountain Peak, from Which the Survey Light Will Shine Out at Night

## Surveyors Who Operate Signal Lamps on Snowbound Summits Have One of the World's Most Lonely Jobs

By DONALD EDWARD KEYHOE

**B**LAZING into the night from a high Arizona peak shot a horizontal beam of light, its reflection silhouetting three figures beside a powerful electric lamp.

"Ten o'clock and no signal from Rogers," complained one of the men. "I wonder what's wrong. The others have been showing for an hour."

He indicated four specks of light gleaming like stars at distant points.

"Maybe it's too far to see him," ventured one of his companions, stooping to sight the lamp more accurately. "We're 153 miles from there."

For the fiftieth time the first man lifted his binoculars and stared into the darkness. After a minute he gave an exclamation of satisfaction. Another pinpoint of light had suddenly become visible. As he watched, it began a series of flashes.

"Send him a 'Z' and we'll get to work," he directed the man at the lamp. "We're late already."

He stepped back and swung his surveying theodolite toward the first of the far-off lights. As the lamp operator shielded the lens to start the code signal, the third man opened a recording book and poised

his pencil, awaiting the first angle reading.

Four hours later, with lamp, batteries, and theodolite in back packs, the little party began its laborious descent of the mountain. Tired and hungry, the three men reached the base just at dawn and stowed their instruments in a waiting truck. A hasty breakfast and they were on their way to another peak.

Forced marches like this, with only a few hours of sleep snatched between long periods of climbing and observing, are not unusual in the operations of the coast and geodetic survey. They are generally the rule in mountain states, where short summers and smoke from forest fires greatly reduce the working time. Transportation in such regions is always a problem. William Mussetter, a geodetic engineer of the survey, tells of several difficulties encountered recently:

"At one place, on a single-track sidehill road in the northern California mountains, we came to a hairpin turn so sharp that we had to jack up the rear of our truck to get around. Another truck started to slide down a ravine and was stopped by a big tree, the only one for a hundred feet.

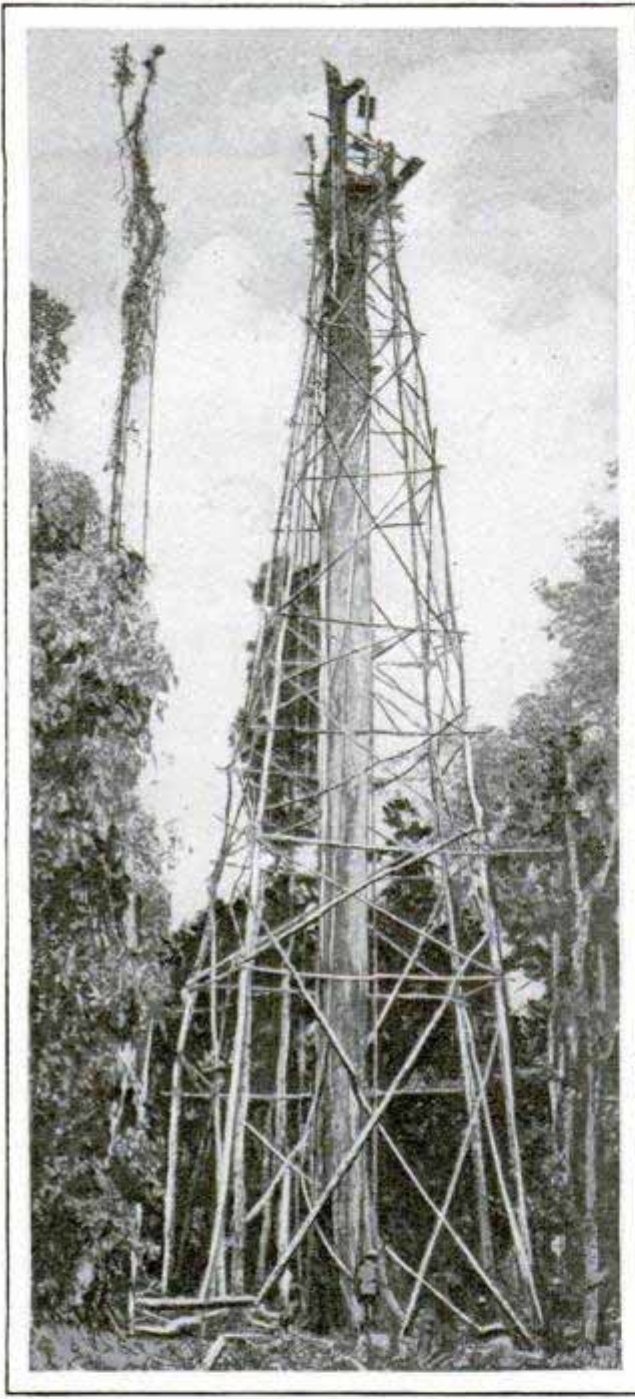

Signal Tower in the Philippines, Utilizing a Tree to Lift the Signal Light above the Jungle

"On the work between Salt Lake and Needles, Calif., our worst trouble was keeping enough water. While packing up a slope near Death Valley, where the temperature was 105 degrees early in the morning, six of us drank eight and one-half gallons of water in less than five hours. We observed at night and tried to sleep in the daytime, but it was usually too hot.

"We ran into cold weather, too, especially in mountain work. I remember we had to cross the Verde river several times when it was swollen by melting snow. Our boots filled up with sand and our socks would stay frozen all day, so we tried

fording it barefooted. We got over all right, but it was chilly traveling."

Experiences of this nature may seem incredible to people accustomed to the comforts of a city, but they are necessary in surveying remote parts of the country. Often the weight of instruments and supplies makes the carrying of bedding impossible. Sleeping for three or four nights in scooped-out hollows on mountain tops is not at all uncommon. The frequency of thunderstorms is another feature of high-altitude work. Two engineers of the survey were burned by lightning while working on Ladrone mountain, N. Mex., and others have had close escapes. Mr. Mussetter describes a strange scene on Boulder mountain, Mont., where such storms were daily occurrences:

"During the most severe storm I heard a queer 'frying' noise outside the tent. Going out, I saw the tops of our steel poles glowing brightly from charges of electricity. And at the same time my hair began to lift and crackle. I wasn't any too comfortable, but luckily we weren't struck, though we saw near by spots that were.

"It isn't always serious work," Mr. Mussetter continues. "Funny things often happen. Once we were coming down a steep slope which was covered by snow with a hard crust. To keep from slipping, we had to dig in with our heels. The man behind me was a rather short chap, and in trying to walk in my steps he made a miscalculation. The first thing I heard was a rather indignant outburst and then this fellow slid by me at high speed, whirling around like a top in his efforts to stop himself. He brought up about 120 feet away against a heap of brush. He got up at once and began to dance around.

"That's the first time I knew snow was hot!" he exclaimed, as I reached him.

"Another member of our party, who had not seen this, attempted to slide down a snowbank later on. He had seen others do it on a board, but rather thoughtlessly he chose a shovel. From his subsequent remarks I judged that he would not try it again for some time."

Sometimes peaks are not available for lights or observing stations. Signal towers must then be built or tall trees made to serve in their stead. Comm. E. H. Pagenhart of the coast and geodetic survey re-

lates a thrilling experience he had while working in a 250-foot tree in the state of Washington:

"Using climbing irons and a safety belt, I started up the tree, which was nine feet in diameter at the base. At 130 feet, I had to discard the belt to get around the first limb. Then I worked on up, driving big spikes to be used as steps. When I reached the top I cut off about thirty-five feet of it so that a platform could be built. On descending I found the falling limb had knocked out some of my spikes. I had slung a line at the top, so I started to slide down on it. In a moment I loosened my hold and commenced to gain speed. Then I came to the spikes. The first one whizzed by uncomfortably close. I made a grab at the next one or two but missed. Finally I managed to slow down and get a tight hold on a small limb. And I stayed there several minutes, getting my breath back.

"We were at that station three weeks. Every night a lightkeeper had to climb up there in the dark, show his light three or four hours and climb back down. He said his biggest fear was going to sleep on the platform and rolling off."

Comm. Pagenhart had put in the spikes at intervals equal to the distance he could step, which was unusually long, as he was a tall man. The lightkeeper working with him was also tall. However, the officer who followed a few months later was somewhat shorter. His monthly report contained this paragraph:

"I earnestly recommend that the man selected to put in spikes after this be the smallest man in the party."

In few stories of the survey is there any mention of the lightkeepers, and yet they



Electric-Signal Lamp Set Up and Ready for the Keeper, Who Will Tend It on Many Lonely Nights on His Isolated Hilltop

form a vital part of its geodetic work. Like their lonely brothers in lighthouses, they live a hermitlike existence, sometimes going days without seeing a human being. Night after night, their lamp shines from some isolated peak, its only answer a brief signal from the observer. Often there is no answer, as the observer is short-handed and cannot spare the time. But the lightkeeper must show his light regardless of whether he gets an answer or not.

Few men can stand such a desolate life for long, and many who try it "burn out" quickly. Yet there are several who have spent years in faithful service, taking blizzards, lightning, back-packing and other trials as part of the day's work. Seldom has a lightkeeper failed in his important duty, and then only for good reasons.

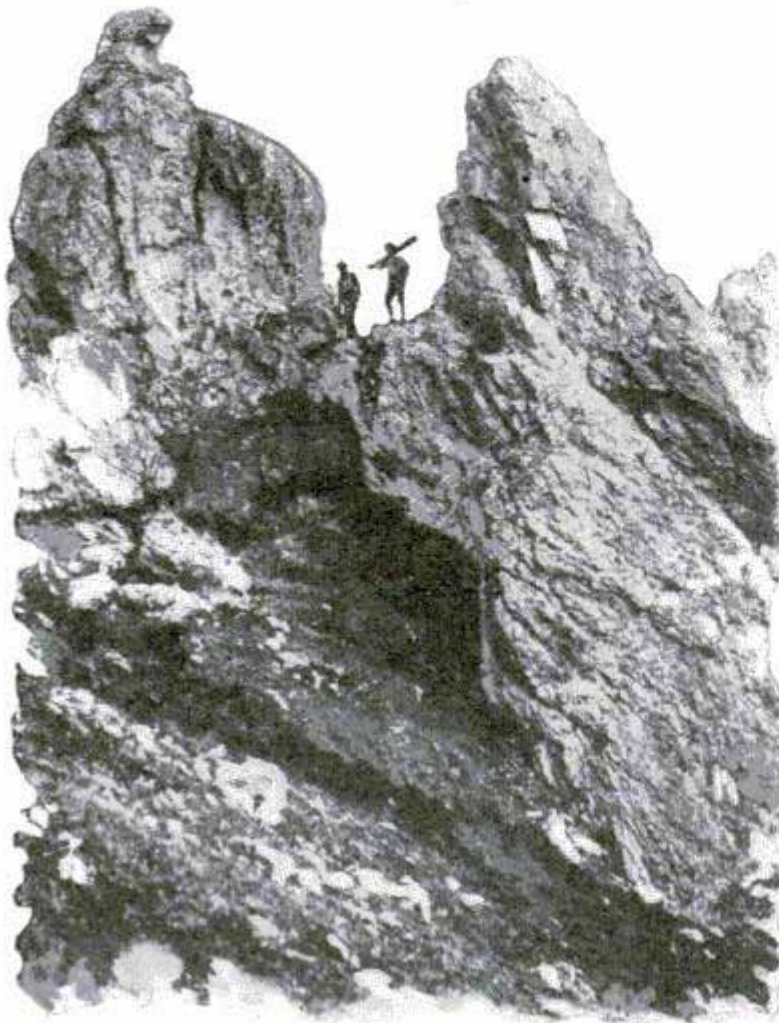

Engineers Climbing an Almost Vertical Cliff on the Boundary Line between Alaska and Canada, to Found a Lighthouse

Lieut. C. M. Durgin explains two of these rare instances:

"For two nights," he says, "we had missed a signal from a veteran lightkeeper named Wakefield. At last the officer in charge made a hurried trip to find the cause. It turned out that a large bear had taken possession of Wakefield's camp and had chased him off the peak. At another time, while observing on a light thirty miles away, we signaled the keeper for the time. He read 'Time' (— . . — . .) to be 'DG' (— . . — . .), which means 'Done at this station. Pack up and go to next one.' He didn't waste any time, but started at once, while we were fuming because the light went out. We didn't find out until the next day what was wrong.

"Montana seems to be an unlucky place for lightkeepers. One fellow came back to camp, after rustling some food, in time to see most of the camp destroyed by lightning. He fixed it up as well as he could, leaving his supplies while he went after limbs for shelter poles. When he got

back, the lightning had burned the rest of his camp and also his food. He's one man you don't want to tell 'lightning never strikes twice in the same place.'

"Another chap, William E. Black, of Idaho, was sent up on Neihart mountain, Mont., late in the fall. He stuck out three days and nights in a heavy blizzard, without even an encouraging signal from his observer. Seeing he couldn't communicate, he abandoned his station, packing his lamp, batteries, and full camp equipment on his back. In going down he had a bad fall that started a stitch in his side. When he reached the village of Neihart, after staggering through miles of blinding sleet and cutting his way through undergrowth with an ax, they found he had a broken rib. Many a man would have dropped his pack rather than suffer like that, but Black never thought of it."

The opposite kind of lightkeeper, who never lasts long with the survey, is described by Comm. Pagenhart:

"I had hired a new man at a village and had spent all afternoon explaining his duties to him. Then my recorder and I started for the observing station, twenty miles away. I told the lightkeeper, if he had any trouble, to tell my wife, who was staying at a house near by, and who understood the principles of the work. The recorder and I reached the station at dusk and started observing. At nine o'clock the light went out. I was airing my opinion of the keeper when it came on again and began to flicker. Knowing the man didn't understand the code, I paid no attention but continued to observe in spite of the unsteady light. We finished at last and drove back to the village. My remarks concerning the intelligence of the lightkeeper were interrupted by my wife, who explained that she had been sending me a message. Earlier in the evening she had sent a man to see how the new keeper was getting on. All he had found was a dark lamp, with a note which ran: 'Life is too short.'"



962 W. 7th St.  
Oakland, Calif.

215

**ELECTRIC LIGHTS AS BUG TRAPS  
GUARD RICE FIELDS**

2562

Electric lights suspended over vats of water are used successfully in Japan to trap insects that damage the rice plants. Attracted by the glow of the lamps, the bugs strike the bulbs and drop into the water. About one trap to each two and one-half acres is effective and while the method does not kill all the insects, it reduces their number materially.

**POST THAT SCREWS IN GROUND  
SAVES DIGGING HOLES**

2275

Anchorage for guy ropes and other purposes are quickly set without having to dig holes by means of a unit which is screwed into place. An auger head on the end of the bar is twisted into almost any kind of soil, from five to fifteen minutes being sufficient for installing it with two men working. In very hard areas, it is sometimes necessary to bore a small pilot hole first. The anchor is so designed that the weight of hundreds of cubic feet of earth

*Scrulix Anchors*

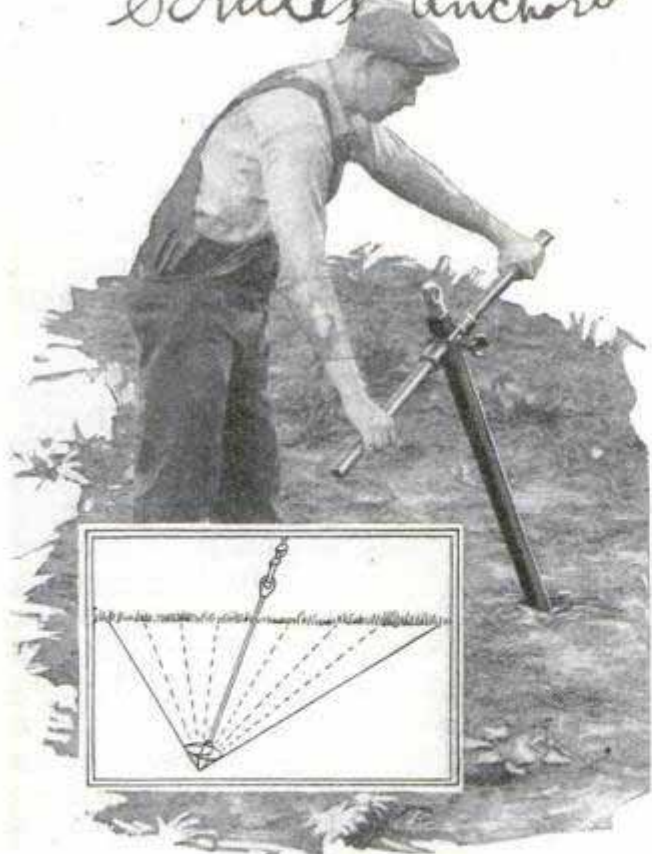

Setting the Anchor, and Diagram Showing How It Grips Wide Area When in Place

around it is brought into play in helping to hold the shaft in position under strain.

*W. H. Matthews Corp.*



Advertising a Town's Leading Industry, the Huge Chair at Thomasville, N. C.

**HUGE CHAIR MONUMENT BOOSTS  
TOWN'S INDUSTRY**

Thomasville, N. C., is one of the largest chair-manufacturing towns in the country, and, to advertise the fact, a giant seat has been erected on a pedestal in a conspicuous part of the city. It is thirteen feet high, the front legs are six feet tall and the seat slants to five and one-half feet at the rear. The chair contains sufficient lumber to make 100 of the ordinary kind and a week's time was required to build it.

**"BREATH CURRENT" GIVES ALARM  
TO FOIL BURGLARS**

250

Wood, paper, glass and other materials generally used for insulation can be employed as current conductors in operating burglar alarms and other units, a Berlin engineer has demonstrated. The apparatus functions on less than one ten-millionth of an ampere through a sensitive relay of wood. Merely touching objects guarded by the alarm actuates the signal, it was shown, while the "breath currents" of electricity spread over walls and curtains touching the things protected.

*Blair Berlin Germany  
Dr. Walter*

*St. Louis*

Bed Folded in Knapsack for Carrying, and Extended; Note How Sleeper Is Raised from the Ground



HOSPITAL FOR SEA GIVES SERVICE TO U. S. FLEET

2539 One of the most important units of the navy is the hospital ship "Relief," the first vessel in the world built from the keel up for naval hospital purposes. Besides having every modern device for the safety, comfort and care of the sick and wounded, it is fitted as a fleet medical depot to fill the requisitions for emergency supplies from the other ships, and carries materials for a field hospital in case there is need of such a unit by a landing party. The ship has twenty-nine officers, 324 enlisted men, is 483 feet long and of about 9,800 tons' displacement. During maneuvers, the "Relief" usually occupies a position in the rear of the fleet formation. Patients seriously ill or injured are lifted aboard on special stretchers, the gangway platform being built extra large to accommodate such equipment, and are quickly taken to operating rooms, wards or special-treatment quarters. Berths in the wards are detachable and accessible from both sides.

2539  
Camp 5/14  
Washington D.C.  
cont.

BED FOLDS UP AS KNAPSACK FOR HIKERS' COMFORT

For outing trips, a folding bed is carried as a knapsack and, when in use, keeps the occupant off the ground. It is made of rainproof canvas and the small metal parts necessary are of duralumin and weigh a little over three pounds. It offers an elastic and comfortable resting place and can be securely adjusted so that it will not sag down and touch the ground. In the home it may be used as an emergency bedstead.

BACKLASH IN CASTING ENDED BY WINDING LEVELER 22/3



Adjustable to spools of different width, a winding attachment for the fishing rod is said to enable the fisherman to get a crisscross wind on the reel and thus prevent backlash in casting. It is fixed with two small screws and

may be taken off quickly and easily when not wanted.

MILK IS TREATED WITH STEAM TO PREVENT SOURING

2536 By blowing steam through fresh milk and cream, a Wisconsin dairy expert has discovered a process for keeping them fresh. Milk thus treated was exposed to direct sunlight and kept at a temperature of seventy degrees for three weeks without souring, according to reports. The effectivity of the treatment is said to lie in the fact that the steam kills the bacteria and eliminates the acid that normally cause milk and cream to spoil.

George Lindrod

Lieuwen Cos  
Carron & Co.

2977

MYSTERY TEMPLE IS FOUND IN YUCATAN JUNGLE

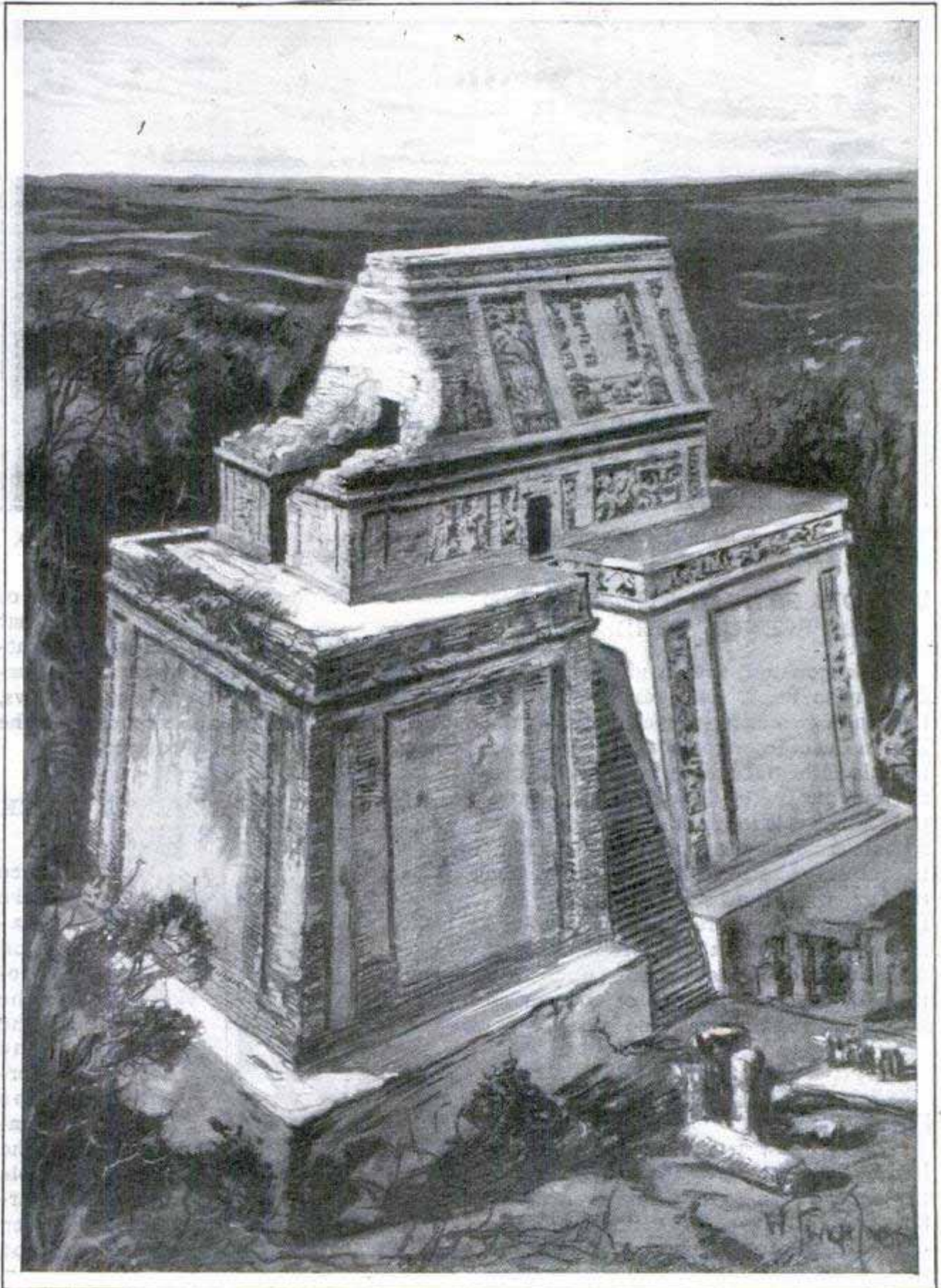

Courtesy The Sphere

B.51

Ruins of One of Several Hitherto Unknown Temples Recently Discovered in the Yucatan Jungles; Some Are Nearly 200 Feet High, Bear Dates of About 400 B. C., Are Covered with Stucco Brightly Painted and Are Remarkable for the Narrow, Three-Foot Rooms at the Top

*Esreat new Sp*  
*London*

*April 9,*  
*1927*

*Pilot Butte Inn, Bend, Ore.*

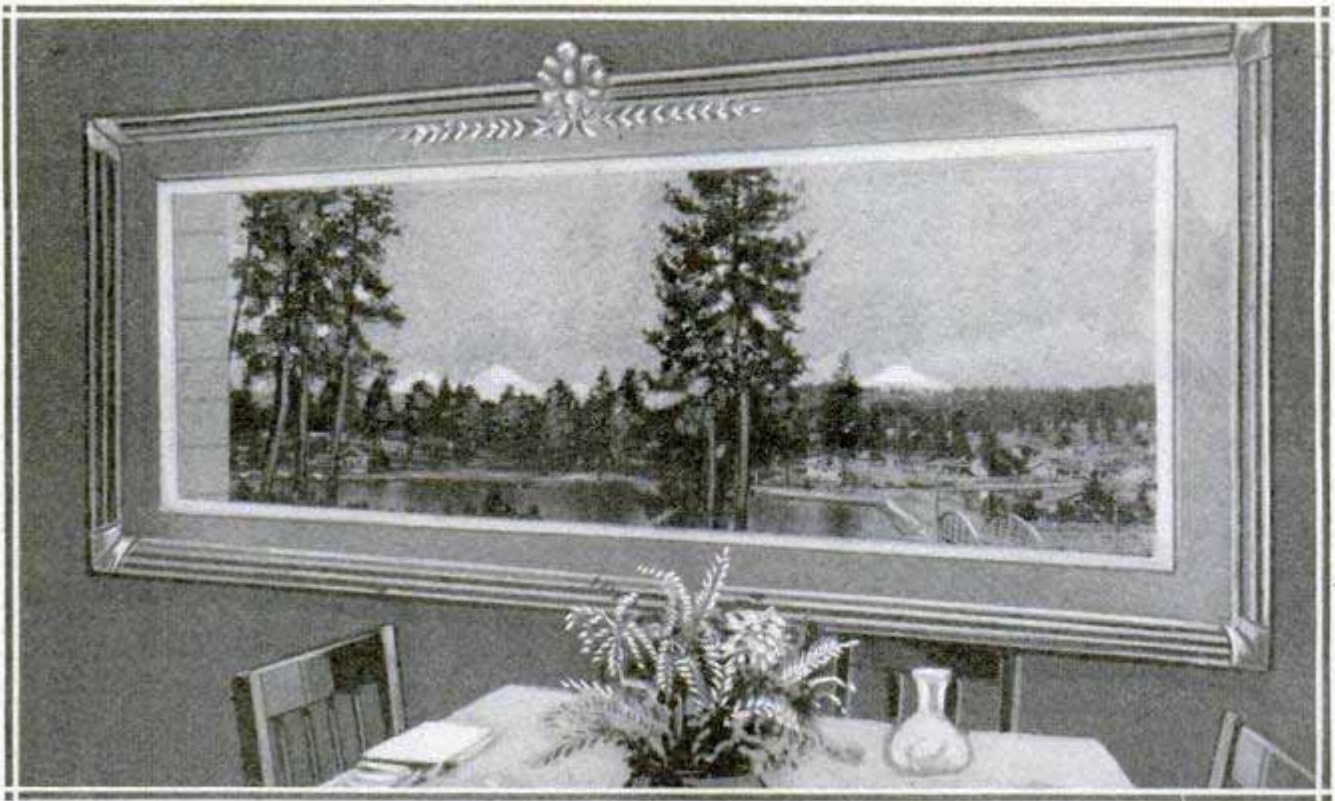

Window Casing Designed to Frame an Outdoor View; You Are Looking through the Wall of an Oregon Inn upon an Actual Panorama of Forests and Mountains

### WINDOW FRAMES THE PICTURE OF SCENIC WONDERS

An Oregon inn, with a matchless view of Douglas fir, a river, distant wooded slopes and two snow-capped peaks of the Oregon Cascades, known as "The Sisters," capitalized the outlook by installing a "picture window" in the dining room. A heavy gold frame replaces the usual window casing and incloses the panorama of distant mountains. The Sisters recently attracted attention when land surveyors of the forestry service discovered that between the two peaks was a "lost" half section of land which by accident had remained unclaimed and uncharted on the map of Oregon, so that officially it belongs to no state.

### PORTABLE CANVAS SNOW FENCE SUBSTITUTE FOR BOARDS

*24 79*

To keep snow from drifting upon the highways, a light, waterproof canvas fence has been devised by a Maine man to replace unsightly wooden barriers. When not in use, it can be rolled up and stored away. The canvas strips are attached to iron rods which are driven into the ground at intervals of ten feet. The strips are six inches wide and are spaced to form a fence

four feet high, using but four lengths of canvas. The rods are long enough so that the lower strip can be removed and attached to the top if desired, making a barrier six feet high. When the wind blows, the strips sway back and forth, causing the snow to drift away from the road.

### SAFETY LAMP-PREVENTS SHOCK AND DANGER OF FIRE



Especially suited for use around the home or in garages, an extension electric light provides safety to the user, as both the socket and the wires are rubber-covered and the guard is fully insulated from the socket. A flexible handle is also furnished. Another electric unit for safety and convenience is a protector, which is easily adjusted and guards the plug from injury when it is dragged along the floor or bumped into objects.

*Chas. Elmer Sargent, Ericson Mfg Co, Portland, Ore.*

**RECORD FLIGHTS WITH GLIDERS  
MADE IN GERMANY** 2488

German flyers have been conducting many experiments with gliders recently, the results assuring experts that these motorless planes have possibilities of considerable usefulness. One aviator skimmed down from the crest of the Zugspitze to the valley of Ehrwald, 10,000 feet below, not long ago, making the ten-mile distance in twenty-five minutes and establishing a record for glider flights from such an altitude. A few day later, another flyer remained in the air for fourteen hours and eight minutes on a glider.

**BIG PIPE SWUNG FROM CABLE  
DEFIES COAST STORM** 1954

During a severe storm, a 100-foot section of the twenty-eight-inch riveted-steel pipe line that supplies San Diego, Calif., with 5,000,000 gallons of water daily, was completely undermined and left without support. Engineers expected that it would break or at least leak, but it held securely. Temporary frames were quickly erected at either end of the stranded section, a cable was stretched between them and vertical lines tied to it, then under and around the pipe to decrease the strain. This held until a permanent support could be made.

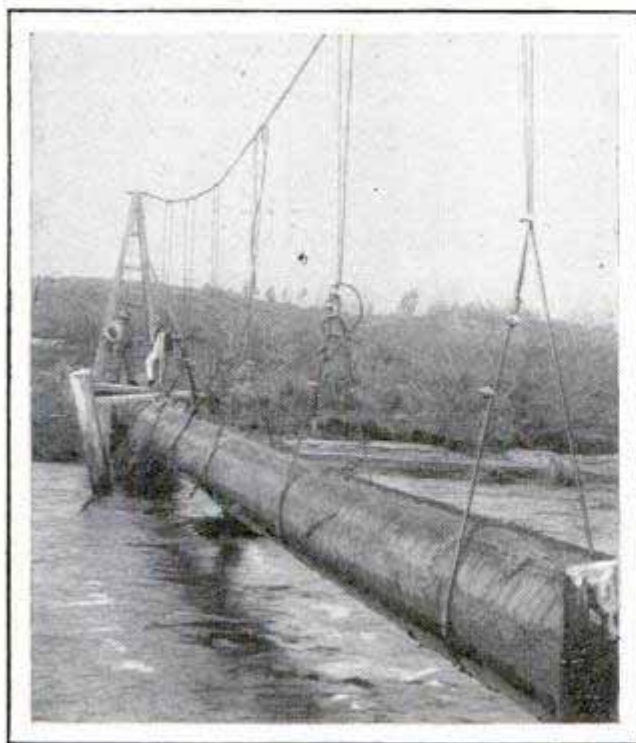

Sling Suspenders for the Pipe Line; It Failed to Break Although Unsupported for Some Time



Demonstrating the "Wooden Ear"; Vibrations from Phonograph Record Carried to Teeth through Stick

**HEARING THROUGH THE TEETH  
POSSIBLE WITH STICK**

Persons afflicted with poor hearing through some defect in the outer ear, can often distinguish sounds clearly when they are transmitted through the bones of the face. This is illustrated in the unit shown here, invented by a Florida man to enable the deaf to enjoy phonograph records. It is essentially a wooden holder with a phonograph needle in one end. The other is inserted between the teeth. The vibrations are communicated through the stick, thence to the ear through the bones.

**FREE SUN BATH IS ALLOWED  
BY PERMEABLE CLOTHING**

Without change of appearance or durability, cloth is treated by a method a British scientist has discovered, so that it allows the healthful ultra-violet rays of the sun to pass through and reach the skin. The way for "free sun-bath treatments" was discovered during the course of some X-ray experiments.

*W. J. Lince, Miami Fla*  
*2497*  
*Prof. A. M. Low.*  
*1. Woodstock Road.*  
*W. Herald Tribune 5/8/27*

*Joseph Stulik, Ogden, Oregon, & Breinerd Ave  
La Grange, Ill*

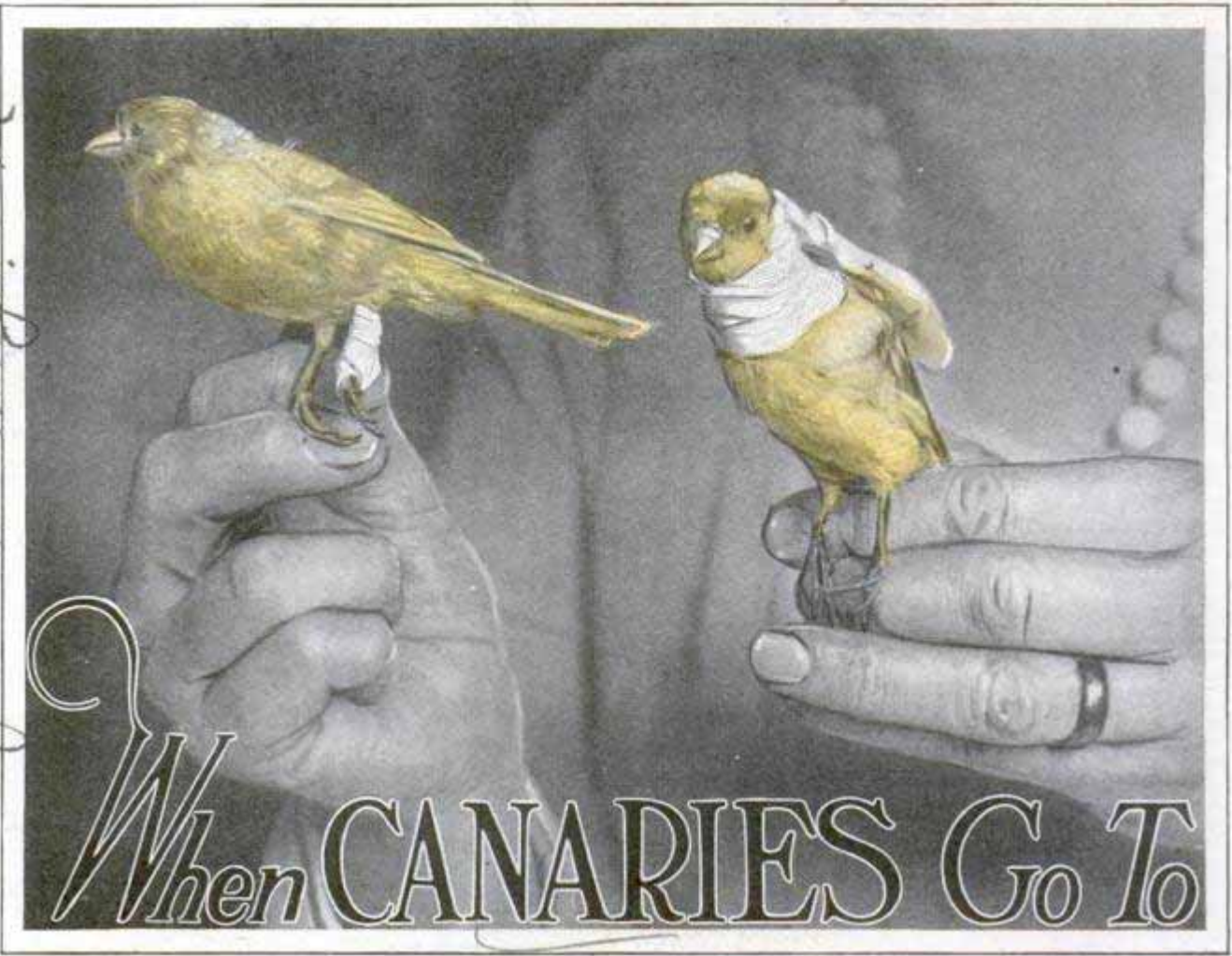

By PAUL PADDOCK

CANARIES are like parrots, they learn by imitation, hence their early instruction is of importance, for most of their singing ability is acquired while they are very young. Not many learn a great deal after they are a year old. Females seldom sing, but if your male canary doesn't do anything but chirp, its early schooling was probably neglected, or it grew up in the wrong company.

A visitor at Stulik's canary farm, close to Chicago, where from 500 to 4,000 pets are housed in one of the largest aviaries of its kind in the world, soon learns that a singing canary is about as temperamental as other "stars," that it is subject to sore throat and other ills that afflict human performers, gets jealous and angry at its rivals, is exceedingly self-centered and requires weeks of careful instruction with expert bird teachers and special instruments before it learns its songs. At this institution is a large flying cage where the birds get exercise after they are eighteen to twenty-two days old, a boarding house,

rooms for breeding cages, and a theater where the singing "pupils" may perform for visitors. It all grew out of a hobby Mr. Stulik started twenty years ago.

Four or five months after the birds are hatched the males are caged in the singing department. Two or three star performers are kept close to them so that they will hear desirable notes at all times and will not learn to imitate the chirping of the females. Each bird is kept partitioned from the next stack of cages, and the entire singing class is curtained off part of the time each day.

Bird raisers use violins, flutes, whistles and many other instruments in teaching their pets, but one of the most interesting aids is the organ. It is operated by weights on a chain and produces three distinct sounds, a whistle, a rapid staccato bass note and a call like that of a cuckoo. As the weight falls, it pumps small bellows which supply air to the proper chambers to make the sounds. It runs forty-five minutes before the weight must be read-

Canaries Recuperating in  
Bird Hospital, and a Class  
of Tricksters Training for  
the Stage

# SCHOOL

justed. How rapidly the bird will learn and how fine its song will be, depend to a large degree upon its breeding and its own peculiarities. It may develop into a genius such as "Yankee," the famous California bird that whistles a number of tunes and is a favorite radio entertainer.

Bird fanciers in England quite recently mourned the death of a remarkable roller canary. The name "roller" describes the soft, rolling notes these birds produce as compared with the sharp, halting ones of ordinary kinds. This particular bird was able to make sixteen different notes a second. It died before another canary could be taught to imitate the song, which is now regarded as the "lost chord" of the bird world. Few canaries can make more than ten notes a second.

In picking a canary from a bird store, some prefer imported ones, but authorities declare that no one country now has any monopoly on fine singing canaries. Of the 500,000 live birds shipped into the

United States in 1925, the majority were canaries, and it is not unusual for a steamer to carry 1,000 or more in one shipment for sale here. Last year, a New York department store sold 18,000 canaries and more than 5,000 love birds, besides hundreds of other kinds. Each year, it takes more than 12,000,000 pounds of imported canary seed to keep the bird pets in American homes well and singing. The increasing popularity of the birds is partly due to the fact that so little time is required to tend them. Five minutes a day is enough if careful attention is given to the diet. Originally a native of the Azores, the Canary and other small islands off the east coast of Africa, the bird has become adapted to less tropical climates and but little resembles the wild varieties in plumage or song.

Many bird owners make the mistake of giving their canary too much sunlight and keeping it too warm. Since the beginning of the sixteenth century the bird has been



How the Singing "Pupils" Are Kept Covered and the Cages Separated with Paper Partitions; an Outdoor Cage at Stulik's Farm, and the Bird Organ Being Adjusted for Operation

a household pet and has become accustomed to indoor life, but it is less delicate than many persons suppose. Last winter one of Stulik's canaries was kept in an outdoor cage all season and apparently was comfortable when the temperature was seventeen degrees below zero. This treatment is not recommended for all birds, but they do not need and should not have constant coddling, authorities declare. Keep the cage in the coolest part of the house in the summer, and in winter where there is likely to be the most even temperature. The bird should not be exposed to direct sunlight nor placed near a window. The cage should not hang too close to the ceiling. Most of the air currents are more pronounced at the top of a room so that there is danger of a draft if too high. On the other hand, the cage should not be under six feet from the floor.

The canary is a voracious eater. One owner reported that his bird ate thirty times its own weight in seeds and other food in one month. This was probably a case of improper feeding, but many persons make the mistake of giving their pets too much. The bird should always have cuttle bone, some kind of fine gravel to help to digest its food, and a plentiful supply of drinking water. The diet depends to some extent upon the bird itself, and owners are advised to study their pets and find out what kinds of food produce the best results. A first essential is good canary seed and rape seed. Celery, cabbage, apple, green pepper, dandelion, chickweed,

raw carrot and lettuce are all suitable extras, although many experts agree that a common mistake is to give the canary too much of the latter vegetable. Hemp seed should be given as an extra and not as a steady item of diet. A daily feed of hard-boiled egg with crackers is given to advantage, especially during the breeding season.

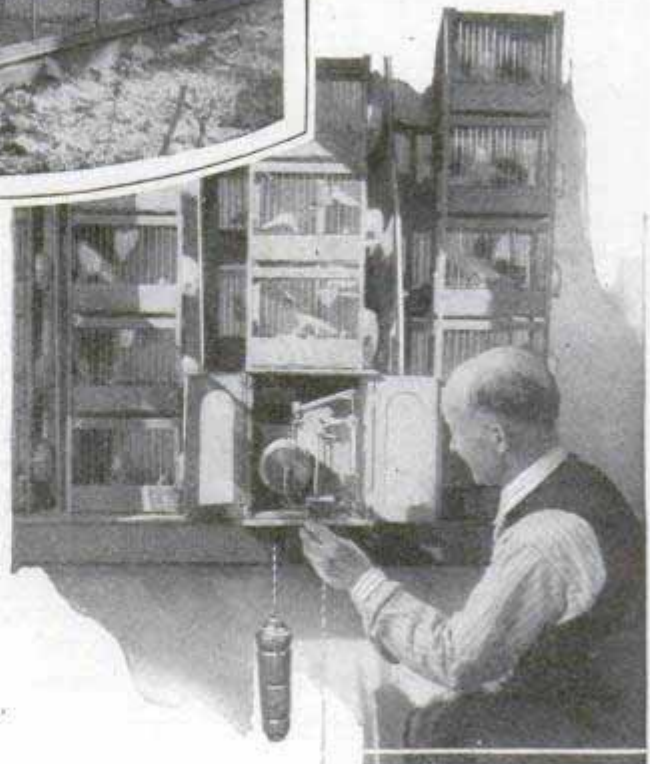
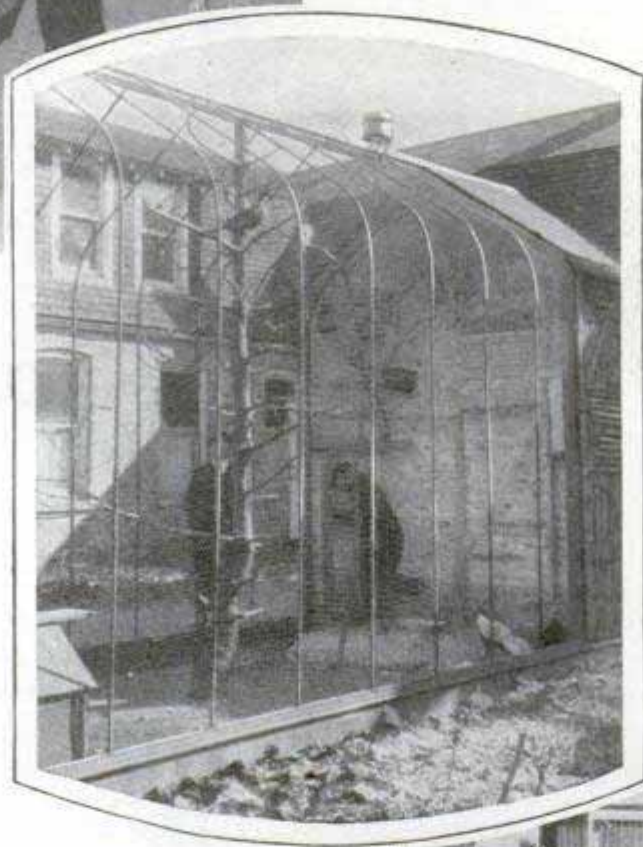



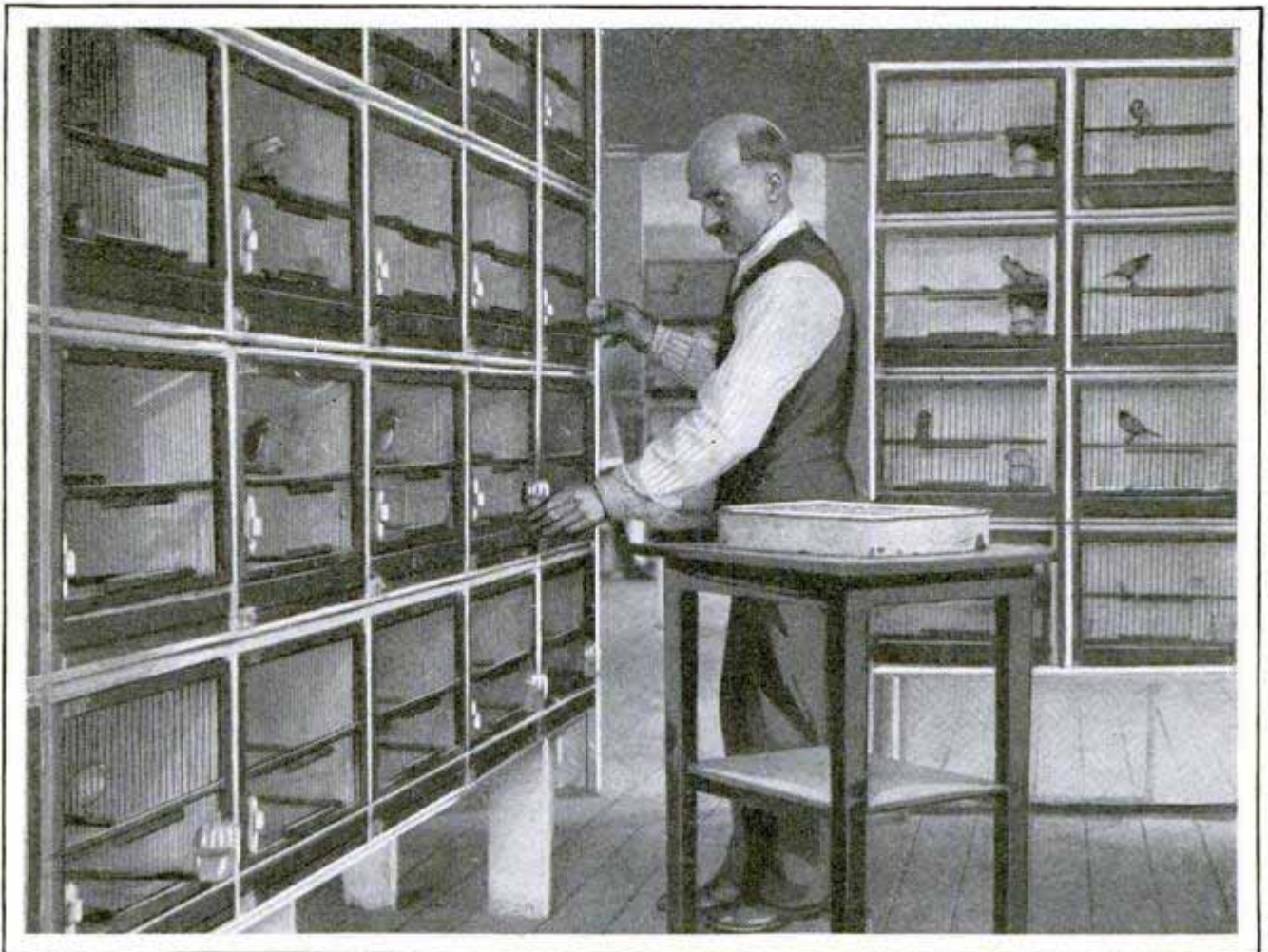

Feeding and Watering Time at the Canary "Farm"; Rations Are Carefully Measured According to the Bird's Appetite; Don't Overfeed Your Pet, the Experts Advise

Canaries are subject to a dozen or more common ailments, some of which need expert treatment. One of the chief troubles is colds, often caused by exposing the bird to drafts, giving ice-cold drinking water, forced cold baths or too sudden change in temperature. A cold may also explain why the canary no longer sings. A drop or two of olive oil down the bird's throat, taking care not to get any on the feathers, a small piece of rock candy in the drinking water and a bit of smoked fat bacon, within easy reach between the bars of the cage, may help restore the bird's voice. Frequently inferior seed is responsible for loss of voice. It may also be stimulated to sing by placing it where it can hear the song of other birds, or musical instruments.

With proper care, canaries often live to be twelve or sixteen years old, and sometimes longer. In selecting from a bird store, the young ones can often be distinguished from the older birds by their feet and legs, which are smooth and of fine texture under the age of a year or so. The more mature birds have coarse and scaly

legs. Experts are fooled many times in distinguishing a male from a female, but, in general, the male birds have broader heads, flatter on the crown, the body is more slender, the eyes are brighter and more bold-looking and color patches on the back are usually of darker hue than those on the female. The male swells its throat when singing and produces a longer, more connected song.

### BRACE TO KEEP HATS IN SHAPE HIDDEN UNDER SWEATBAND

Concealed under the sweatband, an adjustable brace is said to keep the crown of a soft hat in better shape as it prevents the front or back from caving in. The support is partly collapsible so that it may be fitted to hats of different sizes and does not interfere with the wearer when in place.



Hgt. Horner Co.  
Box 155

731 Plum St. Vineland, N.J.

2357



Matching the Washington Monument in Altitude; the New American Insurance Union Building in Columbus, Ohio

## BUILDING RIVALS WASHINGTON MONUMENT IN HEIGHT

Built to the exact height of the Washington monument—555 feet five and a half inches, the new forty-eight story home of the American Insurance Union in Columbus, Ohio, combines a theater seating 3,000 people, a 600-room hotel and an office building, all in one. The main tower rises at the corner of two streets, with wings flanking it on either side, while back of the tower and between the wings is the theater. An alley on one side is bridged to connect several floors to an adjoining hotel, giving a 600-room addition, and above the hotel is the office building. How much material is used in building a modern

skyscraper, is indicated by some of the architect's figures. The concrete would build a sidewalk four inches thick, three feet wide and ninety-six miles long. Ten thousand tons of structural steel, if rolled into quarter-inch plates, would cover forty-six acres or make a seventy-five-foot roadway more than five miles in length. The 1,712 windows in the building, with 34,000 square feet of glass, equal the entire surface area of one side of the building. Three thousand doors, eighty miles of electric wiring, fifty miles of conduit, five miles of telephone wire, five acres of room carpets in the hotel section, two-thirds of a mile of corridor carpet and fifty-seven acres of plastering are some of the other things that are involved.

## TRICYCLE TAXICAB CUTS COST

23P2

Three-wheeled taxicabs, recently introduced in Vienna, are said to be gaining favor, as they operate on reduced rates and make fast time. An additional advantage is that they take up less room than the larger cars and can be handled easily in crowded traffic.



Tricycle Taxicab for Rapid Service through Crowded Streets; Passengers Are Sheltered from Weather

## SADDLE MAKING IS REVIVED AS ART IN FAR WEST



Carving Designs on Leg Fender; Upper Right, a Twenty-Five-Hundred-Dollar Saddle; Left, Standard Type and Elaborate Bits

Despite the passing of the horse-and-buggy days, the saddle business is picking up. While the movies are partly responsible for the revival of the saddler's art, a greater market has been opened by the wealthy sportsmen who have purchased large estates in California and also the "dude" ranches in Montana and elsewhere. Visiting easterners like all the western color they can get, and a handsome silver-mounted saddle is no small part of it. Some of the saddles, with bridle and equipment to match, sell for as high as \$5,000 and require over a month to make. Frequently the buyer comes to Los Angeles to be "fitted," much as a man is measured for a suit of clothes. There is still a considera-

ble market among the real cowboys, and the amount that these men of the plains will invest in a good saddle is surprising. Often its cost is equal to that of a serviceable car. Saddlery is really an art rather than a trade. Frank Moreno, one of the best-known saddlers in the west, has worked continuously at this craft for twenty-seven years, and his father before him, a California pioneer, spent all his active years in making saddles. From cutting down to fashioning the seat and fitting the rich trimmings, saddlery requires great skill. The leather carving in itself is a fine art, and all is done free-hand. Designing and engraving the silver plates and "conchos" is still another highly specialized art.

Brydon Cross  
229 S Main St.

*W. H. Jones  
Oakland,  
Calif.*

### CONTROL FOR SHIP PROPELLERS PREVENTS "RACING"

To prevent the racing of a vessel's propeller when the stern is out of water in a high sea, a control has been designed by a California inventor. It is intended to reduce shock and strain and to result in lower fuel consumption, especially in heavy weather. During a gale, when high seas are running, and the propeller is buried deep one moment and spinning like a windmill, high above the trough of the sea, the next, it is a frequent practice to have two or more men stationed at the throttle valve to meet the ship's motion by cutting down the steam pressure as the vessel rises and the water resistance against the blades is reduced to nothing, then opening the valve the next instant as the ship settles, in order to maintain headway. This method is not efficient and is supplanted in the automatic control which is essentially a weight on wheels that follows the motion of the vessel and actuates a geared valve, at the top of a pendulum, to open or close the steam as the vessel rises or settles.

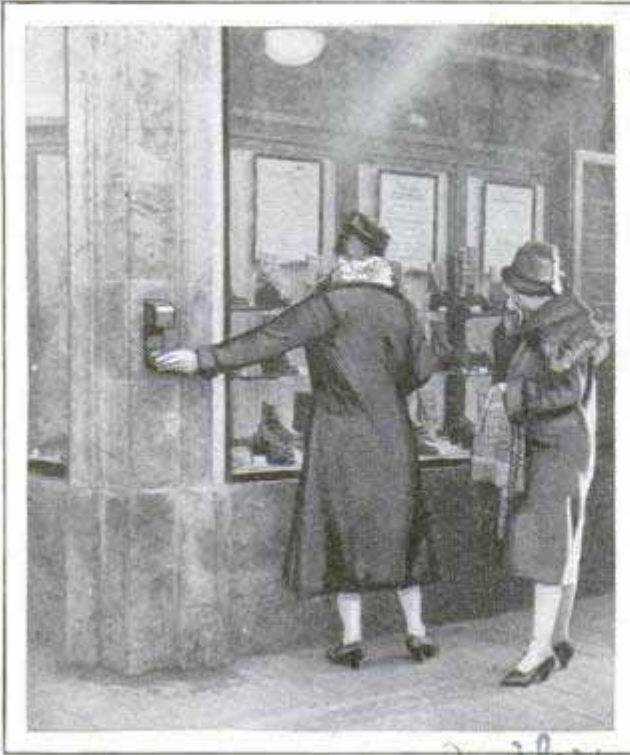

Lighting the Show Window with Outside Switch; Shoppers Learn to Turn It Off and Save Current

### SWITCH OUTSIDE SHOW WINDOW SAVES ELECTRICITY

Instead of allowing the lights in his shop windows to burn for hours at a time after nightfall, a Berlin merchant has installed a switch on the outside, so that persons wishing to see the display can turn the lamps on. Although some go away without snapping them off again, many do so with the result that much less current is consumed.

### EAST MEETS WEST IN TRAFFIC ON STREETS OF INDIA

Although western modes of travel are rapidly being introduced in India, the elephant is still widely used for transportation. Contrasts such as that presented in the accompanying photograph, the "three-seater" elephant with the five-passenger automobile, are commonly seen where the highways have been developed for auto traffic, but the elephant is still retained.

Extremes in Transportation Methods Meet in India Where Elephants Have Not Yet Given Way Entirely to Autos

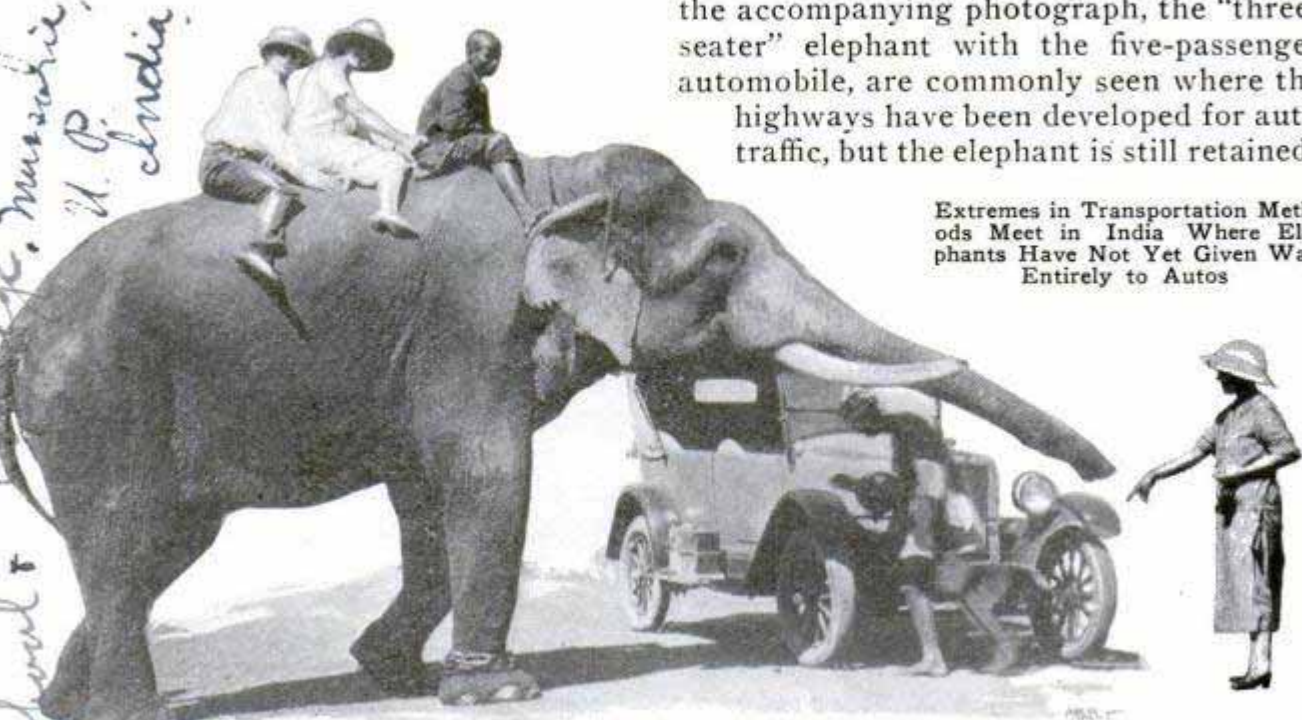

*Mysore State  
South India*

*W. H. Jones, B. Sc. F. R. S. Director of Industries Dept. Mysore State, U. P. India.*

*2497*

*Miller*

*2404*

*meiness, Holland*  
**SUB CIRCLES GLOBE TO STUDY CRUST**

Interesting observations of the earth's crust have been made by a Dutch scholar on a voyage rivaling in reality any described by Jules Verne, a submarine trip around the world. At certain places, the traveler was able to detect with comparative ease one of the phenomena known to scientists for some time, the difference in weight of the same objects at various points on the globe. Such measurements must be made with delicate instruments and are difficult on board a vessel, due to the motion. Inside the submarine, satisfactory results were obtained more easily as there was less interference. The difference in weight is believed to be caused by variations in the density of strata composing the crust of the globe.

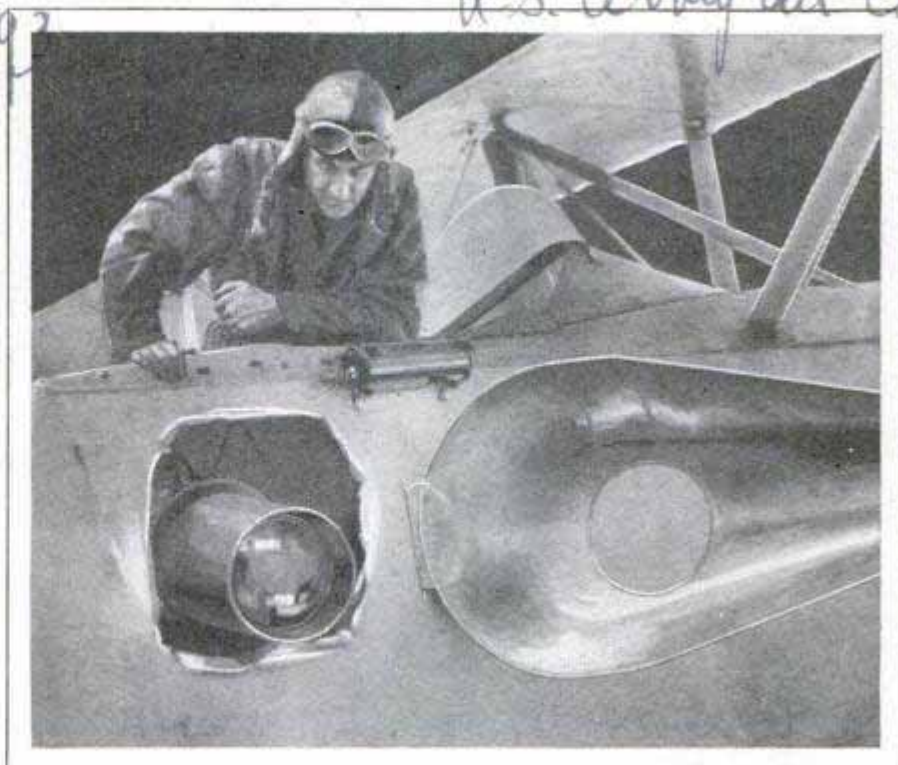

Camera "Cannon" to Take Pictures from Airplane at Range of 200 Miles; Special Ship Was Built to Use with It

**CANNON-SIZED AERIAL CAMERA HAS 200-MILE RANGE**

The biggest aerial camera ever built, with a nine-inch lens and a range of 200 miles or more, is to be tried out at Rochester, N. Y., this summer, taking long-distance pictures of New York city's famous sky line. The camera is so big that when it is thrust through a porthole in the side of an airplane, it looks like one of the ancient cannon of sailing-frigate days. Special filters will be employed to utilize the ultra-violet rays and penetrate clouds and mist. An airplane is being built for the camera, powered to fly higher than any aviator has yet been, so that pictures may be taken from a height of eight miles, at which the view would be between 300 and 400 miles.

**MAGNET KEEPS SAFETY-RAZOR**

*2295* **BLADES KEEN**

The principle of magnetism has been adapted to sharpen and keep in good condition safety-razor blades, saving the trouble of stropping them. When dull, the blade is simply inserted in a little cabinet in which a magnet is so adjusted that it straightens the bent and ragged edge of the blade without any effort on the part of the user. The sharpener has no moving parts to get out of order, is suited to different kinds of safety blades and keeps the blades where they are easily accessible.

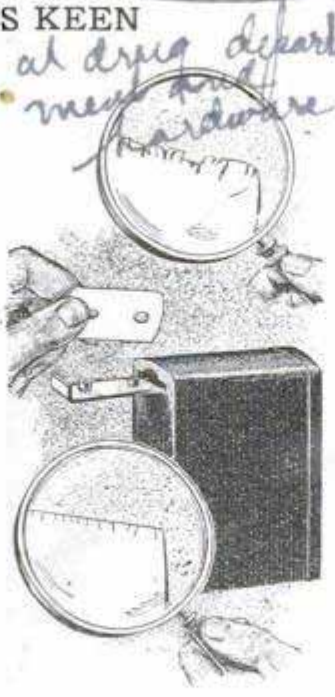

**OIL IS EXTRACTED FROM COAL IN IMPROVED RETORT**

Cheaper and quicker extraction of crude oil and gases from coal is promised with a special retort a South African inventor has devised. A distinguishing feature is an inside brush mechanism which is said to keep the contents agitated, hastening the reduction processes. Volatile matters are said to be vaporized within three minutes after the coal has been loaded into the retort, and oil is produced soon after.

*Everheen Corp.*

*Charles Griffiths*

*Will not remove stock nor restore mety or work on blades*

*Bar 3306  
Kretzschmar  
% Herald*

1198

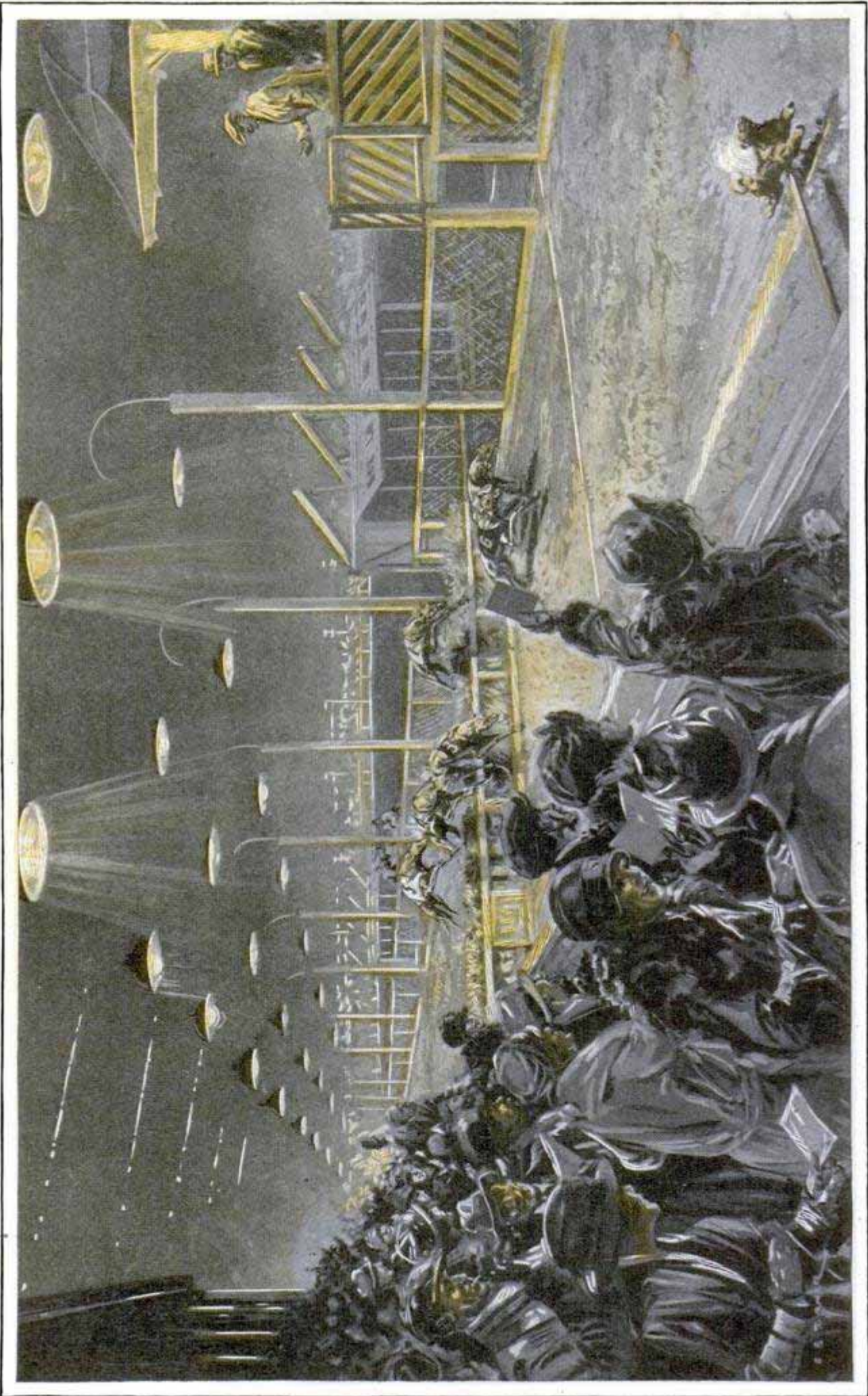

Greyhound Racing after a Mechanical Hare Has Displaced Whippet Coursing in England, Where a Half Dozen Tracks Are Devoted to the Newest Sport from America; the Sketch Shows a Typical Scene during a Hurdle Race on the Oval at Manchester

# Thrills in DOG RACING



Seven Tall and Speedy Greyhounds, Blanketed and on the Leash, Being Led Out for Their Race; the Dogs Are Paraded, Just as Are Horses, Before They Enter the Starting Box

**T**WO thousand powerful greyhounds, trained to the minute, are chasing electrically propelled stuffed rabbits around quarter-mile tracks all over the United States. Across the oceans, in Europe, South Africa and Australia, thousands of other blue-blooded canines are being raced in the latest of American sports, which already rivals the ancient pastime of horse racing in popularity.

Despite the fact that the game is hardly six years old, it has already taken a place as one of the most fascinating of sports. Crowds of 10,000 banked around the oval track are not unusual for the average evening program, all dog races being run at night under blazing electric lights.

To the late O. P. Smith, who, prior to his death a few months ago, was high commissioner of the International Greyhound Racing association, goes the credit for developing the chase of the electric rabbit. Mr. Smith developed his first crude mechanical rabbit as long ago as 1909, but it was not until ten years later that even fair success was attained, and public races really date from 1921. Despite its newness, the sport has spread throughout the

world. England saw its first track at Birmingham last year, and this season has six. Canada had one last year and four this season. One has been built at Cape Town; Australia is constructing several and Mexico has applied for a franchise under the international association.

Track racing differs materially from the "society races" of whippet dogs. The little whippets, weighing from twenty to twenty-five pounds, are raced on a straightaway between cords which mark each dog's path. A trainer at one end of the course releases the dog, who runs to a trainer at the other end.

The track races use greyhounds, standing twenty-four inches or more in height and weighing up to as much as seventy-five pounds, though the best racing animals average from fifty to sixty pounds. On the oval course, with fairly sharp curves at either end, only slightly banked, the better dogs can negotiate the quarter mile in twenty-five seconds, a rate of thirty-six miles an hour, and to keep the electric rabbit ahead of them in shorter dashes, it is geared for a top speed of fifty miles an hour, though its average running speed is

limited to around forty to forty-five miles. Twenty-five horsepower and an electric car weighing more than 1,100 pounds are necessary to whisk about a pound of stuffed rabbit around the course at that rate. Years of work were concentrated in developing the car, the special electric motor and the housing, which hides car and track from the dogs, while permitting the arm carrying the rabbit to project over the track for about five feet.

The dogs know that the rabbit is a fake, and in the early days when power failures or mechanical trouble brought frequent breakdowns, it was not unusual for the dogs to catch the lure and bite the skin until their gums bled from contact with the metal lining, yet they would be out in the next race trying just as hard as ever.

The greyhounds have learned to associate the rumble of the hidden car with the rabbit, and even when they cannot see the animal, will go wild with eagerness whenever they hear the mechanism start. For this reason the dog stables have to be kenneled away from the track, to keep the animals that are not racing from disturbing the peace. In the earlier days, after the rabbit escaped through a trapdoor at the end of the race and disappeared from sight, the car would keep on going for some distance under its own momentum, setting the dogs crazy in their eagerness to follow the noise. The difficulty was removed by the development of a special

motor which utilizes an ingenious electric braking system to bring the car to a stop by the time the dogs have reached the hole through which the rabbit disappeared.

The quarter-mile dirt tracks, twenty-five feet wide and banked two and a half feet at the turns, have front and back stretches, 300 feet in length, and turns with a diameter of about 117 feet. The housing that hides the car and motor is on the outside of the track, with a slot running around its inner face through which the arm carrying the lure projects. A plank track, laid around the outside of the track, provides a runway for a small rubber-tired wheel supporting the arm, keeping the rabbit about five inches above the track.

An improvement which has just been patented makes the rabbit move up and down in a realistic way as it runs along, and the new rabbit has been provided with a squeal to supplement the dog's eyes. Greyhounds have very poor scent and race only by sight and ear. A live rabbit tied in a sack and placed under a dog's nose will not be bothered so long as it doesn't move.

Eight dogs are raced in each event, and eight races, seven flat ones and one hurdle, compose the usual evening program. Occasionally matched races between two, three or four dogs are arranged. Starting boxes with spring trapdoors, each box having eight separate compartments for the dogs, are used. The electric rabbit is

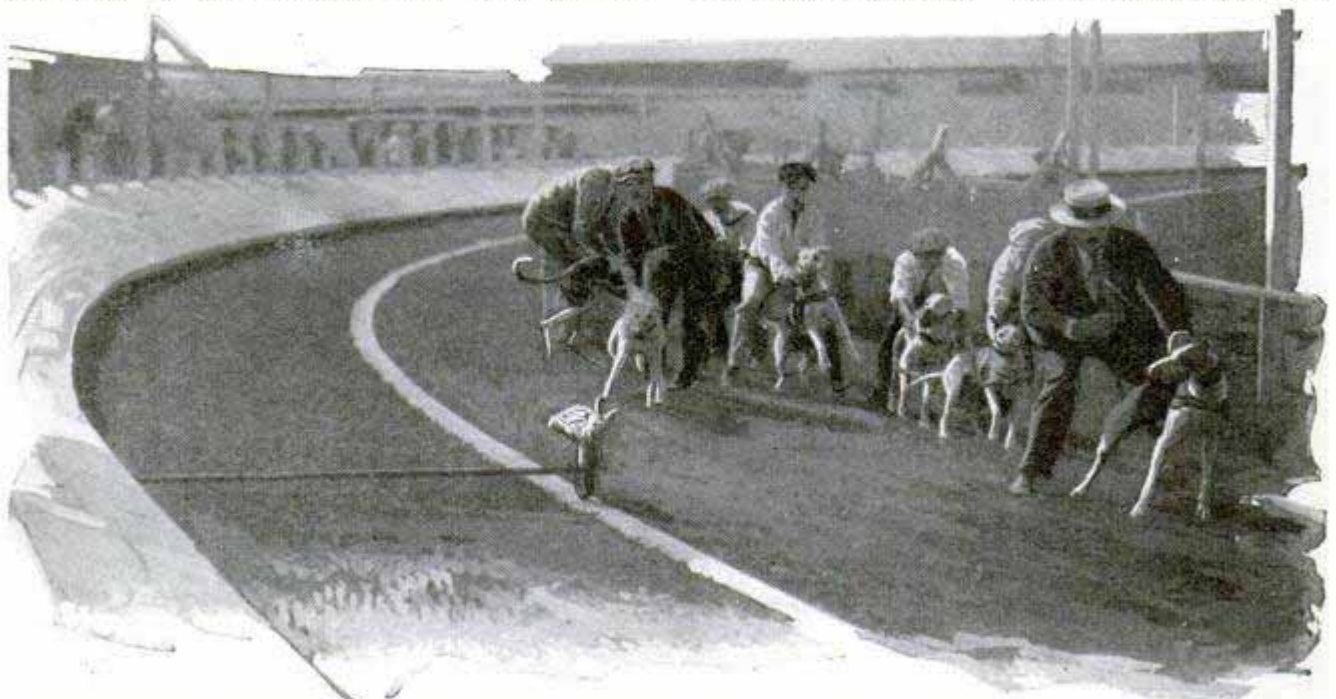

Trainers with a Group of Young Dogs Being Schooled to Chase the Electric Rabbit; the Narrow Track and the Wheel Are Eliminated in the Latest Models to Increase the Realism





The Society Game of Whippet Racing; the Dogs Are Much Smaller Than Greyhounds and Race on the Straightaway, between Tapes, Running from One Trainer at the Start to Another at the Finish

"spotted" at the other end of the track, just out of sight around a bend, and the dogs are placed in the starting box, which is run out on the track. The position of the box is twenty feet behind the starting line, where the clocker stands with his stop watch.

When the dogs are in place, the rabbit is started and run around the track to get up speed. As it passes the boxes, the dogs catch sight and give tongue. When the rabbit gets forty feet ahead, the starter drops his flag and the trapdoors are sprung, releasing the dogs. From then on the man at the controls in a tower, from which the entire track is visible, keeps the rabbit about sixty feet ahead of the foremost dog.

As soon as the animals start, the box is withdrawn from the track, and after the car has passed the right end of the front stretch, the operator in the control car throws a switch in the track so that, when the car gets around again, it will be side-tracked onto a switch track. A barrier is

dropped across the track, containing a trapdoor through which the rabbit disappears. The barrier is 126 feet past the finish line and the dogs continue the chase until the lure vanishes. They rush up and sniff the door, and occasionally try to poke their heads through, but by the time they reach it, the electric brake has stopped the car and there is no sound to follow.

The greyhounds raced are all thoroughbreds. An untrained pup is worth as much as \$300 or more, and trained dogs which have won a race bring from \$1,000 up. The owner of the world's champion hurdler has refused an offer of \$5,000 for his dog.

They are at their best when from two to three years old, though some pups have been raced at fifteen months. The average racer lasts for three or four years, though again there are exceptions, some dogs eight and nine years old still being able to go out and win a race occasionally.

One advantage over horse racing is the lower prices of the animals, the lower upkeep costs and the lower transportation



A Fine Specimen of Greyhound; No Particular Color Scheme Is Standard, the Thoroughbreds Being of Many Types

charges, for a dog in his traveling box can be carried by express for only a fraction of what it costs to ship a horse. Thirty-five cents a day will feed a racing greyhound. One meal a day, after the evening's race, is the usual fare. The most common diet is seventy per cent fresh-ground hamburger, mixed with crumbled dog biscuit or crumbs of very dry bread. Some of the western dog raisers have had success in feeding their animals specially cooked Irish stews.

While one meal a day is the rule, some of the trainers, who had experience in

Irish coursing before taking up track racing, have introduced an unusual novelty by giving their dogs a cup of very black coffee each morning. The animals take to the coffee and the trainers claim that it not only gives them strength and speed, but helps them get through the day on an empty stomach.

One of the things that make dog racing attractive for the spectator is the fact that the dogs run their own race, without control or guidance, which obviates any chance for "pulling" a mount, as has been done in horse racing. Like every other sport in which money changes hands, many attempts have been made to fix or throw races, usually by tampering with the dogs' food. Besides outlawing trainers who were caught in attempting frauds, the govern-

ing association, which supplies all the race officials for each track, has adopted elaborate precautions to defeat crookedness.

The most important is the fixing of a racing weight for each dog. The owner is allowed two weeks to experiment with a new dog, after which he must declare the weight at which he believes his animal performs to the best advantage. Thereafter, until a new weight has been declared as the dog grows, the animal must be kept within a half pound over or under the de-

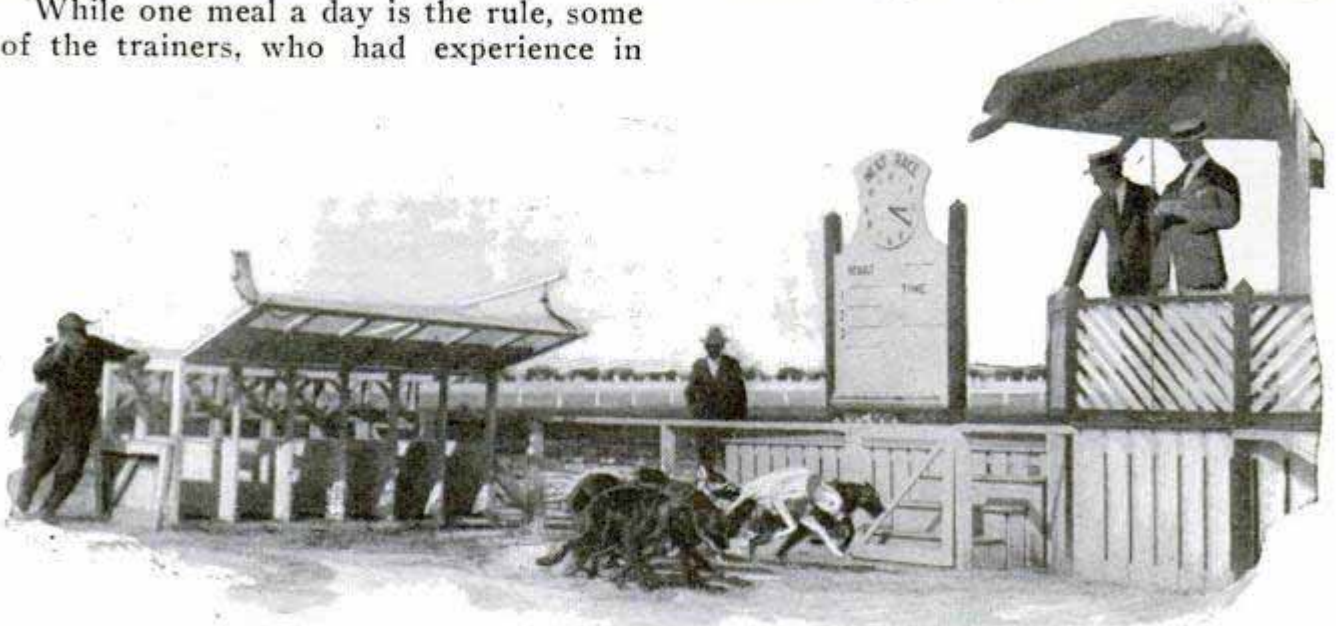

The Start of the Race, Just After the Dogs Have Been Released from the Starting Box to Chase the Electric Rabbit, Which Is Sixty Feet Ahead and Near the Outer Edge of the Track

clared size. The dogs are weighed in at six o'clock in the evening on which they are to race, and if outside the limit, are barred for the evening. After weighing in all the dogs for the eight races, all pass from the owners' control into that of an association kennelmaster, who does not surrender them again until fifteen minutes before race time, when they are weighed again, and the slightest variation from the earlier weight will cause the dog to be ruled out.

Handlers working under the association lead the dogs in the parade before the grandstand, each dog wearing a muzzle and a small blanket bearing his colors and number. The muzzles and blankets are worn throughout the race, the former being necessary to prevent a general fight after the rabbit disappears.

Positions are drawn by lot, and, though the rabbit is only five feet from the outer edge of the track—to keep it in view of the dogs when rounding the turns—the animals quickly learn that the inside rail is the shortest way around the oval. After four or five starts, the average dog has mastered that fact and, if it draws an outer position, will always try to break over to the rail as soon as it is released.

Experiments with other breeds of dogs, notably wolfhounds, have been complete failures, because they either haven't the heart to keep on after another dog passes them, or because, as is the case with wolfhounds, the animals are accustomed to running in pack formation and will follow a chosen leader without attempting to pass him. The greyhounds, on the other hand, are all individualists, striving to be first.

All of the dogs are raced in flat races, but not all can be trained as hurdlers, which makes the good jumpers the more valuable. Four hurdles are used, the first two and a half feet high and each successive one two inches higher, so that the final hurdle is three feet above the track.

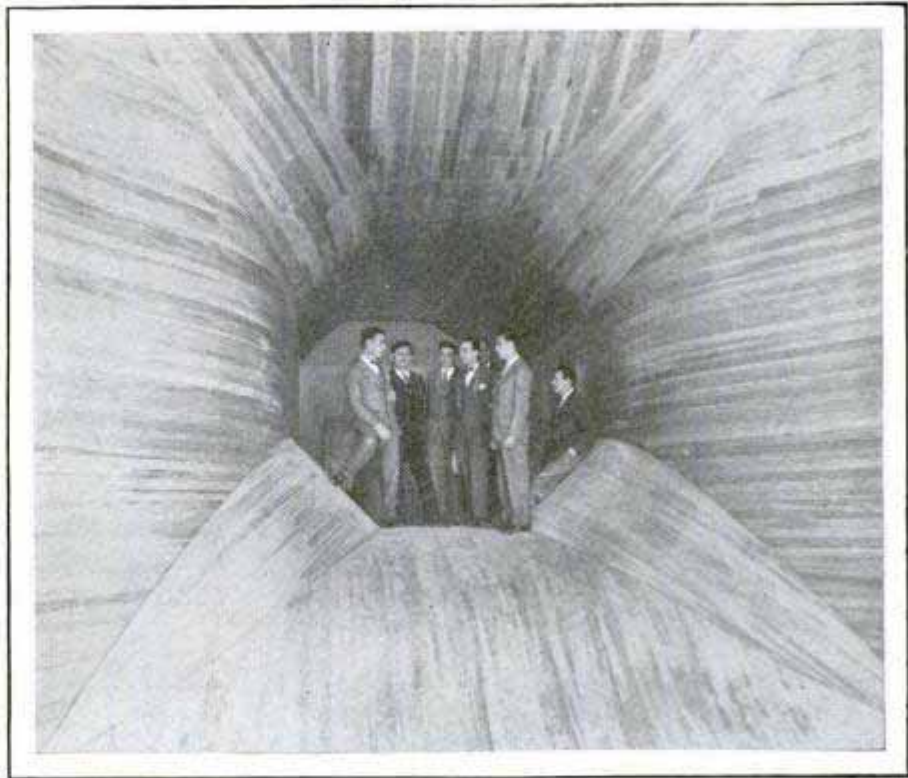

To Illustrate the Size of the Airplane-Testing Tunnel; Group of Men at One End of the Shaft

### HUNDRED-FOOT TUNNEL HELPS IN STUDYING AIRPLANE

Exact scale models of airplanes are flown inside an air tunnel, 100 feet long, at the aeronautical school of New York university, to study their reaction to blasts of air from a huge propeller. The shaft is nine feet in diameter at the working end, and air can be blown through it at the rate of 100 miles an hour.

### CONNECTOR FOR ELECTRIC WIRE REPLACES SOLDERING

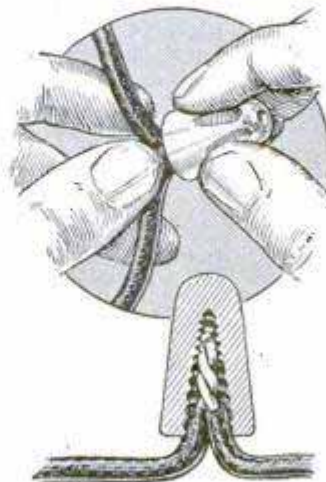

To join electric wires, a porcelain unit, threaded on the inside, takes the place of soldering and taping. It is only necessary to push back the insulation on the wires, insert the loose ends in the cup-shaped connector and twist. The screwing-up action binds the wires together and forces them into the cup as a nut is screwed on a bolt.

Weiss & Bickler  
584 Broadway  
New York City

also London and I wrote.

*2018 Beaver City Neb.*

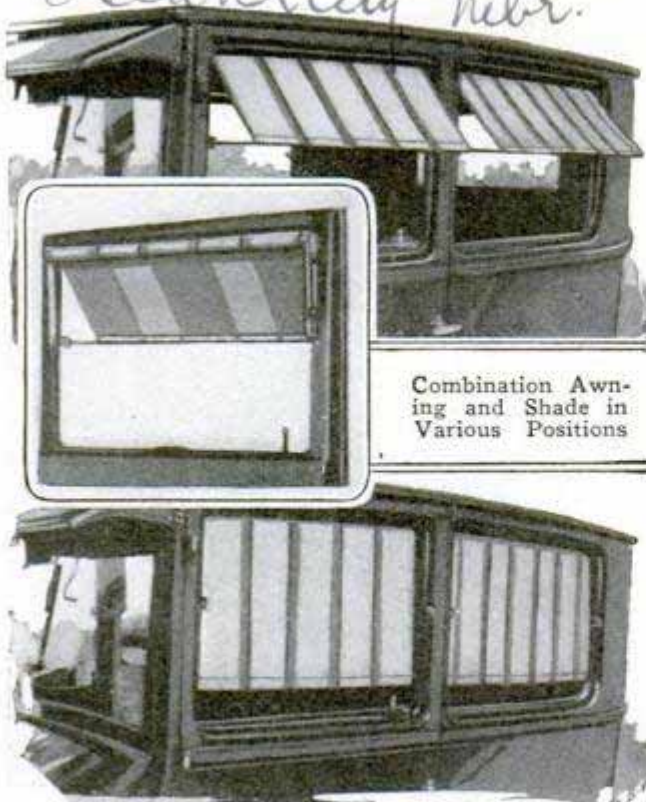

**AUTO AWNING AND SHADE IN ONE RUNS ON SPRING ROLLER**

Easily installed on any model of closed car, a combination awning and curtain is intended to increase driving comfort without detracting from the appearance of the auto. It does not interfere with raising or lowering of the glass and has a strong spring roller that fits neatly on the inside of the window frame. To convert the shade into an awning, a steel rod is simply raised into position either in or out of the car. When not in use, the protector rolls up entirely out of the way.

**LANDING FIELD IS CLEARED OF FOG ELECTRICALLY**

Success in the problem of clearing fogs from airplane-landing fields is promised as the result of recent tests at an eastern factory. A large compartment is filled with

man-made vapor from high-pressure water nozzles. It becomes so dense that electric lights in the chamber are hardly visible. Then a dozen jets of highly electrified water are sprayed into the room, and almost instantly the fog fades out. This experiment is a modification of the laboratory test of clearing a jar of smoke by the passage of an electric spark. Partly successful trials at clearing fog by the use of electrified sand have been made. The dust is shot from an electric chute while the airplane flies above the cloud. Tests have shown that the upper part of the fog bank disappears, and it is believed that more complete success would follow if the sand were more highly electrified.

**CHILD'S HORSE AND BUGGY RUN BY PULLING BRIDLE**

Amusement and healthful exercise for children are afforded in a mechanical horse and buggy exhibited recently at a German show. The operating equipment is concealed within the horse and, by giving the bridle a slight pull, it is set in motion, sending the buggy, rider and all, forward.

*Merkerhaus*

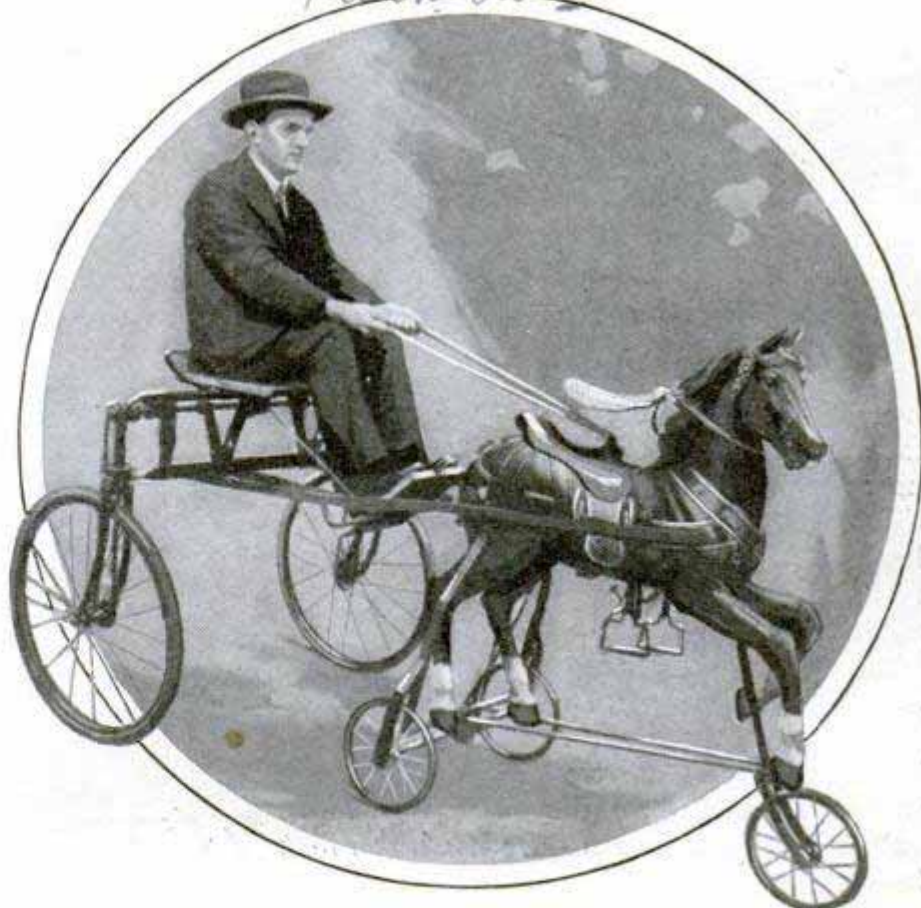

Even Adults Like to Ride the "Racer"; Pulling the Reins Actuates Mechanism in the Horse, Propelling It Forward

*9/24/19  
in Phila.*

*By Bureau of Aeronautics*

Moscow.

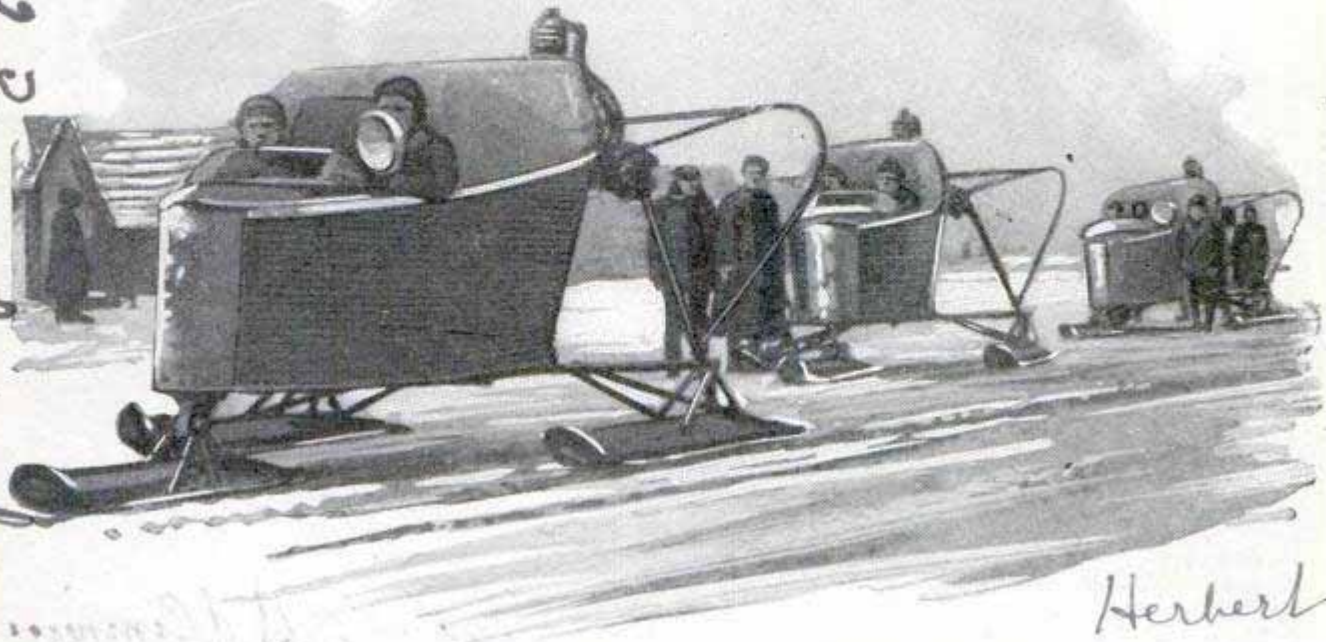

Herbert

For Winter Travel across the Frozen Fields of Russia and for City Traffic, Too; Motor Sleds Developed by the Aerodynamics Institute at Moscow

**SLEIGHS RUN BY PROPELLERS REPLACE HORSES**

Sleds equipped with motor-driven propellers have been tested in Russia for country and city use. They are a product of the aerodynamics institute at Moscow, where research in various fields of motor transportation has been conducted.

— 2453

**TERRAPIN-GROWING ON FARMS NOW PROFITABLE INDUSTRY**

With the best variety of terrapin selling at \$72 a dozen, additionally encouraging reports have been received from the bureau of fisheries to the effect that terrapin culture can be made a profitable business. The conclusion has been reached after several years of experimenting, since heavy demand threatened the extinction of the species about the Chesapeake where the best kinds were found. The most successful results have been attained in the salt and brackish marshlands of the south, where the culture of the terrapin is described as one of the "least-difficult in the live-stock industry." They have few enemies except man, will stand almost any amount of neglect, are subject to few diseases, eat almost anything, hide in the

Bureau of Fisheries

winter and require so little care that one man can easily tend 50,000. On the other side of the picture, they do not thrive in filthy water, overcrowding injures them, they must be impounded to prevent escape and should not be disturbed, especially in the laying season. Some varieties are slow-growing, requiring ten or twelve years before they are big enough for market. Experiments are being made to produce faster-growing varieties.

**WINDOW SQUEEGEE AND SPRAY SAVES TIME AND WORK**

2159

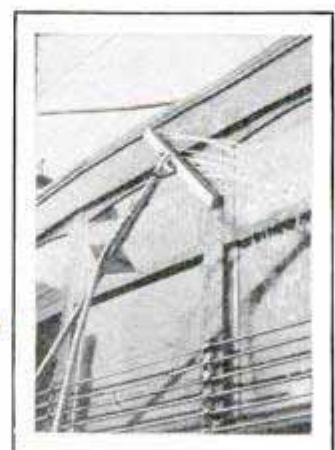

Developed especially for washing car windows, a squeegee and spray combined has proved effective. According to reports, four men using it can clean and dry thirty-six windows and two glass doors of a car in two minutes, a substantial saving in time over usual methods. Water is supplied through a hose at the end of the cleaner.

Developed by Pittsburgh

Artificial propagation of terrapin 14 p. illus. 5k. C. 6. 7. 1914. C. 6. 9. 1914

Amh Tom White, Box 44, Alameda, Calif.

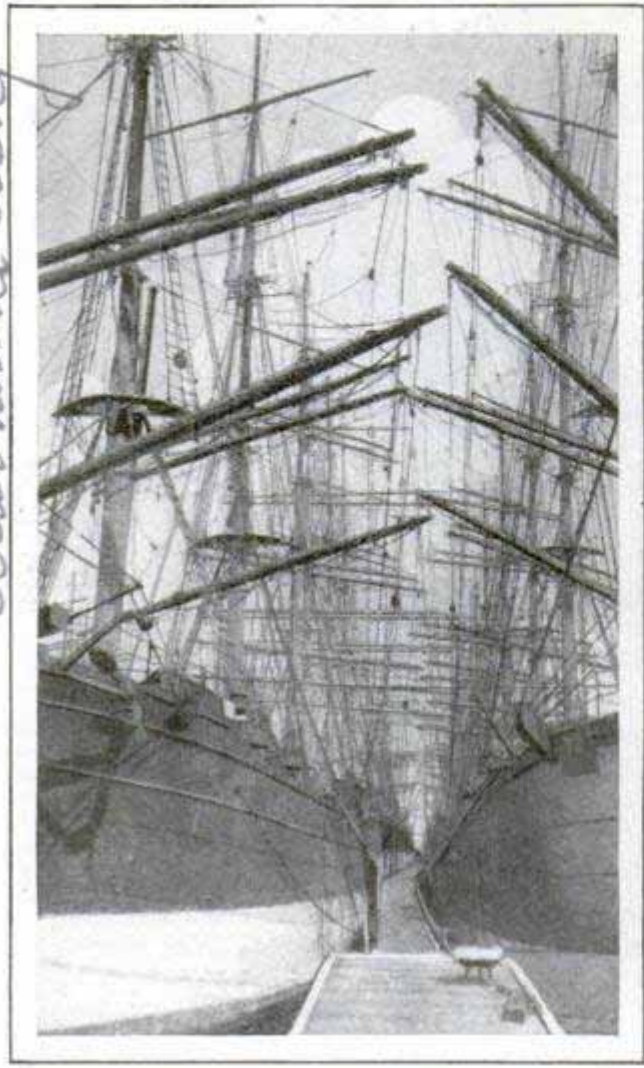

Where Canvas Still Is King: Glimpse of Some of the Vessels in the Alaskan Salmon-Fishing Fleet

### GLORY OF SAILING-SHIP DAYS STILL SEEN IN FISH FLEET

The days of the sailing ship are all but past. Masts piled high with billowing canvas are as rare a sight on the high seas today as was the smudge of a steamer fifty years ago. A notable exception is the fleet of square-riggers used for salmon fishing in Alaskan waters. With the coming of spring, crews are signed on, sails sent aloft and "bent," cannery supplies loaded, and they are off for the Bering sea. When they reach the north, the sailors turn fishermen and daily set out in small boats, delivering the catch directly to the canneries. In the fall, the men rejoin their ships as sailors and the fleet returns to winter quarters in San Francisco bay, near Alameda. In this group of stanch old ships, every one of them sound and seaworthy, are some whose histories date back to the days of the Civil war. There are oaken ships, iron ships and steel ships, rep-

resenting the three ages of marine construction. They range in size from 1,250 to 3,000 net tons and include full-riggers, barks and barkentines, vessels with crack passages to their credit, and most of them have had close calls.

### AMERICAN OWLS TO KILL RATS IN SOUTH SEA ISLANDS

A shipment of owls was recently sent from San Diego, Calif., to Lord Howe island, South Australia, to be used in exterminating rats that have been threatening crops there. The principal produce is palm seeds, and the rodents, arriving from incoming vessels, had multiplied so rapidly that they menaced the life of the palm trees on the island. Attempts were made to eradicate them with cats, but this plan failed, and consequently the owls were called into service.

Announced by Dept. of Commerce

### MEASURE AIR SPACE IN EGGS TO JUDGE QUALITY

As an aid in the government's efforts to further standardize different grades of eggs, the department of agriculture has developed an instrument for measuring the air space in the eggs. It is used in connection with a candling device and is placed over the egg so that the air cell can be compared with measurements

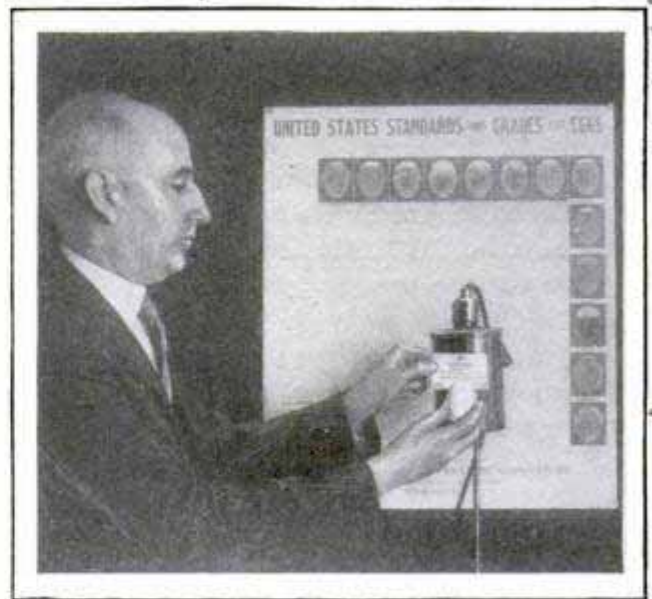

Grading an Egg by Measuring Its Air Space; Chart Behind Gives Diagrams of Different Qualities

printed on the gauge, and the quality thus more quickly judged.

Vertical handwritten notes on the right margin, including "2406" and "1543".



## With the Circus Candy Butchers

Venders Are Keen Students of Human Nature and Help to Keep the White Tops Moving

By EARL CHAPIN MAY

*The National Fertilizer Club 15th Street New York*

WHOEVER heard of a circus without peanuts?

This candy butchers' challenge to the towners sitting on the circus seats or surging into the sideshow and menagerie is answered by millions of annual sales.

The circus college, which gives him his degree after he has studied human nature from the Atlantic to the Pacific coast and from upper Canada to Mexico many years, plays no favorites. No pupil has a pull with the hard-boiled faculty. Anyone who gets a concessionaire's degree earns his honors honestly. Frank Gavin earned his long ago.

"I take no stock in that troupers' tale about how John Robinson invented red lemonade," says Frank. "That yarn asserts that when lemons were scarce on the

Robinson show and John was seeking a substitute, he happened to drop a red horse blanket into a tub of water, whereupon the public, which falls for the red beverage, mobbed the Robinson soft-drink stand.

"From being just a plain peddler, the candy butcher became a concessionaire who either bought the candy privileges outright or shared his profits with the 'governor' or owner of the show. Most big circuses now own their 'concessions' and hire some expert to manage them on salary plus a bonus on the sales. But the title 'concessionaire' still sticks.

"The circus business will never change its nature or its appeal. The elephant, clown and candy butcher will be features of our big-tented shows as long as they hold the road. But while the circus will

never change essentially, changes of business methods follow normal business trends. When I was a candy butcher, working for \$3 a week and sometimes getting it, the slogan of the circus lots was, 'We're here today and gone tomorrow.' Now it's, 'We're coming back next season.'

"In keeping with the increased responsibility of circuses, 'gypping' is no longer practiced on the circus seats; that is, it isn't practiced on the larger shows. Time was, within most memories, when the boy in white coat who sold you peanuts or lemonade walked away with most of your change or charged you all he thought the traffic would bear. Now, on most of the better shows, the price you're to pay for anything you buy from the butcher is plainly marked on a sign he carries in his hat. Also, nine times out of ten, you can trust him with a \$10 bill and he'll come back with all the change you're entitled to.

"Contrary to the popular belief, most of the candy butchers' business during the performances comes not from the high-priced reserved seats but from the 'blues.'

"The color complex which prompted the good people to patronize old John Robinson's red lemonade controls our business to this day. People like anything that's brilliantly colored, and red is the greatest

favorite. So, while we have popcorn bricks made with both yellow and red sirup, you'll find that most of our stock is in the red. You'll also notice that the little birdies that flutter from sticks which our specialists offer to the pulsing crowd, are bright yellow. These novelties were dead stock with us when they first came out in pale shades. That's true of balloons, also. It's the red, blue and yellow ones that go.

"Although my department's income comes pretty close to ten per cent of what the ticket wagon handles each and every day of the thirty weeks' tenting season, each town and district varies in its demands. Boston is a top-notch peanut town. Brooklyn is a darb on ice-cream cones. As soon as we go south, we load up on chocolate.

"Peanuts will always be the most popular, thanks to the human appetite—and the elephants. I've long marveled that the big beasts, which probably never met a peanut in their native Asia, should be so crazy about the goobers from our southern states, but so it is. I've seen 'Alice,' a one-ton elephant, eat \$20 worth of the hump-backed, double-jointed delicacies and do it in one standing without yelling for paregoric afterward. You don't have to teach the circus bulls to boost my peanut game."



Ready to Work the Streets during the Parade with a Line of Canes, Flags, Balloons, Whistles and Other Merchandise; in the Afternoon the Street Venders Turn Candy Butchers in the Tent



### LOSS OF WEIGHT IN BREATH

*2450*

A woman of average weight loses about an ounce an hour in moisture given off by the lungs and skin, and a man's loss is about one-third higher. These interesting results have been attained by scientists of the Carnegie institute in recent experiments, with the aid of special balances. Two scales were used, both sufficiently strong to sustain the weight of a man, yet sensitive enough to record extremely small changes in weight. One indicated differences of one-third of an ounce and the other was 100 times more sensitive. With the aid of an auxiliary device, separate measurements were made of the losses from the skin and from the lungs, and other instruments gauged the amount of carbon dioxide given off, the percentage of water in outgoing breath and also its temperature.

*Washington*



How They Get the "Fighting Close-Ups" for the Movies; the Actor Literally Wrestles with the Camera while Close to the Lens

### "WRESTLING" CAMERA IN MOVIES REGISTERS FIGHTING FACE

To show facial expressions of actors during fights, a "wrestling" camera has been devised. It is similar to other instruments of the type operated by an electric motor, but is mounted on a strong, spiral spring instead of on a solid base. The actor grasps two handles in front and literally struggles with the camera while the film records changes in expression, his face being but thirty inches from the lens. With this system, excellent close-ups can be obtained.

*Used in an Earnest Laemmle Production*

### RIDE WITH A PUNCTURED TIRE ON EXTENSION RING

*1940*

To prevent damage and loss of time due to punctures, an English inventor has devised an extension rim and hard-rubber tire, to support the car in case the pneumatic unit becomes deflated. It is always in service, easily put on or taken off, by means of the slightly longer bolts which are provided, and takes the place of a spare tire, when the motorist does not wish to carry one.

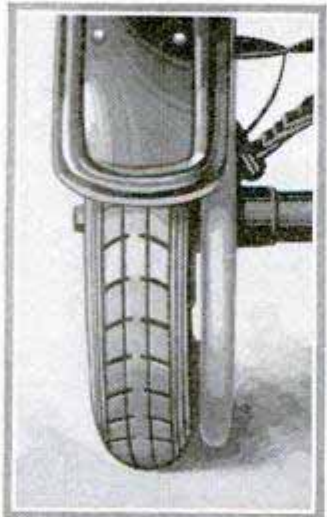

### MERRY-GO-ROUND MAIL BOXES SIMPLIFY DELIVERIES

*2436*

*Ingwood*

At a crossroad in Pennsylvania, mail boxes have been placed on a wheel under a shelter, so that the postman can gain access to all of them simply by turning the rack, and patrons are spared trouble in using their boxes. Only one is exposed in the opening at a time. The shelter is of attractive appearance.

*The Arnold Rubber Co, Ltd.*

2093  
278

1009

David Esrey  
Manning & Co. Inc.  
POPULAR MECHANICS

## AIR BLOWERS INCREASE "LUNG" POWER OF AUTOS

Did you ever see a fat man puffing uphill, gasping to get a little more air? That's just the way an auto engine acts pulling up a steep grade in high, and supplying that extra breath of air is the function of the supercharger. It's just a pump that fills the cylinders full of fresh mixture at every stroke. It doesn't wait for the pistons to suck it in, but goes right ahead and pushes it into the cylinders under pressure. You see, it takes about four-



Examining a Supercharger Built for Passenger Cars, with Carburetor Attached

teen pounds of air to burn one pound of gasoline, and the more air you can force into the cylinders the more fuel you can burn, and the greater the power. Superchargers have developed along two distinct lines, the positive and the centrifugal type. The first is a pump that takes in a large volume of air and forces it into a smaller cylinder, thus building up pressure. The centrifugal type builds up pressure by taking air in at the center of a rapidly revolving fan and flinging it out to the tips by centrifugal force, where its velocity is converted into still more pressure by passing through a diffuser which slows up the air flow, and makes it more dense. It must operate very fast and give practically no pressure at low engine speeds. For this reason it is used mostly on racing cars and on airplanes, while the positive type is being perfected for passenger cars. Of course, you've seen these little racing cars scooting around the tracks. They are all supercharged. Engines half the size of a Ford, and developing six times as much power, that's what the supercharger does for them! Gas is pumped into the cylinders at a pressure as high as twenty pounds a square inch. For passenger cars, the supercharger offers even more advantages than it does for rac-

ing. For one thing, smaller engines can be used, with better mileage. The modern car of fifty horsepower uses only fifteen or twenty horsepower for average driving, the rest is reserve power for hills, acceleration and fast driving. If you replaced this engine with one of twenty-five horsepower, plus a supercharger, the engine would operate at better efficiency under average driving conditions, giving more miles to the gallon

of fuel, while the supercharger would supply the reserve power required. A short while ago an experimental supercharger was attached to a six-cylinder car. Acceleration and flexibility were amazing. You could use high gear for starting and drive through traffic without shifting. From a bare crawl the car picked up swiftly and smoothly, with never a jerk or hitch, when the throttle was pressed clear to the floorboards. Valve timing, ignition setting and carburetor adjustment were less sensitive, and could vary appreciably from the correct value without affecting the operation, thus increasing the interval between adjustment and overhaul. As to cost, an engine that will develop fifty horsepower without a supercharger will develop well over seventy-five horsepower with one. The cost of the fifty-horsepower engine with the supercharger will be less than the cost of the unsupercharged seventy-five-horsepower engine.

### ELECTRIC WALLS AND FLOODS 250' GUARD BANK VAULTS

A man touching a switch ten miles outside of London can now flood the big vaults of the Bank of England should a foreign army ever land in England or a

*Colombier, Barnes Road, Besley Heath near London Eng*

mob threaten the security of its treasure rooms. The structure is being rebuilt so that the bullion vaults, in an emergency, could be flooded from two other places, one in the bank itself and the other in a distant place, the locality of which is a carefully guarded secret. Besides the flooding devices, an ingenious system of paneled concrete blocks is designed to render the vaults burglar proof. New walls are being built of concrete reinforced with the wire of old ships' cables. The blocks are two feet thick, two feet wide and six feet long and the cables separated into strands and fashioned into a sort of matting. The units are locked together and electric wires connect them. A cracksmen, trying to pry through them, would break one of the wires and sound an alarm

**SEAM CLEANER FOR TROUSERS PROLONGS THEIR LIFE** 1902

Accumulations of lint and dirt are quickly removed from the seams of trousers with an outfit which a Michigan man has devised to simplify dry-cleaning. The essential part of the assembly is a cleaning wheel and blower operated by a motor. One leg of the trousers is slipped on a standard reversible cleaning board, the seams exposed, and in less than a minute, it is said, all four can be ridded of dirt. Besides helping to increase the service-

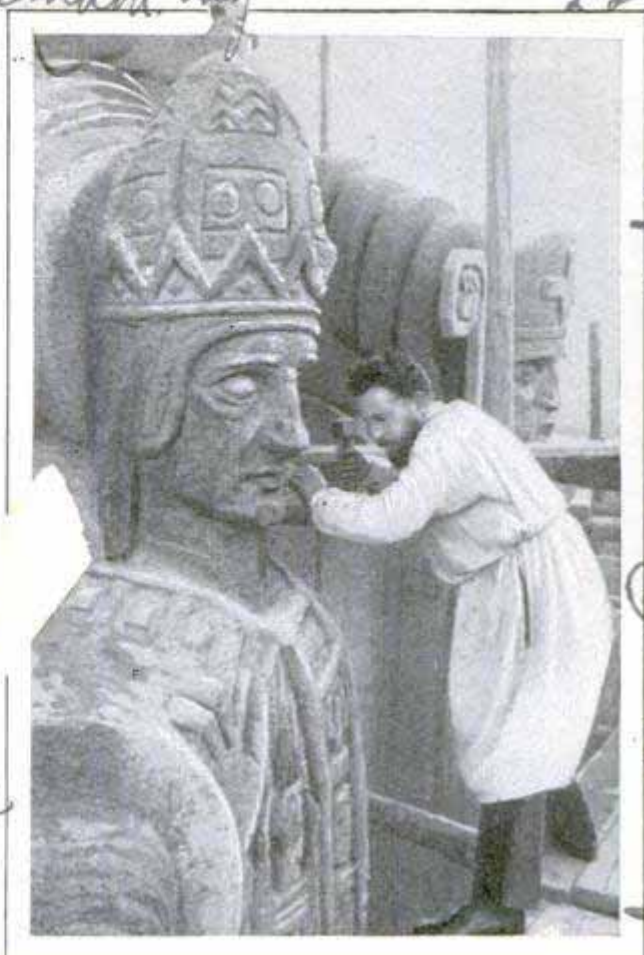

Carving Concrete Figures for Church Steeple near Paris; the Process Proves as Successful as Molding

**SAINTS CARVED IN CONCRETE FOR CHURCH STEEPLE**

The adaptability of concrete to decorative purposes is illustrated in a church near Paris. Its steeple and the figures of saints, and other ornaments on it, are made of cement, some of the details being carved by a French sculptor.

**WEATHER HUNDRED YEARS AGO AFFECTS GLACIERS TODAY** 2506

Effects of the "dry seasons" of 150 years ago are revealed by some of the great glaciers in the Canadian rockies. Measurements made by the Smithsonian institution suggest that the ice masses have been receding at an increased rate lately, indicating that there was milder weather and lighter snowfall about a century and a half ago. The conclusion is based on the rate of movement followed by glaciers which "flow" less than 100 feet in twelve months. Because of this snail-like progress, it would take 150 years for an effect to transmit itself from the ice field to the tongue of a three-mile glacier.

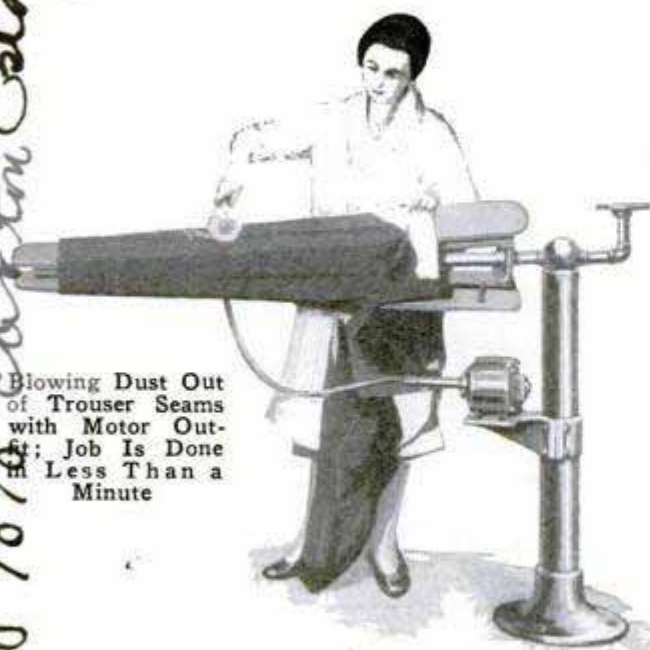

Blowing Dust Out of Trousers Seams with Motor Outfit; Job Is Done in Less Than a Minute

ability of the garments, the cleaner promotes more sanitary methods.

*Church of Villenoble, Paris sculptor*

*Chicago - C. H. Palmer, 1010 East 10th St.*

*National Sewing Machine Co. 4032 Cherry St. North*

*St. Paul, Md. Baltimore, Md.*

2 100

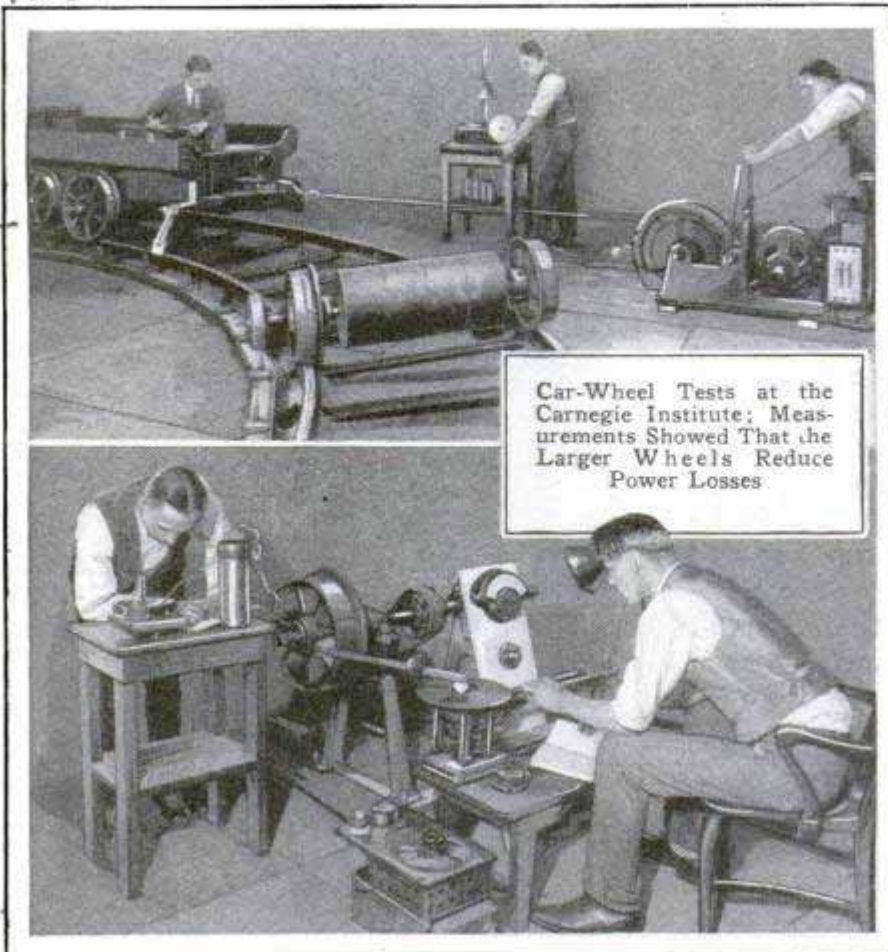

Car-Wheel Tests at the Carnegie Institute; Measurements Showed That the Larger Wheels Reduce Power Losses

tute to determine the effect of the size of their wheels on the performance of mine cars, the results of the study being as applicable to other types.

These tests proved that the larger the wheel diameter the lower was the relative friction and consequent loss of power and load-carrying capacity. The power saving possible on straight track through the use of larger wheels may amount to thirty-eight per cent in making a change from eight to eighteen inches in diameter.

### 2034 AUTO HEADLIGHTS SET IN BUMPER REDUCE GLARE

Elimination of the glare in the eyes of the motorist approaching and better

### HOW BIG A WHEEL SHOULD BE ANSWERED BY TESTS

The average person who utilizes the products of factory, mill and mine would hardly consider that the prices of many of these articles depend to some extent on the size of car wheels; yet it is a fact that this is an item which plays its part in the cost of living. The size of the car wheel is definitely known to have a very direct bearing on the load carried. Giving the proper diameter to the car wheel is, therefore, an important factor in obtaining a maximum of service and speed and a minimum of resistance. Experiments have been conducted by the Carnegie Insti-

illumination of the road, particularly at the sides, are claimed for an automobile bumper with headlights. They shine directly down upon the highway and are too low to seriously interfere with other drivers, while the rays are directed in such a manner that they show the ditch at the side of the road without the use of spot-



Bumper with Lights and How Rays Shine Down

light, it is said. The bumper is a strong, seamless tube, and the lamp lenses are so protected that they are little likely to break unless they come in forcible contact with a pointed object.

Popular Mechanics Magazine does not publish the name of the maker or seller of any device described, but our Bureau of Information will furnish it, free.

Chas. G. W. Padden  
Lockport, N.Y.

PLANTS' NEED OF SLEEP IS SHOWN BY LIGHT TESTS

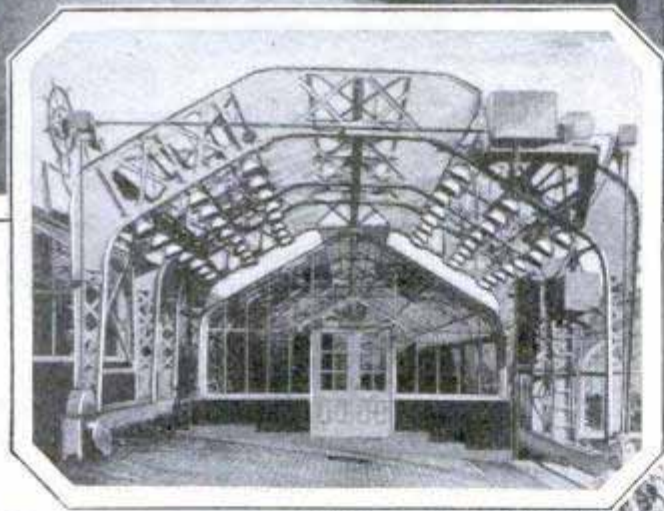
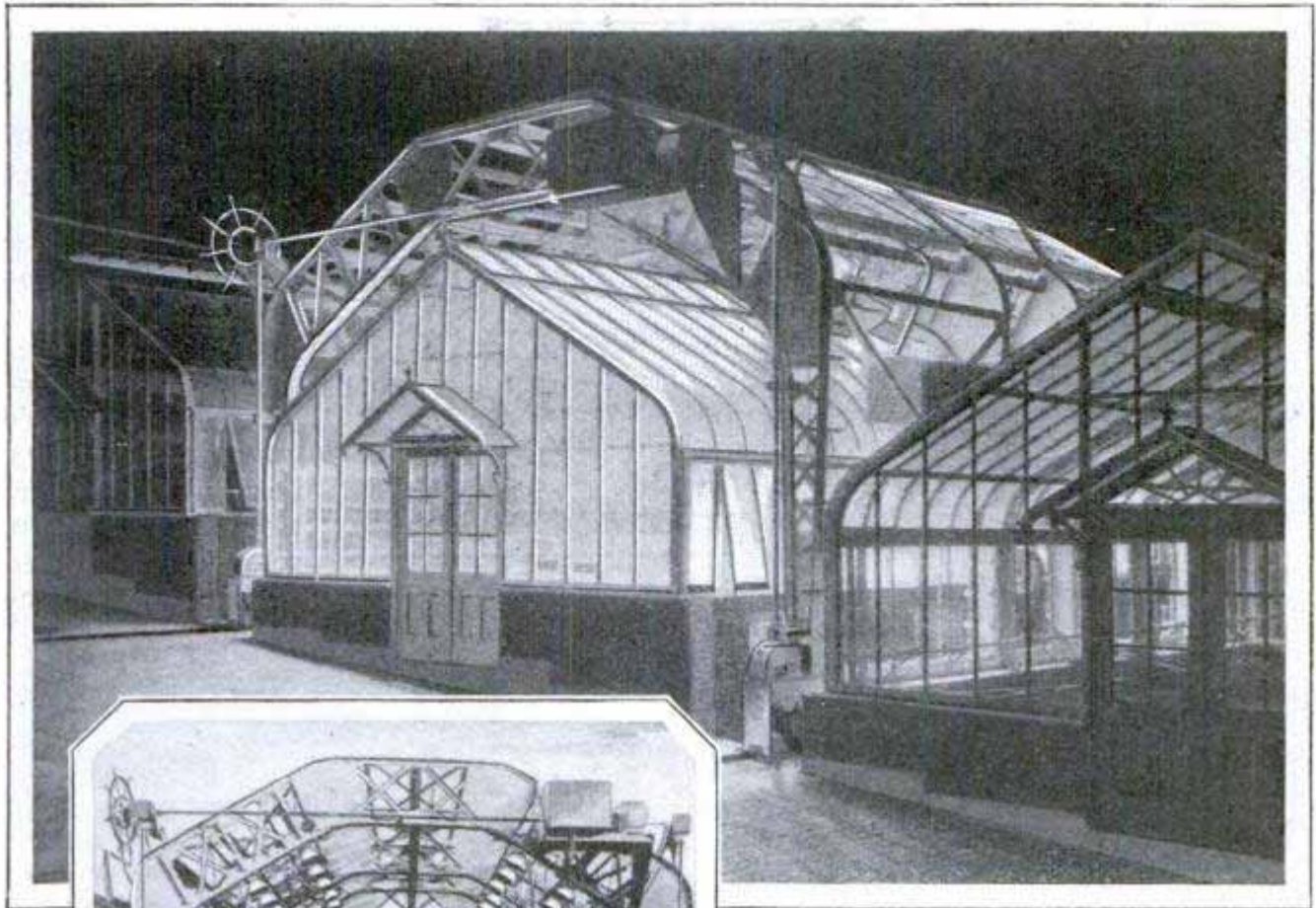

Plants Need a Good Night's Rest as Well as People, Experiments at the Boyce Thompson Institute for Plant Research Show; Above Is the Electric-Lighted Greenhouse; at Left, the Crane Carrying the Night Lights, and, Below, Plants, Showing How Too Much Light Kills and Not Enough Stunts Growth; the Control and Twelve-Hour Sunlight Plants Are Nearly Alike

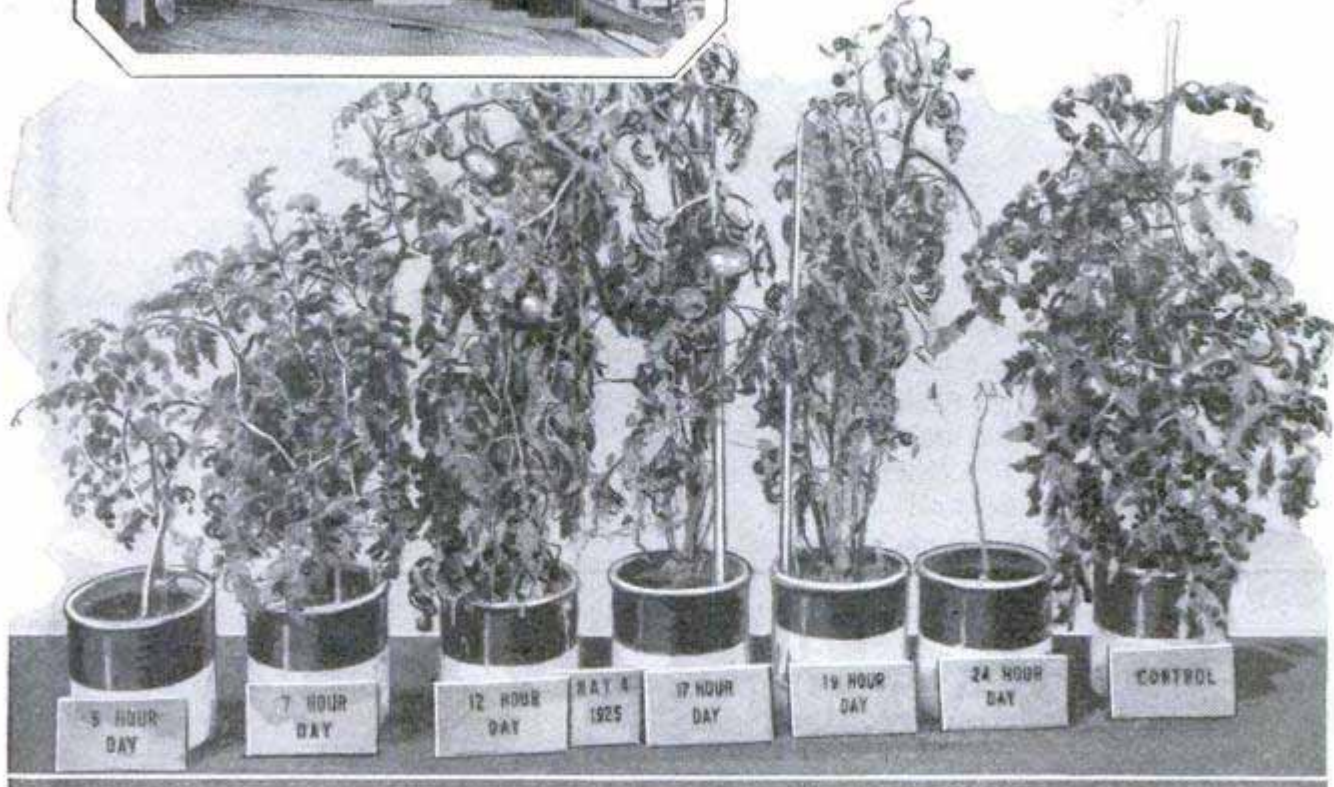

5 HOUR DAY    7 HOUR DAY    12 HOUR DAY    MAY 4 1925    17 HOUR DAY    19 HOUR DAY    24 HOUR DAY    CONTROL

## MACHINE TALKS, PRINTS AND SERVES AS A TEACHER

By combining the principles of a phonograph and a printing press, a machine has been invented by A. L. Runyan of Los Angeles, Calif., that translates languages, speaking and printing the correct words



familiar mode of expression and synchronize it with related unfamiliar modes of expression, seeing it printed and hearing it spoken, will revolutionize home study of foreign languages, it is expected. The immigrant, wishing to learn English, would have a night school and a master tutor in the ma-

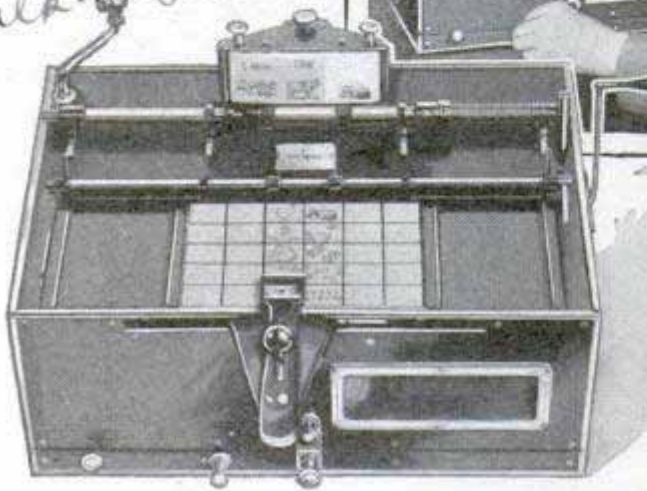

Machine Showing Index Chart and Record Tape, Synchronizing Knob above Operator's Left Hand and Cabinet Open for Removing Record



simultaneously and, with a proper set of charts and records, teaches shorthand, telegraphy, both in the Morse and Continental codes; music harmony, voice, plays a game of bridge, printing each trick as played, and gives a general summing up of the game. Any child can operate it, and it lends itself to kindergarten study, giving the child both the auditory and visual perception of the subject matter, teaching him reading and number work. With a set of bird records, it will print the name of the birds on record tape, give their song or call, or print the name and tell a story of the different animals, should he place such a set of records in the machine. It is a portable phonograph as well, weighing about eighteen pounds, and will play any ten-inch disk record. Teaching with a phonograph is not a new idea, but the ability to select any portion of the sound record, automatically repeat that portion as often as you wish and print on the tape the contents of the sound record you are hearing is a new development. To select from an index chart subject matter in a

chine. To operate the machine, a set of index charts is prepared in English by professors, having the lessons that are to be reproduced. Translations are made into the languages, for instance into the French, set up in type and the accompanying record is recorded in French. This is put in the machine, and the synchronizer, when it is set at any particular square on the index chart, moves a related section of the print record to printing position and the sound reproducer to a corresponding position on the sound record. When a crank is pulled, the machine talks and prints the French translation of the index chart. With sixteen double-faced index charts, rubber-stamp sheets and sound records, the user can have at his command 10,000 words in French or any other language. The sound reproducer may be changed to an electric one and, by plugging into a radio set, will amplify the reproduction for classroom or group study. By giving each student an index lesson chart, any number could get the results at one time.

**PAINT STILL GROUND BY STONES  
 PREPARED BY EXPERTS**

Although years have elapsed since man first learned to prepare grain for bread by grinding it between stones, a direct survival of this process is seen in many milling operations today and is clearly demonstrated in one where the layman would least expect it. That is in paint making. A stone-age process is still an important step in preparing the protecting film for your house, your automobile and many other articles. In several mills, before the paint is tinted and diluted with oils for final consumption, it is ground between special stones to crush the ingredients thoroughly and to insure perfect mixture of the pigment. These stones must be of a particular kind, to prevent glazing and too rapid or uneven wear. Some of the best ones come from France and another excellent variety is quarried only a few miles from New York city. Dressing the stones for the mill, that is, cutting the grooves and furrows to afford a grinding, crushing surface, is a special task that only experts can do. The art is said to be known to only a few men in this country.

2463

*one made by Conner & Co. d. p. e. Phila. Pa. Sugerman for asphalt*



Cone-Shaped Pouring Pot for Applying Hot Asphalt in the Repair of Streets

**ASPHALT POURING POT HELPS  
 PATCHING ROADS**

For breaks and cracks in private driveways, as well as public roads, a conical asphalt-pouring pot has been found helpful. The flow of the material is easily regulated and directed where needed, reducing waste and trouble.

**ELECTRIC VAPOR INHALER AIDS  
 TREATMENT OF COLDS**

To supply hot, medicated vapor for the relief of colds and various nose and throat ailments, an electric unit has been devised. It operates on 110-volt house current and consists of a small heater which is placed in a glass partly filled with water, having a cone attachment that directs the vapor toward the nose and mouth.

2315

*Vapor Unit*



Medicine used is held in a special container and a metal cover over the glass prevents wasting of the fumes. The outfit is especially useful when quick relief is wanted, saves bothering with stoves and kettles and, when not needed for inhaling, may be employed as a sterilizer for liquids.

**ENDLESS STEEL-JOIST BRIDGING  
 SUBSTITUTE FOR WOOD**

Reduction of cost, and greater durability and strength are claimed for a steel substitute for wood as bridging between building joists. It is furnished in three types of construction, is applied with stretching wrenches and affords tension before the load is placed on the floor. It is painted with acid-proof paint and comes in convenient coils 100 feet long. The steel eliminates weaknesses caused by poor fitting, flaws and splits in wood bridging.

1998

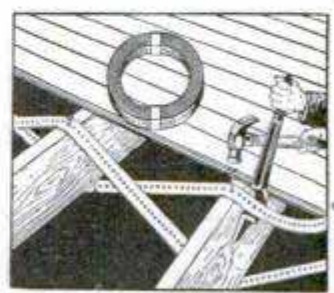

*William Le Thorbe, Oregon, d. d.*

*Macco Mfg. Co. 1112 S. 1st St. Chicago, Ill.*

*Wm. Le Thorbe*

# HOW SCIENCE GUARDS THE THINGS YOU USE DAILY

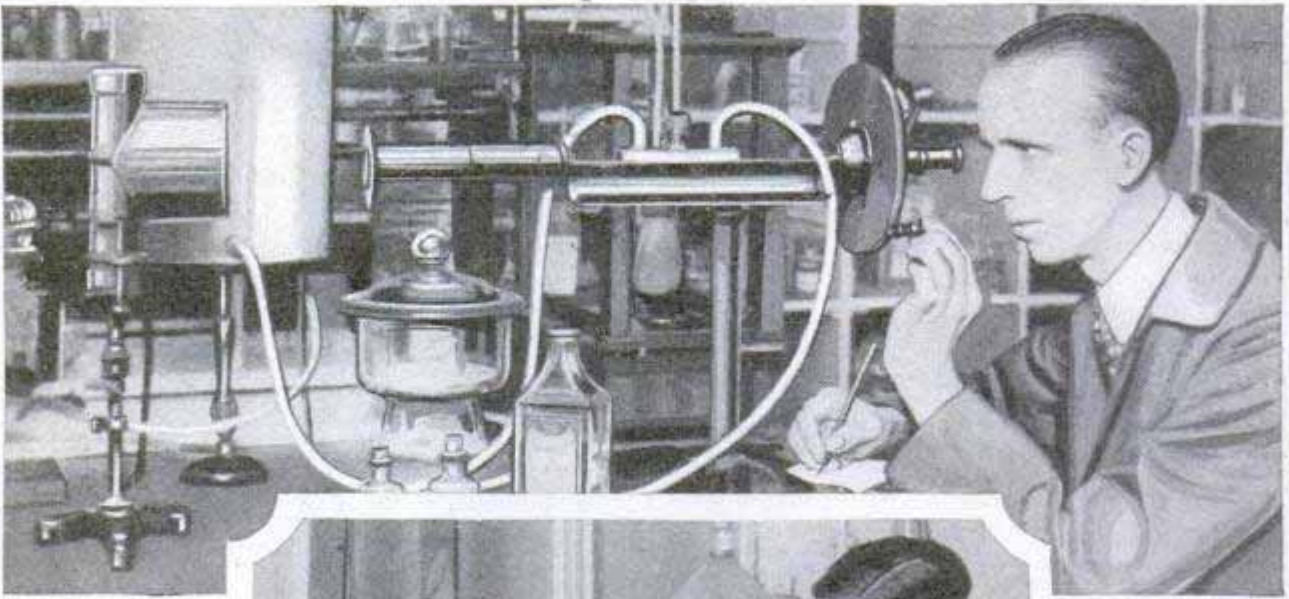

A Chicago Mail-Order Company Maintains a Laboratory to Test Samples of Everything It Sells. Above Is an Expert Testing Sugar, Essential Oils and Extracts, and Below Is a Light Test That Gives Suits and Other Cloth a Year's Exposure in Forty-Five Hours



Wear-Testing Machine, at Left, Which Draws Abrasive Bricks over Samples of Leather Belting and Shoe Soles, Again and Again, to Determine How Much Wear They Will Stand before Giving Out; the Machine Was Built from an Old Automobile Crank Shaft



The Hardness-Testing Machine, at the Right, Discloses How Much Life You Will Get Out of Your Anti-Skid Chains





**NEW PRINTING INK TO HELP RECLAIM OLD PAPER** 2465

Removal of the ink is one of the greatest difficulties in reclaiming newsprint and other paper for use again, but this obstacle is said to have been largely overcome in an ink German experts have prepared. It contains chemicals which are said to fade almost completely under a half hour's treatment with an acid, yet it does not change under ordinary light and air. A faint blue, remaining after the acid treatment, is said to disappear in the pulping process. Although it costs more than ordinary inks, a future saving is seen through less expense in de-inking old paper.

**PUPILS ARE TAUGHT TO SPELL BY BLOCK MACHINE** 2400

Instruction and amusement are both afforded children in a novel outfit combining some of the features of the typewriter and printing press. It has twenty-six keys, one for each letter in the alphabet and an accompanying character. When a key is pressed, a little wooden block appears, bearing that letter. The block is lifted out, placed in any one of several ledges above the keys and another block obtained by pressing a different key for making up words or arrangements of numbers. The key controls a magazine, each containing fifteen blocks, making 390 for the entire set. Each block bears two capital letters, one in lower case and a character. When finished with the blocks, the child inserts each in its proper magazine or holder at the top of the rack and it slides down, ready for removal again when its turn comes at the key. Children thus learn to associate the letters with the words more quickly and are aided in working simple problems in arithmetic. There is space for a lesson of considerable length on the rack.

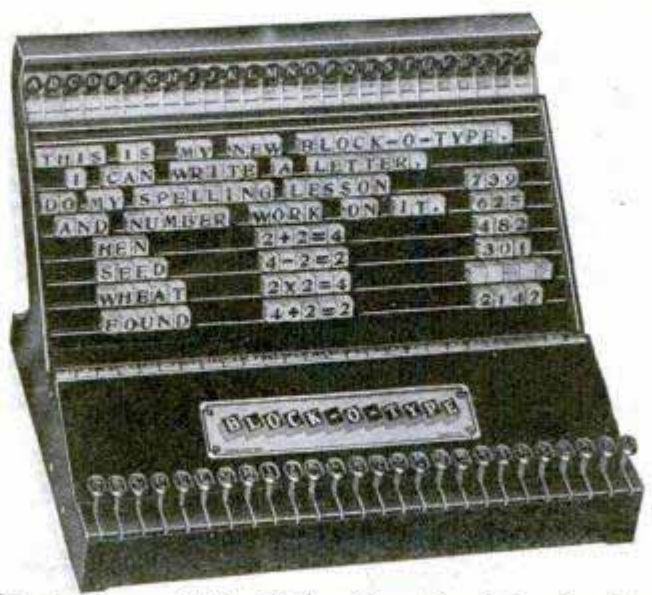

Blocks Arranged after Lifting Them from Magazines by Pressing Keys at Bottom; Feeder Openings at Top



Electric Heart Tester in Operation; Pulse Is Accurately Registered and Charted as It Beats under Pad

**ELECTRIC DOCTOR TESTS HEART TO DIAGNOSE DISEASE** 2432

"Just let me slip this on your wrist, please." The nurse adjusts a pad over the patient's hand, a wire is connected and without the knowledge of the wearer, his pulse is registered in another part of the hospital, where a doctor, examining the beats, can detect various heart ailments if they are present. The apparatus is known as an electrocardiograph. With its aid, heart beats have been broadcast by radio, so that a physician in one city can diagnose the heart trouble of a person many miles away. The instrument will scarcely disturb the patient, so that his heart action stays normal instead of being accelerated or modified by knowledge of the examination.

*Ballou Bldg San Francisco*  
*Annual session Medical Association California*  
*An display at 56th*

*Ans. A. L. Curran, A. Blvd Hollywood*

884

# To SAVE WORK

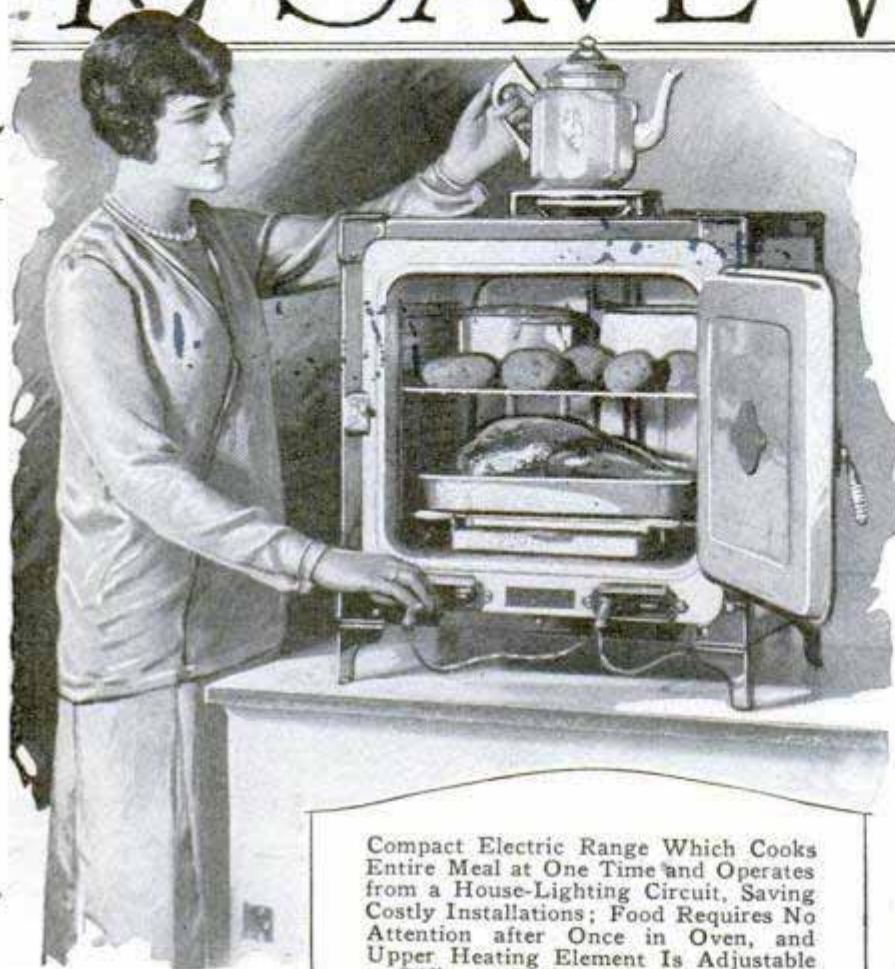

Compact Electric Range Which Cooks Entire Meal at One Time and Operates from a House-Lighting Circuit, Saving Costly Installations; Food Requires No Attention after Once in Oven, and Upper Heating Element Is Adjustable to Different Heights for Special Dishes

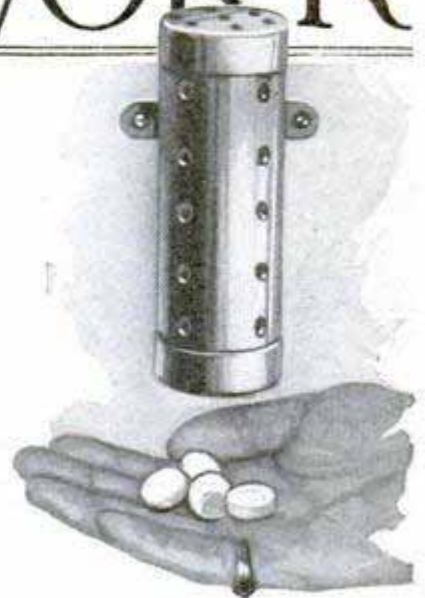

To Eliminate Cooking Odors, Perfume Tablets Are Kept in Perforated Holder Attached to Wall



Air-Tight Toothbrush Holder Has Sterilizing Agent in Bottom, Fumes from Which Eliminate Bacteria

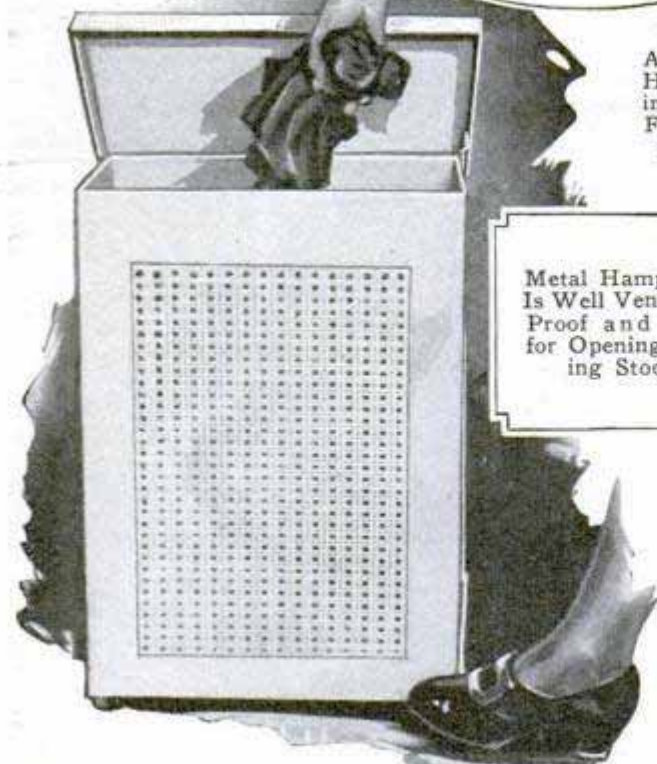

Metal Hamper for Clothes Is Well Ventilated, Mouse-Proof and Has a Pedal for Opening the Lid, Saving Stooping Over



Dirt Is Ejected from Collapsible Comb by Metal Teeth Formed on the Edge of the Holder

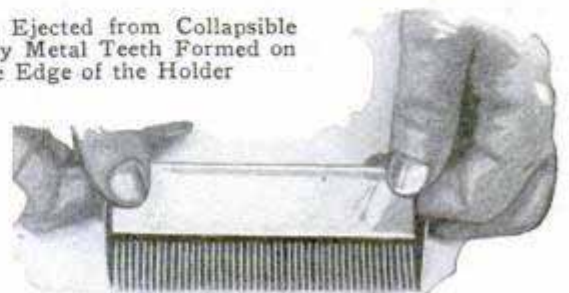

# in YOUR HOME



To Keep Cakes Moist and Protected from Dirt, This Container Is Useful for Storing and Carrying Too, as It Closes Tightly and Can Be Taken on Picnics; the Lid Is Held by Means of a Spring Clamp



Metal Clamp Holds Dishcloth or a Cork for Scouring and Utilizes Last Bit of Steel Wool, Reducing Waste



Simple Tester Tells if Milk Has Been Adulterated by Addition of Water

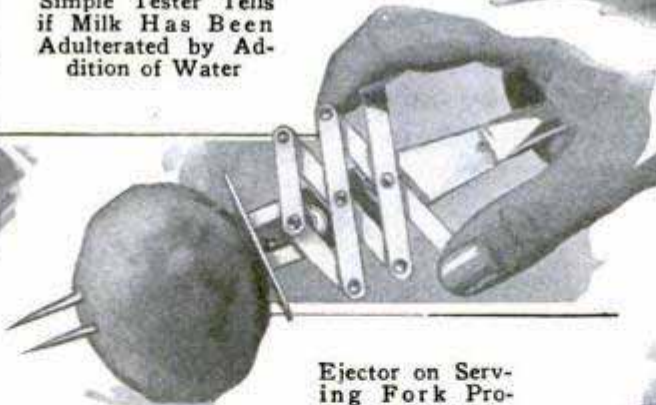
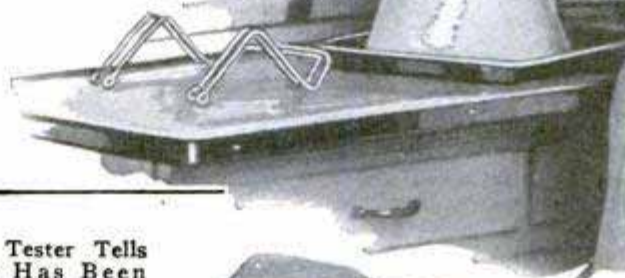

Ejector on Serving Fork Protects the Food and Fingers Too

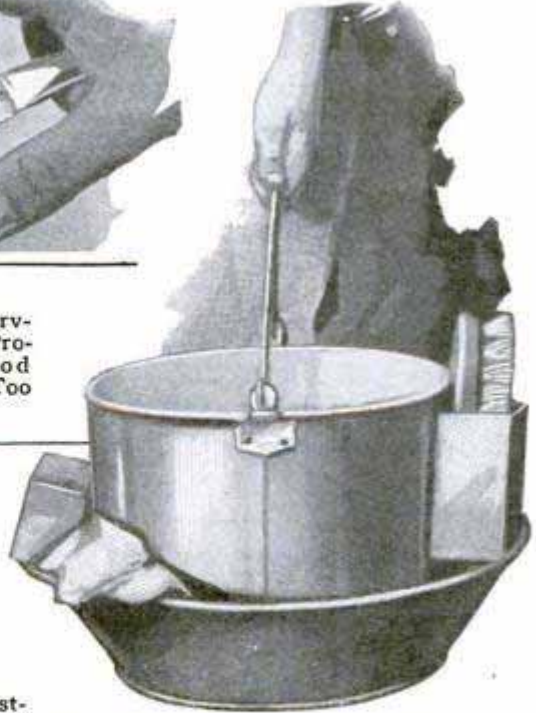

At Left, an Adjustable Steaming Grid in Kettle Permits Cooking Food So That Valuable Substances Are Saved and Reduces Shrinkage; at Right, Is a Special Outfit for Cleaning Floors, with Pockets for Brushes and Soap and Compartments for Cloths, Clean and Dirty Water

Runs from Liberal to Woods  
Kansas

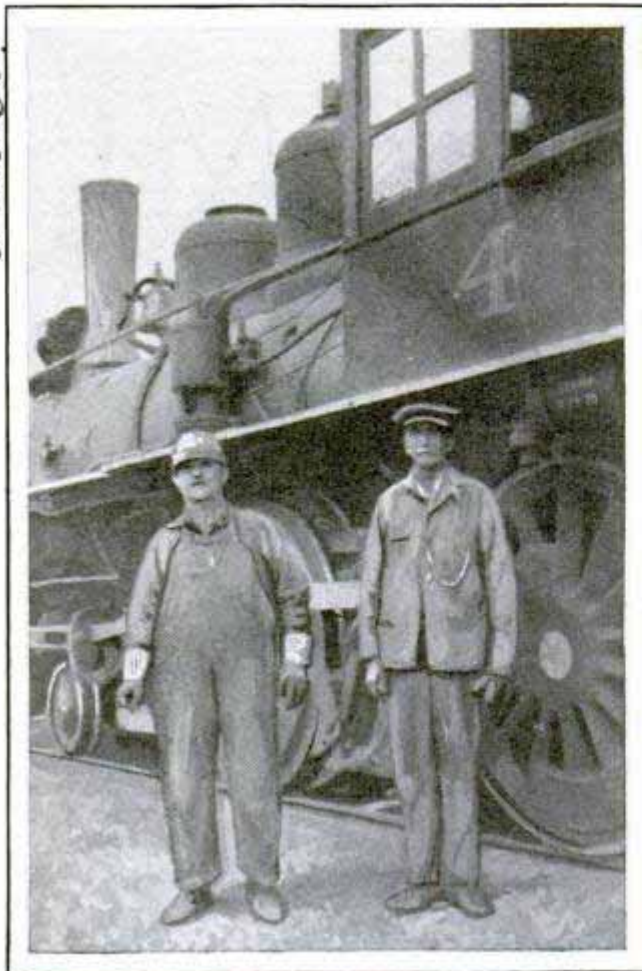

Personnel of the Kansas and Oklahoma Railroad, a Steam Line Operated Entirely by Two Men

### TWO-MAN RAILROAD<sup>2</sup> SERVES KANSAS FARMERS

Although it is operated entirely by only two men, a nineteen-mile railroad in Kansas serves six stations and hauls hundreds of grain and other cars yearly. D. W. Platz is ticket agent, freight agent, train dispatcher, section foreman, roadmaster, conductor, fireman, brakeman and claim agent, while J. H. Hodges is engineer. When farmers along the line want a few cars, they call Platz, the engine is fired up and the orders delivered. In busy seasons, a daily trip is made and at other times, three a week.

### WATER AND OIL PUMP FOR AUTO ALSO OPERATES HORN

Quickly installed on the Ford car or truck, a water-circulating pump has an oil-pump attachment and a powerful horn which is operated by a pedal on the floorboard. Power is supplied to the unit from the fan belt, the water pump having a capacity of thirty gallons a minute and

Chicago - North Park Garage  
5013 N. Kedzie Ave

the oil, three gallons. The latter is so adjusted that oil is sprayed on the connecting rods under any angle at which the car may be operating. A spray nozzle is screwed into the side of the crankcase directly in front of each connecting rod.

### MUCH IS UNSEEN TO THE EYES 2 472 IN RAY OF SUNLIGHT

While the human eye is a wonderful instrument, it records but one-third of the sunlight, the rest being on wavelengths either too high or too low to register. Certain insects are believed to see these rays that escape the human eye and their presence is manifest by their effects. Ultra-violet rays, for instance, react on photographic plates, although our eyes cannot see them, and while the X-rays are invisible, their "shadow" can be observed on a fluorescent screen.

Kansas City Star 4/22/27

### 1893 HORSES WEAR RUBBER ARMOR DURING BULL FIGHTS

To shield them from the horns of the bull during fights, horses used in the rings of Madrid have been fitted with an armor of rubber padding. It is adjusted so as not to interfere with the movements of the animals and guards them at vital points.

Protection for Horses in Bull Fights; Rubber Padding Designed to Ward Off Horn Thrusts without Interfering with Movements

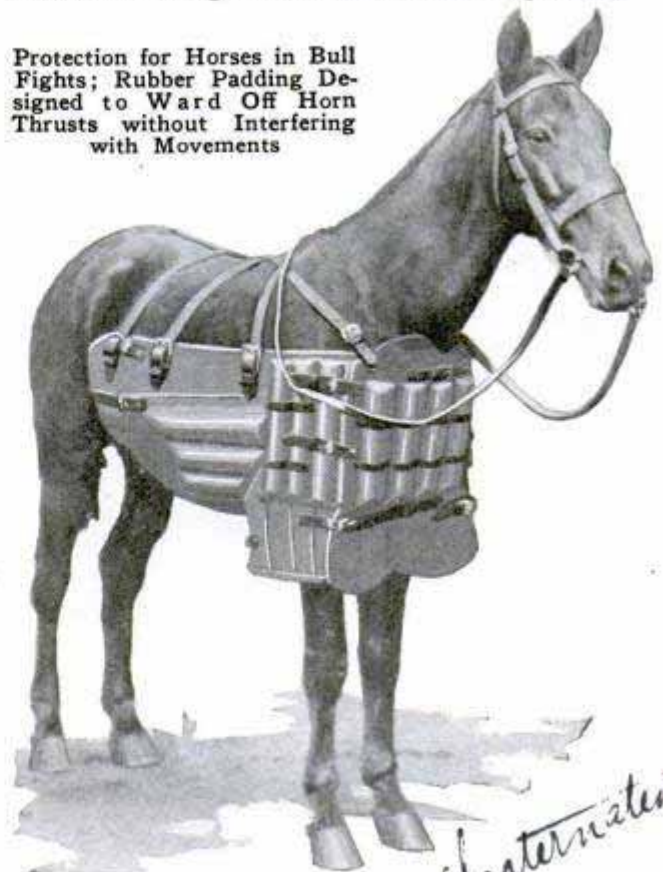

International

W. A. Mfg Co.

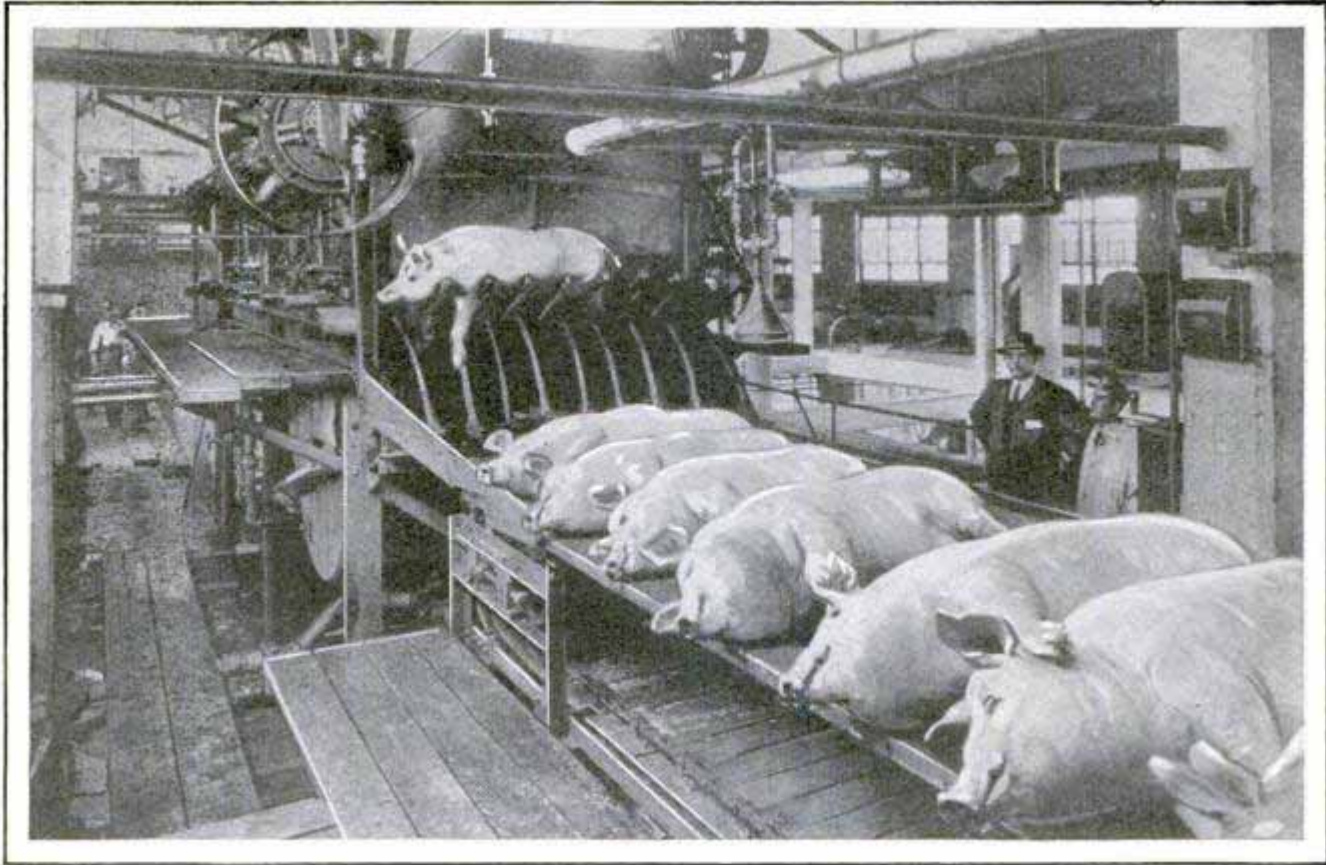

Hogs Coming from the Hair-Removing Apparatus; as Many as 1,000 an Hour Can Be Scraped in the Larger Outfits of This Kind, Saving Hand Processes and Loss of Time

### SCRAPING HOGS BY ELECTRICITY ELIMINATES USE OF HOOKS

One of the most recent units to speed operations in large butchering plants, is an outfit for scraping hogs. As the animals come from the scalding vat, they are conveyed into a cabinet arrangement in which are sets of flexible scrapers. These are said to thoroughly remove all hair and refuse, and after the hog has been cleaned, it passes out of the machine, drops on a table and is ready for the next step in butchering. A separate conveyor is supplied for salvaging the hair. The largest machines have a capacity of 1,000 hogs an hour. They save using hooks and insure greater regularity in handling.

### RETIRED TOPEKA STREET CARS USED AS STORES 2350

Instead of being junked, several street cars, replaced by auto busses in Topeka, Kans., are in useful service although they are no longer running. They have been converted into stores, cottages, tourists' camps and chicken coops. A motorman purchased one car for \$50 and used it as a display room for a stock of stoves. An-

other was fitted as a confectionery and refreshment stand, and a third was remodeled into a home and rented for \$12 a month. Two cars were rebuilt into dining and sleeping quarters for a summer camp.

### LINOLEUM ON CURVED MOLDING PROTECTS BASEBOARD 2321

To guard the baseboard against mop marks and other scratches and to eliminate the usual crack where dust and dirt collect, an improvement in laying linoleum has been introduced. Next to the base, a length of inverted quarter-round molding is placed, and the linoleum is carried up about six inches. A very narrow molding is placed at the top to hide the edge.

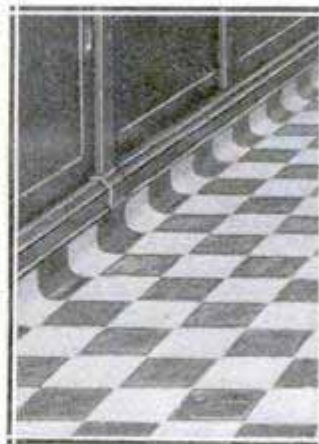

This plan results in a curved channel all around the room, so that sweeping is more easily done, the base is shielded and a more attractive appearance presented.

*See by special and Topeka Calif*

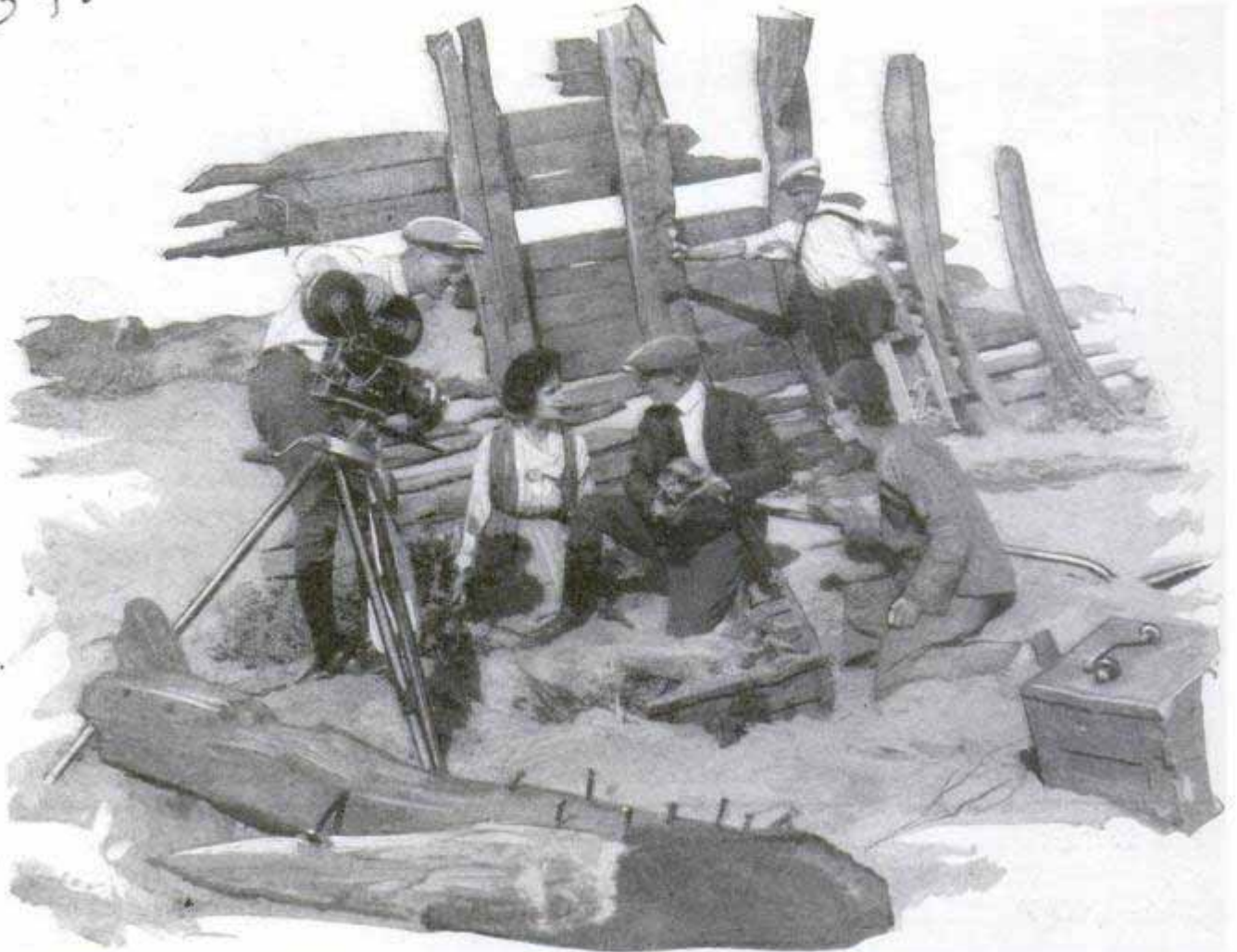

The Realistic Ribs of a Ship Buried in Sand, an Excavation and a Recovered Skull, with the Director Explaining the Action; a Typical Set Manufactured for the Movies

## Doing the "Impossible" in the Movies

Answering Strange Questions and Supplying Queer Things Quickly Is Function of Unique Organization

**D**OING the "impossible" quickly, answering questions that are beyond belief or reason and supplying everything from skeletons to ships, is the business of a Los Angeles organization.

"Hello," a voice from a busy movie studio calls. "How tall was Cleopatra?"

"Five feet, two and one-quarter inches," is the immediate answer to a question that might have taken a studio's research expert a month or more to solve.

Throughout the day demands and inquiries pour into this amazing establishment, the like of which can scarcely be imagined:

"Get us 2,000 lady bugs by Friday."

"Could the Gulf of Mexico be used as a location for the Bey of Tunis?" And, the answer: "No, not unless you put him in

a rowboat. He is a man and not a body of water."

To give an idea of the extent of the stock carried by this organization, the Western Costume company, the present contents of the building would dress and fully outfit over 25,000 people—and furnish their homes also.

The reference library is worth hundreds of thousands of dollars to motion-picture producers. Shelf upon shelf of books, pamphlets and tomes intermingle with common, costly and rare volumes. Every known science is represented, but books of travel predominate.

These volumes are in charge of Edward Phillips Lambert, director of research. He supplies the answer to the comedy director who wants to know how the Eskimo says

2870

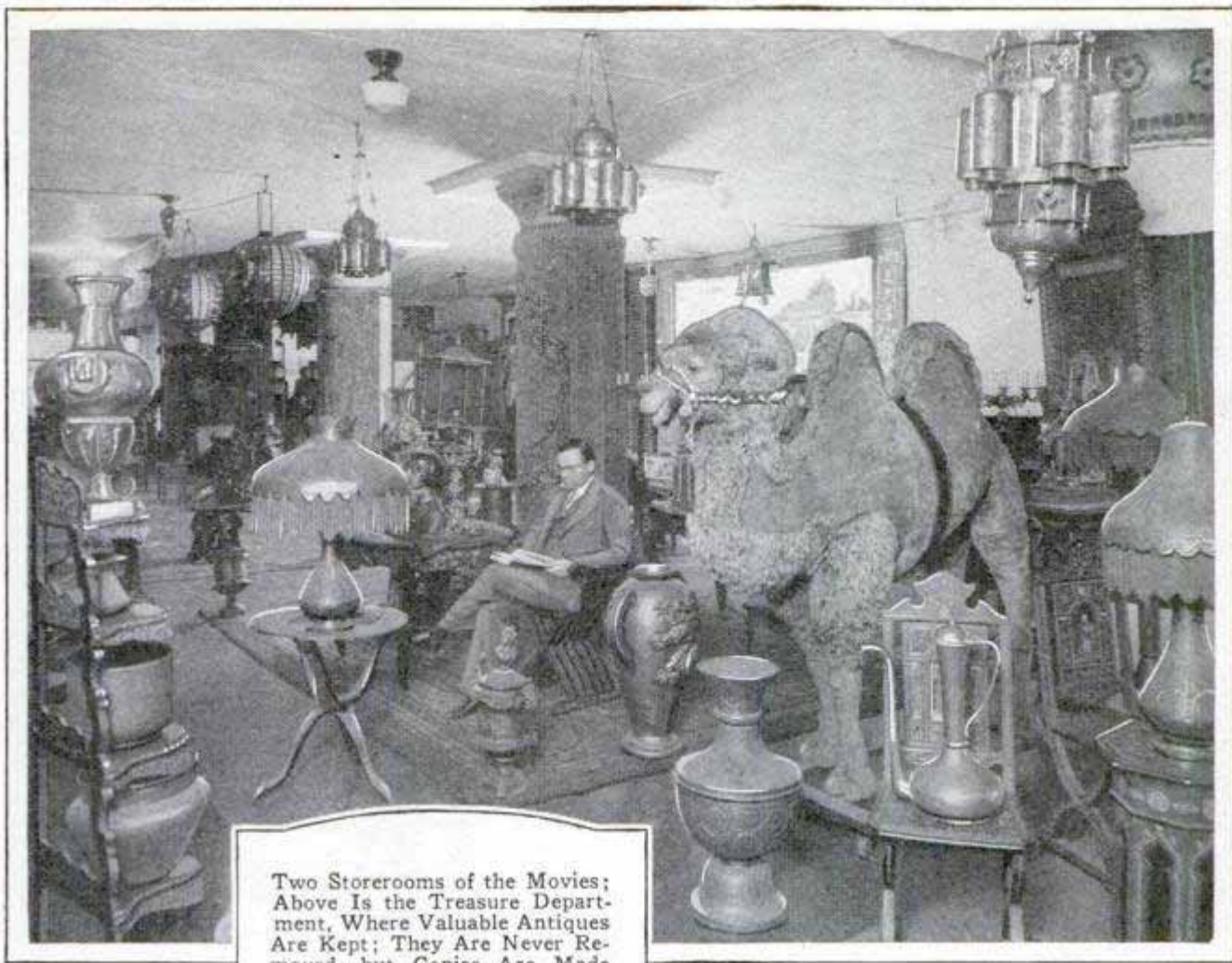

Two Storerooms of the Movies; Above Is the Treasure Department, Where Valuable Antiques Are Kept; They Are Never Removed, but Copies Are Made from Them; Below Is the Armorer's Department; the Gunsmith Keeps All of the Weapons in Repair





"I love you," and condenses the plot of Hamlet after this fashion: "Well, a man murders his stepfather out of revenge for the slaying of his own father. And the crux of the play is a mix-up with swords and poison."

Wandering through the twelve floors which the establishment comprises, is like taking a trip around the world—from prehistoric times to the present—and beyond. Many of the things to be seen never existed except in someone's imagination. The "Goofus," for instance, has the tail of a fish, the wings of an eagle and the head of a mummy. There are miniature ships, including everything from a replica of Noah's ark to a tiny ocean liner, and figures of saints, old liquor bottles, coffins, glass eyes and even stuffed elephants.

The medal collection, comprising at least one duplicate of every known medal cast from the time of Julius Cæsar, is considered one of the best in existence. Originals of this collection, as well as musical instruments, arms, saddles and a myriad of other priceless antiques, never leave the

building. They are guarded as zealously as a museum protects its treasures. Only duplicates are rented out.

The shoe collection contains thousands of pairs brought from all parts of the world. Persian sandals, Indian moccasins, Chinese clogs and fur boots from Greenland lie side by side; shoes of wood, shoes of straw, of paper, cloth and leather, in all grades and all sizes.

The arsenal contains practically every offensive and defensive weapon that was ever used by man. Everything—from a stone club to a high-powered rifle—is there. A German machine gun, relic of the late war, frowns disdainfully on the long-barreled silver-mounted guns of the Moors. And

there are bayonets, belts, holsters and hand grenades in stacks, and every imaginable type of sword—those of the Crusaders beside the great two-handed blade of Richard the Lion-Hearted. Brass knuckles appear puny in comparison with Stone Age weapons, war clubs and African spears. No matter what the movie director may

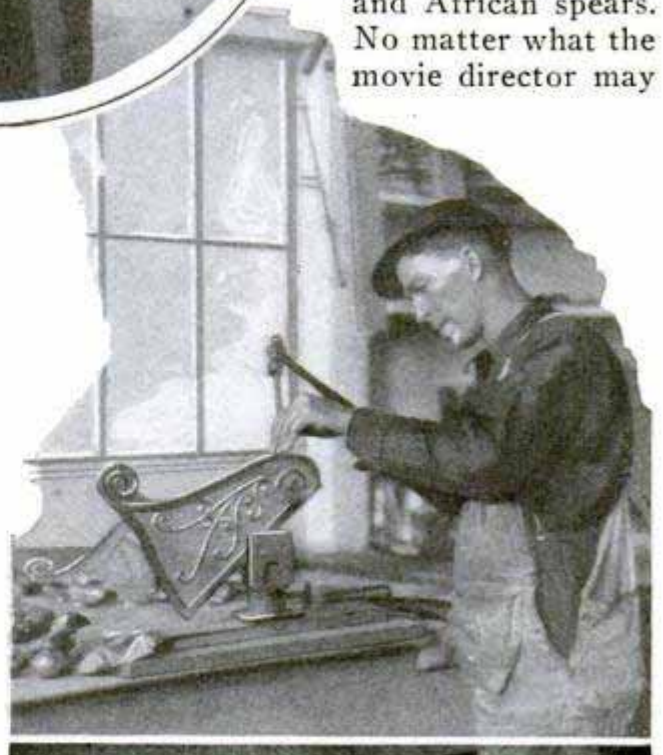

Molding a Statue, a Completed Mask and Wig, and a Worker in Ornamental Brass in Movieland



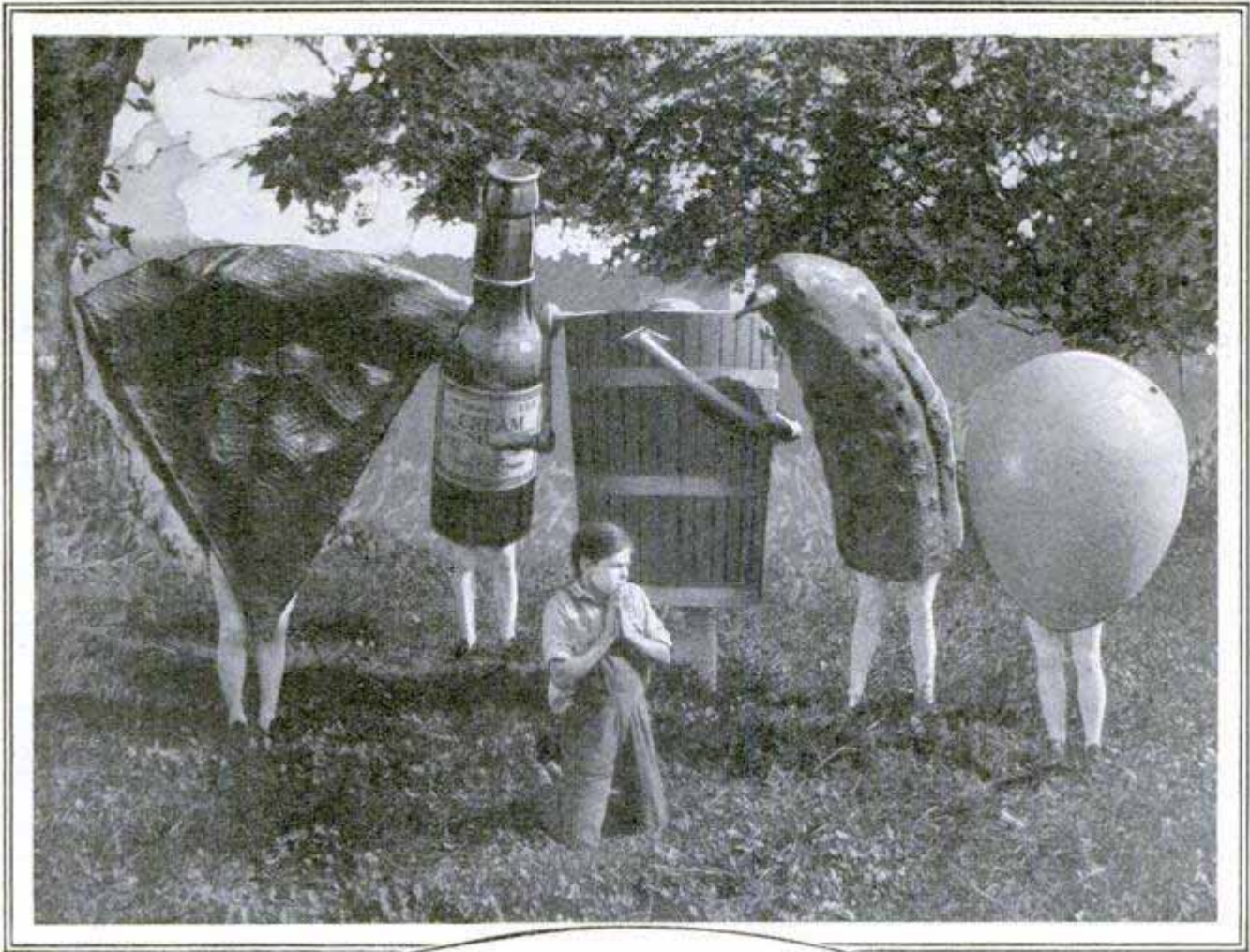

Weird Bipeds Manufactured to Illustrate a Dream, Above, and, Below, the Saddlery in Which the Hundreds of Riding Sets Are Stored When Not in Use by the Cavalry, the Cowboys or the Hollywood Indians Who Ride through the Western Films

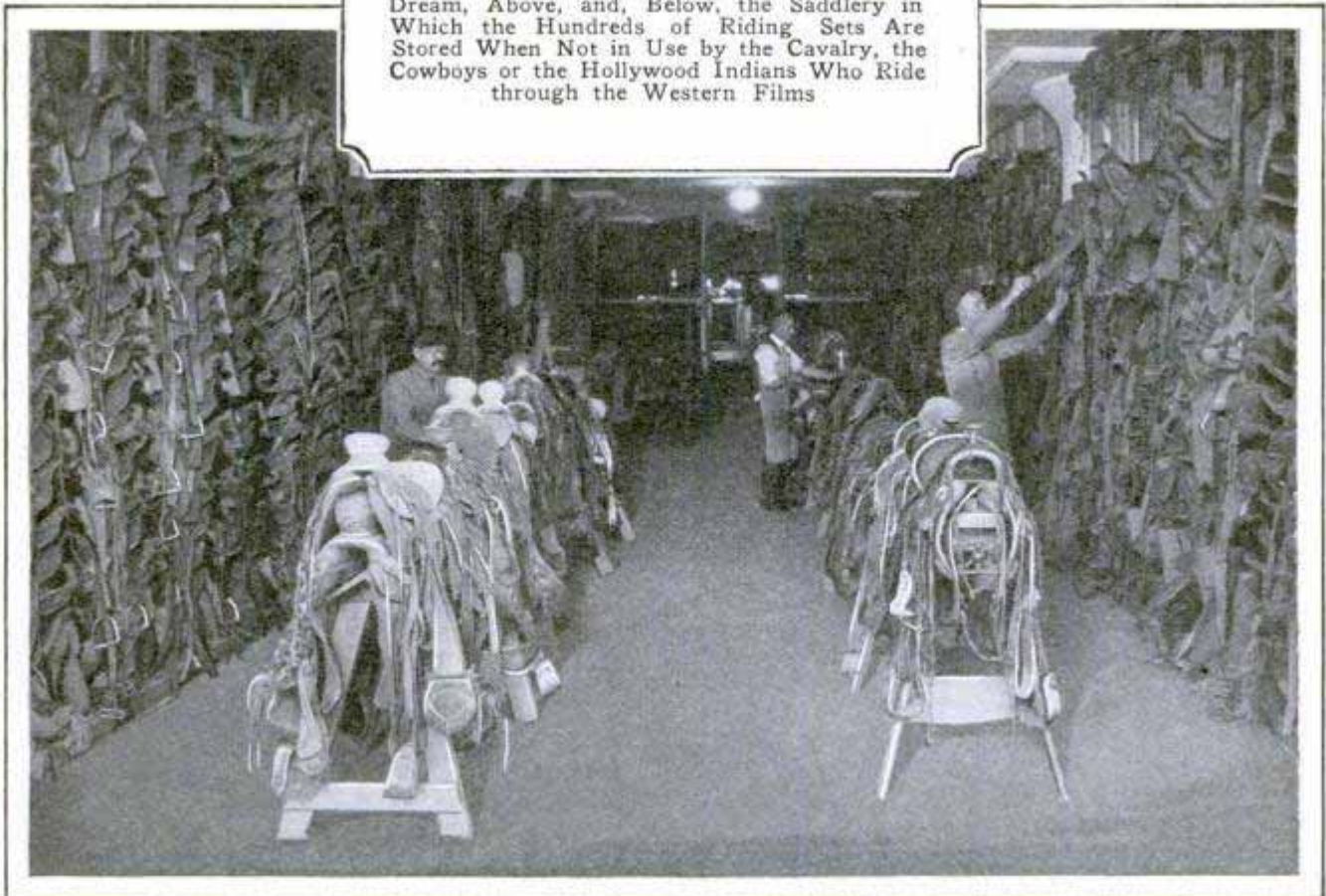

ask for in the way of a weapon, it is there. The armor collection shines like well-polished silver. And no wonder. It is kept as well oiled as the finest of machinery. Were the Knights of the Round Table to visit here they would go wild with envy. No longer would it be necessary for them to stagger around in steel suits that weighed a ton. A lightweight substitute has been invented that has all the appearance of genuine metal but which is as light as felt. And it actually is felt—a composition with a metallic surface.

A casual glance about the costume floors reveals uniforms of every nation and period of history—classified according to their types. Cowboy outfits, waiters' togs, Chinese coolie dress, miners' caps, all kinds of army and navy uniforms, tights and African "G" strings. In fact every conceivable piece of apparel, worn by humans since the beginning of time, is represented.

There is the uniform worn by Gen. Sherman of Civil war fame. Old and blue—showing signs of active wear—it was pur-

chased for \$35. Embroidered on each shoulder are two silver stars denoting the rank and recalling the famous "March to the Sea." Hanging behind it is the uniform of Gen. Grant and one worn by Adm. Farragut at the battle of Mobile bay.

Motion-picture cameras have been so perfected in the last few years that the quality and texture of fabrics show with remarkable accuracy. For this reason the very finest of silks, satins, linens, woolens and furs are used—and tailored to measure. Therefore, your favorite star can, and often does, wear screen clothing on the street and at social affairs. And when you see what you think are antique furnishings on the screen, they really are as represented. Exquisite importations that are upholstered in the most delicate shades and tapestry are not "cheaters." They are genuine articles and many are priceless.

An idea of the tailors' abilities to do things in a hurry is demonstrated by the fact that 1,500 military uniforms have been designed, made to order, and turned out



An Elaborate Costume Piece That Required Much Research and a Vast Investment in Special Equipment; a Scene from a Film Depicting One of the Battles of Washington's Continentals

*dir. Lake St  
2000 Lake St  
Chicago*

complete in every detail, including equipment, within thirty days without interfering with regular business. Three or four costumers in this department often get out rush orders of fifty and one hundred costumes on an hour's notice. These are, of course, taken from stock.

Once someone sold a load of old costumes for junk. The very next day there came a call from one of the upper floors for rags—more rags. Beggar costumes were being made and old rags were needed. New rags would not do. They photographed new. That little sale to the junkman, which netted \$12, cost the company over \$900. Natural wear cannot be faked—at least not for the eye of the camera. For this reason even the most tattered costumes are preserved for the time when the busy telephone calls for rags of streets of Paris, 1870, or other similar requests.

*2899*  
**CLAMP FOR CONCRETE COLUMNS CUTS CONSTRUCTION COST**

To simplify the task of holding the forms for concrete columns in place, an improved clamp now on the market is said to have met the requirements of contractors and is so easily adjusted that two men can attach sixty of them in an hour. They are used in connection with an iron strap which is anchored to the clamp, passed around the column and through an opening in a drum on the clamp. This drum is then tightened with a nut and locked when the desired tension has been reached. The straps can be used repeatedly on columns of the same size, and the clamps are said not to injure the forms in any way.



*2318*  
Old railroad rails have been salvaged for ties on an eastern line, two pieces being used for each tie; they are held together by metal plates welded in position at each end of the pieces of rail.



Suit in Carrying Rack Which Is Slipped into Case, Keeping the Garments Neatly Pressed

**SUIT HOLDER FOR TRAVELERS KEEPS GARMENTS PRESSED**

For traveling and for delivering suits of clothes from stores or the tailor's, a special rack that holds the garments tightly, so that they cannot wrinkle or become disarranged, has been devised. It is made of wood or fiber. Suits are easily inserted or taken out and use of the holder saves room in the luggage.

**STEAM HEAT SOLD BY METER IN NEW YORK BUILDINGS 2530**

Steam is bought instead of coal to heat and operate some of New York's skyscrapers and apartment buildings. A recent survey shows that more than seven billion pounds are being sold through meters annually to serve over 800,000,000 cubic feet of space. While discussions have been going on concerning the erection of central heating plants, forty-five miles of mains have been extended over the east side of the city. More than 2,000 buildings, including some of the largest in Manhattan, are each buying an average of 3,500,000 pounds of steam every year.

*William Walter, General Electric Co.  
Hudson  
Belaware*

*W.A. Kuhlman & Co.  
111 S. La Salle St.  
Chicago*

May 1927

*Tokyo Electric Co., Osaka, Japan*



Evidence of Electrical Progress in Japan; Beautiful Tower at Recent Exposition as It Appeared under Floodlights

**BEAUTY OF JAPANESE TOWER REVEALED BY FLOODLIGHT**

Sparkling under the radiance of hundreds of floodlights, a crystal tower was one of the spectacular features of Japan's electrical exposition in Osaka. The fair showed what great strides have been made in recent years in adapting electricity to the industries of the land of cherry blossoms. The development has extended to factories, street and interurban railways and to the Japanese home,

where time and labor-saving devices, such as are popular in this country, are winning approval.

**UNWASHED DISHES MAY BREAK**

Dishes in which gelatin desserts have been served, may be found broken if they are left standing for some time without washing. The reason is that when the gelatin dries, it exerts a force strong enough to pull the dish apart or to chip it, in some instances. Egyptians similarly used wooden wedges, soaked with water, to split rock. The expansion of the dried substances in the wood caused the stone to break.

**FLOOR FINISHER FITS CORNERS**

Places that cannot be reached with the usual type of electric floor finisher are accessible to a compact unit now on the market. It is equipped with both disk and drum to which sandpaper is readily attached by patented devices. For work in corners, against baseboards around curved edges and similar tasks, it is especially adapted, eliminating the need of hand work which is usually necessary when large machines are used. The outfit is run by a one-fourth or one-third-horsepower motor, furnished for direct or alternating current at thirty-two or 110 volts. One of the special features is an automatic pressure release. As soon as the hand is removed from the grip, the finisher is disengaged.



Polishing Close to a Rounded Corner; This Task Is Possible with Finisher That Reaches Hard Places

2422

2 3 7 3

*Chicago Electric Rotary Machine Co., 312 5th Lake*

*La Kel Mfg Co., Bourse*

# Speaker Built from Cigar Boxes

By S. N. EDWARDS

**T**HE neat and serviceable loud speaker shown in the photo was made from no more expensive material than a few empty cigar boxes. Speakers of this type may be placed either on the table or hung on the wall. If properly built and equipped with a good speaker unit, the tone is remarkably good for a horn of this size. The built-in horn is supported only from the top and front, which type of non-rigid construction seems to add much to the tone. The horn proper should be built entirely of cigar-box wood, as this gives the best tone quality; the casing, however, may be built of any  $\frac{1}{4}$ -in. wood.

The first step is to form the block for the speaker unit. Three pieces of wood are cut  $1\frac{3}{4}$  in. square and glued one on top of the other to make this block. When the glue is thoroughly dry, a hole, slightly

smaller than the nose of the speaker unit, is drilled through the center of the block. Any good standard unit of the type designed for phonograph or horn will make a very satisfactory speaker. The block is then set aside and the inner-horn front and back pieces are prepared. These pieces are  $5\frac{1}{2}$  in. long,  $3\frac{1}{2}$  in. wide at the top and tapering to  $1\frac{1}{2}$  in. at the lower ends. The horn sides are then cut, and a center line drawn on the board will be found helpful when making these; the width at the bottom is  $1\frac{1}{2}$  in. At a height of  $5\frac{1}{2}$  in., on the center line, the width is  $3\frac{1}{2}$  in., and from this point the sides are cut straight. On the front side, this straight cut is 5 in. long but at the back it is only 2 in. From this point, at the back, the sides are polygonal to form the upper "curve" of the horn. This may be laid out

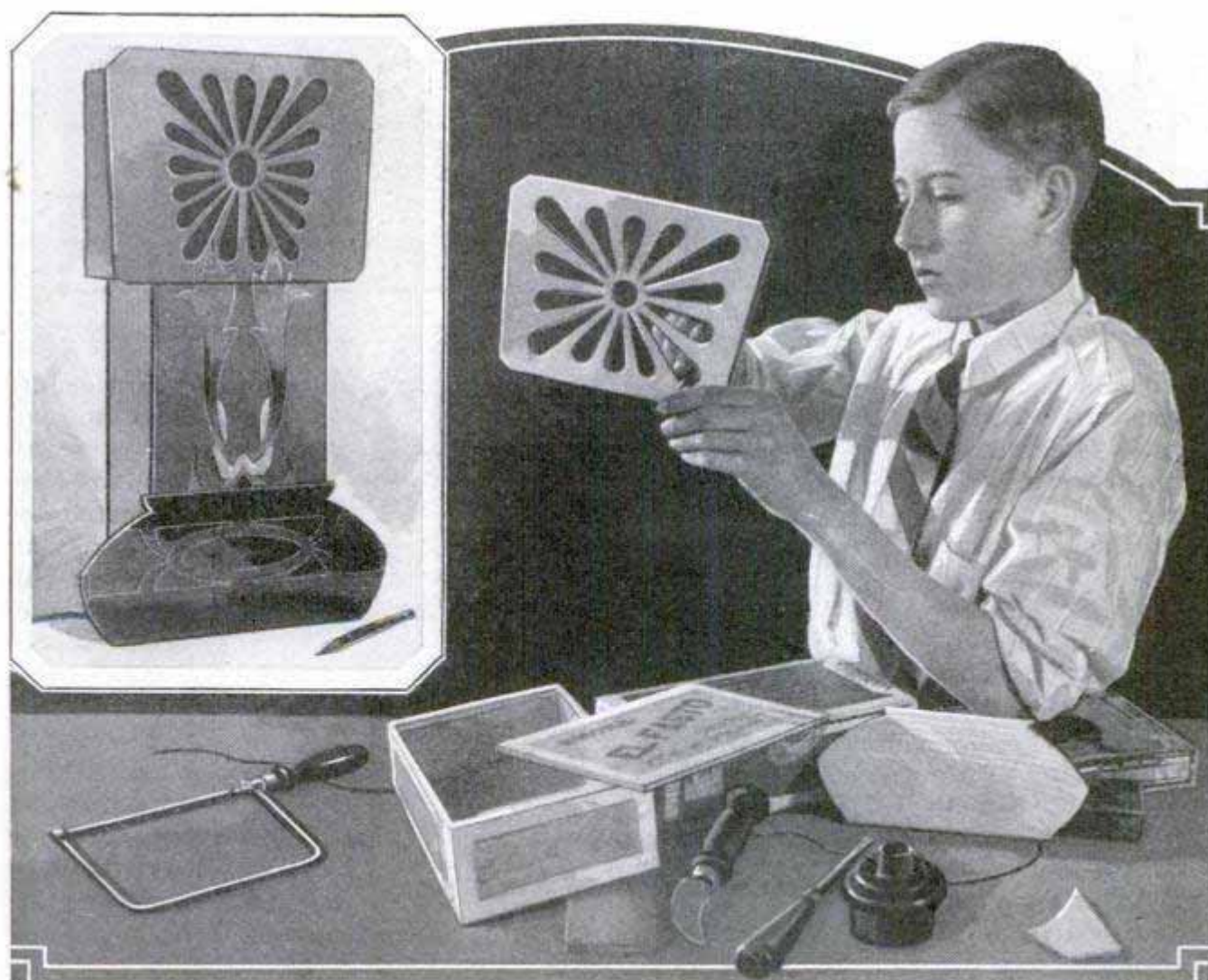

Upper Left, Finished Speaker Showing Suggested Decoration; Above, Cutting and Trimming the Grill

by marking off 1-in. "flats," each at an angle of  $18^\circ$  to the next. With small brads and glue fasten the back, front and sides together, and complete the upper curve with 1-in. strips of the  $\frac{1}{4}$ -in. wood. Fill in any crevices with glue and trim off the ends of the strips.

The unit block is then beveled so that

the bottom. The "bulge" is 8 in. wide at the widest section,  $1\frac{3}{4}$  in. from the bottom. The sides of the lower casing are  $8\frac{1}{2}$  by  $3\frac{3}{4}$  in. and the upper sides  $5\frac{1}{4}$  by  $3\frac{3}{4}$  in. The bottom and top pieces are  $5\frac{3}{4}$  by  $3\frac{3}{4}$  in., the lower back piece  $8\frac{1}{2}$  by  $4\frac{1}{2}$  in. and the upper back piece  $4\frac{1}{2}$  by  $5\frac{1}{4}$  in.

The casing is now assembled, the front

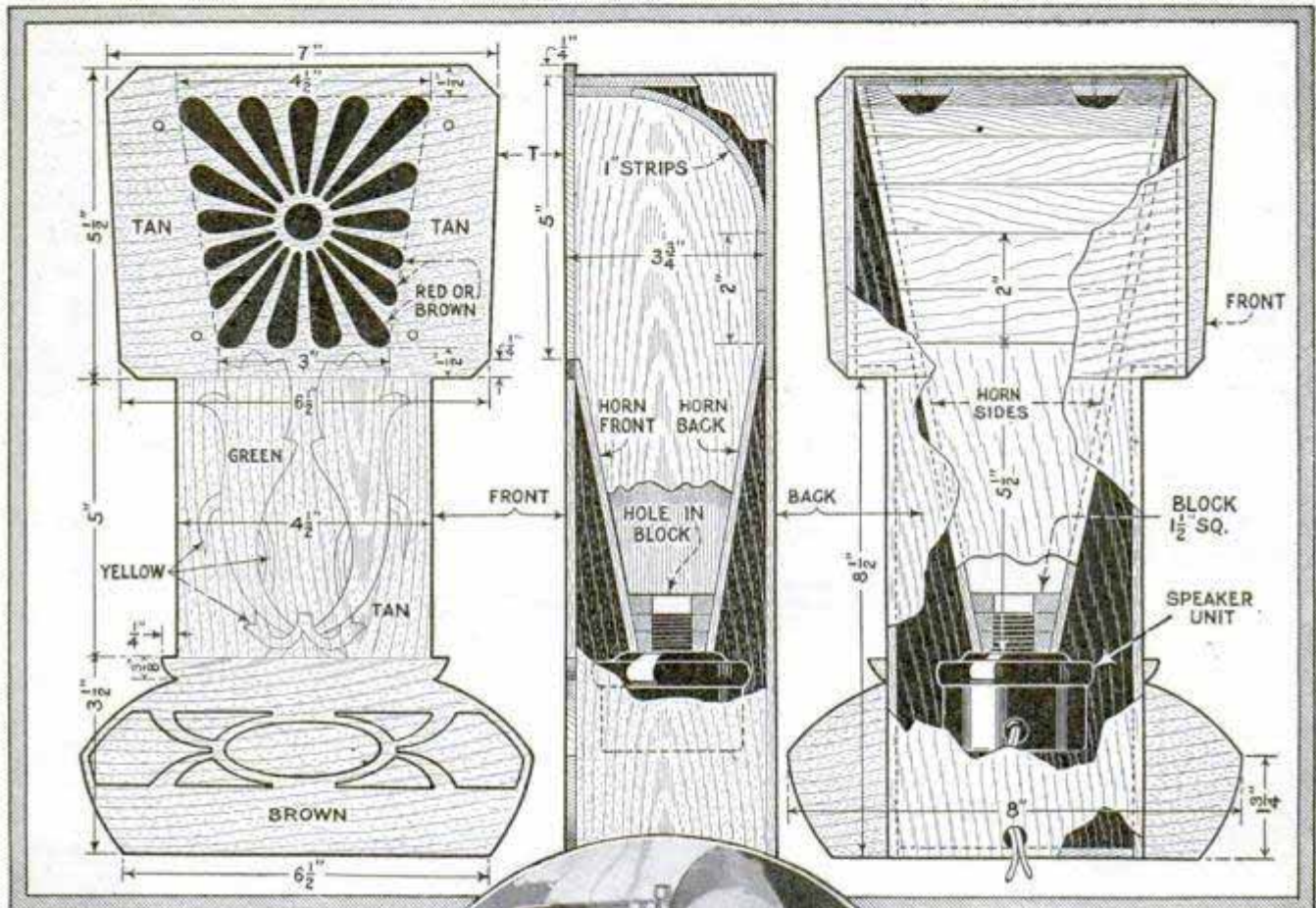

it will fit inside the lower end of the horn, where it may be fastened with glue or brads. Next, the grill front of the speaker is cut; this is  $5\frac{1}{2}$  in. by 7 in. at top and  $6\frac{1}{2}$  in. at bottom. The design is cut out with a scrollsaw and any rough edges smoothed with a file, as shown in the illustration. The grill is then covered

with a square of silk, glued to the back. The center front piece of the casing is  $4\frac{1}{2}$  by 5 in., and the lower vasselike base is  $3\frac{1}{2}$  in. high, 5 in. wide at top and  $6\frac{1}{2}$  in. at

Construction Details, Showing Section View of Side, and Cut-Away View from Back; Inset, Method of Using Scrollsaw in Cutting Out Lower Panel and Grill

of the horn being fastened to the rear of the grill by means of brads at the points indicated by the small circles at the four corners of the front view and at the top. When the grill is in place, the horn is supported only from the top and at the four points at front, a floating effect being thus obtained that increases the

clarity of tone. If care is taken in cutting and fitting, so that the assembly is solidly constructed, the results will be well worth while. The design may be outlined on the

*St. Charles Ill.*  
**Cabinet Speaker Has Eighty-Six-Inch  
 125 P. Q. Tone Chamber**

front with a tracing wheel, after the back ground has been carefully sanded and lacquered. This design may then be filled in with brushing lacquer in suitable colors, which will give a pleasing and attractive appearance to the finished speaker.

A new speaker, employing an 86-in. tone chamber built into a neat walnut console, has recently made its appearance on the

**Reamer a Useful Radio Tool**

The long tapered reaming tool that fits the standard brace is one of the handiest tools a radio builder can own. Quickly enlarging panel holes to fit various sizes of screws, instrument shafts or bushings, this tool saves time as well as wear and tear on the experimenter's patience. Drills are not always available for the exact size of the hole wanted, but it is an easy matter to use a small drill and enlarge the hole to the proper diameter with the reamer.

**Charging a Radio Battery**

When one does not feel justified in purchasing a separate charger for the radio battery, it can be fully charged within a few hours, if hooked up with the auto electric system, as shown in the illustration. A knife switch is mounted under the seat, or in any other convenient position. One end terminal of the switch is connected to the starter switch, the center terminal to the ammeter, and the other end terminal to the positive post of the radio battery that is to be charged, while the negative post is connected to the negative post of the car battery. The two leads which connect to the radio battery may be set on the floor behind the front seat. The knife switch permits the current to be cut off from these leads when not used. It is advisable to provide a rubber mat under the storage battery to prevent possible damage to the floor rug. —Wm. Rosenblohm, Mountain View, N. J.



Above, Front View Showing Large Grill; Below, Rear View with Back Panel Removed

market. The cabinet is large enough to be used for any table set and also provides ample room for batteries or power units. The large grill at the front of the type shown in the upper photo is backed with gold cloth, but other models are provided with doors. The lower photo shows the rear of the console with the back panel removed; the horn is mounted at the front on sponge-rubber cushions. The air chamber is scientifically designed and is claimed to give flawless reproduction of both high and low notes. The cabinet is 34 in. high, 26½ in. wide and 16⅝ in. deep.

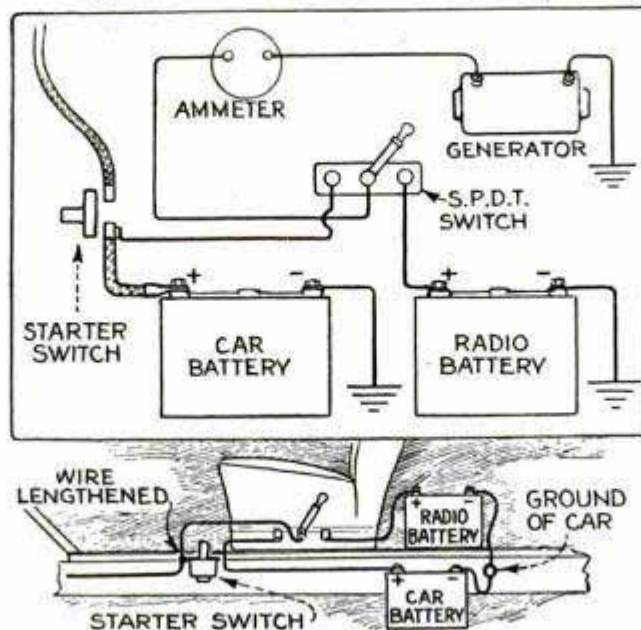

Method of Charging a Radio Battery in an Automobile and Connections to Be Made for the Purpose

The air chamber is scientifically designed and is claimed to give flawless reproduction of both high and low notes. The cabinet is 34 in. high, 26½ in. wide and 16⅝ in. deep.

Ⓞ B - batteries should be not more than six feet from the set if best results are to be had.





Push-Button Plug Corrects Polarity

A push-button plug for correcting the polarity of the loud-speaker or phone connections is a new device offered to radio fans. It insures maximum results of speaker or headset by providing immediate means of obtaining the correct polarity. Just press the button and you have it without withdrawing the plug from the jack or changing the connections.



the secondary being shunted with a variable condenser, and the usual arrangement of A and B-batteries. In Fig. 2 a special tube known as type 2 H.F. developed for long-distance work is shown; in external appearance this tube is similar to the type 3 N.F.; it consists of two double-grid tubes and the necessary coupling, as shown in the diagram. The filament voltage for this tube is also 4, directly applied; a 90-volt B-battery and from 10 to 20 volts of C-battery being required. This long-distance tube may be used as a first stage for all types of receivers; it is, however, particularly suited for use in conjunction with the type 3 N.F. triple tube.

Filament-Control Units Simplify Wiring

The simpler the wiring the better, both from the mechanical as well as the electrical standpoint, in wiring the radio receiver. Long leads should be avoided wherever possible, and the elimination of unnecessary hand-operated rheostats from the front panel will enable the builder to use much less wire. Automatic filament-control units of the cartridge type may be mounted at the side of the tube socket, or several tubes of the same type may be controlled with the same unit if the proper resistance value is employed. These control units require little room, and may be placed in any odd corner since, once installed, they require no further attention.

Solderless Cable Terminals

Snap terminals of the kind shown in the drawing, which come in different colors so that they can readily be distinguished, are convenient to use on flexible, stranded battery wires, as they do not have to be soldered on, yet make good electrical connection. About 1/8 in. of the end of the wire is bared and slid into the bakelite sleeve, after which the connector end is screwed on. This spreads the end of the wire in the sleeve, and binds it with perfect security.



Handy Markers for Battery Leads

Handy identification markers for battery leads, now available, are made of polished aluminum and can be clamped around the wire with a pair of pliers. As it is highly important that battery leads be carefully marked to prevent mistakes in making connections, the tags are particularly handy in wiring console sets in which the battery leads are long and difficult to trace. The markers are made stamped in black and come in assortments of nine, bearing A, B and C-battery designations.

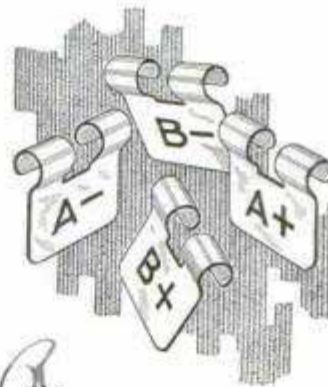

Small Clamp Used as Vise

A little metal clamp of the type used for holding small glued wood parts may be used as a vise for holding any small object you may wish to solder. It is often difficult to hold small parts while soldering, especially radio parts such as lugs, switches, fixed condensers, etc. Get the type known as the C-clamp; mount the back of the clamp between two small blocks of wood and the result is a vise that is very handy for small work.

Connect and stud. 15x

Rayah Auto Supply Co.

39 Avenue L, Newark, N.J.

9312  
Tahmad Co. 11600 Ch...

# Safety First in

LIKE any other piece of electrically operated apparatus, the radio set requires intelligent installation for safety, convenience and efficient functioning. Early radio experimenters, interested only in results, had to use such equipment as was readily obtainable, and the work progressed amid a jumble of unsightly wires, batteries and charging devices. Then the console cabinet came into use in an effort to hide the mess and was partly effective, though there were still aerial and ground wires and a tap from the lighting line stretched around the room behind the picture molding or tacked to the baseboard. The cost of the console keeps most of those who already have a good table-type cabinet from buying one, and their batteries remain in plain view or partly hidden in a dark corner. Installations of this type are not only unsightly but a decided liability, because damage to rugs from spilled battery acid, and short circuits caused by trailing wires, are likely to occur.

Within the last few months the widespread use of B-battery eliminators for higher B-voltages and trickle chargers has not only complicated the problem of hiding these accessories, but has introduced a need for better insulating and more orderly installation. Any electrical device operated from the house-lighting line may cause serious shock if the body is well grounded, as has been demonstrated many times when people have tried to use electrical devices, such as curling irons or massage machines, while in the bathtub or in contact with a well-grounded water or plumbing system. There is no particular case known to the writer where such accidents have happened to users of radio sets, but now that the house-lighting current is employed, the sensible thing to do is to take the same precautions as employed for any other devices using lighting current.

When installing the new set or modernizing the old, the part to begin with is the aerial, and the sketch in the insert on this page shows the correct method of bringing the aerial lead into the building. Note that the insulator tube is slanted from the inside down so as to prevent the entry of water during rains. A lightning arrester should be installed on the outside of the building in the manner shown, and run to

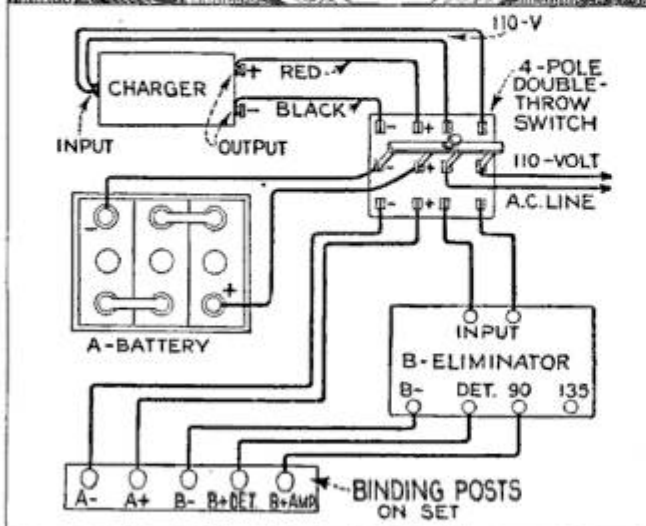
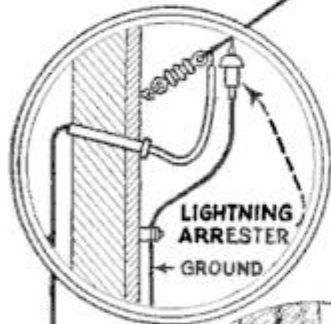

# Receiver Installation

By Frank L. Brittin

a good outside ground; this protects both the building and the set, and requires no attention later on. The switching device shown in the diagram at the bottom is of the manually operated type still in common use by the experimenter, and is safe enough when properly installed. However, it is not recommended where there are small children about and is shown only as a comparison between the old and new methods. With the new devices now on the market, safety and neatness are both possible, for the A-battery, B-eliminator and charger can be removed to the basement (directly below the set) or hidden away in a near-by closet, and the wires carried through the wall in insulating tubing to a plain brass outlet plate little different from the wall outlets in common use for portable lamps and other fixtures.

With such equipment the radio set can be disconnected as easily as a floor lamp

and moved to permit cleaning of the room, since it is neither tied down by a mess of wires to a lot of batteries, nor weighted down, as in a console cabinet, by fifty or sixty pounds of accessories.

A very complete installation of this type is shown on this page, and, in addition to the battery equipment, aerial and ground connections as well as loud speaker outlet, facilities for other rooms are taken care of. If it is impossible to run wires in the wall, the outlet plate can be placed in the floor, and the multi-cord cable plugged into it or, as an alternative, a small hole can be bored through the floor and the wires brought up through it from the basement and directly to the set. When batteries and charger are placed in the basement or in a closet, an automatic switch is almost a necessity, and during the past few months several highly efficient devices

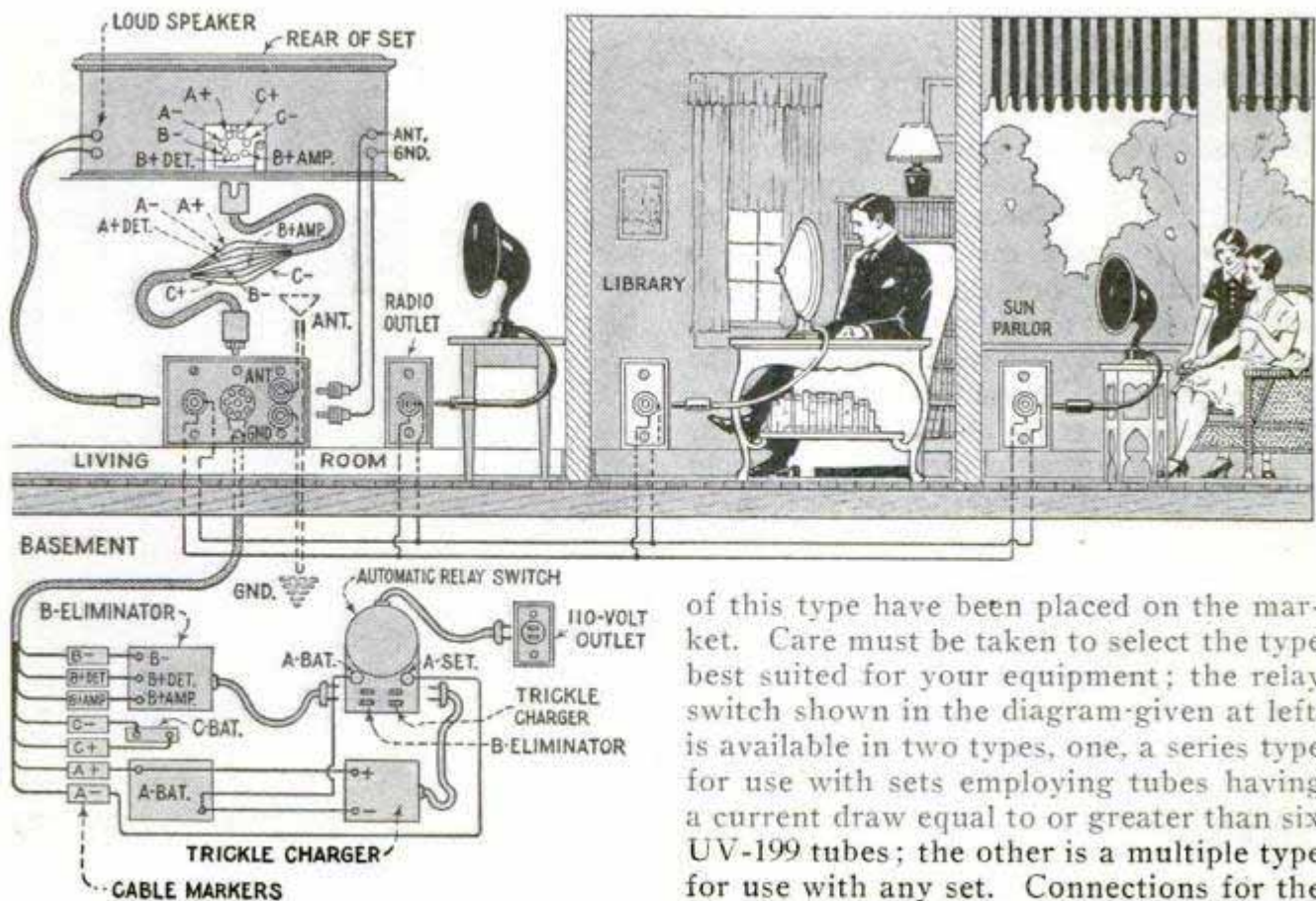

of this type have been placed on the market. Care must be taken to select the type best suited for your equipment; the relay switch shown in the diagram given at left, is available in two types, one, a series type for use with sets employing tubes having a current draw equal to or greater than six UV-199 tubes; the other is a multiple type for use with any set. Connections for the

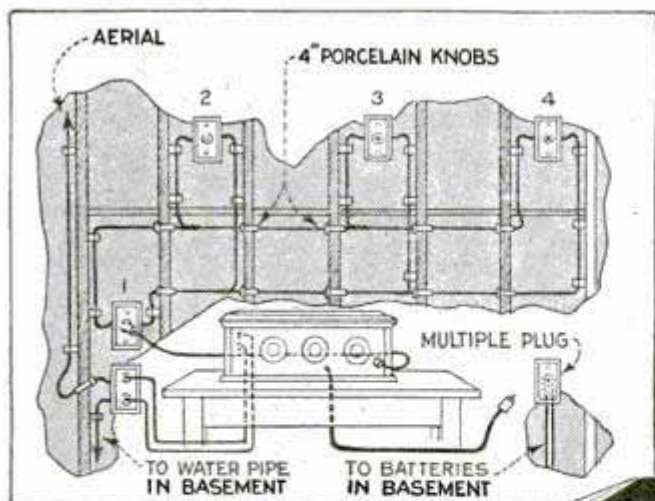

first type only are shown in the diagram, but the connections for the second type are very similar. The relay is used for the purpose of switching such devices as trickle chargers, B-eliminators, etc. It may be used to connect and disconnect either a trickle charger or a B-eliminator, or it may be used to connect and disconnect both by simply operating the filament switch on the set. Another and similar device is shown on page 306; this unit is tapped for use with 3 to 5 tubes drawing  $\frac{3}{4}$  to  $1\frac{1}{4}$  amp., and for 5 to 10 tubes drawing from  $1\frac{1}{4}$  to  $2\frac{1}{2}$  amp. It will be noted that both of these devices are designed for use only with chargers of the trickle type. An automatic control unit for use with 5-volt tubes and a 2-amp. tungar charger is shown in the basement assembly on page 305; this new device has lately made its appearance and solves the automatic switching problem where 2-amp. chargers are involved. The diagram given below the photo is self-explanatory, and requires little comment, charger and B-eliminator being automatically controlled by the filament switch on the set. When the set is not in use, the charger is automatically connected to the storage A-battery and the charge continued until complete, when the unit automatically discon-

nects the charger. This instrument is not for use with the older types of chargers employing an auto-transformer in their construction, such as the vibrating type, or the older model of the Westinghouse charger, unless a condenser is connected in series with the ground lead of the set. A .006-mfd. molded-type condenser is recommended in this case.

The home completely wired for radio is

not the curiosity that it was a year or so ago, since radio-broadcast reception has become such an indispensable element in the home life of the typical American family that it has outgrown the living room. The housewife, busy about her daily work in various parts of the house wants to listen in on programs especially broadcast for her; she cannot remain in the living

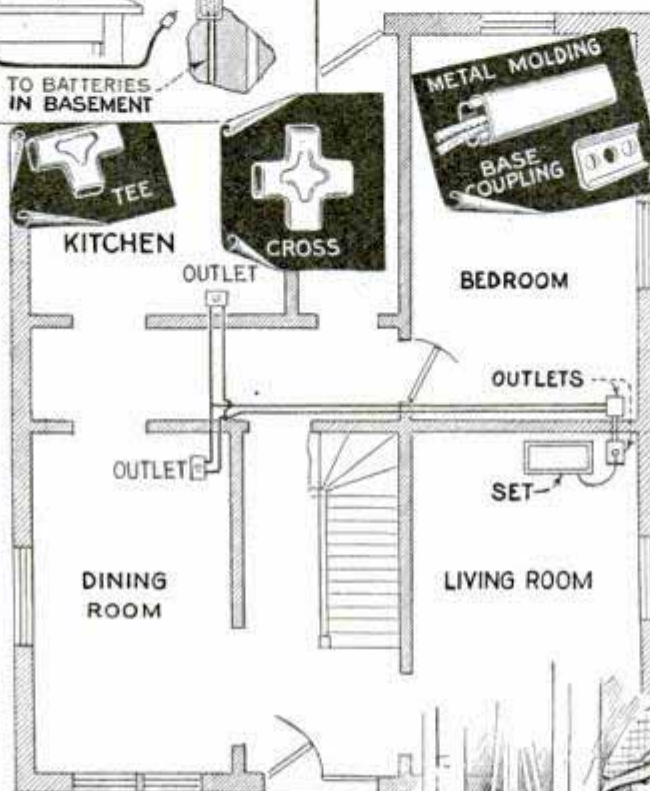

room and get any work done; radio has entertainment for the summer evening group on the porch; it is used in the ser-

vants' quarters; to provide music during the dinner hour; for the morning setting-up exercises and to tell bedtime stories to the children. If advantage is to be taken of these privileges, it is necessary to provide a speaker outlet in each of the various rooms. This is not difficult but must be carefully done. The wiring may be as simple or as elaborate as pocketbook and taste may dictate; it is often, unfortunately, a temporary type of exposed wiring offensive to the eye, as well as a sample of poor judgment in handling electrical wiring. It should be a permanent, concealed wiring job, either built into the house under construction, or installed in the house already built. The diagram at upper left

is to be distributed, and then consult the radio dealer or electrical contractor regarding the installation, or undertake the work himself. It is always best to wire for high voltages even if the present set is a small one requiring low power, so that the wiring need not be torn out to accommodate a larger set. The wiring should be in accordance with the fire underwriters' requirements, and if the home is under construction, it can be run in flexible armored cable or conduit, side by side with the usual electric wiring. If the wiring is to be installed in a house already built, it may be of the concealed variety, run in flexible armored cable which is slipped between the walls and floors, or the much simpler

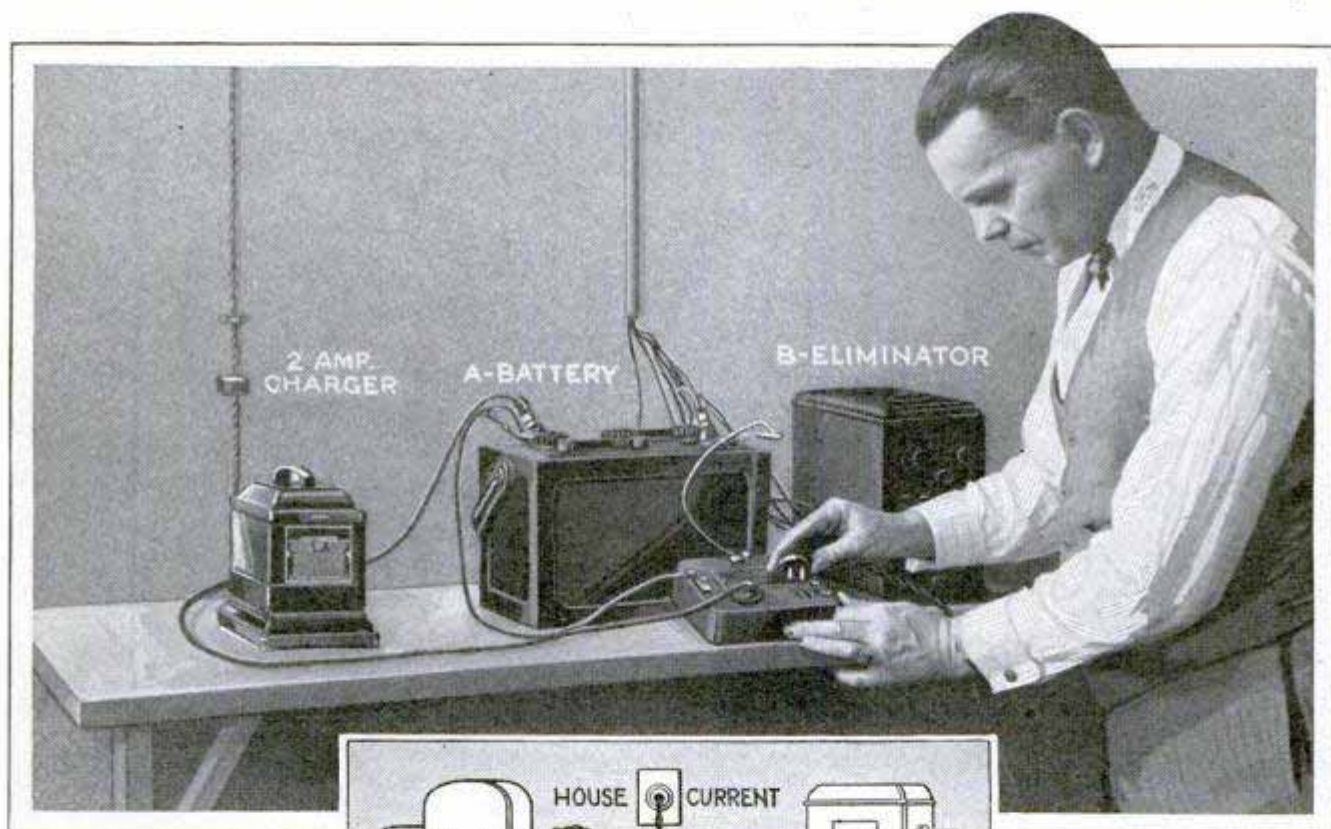

on page 304 will give the reader an idea of the usual method employed.

There are no fixed rules as yet for radio wiring, so each case must be handled individually with the safety factor always in the foreground. The home owner must decide just to what extent radio service

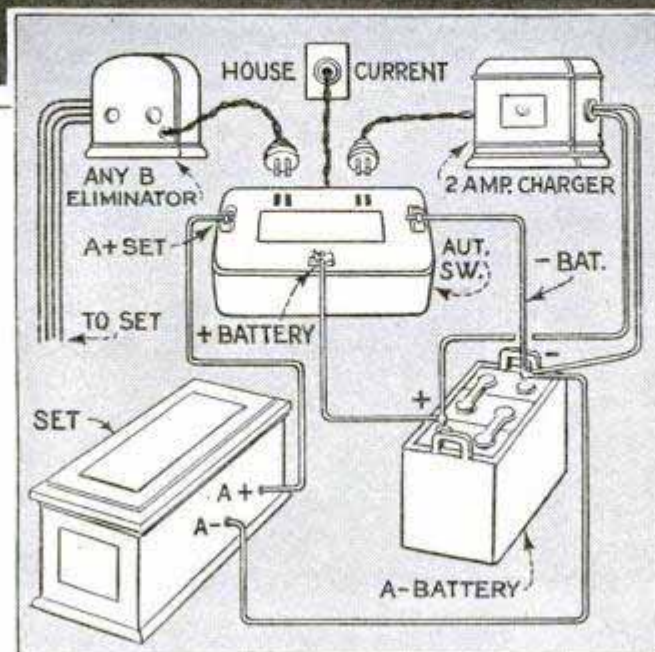

method of using neat metal molding may be employed. This molding, although exposed to view, is not objectionable, especially when it is painted to match the color of the walls, ceiling or woodwork. A short section of the molding is shown on page 304, together with a tee,

and cross, required at junction points. Elbows, of course, are also available. The ground-floor plan gives the reader an idea

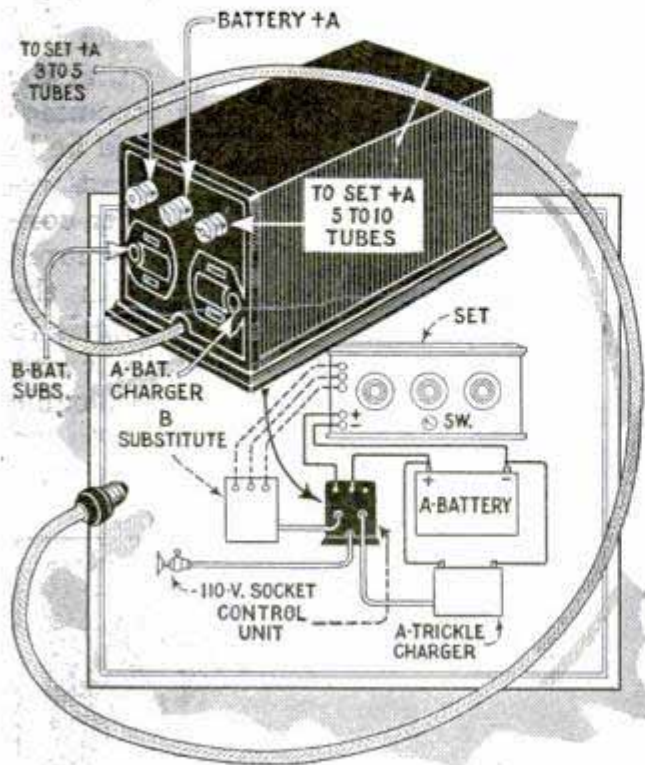

for laying out a similar plan covering his own requirements. The wires are shown away from the walls for the sake of clarity; the outlets in each room should be laid out in parallel and not in series. By this means, any number of outlets can be used at the same time without interference, and without switches being required at the remaining outlets. When laying out your wiring plan, group the outlets and select the location of the set so as to require the least possible amount of wiring; this idea is illustrated in the diagram.

### Repairing Defects in Radio Cabinets

Flaws in radio cabinets or consoles caused by cracks in improperly cured wood or accidents that sometimes happen regardless of the amount of care taken by the cabinetmaker, can often be repaired by the following simple method. A special wax for this purpose is obtainable at all finishers' supply houses and comes in various colors to match the woodwork on which it is to be used. Use a thin pliable blade such as an artists' spatula, heat the blade and the wax over a gas or alcohol flame and apply the soft wax with the heated blade. Use the wax sparingly,

smoothing the surface with the hot blade. This should be carefully done so as not to damage the adjoining surface; an application of polishing wax or furniture polish will then blend the repaired surface, and it will be difficult to locate the flaw.

### Time Chart for Daily Programs

A handy little chart giving the time of favorite programs broadcast each day is shown in the accompanying sketch; this little device, of simple construction, saves referring to the daily papers in search of the program desired. Most Sunday editions of the daily papers carry a complete schedule of local-station programs for the coming week; these programs are selected and inscribed on the dial card opposite the time, identifying the station with the hour. The dial is divided into seven sections, one for each day, and may be made of cardboard or celluloid. It is 4 in. in diameter, each of the seven segments being permanently inscribed in ink, with the day of the week and the hours as shown. Station letters should be entered with a pencil so that they may be erased as changes may demand. The sketch at left shows the completed unit and the simple construction details are shown at right; the stand is 8 in. high and may be made of cigar-box wood. The wood dial is 4 in. in diameter and drilled at the center for the shaft; the window at the top may be cut out with a scrollsaw, or a section removed by straight

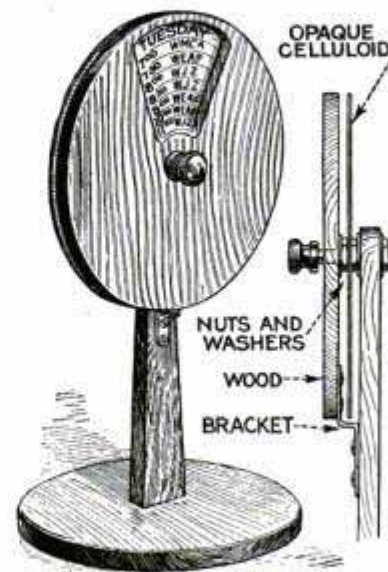

cuts from the outer edge if desired. This front cover is held in position on the upright by means of a small thin brass bracket bent in the manner shown in the sketch. A knob and shaft from an old rheostat can be employed to turn the celluloid dial. The dial is clamped between two hexagon nuts and mounted, as shown, on the upright.—W. P. Craig, New York City.

**Aluminum Shields for Standard Sets**

Leading radio engineers have long recognized the fact that proper shielding is an important necessity in a receiver to-

around the pipe, and it is then allowed to slip back until the edges of the slot catch the proper notch. Then the thumbnut is tightened, which makes the band secure around the pipe and prevents it from get-

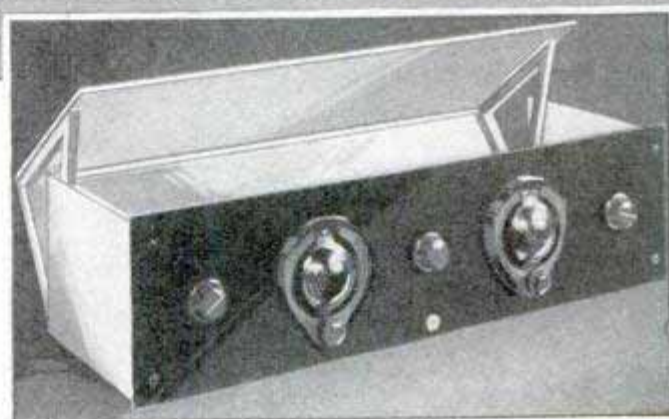
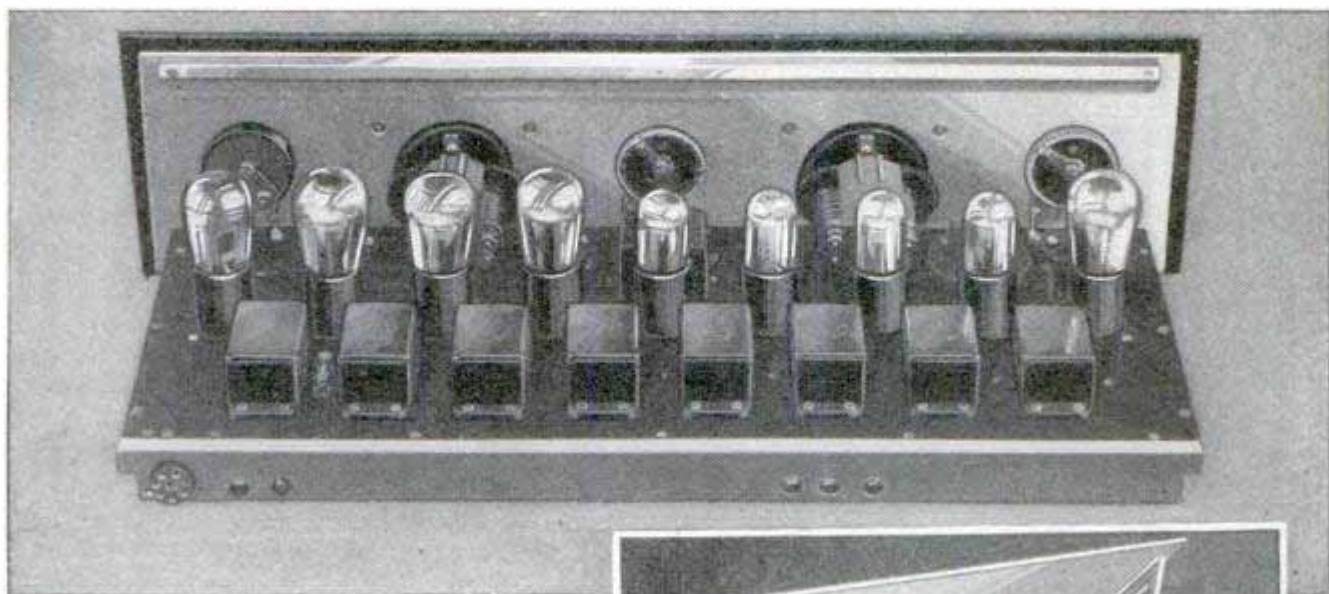

Above, Completely Assembled Set Mounted on Aluminum Chassis with Front Shield in Position; Below, Sides in Position, Back and Top Assembled in One Piece

day, and now complete aluminum shields are available for most of the standard sets. These shields are supplied in the knocked-down form and are very simple to assemble. The upper photo shows the Nine-in-Line superheterodyne mounted on an aluminum chassis, and with one of the metallic front shields screwed to the rear of the front panel. The lower photo shows the sides in place. The top and rear shields assembled in one unit are easily placed in position or removed to get at the set.

ting loose. There is sufficient surface to insure a good electrical contact and the bared end of the ground lead from the receiver is fastened to the snap clip, which holds it securely. The clamp is made of heavy copper for strength and durability, and can be used on pipes ranging from 1/2 to 2 in. in diameter.

**Adjustable Ground Clamp Fits Any Pipe**

Features not found in ordinary ground clamps are embodied in the one shown in the illustration.

No tools are needed for its installation, the band being simply pulled through the slot diagonally, which prevents it from binding until it is pulled up snugly.

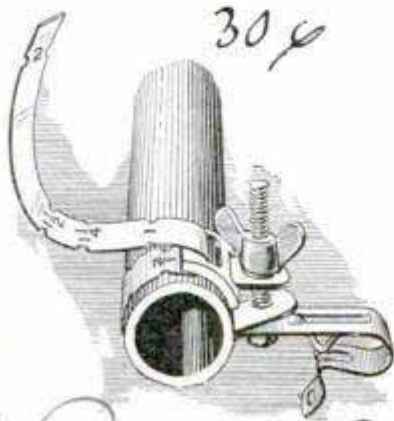

**Ribbon Aerial from Old Ford Part**

A ribbon aerial can be made from a discarded Ford magneto field coil. Each coil contains 11 feet of copper ribbon, 1/4 in. wide, and these copper strips may be soldered together until the desired length is obtained. This makes a very good aerial.

☐ If you wish to add materially to the appearance of your set have the panel engraved after all necessary holes have been drilled. The average cost of this work is two cents per letter and most dealers in radio supplies are prepared to do the work.

*Frost Radio Co.*

*Chicago*

*116 A. Wells St. Chicago*

### Three-Barrel Hydrometer Easy to Read

Ordinary hydrometers have one barrel and a weighted, graduated float inside. It often happens that the low level of the electrolyte in a cell does not permit enough to be taken up into the barrel of the hydrometer to raise the float sufficiently, which makes it impossible to take a reading. Another objection to the usual form of hydrometer is that the float, which is made of glass, is apt to break. Both of these troubles have been overcome by the

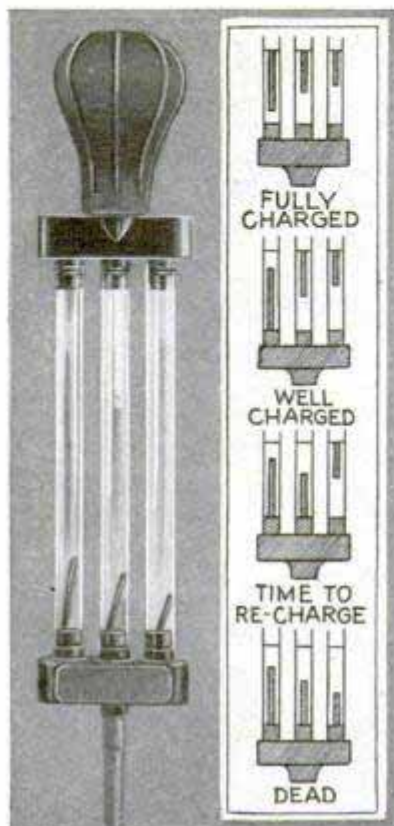

*make hydrometer*

novel three-barrel hydrometer shown in the photo. Only a spoonful of electrolyte is needed to obtain a reading. Each barrel contains a float of different specific gravity. If the solution raises all three floats, the battery is fully charged; if it raises the medium and small float, it is half charged, and if only one of the floats rises, it is time to recharge. If none of the floats rise, the battery is completely exhausted. A special tip extension on the nozzle is provided to facilitate testing storage B-batteries.

### Adapting Short-Prong Tubes to X-Sockets

A simple but effective method of converting the UV-type base tubes so that they may be used in X-type sockets is to solder standard phone-cord tips to the short prongs. This is a simple matter for anyone having an electric soldering iron. Tin the inside shank of the phone tip and also the short prongs of the tube. Slip the phone tip over the tube prong and place the hot iron against the tip. It will not require much heat to make the two adhere, and when this is done to all four

tube contacts, the tube may be slipped into the new X-type socket without any trouble. It is essential that the contacts in the socket make the right connections with the tube prongs, that is, the grid prong must connect with the socket contact carrying the grid-circuit connection, etc. This information may be obtained from any instruction sheet furnished with the standard tubes. If this is not handy, take an extra X-socket and push the tube into it. You will then note that the filament contacts are under the large holes in the socket. Most of the newer X-type sockets have a small engraved arrow pointing to the grid post, and in this case the tube is pushed into the socket with the pin on the side of the base in line with the arrow.

### 1145-R Umbrella Aerial

Several types of aeriels are now on the market, which are designed to occupy little space, and most of these are in the form of a conducting device such as a ball, sheet of copper or brass, or a wire coil mounted on a standard, which in turn has a special base permitting it to be fastened to the roof. The "umbrella" aerial shown in the drawing also belongs to this class. It has a ~~100~~ <sup>60</sup> ft. length of wire wound over the

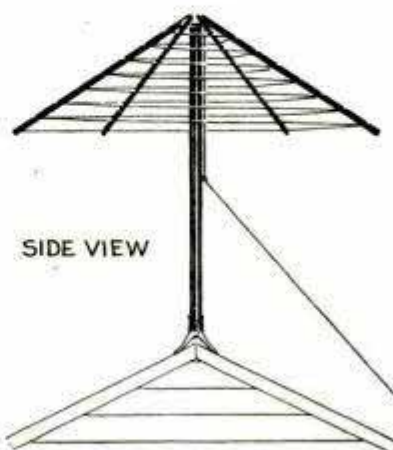
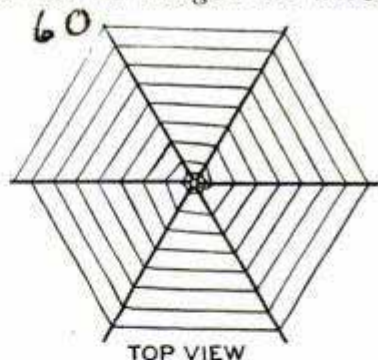

insulated ribs and is collapsible, permitting it to be dismantled when moving to a new location. As it requires very little space, it is especially useful to radio owners living in apartment buildings. Greater selectivity than that of a straight-line aerial is claimed for this type, and it has no directional qualities. No guy wires are needed to hold it in position and the outfit comes complete.

*Edmund P. La Salle*



# Facts and Fads for Radio Fans

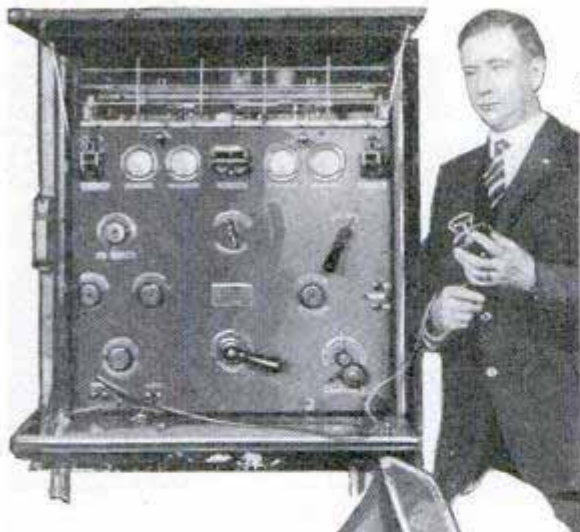

Upper Left, Capt. Paul Edwards of U. S. Signal Corps with New Transmitter for Communication between Ground and Planes in Flight; Above, Miss Mary Texanna Loomis, President and Lecturer of Loomis Radio College, Demonstrating One of Her Transmitters

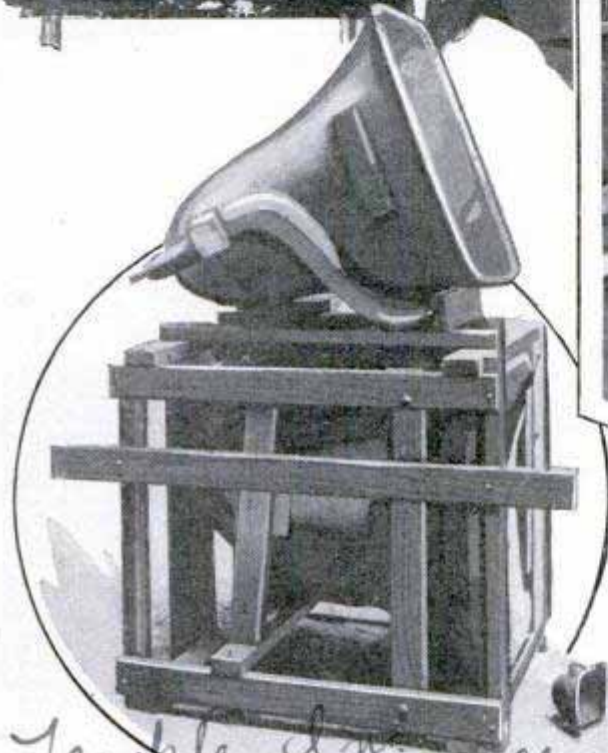

*Temple, D. M.*  
*St. Charles doll letter*  
*7/29/21*  
Built for Experimental Purposes, This Large Horn Employs a Ten-Foot Air Column and Is Made of a Plasterlike Composition; It Is Claimed to Reproduce with Fidelity Both Bass and Treble Notes



Ray Hurling, Owner of the Trained Seal, Persuaded His Pet to Address the Radio Audience of Station WEEI at Boston; Bob Emery Is Holding the Microphone



*130 768*  
*Ora*

Twin Rotor Condensers in Gang Form

Several new adaptations of twin rotor variable condensers are now available for the radio builder. This popular type of condenser is unique in that both sets of

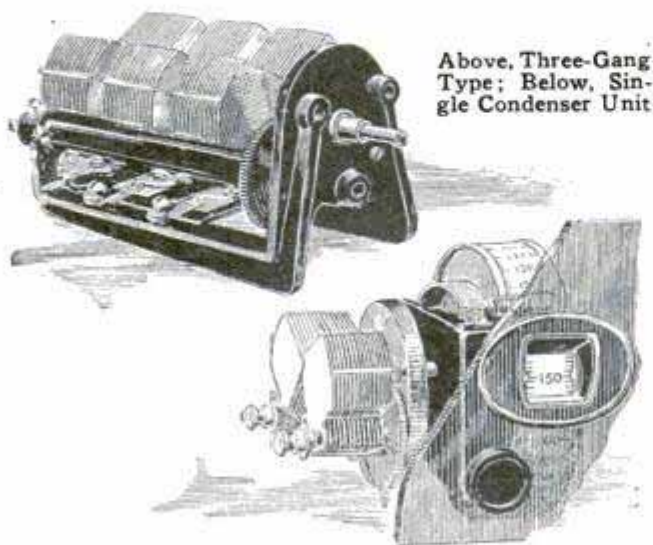

Above, Three-Gang Type; Below, Single Condenser Unit

plates rotate, being driven by bakelite gears. This construction results in complete insulation of the dial shaft from the plates, allowing the dial to be grounded, and eliminating body capacity effects. The three-gang type, shown above at the upper left, is mounted on a frame of die-cast aluminum with black crystalline enamel finish; special staggered connections of plates make it self-shielding, preventing interstage coupling. The lower sketch shows a single condenser of the same type fitted with a special drum dial; the drum carries easily mounted calibration strips upon which station call letters may be written. This drum is rotated by means of the small knob shown at front, a spiral gear giving quiet operation without backlash. A socket and lamp are furnished for illuminating the dial at front; the dial-indicator plate is easily mounted.

Disposing of the Hot Soldering Iron

One of the most useful tools for the radio builder is the electric soldering iron, but, since this very necessary tool gets hot on the tip and stays hot, it must be carefully handled. It must not be carelessly disposed of when not in immediate use, but some sort of stand should be devised to support the hot tip above the surface of the table. Crossed nails, driven into a block of wood, make an efficient tempo-

rary stand, but a stand of this type leaves the hot tip exposed, and there is danger of the hand coming in contact with it, or of damaging some near-by material. A simple method of keeping the tip out of the way is to bore a hole through the work table near the front edge and drop the hot portion of the iron through this hole when it is not immediately required, the handle supporting the tool. The hole should be plenty large enough to pass the copper tip and shank, but not the handle, and in this position it is out of the way but readily accessible. Another point well worth remembering is to turn off the current when the iron is no longer required; absent-minded experimenters have been known to leave the current on unnecessarily many hours at a stretch; this is not only a fire hazard but is decidedly bad for the iron. A simple method of overcoming this difficulty is to install a socket and switch on top of the table in plain view, then use a two-way socket in the first one, employing a pilot lamp in one side and plugging the iron in on the other side. The lamp burning is a constant reminder that the iron is hot.

Bottle Makes Battery Filler

An ordinary bottle, with two glass tubes extending through the stopper, makes a



handy device for adding distilled water to storage A and B-batteries, especially B-batteries. The cork or rubber stopper is drilled for the tubes, which are bent as shown by holding them over a hot flame until soft. The bottle may be held in an inverted position

and no liquid will run out of the delivery tube while the end of the air tube is closed by holding the thumb over it. The amount of water added to each cell can be easily controlled.

Bender Division of

1248

*Handwritten notes:* 260 *First* *San Francisco, Calif*



## The Tricks of Camping Out

By EARLE W. GAGE

FOR summer camping or hiking, elaborate clothing supply is an incumbrance. For a short trip, special clothing is unnecessary. Old things will do. If outing clothes are bought, they should be of rain-shedding duck, khaki or forestry cloth. Better travel in lightweight things, with extra garments to put on when resting. A sweater is invaluable and may take the place of a coat if something waterproof is provided against rain. This may be an army poncho or a waterproof silk cape, about 4 by 7 ft. in size, with a slash in the

and high boots, but bloomers and short skirts will do; an outing shirt is better than a middy blouse, and woolen shirts are better than cotton, except in very hot weather. Underwear should usually be medium-weight cotton or lightweight wool. Felt hats give best all-round service.

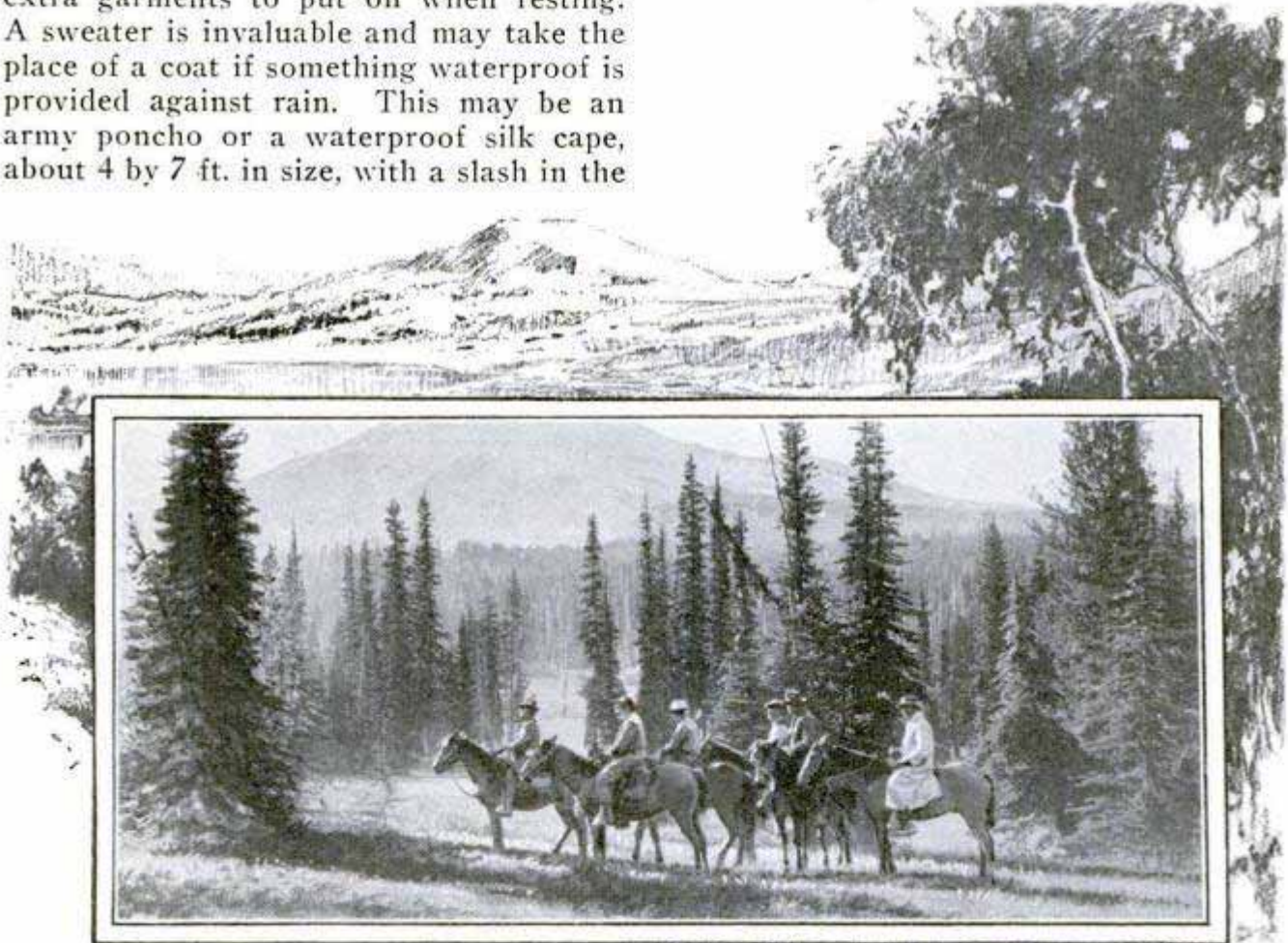

center for the head, also serving as bedding. A cruiser's shirt of closely woven woolen goods serves as both coat and waterproof. Men should wear leggings or high boots. Women usually wear knickers

LEWIS  
YOUNG

Buckskin gloves, without cuffs, are good for working around camp and to keep off mosquitoes, but hop pickers' canvas gloves will do. It is also a good idea to take along a yard or two of mosquito netting, especially in the mountains or for sites near low water.

Footwear is most important of all. Comfortable shoes and wool socks are absolutely essential. The uppers of the shoes need not be of the heaviest weight but the soles should be thick, as they keep the feet from tiring and hold hobnails, important because soles become slippery on forest trails. New shoes should be broken in before starting, for blisters are dangerous as well as painful. Avoid narrow heels. If your ankles turn in or out, running your shoes over, buy side plates that screw to the heels and stiffen the counters. Instep and ankle straps, buckled outside the shoes, are excellent in steep country to prevent jamming the toes and blistering the heels. Always have insteps tightly laced. If, after all, heels slip and blister,



ram with a stick as much cotton or moss as you can force in between the ankle and heel on both sides. This prevents slipping. Moccasins will be found restful after a hard day's hike.

Trunks, suitcases, grips and satchels should never be taken on extended camping trips; the rough usage incident to camping will soon ruin them. Aside from this fact, they are very inconvenient to

handle, especially if pack horses are to be used for transportation.

Extra clothing and other personal equipment are best carried in a heavy canvas bag, known as a "duffle" bag, which can be purchased from any firm handling sporting goods. Such a bag is fitted with a canvas loop or handle at one end and another at the side; the top has an inside hood, which should be waterproof, and the bag is shut with a drawstring or bar lock which is passed through eyelets at the open end.

A tarpaulin is used as a protection for the bedding when the latter is rolled into

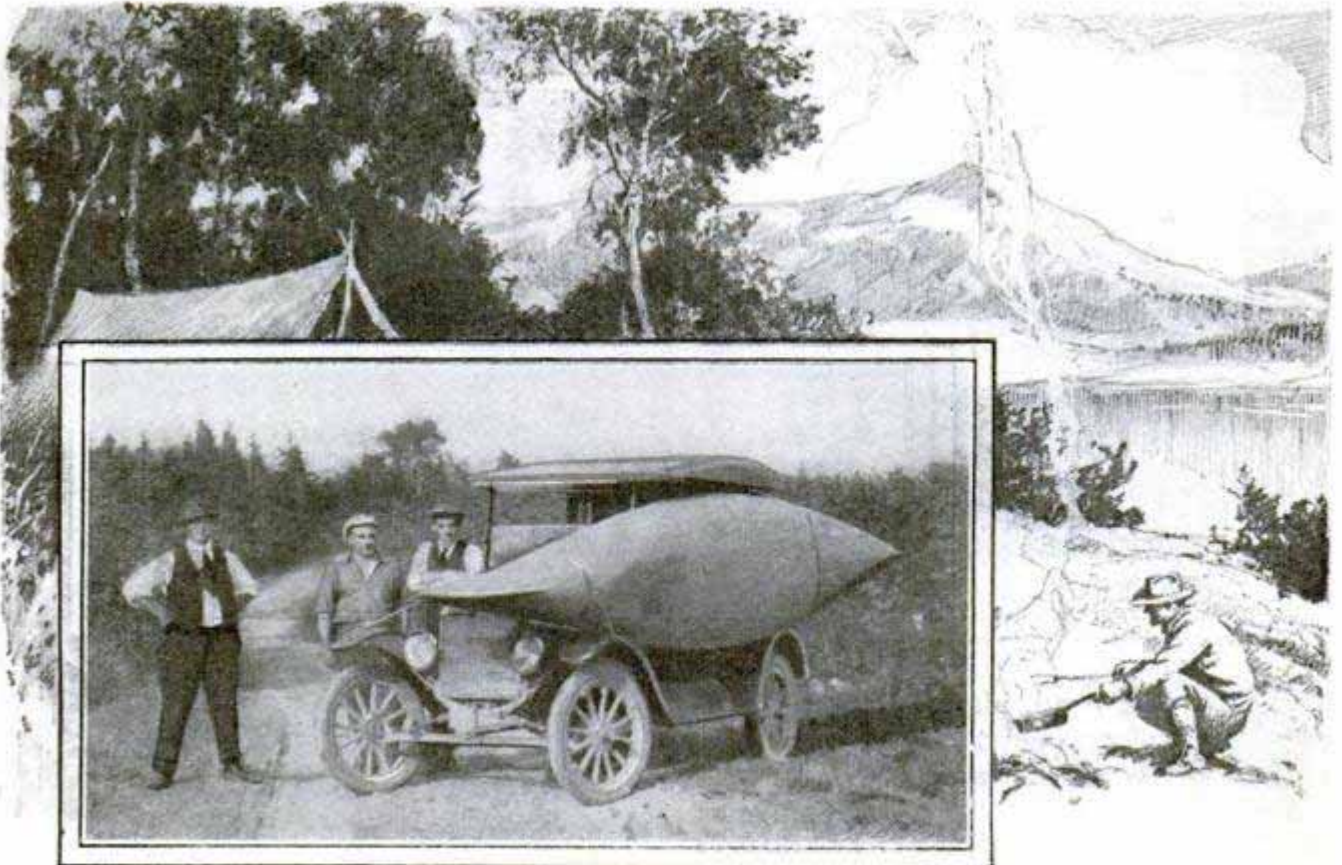



a pack or made up down on the ground. The best size is 11 by 15 ft., or the same size as a regulation wagon sheet or cover. It should be of not less than 8-oz.

duck, and should weigh approximately 10 lb. No waterproof blanket need be included in the bedding if a good grade of tarpaulin is used. A 30-ft. length of  $\frac{1}{2}$ -in. manila rope is used to tie the bed for packing.

Amateurs cannot handle or care for pack animals and should never attempt a trip on which they are to be used without employing an expert packer as well as a complete outfit. Auto equipment may be had on any scale up to running-board kitchens and trailers, special beds and tents. Gasoline or kerosene stoves are labor-saving and practical except for heavy cooking and baking, obviating wood rustling and trouble with fire wardens. The prime requisite of all auto equipment in connection with the food supply is that it be dust-proof. All covers should overlap and close down on felt straps. Plenty of canvas covering is also a good thing to use.

For back packing in the woods, there are four standard devices, their relative

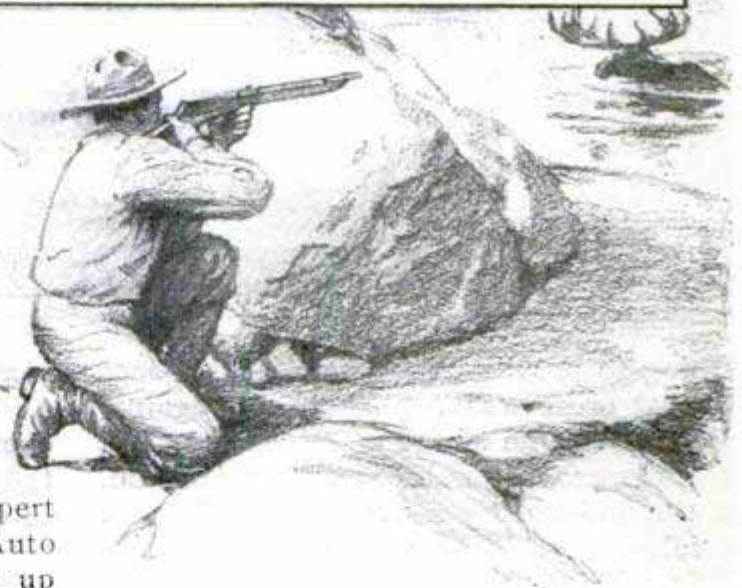
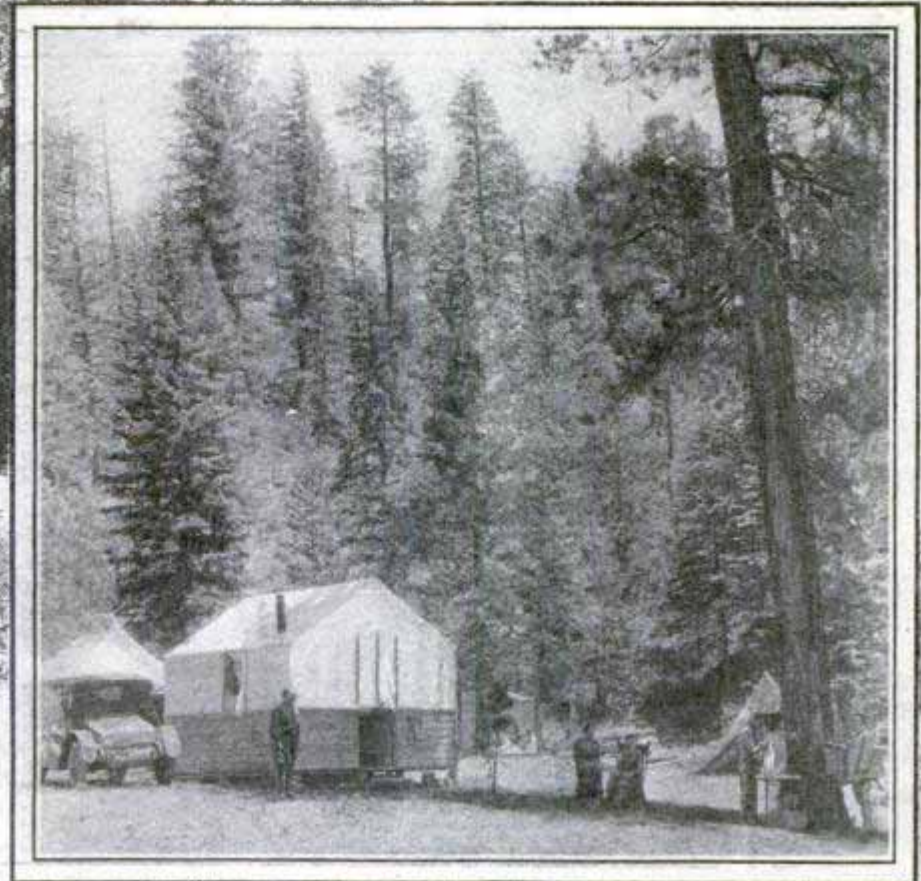

superiority being much a matter of personal opinion. The canvas pack sack with straps is simple, easy to load and can be bought in any size or quality. Its chief defect is that it is rather inadjustable to the shape and weight of the load, which likely will rest too low on the back. Packs should always ride high. The pack board is a flat wooden frame with shoulder straps. The load is lashed to it or suspended in a sack into which the frame is built. A variation of this form is one made of hollow

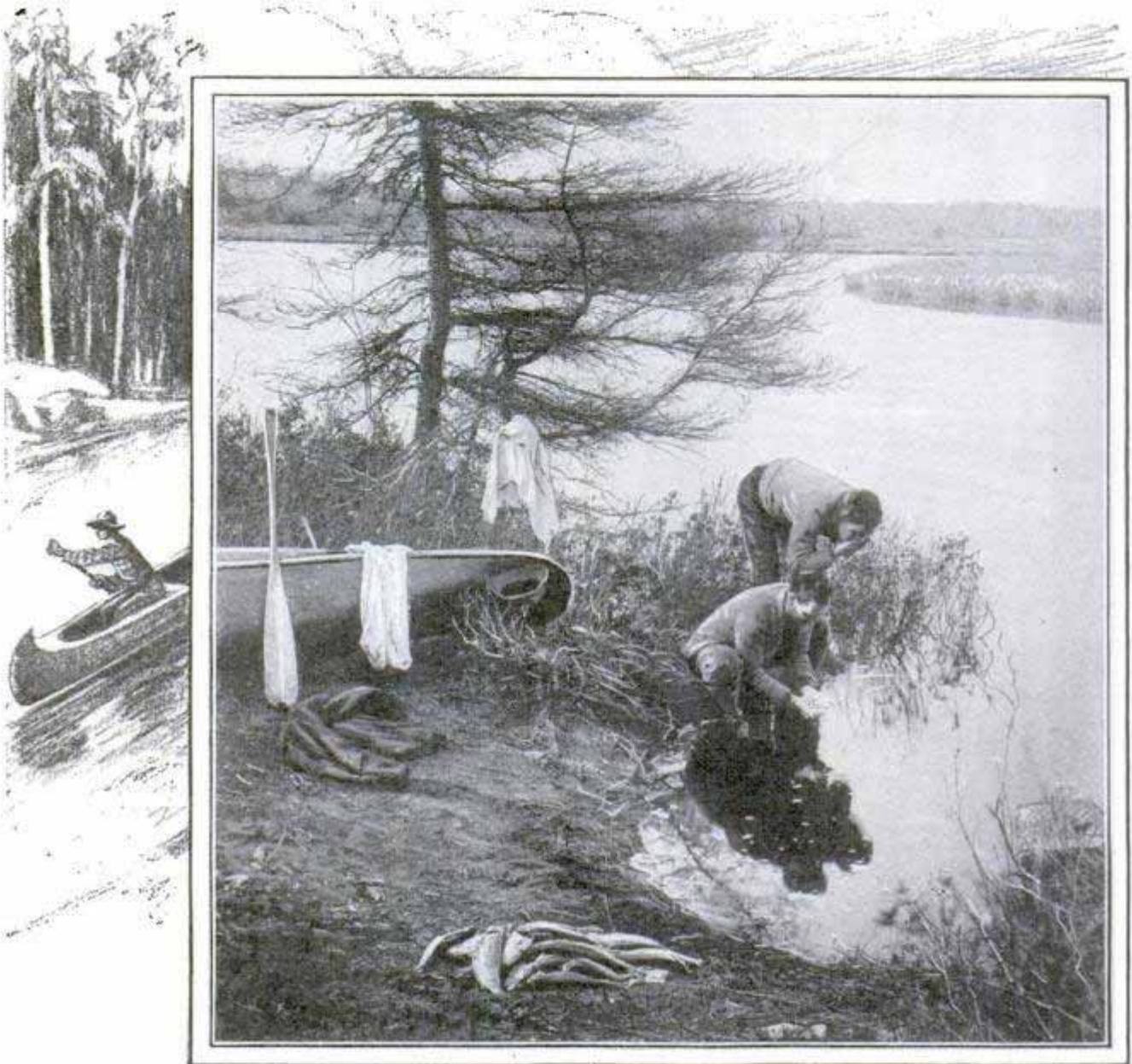

tubing to provide ventilation, and is bent so that cross webbing bands rest against the body. One of the most common and best devices, if employed with some skill, is the old-timer's bedroll. The blanket is folded lengthwise, until it is about 2 ft. wide, with the edges lapping over the food and small articles, which are first laid compactly in the center and near one end. The roll is begun at this end to form a cylindrical bundle, with all the hard articles in the center. Straps or cords around each end hold it firmly, and to these the shoulder straps are attached, together at the top and separated a foot or more at the bottom, to prevent swaying. Sometimes the roll is put in a sack before strapping.

Gunnysacks and overalls furnish a variation of the above system and this equipment is preferred by many. The leg bot-

toms of a pair of old soft overalls are tied to the bottom corners

of a gunnysack with a chip or pebble in each corner so that the string will not slip off. The load is placed in the sack, the top of which is gathered down as close to the load as possible and there lashed with a string to the overalls, which are gathered exactly at the crotch. The legs form the shoulder straps, and the waist is spread back over the pack to shed rain.

Always use some method of suspending even a light pack from both shoulders. Anything on one shoulder, even a long slender blanket roll, is very tiresome. See that the shoulder straps are not too wide, narrow, tight, loose or hard. Keep the pack as high as possible without binding the

arms or the chest, or it will tip back and hit the small of the back, and also tire you by swaying.

Next to the badly slung pack the commonest errors are too much load and too much speed. Avoid non-essentials and duplicate articles in the party. Anything above 25 or 40 lb. is too much to carry conveniently. A four-day trip can be made comfortably with less than 30 lb. Always travel slowly and rest often.

The most important thing to consider when choosing a camp site is the supply of water. This is absolutely essential except at temporary camps, where water is provided in barrels or canteens. When a camp is to be more or less permanent, it should be located at a point far enough away from the source of water supply to prevent its contamination from camp refuse, if this is allowed to accumulate. Refuse should always be burned or buried, as it attracts flies and other insects.

Fuel is the next important item to consider. Ordinarily, where camps are established in wooded regions, there will be found sufficient dead wood for all heating or cooking purposes. But if no wood is available and a camp is to be made in the open country, dry stock manure will prove

an excellent substitute. This is the fuel the old-time pioneers used when crossing the prairies, where they sometimes saw no trees for months.

The accessibility of the camp must also be taken into consideration. If equipment and supplies are to be transported by means of wagons, it is especially desirable to have the camp located at a point which wagons may reach without difficulty and where there is plenty of room for backing or turning them about. The camp may, however, be located in a much rougher place, if pack animals are to be used to carry the equipment and supplies. In either event, it should be so located that it will provide easy access.

After the questions of water, fuel and accessibility have been satisfactorily settled, the one

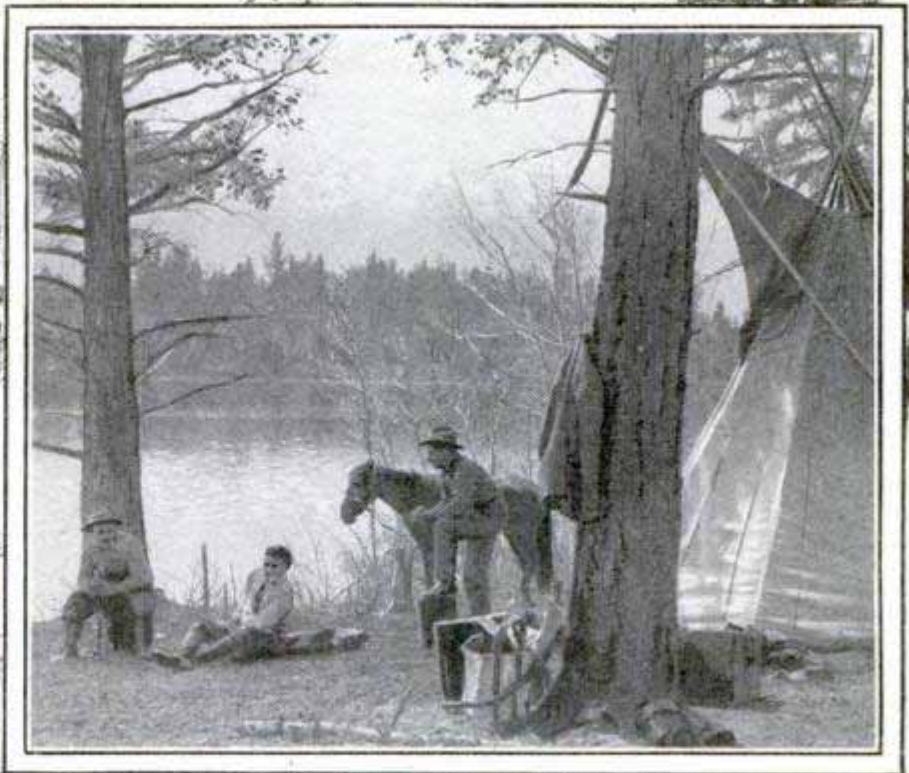

of protection should be considered. Winter camps located on northern slopes, which have little sunshine or are covered with heavy timber, are usually dreary and uncomfortable. On the other hand, summer camps located on bare, exposed south slopes are also uncomfortable. When camps must be established in country where stock grazes at large, it is always advisable to construct some sort of fence around the tents.

(To be continued)

### Carrier for Firewood

When wood has to be carried into the house from a wood pile in the yard, the



Convenient Method of Carrying Firewood without Soiling Clothes

task is rather unpleasant, especially during rainy weather. The provision of a carrier of the kind shown in the drawing will be found to lighten the work considerably and it will also protect the clothes to some extent. The handle consists of a 30-in. length of old curtain pole or broomstick. The crossbar is a piece of 2 by 4-in. wood. Barrel hoops can be used for

the side bars, but 34-in. lengths of strap iron, bent as shown, will be more satisfactory. Two holes are drilled in the middle so that the side bars can be securely screwed to the cross member.

### Casein Glue

Casein glues are splendid for woodworking, for making cardboard articles, and when the composition is varied somewhat, make excellent cements for china and metals. To make the glue, soak a quantity of casein powder two hours in an equal weight of hot water. To this gummy mass add one-seventh the weight of the casein in borax, which has been dissolved in very little hot water. Stir until all is dissolved after mixing borax and casein. This can be thinned with water to suit and is a good glue, but it can be made more adhesive by the addition of a little sodium arsenate. Any alkali, such as soda or ammonia, can be substituted for the borax. To make a china cement, lime or water glass should be substituted for the borax. Addition of burnt magnesia increases the speed of hardening.

### Electric-Light Telegraph

While radio is the modern means of code transmission, even the simplest sending set is costly and needs a special license to operate it. For the boy who wishes an efficient and inexpensive telegraph system, one can be built that will transmit messages over a considerable distance. Government experiments have shown that a common auto headlight will transmit readable signals for over 150 miles, so, with two outfits similar to the one shown in the illustration, signals can be sent and read by two operators miles apart, as for instance across a wide harbor or lake, or between two hilltops. Such transmission must necessarily be done at night, and, by employing lenses that will shoot a narrow beam, messages can be confined to a fairly straight line and not be noticeable out of the line of the light. A 32-cp. bulb and a storage battery can be used. The outfit is constructed as follows: Make a heavy wooden base, at least 18 in. long and 10 in. wide. Near the right end, fasten a common telegraph key. Some space



should be left to the right and in front of the key for the operator's hand. Then, at the left and about 3 in. from the end, mount two metal trunnions as indicated. These are merely angle irons with a pivot hole in the center of the uprights. They can be made from any fairly stiff metal. Place them 4 in. apart and between them pivot a wide U-shaped piece with a hole in the center of the horizontal side into which the threaded end of the headlight shank is fitted. Two washers and a nut serve to hold it in place but allow sufficient play so that it can be turned if desired. The U-iron can also be swung forward or backward, and is locked by a wingnut on one of the pivot bolts. Drill the light shank as suggested, and insert a handle for turning the light. Place two binding posts on the baseboard and wire one to the key. The other key terminal is wired to a 10-amp. auto-light fuse in a spring-clip holder fastened to the baseboard, and the other end of the fuse is then wired to the trunnion. The other binding post is wired direct to the bulb socket in the light. Mount the whole affair suitably near a window or outdoors on a tripod. Connect the battery to the binding posts and you are ready to send. Pressing the key for a short or a long time makes dots or dashes of light. Direct the light toward the desired point, lock it in place, and the beam will travel straight to your correspondent at the receiving end.

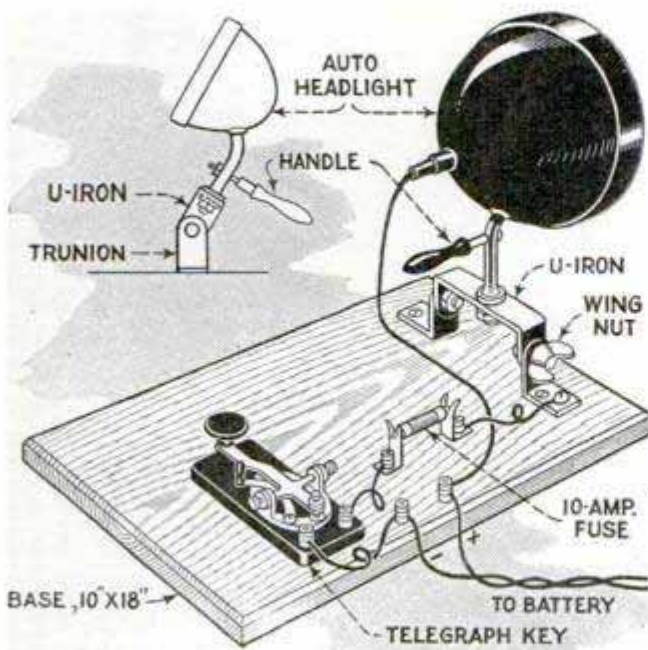

Using Auto Headlight and Telegraph Key to Flash Messages by Rays of Light

## Dolly Aids in Landing Small Boats

Dragging rowboats or canoes along a dock or float is hard work, and is also in-

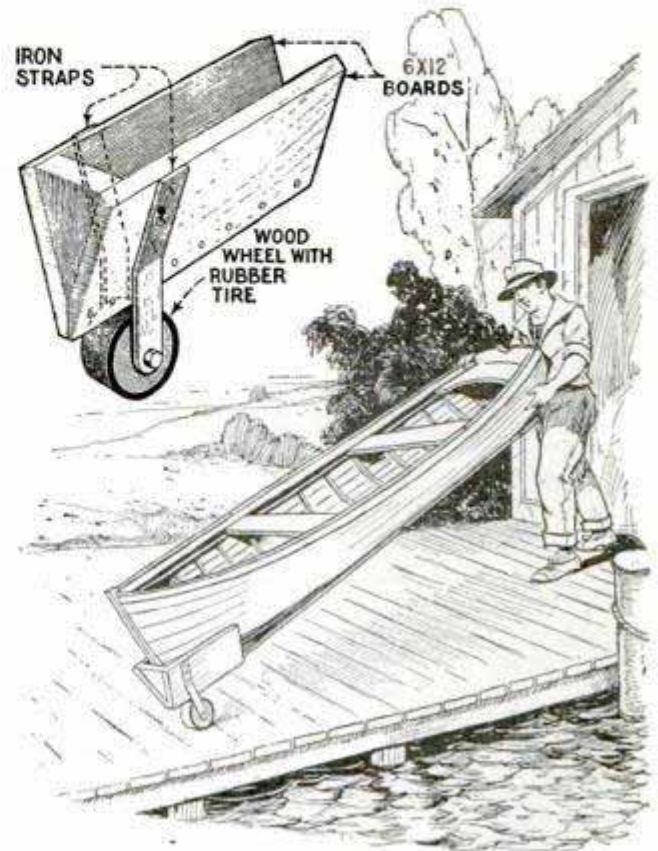

Handy V-Shaped Dolly with Roller-Skate Wheel for Moving Rowboats

jurious to the bottom of the boats. A dock tender at a yacht club overcame all this trouble by building a dolly for the purpose, as shown in the illustration. Two boards, 12 in. long and 6 in. wide, were beveled along one long edge and screwed together. A V-shaped block was fastened in one end and two pieces of flat iron were bolted to the sides, about 4 in. from the end block. The lower ends of these were drilled and fitted with an old skate roller. When a boat was to be moved it was lifted by the stern and the dolly slid in under the keel. The weight of the boat held it in place as the keel pinched down into the "V." It could then be easily wheeled in any direction.—L. B. Robbins, Harwich, Mass.

## Outboard Motors as Baggage.

According to the western association of general baggage agents, outboard motors, regardless of how they are packed, must be shipped by express, and cannot be checked as baggage.

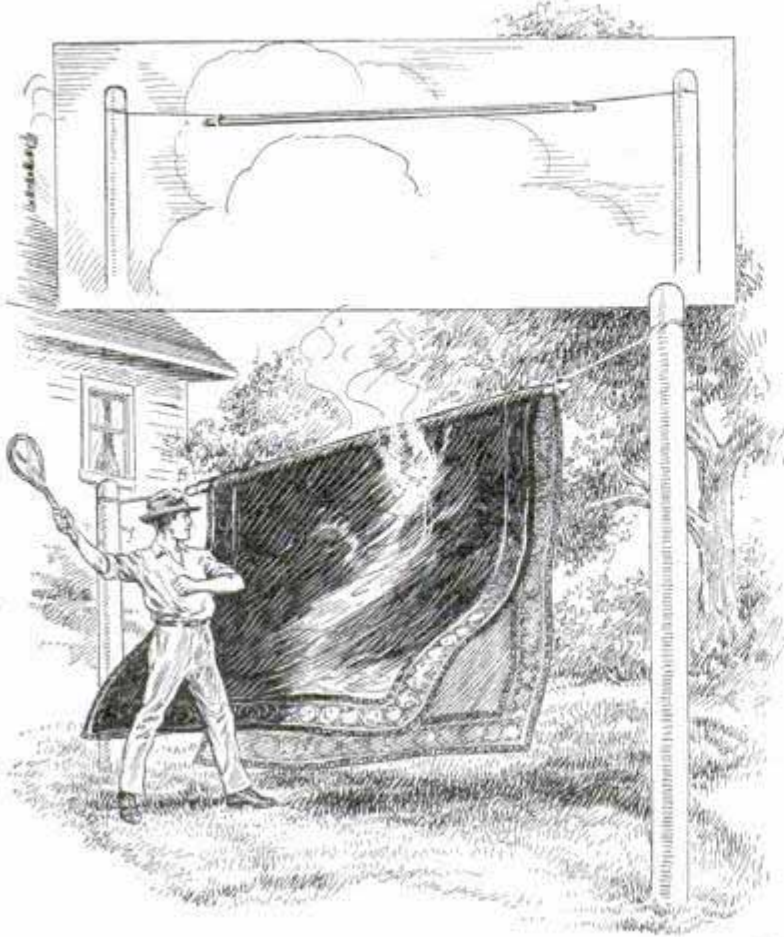

Clothes Pole Attached to the Line Holds Rug in Place Evenly So That It Can Be Beaten More Efficiently

### Non-Sagging Clothesline for Beating Rugs

When a heavy rug or carpet is thrown over the clothesline for beating and cleaning, it usually causes the line to sag, wrinkling the rug so that the work cannot be efficiently done. To avoid this we attached two small wire hoops to our clothesline, as shown in the illustration. These, when not in use, are slid back to drop over the poles supporting the line. When a rug is to be cleaned, the hoops are drawn out and one slipped over each end of a clothes pole. The rug is thrown over both line and pole and will then hang smoothly and evenly. —G. E. Hendrickson, Argyle, Wis.

### Assembling and Hanging Electric Fixtures

After unpacking fixtures that are to be wired and hung from the ceiling, see that all the parts are put together, then wire the parts of the sockets and assemble them. Never use wire smaller than No. 18 stranded fixture wire, with rubber insulation, for the arms and chains of the fixture. Also note that No. 16 gauge of such wire is used as a feeder of two or

three lights, and No. 14 gauge as a feeder of four or six lights. Be sure that all joints are mechanically tight. They are twisted in pig-tail fashion and are soldered and taped. To make a good tape joint, take a piece of friction tape, about 4 or 5 inches long, place it between the connected wires and wind it around them once. Then take 2 in. of rubber tape and bind it around the joint, then over and lap it back to the beginning of the joint to make the tape firm. It is also a good plan to paint the joint with insulating paint over the tape. Be sure to test out the fixtures after they are wired for bad sockets or bad insulation in wires, caused by burrs and sharp edges in the pipe or fixture parts. Bare wire touching the fixture will sometimes cause a short circuit. Always use heavy wood screws to fasten the crowfoot or base of the fixture to the ceiling; the screws should project through the plaster laths and into a support board

provided above them. Heavy fixtures and ceiling domes should always be hung from fixture hooks screwed into the joists or fastened to bridging between the joists.—J. W. Wright, Hudson Falls, N. Y.

### Spring Clip for Depth Gauge

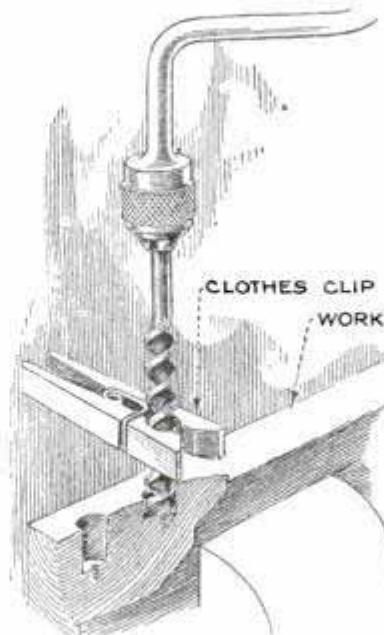

When boring holes in wood to a predetermined depth and a depth gauge is not available, an ordinary spring clothespin can be used for this purpose. It is attached to the bit as shown and can readily be adjusted, serving just as

any gauge especially made for this purpose.—Chas. Illingworth, Vancouver, Can.

# BETTER GARDEN GATES

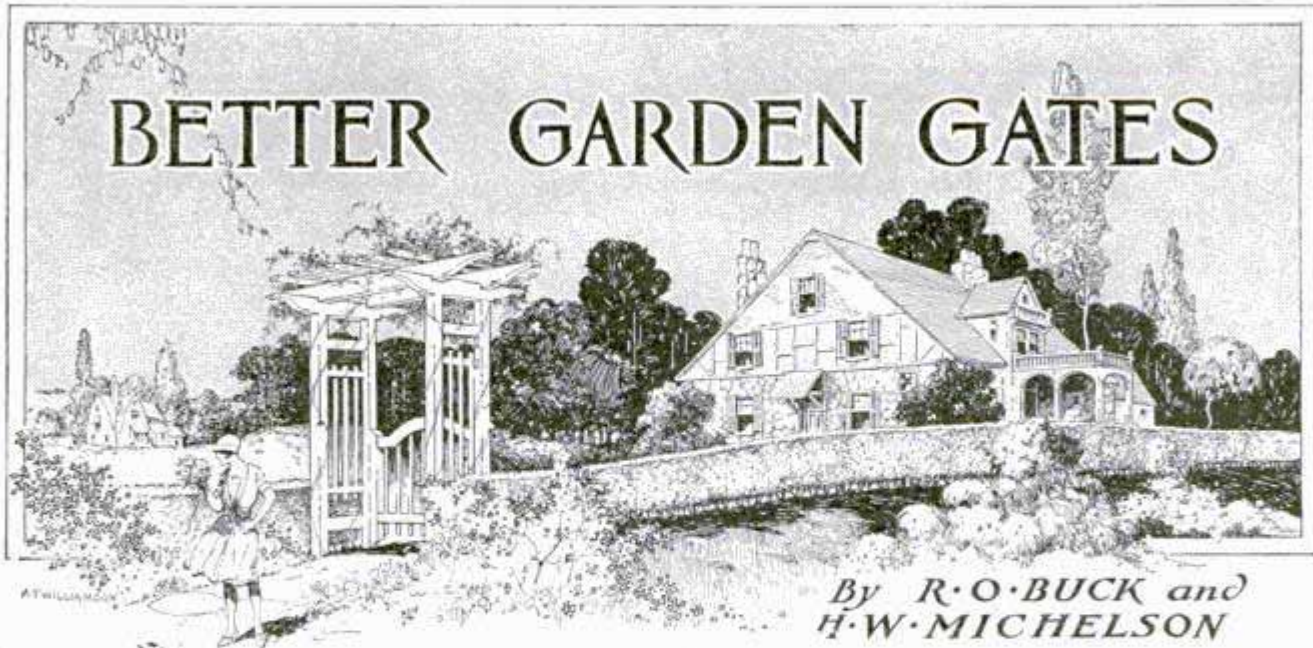

By R. O. BUCK and  
H. W. MICHELSON

WOULD a bit of landscaping change your house and lot into a home, in the true meaning of the word? A place of beauty and comfort, that is pleasant and restful to the eye, and which gives one that feeling of pride that only a beautiful home can give? An attractive and convenient house, whether new or old, cannot accomplish this purpose alone, but add to this a flower garden, one or two garden structures, green lawns, well placed trees and shrubs and, perhaps, a lily pool, and one cannot fail to produce an appealing and altogether delightful place in which to live.

There is an added pleasure in a home when much of the beauty and convenience are the result of one's own handicraft. When one can so easily add to

the beauty and comfort, as well as monetary value, of one's home and at the same time derive pleasure and profit from the small expense and labor involved, it needs but the inspiration, with some few hints and general information in regard to good design in lines and proportions, to begin a

structure for our home beautiful.

The three designs for inclosed garden gates illustrated herewith are all well within the ability of the average home owner. Only the ordinary tools are needed, as difficult and tedious joint making has been largely eliminated. Practically all of the material can be obtained, dressed to width and thickness, from most lumber dealers.

The lumber to be used for garden structures should be

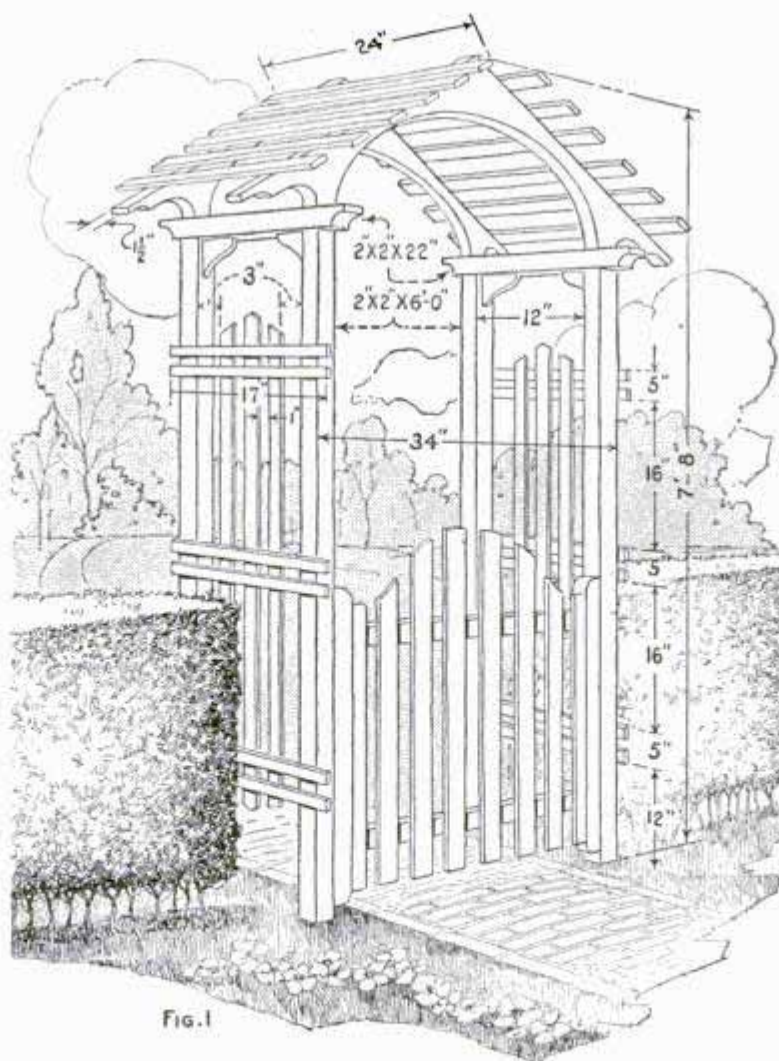

FIG. 1



Fig. 4

weather-resisting, strong and straight-grained, as it is subjected to extremes of temperature, wind and rain and sometimes to other abuse. Southern pine, cypress or redwood all fulfill these requirements admirably. If you live east of the Rockies you will probably find pine the most easily obtainable. All of the material should be dressed on all sides and the ends smoothed for painting, to prevent the entrance of moisture and consequent decay.

All the pieces should be cut to size and given a priming coat of paint before as-

sembling. White lead, mixed with pure boiled linseed oil and a little drier and thinned with plenty of pure turpentine, makes the best priming coat. The life of the structure depends largely on the thoroughness of the priming coat as the places where the pieces lap are the points where decay starts.

After the structure is all assembled and set up, it should be given two coats of a good qual-

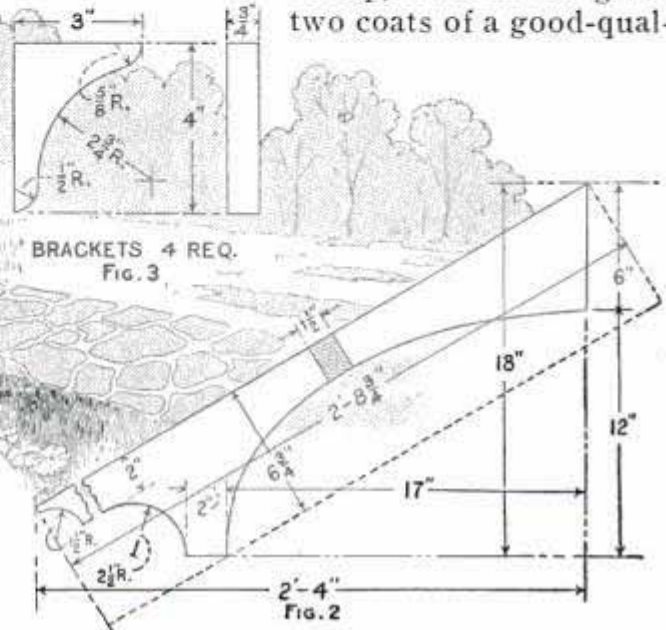

ity outside paint. White or pale cream are the preferred colors for garden structures, though a brown creosote stain which preserves the wood, or an aged effect produced with acid, is very effective also in proper surroundings.

Eighteen inches is added to the length

#### MATERIAL LIST

##### For Fig. 1

- 4 corner posts, 2 by 2 in. by 7 ft. 6 in.
- 4 rafters, 1½ by 7 in. by 2 ft. 4 in.
- 2 purlins, 2 by 2 by 22 in.
- 2 posts, 2 by 2 in. by 3 ft.
- 12 lattice, ¾ by 1¾ in. by 2 ft.
- 4 brackets, ¾ by 3 by 4 in.
- 12 cross lattice, ¾ by 1¾ by 17 in.
- 6 vertical lattice, ¾ by 1¾ in. by 4 ft.

##### For Fig. 4

- 4 corner posts, 2 by 2 in. by 7 ft. 6 in.
- 2 rafters, 2 by 4 in. by 4 ft. 10 in.
- 2 purlins, 2 by 4 in. by 2 ft. 5 in.
- 7 lattice, ¾ by 1¾ in. by 2 ft. 8 in.
- 2 posts, 2 by 2 in. by 3 ft.
- 4 rails, 1 by 4 by 12 in.
- 4 rails, 1 by 2 by 12 in.
- 8 lattice, ¾ by 1¾ in. by 3 ft. 9 in.

##### For Fig. 6

- 4 corner posts, 2 by 2 in. by 6 ft.
- 2 purlins, ¾ by 3 by 10 in.
- 1 roof slat, ¾ by 1¾ by 19 in.
- 2 roof slats, ¾ by 1¾ by 13 in.
- 2 roof slats, ¾ by 1¾ by 13 in.

- 2 roof slats, ¾ by 1¾ by 11 in.
- 2 roof slats, ¾ by 1¾ by 18 in.
- 20 roof and side slats, ¾ by 1¾ by 10 in.
- 2 posts, 2 by 2 in. by 4 ft. 6 in.

Also material for rafter segments.

##### For Fig. 10

- 2 cross slats, ¾ by 2 in. by 2 ft. 6 in.
- 8 vertical slats, ¾ by 2 in. by 3 ft. 3 in.

##### For Fig. 11

- 2 rails, 1½ by 3 in. by 2 ft. 10 in.
- 1 rail, ¾ by 3 in. by 2 ft. 6 in.
- 1 rail, curved, ¾ by 7 in. by 2 ft. 6 in.
- 1 slat, ¾ by 5 in. by 2 ft. 11 in.
- 6 slats, ¾ by 2½ in. by 2 ft. 10 in.

##### For Fig. 12

- 2 vertical rails, 1½ by 1½ in. by 3 ft. 6 in.
- 2 cross rails, 1½ by 2 in. by 2 ft. 6 in.
- 1 curved rail, 1½ by 9 in. by 2 ft. 6 in.
- 4 vertical slats, ¾ by 1¾ in. by 3 ft. 6 in.
- 5 vertical slats, ¾ by 1¾ in. by 2 ft. 6 in.

Climbing roses, wistaria or other colorful vines should be planted on each side of the structure and trained to grow up the lattice and over the top.

of each corner post or leg of the structure to anchor it in the ground. This is not shown in the drawings but is taken into consideration in the stock bill. The portion below the ground should be well painted or tarred, especially on the end, to prevent the entrance of moisture. The legs should be buried in concrete. This is best accomplished by digging four properly spaced holes, about 6 in. in di-

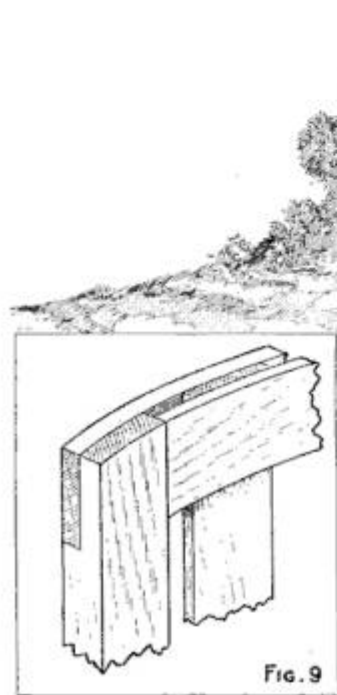

FIG. 9

ameter and a few inches deeper than the post is to enter the ground. The bottom should be filled with a bit

of concrete for the ends of the posts to rest on. After this concrete has partly set, the structure should be set in place and braced with laths, to act as stays, so that it is plumb. The holes are then filled with concrete a little above ground level. No form will be necessary for the concrete unless the soil is very loose or sandy.

Nails are used to fasten the parts together. If you wish to make a very nice job, you will use finishing nails, so that they may be set and the holes puttied, but this is not necessary. The lattice is fastened with fine two-penny nails clinched on one side. Brass screws, of course, make a better job.

The corner posts are shown doubled on the side where the gate is attached. This is a satisfactory method of reinforcing, but if the gate will be subjected to much hard usage, it might be well to hang it on a 4 by 4-in. post, set directly back of the corner post but unattached to the latter, so that the structure will not receive

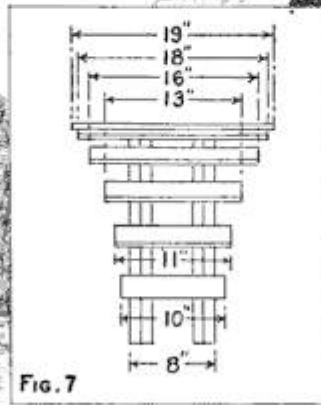

FIG. 7

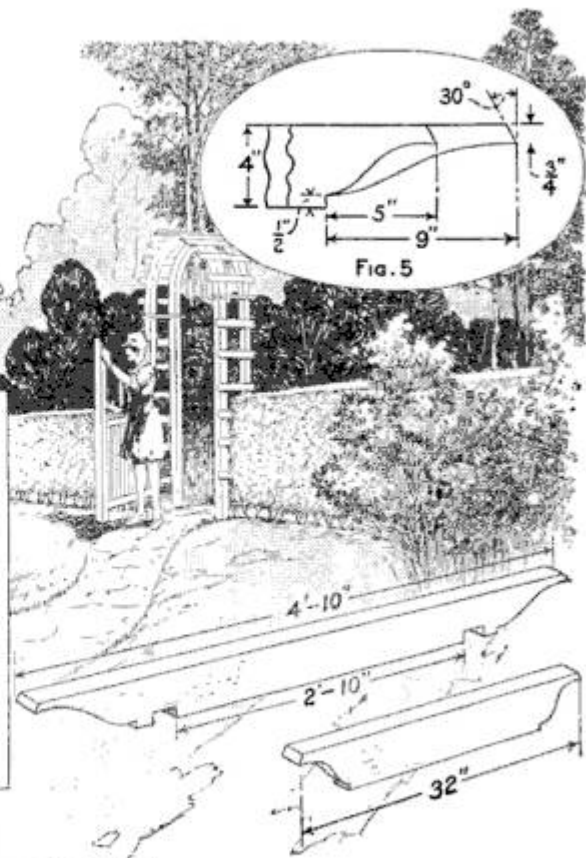

FIG. 5

the vibration of the gate when slammed. A good sturdy latch with hinges of rust-proof material, if possible, is suggested.

Lattice is carried in stock in most lumber yards in two standard sizes,  $\frac{3}{8}$  by  $1\frac{3}{8}$  in. and  $\frac{3}{4}$  by  $1\frac{3}{4}$  in. The sawing of some of the rafters and rafter ends may either be done on a bandsaw at the mill, or, if you prefer and don't mind a bit of rather hard work, cut with a turning saw.

Detail drawings, showing the shapes of

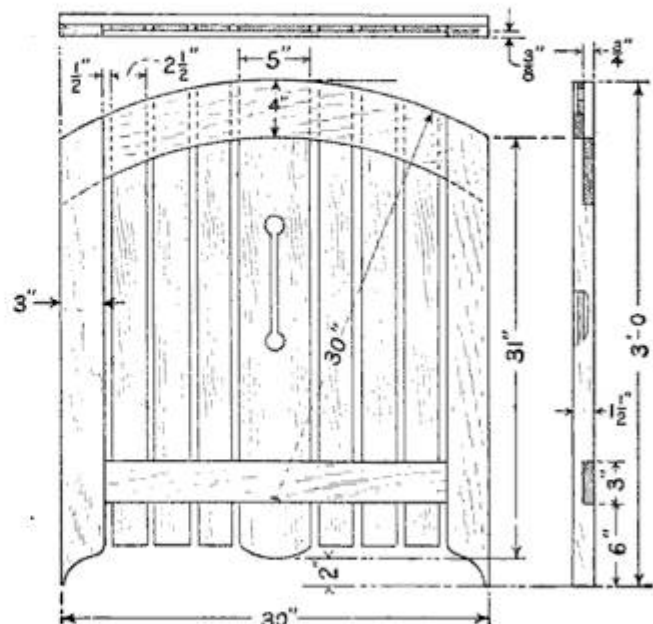

FIG. 11

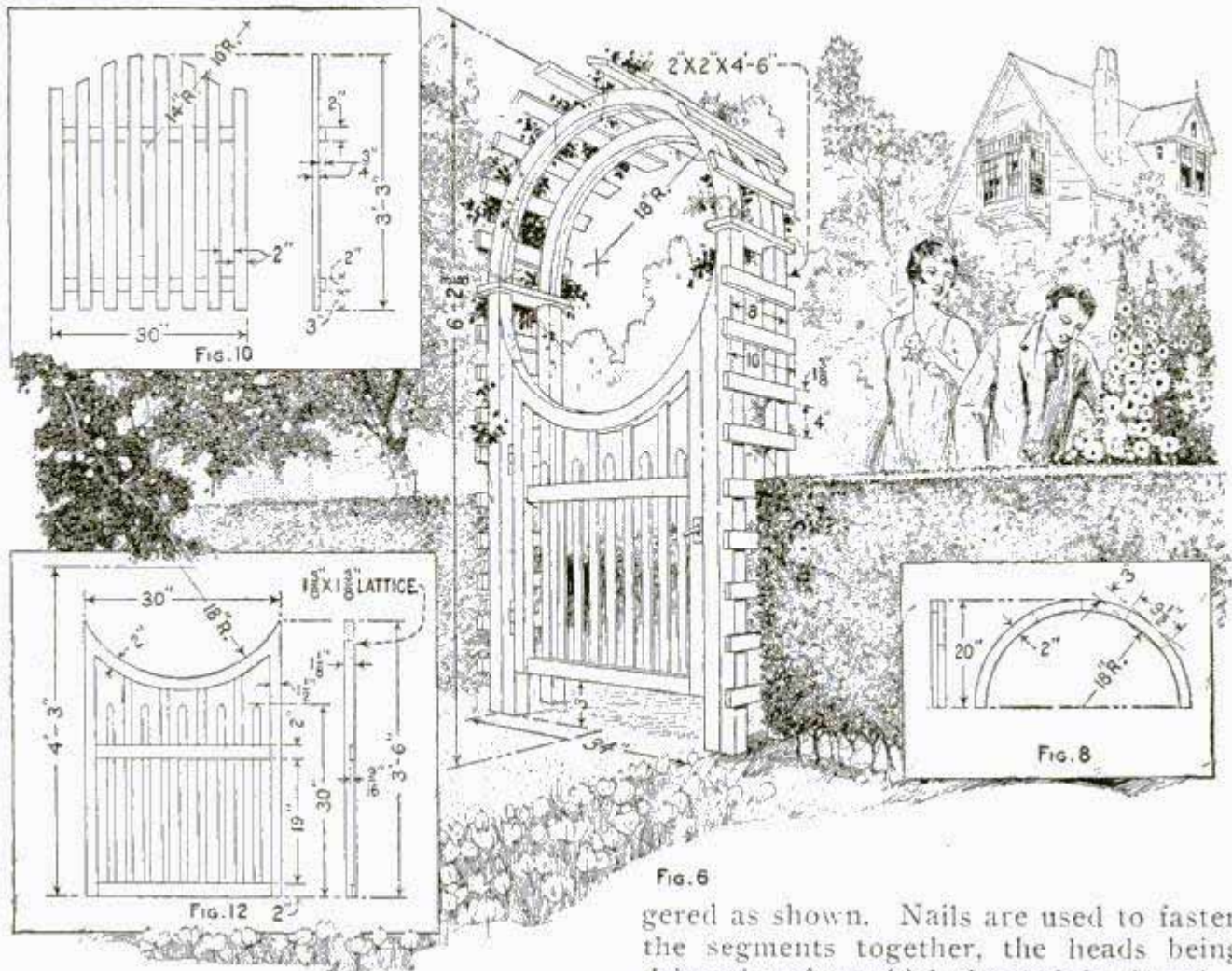

FIG. 6

gered as shown. Nails are used to fasten the segments together, the heads being driven in, after which the arch is planed.

The three types vary greatly in the degree of skill required to construct them. The one illustrated by Fig. 10, of course, is the simplest and most easily constructed. By changing the curve at the top this general arrangement may be used for any of the gates. The joints are all of a simple butt-nailed type and require only care in nailing. The curve should be laid out and cut after the gate is constructed. Housed or half-lap joints are used on both of the others, as shown by Figs. 11 and 12. Fig. 9 is an enlarged detail of the joint.

### How to Make a Taper Ferrule

Having occasion to make a taper ferrule of irregular form, a pattern from which to cut the material was made as follows: A mandrel of the desired shape was made, a piece of writing paper, soaked in water, wrapped around the mandrel, and a piece of twine wound over it, coil after coil like the thread on a spool. This was allowed to dry thoroughly, using a little heat. The string was then removed and a longitudinal cut made in the paper while on the man-

the rafter ends and brackets as well as the gate construction, give you all the information necessary to construct any of the inclosures and gates in a workmanlike manner. As the gates are all the same size, they are interchangeable so that you may select one to go with your inclosure.

A little explanation of the detail sketches may not be amiss. Fig. 2 shows the size and shape of the rafters for the archway. Fig. 1, and Fig. 3, the brackets for the same project. It is advisable to lay out a full-size pattern of each of these pieces before cutting the stock. The dotted lines of Fig. 2 indicate the width of the stock.

Fig. 5 shows the shape of the rafter and purlin ends for the type shown in Fig. 4. No dimensions are given for the curves, which may be designed to your fancy.

Figs. 7 and 8 give details for the inclosure shown in Fig. 6. The varying lengths of the lattice over the top give a pleasing curve which is not very evident in the perspective sketch. Fig. 8 shows the method of building up segments for the arched rafters. The two layers consist of short sections, with the joints stag-

drel. When opened, this paper formed the pattern. A piece of metal was cut from the pattern and the edges were brought together and brazed with spelter. The point of the mandrel was driven through a piece of block tin, about  $\frac{1}{2}$  in. thick. The mandrel was then removed, the ferrule was placed on it and both started in the hole in the tin and driven through it. As the mandrel with the ferrule passed through the tin, the metal was shaped exactly to the mandrel. It is best to oil the hole in the tin.—James Beebee, Rochester, N. Y.

### Improved Diving Board

To give greater spring to a diving board, a group of boys used a set of auto springs which greatly increased the height to which a diver could jump. Two posts, with crosspieces at the bottom to prevent them from pulling out, were buried securely in the bank, as shown in the drawing. A bolt, which fitted over the end of the plank, was connected to the tops of the posts, and two cleats held the spring board in place. Two smaller stakes in front supported a crosspiece upon which the springs were mounted. A little adjusting was necessary before the proper position for the springs was found. Divers who have used the board claim that the action of the board when thus equipped is different.

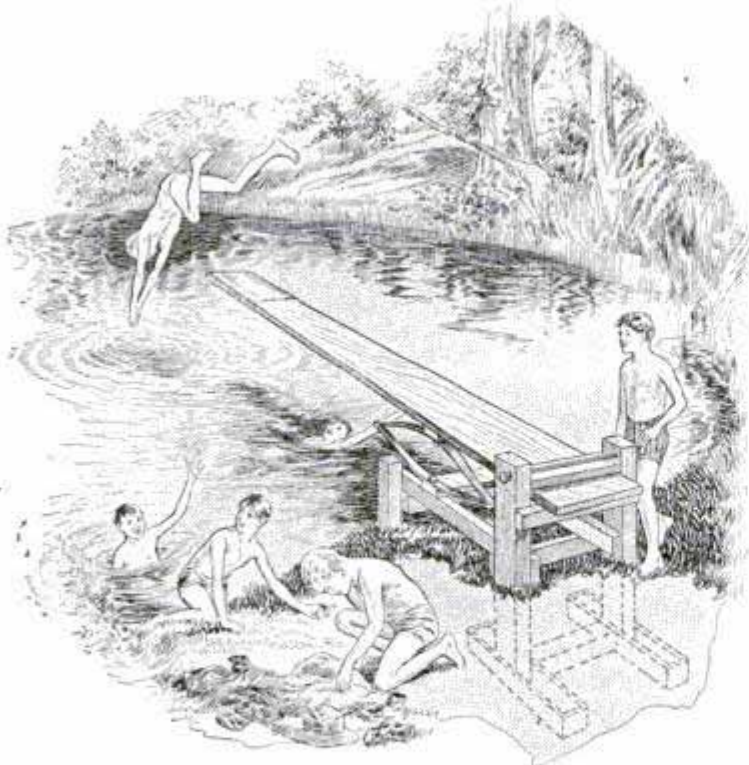

Discarded Auto Springs Improve Spring of a Diving Board So That Height of Jump Is Increased



Gas and Electric Meters Arranged in Basement Window

### Handy Place for Meters

When installing the gas and electric service, I arranged to have the meters placed near a basement window so that they could be read by the inspectors from the outside. This overcomes the annoyance of admitting them, which is especially objectionable when they have wet and muddy feet. Besides, in this way, they can always read the meter, whether there is anybody at home or not.—Mrs. R. A. Jessen, Keansburg, N. J.

### Repairing Worn Escapement Wheel

When a clock has served its usefulness and is apparently worn out, the jeweler's price to overhaul it frequently amounts to almost as much as the original purchase price. One weak place in the clock is the escapement wheel. The points soon wear down, thereby producing a greater escapement and pendulum movement, which results in an increased strain and wear of the clock. If the tips of the teeth on the wheel are bent up slightly with a pair of pliers, the swing of the pendulum will be reduced, thereby increasing the life of the clock. Many of the grandfather's clocks can be put in order in this manner so as to serve as timepieces.

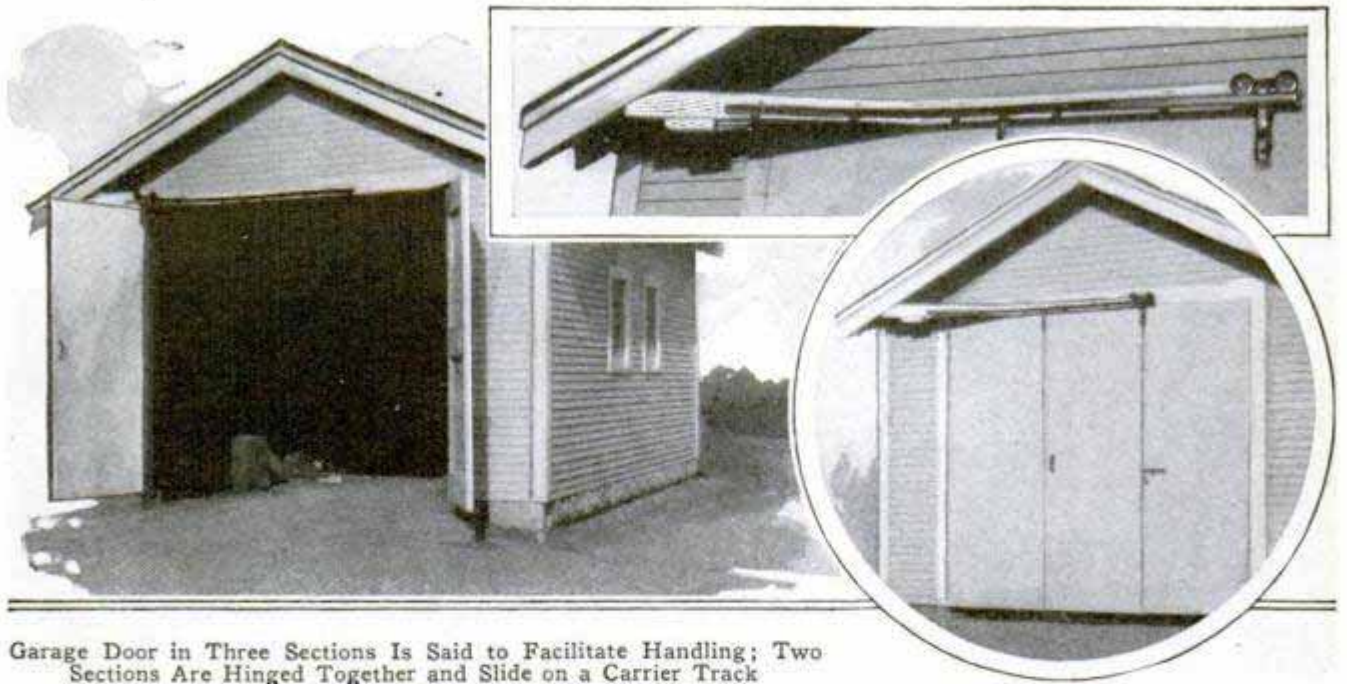

Garage Door in Three Sections Is Said to Facilitate Handling; Two Sections Are Hinged Together and Slide on a Carrier Track

### Novel Garage-Door Installation

This garage-door installation will appeal to the man who does not care to go to the expense of getting special fittings for his garage and yet wishes to have the installation stand up under constant use. In this case, three doors are used, all of the same width. Two of the sections are hinged together and one of these is hinged to the left side of the door opening. The third section is hinged to the opposite side. A short length of door-carrier track is mounted directly over the door, on the outside, with two-thirds of its length running parallel to the side of the garage. The other third is mounted on a 2 by 4-in. piece, which is set at a slight angle, approximately  $12^\circ$ , as indicated in the upper right-hand photo. A swiveled double-wheel support is mounted on the upper free corner of the two-unit door section so that it will ride along the track. A latch which can be locked at the top, is provided near the middle of this two-section unit. The third door swings to the

right like any ordinary door. It is fitted with a latch so that it can be padlocked to insure safekeeping of the car.—Dale R. Van Horn, Walton, Nebr.

### Wedge Fastener for Portable Equipment

Parts of portable equipment are usually held together by wingnuts or cotter pins, but both these methods have their disadvantages. Having occasion to build a portable outfit I used an idea of an old master blacksmith, which gives rigidity and allows quick assembling or dismantling. The upper detail in the illustration shows a rod fastened in place by a cotter pin. This not only allows play, but the ends of the pin must be spread for safety, with consequent difficulty in removing it. The wedge in the other figures will be found much more convenient. The end of the rod is slotted and a pin is fitted through it as shown, of such a size that the wedge, which is slotted slantingly, will just slide freely upon it. It will be noticed that the wedge is just as

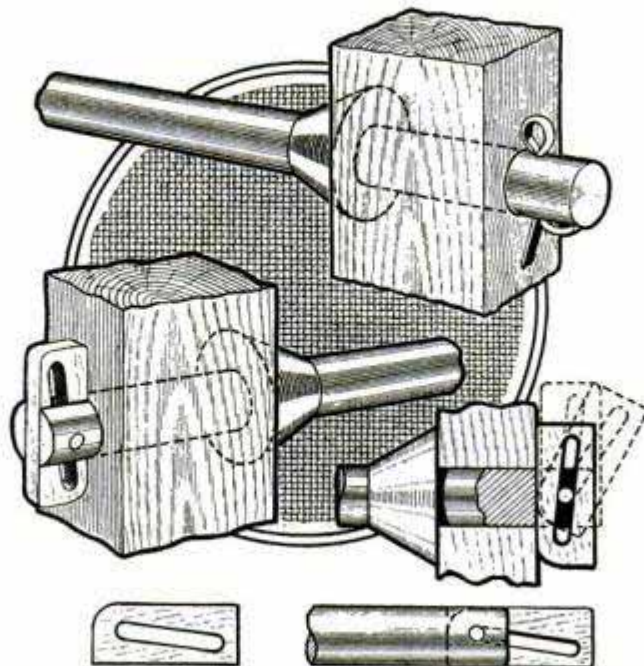

Quick-Acting Wedge Is Better Than Cotter Pin for Use with Portable Equipment



wide as the diameter of the rod and that, when horizontal, it allows the rod to be inserted in a hole drilled to fit. When the wedge is turned upright, a light tap or two will drive it home snugly. Removal is just as easy. Thus, with quick positive action, a tight fit is assured and there are no loose parts to be lost.—Herbert C. McKay, Eustis, Fla.

### Handling Sticky Flypaper

It is sometimes rather amusing to see someone trying to move or handle a piece of sticky flypaper, but when I had to handle it myself I found it very annoying. The paper flattens out when it gets warm and is hard to pick up; it seems to jump around like a grasshopper. The trouble was, however, easily overcome, by using a number of ordinary paper clips, bent at right angles and slipped over the edges. When it is necessary to move the paper, just take hold of the clips and it will not get away from you.—Frank W. Bentley, Jr., Missouri Valley, Iowa.

### A "Bird Filling Station"

The novel bird house shown in the photo has appropriately been called a "Bird Filling Station." It is a duplicate, in miniature, of a gasoline-filling station, and is painted red and white. A wire basket is provided and filled with suet. The inside of the "office" is arranged so that grain



An Interesting Novelty in Bird Houses; Grain Drops Out Automatically as the Birds Feed

flows out onto the floor of the exterior as fast as the birds consume the first supply.—Geo. B. Dolliver, Battle Creek, Mich.

### Gate Closes Automatically

Three horizontal bars used to provide passage through a fence from one field



Novel Gate Permits Easy Passage of Persons and Drops Back into Position Automatically

into another, are always certain to return to their original position after being weighted at one end and pivoted as shown in the photo. Although such a set of bars will not permit the passage of vehicles, there are many situations where they serve to maintain an unbroken fence line and yet allow persons on foot to pass without difficulty.—Orin Crooker, Elgin, Ill.

### Homemade Humidity Indicator

A simple weather indicator that may be used in determining the humidity of the atmosphere can readily be made. Dress a small figure in the form of a doll, with a piece of cloth, previously dipped in the following solution: chloride of cobalt, 30 parts by weight; sodium chloride, 15 parts; gum arabic,  $7\frac{1}{2}$  parts; calcium chloride,  $4\frac{1}{2}$  parts, and water 400 parts. This cloth will change color as the amount of moisture in the atmosphere changes, the change being due to the cobalt salt, which in dry air is lavender blue. As the humidity of the atmosphere increases the color changes first to bluish-red, then light red and finally pink, according to the amount of moisture. With a decrease in humidity, the colors change in the reverse order and the original blue color will return when the air becomes dry.

# Effective One-Man Stump Puller

By CHAS. A. KING

**P**ULLING stumps is always a more or less difficult task. Even with horses or a tractor, it is, at best, a slow process, to say nothing of the danger of cutting the horses' legs with the sharp ends of the roots. However, the writer's experience in removing hardwood stumps of 15 years' growth by hand, with the use of the stump puller described, has been very satisfactory.

A straight, dry hickory pole, about 10 ft. long and  $3\frac{1}{2}$  in. in diameter at the large end, was selected, though later it seemed that one somewhat shorter and smaller would have been heavy enough. The checks were carefully filled with wooden feathers glued in and afterward smoothed so that splinters would not endanger the hands, and several coats of raw linseed oil were applied and allowed to soak in.

A plate and hook for the end of the pole were bent to the shape shown and securely fastened by two eyebolts. A 15-ft. length of  $\frac{3}{8}$ -in. steel cable was next attached; it had a grommet and clips at one end to fasten it to one eyebolt on the hook, as shown, and had clips, a grommet and a hook at the other end to permit fastening it around an anchor stump. A 24-in. length of short-linked  $\frac{3}{8}$ -in. chain, fitted with a split hook at the outer end, was attached to the other eyebolt. The radius of operation of the device could, of course, be made greater by providing a longer chain and cable. A 20-ft. chain of the same kind was also fitted with a stout split hook at one end. A light  $\frac{1}{4}$ -in. chain, about 4 ft. long, was attached to the handle end of the pole and a hook provided

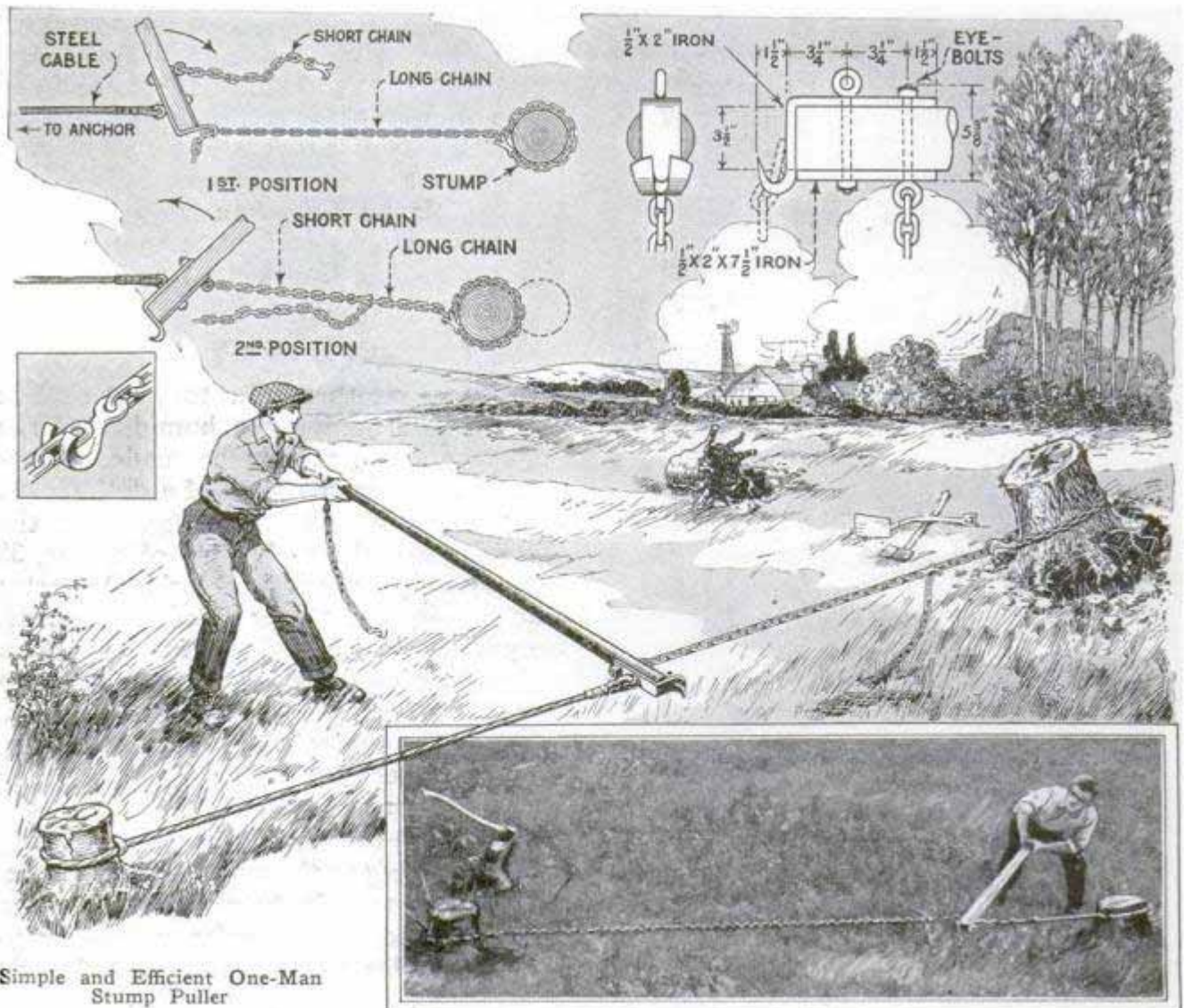

Simple and Efficient One-Man Stump Puller

at the free end, which could be fastened to the steel cable or long chain when the worker came to the end of the stroke and had to reset the chains.

It is, of course, obvious that, while one man can use the device efficiently, a helper would permit him to accomplish more than twice as much during the same time. A study of the first and second positions shown in the illustration will explain the method of using the stump puller. With it, stumps are pulled with ease and speed, with no horses to consider or to manage; the gains are held securely, allowing changes of chains to be made and roots to be cut with the ax, and plenty of power can be exerted.

### Telltale Light on Basement Circuit

After having come up from the basement without putting out the light a number of times, I resolved to put an end to the omission. I purchased an ordinary doorbell transformer designed to connect to 110-volt lighting lines, a roll of bell wire, and a small 6-volt auto-parking lamp. I connected the two rubber-covered wires from the transformer to the two terminals on the basement light socket, so that, when the light was on, the transformer was also on. Then I ran two lengths of bell wire from the two 6-volt terminals of the transformer up through the floor into the kitchen, where the basement light switch was located, and up the outside of the kitchen wall to the small lamp, which I had fastened on the wall about 4 ft. above the floor. Whenever the cellar light is on, the auto light is also lighted, and is a constant reminder not to forget the former. This telltale lamp uses less current than the smallest 110-volt lamp, and materials cost less than for a 110-volt installation.—Chas. W. Brown, Springfield, Mass.



Bright-Colored Pieces of Paper Glued Irregularly on Wooden Book Ends

### Lifting Wagon Wheel

One of the rear wheels of a huckster's wagon came loose and the driver had to repair it single-handed. The simple method



Lifting Wheel of Loaded Wagon by Using a Prop

shown in the drawing enabled him to do this without much trouble. Instead of attempting to lift the wheel directly, he placed a prop under one spoke and pulled upward on the opposite spoke.

### Japanese-Effect Book Ends

A pair of book ends to match the Japanese lamp which adorned my table were greatly desired and they were constructed from an old board as follows: The board was cut into four pieces, each piece  $\frac{1}{2}$  by 4 by 6 in. These pieces were nailed together along the 6-in. side. A number of tiny triangles, squares, crescents and circles were cut from brightly colored advertising pages. These were pasted irregularly over the wood, thoroughly covering it. The finished pieces were then shellacked.—Clyde E. Volkers, Terre Haute, Ind.

254 Spencer St  
Marion Ohio

# How to Make Typewritten Silhouettes

By ROBERT GREGG

**S**ILHOUETTES on a typewriter? Certainly. All you need is a sharp penknife and some sheets of thin paper, and you can make something far more attractive than the ordinary typewritten page. Draw the outline of the picture you desire to make a silhouette of, on a sheet of thin paper and then cut it out, using a pair of scissors or a sharp penknife. With tiny dabs of paste fasten this picture on a sheet of clean paper. Insert the double sheet into the typewriter, the cut-out to the front. The small letter "m" is the blackest

letter on the typewriter keyboard. Using this letter as your "brush," run a line of them across the sheet. After completing one line, release the ratchet that

turns the platen of the typewriter, and move down so that the top of the next line will just fit under the first line. Type the second line and then finish the whole picture in this manner

In the illustration are shown some samples of the work. For silhouettes composed of only one tone, one cut-out is needed. But if you wish to make a picture of two or more tones, as many stencils as tones are needed to make the finished picture. The picture of the farmer sharpening a scythe and that of a man's head were made with one stencil. In the former the object was cut out, while in the latter everything was cut out but the object. The girl's head consists of two tones.

Another method of making silhouettes is to cut the picture desired on a sheet of carbon paper. Lay the carbon cut-out on a sheet of clean paper and over this place another sheet of paper. Insert the three sheets of paper in the typewriter. Mark out lightly on the top sheet the approximate area of the carbon stencil and fill this space with the letter "m." Where the carbon paper has been cut away, the bottom sheet receives no impression and in this way the silhouette comes out in black and white. By using sheets of black, blue and carbon paper at the same time you can get three different tones in the picture. You can add a touch of distinction to your stationery by typing a silhouette of your own head, as shown in the circular insert.

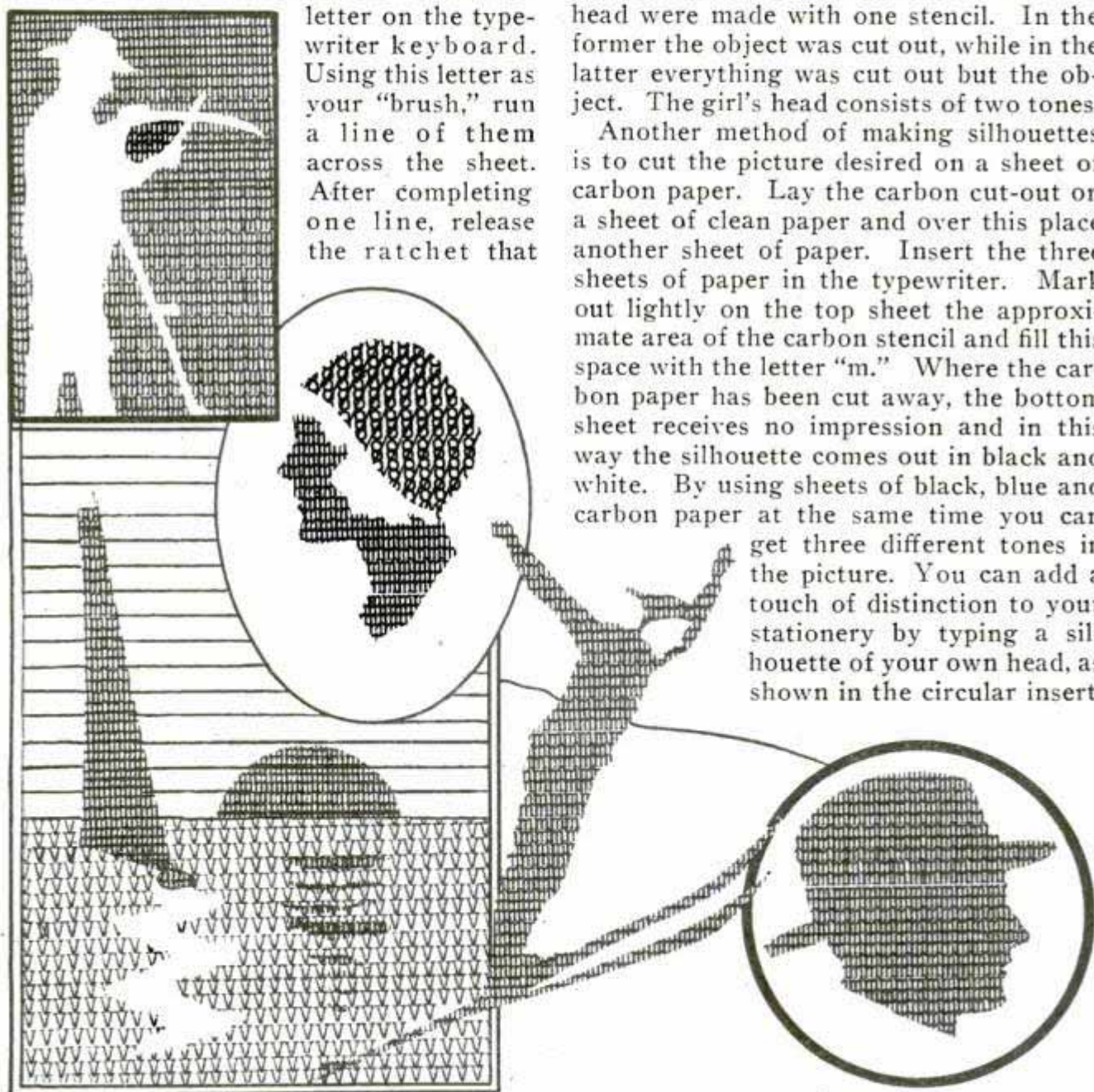

Novel Silhouettes and Two or Three-Tone Pictures Can Be Made on a Typewriter by the Use of Stencils and Different Letters for Various Degrees of Shading

### Removing Vegetable Stains

To remove stains of vegetables or fruits of any kind from cloth or wood, the following method is very good: The stained piece is first moistened with water and then put in a jar or pail that can be covered. A lump of sulphur is ignited and dropped into the jar. Place the sulphur on a fire shovel when lighting it, to avoid burns. The burning sulphur should be placed in the receptacle on the side where the stain will be exposed to the fumes. The sulphur burns slowly so that the articles will not be harmed. After the sulphur has burned away, the jar should be kept closed for a few minutes and when the articles are removed the stains will be gone. This is harmless to try, and the cloth will not be injured if it is dry. However, the articles should be washed and dried immediately after they have been removed from the jar.

### Protection for Wall behind Stove

When a gas stove is set up near a painted wall, the heat from the oven will soon blister the paint. The gas company may offer to tack a sheet of asbestos to the wall, but besides marring the paint, quite a difference in shade can be seen, when the asbestos is removed and the protected surface exposed.

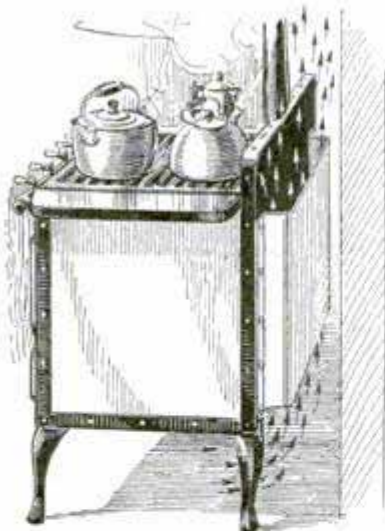

A better protection is shown in the drawing. A sheet of metal, as large as the back of the oven, is bent with a 1-in. flange on each side and riveted to the oven back. In this way, a sort of chimney is formed, which is closed at the sides and open at the top and bottom. The hot air between this plate and the oven flows upward, causing cold air to be drawn from beneath, and thus preventing radiation of heat against the wall.—Harold E. Benson, Denver, Colo.



Screened Shelf Outside of the Window Permits Proper Airing of Dairy Utensils

### Screened Shelf for the Milk House

The idea represented in the drawing will appeal to the dairyman having a small milk house. It permits airing and drying of the utensils outside, but is within easy reach from the inside of the building. To make such a device, run strips of wood at an angle from the top corners of the window down to a point on the level with the bottom of the window opening. Provide a solid shelf below and cover the three sides with screen. When the window is down, no dust can enter the building, yet, by merely raising the sash, dishes that should be sunned can be placed outside.

### Striping In White on Furniture

Many amateur painters who have tried to stripe furniture with flake white have difficulty in getting a mixture that will flow freely and dry rapidly without running. It has been found, however, that this can be done easily by mixing a few drops at a time of good rubbing varnish with the flake white. If it should still be a little thick, use a few drops of turpentine to thin the flake white before adding the varnish.—L. H. Georger, Buffalo, N. Y.

# Cycling Clown Amuses the Youngsters

By HERBERT C. MCKAY

A CLOWN who rides a monocycle along a taut string will amuse the children for hours and is very easily made. The material used is heavy cigar-box wood, and the only tools required are a scrollsaw and a few others that are found in almost every home.

The pieces are laid out as shown in the drawing, on paper ruled off in  $\frac{1}{4}$ -in. squares. The wheel is 4 in. in diameter. A short length of square wire, such as radio busbar, about 1 ft. of 18 or 20-gauge hard iron wire, and a 2-oz. weight are necessary besides the wooden parts. A groove is first cut around the edge of the wheel. If no lathe is available, this can be cut with a handsaw, making the cuts exactly the same depth all around the wheel. Then place the wheel against the saw and turn it, to cut down irregularities in the groove. After the other pieces are cut with the scrollsaw, they should be sandpapered smooth.

Painting is more easily done before the assembly than afterward. The quick-drying lacquers now on the market are best adapted for this kind of work, and the finish is smooth, glossy and brilliant. Naturally the colors chosen will depend on individual taste. In the original, these colors were used: wheel, bright green; clown suit, bright red with yellow polka dots; bands at the wrist, ankle and knee, bright yellow; hat, collar and saddle, lavender; face, white with features in crimson. The umbrella, which may be added if desired, was bright green.

The assembly should proceed in the following way: Attach the square ends of the two pieces, 2, to the bottom of the body, 3, with  $\frac{1}{2}$ -in. wire nails, first placing a cardboard spacer on either side of 3; the arms, 6, are nailed to the body in the fixed position shown in the completed figure; the wheel is inserted between the side-

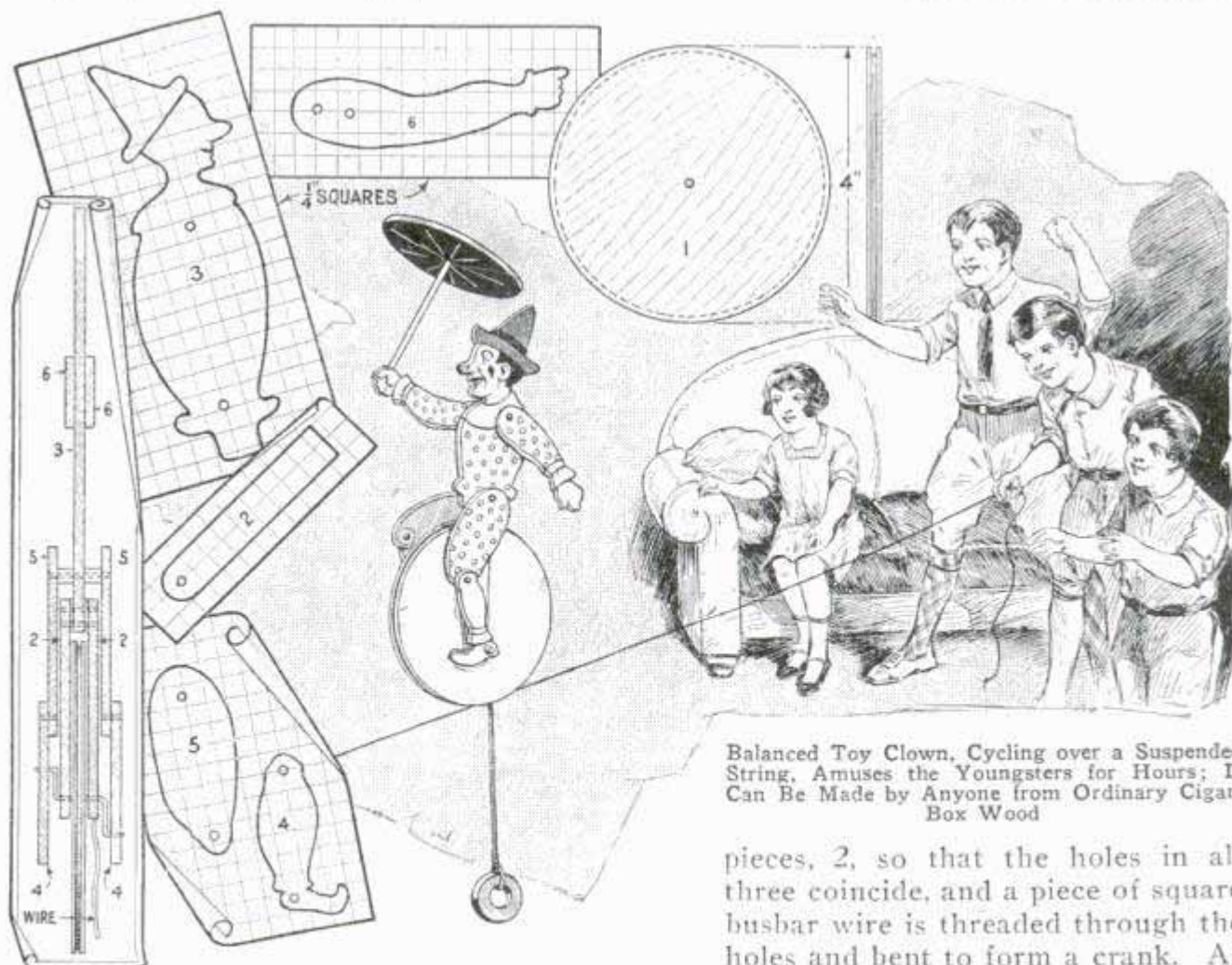

Balanced Toy Clown, Cycling over a Suspended String, Amuses the Youngsters for Hours; It Can Be Made by Anyone from Ordinary Cigar-Box Wood

pieces, 2, so that the holes in all three coincide, and a piece of square busbar wire is threaded through the holes and bent to form a crank. As

it is to serve also as an axle for the wheel, it should fit tightly in the hole in the latter, but loosely in the side-piece holes. A drop of glue at the points where the axle passes through the wheel will help hold the axle firmly. The upper parts of the legs come next. A piece of busbar wire is fixed firmly in the lower body hole (piece 5), a washer, cut from an old auto gasoline pipe, is fitted on either end, and the pieces 5 are placed on the outer ends of the wire so that they will move freely, the washers being of such thickness that the leg pieces will not bind against the pieces 2. The lower legs (4) are fitted loosely to parts 5 and to the crank ends as shown. There is only one thing to watch for; see that the radius of the crank arms is such that the legs never become fully extended, or they may lock, and the wheel refuse to turn. The wire on which the balancing weight is hung is driven into the lower end of one of the pieces 2, and a hook is formed on the lower end for the weight.

Stretch a string tightly in a horizontal position and place the groove of the wheel on the string. By carefully bending the wire you can readily find the best position for the weight so that it will hold the toy upright. If such a position cannot be found, the weight is too light and a heavier one should be substituted. When the balance has been found, lower one end of the string, place the toy at the upper end and it will roll down the string, the legs working in the proper fashion. An umbrella can be made from a disk of cardboard glued to the end of a short stick, which is in turn glued to one of the hands.

☐ A cure for ivy poisoning that never fails is to wash the affected parts with a solution of sulphate of magnesia, commonly known as epsom salts, and then apply sulphur.

### Carrying Ice on Running Board

To carry ice on the running board of a car, take the lid of a small spice can and screw it to the running board, upside down. The edges can be notched but do not necessarily have to be. The holder is not in the way at all and need never be removed. The ice is placed on it, and as it melts, the edges enter into it, so that the piece will not slip off easily.—Thos. F. Johnson, Cuero, Tex.

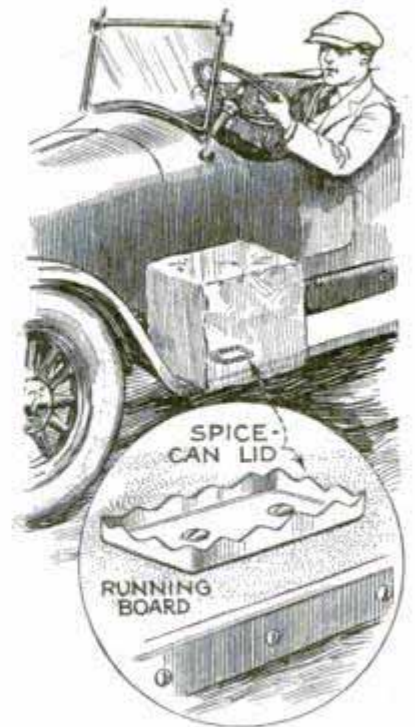

### Combination Ladder and Wheelbarrow

For doing odd jobs about the farm, the workman is generally handicapped by the necessity of first wheeling the tools to the scene of operation and then bringing the ladder. By combining the ladder and wheelbarrow as shown in the illustration, much work and time can be saved. Drill a hole in the ends of the ladder sides and cut a slot to accommodate an old barrow wheel and axle. Then drill smaller holes through the sides, at right angles to the slot, to receive long bolts. Make two metal brackets and screw them to the ladder about 18 or 20 in. back of the wheel. Then fit two wooden stakes in these brackets to hold the box of tools.

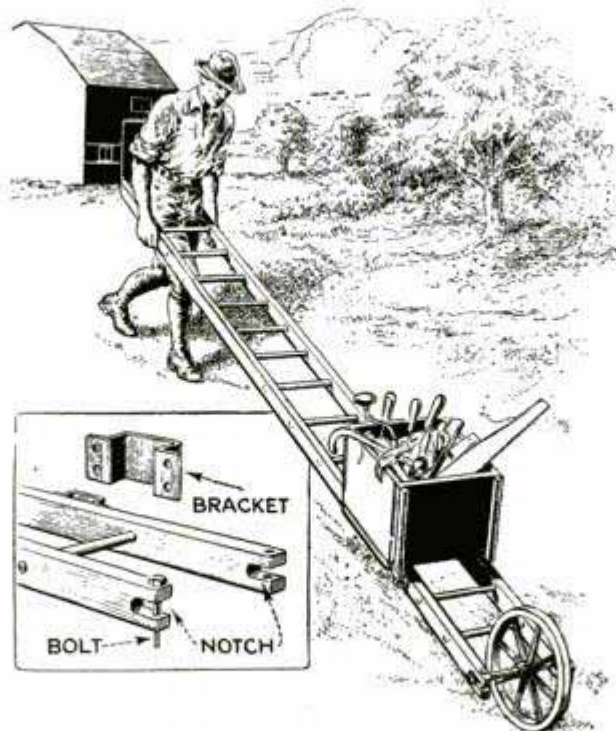

One Method of Saving Time and Labor on the Farm

### Painting Shingles Quickly

It is a tedious task to paint a large number of shingles by hand. A quick method of doing it is to dip them as shown in the



Quick and Handy Method of Painting or Staining Shingles without Waste

photo. A 5-gal. oilcan will be found useful for holding the paint, the top being cut off to permit the shingles to be inserted easily. A large piece of sheet iron, triangular in shape and having two sides bent up to form a ridge, makes a good drip pan. It is set at an angle and a pail is set directly under the lower corner. A wheelbarrow will be found convenient for holding both the dipping bucket and the drip pan. With this arrangement very little paint is wasted.—Mrs. V. S. Martin, Detroit, Mich.

### How to Demagnetize a Watch

Quite often an attendant, or a visitor, at an electric power plant, discovers, after a few days, that his watch is losing a half hour or more a day. The reason for this probably is that the watch has been magnetized by the generators.

A jeweler demagnetizes a watch in the following way: He has a piece of soft iron with an opening cut in its center of such a shape and size as to receive the watch, and with a fine wire wound about it. After the watch has been placed in position, an alternating current is sent through the winding, and thus a magnetic field is produced that also changes in direction as the current reverses. The current is gradually reduced in value and the magnetism orig-

inally possessed by the watch is removed. When an alternating current is not available, a direct current may be used, its direction being rapidly reversed by what is known as a polarity changer.

Anyone can demagnetize his own watch, however, with very little trouble and no expense. Obtain a piece of heavy linen thread, about 3 ft. long, attach one end of it to the ring of the watch, hold the other end and turn the watch around until the thread is twisted at least 100 times. Now allow the thread to unwind and as the watch revolves move it back and forth near a strong electromagnet. The field magnet of a good-sized generator or motor will answer. The machine should be in operation, or at least there should be a current in the windings about the field, when you attempt to demagnetize the watch. While the thread is unwinding and the watch moved in the magnetic field, gradually withdraw from the magnet so that when the watch ceases to revolve it is just outside of the field. Always be sure to keep the watch revolving while it is in the magnetic field, otherwise the results will be very unsatisfactory, and more harm than good will result.

### Floating Frame Holds Milk Can

When a partly filled milk can is placed in a cooling tank, it is common practice to weight it down with rocks or iron to prevent it from turning on its side and



spilling the contents. As the removal and replacing of the weights makes access to the contents rather difficult, an Illinois dairy farmer devised a floating frame, consisting of 2 by 6-in. pine planks, in which the can stands upright at all times. The lid may be left loose or removed entirely to facilitate the cooling process. When the float is used in a large tank, a short length of chain should be used to hold it to the side of the tank.



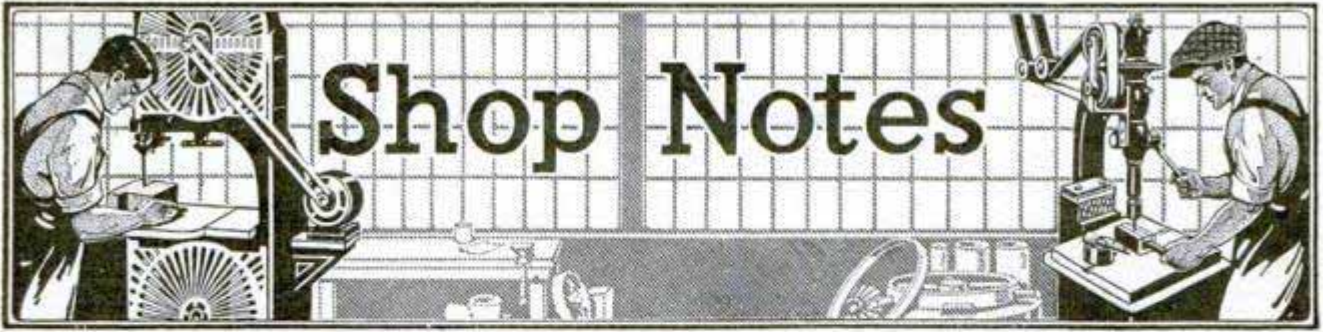

All Shop Notes published in 1926, in book form—Fifty Cents—from our Book Department

## Make Your Own Flagstone Walk

By ALLAN R. SMITH

**T**HE flagstone walk as a useful and beautiful addition to the home landscape has long been confined to sections of the country where suitably shaped rocks, stone or slate could be found. Lately, however, the adaptation of concrete to such walks has made it possible for anyone with a knack for tools to build one regardless of location. The cost is very small and the work so easy that it is almost play.

The first step is to lay out the design of the stones, according to the width and length of the walk to be flagged. Any pat-

tern that strikes one's fancy and conforms to the shape of natural rock can be used. A suggested pattern is given in the drawing. It can be drawn on a small scale until the right shapes are found, and then the actual size of each piece may be cut from cardboard. Rather than make individual patterns for the full length of the walk, a good plan is to cut patterns for about 10 ft. of the walk, repeating the same patterns for the full length of the flagging.

A cord is stretched along each side of the intended walk, curving around flower beds

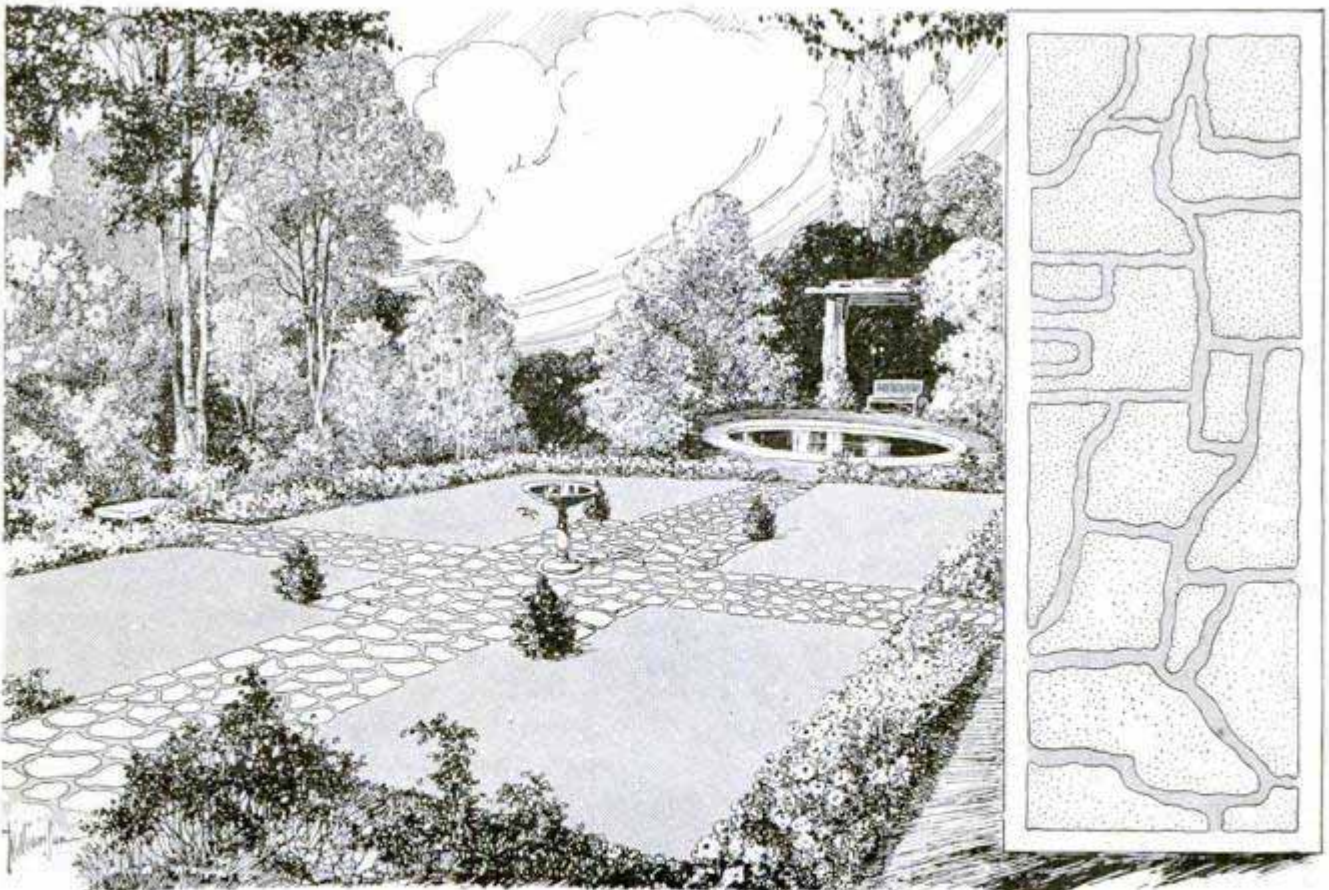

This Drawing of a Flagstone Walk Is from an Actual Photo of a Walk Done in Concrete, as Described in the Article; Right, Pattern for Flags

or trees to add to its beauty. Between these cords the cardboard patterns are laid on the sod and the outline of each is marked with a knife, the pattern removed, and a hole, 3 in. deep, scooped out. The bottom of each hole should be tamped



Entrance Walk Laid with "Natural" Concrete Flags, Closely Simulating the Real Thing

thoroughly to provide a solid base for the flagstones.

The best concrete for flagstones is a 1:3 mixture. By this is meant one part of portland cement to three parts of sand. The materials must be clean and measured accurately.

Three cubic feet of sand are spread on the mixing board, usually a level platform made of tongued-and-grooved boards. One sack (1 cu. ft.) of portland cement is spread over the sand and thoroughly mixed by turning over and over with shovels until the color of the mass is uniform. Adding the right amount of water is most important. Too much water in concrete weakens its final strength and is just as bad as leaving out some cement. Only sufficient water should be added to make a quaky jellylike mixture.

As soon as the concrete is thoroughly mixed, it is ready for the earth forms that have already been dug. After it is placed, a wood float is run over the top of each stone to make a level, gritty surface.

In hot weather, the walk will be ready to use within three days. In the meantime, better concrete will result if the flagstones are covered with earth and sprinkled once or twice a day to keep them from drying too fast. In cool weather, the walk should not be used for a week to ten days, and the same earth covering and sprinkling should be done.

If the maker of the walk does not care for the flat finish produced by the float,

but desires to imitate the worn surface of old flags, all that is necessary is to select a single flat stone, with a surface as irregular as desired, and impress this stone on the surface of the concrete flags while they are still plastic enough to retain the impression. If cement colors are used to tint the flags in light blues and grays, an even closer imitation of the natural stone may be obtained.

### Inlaying Brass Letters in Steel

Letters, names or numbers cut in a steel surface with acid or steel letter punches can readily be filled with brass. This is accomplished by heating the prepared steel red-hot in a brazing furnace, forge or kitchen range, and flowing spelter in the indentations. Use borax as a flux and a piece of brass wire for the spelter. The wire can be handled much easier than the regular brazing spelter. Be sure to braze a good thick coat of brass on the lettered surface. After cooling, the surplus brass is filed away from the top of the article and the steel surface is polished. The indentations will be filled with brass. Tools may be marked in this manner.

### A Place for the Shop Needle

Most mechanics who keep a needle and thread in the tool box, for first aid to overalls and buttons, have a hard time keeping track of the needle. Take two used lead



A Leadless Pencil Pushed through Spool Provides a Safe Place for Needles

pencils, a little longer than a large needle. Remove both the eraser ferrules, smoothing off the slightly burred points on the inside, which clinched them to the wood. Push the lead out of one of the pencils and whittle the ends so that the ferrules will act as caps on the ends. Push the hollow pencil through the spool, and there is the whole thing together. You will not lose the needle any more.

### Homemade Corn-Stalk Cutter

After "corn picking," the stalks have to be cut, and the homemade cutter shown in the drawing has been found quite efficient. It consists of four old binder bull wheels mounted in pairs at either end of one axle, each pair being bound together with six lengths of  $1\frac{1}{2}$ -in. angle iron

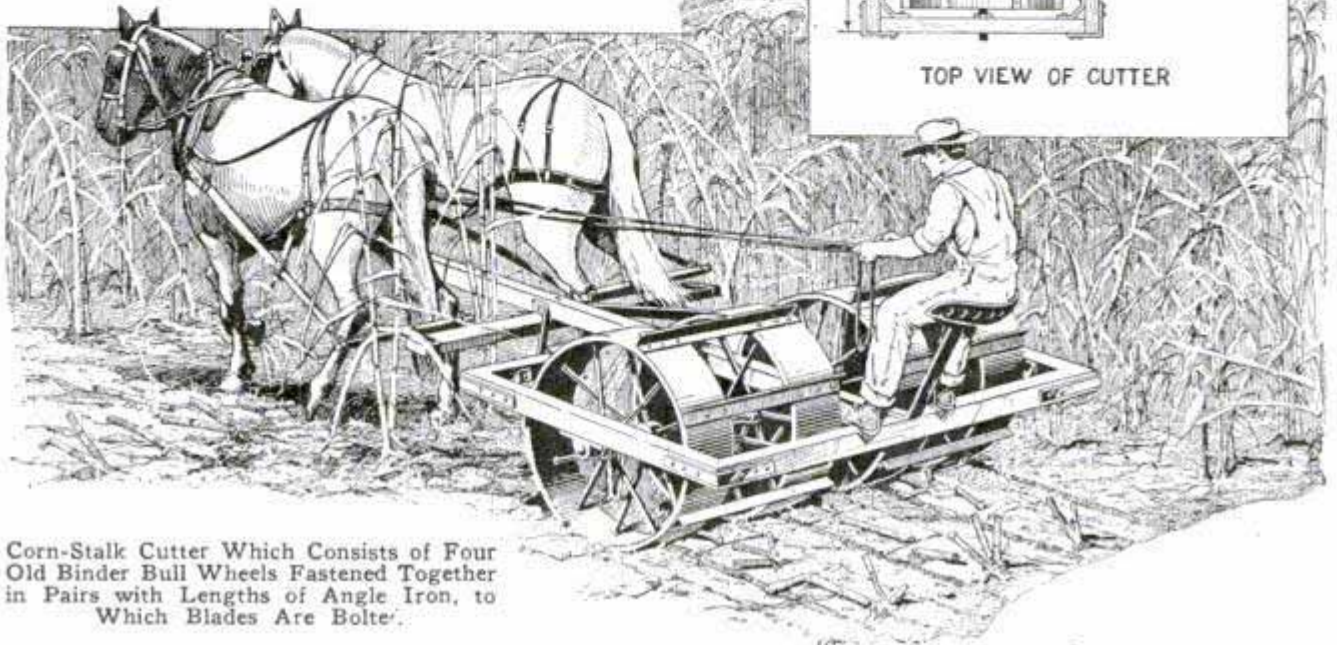
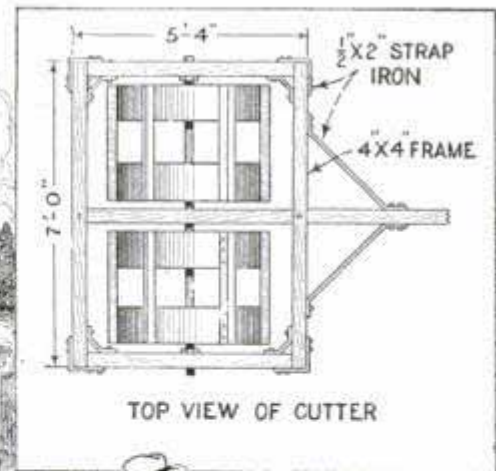

Corn-Stalk Cutter Which Consists of Four Old Binder Bull Wheels Fastened Together in Pairs with Lengths of Angle Iron, to Which Blades Are Bolted.

which are riveted to the wheels as shown. The protecting side of the angle iron is drilled and steel blades, 4 in. wide and  $\frac{1}{2}$  in. thick, are bolted on. Ordinary angle iron will serve the purpose if the field is free from rocks. If not, it is advisable to use steel blades. The frame is 7 ft. long and 5 ft. 4 in. wide and is made of 4 by 4-in. stock. All the iron braces used are made of flat stock,  $\frac{1}{2}$  in. thick and 2 in. wide. The ends of the axle are supported under the frame by means of ordinary bearings, bolted in place with lag screws. Each wheel is also anchored by means of the flange and setscrew, with which each was originally provided. The tongue is securely mortised or bolted to the frame, as indicated, and is further strengthened with flat-iron braces. The centers of the two pairs of wheels must be 3 ft. 6 in. apart, so that the cutter will take two rows of corn. If desired, the front end can be weighted down and a seat from an old mowing machine can be mounted on the back. To do this, the seat should be attached first and, with the driver seated on it, the weights in front should be put on so that there will be a slight steady

weight on the neck yokes of the team. The doubletree is attached to the underside of the tongue.—Dale R. Van Horn, Lincoln, Nebr.

### Clamp Holds Pedal Depressed

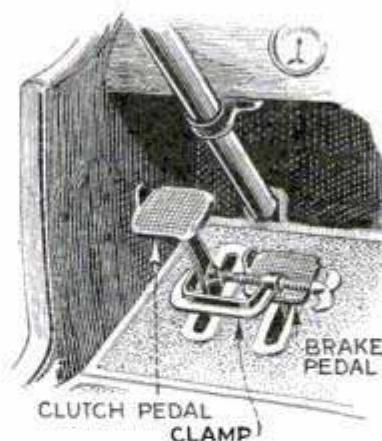

The drawing shows a good method of holding the brake or clutch lever of an automobile immovable while adjusting, renewing parts, cleaning the clutch faces or other

repairs. Screw a large C-clamp to the clutch pedal so that the clamp screw will press against the brake pedal as indicated. The work can then proceed without danger of the pedal slipping. If the clutch pedal is to be held in, the clamp, of course, is screwed to the brake-pedal shank.—G. A. Luers, Washington, D. C.

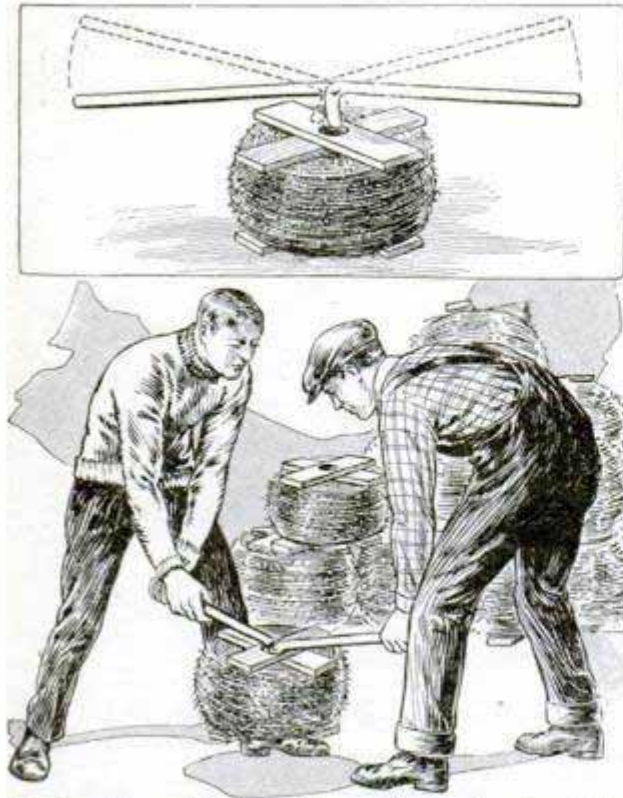

Handy Tongs Used to Carry Heavy Spools of Barb Wire Safely

### Tongs for Handling Spools of Barbed Wire

Handling barbed wire often results in serious injury to hands and clothing. One dealer employs a simple pair of tongs with which the spools can be handled rapidly and safely by two men. They are constructed and used as shown in the illustration. When the "beak" ends are inserted in the opening in the center of the spool of wire and the handles raised, the ends grip the spool so that it can be carried about easily and without any danger.

### Replacing Ford Crank Spring

The spring on a Ford starting crank must be replaced now and then. This is usually because the inner end has worn thin, and jams between the crank and its bushing when trying to use the crank. The trouble also occurs on starter-equipped cars, as the crank swings while the car is being driven and wears the spring. Since the crank is used only when the battery is run down or the motor is cold and stiff, a jamming crank is very troublesome. On the later-model cars, the spring can easily be replaced without removing the crank or ratchet. Such cranks are a one-piece, round iron rod with a sleeve, free to turn, pressed over the outer end. The old spring

is removed by grasping the outer end with a pair of pliers and pulling until it unwinds and comes off. A good grip must be kept on it or it will fly out and may injure someone. The new spring is compressed by the fingers and twisted slightly to unwind it, which will increase the size of the opening through it. It is slipped over the crank sleeve when held in this expanded condition and worked over the crank into place against the front end of the crankcase. The bent-over end of the spring, which fits into the small hole drilled in the crank, is sometimes bent out so that it will not stay in the hole. In this case, the end of the spring wire should be held slightly out of the crank, about 1 in. from the bent-down end, and bent down again with a pair of pliers.

### Handy Method of Setting Surface Gauge

Many mechanics have a habit of holding a scale flat against an angle plate when setting the needle of a surface gauge. However, if the scale is held by one hand, it is rather difficult to set the gauge with the other, and if the scale is not so held, it will fall down at the slightest touch. I solved this difficulty by drilling and tapping a hole in the bottom of the angle plate and putting in a screw, as shown.

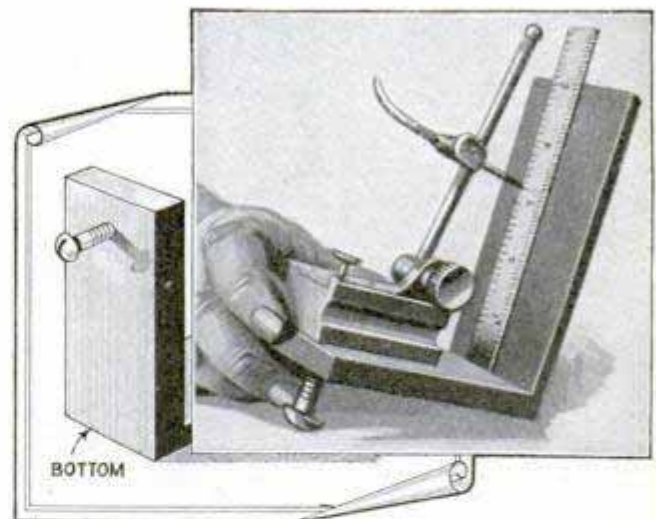

Practical Method of Setting the Mechanics' Surface Gauge Also Makes Reading Easier

I lay the scale up against the back where it does not have to be held at all. A further advantage I found upon use, was that the scale marking was much easier to read than when it was held in a vertical position.—Harry Moore, Montreal, Can.

# Hints for the Builder

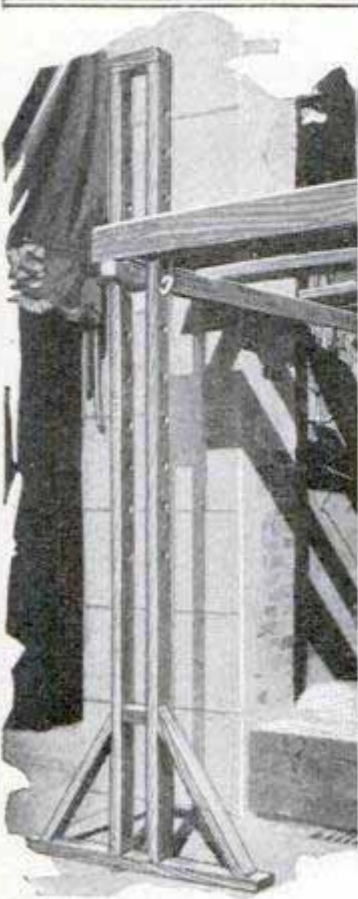

Simple Adjustable Scaffold for Store-Front Erection

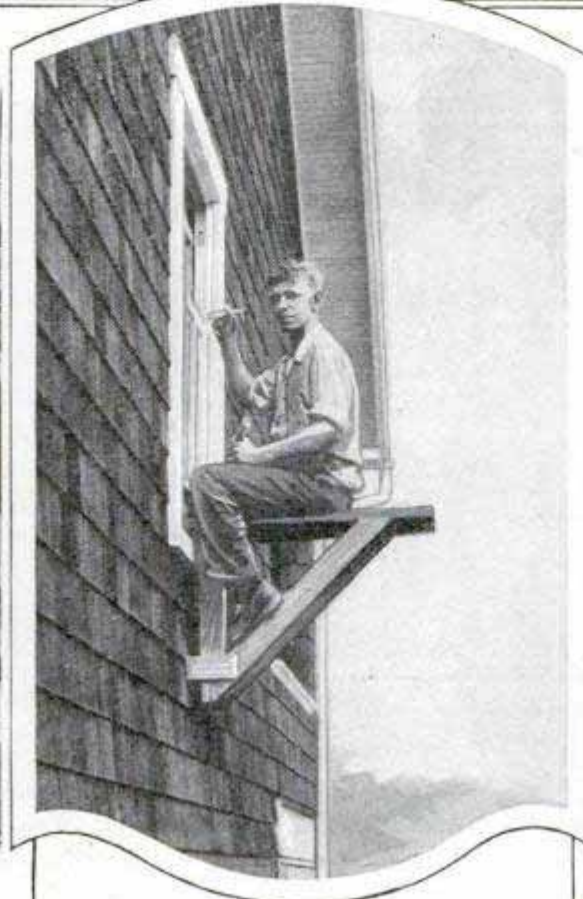

A Painter's "Cripple" That Makes the Painting of Trim Easier; a Couple of Lengths of Pipe Pass through the Members Projecting Inside

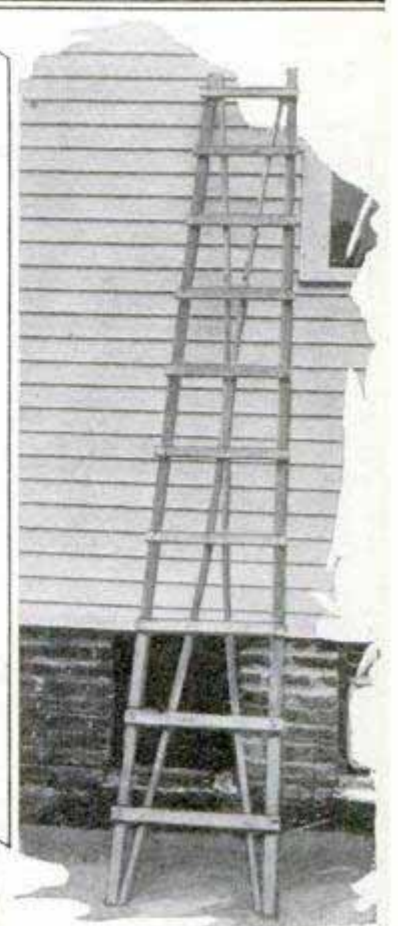

A Well-Braced Light Ladder for Interior Work

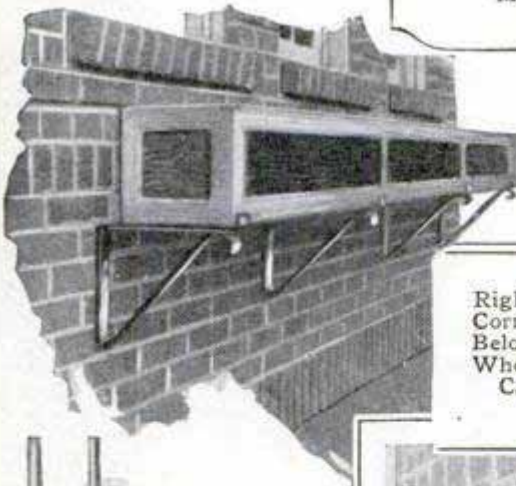

Above, Built-In Box Brackets; Left, Home-made Tamper



Right, the Correct Way to Corner a "Soldier" Course; Below, Difficulty Encountered When a "Soldier" Course Is Carried On to the Corner

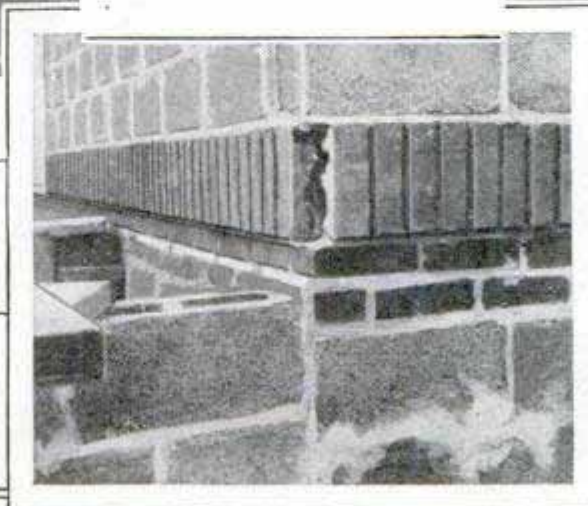

Below, Barrel Staves Make Good Legs for Light Horse

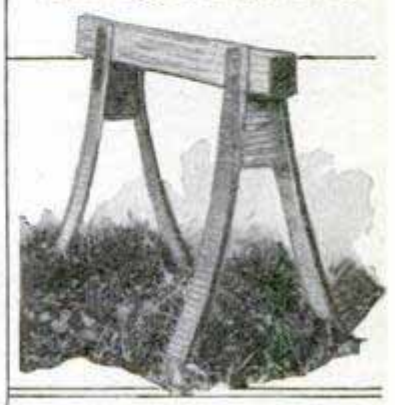

### Concrete Garage Bumpers

The accompanying photo shows how one garage man solved the problem of

by hand in cases where cutting and burning cannot be resorted to, as in the crotches of large branches. The only change made on the oilcan, besides attaching the tubing,

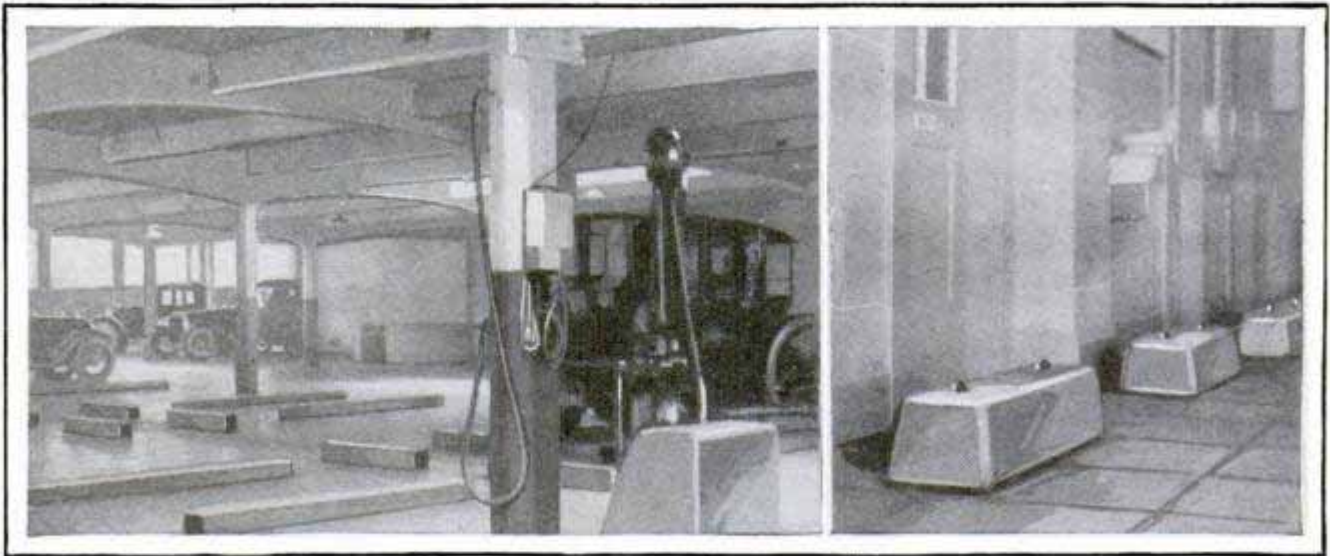

Concrete Bumpers in a Large Garage Are Heavy Enough to Withstand Abuse and Can Readily Be Moved from Place to Place

providing bumpers in his garage. He makes them of concrete and they are heavy enough to stand considerable abuse, although they are readily portable. Ropes or chains are fastened to the eyelets so that the bumpers may easily be moved from place to place.—A. S. Bowes, Chicago, Ill.

### Killing Tent Caterpillars

Cutting or burning the web of tent caterpillars, which form in trees in many sections of the country, is rather difficult. A much better method of killing these pests is to use auto crankcase oil and kerosene, or the latter alone, in the following way: A 1-pt. plunger oilcan is obtained and a 3-ft. length of hard-copper tubing, such as is used for auto-feed systems, is securely soldered to part of a threaded coupling, while the other part is soldered to the spout of the can. The end of the tubing is bent to form a hook. The hook is inserted in the web and a stroke or two of the plunger saturates it. No more than a teaspoonful is required for a small web (and more for a larger one) to completely destroy the pests in a few minutes. This method is quick and easy, and the oil injures the tree much less than cutting or burning the webs. It is also more pleasant to apply the oil than to remove the webs

is to reinforce the lower cup bearing in the plunger with a  $\frac{1}{2}$ -in. iron washer, to take care of the increased "head" of oil.—W. H. Pennypacker, Ashland, N. J.

### Extra Handle Aids Filing

A blacksmith contracted to turn out a large number of duplicate pieces of work, all of which needed filing.

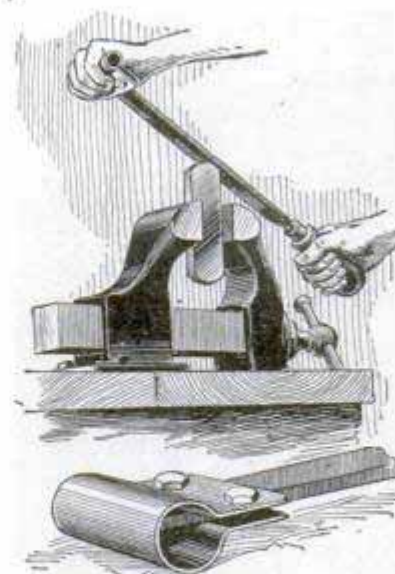

After using a file in the regular manner for some time, the constant pressure of the point of the file on the palm of the left hand was more or less tiresome and painful. He therefore fashioned a point handle, as shown in the drawing, and this made the

job much easier. A piece of flat steel, about 2 in. wide, was doubled and bent to the shape indicated. Two holes were drilled through the sides of the handle near the corners and tapped for bolts. The

handle was slipped over the point of the file and the bolts tightened until the file was gripped firmly.

### Cooling System for Crude-Oil Engine

In order to keep the water used in the cylinder jackets of a large oil engine at a moderate temperature, the structure seen in the photo was erected and found to be both effective and cheap. A water pump is installed in a circuit of 1-in. piping that connects with a concrete pool on the ground, under the frame, and with the barrel mounted on its top. As the engine runs, the pump forces the water into the barrel until it is filled, when it overflows through notches in the ends of the staves and trickles down the sides all around the barrel. Underneath the barrel, several decks or floors are made of narrow slats, spaced about  $\frac{1}{4}$  in. apart. Although not so shown in the photo, the floor of each deck is preferably laid at right angles to the one above. The water drips through the several floors, and this cools it thoroughly. The return pipe to the pump and engine is connected to the concrete pool, which is larger than the frame of the "radiator," to prevent waste of water.

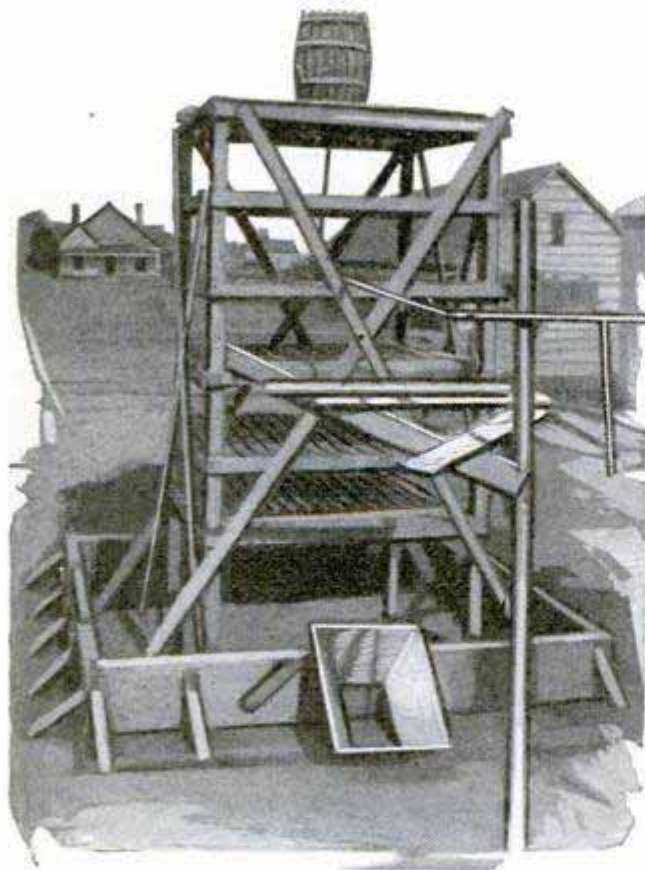

Cheap and Effective Device for Keeping a Crude-Oil Engine Cool

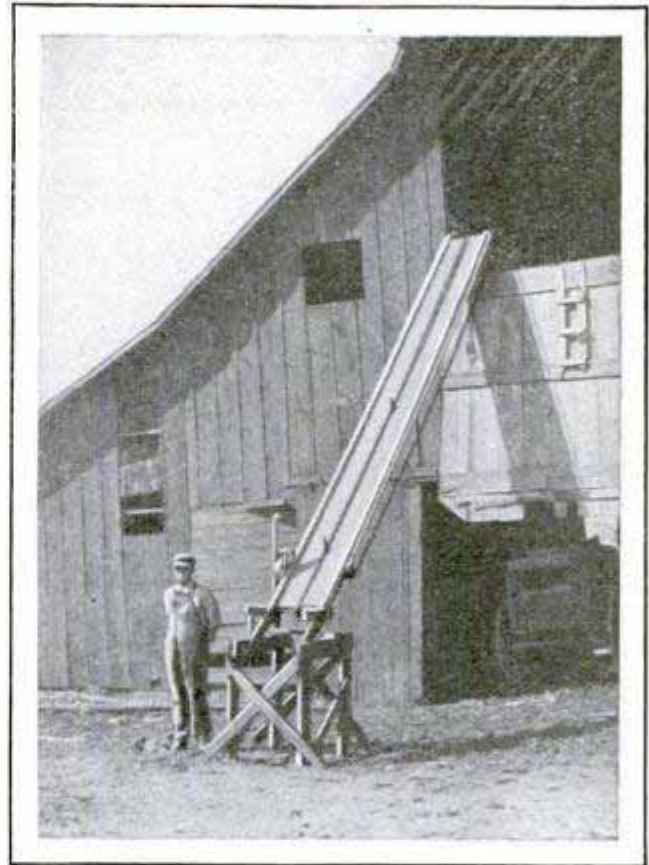

Convenient Homemade Apparatus for Hoisting Baled Hay into Barn Loft

### Hay Hoist Saves Work

The baled-hay hoist shown in the photo has saved much time and hard labor on the farm of John Dickens, near Floral, Kans. The chain in the middle of the slide carries the bales up. Chain links with extensions, taken from a discarded corn binder, were placed in the hoisting chain at 6-ft. intervals. The links bear against the ends of the bales and move them up the slide. The chain, which is countersunk in the surface of the slide, is driven from the top by another chain as shown at the side of the slide, a  $1\frac{1}{2}$ -hp. engine furnishing the operating power and raising the hay as fast as one man can lay it on. The base of the hoist is of a convenient height for unloading bales. When the hay is to be taken out of the barn, the hoisting chain is removed and the bales slide down by gravity.—Stanley Russell, Winfield, Kans.

☐ When it is necessary to cut a slot in a piece of steel and the hacksaw cut is not wide enough to admit even a file, a wider slot can readily be made by using two blades and putting them side by side in the hacksaw frame.

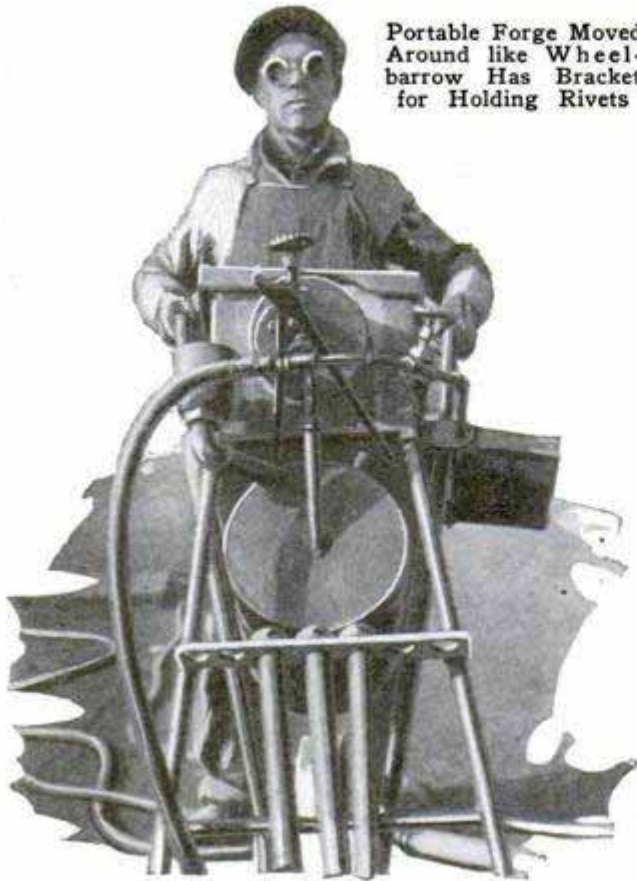

Portable Forge Moved Around like Wheelbarrow Has Bracket for Holding Rivets

### Portable Forge Carries Rivets

The rivet forge shown in the photo is equipped with a wheel and handle like a wheelbarrow, making it very handy and permitting it to be readily pushed from place to place. When stood on end, two legs hold it up, ready for use. However, the operator sometimes discovered, after a move, that there were no rivets along with which to do the job, so he devised the rivet holder shown. It consists of a steel bracket,  $\frac{1}{2}$  in. thick and  $3\frac{1}{2}$  in. wide, with holes drilled through it to accommodate seven rivets. The bar is welded to the front legs of the forge.

### Producing Marble Effects with Paints

Prepare the colors to be shown in the marble, using varnish for the vehicle, and japan colors, reduced in turpentine, for making glaze colors or varnish stains. Put in the ground color with lead and turpentine and allow it to dry, then apply different glaze colors so as to give a mottled, variegated effect. No care need be taken in this part of the work, as the crudest efforts give the best results. Dissolve a lump of potash, the size of a pea, in 1 oz. of kerosene, and while the glaze coat is

fresh, dash small drops of this on the painted surface. This will separate the colors and blend them into very pretty marble effects. By the exercise of a little taste and ingenuity, surprising effects can be obtained. If spar varnish is used, it can be rubbed down and a coat of clear spar put on as a protector. I have in my yard a pair of large garden urns made of plaster of paris, marbled to a malachite green, and these have stood the weather for four years.—Wm. G. Browning, Los Angeles, Calif.

### Binding Short Grain Evenly

When the heads of wheat or barley are unusually heavy or the straw is short, the heads fall forward faster than the butts and a loose, misshapen bundle results. To prevent this, bolt a piece of clock spring, about 1 ft. long, to the binder table, as shown, just even with the twine as it is drawn taut before the straw is forced into it. The spring holds the heads back even with the butts until the packers gradually force it down with the twine. Much grain is saved in this way and a compact bundle that can be easily shocked is formed. The spring shown has been in use three seasons and the steel is worn down thin as a razor.

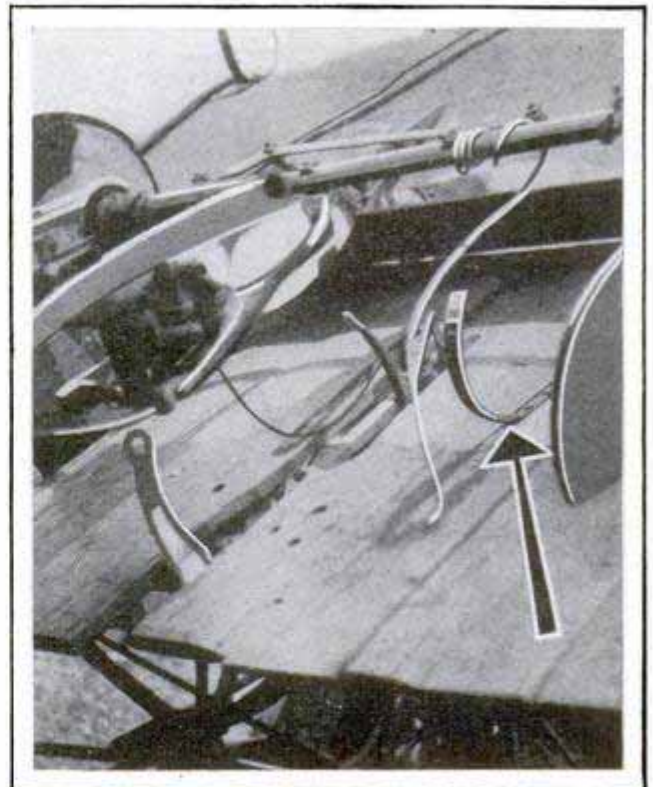

Length of Clock Spring Bolted to Binder Table Helps Bind Short or Heavy Grain Evenly



100 West 11th Street, New York  
140 North Ave + 13th St. New York

# Attractive Ship Plaque Easy to Make

by J. Tate

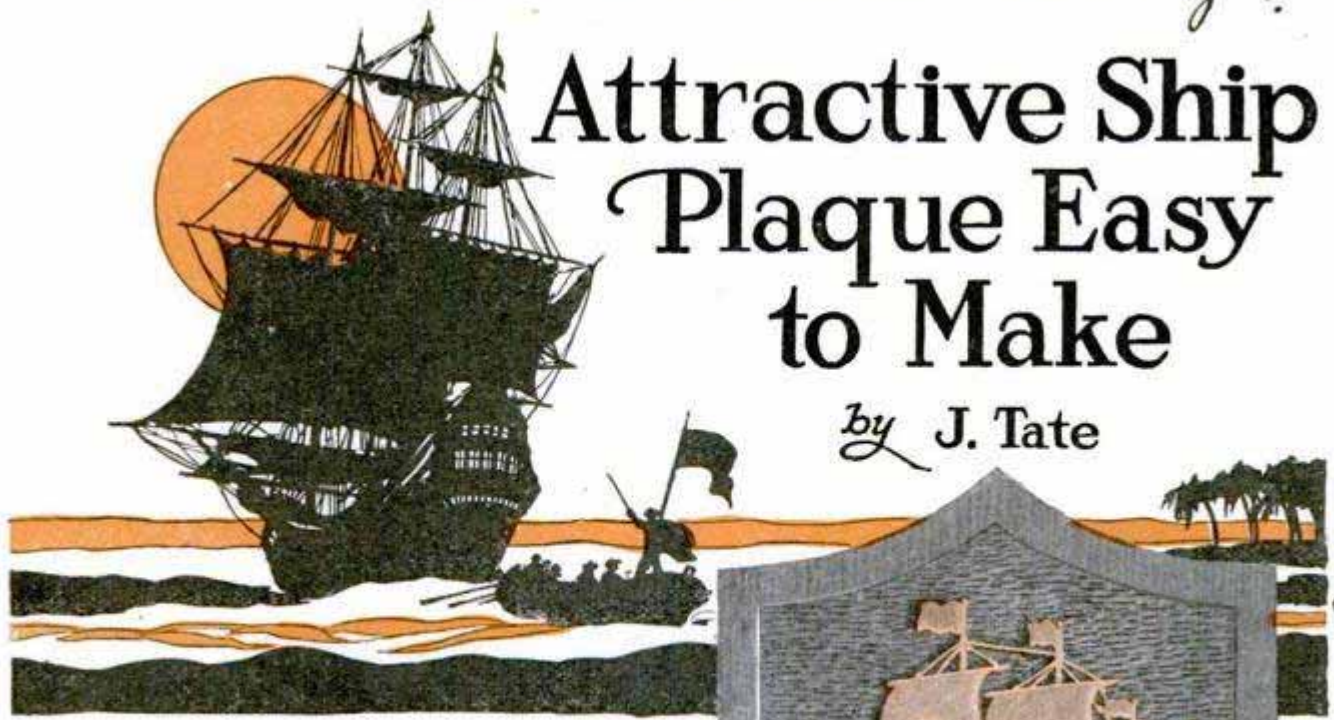

THE ship plaque described in this article is not only easy to make, but it forms a most unusual and handsome wall decoration. Its uses are not confined to this, however; as suggested in one of the drawings, it will make an attractive fire screen, or, with the addition of suitable brackets, a holder for the fire tools, such as tongs, poker and brush. Omitting the shield, the brass ship may be fastened directly to the front of a wire fire screen, where it will present a fine appearance, especially during the winter, standing out boldly against the firelight behind it.

The only materials necessary are a piece of 1/16-in. sheet brass, 12 by 15 in. in size; a piece of 1-in. veneer paneling, 17 by 25 in., to make the shield, or any other suitable lumber; about 1/2 oz. of nitric acid and a cake of paraffin wax. The tools necessary are a coping saw or a bracket saw, with about a dozen fine metal-cutting blades, a set of diemakers' files, a supply of fine emery and crocus cloth, a bottle of lacquer and a good badger brush, 1 in. wide.

The first step is to enlarge the pattern for the ship, given on page 343. The squares in the drawing represent 1 in., so the first thing to do is to lay the paper for the pattern out in 1-in. squares. The pattern should be made on stout brown wrapping paper, about 14 by 17 in. in size, and the squares on the top and one side should be numbered serially to facilitate transferring the layout points. Number the squares on the original to correspond.

Now, with the brown paper tacked down flat, transfer the various points on the original design to the pattern, and draw in the enlarged design. This looks harder than it actually is, as, once the starting points are established, the remainder of the design is easily put in. As noted elsewhere, a blueprint is obtainable, which will eliminate the task of enlarging the pattern.

It is not necessary to cut out the design on the pattern. Trim the brown paper to the size of the brass sheet, and paste it down on the latter. Rubber cement will be found best for this purpose, although shellac or liquid glue will serve fairly well in its absence.

Now drill holes right through the pattern and brass wherever an opening appears in the design, so that the end of the saw blade can be passed through. The

James. Any lumber company -  
Schuyler Co. 29 S. Water St. Albany

Trojan Saws - Ackerman 341

100, U.S.



Above, Use of Bracket or Fret-saw in Cutting Out Ship; Below, Coping Saw Used for the Same Purpose

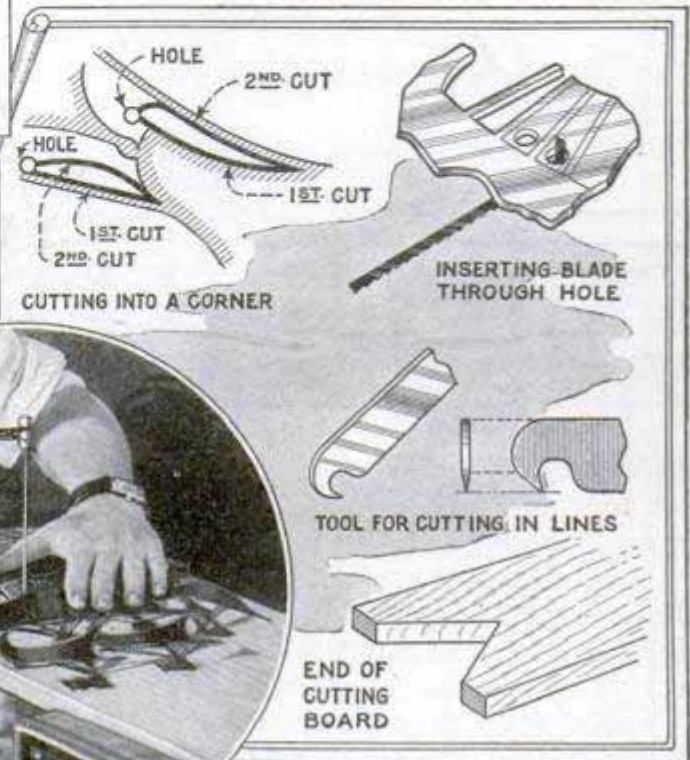
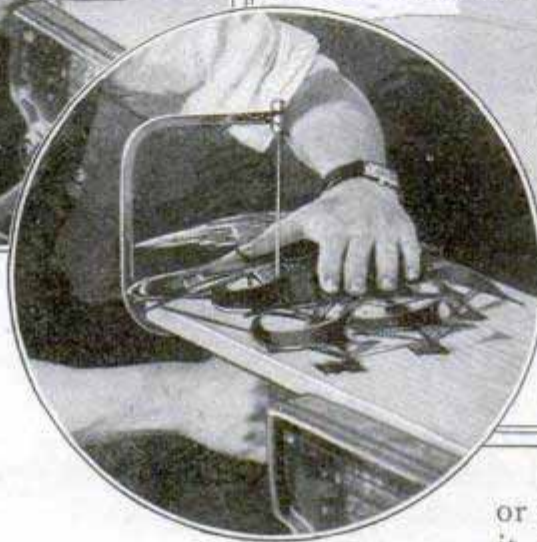

metal-cutting saw blades used have a doubled-over end, as shown on this page, and, in the larger openings, a hole sufficiently large to admit this end can be drilled quite easily. For the smaller slots, such as the spaces between the shrouds, it is necessary to cut the upper part of the doubled-over end of the blade off, and then to drill a hole in the wider end of the opening in the design, just large enough to admit the blade as shown in the same drawing. The saw can easily be "wangled" through in this manner, and, while the cutting of the upper end weakens the hook of the blade, it will be found to serve all right for the relatively few small openings to be cut, provided too much tension is not put on the blade in the frame.

Next, take a piece of board, 10 or 12 in. wide, about 1 in. thick and 16 or 18 in. long, and cut a wide "V" out of one end (see above). This is clamped in the vise or to the bench, and the sawing is done on it. The parts of the board on each side of the "V" support the work while it is being sawed and make the sawing easier.

The actual sawing out of the design is simple, demanding nothing but care and patience, but there are one or two little points that will aid the amateur if he observes them from the start. If you have had any previous experience with the fret

or bracket saw, you will find it as good a tool as any; if not, the coping saw will probably be found easier to handle, although more inconvenient in threading and straining the blades. If a coping saw is used, it must be one in which the blade can be turned to any angle desired; the ten-cent store, wire-frame variety will not do. The blades should be inserted with the teeth pointing downward, so as to cut on the down stroke of the saw.

When sawing into a corner, make the cuts as shown above. The first cut runs into the corner from the hole, cutting out one side of the design; then the blade is drawn back to the hole again, and a second cut made to complete the cutting out of the corner. A few minutes' sawing, however, will teach you more about the best way to do this than a volume of instruction. The main thing is to go slowly and carefully. If the outline of the ship is cut out first, it will help in cutting out the interior parts, especially if the coping saw is used, since it will enable the frame of

the saw to go closer to the work. Cut just on the outside of the lines of the design, and leave a trifle for finishing with the file.

After the sawing is completed, clamp the ship between two pieces of board in the vise and clean up all over with the die-sinkers' files. When a line has been filed

straight, drawfile it, that is, just draw the file back and forth along the edge, at right angles to the usual direction of filing. This is not essential, but it adds to the finished appearance of the work, especially on the outside edges. It will be found easier to keep the lines straight or the curves of the design uniform and true, if the filing is

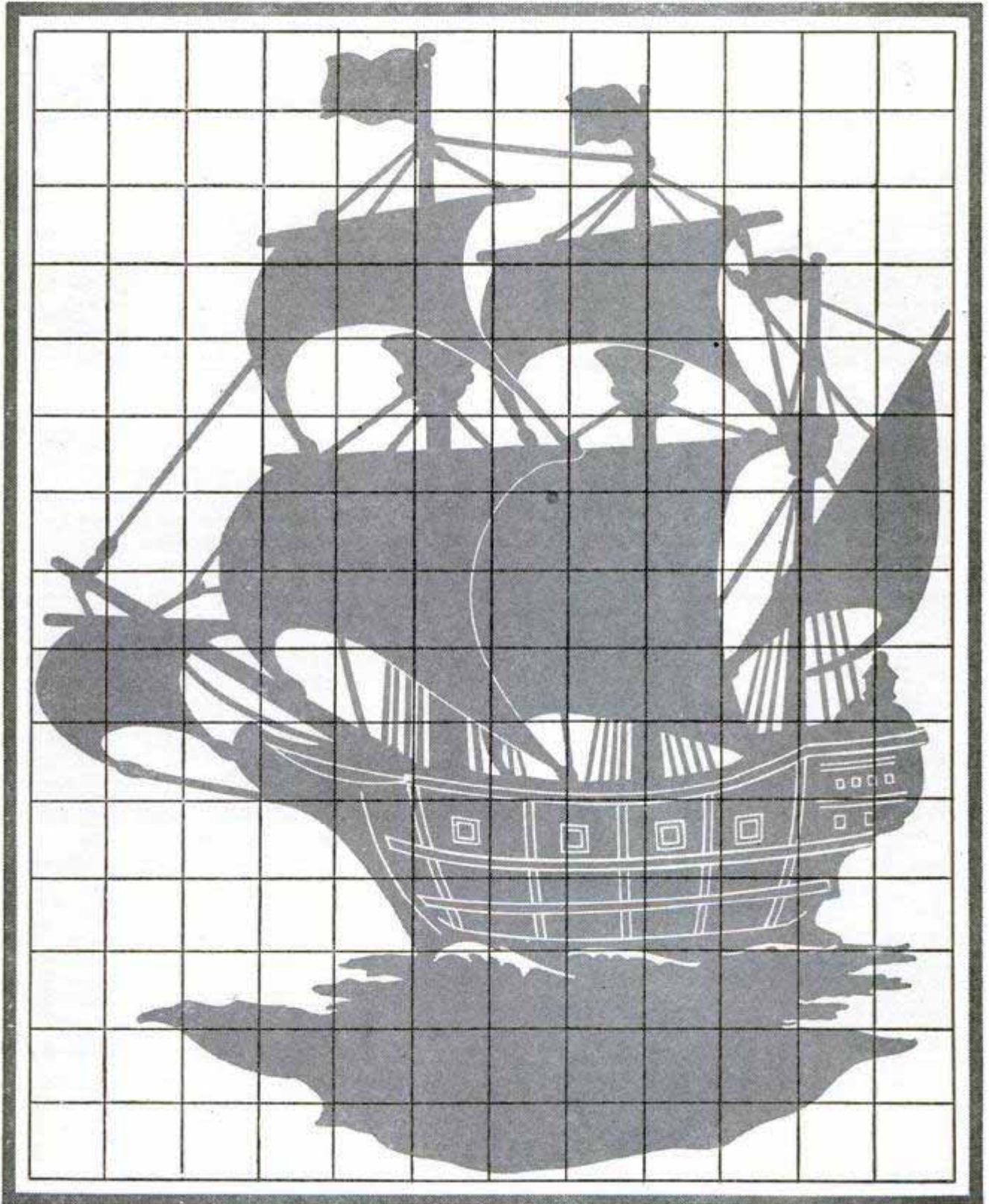

Each Side of the Square in the Diagram Above Represents One Inch, and the Enlarged Pattern Can Be Made by Measurement from This

done from the back, that is, the side opposite that on which the pattern is stuck, since the sawing roughs up the pattern to some extent. In fact, the writer pulled off the pattern and scraped off the cement as soon as the sawing was finished, and filed "by eye" only.

The next job to be done, when all the edges have been filed true and clean, is to remove the pattern and cement, if that has not been done before filing, and then to select the side that is to be the face of the finished ship. Choose the side on which there are no deep scratches that will show up when the work is finished. Clean this side by polishing it with No. 00 emery cloth, polishing only in one direction, and preferably straight up and down in the direction of the masts of the ship. Now heat the ship gently over a gas stove or electric plate, and, when hot enough to melt the paraffin wax, coat the sheet by rubbing the cake of wax over the surface. Coat the whole ship evenly and completely, and set aside for the wax to harden. Mix one part of the nitric acid with two parts of water to make the etching solution (adding the acid to the water, not the water to the acid), then scratch in the lines of the side strakes, ports, etc., shown in white on the layout diagram, through the hardened wax on the ship. Use a fairly blunt steel point for this, and be sure that the lines are cut clean through the wax down to the brass. Do not try to scratch in these lines freehand, but use a French curve as shown on page 345, so that the curves will be fair and sweeping.

Then apply the etching solution to the lines, using a medicine dropper for the purpose, and, when the lines have been etched deeply enough, which will take but a few minutes, wash the acid off with water. It is best, when using this method of etching, to work on one line at a time, so that the etching can be controlled more easily. This is not the best method of etching, but it is the quickest and simplest, and demands little equipment.

When all the lines have been etched deeply enough, wash off the paraffin with benzine, and look over the lines. Any that are not etched in deeply enough may be cut deeper by the use of a tool made from an old hacksaw blade (see page 342). This is ground as shown, so as to cut on the

draw, and is used with the French curve, just as in scratching the lines through the wax. If you are sufficiently sure of your command over the tool, you can dispense with the etching entirely and cut the lines in with the tool directly, first penciling in the lines lightly, and using the curve. Don't forget the line defining the after edge of the foresail, and those showing where the topsails come in front of the masts and tops.

The ship is mounted on the plaque by means of two No. 8-32 flat-head brass screws, 1 in. long, the heads being soldered fast to the back, one about the center of the hull, and the other above it near the top of the mainsail. Solder these on now, and make a good job of it. Drill two holes in the cutting board to suit the screws, and countersink them for the heads, drop the ship, with the screws through the holes, on the cutting board, and you are ready for the polishing.

Fold a piece of No. 000 emery cloth over a piece of  $\frac{1}{2}$ -in. felt, cork or even a piece of  $\frac{1}{2}$ -in. wood, and start polishing as on page 346. Polish always in one direction, in the direction of the masts, and follow the No. 000 emery with a piece of the finest crocus cloth you can obtain. Get as good a polish as you can with the crocus, then finish with a good brass polish. Clean away every particle of dust from around the work with a soft brush, paying particular attention to the interior corners, then fill in the etched or cut lines with India ink, using a fine pen. Do not let the fingers touch the surface while doing this; keep a piece of clean blotting paper under the hands. The ship is now ready for lacquering.

The lacquer used should be one intended for metal; do not use a furniture lacquer. Use a soft badger brush, fill it full of the lacquer, but not too full, then, starting at one side of the ship, draw the filled brush straight down from top to bottom, coating a strip of the ship. As quickly as you can, coat a second strip alongside the first in the same manner, and coat the whole surface in this way. You must work fast, and the edge of the first strip must still be wet when the second is coated. Also, each brush stroke must cover a strip completely, for you cannot go back over it; hence the importance of

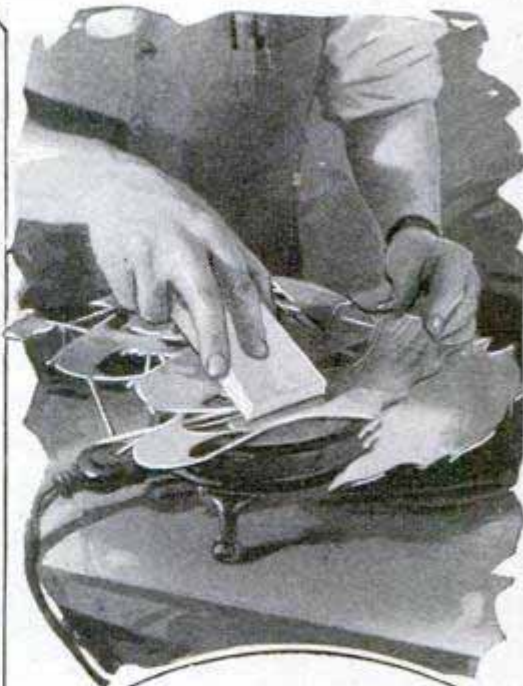
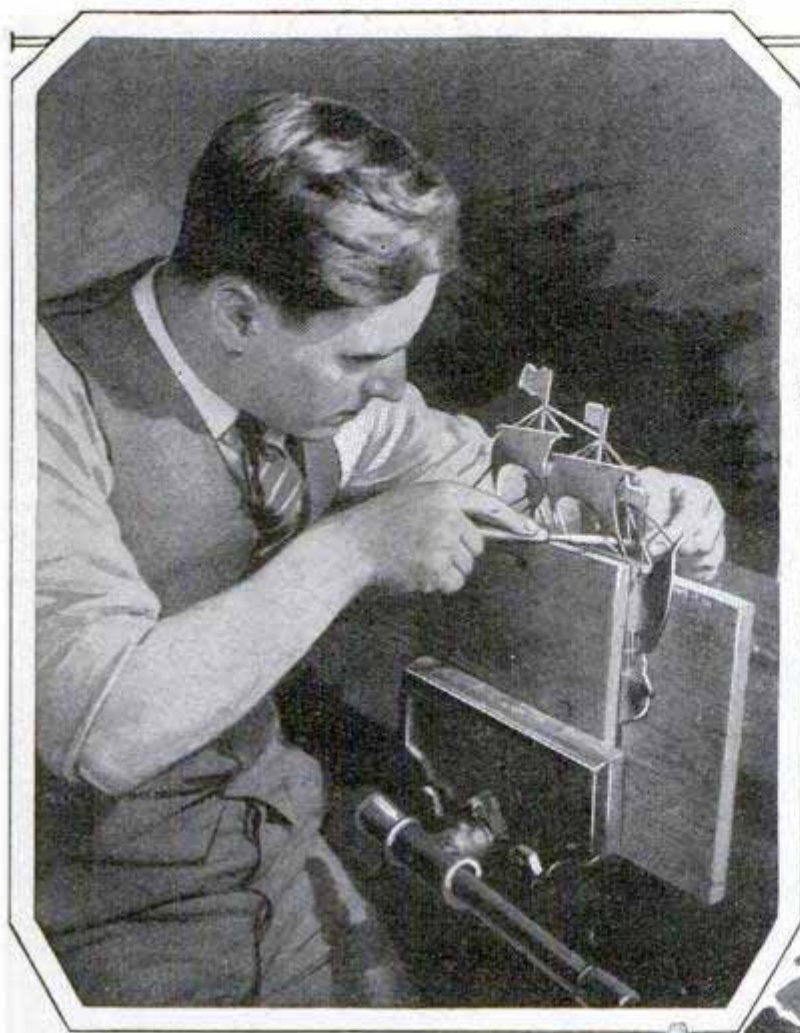

Left, Ship Clamped between Two Boards in Vise for Filing; the Edges of the Boards Come Up Close to the Edge to Be Filed, to Support It. File from the Side Opposite the Pattern, or Remove the Pattern before Filing. Above, after Filing, the Ship Is Heated on a Hot Plate and Coated with Paraffin Wax by Rubbing a Cake over the Surface; the Whole Surface Should Be Covered to an Even Thickness with the Wax, but as Thin as Possible



Above, Applying the Diluted Nitric Acid to the Lines Engraved through the Wax, Using a Medicine Dropper; Keep the Acid off Hands and Clothes. Right, Cutting the Lines through the Wax Coating, Using a French Curve to Get the Lines Bold and True

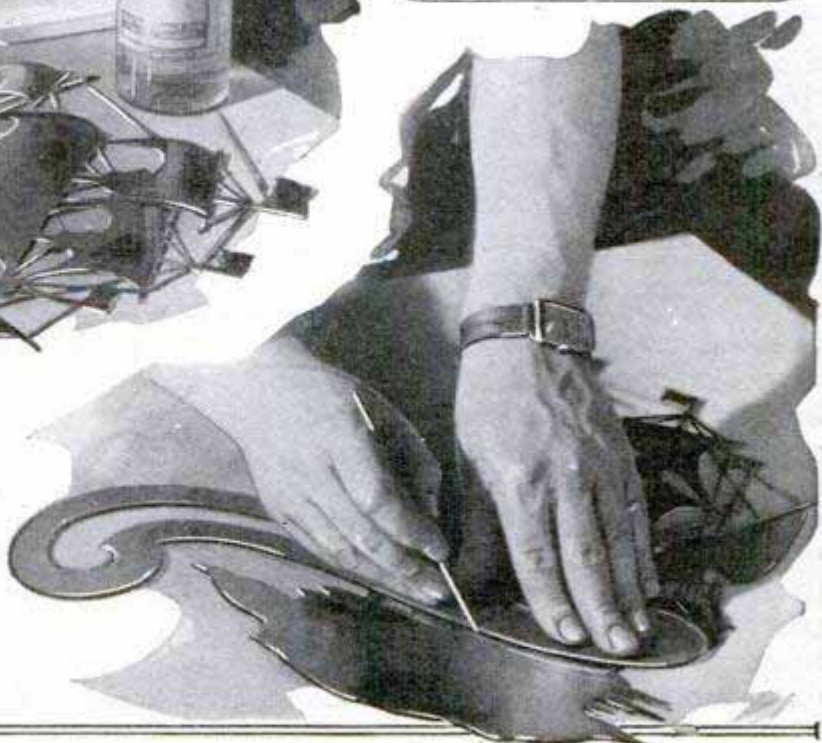

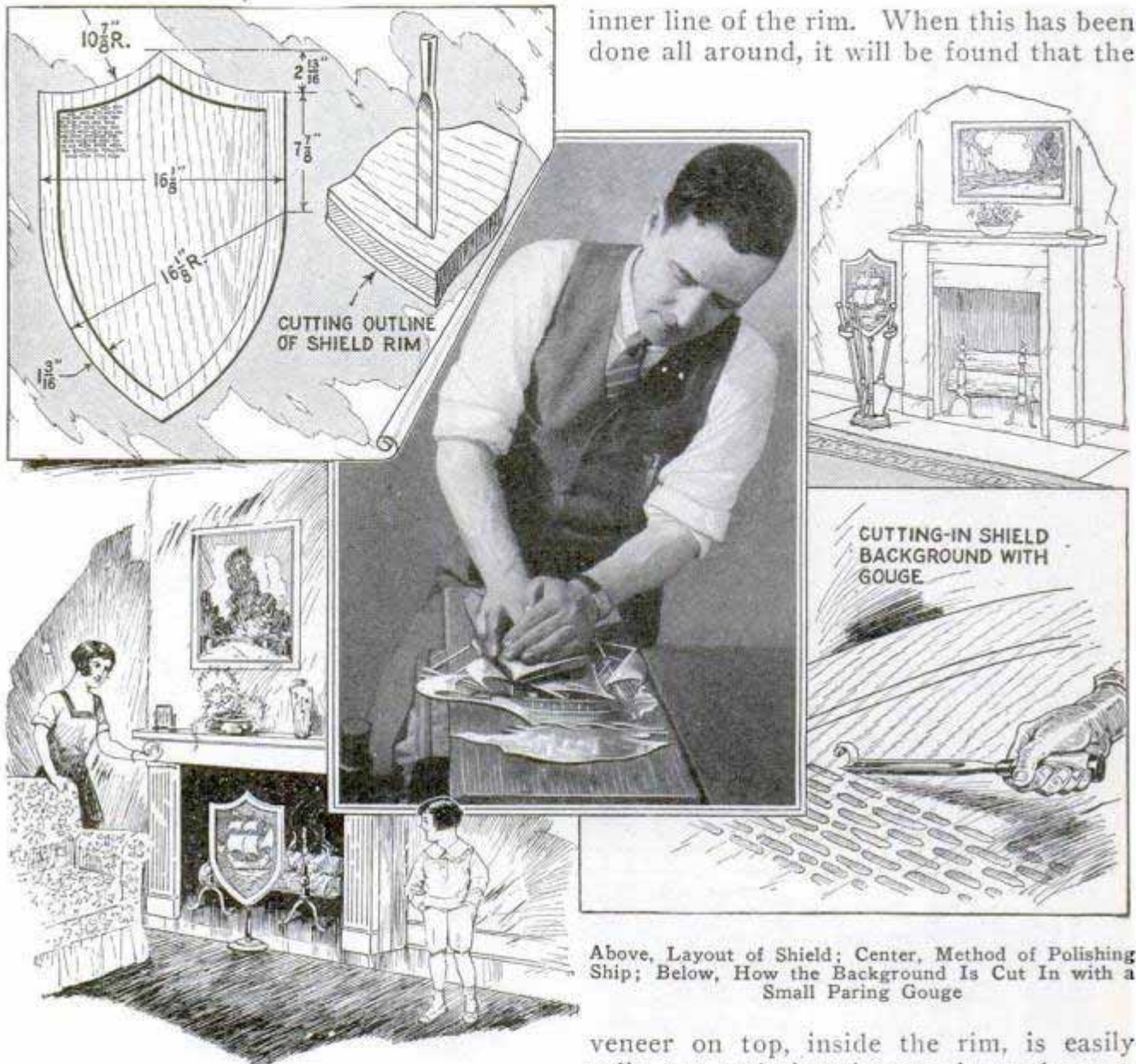

inner line of the rim. When this has been done all around, it will be found that the

Above, Layout of Shield; Center, Method of Polishing Ship; Below, How the Background Is Cut In with a Small Paring Gouge

the well-filled brush. Set the ship aside to dry while you make the shield. If the first job of lacquering is poor, wash it off at once with turpentine, repolish and lacquer again.

The writer happened to have on hand a piece of five-ply veneer of the proper size for the shield, and therefore this was the material used. It may be made in any way desired, however, and perhaps the best material would be oak, with the background carved out and the whole finished in dark Flemish. Or the rim may be made of a piece of  $\frac{1}{8}$ -in. veneer, cut out and glued in place on a flat back.

To make it in veneer, lay out the shape as indicated, using a piece of string, a tack and a pencil for the curves; then take a narrow chisel and cut down through the top two layers of the veneer along the

veneer on top, inside the rim, is easily split, cut and ripped away from the surface of the core, leaving the rim intact. Should the core, as it usually is, be knotty and full of holes or other imperfections, fill these up with plastic wood, or a good crack filler, and, when hard, pare and sand the surface down smooth. It will probably look pretty spotty after this operation, but pay no attention to this. Now take a  $\frac{1}{4}$ -in. gouge and go all over the background, as indicated in the drawing and in the photo of the finished plaque. Make the cuts all about the same depth, but varying in length. When the whole background has been treated, give it three coats of ivory black in japan (not in oil), also known as carriage color, allowing it to dry between coats. You don't want a shiny black behind the brass, but if the last coat of japan black is rubbed gently with a soft cloth, it will acquire a slight sheen and the

black will be deepened. Stain the rim to suit your taste. It looks best in dark oak, dark walnut or dark-brown mahogany, just a shade lighter than the background. Lighten up the stain for the edges, or they will be too dark, as they absorb the stain more. Give the rim a coat of shellac after the stain has had 24 hours to dry. When the shellac is dry, rub down with the very finest steel wool, taking care not to rub through the shellac; then give a coat of fine cabinet varnish. When this has dried at least 24 hours—or better 48—rub it down to an even, soft gloss with rottenstone and oil. If oak is used for the shield, it would be best to finish it with wax.

After the shield has been completed, lay the ship in the proper position on top of it, and press the screw ends into the wood to mark the position of the holes; drill these, countersink on top for the screw-heads and counterbore on the back for nuts and washers. After tightening the

nuts, cut off the projecting screw ends flush with the back of the shield. Put in a couple of fine screweyes on the back, almost at the top, for the cord to hang it with, and the job is done.

There are just two hints on hanging the plaque. Let it hang flat against the wall, not tilted forward at the top. If possible, hang it on the same wall as the window that lights the room. If hung facing a window, or with the light coming from one side, in certain positions the ship "glares." When hung on the same wall as the window, the "back light" deepens the black on the shield, and the ship looks splendid from any angle.

To simplify the task of laying out the ship design, we have prepared a full-size blueprint, which can be cemented direct to the brass sheet. Send 25 cents for this to Shop Notes dept., Popular Mechanics magazine, 200 E. Ontario st., Chicago, specifying ship-plaque blueprint.

### Concrete Mixture

A rich mixture of concrete consists of 1 part cement,  $1\frac{1}{2}$  parts sand and 3 parts gravel or crushed stone. This mixture should be used for structural parts where water is to be kept from columns and other parts subjected to high strain. A standard mixture consists of 1 part cement, 2 parts sand and 4 parts gravel. This should be used for reinforced foundations, for machines or engines, subject to vibration; for reinforced beams, columns, arches, floors, and for water-tight work, such as tanks, conduit sewers, etc. A medium mixture consists of 1 part cement,  $2\frac{1}{2}$  parts sand and 5 parts gravel. This mixture is used for ordinary floors, and machine foundations, piers, thin foundation walls, abutments, retaining walls, sidewalks and heavy-wall

sewers. A lean mixture consists of 1 part cement, 3 parts sand and 6 parts gravel. This mixture should be used only for heavy walls, backing for stone masonry and for large foundations.

### Keeping Building Paper on Sawhorse

When building paper is being used on a house-construction job, it is often difficult to find a place where it may be unrolled conveniently. One contractor found a sawhorse handy for this purpose. Two notched crosspieces were nailed onto the legs of the sawhorse, as shown in the illustration, and upon these the roll of paper was supported by means of a length of broom handle. The paper can thus be unrolled as needed, and the roll is at all times protected from damage.—G. A. Hendrickson, Argyle, Wis.

Sawhorse Holds  
Building Paper  
So It Unrolls  
Conveniently





Wide Rubber Band  
on Base of Torch  
Prevents It from  
Slipping

### Non-Slip Base for Blowtorch

When soldering eave-trough joints or roof valleys, it is often difficult to place a blowtorch in such a position that it will not slip yet be convenient. A Wisconsin tinsmith cut a wide rubber band from a discarded inner tube, and snapped it around the flanged bottom of the blowtorch, as shown in the drawing. The torch could then be placed on a steep roof without any tendency to slip.

### Improving the Small Forge

The average small-shop forge stands on three legs, has an 8-in. blower and a pan, 18 to 22 in. wide and about 3 in. deep. The blower is usually rated at 1 to 48 and has a sufficient blast for iron bars up to 1½ in. in thickness. However, the chief drawback is the shallowness of the fire, as by claying the pan to about half its depth, and using the remainder for fuel, the fire is seldom over 2 to 2½ in. thick, which is insufficient for heavy work.

With this in mind and noticing the lack of steady heat in my forge, I improved it as follows: I obtained a strip of heavy galvanized tin, about 6 in. wide, from a piece of culvert and cut it to the right length to fit around the pan and connect with the hood on both sides. This piece was securely and snugly fitted on the out-

side of the original pan with stove bolts, and similarly attached to the sides of the hood, to make the pan about 6 in. deep. It was then clayed to a depth of nearly 4 in., leaving a tapering hollow in the center, about 7 in. wide at the top and equal to the width of the tuyere at the bottom. The difference in the heat of the fire was surprising. To allow longer pieces of iron to be placed deeply into the fire, a hole, 3 in. wide and 2 in. deep, was cut in both sides of the pan, in a horizontal line across the center of the tuyere. To prevent wastage of coal through these holes, when not in use, they were closed by bending a light piece of tin, 6 by 4 in. in dimensions, to a U-shape so that it could be clipped over the side and pushed down on either side of the opening.

A good way to determine the right depth of a forge fire is to place a small piece of iron into the center of a good fire without a blast. The fire alone will keep the iron bright red. Now turn on a steady, slow blast; if the iron turns dark as soon as the blast is on, it is a certain indication that the fire bed is too shallow. The iron should be so deep in the fire that the air above will not cool it.—Joel E. Shoeberg, Rosewood, Minn.

### Staggered Screws Hold Cable

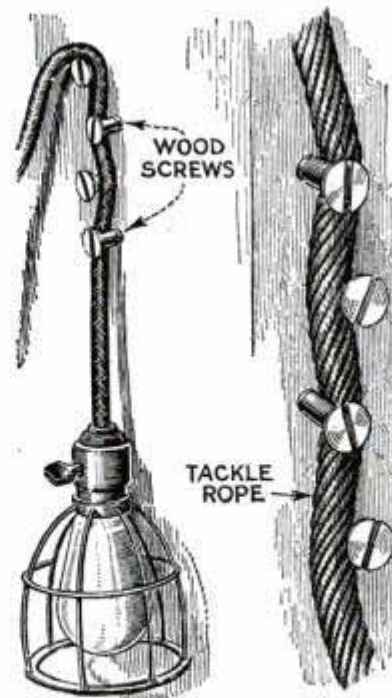

For the purpose of holding the loose ends of pulley ropes, hoisting cables or electric-light cords against the walls of buildings, the method shown in the drawing will be found convenient. Four screws are driven into the wall slightly staggered, so that the rope or

cable will be held securely when placed between the screw heads and wall as shown, and the cable will not be injured.



# Safety Hints for the Builder

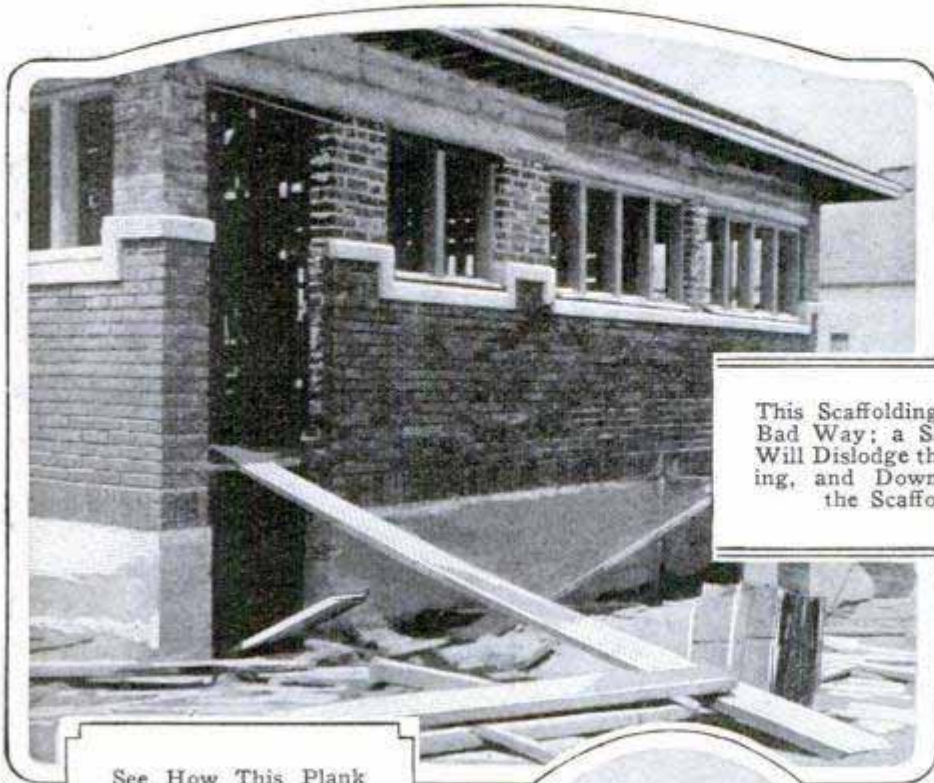

This Scaffolding Is in a Bad Way; a Slight Jar Will Dislodge the Blocking, and Down Comes the Scaffold



See How This Plank Sags under Its Own Weight; It Is More Than Likely to Break When a Man Carries a Load over It

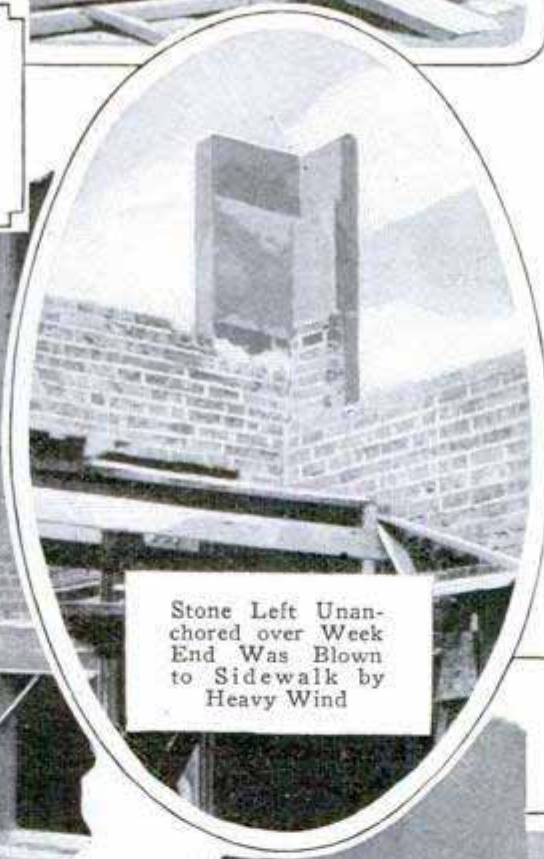

Stone Left Unanchored over Week End Was Blown to Sidewalk by Heavy Wind

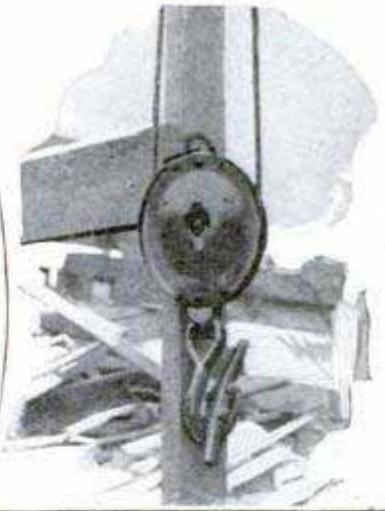

A Good Practice; Always Hook the Derrick Block to Prevent Its Swinging

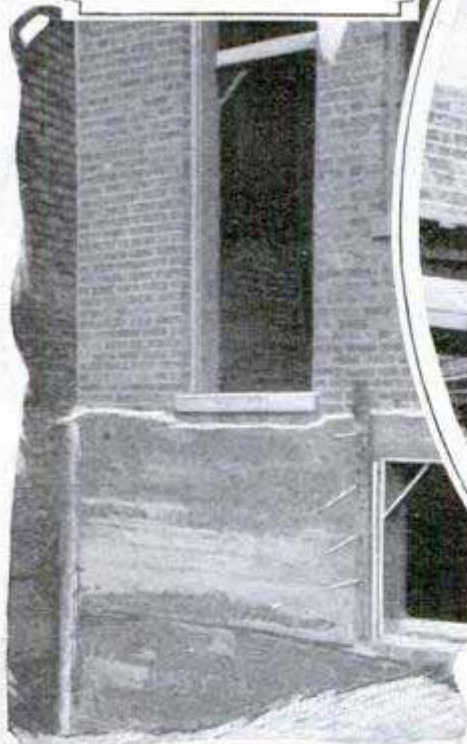

Never Leave an Opening, like That Above, Unguarded; Someone May Think the Level Outside Is the Same as That Inside and Injure Himself Badly; a Few Boards from the Scrap Pile Will Guard an Opening, as on the Right

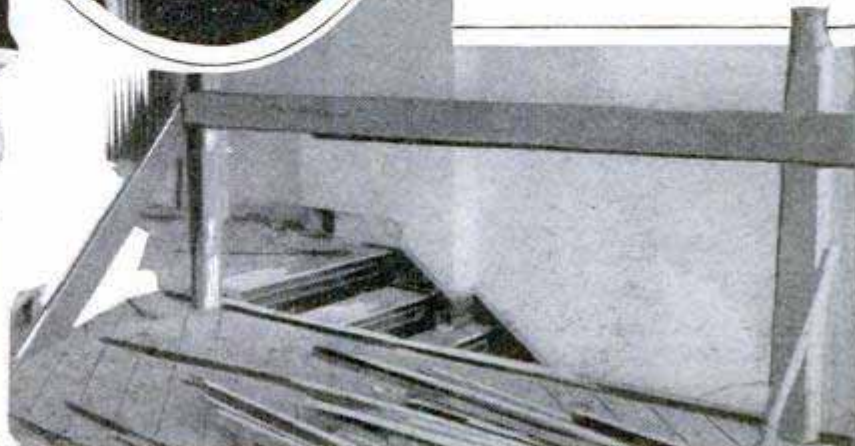

# Better Sifters for the Builder

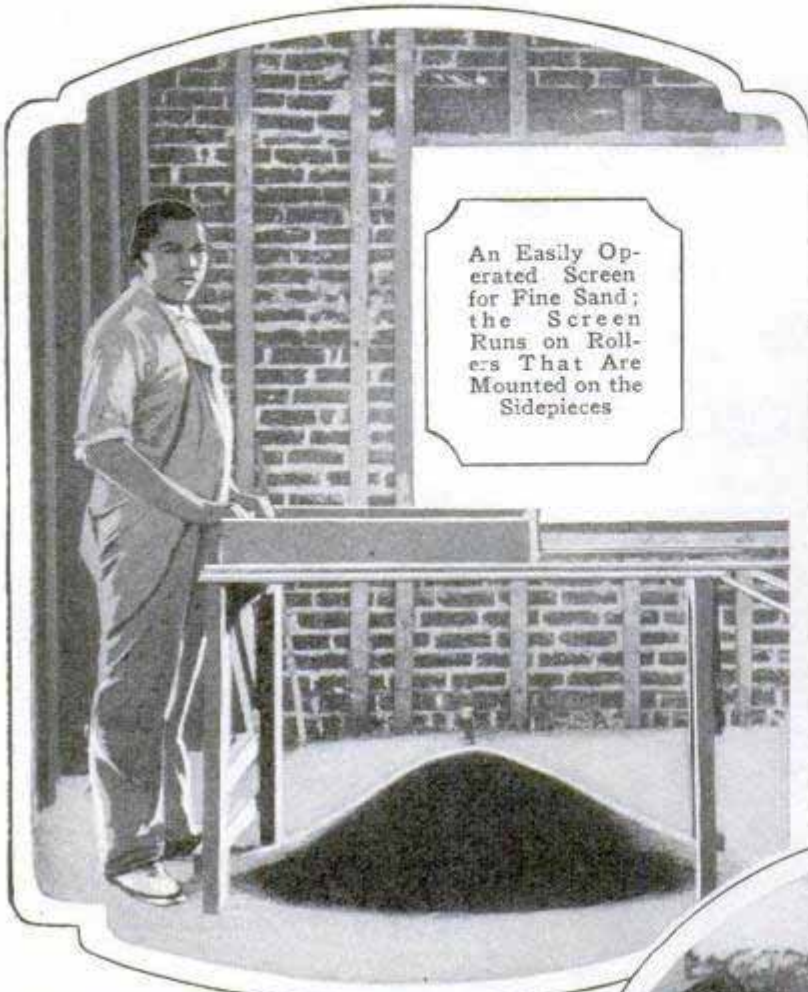

An Easily Operated Screen for Fine Sand; the Screen Runs on Rollers That Are Mounted on the Sidepieces



A Vertical Folding Screen; the Legs and Braces Fold against the Screen for Easy Transportation

The Roller-Screen Idea in Improved Form; a Piece of Pipe, Resting on Longitudinal Bearers, Forms the Roller; the Screens Have Handles Attached for Ease in Operating

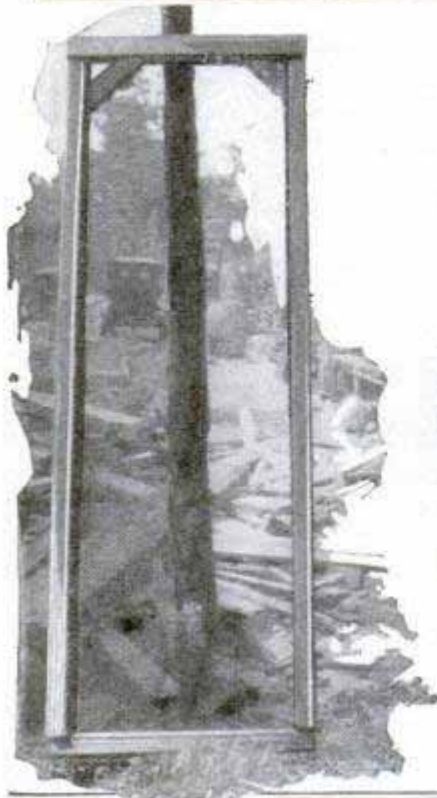
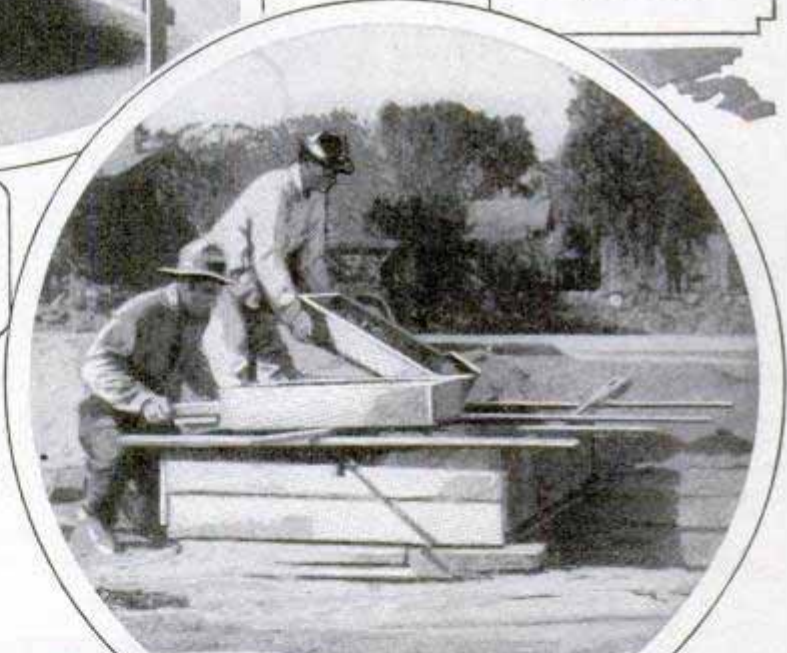

Left, a Vertical Sifter with a Wire-Lath Screen, for Use on Coarser Work

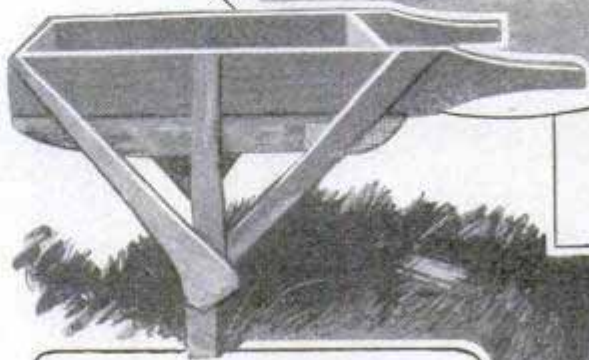

Left, a Tilting Screen That Takes Weight off the Arms



### Moving Stationary Engines

I had to move a 1½-hp. stationary gasoline engine for about 100 yd. and there was no one to help me. So I tipped it over, grasped the skids and pushed the engine over the ground just like a wheelbarrow. I found later that it could be pushed much more easily if the cotter pin in the intake-valve spring was first removed. In another case a 10-hp. gas engine was used at different pumps and had to be hauled from one to the other. This was hard to do until we noticed that the flywheels projected a trifle lower than the cast-iron base. Then, by raising the rear cylinder end, putting a mowing-machine axle and wheels under it and bolting it in place securely, we could drag it all over the ranch with one horse.—C. E. Mack, Jr., Sacramento, Calif.

### Dumping Boxes Help to Load Wagons

To speed up the work of loading wagons from freight cars filled with gravel and cement, the dumping box shown in the photo was found very helpful. It was hung over the side of the car so that the wagons could be driven directly under it. The workers inside of the car fill the box and when the driver comes to get a load he only has to pull a cord, which releases a catch and allows the bottom to drop open.

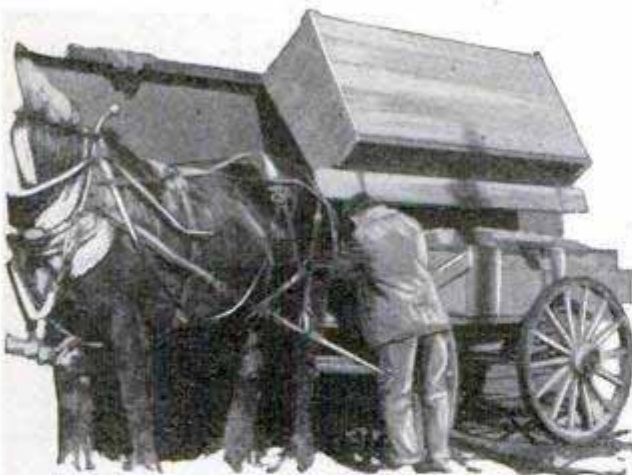

Dumping Box for Loading Sand or Gravel into Wagons from Freight Cars

After the contents has been dumped into the wagon, he closes the bottom and adjusts the catch so that the box can be refilled. The box holds 1½ cu. yd. of sand and four boxes can be hung on one car.—R. O. Parks, Beatrice, Nebr.

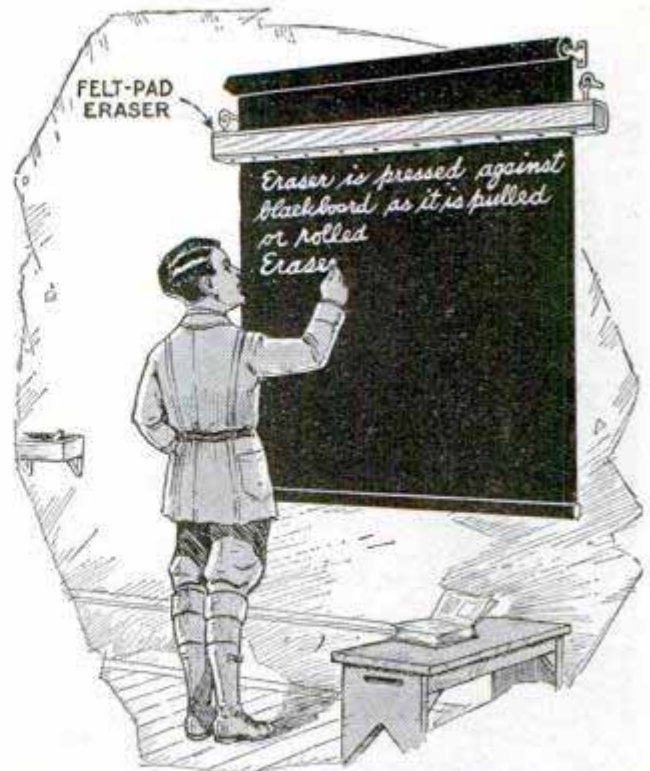

Self-Erasing Blackboard Used as Bulletin Board by Wisconsin School

### Self-Erasing Blackboard

A self-erasing blackboard is used in a Wisconsin high school for the announcement of school athletics or other school news. It consists of an ordinary window shade and shade roller, the shade being painted with several coats of blackboard paint. The roller is attached permanently to the wall near the entry door. Just below the roller and over the shade, is suspended an eraser, made from a suitable length of pine board covered on the inside with a heavy layer of felt. When an announcement on the board is "dead" and other copy ready, the shade is raised. By pulling the shade down again and pressing the eraser firmly against it, the board is wiped clean for use in an instant.

### Handy Stone Boat

Most farmers have occasional need for a stone boat for moving large, heavy rocks. An efficient one can be quickly improvised from a piece of ¼ or ⅜-in. sheet metal, or iron plate, and it is an easy matter to roll the stones on it with a bar. Two iron couplings are riveted to one end to permit the attachment of a chain, which is in turn hooked to the tractor, or doubletree if a team of horses are used.—James Hall, Victoria, Australia.

2068

# Is This Your Home?

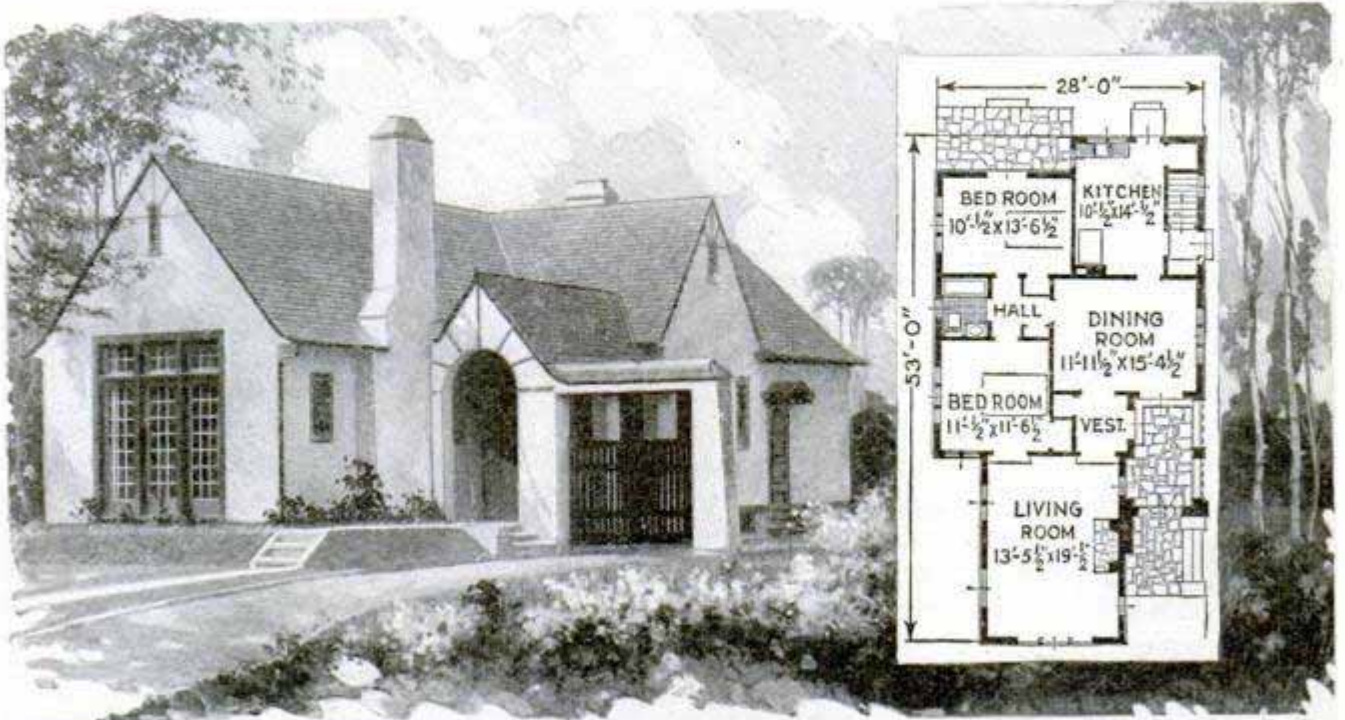

Copyright, Architects' Small House Service Bureau

Plan No. 5D28

**Q**UESTIONS regarding home building addressed to this magazine will be answered by The Architects' Small House Service Bureau of the United States, Inc., controlled by the American Institute of Architects and endorsed by the United States department of commerce. Inclose 10c and self-addressed envelope. Blueprints, specifications and material list for the house shown here may be obtained at nominal cost. Inclose self-addressed stamped envelope for reply. If further information is desired, send 5c and stamped envelope for a 24-page booklet explaining how the Small House Service Bureau functions and showing 12 sample plans. A new booklet, entitled "Fifty Ways to Lower Home Building Costs," illustrated by ten bureau houses actually lived in, and showing how as much as \$1,000 can be saved on a home, may be obtained for 20 cents.

**T**HIS design is an example of what may be done with a house that has its long axis corresponding with the long axis of the lot, and here we see how well this principle may be made to work.

The living room has been given the important position which it deserves. The lighting and ventilation are all that they could reasonably be. Placed in this position, there is a broad expanse of green-sward on three sides. Those parts of the house that are more directly associated with family life are placed at the rear. Certainly this living room is the distinct feature of the house. Its floor level has been lowered and its ceiling raised so that there is a clear height of more than ten feet. In the end is a great window, an English addition, and on one flanking wall is a massive fireplace.

One enters the house through a covered portico, beyond which is a vestibule. French doors also open onto the portico

from the dining room. The kitchen is placed at the rear, where its connection with services is convenient. Among these may be mentioned a door to the side entry which leads outside and to the basement stairs. There is also a door opening onto the service yard at the rear. At the left, two bedrooms with bath complete the sleeping quarters. At the rear of one of these there is an open terrace.

This design is an especially beautiful one. The high-pitched roof, massive outside chimney, great window in the living room, and gate to the garage driveway are marked by English influences. Here it forms a screen to the garage and adds to the privacy of the rear lot.

The construction is wood frame with exterior finish of stucco and roof of shingles in variegated colors; approximate width of lot, forty feet. The house should be faced to take advantage of prevailing winds and best exposures.

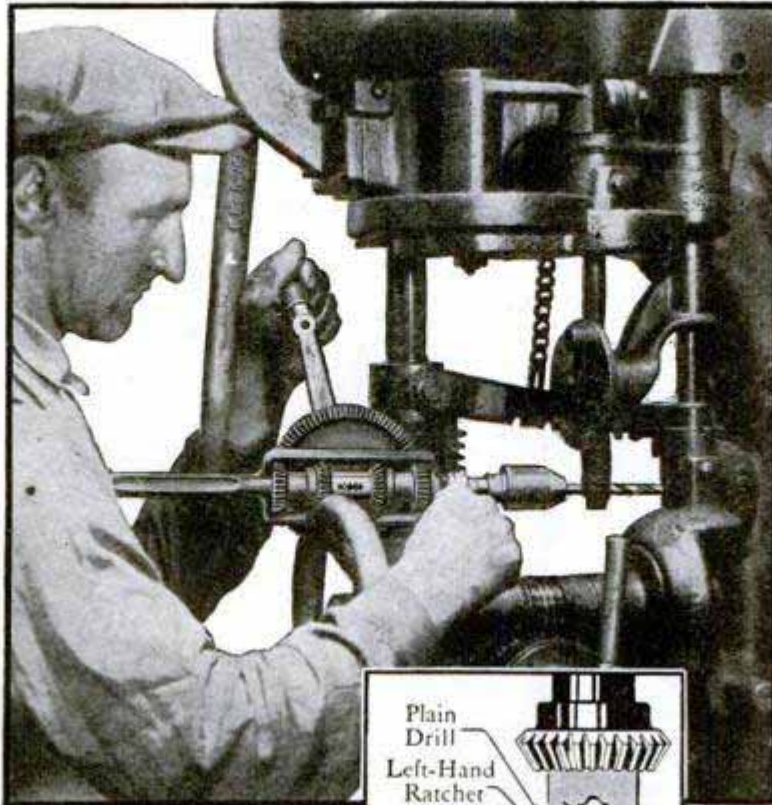

"Yankee"  
Ratchet  
Breast  
Drill  
No. 1555

A finger touch on Ratchet Shifter gives any one of five adjustments.

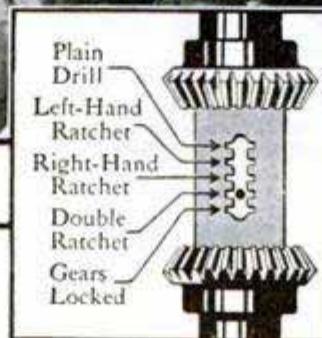

## A job can't hide from "YANKEE" No. 1555

Cramped space makes little difference. Lack of room to turn the crank doesn't matter — when you use "Yankee" Ratchet Breast Drill No. 1555. For "Yankee" ingenious design uncovers the work in spite of obstructions.

And nothing need be removed. No lost motion. No lost time. Simply set Shifter on DOUBLE Ratchet! Then the slightest movement of the crank, either back or forth, lets you drill continuously.

The four other ratchet adjustments shown above, and two speeds, make this "Yankee" Drill the handiest and fastest ever designed. You can change speeds instantly

without removing drill from work. Just shift lever at base of hub.

Ratchet Breast Drill No. 1555 (Illustrated), 3-jaw; No. 555, 2-jaw. Hold  $\frac{1}{2}$  in. Drills. Ratchet Hand Drill No. 1545, 3-jaw; No. 545, 2-jaw. Hold  $\frac{3}{8}$  in.

For smaller drilling jobs use "Yankee" Ratchet Hand Drill No. 1530, with five ratchet adjustments.

Some other "Yankee" Tools are: Ratchet Bit Braces, Spiral Screwdrivers, Automatic Feed Bench Drills, Automatic Push Drills, Plain Screwdrivers, Ratchet Tap Wrenches, Vises—removable base, etc.

Dealers Everywhere Sell "Yankee" Tools

"Yankee" on the tool you buy means the utmost in quality, efficiency and durability.

Philadelphia, U. S. A.

NORTH BROS. MFG. Co.,  
**"YANKEE" TOOLS**  
*Make Better mechanics*

FREE

"Yankee" Tool Book for all lovers of fine tools. Write for it.



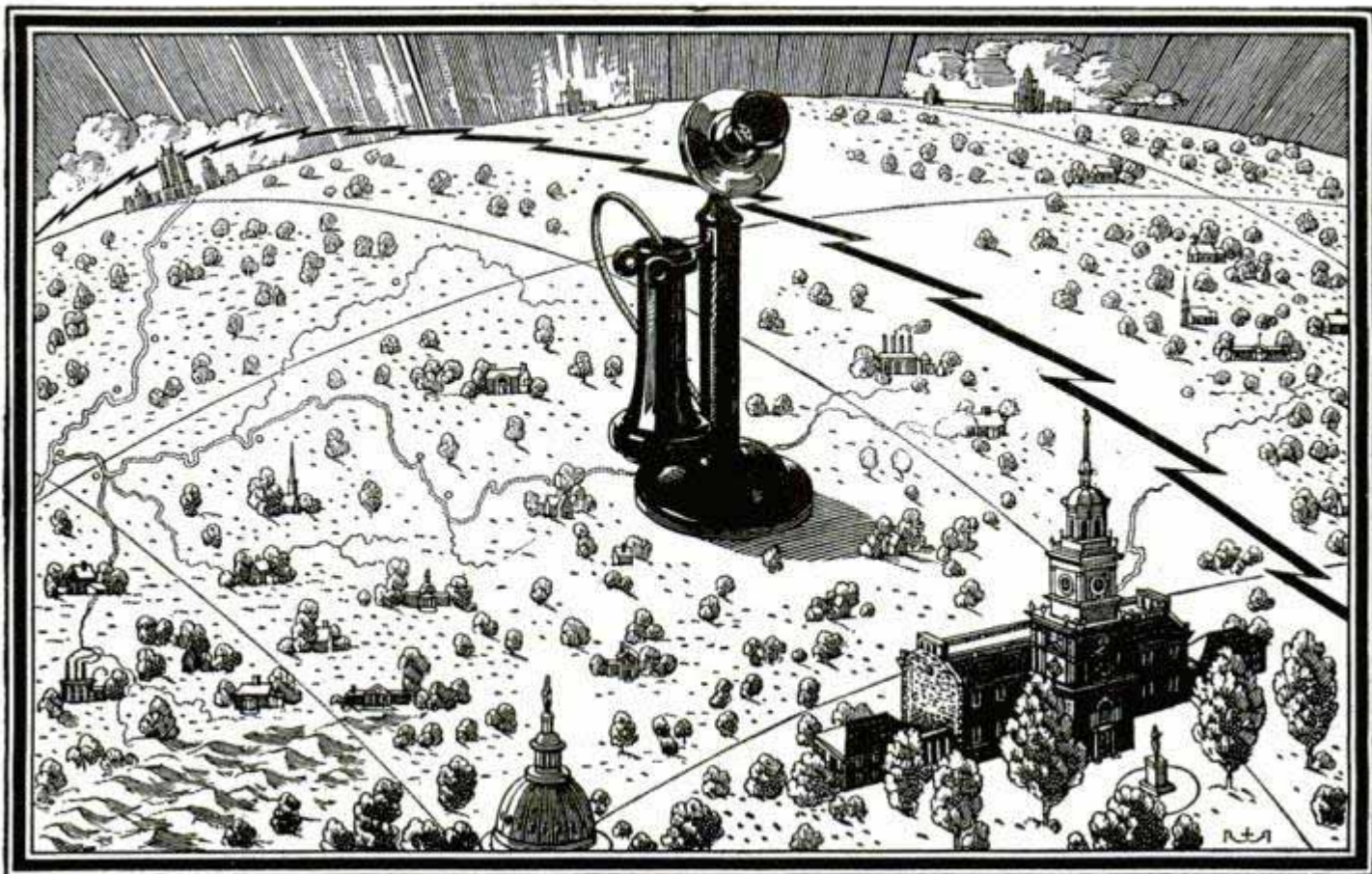

# The Traveler's Telephone

*An Advertisement of  
the American Telephone and Telegraph Company*

AMERICANS are the greatest travelers in the world. They have knit the country together by steel rails and made it the largest and most prosperous business community the world has ever seen. Business, friendship and political solidarity are maintained by personal touch, by travel and the telephone. Wherever the business man goes in this country, be it thirty miles or three thousand, he is still within earshot of his office, his family and his friends. He can get them and they can get him, and for the longest call in the United States the day rate is only \$12 and the night rate is only \$8.



For the Bell Telephone System is an idea in force nationally. All the instruments are designed in the largest industrial laboratory in the world and made in the same factories to the one standard of fitness. All of the telephone builders, repairers and operators are trained to the same ideal and aim; stated by President Walter S. Gifford as:

"A telephone service for the nation, so far as humanly possible free from imperfections, errors or delays, and enabling at all times anyone anywhere to pick up a telephone and talk to anyone else anywhere else, clearly, quickly and at a reasonable cost."

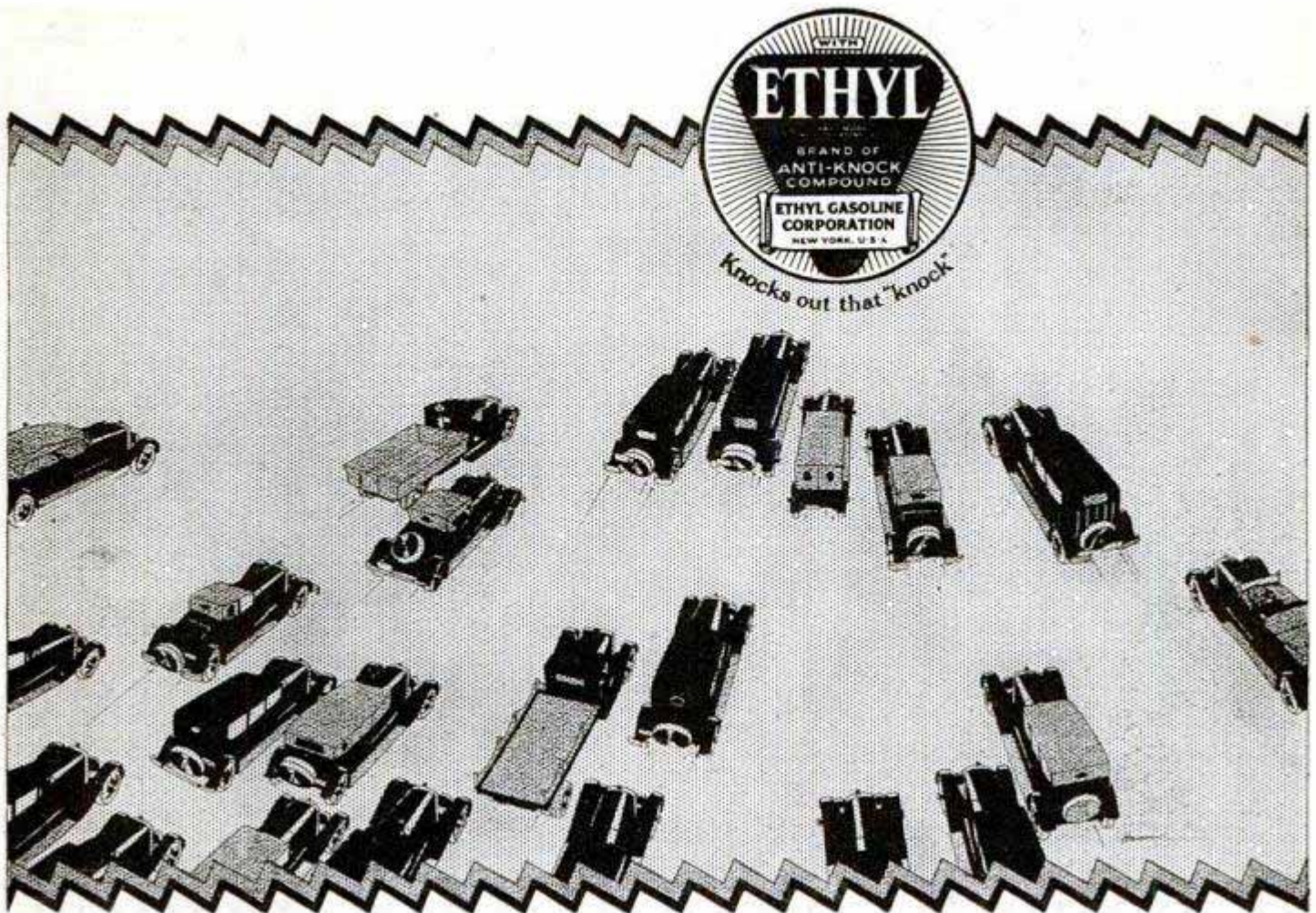

## Get the benefits of *high compression*

**A**UTOMOTIVE engineers have long known that the efficiency of gasoline engines increases as their compression is raised.

The compression of the present day automobile is as high as the limitations of ordinary gasoline permit. Gasoline is not a perfect fuel. It explodes too soon (*i.e.*, "knocks" and loses power) when it is compressed beyond certain limits.

That is why automotive research devoted many years to the development of "ETHYL" fluid, which, when mixed in very small quantities with motor gasoline, eliminates its knocking tendencies and makes it a high compression fuel. The fuel so mixed is Ethyl Gasoline.

Ethyl Gasoline has brought the benefits of high compression—greater power and flexibility, faster pick-up, reduced gear-shifting—to hundreds of thousands of motorists. This is because carbon deposits raise the compression of your engine beyond the point at which it was designed to perform efficiently with ordinary gasoline.

Try Ethyl Gasoline today. Enjoy a driving satisfaction and engine performance that you have never before experienced with your car. The "ETHYL" trademark above identifies the Ethyl Gasoline pump.

ETHYL GASOLINE CORPORATION, 25 Broadway, New York

### What high compression means to you

**T**HE principle of high compression is readily understood. The tighter you pack the powder charge in a muzzle loading gun, the greater the force given the bullet. Similarly, the tighter gasoline vapor and air are packed or compressed in the combustion chamber (the space between the head of the cylinder and the top of the piston) before ignition, the greater the power derived from the explosion.

Increasing compression therefore simply means decreasing the size of the combustion space, which may be accomplished mechanically or through the formation of carbon.

*In terms of you and your car, higher compression means a more powerful and flexible car, less gear-shifting, faster pick-up. In short, a performance impossible with lower compression and the use of ordinary gasoline.*

# ETHYL GASOLINE

Buy separately or  
in assortments

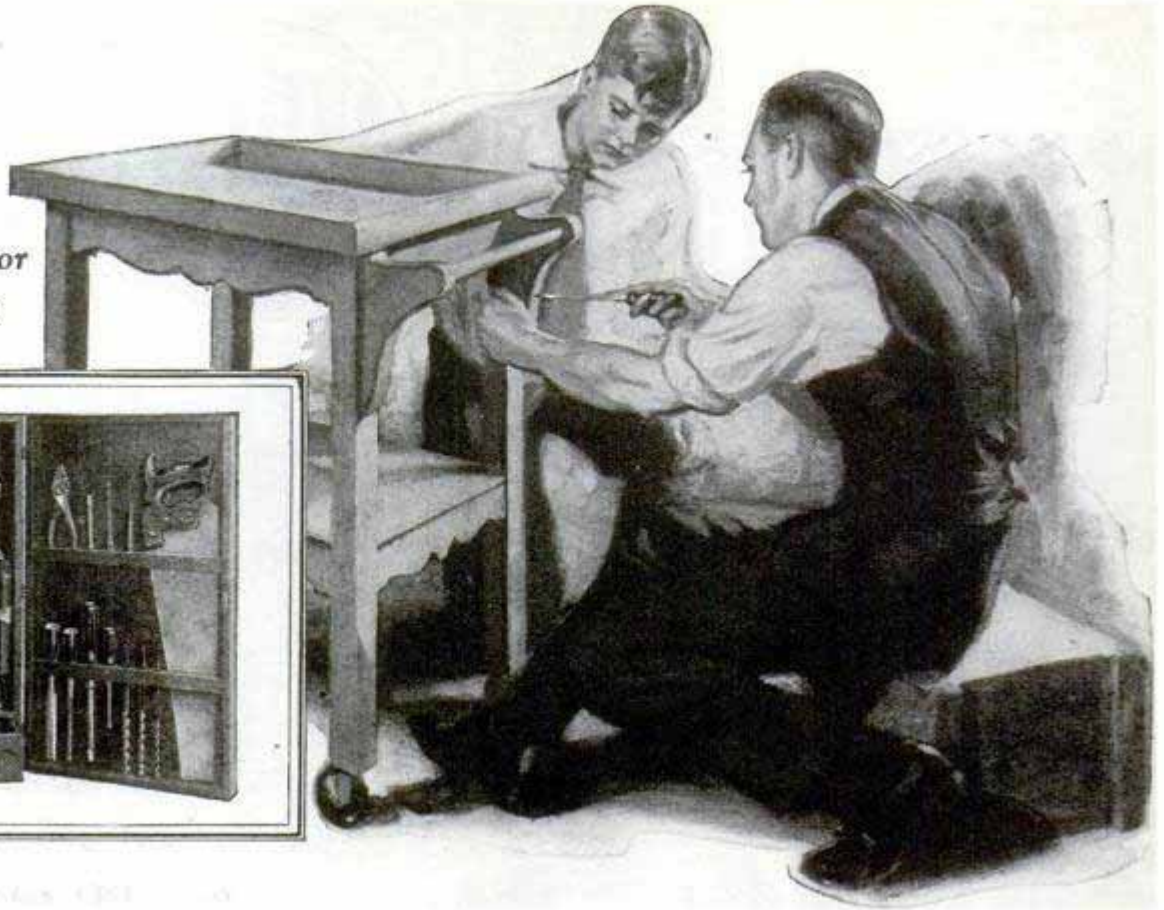

# A social celebrity in wood!

*Make a Tea Wagon from Plan No. 17d*

**T**HE tea wagon has long occupied the center of the stage at afternoon teas, bridge parties and informal luncheons. Why not make one for your own home? Stanley Plan No. 17d gives you all the necessary designs and details of construction. You will find it comparatively easy to make.



But it certainly doesn't pay to gamble on results by using inferior tools. In the long run the best tools are really the cheapest to use. Carpenters the world over prefer Stanley Tools. They know that the name Stanley assures durability, correct design, and right "feel." And Stanley Tools are first choice in thousands of manual training classes.

You can buy Stanley Tools separately and so collect your own set. For your convenience in buying there are also complete sets of Stanley Tools in chests at a wide variety of prices from \$15 to \$95. Or there are assortments in strong cardboard boxes containing directions for making your own tool chest. Priced from \$5 to \$20.



Your hardware dealer has Plan No. 17d as well as other Stanley Plans for making useful articles, or he can get them for you. Plans cost only 10c each. Ask him for small Catalog No. Sd50, which shows many useful Stanley Tools. It is free. If he cannot supply you write to The Stanley Works, New Britain, Conn.

The best tools are the cheapest to use  
Ask your hardware dealer



# STANLEY TOOLS



---

---

**N**  
**I** T'S WHAT THE *YOUNGER CROWD* THINKS ABOUT IT!

**N**OW the whole world  
talks the language of this  
younger generation, follows  
their fashions, plays their  
flashing games—and obviously  
takes their opinion on tobacco  
matters very seriously, for  
the younger set's most favored  
brand is the *largest selling*  
*quality cigarette in the world!*

**F A T I M A**



*What a whale of a difference just a few cents make!*

---

---

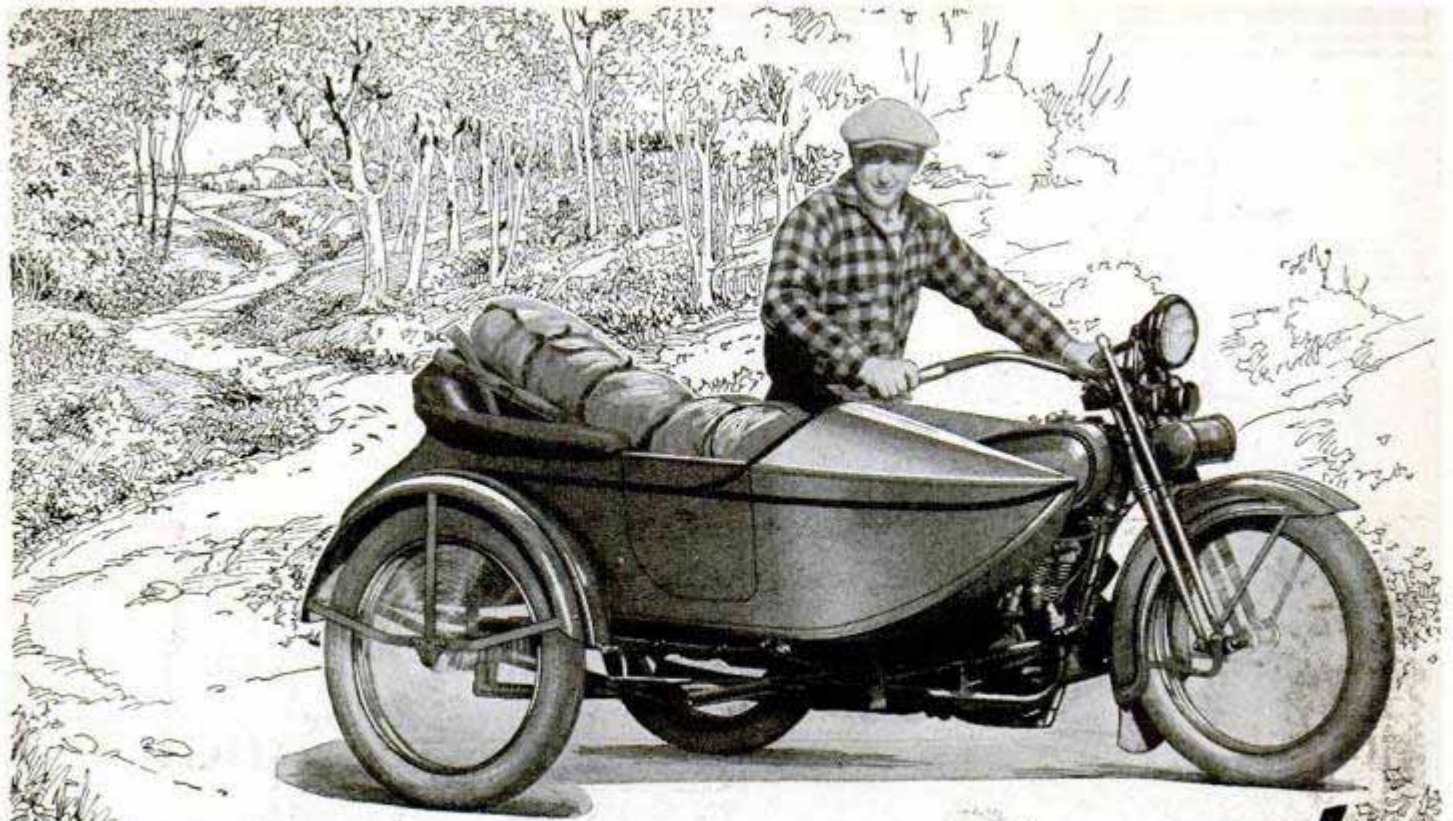

## All Outdoors Is Yours!

**S**LIP AWAY from traffic jams and city heat ~ miles into the green, fresh country. Follow the trail to happy, carefree hours. Week-end trips with tackle and rod! Moonlight spins in the clear night air! Glorious vacations that will never be forgotten! Thrills galore! Fun aplenty!

All yours with a Harley-Davidson Twin. There's room in the sidecar for a friend and your outfit. Up-keep cost is only 2 cents per mile for gas, oil, tires and all ~ a fraction the cost of a car!

Prices as low as \$310 f. o. b. factory ~ on easy Pay-As-You-Ride terms. See your dealer ~ send coupon for catalog.



The single is the famous Harley-Davidson solo mount ~ 80 miles per gallon!

HARLEY-DAVIDSON MOTOR COMPANY  
DEPARTMENT P MILWAUKEE, WIS.

# HARLEY-DAVIDSON

## Motorcycles

HARLEY-DAVIDSON MOTOR CO.  
Dept. P, Milwaukee, Wis.  
Interested in  Twin  Single  
Send catalog.

Name.....  
Address.....

# KUPROX

*No Bulbs • No Liquids • No Noise*

## DRY ALL-METAL REPLACEMENT UNITS



### KUPROX

*No Bulbs • No Liquids • No Noise*

can be attached to any standard trickle charger or power unit in less than two minutes without tools of any kind

Merely disconnect the acid jar and throw it away—acid and all. Install KUPROX in its place and make two simple binding post connections. Attach the charger to the battery and forget it.

Price, Complete ready for installation

**\$4.50**  
from any  
radio dealer

DEALERS—JOBBERs

Write for complete trade details and discounts.

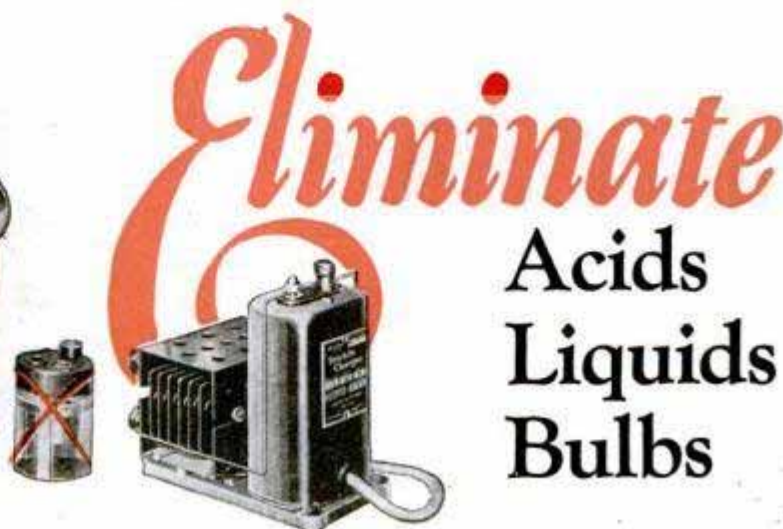

*Eliminate*  
Acids  
Liquids  
Bulbs

## in Trickle Chargers and Power Units

Modernize your trickle charger or "A" power unit—throw away the messy acid jar—install the new KUPROX all-metal replacement unit—eliminate all troubles, all the attention, all the bother. THE KUPROX dry, all metal unit replaces acids, liquids, bulbs with their constant watering and attention. It brings your old trickle charger or power unit up to date—makes it dry, silent, everlasting.

**Makes any trickle charger, dry, silent, everlasting**

KUPROX can be attached to any trickle charger or power unit. Once installed your charger requires no watching, no watering, no attention of any kind. The KUPROX replacement Unit is all-metal. It uses no acids, no liquids—it has no moving parts—nothing to wear out.

**KUPROX doubles the charging rate—  
Requires No Attention**

KUPROX doubles the charging rate of any standard electrolytic charger. Keeps your battery always in tip-top shape, packed full of power. If your dealer cannot supply you write to us for information as to where you may purchase KUPROX. If you intend purchasing an "A" eliminator or power unit, insist that it be KUPROX-equipped.

{ Write for free literature illustrating the new KUPROX dry Trickle Chargers and Transistors (A, B, and C Battery Eliminators). }

THE KODEL RADIO CORPORATION

517 E. Pearl St.

Cincinnati, Ohio

The story of the remarkable discovery of KUPROX was told in the July issue of Popular Mechanics—pages 5 and 6—"Copper that Defies Electrical Laws"

# We Amaze Men

With this shaving cream, whatever they expect



GENTLEMEN:

It's hard to make you realize that the five superiorities of Palmolive Shaving Cream aren't just "selling talk." They sound too good to be true. Yet they've tempted millions to ask for samples.

On that sample our whole case rests. We let you prove to yourself that our claims are justified.

### 5 exclusive features

1. Multiplies itself in lather 250 times.
2. Softens the beard in one minute.
3. Maintains its creamy fullness for 10 minutes on the face.
4. Strong bubbles hold the hairs erect for cutting.
5. Fine after-effects due to palm and olive oil content.

### All we ask is a chance

While your present method may suit you well, still there may be a better one. This test may mean much to you in comfort. Send the coupon before you forget.

To add the final touch to shaving luxury, we have created Palmolive After Shaving Talc—especially for men. Doesn't show. Leaves the skin smooth and fresh, and gives that well-groomed look. Try the sample we are sending free with the tube of Shaving Cream. Here are new delights for every man. Please let us prove them to you. Clip coupon now.

THE PALMOLIVE-PEET COMPANY  
CHICAGO, ILL.

3698

## 10 SHAVES FREE and a can of Palmolive After Shaving Talc

Simply insert your name and address and mail to Dept. B-1368, Palmolive, 3702 Iron St., Chicago, Illinois. Residents of Wisconsin should address Palmolive, Milwaukee, Wisconsin.

(Please print your name and address)

# More than HUMAN

The only automatic self-adjusting filament control, supplying at all times just the current your tubes require. Insures 100% tube performance. Safeguards against damage. Eliminates hand rheostats. Simplifies wiring. Insist on Amperite. Refuse substitutes claimed just as good. Price \$1.10 complete.

RADIALL CO., 50 Franklin St., New York City



Write Dept. PM 8 for new "Amperite Book"

## AMPERITE

The "SELF-ADJUSTING" Rheostat



THIS 100 PAGE  
RADIO  
CATALOG  
FREE

Contains "Hook Ups"  
5 Radio Illustrations  
500 Over 1,000  
Articles

"Build your own with 'RASCO' Parts"

RADIO SPECIALTY CO., 98 E Park Place, New York, N. Y.

# RADIO AT HALF USUAL COST

Now—we give 30 Days' Free Trial on newest 5-tube—ONE DIAL—Coast to Coast Radio. Buy direct from factory—save half and get 2 year guarantee. Full line table type, consoles or complete outfits at prices that will surprise you. Over 15,000 satisfied owners. Don't buy any Radio until you write us for FREE Catalog, low prices and 30 Day Trial offer.

Westingale Electric Co., 1761 Belmont Ave, CHICAGO

## FREE RADIO MAP

Size 28 x 33 inches with rule for measuring distances. List of radio stations, with call letters, and wave length. FREE if you send us names and addresses of five friends who have radios and what kind.

A. A. VIKING, 124 W. Austin Ave., Chicago

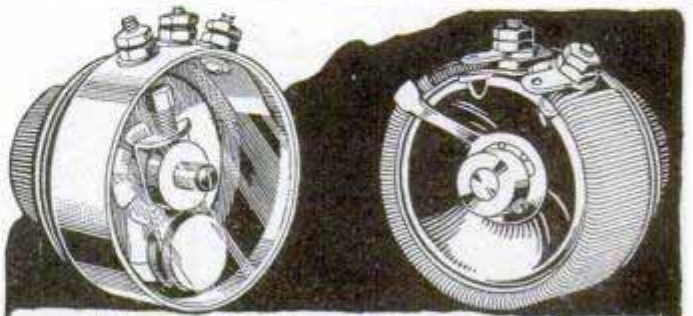

### Thoroughbreds of the Radio Field

THESE popular Frost-Radio items are quality-built products of the world's largest radio parts factory. Ask your dealer about the Frost-Radio DeLuxe Super Variable High Resistance Unit and the Frost-Radio DeLuxe Metal Frame and Bakelite Rheostats and Potentiometers. They give long service, operate smoothly and noiselessly and cannot burn out. See your dealer today.

HERBERT H. FROST, Inc., Main Offices and Factory: ELKHART, IND.

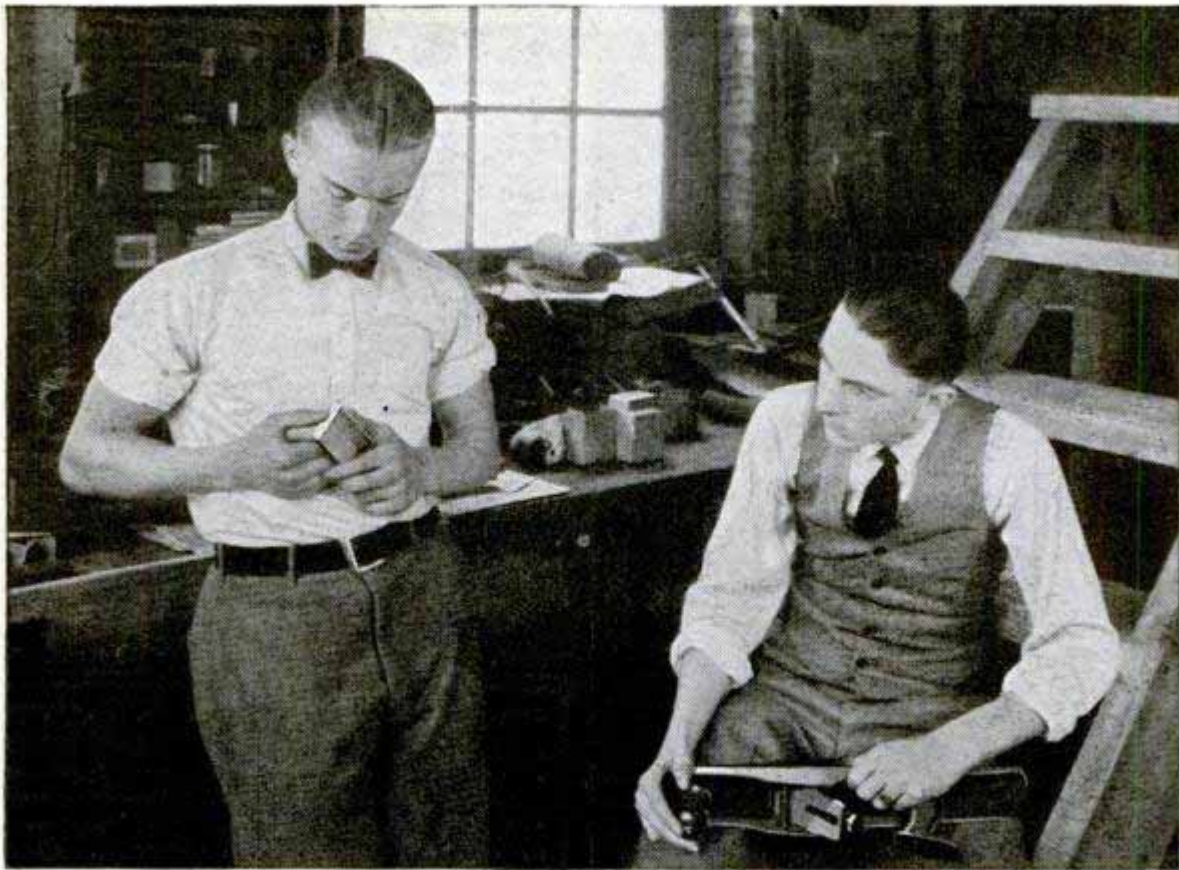

## Keeping an Auto-Set sharp is child's play

THE thin chromium steel cutter of a Sargent Auto-Set Plane is as tough and as keen as they come. It doesn't nick easily; it keeps its edge for a long time. But when it does need to be sharpened, it can be taken out, sharpened, and put back at its former place with no fussing to readjust whatever. This is an exclusive Auto-Set feature. You can imagine the time it saves, and the better work it means.

The Auto-Set and the small Sargent Steel Block Plane should be on every home and school bench. They cost much less than you would expect the tools of professional carpenters to cost. They are so strongly made that you should never have to replace them. With them any job is quickly finished. See them at dealer's. Write for booklet. Sargent & Company, *Manufacturers*, 49 Water Street, New Haven, Conn.

# SARGENT PLANES

*Sargent Steel Block  
Plane No. 5206*

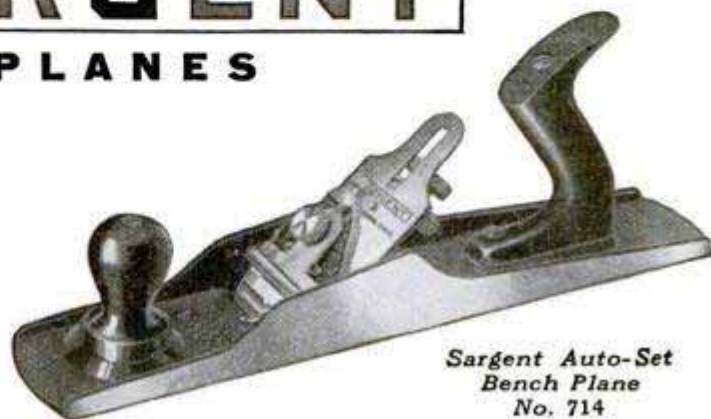

*Sargent Auto-Set  
Bench Plane  
No. 714*

*painting?*  
... *remodeling?*



Send for facts about this  
new way to save money

A NEW way to reduce paint-bills! Lay Creo-Dipt Stained Shingles right over the old side-walls. Costs only a third more than re-painting; saves its entire cost in paint-bills alone in the first 5 to 7 years.

Creo-Dipts over side-walls save fuel, too—many owners estimate as much as 15% to 25% per year. And they make your house cooler in summer, because they add a coating of insulation which keeps out summer-heat as well as winter-cold.

Send for helpful photographs

Thousands of home owners are re-beautifying their old homes with Creo-Dipts over side-walls—re-roofing with them, too! Send for photographs of these old homes... color suggestions, too. See how Creo-Dipts could re-value your old home. Mail the coupon now!

Genuine Creo-Dipts are carried in stock by leading lumber-dealers everywhere.

## CREO-DIPT Stained Shingles

MAIL THIS COUPON



Creo-Dipt Co., Inc., 1229 Oliver St., No. Tonawanda, N. Y. (In Canada: Creo-Dipt Co., Ltd., 1610 Royal Bank Bldg., Toronto.) Sales offices in principal cities.

Enclosed find 25c for portfolio of large-size photographs of Creo-Dipt homes, booklet of color suggestions, and name of local Creo-Dipt dealer.

Check the use that interests you

Covering old side-walls  New roof   
Building new  Re-roofing

NAME.....

ADDRESS.....

© C-D Co., Inc., 1927

## 30 DAYS FREE TRIAL 7 Tube-Single Dial RADIO SET

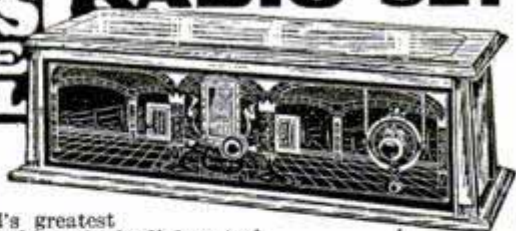

Write TODAY for This Wonderful Offer Direct from

Factory! World's greatest radio. Perfect working, single dial control, 7-tube receiver, shipped to your home for 30 days' free trial. Test it for distance, volume and tonal quality—and if you are not convinced that it is the best single dial set you ever heard, return it to factory.

Retail Price

**\$75**

Completely Assembled

### Metrodyne Super-Seven

Only one dial tunes in all stations. Get 1,000 to 3,000 miles on loud speaker. Easiest set to operate. Highest grade parts used. Magnificent Two-tone Walnut Cabinet.

Big Profits to Agents and Dealers

selling Metrodyne radios. All or part time. Great money making opportunity. Demonstrating set on 30 days' free trial. WRITE FOR OUR OFFER.

METRO ELECTRIC CO.

2161 N. California Ave., Dept. 14B CHICAGO, ILLINOIS

## RADIO PANELS OF GENUINE BAKELITE

Cut, drilled and engraved to order. Send rough sketch for estimate. Our complete Catalog on Panels, Tubes and Rods—all genuine Bakelite—mailed on request.

STARRETT MFG. CO. 524 S. Green St. Chicago, Ill.

## RADIO DEALERS' CATALOG—FREE!

A most complete catalog of everything in Radio. All the latest hook-ups. Sets, Parts and Kits of every description. Live Dealers need this book. Write on your business stationery.

COLUMBIA RADIO CORP., 711 W. Lake St., Dept. 246, CHICAGO, ILL.

## BURGESS RADIO BATTERIES

## SET BUILDERS!

Before you build get our special prices on the parts you are planning to use. We'll save you money. Largest and most complete stock in U. S. A.

CHICAGO SALVAGE STOCK STORE  
Dept. P. M. 509 S. State St., Chicago, Ill.

The man who studies gets ahead. Popular Mechanics Press will advise you what books to read to advance in your trade. 200 East Ontario Street, Chicago, Illinois.

## SOLDERALL

METAL IN PASTE FORM



Every Electrical Connection needs Solderall for perfect reception  
The SOLDERALL CO., NEWARK, N.J.

# New and Better Furnace!

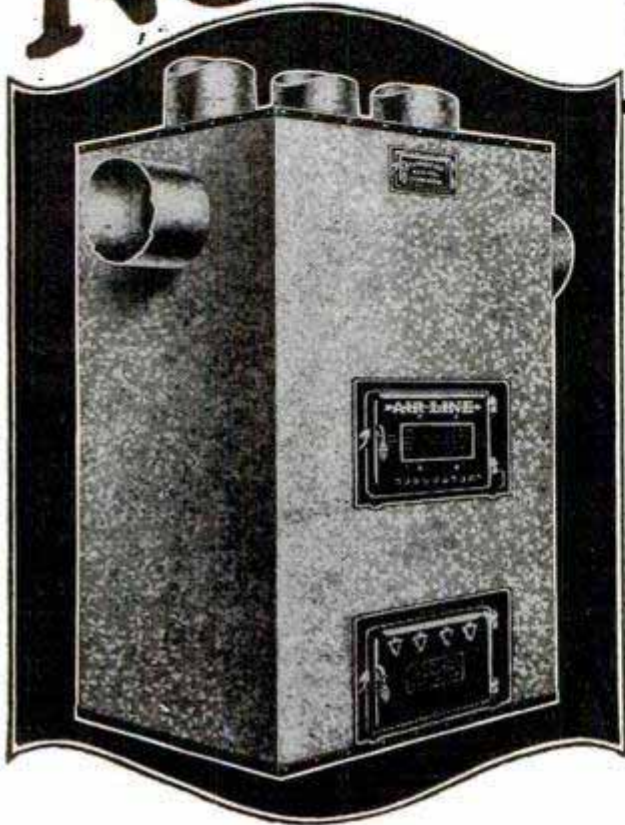

## AIR-LINE Heating System Not a Pipeless

The Air-Line firepot burns ANY fuel and LESS of it; because it is lined with Power Plant Fire Brick and has Oxidizers that get the entire heat value out of any fuel. Keeps even a wood fire over night! The Air-Line is absolutely dust proof and gas tight and its copper-steel Fire-Ray Radiator receives all the direct rays of the fire. No dark sooty flues to waste the heat.

**H**ERE is the latest and greatest advance in heating. It circulates fresh, warm air through your home, just as hot water is circulated through a radiator. There is an individual air supply for each principal room, so that no room is either over or under heated. The circulating grills are so located that there are no disagreeable drafts along the floor. No other heating method affords such economy, comfort and safety as does the Air-Line.

## 4 Tons Heats 8 Rooms!

"The Air-Line is the best heating system there is! It heats my 8-room house perfectly and saves fuel, too, as I burned only 4 tons of coal."—Frank Faber, 37 Center St., Little Ferry, N. J.

### Comes Completely Assembled— You Install It Yourself

Yes, in a few hours! Send us no plans! If your house is from 4 to 8 rooms, just write us and we will send you the Air-Line for FREE INSPECTION. You will receive the heater, welded together and cased at the factory with all collars cut in, ready to receive the piping, in one substantial crate. Just place the heater in position, and knock off the crate. In another crate is all the necessary piping for the average house, so standardized that you can put it together **more** easily than you can put a smoke pipe on your kitchen range. In a few hours after receiving the Air-Line you can have a fire going and a thoroughly warm house.

# No Money Down Then Small Monthly Payments

**Send for Free Book!** Mail the coupon for our free book and special offer. **Do it NOW!**—while this great offer lasts! You do not pay us one cent until after you have received the heater and are absolutely satisfied that you want it. Then you make only small monthly payments at our low price. And the Air-Line soon pays for itself in fuel saved!

To find out ALL about this marvelous heating system, just SEND US THE COUPON BY RETURN MAIL!

**Air-Line Furnace Co.**  
2845 West 19th St., Dept. 18-C Chicago, Ill.

-----  
Air-Line Furnace Co. Dept. 18-C  
2845 West 19th Street, Chicago, Illinois

Without obligating me in any way, please send me your free catalog and special offer on the Air-Line Furnace.

Have you a basement? Yes  No

Name.....

Address.....

# You can blow tunes like "Whistling Bud" Does!



YOU can blow popular tunes on a PAN-AMERICAN Clarinet, or other band instrument, in 3 lessons. Send for a FREE copy of "Whistling Bud Allen," the thrilling story of a boy who learned to play a PAN-AMERICAN. You can do the things "Whistling Bud" did.

You can take your choice of the PAN-AMERICAN factory guaranteed complete line of superior quality, medium-priced band and orchestra instruments. Pay while you play; only a few dollars down—balance monthly. Ask for our beautifully illustrated free catalog of PAN-AMERICANS that have won the recommendation of America's leading bandmasters.

**Learn to play a PAN-AMERICAN in 3 Lessons!** Don't delay! Find out how you can easily get and learn to play your choice of PAN-AMERICANS. Read "Whistling Bud Allen." This amazingly interesting story is offered for only a limited time. So write for your FREE copy TODAY!

Send Coupon Right Now!

### SEND NO MONEY—MAIL COUPON

THE PAN-AMERICAN BAND INSTRUMENT & CASE CO.  
Dept. G-9, Elkhart, Indiana

Yes—send me, FREE, a copy of "Whistling Bud Allen" and a beautifully illustrated catalog of PAN-AMERICAN band instruments. I am interested in (name of instrument here).....

Name.....

Street or R. F. D. Address.....

City.....State.....

## PLUMBING-HEATING Install Your Own—Save Half



Lowest wholesale prices on highest quality Grade A goods. Any Handy Man can install his own Plumbing and Heating BY OUR NEW EASY METHOD. Get the best and pay only a little each month.

Send for FREE Book

New bargain catalog just issued. With our cut-to-fit systems you save waste material and high labor cost. 50 years of economical service to home owners, farmers, builders and mechanics. Million Dollar Plants back up our Bonded Guarantee. FREE book gives you the whole story. Write for your copy today.

OVER 50 YRS. **HARDIN-LAVIN Co. EST. 1876**  
107-17 West Pershing Road, Chicago, Ill.

## SELL AUTO SEAT COVERS This Summer

**MAKE \$100.00 A WEEK**

Cash in on this Big Money-Making opportunity. Leading Made-to-Measure Auto Seat Covers are in demand everywhere. 4 out of 5 auto owners buy. Very popular right now. Wide selection of patterns—biggest values. Lowest prices. Made with glove fasteners. Guaranteed to fit. Quick delivery. Big commissions paid in advance. Beginners make \$10.00 and up daily. Old-timers make \$100.00 weekly, and more.

### FINE SELLING OUTFIT FREE!

Write today for elaborate selling outfit, showing four color illustrations, and containing actual samples of materials, with leather trimmings. Everything needed to begin taking orders furnished FREE, on request. Write Quick!

**THE JOHN LEEDING COMPANY**  
70 E. 18th Street Dept. 100 Chicago, Ill.

# FREE!



## This 80 Page Book New & Used Auto Parts

Everything for the auto at rock-bottom prices, made possible by quantity buying and big-volume selling. Thousands of bargains—Timken Axles and Bearings, Brown-Lipe Transmissions, Pistons, Rings, Hayes and Firestone Wheels, Rims, Tires, Tubes and a complete line of accessories—new, except where specified.

**SAVE 30 to 80%**



### A Typical Value Gilman Shock Absorbers

Set of Two \$4.75

For Fords, up to '26. Installed in center of car to insure perfect balance. No displacement of any Ford part necessary, no drilling of holes. A set on your car will add years to its life.

Write for Your Catalogue Today—FREE!

**WARSHAWSKY & Co.**  
World's Largest Replacement Parts House  
1915-35 S. State St. Dept. PM 8 CHICAGO

## WANTED 1500 MEN AND WOMEN

With ambition and industry, to distribute Rawleigh's Household Products to steady users. Fine openings near you. We train and help you so you can sell up to \$200 a week or more. No experience necessary. Pleasant, profitable, dignified work. Write today

**W. T. RAWLEIGH CO.**

Dept. IL8267 Freeport, Ill.

## Bodies of Rare Beauty for Fords At Factory Prices!

Write for circular A-3 showing Chummy Sportster and others.  
\$22.75 and up



SPORT FACTORIES

AURORA, ILL.



## Let Me Send You the Greatest LOG SAW Offer

—I ever made. One man saws 15 cords a day—easy. Falls trees, saws limbs. Make big money. Use 4 H.P. Engine for other work. Saws faster than 10 men. Shipped from Factory or nearest of 10 Branch Houses. Cash—Easy Terms. Write for 30-Day Trial Offer and big FREE book.  
**OTTAWA MANUFACTURING COMPANY**  
1741-W Wood Street, Ottawa, Kan.  
Room 1741-W Magee Bldg., Pittsburgh, Pa.

Put the OTTAWA Working For You

Now, Only \$39



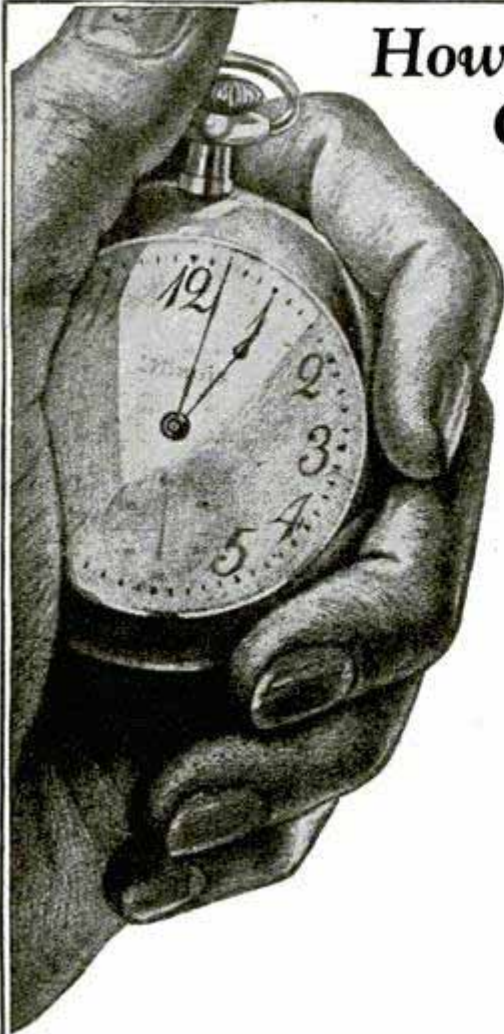

## How Far Does The Large Hand Of Your Watch Move In A Second's Time?

Take out your watch and look at it closely. Can you see how far the minute hand moves in one second? If your watch is the size of the one shown at the left, the large hand moves about one thousandth of an inch in a second's time.

This slight movement of the minute hand—one thousandth of an inch—is a common working measurement for mechanics. Every day, mechanics working with Brown & Sharpe precision tools measure thousandths and often to ten thousandths of an inch.

The performance of Brown & Sharpe tools sets a standard of accuracy for the mechanical world. Obtain a #30 Catalog from your hardware dealer, or write us direct.



**B S**

DEPT. P M

**BROWN & SHARPE MFG. CO.**  
Providence, R. I., U. S. A.

# BROWN & SHARPE TOOLS

"World's Standard of Accuracy"

## MOVIES AT HOME

Many models of genuine MOVIE MACHINES, some as low as \$3.75, all using standard size big theatre films. Our stock of films is the most complete and lowest in price—with an exchange service. Films of leading stars and religious subjects are available. **DON'T DELAY. WRITE FOR FREE INTERESTING CATALOGUE NOW!**

**PARAMOUNT MFG. CO.**

Dept. 1371 BOSTON, MASS.

## Your Coat and Vest Can Be Matched with New Trousers

Save the price of a new suit. We match hundreds of coats and vests satisfactorily every day. Each pair tailored to your measure. 80,000 patterns. We submit sample of cloth for your approval. Just mail your vest or a sample of the suit.

*We employ no agents.*

**ACME PANTS MATCHERS**

Dept. BH 14, 20 W. Jackson, Chicago

Enclose return postage if vest is sent.

## BURN YOUR NAME ON TOOLS

WITH THE  
**ARKOGRAF**

### PROTECT YOUR TOOLS FROM THEFT

Write with electricity any name or design on the hardest and finest tools and instruments, or any metal, like writing on paper with pen or pencil. **Complete Outfit \$3.50**—Prepaid Anywhere. Interesting illustrated circular free. Write today. Agents wanted. **ARKOGRAF PEN CO., 1171 E. Stark St., Portland, Oregon**

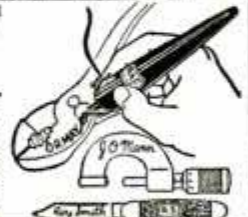

## "JUST LIKE LINDY'S" SENSATIONAL SAIL-ME AIRPLANE

is making our active agents \$50.00 profit daily. The plane glides—spirals—loops the loop—folds neatly in a flat envelope. You fly them—the people buy them. Tremendous demand everywhere. They sell for 15c, two for a quarter. Cost you cash with order—100 for \$4.00; 500, \$15.00; 1000, \$25.00. Our plan of selling assures you of immediate success—ask for it. And when you get to selling 500 and 1000 planes daily we will make you lower prices.

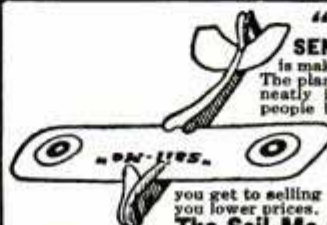

**The Sail-Me Co., Inc. 600 W. Van Buren Street, CHICAGO**



# LUMINOUS PAINT

### Make Your Watches, Clocks, Etc., Visible by Night

The very latest discovery in the scientific world. Hitherto, practically unobtainable except at an exorbitant price, we have at last succeeded in producing this remarkable LUMINOUS PAINT, which, applied to the surface of any article, emits rays of white light, rendering it perfectly visible in the dark. THE DARKER THE NIGHT, THE MORE BULBULIANT IT SHINES. Quite simple to use. Anyone—you can do it. A little applied to the dial of your watch or clock will enable you to tell the time by night. You can coat the push buttons or switch plates of your electric lights, match boxes, and innumerable other articles; make your own Luminous Crucifixes, Luminous Rosaries, etc. Small bottle, price 25c. Larger sizes, 50c and \$1 postpaid. JOHNSON SMITH & CO., Dept. 812 RACINE, WIS.



## CIGARETTE MAKER

Roll your own and save money. Better and quicker; saves more than half. Use your favorite brand of tobacco. Neat, useful, handy. Pocket size, weighs 1/4 oz. Made entirely of metal, nickel plated. 25c, 3 for 65c postpaid anywhere.



## GOOD LUCK RING

Very striking, quaint and uncommon. Silver finish; skull and crossbones design, two brilliant, flashing gems sparkle out of the eyes. Said to bring good luck. Only 25c pdd.



## Exploding Cigarettes

JUST LIKE ORDINARY CIGARETTES. BUT SUCH REAL STARTLERS! The box contains ten genuine cigarettes of excellent quality. They appear as real, but when each cigarette is about one-third smoked, the victim gets a very great surprise as it goes off with a loud BANG! A great mirth provoker yet entirely harmless. Price 25c box.

## NOVELTY BADGES



Kissing Permit 10c. Garter Inspector 10c. Two very novel metal badges, nickel plated, that you can wear, giving you fun out of all proportion to their trifling cost. 10c, each badge, 3 for 25c, or 75c per doz. postpaid anywhere.

## MIDGET BIBLE

GREAT CURIOSITY Smallest Bible in the World. Size of a postage stamp. 200 Pages. Said to bring good luck to the owner. A genuine work of art. Most to be seen to be appreciated. Make good money selling them to friends, church acquaintances, etc. PRICE 15c each, 3 for 40c, 12 for \$1.35, 100 for \$7.50. Also obtainable in Leather Binding, with gold edges. Price 50c each, 3 for \$1.25, \$4.50 per doz. Magnifying Glass for use with Midget Bible, 15c.



## STAGE MONEY



With a bunch of these bills, it is easy for each person of limited means to appear prosperous by flashing a roll of these bills at the proper time and peeling off a genuine bill or two from the outside of the roll, the effect created will be found to be all that can be desired. Prices, postpaid: 40 Bills 20c, 120 for 50c, or \$3.50 thousand postpaid.

## MAGIC FLUTE



The Magic Flute, or Human-tone, is a unique and novel musical instrument that is played with nose and mouth combined. There is just a little knack in playing it which, when once acquired after a little practice, will enable you to produce very sweet music that somewhat resembles a flute. There is no fingering, and once you have mastered it you can play all kinds of music with facility and ease. When played as an accompaniment to a piano or any other musical instrument, the effect is as charming as it is surprising.

# JOHNSON SMITH & CO.

Dept. 812 RACINE, WIS.

A De Luxe Edition of our new 1928 CATALOG mailed on receipt of 25c. Handsome binding. Bigger and better than ever. Only book of its kind in existence. 550 pages of all the latest tricks in magic, the newest novelties, puzzles, games, sporting goods, rubber stamps, unusual and interesting books, curiosities in seeds and plants, etc., unprocureable elsewhere. Remit by Stamps, Coin, Money Order, Check, etc. Unused U. S., Canadian and Foreign Stamps also accepted.

# BLANK CARTRIDGE PISTOL



Protection against Burglars, Tramps, & Dogs. Special Offer 1 Blank Cartridge Pistol 100 Blank Cartridges 1 560-pure Novelty Catalog ONLY \$1.50 The Lot Shipped by Express Only Cash With Order Only Well made and effective, modelled on latest type of Revolver; appearance alone is enough to scare a burglar. When loaded it may be as effective as a real revolver without danger to life. It takes standard .22 Cal. Blank Cartridge—obtainable everywhere. Special cash with order offer: 1 Superior quality Blank Cartridge Pistol, 100 Blank Cartridges, and our new 550-page De Luxe Catalog of latest novelties; all for ONLY \$1.50. Shipped by Express only. Cannot go by parcel post. Extra Blank Cartridges 50c per 100. Special Holster (Cowboy Type) for pistol 50c. No C. O. D. shipments.

# THROW YOUR VOICE



Into a trunk, under the bed or anywhere. Lots of fun fooling the teacher, policeman or friends. THE VENTRILO a little instrument, fits in the mouth out of sight, used with above for Bird Calls, etc. Anyone can use it. Never Fails. A 16 page course on ventriloquism, the Ventrilo, ALL FOR 10 CENTS



It is made in the shape of and looks like a regular Automatic Pistol. No one is likely to stop and ask you whether it is real or not. This is likely to prove itself very handy in an emergency. On pressing the trigger it opens up, as shown in the illustration at the right, revealing nine most useful articles—Opera and Field Glass, Telescope, Mirror, Magnifying Glass and Burning Lens, Reading Glass, Sun Dial, Sun Compass, etc. In the handle of the revolver there is a place for various pocket necessities, such as First Aid Articles, Buttons, Pins, etc. The Pistol is of sheet metal, blued finish, that can be carried comfortably in pocket. PRICE \$1.00 postpaid.



Watch Charm Pistol \$1.75 Exact reproduction of a real pistol; actually fires REAL BLANK CARTRIDGES of miniature size. Illustration is actual size. 1 1/2 inches long, with ring at end for attaching to watch chain. Pistol in break open type; illustration shows position for loading. Made entirely of high grade steel, nickel plated, octagon barrel, Randomly engraved handles, complete in box with cleaning rod. PRICE \$1.75. Also furnished with pearl handles, \$2.50. BLANK CARTRIDGES, 50c per box of 25. JOHNSON SMITH & CO., Dept. 812, RACINE, WIS.

## SURPRISE MATCHES

More fun than fighting with your wife. Look just like ordinary matches. Put up in boxes just like regular Safety Matches. As the victim tries to light one he gets quite a surprise. Price 10c per box, 3 boxes for 25c, 12 for 75 cents.

These clever locks cannot be opened unless you know the combination. No key necessary. For your locker, bicycle, tool chest, mail box, thousands of uses. Shackles and tumbler nickel plated. Weighs a trifling over one ounce. Small yet strong. Secret and full instructions with each lock. Price 25c or 3 for 65c postpaid.



## Wonderful X-Ray Tube

A wonderful little instrument producing optical illusions both surprising and startling. With it you can see what is apparently the bones of your fingers, the lead in a lead pencil, the interior opening in a pipe stem, and many other similar illusions. A mystery that no one has been able to satisfactorily explain. Price 10c, 3 for 25c, 1 dozen 75c. Johnson Smith & Co.

## Every Boy His Own Toy Maker

Greatest boys' book written. Tells how to make a Pinhole Camera, a Canoe, model Railroad, a Telephone, Boomerang, Telegraph Instrument, Box Kite, Talking Machine, Microscope, Electric Motor, Electric Door Bell, Water Wheel, Paddle Raft, a pair of Skis, a Dog Sled, Bird House, Rabbit Yard, etc. 64 pages, 150 illustrations. PRICE, 10c postpaid; 3 for 25c postpaid.

## Serpent's Eggs

Box contains 12 eggs. When lit with a match, each one gradually hatches itself into a snake several feet long, which curls and twists about in a most life-like manner. Price per box, 10c postpaid, 3 for 25c.

## MICROPHONE TRANSMITTER BUTTON



You can easily make a highly sensitive detector-phone by using this Transmitter Button to collect the sound waves. You can build your own outfit without buying expensive equipment. It is simple and inexpensive. You can install an outfit in your home and hear conversations being held all over the house. You can connect up different rooms of a hotel. This outfit was used by secret services operatives during the war. It is being used on this stage. It is ultra-sensitive and is the greatest invention in micro-phones. You can mount the button almost anywhere—card board boxes, stove pipes, stiff calendars, on the wall behind a picture frame, etc. Button is so light and small it cannot be detected. Persons can be overheard without suspecting it. You can listen in on conversations in another room. A deaf person in the audience can hear the speaker. Connected to phonograph, piano or other musical instrument, music can be heard hundreds of feet away. Button may be used to renew telephone transmitters; often makes an old line "talk up" when nothing else will. The ideal microphone for radio use; carries heavy current and is extremely sensitive. Amplifies radio signals. Countless other similar uses will suggest themselves. Experimenters find the button useful for hundreds of experiments along the lines of telephones, amplifiers, loud speakers, etc. Many fascinating stunts may be devised, such as holding the button against the throat or chest to reproduce speech without sound waves. PRICE \$1.00. JOHNSON SMITH & CO., DEPT. 812, RACINE, WIS.



### The Vulcanized Repair

When you fix a puncture with the Shaler 5-Minute Vulcanizer the patch is there to stay for the life of the tire. Even under the constant flexing of Balloon tires which loosens ordinary cemented patches, Shaler improved Patches are not affected. Be sure you have one in your car today. In stock wherever auto accessories are carried.

The SHALER Company, Waupun, Wis.

2709 4th Street

# SHALER

5 MINUTE VULCANIZER

### EASY TO USE

Fixes punctures in a jiffy anywhere—and fixes them right. Complete outfit—\$1.50. Extra Patch & Heat Units, 75c per box of 12. (Prices slightly higher in Canada and far West.)

## SOLID GOLD Point Pen & Pencil Set \$2.98



Real Value \$5.75. Diamond-Hard Tip. Smooth writing for years. Self-filing. Unbreakable. Always ready. Guaranteed completely. Perfection Propel Pencil. Elegant lined gift box.

**FREE** Six 50c coupons free with each set enable you to get back every cent paid.

Send M. O. or pay C. O. D. plus postage.

DAVLEY CHEM. CO., P. O. Box 1234, St. Johns Place, Brooklyn, N. Y.

CAL. 30-40

## KRAG CARBINE STYLE

The Choice of those who know. 5 shot, 22 inch Barrel. A few used, but serviceable, for \$9.75. Shipping weight, 13 lbs. Shipping extra. **\$15**

Krag Rifles.....\$12.50 Krag Sporting Rifles.....\$14.00  
Springfield 45 Shot Guns... 4.75 SPRGFLD. 45 Carbines..... 4.50

Krag Bayonets 40 cents each. Postage Extra—Shipping Weight 2½ lbs.

Terms Strictly Cash. No C. O. D. Shipments.

Catalogue Free on Request.

W. STOKES KIRK, 1627-P. M., North 10th St., Phila., Pa.

## Men Like YOU Make

### \$200 A WEEK

**Selling STICK-A-LITE** the fastest selling trouble light—spot light—camp-light—NOW is the time to "clean up" selling the motorist—tourist—garage and accessory stores—no salesmanship needed—sell full time—part time or evenings.

### STICK-A-LITE

**Trouble light—Spot light—Camp light**  
All in one—Powerful Electro Magnet sticks to metal on car with 8 lb. grip—at any angle—won't jar loose—throws powerful beam 250 ft. Ideal for tire repairing and motor trouble at night—Territory now open—cash in on STICK-A-LITE—Send \$2.00 for Order-Taking Demonstrator today. Money back guarantee, or send for FREE information.

PREMIER ELECTRIC COMPANY  
Dept. 349, Grace at Ravenswood, Chicago, Ill.



# I Want to Send You a Santa Fe Special-Watch

for You to see and examine

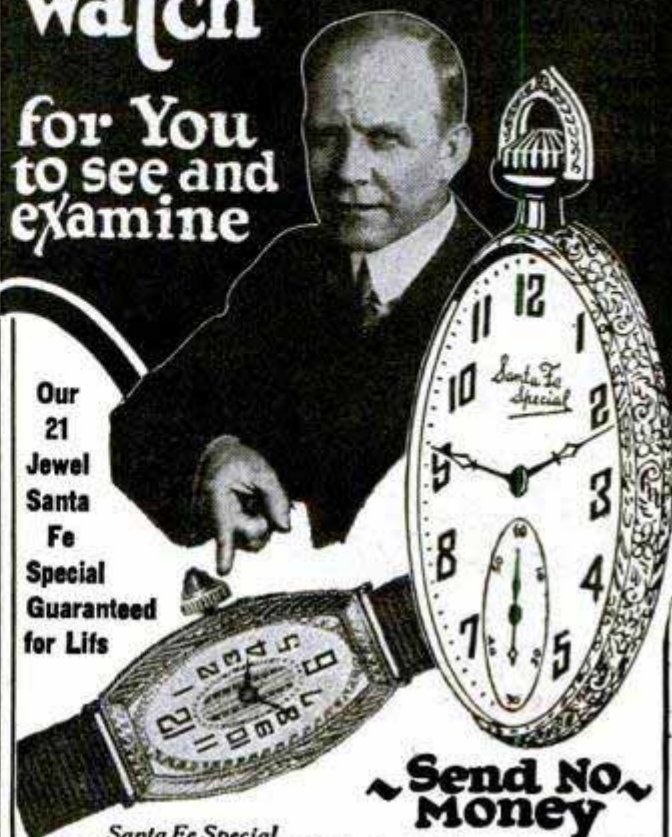

Our 21 Jewel Santa Fe Special Guaranteed for Life

Send No Money

*Santa Fe Special Watches are today being shipped to every civilized country in the world, and are probably the best and most favorably known watch in both Army and Navy.*

## Watch Sent on 30 Day Free Trial

In addition to our NEW LOW PRICE, I will send for your approval one of these Standard Watches, guaranteed for a lifetime of satisfactory service, not only by the Santa Fe Watch Company, but by the Great Illinois Watch Factory. So accurate, Government officials carry them; so perfect and beautiful, jewelers say they are worth 1-3 to 1-2 more than we ask for them. I will send you one to see WITHOUT ONE PENNY DOWN—allow you to wear it 30 days FREE—then sell it to you on easy payments.

### WHY NOT OWN A 21 JEWEL SANTA FE SPECIAL WATCH ?

You will never miss the few cents a day that will make you own one of these watches—SEND FOR WATCH BOOK—illustrating in beautiful colors hundreds of designs and combinations in cases in the POCKET WATCH, MEN'S STRAP WATCH and LADIES' WRIST WATCH. You can have your name or monogram and any emblem you may desire engraved in the Case to suit your own ideas. Write today for Free Watch Book, and make your selection at once, while this offer lasts.

**FREE** A limited offer! With every Santa Fe Special, beautiful gold chain or strand of exquisite pearls. Write today. Mail coupon for both Watch and Diamond Catalog

**SANTA FE WATCH COMPANY**  
86 Thomas Building Topeka, Kans.  
(Home of the Great Santa Fe Railway)

Mail coupon to-day!

**SANTA FE WATCH COMPANY**  
86 Thomas Building, Topeka, Kansas

Please send prepaid and without obligation your Watch Book Free, explaining your "No Money Down" Offer on the Santa Fe Special Watch.

Name.....  
Address.....  
City..... State.....

# DEVITT 8" COMBINATION SAW

## 13 TOOLS IN ONE

Saw table raised, showing Emery wheel, saw guard and drill attachment.



Planer attachment on saw table.

Showing Sanding disc attached.



Table tilted for beveling.

Dado head attached for grooving.

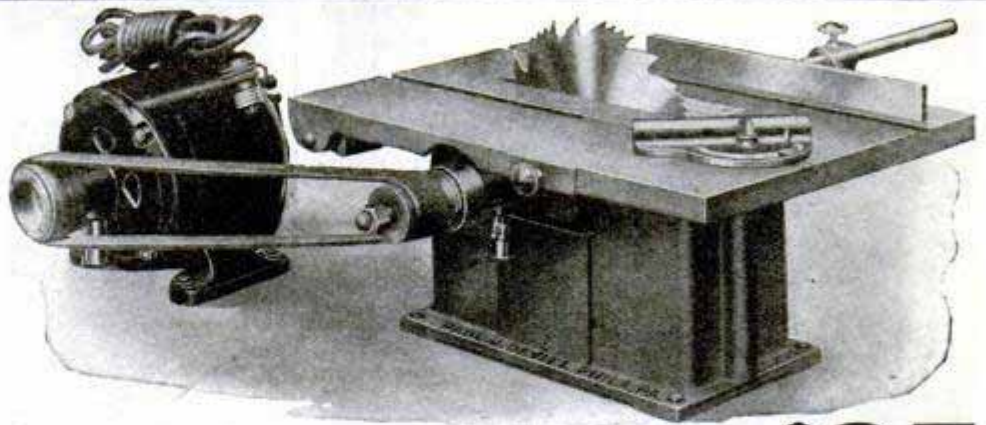

**YOU** save a great deal of money, time and space by buying a Devitt 8" Combination Saw. Why buy special tools for beveling, grooving, buffing, etc.? The Devitt Combination Saw will rip, cross cut, bevel, miter, groove, mortise, tenon, drill, rabbet, grind, buff and polish. The attachments are easily and quickly adjusted. The saw and motor when set up ready for work occupy very little room. The  $\frac{1}{4}$  H. P. 60 cycle 110 volt A. C. motor can be run from a light socket and provide power for other purposes when the saw is not in use. A cut up to  $2\frac{1}{4}$ " can be made with the 8" Combination Saw without planing. The ideal machine for shop, factory or home, complete with attachments: 12"x16" table, 8" Combination Saw, iron pulley for saw table, 10" ripping fence, adjustable cut off miter gauge, motor-specifications as above,  $1\frac{1}{4}$ " endless leather belt, wood pulley, 8 ft. cord and plug, 6" buffing wheel,  $\frac{3}{4}$ " 3 jaw drill chuck, 5" emery wheel, 6" sander, saw guard, and 2" dado insert. \$35.00 F. O. B. Phila. Height  $7\frac{1}{2}$ ", shipping weight, 100 lbs. (Planer attachment to fit on table top will smooth pieces up to 2 in. wide, \$12.00 extra F. O. B. Phila.)

**\$35**  
F. O. B. Phila.

Write for our beautifully illustrated 4 page circular.

**PAUL J. DEVITT** 1102 South 2nd Street PHILADELPHIA, PA.

## FOR THAT VACATION TRIP!



Touring, camping or fishing—on any trip you'll need this handy *Crescent Kit*. It contains a genuine 8-inch Crescent Wrench, a pair of thin nose pliers and an all-steel screwdriver. All neatly packed in a case of stout brown duck. Many fishermen find the No. 655 *Needle Nose Pliers* ideal for keeping their tackle in shape. They have keen side-cutters which make them useful for a thousand and one camp jobs.

The Crescent-Smith & Hemenway line includes many handy tools, all sold with a money-back guarantee.

YOUR HARDWARE DEALER SELLS CRESCENT TOOLS

CRESCENT TOOL CO. 210 Harrison Street JAMESTOWN, N. Y.



**CRESCENT**  
and Smith & Hemenway  
**TOOLS**

## MOTORCYCLES



Price \$10 and up purchased through our Co-Operative Plan for as low as \$1.00 down and \$1.00 per week  
Indians Harley-Davidsons Ace Henderson and Cleavelands  
Send ten cents for Bulletin A.  
Motorcycles shipped to all parts of the world

**WALKER-INDIAN CO., 168 Mass. Ave., BOSTON**



## HOLLAND PRINTS

Wonderful new way of binding kodak pictures. Keep a photographic record. Sample Holland print from your negative for 10c.

FRANK SCODIE, 43-B, SLEEPY EYE, MINN.

## His Bank Account Is Growing!

He is one of the many men who have sent for a remarkable book, "The Nestler Plan." It tells how you too can establish a money-making business all your own, servicing tires by the patented Nestler Rubber Fusing Process. You can easily learn this scientific, modern rebuilding and repairing method in your spare time. Big profits; protected territory; little capital required; no experience necessary.



Send for FREE illustrated book of facts, "The Nestler Plan." Write TODAY to Dept. 38.

**NESTLER RUBBER FUSING CO., Inc.**  
245 West 55th St., New York, N. Y.



Starrett  
Stainless Steel  
Tape No. 520

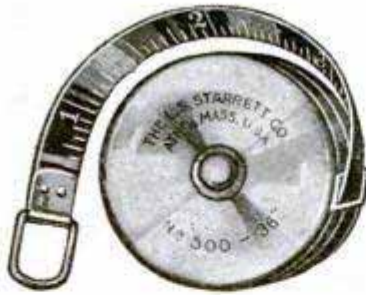

Starrett  
Pocket Steel  
Tape No. 500

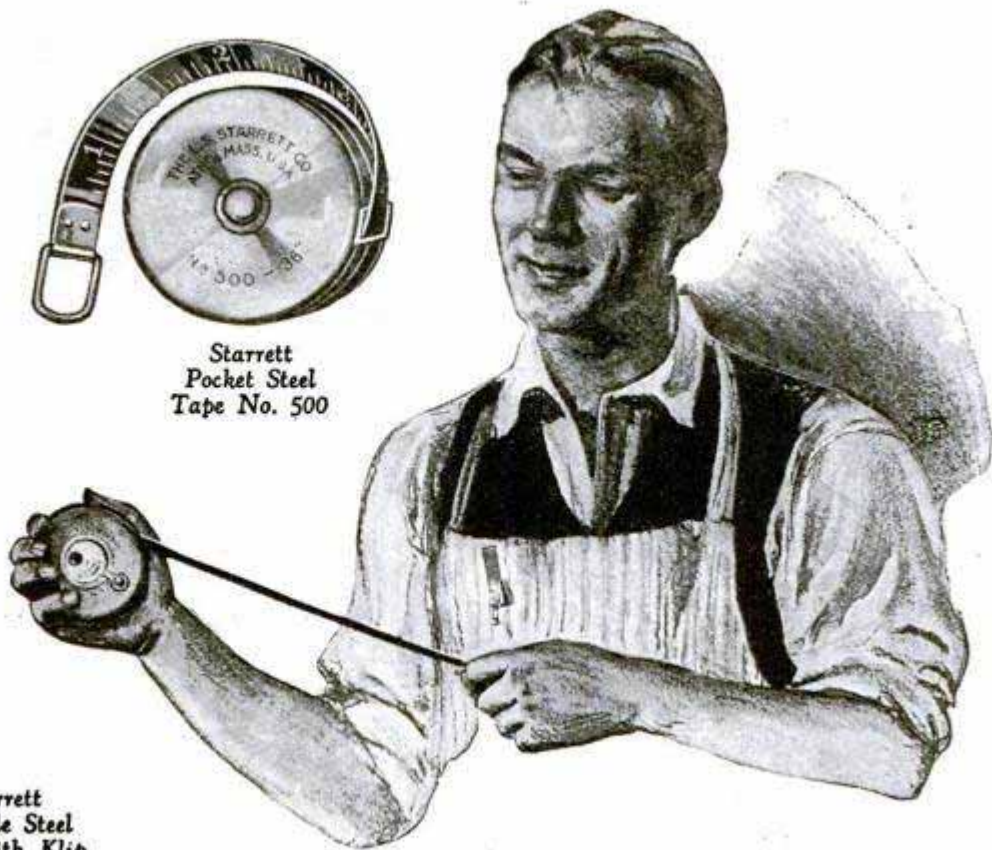

Starrett  
Flexible Steel  
Rule with Klip  
No. 320K



Starrett  
Stainless Steel  
Rule No. 1000

Step into your favorite tool store and examine a Starrett Steel Rule. Notice how distinctly and accurately the graduations are cut deep into the steel. See how the comparative lengths and weights of the various lines assist in making more accurate reading easier.

## Here's easy reading for you —

One glance is all you need if you're taking measurements with a Starrett Steel Tape.

The bright steel lines and figures stand right out against the jet-black background. And for even faster and more accurate reading the small foot figures placed between each inch mark give the correct reading in feet and inches at once.

There are Starrett Steel Tapes for every man's needs, including the Starrett No. 520 Stainless Steel Tape for use in mud or wet.

Our Starrett Catalog 23 "AP" will help you to select the tape or rule you want, and it shows over 2500 other fine Starrett Tools. Write us for your free copy.



Starrett  
Steel Tape  
No. 530

THE L. S. STARRETT CO.  
World's Greatest Toolmakers  
Manufacturers of Hacksaws Unexcelled  
Steel Tapes—Standard for Accuracy  
ATHOL, MASS.



# Use Starrett Tools

**\$5.00**  
**DOWN**  
buys a

## WITTE Engine

Write Me Today—for new FREE Witte Book telling how you can buy a WITTE Engine for ONLY \$5.00 Down and small EASY Payments. No interest. Absolutely the greatest engine made. Guaranteed for a lifetime. Used all over the world—from the frozen wastes of Alaska to the burning sands of Arabia. Will increase your farm profits \$500.00 to \$1,000.00 a year. Runs on all fuels. Simple, sturdy. Gives most power at least expense. Sizes 1½ to 30 H. P. Engines; also 2-in-1 Saw Rigs and Pump Outfits. Write me today for FREE book.

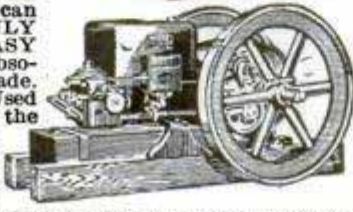

### Witte Engine Works

174-C Witte Bldg., Kansas City, Mo.  
174-C Empire Bldg., Pittsburg, Pa.



**Gerstner Tool Cases** are unusual values. Selected materials, skilled workmanship, finest finish and the latest designs give a value that cannot be beaten. Toolmakers and Machinists get our free catalog

*H. Gerstner Sons*

444 Columbia St., DAYTON, OHIO.

## PARKS Manual Trainer \$35.00



For your home shop! Combination 11-inch band saw and 11-inch wood lathe. If you have a knack for wood working you can turn out first-class bridge lamps, cabinets, furniture, ship models, etc., in fast time. Get one!

Write for specification circular

**THE PARKS WOODWORKING MACHINE CO.**  
1500-40 Knowlton Street Cincinnati, Ohio  
CANADIAN FACTORY: 208 Notre Dame East, Montreal, Canada

I made \$250.00 extra  
in 3 months with  
my TORIT handy Torch



**THOUSANDS OF MECHANICS** in the U. S. and Canada are doing the same—Cashing in on quick, easy profits. One man writes, "I received my Torit Torch in the morning and by night had made an extra \$7.50 on jobs I ordinarily turn down. The Torit has already paid for itself and is now the **HANDIEST TOOL IN THE SHOP.**" Beats anything you ever tried for soldering, lead burning, radiator repairing, etc.

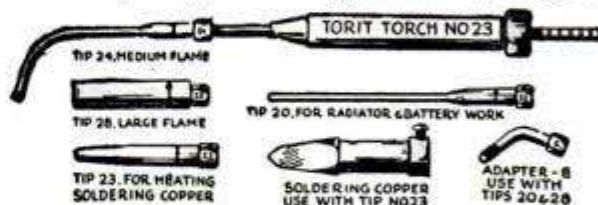

PAT. JAN. 5, 1926

Uses Acetylene Only. No oxygen or air pressure is required. Tips suck in air. Simply connect to Presto auto tank, light gas, and outfit is put to work. Consists of torch, 4 tips, soldering copper, 5 ft. rubber tubing, tank connection and instructions. Price **\$7.50**  
**ST. PAUL WELDING & MFG. CO., 177 W. 3rd St., St. Paul, Minn.**



Lathes \$6.00 to \$75.00. Largest line of small lathes in America. Send four cents for 24 page catalog of lathes, drill presses, bench saws, jig saws, band saws, etc.

**SYPHR MANUFACTURING COMPANY**

Dept. D

**\$10.00**  
**DOWN**

**Brings  
this Lathe  
to You**

**Toledo, Ohio**

## When You Want a BLOTORCH

That gives 400° more heat—  
That's 100% safe—send for

**TURNER MASTER No. 45**  
Only \$7.75, postpaid

**TURNER BRASS WORKS, Industry Ave., Sycamore, Ill.**



## Crescent Wood Working Machines

are neat in design, substantially built and are intended for hard, continuous service. Users of wood working machinery who appreciate quality always investigate Crescent machines before placing their orders. Send today for circulars of Band Saws, Saw Tables, Self Feed Rip Saw, Shapers, Jointers, Variety Wood Worker, Planers, Planer and Matcher, Disk Grinders, Cut Off Table, Swing Saws, Boreas, Hollow Chisel Mortisers, Tenoners, Universal Wood Workers.  
**The Crescent Machine Co., 93 Columbia St., Leontia, Ohio, U. S. A.**

**Tight Handles—Send for booklet  
"HOW to KEEP TOOL HANDLES TIGHT"**  
Fayette R. Plumb, Inc., 4857 James St., Philadelphia

## Makes Old Ford a Tractor

Now you can convert that old Ford car into a useful farm tractor without altering any Ford parts. We furnish the traction wheels, drive gears and auxiliary axle and mountings, ready to clamp on to the Ford frame. Pulls 16" plow.

Write for Free Particulars.  
**SHAW MFG. CO., Dept. S, Galesburg, Kan.**



Any electric hand saw or portable rig works better with a

# SIMONDS

## "60"

AVAILABLE ON

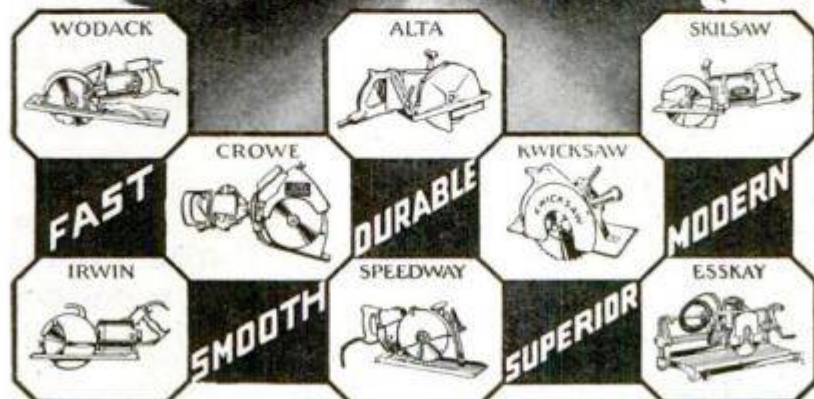

When ordering specify that the blade shall be SIMONDS  
**SIMONDS SAW AND STEEL COMPANY**  
 FITCHBURG, MASS.

"The Saw Makers"

Branch stores and service shops in principal cities

Established 1832

**NO MORE FOLDING—IT SLIDES!**

**THE SPEEDY RULE**

A direct-reading inside caliper. Fine for outside measurements, too. Quick, strong, durable. All lengths, 2 to 8 ft., 20¢ per lineal ft. If not at dealers, sent postpaid.

## Interlox

MASTER SLIDE RULE

Master Rule  
Mfg. Co.  
813 E. 138th St.  
New York

Dealers and Agents: Write for attractive proposition.

**Make Things at Home  
 with a Speedway Shop**

Eight motor-driven tools, complete lathe, bench saw, jig saw, portable electric handsaw, stationary power drill, buffer, grinder, scratch brush. Works from any lamp socket. \$10.00 down, 10 days' free trial; free working blueprints furnished. Write for full information.

**ELECTRO MAGNETIC TOOL CO.**  
 Dept. 2A2, 1830 S. 52nd Avenue      CICERO, ILL. (Adjoining Chicago)

### CALCULATIONS

in Office, School, Store and Shop can be instantly made with the Midzet Slide Rule. It gives the answer to any problem involving fractions, mixed numbers, decimals, whole numbers, roots, powers, Logs, and Trig. Functions. Thousands of these rules are used by Accountants, Engineers, Clerks, Students, etc. It is the most versatile calculator ever invented. If you have any figuring to do, order a Midzet Slide Rule on trial. Made of aluminum with figures on white celluloid. Size 4". Price with Instruction Book, \$1.50. Leather Case 50¢ extra. Catalogs Free. Sent C. O. D. if desired. Your money back if you are not satisfied.

**GILSON SLIDE RULE CO., Stuart, Florida.**

\$25 to \$45

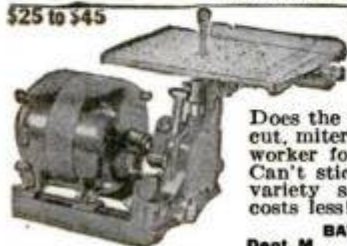

**GET THE NEW IDEA**  
**BATES MOTOR SAW**  
 — 6 SAWS IN 1 —

Does the work of band-saw, rip-saw, cross-cut, miter, bevel and scroll-saw. A wonder worker for the home shop. Direct drive! Can't stick! Cuts 2" wood. Most amazing variety saw ever invented. Does more, costs less! Not a toy. Write for circular.

**BATES MOTORCRAFT COMPANY**  
 Dept. M      28 N. Clinton      CHICAGO, ILL.

IF YOU DON'T LIKE YOUR JOB  
**QUIT**

Start Working for Yourself  
**American Universal  
 Floor Surfacing Machine**



offers you the opportunity for which you have been waiting.

This electrically driven machine sure does roll the money in fast. No trouble to get work — we start you — supply you with simple working plan that insures success.

One year-to-pay plan requiring only \$75 down on de-

livery of machine is available to you if you want it.

This is your chance not only to earn more but to have all you earn for yourself.

Write at once for details.

**American Floor Surfacing Machine Co.**  
 523 South St. Clair Street      Toledo, Ohio



*Just  
what I wanted!*



## The New Model Pocket Ben

**\$1<sup>50</sup>**

You will like this new model Pocket Ben.

The service it will give is equaled only by its good looks. You will especially like its attractive, easy-to-read dial.

It's a sturdy, steady, faithful friend—just the watch you'll want to carry every day.

The New Model Pocket Ben is sold everywhere. Price \$1.50. With luminous night-and-day dial \$2.25.

WESTERN CLOCK COMPANY  
LaSalle, Illinois

## Make \$40 a Day Introducing MASTERLITE POCKET LIGHTER

**Lights On New Marvelous Principle—Without Flint**  
Attracts crowds everywhere. Works every time in any weather. Sells for only 50c. Equal to \$10 and \$20 lighters. Every smoker instantly appreciates its wonderful convenience. No wind can blow out the flame.

**Every Smoker Buys on Sight!**  
**100% CLEAR PROFIT. Repeat Business Guaranteed**  
Sells instantly to smokers and dealers at big profits. Guaranteed for life. Each sale builds an everlasting repeat business. \$3.00 brings sample dozen in handsome display box with our sure-fire selling plans. Masterlite retails at 50c. **Sells on a Flash Demonstration at over 100% Profit.**



**Sample 50c**

## Radio Gas Lighter Lights Gas without Flame

**PROTECTION CAP FREE**  
No friction, spark, or flame. Lights instantly mantles, gas stoves, jets, and heaters. Held directly over gas flow. Flame appears instantly. Absolutely safe. Banishes danger from matches.

### Make \$26 a Day

A big 25c seller, paying 300% clear profit. A gross easily sold in a day brings \$36.00 and costs you \$10.00 — \$26 a day clear. Rush \$10.00 for gross or \$1.00 for sample dozen, with amazing new sure-fire self-selling plans.

Masterlite Mfg. Co., Dept. H-23, 110 East 23 St., New York

## Own a CORONA

The portable typewriter built like an office machine. Has four-row keyboard and big-machine features throughout. Write to



L. C. Smith and Corona Typewriters, Inc.  
812 E. Washington St., Syracuse, N. Y.

## Beautiful HOUSES \$900 and BUNGALOWS

**CAN BE BUILT FOR AND UP**

This and many others in my new book, Building Plans for Modern Homes, will save you hundreds of dollars. One of the most complete and comprehensive books of plans ever published by any architect. New edition just off the press. Nearly 600 floor plans and photographs of Colonial houses, bungalows, etc., costing from \$200 up; gives sizes and cost to build. Sent postpaid for \$3.00.



FREDERICK H. GOWING  
ARCHITECT  
101 Tremont St., BOSTON, MASS.



## Take Absorbine, Jr. along to camp!

—to limber up stiff leg muscles. For the lame shoulder. For insect bites. To guard against infection from cuts and bruises. For after-shaving comfort (dilute). For plant poisoning. For sunburn.

\$1.25 at your druggist's  
W. F. YOUNG, Inc., Springfield, Mass.

**Absorbine Jr.**  
THE ANTISEPTIC LINIMENT

Use the  
magic bottle





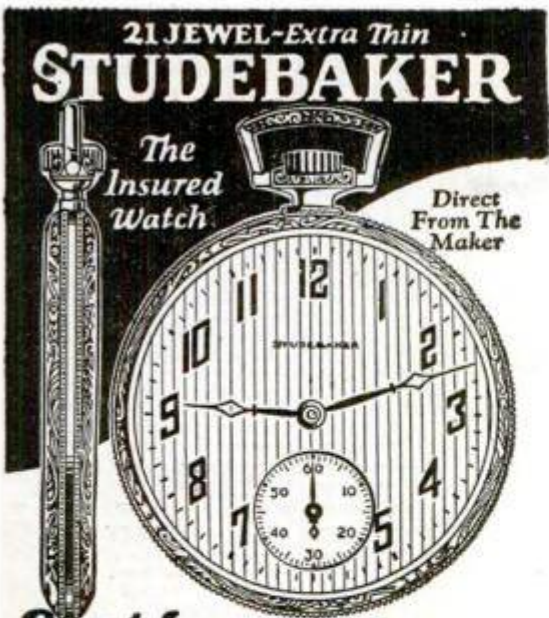

21 JEWEL-Extra Thin  
**STUDEBAKER**

The Insured Watch

Direct From The Maker

**Sent for \$100 DOWN** Just \$1.00! The balance in easy monthly payments. You get the famous Studebaker 21 Jewel Watch direct from factory at a saving of 80% to 60%.  
Your choice of 80 new Art Beauty cases and dials. Latest designs in white gold, yellow gold and green gold effects. 8 adjustments including heat, gold, isochronism and five positions. Insured for a lifetime. Ladies' Bracelet Watches, Men's Strap Watches, Diamonds and Jewelry, too. All sold on easy monthly payments. Your credit is good! Write today for free book of Advance Watch Styles or Jewelry Catalog.

**Watch Chain FREE!**

For a limited time we are offering a beautiful Watch Chain free. This special offer will be sent to everyone who writes at once. Don't delay! Get this free chain offer today—while it lasts.

**STUDEBAKER WATCH COMPANY**  
Directed by the Studebaker Family—known for three-quarters of a century of fair dealing.  
Dept. T 806 South Bend, Indiana  
Canadian Address: Windsor, Ont.

**FREE TO BOYS**

**"THE SHOOTER'S ART"** Tells how to hold, aim and handle rifles; helps you guide others in correct knowledge of guns. Gives facts that make crack shots. Contains safety and common sense instruction every parent and boy should have. Helps to make boys leaders. Your copy Free. Write at once.

**The NEW BENJAMIN Air Rifle**  
America's Original Air Rifle  
Outshoots All Others  
The Shooter's Art  
BENJAMIN \$5 at your dealer's or sent postpaid. Write! Air Rifle & Mfg. Co., 645 N. Broadway, St. Louis, Mo.

**AGENTS AND SIGN MEN**  
Now Making \$50.00 to \$100.00 and Up Per Week Selling Our **GOLD LEAF SIGN LETTERS**  
**R** For store and office windows, board signs, trucks and glass signs. We also make to order script signs and business emblems singly or by the thousands. A permanent business. No capital or experience required. Big demand in every city. Samples and Literature Free.  
CONSOLIDATED SIGN LETTER CO. 69X W. Van Buren CHICAGO, ILL.

**I'll Pay YOU \$100 a Week**  
Make \$100.00 a week and up, selling our fine made-to-measure, all-wool suits, direct to wearer. Biggest values—positively sell on sight. Biggest commissions paid in advance. We attend to delivery and collections. 6x9 cloth samples—over 100 styles—furnished FREE. Ambitious men write at once.  
**W.Z. GIBSON, Inc., 161 W. Harrison, Dept. H516, Chicago**



**WURLITZER**  
REG. U.S. PAT. OFF.

"Bill Carola"  
Landaus Seranaders

**Couldn't Play a Note—Now Makes \$100 a week**

"When I sent for your catalog, I didn't know a note of music. A few months after I bought my Wurlitzer instrument, I had taken my place in a professional orchestra. Now I am making \$100 a week, three times what I made as clerk. I wish everybody knew how easy it is—anyone who can whistle a tune can learn to play a musical instrument."  
—Bill Carola

**Free Trial Easy Payments**

You may now have any Wurlitzer instrument for an ample free trial in your own home. Examine the instrument, note the fine workmanship, the full, rich tone value and especially how easy it is to play. No obligation to buy—no expense for the trial. We make this liberal offer because we want you to try for yourself a genuine Wurlitzer instrument, the result of 200 year's experience in musical instrument building.

Easy payments are arranged to suit your convenience. This is your opportunity to try a famous Wurlitzer instrument in your own home. Send for

**Free Book**

Illustrates and describes every known musical instrument—more than 3000 articles, many of them shown in full colors. All genuine Wurlitzer instruments—buy direct from Wurlitzer and save money. Special offers on complete outfits.

We also give you our Free Trial, Easy Payment Plan. No obligation.

**Send Coupon Today!**

**The Rudolph Wurlitzer Co., Dept. C177**  
117 E. 4th St., Cincinnati 329 S. Wabash Ave., Chicago  
120 W. 42nd St., New York 250 Stockton St., San Francisco  
Send me your Free Book on musical instruments. Also your Free Trial, Easy Payment Plan. No obligation.

Name .....

Address .....

City ..... State .....

Instrument .....



"After 10 years' selling I've found the biggest money maker of them all. MARCELWAVER. My first week's profits were \$176."

A. R. Mohr,  
New York

**\$176**  
**CASH PROFIT**  
**VERY FIRST**  
**WEEK!**

**MAKE BIG MONEY QUICK WITH**

**Here's Big Money Quick**

**\$29 First Day** Geo. B. Eberts of Iowa made that.

**\$389 in 1 Week** A. F. Steinert of Pennsylvania hung up this record.

**\$213 in 4 Days** Frank W. Wander of Minnesota sets that mark to shoot at.

**\$40 Spare Time** Mrs. V. T. Krone of Alabama averaged that for seven weeks.

**MARCELWAVER**

**NEW!** Amazing invention of French experts gives perfect marcel wave in 15 minutes—costs only 2c. Women everywhere wild over astonishing results.

**EXCLUSIVE!** Agents cleaning up biggest profits in years—no competition—patented in all countries—\$3 cash profit on every sale—every woman and girl buys. Exclusive territories now being allotted—no time to lose.

**FREE!** Send name and address and territory wanted. Full information and protection on territory Free—also finest selling outfit. Send now.

**MARCELWAVER CO., Dept., K121, Cincinnati, Ohio**

**MARCELWAVER CO., Dept, K121 Cincinnati, Ohio**  
Rush full information about MARCELWAVER and Free Selling Outfit Offer. Also consider my application for exclusive sale in my territory.

Name.....  
Address.....  
City.....

Do you want District Managers' Offer?       Will you act as local representative?

**LE PAGE'S** Handiest tool in your workshop.  
**GLUE** In bottles, tubes and cans.

**MEN! BIG MONEY**  
**IN SPARE TIME**  
*And this Suit FREE*

You can easily earn \$50 a week in spare time taking orders from your friends and neighbors for our fine tailoring. Orders come easy when you show our swell samples and smart styles. **We Show You How**—you don't need to know anything about tailoring—simply follow our directions—we make it easy.

**YOUR SUIT FREE**

Our new plan enables you to get one of our fine made-to-order suits, in any style you want, by simply taking a few orders, without one penny cost to you.

**FREE** New Big Sample OUTFIT. New style convenient carrying case outfit; large all-wool samples and all supplies furnished **FREE**. Write at once.

**PROGRESS TAILORING CO., Dept, H216 CHICAGO, ILL.**



**AGENTS Big-Quick PROFITS**

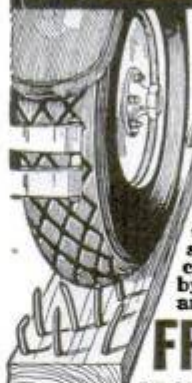

**Tires Hammered Full of Nails, Leak no Air. GALACITE a new Viscous Pneumatic Cement (NOT A LIQUID)**

**Seals PUNCTURES Instantly**—the very moment they occur. One application made in a minute without taking tire off wheel or rim does the work. Seals slow leaks and porous tubes. Galacite aids in preserving rubber often doubling Tire Mileage. Don't confuse with anything else intended for the same purpose. Galacite is new, different, clean and scientifically correct. Made by a long established, highly rated financially responsible concern.

**FREE SAMPLE**

**AT OUR RISK, MAKE THIS TEST**  
Hammer as many nails into a tire as you wish—Pull them out. No air will escape. No pressure will be lost. If you are not delighted we will pay you for your time and trouble.

**AGENTS** It will pay you to get the facts and get them NOW. You can't get rich in an hour but you can make immediate, sure, steady profits that are amazing. No talking. Just drive nails in an old tire. We back our men with powerful advertising helps. Banners Posters, Newspaper Advertisements and circulars.

**FREE SAMPLE** Full particulars, big book and a free sample will be sent you postpaid, by return mail. Territory is going fast. Send no money, just your name, but **ACT NOW.**  
**JOHNSON & CO., 19 W. Jackson Blvd., Dept. 621, CHICAGO**

**You and This New Machine Can Earn \$500 a Month**

**Operate a Tire Repair Shop**  
90,000,000 Tires in use. America's greatest opportunity for men with small capital. We furnish everything—\$100 and up. Easy payments. We train you FREE right at home. Start making money at once. Write today for Free Book "Steps to Success."

**Haywood Tire Equipment Co.**  
1334 South Oakley Chicago, Illinois



**DENINGER WILL TRUST YOU**  
SEND 20c IN STAMPS FOR CATALOGUES  
**BIG MONEY SAVING FOR YOU**  
Used and rebuilt motorcycles \$25 to \$100, used bicycles \$9.50, tandems \$20. All machines fully guaranteed. New bicycles and motorcycles at factory prices, save dealers' profits. Motorcycle and automobile tires \$3. Complete line frames, engines, supplies.

**DENINGER PRICE CUTTER, ROCHESTER, N. Y.**  
**PAY AS YOU RIDE**



**Sport Bodies for Fords AT FACTORY PRICES!**

This Model in Grey Prime **\$39.50**

Write for Booklet A-2 Showing Other Models.

**SPORT FACTORIES, AURORA, ILL.**

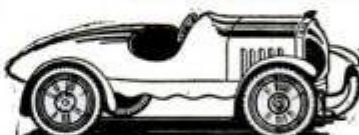

**MOTORCYCLES**

**WE WILL TRUST YOU**  
Pay As Low As \$2.00 per Week  
Hendersons, Harley-Davidsons, Indians

Slightly used and rebuilt. Hundreds to select from.  
Send 10c for list today.

**MYEROW BROS. CO., 15 Berkeley St., Boston, Mass., U. S. A.**





Ready for you  
**FREE FOLDER**

TELLS ALL ABOUT THE  
**15 New Features**

as well as the many other features of the wonderful Motor that thrilled the world in 1926 by its remarkable speed and power. You will want to know especially about "The Pilot" — a NEW device that steers your boat in any course you choose — straight or curved, without attention from anyone. Leaves you free to cast, or troll or rest. The New—

# LOCKWOOD BOAT MOTOR

also offers you many other advantages—improvements in Power, in Speed, in Ease of Starting, in Stopping, in Convenience and Durability. Find out all about them before you choose any Motor. Get the facts now.

WRITE FOR FREE FOLDER

Just out — See how Lockwood is blazing the way by advanced engineering methods backed by 23 years of marine engine building experience. (24)

# LOCKWOOD MOTOR COMPANY

716 Jackson St. Jackson, Mich.

## Catch Fish!



Eels, Mink, Muskrats with our new folding galvanized STEEL WIRE TRAP. Write for our FREE TRAP OFFER and Bargain Catalog. \$1 Box of our famous Fish Bait FREE to introduce our traps. WALTON SUPPLY CO., 3501 JUNIATA AVE., ST. LOUIS, MO.

Many Agents Make **200<sup>00</sup> to 500<sup>00</sup>** per month

New Patented Instant Plug Inserting Instrument. Best, Easiest and Quickest Plug Inserting Instrument known. That's why every Garage, Vulcanizer and Tire Man is easily sold. Mr. Pim writes: "Sold 26 out of 30 demonstrations. Easiest seller and best profit maker I've ever seen. Demonstrate and they buy. Write today for exclusive territory proposition and watch your bank account grow."

**TOURISTS PRIDE MFG. CO.** Dept. 5-H Minneapolis, Minn.

# Thompson BEATS the World on BOATS

**BETTER BOATS at Lower Prices**



**The BEST that Skill and Experience can Produce**  
**TWO BIG FACTORIES**

Our complete line of 22 models offers you a variety to choose from. Prompt shipment from factory to you. **Catalog Free—Save Money—Order by Mail** Please state kind of boat in which you are interested.

**THOMPSON BROS. BOAT MFG. CO.** (20)  
 201 Ann St., PESHTIGO (Write to either place) 101 Elm St., CORTLAND WISCONSIN NEW YORK

# Most Smiles Per Dollar

Your happy face will smile right back at you when you begin to shave with Barbasol. No brush. No rub-in. No after-smart. Try Barbasol—3 times—according to directions.



"Mister, you're next!"

# Barbasol

For Modern Shaving

The Barbasol Company  
 Indianapolis, Ind.

I enclose 10c. Please send trial tube.

Name.....

Address.....

P-M-8-27

# NEW VEST POCKET ADDING MACHINE

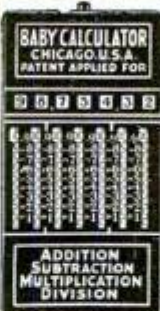

**ADDS, SUBTRACTS, MULTIPLIES, DIVIDES**  
 Does work of \$300 machine. Guaranteed 5 years. NOT A TOY. Made of steel and indestructible. Million dollar capacity. Fits in pocket. Will not make mistakes. So simple child can operate it. Instructions furnished. Everybody should carry one for figuring.

**FREE \$2.50 TRIAL**  
 Total Cost

**SEND NO MONEY**—Just name and address. We will ship Calculator immediately. On delivery pay postman \$2.50 (Plus few cents Postage). (If outside U. S. send cash). 10c additional in Leatherette Case. If not satisfied after 10 day trial you get your money back. THOUSANDS OF SATISFIED USERS. This is lowest priced practical calculator made. "Why pay more for inferior imitations?" Order from this ad.

Guaranteed  
 --- Mail Coupon Today ---

**BABY CALCULATOR SALES COMPANY**

Dept. 41, P. O. Box 1118, CHICAGO, ILL., U. S. A.  
 I am enclosing \$2.50—send adding machine prepaid.  
 Send Adding Machine C. O. D. \$2.50 plus postage. (10c additional in Leatherette Case)

Name.....

Address.....

City..... State.....

**AGENTS** Write for big commission and territory proposition.



Even in  
*flying*

... American soldiers learned how much they owed to strong, well-formed feet developed in youth

"A SOLDIER is only as good as his feet," even in the Air Service where, though there is little walking to do, the rudder bar must be manipulated by the feet, often against high pressures.

And so over 300,000 young Americans were found imperfect for military service by Draft Boards during the War.

Heavy, ill-fitting shoes worn in youth were blamed more than anything else for this condition.

That is why foot specialists everywhere recommend Keds.

For Keds give feet almost barefoot freedom for natural development and growth. They encourage supple strength and well-formed arches.

*Keds—the Shoe of Champions*—And of course Keds are ideal for sports, on turf or track or floor, or for everyday wear. They cost from \$1.25 to \$4.50. Keds are made only by the United States Rubber Company

THE "RENOWN"  
A New Keds with closed vamp for athletic wear. Comes in white or brown



They are not **Keds** unless the name Keds is on the shoe

# EDWARDS WILL SAVE YOU MONEY ON METAL ROOFS

We own our own steel mills, roll our own sheets, make them into high-grade REO METAL SHINGLES, Sidings, Ceilings and Roofings of every type and style for every kind of building. We control every operation from the raw material to the finished roof and we sell direct from our factories to the user. Not a dollar to divide with anybody but the customer! You get better value for less money.

## GUTLAST THREE ORDINARY ROOFS

EDWARDS METAL ROOFS are weather-proof, lightning-proof, fire-proof! The galvanizing bends with the metal. No tools required.



## LOW-COST ALL-METAL GARAGES

Any size. Any style. Portable. Ready to erect. Complete with frames, doors, sash and hardware. Ornamental,

durable, economical. Blue-prints and complete instructions FREE. Write today. Get our low prices and Free Samples. Ask for Roofing Book No. 150 or for Garage Book No. 150.

THE EDWARDS MFG. CO.  
800-850 Butler St. Cincinnati, O.



## MAKE YOUR FORD Into The "LARK"

\$5.00 Red-i-Kut life size patterns

Class—Snap



Famous sure-fit RED-I-KUT life-size patterns and picture instructions show how you can easily convert your Ford into this Fast, Saucy, Sport Car as thousands have done, with easily obtained materials. No need to lay up the car. Rear seat folds, making 4-passenger car. Send 10c coin for actual body photo

and new manual of other distinctive sport body patterns from \$3.50 up—"EKO" Steel 'Swing-Le' irons, Tops and Windshields. ORDER RIGHT NOW.

KUEMPEL COMPANY, 87 Kuempel Bldg., GUTTENBERG, IOWA



## STOP FORD CRANKSHAFT END-PLAY!

C-A ADJUSTABLE BEARING corrects and prevents end-play without removing motor. Eliminates many troubles. Easy to install—simply drop pan. Only \$3.75. Ask your dealer or sent prepaid by ADJUSTABLE BEARING CO., Dept. P, 405 Virginia Ave., Indianapolis, Ind.



## AMAZING INVENTION

Appeals to every motorist. Gets any car out of mud or sand. Nothing like it.

## GETS-U-OUT TIRE LUG

Special offer to agents. Ask for details and territory. Chicago Tire Lug Co., 860-336 W. 47th St., Chicago



## A Motor Boat -for half the cost!

The Super Elto clamps on any open boat — gives all motor boating pleasures at amazingly small cost. Powerful, speedy, reliable. Light and portable. Write today for intensely interesting catalog! ELTO OUTBOARD MOTOR CO., Ole Evinrude, President, Mason St., Dept. A.A. Milwaukee.



The **Super Elto**  
Starts with a quarter turn

# The MODERN Blow-Torch

USE this modern blow-torch because PREST-O-LITE IS QUICKER; no pumping, no generating; no pre-heating. Just turn on the gas and get busy.

IT IS SAFER; the concentrated flame prevents injury to nearby parts.

IT IS BETTER; a wide range of heat under perfect, focused control.

IT IS INEXPENSIVE; simply exchange an empty tank for a full one (paying for the gas only) at any one of the 15,000 or more Prest-O-Lite Gas Exchange stations.

For soldering you use either the open flame or a special soldering copper with flame in head.

Write for details, giving the class of work you do with blow-torches.



THE PREST-O-LITE COMPANY, Inc.  
 New York                      INDIANAPOLIS                      San Francisco  
 In Canada, Prest-O-Lite Company of Canada, Ltd., Toronto, Ontario  
 Unit of Union Carbide and Carbon Corporation

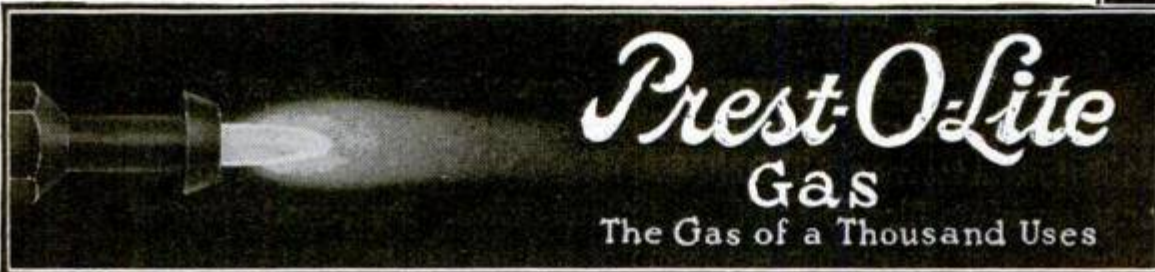

## BUILD YOUR OWN GRANDFATHER'S CLOCK

We furnish blue prints and instructions. Buy the works and dial from us at surprisingly low prices. Make fine profit building artistic clocks for your friends. Plain Works as low as \$5.00. Others with Chimes at all prices. Ask for attractive free offer.

AMERICAN CHIME CLOCK COMPANY  
 1670 RUFFNER STREET                      PHILADELPHIA

## AGENTS 500% PROFIT GENUINE GOLD LEAF LETTERS

guaranteed to never tarnish. Anyone can put them on stores and office windows. Enormous demand, large profits. Paul Clark says: Smallest day \$28.70. R. L. Reel made \$920 in two months. Write today for free sample and liberal offer to general agents.

METALLIC LETTER CO., 433-B N. Clark St., CHICAGO

## AGENTS! EXPERIENCE UNNECESSARY



Science has finally produced it. An instantaneous metal cleaner—neither sloppy liquid nor messy paste. Dry magic floss. Touch it to nickel, copper or brass. The metal shines bright and clean instantly. No hard rubbing! Lightning Silver Cloth does same for Silverware. Lightning Furniture Floss instantly cleans and puts high lustre on furniture. No liquid! Lightning Polishing Cloth is approved by Good Housekeeping Institute. Agents making up to \$30 a day!

## AMAZING DISCOVERY ABOLISHES METAL AND FURNITURE POLISH

Imagine! Touch tarnished articles with a Lightning Polishing Cloth or Floss and you make them bright as new. Demonstrations positively astonishing! Every one a sale! Agents collect real money on every call.

Everybody Buys These Products. Housewives buy the Lightning Silver Cloth and Furniture Floss. Autoists buy Lightning Polishing Floss. Sell all three to stores and offices in big quantities. Nothing else like them. Sure big, quick MONEY GETTERS.

Sample Free! Exclusive territory. Real cooperation. Triple profit. Answer this ad at once. Make big money. Easy! Quick! Don't delay. Write NOW! FREE test sample and proposition by return mail.  
 F. M. LIGHTNING PRODUCTS CORP., 1773 Greenleaf Ave., Chicago

## The Sax' you've always WANTED to play

To learn quickly and play well you must have a perfect instrument. All great artists play the

**BUESCHER**

## True Tone Saxophone

If you can whistle a tune you can learn to play a Buescher. 3 lessons given on request with each Buescher Sax' give you quick, easy start. Many learn scales first hour. play tunes first week, with their Bueschers.

### Easy to Play — Easy to Pay

Take any Buescher Instrument home for six days' trial. See what you can do. If you decide to keep it, pay a little each month. Send for Beautiful Catalog and details of this liberal plan. No obligation. Mail the coupon today.

BUESCHER BAND INSTRUMENT CO.  
 Everything in Band and Orchestra Instruments  
 2013 Buescher Block                      Elkhart, Indiana



BUESCHER BAND INSTRUMENT CO. 386  
 2013 Buescher Block, Elkhart, Ind.  
 Gentlemen: Without obligating me in any way please send me your free literature. Mention instrument interested in.  
 Age?.....Name instrument.....  
 Name.....  
 Address.....

SEND FOR FREE BOOK

# PATENT

## Protect Your Ideas

### Take the First Step Today

If you have a useful, practical, novel idea for any new article or for an improvement on an old one, you should communicate with a competent Registered Patent Attorney AT ONCE. Every year thousands of applications for patents are filed in the U. S. Patent Office. Frequently two or more applications are made for the same or substantially the same idea (even though the inventors may live in different sections of the country and be entirely unknown to one another). In such a case, the burden of proof rests upon the last application filed. Delays of even a few days in filing the application sometimes mean the loss of a patent. So lose no time. Get in touch with me at once by mailing the coupon on the opposite page.

### Prompt, Careful, Efficient Service

This large, experienced organization devotes its entire time and attention to patent and trade mark cases. Our offices are directly across the street from the U. S. Patent Office. We understand the technicalities of patent law. We know the rules and requirements of the Patent Office. We can proceed in the quickest, safest and best ways in preparing an application for a patent covering your idea. Our success has been built on the strength of careful, efficient, satisfactory service to inventors and trademark owners located in every state in the Union.

### NO CHARGE for Information On How to Proceed

The booklet shown here contains valuable information relating to patent procedure that every inventor should have. And with it I will also send you my "Record of Invention" form on which you can sketch your idea and establish its date before a witness. Such evidence may later prove valuable to you. Simply mail the coupon and I will send you the booklet, and the "Record of Invention" form, together with detailed information on how to proceed and the costs involved. Do this NOW. No need to lose a minute's time. The coupon will bring you complete information entirely without charge or obligation.

My Patent Law Offices  
Just Across  
Street From  
U.S. Pat. Office



# NEWS

*Inventors  
Write for these*

**Free  
Books**

Above is a view of my drafting and specification offices where a large staff of experienced experts are in my constant employ. All drawings and specifications are prepared under my personal supervision.

**Strict Secrecy Preserved**

All communications, sketches, drawings, etc., are held in strictest confidence in strong, steel, fireproof files, which are accessible only to authorized members of my staff. Feel free to write me fully and frankly. Your case will have my personal attention. It is probable that I can help you. Highest references. But **FIRST**—clip the coupon and get my free book. Do **THAT** right now.

**Clarence A. O'Brien**

*Registered Patent Attorney*

Member of Bar of: Supreme Court of the United States; Court of Appeals, District of Columbia; Supreme Court, District of Columbia; United States Court of Claims. Practice confined exclusively to Patents, Trade marks and Copyrights

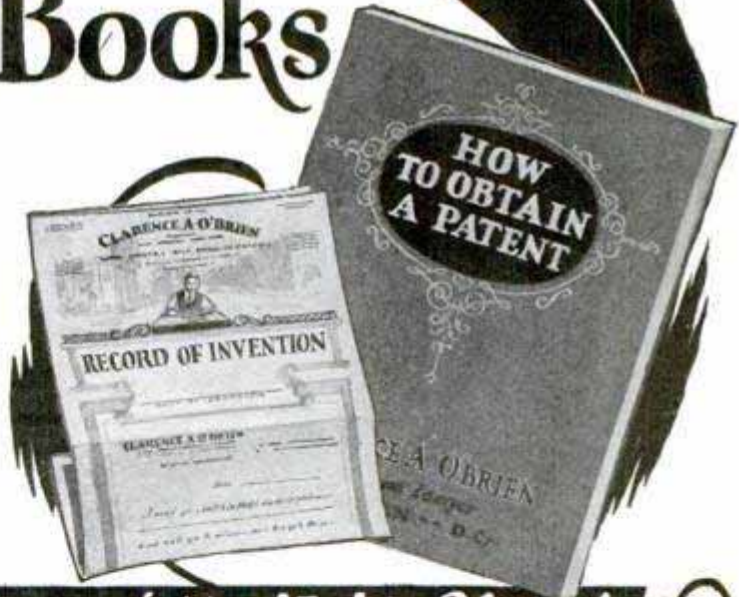

**Clip this Coupon and Mail it Now!**

**CLARENCE A. O'BRIEN, Registered Patent Attorney**

70-A Security Savings and Commercial Bank Bldg., Washington, D. C.

Please send me your free book, "How to Obtain a Patent," and your "Record of Invention" form without any cost or obligation on my part.

Name.....  
*(Important: Write or Print name clearly.)*

Address.....

# PATENTS TRADE-MARKS AND COPYRIGHTS

## Have You An Idea?

### Our Offer: FOR THE PROTECTION OF YOUR INVENTION YOUR FIRST STEP

Before disclosing an invention the inventor should write for our blank form

#### "RECORD OF INVENTION"

This should be signed and witnessed and returned to us together with model or sketch and description of the invention for **INSPECTION and INSTRUCTIONS**

*No Charge for the Above Information*

**Our Four Books Mailed  
Free to Inventors**

*Our Illustrated Guide BOOK*

#### How to Obtain a Patent

Contains full instructions regarding U. S. Patents, Our Methods, Terms, and 100 Mechanical Movements illustrated and described.

#### Our Trade Mark Book

Shows value and necessity of Trade Mark Protection. Information regarding *Trade Marks and unfair competition in trade.*

#### Our Foreign Book

We have Direct Agencies in Foreign Countries, and secure Foreign Patents in shortest time and lowest cost.

#### Progress of Invention

Description of World's Most Pressing Problems by Leading Scientists and Inventors.

*We Regard a Satisfied Client* as our best advertisement, and furnish anyone, upon request, lists of clients in any state for whom we have secured patents.

*Highest References—Prompt Attention  
—Reasonable Terms*

## VICTOR J. EVANS & CO.

### PATENT ATTORNEYS

Main Offices: 956 9th St., N. W., Washington, D. C.

*Opposite U. S. Patent Office*

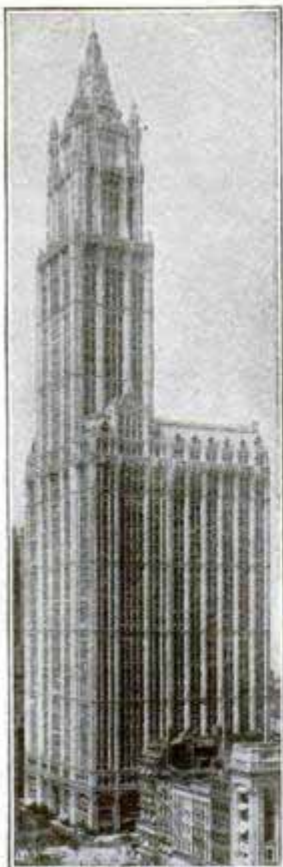

Our New York Office  
Suite 1007 Woolworth Bldg.



Our Philadelphia Office  
Suite 714-15 Liberty Bldg.



Our Washington Office  
Victor Building





# PATENTS TRADE-MARKS AND COPYRIGHTS

## IMPORTANT

TO HAVE YOUR CASE MADE SPECIAL AND AVOID DELAY YOU SHOULD HAVE YOUR CASE MADE SPECIAL IN OUR OFFICE to secure protection, save correspondence and secure early filing date in Patent Office. To secure special preparation of your case send \$25.00 on account with model or sketch and description of invention.



MAIN OFFICE, VICTOR J. EVANS & CO.—VICTOR BUILDING, WASHINGTON, D. C.

*Our Lawyers Practice in all U. S. Courts and defend Clients in Suits involving Patents, Trademarks and Copyrights*

All Communications and Data Strictly Confidential. Interference and Infringement Suits Prosecuted

OUR ORGANIZATION OFFERS PERSONAL SERVICE By Experienced Patent Lawyers, Solicitors and Draftsmen

**FREE  
COUPON**

**VICTOR J. EVANS & CO.  
PATENT ATTORNEYS**

NEW YORK OFFICES  
1007 Woolworth Bldg.

CHICAGO OFFICES  
1114 Tacoma Bldg.

PHILADELPHIA OFFICES  
714-715 Liberty Bldg.

PITTSBURGH OFFICES  
514 Empire Bldg.

SAN FRANCISCO OFFICES  
Hobart Bldg.

MAIN OFFICES: 956 9th Street, N. W., WASHINGTON, D. C.

Gentlemen: Please send me *Free of Charge* your books as described on preceding page.

Name .....

Address .....



Our Chicago Office  
Suite 1114 Tacoma Building



Our Pittsburgh Office  
Suite 514 Empire Building



Our San Francisco Office  
Suite 1010 Hobart Building

# PATENTS

Just as it is important that you protect your idea with a patent, so it is imperative that your patent covers your invention completely. The one best way to assure this is to retain a reliable, experienced patent attorney

## MUNN & CO. PATENT ATTORNEYS

*Associated for 81 years with the Scientific American*

1572 SCIENTIFIC AMERICAN BLDG.  
*24 West 40th Street, New York*

523 SCIENTIFIC AMERICAN BLDG.  
*Washington, D. C.*

1312 TOWER BUILDING  
*Chicago, Ill.*

520 VAN NUYS BUILDING  
*Los Angeles, Cal.*

655 HOBART BUILDING  
*San Francisco, Cal.*

*Ask for free copy of "Patents — A Book of Facts Every Inventor Should Know" and for "Inventor's Diary." Send for them NOW.*

# PATENTS

Booklet Free Highest References  
Promptness Assured Best Results

Send drawing or model for preliminary examination of Patent Office records.

## ALL BUSINESS GIVEN PROMPT AND PROPER ATTENTION

Listed Patent Lawyer in the latest editions of the Rand-McNally Directory of Bankers and Attorneys, of Chicago, Ill.; The Baggott & Ryall Directory of Attorneys, New York City; The Lawyers Guaranteed Directory, Detroit, Michigan; The Lawyers and Bankers Quarterly, published by the Legal Directory Publishing Company of St. Louis, Mo.; the American Lawyers Annual, Cleveland, Ohio.

**WATSON E. COLEMAN,**  
REGISTERED PATENT LAWYER

Victor Building, 724 Ninth Street, N. W.  
**WASHINGTON, D. C.**



## PATENTS

Send us sketch or model for advice and exact cost of patent. Our book "How to Obtain a Patent" sent free. It tells how to apply for Patents, Trade Marks, Foreign Patents, Copyrights, etc.; gives information on Patent Procedure; tells what every inventor should know. Thousands of Inventors, who are our clients, are our reference.

**CHANDLEE & CHANDLEE, 25 Years' Experience**  
473 7th St. Washington, D. C.

## PATENTS

Trade Marks, Copyrights, Patent Litigation Handbook with illustrations, 100 mechanical movements. Sent free on request.

**ALBERT E. DIETERICH**  
formerly member examining corps U. S. Patent Office  
**PATENT LAWYER and SOLICITOR**

621-A, Ouray Bldg.  
27 Years' Experience Washington, D. C.

## Will Finance Patents

Patents of commercial value financed on royalty basis without expense to inventor. Mail models and copies of patents or full details to

**KAMSTONE HOLDING CORP.**  
41 East 42nd Street N. Y. C.

## BLUE BOOK ON PATENTS

AND PRIORITY RECORD BLANK GRATIS.

**MONROE E. MILLER, PATENT LAWYER**  
411-2 Ouray Building, WASHINGTON, D. C.  
ELECTRICAL AND MECHANICAL EXPERT

# PATENTS

## To the Man with an Idea

I offer a comprehensive, experienced, efficient service for his prompt, legal protection and the development of his proposition.

Send sketch, or model and description, for advice as to cost, search through prior United States patents, etc. Preliminary advice gladly furnished without charge.

My experience and familiarity with various arts frequently enable me to accurately advise clients as to probable patentability before they go to any expense.

*Booklet of valuable information and form for properly disclosing your idea free on request. Write today.*

**Richard B. Owen, Patent Lawyer**  
9-303 Owen Bldg., Washington, D.C.  
41-E Park Row, New York City

## TRADE-MARKS

REGISTERED

# INVENTORS PROTECT YOUR IDEAS

Send for our Guide Book, **HOW TO GET A PATENT**, and Evidence of Invention Blank, sent Free on request. Tells our terms, methods, etc. Send model or sketch and description of your invention for **INSTRUCTIONS**. No charge for the above information.

**RANDOLPH & CO.**  
301 Victor Bldg., WASHINGTON, D. C.

NAME.....

STREET.....

CITY..... STATE.....

**Charge it**

**\$3950**

G-50 2 diamonds and 4 blue sapphires adorn this 14 karat solid white gold Wrist Watch with 15-jewel movement. \$3.85 a month.

G-51 5 blue-white diamonds in 18 karat white gold Wedding Ring. \$32.50. \$3.15 a month.

**With 10 MONTHS TO PAY**

Your choice of these exceptional bargains will be sent to you for approval and 15 day trial if you will simply send \$1 with your name and address. If satisfied, pay balance in 10 equal monthly payments, otherwise return and your dollar will be refunded.



G-52 AA1 blue-white diamond in Ladies' Engagement Ring. \$50. \$4.90 a month.

Our charge System is simple, easy, convenient . . . prompt delivery, no red tape, everything confidential.

Other Big Bargains in Diamonds, Watches and Jewelry in this booklet. SEND FOR IT TODAY. IT'S FREE.



G-53 1 blue-white diamonds in 18 karat white gold Dinner Ring. \$39.95. \$3.89 a month.

**L.W.SWEET Inc**

**BULOVA PATENTED DUSTPROOF**

You pay the Nationally Advertised Cash Price **\$28.50**

DEPT. 67-N  
1660 Broadway  
NEW YORK

G-54 Gent's Bulova Strap Watch, 14 karat white or green gold filled case; 15-jewel movement. \$28.50. \$2.75 a month.

Flexible transparent cap which protects the movement.

**If You Are A MAN**

worthy of the name and not afraid to work, I'll bet you \$50 that you can't work for us 30 days and earn less than \$200. Think I'm bluffing? Then answer this ad and show me up. Openings for Managers. The "Wonder Box" sells on sight.

**TOM WALKER**  
DEPT. 25 • PITTSBURGH, PA.

# 1000 NEEDED INVENTIONS!

Here is the most remarkable book ever offered to inventors. One Thousand needed inventions listed and described. Arranged as follows: General Problems; Automotive; Mechanical; Electrical; Chemical; Radio; Marine. Separate chapter on the Ten Most Needed Inventions. This book may give you one idea that will win you a fortune. Nothing else like it has ever been published. Compiled at enormous expense. Edited by Raymond Francis Yates, formerly Managing Editor of a leading scientific magazine. Over 100 pages, durably bound. Send no money. Pay postman only \$1.00 plus postage on arrival. Money back after 10 days' examination if desired. Limited edition. Write NOW.

**BUREAU OF INVENTIVE SCIENCE**  
DEPT 38 ROCHESTER, NEW YORK

## PATENTS

**Don't Lose Your Rights To Patent Protection**

Before disclosing your invention to anyone send for blank form "EVIDENCE OF CONCEPTION" to be signed and witnessed. As registered patent attorneys we represent hundreds of inventors all over the United States and Canada in the advancement of inventions. The form "Evidence of Conception," sample, instructions relating to obtaining of patents and schedule of fees sent upon request.

**LANCASTER & ALLWINE**  
480 O'ray Bldg. WASHINGTON, D. C.  
*Originators of forms "Evidence of Conception."*

**Materials For Handy Men**

Bearings, Belting, Blue Prints, Books on Mechanical and Scientific Subjects, Brass Castings, Compressors, Gears, Lathes, Motors, Saws, Shafting, and Supplies of every kind for MODEL MAKERS and HANDY MEN.

Complete Catalogue 25c which is allowed on first \$2 order.

Amalgamated Sales and Service Corporation  
327-E South La Salle St., Chicago, Ill., U. S. A.

## PATENTS

As one of the oldest patent firms in America we give inventors at lowest consistent charge, a service noted for results, evidenced by many well known Patents of extraordinary value. Book, Patent-Sense, free. Lacey & Lacey, 646 F St., Wash., D.C. Estab. 1868.

**INVENTORS AND MECHANICS**

Send 10 cents in stamps for Material Catalog

**COLBURN GEAR & MFG. CO.**  
98 Holmes St., Quincy, Mass.

**RAISE BELGIAN HARES**

NEW ZEALAND REDS—Chinchillas—Flemish Giants

**MAKE BIG MONEY—We supply stock and pay you** following prices for all you raise: Belgian Hares \$2 each—New Zealand \$3 each—Chinchillas \$4 each—Flemish Giants \$5 each. 32-page illustrated book, catalog and contract, also copy of *Fur Farming* magazine, tells how to raise skunk, mink, fox, etc., for big profits, all for 10c. Address

**OUTDOOR ENTERPRISE CO.,** Box 25, Holmes Park, Mo.

**Direct at Factory Prices**

Sample \$1.18 3 for \$3.00 Postpaid

**Hand Forged Razor Steel Blades**

Send for our 100-page FREE List and "HOW TO USE A RAZOR."

**Maher & Grosh Co.**  
106 A St., Toledo, Ohio

**A Genuine \$2 Knife for \$1.18 Postpaid**

Handy shaped Blade makes this knife best for mechanics, sportsmen and farmers; light but strong; re-sharpened easily. Stag handle. German silver finish; blades file tested, hand forged from razor steel and warranted.

**easy**  
\$ **100**  
**cash**  
per week

2 sales instead of 1 at these low prices  
1 qt. size \$5  
2 qt. size \$7.50



**NEW, Simple, Automatic FIRE PROTECTION**  
at a price that brings **VOLUME SALES**

Nothing else can give you Fugo's BIG money-making advantages. Representatives "cleaning up" fast — \$15 and \$20 cash-in-pocket from just one day's work not unusual. Most sales made without demonstration. Fugo is the only **instantaneous AUTOMATIC** home and life protection—using same chemical all Fire Departments use. America's biggest Fire Chiefs recommend it. It's your opportunity to make good in a **BIG WAY**.

**65%—90% Cash Profit**

No investment. No red tape. Full commission same day you take order. Biggest field. **Every** home, factory, church, store, theatre, truck, automobile, etc. wants FUGO! For FUGO **outperforms**, therefore outsells competition. Easy to make \$100 a week—many doing better. No experience needed—simply ambition and ability to follow instructions. Waiting profits all around you.—**Act Quick!** Write **AT ONCE** for full details.

**THE NATIONAL FORMETAL CO.**  
6535 Metta Ave., N. E. Cleveland, Ohio

**Distributors!**  
Write at once for State rights.

**STANLEY**  
Plumbing Supply Co., Inc.



**Save one-half**  
We sell everything in plumbing, heating, hardware, paint, roofing and millwork supplies. Due to large-quantity buying, we are able to offer you Grade A merchandise at enormous savings. Satisfied customers in every State. Send for our elaborate catalog—over 95 pages of surprising bargains.

**STANLEY PLUMBING SUPPLY CO., Inc.**  
400 N. 12th Street, PHILADELPHIA, PA.

**DO YOU** WANT a new business profession of your own, with all the trade you can attend to? Then become a **foot correctionist**, and in a few weeks earn big income in service fees,—not medical nor chiropody—easy terms for home training, no further capital needed, no goods to buy, no agency. *Address*  
**Stephenson Laboratory, 1 Back Bay, Boston, Mass.**

**Agents!-New Invention Brings Easy \$15<sup>00</sup> a Day Profit!**

a \$150  
**Seller that pays you 85% profit**



Show the **Lookout** to scary housewives. They buy on sight. **Gives protection and safety.** The **Lookout** sees outside the door before opened. **Burras, St. Louis,** sold five in one house — **Etson, Pittsburgh,** 12 in an hour. **Says greatest seller in years.** In these days of terrible crime the **Lookout** just fits in. Make 85c on every one you sell at \$1.50.

**\$10.00 Outfit Without Cost**  
Get our plan giving full particulars. Send \$1.00 today for sample and particulars about unique selling plan and money back guarantee.  
**NEW INVENTION FACTORIES**  
A-9 GOVERNOR PLACE  
LONG ISLAND CITY NEW YORK

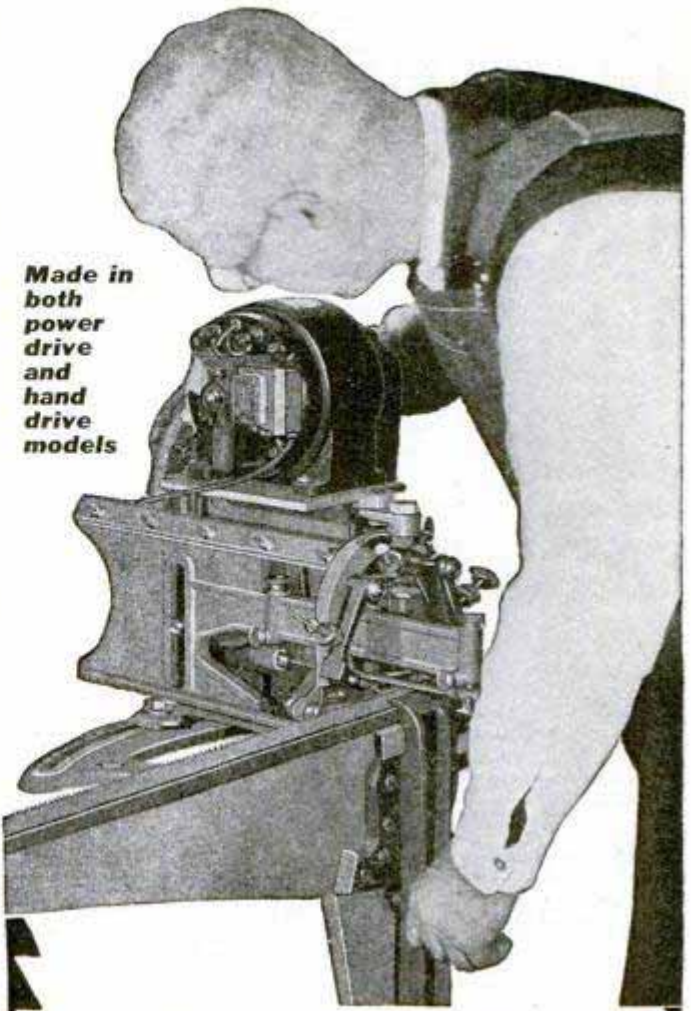

Made in both power drive and hand drive models

**\$15 to \$20 a Day Profit**  
In Your **own Business**

Here's a business that's not overcrowded with competition, a cash business—no credit losses—a business for whose service there is a big, steady, year 'round demand everywhere, a business that requires very little capital to start—a clean, dignified business.

Think of the carpenters, contractors, butchers, factories, farmers and many homes that have saws to be filed frequently.

**FOLEY Automatic SAW FILER**

With it one man can do four to six times as much filing as the most expert hand filer, and so accurately that saws will cut better than new. It files hand saws, band saws, back saws and circular saws. It is very easy to operate.

You get 50 cents or more for filing each saw, and \$1.25 to \$1.50 for retreating saws. The Foley quickly pays for itself and goes on earning profits year after year.

**Guaranteed!**

The Foley Filer is a high grade machine, guaranteed to do speedy, accurate saw filing that will satisfy you. Send the coupon now for full information.

**FOLEY SAW TOOL CO., Inc.,**  
218 Foley Bldg.,  
9 Main St., N. E.,  
Minneapolis, Minn.

Send me full information on Foley Saw filing equipment.

Name.....  
Address.....

# CAN YOU SELL HEAT? IN WINTER?

# Hot Dollars All Winter!

Man, you don't have to sell heat. Everybody wants it. Everbrite agents cleaning up \$3000 to \$5000—no soliciting—no investment—no risk—just visiting prospects secured by our national advertising and leaving the heater for a night's trial.



**When It's 23 Below Zero** The Everbrite Radiant Oil Heater will keep you comfortable. Mrs. Senften, Genoa, Nebraska, writes: "23 below zero, but the Everbrite kept us warm and burned 25 hours on 1 filling." A portable heater for homes, stores, churches. Makes and burns its own gas from common kerosene.

Pours out flood of pure, clean, intense heat at cost of 1 cent an hour.

**FREE** Just send name for amazing agents' offer. Clean up \$200 a week or more! Get a demonstration heater for your own use. Or if not interested in agency, write for special offer on heater. No wick—burns like city gas. Cleaner, cheaper, more comfortable than wood or coal. Low price.

**WRITE TODAY**

**The EVERBRITE STOVE CO. KANSAS CITY, MO.**

2216 Gateway Sta.

*The* **EVERBRITE**  
Radiant Oil Heater  
**\$250 a Week**

J. O. Hand, California, made over \$250 a week last year. Knabb and Godwin of Florida both did better than \$200 a week. H. T. Rees of Kansas, averaged \$300 a week. F. W. Hubbel, Iowa, beat \$400 a month. So did Senften and Cassel, Nebr., Richie of Iowa, Shook of New Mexico, Webb of Arkansas, Wilson of Louisiana, and Alfred of Kansas.

## Have You a TYPEWRITER? Would You Like to Have One?

For Fast Business-Like  
Correspondence for

Professors  
Teachers  
Clergymen  
Prominent People



Salesmen  
Club Sec'y's  
Students  
Storekeepers

For a Full-Time  
Well Paid Position for

Stenographers Clerks  
Bookkeepers Telegraphers

For Profitable  
Spare Time Income for  
Housewives Office Girls  
Students Clerks

**10 DAYS'  
FREE  
TRIAL  
A  
Year to  
Pay**

**ILLUSTRATED CATALOG**

of all standard machines remanufactured from top to bottom at saving of 40 to 60%—Free. (Mail coupon.)



Young Typewriter Co.  
654 W. Randolph St.  
Dept. 1108, Chicago

Without obligation send me free catalog of bargain typewriters and EZ pay plan.

Name.....

Address.....

City..... State.....

**Note!** A less expensive machine may answer your need. Indicate type of work. We may have a bargain for you

**WONDER  
AN  
INSTRUCTIVE  
AMAZING**



**BIRDS  
AMUSING  
INTERESTING  
SCIENTIFIC NOVELTY**

This is the World's Newest and Greatest Novelty Toy. Be first in your town to write for exclusive territory and attractive quantity prices.

Agents sample and particulars sent for 25 cents.

Wonder Bird Novelty, 75 Arcade Bldg., Vancouver, B. C. Canada

## THIS WONDERFUL INVENTION



converts any ordinary cook stove into a gas stove. OXO-GAS is made from kerosene and air. Cheaper, cleaner and more efficient than coal. Responsible distributors wanted.

**GLORIA LIGHT CO.**  
111-8 N. May St. Chicago, Ill.

## Start to Play Very First Day

Be the life of the party. Xylorimbists make \$5 to \$25 a night. No knowledge of music required. Wonderful for home. Free, easy lessons; five days' trial; a year to pay. Write for big FREE Book.

**J. C. DEAGAN, Inc.**  
C-145 Deagan Building  
CHICAGO

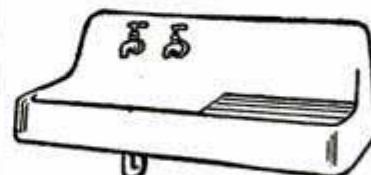

**SPECIAL  
Porcelain  
Enameled  
SINK \$28.25**

One of many bargains  
Write for Plumbing and Heating Catalog. Save 40%

**B. KAROL & SONS CO., Dept. 20, 800 So. Kedzie, CHICAGO**

## New Improved SPORS Fountain Pen. 60 Day Trial. Money back if not pleased GUARANTEED 2 YEARS—Improved Point! LADIES' OR MEN'S STYLE

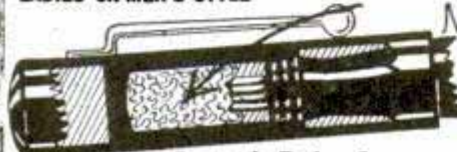

Comes in Red or Green

Newest Invention. Rubber sponge keeps point moist. Writes the instant it touches paper.

Agent's Sample **65c** Sells for \$1.25. Writes like a \$7 Pen. Make \$10 Daily Easily

**MAKES \$8.40 IN TEN MINUTES**  
I sold my dozen pens in about 10 minutes. Will order another dozen soon. TRACT KRANS, Nebraska.

**F. SPORS CO.**

627 Main St. Lesueur Center, Minn.

# 3 Greatest SPECIALS \$29.75

Your Choice at



**AA1 -** Gorgeously pierced, lace design dinner ring; 18K white gold set with 3 perfectly matched genuine diamonds. Special \$29.75

## A Full Year To Pay

The greatest genuine jewelry bargains ever offered! Credit values which defy cash store competition. Pin only \$1 to your order and your choice comes to you parcel post prepaid on **10 Days Free Trial**. Then pay postman only \$1 more on delivery; after free trial period pay balance in 12 equal monthly payments of **\$2.32 each**. Satisfaction absolutely guaranteed or your money refunded—our policy for 32 years.

## FREE—Royal Book of Gems

Thousands of special values in genuine diamonds, jewelry and watches. Send for your copy at once.

**Wear while paying.**



**AA2 -** Spectacular value! Lady's wrist watch, 14K solid white gold engraved case set with 2 genuine diamonds and 4 French Blue Sapphires; guaranteed 15 jewel movement. Special \$29.75



15 JEWELS

Elgin or Waltham

**AA3 -** Never before offered at so low a price! Gents strap watch; 20 year guaranteed, newest Olympic octagon case, white or green gold filled. Fitted with 15 jewel nationally advertised Waltham or Elgin movement. Special \$29.75

**ROYAL DIAMOND & WATCH CO.**  
ESTABLISHED 1895  
ADDRESS DEPT 1E37 170 BROADWAY NY



## When Commandant DePinedo left Italy on his recent record-breaking flights

he insisted on carrying a 5-pound can of

# SMOOTH-ON No. 1

and in the last minute personally sent out a rush order for this Smooth-On to be billed to himself.

This insistence on Smooth-On for possible engine repairs, where every ounce of surplus weight had to be avoided, is good evidence that Smooth-On No. 1 makes dependable repairs. Get the Smooth-On habit and you will quickly find that it keeps many dollars in your own pocket. Try it on the following and see for yourself:

## IN THE HOME

Stopping leaks in steam, water, gas, oil or stove pipes, mending cracks, breaks or leaks in furnaces and boilers, radiators, tanks, sinks, pots and pails, making loose handles tight on umbrellas, knives, hammers, brushes, drawers, etc., tightening loose screws, hooks, locks, door knobs, etc.

## ON THE AUTOMOBILE

Making bursted water jackets and pumps good as new, stopping leaks in radiator, hose connections, gas tank and gas, oil and exhaust lines, making a fume-proof joint between exhaust pipe and tonneau heater, tightening loose headlight posts, keeping grease cups, hub caps and nuts from loosening and falling off, etc.

To get perfect results, write to us for and use the Smooth-On Repair Book Free if you return the coupon.

Get Smooth-On No. 1 in 7-oz., 1-lb. or 5-lb. tins at any hardware store, or if necessary direct from us.



**WRITE FOR FREE BOOK**



# Do it with SMOOTH-ON

SMOOTH-ON MFG. CO., Dept. 37,  
574 Communipaw Ave., Jersey City, N. J.  
Please send the free Smooth-On Repair Book.

Name.....  
Address.....  
City.....  
8-27

## LIGHTING FIXTURES

Ready to hang

Direct from the manufacturer. Completely wired, including glassware. Send for new catalogue No. 28. Just Reduced Prices. Special Proposition to Dealers.

**Erie Fixture Supply Company, Inc.**  
Station A ERIE, PA.

## FOY'S BIG PIGEON BOOK

In NATURAL COLORS, a complete guide to successful Squab and Poultry Raising. Tells how to feed, breed, grow and make money raising squabs. Quotes low prices. Write today. FREE.

**F. FOY** Box 5 **CLINTON, IOWA**

## SQUAB BOOK FREE

Breed squabs and make money. Sold by millions for more than chickens. Write at once for free 40-page book beautifully printed in colors telling how to do it. You will be surprised.

**PLYMOUTH ROCK SQUAB CO.**  
634 H Street Melrose Highlands, Mass.

## How Fast Can You Take Orders?

Many average \$75 a week showing women our eye-catching, money-saving line of imported and domestic fabrics. Large repeat sales. 1000 samples and selling instructions furnished. Men and women wanted on either part or full time. Complete details free. Write

**THE NATIONAL IMPORTING CO., Dept. V-6, 573 Broadway, N. Y. C.**

Auto Bodies, Boats, Blinds, Caskets, Antiques, Doors, Screens, Furniture, Sash, Cabinets, Patterns

# If you work with WOOD

you can save, every day, a good many hours of the slow, monotonous work of hand sanding, rubbing, grinding, finishing and polishing—do it accurately and much BETTER with the

## TAKE ABOUT Sander

The only hand belt surfacing machine

It's a little machine—only 13 pounds—but it buys and pays for itself every few days on any kind of wood-working. Bench stand converts for hard-to-get-at places. 1001 uses pads. Easy, quick change of belts for every purpose. Carries you over the rough spots and gets your jobs out on time PROFITABLY.

Put it up to us—no obligation—just say "my work is . . . ." Do it now, before you forget.

**PORTER-CABLE MACHINE CO.**  
1704-10 N. Salina St.  
Syracuse, N. Y.

Building contractors, Vocational Schools, Floor surfacing contractors, Carpenter shops, Planing mills, Refrigerator manufacture, All General Repairing, Finishing, Polishing



### Why Not Become— A Building Washing Contractor

Make \$200 a week! Earn big profits! Employ others. We want industrious, reliable men in protected territory. The NIELCO Lightning Washer opens a very profitable business field with a very moderate outlay of capital. Write for exclusive contract.

**Nielsen Industries, Inc., 1209 Macabee Bldg., Detroit, Michigan**

### A SHIP MODEL FOR \$4.98



Build an exact replica of the historic Santa Maria or the Mayflower with your own hands. We will furnish the parts complete for only \$4.98 plus a few cents for postage. No tools needed except a small hammer.

Write for our illustrated catalog.

**MINIATURE SHIP MODELS**  
Dept. O, 3818-20-22-24 Baring St., PHILADELPHIA, PA.

### \$100 to \$125 PROFITS Weekly!



New line of quality toilet goods sells like wildfire. 300% to 500% profits. No experience required. All you do is take orders from this beautiful sample case. Finest perfumes, soaps, facial creams, bath salts, face powders—wonderful products at prices that appeal to all women.

#### FREE SAMPLE CASE

Just send your name and address. This money-making opportunity is unequalled. Be your own boss. Get paid every day. Write today—we show you how to make BIG money with little work.

**THE NATIONAL SOAP & PERFUME CO.**  
512 W. Huron St. Dept. 53 Chicago, Ill.

## Time, Labor and Money Saving Ideas for Auto Repairmen, Owners and Tourists

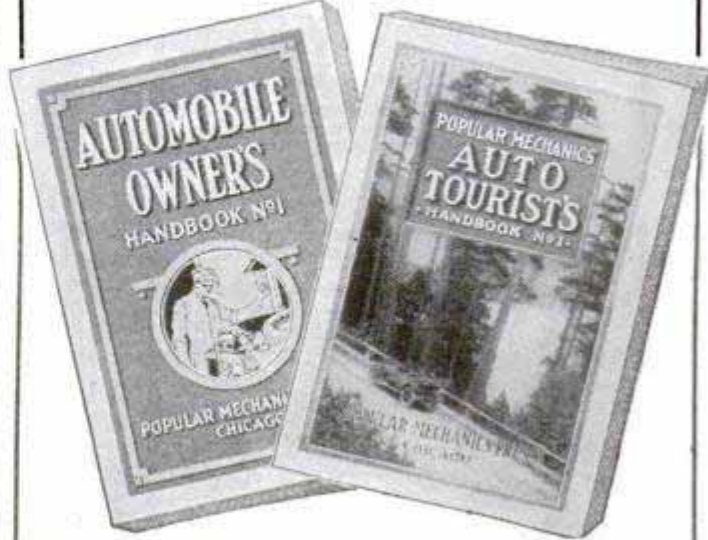

334 Valuable Discoveries made by Hundreds of Auto Mechanics are contained in our Auto Repairman's Handbook. 337 Illustrations. . . . . **Price 50c**

286 Practical Kinks based upon the actual experiences of 171 auto owners who have encountered emergencies and been successful in overcoming them are found in the Auto Owner's Handbook. 221 Illustrations. . . . . **Price 50c**

133 Practical Plans for making touring easier, less expensive and more enjoyable contributed by those who have toured extensively and know whereof they write in the Auto Tourist's Handbook. 169 Illustrations. . . . . **Price 50c**

These 3 books (regular \$1.50 value) are offered for a limited time only for 98 cents plus the postage. Pay postman when he delivers the package. If outside U. S. send remittance and include 15 cents extra for postage.

**POPULAR MECHANICS PRESS**  
ROOM 608  
200 E. Ontario Street CHICAGO

# EXPOSED!

## 69 Tricks of Mediums Fully Explained

Every detail given for performing the seemingly impossible feats of famous mediums. Startling revelations that show how easy it is to fool the credulous. Many of these tricks have made the greatest magicians wonder.

### You Can Do These Tricks

What makes a trick good is its simplicity. No complicated or expensive apparatus needed for these, the best of spiritualistic tricks. You can do such wonders as:

1. Produce spirit message on blank paper.
2. Read messages while blindfolded.
3. Produce spirit rappings.
4. Produce spirit voices.
5. Produce writing on blank slates.
6. Read sealed letters in total darkness.
7. Reproduce a burned message.
8. Read messages retained by the writers—and 61 other marvels used in spiritualistic seances.

### Make Money Giving Entertainments

Clubs, Lodges, Sunday Schools, Churches, and organizations of all sorts are eager for entertainers who can mystify audiences with such inexplicable manifestations as these. You can make from \$10 a night up to \$50 or more, depending upon the size of the community in which you work. Anyone can do this. You need no special gifts.

**Price \$1.50** Sent C. O. D. anywhere in U. S. Pay postman price and postage. If outside U. S. remit when ordering and include 10 cents extra for postage.

**POPULAR MECHANICS PRESS**  
Room 708, 200 East Ontario Street CHICAGO, ILL.



## CLAROSTAT

is the perfect variable resistor for every radio purpose: Line control for voltage compensation; B-eliminator voltage control; R. F. tube plate voltage control; volume control and 57 other uses.

WHY and HOW is explained in 32 page book, "THE GATEWAY TO BETTER RADIO." Send 25c to

**AMERICAN MECHANICAL LABS.**

Dept. P. M. 285 North 6th Street Brooklyn, N. Y.  
CAUTION! CLAROSTAT is being imitated. Don't be misled. Insist on seeing the name which is stamped on every genuine CLAROSTAT.

# CLAROSTAT

Turn | Dial-get programs everywhere: **30 Days FREE!**



**MIRACO**  
Unitune 5

28 in. long

**MIRACO**  
RADIO  
GETS 'EM  
COAST to  
COAST

Users report Miraco Radios get Coast to Coast, Canada to Mexico, loud and clear on speaker; outperform \$100 to \$200 sets. Some hear Europe. Marvelous bargain! Don't buy unless 30 Days Trial proves it Most Selective, Clearest and Most Powerful Distance-Getter among big, fine 5-tube radios. Solid walnut cabinet. Write for **Factory Prices—SAVE UP TO 1/2** Every set completely assembled, rigidly tested, fully guaranteed. Ultra-5, \$49.75 list. Speakers, batteries, tubes, etc. at big savings.

**Free** literature, users' testimony and BIG SPECIAL OFFER

**MIDWEST RADIO CORPORATION**  
Pioneer Builders of Sets

**USER-AGENTS WANTED**  
Write for discounts

Send for Proof 407- E Miraco Bldg., Cincinnati, O.

**SM**

**Do You Know the Secret of Quality Reproduction?**

"The Secret of Quality" tells you simply and concisely how to get the most out of your amplifier—how to get quality. This 96 page booklet is yours for the asking—it's free. Write for your copy.

**SILVER-MARSHALL, INC., 840 W. Jackson Blvd., Chicago, U. S. A.**

## 5 TUBE RADIO KIT COMPLETE—\$16.95

Genuine Blue Ribbon Neodyne Kit—2 dial control gets real distance. Simple plans, instructions furnished. Can be built in 2 hours. FREE 21 inch Erla Cone Speaker. 5 tubes included. Kit sent C. O. D. Order today.  
**RADIO EQUIPMENT CO., Dept. P. D., 549 S. Wells St., Chicago, Ill.**

## Simplified Radio Blueprints

Blueprints for the most popular sets described in Popular Mechanics Magazine can be obtained for a charge just sufficient to cover the cost of production and mailing. The sets for which blueprints are available are:

Simple One-Tube Receiver.....	April 1926	— 25c
Two-Tube, Loud Speaker Set.....	May 1925	— 25c
Three-Tube, Cockaday Receiver.....	April 1925	— 25c
Three-Tube, Low-Loss, Short-Wave Set.....	Oct. 1925	— 25c
Three-Tube, Loud Speaker, Loop Set.....	Dec. 1926	— 25c
Three-Tube, 15 to 550 Meter Set.....	Nov. 1926	— 25c
Four-Tube, Loop Set, for Car or Home.....	Aug. 1926	— 25c
Five-Tube, Browning-Drake Set.....	May 1926	— 25c
Six-Tube, Self-Contained Receiver.....	July 1925	— 25c
Six-Tube, Counterphase Receiver.....	Feb. 1926	— 25c
Six-Tube, Portable, Loop Set.....	June 1926	— 25c
Electrolytic B-Eliminator.....	Feb. 1927	— 25c
Eight-Tube, 1927 Model Superheterodyne; this set of blueprints includes drilling templates and extra photos.....	Oct. 1926	— 75c
B-Battery Eliminator.....	Mar. 1926	— 25c
Non-Radiating Unit.....	May 1926	— 25c
Simple Tube Tester and Chart.....	July 1926	— 25c
New Perfect-Tone Six.....	Mar. 1927	— 25c

Address the **RADIO DEPT.**

**Popular Mechanics Magazine**  
200 E. Ontario St., CHICAGO

Back numbers of the magazines describing the construction of the sets can be obtained from our Circulation Department, price 25 cents each.

# The CROSMAN .22 RIFLE

## The Wonder Gun "Power Without Powder"

Here is the most remarkable gun that has appeared in years—a .22 rifle that uses no powder, has accuracy not obtainable in any other gun, abundant power, never needs cleaning, silent, scientifically correct. The delight of men who glory in precision shooting and the ownership of a handsome, powerful gun.

### Unsurpassed Accuracy

Experts find this new gun accurate beyond anything in their experience. By its use amateurs become experts in a short time. Absence of powder deposit in rifling keeps it true, from first shot to last—like shooting a newly cleaned gun every time. Put bullet after bullet through same hole, establish new high records and astonish your friends. Perfected by a West Pointer. Used and endorsed by men like Richard L. Sutton. Army men delighted with its marvelous accuracy and self-cleaning feature. Knocks down quickly to fit 22-inch suitcase.

### Never Needs Cleaning

Powderless, smokeless, noiseless. Never needs cleaning. Every bullet passing through barrel acts like swab and leaves it brighter and cleaner. Shoot all day, put gun away and rest while your friends mess around with oily, blackened rags. Next day outshoot them again with your wonderful Crosman.

### Do Target Shooting at Home

Set up range in your attic, cellar, yard, or even in your apartment—if you live in a crowded city. Power adjustable for indoor shooting with same superb accuracy. No smoke to annoy, no noise to disturb anyone, no shells dropping over floor. Simply shoot to your heart's content any time you feel like it. Gets all kinds of small game, pests, rats, sparrows, etc.

**FREE**  
Target  
and  
Game  
Shooting

Send  
for this  
Booklet



**CROSMAN ARMS CO., Inc.**  
384 St. Paul Street, ROCHESTER, N. Y.  
70 West King Street, Toronto, Canada

**WE SET YOU UP IN BUSINESS!**

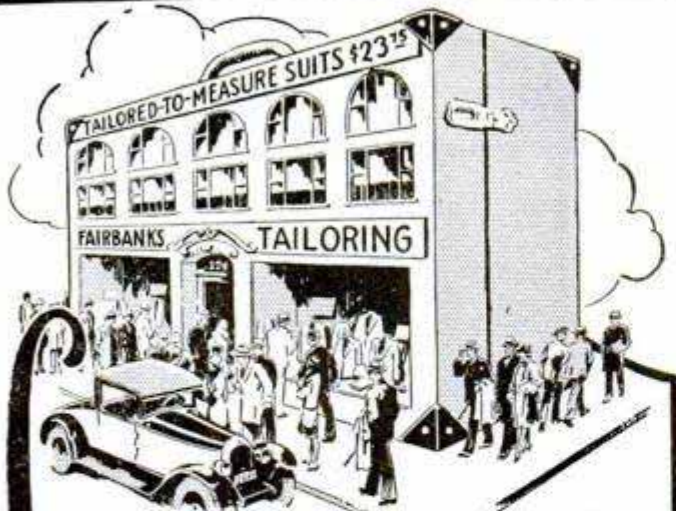

**Can You Sell \$35 Suits for \$23.75**

YOU can do as much business with a Fairbanks sample line as if you had an expensive Main Street location, costly fixtures, and thousands of dollars tied up in "STOCK." And you can deliver bigger value because your "store" pays no rent, no clerk hire, no "overhead" expenses. You can give your customers every cent of this saving. You can sell ALL-WOOL suits and overcoats, tailored to measure, actually the \$35 kind, for only \$23.75.

**BIG Money for Real Salesmen**

We pay you \$4 to \$5.25 cash on every order, and you can sell hundreds of suits and overcoats each season by our plan. Sliding scale of cash bonuses in addition.

**Write Us a Letter!**

Tell us all about yourself, selling experience in detail, your record of tailoring sales, if any, age, references, territory wanted, etc. No writing back and forth—if your application letter looks O. K. we will send you line immediately.

You can build up a permanent, repeating business of your own with our help and backing. Tailoring experience preferred, but not absolutely necessary. But only men with a record of successful selling in wholesale, retail, or direct lines will be considered.

**Sample Outfit FREE if You Qualify**

Men who mean business, who are willing to work persistently and devote full time to this work will be given the preference. Costly, hard-hitting outfit, a "portable tailoring store" and all necessary supplies furnished absolutely free. 143 smart, all-wool fabrics in the big line for Fall. Write today for QUICK ACTION!

**FAIRBANKS TAILORING CO.**  
Dept. 132, Oakley Blvd. at Wabansia, CHICAGO

**BOW LEGS?**

THIS GARTER (Pat'd) Makes Trousers Hang Straight IF LEGS BEND IN OR OUT  
Free Booklet—Plain Sealed Envelope  
Dept. 2, New London, New Hampshire  
The T. GARTER CO.

**Diamonds Here at 60% of Market Price**

Free Bulletin lists diamonds as low as \$60 per carat, also Gems of Finest Quality at higher per carat charges, but proportionately low Bargain Prices. This 3/4 less 1-16 carat correctly cut diamond, a snappy blazing solitaire at \$68.50. This 75 year oldest largest Diamond Banking Firm in all the world lends money on diamonds. Thousands of unpaid loans and other bargains. Many from big cash deals direct with European Diamond Cutters. Must sell NOW.

**WHY PAY FULL PRICES**  
Costs Nothing to See

Any Diamond sent for absolutely free examination at our risk. No obligation. No cost to you. Latest Listings—Unpaid Loans. Sent Free. Describes Diamond Bargains in Detail, & gives cash loan values guaranteed. Explains unlimited exchange privileges. Write today for your copy of Diamond Bargain List. Use blank below, clip ad and mail.

Name \_\_\_\_\_

Address \_\_\_\_\_

Tear out and mail today to— Jos. De Roy & Sons, Only Opposite Post Office 1959 De Roy Building Pittsburgh, Pa.



\$68.50  
3/4-1/16 Carat Correctly Cut

**No Joke to be Bald**



**Grow New Hair Quick**

**Let Me PROVE It To You FREE**

What I accomplished on my own head, pictured above, I believe I can do for you, provided you are under 45 years of age and loss of hair was not caused by burns or scars. Anyhow, I must succeed or you pay nothing. No apparatus—my home treatment is simple, quick and inexpensive.

**Send No Money** Just your name and address and I will mail you full information with PHOTOGRAPHS, NAMES and addresses of men and women who have successfully used my treatment for dandruff, falling hair and particularly for baldness. Write Now. A postal will do.

**VREELAND'S,** C-135 Euclid-Windsor Bldg. CLEVELAND, OHIO

**QUIT TOBACCO**



No man or woman can escape the harmful effects of tobacco. Don't try to banish unaided the hold tobacco has upon you. Join the thousands of inveterate tobacco users that have found it easy to quit with the aid of the Keeley Treatment.

**KEELEY TREATMENT STOPS Tobacco Habit**

Quickly banishes all craving for tobacco. Write today for Free Book telling how to quickly free yourself from the tobacco habit and our Money Back Guarantee.

**THE KEELEY INSTITUTE**  
Dept. A900 Dwight, Illinois

**SKIN-TROUBLES**

**ANDRE'S ACNE CREAM** is Excellent for all Skin Troubles no matter how severe or chronic. Quickly ends Pimples, Black-heads, Eruptions on face or body. Eczema, Barbers' Itch, Scabs, Crusts, Pustules, Enlarged Pores, Oily, Shiny or Itching Skin. Lightens Freckles, softens and whitens the skin. Immediate Results. Full Particulars FREE. Write at once.

Andre & Co., 4029 Cottage Grove Av., Suite 430, Chicago, Ill.

Write today for our 168 page **Deafness** FREE Book on

and learn how Perfect Hearing is now being restored in every condition of deafness or defective hearing. Our "Little Wireless Phones for the Ears" require no medicine but effectively replace what is lacking or defective in the natural ear drums. They are simple devices, which the wearer easily fits into the ears where they are invisible. Soft, safe, and comfortable.

**WILSON EAR DRUM CO., Incorporated**  
661 Inter-Southern Bldg. LOUISVILLE, KY.

**Save Your Feet**

When all else fails, end your suffering with the **Heefner Arch Support No Metal**



Fully patented. It re-adjusts the entire foot. Write for free book and statements from doctors and users.

Heefner Arch Support Co. 654 M. E. Taylor Bldg. Louisville, Ky.

## TIME AND LABOR SAVING IDEAS FOR SHOPMEN

VOL. XXIII—POPULAR MECHANICS SHOP NOTES FOR 1927



**POPULAR MECHANICS SHOP NOTES**  
FOR 1927  
VOL. XXIII PRICE 50¢

**EASY WAYS TO DO HARD THINGS**  
POPULAR MECHANICS PRESS  
CHICAGO

479 Valuable Articles covering a wide range of Practical Subjects are found in Shop Notes for 1927. 374 Illustrations.  
Price 50c

301 ways to use drills, drill presses, taps and dies, with greater effectiveness, are given in our Drilling and Thread Cutting Handbook. 298 Illustrations... Price 50c

259 Kinks furnished by 106 of the most successful Lathe Operators are contained in our Lathe Handbook. 212 Illustrations... Price 50c

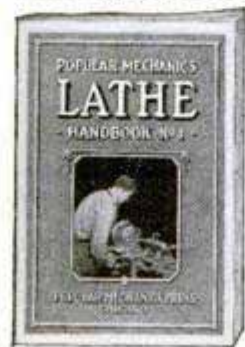

### SPECIAL OFFER

These three books (regular \$1.50 value) are offered for a limited time only, for \$1 plus postage. Pay postman when he delivers package. If outside U. S. send remittance and include 20 cents extra for postage.

Popular Mechanics Press  
Room 708  
200 E. Ontario St. Chicago

# Oh! the joy of RADIO with a SUBANTENNA

NEW UNDERGROUND ANTENNA

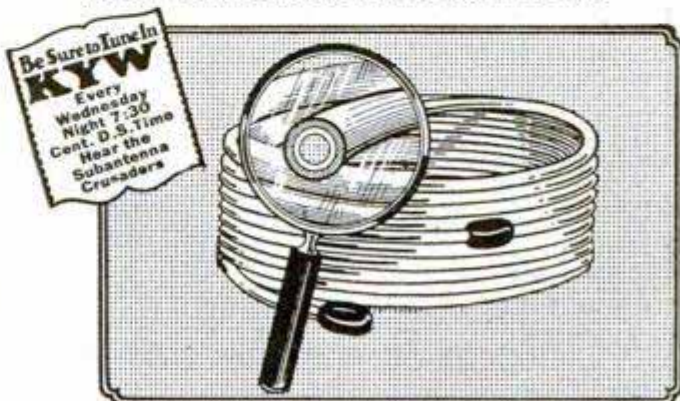

## Use Static-Free Ground Waves Get Distance Clear in Summer

IMAGINE the intense pleasure of bringing in your favorite distant station loud and crystal clear—right through summer's curtain of static and noise! You can do it with SUBANTENNA. In summer air, the ratio of static strength to signal strength favors static. The "noise" is so much greater than the broadcast signal that it hides the music you wish to hear. But, when you use SUBANTENNA, the situation is just reversed. For, in the ground, the ratio of static strength to signal strength favors the latter. In fact, there is so little static in the ground that the broadcast signal easily dominates it, with the result that you don't hear the static. Radio research men have long known this fact, but until the advent of SUBANTENNA, no device had ever been perfected by which ground waves could be used.

# FREE TRIAL

## Make This Convincing Test

Install SUBANTENNA. Select a bad night when DX is almost impossible with the aerial. Make a comparison station for station, connecting first your aerial, then SUBANTENNA. If from stations that are just a mess of jumbled noise with the aerial, you don't get reception that rivals local in sweetness and clarity the instant you switch to SUBANTENNA, this test won't cost you a single penny. Obtain a SUBANTENNA from your dealer or send coupon at once for particulars of GUARANTEE and FREE TRIAL OFFER.

**CLOVERLEAF MFG. CO.**  
2717-E Canal Street CHICAGO

### MAIL THIS NOW

Cloverleaf Mfg. Co.,  
2717-E Canal St., Chicago.

Tell me all about SUBANTENNA, your unqualified, unconditional guarantee and your FREE TRIAL OFFER.

Name.....

Address.....

## Don't Be Afraid To Tackle That Concrete Job!

What is it you want to make out of concrete?

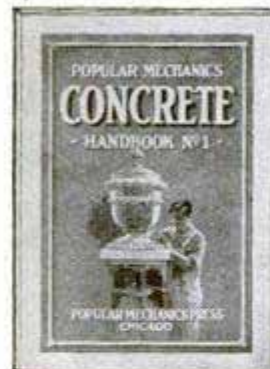

A Garage floor—Garden seat—Bird bath—Auto Drive-way—Curbs and Gutters—Flower boxes—Rural Mail Box Post—Garden Fountain—Ornamental Pool—Drinking Fountain—Boat Landing—Cistern Cap—Milk House—Engine Foundation—Watering Trough—Sidewalk—Steps—Gateposts—Fence Posts—Tile—Blocks—Silo—Pedestal—Vases—Forge—Smokehouse—Chimney Cap—Horse Stalls—Foundation Support—Cyclone Cellar.

With the instructions found in Popular Mechanics Concrete Handbook you can make 173 different useful articles.

### Build With Ease for Permanence and Beauty

With the Concrete book we send you another remarkable book called Home Mechanics. This contains 329 valuable discoveries for doing the various jobs that come up about every home, both in the house and outside. These articles cover Furnaces, Stoves and Fireplaces—Homemade Furniture and Repairs—Building Refinements—Home Shop—Home Plumbing—Kitchen Equipment—Devices for Men—Home Electric Work—Outdoor Work—Water Supply—Garden—Bees—Miscellaneous.

Simply write and ask us to send you these two books. When postman hands you the package pay him 98 cents plus the postage. If outside U. S. remit when ordering and include 15 cents extra for mailing.

**POPULAR MECHANICS PRESS**  
Room 608 200 E. Ontario Street CHICAGO

# Houdini's Great Trunk Trick

Bound — locked in a trunk—yet he escaped! How?—That's revealed to you in the great Tarbell Course in Magic. And much more!

Houdini was a Master Performer. Yet he recognized Dr. Tarbell as the Master Teacher. He valued his teachings so much he ordered THREE Tarbell Courses in Magic!



## NOW— YOU can learn the secrets of Professional Magicians

Many of the wonderful tricks that Houdini featured on his programs—Effects that the world's most famous Magicians are using on the stage today. These and MORE are taught to you in the Tarbell Course. For the first time in history YOU can learn the deep secrets of the Magic Profession. Learn them easily—in a short time—in your spare time—at home! Study three or four lessons and you are ready to "give a show" before the public! Card Effects, Coin Tricks, Sleight of Hand, Mysteries of the Orient, Great Stage Illusions—EVERYTHING—confidentially revealed to YOU! All made easy for YOU to learn and for YOU to perform. Full information—FREE! Send the coupon TODAY!

## Make \$250 to \$1000 a Month

Houdini made as high as \$1000 for one performance! You know there's big money in Professional Magic. But there's good money to be made "on the side," too. Keep your job and make a lot of EXTRA MONEY. All you have to do is master a few easy tricks. Great demand for Magicians in clubs, lodges, conventions, schools, theaters. BIG PAY—\$25 to \$100 for perhaps half an hour's program. Salesmen—business men—professional men—all can use Magic to gain popularity and profits. Easy for YOU to make \$250 to \$1000 a month.

**Send Coupon Now!**

**Tarbell System, Inc., Dept. C-135  
1920 Sunnyside Ave., Chicago**

Please send me your big FREE illustrated circular giving full information on the Tarbell System of Magic. No obligation on my part whatever.

Name.....  
Address.....  
City and State..... Age.....

## 861 PRACTICAL IDEAS for REDUCING FARM LABOR and INCREASING INCOME

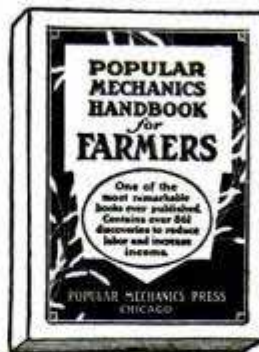

One farmer writes: "I would not take \$100 for my copy if I could not secure another."

The Handbook for Farmers contains: 138 ideas for the farm shop, 35 on fencing, 98 on auto, truck and tractor, 61 on farm buildings, 36 on field machines, 48 on concrete work, 22 on orchard work, 23 on painting, 15 on live stock, 34 on poultry, 54 on garden work, 25 on electrical work, 22 on farm tools, 16 on hunting, fishing and trapping, 140 household helps.

## 394 HELPFUL KINKS to LIGHTEN the LABOR of the FARMER'S WIFE

The Handbook for Women contains: 83 kitchen and dining room helps, 17 on garden and flowers, 19 on sewing and mending, 37 on furniture, pictures and fixtures, 38 on laundry and cleaning, 32 on house cleaning, 12 on music, 14 on sleeping rooms, 11 on care of children, 16 on lights, 9 on photography, 14 on clothing and shoes, 23 on house temperatures, 12 on water and drains, 10 on insect pests, and 47 miscellaneous.

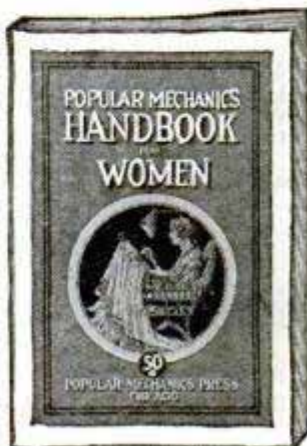

## SPECIAL OFFER BOTH for \$1

(Regular \$1.50 Value)  
For a limited time you are offered both books for \$1 plus the postage. Pay postman when he delivers package. If outside U. S., send remittance and include 15 cents extra for postage.  
**POPULAR MECHANICS PRESS**  
Room 707, 200 E. Ontario St., Chicago

## OUTDOOR SPORTS THE YEAR 'ROUND

Popular Mechanics New Useful Book—Outdoor sports appeal to us all. But the fun is double when you make your own devices. There are 226 clearly written and concise articles telling how to make equipment for new and popular sports of many kinds in the new Outdoor Sports book. There are clever devices for such sports as:

- |                  |              |                      |              |
|------------------|--------------|----------------------|--------------|
| Swimming         | Trapping     | Photography          | Kite Flying  |
| Camping          | Tobogganing  | Tennis               | Summer Games |
| Football         | Baseball     | Outdoor winter games | Nutting      |
| Swinging         | Fishing      | Skating              | Pushmobiling |
| Trolley Coasting | Golf         | Boating              | Racing       |
| Roller Skating   | Boat sailing | Toy Making           | Skiing       |

It is easy to make the devices described above because there are 317 helpful illustrations. The articles are clear enough for boys, yet interesting enough for any man.

This offer also includes a copy of our valuable Boat Book which tells

## HOW TO BUILD 21 KINDS OF BOATS

Complete and simple directions and illustrations are given for building the following: Fast Runabout Motor Boat; Canadian Model Canoe; Open Sailing Canoe; Portable Folding Boat; Motor Canoe; Petersborough Canoe; Canvas Covered Cedar Canoe; Hydroplane Catamaran; Cruising Catamaran; Paper Boat; Long Island Scooter; Paddle Wheel Boat; Log Canoe; House Boat; Sea Gull Sail Boat; Pile Driver Punt; Inexpensive Motor Boat; Steel Boat; Concrete Boat; Bicycle Boat and Power Driven Catamaran.

Just write us to send these two books. When the postman hands you the package pay him \$1.98 plus the postage. If outside U. S. remit when ordering and include 15 cents extra for postage.

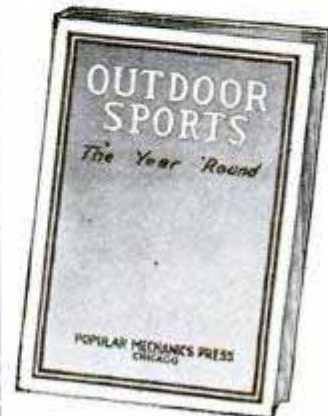

**Popular Mechanics Press**  
Room 706 200 E. Ontario St., Chicago

**New "Wonder" Money-Maker**  
**EARN \$1,000 A MONTH**  
**Spare Time Pays Big**



**THIS AMAZING 17-OUNCE**  
**Tool CONQUERS 60-lb. Kit**  
**World Flight Equipment**

The most revolutionary hand tool ever invented. Does the work of other tools costing over \$50—truly a tool of 1000 uses. Just the "hand-grip" of a tiny rubber band holds a hard bearing ball—the hardest-to-hold thing known—against a 300 Pound Pull!

**Grips with 1 Ton Direct—128 Tons Per Sq. In. Pressures**

through its 10-to-1 Leverage Power-Gear Transmission. In addition, the Grip **LOCKS!**

**World Flight Equipment**

It was standard equipment for the U. S. WORLD FLIGHT and the U. S. S. Shenandoah. Creates a sensation everywhere. Just its astounding 1-Ton Grip makes it worth ten times its cost.

The amazing EIFFEL-FLASH PlieRench is a true Ratchet WRENCH—Parallel Pliers—Speed VISE, and more. Instantly and automatically it **LOCKS** its death-grip Jaws on the most worn and chewed nuts in the tightest places and **TURNS THEM!**

AND—in the EIFFEL-FLASH PlieRench KIT—weighing only 1½ lbs.—you get a complete UNIVERSAL Tool Service that beats any number of other hand tools weighing 60 lbs. and costing \$50.00.



**Whole Kit in 1 Tool**

You get in a Royal Blue Leatherette HOLSTER, the 8½" Universal PlieRench with 2 EXTRA Jaws—a PIPE Jaw—and a WIRE Jaw—each giving undreamed of performance. Instantly (in 1/5 second) you insert the Jaw you need, and as quickly snap a One-Ton Grip on work of any possible kind, or shape, or size from 0-in. to 1½-in.! And—nothing Ever can get away from that grip!

HAVE YOU EVER HEARD OF A TOOL THAT WORKS LIKE THIS?—it actually outgrips a 40-lb. Vise, and applies a 1-TON grip at the very jaw-tips. Will remove broken studs, taps, drills, etc., with next to nothing to hold on. Yet its smooth grip will hold a hair and coil a spring of hair-fine piano wire.

**Get Yours Free**

We want distributors everywhere and for introductory purposes offer 1 PlieRench Kit Free to the first interested person in each locality—Here is a real opportunity—Be the first in your locality.

**THE FLASH SALES CORP'N**  
 HP-4809 N. Ashland Avenue, Chicago, Ill.

**GUARANTEED**

The PlieRench KIT is positively guaranteed.

It has stood the most trying tests of time and service. Of thousands—the First Commander of the U. S. World Flight said—"It should form part of the equipment of each and every Airplane and Automobile." One Engineer said—"I have used my PlieRench for 5 years and wouldn't be without it for \$100—and I mean it!"

**Agents Make Big Money**

Studebaker has approved it for use in its Service Stations throughout the World. Thousands of housewives are using it too, because it does so many useful and amazing things so easily, so instantly. And even a woman's hand applies a HALF-TON Giant's Grip! Every Auto and Home Owner—every man who ever uses any tools needs it every day.

**Can You Sell Gas At 5c Per Gal.?**

If so write me quick. My Distributors make as high as \$3,000.00 per month with amazing new thermostatic carburetor device. Let me show you how.

**SEND FOR FREE TRIAL**

Proof of astounding success and my \$15.00 a day Guarantee to Distributors.

Frank Andrews, Pres., **BLANCHE AUTO DEVICES CO.**  
 154 E. Erie St., Dept. 805-L, Chicago, Ill.

**Fansteel Products Company, Inc.**  
 North Chicago, Illinois

For Better Filament Control on your radio set use the **NEW Lynch EQUALIZER** in place of rheostats. \$1 complete with mounting. At your dealer's or post-paid. Money back if dissatisfied. In ordering, state number and types of tubes in your receiver. **ARTHUR H. LYNCH, Inc.,** Manufacturers of the Lynch Metallized Resistor, 250 West 57th Street, NEW YORK, N. Y.

**REMINGTON**  
**PORTABLE TYPEWRITER**  
 Dealers and Branches Everywhere

**ENCYCLOPÆDIA BRITANNICA**  
 in the New Form—at a saving of 40%  
 Write for full details. Address Dept. PM7  
**THE ENCYCLOPÆDIA BRITANNICA, Inc.**  
 342 Madison Ave., New York City

**Do Your PRINTING**  
 Cards, stationery, circulars, tag, labels, paper. Complete Outfits, \$8.85 up, Job Presses \$11 up, Rotary \$149. Card Cutters, \$3. Save money. Print for others, big profits. All easy rules sent. Write for catalog presses, type, paper, cards, ink etc. **THE KELSEY CO., C-37, Meriden, Conn.**



**Establish and Operate a Specialty Printing Business**

No experience required. Our condensed course (price \$5) tells you how. Every kind of business needs Specialty Printing. Letterheads, Noteheads, Billheads, Statements, Cards, Blotters, Envelopes. Sent postpaid for \$5. Send Money Order or Currency. **ACKERMAN'S COMMERCIAL PRESS, Dept. 25, 78 Dawson St., Kingston, N. Y.**

**For Real "Woodworking Efficiency"**

is your woodworking ability lying dormant? **Wake it up!** With this new

**JUNIOR CABINET WORKER**

at your service  
**\$156.00**  
 complete

From raw material to finished product all on this complete woodworker. An ideal outfit for special furniture jobs. Indispensable to the home shop. Carry it on the job.

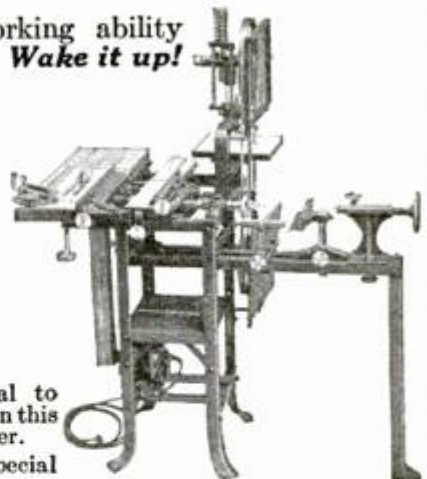

Write for details  
 Mfg. by **KORNAU MACHINE COMPANY**  
 Station A Cincinnati, Ohio

**KEEP YOUR LAWN MOWER SHARP**



You can do it yourself easily and quickly with a Berghman Lawn Mower Sharpener. It is adjustable and lasts forever. A few strokes on each blade and your mower cuts like new. To keep your lawn mower in shape this summer **SEND** for this handy sharpener **TODAY**—postpaid—**\$1.95**  
**G. BERGHMAN COMPANY**  
 5737 W. Chicago Ave., Chicago, Ill.

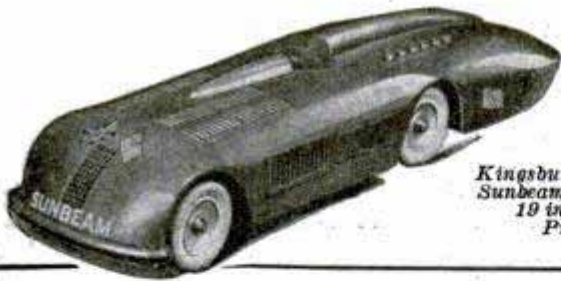

Kingsbury toy Sunbeam Racer 19 in. long. Price \$3

# "203 Miles an Hour!"

Here it is—the toy sensation of the season—model of the famous "mystery" Sunbeam Racer—fastest car in the world! You remember—the car that made 203 miles an hour down in Florida last February. The "speediest toy on wheels." Equipped with high speed spring motor, geared to instant swiftness. Dunlop rubber tires. Go see it at your toy dealer's. If he is not supplied, write us for pictures and description, or order direct.

**KINGSBURY MFG. CO.**  
83 Myrtle Street, Keene, N. H.

Complete Catalog in Colors Free



Send 10c for this Kingsbury Disc Wheel Eraser

## KINGSBURY MOTOR DRIVEN TOYS



# Mechanics Proud of CORNWELL Hand Forged Tools

MORE than 100,000 mechanics throughout the United States are proud of their Cornwell Tools and use no others....Cornwell Tools accomplish results where other tools fail....You can put them to any test....Use them in shop or home and get your money back if you are not absolutely satisfied that they are the finest tools you ever saw....The widespread use of Cornwell Tools is the astounding evidence of their quality.

### Tools of Amazing Strength

Chisels, ratchet busters, punches, wrenches, screw drivers, pry bars, socket wrenches, universal joints, pliers—for use in garage, shop or anywhere where strong tools are required....Nothing like them in the world—if you ever saw tools as good as these, return your order and get your money back.

### Test These Tools at Our Risk

Try any test described in booklet....if the tools fail or show the slightest harm, we will instantly replace them or give you your money back....Can any guarantee be stronger than this?



Mail Coupon Today

**CORNWELL QUALITY TOOLS CO.**  
Dept. N, Mogadore, O. (Formerly at Cuyahoga Falls, O.)

Send me illustrated booklet with prices on full line of Cornwell Hand-Made Tools.

.....Occupation  
Name.....  
Address.....  
City.....State.....

# Books on 67 Practical Subjects

Popular Mechanics Press specializes in supplying the outstanding best book on any subject. Check the books you want, and mail this advertisement as your order blank.

- ARCHITECT**  
Architectural Drawing \$1.50
- ARMATURE WINDER**  
Armature Winding... \$3.00
- ARTIST**  
Practical Art..... \$5.00
- ARTS CRAFTS**  
Art Metal Work..... \$4.25
- ASTRONOMY**  
Amateur Telescope Making..... \$2.00
- AUTOMOBILE**  
Dyke's Encyclopedia... \$6.00
- AVIATOR**  
Practical Aviation.... \$3.00
- BOAT BUILDER**  
22 Different Boats.... \$0.50
- BOOKKEEPER**  
Bookkeepers' Handbook..... \$1.00
- BOYS' BOOKS**  
The Boy Mechanic (4 vols.)..... \$7.00
- BRICKLAYER**  
Plain and Fancy Brickwork..... \$1.50
- CABINET MAKER**  
Furniture Making.... \$3.50
- CALCULATOR**  
Ropp's Calculator.... \$1.00
- CARPENTER**  
Carpenter's Handbook \$1.50
- CARTOONING**  
Cartooning Made Easy \$2.00
- CHEMISTRY**  
General Chemistry.... \$3.75
- CIVIL SERVICE**  
Course in Civil Service \$1.50
- CONCRETE**  
173 Ways of Using Concrete..... \$0.50
- COOKING**  
Foods from 20 Lands.. \$1.50
- DETECTIVE**  
Instruction for Detectives..... \$1.00
- DIESEL ENGINES**  
Diesel Engines, Marine, Locomotive, Stationary..... \$5.00
- DOG FANCIER**  
Dog Encyclopedia.... \$2.00
- DRAWING**  
Drawing Made Easy... \$1.25
- DRILLING**  
Drilling and Thread Cutting..... \$0.50
- ELECTRICIAN**  
American Electricians' Handbook..... \$4.00
- ELECTROPLATER**  
Electroplating..... \$1.00
- ENGINEER**  
Bailey's Handbook for Stationary, Marine, Diesel..... \$2.00
- ENGLISH**  
Self-Improvement in English..... \$2.50
- ENTERTAINMENTS**  
Producing Amateur Entertainments..... \$2.00
- ETIQUETTE**  
Book of Etiquette (2 vols.)..... \$1.98
- FARMER**  
Popular Mechanics Handbook for Farmers..... \$1.00
- FORD**  
My Ford, Its Care and Repair..... \$3.00
- FORMULAS**  
10,000 Formulas..... \$4.00
- FUR RAISER**  
Outdoor Opportunities \$2.00
- FURNITURE MAKING**  
Mission Furniture Making, (3 vols.)..... \$3.00
- GLASS WORKER**  
Decorative Glass Processes..... \$3.25
- HAND FORGING**  
Hand Forging and Wrought Iron Ornamental Work..... \$2.00
- HOME BUILDING**  
Concrete Houses..... \$3.00
- HOME REPAIRS**  
Practical Book of Home Repairs..... \$2.50
- INTERIOR DECORATOR**  
Interior Wall Decoration..... \$4.00
- INVENTOR**  
Inventors' Manual..... \$1.50
- LATHE WORK**  
Lathe Handbook..... \$0.50
- LEATHER WORKER**  
Leather Work..... \$1.50
- LETTER WRITING**  
Better Business Letters \$1.00
- LOOM FIXER**  
Practical Loom Fixing.. \$1.50
- MACHINIST**  
Complete Practical Machinist..... \$3.00
- MAGIC**  
Modern Magic..... \$2.00
- MASON**  
Practical Stone Masonry..... \$1.25
- MATHEMATICS**  
Mathematics for the Practical Man..... \$1.50
- MECHANICAL DRAFTSMAN**  
Practical Course in Mechanical Drawing.... \$1.00
- MODEL MAKING**  
Model Making..... \$3.00
- OUTDOOR SPORTS**  
Outdoor Sports the Year Round..... \$1.50
- PAINTING**  
House Painting Methods \$2.00
- POULTRY RAISER**  
\$4,223 from a Town Lot \$1.00
- PSYCHO-ANALYSIS**  
Outwitting Our Nerves \$2.50
- RABBIT RAISING**  
Practical Rabbit Keeping..... \$1.50
- RADIO**  
Lefax Radio Handbook \$3.50
- REFRIGERATION**  
Homemade Refrigerating Machine..... \$0.50
- SHIP MODELS**  
Ship Model Making... \$2.50
- SHOP WORK**  
Shop Notes (16 vols.).. \$7.50
- SPIRITUALISM**  
Behind the Scenes with the Mediums..... \$1.50
- TAXIDERMIST**  
Methods in Taxidermy \$3.50
- TOY MAKER**  
Toy Manufacture..... \$1.50
- WELDER**  
Welding Encyclopedia.. \$5.00
- WIRING**  
House Wiring..... \$1.00
- WOOD WORKER**  
Wood-Working for Amateur Craftsmen..... \$1.00
- WRITER**  
Free-Lance Writers' Handbook..... \$5.00

## Books sent C. O. D. anywhere in U. S.

Just check the ones you want, write your name and address below, and mail the whole advertisement. It is your order blank. When postman hands you books, pay him the price and the postal charges. If outside the U. S. remit when ordering and include 10 cents per book extra for postage. We have many other books on these subjects and on 2,000 other subjects. Catalog free.

Name.....  
City.....State.....  
Address.....

Mail to Popular Mechanics Press,  
Room 708, 200 East Ontario St., Chicago, Ill.

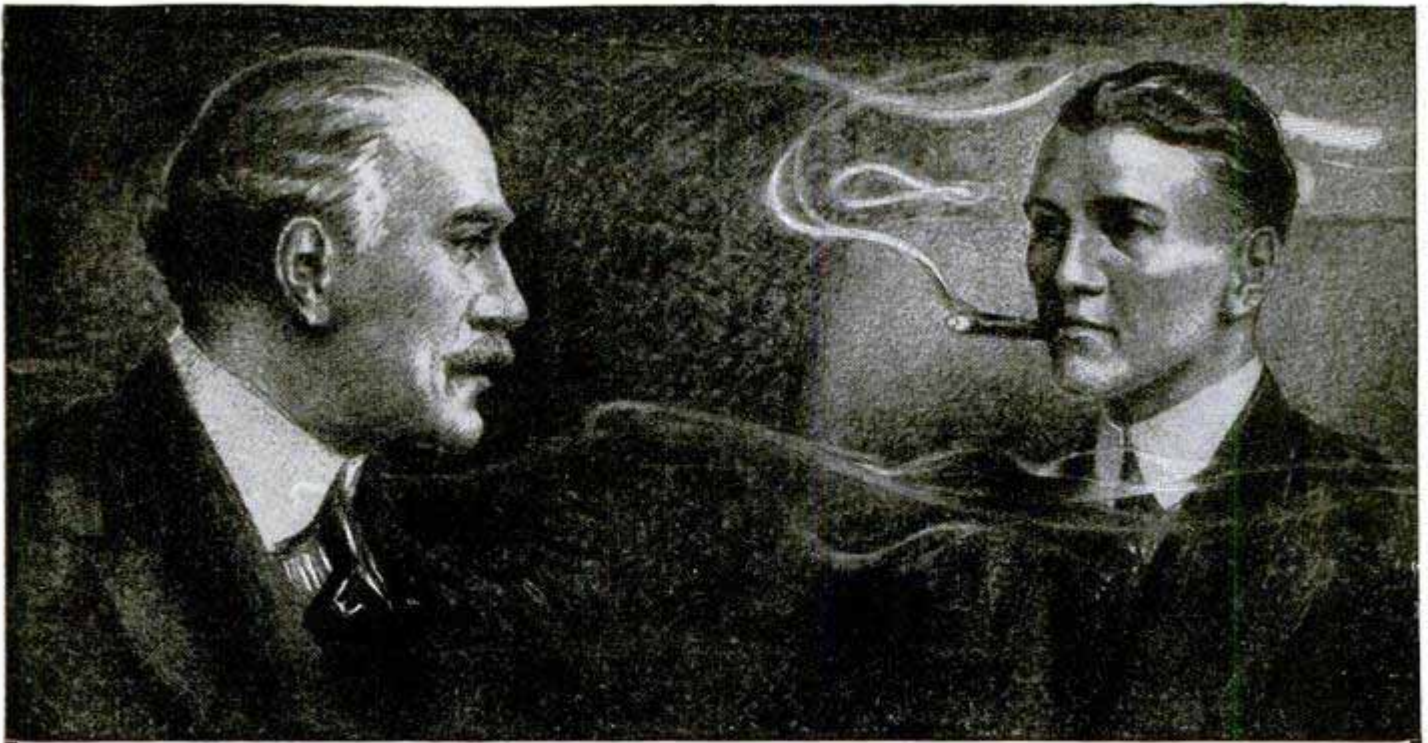

## Tobacco Is Hurting You

Look at the facts square in the face, Mr. Tobacco User. You may think tobacco is not hurting you.

That is because you haven't as yet, perhaps, felt the effects of the nicotine poison in YOUR system. For you know that nicotine, as absorbed into the system through smoking and chewing tobacco, is a slow working poison. Slow, yes—but sure.

Tobacco is lowering your efficiency. It slows a man down. Makes it harder for you to concentrate your mind on your work. You haven't near the amount of "pep" and energy you would have if you stopped using it. There's many a man twice as old as you in years who's twice as young in energy, simply because he lets tobacco alone.

Some day you will realize to what an alarming extent tobacco has undermined your system.

When your hands begin to tremble—  
and your appetite begins to fail—  
and your heart seems to "skip a beat" now and then—  
and slight exertion makes you short of breath—  
then you have a right to suspect that  
**TOBACCO** is getting the upper hand.

Any well-informed doctor will tell you that these are only a few of many symptoms of tobacco poisoning.

And YOU know that the use of tobacco in any form is an expensive, utterly useless habit. You know you ought to quit.

## Tobacco Habit Banished Let Us Help You

It doesn't make a particle of difference whether you've been a user of tobacco for a single month or 50 years, or how much you use, or in what form you use it—whether you smoke cigars, cigarettes, pipe, chew plug or fine cut or use snuff—**Tobacco Redeemer** will positively remove all craving for tobacco in any form in a very few days. Not the slightest shock to the nervous system. Your tobacco craving will usually begin to decrease after the very first dose—there's no long waiting for results.

**Tobacco Redeemer** contains no habit-forming drugs of any kind and is marvelously quick, scientific and thoroughly reliable.

It is in no sense a substitute for tobacco. After finishing the treatment you have absolutely no desire to use tobacco again or to continue the use of the remedy. It helps to quiet the nerves and make you feel better in every way.

**Results Guaranteed** A single trial will convince you. Our legal-binding, money-back guarantee goes with each full treatment. We will refund every cent you pay for the treatment if after taking it according to the easy-to-follow directions, it should fail to banish the tobacco habit completely.

**SEND Coupon for Free Proof** Let us send you our free booklet on the deadly effects of tobacco, together with testimonial letters from men all over the country telling how they have been absolutely freed from the tobacco habit by this simple home treatment. You could not ask for stronger proof that **Tobacco Redeemer** will free you from the habit than the evidence we will gladly send on request. Just mail the coupon—or a postal will do.

**NEWELL PHARMACAL CO.**  
Dept. 300 Clayton Station St. Louis, Mo.



## Free Book Coupon

NEWELL PHARMACAL CO.

Dept. 300 Clayton Station St. Louis, Mo.

Please send, without obligating me in any way, your free booklet regarding the tobacco habit and proof that **Tobacco Redeemer** will positively free me from the tobacco habit or my money will be refunded.

Name .....

Street and No. ....

Town..... State.....

On Parade  
In Camp  
At Home

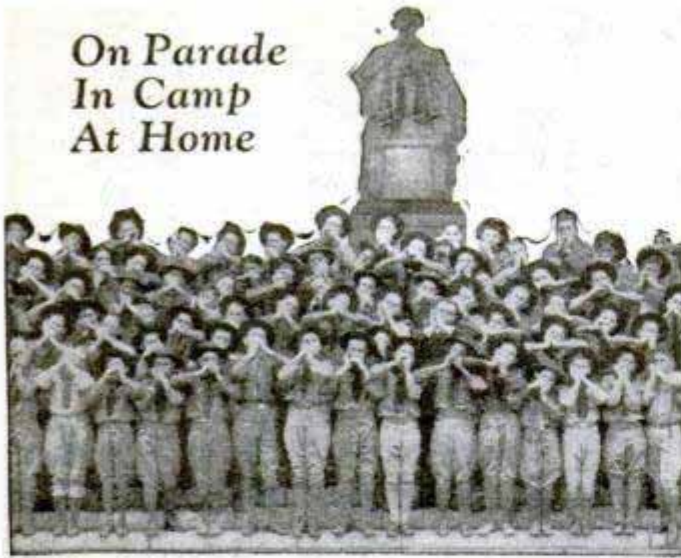

## Your "Musical Pal"

To be "in the swim" nowadays, you must play the harmonica—and play every new thing that comes along!

A million boys last year received free instruction books and learned to play the world-famous "Marine Band" Harmonica.

Then thousands more bought the fascinating new "Chromonica"—a harmonica which supplies every sharp and flat, so that you can play any selection in any key. When you master this instrument, you are in a class with the harmonica professionals.

### The NEW Way to Learn

A special orthophonic Victor Record (No. 20377) "How to Play the Harmonica" is now available for those who wish to learn by listening to the living voice of the instructor, and following the notes as they are sounded on his harmonica. Illustrated instruction sheet also included. Reverse side reproduces "Old Black Joe" as rendered on harmonica with piano accompaniment. At all dealers selling Victor Records . . . complete 75c



### FREE Instruction Book

Anyone can learn to play the harmonica by following the clear, simple, illustrated instructions given in our booklet "How to Play the Harmonica." Free at your dealer's — or write to M. Hohner, Inc., Dept. 508, 114 East 16th Street, New York.



# \$351<sup>00</sup> CLEARED IN ONE DAY

So writes W. H. Adams of Ohio. Letter from V. A. Marini of California reports \$11,275 sales in three months. Jacob Gordon of New Jersey "\$4000 profits in two months". Alexander of Pennsylvania "\$3000 profits in four months." Ira Shook \$365 sales in one day. Bram bought one outfit April 5 and 7 more by August 25. Iwata, bought one outfit and 10 more within a year. Mrs. Lane of Pittsburgh says "sold 8000 packages in one day." J. R. Bert says "only thing I ever bought that equaled advertisement." John Ciup says: "Everything Going Lovely. Crispette wrappers scattered all over town. It's good old world after all." Kellog, \$700 ahead end of second week.



## WE START YOU IN BUSINESS

Furnish secret formulas, raw materials, and equipment. Little capital required; no experience needed.

### BUILD A BUSINESS OF YOUR OWN

No limit to the sale of Crispettes. Everybody likes them. It's a delicious food confection. Write for facts about a business that will make you independent. Start now in your home town.

### Profits \$1000 a Month Easily Possible

Send postal for illustrated book of facts. It contains enthusiastic letters from others—shows their places of business, tells how and when to start, and all information needed. Free. Write now!

## LONG-EAKINS COMPANY

828 High Street

Springfield, Ohio

## A Big New Edition of DYKE'S Automobile Encyclopedia

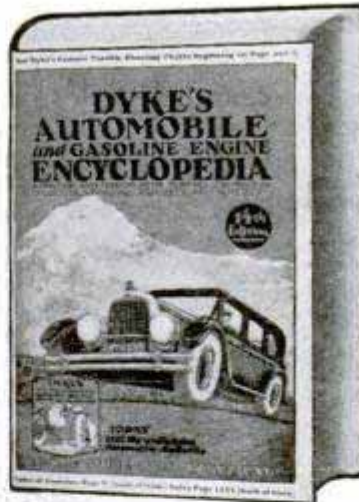

For 15 years "Dyke's" has been the one recognized and undisputed authority on the Automobile. Each succeeding edition has surpassed the last one. Now comes the greatest book of all—the wonderful 14th Edition—A. L. Dyke's crowning triumph—the super auto book of all times.

### Some "High Spots" of the New Book!

1,249 pages covering every known auto fact.  
4,200 Pictures, Plans, Diagrams and Charts.  
15,000 lines of Index by which you can instantly locate any subject you want.

A new section of "Trouble Shooting" Charts in Colors to enable you to quickly locate any major or minor trouble on any car.

Special instructions on testing and adjusting every part of the automobile.

Specifications of Gasoline Passenger Cars, Trucks and Tractors.

Specifications for Replacements, Accessories, Interchangeable Parts and Equipment.

Large colored Combination Chart which shows the working principles of the Automobile.

Large Charts showing the working principles of Trucks and Tractors.

Cloth \$6.00; Limp American Morocco \$7.50

Sent postpaid upon receipt of price.

POPULAR MECHANICS PRESS

Room 608—200 E. Ontario St., Chicago



# GASOLINE NOW 11¢

## AUTO OWNERS MYSTIFIED BY NEW DEVICE

The problem of high cost gasoline has apparently been solved by a mysterious little device that can be installed in a few minutes on any car. With this device installed the saving in gasoline effected will be so great that the cost of gas, as compared with previous cost, will be even less than 11c.



## Free Sample Offer

We have arranged a plan that supplies you with this device free so that you can get out and take orders right off the jump.

A newly invented device has actually made it possible for automobile owners to ride on 11c gas. This device, by utilizing air, cuts down the gas consumption amazingly and in many cases bona fide reports have been received of cars running as high as

## 40 MILES ON A GALLON OF GAS

It is not an experiment, but the outcome of years of accurate tests. Thousands of motorists have already equipped their cars. They report mileage tests that seem almost unbelievable. Thirty, forty and more miles on a gallon is nothing unusual. Increase in power and pick-up, instant starting and disappearance of carbon is also reported.

## \$100 a Week Territory Open

Every auto owner wants to save gasoline. The Whirlwind is so practical, so easily explained, that it does not require a high-pressure, experienced salesman to make big money introducing it. The literature we supply and the device itself do the selling. Word-of-mouth advertising brings you tremendous repeat business. For those who can devote full time, this is a knock-out proposition. It means a sure road to independence with an ever increasing future. Every new car in your territory is a prospect for you. We stand back of you 100% and supply constant sales helps to increase your business. When you get big enough to handle it, we then forward to you business in your territory that comes to us direct. Even if you are not in a position to devote full time, the Whirlwind agency offers big possibilities to you. It is easily possible to make as high as \$20.00 in an hour with this device. It has been done and it can be done by you if you will just push it as actively as other salesmen have done. You have to decide now if you want to make some real money supplying the demands for the latest agency item of the year. **HERE IS YOUR CHANCE. JUST FILL IN THE COUPON AND MAIL IT TODAY.**

## FREE SAMPLE COUPON

Whirlwind Carburetor Co.,  
1041-446 Winnebago St.,  
Milwaukee, Wis.

Gentlemen: Please send me your free sample offer and full particulars of your sales proposition.

Name.....

Local.....

County.....

City..... State.....

# Whirlwind Carburetor Co.

1041-446 Winnebago St. Milwaukee, Wis.

**How to Straighten Bow and Knock-kneed Legs!**  
Improve your personal appearance by using the new patent "Lim-Straitner," Model 18. Corrects now Bow and Knock-kneed legs safely, quickly and permanently at home. No costly operation or discomfort. Is worn at night. Easy to adjust; its result will save you soon from further humiliation and will improve your personal appearance 100 per cent. Write today for copyrighted Physiological and Anatomical book and experience of others without obligation. Enclose a dime for postage.

**M. TRILETY, Specialist** Dept. 1524L BINGHAMTON, N. Y.

**BUCHSTEIN'S FIBRE LIMB**  
is soothing to your stump—strong, cool, neat, light. Easy payments. Braces for all deformities.

**D. BUCHSTEIN CO.**  
610 3rd Ave., So. MINNEAPOLIS, MINN.

Send for Catalog Today

## STOP USING A TRUSS

**STUART'S PLAPAO-PADS** are different from the truss, being mechanic-chemico applicators made self-adhesive purposely to hold the distended muscles securely in place. No straps, buckles or spring attached—cannot slip, so cannot chafe or press against the pubic bone. Thousands have successfully treated themselves at home without hindrance from work—most obstinate cases conquered. Soft as velvet—easy to apply—

**Reduced Fac-Simile Gold Medal**

**Fac-Simile Grand Prix**

inexpensive. Awarded Gold Medal and Grand Prix. Process of recovery is natural, so afterwards no further use for trusses. We prove it by sending Trial of Plapao absolutely **FREE**. Write name on Coupon and send **TODAY**.

**PLAPAO CO., 733 Stuart Bldg., St. Louis, Mo.**

Name.....  
Address.....  
Return mail will bring Free Trial Plapao.

**Music Opens The Door**

INSIDE that closed door there is joy and good-fellowship. Outside there is loneliness, long evenings that seem never to pass. You can play better on King instruments. They are in tune because they are tested to the largest set of tuning bells in the world.

Let us tell you more about your favorite instrument. We will send our brand new handy reference catalog with full particulars on request. Our easy payment plan puts King band instruments within easy reach of all. Clip the coupon now.

**THE H. N. WHITE CO.**  
5211-90 Superior Ave., Cleveland, Ohio  
Kindly send me your Handy Reference Catalog. I am interested in a \_\_\_\_\_ Instrument

**KING Band Instruments**

Name.....  
Address.....  
City..... State.....

# You can now Own a Typewriter!

**\$3.00**  
DOWN  
and its  
yours

*Guaranteed for 5 years*

Be up-to-date—know the pleasure and convenience of having one in your home. You'll be amazed at the uses everyone in your household will find for this real Underwood typewriter. Every member of the family will use and enjoy it! Don't send a cent—but do get our big special offer—our valuable book on typewriters and typewriting—FREE.

## Any One Can Learn to Operate a Typewriter!

You can learn to write on this standard-keyboard machine in one day; it's so simple that even a child can use it. A week after the expressman has brought it, you'd feel LOST without it. A trial will PROVE it—and doesn't cost you a penny!

## SPECIAL FREE TRIAL OFFER

We don't want a penny now. Nor any money at all unless this proves the typewriter bargain of your life. The trial is FREE. If you buy, our easy terms make it a pleasure to pay. There's no excuse now, for not owning a typewriter—and the finest make!

We include all tools, a cover, etc., all complete, all ready to write. Write us now. Deal direct; we are the largest factory of the kind.

Our plan gives you the opportunity of a thorough trial before you buy. You run no risk whatever. You start to pay for your typewriter AFTER you have found it the only machine for you!

But get the facts before this lot of machines is all in use. Clip the information coupon before you turn the page. It will pay you! Note the very useful book you will receive free! Write for full particulars at once.

## The Greatest Typewriter Offer Ever Made

If you know typewriters, you know the perfect work and the ease and speed of a Shipman Ward rebuilt Underwood typewriter.

New machines are guaranteed for only one year; WE GUARANTEE EVERY ONE OF OUR MACHINES FOR FIVE YEARS! If you have never owned a typewriter, start with the finest! You can try this one at our risk. But, the time to act is NOW. Don't miss out on this present bargain offer whereby you can get this genuine Underwood at a big savings. Don't do longer without the convenience of a typewriter.

**FREE!** Get our catalog free; lowest prices and terms. A manual free, too; valuable instruction for learning rapid typing.

## Mail Today!

Shipman Ward Manufacturing Co.,  
C-212 Shipman Building, Chicago, Ill.

Please send me your Free Trial Plan and Typewriter Book, together with your special offer on prices, terms, free course in Touch Typewriting and also how I can make money with this typewriter, without obligation. This is not an order.

Name.....  
Street or R. F. D.....  
City.....  
State.....

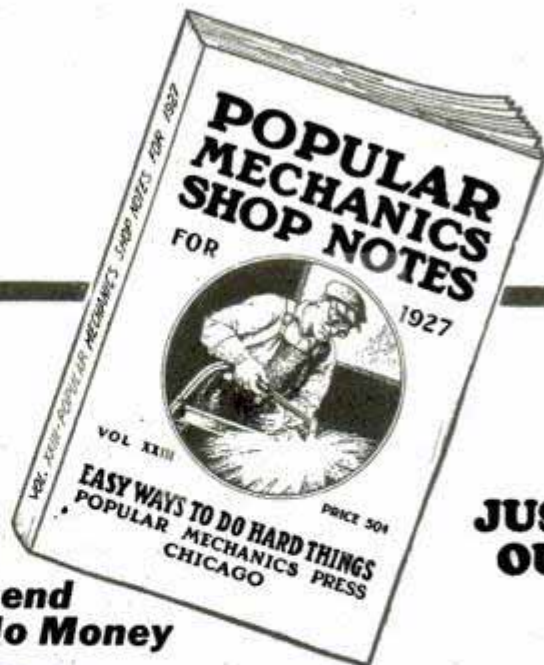

**JUST OUT**

**Send No Money**

# Shop Notes

479  
Articles

FOR  
**1927**

374  
Pictures

This announcement will be welcomed by thousands because they have learned that each yearly issue of Shop Notes contains dozens of short cuts that save time and money. Every article is written by some man who has tried the idea and found it worth money. The variety of subjects covered is one reason why so many buy Shop Notes each year. In many ways the 1927 issue surpasses previous numbers. The following brief list will give you an idea of the variety of subjects covered.

### SOME OF THE SUBJECTS

- |                           |                        |                           |
|---------------------------|------------------------|---------------------------|
| Auto Repairing            | Carpenters' Shortcuts  | Painter's Equipment       |
| Battery Care and Repair   | Fitting Muds Easy      | Motorist's Help           |
| Lapping Bushings          | Ventilation Flues      | Storekeeper               |
| Bracing Fence Corners     | Tool Boxes             | Pattern Making            |
| Novel Cab Stands          | Printers' Helps        | Drainage                  |
| Cleaning Lantern Chimneys | Making a Blowtorch     | Outdoor Air Press         |
| Outside Hay Chute         | Garage Equipment       | Workbench                 |
| Repairing Air Compressor  | Irrigation Canals      | Welding                   |
| Durable Nests for Poultry | Jewelers' Kinks        | Plumbing                  |
| Boxes for Cream Cans      | Draftsman's Kinks      | Using Spindle Drills      |
| Shop Tools                | Lathe Operator         | Making Grinders           |
| Electrical Equipment      | Electroplater          | Raising Vertical Piping   |
| Homemade Elevator         | Cabinet Worker         | Cutting Wallboard         |
| Wings                     | Lumber Yard Management | Rubber Stamp on Thimble   |
| Cleaning Enamel           | Mechanical Drawing     | Pin Stamping              |
| Concrete Working Ideas    | Farmer's Helps         | Service Station Attendant |
|                           | Micrometers            | Lettering                 |
|                           | Sheet Metal Working    |                           |

## 6,000 Ideas on All Shop Work

There are now 16 volumes of Shop Notes available. And this unrivaled library of shop helps may be had for a special price of \$7.50. If you do not have the back numbers of Shop Notes, you should purchase the entire library. The following are now available:

- 1908, 1912, 1913, 1914, 1915, 1916, 1917, 1919  
1920, 1921, 1922, 1923, 1924, 1925, 1926, 1927

## Amateur's Guide PROFESSIONAL'S HANDBOOK

Both amateurs and professionals find Shop Notes of wonderful value. The articles are so clearly written and so thoroughly illustrated that even a boy can follow them. Teachers of Manual Training should have the complete library.

# SEND NO MONEY

Don't send a penny. Just fill in the coupon with your name and complete address, indicate whether you want the whole library or the special offer of 1927 Shop Notes and Lathe Handbook for 98 cents. When the books are delivered to you, pay the postage and deposit price of books with postman.

### SPECIAL OFFER COUPON

**POPULAR MECHANICS PRESS,**  
200 E. Ontario St., Room 718, Chicago, Ill.

Send me, as per your special offer the following books. I will pay postage and the price of books when they arrive. My money will be refunded if I am not satisfied. (Check what you want.)

1927 Shop Notes and Lathe Handbook, 98 cents       Complete Shop Notes Library (16 vols.) \$7.50

Name.....  
Street and No.....  
City..... State.....

## Books on 30 Subjects

Popular Mechanics Press has specialized in supplying books on any subject. Look over this list. Check the books you want, and mail this advertisement as your order blank. Catalog with lists on 2,000 subjects free.

- AMATEUR MECHANICS**  
How to Make and How to Mend.....\$0.75
- AUCTION BRIDGE**  
M. C. Work's Latest Book.....\$2.00
- AUTOMOBILE ELECTRICITY**  
Electrical Trouble-Shooting on the Motor Car...\$4.00
- BLUE PRINTS**  
Blue Print Reading...\$2.00
- BOYS**  
How to Put on an Amateur Circus.....\$1.75
- BUILDING TRADES**  
Building Trades Handbook.....\$1.00
- CHALK TALKER**  
Chalk Talk and Crayon Presentation.....\$1.25
- CHEMISTRY**  
Chemists' Handbook...\$1.00
- DICTIONARY**  
Self Pronouncing, Large Type—1100 pages...\$1.25
- ELECTRIC SIGNS**  
Electrical Advertising...\$5.00
- ELECTRICITY**  
Practical Applied Electricity.....\$2.00
- FORD**  
Ford Standard Electrical Equipment.....\$2.00
- FURNITURE**  
Finishing, Decoration and Patching.....\$5.00
- GARDENING**  
Garden Guide.....\$1.50
- LETTERING AND DESIGN**  
For Artists and Advertisers.....\$3.00

- MILLWRIGHT**  
Erecting and Operating Machinery.....\$2.00
- MIRRORS**  
Silvering.....\$1.00
- OUTDOOR OCCUPATIONS**  
Outdoor Opportunities.....\$2.00
- PLUMBING**  
Plumber's and Fitter's Handbook.....\$1.00
- PUZZLES**  
Real Puzzles.....\$2.00
- RADIO**  
Modern Radio Receiving.....\$5.00
- RUSTIC WORK**  
Rustic Carpentry.....\$1.00
- SHEET METAL**  
Sheet Metal Work.....\$2.00
- SHIP MODELS**  
Clipper Ship. How to Make.....\$2.50
- STEAM ENGINEER**  
Steam Engineer's Handbook.....\$1.00
- STEEL SQUARE**  
A B C of the Steel Square.....\$1.00
- STORAGE BATTERY**  
Making, Repairing, Rebuilding.....\$5.00
- TOOLS (Using)**  
Tinkering with Tools...\$2.00
- TRAFFIC MANAGER**  
Traffic Handbook.....\$1.00
- WINDOW TRIMMER**  
Handbook of Window Display.....\$5.00
- WOOD FINISHER**  
Wood Finishing, Plain and Decorative.....\$2.00

-----SEND NO MONEY-----

Just check the books you want, and mail the whole advertisement it is your order blank. When postman hands you books, pay him the price and the postal charges. If outside the U. S. remit when ordering and include 10 cents per book extra for postage.  
**POPULAR MECHANICS PRESS, Room 708, 200 East Ontario St., Chicago, Ill.**

## Mathematics Made Easy by ROPP'S CALCULATOR AND SHORT-CUT ARITHMETIC

Shows the Answer as Quickly as a Watch shows the Time to all Problems likely to occur in the Office, Store, Shop, Bank, Farm, or Factory.



Explains and simplifies every principle in Arithmetic, Mechanics, and Mensuration.  
**PRICES POSTPAID**  
Desk Size...\$1.50  
Leatherette, Pocket Size...\$1.00  
Pocket Size, Cloth...\$0.50  
Pocket Size, Paper...\$0.35

Popular Mechanics Press, Room 208, 200 E. Ontario St., Chicago

## NEED A BETTER GRIP ON MATHEMATICS?



SEND for a copy of "Mathematics for the Practical Man," only \$1.50. By common sense methods it removes the mystery and difficulties so that algebra and even calculus are made simple. Assuming your knowledge is limited to arithmetic you quickly and easily gain a working knowledge of Algebra, Geometry, Trigonometry and Calculus. Simply pay postman price of book plus the postage when he hands you the package.  
**Popular Mechanics Press**  
Room 108  
200 E. Ontario Street, Chicago

## This Marvelous Wrench Pays \$1000 a Month

### No Thumb Screw Adjustment



That simple slide motion locks securely, with a better hold than is possible with any other wrench. Does away with the old thumb screw idea that was always a handicap.

### First and Only One Hand Monkey Wrench

Any job can be tackled and finished with ONE HAND quicker with the H&E WRENCH than any tool on the market. Fully Patented and the first and only tool of its kind.

### Slides Up and Down Locks Automatically

It creates a sensation wherever shown, its simplicity, smooth action, strong grip, and practical value arouses the interest of everyone. Mechanics are wild over it.

### Saves Time

As a labor and time saver it simply can't be beat. Any job is done quicker and easier.

### Agents Wanted Everywhere

Rapid sales with a handsome profit makes this a very attractive proposition for Agents and on account of this increased demand we want Agents everywhere and the opportunity is open to you NOW but you must ACT PROMPTLY.

### Pressure 1,200 Inch Pounds

All tests passed Government specifications. Actual service with Railroads assures High-Class Practical Value.

### Praised by Big Concerns

C. B. & Q. Railroad and many other large Corporations have acknowledged its value and endorsed it. Factories, Machine Shops, Garages, in fact, wherever tools are used need it. Every home should have one.

### MAIL TODAY GET YOURS FREE

H & E WRENCH SALES CORP.  
Dept. W, 228 No. LaSalle St., Chicago, Ill.  
Gentlemen:—Please mail me free particulars. This does not obligate me in any way.

NAME.....  
ADDRESS.....  
STATE..... R.F.D.....

DIAMONDS

**The Old Reliable Original Credit Jewelers**  
Largest in the World

# LOFTIS

**BROS. & CO. 'ESTD**

Address Dept. C-894  
108 N. State St.  
Chicago, Ill.

WATCHES

No. 849  
\$100  
\$2.50 a wk.

No. 851  
\$50  
\$1.25 a wk.

No. 834  
\$75  
\$1.75 a wk.

**Genuine Diamonds Guaranteed - CASH or CREDIT**

Tremendous Diamond values! Buy from Loftis, the Direct Importer, and be sure of highness of quality and most value for your money. Our ring mountings are the latest creations in 18-k white gold, elaborately carved and pieced. Satisfaction guaranteed or money back. Goods sent for your free examination on request.

**CREDIT TERMS:** Pay one-tenth down; balance weekly, semi-monthly, or monthly at your convenience. All goods delivered on first payment.

**SEND FOR FREE CATALOG!**

Big 132-page book, illustrating our Diamonds, Watches, Jewelry, Silverware, and gift articles for all occasions, sent absolutely free. Write today.

**19-Jewel Adjusted Waltham No. 846—** 14-k white gold filled; assorted patterns, \$42.50. \$4.25 down and \$1.00 a week.

**Railroad Watches—**  
Guaranteed to Pass Inspection

**HAMILTON NO. 992,** 21 Jewels, adjusted to 5 positions. Gold-filled 25-year case. **\$55**

**ELGIN'S LATEST RAYMOND,** 21 Jewels, 8 adjustments. Runs 40 hours one winding. Gold-filled 25-year case. **\$55**

**ILLINOIS "RHIN SPECIAL,"** 21 Jewels, adjusted to 6 positions. Gold-filled, 25-year case. 40 hours on one winding. **\$50**

**HOWARD RAILROAD WATCH,** 21 Jewels, 8 adjustments, 25-year gold-filled case. **\$80**

No. 852  
\$37.50  
\$1.00 a wk.

No. 859  
\$125  
\$3.25 a wk.

No. 847  
\$150  
\$3.75 a wk.

**Wedding Rings**

No. 824—The "Elite" 18-k white gold. Set with 3 Diamonds, \$22.50; 5 Diamonds, \$32.50; 7 Diamonds, \$42.50; 9 Diamonds, \$52.50; 12 Diamonds, \$67.50

Our ref. any bank or banker in U.S.

**CREDIT AT CASH PRICES**



## \$10<sup>00</sup> to \$25<sup>00</sup> a Day!

### Selling Freshly Roasted Peanuts

Wherever you find a crowd, hot, savory peanuts and crisp, sweet popcorn are in demand. Set up a Kingery Machine anywhere—in stores, at ball games, races, fairs. Profits 250%. Machines take little room; are easy and inexpensive to operate. Barbecue machines, too. Write now for Free Catalog.

**The Kingery Mfg. Co.** Dept. P. M. 6, 410 E. Pearl St. CINCINNATI, OHIO

## E-Z WIRE STRIPPER \$3<sup>00</sup>

INSTANTLY STRIPS INSULATION FROM ELECTRIC WIRES. BIG SENSATION.

The **Only Tool** in the world for this purpose wherever electric wires are used—Does the job—**Clean—Quick and Easy.** Compact—Handy—Efficient. Endorsed by Largest Electric Concerns. Every electric worker needs one. **Agents Make Big Money.** Choice Territory still open. Investigate Quick.

PYRAMID PRODUCTS CO., Dept. C, 2311 S. State St., CHICAGO, ILL.

**FREE**

1000 illustrations

## ELECTRIC FIXTURE CATALOG!

Write today for your copy. Save 50% direct from Manufacturer. No Middleman's Profit. **OUR SPECIAL:** 8 Room Electric Set, ready to hang, \$24.50—Other bargains.

**UNITED LIGHTING FIXTURE CO.**  
83 Flatbush Ave., Dept. M, Brooklyn, N.Y.



## DEAFNESS IS MISERY





Multitudes of persons with defective hearing and Head Noises enjoy conversation, go to Theatre and Church because they use Leonard Invisible Antiseptic Ear Drums. Tiny Megaphones fitting in the Ear entirely out of sight. No wires, batteries or head piece. They are Unseen Comforts and inexpensive. Write for booklet and sworn statement of the inventor who was himself deaf.

**A. O. LEONARD, Inc., Suite 699, 70 5th Ave., New York**

---

**Amazing New Tenor Banjo**  
Way to Play Guitar, Ukulele, Mandolin

NO music to learn. NO tiresome practice. Marvelous patented device makes playing **easy**. Just press the keys and play on the same easy principle as a typewriter.

**Play a Tune in 10 Minutes**  
We guarantee you'll play a Ferry E-Z Playing Instrument — "no play no pay." Terms as little as 50c a week.

**FREE BOOK** explains all. Popularity—more friends—make money. No obligation. Send for book today!

**Ferry & Company, 9777 Ferry Bldg., Chicago, Ill.**

### BUILD SHIP MODELS!

Easy to build and sell. Plans and instructions: "Santa Maria" \$1.00—Viking Galley, 40c—Pirate Ship, 50c—or all for \$1.75. Catalog 6c.

**SEA ARTS GUILD**  
405-A Eleventh Ave. Milwaukee, Wis.



**NEW TIMER FOR FORDS**

MARVELOUS INVENTION FREE OFFER TO USERS **FORD DYNAMO**

**60,000 MILES WITHOUT TROUBLE**

WRITE TODAY FOR FREE OFFER

Agents Wanted Everywhere  
Eclipse Timer Co., 2929 Meinecke Av., Milwaukee, Wis.

## Fibre-Lite Limbs

Our Prices \$85.00 to \$175.00

GREAT INVENTION. BRACES MADE TO ORDER. EASY TERMS. AGENTS WANTED. FREE FIBRE SAMPLE. **WORMAN CO.** 252-P HENNEPIN AV. MINNEAPOLIS, MINN



## MAKING IT EASY TO BUILD THINGS

*You can perform every woodworking operation with greater speed, accuracy and economy on*

### Boice-Crane Bench Machines

Do ripping, mitering, grooving, rabbeting, sanding, grinding and band saw operations better, quicker and easier. Driven by 1/4 to 1/2 h. p. motor attached to light socket. Sold with or without motor.

Send 10c today for 64-page booklet on Bench Saws, Drills, Jointers, Lathes, Band Saws, etc., also contains list of books which have over 250 working plans of furniture! Send NOW!

**W. B. & J. E. BOICE, DEPT. P. M. 8-C, TOLEDO, OHIO**





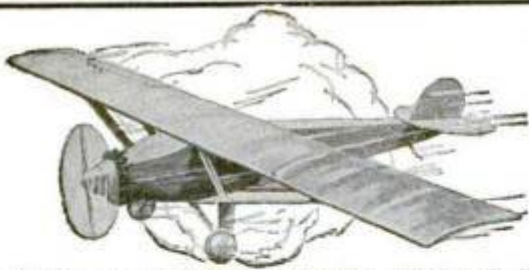

## Build and Fly a 3 ft. Model of LINDBERGH'S NEW YORK-PARIS MONOPLANE

Plans for Other Model  
Airplanes 25c per set.  
**FOKKER North Pole  
Plane**  
**CURTISS JN4D-2  
Plane**  
**DeHAVILLAND World  
Flyer**  
**NC-4 Naval Seaplane**  
**Bleriot, Nieuport or  
Taube Monoplanes**  
**Cecil Peell Racer Plane**

(All 6 Planes  
for \$1.50)

This IDEAL New York-Paris Monoplane is a perfect copy, 3-ft. size of the machine in which Lindbergh crossed the Atlantic Ocean. Any bright boy can build this model. The IDEAL Construction Outfit contains everything needed; all parts, fittings, materials and supplies, including careful instructions, plans and diagrams. The model is wonderful; has many features of the original and is guaranteed to fly. Complete Construction Outfit..... \$7.50 (West of Denver, Colo., and in Canada, price is \$8.00)

Ask your dealer or order direct. Plans and instructions only (No materials included), postpaid 25c.

IDEAL AEROPLANE & SUPPLY CO.  
408 West Broadway NEW YORK CITY

Catalog of Model  
Airplanes, Parts,  
Supplies, etc.,  
5c postpaid



## “What would I do if I lost my job?”

SUPPOSE your employer notified you tomorrow that he didn't need you any longer? Have you any idea where you could get another position?

Don't have this spectre of unemployment hanging over your head forever. Train yourself to do some one thing so well that your services will be in demand. Employers don't discharge such men. They promote them!

Decide today that you are going to get the specialized training you must have if you are ever going to get—and keep—a real job at a real salary. It is easy if you really try.

Right at home, in the odds and ends of spare time that now go to waste, you can prepare for the position you want in the work you like best. For the International Correspondence Schools will train you just as they are training thousands of other men—no matter where you live—no matter what your circumstances or your needs.

At least find out how, by marking and mailing the coupon printed below. There's no cost or obligation, and it takes only a moment of your time, but it may be the means of changing your whole life.

### Mail the Coupon Today for Free Booklet

#### INTERNATIONAL CORRESPONDENCE SCHOOLS

Box 5663-E, Scranton, Penna.

Without cost or obligation, please send me a copy of your booklet, "Who Wins and Why," and full particulars about the course before which I have marked X in the list below:

#### BUSINESS TRAINING COURSES

- |  |   |
|--|---|
| <input type="checkbox"/> Business Management                     | <input type="checkbox"/> Salesmanship                                     |
| <input type="checkbox"/> Industrial Management                   | <input type="checkbox"/> Advertising                                      |
| <input type="checkbox"/> Personnel Organization                  | <input type="checkbox"/> Better Letters                                   |
| <input type="checkbox"/> Traffic Management                      | <input type="checkbox"/> Show Card Lettering                              |
| <input type="checkbox"/> Business Law                            | <input type="checkbox"/> Stenography and Typing                           |
| <input type="checkbox"/> Banking and Finance Management          | <input type="checkbox"/> English  |
| <input type="checkbox"/> Accountancy (including C.P.A.)          | <input type="checkbox"/> Civil Service                                    |
| <input type="checkbox"/> Cost Accounting                         | <input type="checkbox"/> Railway Mail Clerk                               |
| <input type="checkbox"/> Bookkeeping                             | <input type="checkbox"/> Common School Subjects                           |
| <input type="checkbox"/> Private Secretary                       | <input type="checkbox"/> High School Subjects                             |
| <input type="checkbox"/> Spanish <input type="checkbox"/> French | <input type="checkbox"/> Illustrating <input type="checkbox"/> Cartooning |

#### TECHNICAL AND INDUSTRIAL COURSES

- |   |  |
|---|--|
| <input type="checkbox"/> Electrical Engineering                     | <input type="checkbox"/> Architect                                       |
| <input type="checkbox"/> Electric Lighting                          | <input type="checkbox"/> Architects' Blueprints                          |
| <input type="checkbox"/> Mechanical Engineer                        | <input type="checkbox"/> Contractor and Builder                          |
| <input type="checkbox"/> Mechanical Draftsman                       | <input type="checkbox"/> Architectural Draftsman                         |
| <input type="checkbox"/> Machine Shop Practice                      | <input type="checkbox"/> Concrete Builder                                |
| <input type="checkbox"/> Railroad Positions                         | <input type="checkbox"/> Structural Engineer                             |
| <input type="checkbox"/> Gas Engine Operating                       | <input type="checkbox"/> Chemistry <input type="checkbox"/> Pharmacy     |
| <input type="checkbox"/> Civil Engineer                             | <input type="checkbox"/> Automobile Work                                 |
| <input type="checkbox"/> Surveying and Mapping                      | <input type="checkbox"/> Airplane Engines                                |
| <input type="checkbox"/> Metallurgy <input type="checkbox"/> Mining | <input type="checkbox"/> Agriculture <input type="checkbox"/> Navigation |
| <input type="checkbox"/> Steam Engineering                          | <input type="checkbox"/> Mathematics <input type="checkbox"/> Radio      |

Name.....

Street Address.....

City..... State.....

Occupation.....

Persons residing in Canada should send this coupon to the International Correspondence Schools Canadian, Limited, Montreal, Canada

## Great New Invention

### for Seekers of Health—Power—Beauty Elco Electric Health Generator

Generates High Frequency Violet Ray, Mechanical Vibration Medical Electricity, and Ozone. Four of Nature's Greatest Curative Agents. For Home Treatments at less than 50 cents per year.

**FREE BOOK** "Health, Power, Beauty" describing this Great New Invention. Re-vitalize yourself. Bring back energy. Be wholly alive. Write today. Lindstrom & Co., 30 W. Lake St., Dept. C-135, Chicago



## Oh Boy! See All! Big 3½ Ft. Telescope



Lend wings to your eyes! People and objects miles away seem close. Wonder telescope brings new pleasures to home, farm, camp, travel, sport. Study the mysterious Sun spots; see Moon and Stars as **Solar Eye Piece** never before. See people on the beach, on the mountains, etc.

**FREE** Yes, absolutely free! A handsome leatherette Carrying Case and Shoulder Strap. Also Solar Eye Piece to view the sun—a special feature, found only on expensive instruments.



CLIP THIS AD

#### Thousands Pleased

P. Brush wrote: "Watched submarines three miles off coast." Ed. Foster: "Tell time on clock five miles away." C. Scribner: "See lighthouse 18 miles away." Mrs. Yarbrough: "Could tell color of aeroplane four miles away." E. M. Gearhart: "Can see men working seven miles away."

Brass bound; measures 12 in. closed; powerful achromatic lenses protected by dust caps.



Sports



Touring



Beach Views

### SEND NO MONEY

On delivery of Telescope, free Case, Strap and Eye Piece pay Postman only \$1.85, plus postage (2 complete outfits \$3.50). Satisfaction guaranteed or money refunded. Send today, entertain your friends! Be first to have one.

**FERRY & CO., Dept. 1777, Chicago, U.S.A.**

# Book of 100 Homes FREE!

Home No.  
6335 Rooms,  
Bath;  
Materials  
\$1,860

## Buy Direct from Mill! Build Plan-Cut—Save Up to \$2,000—Write!

We furnish lumber, millwork and other materials. Plan-Cut at mill, shipped to your station. Each piece sawed, cut and notched to fit—Save 30% labor cost and 18% lumber waste. Gives you stronger, lighter home. Easy to build—many put up own homes. Architects plans and full instructions furnished Free. One guaranteed price covers all materials. Send for Free Book and lowest wholesale prices.



Gordon-Van Tine Company  
983 Case St., Davenport, Iowa

Please send catalogs.

I expect to build.....

Name.....

Address.....

## A SHIP MODEL FOR \$4.98



Build an exact replica of the historic Santa Maria or the Mayflower with your own hands. We will furnish the parts complete for only \$4.98 plus a few cents for postage. No tools needed except a small hammer.

Write for our illustrated catalog.

**MINIATURE SHIP MODELS**  
Dept. O, 3818-20-22-24 Baring St., PHILADELPHIA, PA.

# TISIT



## Solders

**Aluminum, Agate ware, iron, china, wood, glass**  
Not affected by heat. Can be used to repair steam pipes, wash boilers, automobiles, motor boats, etc. Applied cold with a stick. No soldering iron necessary. Sets in 20 minutes. Efficient. Positive. Anyone can use it. No experience necessary. Makes soldering a pleasure instead of a hard job.

50c at your dealer's. If he cannot supply you, send us 50c—we will ship you bottle direct, postpaid. Money back if dissatisfied.

**Letellier Laboratories, Inc.**  
185 Main St. E. Rochester, N. Y.  
Representatives wanted everywhere.  
Big profits. Write today.

**MORE MONEY!  
EASIER SELLING!  
FINANCIAL  
INDEPENDENCE**

**SUPERIOR  
'GILBRAND'  
PHOTO NOVELTIES**

**FREE  
SAMPLE OUTFIT!**

**EVERY NAME A  
PROSPECT  
EVERY  
CALL  
A SALE**



Beautifully designed clock medallion. Only one of the great many money-makers in our line. Sells from \$4.98 up. You make \$3.00 profit and more on each sale.

Every number in our line is a big money maker. Photo medallions, photo mirrors, photo jewelry, photo fountain pens, photo compacts, and other photo novelties.

We quote you Our Lowest Net Prices and let you Name your own profits. Many of our men make \$100 to \$150 a week. You can do the same.

### 4 Days' Service Guaranteed

Earn more money than you have ever made before. Send for free catalogue today.

**GILBERT PHOTO NOVELTY CO.**  
Dept. P53, 8 Cooper Square, NEW YORK, N. Y.

## Amazing New Invention Ends Punctures Forever

At last a puncture-proof that makes good! Puncture-Nix—the only puncture-proof ever endorsed by leading magazine and newspaper men. Don't class it with anything else. Now! Different! Not a thin liquid, solid filler, liner, or concretion. Does not take the place of air. \$1,000 Insurance Policy free to users backs guarantee. Instantly, permanently banishes punctures, slow leaks, valve leaks. Forget blowouts, rim cuts, tire changing. Double tire miles. Costs only a few cents to make new or old tire puncture-proof. Outlasts tire. Agents—we guarantee sales.

**FREE TRIAL** To introduce it quick to Agents and motorists. Send no money --\$50 a Day Plan and Free Goods to start Agents.  
**Puncture-Nix Corporation**  
3841 Ravenswood Ave., Dept. 9-A, CHICAGO

**AGENTS  
\$50 A Day**

## New Electric "Red Hot" Roaster

Wonderful automatic, sanitary machine soon to be announced. Get advance details. Big money maker.  
**FOOD DISPLAY MACHINE CO., Dept. C-135,**  
350 W. Huron St., Chicago

Books on all subjects are sold by Popular Mechanics Press, 200 East Ontario Street, Chicago, Illinois.

## Learn How to Make Money as a COMMERCIAL ARTIST or CARTOONIST!

This Course is designed to lead you from the simplest elementary drawing to the higher branches of illustration.

### OVER 125 ILLUSTRATIONS SHOW YOU HOW

The drawings are explained in detail and every method or trick of the trade employed by professional artists is explained in full.

Send for this new book, Commercial Art and Cartooning, by Matthews. Pay postman \$1.25 plus the postage when he delivers the package. If outside U. S. remit when ordering and include 10 cents extra for postage.

**POPULAR MECHANICS PRESS**  
Room 608, 200 East Ontario St., CHICAGO

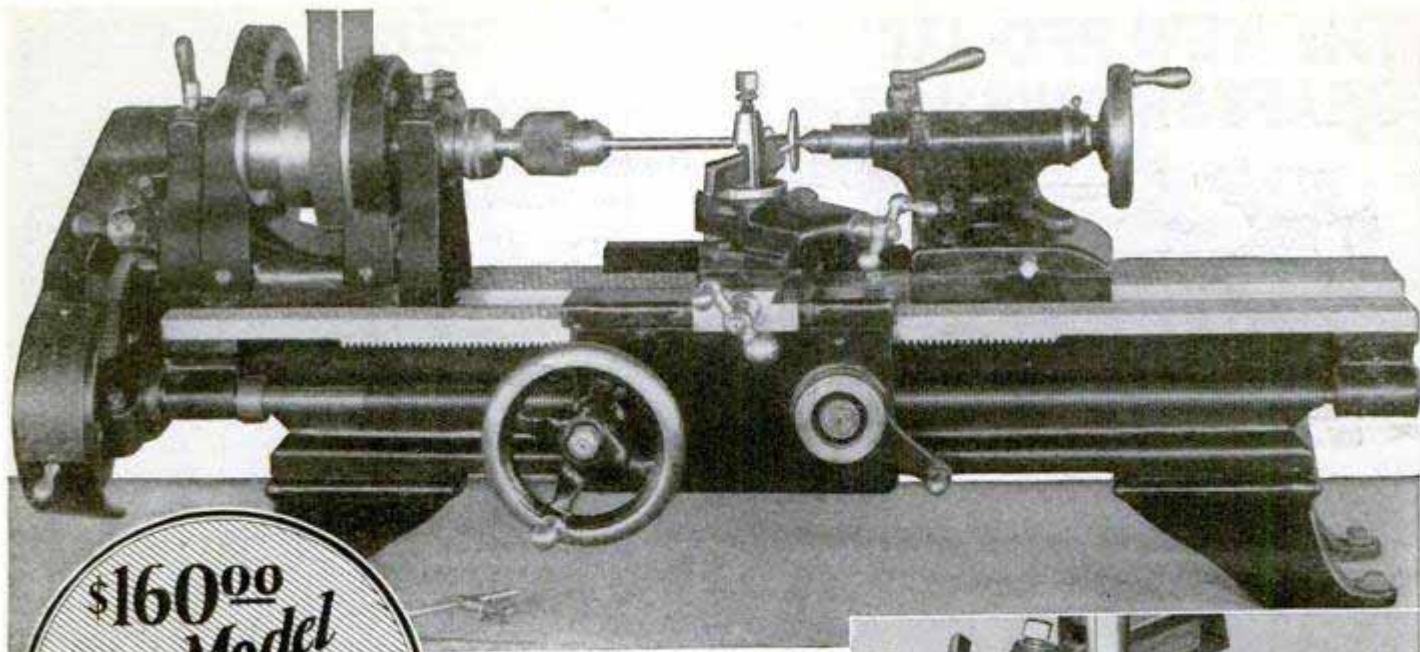

**Motor Drive if Desired**

The 9 in. Junior South Bend Lathe is ideal for refacing valves. Using the compound rest set at the proper angle, one or two light cuts with a turning tool will true the valve face with utmost accuracy in five minutes. Refacing valves by turning in a lathe is now universal practice in larger shops.

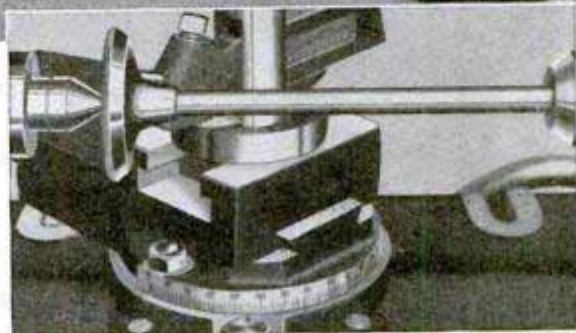

Rear view of compound rest of lathe set at 45 degree angle for refacing valves.

**\$160<sup>00</sup>**  
**New Model**  
**9 INCH JUNIOR**  
**Back Geared-**  
**Screw Cutting**  
**Bench Lathe**  
 With Plain Rest Countershaft and Equipment

**For Auto Repair Work**

There is one outstanding tool for the auto repair shop of today—used and recommended by thousands of the larger shops and recommended by all automobile manufacturers. It is the back geared screw cutting lathe. It is the one master tool that does the same work with a greater degree of accuracy and speed of scores of other tools combined—and in addition, there are hundreds of jobs that it alone can do.

**and Thousands of Machine Jobs**

But auto repair work is only one small part of the work done by the 9 in. Junior South Bend Lathe. It is the ideal tool for metal work, regardless of it being auto repair work or any other kind of repair work. The Junior lathe has all the features of the larger lathes, cuts screw threads 4 to 40 per inch and is built in 2½, 3, 3½, 4 and 4½ ft. bed lengths, either bench or floor legs. Weight, complete, 375 lbs.

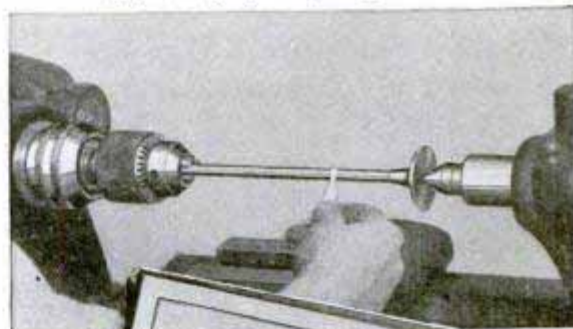

Testing a bent valve stem in the lathe.

**FREE** BOOKLET 22-K. Just off the press! 24 interesting pages of practical lathe information. 150 photographs completely illustrates the lathe at work and describes all types and drives. A booklet of real interest and value to any mechanic.

**South Bend Lathe Works**  
 624 E. Madison St. South Bend, Indiana  
 New York City Salesroom—183 Centre St.  
 Phone. Canal 9085.

**Time  
 Payment  
 Plan  
 if desired**

**Time Payment Plan if desired**

**SOUTH BEND LATHE WORKS, South Bend, Ind.**  
 624 East Madison Street

Gentlemen: Send me immediately a copy of your new booklet, 22-K. This booklet is FREE, post-paid to any inquirer.

Name .....  
 Address .....  
 Town .....  
 State .....



**USE THE COUPON**

## THE NEW RED JACKET CRAFTSMAN'S LATHE

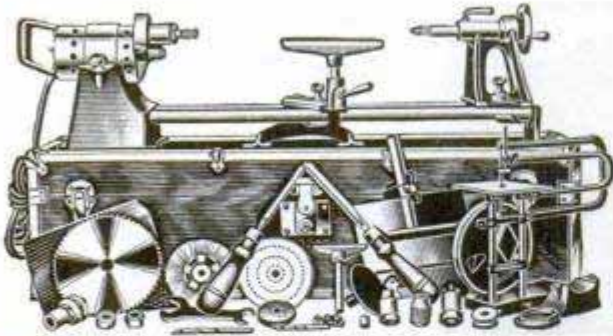

### Makes Homework Easy Now

It's fun to make furniture, garden trellis, toys, improvements and repairs with a set of tools like this carefully designed by a master workman.

The complete equipment consists of the powerful Red Jacket Motor, with **direct drive to an accurate wood turning lathe** (capacity 9 in. x 34 in.); a **bench saw**, that has depth and side gauges; **scroll and jig saw**; and **all accessories for both portable and stationary power drilling, buffing, grinding and cleaning**. Attaches to any light socket and converts your work bench into a complete private tool and machine shop.

### A Special CRAFTS COURSE

And **Blueprint Service** is free to Red Jacket Shop owners—all that there is to know about handcraft methods, raw materials, woods, carving, sawing, turning, designing, carpentering, decorating, is taught by special correspondence.

### Buy On Your Own Terms

Only \$10.00 down. Liberal discounts for cash. Easy monthly payment plans. It is no hardship to own a Red Jacket.

### Interesting Literature Free

Just send the coupon. You will be surprised with all it contains. Beautiful, instructive, fascinating, interesting. Everything explained in our literature.

only  
\$10.00  
down

..... MAIL COUPON TODAY .....

WACO TOOL WORKS, 542 No. Parkside Ave.  
Chicago, Ill.

Manager, Dept. 108. Please send me particulars about 10-day free trial, free blue-prints and \$10 down payment.

Name .....

Address .....

Write for free 400 page catalog illustrating and describing our complete line of 1500 Good Tools.

**GOODSELL-PRATT COMPANY**  
Toolsmiths  
Greenfield, Mass., U. S. A.



## Auto Owners Wanted

To introduce and use **HYDRO Insured TIRES**. Hydro Agents make money selling the only Tires in the World **Insured for One Year** against all road hazards regardless of mileage. **HYDRO TIRES** sell fast because they have no competition in price; no rival in quality; no imitation in appearance and no equal in the Insured Protection to the user. Insurance Policy with every tire. Are made by the only tire factory in America selling its own product through authorized Salesmen-Agents. We offer opportunity of lifetime to establish profitable tire business of your own. **No capital required**. Sales kit and advertising helps furnished. Exclusive territory granted. Write today for catalog and complete information about the Hydro Agency Plan.

**HYDRO**  
Insured  
**TIRES**  
"The Most Beautiful Tire in America"

Address nearest branch

Dept. 59, **HYDRO-UNITED TIRE CORP.**  
Pottstown, Pa. Millersburg, O. Chicago, Ill.

## Amazing New Tool

### Doubles Incomes for Mechanics

Yes, almost incredible as it sounds, we've discovered a single, remarkable tool that takes the place of 10 old style wrenches! No wonder this queer device is a sensation in factories, garages, repair shops, etc., everywhere!

IMAGINE a super-wrench, so powerful that it can stand 9,400 pounds pressure without losing its grip! Yet instantly adjusted so it fits any nut or bolt! No screws to fuss with. No side-slipping or binding—it grips and grips and never slips! Banishes skinned knuckles forever! Yet no teeth on gripping surfaces to chew bolt heads and nuts ragged. Nothing to get out of order. Is it any wonder that expert mechanics, as well as shop workers, home tinkers, motorists, etc., simply go wild over this remarkable discovery? Or that workers everywhere report surprising extra incomes—as much as \$20 in a single hour—just demonstrating it to their friends?



ONLY  
**\$3.75**  
Kit of 3

Special limited introductory offer now lets you get your complete Kit of 3 Polly Wrenches for deposit of only \$3.75. Your money back any time within 2 weeks on return of Kit. Learn how you can get your Kit absolutely FREE. Also find out how easily you can double your income in an hour or two of your spare time each day. Act quick. Address.

**Denton N. Higbe and Associates**  
115 Botsford Building, Chicago, Illinois

**AGENTS**  
\$8 to \$16 an Hour

Here's the most sensational, ground-floor, profit opportunity you ever saw. Mechanics everywhere—and 20,000,000 motorists—are waiting for this new wonder-worker. You can sell 5 to 20 in any shop or garage. Experience unnecessary. Write quick for proof of huge earnings and generous exclusive territory offer.

## ELECTRICITY LEARN AT HOME

By the most modern plan. Get into the big-paying jobs, study the factory way, where dynamos, motors, etc., are made. Students assemble this large commercial motor, goes with each course.



Write today for our special offer.

**LOOMIS ELECTRIC CO.,** 1427 N. ARTESIAN AVENUE  
CHICAGO, ILLINOIS

## TYPewriter PRICES CUT

World's best makes—Underwood, Remington, Oliver—prices smashed to almost half.

**\$2 and it's yours**

All late models, completely rebuilt and refinished brand new. **GUARANTEED** for ten YEARS. Send no money—big FREE catalog shows actual machines in full colors. Get our direct-to-you easy payment plan and 10-day free trial offer. Limited time so write today. International Typewriter Ex., 186 W. Lake St., Dept. 894, Chicago



Free Trial

**WANTED**—Volume 1, Number 1, January 11th, 1902, issue of Popular Mechanics Magazine. Must be intact and in at least fair condition. Will pay \$1 for same.

Communicate with Manager, Book Department  
**Popular Mechanics, 200 E. Ontario St., Chicago, Ill.**



## LEARN to PITCH

Lessons by "MATTY," ED. WALSH, "DOC" WHITE, WALTER JOHNSON, "NAP" RUCKER, "SMOKY JOE" WOOD. **PITCH THE FADE-A-WAY, SPITTER, KNUCKLER, SMOKE BALL, etc.** Clearly Described and Illustrated by 56 Pictures. Entire COURSE OF LESSONS SENT POSTPAID for 60 cents.

**BENEDEK, 2300 N. Mason Avenue, CHICAGO, ILLINOIS**



**\$148<sup>00</sup> A Week & Up**  
**Driving Around In Your Car**  
*Make Startling Demonstrations*

**VIX**  
*new* **VIX**  
**Vapor Humidifier & Gas Saver**

**For all Autos, Trucks, Tractors, Busses, Taxis, Engines. Most Amazing On Market**

To Show and Demonstrate VIX is to make a sale. **DOUBLES SPEED OF CAR WITHOUT MORE GAS.** Make Gas Tank Test; Prove Amazing Mileage Increase. Make Hill Test; Prove Added Power. Show how car runs **ALL THE TIME** with the same wonderful efficiency as on a cool, moist, night. Silences engine noise, smoother running. VIX sells on **DEMONSTRATION**—it makes a **SENSATIONAL** demonstration. **QUICK SALES—BIG PROFITS Assured.** Unbelievable mileage gains are reported by thousands of VIX users. Sworn affidavits make this proof convincing. Not anything like it on the market. Not even one! Not connected with any other gas saver or company.



**Model "A-1" VIX Vapor Humidifier and Gas Saver.**  
 5 Models to fit every auto, truck, tractor, bus, taxi, engine, etc., including **NEW Ford** with Holly Vaporizer. Not a toy. Retails \$4.00 to \$25.00, installed and guaranteed.

**Moisture In Engine Does It**

*Increases Mileage 1/4 or MORE.* Gives that wonderful smooth running, night-driving effect; with added power; faster pick-up; more "snap" and "pep" in engine; higher top speed; and automatically frees engine from hard carbon, plug and valve troubles. If you want to Make Money get into the VIX business now. VIX demonstrations are **STARTLING—ASTOUNDING—CONVINCING**—and make sales **EASY.** Have a business of your own and reap **BIG, QUICK PROFITS.**

**Reports from Users**

- Oldsmobile 360% Gain**  
 SWORN AFFIDAVIT—Wilson T. Jarboe, Minister, Baltimore, says "on my 1926 Oldsmobile, with VIX on 43.2 miles per gallon, 12 to 14 before."
- Ford—42.8 Miles 1 Gallon—No Carbon**  
 SWORN AFFIDAVIT—H. G. Plymate of Ariz. says: "My Ford 16 to 18 miles per gallon, with VIX on 42.8 miles. Took off cylinder head and instead of using putty knife and emery paper to clean carbon I could wipe it off with cloth."
- Ford 1/3 More Mileage**  
 SWORN AFFIDAVIT—Michael Biehl, Chicago, says: "Ford without VIX averages 23 1/2 miles per gallon. With VIX, nothing changed, the gasoline saving on all trips averages 1/3 saving or better."
- ALSO Thousands of Other Remarkable Records.**  
 Sworn affidavits make this proof convincing.

**1 VIX FREE To Introduce**

Factory Sales-Distributors wanted everywhere, who can make \$275 to \$1250 per month. Spare or full time. Sell this remarkable invention in your territory on generous 10-day trial plan. Every Salesman, Agent and Car Owner should write the inventor at once. Address,

**WALTER CRITCHLOW,**  
 Inventor and Manufacturer  
 W2-805 St., Wheaton, Illinois, U. S. A.



**Salesmen, Agents Dealers, Distributors WANTED**

**QUICK SALES—BIG PROFITS**

\$4,939.66 drawn in 3 3/4 months by one VIX man. Another made \$1,556.40 in 58 days. Still another, at work right now, in the past 5 months has taken 4 1/2 VIX'S up to this writing—and is going stronger than ever. His profits approximately \$5,150.00 in 5 months, or **OVER \$1,000.00 PER MONTH**

Thousands of other records. Some poor, many fair, a lot of them very **BIG.** It's up to **YOU.** If you can make anything in any business, you ought to make **MORE** with VIX.

Do you want a business of your own?  
 Do you want to make money **FASTER** than ever before?  
 Are you willing to work earnestly for **SUCCESS?**  
 Write for the VIX proposition. For the fellow that can put it over, it is a **WHALE** of a money-maker and a good time and fine health for you while doing it. There are no **DULL** times in the VIX business.

# More Profits

For Your  
**BUSINESS**

**Only \$16 Monthly  
Brings You \$250 to  
\$500 Added Bus-  
iness Each Month**

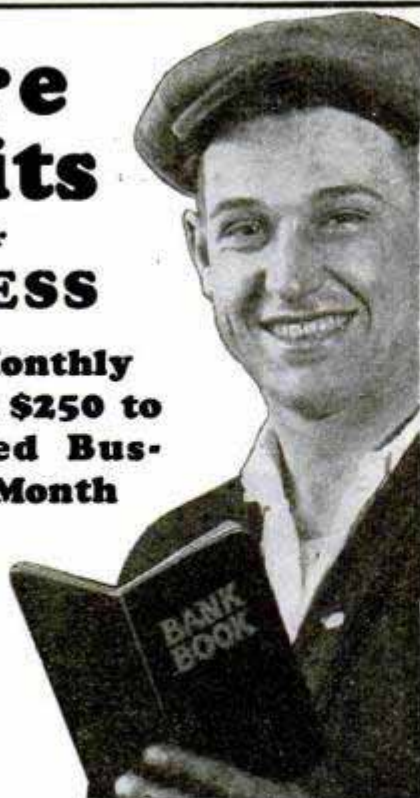

You now can have the best up-to-date money-making equipment with practically no investment on your part. Every HB Outfit pays its own way and an ample profit besides. Get 30 days' trial at our risk to prove it.

8 Hour Battery Service brings hundreds of new customers. Saves 30% to 50% on electric bills over rectifiers. Gives you a big edge on competition. Check No. 1 below.

Profitable Starting, Lighting and Ignition work comes in volume to the shop properly equipped with an HB Test Bench. Priced to save you at least \$100 over any similar quality bench on the market because we build it—not assemble.

Portable Paint Spray—does five painters' work. You get four men's labor as profit.

Business Building Air Service—for as little as \$11 monthly you can have the best of day and night automatic air service.

**HOBART**  **BROTHERS**  
Successful manufacturers ~ since 1893 ~

BOX M87

TROY, OHIO

**Tear Off Coupon and Mail Today**

HOBART BROTHERS CO.  
Box M87, Troy, Ohio.

Send me complete information on the items I've checked with your 30 day trial offer, easy payment terms, and information on how HB equipment will increase my earnings.

- 1  One Day Battery Service Profits  
2  Electrical Test Bench Opportunities  
3  Portable Paint Spray Business  
4  Better Automatic Air Compressor

NAME.....

ADDRESS.....

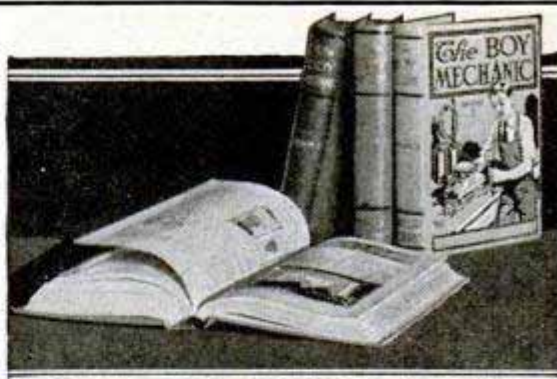

# BOYS

## It's Fun to Make Things



Let the other boys wonder how you can make so many interesting things. Make your own automobile. Make your own radio. Make your own kites and gliders. You can learn how to make almost anything that any boy could want by following the pictures and the simple directions in

## The Boy Mechanic Library

And just think of it, there are nearly 4,000 separate articles in the four beautiful volumes! Some of the most fascinating subjects are listed below:

### How to Make Things

Boats	China painting
Winter sports	Decorative metal work
Camping	Furniture making
Ice boats	Farming
Water sports	Poultry
Toboggans	Models
Tents	Laboratory helps
Skis	Household helps
Indian snowshoes	Wood working
Skating	Electrical devices
Gymnasium	Photography
Wind wagons	Music
Motor sleds	Outdoor games
Radio	Stoves
Magic	Furnaces
Trapping	Wireless
Pets	Tricks
Leather work	Puzzles
Carpentry	Bicycle
Painting	Flowers
Toys	Hunting
Fishing	Kites
Fruit growing	Metal working tools
Entertainments	Secret locks
Automobile	Swings
House decorations	Sleds
Drafting	Power devices

Buy the complete library, including Book 1, Book 2, Book 3 and Book 4 for \$7, thus saving \$1 as single volumes are \$2. If you want individual books at \$2 each order by number 1, 2, 3 or 4.

When the postman delivers the books to your door, pay him the price of the books and the postage. That is all. If outside U. S. remit when ordering and include 28 cents per volume extra for postage.

**POPULAR MECHANICS PRESS**

200 E. Ontario St.

Room 608

CHICAGO, ILL.

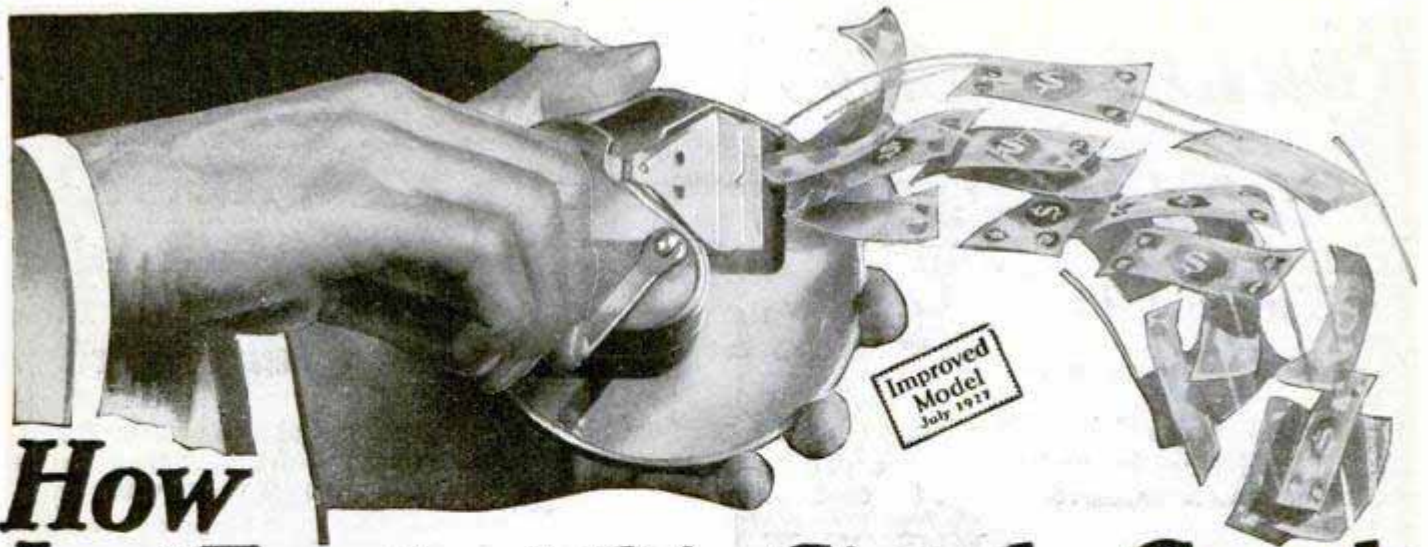

# How Just Turning this Simple Crank Brings Agents \$30 to \$60 A DAY!

New Shaving Invention Proves the Most Talked-of Invention in America. Agents Everywhere Say It Simply Sells Itself! All They Do Is Turn the Crank to Demonstrate! Eager Shavers Do the Rest! Get Details of Generous Offer at Once!

NO matter how you look at it, KRISS-KROSS—the amazing new razor-blade stropper—offers you the biggest money of your life. It has put more salesmen and agents on Easy Street than any other invention ever patented. Its uncanny faculty to sell itself is the talk of the direct-selling field. Novel mechanical features capture any prospect's attention *instantly*. All you need to do is twist the operating crank a couple of times and 999 men out of a thousand will reach for it and say, "Let's see how it works!" And once they have it, it's a *rara avis* who wants to let go!

You don't have to *push* a KRISS-KROSS demonstration as you do when selling ordinary, uninteresting things like suits, shirts, dresses, toilet articles, fire-extinguishers—things that are "old stuff" to a customer the minute he lays eyes on them. KRISS-KROSS is new, clever, ingenious and *unique*! No wonder it brings salesmen \$30 to \$60 a day!

## Big Profit Records Are On the Jump

Reports of KRISS-KROSS earnings continue to soar. During the month K. P. Rapf made \$602. R. C. Walker (Idaho) made \$9 his very first demonstration. J. Spencer, out in Honolulu, made \$10 in 20 minutes—or 50 cents a minute! And then there's H. King, of Massachusetts, who made \$66 in one day—and J. C. Kellogg, who cleared \$200 in 7 days at spare time alone!

Every single one of these men gives unqualified credit to KRISS-KROSS itself. Many of the biggest profit-checks go to men who never sold a thing in their lives before!

## Cleverest Device Ever

KRISS-KROSS mechanical ingenuity is little short of marvelous. It strops your blade (any make) on the diagonal just like a master barber, but with unvarying accuracy. Eight "lucky" leather grooves do the trick in 11 seconds. Automatic pressure and blade reverse. Strops heavy at the start—light at the finish, and leaves your blade with the keenest cutting-edge steel can take! Prolongs the life of any blade for months and even years! Many cases are on record where one blade has lasted over two years and still going strong! No wonder it sells like wildfire!

## Get Details—Offer FREE

Send right now for full details and information on a FREE new kind of razor you give every customer to boost sales. Wonderful opener. Adjusts 3 ways and makes every other razor seem as antiquated as a horse and buggy!

Find out about this money-making business without delay. There's not a reason in the world why you shouldn't be getting your share of these quick, easy profits. See how simple it is to make \$100-\$225 a week with KRISS-KROSS—the most unique self-seller of all time. Quick action! Clip the coupon now!



Rhodes Mfg. Co., Dept. K-371, 1418 Pendleton Ave., St. Louis, Mo.

Please send me full details of your nationally advertised KRISS-KROSS stropper, which is never sold through stores—and tell me about your unusual offer of big profits to salesmen and agents.

Name.....  
 Address.....  
 City..... State.....

# Rhodes' KRISS KROSS STROPPER

Dept. K-371, 1418 Pendleton Ave., St. Louis, Mo.

Largest Manufacturers of Mechanical Stoppers in the World

# Radio's Great New Achievement

## The CROSLEY "Bandbox"

A Remarkable 6-Tube Receiver

For fans who demand the best that Radio affords

Truly this is wonderful news for lovers of Radio. Now, brought together under one banner of scientific and commercial achievement are the enormous resources, the great discoveries and ideas embodied in patents of

The Crosley Radio Corporation, The Westinghouse Co., The General Electric Co., and the American Telephone and Telegraph Co.

Under these patent holdings and licenses Crosley has succeeded in presenting the most sensational radio value ever offered.

### The "Bandbox"

The "Bandbox" is a veritable "little theatre" of radio quality and interest, a real 6 tube set of astonishing sensitiveness, the first moderate priced radio to employ completely balanced or neutralized radio frequency stages.

The handsome metal outside case of beautiful frosted crystalline finish is, in itself, an effectual barrier to the interference of strong local signals. Added to this is the shielding of the individual coils and condensers, a feature hitherto found only on the most expensive sets.

A Master Station Selector

"You're there" with illuminated dial, enables tuning by the turn of a single knob. Crosley "Acuminators" inten-

### The MUSICONE

Most demanded of all loud speakers, the Musicone in 12-inch and 16-inch sizes is the perfect companion for the "Bandbox," both in beauty and in radio excellence. \$9.75 and \$12.75. New Tilt Table Model, \$29.75.

sify weak signals like a powerful lens reveals distant scenes, affording a sharpness of tuning that stands unequalled in sets at anyway near the Crosley price.

By the "Volume Control" you can cut down to a whisper or increase to room-filling volume for dancing.

Of beautiful appearance and modest size the "Bandbox" adapts itself charmingly to the requirements of any interior arrangement or scheme of decoration. For installation in console cabinets the metal case is easily and quickly removed.



\$55 for the Battery type and only \$65 for the AC type  
Prices slightly higher west of ROCKIES

### A C and Battery Operation

Using the new RCA—A C tubes the "Bandbox" is a revelation in radio on either battery or house current. Leads for power or other connections are conveniently contained in a single rubber covered cable.

The "Bandbox" has no A C hum. The power unit at only \$60 is a marvel of radio engineering ingenuity and supplies A, B and C current direct from lamp socket to tubes.

Crosley

When the gong rings for the third round; when there's three on bases and the Babe at the bat; when it's the third down and 10 yards to go—"You're There with a Crosley." Your nearest Crosley dealer is ready to prove it to you before you buy.

Three handsome console cabinets, especially designed to hold the shielded chassis of the "Bandbox" have been approved by Powel Crosley, Jr., as mechanically and acoustically ideal.

H. T. ROBERTS CO.  
914 S. Michigan Ave., Chicago, Ill.  
Sales Agent for Approved Console Factories.  
Shower Brothers Company  
The Wolf Manufacturing Industries

Write Dept. 15 for descriptive literature.

Crosley Radio is licensed only for Radio Amateur, Experimental and Broadcast Reception.

RCA Radiotrons are supplied at standard prices with each Crosley Receiver.

The

# CROSLEY

# RADIO CORPORATION

Powel Crosley, Jr.,  
President  
Cincinnati,  
Ohio



# Drive Nails In Tires! -and Make \$150 A Week

Simply Pound Nails Into an Old Tire in Front of Astonished Crowds and Make \$10-\$18 an Hour! Most Sensational Demonstration You Ever Heard Of. And No Matter How Many Times You Puncture Your Tires — They Can't Leak a Pound of Air! No Wonder This Amazing Invention Brings Demonstrators and Spare-Time Workers the Biggest Money of Their Lives!

## Mystic Fluid Heals Punctures

### 987 Punctures Yet Leaks No Air

"I tested out the sample sets you sent me a few days ago and the results were amazing. I drove 987 nails into one tire without the loss of one single pound of air.

"Now I want to sell AIR-STOP. Please send me 100 sets at once and hold four counties for me." J. W. Simpson.

### Convinced by Driving 54 Spikes

Dear Sir: We are in receipt of your letter of the 16th, also the samples, and gave the same a thorough test today, using a 35x5 tire, driving fifty-four spikes into the same. So AIR-STOP has proven entirely satisfactory. Please send us via Express 100 sets 3 or 3½ in. size and 6 guns. Ralph Gates Pa.

**AIR-STOP** — the amazing new tire fluid — seals punctures automatically while you drive. No matter how many nails you run over, it doesn't make a bit of difference. You just keep spinning along as if nothing had happened. And that isn't all! AIR-STOP not only seals punctures, but slow leaks, valve leaks and porous tubes as well. It thus prevents cracked sidewalls and rim cuts and increases tire mileage because it eliminates driving with semi-flat tires, which is ruinous to any casing!

### How It Works

AIR-STOP is a simple, harmless fluid you just inject into the tire with a common grease gun. Non-injurious to tube or casing. Actually helps PRESERVE rubber. Never hardens in tire or becomes thin. Does its work equally well in summer or winter — whether the thermometer registers 10 below zero or 100 in the shade! AIR-STOP never fails and a single application lasts the life-time of any tube!

### Wonderful Money Maker

So astonishing is the effectiveness of this new invention that agents and demonstrators everywhere are simply coining money

for a few hours' work. Some of their profits are really astonishing. L. B. Watson made \$337.00 in two weeks. J. H. Roser made \$22.95 in 1½ hours. Hundreds of others are doing as well or better — in full or spare time.

All you have to do is hammer nails into an old tire in front of auto owners, crowds on main streets, etc. They simply can't believe their eyes when you pull the nails out and the tire doesn't leak a bit! But you don't have to have a car to make money with AIR-STOP. Just an old casing mounted on a rim for demonstration is all you need to take in \$10-\$18 an hour.

### Free Sample Order

And now to introduce this amazing invention, the discoverer — Mr. W. S. Hill — offers to send you a full size sample FREE! And more than that, he actually offers to PAY you for your cooperation in testing it. If you are not surprised and delighted with results. Take advantage of this opportunity to see for yourself

how astonishing AIR-STOP really is! Clip the coupon now! Mail it today!

### Sells 250 Sets In Two Weeks (Profit \$562.00)

Dear Sir: I sold 250 sets of AIR-STOP. Have a party to go in with me on the state of Montana. Yours truly,

E. E. AHES, N. D.

### One Sale \$450.00 Profit

"I am now on a deal to treat 214 cars all belonging to one company. (Profit over \$450.00). Bowman's Garage."

### Profit \$122.00

"Have disposed of 56-set order (Profit \$122.00). Will send order for 200 sets by mail." Peebles, Ohio.



## AIR-STOP Mfg. Co.

K-526 Hewitt Bldg.,  
DES MOINES, IOWA

AIR-STOP MFG. CO.  
K-526 Hewitt Bldg., Des Moines, Iowa

Please send me full details of your Sample Offer and agreement to pay me for testing AIR-STOP if I am not surprised and delighted with it. Also list of generous agent discounts.

Name .....

Address .....

City ..... State .....



## BULLDOG PIPELESS FURNACE

# 2½ Tons Heats 5 Rooms

"There is no heater to compare with the Bulldog. I burned 2½ tons of coal last winter and heated five rooms and a bath."—Walter Geary, Gloucester, Mass. That's what the Bulldog

does with coal! Now read, in the letter of Mr. Redetzke, what it does with about the lowest grade fuel you can think of! Why not cut down *your* fuel bills?

**Heats Home for 25c a Week**  
"I can run my bulldog furnace for fourteen days in normal weather conditions on the actual cost of *17½* cents." So writes F. R. Redetzke, of Cleveland, North Dakota, and he adds: "Hard to believe, is it? That's what some of my neighbors thought until I showed them! We have an unlimited amount of grain screenings which I use for fuel."

**Heats Seven Rooms Instead of One!**  
"Your letter received asking about the Bulldog furnace. We have had ours in about six weeks and so far it does all Babson Bros. claim for it. We have seven rooms, four on the first floor and three on the second, and it heats them fine. We find it takes a little more coal to heat the whole house than it did to heat one room with a stove using chestnut coal."—J. B. Smith, 19 Elm St., Somerville, N. J.

**Cuts Coal Bills in Half**  
"I had a hot air furnace in our 7-room house before I got the Bulldog and our house was always cold. With the Bulldog it only takes *half as much* coal and we had weather below zero, and the house was nice and warm in the morning when we got up. We never have the draft on more than half an hour at a time, and it has the place red hot. It is easy to regulate and keeps the fire all day in mild weather."

Jess T. Conrad,  
1211 W. Arch St. Shamokin, Pa.

## No Money Down!

**Comes Completely Erected. You Install It Yourself.**

The Bulldog is sent to you for *free inspection*. Then, if satisfied, you make only small monthly payments at our remarkably low price. Write today! *Don't* miss this chance to cut down your fuel bills! *Install a Bulldog Furnace*. It comes to you completely erected—goes through any door—fits any height of basement—and you install it yourself in less than two hours! In fact, H. B. Keater, of Libertyville, N. Y., says he installed

his Bulldog in 28 minutes! *Don't* put up with the old fashioned stove heat or some outworn furnace—when you can so easily get the greatest advance in scientific heating at an astonishingly low price. The Bulldog burns almost *any* kind of fuel, from hard coal to cheap screenings. Keeps a wood fire over night. We have factory connections in both east and west and ship from the nearest point.

**Bulldog Furnace Co., Dept. C-135**

BABSON BROS., Sole Distributors  
19th St. and California Avenue, Chicago

Without obligating me in any way, please send me your free catalog and special offer on the Bulldog Pipeless Furnace.

(Print Name and Address plainly)

Name .....

Address .....

## Send for Free Book

Learn how to have all the heat you want—where you want it—and save money! Remember the Bulldog is *different*—and *better!* Complete combustion of gases save 25% of your fuel bill. Exclusive Gable-Top Radiator receives *all* the direct rays of the fire. Exclusive oblong fire-pot is not only ideal for coal, but enables you to keep a wood fire over night. Remember—the Bulldog is sent for *free inspection*—then small monthly payments at an amazingly low price! Send for Free Book TODAY!

**Bulldog Furnace Co.,**  
Babson Bros., Sole Distributors

19th St. and California Ave.  
Dept. C-135 Chicago, Ill.