

# POPULAR MECHANICS

## MAGAZINE

WRITTEN SO YOU CAN UNDERSTAND IT

REG. TRADE MARK GREAT BRITAIN No. 410426

REG. U.S. PAT. OFF.

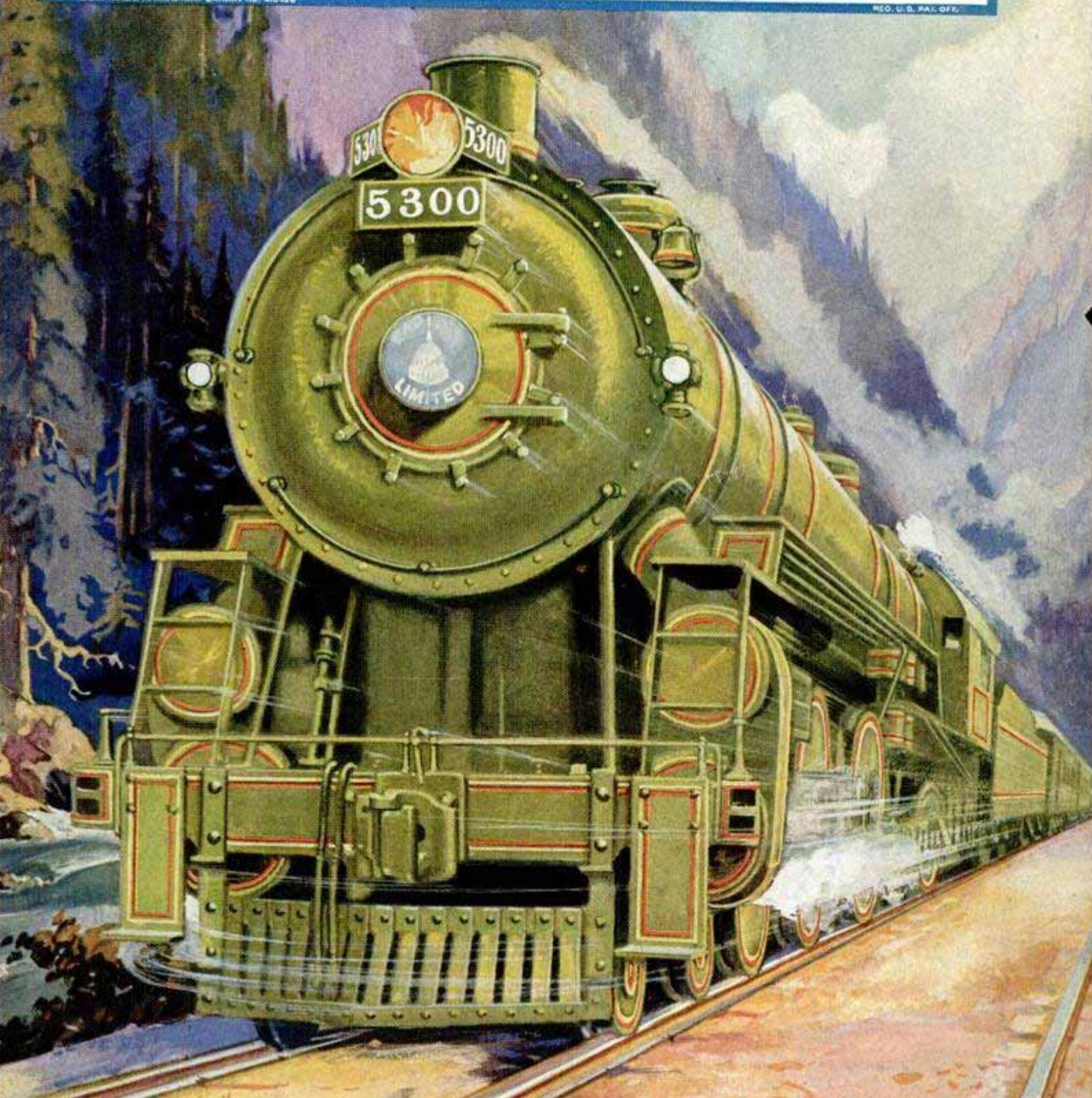



Mr. Happy  
Man says - "at Your Hardware Store"



## ATKINS SILVER STEEL HACKSAW BLADES

Economical  
because  
they  
last  
longer

WILL LAST  
LEAST SIX TIMES AS LONG  
AS ANY OTHER HACKSAW BLADE

25  
TEETH  
EACH

Will

Keep  
Their  
Teeth

THE RIGHT NUMBER OF TEETH FOR YOUR WORK

## Cut SIX Times More Metal

**N**OW—before YOU cut metal—YOU can get these wonderful, new ATKINS "Silver Steel" Hand Hack Saw Blades at YOUR Hardware Store. Developed by steel experts in Atkins laboratories, actual use shows "Silver Steel" Blades cut SIX times longer than ordinary hack saw blades.

YOUR Hardware Store can show you these new "Silver Steel" Hack Saw Blades displayed as shown above, for every metal cutting use. No need to waste time, material and labor cutting metal. Look for the ATKINS name on the blade. We will gladly send you descriptive folders of "Silver Steel" Hand and Power Hack Saw Blades.

If your dealer cannot supply you, tell us what kind of metal you are cutting, enclosing 25c, and we will send you a sample "SILVER STEEL" hand hack saw blade.



E. C. ATKINS & CO., Est. 1857, 426 So. Ills. St., Indianapolis, Ind.

Leading Manufacturers of Highest Grade Saws for Every Use; Saw Tools, Saw Specialties, Plastering Trowels, Machine Knives, Grinding Wheels and Files

# ATKINS SILVER STEEL SAWS



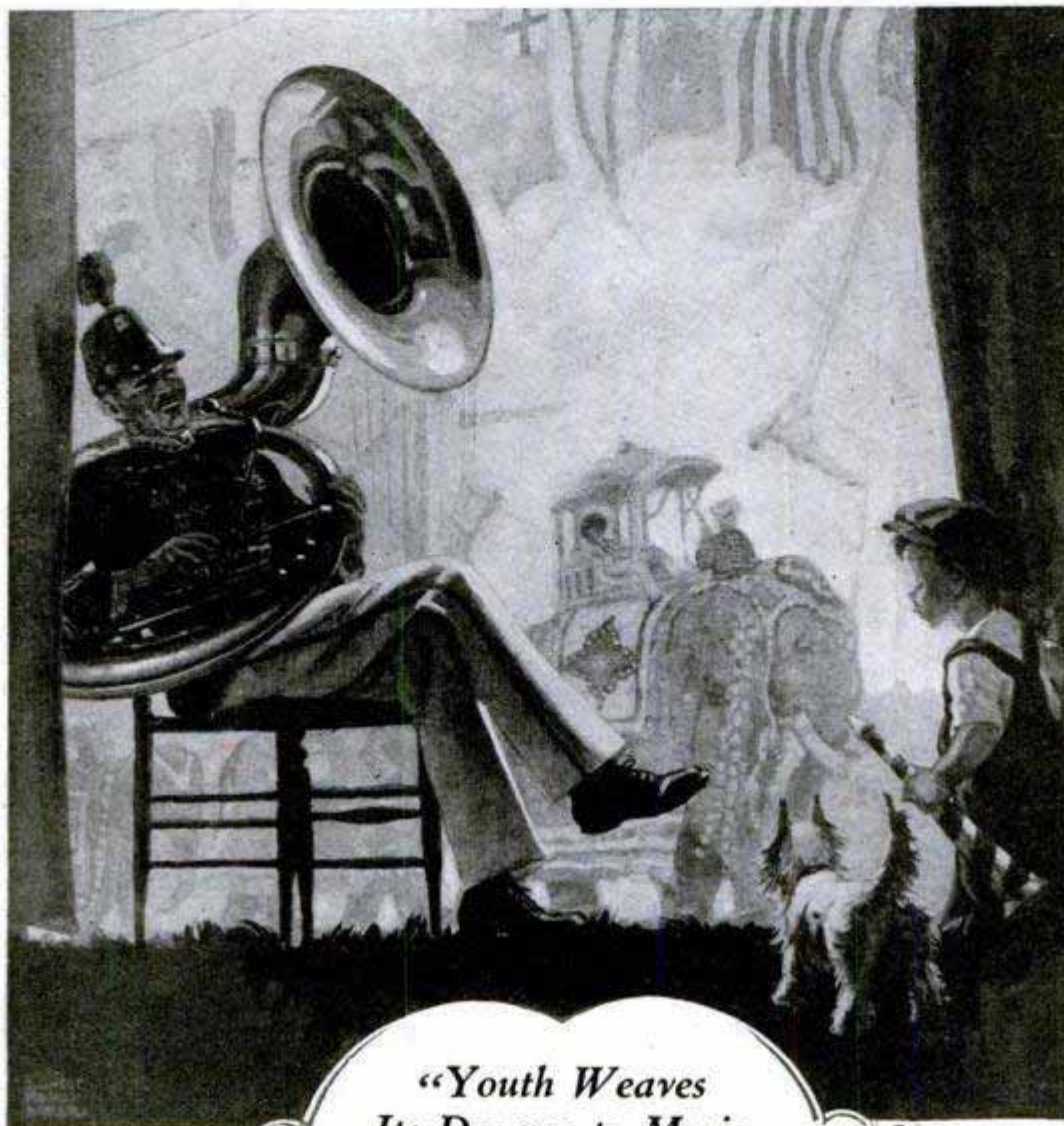

*“Youth Weaves  
Its Dreams to Music  
of the Band”*

From the blare of the herald's trumpet ...through every crowded minute of the glittering pageant...flying acrobats...elephants...clowns...to the last furious dash of the charioteers, *every thrill in the circus is timed to the music of the band!*

In this world of a thousand wonders grown-up America rekindles youth—and Youth weaves its glamorous dreams of Life.

And, here, as in the concert band, the symphony, opera and broadcasting orchestra, Conn instruments are chosen for their superior quality—a remarkable ease in playing, dependable mechanism, surpassing beauty and brilliance of tone.

**Free Trial; Easy Payments** on any Conn. Send coupon for free literature and details.

**C. G. CONN, Ltd., 731 Conn Bldg., Elkhart, Ind.**

*Dealers and Agents Throughout the World*

**CONN**  
BAND  
INSTRUMENTS  
WORLD'S LARGEST MANUFACTURERS

C. G. CONN, Ltd.

731 Conn Bldg., Elkhart, Ind.

Gentlemen: Please send me free literature and details of trial offer on \_\_\_\_\_ (Instrument)

Name \_\_\_\_\_

Street or R. F. D. \_\_\_\_\_

City \_\_\_\_\_ State \_\_\_\_\_

County \_\_\_\_\_





## You may "kid" the "cold-bath liar"

*but you envy him one thing*

**Y**OU know him—the "cold-bath liar." He brags, offensively, about the bracing, stimulating, zestful feeling he gets when he tumbles out of a nice warm bed and jumps under the icy shower. He gets by with a reputation for being antiseptically clean.

How about yourself? Have you recently shoved your own familiar face up close to a truthful mirror for a good honest look? Try it. You are due for a surprise and a couple of shocks. You are going to discover that your face is really not quite clean.

That off-color, almost-but-not-quite-clean look about your skin is caused by ordinary, unpleasant dirt. It comes from the air. The

U. S. Weather Bureau estimates that there are 115,000 swirling bits of dust and grime in one cubic inch of city air. These invisible bits of smoky grime collect upon your face, in tiny wrinkles and open pores. Once there, they resist every effort of soap and water to get them out.

You can get clean—and stay clean. A Pompeian massage in your own home takes only seventy seconds—no more time than a hot towel and rinse. Use this invigorating massage cream after shaving, for that stimulating, zestful "feel." Use it to get clean, stay clean; then absorb some of the glory that gravitates to the cold-bath enthusiast.

Above all, use it for the grand and glorious feeling that, by gosh! you really are clean!

### MAKE THIS CONVINCING TEST!

Wash your hands thoroughly. Rub a little Massage Cream into the back of your hand. Keep rubbing. The cream goes in pink and comes out black! The black is dirt you couldn't remove by washing. Make this simple but convincing test today. Get a jar of Massage Cream in any drug store—60c. Mail the coupon below for free sample.



### FREE .. TO MEN ONLY

The Pompeian Company, Dept. 303G, 595 Fifth Ave., New York. Please send me free, the sample tube of Massage Cream, with enough cream to make the hand test, and to give me several massages.

# POMPEIAN MESSAGE CREAM

*Increases Your Face Value*

Name \_\_\_\_\_

Street \_\_\_\_\_

City \_\_\_\_\_ State \_\_\_\_\_



# Popular Mechanics Magazine

200 E. Ontario Street, Chicago, U. S. A.

H. H. WINDSOR, Founder

H. H. WINDSOR, Jr., Editor and Publisher

London: Hachette & Cie.,  
16-17 King William Street, Charing Cross, W. C. 2

Paris: Hachette & Cie.,  
111 Rue Reaumur

Melbourne: Gordon & Gotch  
509-513 Little Collins St.

ISSUED MONTHLY

SUBSCRIPTION:

SINGLE COPY, 25 CENTS

In United States and its possessions, also Canada, Cuba, and Mexico, per year, postpaid . . . \$2.50

To all other countries in the Postal Union . . . . . 3.00

All subscriptions are discontinued at expiration. Please examine the date printed on your wrapper.

Entered as Second Class Matter Sept. 15, 1903, at the Post Office at Chicago, Illinois, under Act of March 3rd, 1879.

Entered as Second Class Matter at the Post Office Department, Canada.

Published monthly by POPULAR MECHANICS CO.

Copyright, 1927, by Popular Mechanics Co.

Copyright in Australia. Copyright in France

Vol. 18

Contents for July, 1927

No. 1

Acetylene gas—auto fuel cuts cost of motoring . . . . .	34	Fingerprint—magnifier aids crime war . . . . .	4
Adhesives—air tight pot prevents waste of . . . . .	109	Fire Fighting—blazing skyscraper offers problem . . . . .	3
Advertising		Fireproofing—wood and paper with new compound . . . . .	79
huge cigaret on auto top advertises product . . . . .	63	Fish and Fishing—Belgian shrimp fishermen use horses . . . . .	97
information office resembling a bureau advertises . . . . .	112	Flowerpots—on sidewalk beautify city . . . . .	94
town . . . . .	49	Fog Horn—two tone heard forty miles . . . . .	56
Air Mail—parachute delivery to save landings . . . . .	49	Forestry	
Airplanes		forest clubs for boys and girls . . . . .	115
endless-track landing skids help planes alight . . . . .	21	inside forest helps in study of . . . . .	106
towing ten-passenger fuselage . . . . .	13	Fruit—bushel basket packer saves time and work . . . . .	40
Airships—Riding the clouds in an air pullman . . . . .	101	Fur Coats—of artificial silk . . . . .	16
Antiques—Treasure hunting in your attic . . . . .	52	Fur Trading—A race for a fortune . . . . .	69
Archæology		Garage—old airplane is sign on . . . . .	95
Bible cities give up secrets . . . . .	82	Golf Club—sight on, to improve stroke . . . . .	11
Glory that was Egypt now tourists' haunt . . . . .	119	Golf Ground—new sod for putting greens . . . . .	114
Architecture—reviving the wonders of Maya kings . . . . .	76	Grain—portable loader helps market . . . . .	80
Army—tanks carry wireless . . . . .	8	Gun—of rubber shoots arrows . . . . .	117
Astronomy—What star gazers are doing for us . . . . .	26	Hats—luminous reduce night accidents . . . . .	73
Automobiles		Heart—marvels of human . . . . .	120
five foot car makes fast time . . . . .	49	Hobos—railroad fares from . . . . .	65
towline kept from sagging . . . . .	118	Hogs—automatic currier and oiler for . . . . .	34
Automobiles—Brakes—ratchet tester eliminates guess-work . . . . .	99	Hoist—hydraulic dumps grain from trucks or wagons . . . . .	90
Automobiles—Design—four speed and "fast" axles . . . . .	18	Hole Borer—motor driven helps in planting trees . . . . .	64
Automobiles—Equipment and Supplies		Homes—water tank converted into apartment building . . . . .	49
adjustable awning and ventilator . . . . .	79	Hotel—world's biggest (Stevens, Chicago) . . . . .	9
car easily locked with brakes set . . . . .	23	House Cleaning—washer for scrubbing reduces paint . . . . .	81
jack for balloon tires . . . . .	13	cost . . . . .	81
oil and gas recorder on steering wheel . . . . .	65	Household Devices . . . . .	110
windshield screen keeps out dust and bugs . . . . .	6	Hydrography—navy charts sea bottom for submarines . . . . .	19
Automobiles—Lighting		Jail—concealed on top of courthouse . . . . .	114
automatic spotlight cuts out all glare . . . . .	64	Jefferson, Thomas—honored at celebration as inventor . . . . .	12
flasher for stoplights . . . . .	113	Knife—safety wood-splitting substitute for hatchet . . . . .	41
Automobiles—Repairing—compact auto shop hauled in trailer . . . . .	39	Laundry—tests show how to make clothes last longer . . . . .	60
Automobiles—Tires		Lawn Sprinkler	
flap with slots fits many sizes . . . . .	48	clockwork spray nozzle reduces water waste . . . . .	17
puncture sealing inner tube reduces troubles . . . . .	11	makes rain and won't clog . . . . .	24
Aviation		Lenses—sand blast cleans lenses on railroad signals . . . . .	75
air garage to launch planes from all floors . . . . .	33	Lions—The man-eaters, Part II . . . . .	43
lamp facilitates night landings . . . . .	24	Locomotives—eat their smoke and drink steam . . . . .	15
Barber Shop—sign inspired by comic strip . . . . .	75	London—shopping district beneath Piccadilly Circus . . . . .	42
Barrels—lever for handling saves lifting . . . . .	94	Market—open air for motorists . . . . .	120
Bathbats—individual aid health of Swedish children . . . . .	23	Microphone—police hear through wall with . . . . .	73
Birds—for study protected by transparent case . . . . .	31	Microscope—small pocket, like pencil . . . . .	66
Boats and Boating—decorated boats for carnival . . . . .	74	Motor Truck—rear dump has crane for loading . . . . .	31
Boxing—gauge for measuring force for punches . . . . .	96	Motorboats—backfire danger stopped by valve on carburetor . . . . .	57
Bridge—two hundred feet high for logging . . . . .	113	Moving Pictures	
Building—house without windows lighted by glass roof . . . . .	25	aid in diagnosis of disease . . . . .	90
Calendar		fool cats and birds but not dogs . . . . .	12
five year serves as paper weight . . . . .	56	new light for indoor amateur movies . . . . .	57
for recording weather conditions . . . . .	98	Mudguards—on shoes, protect stockings . . . . .	18
Carbon Paper—tabs simplify removal of sheets . . . . .	66	Music Rack—parade light for . . . . .	95
Catgut—for surgical use spun in hospital . . . . .	22	Nail Driver—double barreled speeds car building . . . . .	57
Chemistry—high pressure creates new field in . . . . .	104	National Guard—cherry tree crest for District of Columbia . . . . .	75
Cigar Lighter—when lifted turns on electric current . . . . .	90	Navigation Chart—of bamboo sticks guided early sailors . . . . .	56
Clothes Closet—cedar lining for in convenient form . . . . .	7	Navigation, River—Bringing back the packets . . . . .	35
Clothing—trouser pocket is "pick-proof" . . . . .	63	Noise—what it does to your nerves . . . . .	107
Coconuts—curios carved from . . . . .	98	Ocean—mysteries bared by depth samples . . . . .	118
Comb—clip prevents loss of pocket . . . . .	66	Odors—number code identifies . . . . .	24
Copper—defies electrical laws . . . . .	5	Oil Fields—located with dynamite and seismograph . . . . .	94
Crane—wrecking for airplanes . . . . .	105	Ostrich—feathers used in dusters show change in style . . . . .	8
Electricians' Supplies—outlet for current easily hung . . . . .	33	Painting	
Figurehead—clipper ship "America's" now garden decoration . . . . .	12	three ton of world war sent to America . . . . .	41
		with colored sand is art novelty . . . . .	42
		Paving—rails keep road open during . . . . .	22







# DRAKE'S PRACTICAL MECHANICAL BOOKS

## THEY WILL RAISE YOUR PAY— ORDER ON 5-DAY TRIAL

The books listed below will perfect you in your chosen trade—pave the way to the big positions. Written in non-technical language—easy to read and understand. Every book covers its subject completely. An entire course of instruction condensed into one volume. Your choice sent postpaid—your benefit 5 days—money refunded in full if not entirely satisfactory. Order direct from this page.

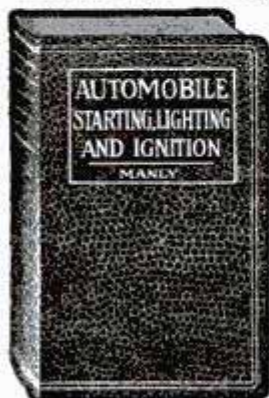

### Automobile Books

- Automobile Starting, Lighting and Ignition, by Manly... 700 pp. \$3.00  
 Crookes' Automobile Handbook... \$2.00  
 Ford Motor Car, Truck and Tractor, by Manly... Cloth \$1.50  
 Automobile Battery, Care and Repair, by Manly... Leatherette \$2.00  
 Motorcycle Handbook, by Manly... \$1.50

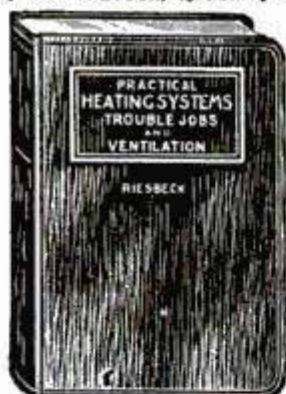

### Shop Practice Books

- Practical Heating Systems, Trouble Jobs and Ventilation... \$4.00  
 Sheet Metal Workers' Manual... \$2.00  
 Oxy-Acetylene Welding and Cutting... Cloth \$1.25  
 Slide Rule and Logarithmic Tables... \$2.00  
 Handbook for Millwrights... Cloth \$2.00  
 Machine Shop Practice... Cloth \$2.00  
 Mechanical Drawing and Machine Design... Cloth \$2.00

### ORDER DIRECT FROM THIS PAGE —ON OUR MONEY-BACK PLAN

The books listed above are only a few of the many in our catalogue, which you will receive promptly after filling out and mailing us the attached coupon. For quick action order direct from this page—cross name of each book wanted and send in with price quoted. We prepay postage and send the books on our money-back plan.

**FREDERICK J. DRAKE & CO.**  
Publishers

1008 Michigan Ave. CHICAGO  
Drake Books Are For Sale at All Book Stores

Mail Coupon For Free Catalogue  
Your Guide to Home Study

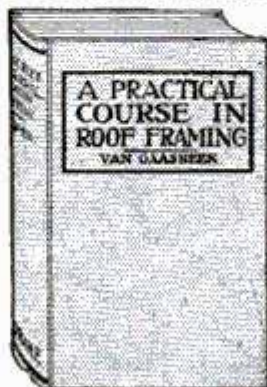

### Carpentry Books

Cloth Binding

- Modern Carpentry, 2 vols... \$3.00  
 The Steel Square, 2 vols... \$3.00  
 Modern Estimator... \$1.50  
 Timber Framing... \$2.00  
 Builders' Architectural Drawing... \$2.00  
 Concrete... \$1.50  
 Practical Bungalows... \$1.00  
 Roof Framing, by Van Gaasbeek... \$1.50

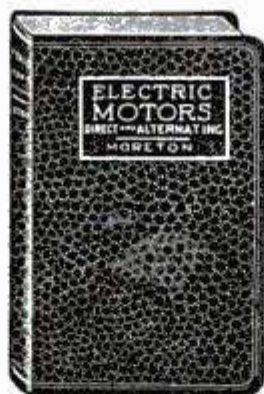

### Electrical Books

- Telephony, Including Automatic Switching, by Smith, 450 pp. Leatherette \$2.50  
 Practical Applied Electricity... \$2.00  
 Wiring Diagrams and Descriptions... \$1.50  
 Armature and Magnet Winding... \$1.50  
 Electric Motors, D. & A... \$1.50



### Painting and Decorating

- Ross Crane Book of Home Furnishing and Decoration... Cloth \$3.00  
 Furniture, Furniture Finishing, Decoration and Patching... \$5.00  
 House Painting Methods with the Brush and Spray Gun, by Vanderwalker... Cloth \$2.00  
 Interior Wall Decoration, by Vanderwalker... Leatherette \$4.00  
 The Mixing of Colors and Paints, by Vanderwalker... Cloth \$2.00  
 Studio Handbook—Letter and Design... \$3.00  
 A Show at Sho' Cards... Cloth \$4.00  
 Sign Painting, by Atkinson... Cloth \$4.00  
 Strong's Book of Designs, Leatherette \$4.00  
 Modern Painters' Cyclopaedia... Cloth \$2.00  
 Automobile Painting... Cloth \$1.50  
 New Hardwood Finishing... Cloth \$1.50  
 Wood Finishing, Plain and Decorative... Cloth \$2.00  
 Owen's Paint Guide... Cloth \$1.00

### Steam Engineering

- Swingle's... for St... Engineers... \$4.00  
 ... \$2.00  
 ... Leatherette \$1.50

### Foreign Languages

- By Prof. P. S. Allen, U. of Chicago  
 French without a Teacher... Cloth \$1.25  
 Spanish without a Teacher... Cloth \$1.25  
 German without a Teacher... Cloth \$1.25  
 Everyday French... \$1.25  
 Everyday Spanish... \$1.25

**FREDERICK J. DRAKE & CO.**  
1008 Michigan Avenue  
Chicago, Ill.

GENTLEMEN:—Please send me free, postage paid, your illustrated catalogue which lists and describes 100 Practical Mechanical Books for Home Study.

My name is .....

and my address .....





# "Were You Born a Money-Maker?"



Neither was I, but I have learned the secret of making money—and here it is—

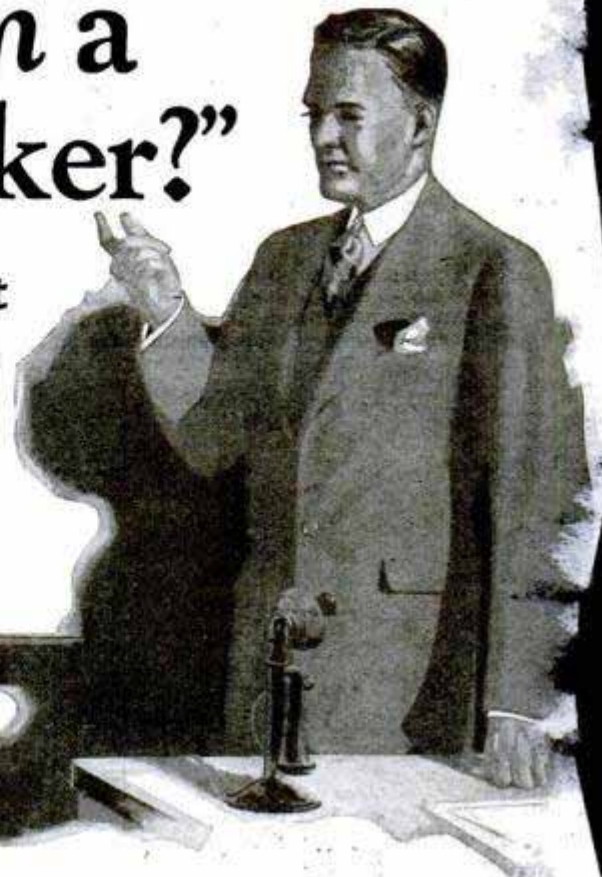

I'M going to let you in on a little secret, Tom. It ought to be worth at least \$5,000 a year to you, and I'm not going to charge you a single penny—

"When I was your age, I was always wondering why the boss never seemed to take much interest in me. Every six months or so I would hit him for a 'raise'—and once in a great while I would get an extra \$5 a week. But the big jobs—the jobs that paid real money—always went to someone else.

"Then something happened that set me thinking—

"Bob Harris, who had started at the same time I did, was promoted to the very job I had picked for myself—salary \$6,500. I knew Bob didn't have any more natural ability than I had—yet the fact remained that he got the place. And I had to admit he was better able to swing it!

"Well, I took myself aside, and for the first time in my life I looked the situation squarely in the face. That night I clipped and mailed a LaSalle coupon.

## How He Landed the Big Job

"And now came the big surprise—for me, at least.

"I had always looked upon home-study business training as drudgery. Inside of three weeks, however, I actually got to *looking forward* to those different lesson assignments. You see, instead of reading a lot of heavy, theoretical stuff, I took up case after case that represented *actual business problems*. I was shown the principles that governed them; *then I worked them out for myself*. It fascinated me, because I could actually see myself grow.

"First thing I knew, I received my first real 'raise'—then a better job—and a better one yet—

"I told you I was going to let you in on a little secret. Well—the secret is this: Always give a little more than you're paid for. And—so that you can be *sure to give more, first get more to give!*"

## Send for These Free Books—They Tell You

You want to make more money—as soon as possible—with the least lost effort.

Then there's one thing you should do immediately—you should send to LaSalle Extension University and find out how you can turn that secret into cash.

During only six months' time—as a direct result of putting that secret into practice—as many as 1,248 LaSalle members reported definite salary-increases totalling \$1,399,507—an average increase per man of 89 per cent. *Find out how you can duplicate or even exceed this record.*

To aid you in this purpose, LaSalle has prepared two very interesting and helpful books and will send them to you without cost or obligation. One is a 64-page book outlining the opportunities in the business field that most appeals to you—telling you exactly how you can turn them to your own advantage. The other has marked the turning point for thousands. It is entitled, "Ten Years' Promotion in One."

Face your problem—decide the field in which you want to make a big success—then fill in, clip and mail the coupon NOW.

— — — Find Yourself Thru LaSalle — — —

## LaSalle Extension University

The World's Largest Business Training Institution

Dept. 764-R

Chicago

I would welcome an outline of the LaSalle plan, together with a copy of "Ten Years' Promotion in One," all without obligation.

- Business Management
- Modern Salesmanship
- Higher Accountancy
- Traffic Management
- Railway Station Management
- Law: Degree of LL. B.
- Commercial Law
- Industrial Management Efficiency
- Modern Business Correspondence and Practice

- Banking and Finance
- Modern Foremanship
- Personnel Management
- Expert Bookkeeping
- Business English
- Commercial Spanish
- Effective Speaking
- C. P. A. Coaching
- Stenotypy

Ten years  
promotion  
in one

Name .....

Present Position .....

Address .....



# BUILDERS

## TRADE GUIDES

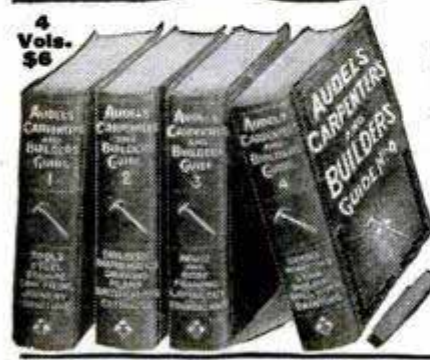

### AUDELS CARPENTERS AND BUILDERS GUIDES—4 VOLS. \$6

Inside Information for Carpenters, Builders, Joiners, Building Mechanics—all Woodworkers. **1600 pages; 3700 diagrams; flexible; pocket size.** Short-cut instructions, new methods, ideas, solutions, plans, systems—money saving suggestions. An easy progressive course for the apprentice. A practical daily helper and Quick Reference for the master worker. A Helping Hand to Easier and Better Work and Better Pay. To get this aid for yourself, simply fill in and mail the **FREE COUPON** below.

**INSIDE TRADE INFORMATION ON:**

How to use steel square; How to file and set saws; How to build furniture; How to use mitre box; How to use chalk line; How to use rules; How to make joints; Carpenters' arithmetic; Mensuration problems; Estimating strength of timbers; How to set girders and sills; How to frame houses and roofs; How to estimate costs; How to build houses, barns, garages, bungalows, etc.; How to read and draw plans; Drawing up specifications; How to excavate; How to use settings 12, 13 and 17 on the steel square; How to build hoists and scaffolds—skylights; How to build stairs; How to put on interior trim; How to hang doors; How to lath—lay floors; How to paint.

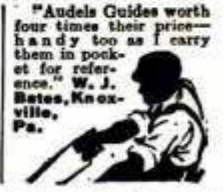

### AUDELS PLUMBERS AND STEAMFITTERS GUIDES—4 VOLS. \$6

A new set—just out! A practical, illustrated, Reference Library and Study-Course for Master Plumbers, Journeymen and Apprentice Steamfitters, Gas Fitters and Helpers, Sheet Metal Workers, Draughtsmen, Master Builders, Engineers and all Building Trade Students. **1670 pages; 3642 diagrams; flexible; pocket size.** Guides explain all the principles, advances and short cuts of the Plumbing and Heating trade. Contains instructions on how to figure and estimate jobs. Use **FREE COUPON** below to examine, without obligation, this valuable work.

**INSIDE TRADE INFORMATION ON:**

Soldering, tinning. Joint wiping, bending, beating. Pipe—iron-steel, threading. Mathematics, tables, physics. Materials—iron, steel, copper, brass, lead, tin, antimony. Sheet metal—galvanized—plate. Sanitation, syphonage, tanks. Drainage, sewage, purification. Fixtures—bath—kitchen. Pipe fittings, soil pipe, tools. Laying out work. Roughing. Screwed fittings, flanges, joints. Pipe bending, examples. Elbows. Heating, ventilation, refrigeration. Water supply, mains, wells, tanks. Gas-fittings. Underwriters. Sheet metal work, problems, methods, brazing, heating, lead burning. Welding, various welds, methods. Blacksmithing, forges, tools.



### AUDELS MASONS AND BUILDERS GUIDES—4 VOLS. \$6

A new, complete, illustrated trade reference library, for Bricklayers, Cement Workers, Plasterers, Tile Setters and Stone Masons, including a practical outline of Steel Construction. **1100 pages; 2067 diagrams; flexible; pocket size.** A practical Trade Assistant explaining modern methods of masonry construction. Easy to understand and apply. A reliable and authentic reference work and study-course for Master Journeyman and Young Mechanic. Use **FREE COUPON** below and find out for yourself, without obligation, whether this set will benefit you.

**INSIDE TRADE INFORMATION ON:**

Bricklaying, tools, materials; Brick designs, patterns, bonds; Setting frames and foundations; Mortars, scaffolds, estimating; Mortars and mortar mixing; Tile setting, mosaic, hollow tile; Straight edge test, troweling; How to figure brick work; Safe loads, piers, chimneys; Boiler settings, anchors, fire stops; Labor tables; Concrete, forms; How to figure concrete work; Stucco—on old and new buildings; Plastering—wood lath—metal; Plasterers agreement; Plastering on various surfaces; Stonemasonry; Cutting, finishing, estimating stone; Derricks, rigging; Steel construction; Fire proof; How to read blue prints.



### PRACTICAL ELECTRICITY — 1 VOL. \$4

Audels Handy Book of Practical Electricity is a simplified Ready Reference and Study Course in one pocket size, leather bound volume—for Engineers, Professional Electricians and Students. **1040 pages; 2600 diagrams; flexible red leather bound.** A reliable authority and handy helper for every electrical worker. Contains important and valuable wiring diagrams, calculations, machine sketches, helps on maintenance and repair. Use this **FREE COUPON** today and find out, without obligation, how this handy book will help you in your daily work.

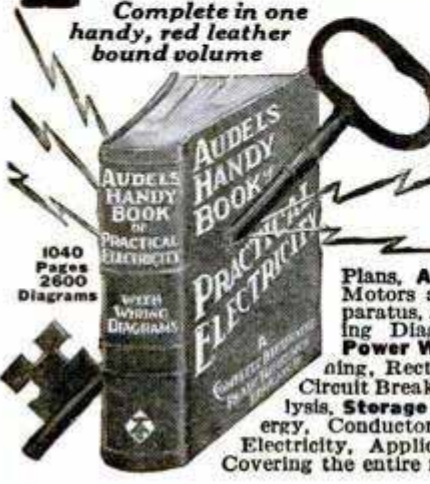

**INSIDE TRADE INFORMATION ON:**

Electro-Therapeutics, X-Rays, Shocks, Welding, Brazing, Radio Hook-ups, Motion Pictures, Telephone, Telegraph, Cranes, Bells, Elevators, Pumps, Tools, Ship Drive, Railways, Vehicles, Automobile Electric Systems, Ignition, Generation, Lighting, Plant Management, Power Plans, Armature Winding, Repairing, A. C. Motors and Apparatus, D. C. Motors and Apparatus, Alternator Construction, Dynamos, Wiring Diagrams, Sign Flashers, Cable Splicing, Power Wiring, Outside Wiring, Switches, Lightning, Rectifiers, Converters, Transformers, Fuses, Circuit Breakers, Rheostats, Electro Plating, Electrolysis, Storage Batteries, Magnetism, Electrical Energy, Conductors, Insulators, Static, Dynamic, Radio Electricity, Applications, Ready Reference and Index Covering the entire field of Modern Electricity.

### Learn More and You Will Earn More!

Know your job and you'll never be without one. The skilled man is always in demand. Knowledge is power. Learn your trade thoroughly by easy reading. This coupon is your opportunity for advancement and better pay. You risk nothing in sending for Audels Guides for free examination. Send it NOW!

**FREE EXAMINATION COUPON**

**THEO. AUDEL & CO.,**  
65 W. 23 ST., NEW YORK CITY

Please mail me for free examination the books marked (x) below. If I find them satisfactory, I agree to mail \$1 in 7 days, on each set ordered, and to further mail \$1 monthly on each set until I have paid the purchase price.

4 CARPENTERS GUIDES \$6 |  4 PLUMBERS GUIDES \$6

4 MASONS GUIDES \$6 |  1 ELECTRICIANS HANDY BOOK \$4

NAME .....

ADDRESS .....

OCCUPATION .....

EMPLOYED BY..... 7T30



# Be an ELECTRICAL & MECHANICAL AUTO EXPERT



I WILL TRAIN YOU AT HOME

**\$100**  
a  
**Week**  
and his business growing fast!  
says Geo. C. Deal

## Will You Be Earning \$50 to \$100 a Week by January First?

The world's biggest business needs you! Why slave away at small pay when there are so many opportunities to make money QUICK in the Auto Business! Mail Coupon now. Get all the facts about "Job-Way" Auto home Training.

### The Only "Job-Way" Training

Mine is the original, genuine "Job-Way" Training. I train you with (1) Lessons, (2) Job Tickets, (3) Tools which I give you without extra cost, and (4) Actual Auto Jobs. 15,731 letters in my files, all telling of actual auto experience, prove that "Job-Way" is the Practical Training for you! I give you complete instruction in every important branch of Auto Work, both Mechanical and Electrical. And my Employment Department helps you find a good job!

### CLIP COUPON NOW!

When you read that there are now 22 MILLION Autos, trucks and tractors—that car owners are paying out SIX THOUSAND MILLION DOLLARS A YEAR for upkeep, you will realize that here is the business to get into! You'll understand why scores of men are making \$40, \$50 and \$60 a week, just a few months after enrolling for "Job-Way." My Free Book tells all. Get it!

4 testing and repair OUTFITS given

Without Extra Cost

Tools, Test Bench, Electrical Experimental Outfit and Wiring Diagram Charts included. Coupon brings details.

### Go Into Business!

I can show you men who are making as much as \$175 a week in their own Auto Businesses! They are exceptions—but there are dozens who are making anywhere up to \$5,000 a year. George C. Deal was earning only \$10 a week as a farmer, but is now making \$100 a week in his own business. James T. Summers, of Statesville, N. C., was making only \$25 a week. Now it's \$50 to \$75 a week!



Geo. C. Deal  
High River,  
Alberta,  
Canada

## FREE! AUTO BOOK

B. W. COOKE, Directing Engineer,  
CHICAGO MOTOR TRAINING CORPORATION,  
1516 Sunnyside Avenue, Dept. B-16, CHICAGO, ILL.

Send me FREE Auto Book, and proof that you will show me the QUICK WAY toward a BIG JOB and a RAISE IN PAY. Also your 4 working outfits offer. It is understood that this obligates me in no way.

**Earn While You Learn!** Get my new Book today! It's Free! See how hundreds of men are making as high as \$30 a week extra money in their spare time only. See what you can do. Send Coupon.

**Big Auto Book FREE!** If you are between the ages of 17 and 50—can read, write, and understand plain English, and are a normal, live fellow—send for this Free Book. Whether you're experienced or not, I'll train you for Quick Success and my written Money-Back Agreement protects you! Get all the FACTS! Mail coupon now!

**B. W. COOKE, Directing Engineer,**  
CHICAGO MOTOR TRAINING CORPORATION  
Dept. B-16, 1916 Sunnyside Ave., CHICAGO

.....Name  
.....Address



# "I WAS FIRED TWICE BEFORE I WOKE UP"



### Always Liked Mechanical Things

As a boy it was always Edward T. Adams' great ambition to study engineering at a technical school. But the prospect wasn't very bright. It was difficult enough to make both ends meet in the Adams household without saving money to send a boy to college.



### Worked as Waiter to Get Education

As Edward T. Adams grew older his desire for a good education became stronger and by working in the afternoon and at nights he finally saved enough money to enter college. Once there he worked as a dish-washer, waiter and tutor to pay his way through.



### Finds It Hard to Get and Hold a Job

After graduation, he started out confidently to get a position and was somewhat surprised when employers did not seem any too eager to put him on the payroll. As a matter of fact, he lost two jobs in less than a year before he saw the need of special training.



### Asks His Friends About I. C. S.

"Just about that time," writes Mr. Adams, "I heard about the International Correspondence Schools and I asked some of my friends about it. I was surprised to find how many college men had taken a course with this school to get practical training. So I decided to enroll too."



### Finds Just the Help He Needed

"The minute I started on the course I could see that it was the very thing I needed. It gave me a practical knowledge of engineering that I could otherwise have obtained only by long and tedious years of shop work. It really marked the turning point in my life."



### Now Mechanical Engineer With Big Concern

Today Edward T. Adams is the Mechanical Engineer in charge of mechanical supervision for the Fairbanks Company at Binghamton, N. Y., and a member of the American Society of Mechanical Engineers. He has also patented a number of inventions.

Every mail brings letters from students and graduates of the International Correspondence Schools telling of promotions and increases in salary due directly to spare-time study.

For years this list has been growing until today there is hardly an office or industrial plant in this country

which does not number among its executives at least one man who received his first real start toward Success through these Scranton schools.

For the sake of your future, your family, your happiness in the years to come, at least take a few moments today to find out what these great schools can do for you.

## MAIL THIS COUPON FOR FREE BOOKLET

INTERNATIONAL CORRESPONDENCE SCHOOLS, Box 5656-E, Scranton, Penna.

Without cost or obligation, please send me one of your booklets and tell me how I can qualify for the position or in the subject before which I have marked an X:

#### BUSINESS TRAINING COURSES

- Business Management
- Industrial Management
- Personnel Organization
- Traffic Management
- Business Law
- Banking and Banking Law

- Accountancy (including C.P.A.)
- Nicholson Cost Accounting
- Bookkeeping
- Private Secretary
- Spanish
- French

- Salesmanship
- Advertising
- Business Correspondence
- Show Card Lettering
- Stenography and Typing
- Good English

- Civil Service
- Railway Mail Clerk
- Common School Subjects
- High School Subjects
- Illustrating
- Cartooning

#### TECHNICAL AND INDUSTRIAL COURSES

- Electrical Engineering
- Electric Lighting
- Mechanical Engineer
- Mechanical Draftsman
- Machine Shop Practice
- Railroad Positions

- Gas Engine Operating
- Civil Engineer
- Surveying and Mapping
- Metallurgy
- Steam Engineering
- Radio

- Architect
- Blueprint Reading
- Contractor and Builder
- Architectural Draftsman
- Concrete Builder
- Structural Engineer

- Chemistry
- Automobile Work
- Airplane Engines
- Navigation
- Agriculture and Poultry
- Mathematics

© 1927

Name .....

Address .....

Canadian address—International Correspondence Schools Canadian, Limited, Montreal



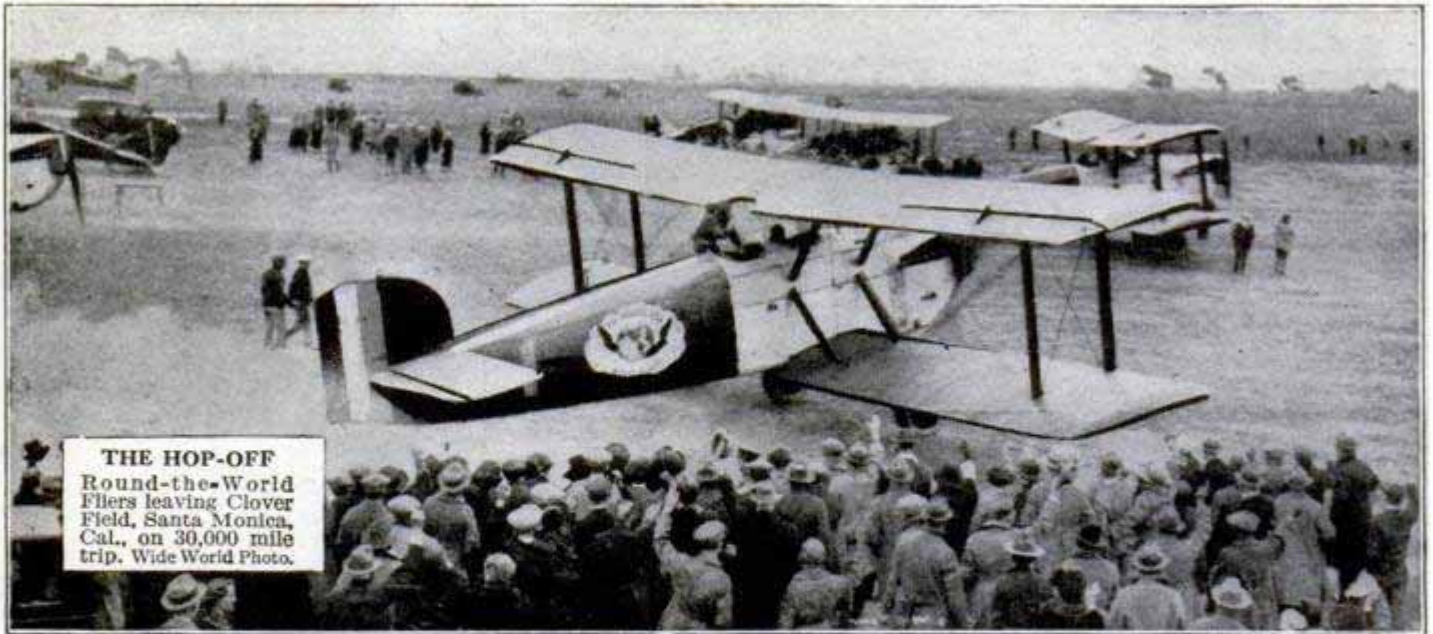

**THE HOP-OFF**  
Round-the-World  
Fliers leaving Clover  
Field, Santa Monica,  
Cal., on 30,000 mile  
trip. Wide World Photo.

# Daring Young Men Needed in Aviation

**T**HERE is no field of work in the world today which offers such amazing opportunities to young men of daring and who love adventure as does Aviation. Although still in its infancy, there is a crying demand in Aviation for young men with courage, nerve and self-reliance. For those who can qualify there will be thousands of highly paid jobs which will lead quickly and surely to advancement and success.

## Big Opportunities Await The Trained Man

Look over the fields of work which are open to the young man today. You will find that Aviation is the ONE FIELD that is not overcrowded—the ONE FIELD in which there is plenty of room at the top. Think of it. Only 21 years ago Orville and Wilbur Wright made the world's first airplane flight. Now airplanes fly around the world. Yes, Aviation offers the same wonderful opportunities today that the automobile and motion picture industries did 15 and 20 years ago. Men who got in on the ground floor of those industries made fortunes before others woke up. AVIATION IS NEW! It clamors for nervy young men—and the trained man has the world before him in Aviation.

## Easy to Become an Aviation Expert

You can qualify now quickly for one of these exciting highly paid jobs through a new, sure, easy method of training. The study of Aviation is almost as interesting as the work itself. Every lesson is fascinating and packed full of interest. That's why Aviation is so easy to learn—you don't have to force yourself

to study—once you start, you can't get enough of it. Only one hour of spare time a day will give you the basic training in an amazingly short time.

### PICK YOUR JOB!

- Airplane Instructor
- Airplane Engineer
- Airplane Repairman
- Airplane Assembler
- Airplane Mechanician
- Airplane Inspector
- Airplane Builder
- Airplane Salesman
- Exhibition Manager
- Airplane Contractor
- Airplane Motor Expert
- Airplane Designer

One student, S. F. McNaughton, Chicago, says: "Your lessons are like a romance, and what is more, after one reading, the student gets a thorough understanding. One never tires of reading them." James Powers, Pa., another student, says: "I am indeed surprised that such a valuable course can be had from such practical men for so little cost."

## Personal Instruction by Experienced Men

Men who have had actual experience in Aviation give you personal attention and guide you carefully through your training. They select the lessons, lectures, blueprints and bulletins. They tell you the things that are essential to your success. Every lesson is easy to read and quickly understood.

## Big Book on Aviation FREE

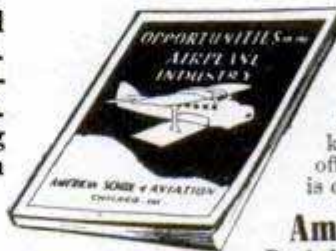

Send coupon below for New Free Book, just out, "Opportunities in the Airplane Industry." It is interesting and instructive and will show you many things about Aviation which you never knew before. Only a limited number offered—get yours before the edition is exhausted.

**American School of Aviation**  
Dept. 135-B, 3601 Michigan Ave., Chicago, Ill.

AMERICAN SCHOOL OF AVIATION,  
3601 Michigan Ave., Dept. 135-B, Chicago, Ill.

Without any obligation, send me your Free Book, "Opportunities in the Airplane Industry," also information about your Course in Practical Aeronautics.

Name..... Age.....  
Street.....  
City..... State.....





None of This!

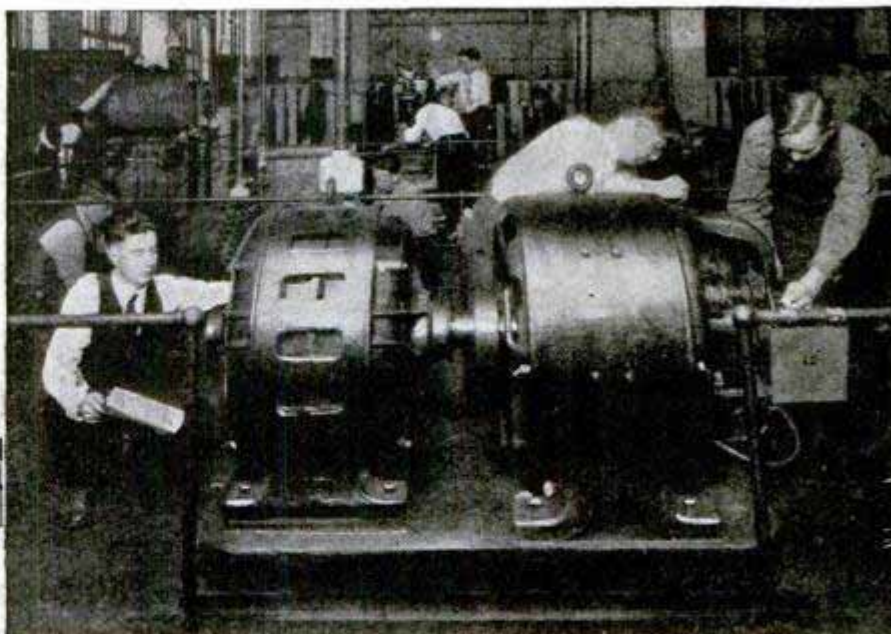

# ELECTRICITY Becomes Amazingly Easy When Taught Without Books or Lessons <sup>IN 90</sup> DAYS

**W**HY work at dull, uninteresting jobs that will never pay you more than \$35, \$40 or perhaps \$50 a week? Make up your mind **now** to become a master of electricity! Train in 12 easy weeks to hold down the kind of a job that pays \$50 and up to \$200 a week, and which creates a constant demand for your services nearly any place in the world!

## No Books—No Classes

Electricity, as taught in the Great Shops of Coyne, is surprisingly easy to grasp. That's because we use no books or dry lessons. You learn by doing actual, **practical** experimenting on big, electrical machinery. You learn by **doing**—and you learn from the ground up.

## Not a Correspondence School

Experts work right along with you every step of the way. You get personal attention—it's not a bit like trying to figure out a lot of correspondence school pamphlets and diagrams all by yourself. The **Coyne Way** gives you real, **sound** knowledge that fits you to do **practical** electrical work in all its branches.

# COYNE ELECTRICAL SCHOOL

Dept. B7-72

H. C. Lewis, Pres. 1300-10 W. Harrison St., Chicago, Ill.

## No Experience or Advanced Education Needed

You don't need one day's previous electrical experience or any advanced education to master electricity the Coyne way. Some of our most successful graduates never went farther than the 8th grade.

## Earn While You Learn

By our special arrangement, our employment department will help you locate part-time work, if you want to earn while you learn. And after graduation we give you the benefit of our **FREE EMPLOYMENT Service** for life. Every week we secure positions for Coyne men.

## Get FREE Book

Write today for my big book on electricity with over 150 photographs. Learn what great opportunity Coyne Training opens up for you. Also get full details of my Big-3 Special offer. No obligation. Mail the coupon now.

## FREE If You Act Now

**R. R. Fare**  
**1** will be refunded upon enrollment from any point in the U. S. to Chicago.

**Radio**  
**2** course given absolutely without any extra charge. Covers new developments in this fascinating field.

**Auto**  
**3** course, covering truck and tractor electricity. Especially valuable if you ever want to start electrical business of your own. See coupon!

## FREE BOOK Coupon

H. C. Lewis, Pres.  
Coyne Electrical School, Dept. B7-72  
1300-10 W. Harrison St.  
Chicago, Illinois

Please send me your free catalog on electricity and details of your 3 special offers. No obligation on my part.

Name.....

Address.....

City.....State.....





G. King Franklin  
Famous Auto  
Painting Authority

# Whether You want a Job or a Business of Your Own

# Be an Auto Painter!

## A Paint Shop of Your Own in Sight!

Little capital needed to start a small shop when you know how to do a professional job of painting and spraying. As profits roll in you can buy spraying equipment, employ helpers and branch out. Hundreds of the largest paint shops in the U. S. started with half a dozen brushes and a few cans of material. My 13 outfits illustrated below include sufficient tools to make a start in a shop of your own.

## Earn \$75 a Week and Up!

Paint and Duco experts are always sure of a well-paid job. That's one branch of auto work never crowded. Twenty million autos, trucks, tractors, busses and taxis need repainting every couple of years.

Paint and Duco experts earn big salaries. Finishers earn \$75 to \$125 a week. Painters and sprayers earn \$50 to \$90 a week.

Plenty of jobs—everywhere—all the time in auto painting, and the work's easy and pleasant.

Here is an uncrowded field that assures your success.

# Learn in a Few Months at Home!



## 13 Outfits of Tools and You Don't Need a Car to Learn by My System

I send you panels of metal and wood to prime, surface, paint, varnish, stripe, etc. I supply sandpaper, chamois, all kinds of brushes, scrapers and other tools—all without extra charge. I start you off by doing actual painting jobs. I guarantee that you can learn quickly and easily. Satisfaction or money refunded is my method. My course includes shop-tickets, shop-lectures, work-tickets, etc. And I tell you how to go out and get the business, how to run it, how to keep order and cost records, etc. It would take many years of actual experience and twice the time and three times the cost at a trade school to learn all branches of the work as I give it to you AT HOME in your spare time.

## Materials Included Sample Shop-Tickets FREE

Mail coupon for complete information and get sample shop-tickets FREE. I want you to see how easy, rapid and practical I have made the learning of auto painting and Duco. Low tuition for this instruction and very small monthly payments. Rush coupon today.

G. King Franklin, Supt.

**American Auto Painting School**  
Dept. 401, 421 South Ashland Avenue, CHICAGO

G. King Franklin, Supt.  
American Auto Painting School  
Dept. 401—421 S. Ashland Ave., Chicago

Send sample shop-tickets free and information on how I may learn auto painting and Duco at home in spare time.

Name.....

Street No.....

City.....

State.....



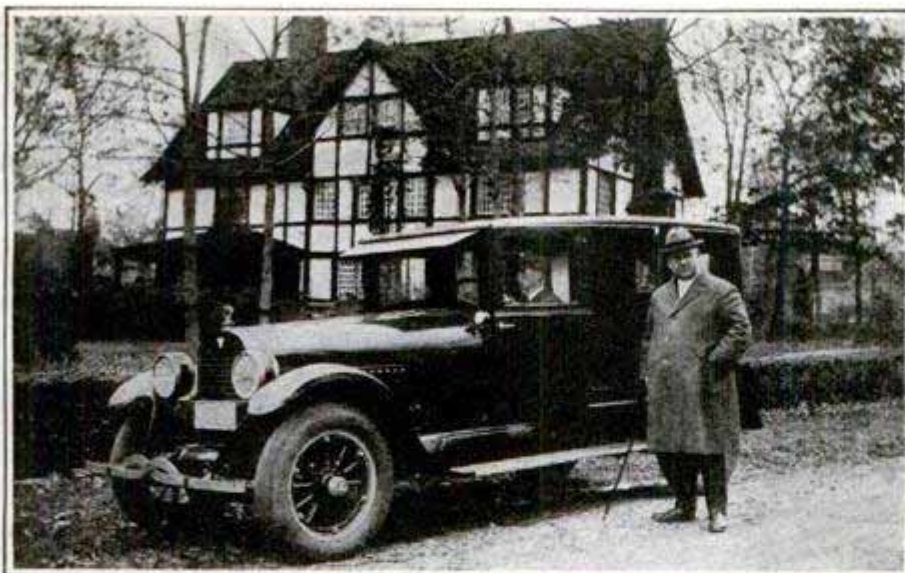

**How, after 12 years' hard work as railroad brakeman, I got into real estate, and now make more in a month than I used to make in a year.**

By L. C. CLARKE  
(Address furnished on request)

**F**OR TWELVE YEARS I was a brakeman on the Mohawk Division of the New York Central.

During that time my wages averaged exactly \$638.40 a year.

Then I got started in the real estate business, and during the past year I made one sale that gave me a commission of \$4,500, which is more than I made on the railroad in seven years of hard work.

And I don't feel that I have done anything wonderful — anything the other fellow can't do if he will, I simply got into the right kind of business—a business of big opportunities—a business where big money is made.

You—who are reading these words—can do what I have done if you have a mind to. You don't need education, experience, capital or influence. I didn't have any of these things.

I had to leave school when I was thirteen, so I had mighty little education. I had no real estate experience. I never earned more than just enough to keep me out of the poorhouse, so I had no capital. And, as for influence, where would a \$50-a-month brakeman get any?

And you don't have to go to a big town to succeed. I am located in a little New York State town of only 3,000 population.

Of course, I'm pretty enthusiastic about the real estate business. I think it's the greatest business in the world. It has more advantages and bigger opportunities than any other business I know of. It is as permanent as the earth itself. It is almost

unlimited in its possibilities—about ten million properties are always on the market. It is easy to learn. You don't need capital to get started, as you do in almost any other business. The business can't grow smaller—it keeps getting bigger and bigger as population increases. And you can get started in the business right at home in your spare time. When I realize that I have an independent, enjoyable business of my own, a good home, two automobiles, and every convenience and comfort a sane man could want, I sometimes find it hard to believe that I'm the same fellow that put in twelve long years of hard work as a railroad brakeman.

Now if you are kicking about what I used to kick about—long hours, hard work and poor pay—if you want to get into a business where you can have the biggest kind of an opportunity to make good—simply send your name and address to American Business Builders, Inc., Dept. 44-GG, 18 East 18 Street, New York, and they will send you, **without cost or obligation**, a copy of their free book, "How to Become a Real Estate Specialist."

In five minutes after you start reading this fascinating book, you will agree with me that you have at last struck the best business opportunity that ever came your way—an opportunity to learn a splendid, money-making business and get started—right at home—in your spare time—without capital or experience—in a safe, sound, independent business of your own.

So get busy. If you want to grab something big. If you are ambitious to make something of yourself—get ahead—make more money—this is one chance you can't afford to let slip out of your grasp. It costs you nothing to find out what there is in this for you. You take no risk. So, mail the coupon at once. Take my word for it, you will never regret the day you send for this free book. And some day you may do just what I did—put through a deal that will put more money in your bank account than you ever saw in one pile before.

**\$4,500 Made in One Sale**

### Free Employment Service

Real estate corporations, sub-division operators, auctioneers, realty bond houses, building and loan associations, insurance companies and others requiring trained representatives (men or women) should register at once for our free employment service. Address—Business Development, Dept. 44-GG, 18 East 18 St., New York.

### Buy and Sell Real Estate

Anyone wishing to buy any kind of real estate, anywhere, write at once (on postal card only) requesting Free Requirement Blank. Owners, wishing to sell, write at once (on postal card only) requesting Free Listing Blank. Address—National Real Estate Exchange, Dept. 44-GG, 18 East 18 St., New York.

**American Business Builders, Inc.,**

(Authorized Capital \$500,000)

**Dept. 44-GG, 18 East 18 Street, New York**



Send me—without cost or obligation—your new free illustrated book, "How to Become a Real Estate Specialist."

Name .....

Address .....



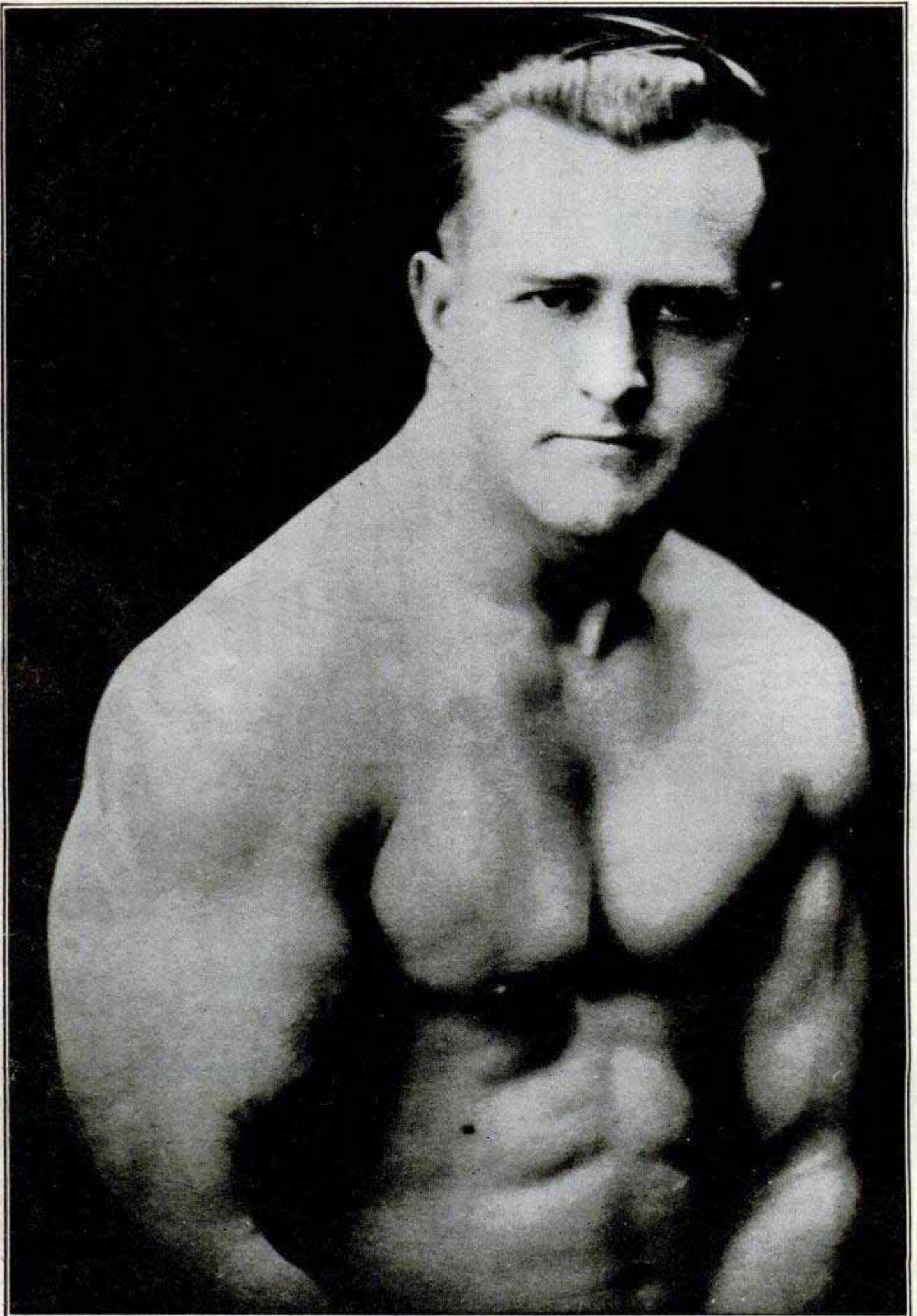

**EARLE E. LIEDERMAN, *The Muscle Builder***

*Author of "Science of Wrestling," "Muscle Building," "Secrets of Strength," "Here's Health," "Endurance," etc.*



# If You Were Dying To-night

and I offered something that would give you ten years more to live, would you take it? You'd grab it. Well, fellows, I've got it, but don't wait till you're dying or it won't do you a bit of good. It will then be too late. Right now is the time. Tomorrow or any day, some disease will get you and if you have not equipped yourself to fight it off, you're gone. I don't claim to cure disease. I am not a medical doctor, but I'll put you in such condition that the doctor will starve to death waiting for you to take sick. Can you imagine a mosquito trying to bite a brick wall? A fine chance.

## A RE-BUILT MAN

I like to get the weak ones. I delight in getting hold of a man who has been turned down as hopeless by others. It's easy enough to finish a task that's more than half done. But give me the weak, sickly chap and watch him grow stronger. That's what I like. It's fun to me because I know I can do it and I like to give the other fellow the laugh. I don't just give you a veneer of muscle that looks good to others. I work on you both inside and out. I not only put big, massive arms and legs on you, but I build up those inner muscles that surround your vital organs. The kind that give you real pep and energy, the kind that fire you with ambition and the courage to tackle anything set before you.

## All I Ask Is Ninety Days

Who says it takes years to get in shape? Show me the man who makes any such claims and I'll make him eat his words. I'll put one full inch on your arm in just 30 days. Yes, and two full inches on your chest in the same length of time. Meanwhile, I'm putting life and pep into your old back-bone. And from then on, just watch 'em grow. At the end of thirty days you won't know yourself. Your whole body will take on an entirely different appearance. But you've only started. Now comes the real works. I've only built my foundation. I want just 60 days more (90 in all) and you'll make those friends of yours who think they're strong look like something the cat dragged in.

## A Real Man

When I'm through with you you're a real man. The kind that can prove it. You will be able to do things you had thought impossible. And the beauty of it is you keep on going. Your deep, full chest breathes in rich, pure air, stimulating your blood and making you just bubble over with vim and vitality. Your huge square shoulders and your massive muscular arms have that craving for the exercise of a regular he-man. You have the flash to your eye and the pep to your step that will make you admired and sought after in both the business and social world.

This is no-idle prattle, fellows. If you doubt me, make me prove it. Go ahead, I like it. I have already done this for thousands of others and my records are unchallenged. What I have done for them, I will do for you. Come then, for time flies and every day counts. Let this very day be the beginning of new life to you.

Send For My New  
64 Page Book

# "Muscular Development"

IT IS FREE

It contains over four dozen full-page photographs of myself and some of the many prize-winning pupils I have trained. Some of these came to me as pitiful weaklings, imploring me to help them. Look them over now and you will marvel at their present physiques. This book will prove to be an impetus and a real inspiration to you. It will thrill you through and through. And it's all yours, I don't ask a cent. This will not obligate you at all, but for the sake of your future health and happiness do not put it off. Send today—right now before you turn this page.

**EARLE E. LIEDERMAN**

Dept. 2007

305 Broadway, New York City

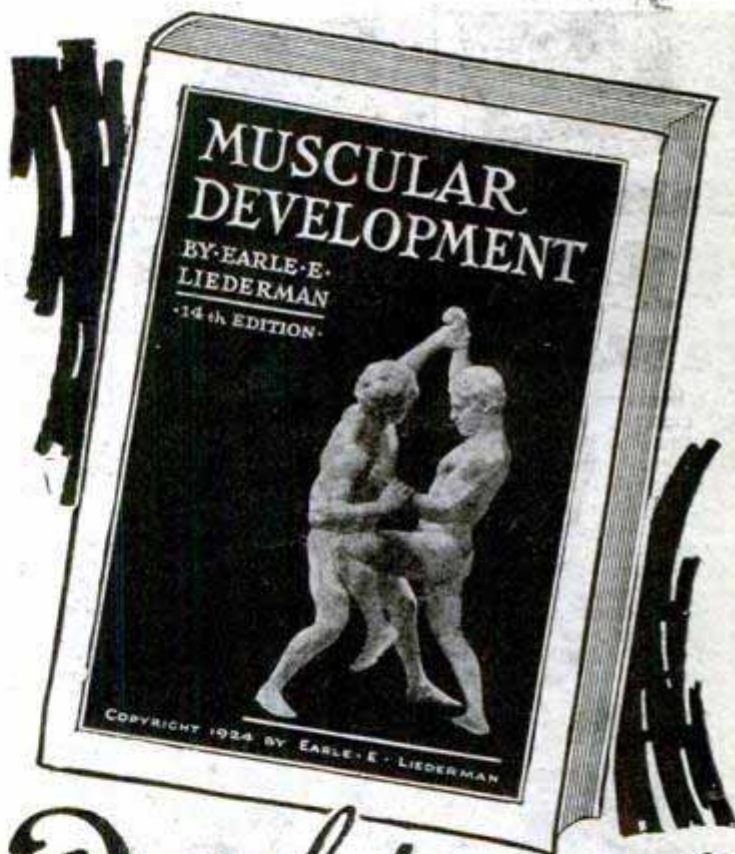

It  
Is  
F  
R  
E  
E

DON'T SEND ONE PENNY — YOUR NAME AND ADDRESS ON A POSTAL WILL DO

**EARLE E. LIEDERMAN**  
Dept. 2007, 305 Broadway, New York City

Dear Sir: Please send me, without any obligation on my part whatever, a copy of your latest book, "Muscular Development." (Please write or print plainly.)

Name.....

Street.....

City..... State.....



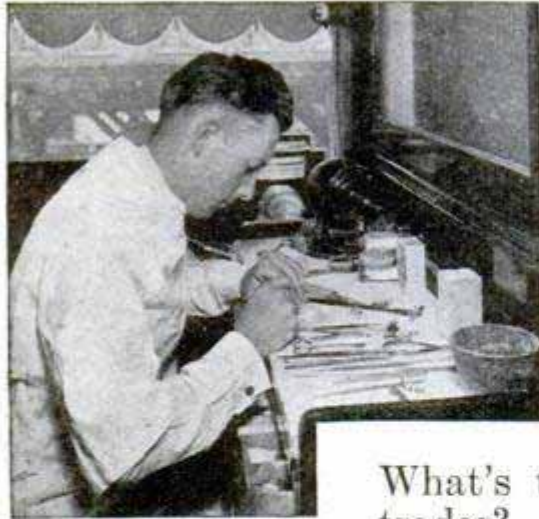

# This Dental Laboratory Expert earns UP TO \$20 a day!

What's the use of training for the old, overcrowded trades? If you're going to prepare for big-salaried jobs or a profitable business of your own GET INTO THE FASTEST GROWING PROFESSION—"Laboratory Dentistry." Biggest opportunity for success of the century, because there are many more jobs than there are experts to fill them, because there are a dozen cities crying for Laboratories for each EXPERT capable of operating one!

Easiest, pleasantest work you ever saw! Your own boss, money and success yours from the very beginning. You can start with a "shoe-string." We prepare you in a few months to run a business of your own, to do any job. Common schooling, ability to use your fingers ALL YOU NEED! R. R. Fare to Chicago, Cleveland, Detroit, Boston or Philadelphia deducted from cost of course for a limited time!



**Jobs Up to \$125 a Week!**

In a business where there are many times as many jobs as Experts, salaries are high, hours are easy, opportunities are everywhere! Dentists recognize the high-standing of our graduates. No books here—learn with tools and instruments. Start quick—get ready in a few months for your big opportunity! Mail Coupon today!

## Rubber Plates

Learn to make partial upper or lower plates with soldered, cast or wire clasps, with palatal bars; with lingual bars. McCarrie-trained Students learn to make full rubber plates of every type, including Vulcanite base-plates, butted gums, carved gums, etc.

## CROWNS

Here's only a small part of your practical training in Crown-work: Two-piece, seamless, open-face, Richmond, cast-base porcelain, Carmichael, split-plate, carved (swaged) cusp, cast cusp, etc.

## BRIDGE WORK

Complete training in both fixed and removable bridgework. Interchangeable teeth, gold dummy, Sanitary porcelain dummy jobs—Roach, Gilmore, Bischoff and all forms of cast-clip work is taught—not with books but in actual Laboratory.

## METAL BASE DENTURES

Cast bases of Aluminum, Watt's metal, etc., are included in your training. Both centrifugal and air pressure casting machines are used. Free Book contains complete list of subjects in course.

**R-R-FARE TO Chicago Cleveland Detroit Boston or Phila. DEDUCTED from TUITION**

## 64,000 DENTISTS NEED LABORATORY WORK!

Only a few hundred Laboratories in all the U. S.—most of them in the larger cities. Dentists can't afford to do their own mechanical jobs. They can buy the services of a Laboratory Expert at about \$3.00 an hour and sell their own time at \$6 to \$15 an hour. Dentists will encourage you to learn mechanical Dentistry, start a "Lab" of your own, give them quicker service than sending their work to other cities. Dentists can't wait and keep their patients waiting. Ask your Dentist.

## WE HELP YOU OPEN A LABORATORY OF YOUR OWN!

Many of our graduates open a Laboratory of their own. To encourage more men to go into this wonderful Mechanical profession, we will help you find a good location for your Laboratory, and help you towards success. Write for complete information on how you can find yourself in a profitable business of your own after you become a Dental Laboratory Expert.

## INTERESTING BOOK—FREE!

Right this minute there are openings for 150 Dental Laboratory Experts in locations where they can do a business of \$5,000 to \$20,000 a year. But you can't cash in, take advantage of these OPPORTUNITIES until you're Trained. Catalog tells you how quickly and easily you can get ready, how hundreds of others have SUCCEEDED! Tells you how you learn in a few months BY DOING ACTUAL LABORATORY JOBS in our famous Dental Laboratory Schools. Brings you R. R. Fare offer and other big inducements. Write for free Book today!

**EARN while you LEARN!**  
Day students make all or part cost of course by part-time night work. Night students can find plenty of good jobs to see them thru.  
**We'll help you!**

## McCarrie School of Mechanical Dentistry

1338 S. Michigan Ave.  
Dept. 124 Chicago, Ill.

McCarrie School of Mechanical Dentistry  
1338 S. Michigan Ave., Dept. 124, Chicago, Ill.

Without obligation, please send me your R. R. fare offer and free Book with complete information about how I may become a Mechanical Dentist. How you will help me open a Laboratory, how you will help me find a job while I take my training, etc.

Name.....  
St. No. or R. F. D.....  
City.....State.....



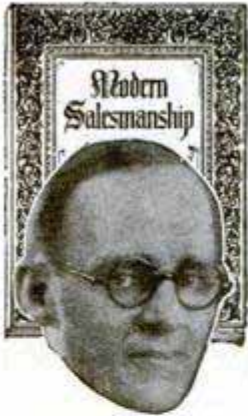

**\$7,500 A Year!**

C. W. Birmingham of Ohio was formerly a clerk in a shop, earning \$15 a week. Within a short time he has increased his earnings 900% so that, today, he is making \$7,500 a year. The book—"Modern Salesmanship"—proved the first rung in his ladder to Success!

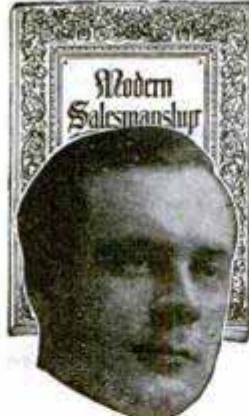

**\$10,000 A Year!**

C. V. Champion of Illinois counts it a "red letter day" when he first read this remarkable book—"Modern Salesmanship." He says "It enabled me to learn more, earn more, and BE MORE!" Today he is president of his company and his earnings exceed \$10,000 a year!



**\$1,000 A Week**

O. D. Oliver of Norman, Oklahoma, was local manager of a mercantile business for 17 years—finally getting \$200 a month. "Modern Salesmanship" opened his eyes and started him on the road to big pay. Today he earns more in a week than he previously earned in 5 months—or \$1,000 in the last 7 days!



**700% Increase**

F. G. Walsh was a clerk earning \$1,000 a year, and trying to support a wife and three children. He had to do something. N. S. T. A. training built up his income last year to \$7,286—an increase of over 700 per cent.

# -and They Started By Reading This Amazing Book!

Now—For a Limited Time Only—This Remarkable Man-Building, Salary-Raising Volume Is Offered FREE to Every Ambitious Man! If You Ever Aspire to Earn \$10,000 a Year or More, Read It Without Fail.

## Where Shall We Send Your Copy FREE?

**A** BOOK! Just seven ounces of paper and printer's ink—but it contains the most vivid and inspiring message any ambitious man can ever read! It reveals the facts and secrets that have led hundreds of ambitious men to the success beyond their fondest expectations! So powerful and far reaching has been the influence of this little volume, that it is no wonder a famous business genius has called it "The Most Amazing Book Ever Printed."

This vital book—"Modern Salesmanship"—contains hundreds of surprising and little-known facts about the highest paid profession in the world. It reveals the real truth about the art of selling. It blasts dozens of old theories, explains the science of selling in simple terms, and tells exactly how the great sales records of nationally-known star salesmen are achieved. And not only that—it outlines a simple plan that will enable almost any man to master scientific salesmanship without spending years on the road—without losing a day or dollar from his present position.

### What This Astonishing Book Has Done!

The achievements of this remarkable book have already won world-wide recognition. The men who have increased their earning capacities as a direct result of reading "Modern Salesmanship" are numbered in the thousands. For example, there is E. E. Williams of California who was struggling along in a minor position at a small salary. "Modern Salesmanship" opened his eyes to things he had never dreamed of—and he cast his lot with the National Salesmen's Training Association. Within a few short months of simple preparation, he was earning \$10,000 a year! Today he receives as much in 30 days as he used to receive in 365!

And then there's J. H. Cash of Atlanta. He, too, read "Modern Salesmanship" and found the answer within its pages. He quickly raised his salary from \$75 to \$500 a month and has every reason to hope for an even more brilliant future. And still they come! W. D. Clenny of Kansas City commenced making as high as \$850 a month. F. M. Harris, a former telegrapher, became sales manager at \$6,000 a year. O. H. Malfroot of Massachusetts became sales manager of his firm at a yearly income of over \$10,000.

### A Few Weeks—Then Bigger Pay

There was nothing "different" about these men when they started. Any man of average intelligence can duplicate the suc-

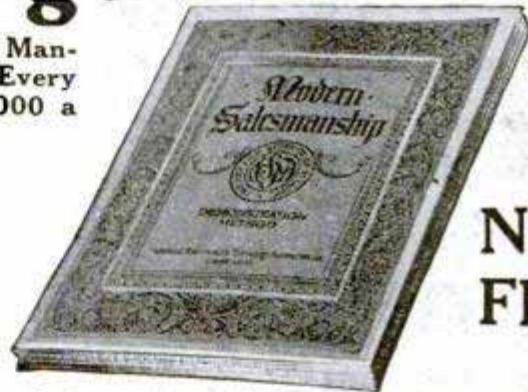

**NOW FREE**

cess they have achieved—for their experience proves that salesmen are made—not born, as some people have foolishly believed.

Salesmanship is just like any other profession. It has certain fundamental rules and laws—laws that you can master as easily as you learned the alphabet. And through the **National Demonstration Method**—an exclusive feature of the N. S. T. A. system of SALESMANSHIP training—you can acquire the equivalent of actual experience while studying. Hundreds of men who never sold goods in their lives credit a large portion of their success to this remarkable training.

### Free to Every Man

If we were asking two or three dollars a copy for "Modern Salesmanship" you might hesitate. But it is now FREE. We cannot urge you too strongly to take advantage of this opportunity to see for yourself what salesmanship has done for others—and what the National Salesmen's Training Association stands ready and willing to do for you. Find out exactly what the underlying principles of salesmanship are—and how you can put them to work for you. No matter what your opinion is now, "Modern Salesmanship" will give you a new insight into this fascinating and highly-paid profession.

Mail the coupon now!



Dept. H-100, N. S. T. A. Building, Chicago, Ill.

National Salesmen's Training Assn., Dept. H-100,  
N. S. T. A. Building, Chicago, Ill.

Without cost or obligation you may send me your free book, "Modern Salesmanship."

Name.....

Address.....

City..... State.....

Age..... Occupation.....





## Ben Dale received \$200 for this drawing *You might have made it*

BEN DALE is one of the best known commercial artists in New York. You see his work in all the leading magazines. You perhaps know that his income is "more than \$15,000 a year."

Ben Dale always had a natural talent for drawing, yet he has not always been the great artist that he is today. Time was when he scarcely could draw a straight line—when he knew less about the correct handling of line and wash and color than you do right now.

But he worked and studied, and "drew and drew" as he puts it, until he trained his hand to put down on paper the dream pictures that he saw so clearly in his mind.

All of his great creative ability might have been wasted without the right kind of training—without hard work.

If you have a natural talent for drawing, you have a priceless gift that is given to but few men and women. By all means take steps to develop it before the years fly by and it is too late.

Write today for the new illustrated catalog describing the art courses of the International Correspondence Schools. You will find the booklet interesting and helpful. It may, perhaps, be the means of changing your whole life.

**International Correspondence Schools**  
Box 5660-E, Scranton, Penna.

Without cost or obligation, please send me your new illustrated Art Catalog. I am checking the subject in which I am most interested:

<input type="checkbox"/> Magazine and Book Illustrating	<input type="checkbox"/> Show Card Lettering
<input type="checkbox"/> Commercial Art	<input type="checkbox"/> Handicrafts Designing
<input type="checkbox"/> Cartooning and Caricature	<input type="checkbox"/> Industrial Designing
<input type="checkbox"/> Newspaper Illustrating	<input type="checkbox"/> Interior Decoration
<input type="checkbox"/> Cover Designing	

Name.....

Address.....

## Don't Envy The Plumber BE ONE!

**\$11.00-\$16.00 PER DAY** and work **EVERY day**, is the Plumber's wage.

Every skilled workman will tell you that Plumbers have the best of it. WINTER and SUMMER the Plumber is busy at top wages. No skilled Plumber is ever out of a job—compare his opportunities with any trade, plus the opportunities of having your own shop.

We teach you Plumbing with TOOLS (not books) under Licensed Master PLUMBERS in one of the finest equipped schools in America. We make you a Plumber, every branch is taught thoroughly—Lead Work—Blue Print for plan reading—all other tricks.

**LEARN IN 8 to 12 WEEKS** without previous experience.

If you are making less than \$60.00 a week you owe it to yourself to investigate. Get FREE catalog that tells in pictures and words how we teach this trade. Special rates now.

**UNIVERSAL PLUMBING SCHOOL**  
2030 Troost Ave. KANSAS CITY, MO.

### LEARN PIANO TUNING AT HOME

**DURING SPARE TIME AND  
EARN \$50 TO \$100 A WEEK.**



**Our Tune-A-Phone Makes It Easy.** With it any one who has ordinary hearing can acquire the knack quickly and accurately. Esmay, Long Beach, Cal., says: "never dreamed there was so much money in Piano Tuning. I earned \$265 in ten days." He is but one of many. Write for Free copy of our book "Winning Independence" and Guarantee Plan.

**BRYANT SCHOOL, 71 BRYANT BLDG., AUGUSTA, MICH.**

### LEARN TO Mount Birds



We teach you At Home by Mail to mount Birds, Animals, Heads, Tax Furs and Make Rugs. Be a taxidermy artist. Easily, quickly learned by men, women and boys. Tremendously interesting and fascinating. Decorate home and den with beautiful art. Make Big Profits from Spare Time Selling Specimens and Mounting for Others.

**Free Book—**Yes absolutely Free—beautiful book telling all about how to learn taxidermy. Send Today. You will be delighted. Don't Delay!

Northwestern School of Taxidermy B-337 Elwood Bldg. OMAHA, NEB.

## Big Money for You as an Automobile Mechanic

These four practical books, written by five well known teachers of automobile practice, will teach you right in your own home during your leisure time just what you need to know about automobile troubles and repair. They will teach you automobile construction, maintenance and repair as experts know them and will help you to earn an expert's pay.

**Practical Automobile Library: Four Books—\$1.50 in 10 days and \$2 monthly for 6 months—only \$13.50 in all!**

Hundreds of question-answering diagrams—hundreds of clearly-marked illustrations—make the books plain and readily understandable. All the explanations and descriptions are clear, simple, direct. Every chapter is packed with definite, step-by-step, how-to-do-it information. Here is your opportunity to enter a big-pay field.

**Sent FREE** **Send No Money**  
Mail the Coupon



### FREE EXAMINATION COUPON

**McGraw-Hill Book Co., Inc., 370 Seventh Ave., New York**

Send me for 10 days' free examination the New Practical Automobile Library. If satisfactory, I will send you \$1.50 in 10 days and \$2.00 monthly until the special price of \$13.50 is paid. If not wanted, I will return the Books at your expense.

Signed.....

Address.....

City and State.....

Position.....

Employer..... P. M. 7-1-27





# Two Years Ago A Coal Miner ~ Now in the \$5,000 Yearly Class!

## He Got Into a Field That's Rich in Opportunity ~

Two years ago a coal miner, doing the hardest, dirtiest kind of work possible—today State Sales executive making upwards of \$5,000 yearly, with a big future ahead. That's the record of William H. Wilson!

Wilson looked ahead and trained himself for the new, live-wire Radio industry. He saw the *great need* for trained men in Radio. And after he had got a thorough training his success came quickly, because he was in a NEW field that's teeming with opportunities. Where advancement comes quickly for the few men who have got a real Radio training, and understand all the "hows" and "whys."



**J. E. SMITH**  
President

### Bigger Pay Waiting for You in Radio

There are even bigger opportunities waiting for you right now—**TODAY**—in Radio than there were when Wilson got in. The reason is: television accomplished, trans-Atlantic Radio telephony in use, many wonderful inventions and developments being made constantly which are widening the field of Radio opportunities.

Salaries from \$50 all the way up to \$250 a week are not unusual in this field. Radio needs you! With N. R. I. training behind you, there's no telling how far you may go in this business of *almost unlimited opportunity*. You may do as well or better than Wilson.

You learn right at home in your spare hours—you can do it easily. Clip the free book coupon below—the same one that Wilson clipped two years ago—and get all the facts and proof before you.

### 64-Page Book Sent Free

When I receive your coupon filled in I'll send you my 64-page book free. It's filled with photos and facts about the opportunities in Radio; tells about the 6 big Practice Outfits I give you—you can build 100 real Radio circuits with them; this book gives you all the pay-raising facts you want to know. No previous Radio experience is needed to take advantage of this offer, and no special schooling is required. Mail the coupon today for the big Free Book—no obligation.

Address **J. E. SMITH, President**

**NATIONAL RADIO INSTITUTE**  
Dept. G-85, Washington, D. C.

## Read This Letter From William H. Wilson!

1429 S. Michigan Ave.  
Chicago, Ill.



**WM. H. WILSON**

Dear Mr. Smith:

I take pleasure in dropping you a line in regard to my success as a direct result of your course, less than two years since I enrolled as your student—a coal miner by trade. I finished your course in eleven months and in the thirteen months since then I have kept climbing. My present position is just the sort of place I have been aiming to reach. I am in the capacity of manager for the entire State of Michigan for the National Lead Battery Company. My income is \$3,480 a year and added to that I get \$360 a year for bonus, also a nice commission on all sales to the dealers and jobbers in the state, which will run my income past the \$5,000 mark. To say that I am perfectly satisfied would be putting it mildly, because I have got now just exactly what I always wanted, and you and your training get the credit.

WILLIAM H. WILSON

### World-Famous Practical Training That "Pays for Itself"

Think of making \$15, \$20, \$30 extra a week "on the side," without interfering with your regular job! That's what I enable you to do, almost at once after you get started with me. My practical training is world-famous as the "Course That Pays For Itself." I show you how to make these extra dollars in your spare hours—while all the time I'm getting you ready for the bigger Radio jobs ahead. I'll show you how you can pay for your course and put money in the bank, while all the time you're studying and holding down your regular job, too. **SEND COUPON TODAY FOR BIG BOOK OF PROOF!**



### SIX OUTFITS OF PRACTICE MATERIAL WITHOUT EXTRA COST-MAIL THIS COUPON

**J. E. SMITH, President**  
**National Radio Institute**  
Dept. G-85, Washington, D. C.

Dear Mr. Smith: Please send me your 64-page Free Book which gives me all information on learning Radio for bigger pay; also information on your offer of 6 Practice Outfits free of extra cost. I understand this places me under no obligation.

Name.....

Address.....

Town..... State.....



# Make That Dream Come True!

Haven't you often pictured yourself playing the Hawaiian Guitar, a happy crowd around you, everybody enjoying and admiring your playing? Now you can reach your goal—and play all the latest hits just as the Hawaiians do!



You can play the HAWAIIAN GUITAR just like the Hawaiians!

**\$15 HAWAIIAN GUITAR** with Genuine Seal Grain Fabrikoid Cover  
**GIVEN** when you enroll

### Complete Conservatory Course

52 complete lessons. Pictures explain every move. Our method is simple, practical and interesting—only 4 motions to learn. No tiresome scales and exercises—you play a real piece your very first lesson.

### Expert Instruction by Native Hawaiians

Get the advantage of expert instruction by Kolomoku, Kalaluki, Ferera and Seville—every one famous as both player and teacher. Even if you never touched a musical instrument in your life, under their direction you make rapid headway—you will be astonished when you see how easy it is!

### This Sweet Toned Hawaiian Guitar

In genuine Fabrikoid Case—and complete playing outfit including picks, steel playing bar, etc.; given you when you enroll. Retailers ask \$15.00 or more for a similar outfit without the case. Remember, there are no extra—we furnish everything with the course.

### Learn In Spare Time

Pick up your guitar at any time and play. Your lessons are always handy—you can always refer to them. You are never hurried or forced. And no waiting for a class to form—start now—go ahead as fast as you like.

### Pay as You Play

Small first payment starts you. And the entire 52-lesson course comes to just a few cents a lesson! Begin now.

### We Guarantee

in writing to teach you. And after graduation we coach and advise you without charge. Over 45,000 successful graduates.

**Tenor Banjo** and other courses—Violin, Tiple, Tenor Guitar, Banjo Ukulele, Ukulele—and other well-known instructors. Write for information.

### FIRST HAWAIIAN CONSERVATORY OF MUSIC, INC.

9th Fl., Woolworth Bldg., Dept. 348, New York, N. Y.  
Approved as a Correspondence School Under the Laws of the State of New York

### SEND THIS COUPON FOR LIBERAL OFFER!

First Hawaiian Conservatory of Music, Inc.  
9th Fl., Woolworth Bldg., Dept. 348, New York, N. Y.

Please mail full information about your 52-lesson Hawaiian Guitar Course. I am not obliged to enroll unless I want to.

Name \_\_\_\_\_  
Address \_\_\_\_\_  
City \_\_\_\_\_ State \_\_\_\_\_

# \$2500 DRAWING COURSE for \$298



Haven't you often wished that you could draw cartoons, illustrate some idea, sketch some pretty face, etc.? You can do all of these things. One of America's most famous Cartoonists and Illustrators has developed a great, simple system for success in all branches of Commercial Art. This system has revolutionized the entire theory of drawing. It means that drawing can be as easy for you as writing—much simpler than learning shorthand, bookkeeping or typewriting. We are now placing this original system for learning Drawing, Art and Cartooning, consisting of 34 lessons with over 500 illustrations, within reach of every one. If you will devote a few hours each week to the Course WE ABSOLUTELY GUARANTEE that you will learn to draw and draw well before you have half finished the Course. If we fail to make this claim good, we will refund every cent paid us. By eliminating a large office force for answering correspondence, expensive catalogs, etc., we are enabled to make a price of \$2.98, the cheapest price ever known for a high-grade, home study course. Many have sent us letters similar to that of Rob't P. Davis of Detroit, who wrote: "I can't see how you ask so little. It is more than I expected." Learn to draw. It is a big asset, no matter what field you are in.

### Send No Money

Just order the course and **\$2.98** on arrival pay postman plus a few cents postage, payment in full for the entire Course and Drawing Outfit. If not entirely satisfied, return within five days and we will Refund Money. Address:

If you order the course at once, we will include a drawing outfit, consisting of artist's pencils, pens, paper, erasers, thumb tacks, etc., enabling you to go to work without any additional cost.

**LEDERER SCHOOL of DRAWING, Dept. 3888-0, Chattanooga, Tenn.**  
Orders from outside the U. S. A. are payable \$3.28 cash with order.

# Learn Advertising at HOME

Many of the highest paid men in the world are advertising men. You can learn easily and quickly at home during your spare time. We guarantee satisfaction. Bigger opportunities now in advertising than ever before. Constant demand for our graduates at splendid pay. Send for FREE Book. Giving interesting information and vital facts—just what you want to know about advertising. Write today.

**PAGE-DAVIS SCHOOL OF ADVERTISING**  
Dept. 1358 3601 S. Michigan Ave., Chicago, U. S. A.

# LEARN MECHANICAL DENTISTRY



making crowns, plates, bridges, etc. for dentists. Unusual demand now and always will be—a human necessity. Steady, dignified Professional Trade. Three to six months training. Easily learned by actual practice. R. R. Fare to nearest school included. Regular arrangement for part time positions to help pay expenses. Ask for Catalog No. 2.

### BODEE DENTAL INSTITUTE

New York 1755 Broadway Philadelphia 1305 North Broad Street Brooklyn 85 Court Street

# LEARN WATCHMAKING

and become independent. We help you secure a position.

Easy to learn. Send for FREE CATALOG.  
**ST. LOUIS WATCHMAKING SCHOOL, Dept. 5, ST. LOUIS, MO.**

# IF YOU STAMMER

Write for my free book "Millard's Advanced Natural Corrective Course" and a free copy of my speech magazine. 10,000 cases successfully treated. Est. 24 years. Largest school for stammerers in world. Millard Inst. of Normal Speech, 2317 Millard Bldg., Milwaukee, Wis.

# GOV'T. POSITIONS \$35 TO \$75 WEEKLY

- ( ) Railway Mail Clerk ( ) Meat Inspector
- ( ) P. O. Clerk ( ) Special Agent
- ( ) Forest Ranger ( ) (Investigator)
- ( ) File Clerk ( ) Stenographer-Typist
- ( ) Matron ( ) Immigrant Inspector
- ( ) General Clerk ( ) City Mail Carrier
- ( ) Chauffeur-Carrier ( ) U. S. Border Patrol
- ( ) Skilled Laborer ( ) Typist
- ( ) Watchman ( ) Seamstress
- ( ) Postmaster ( ) Steno-Secretary
- ( ) RFD Carrier ( ) Auditor

Mr. Ozment, Dept. 111, St. Louis, Mo.  
Send me particulars about positions marked "X"—salaries, locations, opportunities, etc.

NAME.....

ADDRESS.....





# Afraid of My Own Voice But I Learned to Dominate Others Almost Overnight

**S**UDDENLY the boss turned to me and queried, "Well, Conroy, what's your opinion?" They all listened politely for me to speak and in the silence I heard my thin, wavering voice stammering and sputtering a few vague phrases. Like a flash Stoddard interrupted me and launched on a brilliant description of his plan. All sat spellbound as he talked—my views were forgotten—and yet I have been studying the problem for months and I was prepared to suggest a sound, practical plan which I knew would solve all our difficulties.

And that was the way it always was—I was always being given opportunities to show my ability and always failing miserably. I was bashful, timid, and nervous—I never knew how to express myself, how to put my ideas across. In fact, I was actually afraid of my own voice!

In social life, too, I was a total loss—I was always the "left-over"—the one who sat back and watched the others have a good time.

I seemed doomed to be an all-around failure unless I could conquer my timidity, my bashfulness, my lack of poise and inability to express myself.

## What 15 Minutes a Day Will Show You

How to talk before your club or lodge  
How to propose and respond to toasts  
How to address board meetings  
How to tell entertaining stories  
How to make a political speech  
How to make after-dinner speeches  
How to write letters  
How to sell more goods  
How to train your memory  
How to enlarge your vocabulary  
How to develop self-confidence  
How to acquire a winning personality  
How to strengthen your will power and ambition  
How to become a clear, accurate thinker

## In 15 Minutes a Day

And then suddenly I discovered a new easy method which made me a powerful speaker almost overnight. I learned how to bend others to my will, how to dominate one man or an audience of thousands. Soon I had won salary increases, promotion, popularity, power. Today I am able to rise to any occasion, to meet any emergency with just the right words. And I accomplished all this by developing the natural power of speech possessed by everyone, but cultivated by so few—by simply spending 15 minutes a day in the privacy of my own home.

There is no magic, no trick, no mystery about becoming a powerful and convincing talker. You, too, can conquer timidity, stage fright, self-consciousness and bashfulness, winning advancement in

salary, popularity, social standing and success. It is the power of forceful, convincing speech that causes one man to jump from obscurity to the presidency of a great corporation; another from a small unimportant territory to a sales-manager's desk; another from the rank and file of political workers to a post of national importance; a timid, retiring, self-conscious man to change almost overnight into a popular and much applauded after-dinner speaker.

## Send for this Amazing Book

This method of training is fully described in a very interesting and informative booklet, *How to Work Wonders with Words*. You are told how to bring out and develop your priceless "hidden knack"—the natural gift within you—which will win for you advancement in position and salary, popularity, social standing, power and real success. You can obtain your copy absolutely free by sending the coupon.

**NOW SENT  
FREE**

## NORTH AMERICAN INSTITUTE

3601 Michigan Ave.

Dept. 135-B

CHICAGO, ILL.



North American Institute,  
3601 Michigan Ave., Dept. 135-B,  
Chicago, Illinois.

Please send me FREE and without obligation my copy of your inspiring booklet, *How to Work Wonders with Words*, and full information regarding your Course in Effective Speaking.

Name.....

Address.....

City.....State.....



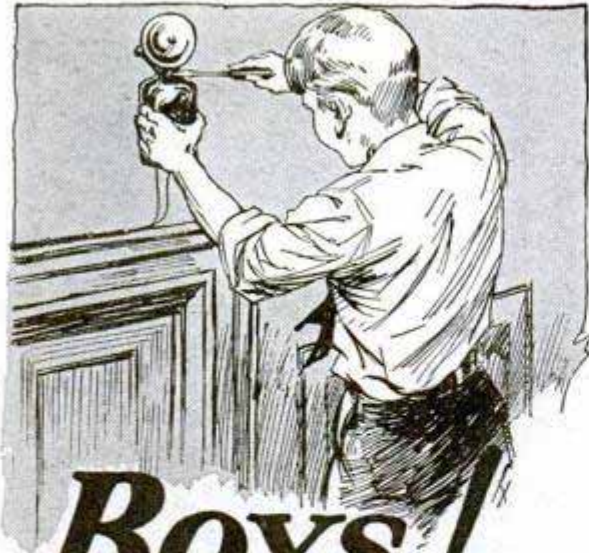

# Boys!

## Electricity is Fun and Pays Big Money

Young fellows who aren't even out of school are making good money doing spare-time electrical work, many of them earning \$10 to \$15 every week! These boys are no different from you except that they are "Cooke" trained. This famous Course in Electricity shows them how to do the things that only the expert can do, and fits them for a fine Big-Pay Job in this wonderful field after school days are over. Thousands of "Cooke" trained boys earn \$70 to \$200 a week.

### Learn Right at Home

**5 BIG WORKING OUTFITS including a REAL MOTOR**

With "Cooke" training you learn electricity in spare time. It doesn't interfere with school work or with your regular job if you are working. And you will find it so enjoyable that it will be more like play than study. The small cost is more than offset by the spare-time earnings we show you how to make.

**\$800 for Spare Time Work!**  
\* For three years I carried on my high school work and completed your Electrical Course at the same time, but by doing electrical work in my spare time I made between \$800 and \$900.

Robert F. Trail,  
Harper's Ferry, W. Va.

**YOU LEARN TO BE A RADIO EXPERT**

Ambitious boys who are determined to be "somebody" when they get out in the business world, will find "Cooke" training just the thing. With the Course go five dandy Working Outfits—all the tools and apparatus you need—including a real electric motor. Enough equipment in this fine layout to enable you to tackle any kind of a spare-time job. Imagine having all this for "keeps"!

### FREE OFFER TO BOYS

neering Works Review."

Mall the coupon and not only will we send you our big 64-page illustrated book, "Secrets of Success in Electricity," but we'll also enter your name for a three-months' subscription to a real Electrical Magazine, "Chicago Engineering Works Review." All this is FREE. Mall coupon today!

### Use this SPECIAL OFFER Coupon

Chief Engineer Cooke,  
L. L. Cooke School of Electricity,  
Dept. 01-B, 2150 Lawrence Ave., Chicago, Illinois.

Send me free your 64-page illustrated book, "Secrets of Success in Electricity"; also enter my name for a three-months' free subscription to your big electrical magazine. This will not obligate me in any way.

Name.....

Address.....

(This coupon only for use of boys 15 years old or more)

# make money DRAWING

If you have natural ability to draw—which only a limited number possess—develop it through proper training for a career as a Commercial Artist. Many Federal Students are earning \$3,500, \$4,000, \$5,000, and \$6,000—some as high as \$10,000 and \$12,000 yearly.

The RIGHT TRAINING can save you several years' time, and bring you quickly to a worth while income. The Federal course is practical from A to Z, and gives you personal criticisms on your lessons.

### TEST YOUR ART ABILITY FREE

Send today for our Questionnaire which tests your natural sense of design, proportion, color, etc. We will also send book "YOUR FUTURE" describing this fascinating home-study course.

Federal School of Commercial Designing  
628 Federal Schools Bldg., Minneapolis, Minn.



# YMCA

Learn Auto Mechanic, Auto Electrical, Battery, Machine, Electrical, Radio Mechanic, Tiling, Bricklaying, Plastering, Plumbing, Welding, Drawing, Estimating, Show Card, Sign Painting, Window Dressing. Write for Catalog 50.

BROOKLYN ENGINEERING INSTITUTE  
(Operated by Bedford Br. Y. M. C. A.)  
1125 Bedford Ave., Brooklyn, New York City.



**PLAY PIANO BY EAR**  
Master Jazz or Ragtime in 90 days by famous Niagara Method, 35,000 pupils. Big, established school. Certificate given on graduation. Send dime Today for booklets: "Entertaining at Piano" and "The Niagara Secret." Niagara School of Music, Dept. C, Niagara Falls, N.Y.



**NOW** → **ONLY \$2.00**

## Giant Chest Expander and Progressive Exerciser

Use This Money Saving Coupon

Be a muscular Marvel. Have the muscles of a super-man. Become strong for your health's sake or to astound your friends with extraordinary feats which only men of giant strength can do.

**Free instructions.**  
The Giant Chest Expander and Progressive Exerciser is made with new, live springy rubber so as to give it long wear and great resisting qualities. Sold with a guarantee to give entire satisfaction or money back. Made two ways, either

**5 Cables or double strength 10 Cables**  
for **\$2** The double strength exerciser has resistance of **\$4** over 200 lbs.

**Send No Money** Send at once and get your Giant Exerciser at the present low introductory price. Deal with a long established, reliable firm. Don't pay more—order from us—get the most for your money. Use coupon now.



**PROGRESSIVE EXERCISER CO.,**  
4007 Langdon Bldg.  
Broadway and Duane Street, New York

Please send  your 10 cable { Progressive Exerciser }  
 your 5 cable { Exerciser }  
(Check the Exerciser you want.) It is understood that if I am not satisfied with this Exerciser, I will return it within 5 days and get my money back.

Name.....  
Address.....  
City..... State.....



# Magic

Learned Easily  
at Home



*Dr. Harlan Tarbell, internationally known magician and teacher of some of the world's greatest magicians.*

## Astonish Your Friends

Gain the magnetic popularity that makes you the center of any crowd. Business and social success is assured the man who can perform mystifying tricks. You can earn big money on the side or as a professional, as well as being the most popular person in your crowd. Why envy others' skill? You can learn Magic yourself, quickly and easily.

**Salesmen!**  
Write me today.  
Learn how my  
**Course  
in Magic**  
will absolutely  
help you increase  
your earning  
power.

**Houdini**  
paid Dr. Tarbell  
this tribute:  
"My Dear Tarbell:  
... Your work was  
certainly a revelation  
to me for its  
originality and its  
misdirection. ..."  
—Houdini

## Earn \$250 to \$1000 a Month

even sleight of hand, generally supposed to require long practice, is NOW made simple to learn. For Dr. Harlan Tarbell, one of the really Great Magicians, has finally opened up the secrets of his profession in a completely illustrated course offered at a merely nominal cost. Through the wonderful Tar-

bell system you will be able to mystify and entertain your friends. After that Dr. Harlan Tarbell takes you through the entire maze of sleight of hand, card tricks and elaborate stage diversions. The apparently superhuman doings of the accomplished magician becomes as simple as ABC.

### Great Special Offer!

There is a tremendous demand for magic entertainment. Clubs, Lodges, Charity and Social affairs — all will pay high fees to the man who knows Magic. Dr. Harlan Tarbell really gets as high as \$250 for a half hour's work right now. Opportunity everywhere to make money aside from your regular occupation. Salesmen find it a tremendous asset. Find out all about this unprecedented opportunity to learn Magic. Learn about the great Special Price and Easy Payment Offer we are making Now, for a limited time only. The coupon brings full details without any obligation. *Mail it TODAY.*

**Tarbell System, Inc.**  
1920 Sunnyside Ave., Studio B-135 Chicago, Ill.

### Mail This Coupon NOW!

Tarbell System, Inc., Studio B-135  
1920 Sunnyside Avenue, Chicago, Illinois  
Gentlemen: Without any obligation send me your free literature and information all about your wonderful "Tarbell Course in Magic." Also tell me about your great Special Price Offer and Easy Payment Plan — offered NOW for limited time only.

Name.....

Address.....

.....Age.....



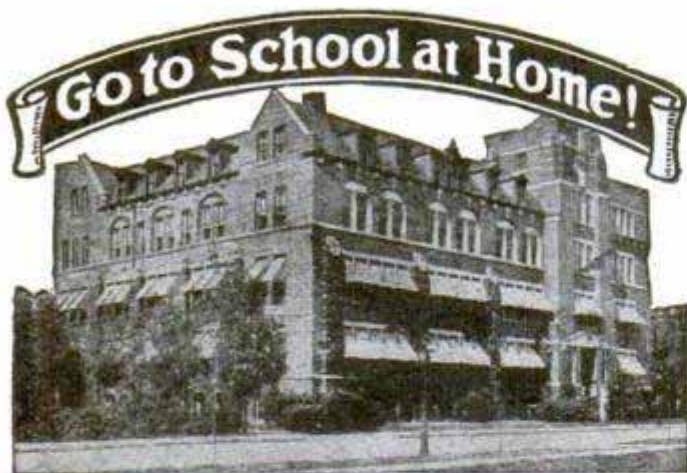

# High School Course in Two Years!

## You Want to Earn Big Money!

And you will not be satisfied unless you earn steady promotion. But are you prepared for the job ahead of you? Do you measure up to the standard that insures success? For a more responsible position a fairly good education is necessary. To write a sensible business letter, to prepare estimates, to figure cost and to compute interest, you must have a certain amount of preparation. All this you must be able to do before you will earn promotion. Many business houses hire no men whose general knowledge is not equal to a high school course. Why? Because big business refuses to burden itself with men who are barred from promotion by the lack of elementary education.

### Can You Qualify for a Better Position

We have a plan whereby you can. We can give you a complete but simplified high school course in two years, giving you all the essentials that form the foundation of practical business. It will prepare you to hold your own where competition is keen and exacting. Do not doubt your ability, but make up your mind to it and you will soon have the requirements that will bring you success and big money. YOU CAN DO IT.

Let us show you how to get on the road to success. It will not cost you a single working hour. Write today. It costs you nothing but a stamp.

### American School

Dept. HB-74, Drexel Ave. and 58th St., Chicago

### American School

Dept. HB-74, Drexel Ave. and 58th St., Chicago

Send me full information on the subject checked and how you will help me win success.

- |                             |                           |
|-----------------------------|---------------------------|
| ....Architect               | ....Business Law          |
| ....Building Contractor     | ....Lawyer                |
| ....Automobile Engineer     | ....Machine Shop Practice |
| ....Automobile Repairman    | ....Mechanical Engineer   |
| ....Civil Engineer          | ....Shop Superintendent   |
| ....Structural Engineer     | ....Employment Manager    |
| ....Business Manager        | ....Steam Engineer        |
| ....Cert. Public Accountant | ....Foremanship           |
| ....Accountant and Auditor  | ....Sanitary Engineer     |
| ....Bookkeeper              | ....Surveyor (& Mapping)  |
| ....Draftsman and Designer  | ....Telephone Engineer    |
| ....Electrical Engineer     | ....Telegraph Engineer    |
| ....Electric Light & Power  | ....High School Graduate  |
| ....General Education       | ....Wireless Radio        |
| ....Vocational Guidance     | ....Undecided             |

Name.....

Address.....

# PREPARE FOR AN ART CAREER

—thru the only school operated as a department of a large art organization. Commercial Artists trained the "Meyer Both Way" earn as high as \$10,000 per year. We today have hundreds of students who had previously studied art elsewhere. Why? Because your instruction is based upon our everyday experience in meeting the art needs of leading advertisers. Home study instruction. Write for illustrated book telling of the success of our students.

**MEYER BOTH COMPANY**  
Michigan Ave. at 20th St., Dept. 16, Chicago, Ill.



## I Teach by Mail

Begin Today — Write for My FREE Book. I can make a good penman of you at home during spare time. Write for my FREE BOOK "How to Become a Good Penman." It contains specimens and tells how others mastered penmanship by the Tamblin System. Your name will be elegantly written on a card if you enclose stamp to pay postage. Write today for book.  
F. W. Tamblin, 418 Ridge Bldg., Kansas City, U.S.A.

## LEARN WATCH REPAIRING

Be a watchmaker—you can learn this profitable trade by correspondence in a few weeks in your own home by the DeSelms Chart System. After you complete the course you will know a watch from A to Z. You will know just what the matter is and how to repair one. When you graduate you will be a practical watchmaker and repairer and competent to fill any position. Positions for our graduates. Ask for our Free Book. It explains our system and terms.



**THE DeSELMS WATCH SCHOOL**  
LOGANSPORT, INDIANA

# "STAMMERING

## Its Cause and Cure"

You can be quickly cured if you stammer. Send 10 cents, coin or stamps, for 288 page cloth bound book on Stammering and Stuttering. It tells how I cured myself after Stammering and Stuttering for 20 years. **BENJAMIN N. BOGUE**  
6945 Bogue Building, 1147 N. Ill. St. Indianapolis

# MUSIC LESSONS IN YOUR HOME

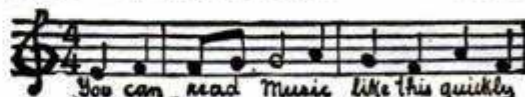

Write today for our FREE booklet. It tells how to learn to play Piano, Organ, Violin, Mandolin, Guitar, Banjo, etc. Beginners or advanced players. Your only expense about 2c per day for music and postage used. **American School of Music, 51 Manhattan Bldg., Chicago**

## MEN WANTED

TO LEARN

## Motion Picture Projection

\$2,000 to \$4,000 a Year

Quickly learned. Short hours, big pay. Best equipped school in Michigan. Projectionists for Movie Houses and Road Shows.

### MOVIE OPERATORS SCHOOL

51 Sproat Street, DETROIT, MICHIGAN



# A FRANTIC CALL FOR MEN WHO CAN READ BLUE PRINTS OF BUILDINGS

## Leads Quickly to Jobs Paying \$4,000 to \$12,000 a Year

See how easy it is to get in the building game. Nowhere else does such simple training count for so much. Nowhere else can a man make \$4,000 to \$12,000 a year so quickly and so easily. Nowhere else are there so many countless thousands of openings as there are with contractors, builders, and real estate firms, who are constantly calling for men who can read blue prints. Six billion dollars a year is spent for building. Trained men are at a premium in this gigantic industry. Untold thousands are needed at steady salaries far above the scale wage.

# 90 DAYS EASY TRAINING PUTS YOU IN THE 6 BILLION DOLLAR BUILDING FIELD

NO longer is it necessary to start at the bottom of the building trades and spend years to work up. Now you can get three years' training in three months. There are no barriers to your success in the great outdoor building field. You do not need more than a common school education. We train you at home, in spare time, by the fascinating blue-print method with lessons that are as easy to read as your newspaper.

These tested plans come to you from one of the oldest and largest schools of building construction and superintendence in the country. This course is endorsed by leading contractors and master builders. These tested, practical plans and lessons are the kind of training that puts men in \$5,000 to \$15,000 jobs and in profitable building and contracting businesses of their own. You learn from actual blue print plans—from practical building experts—you learn how to read all the plans, estimate the costs and supervise the entire construction of a building—you learn everything a contractor has to know when he undertakes the construction of a building.

Amazing opportunities are open to you when you know blue prints, plans, estimating and construction. There is building superintending—the best outdoor profession on earth—that pays handsome salaries and often a bonus for efficient work. Clifford Scholl went from clerk to Asst. Superintendent at 49% increase in salary in 8 months. Thousands of builders and contractors need men like Clifford Scholl.

**IF YOU LIVE IN OR NEAR CHICAGO**

Visit our School for Builders, open day or evening. Thousand men attend each year. Enter any time. You can get the same training at home, by mail. Same plans; same lessons; same instructors. The Coupon brings all facts FREE.

**Every Job Must Have a Contractor**

The building field is wide open for men who want to go into business for themselves. Henry Mehl, Pa., a policeman, now owns his own contracting business. Burgert, Ill., stepped into a foremanship at 200% increase in salary. Busch, Kan., writes, "I have been offered \$300 a month several times." Boyes, Can., writes, "Your school has increased my wages 40% already." Patrick, Mich., says: "My salary has been increased 92%." Marchand, La., writes, "I am getting along fine. My salary is now increased 196%."

**Chicago Technical School for BUILDERS**

Dept. H-140, 118 E. 26th Street, Chicago, Ill.

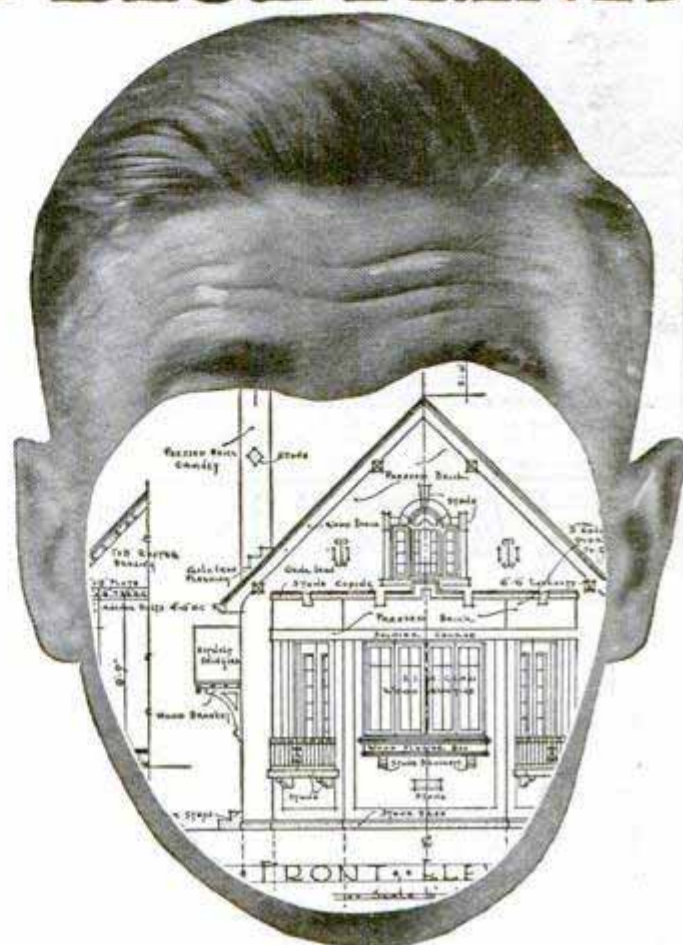

If you really want more money—if you hope to own a business of your own—get into the building business . . . no matter what your job is now. No overcrowding in this tremendous field—room for thousands every day. Why buck competition in crowded industries where only a few men can succeed? Clerk or carpenter—office man or bricklayer—salesman or superintendent—it makes no difference. You can get into the building business quickly . . . easily. Or if you are in it at present, get this training now, that you must have for success.

## FREE Trial Lesson

Simply mail the coupon below for an intensely interesting free book "How to Read Blue Prints," and full information. See what fascinating fun this first trial lesson is. Get these facts before you. See what amazing opportunities open up for you in the Six Billion Dollar Building Field. Don't wait or delay. Act now. Simply mail the coupon below.



Chicago Technical School for Builders,  
Dept. H-140, 118 E. 26th Street, Chicago, Ill.

Send me, without obligation, your free book, "How to Read Blue Prints" and full details of the course and the opportunities in the Building Field. It is understood that no salesman will call on me.

Name.....

Address.....

City..... State.....

Age..... Occupation.....



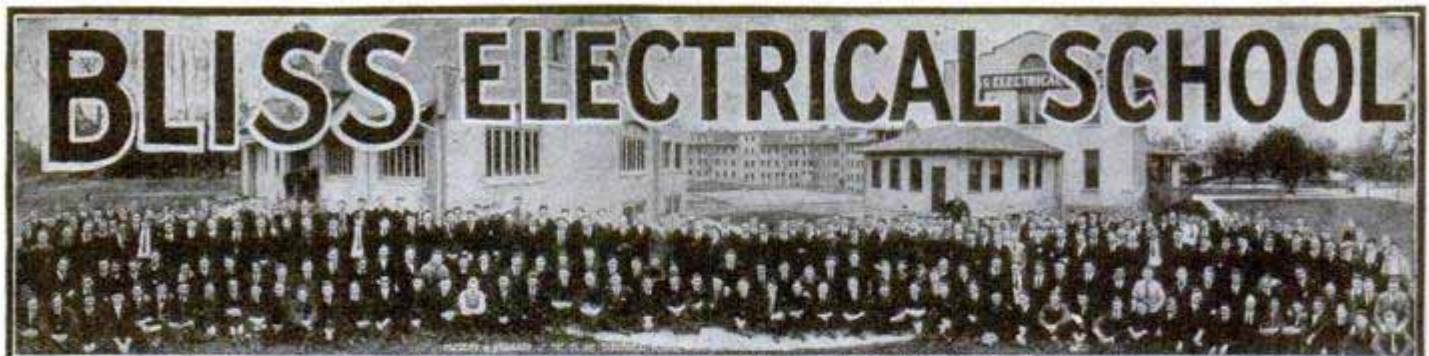

# BLISS ELECTRICAL SCHOOL

A special technical school with concise but comprehensive course in Electrical Engineering designed to be completed in **ONE COLLEGE YEAR**. Thorough knowledge of underlying principles emphasized.

## ELECTRICAL ENGINEERING



The course is designed for earnest, ambitious young men of limited time and means. Curriculum includes mathematics, mechanical drawing and intensive shop work. Students construct motors, install wiring, test electrical machines. Graduates are qualified to enter the electrical field at once.

Bliss men hold responsible positions throughout the world. Thoroughly equipped fireproof dormitories, dining hall, laboratories and shops. Prepare for your profession in the most interesting city in the world. School established 1893. Catalog on request. Address

BLISS ELECTRICAL SCHOOL, 117 Takoma Avenue

Washington, D. C.

# LEARN CARTOONING

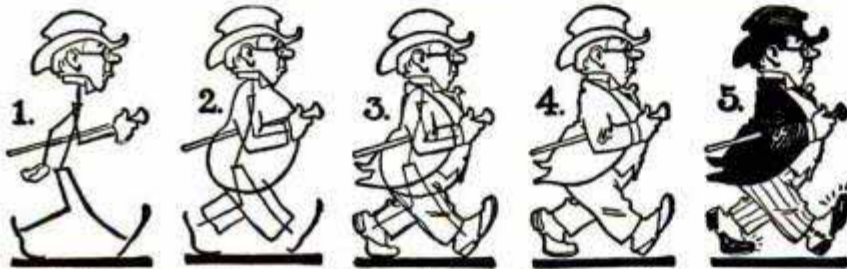

Successful cartoonists earn big salaries. Many of the most popular cartoonists of today learned to draw in their spare time, at home through the Landon Course of Cartooning and now earn \$75 to \$200 or more per week. The Landon Picture Chart Method of teaching ORIGINAL drawing makes cartooning easy to learn. Hundreds of sketches like the above explain every step in creating ORIGINAL heads, figures, animals, and every detail of cartoon drawing. Send 6c in stamps today for sample Picture Chart and full description of this widely known course, also long list of successful Landon students. Complete information showing possibilities for you will be forwarded. *Please state your age.*

Address **C. N. Landon, Director The Landon School, 738 National Building, Cleveland, Ohio**

### Former Students Who Are Now Successful Comic Strip Artists

- BLOSSER—Now drawing "Freckles and His Friends."
- BYRNES—Now drawing "Reg'lar Fellers."
- BRANNER—Now drawing "Winnie Winkle."
- LOCHER—Now drawing "Cicero Sapp."
- TAYLOR—Now drawing "Mom'n Pop."
- EDWINA—Now drawing "'Cap' Stubbs."
- CRANE—Now drawing "Washington Tubbs II."
- ETHEL HAYS—Now drawing "Flapper Fanny."
- PAUL FUNG—Now drawing "Gus & Gussie."

### Better Handwriting

Easily learned, on wonderful new patented device. Children like it, adults pleased. Agents wanted. Sample 98c. Write for information today. **VIC. HANSEN, WALLACE, IDAHO**

### FOREST RANGERS

Men wanting forest ranger, mail clerk, or other government positions, write for particulars. **MOKANE, 236, DENVER, COLO.**

AT HOME — **LEARN TELEGRAPHY** — AT HOME

**TEACH YOURSELF** in half usual time, at trifling cost, with the wonderful Automatic Transmitter, **THE OMNIGRAPH**. Sends unlimited Morse or Continental messages, at any speed, just as an expert operator would. Adopted by U. S. Government, and leading Universities, Colleges and Telegraph Schools. Catalog 6 cents. **OMNIGRAPH MFG. CO., 13-19 Hudson St., NEW YORK**

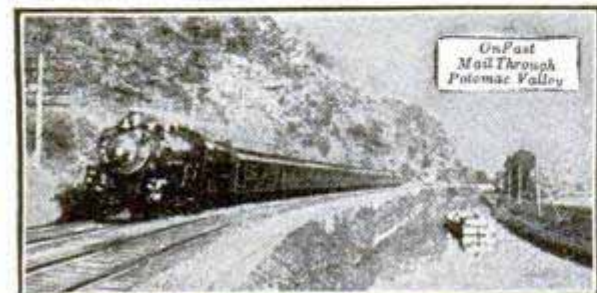

## Travel for "Uncle Sam"

### \$158 TO \$225 MONTH

Mail Coupon Before You Lose It

**FRANKLIN INSTITUTE, Dept. L-174, Rochester, N. Y.**  
 Sirs: Rush to me, without charge, (1) Full particulars, telling how to become a Railway Postal Clerk; (2) send copy of 32-page book, "How to Get U. S. Government Jobs," with list of many positions obtainable.

Name.....  
 Address.....

Many Other Government Jobs Obtainable  
 Steady Work—No Layoffs—Paid Vacations  
 Common Education Sufficient  
**MEN—WOMEN 18 UP**





# Here's a Queer Way To Learn Music!

*No teacher — no monotonous exercises. Just a simple, easy home study method. Takes only a few minutes—costs only a few cents a day. Every step as clear as A-B-C.*

WHO would have ever thought that the learning of music could be simplified? Seems almost too good to be true to think of learning to play your favorite instrument without long hours of practice—tedious scales and expensive teachers, doesn't it? Yet that's exactly how you learn this new way. The only thing that is queer about this amazing method is the fact that it's so different from all ordinary methods.

But although this marvelous home-study method is different and comparatively new, it has already been carefully tested and proved by almost half a million people all over the world. Judge from that how satisfactory, reliable and easy it must be.

## Musical Talent Not Needed

Even if you have never touched an instrument before, you can't go wrong this amazingly easy way. For every step, from beginning to end, is right before your eyes in print and picture. You always know

what to do and how to do it. No guesswork. No delays. If you make a mistake you correct it yourself and continue. It's really *fun* learning to play this way, you proceed so rapidly. From the start you are playing real *tunes* perfectly by *note*. And almost before you realize it you will be able to play anything—the popular "Jazz" or those classical selections for which there is always a big demand at concerts

### PROOF!

"I have completed only 20 lessons and can play almost any kind of popular music I wish. My friends are astonished."

*Turner B. Blake, Illinois.*

"Since finishing the course I have been teaching, playing in churches and at recitals, and receiving a fine salary. I have made money, come into contact with new friends and greatly increased my popularity."

*Ruth M. Peacock, North Carolina.*

"Since I have been taking your lessons I've made over \$200 with my violin."

*Melvin Freeland, N. J.*

and home entertainments. Best of all, no matter which instrument you choose the cost of learning is just the same in each case, just a few cents a day!

## Have Fun—Win New Friends

Just think of all the pleasure you've been missing by not being able to play some musical instrument. Instead of being the center of attraction at parties—you've been unnoticed—out of the social picture. While you've been playing wallflower others have always had something to offer. Now you have a wonderful chance to turn the tables—to treat yourself to some real fun—to surprise your friends! Take some good advice. Learn to play this new easy way. Get your share of a musician's pleasure, popularity, profit. Start Now!

## Free Booklet and Demonstration Lesson

If you are in earnest about wanting to join the crowd of entertainers and be a "big hit" at any party—if you really do want to play your favorite instrument, to become a performer whose services will be in demand—fill out and mail the convenient coupon asking for our Free Booklet and Demonstration Lesson. These explain our wonderful method fully and show you how easily and quickly you can learn to play like a professional at little expense. Instruments are supplied when needed—cash or credit. U. S. School of Music, 77 Brunswick Bldg., N. Y. C.

U. S. School of Music  
77 Brunswick Bldg., New York City.

Please send me your free book, "Music Lessons in Your Own Home," with introduction by Dr. Frank Crane, demonstration lesson and particulars of your special offer. I am interested in the following course:

.....  
 Have you the above instrument?.....  
 Name.....  
 (Please Write Plainly)  
 Address.....  
 City.....State.....

### What Instrument For You?

- |                                     |                          |
|-------------------------------------|--------------------------|
| Piano                               | Cello                    |
| Organ                               | Guitar                   |
| Violin                              | Ukulele                  |
| Drums and Traps                     | Hawaiian Guitar          |
| Banjo (Tenor, 5-String or Plectrum) | Harp                     |
| Mandolin                            | Cornet                   |
| Clarinet                            | Piccolo                  |
| Flute                               | Trombone                 |
| Automatic Finger Control            | Saxophone                |
|                                     | Harmony and Composition  |
|                                     | Sight Singing            |
|                                     | Voice and Speech Culture |
|                                     | Piano Accordion          |



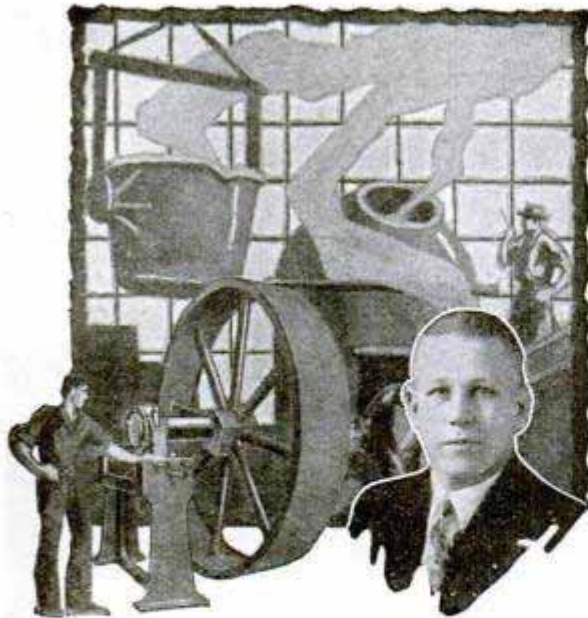

## An Easier Way to Make Money!

What chance has the wage-earner?  
 "A mighty good one," says Ralph H. Berndt—but read his story . . .

Berndt had had only an elementary education. He was assistant roller at the Carnegie Steel Mills, Youngstown, Ohio.

"Realizing that hands and feet would not do for me any longer," he writes, "I decided to give my brain a business training." Today, thanks to Higher Accountancy training with LaSalle, he is Auditor for W. C. DuComb Co., Inc., Detroit—with easier hours, work that he likes, and a larger income. "LaSalle," he adds, "has been the instrument to my success."

Send for Free Book—

"Accountancy, the Profession that Pays"  
 "Get the facts—then use the facts—to get results." That's a slogan of ours, writes W. C. DuComb, president. And you'll agree it's good sound sense!

The facts about LaSalle training in Accountancy and the opportunities in this highly profitable field are clearly outlined in a 64-page book which LaSalle will send you free. It started Berndt on the path to success. No earthly reason why it can't do just as much for you.

If you have the urge and the will to increase your income—clip and mail the coupon NOW.

— Find Yourself Thru LaSalle! —

**LA SALLE EXTENSION UNIVERSITY**  
 The World's Largest Business Training Institution

Dept. 764-HR Chicago

I should be glad to have your 64-page book, "Accountancy, the Profession that Pays," also a copy of "Ten Years' Promotion in One," all without obligation.

### Higher Accountancy—

Training for positions as Auditor, Comptroller, Certified Public Accountant, Cost Accountant, etc.

### Other LaSalle Opportunities

LaSalle opens the way to success in every important field of business. If more interested in one of the fields indicated below, check here:

- |   |  |
|---|--|
| <input type="checkbox"/> Business Management        | <input type="checkbox"/> Personnel Management                        |
| <input type="checkbox"/> Modern Salesmanship        | <input type="checkbox"/> Banking and Finance                         |
| <input type="checkbox"/> Traffic Management         | <input type="checkbox"/> Modern Business Correspondence and Practice |
| <input type="checkbox"/> Railway Station Management | <input type="checkbox"/> Expert Bookkeeping                          |
| <input type="checkbox"/> Law—Degree of LL.B.        | <input type="checkbox"/> C. P. A. Coaching                           |
| <input type="checkbox"/> Commercial Law             | <input type="checkbox"/> Business English                            |
| <input type="checkbox"/> Industrial Management      | <input type="checkbox"/> Commercial Spanish                          |
| <input type="checkbox"/> Modern Foremanship         | <input type="checkbox"/> Effective Speaking                          |



Name .....

Present Position .....

Address .....

## \$500<sup>00</sup> IN ONE MONTH DRAWING

Careful, conscientious training by members of our faculty enables our graduates to earn up to \$500 in a month. The present splendid opportunities in the illustrating field have never been excelled. Publishers and commercial organizations everywhere are in constant need of artists. If you like to draw, let your talent make your fortune. Develop it. It takes practice but so does anything worth while.



### The Federal Course Is A Proven Result Getter

The Federal Authors include such nationally known artists as Neysa McMein, Norman Rockwell, Charles Livingston Bull, Clare Briggs, Fontaine Fox, Sidney Smith, and fifty others. Exclusive, original lessons and drawings especially prepared by these famous artists are included in the Federal Home Study Course. No previous training is needed. Every step is clear and simple. Students get personal instruction and help, originality is encouraged and every aid is offered for the achievement of final success.

Free, illustrated catalog on request. Shows work of students and testimonial letters. Complete outline of course with all the details. Just write your name, age, occupation and address in the margin and send it to us.

# Federal School of Illustrating

7137 Federal School Bldg.

MINNEAPOLIS, MINN.

## PIANO JAZZ

By Note or Ear. With or without music. Short Course. Adult beginners taught by mail. No teacher required. Self-instruction Course for Advanced Pianists. Learn 259 styles of Bass, 684 Syncopated Effects, Blue Harmony, Oriental, Chime, Movie and Café Jazz, Trick Endings, Clever Breaks, Space Fillers, Sax Slurs, Triple Bass, Wicked Harmony, Blue Obligato, and 247 other Subjects, including Ear Playing. 133 pages of REAL Jazz, 25,000 words. A Postal brings our FREE Special Offer.

Waterman Piano School, 1826 W. Adams St. Los Angeles, Cal.



### Results Quick—Part or Full Time

Take up poultry raising. It's interesting, healthful, PROFITABLE. Easy to sell all you can produce at big prices. Our new course by Henry M. Lamon, former gov't expert, gives short cuts to success. Write for free book, "How to Raise Poultry for Profit."

NATIONAL POULTRY INSTITUTE, Dept. 411, Washington, D. C.

## LEARN WATCHMAKING AND ENGRAVING

BY OUR PROFIT-SHARING PLAN  
**OUR GRADUATES SUCCEED**

One of our Iowa students started in a very small way—now doing over \$30,000 a year. Another in Wisconsin, over \$10,000 the first year. Day or night classes. Call or write for FREE BOOK

Chicago School of Watchmaking, Dept. 3001, 4844 Lincoln Avenue, CHICAGO

## Earn \$75 Weekly Building Radio Sets

Join the Association! We train you to build and repair radio sets—start you in business—enable you to earn \$3 an hour upwards. **Free 5-Tube Radio Set to Members.** Write for special limited-time plan whereby your membership need not cost you a cent. Write today!

**RADIO ASSOCIATION OF AMERICA**

Dept. PM-7

4513 Ravenswood Ave., Chicago, Ill.





# 30 Miles of BATHING BEACHES in CHICAGO

## Learn **ELECTRICITY** Here at GREER COLLEGE

**Railroad fare allowed—no extra cost**

Why not enjoy life while you train for life's biggest job? Learn Electricity. Learn it now. Learn it here—at Greer College—in Chicago, the world's greatest vacation city.

Thirty miles of bathing beaches to take the edge off your day's electrical work among our hundreds of motors, rotary converters, generators, telephone and radio equipments. Combine pleasure with educational profit. Leave here after twelve weeks equipped to start after the \$1 per hour to \$25,000 per year that electricity pays trained men.

We take mighty good care of you—help you find a place to live—help find a part-time job if you need

one—and in other ways keep you from feeling like a stranger in a big city. Hundreds of fine men, all ages, already enrolled. You'll find them excellent companions, and perhaps lifetime friends or business associates.

Act fast if you want to get full information in time to enroll for new summer class. Your

name on coupon brings a big Free Book that answers all questions. Tells

how to get an allowance of railroad fare—how to save 37½% of regular cost by taking our Automobile Course along with Electricity. Greer Shops have trained over 60,000 men for better jobs. Come here for good training and fair treatment. And while you learn, enjoy life at Chicago's many summer playgrounds. Mail the coupon and learn all about our School, courses and Greer opportunity Now.

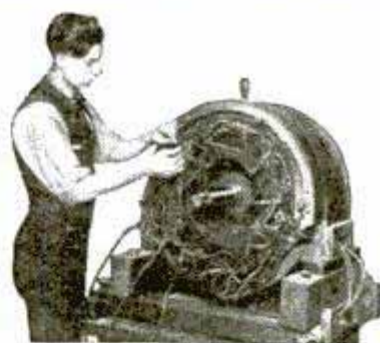

A 25 H. P. Motor for student practice

### FREE Employment Service

Our employment department is ready to help you—while in training and for life. Day and evening classes. Low cost. Easy terms.

If unable to come to Chicago now for resident course, write for information about Home Study Course!

# GREER

College of Electrical Engineering

Dept. 701

2024 S. Wabash Avenue

CHICAGO, ILLINOIS

ERWIN GREER, President, Greer College—  
Dept. 701, 2024 S. Wabash Ave., CHICAGO.

Please send me your FREE BOOK and offer for  Electrical  Automotive course  
It is understood I am not obligated in any way

Name .....

Address .....







## "I wish we had more men like him"

"I've given him two promotions in the last year and he's made good each time.

"I always feel safe in moving him up because I know that he's preparing himself to handle bigger work.

"The International Correspondence Schools keep me advised of the progress he is making and I've encouraged him to keep on. His spare-time studying certainly has made him a valuable man to this firm."

Why don't you study and get ready for promotion too? We'll be glad to help you if you will only make the start. And the way to do that is easy.

Choose the work you like best in the coupon below; then mark and mail it to the International Correspondence Schools today. This doesn't obligate you in the least, but it will bring you information that will help to start you on a successful career. This is your opportunity. Don't let it slip by.

Mail the Coupon for Free Booklet

### INTERNATIONAL CORRESPONDENCE SCHOOLS Box 5659-E Scranton, Penna.

Without cost or obligation, please send me a copy of your booklet, "Who Wins and Why," and full particulars about the course before which I have marked X in the list below:

#### BUSINESS TRAINING COURSES

- |  |   |
|--|---|
| <input type="checkbox"/> Business Management                     | <input type="checkbox"/> Salesmanship                                     |
| <input type="checkbox"/> Industrial Management                   | <input type="checkbox"/> Advertising                                      |
| <input type="checkbox"/> Personnel Organization                  | <input type="checkbox"/> Better Letters                                   |
| <input type="checkbox"/> Traffic Management                      | <input type="checkbox"/> Show Card Lettering                              |
| <input type="checkbox"/> Business Law                            | <input type="checkbox"/> Stenography and Typing                           |
| <input type="checkbox"/> Banking and Banking Law                 | <input type="checkbox"/> English  |
| <input type="checkbox"/> Accountancy (including C.P.A.)          | <input type="checkbox"/> Civil Service                                    |
| <input type="checkbox"/> Nicholson Cost Accounting               | <input type="checkbox"/> Railway Mail Clerk                               |
| <input type="checkbox"/> Bookkeeping                             | <input type="checkbox"/> Common School Subjects                           |
| <input type="checkbox"/> Private Secretary                       | <input type="checkbox"/> High School Subjects                             |
| <input type="checkbox"/> Spanish <input type="checkbox"/> French | <input type="checkbox"/> Illustrating <input type="checkbox"/> Cartooning |

#### TECHNICAL AND INDUSTRIAL COURSES

- |   |  |
|---|--|
| <input type="checkbox"/> Electrical Engineering                     | <input type="checkbox"/> Architect                                       |
| <input type="checkbox"/> Electric Lighting                          | <input type="checkbox"/> Architects' Blueprints                          |
| <input type="checkbox"/> Mechanical Engineer                        | <input type="checkbox"/> Contractor and Builder                          |
| <input type="checkbox"/> Mechanical Draftsman                       | <input type="checkbox"/> Architectural Draftsman                         |
| <input type="checkbox"/> Machine Shop Practice                      | <input type="checkbox"/> Concrete Builder                                |
| <input type="checkbox"/> Railroad Positions                         | <input type="checkbox"/> Structural Engineer                             |
| <input type="checkbox"/> Gas Engine Operating                       | <input type="checkbox"/> Chemistry <input type="checkbox"/> Pharmacy     |
| <input type="checkbox"/> Civil Engineer                             | <input type="checkbox"/> Automobile Work                                 |
| <input type="checkbox"/> Surveying and Mapping                      | <input type="checkbox"/> Airplane Engines                                |
| <input type="checkbox"/> Metallurgy <input type="checkbox"/> Mining | <input type="checkbox"/> Agriculture <input type="checkbox"/> Navigation |
| <input type="checkbox"/> Steam Engineering                          | <input type="checkbox"/> Mathematics <input type="checkbox"/> Radio      |

Name.....

Street Address.....

City..... State.....

Occupation.....

Persons residing in Canada should send this coupon to the International Correspondence Schools Canadian, Limited, Montreal, Canada

# ELECTRICITY

## Practical-Technical TRAINING

Great demand for practical-technical electricians and engineers. A brilliant future awaits you. A high salaried position or a profitable business of your own; these may be yours through our PRACTICAL-TECHNICAL courses. Opportunities unlimited.

Finlay condensed method now in 25th successful year trains head and hand. Thousands of high salaried graduates throughout the world testify to the success of Finlay training. Extensively equipped laboratories and shops. Faculty of recognized experts. One and Two Year courses in Electrical Engineering open in September; 12 Weeks courses in Practical Electricity and Power Plant Operation open at any time. Degrees, diplomas and certificates of efficiency awarded. Students assisted to positions.

SEND FOR FREE CATALOG

**FINLAY ENGINEERING COLLEGE** Fall term starts September 15th  
121 Finlay Bldg. Kansas City, Mo.

## Learn to PAINT SIGNS and SHOW CARDS

We quickly teach you by mail, or at school, in spare time. Enormous demand. Big future. Interesting work. Oldest, foremost school. **EARN \$50 TO \$200 WEEKLY**

John Vassos, N. Y., gets \$25 for single show card. Crawford, B. C., says: "Earned \$200 while taking course". Send today for free information, samples and guarantee.

**DETROIT SCHOOL OF LETTERING**  
154 Stimson Ave. Est. 1899 Detroit, Mich.



## LEARN WATCH REPAIRING



You can learn by our modern and original system of instruction every part of the **Watch Repairing Trade** at home as good or better than at a shop. You can earn money while learning and secure a well paying position or start in business after completing our course of instruction. Good watch repairers are always in demand and earn from \$50 to \$75 per week. For particulars apply to the **Wisconsin School of Watch Repairing** 156 Mason St., MILWAUKEE, WIS.

## NOW YOU CAN STUDY MUSIC AT HOME

earn \$75.00 to \$200.00 each week

With a nationally famous artist as your teacher you can learn to play classical or popular music on your favorite instrument. We guarantee our personal teaching method. Both advanced and elementary courses.

Write for catalogue **CONN NATIONAL SCHOOL OF MUSIC, INC.** 506 S. Wabash Ave., Dept. 516, Chicago



**WHY NOT** spend Spring, Summer and Fall gathering butterflies, insects? I buy hundreds of kinds for collections. Some worth \$1 to \$7 each. Simple outdoor work with my instructions, pictures, price-list. Send 10 cents (not stamps) for my illustrated Prospectus before sending butterflies.  
**MR. SINCLAIR, DEALER IN INSECTS,** San Diego, Calif.  
Dept. 6, Box 1424.



**STAMMERING** easily, permanently corrected. Win happiness and success. Ask for full information and special phonograph record. Send dime for postage 153 Stimson Ave., The LEWIS INSTITUTE, Detroit



Wonderful, new device, guides your hand; correct your writing in few days. Big improvement in three hours. No failures. Complete outline FREE. Write C. J. Ozment, D-34 St. Louis, Mo.



# Dobe Trained Draftsmen!

They Learn Quick ~ They Make Good



**\$7000 to \$9000  
Per Year!**

— That is what I earn,  
*A.H. Bernier*  
Dobe Trained Draftsman

**\$1000 a Month**

— That is what I make,  
*A.H. Bowen*  
Dobe Trained Draftsman



**\$400 per Month**

— That is what I average,  
*Arthur Llewellyn*  
Dobe Trained Draftsman

**\$130 a Week**

— That is my income as  
a Draftsman,  
*O.E. Carmack*  
Dobe Trained Draftsman



**\$600 a Month!**

— I refused that salary,  
because I am making  
more.  
*Carl J. Dupre*  
Dobe Trained Draftsman

**\$475 a Month!**

— I make that from  
drafting,  
*S.C. Stroop*  
Dobe Trained Draftsman



## You Can Learn Drafting Easily ~ Quickly at Home

Before Dobe's "Easy Drafting Training at Home" it was almost necessary to go away to college to learn drafting. But now you can stay home, hold down the job you've got, keep on earning money and easily and quickly equip yourself to enter the drafting profession. All the men you see pictured here did just that. Get into drafting. It is a big appealing field! Drafting is growing bigger and more important every

year. Before any house or machine or factory can be built there must be a PLAN.

That plan must be DRAWN. A draftsman must DRAW it. Learn how now. Be ready when the time comes. It is smart to choose a profession that has always been and always will be. A profession which is standard and essential. A profession which the world must have.



**WRITE! FOR FREE  
BOOK—  
Successful Draftsmanship!**

Read this book! After you have read it, make up your mind whether you want to be a draftsman! But write for it today. Certainly reading the book can't hurt you. Mr. Dobe will tell you about other men besides those pictured above who have been successful—many—many of them. No matter what you are making now ask for the book today.

**DOBE EASY DRAFTING**  
1951 Lawrence Ave., Div. B. 135 Chicago

**DOBE EASY DRAFTING**  
1951 Lawrence Ave., Div. B-135 Chicago

Please send me free your book, "Successful Draftsmanship", and names of other big money earning draftsmen you have trained.

Name.....Age.....

Address.....

Post Office.....State.....





# Want Some Money?

Here's a wonderful way to get it

Our beautifully illustrated book tells how. It tells all about our new methods of art decoration, art treatment and how anybody can learn without previous training or experience. It contains page after page of handsome color illustrations of what you can make and sell. You can make good money and this book is **FREE**. All supplies are sent by us with the instructions and many have made \$25 the first week. Some society women have taken up this work for their own amusement.—Either way, pleasure or profit, it's the most delightful home work you can imagine. Write Now for your copy of this valuable book: it's **FREE**.



## Fireside Industries

DEPT. 66-H. - ADRIAN, MICH.

### Two Years' Engineering Course With Diploma and Degree

Civil Mechanical Electrical Chemical

Compact courses of essentials. Rich in higher mathematics, higher science, mechanical drawing and field work. Planned for those short in time and money, but strong in purpose. Courses distinguished alike for what is embraced and what is omitted. Adapted to

**Engineers with Practical Experience desiring a Degree**  
**No Entrance Examination or High School Diploma Required**  
 Indispensable preliminary work provided for students with only elementary school education. Modern laboratories. Students may begin a course in Sept., Jan., Mar., or June. EXPENSES LOW. For catalog address

**TRI-STATE COLLEGE OF ENGINEERING**  
 Box M-77 **Angola, Indiana**

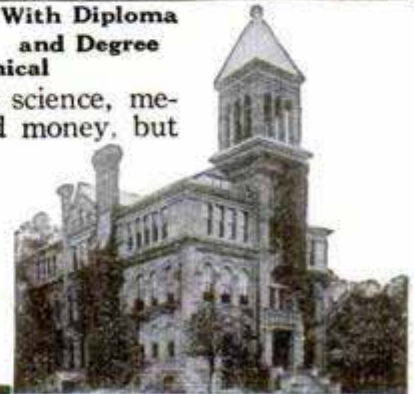

# LAW THIS BOOK

**Study at Home**  
 Become a lawyer. Legally trained men win high positions and big success in business and public life. Greater opportunities now than ever before.  
**Earn \$5,000 to \$10,000 Annually!**  
 We guide you step by step. Degree of LL.B. LaSalle law graduates practicing in every state. We furnish all text material, including 14-volume Law Library. Low cost. Easy terms. Valuable, interesting 96-page book free. Send for it NOW.  
 LaSalle Extension University, Dept. 764-L Chicago



WRITE for big book on wrestling. Tells secrets you've always wanted to know.



## Learn How to WRESTLE

In Your Own Home By Mail

### Farmer Burns and Frank Gotch Secrets

Farmer Burns, who taught Frank Gotch—trainer of SEVEN World's Champions, will teach you Scientific Wrestling—Physical Culture—Jiu-Jitsu and Self-Defense. Write today for big wrestling book, illustrated with many fine pictures—shows holds and secret tricks used by champions. Tells how easy it is to learn the marvelous breaks, falls and holds that make you an expert. Send today for this wonderful book. Enclose only 10c to help cover cost of wrapping and postage. Be sure to state age. No obligation.  
 Farmer Burns, 8-377 Ry. Exch. Bldg., Omaha, Neb.

Send Now for Farmer Burns' Book

## LANGUAGE POWER

Masterly English wins friends, increases chances for success. Sherwin Cody's wonderful new invention gives you language power in only 15 minutes a day fascinating spare-time study at home. No rules to memorize. Learn correct English this new, easy way. Write for free book today.  
**SHERWIN CODY SCHOOL OF ENGLISH**  
 57 Searle Bldg. Rochester, N. Y.



## DRAW CARTOONS

### Turn Your Talent Into Money

Cartoonists earn from \$50 to \$300 per week—some even more. Remarkable new Circle System of Drawing teaches you in half the usual time. Send for booklet and sample lesson plate explaining full details of the Course.

**THE NATIONAL SCHOOL OF CARTOONING**  
 623 Penton Building Cleveland, Ohio

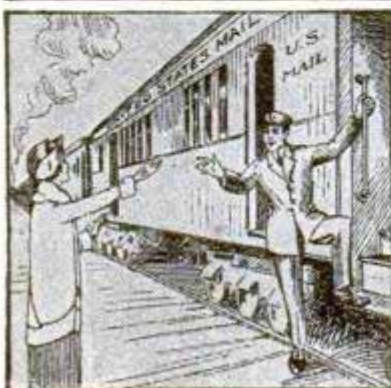

# Travel—For "Uncle Sam"

**RAILWAY POSTAL CLERKS—MEN—BOYS 18 UP**  
**CARRIERS—POSTOFFICE CLERKS**  
**\$1700 to \$2700 YEAR**

**Steady Work No Layoffs**  
**Paid Vacations**

Common Education Sufficient

**MAIL COUPON IMMEDIATELY**

**FRANKLIN INSTITUTE, Dept. L-173, Rochester, N. Y.**

Sirs: Rush to me without charge, 32-page book with (1) Sample Railway Postal Clerk questions; (2) List of government jobs now open to men and women, 18 up.

Name.....

Address.....



# Be a KING of the AIR



They all look up to the aviator. Flying is the greatest and most interesting thing a man can do. Wherever you are in your smart flying togs, people admire and envy you. At fairs, at city

parcs, traveling over the country, you are honored. Pay is big—there's adventure, opportunity and at the same time it's the business of the future. Now it's SAFE, QUICK and EASY to learn flying by the Sweeney system. **All Equipment and instructors examined by U. S. Inspectors.**

## Learn To Fly From Men Who Know

I have taught hundreds of students. Many now doing commercial work at large salaries. World's record of 4000 hours student flying without material damage. All the flying necessary to make you a skilled pilot. Planes under government inspectorship.

**GROUND SCHOOL.** Mechanics in big demand. Take either flying or ground school course or both. Sweeney students are trained by **DOING**. Thorough ground school work, under skilled instructors in the construction and repair of planes, recovering wings, tuning motor, etc., learning everything about the mechanical work by actual practice. This fits you as an aviation mechanic. You can build your own plane and do anything required in aviation mechanics and construction and repairing when you have finished this work. You are thoroughly taught motors, etc., and work with thousands of dollars' worth of new material, including all types of engines. Aviation is now playing in commercial activities. Progress is rapid. More men are needed every day. You can qualify as a mechanic, or an engineer, or repair man, or builder; five men on the ground are needed for one man in the air.

**BIG MONEY in Flying**

Aviation Mechanics—\$50-\$125 Week  
 Riggers—\$50-\$75 Week  
 Flyers—\$125-\$225 Week  
 Taxi-Service—\$100-\$300 Week  
 Aerial Photo Pilot—\$200-\$250 Week  
 Special Messenger Service—\$125-\$200 Week  
 Aerial Advertising—\$225-\$500 Week  
 Crop Dusting—\$125-\$200 Week  
 Crop Survey—\$125-\$225 Week

**FREE SEND NAME TODAY** for full details of this aviation mechanical course and photographs of planes and equipment actually used; also full information as to the commercial end of flying and opportunities for young men. No colored students accepted.

**150 Acre Flying Field  
 Hangar and Club House  
 Skilled Instructors  
 Thorough Construction Course**

LEARN TO FLY BY FLYING  
**Sweeney**  
 SCHOOL of AVIATION  
 3906 SWEENEY BLDG, KANSAS CITY, MO.

— — — — — **SEND THIS NOW** — — — — —

**EMORY J. SWEENEY, President**  
 3906 Sweeney Bldg., KANSAS CITY, MO.

Please send me full information about your Aviation Course.

Name.....Age.....

Address.....

Town.....State.....



# A Great Book Free with this pay-raising library

For a short time only we will give every subscriber to the New Library of Machine Shop Practice a copy of French's Engineering Drawing—the greatest book on mechanical drawing ever written. This book makes drawing as plain as day—tells you all about instruments, plans and methods—and prepares you to handle any drawing job you will ever have to do. It comes to you absolutely free with

## Machine Shop Practice

9 volumes — 3065 pages — 3608 illustrations  
(A combined home study course and reference library)

The New Machine Shop Library is written for practical men. It gives you the best methods for every kind of machine shop work. It explains machine tools and their operation, drawing and design, tool work, gears and grinding, jigs and fixtures, automatic screw machines and their tools and all of the mathematics you will ever have to use. It is plainly written, completely illustrated—the very best kind of help to the machine-shop man who wants to advance himself.

**Sent FREE**



**No money down—only 7c a day**

### FREE EXAMINATION COUPON

**McGraw-Hill Book Co., Inc., 370 Seventh Ave., New York**

Send me for 10 days' free examination the New Library of Machine Shop Practice. If satisfactory, I will send you \$1.50 in 10 days and \$2.00 monthly until the special price of \$19.50 is paid. If not wanted, I will return the books at your expense.

On receipt of my first payment of \$1.50, it is understood that I am to receive, free of charge, a copy of French's Engineering Drawing.

Signed.....

Address.....

City and State.....

Position.....

Employer..... P.M. 7-1-27

# Get Strong QUICKLY and Stay So!

**D**EVELOP your muscles this quick way. Get big broad shoulders. Fill out your chest. Become the strongest man in your town by using the famous GIBALTAR EXERCISER—the strongest tensioned apparatus made! Many famous athletes and strong men use it.

Can be adjusted to from 10 lbs. to 200 lbs. resistance. Every man, woman and child should have one. Made of finest quality, genuine para rubber elastic cables. Guaranteed 50 rubber strands.

We have made arrangements with a prominent author and publisher, who is an authority on physical culture, to present you with 16 complete booklets on every subject pertaining to your muscles and organs.

It is only by special arrangement and additional expense to us that we are able to offer you this wonderful premium **ABSOLUTELY FREE OF CHARGE** with each exerciser.

**ONLY \$3** For 5 Cables  
**ONLY \$5** 10 Cables, Double Strength

**SEND NO MONEY**

All 16 booklets will be shipped free to your home with the exerciser, and you simply pay the postman the price of the exerciser, plus a few cents postage. When ordering, mention that you want a five cabled or ten cabled exerciser. If you live outside the U. S. send cash with order.

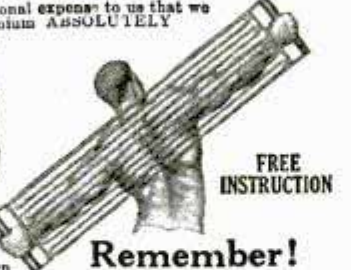

**FREE INSTRUCTION**

**Remember!**

The name Gibraltar on an Exerciser means as much as Sterling on silver.

**GIBALTAR EXERCISER COMPANY**  
Dept. 307, 225 W. 34th St., New York City

Please send me your [10 cable] EXERCISER.

It is understood that I am to get the 16 booklets on the body absolutely free with this order.

NAME.....

ADDRESS.....

CITY..... STATE.....

# Tire Repair Business is good now!

**\$500 a month**

Nation-wide chain of Tire Surgery Shops now being extended to every town and city. Men handy with tools and willing to work are needed. We train you, furnish everything and establish you in a shop of your own. Small investment required. Write for interesting book.

**HAYWOOD TIRE EQUIPMENT CO.**  
1308 S. Oakley Ave. Chicago



**Free Book GIVES DETAILS**

**Learn Watchwork, Jewelrywork and Engraving** A fine trade commanding a good salary, and your services always in demand. Address **Horological**, Dept. P, Bradley Institute, PEORIA, ILLINOIS, for our latest catalog.

# Mathematics Made Easy by ROPP'S CALCULATOR AND SHORT-CUT ARITHMETIC

Shows the Answer as Quickly as a Watch shows the Time to all Problems likely to occur in the Office, Store, Shop, Bank, Farm, or Factory.

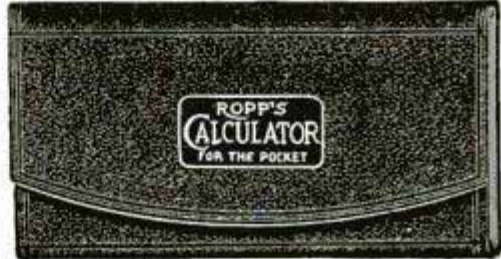

**Over 2,000,000 Sold**

Explains and simplifies every principle in Arithmetic, Mechanics, and Measurement.

**PRICES POSTPAID**

Desk Size...\$1.50  
Leatherette, Pocket Size...\$1.00  
Pocket Size, Cloth...\$0.50  
Pocket Size, Paper...\$0.35

Popular Mechanics Press, Room 207, 200 E. Ontario St., Chicago

# TIME AND LABOR SAVING IDEAS FOR SHOPMEN

**POPULAR MECHANICS SHOP NOTES**

FOR 1927



VOL. 1311 PRICE 50¢

**EASY WAYS TO DO HARD THINGS**  
POPULAR MECHANICS PRESS  
CHICAGO

479 Valuable Articles covering a wide range of Practical Subjects are found in Shop Notes for 1927. 374 Illustrations. Price 50c

301 ways to use drills, drill presses, taps and dies, with greater effectiveness, are given in our Drilling and Thread Cutting Handbook. 298 Illustrations... Price 50c

259 Kinks furnished by 106 of the most successful Lathe Operators are contained in our Lathe Handbook. 212 Illustrations... Price 50c



**SPECIAL OFFER**

These three books (regular \$1.50 value) are offered for a limited time only, for \$1 plus postage. Pay postman when he delivers package. If outside U. S. send remittance and include 20 cents extra for postage.

**Popular Mechanics Press**  
Room 707  
200 E. Ontario St. Chicago



# GO INTO

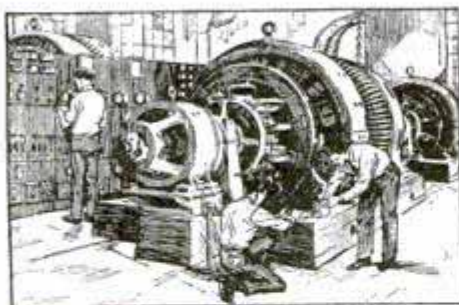

# ELECTRICITY!

GIANT among industries, yet the fastest growing, too! This is the Electrical Age, and if you'll learn Electricity—from beginning to end, as we give it to you, you are always sure of fine, well-paid job and a brilliant future. Let us show you how to become superintendent of an Electrical Power Plant, or in charge of Electrical Construction or installation, or boss of Electrical manufacturing, or Chief Electrician of a big plant. You can learn by our method, at home, in your spare time.

## First We PREPARE You

We send you lessons, job tickets and eight outfits of standard tools and materials. You learn Electrical principles a new, easy, rapid way—by doing actual Electrical jobs. This entire training, prepared by 29 noted Electrical Engineers is built especially for men with limited education—it has been made SIMPLE, easy to understand and remember.

## Then We Help You Get PLACED!

Employment Service now a part of our agreement to train you. If this training does not lead directly to a fine Electrical job and increased pay, it will not cost you a penny.

## This \$10 Motor



is one of the eight outfits sent you without extra charge. Same type as the big boys in a power plant. We send it to you K-D (Knock-down) with job tickets for assembling it, wiring it, changing it over to a dynamo, varying the voltage from battery to 110 volts, etc. That's the way to learn Electricity—that's the way we give it to you.

Chief Engineer Dunlap, Electrical Division



Dept. EB-74, Drexel Ave. & 58th St., Chicago



# LOOK OUT FOR JUNE!

If you're earning less than \$40 a week—if you have only a grammar school education, it would be a wonderful thing for you if the calendar jumped from May to July. I mean June is "bad luck" for you. Because it's in JUNE



Chief Engineer Dunlap

that the high schools and colleges of the U. S. are turning loose HALF-A-MILLION Graduates to make trouble for you. These men with better education, with better weapons to fight the battle of life, are pushing their way into the offices and factories; they are going to compete with YOU for your job, for the promotion you've been expecting. They will elbow you out of the way—if you don't stop them. And so I say BEWARE OF JUNE!

## A New Danger!

Five, six years ago things were different for you. Then it was entirely possible for men with little schooling to succeed. Then, men could slide along and take it easy and at least make a "living." But do you realize how different conditions are today? Don't you know that today the youngsters are

going to high school and many to college, almost as a matter of course? Don't you see that TODAY employers can get all the men they need with better education and that your chances for a good job are growing LESS and LESS? And do you realize that business conditions have been slumping from the high-pitch of prosperity and that the first to be fired are those without either education or TRAINING?

## Only One Way Out!

Schooling only helps men a little. Employers will tell you they are more interested in what a man has done to improve himself after leaving school. The big demand today is for specialized skill they don't teach in any school. You can get this, slowly, by practical experience and haphazard "study." But the QUICK way, the best way, as hundreds of thousands of men have found—is HOME TRAINING.

For 30 years we've invited ambitious men to climb more rapidly to better positions and increased salaries through our training and employment service. Today you face a crisis. It's TRAIN—SPECIALIZE—IMPROVE YOURSELF—or be destroyed by the June army of better-educated men. Ten years ago you could stand still and remain safe. Today, if you do not heed the danger signals, it's the bread-line or manual labor for you!

We offer you here a way out—through the great Electrical industry. We offer to train you and to help you get placed at increased salary. You will be wise indeed to look into these amazing offers—QUICK!

## 5 Electrical Job-Tickets FREE

Chief Engineer Dunlap, Electrical Div.  
The American School, Dept. EB-74  
Drexel Ave. & 58th St., Chicago.

Send me your new booklet "The June Terror" Free.

Send me free 5 Electrical Job-Tickets and facts about your training and employment service in electricity.

Name.....

Address.....

Occupation.....Age.....



# PAIN and DISEASE

Quickly Conquered by

## VIOLET RAY



Let us tell you how thousands of men and women suffering from rheumatism, neuritis, paralysis, nervousness, skin diseases, headaches, constipation, sprains, prostate trouble, goitre and many other ailments, even hay fever and asthma, have found quick relief—new health and vitality with this marvelous, scientific invention. Pains vanish almost instantly.

# Violetta

**Ten Days FREE Trial**

For Health—Beauty—Vigor

Endorsed and used by hospitals, sanitariums and physicians. Every home can now have one. Saves hours, days, months of suffering. No medicine. Painless, pleasant treatment. Only the violet ray can penetrate to every nerve affected. Simple, safe, painless—anyone can use VIOLETTA. Why suffer pain and poor health when you can try VIOLETTA 10 days FREE.

### This Book FREE

Tells all about violet rays—how this marvelous discovery by Nikola Tesla, the electrical wizard, now brings this mysterious curative power to all. Contains many astounding testimonials from our thousands of satisfied users. Send for the facts and our liberal trial offer today. Mail the coupon now.

VI-REX CO., Dept. 731  
2304 Warren Avenue. Chicago



VI-REX CO., 2304 Warren Ave., Dept. 731 Chicago

Please send me your free book on Violet Rays and details of your 10 days' free trial offer.

Name.....

Address.....

City..... State.....

Ailment.....



## \$1900 to \$2700 a year



Long vacations with pay. Work easy. Travel on fast trains with all expenses paid, including hotel. No worries about the future.

**MY FREE BOOK TELLS HOW**

Get my big free book about the Civil Service which tells all about the Railway Postal Service, and other positions, and how I can help you. Write today.

**PATTERSON SCHOOL**

Arthur R. Patterson, Civil Service Expert  
87 Wisner Bldg. Rochester, N. Y.

## Become an Artist

### LEARN AT HOME

You can learn to draw pictures that sell through a remarkable simple home-study method. Earn money while learning and secure a well-paying position after completing course. Good artists are always in demand and earn from \$100 to \$250 a week. Write today for free book. No obligation.

Washington School of Art

Room 307-E 1115-15th St., N. W. Washington, D. C.



# LAW

Personal Instruction  
By Mail Be a lawyer  
or law trained  
businessman. Quality  
to earn \$2,500.00 to  
\$15,000.00 a year.

University Methods. TUITION LOW. EASY TERMS. Textbooks furnished. Practical and authoritative non-resident course. Endorsed by bench and bar. Prepares for bar or business. Over 60,000 students. PERSONAL INSTRUCTION. Guarantee to coach free any graduate failing to pass bar exams. Write today for particulars of low tuition offer now in force and book on law FREE. No obligation.

AMERICAN CORRESPONDENCE SCHOOL OF LAW  
3601 Michigan Avenue, Dept. 135-B CHICAGO, ILL.



## 1,000 Hotel Positions Open!

HOTELS, restaurants, clubs, apartments, hospitals, institutions, schools and colleges everywhere need trained men and women. Over 70,000 high-class positions paying \$2,500 to \$10,000 a year open annually in the hotels of the United States. Nearly one and three-quarter billions of dollars' worth of NEW HOTELS, CLUBS AND INSTITUTIONS, being built this year will need over 200,000 trained men and women. Hotels start you at salaries up to \$3,500 a year, with living usually included. At any time there are over 1,000 hotel positions open.

Previous Experience Unnecessary

You can have one of these fascinating, big-pay positions. The Lewis Schools guarantee to give you the valuable knowledge that it has taken some of the most successful hotel men years to obtain. Age is no obstacle—young and old alike have equal chance for success. Past experience absolutely unnecessary. A common school education is all you need.

We train you in your spare time with the Lewis Simplified Study Plan and put you in touch with big opportunities. All of your training under the personal supervision of Clifford Lewis, Managing Consultant for over 225 hotels throughout the United States. Our students employed by leading hotels everywhere. Send coupon today for Free Book, "Your Big Opportunity," showing how we can train you for one of these splendid positions, and explaining our Money-Back Agreement.

FREE BOOK COUPON

LEWIS HOTEL TRAINING SCHOOLS,  
Room AH-385, Washington, D. C.

Send me without obligation the Free Book "Your Big Opportunity."

Name.....

Address.....

City..... State.....



# Missing a Stiff Pace?

## NOW IT'S GETTING YOU!

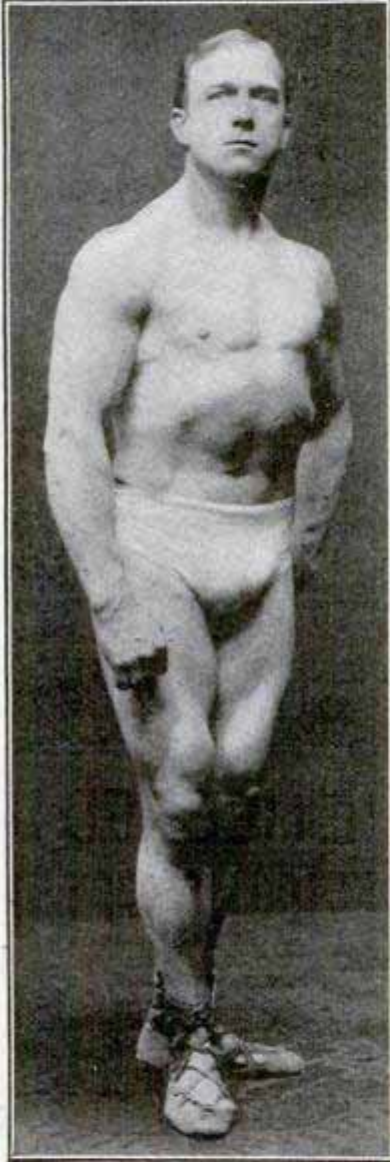

**STRONGFORT**  
Builder of Men

I have been conspicuous in the field of physical culture and muscular development for over 25 years. I am known on both hemispheres. I first made my impress on the public mind by developing myself to marvelous symmetrical proportions — my bodily perfection being the subject of wide comment wherever I exhibited — and performing, in Europe and America, incredible feats of strength. I had "the goods" and I delivered them.

—Lionel Strongfort

**STRONGFORT INSTITUTE**  
LIONEL STRONGFORT, DIRECTOR  
Physical and Health Specialist for over 25 Years  
DEPT. 352 NEWARK, NEW JERSEY, U. S. A.

Maybe, young fellow, you've been going at a pretty good clip and you felt none the worse for wear. Oh, yes—you were "different" from most men. You had a splendid constitution and you could stand the gaff—of course you could! Late hours didn't affect you at all—no indeed! You'd wake up next morning after only a couple hours of sleep and go to work feeling fine. Wild parties were the real thing—and they couldn't come too fast for you. Your motto was, "Go while the going's good."

Now what? You are aware of a change coming over you. You're not so peppy and spry. It's hard to wake up mornings, and when you get up that head of yours feels groggy. Those years of excesses and dissipation are telling on you. And, let me say right here, young man, if they are telling on you now, they are going to tell on you a lot more if you don't get wise quickly. You've got to get back that reserve energy and strength you've dissipated.

### Away With Pills and Piffle

You're tearing down a whole lot faster than you are building up, and the longer you keep going this way the worse you're going to get. Maybe you've been trying to jazz up your system and get back your energy by the pill route. Carrying pills in your pocket, likely—with a pill for every weakness. You become constipated, and you take a pill. You get a headache—you take another kind of pill. You're sleepless nights—you take a pill. Your head isn't clear mornings—it's another pill. You have a pretty pill for your nerves. Another pill for indigestion. Down deep in your heart you know you're throwing your money into the sewer—those pills aren't doing a thing for you except to make you a wretched weakling—a despised dope fiend. They do not build—they destroy! Cut them out. And cut out all dope and poison booze. Forget all artificial stimulants and get back to Nature—to your muscular mechanism and get strength and pep and health at its source. Be a good sport. Give Nature a chance! Let Nature build up your body and increase your muscular strength as nothing else in the world can do it.

## STRONGFORTISM

### —the Basic Science of Health and Strength Will Teach You How

It will show you how to run that body of yours, how to build it up and bring it to its highest efficiency. In a mighty short time you'll laugh at pills and pill eaters, quack remedies and poison booze. A new day dawns for you when you take up STRONGFORTISM. Let me tell you about it—what it has done for thousands of men all over the world, many of whom were wretched weaklings and were restored to robust health and manly vigor. You can't afford to be without this knowledge if you have wasted your vitality in any way and lost your energy and strength.

Listen to me—before it's too late. Each day you wait, each day you delay means just that much harder a job to bring you back. So let's go! Let STRONGFORTISM help you. Let it restore in you those vital powers that you know you are losing and losing fast.

### Send for My FREE BOOK

#### Send this FREE Consultation Coupon

#### ABSOLUTELY CONFIDENTIAL

Mr. Lionel Strongfort, Strongfort Institute, Dept. 352, Newark, N. J.—Please send me absolutely free my copy of your book, "PROMOTION AND CONSERVATION OF HEALTH, STRENGTH AND MENTAL ENERGY." I am enclosing 10c (one dime) to help cover mailing expense, etc., and have marked (x) before the subjects in which I am most interested.

- |             |                 |                         |
|-------------|-----------------|-------------------------|
| .. Catarrh  | .. Overweight   | .. Great Strength       |
| .. Colds    | .. Constipation | .. Lung Troubles        |
| .. Asthma   | .. Weak Back    | .. Round Shoulders      |
| .. Headache | .. Weak Eyes    | .. Stomach Disorders    |
| .. Rupture  | .. Rheumatism   | .. Increased Height     |
| .. Thinness | .. Nervousness  | .. Muscular Development |
| .. Pimples  | .. Short Breath |                         |
| .. Insomnia | .. Weak Heart   |                         |

Other Ailments.....

Name.....

Age..... Occupation.....

Street.....

City..... State.....



Learn



24th Year

# DRAFTING ENGINEERING, ELECTRICITY and ARCHITECTURE

## CHICAGO TECHNICAL COLLEGE

One of "America's oldest and largest schools of specialized engineering" offers you a maximum of practical training in a minimum of time, here at Chicago, the country's building and engineering center. Technical training of college standard for men who have neither the time, money nor preliminary education to attend a university. Each year more than 1000 men and women enroll in day and evening classes.

### Short, Intensive Training

practical in every respect, puts you quickly into a high salaried position. Many of our students are assisted to responsible positions before graduation . . . they earn while they learn.

#### In Spare Time At Home

If you can't come to Chicago, learn Drafting at home. Your spare time is enough. Same practical course. Quick, easy—yet thorough.

#### Trial Lesson FREE

Test yourself and see how easy you can learn Drafting by the Chicago Tech. method. Trial lesson sent free if interested in home study. Address Dept. H-200.

COURSES are arranged to suit your needs—2 year diploma; 3 year B. S. degree; special 3 and 4 months' short courses adapted to the individual. Expert instructors actively at work in the very professions they teach.

Tuition low, terms easy. Enter any time. Day and Evening Classes.

## Write for FREE 84 Page Blue Book

It tells about all the courses . . . fully describes them; about the great demand for Chicago Technical College trained men; about college athletics and other interesting facts you'll want to know. Gives you a vivid picture of what you may expect at this leading technical college. There is no obligation. Send for this free Blue Book today . . . now!

Address Registrar H-75

Chicago **TECHNICAL College**  
Dept. H-75 118 East 26th St., Chicago

# Why Good Dancers Are Popular

EVERYONE admires and wants to dance with the person who knows the latest steps. There is no need of being a wallflower! By my remarkable new easy method **anyone** can learn the newest dances at home in a few hours. Much less expensive than from a personal teacher. No music or partner needed. So simple even a child can learn quickly. **Almost one half million have learned dancing by mail.** Your own success is guaranteed.



Posed by Edna Murphy and Arthur Murray

To prove I can quickly and easily make you an accomplished dancer, I will send you **FREE** my 32 page book and **TEST LESSON**. To pay the cost of mailing, handling, etc., send 10c. Learn in private—surprise your friends. Act now and be a good dancer soon!

ARTHUR MURRAY, Studio 719, 7 East 43rd St., NEW YORK

## BE AN ARTIST

WE CAN TEACH YOU DRAWING in your own home during your spare time. Twenty-five years of successful teaching proves our ability. Artists receive large salaries.

Write Today for Art Year Book

SCHOOL OF APPLIED ART  
ROOM NO. 2 BATTLE CREEK MICH.



### LEARN PHOTO-ENGRAVING!

Earn \$200 to \$500 monthly. Photography and Photo-Engraving taught in few months by largest college of its kind. Established 1893. Big demand for graduates.

Write for free book.

Illinois College of Photography, Box 477, Effingham, Ill.

# YOU ARE NEEDED IN TRAFFIC INSPECTION



EARN UP TO  
**\$250 PER MONTH**  
Salary and Expenses

Trained men are needed to fill important positions in this fascinating and profitable railway work, sometimes called Traffic Observation. You'll be away from office or shop and practically your own boss—seeing new sights and places every minute. It's healthful, dignified work where you report only to high officials and are rapidly advanced.

### No Previous Experience Necessary

For eight years, I have trained men for Traffic Inspection, and, upon completion of 3 months' spare time, home study course I helped them get good positions. Any man of normal intelligence can qualify, regardless of previous training. I will train you on the same basis, and upon completion assist you to a position paying at least \$120 per month salary plus expenses—or refund your money.

Traffic Inspection appeals to live men. It gives variety, independence and opportunity—gets them away from monotonous desk and dirty shop—gives them a chance to "be somebody."

Let me show you what Traffic Inspection holds for you. Send coupon today.

James T. Jarrel, Pres., Div. 2, Standard Business Training Inst., Buffalo, N. Y.

Standard Business Training Inst.,  
Division No. 2, Buffalo, N. Y.

Yes, I'd like to know something about Traffic Inspection. Send me your free booklet "A Profession of Protection."

Name.....

Address.....



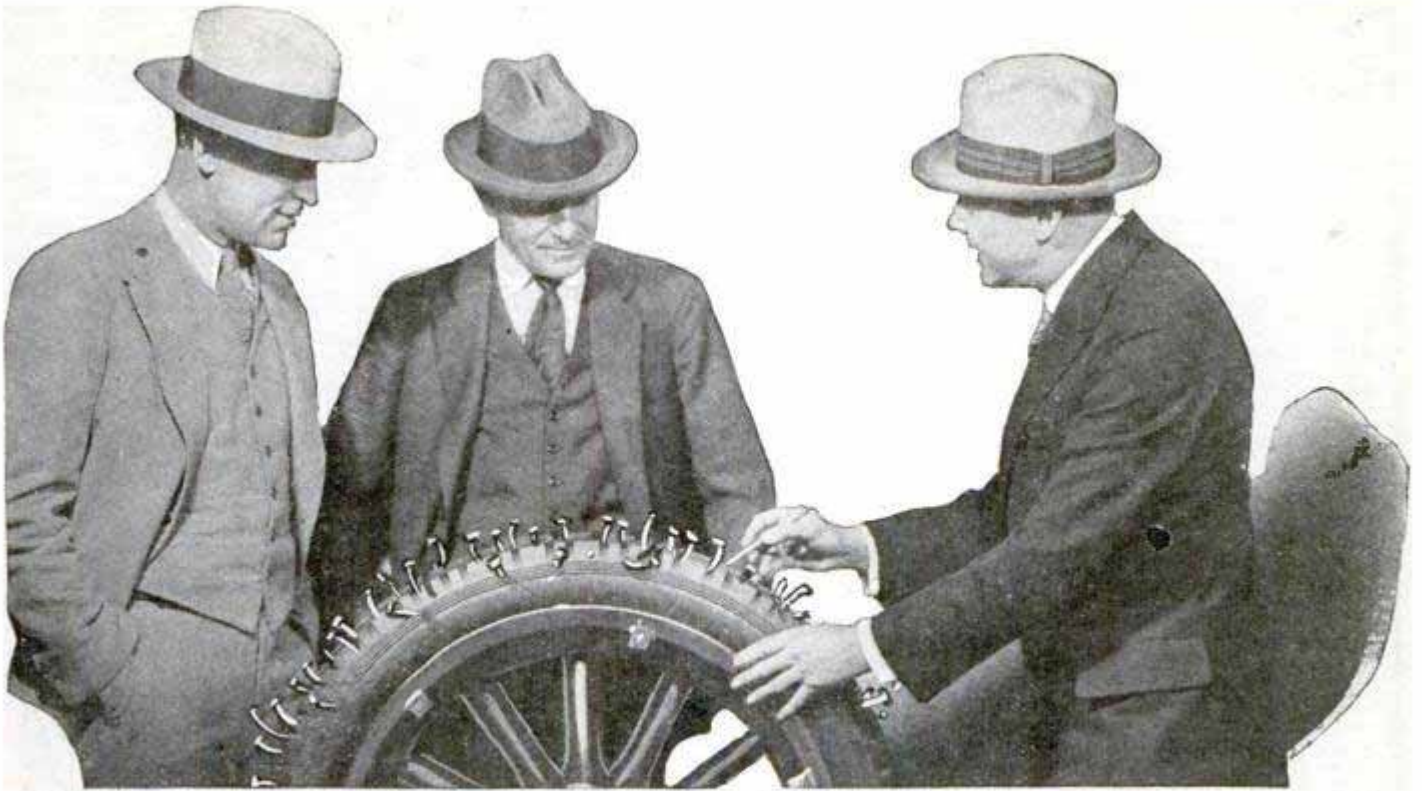

# They Thought I Was *Drunk* When I Drove Nails in My Tire *-but it didn't lose a pound of air!*

Were they dumbfounded? And how! What would you think if somebody pulled out a hammer and some nails and started driving nails in his tire? Yet I did it—without losing an ounce of air. Here's the secret:

**S**OMETIME ago I read an article in a rubber trade magazine which related the discovery of a mysterious fluid that made any tire puncture proof against nails. Other reports were that it sealed slow leaks, valve leaks, etc. And it actually fixed the puncture without the need of removing the tire. You didn't have to wrestle with tight rims, or bother patching tubes on blazing hot days or stormy weather.

Before taking any chances I wrote the inventors, asking for full details. They offered to send samples at their risk for a fair test. They guaranteed to pay a cash forfeit if it didn't live up to their claims. And they also guaranteed to replace any tube that was damaged by this new invention. I wasn't taking any chances. So I sent for the samples.

When I made the test, I was dumbfounded. I had an old dis-

carded tube that previously couldn't hold air for two minutes. Yet this magic liquid sealed them instantly. Then I deliberately drove nails into it—spikes, 20-penny nails, tacks—and still it wouldn't leak air. Then I demonstrated it to a few friends. When I began to pound nails in my tires they thought I was drunk or crazy. But when they saw how instantly Air-Stop sealed the punctures, they wanted the same protection.

And that gave me a tip on a wonderful money-making job. I started taking orders from friends and now am working throughout my territory. I have often made \$25.00 in one demonstration at public garages and street corners. If you are a car owner, take my tip—write the Air-Stop Co. for full details of their free sample offer. And if you want to make \$75 to \$200 in a week also ask for their money-making plan.

## Agents Wanted

Such is the story of the amazing attention this invention is creating and we have openings in every locality for Air-Stop representatives. National advertising is acquainting every car owner with this marvelous invention that sells and proves its story on sight. Cathcart, a Druggist made \$220.00 in one week. E. E. Abes, sold over 250 in two weeks. Mail coupon below for free sample offer to car owners and agents. No obligation. But act now. This is the best time to start.

**AIR-STOP MFG. CO.**  
DEPT. H-526

Hewitt Bldg., DES MOINES, IOWA

Air-Stop Mfg. Co.,  
Dept. H-526, Hewitt Bldg.,  
Des Moines, Iowa.

Yes, send me full details of your free sample offer and money-making plan. This does not obligate me in any way.

Name.....

Address.....

City.....State.....





## \$1,000 Reward For the Capture of This Man

**C**ONVICT 6138, escaped from the State Penitentiary; Name, Charles Condray; age 37; Height, 5 feet 8 inches; Weight, 141 pounds; Hair, light brown; Eyes, gray.

Easy enough to identify him from his photograph and this description, you may say—but, Condray took the name of "Brown," dyed his hair, darkened his skin, grew a mustache, put on weight and walked with a stoop.

Yet he was captured and identified so positively that he knew the game was up and returned to the penitentiary without extradition. How was it accomplished? Easy enough for the Finger Print Expert. They are the specialists, the leaders, the cream of detectives. Every day's paper tells their wonderful exploits in solving mysterious crimes and convicting dangerous criminals.

### More Trained Men Needed

The demand for trained men by governments, states, cities, detective agencies, corporations, and private bureaus is becoming greater every day. Here is a real opportunity for YOU. Can you imagine a more fascinating line of work than this? Often life and death depend on finger print evidence—and big rewards go to the expert. Many experts earn regularly from \$3,000 to \$10,000 per year.

### Learn At Home in Spare Time

And now you can learn the secrets of this science at home in your spare time. Any man with common school education and average ability can become a Finger Print Expert in surprisingly short time.

### FREE Secret Service Reports

Mail the coupon right now and we will send you free, the confidential reports Operator No. 38 made to his chief and tell you of the wonderful opportunity awaiting the man like yourself, who is ambitious to get ahead in the world. We will also send you the illustrated free book on Finger Prints which explains this wonderful training in detail. Don't wait until this offer has expired. Mail the coupon now. You may never see this announcement again! You assume no obligation. You have everything to gain and nothing to lose. Write at once. Address

### University of Applied Science

Dept. B-135 1920 Sunnyside Avenue, Chicago

UNIVERSITY OF APPLIED SCIENCE  
Dept. B-135, 1920 Sunnyside Avenue, Chicago, Ill.

Gentlemen:—Without any obligation whatever, send me your new, fully illustrated, FREE book on Finger Prints and the Free Reports of Operator No. 38.

Name.....

Address.....

Age.....



## Air Commerce Needs Men!

Don't envy the Highly Paid Air Man—Be One! Air Men are in demand. Beat the other fellow to the High Salaried Jobs in Aviation. **Western** training will qualify you to enter Aviation. Learn how through our catalog, sent on request.

**Write for Free Catalog  
"Airplanes and Flying"**

Aeronautical Training Division

**WESTERN AIRPLANE CORPORATION**

Dept. M-7 Monadnock Block Chicago, Ill.



## Electrical Trades/ Need Men

**LEARN** Automobile Starting, Lighting, Ignition; Storage Batteries, Armature Winding, House Wiring, Farm Lighting, Electric Welding, Electric Refrigeration, A. C. and D. C. Motors, Power and Light Switchboards, Radio.

**EARN** \$200 to \$400 monthly. \$320,000,000 paid in wages to electrical workers in U. S. last year. Get your name on the payroll this year. Easy to learn by actual work on real equipment.

**FREE BOOK**—Write today for book which explains the Coleman System of ten week courses.

WM. H. COLEMAN, President

**Coleman Electrical School**  
1628D MAIN ST., KANSAS CITY, MO.



## Learn Tenor Banjo

**BANJOISTS!** Earn big money through Charles McNeill's famous Home Study Banjo Course. Simple as A B C—yet has all technical requirements. Includes phonograph record demonstrating jazz strokes, "breaks" and chords, played by Charles McNeill, 5 years with Isham Jones-Bronswick Records. Easy payments. Send for Free Book.

**CHICAGO BANJO INSTITUTE**  
Dept. B-135 3345 N. Lincoln Street CHICAGO, ILL.

## Learn Watchwork, Jewelrywork and Engraving

A fine trade commanding a good salary, and your services always in demand. Address **Horological**, Dept. P, Bradley Institute, PEORIA, ILLINOIS, for our latest catalog.



## Learn SIGN AND SHO-CARD Lettering

Fascinating work. Pays \$50 to \$200 weekly. Vassos gets \$25 for a sho-card. Some posters bring \$300. Many earn while learning. Study in spare time. Learn quickly. For facts and guarantee write: **DETROIT SCHOOL OF LETTERING**, 173 Stinson, Detroit, Michigan.

# Skin Troubles

Cleared up—often in 24 hours. To prove you can be rid of Pimples, Blackheads, Acne Eruptions on the face or body, Barbers' Itch, Eczema, Enlarged Pores, Oily or Shiny Skin, simply send me your name and address today—no cost—no obligation. **CLEAR-TONE** tried and tested in over 100,000 cases—used like toilet water—is simply magical in prompt results. You can repay the favor by telling your friends; if not, the loss is mine. **WRITE TODAY.**  
E. S. GIVENS, 428 Chemical Bldg., Kansas City, Mo.



## CAR OWNERS

Here is an opportunity to cut down the cost of running your car. Read below how you can test this new way to save gas—WITHOUT RISK!

 296 GAS MILES

 492 GAS MILES

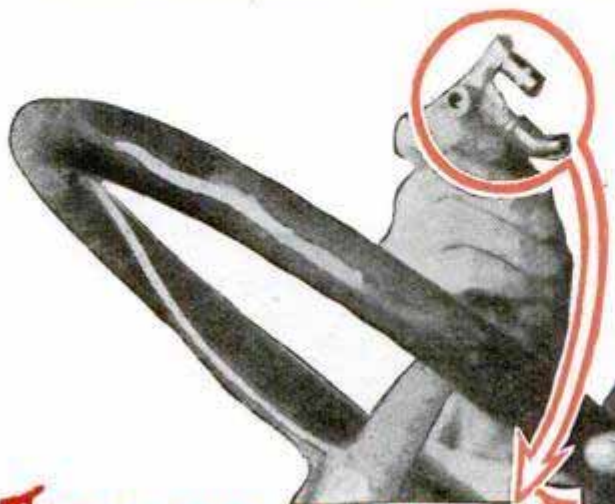

**This Magic Little Invention Gave Me...**

# Half My Gasoline FREE

**I** PUT a Stransky Vaporizer on a Marmon that got only 10 to 11 miles per gallon," writes B. O. Finch. "He drove 492 miles and averaged 20 miles per gallon." This amounts to getting half his gasoline free! Read below how it works—how you can test it without risk—and how you can make big profits.

Over two and a half million car owners have now installed the Stransky Vaporizer—on practically every make of car, truck, or tractor. Many have used it from three to eight years in every day actual use and still praise the way it has saved them gas, ended carbon and spark plug trouble, and increased the power of their cars.

The astounding instant results of the Stransky Vaporizer have made big profits for Stransky representatives. It is now one of the few big steady profit propositions in the country. It is nationally advertised and millions of car owners have probably heard about it.

It is easy to install and has nothing to get out of order. It is a simple piece of metal that fits any car and is guaranteed harmless in every way. Its principle of saving gasoline is in multiplying the vapor power of the raw gasoline of which 20 to 30% is wasted by the average car owner, according to authorities.

### A Challenge

Let us send you without obligation the complete details of how you can test this new way to get more miles per gallon—and how you can build up a wonderful business in your community as many Stransky representatives have done. Now is the big season—the best time to start. Mail the coupon below without obligation.



**Do You Want To Make \$100 IN A WEEK**

**Ambitious men, speak up!**  
This is the money-making opportunity you've been waiting for. Read below these typical records of Stransky representatives. Work full or spare time. No experience required. We show you how to make money.  
**\$357.00 in two weeks.**  
O. F. Foster.  
**\$114.00 in five days.**  
G. T. Fuller.  
**500 sales in one day—next day**  
350—23 in 35 minutes—27 in 45 minutes. W. F. Eberlein.

## The STRANSKY VAPORIZER

**Saves Gasoline**

**J. A. STRANSKY MFG. CO.**

H-10 Stransky Block

PUKWANA, S. D.

J. A. Stransky Mfg. Co.,  
H-10 Stransky Block, Pukwana, S. D.

Yes, without obligation, send me full details of this new way to save gasoline and your money making plan.

Name.....

Address.....

City..... State.....



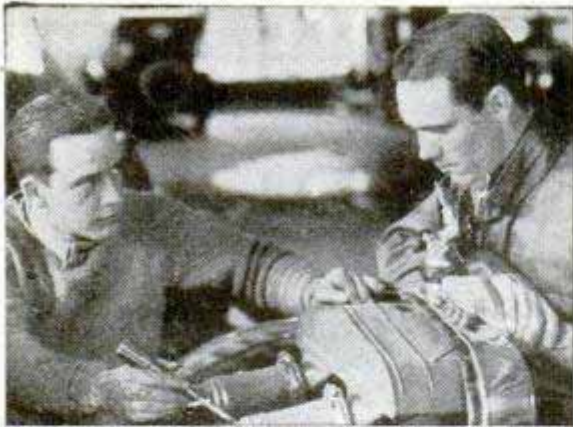

## Automobile Experts in Demand

*Study with the same school that helped  
to train many leading men in the  
automobile industry*

**T**HE best proof of the value of the home-study courses of the International Correspondence Schools is the success of I. C. S. students. This success is especially apparent in the automobile industry.

Jesse G. Vincent, Vice-president of the Packard Motor Car Co., is a former I. C. S. student. So is Walter P. Chrysler, President of the Chrysler Corporation. E. V. ("Eddie") Rickenbacker, Vice-president and Director of Sales of the Rickenbacker Motor Car Co.; Hiram Walker, Chief Engineer of the Chandler Motor Car Co., and John Moore, designer of the famous Ansted Motor, are also former I. C. S. students.

The first step they took was to mark and mail an I. C. S. coupon similar to the one printed below. Make your start the same way and make it right now. We'll gladly send you complete information about the I. C. S. Automobile Courses or any other course in which you are interested.

### INTERNATIONAL CORRESPONDENCE SCHOOLS

Box 5657-E, Scranton, Penna.

*Oldest and largest correspondence schools in the world*

Without cost or obligation on my part, please tell me how I can qualify for the position or in the subject before which I have marked an X:

- |   |  |
|---|--|
| <input type="checkbox"/> Complete Automobile Course                       | <input type="checkbox"/> Gas Engine Operating Course                 |
| <input type="checkbox"/> Automobile Electric Equipment                    | <input type="checkbox"/> Complete Gas Engine Course                  |
| <input type="checkbox"/> Electrical Engineering                           | <input type="checkbox"/> Architect                                   |
| <input type="checkbox"/> Electric Lighting                                | <input type="checkbox"/> Architects' Blueprints                      |
| <input type="checkbox"/> Mechanical Engineer                              | <input type="checkbox"/> Contractor and Builder                      |
| <input type="checkbox"/> Mechanical Draftsman                             | <input type="checkbox"/> Architectural Draftsman                     |
| <input type="checkbox"/> Machine Shop Practice                            | <input type="checkbox"/> Concrete Builder                            |
| <input type="checkbox"/> Railroad Positions                               | <input type="checkbox"/> Structural Engineer                         |
| <input type="checkbox"/> Civil Engineer                                   | <input type="checkbox"/> Chemistry <input type="checkbox"/> Pharmacy |
| <input type="checkbox"/> Surveying and Mapping                            | <input type="checkbox"/> Airplane Engines                            |
| <input type="checkbox"/> Metallurgy <input type="checkbox"/> Mining       | <input type="checkbox"/> Agriculture and Poultry                     |
| <input type="checkbox"/> Steam Engineering <input type="checkbox"/> Radio | <input type="checkbox"/> Mathematics                                 |

### BUSINESS TRAINING COURSES

- |  |   |
|--|---|
| <input type="checkbox"/> Business Management                     | <input type="checkbox"/> Salesmanship           |
| <input type="checkbox"/> Industrial Management                   | <input type="checkbox"/> Advertising            |
| <input type="checkbox"/> Personnel Organization                  | <input type="checkbox"/> Better Letters         |
| <input type="checkbox"/> Traffic Management                      | <input type="checkbox"/> Show Card Lettering    |
| <input type="checkbox"/> Business Law                            | <input type="checkbox"/> Stenography and Typing |
| <input type="checkbox"/> Banking and Banking Law                 | <input type="checkbox"/> Business English       |
| <input type="checkbox"/> Accountancy (including C.P.A.)          | <input type="checkbox"/> Civil Service          |
| <input type="checkbox"/> Nicholson Cost Accounting               | <input type="checkbox"/> Railway Mail Clerk     |
| <input type="checkbox"/> Bookkeeping                             | <input type="checkbox"/> Common School Subjects |
| <input type="checkbox"/> Private Secretary                       | <input type="checkbox"/> High School Subjects   |
| <input type="checkbox"/> Spanish <input type="checkbox"/> French | <input type="checkbox"/> Illustrating           |

Name.....

Street  
Address.....

City..... State.....

Occupation.....

*If you reside in Canada, send this coupon to the International Correspondence Schools Canadian, Limited, Montreal*

**B**E a Motion Picture Cameraman, Portrait, News or Commercial Photographer. Earn a handsome salary or own a studio and *set your own prices!* No experience needed. Spare time work. Big money to be made *while you are learning!*

**Learn Photography** A few minutes a day at home fits you for a big paying position and you get your choice of these standard professional cameras. Instruction also given in our great New York studios.

Cameramen and photographers are *always* in demand. You can quickly qualify for this easy, fascinating work.

**CAMERA GIVEN WITHOUT EXTRA CHARGE** Learn at home or in our great New York Studios. Earn while learning. Write today for Free Book, Job Chart and Camera offer.

**NEW YORK INSTITUTE OF PHOTOGRAPHY**  
Dept. 49, 10 West 33rd St., NEW YORK CITY  
**Write NOW for FREE BOOK**

**\$20 Musical Instruments**  
Your choice of a Violin, Tenor Banjo, Hawaiian Guitar, Banjo, Cornet, Ukulele, Banjo Ukulele, Guitar, Mandolin or Banjo Mandolin. You will be proud to own any one of these instruments and we will give you one without cost. A few cents a day for lessons is your only expense. Our system of teaching is so easy that you can play several pieces by note with the first four lessons. We guarantee success or no charge. Instrument and lessons sent on **one week's free trial**. Write for booklet today, no obligation. Over 200,000 satisfied pupils.  
**CHICAGO CORRESPONDENCE SCHOOL OF MUSIC, INC.**  
1632 North Halsted Street, Dept. 346, Chicago, Illinois.

**ENCYCLOPEDIA BRITANNICA**  
in the New Form—at a saving of 40%  
Write for full details. Address Dept. PM6  
**THE ENCYCLOPEDIA BRITANNICA, Inc.**  
342 Madison Ave., New York City

**WANT THIS JOB?**  
**\$1700 to \$2300 a Year**  
**MAIL CARRIERS—POSTAL CLERKS**  
**Men 18 up**  
**Steady Work** **Paid Vacation**  
Write immediately for FREE list of positions and full particulars telling how to get a position.  
**FRANKLIN INSTITUTE**  
Dept. L-305 Rochester, N. Y.



# Air Transport Company will train you to FLY

Big commercial aviation corporation with hangars, shops and flying field at CHICAGO MUNICIPAL AIR PORT, with new 1927 planes of best commercial types will train ambitious men in ground-work and actual flying by same methods used in U. S. Air Corps. The QUICK, safe way to a fine job as pilot, or ground-expert. Your best chance to get in on "ground floor" of new, rapidly growing industry, backed by billions of dollars.

**Pilots earn \$7 an hour**

The biggest men in America are interested in commercial aviation. The opportunities are like those in the Auto Industry 30 years ago. School education doesn't count. We want men of courage and character for flying jobs, and four-sighted fellows to get into the mechanical and business end. We'll give you training in ALL branches under men who are among the greatest fliers and teachers of aviation in the world—men who trained hundreds of Army and commercial aviators.

**GET INTO AVIATION!**  
**8 Ground Jobs to Each Flyer**

*There are 20 jobs in aviation for every trained man. Not necessary to be a flyer. There are big pay jobs open for expert ground men, mechanics, etc. Aviation needs you, write today for particulars.*

**Get Ground-work at HOME, Actual Flying at Chicago within few weeks**

Amazing new combination home-study and resident school instruction, at a cost within your reach so you can get started at once. Sponsored by big aviation company now actually engaged in transporting passengers and freight by air, and in aerial photography. A complete, modern, practical thorough training service obtainable for the first time. Open to real men and women who can furnish good references.

Aviation Service and Transport, Inc.,  
Dept. 101, 22 W. Monroe Street, Chicago.

Send FREE complete information about your training for AVIATION flying and ground-work, and the opportunities open to ambitious men.

Name.....

Address.....



# FLY

by  
**U. S. Government Methods with U. S. Licensed PILOTS!**



**JOHN MILLAR**  
Former U. S. Chief Instructor at Air Corps Technical School, Eastoud, Illinois.



**NIMMO BLACK**  
Former U. S. Army Instructor and Mail Flyer. Famous Commercial Ace.

**Sensational Offer to Men Who Qualify!**

Send no money—just mail the coupon for all the facts about FLYING, about the business and mechanical end of AVIATION and how we prepare you for the BIG MONEY in them. If you want excitement combined with big opportunities—write me today!

**Aviation Service and Transport, Inc. Dept. 101, 22 W. Monroe St. CHICAGO**

# Now only \$1.87 SMASH Goes the Price!

**SEND NO MONEY The Hercules Builder**

**FREE!** Complete Course of Instructions. Tells how to use the HERCULES BUILDER to develop every muscle in your body.

**FREE!** Hercules Hand Grips Develop Wrists and Forearms of Steel.

HERE'S the offer that startled the whole physical culture world—and no wonder! This overwhelming BARGAIN will make you rub your eyes!

Think of it! Only \$1.87 for the marvelous Hercules Builder, the champion muscle making Exerciser! The Hercules Builder is the real stuff all the way through. It develops tremendous resistance—that's the secret of BIG muscles. You can use as many cables as you please, the Hercules Builder is Progressive. Made to stand the gaff—carefully selected materials, strong, durable construction. And you don't risk a cent. Our trademark GUARANTEE makes YOU the judge and jury.

This sensational offer will bring a flood of orders. Don't wait or you'll lose out. Shoot the coupon along NOW. State whether you want the Hercules Builder with 5, 10 or 15 cables. Your INSTRUCTIONS and your HAND GRIPS will come to you with your Exerciser.

Just write your name and address on the coupon—that's all. Pay the postman when he delivers your outfit. And remember, YOUR MONEY RIGHT BACK if you don't agree that this is the greatest bargain ever offered the physical culture world. Tear off the coupon before you turn the page. And don't forget to mail it TODAY.

Just write your name and address on the coupon—that's all. Pay the postman when he delivers your outfit. And remember, YOUR MONEY RIGHT BACK if you don't agree that this is the greatest bargain ever offered the physical culture world. Tear off the coupon before you turn the page. And don't forget to mail it TODAY.

**The Hercules Co., (Dept. P-116)**  
103 E. 13th St., New York, N. Y.

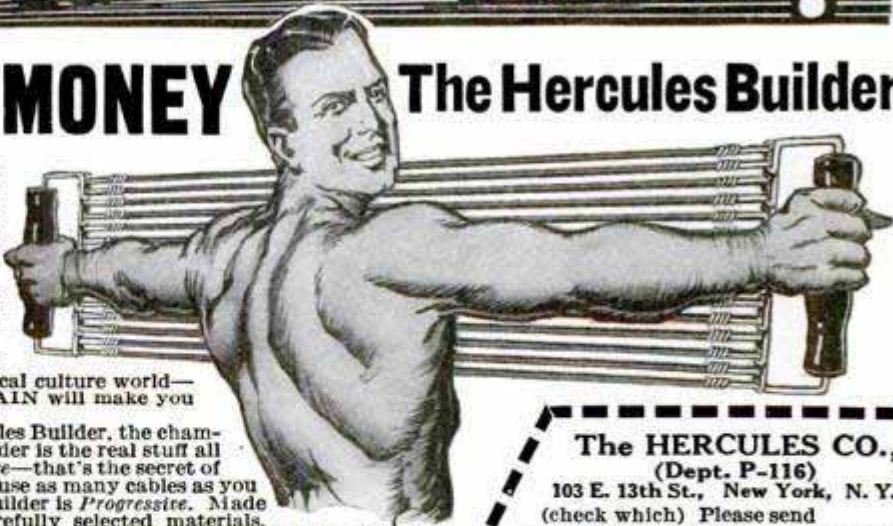

**The HERCULES CO., (Dept. P-116)**

103 E. 13th St., New York, N. Y. (check which) Please send

- 5 Cable Hercules Builder at \$1.87
- 10 Cable Hercules Builder at \$3.98
- 15 Cable Hercules Builder at \$5.75

I am sending no money and will pay postman the low bargain price plus postage on delivery. If I am not thoroughly satisfied with my Hercules Builder I will return it within a week and you agree to refund my money. Complete course of instructions and Hercules Hand Grips are to be included without extra charge.

Name.....

Address.....

City..... State.....

**5 Cables** (develops over 200 lbs. resistance) for \$1.87

**10 Cables** (develops over 400 lbs. resistance) for \$3.98

**15 Cables** (develops over 600 lbs. resistance) for \$5.75

Note: The quality is the same with any number of cables. Instructions and Hand Grips included with each.



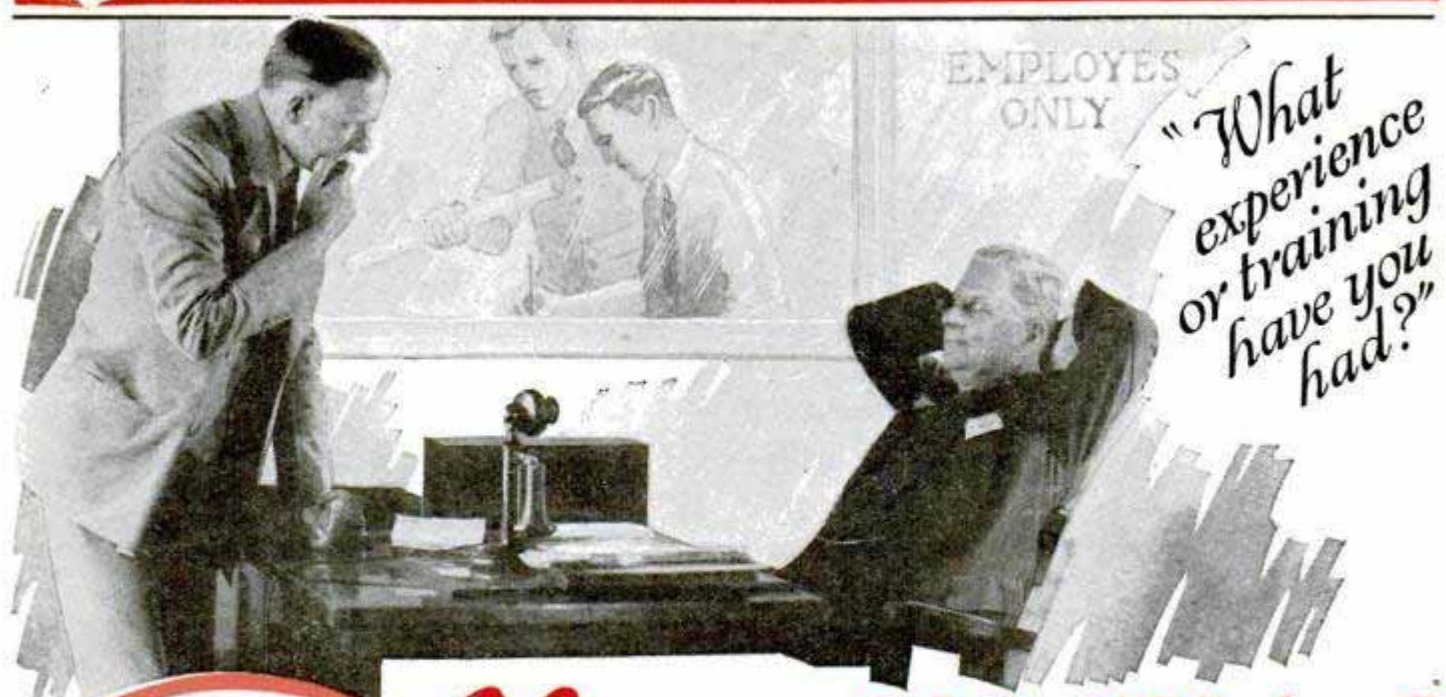

**Go Into DRAFTING!**

Drafting has become a fundamental, ESSENTIAL profession. It is the motive-power underlying all building construction, all engineering, all manufacturing, all public-works. No man can get very far in any of these fields without knowing how to make and read PLANS. Destroy all blue prints, and you will throw thirty million men out of work and stop all the wheels of commerce and transportation — until new plans could be made. Drafting is fascinating work that grips you in a way no other work can. And you'll like the good-natured atmosphere of a Drafting office, and you'll enjoy the friendship of the fine class of men employed there.

**Learn at Home, In Spare Time!**

Drafting is easy to learn by our one - step - at - a - time JOB METHOD. We give you actual Drafting-room jobs to do. And we've figured out how to present them so you can't merely COPY them. For "copying" makes TRACERS and our system develops REAL DRAFTSMEN.

There's a tremendous demand for expert Draftsmen today in the booming building field. In the great automotive industry. In the ten-billion dollar electrical business. In all mechanical and manufacturing lines. By railroads, municipal, state and federal governments.

Drafting offers you the QUICK-EST WAY TO BIG PAY. It guarantees you rapid promotion, and a happy, prosperous and successful future.

*You can't bluff him!*

The man who does the HIRING is usually a wise old bird. He's trained to buy EXPERT SERVICE and you can't sell him anything "just as good." He can spot a bluff a mile away and around the corner. He asks you FACTS, not fancies. "What experience have you had? Just what specialized training have you for this job? What proof can you show me of your fitness for this opportunity?"

**Face the Truth!**

Compare what you have to offer the Employment Manager with what he demands. If you find you're short of the specialized skill he requires, better set about to get it, and then you'll find a warm welcome—for employers are always as eager to land a good man, as you are now to land a good job. And don't forget that men aren't hired on the "general education" they may claim. It's what you

have done to improve yourself after you left school that COUNTS MOST!

**That "June Terror"**

Conditions are different than they were a few years ago. It's true enough that men you know were able to "get by" in the past with little education. But today you must fight better educated men in your battle for success. Remember this—each June you are shoved back half a million places! For each June the high-schools and the colleges of the U. S. are turning loose an army of 565,000 graduates. These men are pushing their way into the offices, factories and drafting rooms. They are elbowing men with LESS EDUCATION AND NO TRAINING out of the way. They will grab off the jobs and the promotions you hoped for. And where in the past it didn't matter—much—whether you improved yourself or not, NOW IT'S BECOME ALMOST A MATTER OF LIFE AND DEATH. And if you doubt it, just ask any employment manager what your chances are today—with neither education or training.

O. C. MILLER, Director Extension Work



Dept. DB-74, Drexel Ave. & 58th St., CHICAGO



"That's a fine bunch of Working Drawings"

"Start work tomorrow morning"



O. C. Miller

plans and draft them. It's funny to see what a pleasant, good-natured fellow the employment man becomes when he sees the proof that you can fill the bill. You know when the Chief Draftsman needs a good draftsman quick, he NEEDS him! Learn Drafting, learn it the way we teach it, learn the engineering end of drawing plans, and getting the job you'd give most anything for today, will take care of itself, almost.

### First, Training!

The American School has been teaching men Drafting, at home, in their spare time, for over 30 years. Sixteen of America's most noted Engineers have built this Drafting instruction. It starts you off Drafting—the way they do it in the big architects' and engi-

neers' offices, and it leads you along by easy stages until you get every branch of the advanced work. Every job you practice, every lesson you do, has been built so men with little education can understand them. One of our graduates is Deputy Building Commissioner of Chicago. Another is Chief Draftsman of the oldest architectural firm on the Coast. Thousands of others are holding down important positions at BIG SALARIES. If you are wise, you will go after that kind of training with no urging from us or anyone else.

### Then, Employment

Don't worry about "selling" yourself to the hiring-boss when you have that kind of training and practice tucked away in your head and finger-tips. Your "samples" will sell you, OR WE WILL HELP YOU TO! For it's part of our course, part of the service you pay for, to help you get placed, as well as trained. To help you get the JOB as well as the preparation for the job. The American School has included a real, national employment service in its training contract for the past 3 years. UNDER PENALTY OF MONEY REFUNDED.

O. C. MILLER, Director Extension Work

**School**

Dept. DB-74, Drexel Ave. & 58th St., CHICAGO

\$60 to \$125  
a Week

Over a period of 30 years, our students averaged \$25 a week when they began their training. And after finishing this course, they report salaries ranging from \$40 to \$125 a week and more. A few have gone into the \$10,000 to \$15,000 class. Most of them are earning \$75 to \$100 a week.

This pay-raising training may be secured on small monthly payments, which we agree to refund if your pay is not increased at least 50%—if you do not secure a good drafting position after you finish.

**START!**  
with the Coupon

Get our training and employment service agreement. Get the facts about your opportunities in Drafting. Find out how easily you can learn it. Look into the "JUNE TERROR"—a booklet we'll send you which tells about conditions today, and the dangers now facing the untrained man. Coupon brings ALL—Mail it today!

O. C. Miller, Director Extension Work:  
THE AMERICAN SCHOOL  
Dept. DB-74, Drexel Ave. and 58th St.,  
Chicago.

Send Free

- Facts about Drafting opportunities and training.  
 Booklet "THE JUNE TERROR."

To.....

Address.....

Age..... Occupation.....  
without cost or obligation.



# Learn Autos in Los Angeles

**Practical Shop Training  
System has  
Helped 17,000  
Men to Earn  
\$50 to  
\$125 a Week**



## Free Employment Service

Jobs are open now paying \$200 to \$500 a month. National will quickly train you for one of these jobs. You perform actual work, under personal supervision of expert instructors, on a half-million dollars worth of new automotive equipment. Superior advantages of National training bring students to California from all parts of the world. In 25 years National has trained 17,000 to make more money.

## Get your Money's Worth Get Practical Training—Not a Rush "Course"

National operates on a system that helps Students to success. We teach you everything about autos and you train here until you are competent. Stay in each department as long as you like. Our students are satisfied. They are making good because they graduate completely trained. Employers are eager to get National trained men. We help you get jobs and promotions. We help you get part-time jobs to pay your expenses while training.

*Paul Briggs of Portland, Oregon, was earning \$100 a month. National training raised his income to \$335 a month.*  
*Alex Hall was a clerk. Now he owns a \$15,000.00 business. "National training did it," he says.*  
*Nineteen-year old Wright Fernley of Bountiful, Utah, increased his earnings 100% after training at National.*  
*Don B. Sterling stepped out of National right into a \$75 a week job in Los Angeles.*

**FREE BOOK** Learn what this auto school offers you. Mail coupon now for big illustrated Auto Book telling how you can get a big-pay job in the fast-growing auto industry.

# NATIONAL

**AUTOMOTIVE &  
ELECTRICAL  
SCHOOL**

Dept. 700 4006 Figueroa St., Los Angeles, California

Send me the big, FREE National Auto Book that explains how I can get a big-pay Auto Job.

Name \_\_\_\_\_

Address \_\_\_\_\_

City \_\_\_\_\_

State \_\_\_\_\_



# LAW *Free Book*

Write today for FREE 125-page book, "THE LAW TRAINED MAN," which shows how to learn law in your spare time and earn more money. Qualify for a high salaried executive position or prepare to enter the practice of law. Study at home through the Blackstone Course prepared by 80 prominent legal authorities including CHIEF JUSTICE WILLIAM HOWARD TAFT. Blackstone graduates practicing law everywhere. L. L. B. degree conferred. Magnificent 25 volume law library furnished immediately upon enrollment. Moderate tuition fee. Low monthly terms. Money Back Guarantee. Write for book today.

**Blackstone Institute, Inc.,** 4753 Grand Blvd., Chicago  
America's Foremost Non-Resident Law School



## HERE AT LAST—

A Home Study Course in Sign Painting—Decorating—Show Card Writing—Graining and Marbling—taught by MOVING PICTURES. We give you a Moving Picture Machine for use in your own Home with our course. Write for full particulars.



**National Painters and Decorators School**  
Room 700, 160 N. Wells St., Chicago, Illinois

# LEARN the Movie Way

## LEARN A REAL TRADE

Be a Linotype Machinist-Operator. Good pay—steady employment. Write Room 40, 211 High Ave., Cleveland, O.

## ELECTRICITY LEARN AT HOME

By the most modern plan. Get into the big-paying jobs, study the factory way, where dynamos, motors, etc., are made. Write today for our special offer.

**LOOMIS ELECTRIC CO.,** 1427 N. ARTESIAN AVENUE  
CHICAGO, ILLINOIS



**SAFE!** MAKE PULLETS LAY EARLY. Knowledge is Power! Eliminate guess work. Let world's greatest poultry school show you quickly by mail how to get more EGGS—make more money. Write for free book. State kind of poultry you like. **AMERICAN POULTRY SCHOOL**, Dept. 70 Kansas City, Mo. *Free book*

## Strength

is not so much muscle as skill. Police Captain Wallander's illustrated "Physical Training Manual" explains fine points of Jiu Jitsu, Boxing and Wrestling. Makes you invincible. A complete course in physical culture, astounding police secrets and simple health rules. Sent C. O. D. for \$1.97 plus postage. Siebel Press, 34-J W. 20 St., New York, N.Y.

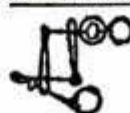

**200** Kinds of **IRON, WOOD and WIRE PUZZLES.** Leader and Illustrated List 10 cents.

**WESTERN PUZZLE WORKS, St. Paul, Minn.**



## LEARN to PITCH

Lessons by "MATTY," ED. WALSH, "DOC" WHITE, WALTER JOHNSON, "NAP" RUCKER, "SMOKY JOE" WOOD. **PITCH THE FADE-A-WAY, SPITTER, KNUCKLER, SMOKE BALL, etc.** Clearly Described and Illustrated by 56 Pictures. Entire COURSE OF LESSONS SENT POSTPAID for 50 cents.

**BENEDEK, 2300 N. Mason Avenue, CHICAGO, ILLINOIS**

## YOU CAN OIL PAINT

Amazing new method teaches men or women to earn after first lesson. **OIL PAINT** photos—portraits, landscapes or art subjects. Earn \$18 to \$50 and more a week. **OIL PAINT OUT-FIT GIVEN.** Send now for free illustrated book. **PICTORIAL ART STUDIOS Inc.** Dept. MP, 2926 Broadway, Chicago, Ill.

## TELEGRAPH—RADIO

\$18 to \$35 a week while training for Radio and Telegraph Operator jobs at \$150 to \$300 per month. Write for particulars.

**CHICAGO TELEGRAPH INSTITUTE**  
Dept. 1-7-7 1338 S. Michigan Avenue, CHICAGO

**WANTED**—Volume 1, Number 1, January 11th, 1902, issue of Popular Mechanics Magazine. Must be intact and in at least fair condition. Will pay \$1 for same. Communicate with Manager, Book Department Popular Mechanics, 200 E. Ontario St., Chicago, Ill.



# No More Razor Blades To Buy!

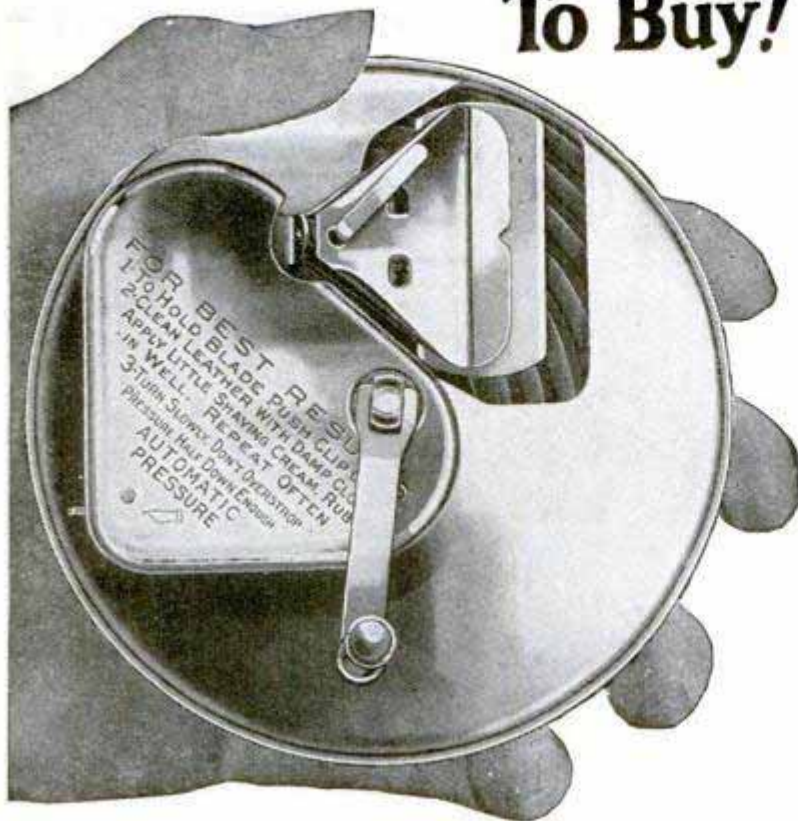

## 365 KEEN SHAVES A Year With One Single Blade

"I want to say that KRISS-KROSS Stropper is the best thing I ever saw. I have been using one blade continuously for one year and nine months and have no idea how much longer it will last."  
C. S. Stephenson, Okla.

# Inventor Discovers Amazing New Way to Shave! -Without Buying Blades!

**K** EEN, velvety shaves forever and no more blades to buy! That's what the astonishing invention of a St. Louis man offers the great army of American shavers today!

KRISS-KROSS is destined to revolutionize all existing traditions of shaving! Its performance is so sensational that it seems hardly fair to call it a stropper. Rather it is a *super-stropper* or blade-rejuvenator! No longer do you find that your blades "die" after five or six shaves. KRISS-KROSS "brings 'em to life" a surprising way! Actually—you can take a blade right out of a fresh package and improve it as much as 100% in eleven seconds with KRISS-KROSS!

### MAGIC DIAGONAL STROKE

KRISS-KROSS employs the famous *diagonal stroke*, same as a master barber uses. Never before has anyone captured the secret of reproducing it automatically. Eight "lucky leather grooves" do the trick in 11 seconds with a precision it takes a master barber years to attain. Stropps from *heavy to light*. Adjustable, automatic jig flies up and notifies you that your blade is ready—*ready with the keenest cutting-edge that steel can take!*

KRISS-KROSS produces unbelievable sharpness and prolongs the life of any razor blade for months and even years. Fits all brands and makes except Durham. Eliminates 83% of shaving costs and solves your blade problem for all time!

### SENSATIONAL OFFER

And now for my surprising offer. To introduce KRISS-KROSS, I am giving with it Free a new kind of razor. Possesses

**Rhodes KRISS KROSS**  
RHODES MANUFACTURING CO. **STROPPER**

Dept. H-371 1418 Pendleton Ave. ST. LOUIS, MO.  
Largest Manufacturers of Mechanical Stroppers in the World.

remarkable features. Instantly adjustable to any shaving position. A flip of the finger makes it (1) T-Shape; (2) straight (old style); (3) or diagonal (new way). Gives a *sliding* instead of *pulling* stroke. Simply zips right through the toughest crop of whiskers. Made of *rustless* metal. Comes with 5 special-process blades and is entirely unlike anything you ever saw before!

### GET FREE OFFER

Send for full information on these surprising new inventions today. KRISS-KROSS products are never sold in stores. You deal direct with me or my authorized representative. Write for illustrated description and full details of free razor offer. It's even more remarkable than I can tell you in this short space. Clip the coupon now. Mail it today.

### Agents \$30 a Day and Up

Make big money with KRISS-KROSS. Giving away FREE razors boosts your profits amazingly. H. King made \$66 in one day. N. C. Paige made \$104 in 3 days! Others average \$350 and up to \$750 a month! *Spare-time* workers, *Office* and *Factory* men make \$6-\$12 extra a day showing KRISS-KROSS to friends and fellow employees. S. Kantala made \$154 extra just working evenings 3 weeks. Get details at once. Check bottom of coupon and mail it tonight!

Rhodes Mfg. Co., Dept. H-371,  
1418 Pendleton Ave., St. Louis, Mo.

Without obligation, please send me illustrated description and full details of your special introductory offer on KRISS-KROSS super-stropper and FREE 3-way razor.

Name.....

Address.....

Town.....State.....

( ) Check here if interested in making money as authorized KRISS-KROSS representative.



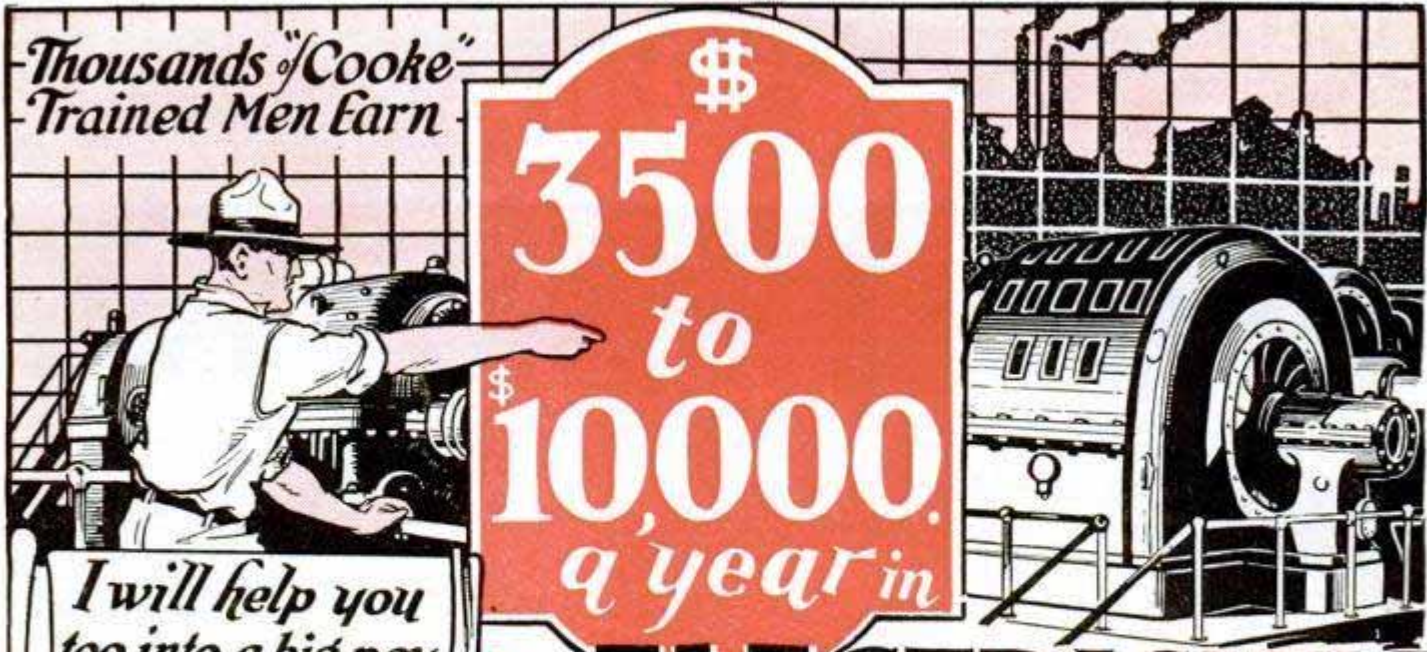

Thousands of "Cooke"  
Trained Men Earn

**\$**  
**3500**  
to  
**10,000.**  
a year in

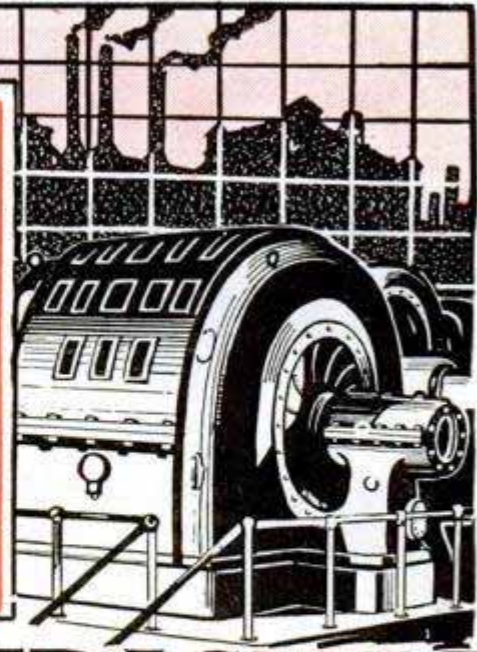

I will help you  
too, into a big pay  
job *L.L. Cooke*

**ELECTRICITY**  
*The* **BIG PAY FIELD**

**LOOK WHAT I'VE  
DONE FOR  
THESE TWO MEN**



**\$75 A WEEK!**  
"Dear Mr. Cooke: I was working in a store for \$18 a week when I started your Course. Then I began doing Electrical Work in my spare time. Now I average as much as \$75 a week."  
J. Wollaston  
104 Robin St.,  
Dunkirk, N. Y.



**\$65 A DAY!**  
"Dear Chief: If it hadn't been for your wonderful Course I wouldn't now be making as high as \$65 a day. It makes me proud to have your Diploma. And believe me I am a booster for your Course."  
Jacob Lentz  
1223 1st Ave.,  
Hillsboro, Ore.

**GET** a real job — be able to afford the better things of life— learn to make \$70 to \$200 every week instead of a mere \$25 to \$35— jump into Electricity and join my thousands of "boys" who are now earning \$3,500 to \$10,000 a year! You can do it—it's easy—I'll show you how in so short a time you'll be amazed!

**Electrical Men In Big Demand**

Even ordinary electricians—the common "screw driver" kind are making big money. But the Trained Man—the man who can plan and boss and supervise the work of others—is needed everywhere today at \$300 to \$900 a month! And thousands of "Cooke" Trained Men are getting this big money right along! Don't YOU be satisfied with anything less!

**Learn At Home**

You don't need a College education nor a High School diploma to learn Electricity from me. And you don't have to quit your job nor even lose a single hour's pay! With my famous "Work Sheet" and "Job Ticket" Method I train you at home. And I train you right! You get not only theory but practice! I give you Six Big Working Outfits without extra charge so you learn by doing! That means you learn Electricity right—learn it so you can quickly become a Big-Pay Man in this Big-Pay field!

**L. L. COOKE**  
—the man who has trained and helped thousands of men.

**Earn While You Learn**

Not only do I give you an electrical training that is thorough and complete—the training that Electrical Experts recommend and Electrical Companies select for their employees—but I show you, right from the start, how to make spare time money doing little electrical jobs that more than pay for the entire Course! Later comes the Big Job and the Big Pay—an income large enough to make you independent the rest of your life!

**Get Started — Mail Coupon!**

You want big money—you want to get into work where men are in constant demand. Then act! Get my Big Pay-Raising Book. It's free. Shows why "The Cooke Trained Man is The Big Pay Man" everywhere and always! Shows how easily YOU too can become a "Cooke" Trained Man with a real honest-to-goodness income. Get started. Mail coupon at once!

**L. L. COOKE,**  
Chief Instruction Engineer  
**L. L. COOKE SCHOOL  
OF ELECTRICITY**  
Dept. 1-B  
2150 Lawrence Ave.  
Chicago, Ill.

Free of  
**EXTRA COST**  
**6 BIG  
OUTFITS**

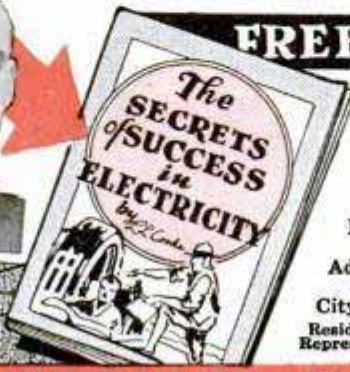
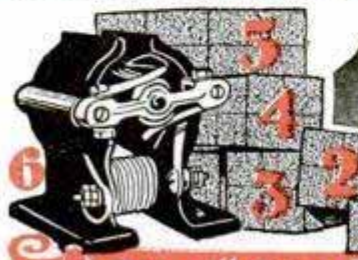

**FREE BOOK COUPON-MAIL IT!**

**L. L. COOKE, Chief Instruction Engineer**  
Dept. 1-B, 2150 Lawrence Ave., Chicago, Ill.

You may send me, entirely Free and fully prepaid, your book, "Secrets of Success in Electricity" together with facts about your Home Study Course in Electricity.

Name \_\_\_\_\_  
Address \_\_\_\_\_  
City \_\_\_\_\_

Residents of Canada may send this coupon to R. A. Farrow, Special Representative, 7 Medbury Lane, East, Windsor, Ontario, Canada.

**The "Cooke" Trained Man is the "Big Pay" Man**



# Classified Advertisements

## WORLD'S BEST WANT AD MEDIUM

Advertisements in this section, 30 cents per word, each insertion, minimum 10 words, payable in advance. To be inserted under proper classification in August issue, copy should be in our office June 18th

### ADVERTISING AGENCIES

**SECURE** Business in other cities. Increase your business by going after out of town trade. Manufacturers, jobbers, wholesalers, importers, etc., can open an entirely new avenue for sales by advertising for Agents and Salesmen. Need not interfere with your other business. Many enterprising big concerns now invading direct field. Names on request. Our Service department guides you on every detail. Copy and literature composed free. Your 24 word ad (4 lines) inserted in the following 20 leading Sunday papers for only \$25.00. Four million circulation (20 million readers). Journal, Atlanta; Tribune, Chicago; Star, Indianapolis; Journal, Sioux City; Eagle, Wichita; Sun, Baltimore; Post, Boston; Free Press, Detroit; Tribune, Minneapolis; Post Dispatch, St. Louis; World Herald, Omaha; Courier, Buffalo; Enquirer, Cincinnati; Oklahoman, Oklahoma City; Press, Pittsburgh; Banner, Nashville; News, Dallas; Times Dispatch, Richmond; News, Wheeling; Journal, Milwaukee. Proof of insertion guaranteed or money refunded. 52 page rate book sent free. Frank W. Lenhoff Advertising Agency, 600 North Michigan Blvd., Chicago. (Established 1897). Chicago's Most Progressive Advertising Agency.

A TEN Dollar Ad may put your proposition over. \$10 pays for a 4 line 24 word classified ad one Sunday in 9 of the largest newspapers. Reach over 6 million readers. Minneapolis Tribune, Buffalo Courier, St. Louis Post-Dispatch, Pittsburgh Press, Indianapolis Star, Atlanta Journal, Birmingham News, Cincinnati Enquirer, Little Rock Gazette. Free catalogue showing other lists of newspapers and magazines sent on request. Ankrum Advertising Agency, 23 West Jackson Blvd., Chicago. Largest classified advertising agency in the world.

**ADVERTISE** in 24 Big Sunday Newspapers. 24 words \$15.00. Excellent for securing Agents, Salesmen, and Business Opportunities. Catalog listing 1,000 leading Dailies, Weeklies, Mail Order Magazines, Everything. Free. Wade Advertising, Baltimore Bldg., Chicago.

**NEWSPAPER** — Magazine advertising — Classified, mailorder, Catalog. Martin, 276B West 43rd, New York.

**SIX** Word Line — 355 rural weeklies \$3.55. Admeyer, 4112-M Hartford, St. Louis.

### FOR ADVERTISERS

**ADVERTISERS** (not curiosity seekers), write for advertising rates on all papers for prompt service to Stanley Day Agency, Plainfield, N. J.

**CUTS** Engraved. Lowest prices. Wine-holt Sales Co., Woodbine, 4, Penna.

**"CONTEST** Magazine, Rates: \$1.00 inch. Beautiful Painted Art Covers. Devoted—Authors, Salesmen, Dealers. Copy 10c. La-Belle, Box 592, St. Paul, Minn.

**ADVERTISE** in 275 country newspapers, 28 words, \$10. Keator, Hartford Bldg., Chicago.

**CUTS**, Drawings \$1.50. Window Cartoons, 6, \$1.50. GPO, Bx471, New York.

**40 WORDS** insert 70 magazines \$2.00. Empire Agency, Shawano, Wis.

### SALES PROMOTION

**\$50 TO \$50,000** Daily Sales Developed During 28 years for clients by our direct mail plans, copy, campaigns. One product, 1923, an idea; this year \$100,000 orders booked. Fifty year old concern desired 50 national representatives in 1925; we produced 40 in three months. 700 dealers in 10 months at \$3 each, for another. Ten years Sales Promotion Manager Larkin Co. Submit sales problems for Free diagnosis. James C. Johnson, 118A Woodbridge Ave., Buffalo.

### LETTER SPECIALISTS

**POWERFUL** Letters coax checks—orders—inquiries, \$5.00. Investigate Finkel, 15 Fairview, Jersey City, N. J.

**"DODDS-Cedar Rapids-Iowa."** Writes Letters—selling anything. "Copy-Expert." Fees reasonable.

### AUTOMOBILE SUPPLIES

**HEADLIGHT** Telltales securely attached to lens. No drilling. 25c and 50c a pair. The Handy Dental Specialty Co., Somerville, Mass.

**BATTERY** and Tire Shop Equipment and Supplies at wholesale. Send for catalog and state business in which you are interested. Adams-Barr, Columbus, O.

**YOU** Are Wanted to Resilver Mirrors at Home. Immense profits, plating autoparts, headlights, tableware, stoves, etc. Outfits furnished. Write for information. Sprinkle, Plater, 77, Marion, Ind.

**DYKE'S** Automobile Encyclopedia. Latest 14th edition. Information on repairing and adjusting every part of all motor cars. How to find trouble and fix it. Send no money. Pay postman the postage and \$6. Popular Mechanics Press, Room 907, 200 E. Ontario St., Chicago, Ill.

**AT Last!** Reasonably priced Auto Emblems for every Lodge. Sells for only \$1.25. Write for attractive selling proposition and free Sample Case offer. North Central Distributors, Dept. 9, Ashland, Ohio.

**VULCANIZING** Auto Tires is a Paying Business. We have Plants near you from \$50 up. Catalog Free. Instruction Book \$1. Equipment Exchange, 108 East 11th, Los Angeles, Calif.

**1 AUTO** Gas Saver Free. To introduce. All makes. Amazing mileage increase. Critchlow, CI-805, Wheaton, Ill.

**CARBURETOR** Supplement to famous Dyke's Auto Encyclopedia. Just out. Deals with every make of carburetor. Just what every auto service man has long been in need of. 106 pages, 246 illus. Price \$2.00. Send for your copy today. C. O. D. if you prefer. Popular Mechanics Press, Room 907, 200 E. Ontario St., Chicago, Ill.

### AUTOMOBILE ARMATURES

**FORD** Armatures rewound like new—\$1.40 plus postage. Wrap a dollar bill around your old armature and mail to us for exchange. You pay postman balance plus postage. Satisfaction guaranteed. Southern Armature Works, Charlotte, N. C.

### AUTOMOBILES

**PATENTS.** Time counts in applying for patents. Don't risk delay in protecting your ideas. Send sketch or model for instruction or write for free book "How to Obtain a Patent" and "Record of Invention" form. No charge for information on how to proceed. Communications strictly confidential. Prompt, careful, efficient service. Clarence A. O'Brien, Registered Patent Attorney, Security Bank Building (directly across street from Patent Office), Washington, D. C. See pages 138 and 139.

**AUTOMOBILE**—Make your own motor car, toy size, operated with motorcycle engine. Any boy can make it. Costs little aside from engine. Full directions with drawings and dimensions in The Boy Mechanic, Book 3. Send no money. Pay postman postage and \$2. Popular Mechanics Press, Room 907, 200 E. Ontario St., Chicago, Ill.

**AUTO TOURISTS**—Here are 133 practical plans for making touring easier, less expensive and more enjoyable. With these we supply a Touring Atlas of the U. S. showing road maps of every state. All this information for the small price of 98 cents plus the postage. Pay postman when he delivers the package. Popular Mechanics Press, Room 907, 200 E. Ontario St., Chicago.

### AUTOMOBILE SERVICE EQUIPMENT

**BATTERY** Shop Equipment, including latest type 8-hour battery charger with full set leads, clips, etc. Reason for selling bought larger size same type. Priced to sell; guaranteed first class condition. W. E. Jordan, Box M771, Troy, Ohio.

**UNIVERSAL** Test Bench like new. Every auto shop needs one. Here's your chance to save \$75 on first-class outfit taken in on bad debt. Write to E. C. Galbreath, Box M773, Troy, Ohio.

**AUTOMATIC** Air Compressor just right for tire shop, filling station or garage. 2½ cu. ft. per minute capacity. Will sacrifice for quick sale. Guaranteed. D. C. Jenkins, Box 772, Troy, Ohio.

**BATTERY** Plates 4c, make them yourself; complete instructions \$1.00. Any formula or question answered \$1.00. Information Bureau, 94 Bonham St., Paris, Tex.

### FOR FORD OWNERS

**PUT** a "Bingo" Timer on your Ford. "More Pep—More Power." Money-Back Guarantee. \$1.50 delivered with simple instructions to install. Write for exclusive Agency—fine proposition. United Machinery Company, Cincinnati, U. S. A.

**DELIVERY** Bodies for Ford Model T. Chassis with inclosed cab, suitable for Contractors, Grocers and Farmers. Three Styles. Price \$39.50. Write Daniel Zimmerman, Craigville, Ind.

**UNDERSLUNG** with "RKO" Swing Lo Irons. See "Red-I-Kut" ad page 135.

**1 AUTO** Gas Saver Free. To introduce. All makes. Amazing mileage increase. Critchlow, CI-805, Wheaton, Ill.

**SIMPLEX** Mechanical Starter (Ford's without electric), \$7.50. American Simplex Co., Anderson, Ind.

**FORD** Electrical Equipment Troubles—Locate and remedy them easily yourself with the aid of our book "Ford Standard Electrical Equipment." Why pay big garage bills? Battery, ignition, starting and lighting covered. Order today. When postman hands you the package pay him \$1.98 and the postage. Popular Mechanics Press, Room 907, 200 E. Ontario St., Chicago.

### MOTORCYCLES, BICYCLES AND SUPPLIES

**MONEY** Saving Motorcycle Bargains—Large stock of Used Harley-Davidson—\$50 and up. Send for Free bargain bulletin—Now! Motorcycle Parts, accessories, repairs. Knuth's Harley-Davidson Agency, 2525 Fond Du Lac Ave., Milwaukee, Wis.

**MOTORCYCLES** at Reduced prices. Save 25% to 50%. Send for our Bargain Bulletin. American Motor Cycle Company, 2041-2047 Chicago Ave., Chicago.

**GOOD** Second Hand Parts for Indian, Harley, Henderson, Ace and Excelsior Motorcycles. No Junk. Ship C. O. D. No Lists. J. B. Dahl, 3661-63 Archer Ave., Chicago, Ill.

**MOTORCYCLE** Bargains. Used, rebuilt. Guaranteed. Shipped on approval. Catalog free. Floyd Clymer, 810 Broadway, Denver, Colo.

**SEND** stamp for Bargain Bulletin. All makes rebuilt motorcycles at lowest prices. Used parts half price. Ash Motor Corporation, Rochester, N. Y.

**REBUILT** Indian Motorcycles, lowest prices. Used motorcycle parts. Hurck Indian Co., 2127 Locust, St. Louis, Mo.

**INDIAN** motorcycles \$50. Standard models \$10. Deposit with order, balance C. O. D. Stern Bros., 1790 1st Ave., New York City.

### AVIATION

**LEARN** to Fly; \$100.00 including Solo. We guarantee to solo you regardless of the number of flying hours required. Our instructors are ex-army aviators and air-mail pilots with wide experience. Our training equipment is the best obtainable. Our course requires about two weeks, depending on the individual. No bond required, no charge for breakage. Eight years without an accident. 76 students graduated in 1925. Commercial aviation is a rapid growing industry. Don't delay! Enroll now in one of the oldest and best known flying schools in America. Write for booklet. Robertson Aircraft Corporation, operators of the United States Air Mail, St. Louis-Chicago, Lambert-St. Louis Airport, Anglum, Mo.

**FOR** Sale—New Cannuck Airplane, Natural finish. Extra gas tank, three-passenger, double control. Pass Government inspection. Urnston Republic, 3720-4400 W. 33rd, Chicago.



TEN lessons in the air of twenty minutes each will make you a pilot by our advanced method of training. This, together with our five weeks' shop course, at \$100.00, makes America's oldest aircraft factory the most popular flying school. Work after class hours guaranteed. Special summer evening course, including shop work, field and flying, \$185.00. Employment assistance on jobs paying \$18.00 to \$40.00 per week. Heath Airplane Company, Chicago, Ill.

**PATENTS.** Time counts in applying for patents. Don't risk delay in protecting your ideas. Send sketch or model for instruction or write for free book "How to Obtain a Patent" and "Record of Invention" form. No charge for information on how to proceed. Communications strictly confidential. Prompt, careful, efficient service. Clarence A. O'Brien, Registered Patent Attorney, Security Bank Building (directly across street from Patent Office), Washington, D. C. See pages 138 and 139.

**AERONAUTICS!** "Aeroplane engines in Theory and Practice," by Rathbun, describes engines fully. Includes all makes. For mechanic, builder and flyer. Send no money. Just order on a postal. When postman hands you book, pay him \$2.50 and postage charges. Popular Mechanics Press, Room 907, 200 E. Ontario St., Chicago, Ill.

**LEARN to fly on New 1927 Swallow Airplanes.** Ten hours actual flying, \$150.00. Send for information. Davenport Airport, Inc., Davenport, Iowa.

**THE American School of Aviation** announces a new correspondence course in Mechanics of Aviation. A thorough training in Practical Aeronautics. American School of Aviation, Dept. 1861, 3601 Michigan Ave., Chicago, Ill.

**AVIATION:** Home study course in aviation complete with blue print of airplane. Price \$5.00. Send check or money order or write for information. Dept. X, The American Society for Promotion of Aviation, 522 Fifth Avenue, New York City.

**BUILD it yourself for \$188.00.** The famous Heath "Parasol" sport plane. Safest to fly—Simplest to build. Wings come already assembled. Send 4c for "Parasol" catalog. Heath Airplane Company, Chicago, Ill.

**AIRPLANE Propellers, Brand New, 8" Diameter, Cost Government \$75.00; Sacrificed at \$3.50.** Equipment Company, Carle Place, New York.

**OUR Protector Goggles Worn by Leading Army, Navy, Air Mail Aviators; \$5.00.** Equipment Company, Carle Place, New York.

**AVIATION positions pay \$2,000 to \$10,000 a year.** Prepare for flying and ground positions thru thorough and complete home study training. Write Dept. K-7, Western Airplane Corp., Monadnock Bldg., Chicago.

**BLUEPRINTS, Prices reduced.** "Aerodrive" boats, sleds. Blueprints only 50c each. Ostergaard Aircraft, 4395 No. Narragansett, Chicago.

**PREPARE in Your Spare Time to Fly and Build Airplanes.** Flying and Evening Shop Course \$150.00. Shop Course only, \$15.00. Wallace Aircraft Co., 4710 Irving Pk. Blvd., Chicago, Ill.

**SEND dime for 12 inch mounted propeller and circulars on free three foot model aeroplane.** No selling. Aero Shop, 3650 Hurbit Ave., Detroit, Mich.

**BIGGEST, Best Catalog Model Airplanes, Parts Supplies; 5c postpaid.** Ideal Company, 165 1/2 Spring Street, New York.

**DICTIONARY of Aviation, \$3.90.** Languages Publishing Company, 15 W. 18th Street, New York.

**SEND for Bargain List of aircraft parts.** Heath Airplane Company, Chicago, Ill.

**THE Age of the Air is Here.** For reliable information on both airplane building and flying we recommend "Aeroplane Construction and Operation," by Rathbun. All features of construction treated. Send no money. Pay postman \$2.50 and postage. Popular Mechanics Press, Room 907, 200 E. Ontario St., Chicago, Ill.

### BOOKS AND PERIODICALS

**"THE Personal Liberty Course"**—A clever combination of mirth, information and instruction for quickly overcoming fear, bashfulness and physical complexes in men. No drugs, no gymnastics. Full particulars free, sealed. The Gardener Pep Club, Box 607, Station C, Los Angeles, Calif.

**FICTION!** Fact! Newest, best—10,000 stupendous pages \$2.00. Cuttingco, Campbell, Calif.

**AMERICA'S best radio text and reference book.** Third edition revised, "Radio Theory and Operating," by Mary Texanna Loomis, member Institute Radio Engineers; President and lecturer on radio, Loomis Radio College. 886 pages, 700 illustrations, flexible binding. Used by Government Radio Schools, private Radio Schools, Universities and Technical Colleges throughout United States and Canada. Comprehensive with wealth of practical information. For students, practical operators, fans and engineers. Price \$3.50 postage paid. Buy of your book store or send money order or check to Loomis Publishing Company, Dept. M, 405 Ninth, Washington, D. C.

**WHAT Subject Interests You?** Select from this list of helpful worth-while books. Social Letters Made Easy, Spelling Made Easy, How to Develop Your Will Power, Tricks and Magic Made Easy, Bookkeeping Made Easy, Chemistry for Beginners, How to Work Your Way Through College, Confidential Chats with Boys. Price \$1.25 per volume. Pay postman price and postage when he hands you the package. Address Popular Mechanics Press, Room 907, 200 E. Ontario St., Chicago.

**QUESTION and Answer fad sweeps country.** Send for a copy of the best book on this popular pastime "Ask Me Another." 2000 Questions and Answers, forty information tests with the scores of 69 people you know from all walks of life. Pay postman \$1.60 and the postage when he hands you the package. Popular Mechanics Press, Room 907, 200 E. Ontario St., Chicago.

**MODERN American Law, 15 Volumes.** New. Reasonable. J. Fitzpatrick, 1791-8th St., Milwaukee, Wis.

**SEND for our unique catalog of 5000 books listed alphabetically under subject headings.** Free on request. Popular Mechanics Press, 200 E. Ontario St., Chicago.

**ANSWERS to mathematical problems of office, store, shop, bank, farm, or factory.** Explains and simplifies every principle of arithmetic, mechanics and mensuration. Send No Money. Just ask for Ropp's Calculator." Pay postman \$1.00 and postage. Popular Mechanics Press, 200 E. Ontario St., Room 907, Chicago, Ill.

**CURIOUS Books, Unique Novelties, Stunning Pictures.** Samples, 10 cents Prepaid. Linds, 214 W. 34th Street, New York.

**INDUSTRIAL Alcohol.** Wright's book. Full directions for making, fully illustrated. \$2.50. Spou & Chamberlain, 120 P.M. Liberty Street, New York, N. Y.

**PUZZLES!** If you like them we recommend an illustrated book containing 122 of the best Mechanical Puzzles. You can have loads of fun working out the solutions as enough hints are given in the text matter to enable one to do so. Pay postman \$1.00 and postage when he hands you the package. Address Popular Mechanics Press, Room 907, 200 E. Ontario St., Chicago.

### PICTURES AND POSTCARDS

**THIRTY views, City of Detroit, twenty-two views Belle Isle Park; twenty views, Ford plant, world's largest; twenty views Detroit's largest industries, hotels; twenty views, Beautiful Parks, Detroit; fourteen panoramic views Detroit.** Folders 4x6, views in colors. Mention views wanted. Each folder 10c, six folders 50c, postpaid. Atlas View Co., Dept. A, Box 681, Detroit, Mich.

**FLOWER Post Cards of exquisite beauty.** Latest importation; made by a new color photo process, direct from nature. 50 different Cards for \$1.00. Sell easy 5c apiece. K. Baumann, 134 Warren Ave., Roselle Park, N. J.

**JOIN Live Postcard club, Membership Lists including Catalog 10c.** Harvey Teeple, Decatur, Ind.

**ART Pictures, Books and Novelties.** Catalog 10c. Howard Sales Co., Dept. 15, 1188 Folsom St., San Francisco, Calif.

**20 CEYLONESE Girl Models.** Dollar bill. Art Photo Galleries, 10 Temple Road, Colombo, Ceylon.

### MAGIC TRICKS, BOOKS AND JOKER NOVELTIES

**NEW 1927 "Fun—Magic—Mystery" now ready.** 100 Pages, profusely illustrated. Over 750 Tricks—Illusions—Jokes—Puzzles—Books—European Novelties, at Reduced Prices. Postpaid 10c. Lyle Douglas, Station A, Dallas, Texas.

**AMUSEMENT? Party?** Send for our list of laugh producers. Sepec Co., 4636 Drake Avenue, Chicago.

**MAGIC—Tricks, Books and Supplies.** For Amateurs as well as the great professionals. Anyone can learn through our instructions. Feature Acts in Mind-Reading, Spiritualism, Rope Ties, etc. Large illustrated Professional Catalog, 20c. Chicago Magic Co., 140 So. Dearborn St., Dept. B, Chicago, Ill.

**COMPLETE Book on Magic.** 563 pages, 318 illustrations. Hundreds of tricks. The standard book for years. Make money giving magic entertainments. Send no money. Just ask for Prof. Huffman's "Modern Magic." Pay postman postal charges and \$2.00. Popular Mechanics Press, Room 907, 200 E. Ontario St., Chicago, Ill.

**SEVEN Magical Delusions and Catalogs—25c.** Gilmagico, Morgan Park, Ill.

**MAGIC Trick Cards That Are Absolutely guaranteed.** Free samples. Write me today. C. D. Blankenship, Adrian, W. Va.

**FREE with \$25 order die box.** Send 20c for our large catalogue of tricks, wigs, sensational escapes. Oaks Magical Co., Dept. 548, Oshkosh, Wis.

**ELECTRIC Fun!** Seventy stunts, 110 volts, \$1. Tacutting, Campbell, Calif.

**CARD tricks.** Coin tricks, Hypnotism, Ventriloquism. 64-page books. Complete guides 10c each. Geo. Fenner, 2401 Jefferson, Louisville, Ky.

**125 CARD tricks, 25c.** Catalog free, Wineholt Sales Co. Woodbine, D4, Penna.

**105 ARTICLE Trick, Magic Catalogue 10c.** Bagdag, 716 Pine, St. Louis, Mo.

**READ Sealed Messages in Dark; messages retained by audience; burned message appears on blank slate; spirit message appears on slate in sitter's presence; spirit rappings; spirits appear in the dark; answer questions written on folded papers while blindfolded.** All this you can do with directions in "Behind the Scenes with The Mediums." 69 best secrets of mediums fully exposed. The best because most baffling, yet all easy to do. Send no money. Just write a postal. Pay postman \$1.50 and postal charges. Popular Mechanics Press, Room 907, 200 E. Ontario St., Chicago, Ill.

### GAMES, ENTERTAINMENTS AND PLAYS

**VENTRILOQUISM** taught almost anyone at home. Small cost. Send 2c stamp today for particulars and proof. George W. Smith, Room S-193, 125 N. Jefferson Ave., Peoria, Ill.

**CHALK-TALK** your way to popularity. Audiences at your feet if you learn how to entertain with a few simple pictures. Little artistic ability needed. "How to Chalk Talk" tells what to say and what to draw. Profusely illustrated. Make \$1 and more a night. Send no money. Just order on a postal. Pay postman \$1.00 and postage. Popular Mechanics Press, Room 907, 200 E. Ontario St., Chicago, Ill.

### NOVELTIES, CURIOS, ETC.

**UNIQUE Key-holder.** Complete elephant head, beautifully made of aluminum; tusks lock and release key-ring a novel way. Fits any belt. 25c postpaid. Fran Mfg. Co., Wilmerding, Penna.

### STAMP COLLECTING

**NOBODY** knows what is happening in China; but we know that Scott Seald Packet No. 277 will certainly please you, for it has in it the Dragon stamps of Imperial China, the Junk and Reaper stamps of the later Republic issues, many surcharges and interesting postage dues. This bargain packet contains 25 guaranteed genuine stamps for only 25c. Other fine Scott Seald packets to pep up your album pages; No. 68, 100 Diff. from Fifty Different countries, 25c. No. 8, 1,000 diff. (general collection), \$1.00. No. 152, 100 different from Europe, 10c. No. 67, 100 diff. of the beautiful French Colonials, 40c. No. 146, 200 diff. from Austria, only 25c. No. 202, 50 different from Wurtemberg, 25c. The Scott price list which is free contains hundreds of sets, dime sets, packets, illustrates Scott albums, hinges, tongs, magnifying glasses, watermark detectors and other accessories. Ask us to send it to you when we fill your packet order. International Junior Postage Stamp Album, 1927 Edition. Spaces for 21,000 stamps. Fully illustrated. No. 1, Attractive blue cover, red corners, \$4.00. No. 2, Bound in cloth, gilt lettering, \$5.00. Forwarding extra; weight 6 lbs. Scott Stamp & Coin Co., 1 West 47th Street, New York, N. Y.

**APPROVAL** books 50% and 25% discount. Premiums. Noemus Stamp Co., 312 East 23rd St., New York.



500 DIFFERENT Stamps for 25c! Big Collection 500 Different Stamps from Bosnia-Herzegovina, Crete, Epirus, Hong Kong, Iceland, Kenya and Uganda, Liberia, Malta, Nyassa, Tanganyika, Wallis and Futuna, Zanzibar, and other "hard" countries. Catalogue value \$10.00. Price only 25c to Approval Applicants! Special Bargains: 1,000 different 7c; 15 triangle stamps 4c; 100 Africa 5c; 100 Asia 6c; 100 Balkan States 3c; 100 British Colonies 25c; 100 French Colonies, 30c; 100 Portuguese Colonies 5c; All 8 packets for \$3.00! Illustrated Lists Free. Loma Stamp Co., 2221 Madison Ave., San Diego, Calif.

**MYSTIC'S "Queer Country" Packet!!** Contains scarce stamps from the following strange lands: San Marino, Antioquia, Congo, Cyprus, Fiji Islands, Gwallor, Hyderabad, Iceland, Jhind, Kenya, Uganda, Lebanon, Monaco, North Borneo, Nyassa, S. Thomas Prince, Port. Guinea, Siam, Sierra Leone, Tanganyika, Trinidad Tobago, Uoangi, Upper Volta, Wallis Futuna, Zanzibar. Get this wonderful packet of "freak countries" and make your friends envious! Price only 10c to approval applicants! Write today. Mystic Stamp Company (Dept. 8), Camden, New York.

**ANCHERS \$\$\$ Outfit—only 12c!** Fine triangle stamp; set German stamps with (pre-war) value forty million dollars (interesting!); perforation gauge, mme. scale; small album; airmail set; scarce stamp from smallest republic on earth; newspaper set; packet good stamps from Travancore, Malay, Dutch Indies, etc. Entire outfit for 12c to approval applicants! (Nice pocket stock book, value 25c, with every order!) Ancher Stamp Co., 148 1/2 Clerk St., Jersey City, N. J.

**\$1.00 FREE.** Black U. S. Postage. Given Away with each order. Pioneer Stamp Album with 500 illustrations, 150 different stamps from 40 countries, Syria, Lebanon, Hejaz, Liberia, New French Colonies, British, Portuguese Colonies, South Africa, Australia, 500 hinges, 36 page illustrated catalogue, All for 15c. Big Commission to Agents for the Best approval sheets of stamps ever offered. Write for sample outfit. Hussman Stamp Co., Dept. M, 620 Olive St., St. Louis, Mo.

**A SNAP—300 Different Foreign and 60 Different U. S. Stamps,** including \$1 and \$2 revenues, all for only 25c. Free, with each order, our pamphlet which tells "How To Make a Stamp Collection Properly," together with our price lists of albums, supplies and hundreds of bargains in sets, packets, etc. Queen City Stamp & Coin Co., Room 36, 604 Race Street, Cincinnati, Ohio.

**GET in on this.** Collection 50,000 varieties broken up for approvals and Want Lists. Liberal Discount. Reference Required. Tower Stamp Co., 42 Westville St., Dorchester, Mass.

**\$15.00 FOR 25c.** Something different. Rare Airmail Stamp Cat. \$9.60; a Fine Flown Cover; 10 mint Airmail stamps. All for 25c to applicants for our super approvals. References required. A real premium for intelligent collectors. Arthur Barger & Co., 839 Beacon Street, Boston, Mass.

**FREE—200 different stamps to collectors** desiring approvals. Lee, 539 South Salina, Syracuse, N. Y.

**STAMPS sent on approval.** Write us. Pine Tree Stamp Co., Box 150, Lewiston, Maine.

**100 FOREIGN Postage Stamps for 4 cents** postage to those requesting our approvals. Write for our free premium offer and lists of low price sets and packets. Palmer Stamp Co., 8221 Linwood Ave., Detroit, Mich.

**FREE Wallet, Gauge, 100 Stamps and Hinges,** if Approvals Requested. Postage 4c. Berkeley Stamp Co., Box 76 South, Berkeley, Calif.

**100 DIFFERENT,** from 35 countries, 7c. Leufbery, Port Orange, Fla.

**SEND Dime—Modern Approvals.** Free Premiums! Sets—Packets and Supplies. Marney's, 400 Broadway, East St. Louis, Ill.

**COLLECTORS! 100 Stamps Free to Approval.** Sets Applicants. Weishaar's, 5813 North Artesian Ave., Chicago, Ill.

**VERY Special—500 Different 25c, 1,000 different 75c.** Ask for price lists and approvals. Cleveland Stamp Co., Caxton Bldg., Cleveland, Ohio.

**MOST Sensational values; over 140 diff.** Algeria, Airplanes, Azerbaijan, Barbadoes, Cameroun, Gabon, Guyane, Irish set, large French Colony packet, largest stamp, 40 year old U. S., gauge, etc., for 10c to approval applicants. List free. 100 diff. U. S. 25c—1,000 hinges 9c—50 Bavaria 7c. Hawkeye Stamp Co., Cedar Rapids, 39, Iowa.

To approval applicants enclosing 10c for our Marvel Packet of 55 different from Gabon, Togo, etc., we will send—absolutely free—a genuine scarce South African triangle stamp! Curban Stamp Co., Gloucester, Mass.

**105 CHINA, etc., 2c.** Album (500 illustrations) 3c. Bullard, Sta. A. Boston.

**STAMPS sent on approval at 70% discount.** Reference required. Emory Renoll, Hanover, Pa.

**CANADIAN—25 different only 10c** and asking to see our Excellent Approvals; receive Beautiful Confederation Jubilee stamp, 5 Newfoundland and Bargain Lists free. Victoria Stamp Co., London, Canada.

**DANZIG Stamps Free—Interesting packet** from Danzig with big catalogues free for 2c. Midland Stamp Company, Toronto, Can.

**50 DIFFERENT United States 10c.** 60% approvals. Reference please. Seidenberg, Baroda, Mich.

**\$10.00 FOR 25c.** A choice assortment of 500 all different stamps guaranteed to catalogue over \$10.00, offered to approval applicants for only 25c. Edgewood Stamp Co., Dept. C, Milford, Conn.

**FRENCH Colonies, 25 different, 5 cents.** Big lists free. Challenge Stamp Company, 425 McDonough Street, Brooklyn, N. Y.

**BRITISH Colonial.** Startling prices. Approvals for reference. Stamp Drawer, Rockville, Conn.

**APPROVALS at 50%.** Ed Basler, 457 Ninth Avenue, Milwaukee, Wis.

**YOUR Government has over 100 different** unused United States stamps for sale to collectors at face value. List and pamphlet about Government Philatelic Agency, only 10c. C. E. Nickles, 212 Seaton, N. E., Washington, D. C.

**ANNIVERSARY Offer!** Seven following sets: "Anniversary," "Jubilee," "Charity," "Airmail," "Eagles," "Prisoners," "Pictorials." Four following packets: (British, French, Dutch Colonies), (Precancel), (Bulgaria), (International) 15c to approval applicants. Deering, Fairmount, Marlborough, Mass.

**300 DIFFERENT Precancel Stamps \$1.00,** 1,000 Different Foreign Stamps 75c. Claud Denney, Box 315, Dallas, Texas.

**FREE—100 different stamps to applicants** for our fine approvals. State Stamp Co., New Kensington, Pa.

**BARGAIN Approvals, 10,000 Varieties.** G. W. Conrad, 5048 Wrightwood, Chicago.

**1000 USED Foreign 35c. 1000 Unused** Foreign 50c. Elwood D. Weber, 1377 Park Avenue, Plainfield, N. J.

**MAP Stamps, 10 different,** and a packet of animals, birds, scenery stamps, all for 10 cents to approval applicants. S. E. Saxe, 1427 N. 58th, Philadelphia, Pa.

**BUY collections without purchasing duplicates.** Write Farley Stamp Co., Auburn-dale, Mass.

**BEST one-cent approvals in America.** F. P. Hand, 1117 S. 60th St., Philadelphia, Pa.

**FRENCH Colonies Free—Jungles, Tigers,** Native Chief. 2c postage. Empire Stamp Co., Toronto, Canada.

**100 DIFFERENT Stamps Free to Approval** Buyers. Postage 3c. Write now. Winholt Stamp Co., Woodbine, 26, Penna.

**FREE! Beautiful unused set 10 Jugo-**Slavia 1920, cataloging \$1.81, to approval applicants. Pennsylvania Stamp Co., Greensburg, Pa.

**300 DIFFERENT Stamps and Premium,** 10c. Central News, Watertown, S. Dak.

**THOUSAND Foreign Stamps, 50c;** catalog free. Prof. McCreery, Chatham, Ontario.

**200 DIFFERENT Stamps, Zanzibar;** Album, 12c. Liberty, 3974 Arsenal, St. Louis, Mo.

**1,000 DIFFERENT, \$0.80; 2,000, \$3.50.** Fred Onken, 630 79th Street, Brooklyn.

**DANDY packet free with approvals.** Wm. Monjar, 1518 Waverly, Cincinnati, Ohio.

**OUR Latest 20-page U. S. and Canadian** price list free. Stanley Gibbons, Inc., 37 Ann St., New York City.

**FOREIGN Revenues, Telegraphs, Locals,** envelopes, rails, etc. pretty, different, cheap. Stamped Marine Policy free to applicants with references. Vanderhoof, 1114 Logan, Denver, Colo.

**200 DIFFERENT stamps 10c; 1,000** Hinges 10c. R. H. Carlton, 380 W. So. Temple, Salt Lake, Utah.

**110 NEW Europe All Different,** a wonderful collection cataloging several dollars, free to collectors requesting our Net Approvals. Postage 2 cents. Badger Stamp Co., Milwaukee, Wis.

**FREE Hungary Charity No. 565 to 567** and a surprise packet given to those requesting for my 1, 2, and 3c approvals, and also my 50% discount. Chas. W. Schmidt, P. O. Box 4832, Frankford Station, Philadelphia, Pa.

**BORNEO, Malay, Liberia, large U. S.** revenue, commemoratives, with 105 other different U. S. and foreign stamps for only 9c. Fennell Stamp Co., Dept. M, St. Louis, Mo.

**109 DIFFERENT, Arabia, Azerbaijan,** Zanzibar, etc., 10c to approval applicants. Floyd Marsh, 524 Hamilton Ave., Indianapolis, Ind.

**110 DIFFERENT Stamps, many unused,** high values, free to collectors requesting our Net Approvals. Postage 2 cents. Christensen, Milwaukee, Wis.

**ONE Dollar catalog value free with first** purchase of \$1.00 net from my popular approvals. Better class of stamps for those willing to spend \$1.00 or more at a time. References please. A. Bauer, Palmyra, N. J.

**500 DIFFERENT, 35c; 350 different, 25c;** 200 different, 12c; 500 mixed, 18c. Evans, Box 366, Reading, Pa.

**STAMPS, 100 varieties, Africa, Brazil,** Peru, Cuba, Mexico, etc., 10c; 25 different U. S., 25c; 1,000 mixed, 40c; 1,000 hinges, 10c. List free. C. Stegman, 5911 Coto Brillante, St. Louis Mo.

**LIBERIA Snake Triangle and two other** triangles in our packet of 53 genuine foreign stamps for five cents. Crowder Company, Waverly, Baltimore, Md.

**24 VARIETIES Cuban stamps, 10 cents.** List of 6,000 low-priced stamps free. Address Chambers Stamp Co., 111P, Nassau St., New York City, N. Y.

**COVERTCO Packet, 250 varieties unused** and used stamps 15 cents. Covert Stamp, 39 State, Rochester, N. Y.

**STAMPS, 100 all different. Postage 3c.** Lists free. P. M. Quaker Stamp Co., Toledo, Ohio.

**TRIANGLES! 75% discount—Special approval** sheets with each 5c packet containing set triangles. 2 sets war tax, set airplane, U. S. stamp before 1880, etc.; over 100 different stamps. Murray Stamp Co., 515A Tower Bldg., St. Louis.

**PENNY Approvals that Satisfy.** Nell Gronberg, Box 5441, Philadelphia, Pa.

**BEAUTIFUL Picture Stamps Sent Free.** Paul Cornish, Schenectady, N. Y.

**200 STAMPS, Bargain List, Magazine** 15c. Harvey Teeple, Decatur, Ind.

#### RARE COINS

**OLD Coins Bought and Sold.** Rare Coin Book 65c. 700 illustrations. Send 10c for Coin collecting booklet. Gutttag Bros., 16 Exchange Place, New York.

**U. S. COINS, Stamps and curios.** Want lists filed. Write us. Braddock Stamp & Coin Co., Box 406, Braddock, Pa.

**CALIFORNIA Gold 1/4, 27c; 1/2, 53c.** \$5 and \$20 1861 Confederate Bills, 15c. 5 different Copper Coins and Price Lists, 10c. 100,000 German Marks, 10c. Al E. Bonsall, Richmond, Ind.

**AMERICAN Coins, Relics Bought Coin** Value Booklet 12c. Frank Saco, 735 45th St., Brooklyn, N. Y.

**OLD Money Wanted.** Will pay Fifty Dollars for nickel of 1913 with Liberty head (no Buffalo). We pay cash premiums for all rare coins. Send 4c for Large Coin Folder. May mean much profit to you. Numismatic Co., Dept. H, Fort Worth, Tex.

**UNITED STATES and Foreign Money;** Military Decorations Catalogue and Greek coin 10c. Alexis Mengelle, Colorado Springs, Colo.

**RARE Coins, Bank Notes, 4 different** foreign Notes, 2 different foreign Coins, and Catalog 10c. Geo. Best, Cedar Rapids, Iowa.

**OLD Coins, Large Spring Selling catalog** of coins for sale free. Catalogue quoting prices paid for coins, ten cents. William Hesslein, 101A Tremont Street, Boston, Mass.



40 OLD coins, all different, \$1.00. 100 different coins, fine lot, \$3.00. Lexington Half-Dollar, Unc., \$1.00. Stone Mountain Half-Dollar, Unc., \$1.00. 1,000 Mixed Austria City Bills, \$1.00. Claud Denney, Box 315, Dallas, Texas.

HALF Dime and Eagle cent, 27c. Durso, 25 Mulberry, New York City.

GET Profit and Pleasure in collecting Old Coins. Send 10c for Large Illustrated Coin Catalogue. You'll be delighted with it. Send for it right now. B. Max Mehl, Numismatist, Mehl Bldg., Dept. P, Fort Worth, Texas. Largest Rare Coin Firm in the U. S.

UNITED STATES. Large Cent, two-cent bronze, three-cent nickel and Bargain List, 25c. Fifteen dates large cents, \$1.00. George Coffin, Greenwood Mountain, Me.

\$2 TO \$500 Each Paid for hundreds of old and odd coins. Keep all old money, it may be very valuable. Send 10 cents for illustrated coin value book, 4x6. Get posted. Guaranteed prices. We buy and sell. Clarke Coin Office, LeRoy, N. Y.

CALIFORNIA Gold—Quarter Size, 27c; 3/4 size, 53c; 3c Piece and Catalogue, 10c Norman Shultz, Box 746, Salt Lake, Utah.

### FOR BOYS

TWENTIETH h.p. electric motors. Fine for fans or experimenting. Runs off dry cells or radio battery. Finest workmanship. \$2.25 each, postage prepaid. Send cash or money order. A. Redmond Co, Flint, Mich.

DRAFTING. Learn Mechanical Drawing. Big demand for men. Pocket size. Start at beginning and learn by a series of simple lessons. Send no money. Just write postal for "Practical Course in Mechanical Drawing." Pay postman postage and \$1. Popular Mechanics Press, Room 907, 200 E. Ontario St., Chicago, Ill.

SHALL I Become an Engineer? You can decide this all-important question better by reading a book called "Engineering as a Career," written by a group of eminent engineers. It costs only \$1.00. You will find the advice of these successful men to be of the greatest value. Pay postman price and postage when he hands you the package. Address Popular Mechanics Press, Room 907, 200 E. Ontario St., Chicago, Ill.

### CAMERAS AND PHOTO SUPPLIES

COLORING photographs is a profitable and pleasant profession; the field is big—expert colorists are in demand everywhere, at all times—not many know how. We teach you by mail. You can color photographs, lantern slides, greeting cards, etc., in your spare time or steady employment. Write today for free booklet. Japanese Water Color Co., 11 Diamond Place, Rochester, N. Y.

KODAK Film—Special Trial Offer—Your next roll developed 5c, prints 3c each. Beautiful 6x10 mounted Enlargement 40c. Sameday Service. Fleet Photo Service, 425 G St., N. W., Washington, D. C.

PHOTOGRAPHIC equipment and accessories of every description are listed and illustrated in our 228-page catalog. It will pay you to secure a copy which is issued free, as our prices are low. We also deal in used goods which are sold under the same guarantee as new goods. Ask for our Bargain Book. Central Camera Co., Dept. E119, 112 S. Wabash Ave., Chicago, Ill.

MAKE money in Photography. Learn quickly at home. Spare or full time. New plan. Nothing like it. Experience unnecessary. American School of Photography, Dept. 3432, 3601 Michigan Ave., Chicago.

START a Home Travel Club. See interesting places in and out of United States without expense and discomfort of traveling. Ask particulars today. The Kenneth Sales Co., Dept. C., Box 893, Poughkeepsie, N. Y.

BIG Money Saved on Photographic Lenses and Apparatus—goods exchanged; repairing done. Ralph J. Golsen, 1128 Argyle St., Chicago, Dept. P.

FILMS Developed. Special Trial Offer. Any Size Kodak film developed 5c, prints 3c each. Trial 6x10 Enlargement in handsome folder 40c. Overnight Service. Roanoke Photo Finishing Co., 209 Bell Ave., Roanoke, Va.

AMATEUR Photographs Profitable. Booklet describing One Hundred Best Magazine Markets 10c. Snyder Publishing Co., Guilford, Conn.

SPECIAL Trial Offer. Any size Kodak film developed 5c. Prints 3c each. 8x10 enlargement beautifully mounted 40c. 24-hour service. Young Photo Service, 405 Bertha St., Albany, N. Y.

HAVE You a Camera? Write for Free sample of our big magazine, showing how to make better pictures and earn money. American Photography, 116 Camera House, Boston, 17, Mass.

### MOTION PICTURES

\$1,250.00 FOR a Photoplay Story by an unknown writer and sold through our Sales Dept. We revise, copyright and market. Located in the heart of Motion Picture Industry, we know the demand. Established 1917. Send Manuscript for free criticism. Booklet on request. Universal Scenario Company, 206 Western and Santa Monica Bldg., Hollywood, Calif.

SEND 10c in stamps for the 1928 edition of the famous Bass Book of Cinema Apparatus, greater than ever. Send \$2.00 for catalog and new book on "How to Make Motion Pictures," by Cameron. Bass Camera Company, 179 West Madison St., Chicago.

NEW 100-foot spring motor camera, \$100; 16 1/2-foot spring motor camera, \$37.50. Eastman negative film 3 cents foot. Motor drivers suitcase. Projector \$50. Movie printer, \$25. 50-foot developing outfit, \$200. Films, \$2 reel. 5 Mazda lamps, 25 volts, 3 amperes, \$5.00. Ray, 296, 5th Ave., New York.

FILMS: \$3.00 per reel up. Comedy, Western, Cartoon, Drama, Serial, Educational, Special Features. Best Movie Stars. Free List. Toy Film 200 Feet Postpaid \$1.50. Dixie Film Co., Box 2042, Memphis, Tenn.

NEW and Rebuilt Projectors for Theaters, Schools, Churches, Traveling Shows. Supplies and Complete Theater Equipments. Bargain Prices. Free Catalog. Monarch Theatre Supply Co., Memphis, Tenn.

UNIVERSAL Movie Outfit—200 ft. dissolve model camera, six magazines, two lenses, masks, tripod, cases for outfit. Fine condition. Value \$830 for \$525. Thomas D. Baker, 605 W. Mercury St., Butte, Mont.

FILMS for toy machines. Cartoons, comedies, westerns. Alton Films, 205 Brush Creek, Kansas City, Mo.

MOTOR-DRIVEN Suit Case Projectors—DeVry—\$90. Acme—\$90. Graphoscope—\$70. New Sept. Cameras—\$37. Films \$5.00 Reel. Apollo Exchange, 286 Market St., Newark, N. J.

BARGAINS—Machines, Films, Stereopticons, Slides, National Equipment Company, Duluth, Minn.

WESTERNS, features, \$2.00-\$3.00 per reel. Stewart Marshall, Rome, Ga.

1000 FEET of Comedy, \$2.00. No lists. Sunset Film Exchange, 298 Turk St., San Francisco, Calif.

### SCENERY TO RENT

WORLD'S Most Beautiful Settings for operas, plays, minstrels. Amelia Grain, Philadelphia.

### EDUCATIONAL AND INSTRUCTION

STORY Ideas Wanted for photoplays, magazines. Big demand. Accepted any form for revision, development and submission to markets. Established 1917. Send manuscripts for free criticism. Booklet mailed on request. Universal Scenario Company, 403 Western and Santa Monica Bldg., Hollywood, Calif.

AAA, learn auto driving by mail. Results guaranteed; for Ladies and Gentlemen; only method in the world; gold medal won in Europe. For \$1.50 you will learn to drive any car; no instructor needed. You will be surprised. Send for your manual to-day. 235 W. 37th Place, Los Angeles, Cal.

WORLD-ROMIC System, Masterkey 5,000 languages. Primers, \$1.98; Arabic, Chinese, French, German, Italian, Japanese, Russian, Spanish. Languages, 15 W. 18th St., New York.

FUN Making Things. Four large profusely illustrated books telling how to make almost everything from a sail boat to a toy automobile propelled by a motorcycle engine. Now \$2 per book or \$7 for the four if ordered at once. Send no money. Just write a postal saying, "Send the Boy Mechanic Library." Pay postman \$7 and postage. For single books, specify either Book 1, Book 2, Book 3, or Book 4. Popular Mechanics Press, Room 907, 200 E. Ontario St., Chicago, Ill.

INSTRUCTION books, all kinds. Catalogue free. Winholt Book Co., Woodbine, 4, Penna.

AMATEUR Cartoonists: Make money in spare time with new cartoon selling plan. Write Smith's Service, PM1194, Wenatchee, Wash.

EARN \$25 weekly, spare time, writing for newspapers, magazines. Experience unnecessary. Details Free. Press Syndicate, 981, St. Louis, Mo.

FAMOUS Bailey Handbook—The book that prepares you to pass the examination for any grade of license for stationary, marine and Diesel engineers, firemen and boiler inspector in any state of the union or any province of Canada. Flexible cover. Handy pocket size. Pay postman \$2.00 plus the postage when he hands you the package. Popular Mechanics Press, Room 907, 200 E. Ontario St., Chicago, Ill.

USED educational matter. Lowest prices; terms. Catalog free. Mention Subject. Fred Goetz, 440-A Sansome, San Francisco.

USED educational matter sold on repurchase basis. Also rented and exchanged. Money-back guarantee. Catalog free. (Books, etc. bought.) Lee Mountain, Pisgah, Ala.

DOUBLE Entry Bookkeeping mastered in 60 hours with 8 keys; guaranteed; diplomas. International Bookkeeping Institute, Dept. 8, Springfield, Mo.

GO Railroad: Rules, Signals, etc., \$1.00 per copy. Publisher, 2213 Central Ave., Kansas City, Kans.

YOU Need a better grip on mathematics? Tell us to send you a copy of "Mathematics for the Practical Man," only \$1.50. By common sense methods it removes the mystery and difficulties so algebra and calculus are made simple. Assuming your knowledge is limited to arithmetic you quickly and easily gain a working knowledge of algebra, geometry, trigonometry and calculus. Simply pay postman when he hands you the package. Address Popular Mechanics Press, Room 907, 200 E. Ontario St., Chicago, Ill.

### RADIO OUTFITS AND SUPPLIES

RADIO Receiver; All stations—American and overseas; all wave lengths—200 to 4,000 meters. This 6 tube Gnome Polyphase, the latest development in modern radio. Agents wanted. 100% profit—\$100—per week easy. Radio Exchange, 925 Broadway, New York.

HOFF'S Trouble Finder and Dictionary. Hundred Radio Ailments and Remedies. Copy 50c. Harold Williams, Morton, Ill.

WRITE for special lists of Transformers, chokes and eliminator parts. Radio Parts Sales Co., Orange, N. J.

RADIO Tubes: Cheap in Price, but not in Construction! Send \$1.00 for Trial Tube. Atwater Radio Shop, 1438 Lexington Ave., New York.

RADIO Up-to-the-Minute. Telegraphy, radio reception, vacuum tubes, telephony, how to build receivers, broadcasting, all treated in new book. Send no money. Pay postman \$1.25 and postage. Just write postal for "Radio Up-to-the-Minute." Popular Mechanics Press, Room 907, 200 E. Ontario St., Chicago, Ill.

BEST Radio Book—New Third Edition, 1927. Revised—Radio Theory and Operating by M. T. Loomis of the Loomis Radio College is America's Standard Radio Text-Book. Used by the various gov't depts. and schools and leading radio schools. 885 pages, 700 illus., flexible krafty leather binding. Sent C. O. D. Pay postman \$3.50 and the postage when package is delivered. Popular Mechanics Press, Room 907, 200 E. Ontario St., Chicago.

### TRADE AND TECHNICAL SCHOOLS

LEARN Bricklaying and earn \$1 to \$1.75 an hour. Wm. M. Woods, who has trained 500 men will teach you bricklaying in our school run by 800 builders interested in giving jobs to Mr. Woods' students. Tuition \$60.00 per month. Time required 3 to 6 months. Board and room \$8.00 to \$10.00. Work is actual bricklaying; you become master in the craft, in line for highest wages and promotion. Ample space and material. Catalog free. Associated Building Employers, P-400, A. B. E. Bldg., Grand Rapids, Mich.

AUTOMOBILE Radiator repairing. Complete instructions. Learn by doing actual work at home or in our school. Bixler Radiator Institute, Frankfort, Ky.

MECHANICS—Learn practical welding and cutting; 4 weeks' day or evening course; special summer rates. Smith Welding School, 250 West 54th Street, New York.

LEARN barbering at home. Practice on the family. Complete barber college instructions, home study, for \$1 bill or money order. Foster, Expert Barber, 6128 Michigan Blvd., Chicago, Ill.



**INTERNATIONALLY** recognized as world's leading radio institution. Investigate through Department of Commerce. Fall Term September 5th. Large staff expert instructors. All graduates placed at splendid salaries to start. Students may earn all expenses while taking course. Write today for catalogue and full particulars. Address Secretary, Loomis Radio College, Washington, D. C.

**GET** a Foreman's job in any trade. You will earn more money. Become an expert Blue Print Reader. You can do it in spare time. My training will advance you quickly. Write now—tell me what trade you want—I will send my plan at once. Carroll Rumsey, 265 Drexel Building, Philadelphia, Penna.

**TELEGRAPHY**—Both Morse and Wireless—taught thoroughly and quickly. Tremendous demand. Big salaries. Wonderful opportunities. Expenses low; chance to earn part. School established fifty years. Catalog free. Dodge's Institute, Fern St., Valparaiso, Ind.

**BIG Pay Jobs.** Learn Sign Painting, Decorating, Paperhanging, Show Card Writing, Graining and Marbling by practical training in a few weeks. Chicago Painting School, 148 West Austin Ave., Chicago.

**BUSINESS OPPORTUNITIES**

**NOTHING** on earth offers bigger opportunity for building wonderful business this summer than manufacturing these popular profitable, big-selling specialties. Start small—watch business grow. Write today for valuable formula literature relative to making: Sealite, guaranteed puncture proof liquid; Ducopol, automobile polish; Cellulac, Duo finishes in color, quick drying; Solvit; powdered hand cleaner; Miracle, non-thermic ice cloths, mendit, fabric patching liquid; Liqui-Seal, radiator cement; Vanil-Ozone, "million-dollar" vanilla flavor; Fruitina; concentrated summer drinks; and a hundred other real honest-to-goodness, money-making propositions. 30 years headquarters for best formula service. Miller, Chemist, 1706-B Jetton, Tampa, Fla.

**GO** into the manufacturing business. Make your own products. Almost no immediate capital required. Orr's Formulas, Trade-secrets, Processes and Sales methods assure easy, big selling products. Free complete catalog includes listing of processes for manufacture of beverages, bleaches, cosmetics, confectionery, cements, dyes, soaps, exterminators, lubricants, household preparations, perfumes, liniments, proprietary medicines and countless other specialties always in great demand. Write for this catalog. Orr Industrial Laboratories, 1356 N. Wells St., Chicago.

**READ** The Mail Order News—America's Pioneer Mail Trade Journal. Quarter Century Old. Approximately 600 pages yearly of valuable information for beginners an established mail-order houses. Analyzes mail-order business, its opportunities. Practicable mail-order ideas, legitimate money-making schemes, instructive articles. Tells how to start, what to sell. Published monthly. Subscription \$3.00 yearly. Send 25c for sample copy. None free. Mail Order News, 360 Bristol Bldg., New York.

**GOLD, Silver** and colored sign letters for windows, sign boards, trucks, automobiles. Make them yourself with our instructions and letter patterns. Fast sellers, big profits all or part time. No experience required. Field unlimited. Collect two profits, making and selling. Stamp brings actual sample and complete description. Enterprise Systems, 616 North Michigan, Chicago.

**ARTIFICIAL** marble sanitary flooring instructions, covering wood or cement flooring 1/2 inch thick, fireproof, waterproof, all colors, low cost. Ornamental casting, concrete, plaster, papier-mache decorations, garden furniture, statuary, flexible molds. 17 years instructing the public; particulars and illustrations free. Chris. Mahler, Huntington, N. Y.

**MAKE** Much Money—Making, Selling Your Own Goods. Formulas, Processes, Trade-Secrets. All kinds. All lines. Catalog Free. B. Thaxly Co., Washington, D. C.

**DON'T** gamble in mail order business. Be sure. Free circular puts you wise. MacRae, M40 Oregonian Building, Portland, Oreg.

**MIRRORS** Resilvered at Home. Costs less 5 cents per square foot; you charge 75 cents. Immense profits plating like new; brass worn-off autoparts, reflectors, tableware, stoves, etc. Outfits furnished. Details Free. Sprinkle, Plater, 127, Marion, Ind.

**PATENTS** Procured; Trade Marks Registered—A Comprehensive, experienced, prompt service for the protection and development of your ideas. Preliminary advice gladly furnished without charge. Booklet of information and form for disclosing idea free on request. Richard B. Owen, 30-Owen Bldg., Washington, D. C., or 41-R Park Row, New York.

**MECHANICS**, painters, carpenters, start furniture refinishing, painting, handyman shop on nearly nothing; winning plan brings customers quickly. John Braceland, 1439 So. Ninth, Philadelphia, Pa.

**\$750,000,000 MAIL** order business in 1925. Many grow rich in this great trade. Sell merchandise, information, patented articles various preparations. Breniser's Famous Mail Order Handbooks tell how. Eleven brochures \$3. One book with complete catalog, 25c; none free. Breniser, (Established 1900), 1607 Sansom, Philadelphia.

**PATENTS.** Time counts in applying for patents. Don't risk delay in protecting your ideas. Send sketch or model for instruction or write for free book "How to Obtain a Patent" and "Record of Invention" form. No charge for information on how to proceed. Communications strictly confidential. Prompt, careful, efficient service. Clarence A. O'Brien, Registered Patent Attorney, Security Bank Building (directly across street from Patent Office), Washington, D. C. See pages 138 and 139.

**DON'T** sell for others. Employ agents yourself. Make your own products. Toilet Articles, Household Specialties, etc. 50% profit. We furnish everything and show you how. Valuable booklet free. Write at once. National Scientific Laboratories, 1978W Broad, Richmond, Va.

**\$15 TO \$30** per day, entire summer. Make good living with our newly invented 1-minute photo-camera; no experience required. Now's the time! Complete information free. Benson Camera Co., 25 Delancey Street, New York, N. Y.

**OPERATE** profitable business of your own. Selling by mail. Quick returns. Small investment. Our methods used in every successful mail-order business. Particulars free. Ray A. Yoder, Wadsworth, Ohio.

**LEARN** to Manufacture—It pays big profits. We teach you how. Start spare time. Few dollars. At home. We show you how to sell. Write for free circular. Heartfinger System, 2202-P Wyoming, St. Louis, Mo.

**MAIL** Order Business Positively Your Big Opportunity. Start Right. Grow. Win. Free Circular. Send Today. Macrae, Publisher, 492M, Oregonian Building, Portland, Ore.

**POSTAL SUCCESS:** Magazine of formulas, instructive articles on mail-order selling, for advertisers, dealers and beginners. Copy 10c, 3 months 25c. Porter's Publications, 9416A 115 St., Richmond Hill, N. Y.

**OWN** Your Own Business—no capital required; learn Real Estate; Business Brokerage and Insurance Agency; earn \$5,000 year. Office at home. Stamp, free booklet. Hayes Realty Association, Cincinnati, Ohio.

**DOLLARS** from dirt! A business of your own. No competition. See ad on page 156.

**MAKE** Money! Spare time! Start mail order business, home, evenings. Easily, quickly learned. Operated anywhere. Ask for particulars. Hilco Service, Room 223, 62 South Sherman, Denver, Colo.

**INCOME** Increaser—newly enlarged 32 page monthly magazine of best, latest ideas, plans, schemes, tips, pointers, starters. Sample copy dime. Buckman, publisher, 63-A Court St., Boston, Mass.

**BIG** Bunch Mail. Year 15c. Kentucky Agency, Covington, Ky.

**HAVE** Automatic Ceiling Ventilator with fan that runs without power; ready for production; want connections with party competent to manufacture and market this device. William Lawrence, 517 Madison St., Maywood, Ill.

**SELL** It By Mail to the Homes. We will place your offer in the hands of 20,000 Mail Order Buyers each month, cost as low as \$15. Particulars Free. Write Mail Order Buyers' Guide, 318 "B" West 39th, New York.

**NEW** Business: Good money painting house numbers, names and window signs with radium composition. Visible day and night. Formulas and complete instructions \$1.00. D. Layne Haynes, Box 612, Parkersburg, West Va.

**TWENTY** Money-making Methods. For Particulars Write Bruce Hudson, Clarks Green, Penna.

**MONEY:** Big money easily made by new, proved method; thoroughly explained in new book. Hundreds of ways open for hustlers. Let me send you, free, a fine big circular that tells all about it. J. Heymann, 325-C, Hot Springs, Va.

**SELL** by mail. Wonderful opportunity. Particulars Free. Mason, 3902 Broadway, Room 5, Chicago.

**YOU** can have an independent business of your own, and I am here to show you the way. Write at once! Wm. E. Heinemann, 2415 Montrose Ave., Chicago, Ill.

**GET** into the mail order business. Unlimited opportunities for ambitious persons. Write today for our big "free" offer. Publisher, 6652-J Gravois, St. Louis, Mo.

**WE** Start You in Business, furnishing everything; men and women, \$30.00 to \$100.00 weekly operating our "New System Specialty Candy Factories" anywhere. Opportunity lifetime; booklet free. W. Hillyer Ragsdale, Drawer 4, East Orange, N. J.

**I** MADE \$30 a Week Home. French Breadmaking. 15 years experience; Free Booklet tells. Ashbrook 67, Marengo, Ohio.

**UNPATENTED** Ideas Can Be Sold. I tell you how and help you make the sale. Free particulars (Copyrighted). Write W. T. Greene, 810 Jenifer Building, Washington, D. C.

**"SCHEMER,"** Alliance, Ohio, 36 p. monthly, prints Schemes, Tips, Formulae. Subscriber reports \$25,000 from three; another \$10,000 from one. Try it! Year, \$1.00; 3 months, 30c.

**MAKE** Money at Home—making animal toys. We show you how. Send \$1 for complete working drawings and instructions. DeKalb Designing Co., Decatur, Ga.

**START** Mail Order Business of your own at home. We supply catalogues with your address on. Wineholt Sales Co., Box 4, Woodbine, Penna.

**CHARTERS:** Delaware; best, cheapest; free forms. Colonial Charter Co., Wilmington, Del.

**MAIL** Order Information, where to buy goods, specialties, imprint circulars, everything for mail order business 25c. Harvey Teeple, Decatur, Ind.

**DELAWARE** Incorporator. Charters; Fees Small; forms. Chas. G. Guyer, 901 Orange St., Wilmington, Del.

**CHEMICAL** Expert will furnish Formulas and Trade Secrets. All lines. Lists Free. W. L. Cummings, Ph. D., 228 Gordon Ave., Syracuse, N. Y.

**LEARN** the collection business. Good income, quick results. Interesting booklet, "Skillful Collecting" free. National Collectors Assn., Long St., Newark, Ohio.

**EARN** \$10 daily silvering mirrors, plating and refinishing metalware, autos, chandeliers, bedsteads, headlights. Outfits furnished. E. Decle Laboratories, 1133 Broadway, New York.

**MAIL** Order offers unlimited opportunities. Get free offer today. Messenger, Dept. 62, Stillwater, N. Y.

**RESPONSIBLE** manufacturer wants competent men to manage office and salesmen. \$300 to \$1,500 necessary; will allow expenses to Baltimore if you qualify. Address Manager, 601 N. Eutaw St., Baltimore, Md.

**SIGNS** and Showcards Easily painted with Letter Patterns. Large variety of Styles and Sizes. Samples for stamp. John Rahn, a2120 Neva Ave., Chicago.

**TASTE** flavor of real money selling Annie Blain Flavors, wholesale, retail; new system, samples; other unique methods. Geo. S. Parker, New Brunswick, N. J.

**SELL** by Mail! Books, novelties, bargains! Large profits! Particulars Free! B-Elfeo, 525 South Dearborn, Chicago.

**DIESEL** Engines—Marine, locomotive, stationary. Growing importance of the Diesel engine cannot be overestimated. This new book should be in the hands of every student of mechanical engineering. 500 pages, 280 illus. Pay postman \$5 and postage when he delivers book. Popular Mechanics Press, Room 907, 200 E. Ontario St., Chicago.

**TELEGRAPHY**

**TELEGRAPHY**—Both Morse and Wireless—taught thoroughly and quickly. Tremendous demand. Big salaries. Wonderful opportunities. Expenses low; chance to earn part. School established fifty years. Catalog free. Dodge's Institute, H St., Valparaiso, Ind.



## CHEMISTRY

**EXPERIMENTERS**—Bargain, 20 different chemicals for \$1.00. Service Labs., 900 Belmont, Chicago.

**YOUR** chemical problem solved and working formula or process furnished for \$5.00. Write me. W. Stedman Richard, Industrial Chemist, Box 2402, Boston, Mass.

## FORMULAS AND TRADE SECRETS

**ORR'S** Formulas, Trade Secrets, Processes and Sales Methods assure easy, big selling products. Free complete catalog includes listing of processes for manufacture of beverages, bleaches, cosmetics, confectionery, cements, dyes, soaps, exterminators, lubricants, household preparations, perfumes, liniments, proprietary medicines and countless other specialties always in great demand. Write for this catalog. Orr Industrial Laboratories, 1360 N. Wells St., Chicago.

**MAKE** Much Money—Making, Selling Your Own Goods. Formulas, Processes, Trade-Secrets. All kinds. All lines. Catalog Free. B. Thaxly Co., Washington, D. C.

**10 FORMULAS**, including a Magic Fish Bait, "Run" Preventer for Silk Hose, and "Clearlite" for Oil Lamps. All with instructions, 50 cents. G. McDowell, Box 115, Station W, New York City.

**DON'T** sell for others. Employ agents yourself. Make your own products. Toilet Articles, Household Specialties, etc. 500% profit. We furnish everything and show you how. Valuable booklet free. Write at once. National Scientific Laboratories, 1978W Broad, Richmond, Va.

**FIVE** formulas and lists \$1.00. F. White, 1249 Forest Ave., Woodfords, Maine.

**SAWDUST**, Chemicals makes Sanitary Flooring. Guaranteed directions \$1.00. Universal Supply Co., Auburn, N. Y.

**LACQUERS**—Expert advice on Lacquers and Ducos. Spraying and brush formulas for any and all purposes. A. F. Yeutter, Penns Grove, N. J.

**FORMULA** auto-cleaner polish, \$1.00. Douglas Chemists, 4332 Vanburen, Chicago.

**AUTO** Formulas with Formula Service, buying sources, prices, consultation. Puncture Proof Compound, Body Refinish, Top Dressing, all guaranteed, \$2 each, 3 for \$3. Associated Chemists, Indianapolis, Ind.

**ANY** special formula, including manufacturing instructions; also encyclopedia containing 3000 formulas, trade secrets and supply sources—Only \$2, complete. Cross Chemical Co., 93 Nassau Street, New York.

**1,000,000 FORMULAS**, valuable information, 1016 pages, \$2.25, 500 Formulas Free if you order quick. Ideal Book Shop, Park Ridge, Ill.

**FORMULAS**: Absolutely guaranteed. Best chemical science has devised. Don't risk your money till you've investigated these wonderful processes for all lines. Get my valuable "eye-opening" literature. Highest references. 30 years supplying the best. Miller, Chemist, 1706-P Jetton, Tampa, Fla.

**20c**—ANY Formula, 20c. "Hawkins," 215 Lasaninas, Colorado Springs, Colo.

**15,000 FORMULAS** in "Scientific American Cyclopedia of Formulas." Includes following and many others: Accidents and emergencies, agriculture, alloys and amalgams, artist's materials, beverages, cements, glues, pastes, mucillages, bleaching, renovating, coloring metals, dyeing, glass, heat treatment of metals, household formulas, ice cream, confectionery, chewing gum, lapidary work, exterminating vermin, lubricants, paints, varnishes, photography, condiments, canning formulas, rubber, soap, candles, soldering, toilet preparations, perfumes, waterproofing, fireproofing, writing materials. Send no money. Just write a postal. When postman hands you book pay \$5.50 and postal charges. Popular Mechanics Press, Room 907, 200 E. Ontario St., Chicago, Ill.

**10,000 FORMULAS**. A real gold mine of money-making ideas. Tells how to make almost everything under the sun. You can make and sell cosmetics, mucilage, anti-freeze solutions, battery solutions, beverages, cheese, chewing gum, cleaning preparations, extracts, hair preparations, inks, blueing, leather polish, mirrors, perfumes, polishes, typewriter ribbons, carbon paper, washing powders, liquid soap, and hundreds of other profitable articles. Send no money. Just write a postal for "Henley's 20th Century Book of Formulas." Pay postman postage and \$1. Popular Mechanics Press, Room 907, 200 E. Ontario St., Chicago, Ill.

**TOMBSTONE** Renewing: We will send amazing money getting process to 2 Men, Women or Boys to go partners working cemeteries; spare time or steady; lonesome work but dollars jingle. Sterling Specialty Co., 231 Federal, Denver, Colo.

## AGENTS WANTED

**\$50.00 PER Day**. Our factory is now ready to make first shipments of the "Little Gem" can opener (patented). A Frenchman invented it—the entire universe will use it. Sells for a quarter, worth \$25.00. Sale guaranteed. Money back on demand, without question. We are going to appoint 100 General Distributors—No More—to cover the entire U. S. The "Little Gem" will be a revelation to you. In a class by itself. Enough said. Save time and send \$2.00 for trial dozen. State section of country you desire and we will show you how to make \$50.00 per day. If you do not accept our proposition, return the "Little Gems" and we will immediately return your \$2.00. Write today or you will regret it. References First National Bank, Seattle. Patent Specialties Co., Inc., Dept. A, Securities Bldg., Seattle, Wash.

**SOFT** Drinks in Powder—Orange, cherry, strawberry, etc. Makes best drink you ever tasted. Just add cold water and sugar. Reliable people wanted to place our drink powders in stores and appoint agents. Big profits to stores—you make 80c to \$3.00 profit on each sale. Retail 10c package, makes 10 big glasses. Very attractive advertising matter—nearly everyone buys. Repeat sales sure. Also larger packages for those who sell by the glass. 85c clear profit on each dollar at 5c glass. Particulars free, or send 10c for 10 glass package; 50c for seven packages, all kinds (70 glasses), postpaid. Chas. E. Morrissey Company, 4417 Madison St., Chicago.

**AGENTS**—\$13.80 Daily in advance. Introducing New Insured Hosiery for men, women, children. Must wear or replaced free. 57 styles, 39 colors including latest "Silk to the Top" Ladies' Hose. Nyland made \$95 in one month. Edwards, \$460.60. Mrs. Bone, \$425.45. Why not you? Even spare time should pay you \$3.00 an hour. No experience needed. We furnish samples. Silk hose for your own use free. New Plan. No matter what you are now doing, write quick. Macochee Company, Road 2567, Cincinnati, Ohio.

**AGENTS**, Salesmen, Crewmen—You'll have the Devil's-own-time finding a better seller than "Zippo." Splendid profit on snappy 50c "Go-Getter" repeat article that sells on a ten-second demonstration. Works while you watch it! Demonstrates value while others waste time making claims. New development! Greatest scientific triumph of the age! It's the berries! Write immediately for complete proposition. Karam-Smith Company, 607 Bozen Street, Fort Wayne, Ind.

**AGENTS**—I want 500 ambitious men and women who want to make big money fast. "Doc" Barber sold 72 in 4 hours. Profit \$64.80 (sworn proof). Every woman buys on ten-second demonstration. New swiveling mop that really wrings dry, without wetting hands. No gears to give trouble. Simple, practical, perfect. Lasts a lifetime. Weighs only two pounds. Your profit up to 150%. Exclusive protected territory. Write quick! Delphos Mop Co., B-101 Tenth St., Delphos, O.

**PATENTS**. Time counts in applying for patents. Don't risk delay in protecting your ideas. Send sketch or model for instruction or write for free book "How to Obtain a Patent" and "Record of Invention" form. No charge for information on how to proceed. Communications strictly confidential. Prompt, careful, efficient service. Clarence A. O'Brien, Registered Patent Attorney, Security Bank Building (directly across street from Patent Office), Washington, D. C. See pages 138 and 139.

**DON'T** sell for others. Employ agents yourself. Make your own products. Toilet Articles, Household Specialties, etc. 500% profit. We furnish everything and show you how. Valuable booklet free. Write at once. National Scientific Laboratories, 1978W Broad, Richmond, Va.

**AGENTS** can make \$250 weekly following our proven successful selling plan. An article you will never want to change from selling. Strictly first-class every respect; just exactly right price to make big worthwhile money selling; over 75,000 sold in Philadelphia. Real \$250 weekly proposition appointing sub-agents, agencies, individual sales. F. Sley & Halpen, Desk 40, Philadelphia, Pa.

**MAKE** your own products. Keep all the profits yourself and hire your own agents. Almost no immediate capital required. Orr's Formulas, Trade Secrets, Processes and Sales Methods assure easy, big selling products. Free complete catalog includes listing of processes for manufacture of beverages, bleaches, cosmetics, confectionery, cements, dyes, soaps, exterminators, lubricants, household preparations, perfumes, liniments, proprietary medicines and countless other specialties in great demand. Write for this catalog. Orr Industrial Laboratories, 1358 N. Wells St., Chicago.

**AGENTS**—Best seller; Jem Rubber Repair for tires and tubes; supersedes vulcanization at a saving of over 800 per cent; put it on cold, it vulcanizes itself in two minutes, and is guaranteed to last the life of the tire or tube; sells to every auto owner and accessory dealer. For particulars how to make big money and free sample, address Amazon Rubber Co., Philadelphia, Pa., Dept. 503.

**MAKE** \$10 a day without selling. New plan. We send customers to you for greatest gas saver. Cuts gas bills 25%, guaranteed. Gives motor more pep and power. Removes carbon. Positively no cold turkey work. We have perfected a plan that sends you buyers as fast as you can handle them. Big money, easy. Write today for complete plan. Mae Auto Products Company, Dept. 50A, 6355 Broadway, Chicago.

**\$18 TO \$25** daily. Biggest selling line of 2-piece suits, \$9.95 and \$12.50; 3-piece wool suit, \$17.95 (regular 28.00 value), All-wool overcoat, \$18.50. Splendid raincoats, slickers and boys' suits. Biggest commissions. Free outfit. "Jim" Foster, Inc., Dept. 42, 2250 S. Spaulding Ave., Chicago, Ill.

**AGENTS** clean up with automobile flag-sets. Bracket with 5 flags. Unger Manufacturing Co., 571 Harrison, Chicago.

**EXPERIENCE** Unnecessary, remarkable discovery removes drudgery from polishing table silver, auto trimmings, all metalware, furniture. Abolishes sticky pastes, messy liquids and powders. Starting demonstrations make sales self-closing. Low price; quick cash gain. Up to 233% profit. Test samples free. F. L. Lightning Corporation, 1773 Greenleaf Ave., Chicago, Ill.

**NEW** Way to make money—We show you how. Earn \$15 a day and get your own suit free, taking orders for our fine made-to-measure tailoring. Write today for new style outfit, all wool samples, etc. Furnished Free. Progress Tailoring Company, Dept. G-217, Chicago.

**TOOL** Salesmen. Distribute Oldforge quality tools, auto mechanics, shops, industrial concerns. Money-back guarantee, highly repeat, 82 pieces, exclusive territory, free tool to customer brings big orders. \$100 week profit. Box 339, New Wilmington, Pa.

**FORDS**—No Boiling plus great gas saving. Airlock does it absolutely. Sells like machine guns fire. Free trial always. Ford demonstrating make \$50.00 daily. Airlock Products, Box 585B, Burnett, Calif.

**DUST** Mittens at \$2.00 doz. Newest, best-looking on market. Sell 50c each, 300% profit. No matter what else you sell, carry one in pocket. Sells on sight to every housewife and autoist. Sample, 25c. Midway Co., 3650 Jasper St., Chicago.

**WOMEN**—\$2 an hour spare time; 100% commission, new ideas sanitary necessity; sells on sight; every woman buys; new feature never before used; designed by physician; revolutionizes old uncomfortable methods; pay every day; no deliveries, no collections, no experience or capital required. Particulars mailed in plain envelope. Write Mrs. Mary P. Coleman, Meriden, Conn.

**GOLD-LEAF** Sign Letters; copyrighted Manufacturing Instructions; profits 1,000%. Johnston Co., Quincy, Ill.

**\$60.00 WEEKLY** easy. Monogramming Automobiles. No experience. No license. Millions of prospects. \$32.50 Profit on \$2.50 Outfit. Fastest proposition on the market to-day. Free Samples. "Evans Products Company," Midian Avenue, Windsor, Conn.

**1 AUTO** Gas Saver Free. To introduce. All makes. Amazing mileage increase. Critchlow, C6-805, Wheaton, Ill.

**SELL** Surety, the Original, Genuine, Powdered Hand Soap, and make \$3,000 yearly. We furnish sales plans, advertising, free samples. Write quick. Surety Mfg. Co., Dept. H7, 26 W. Washington, Chicago.

**JUST** Out—Already a Big Seller. Patented window-washer seat. 100% profit. Send for sample money-making proposition. C. Wolfe, 7041 S. Aberdeen, Chicago.



**WOULD \$100.00 Per Week Interest you?** Millions of photos all over the country just crying to be made into beautiful, artistic medallions. We have new plan. Lowest prices. Speedy service. Experienced agents losing money every day they put off writing us. Art Medallion Co., Department Z, Corner Campbell and Jackson, Chicago, Ill.

**OUR Agents average better than \$75 a week;** Rich's pure fruit soft drink powders. Every home, store, drink dealer buys. Sample Free. Sol P. Rich Co., 622 S. Sangamon, Chicago.

**AGENTS make expenses on fishing trips.** Weedless Spoonbooks does it. Sample 35 cents. Other Specialties. Allen, 314-3rd Ave. South, Minneapolis, Minn.

**\$20.00 DAILY** new Driving Lite. Salesmgr., 518 Quincy Bldg., Denver, Colo.

**AGENTS, Pedlers, Canvassers, sell Hosiery.** Make \$15.00 to \$25.00 Daily. Men's fancy silk, Job \$15.00 per Gross. Write today. Lewis Hosiery Co., 12 N. 3rd Street, Philadelphia, Pa.

**NO matter what else you sell, you can make fast money** with new dust mittens; cost you \$2.00 doz., sell for 50c to 75c. Best-looking article on market. Sells on sight; every autoist and housewife. Sample 25c. Midway Co., 3650 Jasper St., Chicago.

**FUNNY Magazine sells everywhere, 200% profit.** Sample 15c. Fox, Brazil, N. D.

**SENSATIONAL Profits!** Mexican Blu-Flash Gem matches finest Diamond; absolutely deceives experts; sells on sight! The only guaranteed low-price diamond substitute! Write quick for free \$5 Sample Case proposition! Mexican Gem Company, P6C, Monterey, Calif.

**AUTO Mitten Dusters sell like Hot Cakes.** Two and Three at a click that's how they go. Free Sample to workers. Don't answer this ad unless you mean Business. National Fibre Broom Co., St. Louis, Mo.

**FREE working equipment!** Catalogue. Samples. Beautiful gold window sign letters. Any Size, one cent each. Why pay 8c? Write Atlas Sign Works, C. 1032 E. 55th St., Chicago.

**75c PROFIT on \$1.00 sale.** Auto, furniture and glass cleaner. Your name on label. Exclusive rights. Free sample. Mfg. E. 213 Griswold, Detroit, Mich.

**AGENTS wanted to sell Velvet Hand Soap,** a very fine mechanics' hand soap; this soap is a good seller with unusual merits. One giving their entire time can make a very fine commission. However, we would like some to take as side line. Territory rights given. Velvet Chemical Company, 30 N. Michigan Ave., Chicago.

**JUST Landed.** New, imported double-edged safety-razor blades. Retail 50 cents dozen. Big seller and money maker. Write. Suburban, Mt. Washington, Ohio.

**IT'S the cat's meow.** Brand new novelty. Biggest seller on earth. Write today for particulars. Novelties, Box 10, Mt. Washington, Ohio.

**"HOME Work Journal,"** monthly magazine filled with money-making opportunities for men, women. Copy for stamp. Home Work Journal, 234-X Third Ave., New York.

**AGENTS—N-R-G Laundry Tablets,** the old reliable moneymaker for live agents. Millions sold—200% profit—sales waiting for you. Clothes washed spotlessly clean in 10 minutes without rubbing. Free samples. N-R-G Company, 230 W. Superior, Chicago.

**\$2.00 AN Hour** for pleasant introductory work among local families. Pay starts immediately. Write American Products Company, 9210 Monument, Cincinnati, O.

**WHY not sell us your spare time? \$2.00 an hour,** \$19.70 daily easy full time. Introduce 12 months Guaranteed Hosiery—47 styles, 39 colors for men, women, children, including latest "Silk to the Top" Ladies' Hose. No capital or experience needed. We furnish samples. Silk hose for your own use free. New Plan. Milton H. Mathews, Road 5867, Cincinnati, Ohio.

**NEW: Just invented;** Comb fastens anywhere. Send 10c for a 25c value. Never Lose Comb Mfg. Co., Lesueur Center, Minn.

**AGENTS—If low prices and big profits interest you,** buy and sell direct from old established manufacturer. Ladies' and children's dresses, rubber specialties and sanitary goods. To earnest parties we will mail new illustrated catalogue and price list. Write B. & G. Mfg. Co., Dept. 226, Pittsburgh, Pa.

**PRIVATE Brand toilet articles,** household specialties, perfumes, soaps, extracts, etc. We pack these goods for you under your private label. With your name on the goods you get all the repeat business. Don't sell for others but build up a profitable business for yourself. Highest quality merchandise. Extremely low prices. Immediate shipments on both small and large orders. Write at once for low wholesale prices and complete information regarding our amazing offer. Address Supply Department, National Scientific Laboratories, 1904W Broad, Richmond, Va.

**MANUFACTURING Pays Big Profits.** Latest, dependable Formulas, Processes, Trade-Secrets. Best sellers. Valuable information free. Specialty Mfg. Service, 801 So. Farragut, Bay City, Mich.

**\$25 DAILY** showing \$2.98 Slickers. \$1.25 gift to customer makes sales easy. Outfit free. American, 724P Roosevelt, Chicago.

**NEW Invention—400% profit.** Liquid Quick Mend for Fabrics and Hosiery. Stops runs. Every woman buys. Hundred other fast sellers. J. E. Johnson Co., Dept. 455, 6129 Wentworth Ave., Chicago.

**NUTRIP** puncture-proof. Free sample to agents. Miner Specialty Co., Vilas, S. Dak.

**AGENTS, portraits, photo-pillow tops,** frames, sheet pictures, medallions, photo-jewelry, guaranteed hose, laundry tablets, food products, toilet requisites, luminous crucifixes. Catalog 50 specialties free. 30 days' credit. Jas. C. Bailey, Dept. C-7, Chicago.

**NEW Dynamo Timer** guaranteed life of car. 12,000,000 prospects. Earn \$100 weekly. Write today. Free sample. Dynamo Co., 426-1109 Eleventh St., Milwaukee, Wis.

**\$50,000, PICTURE Man Friedman** made canvassing. Beginners can make \$100.00 weekly with my sales talk. Experienced men make more. Free book. "Profits in Portraits" explains. Samples Free. Picture Man Friedman, Dept. 8-J, 541 W. Lake, Chicago.

**AGENTS—Make a dollar an hour.** Sell new kind of sharpeners. Sharpens all knives and tools quickly. Demonstrating sample free. Premier Mfg. Company, Dept. 69, Detroit, Mich.

**MAKE \$100 weekly** supplying demand for new invention. Makes autos run on 7% gasoline. Free sample. Write Whirlwind Co., 1041-358 Winnebago, Milwaukee, Wis.

**A PAYING Position** Open to representative of character. Take orders shoes-hosiery direct to wearer. Good income. Permanent. Write now. Tanners Shoe Mfg. Co., 6-90, C St., Boston, Mass.

**NO difference** what you are selling, you can increase your sales 500% by giving our \$1000 policies as free premiums. Costs you nothing. Name your line and write, National American Benefit Association, B201M, Willow Hill, Ill.

**\$75 WEEKLY.** Man or Woman Wanted with ambition and industry. To distribute Rawleigh's Household Products to steady users. Fine openings near you. We train and help you so you can make up to \$100 a week or more. No experience necessary. Pleasant, profitable, dignified work. Write today. W. T. Rawleigh Co., Dept. IL8253, Freeport, Ill.

**MIRRORS Resilvered at Home.** Costs less 5 cents per square foot; you charge 75 cents. Immense profits plating autoparts, reflectors, tableware, stoves, refinishing metalware, etc. Outfits furnished. Details Free. Write Sprinkle Plater, 128, Marion, Ind.

**HOSLETT Silk Company,** Green Bay, Wis., wants reliable sales people to sell quality line of dresses, lingerie, hosiery, direct.

**WHERE to Buy Half Million Articles Wholesale.** 72-page Directory—1927 Edition. Distributors wanted. Pruitt System, Brookfield, Ill.

**AGENTS; Make \$500.00 monthly.** Pay daily. No investment. Rhinestone initial buckles and novelties. Sell easy everywhere. Exclusive territory. Chaton Novelty Co., 666 Blue Island, Chicago.

**MOCCASIN Manufacturer** Wants Agents Everywhere to sell a complete line of moccasins to wearers. Entire new line. No competition, repeat orders. Get details. Daley Moccasin Co., Fort Covington, N. Y.

**JUST Out—Patented Apron.** No strings or straps; on or off instantly; \$20 a day easy; every demonstration a sale; over 100% profit; commissions daily; write today for free offer. Staput Co., Dept. 207, St. Louis, Mo.

**NOTHING Sells Like Shoes.** Every person a prospect. Take orders for Mason Shoes direct from factory. 85 stunning styles. Amazingly low prices. No experience needed. Free outfit. Mason Shoe Mfg. Co., Dept. 3-A, Chippewa Falls, Wis.

**EASY Money** wearing free shirts and acting as my local distributor. Greatest values ever offered. Revolutionary new money making plan. Nothing like it ever offered. \$75 to \$100 a week for you. Also free shirts for you. Write Fashion Wear Shirt Co., Dept. H-942, 1220 Jackson St., Cincinnati, Ohio.

**"MAGNARLOTH"** taking autoists by storm; one rub absorbs dust from car or furniture; quick sale, big profits. National Service Co., Dept. "P," Pierre, So. Dak.

**AGENTS: \$15.00 daily** easy with amazing fluid. Mends hosiery, dresses, 1000 other articles in few seconds. 100% to 200% profit. Free outfit. New Way Laboratories, Desk N-3, Mt. Healthy, O.

**\$1,000.00 CLEARED** in 30 days by one agent. New Amazing Cleaner. Sample Free. Bestever Products Company, 4317-P, Irving Park, Chicago.

**AGENTS, \$13 daily** in advance. Bonus besides. Introduce finest line guaranteed hosiery you ever saw. 126 styles, colors. Spare time satisfactory. Auto furnished. No experience needed. Credit given. Samples furnished. Wilknit Hosiery Co., Dept. 2631, Greenfield, Ohio.

**MEN—Clean Up!** "Gyco" removes all Carbon from any motor in one hour without removing motor head or any mechanical parts. Increases mileage from 20 to 50%. Write for Free Particulars. G-Y Chemical Company, Gouverneur, N. Y.

**1 AUTO Gas Saver** Free. To introduce. All makes. Amazing mileage increase. Critchlow, C5-805, Wheaton, Ill.

**DON'T sell for others.** Employ agents yourself. Make your own products. Toilet Articles, Household Specialties, etc. 500% profit. We furnish everything and show you how. Valuable booklet free. Write at once. National Scientific Laboratories, 1978W Broad, Richmond, Va.

**\$100 WEEKLY** representing large shirt company direct to wearer, wonderful opportunity for financial independence. Big commissions, easy to take orders. We furnish you with a Sales-Compelling outfit free. Write at once. Supreme Shirt Company, 276 Fifth Avenue, New York City.

**\$30.00 A DAY** Guaranteed to Workers taking orders for Goodwear tailored-to-measure clothes at sensational, new low price. Tremendous assortment Virgin Wool fabrics. Biggest cash commissions paid daily and special cash bonus besides makes our best-paying line in America. \$25.00 Sales Outfit Free. Exclusive Territory. Write at once to Dept. 103, Goodwear Chicago, Inc., 844 West Adams, Chicago.

**BE Independent.** Make, sell your own specialties. Immense profits. Catalog dependable Formulas, special selected agents' best sellers, free. M. Lustrò, 832 East Pershing, Chicago.

**AGENTS—Masco** Corn and Calious Remover will build you a steady repeat business. Send today for pocket size trial outfit. The Moss Company, 380 Searle Bldg., Rochester, N. Y.

**AGENTS, make \$3.00 an hour** taking orders for our 40 fascinating Kitchen Specialties. No competition. Write quick. General Products Co., Dept. 7-F, Newark, N. J.

**WE pay \$18 a week,** furnish auto and expenses to introduce our soap and washing powder. Buss-Beach Company, Dept. A-42, Chippewa Falls, Wis.

**CASH Paid for Butterflies, Insects.** See Sinclair Display Advertisement on page 30.

**"JUST Out!"** No-Glare Spectacles. No Lenses. Green Shade Over Each Eye. Prevent Auto Accidents. Sells Like Wild Fire. Beaches, Fairs, Carnivals. (Retail 75c—Costs 25c.) Sample 50c. Nulife Specs, Hartford, Conn.

**GOLD Sign Letters.** \$9.75 for Thousand! Non-Tarnishable. Free samples. Catalogue. Atlas Sign Works, A1032 E. 55th St., Chicago.

**SALESMEN Wanted—** For automobile magnetic base lamp, by manufacturer of best on market. Write Ulite Manufacturing Company, Inc., 59 Page St., Providence, R. I.

**REAL Money for You.** Our combination Aluminum Cooking Set easy to sell. No delivering, no collecting. Make \$10 to \$15 daily. Espy-Riddle Company, Dept. 2, 2325 Carson St., Pittsburgh, Pa.



**\$8.00 To \$16.00 daily easy.** Introducing "Chieftain" Fine Quality, Guaranteed Tailored Shirts. Just show samples, write orders. We deliver and collect. Your pay every day. No capital or experience necessary. Spare time pays you big. Send today for Free Samples. Cincinnati Shirt Company, Lane 1587, Cincinnati, Ohio.

**AUTOMOBILE Specialties.** Guaranteed formulas for all latest money makers. Lowest prices. Write for free lists. Murphy, Chemist, Tujunga, Calif.

**BIG profits distributing 5c candy specialties to dealers.** Fast sellers. Exclusive territory. Universal Sales Company, 631-B Wilson Ave., Brooklyn, N. Y.

**\$25 DAILY** showing \$2.98 slickers. \$1.25 gift to customer makes sales easy. Outfit free. American, 724-P, Roosevelt, Chicago.

**AGENTS—250% profit selling exclusive new process Artistic Signs.** Finest selection of stock signs in the country, barring none. Details free. Sample 10c. Artistic Signs, 799-R Broadway, New York, N. Y.

**SEND 25 cents for one dollar Cigar Lighter,** and learn how to make \$10 a day. Particulars free. Rapid Mfg. Co., 799 Broadway, New York City.

**AGENTS:** Brand new Automobile Specialty. Costs 10c. Retail 50c. Maher Co., Dover, N. J.

**NEWEST European Novelty Just Out.** One article has four uses. Sells less than dollar. Over 100% Profit. Write T. Kobayashi Co., 208 T Wabash, Chicago.

**AGENTS, \$17.50 daily.** Bonus besides. Sell finest line hosiery. Seven months' guarantee. New selling plan gets orders. Write quick. Silk hose free for your own use. Betterknit Textile Co., Silk 431, Greenfield, Ohio.

**BIG Money easily made without peddling or outfits.** Free particulars. Elite, 38 Elizabeth St., New York.

**EARN Dollar an hour selling pearl necklaces:** Liberal profits. Hanover Trading, 925 Broadway, New York.

**EARN \$15 daily;** pay advanced with our fast sellers. Guaranteed tailored slickers \$2.95. Selling outfit and slicker free. Fisk Warner, 443A South Dearborn, Chicago.

**MAKE \$12 a day from start and liberal bonus selling Pioneer \$23.50 all-wool tailoring.** Commissions paid in advance. Striking leather brief case and 100 large cloth samples furnished. We train the inexperienced. Write now to Pioneer Tailoring Co., 159 W. Harrison, Dept. G-1117, Chicago.

**SELL Magic Puncture Proof Compound.** Seals Punctures, Slow leaks, Leaky valves instantly. Make it yourself. Appoint Agents. 1500% Profit. Formula, Label, Instructions, 10c. P. McCaffery, 481 Ada, St. Paul, Minn.

**FREE working equipment!** Catalogue, Samples. Beautiful gold window sign letters. Any Size, one cent each. Why pay 8c? Write Atlas Sign Works, B. 1932 E. 55th St., Chicago.

**HOSIERY Free and \$12 daily.** Sell nationally known Pure Silk hosiery. Amazing values. Experience unnecessary. Free sample outfit mailed immediately. Pure Silk Hosiery Co., 208 W. Monroe, Dept. P128, Chicago.

**DON'T sell for others.** Employ agents yourself. Make your own products. Toilet Articles, Household Specialties, etc. 500% profit. We furnish everything and show you how. Valuable booklet free. Write at once. National Scientific Laboratories, 1978W Broad, Richmond, Va.

**75c PROFIT on \$1.00 sale.** Auto, furniture and glass cleaner. Your name on label. Exclusive rights. Free sample. Mfg. E. 213 Griswold, Detroit, Mich.

**SELL Feather Flowers.** Every home, church, business house prospect. Buy from factory. Dept. P., DeWitt Sisters, Battle Creek, Mich.

**AGENTS And Mail Dealers cleaning up with Lanowa combination.** 200% profit. Write quick for sample. Fraser Products, 305-J East 43rd., Kansas City, Mo.

**1 AUTO Gas Saver Free.** To introduce. All makes. Amazing mileage increase. Critchlow, C4-805, Wheaton, Ill.

**AUTO Tow-Lines going over big.** Every Carowner a prospect. Agent's Profit \$1.00 on every sale. Write for Selling Plans and Free Sample Offer. National Fibre Broom Co., St. Louis, Mo.

**AGENTS—Something new!** Just out! Big profits. Write for free sample. Samuel Berman, 417 North Eutaw, Baltimore, Md.

**MANUFACTURE glass name and number plates, mirrors, signs, etc.** Outfit \$10.00. Radiant Signs, 15905 Alden, Detroit, Michigan.

**SEND three references for Samples.** 15 Hosiery Styles; 50 colors. \$10.00 Dinner Set Free to customers. S. Q. S. Desk D., Lexington, Ky.

**300% PROFIT.** Fast seller. Cleaner Polish for autos, furniture, metal, glass. Particulars and sample free. Deal Laboratories, Springport, Mich.

**AGENTS earn \$100.00 to \$200.00 weekly** taking orders from industrial plants for our newly discovered oils heretofore unknown by belt-using industries. Secure exclusive territory. Associated Belting Users Supply Co., Inc., St. Louis, Mo.

**AGENTS:** It's a winner. Combined cigarette and match case. Beautiful, compact, flexible container. Holds package cigarettes and box matches. Sells on sight. Big profits. Write for details. All-in-One, Dept. A-7, 2810 Portland Ave., Minneapolis, Minn.

**DISTRIBUTORS:** No canvassing; free samples; stamp appreciated. Honery, Roseto, Pa.

**To market 3A garage Door Holders.** Simple Automatic action; Easy, Quick installation instantly attracts Private Garage Owners, Builders and Dealers. Write for attractive, exclusive territory proposition. Knowlson-Stevenson Company, 1118 Packard, Ann Arbor, Mich.

**\$\$\$ PROFITS Easy—Big Demand—Quick Sales,** large wholesale catalog free to live agents only. Joseph Sales Company, 223 Madison Street, Chicago.

**FREE:** Large wholesale Specialty catalog, showing latest best sellers from many parts of the world. Sports Co., Lesueur Center, Minn.

**A SENSATIONAL seller:** "Kleanzy," the new mop with the steel plate. Housewives delighted. Eager buyers. Will send one prepaid on approval to convince you how easily you can make \$20.00 daily. Kleanzy Mop Co., Dept. 7-G, Delphos, Ohio.

**AGENTS! \$5.00 to \$10.00 profit each sale** with our New Octagon Portraits and Frames. \$50 to \$75 weekly easy. Catalog free. Write Linder Art Company, 551 W. Washington St., Chicago.

**AGENTS make \$10.00 Daily selling Non-Splash Water Filters on sight.** Best canvasser's article on market. Investigate. Write for particulars, Desk 14, Seed Filter Company, 73 Franklin Street, New York.

**MAKE Much Money—Making, Selling Your Own Goods.** Formulas, Processes, Trade-Secrets. All kinds. All lines. Catalog Free. B. Thaxly Co., Washington, D. C.

**DISTRICT Managers—Agents:** Capable men and women financially able to create and sustain branch office for new low-priced household necessity in big demand. Agents also wanted. For particulars write, Pittsburgh Sanatory Supply, Inc., Wilkensburg, Pa.

**AUTO owner tire agent wanted each locality to use and take orders for hand-made Mellinger cord and balloon tires;** guarantee bond 15,000 miles; shipped prepaid on approval; get your tires free; no capital or experience required; make \$100 to \$300 weekly. Write for wholesale prices and sample kit. Address Mellinger Tire Co., Dept. 400, Kansas City, Mo., or Dept. 400, Philadelphia, Pa., or Dept. 400, Oakland, Calif.

**NO Dull Times Selling Food.** People must eat. Federal distributors make big money; \$3,000 yearly and up. No capital or experience needed; guaranteed sales; unsold goods may be returned. We furnish you with sample case, license and Free Samples for customers—Sure repeat orders. Exclusive territory. Ask now! Federal Pure Food Co., A2307 Archer, Chicago.

**\$60-\$200 A WEEK.** Genuine Gold Letters for store windows. Easily applied. Free samples. Liberal offer to general agents. Metallic Letter Co., 438-B North Clark, Chicago.

**DIFFERENT selling plan;** low prices and quality gets the business. 100% profit. Over 100 fast selling brushes, dust mops and household necessities. State age and experience. Kautenberg Co., Box P, Freeport, Ill.

**100% PROFIT.** Every home buys "The Home Patrol" Burglar Alarm. Automatically sounds alarm and locks window. Agents coining money. Particulars free. Turk Mfg. Co., 32 No. Jefferson St., Chicago.

**AGENTS:** Build a permanently profitable business on one easily sold item. Globe Re-Atomizers, a new, patented invention has an untouched, ten-million-dollar market awaiting it. Act now and obtain exclusive representation. Send \$1.00 for sample and complete information. References: Chamber of Commerce, R. G. Dun, National City Bank, Brotherhood Bank, Globe Sales & Distributing Co., 101B Spokane St., Seattle, Wash.

**FIBRE Brooms—detachable handles, fine finish.** Good profits, repeat sales. The Fibre Broom People, 147-C New Jersey Ave., Brooklyn, N. Y.

**DOUBLE Your Income.** Read Opportunity, the Magazine that offers thousands of openings to double your income. Sent Free. Just send name and address. Opportunity Magazine, 750 N. Michigan, Dept. C-2, Chicago.

**"MAKE and Sell Your Own Goods"**—Guaranteed formulas. All kinds. Catalog free. Clover Laboratories, Park Ridge, Ill.

**AGENTS:** We have a whirlwind seller. Get details. Webster, 608 Wrightwood, Chicago, Ill.

**MAN with auto;** one day weekly; \$35. Bens, Woodside, N. Y.

**PORTRAIT Men,** largest frame Portrait House on coast. Foreign shipments our specialty—twenty-hour service. Victor Portrait Co., 2223 Brush, Oakland, Calif.

**SIMPLEX Vaporizer.** 25 to 60% increased mileage guaranteed. Retail \$1. Thirty Days Free trial. Exclusive territory. American Fixture Co., 234 West Water, Milwaukee, Wis.

**MONOGRAM Automobiles, \$1.35 Profit** ten minutes' work; every owner wants them; millions without; particulars free. Motorists Accessories Co., Mansfield, Ohio.

**TOMBSTONE Cleaning;** lonesome work, but dollars jingle. See under classification (Formulas).

**AGENTS Wanted for fast, easy seller—Marvel pipe cleaner;** literature free. Costick Products, 400 West 23rd, New York.

**NEW, Fast Seller; 150% profit;** "Best-ever Powdered Hand Soap"; removes grease, paint, ink, dirt; great repeater. Sample Free. Bestever Prod. Co., 4319-P, Irving Park, Chicago.

**PORTRAIT Agents—Write for new Catalogue—Enlargements, Frames, Medallions, Sheet Pictures, Luminous Crucifixes.** Adam J. Kroll & Co., 2539 So. State St., Chicago, Ill.

**WE Start You Without a Dollar.** Soaps, Extracts, Perfumes, Toilet Goods. Experience unnecessary. Carnation Co., Dept. 2480, St. Louis.

**WANT Distributing Agent for Handslick,** powdered hand soap; removes anything from hands; everybody a customer; sample free. Solar Products Co., J-2142 S. Troy, Chicago.

**ALL-YEAR-ROUND profitable business** selling wonderful new water softener and cleaner. Removes grease, oil, ink and dirt quickly. Every home and business place a live prospect. 100% profit. Big repeat orders. Exclusive territory. Write for free sample. Seacoast Laboratories, Sea Bright, N. J.

**GOLD Leaf window letters and script signs.** No experience; 500% profit. Samples free. Consolidated, 69-U West VanBuren@Chicago.

**AGENTS:** both sexes, we manufacture and control new household article. Fast seller. Big profits. Exclusive territory. Write now. Connolly, 123 Liberty St., New York.

**SEND name, address on postcard.** Free introductory copy Salesology Magazine; contains 1,000 money-making opportunities. Offered by big reliable firms; no obligations. Salesology Magazine, Desk B-38, 500 No. Dearborn, Chicago.

**32 SECONDS complete tire change by Detmer,** Ohio, with Morey Quick Action Rim Tool. Sold, singly, 49 three days, cleared \$100. Anderson, Mont., sold 1400 in 14 weeks. Get details for good territory. Harvest time Now. M. Morey Rim Tool, Buffalo, N. Y.

**REMNANT Store,** Bethel, Ohio. Greatest Dry Goods Bargains on Earth. Agents and Dealers.

**AGENTS—Clever Invention!** Inkspoon makes every pen a fountain pen. Fast office seller; big profit, demand increasing everywhere. Exclusive territory offered. Sample free. H. Marul Company, Tribune Bldg., New York, N. Y.

**EARN \$10 daily silvering mirrors, plating and refinishing metalware, autos, chandeliers, bedsteads, headlights.** Outfits furnished. E. Decie Laboratories, 1133 Broadway, New York.



**AGENTS**—Make a dollar an hour. Sell Mendets, a patent patch for instantly mending leaks in all utensils. Sample package free. Collette Mfg. Co., Dept. 404, Amsterdam, N. Y.

**AGENTS**—Send for Free Sample "Fret-not" Washday Wonder. Big Profit. You don't have to talk; if she doesn't buy at sight, leave sample. Exclusive territory. Credit given. Empire Specialties Co., 1549 N. Wells, Dept. 101, Chicago.

**AGENTS** make \$100 week placing advertising Cigar Lighters with glass front. Every dealer wants one. Write for free plan. Drake Mfg. Co., Dept. M, Milwaukee, Wis.

**BIG Profits.** Sell "No-Splash" 4-Strainer Water Filters. Fast sales, lowest prices; send for 6 dozen, \$1.80 postpaid. Jones Mfg. Co., 243E2 Franklin St., Boston, Mass.

**GENUINE Gold Leaf Letters** anyone can put on Store windows. Guaranteed to never tarnish. Large Profits. Enormous Demand. Free Samples. Write today. Metallic Letter Co., 438-D North Clark, Chicago.

**AT Last! Diamond Rival Discovered!** Amazing blue white Rajah Gem astounds jewelry world and deceives experts. Beautiful sample case free! \$100 weekly. Quick! Rajah Diamond Co., Dept. F20, Salisbury, N. C.

**\$31.00 PROFIT**—with \$1.50 Outfit—Big Money—Easy Work. Selling Gold Monograms for Automobiles, Luggage, Windows, Wagons. No Experience. No License. "Samples Free." NuLife Monograms, Hartford, Conn.

**OUR New Household Device** washes and dries windows, sweeps, cleans walls, scrubs, mops. Complete outfit costs less than brooms. Over half profit. Harper Brush Works, 132 3rd St., Fairfield, Iowa.

**SELL men's neckwear;** wonderful proposition. Astor, 318-M Broadway, New York.

**DO you want good live agents**—fellows who can get the business? Ask me how others are doing it. I'll gladly render the necessary assistance without cost to you. Address, M. L. Rund, Mgr. Classified Advertising, Popular Mechanics Magazine, Chicago.

**AGENTS.** Get our prices on Coffee, Tea, Desserts, Soaps, Perfumes, etc. Endless variety, superb quality, quick service. Sample display free. Address Blair Laboratories, Lynchburg, Va.

**AGENTS:** 500% profit. "Happy Home Make Shampoo" builds your own big business. Martin of Indiana made \$75.00 in one day. Missouri man made \$750.00 one month. Exclusive territory. Geo. A. Schmidt & Co., Dept. P, 236 W. North Ave., Chicago.

**PHOTO Medallion Men and Women,** the largest line of Photo Novelties in the world. Lowest prices, quickest service. Send for catalogue showing over 200 money makers, Photo medallions, photo medallion clocks, photo mirrors, photo fountain pens, photo powder compacts, photo jewelry and photo buttons. Gibson Photo Jewelry Co., 608-614 Gravesend Ave., Brooklyn, N. Y.

**HUNDREDS of manufacturers,** formerly agents selling other goods now owe their success to Miller's Guaranteed Formulas for making biggest-selling, advertised specialties in all lines. Investment small. No machinery needed. Profits great. Make your own goods—get the profit you're entitled to. Write today for my "eye-opening" literature. It's free and tells all. Miller, Chemist, 1706-W Jetton, Tampa, Fla.

**WILLIAMS' Powdered Hand Soap** has taken auto owners by storm. Cleans dirtiest hands instantly. Easy demonstration sells on sight. Free Sample and particulars. W. B. Williams, Inc., Dept. 266, Montclair, N. J.

**THE best tooth-paste for Pyorrhea** is Zi-O-Dine. Every tube guaranteed. Taste and cleansing qualities wonderful. Fifty cent tubes. Agents wanted. Iodine Products Co., Laurel, Miss.

**AGENTS:** Our gold-eyed Needle Cases are wonderful sellers; immense profits; \$50 to \$300 weekly; proof and particulars free; sample outfit 10c; factory prices. Paty Needle Co., 231 Davis Square, Somerville, Mass.

**CALIFORNIA** perfumed heads selling like hot cakes. Agents coining money. Big profits. Catalog free. Mission Factory P, 2328 W. Pico, Los Angeles, Calif.

**SELLING Like Blazes!** Eleven piece toilet goods assortment at \$2.25 with two piece carving set free to your customers. 100% profit. Davis Products Co., Dept. 56, 1321 Carroll, Chicago.

**\$16 A DAY Easy**—I start you in auto accessory business; no investment; no experience necessary. Landin, 3433 Montrose Ave., Chicago.

**OUR Luminous Crucifix Shines** in the Dark. Every one amazed at the wonderful effect. Easily demonstrated. Easily sold. W. G. Hannan Co., Dept. B, 2539 So. State St., Chicago.

**NEW Camera.** Regular black and white photos finished quickly inside camera. Make money selling cameras, taking photos or doing both. Crown Company, Dept. 481, Norwalk, Conn.

**A BUSINESS of Your Own**—Making Sparking Glass Name and Number Plates, Checkerboards, Signs, Big Book and Sample Free. E. Palmer, 512 Wooster, Ohio.

**GET Our Free Sample Case**—Toilet articles, perfumes and specialties. Wonderfully profitable. La Derma Co., Dept. A, St. Louis, Mo.

**BIG Money and Fast Sales.** Every owner buys Gold Initials for his auto. You charge \$1.50; make \$1.35. Ten orders a day easy. Write for particulars and free samples. American Monogram Co., Dept. 40, East Orange, N. J.

**POLMET**—The Wonderful Polishing Cloth that cleans all metals without liquid, paste or powder. Approved by "Good Housekeeping" and "Modern Priscilla"—sells fast at 25c. Sample free. Gale & Co., Inc., 15 Edinboro St., Boston.

**MAN in each town** to plate auto parts, reflectors, bathroom fixtures, refinish beds, mirrors, chandeliers; by new method. No capital or experience required. Simple plan of manufacturing at home starts you in big money-making business. Outfit furnished. Free particulars and proofs. Gun Metal Co., Ave. H, Decatur, Ill.

**REPLATE** brassy worn-off Automobile parts, Reflectors, Bath Room Fixtures, Worn Spoons, Forks, etc., with pure silver. Looks like new. Use U-Kan-Plate Polish. Positively no mercury. \$1.00 half pints. Post Paid. Satisfaction Guaranteed. Agents wanted. Dept. A, U-Kan-Plate Co., Philadelphia.

**AGENTS**—Stamping names on Pocket Key Protectors; sample Check with your name and address, 25c. Stamping Outfits, Emblem Checks, Check Fobs, Name Plates. Hart Mfg. Co., Desk 2, 303 Degraw St., Brooklyn, N. Y.

**\$50.00 WEEKLY** easy. Applying Gold Initials on Automobiles. No experience needed. \$1.45 profit every \$1.50 job. Free Samples. "Ralco Monograms," 1043 Washington, Boston, Mass.

**OVER 100% Profit.** Self Lighting Gas and Cigar Lighters; Everybody interested, repeat business. Sell individuals, dealers, subagents. Particulars Free. P. Bernhardt, 127 West 30th St., New York.

**DON'T sell for others.** Employ agents yourself. Make your own products. Toilet Articles, Household Specialties, etc. 500% profit. We furnish everything and show you how. Valuable booklet free. Write at once. National Scientific Laboratories, 1978W Broad, Richmond, Va.

**AGENTS**—Mac's Liniment (liquid mustard plaster) for coughs, rheumatism; Mac's Black Lotion for pyorrhea, wounds, sore gums, piles. Mac Chemical Corp., 74-A West St., New York.

**EVERY Woman** Wants a Sewing Set. Home Sewing Sets contain 142 useful sewing articles. \$4 an hour easily made with this 50c seller. Prentice-Lee, 145 East 23rd St., New York.

**BIG Profits:** Steady Income our line food products, toilet articles, soaps. No cash or experience needed. Sample case free. Write Linro Co., Dept. 242, St. Louis, Mo.

#### HIGH-GRADE SALESMEN WANTED

**STEAM Equipment Salesmen** Experienced with Cleaners, Laundries, Bakeries, Dairies. Unlimited possibilities. Advertising creating leads. Monarch Engineering Co., 2010 Locust, St. Louis, Mo.

**\$150 A WEEK** Placing Radio Agencies. Nothing to sell. Dealers' sales guaranteed. Commissions on repeats. Radio knowledge unnecessary. Box 491, Iowa City, Iowa.

**\$10,000 YEARLY** Easy. No Experience Necessary. Selling Fast Seller Royal Special Policy which Pays \$5,000 Accidental Death, \$1250 Death from Any Cause; \$25 Sick Weekly Benefits, \$50 Weekly Accidental Disability—\$24 yearly—Other Amounts Proportionate. No Medical Examination. Greatest Bargain. \$5,000 Accident Policies given free to first 500 answering this ad. Mr. Minne, American Peoples Life, 1107-159 North State St., Chicago.

**WANTED**—Openings for territorial Salesmen in every state. We are the largest made-to-measure tailoring house in the country. Our full time men earn \$60 to \$125 per week. Spare time workers earn \$35 to \$60 per week. Complete \$40 selling outfit sent free—150 all-wool fabrics—featured to sell at \$23.50-\$29.50-\$34.50-\$43.50. Large commissions paid daily. Our prices save customers \$15-\$20 on their garments. Absolute Satisfaction Guaranteed or money refunded. 6-day delivery service. Write for line today and full particulars. Edward E. Strauss & Co., Inc., Dept. 101, 400-416 S. Market St., Chicago.

**SPARK Plug**—A Double Plug with two spark gaps. Costs no more. Produces bigger, hotter spark on weaker current and leaner mixture. Sold on positive guarantee to excel other plugs or money refunded. Good commissions. Agents and side-line men wanted. Affinity Spark Plug Co., Woodmen Bldg., Omaha, Neb.

**MEN**—Sell dependable shrubbery, fruit trees, etc. Steady demand. Complete cooperation. Commissions paid weekly. We deliver and collect. Write Perry Nurseries, Dept. R-7, Rochester, N. Y.

**WALKER Made \$165.00 First Day** selling Collection System to Doctors and Merchants. Retail \$6.50, Collects \$65.00, Costs \$1.50. Adjustment Bureau, Mobile, Ala.

**BIG Season Just Ahead.** Advertising pencils more popular every day—every business prospect. Our line repeats. Big commissions. Established 1902. North American Pencil Works, 126 So. Clinton, Dept. 55A, Chicago.

**DEMAND for Electric Window Displays** is Established. Our Hustlers easily hitting \$100 weekly with the Leader—Magic Window Salesman—Color, Light, Motion. High-class. Buyers fall quick on demonstration. Greatest quick-change Letter System known, and new, snappy, Two-color Poster Service the answer. Live salesmen getting protected territory Now. Display Products Co., A407-9 East 31st, Kansas City, Mo.

**\$40.00 SUITS** for \$23.50! All one price. Union made of finest quality Virgin Wool. You don't have to know anything about selling clothing. We guarantee your success if you are honest and willing to work. Write at once. William C. Bartlett, 850 Adams, Dept. 501, Chicago.

**DON'T sell for others.** Employ agents yourself. Make your own products. Toilet Articles, Household Specialties, etc. 500% profit. We furnish everything and show you how. Valuable booklet free. Write at once. National Scientific Laboratories, 1978W Broad, Richmond, Va.

**EARN \$20 a Day.** Establish income for life selling for \$1 a year, \$1,500 accident policy. Write W. C. Stone, A-11 So. LaSalle, Chicago.

**SALESMEN**—Get free outfit and make \$90 a week taking orders for famous Taylor rain-proof, made-to-measure caps and knickers for men. Also eight other big profit-makers. Commission in advance. We deliver. Taylor Cap Manufacturers, Desk T-6, Cincinnati, Ohio.

**OUR Superior Proposition** will Net You \$100 a week, every week in the year. Equipment and car furnished. No capital or experience necessary. Immediate profits. Write today for particulars. American Products Company, 9353 Monmouth, Cincinnati, O.

**OFFICE specialty salesmen** wanted. Exclusive agencies. Dibb Manufacturing Company, Minneapolis.

**AGENTS**—Genuine Broadcloth Novelty Shirts for wear with or without coats—Great Summer Sellers. Write quick for territory and free Samples. Cincinnati Shirt Company, Lane 2947, Cincinnati, Ohio.

**NEWLY Patented Pocket Leather Specialty.** \$6.50 value \$3.45. No competition, \$10-\$25 paid daily in advance. We Deliver. Full—Part time. Free Sample offer. Initialite Co. (Manufacturers), 22E Quincy, Chicago.

**FREE working equipment!** Catalogue. Samples. Beautiful gold window sign letters. Any Size, one cent each. Why pay 8c? Write Atlas Sign Works, D. 1032 E. 55th St., Chicago.

**SALESMEN.** Distributors—Sensational new patented telephone and electric fan necessity that sells itself to offices, stores, homes and factories. Quick seller, 100% profit. Opportunity to develop big business quickly. R. Johns, Manager, 219 South Dearborn, Chicago.



**SALESMEN**—Become Independent. Own Your business, experience unnecessary selling our \$7,500.00 Accidental Death; \$50 Accident; \$25 Sick Weekly Benefits—\$12.50 Yearly. Other Amounts proportionate. Guaranteed steady income from renewals. \$250,000 Deposited Insurance Department. Universal Policy, Dept. A, 30 Clinton St., Newark, N. J.

**MILLIONS** of business men waiting for Brand New indispensable \$10.00 office utility saving hundreds of dollars annually. One man sold sixteen in three hours. Splendid profits. Write quick for trial offer and exclusive Virgin territory. Lightning Calculator Co., Dept. FT, Grand Rapids, Mich.

**COLLECTS** Money from the Dead-Beats. - Retailers \$5.00—Cost \$1.00—Profit \$4.00. "New Method." Every Storekeeper, Doctor buys quickly. Wonderful Money Getter. Federal Association, Hartford, Conn.

**SALESMEN and Salesladies:** Take orders for rugs, damask, Novelty designed bedspreads and draperies. Liberal territory and commission. Rainbow Novelty Mills, Grover, N. C.

**75c PROFIT** on \$1.00 sale. Auto, furniture and glass cleaner. Your name on label. Exclusive rights—free sample. Mfg. E. 213 Griswold, Detroit, Mich.

**TRAVELING Salesmen** Calling on Retail Stores wanted by large manufacturer of fast-selling specialties entirely different from the average. Year-round sales, main or sideline. Big commission paid immediately on original and repeat business. Opportunity for well paid and permanent connection with old-established firm. If not making \$150 weekly, write today. Union Specialty Works, Dept. 222, Boonville, N. Y.

**GOLD** Leaf window letters and script signs. No experience; 500% profit. Samples free. Consolidated, 69-V West Van Buren, Chicago.

**IF You Think In Terms Of \$6,000 This Year**, write us now. Strong line for retail stores. Nationally advertised. Established concern. Best season now starting. Liberal weekly advance to producer. Continental Co. 2010 Euclid, Dept. 1300, Cleveland, Ohio.

**SELL** Printing—Business and Personal stationery. 40% commission. Large line; big repeater. Samples free. Roberts Printing Co., 515-1 Broadway, Albany, N. Y.

**\$60-\$200 A WEEK.** Genuine Gold Letters for store windows. Easily applied. Free samples. Liberal offer to general agents. Metallic Letter Co., 438-A North Clark, Chicago.

**FOUR \$7.50 sales** to merchants net you \$20.00 daily. Sayers Systems, 2803 Sheffield Ave., Chicago, Ill.

**ANY Salesmen Can Sell Them!** Merchants everywhere use punchboards. Someone sells them, why not you? Collect big commissions daily. Newest, largest, elaborate catalog sent upon request. Lincoln Sales Co., 9 So. Clinton, Chicago, Dept. D.

**DOUBLE Your Income.** Read Opportunity, the Magazine that offers thousands of openings to double your income. Sent Free. Just send name and address. Opportunity Magazine, 750 N. Michigan, Dept. C-3, Chicago.

**SEND** name, address on postcard. Free introductory copy Salesology Magazine; contains 1,000 money making opportunities. Offered by big reliable firms; no obligations. Salesology Magazine, Desk B-39, 500 No. Dearborn, Chicago.

**SPECIALTY Salesman** wanted. Big commissions being earned selling Ever-Ready cans. Write for particulars. Ever-Ready Can Company, Greenfield, Ohio.

**TAKE** orders for coffee, flour, dried fruits, canned goods, staple groceries, toilet articles, paints, radio sets, auto and tractor oils. No capital or bond required. We deliver and collect. Permanent business. Big pay. Write at once. Hitchcock-Hill Co., Dept. 50, Chicago.

#### HELP WANTED

**MR. MAN!** There's mighty big money re-finishing furniture, radio-cabinets, etc. Spare-time, full-time. Practically no capital required. Valuable information free. F. L. Jackson, 716 W. Exchange, Owosso, Mich.

**MEN** to train for locomotive firemen on railroads nearest their homes—everywhere; beginners \$150-\$250 monthly; promoted, locomotive engineer, \$3,000-\$4,000 yearly. Best paying positions on railroads. Railway Association, Desk M1, Brooklyn, N. Y.

**MR. BRUSH Salesmen**—Old Established New York brush manufacturers require services of men in all territories to sell their extensive line of Sanitary Twisted in Wire Brushes. We pay larger commission than any other brush house in the country. Write immediately for our proposition. Wire Grip Sanitary Brush Corporation, 15 Mercer St., New York.

**U. S. GOVERNMENT jobs.** Become Railway Postal Clerks (\$158-\$225 monthly). City Carriers—Postoffice Clerks (\$142-\$192 monthly). Rural Carriers (\$175-\$255 monthly). Men 18 up. Steady work. Life positions. Common education sufficient. Experience unnecessary. Sample coaching and full particulars free. Write today sure. Franklin Institute, Dept. L-3, Rochester, N. Y.

**MEN, Women,** permanent Government positions. Carriers, Postal, Railway Mail Clerks, Customs, Immigration, Prohibition Inspectors, Home training with guarantee. Big Pay. O'Brien School, 219 South Dearborn, Chicago.

**CASH** paid for butterflies, insects. See Sinclair Display Advertisement on page 30.

**YOU** are wanted. Men—women. 18 up. Government Jobs. \$1,140-\$3,000 year. Common education sufficient. Sample coaching—Free. Franklin Institute, Dept. L-14, Rochester, N. Y.

**STEAMSHIP Positions,** Europe, orient, etc. Good pay; experience unnecessary. We help you to secure them. Write for free application form. Box 30-A, Mount Vernon, N. Y.

**WANTED:** ambitious, reliable man with selling experience to start business of his own in his home town. Right man will be financed, \$5,000.00. Write fully, stating references. Imperial Stationery Company, Desk CG-100, Greenfield, Ohio.

**DON'T** prepare for any Civil Service Examination without seeing our catalogue. Free. Columbian Correspondence College, Washington, D. C.

**BOYS**—Men, 16 Up. Become Auto Mechanics. \$35.00 week. Franklin Institute, Dept. L-400, Rochester, N. Y.

**FREMEN, Brakemen, Baggage men** (white or colored), sleeping car, train porters (colored), \$150-\$250 monthly. Experience unnecessary. 810 Railway Bureau, East St. Louis, Ill.

**GREAT** neckwear line now free! Features finest quality neckwear at factory prices. Collect big commissions daily. Write for free tie offer and free outfit. Nawco Neckwear, Desk 7-W, Covington, Ky.

**MAKE** fortunes as Real Estate Specialists. I made \$100,000. Cooperate with me. Learn the secret of my success. Use my remarkable system. Start at home in spare time. Build wonderful business without capital or experience. Write at once for my amazing money-making offer. Address Osterlander, Room 44, 18 East 18th St., New York.

**WHY** Not Sell Us Your Spare Time? \$2 an hour, \$19.70 daily easy Full Time. Introducing New Style Guaranteed Hosiery for men, women, children. Silk hose for your own use free. No capital or experience required. Your pay daily. Monthly Bonus Extra. We furnish samples. Milton Mathews, Road 2607, Cincinnati, Ohio.

**YOU** Are Wanted. Government Jobs. \$1,140-\$3,000 year. Sample coaching Free. Franklin Institute, Dept. L-14, Rochester, N. Y.

**DOUBLE Your Income.** Read Opportunity, the Magazine that offers thousands of openings to double your income. Sent Free. Just send your name and address. Opportunity Magazine, 750 N. Michigan, Dept. C-1, Chicago.

**MEN** wanting to prepare for forest ranger job; \$125-\$200 month; nice cabin. Hunt, trap and patrol. Nat'l Forest list free. Write, Rayson, Dept. B-46, Denver, Colo.

**IF** you are a man worthy of the name and not afraid to work. I'll bet you \$50.00 you can't work for us thirty days and earn less than \$20.00. Think I'm bluffing? Then answer this ad and show me up. Openings for managers. Wonder Box sells on sight. The best selling proposition in America today. Write Tom Walker, Dept. 120, Pittsburgh, Pa.

**SEND** name, address on postcard. Free introductory copy Salesology Magazine; contains 1,000 money-making opportunities. Offered by big reliable firms; no obligations. Salesology Magazine, Desk B-40, 500 No. Dearborn, Chicago.

**U. S. GOVERNMENT** wants men. \$1,700-\$1,900 and up at start. Railway Mail clerk examination coming. Let our expert (former Government examiner) prepare you for this and also Rural Carrier, Post Office, Customs, Internal Revenue, and other branches. Write today for free booklet. Dept. 8, Patterson School, Rochester, N. Y.

**GOVERNMENT** positions pay \$35 to \$75 weekly. We help you get them. Big List Free. Write, Mr. Ozment, 101, St. Louis Mo.

**EARN \$10** daily silvering mirrors, plating and refinishing metalware, auto, chandeliers, bedsteads, headlights. Outfits furnished. E. Decie Laboratories, 1133 Broadway, New York.

**BECOME** a Landscape Architect. Uncrowded profession of wonderful opportunity for money-making. Easily mastered by mail. Earn while you learn. Write for book. American Landscape School, 56-E, Newark, N. Y.

**SILVERING** Mirrors, French Plate. Easily learned; immense profits. Plans free. Wear Mirror Works, Excelsior Springs, Mo.

#### INFORMATION

**PUZZLES!** If you like them we recommend an illustrated book containing 122 of the best mechanical puzzles. You can have loads of fun working out the solutions as enough hints are given in the text matter to enable one to do so. Pay postman \$1.00 and postage when he hands you the package. Address Popular Mechanics Press, Room 907, 200 E. Ontario St., Chicago.

**WHAT** Subjects Interest You? Select from this list of helpful worth while books. Social Letters Made Easy, Spelling Made Easy, How to Develop Your Will Power, Tricks and Magic Made Easy, Bookkeeping Made Easy, Chemistry for Beginners, How to Work Your Way Through College, Confidential Chats with Boys. Price \$1.25 per volume. Pay postman price and postage when he hands you the package. Address Popular Mechanics Press, Room 907, 200 E. Ontario St., Chicago.

#### MAILING LISTS

**99% GUARANTEED** Mailing lists. Accurate. Reliable. Guaranteed. The kind that produces business; compiled for every possible business or individual. Lists of every kind of any business or individuals compiled for your individual needs anywhere. Catalog and information on request. National List, 847 Broad, Newark, N. J.

**1,000 NAMES,** \$1.00. Mention Classification. Wineholt Sales Co., Woodbine, Penna.

**BIG** Mail Directory listing, 25c. Larson Bros., 3410 North Ave., Chicago.

#### BUSINESS SERVICE

**REPRESENTATION** in Washington, D. C. Information, Anything, Anytime. Service, Victor Bldg.

#### TYPEWRITERS AND SUPPLIES

**UNDERWOOD** Typewriters—only \$3.00 down. Easy monthly payments. Low prices at less than manufacturers, 10 days' free trial. Rebuilt, all worn parts replaced. Just like a new machine. 5-year guarantee. Write for a big free catalog. A-151, Shipman-Ward Mfg. Co., B-151 Shipman Bldg., Chicago, Ill.

**TYPEWRITERS,** all standard makes, thoroughly re-manufactured by the famous "Young Process" and shipped direct from factory to you on 10 days' trial. Guaranteed 5 years. Easy monthly payments. Write today for free catalog. Young Typewriter Company, Dept. 5747, 654 W. Randolph St., Chicago.

**100 TYPEWRITERS** Free. Overstocked. Rent Rebuilt Underwood or Remington \$3.00 month. If you pay its value in rental, we give machine free. Particulars free. Pittsburgh Typewriter Exchange, 945 Hersch Bldg., Pittsburgh, Pa.

**TYPEWRITERS,** all standard makes. \$10 up. Fully guaranteed. Free trial. Write for complete illustrated lists. Northwestern Typewriter Exchange, 121 N. Francisco Ave., Chicago.

**TYPEWRITERS,** Radios, Motorcycles, \$5-\$45. Knights, 1512 Locust, St. Louis, Mo.

#### PRINTING, ENGRAVING AND MULTIGRAPHING

**500 ATTRACTIVE** two-color letterheads \$2.65. Cloister, 1949-X5 Arrow, Indianapolis.



**MULTIGRAPHING** business correspondence, two dollars thousand. Hammermill letterheads, four dollars. Miscellaneous printing. Mayera Corporation, Monmouth, Ill.

**GENUINE Engraved Stationery**—125 sheets and 100 envelopes engraved three lines for \$5. Request samples. Artcraft Engraving Co., 117 N. Wells, Chicago.

**MIMEOGRAPHED** Letters by Specialists; Low prices; Samples. Letter Service, 620 Woodland, Kansas City, Mo.

**\$3.00 DELIVERED**, 500 watermarked bond letterheads 8½x11 and 250 envelopes. Cash. Catalog free. Printing bargains. National Printing, Goshen, Ind.

**COMMERCIAL** Printing. Prices Right. Samples Free. The Fox Press, Frankfort, N. Y.

**DISTINCTIVE**—Artistic Business Stationery that Creates Confidence. 1,000 Letterheads or Envelopes \$3.00. Samples. Moulton Printing Company, 1410-P East 8th, Kansas City, Mo.

We print Stationery, Booklets, Catalogs, Circulars. Samples. Commercial Press, Batavia, Ohio.

**QUALITY** Printing! Reasonable Prices! Send for Free Standardized samples and prices. Folders, Circulars, Catalogs our specialty. Ernest Fantus, 525 South Dearborn, Chicago.

500 **BOND** Letter Heads and 250 Envelopes, \$3.25. Pfleger Bros., Hackensack, N. J.

1,000—6½ **WHITE** envelopes printed, \$2.35; 5,000—\$8.85. Letterheads, 1,000—\$2.95. Spors Printery, Lesueur Center, Minn.

**BLUE** Social Stationery \$1. Not printed. P. Lavin, Coshocton, Ohio.

1,000 **LETTER HEADS** \$3.25, 1,000 Envelopes \$2.75. H. B. Adams, Penns Grove, N. J.

**MULTIGRAPH** Letters \$2 Thousand. Letterheads \$4. Printerasters, 1390 Temple, Detroit.

300 **LETTERHEADS**, 300 envelopes, \$3.00. Jean McLane, 1215 Russell Ave., Bethlehem, Pa.

**PUBLISH** Your Own Magazine or House Organ. Our standardized service at one-fifth ordinary prices. Samples and particulars free. Evans Printing Company, Grand Rapids, Mich.

1,000 **LETTERHEADS**, Envelopes or Business Cards, \$2.95 delivered. 4605 Wells, Milwaukee, Wis.

100 **CARDS**, name and address, 25c. Samples free. Altheide, Printer, Plymouth, Ind.

500 **ENVELOPES**, Letterheads, Cards, \$2.00 each. Consolidated, 553 Greenfield, Milwaukee, Wis.

250 **LETTERHEADS**, 250 Envelopes—Bond, \$3.00. L. Altheide, Printer, Plymouth, Ind.

**ADVERTISING** Gummed Labels that satisfy. Samples free. P. Watzel, Valhalla, N. Y.

250 **LETTERHEADS**, 250 white envelopes printed and mailed \$3.00. Samples printing free. Sunco, Mohawk, N. Y.

**PRINTING**—Stationery, Circulars, Booklets. Fine work; prices right. Battlefield Press, Gettysburg, Pa. Free battlefield souvenir.

200 **HAMMERMILL** Letterheads, Envelopes, Billheads or Cards, \$1.00. Bace Printery, Hudson, N. Y.

250 6½ **ENVELOPES**, \$1.00. 200 Bond, \$1.00. Retter-Greene, Tippencanoe City, Ohio.

100 **20LB.** Bond Letterheads, 8½x11, and 100 Envelopes printed, \$1.50. Lehman Sales Company, Box 249, Duluth, Minn.

**PRINTING**: Lowest prices in America. Fine work, quick service. Stationery, circulars, office forms, etc. Large price list and samples free. Pitts, Amana, Iowa.

**"NEARGRAVUREMBOSSO"** (type embossed) Stationery—Cabinet 125 Sheets, 100 Envelopes, \$2.25 postpaid. Exquisite. Samples. Solldays, Knox, Ind.

**EMBOSS** your Stationery with Hand Embosser. Circular free. Midwest, Box 47, Springfield, Ill.

250 **HAMMERMILL** Bond Letterheads, Envelopes, \$3.00. Midland Press, 543 West Hickory, Kankakee, Ill.

250 **BOND** Letterheads, Envelopes, Billheads, Cards, \$1.35 each. Economic Press, Leonia, N. J.

## PRINTING, OUTFITS AND SUPPLIES

**PRE-USED** printing presses, type, materials. Lists 2c stamp. Popular Bargains, Richland, Pa.

**COMPLETE** printing outfits, presses, type, ink, paper, supplies. Write for Catalogue, Kelsey Company, G-11, Meriden, Conn.

**PRINTING** Presses, type, supplies. List 2c stamp. Bargains. Geo. Foster, 4342 North Robey, Chicago.

**PRINTING** Outfits—Presses, type supplies, type novelties. Send stamp for catalogue. Model Press, York, Penna.

## RUBBER STAMPS

**RUBBER** Stamps—Name and address, two line 25c; three line 35c. Newman & Son, Auburn, Nebr.

## ADDING MACHINES

**NEW** \$3.50 Automatic Adding Machine. Adds, subtracts, multiples absolutely accurate. Capacity \$999,999.99. Fully guaranteed. 75,000 pleased users. Makes adding easy, positive, quick. Eliminates mistakes. Saves time. Postpaid \$3.50. Bassett Co., 1458 E. Hollywood Ave., Chicago.

**FREE** trial. Marvelous Calculator, Adds, Subtracts, Multiplies. Divides automatically. Work equals \$300.00 machines. Five year guarantee. Price only \$15.00. Write today for free trial offer. Special: \$3.00 Pocket Calculator, only \$2.00 cash. Lightning Calculator Co., Dept. E, Grand Rapids, Mich.

## FOR SMOKERS

**BETTER** Tobacco! Fragrant, mellow! Ten pounds smoking, \$1.50. Four pounds chewing, \$1.00. Farmers' Club, 57, Hazel, Ky.

## FOR THE HOME

**WEATHERPROOF**, Waterproof Finishes are needed for everything used outdoors, and also indoors, and no such finishes you can apply compare with those bearing the famous name Valspar. Prove it yourself by testing articles finished with Valspar in sun, rain, heat and cold. Neither boiling water nor sub-zero temperatures injure Valspar. It comes clear and in Red (light and deep), Green (medium and deep), Blue (light, medium and deep), Vermillion, Yellow, Brown, Ivory, Gray, Orange, Mahogany, Oak (light, dark), Walnut, Cherry, Moss Green, Black, White, Gold, Bronze and Aluminum. Ideal for automobiles, bicycles, aircraft, boats, toys, radio cabinets, machines of all kinds and all uses about shop, home, farm and office. Absolutely waterproof and resists hard wear. Dries overnight. Send 20c for 40c sample stating color desired and you'll soon discover why Valspar is known favorably the world over. Valentine & Company, Dept. 1, 456 Fourth Avenue, New York, N. Y.

**HOME** Redecoration Time is here. Get newest ideas and methods from books just published for sale by Popular Mechanics Press. Interior Wall Decoration, Plain and Decorative Finishes, Practical Working Methods. 450 pages. Price \$4. Mixing of Colors and Paints, 292 pages \$2. Wood Finishing, Plain and Decorative, 360 pages, \$2. House Painting Methods, Brush and Spray Gun, 386 pages, \$2. Books will be sent C. O. D. Pay postman price plus postage when he hands you the package. Popular Mechanics Press, Room 907, 200 E. Ontario St., Chicago.

**GRANDFATHER'S** Clock Works, \$5.00. Build your own case; Instructions free; make good profits selling your friends. Clock works with chimes for old or new cases. Write for full particulars. Clock Co., Ruffner St., Philadelphia.

**CEDAR** chests only \$11.65—"Red-i-Kut" complete with rich copper trim—your assemble and save half—send for pictures. Kuempel Furniture Company, Guttenberg, Iowa.

**WORLD'S** most beautiful mantel clocks, \$5. Prepaid, or write P. V. Grasberger, Bunnass, Va.

**THAT** Concrete Job. Don't be afraid to tackle it. With the instructions found in Popular Mechanics Concrete Handbook you can make 173 articles of utility and beauty ranging from ordinary steps to garden furniture. This book with our Home Mechanics Handbook that contains 329 helps about jobs that come up about the home will be sent for only 98c plus postage C. O. D. Send your order today to Popular Mechanics Press, Room 907, 200 E. Ontario St., Chicago.

**DARCHE** "Call-Me" Electric Alarm and Light Clock. No home complete without one. Will ring until you get up and stop it. Write for information how to get one free. Darche Mfg. Co., 643 Washington Blvd., Chicago.

**THIS** is the season for making repairs about the home. Easily done with instructions in our new book. Tells exactly how to use tools, sharpen tools and cutlery, repair furniture and cabinets, upholster, work metal, solder, work glass, paint, stain, varnish, hang paper, repair plumbing, furnace, electrical equipment, shoes, harness, gloves and concrete work. Send no money. Just write and ask for "The Practical Book of Home Repairs." When postman hands you the book, pay him \$2.50 and the postal charges. Popular Mechanics Press, Room 907, 200 E. Ontario St., Chicago, Ill.

**HOW** to Make and How to Mend. 1000 articles telling how to repair almost everything in use or needed about a home or farm. Many illustrations; formulas and trade secrets. Send no money. Just ask for "How to Make and How to Mend." Pay postman postal charges and \$1.00. Popular Mechanics Press, Room 907, 200 E. Ontario St., Chicago, Ill.

## RAZORS AND BLADES

**NO** more trouble with a razor; send 25c (coin) for strip paste with directions. S. Schultz Service, Box 457, Zeigler, Ill.

**GILLETTE** Style Razor with 10 Blades in leatherette case 69c prepaid. Mele Station A, New Haven, Conn.

**GILLETTE** Type Razor Blades, 30c per 10 blades. J. Wandoe, Wyandotte, Mich.

## BOATS AND LAUNCHES

**BUILD** Your Own Boat using our Knock-Down ready cut materials. 55 models, outboard motor speedsters, runabouts, cruisers, sail, or row. Send 25c for catalog. Brooks Boat Co., Inc., Rust Ave., Saginaw West Side, Mich.

**SIXTEEN** foot outboard cabin cruiser. Complete plans 50 cents. Free boat building catalog. The Rudder 15 Murray Street, New York.

**NEW** Boat Book telling how to make 21 kinds of boats. Also many other helpful ideas on boating. Profusely illustrated. With this we include the big book, "Outdoor Sports the Year Round." Directions for making all sorts of devices for outdoor recreation. Send no money. Simply pay the postman \$1.98, plus postage when books are delivered. Popular Mechanics Press, Room 907, 200 E. Ontario St., Chicago, Ill.

**HUBBELL** Marine Coolers convert Ford engines into marine motors. Booklet free. Ford speedboat, easily built, blueprint and directions, sixty cents. C. C. Hubbell, 14B Cottage St., East Norwalk, Conn.

**PROPELLERS**, stuffing boxes, bearings, etc. Used reverse gears bought, sold. Wm. H. Baker, Pond St., Quincy, Mass.

**SHIP** Models—Worth while. Easy to make. Decorative Ships Picturesque Barbary Pirate Felucca and Beautiful Spanish Treasure Galleon (both 17th century). Instructions so simplified that any handy person can make these models with a few household tools almost without expense. No personal knowledge of ships or naval architecture required. New book only one of its kind. Pay postman \$2.50 plus postage when book is delivered. Popular Mechanics Press, Room 907, 200 E. Ontario St., Chicago, Ill.

## DIAMONDS, WATCHES AND JEWELRY

**SEND** Today for an Elgin cushion strap watch radium dial. Bargain \$16.50. Watches repaired. Moderate rates. Guild Time Service, Mt. Vernon, Ohio.

**EXCHANGE** your old broken watch for new Elgin or Waltham. Small difference. Ralph Pile, Somerset, Penna.

## WATCH REPAIRING

**ALL** makes of Watches repaired by experts. Write International Watch Service, Box 5P, Fordham Station, New York.

## ANTIQUES, WAR RELICS AND INDIAN GOODS

100 **GENUINE** Indian arrowheads from Arkansas \$4.00 postpaid. H. Daniel, Lamar, Ark.

**SEND** 5c for fine new list Indian relics, antique firearms. F. E. Ellis, Webster Groves, Mo.

## PHONOGRAPHS AND RECORDS

**PRACTICALLY** new Victor console phonograph in perfect condition, with 30 records \$55. R. E. Haesly, Winona, Minn.



**RECORDS**, latest selections thirty cents each. Write for catalogue. Pleasing Sound Phonograph Company, 204 East 113th Street, New York, N. Y.

**BUILD** your own Phonograph. Parts catalogue free. American Phonograph Company, 4116 West 24th Place, Chicago.

### MUSIC AND MUSICAL INSTRUMENTS

**PLAY** an Instrument? Like to laugh? Send ten cents for sample copy of The Music Jester. The Music Jester Co., Dept. P, 246 Fifth Ave., New York City.

**SONG** Poem Writers. Write Sequoia Song-writers' Service, Sherman Branch, Los Angeles, Calif.

**SONG** Poem Writers—Submit poems. Expert professional service. Diamond Music Company, Suite EHS, 790 Seventh Avenue, New York.

**RUDY WIEDOEFT'S** "Talks to Saxophonists." Free. Valuable advice on playing by America's Premier Saxophonist. Selmer, Elkhart, Ind.

**YOUR** Song Words can be set to music by composers whose songs have been sung by millions. Send your song poem today for free examination, criticism, and advice—We are copyright experts. Roberts' Music Studio, 114 West 44th Street, Suite 307D, New York City.

**SONG** Poem Writers Address Monarch Music Co., 236W-55th, New York.

**I BUY, Sell, Publish** Songs. Chester Escher, 455 Wayne St., Jersey City, N. J.

**SONG** Poem Writers—Address Ray Hibbler, D1, 2104 N. Keystone Ave., Chicago.

**VIOLINS**, Deep, Mellow, Soulful—on credit. Easy terms for wonderful instrument. Get details today. Gustav F. Henning, 2424 Gaylord St., Denver, Colo.

**"MUSIC Composed"** to words. Bauer Bros., (formerly of Sousa's Band), Oshkosh, Wis.

**WRITE** Songs. Big money and reputation. Write for information. J. Gordon Pub. Co., 201 N. Hoyne Ave., Chicago.

**I WANT** Song Poems. Casper Nathan, 3544 N. Racine, Chicago.

**SONG** Poem Writers—Stamp brings "Song Writers' Guide." Wm. Van Beaver, R1-1239 Elm St., Green Bay, Wis.

**CORNETISTS—Trombonists—Saxophonists—Clarinetists**. Get "Free Pointers." Name instrument. Virtuosi School, Buffalo, N. Y.

**VIOLINS—Fine hand-made**. Low Prices. Lehto, 935 14th, San Pedro, Calif.

### PATENT ATTORNEYS

**PATENTS**. Time counts in applying for patents. Don't risk delay in protecting your ideas. Send sketch or model for instruction or write for free book "How to Obtain a Patent" and "Record of Invention" form. No charge for information on how to proceed. Communications strictly confidential. Prompt, careful, efficient service. Clarence A. O'Brien, Registered Patent Attorney, Security Bank Building (directly across street from Patent Office), Washington, D. C. See pages 138 and 139.

**PATENTS** Procured: Trade Marks Registered—A comprehensive, experienced, prompt service for the protection and development of your ideas. Preliminary advice gladly furnished without charge. Booklet of information and form for disclosing idea free on request. Richard B. Owen, 30-Owen Bldg., Washington, D. C., or 41-R Park Row, New York.

**MILLIONS** spent annually for ideas! Hundreds now wanted! Patent yours and profit! Write today for free book—tells how to protect yourself, how to invent, ideas wanted, how we help you sell, etc. American Industries, Inc., 500-Victor Bldg., Washington, D. C.

**INVENTORS—Write** for our Guide Book, "How to Get Your Patent" and Evidence of Invention Blank. Send model or sketch of your invention for our prompt examination and instructions free. Randolph & Co., Dept. 430, Washington, D. C.

**PATENTS**, Trade-marks, Copyrights. Reliable services by an experienced practitioner devoting personal attention to each case. Inquiries invited. References furnished. B. P. Fishburne, Patent Lawyer, 525-A McGill Bldg., Washington, D. C.

**UNITED STATES** and Foreign Patents and Trade Marks; Low rates; easy terms. H. Sanders, Registered Patent Attorney, 7 Rand McNally Building, Chicago.

**LANCASTER** and Allwine, 221 Ouray Bldg., Washington, D. C. "Originators of the Form Evidence of Conception." Before disclosing your invention to anyone send for blank form to be signed and witnessed. Form and patent information bulletin free.

**EDWARD C. SASNETT**, Formerly a Principal Examiner U. S. Patent Office, Attorney at Law. Strictly personal service. Correspondence invited. McGill Building, Washington, D. C.

**MONROE E. MILLER**, Ouray Bldg., Washington, D. C., Patent Lawyer; Mechanical, Electrical Expert. Booklet and Priority Record blank gratis.

**PERCY S. WEBSTER**, 203 Saving and Loan Building, Stockton, California. Long established organization. Patent booklet free.

**PATENTS—Write** for our Guide Books and "Record of Invention Blank" before disclosing inventions. Send model or sketch of your invention for Free Inspection and Instructions. Terms reasonable. See advertisements on pages 140 and 141. Victor J. Evans & Co., 334 Ninth, Washington, D. C.

**"INVENTORS' Guide"** sent free on request; this book contains illustrations of patented inventions and gives valuable information and advice for all who have original ideas or improvements. Frank Leder-mann, Registered Attorney and Engineer, Woolworth Bldg., 1712, New York.

**LANCASTER** and Allwine, 221 Ouray Bldg., Washington, D. C. "Originators of the Form Evidence of Conception." Before disclosing your invention to anyone send for blank form to be signed and witnessed. Form and patent information bulletin free.

**INVENTORS**: Send sketch or model for advice and exact cost of patent. Ask for our Free book: "How to Obtain a Patent." Tells what every inventor should know. Established twenty-eight years. Highest references. Prompt service. Reasonable charges. Chandlee & Chandlee, 474 Seventh, Washington, D. C.

**PATENTS**. Booklet free. Highest references. Best results. Promptness assured. Send model or drawing for preliminary examination. Watson E. Coleman, Patent Lawyer, 724 Ninth St., Washington, D. C.

**PATENTS** of maximum protection by registered attorney. Former examiner patent office. Albert Jacobs, Barrister Building, Washington.

**MILLIONS** Made annually from new inventions. Why not patent yours? Advice Free. Chester W. Brown, Registered Patent Attorney, 510 Van Buren St., Chicago.

**PATENTS—Write** for Instructions. Carl Miller, Registered Patent Attorney, (former member Examining Corps, United States Patent Office), McGill Building, Washington, D. C.

**PATENTS** Procured. Prompt service. Personal, careful and efficient service. Highest references. Moderate fees. Send sketch or model for actual search and advice. George P. Kimmell, Master of Patent Law, 51 L. Legal Bldg., Washington, D. C.

**PATENTS** obtained under Cooperative Payment Plan. Write for particulars. W. E. Beck, Registered Patent Lawyer, 951 Jenifer Bldg., Washington, D. C.

**INVENTORS** having ideas to patent: Write for Booklet explaining Co-operative Plan for handling your applications. Tells how to sell and safeguard your inventions at lowest cost. Ralph Burch, Patent Lawyer, Jenifer Bldg., Washington, D. C.

**ESTABLISHED 1864**. Milo D. Stevens Company. Free Booklet. Patents, Trade-Marks, Copyrights. Offices, Monadnock Block, Chicago; Barrister Building, Washington, D. C.

**PATENTS**, Trade-Marks, Designs. This firm has 27 years' experience and gives expert personal service at reasonable rates. We properly protect your invention. Write for free information and exact cost of procuring patent before proceeding. John B. Thomas & Co., 902 F St. N. W., Washington, D. C.

**UNPATENTED** Ideas Can Be Sold. I tell you how and help you make the sale. Free particulars (Copyrighted). Write W. T. Greene, 807 Jenifer Building, Washington, D. C.

**RICHARD E. BABCOCK**, Patent Lawyer, Washington Loan & Trust Bldg., Washington, D. C. Booklet.

**LACEY'S** Patent Sense. Valuable book free. See ad page 144.

### FOR INVENTORS

**PATENTS**. If you have an invention which you wish to patent you can write fully and freely to Munn & Co., for advice in regard to the best way of obtaining protection. Please send sketches, or a model of your invention and a description of the device, explaining its operation. All communications are strictly confidential. Our Hand-Book on Patents is sent free on request. This explains our methods, terms, etc., in regard to Patents, Trade Marks, Foreign Patents, etc. "Scientific American" contains Patent Office Notes, Decisions of interest to inventors and particulars of recently patented inventions. Munn & Company, Solicitors of Patents, 1523 Scientific American Building, 24 W. 40th St., New York City; 524 Scientific American Bldg., Washington, D. C.; 1313 Tower Bldg., Chicago, Ill.; 666 Hobart Bldg., San Francisco, Calif.; 521 Van Nuys Bldg., Los Angeles, Calif.

**PATENTS**. Time counts in applying for patents. Don't risk delay in protecting your ideas. Send sketch or model for instruction or write for free book "How to Obtain a Patent" and "Record of Invention" form. No charge for information on how to proceed. Communications strictly confidential. Prompt, careful, efficient service. Clarence A. O'Brien, Registered Patent Attorney, Security Bank Building (directly across street from Patent Office), Washington, D. C. See pages 138 and 139.

**PATENTS** Procured: Trade Marks Registered—A comprehensive, experienced, prompt service for the protection and development of your ideas. Preliminary advice gladly furnished without charge. Booklet of information and form for disclosing idea free on request. Richard B. Owen, 30-Owen Bldg., Washington, D. C., or 41-R Park Row, New York.

**I SELL** Patents. Established in 1900 The Service of Nationally-known reliability. The Service you will eventually employ if you have a valuable patent to sell. Charles A. Scott, 773PM Garson Avenue, Rochester, N. Y.

**INVENTORS** Universal Educator—contains 900 mechanical movements; 50 perpetual motions. Tells how to obtain and sell patents. Suggests new ideas. Explains how to select your attorney and avoid patent sharks. Price (revised edition) \$1.00 post-paid. Albert E. Dieterich, 621-Ouray Bldg., Washington, D. C.

**GET** your own patents. Legal blanks, complete instructions \$1. Cutting Sons, Campbell, Calif.

**WANTED**, by National Sales Organization for the Retail Hardware Trade: One or more meritorious items for sale in this channel for which ready demand now exists. Can assist patentee or manufacturer financially, if necessary. Give full details in first letter, please. Box M. L. R., % Popular Mechanics Magazine, 200 E. Ontario St., Chicago.

**GOOD** pending patents readily marketed. Booklet free. Chartered Association American Inventors, Barrister Building, Washington, D. C.

**PATENTS** wanted by manufacturers; send description. Box 126, Dowagiac, Mich.

**INVENTOR'S** Advice, valuable patent book, sent free. Labinere, 3 Parkrow, New York.

**WE** will manufacture your invention on a royalty basis. Metal Specialties only. Sterling Metal Products, Sterling, Ill. Box 338.

**INVENTORS**: Why waste time? \$2.00 will buy names of real prospects for your invention. Send draft or money order, and good description of invention. Inventors Service Bureau, Dept. P, Box 1966, Chicago.

**PATENTS—Write** to B. P. Fishburne (a South Carolinian). Registered Patent Lawyer, 525-E McGill Bldg., Washington, D. C.

**PATENTS** obtained under Cooperative Payment Plan. Write for particulars. W. E. Beck, Registered Patent Lawyer, 950 Jenifer Bldg., Washington, D. C.

**INVENTIONS** Developed—Your crude ideas developed into practical form for your patent application. Model not necessary. Send rough sketch and description for estimate of cost and advice. 27 years' experience. Albert E. Dieterich, Engineer and Registered Patent Attorney, 621½ Ouray Building, Washington, D. C.



**INVENTORS**—Write for our Guide Books and "Record of Invention Blank" before disclosing inventions. Send model or sketch of your inventions for our free inspection and instructions. Terms reasonable. See advertisements on pages 140 and 141. Victor J. Evans & Co., 157 Ninth, Washington, D. C.

**INVENTORS**: Manufacturers' names in the line of your invention \$1.00. W. D. Schwenk, Box 133, Ferndale, Mich.

**LACEY'S Patent Sense**. Valuable book free. See ad page 144.

**UNPATENTED Ideas Can Be Sold**. I tell you how and help you make the sale. Free particulars (Copyrighted). Write W. T. Greene, 806 Jenifer Building, Washington, D. C.

I AM in touch with hundreds of moneyed men and manufacturers who wish to buy good inventions. Write Hartley, 38 Court St., Bangor, Me.

#### PATENTS FOR SALE

**OUTRIGHT or Royalty**, U. S. and Canadian rights. Safety Delivering Device for Messages or Register Cards off of non-stop trains to operators or trackmen. Indestructible; will not bound or blow away. Quick information regarding defects of public highways or other signals. One tone of scrap material makes 32,000 safety deliveries. Wm. Hogan, 1803 Wisconsin Ave., Milwaukee, Wis.

**POCKET Check Protector Patent for Sale** Cheap. Fred Rothe, 3949 Metropolitan, Chicago.

**VALUABLE patent for sale**, Combination Ash Pan and Sifter. Write for copies. F. L. Martin, Dunbar, Pa.

**OUTRIGHT**—Newly patented process for briquetting coal dust—Smokeless Binder. Prof. Rudolph Kratochwill, Greenville Tenn.

**OCEAN liner**—which goes across ocean in one-half present average time. Patent 1,630,623. Akos Ludasy, Post Office Box 326 Wilkinsburgh, Pa.

**PATENT for Sale**—Automatic Rocking Chair; fortune in Porch chairs. Stransky, 200 Grefenway Ave., Darby, Pa.

**FOR Sale**—Patent No. 1,571,570. Safety Stirrup. Sell to manufacturers direct. Joseph N. Buron, Santa Barbara, Calif., Gen'l Del.

**TRU-KAP machine** puts true edge on mason jar caps, old and new. John Hug, Ames, Iowa.

**METAL Novelty**. Louis Pichler, 670 E. 102, Cleveland, Ohio.

**MECHANICAL dimmer control**, for Fords, Chevrolets, etc. Otto Meyer, Winchester, Ind.

**UNITED STATES and Canada Patents**—"Gravity Fountain Paint Brush." Only successful one patented. Reasonable price S. G. Sevier, Oenaville, Tex.

**A NEW Game**, Wheels of Opportunity. Estimated value \$50,000. Price \$10,000. Games invented for manufacturers. Ernest Haviland Hobbs, 3810 Gramercy, Washington, D. C.

**PATENT for Sale**: United States and Canada Patents on Illuminable Fish Creel Real opportunity for wide-awake manufacturer. Large profits. Good market everywhere. Advertised Nationally. Chas. Forsburg, Williamsport, Pa.

**FOR Sale Outright**—Animal trap patent. Catches mice and other animals automatically. Extremely simple. Enormous field for sale of this trap. Can be made for 18 cents, sells for \$1.00. Dies ready to begin operations. Pat'd in 1925. Novelty Mfg. Co., 823 N. Market St., Lancaster, Pa.

**OUTRIGHT**, belt guide; keeps belt from running off tractors, etc., when working with side wind. Otto Bochman, Tyndall, S. Dak.

**OUTRIGHT**: Patent 1,627,962. Protect your home. New Door "Knob Burglar Alarm." Write, Joseph A. Fiebigler, 591 Mackubin Street, Saint Paul, Minn.

**OUTRIGHT**, reasonable, pipe joint for bath tubs, basins, toilets, sinks. Robert Dawson, Fairview Cottage, Skillman, N. J.

**FOR Sale**—Patent, Improved Flour Sifter, outright or Royalty Basis. Harry Nakagawa, Tanana, Alaska.

**WHY** let your patents lie idle? Tell our two million five hundred thousand readers about it! The majority of our readers are especially interested in new ideas and inventions. Ask me to tell you how other inventors successfully sold their patents. M. L. Rund, Mer., Classified Advertising, Popular Mechanics Magazine, Chicago.

#### ELECTRICAL

**TWENTIETH** h. p. electric motors. Fine for fans or experimenting. Runs off dry cells or radio battery. Finest workmanship. \$2.25 each, postage prepaid. Send cash or money order. A. Redmond Co., Flint, Mich.

**MAKE Things Electrical**. Complete instructions for making medical coil, buzzer, rheostat, sign flasher, electric toaster, heater, electric grill, soldering copper, crystal receiver, transformer, Tungar rectifier, Duram receiver, motor and other things in fine illustrated book costing \$1.25. Pay postman price and postage when he hands you the package. Address Popular Mechanics Press, Room 907, 200 E. Ontario St., Chicago.

**MAGNETOS**—Splitdorf Dixie, Six Cylinders, Brand New, Complete, Fifteen Dollars Equipment, Air Transport Equipment Co., Carle Place, New York.

#### FOR MECHANICS

**ATTENTION**—Home Mechanics: We sell unusual cabinet hardware, chest trimmings, tea wagon wheels and casters, big line small hinges, locks, etc. Upholstering supplies, electrical hardware, knocked down cedar chests, etc. Send ten cents stamps for catalog. Thurston Manual Training Supply Company, Jobbers and Manufacturers, Anoka, Minn.

**"BLUEPRINT Reading"** is a compact book telling how to read machine blueprints. Send no money. Just pay postman postal charges and \$1. Popular Mechanics Press, Room 907, 200 E. Ontario St., Chicago, Ill.

**RAFTER** chart, an accurate and time-saving method of cutting roof rafters. Price \$1.00. T. W. Martin, 714 E. 14th St., Charlotte, N. C.

**KINKS on Metal Work**. 419 discoveries for anyone who works with metal. For mechanic, machinist or the man who tinkers at home. 287 illustrations. Send no money. Just write a postal asking for "Machinist's Kinks." When postman hands you book pay postage and price of book, \$1.50. Popular Mechanics Press, Room 907, 200 E. Ontario St., Chicago, Ill.

#### SURVEYING INSTRUMENTS

**LARGEST** stock of new and used surveying instruments in the country direct from factory. Satisfaction guaranteed or money refunded. Wissler, 619 N. Broadway, St. Louis, Mo.

#### MODELS AND MODEL SUPPLIES

**PATENTS**. Time counts in applying for patents. Don't risk delay in protecting your ideas. Send sketch or model for instruction or write for free book "How to Obtain a Patent" and "Record of Invention" form. No charge for information on how to proceed. Communications strictly confidential. Prompt, careful, efficient service. Clarence A. O'Brien, Registered Patent Attorney, Security Bank Building (directly across street from Patent Office), Washington, D. C. See pages 138 and 139.

**SHIP Model Hulls**. Flying Cloud, 1/8" Scale \$9.00. Constitution, 1/10" Scale \$10.00. Spanish Galleon \$10.00. Also complete Construction Sets. Send dime for list fittings. Roy Hancock, 323 Douglas Ave., Portsmouth, Va.

**PATTERNS and Models made**. Light Manufacturing. H. W. Hathorn, Mason City, Iowa.

**THE Modelmaker**, a magazine for all interested in making working models, boats, etc. Sample 10c. Modelmaker, 122 Liberty St., New York.

**MODEL** steam engines and boilers. Boat and boiler fittings. Send 10c stamp for catalog. Refunded with first order. Model Machine Shop, 212 Price St., Rahway, N. J.

**WHEELS** for toys, models, Disk and Spoke. One inch up. Few cents a dozen. Circular Free. Santicraft Studio, Lovelock, Nev.

**SHIP Model Fittings**: Send stamp for booklet. A. J. Fisher, 1002 Etowah Ave., Royal Oak, Mich.

**LET** our experience be your guide. Models that are models; tools and equipment for economic manufg. Patterns of all types; manufacturing in all branches. Satisfaction guaranteed. United Machinery Company, Cincinnati, U. S. A.

**WOOD'S** for Models, Scroll Work and Inlaying. George Wild, 510 East 11th St., New York.

**SPECIAL** machine builders, tool and die makers, inventor's models production work of all kinds. Dept. L. Quality Hardware & Machine Co. Ravenswood and Thorndale Avenues, Chicago, Ill.

WE make working models for inventors and do experimental work and carry a complete stock of brass gears and model supplies. Send for catalogue. The Pierce Model Works, Tinley Park, Ill.

**WORKING** models built. Drawings prepared free. Let our designing and engineering departments and 27 years' experience assist you with your invention. Lowest prices. Hohmeier Mfg. Co., 1385 E. 17th St., Cleveland, Ohio.

**MODEL and Experimental Work** at lowest cost. Wagar Model & Machine Works, 115 So. Clinton Street, Chicago.

#### MANUFACTURING

**MACHINE** work and manufacturing. Automatic Machines developed to reduce cost of production. Wide experience and reasonable prices. York Electric & Machine Company, York, Pa.

**DIES, Tools, Production Machine Work, Models and Contract Manufacturing**. Let Kansas City's Largest and Best Equipped Combination Die and Machine Shop figure with you on your requirements. Bank and Commercial Agency References. Schroer Bros. Machine Works, 23rd and Holmes St., Kansas City, Mo.

**WANTED** to manufacture on royalty basis, some Mechanical Appliance or Automobile Accessory. Cincinnati Automatic Machine Co., Cincinnati, Ohio.

**WE** manufacture your invention, help perfect it, make models, dies. Free information. Strand Mfg. Co., 644 W. Randolph St., Chicago.

**WE** help you design, make your models, dies, manufacture your products. Standard Die & Specialty Co., 1932 Austin Ave., Chicago.

**SPECIAL Machinery or parts, dies, tools, metal specialties, models, special gears, stock gears and model supplies**. Send for Catalogue. The Pierce Model Works, Tinley Park, Ill.

**MANUFACTURING Models, Dies, Stampings, Brass Work, one or thousands**. Baum's Metal Specialties, Kansas City, Mo.

**WIRE** goods made to order. Cooley Mfg. Co., 530 N. Western Ave., Chicago.

**STAMPING and light manufacturing**. Acme Tool Co., Mason City, Ia.

**REFRIGERATING Machine, homemade**. Operates successfully. Gives better service than ice. This and 328 other practical articles in our book "Home Mechanics." Just ask for this and "Handbook for Women," containing 394 valuable household helps and pay postman 98 cents and postage for the two books. Popular Mechanics Press, Room 907, 200 E. Ontario St., Chicago, Ill.

#### MACHINERY, TOOLS AND SUPPLIES

16"x6" PRENTICE engine lathe, \$175.00. 20"x10" Davis engine lathe—quick change, \$550.00. No. 60 Heald Cylinder Grinder, \$750.00. 10x32" Landis Universal Piston and General Grinder, \$375.00. 20" Drill Press, \$75.00. 14" Drill Press \$40.00. Complete line of machinery and small tools. Write for catalog. Cincinnati Machinery & Supply Co., 218 East Pearl St., Cincinnati, Ohio.

**BENCH Type Power Filing Machines** eliminate the necessity of hand filing, tight and loose pulley drive; complete and brand new. Price \$25.00 each. Send for our circular. Botwinik Brothers, Inc., 67 Water St., New Haven, Conn.

**CARPENTERS**—Ideas for those who like to tinker with tools, and for professional carpenters. 40 articles on saws and sawing, 17 on benches and bench equipment, 23 on doors and door hanging, 18 on lumber, 13 on mitering, 74 on tools, 22 on shop equipment and many others—366 in all, and 229 illustrations. Send no money. Just write a postal. Pay postman postage and \$1.50. Popular Mechanics Press, Room 907, 200 E. Ontario St., Chicago, Ill.

**WOODWORKING Machinery**: Scroll Saw with motor \$28.50. Motor Head Lathe \$50.00. Our catalog shows complete line. Heston & Anderson, 637 Depot Ave., Fairfield, Iowa.

**CONCRETE Building Block Machine and Molds**. Catalogue free. Concrete Machine Co., 5 N. Main St., St. Louis, Mo.

**OTHERS** have successfully sold their machinery through our columns—so can you. Ask me for proof. M. L. Rund, Manager, Classified Advertising, Popular Mechanics Magazine, Chicago.



**START** Business of your own, small investment required, doing nickel, copper and silver plating. This work is in big demand. Full information free. Electro Platers Supply Co., 547 Considine Ave., Cincinnati, Ohio.

**753 TIME, Labor and Money Saving Ideas** for all who own, drive or repair autos. These practical hints are based upon the actual experiences of hundreds of owners and repairmen. Three books, Auto Owners, Auto Repairman's and Auto Tourists Handbooks, regular \$1.50 value from Popular Mechanics Press will be supplied at 98c, plus the postage C. O. D. for a limited time only. Send your order today to Popular Mechanics Press, Room 907, 200 E. Ontario St., Chicago.

#### ENGINES, MOTORS AND DYNAMOS

**ANOTHER** lot new 110-volt alternating washing machine motors \$5.50 each, cash with order. Also other bargains direct and alternating. Write for prices stating size and kind of current. Queen City Electric Co., 1736 Grand Av., Chicago, Ill.

**GUARANTEED** 1/2 H.P., A.C., 110 V., \$7.00. Double Shaft grinder with wheel, \$12.00. 25% required, balance C.O.D. Elle & Co., 1018 W. Lake, Chicago.

**BARGAINS—Motors, Machinery, Wash Machine Motors \$5.55, 1/2 H.P. \$18.75, 1 H.P. \$25.00, Electric Drills \$14.95, 100 other bargains.** Send for "Bargain Sheet #639." ACME TOOL CO., 627 Washington St., Chicago.

**ALTERNATING** current bargains. 1/4 H.P. Holtzer-Cabot \$7.00. Westinghouse or General Electric 16-inch oscillating fan \$20.00. These special prices for a few weeks only. Send your order now. Hyre Electric Company, 615 TF, So. Dearborn St., Chicago.

**GOVERNORS** for all auto engines where used for power plants. Send for circulars. A. C. S. Governor Co., Springfield, N. Y., or 215 W. Manchester, Los Angeles.

**WRITE** for bargain catalogs on electric motors, generators, electric drills, etc. Do not buy, consult us first. General Distributing Co., Security Bldg., Duluth, Minn.

**MOTORS—New GE 110 or 220 volt 60 cycle Single Phase 1/4 HP. \$11.90; 1/2 HP. \$28.50; 1 HP. \$38.50. Mail \$3 check or money order. We will ship COD anywhere. Motor Specialties Co., Crafton, Penna.**

**STEAM Engines—one H.P. \$18.00; 1/2, \$12.00; governors, \$12.00. James Chambliss, Bessemer, Ala.**

**SHOP Notes for 1927.** Get your copy now. Only a limited edition. Contains all the articles published in the Shop Notes department of Popular Mechanics Magazine during 1926. Send no money. Just write a postal and we'll send 1927 Shop Notes and any one of the other following numbers, 1908, 1912, 1913, 1914, 1915, 1916, 1917, 1919, 1920, 1921, 1922, 1923, 1924, 1925, 1926. Pay the postman 98 cents and the postage when he hands you the two books. Popular Mechanics Press, Room 907, 200 E. Ontario St., Chicago, Ill.

#### BLACKSMITHS

**BE** a Master Mechanic Blacksmith and Expert Tool Maker and Dresser with colored tempering charts. Price \$1.00. Valuable samples free. W. M. Toy, Sidney, Ohio.

#### BENDING MACHINES

**THE Famous Hossfeld "Wrenchless" Universal Iron Bender** is the last word in bending machines. Bends metal cold or hot into most any conceivable shape, including Eye Bolts and Automobile Spring Eyes. Bends up to 1" bars or 1 1/2" pipe cold. Used by all classes of trade, from the smallest shops to the largest railway systems. Write for circular and prices. Hossfeld Mfg. Co., Winona, Minn.

#### FOR SALE—MISCELLANEOUS

**HAIR** Grows when our Vacuum Cap is used a few minutes daily. 60 days' free trial. No drugs or electricity. 20 years success. Stops falling hair and dandruff. Booklet free. Modern Vacuum Cap Co., 555 Quincy, Denver, Colo.

**ADDRESSOGRAPHS, Letter Folders, Multigraphs, Envelope Sealers, Duplicators, less than half price. Guaranteed. Pruitt Co., 117 No. Market, Chicago.**

**GARDEN Time is Here.** Make your garden produce four times as much with only half the labor. Ingenious new method in use of space increases fourfold best previous crop record and with less cultivation and trouble with weeds. Complete instructions cost \$2.50. Pay postman price and postage when he hands you the package. Address Popular Mechanics Press, Room 907, 200 E. Ontario St., Chicago, Ill.

#### WANTED—MISCELLANEOUS

**MAIL** us your discarded Jewelry, Gold, Crowns and Bridges, Watches, Diamonds, Silver, Platinum and old False Teeth. Money promptly mailed. Goods returned if offer refused. United States Smelting Works (The Old Reliable), Dept. 71, Chicago.

#### REAL ESTATE, FARM AND ORCHARD LANDS

**NEW ENGLAND Farms—Close** to the biggest markets in the United States; astounding money-making properties. Free catalog on request. Chamberlain & Burnham, Inc., 294 Washington St., Boston, Mass.

**ATTENTION!** "Get acquainted." Cash for your property. Farm, Hotel, or Retail Store, no matter where located; confidential service. Hayes Business Agency, Cincinnati, Ohio.

**FREE** information concerning beautiful Lake Region for farming, ranching, fishing, hunting or summer outing. Cooperative Sales Agency, Box 405, Frazee, Minn.

**CHEAP** lands and Oil leases for sale. Write Poe, Box 1184, Dallas, Texas.

**\$10 IS** all I ask down on 20 acres in Mich. Potato Belt. Very easy terms. Near markets, lakes and streams. Write for particulars now. G. W. Swigart, P1276 First Nat'l Bank Bldg., Chicago.

**OZARKS—10 acres** near White River and proposed power dam, \$100, \$5 monthly. Alvin Zimmerman, 1802 N. 5th, Kansas City, Kans.

**SELL** your property quickly for cash, no matter where located. Don't pay big commission. Particulars free. Real Estate Salesmen Co., Desk B, Lincoln, Nebr.

**PECAN-Orange-Flg Groves "On the Gulf"** Monthly payments. Guaranteed care. Big, quick returns. Suburban Orchards, Dept. M. Biloxi, Miss.

#### SEEDS, PLANTS, TREES, ETC.

**WRITE** Today for Prices on 1926 Glensong Seed Booklet on Golden Seal Growing. 10c. W. N. Long, Florence, Ky.

#### POULTRY

**NO. 2 Half-Price Chicks.** We have cut our prices almost in two. All kinds. Quick shipment. Three-color catalog free. Missouri State Hatchery, Box 711, Butler, Mo.

#### ROOTS AND HERBS

**HERB Doctor and Medicine Man Book, 10c.** (Worth \$5.) Contains over 250 valuable herb medicine recipes for home use. Shawnee, 145 West 112th Street, Chicago.

**HERB Doctor Book—10 cents.** 250 receipts for making herb medicine. Hazzard Company, Box 1, Vanderveer Park, Brooklyn, N. Y.

#### DOGS AND PETS

**FOR Sale—Foxes, raccoons, mink, skunk, B. Tippman, Caledonia, Minn.**

**BIRD Dog.** Wonderfully well broken. Retrieves. Young, handsome, choice breeding. Price low. Thoroughbred Kennels, Atlantic, Iowa.

**BEAUTIFUL** Fox Terriers, Collies, Shepherds. Barnes Farm, Clay Center, Neb.

#### PERSONAL

**TELL** Fortunes with cards—Complete instructions—also Dream Dictionary. All for 10c. G. Elsea, Bowling Green, Ohio.

**WE** answer your questions, 25c, coin. Fred Klotz, Reading, Pa.

**LINDSEY'S "marriage" hoax exposed!** Joint debate. Killing. Exponent, 15c. Orlando, Fla., Consigned newdealers.

**SEND** for our unique catalog of 5,000 books listed alphabetically under subject headings. Free on request. Popular Mechanics Press, 200 E. Ontario St., Chicago.

**SPARETIME** Employment at home. Details stamp. Gluco, 507 Aetna Bldg., Rochester, N. Y.

**FREE:** Valuable book telling the uses of roots and herbs. Box 29, Station L, New York.

**TOBACCO** or Snuff Habit Cured or no pay. \$1.50 if cured. Remedy sent on trial. Superior Co., N3, Baltimore, Md.

**VACATION** Reading. Ask us to send you lists of books that are 100% entertaining—such books as Beau Geste, Old Ironsides, One Minute to Play, The Nervous Wreck, etc., prices of most of these books not over 75 cents. You will receive at once attractive lists to choose from and from time to time thereafter lists of the newest and best stories as soon as the publishers' announcements are made. Popular Mechanics Press, 200 E. Ontario St., Chicago.

#### MISCELLANEOUS

**MAKE** or refinish your own pearl beads or cover other objects to produce pearly effect. We furnish pearl lacquer in pearl, pink, blue, cream, green, brown or gold colors, with simple instructions for using. Generous size bottle \$1.00 postpaid. State color desired. Dallas Pearl Essence Co., Terminal Island, Calif.

**STEEL** fireproof safe, 38 inches high, \$10. R. E. Haesly, Winona, Minn.

**LOOK!** Fly balloons anywhere. Inflator \$1.00 and \$6.00. Balloon Inflator Co., Box 853, Providence, R. I.

**HOW** to Work with Tools and Wood for the home workshop is an unusually interesting new book just published by the Stanley Rule and Level Plant. 180 pages, illustrated. Cloth bound. Price \$1. Pay postman price and postage when he delivers package. C. O. D. Order from Popular Mechanics Press, Room 907, 200 E. Ontario St., Chicago.

**SAFE** Locksmithing taught by mail. C. T. Mitchell, Temple, Texas.

**MIRRORS** Restivered at Home. Costs less 5 cents per square foot; you charge 75 cents. Immense profits plating autoparts, reflectors, tableware, stoves, refinishing metalware, etc. Outfits furnished. Details free. Write, Sprinkle, Plater, 288, Marion, Ind.

**ARTIFICIAL** Eyes. Booklet free. Denver Optic, 359 Quincy, Denver, Colo.

**MEXICAN-MADE** pistol holsters, cartridge belts, lariats; hand-carved belts and holsters; horse-hair belts, hat bands, fobs; rattlesnake belts, fobs. Tex-Mex Leather Co., 309 Esperson Bldg., Houston, Tex.

**WEEDS—Cut** them with cutter bar on Shaw Garden Tractor. Also plows, cultivates and runs belt machinery. Low prices. Immediate delivery. Shaw Manufacturing Company, Department C, Galesburg, Kans.

**CUTS** anybody can make. Simple, cheap process. \$1. Specimens, particulars, 2c stamp. M. Day, Windfall, Ind.

**HOMEOPATHIC** and Biochemic preparations sent postpaid to all parts of the world. Manual and booklets free. Halsey Bros. Co., 645 St. Clair St., Chicago, Ill. Established 1855.

**GET** a better grip on mathematics. Write for "Mathematics for the Practical Man." "Common sense methods remove mystery and difficulties. Algebra and calculus made simple. Assuming knowledge limited to arithmetic you quickly and easily gain working knowledge of algebra, geometry, trigonometry and calculus. Pay postman \$1.50 and postage when he delivers package. Popular Mechanics Press, Room 907, 200 E. Ontario St., Chicago, Ill.

**LOCKSMITHS—Something new.** Write. Also buy, sell and exchange codes. Free list. Locksmith, 1656 Lawrence, Denver, Colo.

**CASH** in on your Artistic Ability. Your home, your office, your spare time, your gold mine. Not a correspondence course. Sample and particulars 10c. Straco, 1013 Mulberry, Springfield, Ohio.

**861 PRACTICAL** Ways to Reduce Farm Labor and Expense and Increase Income. One farmer writes he would not part with this information for \$100, if he could not duplicate it. Nothing experimental. These ideas have all been put to test and proven practical. Send today for a copy of our Handbook for Farmers and get ready to put these ideas into operation for your own benefit. Pay postman only 98 cents and the postage when he hands you the package. Popular Mechanics Press, Room 907, 200 E. Ontario St., Chicago.

**CASH** paid for butterflies, insects. See Sinclair Display Advertisement on page 30.

**TATTOOING** Supplies Direct from Manufacturer. "Waters," 965 Putnam, Detroit.

**AMATEUR** Cartoonists: Make money in spare time with new cartoon selling plan. Write Smith's Service, PM1194, Wenatchee, Wash.

**TELL** an army of 3,000,000 live readers all about your offer! If you have anything to sell, buy or exchange, or if you have any reasonable proposition, tell our readers all about it—they'll respond quickly. Our booklet "How to Create More Business" contains some very interesting, helpful facts. Write today for your copy—it's free. M. L. Rund, Manager Classified Advertising, Popular Mechanics Magazine, 200 E. Ontario St., Chicago, Ill.





# 1000 Motor Bus Operators Needed

## Earn \$50 to \$200 a Week

Hook up now with the rapidly growing motor bus industry. *Big money now; bigger money later!* A chance for travel, action, advancement! Specially trained men needed now as drivers, executives, despatchers. \$50 to \$200 a week. Prepare now!

**Complete Training in 10 Weeks**  
**Special Summer 1,000 Mile Training Trip If You Enroll Now**

JUST 10 fascinating weeks of practical personal instruction at the Institute fits you for big-pay position. No lessons; no books; you learn by actual driving and operating of giant busses. Previous education or experience unnecessary. Earn while you learn. Investigate!

**FREE FARE TO CHICAGO**  
 When You Enroll

Write today for details about the industry, Institute, free transportation, and Special 1,000 Mile Training Trip.

Harold C. Auer, Registrar

**Motor Transportation Institute**  
 Dept. 1 1214 West Jackson Blvd. Chicago

# Win a Buick or \$1500.00 In Cash

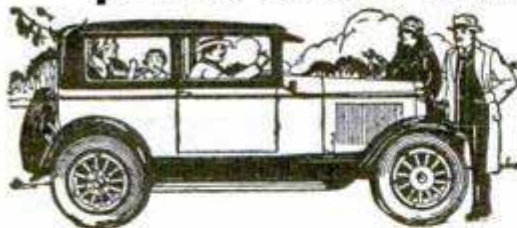

I am going to give away a brand new, latest model Buick Sedan to someone who answers this adv. We have already given away many autos. This is the most liberal offer ever made. It is your chance to win this ideal car. You can win it; why not try? The Sedan will be delivered to the winner, or winner may have the full cash value (\$1,195.00)

## SOLVE THIS PUZZLE

2	21	9	3	11	7	9	22	5	14
---	----	---	---	----	---	---	----	---	----

Can you make out the two words spelled by the numbers in the squares above? The alphabet is numbered, A is 1, B is 2, etc. What are the two words? Send your answer today—not a cent of cost to you now or later.

## \$305 for Promptness

I will also give away a Chevrolet Coach, Orthophonic Victrola and many other valuable Prizes—besides hundreds of dollars in Cash—and \$305.00 Special Extra Prize of Promptness. First Prize winner will receive \$1,500.00 cash or Buick Sedan and \$305.00 cash. All who answer can share in cash and prizes. In case of ties the prizes will be duplicated. **EVERYBODY REWARDED.** Now, get out your pencil and solve the puzzle—send your answer today with name and address plainly written.

**WILLIAM LEROY,**  
 Dept. B177, 315 So. Peoria St., Chicago, Ill.

# The Mysterious Masked Singer Who Was He?



Surely that glorious, golden voice must mean long years of training under some foreign master. And who would have dreamed that The Man Behind The Mask was one of their own crowd and who six months before could scarcely sing a note! How did he do it? How could he possibly, in so short a time, have developed this magnificent voice now that thrilled and amazed his friends?

## I Guarantee to Improve Your Voice 100%

There is only one answer—Physical Voice Culture! Your vocal chords are the same in construction as those of Caruso, Garden or Martinelli. But YOURS are under-developed. Your Hyo-Glossus throat muscle has probably never been used. No amount of scale singing will ever develop this muscle. But scientific muscular exercise will. And only Physical Voice Culture—the amazing discovery of Prof. Eugene Feuchtinger can show you how. Now you can build a strong, magnetic, compelling voice that will be the marvel of your friends and open the door to Success and Fame.

## Scientific Voice Training

Prof. Feuchtinger accomplishes his surprising results by silent, muscular exercises that quickly bring strength and control of certain vital vocal organs, heretofore almost unknown to voice culture. No tiresome scale-singing! Practice these marvelous silent exercises in privacy. Soon you find your voice becoming stronger, richer, with ever increasing range. Thousands have done it. You can, too.

# Mail Coupon for "Physical Voice Culture" Free

Your voice has marvelous possibilities that you may not even suspect. "Physical Voice Culture" will reveal them to you. Send at once for this valuable, beautifully illustrated book. Read the astounding true stories of what others have done. Send Today! The Book is FREE!

**Perfect Voice Institute** 1922 Sunnyside Ave., Studio B-135, Chicago

**Perfect Voice Institute, Studio B-135**  
 1922 Sunnyside Ave., Chicago

Please send me, FREE, and without obligation, Prof. Feuchtinger's new Book, "Physical Voice Culture." I have checked subject in which I am most interested.

Weak Voice  Singing  Stammering  Speaking

Name.....

Address.....

City..... State.....



# You can get there **QUICK**

Automobile service!—the best paying end of the world's greatest business! Trained auto men have steady jobs the year around. It's the open shop industry—no unions, no strikes, no lay-offs. Auto repairing has jumped to a tremendous world-wide business. Many millions of dollars are spent yearly to keep the 24 million cars in condition. Car owners have to pay out all the time—it's \$15.00 here—\$100.00 there. Trained men are getting this big money. *You can get into this business now.* A few weeks' Detroit-training at this world-famous auto school will start you to success.

## 25,000 Graduates

M. S. A. S. trained men are *making good*—in all quarters of the globe. Be sure of a good job *anywhere, at any time.* Or, open a shop of your own. Very small capital needed if you have right training.

## A Steady Job Now

Garage owners search for skilled service men. They soon advance to be superintendents—then, get their own business. Car owners, too, are getting more particular all the time—won't trust their cars to any but trained men. Learn right, at the old reliable "Michigan State"! Here you work on new cars supplied by factories—you learn with tools, under expert instructors. Also complete business course. Send the coupon for particulars and big 17th Anniversary Catalog. Today sure!

# MICHIGAN STATE AUTOMOBILE SCHOOL

A. G. ZELLER, Pres. and Gen. Mgr.  
*The Old Reliable School—Established 17 Years*  
307 Auto Building, DETROIT, MICH.



Get  
this  
Book  
FREE

**Auto Repair  
MEN  
Are Sitting on  
Top of the World  
To-day**

### WRITE TODAY SURE!

Michigan State Automobile School  
307 Auto Building, Detroit, Mich.  
Send without obligation full information about Detroit training to make the most money. Also send me FREE your big new illustrated Catalog and Automobile Training Book.  
Name.....  
Street Number or R. F. D.....  
City.....State.....

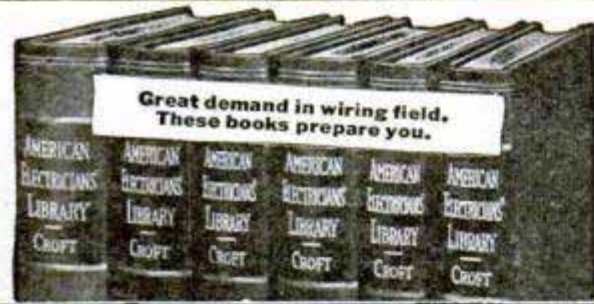

Great demand in wiring field.  
These books prepare you.

## Get into the electric wiring field— big money for you

**KINKS**; helps; short cuts; practical, on-the-job electrical data, written particularly to help wiremen, trouble shooters, maintenance men, armature winders, electrical contractors and students. The whole wiring field covered; concrete and usable details about new and better ways for doing the kind of work you have to do.

**American Electricians' Library**  
6 volumes, 2000 pages, illustrated, \$16 payable  
\$2 in ten days and \$2 a month

The books tell you all you must know about conduit wiring, armature winding, wiring for lighting circuits and switches, wiring for machinery, circuit troubles, circuit testing, or electrical machinery erection. Through a study of this great set you can push yourself into a big-pay job for life.

See it FREE—Send no money—ACT

### FREE EXAMINATION COUPON

McGraw-Hill Book Co., Inc.  
370 Seventh Avenue, New York  
Send me the American Electricians' Library for 10 days' free examination. If satisfactory, I will send you \$2 in 10 days and \$2 monthly until the full price, \$16, is paid. If not wanted, I will return the books at your expense.  
Name.....  
Address.....  
Position.....  
Company..... P. M. 7-1-27

# Learn Photography at HOME

Earn \$3000 to \$10,000 a year. Prepare quickly during spare time. Also earn while you learn. New easy method. Nothing else like it. Send at once for free book, "Opportunities in Modern Photography" and full particulars. Special offer open now.

AMERICAN SCHOOL OF PHOTOGRAPHY  
Dept. 135-B 3601 Michigan Ave. Chicago, U. S. A.

## MAKE BIG MONEY as a Salesman

Train in your spare time for the best-paying profession in the world. Pick your field—control your income—be independent! LaSalle-trained salesmen in every section report promotions and advancement. Low cost; easy terms. Write now for valuable 64-page book—FREE.  
LaSalle Extension University, Dept. 764-S Chicago

## Factory to Rider

Saves \$10 to \$25 on the Mead Bicycle you select. You can have your choice of 44 Styles, colors and sizes. Delivered free on approval. \$21.50 up.

**30 Days' Free Trial** on the bicycle you select from the big free catalog. Ride it a month to be sure you like it. Return it if not satisfied.

best quality, factory prices. Save big money on Tires, Lamps, wheels and equipment, low prices. Send No Money, do business direct with makers.

**Mead CYCLE COMPANY**  
DEPT. K-110 CHICAGO

Write today for free Catalog, factory prices and marvelous new offer.



# WANTED!

Ornamental Iron and Bronze Draftsmen at \$50.00 to \$65.00 a week for beginners. Experienced men as high as \$500.00 a month. Opportunities to become executives. Put yourself in line for a better job. We place you free when you're ready. Write today.

American Institute of Ornamental Iron & Bronze  
3041 Hennepin Avenue MINNEAPOLIS, MINN.



# Learn How to BOX



## JIMMY DeFOREST BOXING COURSE DEVELOPS CHAMPIONS BY MAIL

DeForest Boys are on the Road to Fame and Fortune!

The World's Most Famous Trainer Will Make You a Finished Boxer!

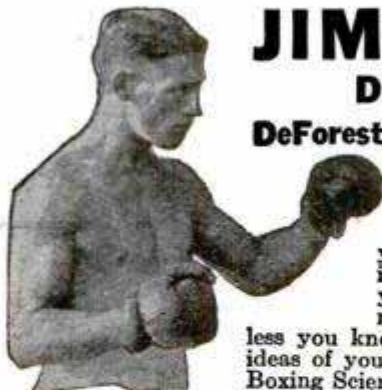

It makes no difference if you never wore a pair of boxing gloves in your life; whether you know a left jab from a right hook or not. In fact the less you know about boxing, the fewer ideas of your own you may have about Boxing Science, the better.

Jimmy DeForest, the World's Leading Trainer and Developer of Champions and Master Ring General, will round you out right in your own home into a finished boxer and teach you the priceless knowledge which has made many champions and started hundreds of boys on the road to Fame and Fortune.

In this marvelous System of Instruction is embodied all that Jimmy DeForest knows about boxing—the identical methods which made more champions and top-notch contenders than any other trainer, either living or dead, ever created. Every trick, blow, defense, movement—every new angle in ring strategy that DeForest taught Dempsey, Firpo, Gans, McCoy and a host of others is explained and illustrated in this one and only Complete Course in Boxing. And it's as simple as A. B. C.

### 20 Weeks and You're Ready!

In twenty weeks you will be able to step into the ring—a finished boxer—and have it over any opponent of equal experience like a tent! Almost invariably the DeForest-trained lad has his self-trained opponent at his mercy after the first round.

**Send for This Gripping Book** Send today for this new famous book "The Golden Age of Boxing," the most remarkable volume of its kind ever written, full of valuable information, photos of great boxers and pupils who became successes over-night. It contains a complete outline of the DeForest Course, week by week, with special picture charts used in most of the lessons. This book will thrill you and open your eyes to the marvelous opportunity that lies before you. Enclose 10c to cover cost of mailing, etc. Do it NOW and mail it AT ONCE.

### Opportunities Without End!

You are literally surrounded, no matter where you live, with opportunity to cash in magnificently on your ability as a DeForest-trained man. The demand for good talent is out of all proportion to the supply. Boxing Promoters from coast to coast are constantly soliciting us to recommend DeForest-trained boys to them.

### A Remarkable Physical Training System!

The DeForest Course has demonstrated its efficiency as a physical training system. Weaklings have been made strong and men physically rebuilt, energy, strength and courage developed. Prominent men and leaders in all walks of life, including Prof. T. W. Seeley, famous Physical Culturist, box regularly to keep themselves fit. It will be a revelation to you.

**Jimmy DeForest Boxing Course**  
347 Madison Ave., Box 120, New York City

**Jimmy DeForest Boxing Course,**  
347 Madison Ave., Box 120, New York City

Enclosed find 10c to cover cost of mailing, etc., of your book, "The Golden Age of Boxing."



Name.....

Street No.....

City..... State.....

**WANT WORK AT HOME?**  
Earn \$18 to \$60 a week **RETOUCHING** photos. Men or women. No selling or canvassing. We teach you and furnish **WORKING OUTFIT** given with each enrollment. Limited offer. Write today.  
Artcraft Studios, Dept. 50, 3900 Sheridan Rd., Chicago

**Learn Watchwork, Jewelrywork and Engraving** A fine trade commanding a good salary, and your services always in demand. Address **Horological**, Dept. P, Bradley Institute, PEORIA, ILLINOIS, for our latest catalog.

# DO YOU LIKE TO DRAW?

It's Easy To Learn When Shown In The Right Way

Some of cleverest cartoonists and comic artists in America today learned how to draw quickly—by following **CARTOONIST EVANS' SIMPLE AND EASY METHOD**. This school is recommended by foremost cartoonists because they know the students are handled right. If you like to draw, send 6c in stamps for **portfolio of cartoons and full details**. The course is **NOT EXPENSIVE**.



**The W. L. Evans School of Cartooning** 821 Leader Building CLEVELAND, OHIO

**\$75 to \$350 Weekly**  
in Aviation jobs. Learn under actual flying conditions in 30 lessons. Send for **FREE BOOKLET** about Aviation and the opportunities in it for you.

**CHICAGO AERONAUTICAL SERVICE, INC.**  
Dept. S 608 S. Dearborn St. Chicago, Ill.

**—What Is Holding You Back?—**  
Pelmanism increases the earning power of the mind as physical training develops muscle. Doubled salaries in six months not at all unusual. Strengthens your weak links; awakens sleeping powers.  
**Scientific Mind Training—FREE**  
If you are not increasing your earnings \$1,000 every year, send today for free book "Scientific Mind Training," showing how Pelmanism has helped 600,000 people.  
**THE PELMAN INSTITUTE OF AMERICA,**  
Dept. 67, 71 West 45th St., New York



# TRAVEL—ON "UNCLE SAM'S" PAYROLL

**\$1900 to \$2700 a Year**  
Mail Coupon Before You Lose It

**Steady Work—No Layoffs—Paid Vacations—Common Education Sufficient**  
**MEN—BOYS, 18 UP—RUSH COUPON**

**FRANKLIN INSTITUTE, Dept. L-176, Rochester, N. Y.**

Sirs: Rush to me without charge: (1) Sample Railway Postal Clerk and City Mail Carrier examination questions; (2) tell me how to get a U. S. Government job; (3) send 32-page book with list of many positions now obtainable.

Name.....

Address.....



# Swear Off Tobacco



Tobacco Tells on Nervous System



Tobacco Ruins Digestion



Tobacco Stunts Boy's Growth



Tobacco Robs Man of Vitality



Tobacco Steals from You the Pleasures, Comforts, Luxuries of Life

## Tobacco Habit Banished Let Us Help You

### Quick Results

Trying to quit the tobacco habit unaided is often a losing fight against heavy odds, and may mean a serious shock to your nervous system. So don't try it! Make the tobacco habit quit you. It will quit you if you will just take **Tobacco Redeemer** according to directions.

It doesn't make a particle of difference whether you've been a user of tobacco for a single month or 50 years, or how much you use, or in what form you use it. Whether you smoke cigars, cigarettes, pipe, chew plug or fine cut or use snuff—**Tobacco Redeemer** will positively remove all craving for tobacco in any form in a few days. Your tobacco craving will usually begin to decrease after the very first dose—there's no long waiting for results.

**Tobacco Redeemer** contains no habit-forming drugs of any kind and is marvelously quick, scientific and thoroughly reliable.

### Not a Substitute

**Tobacco Redeemer** is in no sense a substitute for tobacco, but is a radical, efficient treatment. After finishing the treatment you have absolutely no desire to use tobacco again or to continue the use of the remedy. It helps to quiet the nerves, and will make you feel better in every way. If you really want to quit the tobacco habit—get rid of it so completely that when you see others using it, it will not awaken the slightest desire in you—you should at once begin a course of **Tobacco Redeemer** treatment for the habit.

### Results Absolutely Guaranteed

A single trial will convince the most skeptical. Our legal, binding, money-back guarantee goes with each full treatment. If **Tobacco Redeemer** fails to banish the tobacco habit when taken according to the plain and easy directions, your money will be cheerfully refunded upon demand.

### Let Us Send You Convincing Proof

If you are a slave of the tobacco habit and want to find a sure, quick way of quitting "for keeps" you owe it to yourself and to your family to mail the coupon below or send your name and address on a postal and receive our free booklet on the deadly effect of tobacco on the human system, and positive proof that **Tobacco Redeemer** will quickly free you from the habit.

**Newell Pharmacal Company**  
Dept. 300, Clayton Station, St. Louis Mo.



### Free Book Coupon

NEWELL PHARMACAL CO.,  
Dept. 300, Clayton Station, St. Louis, Mo.

Please send, without obligating me in any way, your free booklet regarding the tobacco habit and proof that **Tobacco Redeemer** will positively free me from the tobacco habit or my money will be refunded.

Name.....

Street and No.....

Town..... State.....



# NOW Boys <sup>earn</sup> Men's Wages

Why go on begging for a raise? Why growl and complain because you don't get it? Why, when every city, town and farming community is pleading for more auto and tractor mechanics — trained as McSweeney students are trained, to know cars of every make and to know them "inside out"?

Every month my men are taking fine jobs formerly filled by half-trained students or half-baked, self-trained mechanical tinkers.

## I Train You in 8 Weeks

Think of it! Working with real tools on real equipment you become in only EIGHT WEEKS a better auto mechanic than men who have "fiddled" around an ordinary garage for years trying to learn. Let me send you the proof, letters from former McSweeney students now earning up to \$10,000 a year. "Mac's SHOP WAY Means Bigger Pay."

## Your Money Back Guaranteed

If, when you have finished your training, you are not perfectly satisfied; if you are not qualified to fill a big pay job, I will re-

# McSWEENEY

AUTO, TRACTOR AND ELECTRICAL SCHOOLS

CINCINNATI, OHIO CLEVELAND, OHIO

## OUTDOOR SPORTS THE YEAR 'ROUND

Popular Mechanics New Useful Book—Outdoor sports appeal to us all. But the fun is double when you make your own devices. There are 226 clearly written and concise articles telling how to make equipment for new and popular sports of many kinds in the new **Outdoor Sports** book. There are clever devices for such sports as:

Swimming	Trapping	Photography	Kite Flying
Camping	Tobogganing	Tennis	Summer Games
Football	Baseball	Outdoor winter games	Nutting
Swinging	Fishing	Skating	Pushmobiling
Trolley Coasting	Golf	Boating	Racing
Roller Skating	Boat sailing	Toy Making	Skiing

It is easy to make the devices described above because there are 317 helpful illustrations. The articles are clear enough for boys, yet interesting enough for any man.

This offer also includes a copy of our valuable Boat Book which tells

## HOW TO BUILD 21 KINDS OF BOATS

Complete and simple directions and illustrations are given for building the following: Fast Runabout Motor Boat; Canadian Model Canoe; Open Sailing Canoe; Portable Folding Boat; Motor Canoe; PETERSBOROUGH Canoe; Canvas Covered Cedar Canoe; Hydroplane Catamaran; Cruising Catamaran; Paper Boat; Long Island Scooter; Paddle Wheel Boat; Log Canoe; House Boat; Sea Gull Sail Boat; Pile Driver Punt; Inexpensive Motor Boat; Steel Boat; Concrete Boat; Bicycle Boat and Power Driven Catamaran.

Just write us to send these two books. When the postman hands you the package pay him \$1.98 plus the postage. If outside U. S. remit when ordering and include 15 cents extra for postage.

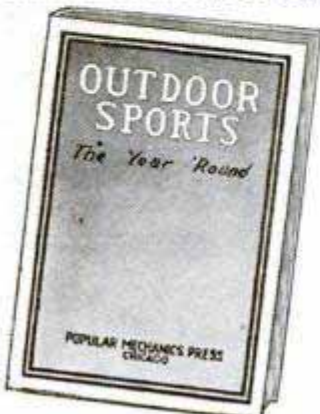

Popular Mechanics Press  
Room 706 200 E. Ontario St., Chicago

\$75<sup>00</sup> to \$125<sup>00</sup> Weekly, Paid to

# AUTO MECHANICS

fund every cent of your tuition. There is a reason for my making such a convincing offer. Ask yourself why. Then write quick for my remarkable SPECIAL TUITION OFFER. Save one-third now. See what you yet:

## Special OFFER Your Board for 8 Weeks and Your Railroad Fare

For a limited time only, and when you enroll, I will pay your railroad fare to Cincinnati or Cleveland and give you your board for 8 weeks. Send the coupon NOW—before it is too late—for full particulars of this amazing offer. Don't delay.

McSWEENEY Auto, Tractor and Dept. 14 TG Electrical SCHOOLS  
Cincinnati, Ohio, 654 McMillan St.  
Cleveland, Ohio

Please send your Special Offer and Big Illustrated Book.

Name .....

Address .....

City.....State.....

## Don't Be Afraid To Tackle That Concrete Job!

What is it you want to make out of concrete?



A Garage floor—Garden seat—Bird bath—Auto Drive-way—Curbs and Gutters—Flower boxes—Rural Mail Box Post—Garden Fountain—Ornamental Pool—Drinking Fountain—Boat Landing—Cistern—Cap—Milk House—Engine Foundation—Watering Trough—Sidewalk—Steps—Gateposts—Fence Posts—Tile—Blocks—Silo—Pedestal—Vases—Forge—Smokehouse—Chimney Cap—Horse Stalls—Foundation Support—Cyclone Cellar.

With the instructions found in Popular Mechanics Concrete Handbook you can make 173 different useful articles.

## Build With Ease for Permanence and Beauty

With the Concrete book we send you another remarkable book called Home Mechanics. This contains 329 valuable discoveries for doing the various jobs that come up about every home, both in the house and outside. These articles cover Furnaces, Stoves and Fireplaces—Homemade Furniture and Repairs—Building Refinements—Home Shop—Home Plumbing—Kitchen Equipment—Devices for Men—Home Electric Work—Outdoor Work—Water Supply—Garden—Bees—Miscellaneous.

Simply write and ask us to send you these two books. When postman hands you the package pay him 98 cents plus the postage. If outside U. S. remit when ordering and include 15 cents extra for mailing.

POPULAR MECHANICS PRESS  
Room 606 200 E. Ontario Street CHICAGO



# A Million Dollars CAN OPENER

**Patented!**

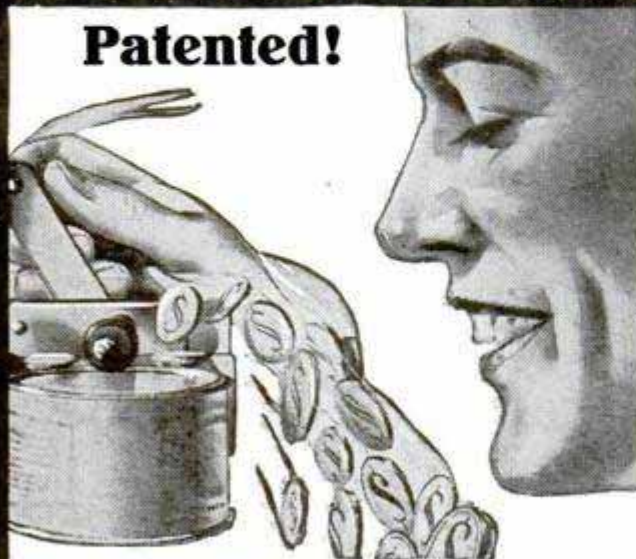

## Will You Make This Free Test?

Men, this is something absolutely novel and unique. It's a queer new kind of can opener that is radically different. Needed in every home! No wonder the dollars simply pour in for Speedo representatives everywhere!

**\$75 TO \$150 A WEEK—EASY!**

Imagine an almost magical little device—so small that you can easily slip it into your coat pocket—that ends forever all the stabbing and hacking, all the danger and bother of old-style can openers! It takes hold of the can—opens it—flips up the top so you can grab it—and gives you back the can in a couple of seconds with the entire lid completely cut out, slick, smooth and clean!

### Sells on Sight

Everyone knows that women all hate the awkward, dangerous old-style can opener. Imagine, then, how they welcome this startling new method—this automatic way of doing their most distasteful kitchen task!

And men, here's the best part of it. We have worked out a sure-fire demonstration for you that opens every door for you instantly—closes sales in 10 seconds by the clock, and gives you 4 orders out of every five calls!

### No Cost or Obligation

There is not space here to go into all the sensational details of this new money maker. But every wide-awake, ambitious man will see the possibilities instantly. So accept my offer. Test your profits absolutely without cost or obligation. Territories are closing fast. Get the facts about \$75 to \$150 a week, today. Mail the coupon at once.

### CENTRAL STATES MFG. CO.

Dept. H-700, 4500 Mary Ave., St. Louis, Mo. Est. Over 20 Years

Central States Mfg. Co., Dept. H-700,  
4500 Mary Ave., St. Louis, Mo.

Rush me details of your free Test Offer. This does not obligate me in any way.

Name.....  
Address.....  
Town..... State.....



LEARN  
BY DOING

Every phase of all branches of

**ELECTRICITY**

taught by

**Actual Practice**

In one of America's foremost  
institutions for  
trade training

ESTABLISHED 1902

**No Books Used**

Individual Instruction  
Start Any Day

Write for FREE 64-page catalog

**THE NEW YORK  
ELECTRICAL SCHOOL**

44 West 17th St., New York City

## FREE TRIAL Grows Hair



**AMAZING NEW  
ELECTRICAL  
DISCOVERY**

A noted surgeon has discovered an amazing way to grow hair, called Dermo-Ray. In 30 days no more dandruff. Scalp tissues are given new life. Then within a few weeks, luxuriant new hair! The startling discovery of the almost magic effect of Infra-Red Rays on the hair-growing tissues was made by a leading surgeon. Two years ago he was himself bald. Today his hair is full and thick.

### FAMOUS SURGEON'S DISCOVERY

Here is his own personal, home treatment, called Dermo-Ray. At last a home method endorsed by science. **Guaranteed to bring you these same results in 30 days—or you pay nothing.** You can use Dermo-Ray in any home with electricity. The warm, soothing Infra-Red Rays vitalize the scalp while you rest—a few minutes each day is all the time required.

**SEND NO MONEY** Complete facts about this astounding new scientific discovery, opinions of authorities, incontrovertible evidence, and details of **special trial offer** sent free, if you mail the coupon below. To end your scalp and hair troubles, act at once. Print your name and address plainly—and mail the coupon NOW!

-----**FREE TRIAL OFFER**-----

The Larson Institute  
Michigan Ave. at Lake St., Dept. 46, Chicago, Ill.

Send me at once, without obligation, full particulars—in plain envelope—of your 30-day Free Trial of DERMO-RAY.

Name.....  
Address.....  
City.....State.....



## NEED A BETTER GRIP ON MATHEMATICS?



SEND for a copy of "Mathematics for the Practical Man," only \$1.50. By common sense methods it removes the mystery and difficulties so that algebra and even calculus are made simple.

Assuming your knowledge is limited to arithmetic you quickly and easily gain a working knowledge of Algebra, Geometry, Trigonometry and Calculus. Simply pay postman price of book plus the postage when he hands you the package.

**Popular Mechanics Press**  
Room 107  
200 E. Ontario Street, Chicago

## Learn How to Make Money as a COMMERCIAL ARTIST or CARTOONIST!

This Course is designed to lead you from the simplest elementary drawing to the higher branches of illustration.

### OVER 125 ILLUSTRATIONS SHOW YOU HOW

The drawings are explained in detail and every method or trick of the trade employed by professional artists is explained in full.

Send for this new book, Commercial Art and Cartooning, by Matthews. Pay postman \$1.25 plus the postage when he delivers the package. If outside U. S. remit when ordering and include 10 cents extra for postage.

**POPULAR MECHANICS PRESS**  
Room 607, 200 East Ontario St., CHICAGO

# LOANED FREE!

5-Volume

## Auto Engineering Library

If you want a better job and bigger pay don't depend on "practical experience" alone. That may take years. Take a tip from thousands of go-getters who have improved their knowledge and skill and earnings thru a systematic study of "Auto Engineering." Follow the example of garagemen, foremen, mechanics and helpers who keep this famous library constantly at hand to solve their daily problems. Even the one chapter on Ignition may double your pay. 5 Big Volumes, 2320 pages, 2400 charts, wiring diagrams and illustrations.

### AUTO OWNERS— FIX IT YOURSELF!

— and Save Money

Be prepared to make emergency adjustments and repairs, to locate trouble and fix it, on the road. KNOW YOUR CAR. The Jiffy Index places the right answer to any question at your finger tips. Borrow a set free and prove its value without obligation to buy.

**American Technical Society** Dept. A-819  
Chicago, Ill.

### 3 FREE FEATURES

- 1 Home-Study guidance FREE.
- 2 Membership in American Technical Society and a year's consultation FREE.
- 3 FREE Employment service.

**American Technical Society**  
Dept. A-819 Chicago, Ill.

I want to borrow FREE for 15 day's use, a brand new set of "AUTO ENGINEERING" the latest 5 volume edition. I will pay only a few cents express charges when books are delivered, but not one penny for the use of the library itself. In return for this, I agree to look them over very carefully, and determine for myself if I wish to keep them. If I do, I will pay you \$2.00 after 15 days, then \$3 a month until \$24.80 is paid, your special advertising price. If not, I will return express collect, and owe you nothing.

Name \_\_\_\_\_

Address \_\_\_\_\_

Attach letter stating references' and employer's names and addresses, or write same plainly in margin.

# Learn Electricity in Los Angeles



Motor Manufacture—  
just one of the 14  
modern, completely  
equipped departments

## Get Practical Training on Half Million Dollars Worth Newest Electrical Apparatus

You learn all branches of electricity here—actually performing work that employers pay big money for, on modern equipment, under personal supervision of skilled instructors. Unlimited training until competent in Electrical Fundamentals—Drafting—Armature Winding—Motor Building—House Wiring—Illumination—Power House Operation and Testing—Motors and Controls—Radio Construction—Battery Manufacture—Automotive Electricity—Central and Sub-station Operation—Machine Shop. This training starts you on the way to qualify for weekly salary of \$200 and up in the fast-expanding electrical industry—and helps you succeed years ahead of the untrained men. Big electrical employers endorse this school.

## 16,000 Successful Graduates Now Earning Bigger Pay

Quality training helps National students to succeed. You get a most complete and thorough electrical course and you learn everything right. You aren't rushed through. National students are SATISFIED because they know this school will go the limit to help them succeed. For a quarter-century, men and boys have come to Los Angeles from all over the world to get the superior advantages of National training.

### FREE Employment Service

Over 200 National graduates own their own businesses in Los Angeles and are employing other students. Our Welfare Department will help in every way possible to get you a job and get you promoted, and will assist you to part-time jobs to pay your expenses while training. Mail coupon for full information.

# NATIONAL ELECTRICAL SCHOOL



Dept. 508, 4006 Figueroa St., Los Angeles, California

Please send me your Free, illustrated National Electrical Book describing opportunities in the electrical industry and illustrating National training methods.

Name \_\_\_\_\_

Address \_\_\_\_\_

City \_\_\_\_\_

State \_\_\_\_\_







## 10 Days' Free Trial

An extraordinary offer! Genuine No. 5 L. C. Smith ball-bearing typewriter at a 50% saving—and for only \$4 a month. Here's your chance to own the finest machine made at rental prices. Only a limited number of these superb typewriters available at these low prices and easy terms.

You cannot imagine the perfection of this wonderful ball-bearing typewriter until you have used it. Positively the easiest writing, fastest running, longest wearing typewriter made. Test this magnificent machine in your home or office for 10 days. Then you'll know money cannot buy a better, more beautiful, rebuilt typewriter.

Only  
\$**4**  
a Month

### Guaranteed 5 Years

For over 20 years the L. C. Smith has been recognized as the best typewriter made. The U. S. Government bought 40,000. It is the choice of big corporations like the Standard Oil Co., etc. IT IS THE WORLD'S ONLY BALL-BEARING TYPEWRITER.

### SEND NO MONEY

Just mail the coupon—we'll send you the typewriter for a 10 day trial. No one will urge you to buy. Unless the typewriter sells itself to you, return it at our expense. But you'll want to keep it, and you can for only \$3 down and \$4 a month. By using the coupon below, you receive \$3 worth of extras free. Send coupon now before the offer is withdrawn.

**\$50 SAVED** BY USING THIS COUPON

Smith Typewriter Sales Corp.  
117-360 E. Grand Ave., Chicago.

Ship me the No. 5 L. C. Smith F. O. B. Chicago. On arrival I'll deposit \$3 with express agent. If I keep machine, I'll send you \$4 a month until the \$45.50 balance of the special \$48.50 price is paid; the title to remain in you until then. I am to have 10 days to try the typewriter. If I decide not to keep it, I will repack and return to express agent who will return my \$3. You are to give your standard 5-year guarantee.

Name.....  
Address.....  
City..... State.....  
Occupation.....  
Employed by.....

24th Year

## CHICAGO TECHNICAL COLLEGE

LEARN  
**DRAFTING**  
IN 4 MONTHS

Trained Draftsmen earn \$60 to \$100 a week. 4 months' interesting study at Chicago Tech. fits you to earn big money in drafting's fertile field. Common schooling all you need. Expert instructors. Opportunities for self-support while studying. Free Employment Service. Day or Evening Classes. Athletics. Enter any time. Also intensive courses in Engineering, Electricity and Building. Write for free 84-page "Blue Book" and facts about how to qualify for a high-pay drafting job in 4 months.

Dept. H-400  
118 East 26th St. Chicago Technical College  
Chicago

If you can't come to Chicago, study at home.  
Write for Free Trial Lesson in Drafting.



### The RIGHT School for Your Son or Daughter

In touch with the latest developments in education for the last seven years, it has been our privilege to see hundreds of boys and girls happily enrolled in schools and camps of our recommendation. Let the Red Book Magazine Educational Department help you select the right school for your son or daughter.

Write in detail giving past schooling, individual needs, kind of school or camp desired and approximate expenditure planned. This service is free. Address The Director, Educational Department

The Red Book Magazine A-420 Lexington Ave. NEW YORK CITY

### Keynote To Popularity

Popularity is yours. Everyone will seek your company if you play tenor banjo. Enroll for our course. We start you with an \$18 professional tenor banjo. Prof. Six was director of Glee and Instrumental Clubs at N. Y. University. His picture, diagram and phonograph record method is so simple you play immediately.

Don't Send a Single Cent  
Write for particulars about our course and we will reserve an \$18 tenor banjo for you. Write now for book and free first lesson.  
New York Academy of Music, Studio 107, 100 Fifth Ave., N. Y. C.



**MAGIC** Earn \$250 to \$1000 Monthly  
New! Different! Teaches you Big Tricks, Illusions, Stage Stunts, "Patter" and the Principles of Magic. Learn at home. Earn \$250 to \$1,000 a month. Write today for special offer.  
Tarbell System, Inc., 1926 Sunnyside Ave., Dept. B-935 Chicago, Ill.

**"BECOME A LIGHTNING TRICK CARTOONIST"**  
Send \$1.00 for Laugh Producing Program of 22 Trick Drawings with Instructions. Catalog of Chalk Talk Supplies Free.  
BALDA ART SERVICE, Dept. 1, Oshkosh, Wis.

**Fishermen!**  
3 BIG ISSUES 10¢  
Read Sportsman's Digest, famous fishing magazine. Fishing, hunting, trapping stories and pictures; information, tips, successful secrets, on tackle, guns, dogs, all outdoor sports. Special advertising offer—send 10c coin or stamps, with name and address, for three months' subscription.  
SPORTSMAN'S DIGEST Dept. 9-G CINCINNATI, OHIO



# Let SWEENEY Help YOU to \$10 to \$18 a day



**My Employment Department Helps My Graduates to Jobs at \$10 to \$18 a Day**

*E. J. Sweeney,* Yes, my EMPLOYMENT DEPARTMENT helped L. W. Kelley to a job at \$18.00 A DAY—IT helped J. H. Miller to a job at \$10.50 A DAY—IT helped Gordon Shyrook to a job at \$10.50 A DAY, and it, also, is helping dozens of other Sweeney Graduates to fine jobs at \$10 to \$18 a day, IMMEDIATELY after finishing ONLY A SHORT COURSE of SWEENEY TRAINING. Clip the coupon. Find out about this WONDERFUL JOB SERVICE my EMPLOYMENT DEPARTMENT renders. It will simply astonish you.

## Coupon Brings Full Facts About Valuable Job Service

That's what a REAL, "ON THE JOB" EMPLOYMENT DEPARTMENT SHOULD DO, and that is—help men GET REAL JOBS. Think of it—FIFTY-FIVE WONDERFUL JOBS OPEN TODAY for SWEENEY TRAINED men. I have ONLY FIVE MEN READY so that I can help them to these jobs. And the peculiar thing is—it takes me ONLY FOUR WEEKS to TRAIN some of these men. Now what more do you want? Challenge me. Send for my Big Free 72 Page Book. If you go on depriving yourself—if you WANT TO BE OUT OF A JOB—and don't let me help you—PLEASE DON'T READ ANOTHER SWEENEY AD. If you have—(you know what I mean) in you—you will find out NOW. Just clip the coupon below.

## Today 50 More Jobs at \$11 a Day GO BEGGING

This very day, I could help 50 more men than I have available at \$11 a day. The future looks even better. There is a shortage of men trained like SWEENEY has trained thousands of men. That's why SO MANY SWEENEY TRAINED MEN get TREMENDOUS PAY and are in BIG DEMAND.

Get my Free Book today and see that WELDING is only one of BIG PAY Branches I get you ready for.

## THE SWEENEY SCHOOL

with over 65,000 graduates, trains you in a good trade. What appeals to you? Auto repairing—bus line driving—garage—repair shop—tire shop—welding—radio, broadcasting—auto painting? Write me today—GET THE FACTS—about wages—profits—opportunities and HOW THE SWEENEY SYSTEM is equipped to give you successful training. Auto Mechanics make \$50 to \$100 a week. Learning is easy by the Sweeney System of Practical Training. Use tools not books. Be an auto mechanic—driver—truck driver—repair man—tire man—demonstrator. Own your garage or repair shop. Run a welding and vulcanizing shop. You can learn these trades separately or in a combined course.

## Sweeney System "Learn by Doing"

If you are mechanically inclined, if you like to work with tools, you will learn under the "SWEENEY SYSTEM" by actually doing the work on the most complete gas engine and electrical equipment. Over \$200,000 invested. \$50,000 Radio Station WIIB. You'll get dirty and greasy, but you'll learn through the SWEENEY SYSTEM OF PRACTICAL TRAINING that fits you for the big pay jobs waiting for Sweeney Trained Men.



## COME RIGHT NOW

Never Before Have I Made Such an Amazing Offer. I now make it possible for you to come to this Million Dollar Sweeney School Right Now.

## FREE CATALOG AND SPECIAL OFFER

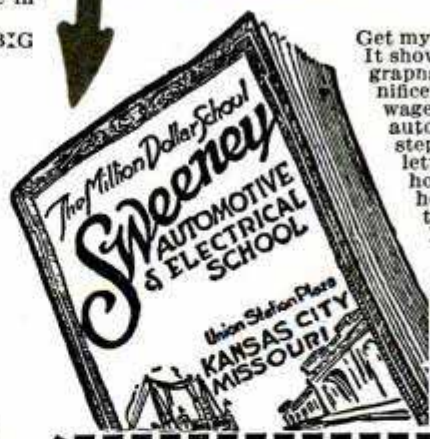

Get my big FREE 72-page catalog. It shows hundreds of actual photographs of men at work in my magnificent new school. Tells all about wages, profits, opportunities in auto business. Explains step by step how you learn. Interesting letters from graduates telling how they made good. Shows how men come from all over the world to this big school. Makes you want to join the crowd. Tells everything you want to know. I will gladly send you a copy beautifully illustrated. I'll tell you how to get into business for yourself. No colored students accepted.  
E. J. Sweeney, President

EMORY J. SWEENEY, President  
3931 Sweeney Building, Kansas City, Mo.

Send me free, without any obligation, your catalog and Special Offer!

# LEARN A TRADE- Sweeney AUTOMOTIVE & ELECTRICAL SCHOOL 3931 SWEENEY BLDG. KANSAS CITY, MO.

NAME.....  
P. O.....  
STATE..... AGE.....



# SIAMESE TOWER IS BUILT OF SALVAGED CROCKERY

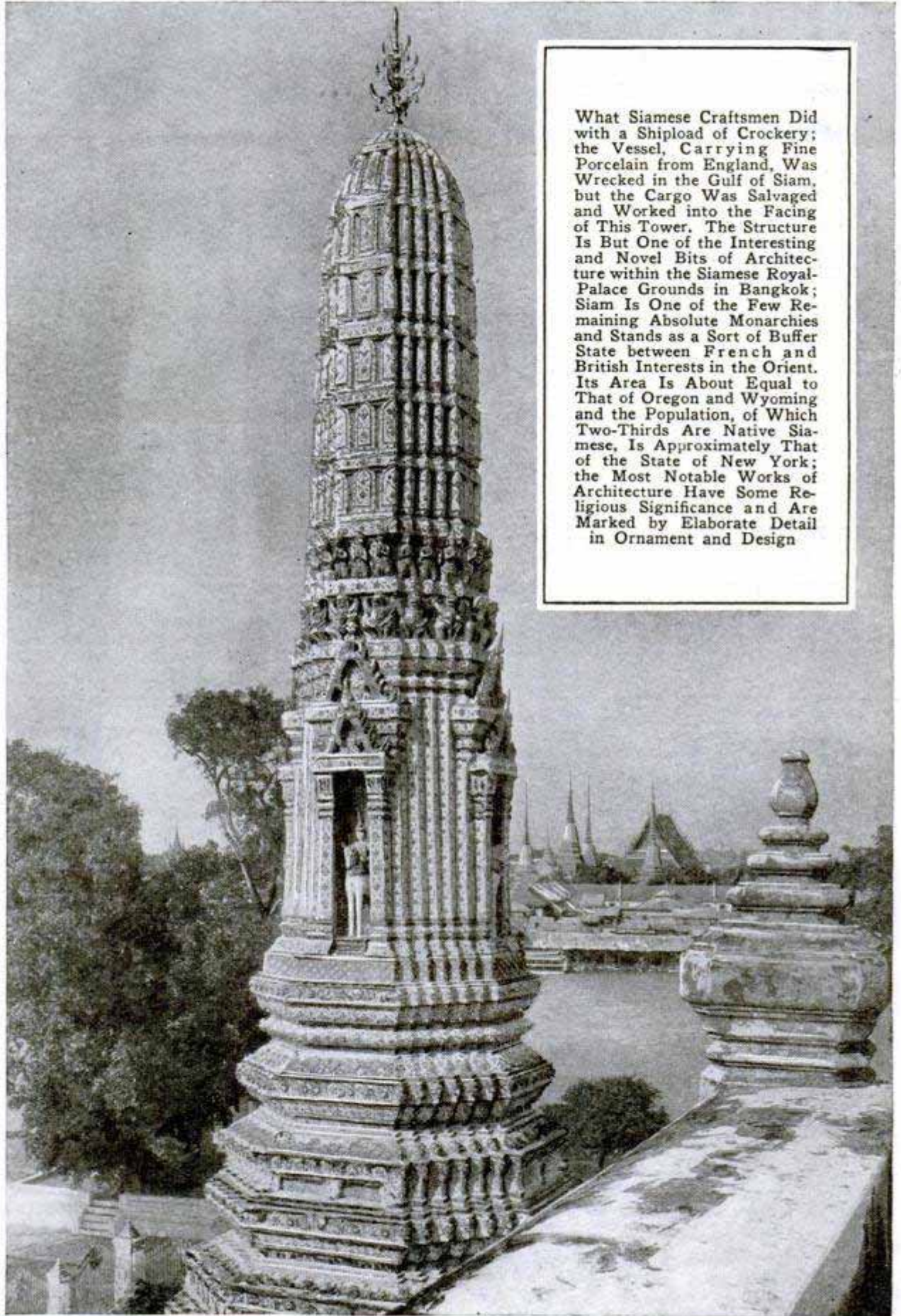

What Siamese Craftsmen Did with a Shipload of Crockery; the Vessel, Carrying Fine Porcelain from England, Was Wrecked in the Gulf of Siam, but the Cargo Was Salvaged and Worked into the Facing of This Tower. The Structure Is But One of the Interesting and Novel Bits of Architecture within the Siamese Royal-Palace Grounds in Bangkok; Siam Is One of the Few Remaining Absolute Monarchies and Stands as a Sort of Buffer State between French and British Interests in the Orient. Its Area Is About Equal to That of Oregon and Wyoming and the Population, of Which Two-Thirds Are Native Siamese, Is Approximately That of the State of New York; the Most Notable Works of Architecture Have Some Religious Significance and Are Marked by Elaborate Detail in Ornament and Design



# Popular Mechanics Magazine

REGISTERED IN U. S. PATENT OFFICE

WRITTEN SO YOU CAN UNDERSTAND IT

Vol. 48

JULY, 1927

No. 1

2298

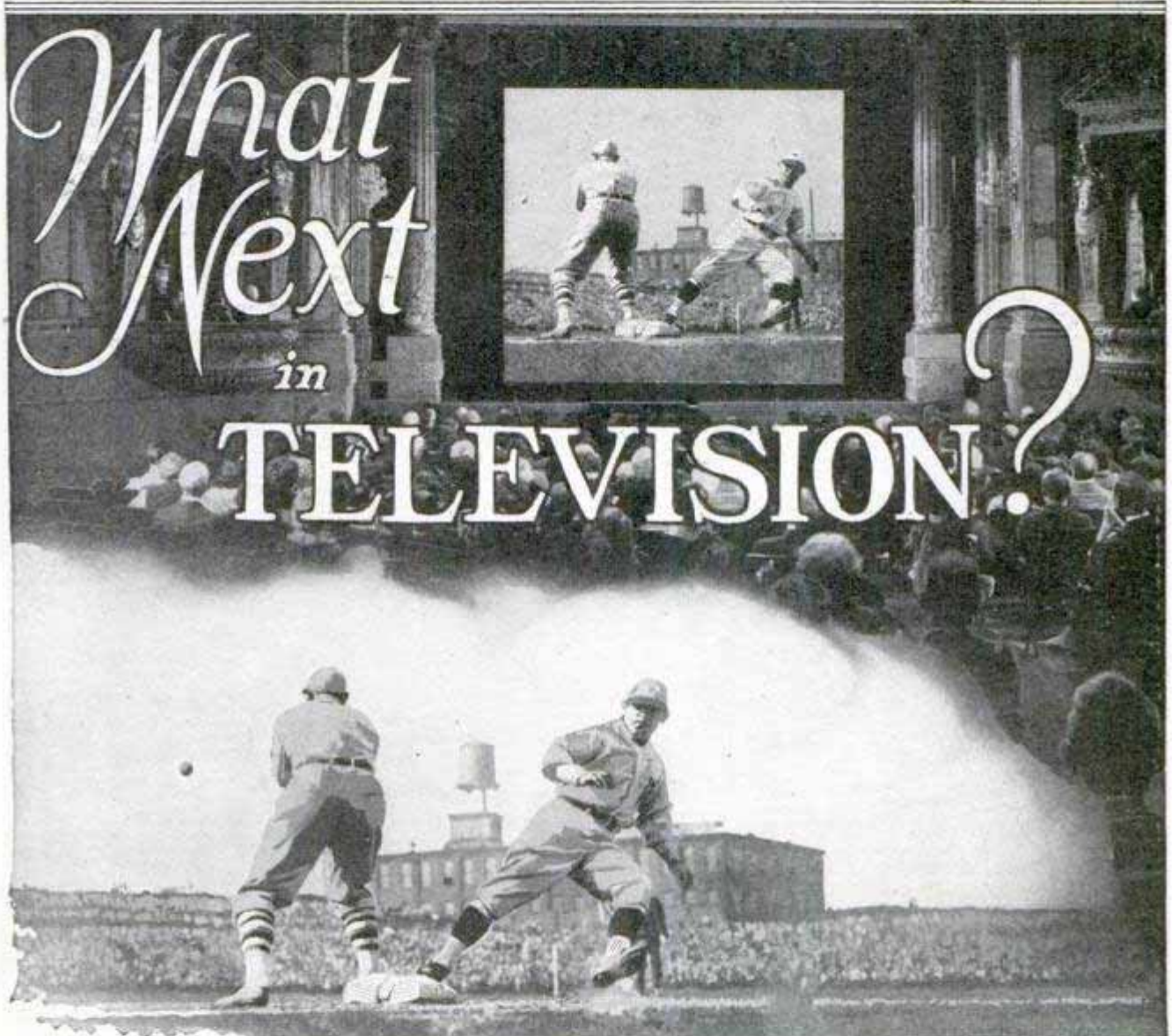

Successful Television Experiments Suggest That Soon Audiences Gathered in Distant Cities May Be Able to See World-Series Games on the Screen at Same Time They Are Played

By A. A. ALBELLI

**P**RIZE fights via television may be a reality before the end of this year. Engineers are working now on this first step in the practical utility of seeing by wire or radio at the Bell laboratories in New York City.

Arthur W. Page, of the American Telephone and Telegraph company, recently predicted: "The leaves will not begin to fall before you hear that we have per-

fectured apparatus whereby a boxing match will be radio-vised."

The efforts to apply television practically follow the successful test recently between speakers in New York City and Washington, D. C. Secretary of Commerce Herbert Hoover at the Washington end conversed with Walter S. Gifford, president of the American Telephone and Telegraph company, who was in New



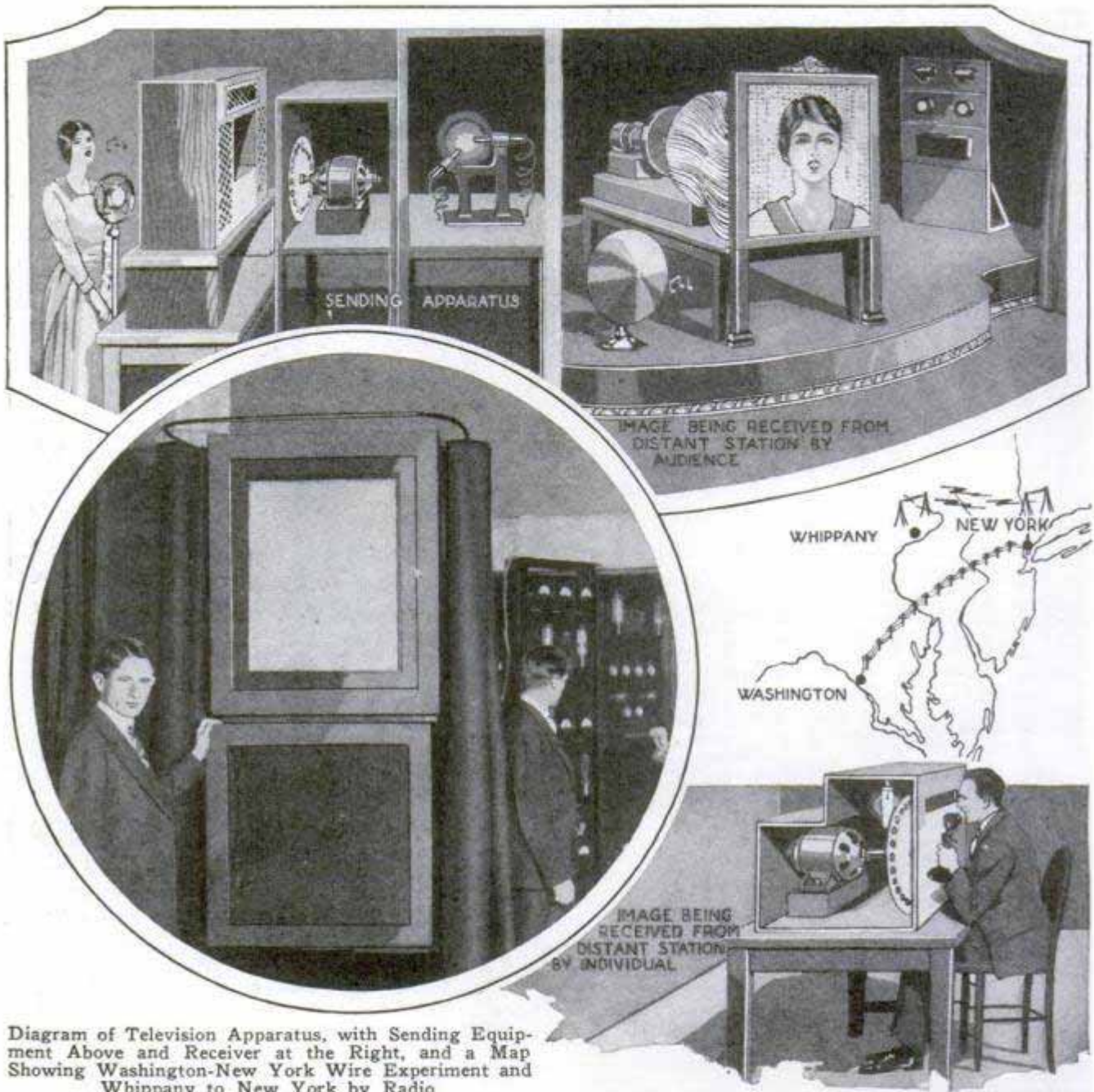

Diagram of Television Apparatus, with Sending Equipment Above and Receiver at the Right, and a Map Showing Washington-New York Wire Experiment and Whippany to New York by Radio

York. By means of the television instruments, Mr. Gifford was able to see the image of the face of Secretary Hoover.

Already indefatigable scientists, working diligently to push nature's frontiers still farther back, are arriving at tangible ends in the practical application of the television principle. One of the men vitally associated with the practical side of television has come forward to predict that next summer's world-series games will be broadcast via television.

As far as the practical application of television to the everyday life of the average citizen is concerned, the process is still too complicated and costly. But the economic problem involved would be solved if large numbers of persons could use the

same apparatus. Initial uses of the device will probably center around this fact.

Officials of the company believe that in time it will easily be practicable, and also profitable, to exhibit in a Chicago theater or hall a championship fight which may take place in another city, even as far away as New York.

With the same thought in mind, it is planned to establish television stations in the leading cities. Persons desiring to avail themselves of television would go to those stations.

The biggest of the problems facing the engineers have been solved. They are now confronted with the task of putting their principles to practical uses. The process by which television has been attained



seems infinitely complicated and difficult on first encounter, but becomes fairly simple when traced step by step. The thing that chiefly staggers the mind is that all that travels over the wire and over the air is a series of electrical impulses.

Speed and exactitude are the tremendous achievements in the process. Dots of light are put together at the rate of 45,000 a second to form the motion pictures. Each dot has to be in its exact place. The mosaic of squares would be a jumble if there was an error of one ninety-thousandth part of a second between the sending and receiving apparatus.

The receiving and transmitting of the picture are harmonized by a system which causes every one of the 2,500 squares or units to fall in its proper place eighteen times a second.

As in motion pictures, it is the phenomenon of persistence of vision which causes all those flickering squares of light to fuse so that the eye sees them as objects in motion. Motion pictures really consist of still pictures shown at the rate of eighteen a second. The eye blends the stills into motion.

In television, the eye is even more deceived. Here is only a series of spots of light flashing on and off, but each spot maintains its effect on the human eye long enough for the brain to comprehend them as an organized picture.

2312.

### BLAZING SKYSCRAPER RAISES FIRE-FIGHTING PROBLEM

A blazing wooden scaffold, thirty-eight stories above the ground on the side of a new skyscraper hotel in New York, recently brought firemen face to face with an entirely new problem in fire fighting. The tallest water tower fell short by hundreds of feet, the standpipes in the new building were not in commission, and hose, laboriously carried up flight after flight, in the absence of elevators, burst when the water pressure was raised in an effort to force a stream to the top. Eventually the fire burned itself out, but not before it had scattered blazing timbers for blocks around. City officials who conducted the investigation recommended that wooden scaffolding be barred from use on high buildings.

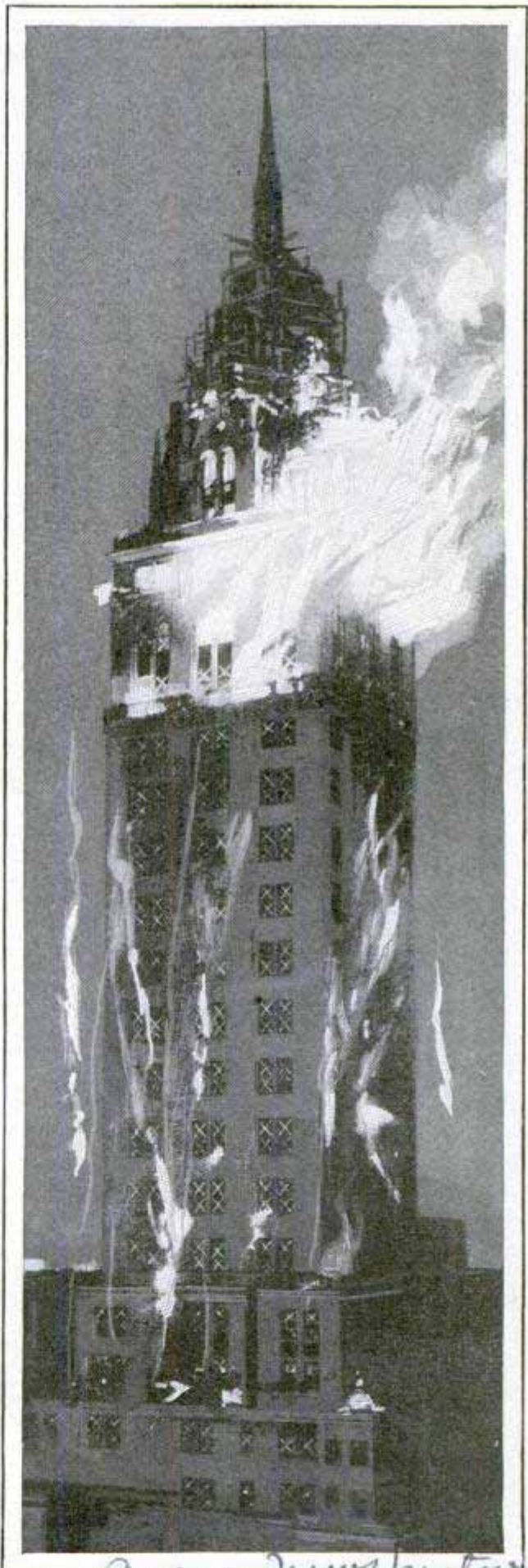

*Some newspaper pictures*  
Night Photograph of New York's Highest Fire, atop a New Skyscraper; the Streaks Are Falling Firebrands. Such Fires Offer a New Problem

*New Netherlands Hotel*



4  
2113

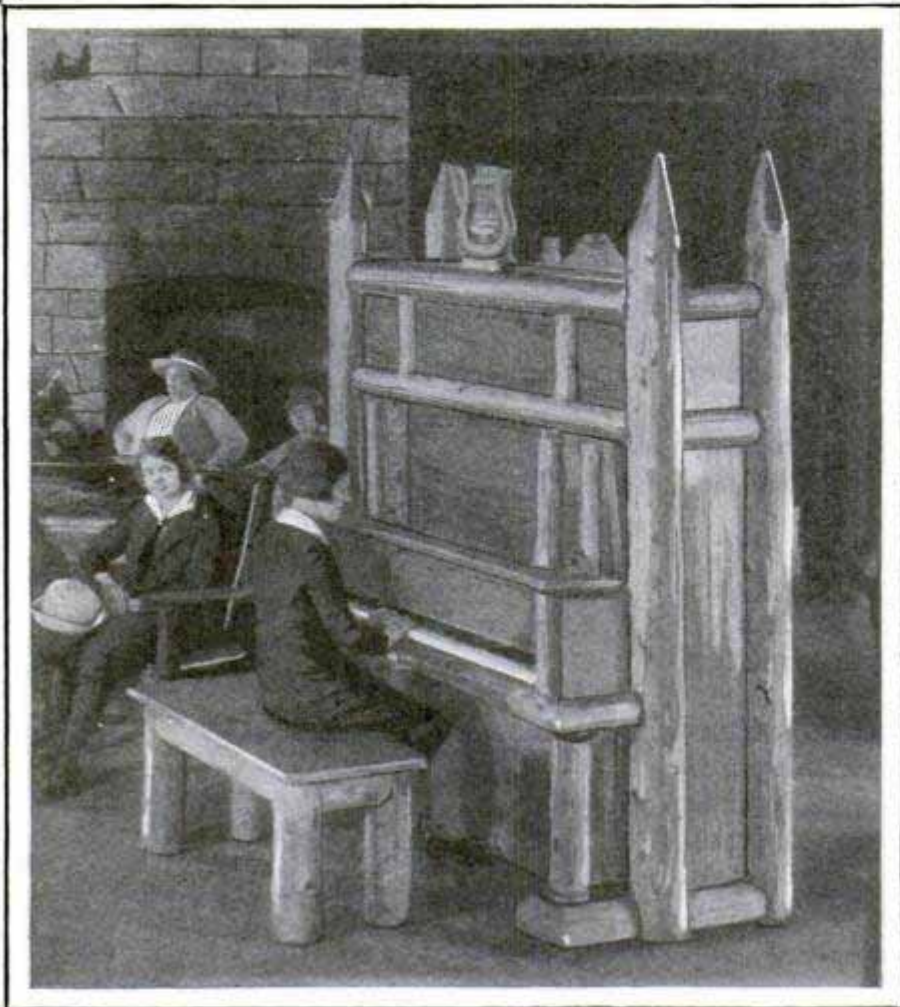

Rustic Piano Case in the Lobby of Paradise Inn, Rainier National Park; It Was Made from Logs Cut in Forest Close By

### RUSTIC LOG CASE FOR PIANO FEATURES PARK INN

Novel rustic furniture is used with pleasing effect in the lobby of Paradise inn, at Rainier national park, and one of the most unusual pieces is the piano. The case is constructed of logs cut in the forest near by. They are of Alaskan cedar, silver-gray and weathered to a soft color.

### GAS MADE FROM FARM WASTE USED FOR COOKING

Almost any kind of vegetable may be used as a source of gas in a generator recently introduced, the inventor claims. Cotton, cornstalks, straw and sawdust have been employed successfully, according to reports, a ton of the material producing about 1,200 cubic feet of gas suitable for heating or cooking. It burns with a clean, blue flame. The plant also yields valuable by-products in the form of tar, vegetable oils and charcoal.

*H. J. Esilbert*

### CUTTING STONE WITH SHOT <sup>2369</sup>

Chilled-steel shot is being widely adopted as a substitute for sand and water in sawing slabs and blocks of stone. It is made so hard that it cannot be bruised or crushed under the heaviest pressure, whereas sand or emery is quickly reduced to ineffective powder. The work is done more rapidly and there is less wear on the tools. The shot is also being substituted for sand and emery in grinding and polishing.

### CRIME WAR AIDED BY FINGERPRINT MAGNIFIER <sup>2179</sup>

One of the most recent aids in police investigations is a special magnifying apparatus for the study of fingerprints. It enlarges them twenty

diameters and, at the same time, projects the lines in clear definition on a miniature screen facing a camera attachment. By means of special adjustments, a bit of fingerprint or an entire impression taken from some object or surface, can be alined and superimposed on a print from a suspect's finger so that accurate comparison can be quickly made.



Outfit for Enlarging and Comparing Fingerprints; They Are Projected on a Screen for Close Analysis

*Wm. S. Daubertich*  
*H. Scherino*

*American Scientific Instrument Co.*



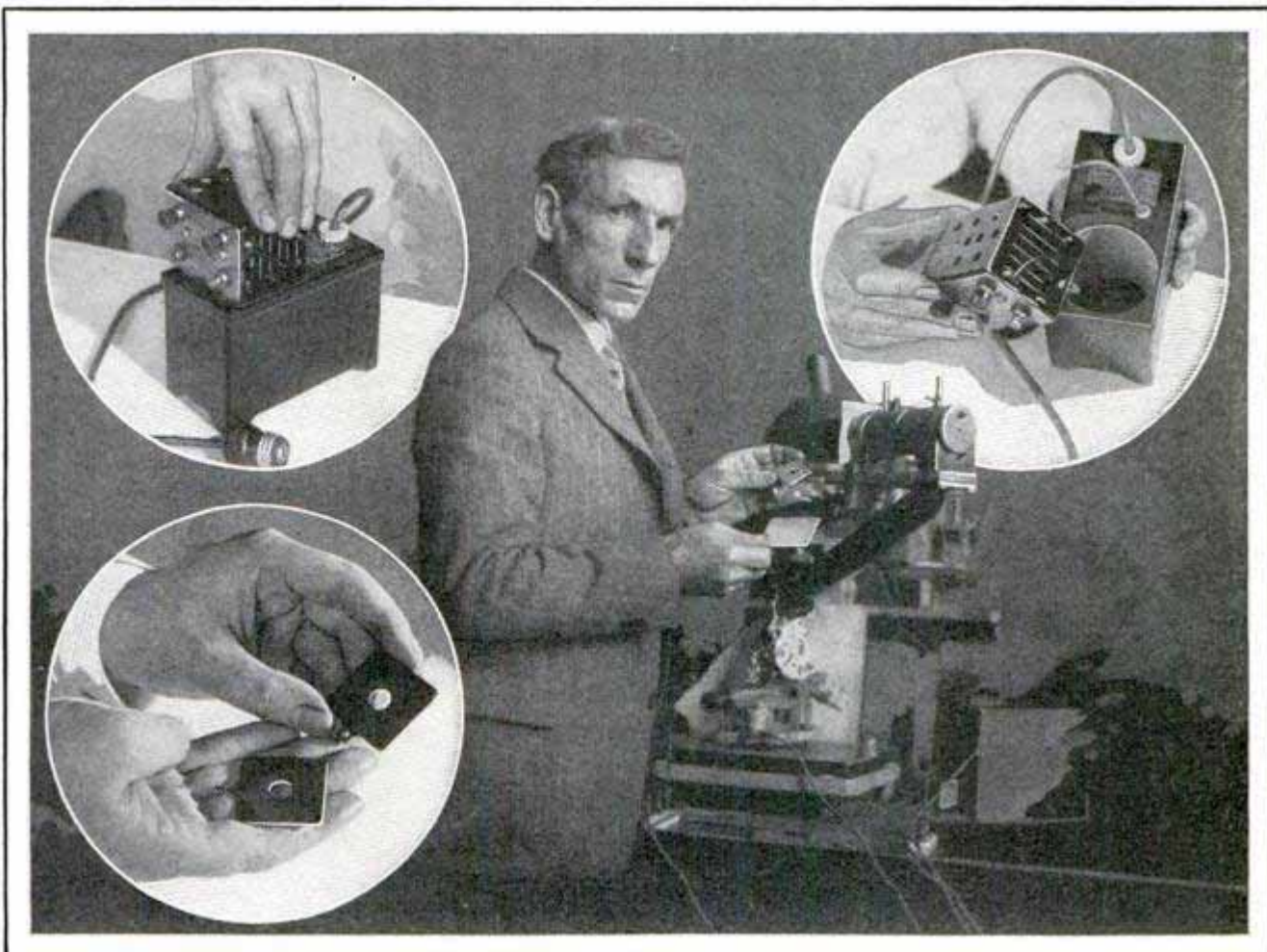

Professor Allen, Inventor of Copper That Is a One-Way Electrical Conductor; a Rectifying Equipment for a Battery Charger, Left and Right at Top, and Individual Plates at Lower Left

## Copper That Defies Electrical Laws

Metal through Which Current Can Flow in Only One Direction to Revolutionize Radio Battery Chargers and Eliminators

A LITTLE piece of copper, slightly more than an inch square and so thin that it would take sixty-five of them to make a pile an inch high, has won a place in the electrical hall of fame by defying all the accepted laws of electricity. For, while copper is the best of all the cheap and available electrical conductors, this particular piece has the unique property of carrying a current in one direction only—from its face toward its center.

Because of that property it can be used to turn alternating current into direct current, opening a field of vast possibilities, since copper is cheap and "kuprox," as the material is known, is easy to make, after you know how. It is already on the market in the form of units to replace the electrolytic jars in radio-battery chargers or

the rectifying tubes in vacuum-tube chargers, and as rectifiers in several pieces of X-ray and medical apparatus.

Battery eliminators, using the unit and replacing both A and B radio batteries, are working in the laboratory and soon will be in production, and, wherever alternating current must be changed into direct, engineers are interested in the possibilities of the new material. Alternating current is far more economical and practical to generate, but direct current is best in some fields, particularly for elevator motors and similar machines where a high starting torque is required. So, in practically every city of any size, the power company is forced to generate some direct current for its business and factory customers, maintaining power houses and lines for both.

Kodak Radio Corporation  
 512 E. Pearl St.

849 Rush St., Chicago

ca  
st  
o:  
tv



With the new copper rectifiers, the power company could deliver alternating current to the consumer, using a small rectifier on the premises to convert it into direct. A pile of copper plates, three inches square and less than five inches high, would be sufficient to rectify 100 amperes at 200 volts.

The invention of kuprox is one of the romances of modern research. Scientists years ago discovered that copper, when coated with one of its oxides, became a one-way conductor of electricity, but, because of the high resistance of the black oxide which forms over the surface of copper when oxidized, the discovery had no practical use. When the coating of black oxide was removed, the inability to get a good electrical contact interfered with its application to practical work.

It remained for a Cincinnati man to invent a method of replacing the black-oxide coating with a layer of pure copper, which not only eliminated the high resistance and provided a good contact, but likewise offered a surface to which connections could be directly soldered. The first discovery, years ago, was just an existing fact, but the perfection of kuprox is a true invention of something that never existed before, a method of getting a coating of virgin copper over oxide, so that in the final product the oxide rests between sheets of pure metal.

John G. H. Liebel is responsible for the invention as a result of his curiosity as to why the metal and oxide would only conduct electricity from the oxide into the copper, and not in the reverse direction. He surmised that the reason lay in some change in the atomic structure which took place while the oxide was being formed. So he enlisted the aid of S. J. M. Allen, of the university of Cincinnati. Prof. Allen discovered that, if made in a somewhat different manner, the resistance

of the plates of kuprox varied according to the pressure applied to them. He immediately visioned a new and extremely delicate electrical balance for weighing minute amounts of matter in his laboratory. Being the son of a sea captain, a Novascotian by birth and an ex-commodore of the Royal Halifax yacht club, he saw also another field, in which a small tube, let into the bow of a boat below the water line, would have at its rear end a diaphragm against which the sea water would press when the boat was moving, the pressure varying according to the boat's speed. A stylus projecting from the diaphragm would press against a pair of kuprox disks and transmit a varying amount of current to an ammeter, calibrated in knots, on the bridge, a ship's speedometer, in other words.

A friend of the two, Clarence Ogden, saw another field and immediately obtained a patent license covering radio battery eliminators and battery chargers. For battery charging a dozen of the little inch-and-a-half-square plates are connected so that, when the alternating current flows one way, it passes through half of them and when it flows the other, it passes through the other half, but both sets of six plates are so arranged that the output is delivered to the battery in one direction. The result is a trickle charger that charges at twice the rate of the ordinary type, for it is a full instead of a half-wave type.

2268

### SCREEN FOR AUTO WINDSHIELD KEEPS OUT DUST AND BUGS



Windshield Screen  
in Place Showing  
How It Leaves  
Driver's View Un-  
obstructed and  
Breaks the Force  
of the Wind

Easily attached to the car, a fine copper screen fits under the windshield to keep dust and insects from entering when the glass is open and to break the force of the wind. It does not interfere with the driver's vision as it comes below the top of the steering wheel. Rubber bumpers prevent noise and vibrations.

Albion Metal Products Co,  
Albion, Mich.

Mrs. Liebel - Florsheim Co.



*George L. Hall, Melrose, Mass.*

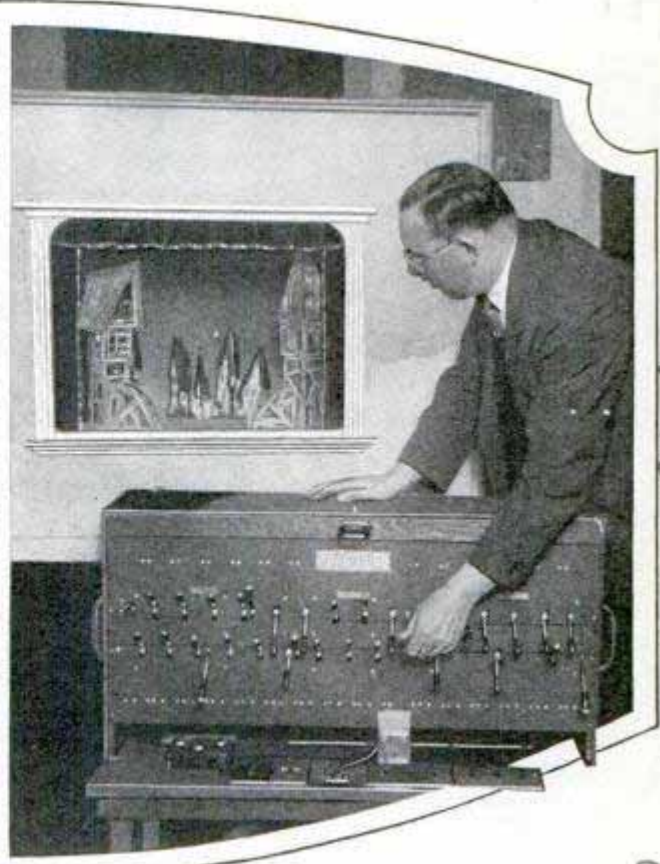
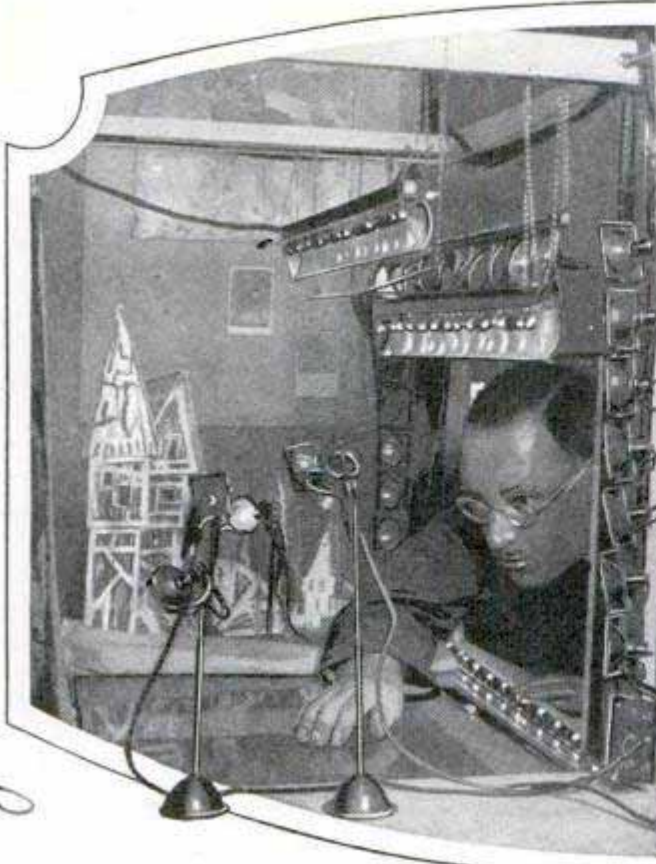

Miniature Stage and Lighting System Save Time and Expense in Planning Effects for Real Plays; a View behind the Scenes and the Control-Switch Box

**LIGHTING TESTS ON TINY STAGE AID SHOW PRODUCTION**

So that various lighting effects may be developed at a minimum expense, a miniature stage and switchboard have been devised by an eastern inventor. They are modeled after a full-size theater with lamps in the same positions they occupy in the real playhouse. Color combinations, time schedules and other details can be worked out with this equipment in little time and with great saving in current.

**CLOSET LININGS OF CEDAR BAR MOTH RAVAGES 23 31**

Closet linings of aromatic Tennessee red cedar, produced in tongue-and-grooved boards with matched ends, are displacing cedar chests as a moth preventive for the summer storage of clothing. The material can be used to line old closets or new, or in the construction of large attic storage vaults. To prevent the natural change which causes the pores of cedar to close when exposed to sunlight, sealing in the aromatic oil which drives away the moths, the boards are packed in air and light-tight

fiberboard packages as soon as they are made, and come to the user in this way. The boards come in three-eighths-inch thickness for walls, and thirteen-sixteenths for floors, and in widths ranging from one and a half to three and a quarter inches. Only the heart wood, which contains the cedar oil, is used.

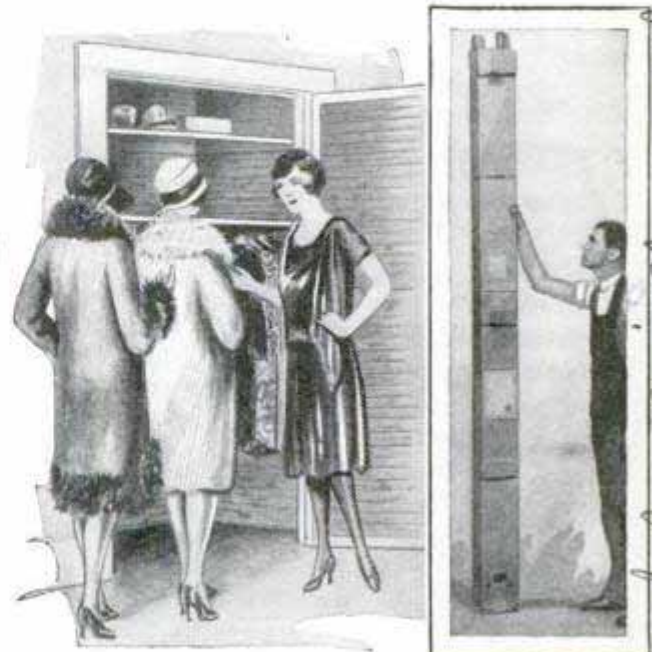

Cedar-Lined Closet and Shipment of the Boards Showing the Air and Light-Tight Container

*George C. Brown & Co. Memphis, Tenn.*

*Wholesale - Chicago J. F. Gleason Lumber Co. 22 W. Monroe St. Chicago, Ill. 1914*



1941

British Tank with Its Radio Mast; Wireless Can Now Be Used to Direct Whole Groups of "Traveling Forts"

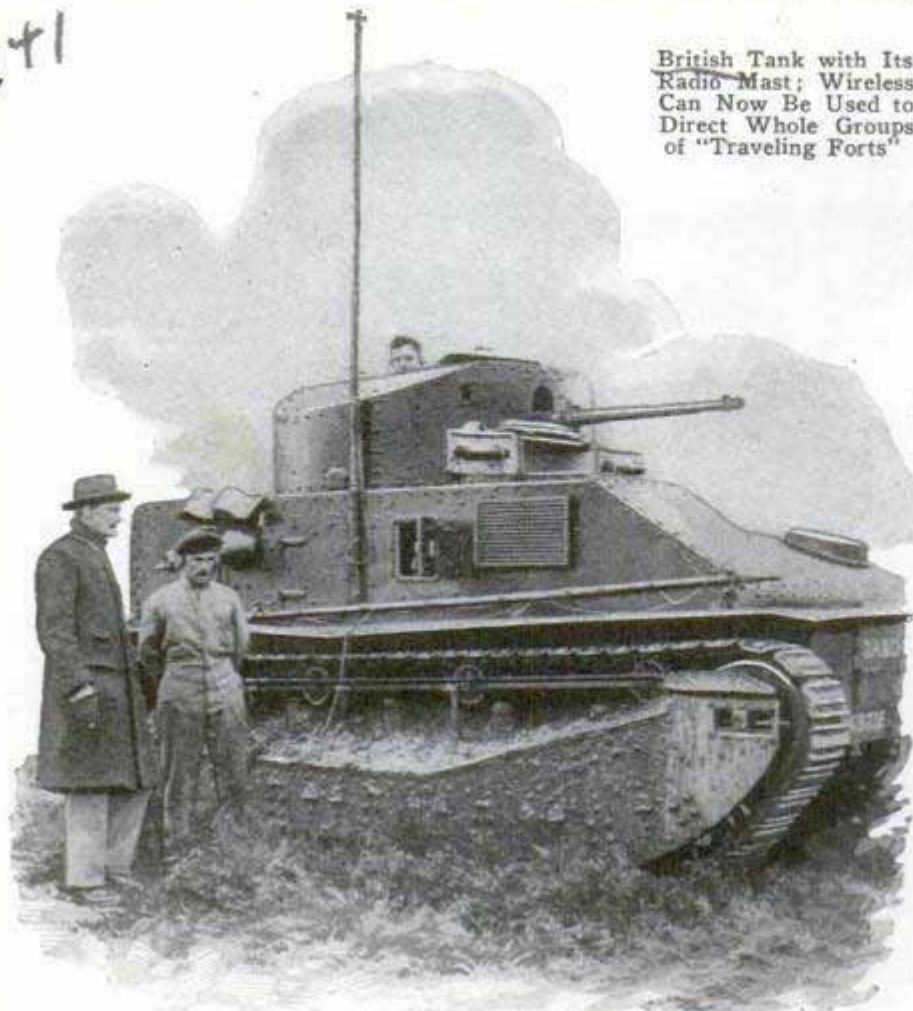

where there were between 200,000 and 250,000 ostriches, the number has shrunk to less than 50,000, and because of the unfavorable season last winter, it was necessary to kill many of the birds to save the expense of feeding them.

2276

**TOY BALLOONS ARE MADE IN MANY QUEER SHAPES**

Toy balloons shaped like such familiar figures as Santa Claus or the Easter rabbit, as well as scores of fanciful and grotesque animals, birds and people have created a new field for inflated rubber toys. Queer cats, with a squawker concealed in them, emit plaintive howls. Another improvement on the old-time balloons is the addition

*Use*  
**ARMY TANKS CARRY WIRELESS FOR BATTLE ORDERS**

The efficiency of the tank as a fighting unit has been increased, army authorities believe, by the development of special wireless outfits for the units. The antenna is rigged on a small upright. Operators can readily receive instructions from a central dispatching station, simplifying the task of giving orders to the "traveling forts" and insuring more successful maneuvers.

*International*  
**OSTRICH FEATHERS IN DUSTERS SHOW CHANGE OF STYLE**

Once prized by the milliner, the ostrich feather is now almost completely out of fashion and is being used in dusters and to trim lamp shades. The effect of the change in style has been noticeable in South Africa, where huge flocks of birds have been raised for their plumes. In one district,

tion of a simple valve which does away with the trouble of tying the balloon with string after inflating. The toys, which appear simple enough, are the product of complicated manufacturing processes. Sheets of special high-grade rubber are cut out by dies, one for each side of the toy, the two parts are then joined at the edges to form an airtight balloon, the designs are stamped on in colors and finally the valve is added.

Cats, Ducks, Rabbits, Chickens and Some of the Other Unusual Shapes of Toy Balloons Which Have Created a New Industry in Rubber-Toy Making

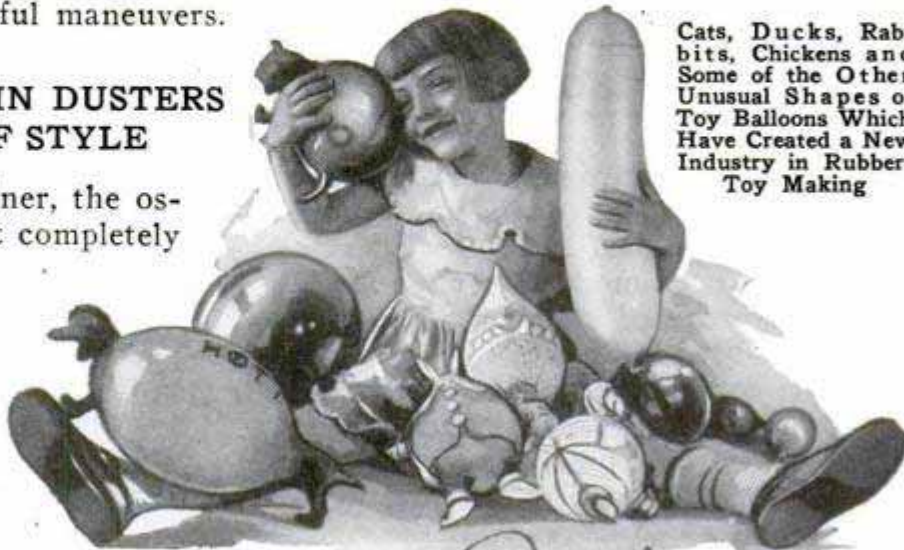

Express 4/13/27

Miller Rubber Co.  
1247 S. High St.  
St. Louis, Mo.

*Chicago Road, Chicago*  
*1965 W. Parkway*





The Stevens Shortly before the Opening; the Structure Is Twenty-Five Stories above Ground and Four Below, Cost, with the Land, \$27,000,000, and Contains 3,000 Rooms

IT would take you eight years, using a different room each night, to sleep in all of the rooms of the world's largest hotel. The entire population of any one of more than 1,000 cities in the United States could be comfortably entertained at the same time in this structure, allowing a separate room for each man, woman and child, and there would be space left for transient guests. A single worker, attempting to wash all the windows would have to labor eight hours a day for nearly five months to complete the task.

Twenty-five stories above ground, four below and costing \$27,000,000 with the land, the Stevens hotel, in Chicago, is best seen in its tremendous proportions when some of its items of household equipment are considered. These include 7,000 chairs, 134,000 plates, other china that would fill fifty carloads, three trainloads of mattresses, 138,000 tablecloths, 300,000 napkins, 48,000 drinking goblets, 5,000 dozen bath towels, three carloads of silverware, sixty miles of carpets and 36,000 feet of picture

frames for the 6,000 original etchings and paintings.

In the lower floors are a ballroom so large that 3,000 persons can comfortably dance in it at one time, six other large ballrooms, dining rooms where 5,184 persons can eat together and an exhibition hall containing 32,000 square feet of floor space. There is a two-ward hospital, a library of 10,000 volumes, and children's recreation rooms where guests may check their youngsters. Travelers arriving with pets will find a special "menagerie" room for the entertainment of the animals and a chef delegated to cook for them. Almost any sort of a pet, from a canary bird to a kangaroo, can be kept here.

To care for the guests' needs, the largest private telephone switchboard in the world was installed. This consists of 3,800 lines with 340 city trunks and positions for twenty-one operators, an equipment so large that 72,000 calls can be handled every twenty-four hours. In all, the hotel has between 2,500 and 3,000 employes.



Below, Fountain Group by Frederick C. Hibbard; the Boys Are "Bill" and "John," Sons of E. J. Stevens

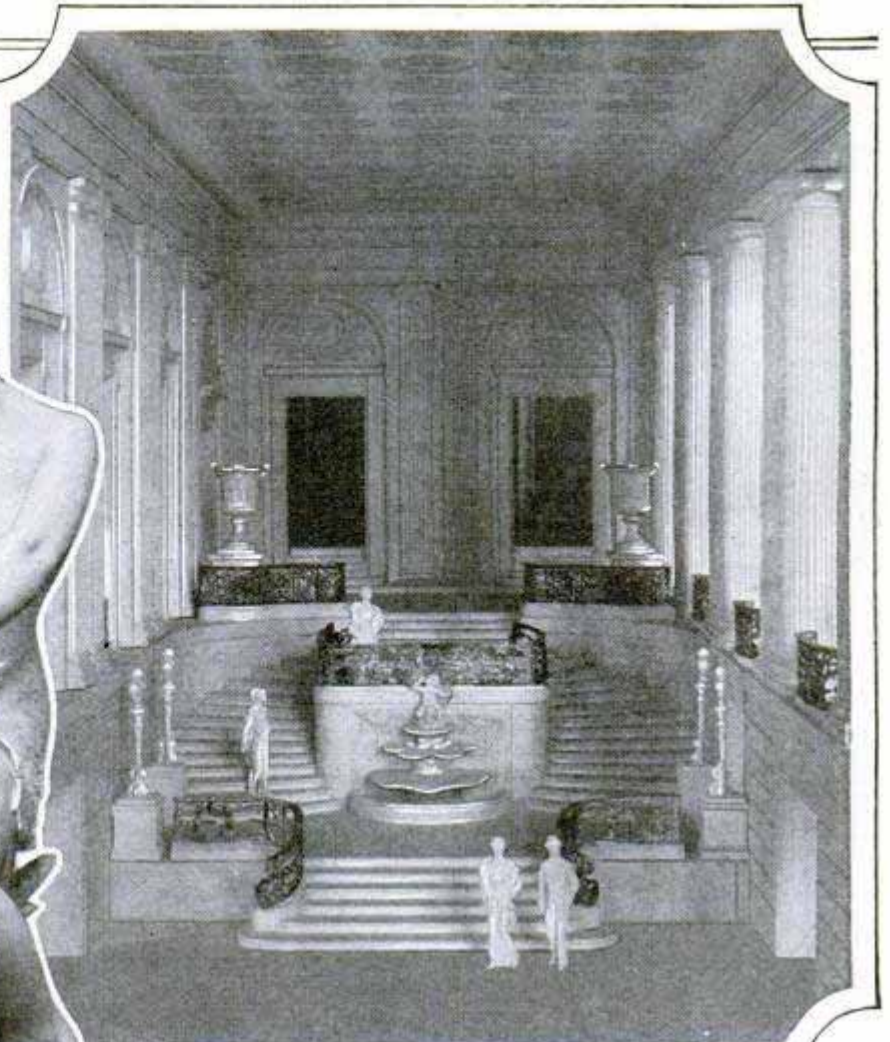

In Planning the Decorations for the Hotel, Use Was Made of a Model of an Interior Detail for Experimenting with Various Color Schemes and Arrangements of Furniture; Below, Norman Tolson, Decorator, Is Developing an Idea for a Staircase, an Enlarged View of Which Is Seen Above; More Than 6,000 Etchings, Dry Points, Wood-Block Prints and Linoleum Cuts by American and Foreign Artists Were Purchased for Hanging in the Public and Guest Rooms of the Hotel; Nearly Seven Miles of Framing Were Required for the Pictures

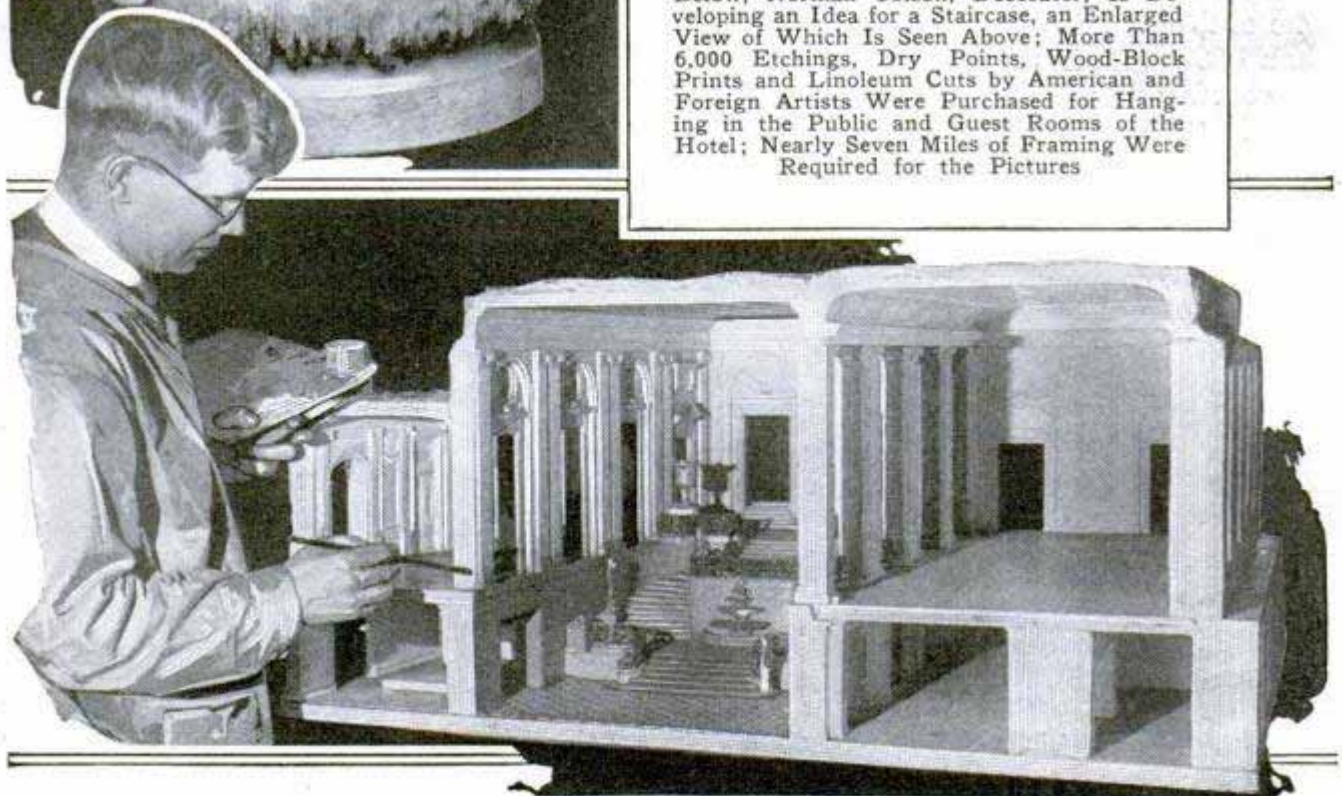



3902 Carnegie Ave  
 POPULAR MECHANICS  
 Cleveland, Ohio

Cycle St 11  
 Westfield, Mass

The Stevens' electric generating plant is large enough to supply all the needs of the average city of 12,000 families. In the heating and power plant, there are seven boilers, an installation sufficient to run all the generators that would be required to supply light for a city of 250,000 inhabitants, and the 5,000 radiators in the hotel have enough heating surface to warm 450 five-room bungalows. If used just for making ice, the refrigerating system could produce 300 tons daily.

In planning the building, the decorators constructed models of the actual rooms and worked out the arrangement of furniture, color schemes and frescoes in these replica rooms as though they were actually in the hotel itself.

2075

**PUNCTURE-SEALING INNER TUBE  
 REDUCES TIRE TROUBLES**

Equipped with a thick section of rubber, vulcanized as an inner tread, a tire tube now on the market seals punctures by compression when inflated and cushions the tire against rock-shock bruises. It is said to outlast four or five sets of casings. The tube is not intended to be proof against such injuries as long cuts or rips, but will promptly seal a hole made by a



nail, tack or similar object after it is withdrawn, and, while the article is in the rubber, it is gripped so tightly that air leakage is said to be impossible. The tubes are especially serviceable on trucks and busses where saving of tires is essential.

**VAST DEPOSITS OF OIL SHALE  
 FOUND IN AUSTRALIA 2356**

Oil to the value of nearly \$16,000,000 has been taken from shale deposits in New South Wales, according to recent reports. Some 40,000,000 tons of the material were located there two years ago and vast resources of lower-grade shale recently have been found. New Zealand has discovered wealth in its deposits of peat, which contains heavy oils suitable for fuel and other substances, valued as disinfectants, etc.

Com. J. W. Walker,  
 Thornusoll Main Road



Stationary Bicycle Riding for Exercise and Reducing; a Speedometer under Handlebars Gives the Mileage

**RIDING ON ANCHORED BICYCLE  
 GIVES REDUCING EXERCISE**

Beneficial exercise, to develop endurance and reduce weight, is afforded on an anchored bicycle for gymnasium use. It is equipped with a speedometer to keep track of the number of miles pedaled. The unit affords practically all the benefits of bicycle riding without the dangers and discomforts of actual trips.

**SIGHT ATTACHED TO GOLF CLUB  
 TO IMPROVE STROKE**

So that the club may more easily be placed in accurate position for making a putt, a sight for the golf iron has been devised. It is about two inches long and has a slight groove cut in it for its whole length. With this aid in sighting there is said to be less likelihood of knocking the ball to the right or left of the hole.

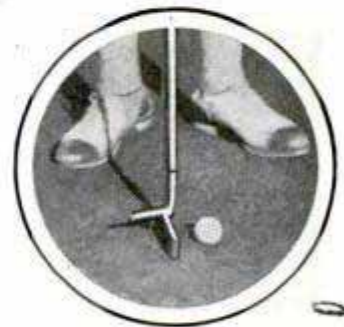

John E. Sawyer and Publisher

The Walker Are  
 Lewis Lanning  
 1996  
 100 Lanning



of Robert Moran at Olga Arcas Island.  
on Puget Sound



Beautiful Figurehead from the Clipper Ship "America," Mounted in Private Grounds on Puget Sound

**FIGUREHEAD OF CLIPPER SHIP NOW GARDEN DECORATION**

One of the best preserved figureheads in existence is that from the Yankee clipper ship "America," now mounted in a private park on Puget sound. It is said to have been inspired by the head on the American dollar and is carved in wood. An interesting development of the figurehead is seen today in the "mascot" pieces on automobile radiator caps.

**MOVIES FOOL CATS AND BIRDS BUT DO NOT INTEREST DOGS**

2389 Dogs do not take the slightest interest in motion pictures, but cats, birds and snakes respond to the shadows as though they were real, tests by a German scientist have disclosed. The experiments emphasized distinctions in animals according to the development of their senses, whether they rely more on the sense of smell or on the eye. The dogs paid no attention even when pictures of other dogs were shown. The only exception was when a little dachshund ran up to the screen, sniffed at the people shown on it and then suddenly

Mr. Mendel

Early Express 4/12/29

lost interest, apparently satisfied that the figures were not real. Cats bristled defiance when a large dog appeared on the scene, domestic fowl exhibited fright at the sight of a hawk hovering over a field, and wild birds showed different degrees of interest. Keen-eyed owls displayed almost human attentiveness to the screen, and an excitable rooster flew repeatedly at an imaginary enemy on the film. When pictures of flies and worms were shown in their natural size on a white screen, various reptiles snapped at them and evidenced astonishment when they caught nothing.

2281

**JEFFERSON AS AN INVENTOR HONORED AT CELEBRATION**

Ceremonies incident to the observance of the 184th anniversary of Thomas Jefferson's birth included reference to some of the things the third president invented. Among these was a duplicator, much like similar articles in use today. It was a double-pen arrangement, a mechanical one moving with that held in the writer's hand so that two inscriptions were made at once. The copier was demonstrated by a student of the university of Virginia, which Jefferson founded. He also devised a revolving-top table, improvements in the mold-boards of plows, built much of his own furniture, designed and planned his home and maintained a sort of manual-training school for his slaves.



Student in Colonial Costume Demonstrating the Duplicating Outfit Invented by Thomas Jefferson

Internationa



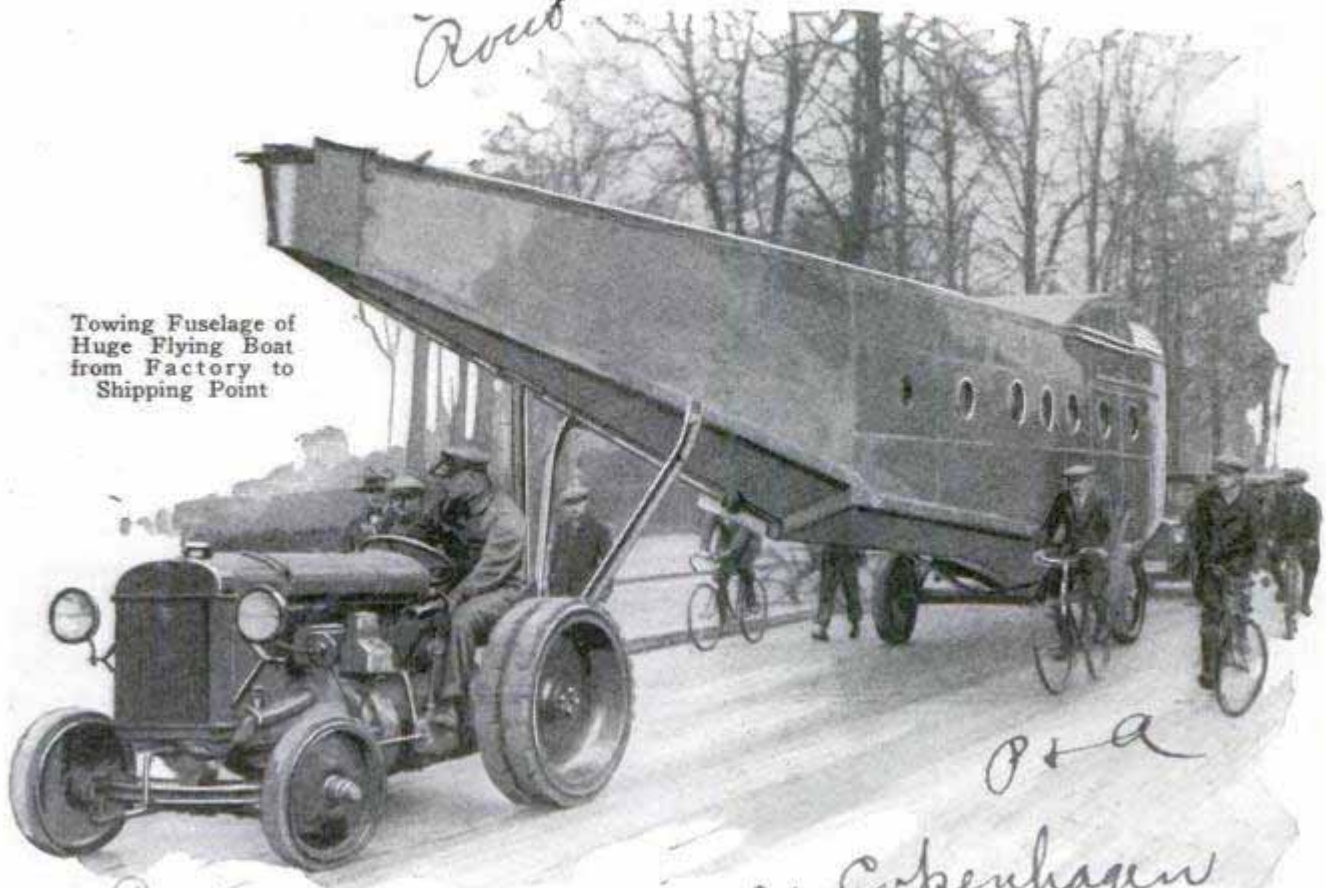

Towing Fuselage of Huge Flying Boat from Factory to Shipping Point

*Road*

*o+a*

*Copenhagen*

**TEN-PASSENGER FLYING BOAT HAS CREW OF THREE**

Built at a German factory for the Scandinavian service, a huge flying boat has a carrying capacity of ten passengers and a crew of three men. The size of the ship is apparent from the accompanying photograph, taken while the fuselage was being towed from the factory to the steamer.

*Berlin at Westhafen*

of three, mother, father and child, makes a comfortable living as models. They pose in the shop windows to display the latest styles, while the daughter's role is to openly admire her parents' costumes. Teaching parrots to talk is the occupation of one man who conducts his "classes" in a series of soundproof rooms. Making upholstered dolls' furniture, collecting sea shells for jewelry and other ornaments and fashioning caricature dolls from dried apples, are other queer callings discovered by the census takers.

**2402**

**DEALING IN WALRUS WHISKERS ONE OF QUEEREST TRADES**

In New York's Wall street district, is a woman who makes her living extracting cinders and other foreign bodies from the eyes of pedestrians and motorists on windy days. She is known as "Cinderella," patrols her "beats" regularly and leaves the amount of her fee to the patients. One of the queerest occupations shown by census reports is that of a man in the state of Washington who buys walrus whiskers and sells them to the proprietors of Chinese restaurants for toothpicks. Another man is employed in packing houses to smell hams. He can quickly determine by the odor if they have soured around the bone in the process of curing. A family

**LOW JACK FOR BALLOON TIRES HAS TELESCOPING HANDLE**

Because of the extreme range of its lift, an automobile jack now on the market is especially suited for cars equipped with balloon tires. It can be lowered to four and three quarters inches or raised to fifteen and one-half. It has a three-foot handle that can be telescoped to occupy small space when not in use.



*\$6.00*

*Do-Do Jack*

*Express 4/14/27*

*Wheels, Inc., 835 9th Ave*



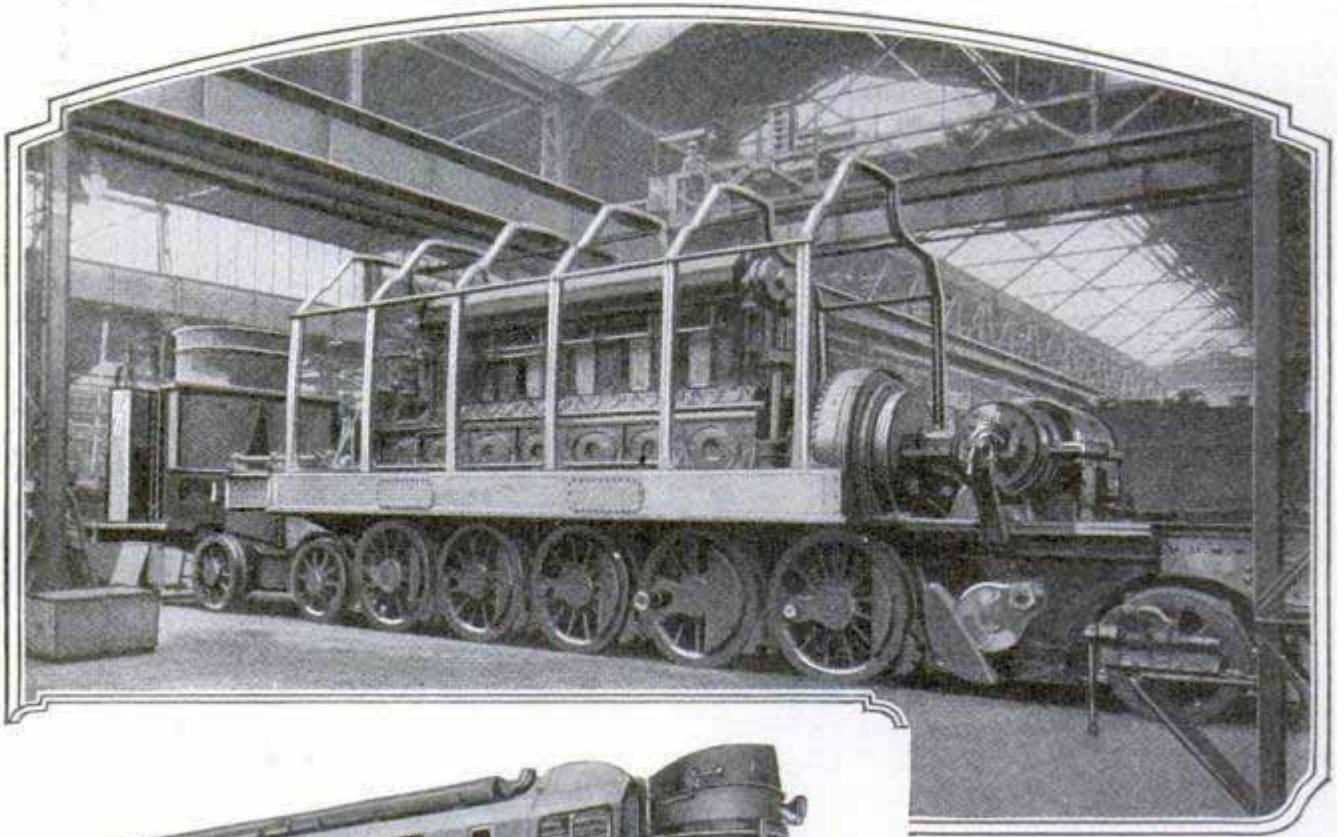

Running Gear and Framework of a Geared Diesel Locomotive, Built in Germany for Russian Railways



Completed Geared Diesel Engine, Showing the Cooling Radiator at Right, with Exhaust-Fan Duct above It

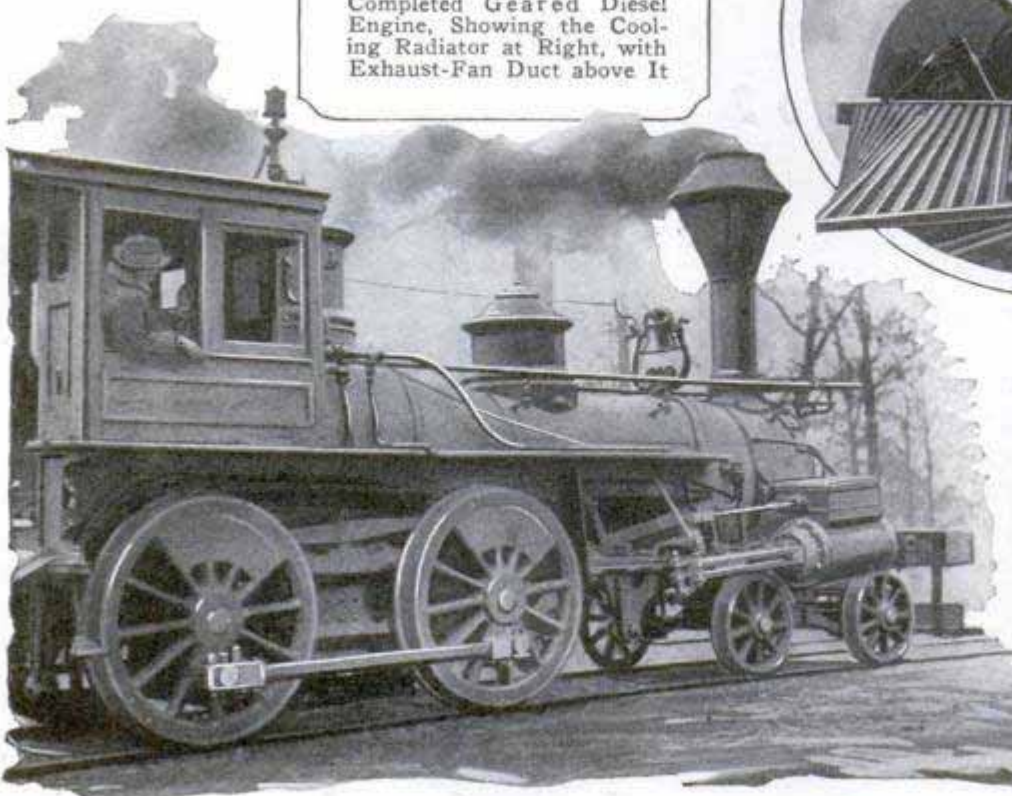
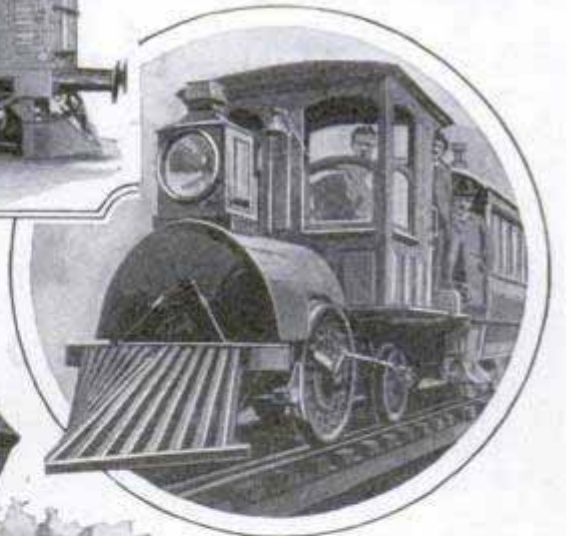

Edison's Original Electric-Battery Locomotive, with the Inventor at the Throttle, Above, and at Left, a Civil War Engine, "Texas," Which Was Used by the Confederates to Capture the Famous "General"



*Chicago*

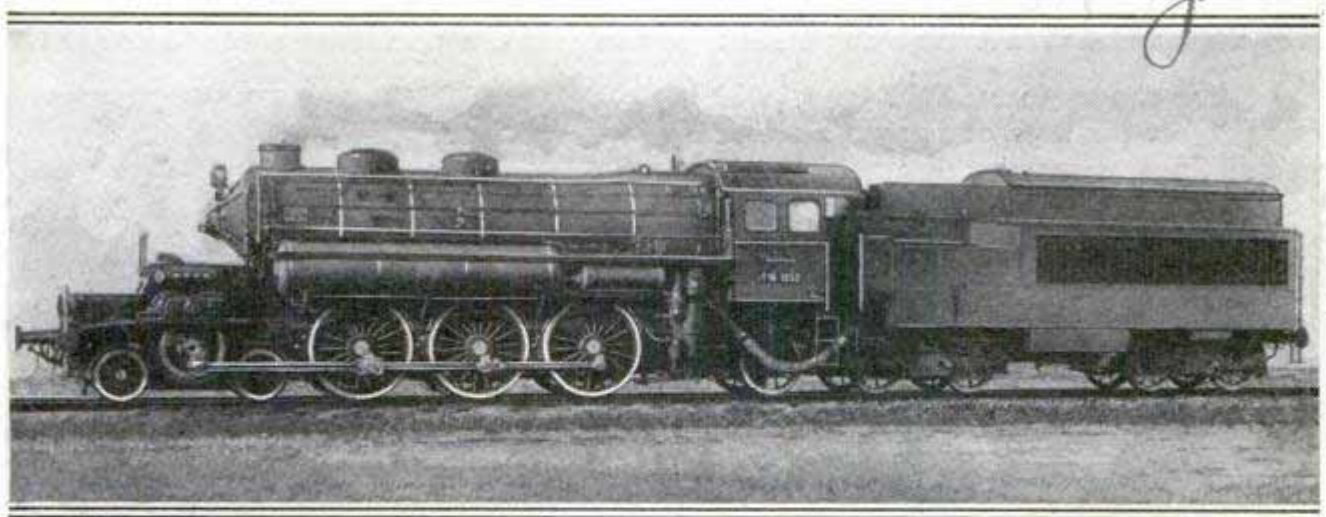

Turbine Locomotive Built in Germany That Eats Its Smoke and Drinks Its Steam, Using Same Water Over and Over by Condensing Exhaust, Thus Eliminating Stops to Replenish Supplies

## Engines Eat Their Smoke and Drink Steam

### New Turbine Locomotives Eliminate Stops for Water and Get Last Ounce of Power Out of Coal by Consuming the Waste

THE poor old steam locomotive, whose speedy demise was predicted by fanciful writers a dozen years or so ago when mountain roads first began experimenting with electric operation, has come back, stronger and better than ever before.

Monsters that develop 2,500 horsepower, that drink their own steam, so they do not have to stop to take on more water, and that eat their smoke, eliminating its waste, have been developed abroad, while in this country huge three-cylinder engines are hauling freight trains at passenger-train speed, and big new passenger locomotives are being decked out in the bright colors of a passenger automobile, the Baltimore and Ohio having just put into service twenty monsters, painted in olive-green and striped in red and gold.

Just now the interest of the railroad world is centered in new turbine locomotives recently produced in Germany and England. The German unit develops 2,500 horsepower from a high-speed turbine, which replaces the usual cylinder arrangement. The turbine has a maximum speed of 9,000 revolutions per minute. It is placed over the forward trucks, just ahead of the boiler, and transmits its power through reduction gearing and side rods. The big economy comes through the saving of fuel and water. The exhaust steam, instead of wasting in the open air, is con-

densed into hot water and passed through the boiler again. Being at a high temperature after condensation, it requires little coal to convert it into steam again. All stops for water are thus eliminated.

Another interesting locomotive developed in Germany is a Diesel-electric engine of 1,200 horsepower, in which the power is transmitted to the wheels through direct gearing. The problem of power transmission has been one of the drawbacks to wider use of internal-combustion engines for railways, and has been only partially solved by the Diesel-electric combinations being built in this country. In the German locomotive, which was designed by and built for the Russian state railways, four clutches are used, one between the motor and the gear box and the other three operating the different gears.

The new electric locomotives of the Great Northern are unusual in that the current used to pull the train is generated in the locomotive by a motor-generator set, the motor being driven by power taken from the trolley wire. The arrangement permits the use of alternating current in the trolley wire and a direct-current motor drive. Alternating current is much more economical both to generate and deliver over long distances at high voltages, while direct current is best for motors requiring a high initial starting impulse.



6/6/30

SEARCHLIGHT GUN FLASHES PICTURES ON CLOUDS

A long-range searchlight gun, which can project pictures or images on clouds or buildings at varying distances, depend-

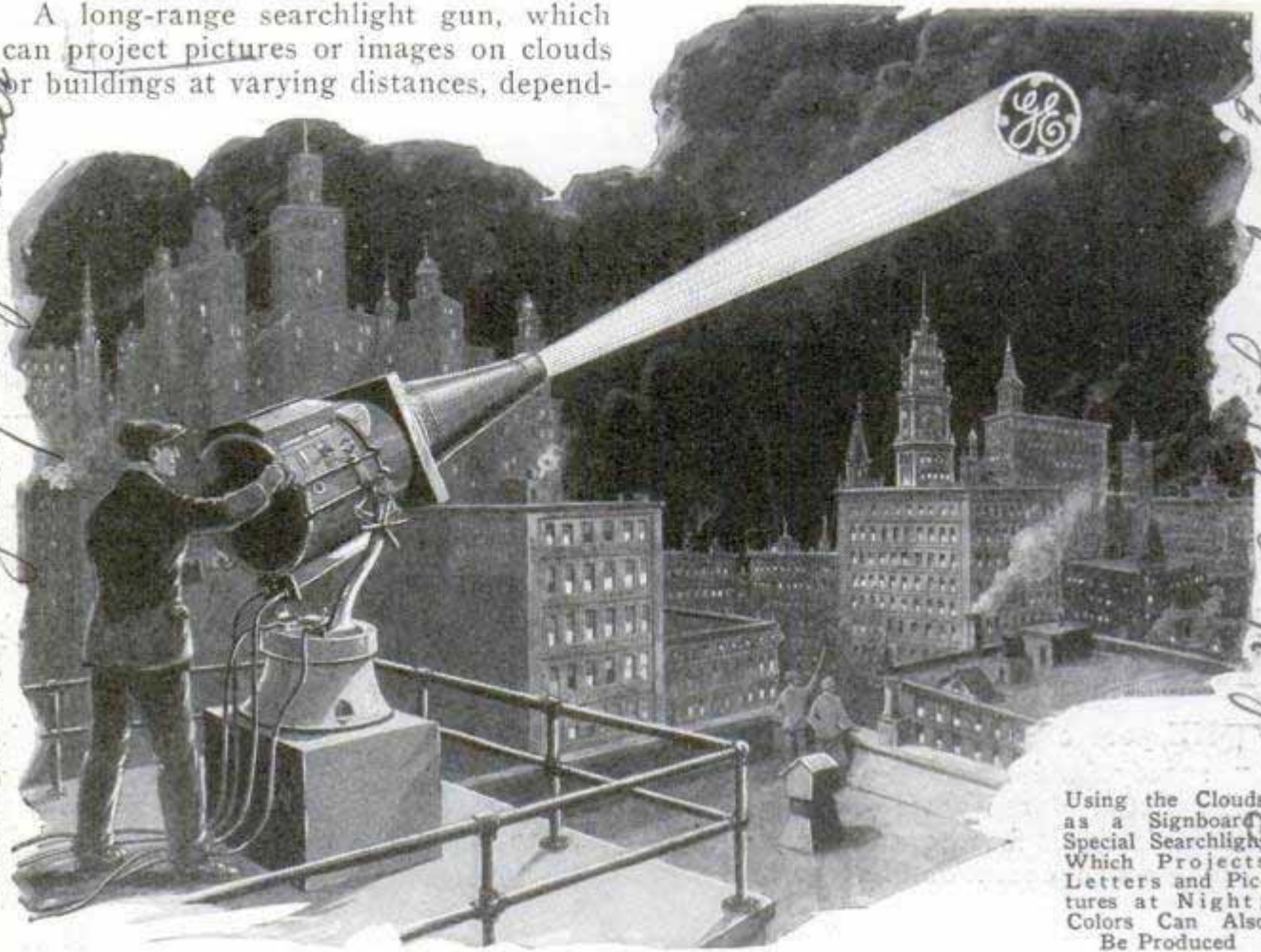

Using the Clouds as a Signboard, Special Searchlight Which Projects Letters and Pictures at Night; Colors Can Also Be Produced

Attr. H.C. Ritchie  
Aviation Lightening Specialist

Holland and Park Hall, W. London, Eng.

ing upon atmospheric or cloud conditions, has been introduced by an eastern company for advertising and amusement purposes. In appearance, it somewhat resembles a cannon with a tapering barrel painted a battleship-gray. The light is placed at the rear, the lenses are in the barrel, and a slot is provided for inserting the slide to be projected. The lenses are so arranged that the image is in constant focus at any distance more than twenty feet from the end of the barrel. Changing colors can also be produced.

dyeing processes. One of the most successful of the fabrics is artificial-silk fur. It is being made up into coats which are difficult to detect from those of leopard, gazelle and mole.

THERMOMETER IS EASILY READ THROUGH MAGNIFYING FACE

So that it can be read from various angles and at a distance of ten to fifteen feet,



a circular glass thermometer has a magnifying face which enlarges the figures. In addition to this feature, the usual numbers on the scale are supplemented by larger ones on the sides of the indicator

with marks leading to corresponding positions of the mercury.

"FUR" COATS OF ARTIFICIAL SILK  
LATEST FASHION NOVELTY

Artificial silk is now employed in the manufacture of many fabrics that formerly could be woven only from the natural product. These include taffeta, crepe de chine, foulard and other materials. Some of the threads are almost as fine as those of a spiderweb, and special methods of color blending have been developed in the

The Donald & Lalor  
19 E. 48th St. N.Y.C.

Worship  
Screen-wich  
Inc. 259  
mpro.



**WHISTLES INAUDIBLE TO MAN  
—SUMMON POLICE DOGS** *299*

In Germany, dogs are employed extensively by the police, but the problem arose how to call or whistle for them without warning a suspect being pursued. A solution was reached by testing the dogs' ears. It was found that they can detect sounds above the audibility limit of the human organ. Patrolmen were therefore equipped with whistles that produce notes totally inaudible to the human ear but which can be heard distinctly by the dogs. A "silent" signal system was developed for giving them orders.

*J. Sais Tech April, 1927*

**CLOCKWORK IN LAWN SPRAYER  
REDUCES WATER WASTE** *2092*

At a recent exhibition in Europe, a clockwork garden or lawn sprayer, intended to irrigate a rectangular plot without waste or needless overlapping was shown. The nozzle is made to swing in a vertical plane by means of the mechanism which runs for three hours with one winding. This insures directing the water where it is most needed and prevents moistening ground that should be kept dry. The sprinkler will cover from 2,700 to 4,300 square feet and can be adjusted to project spray of varying fineness.

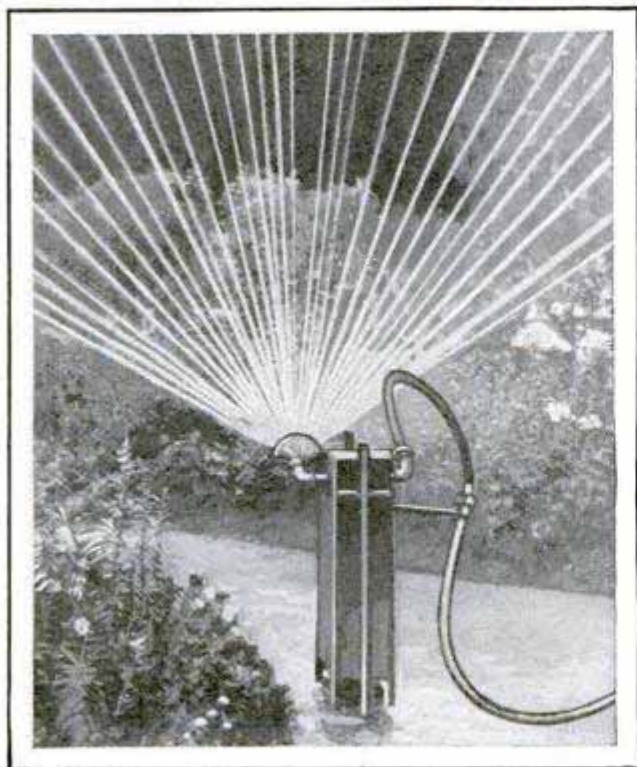

Clockwork Spray Nozzle in Operation; It Runs for Three Hours on One Winding

*From illustrierte*

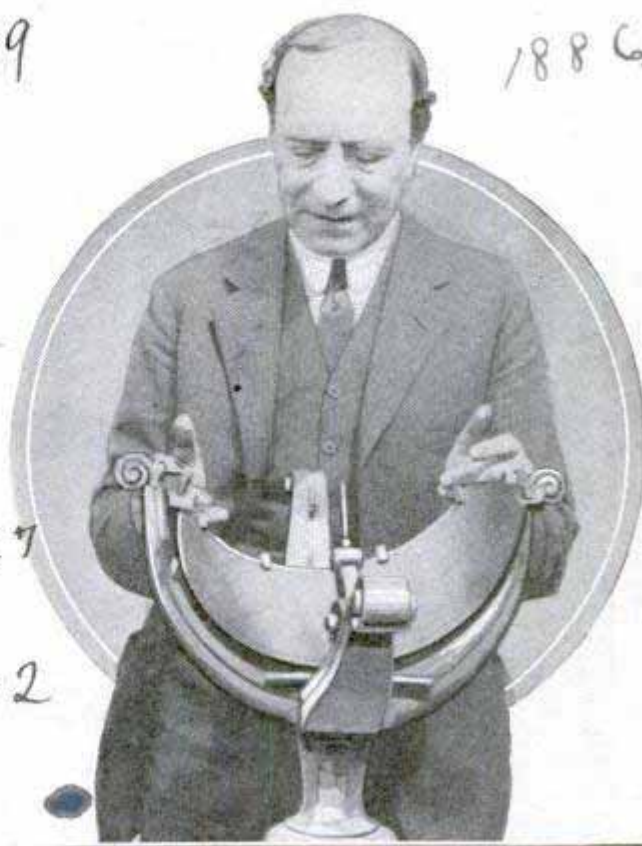

*1886*

To Make It Easier to Tell Time by the Sun; the Curved Dial Which Requires No Calculating

**CURVED SUNDIAL EASILY READ  
AND SET FOR LATITUDE**

Most sundials are more ornamental than practical, for calculations must generally be made to tell the time accurately with them. An indicator designed by Julius Wangerheim, a regent of the University of California, is said to eliminate this objection, registering the hour as closely as a watch and requiring no computation. It is a curved bronze plate so adjusted that it can be set for any latitude. Corrections are worked out with curved lines, and the measurements are indicated for the longest as well as the shortest day. Plans have been made to set replicas of the dial at various places on the university campus, to aid students in reaching their classes on time, and at Mt. Hamilton, where astronomers may consult them.

*2225*

**DUTCH WINDMILLS DECREASING**

More than forty-five per cent of the windmills in Holland have been removed or demolished since 1923, according to a report from an official mill association in that country. About four years ago, there were 3,604 mills, but since then the number has decreased by 1,626.

*daily mail 3/15/27*

*San Diego, Calif.  
Southern Title Bldg.*



37 Dead Ave.  
Tuckahoe, NY

2111

Machine

**ICE FACTORY FOR KITCHEN USE  
TAKES LITTLE POWER**

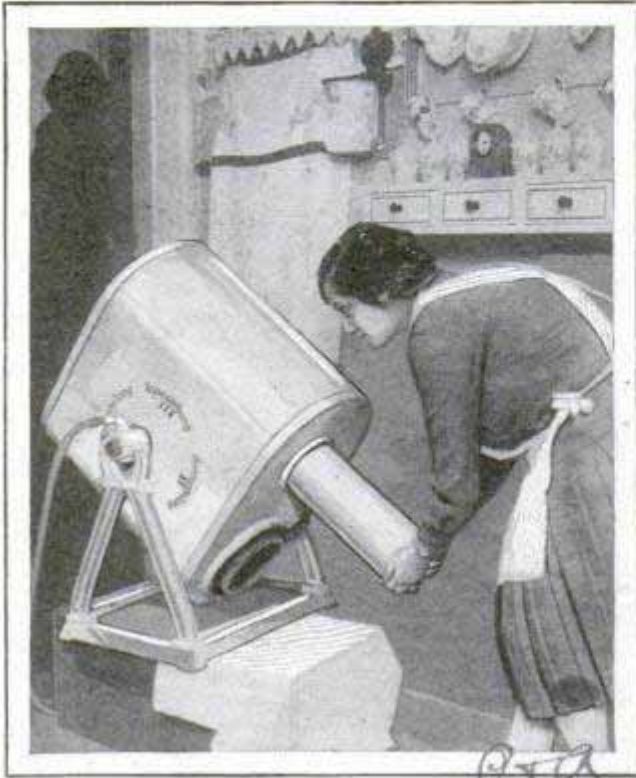

**Kitchen-Size Ice Plant That Utilizes Electricity or Gas and Is Rapid in Operation**

From ten to sixteen pounds of ice are frozen for home use in only one hour, in a refrigerating unit recently demonstrated in Germany. It utilizes electricity or gas and is said to be not only simple to operate but inexpensive in maintenance.

**LONGER-LIVED CARS ARE SEEN  
IN "FAST" AXLES**

"Fast" rear axles and four-speed transmissions promise not only faster cars but less vibration, noise, engine wear and lower fuel consumption. One maker already has announced a car with a "twin-high transmission," and from the interest automotive engineers are displaying in this development, it is predicted that several similar cars will be seen soon. Fourth, or top gear, is direct-drive, as usual, while third speed is secured by gears which are so constructed that, when running on third, the noise is almost inaudible. Therefore, since third gear is almost as silent as high gear, it is, from a practical standpoint, another high. Gear shifting is just as simple with a four-speed transmission as with the conventional three-speed type. First gear is only for emergency use to

pull the car out of deep snow, mud or sand. In other words, the average driver might run his car a year without ever having occasion to use first gear. Engine noise and wear are proportional to the speed and, since the motor makes more revolutions with the slow axle to attain a given speed, the use of a higher gear ratio results in greater quietness and longer life. The average reader probably will be surprised to learn that the fast axle does not increase the maximum speed very much. Five miles per hour additional is about the top, and in many cases the increase will be less. The explanation is simple: If it requires fifty horsepower to drive a certain car sixty miles per hour, nearly sixty horsepower will be required to drive the same car sixty-five miles per hour. The average slow axle is a compromise between hill-climbing ability and smooth running on the level—a compromise because it isn't fast enough for ideally smooth, silent running under the high road speeds now in vogue, and because it isn't low enough to climb all hills on high; therefore the interest in four-speed transmissions, which are already in general use abroad.

**MUDGUARDS ON LADIES' SHOES  
PROTECT STOCKINGS**

To shield the stockings from splashes on wet days, protecting guards are quickly adjusted on women's shoes. They fit neatly around the back of the ankle and



**Stocking Guards in Place; They Are Quickly Adjusted and Are Made of Washable Material**

extend up far enough to cover the part that usually is most likely to be splattered. The shields are washable.

Reinert Rubber Co.  
485 7th Ave

Warner Gear Co., Muncie, Ind.

2272

Price 8.



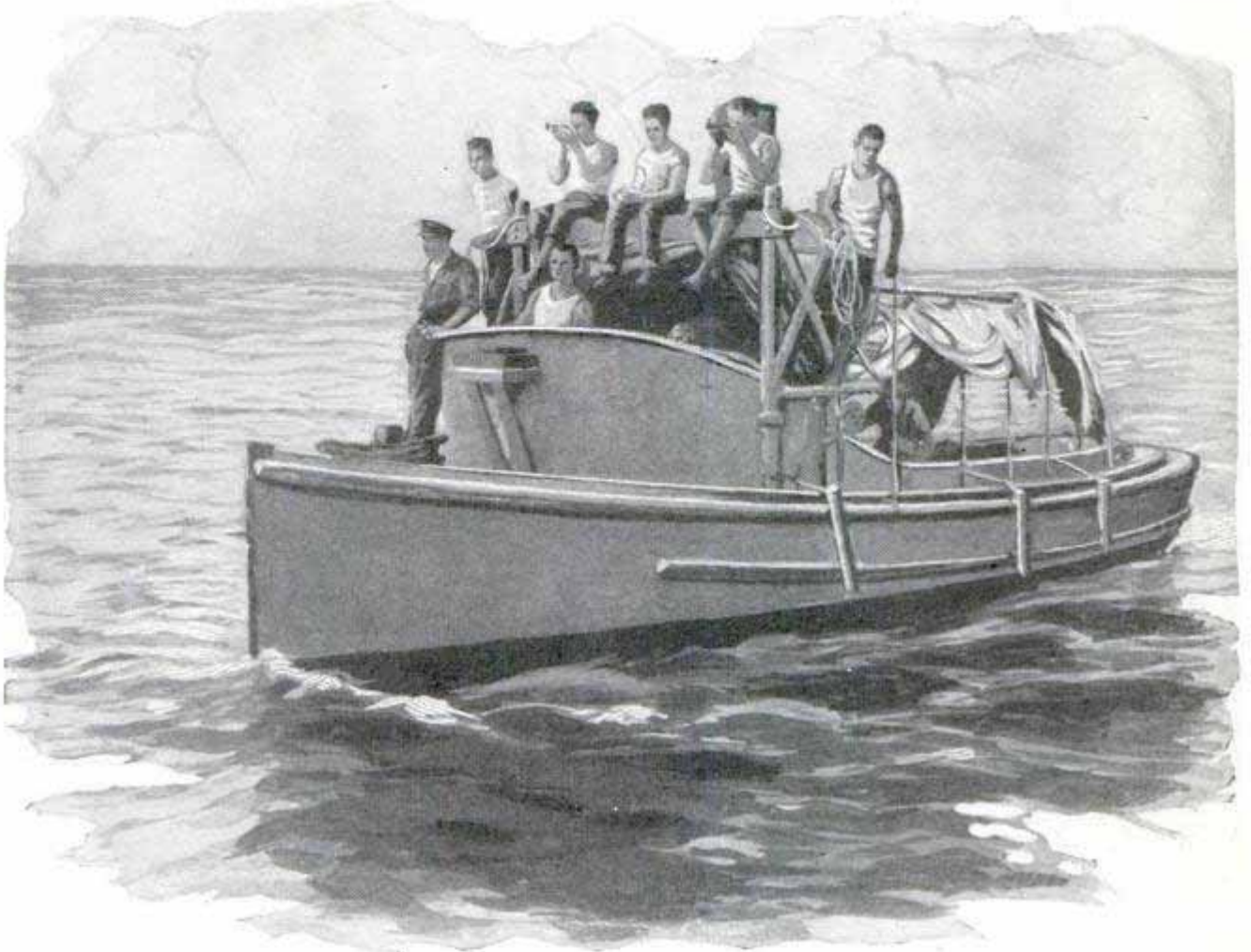

Mapping the Submarine's Playground, a Survey Boat, with Angle Observers, Recorder and Leadsman at Work, the First Fixing Their Position While the Last Measures the Depth

## Navy Charts Sea Bottom for Submarines

Gulf of Panama to Be Explored to Save Canal Defenders from Coming to Grief on Uncharted Shoals or Rocks

**C**HARTING of the sea floor in the Gulf of Panama and at the Pacific approach to the canal has been undertaken by the navy to make the underwater safe for the growing fleet of submarines based at the canal to protect it in event of war.

The surface of the gulf and the shoals that reach near enough to the surface to endanger shipping are well charted, but the underwater depths are not so well known, and the charts in many cases are incomplete and incorrect. The U.S.S. "Niagara," one of the three hydrographic-office ships working in southern waters, has been assigned the task, following the successful completion of one of the most difficult surveys of recent years, the charting of 6,400 square miles along the coast of Venezuela and the running survey of the Gulf

of Venezuela, a piece of work that consumed fully two years.

The Venezuela survey was made especially difficult by the high wind that blows almost constantly through the gulf, averaging thirty-five miles an hour day after day. The high wind, in fact, was so constant, that, after two years' study of the weather, the only successful prediction that could be made was found to be that "the wind will blow hard tomorrow." Because of the wind, landing parties, set ashore to erect tall tripod platforms for the survey boats to take sights on, frequently were marooned and unable to return to the ship for many hours, or even days, while the surf on the unprotected sand beaches made it impossible to send a boat ashore and food could reach the men only



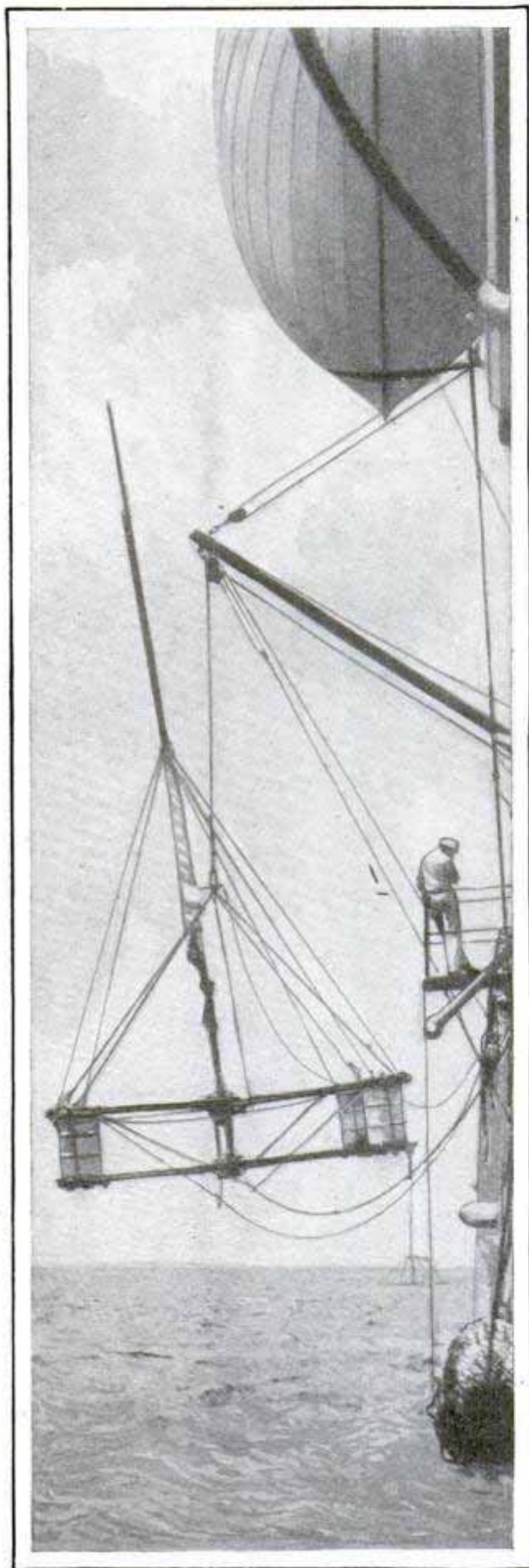

Having Dropped One Floating Signal, Seen in the Distance, the Survey Mother Ship Is Launching a Second to Serve as a Guide for the Boats

when it was lashed to timbers and floated to land on the waves.

In one section of the gulf, the surf was so bad that no boats could be landed; so the shore crew had to be sent miles around to the lee of an island, from which they walked over the sand dunes. The timber for the tripods was thrown overboard to be washed ashore, and all tools, supplies and food were floated to land. The only life along the sandy beach consisted of cameleons and iguanas, giant lizards, with an occasional hunting party of Guajira Indians, armed with bows and arrows.

Owing to the difficulties in landing, the surveying crew obtained no recreation except for a few hours once a month when the "Niagara" went to the Dutch town of Willemstad, Island of Curacao, to replenish its stocks of food, water, fuel and other supplies. The visits were limited to two and a half days, most of which was taken up with loading supplies. The Venezuelan survey is of much importance because of the discovery of oil fields in the vicinity of the city of Maracaibo, where concessions have been obtained by several American companies. The Gulf of Venezuela terminates in a sand bar, at San Carlos island, which forms a division between the gulf and Lake Maracaibo. Ships drawing more than fourteen feet cannot pass over the sand bar, so all supplies for the oil fields are carried in by light-draft ships, and the oil is taken away by specially designed tankers drawing less than fourteen feet of water. Hundreds of the oil derricks stand in the lake itself, which also is quite shallow.

Sea surveying not only requires soundings to find every submerged rock and shoal, but also their accurate location on the map. In inshore work along a coast, the tripods or towers, erected on high points along the beach, are fixed on the map, and all bearings taken from them, while farther out markers are erected on floats, held in place by anchors. Building the big shore towers is a task in itself, for the lower ends of the legs are made of four-by-four-inch timbers, forty feet long.

The other two survey ships in southern waters, the "Hannibal" and "Nokomis," have been working in Cuban waters for five years and have completed the charting of all of the south coast of the island



and the Isle of Pines and are now working around the north coast toward Havana. They are being assisted by a pair of amphibian airplanes which photograph the area to be charted from the air. The photographs, when pieced together, show the bays and points accurately, giving locations for landing shore parties, and also show sand dunes, hills, forests and shoals and channels beneath the water. Unfortunately, however, they cannot show the depth of water, so the channels and shoals must be sounded.

Each of the surveying ships has a large fleet of small craft to help with the soundings. The "Hannibal" numbers among her auxiliaries two large barges, a houseboat to provide extra living quarters for officers and men, two 110-foot sub-chasers, and six forty-foot steam launches.

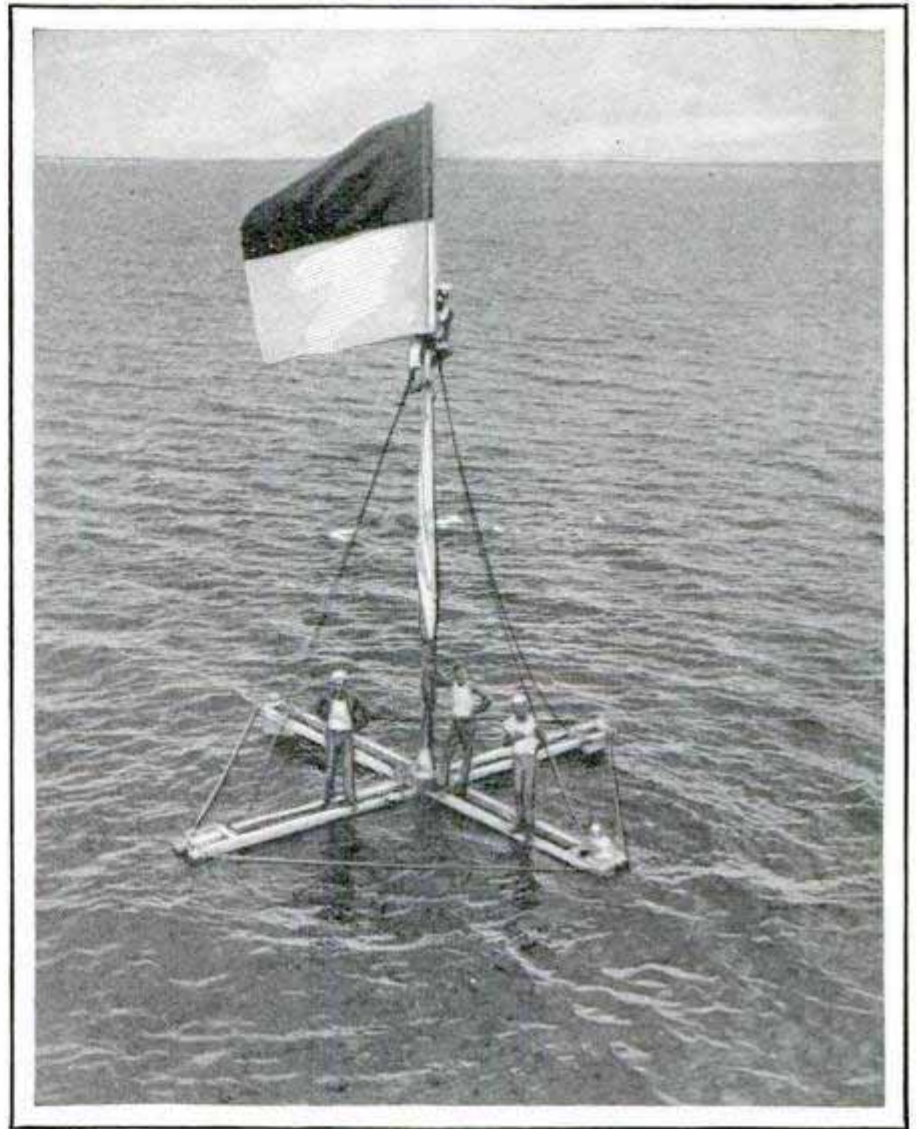

Floating Signal Launched and Anchored; the Survey Boats Get Their Exact Bearings from It for Several Miles Around

**ENDLESS-TRACK LANDING SKID HELPS PLANES ALIGHT**

Endless-belt landing skids to take the place of wheels have been introduced for airplanes in France and have been favorably received, according to reports, as they are said to reduce the chance of the

plane overturning, simplify the task of landing on rough ground and are adjusted to ease the shock. The belt, or "traveling track," is mounted on a set of ball bearings between two aluminum shells.

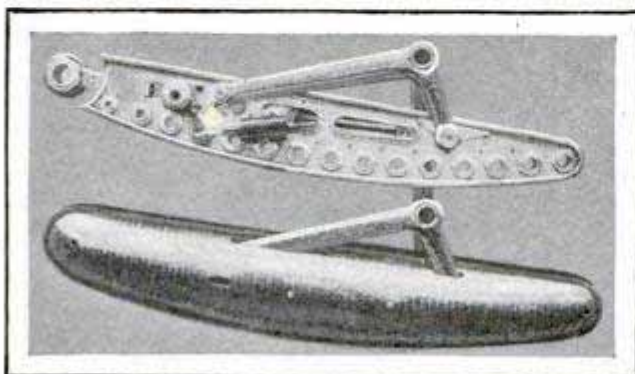

Views of the New Airplane Landing Skids, Showing the Belt Construction

*Louis Vinay, 670 Ed.*

**LIFETIME OF A WATCH**

Experts say that the lifetime of a good watch is fifty years. In its daily duties, the balance vibrates 18,000 times every hour, or over 157 million times a year. The hairspring makes a similar number of vibrations and an equal number of ticks come from the escapement. This is a marvelous record, considering the small quantity of "food" that has been consumed by its constant action. Experts say "food," because whatever labors must be fed, and the watch "lives" on about sixteen inches of mainspring every twenty-four hours.

*Com. Edwin Jarvis*

2305



2246  
22

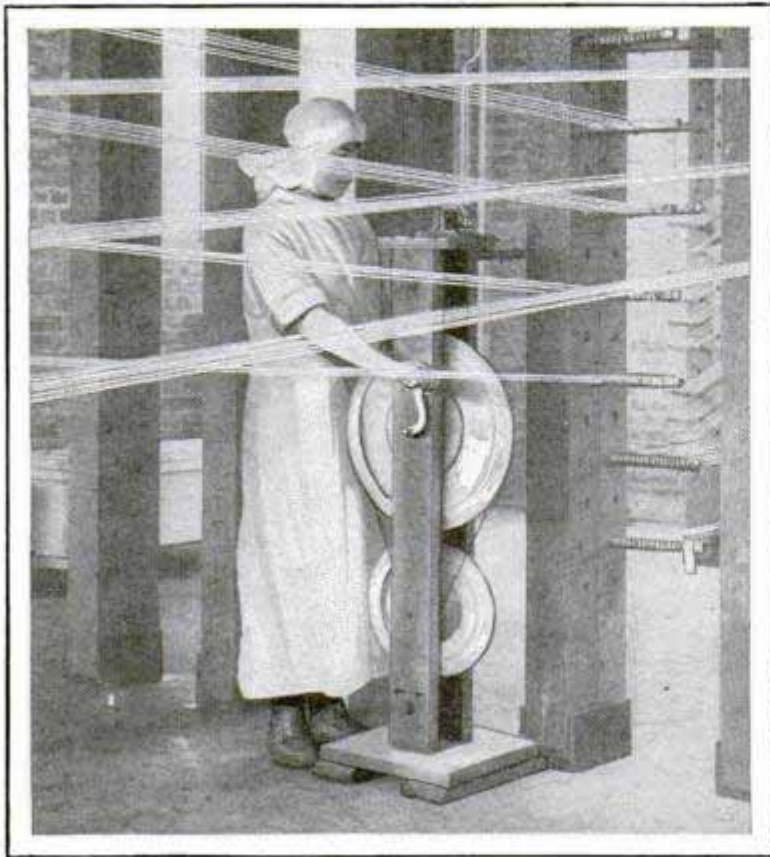

Ribbons Being Spun into the Ligature; They Are Still Saturated with a Sterilizing Solution to Insure Cleanliness

### CATGUT FOR SURGICAL USES SPUN IN HOSPITAL

Making catgut for surgical ligatures is one of the activities at a London hospital. Profits derived are used to treat out-patients and to provide more beds. The material usually is spun from the intestines of sheep and must be thoroughly sterilized in order to make it aseptic and safe for usage.

### BILLIARDS AN ANCIENT GAME OLD RECORDS SHOW

That the game of billiards was known many centuries ago is revealed in the writings of a Thracian historian who states that such a sport was played in Greece as early as 400 B. C. Another record shows that an Irish king, in 148 A. D., bequeathed "fifty billiard balls of brass with pools and cues of the same material" to one of his heirs. English adventurers on the first crusade brought back from Palestine a game of staff and balls, played on a table and similar to the modern pastime. The original game is believed to have been played out of doors on the ground. The name is derived from the old English word

"balyards," itself a survival of the Norman "bal" for ball and "gyard" or "yard" for stick. By 1674, almost all towns in England had a public billiard table. The game was played, with broad, pointed cues, curved so that, when the handle was rested on the shoulder, the other end of the cue was flat on the table. It was manipulated with one hand and pushed against the ball with an easy shove. The tapered cue did not come into popular use until about the close of the eighteenth century.

### RAILS KEEP ROAD OPEN WHILE IT IS PAVED

1992.

To protect the subgrade of the highway during the construction of concrete paving, a western contracting firm made use of steel channels, laid as a railroad, so that trucks could be driven to the mixer without damaging the foundation prepared for the cement. The track was quickly laid and taken up, bent members were easily straightened by inverting them, then running a loaded truck over them, and the only depressions requiring attention as the mixer was moved forward



Steel Roadway for Trucks That Protected Subgrade While Pavement Was Being Constructed

were two narrow slots at the points where the flanges of the tie had been partly driven into the ground.

2334

Charles C. Peterson

Used by Highway Construction





Bathing Hour in a Stockholm School; Each Pupil Has a Separate Tub Assigned for Individual Use like the Desks, and Baths Are Taken at a Specified Time Each Day

**BATHTUB FOR EACH PUPIL AIDS HEALTH IN SWEDISH SCHOOL**

As a part of a campaign to promote health and eliminate disease among the school children in Stockholm, Sweden, the board of education has installed individual bathtubs for the pupils. The tubs are assigned like the desks, which are also of the individual type, and specified periods are set apart for their use. While the children are bathing their clothing is fumigated.

**BRAINS AND BEAUTY** 2332

Can genius be detected by facial expression, is a question yet to be solved by science. Socrates and Lincoln are notable examples of geniuses whose looks were not in keeping with their brilliant minds. On the other hand, Byron and Shelley were both attractive in appearance, so there is no ground for assuming that mental "beauty" and facial are connected. One peculiarity of many great men is that their faces are not the same on both sides. This can be tested with a photograph. By covering half of it and then comparing the two parts, two distinct faces will sometimes be revealed. An explanation of this is suggested by the fact that, since the left

*Answers 4/16/27*

side of the brain controls the right side of the face and vice versa, an unusually developed right or left brain, as in the case of a genius, might cause a different expression on the other side of the face.

**AUTO LOCKS WITH BRAKES SET AT TOUCH OF FINGER** 1911



Secured at a touch of the finger and released only with a key, a transmission lock for Fords is so arranged that when the emergency brake is pulled back, the auto is locked, out of high and low gear and with the brakes set. The motor may be started, but the car cannot be

driven away and nothing is likely to be broken. The lock is in an accessible position, does not interfere with the pedals while driving or hinder servicing the car. It weighs about thirty-two ounces and is placed high enough to escape floor dirt.

*Rozzy Koop, Mfg Co.*

*Mr. John G. McLeod.*



1988 Westinghouse  
 165 Broadway  
 24  
 1110 Washington  
 New York City



Examining the 10,000-Watt Lamp, and Picture of the Beam, Showing Its Concentrated Layer Effect That Reduces the Glare, Yet Illuminates the Landing Field Brightly

**LAMP CASTS LAYER OF LIGHT FOR AIRPLANE LANDINGS**

To facilitate night landings at airplane fields, a 10,000-watt electric-light bulb has been devised to shed a brilliant gleam to a height of about ten feet above the ground and down the entire length of the average airport runway. The radiance is directed in such a manner that it does not shine into the flyer's eyes, and it makes the field visible from a considerable distance to help guide the pilot. A lens of somewhat the same construction as that in a lighthouse is used to spread the rays.

**NUMBER CODE FOR ODORS**

Odors are divided into four main classes and can now be expressed in a number code which chemists have devised to simplify their processes. Under this system, there are fragrant, acid, burnt and caprylic odors, each of the four groups affecting a different set of nerves. Numbers of four digits are used in the code, each digit expressing the relative intensity of the odor's

effect on the nerves. For instance, the odor of the rose is 6423; of acetic acid, 3803; of freshly roasted coffee, 7683. By means of these figures, in combination with a set of standards now being developed, it will be possible to use the code either for complete description of odors or for identifying them from the numbers.

*Chicago Butler Bros.*

**LAWN SPRINKLER MAKES RAIN AND WON'T CLOG**

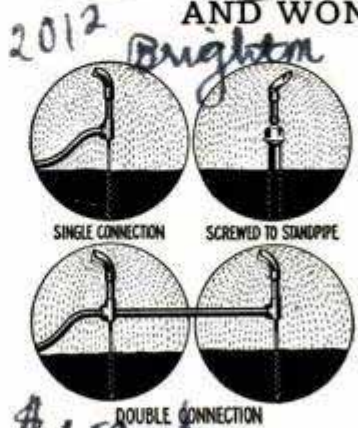

Operated singly or in series, a lawn-sprinkler nozzle now on the market will not rust or clog and has a special spreader blade that directs "raindrops" over a wide circle. It is secured by a spike

which is simply stuck into the ground and may be adjusted at different angles for watering half-circle plots and corners. From two to four sprinklers may be con-

2339

Report made to American Chemical Society

*St. Louis, Mo.  
 212 Brighton  
 J. The W. Bright  
 Arsenal St.  
 3550  
 St. Louis, Mo.*



Architect Lloyd Wright

2200

Ballofan

ected to the same line of water supply and operated from a single faucet. The nozzle may also be screwed to a standpipe or to an elbow frame and pulled about as wanted without the need of shutting off the water.

**GLASS ROOF LIGHTS HOUSE WITHOUT WINDOWS** 2189

Almost complete seclusion from the outside world is said to be afforded in a novel house in Hollywood, Calif. It has no windows, the walls being of massive concrete two stories high. The rooms are arranged about an interior court and receive light through glass in the ceilings. Other features are a tall fountain with golden tiles in the center of the house, an entrance decorated with concrete blocks set in odd pattern and a small lily pond near the sidewalk, surfaced with glass and gold-leafed tiles, which lend a rich color to the entrance. The building is said to present the effect of a cloister as almost all sound is excluded by the massive concrete walls and the lack of side windows, and the occupants cannot see the outside world.

on Franklin Ave.



Entrance to the Sheltered House; Note the Windowless Walls at the Sides

Cont. Welford H. Morgan



Balls Made from Inner Tubes Are Strong, Resilient and of Convenient Size for Exercising

**RUBBER BALLS OF INNER TUBES GIVE HEALTHFUL EXERCISE**

Mitchell Carter

A Los Angeles inventor has developed a new use for old inner tubes. Those that are still resilient are cut into proper lengths and formed into balls for exercising. They can be made into various sizes from that of a football to a pushball.

**LONGER ENGINE-WHISTLE TOOTS REDUCE ACCIDENTS** 2335

Giving the longest and loudest toot at the end of the crossing whistle, instead of "two long and two shorts," has helped reduce accidents on several lines. One reason is that, with the old signal, the most noise was made when the engine was farthest from the crossing. With the new warning, the loudest and longest blast comes just before the locomotive reaches the road. One railroad had twenty-eight fewer crossing accidents during the year after the new signals were adopted.

KC James



889

# What Star Gazers

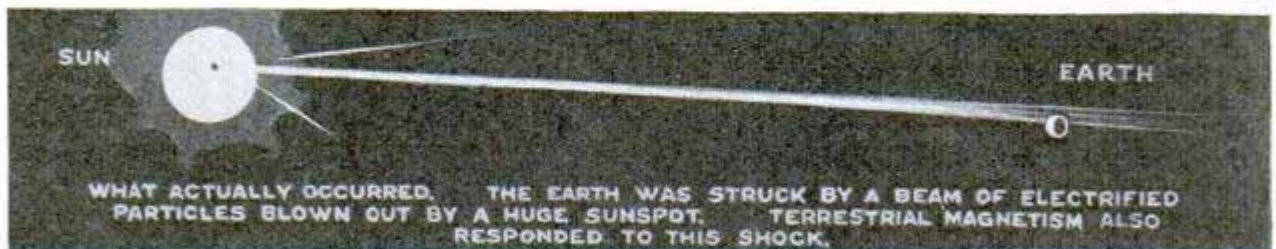

WHAT ACTUALLY OCCURRED. THE EARTH WAS STRUCK BY A BEAM OF ELECTRIFIED PARTICLES BLOWN OUT BY A HUGE SUNSPOT. TERRESTRIAL MAGNETISM ALSO RESPONDED TO THIS SHOCK.

© Illustrated London News

Brilliant Display of Northern Lights Seen from London Bridge Last Winter; as Static, the Show Put the Radio and Telegraph Out of Business, and the Sunspot Upset the Weather



# Are Doing For Us

THE practical place in the scheme of things of an astronomer spending his nights studying the stars is one of the mysteries that often puzzle a layman. Yet two or three of the biggest discoveries of the last ten years were made possible by the work of these scientists.

Take your radio, for example. Did you know that an astronomer, viewing the eclipses of some of the eight moons of the planet Jupiter, made the initial discovery that led to the finding of radio waves? Or if you have ever seen the big dirigible "Los Angeles" slipping along in the clouds overhead, did you know that the helium gas with which it is filled, and which, being noninflammable, makes it safe, was first found in the spectrum of the sun by an astronomer? No one knew that such a gas existed until it was found on the sun, and just about forty-nine years passed before it was discovered in commercial quantities as part of the natural gas in Kansas and Texas.

Those are just two typical examples of how the seemingly useless work of studying the stars bears practical fruit.

Yet the astronomers who make these and similar discoveries are dealing with objects so far away that it wasn't until 1920 that the diameter of one of the biggest of all the stars was actually measured. With their telescopes, they conquer distances so great that a beam of light traveling 186,000 miles a second must speed not only years but often millions of years to reach them. They study light waves that started on their way to earth before

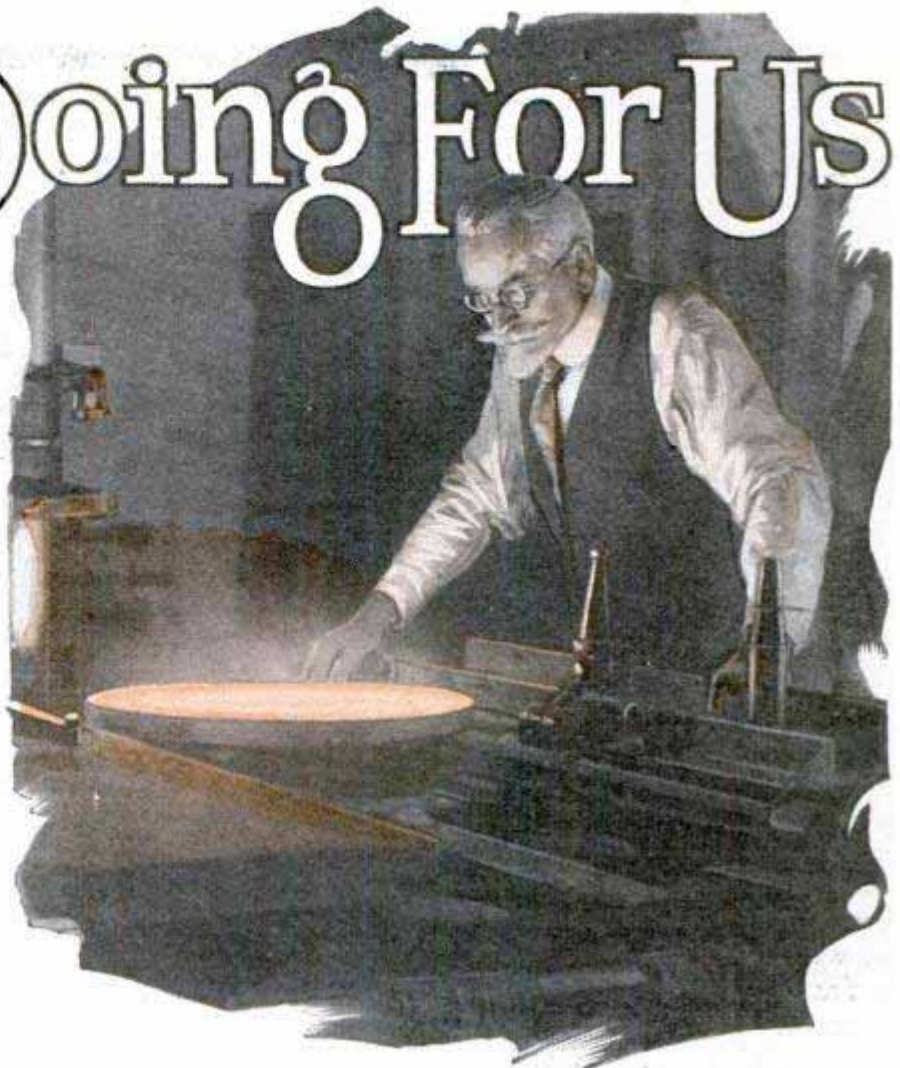

Ferdinand Ellerman, of Mt. Wilson Observatory, Studying Sunspots at the Bottom of a 150-Foot Mirror Tower

the dawn of recorded history, and are just now arriving.

Imagine a tennis ball to represent the sun, and you will have to place a grain of sand twenty-three feet away to represent the distance to earth, with their respective sizes. And then another tennis ball, to represent the nearest star, will be 1,100 miles away from your grain of sand.

The discovery of helium gas on the sun preceded its discovery, in commercial quantities, on the earth by about fifty years. Often it takes longer than that to find the practical application of the astronomer's discoveries, and seldom less. Some of them never yield results that can be measured in dollars and cents, but many do, and all are interesting.

Lockyer, in 1868, found a new gas in the spectrum of the sun while studying the flames shooting out from its surface. The gas was new because the color of the line representing it, when analyzed by the spectroscope, was distinctly different from



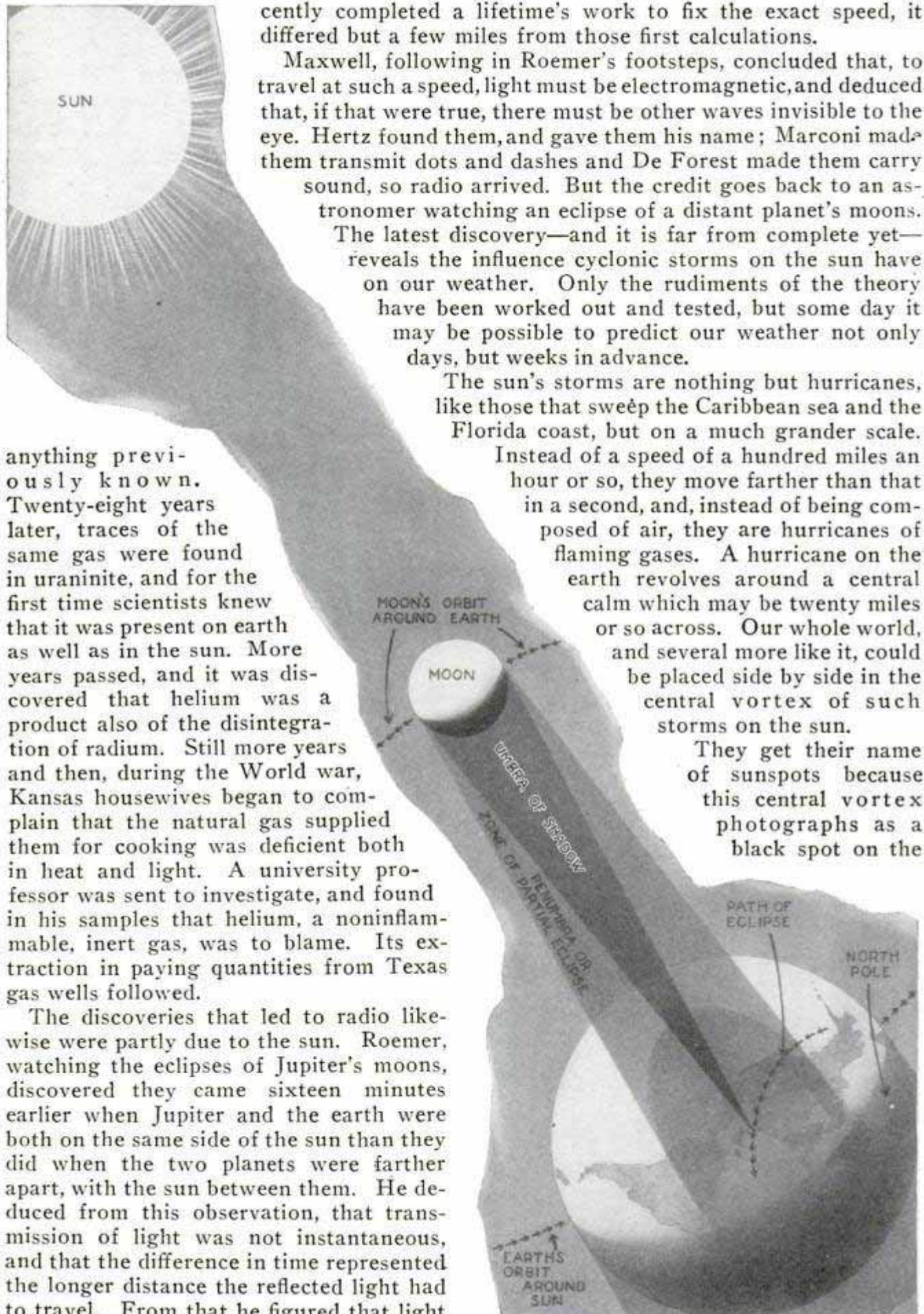

anything previously known. Twenty-eight years later, traces of the same gas were found in uraninite, and for the first time scientists knew that it was present on earth as well as in the sun. More years passed, and it was discovered that helium was a product also of the disintegration of radium. Still more years and then, during the World war, Kansas housewives began to complain that the natural gas supplied them for cooking was deficient both in heat and light. A university professor was sent to investigate, and found in his samples that helium, a noninflammable, inert gas, was to blame. Its extraction in paying quantities from Texas gas wells followed.

The discoveries that led to radio likewise were partly due to the sun. Roemer, watching the eclipses of Jupiter's moons, discovered they came sixteen minutes earlier when Jupiter and the earth were both on the same side of the sun than they did when the two planets were farther apart, with the sun between them. He deduced from this observation, that transmission of light was not instantaneous, and that the difference in time represented the longer distance the reflected light had to travel. From that he figured that light traveled at a speed of 186,000 miles a second, and when Dr. Albert Michelson re-

cently completed a lifetime's work to fix the exact speed, it differed but a few miles from those first calculations.

Maxwell, following in Roemer's footsteps, concluded that, to travel at such a speed, light must be electromagnetic, and deduced that, if that were true, there must be other waves invisible to the eye. Hertz found them, and gave them his name; Marconi made them transmit dots and dashes and De Forest made them carry sound, so radio arrived. But the credit goes back to an astronomer watching an eclipse of a distant planet's moons. The latest discovery—and it is far from complete yet—reveals the influence cyclonic storms on the sun have on our weather. Only the rudiments of the theory have been worked out and tested, but some day it may be possible to predict our weather not only days, but weeks in advance.

The sun's storms are nothing but hurricanes, like those that sweep the Caribbean sea and the Florida coast, but on a much grander scale.

Instead of a speed of a hundred miles an hour or so, they move farther than that in a second, and, instead of being composed of air, they are hurricanes of flaming gases. A hurricane on the earth revolves around a central calm which may be twenty miles or so across. Our whole world, and several more like it, could be placed side by side in the central vortex of such storms on the sun.

They get their name of sunspots because this central vortex photographs as a black spot on the

What Happens When the Moon Passes between the Sun and the Earth, and Eclipses the Former; the Zone of Total Darkness Is About Fifty Miles Wide





Like Some Gigantic Prehistoric Dragon; a Flaming Storm on the Sun, Leaping 300,000 Miles into the Air

astronomer's plate. But it is only a comparative black, for actually it is a flaming zone far brighter than the brightest lime-light, brighter than the greatest search-light ever built. It is only in comparison with the intense brightness of the rest of the sun that it appears black.

Besides influencing our own storms, the cyclones of the sun are the cause of the aurora, or northern lights. When sun storms are near the sun's equator, the aurora flames up in the north, and the nation's telegraphic and radio communications go out of business.

Our moon, a dead world whose chief function is to reflect sunlight at night and



Enlarged Picture of a Sunspot, Above, Showing a Giant Whirling Tornado of Fire, Brighter than Any Flame on Earth, but So Dull Compared to the Rest of the Sun's Surface That It Photographs Black; the White Line across Its Center Is a Bridge of Calcium Flame, 20,000 Miles Long; at Left, a Pair of Sunspot Storms as They Appear in Relation to the Entire Disk

supply us with illumination when the sun is busy on the other side of the earth, serves an equally important part for the astronomer, for at periodic intervals, it gets between us and the sun, causing an eclipse to let the astronomer study the vicinity of the latter, untroubled by the intense glare of its normal aspect.

An eclipse discloses the sun's corona, a vast belt of greenish-gray haze, extending for millions of miles into space, and traced with lines emerging from the sun's poles just like the magnetic lines

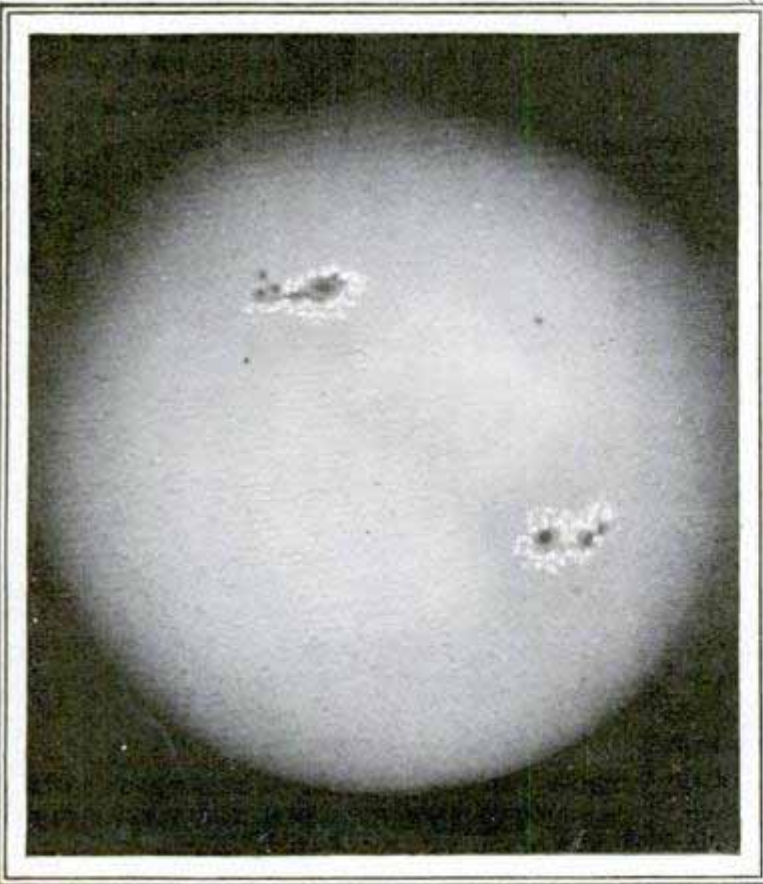



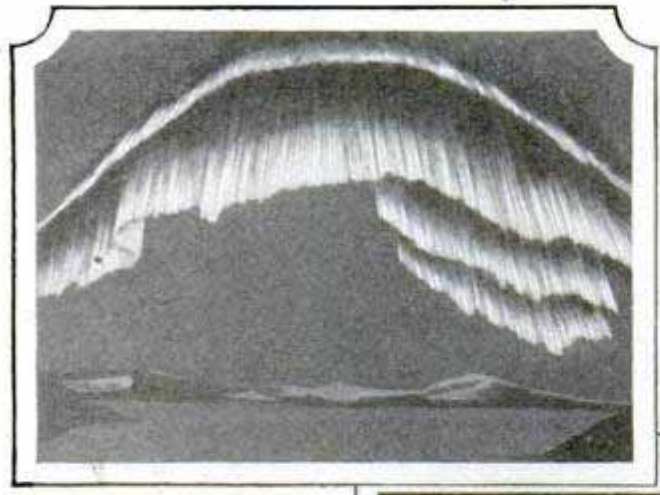

space as flaming clouds. Series of pictures taken at intervals during the day show the process of the formation, and the eventual separation of sun and flame.

Even the dark vortex spots themselves at times are bridged by flaming gas. A flare of calcium vapor, leaping 30,000 miles across the darker spot is visible in one picture on the preceding page.

When flames can flare a half million miles into space, bridge 30,000-mile gaps

at a single leap, and go on raging through centuries of time, there is a vast amount of useful power going to waste. To catch some of the sun's power, whether in the form of direct heat or electrical energy, is the dream of science. Langley and Abbott estimate that the energy given off by the sun in a single hour is equal to that which would be produced by burning a fifteen-foot layer of the best hard coal over the whole surface of the sun. That

set up when iron filings are sprinkled over a paper above a bar magnet. The corona is partly electrical and, probably, partly gaseous. It is believed to have an effect on our weather.

Improvement of radio, elimination of static interference, and kindred subjects all may come with a better knowledge of the sun's corona, and of the electrical effect of sunspot storms.

Photographs of the sun's spectrum, and pictures which separate and record individual gases, have shown the cyclonic nature of the storms whirling about the central

vortex. Along the sun's rim the vertical height of the flames can be measured—some of those photographed have extended as far as 500,000 miles into space. They change form almost every moment, assuming weird and fantastic shapes. One is called the "woolly elephant" because of its likeness to that beast, and others resemble huge prehistoric monsters. Sometimes vast masses of flaming gas rise upward, and then separate their visible connection with the sun, drifting off into

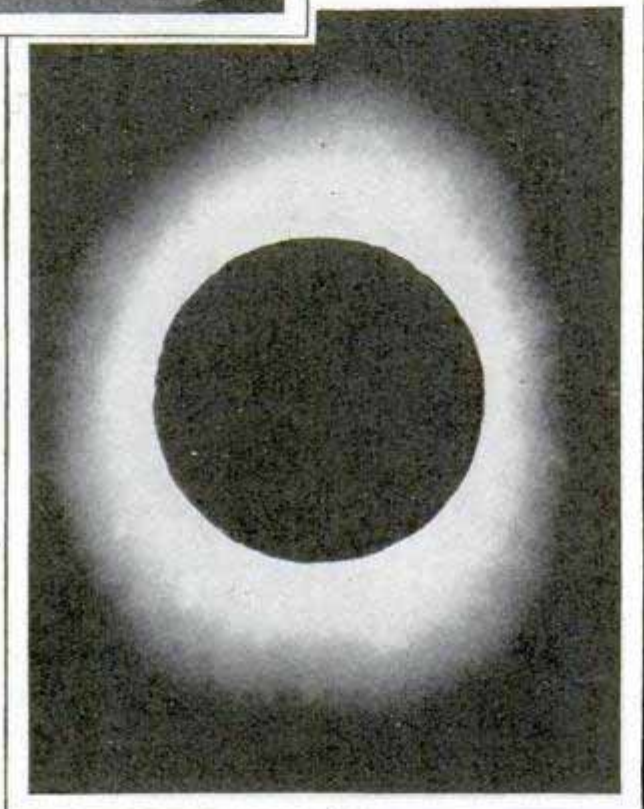

Rare View of the Northern Lights, from a Photograph Made above the Arctic Circle, Top, and, Center, One of the Rarest Sights in the Heavens, the Corona of the Sun during a Total Eclipse; for a Few Seconds Only the Vast Glowing Ring of Diffused Light Is Visible



Most Observatories Are in the Northern Hemisphere, But Here Is the Lick Observatory Branch under the Southern Cross in Chile



part of the sun's energy which reaches the earth as heat is only an infinitesimal fraction of the whole, yet it is estimated to be the equivalent of no less than about 265,000,000 horsepower.

Sun motors, as an experimental fact, have been made to work, catching the sun's rays over a large area, concentrating them, just as a burning glass does, on a small space to heat the water in a boiler and generate steam. Dr. Abbott, at Mt. Wilson observatory, has built a sun cooker in which he prepares the family meals, utilizing heat that comes 93,000,000 miles through space.

The cooker and the sun engine have not yet reached the stage of general application. Much remains to be done in the realm of pure science before we succeed in harnessing the sun to do our work. If it is eventually done, and it seems quite possible now, to the astronomers will belong the credit for having paved the way through their studies.

2257

**SENSE OF SMELL GUIDES BEES**

That the sense of smell is the bee's chief guide in its quest for honey is the conclusion of Prof. Karl von Frisch, a German authority. He declares that when the bees return to the hive after visiting the flowers, they perform a sort of dance on the honeycomb and give out a particular perfume, depending upon the kind of flower from which nectar has been taken. The other bees gather around, and take the scent as a clue. If it is that of the rose, they hunt for roses. The bee does not give out the "scent signal" unless it has more nectar than it needs. The sense of smell is also believed to aid the bee in finding its way home. Moving the hive to a new location has been attempted in an effort to mislead the bees, but they continue the search until their home is found. The experiments were conducted in the Munich botanical garden.

*N.Y. Times*  
4/3/27

**BIRDS FOR STUDY KEPT IN CASE TO PROTECT FEATHERS**

Due to handling, stuffed-bird specimens used by classes often become damaged in



Bird Specimen in Transparent Case for Study Can Be Handled without Damaging Feathers

a short time. To eliminate this, Prof. William S. Wright, of the natural-history museum in San Diego, Calif., has devised a small case of transparent material in which the bird is protected, but may be viewed from all angles. On the base of the stick of wood used for mounting the specimen is a descriptive legend.

*Balboa Park*

**REAR-DUMP TRUCK HAS CRANE TO AID IN LOADING**

2146

In handling garbage, cleaning out sewer manholes and in similar work, a closed, rear-dumping truck seen in Germany, can

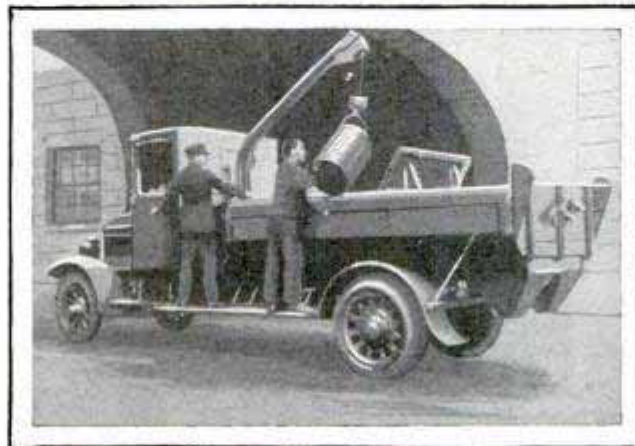

Garbage Truck with Its Loading Crane Saves Lifting Heavy Cans by Hand

be operated by one man with much less inconvenience than with open vehicles. A special feature is the swinging crane to help in loading. This has a lift of 770 pounds and with the tilting body mechanism, is operated by the truck motor. The crane is swung by means of a lever.

*From Deutsche Motor-Zeitschrift No. 3, 1927*



1327 E. Weber Ave  
 Stockton, Calif  
 1967<sup>32</sup>

POPULAR MECHANICS

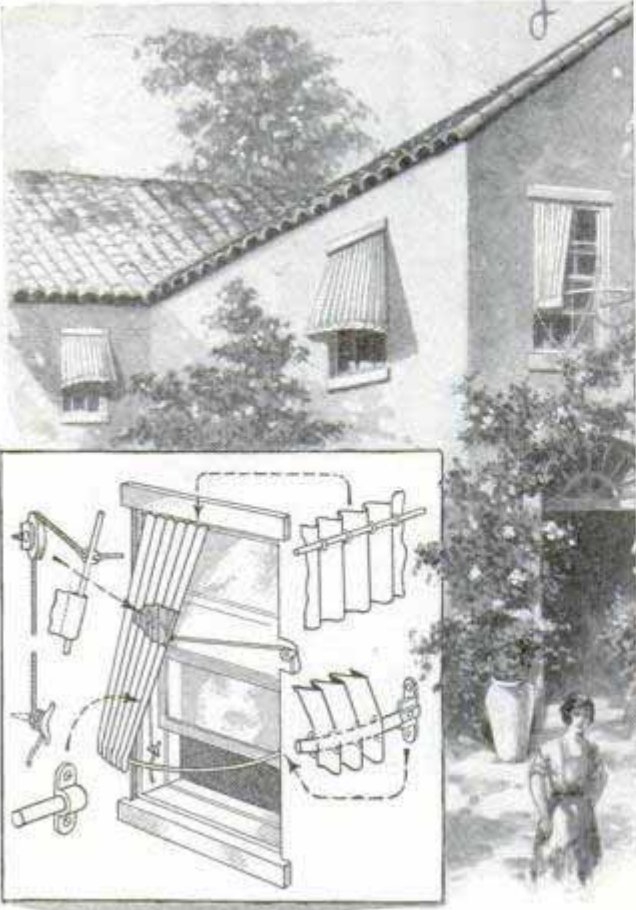

Drawing of Awnings Installed, and Diagram Illustrating How They Are Attached and Operated

**SIDE-PULL WINDOW AWNINGS  
 FOLD IN SMALL SPACE**

Manipulated from side to side, like a theater pull-curtain, a window awning recently introduced is easily installed, simple to operate and, when not in service, can be drawn to a compact fold. Adjustments are made by a small rope. The awning is less exposed to weather and fire hazard if left in folded position.

**BOLT OF LIGHTNING STRIPS  
 WALLS FROM HOUSE**

What may happen when a radio set with outside aerial is not properly grounded and provided with a lightning arrester, was demonstrated recently when a bolt struck the home of a doctor in Stillwater, Okla., and stripped all four outer walls from the house, leaving the undamaged roof supported by the interior partitions. Seven occupants, who were asleep, woke up in public, but uninjured. The lightning apparently enveloped the entire house in a curtain of rarefied air, while the interior pressure blew out the

walls. In nearly every room the bolt played queer pranks. Clothes which had been sent down the chute to the laundry were sucked back up to the second floor, a vase of dried flowers was emptied of its contents and, in two bedrooms, shoes were forced under the partitions and held there by the toes.

2221 **NEW X-RAY CAMERA CONTROL  
 AIDS IN DIAGNOSIS**

Taking the X-ray photograph at exactly the right time is essential in many cases, for instance, in studying the stomach, for its movements sometimes give a clue to diseased conditions. This is now possible in a control unit by which the operator may change from the current being used for visual examination to that required for a radiograph or X-ray photograph and back again to the visual, fluoroscopic current. This is done simply by pressing foot levers on the control so that the operator need not leave his seat to turn a switch or make other adjustments. He can thus record conditions at the instant desired. As the films are exposed, they are shifted into a magazine, and when all six on the machine have been used, the holder is lifted out and the films developed.

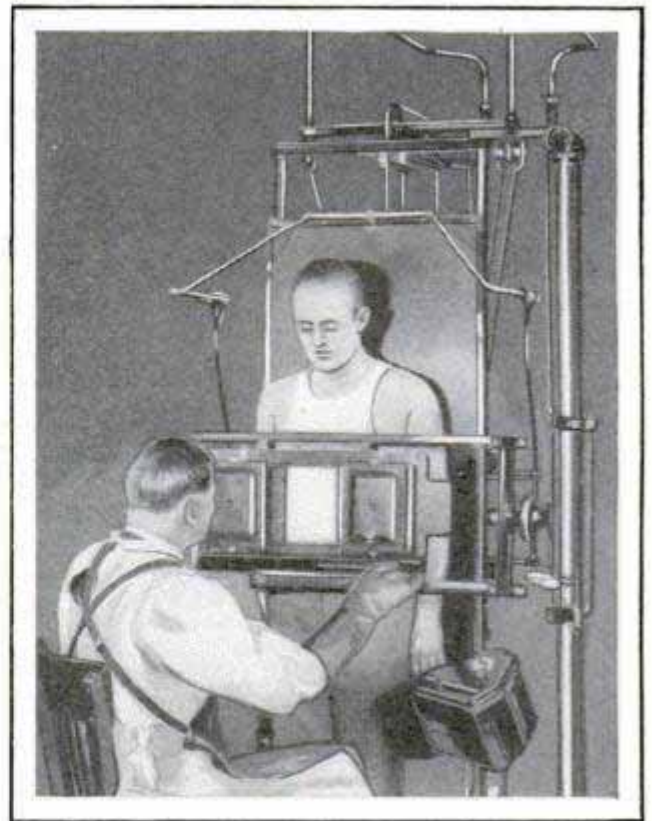

Making a Visual Examination; Operator Is About to Move Film In for Taking X-Ray Photo

Victor X-Ray Corp.

Mr. J. K. McClure

2347



AIR GARAGE TO LAUNCH PLANES FROM ALL FLOORS

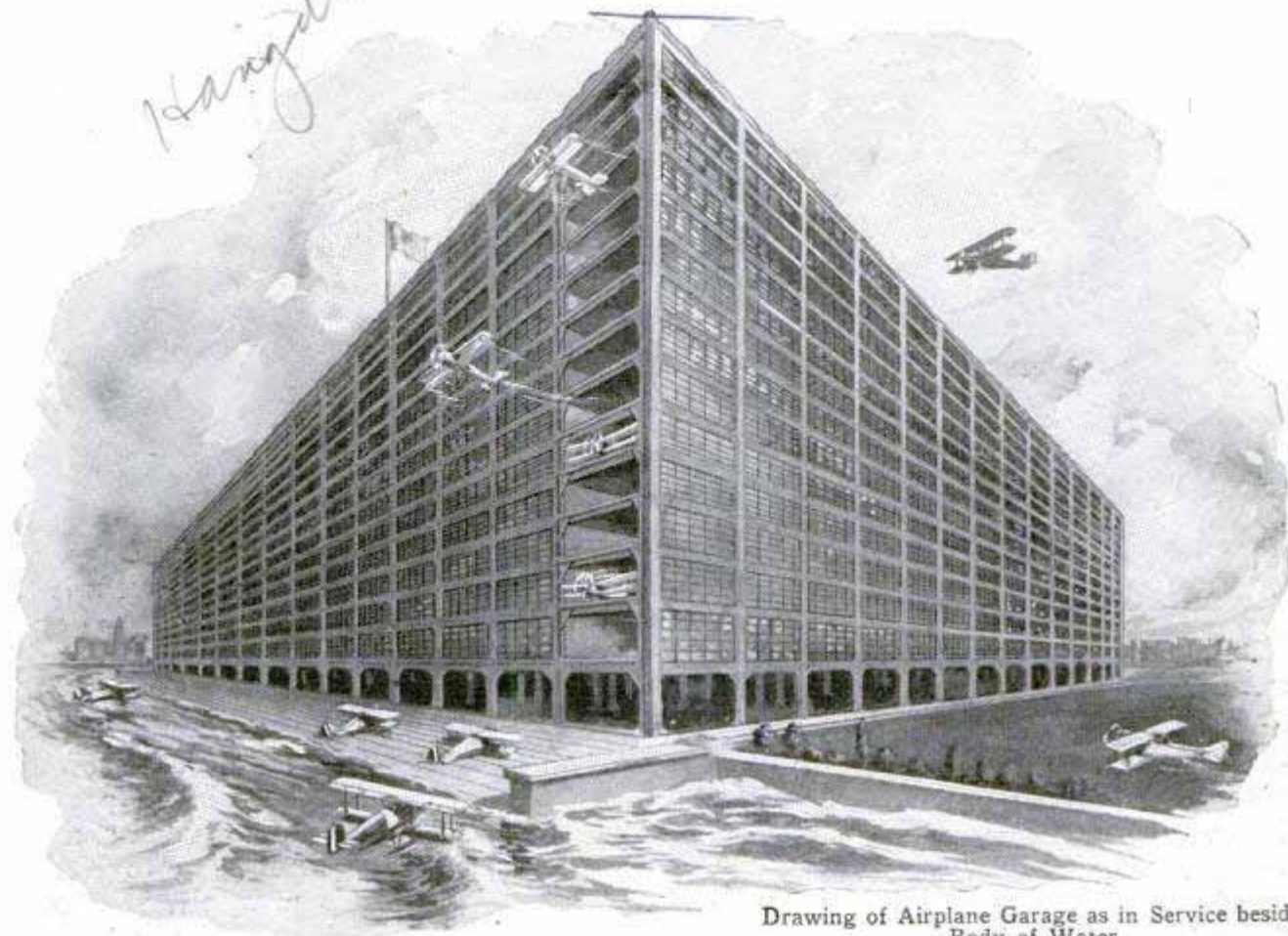

Drawing of Airplane Garage as in Service beside Body of Water

Huge garages for airplanes are suggested as the next step in aviation, their usefulness being more and more apparent as flying develops. They could be arranged so that the craft might taxi up by land or by water, if the location permitted, enter the lower story and then be elevated to the different floors on special lifts. A landing space on the roof also has been suggested. Mooring masts would be erected at the airports for dirigibles. One student of aviation predicts that in the near future every air "flivver" will be equipped with a parachute on the wings, so that safe descents could be made in case of accidents. The support would be released by the pilot and would permit the plane to settle easily to the ground.

2368

LIFE OF A FREIGHT-CAR WHEEL SIX AND ONE-HALF YEARS

Cast-iron freight-car wheels weigh from 650 to 850 pounds each and their average life is six and one-half years. In that time, they will travel 100,000 miles and more. They suffer greater wear from the brakes

than from the tracks and for that reason, as well as for safety in stopping the train, rigid tests are made to keep the air brakes working properly and the shoes in correct adjustment.

OUTLET FOR ELECTRIC CURRENT EASILY HUNG AND CENTERED



Quickly attached with one nail, an electric-current outlet-box hanger simplifies installations and is convenient where wall or ceiling conditions present difficulties with the ordinary type of apparatus. The box itself rests on a bar and may be slid to the

extreme end so that it can be exposed at the desired place whether the joists are arranged for such opening or not.

Com. Edwin Tarise  
17 Franklin Washington

Radell Electric Mfg. Co. Chm. Bary. d. ind.  
1060 Washington St., Wash. D.C.



*French engineer*

1498



Acetylene-Gas Generator in Automobile; It Is Said to Reduce Expense of Running the Car

### ACETYLENE GAS AS AUTO FUEL CUTS COST OF MOTORING

Reductions of forty to sixty per cent in the cost of operating an automobile are reported from France as a result of using acetylene gas instead of gasoline for fuel. An engineer has devised a small generating plant attached to his automobile which is said to assure a constant supply to the carburetor. The motor has been adapted for the use of acetylene gas only.

### TRAFFIC JAMS IN ELEVATORS LATEST CITY PROBLEM

Crowded city streets have long presented problems and now the task of carrying thousands of persons up and down in the elevators of huge buildings requires expert traffic management. It is no longer left to chance. Schedules are arranged to meet rush hours. One New York building has seven, with skip-stop and express service at different times. Half of the employees are due to arrive at 8:45 in the morning and the rest at 9 o'clock, to reduce the congestion. The same interval is applied at night. Automatic elevators that stop at any floor desired by pushing a button as the passenger enters and doors that operate automatically by compressed air are now widely used to speed up service. A building in lower Broadway has a synchronizing clock arrangement that keeps

all the elevators the proper distance apart, so that they arrive on the ground floor in time to depart at thirty-second intervals. A white light tells the operator when to start up, a red light gives the signal for going down and a green light flashes when he should be midway on his "route." In another building, a dispatcher, hidden from the public, keeps constant watch on the elevators' movements by means of a lighted board and flashes directions to passengers, telling them when a car is not in service, or will not stop at a certain floor, etc.

### CURRIER AND OILER FOR STOCK HAS AUTOMATIC FEED

Suitable both for cattle and hogs, an automatic currier and dipping outfit is so arranged that the liquid is dispensed only when the machine is used, and has curved brushes which fit over the animal's back, giving treatment to a large area. A shut-off valve is opened by the action of the brushes and is closed again to prevent waste of oil. The unit is rigged sturdily between posts and is not likely to get out of order. Stock raisers who have used it say that the animals soon learn how to operate it and show marked improvement.

Hogs Enjoying the Luxury of a Scratch; the Liquid Is Dispensed from the Tank Only as Outfit Is Used

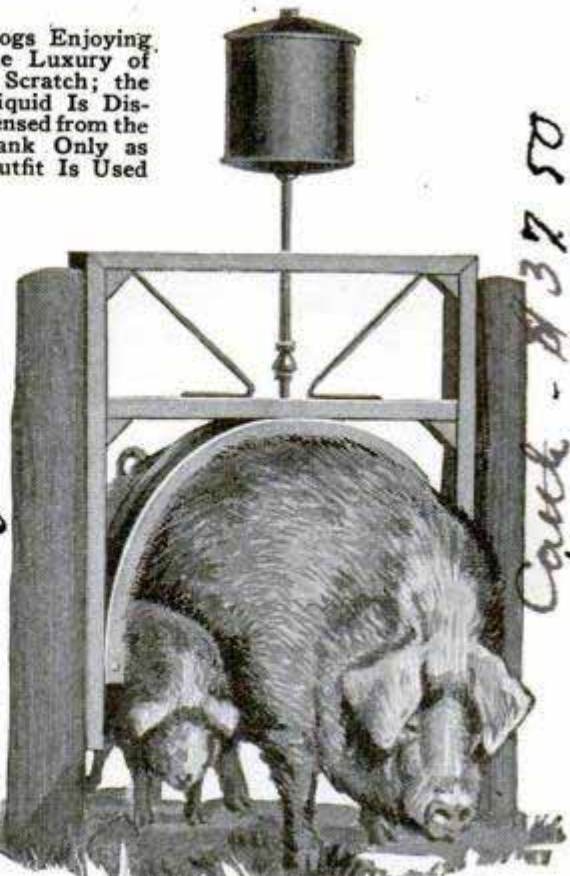

*Chicago*

*Cash - \$37.50  
Hog - \$75.00*

*Automatic Currier & Dipping Machine Co.*

*New York Times 4/17/27 2353*



# Bringing Back *the* Packets

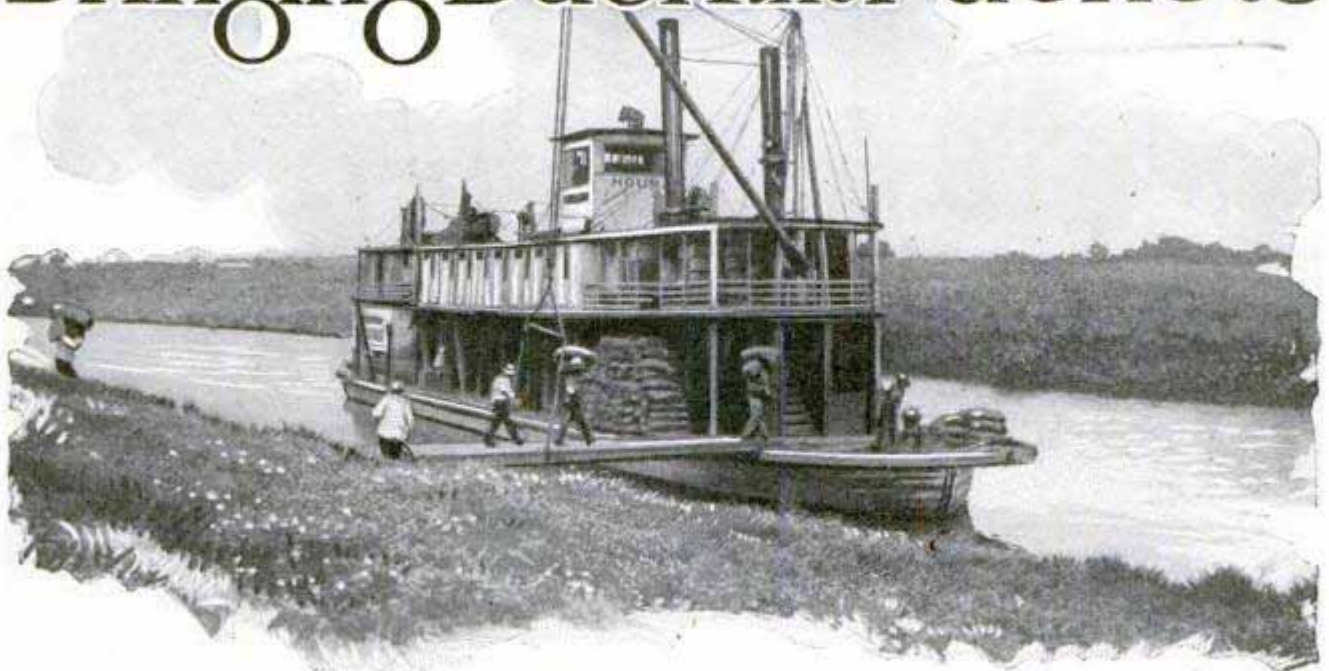

Loading a "Bayou Packet" of Louisiana, Where the River Boats Still Ply on the Thousands of Miles of Shallow Rivers and Bayous, the Only Roads of a Vast Inland Area

By H. H. DUNN, 27 22 *Pravice St. Berkeley, Calif*

REPLACING passenger and freight trains, motor stages and motor trucks, even ousting steam-driven craft and eliminating horse-drawn vehicles, what is probably the largest fleet of small commercial craft in the world handles the greater part of the inland traffic of two states. There are more than 3,000 motorboats in this busy fleet.

They are the successors of the famous steam packets of half a century and more ago on the Mississippi, the Missouri, the Ohio and other rivers. Known as the "Little Packets of the Lower Mississippi," their field of operation is the vast network of inland waterways which lace the interior of Louisiana west of the Father of Waters, and, to a less extent, the state of Mississippi on the east.

The surface of the Mississippi was more than fifteen feet above the city of New Orleans when I stepped on board the "F. and J." Logs, timbers, whole trees, came rushing by on the yellow current of the flooded river when this 100-ton motor packet turned her nose into and across the stream to the company canal locks at Westwego. Three small cabins on the upper deck cared for two other passengers besides myself. Below, the main deck was

piled high with merchandise of all kinds. There was a piano, a traveling motion-picture projection machine, whose owner and operator was a fellow voyager; a diving outfit for a man at Grande Terre island; a complete soda fountain for a little town on the Bayou Barataria; a marine gasoline engine for a fisherman, building his own boat in the heart of the "Great Marsh"; a sack of steel traps for a muskrat hunter on Lake Salvador, and innumerable boxes and bags of merchandise for keepers of small stores, all the way from a point on Lake Cataouatche south to Grande Isle.

The overhanging deck of the "F. and J." cleared the waters of the Mississippi by less than a foot, but the captain knew his river, and we came into the lock dry and safe. There we were let through slowly, gently, and with no regard for time, by an ancient and deliberate negro, white of hair, hands on a long pole let into the capstan of the lock gates, walking in a circle about the steel spool.

Once inside, the river gates were closed, and we looked down more than fifteen feet into the quiet waters of the canal below. Slowly the inner gates opened, and we dropped gently with the seeping waters



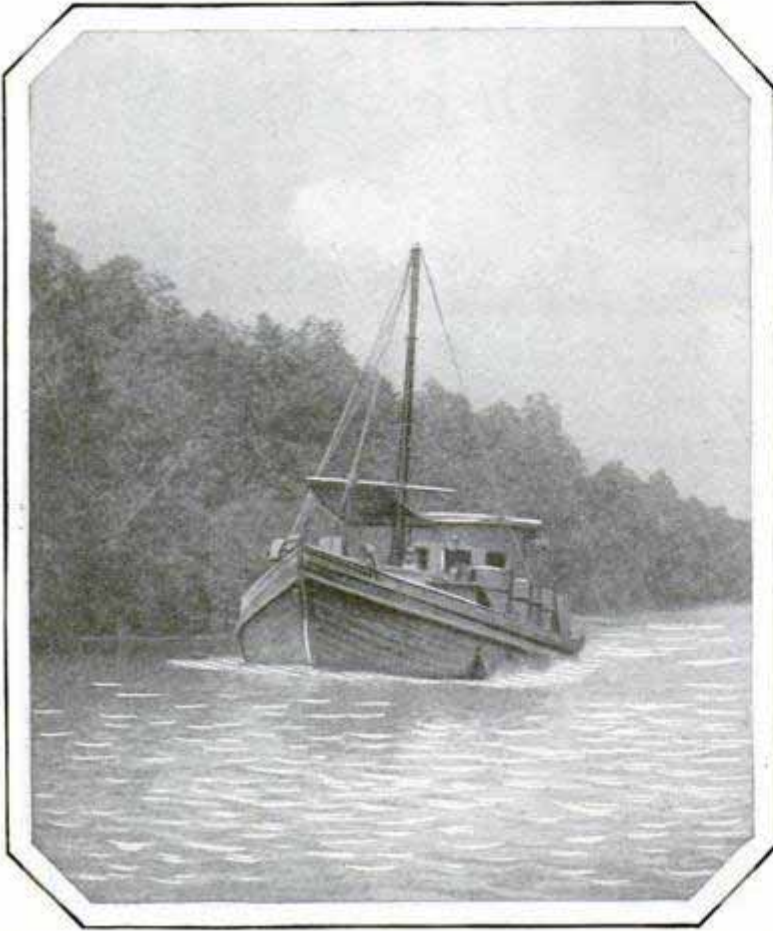

Small Gasoline Freighter Coming down a Bayou of the Great Marsh of Louisiana, Where the Packet Ships Still Ply

to a level with the artificial stream. At last the cypress doors, more than thirty feet high, swung open, the bell jangled in the little engine room, and we were clear of the river.

Passing through a fleet of more than 200 small freighters, taking on gasoline, oil, and a few of them ice for shrimp and fish cargoes on their return, we moved slowly down the stream, into the long, black, cypress-bordered Bayou des Allemands, on whose banks, in some remote, almost prehistoric day, "the Germans" must have lived, to give the stream its name. Passage of these narrow canals and bayous, few of them more than 100 feet wide and most of them narrower, is essentially slow, and when we met, as we did, four returning freighters, all smaller than "F. and J.," we had to pull as close to the bank as possible, and stop, so that our wash might not overturn them, or throw them into the opposite banks.

From boat to boat there was a cheery hail, and from one, evidently manned by descendants of those Acadians of whom Evangeline was one, floated a sturdy baritone voice:

"O Jean Ba'teese, pourquoi?  
O Jean Ba'teese, pourquoi?  
O Jean Ba'teese, pourquoi you grease  
My leetle dog's feet wit' ta-a-a-ar?"

There is more to this song, in which "Jean Ba'teese" replies at length regarding his reasons for applying the tar, but the answering singer, another boatman, and his song, were lost around a bend in the bayou.

Where a man waited in a twenty-foot motorboat at the bank of the bayou just before we reached Lake Cataouatche, we halted long enough to pile high his craft with packages of merchandise from New Orleans. Cash passed from the dark-skinned 'Cadien to the captain of the "F. and J.," who had been his purchasing agent as well as transportation man. This was only one of several times when storekeepers on side streams in the great marsh, or private dwellers in the "Trembling Prairie," met us with their boats and took off goods ordered several days before, when

the motor packet had passed up on her way to New Orleans.

So we passed onto the lake, across it, down the Bayou Couba into Lake Salvador, delivering goods here, picking up cargo there, greeted everywhere as the connecting link with the outside world, until darkness overtook us on long, shallow, storm-swept, tricky Baratania bay. Pulling over to a little bayou, the captain anchored the "F and J." Darky deckhands put up screens around the forward end of the lower deck, and we ate. Behind screens in the improvised dining room, I listened to stories of the great marsh, including one of the mermaid of Grande Terre, until the tellers tired, and we slept, in our own bedding, on cots below, or in the little cabins above.

Motion of the boat awoke me in the morning, but we had not covered more than a few miles before two trappers in their small motorboats hailed us and the captain took on bales of skins to be sold in New Orleans and the receipts, less a reasonable commission, returned to the owners, who would meet him at the same point, at the same time, one day of the



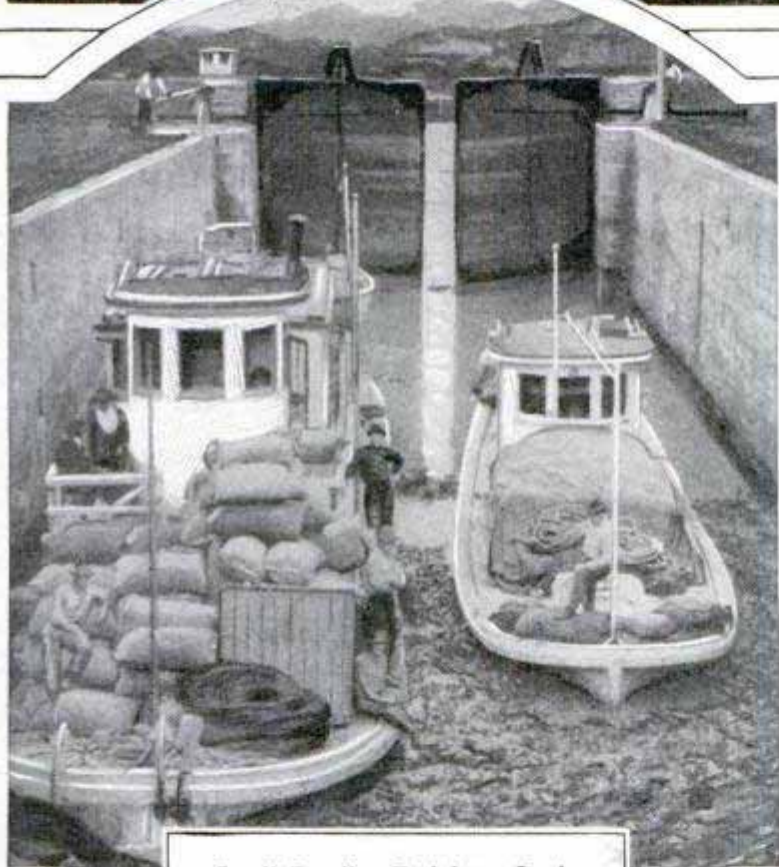
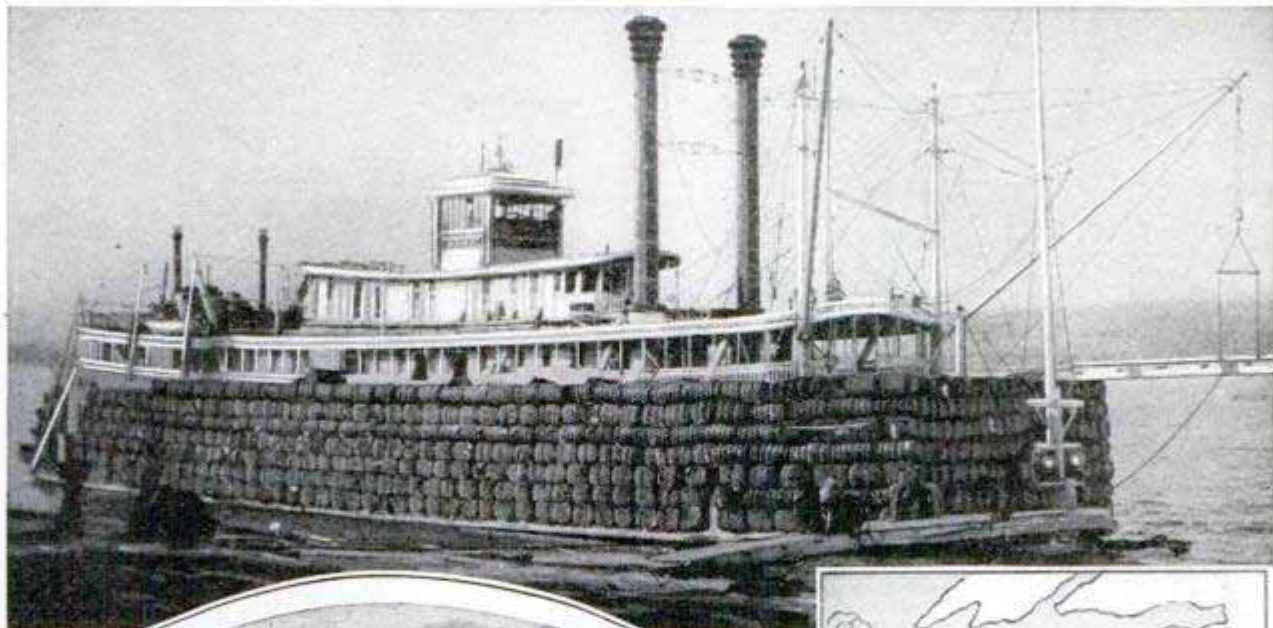

Small Gasoline Freighters Locking Out of the Great Marsh into the Mississippi



Map of the Water System of the Mississippi Valley, Where Thousands of Miles Are Served by River Packets

A Homemade Packet, Just a Barge with an Automobile Engine, Which Supplies Gasoline and Oil to the Marsh Freighters, at the Right, and at Top of Page, the Mississippi Steamer "America," with a Deck Load of Cotton; She Is One of the Largest and Finest Boats Plying on the Father of Waters, and Still Keeps Alive the Traditions of Mark Twain's Days





2069

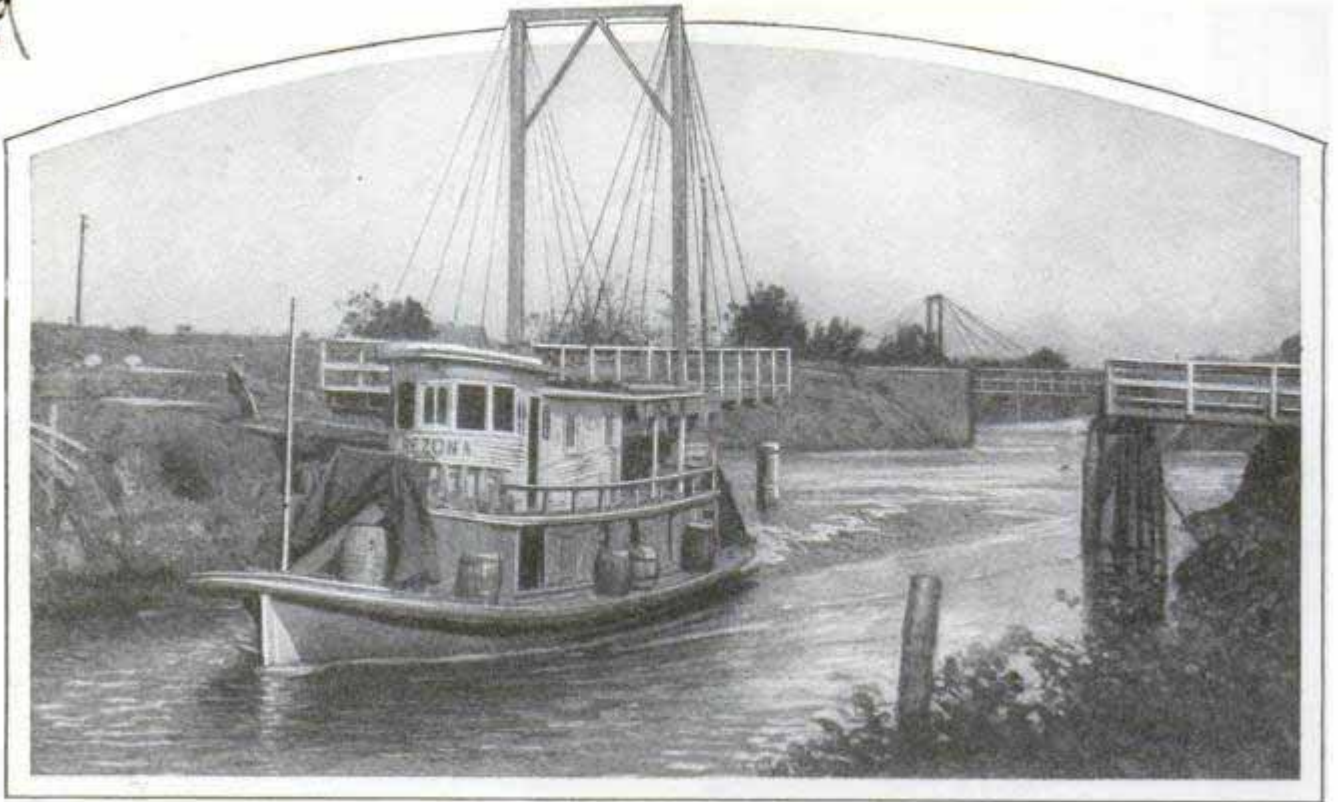

With a Portable Organ under a Tarpaulin on the Forward Deck, This Gas Packet Is Heading into the Great Marsh of Louisiana, Carrying a Missionary and His Equipment to His Post

next week. When we had circled to Manila village and other settlements on the bay and on some of the surrounding bayous, much of our merchandise was gone, but in its place, "F. and J.'s" deck was well filled with produce of the great marsh, to be carried back to New Orleans. Passengers between the villages and the fishing camps came and went. Boats met us and took off merchandise or passengers. Gasoline was supplied to a fishing boat which had suddenly gone dry, and another with a broken propeller was given a tow to the nearest village.

So, serving and being served, the little packet moved, as important in her place and service as any transoceanic liner, until we passed the old and abandoned Fort Livingston, crossed the millrace current which rushes out into the Gulf of Mexico and rounded to at the end of the journey, on the lee side of Grande Isle. There, in a village of a few hundred fishermen, trappers and truck gardeners, we unloaded the last of our cargo from the city, finished loading with the products of the great marsh, and, the following morning, turned back to the Mississippi for the return trip to New Orleans.

Just as regularly, thousands of other passenger and cargo packets of this, probably the largest fleet of motorboats in any

one industry in the world, carry the products of civilization to dwellers on one of America's last frontiers—the great marsh of Louisiana. Others go north, others west, on inland voyages which last two or three weeks, and still others east to Mississippi, and even Alabama and Florida, just as we had gasolined south to the rim of the gulf, through the haunts of the last of America's pirates—Jean Lafitte and Dominic You—on Barataria bay.

2078  
**FAN HIDDEN IN LIGHT FIXTURE  
 FOR BETTER VENTILATION**

Besides improving the appearance of a room, a type of electric fan concealed in



the base of the chandelier is said to give greater comfort, as it has a slowly revolving reflector which breaks up the direct blast of the blades. It is regarded as beneficial in winter as well as summer for keeping the

air in motion as an aid to health and more efficient ventilation.

Safety Car Heating  
 & Light Co.,  
 New York



*S. Smithman & Institution  
Washington D.C.*

*549 W. Washington Blvd  
Chicago  
1916*

**STRENGTH OF RADIO RECEPTION  
DEPENDS ON SUN** 2363

That the strength of long-distance radio reception appears to be almost wholly a function of the variation in the sun's radiation is the conclusion of government experts. Dr. L. W. Austin, of the bureau of standards, made a three-year study of radio reception, comparing the curves that he plotted with curves for solar radiation prepared for the same period by the Smithsonian Institution. The curves correspond almost exactly. It was also found that the sun's radiation varies according to a definite period. This has been measured at twenty-five and two-thirds months.

**AUTO SHOP SO COMPACT IT IS  
HAULED IN TRAILER** 2032

To meet the needs for more practical, compact repair equipment, a small bench lathe for the machining of armatures, valves, bushings and other parts, in the garage or service station, has been devised. In demonstrating it, use was made of a small automobile trailer with the machine and attachments complete, so that the various functions of the lathe could be clearly illustrated under actual shop conditions. It was operated by a small electric motor, and correct methods and tools for executing various jobs were shown.

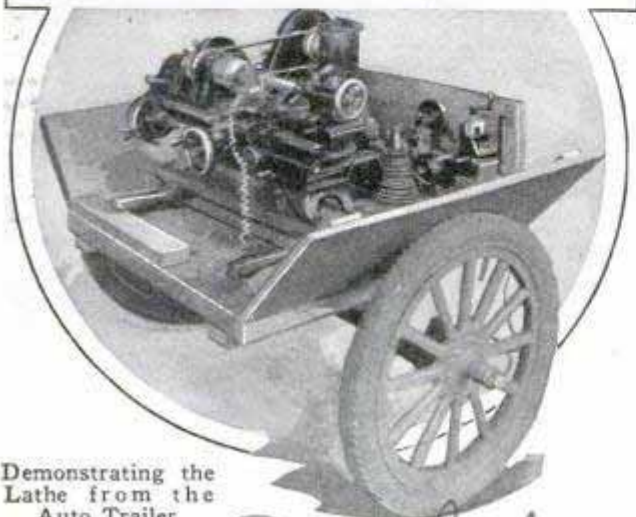
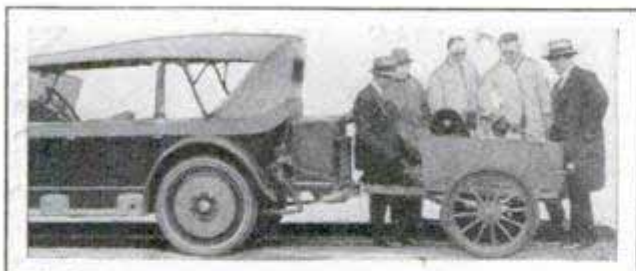

Demonstrating the Lathe from the Auto Trailer

*South Bend Lathe  
211 W. 1125 E. Madison St*



Compact Electric Lantern, for Railroad Service, Has a Red and Two White Lights

**THREE-LIGHT SIGNAL LANTERN  
AIDS RAILWAY SAFETY**

A particular advantage of an electric lantern for railroad service, is that it provides three lights, two white and one red, and has space for carrying an extra bulb. This insures operation even if one of the lights is extinguished. Another one is lighted simply by moving a switch. One of the white lights is focused as a "spot," and is said to illuminate car numbers for easy reading as far away as 100 feet. The red is used for signaling, and is visible for a mile, the manufacturers assert.

**SAND MODELING FOR CHILDREN  
DEVELOPS SKILL** 2379

School children of Cape Town, South Africa, look forward to the annual sand-modeling contest held on the beach at one of the suburbs near by. Between 200 and 300 compete and are divided into classes according to age. Several subjects are prescribed for each class, and there is an open contest in which modelers of any age may compete, choosing any subject they desire. Novel effects are obtained by the use of colored chinks and other materials to add realism to the figures.

*Capt. Herbert C. Withey  
The Homestead Cornhill Bay*

*With red light \$7.00  
Without \$6.50*



General Accessories Mfg. Co.  
 6452 S. Hoyne Ave. Chicago  
 12/1/26

6452 S. Hoyne Ave  
 POPULAR MECHANICS  
 Chicago

A. Manfras, Chief  
 Electrician

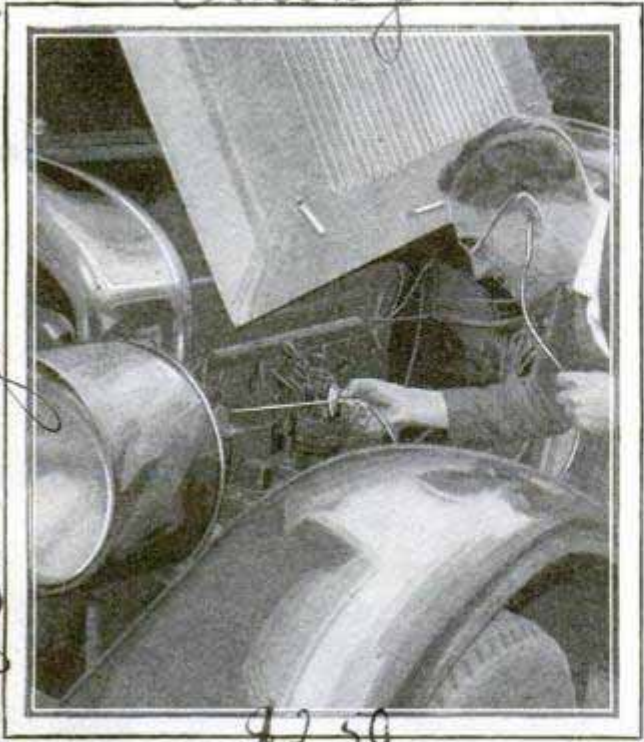

Running an Engine Noise to Its Source with a Stethoscope That Reaches Constricted Places

**AUTO'S KNOCKS AND SQUEAKS TRACED BY STETHOSCOPE**

A conveniently portable stethoscope which can be carried in the door pocket has been invented to detect and locate engine trouble. The device also can be used to run down the exact location of body squeaks and other noises. It has the usual ear tubes and rubber connections of the doctor's outfit, but the diaphragm is sturdily housed to protect it from damage, and is fitted with a brass rod, several inches long, to reach out-of-the-way spots under the hood. Owing to the brass casing over the diaphragm, which is of the full-floating type, the stethoscope can be dropped or struck without suffering any damage.

**RADIO AT WATER TANK BROADCASTS LEVEL AUTOMATICALLY**

An automatic radio-broadcasting station is owned and operated by the waterworks department of Akron, Ohio, to send reports from the city reservoir to the municipal pumping station, fifteen miles away. It is on the air every hour of the day, except between eight and eleven o'clock in the evening,

to broadcast the height of the water in the reservoir so that the pumping-station attendant will know how much water to send through the city mains. Before the radio installation, the work was done by telephone which was not always satisfactory, but the wireless plan costs practically nothing to operate, was placed at little expense and requires no attention save winding a master control clock once a week. This clock closes a circuit for fifty seconds, bringing various relays into operation and sending current to the transmitter which broadcasts one of ten different signals to denote a corresponding level in the tank.

**BUSHEL-BASKET FRUIT PACKER SAVES TIME AND WORK**

Filling a well-packed bushel basket almost as fast as the fruit can be placed in it is now possible with three simple aids for the worker. One is a metal lid with a series of grooved rings in it. The others are a metal shell without top or bottom and a sleeve cardboard liner. A layer of the fruit is fitted tightly into the rings of the lid; the shell, with the liner inside, next placed on, filled and then removed. The basket is then slipped over the cardboard, turned right side up and the lid taken off. The fruit is thus attractively arranged and the lining protects it from moisture, rubbing and bruising.

Paid Feb 76 1926.

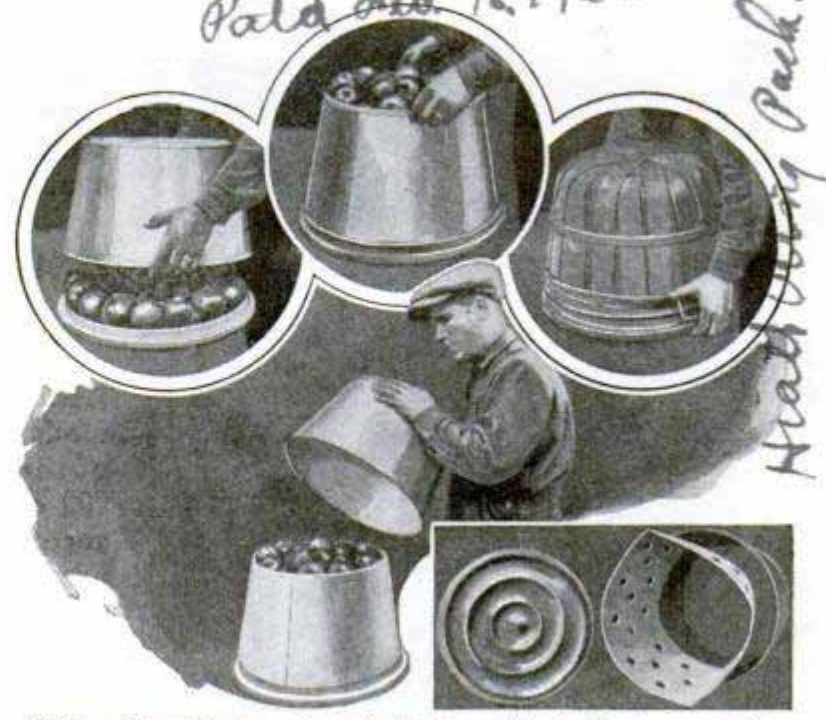

Various Steps in Preparing the Basket with the Packer, and View of the Grooved Lid and Lining

G. H. Duke, Inc.



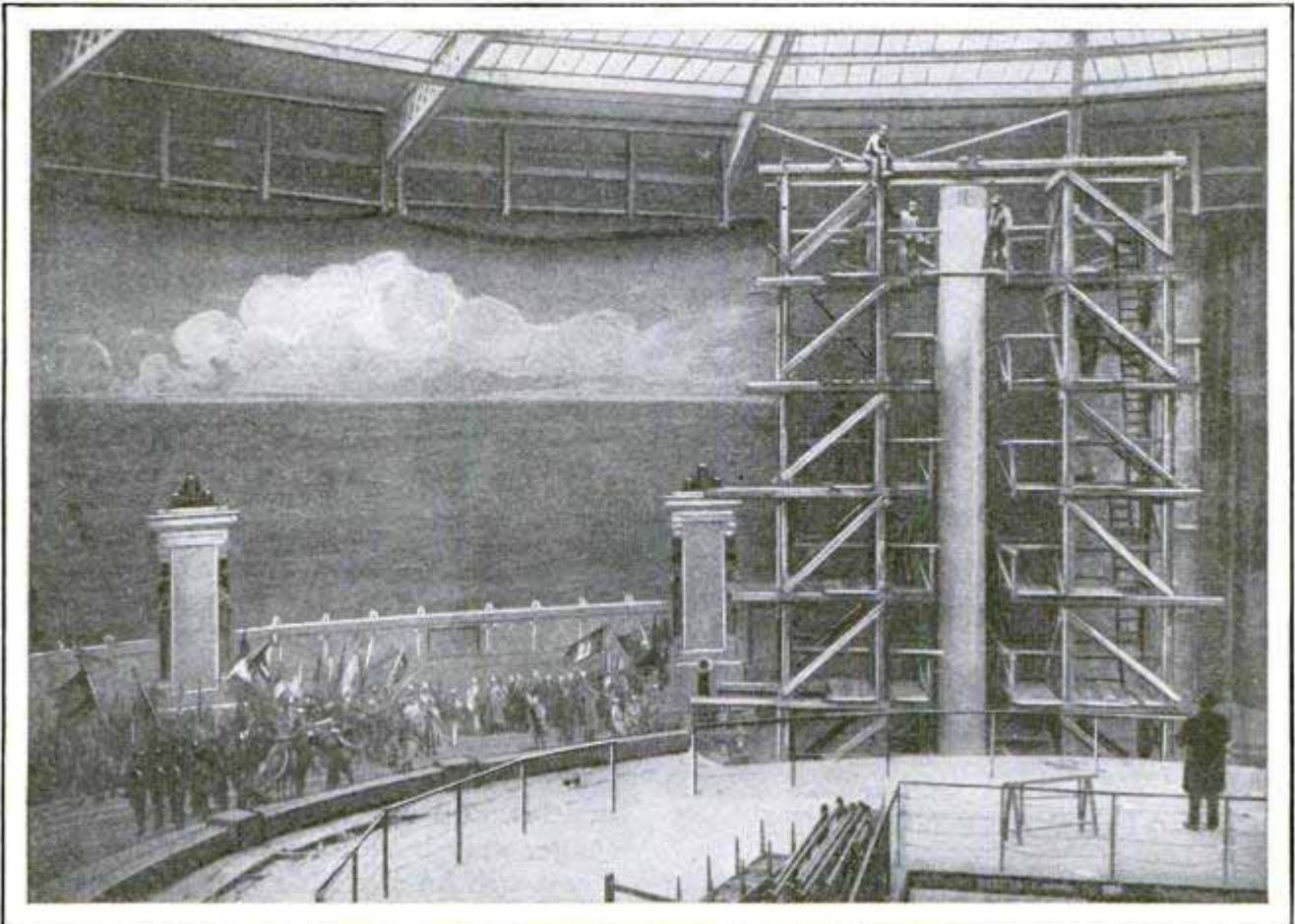

Rolling Up the Huge War Painting for Shipment; the Enormous Canvas Was Wound on a Reel Which Was Transported in a Special Truck to the Steamer for New York

### THREE-TON PAINTING OF WAR SHIPPED TO AMERICA

Special apparatus was required for dismantling and handling the huge "Pantheon de la Guerre," a painting sent to this country recently from France. The canvas is forty-five feet high, 363 feet long and weighs about three and one-half tons. It was wound vertically on a special roller, placed in a sealed case and carried to the shipping port on a truck designed for the purpose. The work depicts scenes from the World war and has been viewed by thousands from all over the globe.

### REINDEER FURS NEW INDUSTRY IN ALASKA 2340

Reindeer skins of certain grades are being used in the fur trade, many having proved superior to pony and calf hides. They are suited for making coats and, in the hands of skilled furriers, are prepared to resemble mink in texture and color. About 15,000 hides from fawn and young calves are available in Alaska each year,

and these are considered particularly desirable because of their light weight and strength. Many of them were previously wasted, but the new demand has developed an additional source of revenue.

### SAFETY WOOD-SPLITTING KNIFE SUBSTITUTE FOR HATCHET 1888

For splitting kindling wood without danger to the fingers, a German inventor



has devised a lever knife which is easily operated and said to be entirely satisfactory on small pieces. The blade acts as a wedge which can be applied with great force anywhere on the stick, or to produce splinters and

shavings. An additional feature is that there is much less wear on the chopping block, and the cutter will not get lost.

Chicago Daily News  
 14/18/27

Mr. Arthur Schönbel  
 Thiersee bei Kufstein



*Peter Van Lane Los Angeles Calif 1890*

Making Sketch by Sprinkling Different Colored Sands on Wet Canvas

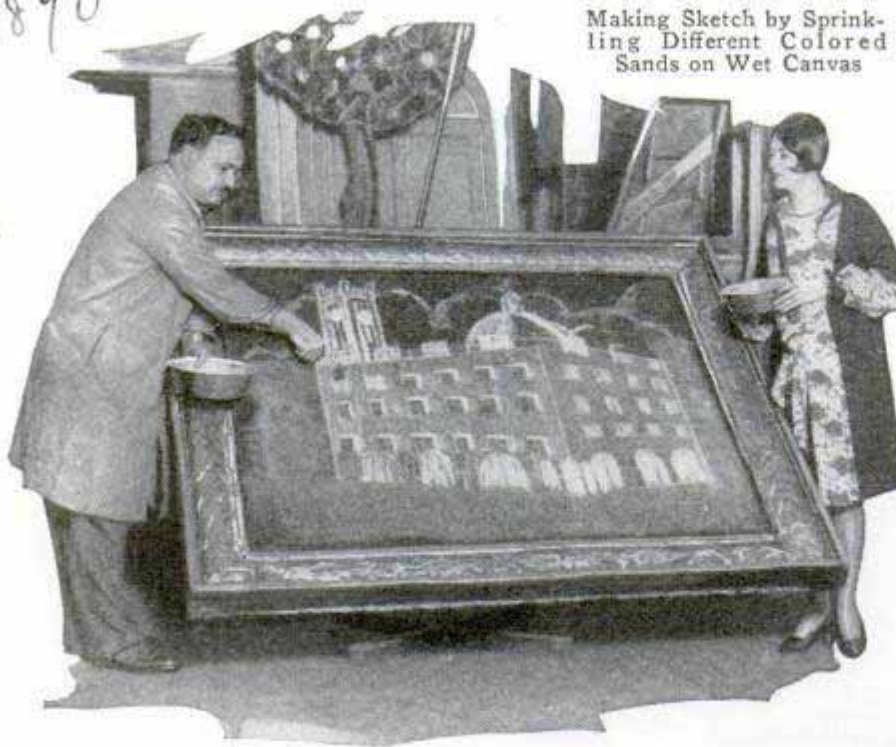

turing by de-inking mills. In 1922, the United States used more than 8,000,000 tons of paper. The daily consumption of newsprint is approximately 7,000 tons, of which nearly half could be used again.

### SHOPPING CENTER UNDER HEART OF LONDON

*1885* Beneath Piccadilly Circus, in the heart of London, amid a tangle of passages to subway trains, a number of brilliantly lighted fashion shops have been constructed. Here customers may see

### PAINTING WITH COLORED SAND LATEST ART NOVELTY

Fine sand, dyed in various hues, is used by a California artist instead of oil paints or water colors, in preparing novel sketches. They are made on wet canvas so that the sand will stay in position. No brushes or other tools are used, the grains being sprinkled on by hand.

latest styles in dresses, jewelry and other articles, and many things which the passenger may have forgotten to buy on the street will be available just before taking the train. It is planned to install electric stairways to the upper, outside levels for the convenience of patrons. Numerous difficult engineering problems had to be solved in construction of the tunnels. During the digging, bits of fossilized trees were found, indicating the existence of an ancient forest on the spot and a fossil oyster shell was also picked up, showing that the district was once under the sea.

### SAVING OF OLD NEWSPAPERS TO SPARE FORESTS

*2362.* Thousands of acres of forest could be saved yearly in the United States if the waste newspapers were collected and put through ink-removing processes. It is estimated that over 300 tons of papers might be collected daily in the city of Chicago and converted into more than 200 tons of clean paper ready for use again. This would mean a daily saving of the cut of many acres of trees. Experiments have shown that a saving of about \$15 a ton can be made in paper manufac-

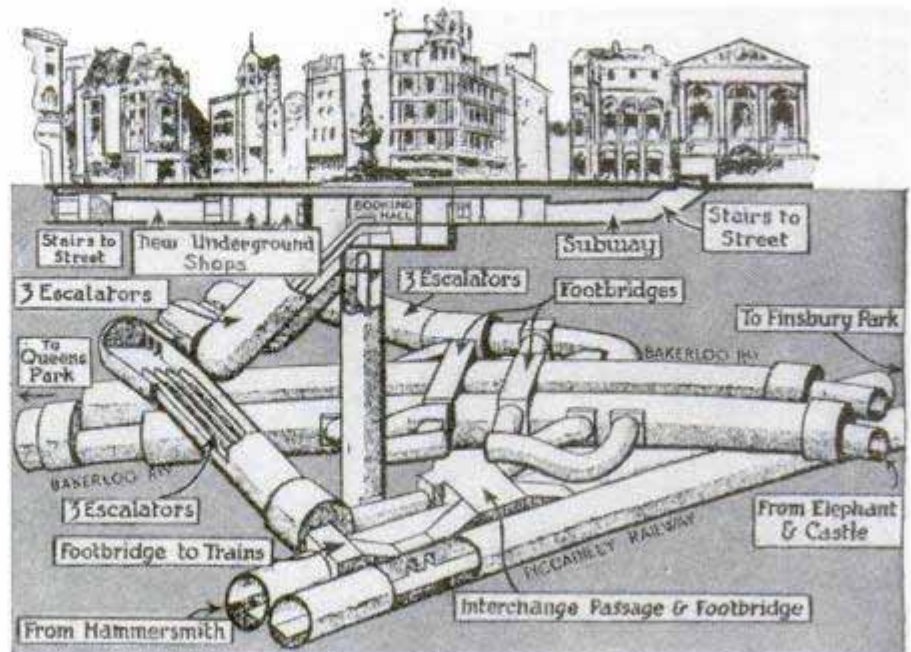

Part of the Labyrinth beneath London's Streets; the Shopping Section under Piccadilly Circus Seen at Upper Left

*Cont. H. J. Williams, Eng. Road, Paris to SW 9*



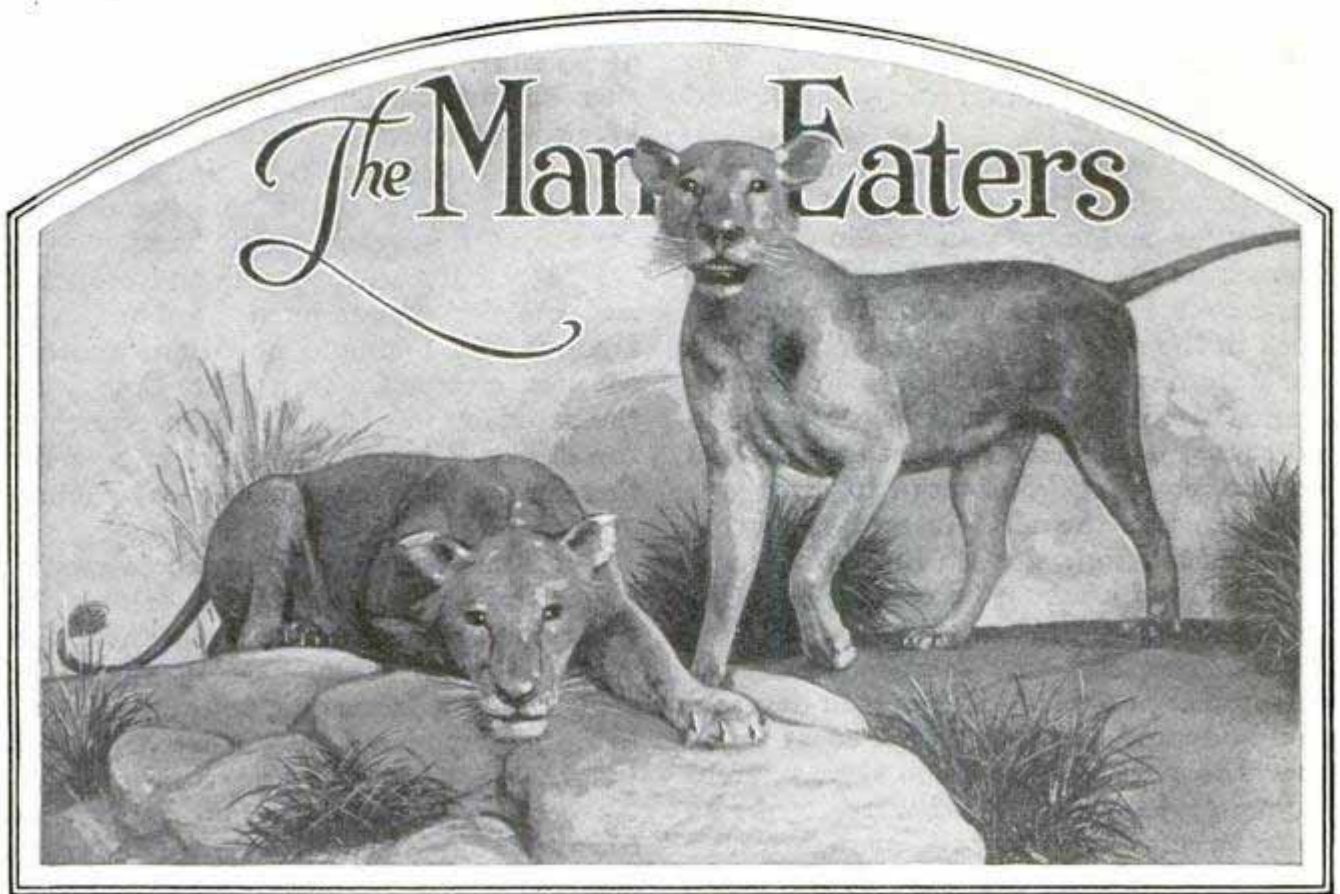

Courtesy Field Museum of Natural History

The Tsavo Man-Eaters as They Appear Today, Stuffed and Mounted in the Field Museum of Natural History; They Devoured 135 Men Before Col. Patterson Killed Them

By LIEUT. COL. J. H. PATTERSON, D. S. O.

## PART II

I COULD not understand what they had found to eat, for I had heard no commotion in the camps and I knew by bitter experience that every meal the brutes obtained was announced by shrieks and uproar. The only conclusion I could come to was that they had pounced upon some poor, unsuspecting native traveler. I knew, of course, that it must be a man they were eating, because they would touch nothing but human flesh.

After a time I was able to make out their eyes glowing in the darkness, so I took as careful aim as was possible and fired. The only notice they took was to carry off whatever they were eating and retire over a slight rise which prevented me from seeing them. As soon as it was daylight, I got out of my crib and went toward the place where I had heard them growling, and on the way whom should I meet but my missing guest, Mr. Whitehead, looking very pale and ill and generally disheveled.

"Where on earth have you come from?"

I exclaimed. "Why didn't you turn up to dinner last night?"

"A nice reception you give a fellow when you invite him to dinner," was his reply.

"Why, what's up?" I asked.

"That infernal lion of yours nearly killed me last night," said Whitehead.

"Nonsense, you must have dreamt it," I cried in astonishment.

"That's not much of a dream, is it?" he asked, turning around and showing me his back.

His clothing was rent by one huge tear from the nape of the neck downward, and on the bare flesh there were four great claw marks showing red and angry through the torn cloth.

Without further parley, I hurried him off to my tent where I bathed and dressed his wounds and when I had made him comfortable I got from him the story. It appeared that his train was very late, and it was quite dark when he arrived at Tsavo. He set out afoot along the railway track



to my camp, accompanied by Abdullah, his sergeant of askaris (police), who walked close behind him carrying a lighted lantern.

All went well until they were about half-way through a gloomy cutting when the man-eater suddenly jumped down upon them from the high bank, knocking Whitehead over like a ninepin and tearing his back in the manner I have described. Fortunately, my friend had his rifle and instantly fired. The flash and the loud report must have dazed the lion for a second or two, enabling Whitehead to disengage himself. But the next instant the brute pounced like lightning on the unfortunate Abdullah, with whom he at once bounded up the bank and made off.

The lions had now established such a terror that practically all the men deserted in a body and fled back to the coast. The few who remained with me slept in trees or perched on the top of water tanks so as to be out of reach of the man-eaters.

A few days after the death of Abdullah, I was leaving my inclosure soon after dawn, when I saw a native running excitedly toward me, shouting out, "Simba, Bwana, Simba" (Lion, Master, lion), and

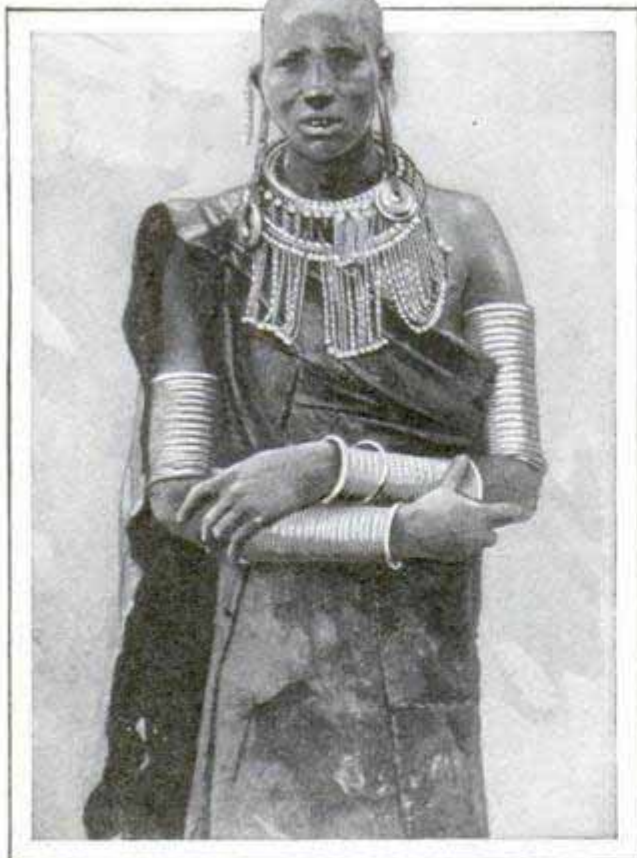

Love of Finery Is Also a Characteristic of African Women, Though They Are Not Highly Civilized

every now and then looking behind him as he ran. On questioning him, I found that one of the man-eaters had tried to break into the camp by the river, but, being foiled in this, had just seized and killed a donkey and was at that moment devouring it in the jungle close at hand.

I rushed for a heavy rifle and crouched and crawled from bush to bush, very anxious lest I should be discovered and the lion clear off. In a short time I had the satisfaction of hearing him crunching the donkey's bones and then, after a further short stalk, I saw the man-eater faintly outlined in the undergrowth.

But some uncanny influence seemed to guard this brute, for as I was taking aim, my guide put his foot on a rotten branch, and the wary beast, hearing the noise, growled his defiance and, before I had time to fire, disappeared into a patch of thick jungle. In desperation at the thought of his escaping me once again I ran back to camp, summoned all the available workmen and told them to bring every tom-tom, tin can, whistle and other noisy instrument that could be found.

As quickly as possible I posted them in a half circle as near as was safe to where the lion was hiding and gave the head jemadar instructions to start a simultaneous shouting and beating of the tom-toms and cans as soon as I had time to get round to the other side. I then circled rapidly behind the lion where I found a good position beside an anthill which the brute was most likely to pass when he left his hiding place.

Very soon I heard a tremendous din being raised by the advancing workmen and, almost immediately, to my intense joy, out into the open path stepped a huge maneless lion. Slowly and majestically he advanced along the path, stopping every few seconds to look round first to one side and then to the other, apparently not the least alarmed or flurried by the noise.

I covered him with my weapon, took a bead on his brain and pressed the trigger, but the gun misfired! Fortunately the lion was so distracted by the terrific din and uproar made by the advancing workmen that he bounded aside into the jungle and once more escaped.

After having heartily cursed the maker and owner of the rifle, I set off to take a



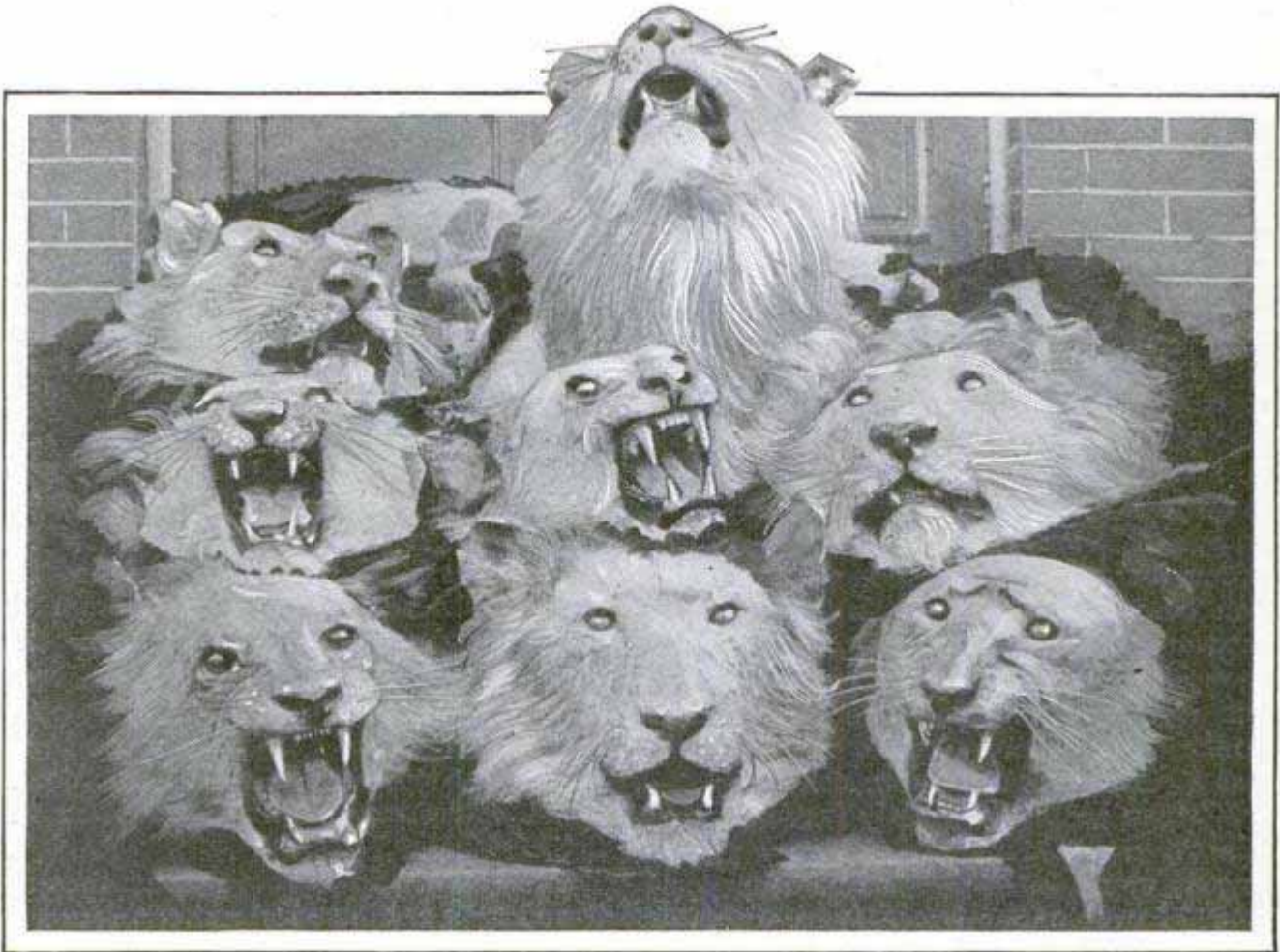

Heads of the Lions That Stopped a Railway; One Took Temporary Possession of a Station, Pacing Back and Forth on the Platform

look at the donkey for, of course, it would have been useless to follow up the lion in that tangled wilderness. I was delighted to find that only a small portion of the donkey had been eaten, and as I felt that the lion would return to finish his meal, I determined to be present to meet him.

Accordingly, as there was no suitable tree close at hand, I had a staging erected some ten feet away from the dead animal. This "machan" was about twelve feet high and was composed of four poles stuck into the ground and inclined toward each other at the top, where a plank was lashed to serve as a seat. Further, as the nights were still pitch-dark, I had the donkey's carcass secured by strong wires to a neighboring stump, so that the lion might not be able to drag it away before I could get a shot at him.

At sundown I took my position on my flimsy perch and, much to the disgust of my gunbearer, Mahina, I decided to go alone. I would gladly have taken him with me, indeed, but he had a bad cough

and I was afraid lest he should make any involuntary noise or movement which might spoil all.

Darkness fell almost immediately, there was not a breath of wind and everything became extraordinarily still. The silence of an African jungle on a dark night is most impressive, especially when one is absolutely alone. The solitude, the stillness, the purpose of my vigil, all had their effect upon me, and from a condition of strained expectancy, I gradually fell into a dreamy mood which harmonized well with my surroundings.

Suddenly I was startled out of my reverie by the snapping of a twig, and, straining my ears for a further sound, I fancied that I could hear the rustling of a large body forcing its way through the brush. Profound silence again followed. I sat on my perch like a statue, every nerve tense with excitement. Very soon all doubt as to the presence of the man-eater was dispelled. A deep long-drawn sigh—a sure sign of hunger—came from the bushes, and the rustling commenced again,



as he cautiously advanced. In a moment or two a sudden stop, followed by an angry growl, told me that my presence had been discovered, and I began to fear that disappointment awaited me once more.

But no; events now took a turn which made my blood run cold, for, instead of either making off or coming for his kill, the lion began stealthily to stalk me! For about two hours he horrified me by slowly creeping round and round my crazy structure, always out of sight, but gradually edging his way nearer and nearer. Every moment I expected him to rush the staging and it had not been constructed with an eye to such a possibility. If one of the rather flimsy poles should break, or if the lion could spring the twelve feet which separated me from the ground—the thought was not a pleasant one. I remember saying to myself, "There is a dead donkey down below there, but if there was a real live one, here he sits."

I began to feel distinctly "creepy" and heartily repented my folly in having placed myself alone in such a dangerous position. I kept perfectly still, hardly daring even to blink my eyes, but the long continued strain began to tell on my nerves and my feelings can better be imagined that described when, just about midnight,

something came flop and hit me on the back of the head!

For a moment I was so terrified that I nearly fell off the plank, for I thought that the lion had sprung on me from behind. Regaining my senses in a second or two, I realized that I had been hit by nothing more formidable than an owl, which had doubtless mistaken me for the branch of a tree. Not a very alarming thing to happen in ordinary circumstances, I admit, but coming at the time it did, it almost paralyzed me.

The involuntary start which I made when struck was immediately answered by a sinister growl from below. After this I kept as still as I could, though by this time I was actually trembling from the effects of the shock I had received. In a few moments I heard the rustling begin again. The lion started once more to stalk me, and presently I saw him move in the whitish undergrowth beneath. Before he could come any nearer I took aim and fired.

The sound of the shot was at once followed by a terrific roar and the brute began plunging about below me. I was no longer able to see him for he had leaped

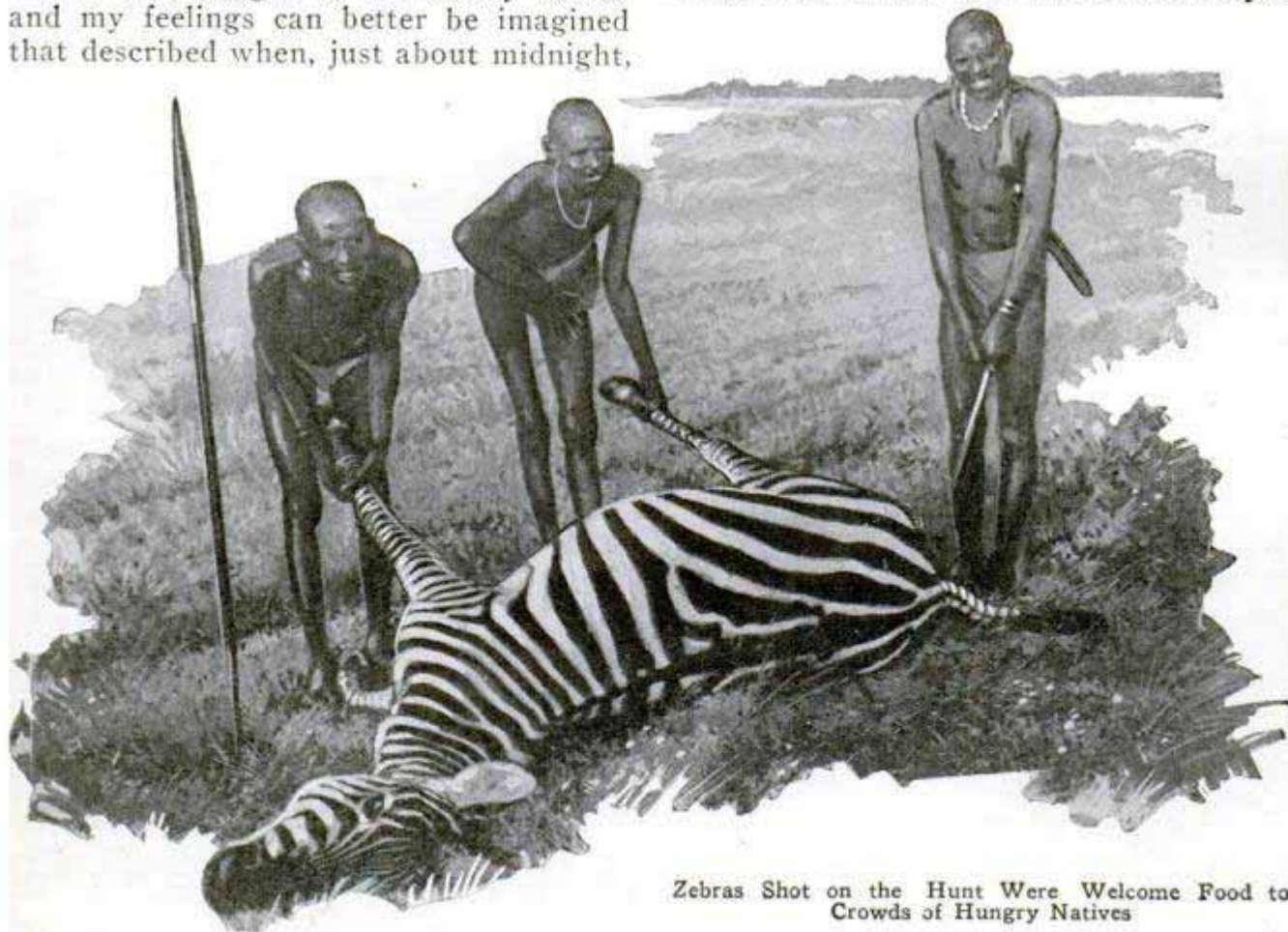

Zebra Shot on the Hunt Were Welcome Food to Crowds of Hungry Natives





Mr. Whitehead at the Spot Where Lion Attacked Him; Water Tank Fitted as Lion-Proof Apartment Rented at a High Figure; a Moment of Ease in the Jungle



into a bit of thick bush, but into this I kept firing until I had emptied my magazine. After a couple of mighty plunges and groans came complete silence, and then I knew that at last I had killed the dreaded man-eater.

As soon as I ceased firing, a tumult of inquiring voices was borne across the dark jungle from the men in camp about a quarter of a mile away. I shouted back that I was safe and sound and that the lion was dead. Whereupon such a mighty cheer went up from all the camps as must have frightened the denizens of the jungle for miles around.

Soon I saw scores of lights twinkling through the bushes. Every man in camp turned out, and, with tom-toms beating and horns blowing, came running to the

scene. They surrounded my perch, and, to my amazement, prostrated themselves on the ground before me, saluting me with cries of "Mabarak! Mabarak!" (Savior, savior).

When we found the lion in the bush, the men laughed and danced and shouted with joy like children and bore me in triumph shoulder-high around our fallen foe. I examined my trophy and found that my prize was indeed one to be proud of. His length from tip of toe to tip of tail was nearly ten feet and he stood almost four feet high, while it took eight men to carry him back to camp.

Our troubles, however, were not yet over. There was still the second man-eater left to harry us and demand his toll of human life. Eventually, however, I killed him. These two man-eaters had carried off and devoured no less than 135 of my men. The surviving workmen, to show their gratitude, presented me with a huge silver bowl.

☛ Veneer is being made by slicing blocks of wood instead of rotating and cutting them with saws.

*National White Cedar  
Co. 1111 Broadway*

*Mr. Edward Muller*



FLASHING LIGHTS SHOW MOVEMENT OF TAXIS

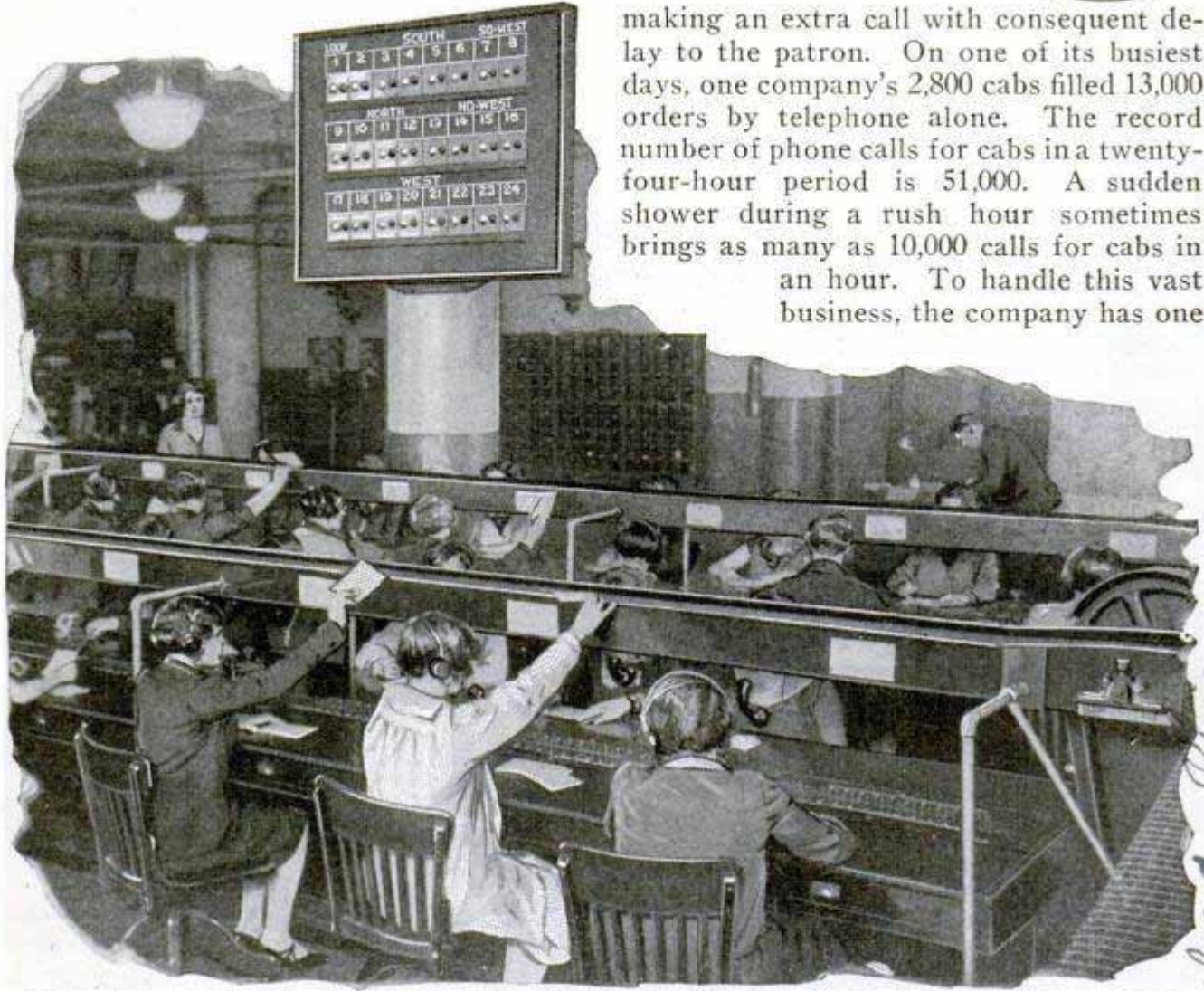

making an extra call with consequent delay to the patron. On one of its busiest days, one company's 2,800 cabs filled 13,000 orders by telephone alone. The record number of phone calls for cabs in a twenty-four-hour period is 51,000. A sudden shower during a rush hour sometimes brings as many as 10,000 calls for cabs in an hour. To handle this vast business, the company has one

Taking Orders for Taxicabs; as Slips Are Made Out, They Are Tossed on Moving Belt Which Conveys Them to the Dispatchers; Big Light Board, Above, Shows if Cabs Are Available

"Sorry, sir, but we are not taking any more orders for cabs." It is a rainy night and you have just phoned for a taxi. How did the operator know that all the cabs were busy? The mystery is explained by two sets of electric lights on either side of the long tables where rows of order takers at the receiving switchboard can see them. The lights are yellow and red and are grouped to represent cab-stand locations in all sections of the city. A red light flashing for the stand that would have served the caller's order, signifies that no more cabs are available. A yellow light means a delay of thirty minutes. The little signals are controlled from a set of switches near the line of order dispatchers, girls at a huge switchboard connecting directly with all the cab stands. The dispatchers can give instant information as to how many cabs are ready for service at any time, saving the order takers from

of the largest private telephone switchboards in the world, with seventy operators. Many girls in other departments are trained to aid during rush periods.

1566

**TIRE FLAP WITH SLOTS FITS MANY DIFFERENT SIZES**

Fashioned of a rubberized, fleece-lined cotton fabric, a tire flap now on the market

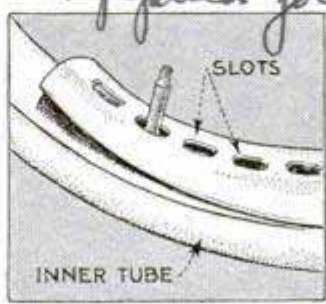

has seven elongated slots for the valve stem, so that it can be adapted to tires of every size with little adjustment. The ordinary flap with only one hole for the stem has to

be cut to fit a tire of a size different from that for which it was intended.

*The H. A. Schwartz  
Tire Flap Mfg. Co.*

*Cleveland, Ohio.  
Payne and  
3708*



Number 4/1/27

in northern part of Berlin.

**AIR-MAIL PARACHUTE DELIVERY TO SAVE LANDINGS**

2245

What the mail-pouch-snatching devices are to the small towns where trains do not stop, the parachute may be in delivering letters from airplanes, recent tests by the navy indicate. Crates of canned goods, packages of food and other articles have been sent overboard from low-flying planes and reached the ground safely, kept from crashing by the parachute which is much the same as those used by the flyers themselves. Success of the plan would eliminate a number of landings and would speed the handling of the mails. Tests have been made to determine what size of chute is best suited to the purpose. Small articles are sometimes picked up without stopping by using a lead line that grapples another to which the package is attached. This method has not been adapted to mail service, so far, being used only for relaying messages from the ground to the pilot.

*Small*

**AUTOMOBILE FIVE FEET LONG MAKES FAST TIME**

1146

Twenty-eight inches wide and only five feet long, an automobile built by a New York mechanic during his spare time, can attain a speed equal to that of much larger cars, he declares. It is completely enclosed and comfortably accommodates one person.

Midget Auto, Built by Mechanic during His Spare Time, Develops High Speed



*Built by d. sidor Lubin*

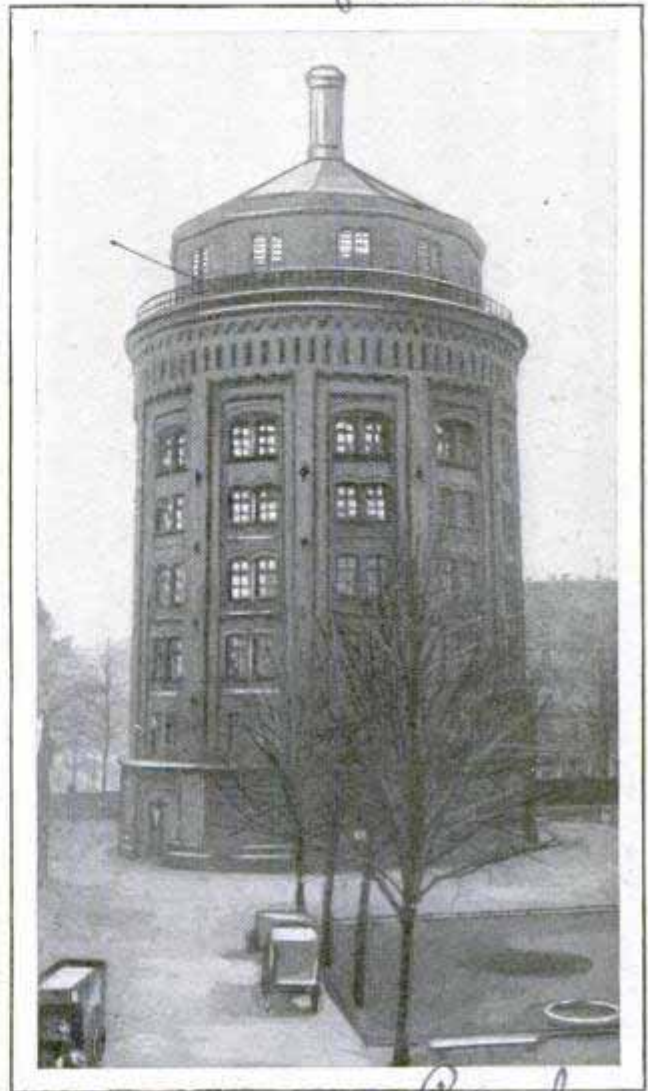

Berlin Water Tank Converted into Apartment House; Rooms Proved Popular Because of View

*Paul*

**OLD WATER TANK AS DWELLING RELIEVES HOME SHORTAGE**

Due to the house shortage in Berlin, it was found necessary to convert a famous old water tower into an apartment building. Floors, stairways and partitions were constructed and living quarters provided for several families. A feature of the arrangement is the unobstructed view afforded from most of the windows.

2253

**FOLDING GUARD FOR FIRE HOSE**

So that fire hose will not be damaged when run over by vehicles, a pair of hinged steel bridges, curved to fit over the hose, is quickly adjusted over the lengths. The guards fold up when not in use, are easily carried and weigh less than twenty pounds. They are conveniently stored in a fire truck, and serve to keep the streets open although the hose is down.

*J. W. Carpent Holmesch*



### NEW OVERNIGHT SLEEPING CAR HAS HOTEL COMFORTS

For travelers who make a single night's journey, a railroad sleeping car, recently introduced, has fourteen single rooms instead of the customary berths or com-

and a box under the bed, in which shoes are placed to be polished, waste basket and racks for baggage. Three bracket lamps furnish illumination and there is a small five-watt blue light for night use, saving the eyes from the glare of the regular lamps. Adjustments are made for

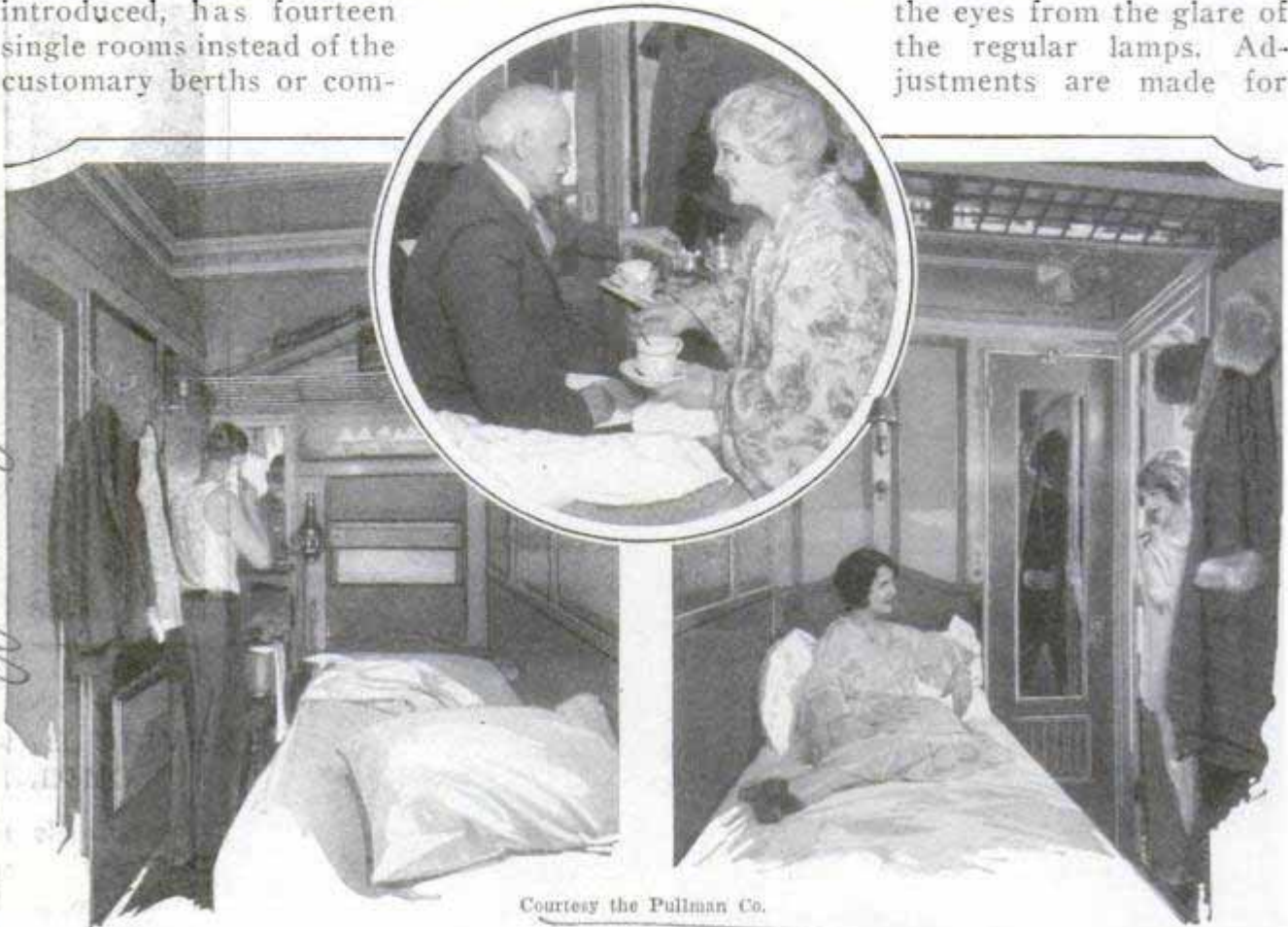

Courtesy the Pullman Co.

Views inside the Rooms of the Overnight Sleeper; Complete Toilet Facilities Are Afforded, Meals Can Be Served in Them and They Are Arranged with Connecting Doors

partments and many of the conveniences of a modern hotel. Each room has a bed instead of a berth, a washstand, toilet and cushioned chair, folding table for writing or for breakfast service, storage space

ventilation and heating to suit a wide variety of tastes. The rooms are arranged with communicating doors for the convenience of those traveling together and have entrance from a public aisle.

### STEEL GUARD IS WORN ON SHOE TO PREVENT INJURIES

Painful injuries to the feet and toes are suffered in many lines of factory and other work, due to accidentally dropping heavy weights. To prevent these casualties, a steel guard has been devised. It slips over the shoe, protecting almost the whole foot and is capable of withstanding severe blows. In a test, a 200-pound weight was

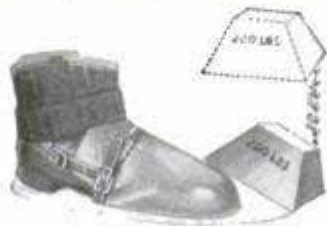

dropped upon the shield without damaging it. While wearing it, the worker's movements are scarcely impeded at all.

### EXCITEMENT ADDS TO WEIGHT OF CROWDS

Jumping up and down at a race or a football game, excited persons exert far more strain on a grandstand than the same number of spectators sitting still. Engineers must take this into account when constructing the seats, for the "weight of excitement" may result in mishaps unless due allowance is made for it. In building

Standard Safety Equipment Co

1060 Broad St, Newark N.J.  
220 Delaware and Buffalo, N.Y.

daily mail 3/11/21



a grandstand, if the total weight of the persons to be accommodated is placed at 300 tons, for instance, a support strong enough to hold 1,000 tons will be made if the builders are wise, so that there will be a liberal margin for extra strain. A man crouching adds about sixty-five per cent to his weight in straightening up. Rising from a sitting position adds nearly eighty per cent, and it is possible, by getting up with a sudden jerk, to increase the normal strain on the support by more than 150 per cent. Another factor taken into consideration is the effect of vibrations from many feet beating in unison or the united sway of numbers of rooters.

**OIL-ELECTRIC TUG COSTS LESS TO OPERATE** 2011

Maneuvered more easily than an automobile and able to turn around in its own length, an oil-electric tug has been added to the New York harbor fleet of an eastern railroad. Engines, propulsion machinery and rudders are all controlled from the pilothouse, the captain keeping one hand on the steering wheel and the other on the control lever with which he can vary the speed for ahead and astern movements. The tug is 108 feet long over all and has a twenty-six-foot beam. The average fuel cost per day in twenty-four-hour service is approximately \$45 as against \$156 for an equivalent steam tug, it is said.

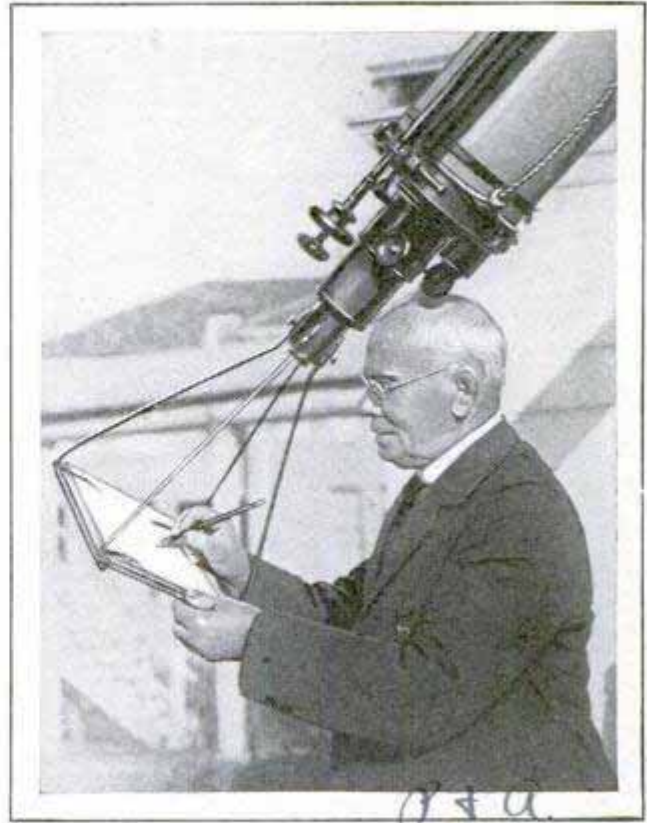

Father Ricard at His Telescope, and Map on Which He Records Position of Sunspots

**SUNSPOTS ARE DRAWN ON MAP AS CLUE TO WEATHER**

By studying the size and location of the spots on the sun, Father I. S. Ricard, of Santa Clara, Calif., known as the "Padre of the Rains," makes deductions and prophecies concerning the weather. He charts the spots with the aid of a record board in connection with his telescope.

According to his theory, these phenomena, weather cycles and the conjunction of the planets Saturn and Jupiter, are associated. The spots are believed to cause a decrease in solar energy and therefore lower temperatures on the earth if they occur in sufficient number and often enough. On the other hand, when the planets are in conjunction, it is thought that an abnormal fall of meteoric matter occurs on the sun, with a consequent increase in its heat, which will result in a hot dry season on our globe.



For Rapid Service in New York Harbor, Oil-Electric Tug That Is Entirely Controlled from the Pilothouse

*Chiggersoll - Rand Co, 11 Broadway New York*  
*Engines - Generator - Westinghouse*



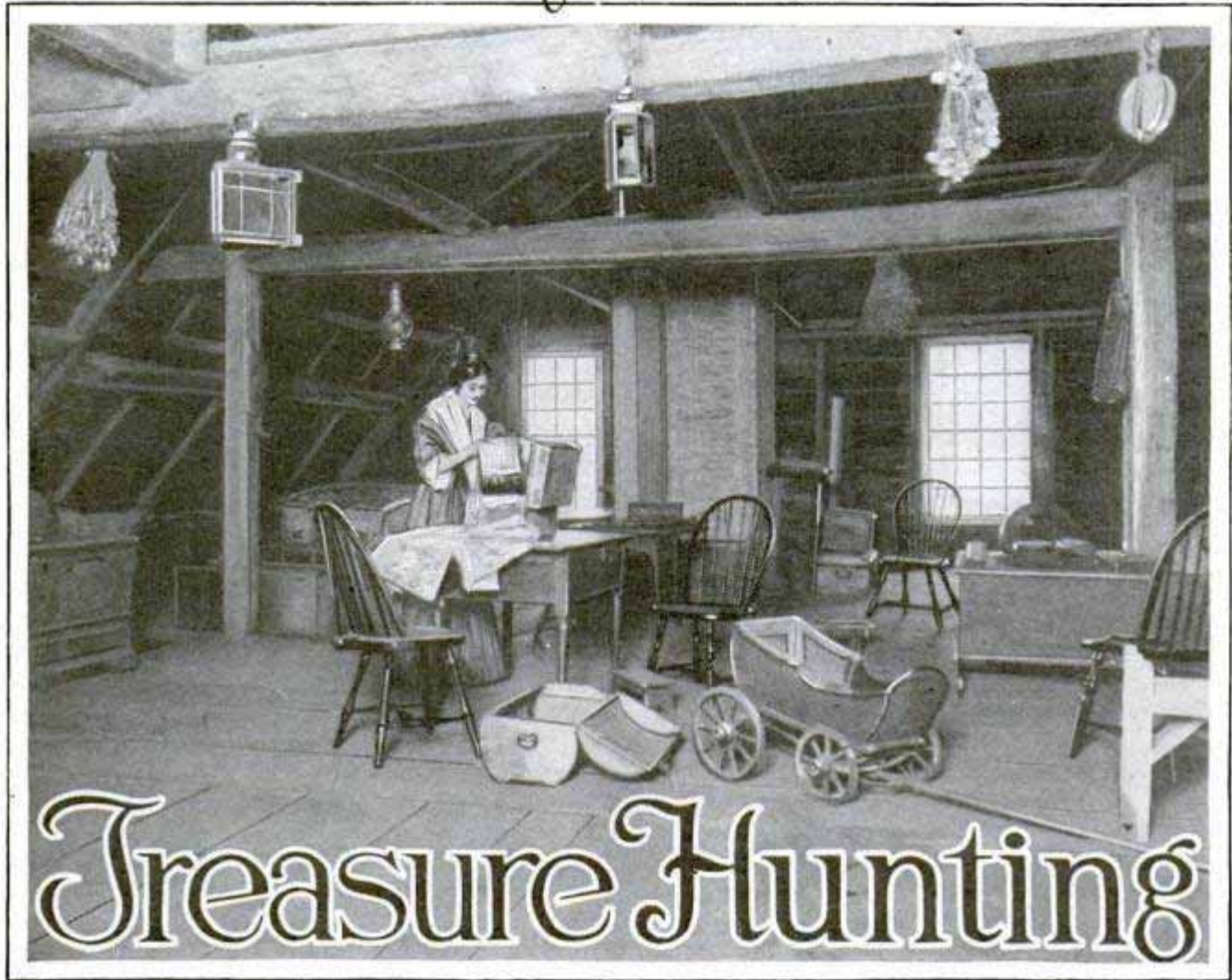

By PAUL PADDOCK

Copyright

**F**INDING fortunes in old chests smacks of pirate days and buried gold, but treasure that would make a pirate's palms itch is now discovered in old attics.

Rummaging in her garret a few weeks ago, a woman found an old platter that had belonged to her grandmother. She showed it to an antique collector who appraised it at \$1,000, for it happened to be a rare old blue Staffordshire piece decorated with an American scene. In an old scrapbook among a boy's possessions, what he thought was just a number of colored pictures turned out to be Currier and Ives prints worth \$100. A secretary desk that had been "knocking around" a farm house for years sold for \$1,000.

You, too, may find treasure in your attic, but the probability is that few, if any, of the old articles you locate, will have any startling value. The reason is simple. For nearly fifty years, collectors have been busy in this country. With few excep-

tions, the choicest pieces have been purchased. They are now in museums or in private collections. Of the antiques now available, reputable dealers and collectors assert that fully eighty per cent are either copied from genuine articles, are actually of mediocre value or worse, or are frauds, cleverly executed and difficult to identify.

But there are still many valuable things "at large," and the whims of collectors produce startling changes in demands. To know and appreciate the value of old things requires long experience, extensive study, close touch with current prices and markets, and a discriminating sense of beauty and good taste. There is no set of rules by which identifications can infallibly be made. Even experts cheerfully admit that they, no less than the layman, are fooled almost every day.

In the eyes of the government, an article must be at least 100 years old to be an "antique." If it is, it may be imported free



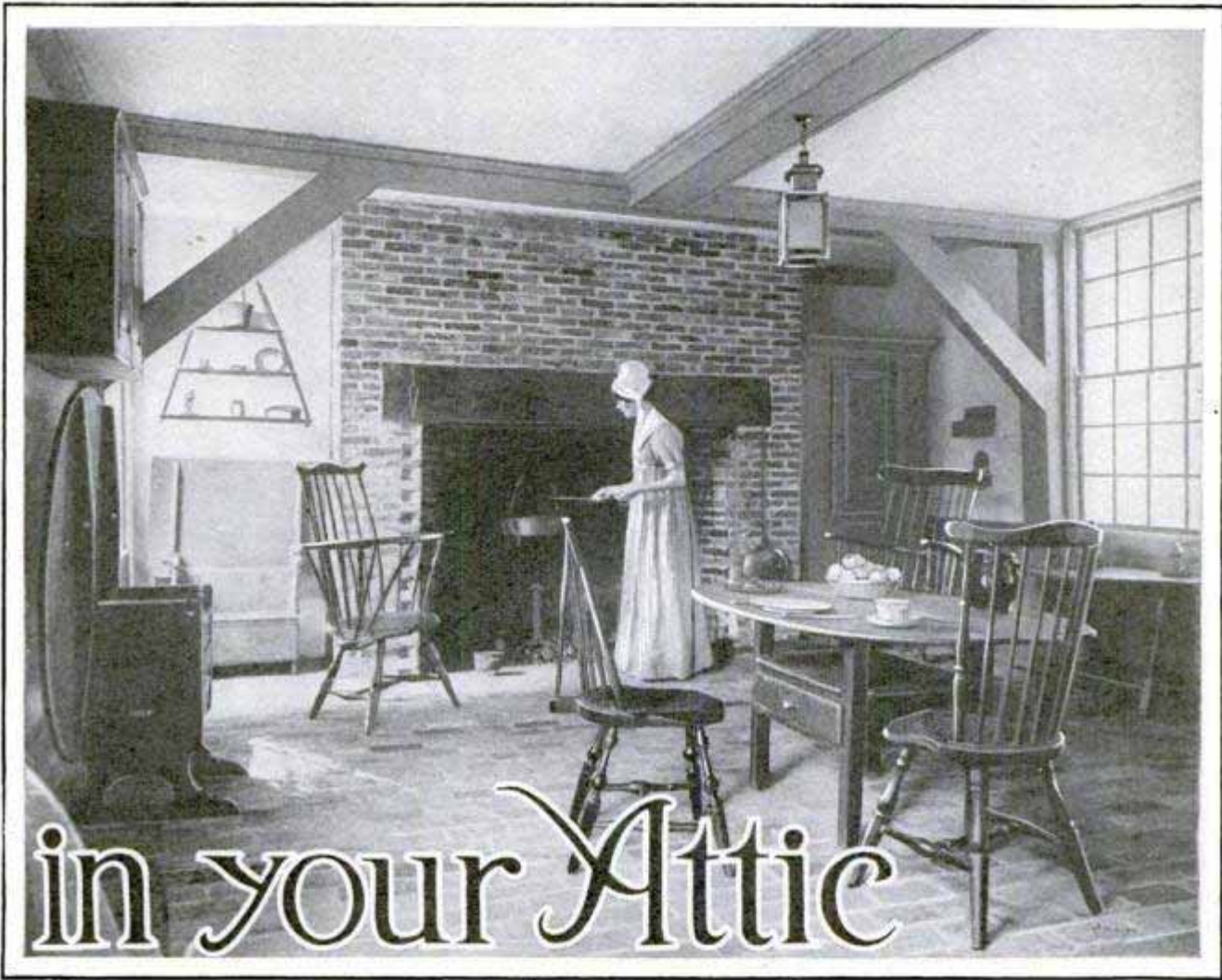

Wallace Nutting

of duty. This regulation simplifies the definition, but it has placed a burden on inspectors and has led to all sorts of embarrassing consequences to ardent collectors who pay immense sums for articles only to find that the goods are spurious and that duty must be paid on the basis of the price. If you buy an imported antique, ask to see the affidavits establishing its age or find out if it passed the custom office duty-free.

Many American-made objects not yet a century old, however, are in demand. Things made here during the early colonial days and for several years after the revolution are prized not merely for sentimental reasons, but because many of them are still in splendid condition and are both rare and serviceable. That period saw the establishment of the first glass factories in this country, the early Stiegel and Wistarberg products now being highly prized for their rich and beautiful colorings. At the looms, women were making the choice

coverlets and other articles that since have been dignified with the name "American tapestries."

Duncan Phyfe, America's greatest cabinetmaker, had his shops going shortly after the revolutionary war. New Yorkers of his day thought nothing of paying \$800 for a set of his furniture. At one time, he had 100 men working for him, and at his death, his fortune was placed at \$500,000. He was such an expert cabinet craftsman that the government commissioned him to make the box in which the bottles that contained Lake Erie water were placed and sent to Lafayette at the time of the opening of the Erie canal. Phyfe, William Savery, and other early artisans, did not originate patterns, but they carefully and expertly copied or adapted the best designs of their day. They had plentiful stocks of wood from which to select. They were careful to cut it at a time of year when the sap would not discolor it and when it would cure the best. The simple



fact that many of their pieces have lasted all these years and are still in almost perfect condition, proves their worth. Partly because there is a reaction from the sameness of the machine-made products of this modern age, because many of the old pieces of furniture and other objects are

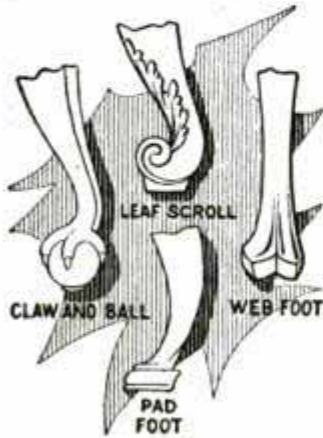

still beautiful, serviceable and now rare, and because many Americans have the time and money to devote to collecting, the buying and selling of antiques has become a profitable business to hundreds of persons and an in-

spiring hobby, full of adventure, romance and discovery, to others.

The first American furniture was of oak, pine, maple, cherry and walnut. You will not find the earliest pieces in mahogany. Interiors of drawers in American-made chests and bureaus were usually of pine, while the English-made were of oak. On the underside of the drawers, hand-plane marks are often visible and the center of the drawer bottom is often a little thicker than the ends. Dovetailed corners predominate in American-made pieces. Look for the natural signs of age. In chairs,

for instance, the front legs tend to wear down on the front side and the rear legs at the back simply through repeated draggings over the floor. Overlooking this simple point cost a wealthy collector several hundred dollars. He was tricked into buying a modern chair as an antique. Its straight unworn legs, revealed the fraud to a practiced appraiser. Old mahogany rarely contains genuine worm holes. A deciding factor is often the aged look and "feel" of the wood. Time puts on a finish, or patina, that is hard to imitate.

Determining the age of an article is but one consideration in the appraisal and but



one feature of its importance as an antique. To have sales value of any consequence, an article usually must be in good condition. In furniture, certain patterns are considered more choice than others. The would-be collector or purchaser will

do well to study such styles as Chippendale, Sheraton, Adam and Heppelwhite. If a piece is said to be a Chippendale, it probably is either comparatively new or at least 130 years



Group of Early Lighting Implements, Showing Development from Candlestick to Lantern of Paul Revere's Time and Down to Glass Lamps, Forerunners of the Modern Fixtures



old, for it was not made in any quantity after 1800, being supplanted by other styles. There was an abundance of cheap and poorly made furniture in the old days just as there is now.

Identifying old glass requires the skill of an expert, but the novice can learn to look for the rounded corners and edges that indicate old age, the minute pits, best seen under a microscope, showing that the glass has weathered, and by thumping a piece and listening for the ring, he can learn something of its quality. Experts tell much by the sound and even more by the color. In blown pieces, they feel the pontil mark, that rough spot at the base of the article where it was broken off, while still hot from the blower's rod. A large, rough pontil mark is generally associated with considerable age. Just now, collectors seem to be interested in more than fifty kinds of china and porcelain. Each has its peculiar qualities, as have the dozens of different kinds of glass. It takes a skilled appraiser to identify an old

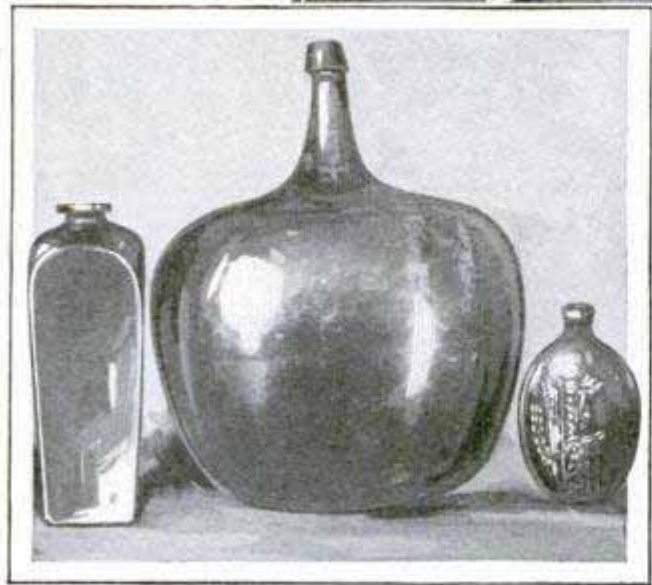
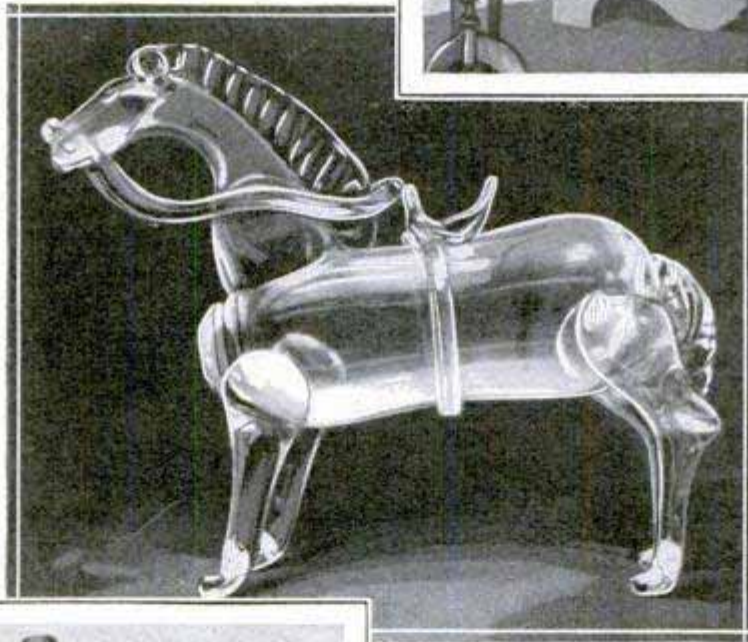

clock, but it is helpful to remember that the oldest "grandfather" specimens did not have seconds markings and the cord that held the weights was made of gut.

Appraisal of old paintings is a difficult task even for the professional. In a doubtful case, the name, canvas or panel cannot be relied upon, for all are commonly faked. Sometimes a retouched painting is detected by a simple method. Examine the cracks on the surface. If the subject has been retouched, some of the paint probably will have lodged in the cracks, otherwise the openings will be sharp and clean.

Benjamin K. Smith, an art appraiser of thirty years' experience, gives this advice to the antique buyers: "Read about antiques, familiarize yourself with them by visiting museums and private collections, if possible, and know what you want before buying." Use common sense and you often will be able to detect a fraud.

Center Photo Courtesy Art Institute, Chicago  
Cupboard of Early American Articles; Glass Bottle in Form of Horse (Eighteenth Century English), and Colonial Rum Bottles



56  
2157

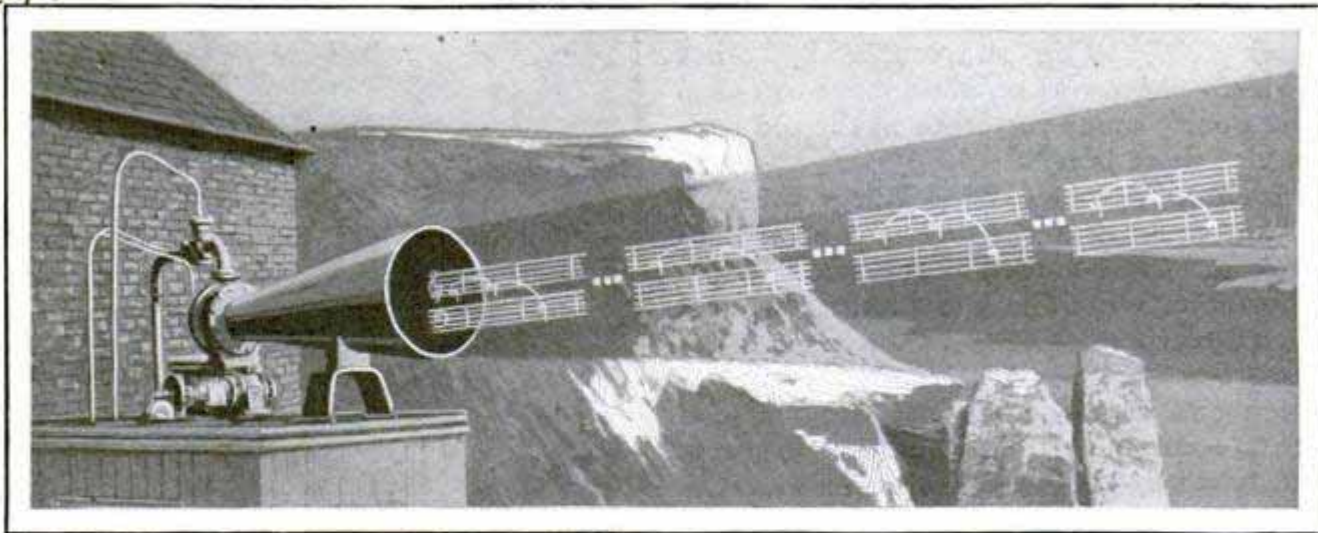

Courtesy the Sphere

Huge Fog Horn and Scale Diagram to Illustrate Its Changes in Pitch; the Signal Is Repeated Every Three Seconds and Can Be Heard Many Miles

### POWERFUL TWO-TONE FOG HORN HEARD FORTY MILES

2157 Two-note blasts are sounded every three seconds from an improved type of fog horn which has been devised to help guard the English coasts. The signal starts on one tone and drops an octave and two full notes, producing a sound somewhat like that of the trumpet on an organ. One type of this horn has been heard a distance of forty nautical miles.

### SEA CHART OF BAMBOO STICKS GUIDED EARLY SAILORS

2152 One of the interesting objects in the American museum of natural history is a navigation chart constructed of thin strips of bamboo, securely tied together to form a kind of pattern of routes among the South Sea islands. This particular chart was given to the

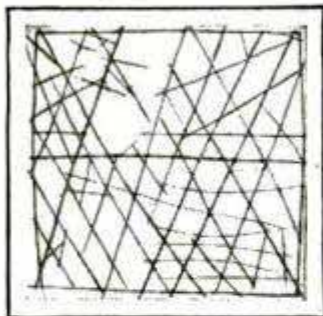

museum by Robert Louis Stevenson and was used by early navigators long before more modern means were known. It is believed that the sticks represent currents as there are four distinct sets of swells from four quarters of the seas at various seasons of navigation, which were closely studied by the natives. Charts like these are but little used now, but there was a time when young children were required to pass an

examination in them, learning them by heart, as they were never taken to sea. Distances between the islands were measured in terms of hours instead of miles.

### FIVE-YEAR CALENDAR SERVES 1934 AS PAPER WEIGHT

Calendar sheets for five years and a glass paper weight, suitable for the desk or table, are combined in one useful article now on the market. The calendar months are printed on a roller which is quickly adjusted by inserting the finger in a hole at the bottom of the weight. The fact that the calendar cannot tip over commends it especially.



### HINGES ON PILL BOXES PREVENT 2300 PATIENTS' MISTAKES

To safeguard against administering or taking the wrong kinds of pills, the navy medical corps has had hinges placed on the boxes containing these medicines. This prevents misplacing covers and identifies containers that have special pills. The plan was adopted in view of the tendency of influenza and other patients to regard capsules merely as capsules and to take them without always first determining their nature. Aspirin, quinine, calomel, etc., are now kept in the new hinged boxes.

Muller Bros. 2941 W. Park St. Chicago

South Sea Island Hall



GETTING MAHOGANY TO MARKET  
BIG ITEM IN ITS COST

2255

One of the chief reasons why mahogany costs as much as it does, is the expense of logging and bringing it to the markets. The supplies are found in the forests of Mexico, Honduras, Guatemala, Costa Rica and Nicaragua, where trails must be blazed through dense growths to the nearest streams for floating the logs out. The trees are sighted by scouts who are guided by the mahogany blossoms. To avoid the onslaughts of the teredo, the logs must be "boomed" in fresh water. Often whole shipments of the wood are destroyed by this parasite, which attacks mahogany more quickly in salt water than in fresh.

*Have*

INDOOR MOVIES FOR AMATEURS  
TAKEN WITH NEW LIGHT

*Kirby. Lite*

2061

A motion-picture studio in his own home, without the need of special electric wiring or elaborate apparatus, is now afforded the owner of a movie camera in a 500-watt lamp supplied with current from the house-lighting circuit. It has a lens of prismatic construction to direct the rays for the most efficient picture taking, is cool to the touch after long use, and can easily be moved about on an adjustable tripod. More than one lamp may be used for special purposes, as in photographing of groups, and a reflector made from white paper or cloth is effective in reducing shadows. The lamp is also suited to the needs of sculptors, artists and surgeons.

42.75

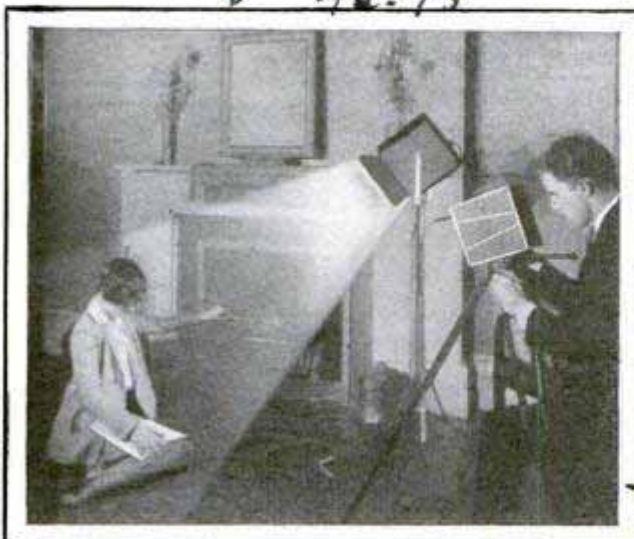

Amateur Taking Movies in Living Room with Aid of the Portable Light for Home Use

*Kirby, Inc., 2 E 23 rd St. New York*



1583

For Faster Work in Building Cars; the Double-Barreled Nail Driver Operated by Compressed Air

DOUBLE-BARRELED NAIL DRIVER  
SPEEDS CAR BUILDING

Having two tubes, or barrels, instead of one, as is the case in the ordinary unit of its kind, a nail-driving apparatus devised by a railroad repairman saves time in car construction and similar work. It operates by compressed air, and is suited to twenty, thirty and forty-penny spikes. In a test, it drove 2,000 nails in one hour. It weighs only twenty-five pounds, is three feet high and is said to function with great efficiency, bending and kinking being impossible unless the nails strike metal.

*W. J. Miller, Benga All-Car Repairman, Rogersport, Ind.*

BACKFIRE DANGER IN BOATS  
STOPPED BY VALVE

2254

Danger of fires on boats is reduced in a motor equipped with an automatic safety valve at the air intake of the carburetor. It closes in case the engine backfires, and the intake is so arranged as to trap gasoline which ordinarily leaks through the carburetor when the motor is flooded by too much choking. This feature also prevents waste and insures better operation, when the engine is cold, by affording a richer mixture.

*Chicago. 800 h. Clark*

*Universal Motor Co. Ash Grove, Wis.*

206 Madison



**METER ON PHONE  
WILL REDUCE  
IDLE TALK**

2199

Better service to patrons as well as a reduction in operating costs to the company, are results reported in a western city from the use of a special meter on the telephone. It measures the charge to be made on the basis of the actual time the instrument is employed. It is said to discourage the person who ordinarily would monopolize the phone, and while twenty-five per cent of the patrons paid twenty-two per cent more with the meter than on the flat-rate plan, seventy-five per cent averaged twenty-seven per cent less. The company effected a saving through installing a large number of multi-party lines instead of expanding private facilities, which would have cost \$238,000. Shorter conversations made the many-party lines practical. The average time of telephone conversation was practically cut in half, thus dou-

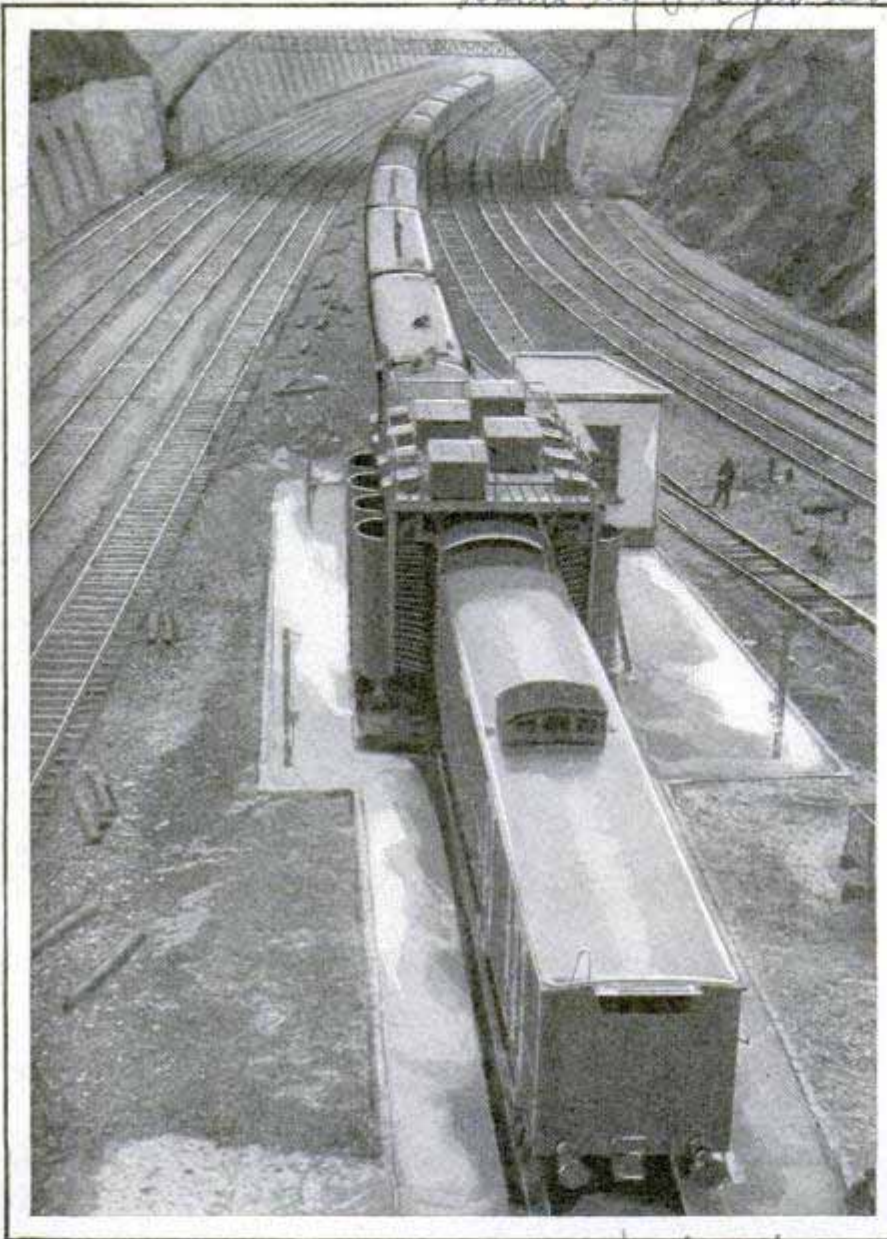

Cars in the Cleaning "Tunnel"; Brushes Wipe Sides and Windows, and Vacuums Help Remove Dust and Dirt

### **"TUNNEL" FOR POLISHING TRAIN SAVES HAND LABOR**

After passing through most tunnels, trains are usually dirtier than they were when they entered, but exactly the reverse is true of a passage over one of the railroad lines in France. After going through it, every car is brushed and vacuum-cleaned, saving the time and labor required for scrubbing with hand implements. The tunnel is an archway which is lined with brushes and vacuum-cleaning attachments. As the train is pulled slowly along, the polishing and cleaning apparatus functions automatically and, in doing so, reaches almost every part of the exterior of the cars.

bling the capacity of the company's switchboards. The meter also discourages "listening-in" on other conversations as it registers a charge for such an intrusion, just as though the subscriber were making a call of his own. Rates are based on a sliding scale, the cost decreasing as the calls are longer.



☞ Laws protecting native wild flowers have been passed in fifteen states.



330 Fifth Ave  
New York City

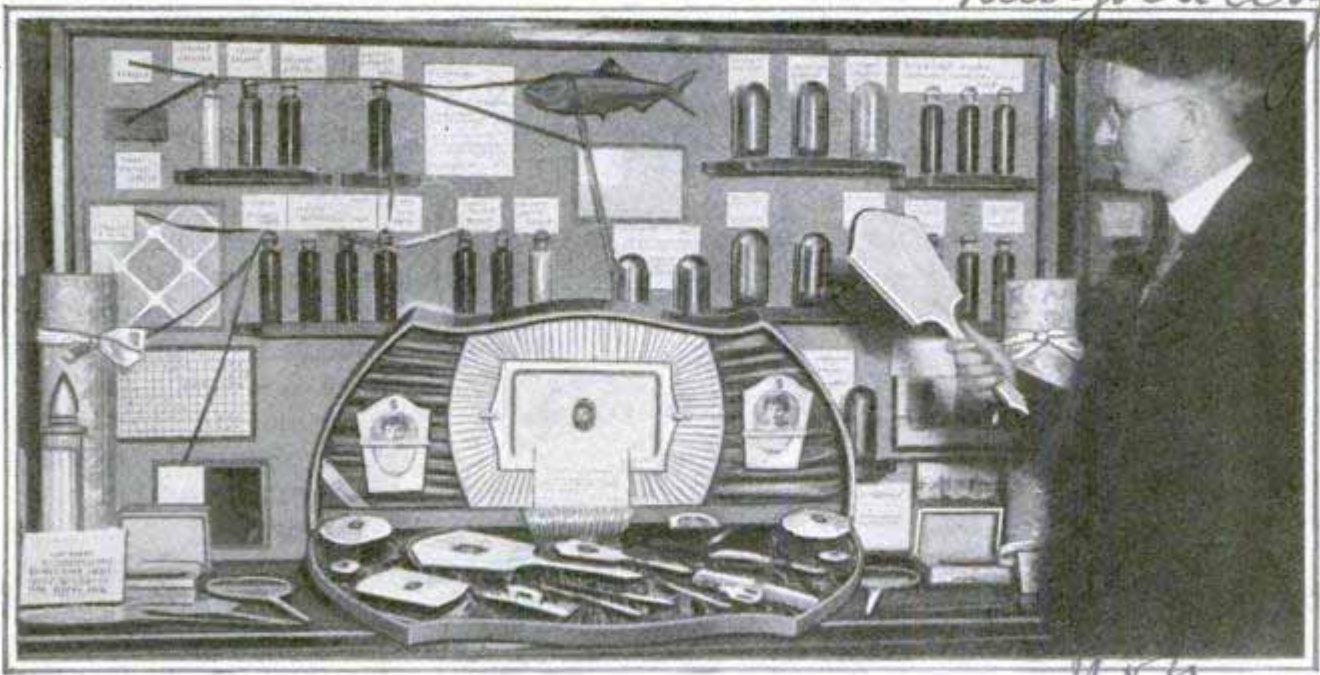

Lewis Radcliffe, Acting Chief of the Bureau of Fisheries, Holding a Mirror, the Back of Which Is Made of Fish Scales, Other Articles of Same Material in Case

### TOILET GOODS OF FISH SCALES LIKE MOTHER-OF-PEARL

Some 2,000,000 pounds of fish scales are used every year in the United States in manufacturing backs for toilet articles. The material resembles mother-of-pearl.

### TUBE CAN START GREAT SHIP WITH ENERGY OF FLY

Stopping a train with a dewdrop and starting a battleship on a fraction of the energy exerted by a fly walking upward at the rate of an inch a second, suggest impractical fancies, but they are possibilities with an electrical control tube recently introduced. It is so sensitive that the shadow of the hand, a drop of water, the flame of a match, or the raising and lowering of a window shade sets it in operation. Many practical uses are seen for it. Window-display lights might be flashed on and off by the shadows of per-

sons looking in; it could be adjusted to count automobiles or pedestrians passing a given place, provide fire and burglar alarms, turn lights off at daybreak and on at night, or shut off gas when the burners or lights are extinguished by accident. The unit is like a radio tube in size and external appearance, but has no filament and contains neon, argon or some other gas. It functions as a relay, operating on about one-billionth of a watt, but has an amplifying power of about 100,000,000, or sufficient to start a current through the tube

which will close or open a switch handling upward of twenty-five amperes. This is enough for controlling almost any operation. The tube is connected directly with an ordinary 110-volt alternating house current.

D. D. Knowles, the Inventor, Demonstrating Effect of Hand's Approach on Sensitive Tube

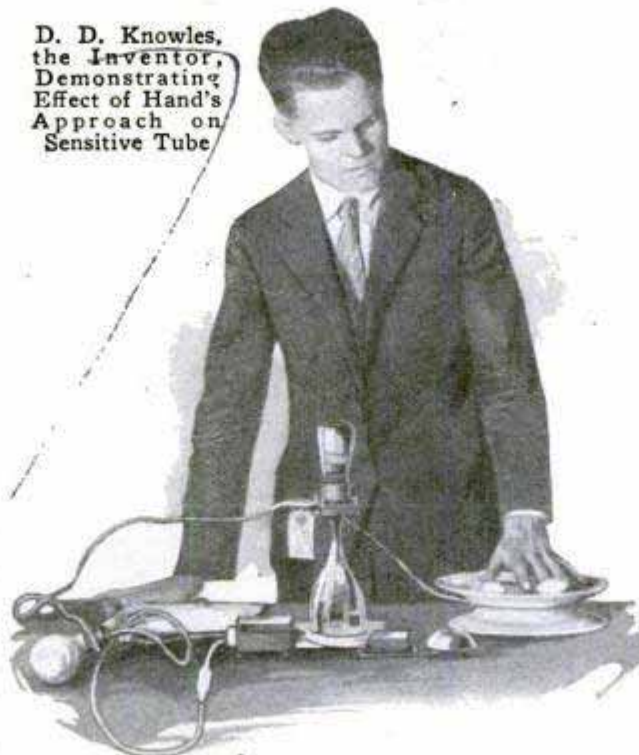

☐ We want all our readers to write us freely and often whenever they wish additional information on articles published in this magazine. Address Bureau of Information, Popular Mechanics.

Westinghouse Electric & Mfg. Co.



315 Trinity Bldg 168 Northmouth St  
 60 POPULAR MECHANICS  
 2142 Boston, Mass.

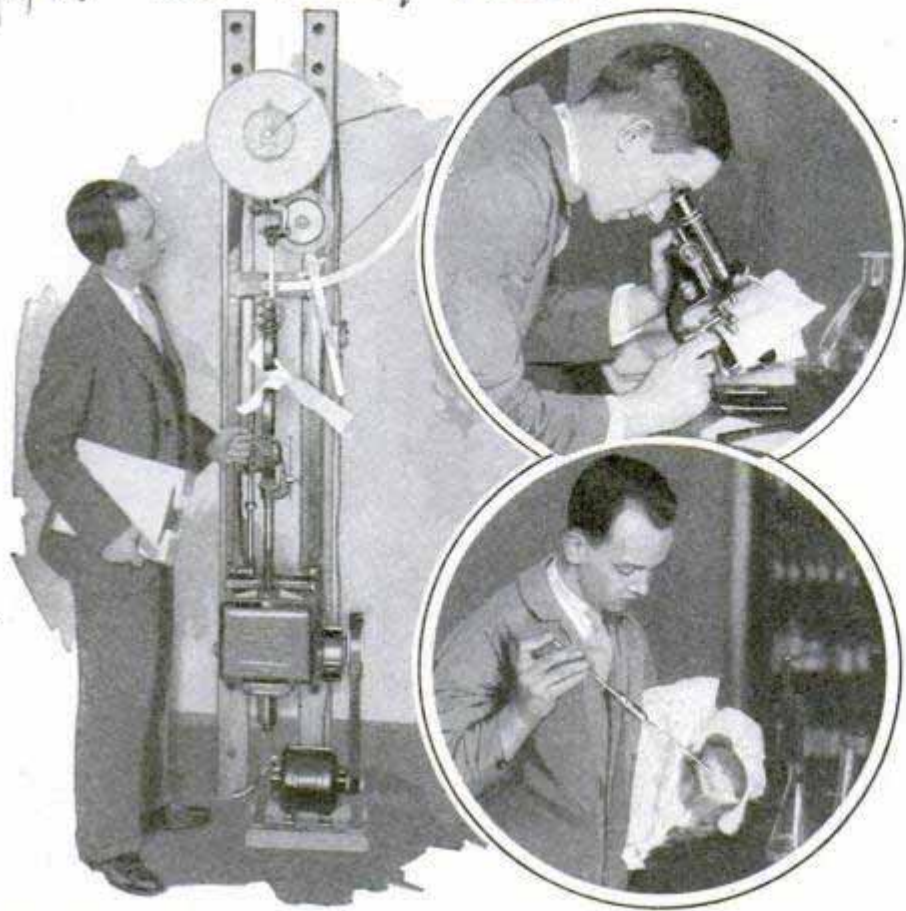

Tearing a Collar to Test Its Strength; Examining Laundry Spots under the Microscope, and Treating a Plum-Juice Stain

**HOW TO MAKE CLOTHES LAST LONGER TOLD BY TESTS**

2142

Methods of prolonging the life of clothing and linen have been tested at the Massachusetts institute of technology. Collars that will wear nine months instead of six, sheets that will last four years instead of two, wash-dress materials, tablecloths and other linens whose durability has been greatly extended; these are some of the results already achieved by the research, which was started more than two years ago. With collars, it was found that the greatest wear comes at the point where repeated flexing in fastening causes cracking at the fold. The habit of frequently adjusting the collar, tightening the tie or taking the collar off and on rapidly breaks down the fabric. It

was also found that stains which often appear on table linen are the most difficult to remove. Among these are blueberry, tea, peach, plum, grape and mustard, the latter being the hardest to remove, while grass stains are also difficult to treat. Orange juice leaves virtually no stain and tomato stain is easily removed. A study of twenty-three laundries co-operating in the research revealed the great contrast between the washboard, tub and household ironing board and modern laundry equipment. In the average plant, it takes about one and one-quarter hours to run 250 pounds of clothes through the washer. Where our grandmothers used one or two changes of water,

the modern laundry washes in eleven waters, including three complete changes of soap and a number of rinses. Control of temperature is a most important item. The water should not be above 190 degrees Fahrenheit during the soap bath.

**MULTIPLE-LINE RUBBER STAMP HAS MANY USES**

Interlocking lines, which can be arranged in various combinations, feature a rubber stamp that performs the service of several, saving the purchase of extra units and the trouble of storing and selecting them. The lines are simply separate small stamps and are set up like a "stick" of type. An ordinary elastic band is sufficient to hold the different parts together and they are quickly rearranged.

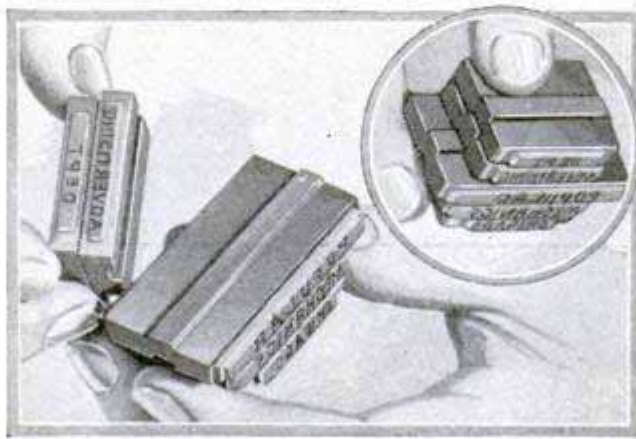

Rubber-Type Lines Arranged in Various Combinations Afford Service of Several Stamps in One

*William James, 1777 Esplanade*



Paul St. Baltimore, Md

# Harvesting Telephone Poles

**A**N endless stream of telephone poles must be kept moving from American forests to supply the demand that sees no interruption from one year's end to another.

During a sleet storm in February, the telephone company which serves Baltimore reported the loss of 783 poles in a single night. Multiply this by the number of companies operating in the snow belt

and the aggregate is startling. For replacements and new construction, the wire companies of the United States require more than 4,000,000 poles a year, equivalent to one pole for every fifth family. Most of these are used by telephone and telegraph companies, with the remainder divided among the electric-light and power corporations and other users. The Bell telephone system alone has approximately 15,000,000 poles in service. The



Comparative Height of a Stand of Douglas Fir and Ten-Story Office Buildings in Seattle; These Immense Trees Yield an Enormous Footage When Cut Up into Lumber, Leaving the Tip for a Telephone Pole



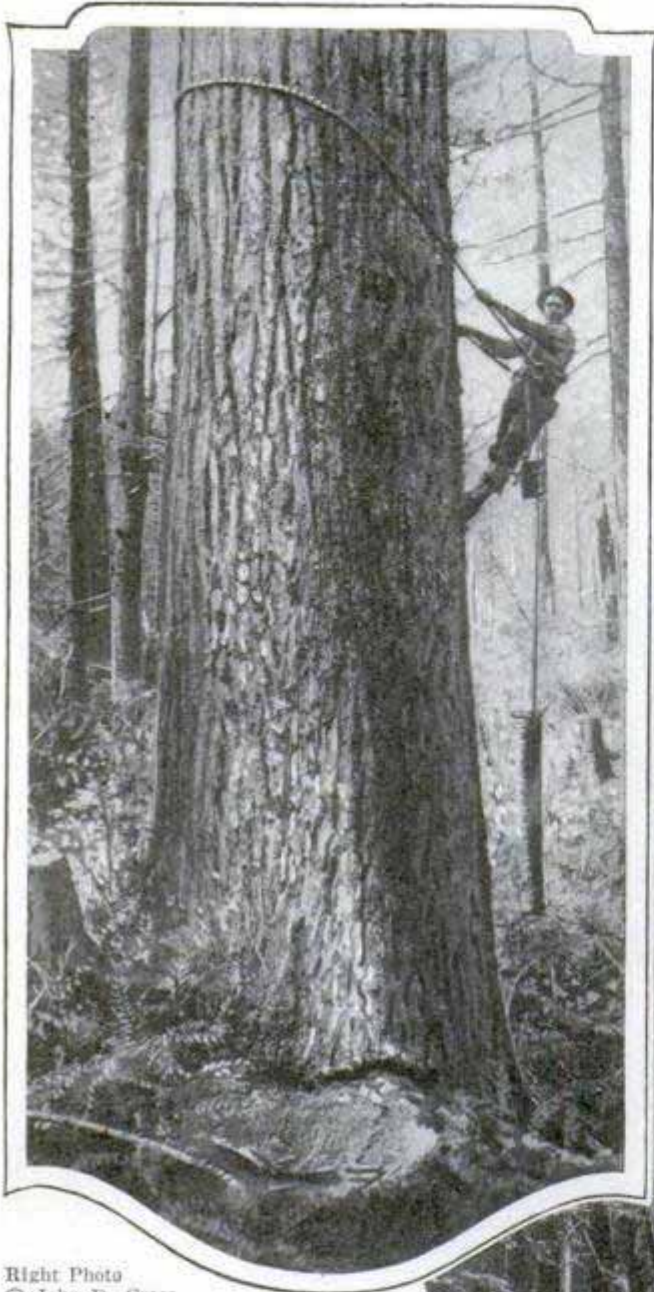

Right Photo  
© John D. Cress

cost of the poles averages about \$16 a piece for the standard thirty-five-foot length.

There are four regions of the United States to which the nation looks for its pole supply. The lake states furnish northern white cedar. From the south come the trunks of yellow pine trees. The eastern states furnish a diminishing volume of chestnut. From Idaho, Oregon and Washington there is a growing output of western red cedar, supplemented by the lodge-pole pine and Engelmann spruce of various states in the west and northwest. Southern white cedar is find-

ing increased favor in the warm climate of the south, where severe ice storms are not a factor of destruction.

With growing demand and with a supply steadily curtailed by vanishing forest resources, the life of a pole becomes a matter of much concern to the wire companies. The best practice calls for preservative treatment in tanks filled with coal-tar creosote, before the poles are planted in the earth. Poles in service are given brush treatment below the ground line. This latter method requires the dig-



A Topper Starting up a Douglas Fir, at Left, and, Above, Waving a Greeting to the Crowd after Topping the Tree

ging of a hole, two or three feet in depth, the scraping off of all decayed wood and dirt from the exposed part of the butt, and the application of creosote to the underground surface.

A simple and inexpensive practice for extending the life of poles already in place



*Assumption of Clothing Designers at Waldorf*  
 "PICK-PROOF" TROUSERS POCKET  
 PUT IN UPSIDE DOWN  
*Astoria, N.Y. 1538.*

is that of providing reinforcement in the form of a durable stub. Wired or bolted to the parent stem, the stub will carry the load even if the pole itself is severed by decay at the ground line.

The task of harvesting 4,000,000 telephone poles a year employs many thousand forest workers. Much of the labor must be performed by hand. In cutting the taller poles, and the trunks that are to be used for flagstaves, there is call for a steeplejack of the forest, who climbs the slender trunk and removes the top before the tree is felled. Topping prevents much of the damage to surrounding growth that would result if the tree were allowed to fall with its spreading limbs cutting a swath among the other trees.

There is a flagstaff at Fort Bonneville, Oreg., which has a clear length of 205 feet—equal to that of an eighteen-story office building.

**HUGE CIGARET ON AUTO TOP ADVERTISES PRODUCT**

Attached to the top of an auto delivery truck in Portland, Oreg., an imitation cigaret glows and gives off smoke from the exhaust, to attract attention. It is made of sheet iron, is twelve feet long and fifteen inches in diameter. Fumes from the engine are diverted through a metallic hose, and the amount of smoke can be increased by a pressure pump which sprays light oil into the manifold exhaust and is regulated from the driver's seat. The glow is produced by an electric light shining through a red screen near the end of the cigaret. To carry off moisture from the condensed vapors, a drain pipe is installed at the bottom of the replica.

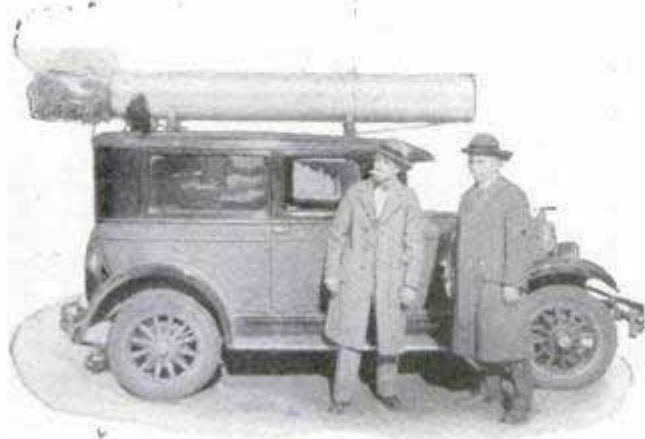

Huge Cigaret on Auto Top Has Realistic Tip and Fumes from Motor Represent the Smoke



How the Pocket Foils the Thief, and Closer View That Illustrates the Position of the Opening

pocket to foil thieves. It folds into the trousers and the opening is at the bottom instead of at the top so that it would be extremely difficult for a thief to pick it.

**WIDER USE OF STEEL MARKS ADVANCE OF MAN**

Steel production in the United States last year reached 48,000,000 tons, more than half of the world output, according to recent reports. Americans used about six times their own weight of the material as compared with little more than two times the weight of the population at the beginning of the twentieth century. In 1500, the total estimated output of steel and iron for the entire world was about 50,000 tons. The increase in the production of the metals, keeping pace with the development of power machinery, has enabled a laborer to earn in a few hours today what would have required days a few centuries ago. One economist estimates that the ratio in favor of power over man toil is as high as 590 to one.

*Made up by Rev. Fred*  
*Chicago Tribune 9/10/27*



National  
 Corp. 516 W. Vernon Ave.  
 Los Angeles, Calif.

Aircraft Radio Laboratory  
 MECHANICS

**POPULAR  
 AUTOMATIC SPOTLIGHT CUTS  
 OUT ALL GLARE**

1751  
 naclets \$19.00

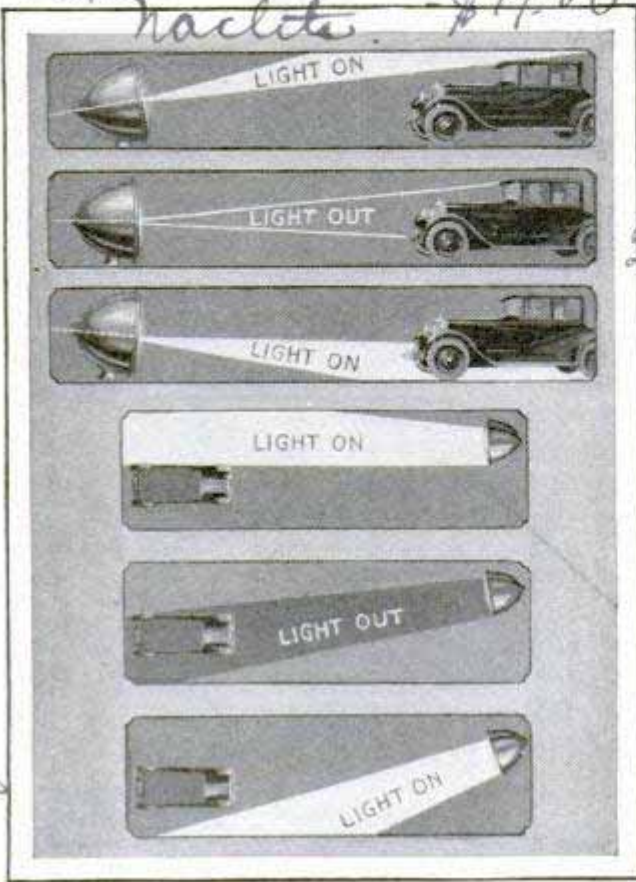

Drawings Illustrating the Position of the Light Beams When the Lamp Is at Different Angles

Several unusual features are found in an improved spotlight for the automobile, a principal one being that it is automatically cut out, by moving it slightly, to avoid shining directly into the eyes of an approaching driver. The regulating knob is on the dashboard close to the light switches so that the driver does not have to reach out at a difficult position to direct the rays. A further innovation is that it can be swung entirely around to illuminate the rear of the road as well as the front, can be inclined downward to serve as a trouble lamp when repairing the engine or adjusted to intermediate po-

Drop Lite \$24.00

Chicago - Mot. Acc. Co.,  
 29 & Michigan Ave.

sitions for safety and ease in driving, alighting from the car, looking for street numbers, and similar purposes. The light is manipulated by means of a flexible control extending through a hole in the cowl of a bracket attached to the windshield.

**VISUAL SIGNALS SENT BY RADIO FROM GROUND TO AIRPLANE**

2259

By modifying the radio system used in keeping aviators on their course, Capt. Paul A. Edwards, of McCook field, has developed a way to transmit visual signals to moving airplanes from the ground. Several advantages are seen in the plan. Flyers would not have to wear headphones during flight, and with planes equipped so that communications could be carried on between them, a better way would be afforded to check artillery fire. The number system used makes it possible to employ a code. The sending apparatus includes a radio transmitter with a dial having combinations of numbers from 00 to 99. As the code is sent, a small light is flashed behind corresponding numbers in the receiving set. It is believed that this system could be used also for short messages between ground stations, eliminating the need for trained Morse operators.

**HOLE BORER DRIVEN BY MOTOR HELPS IN PLANTING TREES**

1894



Boring Holes for Trees with the Corkscrew Digger: Dirt Is Piled for Convenient Replacement

Planting of trees on rubber cultivations in French colonies is speeded by a specially designed hole digger. It is essentially a large corkscrew, turned by a forty-horsepower motor, and is said to bore a hole about thirty-two inches deep and twenty-three and one-half inches in diameter in one minute, providing the soil in which it is used is not unusually hard.



*University of Cambridge  
Training Corps*



© The Times

Water-Tight Wagon Box Being Used as Raft during Army Tactics in England; There Was Room for a Squad of Soldiers besides Their Equipment

**WAGON BOX SERVES AS RAFT  
IN ARMY MANEUVER**

How a supply-wagon box could be adapted as a raft in emergencies, was demonstrated during army maneuvers in England not long ago. A bridge had been blown up in the course of the tactics game, but this did not prevent the troops from landing on the other side, for the boxes floated several soldiers each.

**REVENUE FROM "HOBOS" 2 2/5**

That hobos by no means are all penniless travelers is seen in the experience of the Denver and Rio Grande Western railroad in collecting more than \$18,000 in fares from 5,233 "head-end" passengers and freight-train riders last year. The special agents of the road arrested nearly 28,500 men of this class. Those who had money were taken to the ticket office and instructed to purchase tickets. From a study of hobo traffic, officials of the rail-

*Railway Age 3/26/27*

road concluded that these travelers follow somewhat the same routes as other tourists, most of them being drawn to Colorado during the months of April to October, inclusive, when the scenic attractions are at their best.

**AUTO OIL AND GAS RECORDER  
FITS ON STEERING WHEEL 1907**

To simplify keeping a record of the quantity of gasoline and oil purchased for the automobile and the dates when new supplies were obtained, a disk, attached to the steering wheel, is easily used and always ready for reference. It contains a round card with entries for an entire month. To turn from one day to another, it is only necessary to move the outside rim of the disk.

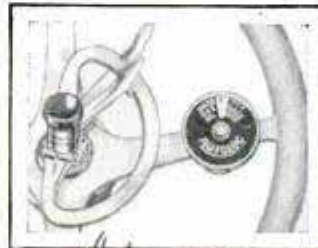

*\$1.00*

*Chicago - E. Hartman 332 S. Madison  
Rit. Lerna Co, Inc  
202 Centre St.*



1898  
66

495 Worcester Road  
Akron, Ohio



Dr. Strong at Her Desk, Preparing a Map for Use in Developing New Territory in Sales Campaigns

### WORK AS MAP-MAKER WINS FAME FOR WOMAN

Charting the little-known places of the world for the special information of various commercial firms, is the interesting work of Dr. Helen M. Strong, geographer of the United States department of commerce. Accuracy of location and indication of distances are of paramount necessity on her maps, which serve as guides for opening up new territories in selling and similar campaigns.

### SPRING CLIP ON POCKET COMB PREVENTS LOSS

Fitted with a spring clip somewhat like that on a fountain pen, a small comb for men or women can be attached to the pocket, blouse, belt or tie without likelihood of becoming lost and in a position where it will always be handy. The arrangement is especially adapted for the convenience of women with bobbed hair who have constant need for a comb but do not always care to include one in the vanity case. Slight pressure with the thumb on a spring under the comb lifts the clip up so that the cloth may be inserted.

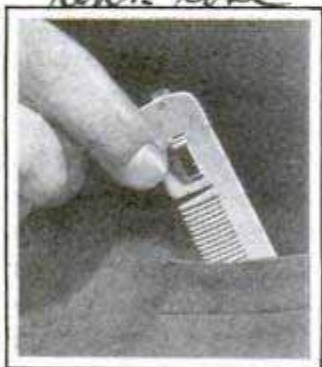

### RUBBER IS MEASURED BY RADIO TO INSURE EQUAL THICKNESS

One of the latest applications of radio principles to industry is in measuring the thickness of rubber for tires, bathing caps and similar articles. Like many other discoveries, this was the result of an "accident." One night, an inventor placed a piece of tissue paper in the condenser of his radio receiver, thinking that the station he was hearing would come in better. He got an entirely different station. A thicker piece of paper brought in still another. He had not discovered a new radio principle, for it was then well known that affecting the condenser in that way would alter the set's performance. If, he reasoned, changing the size of the paper, changes the receiver's action, why could not the thickness of the paper be measured by noting the changes in wavelengths? Accordingly he constructed an apparatus whereby this radio principle was utilized to measure, in thousandths of an inch, the thickness of the rubber sheets as they pass through the rolling machines. Any variations are recorded on a visible dial so that the operator can make proper adjustments to correct the error.

### TABS ON CARBON-PAPER SHEETS SIMPLIFY REMOVAL

Taking sheets of carbon paper from between the leaves of copy stock is made easier by the addition of tabs at the lower right-hand corner of the carbon and a cut-away portion at the opposite corner. These changes make it simple to pull the duplicating sheets out after the work has been typed, save blurs and also prolong the life of the carbon by keeping it straight and uncrumpled.



Write our Bureau of Information if you wish to know who makes or sells any article described in this magazine. Send no postage; the service is free.

Frank Sporo Co., 25c. Wholesale sample 10 cents.

W. Broadway, New York

\$1.18 doz. \$13.45 gross



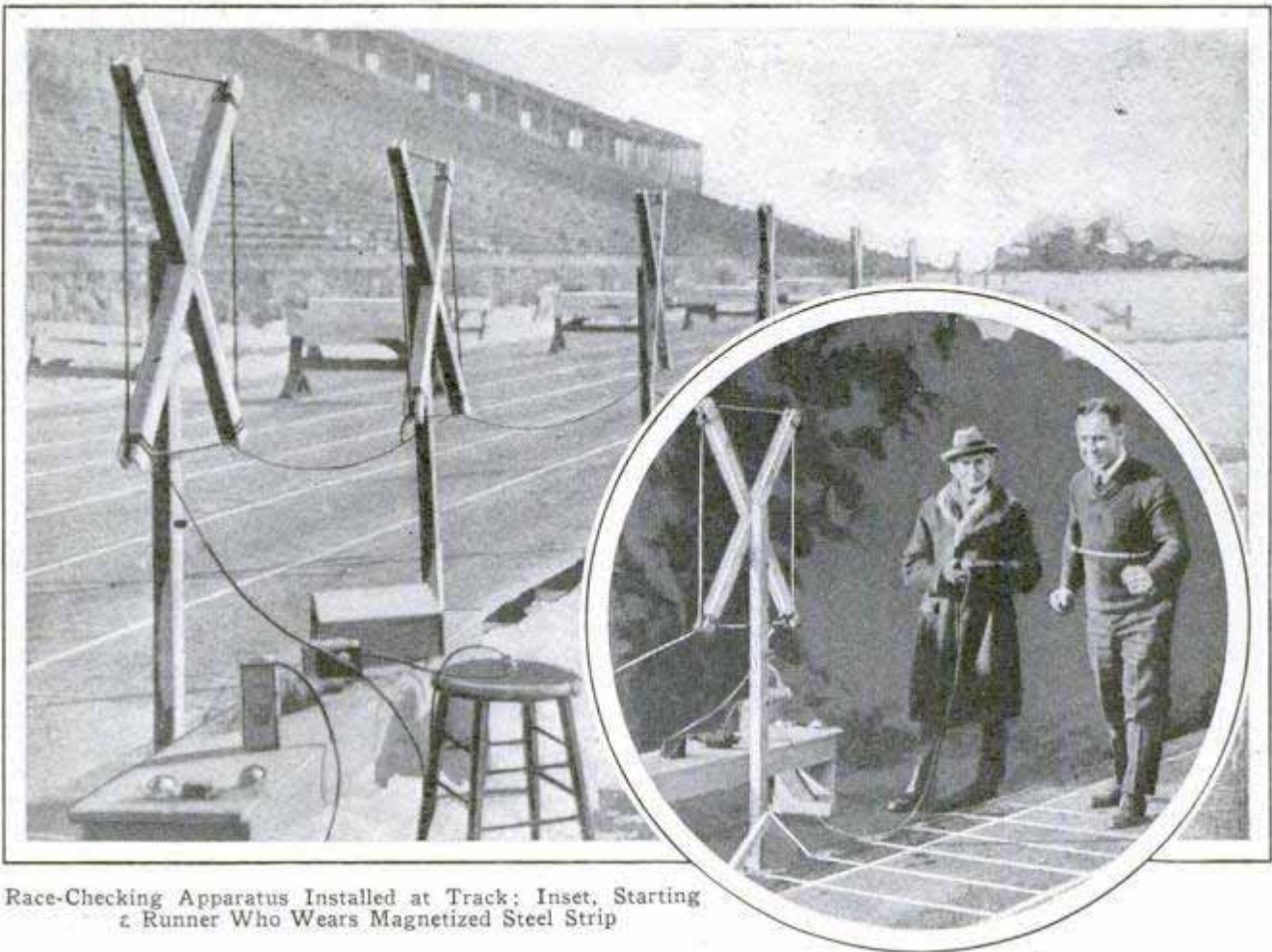

Race-Checking Apparatus Installed at Track; Inset, Starting a Runner Who Wears Magnetized Steel Strip

**RUNNER WHO "JUMPS THE GUN" DETECTED BY COILS**

To reveal unfair starts in footraces and to afford an additional check on the running time, Prof. A. V. Hill, of Cornell university, has devised an electrical installation consisting chiefly of a set of ten coils and a magnet. The coils are made of 200 turns of insulated copper wire and are placed at regular intervals at the side of the track. They are connected in series to a galvanometer. A current is induced in each coil as the runner, carrying a magnet, runs past it. The induced current is strongest when the racer is on a line with the coil. By studying

the fluctuations in the current as they are graphically recorded, irregularities in the runner's start may be detected.

**VACUUM CLEANER FOR RAIL BED REDUCES UPKEEP COSTS 2190**

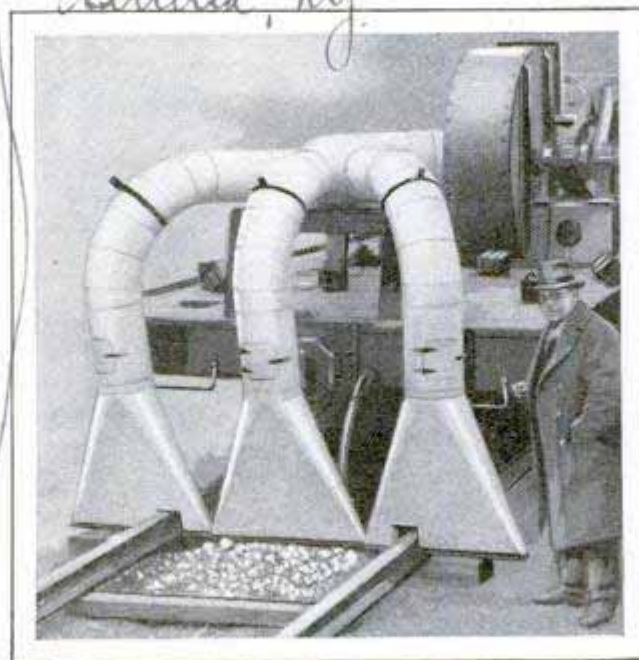

Three-Nozzle Vacuum Cleaner, Which Sucks Cinders and Other Refuse from the Railroad Ballast

Cinders and refuse are quickly removed from the railroad ballast with a vacuum cleaner an eastern engineer has devised. The outfit is mounted on a car and has three galvanized suction chambers, the bases of which run just above the rails and the ground. They are effective even when the cleaner is run at considerable speed, so that many miles of track can be cleaned in limited time.

*Baker Laboratory of Chemistry*

*Walter M. Spring  
no address*



2121  
John J. Kingsey, 920 Centre St  
Salem, Mass.

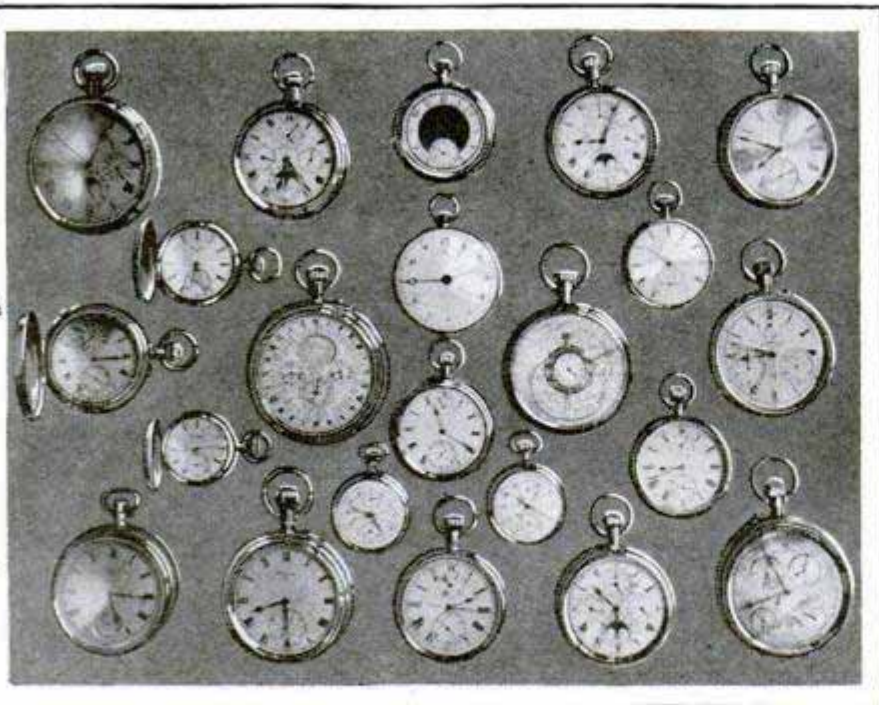

A Few of the Watches in the Famous Collection; Some of Them Required Years for Making and Cost Thousands of Dollars

*Value*  
**WATCHES THAT RING CHIMES  
IN ODD COLLECTION**

What is said to be the largest private collection of watches is owned by a Boston man and is noted for its many odd specimens. Many are without duplicates and are valued at thousands of dollars. Several were made especially to the order of a former owner, a deceased millionaire. One, valued at \$14,000, took several years to make. It has a dial with a frame attached, which shows the hours and minutes while it revolves under the constellations as they are visible or not in countries of the western hemisphere. Another has 3,000 parts and cost \$18,000. This one required eight years to finish. It has an hour-and-minute register, a set of Westminster chimes of four bells, striking the quarter hours, a minute repeater and an alarm and winding indi-

*6/62*  
largement of thirty-five diameters. The lenses may also be arranged in another combination giving twenty-five-power magnification. The upper end of the barrel is equipped with a pocket clip, while the lower end, including the objective lens, may be removed and reversed, the lens being contained in a sleeve which acts as a foot and automatically brings the microscope the right distance from the object on which it is placed, while a cut-out section of the sleeve admits the light. To get thirty-five power, the objective lens is not reversed, but the pocket clip is removed from the upper end of the barrel, fitted over the lower end, acting as a foot, and the objective tube can then be slid in and out to bring the glass to a focus. The microscope is designed for use by toolmakers, textile workers, chemists, biologists, geologists and others who need a small portable glass.

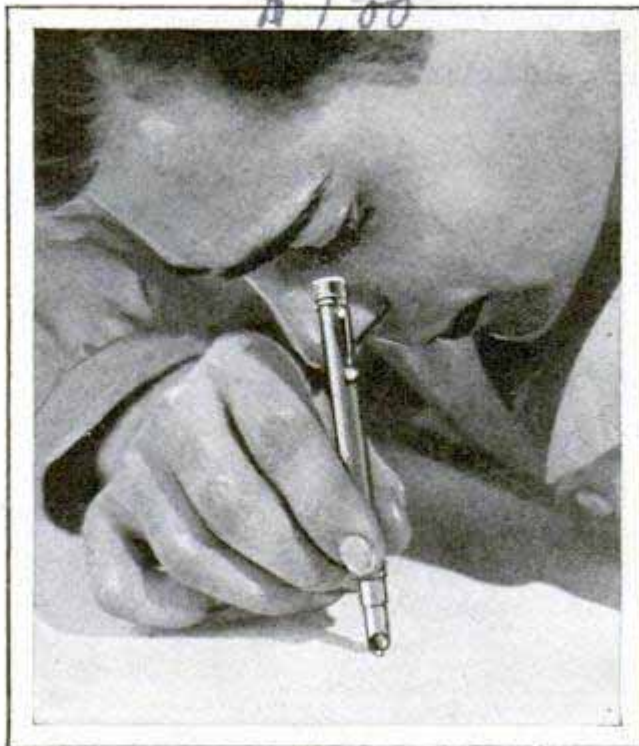

Pocket Microscope in Use: Note Clip at Top, for Fastening to Pocket, and Light Aperture at Bottom

cator. One of the wheels in the works revolves only once in four years and indicates February 29 in leap years. There is also a barometer mechanism, a back dial which shows the moon's phases and a perpetual-calendar apparatus. This wonder among watches has ten hands on one dial and five on the back.

**TINY MICROSCOPE  
OF HIGH POWER  
LIKE PENCIL**

A three-lens pocket microscope, built like a metal pencil, is capable of giving a maximum enlargement of thirty-five diameters.

The lenses may also be arranged in another combination giving twenty-five-power magnification. The upper end of the barrel is equipped with a pocket clip, while the lower end, including the objective lens, may be removed and reversed, the lens being contained in a sleeve which acts as a foot and automatically brings the microscope the right distance from the object on which it is placed, while a cut-out section of the sleeve admits the light. To get thirty-five power, the objective lens is not reversed, but the pocket clip is removed from the upper end of the barrel, fitted over the lower end, acting as a foot, and the objective tube can then be slid in and out to bring the glass to a focus. The microscope is designed for use by toolmakers, textile workers, chemists, biologists, geologists and others who need a small portable glass.

Imported by Alden Loring  
1700 Centre St. N. A.





EVERY year for nearly half a century, from 100 to 400 men, in seven to a score of ships, have been running the longest and hardest race ever attempted in the world. They are likely to continue running it for the next half century, or until railroads will reach the north pole. There is no regular course for this race, no judges, no referee, no track officials, yet it is a most orderly, well-conducted contest, in which each entrant carries his own law and makes his own rules. No prize is offered, yet the race is worth many thousands of dollars to the winner. It is a race between machines, and, as a rule, the best mechanic wins.

It is the annual race for the fur crop of Alaska. The course is from Oakland, Calif., to Demarcation Point, the northerly terminus of the eastern boundary of Alaska, on the Polar sea, and sometimes beyond, as far as Herschel island. It lasts seven months, and the distance for the round trip—since the race is run both ways—is 4,000 miles. It started, away back in the late eighties, with seven ships; today a score are in it, some starting from Oakland, some from San Francisco, others

from Portland and Seattle. Steamers, motorships, auxiliary schooners and sailing vessels are the entrants, but for the past three years, the auxiliaries have been the winners. In 1923, 1924 and 1925, "Nanuk" (Polar Bear) was the first into the Arctic ocean, and the first back to Oakland. In 1926, "Patterson," owned by Capt. C. T. Pedersen, who also owned "Nanuk," held the record. This year, "Nanuk" is in Siberia, trading out of Seattle, so "Patterson" seems to be leading the field again.

The prize is \$250,000 to \$300,000 worth of the finest furs produced in the world, the cream of the season's catch of the native and white hunters and trappers of Alaska. On each of its winning trips, "Nanuk" brought back almost exactly \$300,000 worth of furs, and nearly \$50,000 worth of carved ivory, walrus tusks, walrus hides, whale oil, whale bone and other products of the far north.

The race starts in April, the Oakland boats being the first out, owing to the greater distance to run. In order to get first chance at the fine furs, each boat strives to be the first "beyond Barrow," that is to say, to turn the northernmost



point of Uncle Sam's dominion in Alaska, and slip along eastward on the shore of the Arctic ocean. The race home is to be the first to reach the markets of the United States, so as to get the best prices from the fur buyers. Once in a Pacific coast port, the furs, carefully packed and locked in great chests, are shipped by special express direct to New York. The ship owner or trader who comes back with less than \$200,000 worth of furs for a season's trading considers himself far from successful.

The height of the fur-trading season is in June and July. By the middle of August, the traders turn back from the Arctic, rounding Point Barrow again, picking up the trade of the Siberian natives who have crossed the strait to the Alaskan side and moving steadily homeward. On the way, though they are racing all the time, they pick up an occasional whale, which they kill, and whose oil they try out on board, or a few walrus, for their skins and ivory. They reach the Pacific-coast ports not later than October, and the first arrival is

the first into the New York market with his silver fox, sea otter, seal and other furs.

"Nanuk" has been in the race for thirty-four years, first as a three-masted schooner, depending on sail when others sailed, but installing a 300-horsepower Diesel plant when the traders went into steam. It has been first both ways in the race a number of times in those three decades, but the three years mentioned were the first in which it had consecutive postings as the winner. It is of only 280 tons, built entirely of wood, with bow walls two feet or more in thickness, the entire hull sheathed in ironwood, the shell as thick as the armorplate on a battleship. And wood has been found to be the best material for ships constantly at war with ice—for the hull slips on and over the ice, where the more rigid steel or iron ship attempts to smash through.

Indeed, both "Nanuk" and "Patterson," its successor, have rescued the crews of a number of iron and steel ships which were unable to make their way through the ice

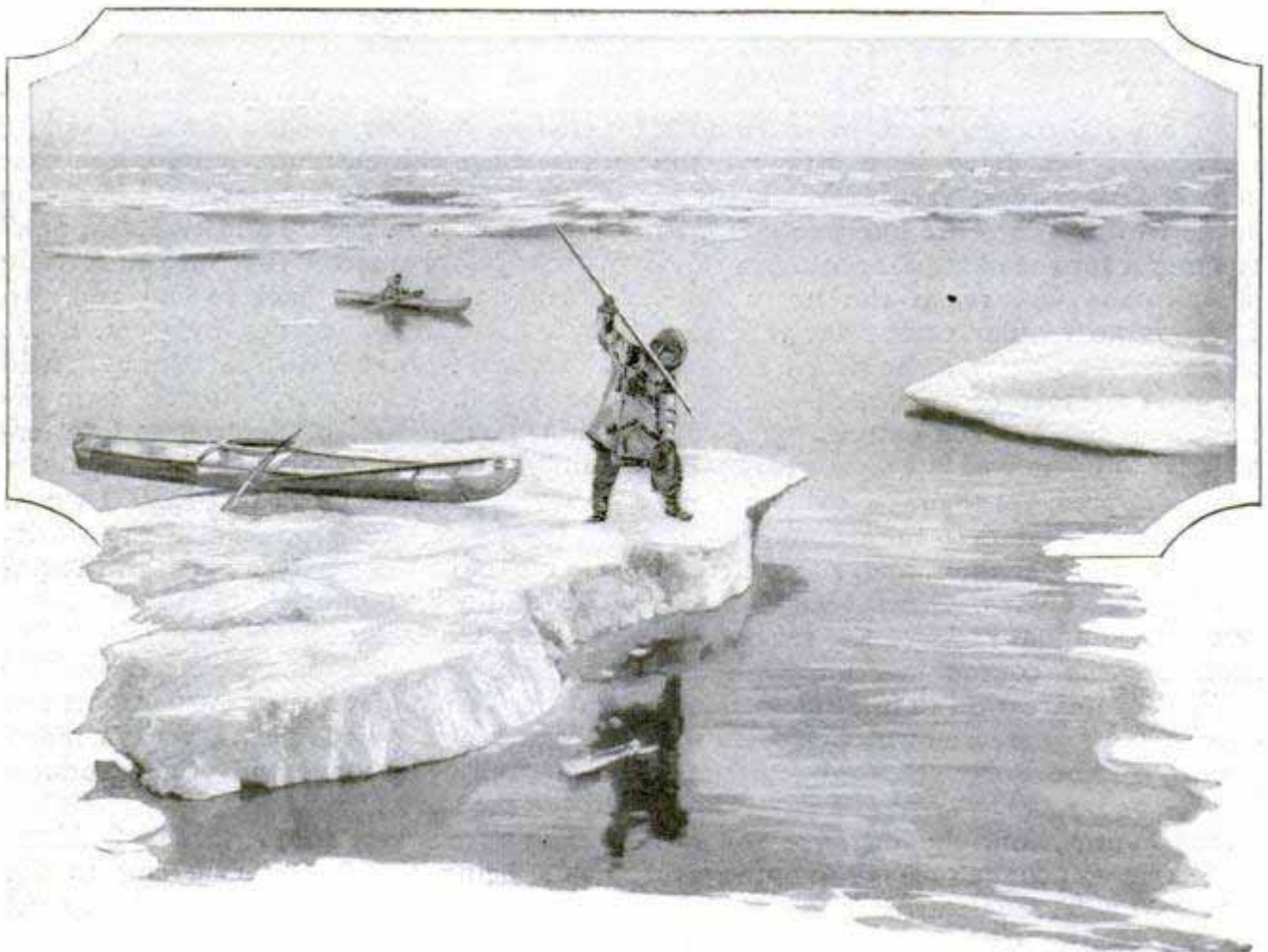

© Lomen Bros.

Where a Sealskin Coat Begins; Native Alaskan Hunter and His Snug Boat in Which He Ventures among the Ice Floes for Skins to Exchange When the Traders Arrive



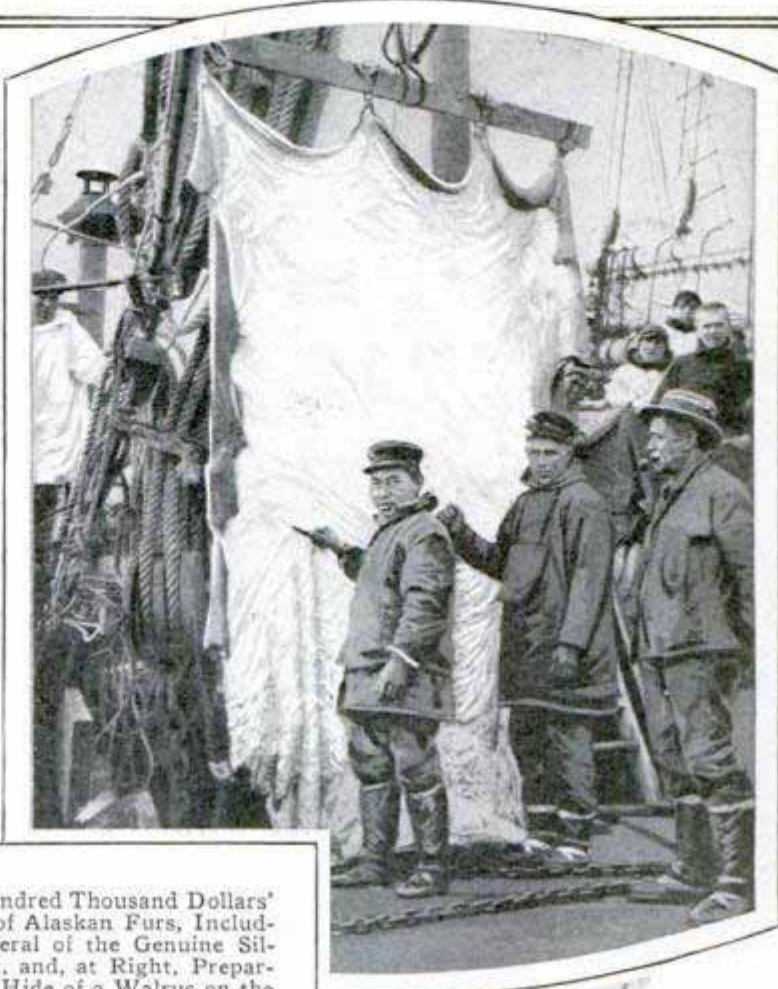

One Hundred Thousand Dollars' Worth of Alaskan Furs, Including Several of the Genuine Silver Fox, and, at Right, Preparing the Hide of a Walrus on the Deck of the "Nanuk" off Point Barrow; the Walrus Is Also Valued for Its Ivory, and Whales Are Caught En Route for Their Oil



"Ay-Muk," an Alaskan Beauty, Wearing a Sealskin Coat Valued at \$25,000; It Is Made Double with Fur Inside and Out

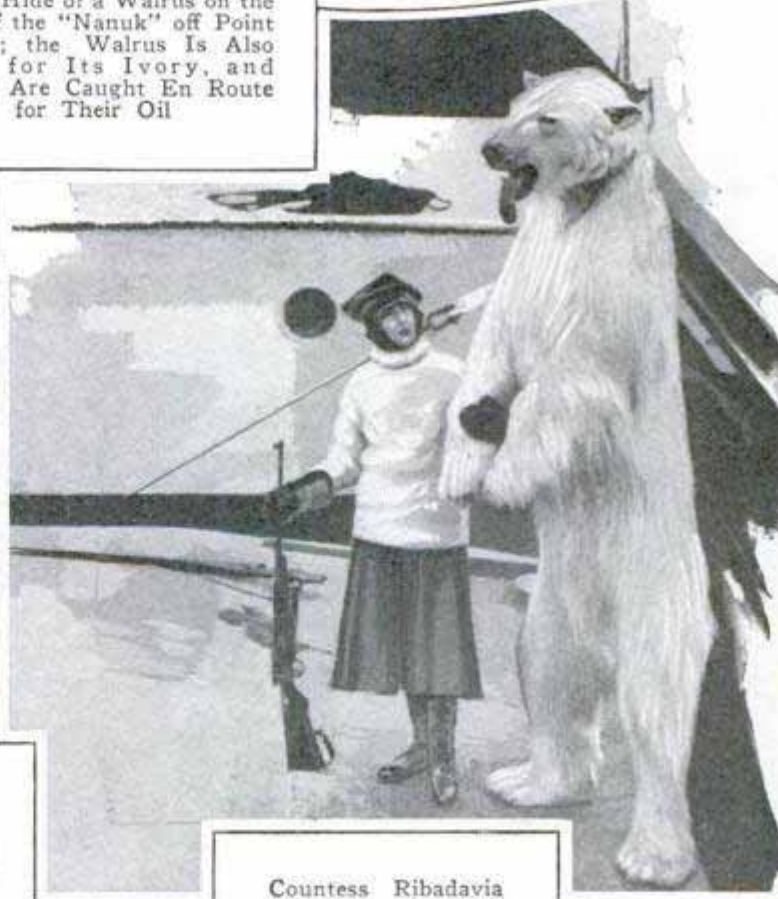

Countess Ribadavia and Polar Bear She Shot on Expedition Last Year



2160  
72

pack on the Polar sea, and so have become frozen in. "Patterson" is slightly larger than "Nanuk," with somewhat more power, but it is the same type of wooden ship, with the whale-blubber caldron, and the walrus hangers on deck, and the long salon below, lined with every manner of trade goods alluring to the eyes and minds of the native men and women.

With Capt. Pedersen, winner of the race for four consecutive years, goes each spring Mrs. Pedersen, formerly a trained

nurse, who aids the natives in their illnesses, stands witness at weddings performed by the captain, and assists him in selecting the finest furs in the process of trading with the Eskimo and the Siberians. Up the Pacific, along the jagged, treacherous coast of Alaska, through the Aleutian isles, across Bering sea, past Point Barrow, and on east to the mouth of the MacKenzie river and beyond, this intrepid woman goes each year in the fur race—and declares she likes it.

Keeping his Diesel engines in perfect working order, knowing every current on the coast, calculating the closing in of the ice, and treating the natives with absolute justice, are given credit by Capt. Pedersen for his winning so many of the annual races, but some of the credit also must go to Mrs. Pedersen. For her, many of the hunters and trappers, whose wives and children she has helped through sickness and probably saved from death, hold up their furs until they can trade them to

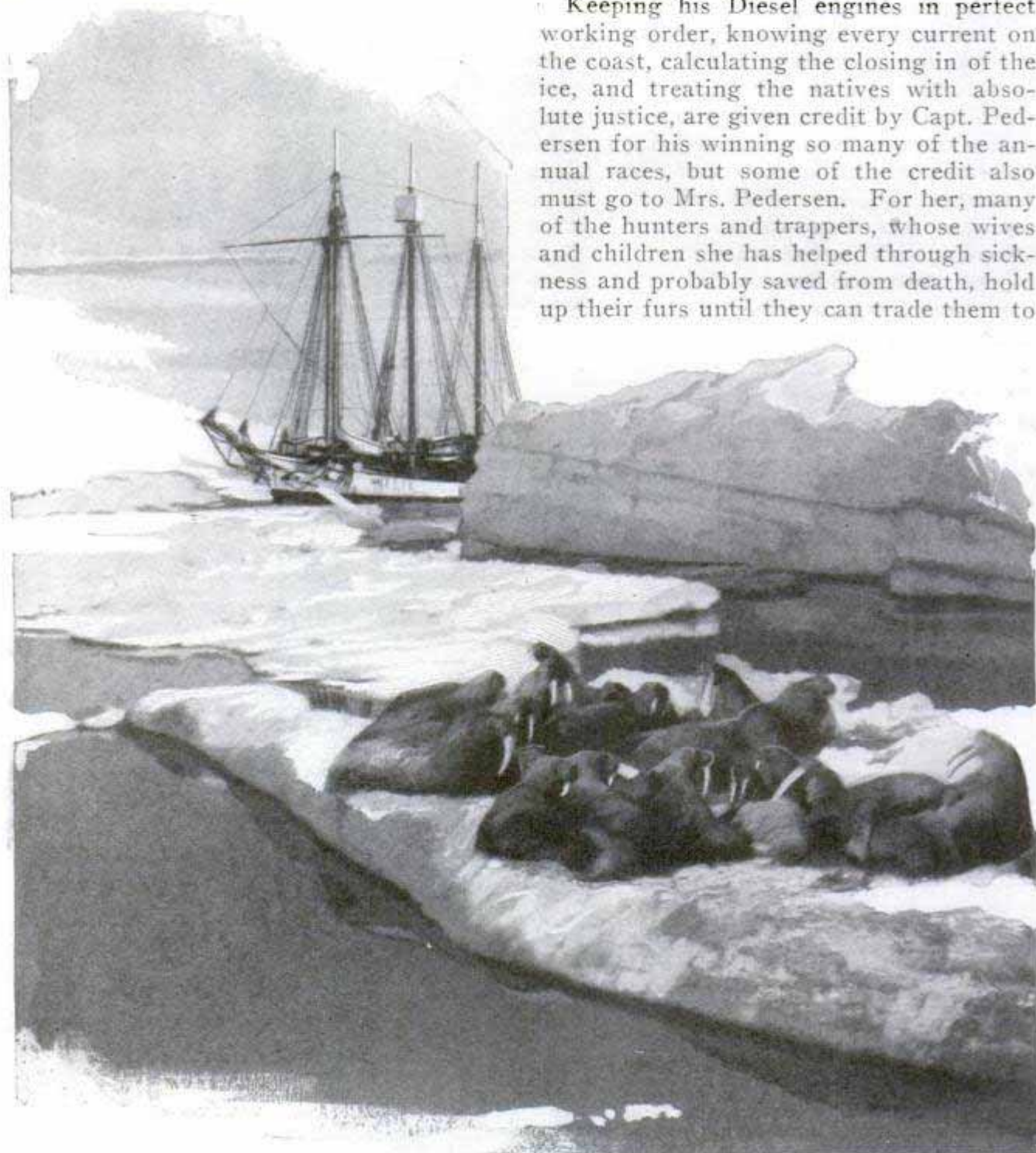

"The Nanuk" Poking Her Wooden Nose around an Ice-Covered Point on the Northern Shore of Alaska, near Demarcation Point, Where the Ice Never Melts



her husband. One such native brought Capt. Pedersen 265 pelts as the result of one winter's trapping. Another had fifty white-fox skins; a third brought twelve walrus hides and more than 200 pounds of carved ivory. In the far north, industry and ability appear to count as much as in more civilized centers.

"Two successful trappers at Herschel island are Ahlowuk and Penatuk, real Polar Eskimo," said Capt. Pedersen. "When non-breakable lamp chimneys first came out, I took a stock of them on one trip, have carried them ever since, and they are one of my best articles of trade. Ahlowuk and Penatuk came into the cabin. 'Need a chimmie?' I asked, at the same time tossing one of the chimneys gently at Ahlowuk, who promptly put out his hands to catch it, while Penatuk stood by, his mouth open in surprise at my carelessness with so valuable a thing.

"Ahlowuk missed the chimney, which hit the floor, bounced, and rolled uninjured away. Both the Eskimos leaped back and tried to get out the door at the same time. When I explained the virtues of the new lamp chimney to them, they bought six, though they had only one lamp."

All the trading vessels in the great fur race are adapted by their captains to the peculiarities of navigation which they encounter. For example, after leaving the Aleutian isles, "Nanuk" is controlled and steered entirely from the crow's-nest, a boxlike structure hung nearly at the top of the mainmast. This is the only point on the ship from which an uninterrupted view of the sea can be obtained.

There the captain takes turns with two other trusted men, in four-hour tricks, each one taking a trick every eight hours. This crow's-nest is connected with the engine room by telegraph and telephone, and, should these fail, there are direct electric controls to the great Diesel engines and the steering gear.



Testing the Sensitive Disk; It Is Attached to the Door and Is Relaying Sounds from the Other Side through Earphones

2237

### POLICE HEAR THROUGH WALLS WITH "PHONE" DISK

A Boston policeman has devised a compact electric apparatus to aid in various detective tasks. An essential unit of the equipment is a sensitive disk which can be quickly attached to a door, window pane or wall. Sounds from the other side are audible to the listeners through earphones.

### LUMINOUS HATS FOR WOMEN REDUCE NIGHT ACCIDENTS 1764

Automobile accidents involving women pedestrians at night have become so numerous in a section of London that a luminous hat has been designed, to protect the wearer. Figures painted in glowing chemicals are plainly visible at some distance, so that motorists can see the women in time to avoid striking them. As



the designs are not conspicuous where the streets are brightly illuminated, the usage can cause no confusion.

the designs are not conspicuous where the streets are brightly illuminated, the usage can cause no confusion.

Cont. H. J. Wilkins, Esq.  
4 Crowhurst Road,  
London, S.W. 13



*France*

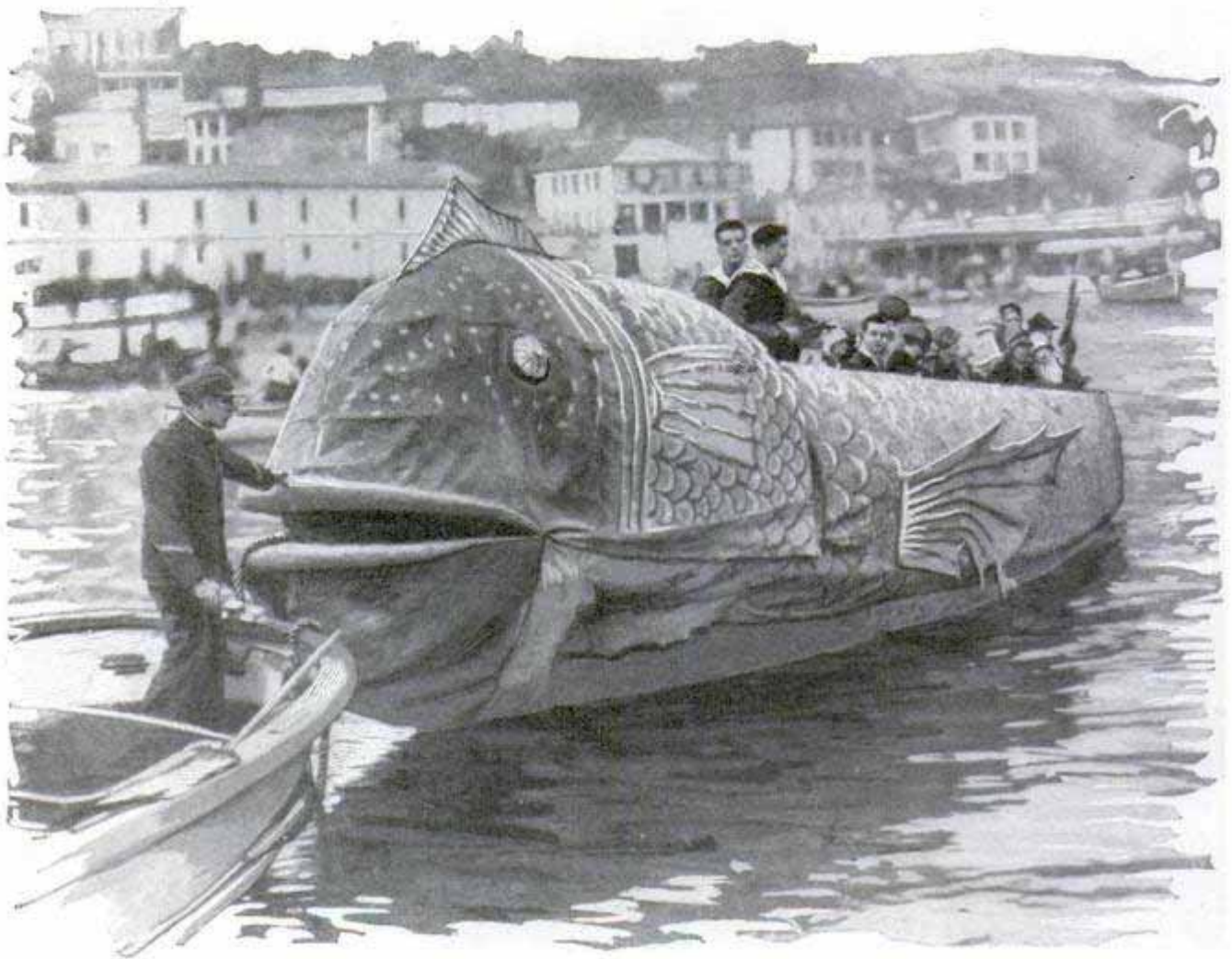

Where the Boats Wear Costumes as Well as the Merrymakers; One of the Craft at a French Water Fete Disguised to Represent a Dolphin

### BOAT IS DISGUISED AS WHALE FOR WHALE CARNIVAL

Costumes for the boats as well as for the people is the rule at a French water fete during which a "battle of the flowers" is observed. The craft are decked out to represent various marine subjects, including mammals, fishes and mythological creatures. A whale replica is shown here.

### BATHTUBS LEAD IN ACCIDENTS REPORTED IN HOMES

You are more likely to be hurt while using the bathtub than you are in getting in or out of bed or standing on a stepladder, according to accident reports of a large insurance company. In 1926, out of a total of 33,303 claims paid, ninety-eight went to persons injured in bathtubs, thirty-six to those who had fallen from ladders and forty-four to persons hurt while entering or leaving their beds. Another feature of the company's report was that more men

were injured in the comparatively mild sports of fishing, golf, tennis and gymnasium exercising and squash than in the more active game of football. Nearly one-third of the total number of claims was for automobile accidents.

### POLISH IN SHOE-SHINING PAD SAVES USING PASTE

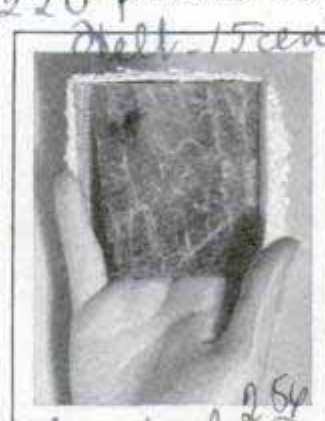

For keeping shoes polished, a shoe-shining pad is waxed on one side and will give more than 300 shines without the use of paste or liquids. It can be carried in the pocket or handbag and is always ready for use. It is slipped over the fingers, does not stain and is said to prolong the life of the leather.

*220*  
*25¢*  
*Handy Shine Co.*  
*328 S. ... Ave. N.W.*

*Traveler 129*

*Handy Shine*



1863

Ohio

### WHALING THRILLS IN ICY SEAS AMONG WINDS AND BERGS

2228  
Dodging icebergs, thousands of feet high and miles long, and battling with winds that threatened to crush one of the ships with a whale that had been killed; these and other thrills were experienced recently by a fleet of Norwegian whalers in the Antarctic seas. Their season was reported successful with a total yield of oil approximating \$2,500,000 in value. At one time, forty-one icebergs were sighted in the space of an hour. One of them was 3,000 feet high and several miles long. During a severe gale, the wind carried away the whales that had been lashed to the mother ship, and a smaller vessel, the "Star I," was compelled to cast adrift the two it was towing. For a time, there was danger that the waves would throw one of the whales on top of the vessel. Among the whales caught was one that measured no less than 125 feet and yielded 175 barrels of oil. Efforts are being made to effect stricter control of the whaling industry in this part of the world, as some authorities believe that the whales will be extinct there within twenty years unless the activity is limited.

Reflecting Woman's Invasion of the Barber Shop; Sign That Advertises Bobbing

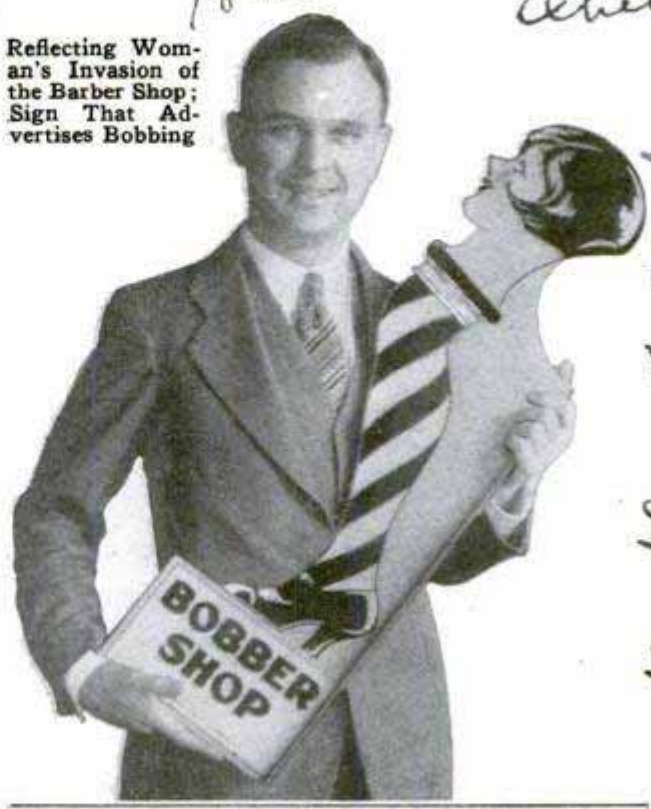

Artist: Dudley J. Fisher, Jr. Staff artist, Columbus Dispatch

### NEW-STYLE BARBER-SHOP SIGN INSPIRED BY COMIC STRIP

A newspaper cartoon suggested the idea for the new-style barber-shop sign shown here. About the only feature borrowed from the old posts, which are said to date back to the times when barbers were surgeons and advertised their profession by the pole design, is the stripe.

### FAMOUS CHERRY-TREE TALE INSPIRES ARMY DESIGN

1869  
George Washington's hatchet and a cherry-tree sprig laden with fruit form the basis for the crest in the color-bearing organizations of the District of Columbia's national guard. The design has been authorized by the war department. There are thirteen green leaves in the branch, while the location of the district within the territory of the original thirteen states, whose white population was predominantly of English origin, is indicated by the twists of the wreath which are alternately white and red. The cherries, of which there are seven, may be red or yellow.

### SAND BLAST REPLACES WATER IN CLEANING LENSES

2249  
Glass lenses on railroad signals in the terminal yards of the Chicago union station are being cleaned with sand blast instead of with water. This insures a more thorough cleansing and, in winter, there is no water to freeze on the glass. A lens can be cleaned in four seconds and two men can do the entire job in a few hours. To keep the sand from removing the paint from the metal hoods of the signals, cup-shaped pieces of tin are used for their protection.



National Guard Crest for the District of Columbia, Incorporating the Hatchet and Cherry-Tree Sprig

Compressed Air April 1927



2079  
 205  
 205  
 Maya Kings  
 May. King  
 Cal.

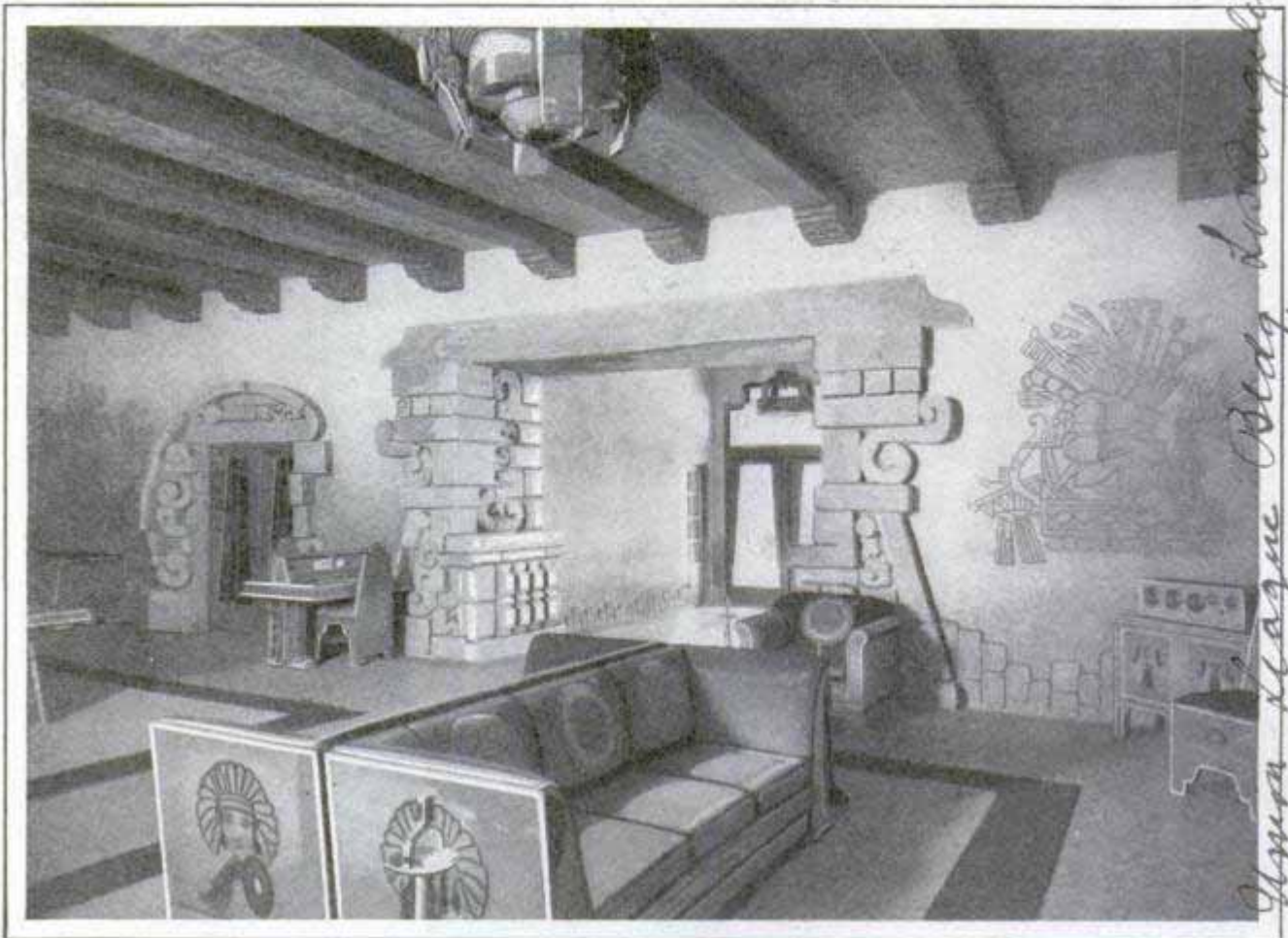

Heavy Carved-Stone Doorways, Mayan Paintings on Walls and Furniture, and Beautifully Painted Beamed Ceilings Are Features of a Western Hotel Modeled on Maya Lines

## Reviving the Wonders of Maya Kings

Architects Use the Halls of Montezuma in Creating a Distinct American Architecture Older Than Columbus

By N. M. HARKINS, *of Hager Nord,*

**S**PECTACULAR and weird uses of spiral, pyramidal and rectangular shapes in modern architecture, as a result of discovering similar distinctive features in the recently unearthed Mayan buildings in Central America and old Mexico, mark the beginning of what architects consider a new and distinctly American type of construction in this country. This style of building design is in sharp contrast to all other architecture, which usually has copied closely after European patterns.

The result of this development, which has been led by a western architect, after extensive study of the ruins in Central America, is a type of building so different from conventional construction as to be most startling. The ancient cities of the Mayas have been unearthed by the Mason-

Spindler expedition of Harvard, and have revealed the distinctive architecture which existed on this continent in pre-Columbian ages. While the recent development is in no sense an exact copy or duplicate of the ancient Mayan work, the themes of the early Indian builders have been modernized and incorporated in the present-day structures through the use of geometric shapes and vivid colorings. Pillars, doorways, chandeliers, and patterns in floors and ceilings all take on a weird and striking effect.

Among notable structures which have been built in this style are hotels, country clubs and yacht-club buildings, as well as theaters. In these buildings the use of massive composition, such as pillars composed of stone layers cut in fantastic



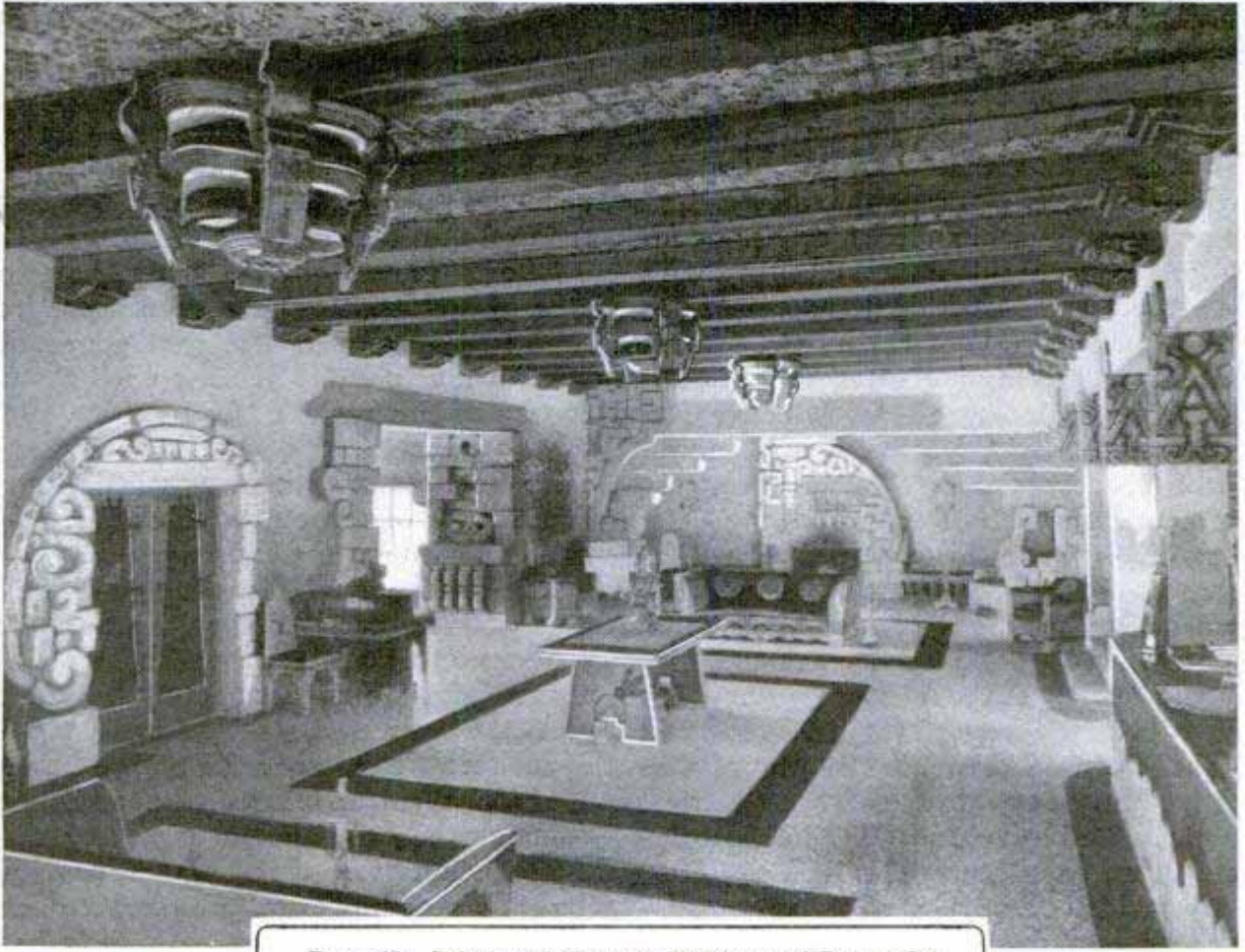

Pyramids, Spirals and Unusual Treatment of Rectangles Are Lifted from the Temples of the Aztecs and Mayas, to Lend Originality to America's Newest Form of Architecture

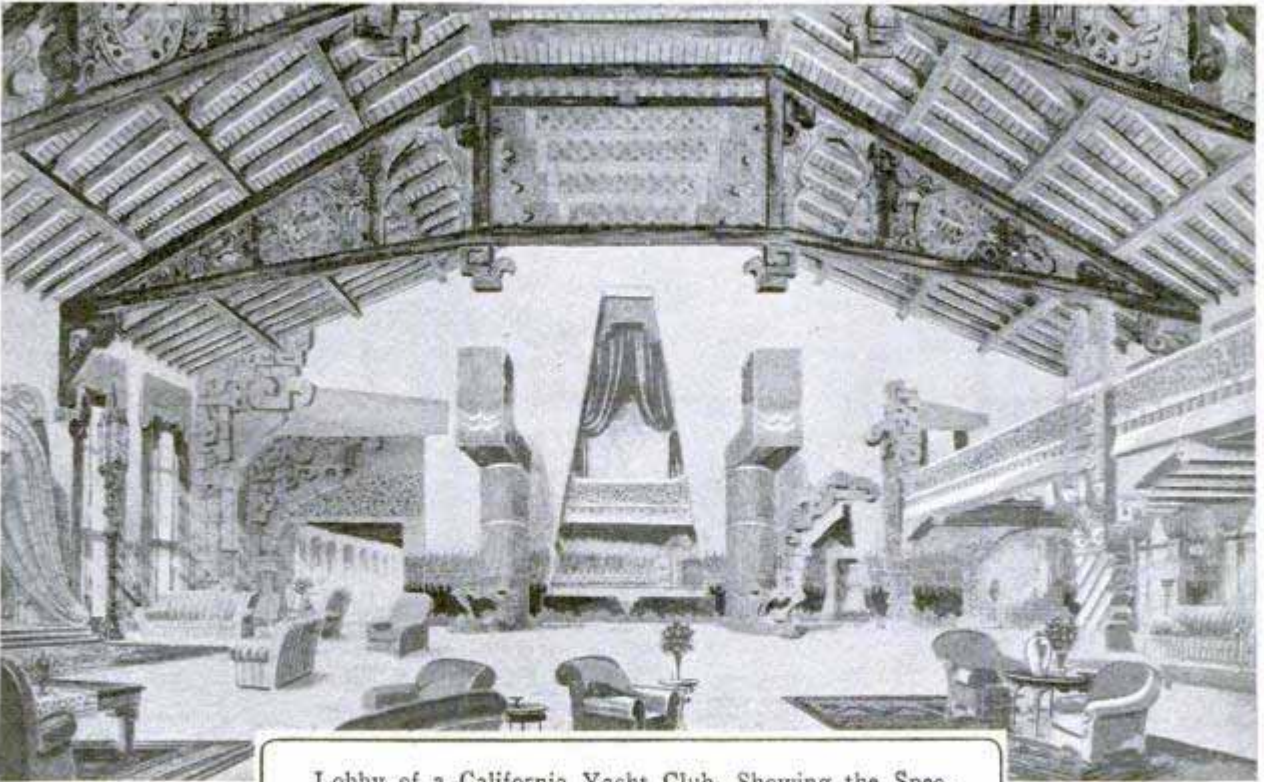

Lobby of a California Yacht Club, Showing the Spectacular Effect, Which Is Heightened by the Brilliant Colors Used



shapes, very successfully suggest the principles of construction and decorative effects found in the well-preserved sections of the vast and beautiful palaces of the early Maya kings. The decorative motifs of the ceilings are an adaptation of the intricate mosaic work of the Mayas, and the pendant electric fixtures, original conceptions of the architect, are designed with the carved-stone treatment.

The rooms of one of the hotels, for example, are strikingly treated in a primitive style of coloring, the walls being decorated with vivid, yet pleasing, mural paintings, representing the progress in commerce and art of the races, and the influx of whites on this continent. In other instances the murals portray the religious themes and faith of the Indians. In some cases the ceilings are heavily beamed, giving the rooms the effect of great width and depth. Fireplaces are rendered uniquely ornate through the use of distinctive Mayan scrollwork and geometrical designs. The huge doorways in the original Mayan palaces were built in the form of pyramids, or with straight sides surmounted by a huge stone piece, and this theme is invariably incorporated in the modern buildings, sometimes through a pyramidal decorative design on the door or wall surrounding it.

In the modern houses designed by the western architect, the Mayan principles are carried out on a much finer and more subtle scale, although equally distinctive and effective as the public buildings. The

architect has succeeded in adapting the Mayan principles to the living rooms, dining rooms, halls and other rooms, so that these apartments remain quite in keeping with present-day requirements. In some of the hotels and clubs, special furniture has been designed in keeping with the architectural motif.

Efforts to establish a truly American type of architecture have been made from time to time during the past generation, but without notable success until the discovery of the ancient Mayan cities. Prior to the unearthing of these examples of early architecture, there was little known of the type of structure which existed on this continent in the early ages.

The architect who has led in this new development declares that the actual reproduction of a Maya building would be absurd and would completely fail to express the concerted, strong American spirit of modern times, since the nation has created a civilization infinitely finer and more complex than the ancient race.

The adaptation of the Mayan principles and themes, however, promises to mark a new epoch in building, so eagerly has it been received in several western cities.

### MOST OF SUN'S ENERGY NOW WASTED ON FARMS

Although the sunshine on an acre of land during the growing season of ninety days has a heat equivalent of more than 240 tons of coal, most of this energy is wasted before it reaches a form that man can use directly. For instance, twenty-five bushels of corn from an acre would have a heating value of but one-third of a ton of coal. If the corn were

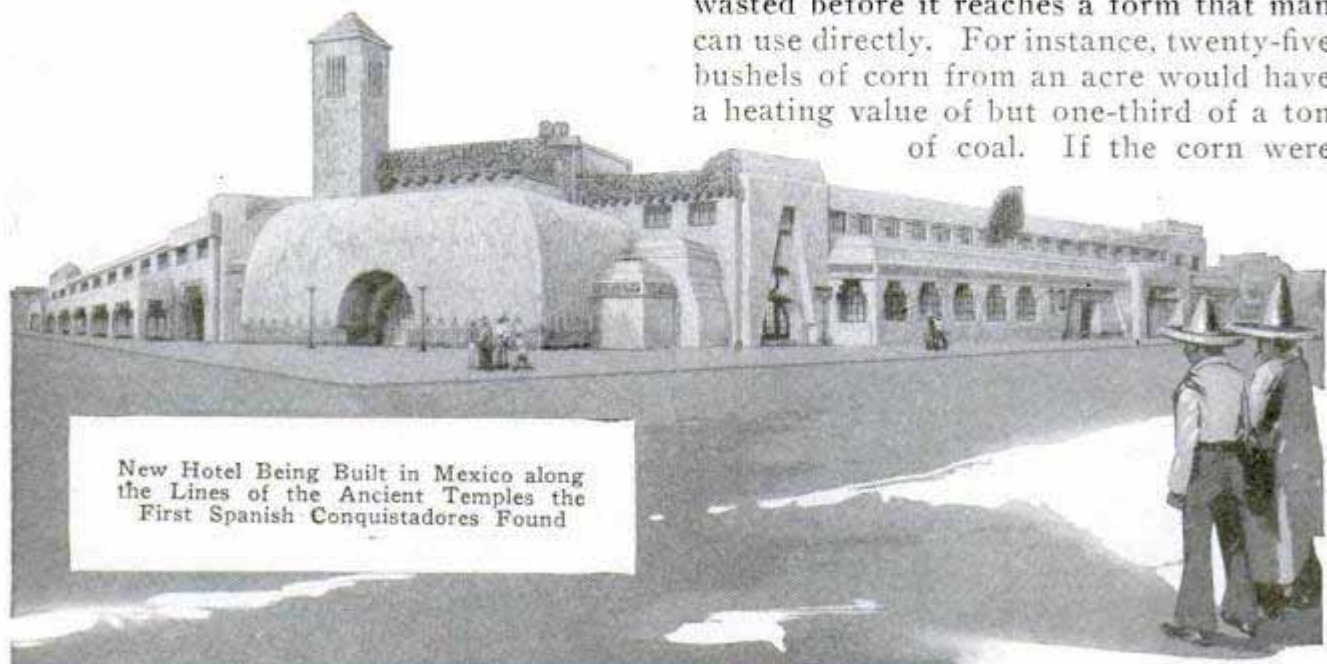

New Hotel Being Built in Mexico along the Lines of the Ancient Temples the First Spanish Conquistadores Found



Colliers.

Mr. Apranido Amara, 90 West 11th St. Philadelphia, Pa.

fermented into alcohol, the energy would be reduced to about one-fifth of a ton and, if fed to cattle, the meat from the corn would have the equivalent of only sixty-six pounds of coal. There is a larger return from trees. Redwood grows rapidly, yielding timber at approximately the rate of 300 cubic feet per acre per year. Burning the wood, heat equal to about half a ton of coal would be realized.

PERIL FROM SNAKES LESSENERED BY LATEST CURES 2301

Antidotes for the poison of the rattlesnake, the copperhead and the water moccasin, which, if injected into the bloodstream within a few hours after a bite has been suffered, will almost certainly prevent death, have been prepared by a Brazilian doctor. With the aid of the army and other agencies, he collected the venom of more than 4,000 rattlesnakes in this country, then proceeded to develop antidotes or antitoxins by inoculating horses. The process was a complicated one and involved preparations from the venom of more than thirty species of rattlesnakes. Each is slightly different but all work on the same principle. The preparations have been tested by the public health service.

1912. AUTO AWNING AND VENTILATOR AIDS HEALTH AND COMFORT

Adjustable to twelve different positions, a combination awning and ventilator for the automobile windows and doors is easily attached and does not interfere with opening and closing. As a sunshade, it may be quickly set to the desired position, is used as a curtain for shade when the windows are closed and helps break the draft when they are open. The material is hard-finished, permitting easy cleaning. When not in service, the awning is folded inside, out of the way.

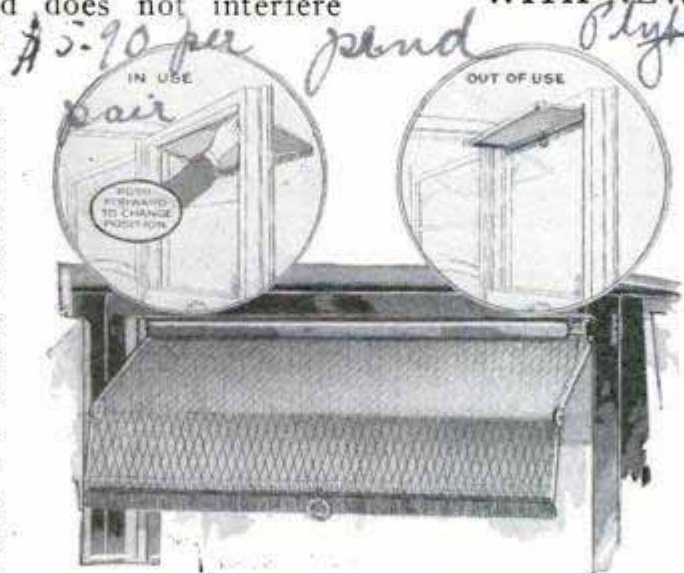

Auto Shade in Various Positions; When Not Wanted, It Can Be Folded Inside the Car

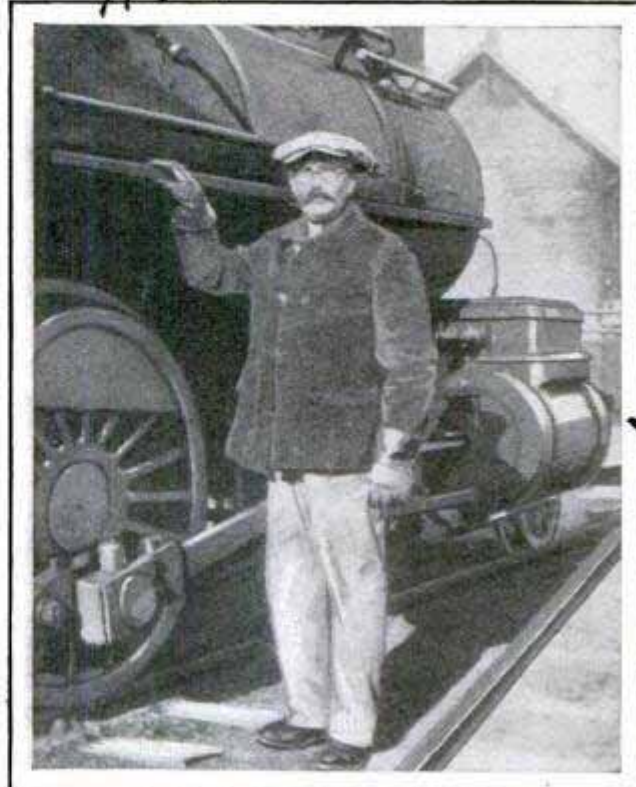

Dave Dingler, President, Part Owner and Engineer of the Cassville and Exeter Railroad

Cassville Mo. FIVE-MILE RAILWAY'S ENGINEER IS ALSO ITS PRESIDENT

Being president, part owner and the only engineer is the distinction of a Missouri railroad operator. The line, five miles long, runs through a section of the Ozarks in the southwestern part of the state. Seven other persons, including the president's wife, manage all the affairs of the company.

see letter WOOD AND PAPER FIREPROOFED WITH NEW COMPOUND 2285

A chemical compound which is said to fireproof wood and paper without destroying any of their properties has been developed in Norway. A house built of wood impregnated with the material has resisted fire in repeated tests. Wall-paper and hangings treated with the chemical are also made fireproof.

The Stoll Mfg Co, 3227 Larimer St.

Produced by inventor in connection with sawmill. Westgate, Eggenbrot. Announcement of U.S. Dept. of Commerce



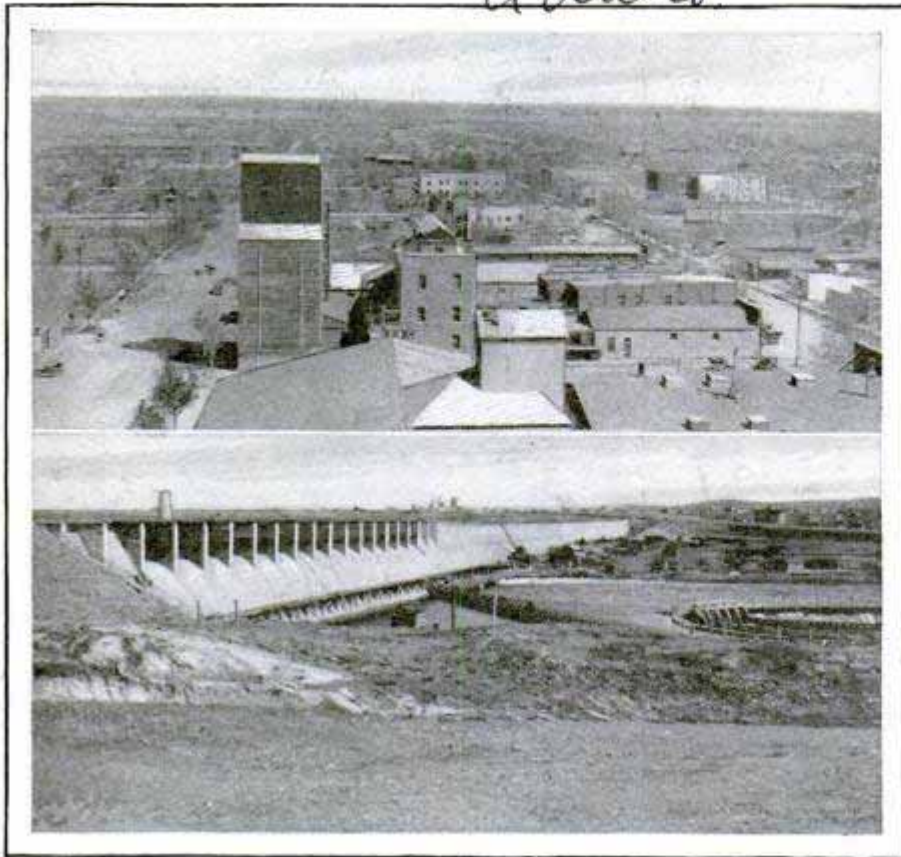

American Falls, Idaho, before Moving, and a Rear View of the Dam Which Will Store Up Water for Irrigation

### ENTIRE TOWN MOVED A MILE IN BUILDING DAM

To permit construction of a huge reservoir and dam across the Snake river, it was necessary to move the whole town of American Falls, Idaho, a mile from its original site. This involved an engineering feat comparable to the building of the dam itself, as the structures included substantial brick stores and dwellings, grain elevators and other buildings. The steel and concrete bridge, on which the railroad crosses the river, had to be raised twenty-one and one-half feet and two miles of track moved. All this was done without interrupting traffic. The dam is a mile long, its greatest height is seventy-six feet, width at bottom, sixty feet, and a roadway for vehicle traffic has been constructed on the top. It will impound 1,700,000 acre-feet of water and the floor of the reservoir will cover 56,500 acres. By adding twenty

feet more to the top of the dam, 3,000,000 acre-feet of water will be impounded. The structure alone cost \$3,000,000, and an additional \$6,000,000 was used for acquiring property rights and moving the town. The work was started in 1923, and the storage of water was first commenced in October last year.

### 2088 — PORTABLE LOADER FOR GRAIN HELPS IN MARKETING

Getting the grain to market while prices are right is an important matter to the farmer, and in some sections of Canada and the northwest, the larger, permanent elevators along the railroads are unable to handle all the loads in harvest time. To solve the difficulty, some farmers have their own elevator rigs, a simple portable outfit that delivers the grain from the wagon into the waiting freight car. The conveyor can be set at different angles and the flexible spout, at the top, swung about inside the car so that little shoveling of the grain is necessary. A small gasoline motor, mounted on the base of the outfit, supplies the power.

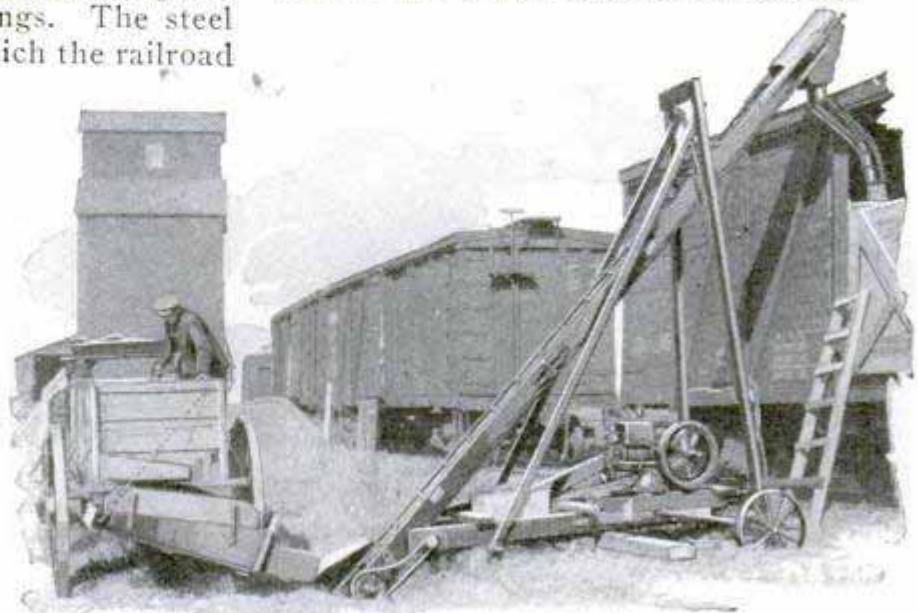

Unloading Grain from Wagon Directly into Freight Car with the Portable Elevator Outfit, a Useful Aid to the Farmer

Hart Lsrain Weigher Co





When Grown-Ups Take to the Coasters; Exciting Moment during a Scooter Polo Game on the Gymnasium Floor; the Sport Offers Unusual Opportunities for Exercise

**SCOOTER POLO FOR GROWN-UPS  
LATEST INDOOR SPORT**

Children's coasters serve as horses for adults in playing an indoor polo game recently introduced in California. Small mallets and a leather-covered ball are used, and as the sport has not yet become "nationalized," the few rules permit a wide variety of independent tactics. The game is said to be popular as a novelty in gymnasium exercises which are likely to become tiresome because of monotony.

*Oakland.*

**WASHER FOR SCRUBBING HOUSES  
—REDUCES PAINT COSTS**

For washing buildings, a portable outfit now on the market is designed to save the time that ordinarily is wasted in wringing sponges and changing water and to make possible a thorough cleaning which is often as desirable as a coat of paint yet costs much less. The apparatus consists chiefly of a mixing tank on a wheeled platform, for easy moving, connections to any convenient water faucet and an electric motor, supplied with current from a lighting socket. Cleaning compounds are carried in a hopper on top of the tank. In operation, the mixture is pumped through a hose and distributed to the surface through a fountain mop or other attach-

ment. An agitator in the tank admits a definite quantity of the compound to the supply, insuring the proper solution. By turning a valve, clean water is admitted to the hose for rinsing. The washer is suited to frame houses, terra-cotta, tile and glazed-brick surfaces, while the compound is said to help destroy insect pests.

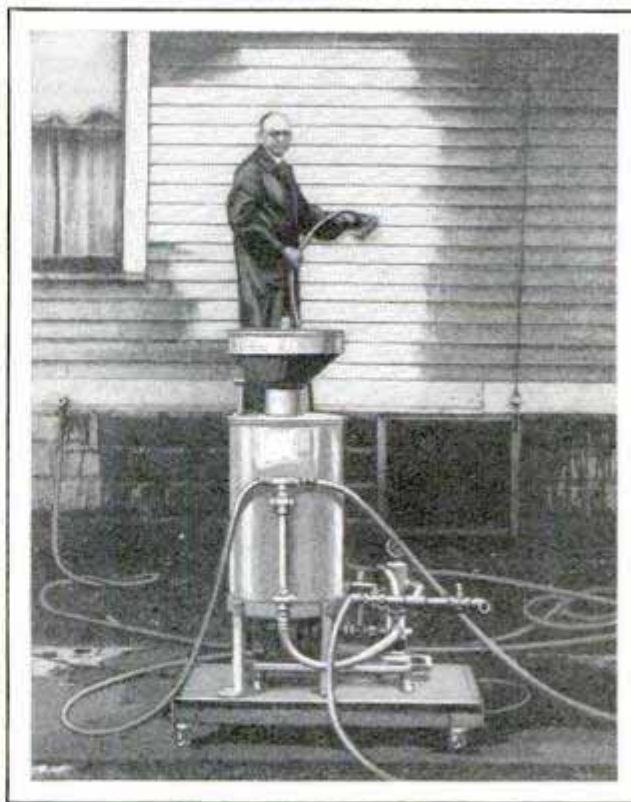

House-Washing Outfit and Sample of Its Work; Rinsing Is Done through Cleaning Nozzle

*Chicago. William H. Bent, 815 W. Erie*

*Nielson Industries, Inc. 12*



1401

Outline

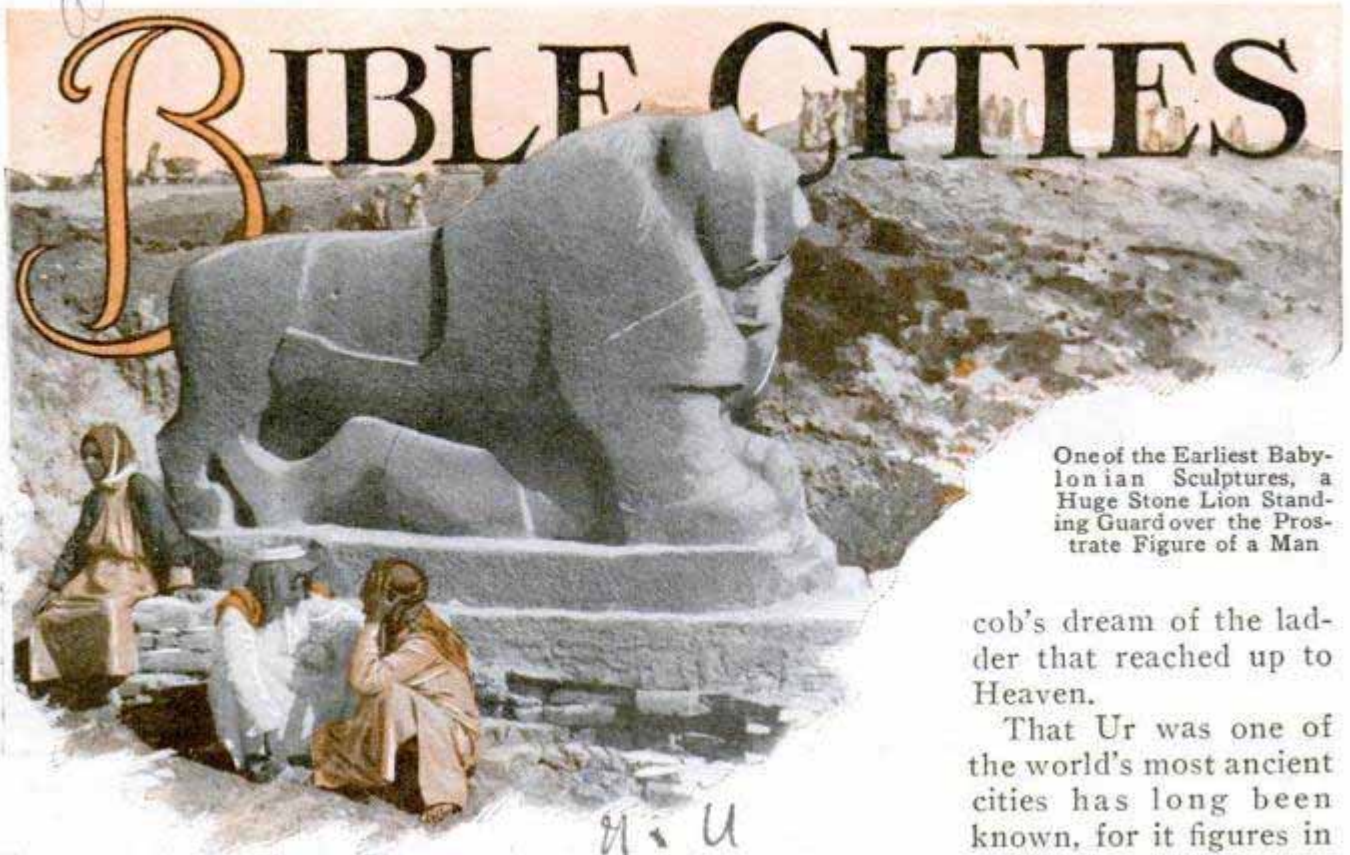

One of the Earliest Babylonian Sculptures, a Huge Stone Lion Standing Guard over the Prostrate Figure of a Man

U. U.  
By J. EARLE MILLER

**T**HE temple courtyards where Nebuchadnezzar, king of Babylon, walked when he visited the god and goddess of the moon at Ur, the immense Hall of Justice, where the king or his representative, the high priest, dispensed the law, and the towering temples of the moon are being dug up again to fill in some of the gaps of Biblical history. An expedition which has been working in the ruined city of the Chaldees, from which Abraham and his father started their trek into the land of Canaan, has already recovered enough material and rebuilt enough of the ruins to piece together much of the story of daily life 4,000 years ago in what is now Mesopotamia.

The excavators, members of a joint expedition representing the museum of the University of Pennsylvania and the British museum in London, have uncovered the progressive story of the Chaldeans as far back as 6,000 years ago, or 4,000 years before Christ. The once important city of Ur, at the junction of the Euphrates and Tigris, one of the main crossroads of the world in Biblical days, has been dug out from beneath the desert sands and enough reconstructed to show the design of the enormous towerlike temples, which, it is believed, may possibly have inspired Ja-

cob's dream of the ladder that reached up to Heaven.

That Ur was one of the world's most ancient cities has long been known, for it figures in the early part of the Book of Genesis, which

states that "Terah took Abram his son, and Lot the son of Haran his son's son, and Sarai his daughter in law, his son Abram's wife; and they went forth with them from Ur of the Chaldees, to go into the land of Canaan."

The excavations disclosed how old it was when they went back through the debris of successive centuries, from well-burned brick, marked with the seals of various kings, through layers of less well-made building material, until the final foundation piles uncovered unburned brick, made before man had learned to replace the drying heat of the sun.

The excavators also have uncovered a graveyard whose tombs date back as far as 3,500 years before Christ, and in their search of them, have found unmistakable evidence that Mesopotamia possessed a high degree of civilization before the time of the first dynasty in Egypt, a discovery that goes far to settle the mystery of which civilization was the oldest, Sumerian or Egyptian. More than 400 of the graves have been opened and from them taken a marvelous collection of gold, silver and other rare objects, along with the earliest known carving, a fragment of a limestone plaque, as delicately carved as the work of two or three thousand years later. The



# Give Up SECRETS

fragment shows four lions drawing an empty chariot, with one man walking ahead of them and another behind the vehicle, holding the reins. A tiger skin is thrown over the chariot, and to the car are fastened spears and arrows, apparently the battle weapons of a dead king whose funeral ceremony was being pictured.

The gold ornaments found in the graves comprise beads, pins, toilet articles, including tweezers. Some of the gold ornaments were made of thin leaf laid over copper, but others were solid and massive. The greater number of the objects in the graves were for personal adornment and similar uses.

Reconstruction of the Recently Discovered Temple of the Moon at Ur, Mesopotamia





1901

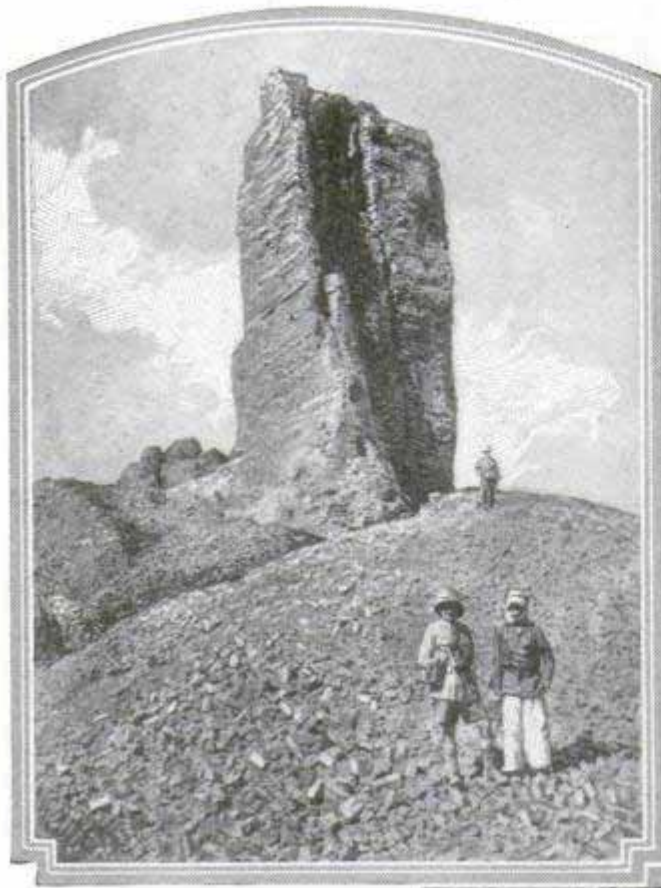

the time of Abraham, Isaac and Jacob is important both from a Biblical and historical standpoint, chief interest in the excavations of Ur centers around the vast temples of the moon god and goddess and the buildings which link the city with such famous names as Nebuchadnezzar, Cyrus and Darius of the Medes and the Persians, and, eventually, Alexander the Great and the conquest by Greece.

One of the first things uncovered was a shrine to the moon goddess, built by King Dungi, with a statue of himself placed in it as a memorial. Time and many wars had destroyed the temple down to the foundation stones, but in the latter were found four ancestors of modern cornerstone boxes. They were boxes of brick,

The cemetery was in use between 3200 and 2500 B. C., and its discovery opens up a new chapter behind the first dynasty of Ur and back into the days of the legendary kings of the dynasty of Erech, who each reigned, according to the tales handed down, for periods of several hundred years. Seals of these kings, engraved on tile cylinders, definitely fix Ur as having been a royal city before the time of Abraham, and then new finds carry its story back to close the gap from the flood down to the time of the Bible patriarch.

In one of his latest reports, Director Leonard Wooley pointed out that the rare objects found in the graves of Ur were equal in workmanship to anything of the time of Nebuchadnezzar, though they were made more than 3,000 years before Christ and the period of the king of Babylon was about midway between that time and the present day.

While the examination of the relics of

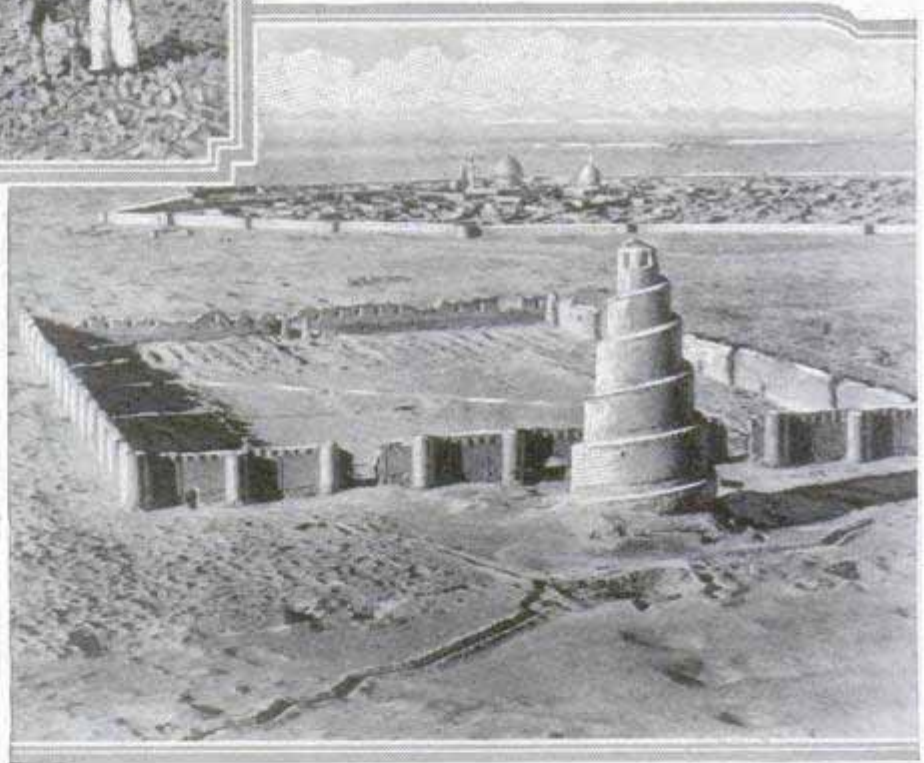

The Walled City of Samarra, with Its Ancient Tower of the Seven Planets, and, Top, Ruins of Tower of Babel

lined with pitch, and in them the king or high priest, more than 4,000 years ago, had deposited a little copper statue, a diorite tablet and some offerings of food and drink. The statue, representing a basket carrier, and the stone tablet both survived the centuries, and on each the same inscription gives the name of the god, of his temple, and of the royal builder. The statue of King Dungi, which had stood in the temple, had lost its head long ago, but on its back was an inscription giving the king's name and dedicating the statue to



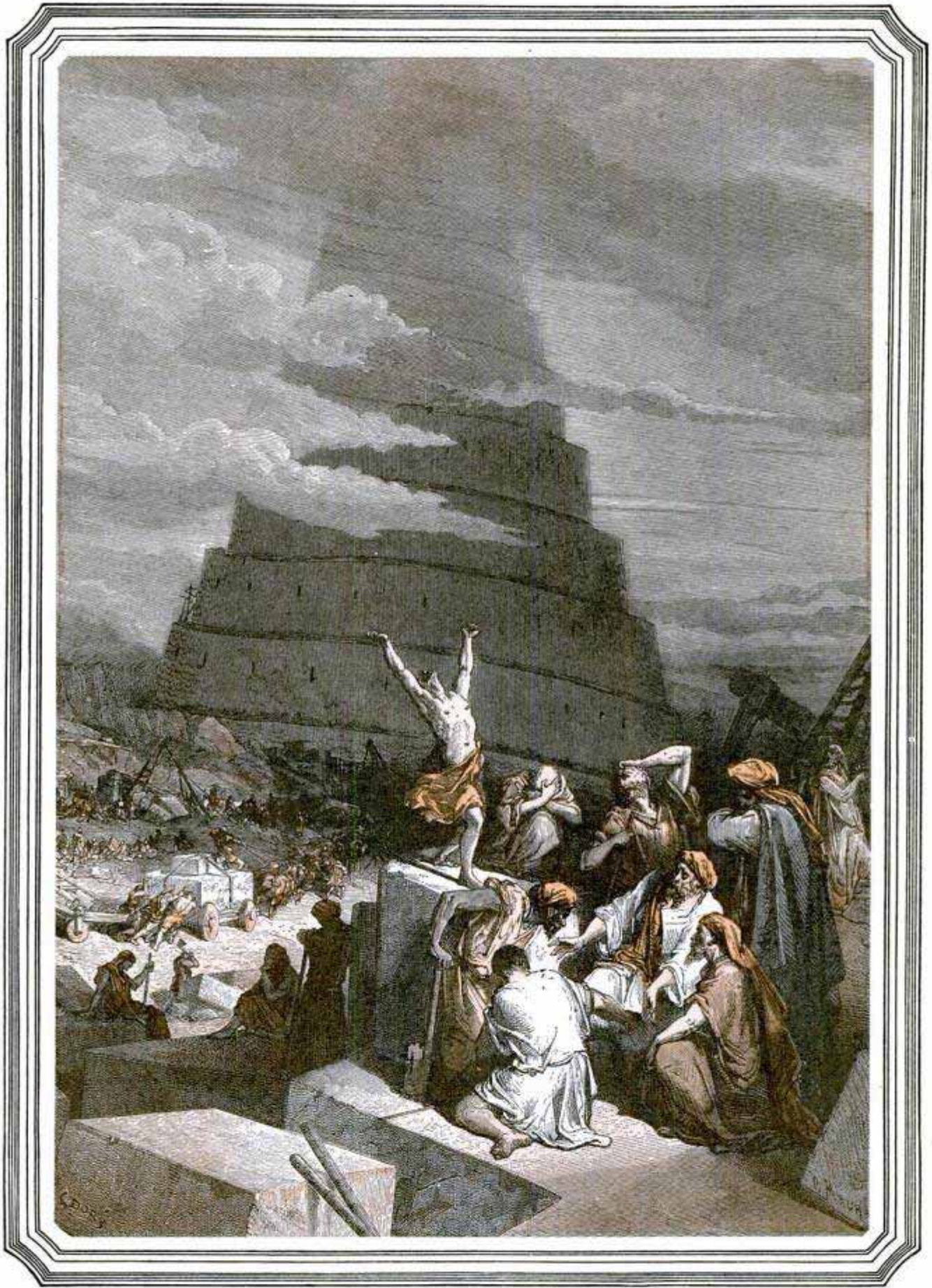

Dore's Famous Drawing of the Building of the Tower of Babel; the Spiral Form Shows a Marked Resemblance to the Tower of the City of Samarra, Shown on the Opposite Page

the moon god for the life of the ruler. Near by, under three feet of rubbish, the

diggers uncovered the most perfect and complete Sumerian temple, of 2400 B. C.,



1401  
86



Some of the Finds in Ur; a Dairy Scene, at the Top, a Stela Showing the Sun God Shamash on His Throne, and, Below, a Fragment of a Stela Showing Minor Gods Leading Gudea before the Chief God, at the Right.

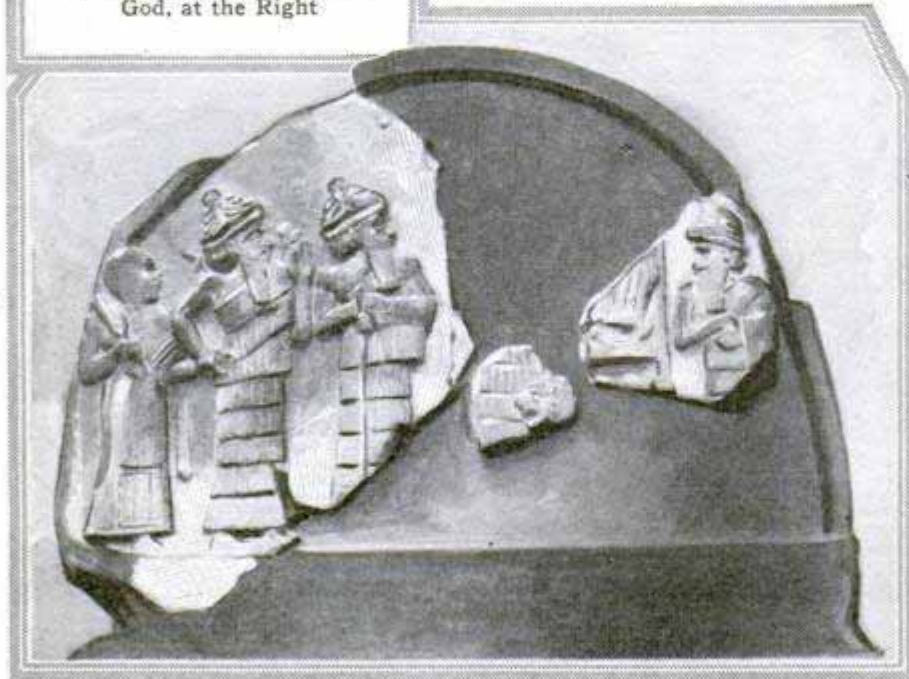

ever found. It is complete with walls, courts, shrines, store-rooms, kitchen, wells, altars, statues, stelæ, or monolithic instruction columns, and even with the door sockets in which its brass and goldplated cedar doors once swung. More than thirty of the door sockets were found in place, each with the inscription to show the temple was the work of Ur-Nammu, King of Ur, and his grandson, Bur-Sin, who followed him. This temple was the private residence of the moon goddess, the mother of the city.

The crowning architectural achievement of the city, however, was the enormous Ziggurat, a vast pile that somewhat resembles the pyramids of Egypt in its bulk, while its sides were flanked by sweeping stairs and terraces, and the top was crowned by a small building, in which, it is believed, the prettiest girl of the city, who was dedicated to the moon god as his bride, made her home in lonely state.

The huge Hall of Justice, near by, the walls of which are in a very good state of preservation, was dedicated also to the moon god, whose statue once crowned an enormous dais at one end of the building. All of the statues, plated with gold and set with precious gems, the metal plates of the door, walls and ceilings, and everything else that had value and could be removed, have long since disappeared, just as the tribes who followed after the

downfall of the kingdom of Babylon carried away much of the bricks to build their homes. The foundation bricks of the altars, brick daises on which statues once stood, and the hollowed-out sockets in which the doors once turned, are all that is left to show where they once stood.

The frequent inscriptions and the occasional barrellike clay records on which the king's secretaries inscribed his achievements, however, enable the excavators to



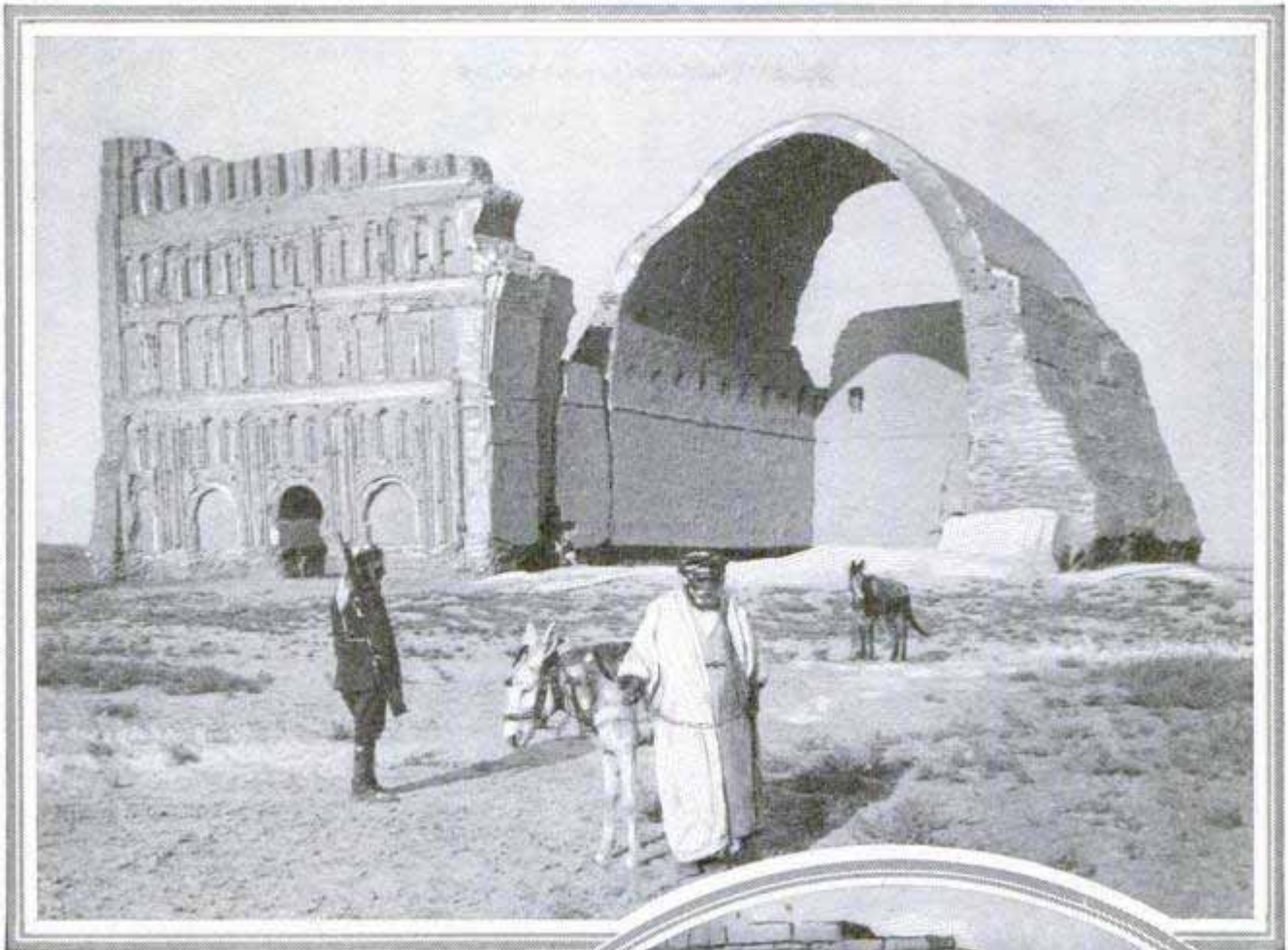

The Famous Arch of Ctesiphon, Twenty Miles from Bagdad; It Was the Roof of the Throne Room; at Right Are Bas-Reliefs Made in Bricks, and, Below, a Modern Water Carrier of Bagdad

piece together the story of the city in its glory. One of the cylindrical documents of Nebuchadnezzar in the University of Pennsylvania museum gives a detailed record of the building, of the embellishment of a city and the restoration of its temples, a description that probably, in all its details, fits the

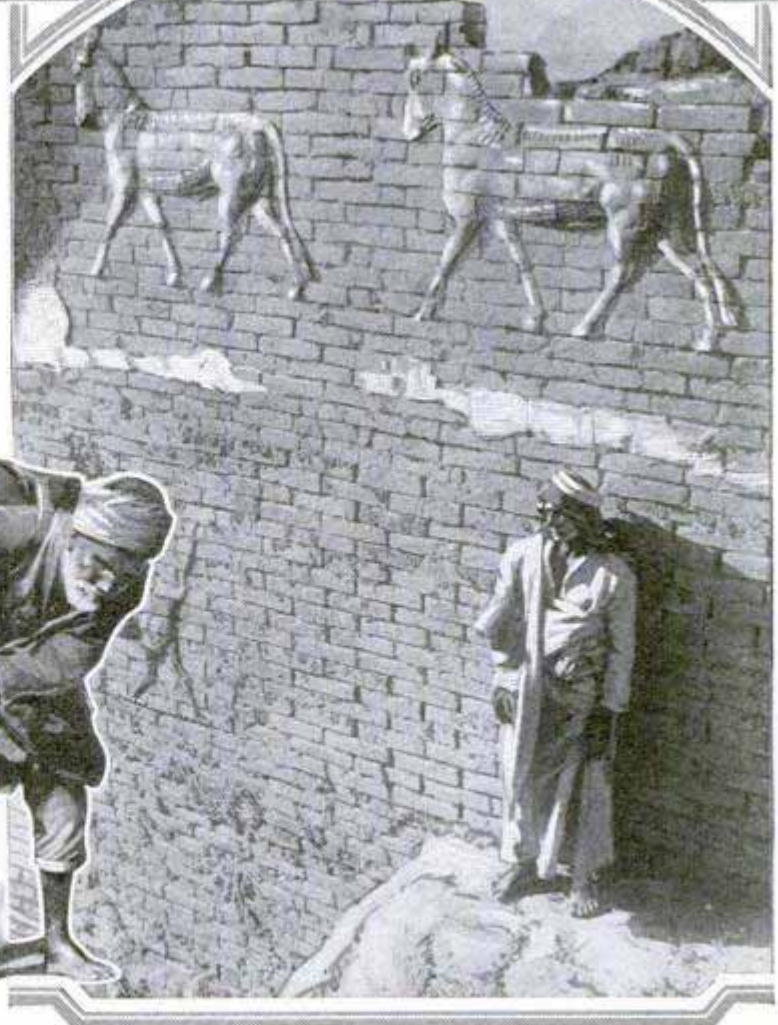



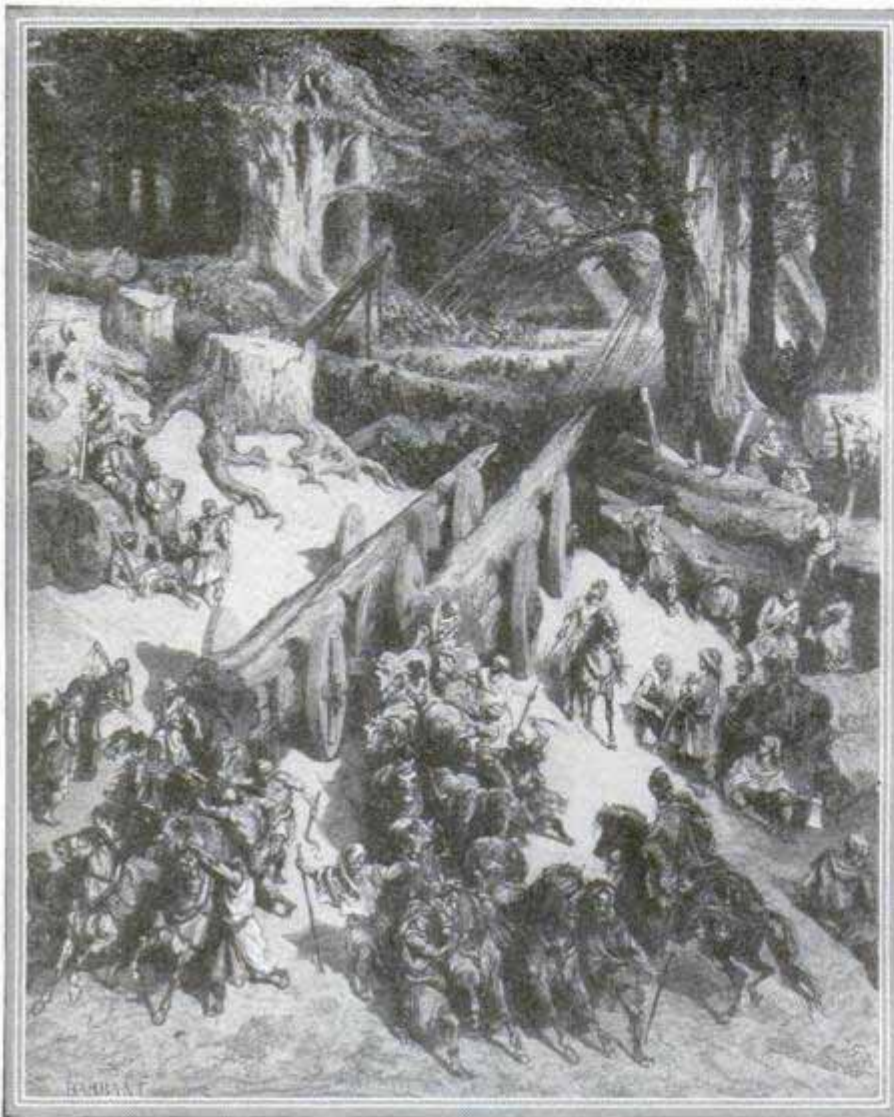

Dore's Drawing of the Cedars of Lebanon Being Transported to Solomon's Temple, Just as Nebuchadnezzar Describes the Process

of Nabu, I adorned their cedar roof with bright silver. As a roof over all these rooms I laid huge cedar trees. I enveloped magan wood with bronze and I placed it as lintels on high. I fabricated huge bulls of bronze and I clothed them with a coating of gold and adorned them with precious stones and I placed them on the threshold of the shrine gate. The threshold, the fetter, the bar, the doorwings, the lintel, the knob, the lock, the bolt of the shrine gate I plated with shining gold. With tiles of clear silver I made bright the passage to the shrine and the entrance to the temple. The doorwings of magan and cedarwood I incased in clear silver, and over the hollow of their span I placed lustrous alabaster, and I fixed the lintel of all their doors. I made the dais of Ezida shrine, the lintel and the hinges in a fabric

buildings of Ur as well as any other city in his land. Describing the restoration of the Ziggurat of Babylon he wrote:

"I enveloped tall cedars with bronze and laid them as a cover. Magan wood, sidaru wood, strong cedar wood overspread with shining bronze, I placed above. Inside its foundation stones, to frame it in, I laid cedar trees and I strengthened their joints with shining bronze (clamps). The huge cedar trees which my pure hands cut in their forest of Mount Lebanon I clothed with shining gold and I adorned with precious stones, and I had them laid across by three as a roof. . . . Above these cedars I spread shining bronze as a covering. Above the bronze I placed a tahlal as a crowning fence on their top. In order that no rain, storm or cataract of heaven should reach them I redoubled and with strong cedar wood built a roof above them. As for the six rooms adjoining the shrine

of clear silver and placed them inside. I covered with clear silver the cedar wood of the roof of the Dara gate, through which comes and goes the son of the lord of the gods. . . . I fabricated huge bulls of silver and I placed them on its threshold."

The cylinder goes on through column after column of description of temple rebuilding and new walls for the city defense, in much of which gold, silver, bronze and precious stones were used lavishly.

The moon goddess temple at Ur, which shows every sign of having been such a building as the king describes, is built on a rectangular plan, surrounded by a double wall with a passage between for the guard. A terraced roof, reached by stairs within the passage, covered it. The various shrines, stores and apartments were grouped around three open courts, the northern and southern of which were sa-



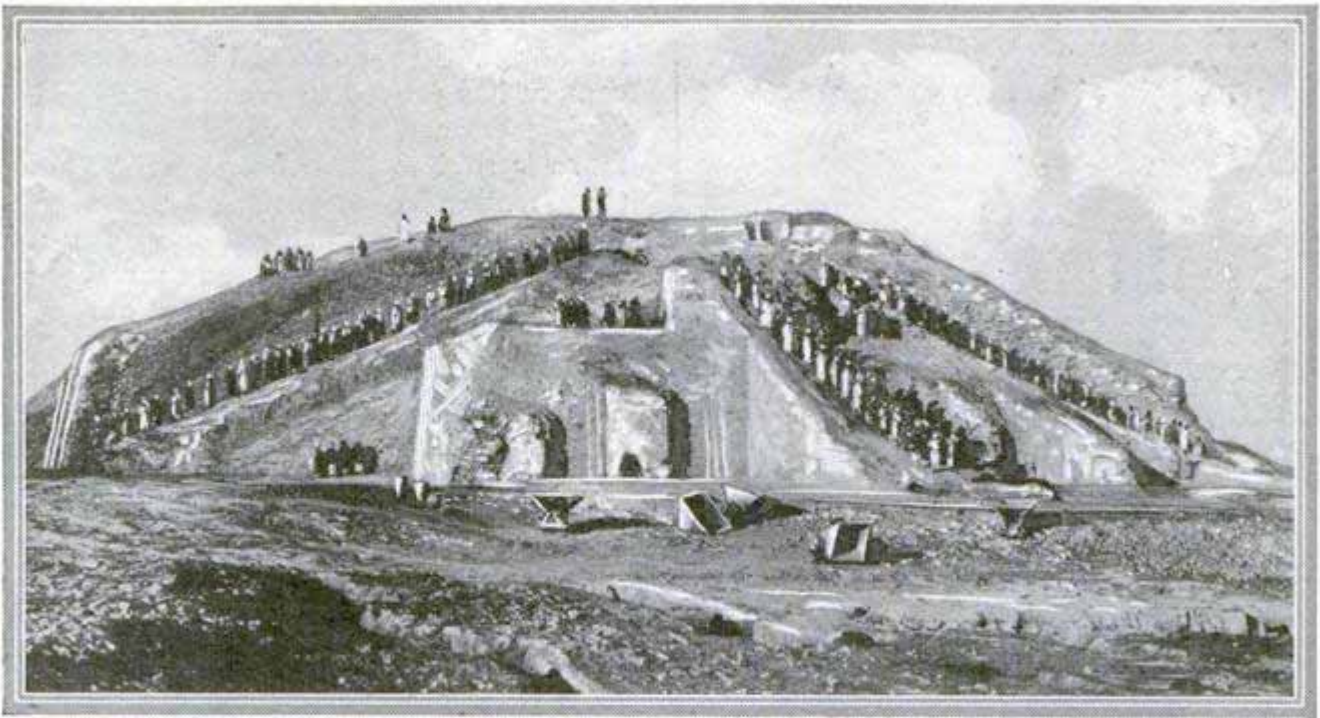

Temple of the Moon God at Ur as It Appeared during the Excavation; the Entire Building Was Buried under the Desert Sand Before the Work of Uncovering It Began

cred places where the daily sacrifices were held. One of them is the most perfect sacred place of the time—three centuries before Abraham—to be found. The bronze gates which formerly closed it are gone, but the door sockets, round pieces of diorite stone, are still in place, with their inscriptions "King Ur-Nammu and King Bur-Sin, king of Ur, kings of the four corners of the world." The copper shoe of the door post, swinging in its hollowed cup, has left its record in green oxide which still endures.

Clay tablets containing the records of the temple "stenographers," who did their writing with a stylus and baked the result to insure its permanence, have been found in the storerooms telling of the pots of oil issued once a month for the greasing of the hinges of these temple doors.

Shrines and altars are still clearly defined, along with water tanks of brick lined with pitch, in which the supplies for the ceremony of libation, as well as for courtyard-pavement washing, were kept.

Like the Greeks who many centuries later erected a statue to the Unknown God, for fear they might have overlooked some powerful deity, the Sumerians were friendly to other peoples' religions. In addition to the main shrines of the moon goddess there are a number of alcoves and side shrines built to contain statues of foreign gods and goddesses, and, in fact,

the only complete statue found in the building was a squat little figure of the goddess Bau, better known to archæologists as "Mother Goose," as she is shown riding the waves of the Euphrates flanked by two geese. Mother Goose did not belong to Ur, but was the wife of the god Ningirsu, at Lagash, forty miles away.

In the storerooms and treasury only broken stone and alabaster vessels remain. A fine stone casket, plainly encircled, at one time, by a gold band, which has long since been ripped away, apparently contained the temple jewels. Many of the record tablets tell of great journeys and marvelous cargoes. One describes a sea expedition, which returned after three years with gold, silver, lapis lazuli, precious stones, ivory and caskets of rare wood.

At every turn the excavation sheds new light on customs described in the Bible. One of the familiar passages of the Old Testament relates that "the sons of Eli were sons of Belial; they knew not the Lord," and the custom of the priests was to send their servants, with a triple-toothed flesh hook, to stick it in the sacrificial kettle and hook out some meat for the priest. Exactly the same custom was practiced in the moon goddess' temple, for the kitchen contains a vast circular range for boiling, with a small platform, reached by a circular staircase, on which the servant could stand to exact his toll.



*Superior Products*  
 90  
 1918  
 638 W. Jackson Blvd  
 POPULAR MECHANICS  
 Chicago

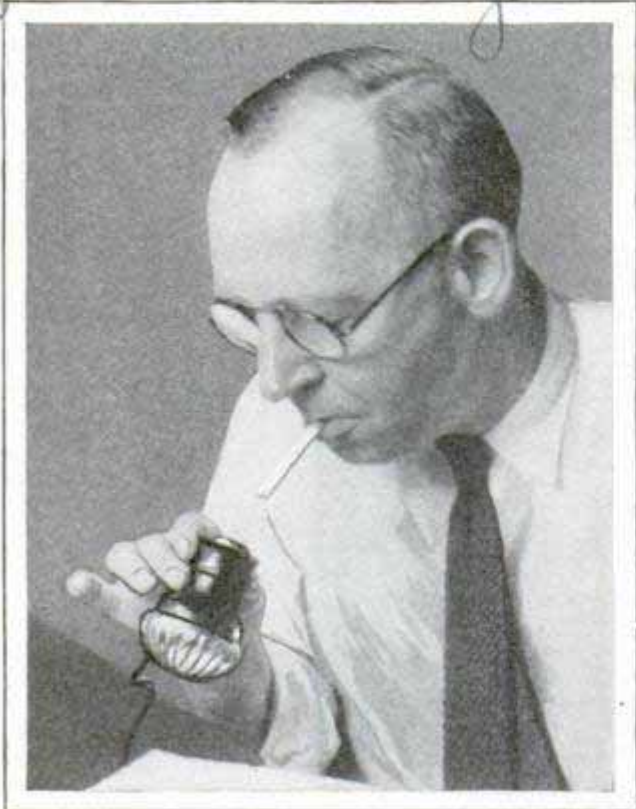

Weight of the Base of This Lighter Turns Current On When It Is Lifted

**LIFTING CIGAR LIGHTER TURNS ON ELECTRIC CURRENT**

Picking up an electric cigar lighter now on the market, automatically turns the current on, sparing the user the trouble of depressing a switch or button, while the flow is instantly turned off when the unit is put down again. This is accomplished by a weighted base and a moving top section, so arranged that contact is made with the heating element when the lighter is lifted. The wires are glowing by the time they reach the cigar. The device also is suited to cigarets or pipes, saves current, and being of small size, is convenient wherever a socket connection is available.

**MOVIES ARE AID TO DOCTORS IN DIAGNOSIS OF DISEASE**

235

How the body tissues change during an illness, how steel looks when it is fatigued, what an unborn mosquito looks like while struggling to escape from the egg, these and many other marvels can now be studied at leisure by means of the motion-picture camera in a "hookup" with the microscope and other instruments. Movies have been taken of the opening and closing of the valves in a calf's heart

through glass windows in the walls of the organ. In the medical field, the movie camera has proved of great value in identifying disease and, by picture analysis, more is said to have been learned about the peculiarities of various types of steel than by any other method. Especially interesting studies of fatigue in metals have been made through the gradual change in their molecular make-up as registered by the motion-picture camera.

**HYDRAULIC HOIST DUMPS GRAIN FROM TRUCKS OR WAGONS**

927

When farmers began to use motor trucks to haul their grain to the elevators, a difficulty was met with, when it was found that the usual 130-inch wheelbase was too long to handle on the eight-foot dump beams that had been used on farm wagons for many years. It was not practical to lengthen the beams, for then they would hit the horses. The problem has been solved at many elevators by installing a hoist platform which accommodates either trucks or wagons. It lifts the front wheels of the vehicle sufficiently to permit the load of grain to slide out at the rear to the elevating apparatus, and is operated by

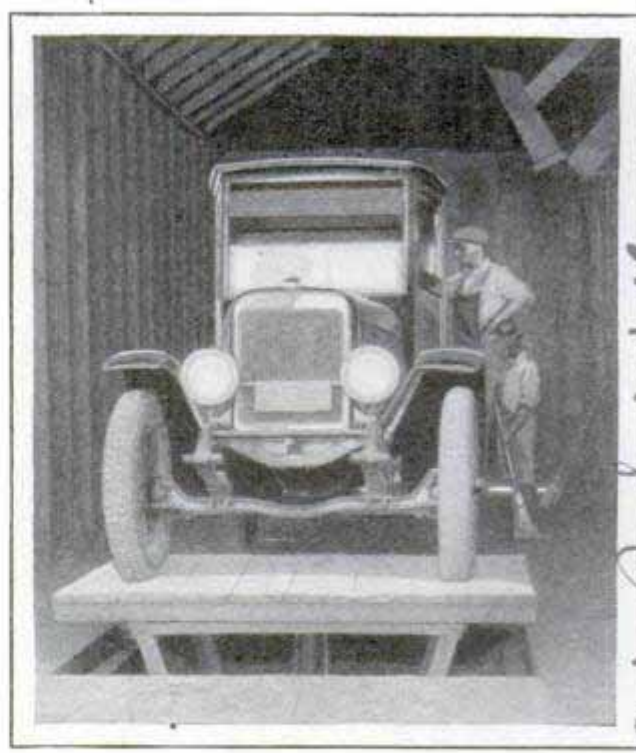

Elevating the Front Wheels of the Truck with Hydraulic Hoist, So That Grain Can Run Out

the same power plant that serves the rest of the machinery.

*Sold by Mr. Alfred B. Hitchens  
 Research Picture Corp*

*Emb. R. S. Williams 2237 E. 70th St. Chicago*



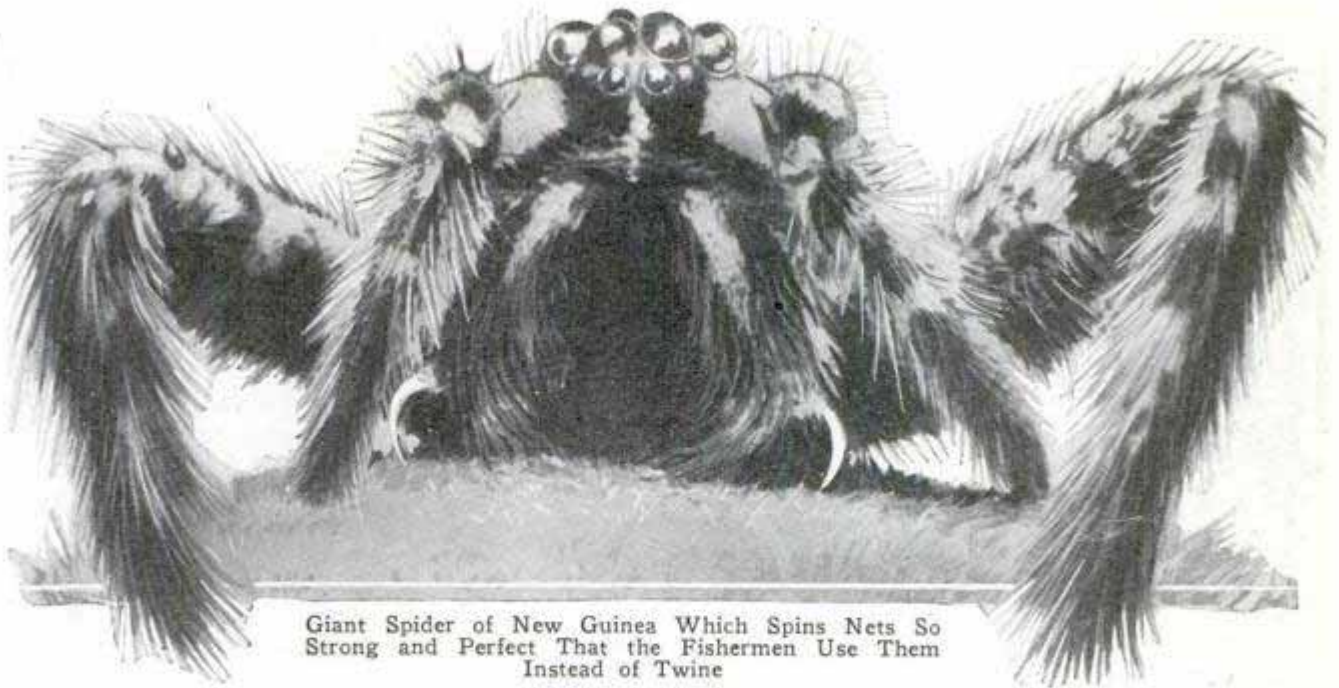

Giant Spider of New Guinea Which Spins Nets So Strong and Perfect That the Fishermen Use Them Instead of Twine

## Secret of Spiders' Skill Sought by Science

Strength of Web and Intelligence of Nature's Greatest Engineers Shown by Government Tests

By UTHAI VINCENT WILCOX, *Sakoma Park*  
*Washington, D. C.*

SCIENCE has been discovering some new facts about the spider. Whether or not this creature ever reached our earth from some other world, as some may believe, scientists are agreed that the spider is supreme in cunning, ruthless ferocity, inventiveness and courage.

H. G. Wells once said that if man ever lost his mastery of this planet, the next race to dominate it would be the spiders! And Dr. E. W. Gudger, of the American Museum of Natural History, who for years has been studying the spiders, now announces the results of his observations which would make of Mr. Wells a prophet. Experiments with spiders and careful watching of various kinds reveal an intelligence that leaves mankind amazed.

So important is the study of the spider that the United States department of the interior has been making an investigation of the spiders' web. This silken thread, spun by a spider, when photographed through a microscope that enlarges some 2,000 times, is but the size of an ordinary horsehair. On the other hand, a human hair, magnified on the same scale, would be six inches thick. This is comparative,

as well, of the relative strength of the two. The spider with such an apparently fragile and transparent wisp of line is able to bind animals several times larger than itself.

Dr. Gudger tells of how he has seen spiders attack tadpoles, small frogs and snakes, lizards, and even bats. He found some of the results hard to believe and as a true scientist waited a long time before announcing the results of his own conclusions. He tested some spiders by capturing a dozen tadpoles and three tree frogs for his experiment.

Taking a jar with the tadpoles swimming in the water and a bit of a tree branch to keep the spider and the frogs out of the wet, he saw that the spider soon ate nine of the tadpoles and then made a meal of one of the little frogs. After this he observed spiders about ponds and small bodies of water. It seemed true that tadpoles and small frogs are favorite dishes of hungry spiders. When the spider wants something to eat he goes fishing. Even minnows have been known to vanish from an aquarium if a large spider is about.

But spiders, Dr. Gudger found, will even attack snakes. At Batavia, N. Y., a small



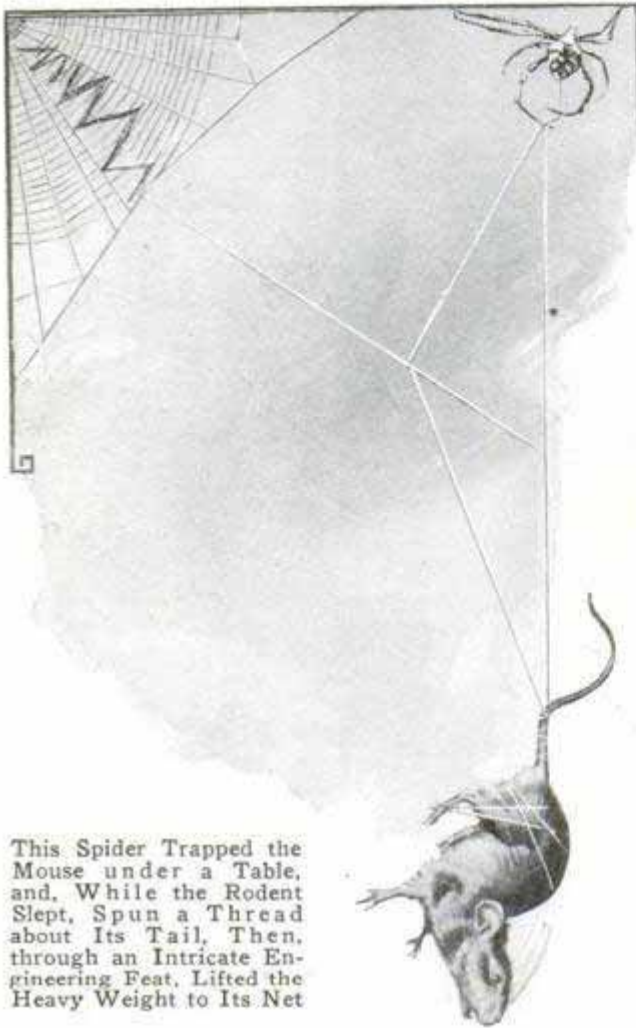

This Spider Trapped the Mouse under a Table, and, While the Rodent Slept, Spun a Thread about Its Tail, Then, through an Intricate Engineering Feat, Lifted the Heavy Weight to Its Net

ringed snake, nine inches long, was found trapped by a spider in a cellar. The spider, its body hardly bigger than a good-sized pea, had spun a web in the form of an inverted cone, from the tip of which hung a silken cable of about the thickness of ordinary sewing silk. By this cable the snake was found suspended still alive, its mouth muzzled with multiple strands of web, and its tail tied by means of more of the silken cord.

Dr. Gudger also tells of a mouse that was snared by a spider. Apparently the snaring was accomplished at the start by winding silken threads around the tail of the rodent, perhaps while it was asleep. Anyway, the mouse was securely tied, and the spider, its web located beneath the table, showed its engineering skill, using a loop to hoist the mouse off the floor.

In New Guinea the Papuans use spiders' webs for fishnets. The spider which is found there is a forest species and spins giant webs, six and seven feet in diameter and woven in large mesh, for the catching of small birds as house spiders catch flies and moths. The primitive Papuan goes

to the forest where the spiders are thickest and sticks upright in the ground the stem of a long and pliant bamboo, the top end of which has been bent over and tied so as to form a large loop. This loop makes a convenient frame in which to build a web and the spider, dark brown and about the size of a hazel nut, seeing the ideal place for a web soon takes advantage of the loop left by the native. The Papuan then takes the net which has been presented to him and uses it for catching fish.

If man points to his mastery of the air, the spider can show that he has for untold centuries used aerial navigation. Many spiders are skilled aeronauts. Almost any warm day will show a spider in the act of taking a little joy ride through the air. Climbing to some elevated place, and letting loose a number of threads, the spider is carried through the air by the wind. It is able to descend at a convenient time by reducing the sail-spread, so to speak, and taking in some of the threads. These spider ships of the air are sometimes found at great heights. Even ships at sea have found them hundreds of miles from land.



The New Guinea Native Erects the Framework and Tricks the Spider into Weaving the Net



1719

It is this quality of adaptability to the air, to the water, to the needs of its appetite that gives the spider the respect, if also the fear, of mankind in general. Dr. Gudger observed a spider making a web. He said that a spider perched on a twig fifteen feet above the ground and wishing to throw a line to another twig twelve feet away will either take note of the direction of the wind and use it, or will lower itself to the ground, running across to the desired spot, fasten the thread to it and then pull in the slack until the first line is taut. After that it is a simple matter of casting other lines at right angles and parallel where, by dropping down or climbing up and pulling in the slack, a web is spun that will catch the needed food.

What couldn't man do if he were able to make ropes and cables with the approximate strength of a spider's web. Suspension bridges would be thrown across on tiny cables about the size of binders' cord. With the secret of making of cord



A Tragedy of the Tropics, Capture of a Humming Bird by a Giant Spider; Not Even the Bird's Great Speed Can Save It

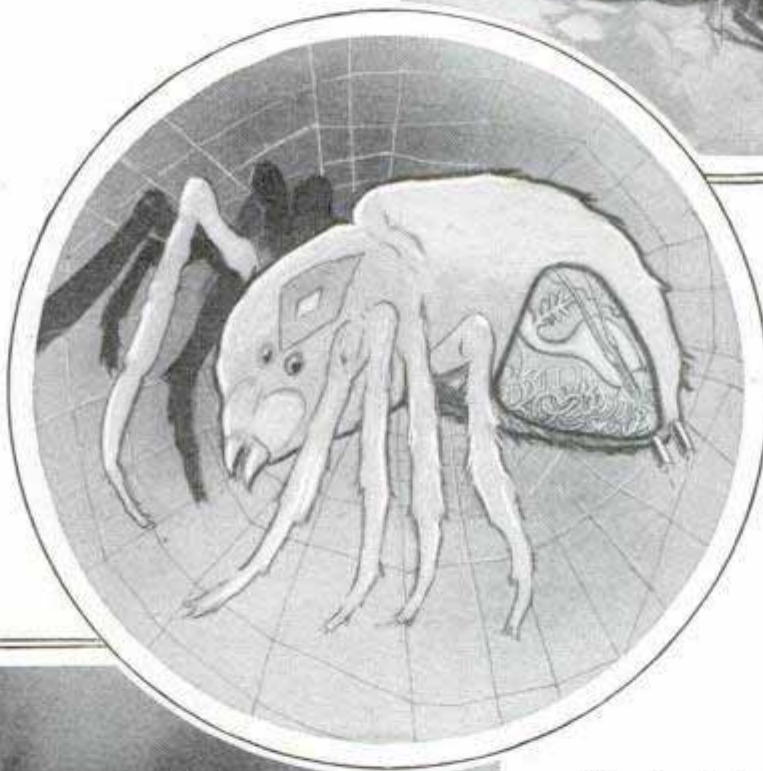

after the manner of the spider, the whole course of engineering as we know it today would be altered. The making of a web is a fascinating process. The

spider first stretches the boundary lines, which may inclose a square or a triangle, according to the place. Then it drops a center line from top to bottom and, working from the center of that, spins a series of rays, that radiate like spokes from a hub. After that, starting at the center, it spins a spiral, using the rays as steps on which to work, and attaching the spiral to each ray in turn. The spiral, however, is only a scaffold to be used in making the final web, which is coated with a sticky substance to trap

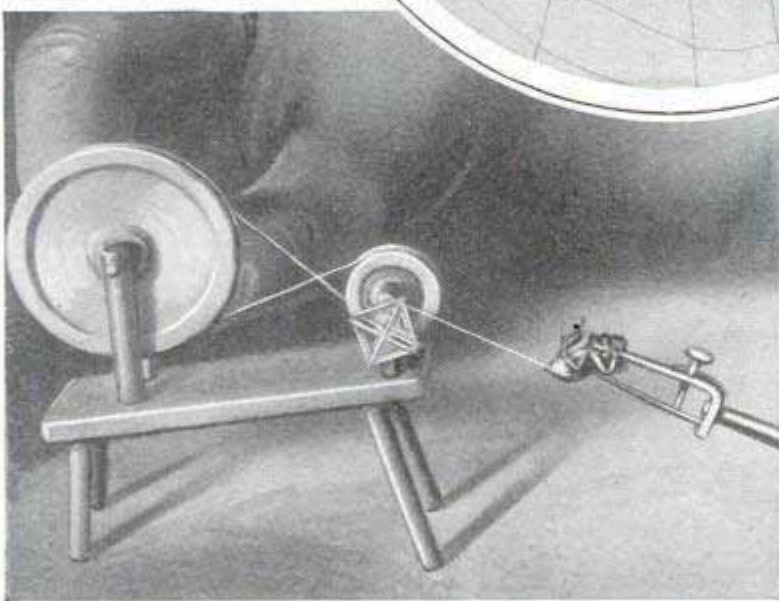

Diagram of a Spider's Silk-Making Apparatus, and a Captured Spider Spinning 280 Feet of Silk Thread a Minute



*arcade Bldg St Louis, Mo.*

flies. The spider starts it at the outer edge and spins another spiral toward the center, walking on the first one, and eating as it proceeds.

**FLOWERPOTS ON SIDEWALKS  
BEAUTIFY CITY**

*1478*

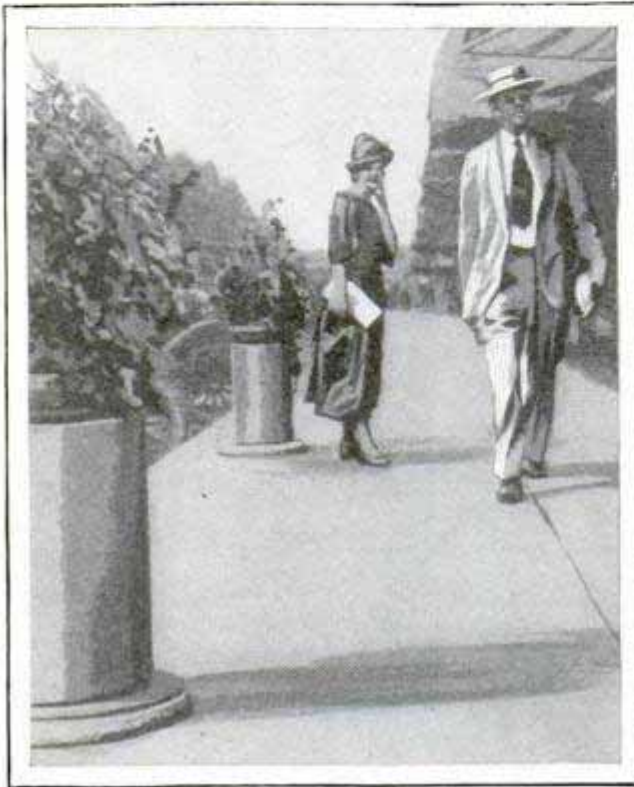

Brightening the Walks in Greeley, Colo.; Flowerpots along Curb Are Paid For by the Merchants

Flowers are grown in special pots set in cement standards along the sidewalks of the business section in Greeley, Colo., to brighten the thoroughfares. The plan is a co-operative one, the merchants sharing the expense of the pots and the replenishing of the miniature gardens. Hardy varieties of geraniums, petunias and other plants have been grown with greatest success.

**HUNTING OIL WITH DYNAMITE  
REDUCES GUESSWORK**

*2324*

Locating underground oil fields by means of dynamite and the seismograph, has proved successful in Texas and other sections. The explosive is fired at the surface, the force penetrating to the nearest hard formation then reflected back. The seismograph registers this "throw-back," thus indicating whether hard strata are close or far from the top, and revealing the presence of subterranean domes

where oil is likely to be found. Oil generally lies on the high spots of the earth's interior and water on the lower, as the oil is the lighter. This method is an outgrowth of that used during the war when the seismograph was used to locate batteries of concealed artillery. The plan has so far proved successful mainly where subsurface structures are such as to give back "reflections" that the instrument can register plainly. In some fields the machines are used with radio-broadcasting outfits. Three are set up in the form of a triangle, within three to five miles of the shot, which is fired in the center of the triangle. Each machine registers the wavelength and makes a picture of the shooting. The operators are informed as to the exact time of the blast and all watches are synchronized by means of a radio clock so that results can be determined at exactly the same instant. In one section of the oil district, approximately 1,000,000 acres are now being surveyed by this new method.

*See by general assembly Sun, 14th and 15th*

**LEVER FOR HANDLING BARRELS  
SAVES HEAVY LIFTING**

*1321*

One man can do the work of several in handling heavy barrels with the aid of a simple lever, especially devised for loading oil drums. It has an adjustable handle which can be placed at various angles for lifts of 500 or 600 pounds.

Once Properly Adjusted, This Grappling Lever for Handling Drums and Similar Articles Is Not Likely to Slip; It Can Be Set for Light or Heavy Lifts by Means of Special Grip



*Thomas L. Wilson  
Pattern Works, 3209*



**BIRD MIGRATIONS  
DUE TO GLANDS?**

Bird migration <sup>2330</sup> may be due to the effect of certain gland secretions, in the opinion of Dr. William Rowan, of the university of Alberta, Can. Results of experiments on 200 juncos substantiated his theory. The birds were divided into two groups, each being placed in an unheated aviary, but in one electric lamps were adjusted to increase the light daily as it would normally increase in spring time. After a period, the birds were let loose. The juncos from the unlighted aviary showed no disposition to leave the locality and were in the condition normal for winter. But only a few of those from the lighted section were recovered, and examination showed that changes had occurred in them such as are normally found after the winter season. Dr. Rowan believes that light produces a stimulus which gives the bird a desire to start on its migration.



Veteran Airplane, No Longer Fit for Flying Service, Carries On as Advertising Sign for Garage; It Was in the War

**OLD AIRPLANE AS GARAGE SIGN  
ADVERTISES SHOP**

Visitors in south London are attracted by what appears to be a wrecked airplane lodged on top of a garage. In reality, the ship was placed there for the purpose of advertising the shop. It is the fuselage of an old plane which did service in the war. The right wing has been removed, so that the body fits snugly against the wall and most of the other is also cut off.

**PARADE LIGHT FOR MUSICIANS  
FITS ON RACK 2232**

Attached to the music by a special clip, a small electric light and battery illuminate the page during parades at night. The unit is said to be easy to keep directed on the music and is intended as a substitute for the coat-lapel lamp which offered some objections in that the rays could not always be held on the notes. A small reflector increases the effectiveness of the light.



**SOIL HEATED WITH ELECTRICITY  
SPEEDS GARDEN GROWTH 2352**

Lettuce was ready for market in March from an outdoor garden in Sweden this year, a result of heating the soil with electricity. That the product may be matured earlier is considered a probability and further tests are planned. A main object is to obtain a ground temperature which will correspond to the comparatively high air temperature in spring. At the Stockholm experiment station, arrangements have been made to heat a large open field with 110 electric wires, set 130 feet apart. It is hoped that potatoes may be planted in April and harvested in June by this means.

*Monarch Electric Light*

*Carl Fischer, Inc.  
Cooper Square, New York*

*Reports received by Dept. of Commerce.*

*New York Times April 16, 1927*



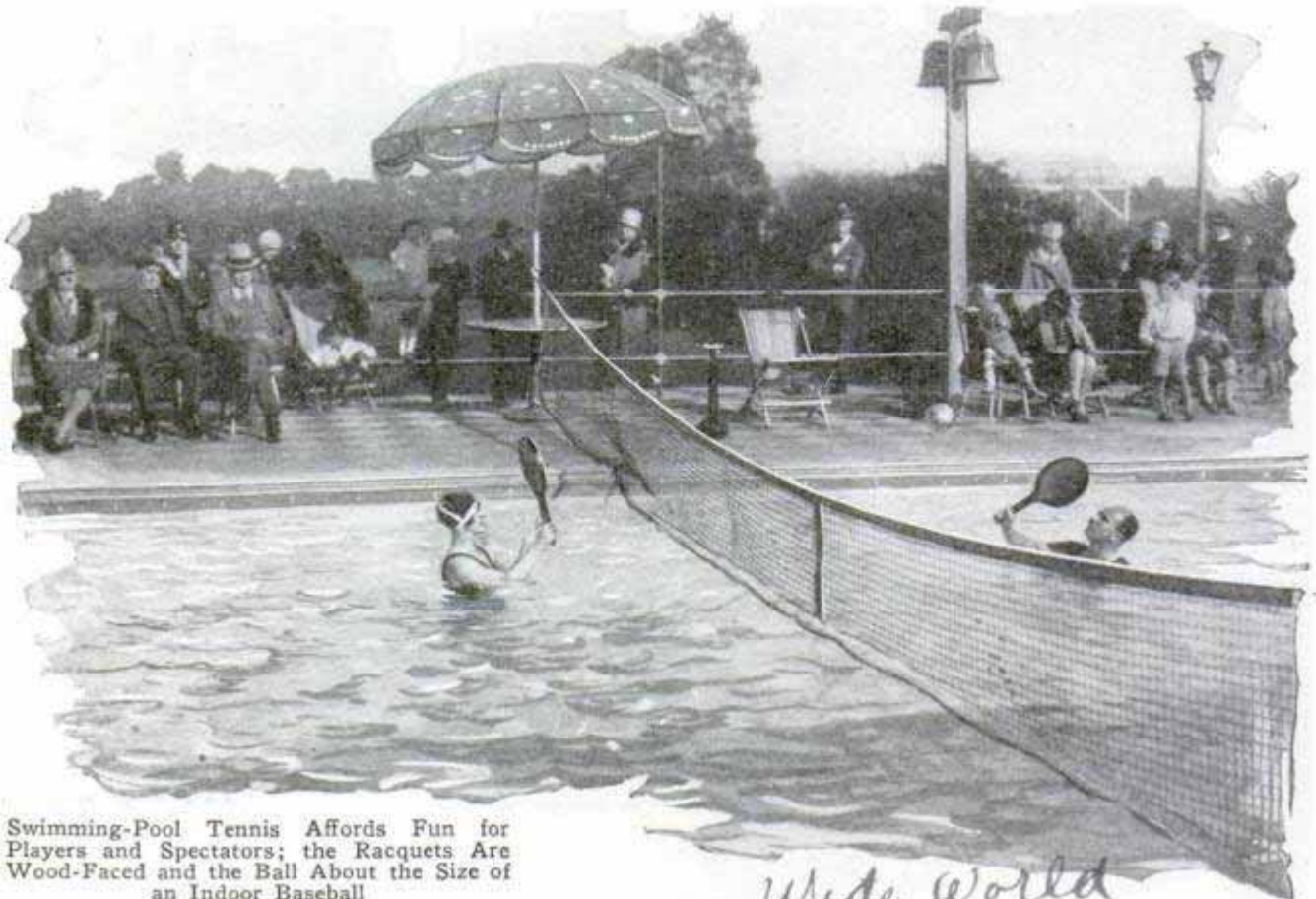

Swimming-Pool Tennis Affords Fun for Players and Spectators; the Racquets Are Wood-Faced and the Ball About the Size of an Indoor Baseball

*Wide World*

**TENNIS IN SWIMMING POOL IS LATEST SPORT NOVELTY**

*Hotel Ambassador*

Aquatic tennis has appeared on the western coast and is reported to be popular where swimming pools can be used for courts. The ball is somewhat larger than that employed in the usual game and the racquets are entirely of wood.

industry here and to American agriculture in general. His work is done on an experimental plot of his farm, and he has become so skilled in selecting and crossing the plants that he can "grow a head of rice to order in much the same way as a tailor builds a suit to a customer's back." One of his first successes was the development of a rice head that would mill perfectly. He started his activities largely through love of experimenting.

**"BIRD-PROOF" RICE DEVELOPED BY GRAIN WIZARD**

*2293*

A rice head that has a short, sharp barb, too tough and cutting for the birds to devour, has been developed by Sol L. Wright of Crowley, La., the Burbank of the rice fields. He already is credited with cultivating several superior varieties of heads which have been raised successfully in this country, proving of great benefit to the rice

**STRENGTH OF BOXERS' PUNCHES TESTED BY ELECTRICITY**

*2102*

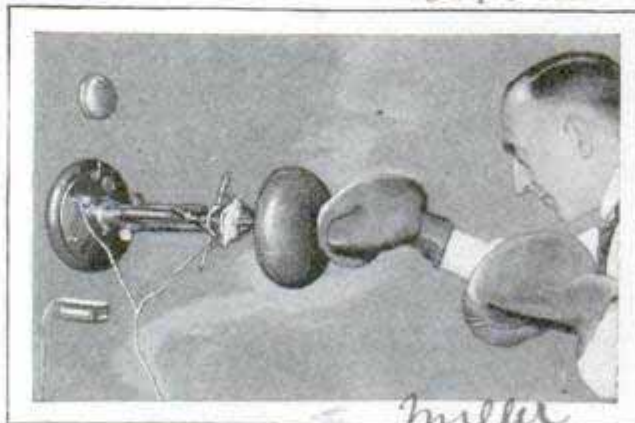

*Miller*

Testing Force of a Punch on Electric Gauge

Accurate measurement of the force of a boxer's blow is obtained with an electric gauge used in Berlin, Germany. The punch is made on a movable padded rest, the pressure received being recorded with the completion of an electric circuit.



*described in Journal of Mathematics and Physics*

*the Physical Institute of Leningrad*

*2174 514 Woodward Bldg Washington, D.C.*

**POPULAR MECHANICS**

**NEW VARNISH MAY LOWER COST OF ELECTRICITY**

2302

Cheaper electricity for heating and lighting and more successful high-power transmission are promised in a new insulating material developed by a Russian investigator and his associates. It is said to resemble a light varnish, and a thin coating of it is reported to serve as a substitute for the bulky and more costly porcelain insulators now in use. Besides providing efficient insulation for electrical operations, it has been found an aid in laboratory experiments. Experts believe that the expensive method of pole construction now necessary on high-voltage lines may be eliminated by using the new material.

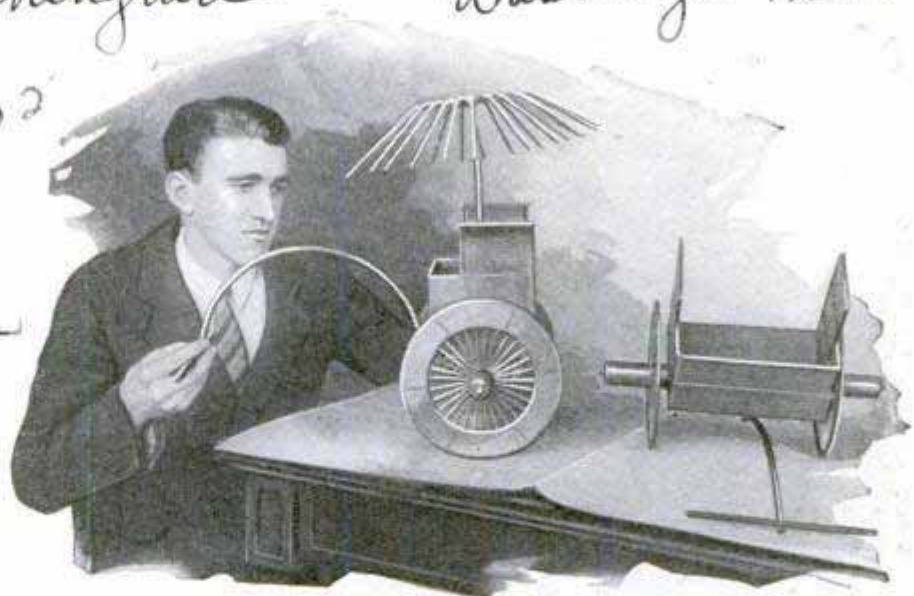

How Ancient Chinese Warriors Rode to Battle; Replicas of Chariots on Exhibition in Smithsonian Institution at Washington

**MODELS OF ANCIENT CHARIOTS SHOW PROGRESS OF WHEEL**

Models of two old Chinese war chariots, based on bronze fragments dating from about 500 B. C., have been received at the Smithsonian Institution and are considered of special interest in that they show the development of the wheel. The discovery of this way of transportation goes back to a time before the dawn of history when it was found that heavy burdens could be rolled on logs. The earliest object representing such a method, and now included in the museum's exhibits, dates from only the fourth century before Christ.

The chariot wheels, much older and far more elaborately developed, indicate what a high degree of civilization had been attained in China in very early times. They have long, protruding hubs and flanged spokes to prevent the chariots from sinking in the mud. A feature of the equipment was the umbrella set to protect the warrior's head from rain and sunshine. The fragments were found during excavations.

☐ The first grain reaper was constructed on an anvil in a blacksmith shop.

**GATHER SHRIMPS WITH HORSES ALONG BELGIAN COAST**

Shrimp fishermen in Belgium save time and labor by using horses to drag their nets through the surf. The plan permits use of larger equipment and working of a wider area, as the horse carries the fisherman and his outfit to and from the beach.



© P. & A. Where the Horse Does Double Duty; Shrimp-Fishing on Belgian Coast



2057



Mr. Cathcart and Specimens of His Coconut Carvings; the Shells Are Exceedingly Tough and Hard to Cut

### PALM-TREE FRUIT IS TURNED INTO CURIOS

During the last twenty-six years, E. A. Cathcart, of Miami, Fla., has carved more than 100,000 coconuts into souvenirs and curios which have been circulated by an ever-increasing tourist army throughout the United States.

Give him a Bahama or Florida nut about the size of a football, and, in four minutes, he will convert it into the grotesque effigy of a Seminole chieftain arrayed for the warpath. Or, if you desire a fancy necktie holder, a new tobacco box, a pin tray, an ornamental hanging basket, a lamp or similar article of utility, this talented artisan will make it for you from the fiber-husked fruit. He uses paints and pigments, razor-edged knives, clamshells, red and green leather, and the art

and artifices of the novelty producer, in converting the tough, shaggy nuts of a curious tropical tree into curios which sell for from \$1 to \$15 or more a piece. If you think coconut carving is an ordinary, routine, unadventurous calling, you should spend a few hours with Mr. Cathcart in his workshop. It really is a rather hazardous occupation. Mr. Cathcart's arms, hands and torso are speckled with scars, the relics of the innumerable wounds and cuts which he has suffered in carving more than twenty-five shiploads of coconuts. The fiber of the coconut is one of the most tenacious substances which human hands ever

attempted to cut with edge tools. It is tougher than seasoned locust wood and stronger than hemp. It is practically impossible to cut against the grain. It requires the full force of a strong arm even to sever chips from the mature nut.

### CALENDAR FITTED TO RECORD WEATHER CONDITIONS

Besides presenting the dates, a calendar has space for yellow, gray and black disks to indicate whether the day was bright, cloudy or stormy. The disks are pasted on according to the weather conditions, so that at the end of the month, for instance, it is possible to tell at a glance if there was more sunshine than cloudiness or just what the days were without consulting the written reports. There is also room for temperature entries if desired.

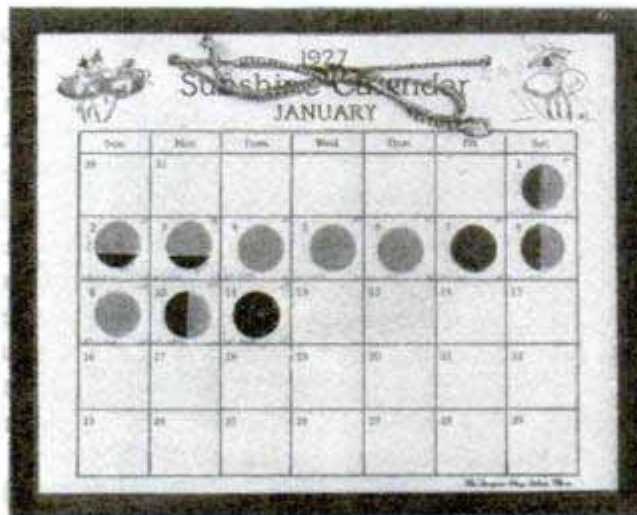

For a Visual Record of Sunshine and Cloud; Calendar with Colored Disks That Tell Weather Conditions

*The Surprise Shop  
Mass.*



**STARS ARE SOURCE OF X-RAYS  
ASTRONOMER BELIEVES**

229

Like rays of light, the X-rays are waves, traveling at the same speed but vastly shorter than those of light, and although they have been put to useful tasks, they are still much of a mystery. A new interest attaches to them in the discovery that they are reaching us from the celestial spaces and seem to be peculiarly strong when the Milky Way is in the zenith. As they are nearly as intense at night as by day, it is thought that they cannot originate in the sun but must come from the stars. According to an English astronomer, all energy is the result of radiation produced as the substance of the star proceeds toward annihilation. The process is marked by peculiar behavior of the waves of energy. In old highly condensed stars like the sun, the waves, moving from the center to the outer layers, are increased in length and reach the surface as heat and light waves. In young, slightly condensed stars, the X-rays from the center encounter little matter and reach outer space almost unaltered, this authority believes.

**RATCHET AUTO-BRAKE TESTER  
ELIMINATES GUESSWORK**

1812

Testing and adjusting the auto brakes alike are simplified by a small ratchet unit recently placed on the market. After the car is jacked up and the brake pedal depressed and immobilized with a holder, the tester is placed under a rim lug which has been turned to the rear and parallel with the center of the hub. The ratchet is then operated to compress the spring in the tester. Rear brakes should be adjusted to register from 250 to 300 pounds and the front brakes fifty pounds less.



\$ 12.50



Spraying Trees from the Portable Tower for Better Treatment of the Tops and Less Waste

**SPRAYING TOWER FOR GARDEN  
INSURES THOROUGH WORK**

Reduction of waste and more efficient spraying are claimed for a compact outfit developed in Germany. Its outstanding feature is a tower which enables the operator to work at a convenient height, where the spray will reach the branches with the best results. The stand also permits the use of shorter nozzles, easily reaching all parts of a tree.

**GRAY WOLVES ARE VANQUISHED**

2256

Depredations of the large gray wolf are believed to be almost at an end in the west because of the unremitting activities of the United States biological survey and other agencies against them. In New Mexico, only eight were caught last year and thirty-one the preceding year. Arizona reports that no wolves are now known to be within the borders of that state. A constant patrol is kept along the international boundary to prevent invasions by timber wolves and mountain lions from Mexico.

Our Bureau of Information will answer all questions regarding articles appearing in this magazine.

*Master Mfg + Sales Corp*  
*504 Indiana Ave. Bldg*  
*N.Y. Times 4/3/27*



53 47

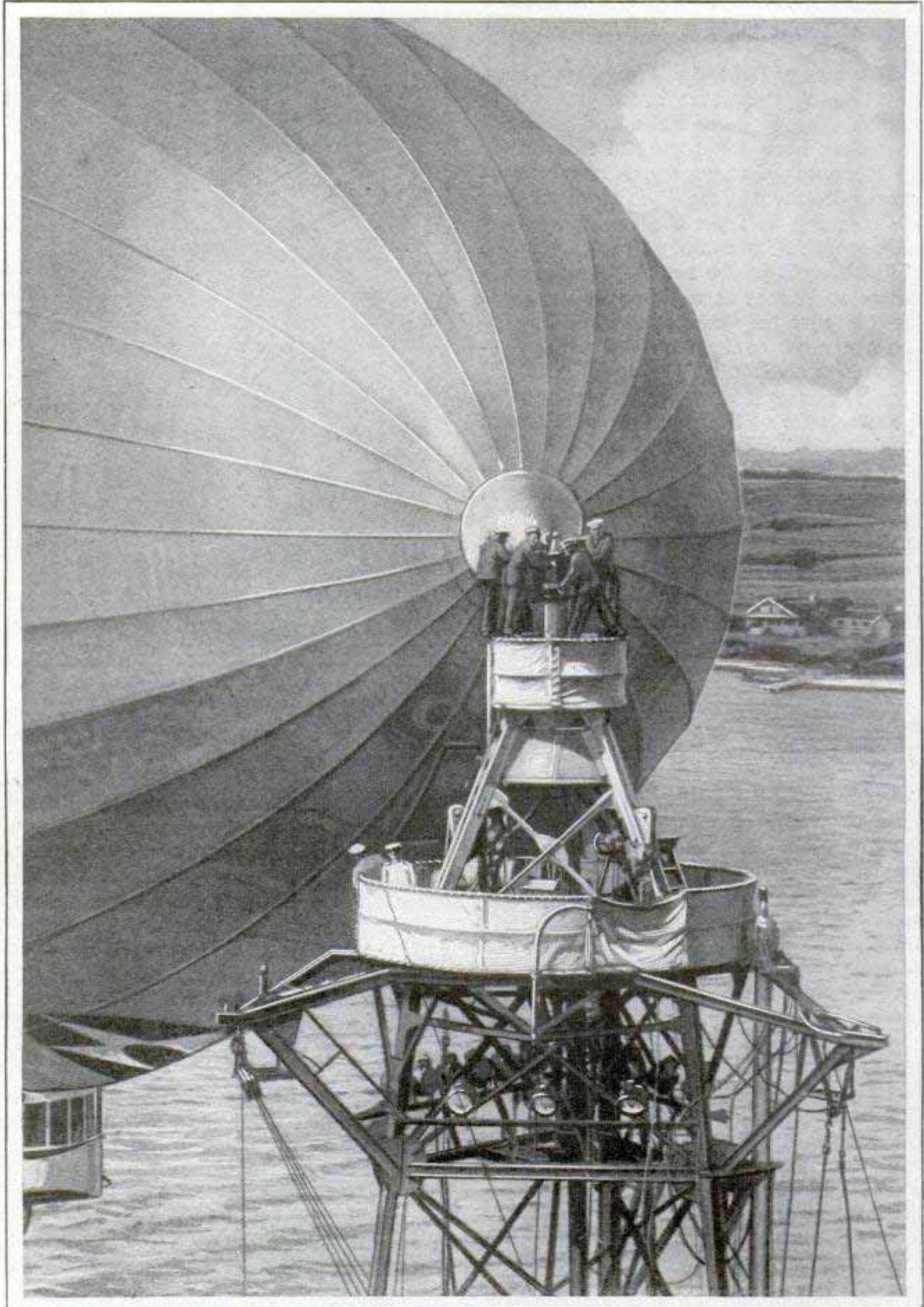

Copyright, H. Miller

Anchoring the Nose Cone of the "Los Angeles" to the Cup on the Mooring Mast of the "Patoka," the World's Only Floating Landing Field for Airships; the Lofty Mast Is Ascended by Elevator



537

# Riding *the* Clouds *in an* AIR PULLMAN



Friends Bidding Goodby to Passengers in the "Los Angeles"; the Round Portholes Are Windows in the Cook's Galley, and the Triple Windows Light the Pullman Staterooms

By CLIFFORD A. TINKER

I SAT one morning at dawn on the rim of the hatch in the very top of the "Los Angeles" great gas bag and watched the sun come up. Far aft, bowed in the face of a sixty-mile wind and protected only by a light life line, a petty officer was moving along on the smooth aluminum-painted fabric of the huge ship, pausing to inspect each of the helium escape valves. Eighty feet below, on the narrow catwalk along the keel, officers and men were watching the gasoline tanks and water ballast and the helium gauges, while below them, in the engine nacelles and control cabin, the rest of the crew stood on duty.

Far underneath, Sandy Hook and the Narrows at the entrance of New York harbor were slipping past, shrouded in low-lying mist. Giant ocean liners, a six-masted schooner and a sprinkling of smaller craft were coming in with the tide, while the lighthouses on land and the lightship at sea continued to send their beams through the darkness.

As I watched, away to the east, at the rim of my sixty-mile vision, the coppery

clouds dissipated, the golden glow of the morning reached up from the horizon, turning the lower sky to a robins'-egg hue which graded off to blue, deeper blue and finally to indigo, set with stars, at the zenith. Suddenly intense flaming light leaped above the paling darkness of the ocean, and the upper limb of the sun appeared, growing rapidly to a ball of fire. Down below, the world was still dark, awaiting the dawn.

That is just one thrill, but probably the biggest, that comes to the passenger on the world's biggest aerial pullman. We had weighed off from the mooring mast at Lakehurst at four o'clock, a favorite hour for starting an aerial cruise, for the gas is still condensed from the night's cool air, and hence the ship can start with the largest possible supply of lifting power. We were bound on a two-day cruise to Newport, to moor for a few hours at the floating mast of the "Patoka," the only seagoing airship anchorage in the world.

The night before, the passengers had arrived at the Lakehurst field just as dusk



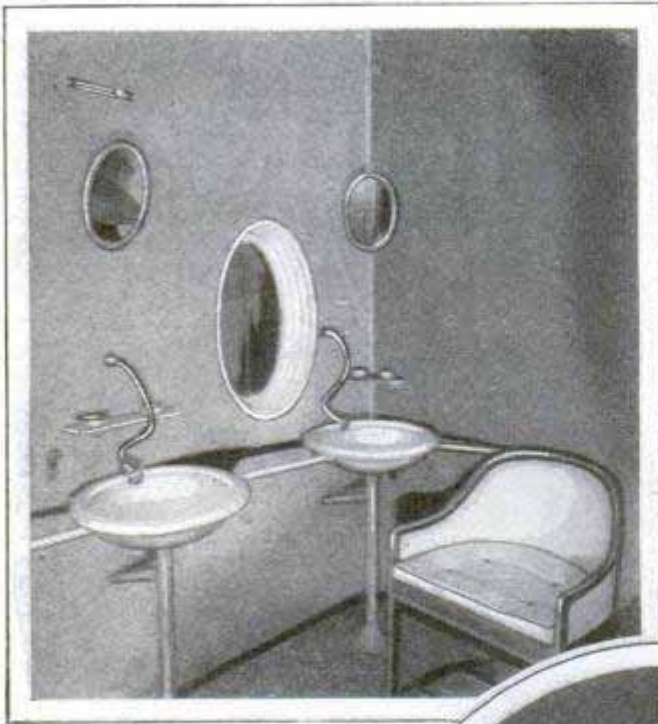

Accommodations Are Good; Above Is One of the Washrooms; Center, a Stateroom with Seats Which Can Be Turned into Four Berths

was closing over the giant airship, already swinging in the breeze at the top of the lofty mast. A searchlight cut the gloom and flashed along the silvery bag as the ground crew kept watch against sudden wind squalls which might make it necessary to cut loose and seek the safety of higher altitudes. When the summons came to go aboard, passengers and those of the crew who had spent the night on land hurried to the mast, rode up in an elevator and climbed the gangplank which stuck up to an open hatch in the underside of the airship's nose. Down the narrow catwalk of the keel they went, following orderlies carrying the baggage, to the ladder that drops to the control car, where passengers were shown to their staterooms which are equipped with cushioned seats that are made up into berths at night. Near by are washrooms, with hot and cold water, and all the comforts the finest transcontinental train affords.

The drone of powerful engines fills the cabin with a low-pitched buzz and you look out to find Lakehurst slipping away

into the distance. The ship has got under way so quietly, that before you realize the fact it is headed for the Jersey shore and distant Sandy Hook. There is no rolling, for the stabilizers correct that, and only infrequently a pitching motion as the ship wallows in the long air waves, and even that pitching is speedily checked as the elevatorman corrects it with a slight movement of the flippers, as the elevator rudders are called.

The control cabin, a glass-walled navigating bridge in the bow of the car, is a hive of industry, with activities little different from those on the bridge of a warship at sea. At the chart-covered table, the navigator is busy computing the steering

allowance to be made for the early morning breeze and plotting the course and position from time to time. The officer of the deck checks the recording instruments, records his data and watches the helmsman, standing at the steering wheel in the bow, with a compass before him, and the elevatorman, whose

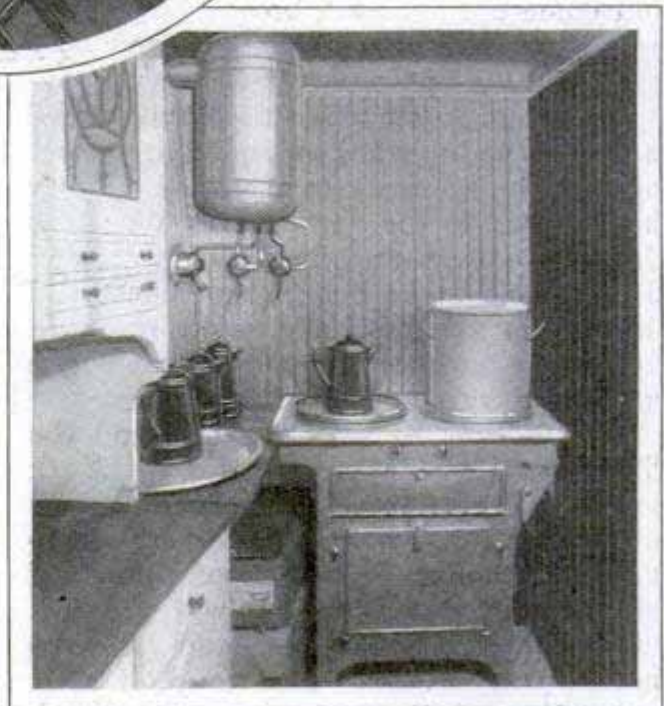
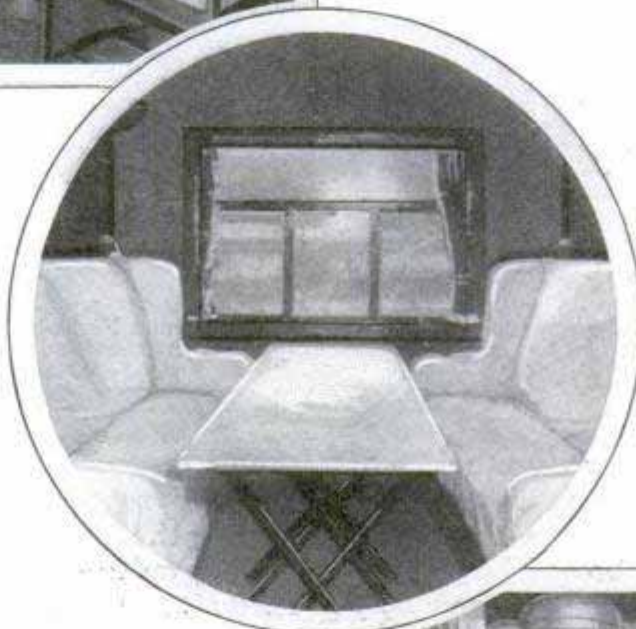

A Corner of the Electric Galley in the Big Airship "Los Angeles"; the Necessary Electric Current Is Delivered by a Generator That Is Driven by a Small Propeller under the Control Car



process by which nitrogen is obtained from the air for food, fertilizer and explosives, and the synthetic production of methyl alcohol are developments of this method. Research in this line has been going on little more than twenty years, but investigators already see the production of synthetic motor fuel from coal and water by combining carbon monoxide and hydrogen under high pressure, as a possibility. Sugar and starch from petroleum and soap from kerosene are other achievements likely to be realized. According to Prof. Norman W. Krase, of the University of Illinois, the United States would be independent of outside sources in wartime for its nitrogen supply, due to the success of the process for obtaining it from the air.

**GLIDING ROLLER SKATES ARE LESS TIRING**

Roller skates with which, by an ordinary walking step, the wearer can glide along at considerable speed are the latest novelty for covering distance. They resemble ordinary roller skates, but are arranged in such a manner that, when pressure is put on them, the wheels automatically lock, and cannot turn backward. The wearer advances one foot, as though to take a step, and glides along on the skate while the other foot is being brought forward and advanced. When the second foot is placed on the ground and the weight transferred to the first, the wheels of the latter skate are locked, so they cannot slide backward, thereby giving a firm footing for starting the glide of the other foot. The skates are equipped with rubber rollers so they can be used in office or home.



Small cubes of ice, wrapped in paraffin paper and packed in wax cartons, are being sold in drug stores.

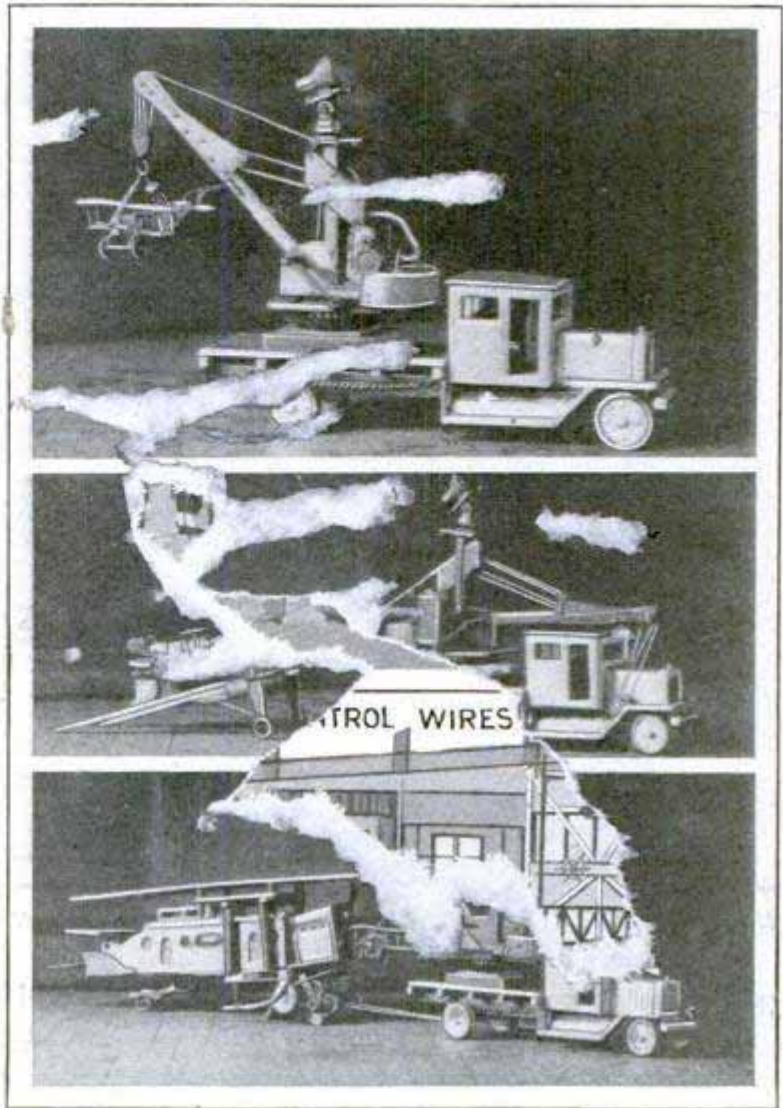

Models of the Airplane Wrecking and Towing Outfit. Showing How It Could Be Used to Haul Disabled Craft to the Hangar

**WRECKING TRAIN FOR AIRPLANE TO AID IN LANDINGS**

Designed to aid the air service in somewhat the same way as a wrecking train serves the railroad, a crane devised by an Ohio inventor is capable of various tasks. A particular function would be to bring in planes that have been compelled by a storm, fog, ice formation under the wings, or from any other cause, to alight on emergency fields some distance from the main one. In case the ship were disabled, the crane could be sent out along the highway, a cable extended and the plane pulled in. The towing skid is so arranged that it will straddle rows of corn, and the plane would be elevated so that it would not damage corn in the tassel. The wheels are guarded to protect smaller grains like wheat and oats. The crane could pull in a plane a quarter of a mile away, it is said.

Mrs. Clean & Bangy, Hotel Holland  
 151 Main St.

East. L. Roll Co., Inc.  
 151 Main St.

1891  
 Self photos. Ohio



1370

The Haverly Tree Export Co. 56 City  
Baahk Bldg. Kent, Ohio

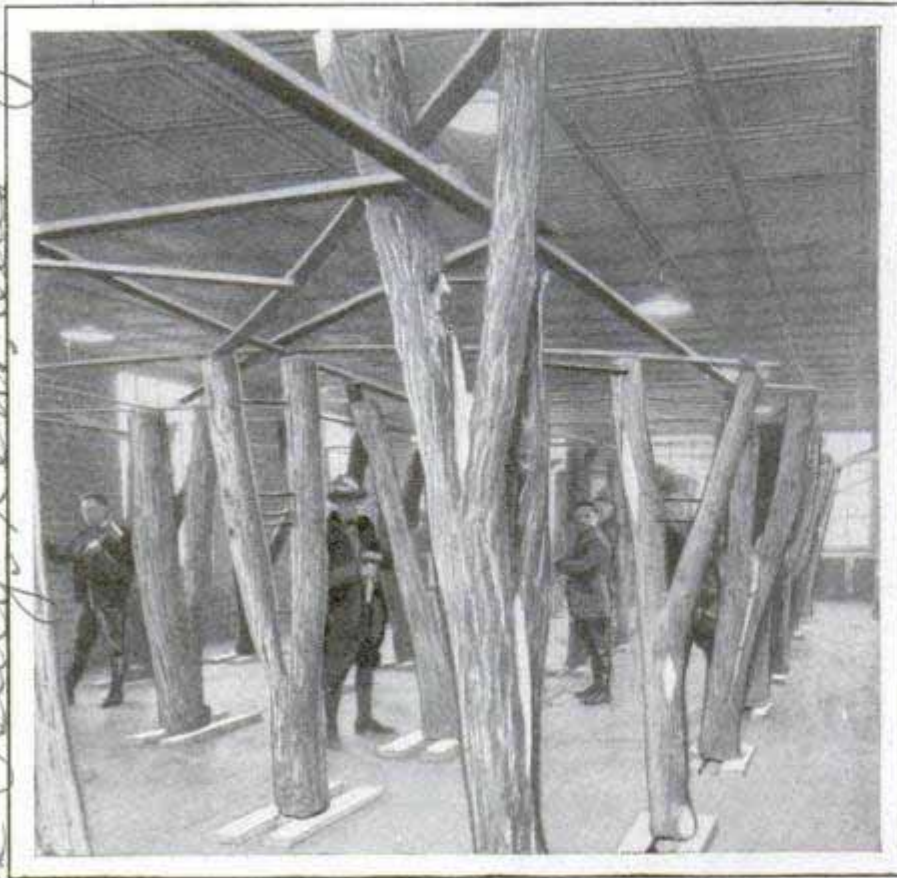

Where Students Study a "Forest under a Roof"; Glimpse of the Winter Laboratory for Tree Doctors

### INSIDE FOREST HELPS IN STUDY OF TREE SURGERY

When winter weather prevents work in the woods, students of forestry and tree surgery at an Ohio school are able to continue their research indoors without interruption. This is made possible by an "inside forest," a group of tree trunks fastened in upright position in a laboratory building protected from the cold. Study of the specimens can thus be made in comfort, and operations performed with attention to detail that would be impossible in the frosty woods.

### MAKING WEATHER FOR THE ZOO TO GUARD ANIMALS' HEALTH

Equipment for washing, circulating and keeping the air at the proper temperature is being installed in buildings of the national zoological park at Washington, D. C., to protect the health of 2,600 animals and birds. In most of the houses, conditions like those of an ideal June day will be maintained with a temperature of sixty-eight degrees, relative humidity of forty to forty-five per cent and the air slowly

moving. The installation is expected to make possible the safekeeping of animals that ordinarily would not thrive in American climate.

### WOMAN INVENTS TRAFFIC SIGN FOR COLOR-BLIND

2166

Designed so that it may be suspended in the center of the street, or mounted on a pole at the side, an electric traffic signal, invented by a western woman, is featured by the different-shaped lenses for the lights. The red is inclosed in a triangle, the central amber, or "wait," light is in a square and the green sign, underneath, in a circle. This is intended to aid persons

who have difficulty in distinguishing colors or in reading the sign on the lens. An additional innovation is the manner in which the lights flash. The red is surmounted by smaller bulbs that flash in a manner suggesting a policeman waving his arms, and a circle of bulbs around the green light rotates to indicate that traffic may proceed.



Traffic Signal with Warnings Inclosed in Frames of Different Shapes, for More Accurate Reading

Mrs. M. Ashland, Ore.  
Carter

Vertical text on the right edge of the page, possibly a page number or reference.





With Gas Mask to Collect the Breath, So That the Energy Consumed Can Be Measured, and an Observer with Stop Watch to Time the Output, the Typist Is Ready for a Noise Test

## What Noise Does to Your Nerves

Tests Show Office Workers Use More Energy and Are Fatigued More Quickly When Ears Are Assailed by Din of City

A TYPIST working in a very noisy room will not make more errors than when working in a quieter place, but will use as much as twenty per cent more energy because of the strain, with consequent earlier fatigue, and, as the day advances, progressive slowing down in output.

These facts have been uncovered by Dr. Donald Laird, of Columbia university, who recently staged a two weeks' experiment to determine the effect of the noise of a modern city on a worker who was using brain and fingers at the same time.

For two hours each day, a skilled typist wrote the same letter over and over, while noise machines produced the clatter of typewriters and duplicating machines, the intermittent ringing of telephone bells, rumble of traffic in the street, an occasional blaring auto siren, and a phonograph from time to time reeled off a disturbing dialogue. While she worked, a gas mask,

fitted over nose and mouth, carried her breath to measuring instruments in an adjoining room, where, every fifteen minutes, a test of the oxygen and carbon-dioxide content was made to measure the energy consumed. All the while an observer, armed with a stop watch, timed the period taken to write each letter, to insert the paper in the machine and later remove it, and the pauses between operations.

For the first few days the experiment was carried out in a room lined with sound-absorbing material, so that the noises produced by the machines would be deadened. Then the typist was moved to a room lined with brick walls, so that every sound would be reflected and multiplied as it reverberated again and again.

In both rooms the subject declared she was not particularly disturbed by the usual office noises, typewriters, telephone, conversation and the rumble of distant traffic,



2122

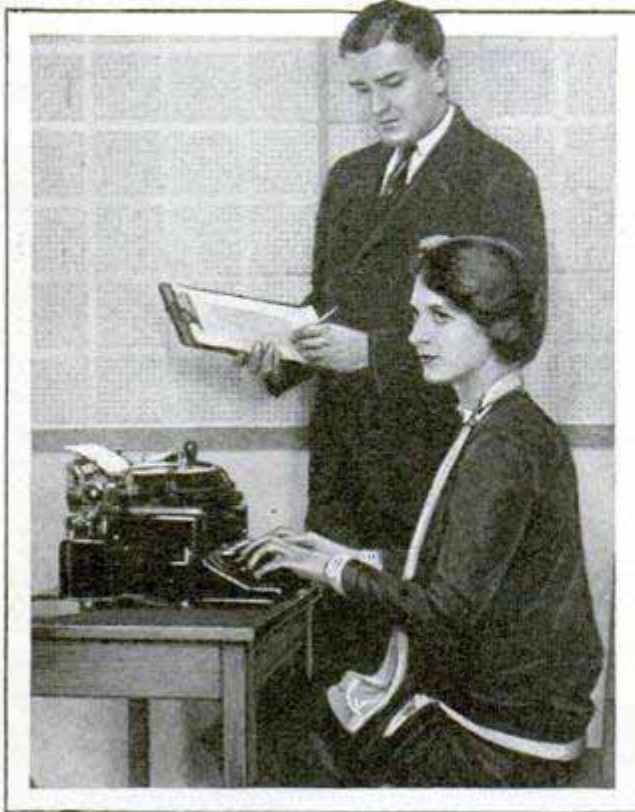

Posed for Speed, with Back Unsupported, Hands Following the Keyboard Slant and Fingers Close to Keys

but the occasional blare of the auto horn caused her to make mistakes. Despite her belief that the increased noise was not especially disturbing she collapsed on the second morning in the brick-walled room before the two-hour period was over.

The scientific apparatus showed that her report on how she felt was not an accurate index of what was really happening, for, while there was no perceptible difference in the number of errors made from day to day, the carbon-dioxide count showed a twenty-per-cent increase in energy consumed trying to concentrate in the greater din, and the stop watch showed a steady loss in output.

In the quieter room her speed increased steadily during the two-hour period, so that she worked at the highest rate toward the end. But in the noisy room, after the first forty-five minutes, speed began to fall off. Even the time taken to remove a sheet and replace it with another increased when there was noise and confusion in the room.

On the final day of the test, the noise machine was turned off and she worked in absolute quiet, even her typewriter being of a noiseless kind, but the output for the day did not differ materially from that in the moderately noisy room, indicating

that up to a certain point noise does not interfere with work.

To check the results obtained with his skilled typist, Dr. Laird performed a similar, though briefer, experiment with several girls of average ability, and found they were still more susceptible to disturbance. On the average, they consumed thirty-five per cent more energy in concentrating against the disturbances.

Other scientists who have been investigating the relation of noise to slowing down of work have had similar experiences. Dr. Linus W. Kline, of the Harvard psychological laboratory, tied strings of tin cans together and dragged them across the floor while his students tried to concentrate on a mental problem. He found the noise interfered appreciably with their ability.

Another experimenter, Dr. John J. B. Morgan, of Columbia university, rigged up a typewriter so that the pressure applied to the keys could be measured. He found that under the influence of disturbing sounds typists used more energy by striking the keys harder than they normally did.

Workers in machine shops and similar places, where excessive noise is a daily routine, eventually become more or less deaf, but recent experiments show that others in far less noisy places have their hearing impaired merely through fatigue of the ears. In tests made at the university of Wisconsin with a watch mounted on a traveling carriage, it was discovered that students could not hear the ticking as far when they concentrated on a mental problem as they could when their minds were at rest, and that strenuous physical exercise had the same effect. Diminished hearing power, it was found, would give warning of approaching fatigue some time before the body began to feel the effects of too much exercise.

Even in sleep, Dr. Laird discovered, the ears are active. The passing of a street car or the blowing of an automobile horn raises the blood pressure instantly, even though the sleeper does not wake.

All of the experiments are being made with the view of devising rules for rearranging offices or shops so that workers who must concentrate can be relieved from the strains that will affect their efficiency.



206

Washington Court House  
Ohio.

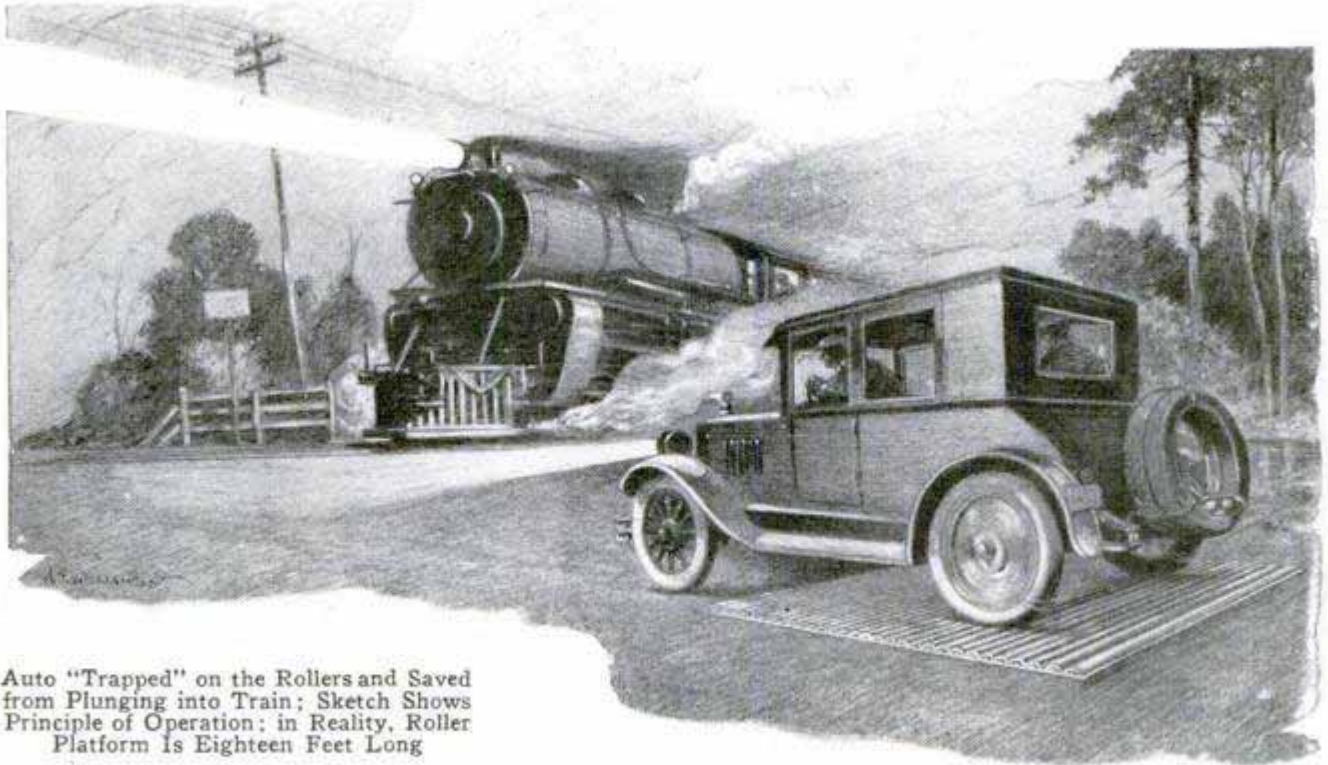

Auto "Trapped" on the Rollers and Saved from Plunging into Train; Sketch Shows Principle of Operation; in Reality, Roller Platform Is Eighteen Feet Long

### ROLLERS AT RAILROAD CROSSING TO PREVENT ACCIDENTS

As a means for reducing automobile accidents at railroad crossings, an Ohio inventor has patented a roller device which has proved effective under tests. There are two sets of rollers, each eighteen feet long, installed in the highway near the rail approach. They revolve only one way and when the automobile strikes them, as a train is approaching, they turn, keeping the car from going forward. When the train passes, a switch locks the rollers so that the auto can proceed.

### AIR-TIGHT POT FOR ADHESIVES PREVENTS WASTE

*Airtite Container*



Devised especially for cement to be used in shoe-repair shops, a glass container has spring jaws on the opening for the brush, so that the glue will not evaporate when the swab is taken out. It has been estimated that approximately thirty per cent of

the cement is lost in open jars through evaporation. The jaws not only seal the bottle, but remove excess liquid from the brush, preventing additional waste and keeping the hands from becoming unnecessarily sticky. The glue is constantly kept at a level no higher than the bristles.

### VACUUM SWITCH STOPS ARCKING IN POWER LINES 2137

Elimination of the dangerous arc that usually attends operation of the switch in a high-power circuit is the chief feature of a vacuum unit invented by Prof. Royal W. Sorenson and Dr. Robert A. Millikan, of the California institute of technology. The new type of switch is said to have handled current of 1,000 amperes at 40,000 volts without the arc that accompanies use of the oil switch. It is built to accommodate a potential of 60,000 volts and is expected to effect improvements in methods on high-power lines.

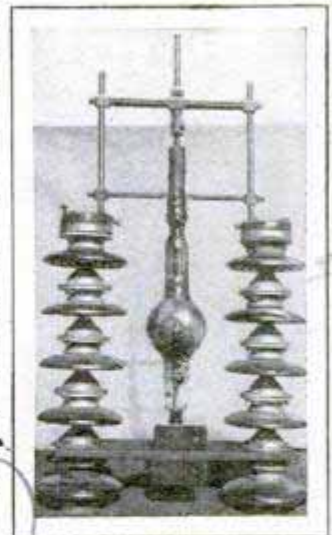

Chicago - Norman P. Chalder Co. Inventor

Cable Bros. Kalamazoo

Pasadena Calif.



1903

# NEW WAYS to avoid

Cardinal Toggery Rack

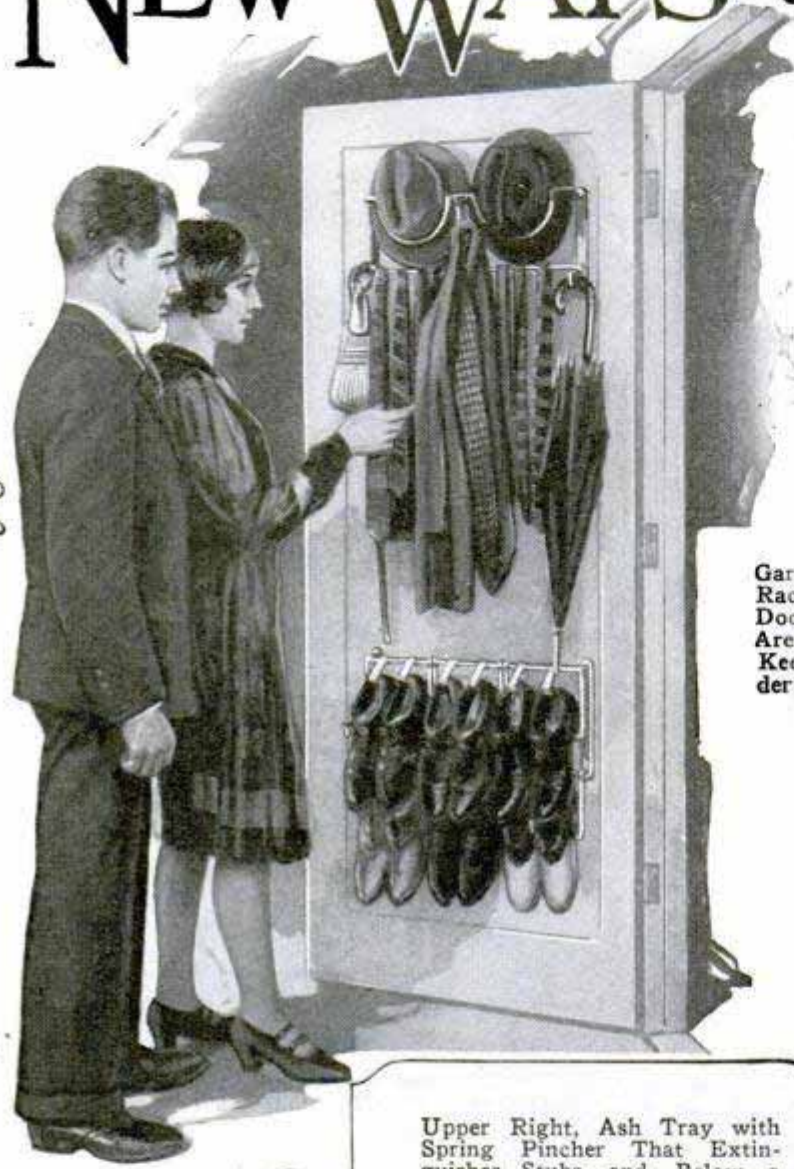

To Remove Dust and Dirt from Clothesline; Brush Is Clamped On and Cord Pulled through It



Garment and Shoe Racks on Closet Door Save Space, Are Accessible, and Keep Things in Order and Out of Dark Corners

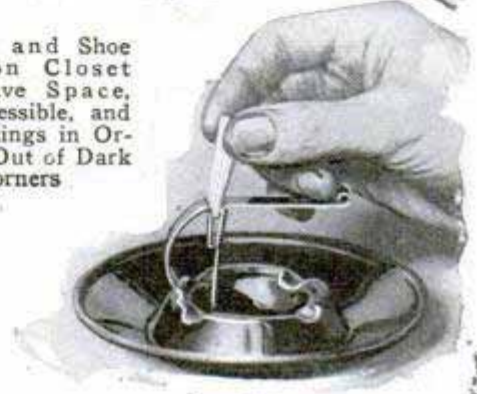

Upper Right, Ash Tray with Spring Pincher That Extinguishes Stubs, and, Below, a Cozy Sleeping Bag for the Baby



Alumette \$5.00  
Factory - \$15.00



At Left, Can Opener Operated with Crank and Gripping Handles; It Turns the Can, Neatly and Easily Severing the Top, Leaving a Smooth Edge; Opens Cans of Any Shape

Aluminum Mender and Stretcher That Will Prolong the Life of Gloves

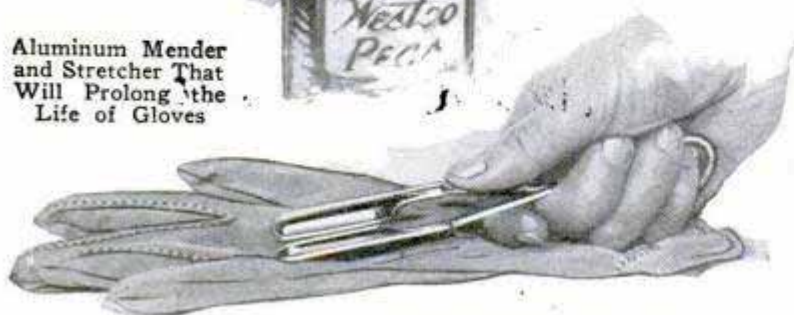



# HOME DRUDGERY

Portable Electric Kitchen in Use and Folded Up into Attractive Table; It Has Two Electric Outlets and Can Be Adapted for Gas

*Helps the hostess*



Said to Make Better Coffee, a Special Filter, Directly under Grounds. Allows Only Best Substances to Pass into Urn

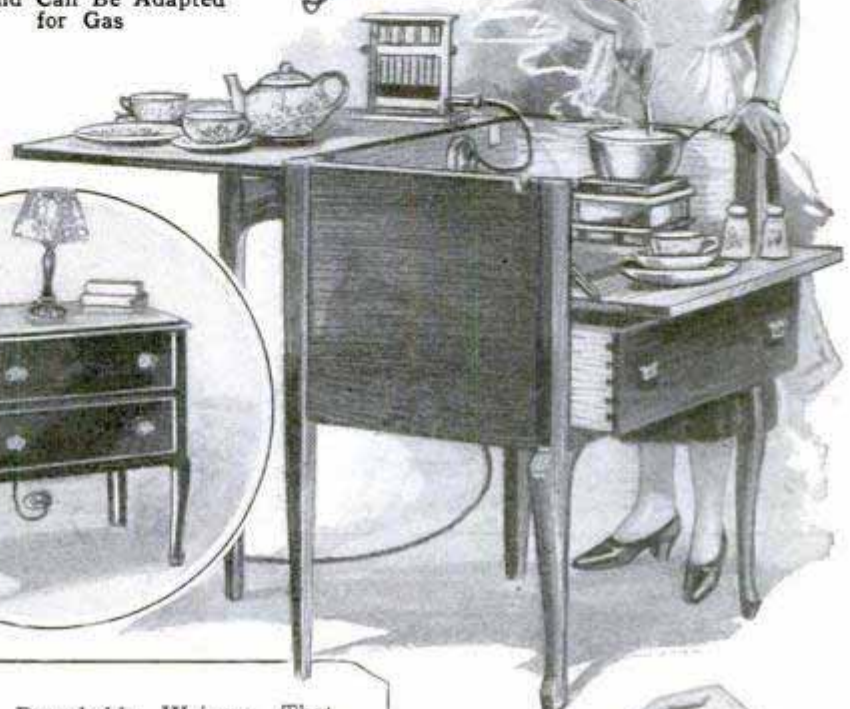

Left, Detachable Wringer That Fits Ordinary Galvanized Pail and Takes Much of the Drudgery Out of Mopping



*\$1.50*

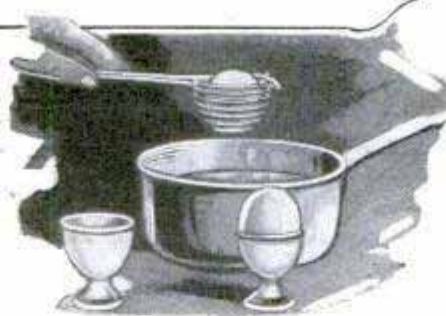

Convenient for Separating Egg Yolks and Whites or Straining Liquids, This Handy Kitchen Aid Also Serves to Separate Kernels and Fruit

*25¢*

For Preparing Fancy Dishes, Cutter Makes Screw-Thread Designs of Vegetables and Other Foods

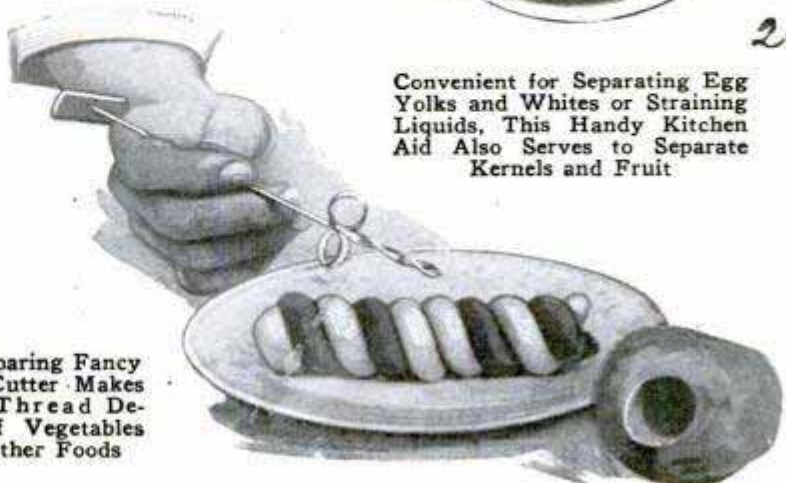



Alexander Milburn  
1416 W. Baltimore St

112

POPULAR MECHANICS

1191 Baltimore, Ind.

Mr. James Dougherty  
514 Woodward Bldg  
Washington  
D.C.

who quickly rowed out from land to tow it in. The raft plan had been devised so that none of the "Andes" crew would be exposed to the disease.

### OLD BANKNOTES ARE SALVAGED FOR WRITING PAPER

2220

Profits for the government of \$50,000 a year or more, are seen as a result of a recently developed process for converting worn-out banknotes into serviceable writing paper of high quality. The saving has been made possible by the discovery of a method of removing all the ink and impurities from the pulp into which the paper money is macerated after the notes are no longer fit for service. About four tons of this material and trimmings from the currency printings are available daily.

### A REAL INFORMATION "BUREAU" ADVERTISES TOWN

1412

Furniture manufacturing is the chief activity in a North Carolina city, so the chamber of commerce considered it entirely fitting that the bureau of information to guide visitors should be housed in an office resembling a product of the local mills. The unusual building is designed to resemble a bureau with a large sign in the mirror space, and is twenty-seven feet wide and thirty-two feet high.

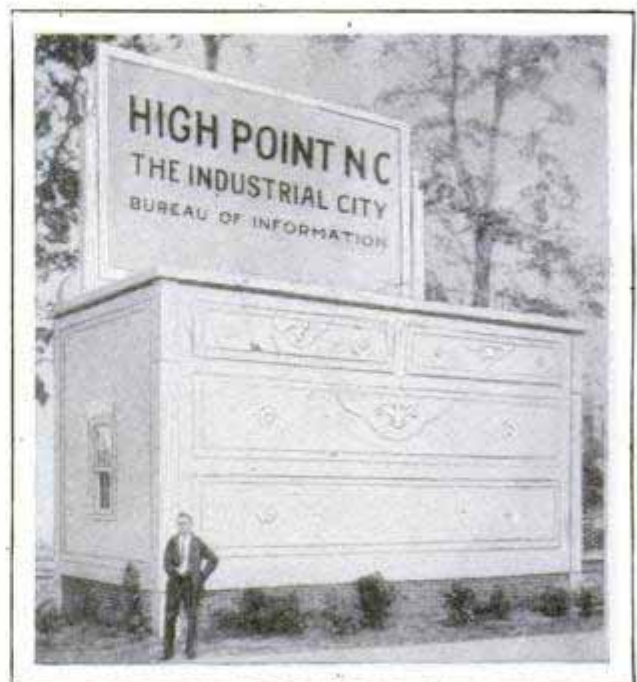

A Bureau That Is a Bureau; Information Office at High Point, N. C., Housed in Dresserlike Structure

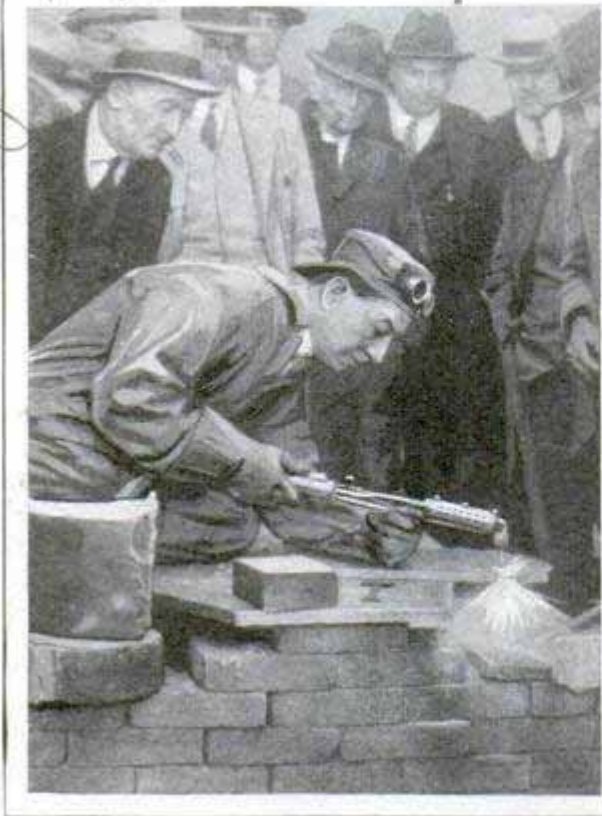

Demonstrating the Cutting Torch Which Uses Natural or Manufactured Gas; It Has a "Superheating" Unit

### CUTTING TORCH USING CITY GAS REDUCES EXPENSE

Manufactured or natural gas can be used instead of acetylene or other gases in a cutting torch equipped with a "superheating" unit, which raises the temperature of both gas and oxygen to a point of great efficiency. It is said that this torch saves twenty-five per cent in operating costs over the usual kind.

### REMEDIES ON RAFT ARE SENT TO ISLAND BY LINER

2227

Speeding from South America to Lisbon recently, the Royal Mail liner "Andes" intercepted an urgent SOS signal by wireless. The call was from the little West Indian island of St. Vincent. "Influenza is raging among the islanders," was the message. "Medical supplies are scarce. Can help be sent at once, please?" Charts were consulted, the "Andes" was steered 170 miles off its regular route. When the island was sighted and the ship had approached within a mile of the shore, supplies were lowered to a special raft which had been built for the purpose, and the cargo of mercy was left adrift for the men

220 S. State, Chicago



**BRIDGE FOR LOGS IS TWO HUNDRED FEET HIGH**

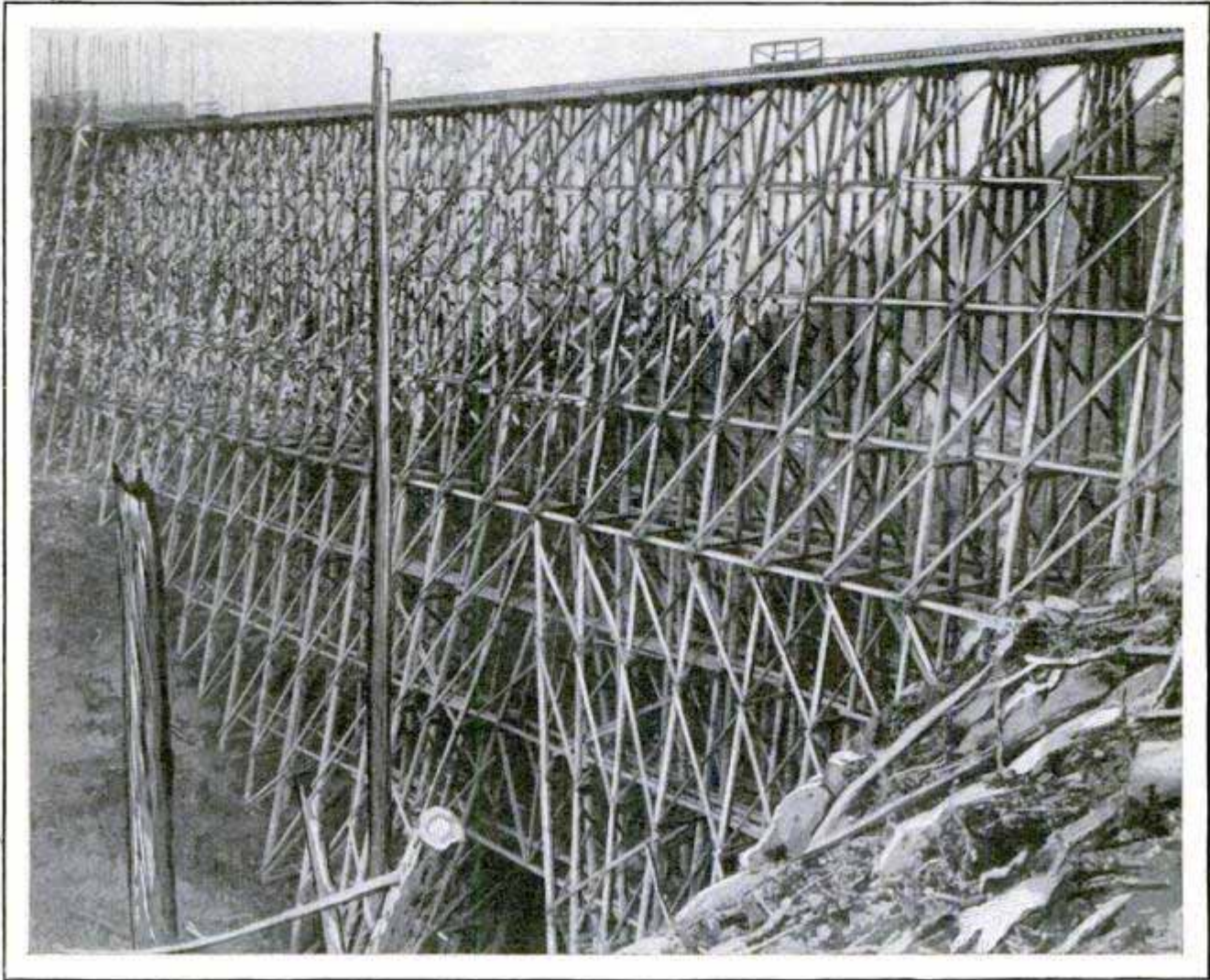

High Timber Bridge over Ravine in Washington Lumbering District; It Is More Than 204 Feet above the Bottom of the Canyon and Nearly 900 Feet Long

What is said to be the tallest timber bridge in the world has been completed in Washington for hauling logs across a deep ravine. It is slightly over 204 feet high, 893 feet long and required 836,000 feet of lumber and pilings to complete it. According to figures of the company, 8,000,000 lineal feet of lumber are hauled across it each month.

**SCHOOLS CARRIED ON SHIP TO LAND OF ESKIMOS 2235**

Three schoolhouses, complete with brick chimneys and furniture, were part of the cargo of the "Boxer" on its recent journey to Alaska. The buildings were shipped in knock-down form, and carpenters to erect them went along. Alaska's bureau of education now has eighty-nine schools. Instruction in vocational subjects, such as carpentry, cooking and sewing, receives

*Al. Herald. 4/1/27*

special emphasis. A standard motion-picture machine and a phonograph were also on board. These were purchased by Alaskan natives.

**FLASHER FOR AUTO STOPLIGHTS PROMOTES SAFETY 1923**

So that the automobile stoplight may more easily be seen, a flashing unit, spliced into the circuit, causes the lamp to wink continuously with a sharp, commanding signal, as soon as the foot brake is depressed. It may also be used to animate the lighted radiator cap, and is serviceable to the taxi driver when connected with the "vacant" sign to attract the attention of passengers.



*Stop dr.*

*General Appliance Corp  
122 8th St*



1556

"Skyscraper" Jail at Shreveport, La.; Cells Are Concealed in Upper Portion of Building behind Artistic Gratings



**JAIL ON TOP OF COURTHOUSE  
IS CLEVERLY CONCEALED**

The top stories of a handsome courthouse building for Shreveport, La., contain the jail, but there is little if any outward evidence of the fact, for ornamental latticework about the windows serves as bars and the section is cleverly incorporated into the structure as a whole. An additional advantage of the plan is that prisoners will have less opportunity to escape from their lofty cells.

**CLAIMS FOR PENSIONS INCREASE  
WITH PASSING YEARS**

It is more than sixty years since the close of the Civil war and twenty-eight since the Spanish-American war, but the number of pension claims is increasing each year. Veterans and widows to the number of 95,000 filed applications, relating to both wars, last year, the number for the Spanish-American war alone being four times the total filed for pensions twenty years ago. In five years, the pension bureau has handled more than 660,000 applications, a number exceeding the total roll of pensioners now on the government books.

One of the interesting phases of the task is that relatively few cases of dishonesty are found. Out of 120,000 claims investigated annually, only an average of about ten reveal false claims or impersonations. Exceptional attempts at fraud are sometimes encountered. One veteran, familiar with the service records of two comrades, tried to collect pensions in their names, although both had died years before. One claim was allowed, but when an agent failed to find one of the veterans, the subsequent investigation led

to the discovery of the fraud. Another man filed the record of a friend although he himself had never served in any war. In checking the claim, officials found that the man had committed suicide shortly after the end of the war.

**NEW SOD FOR PUTTING GREENS  
TO IMPROVE GOLF GAME**

One of the latest developments at the government's plant-experiment station, near Washington, D. C., is an improved sod for golf-putting greens. It can be handled in large sections, is extremely flexible and is said to remain fresh and green in spite of dry seasons. It is expected to reduce maintenance costs on courses as well as to insure better playing.

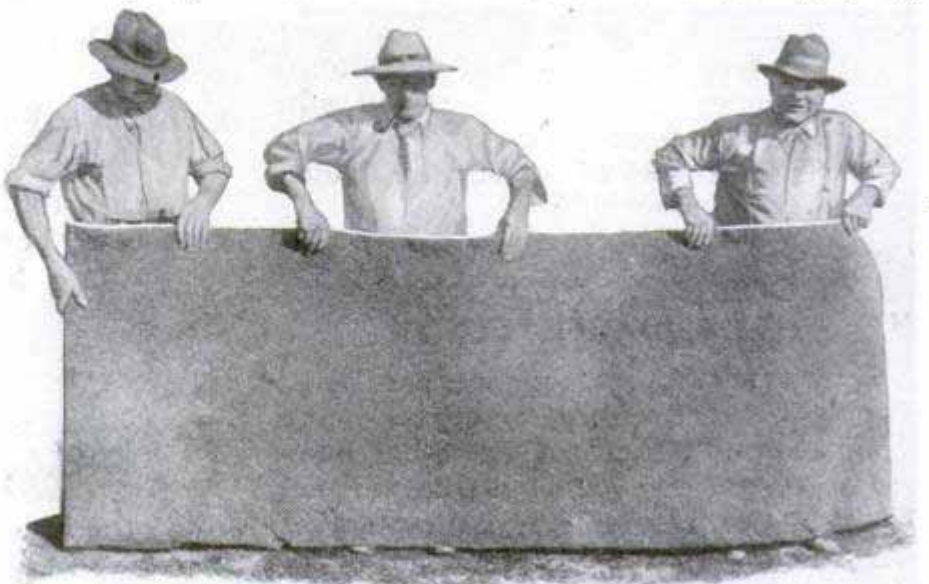

Sod Handled like Carpet; Flexible Growth Developed at Government Experiment Station for Use on Golf Greens

New York Times 8/27/27

2214

Arlington, Va.





Learning How Logs, Cut for Making Ties, Are Peeled; Young "Tree Farmers" Are Instructed in Efficient Methods of Lumbering as Well as in Ways of Preserving Trees

## "Know Trees" Is the Aim of Forest Clubs

Boys and Girls in Many States Unite to Learn  
Woodland Lore and Save Trees

By S. R. WINTERS

*Instruct, National Bank Bldg, Washington, D.C.*

"PLANT a forest and grow up with the trees," is the slogan of a boys' club in North Carolina. "Know Your Trees Club" is the name of a girls' organization in Vermont. Forestry clubs in New Hampshire planted 58,400 seedlings on fifty-one different farms last year, and Tennessee boys are forming woodlot clubs with each member pledged to gather, for planting purposes, a peck of seeds of the black-locust tree.

woodlots as schoolrooms. Reforestation is the big objective of this school, and, through the activities of farm boys and girls, the process of replenishing barren woodlots may be speeded up measurably.

These reports are part of the latest extension project of the department of agriculture. The forestry-club work is a new form of education, with fields, forests and

Farm-forest clubs among boys and girls are barely more than a year old and yet the work has extended to eighteen states, scattered throughout the nation. Oddly illustrative of this new club activity is an organization in Orleans county, Vermont, composed exclusively of girls. Instead of enrolling in canning and sewing clubs, these ten girls go into the forests and measure the height and diameter of trees.

*Office of Co-operative Extension Work*



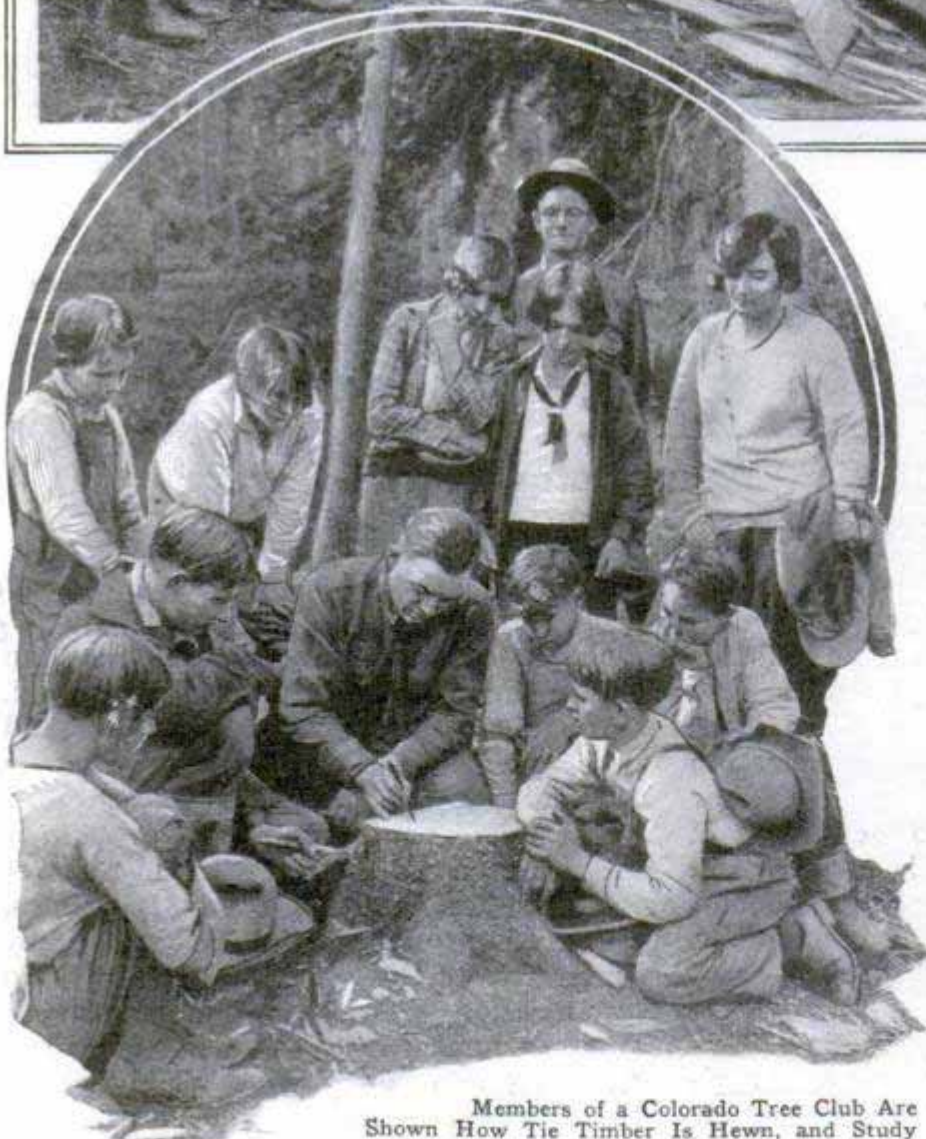

Members of a Colorado Tree Club Are Shown How Tie Timber Is Hewn, and Study Stump Rings for Computing Tree's Age

Leaf and tree identification, the planting of trees, study of use of trees, shrub identification, and the mounting of birds, are among the other activities of this self-styled "Know Your Trees Club."

In New Hampshire, where 400 boys are enrolled in farm-forestry clubs, the mounting of wood collections is a stimulating activity, one boy having mounted thirty-five beautifully finished specimens, labeled and arranged on boards so as to form sides of a box. Robert Granville, a New Hampshire youth, in thinning and pruning the forests to a proper density, cut eighteen cords of wood as his contribution to the winter's fuel



*Labbo*  
*Myg-Jo,*  
*St. Louis 117*  
*Ma*  
*605 Carleton Bldg*

supply. The importance of this new agricultural extension project is apparent when we are told that wood is the source of twenty per cent of the average farm income and that the woodlot spreads over half the farm area.

The forest craft in Wisconsin has adopted the pine cone as the fraternity emblem, and the tree planter accepts the mattock as his symbol of activity. The Wisconsin conservation commission furnishes seedlings free to junior foresters, for planting purposes, and the junior forest ranger has adopted the following creed: "To learn the ways of tree, forest and wild life that I may be of service in protecting and propagating these natural resources; to learn to love the things of outdoor life worth preserving and to understand nature's method as means of preparing myself to be master of myself, ready to take my place among men, and ready to face courageously the self-interest that tempts men to use selfishly the resources they in no wise help to build up; thus, in these ways, to help restore, and to enjoy, and to pass on to posterity our state more beautiful, enjoyable and provident than it was passed on to us."

Father and son participate in a co-operative enterprise in forestry clubs of New Jersey. Each boy enrolling in this juvenile woodcraft organization obtains from his father the loan of at least one acre of abandoned or low-productive land for tree farming. The junior forestry project is stimulated by the award of prizes to members demonstrating proficiency in the various activities of the clubs.

*2391*

**WASTE BIN FITTED UNDER DESK  
SUBSTITUTE FOR BASKET**

Attached to a rod underneath the office desk, where it is readily accessible when needed, a durable bin has been devised to take the place of the usual waste basket. It is easily adjusted, saves floor space and does not interfere with a person sitting at the desk.



Bin in Place, Showing How Convenient It Is for Use without Interfering with Person at Desk

*Art Metal Products Co.*  
*614 S. Esplanade St.*

How the Gun Is Held for Shooting Arrows; a Strong Rubber Band Furnishes the Propelling Power



*Labbo. Cro. Run*  
*\$2.00*

**RUBBER GUN SHOTS ARROWS  
TO KILL SMALL GAME**

For target practice and killing small animals, such as rabbits, gophers, and the like, a steel-barreled gun uses a stout rubber band to project a dart with great force. Since it is noiseless, it has advantages in hunting and is said to afford healthful recreation when used for shooting arrows high into the air.

**BOX CAR FITTED AS LIBRARY  
TRAVELS WITH LUMBERMEN**

*2251*

Lumberjacks employed by a Montana company have abundant reading material wherever they move their camp, for a box car, fitted up as a library, is hauled with the rest of the train and shunted on a side-

track. Steps are lowered and the car is ready for service. Two-thirds of the walls are occupied by open cases, and many books are packed for carrying to distant camps. More than 3,000 books were borrowed last year, and in leisure hours, the car is usually filled with readers.

*Unacanda Cupper*  
*Abbracunday*  
*Munmy Co.*



1658  
118

3/17/27



Lieut. Comm. R. R. Lukens of the U. S. Coast and Geodetic Survey, the U. S. S. "Pioneer," and Samples of Deep-Sea Water

the U. S. survey has plumbed a depth of 4,500 fathoms north of Porto Rico. Crews now working in the Pacific are measuring depths of an average of 1,000 fathoms.

**ODD HATS FOR MEN**

<sup>22 23</sup> In New Guinea, the men wear their hair in the form of an enormous mop and decorate this with feathers of the bird of paradise. A bamboo comb is used to keep it in position. A Chinese general was distinguished by his hat of sable skins, studded with diamonds, rubies and other precious stones, and set off with a fringe of beaten gold. One of the shahs of Persia was known as the "Sea of Light" when arrayed in his glittering robes and jewel-decorated hat. Formosa head hunters wear a hempen cloth adorned with plaits of hair from their victims. Hats woven of leaves,

**OCEAN MYSTERIES ARE BARED BY WATER FROM DEPTHS**

Five miles deep into the ocean, and all for a bottle of water! Such a stunt suggests an idle pastime, but it is one of the interesting activities of the men in the United States coast and geodetic survey, who are plumbing the seas to learn more of its dark bed, the density, temperature and contents of its waters. Braving the ocean in the little vessels of the coast-guard fleet, the sea explorers drop a large, pear-shaped apparatus into the depths until it reaches the bottom. An attachment gathers in a quantity of water from the ocean floor, while another instrument scoops up mud and sand to show the character of the sea bed. A thermometer records the temperature. Depths of 30,000 feet have been examined in this way off the Philippine and Japanese coasts, while

bark and bamboo are common among people of northern Burma. Some of them are at least four feet wide and are used as receptacles for food and other articles or as trays, while, among the women, they customarily are employed as cradles in which they carry their babies.

**AUTO TOWLINE IN SPRING REEL KEPT FROM SAGGING**

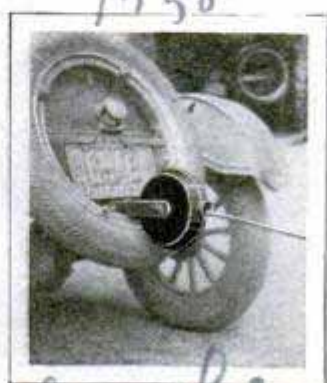

Inclosed in a spring reel which may be quickly attached to any car, an automobile towline is kept taut and does not sag when in use. This reduces wear and keeps the line from dragging.

Chas. L. S. Chapman



2120

# GLORY THAT WAS EGYPT NOW TOURISTS' HAUNT

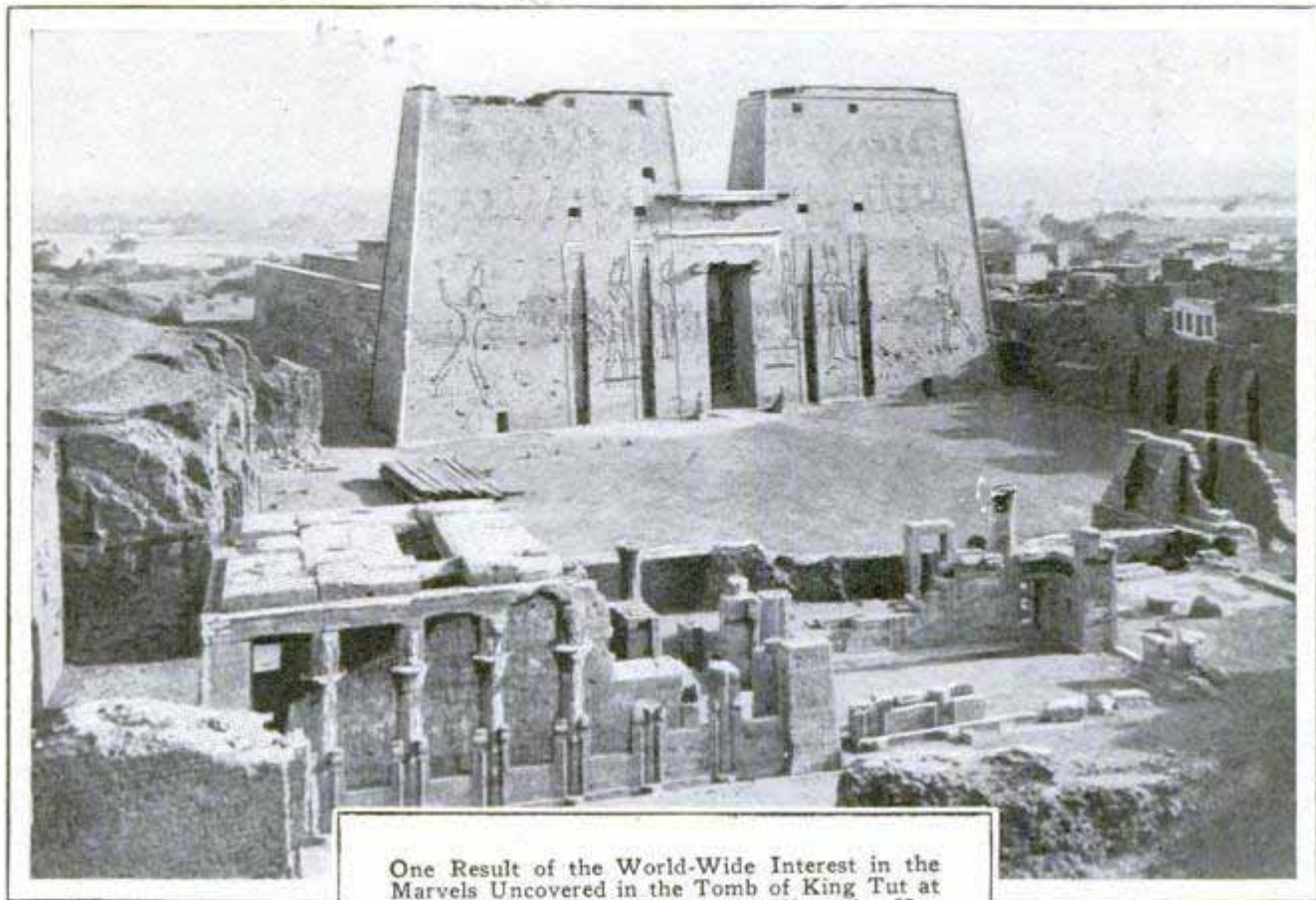

One Result of the World-Wide Interest in the Marvels Uncovered in the Tomb of King Tut at Luxor, the Ancient Thebes of the Pharaohs, Has Been Unprecedented Travel to the Nile; Above Is the Famous Temple at Edfu, Which Lay Buried under Sand for Ages

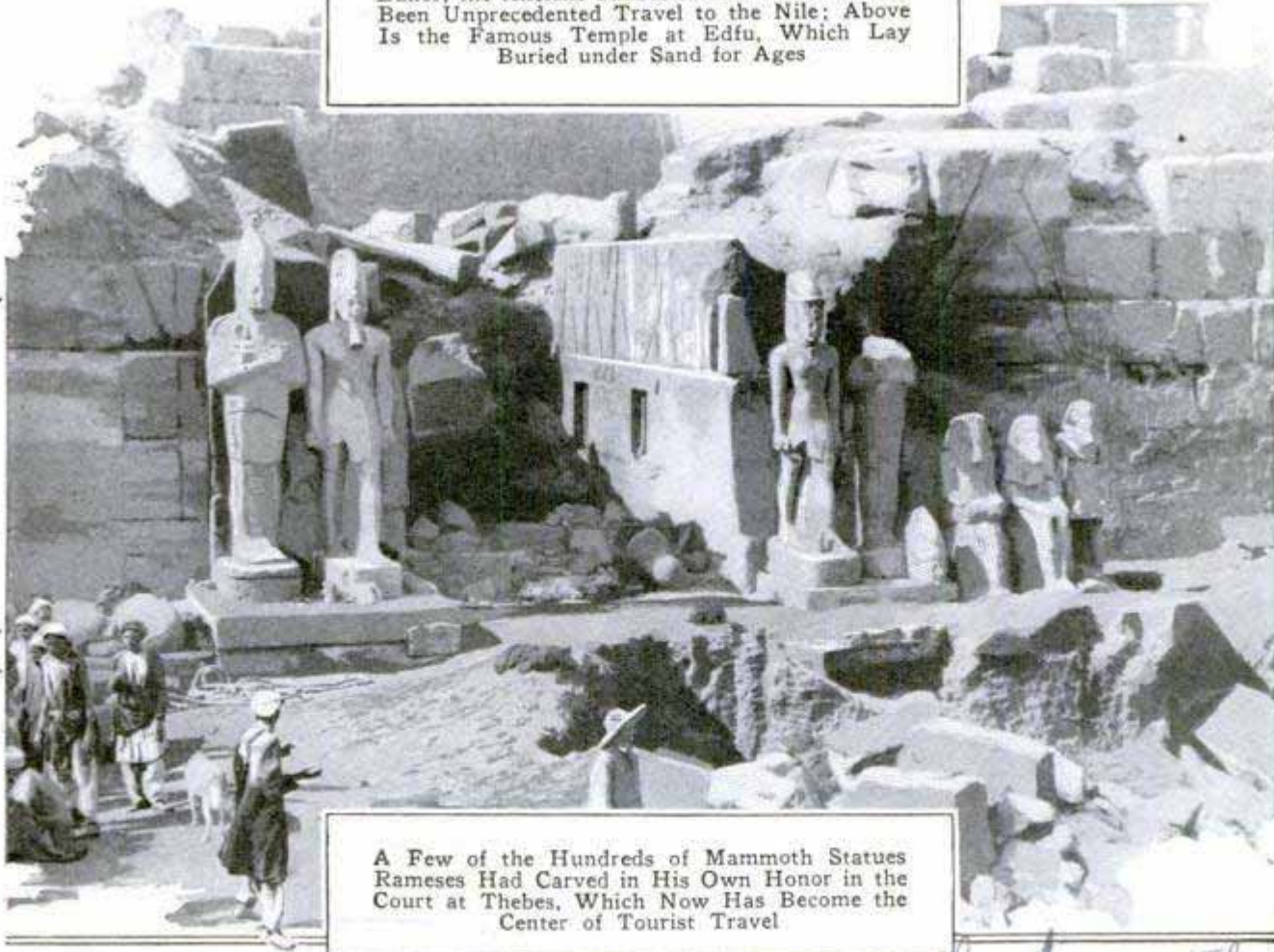

A Few of the Hundreds of Mammoth Statues Ramses Had Carved in His Own Honor in the Court at Thebes, Which Now Has Become the Center of Tourist Travel

*International*



*Lecture at Royal Institution*

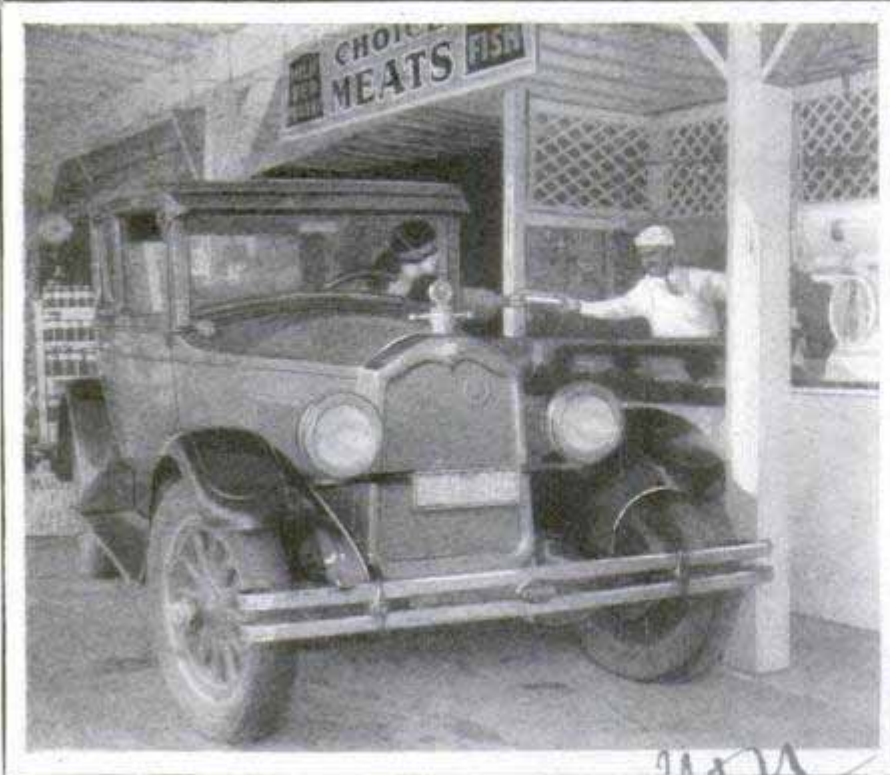

Where Customers Can Shop from Their Autos; Wayside Markets in Los Angeles Save Time and Parking Worries

### MOTORISTS' OPEN-AIR MARKET SAVES LEAVING CAR

Solution of the parking problem while shopping and greater convenience are afforded in an open-air market system introduced in Los Angeles. The motorists can drive directly alongside the store counter, make selections and purchases and drive on without getting out of the automobile. The stores are so arranged that goods can be protected from the weather with but little trouble.

### SEALED TYPING-RIBBON BOX PREVENTS DRYING OUT

Where stocks of type ribbons are kept for a considerable time, there is likelihood of their becoming too dry to function satisfactorily. This hazard is said to have been eliminated by a hermetically sealed tin for the ribbon, opened by a winding key like that on containers of food.



The box is especially suited for localities where dry weather prevails or there are few opportunities for renewing supplies.

### MARVELS OF THE HUMAN HEART

Under normal conditions, the human heart moves more than 500 pounds of blood each hour in an adult person, while as much as eight gallons a minute may be pumped through it under such severe exercise as rowing. The heart has various speeds, from forty-five to 180 beats a minute, a total of 100,000 for the twenty-four hours being common. A statistician has estimated that the blood of a grown person travels about seven miles an hour, 168 miles in a day or more than 61,000 miles a year. If a

man eighty years old had a corpuscle that had been in his blood since birth, that corpuscle would have made a journey of nearly 5,000,000 miles. An adult man's heart weighs from ten to twelve ounces, about two ounces more than a woman's.

### INDICATOR TELLS WORLD TIME AT TURN OF DIAL

Speed of communication has made it necessary to make many more time calculations than were formerly required and, to aid in this, a card indicator has been devised which shows, at a glance, the correct hour for practically all parts of the globe. A revolving center dial marked with the hours for day and night, is turned about a table of longitude divisions from 0 to 180. Names of cities are printed to correspond with their approximate location so that, when the dial is set at Greenwich time, the local time of other cities is shown, every fifteenth degree being used as a time meridian.



© J. P. Becker

*516 W. Jackson Blvd*

*Old Town Club Mt*

*J. P. Becker Co.*

*San Francisco, Calif.*



# Making A THREE-FOOT CONE For TEN DOLLARS

By Harry F. Brown



WITHIN the last few months various manufacturers have placed on the market specially designed units for home-made cone speakers. These are equipped with a suitable pin or "thrust rod" for attaching to the cone apex itself, making possible the construction of a good cone by the amateur. Heavy parchment paper is supplied with the unit, and in some cases the necessary sticks for mounting the cone, making the outfit complete. The size of the cone is optional with the builder; he can select either of the sizes suggested on page 122 and lay out the cone accordingly.

Lay the parchment on a table or other flat surface and pin it down at the four corners with thumbtacks. Locate the exact center of the sheet by snapping a chalked string across the paper from corner to corner. We will assume that the builder has decided to make a 36-in. cone. A glance at the note on page 122 shows that the outside circle A requires a radius of 19 in. The simplest and most efficient method of drawing the circle is to use a length of common round busbar wire bent in the manner shown in the upper illustration on page 123. This guide is bent into a single hook at one end and a double loop at

the other. The inner loop X should be measured from the hook to describe the inner circle and the inner radius given for the 36-in. cone would be the one shown at B in the diagram on the same page, or  $18\frac{3}{8}$  in. The outer loop X should be 19 in. from the hook. The method used to describe the circle is clearly shown in the photo on this page. An ice pick is driven in the exact center of the parchment and the hooked end of the wire placed around the pick; a pencil is then put in the outer loop and the outer circle drawn; when this is completed, the inner circle is scored (not cut) with a blunt tool placed in the inner loop.

The next step is to cut out the outer circle with a pair of scissors. A radial incision is then made from circumference to center along the grain of the paper. The section to be cut is shown at C, and is measured at the outer edge for a width of  $6\frac{1}{4}$  in. Allowance should be made for

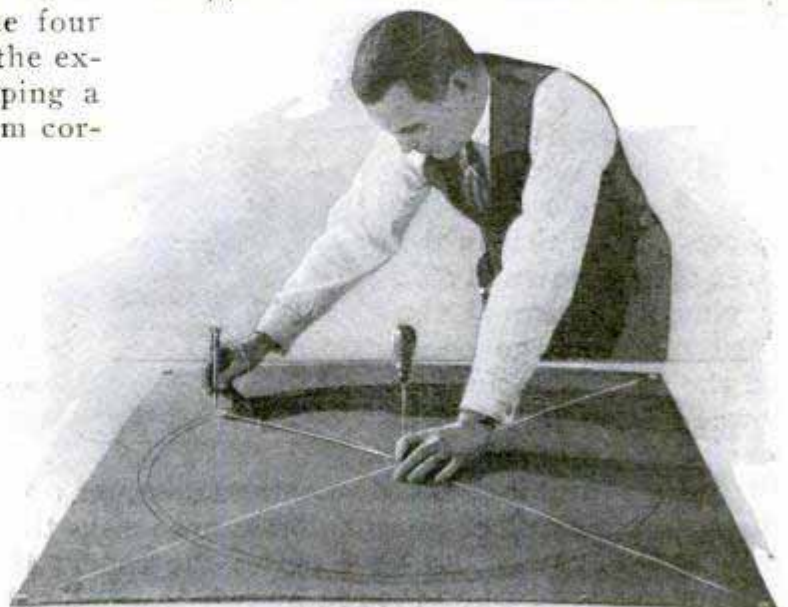



a  $\frac{7}{8}$ -in. flap for gluing, and this should be outlined with a pencil before cutting. This flap is brushed with glue and the edges drawn together as shown in the central photo on this page. The glued edge should be covered with a ruler or other wood strip, and held down with a flatiron or other weight for at least 20 minutes, or until thoroughly dry. A  $\frac{1}{4}$ -in. hole is now cut at the apex of the cone to take the thrust rod of the unit, and the next step is to cut out a little disk of the heavy parchment, shaped as shown in the upper right-hand corner of the diagram. The radius of this disk is  $1\frac{1}{2}$  in. and the

The cone is now ready to mount on the cross sticks. These are notched at the center and the supporting block for the unit is screwed to the sticks at the center. Mount the unit on the block so that the thrust rod will be in the exact center of the crossed sticks; this is important, because the rod must center at the apex of the cone. Lay the sticks on the table with the unit and thrust rod up, remove the top nut on the rod and slip one of the brass disks over it so that the disk rests on the lower nut, point side up. Now, gently lower the large cone over the rod and let it settle in place over the disk; the upper disk is then placed over the top and held in place by means of the other nut. The disks need not be changed to compensate for variations in amplifier current, and the cone is completed except for fastening the outer turned-back edge

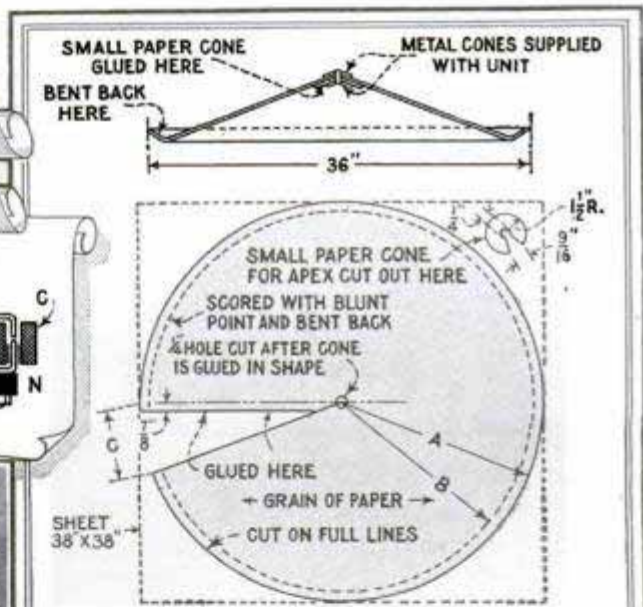
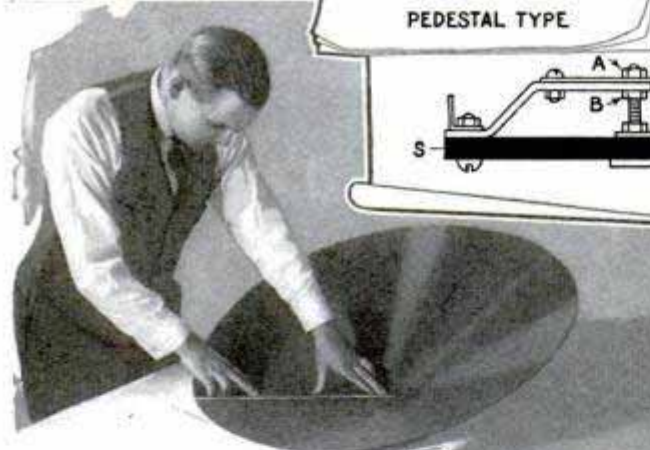
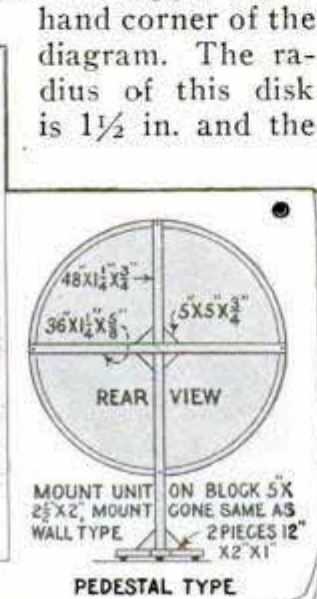
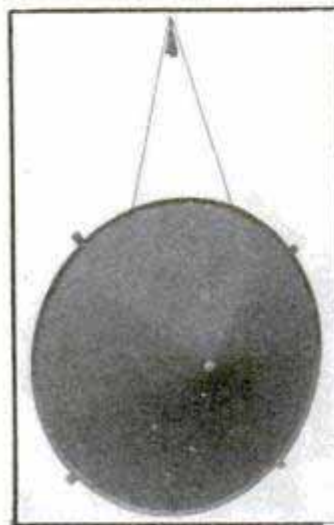

NOTE: FOR 36 CONE A=19", B=18 3/8", C=6 1/4"  
 " 33" " A=17 1/2" B=16 3/8", C=5 1/4"  
 " 30" " A=15 3/8" B=14 3/8", C=5 1/4"  
 " 24" " A=12 1/4" B=12 1/8" C=4"

cut-out section is  $\frac{1}{16}$  in. for all cone sizes given; the center hole is  $\frac{1}{4}$  in., to conform to that in the large disk. The small disk is glued in place at the apex of the large cone, on the underside, and allowed to dry. Hold the small cone in place with the fingers until it sticks, care being taken not to damage the large cone. The two small brass nose disks that come with the unit need not be glued to the paper; they are held lightly in place on the rod by two No. 4-36 nuts.

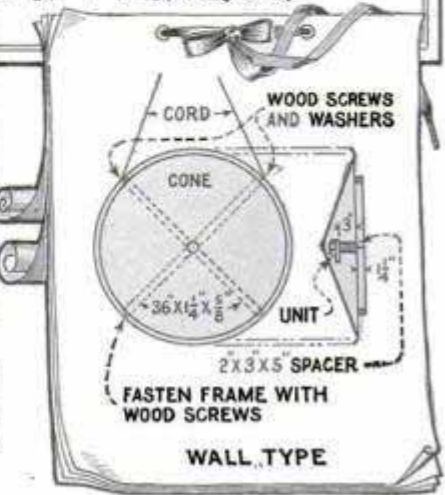
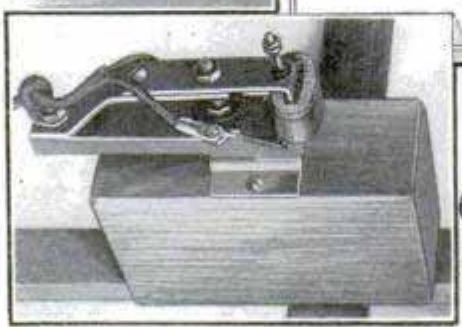



to the sticks by means of four thumbtacks. Now connect the unit to the radio set, making sure that the lead with the tracer in it is connected to the positive or B-battery side of the circuit. In case you do not know which is which, try connecting the unit one way and then

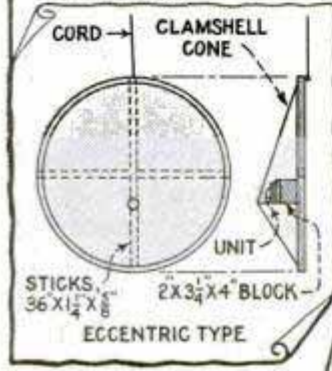
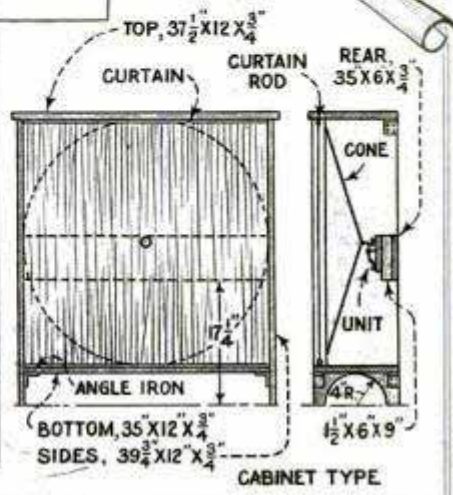
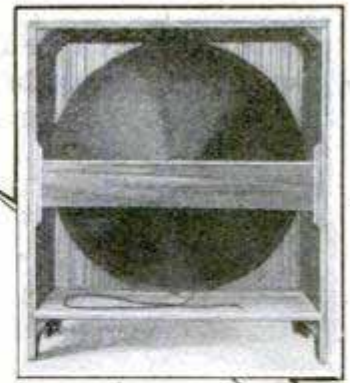
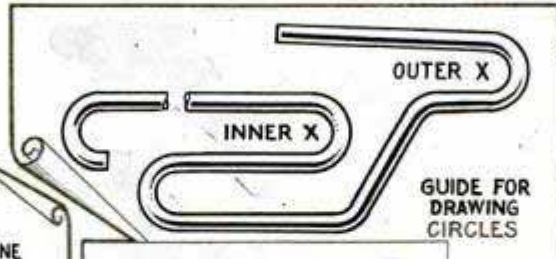
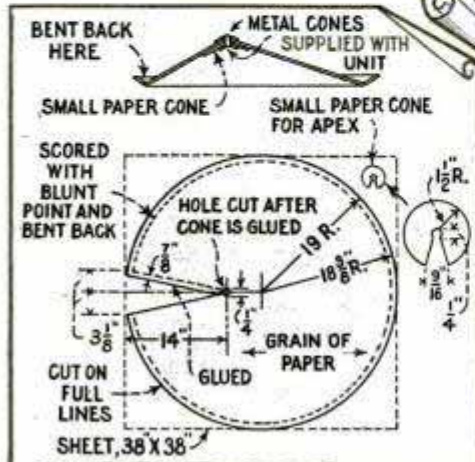

DIMENSIONS FOR CUTTING ECCENTRIC CONES

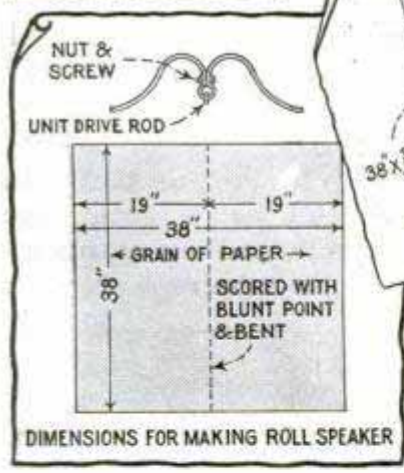
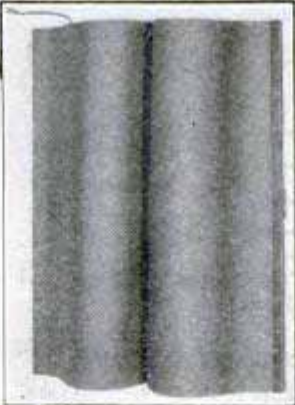
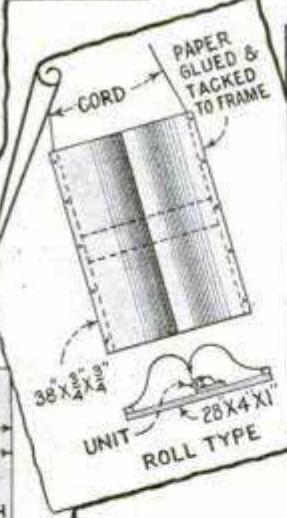

the other, leaving it in the position that gives the loudest results.

If the air gap (page 122) is too small the cone will chatter; to open this gap, loosen nut A about 1/8 turn, and tighten nut B. If the air gap G is too wide, the volume will be low; to remedy this, reverse the above directions. The cone, of course, must be removed for this operation, so as to get at the unit. When the unit is mounted at the center of the cone, as in the type just described, and the support block furnished is not large enough to

bring the thrust rod through the apex of the cone a small extension pin is provided for the end. In other types shown in the illustrations this extension is not required.

The pedestal type is the same as the wall type with the exception that one of the cross sticks is extended to the base. On this page the necessary details are given for mounting the cone in a cabinet, if preferred. These drawings are self-explanatory. At the top, left, construction details for a cone of the eccentric type are given. In this case follow the dimensions exactly as no variation in size has been provided for. Still another type will be found below, at right; this is known as the roll or book type and its construction is extremely simple, as no gluing is required. The heavy paper is creased in the center and held in place by the wood side strips. Excellent results were obtained with all of the types shown.

Any inquiries regarding the various types described, and the addresses of the man-



Manufacturers supplying the parts will be given without charge upon application to Popular Mechanics Radio department, 200 E. Ontario st., Chicago.

### Demonstrating Loud Speakers

Dealers who have to demonstrate several types of loud speakers will find the illustrated device handy, as it enables them

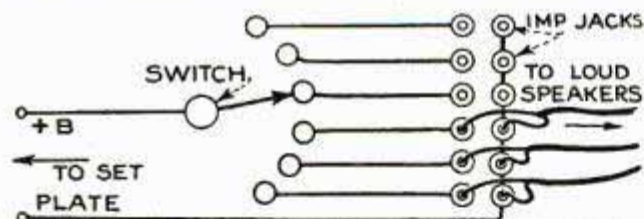
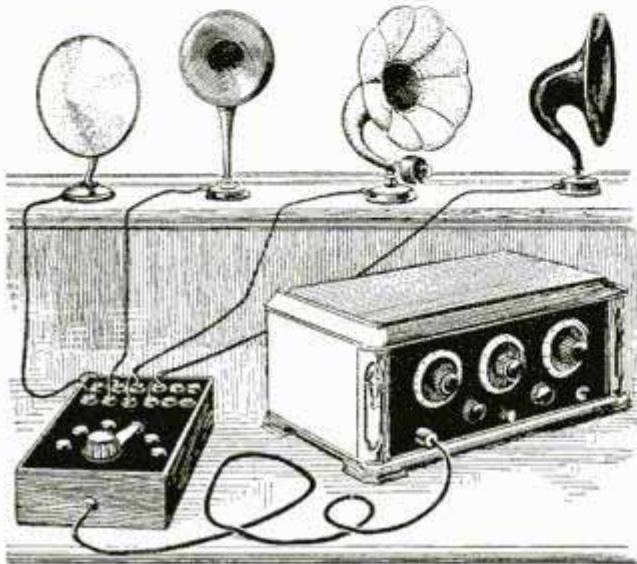

Convenient Switch Box Which Facilitates Making Comparison between Speakers

to switch on any one of a number of loud speakers by turning a switch lever, eliminating the necessity of connecting each one to the radio set separately. The device consists of a shallow box, fitted with a bakelite cover, on which several switch points, a lever to make contact with them, and a number of cord-tip jacks are arranged in two rows. It is wired so that one row is connected with the plate output of a receiver, each jack of the other row being connected to a switch contact and the switch lever to the B-positive supply.

### Combining Horn and Cone Speakers

It is a well-known fact that the cone speaker reproduces the low notes sometimes lost in speakers of the horn type, while the horn is especially good on the higher notes. This suggests a combina-

tion of the two, connecting them in series. If the terminals are marked for polarity, the positive is usually indicated by a red tracer cord. The positive terminal of one horn is connected to the negative of the other in a double binding post, the remaining terminals being connected in the plug.

### Improving the Filament Control

Faulty filament adjustment results in poor reception. This is often due to the fact that the operator must guess at the proper rheostat setting to obtain the filament temperature suitable for the tube. The filament is usually operated with too high a temperature, tending to shorten the life of the tube as well as adding another critical adjustment to the set. Ballast resistors, and other types of automatic control for the filaments, are now coming into general use. The automatic devices supply the proper filament temperature for the various types of tubes and insure uniform operation. These devices are based on the principle that a metal conductor will increase in resistance if heated, so that, as the current increases and produces more heat, the heat, in turn, increases the resistance, bringing the current back to normal. As the battery becomes discharged, the current through the ballast device drops, and fails to heat as much, thereby allowing the proper current to flow to the filament at all times. Automatic filament control also tends to simplify wiring, as shown in the diagrams. At left, two tubes are shown with the complicated wiring necessary when the detector tube requires pos-

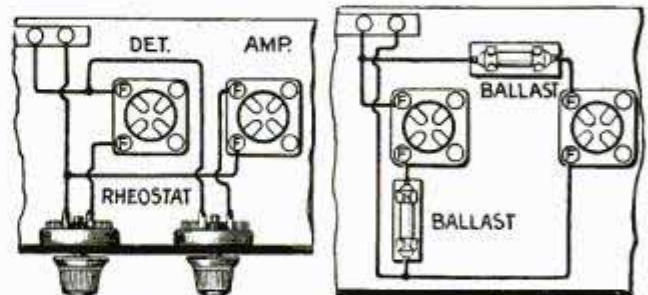

Left, Detector and Amplifier Tubes Controlled with Rheostats; Right, Automatic Filament Control

itive grid-to-filament return and the amplifier negative. The diagram at the right, with the same tube arrangement, shows the simplified wiring of the automatically controlled set.



# FOUR-TUBE SET FOR SOCKET POWER

By Frank L. Brittin



**A**LTHOUGH specially designed for the ABC power unit described in the June issue, this set may also be operated with A and B-batteries if desired. Combining simplicity with exceptionally good selectivity, the set will bring in distant stations with volume sufficient to operate even the largest loud speakers. The compact construction makes it suitable for small consoles, and ideal for building into phonograph compartments. The circuit employs one stage of r.f., a regenerative detector and two stages of transformer-coupled a.f. amplification.

The layout and wiring diagram on page 126 may be varied to suit the needs of the builder; the baseboard is 1 by 12 by 13½ in., this size being selected to fit the special cabinet shown, and allow room for the ABC-unit in the same cabinet.

The front panel is ¾ by 7 by 24 in., with the three controls grouped in front of the receiver unit. This leaves the section in front of the ABC-unit blank, unless the builder wishes to mount the voltmeter, suggested for checking the filament voltage across the tubes, in the receiver. In this case the voltmeter, which is an ordinary d.c.-battery type, is mounted in the center of the blank section. Two strips of wood, 1 by 1½ in. by 12 in. long, are used to raise the baseboard so that the two 1-mfd. fixed



condensers and a portion of the wiring can be placed underneath. These condensers, and the wiring referred to, are indicated by the dotted lines on the detailed diagram. The exact location of the three variable condensers on the front panel is not important, but they should be arranged as shown with the 135-mmfd. condenser at lower center. An ordinary rheostat knob may be used on this small condenser as it acts as a regeneration control and does not affect the logging of the set in the least, the stations being tuned in by means of the two dials. The coils used are of the plug-in type, and fit into a universal socket specially designed for them.

The aerial coil, type 116-A, is shown at right, the connections being numbered on the base to correspond with the numbers given in the diagram. It will be noted that contact posts 1 and 2 are not in use; the r.f. tube is placed directly behind this coil. The coil, type 115-A, shown at the left must be rewound for best results in this particular set, but this is a simple matter, as

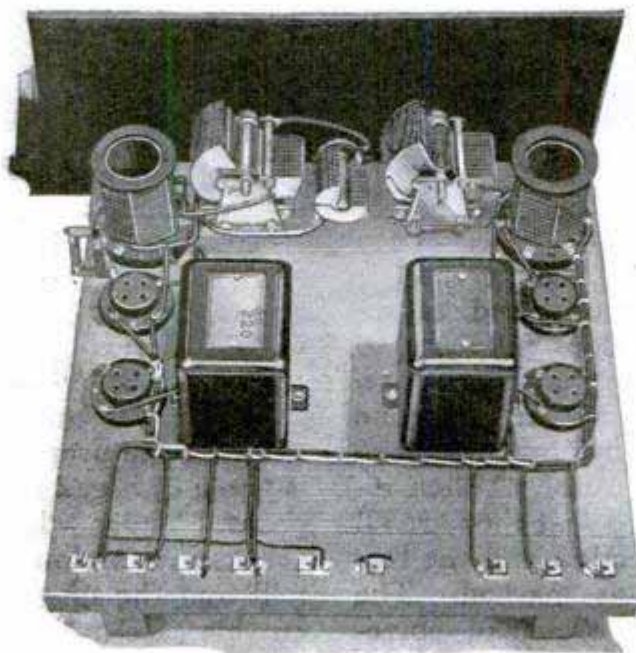

Completed Receiver Unit, Showing Cabled Leads



shown in Fig. 3. The grid coil, consisting of 90 turns, in the regular type 115-A coil

socket directly behind this coil has the grid condenser and leak mounted directly on the grid post; the other instruments are then mounted in the positions shown and the set is ready to wire. If the a.f. transformers shown are used, place soldering lugs under each terminal and bend them up carefully so that they do not touch the metal shell of the transformer. The schematic diagram, Fig. 1, is identical with the wiring shown in the detailed drawing, the tube fila-

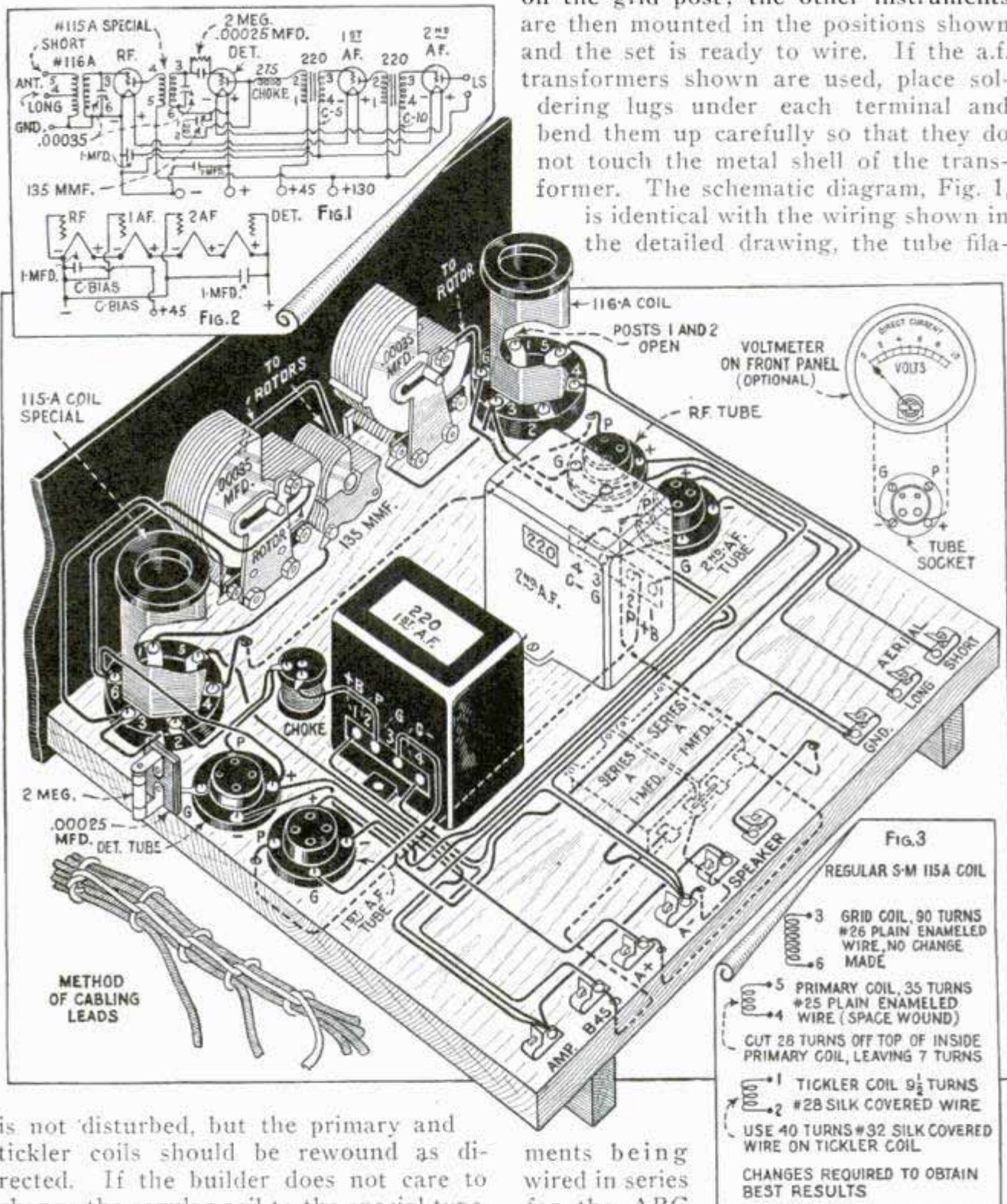

is not disturbed, but the primary and tickler coils should be rewound as directed. If the builder does not care to change the regular coil to the special type, any dealer in radio supplies can make the change, or the special coil can be obtained direct from the manufacturer. When rewinding the coils, be sure that they are all wound in the same direction and the terminals connected just as marked. The numbered terminals must make corresponding connections in the socket when the coil is plugged in. The detector-tube

ments being wired in series for the ABC

socket power unit. The filament wiring showing the proper sequence of the tubes is given in Fig. 2 merely for checking purposes. Those who wish to wire the set for use with standard A and B-batteries will find the diagram given on page 128. In this case a 3 or 6-ohm rheostat and a filament-battery switch are required and are mounted on the front panel, one at



either side of the .00035-mfd. variable condensers, so as to make a neatly balanced appearance. When batteries are used, the builder will not need the 26-in. front panel, but may employ either the 7 or 14-in. standard size, or any other size he may desire. Use flexible, insulated hookup wire for the circuit, making the leads long enough so that they may be cabled together with string in the manner shown. This is especially important if the set is to be wired for the ABC-unit. When wired for standard batteries, the tube filaments are connected in parallel in the usual way, and the two series-A 1-mfd. fixed condensers are not required; otherwise the circuit is the same. Note carefully that the rotors of the 135-mmfd. and the .00035-mfd. condenser at left, are connected. The exact location of the rotor connections will of course differ in other types of condensers; in the .00035-mfd. used, a rotor connection could be taken either at front or back. As the 135-mmfd. condenser has the rotor terminal at front, the connecting lead is run to the front of the large condenser at left. The other rotor connection of the .00035 condenser is taken from the rear and run to terminal 6 on the coil socket. If the receiver has been built for use with the ABC-unit referred to in the June issue, connect the set to the power unit in the manner specified, using a 25-watt 115-volt Mazda lamp in the power unit to obtain  $4\frac{1}{2}$  volts across each of the four 201-A tubes in the receiver. Be sure that all tubes in the set are in their sockets before turning on the power unit. Never leave the current turned on when the set

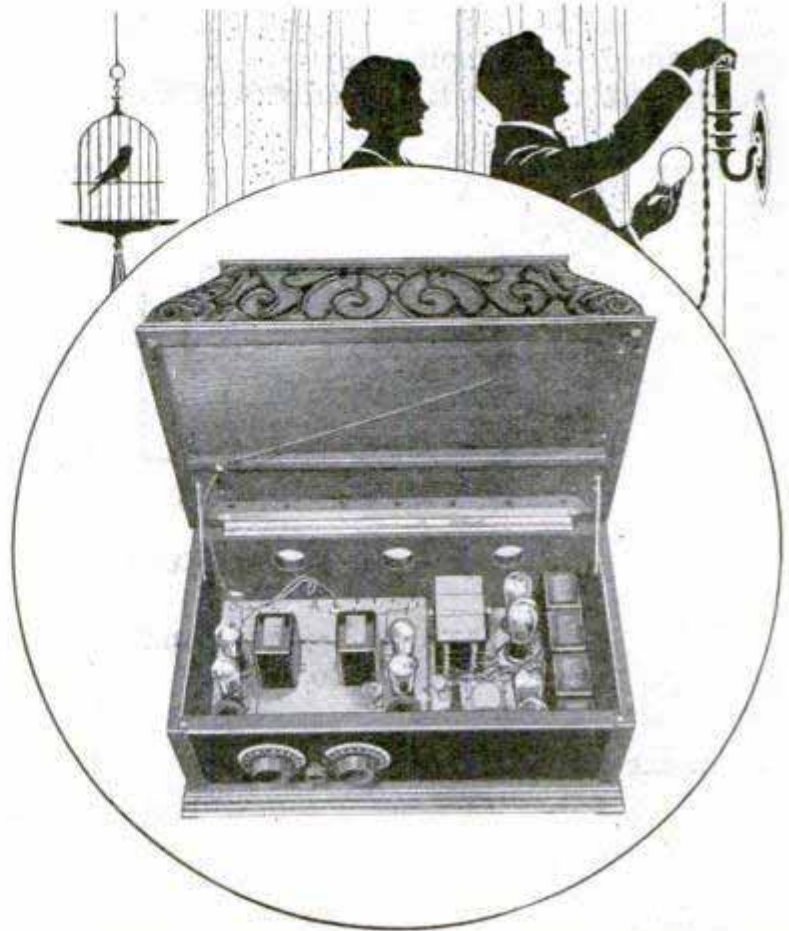

Power Unit and Receiver Combined; the Loud Speaker Is Built into the Lid of the Cabinet

is not in use; also turn off the current before removing any of the tubes in the receiver. The set is very easy to tune; rotate the dials in step until a station is located, then adjust the 135-mmfd. condenser for the desired volume. The cabinet shown in the illustration on this page, which permits both set and ABC-unit to be installed together, is a regular commercial product; the loud speaker is built into the top of the cabinet. This is shown only as a suggestion, and readers who wish to use a similar cabinet can obtain the address of the maker on request.

A large blueprint has been prepared showing all wiring diagrams, and, in addition, detailed connections for those who

#### MATERIAL LIST

- |  |  |
|--|--|
| 1 front panel, 3-16 by 7 by 26 in. (if built for type of cabinet shown). | 4 X-type sockets.                                      |
| 2 wood strips, 1 by $1\frac{1}{2}$ by 12 in.                             | 2 a.f. transformers (any good standard type).          |
| 1 baseboard, 1 by 12 by 13 in.   | 1 grid condenser, .00025 mfd., with leak clips.        |
| 1 S-M coil, type 116-A.  | 1 gridleak, 2 meg.                                     |
| 1 S-M coil, type 115-A (or special of same type).                        | 9 Fahnestock clips.                                    |
| 2 S-M universal coil sockets, type 515.                                  | 1 d.c. filament voltmeter.                             |
| 1 S-M choke coil, type 275.  | 1 6-ohm rheostat (if set is wired for batteries).      |
| 2 variable condensers, .00035 mfd.                                       | 1 filament switch (if set is wired for batteries).     |
| 1 Precise variable condenser, 135 mmfd.                                  | 4 UX-201-A or CX-301-A tubes.                          |
| 2 Sangamo, series A, 1-mfd. fixed condensers.                            | Wood screws, soldering lugs and insulated hookup wire. |



wish to use batteries. The blueprint may be obtained from Popular Mechanics Radio department, 200 E. Ontario st., Chi-

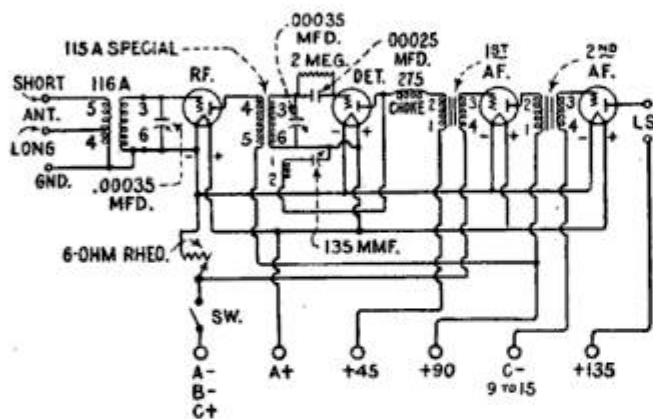

Schematic Diagram for Wiring the Receiver for Use with Batteries

cago, for 25 cents, to cover postage and packing. Specify blueprint No. 120.

### Automatic Cut-Out for B-Eliminator

Many B-eliminators are fitted with a switch which is set on the off position when the set is not in use. This, however, does not eliminate the necessity of turning off the switch on the receiver panel, so that, in fact, two switches have to be operated to cut out the eliminator. With the automatic device to be described, turning off the filament switch on the set does the trick. The device is very small and is mounted in the receiver cabinet. The base is a bakelite strip, 4 in. long, 1 in. wide and  $\frac{1}{4}$  in. thick. The armature is made from a clock spring, or similar heavy strip of steel. It is advisable to hold the end that is to be placed above the coil over a flame for a few seconds before mounting it on the support bracket. The diagram shows the construction details so clearly that little remains to be said of the assembly. The coil bobbin was taken from a buzzer, the old

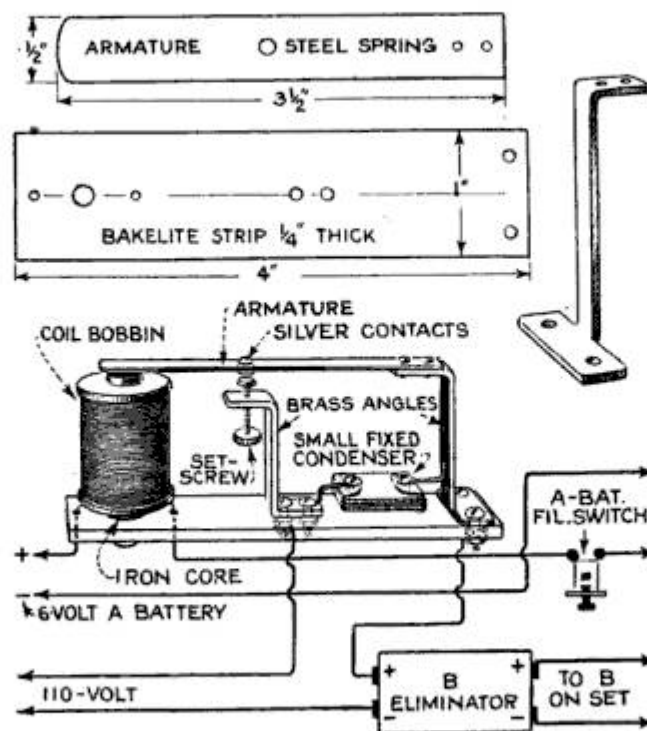

Construction Details; Bracket Dimensions Will Depend on Size of Coil Bobbin Used

wire removed and a few feet of No. 18 wire wound on it. The silver contacts were taken from an old spark coil, the contact on the armature being hammered into a small hole punched in the steel strip. The fixed condenser can be of any capacity around .001 mfd., and is used to prevent excessive arcking and sparking. The lower contact is mounted on a screw, as shown, for adjustment of the distance between contacts, and the bracket is mounted at a convenient point below the contact on the armature.

### When the Loud Speaker Quits

Before calling the radio repair man, or attempting to take the radio set apart because of its failure to work, make sure that the loud speaker is not at fault.

The loud speaker is a very sensitive instrument, and easily gets out of adjustment. This is likely to happen if it is moved about frequently, with the result that the volume suddenly drops and the owner will often blame the set instead of the horn.

It is not wise to invest in a fine radio receiver and then cripple it with an unsatisfactory loud speaker; distortionless amplification is wasted on such an instrument. Make sure that the positive cord of the loud speaker is connected to the

positive side of the loud-speaker jack connections. The cord tip marked with a red tracer must go to the positive side; if in doubt as to the horn-plug connections in your particular set, have your local radio dealer mark them for you.

Some radio-set owners boast that they never use phones and never owned a pair, but on the particular night when they wish to hear a fine program, something may go wrong with



115 Federal St.  
Boston Mass.  
Radio Set Contained in Book

An attractive radio receiver of the crystal variety, apparently a cloth-bound book,

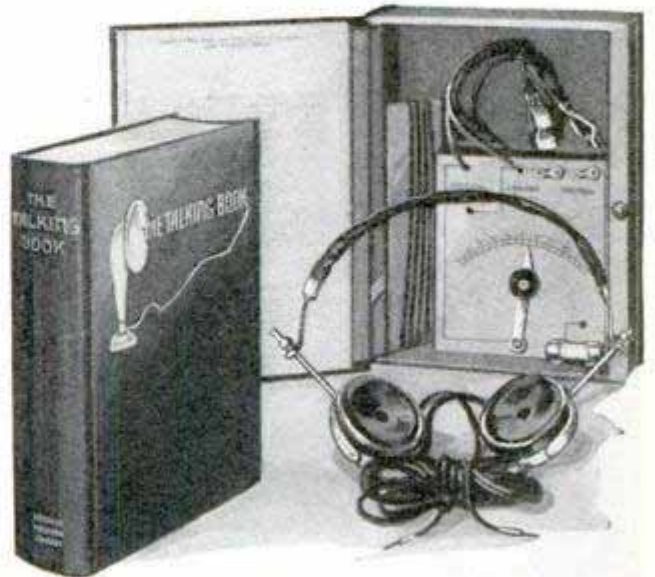

Small Crystal Set Contained in a Cloth-Bound Box Made to Resemble a Book

has been placed on the market recently. It is a nicely constructed device and has enough space to accommodate a pair of headphones, as well as aerial and ground leads. Stations within a radius of 20 or 30 miles can be tuned in satisfactorily.

### Mounting a Portable Meter

Many small meters that are designed to be mounted on panels would, if used for portable work, be unhandy and easily injured. One way to overcome this trouble is to mount the meter in an auto distributor cap, which makes an excellent base. It may fit the cap exactly and can then be fastened by drilling and tapping the cap. A hole is also drilled through the side of the cap for a two-strand cable, which is connected with the meter as indicated, and has cord tips or small spring clamps at the other end to make contact with the device to be tested. If the meter is too small to cover the open end of the cap, short metal strips, with a hole at each end, are fastened to both the meter flange and cap to carry the meter.

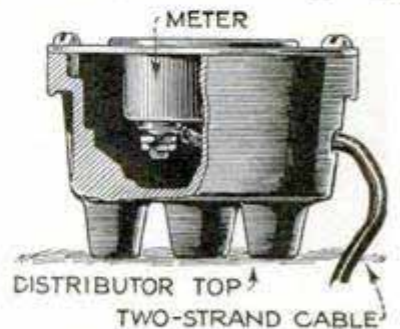

Cutler-Hammer Mfg. Co., 12th & St. Paul St. Milwaukee Wis.

the loud speaker and a pair of phones would come in very handy. With phones it is easy to determine if the trouble is in the loud speaker or the set and, perhaps, save a repair bill. There are many kinds of loud speakers on the market, but most of them are of the double-diaphragm, the adjustable or the non-adjustable types; the adjustable speaker of the horn type, and the non-adjustable cone type are both popular. Cone speakers may get out of order and sound rattly due to weather conditions. This can be remedied if there is some way of tightening the paper cone by resetting the phone unit. On the non-adjustable horn-type speaker there is usually one or two gaskets between the diaphragm and shell of the phone unit. If the magnets are not strong enough, they fail to actuate the diaphragm properly, and weak tones are the result. To remedy this, remove one of the gaskets or screw the cap down tighter, so as to bring the diaphragm closer to the magnets. The adjusting knob of the other type often slips, and turning it seems to have no effect on the volume; in this case the setscrew should be loosened and set to a different position until reception is improved. After repeated adjustments the diaphragm may become warped, and the only remedy for this is to remove it and level it on a perfectly flat surface.

### Gridleak Is Operated by Panel Knob



To gain access to a variable gridleak, the radio owner must usually open the cabinet or remove the receiver from the console, and this inconvenience often causes him to neglect adjusting it carefully under various conditions. There is now a gridleak on the market which can be adjusted from the panel. It is attached directly to the grid terminal of the detector-tube socket, and a shaft extends through the panel, a knob being provided for the adjustment.

Wahner & McLaughlin Co.



### Five-Tube Portable Receiver Weighs Only Twenty-Four Pounds

A small portable set that uses five tubes, operates on a loop and weighs only 24 lb.,

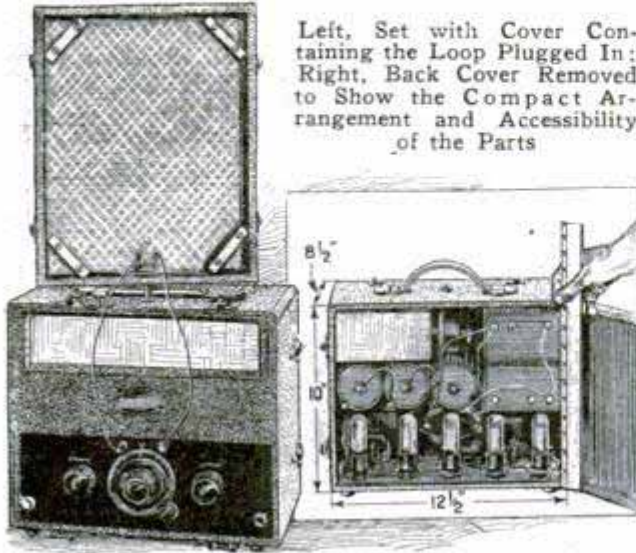

Left, Set with Cover Containing the Loop Plugged In; Right, Back Cover Removed to Show the Compact Arrangement and Accessibility of the Parts

fully equipped, has recently appeared on the market. A sturdy cabinet contains all the equipment, and the loop is wound in the lid which is plugged in at the top when the set is in use. The circuit employs two stages of r.f., detector and two stages of a.f. amplification. Other interesting features are single dial control, spring-base sockets and built-in loud speaker. For use in the home, or en route on train, automobile or boat, this compact little receiver makes an ideal companion.

### Tube for Resistance-Coupled Amplifiers

Because of the widespread interest in resistance coupling, a high MU tube, especially designed with a view to providing high amplification and suitable as a detector as well as an amplifier, is announced by one of the large manufacturers. This is the UX-240 or CX-340; the new tube is of the storage-battery type, similar to the well known 201-A, and a standard X-type base is provided. It is intended to provide the highest practicable voltage amplification so essential in resistance-coupled amplifiers. This method of amplification, in contrast with the transformer-coupled method, depends entirely upon the tube for the step-up effect. In transformer coupling, on the other hand, the step-up effect is brought about by the transformer ratio as well as the tube.

Therefore the new tube has been designed to provide an amplification factor of 30. The over-all amplification of one stage of resistance coupling, employing a UX-240 or CX-340, is substantially equivalent to the average stage of transformer coupling employing a UX-201-A. This is contrary to general belief, which holds that resistance-coupled circuits give such poor amplification that an additional stage or two are necessary to get satisfactory volume.

### Rack Holds Battery Leads

For the radio experimenter or dealer who tests a number of radio sets, a rack for holding battery leads that permit quick connections, will be found to be of considerable usefulness. It consists of a bakelite strip with a number of snap terminals fastened with screws, a soldering lug being provided under each screw. The leads to the A, B and C-batteries are soldered to the lugs, and the strip is mounted on the wall or on a specially made base, as shown. Cords, equipped with a phone tip at one end and a spring clip at the other, facilitate making connections from the terminals on the strip to the receiving set.

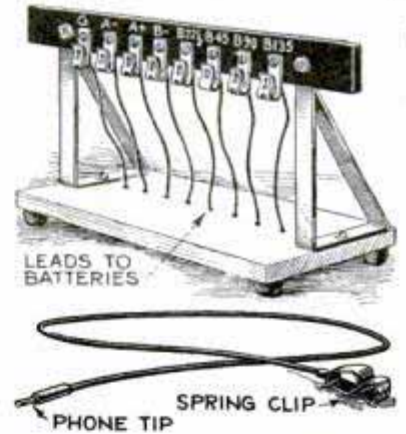

### Tips Lock Themselves in Plug

Simple to use, the plug shown in the drawing insures good electrical contact with any kind of cord tip. The cord is first pushed up through the hole, as indicated at the left, and, after it is doubled over, is then pulled back into the body of the plug, where it wedges against the plug contact securely. It can be loosened again by merely pushing up the tip, which projects from the end.



Radio Corp. of America  
Cuba, Stearns



Base Plug for Wiring Radio Receiver

The plug described is very simple to make and is a neat and efficient means of

discarded B-batteries if desired. The panel consists of a piece of bakelite, or hard rubber,  $2\frac{3}{4}$  by  $4\frac{1}{2}$  in. in dimensions and about  $\frac{1}{4}$  in. thick. One side is beveled

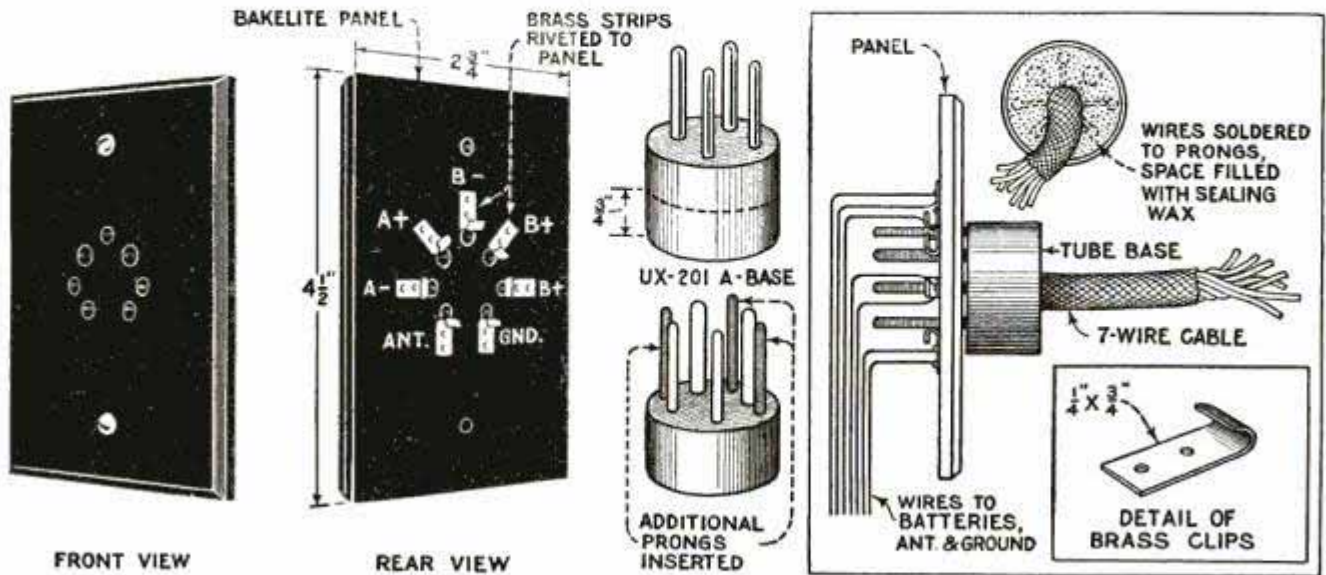

Left, Front and Rear Views of Completed Panel; Right, Construction Details and Sectional View of Plug Inserted in Panel

connecting batteries, aerial and ground to the set. All wiring and batteries are kept out of sight; the batteries may be placed in a closet or in the cellar, and the small outlet panel fastened to the baseboard of the room. When it is necessary to move the set, all that is required is to pull the plug out of the baseboard. The panel described fits the regular electrical outlet box in case one is used, or may be any size required. Two old UX-tubes are required, the bulbs removed and the bases employed for the plug. One of these bases may be cut down to about  $\frac{3}{4}$  in., as shown in the drawing, making a smaller and neater job. The other base is broken up for the prongs and three of these are inserted in the first base as shown. They should not be placed too close together. To insert them, drill holes in the bakelite base, for a driving fit, and tap the prongs in place with a tack hammer. A seven-wire battery cable is provided and the short leads soldered to the prongs inside the base. The base is then filled with sealing wax, which can be taken from

for the sake of appearance. The holes are drilled in the panel, care being taken to locate them properly, by setting the base on the panel and pressing it down so that the prong ends will leave marks on it. Due to the arrangement of the holes for the prongs, it is impossible to insert the plug in any other manner than required, and hence there is no possibility of damaging either the tubes or the receiver.—Herman R. Wallin, Brooklyn, N. Y.

Trickle Charger Uses Rectifier Bulb 111 65

Trickle chargers for keeping the A-battery fully charged at all times are now in general use. A new type employing a rectifier bulb has recently made its appearance on the market. This small unit requires very little space and is tapped for several different charging rates to meet the requirements of the set with which it is to be used. The illustration at left shows the size of the unit, as compared with the battery, and the simple connections that are necessary for its installation.

New Type of Trickle Charger Which Uses a Bulb for Rectification

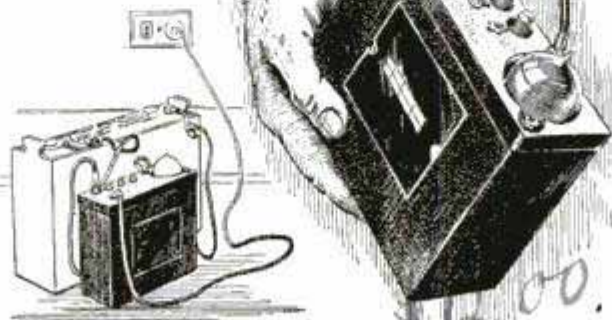

*General Electric Co.*



**Measuring Flexible Cable**

A radio dealer found it rather inconvenient to measure off long pieces of flexible cable with a footrule, so he devised the simple winder shown in the drawing for doing it. A piece of heavy cardboard is cut 6 in. long and about 3 or 4 in. wide so that one turn around it will measure exactly one foot.

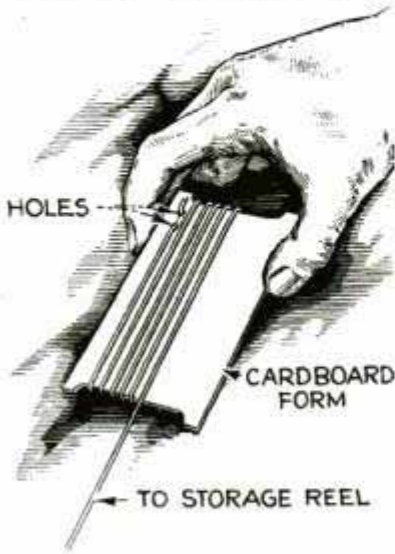

By counting the number of turns while the cable is wound on the card, any length can be quickly measured. If desired, a number of these cards can be made up and the cable sold to the customer can be left on, which will insure it against being twisted and kinked.—C. A. Oldroyd, Barrow-in-Furness, England.

By counting the number of turns while the cable is wound on the card, any length can be quickly measured. If desired, a number of these cards can be made up and the cable sold to the customer can be left on, which will insure it against being twisted and kinked.—C. A. Oldroyd, Barrow-in-Furness, England.

**Preventing Short-Circuited Battery Leads**

When one disconnects the terminals of the radio-battery cable, either at the battery or at the set, there is some risk of the ends coming together and possibly causing a short, that may burn out tubes or run down the batteries. As a precaution against this, five spring clips, mounted on a strip of bakelite as shown in the drawing, will be found helpful for holding the cable wires apart.—Lester P. Young, Culver, Ind.

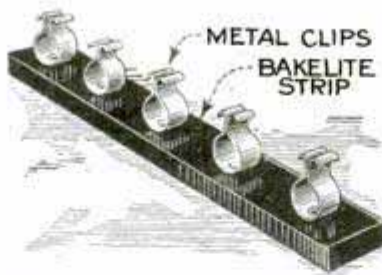

**Improving Tuned R. F. Receivers**

The present day r.f. receiver leaves little to be desired in the way of simplicity, selectivity and sensitivity, provided it is properly built and balanced. In congested districts, and particularly in the vicinity of powerful broadcasting stations, it

should be well shielded. However, to realize the utmost sensitivity and volume from this type of receiver, it is necessary to have some means of adjusting the plate voltage of both r.f. tubes and detector at any given wavelength or frequency and for a given strength of signal. Many of the manufacturers are now employing variable plate voltage for at least the r.f. tubes, gaining noticeably in efficiency and at the same time controlling the volume without distortion. Instead of employing 67½ or 90 volts, as is the common practice, it will be found advisable at times to increase the voltage to well over 100, particularly when tuning in weak distant stations. On the other hand, it is well to reduce the r.f. plate voltage to 45 on powerful locals. Plate voltage on the detector tube also plays an important part. A most satisfactory arrangement, irrespective of the type of r.f. receiver, is to tap the full B-battery output for all plate circuits, r.f., detector and first a.f., with an efficient variable resistor in each of the positive-B leads. The power tube will, of course, require the full voltage obtainable at times. There are several highly efficient variable-resistance units now on the market for this purpose, and anyone can bring his present set up to date with little effort and at small cost.

*1184-TR*  
**Electric Phonograph Reproducer**

The electric phonograph reproducer shown in the drawing gives a rich, smooth tone with considerable volume. It operates in three ways: through a stage of a.f. amplification and then through a loud speaker; through an ordinary loud speaker

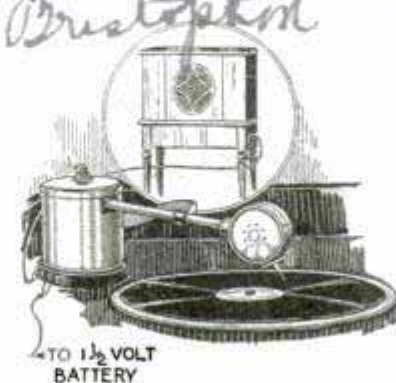

or through power loud speaker. When attached to an a.f. amplifier and loud speaker, a dry cell is connected to the unit, for which

leads are provided. When used with the speaker alone, six volts are required. The volume can be regulated by merely turning a thumbnut.

*Central States*  
*316 S. Wells, Chicago*  
*Electric Supply Co.*



# Facts and Fads for Radio Fans

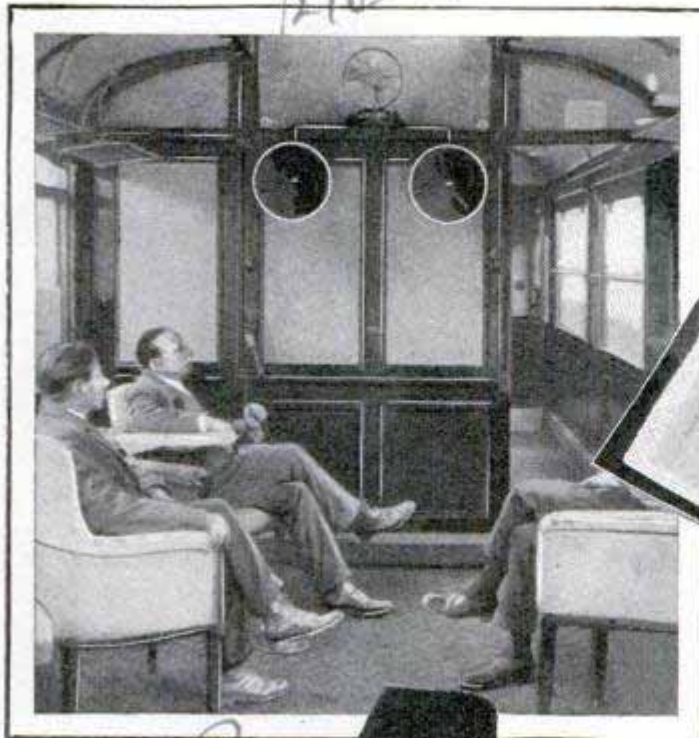

Left, Crack French Train Has Loud Speakers in Smoking Room; Right, E. B. Judson, of Bureau of Standards, Examining Apparatus Which Records the Relationship between Static and Temperature Changes, Indicating the Strength of Static at Various Hours



*kerbert*  
Above, Built into a Miniature Baby Grand Piano, This Six-Tube Home-made Set, with the Cone Mounted on the Sounding Board at the Rear, Makes an Attractive and Efficient Installation; Right, Recording Interference between Stations, to Obtain Data to Be Used by the New Radio Control Board in Allocating New Wavelengths

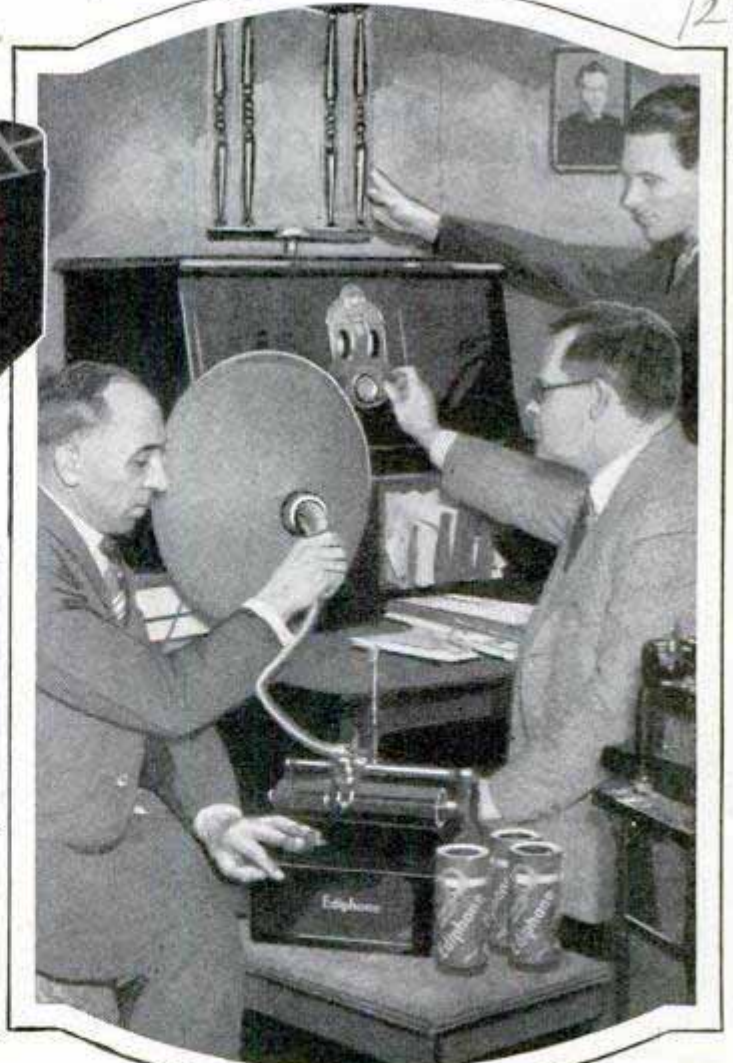



### Radio Table from Sewing-Machine Stand

Requiring a radio table and not caring to invest in an expensive type, I decided

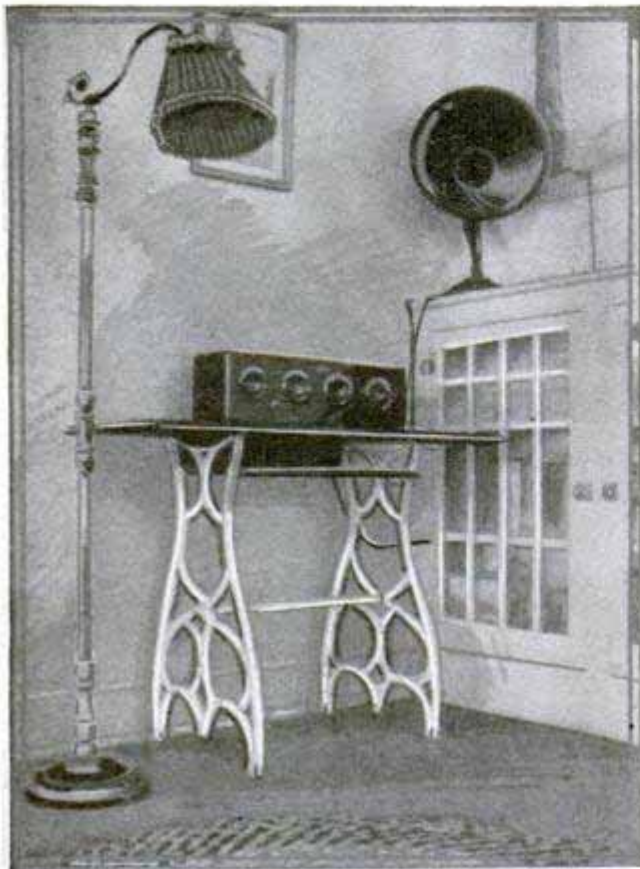

Radio Table Made from Sewing-Machine Stand, Showing Radio Set in Position

to make one from a discarded sewing machine. Only the iron framework was used. The four screws holding the upper portion of the machine were removed, but were saved for mounting the table top on the frame. The frame was taken apart, the crank wheel, guard and crosspieces being discarded. In the make of machine used, it was found that the cross rod directly under the pedal could be moved up about midway on the framework. In other models that may not be possible, but the lower rod will support the frame in either event. The iron frame was carefully sandpapered and given a coat of enamel. A 12-in. board, of the same length as the cross rod, approximately 20 in., was then fitted between the sidepieces of the frame near the top, and screwed in place. Holes in the frame, at the location of the machine drawers, made the mounting of this shelf an easy matter. As the shelf came about 3 in. below the table top, it provided a convenient place for log sheets and extra tubes. A 3-in. board was screwed along

one edge of this shelf at the rear to prevent articles being pushed through. For the top, a clear pine board, 1 by 16 by 36 in., was used. It was beveled and carefully sanded before applying stain or varnish. Beveled and sanded at a local mill, such a board would cost about 85 cents. A little less than half of a 15-cent can of mahogany stain was used; a final coat of shellac or varnish can be applied later and rubbed down to a high finish.—Ivy Barrow, El Paso, Tex.

### Radio Tube Serves to Light Room

A radio tube that can be used to illuminate a room as well as to act as a radio detector or amplifier was brought from Spain recently by Dr. Lee DeForest. It is claimed that the new tube eliminates batteries, and requires no aerial or ground, as the house-lighting wires perform the necessary pick-up function. Its use will cost practically nothing, as a lamp would be needed for illuminating purposes anyway. The suggested adaptations for the tube would be in the form of a desk or table lamp. The radio filament is in series with the lighting filament, and the regular plate and grid used in the radio vacuum tube are employed without affecting the lighting ability of the lamp. It is claimed that four of the new tubes will do the work of five of the present tubes.

### Transformer Has Variable Ratio

By means of the taps on the a.f. transformer shown in the drawing, three ratios, 4 to 1, 6 to 1 and 8 to 1, can be obtained. This is of great value to the experimenter, as the transformer can be used



in any set, and, if the ratio is too high for the tubes, which causes distortion, it can be reduced as desired. In a set having power tubes, for example, which have a higher mutual conductance than ordinary tubes, the high-ratio transformer can be used, with the result that more volume and less distortion will be obtained.

Como Apparatus Co,  
Waltham, Mass.





## How to Make a Shelter Tent

By CLAUDE P. FORDYCE

**T**HE lean-to or "reflecting-baker" tent is one of the simplest types of all and easy to construct at home. It is especially good for cool-region camping when you want a warm shelter. This works like the reflecting baker of our forefathers. A fire, built a few feet in front of the tent on a cold night, with a back-log reflector throws the heat waves to the slanting roof of the tent and down upon the sleeper. The ends keep out drafts and it is easily pitched with the ridge rope between two trees or over forked saplings.

In making the tent, follow the diagram. The "roof" is a rectangle of cloth, 7 ft. 6

sheet. A rope is sewn to the ridge or tie tapes are sewn every 15 in., to be tied to a rope or pole ridge. Around the bottom, sew on a 6-in. sod cloth, to keep out the wind, rain and bugs, and lay the bed to overlap this. For mosquito protection, cover the front with loose cheesecloth sewn to the ridge. Two men traveling together can each take a lean-to and pitch them together and make a wedge or A-tent. If pitched so that the prevailing wind strikes the roof of the tent, you will rest easily and, if cold, a fire in front insures warmth.

This tent is the preferable one for hike

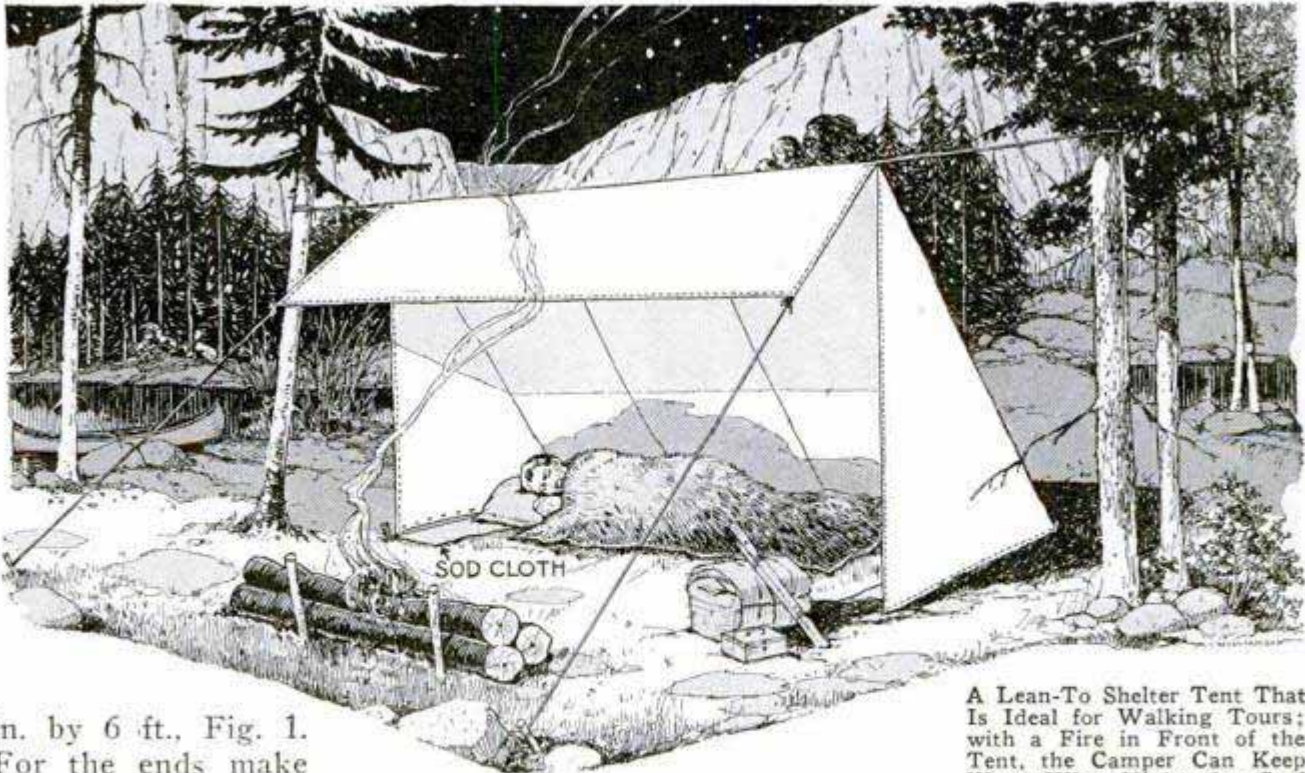

A Lean-To Shelter Tent That Is Ideal for Walking Tours; with a Fire in Front of the Tent, the Camper Can Keep Warm When Nights Are Cool

in. by 6 ft., Fig. 1. For the ends make another rectangle, 3 ft. 10½ in. by 4 ft. 7½ in., Fig 2; cut this diagonally from corner to corner and sew these pieces to either end of the large

trips where weight must be reduced to the absolute minimum consistent with comfort. Hence the material must be the



lightest waterproof fabric obtainable, and for this there is none surpassing balloon silk or sail cloth, procurable from tent and awning companies. The completed lean-to weighs  $3\frac{1}{2}$  lb. Use lightweight tarpaulin for the stake loops and ridge rope, and waterproof these along with the

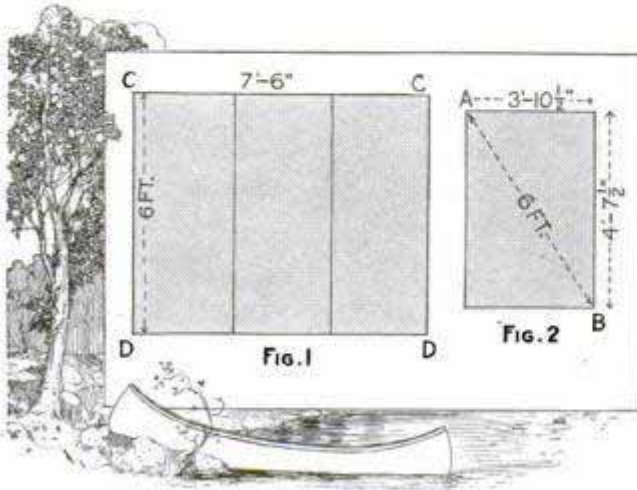

tent so they will not shrink in a rainy spell. Some campers add an awning extension to the ridge, to be pitched horizontally in fair weather, slanting in rainy weather, or it can be made wide enough to be brought down to close the front entirely. One outdoorsman made this awning removable from the tent (attached by snap buttons or tape ties) and in its center he had cut a slit and a neck piece so it can be used as a poncho on the trail.

### Loosening Screw Caps



Screw caps on cans and jars can readily be loosened by the device shown in the drawing. It consists of two pieces of wood, 3 by  $\frac{3}{4}$  by 24 in. in dimensions. These are fastened vertically with two hinges to any stout wooden facing, as shown. The device will grip a can of any size, even the lid of a fruit jar. The pressure on the cap increases as

the device approaches the closed position.—L. Pyle, Laporte, Pa.

### Ground Wire for Ignition Breaker

Most automobiles have a distributor head on the battery ignition which is moved by the spark lever to control the spark timing. On some cars the bearing in which this part moves becomes worn, and this allows the casing to wobble and fail to ground the primary circuit of the ignition at times. This will cause missing and hard starting. The cars having full automatic spark advance have the distributor head and casing firmly clamped in place and do not wear at this point. The ignition can be kept working, unless the wear is great enough to cause missing by failing to open the points, by attaching a ground wire to the breaker case. One end of this wire is attached to the movable case of the breaker, and the other end is grounded on the motor. With this ground wire in place, the primary current is grounded even if there is a loose and dirty bearing on the breaker case.

### Stopping Auto-Door Rattle

It is often suggested that pieces of rubber be used to check the rattle of car doors. After watching one motorist endeavor to utilize this idea unsuccessfully the writer tacked a piece of inner tube on the hinge side of the door jamb, as shown in the drawing, and eliminated the rattle entirely. If necessary, two or three pieces can be used, depending on the space to be filled.—G. A. Luers, Washington, D. C.

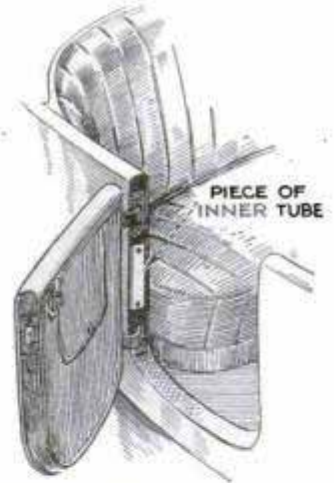

### Mangling with Clothes Wringer

When an ironing machine is not available, flat linen, towels, pillow slips, wash cloths, small sheets and other flat pieces can be mangled in an ordinary clothes wringer. Before they are entirely dry, the articles are run through the wringer with the screws set tight. Then the pieces are hung on a clothesline.



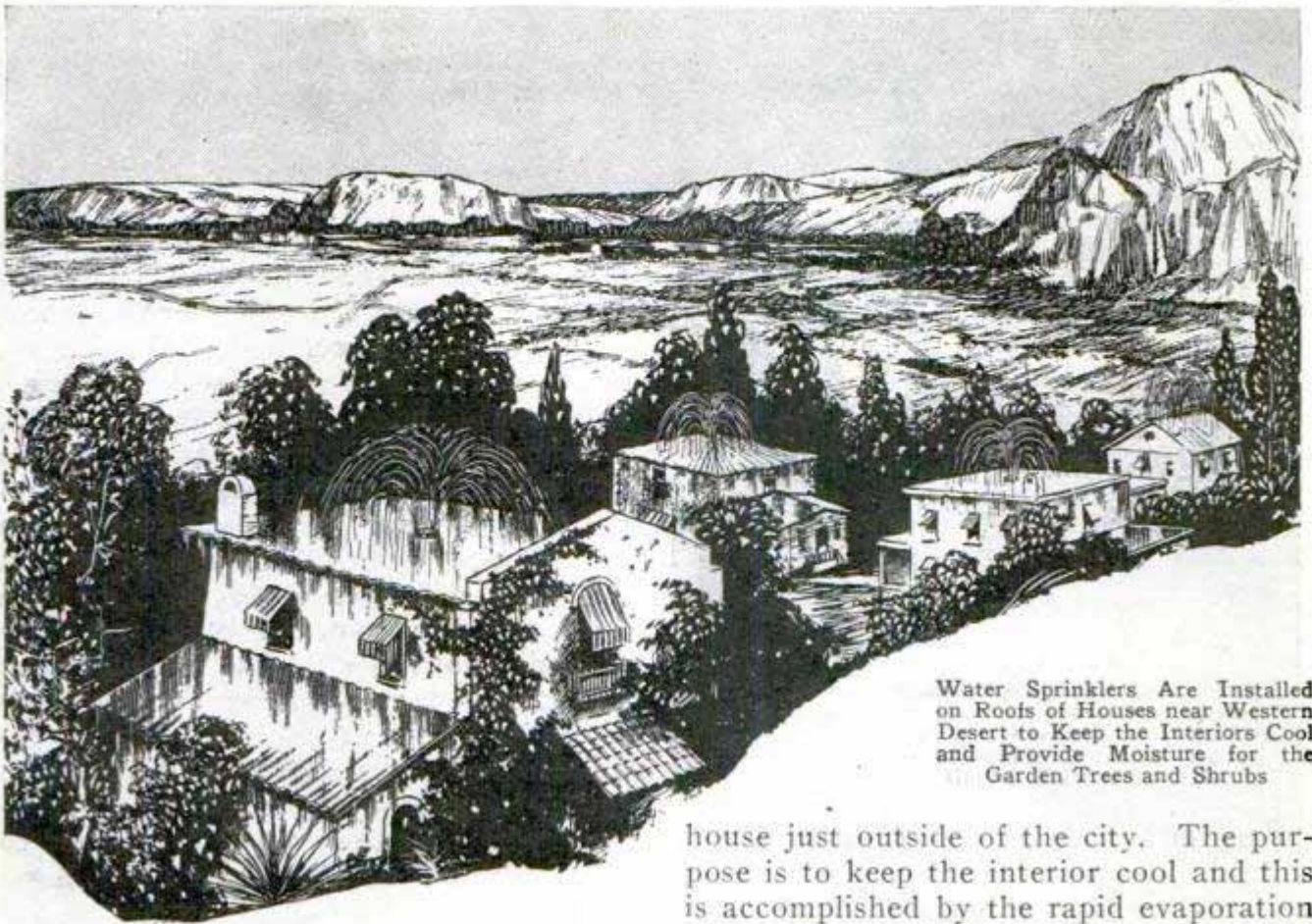

Water Sprinklers Are Installed on Roofs of Houses near Western Desert to Keep the Interiors Cool and Provide Moisture for the Garden Trees and Shrubs

### Water Sprinkler on Roof Keeps House Cool

Tourists coming into Tonopah, Nevada, across the desert on the Midland highway find a water sprinkler on the roof of a

house just outside of the city. The purpose is to keep the interior cool and this is accomplished by the rapid evaporation of the water, which also drips down the sides and provides plenty of moisture for the rose bushes and trees. The cooling effect is so pronounced that other residents are also using this method.—Letson Balliet, Tonopah, Nevada.

### Open-Air Scratching Shed

A farm poultry flock, which had shown traces of disease during the winter, was given free access to a special open-air scratching shed with the result that the disease disappeared. The frame for the shed is made of scrap lumber and was built onto the south side of the poultry house. Rafters extend from the top to a low wall, about 1 ft. above the ground, and the roof and sides are covered with inexpensive muslin, lath being used to hold it in place. Access to the shed is obtained through a small door from the poultry house. At night, this

door is closed. The muslin admits warmth and sunlight, yet the air is continually fresh. The shed is kept littered with straw which is frequently changed.

### Tissue Paper Protects Hat

On a long motor trip from Alabama to Florida, over dusty roads, one passenger protected her hat with green crepe tissue paper, the kind used by florists. From a few feet's distance it looked like felt and, as the appearance was so neat, it was left on in restaurants and other stopping places.—Mrs. V. S. Martin, Detroit, Michigan.

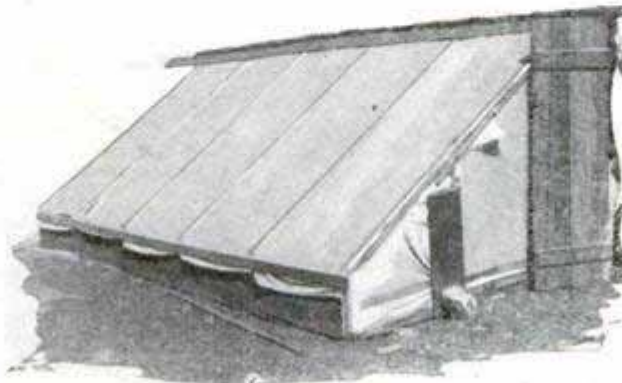

Canvas-Covered Shed Gives Chickens a Place for Scratching with Plenty of Fresh Air



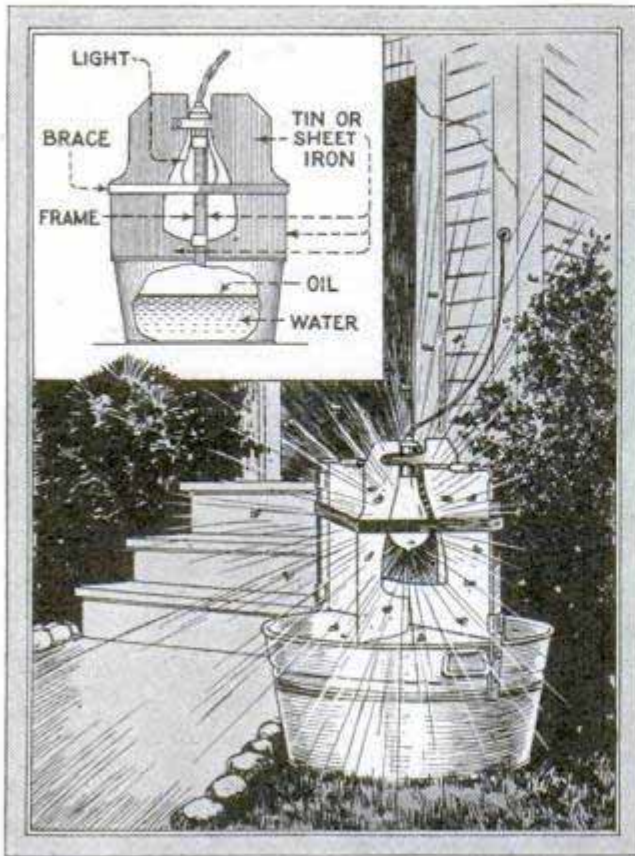

Effective Bug Catcher, Consisting of a Tub, Sheet-Metal Shields and an Electric Lamp

### Effective Bug Catcher

The operators of a western power plant, located on a river, were annoyed by the great number of insects attracted by the lights in the plant. To overcome this, the device shown in the illustration was made and proved entirely satisfactory, as much as  $\frac{1}{2}$  bu. of June bugs being collected in a single evening. The trap consists of an old tub with three pieces of sheet iron mounted vertically on top, in the form of a cross, and supported by strap-iron brackets. The shields are cut out sufficiently to permit the fitting of a lamp, as indicated. The tub is about half filled with water, which is covered with a film of old crankcase oil. The lamp is connected with an extension cord to a near-by light socket and the device is placed outdoors. The insects fly toward the light and collide with the shields, which causes them to drop into the liquid below. If only water was used, the bugs

would climb out again, but the oil prevents this and they soon drown.—Dale R. Van Horn, Lincoln, Nebr.

### "Portaging" the Outboard Motor

To transport the outboard motor between the shore or boat landing and the residence was found difficult when the motor had to be carried back and forth each day. A small truck was therefore constructed, so that the motor could be hauled easily. As shown in the photo, the truck consists of a substantial frame carried by two baby-carriage wheels. The distance between the wheels should be fairly wide so that the truck will have no tendency to turn over, and the motor should rest high enough above the axle to prevent dust picked up by the wheels from being thrown up on it. Various types of motors will require different kinds of support, owing to the differences in the clamping arrangement with which the motor is attached to the stern of the boat. In all types, however, the lower portion of the propeller housing rests in a recess in the upper portion of the leg or prop, and is held in position by a leather strap fitted with an automobile curtain fastener as a snap catch. Using the above method, the motor is very easily transported, and may even be trailed behind the automobile.



Light Rubber-Tired Cart Facilitates Hauling Outboard Motor Back and Forth, or May Be Attached to Auto as Trailer



# MOUNT YOUR OWN FISH TROPHIES

by O. J. W. Hansen

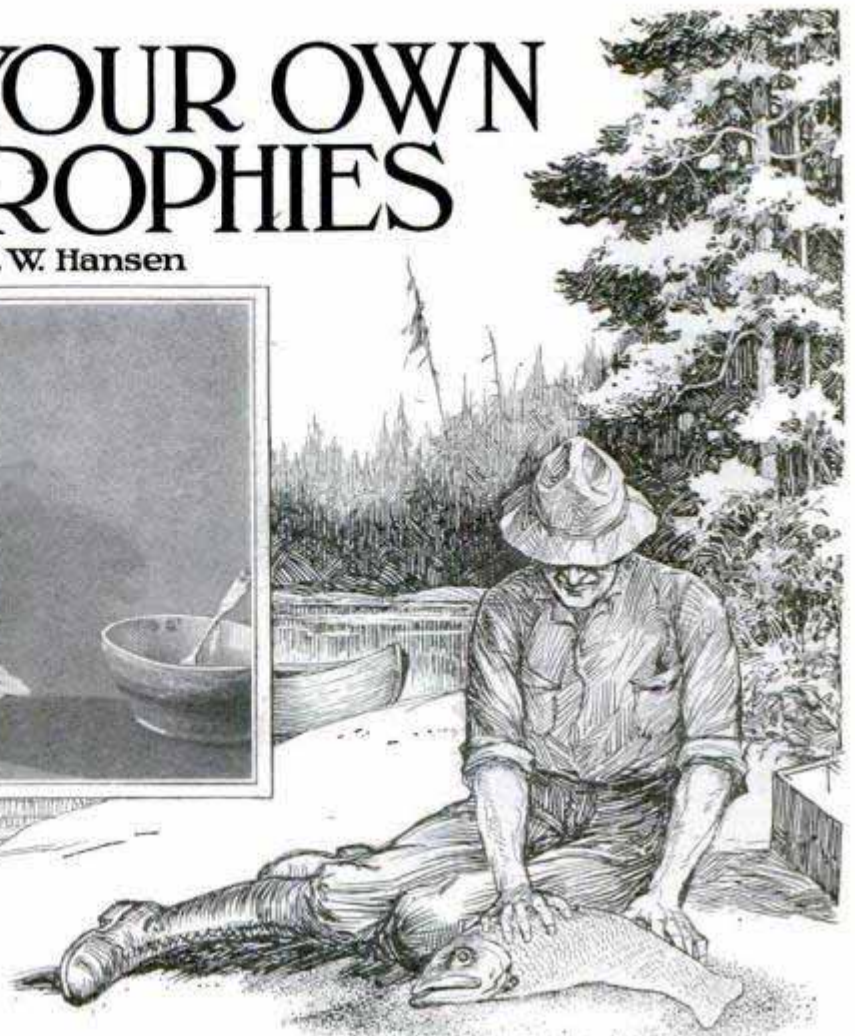

FIG. 1

WHEN Sam Jones invited me over to his house to see the fish he brought back from the north woods, I came fully prepared to listen to another long one. But when he led me into his den and showed me several really lifelike and finely mounted specimens, I began to feel a bit uneasy and mystified. Was Sam trying to put one over? "Did you buy out a museum?" I asked.

Sam smiled. "No," he said, "but I visited one last year. In the laboratories of the Field museum of natural history I learned how their fish exhibits were prepared. This craft was so fascinating and the results so remarkable that I determined to make my summer's vacation not only a fishing trip, but a source of material for work in my home shop, and for real decorations, not simply 'stuffed fish' for my den." Here is the story of how you can do it, too.

Besides the regular camping and fishing outfit, provide yourself with a fairly large wooden box into which you can pack your scientific field kit. This box should be covered with either oilcloth or a painted canvas to make it absolutely waterproof. A box like that can easily be made to fit

either on the running board or on the luggage carrier of your automobile, or, in a smaller size, with a strap, for carrying when on foot. This box should be divided into three compartments. The largest and longest one is to receive the molds of your fish. It should have some ventilating holes in the bottom so as to prevent too much moisture from the wet molds. The entire inside of the box should be given a couple of coats of light-gray paint.

The second largest compartment should accommodate a good-sized square tin box with a tight-fitting lid. Fill this box with fine plaster of paris. The amount of plaster needed will, of course, depend upon the size and number of fishes you may want to prepare. Thirty pounds for an automobile kit or 12 lb. for a carrying kit would be about right. This must be kept perfectly dry. Into the smallest compartment put a package of powdered alum, a paper of ordinary pins, a small can or bottle of benzine, a sharp knife and a good-sized notebook with a set of colored crayons or pencils. Into each corner of the inside of









FIG. 6



FIG. 7

doing this is to cut through the gill on the side that will not show on the finished mount, and to puncture the wind bladder from that side also. Since most of the blood of the fish is in the gills, it will bleed to death in a few seconds. Begin at once your work of preparing the fish for molding. Take your sharp knife and

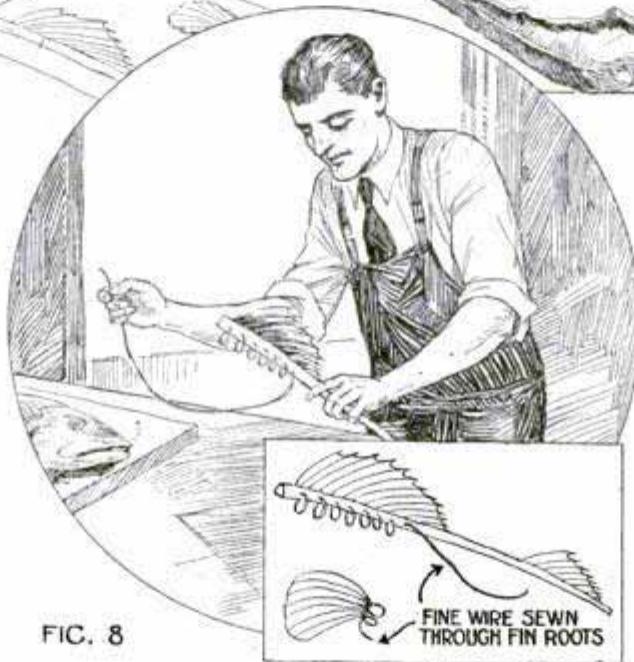
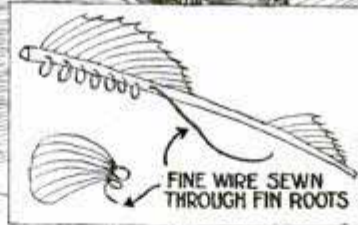

FIG. 8



carefully remove all the fins and the tail. This is done by making V-shaped incisions (Fig. 3) into the fish so as to preserve the roots of the fin bones. Care should be taken to make this incision as narrow as possible, and especially not to tear the surrounding skin or knock off any scales. The incision should also be made in such a manner that the side which will be toward you when the fish is mounted will be nearly whole. The open end of the V-cut should slant toward the rear and the root of the tail should also be cut out from the back. The fins are then carefully washed with benzine so as to remove the gluey slime. They are then stretched out on one of the cardboards and pinned down so as to dry in their proper shape. This should be done in accordance with your notes, so as to let the fins assume the

posture you wish to imitate when the exhibit is assembled.

The next step is to cast the body of the fish. Again consult your notebook and select the proper position. As you only need to cast two-thirds of the surface of the fish you can reproduce the position wanted by building

up under one side of the fish with sand, as in Fig. 1. By the use of a sand support you can give the body of the fish any desired curves. Before you definitely place your fish in the sand for casting, the entrails should be removed and replaced with a packing of fine sand. The stomach cavity and air bladder are partly filled with air, and otherwise would become deflated and out of shape by the pressure of the mold. The incision for the removal of the entrails should be made on the side that will not show in the finished cast. Before the incision is made, the fullness of the belly should be carefully noted so as to be reproduced exactly by the sand packing. It is preferable that all this work should be done out of the direct rays of the sun and as soon as possible after the fish has been killed.



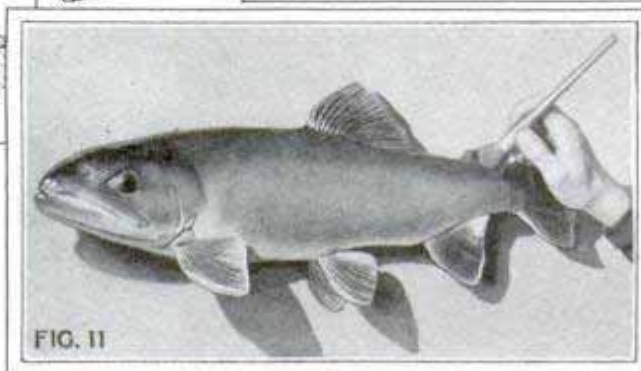
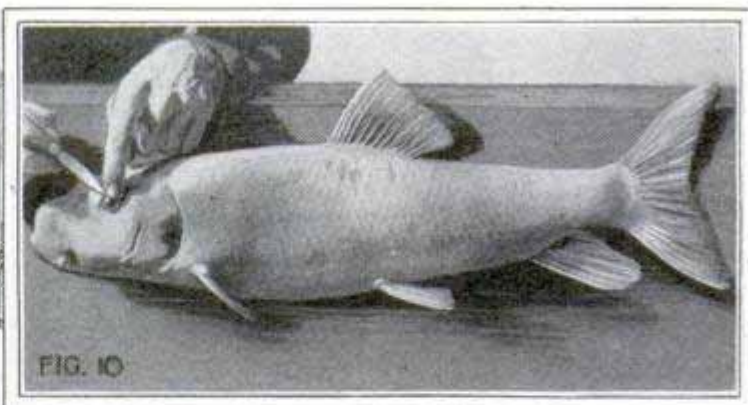

Now get the washbasin and prepare the plaster for casting. In 1 qt. of water dissolve two teaspoonfuls of powdered alum.

The alum hardens the protective gluey slime of the fish skin and prevents it from destroying and decomposing the fine impressions on the plaster-of-paris mold. To this alum water add slowly the powdered plaster until it has reached the consistency of cream, and stir until there are no lumps. As the fish is already placed in the proper position in the sand you can begin to apply the creamy-plaster mixture. The best way is to spread a thin coat all over the fish and blow the creamy plaster into every crevice and scale impression. Then, as the plaster hardens, the mold is made thicker by carefully adding to the underlayer, as in Fig. 2. The main thing is to get a clean impression in the underlayer. You cannot attach too much importance to the blowing of the plaster into all the depressions, so as to preserve every minute detail. Fresh plaster should be added until the mold has reached a thickness of about  $\frac{1}{2}$  in.

After the plaster has hardened (for about twenty minutes) remove the fish from the mold. If you had your sand piled in the proper manner before the mold was made, the removal of the fish will be easy. Fig. 4 shows the mold, together with the fins previously removed. Clean the fish of any sticking sand or plaster by careful washing, and begin to make your color notes of the skin. The simplest way of

making color notes is to follow a system similar to that used by landscape painters in noting the quickly changing colors of a sunset. Take your brown charcoal paper and make a contact pattern from

the mold of the exact size of your fish skin. This is done by simply laying the paper into the mold and cutting it at the top and bottom where the fish would divide, if cut in half lengthwise. Upon this paper mark down the exact location of the various dark and light areas of the skin. Carefully locate all the lines, peculiar color markings and spots. With your colored crayons give, as near as you can, a suggestion of the color values in their proper places. Support this color drawing with exact notes on the intermediate colors. Fig. 5 is an exact copy of a field note on a specimen. Note the position and color of the eyes. As the color changes rapidly in some fishes after death, and the eyeballs recede into the sockets, these notes should follow the live fish as closely as possible. A careful set of the eyes with a proper coloring is a very important detail in making your reproduction lifelike. When you have completed your color notes, you may remove a small cross section of the skin and take it home with you as a guide for future reference. Now carefully pack the mold of your fish, in some sand, in the large compartment of the field kit. In this manner you may collect molds of a number of different specimens before starting for home. The remainder of your work can be done at your leisure in your own shop.



The first step involved is, of course, to take a cast from your plaster mold. Place the mold in water for at least fifteen minutes so it will absorb a great deal of moisture. Then brush the inside of the mold with a saturated solution of zinc chloride. This should be repeated several times until the mold has become thoroughly saturated. Then take a soft piece of cloth and carefully wipe out the surplus moisture. The mold is now ready to be filled.

A very strong and practical cast can be made by the use of a synthetic stone called "clover rock." This is mixed in much the same way as the plaster of paris, except that the alum is omitted and the mixture is made heavier, like a thin paste. This paste is stirred until it is smooth and free from lumps and air bubbles, when it is gently tapped with the ends of the fingers into the inside of the mold (Fig. 6). As this mixture sets very slowly, you can take all the time you wish to get a clean impression. Again, the secret is to fill the entire mold with a thin layer, and then, as the material hardens, to build up to the desired thickness. Into the back of your cast you may now imbed the heads of two or three small stove bolts (Fig. 7). These bolts should be just long enough so that the nuts can be countersunk into the back of the finished mounting plaque. After the mold is filled, the cast is allowed to dry for 24 hours. The drying should not be forced by heating or placing the cast into the sunshine. It is better to let it set naturally in a cool and moist place.

After the cast has set, the mold is taken off by carefully breaking it away with a hammer and the blunt end of a screwdriver, or small chisel. In order to prevent breakage, the whole cast should be supported on a cushion. The solution of zinc chloride with which the mold was soaked will allow the cast to be separated from the mold without much trouble.

The cast can now be mounted on a temporary working plaque, to give greater ease in the handling during the work of mounting the fins and the subsequent coloring. The fins are removed from the cardboard and a fine wire is threaded in small spirals through the roots of the fins, as in Fig. 8. A socket is hollowed out of the cast to receive them, Fig. 9, and the fins are then secured in their proper places by the use of some fresh plaster of paris; or, if you care to wait another 24 hours, you may employ a thin mixture of the clover rock you used for the cast.

After the fins are mounted correctly in accordance with the notes and drawings in your book, they are given a coating consisting of 75 per cent hot gelatin and 25 per cent glycerin. This gives them a natural transparent color and reproduces very faithfully the glossy, slimy condition of a live-fish fin. If the membranes between the fish bones have been torn and look ragged, they can be repaired with a small piece of white silk chiffon. The glycerin mixture will render the silk transparent, and a little coloring to match the natural membrane will make this patch hard to detect. The glycerin also acts as a glue to hold the patch in place.

Glass eyes of any size can be bought from any taxidermy-supply house. They come in clear glass and are colored, according to your notes, from the inside. Again, care should be taken in selecting these blank eyes as they vary greatly in shape and protuberance. The majority of fishes, however, have a rather flat retina. These eyes are painted and mounted into their sockets in the cast, according to the field notes, as in Fig. 10. The fish is

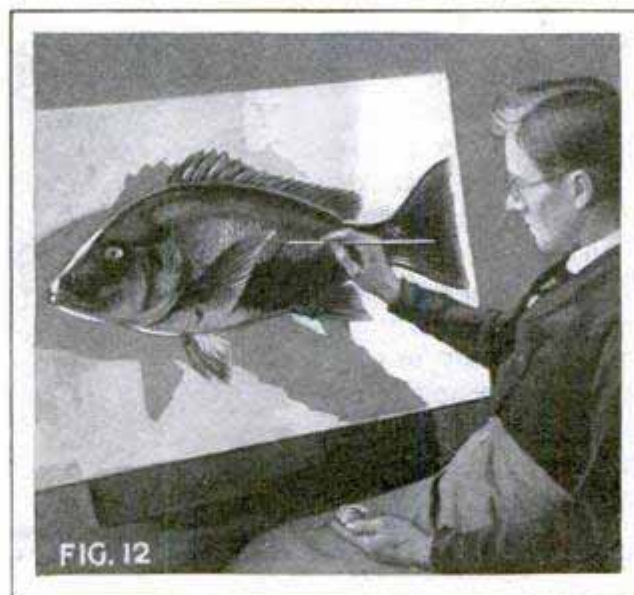

now ready for the coloring.

As a foundation for the coloring, the cast is given a thin coating of white shellac, reduced 50 per cent by the addition of one-half denatured alcohol. When this



is dry, the coloring is applied according to the color chart and notes made in the field. The colors used for this are any of the permanent artists' tube colors in oil. They are mixed into a conveying medium called "megilp," two parts, aluminum thinner, one part, and a little spar varnish as a drier.

The best method to follow in applying the colors is to shade in the large color areas first and put in the markings and spots afterward. For example, the back of a fish is usually dark, the belly is light, and so on. Mix your colors for these general tones and put them on rather heavy, then with a piece of cheesecloth and a small camel's-hair stippling brush, as in Fig. 11, wipe and blend these colors until you have the desired shades of light and darkness. Again consult your field notes and mix the colors for the stripes and markings. Most of the markings are indicated by the scale divisions in your cast. All you have to do is to color them correctly. Some fishes have a color outline to every scale. In such cases you can use a very fine camel's-hair water-color brush, as in Fig. 12, and by following the scale impressions on your cast you can easily reproduce these markings.

Some of the highly lustrous silvery fishes require a special color treatment different from the above. After the sizing, they are given a thin coat of "crystalline guanin" mixed with "liquid celluloid." Crystalline guanin is a compound of tiny silvery fish scales, which are ordinarily used in the manufacture of artificial pearls. This treatment gives a shiny, transparent effect which causes each scale impression to reflect light like a small mirror. This reflected light in the brilliant fishes is in reality their main protection against their enemies. The scintillation of their moving bodies makes them look dangerous. The coloring of the darker fishes is of course a disguise which makes them one with their natural surroundings. Over this silvery color, a very thin wash is given to add the shadings. It is composed of the ordinary tube colors in oil and is made very thin by being reduced with liquid celluloid.

While the colors are thoroughly drying, you may make the permanent mounting plaque. This should be cut from a fine

piece of wood, stained, then given several coats of good rubbing varnish, and finished with rotten or pumicestone to a dull surface. Some might even want to make showcases, such as are found in museums, and paint in the natural submarine scenery. However, the fish mounted on the wooden plaque is a fine decoration for dining rooms, dens and lodge rooms. Not only that; it brings back to you the breath of the glorious outdoors and adds many pleasant hours to the all too short summer vacation.

### Handy Wagon Brakes

When climbing long grades with a heavy wagon, the horses must be given an occasional rest, but in most cases they must even then hold the weight of the load against the tendency of the wagon to roll down. One farmer, realizing that his horses, due to this strain, were not getting the full benefit of the rest, provided a brake on the rear end of his wagon as shown in the drawing. It consists of a stout piece of wood, securely hinged to the rear end. A rope was attached to the end of the brake and was slipped over the back



Brake on Wagon Relieves Horses of Heavy Load While Resting on Long Grade

of the wagon to the driver, enabling him to raise or lower the brake at will.—Frank S. Reynolds, Ft. Morgan, Colo.

☛ Fancy handles from old umbrellas make fine handles for files and other tools.



### Hot Water Cleans Old Paintbrushes

Having several expensive paintbrushes, which had been used and the cleaning neglected, it occurred to me that by heating the paint-covered brushes over a flame, the paint might be easier to remove. However, heating a bristle brush over a flame was out of the question as the brush would undoubtedly be ruined, so I thought of immersing it in boiling water and letting it remain there while the water was kept boiling over a gas flame. To my surprise the paint melted in one mass and it was then an easy matter to remove it and clean the bristles in turpentine, in the ordinary manner.—R. F. Kleinginna, Du Bois, Pa.

### Mat Is Handy for Moving Furniture without Damaging Floor

A strip of carpet may be used for moving heavy pieces of furniture about the home, as shown in the accompanying illustration. The article to be moved is placed upon two pieces of board which are laid across the mat. The load is pulled by means of a bar attached to the free end of the mat, as shown in the drawing. About 8 ft. is a convenient length and the strip should be cut 28 in. wide to allow easy passage through doorways. A piece of wood, 1 by 1 by 28 in., is rolled into one end of the mat and securely tacked. This prevents the load from slipping. The other end of the mat is folded back 6 in. or more and sewed. Several slashes are cut in the folded end through which a rod, to serve as a drawer, is passed. This method saves the floor from damage.



Moving Heavy Pieces of Furniture Quickly with the Aid of a Strip of Carpet

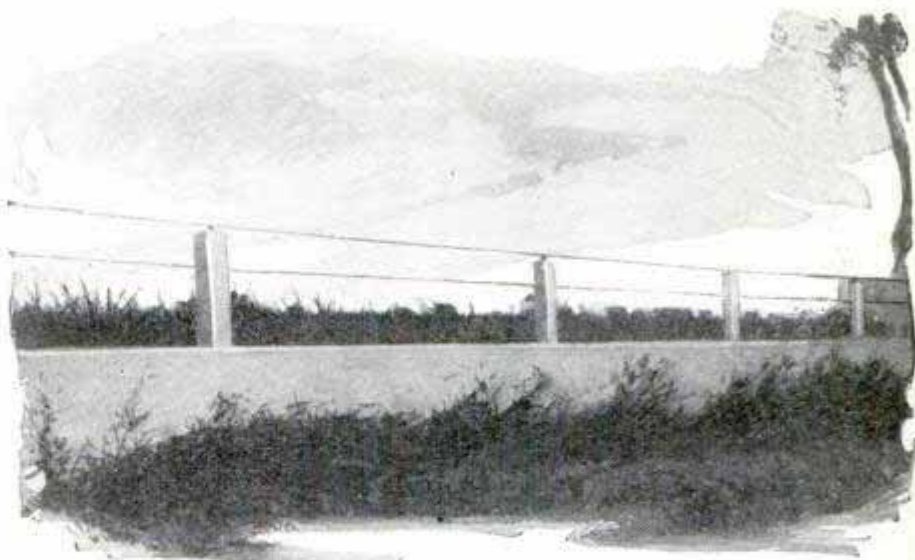

Lower Part of Fence around Pasture Field Built of Concrete to Keep Sheep and Hogs from Getting Through

### Pasture Fence Reinforced with Concrete to Keep Animals In

Originally the fence shown in the photo was composed of steel posts and barbed wire. When the farmer decided to pasture sheep and hogs in the inclosed field some alteration was necessary, and as plenty of sand and gravel was available, it was decided to run a solid wall around it instead of using woven wire. This made the fence practically indestructible and when the barbed wire broke, it could readily be renewed.—Dale R. Van Horn, Walton, Nebr.

### Greasing Fly-Casting Line with Lanolin Prevents It from Sinking

In casting the dry and various types of floating bugs used for bass fishing, it will be found that if the line is properly greased it will not sink and one will be able to pick up the fly from the water with ease in making a back cast. For this purpose so-called lanolin, which is a grease obtained from sheep wool, cannot be equaled.

It is usually obtainable in any well-supplied drug store.



### Gear Reduction for Pump Jack

To reduce the engine speed for his pump a farmer got two discarded pulleys of dif-

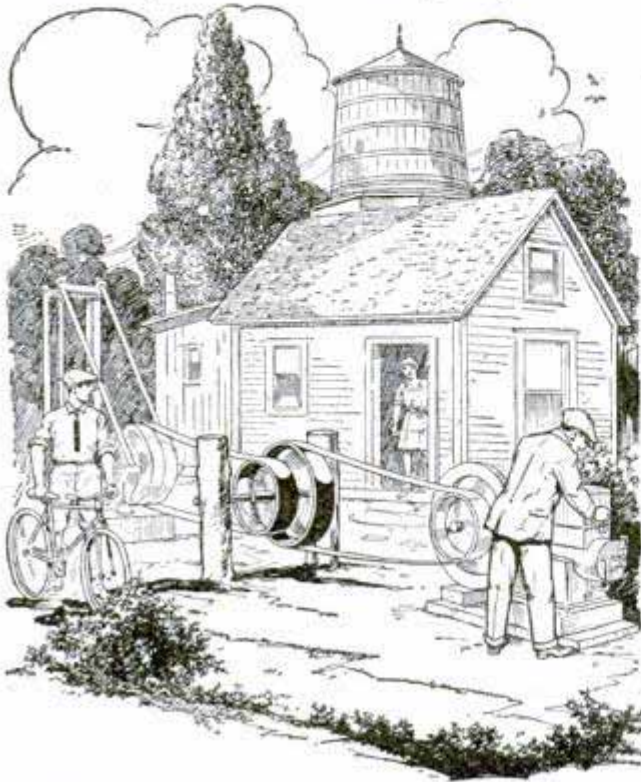

Improved Device for Reducing Speed for Deep-Well Pump Jack

ferent size and mounted them on a length of 1-in. gas pipe, which served as a shaft. Two posts, firmly planted in the ground between the engine and the jack, were drilled to accommodate the shaft. The wheels were keyed to the pipe while two collars were also fastened to the outside ends to prevent end motion. The whole job took less than two hours. This arrangement operated the pump at the correct speed and eliminated excessive jerking of the mechanism.

### How to Make a Rat Trap Effective

An Illinois grain dealer, who lost much produce through damage caused by rats, tried traps of all kinds with little success. A visiting farmer, learning of the difficulty, advised a novel method which proved effective. One of the twenty or more traps set was covered with a sheet of newspaper upon which was smeared lard, the paper resting directly over the bait pan. The other traps were temptingly baited as before, but the following morning it was noticed that the paper-covered trap was the only one that had made a catch.

The other traps were set in the same way the following night, and a general slaughter of rats soon cleared the premises.—G. E. Hendrickson, Argyle, Wis.

### Flashlight Kink

The next time your flashlight seems to need a new battery, try putting a penny between the batteries. This tightens them in the tube and makes a good connection. I bought batteries with astonishing frequency until I decided that they were not worn out when I threw them away, but that there was a loose connection, as, even with new batteries, the light would sometimes dim or die out just like a weak battery. Since then a penny is a part of my flashlight equipment, and the batteries last until they are really worn out.—V. S. Martin, Detroit, Mich.

### Holding the Cow's Tail

Because he was invariably troubled by the switching of the cows' tails at milking time, a dairy farmer conceived the idea of making a "tether" that could be carried from stall to stall to hold the tails. The band to fit on the tail consists of a short length of old harness leather provided with a button and hole, so that the ends could be fastened together. A long stout cord was attached to the band and the opposite end of the cord was fitted with a snaphook so that it could be fastened to a screweye driven into the post at each stall.—L. B. Robbins, Harwich, Mass.

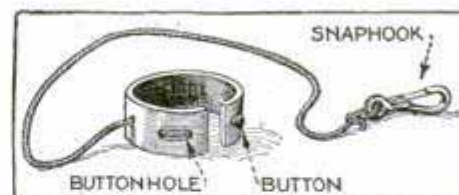

Holding a Cow's Tail to Prevent Her from Switching It While Being Milked



# A Chinese Humidor You Can Make

By ROBERT E. CALDER

WHILE the fine ornamental box described in this article was originally designed as a humidor, it can be used for many other purposes. It makes a splendid

but for many purposes it need not be as heavy as this. It is  $11\frac{3}{32}$  in. long,  $7\frac{5}{16}$  in. wide and  $4\frac{1}{2}$  in. deep. The lid is  $1\frac{5}{16}$  in. deep, making the depth of the bottom part  $3\frac{3}{16}$  in. In order to make a good, true joint between the lid and the bottom, it is best to make the box "solid,"  $4\frac{1}{16}$  in. deep, and then rip off the lid, first squaring a line all around the box where the lid is to be cut off. The extra  $\frac{1}{16}$  in. in height allows for the saw kerf. The lumber used is preferably hardwood, but, since the box is to be finished with lacquer, any available wood can be used, provided it is free from knots and shakes. The type of joints is shown quite clearly in the detail drawing. The hinges are two small 1-in. brass butts, although a piano hinge would be better, if it can be obtained. If the reader is unable for any reason to make the box, a local cabi-

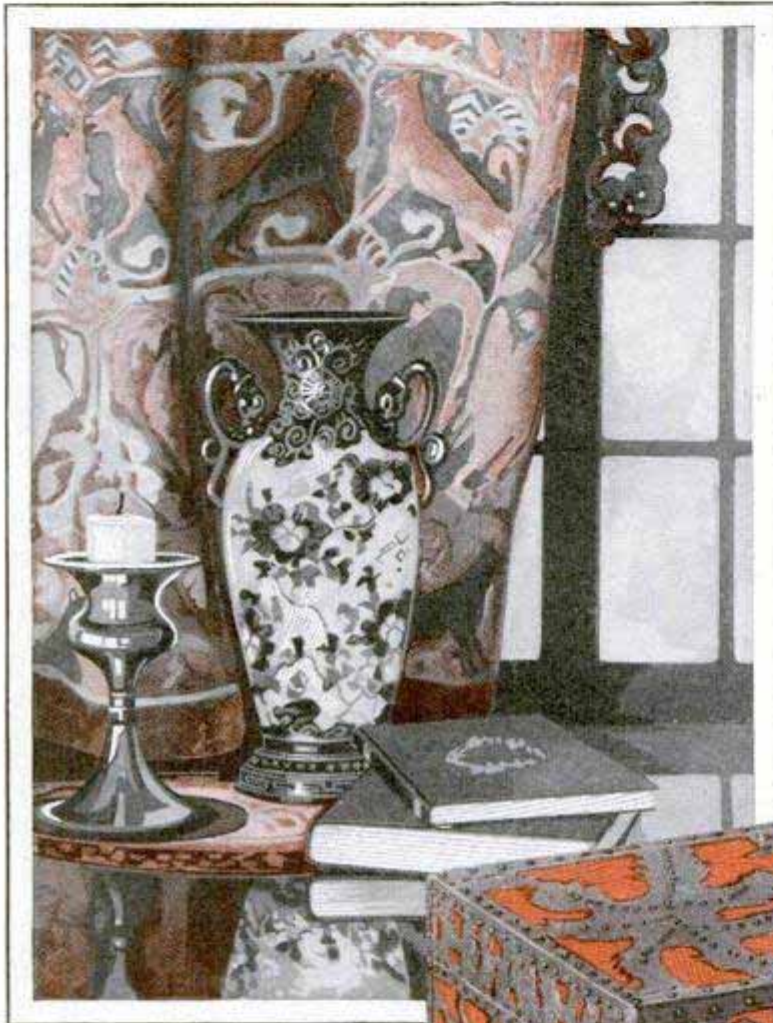

Ordinary Sheet Lead Is the Material from Which the Decorations on This Beautiful "Chinese" Box Are Made

jewel box, or a container for papers or photographs; in fact, it can be adapted to any purpose for which an ornamental box or casket is desired. The size and shape given for the box itself need not be strictly followed, as this may depend on its contemplated use, but it would be wise to keep to the proportions of the original, so that the enlargement of the decorations can be made without any trouble.

The box itself is very simple. The original was made of  $\frac{5}{8}$ -in. dressed lumber,

netmaker will build one for a small sum.

The overlaid decorations, while very effective, are made in an extremely simple manner. The material is ordinary sheet lead about  $\frac{1}{32}$  in. thick, obtainable at many hardware stores, and from almost all plumbers' shops. The gray of the lead against the bright red of the lacquer finish is a most attractive combination, and the lead is absurdly easy to cut in

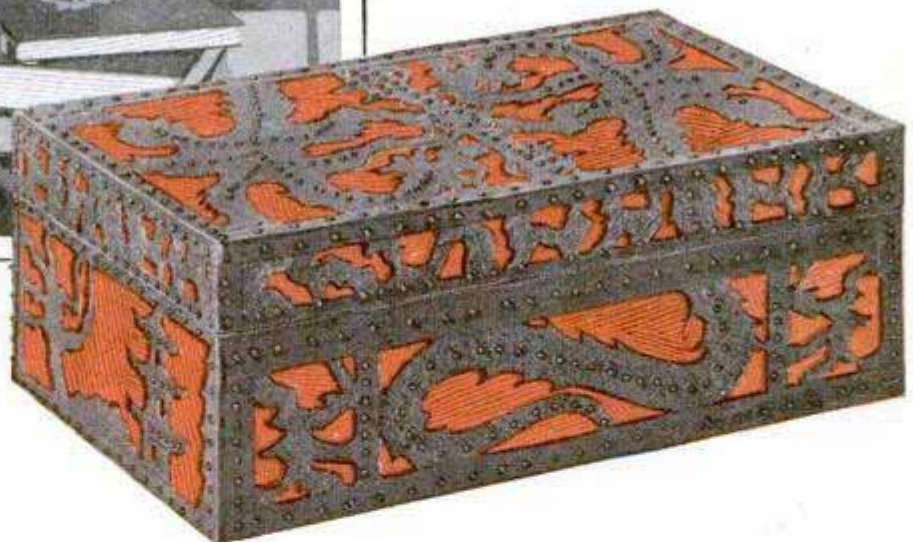



comparison with the sheet brass or copper usually employed for such overlays. Cutting in brass or copper demands the use of a coping saw, while the lead can be cut with a knife, and the whole job takes much less time than with the other materials, besides looking much more effective for this particular purpose.

To make the patterns for the overlays, get a sheet of heavy wrapping paper or thin cardboard, and rule it off into 1-in. squares. Then, with scale and dividers, locate the points through which the various outlines of the design pass, by measurement from the edges of the squares. If the squares along the upper and side edges of both the pattern in the magazine and the enlarged one are numbered, it will be found to help greatly in locating and measuring the points. Since the squares in the drawing herewith are  $\frac{1}{4}$  in. wide and high, it is only necessary to take off a measurement with the dividers, and step it off four times on the enlargement. It is well to lay out the edges of each section of the overlay first, and check it for size before going ahead with the laying out of the interior parts, so that one will not find the pattern off-size after it is made.

See also that allowance is made for the laps, as mentioned hereafter. It is only necessary to make one pattern for the sides and one for the ends, since they are exactly alike.

Another method of getting a full-size pattern is to make a photographic enlargement. This is much the easier method, and if the reader cannot do it himself, the local photographer can, or perhaps the reader has a friend who will do it for him. The photographer will have to be instructed to keep close to the sizes given to him.

When the pattern has been redrawn or

enlarged, cut out the design with a sharp knife, then lay the pattern down on the lead sheet and mark the outlines of the design, using the point of a scribe, a sharp awl, or any other tool which will leave a sharp and distinct mark on the lead that can be followed easily.

Before going ahead with the cutting of the lead, it would be well to lacquer the box, so that it may dry while the rest of the work is being done. Give the whole box, inside and out, a coat of shellac. When this is dry, give it one coat of Chinese-red brushing lacquer, preferably one that leaves a semi-gloss or a dull surface, rather than one that has a high gloss. While the inside of the original was coated with red as well as the outside, black lacquer may be used inside with good effect.

It may be found necessary to give the box two coats of the lacquer, but this can be determined when the first coat has dried. After the lacquering has been completed, lay the box aside to dry thoroughly while the patterns are being cut.

The cutting of the lead, in the original, was done entirely with a sharp jackknife, although the reader can use his own judgment about what tools to choose for the job.

In cutting, it is not necessary to get the lines of the borders, etc., exactly straight; in fact, it is better if they are just a little uneven, although the curves of the dragon's tail, for example, should be regular and sweeping. The knife, in cutting, is not drawn along the edge of a ruler or straightedge, but the cuts are made free-hand, and with somewhat of a chopping or digging motion, so as to leave the edges rather uneven, as mentioned before. A chisel, if not too wide, and if used properly, will give the same effect.

After cutting, the overlays are fastened to the box by means of gimp tacks, which

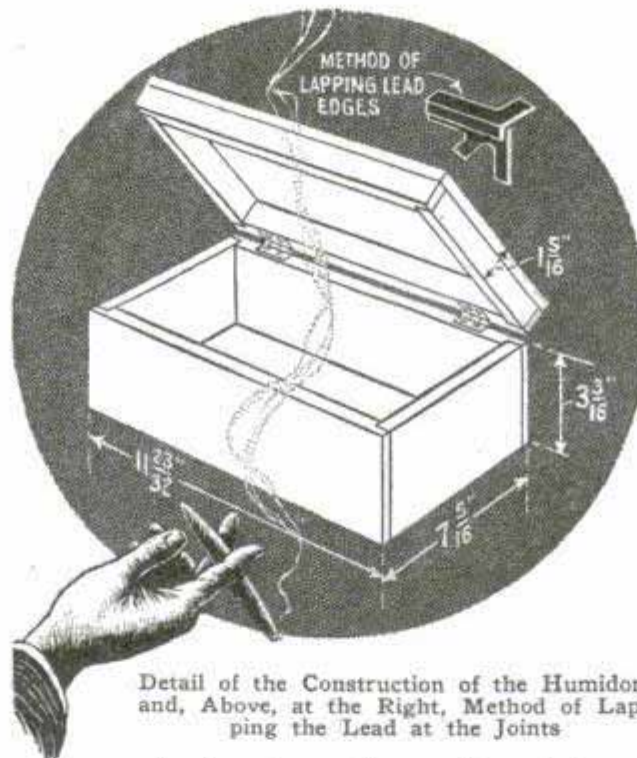

Detail of the Construction of the Humidor, and, Above, at the Right, Method of Lapping the Lead at the Joints



can be obtained from any upholsterers' supply house. These tacks have irregular round heads, of almost the same color as the

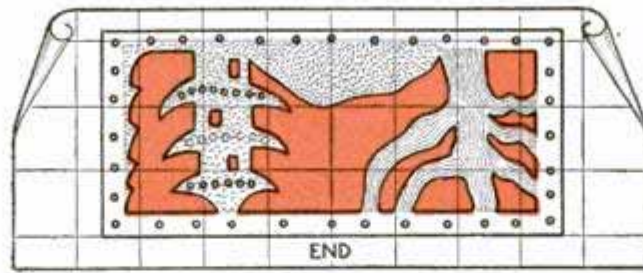

lead. The laps are about  $\frac{3}{32}$  in. wide, and allowance must be made for them on the side overlays on box and lid, when cutting the

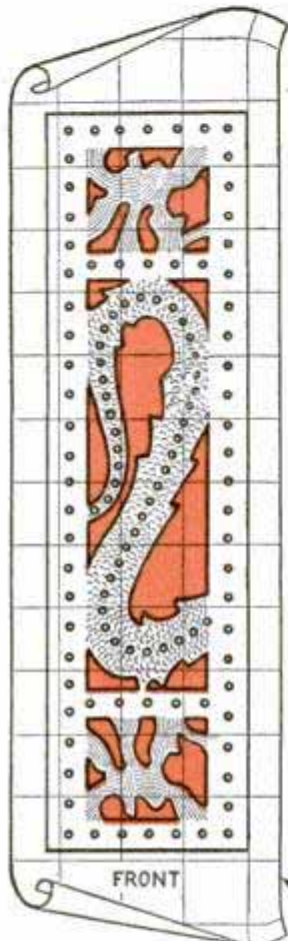

PATTERN FOR LEAD COVERING LAID OUT IN 1 INCH SQUARES

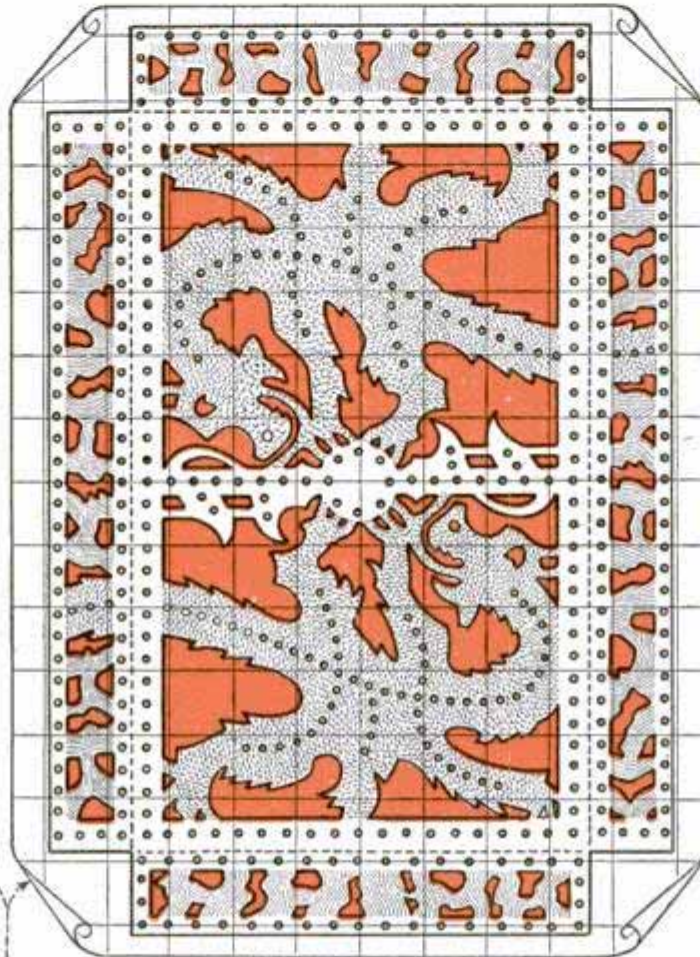

PATTERN FOR LID COVERING

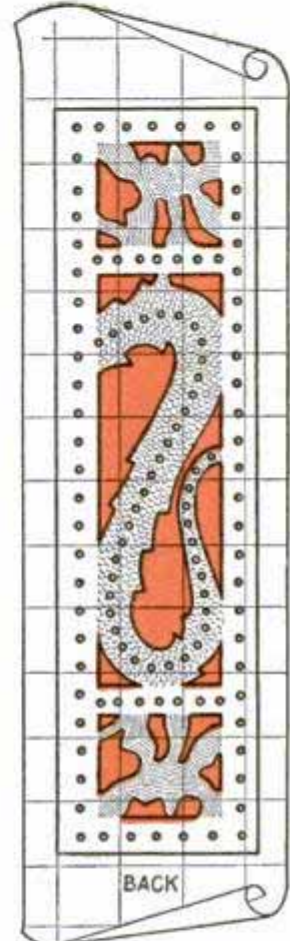

Patterns for the Lead Overlays of the Chinese Box; the Squares Are One-Fourth the Size of Those in the Finished Job

lead, and no other kind of tacks should be used. Drive them in, spaced as indicated in the illustrations, and do not be too particular about getting them in a mathematically straight line. A little irregularity only adds to the appearance of the finished job.

The method of lapping the edges of the lead, where the sides and ends meet, is shown in the detail, and if the lap is well hammered down, the joint hardly shows. If the underside of the edge, on the side, and the upper side of the edge, on the end, are beveled with a file, a still better job of lapping will result, but this is not essen-

patterns. Now for finishing touches. Get an ordinary nut pick and break or cut off the "pick" end. Grind this end flat. The other end is round, and it is this end that is used as a punch to give a hammered effect to certain portions of the design.

Go over all the parts of the dragons with this punch, using a light hammer, and be careful not to punch too hard near the edges of the lead, or it will spread and make the outlines too irregular. Punch the dragons on the top of the lid, the sides of the lid and the sides of the box, as indicated by the scalelike marks on the pat-



tern diagrams. Punch also the pagodas and the hills in the "scenery" on the ends. Then lay aside the punch, and, with a screwdriver having a point about  $\frac{1}{8}$  to  $\frac{3}{16}$  in. wide, press in the "texture" of the trees, as indicated by the short straight lines in the diagrams. Just press the

screwdriver point down on the lead and not too regularly.

Leave the borders of the individual sections of the overlays and the central part of the top design plain, as shown by the white portions of the diagrams. This completes the job.

### Umbrellas Used When Swimming to Teach Life-Saving

To develop ease and ability to rescue drowning persons, one swimming school



The Umbrellas Are Not to Keep the Swimmers from Getting Wet, but to Teach Life-Saving Methods

teaches the students to swim on their back while holding an open umbrella high above the surface of the water. As preliminary instruction before this is reached, the student first learns to swim on his back, using a scissors kick, and then tests his ability to hold objects in one hand. He starts with a small piece of wood and ends with the umbrella.—R. G. Thackwell, Chicago, Ill.

### Gnat-Proof Screens

In many places gnats, sand flies and other small insects get into the house through screened doors and windows. To prevent this, fasten a piece of cheesecloth directly over the screen and it will keep them out, as the fuzziness of the cloth is a barrier to them. This method has been used aboard a ship off the coast of the southern states and in the tropics, especially in Mexico, where the small sand flies are a great pest. When the light is

turned on at night, great numbers of these insects are caught in the fuzzy cotton and at times the entire cloth is black with them.—H. R. Wallin, Tampico, Mex.

### Preserving Glue

Glue made up for woodwork and left in the pot for any length of time becomes rancid and develops a very objectionable odor. To prevent this, add to approximately every 8 oz. of glue a pinch of caustic soda. This is of particular advantage in the home shop, since the amateur often makes up too much glue at one time, and must either throw the remainder out or preserve it in some way.

### Bell Announces Arrival of Mail in Farm Box

Farm mail boxes are at quite a distance from the house, and in many cases are hidden by trees. An electric-bell installation, as shown in the drawing and diagram, will announce automatically when mail is placed in the box. A false bottom is arranged in the box and provided with a spring to hold it up above an insulated contact point which is attached to the bot-

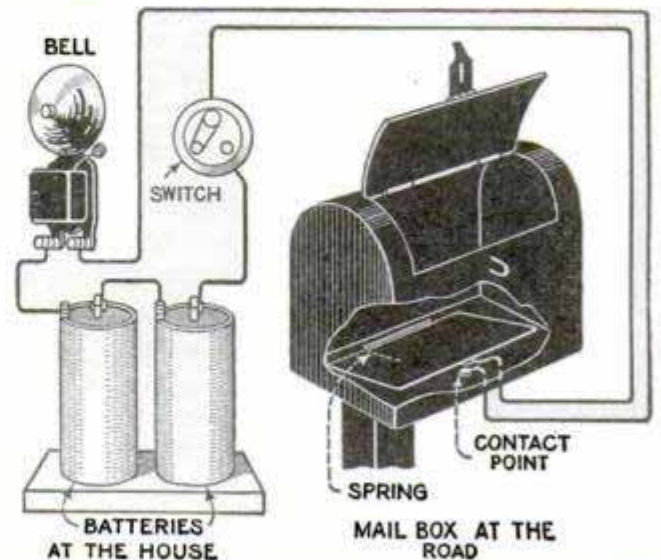

Electric Bell Rings in House When Mail Is Deposited in the Box



tom, as indicated. The moment mail is dropped into the box, the false bottom touches the contact point and closes the circuit, which rings the bell in the house. A switch in the house permits the circuit to be broken to prevent the bell from ringing longer than necessary.—Arthur F. Routh, New Haven, Conn.

### Kink in Gasoline-Lamp Generators

Many gasoline-lamp generators are thrown away before they are really worn out. With poor gasoline, the generator soon becomes plugged at the top of the asbestos wick. This can generally be opened up with a small drill about  $\frac{3}{64}$  in. in diameter. The generator should be washed afterward to prevent small particles of carbon from clogging the tip. Boiling in vinegar will also help clean a generator.—Eden W. Robinson, Bear Flats, B. C., Can.

### Emergency Repair for Broken Ball Socket

On several types of automobile-steering gears, a ball-and-socket joint connects the steering arms and the drag link. The

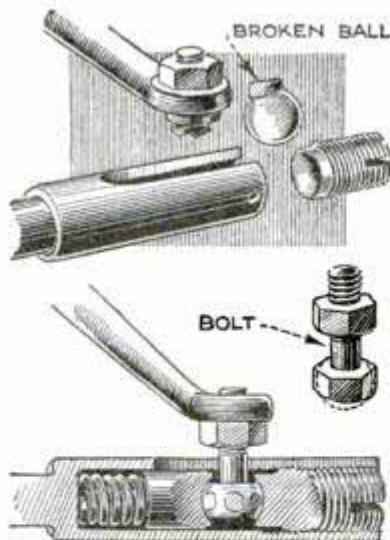

ball sometimes breaks off when the front wheels meet with an unusual shock, and if this happens in the country, repair presents a difficult problem. An emergency repair can be made, as indicated in the drawing,

if a file and a bolt of the proper size are handy; the thread should fit the thread in the steering arm. The bolt head is rounded to fit the socket in the drag link, so that it will serve the purpose of the ball. A nut holds the bolt to the steering arm. A repair of this kind is not intended to be permanent, but will last until a garage is reached.—G. A. Luers, Washington, D. C.

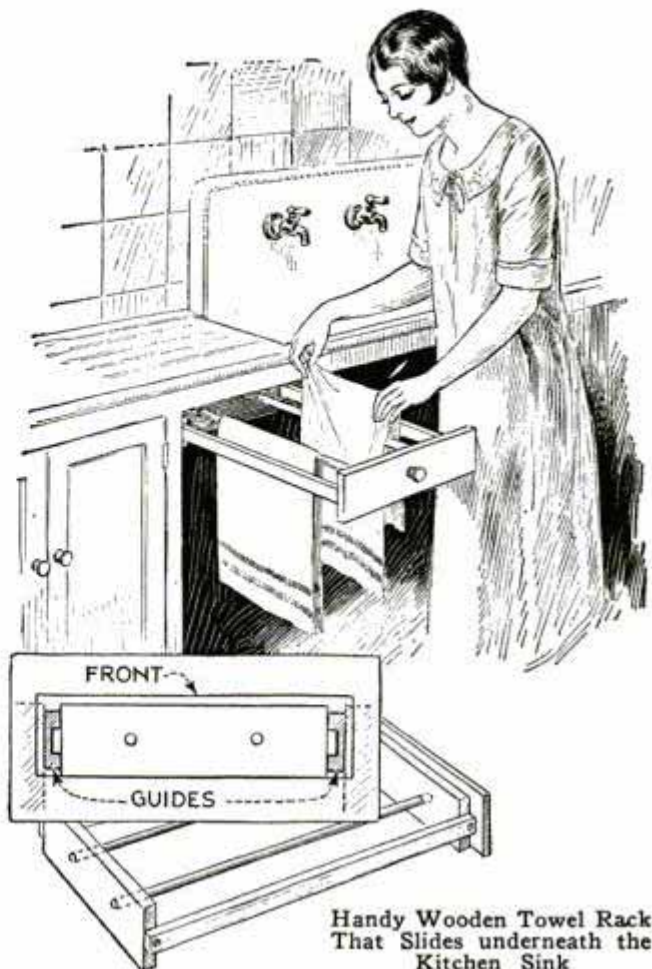

Handy Wooden Towel Rack That Slides underneath the Kitchen Sink

### Towel Rack under Drainboard Is Out of the Way

A kitchen towel rack made to slip under the drainboard of the sink when not in use is shown herewith. It consists of two end-pieces of  $\frac{3}{4}$ -in. wood, two lengths of dowel stock, to slip into holes drilled in the end-pieces, and two strips of  $\frac{3}{8}$ -in. wood forming slides which are fastened with screws. A knob at the foot serves to pull the rack out. The strips on the sides are planed smooth so that they will slide easily in guides provided for the purpose.—Neil Nelson, Kansas City, Mo.

### Carrying Camera in Auto

A camera in the tool box, or other handy place in your automobile, will be found useful in case of accidents. A photo of the positions of the cars can be used to settle claims later. I have carried a cheap camera in this way for some time. Once, coming on the scene of an accident, I took a few snapshots and sold them to the parties involved for much more than the cost of the camera.—H. R. Harrington, Berkeley, Calif.



*Similar chest can be bought from Federal Equipment Co*  
**Wardrobe Chest Attached to Bed**

*Carlisle, Pa*  
 In small bedrooms where space is limited, the attachment of a wardrobe chest

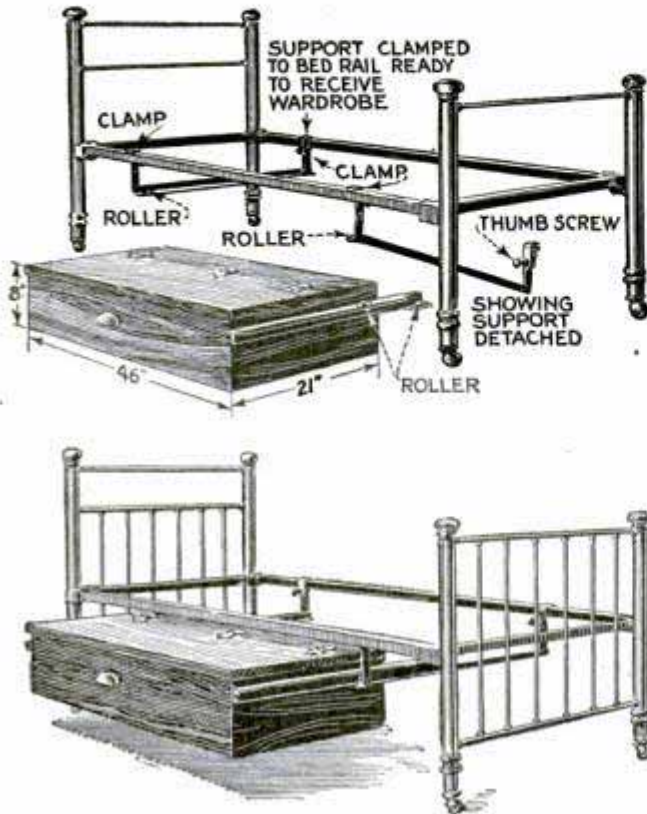

A Wardrobe Chest Sliding under the Bed Utilizes the Wasted Space in a Small Bedroom

to the underside of the bed, as shown in the illustration, will give extra storage space without using additional floor space. Two angle-iron braces are attached to the ends of the wardrobe chest, which is about 8 in. deep, 4 ft. long and 2 ft. wide. Similar lengths of angle-iron are attached to the underside of the bed rails by means of clamps, which are made for the purpose. The angle-iron braces are so arranged that there will be clearance of a few inches between the top of the chest and the bed, and rollers are provided on both braces at the points indicated, so that the chest can readily be pulled out or pushed in. The roll-

ers may consist of ordinary small casters with the shank cut off and having a hole in the bracket. A similar hole is drilled through the angle-iron brace, and a bolt is used to hold the caster on securely.— Claude P. Fordyce, Falls City, Nebr.

### Sandpaper Used to Peel Potatoes

Peeling potatoes is usually a disliked task, especially around the camp, and it will be found that the use of sandpaper will facilitate the work considerably. Get a pair of cheap canvas gloves and pin a piece of sandpaper to the palm of the left-hand glove. The potato is taken from the water with the right hand and is then rubbed briskly against the sandpaper to remove the skin. This takes less time than a knife and there is no loss resulting from deep cuttings. Emery cloth can be used instead of sandpaper. The same idea was applied by a potato peeler in a hotel. He lined the inside of a wooden cylinder with sandpaper, inserted the potatoes and closed the ends of the cylinder. Rotating it for a short time removed the peeling effectively and saved a bit of time.

### Tool Helps Replace Tires

When mounting tires of the clincher type on demountable rims, especially the large balloon style of tires, it is often found difficult to hold the valve section in place while pulling on the opposite side of the tire. For this purpose the hook shown in the drawing will be found convenient. It is simply a U-shaped iron strap, which is pushed down over the tire near the valve. The hook is made of such a size that it will hold the tire to the rim securely. This will keep the beads and valve stem in position, leaving the worker's hands free to use the tire tool on the opposite side.

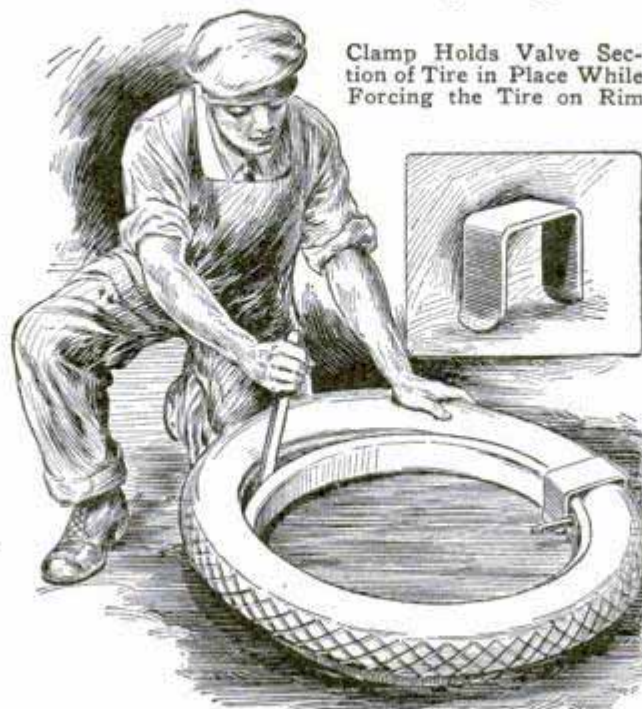



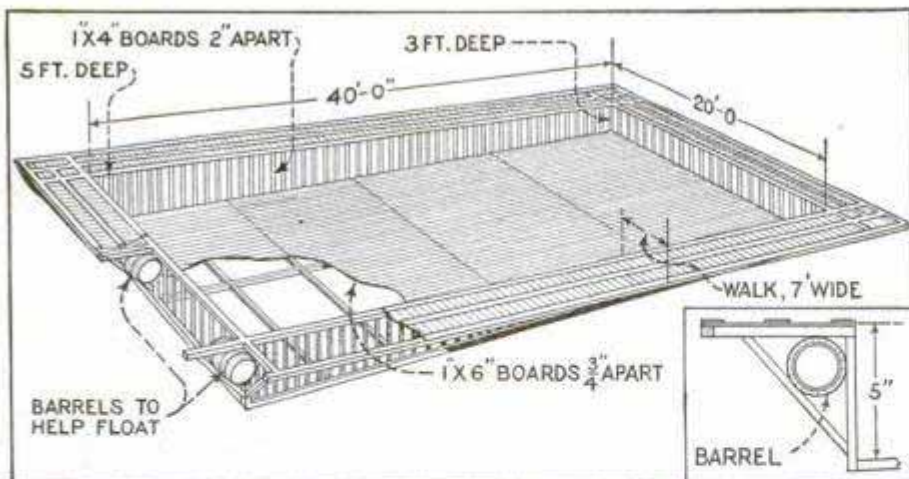

all times. The pool is 20 ft. wide and 40 ft. long, inside measurements. It is 3 ft. deep at one end and about 5 ft. at the other. Seats are provided at the shallow end and the whole tank is an-

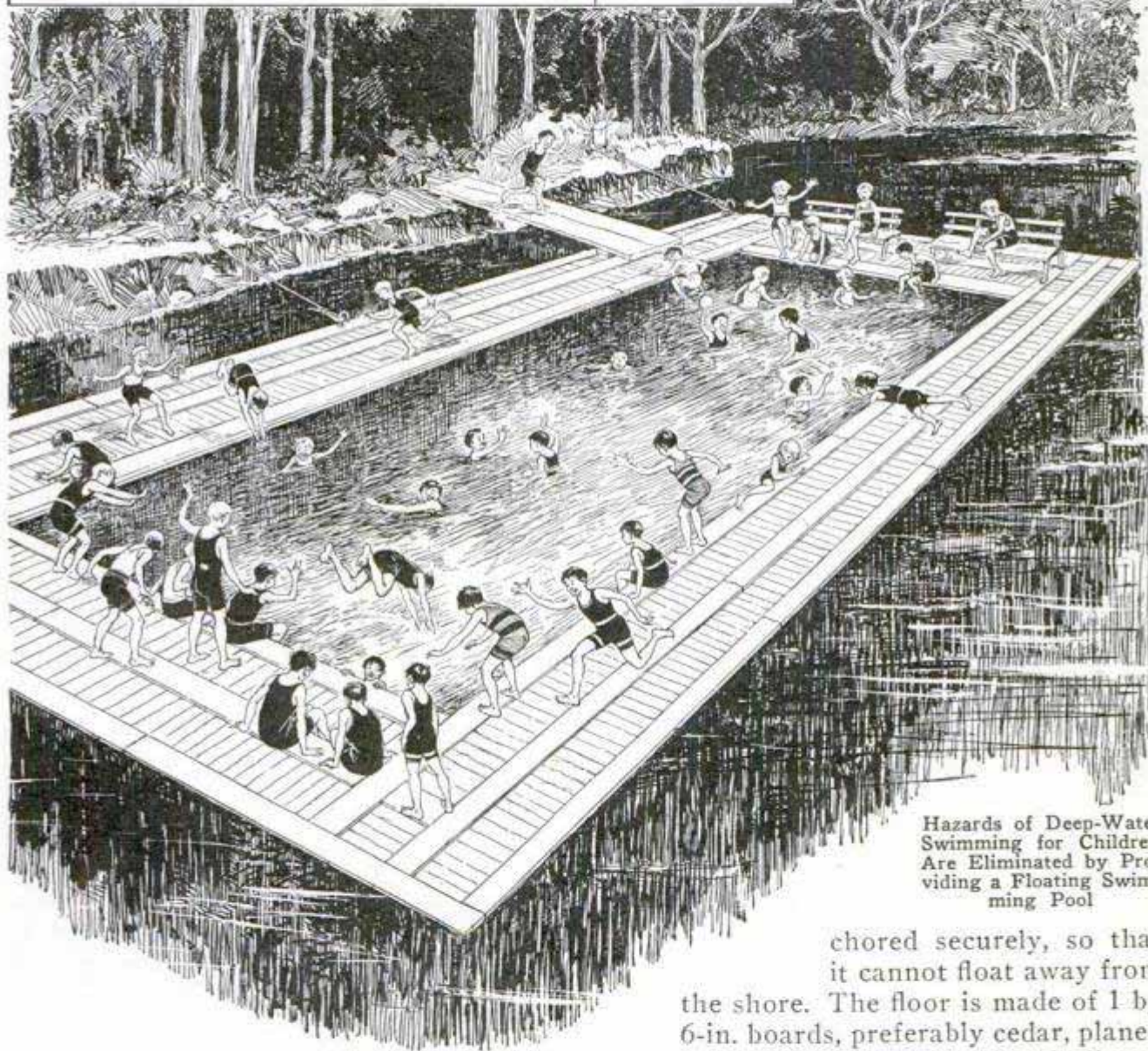

Hazards of Deep-Water Swimming for Children Are Eliminated by Providing a Floating Swimming Pool

### Floating Swimming Pool Safe for Children

A floating swimming pool, which is safe for the children and protects them from the danger of deep water, is in use at Hillsboro, Ill. It is located in a large body of water and its construction is such as to allow a constant change of water at

chored securely, so that it cannot float away from the shore. The floor is made of 1 by 6-in. boards, preferably cedar, planed smooth to forestall the risk of splinters. These boards are spaced about  $\frac{3}{4}$  in. apart. The walls are made of 1 by 4-in. boards spaced 2 in. apart. Walks, 7 ft. wide, are arranged around the whole pool. They are made of 1 by 8-in. boards. Barrels are used beneath the walk to help keep the pool afloat.—Herbert C. Crocker, Edwardsville, Illinois.



### Outside Light Keeps Porch Free of Bugs

During the summer months when insects and bugs are prolific, electric lamps on porches and in houses attract them

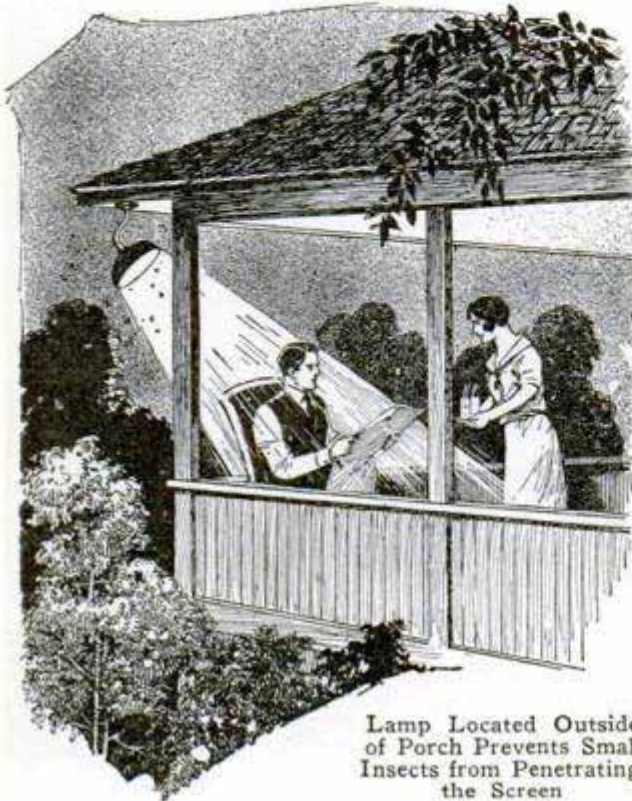

Lamp Located Outside of Porch Prevents Small Insects from Penetrating the Screen

and they cause considerable annoyance. Small insects can even penetrate the screen and it is impossible to sit on a screened porch at night under a light to read. A good method of eliminating this trouble is to keep the porch in the dark and locate the light just outside of the porch so that there will be no attraction on the inside for the insects. This has been tried at a summer resort and found entirely satisfactory.—K. M. Coggeshall, Webster Groves, Mo.

### Inflation of Balloon Tires

Many users of balloon tires think that they lose more air than high-pressure tires. This is not the case; the average high-pressure tire is kept inflated at a pressure of about 50 lb., and most motorists let them go a month before reinflating them, during which time the pressure will have decreased about 25 lb. Yet, due to the rigid construction of the tire, this loss is hardly noticeable. Balloon tires, kept at a pressure of about 30 lb., lose air at the same rate, but at the end of two weeks, when they have lost about  $7\frac{1}{2}$  lb.,

the deflation is noticeable, and the motorist has to pump them up, thinking that they lose their pressure more quickly than high-pressure tires.

### Cleaning Silverware

Tarnish can readily be removed from silverware by placing the articles in an aluminum pan containing water, adding a teaspoonful of baking soda and a teaspoonful of salt to each quart of water, and then boiling the water over a flame for a few minutes. The cleaning is claimed to be effected by means of electrolysis, the oxide forming the tarnish leaving the silverware and being deposited on the aluminum, from which it can easily be removed. The cleaning should be followed by a thorough washing and wiping before the articles are put away.

### Hinges Lock Bed Joints

The problem of fastening the sidepieces of an old four-post bed together, when adapting it to a modern bed spring, in such a way that they could easily be separated if desired, was solved by the use of loose-pin hinges, as shown in the accompanying photo. Also, when it is desired to attach shelves, seats, ironing boards, etc., to walls, hinges of this type will be found convenient, as they permit the article to be detached when desired.—Leslie H. Phinney, Springfield, Mass.

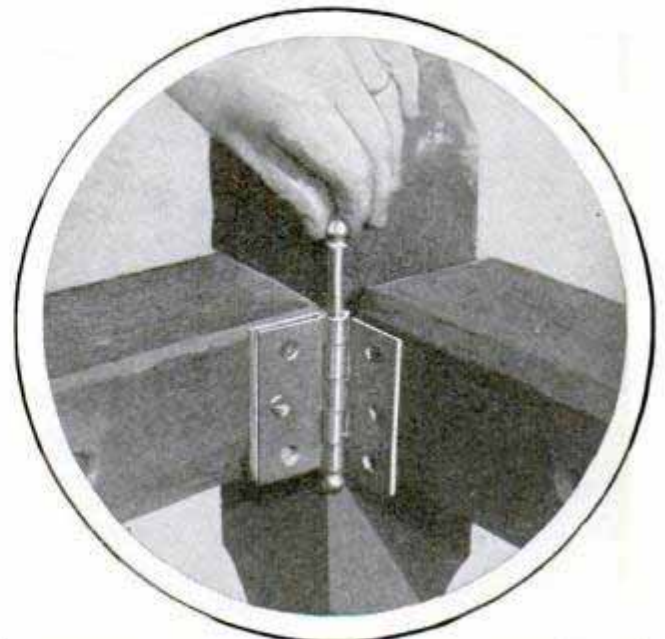

Loose-Pin Hinges on Old Beds Hold Sidepieces in Place Securely



### The Complete Tourist

Many motorists have realized that lengthy vacation tours are far more enjoyable if made with cars fitted for the purpose. Outfits of such type are numerous, and one, novel in its arrangement, is shown

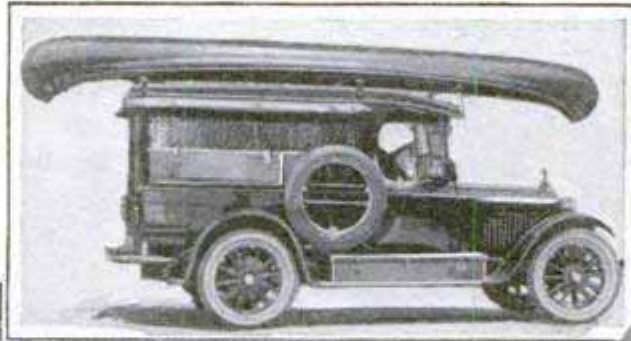

vision for carrying personal effects and camping equipment in built-in lockers, which have cushioned tops and serve as comfortable berths. Roll curtains give privacy and protect against the weather. A 15-ft. canoe is carried on top of the car. Being very light, it rides easily and securely and is

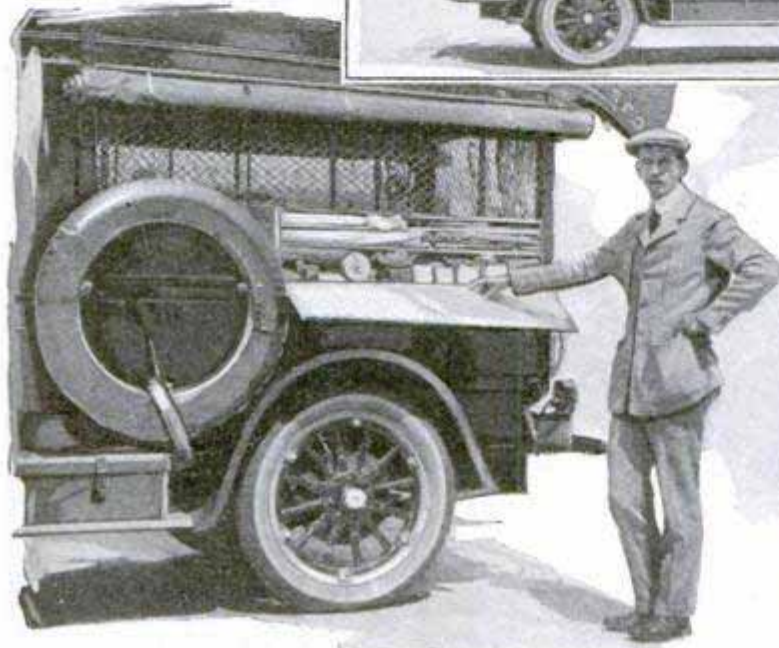

Car with Screened Sides, Fitted for a Sportsman Whose Hobby is Angling; a Canoe Is Carried on Top. Comfortable Berths Are Provided Inside and There Is Plenty of Space for Camping Equipment and Food

in the photo. Angling was the hobby of the man who planned this car, and he therefore sought to incorporate in it every feature for this purpose. He purchased a screened commercial car and made pro-

held by metal supports with wingnuts, so that it can be loaded on the car or removed. With this outfit the owner and his wife set out on a 5,000-mile tour extending over a period of three months.

### Preserving Outside Doors

Outside doors often show evidence of loosening, splintering and decay at the ends. A careful examination will show a lack of paint at these points, which is a contributory cause of decay. While it is customary to paint the surfaces of the doors and the two vertical edges, painters seldom take the trouble to apply paint at the top and bottom. As a result the water soaks into these edges and causes gradual decay, loosens the glue and necessitates repair. On veneer doors, this condition will make the surface peel and greatly detract from the appearance. It requires only a

few minutes to make the door as durable at these edges as elsewhere by applying paint.—G. A. Luers, Washington, D. C.

### Substitute for Moth Balls

A pleasant substitute for moth balls was discovered accidentally by a Chicago woman. Dried orange and lemon peelings, which had been placed in a paper bag and put away in a moth-infested closet completely rid the closet of the insects. A pound or so of the peelings will act as an effective killer, and the unpleasant odor of moth balls is avoided.—Harlem James, Evanston, Ill.



### Dash Mounting for the Spotlight

A spotlight can be used inside of an auto as shown in the illustration. The lamp is mounted on a strap-iron bracket and attached to the dashboard so that it will be close to the windshield yet can be turned easily. When mounted so close to the glass, the lamp hides the spot of light thrown on the windshield. The bracket must be stiff enough to prevent vibration of the lamp, as a slight movement will throw its beam on the road some distance.



### Reinforcing Kitchen-Chair Seats

When children play in the kitchen and stand on the chairs, the seats will not last very long. A good method of repairing them is to use a piece of fairly heavy sheet metal as a reinforcement for the new seat. The children can then jump on them to their heart's content without breaking through.—C. M. Wilcox, Torrington Connecticut.



### Fighting the Mosquito

Water is the mosquito's breeding place, so be sure that your roof gutters are not choked. They breed at the rate of 60 per square inch if the water is allowed to stand in the gutters, and as the average dwelling has at least 2,000 sq. in. of water space in gutters, the pests will multiply by the thousands, if the gutters are not drained immediately. Be sure, too, that cisterns are tightly covered and that there are no small holes or cracks in the cover, which will allow the entrance of the female

mosquito. Most spouts in the conductor leading to the cistern are not closed tightly and this is a place where they can readily get in, and therefore the spout should be covered with fine wire mesh. Never let tin cans lie around the yard, as they collect water when it rains and make a nice breeding place. If you have trouble with a wet basement, remove the water instead of letting it dry. Do not take out the window and door screens until the beginning of cold weather, as the mosquitoes look for a place to hibernate just before. Tall weeds and grass make ideal breeding places and should not be allowed to stand. By following the above precautions, it is an easy matter to eliminate the pests.

### Electrically Lighted Flower Boxes

Installing electric lights in flower boxes is the latest idea of a Los Angeles architect. Each box has one light which is incased in a water-tight globe of heavy glass. The plants can be watered at any time without danger of short-circuiting the light current in the boxes. At night, when all lights are turned on, the effect is very beautiful, especially during the blooming season of the plants. The plant boxes are placed on the roof, stair headings and corners.—Willard D. Morgan, Los Angeles, Calif.

### Preventing Slits in Tubes from Lengthening

If a patch is applied over a slit in an inner tube in the usual way the slit has a tendency to lengthen, but this can be prevented by applying the same method as is used when patching boiler plate. Make a small circular hole at each end of the slit as shown in the illustration, before applying the patch. This can be done with a sharp knife or a punch, or by means of a metal eraser holder on a lead pencil if nothing else is available, although this will make a hole that is a bit too large.

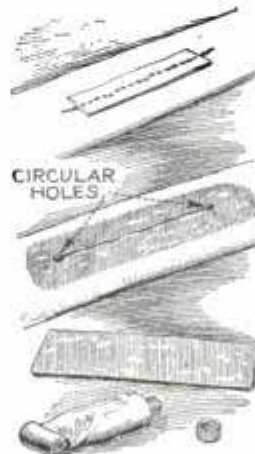



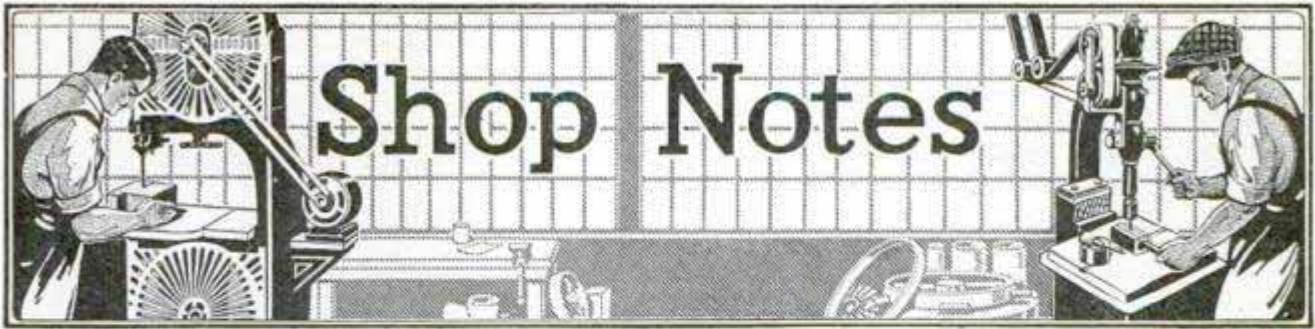

All Shop Notes published in 1926, in book form—Fifty Cents—from our Book Department

## The Log Cabin Up-to-Date

By L. C. VECELIUS

*Hamburg, Mich*

UNTIL within possibly the last five or six years, the prevailing idea of a summer home was a place to go for "roughing it," and any sort of shack was acceptable; that is, a place constructed at a very minimum of cost and barely providing protection from the weather. Any old furniture obtainable was used for furnishings, since the cottage would possibly be used only for two weeks' vacation and an occa-

sional weekend. Therefore, with a hundred-dollar lot, three or four hundred dollars' worth of materials and our friends to help nail it up, we were well fixed for a summer home.

Now, however, with improved roads and automobiles, much more time can be spent at the summer home, and, while we may want to get away from the exactness of our city home, many more comforts and

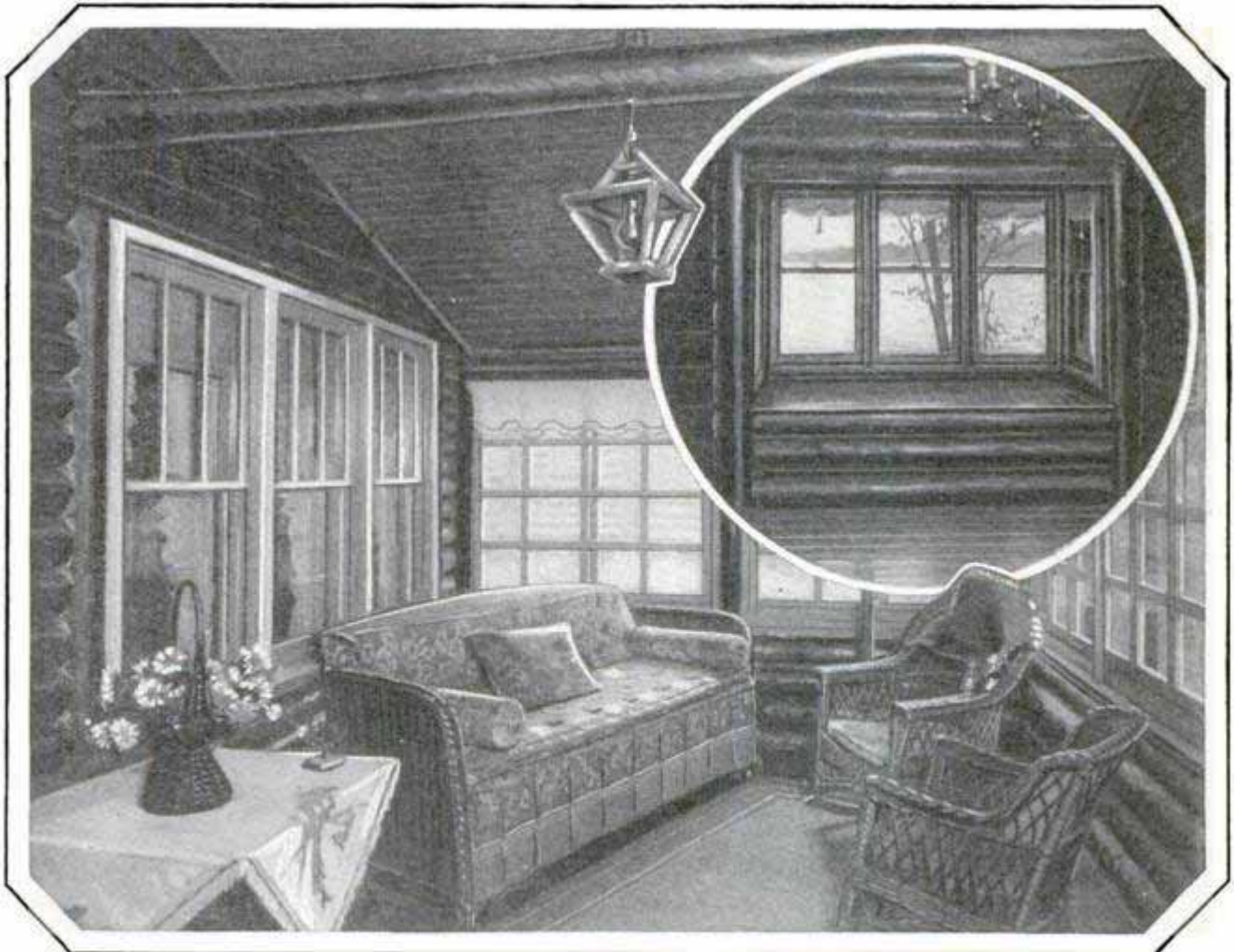

The Front Porch, or Sun Parlor, of a Modern Log-Cabin Summer Home; Inset, a Built-In Window Seat That Forms an Attractive Lounging Nook



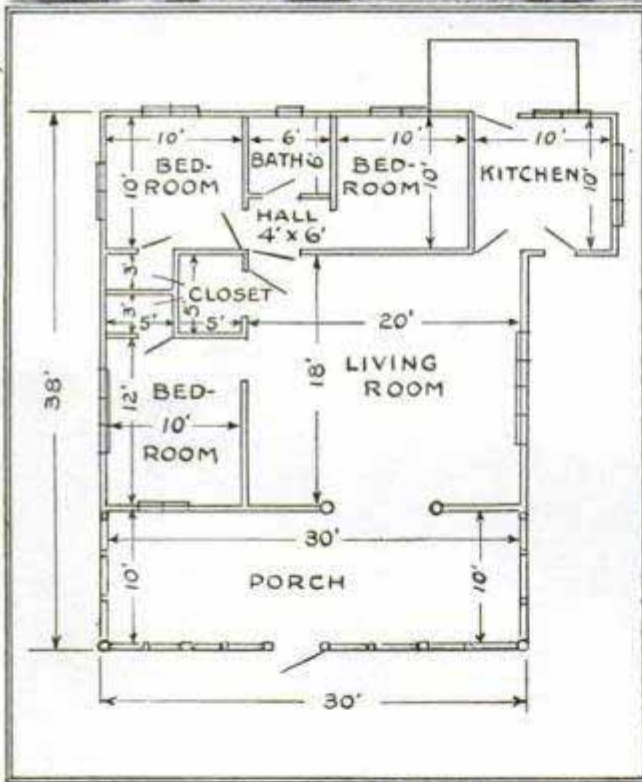

Floor Plan and Exterior View of a Cabin Built as Described in This Article; Note That the Foundation Posts Are Made of Concrete

well be adapted for permanent homes. People who now own cabins which I have constructed make use of them practically every weekend throughout the year, and many are occupied permanently. Inside of one-half hour the cabins can be comfortably heated after being cold for the preceding week.

The design proper for any particular cabin must be governed by the surrounding landscape. The desirability of this can readily be appreciated when one sees a cabin that is ill-adapted to its site, and then one that has been built with proper regard to the locality. I might even go so far as to say that no two cabins really should be absolutely identical.

The foundation is very important when the weight of the logs above it is taken into consideration. A log 9 in. at the butt, running 40 ft. in length and tapering to 4 in. at the top, weighs approximately 600 lb. The average six-room-and-bath cabin takes about 190 logs, giving a total weight for logs alone of 57 tons. It is my general practice at present to use concrete abutments for foundations. Those supporting outside walls and partitions should not be over 6 ft. apart. They should be at least 24 in. square at the bottom, tapering to 10

much more beauty are now required of the summer home than formerly was the case.

Some five years ago, while traveling about the country, I saw here and there log cabins from fifty to seventy-five years old, and most of them in fair state. It occurred to me that log structures of modern designs and comforts would be attractive both as summer and permanent homes. I had plans drawn and built a few cabins. They took well from the very first. Every prospective buyer would suggest new ideas both in design and construction. As building progressed, I found the cabins could



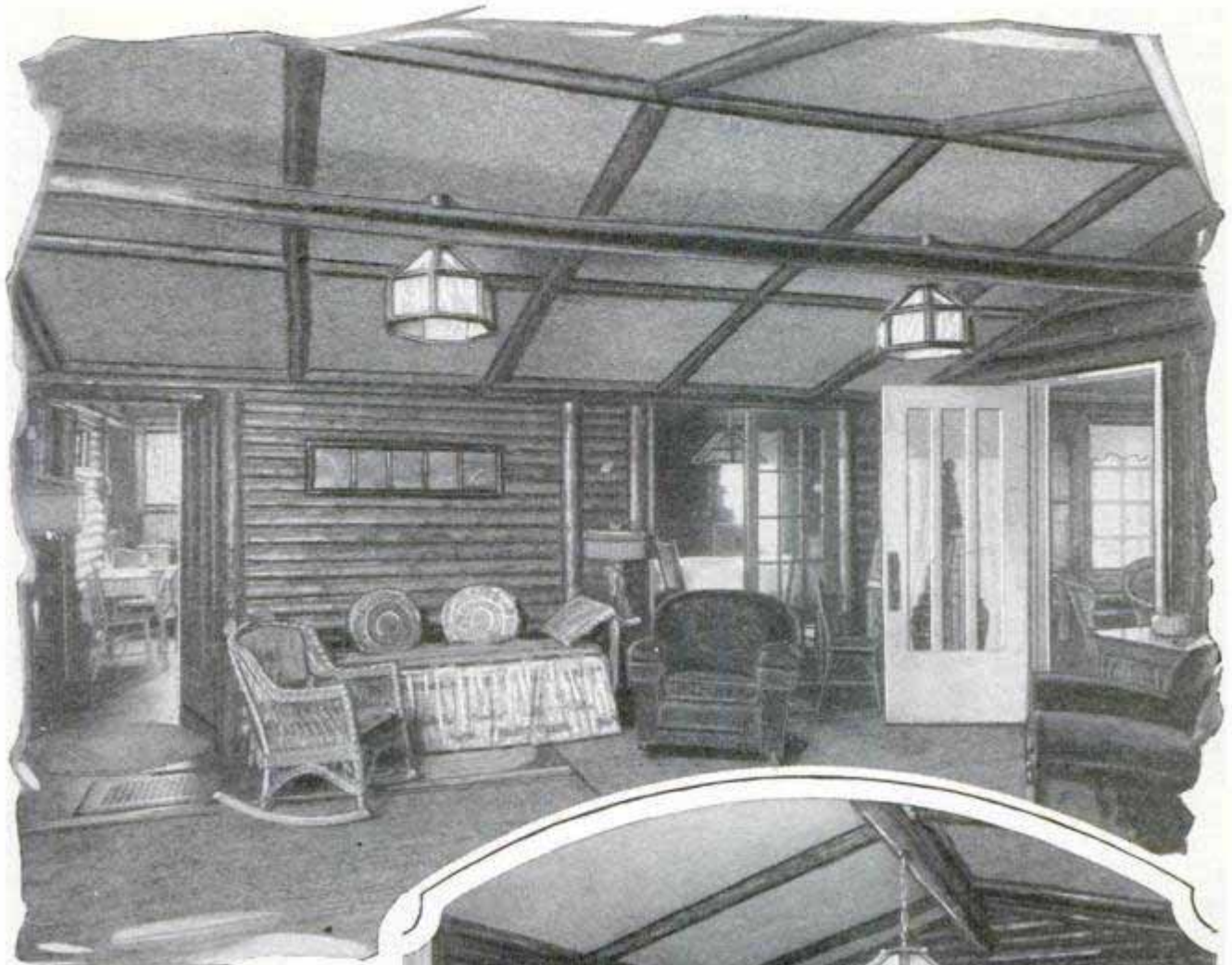

Very Different from the Popular Conception of the Log Cabin Are These Attractive Interiors; Note the Log Buffet in the Bottom View

or 12 in. at the top. Abutments should extend to a depth of at least 8 in. below the frost level, not simply a foot below the ground.

I have tried all kinds of timber available in my vicinity—northern Michigan—such as cedar, pine, ash, elm, oak, maple, tamarack and poplar, but the last-mentioned seems to be best for all purposes. It does not shrink or check, if treated as soon as peeled with oil stain filler. I use the following formula for a filler: 5 gal. boiled linseed oil and 2 qt. turpentine, with color to suit. The log thus treated dries out readily and becomes very hard and light. It also takes varnish well, giving a very glossy finish. It is advisable to use a varnish which is heavy with rosin, and one that dries quickly, for the first coat. For the second coat the very

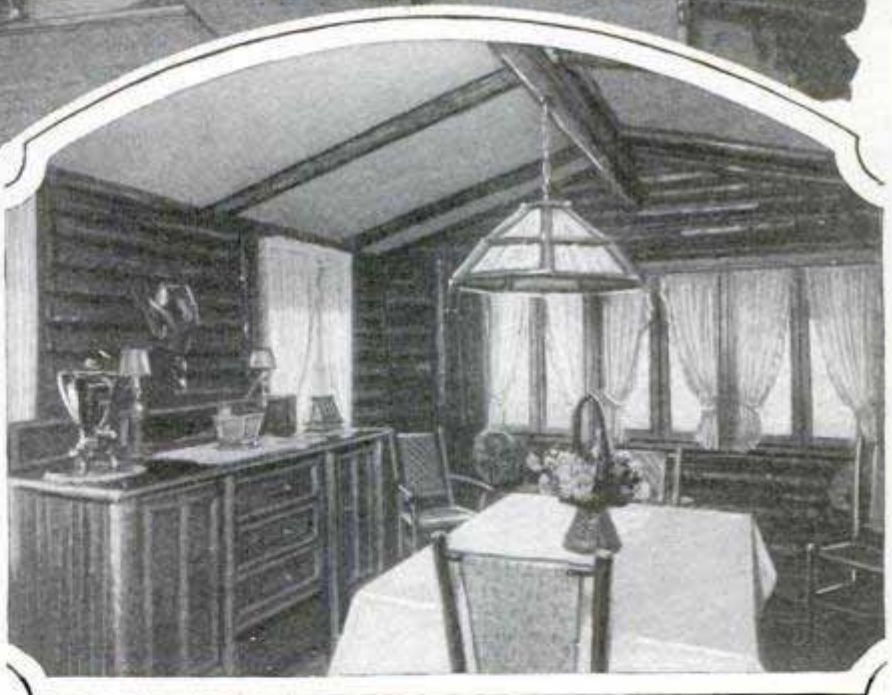

best grade of spar varnish should be used.

I always use dead rafters to make each room have an equal gable and, in doing this, provide air chambers above the ceiling for better ventilation. Woodboard or plasterboard and quarter-sawed logs are used for ceilings. The plasterboard is finished by using sponges to apply different colors of either stain or paint.

The logs must be laid as close together as possible; in fact, close enough to use a  $\frac{3}{4}$ -in. trowel to apply the chinking. All logs as they are laid up are fastened to-



gether with No. 60 spikes, every 4 ft. I bore a 1-in. hole halfway through the log on the top side and drift the spike down into the log below. This keeps all the shift out of the walls.

I chink with a mixture of 18 shovels of fine, sharp sand, one bag of lime and one-half bag of cement. After the chinking is thoroughly dry, I cover it with plastic gum, lapping over about  $\frac{1}{4}$  in. onto the logs. This plastic gum is made to my own order to get the proper consistency and comes in two shades each of red, green, gray and brown. This gives and takes with the setting of the logs and holds the chinking intact indefinitely.

I find that any good make of hot-air furnace with a 24-in. firepot will heat a cabin as large as 48 by 54 ft., using about 9 tons of soft coal a year.

All door and window frames, screens and rafters are cut at the mill and taken

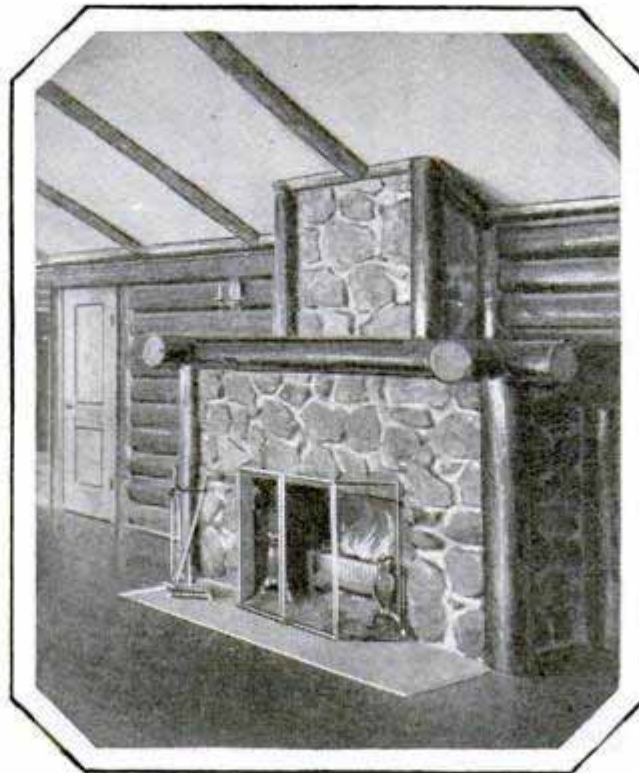

A Random Stone Fireplace and Log Mantel That Harmonizes Completely with the Spirit of the Log Cabin

to the job. The logs are cut in lengths from 12 to 20 ft. in the woods, trucked to the job and sawed to proper lengths by power saws. Most window and door frames are made of 2 by 8-in. cypress or white pine. When logs are used, they are taken to the warehouse and slabbed for door jambs and window stops. The sub-floors and partitions are built in before the roof is put on, in order to tie the outside walls.

Log houses are practical in any climate. I have built in many states and find that all climatic conditions are favorable for log construction. The logs will not deteriorate as long as they are kept varnished and given the same care as a frame building should be given.

I also have built all kinds of log furniture, lighting fixtures and lamps, as well as buffets, china cabinets, cellarettes, dining tables, writing desks, etc. Some of them are seen in the accompanying photos.

### Mowing Large Lawns

I have a large campus to take care of, so that mowing the grass, which must be

done frequently, is a big job. However, the work was greatly simplified by using five lawn mowers in tandem and driving them over the lawn with a small tractor, as shown in the accompanying photo. A special attachment ahead of the tractor permits the driver to see what he does.—T. W. Aitken, Guelph, Ont.

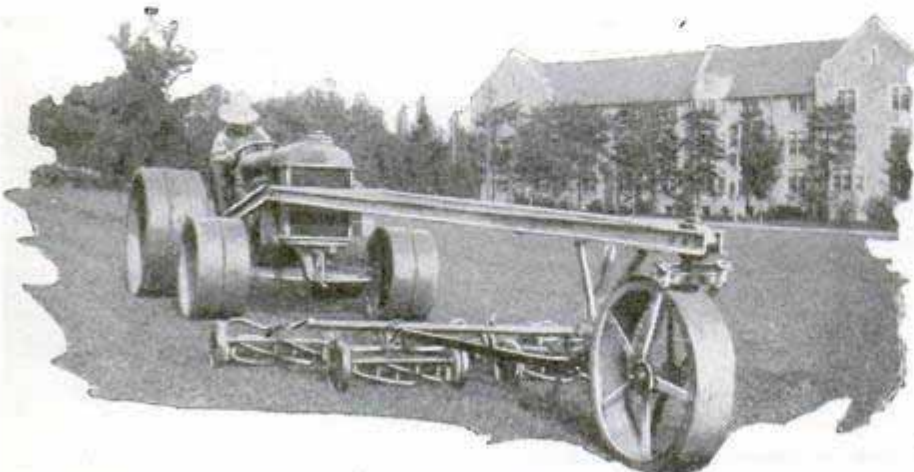

Coupled Together and Driven by a Tractor, Five Lawn Mowers Cut the Grass on the Campus of the Ontario Agricultural College

### A Shrinking Kink

When shrinking a pulley, collar or ring on a shaft, it is well to have a shoulder to shove the ring up against for a stop. There are, however, cases



where it is impossible to provide such a stop and where it is more a case of luck than anything else that the ring cools at the right spot, longitudinally, on the shaft. Lathe dogs are good for this purpose. The dog should be set so that when the ring butts up against it, it will be in the right location. Be careful not to put on a dog and find, after shrinking, that it is a prisoner between two rings or collars. More than one worker has had to help himself out of such a difficulty by sawing the dog in two. Where this is apt to occur and the dog cannot be placed otherwise, use a split dog. It would be well to use the latter in any case, for then no sawing or removing of newly shrunk pieces would be necessary.

### Shipping Tag Made from Envelope

When making up a parcel, one often finds that all the tie-on tags have been used up. A very strong and handy one can be improvised from an end-opening envelope, as indicated in the illustration. The envelope is first doubled, then folded once more and finally the flap is gummed over the back of the folded tag and a hole is punched through near one end. To attach it to the parcel, a cord is drawn through the hole. The tag is strong and

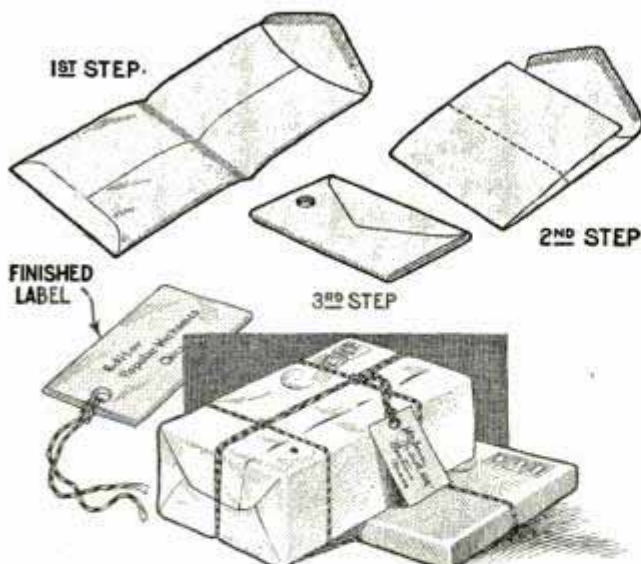

Strong Parcel Tag Can Be Improvised from an Envelope

not easily torn off, as the cord passes through several thicknesses of tough paper. It takes typing very well, but the address should be written or typed on before folding it.—C. A. Oldroyd, Barrow-in-Furness, Eng.

Peeling Tread from Old Auto Tires with a Crank



### Tool for Removing Tire Tread

Most vulcanizing shops occasionally have to strip the rubber tread from an old tire, either to prepare the casing for a retreading job or to use the stripped fabric for repair boots. To facilitate this task, a Wisconsin repairman devised the simple tool shown in the drawing. A length of  $\frac{3}{4}$ -in. steel shafting was bent to form a crank and holes were drilled through it to accommodate two steel spurs. The crank was mounted to extend from the underside of the workbench. In use, the rubber tread of the tire is first cut and a few inches are peeled off by hand so that the loose end can be pierced with the spurs. With the tire standing up under the crank, it is only necessary to turn the crank to remove the tread. If the tread is heavy, the tool is stopped after several turns so that the rubber wrapping can be removed from the shaft and cut away.

### Area Covered by Paint

It is often asked why paint will cover more square footage for some painters than for others. The secret of making paint go a long way does not, as some suppose, lie in the brushing but rather in the mixing and straining. The more it is passed through a fine cloth or screen, the farther or the better it will spread.



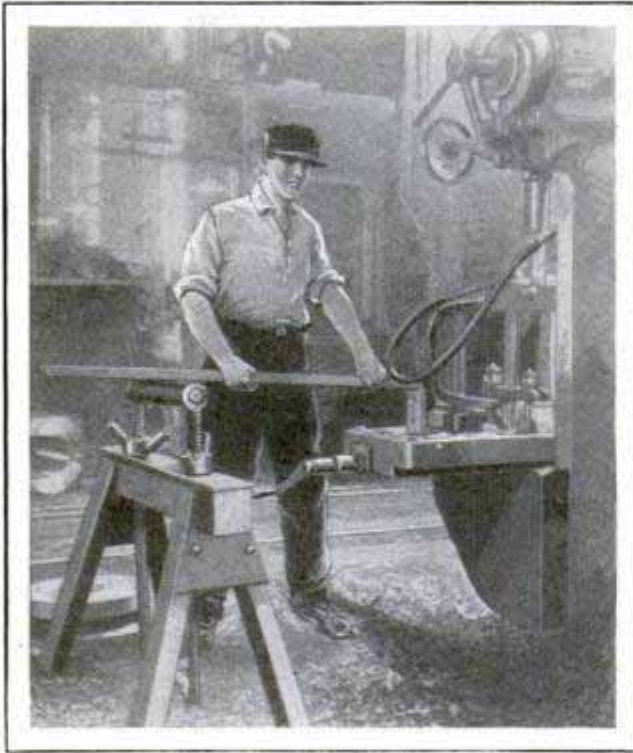

Supporting Long Work at the Drill Press with an Adjustable Horse

### Screw-Jack Horse an Aid at Drill Press

This wooden horse, 2 ft. high and 3 ft. long, with strap iron on top section, was quickly converted into a handy accessory to the drill press for holding long work in a Denver shop. A roller was placed in the end of two 30-in. screw rods, which passed through holes in the top of the horse. By means of the two collars, the roller is raised to hold the work at any height.

### Coloring Mimeograph Work

Mimeograph work can be made more attractive in appearance by adding color to it. This can be done by using a bronze powder on the sheets before the ink dries. As you run off two or three sheets, dust the powder with a small camel's-hair brush while the ink is still fresh. It is best to use a better grade of paper, as the ink dries quickly on the regular mimeograph paper. The powder clings only to the

parts covered by the ink; therefore all the rest can be brushed off and you have a pretty copy with bronze color. This adds much to the appearance of invitations and illustrations, etc., on stencils. The bronze powder can be purchased at any paint or drug store and some 5 and 10-cent stores. Other metallic powders can, of course, also be used, if you prefer a different color.

### Flat Black Paint

In making a few experimental patterns, I had trouble in getting a good black paint for finishing them. I tried enamels, but found that they remained soft under the surface. I tried flat blacks of all kinds, but they either dried too slowly on the wax or rubbed off. By experimenting with some material on hand, I obtained a flat black that is fast, dries in a few minutes and sticks to wood or metal. The mixture consists of one part of lacquer thinner, two parts of white shellac and one and one-half parts of good dry lampblack, stirred thoroughly.—R. H. Williams, Chicago.

### Temporary Support for Overhead Joists

When fastening overhead joists to certain structures, where they must be mortised into the roof

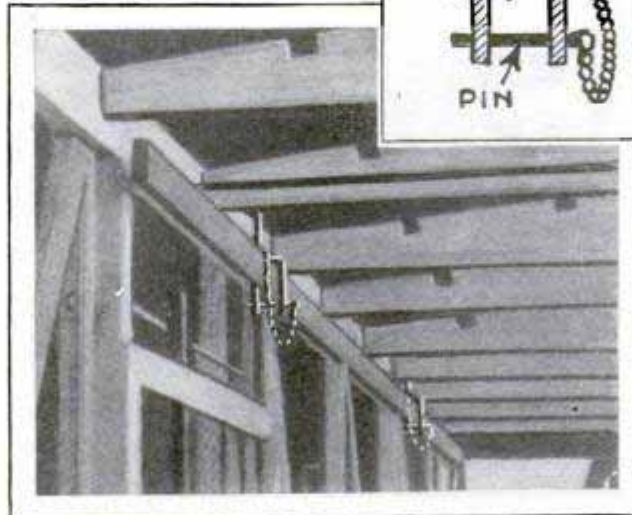
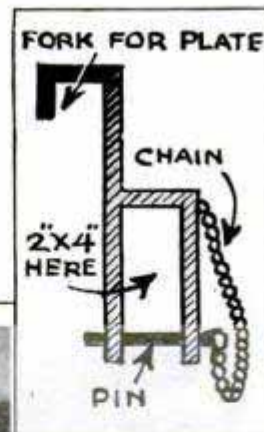

Handy Forked Hook Holds Support, Which Facilitates Fastening of Overhead Joists

plates and held in place by bolts, there is danger of the joists falling upon workmen below. To prevent this, a length of 2 by 4-in. wood may be used under each end of the joists, as shown. It is held in place by a forked hook, hung over the roof plate at each end. A pin is provided to slip through the lower ends of the fork to hold the support securely. The advantage of this hook is that the joists do not hinder the removal of the support.



# A Folding Bed for the Ford Roadster

By C. KUIPERS

WHEN making a cross-country trip in our Ford roadster, we decided to camp in the open, but did not like to go to the expense of purchasing a tent, nor did we relish the idea of erecting it every night and taking it down again in the morning, which seemed to be a waste of time. So I went to the lumber yard and bought 44 ft. of 12-in. boards to make the box extension shown in the accompanying photos and drawings.

The tire carrier and the "turtle back" were first removed, and then I constructed a small truck box, 4 ft. long and 3½ ft. wide, with 10-in. sides. The floorboards were laid lengthwise and nailed to two 8-in. cross strips, one on each end. Screws, 4 in. long, were driven through the floorboard, strip, floor of the car and the car-body crosspiece. I used eight screws and

had no trouble; the box remained firm all the way and the screws were easily taken out when I wanted to replace the turtle back, which was carried along. A 2-ft. extension for the floor was then made. It was hinged on, as indicated, so that it could be laid flat on the floor or swung out and held up by means of a support. The extension was 38 in. wide, which gave it plenty of clearance to fit inside the box. The support consisted of an endpiece and two legs, a cleat being nailed to the former to fit under the end of the extension, and small hooks were used to keep the extension from slipping off. This endpiece formed the "foot" of the bed. An endgate for the box was also provided; this was hinged on, and when the bed was extended, the endgate hung underneath, as shown in one of the photos on this page.

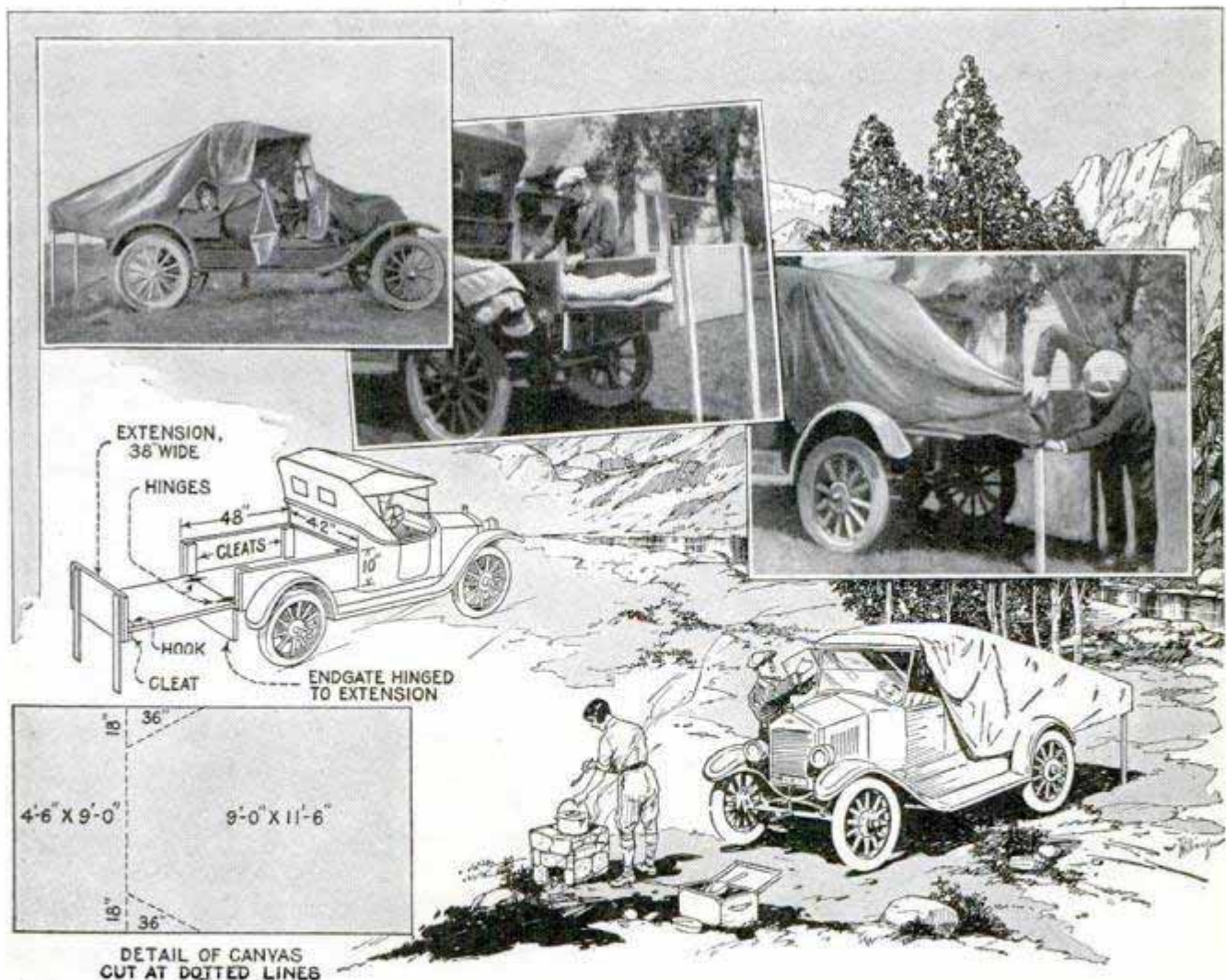

Dimensions and Constructional Details of the Box, Extension, Endpiece, and the Canvas, Which Is Cut in Two Sections, One for the Roof and the Other to Cover the Baggage While Traveling



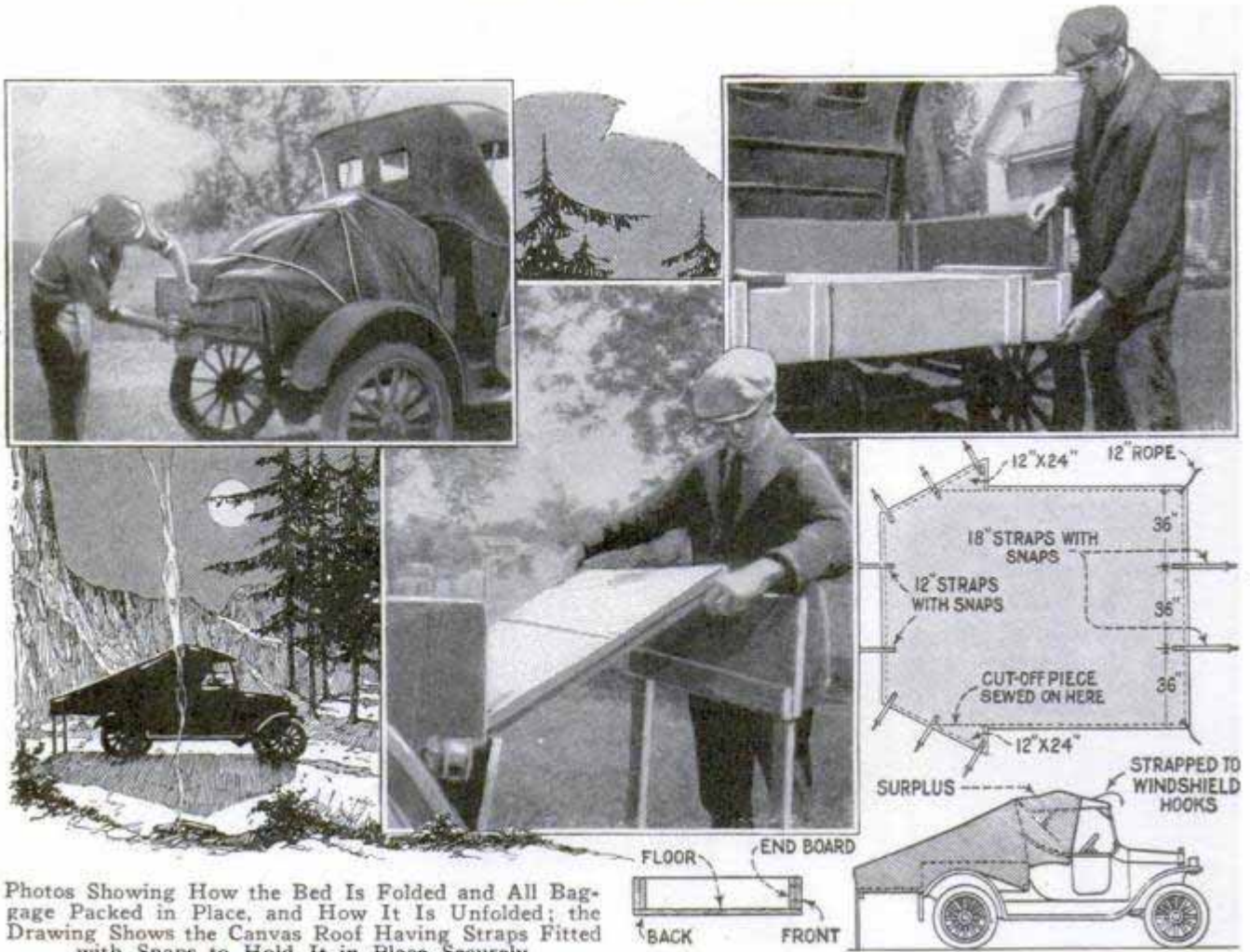

Photos Showing How the Bed Is Folded and All Baggage Packed in Place, and How It Is Unfolded; the Drawing Shows the Canvas Roof Having Straps Fitted with Snaps to Hold It in Place Securely

A roof was, of course, necessary to keep out rain and insure privacy. I bought a piece of canvas, 9 by 16 ft. in dimensions, which cost \$8. It was cut in two pieces, as shown in the detail, measuring 9 by 4½ ft. and 9 by 11½ ft. Triangular pieces were cut from the larger, and sewed on in another position, the edges were hemmed all around to prevent the canvas from tearing, and a number of straps, provided with snaps, were attached along the edge, as shown. The top was fitted in place and screweyes were driven into the car at various points to correspond to the snaps, which were then fastened to the screweyes to hold the roof in place securely. The wind could not blow it off and the rain could not get inside. The smaller piece of canvas was also hemmed and was used to cover the baggage while we were traveling.

This folding arrangement was found very handy, as it took only a few minutes to make the bed or to pack up. At night, the baggage was set on the seat of the car. To improve the appearance and to preserve the wood, the box was painted to

match the color of the car. The cost of the whole thing, including the paint, was only about eleven dollars.

### Snubber for Ford Truck

The illustration shows a very efficient and cheap snubber for a Ford truck. It consists of the main leaf of an old Ford spring and two short chains. The leaf is placed as shown and fastened by the tie-bolt. The ends are thus held securely

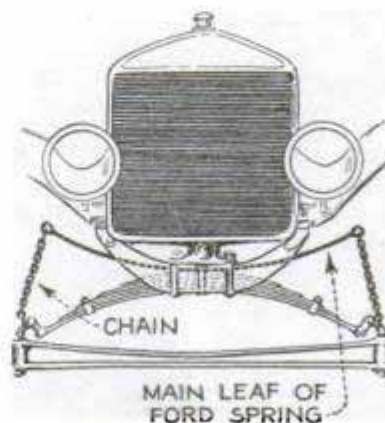

to the spring perches with short chains, and should be pulled down only tight enough to leave no slack. As is the case with any snubber, the chief purpose of this one is to check the rebound of the spring when the truck strikes a rough place.



### Inverted Shelf in Brood Pen Saves Suckling Pigs

When suckling pigs are confined in a small brood pen with the mother, it frequently happens that the parent porker lies down and crushes or smothers one or more members of the family against the wall. To avoid this loss, many Wisconsin farmers are building small shelves around the sides of the pens, at a height of about 7 in. above ground. Under these shelves the young pigs are insured against crowding or crushing and can scramble out of the danger zone uninjured.—G. E. Hendrickson, Argyle, Wis.

### Sliding Hay Door for the Barn

Instead of the usual hay door, which is hinged at the bottom and requires considerable effort to open and close, a Nebraska farmer installed the vertically sliding door shown in the photo. The guide-ways for the door are angle irons. Two pulleys at the top of the doorway and just inside of the barn wall provide bearings for ropes, which are attached to the upper corners of the door and also to two concrete counterweights. One man can quickly and easily raise or lower the door.—Dale R. Van Horn, Lincoln, Nebr.

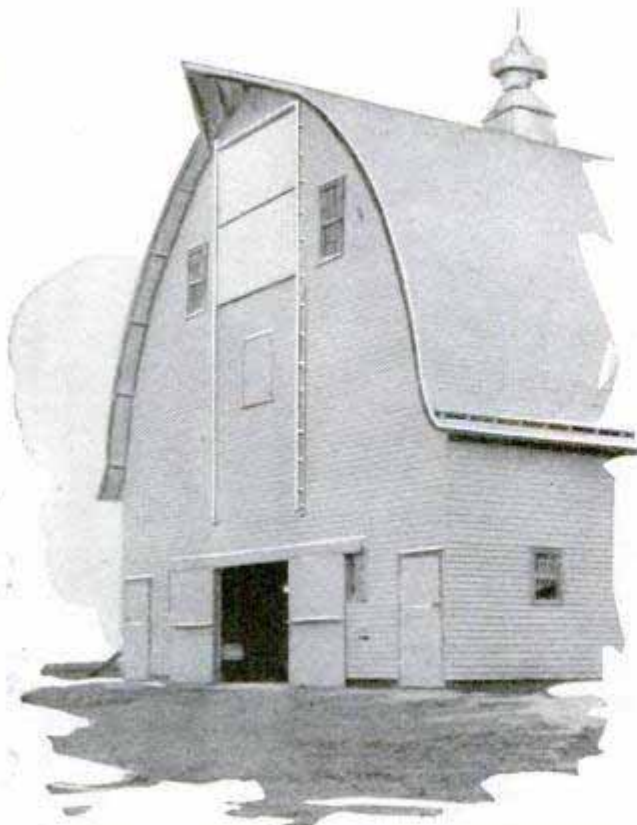

Sliding Hay Door Easily Operated by One Man

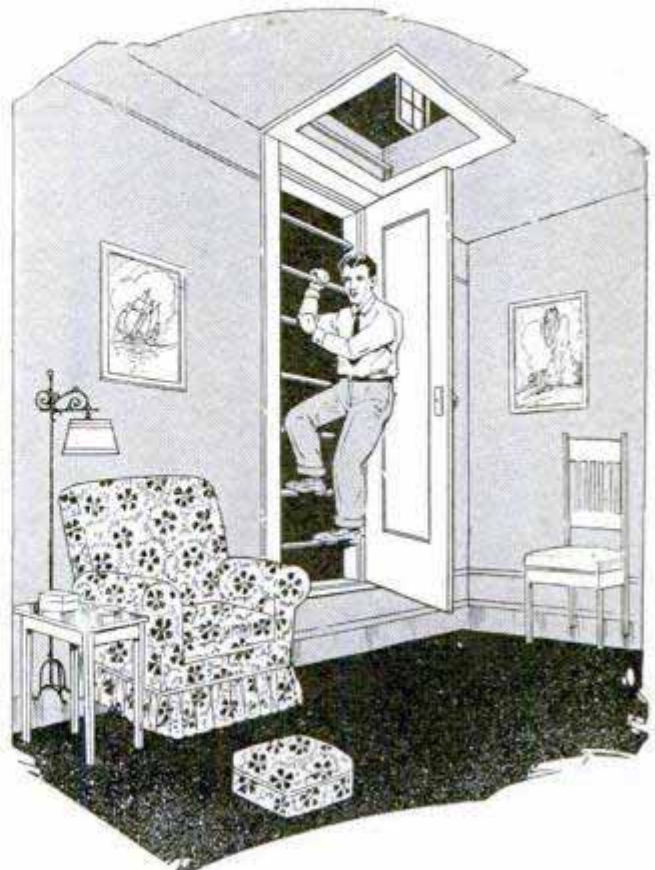

Built-In Ladder Permits Easy Access to the Attic from the Hallway

### Attic Ladder Concealed in Closet

In many bungalows and small homes the entrance to the attic is through a scuttle in the ceiling of the hallway, and access is very inconvenient, as a ladder cannot be kept at hand at all times. One home owner, who wished to inspect the attic occasionally, without undue trouble, arranged a built-in ladder as shown in the drawing. In the wall of the hallway, just beneath the scuttle in the ceiling, a small cabinet was built in the space between two studs. In this cabinet rungs were fastened and a neat door served to conceal them when not in use.

### Valve Clearance Gauge

A Gillette razor blade makes a good overhead valve clearance gauge, where the clearance must be exactly .006 in. The sharp edge can be ground off one side and covered with friction tape to facilitate handling it. Such a blade makes a handy tool in every repair kit, not only for measuring valve clearance, but for many other purposes where a good sharp edge is needed.—Philip S. Mentz, Jefferson Barracks, Mo.



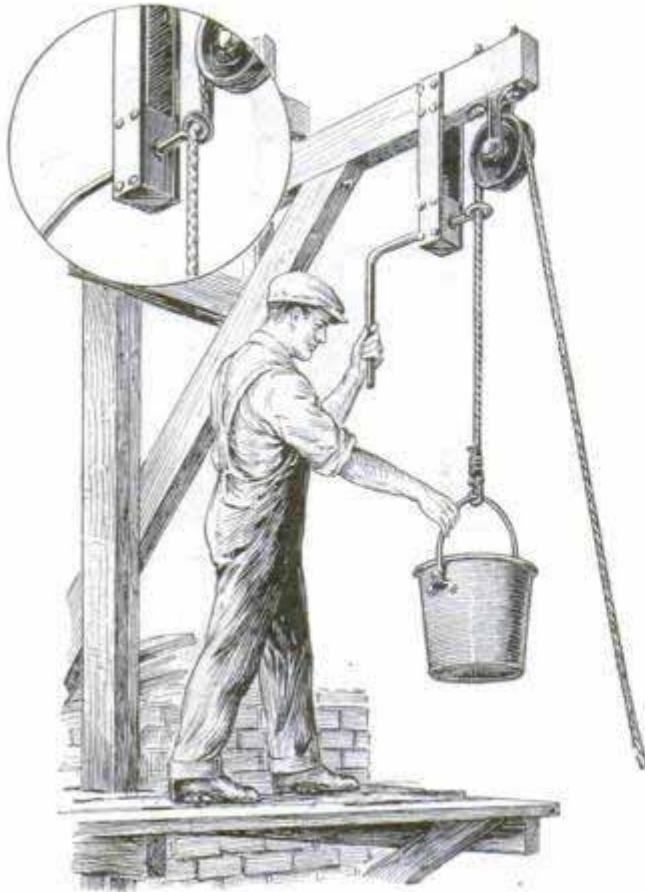

Emergency Brake on Hoisting Rope Helps Avoid Accidents in Building Construction

### Emergency Rope Brake

Using a rope and pulley to haul materials to the top floor of a building under construction nearly caused an accident recently when the worker pulling on the rope below misunderstood the signal of the worker above and let go too soon, with the result that a heavy bucket descended with lightning speed. To avoid such occurrences, the contractor devised an emergency brake so that the worker above could stop the descent of the bucket instantly. To accomplish this, he had a piece of  $\frac{1}{2}$ -in. round rod bent to form an eye at one end. Then two pieces of board were nailed to each side of the beam holding the pulley, and another piece, the same thickness

as the beam, was nailed between them, and a  $\frac{1}{2}$ -in. hole drilled through the whole. The rod was inserted through the hole, as shown. Turning the handle either way locks the rope in the eye of the rod and stops the bucket. If the man below lets go of the rope accidentally, the man above still has control of it.

### Installing Feed-Pipe Packing

One-piece packing used in Ford feed pipe pack nuts is often too large in diameter to be easily placed in the nut. It should be rolled between the fingers and gently pulled apart lengthwise. This makes it slender enough to fit. The nut and packing are slipped over the end of the feed pipe and the projecting packing is pressed back into the nut with a blunt tool, until the nut can be started on the end of the connection.

### Blanching Celery with Paper

American celery growers of southern California found themselves hard pressed by Japanese competition, until they began to apply better methods. The celery crop was customarily blanched by wrapping each plant with old newspaper, a method too costly for American farmers, but still used by the Japanese. The American farmers tried boards, but found this too expensive also. Experiments were made with long strips of roofing paper. While this method was not satisfactory, it furnished a clue. A white paper was then used. It was made of 12-in. two-ply strips, and reinforced with strings held in place with asphaltum. Two strips are required for each row. They are secured by wire staples, which fit over the rows and are driven into the ground. The paper and the staples will last for years provided they are properly stored.



Using Heavy Two-Ply Paper Strips for Blanching Celery; the Strips Are Held by Wire Staples

*R. C. Parker, 1711 Grand St., Seattle, Wash.*  
*Major W. Barclay*  
*Houston, Swaledale*



# Cutting Glass in the Small Shop

By J. F. HARDECKER

WE all appreciate that the expert can save us time and money in cutting glass on a production job, but on a little repair job the average mechanic feels he can do well enough. Even though in passing through a shop I have seen this selfsame average mechanic spoil piece after piece of glass in the fostering of his theory, I am inclined to agree with him, if he will but observe a few practical rules developed through long experience, and not persist in inventing a way of his own. And what applies to the mechanic in the shop applies equally to the handy man around the home. Many a hasty and crestfallen fellow from the home to the glazier's shop, with a trail of broken glass behind, can be avoided by a little forethought and respect for the proper way to do it.

Right at the start, it is necessary to point out that there is one particularly important point to look out for that is seldom given any consideration or even thought, and that is the age of the glass. So, if it

is an old piece of window pane you are operating on, don't expect too much of it; it has seen better days. The facility with which you can cut glass is directly proportionate to its age. If it is a small piece you are dealing with, and it is not too inconvenient, discard it and start out with a new piece of glass.

We will assume that you want the bottom half of a bottle to insulate a pole for your radio antenna, or for any one of a hundred other uses around the shop. Naturally you want a good clean cut around the middle of the bottle without any ragged edges. That sounds hard to do, but here's a very easy way to accomplish it. Just take a piece of ordinary string, dip it into kerosene or gasoline, wrap it once around the bottle at the point you want the cut to come and tie it. Now hold the bottle sideways with the knot at the

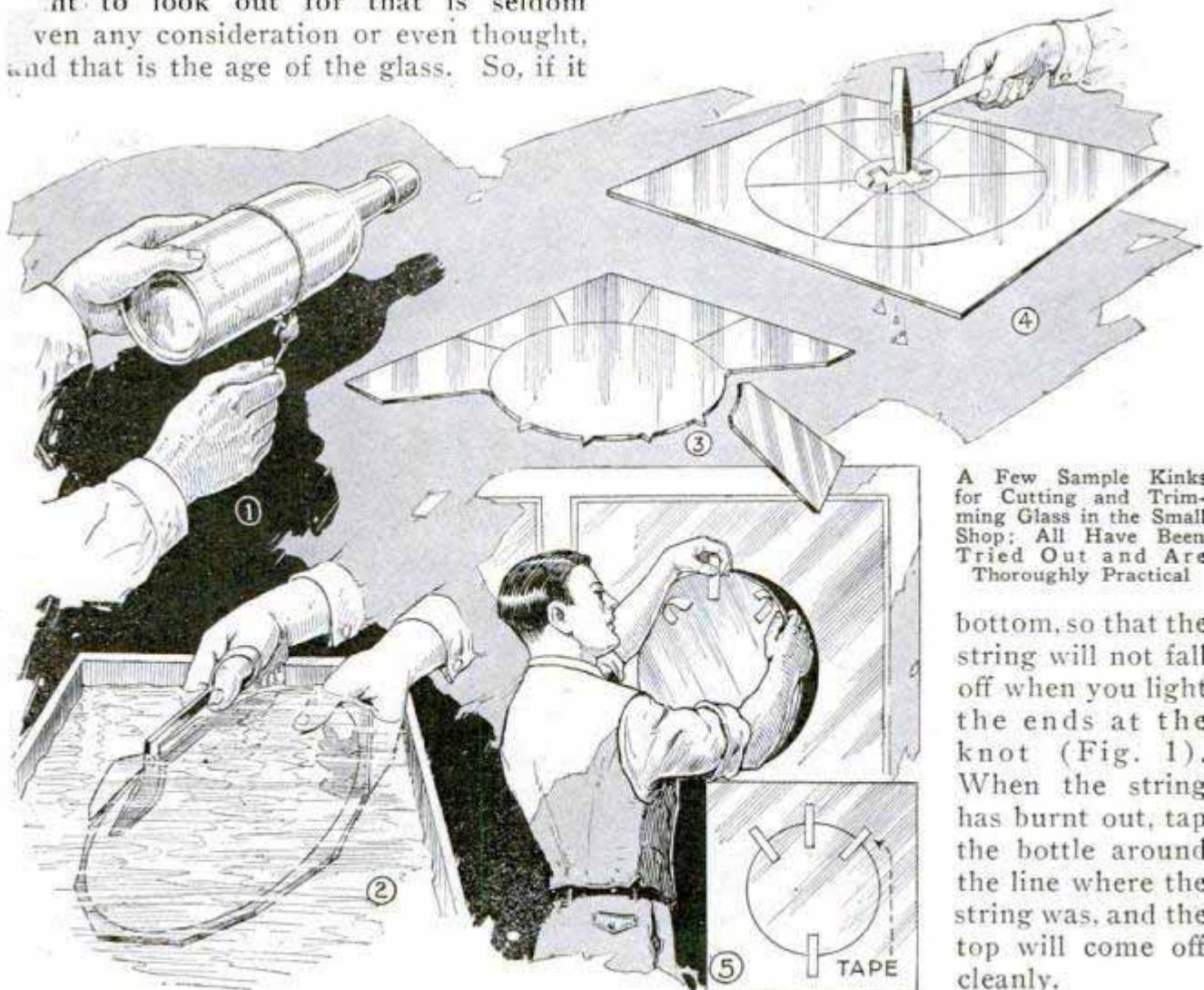

A Few Sample Kinks for Cutting and Trimming Glass in the Small Shop; All Have Been Tried Out and Are Thoroughly Practical

bottom, so that the string will not fall off when you light the ends at the knot (Fig. 1). When the string has burnt out, tap the bottle around the line where the string was, and the top will come off cleanly.



You can cut glass with a red-hot poker or other piece of metal by just tracing over the line of cut slowly with it. Tap the glass carefully along this line and you'll get a nice, clean cut. The bottle neck previously mentioned may be cut in this way as well as any form of sheet glass.

If you lack fire, you can call to your aid another of the elements of the ancients, that is, water. In this case, however, you must confine the operation to trimming, as this method is not applicable to cutting a large pane in half, for instance. The water really serves to dampen the vibrations of the glass in cutting. The cutting medium is usually a large pair of tinner's shears, as in Fig. 2, and the entire operation is carried on under water in any convenient tank. Among the things that most frequently need replacing are the glass disks that shield instruments, headlights, etc. And as they are invariably held

in place by a bezel or frame, it is not even necessary to have an absolutely smooth edge. If you must have a perfect edge, use a circular glass cutter, but do it under water. If a perfect edge is not necessary, just keep trimming it off under water with tinner's shears, usually the larger the better. Be sure to turn the cut edges away from you. If you choose, you can even resort to grinding to smooth off the job. If you don't like the water method, it is necessary to use rough lines scribed outward to the edge of the glass from the circumference of the scribed circle (Fig. 3). Here's the real trick though: If you scribe the circle, cut the rough lines and tap the glass, it will break off all right, but it will leave a ragged projection at every point where the scribed line joined the circumference and this must be ground off. But if you tap the glass all around the scribed circumference immediately after scribing it, and then cut your radiating lines, you'll get a perfect job.

To cut a circular hole, scribe the circle

with a circular cutter, but if you try to break it out directly, you are almost sure to spoil the piece of glass through its cracking past the scribed circle. Just carelessly scribe a few radial lines from the edge of the circumference to the center, and then scribe an approximate small circle at the center. Break out this small circle first by tapping, and then continue tapping to break out your segments and you will have a nice neat circular hole which you cannot possibly spoil. (See Fig. 4.)

If you want to cut an opening in a piece of glass already installed and which is not accessible from the inside, and you want to be certain the cut piece of glass will not fall inside to perhaps damage a delicate

mechanism, a little thoughtful use of adhesive tape will solve the problem. Start your cut in the regular way with a glass cutter, but at the top put across the scribed line a few pieces of adhesive tape

as you are progressing with the scribing, as in Fig. 5. At the bottom put a single piece of tape (perhaps two if the glass is very large), tap the glass around the entire cut to break it free, and then, using the outer edge of the lower tape as a handle, lift your glass out free. The inside is safe from any damage and the tape even acts as a protection to your hands in handling the cut-out piece of glass.

There is perhaps no single operation that appears harder and is actually easier when you know how than the drilling of glass. The first thing to do is take a setscrew or any other rounded object of approximately similar contour and clamp it by the shank in a bench vise, the head being uppermost and free of the vise. Then hold the glass to be drilled over this setscrew, with the center of the hole to be drilled directly over the center of the screw head, and with a light steel hammer, as in Fig. 6, tap around this point, being careful, of course, not to tap around a greater area than that of the hole to be drilled. This

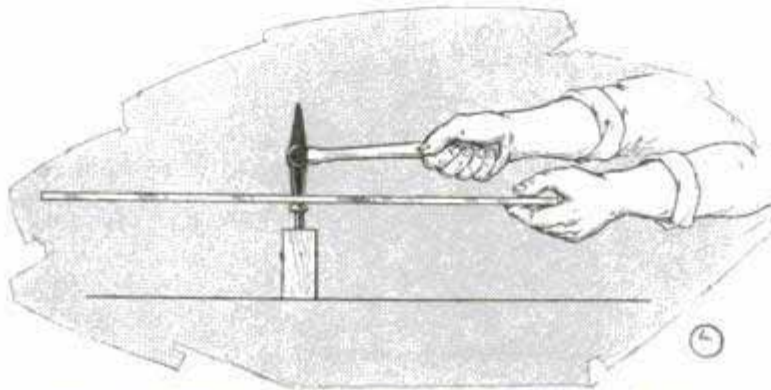

Roughing the Surface of Glass before Drilling with a "Drill" Made from a Three-Cornered File



tapping will merely break the hard surface of the glass, roughing it so that the drill point can take hold. An ordinary machinists' hand brace will do, but when it comes to the drill, that's another story. Take any small ordinary three-cornered file and sharpen the triangular end to a point; so as not to lose the temper by excessive heat, this sharpening should be done by grinding on a wet grindstone or grinder. If a grinder is not available, a wet flat stone will do almost as well. Now chuck the file in your drill and go ahead. The size of the hole, of course, will be dependent upon how far you drill into the piece of glass, due to the ever-increasing diameter of the file as you go deeper.

In conclusion, just a word of caution. The above are not the only ways to accomplish the results predicted, but they have been tried out practically; so, unless you actually know of a better way, it is important, simple as the rules appear, that, to be successful, you stick to them rigidly, and carefully.

### Worn Slitting Saws Make Shaper Tools

Milling-machine slitting saws that have become useless either by reason of being ground down until the teeth are too shallow to do effective work, or by breakage of a part of the periphery, can still be made to do good work as parting tools. The drawing shows a style of holder for such tools; it is slotted to the thickness of the cutter, and drilled to take a capscrew that should be of the same diameter as the hole in the center of the saw. A nut on the opposite end of the capscrew is used to clamp the saw

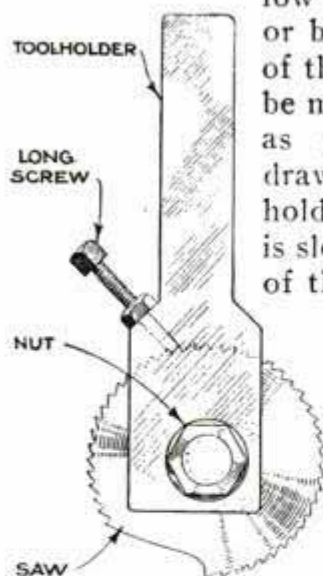

in the holder. To take the thrust of the cut, a long setscrew is threaded into one holder in a suitable position to bear against the back of the saw teeth. A parting tool of this type is quite efficient for comparatively thin work.—Harry Moore, Montreal, Can.



Handy Tray  
for Holding Jars  
That Contain Sol-  
dering Acids

### Acid Tray for the Tin Shop

The tray shown in the drawing, for carrying acid jars, was devised in a Denver tin shop. It is made from a flat sirup or other can by soldering a doubled strip of tin, 1 in. wide and 16 in. long, to the can at each side, to form a handle, and cutting two holes in the top side of the can, of such size as to allow the insertion of small glass or stone jars to contain the acids for soldering.—Jos. C. Coyle, Denver, Colo.

### Carton Forms Display Case

The keeper of a small store or shop can make a serviceable improvised display case from the original carton in which articles are shipped by cutting and folding the carton as indicated in the lower figure. With the aid of a few of these display cases, a show window or counter can be made much more attractive than without their use.—Lester P. Young, Culver, Ind.

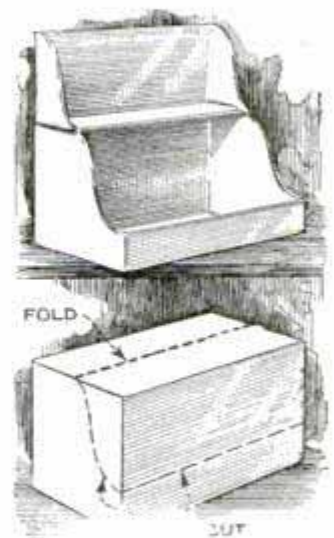



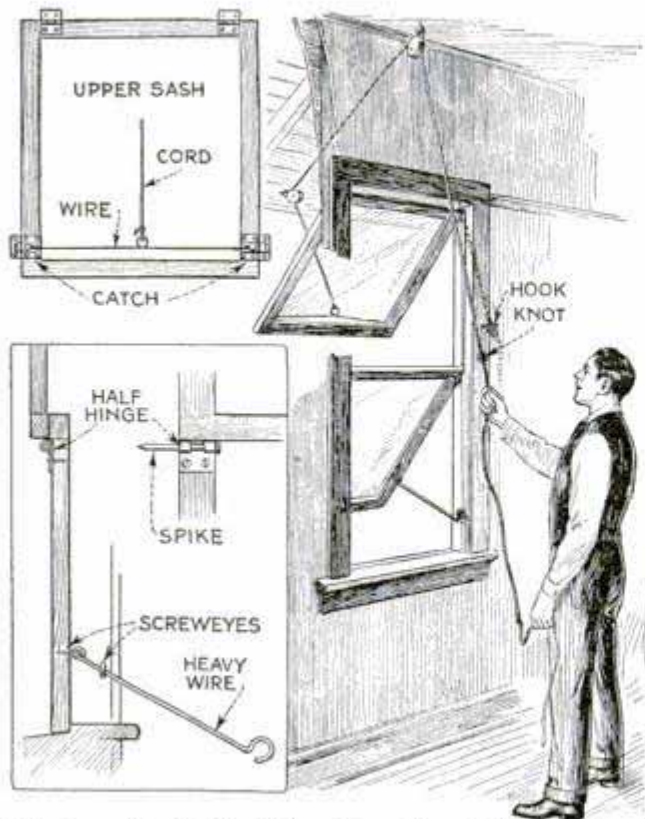

Windows Shed Rain When Opened and Can Be Closed Quickly for Severe Showers

### Hinged Windows Found Effective in the South

In southern sections of the country, where windows usually are kept wide open most of the time, and sudden showers are apt to come up without warning, the windows shown in the drawing will be found very handy, as they can be closed instantly. They are so arranged that, if not closed for a light rain, the water will run off and can hardly get inside of the house. The sashes are hinged at the top and a length of sash cord is provided to raise and lower the upper sash, while a length of heavy wire, bent to the shape shown, is attached to the lower sash with screweyes to serve the same purpose. Other details of construction are given in the drawing, and, if desired, this method may be followed or changes may be made to suit the builder.—G. M. Beerbower, Hollywood, Fla.

### Device for Scouring Brass Ball Valves

Brass balls in pump or check valves often become so corroded that they stick or fail to seat properly, and it then becomes necessary to remove them for cleaning and scouring. One Wisconsin engineer made a device from a length of small

rubber steam hose, which helped him considerably in doing the work. The hose was approximately of the diameter of the balls and was prepared for use by cutting the ends so that they were beveled inward. In use, the end of the hose is moistened with water and is dipped in a suitable abrasive, after which the brass ball is placed in position in the beveled end, and rotated under slight pressure to scour and polish it. This completes the work very rapidly and with little or no danger of destroying the original spherical shape of the ball.—G. E. Hendrickson, Argyle, Wis.

### Sawing Balusters

Recently we had quite a number of 2 by 2-in. balusters to cut. As they were 16 ft. long, they could not be cut on the circular saw, so we took a couple of pairs of 6-ft. clamps, fastening as many of the strips together as possible, and it was then a very simple matter to square a line across them and do the sawing by hand.—Neil Nelson, Kansas City, Mo.

### Attaching Truck Springs to Axle

On some worm-drive truck axles U-bolts are used to hold the rear springs. The U-bolts extend through the axle housing, as shown in the illustration, and after a few months usually rust so badly that their tops must be cut or sawed off and the pieces driven down through the axle or drilled out when new springs are provided. If studs of the proper length are used instead of bolts in connection with a plate of  $\frac{1}{2}$ -in. or  $\frac{3}{4}$ -in. stock to clamp the spring to the axle, it will be an easy matter to replace springs by

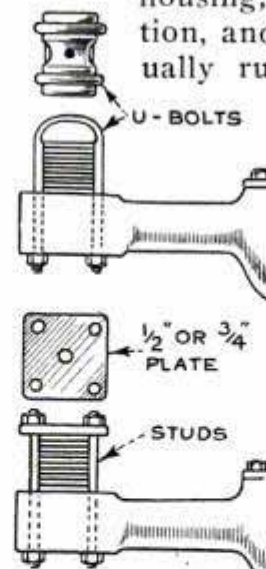

simply removing the plate and lifting the spring. The corner holes in the plate are drilled  $\frac{1}{64}$  in. larger than the studs and a central hole is provided to take the head of the spring center bolt.—G. C. Douglas, Raleigh, N. C.



# How to Kill Moths in Furniture

By E. J. EDWARDS

**O**VERSTUFFED furniture is a good breeding place for moths, and there are several methods of killing them. One of the simplest is to use the heat treatment, which is illustrated in the accompanying photos. All that is needed is an ordinary electric heater of the radiant type or any other source of heat with which there is no danger of fire. The inclosure for the furniture may even be erected over a steam radiator or a hot-air register. A thermometer is laid on the sofa to indicate the temperature and the sofa is then covered with a number of heavy comforters and blankets to keep in the heat. It must be remembered, however, that the direct rays of an electric heater or too close proximity to a register or radiator may blister varnished surfaces. Therefore, be sure to protect the furniture by means of a piece of asbestos millboard,

which can be obtained in most large hardware stores, or in any engineers' supply house. The blankets should be hung over supports so that one can reach in and grasp the thermometer quickly to read the temperature without making a large opening and letting cold air in.

Moths die at 110° F., but the eggs are not killed until a temperature of 125° is reached, so it is a good idea to keep the heat at 130° for a few hours. Glue joints in furniture will stand 140° without damage, and the wood and other materials, used in the construction of upholstered furniture, will easily stand this heat without any injury. Heat does not penetrate to the center of upholstered goods in less than three hours, and therefore the killing temperature should be maintained from eight to ten hours. To be doubly sure of killing all the moths, a second treat-



Preparing Stuffed Furniture for Heat Treatment to Exterminate Moths; the Job Takes Eight to Ten Hours



ment may be given about a week later. If comforters alone do not keep the heat in to permit the proper temperature, a layer of newspapers over the comforters and then a covering of blankets will produce



Sofa Completely Inclosed So That No Cool Air Gets In or Any Heat Is Lost

results, as paper is an excellent insulator. To support the covering over a davenport, two chairs can be arranged at each end as indicated. These will bear the weight nicely and permit the hot air to

envelop the sofa completely, and if the chairs have upholstered seats, the propagation of moths will also be prevented in them.

For those who do not have access to heaters, or are located in such cold climates that it would be a difficult matter to get a temperature of 130°, it may be interesting to know that all moth life ends after two hours' exposure to zero temperature. Three hours are required for the cold to penetrate to the center of the sofa, so an exposure of eight to ten hours is necessary. If zero weather is not prevalent, 24 hours' exposure to 15° above zero will give good results. This will prove fully as effective and involves no cost or trouble excepting opening a window and shutting a door. The same methods can be used for killing moths in other articles.

### Control for Forge Blast

When installing his forge and blast pipe, a blacksmith in a large machine shop made a convenient device out of an old steam valve for shutting off and turning on the blast. The valve was of the gate type and the threads of the stem were ground off with an emery wheel, making a smooth rod so that it would slip through the threads. The valve was then installed in the blast line, which consisted of piping of the same size as the valve. A lever taken from an old sawmill saw frame was pivoted on the edge of the forge and the end opposite the operator was attached to the end of the valve stem, as shown, extending within easy reach of the anvil and hammer. By merely pressing on the lever, the blast line can be opened or adjusted, and a slight lift on it shuts off the draft. The lever can be balanced

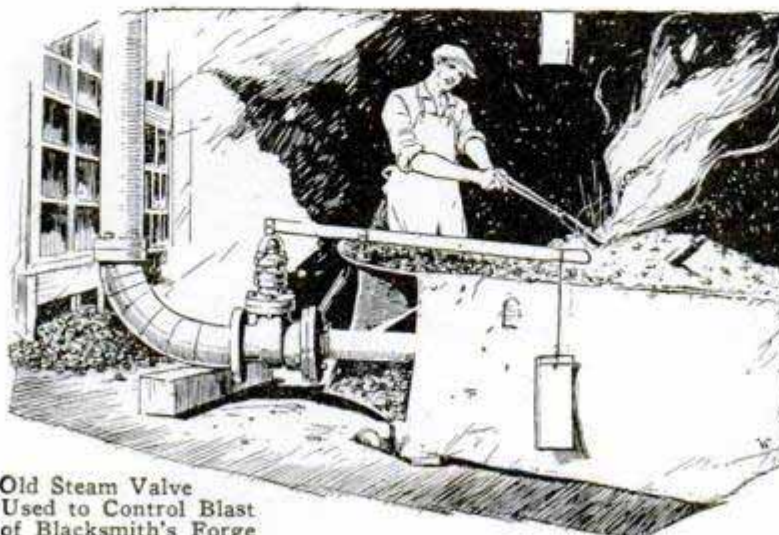

Old Steam Valve Used to Control Blast of Blacksmith's Forge

to stand in any desired position by attaching a counterweight at the outer end, as shown.—L. M. Jordan, Vredenburgh, Ala.

### Applying Lime to Sour Soil

Rapid, vigorous growth and large yields of vegetables from the garden are aided by the use of lime. Practically all garden soils, particularly in towns and cities, need lime, and would be benefited considerably by about 10 lb. per 100 sq. ft. Any finely pulverized lime is satisfactory for this purpose. Hydrated lime, used in building construction, can be obtained from any building-supply dealer. Even if commercial fertilizers and manure are used freely, sour soil needs liming as manure will not decompose readily in such soil. Besides, lime aids the plants to absorb their food and it is therefore essential to their growth. April is the best time of the year



to lime gardens. For the home gardener, the simplest test to ascertain whether or not the soil needs lime is to stir up a thimbleful of it in a tumbler of clean water to which a tablespoonful of household ammonia has been added. Let the mixture stand for 10 minutes, and if the liquid has a dark or inky color, the soil needs lime. If the liquid has a light-straw color, liming is not necessary. When fresh manure is used, it should be spaded under to a depth of 6 or 8 in. and entirely covered with earth. On the other hand, if the manure is well rotted, only half of it should be spaded under, the other half scattered and raked into the ground. The right time to apply lime is after the manure has been spaded under. The lime should be scattered and raked into the surface.

### Determining Position of Car in Garage

The usual garage is just large enough to accommodate one, two or three cars, and the space in front of and behind the cars is rather limited. To prevent running the car into the garage too far, one owner suspended a card from the ceiling, so that it would just touch the windshield when the car was in the right position. Another method of preventing the car from going too far is to provide a removable wooden bumper on the floor as shown in the lower sketch.—G. A. Luers, Washington, D. C.

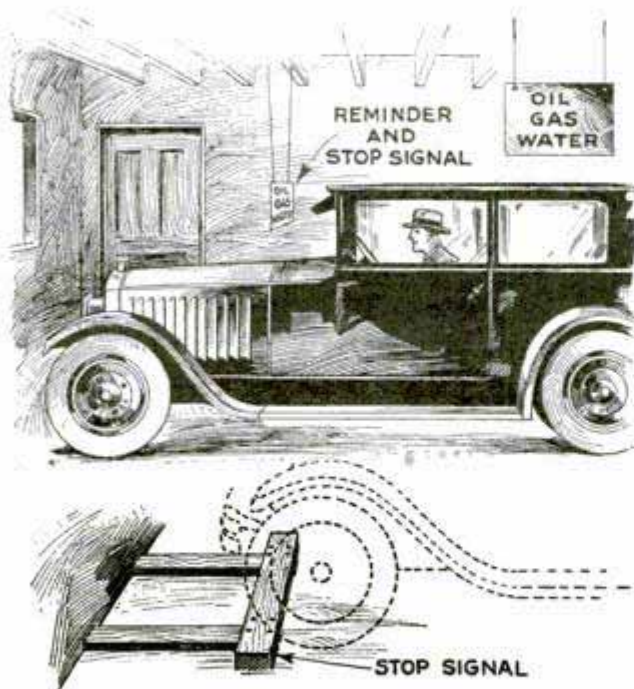

Two Handy Methods of Stopping a Car in the Correct Position in a Garage



Improved Buck on Top of Stepladder Makes the Work of Lathing Much Easier

### Ladder Buck Holds Lath

When lathing ceilings of ordinary height most carpenters employ portable scaffolds upon which the bundles of lath are thrown. This, however, necessitates much tiresome stooping, and one Wisconsin contractor conceived the idea of employing a stepladder in the manner shown. Four laths were temporarily nailed onto the legs of the ladder, crossing as indicated to provide a buck or hopper. The opened bundles of lath were placed in this, handy for the workmen. By providing wheels on the legs of the ladder the worker can push himself along without getting off.

### Oilcan Aids in Gluing

By keeping glue in an ordinary oilcan it can be applied wherever needed in small or large doses, just as desired, and it can be run in grooves and deep holes without getting any on the edges. This method is easier and cleaner than using a brush. The can should be kept warm all the time, which can be done by placing it in a pan of hot water.—W. F. Schaphorst, Newark, New Jersey.



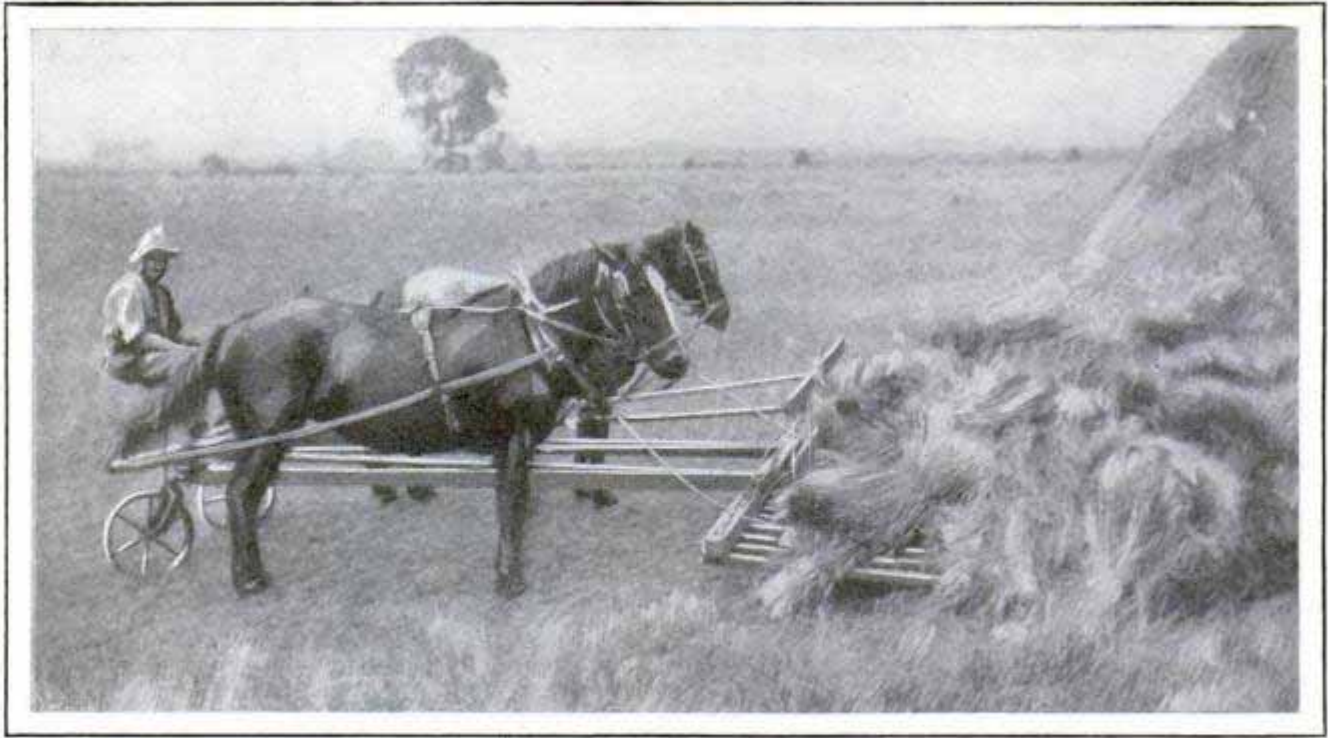

Improved Buck Rake, Attached to Tongue of Horse-Drawn Rig to Project in Front of Horses, Facilitates Raking Bundles to Thresher

### Improved Buck Rake

A farmer near Danvers, Ill., uses the improvised buck rake shown in the photo. It enables him to bring bundles to the threshing machine or stack without any assistance. It consists of an old hayrack arranged in front of the horses as shown.—L. B. Lyons, Washington, Ill.

### Movable Concrete Forms

In the Peruvian Andes, where there are no trees and lumber is very costly, it is a difficult matter to erect a concrete build-

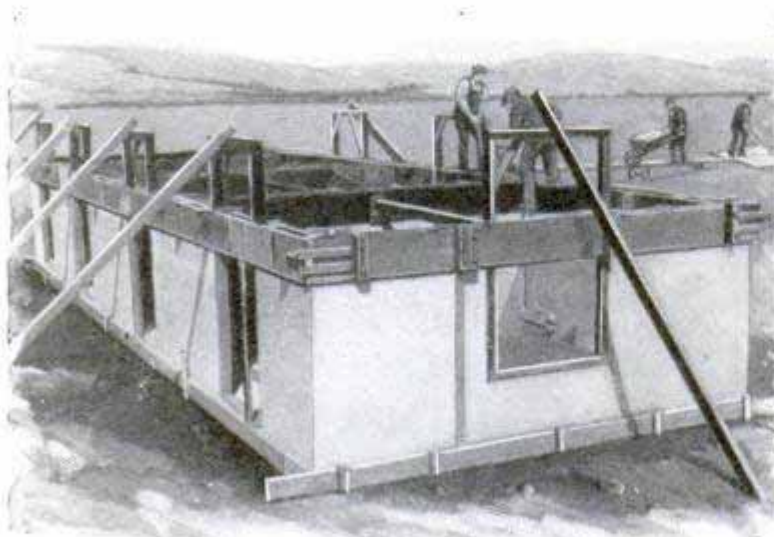

Where Lumber Is Scarce and a "One-Course" Concrete Form Has to Be Used

ing without forms. One builder overcame the difficulty by making a movable form from a few pieces of available lumber. There were enough 2 by 12-in. planks to make a "one-course" form, as shown in the photo. The boards were carefully fitted and held together with bolts and clamps. Concrete was tamped into the mold and allowed to harden overnight. The next day, the mold was taken apart and raised so that a new layer of concrete could be added. In this way the walls rose at the rate of one course every day, which was not very rapid, but was much better than waiting six months for enough lumber to build a complete form. The building, when completed, was entirely satisfactory, in spite of its odd construction.—Charles M. Little, Mt. Rainier, Md.

### Keeping Wasps from Beehives

The average bee keeper knows that a few wasps or hornets will destroy a producing hive in a very short time. In order to rid his hives of the pests, and knowing their weakness for fresh meat, one keeper soon disposed of them without interfering with the bees in the following way: A wire screen of  $\frac{1}{2}$ -in. mesh was slipped



over the top of a discarded water bucket so as to keep the birds out. Fresh meat was dipped into a solution of cyanide and placed in the bucket, which was then hung over the hive. A pulley arrangement was used so that the bucket could be pulled away and refilled without disturbing the bees. If cyanide is not handy, almost any poison can be used, and in any case proper care should be taken that humans and domestic animals can at no time get at the poison or the poisoned meats.—H. R. Harrington, Berkeley, Calif.

### Factory Gate Locks

At one of the refineries of a western oil company, where the yards are large and there are many gates that must be kept locked, although superintendents and other department heads must pass them frequently, much time and effort was saved by installing a small gate through which the men could pass without opening the larger ones used by automobiles and trucks. The novel feature of the arrangement was the way in which the padlocks were installed. The latch, which would normally hold the gate shut, and the bar in the gate to which the latch was pivoted, were drilled as shown, so that the latch cannot be raised when the lock is in po-

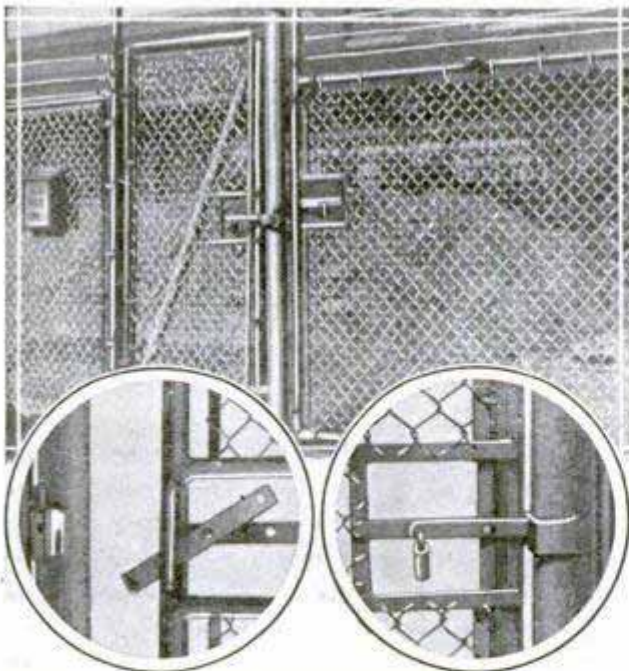

Convenient Method of Arranging Lock on Gate Latch

sition. In opening the gate the padlock is removed and the latch lifted.—Edward H. Flaharty, Parco, Wyo.

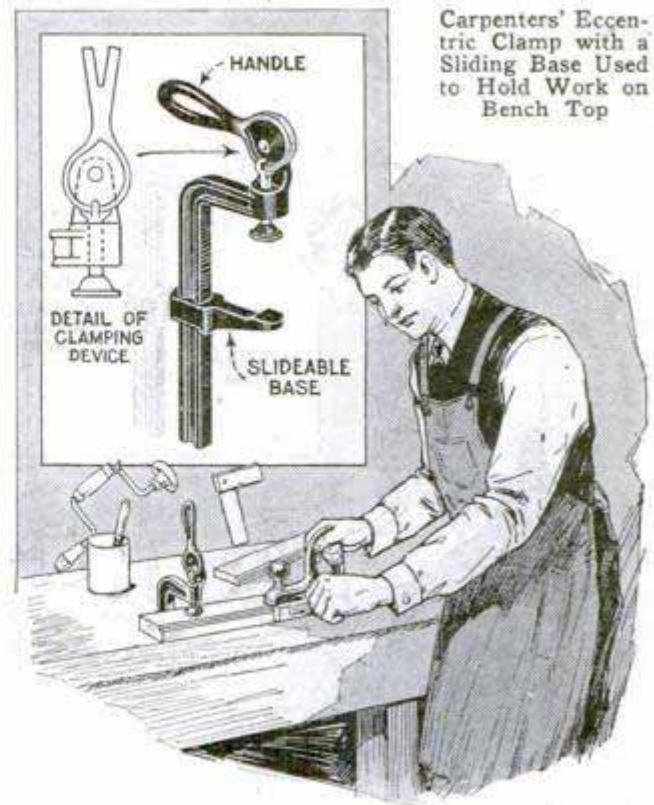

Carpenters' Eccentric Clamp with a Sliding Base Used to Hold Work on Bench Top

### Clamping Small Work to Bench

As can be seen from the drawing, a good clamping device used to hold small work to the bench top to facilitate planing, beading, etc., consists of a carpenters' eccentric clamp with a sliding base. The burr at the end of the shank is removed so that the base can be taken off. The shank is then slipped through a hole drilled in the top of the bench, the base put on again from below, and the clamp is ready for use. When one operation is to be performed on a number of pieces of the same size, this arrangement will be found particularly convenient.—C. R. Gains, Muscatine, Iowa.

### Shade Cloth Covers Cracks between Plasterboard

Cheesecloth strips are generally used to cover cracks between sections of plasterboard when wallpaper is to be applied as a finish. This material, however, is hard to keep in place, and it is much better to use strips cut from window shades, preferably those that are old and have lost their original stiffness. The strips should be about 2 in. wide and the adhesive ordinary flour paste. When the wallpaper is put on, no trace of these strips will show. Such strips can also be utilized to advantage in corners where the edges of the plasterboard meet.



14762

# Is This Your Home?

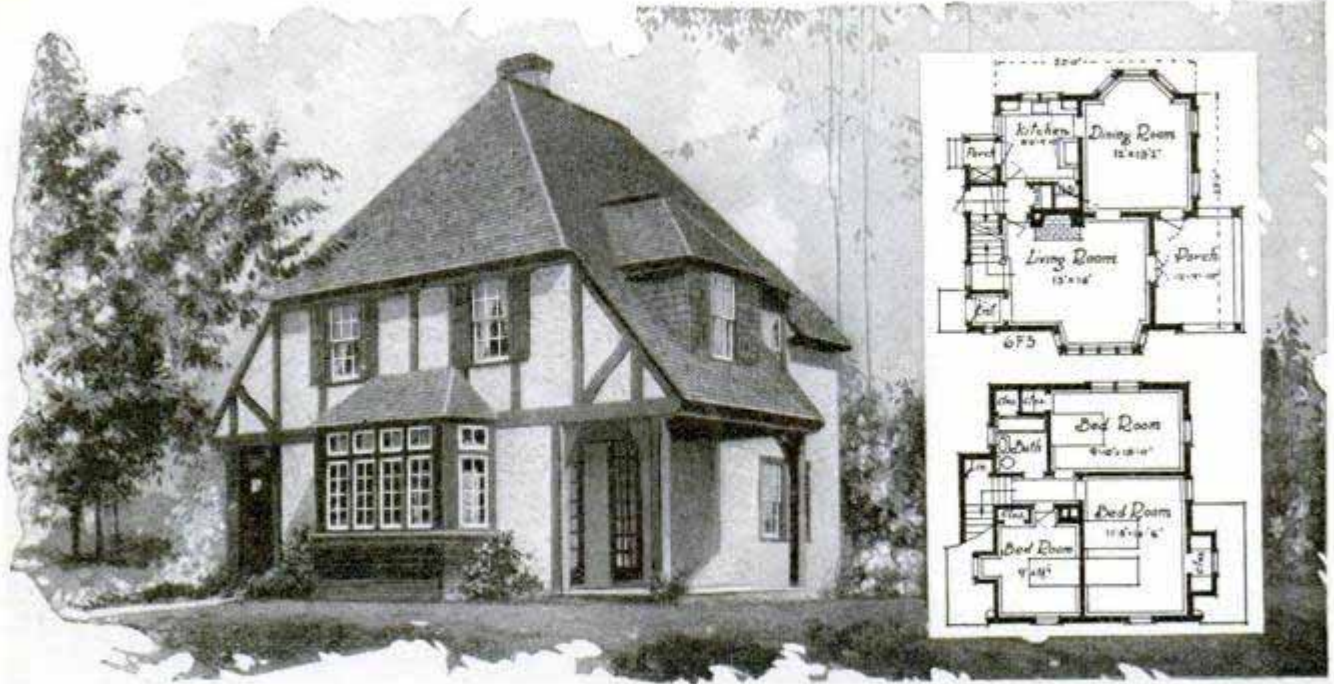

Copyright, Architects' Small House Service Bureau

Plan No. 6F5

**Q**UESTIONS regarding home building addressed to this magazine will be answered by The Architects' Small House Service Bureau of the United States, Inc., controlled by the American Institute of Architects and endorsed by the United States department of commerce. Inclose 10c and self-addressed envelope. Blueprints, specifications and material list for the house shown here may be obtained at nominal cost. Inclose self-addressed stamped envelope for reply. If further information is desired, send 5c and stamped envelope for a 24-page booklet explaining how the Small House Service Bureau functions and showing 12 sample plans. A new booklet, entitled "Fifty Ways to Lower Home Building Costs," illustrated by ten bureau houses actually lived in, and showing how as much as \$1,000 can be saved on a home, may be obtained for 20 cents.

**A**N English type of home of stucco and timbers is shown here. It has six rooms, large porch, inclosed rear porch, bath and seven closets. The entrance is at the side through a small vestibule to the living room. In the latter and in the dining room bay windows add to the charm, and French doors lead to the porch.

The kitchen is efficiently planned and has the sink under two windows. A good closet for pots and pans will be appreciated by the housewife.

Perhaps in our home building we have borrowed more from our English cousins than we have from any other people. Certainly we are indebted to the English for much of the tradition of our home design. One of the most characteristic things of all about English architecture, especially in respect to smaller homes, is its unassuming character. It does not project up into the sky with bold effront. The tendency always is to bring the roof close to the ground; to make the breadth of the

house more apparent than its height. In the design illustrated here these characteristics have been skillfully worked out.

The timber-and-plaster effect is graceful. The heavy wooden shutters at the openings are in keeping with the timber design. The two large bay windows are light and airy with much glass and little construction in evidence. The roof breaks down low to the level of the second story, but through skillful adaptation of the roof to the plan, the second-story rooms are all well lighted.

Another detail that is characteristic of English domestic architecture is the use of the bay or oriel window by means of which a number of rather large windows are grouped together. The effect thus gained is an extremely graceful one.

The house is of frame construction with exterior finish of "timbers" and stucco on metal lath, and its dimensions are twenty-five by thirty feet and the lot should be forty feet wide.



# a glance shows whether on ratchet or rigid

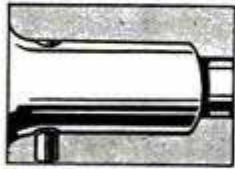

Shifter position  
(down) for right-  
hand ratchet.

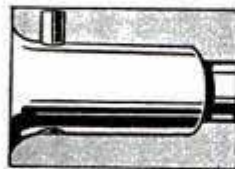

Shifter position  
(up) for left-hand  
ratchet.

With the "YANKEE" Bit-brace you do not have to try the tool this way and that to find out *which way* the ratchet is set.

A glance tells the story: with *ratchet shifter* centered, the brace is rigid. When shifter is down, the brace is on right-hand ratchet; when up, left-hand ratchet.

You change the ratchet adjustment at a fingertouch—and you see what you are doing!

The "Yankee" Ratchet is famous for its easy action. Smooth, silent, powerful! Chuck is quick centering, accurate and will not loosen in work. Hard Rubber Handles do not warp, shrink, crack nor bind.

Try the "Yankee" Brace at your hardware dealer's. You will see the economy of owning the finest tool of its kind. Ask him to show you the new "Yankee" Bit Extension.

## Some Other "Yankee" Tools

Spiral Screw-drivers	Automatic Feed Bench Drills
Plain Screw-drivers	Ratchet Tap Wrenches
Automatic Push Drills	Vises—Removable Base
Ratchet Breast and Hand Drills	

Dealers Everywhere Sell "YANKEE" Tools.

"Yankee" on the tool you buy means the utmost in quality, efficiency and durability.

NORTH BROS. MFG. Co.,  
Philadelphia, U. S. A.

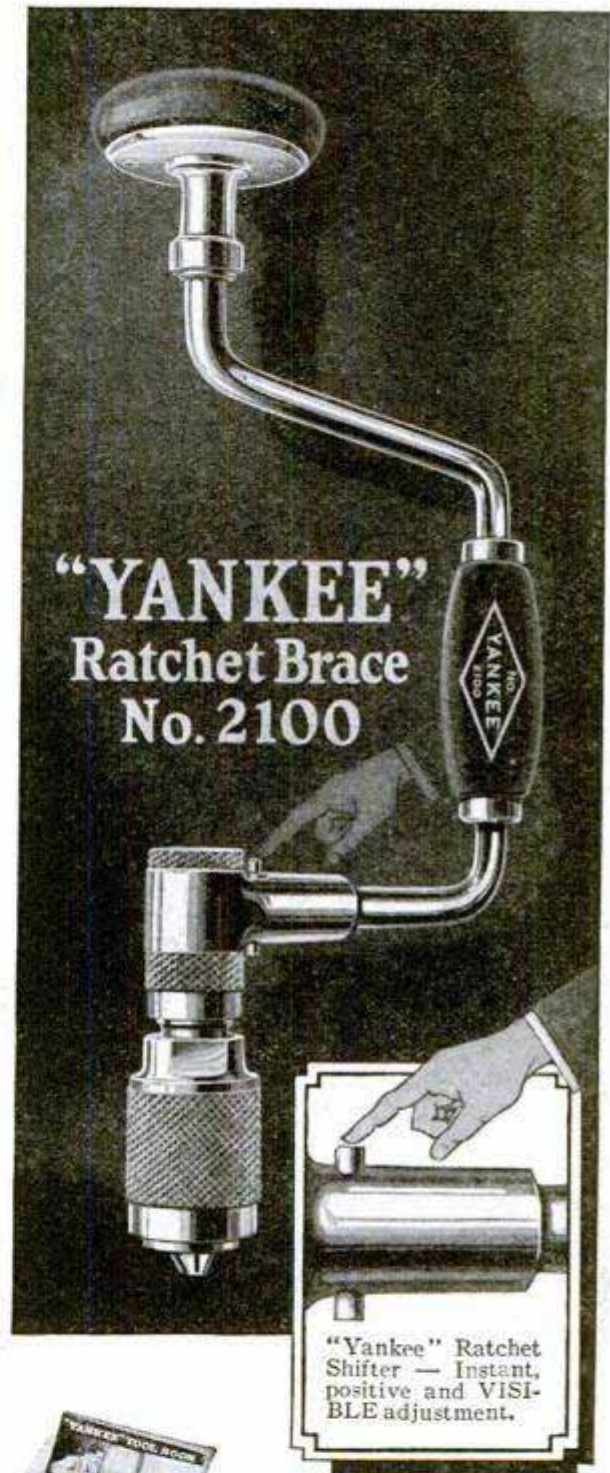

## FREE

New "Yankee" Tool Book

This interesting little book is for all lovers of fine tools. It tells just what you want to know about all the famous "YANKEE" Tools for making work easier and quicker.

# "YANKEE" TOOLS

*Make Better mechanics*



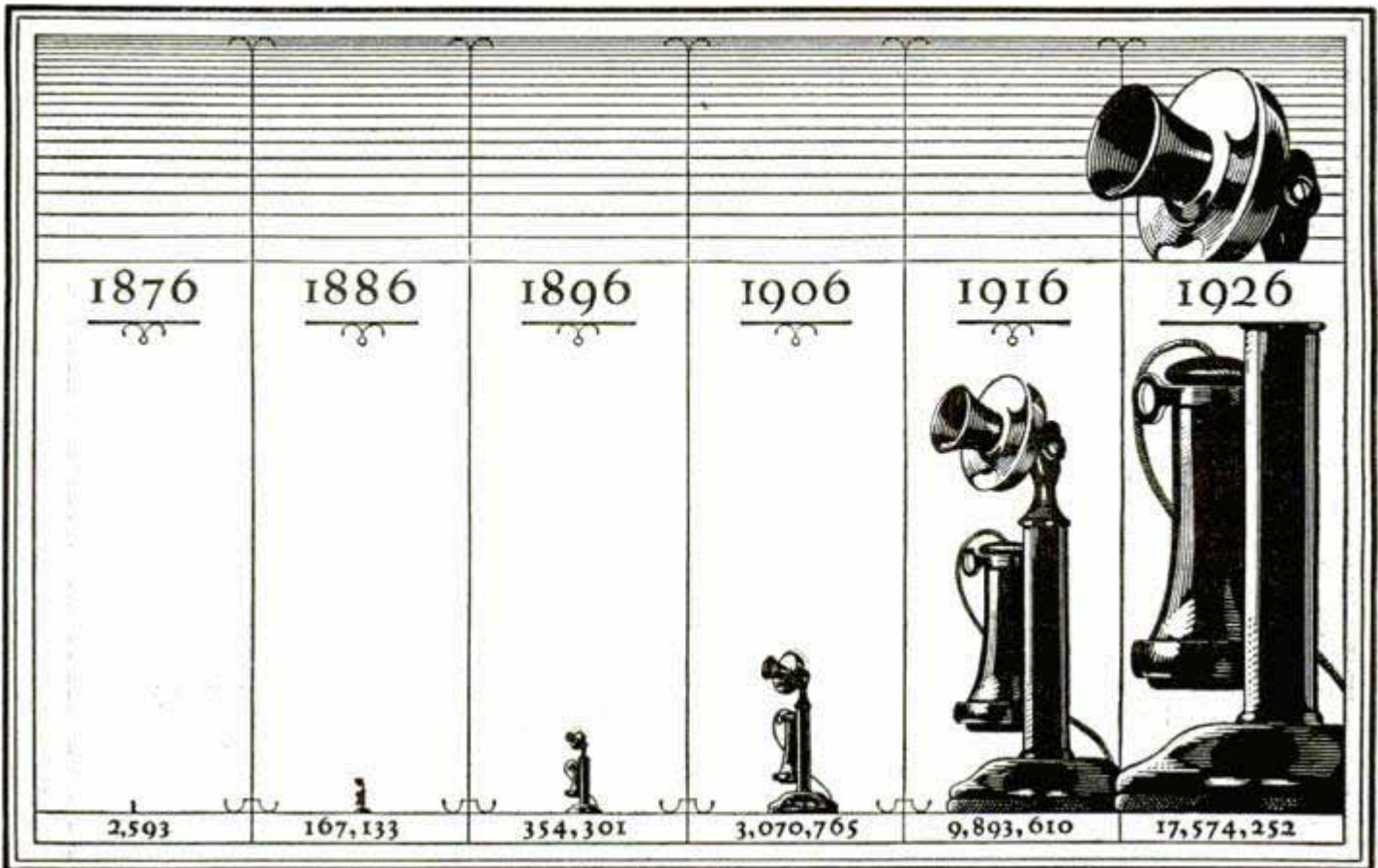

## Milestones in National Service

*An Advertisement of  
the American Telephone and Telegraph Company*

THERE are twenty-five Bell companies but only one Bell System—and one Bell aim and ideal, stated by President Walter S. Gifford as:

“A telephone service for this nation, so far as humanly possible free from imperfections, errors or delays, and enabling anyone anywhere at any time to pick up a telephone and talk to anyone else anywhere else in this country, clearly, quickly and at a reasonable cost.”

The past year brought the service of the Bell Telephone System measurably nearer that goal. Seven hundred and eighty-one thousand telephones were added to the System—bringing the total number interconnected in and with the Bell to more than



seventeen and a half million. The number of applications waiting for service, including those in new and outlying sections, was reduced fifty per cent.

A third transcontinental telephone line was completed to the Pacific coast.

The largest number of miles of toll wire for one year was added to the System—more than 664,000 miles.

The average length of time for completing toll calls throughout the System was lowered by thirty-five seconds.

A seven per cent improvement over the previous year was made in the quality of voice transmission in toll calls.

An adjustment was made in long distance rates amounting to a reduction of about \$3,000,000 annually.





# Automobiles have improved *but* *what about gasoline?*



It is a far cry from the "horseless buggy" of yesterday to the automobile of today. But the first cars and the latest cars are alike in one fundamental respect: *both depend on gasoline for fuel.*

Gasoline is not a perfect fuel. It has always had one inherent fault. It explodes too quickly ("knocks") as temperature and compression increase.

Carbon increases both temperature and compression beyond the point at which the present day automobile is designed to operate efficiently on regular gasoline. And the full efficiency of the modern motor car and its continued development have both depended upon the discovery of a "knockless" fuel.

After eight years of experiment, General Motors Research Laboratories developed Ethyl brand of anti-knock compound, a chemical ingredient which leading oil companies are mixing with their regular gasoline to form *Ethyl Gasoline*.

Ethyl Gasoline is *the* efficient fuel for automobiles of today and tomorrow. This super-gasoline will give your engine a performance such as you have never known. It is available throughout the United States and Canada and is sold at pumps which display the "ETHYL" trademark. Try it today.

ETHYL GASOLINE CORPORATION, 25 Broadway, New York

## ETHYL GASOLINE





# On making a House into a Home



## Make a Garden Trellis from Plan No. 22d

**A** HOME is what *you* make it. It starts as a bare house on a plot of ground. Then some one sets out shrubs. The first skimpy grass develops into a rich green lawn. Vines—either plain or flowering have turned many a house into a *home*. Have you ever thought of building a garden trellis? It is comparatively simple when you have Stanley Plan No. 22d to help you.



But did you ever think of this? The occasional user of tools needs good ones even more than the professional. For good tools are a real encouragement to good work.

You can buy Stanley Tools separately and so collect your own set. For your convenience in buying there are also complete sets of Stanley Tools in chests at a wide variety of prices from \$15 to \$95. Or there are assortments in strong cardboard boxes containing directions for making your own tool chest. Priced from \$5 to \$20.



Your hardware dealer has Plan No. 22d as well as other Stanley Plans for making useful articles, or he can get them for you. The plans cost only 10c each. Ask him, also, for small Catalog No. Sd50, which shows many useful Stanley Tools. It is free. If he cannot supply you write to The Stanley Works, New Britain, Conn.

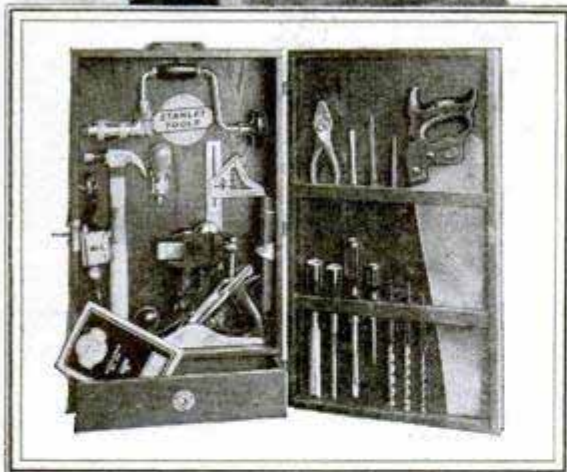

Buy separately or in assortments

The best tools are the  
cheapest to use  
Ask your hardware dealer



# STANLEY TOOLS



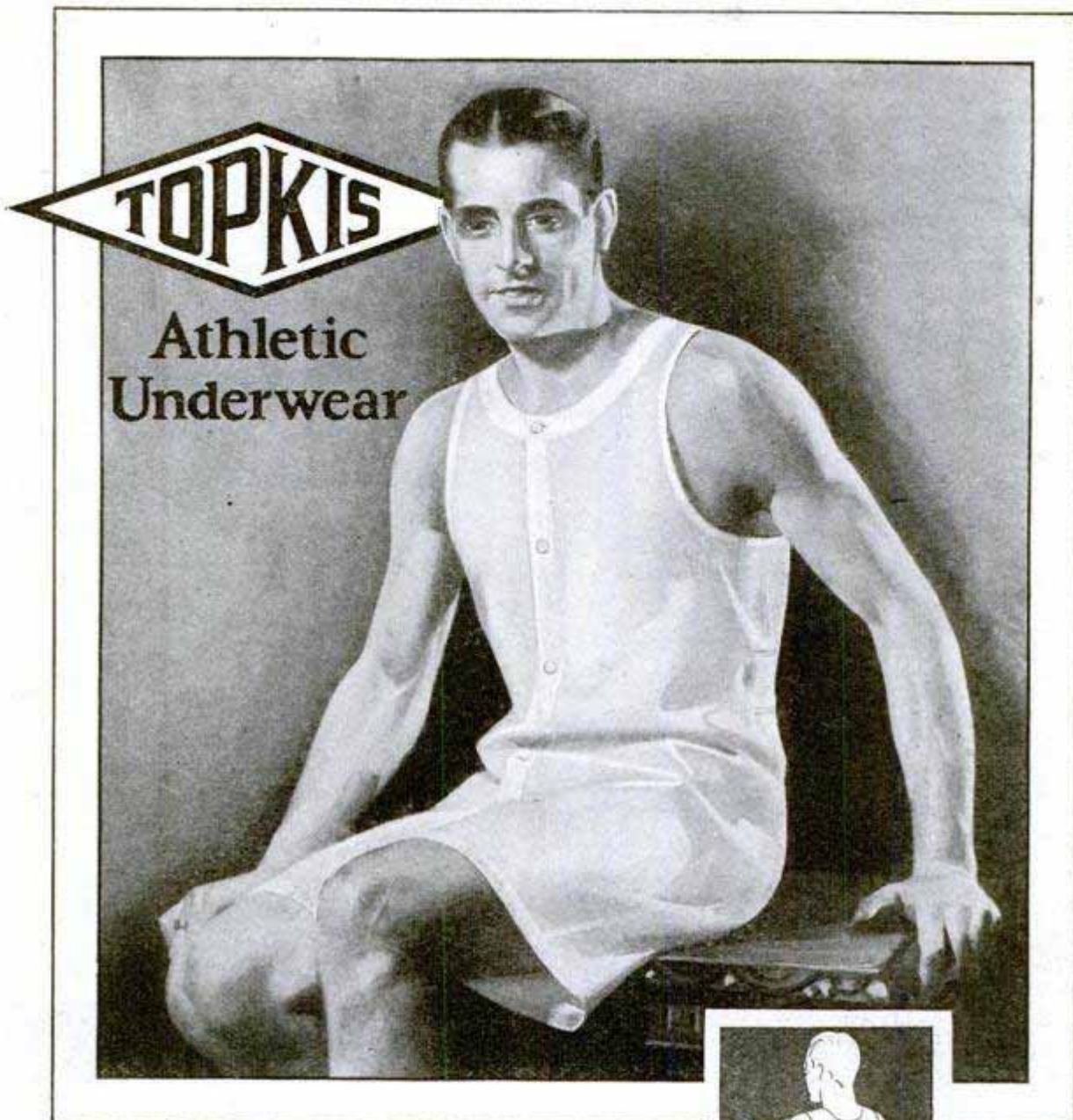

Say "Topkis"!  
pay One Dollar



#### Reinforced Back

The seams at waistline are made unbreakable, by the Topkis Flat-lock stitch of nine threads instead of one.

**C**OMFORT comes first; then price. You can settle both, when you buy union suits, by saying "Topkis". This name means the right design for an athletic union suit; fit and comfort, fine fabric, expert tailor-

ing and finish; long wear . . . All the satisfaction a man can take in fine underwear! And all for the Dollar Price!—because Topkis sells by the millions. Ask your dealer for Dollar Topkis.

*Fine, durable fabrics: Fancy madras, plain madras, white or color stripe, silk stripes, mercerized crepe, pajama check.*

*Write us for free illustrated booklet*

**TOPKIS BROTHERS COMPANY, Wilmington, Del.**  
General Sales Offices: 93 Worth Street, at Broadway, New York

*Men's Union Suits, \$1; Shirts and Drawers, 75c each. Boys' Union Suits, 75c. Children's Waist Union Suits, 50c and 75c. In Canada, Men's Union Suits, \$1.50.*



## IF YOU CAN USE AN EXTRA \$20<sup>00</sup> BILL

write for  
this

# FREE BOOK

You can save \$20.00 in  
no time by using

### SMOOTH-ON No. 1

to do your own house-  
hold repairing—and in addition you will  
have that proud "I-did-it-myself" feeling.

Here is what one enthusiast did with two 35-cent cans:—A \$25 lamp stand loose in base, two big leaks in heating furnace smoke pipe, loose hammer handle, and three loose hooks in tiled bath room wall were all put into good usable condition at an average cost of 10 cents each for the seven repairs—and \$20.00 easily saved over what would have been paid to professional fixers or for new parts.

By using Smooth-On to make dozens of the simple repairs necessary in every home, you can save enough to pay your radio upkeep, buy yourself or your wife a camera, a bull pup or some other pleasure-giving article that you would otherwise hate to spend the money for.

The Free Smooth-On Repair Book will show you how an astonishing number of home and automobile repairs are as easy for you to make as for somebody else.



Mail the coupon for a free copy and get Smooth-On No. 1 in 7-ounce or 1 or 5-pound can from any hardware store.

**SMOOTH-ON MFG. CO.**  
Dept. 37, 574 Communipaw Ave.  
JERSEY CITY, N. J.

Do it with **SMOOTH-ON**

SMOOTH-ON MFG. CO., Dept. 37,  
574 Communipaw Ave., Jersey City, N. J.

Please send the free Smooth-On Repair Book.

Name.....

Address.....

Return this coupon for a  
**FREE** copy of Booklet

How to make  
HOME & AUTOMOBILE  
REPAIRS



Do it with  
**SMOOTH-ON**



Licensed by  
Technidyne  
Corp. under  
U. S. Patent  
No. 1593658,  
July 27, 1926.

It's  
Here!

# Tonatrol

A True Tone and Volume Control

A GAIN Electrad, Inc. comes forth  
with a new and highly perfected  
aid for efficient radio operation.

This time it is TONATROL, a true  
tone and volume control which enables  
you to regulate volume smoothly from  
a soft whisper to the most powerful  
tones.

TONATROL improves the appearance  
of any receiver as it is neat in design  
and made of genuine bakelite. Very  
easy to install.

PRICE \$1.50

Tonatrol—Standard Volume Control, \$1.50  
Tonatrol—Type W. S. (with filament switch), \$2.00  
Write for free installation booklet for the cor-  
rect way to control volume.

At your dealer's  
Dept. 66, 175 Varick Street  
NEW YORK, N. Y.

## ELECTRAD

## RADIO DEALERS' CATALOG—FREE!

A most complete catalog of everything in Radio. All the  
latest hook-ups. Sets, Parts and Kits of every description.  
Live Dealers need this book. Write on your business  
stationery.

COLUMBIA RADIO CORP., 711 W. Lake St., Dept. 244, CHICAGO, ILL.



### FOY'S BIG BOOK, in Colors

A complete guide to successful Poultry and  
Squab Raising. Low prices on CHICKS,  
Breeding Stock and PIGEONS.

Write Today! FREE!

FRANK FOY, Box 18, Clinton, Iowa



Enjoy a Big Powerful Radio: **30 Days**

**FREE!**

MIRACO  
Ultra



27 in. long

MIRACO  
RADIO  
GETS 'EM  
COAST to  
COAST

Users everywhere report it gets  
Coast to Coast, Canada to Mexico, loud and clear  
on speaker; outperforms \$100 to \$200 sets. Some  
hear Europe. Marvelous bargain! Don't buy unless  
30 Days Trial proves it Most Selective, Clearest  
and Most Powerful Distance-Getter among big,  
fine 5-tube radios. Retail LIST price, now \$49.75.

**Factory Prices—SAVE Up to 1/2**

Every set completely assembled, rigidly tested,  
fully guaranteed. Single Dial Sets, Speakers, bat-  
teries, tubes, etc., at big savings.

literature, users' testimony  
and BIG SPECIAL OFFER

**Free** MIDWEST RADIO CORPORATION  
Pioneer Builders of Sets

Send for Proof 407-C Miraco Bldg., Cincinnati, O.

USER-  
AGENTS  
WANTED  
Write for  
discounts



# Pin a Dollar

to this Coupon and get the Famous  
\$350 Rain King Sprinkler

**SEND THIS**

Chicago Flexible Shaft Co.  
5546 West Roosevelt Road  
Chicago, Ill.

Send me the following on approval, postpaid:

Rain King Sprinkler at \$3.50 (Denver and West \$3.75).

Rain King Hose Nozzle at \$1.50 each.

I enclose one dollar (check, currency or money order) and agree to pay postman the balance on delivery or return the articles ordered; you to refund all money enclosed.

Name.....

Address.....

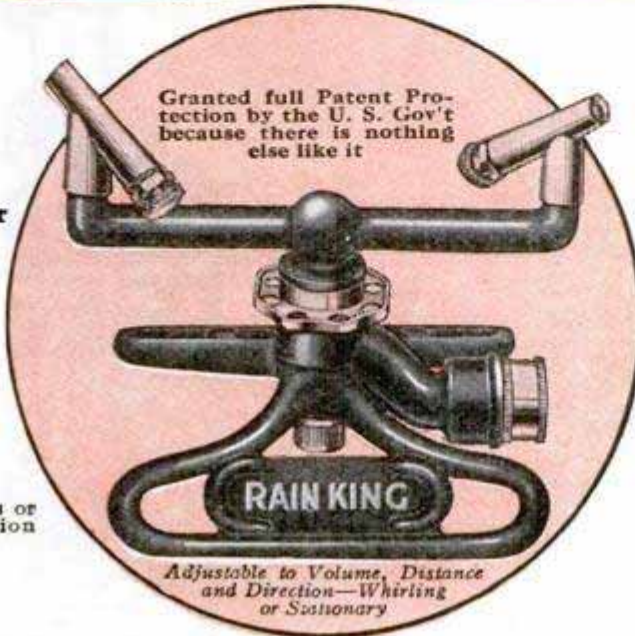

Granted full Patent Protection by the U. S. Gov't because there is nothing else like it

**A One-Time Offer**  
Offer limited to the first 10,000 orders. So rain or shine, don't put off or you'll regret it when the first dry spell comes along.

Plays in circles or in any direction you set it.

Adjustable to Volume, Distance and Direction—Whirling or Stationary

Any Distance, Direction or Volume of Water You Want All From This One Rain King, Whirling or Stationary.



1 Revolving Spray for Lawn or Garden



2 Coarse Jet (left) for Trees—Fine Mist (right) on Seeded Beds. Stationary position



3 Coarse Sprays from both nozzles on Trees and Shrubs. Stationary position



4 Coarse Spray (Stationary position) nozzles adjusted to sprinkle long strip

## Throws Every Known Stream and Throws it Farther

Than any other Sprinkler on the same pressure

Solid Jets, Gentle Spray, Drenching Downpour, Rainbow Mist

Water wide areas, small circles, long narrow strips like parkways, plant beds or hard-to-reach angles—the powerful Rain King Sprinkler will throw any stream or spray you want right in the places you want it! Simply adjust the two nozzles and turn a set-wheel.

Grass, flowers, shrubs, trees or seeded beds—Rain King will water each kind of growth with precisely the jet, stream, spray or mist-cloud the situation demands.

All through the hot, dry, withering days of summer, this remarkable creation will keep your Lawn and Garden as fresh and fragrant as Maytime! It gives such a beautiful play to water that many compare it to an ornamental fountain.

Brass nozzles, bronze bearings, simple, strong and as smooth running as a fly-wheel

—a sprinkler that will weather the hardest kind of usage, and last till the end of your days.

One Rain King will take care of the average yard. But large places, estates, parks and golf courses should order more.

Pin your check, money order or dollar bill to the coupon and send by the next mail, RAIN or SHINE—for this one-time offer is limited to the first 10,000 Rain Kings ordered—that's all we have left for the rest of this season.

On arrival of this remarkable sprinkler pay the postman the balance, \$2.50, [Denver and West \$2.75]. Your money back if you're willing to part with your Rain King then. We pay carrying charges. Send now and be sure of a Rain King.

### Here's the only Hose Nozzle of its kind on earth!

Full Stream-to-Spray-to-Shut-Off by a Quarter of a Turn!

Throws more water a greater distance than any other hose nozzle known

In one year, the Rain King Hose Nozzle—an entirely new principle—has fairly captured America. Thousands already in use around the yard, house, garage, and factory—for

sprinkling, washing windows, and porches, motor cars, cement floors, walks—for anything and everything that can be done with a nozzle.

A scientific discovery in which a cross-cut bore takes the place of the complicated mechanisms found in other hose nozzles. Only 4 pieces—nothing to lose, get out of order or wear out. Leakproof and guaranteed for life. Worth a dozen others, yet only \$1.50 postpaid. Pin a dollar, check or money order to the coupon and send today; pay postman 50c balance on delivery.







# Wood In A Can

~ may be sawed and worked with tools!

PLASTIC WOOD handles like putty as it comes from the can. It hardens on exposure to air into watertight wood which takes paint, stain, lacquer and varnish like any wood.

Use PLASTIC WOOD wherever wood needs replacing. Use it in boat construction, for repairing furniture in cabinet work—in fact in any woodworking job.

Sold by Hardware and Paint Dealers— $\frac{1}{4}$  lb., 35c; one pound, \$1.00. Send coupon if they cannot supply you.

Addison-Leslie Co.  
40 Bollar Street, Canton, Mass.  
Please send me a trial quantity of PLASTIC WOOD for which I enclose 35c.

Name.....  
Address.....  
Name and address of Hardware Dealer.....

**\$5.00**  
**DOWN**  
buys a

# WITTE Engine

Write Me Today—for new FREE Witte Book telling how you can buy a WITTE Engine for ONLY \$5.00 Down and small EASY Payments. No interest. Absolutely the greatest engine made. Guaranteed for a lifetime. Used all over the world—from the frozen wastes of Alaska to the burning sands of Arabia. Will increase your farm profits \$500.00 to \$1,000.00 a year. Runs on all fuels. Simple, sturdy. Gives most power at least expense. Sizes  $1\frac{1}{2}$  to 30 H. P. Engines; also 3-in-1 Saw Rigs and Pump Outfits. Write me today for FREE book and Easy Terms Offer.

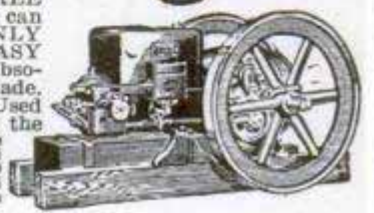

**Witte Engine Works**  
174-B Witte Bldg., Kansas City, Mo.  
174-B Empire Bldg., Pittsburg, Pa.

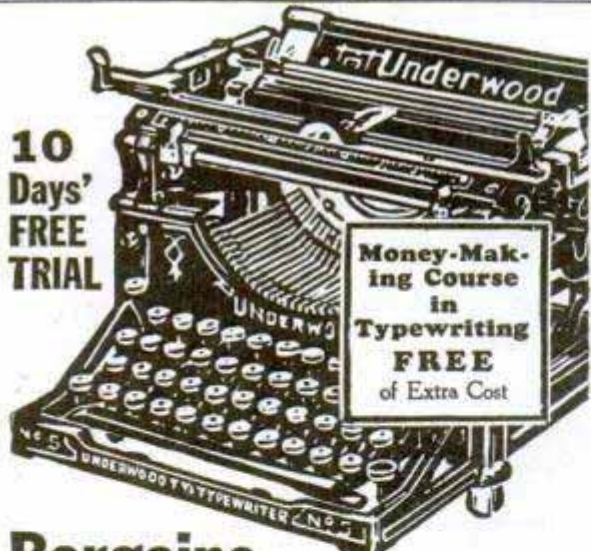

**10 Days' FREE TRIAL**

**Money-Making Course in Typewriting FREE of Extra Cost**

## Bargains in TYPEWRITERS

No excuse now not to own your favorite typewriter, when you see the new prices of these Young remanufactured machines. Save 40 to 60%. Typewriters good as new, guaranteed 5 years. 10 days' trial at home, free. Free instruction to purchasers. Latest models, standard keyboards. Write Typewriter Headquarters today for catalog and our free trial, pay-like-rent proposition.

Mail a postcard now!

**Young Typewriter Co.** 654 West Randolph Street Dept. 1107 CHICAGO  
Typewriter Headquarters



## Auto Owners Wanted

To Introduce and Use **HYDRO Insured TIRES**. Hydro Agents make money selling the only Tires in the World insured for One Year against all road hazards regardless of mileage. **HYDRO TIRES** sell fast because they have no competition in price; no rival in quality; no imitation in appearance and no equal in the insured. Protection to the user. Insurance Policy with every tire. Are made by the only tire factory in America selling its own product through authorized Salesmen-Agents. We offer opportunity of lifetime to establish profitable tire business of your own. **No capital required.** Sales kit and advertising helps furnished. Exclusive territory granted. Write today for catalog and complete information about the Hydro Agency Plan.

**HYDRO Insured TIRES**  
"The Most Beautiful Tire in America"

Address nearest branch  
**Dept. 59, HYDRO-UNITED TIRE CORP.**  
Pottstown, Pa. Millersburg, O. Chicago, Ill.

## MOVIES AT HOME

Many models of genuine MOVIE MACHINES, some as low as \$3.75, all using standard size big theatre films. Our stock of films is the most complete and lowest in price—with an exchange service. Films of leading stars and religious subjects are available. **DON'T DELAY. WRITE FOR FREE INTERESTING CATALOGUE NOW!**



**PARAMOUNT MFG. CO.**  
Dept. 1371 BOSTON, MASS.

## 30 Days' Free Trial on all MEAD Bicycles

Select from 44 styles, colors and sizes. You can easily save \$10 to \$25 on your bicycle. Prices \$21.50 and up.

**Factory to Rider** Do business direct with the makers. We ship on approval for a month's free trial. Rider Agents make big money. best quality, at factory prices. Lamps, wheels and equipment, low prices. **Send No Money.** do business direct with makers.



**Mead CYCLE COMPANY**  
DEPT. K-110 CHICAGO

Write today for free Catalog, factory prices and marvelous new offer.



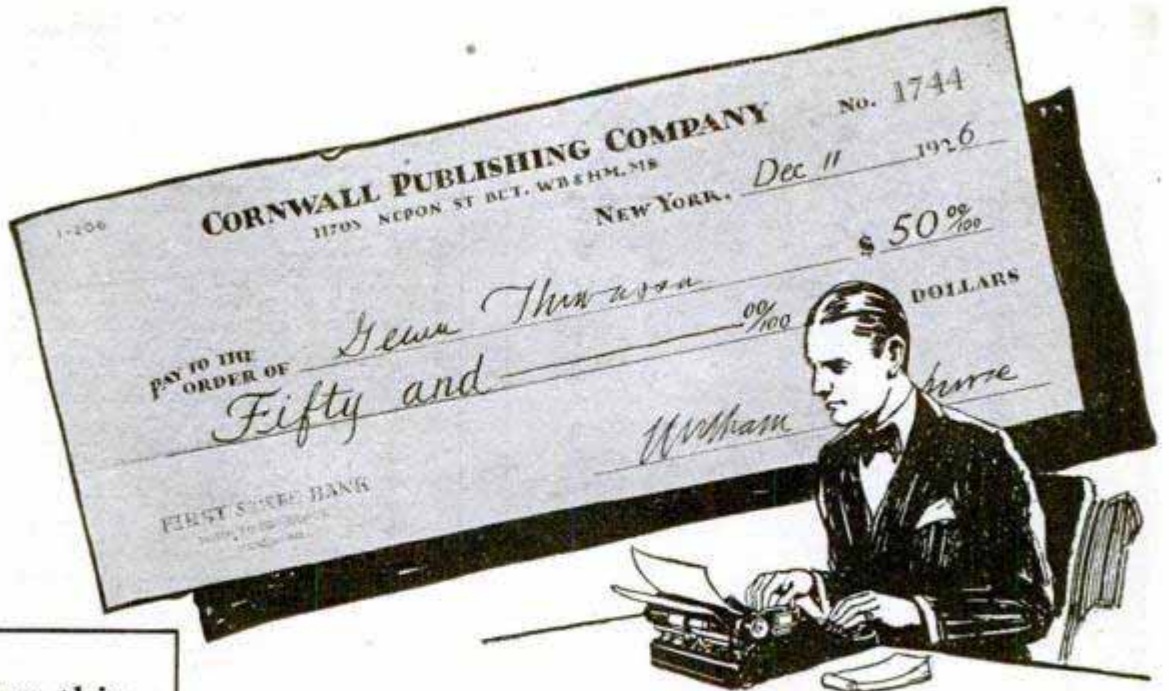

**You can own this latest model Corona**

It's the finest Corona ever built—made by the world's pioneer manufacturers of portable typewriters.

A sturdy, dependable writing machine with full width (10inch) carriage, twelve yard, two color, self-reversing ribbon, variable line spacer, everything you expect in an office machine. Yet it is compact, portable, easy to carry with you wherever you go.

**Standard Keyboard**

Corona has the four row standard keyboard used in all offices and taught in business schools. If you are accustomed to using a large machine, you will be at home on Corona. If you have never used a typewriter before, you'll find that it is easy to learn with Corona.

**Buy a Corona on easy terms**

A small deposit puts Corona in your home and then you can pay on easy, monthly terms just like rent. Your Corona dealer will gladly accept a used typewriter, any standard make, as part payment. You need not wait another day. Just look up Corona in your phone book and the dealer will send you one for free examination.

The coupon will bring you our latest literature.



**\$50 for two hours' work with CORONA**

Extra money is so easily earned if you have the knack of writing articles or stories. Here is a man who often earns \$50 or more in a single evening, writing articles about his own business.

Many people have this talent for writing but have never done anything to develop it.

There's just one way to start. Get a Corona and our new book of instruction for writers. Then begin to write a little every day.

**Why successful writers use Corona**

Corona is compact, portable, easy to carry anywhere—and its light, easy touch makes writing almost effortless. You'll do more writing—and better writing—when you own your own Personal Writing Machine. Mail the coupon. It will not obligate you.

**L C Smith & Corona Typewriters Inc**

Sales offices in principal cities of the world  
Established 1903

Also manufacturers of the L C Smith Typewriter, the Ball-Bearing Office Machine

L C Smith & Corona Typewriters Inc  
712 E. Washington St., Syracuse, N. Y.

Without obligation to me, please send me a free copy of The Writer's Guide—and complete information about Corona.

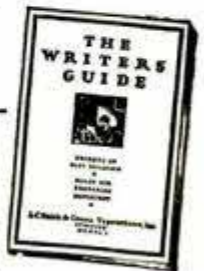

Name .....

Address .....

I own a ..... typewriter. I should like to know its trade-in value.





## Pocket Ben

for the man  
on the job!

**T**HE man on the job wants to know the truth about the time.

He needs a sturdy, steady watch—an accurate time-keeper that will stand rough-and-tumble everyday use.

Pocket Ben is that kind. Sold everywhere for \$1.50. With luminous night-and-day dial, \$2.25.

WESTERN CLOCK COMPANY  
La Salle, Illinois

## 30 DAYS FREE TRIAL 7 Tube-Single Dial RADIO SET

Write TODAY for This Wonderful Offer Direct from

Factory! World's greatest radio. Perfect working, single dial control, 7-tube receiver, shipped to your home for 30 days' free trial. Test it for distance, volume and tonal quality—and if you are not convinced that it is the best single dial set you ever heard, return it to factory.

### Metrodyne Super-Seven

Only one dial tunes in all stations. Get 1,000 to 3,000 miles on loud speaker. Easiest set to operate. Highest grade parts used. Magnificent Two-tone Walnut Cabinet.

#### Big Profits to Agents and Dealers

selling Metrodyne radios. All or part time. Great money making opportunity. Demonstrating set on 30 days' free trial. **WRITE FOR OUR OFFER.**

**METRO ELECTRIC CO.**

2161 N. California Ave., Dept. 14A CHICAGO, ILLINOIS

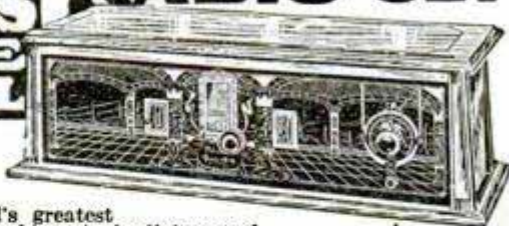

Retail Price

**\$75**

Completely Assembled

## RADIO AT HALF USUAL COST

Now—we give 30 Days' Free Trial on newest 5-tube—ONE DIAL—Coast to Coast Radio. Buy direct from factory—save half and get 2 year guarantee. Full line table type, consoles or complete outfits at prices that will surprise you. Over 15,000 satisfied owners. Don't buy any Radio until you write us for FREE Catalog, low prices and 30 Day Trial offer.

**Westingale Electric Co.,** 1759 Belmont Ave. CHICAGO

## SET BUILDERS!

Before you build get our special prices on the parts you are planning to use. We'll save you money. Largest and most complete stock in U. S. A.

**CHICAGO SALVAGE STOCK STORE**  
Dept. P. M. 509 S. State St., Chicago, Ill.



**BURGESS  
RADIO  
BATTERIES**

## RADIO PANELS OF GENUINE BAKELITE

Cut, drilled and engraved to order. Send rough sketch for estimate. Our complete Catalog on Panels, Tubes and Rods—all genuine Bakelite—mailed on request.

**STARRETT MFG. CO.** 524 S. Green St. Chicago, Ill.

## SOLDERALL METAL IN PASTE FORM



The only convenient metal solder

Every Electrical Connection needs Solderall for perfect reception

**25¢**

The SOLDERALL CO., NEWARK, N.J.



# Crowd *this* summer with real sport!

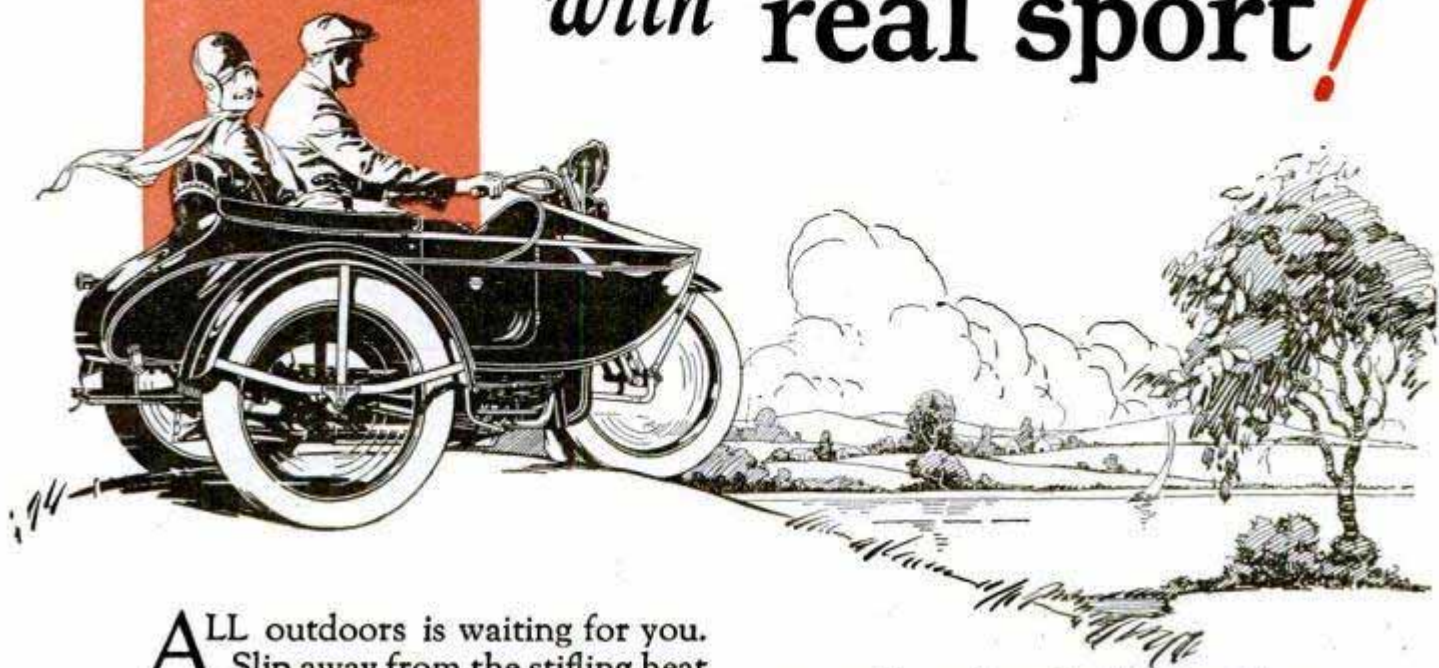

**A**LL outdoors is waiting for you. Slip away from the stifling heat and everyday scenes. A fishing trip for a day or a week! A jaunt over long stretches of country road! A spin through the fresh night air! Happy hours on the golf course — at the beach — or a couple of weeks of glorious, carefree vacation!

Enjoy yourself this summer as you never have before. Know the thrill that comes with the proud

ownership of a Harley-Davidson Twin. This trim, good looking mount—sturdily built and dependable under any conditions — costs only 2 cents per mile for gas, oil, tires and all! Plenty of room in the sidecar for a friend and your outfit. Prices as low as \$310 f. o. b. factory — on easy Pay-As-You-Ride terms. See your Harley-Davidson dealer — send coupon for catalog.

HARLEY-DAVIDSON MOTOR COMPANY  
Department P  
Milwaukee, Wisconsin

## HARLEY-DAVIDSON *Motorcycles*



The Single is the famous Harley-Davidson solo mount — 80 miles per gallon! Price \$235 f.o.b. factory.

*Mail  
the  
Coupon*

HARLEY-DAVIDSON MOTOR COMPANY  
Dept. P, Milwaukee, Wisconsin  
Interested in Twin  Single   
Send illustrated catalog.

Name \_\_\_\_\_  
Address \_\_\_\_\_





*Keds help build well-formed, vigorous feet.*

## A soldier is only as good as his feet—

**M**ORE men were rejected by Army Draft Boards for imperfect feet than for any other cause!

In the West ill-fitting shoes worn in youth had caused foot troubles so widespread that as high as one out of every four men was affected.

But in the South where boys' shoes are more often light and roomy, very few men—sometimes only one in twenty—had serious foot defects.

That is why many athletic coaches, trainers and physicians recommend that boys wear Keds.

For Keds give almost barefoot freedom yet they protect against barefoot dangers.

### *Keds—the Shoe of Champions*

And of course Keds are ideal for sports, on turf, cinder track or gym floor. They are worn by more champions, by more school teams than any other brand of shoe.

They cost from \$1.25 to \$4.50 according to the style you select. Keds are made only by the

**United States Rubber Company**

*They are not Keds unless the name Keds is on the shoe . .*



**THE "CONQUEST"**  
A Keds model with vulcanized crepe rubber sole. White or brown lace-to-toe style.

# GOOD TUBES DESERVE

Nothing else will do—to insure self-adjusting filament control, utmost tube performance, longest tube life. Insist on Amperite. Eliminates hand rheostats. Simplifies wiring. Price \$1.10 complete. Sold everywhere. Write for Free Radiall



Book giving season's popular hook-ups and construction data to Dept. P. M. 7.

**RADIALL COMPANY**  
50 Franklin St.  
New York

## AMPERITE

REG. U.S. PAT. OFF.  
The "SELF-ADJUSTING" Rheostat



THIS 100 PAGE  
**RADIO CATALOG**  
**FREE**

Contains "Hook Ups"  
5 Radio Illustrations  
500 Over 1,000  
Articles

"Build your own with 'RASCAL' Parts"  
RADIO SPECIALTY CO., 98 E Park Place, New York, N. Y.

## FREE RADIO MAP

Size 23 x 33 inches with rule for measuring distances. List of radio stations, with call letters, and wave length, FREE if you send us names and addresses of five friends who have radios and what kind.  
A. A. VIKING, 124 W. Austin Ave., Chicago

For Better Filament Control on your radio set use the **NEW Lynch EQUALIZOR** in place of rheostats. \$1 complete with mounting. At your dealer's or post-paid. Money back if dissatisfied. In ordering, state number and types of tubes in your receiver. **ARTHUR H. LYNCH, Inc., Manufacturers of the Lynch Metallized Resistor, 250 West 57th Street, NEW YORK, N. Y.**

**Fansteel Products Company, Inc.**  
North Chicago, Illinois

**EVEREADY RADIO BATTERIES**  
are manufactured and guaranteed by  
**NATIONAL CARBON CO., INC.**  
New York Chicago San Francisco  
Atlanta Kansas City



### HOLLAND PRINTS

Wonderful new way of binding kodak pictures. Keep a photographic record. Sample Holland print from your negative for 10c.  
FRANK SCOBIE, 43-B, SLEEPY EYE, MINN.

## MOTORCYCLES

Price \$10 and up purchased through our Co-Operative Plan for as low as \$1.00 down and \$1.00 per week  
**Indians Harley-Davidsons Ace Henderson and Clevelands**

Send ten cents for Bulletin A.  
Motorcycles shipped to all parts of the world  
**WALKER-INDIAN CO., 188 Mass. Ave., BOSTON**





# THIS COUPON <sup>is</sup> VALUABLE

## NOW IS THE TIME TO GET YOUR TYPEWRITER!

Be up-to-date—know the pleasure and convenience of having one in your home. You'll be amazed at the uses everyone in your household will find for this real Underwood typewriter. Every member of the family will use and enjoy it! Don't send a cent—but do get our big special offer—our valuable book on typewriters and typewriting—FREE.

### Any One Can Learn to Operate a Typewriter!

You can learn to write on this standard-keyboard machine in one day; it's so simple that even a child can use it. A week after the expressman has brought it, you'd feel LOST without it. A trial will PROVE it—and doesn't cost you a penny!

### SPECIAL FREE TRIAL OFFER

We don't want a penny now. Nor any money at all unless this proves the typewriter bargain of your life. The trial is FREE. If you buy, our easy terms make it a pleasure to pay. There's no excuse now, for not owning a typewriter—and the finest make! We include all tools, a cover, etc., all complete, all ready to write. Write us now. Deal direct; we are the largest factory of the kind.

Our plan gives you the opportunity of a thorough trial before you buy. You run no risk whatever. You start to pay for your typewriter AFTER you have found it the only machine for you! But get the facts before this lot of machines is all in use. Clip the information coupon before you turn the page. It will pay you! Note the very useful book you will receive free! Write for full particulars at once.

### The Greatest Typewriter Offer Ever Made

If you know typewriters, you know the perfect work and the ease and speed of a Shipman Ward rebuilt Underwood typewriter. New machines are guaranteed for only one year; WE GUARANTEE EVERY ONE OF OUR MACHINES FOR FIVE YEARS! If you have never owned a typewriter, start with the finest! You can try this one at our risk. But, the time to act is NOW. Don't miss out on this present bargain offer whereby you can get this genuine Underwood at a big savings. Don't do longer without the convenience of a typewriter.

**FREE!** Get our catalog free; lowest prices and terms. A manual free, too; valuable instruction for learning rapid typing, useful pointers for all who use a typewriter, business forms, social correspondence, work for others, etc. Clip coupon NOW!



## Mail Today!

Shipman Ward Manufacturing Co.,  
B-212 Shipman Building, Chicago, Ill.

Please send me your Free Trial Plan and Typewriter Book, together with your special offer on prices, terms, free course in Touch Typewriting and also how I can make money with this typewriter, without obligation. This is not an order.

Name.....

Street or R F D.....

City.....

State.....



**5  
Year  
Guar-  
antee**

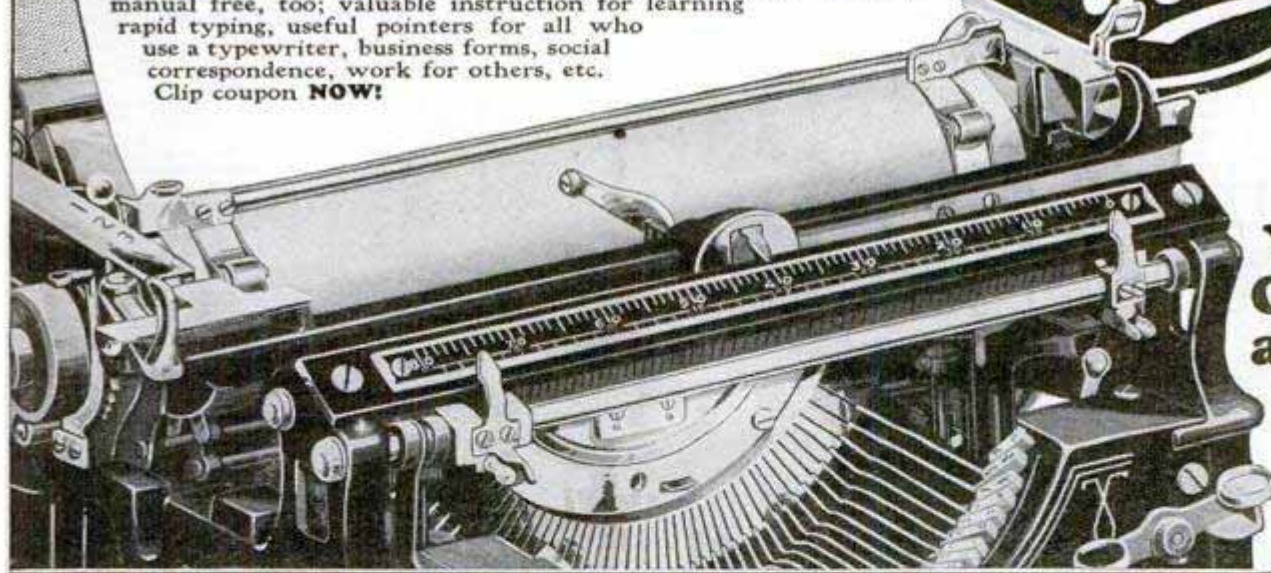

THOUSANDS HAVE FOUND A WAY TO OWN TYPEWRITERS—and make Sparetime Cash too





# LUMINOUS PAINT



**Make Your Watches, Clocks, Etc., Visible by Night**

The very latest discovery in the scientific world. Hitherto, practically unobtainable. LUMINOUS PAINT, which, applied to the surface of any article, emits rays of white light, rendering it perfectly visible in the dark. THE DARKER THE NIGHT, THE MORE BRILLIANT IT SHINES. Quite simple to use. Anyone—you can do it. A little applied to the dial of your watch or clock will enable you to tell the time by night. You can coat the push buttons or switch plates of your electric lights, match boxes, and innumerable other articles; make your own Luminous Crucifixes, Luminous Rosaries, etc. Small bottle, price 25c. Larger size, 50c and \$1 postpaid. JOHNSON SMITH & CO., Dept. 811 RACINE, WIS.

## Serpent's Eggs

Box contains 12 eggs. When lit with a match, each one gradually hatches itself into a snake several feet long, which curls and twists about in a most life-like manner. Price per box, 10c postpaid, 3 for 25c.



## CIGARETTE MAKER



Roll your own and save money. Makes them better and quicker besides saving more than half. Use your favorite brand of tobacco. Neat, useful and handy. Pocket size, weighs 1/2 oz. Made entirely of metal, nickel-plated. Price 25c postpaid.

## MIDGET BIBLE

**GREAT CURIOSITY**  
Smallest Bible in the World. Size of a postage stamp. 200 Pages. Said to bring good luck to the owner. A genuine work of art. Must be seen to be appreciated. Make good money selling them to friends, church acquaintances, etc. PRICE 15c each, 3 for 40c, 12 for \$1.35, 100 for \$7.50. Also obtainable in Leather Binding, with gold edges. Price 50c each, 3 for \$1.25, \$4.50 per doz. Magnifying Glass for use with Midget Bible, 15c.



## STAGE MONEY



With a bunch of these bills, it is easy for each person of limited means to appear prosperous by flashing a roll of these bills at the proper time and peeling off a genuine bill or two from the outside of the roll, the effect created will be found to be all that can be desired. Prices, postpaid: 40 Bills 20c, 120 for 50c, or \$3.50 thousand postpaid.

## Wonderful X-Ray Tube



A wonderful little instrument producing optical illusions both surprising and startling. With it you can see what is apparently the bones of your fingers, the lead in a lead pencil, the interior opening in a pipe stem, and many other similar illusions. A mystery that no one has been able to satisfactorily explain. Price 10c, 3 for 25c 1 dozen 75c. Johnson Smith & Co.



**Good Luck Ring**  
Quaint and Novel Design

A VERY striking and uncommon ring. Silver finish, skull and crossbones design, with two brilliant, flashing gems sparkling out of the eyes. Said by many to bring Good Luck to the wearer, hence its name, Good Luck Ring. Very unique ring that you will take a pride in wearing. ONLY 25 CENTS.

## Exploding Cigarettes



**JUST LIKE ORDINARY CIGARETTES. BUT SUCH REAL STARTLERS!** The box contains ten genuine cigarettes of excellent quality. They appear so real, but when each cigarette is about one-third smoked, the victim gets a very great surprise as it goes off with a loud BANG! A great mirth provoker yet entirely harmless. Price 25c per box.

## Popular Watch Charms

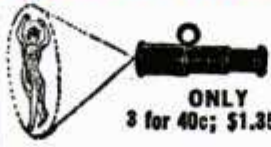

Very pretty little curiosities and decidedly novel. Fitted with Magnifying Lenses that enlarge the picture to a very surprising degree; in fact, it seems almost incredible that a clear picture could be possible in such a small compass, and how sharp and distinct they show up when you look through. Come in assorted views—Antares, views of Panama Canal, Lord's Prayer in type, etc.

## Mystic Skeleton

A jointed figure of a skeleton 14 in. in height, will dance to music and perform various gyrations and movements while the operator may be some distance from it.



## Novelty Badges



Kissing Permit 10c Garter Inspector 10c  
Two very novel metal badges, nickel plated, that you can wear, giving you fun out of all proportion to their trifling cost. 10c, each badge, 3 for 25c, or 75c per doz. postpaid anywhere.

## MAGIC FLUTE

Wonderfully Sweet Toned and Musical



The Magic Flute, or Humanatone, is a unique and novel musical instrument that is played with nose and mouth combined. There is just a little knack in playing it which, when once acquired after a little practice, will enable you to produce very sweet music that somewhat resembles a flute. There is no fingering, and once you have mastered it you can play all kinds of music with facility and ease. When played as an accompaniment to a piano or any other musical instrument, the effect is as charming as it is surprising.

# BLANK CARTRIDGE PISTOL

Protection against Burglars, Tramps, & Dogs  
Special Offer 1 Blank Cartridge Pistol, 100 Blank Cartridges, 1 550-page Novelty Catalog ONLY



Well made and effective, modelled on latest type of Revolver; appearance alone is enough to scare a burglar. When loaded it may be as effective as a real revolver without danger to life. It takes standard .22 Cal. Blank Cartridge—obtainable everywhere. Special cash with order offer: 1 Superior quality Blank Cartridge Pistol, 100 Blank Cartridges, and our new 550 page De Luxe Catalog of latest novelties; all for ONLY \$1.50. Shipped by Express only. Cannot go by parcel post. Extra Blank Cartridges 50c per 100. Special Holster (Cowboy Type) for pistol 50c. No. C. O. D. shipments. JOHNSON SMITH & CO., Dept. 811, RACINE, WIS.

**\$1.50**

The Lot Shipped by Express Only

Cash With Order Only

## BOYS! BOYS! BOYS! THROW YOUR VOICE

Into a trunk, under the bed or anywhere. Lots of fun fooling the teacher, policeman or friends.  
**THE VENTRILO**  
a little instrument, fits in the mouth out of sight, used with above for Bird Calls, etc. Anyone can use it.  
Never Fails. A 16 page course on ventriloquism, the Ventrillo, ALL FOR 10 CENTS



Everything about the Ku Klux Klan told in a clear, fearless manner. Book tells all—How it started and was oppressed in 1871—The New Ku Klux Klan—How Organized—How Members are Enrolled—Oath of the Klan—Questions for Candidates—Creed—Objects of the Order—Obedience—Fidelity—Pledge of Loyalty—Ku Klux Klan and the Masons—The Jews—The Masons—Real K. of C. Oath—The Negro Ku Klux Klan, etc., etc. Latest and most complete book on the Klan published. Price 35c, Postpaid, Stamps or Coin



Female SEX Indicator 25c Male Sex Indicator  
Hold the MAGIC INDICATOR over a man's hand—instantly it moves in a straight line, backward and forward. Hold it over a woman's hand and it describes a complete and continuous circle. The same action can be obtained over a letter written by a man or woman, etc. It is fascinating; baffling. We have never been able to figure out how it's done, but we've never seen it fail. Many novel and entertaining feats may be performed with the Sex Indicator. For example, similar results can be obtained with animals, cats, dogs, rabbits, over birds, chickens, canaries, etc. Also used to predetermine the sex of chickens and birds, etc. In fact it is sold as a patented egg tester in Europe. Price 25c, or 3 for 65c. post.



**LOOK 35c LOOK**  
Wonderful instrument. Greatest thing yet. Nine separate articles in one. Everybody delighted with it. Odd, curious and interesting. Lots of pleasure as well as very useful. It is a double Microscope for examining the wonders of nature. It is also an Opera Glass, a Stereoscope, a Burning Lens, a Reading Glass, a Telescope, a Compass, a Pocket Mirror, and a Laryngoscope—for examining eye, ear, nose and throat. It is worth all the cost to locate even one painful cinder in the eye. Folds flat and fits the pocket. Something great—you need one. Don't miss it. Sent by mail, postpaid. Price only 35c or 3 for \$1.00

# JOHNSON SMITH & CO.

Dept. 811 RACINE, WIS.  
A De Luxe Edition of our new 1927 CATALOG mailed on receipt of 25c. Handsome binding. Bigger and better than ever. Only book of its kind in existence. 550 pages of all the latest tricks in magic, the newest novelties, puzzles, games, sporting goods, rubber stamps, unusual and interesting books, curiosities in seeds and plants, etc., unprocureable elsewhere. Remit by Stamps, Coin, Money Order, Check, etc. Unused U. S., Canadian and Foreign Stamps also accepted.





**COMIC CELLULOID BUTTONS**



These Comic Celluloid Buttons provide subjects for pleasant jokes and amusing conversation and thus smooth the way to a more familiar acquaintance and cordial friendship. There are seventy different titles altogether, all very wittily worded and quite unobjectionable. Wear one and see the effect. All four Buttons illustrated above will be sent postpaid to any address for **ONLY 20c** or a dozen, all different, for **45c**.

**SURPRISE SOAP**

You've heard of people turning green with envy but they haven't turned half as green as the fellow who unwittingly uses this soap. It is an exact duplicate of an ordinary piece of soap. Secret: it contains a chemical which acts like a dye as soon as it comes into contact with water. **PRICE 15c postpaid.**

**KEYLESS LOCKS**

These clever locks cannot be opened unless you know the combination. No key necessary. For your locker, bicycle, tool chest, mail box, thousands of uses. Shackle and tumblers nickel plated. Weighs little over one ounce. Small, yet strong. Secret and full instructions with each lock. **PRICE 25c or 3 for 65c postpaid.**



**Every Boy His Own Toy Maker**

Greatest boys' book written. Tells how to make a Pinhole Camera, a Canoe, model Railroad, a Telephone, Boomerang, Telegraph Instrument, Box Kite, Talking Machine, Microscope, Electric Motor, Electric Door Bell, Water Wheel, Paddle Raft, a pair of Skis, a Dog Sled, Bird House, Rabbit Yard, etc. 64 pages, 150 illustrations. **PRICE, 10c postpaid; 3 for 25c postpaid.**

**INVISIBLE INK**

The most confidential messages can be written with this Ink, for the writing **Makes No Mark.** Cannot be seen unless you know the secret. Invaluable for many reasons. Keep your postals and other private memorandums away from prying eyes. Great fun for playing practical jokes. **Only 15c a Bottle; 3 for 40c.**

**REAL PISTOL**

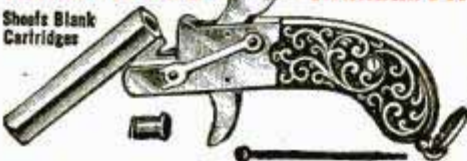

Exact reproduction of a real pistol; actually fires **REAL BLANK CARTRIDGES** of miniature size. Illustration is actual size.  $1\frac{1}{4}$  inches long, with ring at end for attaching to watch chain. Loads like a regular pistol. Illustration shows position for loading. Made entirely of high grade steel, nickel plated, octagon barrel, handsomely engraved handles, complete in box with cleaning rod. **PRICE \$1.75.** Also furnished with pearl handles, **\$2.50.** **BLANK CARTRIDGES, 500 per box of 25.** **JOHNSON SMITH & CO., Dept. 811, RACINE, WIS.**

**Miniature Watch Charm Pistol**

Exact reproduction of a real pistol; actually fires **REAL BLANK CARTRIDGES** of miniature size. Illustration is actual size.  $1\frac{1}{4}$  inches long, with ring at end for attaching to watch chain. Loads like a regular pistol. Illustration shows position for loading. Made entirely of high grade steel, nickel plated, octagon barrel, handsomely engraved handles, complete in box with cleaning rod. **PRICE \$1.75.** Also furnished with pearl handles, **\$2.50.** **BLANK CARTRIDGES, 500 per box of 25.** **JOHNSON SMITH & CO., Dept. 811, RACINE, WIS.**

**RESURRECTION PLANT**



One of the most wonderful plants known. Possesses the strange power of turning in a few minutes from an apparently lifeless, dry herb to a **BEAUTIFUL**

**LIVING FERNLIKE PLANT** of a dark green color. Simply place the plant in saucer of water, it will open up and start to grow in 20 minutes. When taken out it will dry up and go to sleep until placed in water again. Fine house plant—summer or winter. **10 cents each or 3 for 25c., 75c per doz., postpaid.**

**Microphone Transmitter Button**



You can easily make a highly sensitive detectophone by using this Transmitter Button to collect the sound waves. You can build your own outfit without buying expensive equipment. It is simple and inexpensive. You can install an outfit in your home and hear conversations being held all over the house. You can connect up different rooms of a hotel. This outfit was used by secret service operatives during the war. It is being used on the stage. It is ultra-sensitive and is the greatest invention in micro-phones. You can mount the button almost anywhere—card board boxes, stove pipes, stiff calendars, on the wall behind a picture frame, etc. Button is so light and small it cannot be detected. Persons can be overheard without suspecting it. You can listen in on conversations in another room. A deaf person in the audience can hear the speaker. Connected to phonograph, piano or other musical instrument, music can be heard hundreds of feet away. Button may be used to renew telephone transmitters; often makes an old line "talk-up" when nothing else will. The ideal microphone for radio use; carries heavy current and is extremely sensitive. Amplifies radio signals. Countless other similar uses will suggest themselves. Experimenters find the button useful for hundreds of experiments along the lines of telephones, amplifiers, loud speakers, etc. Many fascinating stunts may be devised, such as holding the button against the throat or chest to reproduce speech without sound waves. \$5.00 is given to anyone who sends in a new suggestion for the use of the Button providing the manufacturers find it suitable for use in their literature. **PRICE \$1.00 POSTPAID ANYWHERE.**

Send remittance (Postage stamps accepted) for all articles listed on above and previous page to

**MAGICIAN'S OUTFIT**

Apparatus and Directions for a Number of Mysterious Tricks Enough for an Entire Evening's Entertainment **ANYONE CAN DO THEM 75c**



It is great fun mystifying your friends. Get this Conjuror's Cabinet, and you will be the cleverest fellow in your district. It contains the apparatus for seven fantastic tricks, including The Disappearing Rose, that, when placed on the lapel of your coat, vanishes from sight at will; the Magic Glass and Ball Trick (a Wooden Ball is placed inside, and upon replacing the lid has disappeared and is found in someone else's pocket); The Magic Nail with which you can apparently cut your finger almost in two; the Wonderful Card Trick (a card is placed in an envelope, and when you open an entirely different card altogether is found); The Disappearing Coin Box (a coin is placed in the little wooden barrel, and when opened again, is found to have vanished entirely, or can be made to change into a coin of another denomination); The Famous Dissolving Penny Trick; The Glass Goblet and Vanishing Coin Trick (a coin is dropped into a glass of water, and when the water is poured out the coin has vanished). With the tricks described above we send full printed instructions for performing each trick, so that any one can readily perform all the tricks to the great amusement of their friends or the public. Any boy of ordinary intelligence, with this Cabinet of Tricks in his possession, can give a parlor entertainment not inferior to some regular magicians. Besides the tricks contained in the Cabinet, there are many other tests and illusions fully explained with full printed instructions, for which you easily make or procure the necessary apparatus. This unexcelled Cabinet of Tricks for **ONLY 75 CENTS POSTPAID TO ANY ADDRESS.**

**Great Fire Eater**  
Most Sensational Trick of the Day!

With the Fire Eater in his possession any person can become a perfect salamander, apparently breathing fire and ejecting thousands of brilliant sparks from his mouth, to the horror and consternation of all beholders. Harmless fun for all times, seasons and places. If you wish to produce a decided sensation in your neighborhood don't fail to procure one. We send the Fire Eater with all the materials, in a handsome box, the cover of which is highly ornamented with illustrations in various colors. **Price of all complete only 30 cents, postpaid.**

**SQUIRT ROSE**



**A REAL STARTLER.** This is the most popular of all squirt tricks. The flower in your coat looks so fresh and sweet that everyone is tempted to inhale the delightful perfume. Then is the moment to press the bulb. Go-willikens. Don't they jump? There is a very long rubber tube that easily reaches to the pocket of your coat or trousers, and the bulb is large enough to make a dozen shots with one loading. **PRICE 25c each, or 3 for 65c postpaid.**

**PISTOL, OPERA & FIELD GLASS**

**PRICE POSTPAID, \$1.00**

**LOOK!**

It is made in the shape of and looks like a regular Automatic Pistol. No one is likely to stop and ask you whether it is real or not. Thus it is likely to prove itself very handy in an emergency. On pressing the trigger it opens up, as shown in the illustration at the right, revealing nine most useful articles—Opera and Field Glass, Telescope, Mirror, Magnifying Glass and Burning Lens, Reading Glass, Sun Dial, Sun Compass, etc. In the handle of the revolver there is a place for various pocket necessities, such as First Aid Articles, Buttons, Pins, etc. The Pistol is of sheet metal, blued finish, that can be carried comfortably in pocket. **PRICE \$1.00.**

**SURPRISE MATCHES**

More fun than fighting with your wife. Look just like ordinary matches. Put up in boxes just like regular Safety Matches. As the victim tries to light one he gets quite a surprise. **PRICE 10c per box, 3 boxes for 25c, or 12 for 75 cents.**



**SEEBACKROSCOPE**

By merely placing this clever instrument to your eye, you can see what is going on behind your back, and sometimes you see very interesting things when no one thinks you are looking. Why it is just like having eyes at the back of your head. **PRICE ONLY 25 cents, postpaid, 3 for 50 cents.**

**NEW BOOK ON ROPE SPLICING**

A most practical handbook giving complete and simple directions for making all the most useful knots, hitches, rigging, splices, etc. Over 100 illustrations. All about wire rope attachments, lashing, blocks, tackles, etc. 37 Heraldic Knots illustrated. Of great value to mechanics, riggers, campers, boatmen. **Price 2c cents postpaid.**

**The "Little Giant" Typewriter**  
A First Class Writing Machine For \$1.50

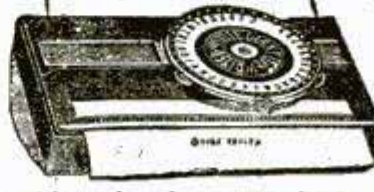

A perfect little typewriter for \$1.50. There are thousands of persons who would like to use a typewriter but whose needs and business do not warrant the expense attached to the purchase and use of a fifty or seventy-five dollar machine. To such persons we confidently recommend our Little Giant. It is strongly made, but simple in construction, so that anyone can quickly learn to operate it, and write so rapidly as they would with pen and ink. The letters of the alphabet, most frequently used are so grouped as to enable one to write rapidly, the numerals 1 to 10, and the punctuation marks being together. With this machine you can send your best girl typewritten love letters, address envelopes, make out bills, and do almost any kind of work not requiring a large, expensive machine. With each typewriter we send a tube of ink and full printed instructions for using the machine. **Price complete \$1.50 by mail postpaid to any address in the world.**





**THERE IS ONLY ONE CRESCENT WRENCH**

Look for the Name

Probably no other tool has been more widely imitated than the **CRESCENT WRENCH**. Its design has been copied, but its quality, easy action and toughness have never been equalled.

That is because the **CRESCENT** name goes only on tools made of special analysis steel. Crescent workmanship must measure up to high standards. And this is true of every tool in the large Crescent-Smith & Hemenway line which includes wrenches, mechanics' and electricians' pliers, screw drivers, punches, chisels, bars, hacksaws, snips, auger bits, etc.

All these tools carry a money-back guarantee. Look for the name "Crescent" on the wrench when buying.

**CRESCENT TOOL CO.**

210 Harrison St. JAMESTOWN, N. Y.

**CRESCENT and Smith & Hemenway TOOLS**

Made under the supervision of and guaranteed by the originators of the Crescent Wrench.

**YOUR HARDWARE DEALER SELLS CRESCENT TOOLS**

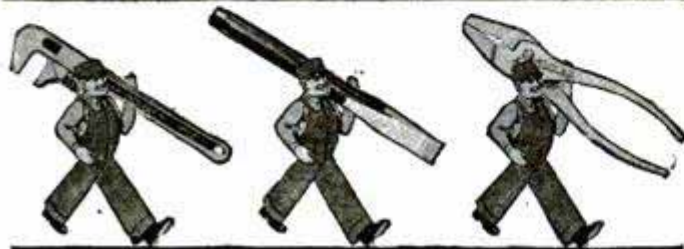

**IF YOU DON'T LIKE YOUR JOB QUIT**

**Start Working for Yourself American Universal Floor Surfacing Machine**



offers you the opportunity for which you have been waiting.

This electrically driven machine sure does roll the money in fast. No trouble to get work — we start you — supply you with simple working plan that insures success.

One year-to-pay plan requiring only \$75 down on de-

livery of machine is available to you if you want it.

This is your chance not only to earn more but to have all you earn for yourself.

Write at once for details.

**American Floor Surfacing Machine Co.**  
523 South St. Clair Street Toledo, Ohio



**\$10.00**

**DOWN Brings this Lathe to You**

Lathes \$6.00 to \$75.00. Largest line of small lathes in America. Send four cents for 24 page catalog of lathes, drill presses, bench saws, jig saws, band saws, etc.

**SYEPHER MANUFACTURING COMPANY**  
Dept. D Toledo, Ohio

**Make Things at Home with a Speedway Shop**

Eight motor-driven tools, complete lathe, bench saw, jig saw, portable electric handsaw, stationary power drill, buffer, grinder, scratch brush. Works from any lamp socket. \$10.00 down, 10 days' free trial; free working blueprints furnished. Write for full information.

**ELECTRO MAGNETIC TOOL CO.**  
Dept. 2J3, 1830 S. 52nd Avenue CICERO, ILL. (Adjoining Chicago)

**PLUMBING - HEATING WATER SYSTEMS**

**SAVE UP TO 40%**



Wonderful bargains—everything guaranteed. Full line of plumbing and heating supplies. Hot water, steam heating plants and fixtures and water systems at big savings.

**Install Them Yourself**  
Finest materials all brand new and perfect. Tell us your wants and mail us a rough sketch of your rooms.

**SEND FOR PRICE LIST**

**B. KAROL & SONS CO.** 800 S. KEDZIE AV. Dept. 20 CHICAGO



“Wish I had one  
of  
those!”

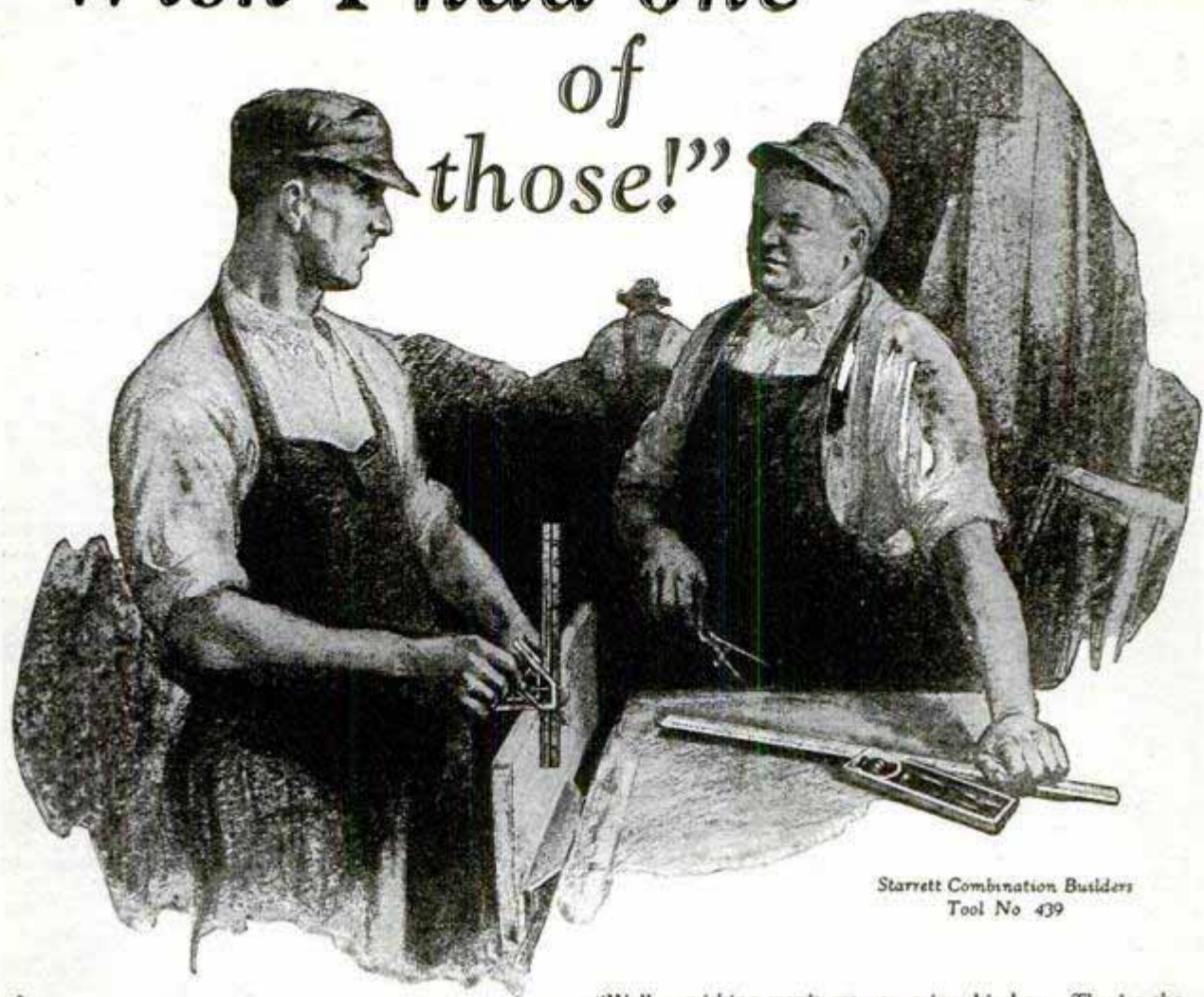

Starrett Combination Builders  
Tool No. 439

“Well — wishing won't get you mine, big boy. They're the handiest tools in my kit. Better get some of your own next pay day — you'll wonder how you ever got along without them.”

The Starrett No. 94 Combination Square is eight tools in one. It combines a Marking Gage, Rule, Try-square, Miter, Depth Gage, Height Gage, Level and Plumb.

The Starrett Combination Builders Tool No. 439 will save you a heap of figuring if you're doing any roof construction work.

Ask your tool dealer to show you these tools. Write us for free copy of Catalog No. 23 “AP” describing over 2500 fine tools.

Starrett Combination  
Square No. 94



### Starrett Universal Scraper No. 194

Here's a scraper with eight sharp cutting edges. The ends of the blade are ground square and any one of them can be brought into use by means of the ball joint.

The spring plunger makes the ball joint easy to adjust to any desired angle.

Starrett  
Universal Scraper  
No. 194



### THE L. S. STARRETT CO.

World's Greatest Toolmakers  
Manufacturers of Hacksaws Unexcelled  
Steel Tapes—Standard for Accuracy  
ATHOL, MASS.



721

# Use Starrett Tools





As  
fine as  
can be  
made

Experienced carpenters and machinists know that the finest tools are, in the end, the cheapest.

For more than eighty years Maydole Hammers have been considered the finest made. Heads are of selected tool steel, press-forged. Handles are of clear, air-dried, second-growth hickory, put on "for good."

If you take pride in your tools, you'll get real pleasure out of owning and using this superior hammer.

Ask your dealer for the genuine Maydole. Look for the "D. Maydole" stamped on the head.

We'll gladly send you a free copy of our interesting and useful Pocket Handbook 23 "L" on request.

YOUR HAMMER SINCE 1843  
**Maydole**  
**Hammers**

The David Maydole Hammer Co., Norwich, N.Y.

785



The Handy Tool  
for the Handy Man

**TORIT No 23**  
Acetylene Torch

PAT. JAN. 5, 1926

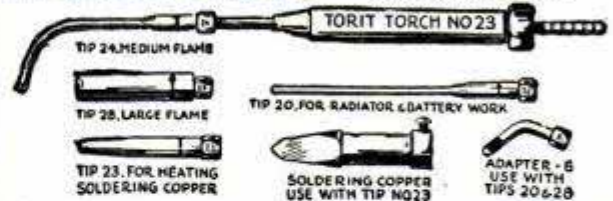

Uses Acetylene Only. No oxygen or air pressure required. Tips suck in air. Simply connect to Presto auto tank, light gas, and the outfit is put to work. Gives Heat Instantly! Beats anything you ever tried for soldering, radiator repairing, melting, lead burning, tempering, heating, light brazing, etc. Consists of torch, 4 tips for different kinds of work, soldering copper, 5 feet rubber tubing, tank connection, and full instructions. All ready to use. Quickly \$7.50 pays for itself. PRICE, complete, without tank.

**ST. PAUL WELDING & MFG. CO.**

177 West Third Street

Saint Paul, Minnesota

### YOU NEED SARGENT PLANES

See them at your hardware dealer's. For booklet write Sargent & Company, Manufacturers  
49 Water Street New Haven, Conn.

### Makes Old Ford a Tractor

Now you can convert that old Ford car into a useful farm tractor without altering any Ford parts. We furnish the traction wheels, drive gears and auxiliary axle and mountings, ready to clamp on to the Ford frame. Pulls 16" plow.



Write for Free Particulars.  
**SHAW MFG. CO., Dept. S, Galesburg, Kan.**

Write for free 400 page catalog illustrating and describing our complete line of 1500 Good Tools.

**GOODELL-PRATT COMPANY**

Toolsmiths  
Greenfield, Mass., U. S. A.



**PARKS**  
Manual Trainer  
**\$35.00**

For your home shop! Combination 11-inch band saw and 11-inch wood lathe. If you have a knack for wood working you can turn out first-class bridge lamps, cabinets, furniture, ship models, etc., in fast time. Get one!

Write for specification circular

**THE PARKS WOODWORKING MACHINE CO.**  
1500 Knowlton Street Cincinnati, Ohio  
CANADIAN FACTORY: 208 Notre Dame East, Montreal, Canada



## SAWS THAT CUT METAL FASTER

**T**HE High Speed Steel Teeth of Simonds Inserted Tooth Saws make short work of heavy, tough metal-cutting jobs. The plates of wear-resisting steel are tempered to give maximum strength and stiffness for heavy duty cutting.

**SIMONDS SAW AND STEEL COMPANY**  
 "The Saw Makers" Established 1832  
 Fitchburg, Mass.



Branches and Service  
 Stations in Principal  
 Cities

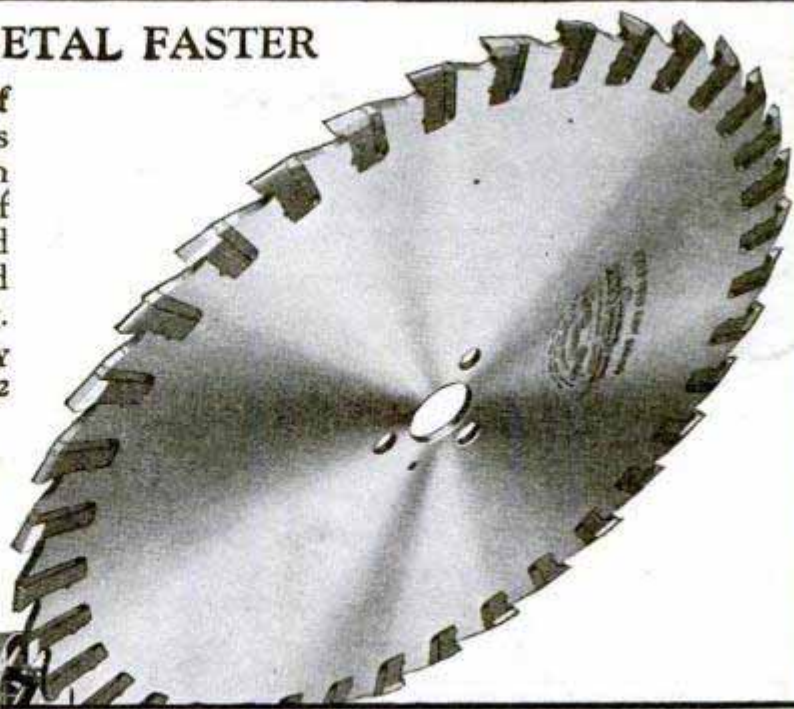

# SIMONDS

Pronounced SI-MONDS

## SAWS FILES KNIVES STEEL



No better, neater cases made than the **GERSTNER TOOL CASES** for Machinists and Toolmakers. You will take pride in one. Send a postal for free catalog.

*Gerstner Sons*

443 Columbia St., Dayton, Ohio

\$25 to \$45



**GET THE NEW IDEA**  
**BATES MOTOR SAW**  
 — 6 SAWS IN 1 —

Does the work of band-saw, rip-saw, cross-cut, miter, bevel and scroll-saw. A wonder worker for the home shop. Direct drive! Can't stick! Cuts 2" wood. Most amazing variety saw ever invented. Does more, costs less! Not a toy. Write for circular.

**BATES MOTORCRAFT COMPANY**  
 Dept. M 28 N. Clinton CHICAGO, ILL.

## Interlox "The Speedy Rule"

**MASTER SLIDE RULE**

Speeds up all measuring. Slides in and out—no folding. Direct-reading for instant inside measurements, as well as outside. Any length, 2 to 8 ft., 20c lineal ft. If not at dealers, sent postpaid.



**MASTER RULE MFG. CO., 813 E. 136th Street, NEW YORK**  
 Dealers and Agents: Write for attractive proposition.

## BURN YOUR NAME ON TOOLS WITH THE ARKOGRAF

**PROTECT YOUR TOOLS FROM THEFT**

Write with electricity any name or design on the hardest and finest tools and instruments, or any metal, like writing on paper with pen or pencil. Complete Outfit \$3.50—Prepaid Anywhere. Interesting illustrated circular free. Write today. Agents wanted. **ARKOGRAF PEN CO., 1171 E. Stark St., Portland, Oregon**

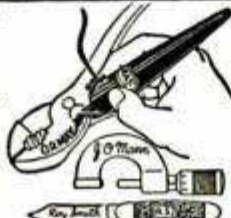

# TOOLS that Do Wonderful Things!

**W**ONDERFUL results have been accomplished with Cornwell Tools. . . They do things that no other tools will do. . . You will be amazed at the demonstration tests, suggested under the various tools described in booklet, for proving their astounding toughness. . . We will replace any tool that does not stand these tests or give you your money back.

**CORNWELL QUALITY TOOLS**

*Made from Special Formula Steel*



The steel used in Cornwell Tools is Swedish Charcoal Process Molybdenum Steel produced under our famous Cornwell Formula. . . They are forged, heat treated, hardened and tempered in oil. All tools made by hand. . . NOT drop forged and case hardened.

*Money Back if Not Satisfied*

You take no risk in buying Cornwell Quality Tools—if you ever saw tools as good as these, return your order and get your money back.

The Cornwell Quality Tools Co., Dept. M, Cuyahoga Falls, Ohio.

Send me new illustrated booklet with prices on full line of Cornwell Hand-Made Tools.

.....Where Employed  
 Name .....  
 Address .....  
 City ..... State .....



The Old  
Reliable  
Credit  
Jewelers

**LOFTIS**  
BROS. & CO. EST'D  
1858

Dept. 8894  
108  
N. State St.  
Chicago  
Ill.

Genuine Diamonds Guaranteed

## Diamonds

CASH OR CREDIT



No.  
849  
\$100  
\$2.50  
a wk.

No.  
852  
\$37.50  
\$1.00  
a wk.

### Diamonds Direct From the Importer!

Thousands of customers in every state of the Union make big savings by buying our Diamonds. Our 69-year-old reputation is your assurance of getting more and better value. Our Diamonds are beautiful, blue-white gems of bewitching color and brilliance set in magnificently engraved mountings of solid 18-k white gold.

Satisfaction guaranteed or money back. Goods sent for your free examination on request. Credit terms: Pay one-tenth down; balance weekly, semi-monthly, or monthly at your convenience. All goods delivered on first payment.

### Send for Free Catalog

Big 132-page book, illustrating our Diamonds, Watches, Jewelry, Silverware, and gift articles for all occasions, sent absolutely free. Write today.



No.  
859  
\$125  
\$3.25  
a wk.

No.  
847  
\$150  
\$3.75  
a wk.



No. 855 Ladies' Wrist Watch  
Solid 14-k white gold case, engraved, fancy wing ends, 15-Jewel movement, guaranteed. \$80. \$3.00 a month

19-Jewel Adjusted Waltham No. 846—14-k white gold filled; assorted patterns, \$42.50, \$4.25 down and \$1.00 a week



Railroad  
Watches—  
Guaranteed to  
Pass Inspection

HAMILTON NO. 992, 21 Jewels, Adjusted to 5 Positions, Gold filled 25-Year Quality Case \$55

ELGIN'S LATEST RAYMOND, 21 Jewels, 8 Adjustments, Runs 40 hours one winding, Gold filled 20-Year Quality Case \$55

ILLINOIS "BUNN SPECIAL" 21 Jewels, Adjusted to 5 Positions, Gold filled 25-Year Quality Case, 60 hours, 1 winding \$50

Credit at Cash Prices



Wedding Rings  
No. 824—The "Elite" \$7.50  
solid 18-k white gold  
Set with 3 Diamonds, \$22.50;  
6 Diamonds, \$32.50; 7 Diamonds, \$42.50; 9 Diamonds, \$52.50; 12 Diamonds, \$67.50.  
All platinum, \$25. With 3 Diamonds, \$50; 6 Diamonds, \$70; 7 Diamonds, \$80; 9 Diamonds, \$100; circled by Diamonds, \$200

**Do Your PRINTING**  
Cards, stationery, circulars, tag, labels, paper. Complete Outfits, \$8.85 up, Job Presses \$11 up, Rotary \$149. Card Cutters, \$3. Save money. Print for others, big profits. All easy rules sent. Write for catalog, presses, type, paper, cards, ink etc. THE KELSEY CO., B-37, Meriden, Conn.

## BUY THIS NEW OIL AND WATER PUMP FOR FORDS ON STARK'S GUARANTEE

The Stark "Twins" Pump for Fords is two pumps in one—oil and water! It gives positive forced cooling and lubrication. PREVENTS OVERHEATING—absolutely eliminates possibilities of burned bearings. Improves Ford performance 50%. Simple design, substantially built—trouble-proof! Price complete with belt, tubes and fittings \$10.00 delivered; with dashboard oil gauge \$12.50. Every Stark "Twins" pump runs smoothly and pumps oil and water, and is guaranteed to have been run in and tested before leaving factory. It works. Pumps 1 Gallon oil in 40 seconds. Easily installed. Order one today. Mention year your Ford was made. Enclose money order or will ship C. O. D.



### DEALERS:

Write for liberal discounts and full specifications of Stark Pumps!

**STARK METAL WORKS, Inc.,**  
1644 Tower Grove Ave. St. Louis, Mo., U. S. A.

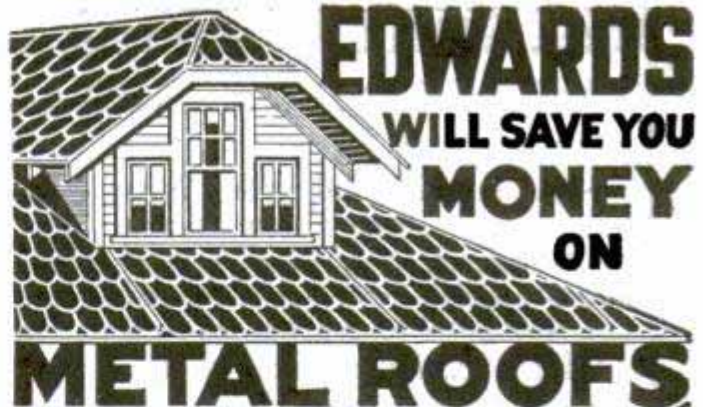

# EDWARDS

WILL SAVE YOU  
MONEY  
ON

## METAL ROOFS

We own our own steel mills, roll our own sheets, make them into high-grade REO METAL SHINGLES, Sidings, Ceilings and Roofings of every type and style for every kind of building. We control every operation from the raw material to the finished roof and we sell direct from our factories to the user. Not a dollar to divide with anybody but the customer! You get better value for less money.

### OUTLAST THREE ORDINARY ROOFS

EDWARDS METAL ROOFS are weather-proof, lightning-proof, fire-proof! The galvanizing bends with the metal. No tools required.



### LOW-COST ALL-METAL GARAGES

Any size. Any style. Portable. Ready to erect. Complete with frames, doors, sash and hardware. Ornamental, durable, economical. Blue-prints and complete instructions FREE. Write today. Get our low prices and Free Samples. Ask for Roofing Book No. 150 or for Garage Book No. 150.

THE EDWARDS MFG. CO.  
700-750 Butler St. Cincinnati, O.



## Sport Bodies for Fords

AT FACTORY PRICES!



This Model in Grey Prime \$39.50

Write for Booklet A-2 Showing Other Models.

SPORT FACTORIES, AURORA, ILL.

## TYPewriter PRICES CUT

World's best makes—Underwood, Remington, Oliver—prices smashed to almost half. \$2 and it's yours



All late models, completely rebuilt and re-finished brand new. GUARANTEED for ten YEARS. Send no money—big FREE catalog shows actual machines in full colors. Get our direct-to-you easy payment plan and 10-day free trial offer. Limited time so write today. International Typewriter Ex., 186 W. Lake St., Dept. 794, Chicago

**Tight Handles—Send for booklet "HOW to KEEP TOOL HANDLES TIGHT"**  
Fayette R. Plumb, Inc., 4857 James St., Philadelphia

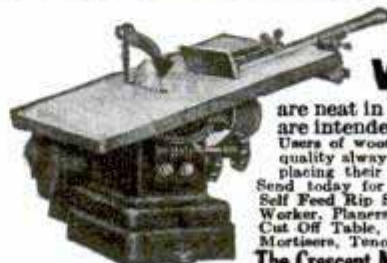

## Crescent Wood Working Machines

are neat in design, substantially built and are intended for hard, continuous service. Users of wood working machinery who appreciate quality always investigate Crescent machines before placing their orders.

Send today for circulars of Band Saws, Saw Tables, Self Feed Rip Saw, Shapers, Jointers, Variety Wood Worker, Planer, Planer and Matcher, Disk Grinders, Cut Off Table, Swing Saws, Bore, Hollow Chisel Mortisers, Tenoners, Universal Wood Workers. 93 Columbia St. The Crescent Machine Co. Leontia, Ohio, U. S. A.



# AGENTS Big-Quick PROFITS



**Tires Hammered Full of Nails, Leak no Air. GALACITE a new Viscous Pneumatic Cement (NOT A LIQUID) Seals PUNCTURES Instantly**—the very moment they occur. One application made in a minute without taking tire off the lorrim does the work. Seals slow leaks and porous tubes. Galacite aids in preserving rubber often doubling **Tire Mileage**. Don't confuse with anything else intended for the same purpose. Galacite is new, different, clean and scientifically correct. Made by a long established, highly rated financially responsible concern.

## FREE SAMPLE

**AT OUR RISK, MAKE THIS TEST** Hammer as many nai's into a tire as you wish—Pull them out. No air will escape, No pressure will be lost. If you are not delighted we will pay you for your time and trouble.

**AGENTS** It will pay you to get the facts and get them NOW. You can't get rich in an hour but you can make immediate, sure, steady profits that are amazing. No talking. Just drive nails in an old tire. We back our men with powerful advertising helps. Banners Posters, Newspaper Advertisements and circulars.

**FREE SAMPLE** Full particulars, big book and a free sample will be sent you postpaid, by return mail. Territory is going fast. Send no money, just your name, but **ACT NOW**. **JOHNSON & CO., 19 W. Jackson Blvd., Dept. 607, CHICAGO**

## 100 SCALE PLANS



for building old and modern ship models. Send 6 cents for catalog of plans, books, prints, maps and other things that smack of the sea.

**SEA ARTS GUILD, 405-A Eleventh Avenue, MILWAUKEE, WIS.**

## AGENTS 500% PROFIT GENUINE GOLD LEAF LETTERS

**S** guaranteed to never tarnish. Anyone can put them on stores and office windows. Enormous demand, large profits. Paul Clark says: Smallest day \$28.70. R. L. Reel made \$920 in two months. Write today for free sample and liberal offer to general agents. **METALLIC LETTER CO., 433-B N. Clark St., CHICAGO**

## Great New Invention



**for Seekers of Health—Power—Beauty**  
**Elco Electric Health Generator**  
Generates High Frequency Violet Ray, Mechanical Vibration Medical Electricity, and Ozone. Four of Nature's Greatest Curative Agents. For Home Treatments at less than 50 cents per year.  
**FREE BOOK** "Health, Power, Beauty" describing this Great New Invention. Re-vitalize yourself. Bring back energy. Be wholly alive. Write today. Lindstrom & Co., 30 W. Lake St., Dept. B-135, Chicago

## REMINGTON PORTABLE TYPEWRITER Dealers and Branches Everywhere

## Women Simply Can't Resist This Fast-Selling Line

Just show women this exquisite display of dress goods, silks, wash fabrics and you can't keep them from buying. Men and women agents needed to devote full or spare time. Good commissions. Average \$40 to \$85 a week. 1,000 samples furnished. Write quickly.



**THE NATIONAL IMPORTING CO., Dept. U-6, 569-573 Broadway, N. Y. C. 1000 Beautiful Samples**

# WURLITZER

TRADE MARK THE WORLDS LARGEST MUSIC HOUSE



**200 Years Ago** in the little Sax on town of Shoeneck lived Hans Adam Wurlitzer, Master Violin Maker. His shop was a gathering place for musicians of the time, for he was a true craftsman. When he died his shop passed into the hands of his eldest son, and for seven generations, down to the present day, the descendants of Hans Adam Wurlitzer have carried on his work.

Today in every Wurlitzer instrument you will find a quality, a character, that could not come from mere excellence of manufacture. It is the heritage of these seven generations of music craftsmanship.



## Try any Wurlitzer Instrument in your Own Home

**Y**OU may now have any Wurlitzer instrument for a generous free trial in your own home. Examine the instrument, show it to your friends, play it as much as you wish. No obligation to buy—no expense for the trial. We make this liberal offer because we want you to try for yourself these wonderful instruments, the result of 200 years' experience in musical instrument Building. Easy payments are arranged to suit your convenience. This is your opportunity to try a famous Wurlitzer instrument in your own home.

## Send for New Catalog

The greatest musical catalog ever published. Over 3,000 articles—every known instrument described and illustrated; many of them shown in full colors. Gives you lowest prices and all details of Free Trial, Easy Payment plan. All sent FREE—no obligation.

## Send this Coupon

**THE RUDOLPH WURLITZER CO., Dept. B177**  
120 W. 42nd St., New York 117 E. 4th St., Cincinnati  
329 S. Wabash Ave., Chicago 134 Golden Gate Ave., San Francisco

Send me absolutely free, your new illustrated catalog, with prices and description of every known musical instrument. Also tell me how I may try any instrument in my own home and pay for it in small monthly sums. No obligation.

Name .....

Address .....

City ..... State .....

Instrument .....

(State instrument in which you are interested)

Copyright, 1927, The Rudolph Wurlitzer Co.





"After 10 years' selling I've found the biggest money maker of them all. MARCELWAVER. My first week's profits were \$176."

A. R. Mohr, New York

**\$176**  
**CASH PROFIT**  
**VERY FIRST WEEK!**

**MAKE BIG MONEY QUICK WITH**

**Here's Big Money Quick**

**\$29 First Day**  
Geo. B. Eberts of Iowa made that.

**\$389 in 1 Week**  
A. F. Steinert of Pennsylvania hung up this record.

**\$213 in 4 Days**  
Frank W. Wander of Minnesota sets that mark to shoot at.

**\$40 Spare Time**  
Mrs. V. T. Krone of Alabama averaged that for seven weeks.

**MARCELWAVER NEW!**

Amazing invention of French experts gives perfect marcel wave in 15 minutes—costs only 2c. Women everywhere wild over astonishing results.

**EXCLUSIVE!** Agents cleaning up biggest profits in years—no competition—patented in all countries—\$3 cash profit on every sale—every woman and girl buys. Exclusive territories now being allotted—no time to lose.

**FREE!** Send name and address and territory wanted. Full information and protection on territory Free—also finest selling outfit. Send now.

**MARCELWAVER CO., Dept. H-121, Cincinnati, Ohio**

**MARCELWAVER CO., Dept. H-121, Cincinnati, Ohio**

Rush full information about MARCELWAVER and Free Selling Outfit Offer. Also consider my application for exclusive sale in my territory.

Name.....

Address.....

City.....

Do you want District Managers' Offer?

Will you act as local representative?

**LE PAGE'S GLUE** Handiest tool in your workshop.  
In bottles, tubes and cans.

**\$75 to \$125 Weekly**

**Charging Batteries Starts You**

Let me show you how to make big money right from the start. I've prepared a FREE book explaining all details. First week's profit pays for all equipment. You can get all the battery charging business in your community with my Service Station Charger—it's years ahead of ordinary chargers—handles 50% to 70% more batteries. I explain everything—start you in a business of your own and put you on the way to big money. Write for FREE Book.

**C. F. HOLMES, Chief Engineer, Dept. 10**  
Independent Electric Works, 5116 Ravenswood Ave., Chicago

**FREE BOOK—Just Out**



**Thompson BEATS the World on BOATS**

**BETTER BOATS at Lower Prices**



**The BEST that Skill and Experience can Produce**  
**TWO BIG FACTORIES**

Our complete line of 22 models offers you a variety to choose from. Prompt shipment from factory to you. **Catalog Free—Save Money—Order by Mail** Please state kind of boat in which you are interested.

**THOMPSON BROS. BOAT MFG. CO. (20)**  
201 Ann St., PESHIGO (Write to either place) 101 Elm St., CORTLAND WISCONSIN NEW YORK

**AGENTS! EXPERIENCE UNNECESSARY**



Science has finally produced it. An instantaneous metal cleaner—neither sloppy liquid nor messy paste. Dry magic floss. Touch it to nickel, copper or brass. The metal shines bright and clean instantly. No hard rubbing! Lightning Silver Cloth does same for Silverware. Lightning Furniture Floss instantly cleans and puts high lustre on Furniture. No liquid! Lightning Polishing Cloth is approved by Good Housekeeping Institute. Agents making up to \$30 a day!

**AMAZING DISCOVERY ABOLISHES METAL AND FURNITURE POLISH**

Imagine! Touch tarnished articles with a Lightning Polishing Cloth or Floss and you make them bright as new. Demonstrations positively astonishing! Every one a sale! Agents collect real money on every call.

**Makes a Sensational Demonstration!**

Everybody Buys These Products. Housewives buy the Lightning Silver Cloth and Furniture Floss. Autoists buy Lightning Polishing Floss. Sell all three to stores and offices in big quantities. Nothing else like them. Sure big, quick MONEY GETTERS.

**Sample Free!** Exclusive territory. Real cooperation. Triple profit. Answer this ad at once. Make big money. Easy! Quick! Don't delay. Write NOW! FREE test sample and proposition by return mail. **F. E. LIGHTNING PRODUCTS CORP., 1773 Greenleaf Ave., Chicago**

**If You Are A MAN**

worthy of the name and not afraid to work, I'll bet you \$50 that you can't work for us 30 days and earn less than \$200. Think I'm bluffing? Then answer this ad and show me up. Openings for Managers. The "Wonder Box" sells on sight.

**TOM WALKER**  
DEPT. 25 - PITTSBURGH, PA.

**RAISE BELGIAN HARES**

**NEW ZEALAND REDS—Chinchillas—Flemish Giants**  
**MAKE BIG MONEY—We supply stock and pay you** following prices for all you raise: Belgian Hares \$2 each—New Zealand \$3 each—Chinchillas \$4 each—Flemish Giants \$5 each. 32-page illustrated book, catalog and contract, also copy of Fur Farming magazine, tells how to raise skunk, mink, fox, etc., for big profits, all for 10c. Address

**OUTDOOR ENTERPRISE CO., Box 25, Holmes Park, Mo.**

**FREE TO BOYS**

**"THE SHOOTER'S ART"** Tells how to hold, aim and handle rifles; helps you guide others in correct knowledge of guns. **Gives facts that make crack shots.** Contains safety and common sense instruction every parent and boy should have. **Helps to make boys leaders.** Your copy Free. Write at once.

**The NEW BENJAMIN Air Rifle**  
Outshoots All Others

America's Original Air Rifle  
\$5 at your dealer's or sent postpaid. Write! **BENJAMIN Air Rifle & Mfg. Co., 645 N. Broadway, St. Louis, Mo.**



The Shooter's Art



**\$30** puts any model **EVINRUDE** on Your Boat



**Play as You Pay**

**F**OUR models—8 H. P. Speeditwin 75 lbs.; 4 H. P. Fastwin 49 lbs.; 2½ H. P. Sportwin 44 lbs.; and 2 H. P. Utility Single. Exclusive, copy-

righted "Boat-Speed Guide" tells at glance which motor will give you the results you want. Standardized down-payment of only \$30 regardless of model. Standardized, low monthly terms—a long time to pay.

**FREE TRIAL GUARANTEE**

Within an hour or less you master every detail of starting, stopping, steering, reversing, trolling and speeding. New, Free Trial Guarantee refunds money if not satisfied. That's the confidence we have in Evinrude superiority and in your liking this sport. Every outing is a real vacation. No traffic rules, no way to be reckless. More room than in your car—new things to see, new places to go.

**New Evinrude Year Book**

Motors in actual colors, 40 interesting pages showing beautiful waterways, speed records—complete facts! Send for free copy today.

**EVINRUDE MOTOR COMPANY**  
2405 27th Street Milwaukee, Wis.

**MAKE FORD Into The "LARK"**

**\$5.00** Red-i-Kut life size patterns Class—Snap Famous sure-fit RED-I-KUT life-size patterns and picture instructions show how you can easily convert your Ford into this **Fast, Saucy, Sport** Car as thousands have done, with easily obtained materials. No need to lay up the car. Rear seat folds, making 4-passenger car. Send 10c coin for actual body photo and new manual of other distinctive sport body patterns from \$3.50 up—"RKO" Steel "Swing-Lo" irons, Tops and Windshields. **ORDER RIGHT NOW.**

**KUEMPEL COMPANY, 86 Kuempel Bldg., GUTTENBERG, IOWA**

**DENINGER WILL TRUST YOU**  
SEND 20c IN STAMPS FOR CATALOGUES  
**BIG MONEY SAVING FOR YOU**  
Used and rebuilt motorcycles \$25 to \$100, used bicycles \$9.50, tandems \$20.  
All machines fully guaranteed.  
New bicycles and motorcycles at factory prices, save dealers' profits. Motorcycle and automobile tires \$3. Complete tire frames, engines, supplies.  
**DENINGER PRICE CUTTER, ROCHESTER, N. Y.**  
**PAY AS YOU RIDE**

**STOP FORD CRANKSHAFT END-PLAY!**  
**C-A ADJUSTABLE BEARING** corrects and prevents end-play without removing motor. Eliminates many troubles. Easy to install—simply drop pan. Only **\$3.75**. Ask your dealer or sent prepaid by **ADJUSTABLE BEARING CO., Dept. P, 405 Virginia Ave., Indianapolis, Ind.**

**MOTORCYCLES**  
**WE WILL TRUST YOU**  
Pay As Low As \$2.00 per Week  
Hendersons, Harley-Davidsons, Indians  
Slightly used and rebuilt. Hundreds to select from.  
Send 10c for list today.  
**MYEROW BROS. CO., 15 Berkeley St., Boston, Mass., U. S. A.**

**Something Your Best Friend Will Tell You**

The clean, swift, modern way of shaving is with Barbasol. . . No brush. No rub-in. No after-smart. Use Barbasol—3 times—according to directions. "Mister, you're next!"



**Barbasol**  
For Modern Shaving

The Barbasol Company  
Indianapolis, Ind.  
I enclose 10c. Please send trial tube.

Name.....  
Address.....  
P-M-7-27

**"OLD TOWN CANOES"**  
glide forward at the slightest dip of the blade. Strong and sturdy too. Priced \$58 up. From dealer or factory. Free illustrated catalog gives detailed information about all models. Write to Old Town Canoe Co., 1767 Middle St., Old Town, Me.

**Diamonds**  
**Here at 60% of Market Price**

Free Bulletin lists diamonds as low as \$60 per carat, also Gems of Finest Quality at higher per carat charges, but proportionately Low Bargain Prices. This 3/4 less 1-18 carat correctly cut diamond, a snappy blazing solitaire at \$68.50. This 75 year oldest largest Diamond Banking Firm in all the world lends money on diamonds. Thousands of unpaid loans and other bargains. Many from big cash deals direct with European Diamond Cutters. Must sell NOW.

**WHY PAY FULL PRICES**  
*Costs Nothing to See*  
Any Diamond sent for absolutely free examination at our risk. No obligation. No cost to you. Latest Listings—Unpaid Loans. Sent Free. Describes Diamond Bargains in Detail, gives cash loan values guaranteed. Explains unlimited exchange privilege. Write today for your copy of Diamond Bargain List. Use blank below, clip ad and mail.

**\$68.50**  
3/4-1/16 Carat Correctly Cut

Name.....  
Address.....

Tear out and mail today to— **Jos. De Roy & Sons, Only Opposite Post Office** 1958 De Roy Building Pittsburgh, Pa.



**Charge it**



**\$39.50**

**G-50** 4 diamonds and 4 blue sapphires adorn this 14 karat solid white gold Wrist Watch with 15-jewel movement. \$3.85 a month.

**G-51** 5 blue-white diamonds in 18 karat white gold Wedding Ring. \$32.50. \$3.75 a month.

**\$1 With 10 MONTHS TO PAY**  
Order

Your choice of these exceptional bargains will be sent to you for approval and 15 day trial if you will simply send \$1 with your name and address. If satisfied, pay balance in 10 equal monthly payments, otherwise return and your dollar will be refunded.

Our charge System is simple, easy, convenient . . . prompt delivery, no red tape, everything confidential.

Other Big Bargains in Diamonds, Watches and Jewelry in this booklet. SEND FOR IT TODAY. IT'S FREE.



**G-52** AA1 blue-white diamond in Ladies' Engagement Ring. \$50. \$4.90 a month.



**G-53** 3 blue-white diamonds in 18 karat white gold Dinner Ring. \$39.95. \$3.89 a month.

**L.W.SWEET Inc**

**BULOVA PATENTED DUSTPROOF**

You pay the Nationally Advertised Cash Price **\$28.50**

**DEPT. 67-M**  
**1660 Broadway**  
**NEW YORK**



**G-54** Gent's Bulova Strap Watch, 14 karat white or green gold filled case; 15-jewel movement. \$28.50. \$2.75 a month.

Flexible transparent cap which protects the movement.

**HOW A BOY BUILT UP A GREAT SQUAB FARM**



Started small in backyard when at school with no money, now has **\$30,000** plant, ships to New York 150 bbls. squabs yearly, receiving **\$75 to \$100** a barrel. You can do the same. Send for this book. Price is fifty cents but we will mail it to you for the names and addresses of four of your friends and your own name and address. Write today to

**Plymouth Rock Squab Co., 634 A St., Melrose High., Mass.**

**OPE-N-SEAL**  
**Fruit Jar Tool Kit**

**Opens and Seals Jars in a Jiffy**

**SAVES FRUIT** from spoiling! Saves hands from injury! Use when canning and every jar will be sealed **SECURELY**. Use in opening each jar and eliminate danger of cutting hands or breaking jar. Simple as A-B-C. Jar Lifter prevents burning hands in hot water. Six piece set. Fits pint, quart and half gallon standard jars. Needed year 'round. Sold direct by Tyler representatives or by mail, \$1.00.

**AGENTS Make \$8 to \$20 a day** selling this outfit. Spare or full time. Write today.

**THE TYLER MFG. CO. Dept. M-8 Muncie, Indiana**



**A Motor Boat - for half the cost!**

The Super Elto clamps on any open boat — gives all motor boating pleasures at amazingly small cost. Powerful, speedy, reliable. Light and portable. Write today for intensely interesting catalog! **ELTO OUTBOARD MOTOR CO.,** Ole Evinrude, President, Mason St., Dept. AAMilwaukee.

**The Super Elto**  
Starts with a quarter turn



**Many Agents Make \$200.00 to \$500.00 per month**

**New Patented Instant Plug Inserting Instrument.** Best, Easiest and Quickest Plug Inserting Instrument known. That's why every Garage, Vulcanizer and Tire Man is easily sold. Mr. Pim writes: "Sold 26 out of 30 demonstrations. Easiest seller and best profit maker I've ever seen. Demonstrate and they buy. Write today for exclusive territory proposition and watch your bank account grow."

**TOURISTS PRIDE MFG. CO. Dept. 5-B Minneapolis, Minn.**



**Bodies of Rare Beauty for Fords**  
**At Factory Prices!**

Write for circular A-3 showing Chummy Sportster and others.

**\$22.75 and up**

**SPORT FACTORIES** **AURORA, ILL.**



**SHAW MOTOR ATTACHMENT**  
**MAKES YOUR BIKE A MOTORCYCLE!**

A high grade 2 1/2 H. P. motor attachment quickly clamped on any bike frame. Speed 4 to 40 miles an hour. 90 to 125 miles per gallon of gas.

**Special Low Price Now!** Write today for Complete Description and Special Low Prices on SHAW Motor Attachments and the SHAW Complete Motorbicycle.

**SHAW MANUFACTURING COMPANY**  
Dept. 37 **Galesburg, Kansas**



**Beautiful HOUSES \$900 and BUNGALOWS \$700**

**CAN BE BUILT FOR AND UP**

This and many others in my new book, Building Plans for Modern Homes, will save you hundreds of dollars. One of the most complete and comprehensive books of plans ever published by any architect. New edition just off the press. Nearly 600 floor plans and photographs of Colonial houses, bungalows, etc., costing from \$200 up; gives sizes and cost to build. Sent postpaid for \$3.00.

**FREDERICK H. COWING**  
**ARCHITECT**  
101 Tremont St., BOSTON, MASS.



**Catch Fish!**

Eels, Mink, Muskrats with our new folding galvanized **STEEL WIRE TRAP.** Write for our **FREE TRAP OFFER** and Bargain Catalog. **\$1 Box** of our famous Fish Bait **FREE** to introduce our traps.

**WALTON SUPPLY CO., 3501 JUNIATA AVE., ST. LOUIS, MO.**



**AGENTS AND SIGN MEN**

Now Making \$50.00 to \$100.00 and Up Per Week Selling Our **GOLD LEAF SIGN LETTERS**

**R** For store and office windows, board signs, trucks and glass signs. We also make to order script signs and business emblems singly or by the thousands. A permanent business. No capital or experience required. Big demand in every city. Samples and Literature Free.

**CONSOLIDATED SIGN LETTER CO. 69X W. Van Buren CHICAGO, ILL.**



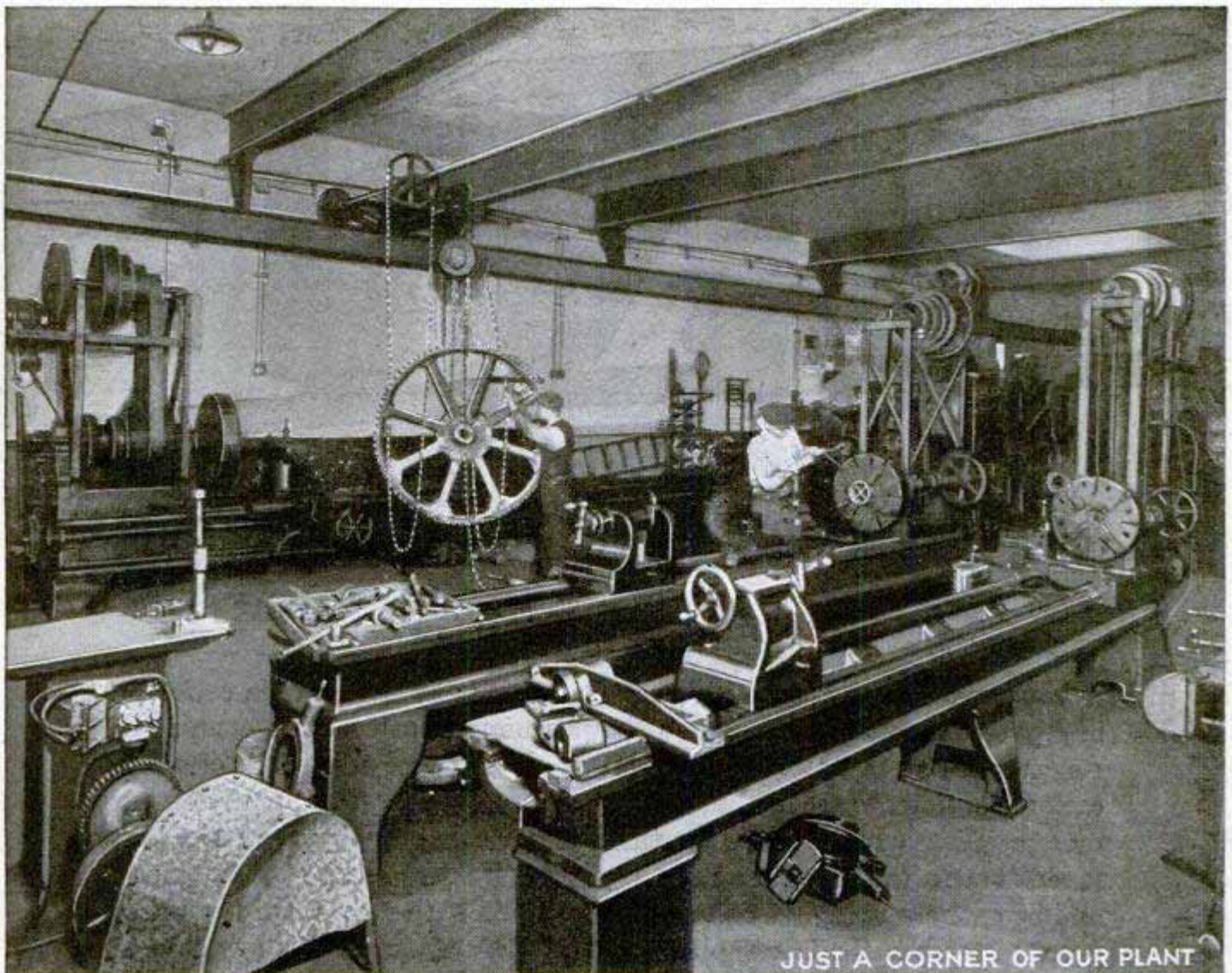

JUST A CORNER OF OUR PLANT

# Let Us Figure on Your Requirements

Complete Equipment: Foundry, Machine Shop, Forge and Pattern Shop

**ALL METALS**—Iron, Brass and Aluminum Castings—**ONE OUNCE to FIVE TONS**

**We Build, Test and Prove Any Kind of Machinery**

Our facilities are unsurpassed for any size job, no matter how large or how small. The men at the head of this company are experienced and thoroughly trained in all kinds of machine work and their knowledge of metal makes it a simple matter to be of valuable assistance to you in the perfection of your product, or on your present production. Get our estimate, it will be worth your while.

## Our Shipping Facilities Cannot Be Excelled

Excellent shipping facilities enable us to ship by rail or water thus extending our range to Foreign as well as Domestic points with the convenience of local handling. Your manufacturing difficulties are easy for us to solve. Investigate now.

**BURTON MACHINE COMPANY**  
Estimator-F.P. **NORFOLK, VIRGINIA**

## Better Material—Lower Cost

**BURTON MACHINE CO.,**  
Norfolk, Va. Estimator-F.P.

Gentlemen:

I am enclosing details and ask you to mail me estimate at once.

Name.....

Address.....

City.....

State.....



# PATENT

## Protect Your Ideas

### Take the First Step Today

If you have a useful, practical, novel idea for any new article or for an improvement on an old one, you should communicate with a competent Registered Patent Attorney AT ONCE. Every year thousands of applications for patents are filed in the U. S. Patent Office. Frequently two or more applications are made for the same or substantially the same idea (even though the inventors may live in different sections of the country and be entirely unknown to one another). In such a case, the burden of proof rests upon the last application filed. Delays of even a few days in filing the application sometimes mean the loss of a patent. So lose no time. Get in touch with me at once by mailing the coupon on the opposite page.

### Prompt, Careful, Efficient Service

This large, experienced organization devotes its entire time and attention to patent and trade mark cases. Our offices are directly across the street from the U. S. Patent Office. We understand the technicalities of patent law. We know the rules and requirements of the Patent Office. We can proceed in the quickest, safest and best ways in preparing an application for a patent covering your idea. Our success has been built on the strength of careful, efficient, satisfactory service to inventors and trademark owners located in every state in the Union.

### NO CHARGE for Information On How to Proceed

The booklet shown here contains valuable information relating to patent procedure that every inventor should have. And with it I will also send you my "Record of Invention" form on which you can sketch your idea and establish its date before a witness. Such evidence may later prove valuable to you. Simply mail the coupon and I will send you the booklet, and the "Record of Invention" form, together with detailed information on how to proceed and the costs involved. Do this NOW. No need to lose a minute's time. The coupon will bring you complete information entirely without charge or obligation.



My Patent Law Offices  
Just Across  
Street From  
U.S. Pat. Office



Above is a view of my drafting and specification offices where a large staff of experienced experts are in my constant employ. All drawings and specifications are prepared under my personal supervision.

# NEWS

*Inventors*

*Write for these* **Free Books**

**Strict Secrecy Preserved**

All communications, sketches, drawings, etc., are held in strictest confidence in strong, steel, fireproof files, which are accessible only to authorized members of my staff. Feel free to write me fully and frankly. Your case will have my personal attention. It is probable that I can help you. Highest references. But **FIRST**—clip the coupon and get my free book. Do **THAT** right now.

**Clarence A. O'Brien**

*Registered Patent Attorney*

Member of Bar of: Supreme Court of the United States; Court of Appeals, District of Columbia; Supreme Court, District of Columbia; United States Court of Claims. Practice confined exclusively to Patents, Trade marks and Copyrights

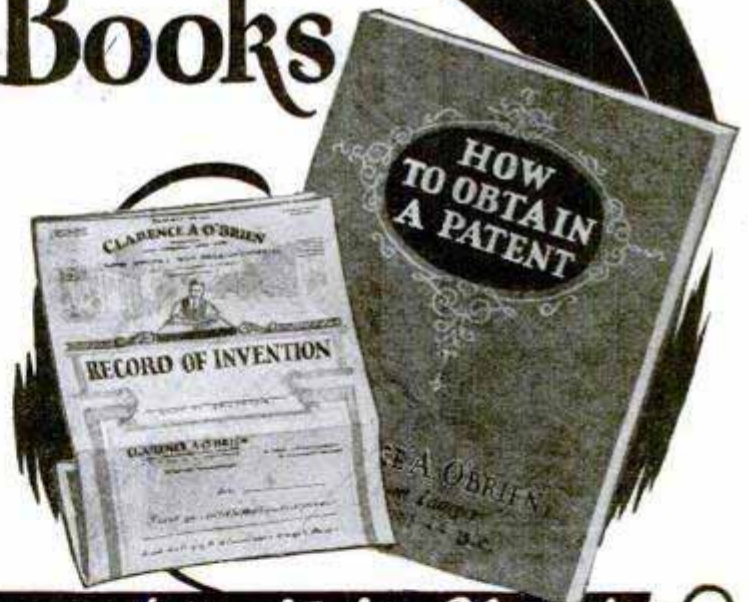

**Clip this Coupon and Mail it Now!**

**CLARENCE A. O'BRIEN, Registered Patent Attorney**

70-Z Security Savings and Commercial Bank Bldg., Washington, D. C.

Please send me your free book, "How to Obtain a Patent," and your "Record of Invention" form without any cost or obligation on my part.

Name.....  
(Important: Write or Print name clearly.)

Address.....



# PATENTS TRADE-MARKS AND COPYRIGHTS

## Have You An Idea?

### Our Offer: FOR THE PROTECTION OF YOUR INVENTION YOUR FIRST STEP

Before disclosing an invention the inventor should write for our blank form

#### "RECORD OF INVENTION"

This should be signed and witnessed and returned to us together with model or sketch and description of the invention for **INSPECTION and INSTRUCTIONS**

*No Charge for the Above Information*

**Our Four Books Mailed  
Free to Inventors**

*Our Illustrated Guide BOOK*

#### How to Obtain a Patent

Contains full instructions regarding U. S. Patents. Our Methods, Terms, and 100 Mechanical Movements illustrated and described.

#### Our Trade Mark Book

Shows value and necessity of Trade Mark Protection. Information regarding *Trade Marks and unfair competition in trade.*

#### Our Foreign Book

We have Direct Agencies in Foreign Countries, and secure Foreign Patents in shortest time and lowest cost.

#### Progress of Invention

Description of World's Most Pressing Problems by Leading Scientists and Inventors.

*We Regard a Satisfied Client* as our best advertisement, and furnish anyone, upon request, lists of clients in any state for whom we have secured patents.

*Highest References—Prompt Attention  
—Reasonable Terms*

## VICTOR J. EVANS & CO.

### PATENT ATTORNEYS

Main Offices: 956 9th St., N. W., Washington, D. C.

*Opposite U. S. Patent Office*

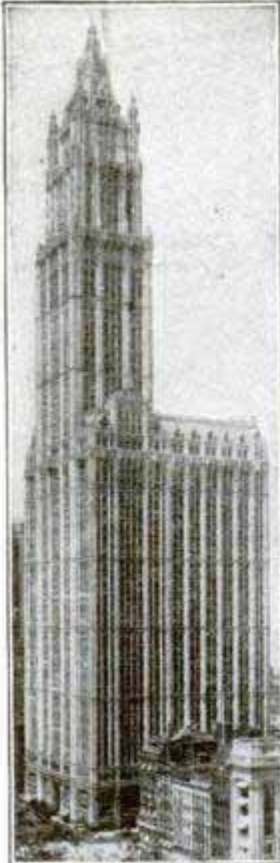

Our New York Office  
Suite 1007 Woolworth Bldg.



Our Philadelphia Office  
Suite 714-15 Liberty Bldg.



Our Washington Office  
Victor Building





# PATENTS TRADE-MARKS AND COPYRIGHTS

## IMPORTANT

TO HAVE YOUR CASE MADE SPECIAL AND AVOID DELAY YOU SHOULD HAVE YOUR CASE MADE SPECIAL IN OUR OFFICE to secure protection, save correspondence and secure early filing date in Patent Office. To secure special preparation of your case send \$25.00 on account with model or sketch and description of invention.



MAIN OFFICE, VICTOR J. EVANS & CO.—VICTOR BUILDING, WASHINGTON, D. C.

*Our Lawyers Practice in all U. S. Courts and defend Clients in Suits involving Patents, Trademarks and Copyrights*

All Communications and Data Strictly Confidential. Interference and Infringement Suits Prosecuted

OUR ORGANIZATION OFFERS PERSONAL SERVICE By Experienced Patent Lawyers, Solicitors and Draftsmen

**FREE  
COUPON**

**VICTOR J. EVANS & CO.  
PATENT ATTORNEYS**

NEW YORK OFFICES  
1007 Woolworth Bldg.

CHICAGO OFFICES  
1114 Tacoma Bldg.

PHILADELPHIA OFFICES  
714-715 Liberty Bldg.

PITTSBURGH OFFICES  
514 Empire Bldg.

SAN FRANCISCO OFFICES  
Hobart Bldg.

MAIN OFFICES: 956 9th Street, N. W., WASHINGTON, D. C.

Gentlemen: Please send me *Free of Charge* your books as described on preceding page.

Name .....

Address .....



Our Chicago Office  
Suite 1114 Tacoma Building



Our Pittsburgh Office  
Suite 514 Empire Building



Our San Francisco Office  
Suite 1010 Hobart Building



# PATENTS

Just as it is important that you protect your idea with a patent, so it is imperative that your patent covers your invention completely. The one best way to assure this is to retain a reliable, experienced patent attorney

**MUNN & CO.**  
**PATENT ATTORNEYS**  
*Associated for 81 years with the Scientific American*

1572 SCIENTIFIC AMERICAN BLDG.  
*24 West 40th Street, New York*

523 SCIENTIFIC AMERICAN BLDG.  
*Washington, D. C.*

1312 TOWER BUILDING  
*Chicago, Ill.*

520 VAN NUYS BUILDING  
*Los Angeles, Cal.*

655 HOBART BUILDING  
*San Francisco, Cal.*

*Ask for free copy of "Patents—A Book of Facts Every Inventor Should Know" and for "Inventor's Diary." Send for them NOW.*



# PATENTS

**Booklet Free**      **Highest References**  
**Promptness Assured**      **Best Results**

Send drawing or model for preliminary examination of Patent Office records.

## ALL BUSINESS GIVEN PROMPT AND PROPER ATTENTION

Listed Patent Lawyer in the latest editions of the Rand-McNally Directory of Bankers and Attorneys, of Chicago, Ill.; The Baggott & Ryall Directory of Attorneys, New York City; The Lawyers Guaranteed Directory, Detroit, Michigan; The Lawyers and Bankers Quarterly, published by the Legal Directory Publishing Company of St. Louis, Mo.; the American Lawyers Annual, Cleveland, Ohio.

**WATSON E. COLEMAN,**  
 REGISTERED PATENT LAWYER

Victor Building, 724 Ninth Street, N. W.  
**WASHINGTON, D. C.**

## 1000 NEEDED INVENTIONS!

Here is the most remarkable book ever offered to inventors. One Thousand needed inventions listed and described. Arranged as follows: General Problems; Automotive; Mechanical; Electrical; Chemical; Radio; Marine. Separate chapter on the Ten Most Needed Inventions. This book may give you one idea that will win you a fortune. Nothing else like it has ever been published. Compiled at enormous expense. Edited by Raymond Francis Yates, formerly Managing Editor of a leading scientific magazine. Over 100 pages, durably bound. Send no money. Pay postman only \$1.00 plus postage on arrival. Money back after 10 days' examination if desired. Limited edition. Write NOW.

### BUREAU OF INVENTIVE SCIENCE

DEPT 37

ROCHESTER, NEW YORK



## PATENTS

Send us sketch or model for advice and exact cost of patent. Our book "How to Obtain a Patent" sent free. It tells how to apply for Patents, Trade Marks, Foreign Patents, Copyrights, etc.; gives information on Patent Procedure; tells what every inventor should know. Thousands of inventors, who are our clients, are our reference.

**CHANDLEE & CHANDLEE, 25 Years' Experience**  
 473 7th St.      Washington, D. C.

## Will Finance Patents

Patents of commercial value financed on royalty basis without expense to inventor. Mail models and copies of patents or full details to

**KAMSTONE HOLDING CORP.**

41 East 42nd Street

N. Y. C.

# PATENTS

## To the Man with an Idea

I offer a comprehensive, experienced, efficient service for his prompt, legal protection and the development of his proposition.

Send sketch, or model and description, for advice as to cost, search through prior United States patents, etc. Preliminary advice gladly furnished without charge.

My experience and familiarity with various arts frequently enable me to accurately advise clients as to probable patentability before they go to any expense.

*Booklet of valuable information and form for properly disclosing your idea free on request. Write today.*

**Richard B. Owen, Patent Lawyer**  
 9-303 Owen Bldg., Washington, D.C.  
 41-E Park Row,      New York City

**TRADE-MARKS**  
 REGISTERED

# INVENTORS      PROTECT YOUR IDEAS

Send for our Guide Book, **HOW TO GET A PATENT**, and Evidence of Invention Blank, sent Free on request. Tells our terms, methods, etc. Send model or sketch and description of your invention for INSTRUCTIONS. No charge for the above information.

**RANDOLPH & CO.**  
 301 Victor Bldg., WASHINGTON, D. C.

NAME .....

STREET .....

CITY ..... STATE .....



# ONE HOUR each evening— Ten evenings

Patented features, easy blowing, perfect tune; these are the reasons you learn so quickly to play a

## **BUESCHER**

### True Tone Saxophone

If you can whistle a tune you can learn to play a Buescher. 3 lessons given on request with each Buescher Sax give you quick, easy start. Many learn scales first hour, play tunes first week, with their Bueschers.

#### Easy to Play — Easy to Pay

Take any Buescher Instrument home for six days' trial. See what you can do. If you decide to keep it, pay a little each month. Send for Beautiful Catalog and details of this liberal plan. No obligation. Mail the coupon today.

**BUESCHER BAND INSTRUMENT CO.**  
Everything in Band and Orchestra Instruments  
2012 Buescher Block Elkhart, Indiana



BUESCHER BAND INSTRUMENT CO. 385

2012 Buescher Block, Elkhart, Ind.

Gentlemen: Without obligating me in any way please send me your free literature. Mention instrument interested in.

Age?.....Name instrument.....

Name.....

Address.....

SEND FOR  
FREE BOOK

## NEW VEST POCKET ADDING MACHINE



**ADDS, SUBTRACTS, MULTIPLIES, DIVIDES**  
Does work of \$300 machine. Guaranteed 5 years. NOT A TOY.

Made of steel and indestructible. Million dollar capacity. Fits in pocket. Will not make mistakes. So simple child can operate it. Instructions furnished. Everybody should carry one for figuring.

**FREE TRIAL \$2.50**  
Total Cost

SEND NO MONEY—Just name and address. We will ship Calculator immediately. On delivery pay postman \$2.50 (Plus few cents Postage). (If outside U. S. send cash). If not satisfied, after 10 day trial you get your money back. THOUSANDS OF SATISFIED USERS.

This is lowest priced practical calculator made. "Why pay more for inferior imitations?" Order from this ad.

Guaranteed

Mail Coupon Today

**BABY CALCULATOR SALES COMPANY**  
Dept. 41, P. O. Box 1118, CHICAGO, ILL., U. S. A.

- I am enclosing \$2.50—send adding machine prepaid.  
 Send Adding Machine C. O. D. \$2.50 plus postage.

Name.....

Address.....

City..... State.....

**AGENTS** Write for big commission and territory proposition.



**A Genuine \$2 Knife for \$1.18 Postpaid**

Handy shaped Blade makes this knife best for mechanics, sportsmen and farmers; light but strong; re-sharpened easily. Stag handle, German silver finish; blades file tested, hand forged from razor steel and warranted.

Direct at Factory Prices

Sample \$1.18 3 for \$3.00 Postpaid

Hand Forged Razor Steel Blades  
Send for our 100-page FREE List and  
"HOW TO USE A RAZOR."

**Maher & Grosh Co.**  
106 A St., Toledo, Ohio

## PATENTS

### Don't Lose Your Rights To Patent Protection

Before disclosing your invention to anyone send for blank form "EVIDENCE OF CONCEPTION" to be signed and witnessed. As registered patent attorneys we represent hundreds of inventors all over the United States and Canada in the advancement of inventions. The form "Evidence of Conception," sample, instructions relating to obtaining of patents and schedule of fees sent upon request.

### LANCASTER & ALLWINE

480 Ouray Bldg.

WASHINGTON, D. C.

Originators of forms "Evidence of Conception."

## PATENTS

Trade Marks, Copyrights, Patent Litigation Handbook with illustrations, 100 mechanical movements. Sent free on request.

### ALBERT E. DIETERICH

formerly member examining corps U. S. Patent Office  
**PATENT LAWYER and SOLICITOR**

621-A, Ouray Bldg.

27 Years' Experience Washington, D. C.

## INVENTORS

who derive largest profits know and heed certain simple but vital facts before applying for Patents. Our book *Patent-Sense* gives those facts; sent free. Write **LACEY & LACEY**, 646 F St., Washington, D. C. Established 1869.

## BLUE BOOK ON PATENTS

AND PRIORITY RECORD BLANK GRATIS.

**MONROE E. MILLER, PATENT LAWYER**  
411-2 Ouray Building, WASHINGTON, D. C.  
ELECTRICAL AND MECHANICAL EXPERT



Inventors and Mechanics

Send 10 cents in stamps for  
Material Catalog

**COLBURN GEAR & MFG. CO.**  
98 Holmes St., Quincy, Mass.

## A PERFECT LOOKING NOSE

Can Easily Be Yours

**Trados Model No. 25** corrects now ill-shaped noses quickly, painlessly, permanently and comfortably at home (excepting cases caused by improper bone structure). It is a safe and guaranteed patent device of precise adjustment that will actually give you a perfect looking nose. Over 90,000 satisfied users. For years recommended by physicians. 16 years of experience in manufacturing Nose Shapers is at your service. **Model 25 Junior** for children. Write for testimonials and free booklet, which tells you how to obtain a perfect looking nose.

M. TRILETY, Pioneer Noseshaping Specialist  
Dept. 2792 Binghamton, N. Y.



## SKIN-TROUBLES

**ANDRE'S ACNE CREAM** is Excellent for all Skin Troubles

no matter how severe or chronic. Pimples, Blackheads, Eruptions on face or body. Eczema, Barbers' Itch, Scabs, Crusts, Pustules, Enlarged Pores, Oily, Shiny or Itching Skin. Lightens Freckles, softens and whitens the skin. Immediate Results. Write for full particulars.

**Andre & Co., 4029 Cottage Grove Av. Suite 451, Chicago, Ill.**



# MEN! BIG MONEY

## IN SPARE TIME

### And this Suit FREE



You can easily earn \$50 a week in spare time taking orders from your friends and neighbors for our fine tailoring. Orders come easy when you show our swell samples and smart styles. **We Show You How**—you don't need to know anything about tailoring—simply follow our directions—we make it easy.

### YOUR SUIT FREE

Our new plan enables you to get one of our fine made-to-order suits, in any style you want, by simply taking a few orders without one penny cost to you.

**FREE** New Big Sample OUTFIT. New style convenient carrying case outfit; large all-wool samples and all supplies furnished **FREE**. Write at once.

**PROGRESS TAILORING CO., Dept. G216, Chicago, Ill.**

# PLUMBING-HEATING

## Install Your Own—Save Half



Lowest wholesale prices on highest quality Grade A goods. Any Handy Man can install his own Plumbing and Heating BY OUR NEW EASY METHOD. Get the best and pay only a little each month.

### Send for FREE Book

New bargain catalog just issued. With our cut-to-fit systems you save waste material and high labor cost. 50 years of economical service to home owners, farmers, builders and mechanics. Million Dollar Plants back up our Bonded Guarantee. **FREE** book gives you the whole story. Write for your copy today.

**OVER 50 YRS. HARDIN-LAVIN Co. EST. 1876**  
107-17 West Pershing Road, Chicago, Ill.

### Materials For Handy Men

Bearings, Belting, Blue Prints, Books on Mechanical and Scientific Subjects, Brass Castings, Compressors, Gears, Lathes, Motors, Saws, Shafting, and Supplies of every kind for **MODEL MAKERS and HANDY MEN**.

Complete Catalogue 25c which is allowed on first \$2 order.

Amalgamated Sales and Service Corporation  
327-C South La Salle St., Chicago, Ill., U. S. A.

# THIS WONDERFUL INVENTION



converts any ordinary cook stove into a gas stove. OXO-GAS is made from kerosene and air. Cheaper, cleaner and more efficient than coal. Responsible distributors wanted.

**GLORIA LIGHT CO.**  
111-7 N. May St. Chicago, Ill.

# BANG! THE BIGGEST SURPRISE OF YOUR LIFE

Harmless Shoots Blanks



**BETSY** The World's Smallest Pistol Shoots Blanks as loud as a 45. At Parties—in business you'll have the time of your life

### SEND NO MONEY

Just pay price on arrival plus few cents express. Price \$1.50. Pearl Handle \$2. Shells \$1.00 per 100.

Dealers Write! **ORDER QUICK—State Style and Shells Wanted**

**ARISTO CO. Dept. 109 408 MALLERS BLDG. CHICAGO, ILLINOIS**



# Here's an Amazing New Business

THAT PAYS UP TO

## \$1,000 A MONTH

A surprising new profit opportunity is now offered to every ambitious man and woman! For a sensational new kind of food business has been invented that can be operated by anyone in either full or spare time. Now, almost incredible as it may sound, \$400 to \$1,000 a month is possible in even the smallest cities!

This new business is shipped to you under our proven, time-tested plan. There are no "strings" or "red tape." You start at once. We supply you with complete equipment to make and sell a delicious new **greaseless** doughnut that is cooked in a remarkable electrical device. It costs less to make, yet sells four times as fast. Easy to digest and more toothsome than old-style doughnuts ever were! No wonder so many people without one bit of experience are literally cleaning up fortunes with this new money-maker. You can open a shop; rent cheap floor space in a grocery, delicatessen, lunch-counter, drug-store, etc. Or start at home—and make up to \$250 your very first week!



"I made \$3000 in 3 months from my greaseless doughnut business!"—T. Chas. Minch, Fla.

# Men — Women — Start NOW!

Men and women everywhere are starting in this business daily! You cannot afford to delay! Details will gladly be sent without obligation of any sort. Such an amazing money maker may never be yours again. So fill in and send the coupon at once! **TODAY!**

# Mail Coupon NOW!

Food Display Machine Corp.  
Dept. B-135, 350 W. Huron St., Chicago, Ill.  
Gentlemen: Please send me the plan by which I can cash in on Brown Bobby, the Greaseless doughnut. It is understood that this obligates me in no way whatever.

Name.....

Address.....

City..... State.....



# I made **\$93** my first week

"Made \$93 my first week. Since then I have been earning over \$100 every week selling Stay-Prest."

—S. L. PATTERSON, Iowa.

## MEN OR WOMEN

**\$509** J. W. Varner, Ia., made \$509 the first month he sold this big money-making specialty. "The best seller ever," he says.

**\$32** Mrs. Helen Rhodesby, Okla., made \$32 the first day she tried selling this device. She is now one of the most successful "salesmen" of it.

**\$875** R. E. Bendine made that in ten minutes on his first call at a bank. Says Stay-Prest is fastest seller he ever had.

**\$17** S. D. Matthews, Minn., gave this a trial as a sideline. He made \$17 in his first 2 hours and decided to devote his full time to the work.

**\$33** G. M. Stewart, W. Va., tried selling this big repeater in spare time and made \$33 his first week, so decided to devote full time to it.

## SELL This New INVENTION Stay Prest Trouser Presser



Folds to 15 inches

Keeps pants always pressed. Puts in knife edge crease, removes baggy knees and smoothes out entire surface. Easy to use—takes only a few seconds. No steam or heat. Saves nap of cloth. Lengthens life of trousers. Durably made of hardwood—lasts years. Finished in black leatherette. All metal parts heavily nickled. Looks rich. Fits any size trousers. Folds to 15-inch package to fit small handbag. Over 250,000 in use.

### Profits in Advance

Your profits in advance. Simply write orders. We ship and collect. Stay-Prest sells quickly—average sale made in 8 minutes. 40% profit. Newest thing out. Big repeater.

### Send No Money

Just send name, address and territory wanted—full information and territory protection FREE! No time to lose!

**THE GETGEY-JUNG CO.**

H-121 G-J Building Cincinnati, Ohio

**FREE!**  
TO ANY MAN OR WOMAN

Special offer enables you to obtain Selling Outfit absolutely free—everything you need to take orders. We guarantee you will make sales.

## Automobile Went Dead!

Heavy rain shorted all connections, no juice, no turn over. A "trick of the trade" dried out all wiring without fire in two minutes and the car started off as though nothing had happened. SPARK PLUG FOULED CONTINUOUSLY in another car, nothing seemed to help. A "trick of the trade" showed how to avoid fouling. An automobile mechanic's note book gives 10 years of practical "tricks of the trade," worth dollars and time to any owner or man connected with automobiles. Not the common "instruction book," but a friend that helps you out of scrapes and difficulties. Ask for free circular.

L. E. SUTCLIFFE, 310 E. 20th St., CHESTER, PENNA.



## 1000 Printed Envelopes \$2.95

Size 3 1/2" x 6 1/2". Made from good grade bond paper, 2000—\$5.60; 5000—\$13.50.

### I PAY POSTAGE

Also note heads or statements, 5 1/2" x 8 1/2" at same prices.

Order from this ad or send for my Free samples: letter heads, bill heads, business cards, etc.

STEVE BOWEN, Dept. 24, 542 So. Dearborn St., CHICAGO

## BIG PROFITS in a NEW BUSINESS

of your own  
—No Competition!

Send for the little book of Big Opportunities—"The Nestler Plan." It tells, in few words and with actual photographs, how any ambitious man can become a Nestler Operator, and build up a flourishing, money-making business of his own. There is a big demand for Nestler service from automobile owners everywhere. The Nestler Rubber Fusing Process is the first and only satisfactory method of servicing tires. You convert an old, worn tire into one as good as new at one-half the cost. Little capital required; previous tire or garage experience unnecessary; exclusive territory; full-time or spare-time, as you prefer.

Send TODAY for free book, "The Nestler Plan"



This book describes the amazing Nestler Method. Shows how to build up profits in your own exclusive Nestler business.

**NESTLER RUBBER FUSING CO. INC.**

Dept. 37, 245 West 55th St., New York, N.Y.

Make \$12 a day from the start

## SELL PIONEER \$23.50 All Wool Tailoring

Full or Part Time

Make \$12 a Day from Start

Part time men \$5 an hour selling famous Pioneer tailored-to-measure all-wool suits at \$23.50.

**Cash Paid Daily**

Commissions PAID in Advance. Striking leather brief case containing 100 large swatch samples furnished—other equally remarkable values at \$29.50 and \$34.50. We train the inexperienced.

Men with determination and willingness to work for success write for this big money making opportunity today.

**PIONEER TAILORING CO., 159 W. Harrison St., Dept. G1116 CHICAGO**

## Get FREE BOOK

Show famous Outing Air Mattress, Sleeping Pockets, Robes, Bags, Tents, Fishing Capes, Folding Boat, etc. SEND YOUR NAME TODAY.

### METROPOLITAN

Camp Goods Folks  
Dept. PM-50  
Athol, Mass.



## BUILD YOUR OWN GRANDFATHER'S CLOCK

We furnish blue prints and instructions. Buy the works and dial from us at surprisingly low prices. Make fine profit building artistic clocks for your friends. Plain Works as low as \$5.00. Others with Chimes at all prices. Ask for attractive free offer.

**AMERICAN CHIME CLOCK COMPANY**  
1670 RUFFNER STREET PHILADELPHIA



## "Independent" GOLD POINT

Lever, Self-Filler Stylopen

"Makes Writing a Pleasure"

Jumbo, \$3.50; Red, \$3.00; Black

**\$2**

J. C. ULLRICH & CO., 161 Washington St., N. Y. Est. 1884 Agents Wanted

## LIGHTING FIXTURES

Ready to hang

Direct from the manufacturer. Completely wired, including glassware. Send for new catalogue No. 28. Just Reduced Prices. Special Proposition to Dealers.



**Erie Fixture Supply Company, Inc.**  
Station A ERIE, PA.



# New Water Trails open to you

WHERE nature is undisturbed... where the ever-changing vista of the great Out-of-doors leads through mile after mile of unsettled country and winding waterways.

With a Johnson Motor astern of any good boat, you may cruise through chain after chain of charming water regions—fishing, hunting, camping.

This summer follow America's water trails with a Johnson. Four new 1927 models offer speeds of 8, 13, 22, and 29 m. p. h. respectively—setting a new standard of water-motoring performance.

Send 10c in stamps or coin for our "Guide to Waterway Travels"—outlining over 50 charted water trips through the United States and Canada. Catalog sent free!

Johnson Motors sold by sport goods—hardware—marine supply dealers.

**JOHNSON MOTOR COMPANY**

2438 Sample St., South Bend, Indiana

Export Division: 75 West Street  
New York, New York, U. S. A.

Canadian Distributor: Peterborough Canoe Co.  
Peterborough, Ont., Canada

Johnson National  
Demonstration  
Week  
June 27th—July 4th  
Water Motoring  
demonstrations. Free  
trial and rides! Races!  
Ask your dealer.

## Johnson Outboard Motors



World's Largest Manufacturer of Outboard Motors

### When You Want a BLTORCH

That gives 400° more heat—  
That's 100% safe—send for

**TURNER MASTER No. 45**  
Only \$7.75, postpaid

TURNER BRASS WORKS, Industry Ave., Sycamore, Ill.

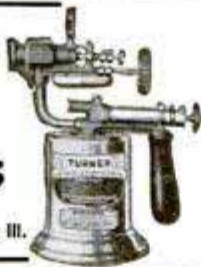

### Simplified Radio Blueprints

Blueprints for the most popular sets described in Popular Mechanics Magazine can be obtained for a charge just sufficient to cover the cost of production and mailing. The sets for which blueprints are available are:

Simple One-Tube Receiver	April 1926	25c
Two-Tube, Loud Speaker Set	May 1925	25c
Three-Tube, Cockaday Receiver	April 1925	25c
Three-Tube, Low-Loss, Short-Wave Set	Oct. 1925	25c
Three-Tube, Loud Speaker, Loop Set	Dec. 1926	25c
Three-Tube, 15 to 550 Meter Set	Nov. 1926	25c
Four-Tube, Loop Set, for Car or Home	Aug. 1926	25c
Five-Tube, Browning-Drake Set	May 1926	25c
Six-Tube, Self-Contained Receiver	July 1925	25c
Six-Tube, Counterphase Receiver	Feb. 1926	25c
Six-Tube, Portable, Loop Set	June 1926	25c
Electrolytic B-Eliminator	Feb. 1927	25c
Eight-Tube, 1927 Model Superheterodyne; this set of blueprints includes drilling templates and extra photos	Oct. 1926	75c
B-Battery Eliminator	Mar. 1926	25c
Non-Radiating Unit	May 1926	25c
Simple Tube Tester and Chart	July 1926	25c
New Perfect-Tone Six	Mar. 1927	25c

Address the RADIO DEPT.

**Popular Mechanics Magazine**  
200 E. Ontario St., CHICAGO

Back numbers of the magazines describing the construction of the sets can be obtained from our Circulation Department, price 25 cents each.

### When the Pressure is Right—



The TIRE POP-VALVE takes the drudgery out of tire inflation... carried right on the valve stem it never has to be hunted... absolutely accurate, it is easy to use in daylight or dark.

### The TIRE POP-VALVE

removes all danger of "blowouts" from over-inflation. A set to equip your tires, pneumatics on any vehicle, costs no more than a good pressure indicator. Practically doubles tire life... equipped with air tight caps... made to fit all makes of tires. Send the coupon today.  
DEALERS write for attractive proposition.

TIRE POP-VALVE CO.

771 20th Street  
DETROIT,  
MICH.

80¢ each  
set of five  
\$3.00

NAME.....  
ADDRESS.....  
MY TIRE PRESSURE IS.....  
Send me in  
with your  
check



# DEVITT 8" COMBINATION SAW

## 13 TOOLS IN ONE

Saw table raised, showing Emery wheel, saw guard and drill attachment.



Planer attachment on saw table.

Showing Sanding disc attached.



Table tilted for beveling.

Dado head attached for grooving.

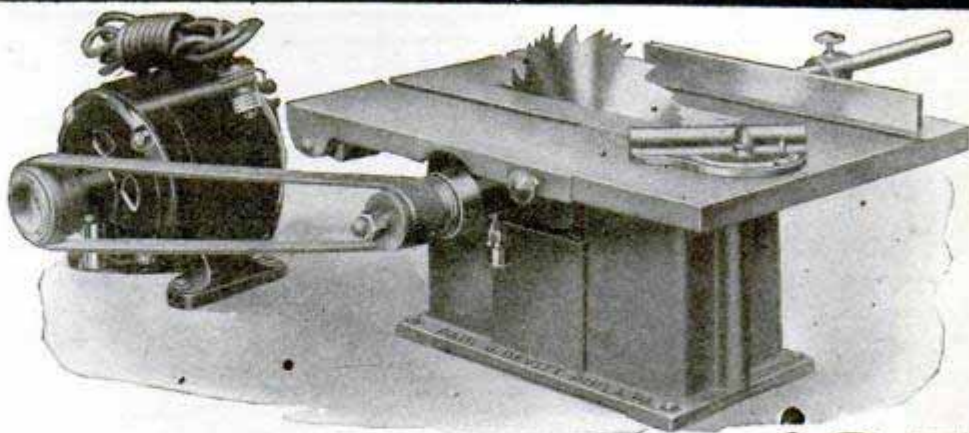

**\$35**  
F. O. B. Phila.

YOU save a great deal of money, time and space by buying a Devitt 8" Combination Saw. Why buy special tools for beveling, grooving, buffing, etc.? The Devitt Combination Saw will rip, cross cut, bevel, miter, groove, mortise, tenon, drill, rabbet, grind, buff and polish. The attachments are easily and quickly adjusted. The saw and motor when set up ready for work occupy very little room. The 1/4 H. P. 60 cycle 110 volt A. C. motor can be run from a light socket and provide power for other purposes when the saw is not in use. A cut up to 2 1/4" can be made with the 8" Combination Saw without planing. The ideal machine for shop, factory or home, complete with attachments: 12"x16" table, 8" Combination Saw, iron pulley for saw table, 10' ripping fence, adjustable cut off miter gauge, motor-specifications as above, 1 1/4" endless leather belt, wood pulley, 8 ft. cord and plug, 6" buffing wheel, 3/4" 3 jaw drill chuck, 5" emery wheel, 6" sander, saw guard, and 2" dado insert. \$35.00 F. O. B. Phila. Height 7 1/2", shipping weight, 100 lbs. (Planer attachment to fit on table top will smooth pieces up to 2 in. wide, \$12.00 extra F. O. B. Phila.)

Write for our beautifully illustrated 4 page circular.

**PAUL J. DEVITT** 1102 South 2nd Street PHILADELPHIA, PA.



### Music Opens The Door

INSIDE that closed door there is joy and good-fellowship. Outside there is loneliness, long evenings that seem never to pass. You can play better on King instruments. They are in tune because they are tested to the largest set of tuning bells in the world.

Let us tell you more about your favorite instrument. We will send our brand new handy reference catalog with full particulars on request. Our easy payment plan puts King band instruments within easy reach of all. Clip the coupon now.

THE H. N. WHITE CO.  
5211-89 Superior Ave., Cleveland, Ohio  
Kindly send me your Handy Reference Catalog. I am interested in a

\_\_\_\_\_ Instrument  
Name \_\_\_\_\_  
Address \_\_\_\_\_  
City \_\_\_\_\_ State \_\_\_\_\_

**KING**  
Band  
Instruments

Information on any book free. Write Popular Mechanics Press, Chicago, Ill.

### NO JOKE TO BE DEAF

—EVERY DEAF PERSON KNOWS THAT



I make myself hear, after being deaf for 25 years, with these Artificial Ear Drums. I wear them day and night. They stop head noises and ringing ears. They are perfectly comfortable. No one sees them. Write me and I will tell you a true story, how I got deaf and how I make you hear. Address



Medicated Ear Drum

**GEO. P. WAY, Artificial Ear Drum Co. (Inc.)**  
80 Hoffman Bldg., 2539 Woodward, Detroit, Mich.



### BUCHSTEIN'S FIBRE LIMB

is soothing to your stump—strong, cool, neat, light. Easy payments. Braces for all deformities.  
**D. BUCHSTEIN CO.**  
610 3rd Ave., So. MINNEAPOLIS, MINN.

Send for Catalog Today

### 150 Miles on 5 Gals. of Gas Guaranteed

Chicago, Ill.—A new Thermostatic Carburetor Control guaranteed to give 150 miles on 5 gallons of gas on Ford cars is proving a big success. With the Blancke Control attached Fords have gotten as high as 43.8 miles per gal. Cadillac, LaSalle and Delco Light are now using Thermostatic Control under Blancke License. Entirely automatic; starts motor instantly. The inventor wants agents everywhere and will send a control Free to introduce. Sales guaranteed. \$15.00 a day guaranteed to Distributors. Write quickly to Blancke Auto Devices Co., 154 E. Erie St., Dept. 805-K, Chicago, Ill.



# \$351<sup>00</sup> CLEARED ~ IN ONE DAY

So writes W. H. Adams of Ohio. Letter from V. A. Marini of California reports \$11,275 sales in three months. Jacob Gordon of New Jersey "\$4000 profits in two months". Alexander of Pennsylvania "\$3000 profits in four months." Ira Shook \$365 sales in one day. Bram bought one outfit April 5 and 7 more by August 28. Iwata, bought one outfit and 10 more within a year. Mrs. Lane of Pittsburgh says "sold 8000 packages in one day." J. R. Hart says "only thing I ever bought that equaled advertisement." John Clup says: "Everything Going Lovely. Crispette wrappers scattered all over town. It's a good old world after all." Kellogg, \$700 ahead end of second week.



**WE START YOU IN BUSINESS**  
Furnish secret formulas, raw materials, and equipment. Little capital required; no experience needed.  
**BUILD A BUSINESS OF YOUR OWN**  
No limit to the sale of Crispettes. Everybody likes them. It's a delicious food confection. Write for facts about a business that will make you independent. Start now in your home town.  
**Profits \$1000 a Month Easily Possible**  
Send postal for illustrated book of facts. It contains enthusiastic letters from others--shows their places of business, tells how and when to start, and all information needed. Free. Write now!

**LONG-EAKINS COMPANY**  
728 High Street Springfield, Ohio

## 50c Cigar Lighter for 15c

Does the work of a \$10.00 lighter. Men and Women Agents. Make Big Money. 30c profit on each sale. 15c for Sample. \$2.50 for a dozen. Money back if you can't sell.  
L. E. LEMKE, Sales Manager, 214 West Kinzie St., Desk 22, CHICAGO

Let us recommend the best books to study on any subject. Popular Mechanics Press, Chicago, Illinois

## Make Decorative Metal Articles

Pictures and instructions for making: book ends, desk sets, jewelry, desk clocks, drawer pulls, hinges, bookmarks, stationery rack, candlestick, letter holder, whisk broom holder, and many similar articles. Send no money. Just write a postal for "Metal Work and Etching", our 88-page book. Pay postage and 98c to postman. Popular Mechanics Press, Room 707, 200 E. Ontario St., Chicago, Ill.

**What Do You Do When You Cannot Find the Book You Want?**

Don't give up in despair. Send for a copy of the unique catalog published by Popular Mechanics Press. It contains 5000 books listed alphabetically under 2000 main subjects and sub-headings—literally from A to Z—Abrasives Manufacture to Zoologist and everything in between.

**FREE UPON REQUEST**  
Send for your copy today

**POPULAR MECHANICS PRESS**  
200 E. Ontario Street, CHICAGO

# BIG

\$75 to \$150 Weekly—\$10 to \$25 Daily

# money

# You Never Saw A Tool Like This

**Makes a Hard Job Easy**

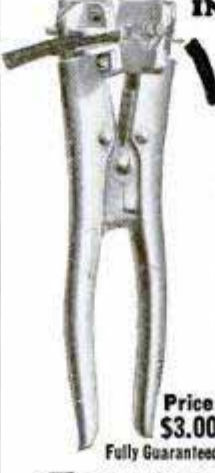

**INSTANTLY STRIPS INSULATION FROM ELECTRIC WIRES**

**"One Inch Strip with Every Clip"**

This E. Z. Wire Stripper is positively a sensation for Radio, switchboards, electric signs, automobile work, battery work, telephones, lamp wiring, in fact, for stripping insulation from electric wires everywhere it is really a necessity—because it does the job SO CLEAN, SO QUICK and SO EASY. Wherever it is demonstrated it draws a crowd. They all want it.

**Everyone Is Wild Over It**

Concerns like the GENERAL ELECTRIC CO. have already expressed their approval of this marvelous tool; in fact—it does the work so neatly and so quickly that its Efficiency and Economy cannot be overlooked. "It really saves money on every job."

## Agents Making Big Money

A Big Money-Maker for wide-awake agents, simply introduce it and every one sold will sell a great many more, every workman wants it, the home-mechanic is glad to get it and you sell in big quantities to shops.

## Get Territory Quick

Mail the coupon for Introductory Outfit at \$3 and tell us what territory you want, remember we give preference to the first person in each locality.

**MAIL TODAY**  
**PYRAMID PRODUCTS CO.**  
2311 So. State Street, Dept. B., Chicago, Illinois  
Kindly mail E. Z. Wire Stripper. I will pay postman \$3.00. Please mail me information only ( )

Name.....  
Street or R. F. D.....  
City and State.....





**You Too Can Add Profits of \$150 to \$300 Monthly**

Mechanics, Repair Men, Garages and Battery Shops are adding customers and profits without expense to them. Start in business yourself with HB One Day Battery Service. You'll get the business by charging batteries in one-third the time required by other methods. HB does better charging—at lower cost to you. Comes to you for

**ONLY \$16 MONTHLY**

Check No. 1 in the coupon below for full information.

### HB Test Bench

Another Big Profit branch of automotive service is Starting-Lighting-Ignition Service. You can do it with practically no investment. **ONLY \$20 MONTHLY** for this HB—priced \$100 to \$150 below anything near its quality. Check No. 2 in the coupon below for full information.

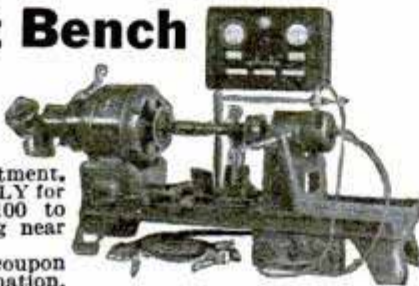

### Bring Customers To Your Door

Better Air Service than the other fellow's is yours for only \$12 monthly. Dependable Day and Night Service keeps car owners coming to your door day after day. Only HB quantity production makes possible the low price on this Silent, Beltless, Upright, Ball Bearing, Twin Cylinder HB Automatic Air Service. Check No. 4 in the coupon below for full information.



### HB Portable Paint Spray

Enables you to underbid every competitor, yet makes more profit for yourself on every job. Does the work of five brush painters and does it better. Paint automobile, houses, barns, garages, furniture. Check No. 3 in coupon below for full information.



**HOBART  BROTHERS**  
Successful manufacturers ~since 1893~

BOX M77 TROY, OHIO

**Tear off Coupon and Mail Today**

HOBART BROTHERS CO.  
Box M77, Troy, Ohio.

Send me complete information on the items I've checked with your 30 day trial offer, easy payment terms, and information on how HB equipment will increase my earnings.

- 1  One Day Battery Service Profits  
2  Electrical Test Bench Opportunities  
3  Portable Paint Spray Business  
4  Better Automatic Air Compressor

NAME.....

ADDRESS.....



**LeDet "B"**  
POWER

A New Scientific Discovery that Provides Perfect "B" Power For your Radio

**Direct from Factory at Half its Retail Price**

Send \$1  
Pay Balance  
after inspection  
TOTAL  
**\$12.50**

Guaranteed to be equal to, or better than the highest price B Eliminators on the market. Equipped with the famous LeDet Condenser and Transformer, made to last a lifetime, has no tube to wear out, years ahead of the ordinary B Battery Eliminator. Eliminates foreign sounds and gives your radio a tone as smooth as velvet. We offer for a short time, to advertise this marvelous new principle of B-Power. A limited number of "LeDets" at \$12.50 each, postage paid. Send \$1, pay balance after inspection. LEDET LABORATORIES, Detroit 12th St., Terminal Bldg. Detroit, Michigan

## CLAROSTAT

is the perfect variable resistor for every radio purpose: Line control for voltage compensation; B-eliminator voltage control; R. F. tube plate voltage control; volume control.

Why and HOW is explained in 32 page book, "THE GATEWAY TO BETTER RADIO." Send 25c to

AMERICAN MECHANICAL LABS.

Dept. P. M. 285 North 6th Street Brooklyn, N. Y.

CAUTION! CLAROSTAT is being imitated. Don't be misled. Insist on seeing the name which is stamped on every genuine CLAROSTAT.

## CLAROSTAT

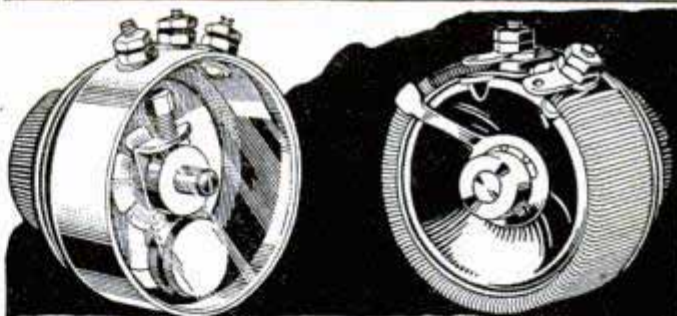

### Two Winners You Should Know

FROST-RADIO DeLuxe Super Variable High Resistance Units, and Frost-Radio DeLuxe Metal Frame and Bakelite Rheostats and Potentiometers are winners! They make any set produce better results—give greater satisfaction. Made right—priced right. Your dealer can supply them in a wide range of resistances. See him today about these items for your set.

**HERBERT H. FROST, Inc.,** Main Offices and Factory: ELKHART, IND.

## Make \$100 a week

with this new magic knife that's always sharp

Amazing new invention has sharp edge always. Does away with dull knives. No grinding. Simply put on new sharp blade as easily as putting blade in safety razor. A child can do it in 10 seconds, and extra blades make you extra money. It's the magic Re Nu Edge Knife.

Every woman is a prospect. Restaurants want several. Make \$100 a week easily. No experience necessary. Sells on sight. 100% profit.

WRITE QUICK! for unique sales plan with special advertising offer for limited time. Hurry!

**BARNETT MFG. CO.,** 418 So. San Pedro St., Los Angeles, Cal. Dept. 18





# SUBANTENNA

## UNDERGROUND ANTENNA SYSTEM

**Be Sure to Tune In  
KYW**

(536 Meters)  
Every Wednesday Evening  
7:30 to 8:00 P.M.  
Central Daylight Saving  
Time. The SUB-  
ANTENNA CRUSADE  
ERS and their accom-  
panists entertain you at  
that time.

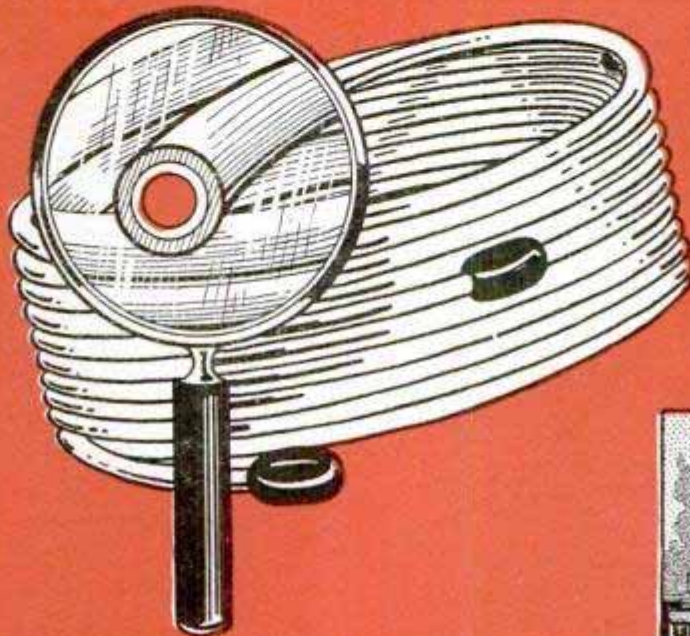

## Gets Distant Stations Clear and Loud— Summer and Winter—Right thru Static

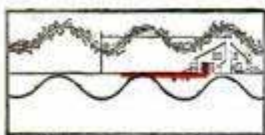

NOW—you can get "distance" in summertime. Loud, clear, clear distance, sweet and true in tone—almost like local. The

marvelous new device illustrated above makes this possible. STATIC is no longer a nuisance.

Engineers have long known that the ratio of static strength to signal strength IN THE AIR, favored Static, but that in the GROUND, the ratio of static strength to signal strength favored the music you wish to hear. They knew that if some device could be perfected whereby broadcast waves could be taken out of the GROUND instead of from the air, that all-year-round distant reception would become a reality. SUBANTENNA is the answer. It completely does away with the old style up-in-the-air aerial; it picks up clear, filtered waves from the ground—it delivers a strong signal; waves so powerful that the tiny amount of weak ground static they may contain is drowned out. The performance of SUBANTENNA is nothing short of marvelous. It will amaze you—just as it has amazed laboratories and thousands of critical fans.

### USER SAYS "STATIC IS NO MORE"

"I have received the Subantenna. My grandson installed it. STATIC IS NO MORE. Am well satisfied. I can tune in stations I never could coax out of the air even though I had a long aerial."—A. E. F., Kans.

### USER SAYS "GREATER DISTANCE"

"To show you that I received a program from Station PWX in Havana, Cuba, I enclose herewith a verification card from that station. On January 28th, I received a program on my set broadcasted from Buenos Aires, South America, at 10:15 in the evening. Many other long-distance stations have been heard on my set after installing the Subantenna. I never could receive such distance on my outside antenna." W. C. F., Chicago, Ill.

### USER SAYS "GETS MORE STATIONS"

"I get plenty of stations with my Subantenna, on the loud speaker that I have never been able to reach with my outside aerial. It absolutely cuts down interference to the minimum, cuts static out, too—not just partly out—but all out." H. S. M., N. Car.

### User Says "Cuts Out Interference"

"Have had Subantenna some months and it beats any antenna I have ever had by forty miles. Have a five tube set and get New York City, Atlantic City, Atlanta, New Orleans, Fort Worth, Denver, perfectly clear, and next to an elevated train with much interference. Cuts it all out." C. H. Y., Chicago.

### USER SAYS "MORE VOLUME"

"We have been receiving stations that formerly did not register on the outside antenna. A marked increase in volume on Stations over 800 Kilocycles has been noted."—Capt. F. W. F., Md.

### ELIMINATES LIGHTNING RISK

Not only does SUBANTENNA make possible loud, clear DX in summer—not only does this remarkable invention better the selectivity of any set—but it also completely eliminates the lightning hazard. With SUBANTENNA one can go right on listening-in during the most severe electrical storm without noise, fear of attracting lightning or damaging the set.

## FREE TRIAL

### MAKE THIS CONVINCING TEST

Install SUBANTENNA. Leave your old aerial up. Select a bad night when DX is almost impossible with the ordinary aerial. Make a comparison station for station, connecting first your aerial, then SUBANTENNA. If, from stations that are just a mess of jumbled noise with the old aerial, you don't get reception that rivals local in sweetness and clarity the instant you switch to SUBANTENNA, this test won't cost you even a single penny. Obtain a SUBANTENNA from your dealer or send coupon at once for scientific explanation of SUBANTENNA and for particulars of GUARANTEE and FREE TRIAL OFFER. Send COUPON NOW!

## CLIP AND MAIL AT ONCE

Cloverleaf Mfg. Co.,  
2715-R Canal St., Chicago, Illinois  
Tell me all about SUBANTENNA, your  
unqualified, unconditional guarantee  
and your FREE TRIAL OFFER.

Name.....

Address.....

City.....

**CLOVERLEAF MANUFACTURING CO.**  
2715-R Canal Street  
CHICAGO, ILLINOIS



# Tires Shot Full of Holes But Not a Single Leak

**Marvelous New Invention Banishes Punctures Instantly Permanently—While You Ride**

**FREE OFFER for 4 TIRES**

To Everyone Who Mails Coupon Quick

It's Name is **Puncture Nix** Nothing Ever Like It!

At last a new, different puncture-proof guaranteed to instantly, permanently banish punctures, slow leaks, valve leaks, pore leaks—while you ride. Does not take the place of air. Now forget blow-outs, rim cuts, stone bruises. Double tire mileage. Save hundreds of dollars.

Now puncture-proof old or new tires in a jiffy without removing them from wheels and double tube and tire mileage. Get in on this special advertising offer. Rush coupon for

**FREE TRIAL**

## Stop Punctures in 1 Second!

Not even a huge 20-penny spike can make tires leak when protected by Puncture-Nix. Never anything like it! Not a thin liquid! Not a tire filler! Not a liner! Not a cement! Not a contraption! A complete success! Costs only a few cents. First cost is the ONLY cost. Guaranteed not to injure tubes or tires or we will give you new ones free.

## Now Forget Blow-Outs!

### PROOF

"I have used your 'Puncture-Nix' in my tires and think it is fine."

R. F. Schimpf, Ohio.

"Received my Trial Set of 'Puncture-Nix' and it is very good."

George Sherrick, Ohio.

"Send me 25 sets of 'Puncture-Nix' by express at once."

H. C. Beine, Iowa.

### \$1,000 Insurance Policy

You can collect \$1,000.00 if we fail to make good our guarantee for Puncture-Nix. Proof that we would not dare make a single exaggeration.

Tires and tubes give far more mileage when protected against punctures, under-inflation, blow-outs, rim cuts, stone bruises. This is where "Puncture-Nix" saves you money again. Good-bye mussy tire changing forever.

**WARNING!** Don't buy any puncture-proof until you try "Puncture-Nix" on Free Trial. Don't confuse it with anything else. It not only prevents air loss instantly—but it prevents air loss PERMANENTLY.

## Demonstrations Astound Crowds!

Hundreds of tacks, nails, and even 20-penny spikes cannot puncture tires protected by Puncture-Nix. No wonder Agents, Salesmen and Distributors are astounding crowds and coining money.

## AGENTS

**\$50 a Day**

**Driving Nails in Tires**

We want men everywhere to introduce Puncture-Nix quickly. Spare or full time. No car needed. Amaze crowds and coin big profits fast. Free goods to start you. No sales experience needed. Get in on the ground floor with this big money maker. Make \$50.00 a day. Get in now with this big money maker. Territories going fast. Rush coupon.

Puncture-Nix Corporation, Puncture-Nix Bldg., 3847 Ravenswood Ave., Dept. 9, Chicago.

I am interested in Free Puncture-Nix offer for 4 tires. \$1000 Insurance Policy and Free Goods to start Agents. No obligation on my part.

Name .....

Address .....

City..... State.....

## TRY IT FREE

Send no money. Just coupon. We trust you. To introduce our marvellous invention in your locality quick we will send you our Free Offer of Puncture-Nix for your 4 tires. If after testing it on your own car you do not proclaim it the marvel of the age, we will pay you \$1.00 cash for testing it. This is an unusual advertising offer.

**PUNCTURE-NIX CORPORATION**

Dept. 9  
Puncture-Nix Bldg., 3847 Ravenswood Ave., Chicago



## Make \$40 a Day

Introducing **MASTERLITE**  
**POCKET LIGHTER**



Every smoker instantly appreciates the wonderful convenience of this pocket lighter. Lights without flint or friction and no wind can blow out the flame.

**Every Smoker Buys on Sight!**  
**100% CLEAR PROFIT. Repeat Business Guaranteed**

Sells instantly to smokers and dealers at big profits. Guaranteed for life. Each sale builds an everlasting repeat business. \$3.00 brings sample dozen in handsome display box with our sure-fire selling plans. Masterlite retails at 50c. **Sells on a Flash Demonstration at over 100% Profit.**



**Sample 50c**

## Radio Gas Lighter

**Lights Gas without Flame**



No friction, spark, or flame. Lights instantly mantles, gas stoves, jets, and heaters. Held directly over gas flow. Flame appears instantly. Absolutely safe. Banishes danger from matches.

**Make \$26 a Day**

A big 25c seller, paying 300% clear profit. A gross easily sold in a day bring a \$26.00 and costs you \$10.00 — 2¢ a day clear. Rush \$10.00 for gross or \$1.00 for sample dozen, with amazing new sure-fire self-selling plans.

**Masterlite Mfg. Co., Dept. G-23, 110 East 23 St., New York**

## Start to Play Very First Day



Be the life of the party. Xyloimbists make \$5 to \$25 a night. No knowledge of music required. Wonderful for home. Free, easy lessons; five days' trial; a year to pay. Write for big FREE Book.

**J. C. DEAGAN, Inc.**  
B-145 Deagan Building  
CHICAGO

**YOU CAN PLAY THE XYLOIMBA**

## FREE SAMPLE CASE OFFER

**\$100 to \$125 Profits Weekly**



New line of quality toilet goods sells like wildfire. No experience required. All you do is take orders from this beautiful sample case. Perfumes, soaps, creams, face powders — wonderful products at prices that appeal to all women. FREE CATALOG.

**NATIONAL SOAP & PERFUME COMPANY**  
512 W. Huron St., Dept. D-7, Chicago

## \$12 in 60 Minutes

# STICK-A-LITE

**Magnet-in-base Auto Light**



No selling talk needed to sell these wonder lamps. Takes a 30-second demonstration to put \$1.50 profit in your pocket. You don't need an auto—use the customer's own car. Show how Stick-a-lite sticks with an 8-pound grip at any angle, on any metal part of car, leaving both hands free to work. Sell every auto driver. Big season ahead. To save time, send \$2 deposit for demonstrator. Money back if returned in 15 days. Or write for Free Stick-a-lite offer, quick!

**Premier Electric Company**  
Dept. 249, Grace St. at Ravenswood, Chicago

# I Want to Send You a Santa Fe Special Watch

## for You to see and examine



**Our 21 Jewel Santa Fe Special Guaranteed for Life**

**Send No Money**

**Watch Sent on 30 Day Free Trial**

*Santa Fe Special Watches are today being shipped to every civilized country in the world, and are probably the best and most favorably known watch in both Army and Navy.*

In addition to our NEW LOW PRICE, I will send for your approval one of these Standard Watches, guaranteed for a lifetime of satisfactory service, not only by the Santa Fe Watch Company, but by the Great Illinois Watch Factory. So accurate, Government officials carry them; so perfect and beautiful, jewelers say they are worth 1-3 to 1-2 more than we ask for them. I will send you one to see WITHOUT ONE PENNY DOWN—allow you to wear it 30 days FREE—then sell it to you on easy payments.

**WHY NOT OWN A 21 JEWEL SANTA FE SPECIAL WATCH?**

You will never miss the few cents a day that will make you own one of these watches—SEND FOR WATCH BOOK—illustrating in beautiful colors hundreds of designs and combinations in cases in the POCKET WATCH, MEN'S STRAP WATCH and LADIES' WRIST WATCH. You can have your name or monogram and any emblem you may desire engraved in the Case to suit your own ideas. Write today for Free Watch Book, and make your selection at once, while this offer lasts.

**FREE** A limited offer! With every Santa Fe Special, beautiful gold chain or strand of exquisite pearls. Write today. Mail coupon for both Watch and Diamond Catalog

**SANTA FE WATCH COMPANY**  
76 Thomas Building  
Topeka, Kans.  
*(Home of the Great Santa Fe Railway)*

**Mail coupon to-day!**

**SANTA FE WATCH COMPANY**  
76 Thomas Building, Topeka, Kansas

Please send prepaid and without obligation your Watch Book Free, explaining your "No Money Down" Offer on the Santa Fe Special Watch.

Name.....

Address.....

City..... State.....



# Wait Just a Moment, Mr.!

Before You Light That Cigarette, Cigar or Pipe—Or Take a Chew of Tobacco—



## REMEMBER THIS:

That no man can escape the bad effects of tobacco. Its active principal—nicotine—is a deadly poison which, in time, is simply bound to injure your health—perhaps seriously.

Most tobacco users realize this. But when they try to quit unaided they find it next to impossible because of the almost unbreakable hold the habit has on them.

Thousands of inveterate tobacco users have found it easy to quit with the aid of the

### Keeley Home Treatment For the Tobacco Habit

A sane, scientific Treatment based on the prescription of Dr. Keeley, who founded the famous Keeley Institute for liquor, drug and tobacco addicts more than 50 years ago. Quickly and completely banishes all craving for tobacco in any form. Contains no habit-forming drugs. No bad after-effects. Not a tobacco substitute. A wonderful tonic. Improves appetites and digestion.

**Money-Back Guarantee** If, after taking this Treatment according to directions you can honestly say you have not been benefited, we will refund your money.

**MAIL COUPON** for FREE BOOK which gives plain facts about the injurious effects of tobacco and tells how easy it is to quit with the aid of this remarkable treatment.

THE KEELEY INSTITUTE

Dept. P. M.-7 DWIGHT, ILL.

The Keeley Institute, Dept. P.M.-7, Dwight, Ill.

Send without obligation your free booklet telling how to rid myself of the tobacco habit.

Name .....

Address .....

# STOP USING A TRUSS



Reduced Fac-Simile Gold Medal

STUART'S PLAPAO-PADS are different from the truss, being mechanic-chemico applicators made self-adhesive purposely to hold the distended muscles securely in place. No straps, buckles or spring attached—cannot slip, so cannot chafe or press against the pubic bone. Thousands have successfully treated themselves at home without hindrance from work—most obstinate cases conquered. Soft as velvet—easy to apply—



Grand Prix

inexpensive. Awarded Gold Medal and Grand Prix. Process of recovery is natural, so afterwards no further use for trusses. We prove it by sending Trial of Plapao absolutely

FREE Write name on Coupon and send TODAY. **PLAPAO CO., 733 Stuart Bldg., St. Louis, Mo.**

Name .....

Address .....

Return mail will bring Free Trial Plapao.



# Deafness

Perfect hearing is now being restored in all cases of deafness caused by Catarrhal troubles, Relaxed or Sunken Drums, Thickened Drums, Roaring or Hissing Sounds, Perforated, Wholly or Partially Destroyed Drums, Discharge from the Ears, etc.

## Wilson Common-Sense Ear Drums

require no medicine but effectively replace what is lacking or defective in the natural ear drums. They are simple devices, which the wearer easily fits into the ears where they are invisible.

Free Book on Deafness

Soft, safe and comfortable. Write today for 168-page book on deafness giving full particulars and many testimonials. The hearing of thousands of grateful users has been restored by these "little wireless phones for the ears."

WILSON EAR DRUM CO., Incorporated 653 Todd Building LOUISVILLE, KY.

# No Joke to be Bald



Grow New Hair Quick

## Let Me PROVE It To You FREE

What I accomplished on my own head, pictured above, I believe I can do for you, provided you are under 45 years of age and loss of hair was not caused by burns or scars. Anyhow, I must succeed or you pay nothing. No apparatus—my home treatment is simple, quick and inexpensive.

**Send No Money** Just your name and address and I will mail you full information with PHOTOGRAPHS, NAMES and addresses of men and women who have successfully used my treatment for dandruff, falling hair and particularly for baldness. Write Now. A postal will do.

**VREELAND'S**, B-135 Euclid-Windsor Bldg. CLEVELAND, OHIO

**Enlarged Nosepores, Pimples, Blackheads, Red Nose, Oily Skin, Sallow Complexion** and other miserable local skin affections will be quickly remedied and overcome with M. Trilety's A. B. A. Lotion, leaving the skin in a clean, clear and natural healthy condition. No sticky or oily substance, but refreshing and fragrant. Applied at night. A 3 oz. bottle sent on receipt of \$ .75. Address M. Trilety, 99 W. U. Bldg., Binghamton, N. Y.



# Save Your Feet

When all else fails, end your suffering with the

**Heefner Arch Support** No Metal



Fully patented. It re-adjusts the entire foot. Write for free book and statements from doctors and users.

Heefner Arch Support Co. 653 M. E. Taylor Bldg. Louisville, Ky.

# DO YOU

WANT a new business profession of your own, with all the trade you can attend to? Then become a foot correctionist, and in a few weeks earn big income in service fees,—not medical nor chiropody—easy terms for home training, no further capital needed, no goods to buy, no agency. Address

Stephenson Laboratory, 1 Back Bay, Boston, Mass.

# A Test Every Man Past 40 Should Make

Medical authorities agree that 65% of all men past middle age (many much younger) are afflicted with a disorder of the prostate gland. Aches in feet, legs and back, frequent nightly risings, sciatic pains, are some of the signs—and now, a well known American Scientist has written a remarkably interesting Free Book that tells of other symptoms and just what they mean. No longer should a man approaching or past the prime of life be content to regard these pains and conditions as inevitable signs of approaching age. Already more than 25,000 men have used the method described in this book to restore the prostate gland to its proper functioning. Send immediately for this book. If you will mail your request to W. J. Kirk, President Electro Thermal Company, 2171 Main Street, Steubenville, Ohio—the concern that is distributing this book for the author—it will be sent to you absolutely free, without obligation. Simply send name and address. But don't delay, for the edition of this book is limited. Western Office, Suite 21-P, 303 Van Nuys Bldg., Los Angeles, Calif.



# FREE!



## This 80 Page Book New & Used Auto Parts

Everything for the auto at rock-bottom prices, made possible by quantity buying and big-volume selling. Thousands of bargains—Timken Axles and Bearings, Brown-Lipe Transmissions, Pistons, Rings, Hayes and Firestone Wheels, Rims, Tires, Tubes and a complete line of accessories—new, except where specified.

### SAVE 30 to 80%

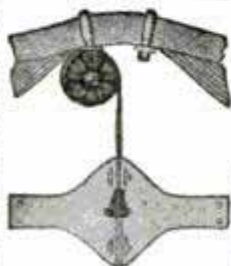

### A Typical Value Gilman Shock Absorbers

Set of Two \$4<sup>75</sup>

For Fords, up to '26. Installed in center of car to insure perfect balance. No displacement of any Ford part necessary, no drilling of holes. A set on your car will add years to its life.

Write for Your Catalogue Today—FREE!

## WARSHAWSKY & Co.

World's Largest Replacement Parts House  
1915-35 S. State St. Dept. PM 7 CHICAGO

## STANLEY

Plumbing Supply Co., Inc.

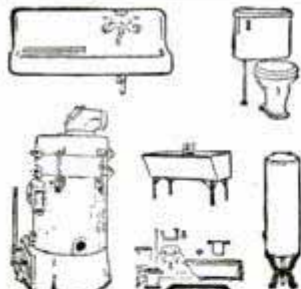

### Save one-half

We sell everything in plumbing, heating, hardware, paint, roofing and millwork supplies. Due to large-quantity buying, we are able to offer you Grade A merchandise at enormous savings. Satisfied customers in every State. Send for our elaborate catalog—over 95 pages of surprising bargains.

STANLEY PLUMBING SUPPLY CO., Inc.  
400 N. 12th Street, PHILADELPHIA, PA.

## MEN INTERESTED IN RADIO

Big money for your spare or full time. Give a service to radio owners and autolists. No machines, no equipment, something all need once a month anyhow. **EVENINGS ALONE PAY YOU SEVERAL DOLLARS EACH**—full time much better. No technical knowledge required—we teach everything. Enclose 25c for sample to try and full details. **ARVEO INDUSTRIES, Dept. 10, GROSSE ILE, MICHIGAN**



Radium Dial  
Jeweled Movement

Silveroid. Cushion  
Shaped Case

This fully guaranteed watch cannot be manufactured in America for less than \$12. Genuine leather strap. Accurate—durable—handsome. **SEND NO MONEY.** Pay on delivery \$3.99 plus postage. **"FEDERAL,"** U. S. Swiss Agents, 561 Broadway, New York City, Dept. W. 10

# NEW!

—and already winning  
Nation-wide Popularity



## Indian SCOUT 45

—the police special and sport solo

VETERANS praise it. New riders welcome it. Already a coast-to-coast motorcycle sensation. That's the startling story of the new Indian Scout 45—a mount winning thousands to the biggest thrills of motorcycling.

The Scout 45 has a super-powerful motor, almost instant acceleration, large oversize brake, classy sport handle bars. Holds boundless power for the veteran rider, easy handling features for the novice. Guides you quickly through traffic—out to the open—anywhere, anytime—safely! Ride the 45 a mile—and find the full meaning of its amazing country-wide popularity.

### Easy to Own

Call on your nearest Indian dealer and find how easily you can own a Scout 45 under our generous pay-as-you-ride plan. Or mail coupon below for the complete interesting story of this popular model.

DEALERS! A few good territories open. Our proposition is a winner for ambitious men. Write now.

## Indian Motorcycle Co.

Dept. P-7, SPRINGFIELD, MASS.

Indian Motorcycle Co.,  
Dept. P-7, Springfield, Mass.

Send me FREE descriptive circular on the new Indian Scout 45. This places me under no obligation.

Name .....

Address .....

City..... State.....



# DOLLARS from DIRT!

## WASHING HOUSES WITH THE NIELCO Lightning Washer

(Patent Pending)

The only machine on the market to wash houses, or in fact any painted surface, tile, terra cotta and glazed brick.

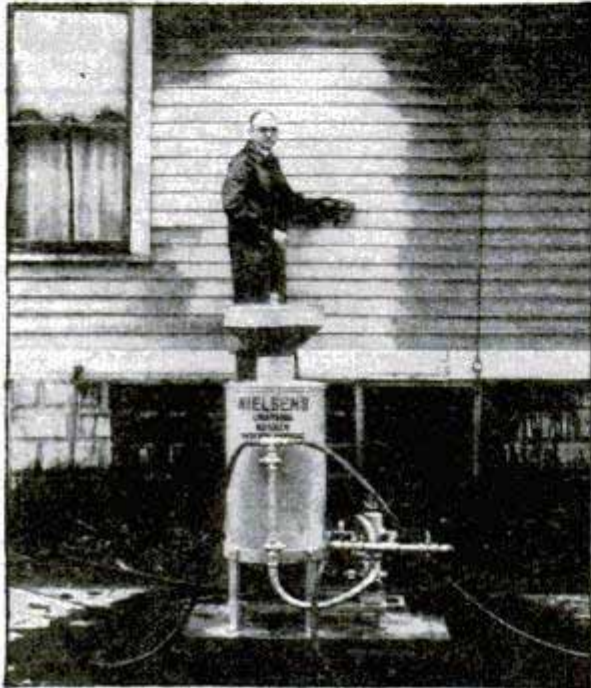

From an unretouched photo of the NIELCO Lightning Washer in action. Just before rinsing.

Do you know that 90% of the houses painted each year are painted because they are dirty and NOT because they need paint?

When a house needs paint—to wash it the NIELCO Way saves paint and money!

EVERY HOME OWNER INTERESTED!

## \$20 A DAY!

is easily made with one machine and two men besides paying themselves regular wages. Count the houses in your territory and then decide to go into this business.

You can do first class work for less than half the cost of the usual hand method.

NIELCO Cleansing Compound used exclusively with the NIELCO Lightning Washer is GUARANTEED HARMLESS to hands, clothing, paint, lawn or shrubbery!

### EXCLUSIVE TERRITORY

To men who can see the BIG MONEY in this business. A liberal franchise protects you from competition. Get the territory you want, NOW. Start the profits coming your way!

### YOU CAN DO IT!

The clerk, "handy man" mechanic, carpenter, etc. all can learn to operate the NIELCO Lightning Washer in a few minutes.

Write today for your territory!

**NIELSEN INDUSTRIES, Inc.**

1207 Maccabee Bldg.

DETROIT

MICHIGAN

Live Distributors Write!

# LIGHTING MATCHES WILL MAKE YOU



## Amazing "Sure Fire" Demonstration

Sells by thousands new automatic attachment that Sworn Public Tests prove makes Fords run

### 43.8 MILES ON 1 GAL. OF GAS

This simple, but sensational demonstration easily convinces and astonishes even the skeptical. Agents everywhere report wonderful results. Mr. R. K. Waite ordered 1000 devices in 1 month. Profit \$3000.00. Mr. Clyde B. Jones sold 63 devices in 1 day. Profit \$189.00. No experience needed. Thrilling demonstration sells for you. Guaranteed results of Blancke Control, backed by National advertising, assure such remarkable savings to users that sales by Blancke Agents are made faster and in greater volume than ever before known in the Direct Selling Industry. No holes to drill, no bolts to remove. Anyone can attach it in 3 minutes. One demonstration never fails to bring big returns.

### FREE SAMPLE OFFER

Also Free Blancke Plan that starts you in a real business without capital or previous experience. Start to make big money—beginning Now! Write today without fail.

**Blancke Auto Devices Co.**

Dept. 805-K

157 E. ERIE ST., CHICAGO, ILL.

Cadillac, LaSalle and DeLco Light now use as Standard Equipment Thermostatic Carburetor Control under Blancke License.

### STRONGEST GUARANTEE

In Automotive history backs sale of Blancke Controls. Guaranteed to increase mileage 50%—100%—eliminate carbon, save half oil, and to START MOTOR IMMEDIATELY IN ANY WEATHER

**SALES Guaranteed**

**\$15.00 a Day Guaranteed To Distributors**

CAL. 30-40

## KRAG CARBINE STYLE

The Choice of those who know. 5 shot, 22 inch Barrel. A few used, but service-able, for \$9.75. Shipping weight, 13 lbs. Shipping extra. \$15

Krag Rifle.....\$12.50 Krag Sporting Rifles.....\$14.00

Springfield 45 Shot Guns... 4.75 SPRGFLD. 45 Carabines... 4.50

Krag Bayonets 40 cents each. Postage Extra—Shipping Weight 2 1/2 lbs.

Terms Strictly Cash. No C. O. D. Shipments.

Catalogue Free on Request.

W. STOKES KIRK, 1627-P. M., North 10th St., Phila., Pa.

The man who studies gets ahead. Popular Mechanics Press will advise you what books to read to advance in your trade. 200 East Ontario Street, Chicago, Illinois.

Locked from Inside

Locked from Outside

**PROTECT YOURSELF**  
From burglars and sneak-thieves. Keelock is guaranteed to make every mortise lock PICKPROOF. Safeguards homes, rooming houses, hotel rooms, offices, lockers, closets, etc., where valuables are stored. Jimmy proof. Send 25 cents for sample. Special proposition for agents. **SELLS AT SIGHT.** KEELOCK MFG. CO., Dept. P. M., 415 W. 50th St., New York, N. Y.

**NEW TIMER FOR FORDS**  
MARVELOUS INVENTION  
FREE OFFER TO USERS  
**FORDYNAMO**  
60,000 MILES WITHOUT TROUBLE  
WRITE TODAY FOR FREE OFFER  
Agents Wanted Everywhere  
Eclipse Timer Co., 2927 Meinecke Av., Milwaukee, Wis.

**Amazing New Way to Play Guitar**  
Tenor Banjo, Ukulele, Mandolin  
NO music to learn. NO tiresome practice. Marvellous patented device makes playing easy. Just press the keys and play on the same easy principle as a typewriter.  
**Play a Tune in 10 Minutes**  
We guarantee you'll play a Ferry E-Z Playing Instrument — "no play, no pay." Terms as little as 50c a week.  
**FREE BOOK** explains all. Popularity—more friends—make money. No obligation. Send for book today!  
**Ferry & Company, 1776 Ferry Bldg., Chicago, Ill.**



# Voyage to vacation land



## Vacation at MACKINAC ISLAND

"The Summer Wonderland"

Overnight from Chicago or Detroit via the fast D&C boats is this scenic wonderland. Here days are warm, and nights refreshingly cool. Here unspoiled natural

scenery, virgin forests, historic points of interest will allure you. Golf, tennis, horseback riding, boating, fishing, and countless other recreations.

## View the illuminated NIAGARA FALLS

—now more interesting and beautiful than ever with the billion candle-

power multi-colored lights playing on the falls every night.

## Utmost in Luxury Aboard

First class accommodations exclusively. All water sterilized. Autos carried. Radio and moving pictures on both the Buffalo and the Mackinac Divisions. On the Mackinac Division

there is also dancing, with hostess in charge, afternoon teas, bridge, golf, horseshoe pitching, etc. Tickets on this Division limited to sleeping accommodations.

## Round Trip Fares between

\*CHICAGO and DETROIT..... \$60

\*MACKINAC ISLAND and  
CHICAGO or DETROIT..... \$30

\*BUFFALO and CHICAGO..... \$79

One Way Round Trip

†CLEVELAND and DETROIT \$3.50 \$ 6.00

†BUFFALO and DETROIT.... \$6.00 \$11.00

\*Berth and meals included. †Berth and meals extra



For Reservations or further information, address E. H. McCracken, Gen. Pass. Agt. Dept. 14 at Detroit, Michigan.

No surcharge.

Unlimited  
stopover  
privileges  
at all ports.

Send  
for  
free  
illustrated  
booklet

DETROIT & CLEVELAND NAVIGATION CO.



## Men Are Changing

### By Scores of Thousands

From old-type shaving soaps to this unique creation—let us send you 10-day tube to try

#### GENTLEMEN:

80% of the present users of Palmolive Shaving Cream once were wedded to rival preparations.

We won them over by giving them liberal test tubes of this unique creation to compare with present favorites.

Now we seek a like opportunity of proving results to you.

#### These 5 advantages

1. Multiplies itself in lather 250 times.
2. Softens the beard in one minute.
3. Maintains its creamy fullness for 10 minutes on the face.
4. Strong bubbles hold the hairs erect for cutting.
5. Fine after-effects due to palm and olive oil content.

#### Let us prove this

We ask your permission to prove these things—to send you a tube to try. We are masters of soap making. One of our soaps—Palmolive—is the leading toilet soap of the world. We have worked hard to excel in a Shaving Cream. We made up and tested 130 formulas before we attained our ideal.

Do us the kindness to mail this coupon, for your sake and for ours.

THE PALMOLIVE-PEET COMPANY,  
CHICAGO, ILL.

361E

## 10 SHAVES FREE and a can of Palmolive After Shaving Talc

Simply insert your name and address and mail to Dept. B-1352, Palmolive, 3702 Iron Street, Chicago, Ill.  
Residents of Wisconsin should address Palmolive, Milwaukee, Wis.

(Please print your name and address)





Licensed by  
Rider Radio  
Corporation  
Pat. Pending  
Pat'd 5-2-'16  
Pat'd 7-27-'26

**New!**

# Phasatrol

A True Balancing Device for All  
Radio Frequency Amplifiers

Bring the set you're building, or the set you own, up-to-date with Phasatrols. This startling new Electrad device stops radio frequency oscillation squeals and distortion in any untuned, tuned or reflex set.

PHASATROLS make tuning easy and prevent radiation interference to your neighbors. No technical knowledge needed to install. And once installed, oscillation troubles are gone forever. Price \$2.75.

Booklet showing how to install Phasatrol in your favorite circuit free upon request.

**At Good Dealers**  
Dept. 65, 175 Varick Street  
NEW YORK, N. Y.

# ELECTRAD

The man who studies gets ahead. Popular Mechanics Press will advise you what books to read to advance in your trade. 200 East Ontario Street, Chicago, Illinois.

## GERMAN FIELD GLASSES EIGHT POWER



**\$9.85**

Postpaid

**THE IDEAL ALL 'ROUND SPORT'S GLASS** Complete with Straps and Lens Cover

European prices have risen. Regardless of this, we will for the present maintain our old price of \$9.85 for the new genuine German War Glass. Sent promptly on receipt of check or money order for \$9.85. Positive guarantee of full cash refund if not satisfactory.

**SWIFT & ANDERSON, Inc.** Largest Importers of Field Glasses in America  
94 E. Federal St., Boston, Mass. 23 Scott St., Toronto, Canada  
Sole distributors for HENSOLDT Binoculars

## Blue Ribbon 5 TUBE NEODYNE RADIO KIT-COMplete



Only  
**\$16.95**

**FREE!**  
GENUINE 20 INCH  
ERLA CONE  
LOUD SPEAKER &  
5 TUBES

Can be  
built  
in 2 hours

Latest 5 tube circuit designed by one of the foremost radio engineers in the country. Clear and realistic reception guaranteed. Solid bakelite panel and sub-panel. Panel beautifully engraved. Sub-base marked for all connections. 2 dial control; Kurz-Kasch bakelite indicator knobs. New type UX sockets. Low ratio transformers for improved tone quality. All hook-up wire and colored battery cable included. Tubes are 201-A type, tested and matched. Value \$60, our price \$16.95.

**COAST  
to COAST  
RECEPTION**

**MAKE  
MONEY  
IN YOUR  
SPARE TIME!**

**Complete Set of Simple  
Plans and Directions to Build**

Very easy to build this set with the plans and instruction we furnish. No complicated drawings. Can be built in 2 hours. Instructions for operation included. Make money by building these sets in your spare time and selling them to your friends.

## SEND NO MONEY

Just write your name and address on a post card and ask us to send you this great kit together with the Erla Cone loud speaker and 5 tubes. We will ship them right away. When they arrive, pay only \$16.95, plus a small delivery charge. **RADIO EQUIPMENT CO., Dept. P.C., 549 S. Wells St., Chicago, Ill.**

**Now, Only \$39**

Let Me  
**Send You the  
Greatest LOG SAW Offer**  
Put the OTTAWA Working For You

—I ever made. One man saws 15 cords a day—easy. Falls trees, saws limbs. Make big money. Use 4 H-P. Engine for other work. Saws faster than 10 men. Shipped from Factory or nearest of 10 Branch Houses. Cash—Easy Terms. Write for 30-Day Trial Offer and big FREE book.

**OTTAWA MANUFACTURING COMPANY**  
1741-W Wood Street, Ottawa, Kan.  
Room 1741-W Magee Bldg., Pittsburgh, Pa.

## Your Coat and Vest Can Be Matched with New Trousers



$\frac{3}{4}$  of the price of your suit is in the coat and vest. Why not get full value out of them by replacing the worn out pants with a new pair.

Send us sample (small piece from seam or the vest) and we will show you how close we can match it. All tailored to measure. Prices range from \$9.00 to \$15.00 according to quality.

**ACME PANTS MATCHERS**  
Dept. BG 14, 20 W. Jackson, Chicago

## You—and This New Machine Can Earn \$500 a Month

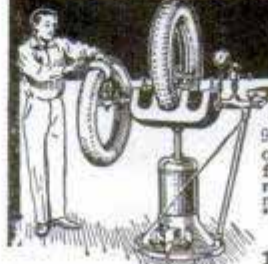

**Operate a Tire Repair Shop**

90,000,000 Tires in use. America's greatest opportunity for men with small capital. We furnish everything—\$100 and up. Easy payments. We train you FREE right at home. Start making money at once. Write today for Free Book "Steps to Success."

**Haywood Tire Equipment Co.**  
1334 South Oakley Chicago, Illinois



# End Truss Torture Now

or  
Never

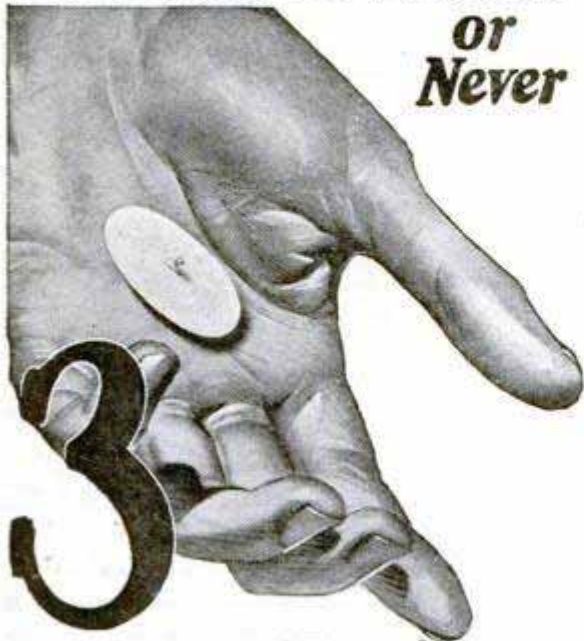

## Sensational Discoveries

Now, if you ever expect to be rid of rupture, is the time to act. (If you hadn't been forced to support your rupture with tight, gouging, cumbersome devices invented 50 years ago, you would probably have a different story to tell.) Now that science has made a real step in the supporting and healing of rupture you cannot afford to waste a minute in giving yourself the benefit of these three marvelous new discoveries.

### Magic Dot Rupture Wonder

An Ohio scientist has developed a tiny device, weighing less than 1/25 of an ounce, which does away with cruel springs, heavy straps and pads. This new invention is called "Magic Dot," and by its use it is now possible to walk, run, jump, exercise, bend, etc., with perfect security. This wonderful invention makes possible an entirely new rupture system with two other unique departures.



### Breathes Air

A wonderful new pad, light in weight, soft and pliable, actually breathes air. Smaller, much smaller, than you ever thought possible. It fits the contour of the body as no old-fashioned pad could do. It is washable, sanitary.

### FREE Sample

The pad is made of an amazing new material called Airtex and a sample will be mailed absolutely free to those who ask for it.

### See It First

We could never tell you all of the remarkable features of this modern, scientific 3-way rupture relief. But without risk on your part you can see it in your own home. Send no money. You can easily get full particulars and free illustrated material. Merely clip coupon, write your name and address plainly and mail it to



### NEW SCIENCE INSTITUTE

2138 Clay Street Steubenville, Ohio, U. S. A.

NEW SCIENCE INSTITUTE,  
2138 Clay St., Steubenville, Ohio.

Please send me at once full details of the New Science System. I am not obligated.

Name .....

Address .....

City ..... State .....

# MAGIC BOX Saves Lives!



## BLINX Amazing New Invention Puts Brakes on the Cars Behind!

Long ago, automotive engineers foresaw one thing. They knew stop lights would become so common they would cease to attract instant attention—that split second attention when most tragic accidents occur. In that fleeting moment cars crash, death follows, damage is done! They knew no steady light could stop the disasters that fill the papers daily. And now, after years of experiment and testing, comes an amazing new invention, a little black box that solves the problem!

## Flash!—Flash! Keep Death at Distance

The inventor calls it the BLINX SWITCH. It is in fact a marvelous little motor with just two working parts—an amazing triumph of electrical engineering. And it goes underneath your car just like a stop light switch. Then three ways for flashing signals—tail light alone—stop light alone—or tail and stop light together! Only a few minutes to install. Anyone can do it. It goes right next to the brake. And it gives you a swiftly flashing warning—100 times a minute!—timed precisely, after countless tests by eye physicians and psychologists, to instantly force notice of drivers behind you. At night tail light burns its steady red as usual UNTIL YOU TOUCH THE BRAKES. Then the flash-flash of warning no driver can ignore. In day when your tail light does not burn, your BLINX works just the same by touching brake!



## Mail Coupon

### FOR FREE OFFER

Every motorist throws PROTECTION around loved ones and himself when he installs the Blinx. You save yourself from crashing collision that may forever ruin your car, the little bumps, too, that merely mar, bend the fenders, do slight damage, BUT COST FOR REPAIR, will last years. Nothing to get out of order. Absolutely guaranteed. And the inventor, for quick distribution, makes you an amazing offer. You can prove for yourself what a wonderful signal light BLINX is, at the INVENTOR'S EXPENSE. Don't risk one penny. He offers you one FREE if you act quickly. Mail the coupon today. No obligation.

### DISTRIBUTORS

Blinx Switch is sweeping the country. Territorial distributors make amazing earnings. Agents earn \$65 to \$120 a week. We have some territories still open for live wires who mean business. One representative writes, "50 sold out in 15 minutes, salesmen even selling samples. Rush 350." Whether interested in territorial rights or as free lance agent, write today. Learn of the amazing possibilities, the big earnings.

## H. L. FISHER MFG. CO.

Dept. X-490

4100 W. Ravenswood Ave.

Chicago, Ill.

H. L. FISHER MFG. CO.  
Dept. X-490, 4100 W. Ravenswood Ave., Chicago.

Rush me full details of your wonderful FREE offer to try your new invention. This places me under no obligation.

Name .....

Address .....

City ..... State .....



# \$244.00 PROFIT *One day!*

Made by R. W. Helmer without experience on Trippe Auto Reflectors  
Wonderful device—100% more light and no glare! Pocket big money waiting for you now—Whirlwind seller, makes astounding demonstration, low cost, agents cleaning up, 300% profit, big repeater, sells on sight. Over 300 sets sold in one town of 2,000 people.

## 24,000,000 PROSPECTS WANT THIS LIGHT

Thousands killed in 1926 by weak lights—or glare. Countrywide movement for long, low, level, powerful beam that protects driver without blinding other fellow. Only Trippe Auto Reflectors do this perfectly. Trippe light floods roads and side ditches. No glare to bewilder other drivers. **Makes spotlights unnecessary.**

### Eliminates Glare Without Dimming or Tilting

Motorists are sick and tired of clumsy headlights, fragile dimmers, flimsy tilters and makeshift reflectors. These obsolete devices fail because **they're not scientifically correct.** The Trippe is—let us prove it.

### Free Sample Offer to July 31st—Write NOW

Seize this offer at once—don't delay—write NOW while you're thinking of it. Address

**AERIAL ELECTRIC CO.**  
100 West Kinzie Street  
CHICAGO

**38,000 CANDLEPOWER  
NO  
GLARE.**

## MAKE MONEY SELLING DRESSES

**STREET DRESS ALL FOR ONLY \$4.70**  
**HOUSE DRESS** Whirlwind Seller Full or Spare Time  
**SERVING APRON** You Make \$1.25 Profit on Every Sale  
**AGENT WANTED IN YOUR CITY.** Write for Free Outfit  
**SUPER-BUILT GARMENT CO., BOX 453, DEPT. 15, CHICAGO**

## 12,000,000 FORD OWNERS Need This NEW Timer!

**Earn \$100. Weekly  
Selling Them!**



Automotive engineers claim that the average Ford may wear out from 8 to 10 ordinary Timers. Think of the sales possibilities when you offer the "Dynamo Timer" with a guarantee for the life of the car. You do not have to be a salesman. This amazing Timer sells itself on sight. You make 200 per cent profit on every sale.

### Makes Old Fords Run Like New

Once a Ford is equipped with the "Dynamo" the timer can be forgotten—the only thing that will prevent forgetting it will be the noticeable improvement in the running of the car. More power, more mileage, instant starting, amazing pickup, are a few of the features that will make any Ford owner a "Dynamo" booster after he once uses this new Timer.

### Get Territory Quick

Our agents can easily make \$5,000, \$6,000, yes, even \$10,000 a year. Sparetime workers make \$20.00 and even \$30.00 a day.

John Cable made \$200 in less than 10 days. Many others report tremendous profits. You too can get into the big money class the same as John Cable and others.

**DYNAMO TIMER CO.**  
426-1165 Eleventh St., Milwaukee, Wis.

### FREE SAMPLE

To aid our agents we have arranged a plan that provides them with a Free Sample so they can equip their own car or carry it for demonstration purposes. The unique principles of this wonderful Timer will make themselves apparent to any Ford owner after a minute's examination. Send name and address for Free Sample Offer and particulars of our big money making proposition.



## HANDY TOOLS FOR HANDY MEN!

Better work with bigger volume can be easily had with amazing speed and accuracy on

### Boice-Crane Bench Machines

Do ripping, mitering, grooving, rabbeting, sanding, grinding and other operations better, quicker and easier. Driven by any 1/4 to 1/2 h. p. motor; portable; attached to any light socket. Sold with or without motor. Greatest values at lowest prices.

Send 10c today for descriptive catalog of Bench Saws, Lathes, Jointers, Drills and Band Saws.

**W. B. & J. E. BOICE, DEPT. P. M. 7-C, TOLEDO, OHIO**



## \$10.00 to \$25.00 a Day!

### Selling Freshly Roasted Peanuts

Wherever you find a crowd, hot, savory peanuts and crisp, sweet popcorn are in demand. Set up a Kingery Machine anywhere—in stores, at ball games, races, fairs. Profits 60% to 100%. Machines take little room; are easy and inexpensive to operate. Barbecue machines, too. Write now for Free Catalog.

**The Kingery Mfg. Co.** Dept. PM-7, 410 E. Pearl St.  
CINCINNATI, OHIO

## Build and Fly Model Aeroplanes



Build your own Model Aeroplane; make trial flights and learn the principles of Aeronautics. IDEAL Scale Drawings and Building and Flying Instructions help you build exact 3-ft. duplicates of any of the following well-known Planes. Send 25c now for complete Plans for the one you want to build. Fokker North Pole Plane; De Havilland Mail Plane; Curtiss JN4D-2 Training Plane; NC-4 Naval Seaplane; Curtiss Military Tractor; Bleriot, Nieuport or Taube Monoplane; also Cecil Peoli Racer; 25 cents each, postpaid.

### Everyboy's Airplane

All parts ready to put together without nails, wire or glue. 3 1/2 ft. wing spread; Monoplane type. Guaranteed to fly. Complete outfit, prepaid, \$6.00.

**IDEAL AEROPLANE & SUPPLY CO., 408 West Broadway, corner Spring St., NEW YORK**



## The Easiest Tube Repair

—is also the quickest  
—and the most permanent



Complete Kit

\$1.50

With a Shaler Vulcanizer you merely clamp on a patch—light with a match—wait 5 minutes—that's all. Yet, whether on a high pressure or a balloon tire, that Shaler Patch is welded on for the life of the tube!

The SHALER CO., WAUPUN, WIS.  
1015 4th St.

# SHALER

REG. U.S. PAT. OFF.

## 5 MINUTE VULCANIZER

## 861 PRACTICAL IDEAS for REDUCING FARM LABOR and INCREASING INCOME

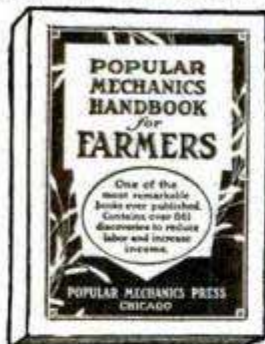

One farmer writes: "I would not take \$100 for my copy if I could not secure another."

The Handbook for Farmers contains: 138 ideas for the farm shop, 35 on fencing, 98 on auto, truck and tractor, 61 on farm buildings, 36 on field machines, 48 on concrete work, 22 on orchard work, 23 on painting, 15 on live stock, 34 on poultry, 54 on garden work, 25 on electrical work, 22 on farm tools, 16 on hunting, fishing and trapping, 140 household helps.

## 394 HELPFUL KINKS to LIGHTEN the LABOR of the FARMER'S WIFE

The Handbook for Women contains: 83 kitchen and dining room helps, 17 on garden and flowers, 19 on sewing and mending, 37 on furniture, pictures and fixtures, 38 on laundry and cleaning, 32 on house cleaning, 12 on music, 14 on sleeping rooms, 11 on care of children, 16 on lights, 9 on photography, 14 on clothing and shoes, 23 on house temperatures, 12 on water and drains, 10 on insect pests, and 47 miscellaneous.

## SPECIAL OFFER BOTH for \$1

(Regular \$1.50 Value)

For a limited time you are offered both books for \$1 plus the postage. Pay postman when he delivers package. If outside U. S. send remittance and include 15 cents extra for postage.

POPULAR MECHANICS PRESS  
Room 707, 200 E. Ontario St., Chicago

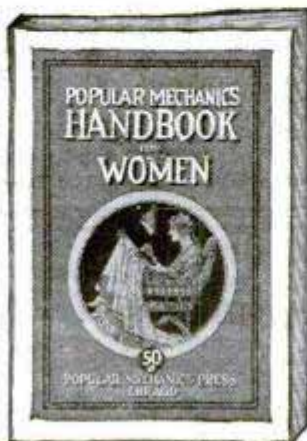

## Get Ready to Join a Harmonica Band!

YES, you can learn to play as well as the next fellow. All you need is a Hohner Harmonica, our free instruction book, and a little practice—and first thing you know, you'll be reeling off the tunes like a veteran!

Pretty soon you'll be looking round for some other chaps to join you in a harmonica band—and that's when you'll really appreciate what fun there is in being able to play this "miniature orchestra."

There are harmonica contests, too, in which thousands of boys take part—and some mighty handsome prizes waiting for those who win!

## The NEW Way to Learn



A special orthophonic Victor Record (No. 20377) "How to Play the Harmonica" is now available for those who wish to learn by listening to the living voice of the instructor, and following the notes as they are sounded on his harmonica. Illustrated instruction sheet also included. Reverse side reproduces "Old Black Joe" as rendered on harmonica with piano accompaniment. At all dealers selling Victor Records . . . complete 75c

## FREE Instruction Book

Anyone can learn to play the harmonica by following the clear, simple, illustrated instructions given in our booklet "How to Play the Harmonica." Free at your dealer's—or write to M. Hohner, Inc., Dept. 508, 114 East 16th Street, New York.





# THE NEW RED JACKET CRAFTSMAN'S LATHE

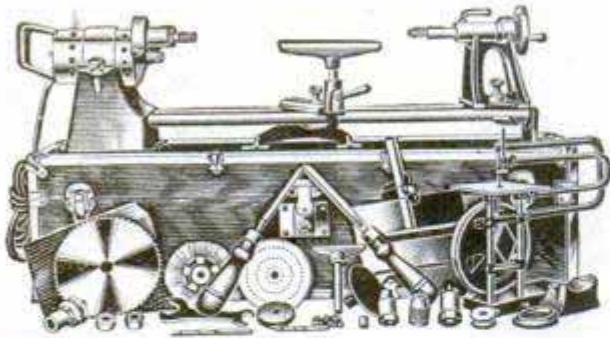

## Makes Homework Easy Now

It's fun to make furniture, garden trellis, toys, improvements and repairs with a set of tools like this carefully designed by a master workman.

The complete equipment consists of the powerful Red Jacket Motor, with **direct drive to an accurate wood turning lathe** (capacity 9 in. x 34 in.); a **bench saw**, that has depth and side gauges; **scroll and jig saw**; and **all accessories for both portable and stationary power drilling, buffing, grinding and cleaning**. Attaches to any light socket and converts your work bench into a complete private tool and machine shop.

## A Special CRAFTS COURSE

And **Blueprint Service** is free to Red Jacket Shop owners—all that there is to know about handcraft methods, raw materials, woods, carving, sawing, turning, designing, carpentering, decorating, is taught by special correspondence.

## Buy On Your Own Terms

Only \$10.00 down. Liberal discounts for cash. Easy monthly payment plans. It is no hardship to own a Red Jacket.

**only \$10.00 down**

## Interesting Literature Free

Just send the coupon. You will be surprised with all it contains. Beautiful, instructive, fascinating, interesting. Everything explained in our literature.

..... MAIL COUPON TODAY .....

**WACO TOOL WORKS, 2915 So. Wabash Ave. Chicago, Ill.**

Manager, Dept. 107. Please send me particulars about 10-day free trial, free blue-prints and \$10 down payment.

Name.....

Address.....



**AMAZING INVENTION**  
Appeals to every motorist. Gets any car out of mud or sand. Nothing like it.

**GETS-U-OUT TIRE LUG**  
Special offer to agents. Ask for details and territory. Chicago Tire Lug Co., 860-336 W. 47th St., Chicago

## Do You Know the Secret of Quality Reproduction?

**SM**

"The Secret of Quality" tells you simply and concisely how to get the most out of your amplifier—how to get quality. This 96 page booklet is yours for the asking—it's free. Write for your copy.

**SILVER-MARSHALL, INC., 840 W. Jackson Blvd., Chicago, U. S. A.**

# Automatic Saw Filing Pays Big Extra Money!

Many men make \$2.00 to \$6.00 an evening with the Foley Saw Filer. Here's what one writes—"I am more than pleased with the Foley Filer. I file 15 or 18 saws a week. Most of my filing is done evenings." Get a Foley and you can file and joint hand, band and cross-cut circular saws for factories, carpenters, contractors, woodworkers, schools. You'll get their business because you can do their filing in less than half the time, and do it better. Don't wait a minute before writing for illustrated information about the money-making—

## FOLEY Automatic SAW FILER

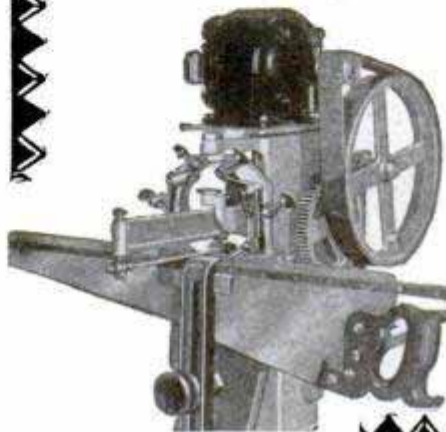

**FOLEY SAW TOOL CO., Inc.**  
217 Foley Bldg.  
27 Main St., N.E.  
Minneapolis, Minn.

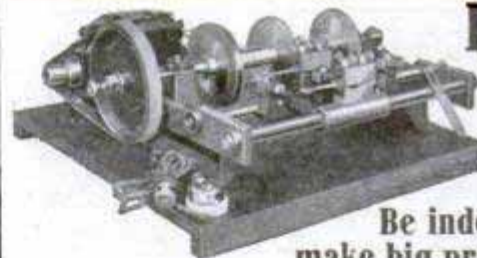

# Don't Be a Slave

Be independent and make big profits with the

## BEISSER KEY MACHINE

You can start a business of your own, no experience necessary. Only machine that will cut ALL KINDS of keys perfectly. No hand filing required. Also first keys by number without need of taking locks apart. Write Today for Full Particulars.

**BEISSER KEY MACHINE CO.**  
407 Fort Street, East Detroit, Michigan

# Outdoor Opportunities

How to raise rabbits, guinea pigs, milch goats, silver foxes, ferrets, white rats, white mice, dogs, cats, pigeons, pheasants, bantams, canaries, bees, frogs, mushrooms, ginseng and golden seal for profit. Practical 250-page book with 120 illustrations. Will be sent C. O. D. When postman hands you the package, pay him \$2 plus the postage.

**POPULAR MECHANICS PRESS**  
Room 506 200 E. Ontario St. CHICAGO

## New Improved SPORS Fountain Pen. 60 Day Trial. Money back if not pleased

**GUARANTEED 2 YEARS—Improved Point LADIES' OR MEN'S STYLE**

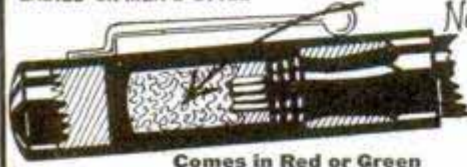

Comes in Red or Green

Newest Invention Rubber sponge keeps point moist. Writes the instant it touches paper

Agent's Sample 65c Sells for \$1.25. Writes like a \$7 Pen. Make \$10 Daily Easily

**F. SPORS CO.**

**MAKES \$8.40 IN TEN MINUTES**  
I sold my dozen pens in about 10 minutes. Will order another dozen soon. TRACY KREBS, Nebraska.

Write for FREE Wholesale Specialty Catalog  
527 Main St. Lesueur Center, Minn.



# 3 Greatest SPECIALS \$29.75

Your Choice at



**AA1 - Gorgeously pierced, lace design dinner ring; 18K white gold set with 3 perfectly matched genuine diamonds. Special \$29.75**

**A Full Year To Pay**

The greatest genuine jewelry bargains ever offered! Credit values which defy cash store competition. Pin only \$1 to your order and your choice comes to you parcel post prepaid on **10 Days Free Trial**. Then pay postman only \$1 more on delivery; after free trial period pay balance in 12 equal monthly payments of **\$2.32 each**. Satisfaction absolutely guaranteed or your money refunded—our policy for 32 years

**FREE—**

**Royal Book of Gems**

Thousands of special values in genuine diamonds, jewelry and watches. Send for your copy at once

**Wear while paying.**



**AA2 - Spectacular value! Lady's wrist watch, 14K solid white gold engraved case set with 2 genuine diamonds and 4 French Blue Sapphires; guaranteed 15 jewel movement. Special \$29.75**



**AA3 - Never before offered at so low a price! Gents strap watch; 20 year guaranteed, newest Olympic octagon case, white or green gold filled. Fitted with 15 jewel nationally advertised Waltham or Elgin movement. Special \$29.75**

**15 JEWELS**

**Elgin or Waltham**

**ROYAL DIAMOND & WATCH CO**  
ESTABLISHED 1895  
ADDRESS DEPT 1828 170 BROADWAY N.Y.



## "It's the Biggest Raise You Ever Had"

"Oh, Tom! You don't know how proud it makes me feel. I knew you could earn more money if you really tried.

"Now we can put a little money aside each week and buy some of the things we need so badly.

"And to think that only a few months ago you were worried for fear you would lose your position!

"Remember how you came home that night and said you were tired of being a failure? Remember how you determined to get out of the rut by taking up a course with the I. C. S.?"

"I knew it would help you and the firm would soon notice the difference in your work. But I didn't think you would get such a big raise so soon! Oh, Tom! You seem like a new man since you started studying at home through the I. C. S."

Every day, in office, shop and factory, you will find men, who are being given better positions and larger salaries because they are studying at home in spare time with the International Correspondence Schools.

An I. C. S. Course helped Jesse G. Vincent to rise from tool-maker to Vice-president of the Packard Motor Company. It helped George Griebel to rise from a stonemason to the owner of a business paying \$12,000 a year. It helped Bert S. Remaley to increase his salary ten times! And it will help you too, if you will only make the start.

**Mail the Coupon for Free Booklet**

**INTERNATIONAL CORRESPONDENCE SCHOOLS**  
Box 5658-E, Scranton, Penna.

Without cost or obligation, please send me a copy of your booklet, "Who Wins and Why," and full particulars about the course before which I have marked X in the list below:

**BUSINESS TRAINING COURSES**

- |  |   |
|--|---|
| <input type="checkbox"/> Business Management                     | <input type="checkbox"/> Salesmanship                                     |
| <input type="checkbox"/> Industrial Management                   | <input type="checkbox"/> Advertising                                      |
| <input type="checkbox"/> Personnel Organization                  | <input type="checkbox"/> Better Letters                                   |
| <input type="checkbox"/> Traffic Management                      | <input type="checkbox"/> Show Card Lettering                              |
| <input type="checkbox"/> Business Law                            | <input type="checkbox"/> Stenography and Typing                           |
| <input type="checkbox"/> Banking and Banking Law                 | <input type="checkbox"/> English  |
| <input type="checkbox"/> Accountancy (including C.P.A.)          | <input type="checkbox"/> Civil Service                                    |
| <input type="checkbox"/> Nicholson Cost Accounting               | <input type="checkbox"/> Railway Mail Clerk                               |
| <input type="checkbox"/> Bookkeeping                             | <input type="checkbox"/> Common School Subjects                           |
| <input type="checkbox"/> Private Secretary                       | <input type="checkbox"/> High School Subjects                             |
| <input type="checkbox"/> Spanish <input type="checkbox"/> French | <input type="checkbox"/> Illustrating <input type="checkbox"/> Cartooning |

**TECHNICAL AND INDUSTRIAL COURSES**

- |   |  |
|---|--|
| <input type="checkbox"/> Electrical Engineering                     | <input type="checkbox"/> Architect                                       |
| <input type="checkbox"/> Electric Lighting                          | <input type="checkbox"/> Architects' Blueprints                          |
| <input type="checkbox"/> Mechanical Engineer                        | <input type="checkbox"/> Contractor and Builder                          |
| <input type="checkbox"/> Mechanical Draftsman                       | <input type="checkbox"/> Architectural Draftsman                         |
| <input type="checkbox"/> Machine Shop Practice                      | <input type="checkbox"/> Concrete Builder                                |
| <input type="checkbox"/> Railroad Positions                         | <input type="checkbox"/> Structural Engineer                             |
| <input type="checkbox"/> Gas Engine Operating                       | <input type="checkbox"/> Chemistry <input type="checkbox"/> Pharmacy     |
| <input type="checkbox"/> Civil Engineer                             | <input type="checkbox"/> Automobile Work                                 |
| <input type="checkbox"/> Surveying and Mapping                      | <input type="checkbox"/> Airplane Engines                                |
| <input type="checkbox"/> Metallurgy <input type="checkbox"/> Mining | <input type="checkbox"/> Agriculture <input type="checkbox"/> Navigation |
| <input type="checkbox"/> Steam Engineering                          | <input type="checkbox"/> Mathematics <input type="checkbox"/> Radio      |

Name.....

Street Address.....

City..... State.....

Occupation.....

Persons residing in Canada should send this coupon to the International Correspondence Schools Canadian, Limited, Montreal, Canada

# Oh Boy! See All!

## Big 3 1/2 Ft. Telescope

Lend wings to your eyes! People and objects miles away seem close. Wonder telescope brings new pleasures to home, farm, camp, travel, sport. Study the mysterious Sun spots; see Moon and Stars as never before. See people on the beach, on the mountains, etc.

**FREE** Yes, absolutely free! A handsome leatherette Carrying Case and Shoulder Strap. Also Solar Eye Piece to view the sun—a special feature, found only on expensive instruments.

**Thousands Pleased**

P. Brush wrote: "Watched submarines three miles off coast." Ed. Foster: "Told time on clock five miles away." G. Scribner: "Sec. lighthouse 18 miles away." Mrs. Yarbrough: "Could tell color of aeroplane four miles away." S. M. Gearhart: "Can see men working seven miles away."

**5 Sections**  
**8 Power Lenses**

Brass bound; measures 12 in. closed; powerful achromatic lenses protected by dust caps.









**SEND NO MONEY**

On delivery of Telescope, free Case, Strap and Eye Piece pay Postman only \$1.85, plus postage (2 complete outfits \$3.50). Satisfaction guaranteed or money refunded. Send today, entertain your friends! Be first to have one.

**FERRY & CO., Dept. 9776, Chicago, U.S.A.**



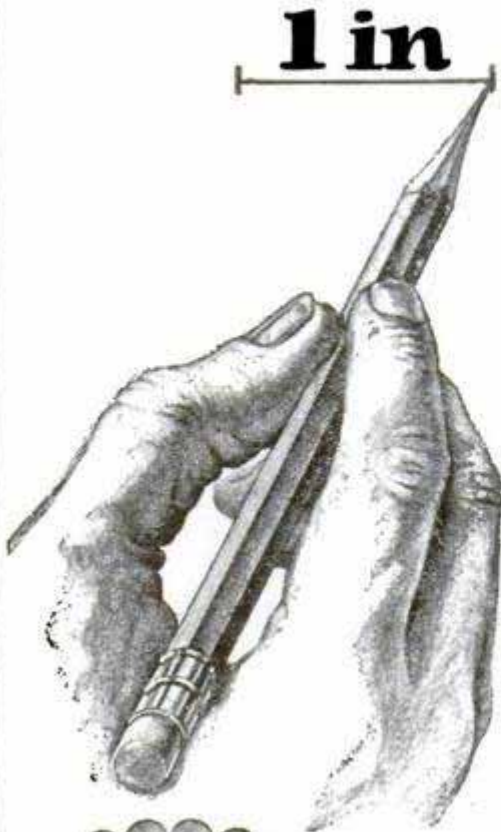

# Can You Divide An Inch Into 1000 Parts?

## Mechanics do everyday!

Making measurements accurate to thousandths of an inch is everyday work for Brown & Sharpe tools in the hands of mechanics.

In fitting small parts in automobiles, sewing machines, motors and in the manufacture of thousands of other products where accuracy is vital, Brown & Sharpe tools play an essential part.

Wherever mechanics must rely on accurate tools, they use Brown & Sharpe products with confidence that the work will be right. For the performance of Brown & Sharpe tools sets a standard of accuracy throughout the mechanical world.



Hardware dealers can supply you or write for Catalog No. 30.



BROWN & SHARPE MFG. CO.  
DEPT. PM  
PROVIDENCE, R. I., U. S. A.

# BROWN & SHARPE TOOLS

World's Standard of Accuracy



**Double Action  
Massage-Shave**

**Christy SAFETY RAZOR**

The world's most comfortable shave is produced by the double-action massage-shave Christy Safety Razor — absolutely! Users are wildly enthusiastic! The massage bar does the trick! Used like any safety razor.

**OH, BOY! — WHAT COMFORT!**

Yes, your present razor works all right, but wait — just wait till you step up to the shaving mirror with a Christy. You'll grin at yourself. The razor and ten blades in leatherette case with hinged cover for only \$1.00 post paid. Clip this ad and send with your name, address and a dollar bill. Money back if you are not delighted. Home Sales Co., Dept. A., Fremont, Ohio

**RAZOR and 10 EXTRA BLADES in CASE \$1.00**

POST PAID

**FOUR MILLION IN DAILY USE**



## CALCULATIONS

in Office, School, Store and Shop can be instantly made with the Midget Slide Rule. It gives the answer to any problem involving fractions, mixed-numbers, decimals, whole-numbers, roots, powers, Logs, and Trig. Functions. Thousands of these rules are used by Accountants, Engineers, Clerks, Students, etc. It is the most versatile calculator ever invented. If you have any figuring to do, order a Midget Slide Rule on trial. Made of aluminum with figures on white celluloid. Size 4".  
 Price with Instruction Book, \$1.50. Leather Case, 50c extra. Catalogue Free. Sent C. O. D. if desired.  
 Your money back if you are not satisfied.

GILSON SLIDE RULE CO., Stuart, Florida.

**I Offer You  
\$12.00 a Day  
— and a**

**CHRYSLER  
4  
Coach**

Write quick for new proposition. We offer \$12.00 a day and a new Chrysler-4 Coach, for demonstrating and taking orders for Corner Suits. Smart styles. Wonderful values. Work spare time. No experience required. Sample outfit given. Write now.



**COMER MFG. CO., Dept. W-5124, DAYTON, O.**



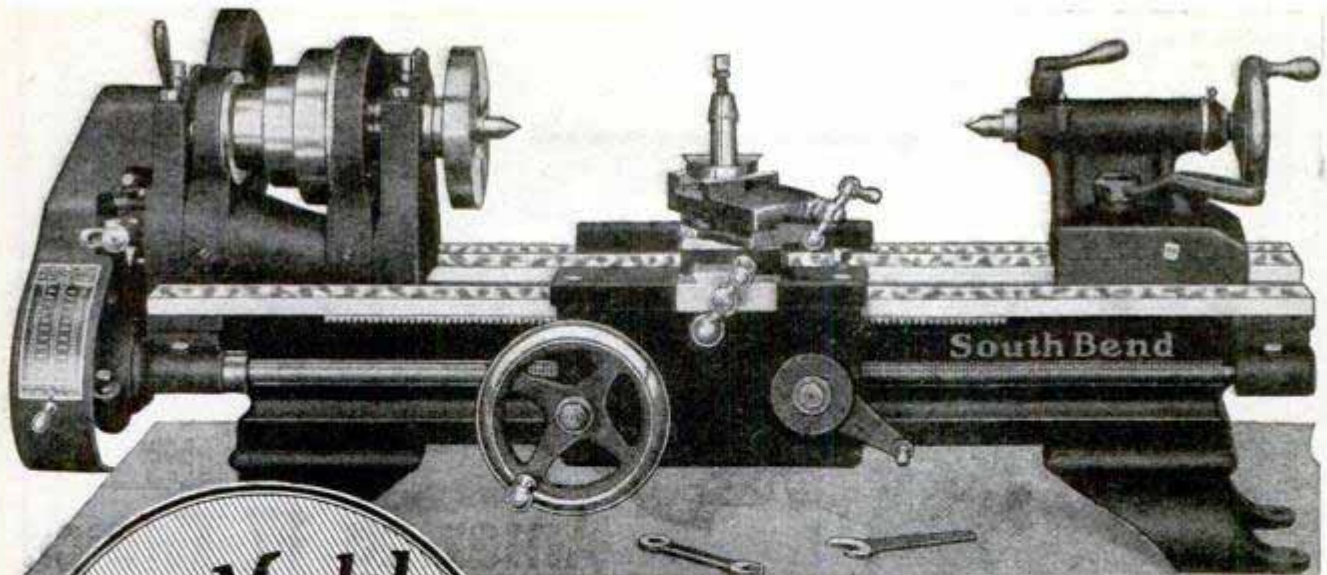

**New Model**  
**9 INCH JUNIOR**  
**BACK GEARED**  
**SCREW CUTTING**  
**BENCH LATHE**  
 [WITH PLAIN REST]  
**\$160<sup>00</sup>**

Time Payment Plan if Desired

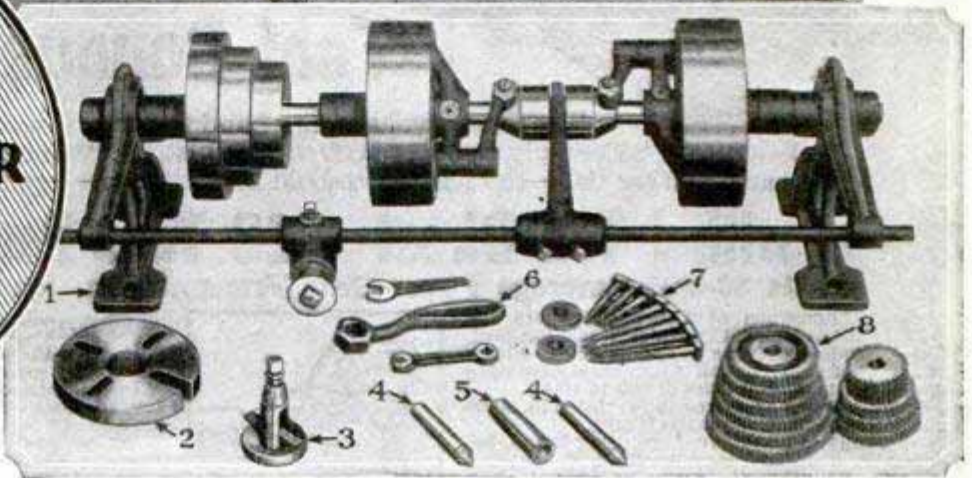

Countershaft and Equipment included in price of Lathe

**Has all These Practical Features—**

Back Geared Head Stock; Six Spindle Speeds; Power Feed to Carriage; ¼-inch Hole through Spindle; Plain or Graduated Compound Rest; Micrometer Graduated Collars on Cross Feed and Compound Rest Screws. Cuts screw threads 4 to 40 per inch, left or right hand. Built in 2½, 3, 3½, 4 and 4½ foot bed lengths, either Bench or Floor Legs. A precision lathe, limit of accuracy one thousandth (.001") of an inch. Weight complete, 375 pounds.

Thousands of these Lathes used by mechanics and small parts manufacturers to bore, drill, ream, turn, chuck and turn tapers and hundreds of other lathe operations. Attachments of all kinds can be added for a variety of work.

The Lathe can be equipped with motor Drive operated by ¼-H.P. Reversing Motor that plugs into ordinary Lamp Socket. Comes complete, ready to use.

**FREE** BOOKLET 22-K—Just off the press! 24 interesting pages of practical Lathe information, 150 photographs. Illustrates the lathe doing different classes of precision work and describes various types and drives. A booklet of real interest and value to any Mechanic.

**SOUTH BEND LATHE WORKS**  
 623 E. Madison St., South Bend, Indiana

New York City Salesroom, 183 Centre St.  
 Phone, Canal 9085

36,000 South Bend Lathes have been shipped to 64 countries in 20 years. They are used in every continent by every race.



Describe the  
**9-INCH JUNIOR LATH**  
 MAY 10, 1927  
**SOUTH BEND LATHE WORKS**  
 623 E. Madison St., South Bend, Indiana  
 Gentlemen: Send me immediately a copy of your new booklet, 22-K. This booklet is free, postpaid, to any inquirer.

**USE THE COUPON**

Name.....  
 Address.....  
 Town.....  
 State.....



# "Why-It's a Whole Machine Shop!"



## This Amazing 17-Ounce Tool Conquers 60-Lb. Kit!

The most revolutionary hand tool ever invented. Does the work of other tools costing over \$50—truly a tool of 1000 uses. Just the "hand-grip" of a tiny rubber band holds a hard bearing ball—the hardest-to-hold thing known—against a 300 Pound Pull!

### Grips with 1 Ton Direct—128 Tons Per Sq. In. Pressures through its 10-to-1 Leverage Power-Gear Transmission. In addition, the Grip LOCKS!

Among Thousands of Large Users are the MAKERS of Buick, Chevrolet, Nash, Packard, Reo, Studebaker, etc. Automobiles, Fisher Bodies, etc.; who with their employes have bought Kits in quantities of 500 to 1000! Studebaker has approved it for use in its Service Stations throughout the World. Thousands of housewives are using it too, because it does so many useful and amazing things so easily, so instantly. And even a woman's hand applies a HALF-TON Giant's Grip! Every Auto and Home Owner—every man who ever uses any tools needs it every day.

#### World Flight Equipment

It was standard equipment for the U. S. WORLD FLIGHT and the U. S. S. Shenandoah. Creates a sensation everywhere. Just its astounding 1-Ton Grip makes it worth ten times its cost.

The amazing EIFEL-FLASH PileRench is a true Ratchet WRENCH—Parallel Pliers—Speed VISE, and more. Instantly and automatically it LOCKS its death-grip Jaws on the

#### AGENTS \$200 a Week

PileRench representatives earn amazing incomes demonstrating this wonderful new tool. One man alone sold nearly 10,000 in just one state. Fastest seller known. Factories buy by hundreds. Every auto and home owner buys. We have wonderful special proposition to agents. Mail coupon for full details. Why not earn \$75 to \$200 and more a week, spare or full time?

#### Whole Kit in 1 Tool

You get in a Royal Blue Leatherette HOLDER, the 8½" Universal PileRench with 2 EXTRA Jaws—a PIPE Jaw—and a WIRE Jaw—each giving undreamed of performance. Instantly (in 1/5 second) you insert the Jaw you need, and as quickly snap a One-Ton Grip on work of any possible kind, or shape, or size from 0-in. to 1½-in.! And—nothing Ever can get away from that grip! HAVE YOU EVER HEARD OF A TOOL THAT WORKS LIKE THIS—it actually out-grips a 40-lb. Vise, and applies a 1-TON grip at the very jaw-tips. Will remove broken studs, taps, drills, etc., with next-to-nothing to hold on. Yet its smooth grip will hold a hair and coil a spring of hair-fine piano wire!



**The Universal PileRench**

For every kind of Pliers, Nut Wrench, Vise, Clamp, and Spring-making Work—Everywhere.



**The Pipe PileRench**

For every kind of Pipe Wrench and Pliers Work; Chewed Nuts that no other tools can budge, etc.



**The Wire PileRench**

For every kind of Wire, Tire Chain, Cable and Spring Work; and the Special work other Tools won't do.

#### Guaranteed

The Pile-Rench KIT is positively guaranteed.

It has stood the most trying tests of time and service. Of thousands—the First Commander of the U. S. World Flight said—"It should form part of the equipment of each and every Airplane and Automobile." One Engineer said—"I have used my Pile-Rench for 5 years and wouldn't be without it for \$100—and I mean it!"

**Special Introductory PRICE \$3.65 ONLY**

**Regular Price \$5.00**

Thousands fortunate enough to be able to see the astonishing performance of this marvelous Pile-Rench KIT are glad to pay the regular price of \$5.00. You can TRY this amazing performance on your own work in your own way for 2 weeks, and if the Pile-Rench KIT has not EARNED FOR YOU in that time the value of its price—just return it, and your money will be refunded as fast as the mails can carry it. Also, with your PileRench KIT you receive a valuable Manual of Mechanics that every man should have. It tells in 64 pages and 145 illustrations some of the marvels of "The PileRench Way"—the quicker, better, and easier way to do every kind of mechanical work.

Make use of the Coupon below, get this incomparably better tool KIT for the price of just one ordinary tool—let the marvelous Pile-Rench with its versatile 3 Jaws SPEAK FOR ITSELF as no Steel Jaws ever spoke before!

#### FREE



Every person using the coupon to order a PileRench KIT will receive absolutely FREE our wonderful R-E ANGLE Screwdriver. It has 7 working edges 1, 8-in. to ¾-in. wide and is so strong it does the work of many screwdrivers—large and small. Handles auto lights and removes bottle caps. Fits keyring and key-tainer. "The World's Greatest Small Tool"—yours FREE with the KIT

**THE FLASH SALES CORP'N**  
GP-4809 N. Ashland Ave., CHICAGO, ILLINOIS

**MAIL TODAY!**

The Flash Sales Corp'n, GP-4809 N. Ashland Ave., Chicago, Ill.  
 (Show with "X" item desired)  
 1. Rush your amazing new Eifel-Flash PileRench KIT. I will pay Postman \$3.65 on arrival (U. S. A. price) if it is underpriced I may return Kit within 2 weeks and get My Money Back, if not delighted.  
 2. Send me user literature.  
 3. Am interested in Salesman's Big Proposition.

Name.....  
 R. F. D. ....  
 St.....  
 P. O. City.....  
 State.....



VOLUME LXXXVI—NO. 97

—28 PAGES—PUBLISHED WEEKLY—PRICE TWO CENTS

# GASOLINE NOW 11¢

## AUTO OWNERS MYSTIFIED BY NEW DEVICE

The problem of high cost gasoline has apparently been solved by a mysterious little device that can be installed in a few minutes on any car. With this device installed the saving in gasoline effected will be so great that the cost of gas, as compared with previous cost, will be even less than 11c. It is estimated that if every car were equipped with this invention, millions and millions of dollars would be saved a year. Autoists also report an immediate increase in power and pick-up when this device is installed. Instant starting is also noticed.

## Motor Runs Much Smoother

Carbon forming disappears. The inventor claims that this is the outstanding automobile invention of the decade and has grounds for his claim.

Thousands of motorists have already equipped their cars. They report mileage tests that seem almost unbelievable. Thirty, forty and more miles on a gallon is nothing unusual. Motorists who have not already equipped their cars with this gas saver should get one just as soon as possible so that this season their gasoline bills will not worry them.

## FREE SAMPLE OFFER

To sell the Whirlwind, you have to have one of the devices to show. We have arranged a plan that supplies you with this device free so that you can get out and take orders right off the jump. If you have a car, you can equip your own car and make the experiment first. Your experiment will make you so enthusiastic that it will make you a doubly successful salesman. If you have no car, just carry it with you.

**WHIRLWIND CARBURETOR CO.**  
1041-420 Winnebago St. Milwaukee, Wis.

## Public Welcomes News

A newly invented device has actually made it possible for automobile owners to ride on 11c gas. This device, by utilizing air, cuts down the gas consumption amazingly. 11c gas is really a conservative estimate, as in many cases bona-fide reports have been received on cars running as high as

## 40 Miles on a Gallon of Gas

With the high cost of gasoline, this new Whirlwind device is the greatest thing of its kind ever discovered for auto owners. It is not an experiment, but the outcome of years of accurate tests. Car after car equipped with this marvelous device has shown amazing mileage tests.

This little device is worth its weight in gold, yet costs such a minimum sum that it pays for itself in just a short time in the gasoline it saves alone, not counting the more pleasurable driving it produces.

## \$100 a Week Territory Open

When you sell a device that actually saves gasoline, you overcome the one big point that makes selling difficult—that is, sales resistance.

Every auto owner wants to save gasoline. The Whirlwind is so practical, so easily explained, that it does not require a high-pressure, experienced salesman to make big money introducing it. On the contrary, the less sales talk used, the more sales you make. The literature we supply and the device itself do the selling. All you do is to take the orders. Word-of-mouth advertising brings you tremendous repeat business. For those who can devote full time, this is a knock-out proposition. It means a sure road to independence with an ever increasing future. Auto registration shows the number of cars is increasing daily. Every new car in your territory is a prospect for you. We stand back of you 100% and supply constant sales helps to increase your business. When you get big enough to handle it, we then forward to you business in your territory that comes to us direct.

Even if you are not in a position to devote full time, the Whirlwind agency offers big possibilities to you. It is easily possible to make as high as \$20.00 in an hour with this device. It sounds like a lot of money, but it has been done and it can be done by you if you will just push it as actively as other salesmen have done.

Big opportunities wait for no man, and this is a big opportunity. You have to decide, now, if you want to make some real money yourself supplying the demands for the liveliest agency item of the year. Here is your chance. Just fill in the coupon and mail it today.

NEW INVENTION  
MAKES THIS  
POSSIBLE

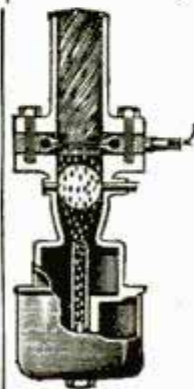

## FREE SAMPLE COUPON

WHIRLWIND CARBURETOR CO.,  
1041-420 Winnebago St., Milwaukee, Wis.

Gentlemen: I want to make big money supplying the demand for Whirlwind Carburetors. Please send me your free sample offer and full particulars of your sales proposition.

Name.....

Local.....

City.....

County.....

State.....



*Drum notes not only heard —  
but identified*

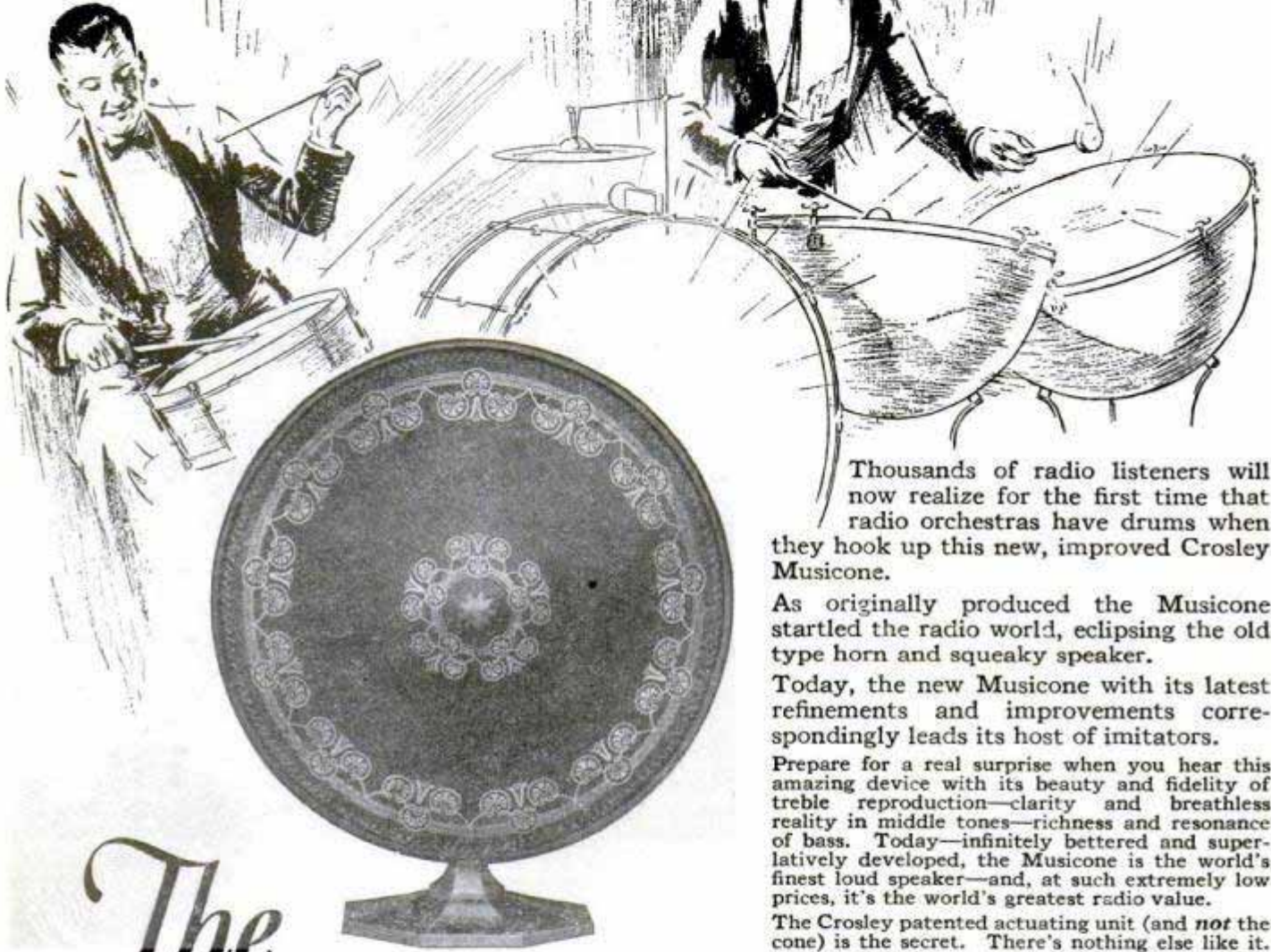

Thousands of radio listeners will now realize for the first time that radio orchestras have drums when they hook up this new, improved Crosley Musicone.

As originally produced the Musicone startled the radio world, eclipsing the old type horn and squeaky speaker.

Today, the new Musicone with its latest refinements and improvements correspondingly leads its host of imitators.

Prepare for a real surprise when you hear this amazing device with its beauty and fidelity of treble reproduction—clarity and breathless reality in middle tones—richness and resonance of bass. Today—ininitely bettered and superlatively developed, the Musicone is the world's finest loud speaker—and, at such extremely low prices, it's the world's greatest radio value.

The Crosley patented actuating unit (and *not* the cone) is the secret. There's nothing else like it.

Write Dept. 15 for descriptive literature.

The CROSLY RADIO CORPORATION  
Powel Crosley, Jr., Pres. CINCINNATI, OHIO

*Prices slightly higher west of  
the Rocky Mountains*

*The  
improved*  
**CROSLY**  
**MUSICONE**

**SUPER-MUSICONE**  
16 inch Cone  
**\$14.75**



**ULTRA-MUSICONE**  
12 inch Cone  
**\$9.75**



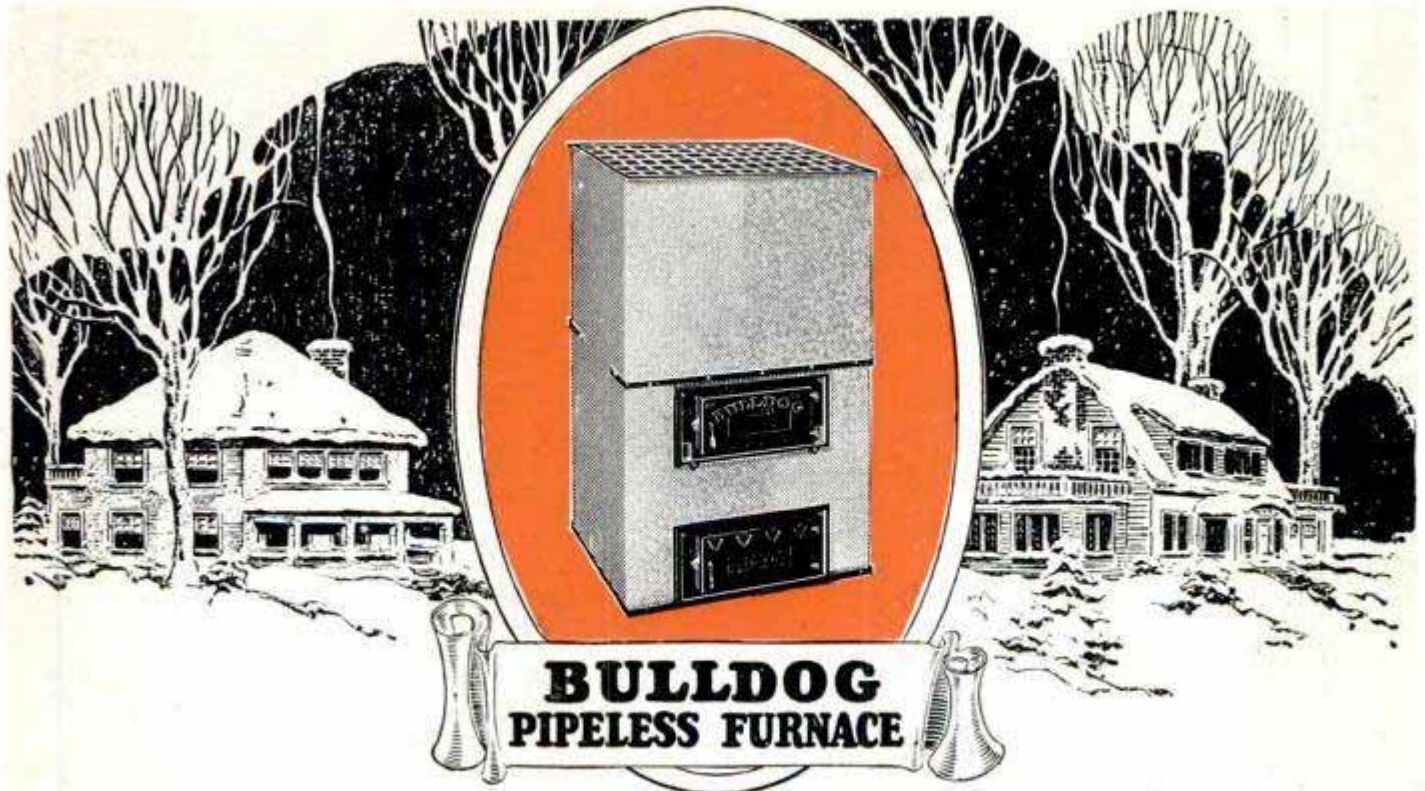

**BULLDOG  
PIPELESS FURNACE**

**Heats Eight Rooms  
at about the  
Cost of One!**

"My 8 room house has 7 windows on the northwest side downstairs, so it takes **SOME** heat! The Bulldog doesn't burn very much more coal than my old stove used to, and it heats the whole house, where my stove would heat only the one room it was in."—Ernest H. Marzoli, 72 South Street, Milford, N. H.

**2½ Tons Heats 5 Rooms**

"There is no heater to compare with the Bulldog. I burned 2½ tons of coal last winter and heated five rooms and a bath."—Waiter Geary, Gloucester, Mass.

**After 6 Years—"Heats as Good as Ever"**

"Our furnace has been in use 6 years and heats as good as ever."—Arthur Cloepfl, R. F. D. No. 1, Rock Port, Mo.

**Does the Work of 3 Stoves**

"This is my third winter with the Bulldog. It does the work of 2 coal stoves, which only warmed up part of the house and not very well at that. My Bulldog not only does that, but also 3 rooms upstairs, with great satisfaction. My house is located in a very cold place, with no protection at all."—Edwin C. Diplock, 106 Elm Street, Camden, Maine.

**No Money Down!**

*Small Monthly Payments—Installed Almost as Easily as a Cook Stove!*

The Bulldog is sent to you for *free inspection*. Then, if satisfied, you make only small monthly payments at our remarkably low price. Write today! *Don't miss this chance to cut down your fuel bills! Install a Bulldog Furnace!* It comes to you completely erected—goes through any door—fits any height of basement—and you install it yourself in less than two hours! In fact, you can install the Bulldog just about

as easily as a kitchen cook stove. *Don't put up with the old fashioned stove heat or some outworn furnace—when you can so easily get the greatest advance in scientific heating at an astonishingly low price.* The Bulldog burns almost any kind of fuel, from hard coal to cheap screenings. Keeps a wood fire over night. *We have factory connections in both east and west and ship from the nearest point.*

**Send for Free Book!**

Learn how to have all the heat you want—where you want it—and save money! Remember the Bulldog is *different—and better!* Complete combustion of gases save 25% of your fuel bill. Exclusive Gable-Top Radiator receives *all* the direct rays of the fire. Exclusive oblong fire-pot is not only ideal for coal, but enables you to keep a wood fire over night. Remember—the Bulldog is sent for *free inspection*—then small monthly payments at an amazingly low price!—Send for Free Book **TODAY!**

**BULLDOG FURNACE CO.,** 19th St. and California Ave.  
Babson Bros., *Sole Distributors* Dept. B-135 Chicago, Ill.

**Bulldog Furnace Co.,** Babson Bros.  
*Sole Distributors*  
19th St. and California Avenue, Dept. B 135 Chicago

Without obligating me in any way, please send me your free catalog and special offer on the Bulldog Pipeless Furnace.

Have you a basement? Yes  No

Name \_\_\_\_\_

Address \_\_\_\_\_



H A V E

A

C A M E L



## *No half-way verdict —Camel is supreme*

THE American people have had many favorites. But there's never been a choice like Camel.

Camel is the most popular cigarette this nation ever had. Millions unite to place it first, and there's no comparison. Camel is supreme.

There must be reasons back of such a preference. There must be mountain-high quality in this famous cigarette to make millions join in saying, "I will have only Camel."

That is true. Camel quality is just as supreme as its leadership. In Camel, no

substitute has ever been made for quality. No compromise has ever been made with expense. For Camels, the world's largest tobacco organization buys the choicest Turkish and Domestic tobaccos grown. There simply are no better tobaccos or blending.

If you don't yet know that supreme tobacco enjoyment, try Camels. All the taste and fragrance, all the mild and mellow pleasure you ever hoped to find! We invite you to compare them with any cigarette made, regardless of price—"Have a Camel!"

R. J. REYNOLDS TOBACCO COMPANY, WINSTON-SALEM, N. C.