

APRIL

Better Outdoor Aerials—Page 649

N.S.E.
25 CENTS

POPULAR MECHANICS MAGAZINE

WRITTEN SO YOU CAN UNDERSTAND IT

REG'D. TRADE MARK. GREAT BRITAIN. 1940485

REG. U.S. PAT.



SEE PAGE 534

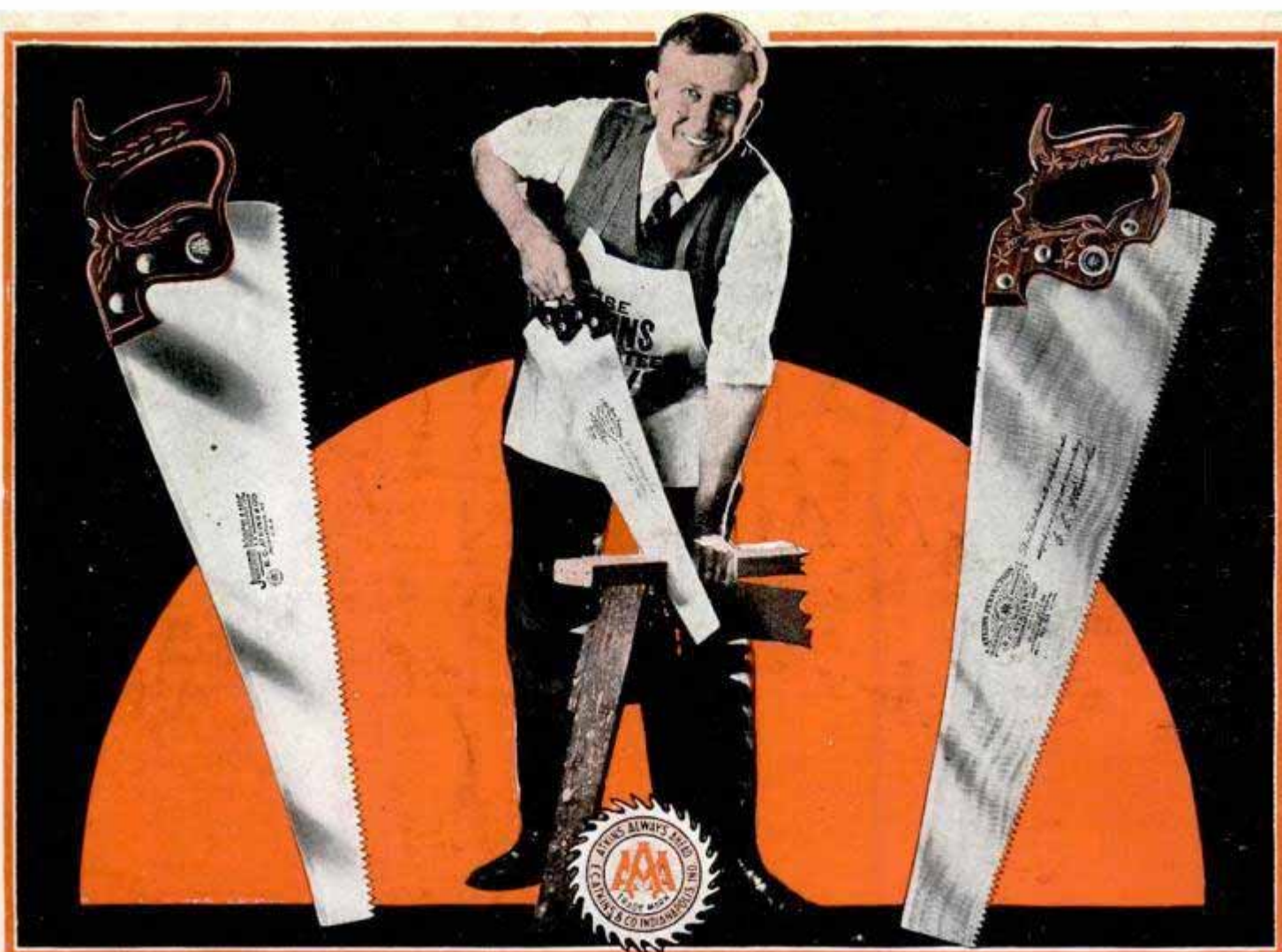

Mr. Happy Man Says— **“It Pays to Buy Better Saws”**

HERE are three popular ATKINS Saws—for carpenter, home-worker or junior mechanic—there’s one to suit your needs!

No. 400 hand saw, preferred by master carpenters everywhere—the finest saw in the world. Extraordinary in quality, workmanship and finish.

No. 53 hand saw, a lifetime saw for the millions of men who need a really good saw for home use.

Junior Mechanic hand saw, for the junior mechanic or Boy Scout. A handy saw for grown-ups, too.

ATKINS Saws are made of “Silver Steel”—the ATKINS exclusive steel that makes a saw hold its keen edge longer, and outlast two or three “cheap” saws. “Taper Grinding” makes ATKINS Saws cut faster, surer and easier.

When you buy a saw, look for the ATKINS name on the blade. It guarantees you a better saw—one that will save you time, money and labor.

E. C. ATKINS & CO., Est. 1857 426 S. Ills. St., Indianapolis, Ind.

Leading Manufacturers of Saws for Every Use, Saw Tools, Saw Specialties and Machine Knives

Write for “Saws in the Home”

Let us send you “Saws in the Home,” an interesting folder on tools for the home—or “Saw Sense,” a helpful booklet on saws. **FREE.** Write today.

ATKINS SILVER STEEL SAWS

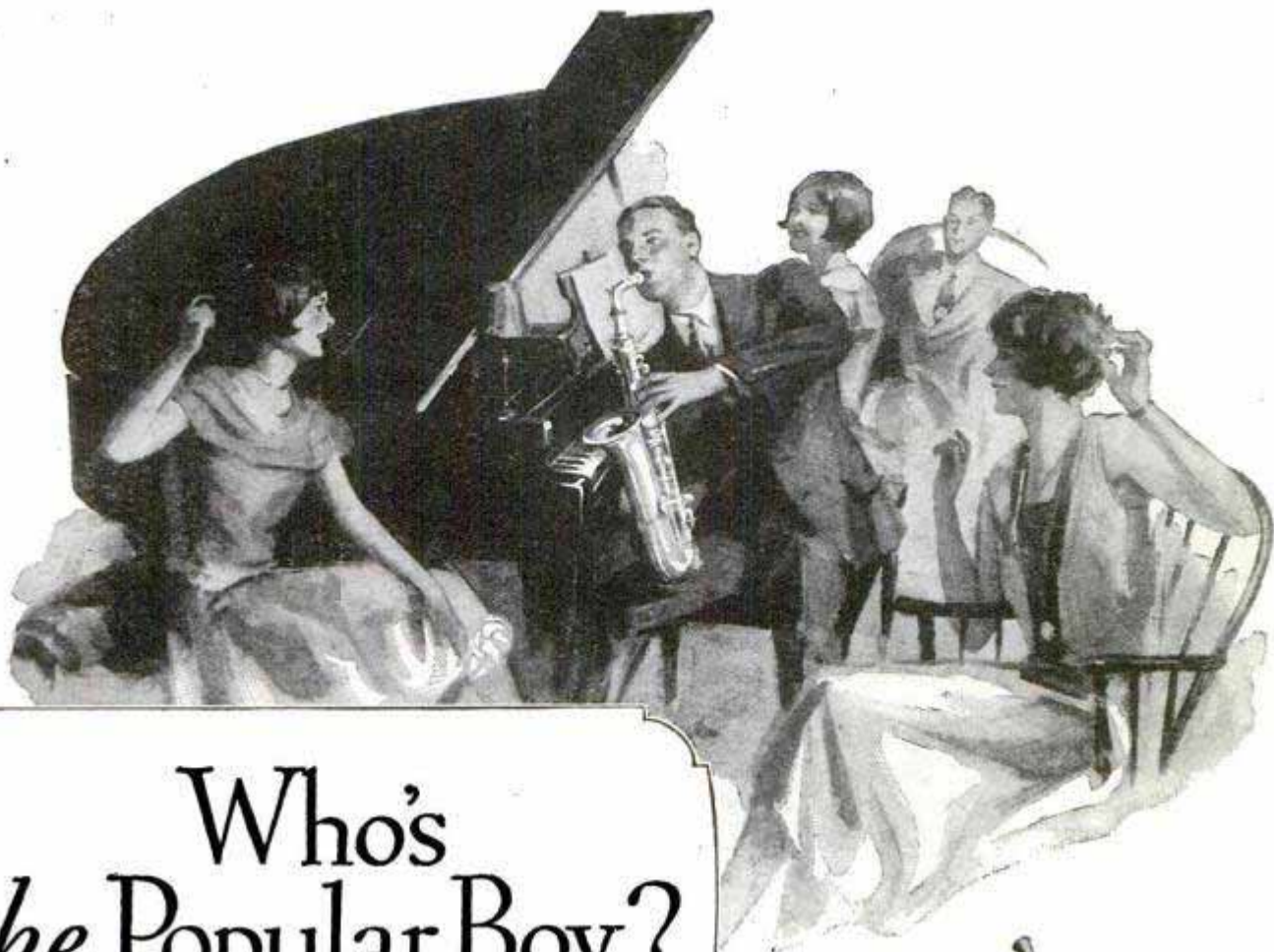

Who's *the Popular Boy?*

THE boy who plays a Conn is the most sought for fellow in his crowd. He's welcome everywhere because he brings zestful, cheering music that everybody likes.

A Conn saxophone is a key to social prestige; it can be a great help to success in any career. Professional playing, whole or part time, is highly paid and fascinating; opportunities are open everywhere. Exclusive, easy-playing features speed your progress.

Choose any instrument; remember Conn makes everything for band and orchestra. Each Conn instrument has its exclusive advantages. Conns are used and endorsed by the world's foremost artists and conductors. *Yet they cost no more than others!*

FREE TRIAL, Easy Payments on any Conn. Select the instrument which appeals to you; try it in your own home. You can own it by small monthly payments. Send the coupon or write now for free literature and details of trial offer.



*Mail
Coupon*

CONN
BAND
INSTRUMENTS
WORLD'S LARGEST MANUFACTURERS

C. G. CONN, LTD.,
431 Conn Bldg., Elkhart, Ind.
Please send free literature and details of free trial offer on _____
Name _____ (Instrument)
St. or R. F. D. _____
City _____ State _____ County _____

CULTIVATE YOUR MUSICAL BUMP



OPM-F ID-NV1 7

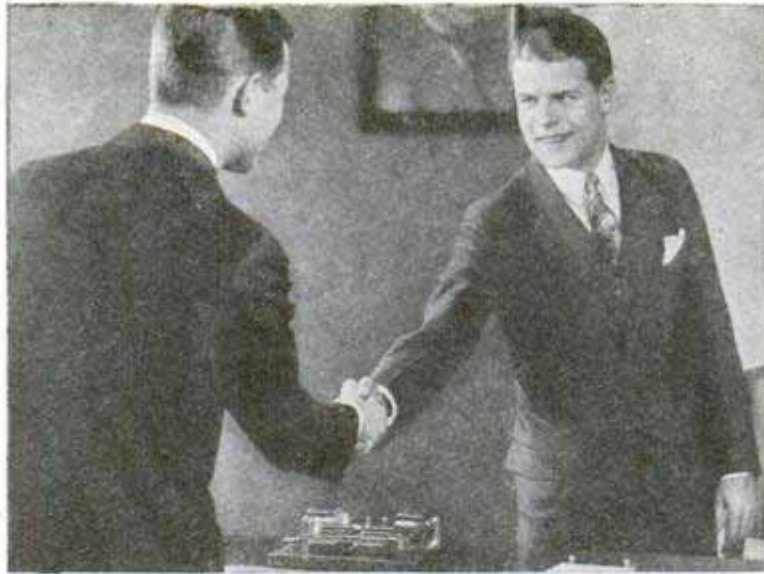

For that clean-cut look of success *try this invigorating massage after shaving*

SUCCESSFUL men look the part. They are clean shaven, clean cut, and well groomed. They have that glowing look of health and vitality.

A muddy, half-clean, blackhead-dotted skin can never be a partner of the successful man. Yet you can have the clean and healthy look of success. It takes no extra time. It can be acquired easily and pleasantly.

After you shave, use Pompeian Massage Cream. You usually use something after shaving—hot towel, lotion, or cream—to remove the dirt and clinging soap

particles that become imbedded in the skin. Water, lotions, soaps—all reach the surface only. They do not remove imbedded dirt and secretions. Pompeian Massage Cream does.

Use this pleasant, gentle cream after shaving. See how your skin takes on the glow of life and action. See how imbedded dirt, even blackheads, rolls out under the mild but efficient urge of this massage, quickly applied in your own home. You will like its restful, zestful "feel." Above all, you will like it for the feeling it gives you that—by gosh! you really are clean.

Make this convincing hand test free!

Wash your hands thoroughly. Rub a little Pompeian Massage Cream into the back of your hand until the cream first disappears, then comes out again. Notice this—*the cream goes in pink and comes out black!*



The black is dirt that you could not remove by washing. You can make this simple but convincing test today. Get a jar of Pompeian Massage Cream at any drug store for sixty cents. If you prefer to make the test before you buy, merely mail the coupon below.

POMPEIAN MESSAGE CREAM *Increases Your Face Value*

FREE TO MEN ONLY

The Pompeian Company, Dept. 46, Cleveland, Ohio. Please send me free, the sample tube of Pompeian Massage Cream, with enough cream to make the hand test, and to give me several massages.

Name _____

Street _____

City _____ State _____

Popular Mechanics Magazine

200 E. Ontario Street, Chicago, U. S. A.

H. H. WINDSOR, Founder

H. H. WINDSOR, Jr., Editor and Publisher

London: Hachette & Cie.,
16-17 King William Street, Charing Cross, W. C. 2

Paris: Hachette & Cie.,
111 Rue Reaumur

Melbourne: Gordon & Gotch
509-513 Little Collins St.

ISSUED MONTHLY

SUBSCRIPTION:

SINGLE COPY, 25 CENTS

In United States and its possessions, also Canada, Cuba, and Mexico, per year, postpaid - \$2.50
To all other countries in the Postal Union - 3.00
All subscriptions are discontinued at expiration. Please examine the date printed on your wrapper.

Entered as Second Class Matter Sept. 15, 1903, at the Post Office at Chicago, Illinois, under Act of March 3rd, 1879.
Entered as Second Class Matter at the Post Office Department, Canada.

Published monthly by POPULAR MECHANICS CO.

Copyright, 1927, by Popular Mechanics Co.

Copyright in Australia. Copyright in France

Vol. 47

Contents for April, 1927

Accident—kill twenty thousand a year	574	Disease—conquest of scarlet fever	611
Advertising		Door—forty-ton bank vault	575
envelope post-office sign aid to tourists	593	Education	
shop that never closes	605	auto bus fitted as school	572
Air—cold, pumped into homes as substitute for ice	605	trade taught by blackboard and paper models	624
Airplane		Electric Battery—elastic sealing	587
model for perpendicular ascents and landings	553	Electric Heater	
motor with eighteen cylinders	605	for water pipe	579
roaring into the land of the pygmies	606	keeps air constantly in motion	532
Airship—air liners to have cabins in keel	557	Electric Power—plant requires no dynamo	545
Animal—man-eating tiger shot	600	Fans—giant, which safeguard life	642
Aquarium—food problem of, a big one	553	Filing—sliding indicator on file card	590
Astronomy		Forage	
lunar alps illuminated by the earth	627	making hay while it rains	640
new worlds in the making	626	pasture plants in struggle for survival	624
Automobile—time required to build low priced	563	Franklin, Benjamin—tablet in honor of	600
Automobile Driving—hazards in driving monster speed automobiles	532	Furniture—ready to fit	623
Automobiles—Design—streamlined racing car has novel engine	340	Game of human volley ball	533
Automobiles—Equipment and Supplies		Garages—Equipment and Supplies—hitch tows autos at high speed	541
auto spray gun and vacuum simplify cleaning	554	Glass—magic of blower's art	647
hood lining protects motor	531	Goldfish—London shop is, home	603
sliding box for small auto gives truck service	631	Great War 1914-1918—monument	575
Automobiles—Fuel		Grinder—disk protects worker	594
light tells when gas is low in auto fuel tank	647	Gun—harpoon gun developed for ocean fishermen	534
race to test worth of oil-burning autos	614	Heating Plant—hot-water wells heat homes	535
Automobiles—Radiator—self-thawing	624	Hotel—warship turned into	531
Automobiles—Safety Devices		House Plans	704
front and rear auto signals	636	Household Devices	638
transparent auto stop sign	577	Hydroelectric Power—power from ocean warmth to produce electricity	641
Aviation—night flying lanes extended for air mail	608	Ice—dike of ice shuts off water for submarine building	603
Blindness—seeing with fingers	587	Insects	
Boats and Boating—ferry boat has tilting bow	553	death traps of plant world	562
Books—Napoleon's library saved by American money	608	making jewelry	555
Bridge—for electricity spans wide mountain chasm	535	Invalid Chair—run by gasoline motor	573
Building		Lens—of telescope on window gives closer view	641
queer, that catch eye in west	602	Life Saving—suit built like diver's dress	544
ship-shaped office building	615	Lighter—flint gun lights gas	576
Building Construction		Loading and Unloading	
church to resist hurricanes	572	big bell on steamer with special crane	579
felling blast furnace tests engineering skill	632	elevator on baggage truck	604
steel "rib" for tunnel building	573	Locomotive—observation booth in front of	569
Cake—model of big building	599	Lottery—prizes in big	625
Calculating Machine—dry-goods meter for taking inventory	599	Lumber—exploding chips in guns to make	589
Camera—takes fifty pictures on single roll of film	570	Magic—the truth about Indian	618
Cards—bridge game lets radio fans play lessons in advance	576	Mail Box—has bell and swinging door	648
Cathedral—Moorish architecture in Mexican church	634	Map—aerial map making with electric camera	543
Cave—hung with icicles	617	Masks—queer, used in dangerous occupations	616
Chronometer—accurate time gauge to aid research work	610	Maya—building America's sacred city (Cuzco)	546
Circus—with "merry joeys" of tent world	595	Mental Test—auto drivers' skill tested by machine	601
Clock		Model	
run by balls, requires no winding	591	glider plane sailed with rubber band	592
with ten hands tells time in all lands	635	hotel in glass	577
Coal—plant plants itself	562	Monument—stones from all states in memorial fountain	633
furnace blower saves	601	Motor Boat—cruise round world in motorcycle boat	586
work done by, doubled	593	Moving Picture	
Concrete—huge mixer	631	copper band as movie film gives pictures' depth	609
Cooker—barbecue roaster for stores	637	crockery in movies made to be broken	635
Cosmetic—sanitary lipstick in package	633	free in railroad station	643
Crime		shadows help to keep world in gear	586
electricity used to solve mystery	604	speed control for movie film	560
melting bullet to aid crime war	573	vibration pictures aid deaf and show bullets' speed	609
Cushion—air pocket camping	555	Moving Picture Projector—vest pocket size	625
		Oil Burner—that uses water	560
		Pencil—and flashlight in one	563
		Police—laboratory on wheels	631
		Pontoon—for raising ships	559

[Continued on Page 4]

higher with black 571

Water Pipe 579
No. 4
Diamonds. Red Not Valuable 578

Walter reading 587
card index
mosquito powder 622

Hydruplane 66

Precious Stone—ninety-five pound topaz	575	Clothesline—adjustable	668
Radio Aerial		Drainage—for yard hydrant	684
better outdoor aerials	649	Fence—at building prevents railroad accidents	679
electric-lighted masts	592	Fire Apparatus—homemade extinguisher	670
Radio Apparatus—radio happenings far and near	661	Fishing—kink for the fisherman	683
Radio Battery		Flashlight—makes red lamp	669
new unit replaces storage A-battery	654	Ford Car	
salvaging old B-battery	658	curtain fasteners	668
Radio Broadcasting—how grand opera is broadcast from stage	578	loose coil bridge causes spark miss	674
Radio Cabinet—homemade	655	protection for radiator core	672
Radio Construction—insulating material easy to work	653	Gun—how to remove stuck rag from barrel	681
Radio Crystal Receiver		Hose—roller guard for	670
adjustable crystal mounted on panel	651	Hotbed—on porch roof	666
detector has vernier adjustment	659	House—combined garage and summer home	669
Radio Ground—good ground connection	659	Ladder—handy chimney	670
Radio Interference	660	Latch—burglar proof	670
Radio Loop—suspended saves space	662	Lighting Fixture—tool for removing lamps from ceiling fixtures	672
Radio Loud Speaker—decorating the cone speaker	660	Model—ship maker's tools	675
Radio Receiver		Outboard Motor—speed from	663
all metal	652	Painting—kinks for auto painter	666
both tubes and batteries eliminated in set	653	Picture—making frames	674
five-tube receiver in kit form	654	Pipe	
pocket set for police	675	leaks stopped with bullets	674
Radio Tube		repair for water leak	672
added pin improves tube contact	659	Piston—arranging rings	681
preventing vibration	653	Poultry—protection for chicks in brooder	680
tester employs lamp	662	Pump—attaching hose to air	667
Railroad		Razor—safety blade holder	684
guard railway from slides with electric fence	617	Smokers' Accessories—from auto parts	683
guarding lives of millions up "stairway to Heaven"	561	Spray	
Rays		for cleaning typewriter	671
invisible carry movies and transmit sounds	539	hand clothes sprinkler	667
seeing in dark by means of black light	571	Storage Batteries—wiring accessories to	672
Rope—tricks of the wild west	564	Stovepipe—crimping	684
Salvage—raising a fleet from Davy Jones' locker	580	Swimming—lines guide underwater swimmers	681
Sander—on heavy truck for slippery roads	561	Varnish—hint on varnishing	680
Sawdust—from dolls to dynamite story of	600	Windlass—making emergency	669
Scales—that weigh emotions in mining tests	569		
Sculpture—art of swiss snow sculptor	542		
Ship			
carved prow on work boat	558		
ocean liner with nine decks	637		
smokestack used for movies on ocean liner	648		
Shoe—soles glued on instead of sewing or nailing	562		
Silk—rubberized bathing suit	591		
Ski—runners practice indoors on chemical snow	625		
Snow—rangers read meters through telescopes	637		
Soot—yearly fall in London	563		
Sound			
box produces sleep	533		
recorded on film reproduced at once	617		
voice recorded on wire and reproduced from it	615		
Speaking Tube—in house door	542		
Speech—produced by bellows through human hands	588		
Street Traffic Regulation			
safety zone guarded by posts	603		
sign arrow tells time between lights	588		
sign has moving disk for stop and go	545		
Swimming—how youth won prize	537		
Table—and typewriter case combined	554		
Target—hand grenade registers hits	593		
Tattoo—instead of lipstick for permanent effect	536		
Telephone			
net of long-distance phones links entire country	536		
stands for taxis	591		
Treadmill—boxers train in to develop breathing	541		
Tree			
marks scene of Indian treaty	570		
trained to form chair	610		
Vacuum Cleaner—run by friction wheel	610		
Watch—handless tells time by moving dial	587		
Weed—disk weeder for railroad	643		
Whale—artist builds huge	636		
Window—washer and polisher	559		

AMATEUR MECHANICS

Automobile Driving—equalizing rear wheel traction	680
Automobiles—Equipment and Supplies—baby carrier	667
Automobiles—Ignition—intensifier	682
Automobiles—Repairing—reinstalling shock absorbers of the strap type	668
Automobiles—Snubber—homemade	673
Bell—hookup for 110-volt lines	674
Butter—server for chips	666
Candle—homemade colonial holders	680
Chair—safety stop morris back rest	671
Churn—improvised	673
Clip—clock spring towel	681
Clock	
emergency key	670
way of regulating	684

Screws	
holder for bendix cover screws	692
how to drive small, in deep slots	702
Sewer—trick for cleaning drain pipe	703
Shaft—temporary repair for broken	695
Shifter—preventing movement of handle	689
Sign—windshield frame makes sign mounting	696
Staple—driving tool	691
Swine	
cement hog wallow uses old oil	695
door keeps chickens out of hog house	702
Switch—safe knife switch thrower	701
Tires—protect pavement from mower	697
Tunnel—safe method of back filling	695
Workbench—portable, for garage	699
Wrench—for union nuts on small pipe	696

SHOP NOTES

Automobiles—Lighting—repair for loose tail lamp socket	701
Automobiles—Repairing	
magnet tool replaces spring in valve grinding	702
testing length of rubber bumpers	691
to free spring bolt of hard grease	702
Bearings—casting oil grooves in	691
Belt—making a V-type fan	702
Brake	
keeping bus and truck brakes efficient	699
keeping it in order	696
Building Construction—units for retaining wall	690
Calipers—gauge for setting in wood turning	696
Cards—how to count them quickly	700
Castings—filling holes in	700
Chalkline—pick for snapping	700
Clamp—strap for clamping tapered work	697
Countershaft—mounted on auto springs	700
Electric Battery—charging with farm engine	693
Glue—triangular gluing table	692
Hotbed—built over brooder house	697
Jack—quick acting auto	703
Loading and Unloading	
carrying tiles on wheelbarrow	700
non-skid loading plate	691
Lubrication—oiling overhead shafts	692
Mica—drilling	699
Motor Trucks—traffic signal for	695
Nichrome—soldering and brazing	688
Nozzle—for hose made from pipe fittings	696
Paintbrush—how to buy and keep	685
Pipe—starting joints in old piping	701
Piston—ring compressor	689
Plane—keyway cutting	701

*Wire Recorded on 615 - Telegraph (Seen by Black Light) 571
Wood floor - 609 - Strawberry tree 570*

*Recorder
Voice in
Wire
615*

*Hand
Pencil
Chalk
44*

New Ideas on Home Decoration

WHETHER you are a practical decorator, furniture finisher, design artist or only a home owner, these practical books will give you new and up-to-date methods of securing the most beautiful effects. Each book fully illustrated. By their help you can secure results worth many times the cost. Study the list:



FURNITURE, FURNITURE FINISHING, DECORATION AND PATCHING

Period Furniture and Modern Styles, etc., illustrated and described and methods of finishing explained. A new invaluable book. 400 pages, cloth, \$5.00.

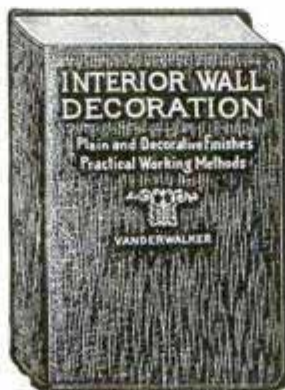

INTERIOR WALL DECORATION

The new artistic and novelty finishes and how they are obtained. New ideas for home owner and decorator. 450 pages, leatherette, \$4.00.



STUDIO HANDBOOK—LETTER AND DESIGN

A new book for artists and others, with every conceivable style of letter and design. Invaluable to advertisers. 233 pages, leatherette, \$3.00.

The Ross Crane Book of Home Furnishing and Decoration	\$3.00
Mixing of Colors and Paints	2.00
Wood Finishing, Plain and Decorative	2.00
House Painting Methods	2.00
The Art of Sign Painting	4.00
Scene Painting and Bulletin Art	4.00
"A Show At" Sho' Cards	4.00
Art of Show Card Writing	4.00
Strong's Book of Designs	4.00

New Stencils and Their Use	\$1.25
Automobile Painting	1.50
Modern Painter's Cyclopeda	2.00
Estimates, Costs and Profits	1.50
New Hardwood Finishing	1.50
The Signist's Modern Book of Alphabets	1.50
The Amateur Artist	1.50
Owens' Paint Guide	1.00
Chalk Talk and Crayon Presentation	1.25
Graining and Marbling75

We also publish over 200 pay-raising books on **Electricity, Automobile construction, care, maintenance and painting, Machine Shop Practice, Steam Engineering, Railroading, Carpentry and Building, Business, Bookkeeping, French, Spanish and German Without a Teacher, General Instruction and Reference Books, Handbooks, Farm Books, etc.** All fully described in catalog **SENT FREE.** Write today.

FREDERICK J. DRAKE & CO.
 Publishers
 1008 Michigan Ave. CHICAGO
Drake Books Are for Sale at All Book Stores

Frederick J. Drake & Co.,
 1008 Michigan Avenue,
 Chicago, Ill.

Gentlemen:
 I enclose \$..... for which send me postpaid the books checked on this page.
 Please send me, free, postage paid, your illustrated catalog which lists and describes over 200 Practical Mechanical Books for Home Study.

Name.....

Address.....

.....

Are You
Wishing
for a Big
"Raise"
—or
Planning
for It?



The **Marion**
Steam Shovel Co.

Marion,  Ohio, U.S.A.

LaSalle Extension University,
Chicago, Illinois.

Gentlemen:

When I enrolled with LaSalle for training in Traffic Management, I admit I didn't see how it could benefit me to any extent, because I had already had ten years' practical experience -- in every branch of traffic work.

Now I know that everything you told me is true -- LaSalle training does increase men's salaries, and I can show anyone exactly how it works.

I completed your training in January, 1923, and in January, 1924, just one year later, my annual report to our General Manager showed a net saving of \$45,502. It was LaSalle training that enabled me to make this showing -- and it was my report of actual savings that brought me the substantial "raise" that came to me quite unsolicited.

Very truly yours,

H. E. Stiffler

Traffic Manager.

WHAT are you *doing* to prove to your employer that you are really and truly worth more money?

H. E. Stiffler, Traffic Manager of the Marion Steam Shovel Company, Marion, Ohio, asked himself that question—and answered quickly—satisfactorily—completely—with LaSalle home-study training.

Read his letter. And as you read it bear in mind that *when Mr. Stiffler started with LaSalle he had had ten years' experience on the job*—had already directed the shipping of Marion steam and electric shovels, excavators, dredges and cranes thru every port in the civilized world.

"We had always found Mr. Stiffler very efficient, but his training with LaSalle has enabled him to make *even better records*." So writes Charles B. King, Vice-President and General Manager.

Can you think of any way so quick—so sure—so certain—as to *plan* for your promotion—and to *win* that "raise" by turning increased *knowledge* into increased *earnings*?

Send for These Free Books

Find out what *you* can do in this highly profitable field of Traffic Management. Get the facts—then plan for bigger pay—within the next twelve months.

The coupon will bring you without obligation a 64-page booklet, "Opportunities in Traffic Management"—also a copy of "Ten Years' Promotion in One," the story of how one man, after many wanderings, found the path to responsibility and power.

A pencil—an envelope—a postage stamp! Get these two books now—and make your start TODAY.

Find Yourself Thru LaSalle!



LASALLE EXTENSION UNIVERSITY, Dept. 464-R CHICAGO

I shall be glad to have your 64-page booklet about the business field I have checked below. Also a copy of "Ten Years' Promotion in One," all without obligation.

- | | |
|---|--|
| <input type="checkbox"/> Traffic Management—Foreign and Domestic | <input type="checkbox"/> Business Management |
| <input type="checkbox"/> Higher Accountancy | <input type="checkbox"/> Modern Foremanship |
| <input type="checkbox"/> Modern Salesmanship | <input type="checkbox"/> Industrial Management |
| <input type="checkbox"/> Law; Degree of LL. B. | <input type="checkbox"/> Railway Station Management |
| <input type="checkbox"/> Commercial Law | <input type="checkbox"/> Personnel Management |
| <input type="checkbox"/> Banking and Finance | <input type="checkbox"/> Modern Business Correspondence and Practice |
| <input type="checkbox"/> C. P. A. Coaching for Advanced Accountants | <input type="checkbox"/> Expert Bookkeeping |
| <input type="checkbox"/> Effective Speaking | <input type="checkbox"/> Business English |
| | <input type="checkbox"/> Commercial Spanish |

Name..... Present Position.....

Street..... City..... State.....

these books free

ELECTRICITY

Complete Study Course and Pocket Library \$10



SHIPPED FREE

A set of **HAWKINS GUIDES** is a true friend to the electrical worker. It tells you how to do any job the right way—without guessing or taking chances.

Hawkins Guides put all the facts about modern electrical engineering at your finger tips. Therefore your chances for advancement in the electrical field are unlimited.

HAWKINS GUIDES DOUBLE YOUR VALUE



Electricity is king! It is the ruling force of today—transportation, communication, light, heat, power—indeed every modern activity is dependent on electricity. Industry is crying for electrical men that know their jobs!

Hawkins Guides teach you all you need to know about electricity in easy, step-by-step lessons. Daily spare time reading of the Guides will greatly increase your value to yourself and your employer in a few weeks. Hundreds of our friends have written us and told us this!

READERS OF HAWKINS GUIDES KNOW HOW



"You can't stump him on an electrical job." "He certainly knows his business." "Certainly have to hand it to him for knowing how." —These are the things employers say about our friends who are readers of **Hawkins Guides**. No matter what question or problem comes up the Ready Reference Index enables you to give an expert answer at once.

HAWKINS STARTS YOU WHERE OTHERS LEFT OFF

Why should you work at low wages when easy reading of **HAWKINS GUIDES** will give you the money-making knowledge of the expert? Easy daily reading of the Guides will teach you in a few months what it has taken the expert a lifetime to learn!

With **HAWKINS GUIDES** in hand you have a running start to success in the electrical field. You will actually begin where others left off!

NOW!

This coupon is your golden opportunity. Tear it out—send it now!

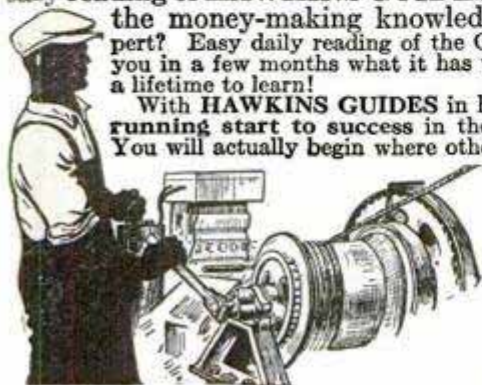

FOR EXAMINATION!

REAL ELECTRICAL EDUCATORS

"Hawkins Guides at \$10 is the best investment I have ever made. Am able to take up almost any electrical job and have never gone to an electrical school."—B. Roessler, Oenaville, Texas.

AS EASY AS A. B. C.

"Everything in Hawkins Guides is very plain and anybody can read and understand them as easy as A. B. C."—J. Knight, Tobyhanna, Pa.

OTHER ENTHUSIASTIC READERS SAY

"Worth ten times their price." "Helped me to two raises in four months." "Better than a school of instruction." "Studied them when I was laid up and got further ahead than if I had been on the job."

Hawkins Guides Explain These Points So You Can Easily Understand:—

Magnetism—Induction—Experiments—Dynamo—Electric Machinery—Motors—Armatures—Armature Windings—Installing of Dynamos—Electrical Instrument Testing—Practical Management of Dynamos and Motors—Distribution Systems—Wiring—Wiring Diagrams—Sign Flashers—Storage Batteries—Principles of Alternating Currents and Alternators—Alternating Current Motors—Transformers—Converters—Rectifiers—Alternating Current Systems—Circuit Breakers—Measuring Instruments—Switch Boards—Wiring—Power Stations—Installing—Telephone—Telegraph—Wireless—Bells—Lighting—Railways. Also many Modern Practical Applications of Electricity and Ready Reference Index.

Hawkins Guides—10 POCKET SIZE NUMBERS

Each number easy to carry around and read in spare time. Big type and clear diagrams. Easy to study and learn. Durable, flexible binding—gold edges. 3,500 pages—4,700 illustrations. Shipped free for examination. Pay only \$1 a month if satisfied. Price of set, complete, \$10.



EXAMINE GUIDES FREE!

Let the Guides themselves demonstrate their practical value to you—as a study course, reference work and complete electrical library. You are the judge. Simply send this coupon. No obligation unless you are entirely satisfied. Tear out on dotted line—fill in—mail it NOW!

\$1 PER MO.

FREE EXAMINATION COUPON

Theo. Audel & Co., 65 W. 23rd St., New York City

Please send me (postpaid) for my approval **Hawkins Electrical Guides**, 10 numbers (price \$1 each). If satisfactory I will mail you \$1 in 7 days and further mail \$1 monthly until purchase price of \$10 is paid.

Name.....
 Address.....
 Occupation.....
 Employed by..... 4T30

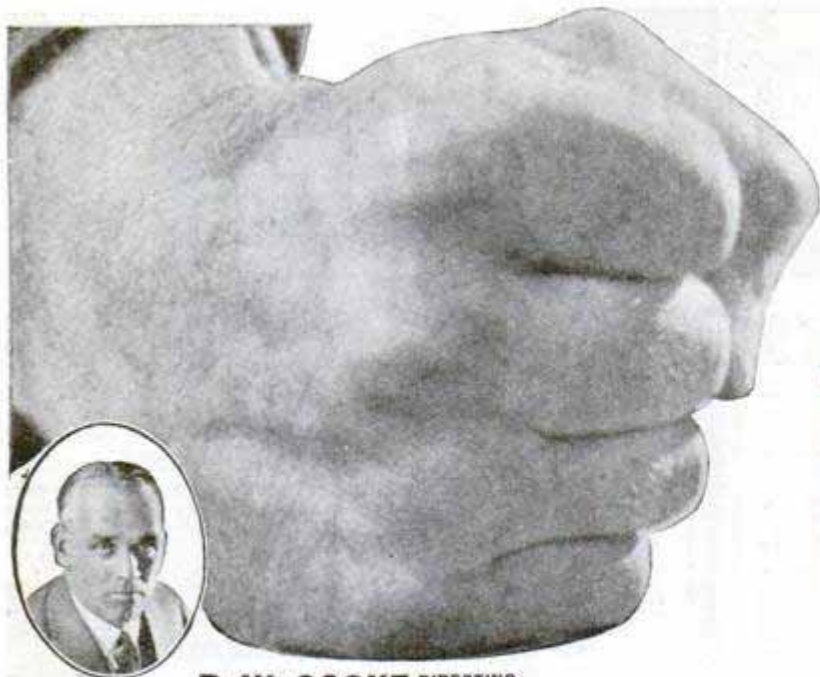

B. W. COOKE DIRECTING
ENGINEER

now! AUTO FACTS

For the Man Who Wants to Make More Money-**QUICK!**

Maybe I can't paint a rosy picture of the Opportunities for you in this Auto Business. I admit it. I am an Auto man. My business is Training men for the Big Pay Auto Jobs—not writing. But I can give you the plain Facts about what the Auto Business holds for you. And that's exactly what I am doing. This is not just talk.

Read it! Then send coupon.

WHEN I say "get into the Auto Business—it's an uncrowded field"—I'm talking **FACTS!** Just look here—Today there are 22,342,457 cars on the roads! Nearly 3 times as many cars to each garage as there were in 1919! **FEWER** expert repairmen to each car **THAN EVER BEFORE!** Training Auto Men has **NOT** kept pace with the growth of this gigantic business! Do I need to say any more about the Opportunities for **YOU** in the Auto Business?

When I say that there's big Money to be made **QUICK** in this business, when you're Trained the "**JOB-WAY**"—**THAT IS A FACT, TOO!** Read those letters in the panel at the right! Remember that they are only 2 of Hundreds! Send Coupon

MAIL THIS "JOB-WAY" COUPON

B. W. COOKE, Directing Engineer
CHICAGO MOTOR TRAINING CORPORATION
1916 Sunnyside Avenue, Dept. 416, Chicago, Ill.

Send me **FREE** Auto Book and proof that you will show me the **QUICK WAY** toward a **BIG JOB** and a **RAISE IN PAY.** Also send your 4 Outfits Offer. It is understood that this obligates me in no way

now and get **MORE PROOF—MORE FACTS**—my New Free Book "Auto Facts" gives them to you!

Learn How I Train You **AT HOME!**

As to whether I can train you successfully at home, I say to you, "**GET THE FACTS!**" Send for my New Free Book. See how men of all ages, with little education, and no previous Auto experience, have made up to **\$150 A WEEK—QUICK!** See why men with years of experience take this complete "**JOB-WAY**" Training—the training of a **THOUSAND JOBS!**

Learn how men earn as they learn—make money in their spare time—in the first few months' training! Learn how others go into Business, become their own bosses with big incomes in amazingly **QUICK** time!

And as to my Training, I simply want to say that it is practical and thorough, yet simple and easy. With it you get many added extra features of Service, including Lifetime Employment Service, Consultation Service, as well as 4 splendid Working Outfits free of extra cost!

THESE ARE FACTS! My New Big Book with dozens of pictures shows **MORE!** Get all of them—get the **PROOF!** Send Coupon Now!

B. W. COOKE DIRECTING
ENGINEER
Chicago Motor Training Corporation
Dept. 416, 1916 Sunnyside Ave., Chicago, Ill.

Read!



"Before starting your course I knew nothing about Auto repair work. I have only a common school education, but find your lessons so clear and easy that a child could understand them. I now own a good paying business. Before taking your course, I only made \$25 a week. Now I make \$50 to \$75 and have good prospects for the near future."
JAS. T. SUMMERS."



"I have learned more from your training than I know in the 14 years that I have worked in the Auto Field where I got from \$2 to \$3 a day! Now I get my own price, and make \$10 to \$30 a day. Your Training is what put me to making this big money."
S. B. DILLARD."

..... Name

..... Address



Fifteen years ago he was making only \$38 a month!

Success of W. H. Forse, Jr., an amazing tribute to the courage and ability of a man who refused to stay down

IF EVER a man had to fight for success it was W. H. Forse, Jr.

He started as an office boy at \$5 a week and for eight long years after that tried vainly to find the work for which he was best suited.

He clerked in the credit department of the Ely & Walker Dry Goods Company, of St. Louis . . . he sold rope and woodenware . . . he even tried conducting a retail grocery store in a small town.

But it wasn't the work for him and he knew it. So, at the age of twenty-four, he decided to start over—to take up a course with the International Correspondence Schools and get into the one field that had always fascinated him . . . *accounting!*

As a result of this training, Mr. Forse secured a position as clerk with the Union Traction Company of Anderson, Indiana. He soon showed such mastery of his work that he was made chief bookkeeper, then acting auditor, auditor, assistant treasurer and then secretary-treasurer of the Union Traction Company and ten subsidiary corporations.

During this period, Mr. Forse was elected president of the American Railway Accountants Association and president of the Central Railway Accountants Association, became a Certified Public Accountant in Indiana, and wrote "Electric Railway Accounting and Auditing."

Today Mr. Forse is the president of the Forse Manufacturing Company, president of the Spinaway Manufacturing Company, treasurer of the Madison Loan Association and treasurer of the Woodlawn Heights Company—a brilliant example of the value of spare-time study.

Thousands of other prominent executives pay similar tribute to the high character of the training they received from the International Correspondence Schools.

Jesse G. Vincent, vice-president of the Packard Motor Car Company, is a former I. C. S. student. So is Walter C. Allen, president of the Yale & Towne Lock Co. So are Walter P. Chrysler, president of the Chrysler Corporation; J. R. Hall, vice-president of the Chandler Motor Car Company; E. V. Rickenbacker, vice-president and director of sales of the Rickenbacker Motor Company; and Aubrey B. Carter, secretary to the Comptroller of the Currency of the United States.

If the I. C. S. can help to smooth the path to success for men like this, it can help you. If it can help other men to

get out of the rut of routine jobs and go upward to the high-salary class, it can help you too.

At least find out how by marking and mailing the coupon printed below. It takes only a moment—it doesn't obligate you in any way—but it may be the means of changing your entire life. "Do it now!"

Mail Coupon for Free Booklet

INTERNATIONAL CORRESPONDENCE SCHOOLS
Box 5641-E, Scranton, Penna.

Without cost or obligation, please send me a copy of your booklet, "Who Wins and Why," and full particulars about the course before which I have marked X in the list below:

BUSINESS TRAINING COURSES

- | | |
|--|---|
| <input type="checkbox"/> Business Management | <input type="checkbox"/> Salesmanship |
| <input type="checkbox"/> Industrial Management | <input type="checkbox"/> Advertising |
| <input type="checkbox"/> Personnel Organization | <input type="checkbox"/> Better Letters |
| <input type="checkbox"/> Traffic Management | <input type="checkbox"/> Show Card Lettering |
| <input type="checkbox"/> Business Law | <input type="checkbox"/> Stenography and Typing |
| <input type="checkbox"/> Banking and Banking Law | <input type="checkbox"/> English |
| <input type="checkbox"/> Accountancy (including C.P.A.) | <input type="checkbox"/> Civil Service |
| <input type="checkbox"/> Nicholson Cost Accounting | <input type="checkbox"/> Railway Mail Clerk |
| <input type="checkbox"/> Bookkeeping | <input type="checkbox"/> Common School Subjects |
| <input type="checkbox"/> Private Secretary | <input type="checkbox"/> High School Subjects |
| <input type="checkbox"/> Spanish <input type="checkbox"/> French | <input type="checkbox"/> Illustrating <input type="checkbox"/> Cartooning |

TECHNICAL AND INDUSTRIAL COURSES

- | | |
|---|--|
| <input type="checkbox"/> Electrical Engineering | <input type="checkbox"/> Architect |
| <input type="checkbox"/> Electric Lighting | <input type="checkbox"/> Architects' Blueprints |
| <input type="checkbox"/> Mechanical Engineer | <input type="checkbox"/> Contractor and Builder |
| <input type="checkbox"/> Mechanical Draftsman | <input type="checkbox"/> Architectural Draftsman |
| <input type="checkbox"/> Machine Shop Practice | <input type="checkbox"/> Concrete Builder |
| <input type="checkbox"/> Railroad Positions | <input type="checkbox"/> Structural Engineer |
| <input type="checkbox"/> Gas Engine Operating | <input type="checkbox"/> Chemistry <input type="checkbox"/> Pharmacy |
| <input type="checkbox"/> Civil Engineer | <input type="checkbox"/> Automobile Work |
| <input type="checkbox"/> Surveying and Mapping | <input type="checkbox"/> Airplane Engines |
| <input type="checkbox"/> Metallurgy <input type="checkbox"/> Mining | <input type="checkbox"/> Agriculture <input type="checkbox"/> Navigation |
| <input type="checkbox"/> Steam Engineering | <input type="checkbox"/> Mathematics <input type="checkbox"/> Radio |

Name.....

Street Address.....

City.....State.....

Occupation.....

Persons residing in Canada should send this coupon to the International Correspondence Schools Canadian, Limited, Montreal, Canada



Aviation Brings Quick Success!

Wide World Photo

Sudden New Demand for Daring Young Men!

AVIATION in America is on the threshold of an amazing new development. For in the past few months gigantic commercial air lines have been established. The biggest capital and business forces in the world are behind this enterprise. Even in the beginning, thousands of young men are needed. For those who can qualify there will be highly paid jobs which will lead quickly and surely to advancement and success.

Big Opportunities Await the Trained Man

Look over the fields of work which are open to the young man of today. You will find that Aviation is the ONE FIELD that is not overcrowded—the ONE FIELD in which there is plenty of room at the top. Think of it! Only 21 years ago Orville and Wilbur Wright made the world's first airplane flight. Now airplanes fly around the world. Yes, Aviation offers the same wonderful opportunities today that the automobile and motion picture industries did 15 and 20 years ago. Men who got in on the ground floor of those industries made fortunes before others woke up.

Easy to Become an Aviation Expert—\$50 to \$100 a Week

You can qualify now quickly for one of these exciting highly paid jobs through a new, sure, easy method of training. The study of Aviation is almost as interesting as the work itself. Every lesson is fascinating and packed full of interest. That's why Aviation is so easy to learn—you don't have to force

yourself to study. Only one hour of spare time a day will give you the basic training in an amazingly short time.

One student, S. F. McNaughton, Chicago, says: "Your lessons are like a romance, and what is more, after one reading, the student gets a thorough understanding. One never tires of reading them." James Powers, Pa., another student, says: "I am indeed surprised that such a valuable course can be had from such practical men for so little cost."

Men who have had actual experience in Aviation give you personal attention and guide you carefully through your training. They select the lessons, lectures, blueprints and bulletins. They tell you the things that are essential to your success. Every lesson is easy to read and quickly understood.

PREPARE FOR ONE OF THESE POSITIONS

Aeronautical Instructor
\$60 to \$150 per week
Aeronautical Engineer
\$100 to \$300 per week
Aeronautical Contractor
Enormous Profits
Aeroplane Repairman
\$60 to \$75 per week
Aeroplane Mechanician
\$40 to \$60 per week
Aeroplane Inspector
\$50 to \$70 per week
Aeroplane Salesman
\$5,000 per week and up
Aeroplane Assembler
\$40 to \$65 per week
Aeroplane Builder
\$75 to \$200 per week



Big Book on Aviation FREE

Send coupon below for New Free Book, just out, "Opportunities in the Airplane Industry." It is interesting and instructive and will show you many things about Aviation which you never knew before. Only a limited number offered—get yours before the edition is exhausted.

AMERICAN SCHOOL OF AVIATION
Dept. 1354, 3601 Michigan Ave., Chicago, Ill.

American School of Aviation,
3601 Michigan Ave., Dept. 1354, Chicago, Ill.

Without any obligation, send me your Free Book, "Opportunities in the Airplane Industry," also information about your Course in Practical Aeronautics.

Name.....

Street.....

City..... State.....



None of This!

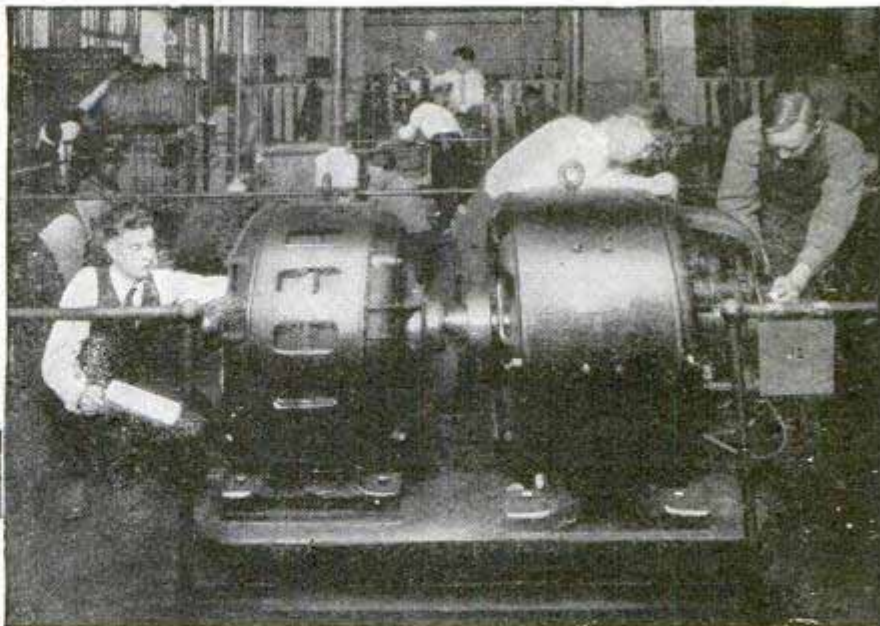

ELECTRICITY Becomes Amazingly Easy When Taught Without Books or Lessons ^{IN 90} **DAYS**

WHY work at dull, uninteresting jobs that will never pay you more than \$35, \$40 or perhaps \$50 a week? Make up your mind **now** to become a master of electricity! Train in 12 easy weeks to hold down the kind of a job that pays \$50 and up to \$200 a week, and which creates a constant demand for your services nearly any place in the world!

No Books—No Classes

Electricity, as taught in the Great Shops of Coyne, is surprisingly easy to grasp. That's because we use no books or dry lessons. You learn by doing actual, **practical** experimenting on big, electrical machinery. You learn by **doing**—and you learn from the ground up.

Not a Correspondence School

Experts work right along with you every step of the way. You get personal attention—it's not a bit like trying to figure out a lot of correspondence school pamphlets and diagrams all by yourself. The **Coyne Way** gives you real, **sound** knowledge that fits you to do **practical** electrical work in all its branches.

COYNE ELECTRICAL SCHOOL

Dept. 47-72

H. C. Lewis, Pres. 1300-10 W. Harrison St., Chicago, Ill.

No Experience or Advanced Education Needed

You don't need one day's previous electrical experience or any advanced education to master electricity the Coyne way. Some of our most successful graduates never went farther than the 8th grade.

Earn While You Learn

By our special arrangement, our employment department will help you locate part-time work, if you want to earn while you learn. And after graduation we give you the benefit of our **FREE EMPLOYMENT Service** for life. Every week we secure positions for Coyne men.

Get FREE Book

Write today for my big book on electricity with over 150 photographs. Learn what great opportunity Coyne Training opens up for you. Also get full details of my Big-3 Special offer. No obligation. Mail the coupon now.

FREE If You Act Now

1 R. R. Fare will be refunded upon enrollment from any point in the U. S. to Chicago.

2 Radio course given absolutely without any extra charge. Covers new developments in this fascinating field.

3 Auto course, covering truck and tractor electricity. Especially valuable if you ever want to start electrical business of your own. See coupon!

FREE BOOK Coupon

H. C. Lewis, Pres.

Coyne Electrical School, Dept. 47-72
1300-10 W. Harrison St.
Chicago, Illinois

Please send me your free catalog on electricity and details of your 3 special offers. No obligation on my part.

Name

Address

City State

Magic

Learned Easily at Home



Dr. Harlan Tarbell, internationally known magician and teacher of some of the world's greatest magicians.

Astonish Your Friends

Gain the magnetic popularity that makes you the center of any crowd. Business and social success is assured the man who can perform mystifying tricks. You can earn big money on the side or as a professional, as well as being the most popular person in your crowd. Why envy others' skill? You can learn Magic yourself, quickly and easily.

Salesmen!
Write me today.
Learn how my

Course in Magic

will absolutely
help you increase
your earning
power.

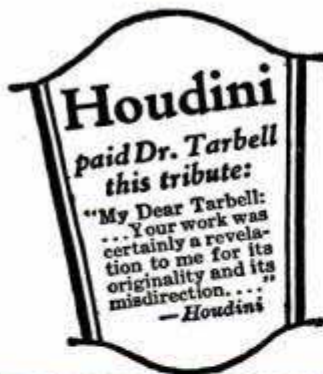

Earn \$250 to \$1000 a Month

even sleight of hand, generally supposed to require long practice, is NOW made simple to learn. For Dr. Harlan Tarbell, one of the really Great Magicians, has finally opened up the secrets of his profession in a completely illustrated course offered at a merely nominal cost. Through the wonderful Tar-

bell system you will be able to mystify and entertain your friends. After that Dr. Harlan Tarbell takes you through the entire maze of sleight of hand, card tricks and elaborate stage diversions. The apparently superhuman doings of the accomplished magician becomes as simple as ABC.

Mail This Coupon NOW!

Tarbell System, Inc., Studio 13-54
1920 Sunnyside Avenue, Chicago, Illinois
Gentlemen: Without any obligation send me your free literature and information all about your wonderful "Tarbell Course in Magic." Also tell me about your great Special Price Offer and Easy Payment Plan—offered NOW for limited time only.

Name.....

Address.....

.....Age.....

Great Special Offer!

There is a tremendous demand for magic entertainment. Clubs, Lodges, Charity and Social affairs—all will pay high fees to the man who knows Magic. Dr. Harlan Tarbell really gets as high as \$250 for a half hour's work right now. Opportunity everywhere to make money aside from your regular occupation. Salesmen find it a tremendous asset. Find out all about this unprecedented opportunity to learn Magic. Learn about the great Special Price and Easy Payment Offer we are making Now, for a limited time only. The coupon brings full details without any obligation. *Mail it TODAY.*

Tarbell System, Inc.

1920 Sunnyside Ave., Studio 13-54 Chicago, Ill.

"I Wonder How He Knows So Much"

How many men do you know who surprise you by the wealth of their general knowledge and information on all sorts of subjects—history, biography, travel, politics, business, sports, and a thousand other things? If you were to inquire, you would find that these men make a habit of consulting an up-to-date Encyclopaedia. Here they have access to the knowledge of centuries—concise and plainly stated, easy to grasp and remember. Through the constant use of the Encyclopaedia they are familiar with all the things that people talk about.

Get YOUR Facts from Nelson's

Every subject on which man would be informed is changing constantly. Nine times out of ten, the information you want is the information of today. With the exception of Nelson's Loose-Leaf Encyclopaedia, all encyclopaedias are deficient in this important thing.

Nelson's Loose-Leaf Encyclopaedia can never grow old. It is always new and up-to-date. It covers the entire field of knowledge from the dawn of civilization to 1927. Every six months new pages (250 or more) are sent to every subscriber to take the place of those that have become out of date. This method keeps Nelson's Encyclopaedia accurate, reliable, and up-to-the-minute in its information.

THIS GREAT AMERICAN ENCYCLOPAEDIA
is dedicated, by permission, to
CALVIN COOLIDGE, PRESIDENT of the UNITED STATES

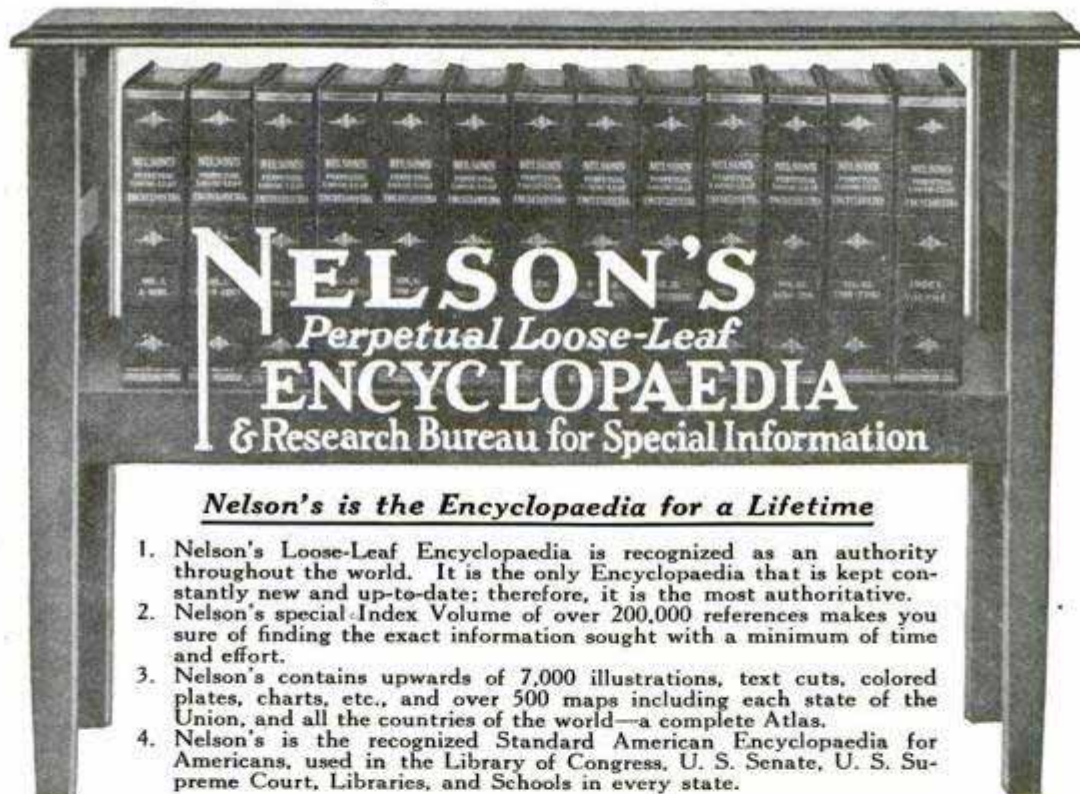

FREE Educational Reading Courses

A Reader's Guide to Nelson's Loose-Leaf Encyclopaedia, including thirty-three courses on as many subjects—from Aeronautics to Zoology—is furnished without cost to all subscribers. These courses are declared by educational authorities to be equal to a college course in each of these departments.

FREE Research Library Service Bureau

FOR SCIENTIFIC REPORTS AND SPECIAL INFORMATION AND CORRESPONDENCE. Every purchaser of Nelson's is entitled to free membership in this Bureau. If at any time you are in doubt on any subject, old or new, write to this Bureau with the positive assurance that you will promptly receive the latest obtainable and most dependable information.

THOMAS NELSON & SONS
Publishers since 1798
 381 FOURTH AVENUE, NEW YORK, N. Y.

THOMAS NELSON & SONS, P.M.A.
 381 Fourth Avenue, New York, N. Y.

Please send me your portfolio of sample pages, beautifully illustrated; and full information how, by easy monthly payments, I can own Nelson's Perpetual Loose-Leaf Encyclopaedia, with FREE membership in Nelson's Research Library Service Bureau for Special Information, and Nelson's Reader's Guide FREE. This must incur no obligation whatever on my part.

Name.....

Address.....

City.....State.....

(Adv. Copyright, 1927, by Thomas Nelson & Sons)

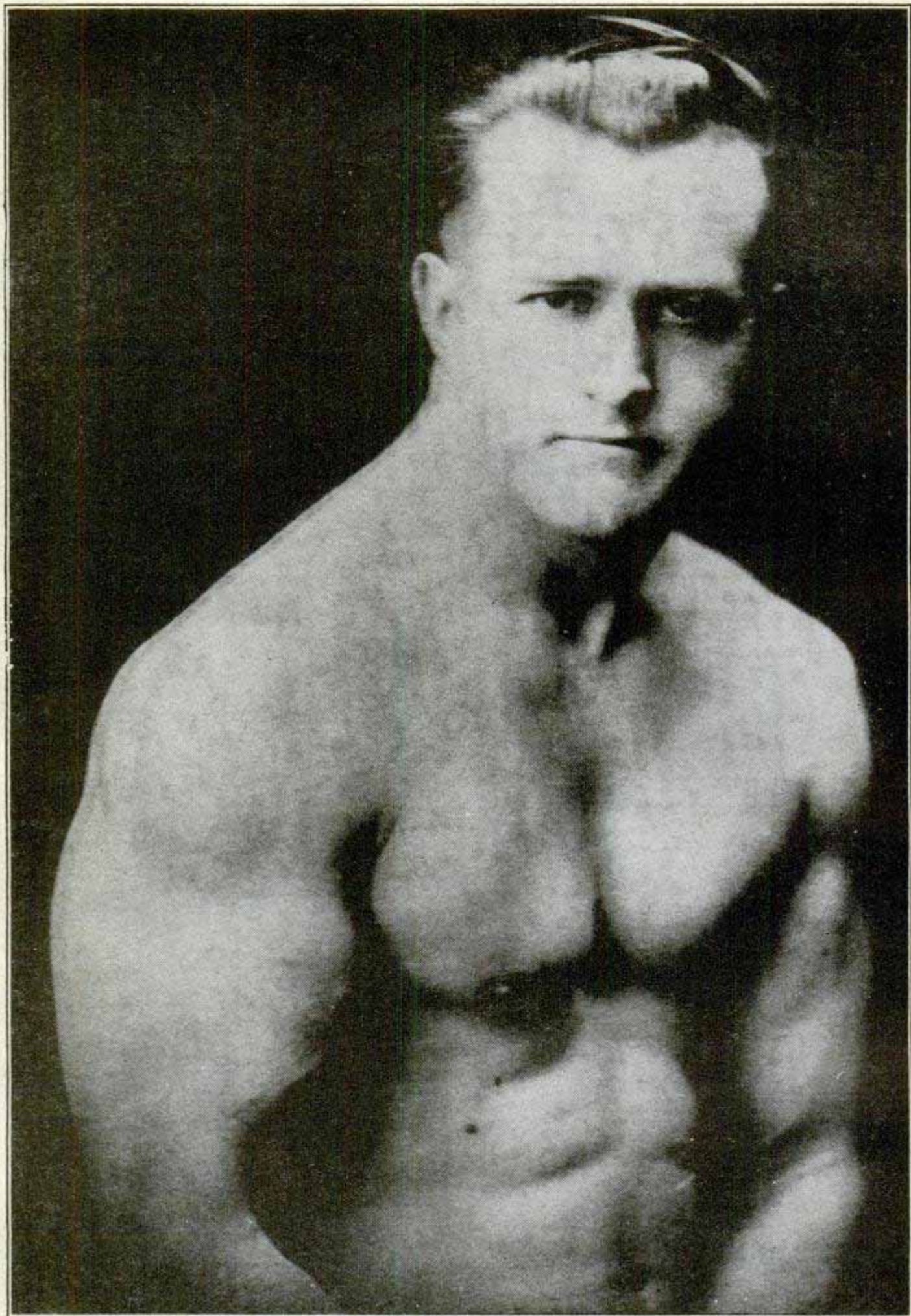

EARLE E. LIEDERMAN, *The Muscle Builder*

Author of "Science of Wrestling," "Muscle Building," "Secrets of Strength," "Here's Health," "Endurance," etc.

POPULAR

Liederman Says:-
Earle Liederman Can Make Anyone Strong
Earle Liederman Can Put One Inch on Your Arm in 30 Days
Earle Liederman Can Put Two Inches on Your Chest in 30 Days
Earle Liederman Will Give You a Physique To Be Proud of
Earle Liederman Will Add Many Healthy Years To Your Life
Earle Liederman Will Make You The Popular Idol of Your Gang
Earle Liederman He Will Take The Wrinkles Out of Your Spine

**He Doesn't Promise—
 He Guarantees**

He has done all these things and more for thousands of others. That's why he backs up his statements with an iron-clad guarantee. You want muscle—you want health and you want the pep that only supermen have. You can have them all—almost as quick as a wink!

Put Him to the Test

An ounce of action is worth a thousand words. Make him prove that he can put one inch of muscle on your arm and two inches on your chest in less than 30 days. Make him prove that he can make anyone strong. Make him prove that he can give you a physique to be proud of. Make him prove that he will add many healthy years to your life. Make him prove that he will make you the popular idol of your gang. Make him prove that he will take the wrinkles out of your spine. He likes to be challenged because he is sure he can make good. Put him to the test. His guarantee protects you against risk.

You Can't Lose

If Liederman doesn't make good every single promise, you are out nothing. He takes all the risk. He has been guaranteeing to make physical marvels out of all sorts of muscleless men, for many years—that's why they call him the muscle builder. You'll call him that, too, before 30 days roll by. Write him today.

He Never Fails

There must be a reason for his success—there is. He discovered the secret of muscles and health. And he knows how to give help to others. He doesn't give you a lot of "don'ts." He tells you what to do. He gives you the "know-how" of strength getting. That's why he never fails. That's why you should write to him today.

**Send For My New
 64 Page Book**

"Muscular Development"
IT IS FREE

It contains forty-eight full-page photographs of himself and some of the many prize-winning pupils he has trained. Many of these are leaders in their business professions today. He has not only given them a body to be proud of, but made them better doctors, lawyers, merchants, etc. Some of these came to him as pitiful weaklings, imploring him to help them. Look them over now and you will marvel at their physiques. This book will prove an impetus and a real inspiration to you. It will thrill you through and through. The book is yours. He wants you to have it with his compliments. Keep it. This will not obligate you at all, but for the sake of your future happiness and health, do not put it off. Send today—right now before you turn this page.

EARLE E. LIEDERMAN
 Dept. 2004, 305 Broadway, New York City

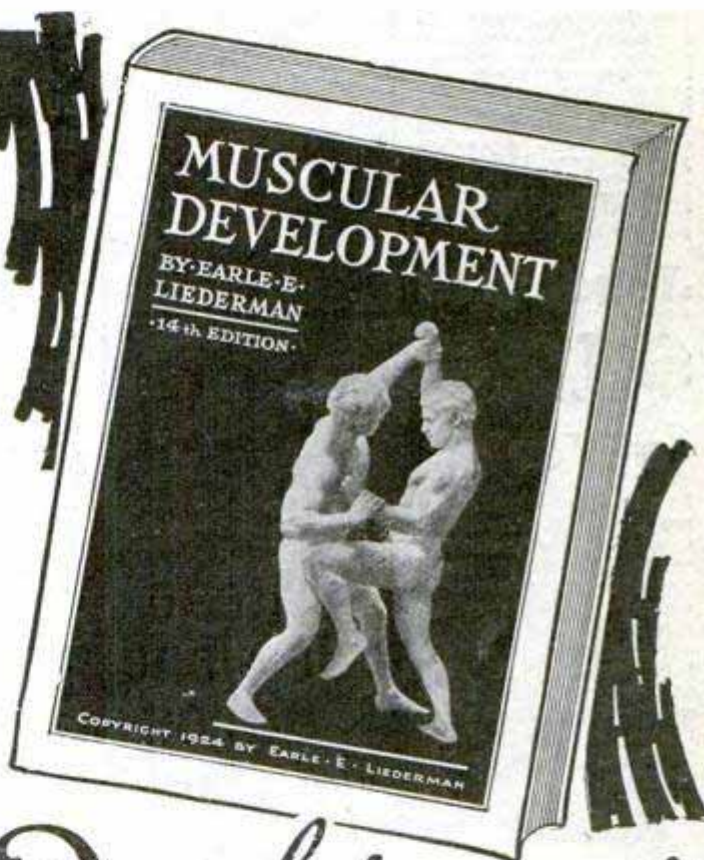

It Is F R E E	DON'T SEND ONE PENNY	EARLE E. LIEDERMAN Dept. 2004, 305 Broadway, New York City
	—	Dear Sir:—Without any obligation on my part whatever please send me a copy of your latest book, "Muscular Development."
	YOUR NAME AND ADDRESS ON A POSTAL WILL DO	Name.....
		Street.....
		City..... State.....
		<small>(Please write or print plainly)</small>



This Dental Laboratory Expert can earn UP TO \$20 a day

What's the use of training for the old, overcrowded trades? If you're going to prepare for big-salaried jobs or a profitable business of your own GET INTO THE FASTEST GROWING PROFESSION—

"Laboratory Dentistry." Biggest opportunity for success of the century, because there are many more jobs than there are experts to fill them, because there are a dozen cities crying for Laboratories for each EXPERT capable of operating one!

64,000 DENTISTS NEED LABORATORY WORK!

Only a few hundred Laboratories in all the U. S.—most of them in the larger cities. Dentists can't afford to do their own mechanical jobs. They can buy the services of a Laboratory Expert at about \$3.00 an hour and sell their own time at \$6 to \$15 an hour. Dentists will encourage you to learn mechanical Dentistry, start a "Lab" of your own, give them quicker service than sending their work to other cities. Dentists can't wait and keep their patients waiting. Ask your Dentist.

WE HELP YOU OPEN A LABORATORY OF YOUR OWN!

Many of my graduates open a Laboratory of their own. To encourage more men to go into this wonderful Mechanical profession, we will help you find a good location for your Laboratory, and help you towards success. Write for complete information on how you can find yourself in a profitable business of your own after you become a Dental Laboratory Expert.

INTERESTING BOOK—FREE!

Right this minute there are openings for 150 Dental Laboratory Experts in locations where they can do a business of \$5,000 to \$20,000 a year. But you can't cash in, take advantage of these OPPORTUNITIES until you're Trained. Catalog tells you how quickly and easily you can get ready, how hundreds of others have SUCCEEDED! Tells you how you learn in a few months BY DOING ACTUAL LABORATORY JOBS in the world's greatest Dental Laboratory Schools. Brings you FREE R. R. Fare offer and other big inducements. Write for free Book today!

EARN while you LEARN!
Day students make all or part cost of course by part-time night work. Night students can find plenty of good jobs to see them thru.
We'll help you!

McCarrie School of Mechanical Dentistry

1338 S. Michigan Ave.
Dept. 111 Chicago, Ill.

McCarrie School of Mechanical Dentistry
1338 S. Michigan Ave., Dept. 111, Chicago, Ill.

Without obligation, please send me your Free R. R. fare offer and free Book with complete information about how I may become a Mechanical Dentist. How you will help me open a Laboratory, how you will help me find a job while I take my training, etc.

Easiest, pleasantest work you ever saw! Your own boss, money and success yours from the very beginning. You can start with a "shoe-string." We prepare you in a few months to run a business of your own, to do any job. Common schooling, ability to use your fingers ALL YOU NEED! Free R. R. Fare to Chicago, Cleveland, Detroit, Boston or Philadelphia for a limited time!



Jobs Up to \$125 a Week!

In a business where there are many times as many jobs as Experts, salaries are high, hours are easy, opportunities are everywhere! Dentists recognize the high-standing of our graduates. No books here—learn with tools and instruments. Start quick—get ready in a few months for your big opportunity! Mail Coupon today!

Rubber Plates

Learn to make partial upper or lower plates with soldered, cast or wire clasps, with palatal bars; with lingual bars. McCarrie-trained Students learn to make full rubber plates of every type, including Vulcanite base-plates, butted gums, carved gums, etc.

CROWNS

Here's only a small part of your practical training in Crown-work: Two-piece, seamless, open-face, Richmond, cast-base porcelain, Carmichael, split-pin, carved (swaged) cusp, cast cusp, etc.

BRIDGE WORK

Complete training in both fixed and removable bridgework. Interchangeable teeth, gold dummy, Sanitary porcelain dummy jobs—Roach, Gilmore, Bischoff and all forms of cast-clasp work is taught—not with books but in actual Laboratory.

METAL BASE DENTURES

Cast bases of Aluminum, Watt's metal, etc., are included in your training. Both centrifugal and air pressure casting machines are used. Free Book contains complete list of subjects in course.

FREE!
R. R. Fare
TO
Chicago
Cleveland
Detroit
Boston
or
Phila.

Name.....
St. No. or R. F. D.....
City.....State.....

**Over \$20,000 a Year**

V. H. Harelson of Florida, formerly worked as a clerk in a grocery for what he now calls "the paltry sum of \$30 a week." His first year after reading "Modern Salesmanship" brought him over \$5,000; his second year \$7,500; and his third year \$22,500! He frankly says: "Without N. S. T. A., I know that I would still be a clerk at \$30!"

**\$100 a Week Increase**

J. L. Jacobsen of Minnesota counts it a "red-letter day" when he first read this remarkable book—"Modern Salesmanship." Within a short time afterward he raised his salary from \$35 to \$135 a week. He says "I attribute this remarkable progress in large part to N. S. T. A."

**Raised Pay \$2,500**

Kingsley Rowland of New Jersey, was formerly a pattern-maker at a weekly wage which fell far short of satisfying his ambition. "Modern Salesmanship" opened his eyes and started him on the road to real pay. Today he earns almost as much in a week as he formerly earned in a month—300% increase!

**\$7,000 a Year**

F. B. Englehardt of Tennessee used to work for less than 45% of his present salary. "Modern Salesmanship" and N. S. T. A. led to big things. Today he says: "Last year I made over \$100 a week and expect to make \$7,000 this year. Some increase since enrollment with N. S. T. A!"

-and They Started By Reading This Amazing Book!

Now—For a Limited Time Only—This Remarkable Man-Building, Salary-Raising Volume Is Offered FREE to Every Ambitious Man! If You Ever Aspire to Earn \$10,000 a Year or More, Read It Without Fail.

Where Shall We Send Your Copy FREE?

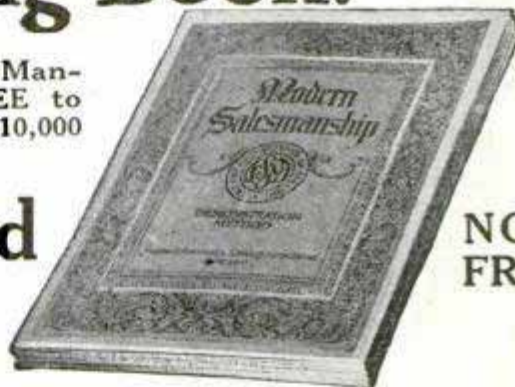

NOW FREE

A BOOK! Just seven ounces of paper and printer's ink—but it contains the most vivid and inspiring message any ambitious man can ever read! It reveals the facts and secrets that have led hundreds of ambitious men to the success beyond their fondest expectations! So powerful and far reaching has been the influence of this little volume, that it is no wonder a famous business genius has called it "The Most Amazing Book Ever Printed."

This vital book—"Modern Salesmanship"—contains hundreds of surprising and little-known facts about the highest paid profession in the world. It reveals the real truth about the art of selling. It blasts dozens of old theories, explains the science of selling in simple terms, and tells exactly how the great sales records of nationally-known star salesmen are achieved. And not only that—it outlines a simple plan that will enable almost any man to master scientific salesmanship without spending years on the road—without losing a day or dollar from his present position.

What This Astonishing Book Has Done!

The achievements of this remarkable book have already won world-wide recognition. The men who have increased their earning capacities as a direct result of reading "Modern Salesmanship" are numbered in the thousands. For example, there is E. E. Williams of California who was struggling along in a minor position at a small salary. "Modern Salesmanship" opened his eyes to things he had never dreamed of—and he cast his lot with the National Salesmen's Training Association. Within a few short months of simple preparation, he was earning \$10,000 a year! Today he receives as much in 30 days as he used to receive in 365!

And then there's J. H. Cash of Atlanta. He, too, read "Modern Salesmanship" and found the answer within its pages. He quickly raised his salary from \$75 to \$500 a month and has every reason to hope for an even more brilliant future. And still they come! W. D. Clenny of Kansas City commenced making as high as \$850 a month. F. M. Harris, a former telegrapher, became sales manager at \$6,000 a year. O. H. Malfroot of Massachusetts became sales manager of his firm at a yearly income of over \$10,000.

A Few Weeks—Then Bigger Pay

There was nothing "different" about these men when they started. Any man of average intelligence can duplicate the success they have achieved—for their experience proves that salesmen are made—not born as some people have foolishly believed.

Salesmanship is just like any other profession. It has certain fundamental rules and laws—laws that you can master as easily as you learned the alphabet. And through the **National Demonstration Method**—an exclusive feature of the N. S. T. A. system of SALESMANSHIP training—you can acquire the equivalent of actual experience while studying. Hundreds of men who never sold goods in their lives credit a large portion of their success to this remarkable training.

Free to Every Man

If we were asking two or three dollars a copy for "Modern Salesmanship" you might hesitate. But it is now FREE. We cannot urge you too strongly to take advantage of this opportunity to see for yourself what salesmanship has done for others—and what the National Salesmen's Training Association stands ready and willing to do for you. Find out exactly what the underlying principles of salesmanship are—and how you can put them to work for you. No matter what your opinion is now, "Modern Salesmanship" will give you a new insight into this fascinating and highly-paid profession. Mail the coupon now!



Dept. D-12, N. S. T. A. Building, Chicago, Ill.

National Salesmen's Training Assn.,
Dept. D-12,
N. S. T. A. Building, Chicago, Ill.

Without cost or obligation you may send me your free book, "Modern Salesmanship."

Name.....

Address.....

City..... State.....

Age..... Occupation.....

BOYS

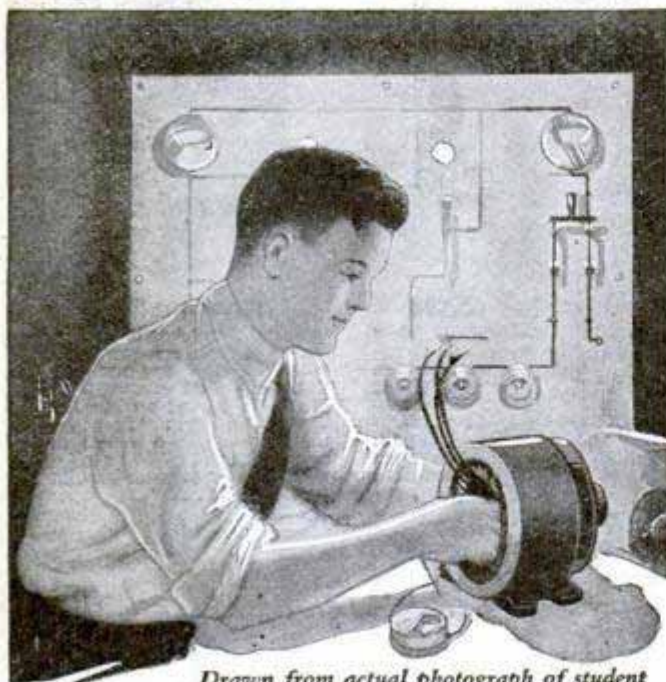

Drawn from actual photograph of student doing spare time electrical work

Learn Electricity Make Big Money

How would you like to earn two or three dollars every evening after school and prepare yourself for a fine big job at the same time? Here's the opportunity of a lifetime for you fellows who like Electricity. Begin right now to prepare yourself for a regular man's size job in this fascinating field. Your chances for a big success are simply wonderful—the pay is big (thousands of men earn \$70 to \$200 a week) and advancement comes swift and sure.

I Will Train You at Home
With my easily earned, spare time Electrical Course I will train you at home like I have trained hundreds of other boys who are now big successful men. It will not interfere with your school work and you can earn more than the small cost of the course doing odd electrical jobs in your spare time. The Course pays for itself. I will show you how to get this work and how to do it. Some of my boy students make \$10 to \$15 a week this way.

Tools, Apparatus and Radio Course—Given Without Extra Charge
Send me the coupon below and I will tell you all about the big outfit of tools, apparatus and instruments and a new Radio Course that I am giving to my students for a limited time. I will send you my big interesting Electrical Book and a sample lesson, too—all Free. You will be tickled with the things I will send you Free. Mail the coupon right now.

L. L. COOKE, Chief Engineer
L. L. Cooke School of Electricity
Formerly known as
Chicago Engineering Works
Dept. O14 CHICAGO

Look What This Boy Is Doing

"Although the School term is coming to a close, and I am pretty busy with my examinations, I manage to keep up with my electrical studies and work. I guess I forgot to tell you I am now in business for myself. Am doing fine, but owe it all to you. If it had not been for your Course, I, being under age, could not have secured my license in this town. But I got it, and now have all the work I can do, averaging \$20 to \$30 a week, thru spare time work. I went out on a job tonight after school, on which I made \$3 and brought home another on which I made \$2.60—\$5.50, for 4 hours' work and no material furnished by me."
ROGERS SMITH,
1215 Chestnut St.,
Greenville, N. C.

Use This "FREE BOOK" Coupon

L. L. COOKE, Chief Engineer,
Dept. O14 2150 Lawrence Avenue, Chicago
Send me your Big Outfit Offer, your big Electrical Book, Sample Lesson and particulars of your Electrical Course and Extra Radio Course. This will not obligate me in any way.

Name.....
Address.....
This Coupon only for use of boys 15 years old or more.



Play Piano Jazz BY EAR -in 90 days!

YOU can play real tunes from the start. No notes to puzzle you—no tiresome scales to practice.

You need not know a thing about music. Even if you have never touched a piano, if you can hum or whistle a tune, we can teach you to play all popular song hits *by ear* at a very small cost. No need now to spend years practicing under old-time method. My new and original system teaches you easily and quickly. Be a jazz master and make yourself popular everywhere you go. And the best part of it is there is nothing hard about it. Write at once for

FREE BOOKLET To show you how easily it can be done. This wonderful home course is offered at a ridiculously low cost. A little practice gives amazing results. You can sit down and play any popular jazz piece that you hum.

David M. Suttle, Director
ILLINOIS SCHOOL OF MUSIC
679 Hearst Square, Chicago

Send NOW for FREE Book



LEARN TO DRAW!

Remarkable book just off the press—"COMMERCIAL ART AND CARTOONING." Explains how to make illustrations for Books, Advertisements, etc. Also tells how to become a successful Cartoonist. **NO CORRESPONDENCE COURSE.** Everything complete in this book—14 chapters, over 125 illustrations. Tells about Elementary Drawing; Still Life; Pen, Ink, Charcoal and Crayon Work; Wash and Figure Drawing; Worth \$5.00. Sent postpaid for \$2.00 (C. O. D. 17c extra).
OGILVIE PUB. CO., 57 Rose St., New York, Dept. 133.



IF YOU STAMMER

Write for my free book "Millard's Advanced Natural Corrective Course" and a free copy of my speech magazine. 10,000 cases successfully treated. Est. 24 years. Largest school for stammerers in world. Millard Inst. of Normal Speech, 2317 Millard Bldg., Milwaukee, Wis.

Learn Watchwork, Jewelrywork and Engraving

A fine trade commanding a good salary, and your services always in demand. Address **HOROLOGICAL**, Dept. P, Bradley Institute, PEORIA, ILLINOIS, for our latest catalog.

Learn Auto Mechanics with "Privileged" Students

In Brooklyn - The Heart of New York City. Free Catalog. Brooklyn Engineering Institute (Operated by Bedford Branch Y. M. C. A.) 1125 Bedford Avenue, Brooklyn, N. Y.

Welding

Become a Welding Expert! Then earn top wages or go into business for yourself. We train you at Home, in your Shop, or on the Job. "Kerr's Training Course for Welders" is a thorough course in practical experience, covering all metals. It trains you in WHAT TO DO and HOW TO DO IT. Write at once for terms and enrollment card. (State if you have the use of a welding outfit.)
KERR'S WELDING SCHOOL Dept. 2, 752 N. Broadway, LOS ANGELES, CALIF.



STATION WOC
BAVENPORT

HERE'S WORK THAT IS
ALMOST ROMANCE!

Now Owns a Radio Store

"The Radio business is rushing just now. Building many Super Heterodynes, also doing installation and repairing. To your course I owe all my success in the Radio profession." A. J. Onmodt, Bowman, N. Dak.



Controls First Car by Radio

"I operate the portable broadcasting station in rear car, driving front car by Radio control. Will operate this car from New York to Fresno—13 months trip. Then we take the car around the world—a three years' tour. I owe it all to you." Leo Paul, New York City.



You Can Do What These Men Did!

I Will Train You at Home to Fill a Big-Pay Radio Job

Get into the great new Big-pay Industry—Radio. If you're earning a penny less than \$50 a week, clip coupon now. Send for AMAZING FREE BOOK, "Rich Rewards in Radio." Why go along at \$25 or \$35 or \$45 a week, many are now earning \$50 to \$250 in the same six days, as a Radio Expert? Hundreds of N. R. I. trained men are doing it—why can't you? I'll train you just as I trained them—just as I trained the men whose letters you see on this page. I'll teach you quickly at home in your spare time and start you on the road to become an expert in Radio, the Easy, Fascinating Big Money field.



Read the true stories printed in this border of men who got out of the rut



Chief Engineer Station WEMC

"Please communicate with my two junior operators here who want to increase their knowledge of Radio. Being a graduate of your course I know they could do nothing better for themselves than study at for it is the way to success in this profession." John E. Pitzer, Chief Engineer, Station WEMC, Bertram Springs, Michigan.



Photo shows Graduate E. F. Spadoni in his own Radio store at Chicago, Ill. "Your course gets the credit," says Spadoni.

Big Jobs Go to The TRAINED EXPERT

It's the thoroughly trained man who gets the big jobs in this profession—paying \$75, \$100, \$200 a week and up. Free book gives all the facts. Hundreds of N. R. I. trained men are today holding down good, big jobs in the Radio field—men like you—men like those whose stories I show you here. You can prepare just as they did by new practical methods, learn right at home in your spare time. Lack of experience no drawback—common schooling all you need. Our tested clear methods make it easy for you. Our years of experience in the big field of Radio means that we can train you as we have thousands of others.

Clip Coupon Now for FREE BOOK

Most amazing book on Radio ever written—full of facts and pictures—tells all about the great Radio field, how we prepare you and help you start. You can do what others have done—GET THIS BOOK. Send coupon today—no obligation. J. E. Smith, Pres. NATIONAL RADIO INSTITUTE Dept. D-85 Washington, D. C.

RADIO NEEDS TRAINED MEN!

Originators of Radio Home-Study Training

These Instruments Given FREE of Extra Cost

All instruments shown here and others sent to all my students free of extra cost under special offer. Clip coupon now—find out all about this big unequalled offer while you still have time to take advantage of it. This training is intensely practical—these instruments help you do the practical work.

My Radio Training is the "Famous Course That Pays for Itself"
Make more money quick when you take up this practical course.



\$70 in one Day for T. M. Wilcox

"I am in business for myself and recently made \$70 in one day. I was an electrician of rich experience and was occupying a splendid position as telephone superintendent when I enrolled with your course believing it would open up greater opportunities—have not been disappointed. Estimate that Radio will be worth tens of thousands of dollars to me in the next few years." T. M. Wilcox, Belle Island, Newfoundland.

I show you how to increase your earnings almost from the start of your course through practical pointers I give you. Howard B. Luce of Friends, Pa., made \$320 in 7 weeks during his spare time. D.H. Suitt of Newport, Ark. writes "While taking the course I earned in spare time work approximately \$900." Earl Wright of Omaha reports making \$400 in a short time while taking his course—working at Radio in his spare time only! Sylvester Senso, 207 Elm St. Kaukana, Wis., made \$500. These records not unusual—these men are a few of hundreds. And when you graduate, my big Free Employment Department helps you get the job. You get just the same preparation and assistance toward success we gave E. W. Novy, Chief Operator of Station WIRNY, Erie Chambers, Radio Engineer for Stewart-Warner, J. E. Fetzer, Chief Engineer of Station WEMC. The National Radio Institute, established 1914, today offers you the same opportunity these men had under a contract that pledges you full satisfaction or money refunded on completing our training. Mail coupon TODAY for my big Free Book and proof!



Kimball With WMAQ Chicago

"Accepted a position with the Chicago Daily News Station WMAQ. My income practically doubled, thanks to your fine course. I handle all consultation also do operating." Keith Kimball, Station WMAQ, Chicago, Ill.



Promoted to Big Job

"Just been made Sales Manager of this Radio firm—received a very good increase in pay. Up to present have been getting salary which in 3 months enabled me to purchase a new car." R. Jones Bay City Mich.



MAIL THIS NOW!

J. E. SMITH, President NATIONAL RADIO INSTITUTE Dept. D-85, Washington, D. C.

Dear Mr. Smith: Without obligating me in any way, send me your free book "Rich Rewards in Radio" and all information about your practical, home-study Radio course.

Name.....Age.....

Street Address.....

Town.....State.....

SEND THIS COUPON



"Last night I came home with great news"

"I'D TELEPHONED Ruth that I had a surprise for her and she could hardly wait for me to get home. You should have seen her face when I told her the Boss had called me in and given me a \$25 increase in salary.

"It's wonderful," she said, "just wonderful. Now we can pay some of those bills that have been worrying us and even put a little in the bank each week.

"Remember the night we saw that coupon in a magazine and you decided to take up an I. C. S. course? It made a new man of you, Bob, and I knew it wouldn't be long before the firm would notice the difference in your work.

"We certainly owe a lot to the International Correspondence Schools. You would never have received this increase if you hadn't studied at home and prepared yourself for bigger work."

How about you? Are you always going to work for a small salary? Are you going to waste your natural ability all your life? Or are you going to get ahead in a big way? It all depends on what you do with your spare time.

Don't let another precious hour pass before you find out what the I. C. S. can do for you. It doesn't cost you a penny or obligate you in any way to ask for full particulars, but that one simple, little act may be the means of changing your entire life. *Do it now!*

Mail Coupon for Free Booklet

INTERNATIONAL CORRESPONDENCE SCHOOLS Box 5644-E, Scranton, Penna.

Without cost or obligation, please send me a copy of your booklet, "Who Wins and Why," and full particulars about the course before which I have marked X in the list below:

BUSINESS TRAINING COURSES

- | | |
|--|---|
| <input type="checkbox"/> Business Management | <input type="checkbox"/> Salesmanship |
| <input type="checkbox"/> Industrial Management | <input type="checkbox"/> Advertising |
| <input type="checkbox"/> Personnel Organization | <input type="checkbox"/> Better Letters |
| <input type="checkbox"/> Traffic Management | <input type="checkbox"/> Show Card Lettering |
| <input type="checkbox"/> Business Law | <input type="checkbox"/> Stenography and Typing |
| <input type="checkbox"/> Banking and Banking Law | <input type="checkbox"/> English |
| <input type="checkbox"/> Accountancy (including C.P.A.) | <input type="checkbox"/> Civil Service |
| <input type="checkbox"/> Nicholson Cost Accounting | <input type="checkbox"/> Railway Mail Clerk |
| <input type="checkbox"/> Bookkeeping | <input type="checkbox"/> Common School Subjects |
| <input type="checkbox"/> Private Secretary | <input type="checkbox"/> High School Subjects |
| <input type="checkbox"/> Spanish <input type="checkbox"/> French | <input type="checkbox"/> Illustrating <input type="checkbox"/> Cartooning |

TECHNICAL AND INDUSTRIAL COURSES

- | | |
|---|--|
| <input type="checkbox"/> Electrical Engineering | <input type="checkbox"/> Architect |
| <input type="checkbox"/> Electric Lighting | <input type="checkbox"/> Architects' Blueprints |
| <input type="checkbox"/> Mechanical Engineer | <input type="checkbox"/> Contractor and Builder |
| <input type="checkbox"/> Mechanical Draftsman | <input type="checkbox"/> Architectural Draftsman |
| <input type="checkbox"/> Machine Shop Practice | <input type="checkbox"/> Concrete Builder |
| <input type="checkbox"/> Railroad Positions | <input type="checkbox"/> Structural Engineer |
| <input type="checkbox"/> Gas Engine Operating | <input type="checkbox"/> Chemistry <input type="checkbox"/> Pharmacy |
| <input type="checkbox"/> Civil Engineer | <input type="checkbox"/> Automobile Work |
| <input type="checkbox"/> Surveying and Mapping | <input type="checkbox"/> Airplane Engines |
| <input type="checkbox"/> Metallurgy <input type="checkbox"/> Mining | <input type="checkbox"/> Agriculture <input type="checkbox"/> Navigation |
| <input type="checkbox"/> Steam Engineering | <input type="checkbox"/> Mathematics <input type="checkbox"/> Radio |

Name.....

Street Address.....

City..... State.....

Occupation.....

Persons residing in Canada should send this coupon to the International Correspondence Schools Canadian, Limited, Montreal, Canada.

How to Earn

**\$50
to
\$75
a Week!**



in Show Card Making!

Hundreds earning \$25 a week in spare time, \$50 to \$75 in full time—making clever, original, sales-building show cards. Learn in few months—right at home—through complete, simplified method. No special ability needed. Earn even while you learn.

Every store owner needs distinctive show cards. Demand ever-increasing. Opportunities steadily multiplying. Start now. Prepare yourself quickly to make show cards of every description. Find market in your own neighborhood. Later expand business. Good show card writers earn \$75 a week—top-notchers even more! Send TODAY for free illustrated descriptive booklet and full details of startling offer.

WASHINGTON SHOW CARD SCHOOL
Room 304-E, 1117-15th St., N. W., Washington, D. C.



Wonderful, new device, guides your hand; correct your writing in few days. Big improvement in three hours. No failures. **Complete outline FREE.** Write C. J. Ozment, D-34, St. Louis, Mo.

MUSIC LESSONS FREE



IN YOUR OWN HOME

Write today for our FREE booklet. It tells how to learn to play Piano, Organ, Violin, Mandolin, Guitar, Banjo, etc. Beginners or advanced players. Your only expense about 2c per day for music and postage used. **American School of Music, 51 Manhattan Bldg., Chicago**

LEARN WATCHMAKING

and become independent. We help you secure a position.

Easy to learn. Send for FREE CATALOG.

ST. LOUIS WATCHMAKING SCHOOL, Dept. 5, ST. LOUIS, MO.

GOV'T. POSITIONS

\$35 TO \$75 WEEKLY

- | | |
|---|---|
| <input type="checkbox"/> Railway Mail Clerk | <input type="checkbox"/> Meat Inspector |
| <input type="checkbox"/> P. O. Clerk | <input type="checkbox"/> Special Agent (investigator) |
| <input type="checkbox"/> Forest Ranger | <input type="checkbox"/> Stenographer-Typist |
| <input type="checkbox"/> File Clerk | <input type="checkbox"/> Immigrant Inspector |
| <input type="checkbox"/> Matron | <input type="checkbox"/> City Mail Carrier |
| <input type="checkbox"/> General Clerk | <input type="checkbox"/> U. S. Border Patrol |
| <input type="checkbox"/> Chauffeur-Carrier | <input type="checkbox"/> Typist |
| <input type="checkbox"/> Skilled Laborer | <input type="checkbox"/> Seamstress |
| <input type="checkbox"/> Watchman | <input type="checkbox"/> Steno-Secretary |
| <input type="checkbox"/> Postmaster | <input type="checkbox"/> Auditor |
| <input type="checkbox"/> RFD Carrier | |

Ozment's Service Bureau, Dept. 111, St. Louis, Mo.

Send me particulars about positions marked "X"—salaries, locations, opportunities, home instruction, etc.

NAME.....

ADDRESS.....

BUILDERS TRADE GUIDES



4 Vols. \$6

AUDELS CARPENTERS AND BUILDERS GUIDES—4 VOLS. \$6

Inside Information for Carpenters, Builders, Joiners, Building Mechanics—all Woodworkers. **1600 pages; 3700 diagrams; flexible; pocket size.** Short-cut instructions, new methods, ideas, solutions, plans, systems—money saving suggestions. An easy progressive course for the apprentice. A practical daily helper and Quick Reference for the master worker. A Helping Hand to Easier and Better Work and Better Pay. To get this aid for yourself, simply fill in and mail the FREE COUPON below.

INSIDE TRADE INFORMATION ON:
 How to use steel square; How to file and set saws; How to build furniture; How to use mitre box; How to use chalk line; How to use rules; How to make joints; Carpenters' arithmetic; Mensuration problems; Estimating strength of timbers; How to set girders and sills; How to frame houses and roofs; How to estimate costs; How to build houses, barns, garages, bungalows, etc.; How to read and draw plans; Drawing up specifications; How to excavate; How to use settings 12, 13 and 17 on the steel square; How to build hoists and scaffolds—skylights; How to build stairs; How to put on interior trim; How to hang doors; How to lath—lay floors; How to paint.



"Audels Guides worth four times their price—handy too as I carry them in pocket for reference." W. J. Bates, Knoxville, Pa.



4 Vols. \$6

AUDELS PLUMBERS AND STEAMFITTERS GUIDES—4 VOLS. \$6

A new set—just out! A practical, illustrated, Reference Library and Study-Course for Master Plumbers, Journeymen and Apprentice Steamfitters, Gas Fitters and Helpers, Sheet Metal Workers, Draughtsmen, Master Builders, Engineers and all Building Trade Students. **1670 pages; 3642 diagrams; flexible; pocket size.** Guides explain all the principles, advances and short cuts of the Plumbing and Heating trade. Contains instructions on how to figure and estimate jobs. Use FREE COUPON below to examine, without obligation, this valuable work.

INSIDE TRADE INFORMATION ON:
 Soldering, tinning. Joint wiping, bending, beating. Pipe—iron—steel, threading. Mathematics, tables, physics. Materials—iron, steel, copper, brass, lead, tin, antimony. Sheet metal—galvanized—plate. tion, syphonage, tanks. Drainage, sewage, purification. Fixtures—bath—kitchen. Pipe fittings, soil pipe, tools. Laying out work. Roughing. Screwed fittings, flanges, joints. Pipe bending, examples. Elbows. Heating, ventilation, refrigeration. Water supply, mains, wells, tanks. Gas-fittings. Underwriters. Sheet metal work, problems, methods, brazing, heating, lead burning. Welding, various welds, methods. Blacksmithing, forges, tools.



"Audels Guides are practical, easy to understand, reliable. Cover the field in plain language." W. F. Arminger, Annapolis, Md.



4 Vols. \$6

AUDELS MASONS AND BUILDERS GUIDES—4 VOLS. \$6

A new, complete, illustrated trade reference library, for Bricklayers, Cement Workers, Plasterers, Tile Setters and Stone Masons, including a practical outline of Steel Construction. **1100 pages; 2067 diagrams; flexible; pocket size.** A practical Trade Assistant explaining modern methods of masonry construction. Easy to understand and apply. A reliable and authentic reference work and study-course for Master Journeyman and Young Mechanic. Use FREE COUPON below and find out for yourself, without obligation, whether this set will benefit you.

INSIDE TRADE INFORMATION ON:
 Bricklaying, tools, materials; Brick designs, patterns, bonds; Setting frames and foundations; Mortars, scaffolds, estimating; Mortars and mortar mixing; Tile setting, mosaic, hollow tile; Straight edge test, troweling; How to figure brick work; Safe loads, piers, chimneys; Boiler settings, anchors, fire stops; Labor tables; Concrete, forms; How to figure concrete work; Stucco—on old and new buildings; Plastering—wood lath—metal; Plasterers agreement; Plastering on various surfaces; Stonemasonry; Cutting, finishing, estimating stone; Derricks, rigging; Steel construction; Fire proof; How to read blue prints.



"Audels Masons Guides are the best books on the subject. Have laid brick 12 years and am able to judge." H. A. Sonnet, Corlies, Pa.

PRACTICAL ELECTRICITY — 1 VOL. \$4

Audels Handy Book of Practical Electricity is a simplified Ready Reference and Study Course in one pocket size, leather bound volume—for Engineers, Professional Electricians and Students. **1040 pages; 2600 diagrams; flexible red leather bound.** A reliable authority and handy helper for every electrical worker. Contains important and valuable wiring diagrams, calculations, machine sketches, helps on maintenance and repair. Use this FREE COUPON today and find out, without obligation, how this handy book will help you in your daily work.



Complete in one handy, red leather bound volume

1040 Pages
2600 Diagrams

WITH WIRING DIAGRAMS

INSIDE TRADE INFORMATION ON:
 Electro-Therapeutics, X-Rays, Shocks, Welding, Brazing, Radio Hook-ups, Motion Pictures, Telephone, Telegraph, Cranes, Bells, Elevators, Pumps, Tools, Ship Drive, Railways, Vehicles, Automobile Electric Systems, Ignition, Generation, Lighting, Plant Management, Power Plans, Armature Winding, Repairing, A. C. Motors and Apparatus, D. C. Motors and Apparatus, Alternator Construction, Dynamos, Wiring Diagrams, Sign Flashers, Cable Splicing, Power Wiring, Outside Wiring, Switches, Lighting, Rectifiers, Converters, Transformers, Fuses, Circuit Breakers, Rheostats, Electro Plating, Electrolysis, Storage Batteries, Magnetism, Electrical Energy, Conductors, Insulators, Static, Dynamic, Radio Electricity, Applications, Ready Reference and index Covering the entire field of Modern Electricity.

Learn More and You Will Earn More!

Know your job and you'll never be without one. The skilled man is always in demand. Knowledge is power. Learn your trade thoroughly by easy reading. This coupon is your opportunity for advancement and better pay. You risk nothing in sending for Audels Guides for free examination. Send it NOW!

FREE EXAMINATION COUPON

THEO. AUDEL & CO.,
 65 W. 23 ST., NEW YORK CITY

Please mail me for free examination the books marked (x) below. If I find them satisfactory, I agree to mail \$1 in 7 days, on each set ordered, and to further mail \$1 monthly on each set until I have paid the purchase price.

4 CARPENTERS GUIDES \$6 4 PLUMBERS GUIDES \$6

4 MASONS GUIDES \$6 1 ELECTRICIANS HANDY BOOK \$4

NAME

ADDRESS

OCCUPATION

EMPLOYED BY..... 4T30

Make That Dream Come True!

Haven't you often pictured yourself playing the Hawaiian Guitar, a happy crowd around you, everybody enjoying and admiring your playing? Now you can reach your goal—and play all the latest hits just as the Hawaiians do!



You can play the HAWAIIAN GUITAR just like the Hawaiians!

\$15
HAWAIIAN GUITAR
with Genuine Seal Grain
Fabrikoid Cover
FREE
when you enroll

Complete Conservatory Course

52 complete lessons. Pictures explain every move. Our method is simple, practical and interesting—only 4 motions to learn. No tiresome scales and exercises—you play a real piece your very first lesson.

Expert Instruction by Native Hawaiians

Get the advantage of expert instruction by Kolomoku, Kalaluki, Ferera and Seville—every one famous as both player and teacher. Even if you never touched a musical instrument in your life, under their direction you make rapid headway—you will be astonished when you see how easy it is!

This Sweet Toned Hawaiian Guitar

In genuine Fabrikoid Case—and complete playing outfit including picks, steel playing bar, etc. sent you free when you enroll. Retailers ask \$15 or more for a similar outfit without the case. Remember, there are no extras—we furnish everything with the course.

Learn in Spare Time

Pick up your guitar at any time and play. Your lessons are always handy—you can always refer to them. You are never hurried or forced. And no waiting for a class to form—start now—go ahead as fast as you like.

Pay as You Play

Small first payment starts you. And the entire 52-lesson course comes to just a few cents a lesson! Begin now.

We Guarantee

in writing to teach you. And after graduation we coach and advise you without charge. Over 45,000 successful graduates.

Tenor Banjo

and other courses—Violin, Tiple, Tenor Guitar, Banjo Ukulele, Ukulele—under well-known instructors. Write for information.

FIRST HAWAIIAN CONSERVATORY OF MUSIC, INC.

9th Fl., Woolworth Bldg., Dept. 348, New York, N. Y.

Approved as a Correspondence School Under the Laws of the State of New York

SEND THIS COUPON FOR LIBERAL OFFER!

First Hawaiian Conservatory of Music, Inc.
9th Fl., Woolworth Bldg., Dept. 348, New York, N. Y.

Please mail full information about your 52-lesson Hawaiian Guitar Course. I am not obliged to enroll unless I want to.

Name _____
Address _____
City _____ State _____

PREPARE FOR AN ART CAREER

—thru the only school operated as a department of a large art organization. Commercial Artists trained the "Meyer Both Way" earn as high as \$10,000 per year. We today have hundreds of students who had previously studied art elsewhere. Why? Because your instruction is based upon our everyday experience in meeting the art needs of leading advertisers. Home study instruction. Write for illustrated book telling of the success of our students.

MEYER BOTH COMPANY
Michigan Ave. at 20th St., Dept. 16, Chicago, Ill.

"STAMMERING Its Cause and Cure"

You can be quickly cured if you stammer. Send 10 cents, coin or stamps, for 288 page cloth bound book on Stammering and Stuttering. It tells how I cured myself after Stammering and Stuttering for 20 years. **BENJAMIN N. BOGUE**
6942 Bogue Building, 1147 N. Ill. St. Indianapolis

FOREST RANGERS

Men wanting forest ranger, mail clerk, or other government positions, write for particulars.
MOKANE, 236, DENVER, COLO.

Paint Like An Expert

"The Expert House Painter," by A. Ashmun Kelly, tells you exactly how to paint walls, woodwork, floors, brick, concrete, roofs, metal work, structural iron, etc., etc. Gives tested formulas for paint mixtures, causes of painters' troubles, and 131 practical methods.

Easy with Directions Like These to Follow

This book enables you to get real professional results without previous experience. Every detail made plain. Do all your own home painting and save money.

Only \$3.00

Sent on 5 Days' Approval—Send No Money

Over 280 pages of concise, easily-used information. Handy volume, cloth bound. Pay postman only \$3.00, plus few cents postage. Money refunded if you return it within 5 days.

Catalog of Mechanical and Engineering Books FREE!

All standard works on Paper-Hanging, Interior Decoration, Wood Finishing, Mechanical Drafting, Auto Mechanics, etc.

SEND FOR IT NOW
DAVID McKAY CO.
Dept. 24, 604 S. Washington Sq., PHILADELPHIA, PA.

DAVID McKAY CO., Dept. 24, 604 S. Washington Sq., Philadelphia, Pa.

Send me "The Expert House Painter" by A. Ashmun Kelly, with your Free Catalog. I will pay postman \$3.00 plus postage, you to refund if I return book in 5 days. [] Check here if you wish catalog only.

Name _____
Address _____
City _____ State _____

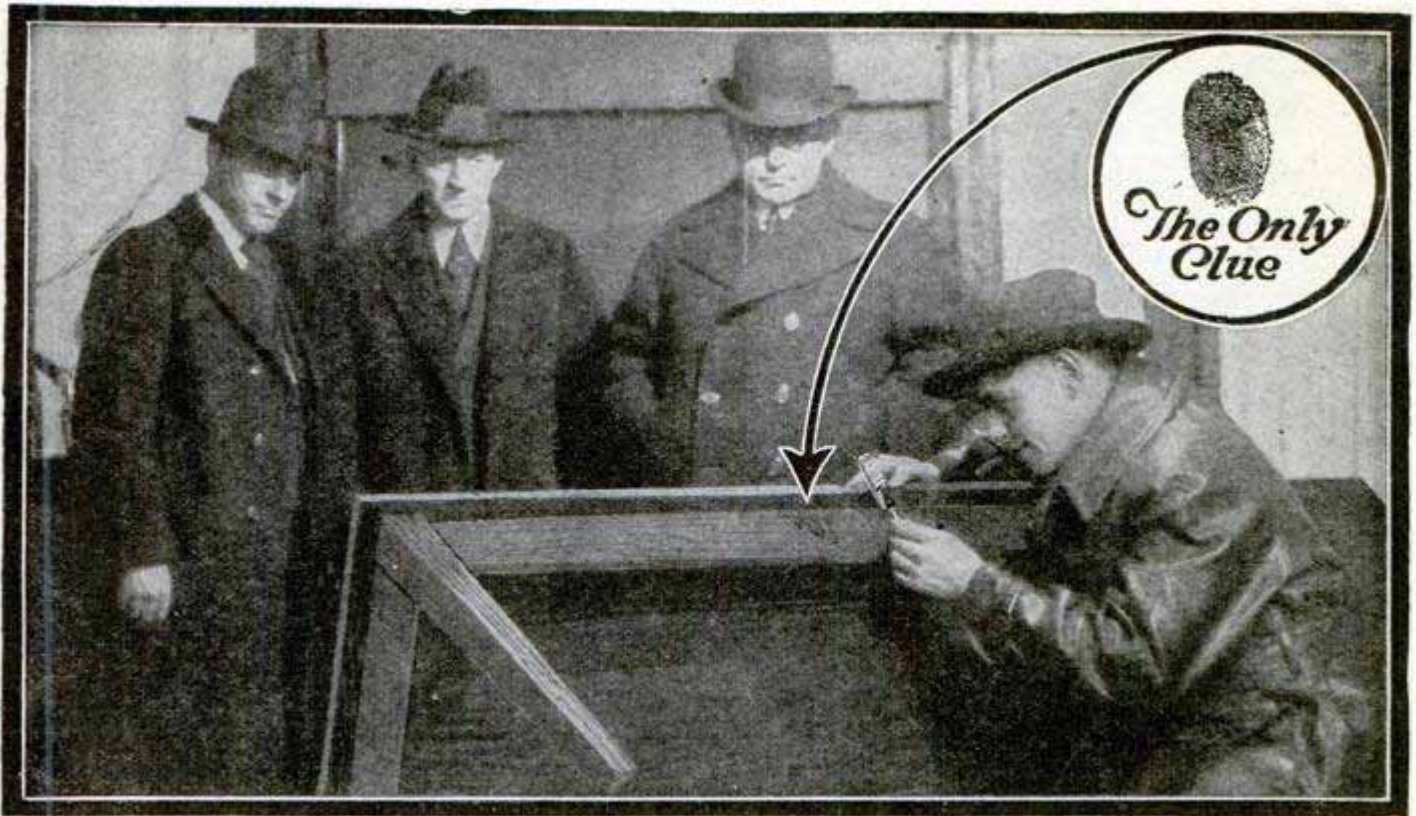

\$500 REWARD for TWO HOURS WORK

WARREN BIGELOW, the Finger Print Detective, was making his usual review in the morning newspapers. He had just finished reading the press reports of the daring robbery of the offices of the T—O— Company when the telephone on his desk rang. Central Office was calling, asking him to come immediately to the scene of the robbery. Although he drove his high powered roadster rapidly and arrived very shortly at his destination, he had plenty of time to consider the main features of the case as reported by the press. The job had undoubtedly been done by skilled cracksmen and robbers of uncommon nerve. Sixty-five hundred dollars in currency—the company pay-roll—were gone. Not a single, apparent clew had been found by the police.

Finger Print Expert Solves Mystery

On his arrival, Bigelow was greeted by Nick Austin, Chief of Detectives, who had gone over the ground thoroughly. "Hello, Warren. Here's a job that has us stumped. I hope you can unravel it for us."

By this time, the district officers and the operatives from Central Office had almost given up the investigation. After hours of fruitless efforts, their work was at a standstill. They were completely baffled.

With lively interest and a feeling of relief they stepped back to await the results of the Finger Print Detective's findings. They were plainly awed at his quiet, assured manner. The

adroit old Chief himself was manifestly impressed at the quick sure way in which Bigelow made his investigation.

Almost immediately Bigelow turned his attention to a heavy table which had been tipped up on its side. Examination of the glossy mahogany showed an excellent set of finger prints. The thief might just as well have left his calling card.

To make a long story short, his prints were photographed and taken to Central Office, where they were matched with those of "Big Joe" Moran, a safe blower well known to the police. Moran was subsequently caught and convicted on Bigelow's testimony and finger-print proof. Most of the money was recovered. In the meantime the T—O— Company had offered a \$500.00 reward, which was given to Bigelow—his pay for two hours' work.

Learn at Home in Spare Time

Could you imagine more fascinating work than this? Often life and death depend upon decisions of finger-print evidence—and big rewards go to the Expert. Thousands of trained men are now needed in this great field. The finger-print work of governments, corporations, police departments, detective agencies and individuals has created a new profession. Many experts regularly

earn from \$3,000 to \$10,000 a year in this fascinating game. And now you can easily learn the secrets of this new Science in your spare time—at home. Any man with common school education and average ability can become a Finger Print Detective in a surprisingly short time.

Why don't You be a Finger Print Expert?

Free Course in Secret Service

For a limited time we are making a special offer of a **Professional Finger Print Outfit, absolutely Free, and Free Course in Secret Service Intelligence.** Mastery of these two kindred professions will open a brilliant career for you.

Write quickly for fully illustrated free book on Finger Prints which explains this wonderful training in detail. Don't wait until this offer has expired—mail the coupon now. You may never see this announcement again! You assume no obligation—you have everything to gain and nothing to lose. Address

UNIVERSITY OF APPLIED SCIENCE

Dept. 13-54, 1920 Sunnyside Avenue, Chicago, Illinois

UNIVERSITY of APPLIED SCIENCE, Dept. 13-54, 1920 Sunnyside Av., Chicago

Gentlemen: Without any obligation whatever, send me your new, fully illustrated, FREE book on Finger Prints and your offer of a FREE course in Secret Service Intelligence and the Free Professional Finger Print Outfit.

Name.....

Address.....

.....Age.....

23rd Year



Learn to Read Blue Prints In 12 Weeks—New, Easy, Short-Cut Method

BILLIONS are being spent in building. There's a frantic call for men who can read blue print plans and lay out building work. Foremen, superintendents and contractors who can read plans are making \$3,000 to \$15,000 a year—and more. Get in on the ground floor now. 12 weeks of fascinating study and you're on the way to a business of your own and big money.

12 Happy Weeks at Chicago Tech —“The School for Builders”

Come to Chicago. See for yourself the millions being spent here in building. 12 weeks of fascinating study, more like play than work—and you're ready to start for home—trained to enter building. A common schooling is all you need. Practical instructors. Opportunities for part time work. Earn while you learn. Free Employment Bureau. Living accommodations arranged for. Day or Evening Classes. Enter any time. Get full information now. Send no money—just the coupon. Fill it out and mail now . . . today.

In Spare Time At Home

If you can't come to Chicago, you can learn Plan Reading, Estimating, etc., at home. Your spare time is enough. Same short-cut methods. Quick, easy, thorough.

Blue Prints FREE

If interested in home-study we'll send you a set of building plans and our booklet "How to Read Blue Prints." Mark the coupon.

Get the Facts Now—FREE!

Find out about this 23-year old school for builders; about the organization, men behind it, etc. Let us show you what training has done for thousands of our graduates who are now top-notchers in the building field. Send for this information if you want to make more money in the world's big pay field—Building. No obligation; just mail the coupon.

CHICAGO TECHNICAL SCHOOL FOR BUILDERS

Dept. D-300, 118 E. 26th St., Chicago, Ill.

CHICAGO TECH. SCHOOL FOR BUILDERS
Dept. D-300, 118 E. 26th St., Chicago, Ill.

Please send me without obligation, free and postpaid, full facts and information on how I can learn to read blue prints and become a trained builder in 12 weeks.

Name.....

Address.....

Town or City..... State.....

Age..... Occupation.....

At Chicago Tech. or by Home Study. Mark Choice with an "X"

CLIP and MAIL COUPON - NOW



Ladies' Patronage has made BARBERING one of the splendid paying professions of the day. 60,000 MOLER GRADUATES know MODERN BARBERING IS EASY TO LEARN—QUICK TO EARN—CLEAN and FASCINATING. Write for catalog B-4.

Address the Branch
of the MOLER SYSTEM OF COLLEGES nearest you.
(Street address not needed)

- | | | |
|------------------|------------------|-------------------|
| Chicago, Ill. | Detroit, Mich. | Atlanta, Ga. |
| New York, N. Y. | Denver, Colo. | Fargo, N. D. |
| St. Louis, Mo. | New Orleans, La. | Memphis, Tenn. |
| Kansas City, Mo. | Omaha, Nebr. | Dallas, Tex. |
| Cincinnati, Ohio | | Houston, Tex. |
| Cleveland, Ohio | Milwaukee, Wis. | San Antonio, Tex. |

Wanted—Cartoonists!

Increasing demand for cartoonists cannot be filled. Get in on the big money by learning the Manuel Rosenberg way through THE MANUEL ROSENBERG COURSE IN CARTOONING—based on fifteen years' experience as cartoonist on Scripps-Howard and other newspapers. Complete Course teaching drawing and cartooning—100 big illustrated lessons postpaid, for only \$5.00—or only five cents a lesson. Send postal order, check or currency—or we will send it C. O. D., you to pay postman. Write TODAY!

MANUEL ROSENBERG, Room 3, Artists' Bldg., Cincinnati, Ohio

LEARN PHOTO-ENGRAVING

Earn \$200 to \$500 monthly. Photo-Engraving and Photography taught by largest college of its kind in the world. Established 1893. Big demand for graduates. Write for free book. Illinois College of Photography, Box 447, Effingham, Ill.



\$20 Musical Instruments
Your choice of a Violin, Tenor Banjo, Hawaiian Guitar, Banjo, Cornet, Ukulele, Banjo Ukulele, Guitar, Mandolin or Banjo Mandolin. You will be proud to own any one of these instruments and we will give you one without cost. A few cents a day for lessons is your only expense. Our system of teaching is so easy that you can play several pieces by note with the first four lessons. We guarantee success or no charge. Instrument and lessons sent on one week's free trial. Write for booklet today, no obligation. Over 250,000 satisfied pupils.
CHICAGO CORRESPONDENCE SCHOOL OF MUSIC, INC.
1632 North Halsted Street, Dept. 300, Chicago, Illinois.

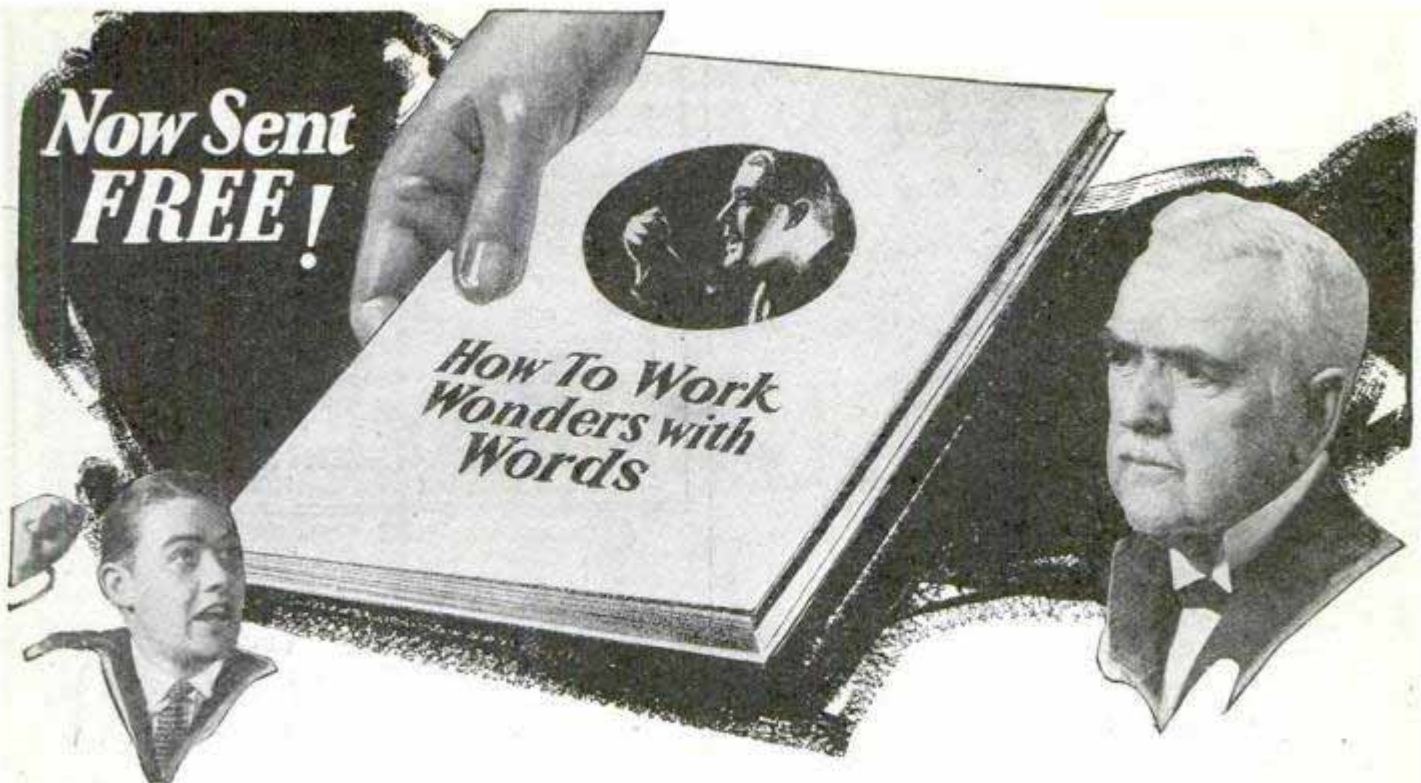

Not Only Men Who Have Made Millions Send for this Astonishing Book ~but Thousands of Others!

Many successful business men have sent for this amazing book NOW MAILED FREE. Such men as Walter C. Ford, of the Ford Manufacturing Company; C. F. Bourgeois, President of Robischon and Peckham Company; H. B. McNeal, President of the Telephony Publishing Company, and many other prominent, prosperous business executives, are unstinting in their praise of it. But don't think it is only for big men. Thousands of young men have found in this book the key to advancement in salary and position, popularity, standing, power and real success.

Today business demands for the big, important, high-salaried jobs men who can dominate others. It is the power of forceful, convincing speech that causes one man to jump from obscurity to the presidency of a great corporation. Another from a small, unimportant territory to the sales-manager's desk. Another from the rank and file of political workers to a post of national prominence as a campaign speaker. A timid, self-conscious man to change almost overnight into a popular and much-applauded after-dinner speaker.

Either You Become a Powerful Speaker —or Your Training is Free

You are shown how to conquer stage fright, self-consciousness, timidity, bashfulness and fear—those things which keep you silent while men of lesser ability get what they want by the sheer power of convincing speech. You are told how to bring out and develop your priceless "hidden knack"—which will win for you advancement in position and salary, popularity, standing, power and real success. This simple, easy, sure and quick training is guaranteed to do this—or it will not cost you a single penny.

What 15 Minutes a Day Will Show You

- How to address business meetings.
- How to propose and respond to toasts.
- How to make a political speech.
- How to tell entertaining stories.
- How to write better letters.
- How to enlarge your vocabulary.
- How to develop self-confidence.
- How to acquire a winning personality.
- How to strengthen your will-power.
- How to be the master of any situation.

Only 15 Minutes a Day Required

There is no mystery about the power to work wonders with words. It makes no difference how embarrassed or self-conscious you now are when called upon to speak. Certain

principles will show you how to rise head and shoulders above the mass and make yourself the dominating figure in any gathering. How to rise to any occasion and demand what you want with force, vigor and conviction. Give only fifteen minutes a day in the privacy of your own home and you can accomplish all this in a few short weeks.

Make This FREE Test

If you will fill in and mail the coupon at once you will receive this remarkable new book, "How to Work Wonders with Words," which gives you an amazing test by which you can determine for yourself in five minutes whether you are one of the seven men out of every nine who possess the "hidden knack" of powerful speech, but do not know it. Decide for yourself if you are going to allow fifteen minutes a day to stand between you and success. Thousands have found this to be the biggest forward step of their lives. If it has played such an important part in the lives of many big men, may it not in yours?

North American Institute

Dept. 1354, 3601 S. Michigan Ave.

Chicago, Ill.

North American Institute,

Dept. 1354, 3601 S. Michigan Ave., Chicago, Ill.

Please send me FREE and without obligation my copy of your famous book, "How to Work Wonders with Words."

Name.....

Address.....

City..... State.....

LEARN TO DRAW CARTOONS

To Show You How
Quickly and Easily
You Can Do So

I'LL TEACH YOU

to draw comic faces like these in 15 minutes. Send me your name and address, and let me mail you a Test Lesson Chart which will teach you how to draw comic faces.



FRECKLES

Mere words cannot express my appreciation of the course of lessons I received from the Landon School.
Merrill Blosser.



BRANNER.

WINNIE WINKLE

When I consider the small investment I made in taking your course and the enormous profits I am making now I feel like a profiteer.
M. M. Branner.



REG'LAR
FELLERS

I attribute my success to the thorough and highly competent course I received from you.
Gene Byrnes.

Whether you think you have talent or not, make this interesting test.

I want to show you that with the aid of my PICTURE CHART METHOD of teaching original drawing you can learn to draw as easily as you learned to write. Every step in producing original heads, figures, animals, and all details of original cartoon drawing are PICTURED in an extensive series of Charts, and the text with each lesson shows how to apply the various steps in producing original drawings of your own. This plan is endorsed by nationally known newspaper artists and is today recognized as the most effective method of teaching drawing ever devised.

RESULTS TELL THE STORY

Here are three of the famous characters created by Landon students who have attained national reputations as Comic Strip Cartoonists. Former students of this School are producing cartoons on political and national affairs, sports, comic strips, etc., for leading newspapers and syndicates all over the United States and Canada. Many newspapers now employ from two to five students of this School; one big newspaper employs nine. Many successful students who prefer to work at home are selling their drawings by mail. The record of results produced by this school is evidenced by the demand for Landon graduates.

Send NOW for complete information and sample Picture Chart to test your ability. Please state your age, and enclose 6c in stamps for postage.

C. N. LANDON, Director.

The Landon School
1238 National Bldg., CLEVELAND, OHIO

ELECTRICITY LEARN IN 12 WEEKS

Finlay method of practical Electrical instruction (now in 24th successful year) prepares you for big paying position in 12 short weeks. Learn by doing actual electrical work. **Double and Triple your income.** Send at once for free Finlay catalog and full details regarding this wonderful business. Enroll any time. Completely equipped shops and laboratories. Faculty of highly trained experts. Certificates awarded. Students assisted to positions. Success can be yours. Write today and get the facts. Ask about One and Two-Year Courses.

FINLAY ENGINEERING COLLEGE
118 Finlay Building KANSAS CITY, MO.

LAW THIS BOOK FREE!

Study at Home

Become a lawyer. Legally trained men win high positions and big success in business and public life. Greater opportunities now than ever before.

Earn \$5,000 to \$10,000 Annually!

We guide you step by step. Degree of LL.B. LaSalle law graduates practicing in every state. We furnish all text material, including 14-volume Law Library. Low cost. Easy terms. Valuable, interesting 96-page book free. Send for it NOW.

LaSalle Extension University, Dept. 464-L, Chicago



Learn to PAINT SIGNS and SHOW CARDS

We quickly teach you by mail, or at school, in spare time. Enormous demand. Big future. Interesting work. Oldest, foremost school. **EARN \$50 TO \$200 WEEKLY**
John Vassos, N. Y., gets \$25 for single show card. Crawford, B.C., says: 'Earned \$200 while taking course'. Send today for free information, samples and guarantee.

DETROIT SCHOOL OF LETTERING
154 Stimson Ave. Est. 1899 Detroit, Mich.



PIANO JAZZ

By Note or Ear. With or without music. Short Course. Adult beginners taught by mail. No teacher required. Self-Instruction Course for Advanced Pianists. Learn 259 styles of Bass, 684 Syncopated Effects, Blue Harmony, Oriental, Chime, Movie and Café Jazz, Trick Endings, Clever Breaks, Space Fillers, Sax Slurs, Triple Bass, Wicked Harmony, Blue Obligato, and 247 other Subjects, including Ear Playing. 133 pages of REAL Jazz, 25,000 words. A Postal brings our FREE Special Offer.

Waterman Piano School, 1826 W. Adams St. Los Angeles, Cal.

LEARN WATCHMAKING AND ENGRAVING

BY OUR PROFIT-SHARING PLAN
OUR GRADUATES SUCCEED

One of our Iowa students started in a very small way—now doing over \$30,000 a year. Another in Wisconsin, over \$10,000 the first year. Day or night classes. Call or write for FREE BOOK

Chicago School of Watchmaking, Dept. 2701, 4844 Lincoln Avenue, CHICAGO

Learn to Mount Birds

Learn at home by mail, to mount birds, animals, game heads; tan furs, make rugs and robes. Complete lessons. Easily and quickly learned by men, boys and women.

FREE Write today for Free Taxidermy Book. Tells all about it. Every Sportsman, Hunter, Trapper and Nature lover should know this wonderful fascinating art. Save your trophies. Big profits. Success guaranteed. Our school is 20 years old—100,000 graduates. Investigate today. Write for Free Book.

Northwestern School of Taxidermy 9774 Elwood Bldg., Omaha, Neb.

Tools FREE

of ANY Extra Charge

Also a Drafting Table
Act NOW!



This is NOT a "Student's" Outfit but an Imported Set of Professional Drafting Instruments, a Chief's Drafting Table, and Standard Supplies.

Yours for the Asking!
No Extra Cost Whatever. No Conditions except to Reply Promptly. This offer Open
to All who Speak Up NOW!

Scores of Firms are in need of Draftsmen now—and I need you. Many offer to take BEGINNERS, at \$50 a WEEK. Graduates can start at \$90 and \$100! GET BUSY!

Every industry in this country is using draftsmen in droves! In twenty-five years, I've never been harder pushed to turn out enough new men. In fact, it's the shortage that brings you this wide-open offer of all instruments—a real drafting table—full working outfit—complete, standard supplies—even paper and pencils and ink! No extra charge for any of them. That's how I hope to get the required men in record time.

Drafting is the field for any man who wants to get somewhere. For men who want to be heard from. Want work that counts, and pay that makes working worthwhile and life worth living.

I'll teach you draftsmanship by practical methods that make a man easily and quickly finish the whole course. I use modern methods; I employ every short-cut; but I leave nothing out that you have to know to earn \$3500 to \$10,000 a year as a practical draftsman.

LEARN AT HOME but on the same kind of actual drafting room jobs we assign you from our own drafting rooms. It isn't hard to do. Drafting isn't "drawing." You don't need "talent." If you are interested and can read and write, I give you the training to become a good draftsman. (Dobe-trained men are draftsmen and chiefs in big concerns all over the country—and many have made good abroad.)

This Opportunity Doesn't Call for Cash, so Don't Pass It Up for Lack of Ready Money

Please don't beat yourself by thinking of your finances at this time! It isn't money I want now—it's men. You, if you mean business. What I am after is your application. Once I get that, you'll get action. I'll have you ready to draft for important pay—in any engineering or industrial line you like—before you know it. So get my proposition in front of you this week! Then, if you do enroll, you're in line for my free outfit offer.

WELL PAID JOBS are soon sighted by men under Dobe training! They get offers before they're through. Are often spoken for months ahead of graduation. And I have students from 17 years of age to 51 at present time! So: first of all, and right now, send this coupon for my new free book Successful Draftsmanship; fully illustrated; explains everything.



YES!

That's Chief Draftsman Dobe's answer to "Can I Succeed in Drafting?"

YES!

Does Dobe really turn out practical draftsmen in a few months?

YES!

Is there always such a big call for men who can draft as Want Ads in the newspapers show at the present time?

YES!

Do I actually get all instruments and supplies without one dollar's extra cost?

YES!

FREE TOOLS COUPON

CHIEF DRAFTSMAN DOBE

1951 Lawrence Ave., Div. 13-54, Chicago

Send me free and postpaid Successful Draftsmanship Book and material telling all about your home course, terms, etc.

Name..... Age.....

Address.....



High School Course in Two Years!

You Want to Earn Big Money!

And you will not be satisfied unless you earn steady promotion. But are you prepared for the job ahead of you? Do you measure up to the standard that insures success? For a more responsible position a fairly good education is necessary. To write a sensible business letter, to prepare estimates, to figure cost and to compute interest, you must have a certain amount of preparation. All this you must be able to do before you will earn promotion. Many business houses hire no men whose general knowledge is not equal to a high school course. Why? Because big business refuses to burden itself with men who are barred from promotion by the lack of elementary education.

Can You Qualify for a Better Position

We have a plan whereby you can. We can give you a complete but simplified high school course in two years, giving you all the essentials that form the foundation of practical business. It will prepare you to hold your own where competition is keen and exacting. Do not doubt your ability, but make up your mind to it and you will soon have the requirements that will bring you success and big money. YOU CAN DO IT.

Let us show you how to get on the road to success. It will not cost you a single working hour. Write today. It costs you nothing but a stamp.

American School

Dept. H-474, Drexel Ave. and 58th St., Chicago

American School

Dept. H-474, Drexel Ave. and 58th St., Chicago

Send me full information on the subject checked and how you will help me win success.

- | | |
|-----------------------------|---------------------------|
|Architect |Business Law |
|Building Contractor |Lawyer |
|Automobile Engineer |Machine Shop Practice |
|Automobile Repairman |Mechanical Engineer |
|Civil Engineer |Shop Superintendent |
|Structural Engineer |Employment Manager |
|Business Manager |Steam Engineer |
|Cert. Public Accountant |Foremanship |
|Accountant and Auditor |Sanitary Engineer |
|Bookkeeper |Surveyor (& Mapping) |
|Draftsman and Designer |Telephone Engineer |
|Electrical Engineer |Telegraph Engineer |
|Electric Light & Power |High School Graduate |
|General Education |Wireless Radio |
|Vocational Guidance |Undecided |

Name.....

Address.....

Don't Envy The Plumber BE ONE!

\$11.00-\$16.00 PER DAY and work EVERY day, is the Plumber's wage.

Every skilled workman will tell you that Plumbers have the best of it. WINTER and SUMMER the Plumber is busy at top wages. No skilled Plumber is ever out of a job—compare his opportunities with any trade, plus the opportunities of having your own shop.

We teach you Plumbing with TOOLS (not books) under Licensed Master PLUMBERS in one of the finest equipped schools in America. We make you a Plumber, every branch is taught thoroughly—Lead Work—Blue Print for plan reading—all other tricks.

LEARN IN 8 to 12 WEEKS without previous experience.

If you are making less than \$50.00 a week you owe it to yourself to investigate. Get FREE catalog that tells in pictures and words how we teach this trade. Special rates now.

UNIVERSAL PLUMBING SCHOOL
2030 Troost Ave. KANSAS CITY, MO.



Make Money in Photography!

We train you quickly at home. No experience necessary. Spare time or full time. Photographs in big demand by magazines, newspapers, advertisers, etc. Portrait Photographers make more money today than ever before. Commercial Photography also pays big money. New plan. Nothing else like it. Write today for details and new FREE book, "Opportunities in Modern Photography."

American School of Photography

Dept. 1354 3601 Michigan Ave. Chicago, Ill.



LEARN MECHANICAL DENTISTRY IN THREE MONTHS

and qualify to earn \$2,000 to \$5,000 a year. FREE employment service enables you to learn WHILE LEARNING this NEW money-making Profession. Age no barrier and no previous training required. The only school in New York where students learn by doing actual work in gold before graduation. Individual instruction. Day or night sessions. Write NOW for free catalog P and SPECIAL TOOL OFFER N. Y. SCHOOL OF MECHANICAL DENTISTRY Penn Arcade, 147 W. 33rd Street New York FREE RAILROAD FARE

MEN WANTED

TO LEARN

Motion Picture Projection

\$2,000 to \$4,000 a Year

Quickly learned. Short hours, big pay. Best equipped school in Michigan. Projectionists for Movie Houses and Road Shows.

MOVIE OPERATORS SCHOOL

61 Sproat Street, DETROIT, MICHIGAN

LEARN WATCH REPAIRING

Be a watchmaker—you can learn this profitable trade by correspondence in a few weeks in your own home by the DeSelms Chart System. After you complete the course you will know a watch from A to Z. You will know just what the matter is and how to repair one. When you graduate you will be a practical watchmaker and repairer and competent to fill any position. Positions for our graduates. Ask for our Free Book. It explains our system and terms.

THE DeSELMS WATCH SCHOOL
LOGANSPORT, INDIANA



WHY NOT spend Spring, Summer and Fall gathering butterflies, insects? I buy hundreds of kinds for collections. Some worth \$1 to \$7 each. Simple outdoor work with my instructions, pictures, price-list. Send 10 cents (not stamps) for my illustrated Prospectus before sending butterflies.

MR. SINCLAIR, DEALER IN INSECTS, San Diego, Calif.
Dept. 6, Box 1424.



"BECOME A LIGHTNING TRICK CARTOONIST"

Send \$1.00 for Laugh Producing Program of 23 Trick Drawings with Instructions. Catalog of Chalk Talk Supplies Free. BALDA ART SERVICE, Dept. 1, Oshkosh, Wis.

Thousands of Trained Men Needed Now

BIG PAY

Up to \$150 Weekly ~ \$10 to \$25

EVERY DAY ANYWHERE

The ONE Great "Open-Shop" Trade. No Scabbing Because No Union to join. No Strikes. No Apprenticeship. Steady Work.

No big union membership fee, no apprenticeship, no Labor Business Agent stands between you and **BIG WEEKLY WAGES**—a steady job in America's greatest industry. What good is training that you can't sell? Choose the right trade. Thousands more men wanted to repair America's 22,000,000 cars and tractors.

8 Weeks' Training Makes You An AUTO AND TRACTOR MECHANIC

McSweeney graduates are earning up to \$10,000 per year.

Learn with real tools on real equipment at either of my three great schools. No book study. No schooling required. Mac's SHOP WAY Means Bigger Pay.



D. M. Collins, Williams-ville, West Virginia, writes, "After finishing McSweeney training, I started in as manager of a garage at \$300 per month."

I PAY

Your R. R. Fare to Cleveland, Chicago or Cincinnati when you enroll. Don't miss this extraordinary opportunity! Write quick for my Special Reduced Tuition Offer and big 48 page book. Mail the coupon.

McSWEENEY

AUTO, TRACTOR and ELECTRICAL SHOPS

Dept. 14YD, Cleveland, O., Chicago, Ill., Cincinnati, O.

Mail This Coupon to Either Address Above 14YD
Please send your Big Free Book and Special Offer.

Name.....

Address.....

City..... State.....

New Way to Make Money at Home

Send 2c now for postage on **FREE BOOK-LET** giving full details



We have openings for new members in Fireside Industries, a national organization of artistic home-workers. No experience needed. We teach you just what to do and furnish outfit to members without extra cost. Satisfaction guaranteed.

FREE BOOK Tells How

You can easily make extra money, in spare hours or full time without leaving home. Fascinating work, decorating beautiful art novelties to supply big demand. Read experiences of successful members. Send 2c stamp postage for beautifully illustrated Free Book.

FIRESIDE INDUSTRIES
Dept. 66-D, Adrian, Mich.

\$10 TO \$20 A DAY

BEST TRADE BY FAR
Interior Decorating—House Painting—Paperhanging—Sign Painting—Show Card Writing—Graining and Marbling.
YEAR ROUND WORK AT BIG PAY
or start a business of your own. A few weeks' training at low cost will put you in the Big Pay Class.
Write today for big free catalog.
MR. BARR, c/o CHICAGO PAINTING SCHOOL
144 W. AUSTIN AVENUE CHICAGO

Anyone CAN LEARN

No talent or experience necessary. Fascinating work. Pays big money. Complete instruction book tells about: Alphabets, Colors, How to Mix Paints, Show Cards, Window Board and Wall Signs, Ready made letters, Gilding, Tricks of the Trade, also gives 100 Alphabets and Designs. Book bound in flexible int. leather-gold edges, and four half bearing Show Card Pens. Sent postpaid \$3.00, C.O.D. 10c ex. Galvite Pub. Co., 57 Rose St. Dept 20, N.Y. City

EARN MONEY IMMEDIATELY—WE FURNISH EQUIPMENT TO START!!

Learn Watchwork, Jewelrywork and Engraving

A fine trade commanding a good salary, and your services always in demand. Address **Horological**, Dept. P, Bradley Institute, PEORIA, ILLINOIS, for our latest catalog.

Health Food Directory

How to select the proper foods for gaining weight; reducing; building vitality; disease resistance; constipation; building muscle, etc. Rates and tabulates standard branded foods. No other book like it. 150 pages of valuable information. Special price 25c, postpaid. I limited edition.

Macfadden Publications, Inc., Dept. P.M.4, 1926 B'way, N.Y. City

MINSTRELS

Musical Comedies and Revues, with full instructions for staging. You can stage your own show with our books. Full line of plays, stage songs, crossfire, monologues, afterpieces, vaudeville acts and make-up. CATALOGUE FREE

T. S. DENISON & CO., 623 So. Wabash, Dept. 19, CHICAGO

200

Kinds of **IRON, WOOD and WIRE PUZZLES**. Leader and Illustrated List **10 cents**.
Western Puzzle Works, St. Paul, Minn.

Skin Troubles

Cleared up—often in 24 hours. To prove you can be rid of Pimples, Blackheads, Acne Eruptions on the face or body, Barbers' Itch, Eczema, Enlarged Pores, Oily or Shiny Skin, simply send me your name and address today—no cost—no obligation. **CLEAR-TONE** tried and tested in over 100,000 cases—used like toilet water—is simply magical in prompt results. You can repay the favor by telling your friends; if not, the loss is mine. **WRITE TODAY.**
E. S. GIVENS, 428 Chemical Bldg., Kansas City, Mo.

I Was Afraid of This New Way to Learn Music

— Until I Found It Was Easy As A-B-C

Then I Gave My Husband the Surprise of His Life

"DON'T be silly, Mary. You're perfectly foolish to believe you can learn to play music by that method. You are silly to even think about it. Why, it claims to teach music in half the usual time and *without a teacher*. It's impossible."

That is how my husband felt when I showed him an ad telling about a new way to learn music. But how I *hated* to give up my new hope of learning to play the piano. When I heard others playing, I envied them so that it almost spoiled the pleasure of the music for me. For *they* could entertain their friends and family . . . *they* were musicians. I had to be satisfied with only hearing music.

I was so disappointed. I felt very bitter as I put away the magazine containing the advertisement. For a week I resisted the temptation to look at it again, but finally I couldn't keep from "peeking" at it. It fascinated me so much that finally, half frightened, half enthusiastic, I wrote to the U. S. School of Music—without letting my husband know.

Imagine my joy when the lessons started and I found that it was as easy as A, B, C. Why, a mere child could master it! My progress was wonderfully rapid and before I realized it, I was rendering selections which pupils who study with private teachers for years can't play. For through this short-cut method, all the difficult, tiresome parts of music have been eliminated and the playing of melodies has been reduced to a simplicity which *anyone* can follow with ease.

Finally I decided to play for Jack, and show him what a "crazy course" had taught me. So one night when he was sitting reading, I went casually over to the piano and started playing a lovely song. Words cannot describe his astonishment. "Why . . . why . . ." he floundered. I simply smiled and went on playing. But soon Jack insisted that I tell him where I had learned . . . when . . . how? So I told of my secret.

One day not long after my husband came to me and said, "Mary, don't laugh, but I want to try learning to play the violin by that wonderful method. You certainly proved to me that it is a good way to learn music."

So only a few months later Jack and I were playing together. Now our



musical evenings are a marvelous success. Everyone compliments us, and we are flooded with invitations. Music has simply meant everything to us. It has given us Popularity! Fun! Happiness!

If you, too, like music—then write to the U. S. School of Music for a copy of the booklet, "Music Lessons in Your Own Home," together with a Demonstration Lesson, explaining this wonderful new easy method.

Don't hesitate because you think you have no talent. Thousands of successful students never dreamed they possessed musical ability until it was revealed to them by a wonderful "Musical Ability Test." You, too, can learn to play your favorite instrument through this short-cut method.

Send the coupon. The Demonstration Lesson, showing you how they teach, will come AT ONCE. Address the U. S. School of Music, 74 Brunswick Bldg., New York. **Instruments supplied when needed, cash or credit.**

U. S. SCHOOL OF MUSIC,

74 Brunswick Building, New York City.

Please send me your free book, "Music Lessons in Your Own Home," with introduction by Dr. Frank Crane, Demonstration Lesson and particulars of your Special Offer. I am interested in the following course:

.....

.....
Have you above instrument?.....

Name.....
(Please write plainly)

Address.....

City.....State.....

Pick Your Course

Piano	Harmony and
Organ	Composition
Violin	Sight Singing
Drums	Ukulele
and Traps	Guitar
Mandolin	Hawaiian
Clarinet	Steel Guitar
Flute	Harp
Saxophone	Cornet
Cello	Piccolo
	Trombone
Voice and Speech	Culture
Automatic Finger	Control
Piano	Accordion
Banjo (Tenor, 5-String	and Plectrum)



Quick, Easy Way to Become an Artist



SCORES are now learning to draw who never dreamed they could. Wonderful quick method makes it easy for anyone to learn Illustrating, Commercial Designing and Cartooning at home in spare time.

Earn big money as an artist. Good artists are in tremendous demand by Magazines, Advertisers, Newspapers, Department Stores, etc. Salaries from \$50 to over \$300 a week are gladly paid them! And now you can easily become an artist. Now you can easily enter this fascinating big paying field.

No Talent Needed

The simplicity of this method is astonishing. You will be amazed at your rapid progress. From simple straight lines and curves, you soon learn to make drawings that sell. It's just like a game—learning to draw at home this way. All your work receives through the mail the individual criticism of successful Art Instructors. It's fun learning—and almost before you realize it, you are able to make real professional drawings.

Coupon Brings FREE BOOK

A new, handsomely illustrated book has just been printed, which gives all the most up-to-date information on the scores of wonderful opportunities in Commercial Art and shows how this startling easy method enables you to enter this field. It tells about our students—their successes—what they say—actual reproductions of their work—how they made big money even while studying. This attractive book will be sent without cost or obligation. Send for it. Mail coupon now. WASHINGTON SCHOOL OF ART, Room 304-E, 1115-15th St., N. W., Washington, D. C.

WASHINGTON SCHOOL OF ART,
Room 304-E, 1115-15th St., N. W.,
Washington, D. C.

Please send me without cost or obligation your new book on art, "Quick Easy Way to Become an Artist," and details of your Attractive Offer.

Name.....
Mrs., Miss or Mr.

Address.....

City.....State.....

Step into a BIG PAY Hotel Job

Earn \$2,500—\$10,000 a Year

in America's 4th Largest Industry. Hotels, Clubs, Restaurants, Institutions, Schools, Colleges, Hospitals, etc., are daily calling for Lewis Trained men and women. Over 70,000 high class positions paying \$2,500 to \$10,000 a year open annually in hotels alone. Salaries up to \$3,500 a year to start. We put you in touch with positions.

Previous Experience Unnecessary

Without cost let us show you how big pay, fascinating work, quick advancement can be yours in the great hotel industry. Age is no obstacle—young and old alike have equal chance for success. A common school education is all you need with the amazing Lewis system of spare-time home training in hotel operation. Our students employed, our methods endorsed by leading hotel men everywhere. Low cost—easy terms—money-back agreement.

Write today for FREE BOOK "Your Big Opportunity" and complete details, mailed without obligation.

LEWIS HOTEL TRAINING SCHOOLS
Clifford Lewis, Pres.
Room AE-363 Washington, D. C.
Charter Member of National Home Study Council.

Send for FREE Book

ELECTRICAL ENGINEERING

Course for men of ambition and limited time. Over 5000 men trained. Condensed course in Theoretical and Practical Electrical including the closely related subjects of Mathematics and Mechanical Drawing taught by experts. Students construct motors, install wiring, test electrical machinery. Complete course

IN ONE YEAR

Prepare for your profession in the most interesting city in the world. School established 1893. Send for catalog.

BLISS ELECTRICAL SCHOOL
114 Takoma Ave. WASHINGTON, D. C.

LAW High-Grade Instruction

By Correspondence Prepares You for the Bar—Est. 1892

University Methods. Standard Text-Books. Approved by Bench and Bar. Graduates practicing in every state. Send today for Free Catalog and Rules for Admission to the Bar.

CHICAGO SCHOOL OF LAW, 802 Reaper Block, Chicago, Ill.

PLAY PIANO BY EAR

Master Jazz or Ragtime in 90 days by famous Niagara Method. 35,000 pupils. Big, established school. Certificate given on graduation. Send dime Today for booklets: "Entertaining at Piano" and "The Niagara Secret".

Niagara School of Music, Dept. 130, Niagara Falls, N.Y.

LEARN WATCH REPAIRING

You can learn by our modern and original system of instruction every part of the **Watch Repairing Trade** at home as good or better than at a shop. You can earn money while learning and secure a well paying position or start in business after completing our course of instruction. Good watch repairers are always in demand and earn from \$50 to \$75 per week. For particulars apply to the

Wisconsin School of Watch Repairing
166 Mason St., MILWAUKEE, WIS.

Men Wanted

Get This New 74-Page Book Today. It's FREE. The First Step to a Big Pay Job.

Garage	\$150 to \$400
Tractor	\$10 a day
Electrician	\$225
Mechanics	\$10 a day
Chauffeurs	\$90 to \$150
Truck Drivers	\$125
Tire	\$100 to \$200
Welder	\$140 to \$200
Battery	\$150 to \$200

You, Too, Can Have Money in Bank \$5,000 Home



E. J. Sweeney

If you are mechanically inclined, the quicker you decide to make auto mechanics your life work, the sooner you will be assured of success, happiness and money. No man can succeed unless he is doing the work he likes, and the mechanical trades offer the greatest opportunities, not only of good paid jobs, but of eventually owning your own business, making yourself independent.

Practical Work

Now there is only one way to train, and that is by learning practical work in the school that has an unsurpassed record of

successful graduates, the best of equipment and a thoroughly proven method of teaching. When you come to the Million Dollar Sweeney School, you are not experimenting, but following the same path that has led thousands of other men to success.

World's Greatest Business

In all my years of teaching with tools, not books, and of training men for high paid jobs, there has never been a time when it was so easy for the trained man to cash in immediately on his work. Over 20 million cars and trucks now running, and annually 4 million new cars poured into the market; good roads everywhere; bus lines, city and country; repair shops, garages, battery and tire stations needed; electrical workers, painters, welders, mechanics, drivers find openings at high pay every place with certainty of sure continued employment. The Automobile industry has taken the world by storm, and the man who knows his job need never worry about assured success. Coming to the Sweeney School means that in a few short weeks you learn from the ground up in the shortest time, at less expense, by proven methods, and under the best surroundings.

How to Make Money

I want every man who is in earnest about success in life and likes mechanics to write today for my big free catalogue that not only fully describes my school and my method of training, but also posts you correctly on the money to be made and the When—Where—and How of Big Pay Jobs when you have completed your course. This book is written after years of experience and handling of over 70,000 men, and you will find it answers every question, and fills you with ambition, to make a step that insures your future.

I agree to prove that any young man, no education or experience needed, can learn quickly and thoroughly, no books or dry lessons, this fascinating work, and can be assured then of profitable employment, locating anywhere he wants, in a fine mechanical trade.

LEARN A TRADE
Sweeney
 AUTOMOTIVE & ELECTRICAL SCHOOL
 3631 SWEENEY BLDG. KANSAS CITY, MO.

Listen man: Do you want money? Do you want independence? Do you want a sure trade that pays \$50 a week up? Do you want to travel and see the world? How would you like a good driving job? Or a place in a repair shop? Or your own service, tire or battery station?

Here's a letter that shows what you can do. \$10,000 CASH says it is true and genuine. Why man—I can show you 500 or a thousand letters just as good. YOU may not have to go broke to pay for your training. But even if you do, what's the odds? See how well it paid Hawkins to go broke.

Dear E. J.: All I can say is I was broke when I left Kansas City—had only 25 cents over my ticket to Meridian; came here—went to work in the Dodge Service Station. Then in N. East Service Station—then opened up a service place of my own. Now moved in a larger place—¼ block square. Keeping six mechanics busy. Just built a nice home over \$5000. Own my own car, and wife has hers—sedan. Owe no one, have a good stock on hand and money in the bank. I can honestly say—it was Sweeney's wonderful training that did it. Before I went to Sweeney's I worked in a dry goods store as clerk—drawing one of top salaries, \$22.50 a week. Now the expenses of my three kids in boarding school are more than the \$22.50 a week I used to make.

I am still with you in the air at night—using an eight tube set, Western Electric amplifier. A. J. Hawkins, Meridian, Miss.

BIG SPECIAL OFFER

Never Before Have I Made Such an Amazing Offer. I now make it possible for you to come to this Million Dollar Sweeney School Right Now.

FREE CATALOG AND SPECIAL OFFER

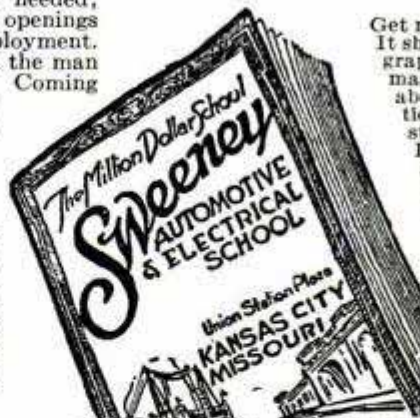

Get my big FREE 74-page catalog. It shows hundreds of actual photographs of men at work in my magnificent new school. Tells all about wages, profits, opportunities in auto business. Explains step by step how you learn. Interesting letters from graduates telling how they made good. Shows how men come from all over the world to this big school. Makes you want to join the crowd. Tells everything you want to know. I will gladly send you a copy beautifully illustrated. I'll tell you how to get into business for yourself. No colored students accepted.

E. J. Sweeney, President

EMORY J. SWEENEY, President
 3631 Sweeney Building, Kansas City, Mo.

Send me free, without any obligation, your catalog and Special Offer!

NAME.....
 P. O.....
 STATE..... AGE.....

THERE'S MONEY IN \$ H C C L S \$

For Any Man who likes Mechanical Work the Shortest Way to Financial Independence is **Making Crowns, Plates, Bridges, Inlays, Etc. for Dentists.** Steady Earnings up to \$5,000 a year—some earn far more in this Profitable Professional Trade.

THREE MONTHS TRAINING

will qualify you to enter this most rapidly growing professional trade—Mechanical Dentistry. Best opportunity for men who like to use tools—dignified work, steady income, rapid advancement, no "slack seasons" as in other trades.

LEADING THE FIELD

Bodee training is recognized as best by dentists everywhere, owing to our 35 years' experience at this work—established 1892—the oldest school. Opportunity is in store for Bodee-trained men, and they make good. After only a few years you find them prominent in this profitable trade—on good salaries or conducting their own laboratories. There's room for many more—think it over! We conduct a Placement Bureau to select suitable positions, and, should you desire to open your own laboratory, we assist you in securing a location and equipping your laboratory.

LEARN BY "DOING"

Individual instruction—No classes whatever—Practical work. You use regular standard tools and learn to do exactly the kind of work which will later be required of you by Dentists.

EARN WHILE YOU LEARN

Don't let lack of money stop you. We have plenty of whole or part time jobs on file to help you pay your expenses.

JUST COMPARE!

Compare this trade with what you are now doing, or with the best you can find in any other line! Compare our unrivalled training—step by step—every point thoroughly covered—no time wasted! Compare also the very reasonable cost at the Institute with the cost at any other school.



FREE { FREE R. R. FARE to our nearest school
FREE PARTIAL SCHOLARSHIPS NOW
FREE POST-GRADUATE INSTRUCTION
A \$50 OUTFIT OF STANDARD TOOLS INCLUDED

Send for Catalog No. 2

BODEE DENTAL INSTITUTE

NEW YORK 1756 Broadway PHILADELPHIA 1306 N. Broad St. BUFFALO 501 Washington St. BROOKLYN 85 Court St.

A Great Book Free with this pay-raising library

For a short time only we will give every subscriber to the New Library of Machine Shop Practice a copy of French's Engineering Drawing—the greatest book on mechanical drawing ever written. This book makes drawing as plain as day—tells you all about instruments, plans and methods—and prepares you to handle any drawing job you will ever have to do. It comes to you absolutely free with

Machine Shop Practice

9 volumes—3065 pages—3608 illustrations
(A combined home study course and reference library)

The New Machine Shop Library is written for practical men. It gives you the best methods for every kind of machine shop work. It explains machine tools and their operation, drawing and design, tool work, gears and grinding, jigs and fixtures, automatic screw machines and their tools and all of the mathematics you will ever have to use. It is plainly written, completely illustrated—the very best kind of help to the machine-shop man who wants to advance himself.

Sent **FREE** No money down—only 7c a day



FREE EXAMINATION COUPON

McGraw-Hill Book Co., Inc., 370 Seventh Ave., New York
Send me for 10 days' free examination the New Library of Machine Shop Practice. If satisfactory, I will send you \$1.50 in 10 days and \$2.00 monthly until the special price of \$19.50 is paid. If not wanted, I will return the books at your expense.
On receipt of my first payment of \$1.50, it is understood that I am to receive, free of charge, a copy of French's Engineering Drawing.
Signed.....
Address.....
City and State.....
Position.....
Employer..... P. M. 4-1-27

LAW

Personal Instruction By Mail Be a lawyer or law trained business man. Quality to earn \$2,500.00 to \$15,000.00 a year. University methods. TUITION LOW, EASY TERMS. Text books furnished. Practical and authoritative non-resident course. Endorsed by bench and bar. Prepares for bar or business. Over 60,000 students. PERSONAL INSTRUCTION. Guarantee to coach free any graduate failing to pass bar exams. SPECIAL REDUCED TUITION OFFER now in force. Write today for particulars and book on law FREE.
AMERICAN CORRESPONDENCE SCHOOL OF LAW
Dept. 1354 3601 Michigan Avenue, CHICAGO

Learn to PAINT SIGNS and SHOW CARDS We quickly teach you by mail, or at school, in spare time. Enormous demand. Big future. Interesting work. Oldest, foremost school.
EARN \$50 TO \$200 WEEKLY
John Vassos, N. Y., gets \$25 for single show card. Crawford, B. C., says: "Earned \$200 while taking course." Send today for free information, samples and guarantee.
DETROIT SCHOOL OF LETTERING
150 Stinson Ave. Est. 1899 Detroit, Mich.



OPPORTUNITIES IN Traffic Management

Become a Traffic Expert
The opportunities in traffic management are limited only by the boundaries of the business world. The trained traffic man is in demand by transportation systems and by industrial organizations.

Three Detroit Firms Pay Their Traffic Managers Over \$20,000 a Year

Prepare for this growing, profitable profession at home in your spare time under supervision of traffic experts. Low cost; easy terms. Thru the LaSalle Problem Method you learn by doing. Valuable 64-page booklet free.



This Book FREE! Send for it NOW. LaSalle Extension University, Dept. 464-T Chicago

Be an Electrical Engineer!

Aim for the BOSS Jobs!

While you're at it, while you're putting your time and money into preparation for a better position and increased salary, aim for the Electrical ENGINEER'S job! Learn how to design Electrical machinery, how to take charge of Electrical installation, how to superintend a power plant. Equip yourself to be more than an Electrician or Electrical mechanic.

There's a tremendous demand for Electrical ENGINEERS, as superintendents of Electrical construction, as Chief Engineers, as Electrical Draftsmen, as Power Plant Superintendents. These positions pay all the way from \$250.00 to \$500.00 a month. We prepare you for these positions at home in your spare time, under guarantee to refund your money if the benefits you expect are not accomplished.

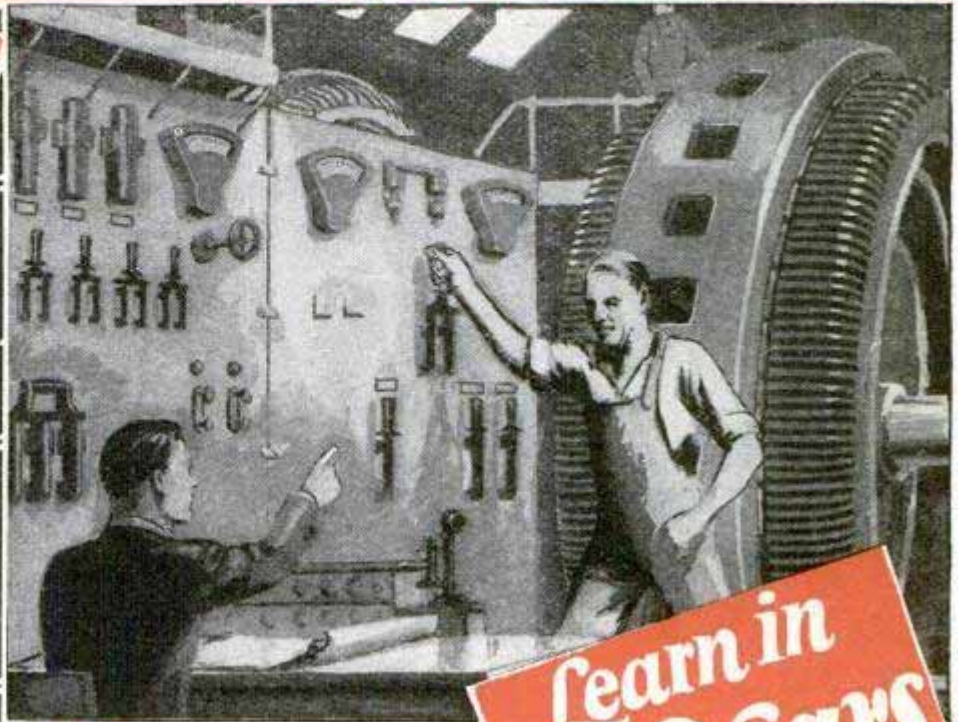

Learn in 2 Years at Home!

COMPLETE Electrical Engineering course in two years, backed with an agreement to help you find a position at increased salary, or money refunded. We invite ambitious men to look into this guaranteed training offer. Here is the chance you have been waiting for—to learn Electrical Engineering, to get into the world's greatest industry with the equipment to make a success in it.



Dunlap is an Electrical Engineer

If you are now earning \$40.00 a week or less, I guarantee to help you get an Electrical Engineer's job at a substantial increase in pay over that you earn today within sixty days after you finish or money refunded.

Can YOU learn Electrical Engineering?

"Can I make good in Electricity?" "Can I afford this training?" I'll answer all these questions to your satisfaction. I'll show you that Electricity offers unlimited opportunities, more well-paid positions, greater chances for advancement, bigger salaries. I'll prove to you that with the backing of this million-dollar institution you have education enough to learn Electrical Engineering in two years' spare time under definite money-back guarantee.

Start with the Coupon!

Get the FACTS about your opportunities in Electricity—they're greater than you ever dreamed. Get the five job tickets I will send you FREE to see how easy and practical this instruction has been made. Coupon brings everything, Mail it today!



-get them FREE!

Training built by 29 Noted Engineers!

The American School has engaged 29 of America's leading Electrical Engineers and Educators to prepare this Electrical Engineering course—men from such great Corporations and Universities as General Electric, Commonwealth Edison, Westinghouse, Massachusetts Institute, etc. Their standing assures you that this training is honest, complete and up-to-date. As far as we know, The American School is the ONLY Home Study School organized as an Educational Institution not for profit. We have been training men deprived of the proper preparation for successful careers right in their own homes in spare time, for over thirty years. We accept your enrollment under an agreement to refund the entire tuition in any case where the benefits and results you seek do not follow the completion of your training. So now you know in advance what this training will do—you take absolutely no risk of loss or disappointment.

CHIEF ENGINEER DUNLAP, Electrical Division



Dept. E-474, Drexel Ave. and 58th Street, CHICAGO, ILL.

CHIEF ENGINEER DUNLAP, Electrical Division
THE AMERICAN SCHOOL,
 Dept. E-474, Drexel Ave. and 58th St., CHICAGO, ILLINOIS

Send 5 Electrical job tickets FREE and proof that I can learn Electrical Engineering at home in spare time. Also your training guarantees and facts about your Employment Service.

Name.....
 Street Number.....
 City.....State.....
 Age.....Occupation.....



Thousands Can Draw CARTOONS Who Have Never Even Tried

Good Cartoonists earn from \$60 to far over \$300 a week. Why tie yourself to work that is drudgery when through a remarkable method you can easily learn at home in spare time to draw cartoons that SELL?

MANY are earning pitifully small salaries who could make wonderful salaries in cartooning. Briggs, Fox, Fisher, Goldberg and other leading cartoonists earn more than the President of many concerns. Yet a few years ago many of our most successful cartoonists never dreamed they could draw a good cartoon!

The World's Easiest, Pleasantest and Best Paying Profession

Just watch a cartoonist work. A few little lines—a couple of simple curves—a splash of black here and there—and then you see a splendid cartoon before you. With a few strokes of his pen, he has taken some little incident of his day's experience—some humorous or sad scene he has witnessed—and produced a wonderful cartoon.

Quick, Easy Way to Learn Cartooning

This fascinating ability to draw cartoons can now easily be yours—this ability which can mean so much real pleasure and profit to you. Through a wonderful method you receive right at home through the mail a complete training in Cartoon Making and personal corrections on all of your work by successful commercial cartooning instructors.

With their help, you can in an amazingly short time, learn to draw the comic strips, humorous, political and animated cartoons which are in such big demand.

Learn More About Cartooning Send for FREE BOOK

Never have cartoons been so popular. Millions of dollars were spent last year on cartoons of all kinds—and every week newspapers increase the amount of cartoons used. Get full details on the amazing opportunities in this fast growing field of Cartooning and full information on this remarkable home study method. Mail coupon for FREE BOOKLET today. WASHINGTON SCHOOL OF CARTOONING, Room 304-E, 1113—15th St., N. W., Washington, D. C.

WASHINGTON SCHOOL OF CARTOONING
Room 304-E, 1113—15th St., N. W., Washington, D. C.
Please send me without obligation your illustrated FREE BOOKLET on Cartooning and details of Attractive Offer.

Name.....
(Write name plainly—State Mr., Mrs. or Miss)
Address.....
City..... State.....
If under 16 years, please state age.....

AGENTS Big-Quick PROFITS

Tires Hammered Full of Nails, Leak no Air. GALACITE a new Viscous Pneumatic Cement (NOT A LIQUID) Seals PUNCTURES Instantly—the very moment they occur. One application made in a minute without taking tire off wheel or rim does the work. Seals slow leaks and porous tubes. Galacite aids in preserving rubber often doubling Tire Mileage. Don't confuse with anything else intended for the same purpose. Galacite is new, different, clean and scientifically correct. Made by a long established, highly rated financially responsible concern.

FREE SAMPLE

AT OUR RISK, MAKE THIS TEST Hammer as many nails into a tire as you wish—Pull them out. No air will escape. No pressure will be lost. If you are not delighted we will pay you for your time and trouble.

AGENTS It will pay you to get the facts and get them NOW. You can't get rich in an hour but you can make immediate, sure, steady profits that are amazing. No talking. Just drive nails in an old tire. We back our men with powerful advertising helps. Banners Posters, Newspaper Advertisements and circulars. FREE SAMPLE Full particulars, big book and a free sample will be sent you postpaid, by return mail. Territory is going fast. Send no money, just your name, but ACT NOW. JOHNSON & CO. 19 W. Jackson Blvd., Dept. 517, CHICAGO

\$5,000 SALARY EXPERIENCE NOT NECESSARY

Have you ever seen this heading in a help-wanted advertisement? No—and you never will! Experience IS necessary. If you are caught in a low-pay job, why not train for a \$5,000-a-year position? Become an expert salesman—fix your own hours—choose your own field—control your own pay—be independent! LaSalle-trained salesmen in every section of the country report salary-increases and promotions. Train in your spare time by the LaSalle Problem Method, under supervision of expert salesmen. Low cost; easy terms. 64-page booklet, "The Modern Salesman, Ambassador of Progress," free. Send for it TODAY.

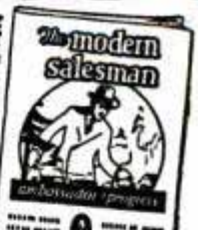

This Book
FREE!

LaSalle Extension University, Dept. 464-S Chicago

Drum Lessons With the Outfit

With each genuine Ludwig Trap Drum Outfit we furnish an instruction method. Ludwig drum sets from \$32.50 up. Call on your music dealer or write us for full particulars. Send for free catalog.

World's Largest Makers of Drums and Banjos

LUDWIG & LUDWIG
1611 N. Lincoln St. Chicago, Ill.

MUSIC LESSONS FREE

In Your Home



Write today for our FREE booklet. It tells how to learn to play Piano, Organ, Violin, Mandolin, Guitar, Banjo, etc. Beginners or advanced players. Your only expense about 2c per day for music and postage used.

American School of Music, 50 Manhattan Bldg., Chicago

YOUR *Great Opportunity* to learn the **AUTO BUSINESS**

SENSATIONAL ANNOUNCEMENT By One of The Finest Auto Training Schools in the World!

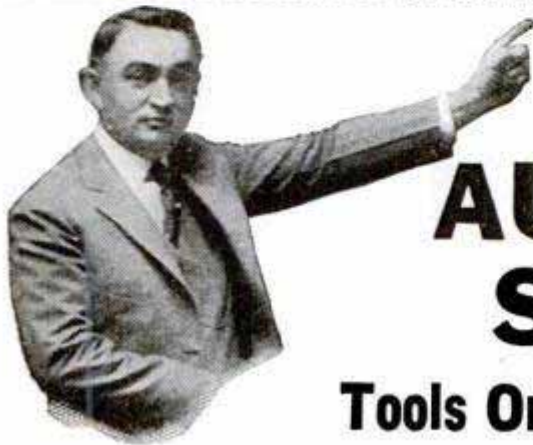

New—Low Priced AUTO MECHANICS SHOP COURSE

Tools Only—No Books—No Classroom Work

Quality training for the greatest business in the world is now within reach of all. I am offering for a limited time only, a complete course in Auto Mechanics—Shop and Garage Work, for scarcely more than the price of your railroad fare! This new course includes auto electricity and is not surpassed by any Auto Mechanics Shop Course in the country. It is all practical instruction, no books, no classroom work. Classes are forming now. This is your marvelous opportunity to get a complete course in auto mechanics if you act at once.

Work With Real Tools on Latest Model Cars

I'll teach you by real practice how cars are made and how to repair them. The big auto factories in Detroit endorse our training and place in our shops chassis of latest model cars for my students to work on. You learn by working on newest standard and up-to-date automobile equipment. Detroit, the auto center of the world, is the logical place to learn autos. This school knows how to train you right, and that is what you want and need to make the most money in this fascinating business.

Mail Coupon TODAY for all Particulars

Mail me the coupon today and I'll send you full particulars of the greatest auto training opportunity in the world. I'll send you my big FREE Catalog and will tell you how you can get a good paying job—how you can go into business for yourself—how you can now learn auto mechanics for scarcely more than the price of your railroad fare! Mail the coupon or send me a postal card today.

Michigan State Automobile School
304 Auto Building, 3729 Woodward Ave., Detroit, Mich.

*Costs Scarcely More
Than the Price
of Your R.R. Fare!*

What This Amazing Offer Means to You—

By enrolling at once in this new low-priced Auto Mechanics Shop Course, you can learn the big-paying auto business in an amazingly short time and for a very special tuition rate. I decided to add this new course to our regular courses in automobile training (which continue as before) so that I'll have plenty of men to help fill the coming Spring and Summer demand for garage men and auto mechanics. This course may be withdrawn at any time so I urge you to send for full particulars at once while this marvelous opportunity lasts.

A. S. Zeller
Pres.

The coupon will bring you all details of the new Auto Mechanics Shop Course together with full information about the other famous "Michigan State" Courses in automobile training. Clip and mail it NOW.

Michigan State Automobile School,
304 Auto Building,
Detroit, Michigan.
Send me free and without obligation, full information about your new Auto Mechanics Shop Course and tell me about Detroit training to make the most money. Also send me FREE your big new illustrated Catalog and Automobile Training Book.

Name.....
Street No. or R. F. D.....
City and State.....

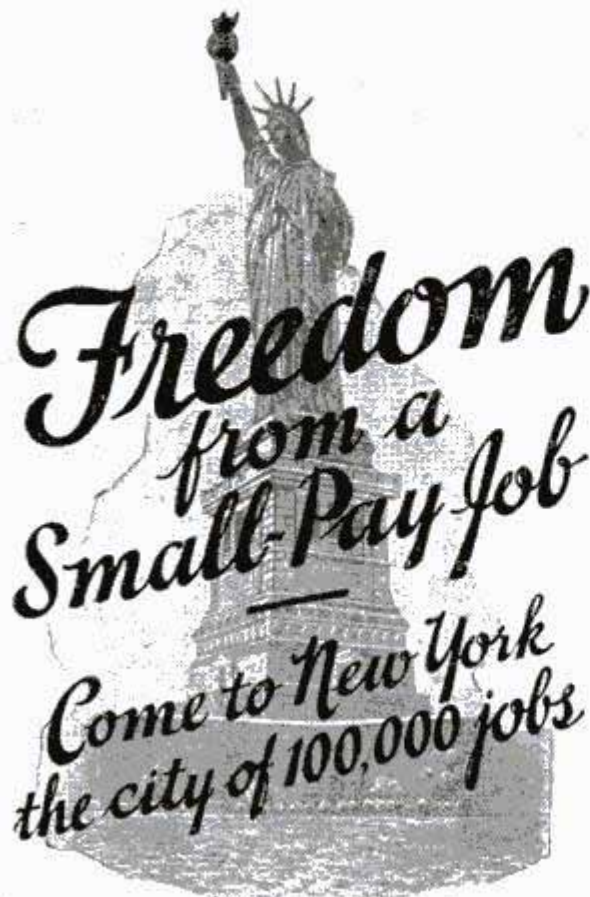

ANY MAN who can read and write and use a pair of pliers can become an electrical expert and free himself forever from the long hours and drudgery of a small pay job.

And you can learn the **BIG PAY** profession of electricity right in New York City—the heart of the electrical world—the city of 100,000 jobs. At the same time you are learning the **BIG PAY** profession you can be enjoying the sights and wonders of New York, the modern Bagdad.

Be An Electrical Expert

Graduates of the **NEW YORK ELECTRICAL SCHOOL** are in demand by all the big electrical companies. Or, if you prefer the independence of a business of your own, there are thousands of opportunities for efficient, dependable men to become electrical contractors. When you are your own boss the money you can make is limited only by your own energy and ability.

Personal Instruction

The **NEW YORK ELECTRICAL SCHOOL** is not a correspondence school. You learn by doing—by personal instruction on full size standard electrical equipment under the personal supervision of trained instructors.

At **N. Y. E. S.** you train your hands and mind at the same time. You learn the theories of electricity—and then you are shown how to put the theories into actual practice by solving the problems with **your own hands.**

The man who has learned electricity by actually doing electrical work under intelligent personal instructors can go to any part of the world and be sure of a good living. There are **N. Y. E. S.** graduates in all the countries of the world.

Write today for the 48-page booklet giving full information about the **N. Y. E. S.** Course and showing pictures of the equipment available for your personal use in our two seven-story buildings. Mail coupon **now!** The New York Electrical School, 44 W. 17th Street, New York.

The New York Electrical School
44 W. 17th Street, New York

Please send me **FREE** your 48-page booklet. It is understood that this request puts me under no obligation.

Name.....

Address.....

AIRPLANES AND HOW TO BUILD THEM

Young man, imagine this is year 1940. See the myriads of airplanes soaring like giant birds in the sky. Imagine yourself at the head of some big corporation manufacturing these monsters of the air. What a thrill! Or, when 1940 comes—will you be telling your friends the old story? "I missed my chance!" Fortunes are made by men of vision—those who see the possibilities of an industry and get in at the right time. The pioneers in the automobile business made fortunes. Some day the same will be said of some who entered the airplane industry in 1927. The day of opportunities has not passed. The age of aviation is here. One hears of amazing expenditures on every hand. Tens of millions of dollars are being spent for aircraft and the industry is still in its infancy. What will it be 20 years from now?

Now Is the Time to Get Started

This is your chance to make good in this new field of unlimited opportunities. We shall all fly some day. Statistics show that the latest, all metal, multipowered airplane is as safe as the automobile. Airplane building offers unusual opportunities to young men mechanically inclined. One need not be an aviator to succeed as a plane builder. No special preparation is necessary. It only takes a small amount of capital—and if you lack that, there are plenty of good business men who will finance you. Many of them are eager to get into the plane building game, but they don't know how. Building airplanes is not as difficult as you may think. It does not take a genius. All you need is proper plans, specifications, and blue-prints designed by experienced engineers who thoroughly understand the construction of an up-to-date airplane. Such plans we can furnish to you at small cost.

Send for These Blue-Prints To-day

They have been prepared specially for those who wish to build their own planes. With the plans before him any person of average mechanical ability can build an airplane that will actually fly at speeds ranging from 50 to 140 miles an hour. Don't experiment. Planes built by guesswork usually stay on the ground. Our plans eliminate guesswork, reduce cost, and make plane building a pleasure. The drawings are exceptionally large, and the specifications and instructions are written in clear, non-technical language any one can understand.

Let Us Show You How to Build a Real Flyer

One of the fastest, safest, sturdiest, easiest to operate, four passenger monoplanes that has ever been produced—the coming type of aircraft—a type almost universally used in Germany. The plans give exact dimensions of every part; location of every bolt; tell how to make laminated wing-spars and ribs; camber, chord, lower and upper curvature of new high-lift wing; internal bracing; etc.; how to install gas tanks within the wing; how to make ailerons, adjustable stabilizers; all metal fuselage; controls, fittings, landing gear, etc. When completed you may be sure the plane will fly because it is an exact copy of airplanes which, in actual practice, have proven the most efficient and reliable.

Commercial Plane Building Pays

Airplane factories, with few exceptions, are working overtime. The profits on some planes run into the thousands. The wide range of motors, now on the market, many of them at prices exceptionally low, will enable you to build planes for commercial purposes at big profit. The blue-prints tell how to make every part, except the motor, bolts, cloth, etc., where to buy motors and such parts the builder may not care to make. The price for a complete set of plans and blue-prints (8 large sheets 18" x 22") with full directions and specifications is only \$2.00, postage included. If you wish we will send plans C. O. D. You can pay postman \$2.10 on delivery. (Canadian and foreign orders cash in advance.) Send for the plans today; it will be money well invested.

DVORAK AIRCRAFT SERVICE
3120 W. 10th St., Dept. 14, Los Angeles, Calif.

YOU CAN OIL PAINT

Amazing new method teaches man or woman to earn after first lesson. **OIL PAINT** photos—portraits, landscapes or art subjects. Earn \$18 to \$50 and more a week. **OIL PAINT OUT-FIT GIVEN.** Send now for free illustrated book. **PICTORIAL ART STUDIOS Inc.** Dept. MP. 2731 No. Clark St., Chicago

\$75 WEEKLY BUILDING RADIO SETS

Join the Association! We train you to build and repair radio sets—start you in business—enable you to earn \$3 an hour upwards. **Free 5-Tube Radio Set to members.** Write for special limited-time plan whereby your membership need not cost you a cent. Write today!

RADIO ASSOCIATION OF AMERICA
Dept. PM-4 4513 Ravenswood Ave., Chicago, Ill.

PAPER BUSINESS NEEDS MEN

EARN
\$3,000
TO
\$10,000
A YEAR

Learn this fascinating business at home in your spare time. Become a paper mill and jobbing representative. Big demand for trained men and women. Our home study course is thorough and practical. We prepare you for big pay jobs and help you secure employment upon graduation. Write for catalog.

FREE BOOK! **GREAT LAKES PAPER COMPANY,**
515 So. Wells St., Dept. 14, Chicago, Ill.

AUDELS ENGINEERS & MECHANICS GUIDES

EXAMINE FREE!



\$12
Complete Set
8 Guides

EASY TERMS

For Every

Engineer
Mechanic

Machinist
Electrician

Fireman; Oiler
Engineer Student

THIS Master Set is a gold mine of daily, practical helps for workers in every branch of engineering. A self-educating study course for the student; the standard reference work for the chief. Thousands of rules, tables, calculations and diagrams make it easy to read and learn. Latest inside information on theory and practice of modern engineering for reference study and review. Thousands of new short-cuts that make the job easier. Examine free! Pay \$1 a month (less than 4c a day) if satisfied that this set will help you to a better job—or make your present job easier.

AUDELS STANDARD LIBRARY

With Questions and Answers That Solve Your Problems

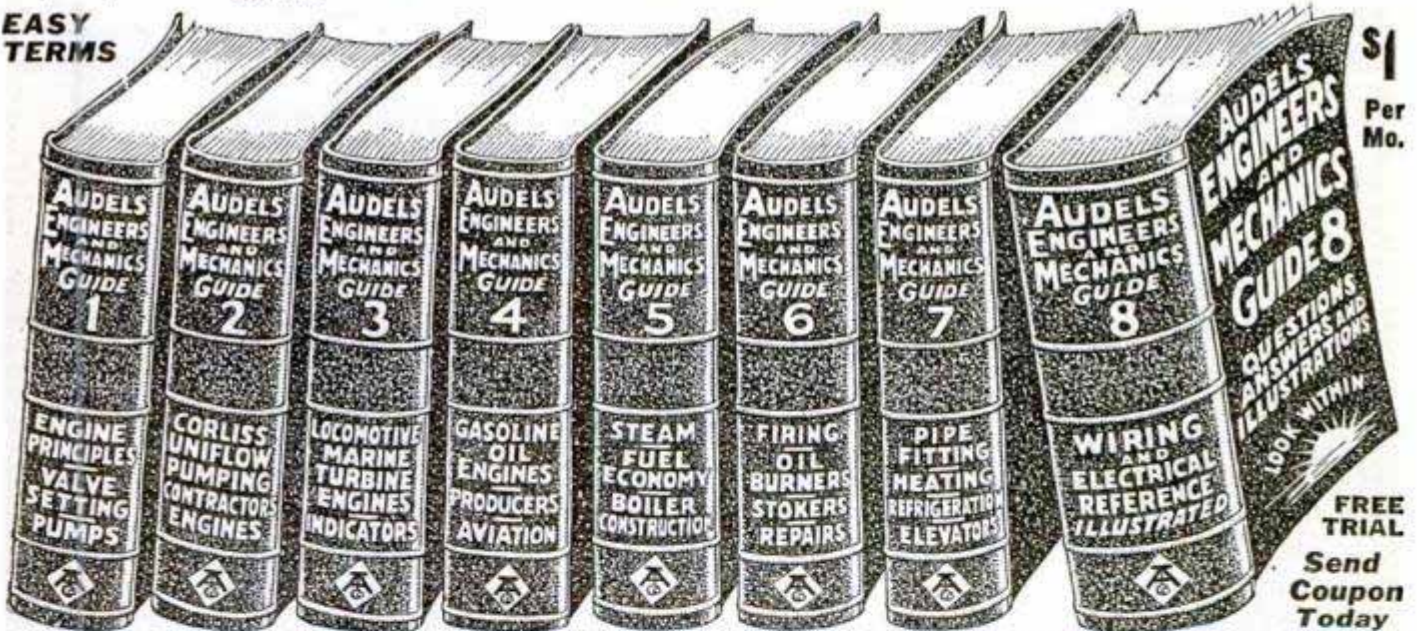

8 GUIDES—8754 PAGES—4750 ILLUSTRATIONS—POCKET SIZE

8 pocket numbers with Ready Reference Index. 8754 pages, 4750 illustrations. Easy to read. Highly endorsed. A good help in securing Engineer's License. Price \$12; terms, \$1 per month. Free Trial.

INFORMATION:—In A Handy Form. Answers to Your Questions and Problems. Here is a partial list of the subjects covered:—**Engine Principles, Valve Setting, Pumps, Corliss Engines, Uniflow Engines, Pumping Engines, Contractors Engines, Locomotives, Marine Engines, Turbine Engines, Gas Engines, Oil Engines, Indicators, Producers, Aviation, Steam, Fuel Economy, Boiler Construction, Firing, Oil Burners, Stokers, Boiler Repairs, Pipe Fitting, Heating, Refrigeration, Elevators, Dynamos, Motors, Lighting, Wiring, Electrical Diagrams, Radio, Electrical Reference and Calculations.**

FREE BOOK—FOR LIMITED TIME.

While the edition lasts, "Audel's Answers" will be included with each set of Audel's Guides. Contains special information for those who want to go before the board to get a license. Makes Engineers exams. easy. Send this coupon at once.

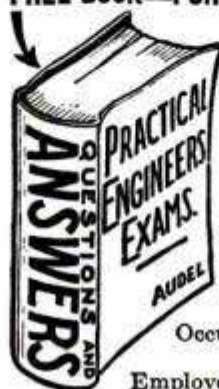

THEO. AUDEL & CO., 65 West 23rd St., New York City.

Send me AUDELS ENGINEERS AND MECHANICS GUIDES, 8 numbers, \$12 and "Audel's Answers" for free examination. If satisfactory, I will send you \$1 in 7 days, then \$1 monthly until \$12 is paid.

Name

Address

Occupation

Employed by..... 4T30



Join The Gasoline War!

Over A Million Car Owners Have Enlisted Now

Now a queer little device is sweeping the country like wildfire! Over a million car owners now use it to save gasoline cost. Thousands report startling savings, vastly increased mileage. J. A. Brest saved \$5.00 in two weeks. Zeigler cut his cost in half. Learn here how it works. Then try it at the inventor's risk.

WHEN a Ford goes 40 miles on a gallon—a Buick 27 miles—a Marmon doubles former mileage—and thousands report similar records—do you wonder why men earn at the rate of \$75 to \$200 in a week just handing it to car owners?

The Stransky Vaporizer is the most sensational selling proposition of the last ten years. Full-page newspaper ads have spread the story all over America. Most car owners have heard about it. Everybody wants to see it. Man alive, what a money-making opportunity!

How It Works

This weird little device has astounded automotive engineers, who have tested it. It is simple, easy to understand and install. It saves gasoline by a new scientific principle of combustion that multiplies the vapor power of the raw gasoline. Naturally, when gasoline is fully vaporized, there is less trouble with



carbon. Also, you can now clean out unavoidable carbon in a jiffy because of this device.

Every day we hear praises of its simplicity, its wonderful savings in gasoline mileage, its foolproof operation. Many have used it from three to eight years and still praise it. Imagine how wonderful it works when a million car owners install it—when it is sold all over America and

29 foreign countries—when distributors compete eagerly to get it.

Cash Forfeit If It Doesn't Satisfy

So convinced is the inventor that this queer device will increase gasoline mileage and end carbon troubles that he makes this daring offer described in the coupon on the opposite page. Obviously, every man will want to accept that offer. It gives you the chance to test this device without risk—and win a cash forfeit if the test doesn't prove the story. It also brings you full details explaining why you can make as big an income, full or spare time, as other Stransky representatives. Why delay? Mail it now.

**NO MORE
CARBON
TROUBLE**

More Miles Per Gallon!

FORD:
40 miles on a gallon.
F. X. Carroll.

BUICK:
36 miles on 1 1/4 gals. Pre-
viously made only 8 to 10 miles
per gal. L. L. Robinson.

CHEVROLET:
Rex Dean was getting only
19 miles a gallon. Installed
the Stransky Vaporizer and
increased it to 25. Took it off
and mileage dropped to 19. Put
it back and mileage moved up
to 25 again.

MARMON:
Averaged 20 miles per gal.
on 492-mile trip. Previously
got only 10 to 11 miles.
B. O. Finch.

STUDEBAKER:
[Special Six]
Saved 50 per cent of his for-
mer gasoline consumption.
F. A. Cole.

OLDSMOBILE:
On a 3,000-mile trip, J. R.
Wood increased his mileage
from 17 miles a gallon to 30
miles per gallon.

**\$51 in
an Hour**

\$137.50 in a Week
Ordered 50 and sold
them the first week. O. F. Foster.

\$39 in 3 Hours
In 3 hours on Saturday I cleared
\$39. In one hour the Saturday be-
fore I made \$18. T. M. Wiley.

\$48 in 3 Hours
In three hours Saturday I took
16 orders. J. A. Williams.

READ THIS OFFER

J. A. Stransky Mfg. Co.,
Dept. D-10, Pukwana, South Dakota.

Yes, I'd like to see a sample of the Stransky Vaporizer at your
risk. Also tell me how I can earn \$75 to \$200 in a week as
your distributor. This does not oblige me to buy anything.

Name.....

Street.....(R. F. D.).....

City.....State.....

**The STRANSKY
VAPORIZER**
Saves Gasoline

J. A. STRANSKY MFG. COMPANY
Dept. D-10 PUKWANA, SOUTH DAKOTA

Strongfort Pupil Continues Wrestling Champ



GUS J. CLEM

Exponent of Strongfortism,
Tarpon Springs, Fla.

Mr. Clem is here shown as he appeared with the magnificent trophy won by him in a recent wrestling contest at Daytona, Fla.

CLEM TAKES TWO FALLS FROM McGOWAN

Loving Cup Remains Property of Tarpon Springs Post for One Year

Daytona Beach, May 7 (Special to The Leader)—Amid the wild cheering of two thousand Legionnaires attending the annual Department convention of the American Legion, Gus J. Clem, Tarpon Springs physical culture professor and wrestler par excellence, pinned the shoulders of Jim McGowan, contender for the Legion cup, to the mat in three minutes flat, in the second fall of their match.

The first fall took a little longer than the second. Both men, well trained and of about the same weight, worked hard. Both showed much skill and strength. The twenty-minute period of the first fall came to an end with Clem on top of his opponent with a deadly scissor hold.

McGowan was sponsored by the Russell Warner Post of Daytona. Clem is a member of the Tarpon Springs post. The match was arranged for this meet and will hereafter be a part of each state convention. The loving cup will remain in possession of its donors, the Tarpon Post.

From Tarpon Springs Leader, Florida
Friday, May 7, 1926

Lionel Strongfort's Free Book Sent on Request

Tells many facts about the human body and methods of developing it to a high state of vigorous manhood and should be read by every man seeking health and strength.

Read opposite page for further facts about Strongfortism.

Gus J. Clem, Exponent of Strongfortism, Retains Tarpon Springs, Florida, Trophy

If anyone has ever had any doubts as to the value of Strongfortism in the development of the human body to the highest state of physical perfection, both in health and strength, he will be disillusioned by performances of Strongfort pupils such as that of Gus J. Clem, physical director, exponent of Strongfort methods and all round athlete.

Gus Clem's career has been a succession of victories over his opponents in whatever contests he saw fit to enter. As a lifter of heavy weights and exhibitor of the popular strong-man stunts he has been an outstanding figure wherever he appeared.

Wins Silver Cup in American Legion Contest

Before the hosts of the American Legion gathered at Daytona, Fla., Professor Clem, his body in a fine state of physical perfection—the admiration of all—a product of which Lionel Strongfort could well be proud, entered the wrestling contest with Jim McGowan and contested for the Legion cup, an account of which appears on this page.

Clem readily overcame his opponent and his fine physique was apparent in every movement.

Not only did Clem win the cup donated by the Tarpon Springs Chamber of Commerce but he won the plaudits of the Legion boys of Florida gathered at Daytona and the event was sent out over the wires of the Associated Press.

Inspiring To Young Men

Clem should be an inspiration to every young man seeking symmetrical physical development and vigorous health and manly strength. What Strongfort's teachings have done for Clem they will do for others who are in earnest in their desire for physical betterment.

Gus Clem is only one of many thousands of Strongfort pupils who are to be found over the world. They, like Clem, will give enthusiastic endorsement to Strongfortism. Their testimonials will prove that no man need be a weakling.

STRONGFORT INSTITUTE

LIONEL STRONGFORT, Director

Physical and Health Specialist for over twenty-five years

Dept. 317

Newark, New Jersey, U. S. A.

Battle Your Way to Manly Vigor and Strength

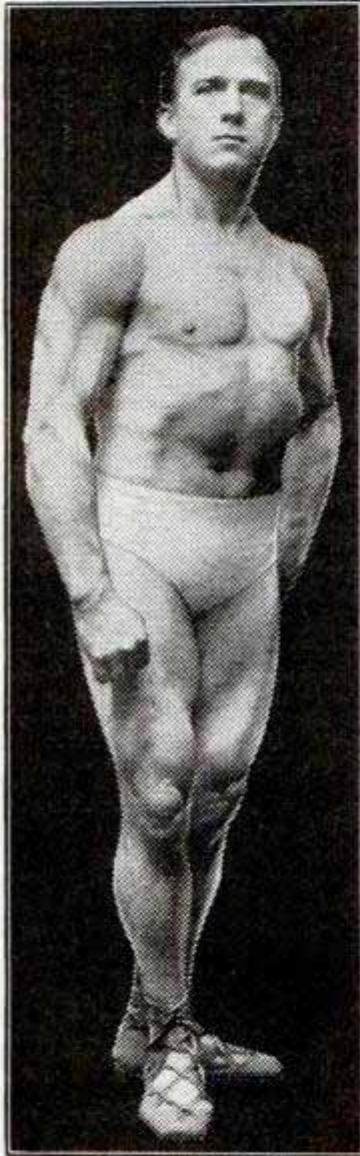

**STRONGFORT
Builder of Men**

Compare Lionel Strongfort's physique, faithfully pictured here, with that of any of the hundreds published of other athletes and strong men. Compare the lines. See the muscles. Note the fact that Strongfort is not crouching, nor pressing, nor expanding—he stands up straight, naturally, normally—the finest and most perfect specimen of physical and health development the world has known.

weakness to health and strength. It is priceless. I'll send it to you on request—FREE. Write for your copy today.

—as Gus Clem has done—as Hajnos, "the Navy Hercules" has done—as thousands of other young men have done—as any fellow can do who feels the shame of weakness—by following the easily understood directions given his pupils by Lionel Strongfort, for 25 years the outstanding physical and health instructor and teacher of the world.

What Weakness Worries You?

What physical defect or mental worry robs you of bodily pleasure and the joys of life? What keeps you from winning honors in sports? What keeps you from attaining favor with men and women—at parties, in business? What blocks you from the better jobs and the higher pay, in the shop, store or office? Maybe you know, deep down in your own heart what keeps you down—what makes you ail and fail—what puts you in the weakling class. No matter what the cause, nor how far below par you have been dragged, Lionel Strongfort wants you to know that you can be a vigorous, manly fellow in every way—that you can be a winner—that you can find delight in being in company, zest in sports, courage in combat, success in the business world.

STRONGFORTISM Creates New Energy and Strength

Through STRONGFORTISM men all over the world have been rejuvenated and restored to health and strength after they have suffered as the inevitable result of excesses, fast living, and abuse of their physical power. STRONGFORTISM has a record unparalleled—there is no other system, or method, or course that compares with it in restoring impaired human beings to health and strength. STRONGFORTISM begins at the source to create new energy and strength by utilizing Nature's forces scientifically. It builds up the internal muscular system first and thus gets rid of constipation, dyspepsia, indigestion, heart ailments, bad blood, catarrhal troubles, rheumatism and other afflictions, increasing your energy and stamina. External muscular development follows quickly and you become a new man inside and out—a fellow to be reckoned with and envied and admired wherever you go.

NO APPARATUS—NO DRUGS

Strongfort's Course does not depend upon artificial means or stimulants—no dope nor drugs. Nature does the work—all you do is give Nature a chance. Only a little of your time, in the privacy of your home, is all that is required. You will be surprised at how easy it all is, how astonishing the results, how speedily you will feel the effects of the new life animating your whole body.

I Want to Send You MY FREE BOOK

This book of many pages and dozens of pictures tells of my wonderful experience

—how I became the outstanding athlete of the world, performing feats others dared not attempt; how I turned the knowledge gained through developing my own body to the benefit of others, and then how STRONGFORTISM was evolved. It tells what I have done for others, what I can do for you. It doesn't mince words. It tells plain truths.

"Promotion and Conservation of Health, Strength and Mental Energy," points the way from disease and

FREE CONSULTATION

Clip and Send this Coupon—Absolutely Confidential

Mr. Lionel Strongfort, Strongfort Institute, Dept. 317, Newark, N. J.—Please send me absolutely free my copy of your book, "PROMOTION AND CONSERVATION OF HEALTH, STRENGTH AND MENTAL ENERGY." I am enclosing ten cents (one dime) to help cover mailing expense, etc., and I have marked (x) before the subjects in which I am most interested.

- | | | |
|---------------|-----------------|-------------------------|
| .. Colds | .. Weak Eyes | .. Great Strength |
| .. Catarrh | .. Flat Chest | .. Lung Troubles |
| .. Asthma | .. Despondency | .. Poor Circulation |
| .. Headache | .. Emaciation | .. Round Shoulders |
| .. Rupture | .. Rheumatism | .. Skin Troubles |
| .. Thinness | .. Nervousness | .. Stomach Disorders |
| .. Pimples | .. Constipation | .. Increased Height |
| .. Insomnia | .. Short Breath | .. Muscular Development |
| .. Overweight | .. Weak Heart | |
| .. Weak Back | | |

Name.....

Age..... Occupation.....

Street.....

City..... State.....

STRONGFORT INSTITUTE
LIONEL STRONGFORT, DIRECTOR,
PHYSICAL AND HEALTH SPECIALIST
DEPT. 317 NEWARK, NEW JERSEY, U.S.A.

O. C.
MILLER
Director
Extension
Work
American
School



The American School

A million Dollar *No-Profit* Educational Institution, now offers men a *double* service—training for a specific job, then help in finding the job. For one small price, on terms of only \$5.00 a month, you are now assured of definite benefits, both in position and salary. Write for complete information—*today!*

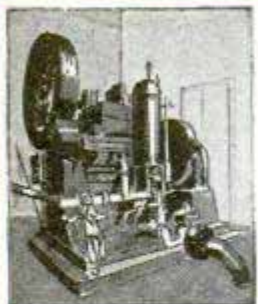

No machine can be built until the Draftsman first builds it on paper. My training prepares you for this work.



Never has the world seen anything like the building boom of today. This has created enormous demand for real Draftsmen.

5 BIG-PAY Branches

The big money in Drafting goes to men who specialize in Machine Design, or Electrical Drafting, or Architectural Drafting, or Structural, or Automotive. It is not enough merely to know *general* Drafting practice. You must know how to calculate and design and plan original work. You need many Engineering subjects to fill the kind of a Drafting position that pays \$60 to \$125 a week. The American School now includes this specialized training in its Drafting course.

Costly Drafting Outfit Given!

Fine, imported instruments like these help you learn Drafting quickly and easily. These standard quality, full size instruments, board, table, triangles, T square, ink, protractor, etc., given to every student without extra cost.

O. C. Miller, Director Extension Work

The American School

3 Drafting

to prove you can

We have invented a new, simplified way to teach Drafting—the first real improvement in Drafting home instruction in history. We want you to see a few of these new Job-lessons, try them, test your own ability to master them—without one penny of cost or obligation. For instance, you will see how we get away from the "copying" methods used in the past, so you develop into a DRAFTSMAN, instead of a "tracer." See for yourself the ingenious new method which compels you to think, to solve problems, to do actual Drafting-room jobs from the very first lesson!

A New, Rapid, Simplified Training

Copying drafting lessons prepares you to be only a "tracer." This new "Job-Method" gives you actual drafting-room jobs in a new one-step-at-a-time way. With pictures which you can understand almost without reading the "lessons." And that is why the American School-trained Draftsmen can qualify for a good job at big pay when they graduate.

Win Success Thru Drafting

Drafting is easy, fascinating work. Short hours. Big pay. And the Draftsman is always in line for promotion to executive positions. This training is complete. It includes high school subjects (if you need them) and all the Engineering and Mathematics Drafting experts require.



FREE Job Service!

The American School now offers its students and graduates, without cost, the services of an efficient employment department keeping in constant touch with employers of Draftsmen all over the U. S. We have placed hundreds of men in good, big-pay Drafting positions. We've made this training so complete, so practical, so easy to master, that our students are bound to make good. And so, because the demand for real Draftsmen continues to exceed the supply and because this training actually prepares men for good Drafting positions we back it with a Free Employment Service.

Dept. D-474
Drexel Avenue and
58th St., CHICAGO

Lessons *Actually* FREE

learn at home in spare time!
Draftsmen Wanted!
\$60 to \$125 a Week!

yourself. Plan your future in Drafting. Even if you have only common schooling, even if you know nothing of Drafting, we guarantee to make you a real Draftsman or to refund your money! Special surprise offer right now to the first 500 men who answer this ad—reduced price, easy terms. Coupon brings complete information.

70,000 fine jobs advertised last year. Get ready to fill one. Get out of the rut. Make something of

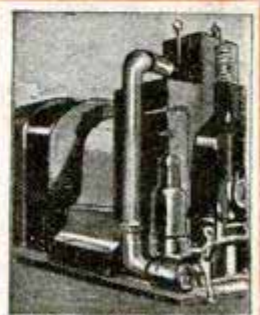

Electricity needs Draftsmen who know Electrical principles as well as general Drafting practice. I give you this training.



The demand for Draftsmen experienced in concrete and structural steel work is enormous. Many big-pay positions open.



Every great Auto factory employs Draftsmen who specialize in Automotive work — men who design bodies, plan engines, etc.

I Will Make This Contract With You
 WHEN you enroll for our home-training in Drafting, we agree to give you:



American School
 —the Million Dollar Educational Institution



1. Complete Drafting training, by the new Practice-Method.
2. Professional Drafting Outfit, as illustrated.
3. We will help you get a good Drafting position at a substantial increase in pay,

4. or we'll refund every cent of your money.

O. C. Miller
 Director Extension Work

Coupon Brings 3 Lessons FREE!

Get them. Test your own ability to learn Drafting and get ready for a fine job and big pay. Coupon also brings surprise offer, and complete information about your opportunities for success in Drafting. **Mail It Today!**

Read These Letters!

City of Chicago
 Department of Buildings
 Gentlemen: The same day I received my diploma I got word that I was one of the two candidates who had successfully passed the examination for Deputy Commissioner of Buildings of the City of Chicago, a position paying \$3600 per year.

There were eight applicants examined besides myself, all men well known to the architectural and engineering profession. Seven of these failed to obtain a passing grade of 70%. My grade was 84.69. Inasmuch as I failed to pass this same examination three years before, my present success is mainly due to the knowledge gained through your School.
 Yours very truly,
ROBERT KNIGHT

Got His Draftsman's Job
 "I wanted to let you know how I came out in getting that job at the Brownell Co., Dayton, Ohio. I was to start and have a trial at Drawing, and I am still in the Drawing room. The engineer seems to like the work I make, and also the other draftsmen. I thank the School very much for getting me in at this place, because your letter of recommendation helped me a whole lot to get the job."
FERNARD WEBER
 730 St. Nicholas Ave., Dayton, O.

Liberty High School
 Bethlehem, Pa.
 Dear Sirs:—This is to thank the American School for all that you have done for me since I signed up for the Drafting and Design Course.

In the eight years since then, I have gradually climbed from the position of tracer to that of Head of the Department of Machine Drawing and Design in our magnificent new \$2,000,000 High School here, at many times the salary which I received at that time.
 The officials of the Pennsylvania State Department, and Dr. Wm. C. Ash of the University of Pennsylvania, all claim that our course in Drafting and Design is the best now being taught in this state. Every drafting graduate that we have turned out has proved successful, and one is now Chief Draftsman in a local steel concern. Yours sincerely,
J. S. LEAR

Has Charge of Large Jobs
 "Even before I had finished my course, I was put in charge of large construction jobs in different cities. I have been doing that ever since, and the jobs are getting larger all the time. I owe my success to the American School because of the knowledge I gained in mathematics and calculations."
ELMER L. LAMB
 1306 Smith St., Peoria, Ill.

3 Drafting Lessons *Actually* FREE

O. C. MILLER, Director Extension Work
AMERICAN SCHOOL
 Dept. D-474, Drexel Ave. and 58th St., Chicago.
 Rush 3 Free Drafting Lessons, Job and Raise Offer, complete information, money-back guarantee, etc., to prove I can become a real Draftsman at home in spare time.

Name.....
 Street No.....
 City..... State.....



"I was afraid to try for a better job"

"EVERY time there was a good opening in our office, my friends would urge me to try for it. But I always put them off with some excuse. I knew I wasn't prepared and that I couldn't make good in a bigger job even if I got it.

"I wasted five good years that way and I might still be struggling along in the same old rut if Ralph Harris hadn't been promoted right over my head.

"That woke me up and I was fighting mad when I got home that night. 'If the I. C. S. can help men like Ralph Harris,' I said to my wife, 'it can help me. I'm going to start right now and make myself the first man the Boss thinks of when the next good position is open.'

"That's exactly what happened. In less than six months there was a fine opening in the office and the Boss said he would give me a chance at it because he had heard I was studying with the I. C. S.

"I've had two other promotions since then and I'm earning nearly double what I was when I enrolled with the I. C. S."

Thousands of men have happy prosperous homes because they had the foresight to prepare themselves for advancement through the home-study courses of the International Correspondence Schools. Hundreds of them report salary increases of \$10, \$15 and \$25 a week. Many are earning \$75, \$100 and \$150 a week. Some have doubled and even tripled their salaries. Some are earning \$10,000 and \$15,000 a year. Others have businesses of their own.

Won't you let the I. C. S. help you too? Isn't it worth a two-cent stamp to at least find out how you can win promotion and a larger salary?

Mail Coupon for Free Booklet

INTERNATIONAL CORRESPONDENCE SCHOOLS
Box 5645-E, Scranton, Penna.

Without cost or obligation, please send me a copy of your booklet, "Who Wins and Why," and full particulars about the course before which I have marked X in the list below:

BUSINESS TRAINING COURSES

- | | |
|--|---|
| <input type="checkbox"/> Business Management | <input type="checkbox"/> Salesmanship |
| <input type="checkbox"/> Industrial Management | <input type="checkbox"/> Advertising |
| <input type="checkbox"/> Personnel Organization | <input type="checkbox"/> Better Letters |
| <input type="checkbox"/> Traffic Management | <input type="checkbox"/> Show Card Lettering |
| <input type="checkbox"/> Business Law | <input type="checkbox"/> Stenography and Typing |
| <input type="checkbox"/> Banking and Banking Law | <input type="checkbox"/> English |
| <input type="checkbox"/> Accountancy (Including C.P.A.) | <input type="checkbox"/> Civil Service |
| <input type="checkbox"/> Nicholson Cost Accounting | <input type="checkbox"/> Railway Mail Clerk |
| <input type="checkbox"/> Bookkeeping | <input type="checkbox"/> Common School Subjects |
| <input type="checkbox"/> Private Secretary | <input type="checkbox"/> High School Subjects |
| <input type="checkbox"/> Spanish <input type="checkbox"/> French | <input type="checkbox"/> Illustrating <input type="checkbox"/> Cartooning |

TECHNICAL AND INDUSTRIAL COURSES

- | | |
|---|--|
| <input type="checkbox"/> Electrical Engineering | <input type="checkbox"/> Architect |
| <input type="checkbox"/> Electric Lighting | <input type="checkbox"/> Architects' Blueprints |
| <input type="checkbox"/> Mechanical Engineer | <input type="checkbox"/> Contractor and Builder |
| <input type="checkbox"/> Mechanical Draftsman | <input type="checkbox"/> Architectural Draftsman |
| <input type="checkbox"/> Machine Shop Practices | <input type="checkbox"/> Concrete Builder |
| <input type="checkbox"/> Railroad Positions | <input type="checkbox"/> Structural Engineer |
| <input type="checkbox"/> Gas Engine Operating | <input type="checkbox"/> Chemistry <input type="checkbox"/> Pharmacy |
| <input type="checkbox"/> Civil Engineer | <input type="checkbox"/> Automobile Work |
| <input type="checkbox"/> Surveying and Mapping | <input type="checkbox"/> Airplane Engines |
| <input type="checkbox"/> Metallurgy <input type="checkbox"/> Mining | <input type="checkbox"/> Agriculture <input type="checkbox"/> Navigation |
| <input type="checkbox"/> Steam Engineering | <input type="checkbox"/> Mathematics <input type="checkbox"/> Radio |

Name.....
Street Address.....
City..... State.....
Occupation.....
Persons residing in Canada should send this coupon to the International Correspondence Schools Canadian, Limited, Montreal, Canada

Wrestling Book

Learn at Home

10c



Men, Boys be perfect physically. Learn right in your own home from **WORLD'S CHAMPIONS** how to be an expert **WRESTLER**. Learn secret trick holds, blocks, breaks and pinning holds. Learn how to defend yourself against bigger, stronger men. Learn Jiu-jitsu. Also most wonderful course in **PHYSICAL CULTURE** ever discovered. The world renowned **FARMER BURNS** and **FRANK GOTCH** are authors of these splendid lessons. Learn to be a real athlete. You can if you'll try. Have a beautiful attractive body that all will admire. Surprise your friends, and the "bully" with your great ability. Learn to protect yourself, your mother, sister or sweetheart. Have perfect health, ability.

Only 10c

Send only 10c coin or stamps, for 82 page book, **ILLUSTRATED**, giving full particulars. Tells the secrets of the big Champions; gives many tricks, holds and other valuable information. A costly book which we send for only 10c—the cost of packing and postage. Don't miss it. Don't delay. **SEND TODAY—THIS MOMENT**. State your age.

Farmer Burns School, 1774 Railway Exchange Bldg., Omaha, Neb.

Stop Making Mistakes in English

Wonderful new way to improve your English. No rules to learn. No hard study. Grammar, spelling, punctuation, and expression, taught in 15 minutes a day—at home. Self-correcting feature makes it fascinating as a game. Write today for Free Book "How to Speak and Write Masterly English." Address



SHERWIN CODY SCHOOL OF ENGLISH
54 Searle Building, Rochester, N.Y.



Learn SIGN AND SHO-CARD Lettering

Fascinating work. Pays \$50 to \$200 weekly. Vassos gets \$25 for a sho-card. Some posters bring \$300. Many earn while learning. Study in spare time. Learn quickly. For facts and guarantee write: **DETROIT SCHOOL OF LETTERING, 173 Stimson, Detroit, Michigan.**

Learn Watchwork, Jewelrywork and Engraving

A fine trade commanding a good salary, and your services always in demand. Address: **Horological, Dept. P. Bradley Institute, PEORIA, ILLINOIS**, for our latest catalog.

WANT WORK AT HOME?

Earn \$18 to \$60 a week **RETOUCHING** photos. Men or women. No selling or canvassing. We teach you and furnish **WORKING OUTFIT** given with each enrollment. Limited offer. Write today. **Artcraft Studios, Dept. 60, 3900 Sheridan Rd., Chicago**



Electrical Trades/Need Men

LEARN Automobile Starting, Lighting, Ignition, Storage Batteries, Armature Winding, House Wiring, Farm Lighting, Electric Welding, Electric Refrigeration, A. C. and D. C. Motors, Power and Light Switchboards, Radio.

EARN \$200 to \$400 monthly. \$320,000.-000 paid in wages to electrical workers in U. S. last year. Get your name on the payroll this year. Easy to learn by actual work on real equipment.

FREE BOOK—Write today for book which explains the Coleman System of ten week courses.

WM. H. COLEMAN, President
Coleman Electrical School
1628A MAIN ST., KANSAS CITY, MO.

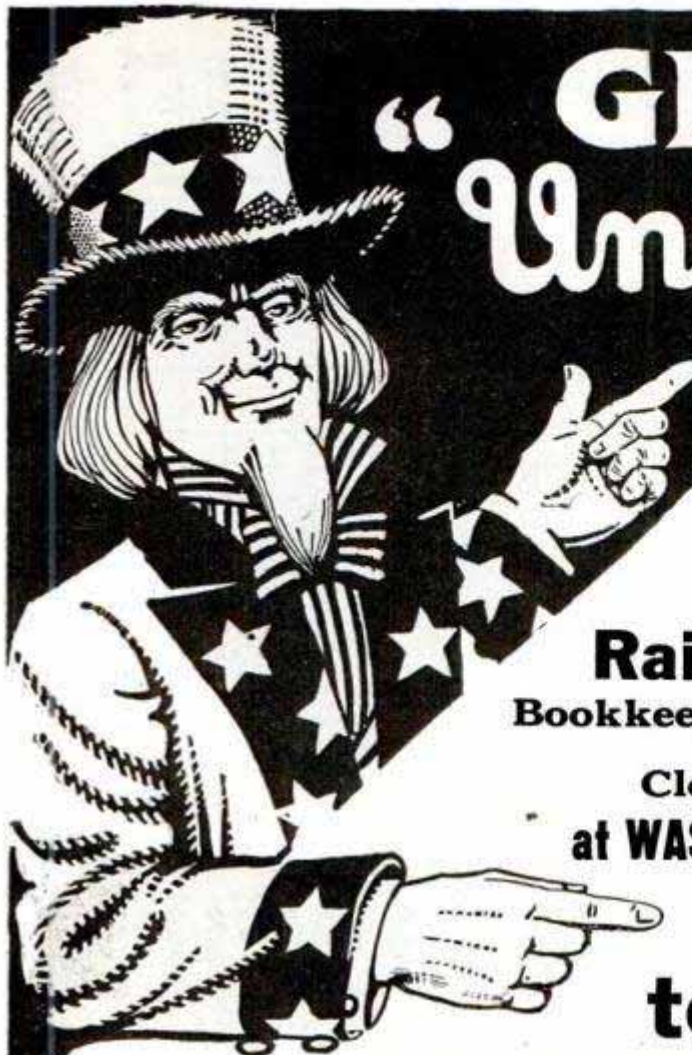

“GET ON” Uncle Sam’s PAYROLL

**Post Office Clerks
City Mail Carriers
Rural Mail Carriers**

Railway Postal Clerks

**Bookkeepers Stenographers
Income Tax Auditors
Clerks in Government Offices**

at WASHINGTON, D. C., and ELSEWHERE

**\$1140⁰⁰
to \$3300⁰⁰ a Year**

These are steady positions. Strikes, poor business conditions, lockouts or politics will not affect them. U. S. Government employees get their pay for full twelve months every year. There is no such thing as “HARD TIMES” in the U. S. Government Service.

RAILWAY POSTAL CLERKS

Railway Postal Clerks now get \$1900 the first year, being paid on the first and fifteenth of each month. \$79.16 each pay day. Their pay is quickly increased, \$100 and \$150 a year, the maximum being \$2700 a year. \$112.50 each pay day. They get extra allowance for hotel expenses when away from home.

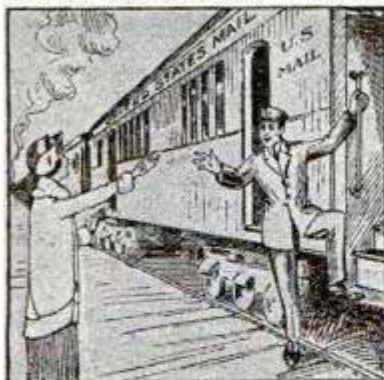

PAID VACATIONS

Railway Postal Clerks, like all Government employees, are given a yearly vacation of 15 working days (about 18 days). On runs they usually work three days and have three days off duty, or in the same proportion. During this off duty and vacation, their pay continues just as though they were working. When they grow old they are retired with a pension. As Railway Postal Clerks are continually traveling, they have an excellent chance to see the country. They are furnished with a railroad pass.

CITY MAIL CARRIERS—POST OFFICE CLERKS

Clerks and Carriers get \$1700 the first year regular, and automatically increase \$100 a year to \$2100 with further increase to \$2300. They also have 15 days vacation. Examinations are frequently held. City residence is unnecessary.

GENERAL CLERK

(Open to men or women 18 or over)

Salary \$1140 to \$1860 a year. Pleasant clerical work in the various departments and offices at Washington, D. C., and elsewhere throughout country.

WHAT WILL YOU EARN 5 YEARS FROM NOW?

Compare these conditions with your present or prospective condition, perhaps changing positions frequently, kicking around from post to pillar, no chance in sight for PERMANENT employment; frequently out of a position and the year's average salary very low. DO YOU EARN \$1900 EVERY YEAR? HAVE YOU ANY ASSURANCE THAT A FEW YEARS FROM NOW YOU WILL GET \$2700 OR MORE A YEAR, EVERY YEAR?

**FRANKLIN
INSTITUTE
Dept. H-174
ROCHESTER,
N. Y.**

GET FREE LIST OF POSITIONS

Fill out the coupon. Tear it off and mail it today—now, at once. DO IT NOW—This investment of two cents for a postage stamp may result in you getting a U. S. Government Job.

MAIL COUPON TODAY

Railway Postal Clerk..... (\$1900-\$2700)
Post Office Clerk..... (\$1700-\$2300)
City Mail Carrier..... (\$1700-\$2100)
Rural Mail Carrier..... (\$2100-\$3300)
Clerk in Government Offices..... (\$1140-\$1860)
Bookkeeper..... (\$1320-\$2040)

Name.....

Address.....

Use This Coupon Before You Mislaid It—Write or Print Plainly

**Make
\$10.00
after supper
while learning**

*That's what Wittenberg
did—and now as a
"COOKE" Trained
Electrical Man
he is earning*

NEVER HAVE SUCH OPPORTUNITIES EXISTED BEFORE. Money! Position! Influence! Success—the electrical industry offers you ALL this. In what other profession could you go out of an evening and earn \$10 while learning?—make \$500 during a season's odd moments?—"knock out" \$25 to \$30 a week doing spare time jobs? Yes, these things ARE being done every day. Hundreds of Cooke trained men are doing them!

**The "COOKE" Way to BIG Pay
Easy—Practical—Sure**

Previous experience not necessary. A half hour a day at home, learning Electricity by the simplified practical "Work Sheet" and "Job Ticket" Method of Chief Engineer Cooke, will make you a Trained Electrical man. He furnishes all necessary tools and apparatus—five big Working Outfits—without extra cost. You have nothing to buy.

And you can make good money while you learn. The Chief shows you how to get spare-time work—how to do it—and tells you what to charge. That's while learning! When you have finished you are ready for a BIG PAY Job. Thousands of Cooke trained men earn \$3,500 to \$10,000 a year. Some even more! It's all a matter of ambition—of getting started right—of placing yourself in the hands of one of America's foremost electrical instructors, Chief Engineer Cooke.

Valuable Book FREE—Send for It

Send now for the big, interesting, 64-page illustrated book that Chief Engineer Cooke has prepared for you—"Secrets of Success in Electricity." It's free. Get it—read it. Learn how Cooke trains men, easily, quickly, thoroughly—how thousands of Cooke trained men have won big-pay jobs—how you, too, can win permanent success in this fascinating, big-pay industry. Do not delay—mail the coupon today!



"Last month I made \$197.00 on spare time wiring jobs. Not bad for a 19-year-old boy. There are fellows in this town who don't make half that much full time. You sure put men in the big pay class." — John Hudec, 223 West 9th Ave., Tarentum, Pa.



"In addition to my regular work I am handling electrical work of all kinds. This is bringing me in from \$300 to \$500 per month, which isn't so bad for spare time work. I am thankful for what you have done for me." —Julius A. Fischer, Wallace, Idaho.

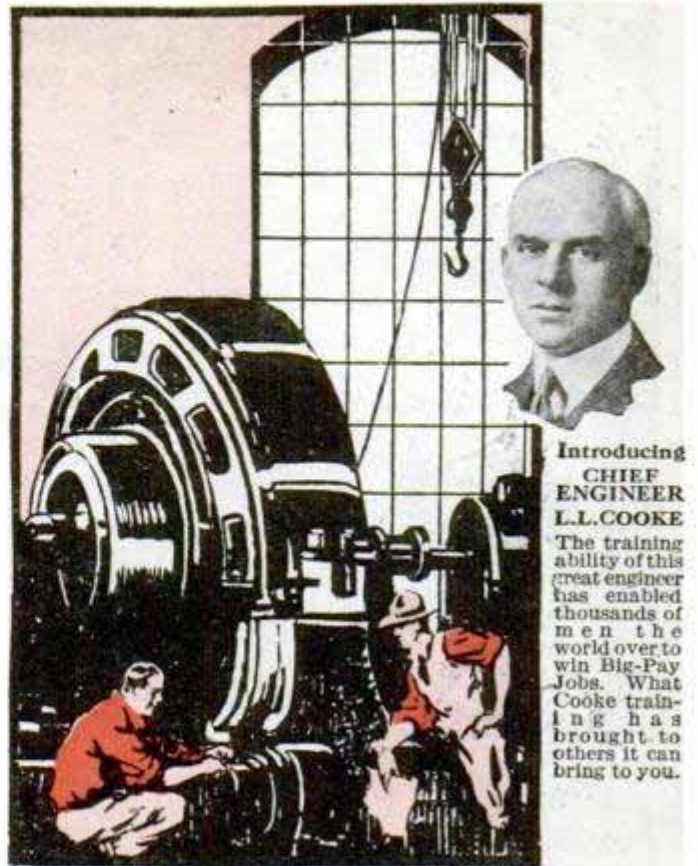

Introducing
CHIEF ENGINEER L.L. COOKE
The training ability of this great engineer has enabled thousands of men the world over to win Big-Pay Jobs. What Cooke training has brought to others it can bring to you.

**Over \$6000.00
a year in
ELECTRICITY**

Read what this Cooke trained man has to say "I have just bought a 5-passenger sedan and my income now amounts to about \$475 a month—\$118 a week. Before I took your Course I never made over \$50 a month. I only had a 6th grade education and this is the only electrical training I have had. Even while taking your Course I often made an extra ten dollars for an evening's spare time work."—Herman Wittenberg, 1930 Grand Concourse, Bronx, New York. Surely, you can do as well! Tear off, sign and mail the coupon to

L. L. COOKE, Chief Engineer

**L. L. Cooke School
of Electricity**
Formerly known as
Chicago Engineering Works
(Incorporated)
Dept. 14
2150 Lawrence Ave.
CHICAGO, ILL.



COUPON

CHIEF ENGINEER COOKE,
Dept. 14, 2150 Lawrence Ave.,
Chicago, Ill.

Please send me your free book, "The Secrets of Success in Electricity," and full particulars of your training that helps men into big pay jobs. This does not obligate me in any way.

Name.....
Address.....
City.....State.....

The "Cooke" Trained Man is the "Big Pay" Man

Classified Advertisements

WORLD'S BEST WANT AD MEDIUM

Advertisements in this section, 30 cents per word, each insertion, minimum 10 words, payable in advance. To be inserted under proper classification in May issue, copy should be in our office March 18th.

ADVERTISING AGENCIES

ADVERTISERS—To buy, sell or to secure agents, salesmen, you can place your 24-word ad. In the following 15 leading Sunday papers for only \$15; circulation over 2,000,000; Age-Herald, Birmingham; Gazette, Little Rock; Journal, Atlanta; Star, Indianapolis; Register, Des Moines; Courier-Journal, Louisville; Times-Picayune, New Orleans; Star, Kansas City; World-Herald, Omaha; Courier, Buffalo; Enquirer, Cincinnati; Press, Pittsburgh; Commercial-Appeal, Memphis; News, Dallas; Journal, Milwaukee. Proof of Insertion Guaranteed or Money Refunded. 52-page rate book sent Free. Frank W. Lenhoff Advertising Agency (established 1897), 600 North Michigan Blvd., Chicago.

A TEN Dollar Ad may put your proposition over. \$10 pays for a 4 line 24 word classified ad one Sunday in 9 of the largest newspapers. Reach over 6 million readers. Minneapolis Tribune, Buffalo Courier, St. Louis Post-Dispatch, Pittsburgh Press, Indianapolis Star, Atlanta Journal, Birmingham News, Cincinnati Enquirer, Little Rock Gazette. Free catalogue showing other lists of newspapers and magazines sent on request. Ankrum Advertising Agency, 22 West Jackson Blvd., Chicago. Largest classified advertising agency in the world.

ADVERTISE in the classified section of newspapers and magazines, to secure help, money, or to sell. 24-word advertisement in nine big Metropolitan papers \$10.00. Nearly two million circulation. Many other bargain lists. Write for Free 58-page Directory No. 26. Brinckerhoff Advertising Agency, 37 W. VanBuren, Chicago.

ADVERTISE in 24 Big Sunday Newspapers, 24 words \$15.00. Excellent for securing Agents, Salesmen, and Business Opportunities. Catalog listing 1,000 leading Dailies, Weeklies, Mail Order Magazines, Everything. Free. Wade Advertising, Baltimore Bldg., Chicago.

ADVERTISE—Newspapers, Magazines, Country papers—classified (Want Ads)—display space. Free catalog. Martin, 37B West 39th, New York.

GET Results—Advertise in 220 Eastern newspapers, 25 words \$8.80. Shaw, Box 983, Wilmington, N. C.

SIX Word Line—355 rural weeklies \$3.55. Admeyer, 4112-M Hartford, St. Louis.

FOR ADVERTISERS

ADVERTISE Free. Your 30 word advertisement free if you send \$1.00 for yearly subscription to National Salesman's Magazine. Start Right! Start Small! Quick Results! Select Salesman's List for Sale. New positions advertised make \$30 to \$200 weekly. New Business Ideas, Advertising, Selling, Promoting Plans Easily Mastered. National Salesman's Magazine, 2213 Lawrence Ave., Chicago.

ENDLESS orders without advertising. Guaranteed plan \$1.00. Any desired formula \$1.00. Popular Institute, AP-430, Milwaukee Ave., Chicago.

40 WORDS insert 60 magazines \$2.00 Empire Agency, Shawano, Wis.

ADVERTISE in 275 country newspapers, 28 words, \$10. Keator, Hartford Bldg., Chicago.

25 WORDS 88 magazines; \$1.00. Thrice \$2.00. Smith's Service, 1194, Wenatchee, Wash.

YOUR 25-word advertisement in Worthwhile and year's subscription, 50c. Sample copy, 5c. Worthwhile, D16, 130 Cady St., Rochester, N. Y.

50,000 NEW, live opportunity seekers reached for \$1.00. A. B. Ceedson, 3570 West 25th, Cleveland, Ohio.

CUTS, Drawings \$1.50. Window Cartoons, 6. \$1.50. GPO, Bx471, New York.

ADVERTISING SERVICE

LET me help you get more cash business by mail. Booklet free describes vital specialized service for old or new advertisers. Ask for it now. E. C. Barroll, 1117-B, Holland Bldg., Saint Louis, Mo.

SALES PROMOTION

\$50 TO \$50,000 Daily Sales Developed During 28 years for clients by our direct mail plans, copy, campaigns. One product, 1923, an idea; this year \$100,000 orders booked. Fifty year old concern desired 50 national representatives in 1925; we produced 40 in three months. 700 dealers in 10 months at \$3 each, for another. Ten years Sales Promotion Manager Larkin Co. Submit sales problems for Free diagnosis. James C. Johnson, 118A Woodbridge Ave., Buffalo.

ONE Client used a paragraph from one of my sales-letters as an ad. Profit \$108 first month. Ad cost \$1.60. Letter paid better. Give me your line, and I'll bait your hook. Vernon Baker, Elyria, Ohio.

SALES letters, booklets, etc., originated. Wilton Webb, Salamanca, N. Y.

SALES Letters, Advertising, Sales Tex Ad Shop, Box 32, Adrian, Mich.

AUTOMOBILE SUPPLIES

SAVE 40—80%. New and Used Automotive Parts, 2,000 models. Bankrupt supplies, 5,000 bargains. Sport shields, \$5.00, roadster tops, \$10.00, complete touring, \$15.00. Wheels, radiators, generators. Brightman Auto Exchange, 321 Windsor Ave., Hartford, Conn.

FORD Armatures. Wind 'em yourself. Simple, easy, practical instructions \$1.00. With wire and insulation for one Armature, \$2.00 postpaid. Pennington Electric, Box 567, Bellingham, Wash.

YOU are wanted to resilver mirrors at home. Immense profits, plating auto parts, headlights, tableware, stoves, etc. Outfits furnished. Write for information. Sprinkle, Plater, 77, Marion, Ind.

MAKE steady profit charging batteries with our new Model "BT" Scioto Battery Charger. Ordered direct, \$50. Equipment and supplies at wholesale. Start a Battery Shop for \$135.94. Get catalogue. Adams-Barr, Columbus, Ohio.

VULCANIZING Auto Tires is a Paying Business. We have Plants near you from \$50 up. Catalog Free. Instruction Book \$1. Equipment Exchange, 108 East 11th, Los Angeles, Calif.

KNOCKOUT Carbon System—Remove carbon from your motor in a few minutes; costs 2c. System prepaid \$2.00. The Craig Company, Box 1061, Fort Worth, Texas.

MAGNETOS, Starters, Generators, Ignition systems, spark plugs, part, timing chains, repairing. Meinert Magneto Co., 1759 E. 21st St., Cleveland, Ohio.

1 AUTO Gas Saver Free. To introduce. All makes. Amazing mileage increase. Critchlow, C1-805, Wheaton, Ill.

AUTO Emblems. Any Lodge. Write. North Central Distributors, Dept. J, Ashland, Ohio.

TRUCK Owners—Stop shoveling, dump your loads. Dependable Hoist Co., Streator, Ill.

RADIATORS, Emblems at wholesale prices. All standard make cars. Send for price list. Imperial Auto Supply Co., 1429 Olive Ave., Chicago.

AUTOMOBILES

75% OF ALL money spent by automobile owners for electrical repairs goes into burned-out generators and lights. One hour's work on each generator will prevent this unnecessary expense. You can make high wages performing a real service if you know how and why. Send \$10.00 today for complete guaranteed instructions, including three months' advisory service on automotive electrical problems. Frank R. Weisgerber, Automotive Electrical Engineer, Olympia, Wash.

620 VALUABLE kinks for all who own, drive, repair or care for automobiles, only 98 cents. Write us to send you Popular Mechanics Auto Owner's and Auto Repairman's Handbooks. Fully illustrated. Pay Postman 98 cents and few cents postage. Popular Mechanics Press, Room 904, 200 E. Ontario St., Chicago.

PATENTS. Time counts in applying for patents. Don't risk delay in protecting your ideas. Send sketch or model for instruction or write for Free book "How to Obtain a Patent" and "Record of Invention" form. No charge for information on how to proceed. Communications strictly confidential. Prompt, careful, efficient service. Clarence A. O'Brien, Registered Patent Attorney, Security Bank Building (directly across street from Patent Office), Washington, D. C. See pages 138 and 139.

SHOP Notes for 1927. Get your copy now. Only a limited edition. Contains all the articles published in the Shop Notes department of Popular Mechanics Magazine during 1926. Send No Money. Just write a postal and we'll send 1927 Shop Notes and any one of the other following numbers: 1908, 1912, 1913, 1914, 1915, 1916, 1917, 1919, 1920, 1921, 1922, 1923, 1924, 1925, 1926. Pay postman 98 cents and the postage when he hands you the two books. Popular Mechanics Press, 200 E. Ontario St., Room 904, Chicago, Ill.

AUTOMOBILE SERVICE EQUIPMENT

ELECTRICAL testing equipment. Biggest profits in automotive work come from complete electrical service. Equipment pays for itself without expense to you on easy monthly payments. Write for full information without obligation. H. B. Equipment Co., Box M-475, Troy, Ohio.

AUTO Repair Shop Lathe 9"x3'. Back Geared, Screw Cutting; price, including countershaft and equipment, \$150.00. For truing armatures, refacing valves, finishing pistons, making bushings, thread-cutting, etc. Write for No. 33 Auto Mechanics Hand Book describing this lathe. South Bend Lathe Works, 620 East Madison St., South Bend, Ind.

BARGAINS in reprocessed battery chargers. Rectifiers of all kind and a few Constant Potential One Day Chargers, two of them practically new. Terms arranged. Very low prices, while they last. I. C. Helmick, Box M-473, Troy, Ohio.

COMMUTATOR and valve truing lathe. Jefferson Mfg., North 2nd St., Fairfield, Iowa.

AUTOMATIC Air Compressors, paint spray outfits in sizes to suit the smallest and largest business. The only equipment of this kind on the market using the Silent Spiral Bevel Transmission. Low prices and easy terms. Automatic Compressor Co., Box M-474, Troy, Ohio.

FOR FORD OWNERS

SPEND cents. Save Dollars. Ford owners. Our book, the Ford Manual tells you secrets of your car. How to start if you lose switch key. Explains troubles that baffle you. 250 repair operations, time and wiring diagram. 40c, no stamps, postpaid. Ford Manual, 1920 Kearny St., N. E., Washington, D. C.

AUTOMATIC Brake and Reverse Band Adjuster \$1.75. Installation simple. Free Sample to salesmen. K-D Manufacturers Company, Jamestown, N. Y.

SIMPLEX Mechanical Starter—all Fords—especially trucks. Easily attached. Guaranteed. \$10. American-Simplex Co., Anderson, Ind.

FORDS: Start instantly with the wonder spark coil Intensifier. Guaranteed satisfaction or money back. \$1.00 postpaid. Joseph Krizan, Jr., Lark, Texas.

1 AUTO Gas Saver Free. To introduce. All makes. Amazing mileage increase. Critchlow, C2-805, Wheaton, Ill.

SEE objects in dark, luminous paint 25c. Universal, 319 McKinley, Waukegan, Ill.

UNDERSLUNG with "RKO" Swing Lo Irons. See "Red-1-Kut" ad page 135.

POWER Tire Pumps for Fords. Claggett Mfg. Co., Marlboro, Md.

MOTORCYCLES, BICYCLES AND SUPPLIES

OVERSTOCKED Used Motorcycles. 1923 Indian Chief \$95.00. 1923 Harley Davidson \$95.00. 1923 Henderson DeLuxe \$120.00. Two hundred others; write for free list. Myerow Brothers Co., 15 Berkeley St., Boston, Mass.

RENEWED Harley Davidson Motorcycles. Unconditionally guaranteed, attractive prices. Send for free list. Heinz Motor Co., 611 North Baltimore Ave., Baltimore, Md., Harley Davidson Distributors.

SLIGHTLY used motorcycles, all models; prices right. Accessories, tires, parts. Send for literature. Harley distributors. Harp Bros., 3139 Grand River, Detroit, Mich.

DON'T buy a Bicycle Motor Attachment until you get our prices. Shaw Mfg. Co., Dept. 27, Galesburg, Kans.

HENDERSON, Excelsior parts, new, used; parts book 25c; used H-D parts half price. All makes used motorcycles cheap; list 5c. John F. Ballak & Co., 100 N. 12th St., St. Louis, Mo.

REBUILT Indian Motorcycles, lowest prices. Used motorcycle parts. Hurek Indian Co., 2127 Locust, St. Louis, Mo.

MONEY Saving Motorcycle Bargains—Large stock of Used Harley-Davidson—\$50 and up. Send for Free bargain bulletin—Now! Motorcycle Parts, accessories, repairs for all makes. Knuth's Harley-Davidson Agency, 2525 Fond Du Lac Ave., Milwaukee, Wis.

GOOD Second Hand Parts for Indian, Harley, Henderson, Ace and Excelsior Motorcycles. No Junk. Ship C. O. D. No Lists. J. B. Dahl, 3661-63 Archer Ave., Chicago, Ill.

BICYCLES \$10; racers \$15; Tandem \$25. Tricycle delivery, reducing, exercising, training machines, repairing. Lakewell Bicycle Store, 175 W. Lake, Chicago.

MOTORCYCLE Bargains. Used, rebuilt. Guaranteed. Shipped on approval. Catalog free. Floyd Clymer, 810 Broadway, Denver, Colo.

SEND stamp for Bargain Bulletin. All makes rebuilt motorcycles at lowest prices. Used parts half price. Ash Motor Corporation, Rochester, N. Y.

AVIATION

LEARN to Fly; \$100.00 including Solo. We guarantee to solo you regardless of the number of flying hours required. Our instructors are ex-army aviators and air-mail pilots with wide experience. Our training equipment is the best obtainable. Our course requires about two weeks, depending on the individual. No bond required, no charge for breakage. Eight years without an accident. 76 students graduated in 1925. Commercial aviation is a rapid growing industry. Don't delay! Enroll now in one of the oldest and best known flying schools in America. Write for booklet, Robertson Aircraft Corporation, operators of the United States Air Mail, St. Louis-Chicago, Lambert-St. Louis Airport, Anselm, Mo.

LEARN Aviation the Watson-Way—Complete course—flying, construction, assembly, repair and maintenance of plane and motor. New method of teaching aviation. All under direct supervision of Lieut. Hugh Watson, flying instructor during the war and a leading commercial aviator for the past ten years. Various makes of modern planes, good location, splendid flying field. No specified number of hours. Write now for complete information. Watson Airport Co., Blue Ash (Cincinnati), Ohio.

AIRPLANES, motors, supplies; 100 h. p. Gnome Rotary motors \$75.00 Florida; 28 h. p. Lawrence motors \$125.00; Curtiss 90 h. p., slightly used, \$250. Sheeplined leather helmets, \$5.00; non-shatterable goggles, oval \$2.50, wide-visor \$4.00. Temperature gauges with 12 ft. tubing \$7.50. Leather breeches \$12.00, leather coats \$18.50, or sheeplined \$23.50. Aerial Camera \$100. Airplane Turnbuckles 15c. Logan Aircraft, 716 W. Superior, Cleveland.

TEN lessons in the air of twenty minutes each will make you a pilot by our advanced method of training. This, together with our five weeks shop course, at \$100.00 makes America's oldest aircraft factory the most popular flying school. Work after class hours guaranteed. Special spring and summer evening course, including shop work, field and flying, \$185.00. Employment assistance on jobs paying \$20.00 to \$40.00 per week. Heath Airplane Company, Chicago, Ill.

DICTIONARY of Aviation, \$3.90. Langages Publishing Company, 8 West 40th Street, New York.

PATENTS. Time counts in applying for patents. Don't risk delay in protecting your ideas. Send sketch or model for instruction or write for Free book "How to Obtain a Patent" and "Record of Invention" form. No charge for information on how to proceed. Communications strictly confidential. Prompt, careful, efficient service. Clarence A. O'Brien, Registered Patent Attorney, Security Bank Building (directly across street from Patent Office), Washington, D. C. See pages 138 and 139.

AERONAUTICS! Are you keeping pace with the new developments? "Aeroplane Engines in Theory and Practice," by Rathbun describes engines fully. Used as a text in Government Schools and includes all makes. For Mechanician, builder and flyer. Send no money. Just order on a postal. When postman hands you book, pay him \$2.50 and postage charges. Popular Mechanics Press, Room 904, 200 E. Ontario St., Chicago.

LEARN to fly by flying. Room and board near field very reasonable. Ground school combined with flying course. Write for details at once. Waco aeroplanes for sale. The Embury-Riddle Company, Lunken Airport, Station C, Cincinnati, Ohio.

AIRPLANE Wheels 26" by 3" complete with tires and tubes, \$9.50. Guaranteed brand new. Air Transport, Carle Place, L. I., N. Y.

AIRPLANES. Send for free cuts, and plans of our wonderful two place, companion type, small, high lift wing monoplane, and information how to build this ship, and be sure it will fly, also propeller literature. Crawford Airplane Mfg., 2225 American Ave., Long Beach, Calif.

TRAINING in building, designing, and flying under the builders of the famous King Bird Airplane. Age must be over sixteen. Wake up. Better yourself. Aviation is booming. Write today. Dept. K-4, Western Airplane Corp., Monadnock Bldg., Chicago.

THE American School of Aviation announces a new correspondence course in Mechanics of Aviation. A thorough training in Practical Aeronautics. American School of Aviation, Dept. 1861, 3601 Michigan Ave., Chicago, Ill.

LEARN flying right. Latest type planes. Large field. Ideal flying climate. Graduates real pilots. Rates reasonable. Address, McMullen Aviation School, Tampa, Fla.

LEARN to fly. Earn tuition, if lacking cash. Varney Aircraft Co., Peoria, Ill.

"HEATH Parasol"—Lowest priced sport plane ever built. Send 5c for circular; \$5.00 for blue-prints. Heath Airplane Company, Chicago, Ill.

SEND dime for 12 inch mounted propeller and circulars on free three foot model aeroplane. No selling. Aero Shop, 3050 Hurbit Ave., Detroit, Mich.

BIGGEST, Best Catalog Model Airplanes, Parts Supplies; 5c postpaid. Ideal Company, 165 1/2 Spring Street, New York.

STURTEVANT Motor, 140 H. P., First Class, \$185. H. Lesieur, 179 Eugenia, New Bedford, Mass.

THE Age of the Air Is Here. For reliable information on both airplane building and flying we recommend "Aeroplane Construction and Operation," by Rathbun, a book used in Government Schools. All features of construction treated. Send no money. Pay postman \$2.50 and postage. Popular Mechanics Press, Room 904, 200 E. Ontario St., Chicago, Ill.

BOOKS AND PERIODICALS

PROFESSIONAL Letter Writer. Big book Free. You'll need this valuable book to write expert business and social letters easily. Free with \$1.00 yearly subscription to National Salesman's Magazine, 2218 Lawrence, Chicago.

THE Truth About the Bible. Tells what the ministers are afraid to tell you. Tells what science has found out about the Bible. Separates double stories of creation, flood, Sabbath, explains mystery of Cain's wife. Explains evolution. Book \$2 postpaid or send for free circulars. Frank Omdorff, Mattoon, Ill.

STENOGRAPHY—Pitman Light-Line Book, 25c, with Squaring-Circle. Interest Problems. Marr, Teacher, B605, Nashville, Tenn.

BOOKS, all kinds 5c. U. Library, Hesse Sta., Boston, Mass.

CURIOUS Books, Unique Novelties, Stunning Pictures, Samples, 10 cents Prepaid. Linds, 214 W. 34th Street, New York.

ENCYCLOPAEDIAS, most makes, slightly used. Bargains in sets. Dalton Riggs, Crilly Building, Chicago.

REPAIRS about home easily made with instructions in our new book. Tells exactly how to use tools, sharpen tools and cutlery, repair furniture and cabinets, upholster, work metal, solder, work glass, paint, stain, varnish, hang paper, repair plumbing, repair furnace, repair electrical equipment, repair shoes, repair harness, repair gloves, repair concrete work. Send No Money. Just write a postal and ask for "The Practical Book of Home Repairs." When postman hands you the book, pay him \$2.50 and the postal charges. Popular Mechanics Press, Room 904, 200 East Ontario St., Chicago, Ill.

EDUCATIONAL books; all kinds; new and used. List free. Lyle's, Pisgah, Ala.

FOODS from Twenty Lands. Popular Mechanics new Cook Book made up of recipes sent by our readers from 29 countries. Many delightful foreign dishes, and many American ones, too. Only a few copies for sale. Send No Money. Just order on a postal. When postman hands you book, pay \$1.50 and postal charges. Popular Mechanics Press, Room 904, 200 E. Ontario St., Chicago, Ill.

PICTURES AND POSTCARDS

TRUE-BLUE friends everywhere exchange postcards, stamps, etc. Membership, 25c. Club book, 10c. Ericson, Elroy, Wis.

JOIN Live Postcard club, Membership Lists including Catalog 10c. Harvey Teeple, Decatur, Ind.

ART Pictures, Books and Novelties. Catalog 10c. Howard Sales Co., Dept. 15, 1188 Folsom St., San Francisco, Calif.

CHALK-TALK your way to popularity. Audiences at your feet if you learn how to entertain with a few simple pictures. Little artistic ability needed. "How to Chalk Talk" tells what to say and what to draw. Profusely illustrated. Make \$10 and more a night. Send No Money. Just order on a postal. Pay postman \$1.00 and postage. Popular Mechanics Press, Room 904, 200 East Ontario St., Chicago, Ill.

GAMES, ENTERTAINMENTS AND PLAYS

VENTRILOQUISM taught almost anyone at home. Small cost. Send 2c stamp today for particulars and proof. George W. Smith, Room 8-170, 125 N. Jefferson Ave., Peoria, Ill.

PLAYS, musical comedies and revues, minstrel music, blackface skits, vaudeville acts, monologs, dialogs, recitations, entertainments, musical readings, stage handbooks, make-up goods. Big catalog free. T. S. Denison & Co., 623 S. Wabash, Dept. 11, Chicago.

100 LIGHTNING Chalk Talk Stunts \$2.00. Cartoonist, 2925 Euclid, Kansas City, Mo.

READ sealed messages in dark; messages retained by audience; burned message appears on blank slate; spirit message appears on slate in sitter's presence; spirit rappings; spirits appear in the dark; answer questions written on folded papers while blindfolded. All this you can do with directions in "Behind the Scenes with the Mediums." 69 best secrets of mediums fully exposed. The best because most baffling, yet all easy to do. Send No Money. Just write a postal. Pay postman \$1.50 and postal charges. Popular Mechanics Press, Room 904, 200 East Ontario Street, Chicago, Ill.

MAGIC TRICKS, BOOKS AND JOKER NOVELTIES

LOOK Here! All for 25c in coin: Game of Authors, 48 cards with full directions; Complete set of Dominoes in compact and handy form; Chess Game with men; Fox and the Geese Game with men; Checker Game with men; Nine Men Morris Game with men; Game of the Spanish Prison—very puzzling—all to be mounted. The real secret of Ventriloquism—has sold for \$100.00. How to stage a Punch and Judy Show. The real secret of Hypnotism—has been known to only a very few people; How to tell Fortunes by cards; 23 astounding and clever feats in Magic fully explained; Mind Reading fully explained—how to find a hidden pin, etc.; 8 complete songs; 21 new and interesting Puzzles; 10 Funny Readings—enough to make your sides split; 57 valuable Money-Making Secrets—alone worth the price asked for the entire package. Remember that our price is only 25c (coin) for all the above which are in one package. Six packages for \$1.00. Benedek Sunnly House, Department 50, 2300 N. Mason Avenue, Chicago, Illinois.

MAGIC—Tricks, Books and Supplies. For Amateurs as well as the great professionals. Anyone can learn through our instructions. Feature Acts in Mind-Reading, Spiritualism, Rope Ties, etc. Large Illustrated Professional Catalog, 20c. Chicago Magic Co., 140 So. Dearborn St., Dept. B. Chicago, Ill.

NEW Sensational Wrist Shackle Escape only 85c complete. Wonderful bargains in other tricks and illusions. Catalogs free. Sample trick 10c. F. & R. Co., Dept. F, Hoboken, N. J.

FOR something different, send 10c for "Fun-Magic-Mystery." New 80-page Book of 500 Tricks. Also contains Catalog largest line Magic Tricks and Supplies in South, at lowest prices. Send 10c today! Lyle Douglas, Station A, Dallas, Texas.

A "BLACK BEAUTY" Stick-Horse with a cotton stuffed head will tickle your little boy or girl. Absolutely and positively guaranteed to delight any child between one and six. Send no money. Pay postman fifty cents and charges. Mother Goose Shop, Marvell, Ark.

AMERICA'S best approvals on all kinds of mystery tricks; worth \$100.00, send \$1.00. Elmer Gutknecht, 445 Idaho St., Milwaukee, Wis.

SEVEN Magical Delusions and Catalogs—25c. Gilmaglio, Morgan Park, Ill.

CARD tricks, Coin tricks, Hypnotism, Ventriloquism. 64-page books, complete guides, 10c each. Geo. Fenner, 2401 Jefferson, Louisville, Ky.

PUZZLE: Latest out. Made of highly polished Celluloid. Guaranteed to puzzle an expert. Easy to sell. Send 25c. The Novelty Company, Box 111, So. Lancaster, Mass.

MAGICAL mysteries—Entertaining Novelties, tricks, puzzles. Catalogue free. Schembri, Box 1124, Detroit, Mich.

FREE with \$25 order die box. Send 20c for our large catalogue of tricks, wigs, sensational escapes. Oaks Magleal Co., Dept. 548, Oshkosh, Wis.

MAGIC, Tricks, Books, Games, Novelties. Catalog free! Makary, Dept. R, 339 Mountain St., Pittsburgh, Pa.

CLEVER New Pocket Trick, 50c. Twenty back numbers Eagle Magician, \$1.00. Two Catalogues 4c. Eagle Magic, Minneapolis, Minn.

BOOKS, Magic, Mysteries, Magic Tricks, Novelties. Catalog Free. Singer, 555, Hancock, Wis.

ELECTRIC Fun! Seventy stunts, 110 volts, \$1. Tacutting, Campbell, Calif.

ILLUSTRATED Magic Catalog 7c. Lynn's, 105 Beach, Jersey City, N. J.

ESCAPE from Sacks, Rope Ties and Chains. Easy with these complete instructions. Give an entire evening's entertainment and mystify the "wise ones." Let them tie you hand and foot, place you in a bag and seal the bag. In a minute you are out. Complete instructions in "33 Rope Ties" and "Sack Escapes." Send No Money. Pay postman \$1.50 and postal charges for these two books. Popular Mechanics Press, Room 904, 200 East Ontario St., Chicago, Ill.

BREAKING Pencil with Dollar Bill. Fifteen other tricks, catalog, special premium offer, 10c. Chester, 403 North State, Chicago.

NOVELTIES, CURIOS, ETC.

TELL Time by the Stars! United States Government takes time from the stars. You can do the same. "Startime," an extremely ingenious and scientifically correct instrument, gives you exact time. Most attractive novelty ever offered. Extremely fascinating! Durably made of aluminum, in fine leatherette case. Sent postpaid on receipt of \$1. Startime Mfg. Co., Garden City, N. Y.

"KANT-B-DONE" Puzzle, with interesting mail, 4c. "Publisher," Box 320-PZ, Grandview, Wis.

STAMP COLLECTING

JUST what every stamp collector wants—Free! The new 1927 Scott Price List is just out, brimming full of wonderful bargains. Hundreds of Scott Seald packets, sets, and dime sets of guaranteed genuine stamps. Many attractive new packets and sets that every collector, advanced or beginning, should know about. Prices that make every item a real bargain. Also describes the complete line of Scott Albums, from 60c to \$55.00; catalogues, hinges, tongs, magnifying glasses, watermark detectors, milimetre scale and perforation gauge and all other accessories needed by the collector. This big illustrated price list of more than 80 pages is free for the asking. Write for it now. Scott Stamp & Coin Co., 1 West 47th Street, New York, N. Y.

SNAPS—Offer No. 1—300 Different Foreign, 60 Different U. S. Stamps including \$1 and \$2 values. All For 25c. Offer No. 2—70 different Foreign Stamps from 70 Different Countries, including Africa, Asia, Australia, Europe, West Indies, etc., Only 16c. Offer No. 3—Stamp Album, providing spaces for 2,220 stamps, with 700 illustrations, packet of 500 different stamps, 500 hinges and millimeter measure, all for only 50c. A big bargain. Free with each order, our pamphlet which tells "How To Make a Collection Properly"; also price list of albums—supplies and hundreds of bargains in sets and packets. Queen City Stamp Company, Room 36, 604 Race Street, Cincinnati, Ohio.

500 DIFFERENT Stamps for 25c! Big Collection 500 Different Stamps from Bosnia-Herzegovina, Crete, Epirus, Hong Kong, Iceland, Kenya and Uganda, Liberia, Malta, Nyassa, Tanganyika, Wallis and Futuna, Zanzibar, and other "hard" countries. Catalogue value \$10.00. Price only 25c to Approval Applicants! Special Bargains: 1,000 different 79c; 15 triangle stamps 49c; 100 Africa 50c; 100 Asia 60c; 100 Balkan States 35c; 100 British Colonies 25c; 100 French Colonies, 30c; 100 Portuguese Colonies 50c; All 8 packets for \$3.00! Illustrated Lists Free. Loma Stamp Co., 2221 Madison Ave., San Diego, Calif.

MYSTIC'S "Queer Country" Packet! Contains scarce stamps from the following strange lands: San Marino, Antioquia, Congo, Cyprus, Fiji Islands, Gwalior, Hyderabad, Iceland, Jhind, Kenya, Uganda, Lebanon, Monaco, North Borneo, Nyassa, St. Thomas Prince, Port. Guinea, Siam, Sierra Leone, Tanganyika, Trinidad Tobago, Ubangi, Upper Volta, Wallis Futuna, Zanzibar. Get this wonderful packet of "freak countries" and make your friends envious! Price only 10c to approval applicants! Write today. Mystic Stamp Company (Dept. 8), Camden, New York.

ANCHERS \$\$\$ Outfit—only 12c! Fine triangle stamp; set German stamps with (pre-war) value forty million dollars (interesting!); perforation gauge, mme. scale; small album; airmail set; scarce stamp from smallest republic on earth; newspaper set; packet good stamps from Travancore, Johore, Dutch Indies, etc. Entire outfit for 12c to approval applicants! (Nice packet stock book, value 25c, with every order!) Ancher Stamp Co., 148 1/2 Clerk St., Jersey City, N. J.

\$1.00 FREE, Black U. S. Postage. Given Away with each order. Pioneer Stamp Album with 500 illustrations, 150 different stamps from 40 countries, Syria, Lebanon, Hejaz, Liberia, New French Colonies, British, Portuguese Colonies, South Africa, Australia, 500 hinges, 36 page illustrated catalogue. All for 15c. Big Commission to Agents for the Best approval sheets of stamps ever offered. Write for sample outfit. Hussman Stamp Co., Dept. M, 620 Olive St., St. Louis, Mo.

MYSTERY Packet! Stamps of Cannibals, Sunworshippers, Savages! Including Albania, Bosnia, Chad, Congo, Cochin, Dominican, Guadeloupe, Goldcoast, Kouang-tchou, Togo, Travancore, Ubangi and other far-off places. Hundred different stamps five cents, but only to those asking for approval sheets. Illustrated lists free. Reimers, Flatiron Building, Fort Worth, Texas.

ANNIVERSARY Offer! Seven following sets: "Anniversaries," "Jubilee," "Charity," "Airmail," "Eagles," "Prisoners," "Pictorials." Four of following packets: (British, French, Dutch Colonies), (Precincts), (Bulgaria), (International) 15c to approval applicants. Deering, Fairmount, Marlborough, Mass.

NEWFOUNDLAND Stamp Bargains! 63 Scotts varieties \$5.00; 38 for \$1.00; 25 for 25c. Illustrated Catalogue 10c. Rev. Butler, St. Georges, Newfoundland.

300-300-300—ALL different stamps (\$5.00 catalogue); 300 hinges, 5 approval sheets; duplicate stamp album; perforation gauge, millimeter scale and ruler to approval applicants for only 20c. Edgewood Stamp Co., Milford, Conn.

EUROPE Collection, 19th Century. Fine condition, over \$7,000.00 catalogue. Price \$4000.00. Also Mint Collection, German Colonies complete. High values, sheets of twenty. Catalogue \$6300.00, price \$5000.00. Carl Hackert, 332 East 87th St. New York City, N. Y.

CANADIAN—25 different only 10c and asking to see our Excellent Approvals; receive Beautiful Confederation Jubilee stamp, 5 Newfoundland and Bargain Lists free. Victoria Stamp Co., London, Canada.

MOST Sensational values; over 140 diff. Algeria, Airplanes, Azerbaijan, Barbadoes, Cameroun, Gabon, Guyane, Irish set, large French Colony packet, largest stamp, 40 year old U. S. gauge, etc., for 10c to approval applicants. List free, 100 diff. U. S. 25c—1,000 hinges 9c—50 Bavaria 7c. Hawkeye Stamp Co., Cedar Rapids, 39, Iowa.

GOOD British Colonials, South and Central America on approval. Books by countries, 50% and net. Reference necessary. Hiawatha Stamp Shop, 113 Peters Street, Syracuse, N. Y.

YOUR Government has over 100 different unused United States stamps for sale to collectors at face value. List and pamphlet about Government Philatelic Agency, only 10c. C. E. Nickles, 212 Seaton, N. E., Washington, D. C.

\$10.00 FOR 25c, Canada Laurentide Airmail, catalog \$9.00, and fine Flown Cover to approval applicants. References, Arthur Barger & Co., 839 Beacon Street, Boston, Mass.

FREE! Fenway Unused Hundred, 100 different, all unused, from far-off countries. Including: Albania, Antioquia, Bosnia, Chad, Dahomey, Cuba, Latvia, Nyassa. This fine packet free to new approval applicants enclosing 4c postage; Big lists also free. Fenway Stamp Company, 161 Massachusetts Ave., Boston, Mass.

TRIANGLES—4 Different 15c, 15 Different 40c. Price lists free. Elwood D. Weber, 1377 Park Avenue, Plainfield, N. J.

AUSTRIAN, Crete and Levant—10 varieties 10c. Allison, Angola, Indiana.

FREE! Guatemala 451-5 Cataloguing \$1.25, with International Package (1,000 stamps) 35c. Walsh, 1889 Albany Ave., Brooklyn, N. Y.

VERY Special—500 different 25c. Ask for price lists and approvals. Cleveland Stamp Co., Caxton Bldg. Cleveland, Ohio.

150 USED and unused foreign stamps 10c. Arcy, Box 483, Muskogee, Okla.

STAMPS on approval at one-third Scott's catalog prices, 25,000 different. References required. Tubbs, 4043 First St., San Diego, Calif.

ZANZIBAR, Abyssinia, Travancore, Mozambique, Quellmane, Menagerie Collection, Album, 10c. Liberty, 3974 Arsenal, St. Louis, Mo.

3,000 ALL different \$8.50, 500 all different "British Colonials" \$3.25. Overman, Birch Tree, Mo.

500 MIXED U. S. and Foreign, 15c. 10 sets different, complete, 25c. Glenwood Stamp Co., 30 Athol St., Springfield, Mass.

FREE 100 different stamps to approval applicants. Postage 2c. C. R. Tempe, 1310 S. Gaffey, San Pedro, Calif.

APPROVAL Books on any country at 50% and 25% discount. Special packets and sets with premiums. Send for lists. Noemus Stamp Co., 312 East 22nd St., New York.

100 STAMPS from 30 Countries, 5c. Lufbery, Port Orange, Fla.

1/4c UP approvals, Carl Schutz, 1313 1/2 North Mariposa, Hollywood, Calif.

ALL Different, mounted, 4,000 \$13.50; 3,000, \$8.25; lists with stamps 10c. Reynolds Stamp Co., Flint, Mich.

LIBERIA Snake Triangle and two other triangles in our packet of 53 genuine foreign stamps for five cents. Crowder Company, Waverly, Baltimore, Md.

MINT packet free—53 different unused free to bargain approval applicants. Postage 2 cents. Taylor, Box 830, Milwaukee, Wis.

FREE! 25 Beautiful unused stamps free to those requesting a selection of our sets on approval. No single stamps but all in sets. The Quickest, Easiest and cheapest way of forming a collection. S. S. Kahn Company, Ardmore, Okla.

BIG Surprise Packet Free with 10c Packet, any country, 1,000 mixed, 35c. H. Simmons, Box 18, Horton, Mich.

BIG Free Offer, Large illustrated list of good stamps and sets at bargain prices; also fine packet 47 different stamps from Camerouns, scarce Costa Rica (cat. 30c), Niger Coast, etc.—all absolutely free. Enclose 4c for postage, etc. Shaw Stamp Co., Bear River, Nova Scotia, Canada.

1000 UNITED States and Foreign Mixed Postage Stamps for Collectors. Including 300 different, 50c. C. W. Parker, 77 Kensington Heights, Meriden, Conn.

50 DIFFERENT South and Central American 15c; 100, 45c; 200, \$1.10. Fred Onken, 630 79th Street, Brooklyn.

150 GOOD mixed foreign stamps, 3 cents. Stanton, Niantic, Conn.

STAMPS—20 Varieties unused free. Postage 2c. P. M. Miami Stamp Co., Toledo, O.

200 DIFF. Foreign Stamps, Cataloging over \$5.50, for \$1.00. C. Taylor, 15 Cross St., Newport, R. I.

FINE Approval Selections at 60% discount. 100 stamps free for 3c postage. Write Now, Winholt Stamp Co., Woodbine, 26, Penna.

OUR Latest 20-page U. S. and Canadian price list free. Stanley Gibbons, Inc., 37 Ann St., New York City.

10 NYASSA free with six months subscription to "Stamp Topics" at 50c. Topics, 423 West 42nd, New York.

500 MIXED 15c. Washington Precancels, 40 var., 25c. Charles Peugh, Elma, Wash.

U. S. 16c Airmail to approval applicants. 2c postage. Jones, 828 South Williams, Denver, Colorado.

FREE packet, approval applicants. Fellowship Stamp Co., 93 First St., Medford, Mass.

FREE 40 Czecho Slovakia Stamps to approval applicants. 2c Stamp. Lightbown's, Osborne Rd., Southsea, England.

AMAZING Offer! 34 Stamps in Wallet, including 7 German, prewar value Forty Million Dollars. Price 8c if you ask for my Famous 60% Approvals. Thousand Unpicked continental Mission stamps 27c. D. M. Ward, 605 Pierce St., Gary, Indiana.

FREE, \$5 U. S. Postage, with purchase 200 different stamps 25c. N.

BUY stamps of value! British, French Colonials, South Americans, good Europeans on approval. Big list free. Penna Stamp Co., Greensburg, Pa.

SPECIAL: Five Liberia "Snake" Triangles and our "Famous Foreign Packet," including Morocco Airmail, Odessa Hunger Issue, Azerbaijan, Armenia, Albania, etc., only 25c to approval applicants. Flower City Stamp Co., St. Thomas, Ontario.

200 NICE foreign revenues 54c. Hartman, 3803 Humboldt, Denver, Colo.

FREE 40 Czecho Slovakia Stamps to approval applicants. 2c Stamp. Lightbown's, Osborne Rd., Southsea, England.

DANZIG Stamps Free—Interesting packet from Danzig with big catalogues free for 2c. Midland Stamp Company, Toronto, Can.

500 DIFFERENT, 24c; 1,000, 59c; 2,000, \$2.39. Price List free. Winholt Stamp Co., Woodbine, 26, Penna.

FREE—Five "Ireland" Stamps to approval applicants. Postage, 2c. Prall, Somerville, N. J.

FREE! 25 British Colonials to approval applicants. Clarence Coleman, Somerville, N. J.

DIME approvals. Modern assortments. Sets—Packets—Singles. Free Premiums. Marney's, 400 Broadway, East St. Louis, Ill.

200 DIFFERENT 7c. 100 U. S. 25c. U. S. Stamps; Foreign Packets. Lists Free. Midwest Stamp Co., Kemper Bldg., Kansas City, Mo.

BEAUTIFUL Picture Stamps Sent Free. Paul Cornish, Schenectady, N. Y.

50 DIFFERENT United States 10c. 60% approvals. Reference please. Seldenberg, Baroda, Mich.

100 DIFFERENT Stamps 10 cents. 1,000 Different \$1.00. Harry Shacklett, 3837 West Pine Blvd., St. Louis, Mo.

200 STAMPS, Bargain List, Magazine 15c. Harvey Teeple, Decatur, Ind.

16 VARIETIES Armenia 5c. Approval Applicants. Vincent Lorimer, Monmouth, Ill.

FRENCH Colonies Free—Jungles, Tigers, Native Chief. 2c postage. Empire Stamp Co., Toronto, Canada.

24 VARIETIES Cuban stamps, 10 cents. List of 6,000 low-priced stamps free. Address Chambers Stamp Co., 111P, Nassau St., New York City, N. Y.

COVERTCO Packet, 250 varieties unused and used stamps 15 cents. Covert Stamp, 39 State, Rochester, N. Y.

STAMPS, 100 all different. Postage 2c. Lists free. P. M. Quaker Stamp Co., Toledo, Ohio.

FREE! Loose Leaf Postage Stamp Album at rate of 8 pages each month given with subscription to monthly Journal. Send 2c stamp for prospectus. United Stamp Co., Marquette Bldg., Chicago, Ill.

BORNEO, Malay, Liberia and 105 other Different Foreign Stamps, Hinges and Lists with Approvals 9c. 35 Different United States, including Commemoratives, 10c. Fennell Stamp Co., Dept. M, St. Louis, Mo.

PENNY Approvals that Satisfy. Neil Gronberg, Box 5441, Philadelphia, Pa.

108 STAMPS, Chad, etc., album, 4c to approval applicants. Hill, Leonard St., Waltham, Mass.

109 DIFFERENT, Abyssinia, Azerbaijan, Zanzibar, etc. 10c to Approval Applicants. Floyd Marsh, 524 Hamilton Ave., Indianapolis, Ind.

TO approval applicants enclosing 10c for our Marvel Packet of 55 different from Gabon, Togo, etc., we will send—absolutely free—a genuine scarce South African triangle stamp! Curhan Stamp Co., Gloucester, Mass.

105 CHINA, etc. 2c. Album (500 illustrations) 3c. Bullard, Sta. A, Boston.

STAMPS sent on approval at 76% discount. Reference required. Emory Renoll, Hanover, Pa.

UNITED STATES—Send on approval. Send me your want list. Ref. Please. M. Hanna, New Kensington, Pa.

FOREIGN Revenues, Telegraphs, Locals, envelopes, rails, etc. pretty, different, cheap. Stamped Marine Policy free to applicants with references. Vanderhoof, 1114 Logan, Denver, Colo.

200 DIFFERENT stamps 10c; 1,000 Hinges 10c. R. H. Carlton, 380 W. So. Temple, Salt Lake, Utah.

110 DIFFERENT Stamps, many unused, high values, free to collectors requesting our Net Approvals. Postage 2 cents. Christensen, Milwaukee, Wis.

STAMPS—1,000, 25c; 500 different, 30c; 1,000, 80c; 2,000, \$3.25. Album holds 2,000 stamps, 60c. Michael, 4444 Clifton, Chicago.

STAMPS on approvals 1/2c up. Free premium. Herbert Keigwin, Middletown, N. Y.

110 NEW Europe All Different, a wonderful collection cataloging several dollars, free to collectors requesting our Net Approvals. Postage 2 cents. Badger Stamp Co., Milwaukee, Wis.

FREE Hungary Charity No. 565 to 567 and a surprise packet given to those requesting for my 1, 2, and 3c approvals, and also my 50% discount. Chas. W. Schmidt, P. O. Box 4832, Frankford Station, Philadelphia, Pa.

STAMPS, 100 varieties, Africa, Brazil, Peru, Cuba, Mexico, etc., 10c. 50 different U. S. 25c; 1,000 mixed, 40c; 1,000 hinges, 10c. List free. C. Stegman, 5941 Cote Brillante, St. Louis, Mo.

RARE COINS

RARE Coin Book 50c; Illustrates all the coins of the United States, Mexico, Central and South America; also the prices we pay for rare U. S. coins. There is no other publication, at even twice the price, that can compare with this book which is entitled "Coins of the Americas." Old Coins Bought and Sold—We have the largest and most representative stock of coins in the United States. Send 2c stamp for Selling Price List. Compare our book and Prices. Guttag Bros., 16 Exchange Place, New York City.

GET Profit and Pleasure in collecting Old Coins. Send 10c for Large Illustrated Coin Catalogue. You'll be delighted with it. Send for it right now. B. Max Mehl, Numismatist, Mehl Bldg., Dept. P, Fort Worth, Texas. Largest Rare Coin Firm in the U. S.

UNITED STATES, Large Cent, two-cent bronze, three-cent nickel and Bargain List, 25c. Fifteen dates large cents, \$1.00. George Coffin, Greenwood Mountain, Me.

UNITED STATES and Foreign Money; Military Decorations Catalogue and Greek coin 10c. Alexis Mengelle, Colorado Springs, Colo.

OLD Money Wanted. Will pay Fifty Dollars for nickel of 1913 with Liberty head (no Buffalo). We pay cash premiums for all rare coins. Send 4c for Large Coin Folder. May mean much profit to you. Numismatic Co., Dept. H, Fort Worth, Tex.

RUSSIAN Bank Note 2 Nickel Silver Coin 1,000 Mark German Commulsory Gold Bond and Catalogue 20c. Geo. Best, Cedar Rapids, Iowa.

OLD Coins, Large Spring Selling catalogue of coins for sale free. Catalogue quoting prices paid for coins, ten cents. William Hesslein, 101A Tremont Street, Boston, Mass.

5 AND 20, 1861 Confederate Bills, 15c. 100,000 German Marks, 10c. 5 different copper coins and Price Lists, 10c. California Gold 1/4, 27c; 1/2, 53c. Al E. Bonsall, Richmond, Ind.

CALIFORNIA Gold—Quarter Size, 27c; 1/2 size, 53c; 3c Piece and Catalogue, 10c. Norman Shultz, Box 746, Salt Lake, Utah.

5 DIFFERENT Civil War tokens 50c. Foreign coin and bargain price list 10c. Arvey, Box 483, Muskogee, Okla.

40 OLD coins, all different, \$1.00. 200 different Coins \$3.00. Alabama Half-Dollar, Fine, \$1.00. Mexican Two Peso Gold \$1.75. 2,000 different Germany City Bills, Unc., \$12.50. Claud Denny, Box 315, Dallas, Texas.

25 ASSORTED Coins 25c. 25 all different coins 50c. 25 assorted bills 25c. 25 all different bills 50c. Oddehon, Box 681, Kansas City, Mo.

BILLION Mark German Government bond \$1.00; ten bonds, \$6.00. American Sales Co., Box 1278D, San Francisco, Calif.

FOR BOYS

BOYS: Make your own electric motor and steam engine. We furnish all parts and full instructions at a price within your reach. Very interesting and educational. Learn our plan to receive these parts free. Write for information giving your age. Hudson Valley Specialty Company, P. O. Box 642, Poughkeepsie, N. Y.

ELECTRIC Toys—Fractional hp. Motors, Electric Steam Engines, Catalogue 10c. Manhattan Co., 333a W. Manhattan Blvd., Toledo, Ohio.

BOYS and Girls. Extra money. Learn beaded work. Send only 25c. J. A. Harvey, 78 Crown, Meriden, Conn.

FILMS for Toy Machines. 200 feet \$1.50 Postpaid. Dixie Film Co., Box 2042, Memphis, Tenn.

BOYS: Build own roller coaster. Barrels fun. Send 50c for plans or \$4.50 for parts. Claude E. Reed, No. Olmsted, Ohio.

FILM 125 feet, comedy \$1.00. Raab, 509 Calhoun, Mishawaka, Ind.

FAMOUS Bailey Handbook—The book that prepares you to pass the examination for any grade of license for Stationary, Marine and Diesel Engineers, Firemen and Boiler Inspectors in any state of the Union or any province of Canada. Flexible cover. Handy Pocket Size. Pay Postman \$2.00 plus the postage when he hands you the package. Popular Mechanics Press, Room 904, 200 E. Ontario St., Chicago, Ill.

IDEAS for those who like to tinker with tools, and for professional carpenters. 40 articles on saws and sawing, 17 on benches and bench equipment, 22 on doors and door hanging, 18 on lumber, 13 on mitering, 74 on tools, 22 on shop equipment, and many others—366 in all, and 229 illustrations. Send No Money. Just write a postal. Pay postman postage and \$1.50. Popular Mechanics Press, Room 904, 200 E. Ontario St., Chicago, Ill.

CAMERAS AND PHOTO SUPPLIES

PHOTOGRAPHIC equipment and accessories of every description are listed and illustrated in our 228-page catalogue. It will pay you to secure a copy which is issued free, as our prices are low. We also deal in used goods which are sold under the same guarantee as new goods. Ask for our Bargain Book. Central Camera Co., Dept. E116, 112 S. Wabash Ave., Chicago, Ill.

MAKE money in Photography. Learn quickly at home. Spare or full time. New Plan. Nothing like it. Experience unnecessary. American School of Photography, Dept. 3432, 3601 Michigan Ave., Chicago.

RUNDRED Best Markets for Your Photographs. Booklet gives names, addresses, wants. Written by a successful correspondent. 20c silver. R. Snyder, Publisher, 18 Derne St., Boston.

HAVE You a Camera? Write for Free sample of our big magazine, showing how to make better pictures and earn money. American Photography, 116 Camera House, Boston, 17, Mass.

BIG Money Saved on Photographic Lenses and Apparatus—goods exchanged; repairing done. Ralph J. Golsen, 1128 Argyle St., Chicago, Dept. P.

FILMS Developed. Special Trial Offer. Any Size Kodak film developed 5c, prints 3c each. Trial 6x10 Enlargement in handsome folder 40c. Overnight Service. Roanoke Photo Finishing Co., 209 Bell Ave., Roanoke, Va.

GERMAN Cameras, Lenses, Bargains. Bartro, 6436 Hotel St., Los Angeles, Calif.

KODAK Film—Special Trial Offer—Your next roll developed 5c, prints 3c each. Beautiful 6x10 mounted Enlargement 40c. Same-day Service. Fleet Photo Service, 825 G St., N. W., Washington, D. C.

GLOSSY Enlargement and twenty Iowa Prints, \$1.00. Essick, Ankeny, Iowa.

MOTION PICTURES

FILMS: \$3.00 per reel up. Comedy, Western, Cartoon, Drama, Serial, Educational, Special Features. Best Movie Stars. Free List. Toy Film 200 Feet Postpaid \$1.50. Dixie Film Co., Box 2042, Memphis, Tenn.

NEW and Rebuilt Projectors for Theaters, Schools, Churches, Travelling Shows. Supplies and Complete Theater Equipments. Bargain Prices. Free Catalog. Monarch Theatre Supply Co., Memphis, Tenn.

\$\$\$ FOR Ideas. Photoplay Plots revised, criticized, copyrighted, marketed. Send for free booklet. Universal Scenario Company, 244 Security Bldg., Santa Monica and Western Ave., Hollywood, Calif.

SEND \$2.00 for startling new Cinemeter. Gives exact exposure for all Movie Cameras or lenses. Fits pocket. Free Bargain List of Motion Cameras. Bass Camera Company, 109 North Dearborn Street, Chicago, Ill.

MOVIE Apparatus. New \$150 Spring Motor Movie Camera, leather case, \$37.50. Eastman Standard Negative Film 2½ cents a foot. Motor driven suit case projectors \$50 to \$100. Movie Printer \$25. Movie developing outfit \$20. Air Brush \$5. Ray, 296 5th Ave., New York.

BARGAINS: Machines, Films, Stereopticons Supplies. National Equipment Co., Duluth, Minn.

"DANTE'S INFERNO," 5 reels. Big money maker, \$225.00. Westerns, Comedies ½c foot. Ward, 386 Pearl, Buffalo, N. Y.

FOR Sale—Moving Picture Film ½c foot. Progress Pictures, 3320 Lindell, St. Louis, Mo.

HUNDRED feet movie film and list rare films, one dollar. Film Classic, Fredonia, N. Y.

FILM \$2.50 per reel, projectors \$80.00. Stewart Marshall, Rome, Ga.

SCENERY TO RENT

WORLD'S Most Beautiful Settings for operas, plays, minstrels. Amelia Grain, Philadelphia.

EDUCATIONAL AND INSTRUCTION

YOU can have a business profession of your own and earn big income in service fees. A new system of foot correction; readily learned by anyone at home in a few weeks. Easy terms for training; openings everywhere with all the trade you can attend to. No capital required or goods to buy, no agency or soliciting. Address Stephenson Laboratory, 1 Back Bay, Boston, Mass.

STORY Ideas Wanted for photoplays and magazines. Big demand. Accepted in any form for revision, development and submission to markets. Send manuscript for free criticism. Booklet mailed on request. Universal Scenario Company, 403 Security Bldg., Santa Monica Blvd. and Western Ave., Hollywood, Calif.

CARTOONING and commercial art work easily learned with new book. Complete art course beginning with simplest drawings and leading through higher branches of illustration. Profusely illustrated. Send No Money. Just write a postal for "Commercial Art and Cartooning." Pay post man postal charges and \$1.25. Popular Mechanics Press, Room 904, 200 East Ontario St., Chicago, Ill.

BE a Laboratory Expert. Earn from \$300 to \$500 Monthly. Study Microbiology Sanitation. Day, Evening classes, Diplomas, Degrees Granted. 71-piece outfit Free to students. Write for our Free Prospectus To-Day. International College of Microbiology, 2517 N. 76th Ave., Chicago, Ill.

MEN wanting forest ranger positions. \$1,500—\$2,400. Write for particulars and list Natl. forests. Mokane, A-21, Denver, Colo.

EARN \$25 weekly, spare time, writing for newspapers, magazines. Experience unnecessary. Details Free. Press Syndicate, 981, St. Louis, Mo.

DOUBLE Entry Bookkeeping mastered in 60 hours with 8 keys; guaranteed; diplomas, International Bookkeeping Institute, Dept. 8, Springfield, Mo.

USED educational matter. Lowest prices; terms. Catalog free. Mention Subject. Fred Goetz, 440-A Sansome, San Francisco.

USED educational matter sold on re-purchase basis. Also rented and exchanged. Money-back guarantee. Catalog free. (Books, etc. bought.) Lee Mountain, Pisgah, Ala.

\$75.00 WEEKLY writing Show Cards. Howard course \$2.00. Confidential Information 10c. Fedra, 7963-T Kingston, Chicago.

FIREMEN, Brakemen, Baggage-men, (white or colored), sleeping car, train porters (colored), \$150-\$250 monthly. Experience unnecessary. 810 Railway Bureau, East St. Louis, Ill.

INSTRUCTION books, all kinds. Catalogue free. Wineholt Book Co., Woodbine, 4, Penna.

"BLUEPRINT Reading" is a compact book telling how to read machine blueprints. Send No Money. Just pay postman postal charges and \$1. Popular Mechanics Press, Room 904, 200 E. Ontario St., Chicago, Ill.

CARTOONEX. Makes anyone draw cartoons. Particulars and hand-drawn cartoon free. Laurence Longway, Muskogee, Okla.

CARTOONIST Course. My 200 illustrations with instructions. Four original drawings, one each, showing expression, action, exaggeration and perspective. My complete course sent postpaid for \$3.00. Why pay more? Edwin A. Kendrick, P. O. Box 742, Waterbury, Conn.

LEARN Bookkeeping in Ten Lessons. Shelby course is brief, concise, complete. Makes bookkeeping easily understood. Price \$3. Write for particulars. Shelby Publishing Co., 605 Cotton Exchange Bldg., Memphis, Tenn.

YOU need a better grip on mathematics? Tell us to send you a copy of "Mathematics for the Practical Man" only \$1.50. By common sense methods it removes the mystery and difficulties so algebra and calculus are made simple. Assuming your knowledge is limited to arithmetic you quickly and easily gain a working knowledge of Algebra, Geometry, Trigonometry and Calculus. Simply pay postman when he hands you the package. Address Popular Mechanics Press, Room 904, 200 East Ontario St., Chicago, Ill.

WORLD-ROMIC System. Masterkey 5,000 languages. Primers, \$1.98; Arabic, Chinese, French, German, Italian, Japanese, Russian, Spanish. Languages, 8 West 40th, New York.

RADIO OUTFITS AND SUPPLIES

300 MILE Radio only \$2.95! New Radio Sensation. Experts amazed. No tubes or batteries. No electric current. No upkeep expense. Loud, clear reception. Finest tone. Amazing power and volume. Simplest long distance radio made. Over 250,000 enthusiastic customers now enjoy finest programs in the country. Mr. Steiner got 57 stations. Customer in Missouri gets Hollywood. You can now hear all the news, market reports, grand opera, band concerts, dance orchestras, baseball games, etc., from the big city broadcasting stations. Write immediately, today, for descriptive folder and picture of the world's biggest radio bargain. American Sales Co., Dept. 699, Springfield, Ill.

FREE—Radio owners, if you want clear reception from your set write for free particulars. Romer Radio Co., Cherryville, N. C.

RADIO Receiver: All stations—American and Overseas; all wave lengths—200 to 4,000 metres. The 6 tube Nemo Polyphase, the latest development in modern radio. Agents wanted. 100% profit—\$100—per week easy. Radio Exchange, 925 Broadway, New York.

RADIO—Supplies—Parts: Lowest prices. Send stamp for list. Atwater Radio Shop, 1438 Lexington Ave., New York City.

MERCHANTS and consumers write for folder—greatest radio value in U. S. 5-tube certified chassis \$18.45. Piano finished cabinets \$3.48 up. Agents wanted. A. J. Musselman, 128 Machinery Hall, Chicago.

GUARANTEED Hook-up for building remarkable one tube Loud Speaker Set 25c—three tube Long Range Set 50c—five tube Super Power Set \$1.00. N. D. Jackman, 1066 E. Colfax Ave., South Bend, Ind.

300-MILE "Pocket" Radio, \$2.00. No Tubes nor Batteries required. Useful and practical, loudspeaker volume. Order direct today. Spencer Laboratories, 116 Atlas, Akron, Ohio.

RADIO Up-to-the-Minute, 1926 edition. Telegraphy, radio reception, vacuum tubes, telephony, how to build receivers, broadcasting, all treated in new book. Send No Money. Pay postman \$1.25 and postage. Just write postal for "Radio Up-to-the-Minute." Popular Mechanics Press, Room 904, 200 East Ontario St., Chicago, Ill.

AGENTS entertain evenings. Big money with easy selling Kings "Distance Pulling" radio. Write us for proposition. Kings Radio Corporation, St. Louis, Mo.

2 VOLT heavy duty storage A batteries \$3 postpaid. Ideal for operation of Radiola III and IIIA. Huyler, 4818 Cedar Ave., Philadelphia, Pa.

TRANSFORMERS and Chokes for Eliminators and Transmitters. New material list ready. Radio Parts Sales Co., Box 24, Orange, N. J.

TRADE AND TECHNICAL SCHOOLS

LEARN Bricklaying from Wm. Woods, who has trained 500 men, in a school run by 800 Builders, interested in giving jobs to Mr. Woods' students. Tuition \$60.00 per month. Time required 3 to 6 months, 5 eight-hour days per week. Board and room \$8.00 to \$10.00. Work is actual bricklaying the same as outside. Ample space and material. Catalog free. Associated Building Employers, L-400, A. B. E. Building, Grand Rapids, Mich.

GET a Foreman's job in any trade. You will earn more money. Become an expert Blue Print Reader. You can do it in spare time. My training will advance you quickly. Write now—tell me what trade you want—I will send my plan at once. Carroll Rumsey, 265 Drexel Building, Philadelphia, Penna.

BIG Pay Jobs. Learn Sign Painting, Decorating, Paperhanging, Show Card Writing, Graining and Marbling by practical training in a few weeks. Chicago Painting School, 148 West Austin Ave., Chicago.

COMPLETE course of the Ideal Paint Manufacturing System is now ready for distribution. (Small investment brings profitable returns) money back proposition. Special inducement to enroll now. Free literature, write today. Illinois Business Service, 800 Annuity Life Bldg., Chicago.

SHOW-CARD Writing and Sign Painting is a big-money business. Demand for expert work enormous. Learn from us quickly and easily. Free particulars by return mail. Detroit School of Lettering, 175 Stinson Ave., Detroit, Mich.

BIG opportunity for you in advertising. Write, Dymont, C4, 4417 Second Boulevard, Detroit.

TELEGRAPHY—Both Morse and Wireless—taught thoroughly and quickly. Tremendous demand. Big salaries. Wonderful opportunities. Expenses low; chance to earn part. School established fifty years. Catalog free. Dodge's Institute, Fern St., Valparaiso, Ind.

BUSINESS OPPORTUNITIES

HIRE yourself as Boss! \$250 a week easily made making these Big-selling Specialties. 300% to 900% Profit. Investment Small. No machinery needed. Let me show you how to make Heetle the New German anti-freeze preparation for Radiators; Fibro-seal Guaranteed Puncture Proof; Para-vulkin, no-cement Instant Weld Patch; Super-Radiolyte, 20-minute Battery charging Liquid, and 30 other big money-makers in the House-hold, Food Beverage and Toilet Specialty lines. Valuable Literature Free! Miller, Chemist, 1706-C Jetton, Tampa, Fla.

READ The Mail Order News—America's Pioneer Mail Trade Journal. Quarter Century Old. Approximately 600 pages yearly of valuable information for beginners an established mail-order houses. Analyzes mail-order business, its opportunities. Practicable mail-order ideas, legitimate money-making schemes, instructive articles. Tells how to start, what to sell. Published monthly. Subscription \$3.00 yearly. Send 25c for sample copy. None free. Mail Order News, 360 Bristol Bldg., New York.

ARTIFICIAL marble sanitary flooring instructions, covering wood or cement flooring ½ inch thick, fireproof, waterproof, all colors, low cost. Ornamental casting, concrete, plaster, papier-mache decorations, garden furniture, statuary, flexible molds. 17 years instructing the public; particulars and illustrations free. Chris. Mahler, Huntington, N. Y.

ENTER a new business. Earn \$3,000 to \$6,000 yearly in professional fees making and fitting a foot specialty, openings everywhere with all the trade you can attend to; easily learned by anyone at home in a few weeks, at small expense; no further capital required, no goods to buy, job hunting, soliciting or agency. Address Stephenson Laboratories, (1) Back Bay, Boston, Mass.

MANUFACTURE house numbers, signs, etc. Investigate! Radiant Co., 118 Davenport, Detroit, Mich.

PATENTS. Time counts in applying for patents. Don't risk delay in protecting your ideas. Send sketch or model for instruction or write for Free book "How to Obtain a Patent" and "Record of Invention" form. No charge for information on how to proceed. Communications strictly confidential. Prompt, careful, efficient service. Clarence A. O'Brien, Registered Patent Attorney, Security Bank Building (directly across street from Patent Office), Washington, D. C. See pages 138 and 139.

ANYONE handy with paint brush can earn five thousand dollars or more yearly installing Waitex—a beautiful plastic paint of many shades and textures. Waitex is installed in homes or buildings where beautiful appearances are desirable. Sells on sight. Get full particulars Everlastone Products Corp., Everlastone Square, Baltimore, Md.

MIRRORS resilvered at home. Costs less. 5c per square foot; you charge 75c. Immense profits plating like new; brassy worn-off auto parts, reflectors, tableware, stoves, etc. Outfits furnished. Details Free. Sprinkle, Plater, 127, Marion, Ind.

DIRTY crank case oil filtered through Reclaimoil comes out beautifully clear. Bucket or barrel makes filter. Ten pound sample \$1.00. Harvey, 709 West Eubank St., Oklahoma City, Okla.

TASTE flavor of real money selling Annie Blain Flavors, wholesale, retail; new system, samples; other unique methods. Geo. S. Parker, New Brunswick, N. J.

OUR Vulcanizers will build your tire-repairing business. Operate economically. Investigate. Adams-Barr, Columbus, Ohio.

"RUNSTOP"—Prevents runs and lengthens life of silk hosiery; harmless. Costs little to make; demand is large; all women want it; 800% profits. Complete process and plans, \$1.00 postpaid. Roth-Junior, Bloomfield, Conn.

ALL-METAL Screen frames made without Tacks, Nails, or Screws. Hinged or Sliding. 4 corners 50c. Strips 10c foot. A Profitable business anywhere. Diamond Hdw. Mfg. Co., Fourth Ave., Pittsburgh, Pa.

FIRST call for Exclusive Distributors! Organize salesforce for new store necessity. Unusual profits. Davis Co., 173 Newbury, Boston.

MODERN Mail Order Methods. A new 72-page book for mail order beginners, and the latest 1927 Pruitt-Sheridan Directory, giving supply sources for half million articles. Both copies sent post-paid for \$2.00. Money refunded if not satisfied. Patrick-Mahoney Co., P. O. Box 931, Schenectady, N. Y.

MAKE Money in your spare time. Start small mail-order business at home. Easily and quickly learned. Operated anywhere. Write for free particulars. P. M. Hilleo, 62 South Sherman, Denver, Colo.

LEARN Real Estate Business. Make \$6,000 Yearly. The Educator, New Edition, book form, 208 pages. It's the Key to Success. Sells for \$2.00. Better than a \$30 correspondence course. Get facts. C. P. Winegar, West Fort Ann, N. Y.

CONNECTICUT Gazette, a monthly magazine of money-making information. Sample copy 10c. Published by Gilbert Sales Co., Milford, Conn.

INCOME Inreaser—Newly enlarged 36-page monthly magazine of best, latest ideas, plans, schemes, tips, pointers, starters. One year, \$1.00. Three months, 25c. Income Inreaser, 63 Court, Boston, Mass.

MAKE money silvering mirrors, refinishing auto headlights, tableware, metal plating, bedsteads, chandeliers. Outfits furnished. International Laboratories, Dept. 71, 309 5th Ave., New York.

15c PUTS your name on mailing list year. Receive offers, magazines, from wholesale supply houses everywhere. Kentucky Agency, Covington, Ky.

MAKE Money at Home—making animal toys. We show you how. Send \$1 for complete working drawings and instructions. DeKalb Designing Co., Decatur, Ga.

MEXICAN Chef reveals secrets on how to make genuine Mexican dishes, tamales, chili con carne, packed products. Enormous demand. Competitionless moneymakers. Booklet 10c. Guerrero, Condesa H-6, Mexico City.

START Mail Order Business of your own at home. We supply catalogues with your address on. Wincholt Sales Co., Box 4, Woodbine, Penns.

CANDIES Home Made—Cost 14c, sell for 60c. Almost no cash capital needed. We teach you by mail making and selling. All ages, ladies or men. Start in home. Sell to stores. We furnish tools free. Free booklet. Capitol Candy School, Dept. 33-DD, Washington, D. C.

\$25 STARTS Clean, Honest, Spare-Time, Home Work Business. Very simple and easy. Circular free. B. M. Smith, Box 359, Morristown, New Jersey.

MANUFACTURING pays big profits; learn to make and sell profitable specialties. We tell you how. New practical plan. Particulars free. Coltic Bureau, Box 265, Winnipeg, Canada.

25,000 FORMULAS, recipes, trade secrets, manufacturing processes. How to secure them free. Send 6 red stamps for information. Hillgovik, Box 881, Boise, Idaho.

ATTENTION! You can have a business of your own. Establish and operate New System Real Estate Business, brokerage and insurance agency in your community. Office at home. Earn \$5,000 a year. Representatives wanted everywhere. Send stamp free booklet. Hayes Realty Association, Cincinnati, Ohio.

NEW Spare Time Money-Making opportunities. Investigate. Osc. Hanson, Mentor, Minn.

START profitable, new exclusive mail trade, book tells, 10c, plans, formulas, information. "Money Making Business Chances" \$2 volume. Satisfaction guaranteed. Wholesale Company, Akron, Ohio.

OPPORTUNITY for independent business at home or outside. Profitable. New. Welbourn, F. St., Marion, Ind.

NEW Business, Virgin Field. Your own boss. Permanent. No traveling. Hurry. Pacific, Prineville, Oregon.

COLLAPSIBLE Garment Hanger and other Household specialties. See page 131. Sample to Agents 75 cents each, including prices and circular. Gause Mfg. Co., Elkhart, Ind.

\$18 To \$25 daily. Biggest selling line of 2-piece suits, \$9.95 and \$12.50; 3-piece wool suit, \$17.95 (regular \$28.00 value). All-wool overcoat, \$18.50. Splendid raincoats, slickers and boys' suits. Biggest commissions. Free outfit. "Jim" Foster, Inc., Dept. 15, 2250 S. Spaulding Ave., Chicago, Ill.

MONEY Making Information—Wonderful Opportunities. Something for Everybody. Anderson's Service, 630 19th St., Milwaukee, Wis.

SEE our ad under Trade and Technical Schools. Illinois Business Service.

SUBSCRIBE for the Booster, a monthly magazine of money making information, one year \$1.00. Sample 20c. Wooster Products, Wooster, Ohio.

INCREASE your income—"Selected Opportunities" listing 24 business plans, two formula charts, \$1.00. Robert Smeriglio, Box 884-P, Stanford, Conn.

EXCLUSIVE Territory "Evertight" Automatic Brake and Reverse Band Tightener for Fords. Retalls \$2.00 installed. A real proposition. K-D Manufacturing Company, Jamestown, N. Y.

"FINANCING Your Business"—valuable booklet; send 25c. Financial Publishing Co. 96 Wall Street, New York.

THAXLY Formulas, Processes, Trade-Secrets, produce perfect products. Catalog, special circulars free. B. Thaxly Co., Washington, D. C.

CHARTERS: Delaware; best, cheapest; free forms. Colonial Charter Co., Wilmington, Del.

OPERATE money-making mail-order business in spare time. Write for free particulars. Triangle Mail Order Service, 600 Blue Island Ave., R31, Chicago.

1 AUTO Gas Saver Free. To introduce. All makes. Amazing mileage increase. Critchlow, C3-805, Wheaton, Ill.

MAIL Order Information, where to buy goods. Specialties, imprint circulars, everything for mail order business 25c. Harvey Teeple, Decatur, Ind.

FREE Mail Order Information. Write today enclosing stamp. Mason, 3900 Broadway, Room 5, Chicago.

RAISE Money for invention, any business proposition. Inexpensive, reliable method. Interstate Servie, Elizabeth, N. J.

RESPONSIBLE manufacturer wants competent men to manage office and salesmen. \$300 to \$1,500 necessary; will allow expenses to Trenton if you qualify. Address Manager, 536 Forst Richey Bldg., Trenton, N. J.

PATENTS Procured; Trade Marks Registered—A Comprehensive, experienced, prompt service for the protection and development of your ideas. Preliminary advice gladly furnished without charge. Booklet of information and form for disclosing idea free on request. Richard B. Owen, 30-Owen Bldg., Washington, D. C., or 41-R Park Row, New York.

GOOD Money easily earned at home spare time silvering mirrors, glass embossing, chipping, frosting, gold leafing, etc., Patterson & Co., Brooksville, Ky.

DELAWARE Incorporator. Charters; Fees Small; forms. Chas. G. Guyer, 901 Orange St., Wilmington, Del.

CHEMICAL Expert will furnish Formulas and Trade Secrets. All lines. Lists Free. W. L. Cummings, Ph. D., 228 Gordon Ave., Syracuse, N. Y.

LEARN the collection business. Good income, quick results. Interesting booklet. "Skillful Collecting" free. National Collectors Assn., Long St., Newark, Ohio.

EARN \$10 daily silvering mirrors, plating and refinishing metalware, autos, chandeliers, bedsteads, headights. Outfits furnished. E. Decie Laboratories, 1133 Broadway, New York.

DON'T gamble in mail order business. Be sure. Free circular puts you wise. MacRae, M40 Oregonian Building, Portland, Oreg.

MECHANICS, painters, carpenters, start furniture refinishing, painting, handyman shop on nearly nothing; winning plan brings customers quickly. John Braceland, 1439 So. Ninth, Philadelphia, Pa.

\$750,000,000 MAIL order business in 1925. Many grow rich in this great trade. Sell merchandise, information, patented articles various preparations. Breniser's Famous Mail Order Handbooks tell how. Eleven brochures \$3. One book with complete catalog, 25c; none free. Breniser, (Established 1900), 1607 Sansom, Philadelphia.

"HOW To Make Ten Dollars A Day With Your Kodak." Illustrated book. Make money with pictures of things people are interested in. Postpaid \$1.50. R. Snyder, Publisher, 18 Derne St., Boston, Mass.

WE Start you in Business, furnishing everything; men and women, \$30.00 to \$100.00 weekly operating our "New System Specialty Candy Factories" anywhere. Opportunity lifetime; booklet free. W. Lillyer Ragsdale, Drawer 4, East Orange, N. J.

I MADE \$30 a Week Home. French Breadmaking. 15 years' experience; Free Booklet tells. Ashbrook 67, Marengo, Ohio.

UNPATENTED Ideas Can Be Sold. I tell you how and help you make the sale. Free particulars (Copyrighted). Write W. T. Greene, 810 Jenifer Building, Washington, D. C.

MAKE toys and novelties at home. Big profits. Instructions and illustrations, 25c. Astrolite Company, Sharpsburg, Pa.

LEARN to Manufacture—It pays big profits. We teach you how. Start spare time. Few dollars. At home. We show you how to sell. Write for free circular. Heartinger System, 2202 Wyoming, St. Louis, Mo.

"SCHEMER," Alliance, Ohio, 36 p. monthly, prints Schemes, Tips, Formulas. Subscriber reports \$25,000 from three; another \$10,000 from one. Try it! Year, \$1.00; 3 months, 30c.

ARE You Old at Forty? See our advertisement on page 74 of this issue. The Electro Thermal Company, 2168 Main St., Steubenville, Ohio.

NOW that you have read all these offers, send 50c for Detailed Information. (None free). "How" and "What" to Sell by Mail; through Agents; or Direct. We want 200,000 Representatives! Opportunity is knocking—Answer! Surety Service, Dept. 274, 25 Exchange St., Rochester, N. Y.

TELEGRAPHY

TELEGRAPHY—Both Morse and Wireless—taught thoroughly and quickly. Tremendous demand. Big salaries. Wonderful opportunities. Expenses low; chance to earn part. School established fifty years. Catalog free. Dodge's Institute, H St., Valparaiso, Ind.

CHEMISTRY

EXPERIMENTERS' laboratory apparatus. Chemicals. List 5c. Chemical Apparatus Co., 4402 West End, Chicago.

YOUR chemical problem solved and working formula or process furnished for \$5.00. Write me. W. Stedman Richards, Industrial Chemist, Box 2402, Boston, Mass.

EXTRAORDINARY offer to introduce our high-grade chemicals for the experimenter—complete outfit containing 107 different chemicals and apparatus; generous quantities. Price \$7.00, express prepaid. Money order, C. O. D. or cash. Pines Chemical Co., 1524 St. Marks Ave., Brooklyn, N. Y.

FORMULAS AND TRADE SECRETS

JUST out, never before published. Book of Formulas on Fireworks, Red, White, Blue, Green, Yellow fires. Flashlight powders, one hundred thousand candle power white light. Colored smokers, bombs, explosives, liquid glues, waterproof cement, liquid shellacs, red, black, transparent, elastic drab and other trade secrets; these formulas disclosed for the first time by the originator retiring from the manufacturing business. Every formula guaranteed or money refunded. Price \$1.00. Frank Dutcher, Pyrotechnicist, Rogers, Ohio.

SPECIAL formulas for Manufacturing and Business purposes. Any one you want, including full manufacturing instructions and where to get all supplies, sent for \$5. Satisfaction guaranteed. Announcements of latest formulas for quick-selling seasonal products sent monthly without charge. Write today. National Information Bureau, 316E Shepherd Building, Grand Rapids, Mich.

FORMULAS, Guaranteed Best Chemical Science can devise. Stamp brings big bunch valuable literature describing Latest Reliable Processes for Manufacturing All Lines. Don't Buy till you've received these Profitable Propositions. No recipe-book Trash. 29 years giving satisfaction. Miller Chemist, 1706-U Jeiton, Tampa, Fla.

500 FORMULAS including Luminous Paint—Renewing Dry Batteries—Resilvering Mirrors—Gas Tonic. Puncture Plugger, 25c. Catalog Free. Ideal Book Shop, Park Ridge, Ill.

MANUFACTURE your own products. Be independent. Make money. List free. The Modern Formula Co., 63 Woodstock Ave., Allston, Mass., Suite 12.

FORMULAS: Cosmetics of the finest grade. Six for \$1.00. W. A. Riedesel, Isabella, Calif.

CEMENTS, glues, pastes and mucilages. Selected and tried formulas \$1. Brandt, 149 W. Austin, Chicago.

ANY formula or preparation duplicated. Overton, 439 Oak, Glendale, Calif.

CHEMICAL Consultation. Manufacturing Ideas made practical. Guaranteed economic formulas prepared, \$5.00. With sample, \$6.00. Associated Chemists, Indianapolis, Ind.

LATEST Formulas, Circulars 2c. Dime Information Bureau, Colorado Springs, Colo.

THAXLY Formulas, Processes, Trade-Secrets, produce perfect products. Catalog, special circulars free. B. Thaxly Co., Washington, D. C.

24 VERY Good Formulas Only 50c. Winters Specialty House, Olmsted Falls, Ohio.

AUTO Polish. 3 good formulas 25c. V. E. Fuller, R-77 Albion St., Wakefield, Mass.

15,000 FORMULAS in "Scientific American Cyclopedic of Formulas." Includes following and many others: accidents and emergencies, agriculture, alloys and amalgams, artists' materials, beverages, cements, glues, pastes, mucilages, bleaches, renovating, coloring metals, dyeing, glass, heat treatment of metals, household formulas, ice cream, confectionery, chewing gum, lapidary work, exterminating vermin, lubricants, paints, varnishes, photography, condiments, canning formulas, rubber, soap, candles, soldering, toilet preparations, perfumes, waterproofing, fireproofing, writing materials. Send No Money. Just write a postal. When postman hands you book, pay \$5.50 and postal charges. Popular Mechanics Press, Room 904, 200 East Ontario St., Chicago, Ill.

AGENTS WANTED

72 SALES in Four Hours. Profit \$64.80 (sworn proof). That's the record of "Doc" Barber. Every woman buys on 10-second demonstration. Profit up to 150%. We want 500 ambitious men and women. Exclusive protected territory. New self-wringing mop that really wrings dry, without wetting hands. No gears, bolts or screws. Weighs only 2 pounds. Simple, Practical, Perfect. Lasts a lifetime. Territory going fast! Write quick. Delphos Mop Co., 1014 Tenth St., Delphos, Ohio.

AGENTS, Salesmen, Crewmen—You'll have the Devil's own time finding a better seller than "Zippo." Splendid profit on snappy 50c "Go-Getter" repeat article that sells on a ten second demonstration. Works while you watch it! Demonstrates value while others waste time making claims. New development! Greatest scientific triumph of the age! It's the berries! Write immediately for complete proposition. Karam-Smith Company, 604 Bozart Street, Fort Wayne, Ind.

AGENTS: I'll pay you \$240 a month taking orders for Stuart's guaranteed household specialties. Handsome selling outfit furnished. Write quick. Stuart & Co., Dept. 431, Newark, New York.

AGENTS \$180 month. Bonus besides. Introduce Wilknit Hosiery. Finest pure thread silk. All fancy combinations silk and lisle, novelty, sport, full fashioned, wool. Guaranteed 6 months. Write for samples. Wilknit Hosiery Co., Dept. 2031, Greenfield, Ohio.

GET Harrison's New Free Shirt Outfit. Big samples. Fine portfolio. Made like custom shirts, but sell quick at amazingly low prices. No experience or capital necessary. Write for territory and Free Equipment. Harrison Bros., Drawer 301, 133-141 West 21st, New York City.

WAIT! You owe it to yourself to read our book "Building a Permanent Business," written by 16 men and women representatives. Gives their complete addresses. Tells how they succeeded year after year, selling our beautiful silk dresses. Sample 9 by 13 in. photograph also sent free to show you quality and workmanship. Write! You'll be mighty glad. Mr. D. Hunt, Peggy O'Neill Dressmakers, 112 West 38th Street, New York, N. Y.

MIRRORS Resilvered at Home. Costs less 5 cents per square foot; you charge 75 cents. Immense profits plating auto parts, reflectors, tableware, stores, refinishing metalware, etc. Outfits furnished. Details Free. Write Sprinkle, Plater, 128, Marion, Ind.

AGENTS—Our new selling plan means quick sales and big profits. Toilet Articles, Perfumes, Household Products. We credit you. Carlisle Co., Dept. PM, Huntington, W. Va.

***AGENTS** Wanted: Something New. Every Motorist a Buyer of our Electro-Magnetic-Emergency Wonderlamp; takes only one minute to demonstrate and make a sale; no experience necessary; \$5.00 an hour easily made, either full time or evenings. Wonderlamp Co., 920 Fisk Bldg., Dept. 10-A, New York.

\$200 TO \$500 monthly. Here is your chance. We have it. All you need is little determination and grit. Be your own employer in pleasant, dignified, permanent work supplying families McNeess guaranteed products in constant daily use. Be fair with yourself. Connect with successful big money maker. Let us show you how. Furst-McNeess Co., 505 Sunlight Bldg., Freeport, Ill.

GOLD-LEAF Sign Letters; make and sell; 1,000% profit. Johnston Co., Quincy, Ill.

SELF-SELLER—Biggest on the market; Cedar kills moths, purifies the air in the home; chases germs, mosquitoes, flies, all insects; 15c brings 25c sample and particulars. Mar Sales Co., 736 Addison St., Dept. H, Chicago.

AGENTS—Big profits; easy to sell. For Ford and Chevrolets. Retail 75c. Money back guarantee. American Fixture Co., 232 W. Water St., Milwaukee, Wis.

BIG money easily made without peddling or outfits. Free particulars. Elite, 38 Elizabeth St., New York.

AGENTS. Biggest Easter Novelty, three million sold last Easter. Get particulars now. Unger Manufacturing Co., 571 Harrison, Chicago.

SELLING Like Blazes! Eleven-piece toilet goods assortment at \$2.25 with two-piece carving set free to your customers. 100% profit. Davis Products Co., Dept. 56, 1321 Carroll, Chicago.

SELL Surety, the Original, Genuine, Powdered Hand Soap, and make \$5,000 yearly. We furnish sales plans, advertising and free samples. Write quick. Surety Mfg. Co., Dept. 56, 26 W. Washington, St., Chicago.

\$25 DAILY showing \$2.98 Slickers. \$1.25 gift to customer makes sales easy. Outfit Free. American, 724P Roosevelt, Chicago.

AT Last! Diamond Rival Discovered! Amazing blue white Rajah Gem astounds jewelry world and deceives experts. Beautiful sample case free! \$100 weekly. Quick! Rajah Diamond Co., Dept. F20, Salisbury, N. C.

AGENTS—Greater profits, year round sales, complete guaranteed line dress and work shirts, overalls, coveralls, work pants, play suits. \$10-\$25 daily easy. We show you. Complete outfit free. Nimrod Shirt Co., Dept. 8, 4922 Lincoln Ave., Chicago.

1 AUTO Gas Saver Free. To introduce. All makes. Amazing mileage increase. Critchlow, C5-805, Wheaton, Ill.

AGENTS—Distributors—Sell "1927 Pruitt-Sheridan Directory" or "Where to Buy Half Million Articles Wholesale." New distributing system. Free particulars. Pruitt System-A, Brookfield, Ill.

CASH Paid for Butterflies, Insects. See Sinclair Display Advertisement on Page 28.

MAKE and Sell Glycerine-Paste, Mechanics Hand Cleaner. Everything furnished. Entirely different. Real profits. Everyone can use it, factory, home or shop. Regular size can 15c prepaid. Particulars free. Great Stuff Products, Minneapolis, Minn.

LET me prove to you that you can make more money supplying the demand for old established popular priced line of Beauty Creations, Food Products and Medicines. Every day necessities. Money back guarantee backed by \$7,000,000 organization. You double your money on every sale. Ford car and other valuable premiums free. Write Mr. Craig, The Tru-San Company, Memphis, Tenn.

\$100 WEEKLY. Hundreds making it. Selling marvelous auto invention. One size—fits all cars. Easily demonstrated. Pocket size. Installed in 3 minutes. We guarantee sale. Send for free introductory sample offer and crew managers or local agents proposition. Mae Auto Products Company, Dept. 904, 6355 Broadway, Chicago.

AGENTS—Get free outfit and make \$18-\$20 daily writing orders for world's greatest cap value at \$1.95. Big commissions in advance. We deliver. Ask for free cap offer. Universal Cap Co., Dept. DC-40, Cincinnati, Ohio.

FREE! Large wholesale specialty catalog, showing latest best sellers from many parts of the world. Sports Co., Lesueur Center, Minn.

NEW! Just invented. Comb fastens anywhere. Send 10c for a 25c value. Never Lose Comb Mfg. Co., Lesueur Center, Minn.

WE have a wonderful Combination Brush Set for the home. Five pieces. Ten uses. Costs less than \$3.00. 100% profit. Write 610 Bankers Reserve Life Bldg., Box 840, Omaha, Nebr.

OUR New Household Device washes and dries windows, sweeps, cleans walls, scrubs, mops. Complete outfit costs less than brooms. Over half profit. Harper Brush Works, 132 3rd St., Fairfield, Iowa.

AGENTS—Can make \$250 weekly following our proven successful selling plan. An article you will never want to change from selling. Strictly first class every respect; just exactly right price to make big worthwhile money selling; over 75,000 sold in Philadelphia. Real \$250 weekly proposition appointing sub agents, agencies, individual sales. Fagley & Halpen, Desk 40, Philadelphia, Pa.

75c PROFIT on \$1.00 sale. Auto furniture and glass cleaner. Your name on label. Exclusive rights—free sample. Mfg. E, 213 Griswold, Detroit, Mich.

NEWEST Invention: Abolishes kinks, snarls, and automatically coils telephone, electric iron and lamp cords. Housewives, companies actually buying 5 to 50. Tremendous profits. Samples worth \$3.40 free. Never-knot, Dept. A4, 4503 Ravenswood, Chicago.

AGENTS: Start a permanent business of your own selling guaranteed Hosiery, Underwear, Lingerie, worn all over world. No capital or experience needed. Many representatives make from \$3,000 to \$5,000 per year. Write for details to Malloch Knitting Mills, 574 Grant St., Grand Rapids, Mich.

GREAT Phonograph Bunk exposed! Cheap invention makes old phonograph play like expensive orthophonic style reproducers, 14,000,000 phonographs, instant sales. Tremendous profits. Everplay, Desk A-4, 4503 Ravenswood, Chicago.

DON'T sell for others. Employ agents yourself. Make your own products. Toilet articles, household specialties, etc. 500% profit. We furnish everything and show you how. Valuable booklet free. Write at once. National Scientific Laboratories, 1946 W. Broad, Richmond, Va.

THAXLY Formulas, Processes, Trade-Secrets, produce perfect products Catalog, special circulars free. B. Thaxly Co., Washington, D. C.

LOOK no further! Here's your money maker. Write for Harrison's New Shirt Outfit. Big samples. Fine portfolio absolutely free! Tailored shirts generously cut. Reinforced. Handsomely finished. Made like custom-tailored shirts, but sell quick at amazingly low prices. No experience or capital necessary. Write for territory, and Free Equipment. Harrison Bros., Drawer 421, 133-141 West 21st St., New York City.

REAL Whirlwind Seller—Nopolout Custom Shirt. Every man buys them. Patented—no competition. Liberal commission. Free selling kit. Make \$15 up daily taking orders direct from consumer at manufacturer's prices. District or local agents. Write Nopolout Shirt Co., Dept. Y, Hazleton, Pa.

SELL absolute necessities. Cost 2c, sells 25c. Prices lowest. Seven different samples 39c. Catalog free. Mills Sales Co., 13 East 16th St., New York.

SALESMEN—Harrison's exclusive New York Style Clothes pay you \$15 a day. Tailored of finest 100% virgin wools. Priced \$15.00 to \$25.00 below others. Collect advance commissions on every order. De Luxe outfit sells for you. Experience unnecessary. Valuable territories open. Write for new, elaborate outfit. S. Harrison Bros., Inc., Drawer 300, 133-141 West 21st St., New York City.

AGENTS \$60 Week. New tool chest, 8 tools in one. Handy. Fits hip pocket. Fine leather case. Newest thing out. Going big. Write quick. Novelty Cutlery Co., Chest 631, Canton, Ohio.

AGENTS—Mosco Corn and Callous Remover will build you a steady repeat business. Send today for pocket size trial outfit. The Moss Co., 357 Searle Bldg., Rochester, N. Y.

AGENTS: Ride in new auto. Show samples and collect \$17.50 cash daily in advance. Bonus besides. Finest new line hosiery—129 styles and colors. Guaranteed 7 months. Priced to sell fast and repeat. Permanent business. Big profits. Steady income. Spare time satisfactory. No experience needed. Start on credit. Write quick for samples. Betterknit Textile Co., Dept. 61, Greenfield, Ohio.

AGENTS Wanted to Advertise our Goods and distribute free samples to consumers; 90c an hour; write for full particulars. American Products Co., 9022 Monmouth, Cincinnati, Ohio.

GOLD Leaf Window Letters and Script Signs. No experience; 500% profit. Samples free. Consolidated, 69U, West Van Buren, Chicago.

MONEY Talks—You can have plenty of it selling—Amazing New Moth Bag. Absolutely air-tight. Never on market before. Sells on sight. Write today. Sta-Put Products Co., St. Louis, Mo.

AGENTS make big money selling Hand Woven Rugs direct to consumer. The Model Rug Co., 235 Main St., Cincinnati, Ohio.

300% PROFIT: Whirlwind selling household, store, office necessity. Fast repeater. Free sample. Chapman Company, Room 200, 332 East 31st, Kansas City, Mo.

EVERYBODY uses toilet preparations. Sell dainty, exquisite, delicately scented. Duo compacts, perfumes, powders, creams and lotions, Flavoring extracts and Specialties. Duo Co., TP-1, Attica, N. Y.

AGENTS make \$40 to \$80 weekly selling typewriters re-manufactured like new by the "Young Process." Lowest prices and easiest terms ever offered. Big Commission—no investment—real opportunity to start in business for yourself. Write Today. Young Typewriter Co., Dept. 5754, 654 W. Randolph St., Chicago, Ill.

RADA-DIAMOND rivals the genuine diamond. Rich or poor buy them. Low price, fast sales, big profits. \$10,000 yearly for hustlers. Pocket case free. National Co., Box 1174-PM, Omaha, Neb.

\$10.00 SLICKER Raincoats \$2.85. Utility Suit \$8.50. Commission \$3.50. Bonus. Free outfit. Paramount Manufacturers, W1561 Milwaukee Ave., Chicago.

AGENTS. Get our prices on Coffee, Tea, Desserts, Soaps, Perfumes, etc. Endless variety, superb quality, quick service. Sample display free. Address Blair Laboratories, Lynchburg, Va.

AGENTS—\$10 Daily Selling the New Japanese unbreakable fountain pens. Retail for \$1.25. Agent's Sample \$1.00. Particulars Free. Oka Products, Box 482, Pottsville, Penna.

REAL money for you. Our combination Aluminum Cooking Set easy to sell. No delivering, no collecting. Make \$10 to \$15 daily. Espy-Riddle Co., Dept. 2, 2325 Carson Street, Pittsburgh, Pa.

AGENTS—Best seller; Jem Rubber Repair for tires and tubes; supersedes vulcanization at a saving of over 800 per cent.; put it on cold, it vulcanizes itself in two minutes, and is guaranteed to last the life of the tire or tube; sells to every auto owner and accessory dealer. For particulars how to make big money and free sample, address Amazon Rubber Co., Philadelphia, Pa., Dept. 595.

AGENTS: Salesmen—Sell New Thermo-static Automatic Carburetor Control Attachment for Fords. Big profit, full or part time. Increases mileage 50-100%. Attached in two minutes. No drilling. Cadillac now using Thermo-static Carburetor Control under Blanche License. Sales guaranteed. \$15.00 a day Guaranteed to Distributors. Write today. Blanche Auto Devices Co., Dept. 805-E-X, 157 E. Erie St., Chicago.

THREAD-CUTTING Thimble 25c. Seller Sample 15c. Irvel, 3973 Elston, Chicago.

AGENTS, portraits, photo-pillow tops, frames, sheet pictures, medallions, photo-jewelry, guaranteed hose, laundry tablets, food products, toilet requisites, luminous crucifixes. Catalog 50 specialties free. 30 days' credit. Jas. C. Bailey Co., Dept. C4, Chicago.

OUR Agents average better than \$75 a week; Rich's pure fruit soft drink powders. Every home, store, drink dealer buys. Sample free. Sol P. Rich Co., 622 S. Sangamon, Chicago.

\$500 MONTHLY advanced showing new colored Durotex slickers—\$10.00 value \$2.98. Beats all competition. Outfit Free. C. B. Clair, Dept. 106, 209 N. Washenaw, Chicago.

WANT \$500 Soon. Sell beautiful Dresses, Coats, Scarfs, Sweaters. Amazing low prices. We deliver. No experience necessary. Get complete outfit free! Write Hirsch Knitting Mills, 1963 South California Avenue, Chicago.

MAKE Money selling E-Z Brite polishing cloths. Every office and home your prospects. Samples 25c. Excello Sales Co., Shreveport, La.

\$5,000 A YEAR—Selling Perry Photo Medallions. Big demand. Ready sales. 400% to 600% profits. Any photo copied perfectly on Medallions, Mirrors, Compacts, Jewelry, etc. Guaranteed likeness. Investigate. Free catalog, full details on request. Write Today. P.M. Perry Photo Novelty Corp., 1793 Jerome Ave., New York.

LITTLE WONDER pencilknife, safetyclip, nailcleaner, fits on pencil. Sample 10c. Gross \$7. Klees Company, 1710 Undercliff Avenue, New York.

AGENTS—Make \$15.00 Daily. Show samples and distribute teas, coffee, spices, extracts; 200 products; things people eat. I go 50-50 and furnish Chrysler closed car. Offer made to first person answering in your locality. Write or wire Health-O Quality Products Co., Dept. 101D, Cincinnati, Ohio.

\$100 WEEKLY representing large Direct to Wearer Company. Complete shirt, necktie and work clothes line. Unbeatable combination means selling everyone. Advanced commission and bonus. Sales Compelling Outfit Free. Howard Shirts, 1213 VanBuren, Dept. M20, Chicago.

\$50,000. PICTURE Man Friedman made canvassing. Beginners can make \$100.00 weekly with my sales talk. Experienced men make more. Free book. "Profits in Portraits" explains. Samples Free. Picture Man Friedman, Dept. 8F, 541 W. Lake, Chicago.

AGENTS—Make a dollar an hour. Sell new kind of sharpeners. Sharpeners all knives and tools quickly. Demonstrating sample free. Premier Mfg. Company, Dept. 66, Detroit, Mich.

JUST Out—Patented Apron. No strings or straps; on or off instantly; \$20 a day easy; every demonstration a sale; over 100% profit; commissions daily; write today for free offer. Staput Co., Dept. 204, St. Louis, Mo.

\$100.00 WEEKLY easily made demonstrating our Rayon bedspreads and slickers. Newest patterns, latest styles, popular colors, lowest prices. Highest commissions paid. Outfit free. Northern Fabric Company, N186 N. La Salle, Chicago.

BIG earnings. Square Deal Polley. Sell "Spines Quality Shoes" direct to ladies. Big values, snappy styles, \$4.00 up. Money Back Guarantee. Protected Territory. Write! Spines Shoe Co., Dept. F306, Cincinnati.

DO you want good live agents—fellows who can get the business? Ask me how others are doing it. I'll gladly render the necessary assistance without cost to you. Address, M. L. Rund, Mgr. Classified Advertising, Popular Mechanics Magazine, Chicago.

SELL Tailor-Made Shoes. Sensational new fitting discovery eliminates foot troubles; makes walking a pleasure. 75 men's and women's styles. 60 leathers. Prices lower than stores. Big commissions. Free outfit. Free sample shoes. Tailor-Made Shoe System, 932 Wrightwood, Dept. OAA, Chicago.

ALWAYS Steady Work at Good Pay, inside or out. Full or part time. Easy. New. Distinctive. Many ways without selling. Free. A. Ceelson Service, 3570 West 25th, Cleveland, Ohio.

THANCO Vanilla—Bottle Yourself! Concentrated; add water! Free labels. Crushes competition! 500% profit! Immense seller! Other concentrated products. Write Thomas Manufacturing Company, Indianapolis, Ind.

MAKE \$20 daily selling merchants \$1.00 changeable letter display signs. 75c profit every sale. Maze Manufacturing Co., Norwood Station, Chicago.

WANTED: Agents for the Big Three. Thermo waterless cooker. Ever-ready coffee pot, and greaseless doughnut molds. Good commission. Dept. G, The Canton Aluminum Co., Canton, Ohio.

MAN with auto; one day weekly; \$35. Bens, Woodside, N. Y.

WOMEN and Men full or part time, experience unnecessary, easy, quick seller. Sample 25c. Guaranteed. 100% profit. Rusch Service, 6001 So. Halsted, Chicago.

\$25.00 DAILY selling Raincoats and Slickers \$2.95; Newest colors, red, blue, green, etc. Outfit free. Commissions daily. Elliott Bradley, 241 VanBuren, Dept. 842, Chicago.

RAISE Money—Bottle, 15c; 150, \$11.25. Springfield Perfume Co., Springfield, Mass.

SEND name, address on postcard. Free introductory copy Salesology Magazine; contains 1,000 money making opportunities. Offered by big reliable firms; no obligations. Salesology Magazine, Desk B32, 500 No. Dearborn, Chicago.

ARE You Old at Forty? See our advertisement on page 74 of this issue. The Electro Thermal Company, 2168 Main St., Steubenville, Ohio.

RITHMETIC KID makes Quick Money. Sample and Wholesale prices 25c. Wholesale Supply Co., Valdosta, Ga.

33% SELLING Monogrammed Stationery and Everyday Greeting Cards. Write Herrings, 1224 N. 19th St., Philadelphia.

QUICK Calculator and five-year calendar combined. It's a beauty. Show 100 people and sell 99 at 25c each. Write Perry-Sparks Co., Box 658, Akron, Ohio.

AGENTS and District Managers: 250% profit selling exclusive, new process Artistic Signs. Hundreds of titles for every business. No competition. Write for details. Artistic Signs, 799R Broadway, New York.

WILLIAMS' Powdered Hand Soap, has taken auto owners by storm. Cleans dirtiest hands instantly. Easy demonstration sells on sight. Free Sample and particulars. W. B. Williams, Inc., Dept. 266, Montclair, N. J.

1 AUTO Gas Saver Free. To introduce. All makes. Amazing mileage increase. Critchlow, C4-805, Wheaton, Ill.

FREE mailorder and agency propositions. Prospect, 5063-p Gateway, Kansas City, Mo.

MAKE money silvering mirrors, refinishing, auto headlights, tableware, metal plating, bedsteads, chandeliers. Outfits furnished. International Laboratories, Dept. 71, 309 5th Ave., New York.

WE want 500 men as district salesmen to sell Nustle Hosiery, Shirts, Underwear and Pajamas. The fastest selling Guaranteed men's line on the market today. Big repeat business. Earnings \$80 weekly and bonus. Full or part time. No investment necessary. Sample outfit free. Write at once. Nustle Fabrics Corporation, Dept. 1-4, Philadelphia, Pa.

\$320 PROFIT First Three Days' Sales for Zindel, Illinois, with Morey Quick Action Auto Rim Tool. Profit \$2 tool. Exclusive territory for hustling agents. Earn \$10 to \$50 cash daily, \$75 to \$300 weekly year round. M. Morey Rim Tool Co., 118 Woodbridge Ave., Buffalo, N. Y.

\$31.00 PROFIT—with \$1.50 Outfit—Big Money—Easy Work. Selling Gold Monograms for Automobiles, Luggage, Windows, Wagons. No Experience. No License. "Samples Free." NuLife Monograms, Hartford, Conn.

AGENTS: \$18 a day easy selling Stetson quality shirts. New line—new sales plan. Outfit free. Write today. Stetson Shirt Co., Dept. A11, Cincinnati, Ohio.

PHOTO Medallion Men and Women, the largest line of Photo Novelties in the world. Lowest prices, quickest service. Send for catalogue showing over 200 money makers, Photo medallions, photo medallion clocks, photo mirrors, photo fountain pens, photo powder compacts, photo jewelry and photo buttons. Gibson Photo Jewelry Co., 608-614 Gravesend Ave., Brooklyn, N. Y.

CHICAGO Diamond Expert overvalued our Mexican Blu-Flash Gem 3,000%! The Diamond's Only Guaranteed rival! Greatest spare-time, side-line agent's article known! Amazing profits! \$5 pocket sample case free! Write quick! Mexican Gem Company, Box P7C, Monterey, Calif.

AGENTS: Make \$500.00 monthly. Pay daily. No investment. Rhinestone initial buckles and novelties. Sell easy everywhere. Exclusive territory. Chaton Novelty Co., 606 Blue Island, Chicago.

CAN you sell Ford size tires at \$3.50 each? Write for plan. Details free. American Accessories Co., Station 431, Cincinnati, Ohio.

SALESMEN—Distributors—Sell novel cigar and gas lighters. Every smoker and gas user buys on sight. Also sell dealers, sub-agents. Self-selling plan free. Master-lite Corp., 110 East 23rd, New York.

EASY to sell to every merchant. Good profits. Repeats. Two sizes. Glassed or unglazed. Write Embossed Show Card Co., 9474 Euclid Ave., Cleveland, Ohio.

SELL Duro-Flex health shoes for men. Low prices. Big profits. No competition. Write Dyer-Sawyer Company, Lewiston, Me.

AGENTS—Big Seller—\$20 Daily Easy selling Taylor Caps—made-to-measure—every man buys—some want 2 or 3 caps. Samples Free to agents. Write quick for fast money making proposition. Taylor Cap Manufacturers, Dept. W-52, Cincinnati, Ohio.

AGENTS: \$15.00 daily easy with amazing fluid. Mends hosiery, dresses, and 1,000 other articles in few seconds. 50% to 200% profit. Free outfit. New Way Laboratories, Desk H-6, Mt. Healthy, Ohio.

AMAZING large cash commissions introducing beautiful \$3.95 and \$4.95 fit-to-measure guaranteed shoes. Actual samples furnished. Write for your territory. Style Arch Shoe Co., Dept. Q-105, Cincinnati, Ohio.

NEW invention—big seller—400% profit. Liquid Quick Mend for hosiery and fabrics. Every woman buys. Hundred other fast sellers. J. E. Johnson Co., Dept. 452, 6145 Wentworth Ave., Chicago.

WANTED—Ambitious person to represent us selling high quality toilet and food necessities. Big profits averaging 50%. Permanent repeat business. Get free sample case offer. Valmor Company, V-5249 Cottage Grove, Chicago.

100% PROFIT. 100 fast selling Brushes, dusters, mops and household necessities. Full or part time. Write for free offer. State age and experience. W. E. Kautenberg Co., Box 255P, Freeport, Ill.

AGENTS \$240 month. Dri-Klean-It makes any car look like new. Removes mud, grease, tar, road oil, all in one operation. No soap or water used. Cleans any car for 10c. Wonderful seller. Exclusive territory. Big opportunity to make \$5,000 a year. Write quick for particulars and free sample. American Accessories Co., Desk 1031, Cincinnati, Ohio.

THE best tooth-paste for Pyorrhea is ZI-O-Dine. Every tube guaranteed. Taste and cleansing qualities wonderful. Fifty cent tubes. Agents wanted. Iodine Products Co., Laurel, Miss.

\$30.00 A DAY for District Salesmen. Responsible man, 30 years old or over, and permanent resident in community, can make \$30.00 a day and up as District Salesman, taking orders for our finest, tailored-to-order clothes at sensational low price. No investment necessary. We supply everything, give exclusive territory to producers, pay highest cash commission daily and big monthly bonus besides. Write at once to Dept. 900, Goodwear Chicago, Inc., 844 West Adams, Chicago.

HERE They Are—Fifty fast sellers everybody needs and buys. Fifty dollars weekly easily made. B. & G. Manufacturing Co., Dept. 153, Pittsburgh, Pa.

EARN \$80.00 weekly with Paris Fashion Frocks for women. Factory prices. Advance commissions. No experience necessary. New Plan! Fashion Frocks, Dept. D-2, Cincinnati, Ohio.

\$10.00 SLICKERS only \$2.98. Biggest commissions. Represent manufacturer. 10 colors. Free Outfit. Roselife Manufacturers, 713 Roosevelt Road, Dept. H, Chicago.

\$25.00 REWARD for any Corn Great Christopher Positive Corn Cure cannot remove. Also good for Warts, Bunions, Moles, Callouses. Price 35c. Sell Dr. King's Ointment for Skin troubles. Price 35c. Sample and particulars for stamp. Reliable Specialty Corporation, Buffalo, N. Y.

AGENTS: Our gold-eyed Needle Cases are wonderful sellers; immense profits; \$50 to \$300 weekly; proof and particulars free; sample outfit 10c; factory prices. Paty Needle Co., 231 Davis Square, Somerville, Mass.

SELL coconuts for growers. Write Export Dept., Box 327, Kingston, Ja., B. W. I.

AGENTS—To sell Catholics—Wonderful Proposition. United Religious Goods Co., 201 United Bldg., Covington, Ky.

AGENTS: Keep in touch with best selling propositions. Send name and address today for next three big issues of How to Sell magazines free. Sam D. Spalding, Mt. Morris, Ill.

AGENTS—Demonstrators—To sell Latonia Ejector Forks. Latest kitchen utensil. Sample 50c. The Latonia Cutlery Co., Desk 48, Covington, Ky.

AGENTS \$60 a week and new automobile. Extra bonus besides. Introduce finest line guaranteed hosiery. Silk hose free for your own use. Samples furnished. Jennings Hosiery Co., Dept. 2631, Dayton, Ohio.

AGENTS \$240 month. Brand new invention. Self-wringing-mop. Talk of the nation. Biggest seller ever put on the market. Push button and turn handle. Hands never touch water. New selling plan. Low priced. Big sales. Territory given. Write quick. Details free. National Products Co., Plan 431, Dayton, Ohio.

MANUFACTURERS lamb wool polishers, dusters. Newhall, 358 Broad St., Lynn, Mass.

1 AUTO Gas Saver Free. To introduce. All makes. Amazing mileage increase. Critchlow, C6-805, Wheaton, Ill.

\$25 To \$50 a week—\$1 to \$2 an hour spare time in easy, pleasant occupation. Thousands of men and women are making this income with the famous Ho-Ro-Co Soaps, Perfumes, Toilet Articles, Specialties. Over 200 items; quick sales, appeal in every home. La-Em-Strait Hair Dressing, the fastest seller wherever introduced. Write at once for Free Sample Case offer—the best yet. Ho-Ro-Co., 791 Ho-Ro-Co Bldg., St. Louis, Mo.

AGENTS make big money selling watch dog burglar alarms; retails for \$1.00; your profit 100%. Particulars free. Tuerk Mfg. Co., 32 No. Jefferson St., Chicago, Ill.

BRAND new plan. Make \$45 a week and up and get your own clothes free. Profits paid in advance. Any man can easily earn this and more, just showing our wonderful outfit and taking orders for our high-grade tailoring. Free suit to each agent. Handsome carrying case outfit of large real cloth samples—everything furnished free. Spencer Mead Company, Sherman and Harrison Sts., Dept. D817, Chicago.

CALIFORNIA perfumed beads selling like hot cakes. Agents coming money. Big profits. Catalog free. Mission Factory P, 2328 W. Pico, Los Angeles, Calif.

SELL delicious food product to homes. Spare time or whole. Liberal profit. Repeat orders certain. Appoint sub-agents. Sample and Selling Plan Free. Cream of Chocolate Co., 40 Central, Waltham, Mass.

AGENTS—Mac's Lintment (Liquid Mustard Plaster) for Coughs, Rheumatism; Mac's Black Lotion for Pyorrhea, Wounds, Sore Gums, Piles. Mac Chemical Corp., 74-A West St., New York.

OUR Luminous Crucifix Shines in the Dark. Every one amazed at the wonderful effect. Easily demonstrated. Easily sold. W. G. Hannan Co., Dept. B, 2539 So. State St., Chicago.

DISTRICT Managers—Agents: Capable men and women financially able to create and sustain branch office for new low-priced household necessity in big demand. Agents also wanted. For particulars write Pittsburgh Sanatory Supply, Inc., Wilkensburg, Pa.

AGENTS make \$3.00 an hour taking orders for our 40 Fascinating Kitchen Specialties. No competition. Write quick. General Products Co., Dept. 7-K, Newark, N. J.

SELL Show-Cards. New Line. Big Profits. Quick Sales. Particulars Free. Elkco, 525 South Dearborn St., Chicago.

KLEENZIT Kleening Pencil Removes spots and stains from men's garments and similar fabrics. Simply mark spot with cleaning crayon and erase with brush-pad moistened with water. Sells readily at 35c to 50c. Big profit. Sample 25c. Argyle Specialty Co., Argyle, Wis.

AGENTS Wanted to sell Men's Hats direct from Factory. Send for Catalogue. Model Hat Mfg. Co., Dept. 5, East Orange, N. J.

OH, Hello! why didn't I see this before. Christy's Iron Rust and Stain Remover sells like blazes. Write for free sample. Chrissy, Inc., 5067 Lakeway, Newark, New York.

EVERY Woman Wants a Sewing Set. Home Sewing Sets contain 142 useful sewing articles. \$4 an hour easily made with this 50c seller. Prentice-Lee, 145 East 23rd St., New York.

BIG Profits: Steady Income our line food products, toilet articles, soaps. No cash or experience needed. Sample case free. Write Linro Co., Dept. 242, St. Louis, Mo.

VANILLA Salesmen—Try our Concentrate. Add water and bottle. Beats them all. Profit biggest. Sample. Trask, Mfg'r, East Vassalboro, Maine.

\$50.00 WEEKLY easy. Applying Gold Initials on Automobiles. No experience needed. \$1.45 profit every \$1.50 job. Free Samples. "Balco Monograms," 1043 Washington, Boston, Mass.

\$11.50 PROFIT, on 50c outfit complete. Hair Tonic in powder form. Simply add water and bottle. Everything furnished. Casey Company, 1043 Washington, Boston, Mass.

SEND three references for Samples. 15 Hosiery Styles; 50 colors. \$10.00 Dinner Set Free to customers. S. Q. S. Desk D., Lexington, Ky.

DISTRICT Agents—Sell \$23.50 All Wool Union Made Suits and Topcoats for large, old established firm. Wonderful values; old price. Liberal commissions in advance; money back guarantee. Expensive 9x13 swatch outfit Free. Protected territory. Write I-D. Harvey, Box 00, Chicago, Ill.

AGENTS make \$10.00 Daily selling Non-Splash Water Filters on sight. Best canvasser's article on market. Investigate. Write for particulars. Desk 14, Seed Filter Company, 73 Franklin Street, New York.

WE Pay \$50 a Week and Expenses and give Ford Auto to men to introduce poultry and stock compounds. Imperial Co., D23, Parsons, Kan.

OVER 100% Profit. Self Lighting Gas and Cigar Lighters; Everybody interested, repeat business. Sell individuals, dealers, subagents. Particulars Free. P. Bernhard, 127 West 30th St., New York.

AGENTS—N-R-G Laundry Tablets. The old reliable moneymaker for live agents. Millions sold—200% profit—sales waiting for you. Clothes washed spotlessly clean in 10 minutes without rubbing. Free samples. N-R-G Company, 230 W. Superior, Chicago.

WANTED—County representatives to market 3A garage Door Holders. Simple Automatic Action instantly attracts Garage Owners, Builders, etc. Write for attractive proposition. Knowlson-Stevenson Company, Ann Arbor, Michigan.

NEW Camera. Regular black and white photos finished quickly inside camera. Make money selling cameras, taking photos or doing both. Crown Company, Dept. 481, Norwalk, Conn.

MAGIC Polishing Cloth—great seller—big profit. Try this cloth—it's a moneymaker. Full size samples free. Get this proposition. Newton Co., 166 Main St., Newark, New York.

AGENTS—just like striking an oil well. New money-making advertising specialty. Particulars free. Suburban, Box 10, Mt. Washington, Ohio.

JUST off the press. "Radio Trouble Shooter." How to find all radio troubles and fix it. Illustrated. Sample copy \$1.00. Particulars free. Publisher, Box 10, Mt. Washington, Ohio.

NOVELTY bedspreads. Silk and cotton fabrics. Guaranteed. Reasonably priced. Every housewife wants one. Liberal territory and commission. Write Rainbow Novelty Mills, Grover, N. C.

WE Start You Without a Dollar. Soaps, Extracts, Perfumes, Toilet Goods. Experience unnecessary. Carnation Co., Dept. 2480, St. Louis.

PATENTS. Time counts in applying for patents. Don't risk delay in protecting your ideas. Send sketch or model for instruction or write for Free book "How to Obtain a Patent" and "Record of Invention" form. No charge for information on how to proceed. Communications strictly confidential. Prompt, careful, efficient service. Clarence A. O'Brien, Registered Patent Attorney, Security Bank Building (directly across street from Patent Office), Washington, D. C. See pages 138 and 139.

MOCCASIN Manufacturer Wants Agents Everywhere to sell a complete line of moccasins to wearers. Entire new line. No competition, repeat orders. Get details. Daley Moccasin Co., Fort Covington, N. Y.

SELL men's neckwear; wonderful proposition. Astor, 318-M Broadway, New York.

\$75 WEEKLY Man or Woman Wanted with ambition and industry, to distribute Rawleigh's Household Products to steady users. We train and help you so you can make up to \$100 a week or more. No selling experience necessary. Pleasant, profitable, dignified work. Write today. W. T. Rawleigh Co., Dept. IL253, Freeport, Ill.

WOULD \$100.00 per week interest you? Millions of photos all over the Country just crying to be made into beautiful artistic medallions. We have new plan. Lowest Prices. Speedy service. Experienced agents losing money every day they put off writing us. Art Medallion Co., Department C, Corner Campbell & Jackson, Chicago, Ill.

SELL Super-Power, the blue wonder crystals. Latest automobile product. Sells like a flash. Saves gas, increases power and pep, removes carbon while driving. Guaranteed harmless. Just pour into gas tank. Steady repeat article. Your profit 100 to 182%. Particulars free, write today. Cassard Specialty Laboratories, 31A Fountain Street, Grand Rapids, Mich.

"MAKE And Sell Your Own Goods"—Tremendous Profits; No machinery; No experience; We show you how; Write quick for Free Book. Clover Laboratories, (P) Parkridge, Ill.

\$16 A DAY Easy—I start you in auto accessory business; no investment; no experience necessary. Landin, 3433 Montrose Ave., Chicago.

GENUINE Gold Leaf Letters anyone can put on Store windows. Guaranteed to never tarnish. Large Profits. Enormous Demand. Free Samples. Write today. Metallic Letter Co., 438-D North Clark, Chicago.

"LIQUID-LEATHER" Fills Holes in Shoes, Rubbers, Tires. Dries Instantly. Pliable, Waterproof. Just Imported from France. Tube Retail 75c—Cost 35c. Sells Housewives, Sub-Agents. Nulife Leather, Hartford, Conn.

REMNANT Store, Bethel, Ohio. Greatest Dry Goods Bargains on Earth. Agents and Dealers.

AGENTS—Clever Invention! Inkspoon makes every pen a fountain pen. Fast office seller; big profit, demand increasing everywhere. Exclusive territory offered. Sample free. H. Marul Company, Tribune Bldg., New York, N. Y.

EARN \$10 daily silvering mirrors, plating and refinishing metalware, autos, chandeliers, bedsteads, headlights. Outfits furnished. E. Decie Laboratories, 1133 Broadway, New York.

AGENTS—Make a dollar an hour. Sell Mendets, a patent patch for instantly mending leaks in all utensils. Sample package free. Collette Mfg. Co., Dept. 404, Amsterdam, N. Y.

AGENTS—Send for Free Sample "Fret-not" Washday Wonder. Big Profit. You don't have to talk; if she doesn't buy at sight, leave sample. Exclusive territory. Credit given. Empire Specialties Co., 1549 N. Wells, Dept. 101, Chicago.

AGENTS make \$100 week placing advertising Cigar Lighters with glass front. Every dealer wants one. Write for free plan. Drake Mfg. Co., Dept. M, Milwaukee, Wis.

BIG Profits. Sell "No-Splash" 4-Strainer Water Filters. Fast sales, lowest prices; send for 6 dozen, \$1.80 postpaid. Jones Mfg. Co., 243E2 Franklin St., Boston, Mass.

FREE Sample. "Rain Shield Wiper." Retail \$1.00—Cost (25 cents). Sold Clear and Rainy Days. No Cloth—No Paste—No Attachment. (1) Rub keeps windshield clear 48 hours. Experience Unnecessary. Nulife Corporation, Hartford, Conn.

NO Dull Times Selling Food. People must eat. Federal distributors make big money; \$3,000 yearly and up. No capital or experience needed; guaranteed sales; unsold goods may be returned. We furnish you with sample case, license and Free Samples for customers—Sure repeat orders. Exclusive territory. Ask now! Federal Pure Food Co., A2307 Archer, Chicago.

\$60-\$200 A WEEK. Genuine Gold Letters for store windows. Easily applied. Free samples. Liberal offer to general agents. Metallic Letter Co., 438-B North Clark, Chicago.

GOLD Sign Letters. \$9.75 for Thousand. Non-Tarnishable. Free sample. Catalogue. Atlas Sign Works, 1032 E. 55th St., Chicago.

AUTO owner tire agent wanted each locality to use and take orders for hand-made Mellinger cord and balloon tires; guarantee bond 15,000 miles; shipped prepaid on approval; get your tires free; no capital or experience required; make \$100 to \$300 weekly. Write for wholesale prices and sample kit. Address Mellinger Tire Co., Dept. 400, Kansas City, Mo., or Dept. 400, Philadelphia, Pa., or Dept. 400, Oakland, Calif.

AGENTS—Here's a New One. "Best-Over Powdered Hand Soap." Sells like wildfire. Marvelous Discovery. Removes grease, paint, ink, oil, in fact anything from the hands. Cannot harm skin. 150% Profit. Great Repeater. Agents simply coining money. "Free Samples Get the Business." Write immediately. Bestever Products Co., 1937 E. Irving Park, Chicago.

AGENTS—Steady income. Large manufacturer of handkerchiefs and dress goods, etc., wishes representative in each locality. Factory to consumer. Big profits, honest goods. Credit given. Send for particulars. Freeport Mfg. Co., 59 Main St., Brooklyn, N. Y.

POLMET—The Wonderful Polishing Cloth that cleans all metals without liquid, paste or powder. Approved by "Good Housekeeping" and "Modern Priscilla"—sells fast at 25c. Sample free. Gale & Co., Inc., 15 Edinboro St., Boston.

MAN in each town to plate auto parts, reflectors, bathroom fixtures, refinish beds, mirrors, chandeliers; by new method. No capital or experience required. Simple plan of manufacturing at home starts you in big money-making business. Outfit furnished. Free particulars and proofs. Gun Metal Co., Ave. H, Decatur, Ill.

REPLATE brassy worn-off Automobile parts, Reflectors, Bath Room Fixtures, Worn Spoons, Forks, etc., with pure silver. Looks like new. Use U-Kan-Plate Polish. Positively no mercury. \$1.00 half pints. Post Paid. Satisfaction Guaranteed. Agents wanted. Dept. A, U-Kan-Plate Co., Philadelphia.

AUTOMOBILE Specialties. Guaranteed formulas for all latest money makers. Lowest prices. Write for free lists. Murphy, Chemist, Tujunga, Calif.

MANUFACTURE Very Latest, Biggest-selling Advertisers Specialties yourself—No Machinery; investment small—All lines. Stamp brings Valuable Interesting Literature explaining how others sell your products and big bunch lists Guaranteed Formulas. 300 to 1,200% profit to you. Reliable Information Only. No "Master Formula" trash. Miller, Chemist, 1706-V Jetton, Tampa, Fla.

AGENTS—Sell 5c fast selling candy specialties to stores. Big profits. Lorrac Products Co., Albany, N. Y.

AGENTS—Stamping names on Pocket Key Protectors; sample Check with your name and address. 25c. Stamping Outfits. Emblem Checks, Check Fobs, Name Plates. Hart Mfg. Co., Desk 2, 303 Degraw St., Brooklyn, N. Y.

A BUSINESS of Your Own—Making Sparkling Glass Name and Number Plates, Checkerboards, Signs. Big Book and Sample Free. E. Palmer, 512 Wooster, Ohio.

AGENTS—New Plan, makes it easy to earn \$50.00 to \$100.00 weekly, selling shirts direct to wearer. No capital or experience needed. Represent a real manufacturer. Write now for Free Samples. Madison Company, 566 Broadway, New York.

GET Our Free Sample Case—Toilet articles, perfumes and specialties. Wonderfully profitable. La Derma Co., Dept. A, St. Louis, Mo.

BIG Money and Fast Sales. Every owner buys Gold Initials for his auto. You charge \$1.50; make \$1.35. Ten orders a day easy. Write for particulars and free samples. American Monogram Co., Dept. 40, East Orange, N. J.

AGENTS: 500% profit. "Happy Home Make Shampoo" builds your own big business. Martin of Indiana made \$75.00 in one day. Missouri man made \$750.00 one month. Exclusive territory. Geo. A. Schmidt & Co., Dept. P, 236 W. North Ave., Chicago.

HIGH-GRADE SALESMEN WANTED

SOMETHING new. "Pack's" Hand Cleaner thoroughly removes all dirt, grease, ink, paint, stains. Used by mechanics, doctors, housewives, everybody. No cheap chemicals. A powerful germicide. Heals as it cleans. Leaves hands soft and white. If sufficiently interested send \$2.00 for a sample case, otherwise do not answer. We offer a sales proposition that will enable you to make real money. Our sales prove it. G. H. Packwood Mfg. Company, Dept. A., 4539 Delmar Boulevard, St. Louis, Mo.

WANTED—Tailoring Salesmen, make \$60 to \$125 per week. We are the largest made-to-measure tailoring house in the country, furnishing elaborate sample equipment. Over 150 all wool fabrics sell at \$23.50, \$29.50, \$34.50 and \$43.50 which includes commissions of \$3.50 to \$8.50 and bonus. Guaranteed absolute satisfaction, perfect fit, best workmanship, or no sale. We maintain an absolute 6-day delivery schedule. Write for our line and all accessories to be sent free. Tell us all about yourself. Edward E. Strauss & Co., Inc., Dept. 101, 402 So. Market St., Chicago.

BIG Season Just Ahead—Advertising Pencils more popular every day—every business prospect—our line repeats—Big commission—Established 1902. North American Pencil Works, 127 AB, So. Clinton, Chicago.

SEND name, address on postcard. Free introductory copy Salesology Magazine; contains 1,000 money-making opportunities. Offered by big reliable firms; no obligations. Salesology Magazine, Desk B33, 500 No. Dearborn, Chicago.

WALKER made \$165.00 first day selling Collection System to Doctors and Merchants. Retail \$6.50—Costs \$1.00. Adjustment Bureau, Mobile, Ala.

MEN—Sell dependable shrubbery, fruit trees, etc. Steady demand. Complete co-operation. Commissions paid weekly. Write Perry Nurseries, Dept. R-4, Rochester, N. Y.

TAKE orders for coffee, flour, dried fruits, canned goods, staple groceries, toilet articles, paints, radio sets, auto and tractor oils. No capital or bond required. We deliver and collect. Permanent business. Big pay. Write at once. Hitchcock-Hill Co., Dept. 50, Chicago.

TAILORING Salesmen. Largest line made to order Union Label Suits. Five price ranges, \$19.50-\$39.50. Exceptional commissions. Quickest deliveries. Positive guarantee. Full co-operation. Big outfit free. Scott System, 597 E. Washington St., Boston.

SALESMEN, distributors to take exclusive selling rights of a scientific drugless health product needed in every home. A world-wide unlimited field is now open to producers. Write Radiumized Applicator Company, 1303-P Fillmore, Buffalo, N. Y.

SALESMEN: Write your name and address on postal and mail to us. We'll show you sure earnings of \$20.00 a day. Will you risk one minute and a one cent stamp against \$20.00. Mind you, we say we'll Show you. Address Sales Manager, 850 W. Adams, Dept. 169, Chicago.

BIG, steady yearly income, selling Souvenir advertising pencils. Oldest, largest manufacturer. Our quality, prices mean your sale, repeat business. Reliable men given steady positions. No dull season. Souvenir Lead Pencil Co., Dept. D5, Cedar Rapids, Iowa.

PUNCHBOARD Salesmen making small towns. One sale a day nets you \$125 weekly. Full commission on repeats. Imperial Novelty Co., 2412 Lawrence Ave., Chicago.

TAILORING Salesmen big extra money for you. Sell direct most complete popular-priced line of Boys' and Young Men's Guaranteed Suits, Topcoats, Trousers, etc. Biggest advance commissions; free business stimulators; Spring outfit free to workers. Write now. Craig-Wilson, 10 Waverly Place, New York, Dept. P4.

BECOME your home town's leading business man. Big Money. Selling groceries, coffee, canned goods, auto oils direct to consumer. Exclusive territory. Undersell competition. Free Sample Case. Commission advanced. Liberal Credit. No experience or capital necessary. Loverin & Browne, D-1615 So. State, Chicago.

MULTEX, the Automatic Card Index wants commission salesmen. Multex Sta. E., Box 29, Atlanta, Ga.

NOBODY ever showed us how to work even part time on our plan and not make mighty satisfactory income, steadily increasing from repeats. Unique line standard value goods, consumed continuously in every home. Opportunity to supervise others. Manufacturer established 1906. Wells Process Co., Cleveland, Ohio.

CAPABLE salesman organizer. Good references. Ask about District Manager proposition. Permanent, interesting work. Same territory. Your own business. Big annual income. Fairlow Nurseries, Dept. MC, Geneva, N. Y.

SALESMAN—to sell an advertising service for window attraction. All or part time. Commission basis. Dispatch Service, 207 W. 25th St., New York.

GOLD Leaf Window Letters and Script Signs. No experience; 500% profit. Samples free. Consolidated, 69V, West Van Buren, Chicago.

DISTRICT Managers—To handle established business on all Patented Products. Not sold in stores. Big commissions. Write today. Sta-Put Products Co., Sales Dept. St. Louis, Mo.

NEW Advertising Novelty. "Oil-Memo" clamps on dash of auto. Big money-maker. Live-wire salesmen wanted. Full time or side-line. Strictly commission basis. Free samples. Give references or experience in first letter. Jubilee Mfg. Co., 26 Sta. C, Omaha, Nebr.

MANUFACTURER of established line guaranteed tools offers profitable connection to men with mechanical and some sales ability; part time men considered; two average sales daily net \$50.00 weekly; advance against commission. Write for free catalogue and money-making plan. J. G. Woods, Inc., Dept. 225, 37 West 20th St., New York City.

"RAYON Bed Spreads." Salesmen and Women. Big Commission. Easy Sales. (Samples Free.) Western Novelty, 12 W. Division, Chicago.

SEE Davis Co's advertisement under "Business Opportunities" in this section.

75c PROFIT on \$1.00 sale. Auto furniture and glass cleaner. Your name on label. Exclusive rights—free sample. Mfg. E, 213 Griswold, Detroit, Mich.

SALESMEN, make \$10 in every hardware you pass selling Pump Oilers. P. V. O. Co., Cedar Falls, Iowa.

PAVED Road Maps—Handy, inexpensive for advertising and premiums. Sell on sight. Full or sideline. Proposition, samples on request. George F. Cram Company, Indianapolis.

REPRESENTATIVES. Both sexes. Exclusive territory. Wonderful Radiumoid Belts and Radium Water Generators. Easily sold. Radium Refinery, 2209 Broadway, Oakland, Calif.

WONDERFUL Opportunity for reliable man as representative of \$4,000,000.00 firm showing nationally advertised line of staple merchandise to business men. Basic necessity—steady repeater. Underselling competition 30%—Earnings start big, grow larger. Our men earn \$50.00, \$100.00 and more weekly—full or spare time. No experience needed. A few exclusive territories are open. Write for full information—Free. J. B. Simpson, Dept. 1316, 843 Adams St., Chicago.

EXPERIENCED Tailoring Salesmen; Sell the most complete line of Boys and Young Men's Clothing direct to consumer; suits, topcoats, novelty suits, longies, slickers, etc. Chest sizes 22 to 42. Guaranteed values; biggest commissions; free business stimulator. Spring Line ready. Sample outfit free to real workers. Write now. Craig-Wilson, Inc., 10 Waverly Place, New York, N. Y., Dept. P3.

SALESMEN—Become Independent. Own Your business, experience unnecessary selling our \$7,500.00 Accidental Death; \$50 Accident; \$25 Sick Weekly Benefits—\$12.50 Yearly. Other Amounts proportionate. Guaranteed steady income from renewals. \$250,000 Deposited Insurance Department. Universal Policy, Dept. A, 30 Clinton St., Newark, N. J.

MILLIONS of business men waiting for Brand New indispensable \$10.00 office utility saving hundreds of dollars annually. One man sold sixteen in three hours. Splendid profits. Write quick for trial offer and exclusive Virgin territory. Lightning Calculator Co., Dept. FT, Grand Rapids, Mich.

MOTION—Color—Light plus changeable letter system make ours the last word in window salesmen. Actually boosts sales 200% to 400%. Every show window means an interested prospect. Get the facts and start pocketing \$100 weekly. Display Products Company, A409 East 31st, Kansas City, Mo.

TOOL Salesmen—Mechanics—Distribute guaranteed line auto repair tools. Exclusive business of your own. Show 71 samples in case. Big commissions. Quality Tools Corporation, New Wilmington, Pa.

WONDERFUL Invention. Seals Fifty Envelopes minute. Sells on sight at \$3.50. Exclusive territory. Kendall Sealer Co., B2, Jaffrey, N. H.

COLLECTS Money from the Dead-Beats. Retails \$5.00—Cost \$1.00—Profit \$4.00. "New Method." Every Storekeeper, Doctor buys quickly. Wonderful Money Getter. Federal Association, Hartford, Conn.

SALESMEN—Are You Making Enough Money? Let us show you how to make Big Profits with Jiffy Washing Tablets. No experience required. Write for Free Sample and Plans. Jiffy Soap Products Co., Dept. A, Dayton, Ohio.

TRAVELING Salesmen Calling on Retail Stores wanted by large manufacturer of fast-selling specialties entirely different from the average. Year-round sales, main or sideline. Big commission paid immediately on original and repeat business. Opportunity for well paid and permanent connection with old-established firm. If not making \$150 weekly, write today. Union Specialty Works, Dept. 222, Boonville, N. Y.

\$60-\$200 A WEEK. Genuine Gold Letters for store windows. Easily applied. Free samples. Liberal offer to general agents. Metallic Letter Co., 438-A North Clark, Chicago.

FOUR \$7.50 sales to merchants net you \$20.00 daily. Sayers Systems, 2803 Sheffield Ave., Chicago, Ill.

ANY Salesmen Can Sell Them! Merchants everywhere use punchboards. Someone sells them, why not you? Collect big commissions daily. Newest, largest, elaborate catalog sent upon request. Lincoln Sales Co., 9 So. Clinton, Chicago, Dept. D.

NOW that you have read all these offers send \$1.00 for Detailed Information. (None free.) We want Partner-Salesman. We pay 50% on net profits! No capital necessary. Only those whose past record is such that they may be bonded need apply! Department 273. Empire Adjustment Bureau, 25 Exchange St., Rochester, N. Y.

HELP WANTED

U. S. GOVERNMENT wants men. \$1,700-\$1,900 and up at start. Railway Mail clerk examination coming. Let our expert (former Government examiner) prepare you for this and also Rural Carrier, Post Office, Customs, Internal Revenue, and other branches. Write today for free booklet. Dept. 8, Patterson School, Rochester, N. Y.

MEN to train for locomotive firemen on railroads nearest their homes—everywhere; beginners \$150-\$250 monthly; promoted, locomotive engineer, \$3,000-\$4,000 yearly. Best paying positions on railroads. Railway Association, Desk ML, Brooklyn, N. Y.

MAKE money silvering mirrors, refinishing auto headlights, tableware, metal plating, bedsteads, chandeliers. Outfits furnished. International Laboratories, Dept. 71, 209 5th Ave., New York.

RAILWAY Mail Clerks. \$158 Month. 25 men. 18 up coached free. Write immediately. Franklin Institute, Dept. H-16, Rochester, N. Y.

LEARN Finger Prints—Excellent paying work; write National Headquarters, 169 East 83rd Street, New York.

CASH paid for butterflies, insects. See Special Display Advertisement on Page 28.

RAILWAY Mail Clerks. Men. 18-35. \$158-\$225 Month. Travel—See Country. Common education sufficient. 25 coached free. Write immediately. Franklin Institute, Dept. H-16, Rochester, N. Y.

STOP—Become Independent: Be your own Boss. Make Big Money! Introduce famous Dura-Tex Work Shoe. Sells on sight. Big commissions. Spare time money. Write President Dura-Tex Shoe Co., 10 Anglim Bldg., Brockton, Mass.

ARE You Old at Forty? See our advertisement on page 74 of this issue. The Electro Thermal Company, 2168 Main St., Steubenville, Ohio.

SEND name, address on postcard. Free introductory copy Salesology Magazine; contains 1,000 money-making opportunities. Offered by big reliable firms; no obligations. Salesology Magazine, Desk B34, 500 No. Dearborn, Chicago.

WANTED—Men—Boys. Learn Auto Repairing. \$35.00 week. Sample lessons free. Franklin Institute, Dept. H-400, Rochester, N. Y.

MR. BRUSH Salesmen—Old Established New York Brush Manufacturers require the services of men in all territories to sell their extensive line of Sanitary Twisted in Wire Brushes. We pay larger commission than any other Brush House in the country. Write immediately for our proposition. Wire Grip Sanitary Brush Corporation, 15 Mercer St., New York.

IMMENSE profits silvering mirrors at home. Plating auto parts, headlights, tableware, stores, etc. Outfits furnished. Details free. Write Sprinkle, Plater, 287, Marion, Ind.

\$95.00 TO \$225.00 Month. Men-women 18 up. Get U. S. Government Jobs. Railway Postal Clerks—Mail Carriers—Postoffice Clerks and Clerical Positions. Steady. Life Positions. Paid vacation. Experience unnecessary. Common education sufficient. 32-page book with sample examination coaching and full particulars Free. Write today sure. Franklin Institute, Dept. H-16, Rochester, N. Y.

ALWAYS steady work at good pay, inside or out. Full or part time. Easy. New. Distinctive. Many ways without selling. Free. B. Ceedson Service, 3570 West 25th, Cleveland, Ohio.

WANTED—Men to learn radio; Free information. Wallace Radio School, Oklahoma City, Okla.

MEN, prepare for Forest Ranger job; \$125-\$200 mo. and home furnished; permanent; hunt, fish, trap, etc. For details, write Norton, 226 McMann Bldg., Denver, Colo.

SEE Davis Co's advertisement under "Business Opportunities" in this section.

EVERYDAY Greeting Cards easy seller. Sample box 75c. Particulars free. Messenger, Stillwater, N. Y.

MEN wanting to prepare for forest ranger or railway mail clerk examinations Write Mokane, A-23, Denver, Colo.

GOVERNMENT positions pay \$35 to \$75 weekly. We help you get them. Big List Free. Write, Mr. Ozment, 101, St. Louis Mo.

EARN \$10 daily silvering mirrors, plating and refinishing metalware, auto, chandeliers, bedsteads, headlights. Outfits furnished. E. Decie Laboratories, 1133 Broadway, New York.

MEN Wanted—prepare as firemen, brakemen, colored train or sleeping car porters, wire for application blank; experience unnecessary; first class roads, no strike. Name position wanted. Railway Institute, Dept. 35, Indianapolis, Ind.

BECOME a Landscape Architect. Uncrowded profession of wonderful opportunity for money-making. Easily mastered by mail. Earn while you learn. Write for book. American Landscape School, 56-E, Newark, N. Y.

SILVERING Mirrors, French Plate. Easily learned; immense profits. Plans free. Wear Mirror Works, Excelsior Springs, Mo.

DON'T prepare for any Civil Service Examination without seeing our catalogue. Free. Columbian Correspondence College, Washington, D. C.

INFORMATION

ADVICE and Information, any subject, \$1.00. Mechanical problems, trade secrets, formulas or anything you want to know. Information Bureau, Arthur Clarke, 94 Bonham St., Paris, Texas.

INFORMATION about German merchandises. Keiser Pelzerstr, 17 Hamburg, Germany.

DECORATIVE work. Directions for decorating with pressed leaves, antique painting, preserving plants, bouquets of colored grass, tree cone decoration, fungi decoration, decalcomania, crystallized grasses, Grecian painting, copper impressions of leaves, skeleton leaves, leather work, modeling in clay, moss work, paper flowers, pearl work, ornamenting with shells, etching shells, transparencies. All this and much more in "Youman's Household Guide." Send No Money. Just order on postal. Pay postman \$2 and postal charges. Popular Mechanics Press, Room 904, 200 East Ontario St., Chicago, Ill.

SHALL I Become An Engineer? You can decide this all-important question better by reading a book called "Engineering as a Career," written by a group of eminent engineers. It costs only \$1.00. You will find the advice of these successful men to be of the greatest value. Pay postman price and postage when he hands you the package. Address Popular Mechanics Press, Room 904, 200 E. Ontario St., Chicago.

MAILING LISTS

1,000 NAMES, \$1.00. Mention Classification. Winehoit Sales Co., Woodbine, Penna.

CAPITAL—Any Amount—Raised by successful plan. Percentage basis. Morris, Financing Specialist, 3608 Warren St., Philadelphia.

WHERE to Buy. American or Foreign Addresses \$1.00. A. Schultz, East Greenville, Pa.

1,000 NAMES \$4.00; Good buyers in prosperous locality, compiled 1927. E. L. Smith, Box 182, Oxford, Mich.

UNITED Big-Mail Directory—Buyer's names 10c. Wetzel, Valhalla, N. Y.

LETTER SPECIALISTS

LETTERS that collect old accounts. \$5. A. H. Lofgren, Cook, Minn.

TYPEWRITERS AND SUPPLIES

TYPEWRITERS—All standard makes; genuine bargains; guaranteed. Typewriter Works, Ada, Okla.

UNDERWOOD Typewriters—only \$3.00 down. Easy monthly payments. Low prices at less than manufacturers. 10 days' free trial. Rebuilt, all worn parts replaced. Just like a new machine. 5-year guarantee. Write for a big free catalogue B-151. Shipman-Ward Mfg. Co., 1514 Shipman Bldg., Chicago, Ill.

TYPEWRITERS, all standard makes, thoroughly re-manufactured by the famous "Young Process" and shipped direct from factory to you on 10 days' trial. Guaranteed 5 years. Easy monthly payments. Write today for free catalog. Young Typewriter Company, Dept. 5744, 654 W. Randolph St., Chicago.

TYPEWRITERS \$5.00—\$35.00. Radios \$14.95—\$75.00. Motorcycles \$15.00—\$75.00. Send cash. Knights, 1512 Locust, St. Louis, Mo.

ROYAL Typewriter No. 10 \$40.00. L. C. Smith No. 8 \$35.00. Underwood Typewriter No. 5 \$38.00. Remington Typewriter No. 10 \$35.00. Perfect Condition \$5.00 down, balance C. O. D. Lion Co., 2218 Lawrence, Chicago.

100 TYPEWRITERS Free. Overstocked. Rent Rebuilt Underwood or Remington \$3.00 month. If you pay its value in rental, we give machine free. Particulars free. Pittsburgh Typewriter Exchange, 945 Hersch Bldg., Pittsburgh, Pa.

TYPEWRITERS, all standard makes. \$10 up. Fully guaranteed. Free trial. Write for complete illustrated lists. Northwestern Typewriter Exchange, 121 N. Francisco Ave., Chicago.

PRINTING, ENGRAVING AND MULTIGRAPHING

ALL kinds rubber stamps, 35c line—Notary Seals, etc. Multigraph Letters, 500, \$2.00; 250 Letter Heads, \$1.25. National Print Shop, 1001 E. Fourth St., Winston, N. C.

STATIONERY De Luxe—Samples. Industrial Press, Jefferson City, Mo.

GUMMED Labels that satisfy, with name, business and address, 500—40c; 1,000—60c; 2,000—\$1.00; prepaid. P. Wetzel, Valhalla, N. Y.

250 LETTERHEADS 250 Envelopes—Bond, \$3.00. Arrow Press, Kankakee, Ill.

1,000 6½ WHITE Envelopes printed, \$2.35; 5,000—\$8.85; letterheads, 1,000 \$2.95. Spors Printing, Lesueur Center, Minn.

500 ENVELOPES printed \$1.50, 6½, 24 lb. (Other printing.) Ross Colortype, Danville, Ill.

1,000 LETTERHEADS, 20 lb. bond, 1,000 envelopes, 3X white wove. Complete \$5.75. Other prices and samples on request. The Low Cost Printers, 121 West 21st St., New York.

PERSONAL Stationery—200 single sheets 100 envelopes all printed with name and address, one dollar. Windsor Stationery Company, Long Island City, New York.

1,000 FOLDERS, 3¼x6, \$4.00. Circulars, \$2.00. 250 bond envelopes, letterheads, statements or billheads, \$1.35. Andrews, Box 1051, Fargo, North Dakota.

MULTIGRAPH typewriting business correspondence, two dollars thousand. Hammermill Bond Letterheads, four dollars. Miscellaneous printing. Mayera Corporation, Monmouth, Illinois.

PUBLISH Your Own Magazine or House Organ. Our standardized service at one-fifth ordinary prices. Samples and particulars free. Evans Printing Company, Grand Rapids, Mich.

EVERYTHING Printed! Distinctive samples free! Franklinpress, B-32, Milford, N. H.

"NEARGRAVURE" Process—Unique—250 letterheads, 250 envelopes, \$3.33 prepaid. Samples. Solidays, Knox, Ind.

EMBOSS your Stationery with Hand Embosser. Circular free. Midwest, Box 47, Springfield, Ill.

100 BOND Letterheads and 100 envelopes printed, 98c. Kalata Printing Company, Ironwood, Mich.

PRINTING—The better kind for less. Arrow Press, Kankakee, Ill.

LETTERHEADS, Envelopes, Cards. Jean McLane, 1215 Russell Ave., Bethlehem, Pa.

ENVELOPE Specialists—5,000 6½ 24-lb. \$9.50. Prompt service. Samples free. Lawrence Envelope Co., 6-B, No. Franklin St., Chicago.

COMMERCIAL Printing. Prices Right. Samples Free. The Fox Press, Frankfort, N. Y.

20 LB. Bond Letterheads, 6½ Envelopes, Billheads, Statements! \$3.00 thousand. Cash with order. Press, Box 428, Middletown, N. Y.

DISTINCTIVE—Artistic Business Stationery that Creates Confidence. 1,000 Letterheads or Envelopes \$3.00. Samples. Moulton Printing Company, 1410-P East 8th, Kansas City, Mo.

WE print Stationery, Booklets, Catalogs, Circulars. Samples. Commercial Press, Batavia, Ohio.

QUALITY Printing! Reasonable Prices! Send for Free Standardized samples and prices. Folders, Circulars. Catalogs our specialty. Ernest Fantus, 525 South Dearborn, Chicago.

5,000 3¼x6 FOUR-page folders, \$13.75; 10,000, \$21.75; 5,000, 5½x8½ circulars, \$10.00; 10,000, \$16.00; 5,000 ad. slips, \$5.00; 25,000, \$17.00. Samples. Good's Printery, Harrisonburg, Va.

200 BOND letterheads, envelopes or business cards \$1.00. 500 \$2.00. 1,000 \$3.00 postpaid. Mogenssen, 1409 Cass, Omaha, Nebr.

250 EACH Hammermill Bond Letterheads, Envelopes, \$3.00. Samples. Midland Press, 543 West Hickory, Kankakee, Ill.

PRINTING, OUTFITS AND SUPPLIES

FOR Sale: 6½x10 Hand press, 10 cases job type \$85.00. Lion Co., 2218 Lawrence, Chicago.

FOR Sale: 8x12 Gordon Press, 20 cases job type. Bargain. Lion Co., 2218 Lawrence, Chicago.

USED presses, type supplies. C. L. Whitfield, Ballentine, Norfolk, Va.

COMPLETE printing outfits, presses, type, ink, paper, supplies. Write for Catalogue. Kelsey Company, G-11, Meriden, Conn.

PRINTING Outfits—Presses, type supplies, type novelties. Send stamp for catalogue. Model Press, York, Penna.

PRINTING Presses—Type—Supplies. List for 2c stamp. (Bargains.) Foster, 4342 North Robey, Chicago.

DUPLICATORS AND DEVICES

YOU can make 50 to 100 copies of a letter, notice, etc., at a cost of three cents on a Heyer Quality Duplicator. Write for free trial offer. The Heyer Duplicator Co., 11 S. Wells St., Chicago, Ill.

"STENCIL-DUPLICATOR" 8x11 \$10 (Complete). Copies like mimeograph. F. Gerwin, Dale, Okla.

RUBBER STAMPS

RUBBER Stamps! Name, Address, two lines 25c. Three lines 35c. Brush & Co., Auburn, Nebr.

NAME and address 25c. Catalog free. Newman Bros. & Sons, Auburn, Nebraska.

YOUR name handsomely moulded upon a rubber stamp \$1.10; also agent's handy three line nickel plated pocket stamp, \$1.50 postpaid. R. Skeffington, 18 Bulfinch St., Boston, Mass.

ADDING MACHINES

NEW \$3.50 Automatic Adding Machine. Adds. Subtracts. Multiplies. Absolutely accurate. Capacity \$999,999.99. Fully guaranteed. 75,000 pleased users. Makes adding easy, positive, quick. Eliminates Mistakes. Saves Time. Postpaid \$3.50. Bassett Co., 1458 E. Hollywood Ave., Chicago.

FREE trial. Marvelous Calculator, Adds, Subtracts, Multiplies, Divides automatically. Work equals \$300.00 machines. Five year guarantee. Price only \$15.00. Write today for free trial offer. Special: \$3.00 Pocket Calculator, only \$2.00 cash. Lightning Calculator Co., Dept. E, Grand Rapids, Mich.

FOR SMOKERS

SEND 10c. Silver or Stamps, for sample package 20 fine cigarettes. Large pocket tin Special Blend smoking tobacco also sent for 10c. Direct-to-Smoker. French Tobacco Company, Dept. 30, Statesville, N. C.

TOBACCO Postpaid, guaranteed Best Mellow, Juicy red leaf chewing, 5 lbs. \$1.40; 10, \$2.50. Best smoking 20c lb. Mark Hamlin, Sharon, Tenn.

CIGARS, hand-made wonderful flavor, 10c retail quality. 19 in can, postpaid only \$1, (or C. O. D.). Order today. Hoffbauer Bros., 580 52nd St., Brooklyn, N. Y.

LOOK! Five pounds good mellow smoking tobacco, \$1.00. Five pounds chewing, \$1.25. Quality and satisfaction guaranteed. Farmers' Club, 57, Hazel, Ky.

HOMESPUN Tobacco—Mellow, sweet, aged in bulk; Smoking, 15 lbs. \$1.50; chewing, 15 lbs. \$2.25. Satisfaction guaranteed. Pay when received. Farmers Union, Mayfield, Ky.

FOR MEN

FURNITURE. Make Furniture at Home. Popular Mechanics books tell how to make all pieces. "Mission Furniture and How to Make It, Book 1, Book 2, Book 3." Send No Money. Just write a postal. Pay postman postage and \$3. Popular Mechanics Press, Room 904, 200 East Ontario St., Chicago, Ill.

DRAFTING. Learn Mechanical Drawing. Big demand for men. Pocket-size. Start at beginning and learn by a series of simple lessons. Send No Money. Just write postal for "A Practical Course in Mechanical Drawing." Pay postman postage and \$1. Popular Mechanics Press, Room 904, 200 E. Ontario St., Chicago, Ill.

RAZORS AND BLADES

'ZIP' does the work of a \$3.00 Strop. Solves blade problem with Keen Velvet-Smooth shaves. Holds all safety blades, heavily nicked, simple, lasts forever. Makes wonderful knife for office, shop, tailor, home. Make \$5.00 and \$10.00 extra a day showing 'Zip' to friends. Show shavers how a folded newspaper makes the best strop. Sample 50c. 3 for \$1.00, \$2.40 doz., \$21.60 gross. Zip Sales Co., 2703 3rd St., N. Minneapolis, Minnesota.

SPECIAL Offer. Gillette type razor blades, 40c per doz. 3 doz. for \$1.00. D. Jankov, 443 St. Anns Ave., New York.

GILLETTE blades sharpened like new. C. C. Calhoun, 312 Stewart St., Seattle, Wash.

FOR THE HOME

GRANDFATHER'S Clock Works, \$5.00. Build your own case; Instructions free; make good profits selling your friends. Clock works with chimes for old or new cases. Write for full particulars. Clock Co., Ruffner St., Philadelphia.

CEDAR chests only \$11.65—"Red-I-Kut" complete with rich copper trim—you assemble and save half—send for pictures. Kuempel Furniture Company, Guttenberg, Iowa.

GARDEN time is coming. Make your garden produce four times as much with only half the labor. Ingenious new method in use of space increases fourfold best previous crop record and with less cultivation and trouble with weeds. Complete instructions cost \$2.50. Pay postman price and postage when he hands you the package. Address Popular Mechanics Press, Room 904, 200 E. Ontario St., Chicago.

READY-CUT Awnings. We sell material ready to assemble. Lowest prices. Write for full particulars. Erler, 675 Elton Ave., New York.

COFFEE—Delicious Coffee—5 lbs. \$1.90. Ground or whole. Send no money. Pay Postmaster on arrival. Coffee guaranteed. Plantation Coffee Co., 128 West Third St., St. Paul, Minn.

HOW to Make and How to Mend. 1,000 articles telling how to repair almost everything in use or needed about a home or farm. Many illustrations, formulas and trade secrets. Especially for amateur mechanics. Send no money. Just ask for "How to Make and How to Mend." Pay postman postal charges and \$1.00. Popular Mechanics Press, Room 904, 200 East Ontario St., Chicago, Ill.

BOATS AND LAUNCHES

REVERSE gears, propellers, pumps, and other equipment, bought, sold, exchanged. Wm. H. Baker, Pond St., Quincy, Mass.

BOAT Building Plans for amateurs. Rowing, sailing, speed, cruising. Free catalog. Rudder Publishing Company, 9 Murray Street, New York.

SHIP Models—Worth-while—Easy to make. Decorative ships. Picturesque Barbary Pirate Felucca and Beautiful Spanish Treasure Galloon (both 17th century). Instructions so simplified that any handy person can make these models with a few household tools almost without expense. No personal knowledge of ships or naval architecture required. New book only one of its kind. Pay postman \$2.50 plus postage when book is delivered. Popular Mechanics Press, Room 904, 200 East Ontario St., Chicago, Ill.

BUILD your own boat for this season's use using Brooks Knock-Down parts or patterns. 55 Models, 9' to 40'; send 25c for complete catalog. Brooks Boat Co., Inc., Rust Ave., Saginaw West Side, Mich.

CLIPPER Ship materials \$5.00. List Model Fittings dime. Roy Hancock, 323 Douglas Ave., Portsmouth, Va.

LATEST Ship Model Book. How to make a model of an American Clipper Ship, "Sovereign of the Seas," by Capt. McCann. Simplified construction. Complete details. Order a copy and pay postman \$2.50 and the postage when he hands you the package. Address Popular Mechanics Press, Room 904, 200 E. Ontario St., Chicago.

WATCH REPAIRING

WATCHES carefully repaired. Over twenty years in business. L. Mathewson, Waukegan, S. Dak.

ALL makes of Watches repaired by experts. Write International Watch Service, Box 5P, Fordham Station, New York.

ANTIQUES, WAR RELICS AND INDIAN GOODS

YUCCA Fire Sets. 2 Yucca fireboards, 2 Yucca drills, bow, thong, socket, tinder; \$1.00 postpaid. List free. Chief Red Eagle, Box 325, Roswell, N. M.

FOR Dens. European battlefields' relics; also medals. Illustrated catalogue and sample war photographs, 25c. International, 1889 Albany Ave., Brooklyn, N. Y.

INDIAN Relics—24 page catalog for stamp. Grutzmacher, Mukwonago, Wis.

SEND 5c for fine new list Indian relics, antique firearms. F. E. Ellis, Webster Groves, Mo.

PHONOGRAPHS AND RECORDS

BUILD your own phonograph. We furnish everything. Catalog sent free. American Phonograph Co., 4116 West 24th Place, Chicago.

MUSIC AND MUSICAL INSTRUMENTS

A NEW kind of violin catalogue. Artistic—as the unique merit of Collingwood Violins demands. Artistic repairs. Write today. Drew Collingwood, 5162 Woodlawn Avenue, Philadelphia, Pa.

SONG Writers—I can be of great help to you. I am the writer of "Knee Deep in Daisies," "Tie Me to Your Apron Strings," "I'd Love to Call You My Sweetheart," and 50 other national song hits. Write for particulars. Joe Goodwin, 54 W. Randolph St., Chicago, Ill.

NEW, Likenu rebuilt, saxophones, cornets, trumpets, trombones, basses, etc. Tremendous stock all makes, lowest prices. Guaranteed plating, repairing. Waltersdorf, Rebuilders, Creston, Iowa.

RADIO created a demand for good songs. I write music. Lyric writers and music composers. Get my circular. Hanson, P. O. Box 4218, Takoma, Washington, D. C.

REAL Jazz piano lessons at home. Live breaks, endings; African harmony; brilliant runs; professional jazz guaranteed; booklet, Sample Lesson Free. United Schools, P. O. Box 1959, Boston, Mass.

SONG Poem Writers—Address Ray Hibbler, D1, 2104 N. Keystone Ave., Chicago.

VIOLINS, Deep, Mellow, Soulful—on credit. Easy terms for wonderful instrument. Get details today. Gustav F. Henning, 2424 Gaylord St., Denver, Colo.

"MUSIC Composed" to words. Bauer Bros. (formerly of Sousa's Band), Oshkosh, Wis.

SONG Poem Writers Address Monarch, 1472 Broadway, Dept. 194, New York.

SONG lyrics solicited—A different proposition. Richard Broughton, Sioux Falls, S. Dak.

I BUY, Sell, Publish Songs, Chester Escher, 455 Wayne St., Jersey City, N. J.

VIOLINS—Genuine handmade masterpieces. Get Details. John Lehto, 935 14th, San Pedro, Calif.

WRITE Songs. Big money and reputation. Write for information, J. Gordon Pub. Co., 291 N. Hoyne Ave., Chicago.

I WANT Song Poems. Casper Nathan, 3544 N. Racine, Chicago.

SONG Poem Writers—Stamp brings "Song Writers' Guide." Wm. Van Beaver, B1-1239 Elm St., Green Bay, Wis.

SHARPS and Flats—Free. Very interesting. Send for it Today. Harry L. Alford, 192 No. State St., Chicago, Ill.

CORNETISTS—Trombonists—Saxophonists—Clarinetists. Get "Free Pointers." Name instrument. Virtuosi School, Buffalo, N. Y.

PLAY Song-O-Phone band instruments. No Practice—No musical education necessary. Clubs, Fraternal Orders, Amateur and Professional Performers write for catalog. Songophone Co., 546 Wythe Ave., Brooklyn, New York.

PIANO Jazz! 15 Easy lessons teaches, beginners. Wonderful Jazz Ear Piano Playing. Circulars? Write "Piano Bill." Toronto 3, Canada.

PATENT ATTORNEYS

PATENTS. Time counts in applying for patents. Don't risk delay in protecting your ideas. Send sketch or model for instruction or write for Free book "How to Obtain a Patent" and "Record of Invention" form. No charge for information on how to proceed. Communications strictly confidential. Prompt, careful, efficient service. Clarence A. O'Brien, Registered Patent Attorney, Security Bank Building (directly across street from Patent Office), Washington, D. C. See pages 138 and 139.

INVENTORS having ideas to patent: Write for Booklet explaining Co-operative Plan for handling your applications. Tells how to sell and safeguard your inventions at lowest cost. Ralph Burch, Patent Lawyer, Jenifer Bldg., Washington, D. C.

ESTABLISHED 1864. Milo D. Stevens Company. Free Booklet. Patents, Trade-Marks, Copyrights. Offices, Monadnock Block, Chicago; Barrister Building, Washington, D. C.

RICHARD E. BABCOCK, Patent Lawyer, Washington Loan & Trust Bldg., Washington, D. C. Booklet.

PATENTS—Send for form "Evidence of Conception" to be signed and witnessed. Form, fee schedule, information free. Lancaster and Allwine, Registered Patent Attorneys in United States and Canada, 221-Ouray Bldg., Washington, D. C.

PATENT and Trade Mark Lawyers, Mason, Fenwick & Lawrence, Washington, D. C. Established sixty-five years. Best references. Other offices, New York and Chicago. Write us.

MONROE E. MILLER, Ouray Bldg., Washington, D. C., Patent Lawyer; Mechanical, Electrical Expert. Booklet and Priority Record blank gratis.

PATENTS Procured: Trade Marks Registered—A comprehensive, experienced, prompt service for the protection and development of your ideas. Preliminary advice gladly furnished without charge. Booklet of information and form for disclosing idea free on request. Richard B. Owen, 30-Owen Bldg., Washington, D. C., or 41-R Park Row, New York.

MILLIONS spent annually for ideas! Hundreds now wanted! Patent yours and profit! Write today for free book—tells how to protect yourself, how to invent, ideas wanted, how we help you sell, etc. American Industries, Inc., 509-Victor Bldg., Washington, D. C.

INVENTORS—Write for our Guide Book, "How to Get Your Patent" and Evidence of Invention Blank. Send model or sketch of your invention for our prompt examination and instructions free. Randolph & Co., Dept. 450, Washington, D. C.

PATENTS, Trade-Marks, Designs. This firm has 27 years' experience and gives expert personal service at reasonable rates. We properly protect your invention. Write for free information and exact cost of procuring patent before proceeding. John B. Thomas & Co., 902 F St., N. W., Washington, D. C.

UNPATENTED Ideas Can Be Sold. I tell you how and help you make the sale. Free particulars (Copyrighted). Write W. T. Greene, 807 Jenifer Building, Washington, D. C.

RELIABLE services by an experienced practitioner devoting personal attention to each case. Inquiries invited. References furnished. B. P. Fishburne, Patent Lawyer, 525-A McGill Bldg., Washington, D. C.

PATENTS—Write for our Guide Books and "Record of Invention Blank" before disclosing inventions. Send model or sketch of your invention for Free Inspection and Instructions. Terms Reasonable. See advertisements on pages 140 and 141. Victor J. Evans & Co., 934 Ninth, Washington, D. C.

LACEY'S Patent Sense. Valuable book free. See ad page 143.

PATENTS Procured. Prompt Service. Personal, careful and efficient service. Highest references. Moderate fees. Send sketch or model for actual search and advice. George P. Kibbell, Master of Patent Law, 54F, Legal Bldg., Washington, D. C.

CARL MILLER, Registered Patent Attorney, McGill Building, Washington, D. C. Write for Instructions.

"INVENTOR'S ADVISOR," Patentbook, with 139 mechanical movements, illustrations, sent free. Labriere, Patent Attorney, Three Parkrow, New York.

"INVENTORS' Guide" sent free on request; this book contains illustrations of patented inventions and gives valuable information and advice for all who have original ideas or improvements. Frank Ledermann, Registered Attorney and Engineer, Woolworth Bldg., 1712, New York.

INVENTORS: Send sketch or model for advice and exact cost of patent. Ask for our Free book: "How to Obtain a Patent." Tells what every inventor should know. Established twenty-eight years. Highest references. Prompt service. Reasonable charges. Chandler & Chandler, 474 Seventh, Washington, D. C.

PATENTS. Booklet free. Highest references. Best results. Promptness assured. Send model or drawing for preliminary examination. Watson E. Coleman, Patent Lawyer, 724 Ninth St., Washington, D. C.

PERCY S. WEBSTER, 203 Saving and Loan Building, Stockton, California. Long established organization. Patent booklet free.

UNITED STATES and Foreign Patents and Trade Marks; Low rates; easy terms. H. Sanders, Registered Patent Attorney, 7 Rand McNally Building, Chicago.

WHY let your patents lie idle? Tell our two million five hundred thousand readers about it! The majority of our readers are especially interested in new ideas and inventions. Ask me to tell you how other inventors successfully sold their patents. M. L. Rund, Mgr., Classified Advertising, Popular Mechanics Magazine, Chicago.

FOR INVENTORS

PATENTS. If you have an invention which you wish to patent you can write fully and freely to Munn & Co., for advice in regard to the best way of obtaining protection. Please send sketches, or a model of your invention and a description of the device, explaining its operation. All communications are strictly confidential. Our Hand-Book on Patents is sent free on request. This explains our methods, terms, etc., in regard to Patents, Trade Marks, Foreign Patents, etc. "Scientific American" contains Patent Office Notes, Decisions of interest to inventors and particulars of recently patented inventions. Munn & Company, Solicitors of Patents, 1523 Scientific American Building, 24 W. 40th St., New York City; 524 Scientific American Bldg., Washington, D. C.; 1313 Tower Bldg., Chicago, Ill.; 666 Hobart Bldg., San Francisco, Calif.; 521 Van Nuys Bldg., Los Angeles, Calif.

REDESIGNING. Selling and Promoting Patents. High grade Model making and Drafting service at reasonable rates. All our work is strictly confidential and guaranteed. L. C. Johnson Engineering Works, 3405 North Clark St., Chicago, Ill.

PATENTS. Time counts in applying for patents. Don't risk delay in protecting your ideas. Send sketch or model for instruction or write for free book "How to Obtain a Patent" and "Record of Invention" form. No charge for information on how to proceed. Communications strictly confidential. Prompt, careful, efficient service. Clarence A. O'Brien, Registered Patent Attorney, Security Bank Building (directly across street from Patent Office), Washington, D. C. See pages 138 and 139.

UNPATENTED Ideas Can Be Sold. I tell you how and help you make the sale. Free particulars (Copyrighted). Write W. T. Greene, 806 Jenifer Building, Washington, D. C.

I AM in touch with hundreds of moneyed men and manufacturers who wish to buy good inventions. Write Hartley, 38 Court St., Bangor, Me.

WE pay cash for patented ideas we can use in the manufacture of amusement devices. Send us your ideas. Spillman Engineering Corp., North Tonawanda, N. Y.

INVENTIONS Developed—Your crude ideas developed into practical form for your patent application. Model not necessary. Send rough sketch and description for estimate of cost and advice. 27 years' experience. Albert E. Dietrich, Engineer and Registered Patent Attorney, 621½ Ouray Building, Washington, D. C.

WANTED—Substantial articles for mail-order business. What have you to offer? Write Liberty Novelty Company, 3557 W. 22nd St., Chicago, Ill.

I SELL Patents. Established in 1900. A Service of Nationally-known reliability. Why take chances. Charles A. Scott, 773PM Garson Avenue, Rochester, N. Y.

LACEY'S Patent Sense. Valuable book free. See ad page 143.

INVENTORS—Write for our Guide Books and "Record of Invention Blank" before disclosing inventions. Send model or sketch of your inventions for our free inspection and instructions. Terms reasonable. See advertisements on pages 140 and 141. Victor J. Evans & Co., 157 Ninth, Washington, D. C.

LEARN Invention. Wonderful new book tells how. Sent \$1.00 C. O. D. Crowhart Publishing Co., 1204 Texas, Fort Worth, Texas.

PATENTS wanted by manufacturers; send description, Box 126, Dowagiac, Mich.

PATENTS Procured: Trade Marks Registered—A comprehensive, experienced, prompt service for the protection and development of your ideas. Preliminary advice gladly furnished without charge. Booklet of information and form for disclosing idea free on request. Richard B. Owen, 30-Owen Bldg., Washington, D. C., or 41-R Park Row, New York.

INVENTORS Universal Educator—contains 900 mechanical movements; 50 perpetual motions. Tells how to obtain and sell patents. Suggests new ideas. Explains how to select your attorney and avoid patent sharks. Price (revised edition) \$1.00 postpaid. Albert E. Dietrich, 621-Ouray Bldg., Washington, D. C.

GET your own patents. Legal blanks, complete instructions \$1. Cutting Sons, Campbell, Calif.

PATENTS FOR SALE

OUTRIGHT or Royalty—Canadian Patent. Steel tool for sharpening disc harrows without taking harrows apart. Easy to manufacture and operate. Every farmer a prospect. O. A. Bills, 814 S. Oakwood Ave., Geneseo, Ill.

OUTRIGHT or royalty—combination padlock. Cost 70c to manufacture and retails for \$2.50. Simple in construction and only small equipment is needed. Jos. McMenamin, 1129 Shelburne, Philadelphia, Pa.

AUTO Inner Tube Tester (Patent Pending)—test tubes under high pressure. Outright or royalty. George Manco, Rt. 4, Richmond, Va.

PATENTED keyhole cover lock. Want to sell outright or royalty. Tadakuma, 1445 Cahuenga, Hollywood, Calif.

OUTRIGHT or Royalty—Paint Brush Attachment. (Mrs.) Geo. L. Howell, Box 18, Sharon, Pa.

PATENT—For sale or royalty; interchangeable automobile wheel. Martin Kayuk, 6832 Brimson, Detroit, Mich.

COPYRIGHT for Sale: Simple Mathematical discovery, solves any triangle without Trigonometry. Includes a table with explanations on back for every case. Can be used as insert in any notebook. Sample copy \$1.00. P. W. Clark, 615 So. Westlake Ave., Los Angeles, Calif.

OUTRIGHT or royalty, Canadian Patent. Toilet Bowl with cleanout plug. John Burcham, 414 G St., San Diego, Calif.

FOR Sale, patent on toy, outright or royalty; something new. T. F. Davis, 1609 Fort Park Blvd., Lincoln Park, Mich.

OUTRIGHT, 1,553,264, combination muffler and cut-out; investigate. J. Roy Reasonover, Kemp, Tex.

OUTRIGHT—Newly patented railroad crossing device that eliminates shocks. James D. Casey, U. S. S., 8-46 Coco Solo, Canal Zone.

PART or all Variable Switch. Plays individual electric Base Ball. Illuminated diamond. Indoor and Outdoor bulletins. Nation-wide advertising possibilities. Adaptable to slot operation. Need sufficient capital for adequate development. Talbot O. Bateman, 311 Park Hotel, Dallas, Texas.

OUTRIGHT—Concrete Column Clamp. Ask for sample. O. C. Wilson, Joplin, Mo.

OUTRIGHT or royalty, new amusement device. Carriage on track is suspended in a circular direction. S. Lautenberg, 164 Main Ave., Passaic, N. J.

RAIL-HANDLING Device—The latest labor-saving device out for Railroad and steel manufacturing companies. Patented January Seventh, Nineteen-Twenty-Seven. Alfred R. Jakes, 44 E. Long Street, Room No. 3, Columbus, Ohio.

FOR Sale—Patent, Improved Flour Sifter, outright or Royalty Basis. Harry Nakagawa, Tanana, Alaska.

DANDY Camp Patent. On market. Sells well. Earl Sanders, Pawnee, Ill.

OUTRIGHT, clothes line protector. Tape eliminates dirty line marks and keeps clothes from freezing on line in winter. Wm. Donnelly, 4 Emerson Ave., Jersey City, N. J.

TOY cart. Type which is propelled by pushing on the ground, imitating a canoe being paddled, the steering being accomplished by the feet. Patent 1,607,958. A. J. Koehler, 5310 So. Lavin, Chicago.

PULLING Device. Capable of universal application for pulling one object from another, especially the removal of wheels from the axle of a shaft. A. J. Koehler, 5310 So. Lavin, Chicago.

FOR Sale outright or royalty, double faced name and emblem displaying device for automobiles. George Hostick, 106 Croukhite St., Danville, Ill.

FOR Sale—Patent on Fountain Mop and Duster. I have one party wants five hundred down per month. Lester Doak, McMinnville, Tenn.

OUTRIGHT—Pump and compressor unit of high efficiency for use in refrigerating systems. Very simple in construction. K. Girwood, Glenavor, Luddington Road, West Orange, N. J.

UNITED STATES and Canadian patents new type vacuum washer. C. L. Morton, Ravenna, Ohio.

ROYALTY basis preferred. Aeroplane device that permits wings to be folded alongside of machine after plane has attained sufficient speed for such an arrangement. Greater speed offer through less resistance. A. V. Broquist, Chicago, Minn.

OUTRIGHT or Royalty Patented Road Signal Marker. F. W. and W. P. Moldenhauer, Oconomowoc, Wis.

FOR Sale to manufacturer Knockdown Screen. Good for Beauty Parlor, Private Home or Hospitals. This folding screen when made up is very effective. Patent number 1,595,929. W. P. Rhodes, 8418 117th St., Richmond Hill, L. I., N. Y.

PATENT for Sale—Hookless piano roll and attaching device; serial number 87,900, division 5; patent pending. Apply to Andrew Drogalis, 530½ W. Arlington St., Shenandoah, Penna.

OUTRIGHT—Royalty; 3 Patents, 3 Applications on ships Log, Tank Gauge, Tank Alarm. B. Star, 84 Flushing Ave., Brooklyn, N. Y.

OUTRIGHT—Drafting instrument for use as T-square, straight edge, curve, protractor, and for finding centers of cylindrical or circular objects. W. R. Pearson, care of Cook's Union, Labor Temple, Portland, Ore.

RETAIN fabric measure—cuts outright on dot. No waste. ¼ competitor costs. McDermott, 74 Buckingham, Hartford, Conn.

OUTRIGHT or Royalty basis, device that will positively straighten automobile fenders, regardless of their condition. Pronounced a huge success by all users. Mart Dolkan, 3137 Vine St., Lincoln, Nebr.

OUTRIGHT, electric window cleaner, successful invention market for twenty million. B. Nichols, 1837 W. Columbia Ave., Philadelphia, Pa.

PATENT Fish Hook, wanted manufacturer. J. Lin, Belmond, Iowa.

CANADIAN Patent 264,048 propellers for boat or aircraft, outright or royalty. G. Amburson, 2192 15th St., San Francisco, Calif.

OUTRIGHT—All-metal rolling window screen. Easily applied and manufactured at very low cost. H. P. Crowell, 380 Lovell St., East Boston, Mass.

FOR Sale U. S. Patent No. 1,593,059, Fluid Transmission. When in high it is in neutral. A Perfect Clutch. W. C. Buckbee, Manteca, Calif.

ELECTRICAL

ELECTRICAL Kinks on all phases of practical electricity. 47 ideas on wiring, 45 on making electrical devices, 19 on lighting, 5 on transformers, 5 on motors, 8 on generators, 11 on switches, 22 on testing, 12 on repairing, 11 on battery manufacture and repair, 5 on telephones, and 9 on electricians' tools. 214 articles, 162 pictures. Send no money. Just write postal for "Electrical Kinks." Pay postman postage, and \$1.50. Popular Mechanics Press, Room 904, 200 E. Ontario St., Chicago, Ill.

DIESEL Engines—Marine, Locomotive, Stationary. Growing importance of the Diesel Engine cannot be overestimated. This new book should be in the hands of every student of mechanical engineering. 500 pages, 280 illus. Pay postman \$5 and postage when he delivers book. Popular Mechanics Press, Room 903, 200 E. Ontario St., Chicago.

SURVEYING INSTRUMENTS

LARGEST stock of new and used surveying instruments in the country direct from factory. Satisfaction guaranteed or money refunded. Wissler, 619 N. Broadway, St. Louis, Mo.

MODELS AND MODEL SUPPLIES

PATENTS. Time counts in applying for patents. Don't risk delay in protecting your ideas. Send sketch or model for instruction or write for Free book "How to Obtain a Patent" and "Record of Invention" form. No charge for information on how to proceed. Communications strictly confidential. Prompt, careful, efficient service. Clarence A. O'Brien, Registered Patent Attorney, Security Bank Building (directly across street from Patent Office), Washington, D. C. See pages 128 and 139.

LET our experience be your guide. Models that are models; Tools and equipment for economic manufg. Patterns of all types; manufacturing in all branches. Satisfaction guaranteed. United Machinery Company, Cincinnati, U. S. A.

MODEL steam engines and boilers. Boat and boiler fittings. Send 10c stamp for catalog. Refunded with first order. Model Machine Shop, P. O. Box 5, Station Y, New York City.

WORKING models built. Drawings prepared free. Let our designing and engineering departments and 27 years' experience assist you with your invention. Lowest prices. Hohmeier Mfg. Co., 1385 E. 17th St., Cleveland, Ohio.

THE Modelmaker, a magazine for all interested in making working models, boats, etc. Sample 10c. Modelmaker, 122 Liberty St., New York.

WOOD'S for Models, Scroll Work and Inlaying. George Wild, 510 East 11th St., New York.

SHIP Model Cannons, wooden, dime each. Leonard, 333 L. W. Hellman Building, Los Angeles.

SPECIAL machine builders, tool and die makers, inventor's models, production work of all kinds. Dept. L. Quality Hardware & Machine Co., Ravenswood and Thorndale Avenues, Chicago, Ill.

HULIT & Co., General Model Makers, 625 W. Jackson, Chicago, Ill. Specializing in high-grade model work on inventions of merit. Complete Equipment, Experienced Workmen.

WE make working models for inventors and do experimental work and carry a complete stock of brass gears and model supplies. Send for catalogue. The Pierce Model Works, Tinley Park, Ill.

MODELS, Experimental Work, Light Manufacturing, and Stamping. Froholm Bros., Syracuse, N. Y.

MANUFACTURING

MODELS, Dies, Manufacturing Ideas developed, screw machine products, metal stampings, and contract manufacturing of metal parts. Schroer Manufacturing Co., 2164 Campbell St., Kansas City, Mo.

INVENTOR'S Models, Machine work, Light Stampings, Nortwed Model Machine Shop, Ethan, S. D.

WANTED, materials for manufacturing wire, twine, fiber, steel, chemicals, etc. A. Jensen, R. 6, B. 86, Stockton, Calif.

MODEL, Experimental and Light Machine work. Accurate; prompt service. Lowest prices. Southern Instrument Works, 1210 Dallas Ave., Houston, Texas.

PATTERNS, wood and metal. Models, tools and dies. Brass, bronze, aluminum and iron castings. Screw machine work, production work of all kinds. Write Modern Machine & Pattern Co., Terre Haute, Ind.

ECONOMICAL manufacturing. Models, instruments, tools. Established 20 years. Swanberg, 5124 N. Kildare Ave., Chicago.

SPRINGS made to order. Wright Bros. 5616 Huron St., Chicago.

WE help you design, make your models, dies, manufacture your products. Standard Die & Specialty Co., 1932 Austin Ave., Chicago.

SPECIAL Machinery or parts, dies, tools, metal specialties, models, special gears, stock gears and model supplies. Send for Catalogue. The Pierce Model Works, Tinley Park, Ill.

MANUFACTURING Models, Dies, Stampings, Brass Work, one or thousands. Baum's Metal Specialties, Kansas City, Mo.

WIRE goods made to order. Cooley Mfg. Co., 530 N. Western Ave., Chicago.

DIES, Jigs and Stamping. Acme Tool Co., Mason City, Iowa.

MACHINERY, TOOLS AND SUPPLIES

16" SPRINGFIELD Crank Shaper \$200, 20"x10" Bradford Lathe, \$325. 16"x16"x4" Hendy Planer, \$210. No. 60 Heald Cylinder Grinder \$750. 10"x20" Landis Piston Grinder \$300. 10" Drill Press with chuck, \$19. Complete line of machinery and supplies. We sell on terms. Write for catalogue. Cincinnati Machinery & Supply Co., 218 E. Pearl St., Cincinnati, Ohio.

PIPE second hand, guaranteed suitable for all practical purposes with new threads and couplings, sixteen feet and over; cut to your requirements, also Boiler Tubes, New Fittings, Pfaff & Kendall, 102 Waydell St., Newark, N. J.

START a business of your own, small investment required doing Nickel, Copper and Silver Plating. This work is in big demand. Full information free. Electro Platers Supply Co., 547 Considine Ave., Cincinnati, Ohio.

CONCRETE Building Block Machines and Molds. Catalogue free. Concrete Machine Co., 5 N. Main St., St. Louis, Mo.

NEW 12 inch Portable Band Saws, complete with 1/4 H. P. motors, ready to run. Price, \$75.00 each. Botwinik Brothers, Inc., 67 Water St., New Haven, Conn.

SURPLUS machinery from our shop. Lathes, Shapers, Milling Machines, Drill Presses, and small tools, real bargains, act quick. Electro Platers Supply Co., 547 Considine Ave., Cincinnati, Ohio.

OTHERS have successfully sold their machinery through our columns—so can you. Ask me for proof. M. L. Rund, Manager, Classified Advertising, Popular Mechanics Magazine, Chicago.

FOR Sale—4 Sloane and Chase Bench Lathes, Style No. 5 1/2, size 7x35 in., with 4 in. three jawed chuck, head stock, slide rest, high speed wall countershaft, etc. Price \$125.00. Used less than 30 days. Nashville Industrial Corporation, Old Hickory, Tennessee.

FOR Sale by Gisholt Machine Company, Madison, Wisconsin, surplus used equipment special and standard lathes, planers, mills, gear cutters, grinders. Correspondence solicited.

ENGINES, MOTORS AND DYNAMOS

NEW full 1/4 HP, 110 volts, AC, 60 cycle grinder and buffer, equipped with 6" wheels, enclosed motor \$15.75 each. New 1/4 HP, 110 volt, AC motors, 60 cycle, with pulley \$10.00 each. Prompt shipments. Westinghouse new 1,000 Watt, 32 volt, light and power generators, ready to run, while they last \$48.00 each. General Distributing Co., Security Bldg., Duluth, Minn.

1/4 H. P. A. C. motors \$6. 1/2 H. P. \$5. New Repulsion type motors, 1/2 H. P. \$28. 1 H. P. \$38. New exhaust fans, A. C. scoop blade, 18 inch, \$37.50. W. L. Steege Electric Co., 25 So. Clinton St., Chicago, Ill.

MOTORS—New GE 110 or 220 volt 60 cycle Single Phase 1/4 HP, \$11.90; 1/2 HP, \$28.50; 1 HP, \$38.50. Mail \$3 check or money order. We will ship COD anywhere. Motor Specialties Co., Crafton, Penna.

GOVERNORS for all auto engines when used for power plants. Send for circulars. A. C-S Governor Co., Springfield, N. Y. or 215 W. Manchester, Los Angeles.

ALTERNATING and direct current motor bargains. All sizes, all kinds. Reliable makes only. General Electric, Westinghouse, Century, Wagner, Holtzer-Cabot. Send for price list or tell us your needs. Hyre Electric Company, 615 MH So. Dearborn St., Chicago.

STEAM Engines—one H. P. \$18.00; 1/4, \$12.00. James Chambliss, Bessemer, Ala.

BARGAINS—Motors, Machinery, 1/4 H. P. \$6.00. 1/2 H. P. \$18.75. 1 H. P. \$25.00. Electric Drills \$14.95. 100 other bargains. Send for "Bargain Sheet 630." Acme Tool Co., 627 Washington St., Chicago.

BRAND New 1/4 Horse General Electric Motors, 110 V, alternating 1750 speed cord plug and pulley \$7.75. 1-12 Horse 110 V. Universal motors \$2.75 each. Also other bargains. Queen City Electric Co., 1736 Grand Ave., Chicago, Ill.

BLACKSMITHS

BE a Master Mechanic Blacksmith and Expert Tool Maker and Dresser with colored tempering charts. Price \$1.00. Valuable samples free. W. M. Toy, Sidney, Ohio.

BENDING MACHINES

THE Famous Hossfeld "Wrenchless" Universal Iron Bender is the last word in bending machines; bends both Pipe and Bars to most any conceivable shape. Bends Eyes, "U"s, Angles, Rings, Coils, etc. Accurately bends anything from a small nail up to a 1 1/2-in. pipe cold. Instantly adjusted without a wrench. Thousands in use. Write for descriptive circular and prices. Hossfeld Mfg. Co., Box 344, Winona, Minn.

FOR SALE—MISCELLANEOUS

ADDRESSOGRAPHS. Letter Folders, Multigraphs, Envelope Sealers, Duplicators, less than half price. Guaranteed. Pruitt Co., 117 No. Market, Chicago.

DELICIOUS alfalfa—clover honey 1-10 lb. pail \$1.85 postpaid 4 zones. Arthur Erickson, St. Hilaire, Minn.

TELL an army of 3,000,000 live readers all about your offer! If you have anything to sell, buy or exchange, or if you have any reasonable proposition, tell our readers all about it—they'll respond quickly. Our booklet "How to Create More Business" contains some very interesting, helpful facts. Write today for your copy—it's free. M. L. Rund, Manager Classified Advertising, Popular Mechanics Magazine, 200 E. Ontario St., Chicago, Ill.

WANTED—MISCELLANEOUS

MAIL us your discarded Jewelry, Gold, Crowns and Bridges, Watches, Diamonds, Silver, Platinum and old False Teeth. Money promptly mailed. Goods returned if offer refused. United States Smelting Works (The Old Reliable), Dept. 71, Chicago.

WE pay Cash for kodak films. Sample pictures, instructions, 25c. O. D. Sibley, Meadville, Pa.

REAL ESTATE, FARM AND ORCHARD LANDS

STROUT'S Spring Farm Catalog Now Ready. Mammoth illustrated time-saving guide to bargains in many states. One buyer writes, "The farm I purchased is the best bargain I ever saw. I wouldn't take \$1,300 profit on it." Write today for your free copy and get best early selection. Strout Agency, 225-P, 4th Ave., New York City.

CANADIAN Land Sold for Taxes. \$49.50 buys 10 acres Ontario hunting camp. \$79.20 buys 9 acres lake front. \$198.20 buys 80 acres Manitoba farm. \$268.20 buys 150 acres British Columbia. \$301.50 buys 160 acres Alberta. These prices are not first payments or the price per acre, but the total amount asked. Also beautifully situated hunting and fishing camps for moose, deer, caribou, ducks, partridge, trout, whitefish, bass, etc.; best in North America. Summer cottage sites, farms, heavily wooded tracts, acreages large and small for pleasure and investment, all offered at ten cents on the dollar of their value and on easy monthly payments of \$5 and upwards. Illustrated list describing the above and hundreds of other properties seized and sold for taxes, mailed free on request. Send no money; send for a list today so you will have first choice. Tax Sale Service, Room 617, 72 Queen Street West, Toronto 2 Ontario, Can.

LAND Free if planted to bananas. Bananas bear a full crop the second year. \$5.00 monthly will plant five acres, which should pay \$1,500 profit annually. Reliable Companies will cultivate and market your bananas for one-third. Bananas ripen every day and you get your check every 90 days. For particulars address Jantha Plantation Co., Empire Building, Block 307, Pittsburgh, Pa.

OZARKS—10 acres near White River and proposed power dam, \$100, \$5 monthly. Alvin Zimmerman, 1802 N. 5th, Kansas City, Kans.

SELL your property quickly for cash, no matter where located. Don't pay big commission. Particulars free. Real Estate Salesmen Co., Desk B, Lincoln, Nebr.

PECAN-Orange-Fig Groves "On the Gulf" Monthly payments. Guaranteed care. Big, quick returns. Suburban Orchards, Dept. M, Biloxi, Miss.

\$10 IS all I ask down on 20 acres in Mich. Potato Belt. Very easy terms. Near markets, lakes and streams. Write for particulars now. G. W. Swigart, P1276 First Natl. Bank Bldg., Chicago.

POULTRY Land \$5 down, \$5 monthly, buys 40 acres Southern Mo. Price \$200. Send for list. Box 22-N, Kirkwood, Mo.

SOUTHERN Virginia Farm Lands Cheap. Write for descriptive list showing name and address of owner. Chamber of Commerce, Emmoria, Va.

ATTENTION—"Get acquainted." Cash for your property. Farm, Hotel or Retail Store, no matter where located; confidential service. Hayes' Business Agency, Cincinnati, Ohio.

POULTRY

No. 1 LOW Booking Terms; Super-Test accredited chicks. All kinds. Our low prices and good service get the orders. Three color catalog free. Missouri State Hatchery, Dept. 711, Butler, Mo.

AMERICAN Cert-o-Culd Chicks. Every chick a purebred. All leading breeds. Highest egg-production strains. Satisfaction guaranteed. Free catalog. Tallent Hatchery, Lineville, Iowa.

FOURTEEN Varieties—Quality—Reasonable prices. Thousands weekly. Catalogue free. Will-Joy Poultry Ranch, Berger, Mo.

HOLLYWOOD-TANCRED 300-336 Egg blood leghorns, hatching eggs, chicks, pullets, prompt shipment. Satisfaction guaranteed. Catalog. R. E. Sandy, Box B, Stuarts Draft, Va.

RABBITS

RAISE Rabbits. Large profits. Breeding stock cheap. George Paul, Fitzgerald, Ga.

MAKE big profits with Chinchilla Rabbits. Real Money Makers. Write for facts. Conrad's, 852 California Bldg., Denver, Colo.

ROOTS AND HERBS

HERB Doctor Book—10 cents, 250 receipts for making herb medicine. Hazzard Company, Box 1, Vanderveer Park, Brooklyn, N. Y.

WONDERFUL 96-page Health Guide, 10c. Contains over 250 valuable recipes for making herb medicines. Worth dollars. Shawnee, 145 West 112th Street, Chicago.

DOGS AND PETS

BEAGLES, foxhounds, coonhounds, setters, pointers, collies, shepherds, greatdanes, St. Bernards, toy dogs. Catalog 10c. Lester Brown, White Hall, Md.

RAISE guinea pigs. Pay better than poultry or rabbits; easy to raise; little space required. Particulars and booklet how to raise free. Cavies Distributing Co., 3162 Grand Ave., Kansas City, Mo.

FLYING Squirrels—Rare, handsome pets. Easily raised in small space. Mated pair \$3.00, two pairs \$5.00; safe delivery guaranteed. Wildwood Fur Farm, Woodville, Texas.

FOXES, raccoons, muskrats, skunk, ferrets, rabbits, squirrels, mink, opossums. B. Tippman, Caledonia, Minn.

SKUNKS—Breeders—Bred females all grades. Choice males. Squirrels, coons, opossums, foxes, rabbits, pigeons. Catalog 10c. Lester Brown, White Hall, Md.

BEAUTIFUL Fox Terriers, Collies, Max-meadow Kennels, Clay Center, Nebr.

PERSONAL

TAKE up Visualism and Cultivate your Memory. 6 simple courses give extraordinary results. 12 courses make you a Genius. 1st Course \$1. 6 Courses \$5. 12 Courses \$9 only. Newall, Church Institute, Stornoway, Scotland.

PERMANENT Spiritual evidence. A new study. Free literature. R. C. Hill, 602 W. Jefferson Ave., Detroit, Mich.

CARTOON of yourself from photo by newspaper artist. Suitable for cut. \$1 cash. Castle Studios, Independence, Mo.

AMAZING Book. Nature's way to health. Right food and exercise to rebuild your body nature's way. 144 pages 6"x9", illustrations easy to understand. Comments by world famous authorities on nature's way to health. Specially priced \$1.00. Money back if not satisfied. Order today. National Health Service, 2725 Calumet, Chicago.

FREE: Valuable book telling the uses of Roots and Herbs. Box 29, Station L, New York.

YOUR birthstone. Send 10c and date of birth. Oriental Jewelry, Roxbury, Mass.

TOBACCO or Snuff Habit Cured or no pay. \$1.50 if cured. Remedy sent on trial. Superba Co., N3, Baltimore, Md.

WONDERFUL health book for only 10c (publisher's price \$1.00). Appreciated by every reader, sick or well. Teaches health the natural way, also suggest reliable self treatment of disease. Address, Author, Box 437, Seattle, Wash.

SEND 25c coin and your date of birth for forecast of your vibrations for 1927. Aryel Synclare, Numerologist, Box 25, Patton, Calif.

WE answer your questions, 25c. coin. Fred Klotz, Reading, Pa.

MISCELLANEOUS

SELF-INFLATING life belt—pocket size. Wonder of the age. Miniature hollow-ribbed life-boat distendable around the body instantly. Sustains wearer in deep, rough water. Most practical safeguard for sea travelers and non-swimmers. Boon to aquatic sports. Get free illustrated booklet. Self Acting Life Belt Co., 55 E. 8th St., New York.

SIMPLEX Sewing Machine Needle Threader 10c. Four glass cutters \$1, prepaid. Each guaranteed—1,000 perfect cuts. American Simplex Co., Anderson, Ind.

MIRRORS resilvered at home. Costs less 5 cents per square foot, you charge 75 cents. Immense profits plating auto parts, reflectors, tableware, stoves, refinishing metalware, etc. Outfits furnished. Details Free. Write Sprinkle, Plater, 288, Marion, Ind.

EXCHANGE or purchase match box labels. Frank Erskine, Portland Place, Torquay, England.

SOURCE of supply of anything made 25c. Any formula you want (fully tested) 50c. Expert advice on any Mail Order question \$1.00. No stamps accepted. United Service Bureau, Auburn, N. Y.

CATCH 2 and 3 mink nightly. Satisfaction guaranteed. Instructions \$1.00. A. Robertson, Hawarden, Ia.

MEXICAN-MADE pistol holsters, cartridge belts, lariats; hand-carved belts and holsters; horse-hair belts, hat bands, fobs; rattlesnake belts, fobs. Tex-Mex Leather Co., 309 Emerson Bldg., Houston, Texas.

HOME Business Plans—List and sample plan, 10c. "Publisher," Box 320-P, Grandview, Wisconsin.

CASH paid for butterflies, insects. See Sinclair Display Advertisement on Page 28.

CASH in on your Artistic Ability. Your home, your office, your spare time, your gold mine. Not a correspondence course. Sample and particulars 10c. Straco, 1017 Mulberry, Springfield, Ohio.

WEEDS—Cut them with cutter bar on Shaw Garden Tractor. Also plows, cultivates and runs belt machinery. Low prices. Immediate delivery. Shaw Manufacturing Company, Department C, Galesburg, Kans.

ST-STU-T-T-TERING and stammering cured at home. Instructive booklet free. Walter McDonnell, 46 Potomac Bank Bldg., Washington, D. C.

I CATCH from 45 to 50 foxes in from 4 to 5 weeks' time. Can teach any reader of this magazine how to get them. Write for particulars. W. A. Hadley, Stanstead, Quebec.

CUTS anybody can make. Simple, cheap process. \$1. Specimens, particulars. 2c stamp. M. Day, Windfall, Ind.

HOMEOPATHIC and Biochemic preparations sent postpaid to all parts of the world. Manual and booklets free. Halsey Bros. Co., 645 St. Clair St., Chicago, Ill. Established 1855.

ARTIFICIAL Eyes. Booklet free. Denver Optic, 559 Quincy, Denver, Colo.

TATTOOING Supplies Direct from Manufacturer. "Waters," 965 Puttnam, Detroit.

ARTIFICIAL eyes fitted by mail, \$5. Free booklet explains. Ramsdell Optical Company, Moline, Ill.

TATTOOING—Learn how with my outfits. Descriptive circulars sent anywhere. Sergt. Bonzey, 367 South Main, Providence, R. I.

AMATEUR Cartoonists: Make money in spare time with new cartoon selling plan. Illustrated chart, complete instructions, \$1. Smith's Service, Wenatchee, Wash.

FORTUNES in Mines and Minerals. Ore specimen 10c. Minerals for sale. Buskett, Joplin, Mo.

\$6000

Per Week!

Dear Mr. Dobe:—"I saw your advertisement, clipped the coupon and got started. Your course has already helped raise my salary to \$60.00 a week and in addition I get 50% of the profit on the construction of all buildings of which I am draftsman and general superintendent."

Phil Zaroni

\$35000

a Month!

Dear Mr. Dobe:—"I just recently jumped to the position of Chief Draftsman, at \$350 per month. That's pretty good as I was a clerk making \$10.00 a week when I enrolled with you."

R. C. Foster

\$60000 a Month

Wouldn't Tempt Him!

Dear Mr. Dobe:—"When I enrolled with you I was making \$3.20 per day. A short time ago I was offered a position to net me \$600 a month but it did not tempt me. I am in business for myself and wouldn't take a position at any price. I have a home worth \$19,000 and two automobiles. You can see what your course has meant to me."

Carl Dupree

Learned Drafting at Home!

Dupree, Zaroni and Foster are all products of the easy and quickly learned Dobe plan of teaching drafting at home. No other man uses the Dobe method. From Dobe you get real practical drafting work, keep the job you have now, stay right at home and in a few months you learn the great profession of drafting. No railroad fare, no board bill, no going to a distant city. If these men have been able to make the great success for which they give Dobe all the credit, how can you afford to pass up the chance? You can't!



Mail This Free Coupon or Write Today for Free Book



They asked for the Free Book first. Will you ask for it today? Certainly you are not obligated at all by writing for "Successful Draftsmanship." Get it and read it. Then make up your mind how successful you can be. These men are making real money and you know the old adage "What man has done man can do." So mail the Free Coupon below—or write a letter or a post-card. Do that now. No man who is dissatisfied with what he is making now should fall to get and read "Successful Draftsmanship."

Dobe Easy Drafting
1951 Lawrence Ave., Div. 93-54, Chicago

You may send me free your book "Successful Draftsmanship" and names and addresses of more Dobe winners.

Name..... Age.....
Address.....
Post Office..... State.....

FREE How to Read Blue Prints

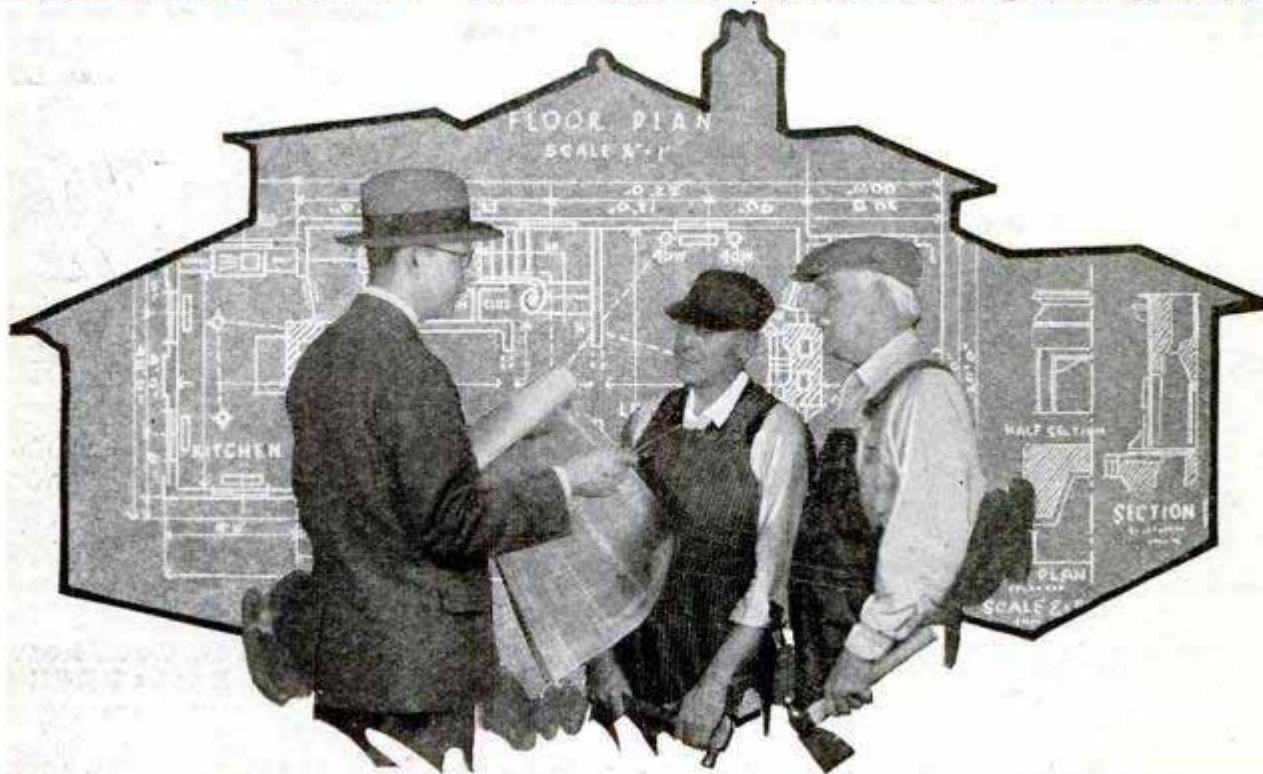

New Easy Practical Way

Leads Quickly to \$4,500 to \$12,000 a Year

Thousands of Men From All Walks of Life Have Discovered an Altogether New Way to Double and Triple Their Incomes! Surprising, Yes—But True! Almost Over Night They Have Taken Their Choice of 9 Interesting, Big-Pay Jobs—Become Foremen, Superintendents, Estimators, Real Estate Experts—or Are Making Big Money in Business for Themselves. The Same Wonderful Opportunity Is Now Offered You. Don't Send One Penny. Just Mail the Coupon for Full Set of Valuable Blue-Print Plans, Big Free Book, and Complete Details.

BIG pay jobs by the score, yes, by the hundreds, are waiting for you in the world's richest industry—Building. There is a constant never-ending call for trained men—and still more trained men—men who have practical headwork training and can read Blue Prints and run jobs.

Many men think the only way they can get this practical "headwork" training is on the job. But thousands of Chicago Tech. graduates have proved that the idea is all wrong. In fact, a man can spend 5 or 10 years working with his tools and never get a real chance to learn the things he must know, if he is ever to get into the big-pay class. Anyhow, it's a long, hard, slow process—on the job.

Amazing, New Kind of Training

But it's all different—the new Chicago Tech. Builders' Course way—amazingly different! It's quick, easy, certain. Right at home you get real Blue Prints used on actual jobs to examine and keep for reference. In language you can understand, as plain as A-B-C, everything is told you and worked out for you in concise, practical home lessons—no textbooks to study—you are taken by experts right through every step of Plan Reading, Estimating, and Superintendence so simply and easily

If You Live in or Near Chicago

Visit our day or evening classes which over 1,000 Builders attend. You can get the same training by mail—same Plans, Lessons and Instructors. Mail the coupon for details.

READ!

"Since starting the Builders' Course I have been raised to Superintendent and my pay raised 100%."

P. F. Blair, Okla.

"I owe a lot of credit to your course. Am now listed as a Brick Contractor and made about \$3,800 clear money this summer."

E. F. Baker, Ohio.

it is just like play. You don't need even a grade school education to understand every word and absorb every fact.

Big Pay in 3 Months

Consider what this quick, practical Chicago Tech. training has done for others. Woodside, in less than three months, rises to foreman, then makes big money in contracting business for himself. In a few months McAvoy goes from bricklayer on the wall to foreman in charge at a big increase in pay. Marchand says, "Ten days after completing course my pay was raised 100%." Hundreds—yes thousands of others say the same, Chicago Tech. has helped them to bigger jobs or a business of their own. It is ready right now to help you.

Blue Print Plans—FREE

We want you to see for yourself how easily you can learn to read Blue Prints and do Estimating this new quick way—how easily you can double and triple your income. Test this yourself. Don't send one penny. Just mail the coupon. We will send you absolutely FREE a full set of practical, working Blue Prints, also valuable book, "How To Read Blue Prints." Act at once as this Free Trial opportunity may not be offered again.

FREE BOOK



CHICAGO TECHNICAL SCHOOL FOR BUILDERS,

Dept. D-140, Chicago Technical Bldg., 118 E. 26th St., Chicago, Illinois

Please send your Free Books and Blue Prints which I understand are mine to keep without obligation. It is also understood that no salesman will call on me.

Name.....
 Address.....
 City..... State.....
 Occupation.....

CHICAGO TECHNICAL SCHOOL FOR BUILDERS

Dept. D-140 118 East 26th Street CHICAGO, ILL.

Like Finding a \$20 Bill!

HERE'S your chance to save \$20.02 on your set of muscle building apparatus with a complete course of instructions!
 Here's a bargain in *Health*—a bargain in *Strength*—a bargain in *New Life* for YOU. You could pay up to \$50 or \$60 for similar apparatus and instruction elsewhere, but you couldn't get a better outfit at any price!

High Tension 10-Cable Exerciser

This is the Champion Muscle Builder of the World! It has steel reinforced handles—the strongest made. It is progressive and can be used with any number of cables from one to ten. When used with my Scientific Course of instruction you will almost see your muscles grow.

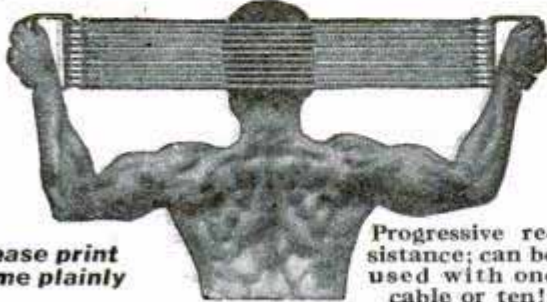

Please print name plainly

Progressive resistance; can be used with one cable or ten!

HENRY VICTOR, Dept. M-108
 109 East 13th Street, New York City

Gentlemen:
 Send me your complete outfit and the two FREE books. I enclose the bargain price of only \$4.98. If I am not satisfied, I will return the outfit immediately and my money will be refunded in full.

Name.....

Address.....

City.....State.....

Read This List—

Complete scientific course of instruction in *Body Building*—Worth \$10.00; CHAMPION PROGRESSIVE TEN CABLE MUSCLE BUILDING EXERCISER—Worth \$10.00; Victor Master Grip (Patented in all countries)—Worth \$ 5.00
\$25.00

Only \$4.98 Complete Outfit

Victor Master Grip

This machine will increase your forearm and wrist muscles to an unbelievable development. It is progressive and can be used with (1) mild; (2) medium; (3) strong springs. It is also a grip tester, registering from 1 to 100 per cent.

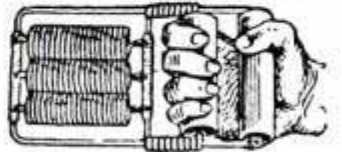

Professional strong men and athletes everywhere praise the Victor Master Grip. No training apparatus is complete without one.

And You Get These Two Books FREE

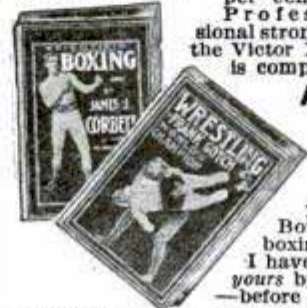

"Boxing" an illustrated book by James J. Corbett and "Wrestling" by Frank Gotch will be sent with your apparatus FREE, if you hurry. Both books are filled with inside dope on boxing and wrestling. I have only a few copies of each left. Get yours by mailing the coupon now, TONIGHT—before you go to bed.

HENRY VICTOR, 109 E. 13th St., Dept. M-108, New York City



DO YOU LIKE TO DRAW?

It's Easy To Learn When Shown In The Right Way

Some of the cleverest cartoonists and comic artists in America today learned how to draw quickly—by following CARTOONIST EVANS' SIMPLE AND EASY METHOD. This school is recommended by foremost cartoonists because they know the students are handled right. If you like to draw, send 6c in stamps for portfolio of cartoons and full details. The course is NOT EXPENSIVE.

The W. L. Evans School of Cartooning 821 Leader Building CLEVELAND, OHIO

AT HOME LEARN TELEGRAPHY AT HOME

TEACH YOURSELF in half usual time, at trifling cost, with the wonderful Automatic Transmitter, THE OMNIGRAPH. Sends unlimited Morse or Continental messages, at any speed, just as an expert operator would. Adopted by U. S. Government, and leading Universities, Colleges and Telegraph Schools. Catalog 6 cents. OMNIGRAPH MFG. CO., 13-19 Hudson St., NEW YORK



Win \$3500!

I am going to give some one a check for \$3500.00 cash—and 399 other checks to 399 other persons. Total of 400 prizes altogether, totalling \$7500.00. We have already given over \$37000.00 of valuable prizes to advertise our business.

Leola L. Markus, Virginia, Minn., received \$2500.00; H A. Andrews, Horse Creek, Wyo., won \$1375.00 prize; Mrs. Wm. Barnhart, Three Rivers, Mich., won \$1250.00 prize; Miss V. Umbarger, Zion, Ill., won \$1350.00 prize and many others—and now YOU can get this \$3500.00!

Divide this World Into 6 Parts So Figures in Each Part Total 26

By drawing 5 lines from one side to the other between the numbers on the globe, you can divide the globe into 6 sections, in each section of which the numbers will total 26. Can you do it? Draw the lines; cut out the ad; and send your name and address. Get the 8,000 points toward the \$3500.00 cash prize. Duplicate prizes will be paid in case of tie.

\$500.00 for Promptness makes total first prize \$3500.00. Be prompt. Nothing to buy now, later or ever—hurry!

F. G. Stayten, Adv. Mgr., Room 374 54 W. Illinois St., Chicago

Join This Happy Throng

**Money Talks
Read These
Records**



\$8,500

in 17 weeks! That's what Chas. F. Worthen, a Massachusetts man, made with this remarkable real estate system. Free book tells how!



\$2,700

on one deal! That's the news from Edw. A. Anderson, of Chicago, Ill., who attributes his success to this system. Free book tells how!



\$14,400

in less than four months! That's the enthusiastic report from H. G. Stewart, a Maryland user of this money-making real estate method. Free book tells how!



\$248

in one transaction! That's the first "pin-money" Mrs. J. H. Hastings of Michigan, made following this plan for business success. Free book tells how!

Be a Real Estate Specialist. Use this wonderful system. Make Big Money—right at home—in your spare time—without capital or experience. New Book giving full facts and amazing proof of success, now mailed free.

IF you walked into your boss' office tomorrow morning and asked him to double—or triple—your salary, would he do it?

Neither would E. K. McLendon's boss. McLendon, who lives in a small city in Oregon, was getting \$35 a week, and he says, "My savings were few and my worries many."

By depending upon himself instead of his boss—by sending for this free book—by following this successful real estate system—McLendon has increased his income from \$35 a week to an average of \$200 per week. He is now enjoying an income nearly **six times** as large as his boss paid him.

If you want your pay—your salary—your income—doubled, tripled or quadrupled, you know that your boss won't do it. You know that to make really big money you will have to get started in some business of your own. You know that as long as you stay in the pay-check class you will get only what the other fellow is willing to pay you.

So, send for this free book now—today. Learn what others are doing—learn what you can do—in the biggest business there is—real estate.

Here are just a few of the great advantages and opportunities offered you in real estate:

(1) Real estate is the biggest thing you can get into. Sixty-five per cent of the wealth of the entire nation is invested in real estate. It amounts to 230 billions!
(2) Users of this remarkably successful method are reporting profits of \$500—

\$1,000—\$5,000—and more—on single deals—sometimes as much money in one lump as the average man in the average business gets for months and years of hard work. (3) With this amazing system you can start in your spare time—without giving up any work—any income you now have. (4) Real estate offers you a permanent business—as permanent as the earth itself. (5) It is a healthful, interesting occupation—no dirty work or hard labor requiring unusual health or strength. (6) The business can't stop growing. It gets bigger as population increases. Last year six billion dollars was invested in new buildings. (7) It is a business suitable to both sexes of all ages from 21 to 75. One woman user of this system made her start at 77. (8) The business is practically unlimited. There are ten million properties always in the market for rent, sale or exchange.

Do you know of any other business, of any kind, that offers you such remarkable advantages and opportunities?

You know that you will never get rich working for somebody else. You know that the way to big money is through a business of your own. And you know that you cannot find a bigger business than real estate.

Why stick to a pay-envelope all your life? Why not start right now—in your spare time—use our scientifically successful system—get into the biggest money-making field there is—begin at once to build up a business for yourself—not for someone else.

Send for this free book at once. You will find it the most fascinating book of real estate opportunity and real estate achievement that ever fell into your hands. It will show you how you can do what other wide-awake men and women are doing—build up an independent business of your own—the kind of a business you have dreamed about—the kind of a business you have longed to get into—the kind of a business you want for your business.



**Blame
Yourself
If You Don't**



\$5,500

profit on first deal! So says Evelyn M. Balster, Illinois widow who was trying to raise three children and make both ends meet on a teacher's salary. Free book tells how!



\$28,000

first six months' profits! That's the record of Thos. C. Mone, Jr., a New York State insurance solicitor. Free book tells how!



\$100,000

first year's sales! This New Jersey man, H. D. VanHouten, worked for twenty-five years for a wholesale grocer until he got into real estate. Free book tells how!



\$500

average monthly profits! That's what this great real estate system is doing for W. H. Robinson, an Illinois man. Free book tells how!

This Free Book Shows How



**American Business Builders, Incorporated
(Authorized Capital \$500,000)
Dept. 44DD, 18 East 18 Street, New York, N. Y.**

You may send me—without cost or obligation—your book giving full facts about your Real Estate System, and how I can use it to build up a profitable business of my own in my spare time.

Name.....

Address.....

Discovered!

The Scientific Secret of Caruso's Amazing Vocal Power

A post mortem of Caruso's throat showed superb development of his Hyo-Glossus muscle—again proving the soundness of Eugene Feuchtinger's theories of voice production.

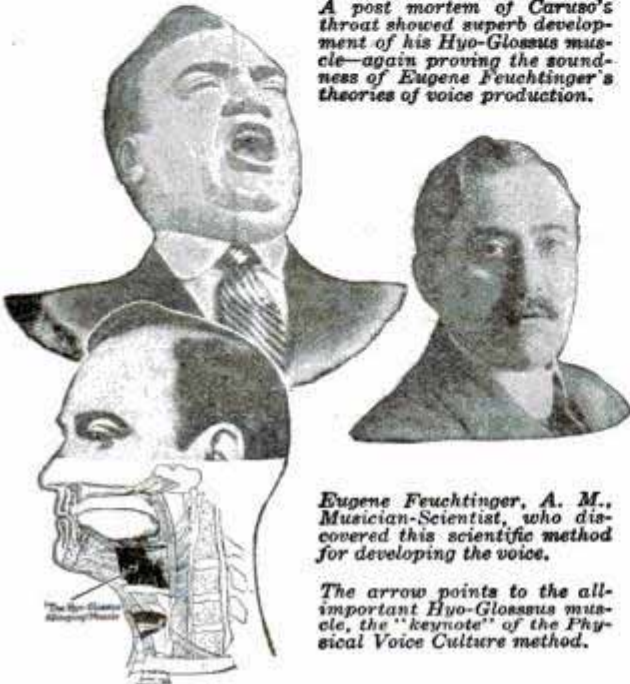

Eugene Feuchtinger, A. M., Musician-Scientist, who discovered this scientific method for developing the voice.

The arrow points to the all-important Hyo-Glossus muscle, the "keynote" of the Physical Voice Culture method.

The Great Discovery

Professor Feuchtinger, A. M.—famous in the music centers of Europe—discovered the secret of the Hyo-Glossus muscle. He devoted years of his life to scientific research and finally perfected a system of voice training that will develop your Hyo-Glossus muscle by simple, silent exercises right in your own home. Since the Professor brought his discovery to America—over 10,000 happy pupils have received his wonderful training.

100% Improvement Guaranteed

The Perfect Voice Institute guarantees that Physical Voice Culture will improve your Voice 100%. You are to be your own judge—take this training—if your voice is not improved 100% in your own opinion, your entire tuition will be refunded.

Inspiring Book FREE Send the coupon below and we'll send you FREE this valuable work, "Physical Voice Culture". You assume no obligation. It may be the first step in your career. Do not delay.

Perfect Voice Institute

1922 Sunnyside Ave., Studio 13.54 Chicago

Perfect Voice Institute 1922 Sunnyside Ave. Studio 13.54 Chicago

Please send me a copy of your new book, "Physical Voice Culture", FREE. I understand that it is mine to keep and there is no obligation on my part. I am interested in

Singing Speaking Stammering Weak Voice

Name

Address

Age

RUSSELL PATTERSON



Makes a \$150 Drawing in a Few Hours!

—and now teaches you his original methods in a series of 20 snappy lessons—brimful with sparkling interest from the very start—a departure from the purely conventional. This training constitutes the last word in Humorous Illustration, teaching a New Art for a New Age—a pleasant relief from the old style, standardized instruction. Learn to draw the dashing, peppy types that are all the rage as exemplified by Mr. Patterson's numerous contributions to magazines. Let him teach you his clever technique. What profession could compare with this in its irresistible appeal or sheer earning power? Write now for full information.

Russell Patterson School of Humorous Illustration

Michigan Ave. at 20th St., Dept. 12

CHICAGO - - - ILLINOIS

FOREST RANGERS

MEN, GET FOREST RANGER JOB; \$125-\$200 MO. AND HOME FURNISHED; PERMANENT; HUNT, FISH, TRAP. FOR DETAILS, WRITE NORTON, 226-B, McMANN BUILDING, DENVER, COLORADO

GET INTO THE SKILLED CLASS Paint POSTERS-SHO-CARDS-SIGNS **QUICKEST ROUTE TO BIG MONEY**

Learn to Earn \$50 to \$200 Weekly

Get into skilled class. Year-around work. Large demand for signs, show cards and posters. High prices paid. Experts make big money. We teach you quickly and easily in your spare time. Thousands of graduates. Years of experience. Oldest and foremost school. Ask any good sign painter about us. Here's your chance. Be your own boss. Own your business. Live where you wish. Get ahead in the world. Fascinating work. Get information, samples and guarantee.

DETROIT SCHOOL OF LETTERING 152 Simson Ave. (Est. 1899) Detroit, Mich.



You may
have
a desk,
but—
do you get
the
salary
?



JOHN A. HALL, C. P. A. (24)
ROBERT PENTLAND, JR., C. P. A.
FRANK L. COMBES, C. P. A.
T. T. EASTON, C. P. A. (1915)

Hall and Pentland
Certified Public Accountants and Auditors
Income Tax Specialists
Miami, Florida

JACKSONVILLE
MIAMI
TAMPA
GAINESVILLE
WEST PALM BEACH
DADE CITY
BAY LAGOON

LaSalle Extension University,
Chicago, Illinois.

Gentlemen:

When I enrolled for Higher Accountancy in 1919, I was a clerk with a clerk's wage.

Now I am a member of a firm having offices in nine cities. Our staff includes fifteen C.P.A.'s and more than thirty other accountants. This rapid progress in six short years is largely due to my LaSalle training.

Several of our staff are LaSalle members and all of our men know of our warm appreciation of LaSalle accountancy training. I only wish that every man could realize the unusual opportunity offered by this training for substantial business progress.

Yours very truly,

Robert Pentland, Jr.

THE DESK in the private office of Robert Pentland, Jr.—member of the Florida State Board of C. P. A. Examiners and partner in the largest firm of Certified Public Accountants in the State of Florida—is about the same size as the desk he had when he was a clerk, in 1919. And there's no great difference in looks—

But his income today is more than ten times as large. His firm has offices in nine cities, and employs fifteen C. P. A.'s and thirty other accountants. And he is not yet thirty!

How did he boost his earnings so tremendously—in just a few short years?

He employed three aids: First, initiative—the courage to make a start. Second, energy—the willingness to work. Third, LaSalle adult business training—the short cut to high-salaried positions.

His first step was to send to LaSalle for information regarding home-study business training—to help him plan *intelligently*.

The coupon brought him "Ten Years' Promotion in One," the story of how one man, after many wanderings, found the path to responsibility and power. It brought him also a 64-page book, "Accountancy, the Profession that Pays," wherein he learned how he could enter a highly profitable profession, how he could step ahead to some of the most attractive and remunerative places in the entire range of business.

Below is just such a coupon as Mr. Pentland signed. Ahead of you are opportunities as great—even greater. If, one year from today, you would look back on a twelve months' record of *achievement*—fill in, clip and mail the coupon NOW.

Find Yourself Thru LaSalle!

LA SALLE EXTENSION UNIVERSITY, Dept. 464-HR CHICAGO

I shall be glad to have your 64-page booklet about the business field I have checked below. Also a copy of "Ten Years' Promotion in One," all without obligation.

- | | |
|---|--|
| <input type="checkbox"/> Higher Accountancy | <input type="checkbox"/> Traffic Management—Foreign and Domestic |
| <input type="checkbox"/> Business Management | <input type="checkbox"/> Railway Station Management |
| <input type="checkbox"/> Modern Salesmanship | <input type="checkbox"/> Banking and Finance |
| <input type="checkbox"/> Law; Degree of LL. B. | <input type="checkbox"/> Personnel Management |
| <input type="checkbox"/> Commercial Law | <input type="checkbox"/> Modern Business Correspondence and Practice |
| <input type="checkbox"/> C. P. A. Coaching for Advanced Accountants | <input type="checkbox"/> Expert Bookkeeping |
| <input type="checkbox"/> Effective Speaking | <input type="checkbox"/> Business English |
| <input type="checkbox"/> Modern Foremanship | <input type="checkbox"/> Commercial Spanish |
| <input type="checkbox"/> Industrial Management | |

Name _____ Present Position _____

Street _____ City _____ State _____



these
books
free!

This Tenor Banjo

FREE

WHEN YOU ENROLL - Worth \$18.00

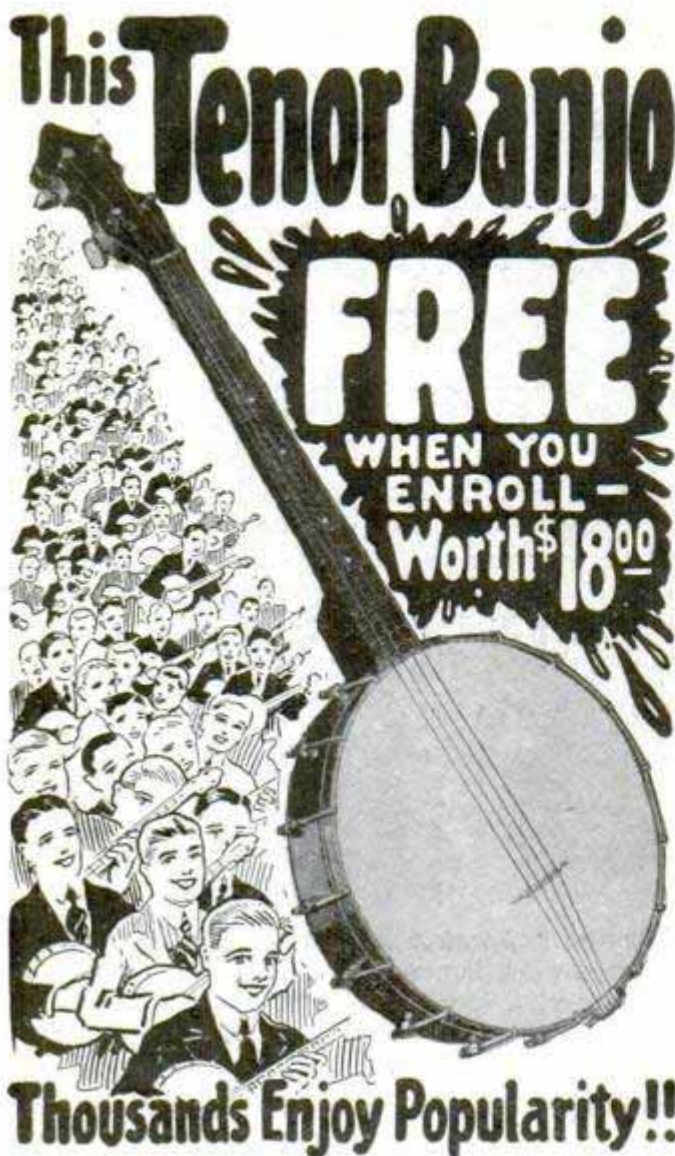

Thousands Enjoy Popularity!!

Popularity can be yours. We start you by presenting this handsome, full size professional tenor banjo. We want to present one of these wonderful, delightful instruments as a gift to each of 1,000 readers of this magazine. We want every music-lover to attain success and this gift offer is made to pave the way. No previous musical knowledge is necessary. Under personal supervision you will be given, by mail, the benefit of Prof. Harry Six's 22 years as director of Glee and Instrumental Clubs of N. Y. University. Our method is different and the simplest devised by man.

Learn in 30 Minutes

We furnish pictures and, as an additional guide, phonograph records of the professor playing the pieces you are learning, along with our thorough, printed and illustrated, easy-to-learn course. It is easy. If you could sit at our desk and see letters from students, you would be convinced that we have perfected the simplest course to insure your mastering tenor banjo.

Don't Send a Single Cent

Investigate today. Don't put off until tomorrow, because you might forget. It might be the turning point in your career. Don't send a single cent. Just drop a line—use coupon, or postal card will do—telling you are interested in receiving full particulars about course, and to reserve one regular eighteen dollar, full size professional tenor banjo for you, which is offered as a gift. Act Now!

EARN BIG MONEY	FREE BANJO COUPON
<p>HUNDREDS HAVE STARTED ORCHESTRAS AND ARE MAKING BIG MONEY</p>	<p>New York Academy of Music Studio 104, 100 Fifth Avenue, New York</p> <p>Please rush all free information relative to your Tenor Banjo Course, sample lesson and reserve a gift tenor banjo for me. This obligates me in no way whatever.</p> <p>Name..... Address..... City..... State.....</p>

CAMERA GIVEN

Without Extra Charge

Your Choice—\$100 Professional MOTION PICTURE Camera or Professional View Camera



BE a Motion Picture Cameraman. Portrait, News or Commercial Photographer. Earn a handsome salary or own a studio and set your own prices! No experience needed. Spare time work. Big money to be made while you are learning!

Learn Photography

A few minutes a day at home fits you for a big paying position and you get your choice of these standard profes-

sional cameras.

Instruction also given in our great New York studios.

Cameramen and photographers are *always* in demand. You can quickly qualify for this easy, fascinating work.

Earn \$75 to \$250 a week

Big money in all branches. Hundreds of positions now open pay \$75 to \$250 a week and more! The most interesting profession in the world.

Send name and address for big, new, illustrated book on Professional Photography. Explains amazing opportunities. Write for your copy tonight!

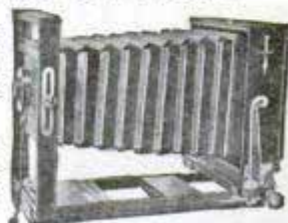

NEW YORK INSTITUTE OF PHOTOGRAPHY
 Dept. 49, 10 West 33rd St., NEW YORK CITY
Write NOW for FREE BOOK



Don't Let Anybody BULLY YOU

Learn Scientific Tricks of Physical Mastery

By a few simple tricks you can have any assailant at your mercy quick as a flash. The astounding secrets of self-defense, used by the New York Police, are revealed in the marvelous, officially recognized system—

Captain Wallander's Course

All Complete In

Physical Training Manual

By Capt. A. W. Wallander

Commander Physical Training, New York Police

A complete course in physical culture. Scores of gripping action photos showing just how to throw a bigger man and overpower him—disarm a hold-up thug—build up muscle—keep in fighting trim. Hundreds of health hints, too; care of the feet, prevention of colds, correct posture, walk without fatigue. This is the genuine book used by the New York Police, now available TO YOU.

Easy to Learn Let Capt. Wallander give you his great secrets and detective tricks. You'll hardly believe that such valuable knowledge could be learned so easily.

ALL YOURS IN WORLD'S MOST AMAZING COURSE

In Physical Culture and Police circles this volume is world famous. Send immediately for your copy. **DON'T SEND MONEY NOW.** Send coupon today. When volume arrives, pay the postman \$1.97, plus few cents postage. If you are not satisfied return volume and get money back. **\$1.97**

SIEBEL PRESS, 34-F W. 20th St., New York.

Send me Capt. Wallander's Physical Mastery Course as contained in the "Physical Training Manual."

Name.....

Address.....

City..... State.....

(\$2.25 U. S. Cash with order outside the U. S. A.)



“The Boss Didn’t Even Know My Name”

“HE SAID my face was more or less familiar and he remembered seeing me around, but he didn’t even know my name until the I. C. S. wrote him that George Jackson had enrolled for a course of home study and was doing fine work.

“ ‘Who’s George Jackson?’ he asked. Then he looked me up. Told me he was glad to see I was ambitious. Said he’d keep his eye on me.

“He did too. Gave me my chance when Frank Jordan was sent out on the road. I was promoted over older men who had been with the firm for years.

“My spare-time studying helped me to get that job and to keep it after I got it. It certainly was a lucky day for me when I signed that I. C. S. coupon.”

How much longer are *you* going to wait before you take the step that will bring you advancement and more money?

It takes only a moment to mark and mail this coupon and send it to the International Correspondence Schools

at Scranton. Yet that one step may be the means of changing your entire life.

Isn’t it better to get the facts today than to wait a year or five years and then wish you had?

Mail the Coupon for Free Booklet

INTERNATIONAL CORRESPONDENCE SCHOOLS
Box 5642-E, Scranton, Penna.

Without cost or obligation, please send me a copy of your booklet, “Who Wins and Why,” and full particulars about the course before which I have marked X in the list below:

BUSINESS TRAINING COURSES

- | | |
|--|---|
| <input type="checkbox"/> Business Management | <input type="checkbox"/> Salesmanship |
| <input type="checkbox"/> Industrial Management | <input type="checkbox"/> Advertising |
| <input type="checkbox"/> Personnel Organization | <input type="checkbox"/> Better Letters |
| <input type="checkbox"/> Traffic Management | <input type="checkbox"/> Show Card Lettering |
| <input type="checkbox"/> Business Law | <input type="checkbox"/> Stenography and Typing |
| <input type="checkbox"/> Banking and Banking Law | <input type="checkbox"/> English |
| <input type="checkbox"/> Accountancy (Including C.P.A.) | <input type="checkbox"/> Civil Service |
| <input type="checkbox"/> Nicholson Cost Accounting | <input type="checkbox"/> Railway Mail Clerk |
| <input type="checkbox"/> Bookkeeping | <input type="checkbox"/> Common School Subjects |
| <input type="checkbox"/> Private Secretary | <input type="checkbox"/> High School Subjects |
| <input type="checkbox"/> Spanish <input type="checkbox"/> French | <input type="checkbox"/> Illustrating <input type="checkbox"/> Cartooning |

TECHNICAL AND INDUSTRIAL COURSES

- | | |
|---|--|
| <input type="checkbox"/> Electrical Engineering | <input type="checkbox"/> Architect |
| <input type="checkbox"/> Electric Lighting | <input type="checkbox"/> Architects’ Blueprints |
| <input type="checkbox"/> Mechanical Engineer | <input type="checkbox"/> Contractor and Builder |
| <input type="checkbox"/> Mechanical Draftsman | <input type="checkbox"/> Architectural Draftsman |
| <input type="checkbox"/> Machine Shop Practice | <input type="checkbox"/> Concrete Builder |
| <input type="checkbox"/> Railroad Positions | <input type="checkbox"/> Structural Engineer |
| <input type="checkbox"/> Gas Engine Operating | <input type="checkbox"/> Chemistry <input type="checkbox"/> Pharmacy |
| <input type="checkbox"/> Civil Engineer | <input type="checkbox"/> Automobile Work |
| <input type="checkbox"/> Surveying and Mapping | <input type="checkbox"/> Airplane Engines |
| <input type="checkbox"/> Metallurgy <input type="checkbox"/> Mining | <input type="checkbox"/> Agriculture <input type="checkbox"/> Navigation |
| <input type="checkbox"/> Steam Engineering | <input type="checkbox"/> Mathematics <input type="checkbox"/> Radio |

Name.....

Street Address.....

City.....State.....

Occupation.....

Persons residing in Canada should send this coupon to the International Correspondence Schools Canadian, Limited, Montreal, Canada

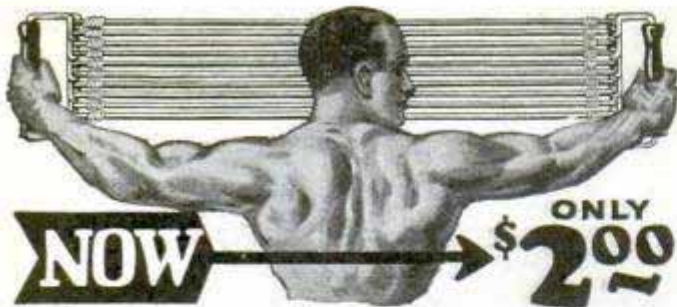

NOW → **ONLY \$2.00**

Giant Chest Expander

and

Progressive Exerciser

Be a muscular marvel. Have the muscles of a superman. Become strong for your health's sake or to astound your friends with extraordinary feats which only men of giant strength can do. In a few short weeks you will easily do stunts which now seem difficult—then real muscles and strength will be yours—and yours to keep.

Send No Money Use This Money Saving Coupon



If you want exercise to just keep in good shape you can reduce the strength of the Progressive Exerciser by eliminating as many cables as you wish. If you want great resistance so as to build up big solid muscles, then use the full strength.

How the Giant Chest Expander and Progressive Exerciser is Made

The Giant Chest Expander and Progressive Exerciser is made with new live, springy rubber so as to give it long wearing and great resisting qualities. Do not pay more for an exerciser that has forty or less rubber strands to each cable. Get the best and most durable. The Giant Progressive Exerciser has 50 strands of the finest rubber procurable to each cable.

Free Instructions

We do not think it enough to send you an exerciser worth double what we ask, but for a limited time, we will also include instructions absolutely free. These instructions are interesting and simple to follow—they show you the short cut to health and strength. Order today before this wonderful offer is withdrawn.

Your Guarantee

The Giant Chest Expander is sold with a guarantee that you will say it is the finest you ever saw or your money back.

5 Cables or double 10 Cables for strength for \$2

\$4
The double strength exerciser has resistance of over 200 lb.

How to Order—Send No Money

Sign your name and address to coupon below and get your Giant Exerciser at the present low introductory price by return mail. The price is made low because we want everyone to enjoy muscles and strength at the lowest possible cost. Don't pay more—order from us—get the most for your money. Use coupon now.



PROGRESSIVE EXERCISER CO.,
4004 Langdon Bldg.,
Broadway and Duane Street, New York

Please send Your 10 cable Progressive.
 Your 5 cable Exerciser.

Check the Exerciser you want, and it will be sent you by return mail. Pay postman introductory price, plus few cents postage on arrival. It is understood that if you are not entirely satisfied with your exerciser you may return it within 5 days and get your money back.

Name

Street

City State

If you live outside the United States, send cash with order.

You Can Study at Home in Spare Time or Specialize At the School Under Personal Direction



Earn \$50 to \$200 Weekly

Painting, Show-Card Writing, Poster Designing and Commercial Lettering. Write for information and Strong's "Book of Facts."

STRONG'S DETROIT SCHOOL OF LETTERING

171 Stimson Ave. Est. 1899 Detroit, U. S. A.
For 100-page catalog of sign and show-card tools and materials, address Supply Dept.

Learn SIGN and SHOW-CARD WRITING
BIG money. Fascinating work. Unlimited field. Chance to own your business. Many earn \$50 to \$200 weekly. Easy and quick to learn.

We teach you in your spare time—few hours weekly—at home or school.

Thousands of successful graduates. Original and largest school devoted exclusively to this profession. Complete, thoroughgoing courses in all branches: Sign

LAW Free Book

Write today for FREE 128-page book, "THE LAW TRAINED MAN," which shows how to learn law in your spare time and earn more money. Qualify for a high salaried executive position or prepare to enter the practice of law. Study at home through the Blackstone Course prepared by 80 prominent legal authorities including CHIEF JUSTICE WILLIAM HOWARD TAFT. Blackstone graduates practicing law everywhere. LL. B. degree conferred. Magnificent 25 volume law library furnished immediately upon enrollment. Moderate tuition fee. Low monthly terms. Money Back Guarantee. Write for book today.

Blackstone Institute, Inc., 4753 Grand Blvd. Dept. 54 Chicago
America's Foremost Non-Resident Law School

Comedies, Dramas, Musical Comedies and Revues, Minstrel Choruses, Songs, Blackface plays, Everything for Burnt Cork Shows and All Amateur Entertainments. Monologs, Dialogs, Speakers.

PLAYS

Vaudeville Acts
How to Stage Play
Make-up Goods
CATALOGUE FREE

T. S. DENISON & CO., 623 So. Wabash, Dept. 9, CHICAGO

Big Money for You as an Automobile Mechanic

These four practical books, written by five well known teachers of automobile practice, will teach you right in your own home during your leisure time just what you need to know about automobile troubles and repair. They will teach you automobile construction, maintenance and repair as experts know them and will help you to earn an expert's pay.

Practical Automobile Library: Four Books—\$1.50 in 10 days and \$2 monthly for 6 months—only \$13.50 in all!

Hundreds of question-answering diagrams—hundreds of clearly-marked illustrations—make the books plain and readily understandable. All the explanations and descriptions are clear, simple, direct. Every chapter is packed with definite, step-by-step, how-to-do-it information. Here is your opportunity to enter a big-pay field.

Sent FREE **Send No Money Mail the Coupon**

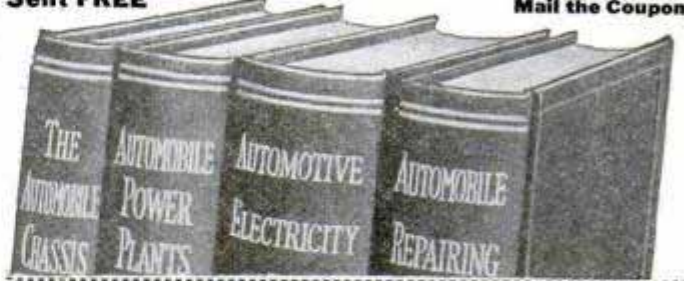

FREE EXAMINATION COUPON

McGraw-Hill Book Co., Inc., 370 Seventh Ave., New York

Send me for 10 days' free examination the New Practical Automobile Library. If satisfactory, I will send you \$1.50 in 10 days and \$2.00 monthly until the special price of \$13.50 is paid. If not wanted, I will return the Books at your expense.

Signed

Address

City and State

Position

Employer P. M. 4-1-27

I'll Pay Your Railroad Fare to Chicago Without Extra Cost

This funny juice~

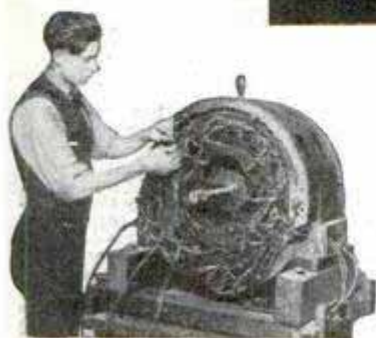

A 25 H. P. Motor for student practice

- helps to run automobiles
- makes radio possible
- makes your telephone work
- makes the wheels go round in thousands of factories
- illuminates homes, factories, office buildings and city streets
- toasts bread, percolates coffee and heats flat-irons
- runs street cars and fast trains

No one knows what it really is—it is called Electricity—but you can learn how to handle it.

—AND IT WILL PAY YOU

\$1⁰⁰ per Hour to \$25,000⁰⁰ per Year

If you get a real "kick" out of this subject of Electricity you're *crazy* if you don't make it earn you real money. Pretty plain speaking—but I want to make you *think*. The world's greatest, most successful men were men who worked at things *they liked*. Work is fun if you like your job. If YOU like electricity, *make it pay you real money*.

Here's Your Chance

To get somewhere you've got to start, haven't you? It'll mean breaking away from home for about 12 weeks—but you and the family will be mighty glad you *started* and *finished* something. Especially something that pays so big.

We'll take mighty good care of you here in the big Greer Electrical Shops. You'll be in company with hundreds of men temporarily away from home, like yourself. And you'll learn Electricity—*oh man*—how you'll learn it! You'll marvel at the way a subject apparently so mysterious is made so easy to understand. Just wait till we turn you loose among our hundreds of motors, rotary converters, generators, telephone and radio equipments. Competent, friendly instructors will show you

how to take 'em apart and put 'em together till you can do it in your sleep.

How to Get This Training

The coupon at the bottom of this page is the open door to pleasant work and big money in the Electrical Profession. We can't tell the whole story here because it takes a Book to tell it. The book is free. Mail the coupon, and be thankful the rest of your life for doing it. Delayed action never put money in the bank. DO IT NOW.

What About Automobiles?

Maybe automobiles interest you as much as electricity—or more. There's a lot of money in fixing autos, too. The well trained auto man is never out of a job. He's ready to go in business for himself. Would you like that kind of work? \$6 a day to \$20,000 a year is what it pays you. Then mark the coupon for the free book on our Automotive Course. We've made automobile experts out of thousands of men who didn't know a carburetor from a universal joint when they came to our big training shops. How much does it cost? You'll be surprised to learn *how easily you can afford it*. Mail the coupon NOW for complete information.



Using the "Wrecker Crane" in the Automobile repair department. Here you learn about all up-to-date auto equipment—by actually using it. Real experience on all makes of cars, under supervision of an expert.

Greer College of Electrical Engineering

Dept. 401 2024 S. Wabash Ave. CHICAGO

FREE Employment Service

Our employment department is ready to help you—while in training and for life. Day and evening classes. Low cost. Easy terms.

ERWIN GREER, President, Greer College
Dept. 401, 2024 S. Wabash Ave., CHICAGO.

Please send me your FREE BOOK and offer for Electrical Automotive course
It is understood I am not obligated in anyway

Name

Address



PAIN and DISEASE

Quickly Conquered by

VIOLET RAY



Let us tell you how thousands of men and women suffering from rheumatism, neuritis, paralysis, nervousness, skin diseases, headaches, constipation, sprains, prostate trouble, goitre and many other ailments, even hay fever and asthma, have found quick relief—new health and vitality with this marvelous, scientific invention. Pains vanish almost instantly.

Violetta

Ten Days FREE Trial

For Health—Beauty—Vigor

Endorsed and used by hospitals, sanitariums and physicians. Every home can now have one. Saves hours, days, months of suffering. No medicine. Painless, pleasant treatment. Only the violet ray can penetrate to every nerve affected. Simple, safe, painless—anyone can use VIOLETTA. Why suffer pain and poor health when you can try VIOLETTA 10 days FREE.

This Book FREE

Tells all about violet rays—how this marvelous discovery by Nikola Tesla, the electrical wizard, now brings this mysterious curative power to all. Contains many astounding testimonials from our thousands of satisfied users. Send for the facts and our liberal trial offer today. Mail the coupon now.



VI-REX CO., Dept. 431
2304 Warren Avenue, Chicago

VI-REX CO., 2304 Warren Ave., Dept. 431 Chicago
Please send me your free book on Violet Rays and details of your 10 days' free trial offer.

Name.....

Address.....

City..... State.....

Ailment.....

MEN past 40



Keep This Vital Gland Active

THOUSANDS of men have found a new secret of health, energy, and vitality. For at last a well known scientist has developed a treatment that directly stimulates that vital gland, the prostate. Many medical authorities say that practically 2 out of 3 men after a certain age suffer with prostate trouble. There is often a direct cause for such distressing disorders as sciatica, aches in back, legs and feet, nervousness, constipation, embarrassing weakness and other painful conditions. Many sufferers blame bladder and kidney trouble when it is not the real cause. If you are a victim of prostate trouble you should not lose a minute in finding out about this amazingly simple new home treatment that has given such marvelous results, in many cases where all other methods have failed. Full details are explained in an interesting, illustrated booklet, "Why Many Men Are Old at 40." No obligation. But write today, before the edition is exhausted. Address

THE ELECTRO THERMAL CO.
2168 Main Street Steubenville, Ohio
Western Address: Suite 21-L, 303 Van Nuys Bldg., Los Angeles, Calif.

NO JOKE TO BE DEAF

—EVERY DEAF PERSON KNOWS THAT



I make myself hear, after being deaf for 25 years, with these Artificial Ear Drums. I wear them day and night. They stop head noises and ringing ears. They are perfectly comfortable. No one sees them. Write me and I will tell you a true story, how I got deaf and how I make you hear. Address



GEO. P. WAY, Artificial Ear Drum Co. (Inc.)
80 Hoffman Bldg., 2539 Woodward, Detroit, Mich.

BOW LEGS?

OUR GARTER (Pat'd) Makes Trousers Hang Straight

If Legs Bend In or Out. Self Adjustable. Free Booklet—Plain Sealed Envelope

THE T. GARTER CO. Dept. 2, New London, New Hampshire

STOP USING A TRUSS

STUART'S PLAPAO-PADS are different from the truss, being mechanico-chemico applicators made self-adhesive purposely to hold the distended muscles securely in place. No straps, buckles or spring attached—cannot slip, so cannot chafe or press against the pubic bone. Thousands have successfully treated themselves at home without hindrance from work—most obstinate cases conquered. Soft as velvet—easy to apply—**inexpensive.** Awarded Gold Medal and Grand Prix. Process of recovery is natural, so afterwards no further use for trusses. We prove it by sending Trial of Plapao absolutely **FREE**. Write name on Coupon and send TODAY.

PLAPAO CO., 733 Stuart Bldg., St. Louis, Mo.

Name.....

Address.....

Return mail will bring Free Trial Plapao.

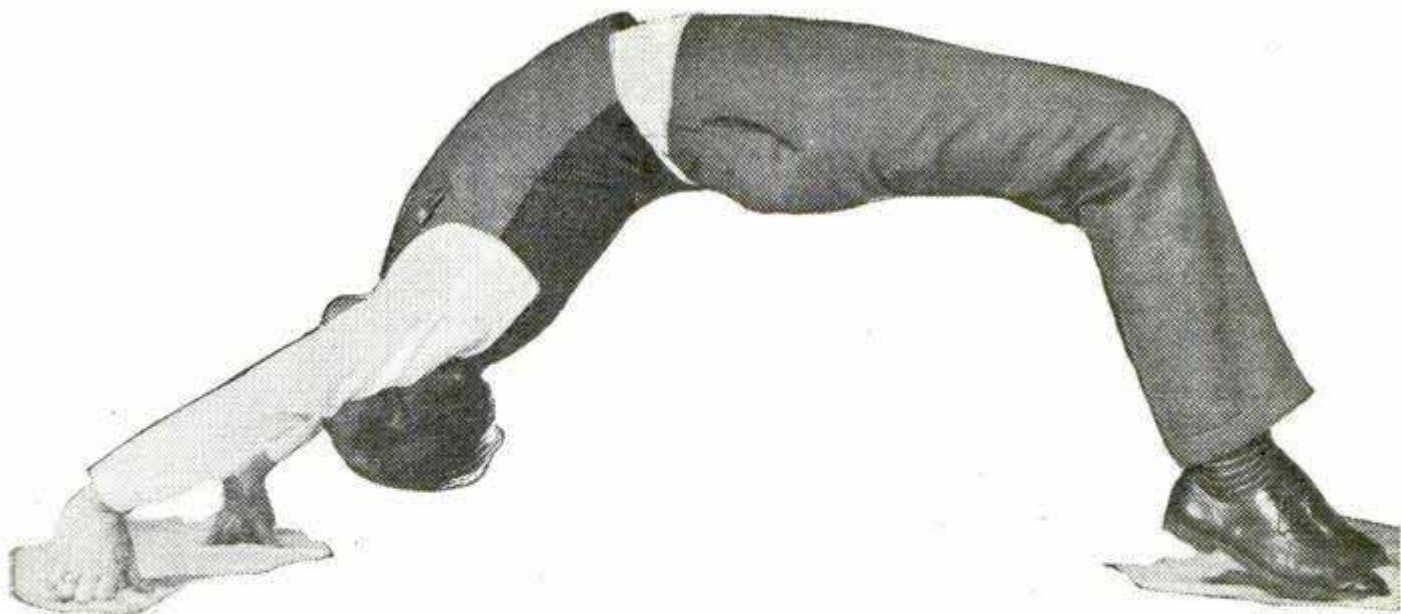

Ruptured 38 Years Is This a Miracle?

A SUDDEN STRAIN AT THE AGE OF TWELVE. . . .
THIRTY-EIGHT YEARS OF PAIN AND DISCOMFORT.
. . . . NOW AT FIFTY RELIEF AT LAST.

"I had despaired of ever getting relief from torture, uncomfortable devices, and fear of strangulation. Then came the day that I learned of this remarkable new discovery. It appealed to my common sense, so I sent for it. Almost immediately I felt its wonderful relief. In a few months I was a new man. Today at 50 I enjoy life as a normal man should."

Is this a miracle? No. Thousands of others have also discovered the almost magic power of an amazing new invention which has revolutionized old-fashioned methods of helping hernia. Although only recently announced to the general public, scientific men have been watching with keen interest the tests made within the last eighteen months. The inventor, an American scientist of note, quietly offered it to a limited number of sufferers in every stage of replaceable rupture. The results are of keen interest to medical science.

A New York man who has suffered for 20 years reported it to be the first device he has ever publicly endorsed—a 90-year-old man writes that his hernia has almost disappeared. . . . A Nebraska man says that he has forgotten he is wearing it. . . . Physicians praise it as an entirely new departure. . . . And now it is available to every rupture sufferer in America!

Seals Rupture With a Quarter

Now a queer little device—little larger than a quarter—weighing less than 1-25th of an ounce—reduces rupture by a new method called "sealing," a modern method heretofore impossible with old-fashioned appliances. No longer need hernia sufferers wear awkward steel springs, weighty cushions, unclean leg-straps, and other make-shift devices that were always slipping off the wound.

Magic Dot cannot possibly slip off—for it anchors to the acute point of rupture. More, it allows free blood circulation to tend to knit the tissues over the wound, and heal it much like every other wound is permitted to heal. This exclusive advantage is important, says science. For the old-time "pressing" method with its harsh pressure, common sense warns, prevents free blood circulation and nature's healing process cannot fully operate. Test this fact—press

the finger against the skin and note the white spot remaining, the spot is white because blood can't circulate under harsh pressure.

No More Heavy Unclean Crotch or Leg Straps

This new modern way is like no other appliance in the world. It is an appliance for human beings. It enables the wearer to bend, cough, run, jump or sleep in any position without fear of the appliance slipping down. For Magic Dot is protected by a flesh-soft, air-porous pad which has no hard corners or harsh surface to grind into the flesh and which flexes with every move of the body. It "breathes." A new kind of comfortable method gently supports the pad. So it is no wonder users say they forget they are wearing it! And no wonder it is healing thousands of rupture cases like those quoted here.

So confident are the inventors that Magic Dot will relieve and delight every sufferer—even cases of many years standing—that they dare a free inspection of this modern device. Send no money. Be under no obligation. Simply get full description and details of the free inspection offer. Learn how easy it is to reduce rupture at home in an amazing short time and banish pain and discomfort forever. Use the coupon.

NEW SCIENCE INSTITUTE

2135 Clay Street

STEUBENVILLE, OHIO

New Science Institute,
2135 Clay St., Steubenville, Ohio.

Yes, send me complete details of the Magic Dot that reduces rupture.

Name.....

Address.....

City.....State.....

From "Puny" to PANTHER-MAN

My FREE Book

tells how you can get a body like I gave this lad. Why delay? The book only costs you a postage stamp and there are no strings to that!

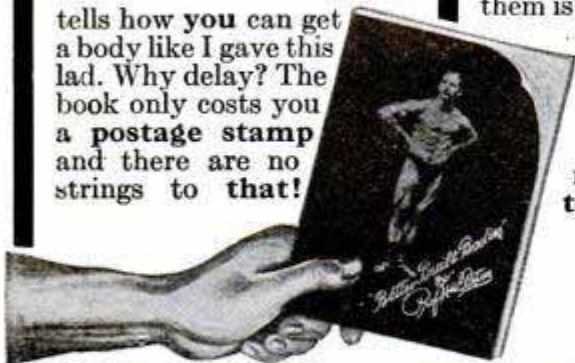

LOOK at these two pictures! LOOK at them!! Then go peek in your mirror and see which one of them is more like you. Never mind blushing! Don't waste time being ashamed! There's no need of staying that way!

The chap in the picture got next to himself and came to me!

In thirty days I built that man from the sparrow-armed boy in the first picture. I loaded him with muscles. I can do as much—maybe more—for you! If you want a real body mail the coupon before you go to bed TONIGHT!

TITUS Dept. P-113
105 East 13th St., New York City

Titus, Dept. P-113,
105 E. 13th Street,
New York City.

Dear Sir:

Mail my copy of your big new illustrated book, Better Built Bodies, absolutely FREE and without obligation.

Name.....

Address.....

City..... State.....

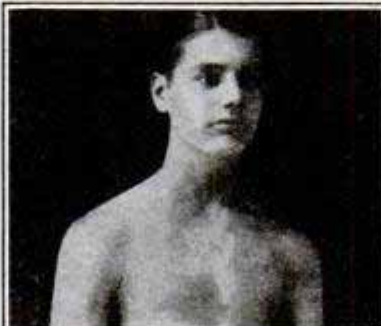

BEFORE

This lad looked pretty hopeless when he came to me. His arms looked like sparrow wings with the feathers removed. His ribs stood out and his bones tried to poke through his skin all over his body. His chest was hollow, his neck scrawny. He had sluggish blood circulation and jumpy nerves. He couldn't sleep. Then he took my course!



30 DAYS AFTER

What a man! In thirty days I built the fellow you see above. I loaded his bones with muscles! I gave him a body that laughs at hardships and illness. He says: "No other apparatus and instruction can touch yours! When the human body will hold another muscle—Titus will put it there!"

Popularity-Wealth!



BE A MAGICIAN!

Learn secrets of magic that will make you popular everywhere! Amaze and mystify your friends with astounding, mirth-provoking tricks and sleight-of-hand! Make money entertaining large audiences at clubs, lodges, fairs and theatres.

16 Amazing Tricks—Big FREE Magic Book
For a short time only I am offering 16 startling NEW easy-to-learn tricks for only 50c, and including FREE my big 64-page book that describes hundreds of wonderful magical feats and illusions. Send stamps or coin at once.
A. P. FELSMAN, Dept. D, 154 N. Clark Street, CHICAGO, ILLINOIS

Factory to Rider

Saves \$10 to \$25 on the Mead Bicycle you select. You can have your choice of 44 Styles, colors and sizes. Delivered free on approval. \$21.50 up.

30 Days' Free Trial on the bicycle you select from the big free catalog. Ride it a month to be sure you like it. Return it if not satisfied.

Best quality, factory prices. Save big money on Tires, lamps, wheels and equipment, low prices. Send No Money, do business direct with makers.

Mead CYCLE COMPANY
DEPT. G-110 CHICAGO



Write today for free Catalog, factory prices and marvelous new offer.

DRAW CARTOONS

TURN YOUR TALENT INTO MONEY

Cartoonists earn from \$50 to \$300 per week—some even more. Remarkable new Circle System of Drawing teaches you in half the usual time. Send for booklet and sample lesson plate explaining full details of the Course.

The National School of Cartooning, 623 Penton Bldg., Cleveland, Ohio



—Be a Railway Postal Clerk

Get \$1900 to \$2700 a Year
EASY WORK—LONG VACATIONS

Why work hard for small pay? Uncle Sam offers you a fine position as a Railway Postal Clerk. Travel on fast trains sorting mail. Travel expenses paid. \$1900 a year TO START. \$100 RAISE EVERY YEAR until you reach TOP PAY.

FREE Information About These Fine Jobs

Let Arthur R. Patterson help you qualify for a position as a Railway Postal Clerk or in Customs, Internal Revenue, Departmental, Immigration, Postmaster, Postoffice, and Rural branches. He trained thousands now in Civil Service. Write for FREE BOOK. Tells how Mr. Patterson coaches you to pass exams. Also read his Money Back Agreement. Mail coupon now.

ARTHUR R. PATTERSON, Civil Service Expert
PATTERSON SCHOOL, Dept. 64, Wisner Bldg., Rochester, N.Y.

Arthur R. Patterson, Civil Service Expert
The Patterson School
Dept. 64, Wisner Bldg., Rochester, N. Y.

Sir: Send me without charge your catalog describing Railway Mail Clerk and other Civil Service positions.

Name..... Age.....

Address..... City..... State.....



Can you fix it

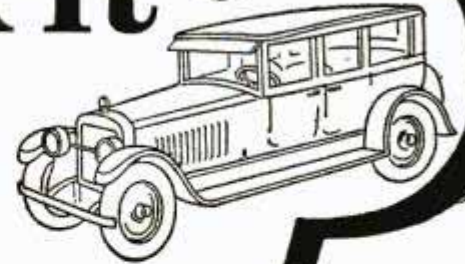

New books have "jiffy index," making all facts instantly available. You find anything you want to know in a moment, in this brand new 1926 edition.

These books tell how

HERE are the most interesting, the most practical books we have ever published on automobile construction, operation and repairs. Brimful of facts, photographs and explanations so easy to understand that anyone can learn how in almost no time.

Over 2000 pages, with diagrams, blueprints and everything else needed to make anyone an authority on automobiles.

Whether you want to qualify as garage owner, auto repair expert or merely wish to know how to keep your own car 100% efficient, you will welcome these books, especially on our

No Money Offer

This plan brings this valuable information within the reach of everyone. You don't send us a single penny. You don't have to pay us anything—just send your name and address and we'll send you the complete set of 5 volumes, specially bound in Flexo covers.

Read them carefully; keep them 10 days; find out anything you want to know, and then if you want to keep them, send only \$2.00 then and \$3.00 per month until the special low price of \$24.80 is paid. There is no further obligation.

American Technical Society Membership Free

This is a great organization for the publishing and spreading of specialized knowledge—we have over a million dollars of resources, enabling us to get the cooperation of the largest automobile manufacturers and dealers, who have furnished us plans and photographs. If you send NOW for this new edition of Automobile Engineering, we will include a Consultation Membership in this great organization.

Eighteen automobile experts will be ready to help you at all times. You can write or wire any time for special information. Answers will be sent to you promptly—without cost.

EMPLOYMENT SERVICE FREE

In addition to all this, those who send now will be entitled to the services of our EMPLOYMENT DEPARTMENT without charge. We are in daily contact with firms all over the country who need good men and are willing to pay big. This service costs you nothing. Don't miss this special offer. Send now.

Don't Hesitate

There are no strings to this offer—it means just what it says. Send name and address on the coupon and ALL of the five books—the complete set—will be sent to you for examination.

Remember one fact only which you can find in these books may save you an expensive repair or help you to a better job.

Learn All About Autos

Get these five big books on this liberal offer and learn all the things you want to know about autos.

Carburetors, engines, springs and spring suspension, brakes, 4-wheel drives, lubrication systems—all are fully covered.

These complete and comprehensive auto books are yours if you want them on this easy plan. Send for a set NOW; there's nothing to pay.



You don't have to read the books through; the index enables you to put your finger on the information wanted in a jiffy.

For Free Offer, Use Coupon

American Technical Society,
Spec. Dept. A-419, Chicago, Ill.

I would like to look at the 5 Auto Books described above. Send them on your FREE offer. I will examine them carefully and return them in 10 days unless I like them; in which case I will send you \$2.00 then and \$3.00 per month until the total price of only \$24.80 is paid. You are to also send me Free Consulting Membership Certificate in the American Technical Society and I am entitled to the services of your employment department without charge.

Name.....

Street.....

City..... State.....

Reference.....

A Quick, Sure Way to a Big Income is to RAISE POULTRY



Easy to make \$1000 a Year Spare Time—\$5000 and up Full Time

Let the Other Fellow Pay YOU the Fancy Prices



When you go into a store and pay 75c to \$1.00 for a dozen eggs, did it ever occur to you that YOU might be getting the 75c to \$1.00 instead of the other fellow? Did it ever occur that a small back yard or vacant lot flock of poultry would pay enormous profits, if properly managed, and require very little of your time? In this country, where 85% of the people live in cities, and live right, want the best of everything—they will pay and pay well for fresh eggs and poultry meat. There will be a QUICK, sure demand for every egg or bird you produce. Poultry raising offers a golden opportunity. Is there any good reason why YOU shouldn't take advantage of it?

Start Small, Grow Fast, Sure Methods Bring Quick Success

Start small, if you like, just as hundreds thousands of others have started. Then, by following the sure, tried, proved, money-making methods which we will give you, you can grow as fast as you wish. Many of our students who began with the idea of having the BEST for their own tables and cutting living expenses, too, soon found in this fascinating, beautiful, profitable business, the quick road to a large, steady, full-time income. You can get into a business of your own—one that will make you YOUR OWN BOSS with an income of \$5,000 a year and UP—or you can make \$1.00 to \$3.00 for EVERY hour of your spare time. Let me show you HOW!

Surprise Yourself—Let This FREE Book Open Your Eyes

All I ask is a chance to PROVE that you can CASH-IN on my forty years experience as Commercial Poultryman and former Senior Poultryman in the U. S. Dept. of Agriculture. A chance to prove that the poultry business DOES have big opportunities for you—and that regardless of your location, whether in a city, a town or on the farm—I and the staff of experts associated with me—can show you the way to real SUCCESS and independence, just as we have already shown thousands of others. My new FREE book on "How to Raise Poultry for Profit," will be an eye-opener. Clip the coupon and send for it today. Do it now—this minute. You have everything to gain by—quick action!

READ! What Others Are Doing

"The results I am getting from your methods speak for themselves. In a flock of 65 fowls, I have gotten 888 eggs from the first of the month up to date (the 23rd). BRADY CHASCE, Dewey, Okla.

"Your course on poultry raising is the most practical and complete in the country. You have opened up a pleasant and profitable way for me to gain an independent living." S. ANDERSON, Barrington, R. I.

"The information contained in your course has been of such great help to me that I would not take \$1,000 for what I have gained." L. M. WRIGHT, Federalsburg, Md.

"I consider my enrollment with the National Poultry Institute the best investment I ever made." Mrs. J. W. CRAWLEY, Farmville, Va.



FREE BOOK TELLS HOW

NATIONAL POULTRY INSTITUTE, Dept. 411-F, Washington, D. C.

Gentlemen: I want to know more about the opportunities for me in the poultry business and about your plan for helping me make \$1,000 to \$5,000 a year and up. Send FREE book.

Name.....

Address.....

Be The Life of Any Party!



LEARN TENOR BANJO

Now you can have the joy of being your own musical self—the thrill of popularity—new friends—happier evenings—more money-making opportunities—if you wish. You can be admired and wanted everywhere, counted in on every party, because you are a clever entertainer on America's most popular instrument—the Tenor Banjo. For the first time in the history of my long playing career—five years with Isham Jones' Recording Orchestra—I am now in position to offer you my famous Home Study Tenor Banjo Course. I call it "The Key to Successful Banjo Playing." It is my Course—compiled after years of study and experience with the tenor banjo—the instrument I helped to develop. I am now using this Course successfully in my school, the Chicago Tenor Banjo Institute, and am training beginners, advance students, and professional artists, to reach new heights of popularity and bigger pay jobs.

Easy to Play the McNeil Way

This course can now be yours. Just as if I were sitting at your elbow teaching you the correct finger positions—melody, chords, harmony, etc., etc. My Course is a personalized "A-to-Z" Course. It includes everything you will ever want to know about Tenor Banjo playing. An added feature to help you is the phonograph record—played by myself, illustrating breaks, jazz strokes, etc., etc.

Be the Life of Any Party!

If you are really eager to learn to play, if you honestly yearn for popularity and increased income, then act now. Write today for free booklet and details.

Charles McNeil, Studio Director,
CHICAGO BANJO INSTITUTE
Dept. 1354, 3345 N. Lincoln St., Chicago, Ill.

Mr. Charles McNeil, Studio Director,
Chicago Banjo Institute,
Dept. 1354, 3345 N. Lincoln St., Chicago.

Dear Sir: I would like to find out more about your Home Study Tenor Banjo Course. Without obligation, please send me literature and full information.

Name.....

Address.....

City.....State.....

THE PRICE GOES UP!

Act now and save

\$4.00

Get your Croft LIBRARY OF PRACTICAL ELECTRICITY now before the price is raised. Increased costs are making it necessary to raise the price of this famous library to \$23.50. If you act now instead of waiting, you save \$4.00. Act today! Mail the coupon now!

The Croft Library of Practical Electricity

A combined reference library and home study course, 8 volumes, 3000 pages, 2100 illustrations, flexible binding, \$1.50 in ten days and \$2.00 monthly for nine months—only 7 cents a day.

The man who gets anywhere in any line of endeavor is the man who KNOWS. And generally the more he knows the more he earns. For the man who wants to know, there is nothing better than these eight volumes packed to the covers with sound, helpful information on every phase of electricity from first principles to central station work.

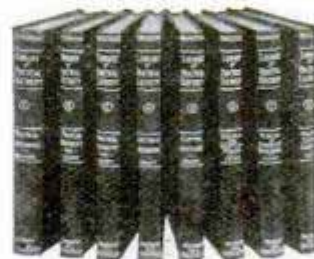

SEE IT FREE—No obligation to Purchase

By just filling out and returning the coupon below you will have, at no cost to you whatsoever, a practical, useful set of books for 10 days' Free Examination. We take all the risk—pay all charges. You assume no obligation—you pay nothing unless you decide to keep the books. Send the coupon NOW and see the books for yourself.

FREE EXAMINATION COUPON

McGraw-Hill Book Co., Inc., 370 Seventh Ave., New York
Send me for 10 days' free examination the Croft Library of Practical Electricity. If satisfactory I will send you \$1.50 in 10 days and \$2.00 monthly until the special price of \$19.50 is paid. If not wanted, I will return the books at your expense.

Signed.....

Address.....

City and State.....

Position.....

Employer..... P M 4-1-27

It takes only 8 weeks to get a big job



Geo. Smith owns an agency and repair shop in West Alexandria, Ohio. He makes \$200 a week.



D. M. Collins, Williamsville, West Virginia, writes, "After finishing McSweeney training, I started in as manager of a garage at \$300 per month."

In the Auto, Tractor and Electrical Business

Read what these men are doing—here is your big chance to get "on easy street." Come to these great shops on the biggest SPECIAL offer we ever made.

Big firms need trained men. The Auto and Tractor Business is on the boom. Thousands of trained men will be needed during the next few months. I get calls every day from Garages, Battery Stations, Auto Repair, and other successful concerns for McSweeney men. When the big fellows need high grade men they know where to come for them. They want McSweeney trained men.

My training is unusual. Scientific tool training—that's the secret. You do things here according to the latest engineering standards. Thousands of dollars have been spent in modern tools and equipment. You'll know a motor like a brother. That's why my men are at home with the biggest shops in the country. If you want to succeed the way Smith, Collins and the rest have—qualify by the same method.



C. E. Gillespie has charge of a fleet of trucks and tractors with the State Highway Commission, due to McSweeney training.

I'LL PAY YOUR RAILROAD FARE AND BOARD YOU!

In order to fill the openings that now exist, I am making this unusual offer including your railroad fare and board without ANY extra charge whatever. But even that is not all. I'll tell you about the rest in my letter.

Send for FREE BOOK

My big illustrated training book tells how others are succeeding. It tells many things you ought to know about Autos and Tractors. Write for it and my short time Reduced Price Tuition offer NOW. It soon expires.

MC SWEENEY

AUTO, TRACTOR and ELECTRICAL SCHOOLS

Cincinnati, Ohio Dept. 14-VD, Cleveland, Ohio Chicago, Ill.



McSweeney Auto, Tractor and Electrical Training Shops, Dept. 14-VD, (Address shops nearest you) Cincinnati, O., Cleveland, O., Chicago, Ill.

Without any obligation send me your big free book on Autos. Also information regarding Special Reduced Price Tuition temporary offer.

Name.....

Street.....

City.....State.....

FORD OWNERS THROW AWAY THE OLD TIMER

Latest Invention—"FORDYNAMO"

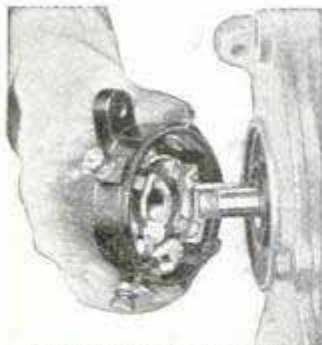

Absolutely Guaranteed

POSITIVELY MARVELOUS

The FORDYNAMO is a complete high class ignition distributing unit to be used in place of the common timer on all Ford cars, trucks and tractors. Built on an entirely different basis. Does away with all roller contacts. No oiling or attention necessary. Gives an instant positive spark. Will not miss at any speed.

Users Say "IT'S WONDERFUL"

The most pleasing results are expressed in letters received from satisfied users saying—"it is the most wonderful device put on a Ford car."

EASY TO PUT ON

The FORDYNAMO was designed for easy installation and is easily put on by anyone, it does not require mechanical service.

EXCEPTIONAL OFFER TO LOCAL DISTRIBUTORS

On account of the extensive Advertising Campaign a very large demand is created and as this demand must be supplied we are anxious to establish distributors everywhere. This opportunity gives those who apply early the advantage of all the business possible in their territory. Opportunities like this are unusual. Previous selling experience unnecessary.

\$60 TO \$120 PER WEEK EASY

Ordinary profits do not belong in this class, here is a proposition that arouses the interest of every Ford Owner to the buying point.

ECLIPSE TIMER MFG. COMPANY

2922 Meinecke Avenue

MILWAUKEE, WIS.

LABORATORY TESTS

SHOW OVER 60,000 MILES

Research Laboratory tests show at a speed of 1100 R.P.M. (equal to 55 miles per hour) for 1111 hours or a total of over 60,000 miles, showed very little wear and working perfectly.

SPECIAL OFFER TO USERS

A Special Introductory Offer is extended to the first user in each locality.

BE FIRST IN YOUR LOCALITY

Of course we must give preference to the first person in each locality so mail the coupon TODAY.

BETTER HURRY

COSTS NO MORE THAN AN ORDINARY TIMER

MAIL THIS TODAY
ECLIPSE TIMER MFG. CO.
2922 Meinecke Ave., MILWAUKEE, WIS.
Gentlemen: Please mail me free particulars at once.

NAME.....
ST. or R.F.D.....
CITY.....
STATE.....

PICK THE JOB YOU WANT

There's a way to get it



Men don't just fall into easy jobs or big pay positions—they prepare for the big chance before it comes.

Make up your mind today what you want to be, then take the first step at once. You don't have to go to college to get ahead. Other men have gone there for you and have put the things they learned there and through years of practical experience into easily understood books which give you a short cut to a better and bigger job.

We have picked 13 of the best paying professions and have published for your benefit new editions of the most practical, the most valuable books we have ever printed on the subjects covered.

JIFFY INDEX

Our new Jiffy Index makes each book a quick reference work—no time need be wasted in search or study—put your finger on the facts you want instantly.

PAY-RAISING BOOKS

Automobile Engineering, 5 volumes, over 2,000 pages	\$24.80
Civil Engineering, 9 volumes, 3,900 pages, 8,000 pictures	34.80
Business Management, 9 volumes, 2,500 pages, well illustrated	29.80
Fire Prevention and Insurance, 4 volumes, 1,500 pages, 600 pictures	14.80
Electrical Engineering, 8 volumes, complete in every way	34.80
Modern Shop Practice, 6 volumes, 2,300 pages, 2,500 pictures	24.80
Steam and Gas Engineering, 7 volumes, 3,300 pages, 2,500 pictures	24.80
Law and Practice (with reading course), 13 volumes, 6,000 pages, illustrated	49.80
Telephony and Telegraphy, 4 volumes, 1,728 pages, 2,000 pictures	14.80
Sanitation, Heating and Ventilating, 4 volumes, 1,434 pages, 1,400 pictures	14.80
Drawing, 4 volumes, 1,578 pages, 1,000 pictures, blue prints, etc.	14.80
Employment Management and Safety Engineering, 7 volumes, 1,800 pages, 640 illustrations, charts and diagrams	24.80
Architecture, Carpentry and Building, 5 volumes, includes 58 beautiful architectural plates free	24.80

SHIPPED FREE

Words alone cannot describe the full value these books may be to you, so we ship Free for Examination. Pick the set you want, the price is plainly shown, but **Send No Money**; just your name and address, and the books will be sent promptly.

Take ten full days to read, test and examine them. You'll realize at once what a tremendous force for your future they can be.

After ten days you send only \$2.00; then \$3.00 per month until the balance is paid. **There Are No Interest Charges of Any Kind**; the price shown is the total.

EMPLOYMENT SERVICE

For the benefit of red-blooded men who look forward to bigger earnings and greater responsibilities—which we give through these books—we conduct a complete employment department and include this service without cost. We are in close touch with a great many employers whose needs you might never hear of except through us.

AMERICAN TECHNICAL SOCIETY,
Dept. X-419, Chicago, U. S. A.

Please send me set of.....

for 10 DAYS' examination. I will examine the books thoroughly and if satisfied, will send \$2.00 within 10 days and \$3.00 each month until I have paid the special price of \$..... If I decide not to keep the books I will return them at your expense at end of ten days.

Name.....

Address.....

Reference.....



Learn to Write

I Teach by Mail

I CAN make a good penman of you at your home during spare time, no matter where you live or how poorly you now write. My simplified system has shown thousands of others the way to good penmanship during the past twenty years — it can and will do the same for YOU!

Beautifully Illustrated Book
"How to Become a Good Penman"
FREE!

It contains general information, with testimonials and beautiful specimens of penmanship showing what others have accomplished by the Tamblin System. (Your name elegantly written on a card if you enclose stamp for postage.) **WRITE TODAY.** Address

F. W. TAMBLYN
 418 Ridge Bldg., Kansas City, Mo., U. S. A.



No Joke to STAMMER

Be successful. Master perfect speech. Win happiness. Send for full information and special phonograph record. Dime covers postage.

153 Stimson, The Lewis Institute, Detroit



Better Handwriting

Easily learned, on wonderful new patented device. Children like it, adults pleased. Agents wanted. Sample 98c. Write for information today. **VIC. HANSEN, WALLACE, IDAHO**

Learn In 10 WEEKS at Home

Become a RADIO EXPERT

Earn Big Money In this Gigantic, Fascinating Field!

WE GUARANTEE TO REFUND TUITION IF YOU ARE NOT SATISFIED WHEN YOU COMPLETE THE COURSE

AERO-SYSTEMS, INC.
Offers You a Remarkably Low Priced High-Grade RADIO COURSE

Now you can get a complete RADIO course at a ridiculously low price. Train to become a high-salaried expert or merely to make and understand your own sets. *Write for particulars before price goes up.*

Aero-Systems, Inc., Dept. 104
 19 South Wells Street, CHICAGO, ILL.

MAIL THIS COUPON NOW!

AERO-SYSTEMS, INC., Dept. 104, 19 S. Wells St., Chicago
 Please send me full particulars of your amazingly low-priced Radio course.

Name.....

Address.....



Tobacco Is Hurting You

Look at the facts square in the face, Mr. Tobacco User. You may think tobacco is not hurting you.

That is because you haven't as yet, perhaps, felt the effects of the nicotine poison in YOUR system. For you know that nicotine, as absorbed into the system through smoking and chewing tobacco, is a slow working poison. Slow, yes—but sure.

Tobacco is lowering your efficiency. It slows a man down. Makes it harder for you to concentrate your mind on your work. You haven't near the amount of "pep" and energy you would have if you stopped using it. There's many a man twice as old as you in years who's twice as young in energy, simply because he lets tobacco alone.

Some day you will realize to what an alarming extent tobacco has undermined your system.

When your hands begin to tremble—
and your appetite begins to fail—
and your heart seems to "skip a beat" now and then—
and slight exertion makes you short of breath—
then you have a right to suspect that
TOBACCO is getting the upper hand.

Any well-informed doctor will tell you that these are only a few of many symptoms of tobacco poisoning.

And YOU know that the use of tobacco in any form is an expensive, utterly useless habit. You know you ought to quit.

Tobacco Habit Banished Let Us Help You

It doesn't make a particle of difference whether you've been a user of tobacco for a single month or 50 years, or how much you use, or in what form you use it—whether you smoke cigars, cigarettes, pipe, chew plug or fine cut or use snuff—Tobacco Redeemer will positively remove all craving for tobacco in any form in a very few days. Not the slightest shock to the nervous system. Your tobacco craving will usually begin to decrease after the very first dose—there's no long waiting for results.

Tobacco Redeemer contains no habit-forming drugs of any kind and is marvelously quick, scientific and thoroughly reliable.

It is in no sense a substitute for tobacco. After finishing the treatment you have absolutely no desire to use tobacco again or to continue the use of the remedy. It helps to quiet the nerves and make you feel better in every way.

Results Guaranteed A single trial will convince you. Our legal-binding, money-back guarantee goes with each full treatment. We will refund every cent you pay for the treatment if after taking it according to the easy-to-follow directions, it should fail to banish the tobacco habit completely.

SEND Free Proof Let us send you our free booklet on the deadly effects of tobacco, together with testimonial letters from men all over the country telling how they have been absolutely freed from the tobacco habit by this simple home treatment. You could not ask for stronger proof that Tobacco Redeemer will free you from the habit than the evidence we will gladly send on request. Just mail the coupon—or a postal will do.

NEWELL PHARMACAL CO.
Dept. 300 Clayton Station St. Louis, Mo.



Free Book Coupon

NEWELL PHARMACAL CO.

Dept. 300 Clayton Station St. Louis, Mo.

Please send, without obligating me in any way, your free booklet regarding the tobacco habit and proof that Tobacco Redeemer will positively free me from the tobacco habit or my money will be refunded.

Name

Street and No.

Town..... State.....

Quickly Learn to Play Hawaiian Guitar Play Like This Native

Bring the romantic, enchanting, entrancing and melodious strains of the great instrument of the Hawaiian Islands into your soul. Become popular and successful. This **short cut method** of home instruction enables you to quickly master Hawaiian Guitar so you will **play as well as Native Hawaiians.**

Our staff of Hawaiian instructors have perfected a method of teaching, so simple, that without musical knowledge, you quickly learn to play real music from notes. **Simple as learning your A, B, C's** and it will not be long before you will play latest Broadway hits.

Only four 'simple motions to learn. You will then play any music, whether it be popular, dance or classical. Almost from first lesson, you play love songs like Aloha Oe.

To help you get started, we furnish **free** when you enroll as a student, a beautiful, full tone, genuine, \$18.00 Hawaiian Guitar. Only 1,000 free instruments given away; if you want to get in on **free offer**, write for particulars at once—you must **act quickly.**



New Invention—

Kno-All-Chart
QUICKLY TEACHES
YOU HOW TO PLAY

The newest invention of our Hawaiian instructor, which is exclusively used by us and which we call the "Kno-All-Chart," quickly

teaches you how to play and read notes. So simple is this device that any one can understand it and begin to play immediately.

Picture Method Easy

We do not depend upon our printed instructions alone for your success as a student, but we also supply you with many pictures of our professors' playing. This enables you to imitate the pictures. **Isn't this easy?**



Phonograph Records FREE

As an additional guide, we also furnish you with **phonograph records** of our Hawaiian instructor's own playing of the piece you are learning. This practically brings our professors from our studio to your own home and enables you to listen to their playing just as if they were actually in front of you.

Genuine \$18 Hawaiian Guitar Free

Enroll as a student, and secure **free**, a beautiful, full tone, genuine \$18.00 Hawaiian Guitar.

We also furnish every bit of equipment so it is never necessary for you to spend an extra penny. When you graduate, you get a **beautifully engraved diploma** and after graduation, we also give you **six months' free service** and consultation. Send for free particulars now.

JAZZ

Your Way to

Popularity and
Success

No forming class to wait for. Start at once and join hand wagon of success and popularity. Do it through Hawaiian Guitar.

Send for free First Lesson and Book. So positive are we

you will become one of our students, that if you write at once, we will send you **free**, our first lesson which will enable you to see just what you can expect when you enroll. You will also receive our **big book** of full particulars. Write for your copy and **free lesson** today.

Write at once **Hawaiian Studio No. 5204**

of New York Academy of Music
100 Fifth Ave., New York, N. Y.

HAWAIIAN STUDIO No. 5204
of New York Academy of Music
100 Fifth Avenue, New York, N. Y.

Please rush your book, "How to Learn Hawaiian Guitar" and my first free lesson. Also reserve a gift Hawaiian Guitar for me. This obligates me in no way whatever.

Name.....

Address.....

City..... State.....

Books on 67 Practical Subjects

Popular Mechanics Press specializes in supplying the outstanding best book on any subject. Check the books you want, and mail this advertisement as your order blank.

ARCHITECT Architectural Drawing \$1.50	FUR RAISER Outdoor Opportunities \$2.00
ARMATURE WINDER Armature Winding \$3.00	FURNITURE MAKING Mission Furniture Making, (3 vols.) \$3.00
ARTIST Practical Art \$5.00	GLASS WORKER Decorative Glass Processes \$3.25
ARTS CRAFTS Art Metal Work \$4.25	HAND FORGING Hand Forging and Wrought Iron Ornamental Work \$2.00
ASTRONOMY Amateur Telescope Making \$2.00	HOME BUILDING Concrete Houses \$3.00
AUTOMOBILE Dyke's Encyclopedia \$6.00	HOME REPAIRS Practical Book of Home Repairs \$2.50
AVIATOR Practical Aviation \$3.00	INTERIOR DECORATOR Interior Wall Decoration \$4.00
BOAT BUILDER 22 Different Boats \$0.50	INVENTOR Inventors' Manual \$1.50
BOOKKEEPER Bookkeepers' Handbook \$1.00	LATHE WORK Lathe Handbook \$0.50
BOYS' BOOKS The Boy Mechanic (4 vols.) \$7.00	LEATHER WORKER Artistic Leather Work \$1.25
BRICKLAYER Plain and Fancy Brickwork \$1.50	LETTER WRITING Better Business Letters \$1.50
CABINET MAKER Furniture Making \$3.50	LOOM FIXER Practical Loom Fixing \$1.50
CALCULATOR Ropp's Calculator \$1.00	MACHINIST Complete Practical Machinist \$3.00
CARPENTER Carpenter's Handbook \$1.50	MAGIC Modern Magic \$2.00
CARTOONING Cartooning Made Easy \$3.00	MASON Practical Stone Masonry \$1.25
CHEMISTRY General Chemistry \$3.75	MATHEMATICS Mathematics for the Practical Man \$1.50
CIVIL SERVICE Course in Civil Service \$1.50	MECHANICAL DRAFTSMAN Practical Course in Mechanical Drawing \$1.00
CONCRETE 173 Ways of Using Concrete \$0.50	MODEL MAKING Model Making \$3.00
COOKING Foods from 20 Lands \$1.50	OUTDOOR SPORTS Outdoor Sports the Year 'Round \$1.50
DETECTIVE Instruction for Detectives \$1.00	PAINTING House Painting Methods \$2.00
DIESEL ENGINES Diesel Engines, Marine, Locomotive, Stationary \$5.00	POULTRY RAISER \$4,223 from a Town Lot \$1.00
DOG FANCIER Dog Encyclopedia \$2.00	PSYCHO-ANALYSIS Outwitting Our Nerves \$2.50
DRAWING Drawing Made Easy \$1.25	RABBIT RAISING Practical Rabbit Keeping \$1.50
DRILLING Drilling and Thread Cutting \$0.50	RADIO Lefax Radio Handbook \$3.50
ELECTRICIAN American Electricians' Handbook \$4.00	REFRIGERATION Homemade Refrigerating Machine \$0.50
ELECTROPLATER Electroplating \$1.00	SHIP MODELS Ship Model Making \$2.50
ENGINEER Bailey's Handbook for Stationary, Marine, Diesel \$2.00	SHOP WORK Shop Notes (16 vols.) \$7.50
ENGLISH Self-Improvement in English \$2.50	SPIRITUALISM Behind the Scenes with the Mediums \$1.50
ENTERTAINMENTS Money-Making Entertainments \$1.25	TAXIDERMIST Methods in Taxidermy \$3.50
ETIQUETTE Book of Etiquette (2 vols.) \$1.98	TOY MAKER Toy Craft \$1.50
FARMER Popular Mechanics Handbook for Farmers \$1.00	WELDER Welding Encyclopedia \$5.00
FORD My Ford, Its Care and Repair \$3.00	WIRING House Wiring \$1.00
FORMULAS 10,000 Formulas \$4.00	WOOD WORKER Wood-Working for Amateur Craftsmen \$1.00
	WRITER Free-Lance Writers' Handbook \$5.00

Books sent C. O. D. anywhere in U. S.

Just check the ones you want, write your name and address below, and mail the whole advertisement. It is your order blank. When postman hands you books, pay him the price and the postal charges. If outside the U. S. remit when ordering and include 10 cents per book extra for postage. We have many other books on these subjects and on 2,000 other subjects. Catalog free.

Name.....

City..... State.....

Address.....

Mail to **Popular Mechanics Press**,
Room 703, 200 East Ontario St., Chicago, Ill.

1,100 Punctures—No Leaks.

"After demonstration I find there were over eleven hundred nails and spikes in one tire."
N. T. Spiers.

400 Punctures in 4 Tires Without a Leak.

"Have punctured all four of my tires at least four hundred times and they still stand up."
Frank Ryman.

Seals Ice Pick Punctures.

"Aer-Pruf just arrived. I punctured one tire with an ice pick and several nails. No leaks."
J. C. Wright, N. Y. C.

150 Punctures—Pressure Good.

"One of my tires was punctured 150 times by actual count on a long trip. It is still standing up under full pressure."
Bernard Houka.

Heals Puncture at 20° Below Zero.

"While driving my car through snow at 20 degrees below zero, one of my Aer-Pruf treated tires picked up a big nail. I pulled the nail and Aer-Pruf sealed puncture."
L. P. Potter.

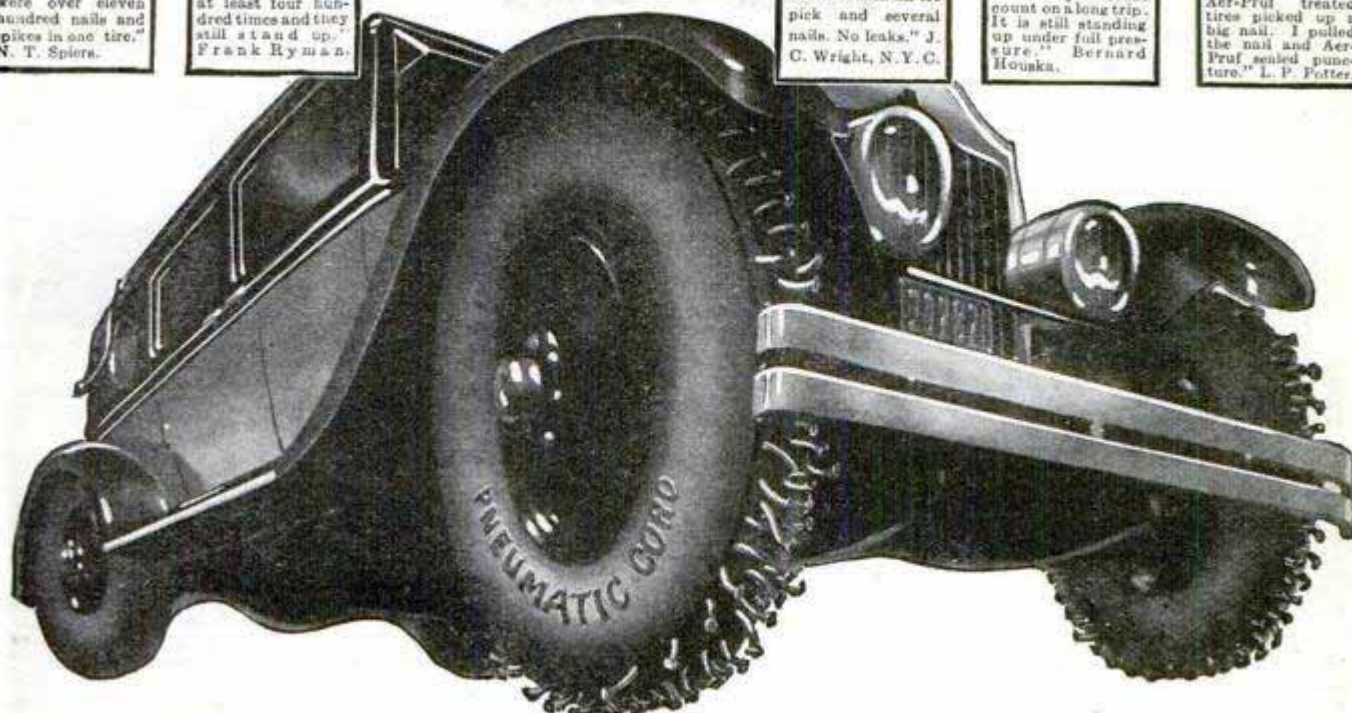

Drive Your Car On Punctured Tires!

New Scientific Fluid Seals Holes Without Removing Tire!

Car owners—now you are free at last from the worst nuisance of owning a car—changing punctured tires. Now your punctures can be sealed automatically, as they occur, without removing the tire from the wheel. Save time yanking at tight rims and bolts. Prevent spoiled trips or dirty hands and clothes. It seals nail holes, slow leaks, valve leaks, porous tubes, etc., instantly. Over 500,000 car owners now protect their tires with Aer-Pruf. You can test Aer-Pruf at manufacturers' risk. Mail coupon.

**MEN \$75 in a Week
Wanted 75 and Up!**

Over 1,000,000 Tire Treatments Sold!

AER-PRUF is a simple, harmless liquid that is poured into the tube. It positively will not injure the tube or casing; in fact, it helps to preserve the rubber, and it will last the life of the tube. It seals punctures as large as a 20-penny spike, and as small as a tack. It prevents rim cuts and cracked sidewalls and prolongs tire mileage by preventing air leaks. It will not freeze in winter nor boil in summer. It can be installed in a few minutes without taking the tire off the wheel. It sells at a low price and will more than pay for itself very quickly by eliminating tire repair expense and labor and increased tire mileage. Actually pays a profit to the user!

No More Changing Tires

Think what a wonderful relief this invention means to car owners! No more changing tires and patching tubes on hot, dusty roads—in blazing sun, drenching rains on dark nights or in freezing snow-storms. Women can now drive without fear of puncture accidents. And in

addition to the convenience, think of the economy.

So quickly does Aer-Pruf prove its story that Aer-Pruf representatives demonstrate its wonderful service by driving nails into their own tires and letting car owners see the truth with their own eyes! That is why this is such a wonderful money-making opportunity for ambitious men in their full or spare time. That is why we can dare to send you a sample can of Aer-Pruf and lose the cost of the preparation if you say that it doesn't work.

FREE OFFER

Mail the coupon below without obligation for full details of our free test offer. Our plan

shows you how to make \$75 to \$200 in a week full or spare time.

**AGENTS
WANTED
Full or Spare Time**

Aer-Pruf Mfg. Co., Dept. D-3187, Mitchell, S. D.
Yes, without obligation to me, send me full details.

Name.....

Address.....

City..... State.....

AER-PRUF

MANUFACTURING CO.

Dept. D-3187 MITCHELL, SO. DAK.



RAISE YOUR PAY with one of these amazingly low-cost McGraw-Hill HOME-STUDY COURSES

One of these practical home-study courses in pocket-size pamphlets—exactly the same text material as used in the Extension Courses at the University of Wisconsin—will help YOU to secure a big-pay job!

- 1 **The Gasoline Automobile** \$3.00
A practical course in the construction, operation and repair of gasoline automobiles.
- 2 **Show-Card Writing** \$2.50
Show-card writing from A to Z. Lettering, layout, arrangement, color in theory and practice.
- 3 **Bookkeeping and Elementary Accounting** \$6.00
The principles and practice of junior accounting. A complete set of blank books is included with the course.
- 4 **Practical Foremanship** \$3.75
The "how" and the "why" of successful foremanship as required by modern shop and factory practice.
- 5 **Practical Banking** \$2.00
A course that gives you a bird's-eye view of practical banking in a moderate sized bank.
- 6 **Selling at Retail** \$2.50
A practical home-study course for the ambitious retail salesman. Packed with sound information on how to sell MORE merchandise.
- 7 **Automotive Ignition Systems** \$2.50
A thorough, systematic course in design, installation and repair of ignition systems on motor cars, trucks, tractors, airplanes, etc.
- 8 **Sheet Metal Drafting** \$2.25
A course of training that helps to fit you for the position of sheet metal draftsman.

10 days' free examination — No money down — No obligation—Mail the coupon NOW!

FREE EXAMINATION COUPON

McGraw-Hill Book Company, Inc.,
370 Seventh Avenue, New York, N. Y.

Gentlemen: You may send me the McGraw-Hill Home-Study Courses (in pamphlet form) checked below. I agree to return them postpaid in ten days or to remit for them at that time.

- () Hobbs, Elliott and Consoliver.—The Gasoline Automobile.....\$3.00
- () Blair.—Show-Card Writing.....2.50
- () Sweeney.—Bookkeeping and Introductory Accounting.....6.00
- () Gardner.—Practical Foremanship.....3.75
- () Jamison.—Practical Banking.....2.00
- () Pelz.—Selling at Retail.....2.50
- () Consoliver & Mitchell.—Automotive Ignition Systems.....2.50
- () Longfield.—Sheet Metal Drafting.....2.25

Signature.....

Home Address.....

City and State.....

Name of Company..... Occupation.....

P. M. 4-1-27

Why Good Dancers Are Popular

EVERYONE admires and wants to dance with the person who knows the latest steps. There is no need of being a wallflower! By my remarkable new easy method anyone can learn the newest dances at home in a few hours. Much less expensive than from a personal teacher. No music or partner needed. So simple even a child can learn quickly. **Almost one half million have learned dancing by mail.** Your own success is guaranteed.



Posed by Edna Murphy and Arthur Murray

To prove I can quickly and easily make you an accomplished dancer, I will send you **FREE** my 32 page book and **TEST LESSON**. To pay the cost of mailing, handling, etc., send 10c. Learn in private—surprise your friends. Act now and be a good dancer soon!
ARTHUR MURRAY, Studio 711, 7 East 43rd St., NEW YORK



BART SUPPLIES

Quality art materials at lowest prices. Save on everything you need. Convince yourself—send today for catalog.

BART SUPPLIES, 441 Eustis Bldg., MINNEAPOLIS, MINN.

Rider Agents Wanted

Select from the 44 Styles, colors and sizes of Mead Bicycles. Models for every age. Ride and exhibit sample and make money.

30 Days' Free Trial Washup the bicycle you select **On Approval** for a month's trial. If not fully satisfied, return it at our expense. Prices from \$21.50 up.

Tires best quality, factory prices. Save big money on lamps, wheels and equipment, low prices. Send **No Money**, do business direct with makers.

Mead CYCLE COMPANY

DEPT. 110 - CHICAGO



Write today for free Catalog, factory prices and marvelous new offer.

FREE TRIAL

Grows Hair

AMAZING NEW ELECTRICAL DISCOVERY



A noted surgeon has discovered an amazing way to grow hair, called Dermo-Ray. In 30 days no more dandruff. Scalp tissues are given new life. Then within a few weeks, luxuriant new hair! The startling discovery of the almost magic effect of Infra-Red Rays on the hair-growing tissues was made by a leading surgeon. Two years ago he was himself bald. Today his hair is full and thick.

FAMOUS SURGEON'S DISCOVERY
Here is his own personal, home treatment, called Dermo-Ray. At last a home method endorsed by science. **Guaranteed to bring you these same results in 30 days—or you pay nothing.** You can use Dermo-Ray in any home with electricity. The warm, soothing Infra-Red Rays vitalize the scalp while you rest—a few minutes each day is all the time required.

SEND NO MONEY Complete facts about this astounding new scientific discovery, opinions of authorities, incontrovertible evidence, and details of **special trial offer** sent free, if you mail the coupon below. To end your scalp and hair troubles, act at once. Print your name and address plainly—and mail the coupon NOW!

-----**FREE TRIAL OFFER**-----

The Larson Institute
Michigan Ave. at Lake St., Dept. 17, Chicago, Ill.

Send me at once, without obligation, full particulars—in plain envelope—of your 30-day Free Trial of **DERMO-RAY**.

Name.....

Address.....

City.....State.....

Do you want one of these Big Pay Auto or Electrical Jobs!

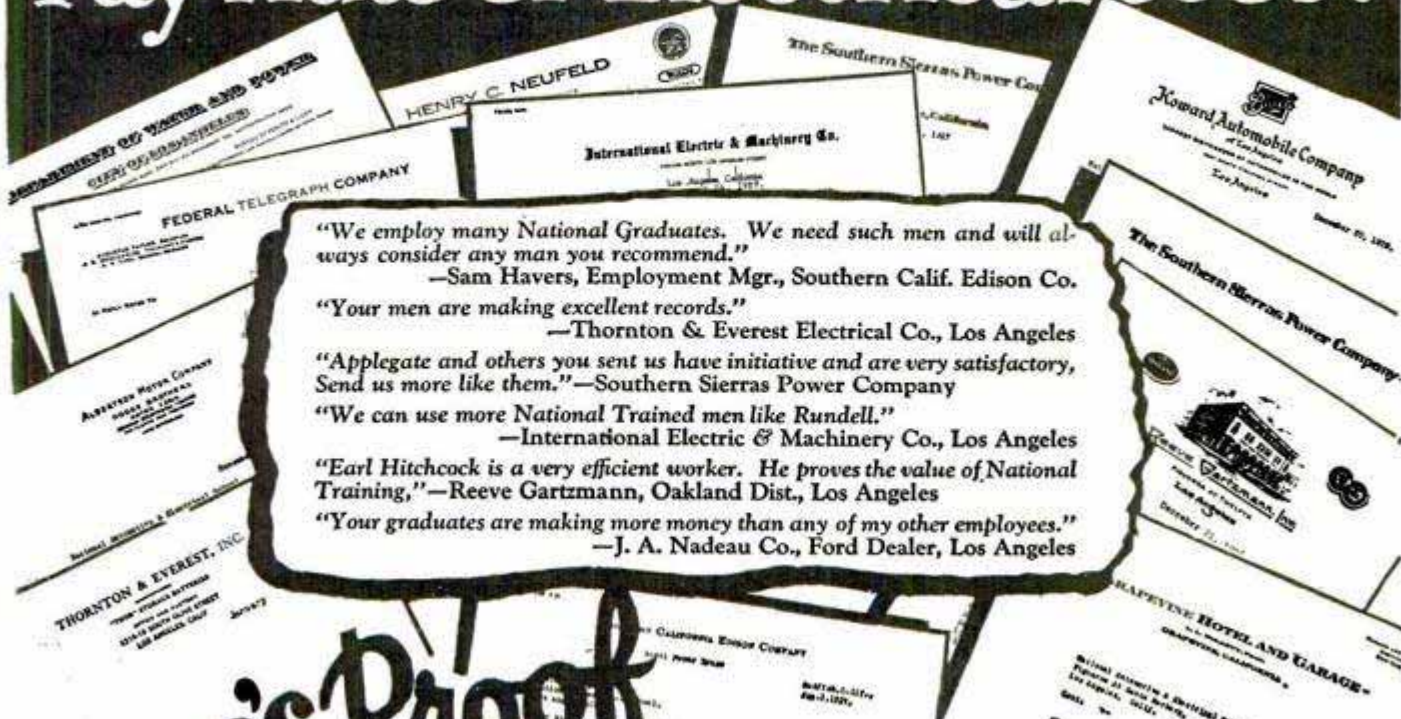

"We employ many National Graduates. We need such men and will always consider any man you recommend."
 —Sam Havers, Employment Mgr., Southern Calif. Edison Co.

"Your men are making excellent records."
 —Thornton & Everest Electrical Co., Los Angeles

"Applegate and others you sent us have initiative and are very satisfactory, Send us more like them."
 —Southern Sierras Power Company

"We can use more National Trained men like Rundell."
 —International Electric & Machinery Co., Los Angeles

"Earl Hitchcock is a very efficient worker. He proves the value of National Training."
 —Reeve Gartzmann, Oakland Dist., Los Angeles

"Your graduates are making more money than any of my other employees."
 —J. A. Nadeau Co., Ford Dealer, Los Angeles

Here's Proof - Big Employers want more National-trained men!

"Send us more men like Stillson," writes the Grapevine (Calif.) Garage. The So. California Edison Co. writes in to praise the work of Roben and Braverman—two National Electrical Graduates making amazingly rapid progress because of their National training. . . . Employers all over the world send in letters praising the work of former National students, saying, "Your school certainly turns out completely-trained practical men. Please put us in touch with other men you have trained."

Employers Want You If You are TRAINED

Auto and Electrical employers everywhere have hundreds of big jobs to be filled—and there aren't enough skilled men to go around! Jobs paying \$50 and up to \$200 a week are open now—and well-

trained men can command \$10,000.00 a year and more in either industry.

But these big-pay positions are not for "book-trained" men or half-baked apprentices. They require men who actually know the practical side. And that's why National-trained men make a hit with employers. In National's huge shops you perform actual work—under personal supervision of expert instructors—on a half million dollars' worth of new equipment. You learn by **doing**—not by books. Employers who know say National training is complete, thorough and practical. And 16,000 successful National graduates testify that the months they spent at National have enabled them to get good, steady jobs at two or three times their former pay.

Free Book Shows You The Way to Bigger Pay

You, too, can soon qualify for a better-paid job. Mail coupon now for the big National Auto or Electrical Book and learn how this world-famous, 22-year-old institution can help you to quick success. Either book is free—but it is worth a fortune to you! Write for it now.



National Automotive and ELECTRICAL SCHOOL

LOS ANGELES, CALIFORNIA

National Automotive & Electrical School,
 Dept. 505, 4006 Figueroa St., Los Angeles, Calif.

Send me the big free book that will show me how to get a Bigger-Pay check which one
 Job in the Automotive Industry
 Electrical Industry.

Name.....
 Address.....
 City..... State.....



9 Big Books covering all subjects fully:
 Surveying
 Map Making
 Roads
 Bridges
 Culverts
 Railroad Engineering
 Estimating for Steel Buildings
 Masonry
 Water Supply
 Water Power
 Cost Systems

Want to make more money?
 ?
Be a Civil Engineer

Here is an easy way to learn. You hold your future in your own hands. If you have a grammar school education, and want the advantages of knowledge usually gained in college, you will welcome this new system of reading at home. No long hours of grinding study; just the meat of every subject told in such a simple way that anybody can understand.

These books were prepared by men who are experts, they are full of boiled-down facts and easily learned methods which save time and study.

Civil Engineers are more important than ever; steel buildings, bridges, highways, railroads and harbor projects make Engineering more important than almost any other profession.

If you want to get ahead—try this easy way
We Ship Nine Books FREE

This is a "straight-from-the-shoulder" offer to men who want a big future. If you could hear half the stories of success we receive, you would not hesitate a minute. Send for the books now; just your name and address; and we'll ship the entire set of nine volumes. Keep them ten days, then if you realize how valuable they are to you, send only \$2.00, and after that only \$3.00 per month until the small total of only \$34.80 is paid.

The special jiffy index puts facts at your finger tips

AMERICAN TECHNICAL SOCIETY, Dept. C-419, Chicago
 You may send me, for Free examination, your nine new books on Civil Engineering. Unless I return them in ten days I will send you \$2.00 as first payment, then \$3.00 per month until the special price of only \$34.80 is paid.

Name

Address

City.....State.....

Reference.....

Learn How to BOX

JIMMY DeFOREST BOXING COURSE

Has Developed Champions by Mail

Hundreds of DeForest Trained-By-Mail Boxers Are Making Good in the ring today!



In 20 weeks under the System of Jimmy DeForest, World's Greatest Trainer and Maker of Champions, you will master the priceless knowledge that has made champions, and started hundreds of boys on the road to Fame and Fortune.

Promising pupils are brought to the front at once. With the co-operation of an Advisory Board of prominent promoters who are enthusiastic about this plan, thirty boys are selected from all weight classes every six months and recommended to leading promoters for engagements.

Champions Give DeForest Course Sole Credit for Success

Champions and other students who are making good in the squared circle, publicly proclaim that the DeForest Course is responsible for their achievements. Read in the "Golden Age of Boxing" the amazing and almost unbelievable stories of John Nemis, welterweight champion of Maritime Provinces, Jimmy Robe, George Tasker, Buell C. Murphy, and other stars. Boys who were rank amateurs are today earning big money. Novices are developed into topnotchers.

Greatest Physical Training System in the World

The DeForest Course is the greatest physical training system in the world. Weaklings have been made strong and men physically rebuilt, energy, strength and courage developed. Prominent men and leaders in all walks of life, including Prof. T. W. Seeley, famous Physical Culturist, box regularly to keep themselves fit.

Read This Gripping Book

Send today for the now famous book, "The Golden Age of Boxing," greatest book of its kind ever written, full of valuable information, photos of great boxers and pupils who became successes over night. Full outline of the DeForest Course. This book will thrill you. Write now.

JIMMY DeFOREST BOXING COURSE 347 Madison Ave., Box 616, NEW YORK CITY

LEARN to PITCH

Lessons by "MATTY," ED. WALSH, "DOC" WHITE, WALTER JOHNSON, "NAP" RUCKER, "SMOKY JOE" WOOD, PITCH THE FADE-A-WAY, SPITTER, KNUCKLER, SMOKE BALL, etc. Clearly Described and Illustrated by 66 Pictures. Entire COURSE OF LESSONS SENT POSTPAID for 50 cents.

BENEDEK SUPPLY HOUSE Dept. 60, 2300 N. Mason Avenue, CHICAGO, ILL.



BOW LEGS and KNOCK-KNEES UNSIGHTLY

Those afflicted with BOW LEGS should wear the "PERFECT LEG FORMS" and overcome this deformity. Trousers hang perfectly straight. Made of the highest grade Aluminum. Sanitary. Light and Durable. Easy to put on or off. Send for booklet showing photos of men with and without the "PERFECT LEG FORMS."

PERFECT SALES CO. 40 N. Mayfield Ave. Dept. S Chicago, Ill.

SKIN-TROUBLES

ANDRE'S ACNE CREAM is Excellent for all Skin Troubles

no matter how severe or chronic. Pimples, Blackheads, Eruptions on face or body. Eczema, Barbers' Itch, Scabs, Crusts, Pustules, Enlarged Pores, Oily, Shiny or Itching Skin. Lightens Freckles, softens and whitens the skin. Immediate Results. Write for full particulars.

Andre & Co., 4029 Cottage Grove Av. Suite 451, Chicago, Ill.



Earn Up to \$250 per month salary as a Railway Traffic Inspector

I can place as many men as I can qualify in this dignified, interesting profession where you are practically your own boss, see new sights and places each minute. It's outdoor, healthy work near home or in more distant cities. Promotions are rapid and opportunities numerous.

No Previous Experience Necessary

For eight years I have trained men for Traffic Inspection and upon completion of 3 months' spare time home study, placed them in good positions. Any man of normal intelligence can qualify regardless of previous training. I will train you on the same basis and upon completion assist you to a position paying at least \$120 per month salary plus expenses—or refund your money.

Let me show you how Traffic Inspection will increase your income and give you a permanent profession. Send coupon today.

JAMES T. JARRELL
 PRES. DIV. 2

Standard Business Training Inst.
 BUFFALO, N. Y.

Standard Business Training Inst. Div. No. 2 Buffalo, N. Y.
 Yes, I'd like to know more about Traffic Inspection. Send me your free booklet "A Profession of Protection."

Name

Address.....

What Spell Does This Strange Book cast over its readers?

Examine it free for 5 days. If it does not give color, charm and magnetism to your personality, return it within the 5-day period—and the examination will have cost you nothing!

HERE is a book that seems to cast a spell over every person who turns its pages!

A copy of this singular book was left lying on a hotel table for a few weeks. Nearly 400 people saw the book—read a few pages—and then sent for a copy!

In another case a physician placed a copy on the table in his waiting room. More than 200 of his patients saw the book—read part of it—and then ordered copies for themselves.

You can sway and control others! You can command success. You can influence people to do things you want them to do. *This strange magnetic book shows how!*

What Personal Magnetism Is

"Instantaneous Personal Magnetism," just completed after fifty years of research and study, is now off the press and ready for you. Edmund Shaftesbury, founder of this interesting system, devoted a lifetime to it. Such men and women as Queen Victoria, Cardinal Gibbons, Lord Beaconsfield, Gladstone, Henry Ward Beecher, were among his friends and pupils.

"Instantaneous Personal Magnetism" tells how to draw people to you at once, irresistibly—how to be popular everywhere, in any society—how to be a magnet of human attraction, popular and well-liked wherever you go!

It not only tells exactly how to accomplish these things—it tells how to accomplish many of them without delay—*instantly!* How to develop your mental, passional and personal magnetism!

Shaftesbury's amazing science of magnetic control was at first confined to the use of those wealthy few who could pay from \$200.00 to \$500.00 for the scientist's private instruction.

With the publication of "Instantaneous Personal Magnetism," Shaftesbury's complete method of magnetic development is within the reach of everyone. Everything that he taught on the

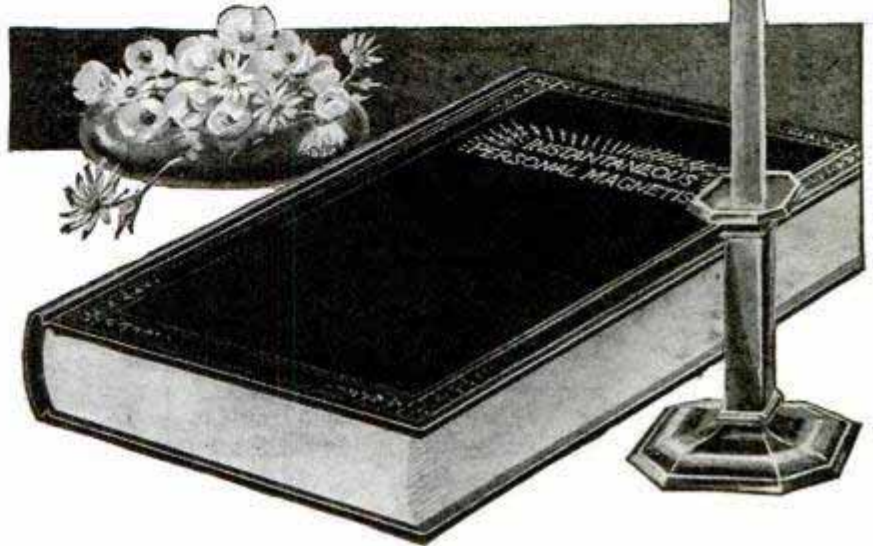

cultivation of personal magnetism is in this one authentic book.

Personal Magnetism is not necessarily inborn. It can be cultivated, fostered, until it becomes a natural part of you. Your eyes, hands, lips, voice, bearing—all radiate personality of an individual kind. All lend themselves to the one great fundamental quality known as *Personal Magnetism*.

Strange Effect on Readers

Readers of this book quickly become masters of a singular power to attract others—to influence men and women around them. Not by force—not by loud argument. But rather by some subtle, insinuating power that sways men's minds and emotions. They are able to play on people's feelings just as a skilled violinist plays upon a violin.

Folks are rarely the same after reading this book. Their manner changes. The tone of their voice, the expression in their eyes—yes, even their actual features seem to change—seem to grow more cultured, more refined.

Release this dormant magnetism within you—and watch yourself become more and more successful, popular!

Give verve, color, magnetism to your personality—and see what a difference it makes in your life!

Read This Strange Book 5 Days FREE

The principles that Edmund Shaftesbury taught to those famous men and

women—and for which many paid as high as \$500—have been brought up to date and the new, revised edition can now be yours—for little more than the cost of an ordinary volume! Imagine it! Edmund Shaftesbury's whole astounding principle of magnetic control to apply to your own personality and use in your daily contacts with people!

If you want a compelling personality—if you want magnetism, new power, new strength, send for "Instantaneous Personal Magnetism" at once. Mail the coupon today; this remarkable volume, bound in handsome dark cloth and gold embossed, will be sent to you at once for a 5-days' FREE examination.

If you are not thrilled and inspired by this amazing book, just return it within the 5-day period, and the examination will have cost you nothing. Otherwise keep it as your own and send only \$3 in full payment. Clip and mail this coupon. NOW, before you forget, for the most magnetic book you ever saw! Ralston University Press, Dept. 13-H, Meriden, Conn.

What Grateful Readers Say

"I am indebted to Shaftesbury for all that I am in this world."

"Made me a success financially, socially and morally."

"I would not give up what Shaftesbury has taught me for \$100,000."

RALSTON UNIVERSITY PRESS,
Dept. 13-H, Meriden, Conn.

You may send me "Instantaneous Personal Magnetism" for a 5 days' free examination in my own home. I will be the judge. Within the 5-day period I will either remit the special low price of \$3 in full payment or return it without cost or obligation.

Name.....

Address.....

City.....State.....

GENUINE CORONA

Limited Offer



200 DOWN
BALANCE
EASY TERMS

HERE'S your chance to secure that Corona you've wanted —on the easiest terms ever offered —at ONE-THIRD OFF regular price! Complete in every detail: two color ribbon, back spacer, beautifully re-newed, NEW MACHINE GUARANTEE. Recognized the world over as the finest, strongest, sturdiest portable built. Only a limited number of these splendid machines available. To get one, you must act now!

Yours For 10 Days FREE
Send No Money

Experience the joy this personal writing portable typewriter can give you! Use it 10 days free! See how easy it is to run and the splendidly typed letters it turns out. Ideal for the office desk, home, travelling. Small, compact, light, convenient. Don't send out letters, reports, bills in poor handwriting when you can have this Corona at such a low price or on such easy terms.

Carrying Case Included
—If You Act Now

Leatheroid carrying case, oiler, instructions free on this offer. Send no money—just the coupon. Without delay or red tape we will send you the Corona. Try it 10 days. If you decide to keep it, send us only \$2—then \$3 a month until our special price of \$36.25 is paid (cash price, \$33.10). Now is the time to buy. This offer may never be repeated. Mail coupon now.

\$16 SAVED
by using this coupon

SMITH TYPEWRITER SALES CORP.
844-360 E. Grand Ave., Chicago.

Ship me the Corona, F. O. B. Chicago. On arrival I'll deposit \$2 with express agent. If I keep machine, I'll send you \$3 a month until the \$34.25 balance of \$36.25 price is paid; the title to remain with you until then. I am to have 10 days to try the typewriter. If I decide not to keep it, I will repack and return to express agent, who will return my \$2. You are to give your standard guarantee.

Name.....
Address.....
Employed by.....

PREPARE NOW!
FOR BIG PAY AVIATION JOBS

Aviators
\$75 to \$300 weekly

Aviation Mechanics
\$50 to \$150 weekly

Aeronautical Instructors
\$75 to \$250 weekly

Airplane Builders
\$75 to \$200 weekly

Aerial Photography
\$100 to \$300 weekly

Aerial Advertising
\$50 to \$250 weekly

And Numerous Other Positions

DARING MEN IN DEMAND!
Aviation Needs You!
You Can Earn \$100 to \$300 Weekly!

Fascinating, Big Paying positions are open to trained men. The U. S. government wants you for its mail routes. Private aviation enterprises—like European Commercial air lines—are springing up in every section of the United States. Aeroplane building gives promises of unheard-of production during 1927.

Train Under Registered U. S. Pilots
They have prepared a course for you packed full of interesting data, facts, lectures, blue prints and bulletins of the industry. 30 LESSONS WITH OVER 400 ILLUSTRATIONS. This course qualifies you for U. S. Civil service. Our NATIONAL AERO EMPLOYMENT SERVICE assists you in securing excellent positions.

A \$10 down payment enrolls YOU! This can at any time be applied on Complete Flying Course to be taken at our airport in Chicago.

Make An Aviator's Decision! Decide Now!
Write today for Free Booklet and information about practical ground school and actual flying.

Chicago Aeronautical Service, Inc.
Dept. H, 608 S. Dearborn Street, Chicago, Ill.

BIG PAY IN THIS NEW PROFESSION
Get This Free Book!



It shows how easily you can have an independent future and salary as an Ornamental Iron and Bronze Draftsman. Beginners can earn \$65 a week—quickly advance to \$500 a month. Wonderful opportunities to become an executive. Thousands of positions waiting for trained men. Easy for you to qualify. No books, higher mathematics, or experience necessary. Learn while on your present job. Don't wait—write for the Free Book right now.

American Institute of Ornamental Iron & Bronze
3033 Hennepin Ave., Minneapolis, Minn.

How to Straighten Bow and Knock-kneed Legs!
Improve your personal appearance by using the new patent "Lim-Straitner," Model 18. Corrects now Bow and Knock-kneed legs safely, quickly and permanently at home. No costly operation or discomfort. Is worn at night. Easy to adjust; its result will save you soon from further humiliation and will improve your personal appearance 100 per cent. Write today for copyrighted Physiological and Anatomical book and experience of others without obligation. Enclose a dime for postage.

M. TRILETY, Specialist Dept. 1524L BINGHAMTON, N. Y.

Deafness
Perfect hearing is now being restored in all cases of deafness caused by Catarrhal troubles, Relaxed or Sunken Drums, Thickened Drums, Roaring or Hissing Sounds, Perforated, Wholly or Partially Destroyed Drums, Discharge from the Ears, etc.

Wilson Common-Sense Ear Drums
require no medicine but effectively replace what is lacking or defective in the natural ear drums. They are simple devices, which the wearer easily fits into the ears where they are invisible. Soft, safe and comfortable. Write today for 168-page book on deafness giving full particulars and many testimonials. The hearing of thousands of grateful users has been restored by these "little wireless phones for the ears."

Free Book on Deafness

WILSON EAR DRUM CO., Incorporated
510 Todd Building LOUISVILLE, KY.



YOUR OPPORTUNITY

Learn One of these

BIG PAY TRADES

QUICK

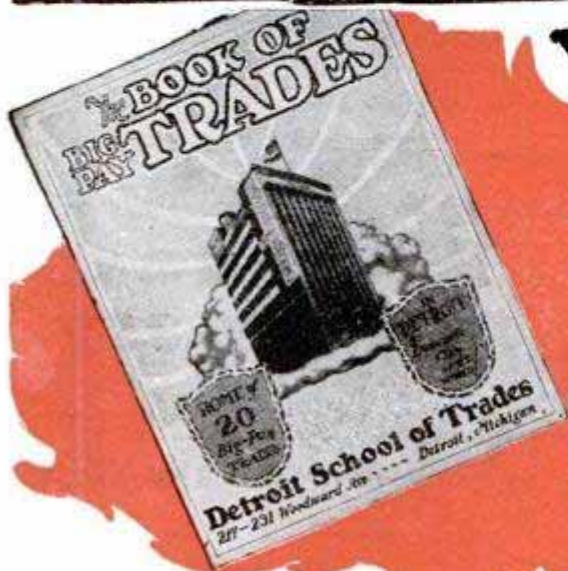

Don't spend months in school or digging through dry books. Here you learn by doing with tools on actual jobs—you learn right—and you learn quick. Before you know it you're ready for big pay right here in Detroit.

DON'T Work At a Hard Low-Pay Job Another Day!

Get out of the grease—leave the rut forever—say "Good bye" to low pay. Take your choice of the clean, big pay jobs and start earning \$50 to \$100 a week right from the start in a real trade.

Come and Work In Dynamic DETROIT

A great city—big—throbbing with life—growing—filled with opportunity—crying for men to take big pay for doing the jobs that need doing. Building trades booming. Automotive trades—real trades—always good—get into the spirit of a big city, fastest growing most dynamic in America—do big things with big men—succeed with successes in this City of Wonderful Opportunity

CHOOSE

In This Great School We Teach These Big-Pay Trades

- Bricklaying—\$1.50 to \$1.65 per hour
- Plastering—\$1.50 per hour
- Plumbing—\$1.25 to \$1.75 per hour
- Carpentry -- \$60.00 to \$125.00 per week
- Electrical—\$10.00 to \$14.00 per day
- Sign Painting—\$1.00 to \$2.00 per hour
- Paper Hanging—\$10.00 and up per day
- Interior Decorating—\$10.00 to \$14.00 per day
- Plan Reading and Estimating—\$70.00 to as high as \$250 a week
- Auto Mechanics—\$1.00 to \$2.00 per hour
- Auto Painting—\$9.00 to \$12.00 per day
- Auto Trimming—\$9.00 to \$14.00 per day
- Auto Striping—\$2.00 per hour
- Metal Finishing—\$10.00 per day
- Acetylene Welding—\$1.00 to \$2.00 per hour
- Tool Making—\$70 to \$200 per week

Get This New Big Pay Book

The Most Amazing Door to Quick Big Money You've ever seen. Twenty trades. Pick the one you are best suited for. Work at a job you like. Learn your trade, quick. This book is free.

Steady Work in Detroit's Big Plants

Scores of Big plants, body plants, auto plants, wheel makers, tool makers, designers, finishers, stripers—hundreds of real estate developments and new buildings—plenty of work inside or outside—at big pay. Steady work the year around for men who know their trades.

BIG PAY JOBS GALORE Not Enough Men

The Detroit School of Trades teaches 20 big pay trades. You don't have to learn some old, low-pay, worn-out business. Send for the book, look through, pick the money you want in the trade you want to learn. Then come here, we'll teach you how and help you get a job. Over three hundred of our men now working in one body plant. Hundreds of others in other plants. Hundreds more needed.

Think of These Facts

Hansen made \$183 for one week's work in bricklaying. Brooks jumped from \$35 a week to \$65.85 the first week he left school. Augustine was making \$6.00 a day—learned plastering and makes \$12 a day. Hundreds double their pay. You can do as well. Remember it doesn't cost you a penny for this book. Risk one postage stamp now on what may be the opportunity of a lifetime. Read it, be convinced. Come and see. Succeed for yourself. Send coupon at once. Don't delay. The Detroit School of Trades can do big things for you.

DETROIT SCHOOL OF TRADES
DEPT. 14 DETROIT, MICHIGAN

TOP WAGES

are paid only to men with training. This is a practical school of "grown-up trades for grown-up men" and you get both training and practical experience. When you leave the Detroit School of Trades you are ready to take your place with the biggest wage earners in your chosen trade. Send at once for big Free book.

FREE Send Coupon TO-DAY

Detroit School of Trades, Dept. 14 Detroit, Mich.

Send me Free and without obligation your big new book of BIG PAY TRADES. I am interested in the _____ trade

Name _____

Address _____

City _____ State _____

**10 DAYS' TRIAL
SEND NO
MONEY**



**NO
NEED
FOR A
NEW
PHONOGRAPH**

New PHONIC Reproducer

**makes an up-
to-the-minute
Phonograph out
of your old one!**

\$3.85

**Direct
from
Factory**

Now at last you can say goodbye to the squeaky, nasal, rasping metallic tone of your phonograph. Now you can have the beautiful, natural, full-rounded tone of the expensive new machines which are startling the world. Yet you need not buy a new phonograph if you have an old one. The reproducer is the HEART of any phonograph—and the New PHONIC reproducer makes your old phonograph like an entirely new one. Based on the new PHONIC principle. Makes you think the orchestra or artist is in the same room.

Gives the New Tone and Volume of Latest New Phonographs

Tones never before heard are clearly distinguished when the new PHONIC reproducer is used. Test it on an old record. Hear the difference yourself. Listen to the deep low notes and the delicate high notes. Hear how plainly and clearly the voice sounds. Note the natural tone of the violin and the piano, and the absence of "tinny" music. You will be amazed. The new PHONIC reproducer is ideal for dancing or for home entertainments. Its volume is almost double that of the ordinary reproducer.

10 Days' Trial — Send No Money.

You cannot realize how wonderful the New PHONIC is until you hear it. That is why we want to send it to you on 10 days' trial. Send no money now—just the coupon. Pay the postman only \$3.85 plus a few pennies postage when the New PHONIC arrives. Then if you are not delighted, send it back within 10 days and your money will be refunded. If sold in stores the price would be at least \$7.50. Our price only \$3.85. Over 350,000 people have dealt with us by mail. You take no risk. Mail the coupon now for 10 days' trial. **BE SURE TO STATE THE NAME OF PHONOGRAPH YOU OWN.**

**NATIONAL MUSIC LOVERS, Inc., Dept. 124
327 West 36th Street, New York**

Please send me a New PHONIC reproducer for.

..... I will pay the postman \$3.85 plus few
(give name of Phonograph) cents postage. If I am not satisfied
after trial, I will return your reproducer within 10 days and you
guarantee to refund my money. *Outside U. S. \$4.10, cash with
order.*

Name.....

Address.....

City..... State.....

It's Fun to Make Things

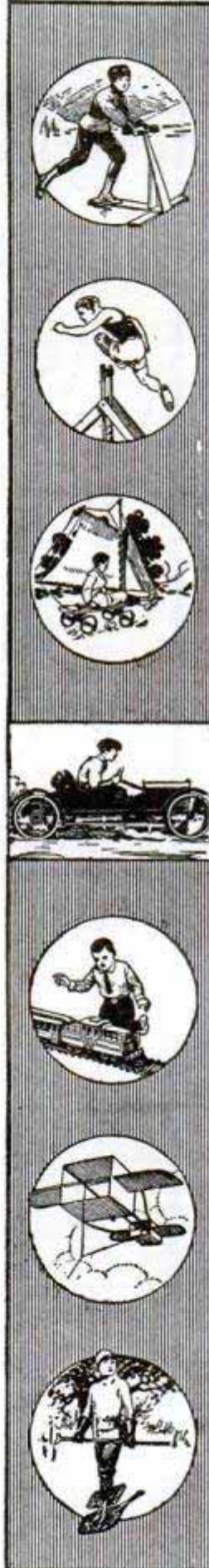

Let the other boys wonder how you can make so many interesting things. Make your own motor sled. Make your own skis and snowshoes. You can learn how to make almost anything that any boy could want by following the pictures and the simple directions in

The Boy Mechanic Library

And just think of it, there are nearly 4,000 separate articles in the four beautiful volumes! Some of the most fascinating subjects are listed below.

How to Make Things

- | | |
|-------------------|-----------------------|
| Boats | China painting |
| Winter sports | Decorative metal work |
| Camping | Furniture making |
| Ice boats | Farming |
| Water sports | Poultry |
| Toboggans | Models |
| Tents | Laboratory helps |
| Skis | Household helps |
| Indian snowshoes | Wood working |
| Skating | Electrical devices |
| Gymnasium | Photography |
| Wind wagons | Music |
| Motor sleds | Outdoor games |
| Radio | Stoves |
| Magic | Furnaces |
| Trapping | Wireless |
| Fets | Tricks |
| Leather work | Puzzles |
| Carpentry | Bicycle |
| Painting | Flowers |
| Toys | Hunting |
| Fishing | Kites |
| Fruit growing | Metal working tools |
| Entertainments | Secret locks |
| Automobile | Swings |
| House decorations | Sleds |
| Drafting | Power devices |

Learn how to make things to sell. Learn how to make things to enjoy yourself. Buy the complete library, including Book 1, Book 2, Book 3 and Book 4.

Send No Money

Simply sign your name and address to the attached coupon and mail it at once. When the postman delivers the books to your door, pay him the price of the books and the few cents postage. That is all.

**POPULAR MECHANICS PRESS
Popular Mechanics Building**

Room 611 CHICAGO, ILL.

Mail the Coupon Today!

**POPULAR MECHANICS PRESS
Popular Mechanics Building
Room 611, Chicago, Ill.**

Please send me at once C. O. D. The Boy Mechanic Library comprising Book 1; Book 2, Book 3, and Book 4. I will pay postman \$7 and the few cents postage.

Name.....

City.....

State.....

St. No. or R. F. D.

If you want individual books at \$2 each, check the numbers of the books you want: 1 2 3 4



Patented

Just A Twist Of The Wrist Banishes Old-Style Can Openers to the Scrap Heap and BRINGS AGENTS \$6 to \$8 IN AN HOUR

WOMEN universally detest the old-style can opener. Yet in every home in the land cans are being opened with it, often several times a day. Imagine how thankfully they welcome this new method—this automatic way of doing their most distasteful job. With the Speedo can opening machine you just put the can in the machine, turn the handle, and almost instantly the job is done.

End This Waste and Danger

You undoubtedly know what a nasty, dangerous job it is to open cans with the old-fashioned can opener. You have to hack your way along slowly—ripping a jagged furrow around the edge. Next thing you know, the can opener slips. Good night! You've torn a hole in your finger. As liable as not it will get infected and stay sore a long time. Perhaps even your life will be endangered from blood poisoning!

You may be lucky enough to get the can open without cutting yourself. But there's still the fact to consider that the ragged edge of tin left around the top makes it almost impossible to pour out all of the food. Yet now, all this trouble, waste and danger is ended. No wonder salesmen everywhere are finding this invention a truly revolutionary money maker!

A "Million Dollar" Can Opening Machine

The Speedo grips the can—holds it—opens it—flips up the lid so you can grab it—and gives you back the can without a drop

spilled, without any rough edges to snag your fingers—all in a couple of seconds! It's so easy even a 10-year old child can do it in perfect safety! No wonder women—and men, too—simply go wild over it! No wonder Speedo salesmen often sell to every house in the block and make up to \$10 an hour.

Generous Free Test Offer

Frankly, men, I realize that the profit possibilities of this proposition as outlined briefly here may seem almost incredible to you. So I've worked out a plan by which you can examine the invention and test its profit without risking one penny. Get my free test offer while the territory you want is still open—I'll hold it for you while you make the test. I'll send you all the facts about \$75 to \$150 a week. I'll also tell you about another fast selling item that brings you two profits on every call. All you risk is a 2c stamp—so grab your pencil and shoot me the coupon right now.



—PATENTED HOUSEHOLD SPECIALTIES

CENTRAL STATES MFG. CO., Dept. D-700
4500 Mary Ave. Est. Over 20 years. ST. LOUIS, MO.

READ!



Averages \$16.35 a Day!

R. A. Stewart writes, "Made 20 sales in 23 calls. Between the 13th and 28th of this month I have made \$248. Speedo has them all beat for real money."

J. J. Corwin, Ariz., says "Send more order books. I sold first 14 orders in 2 hours."

A. Piotraschke, Mich., writes, "Send order book and folders—only worked 3 hours and got 9 orders."

Barb, W. Va., says, "Was only out a few evenings and got 20 orders."

Central States Mfg. Co.,
4500 Mary Ave., Dept. D-700
St. Louis, Mo.

Yes, rush me the facts and details of your FREE OFFER.

Name.....

Address.....

City..... State.....

Auto Painters make \$75 a Week



**Now You Can
Learn Auto
Painting and
Duco at
Home!**

Big city, small town, farm districts ALL need expert AUTO PAINTERS. Twenty million cars need repainting or new Duco finish every year or two. Men—you can make BIGGER MONEY—make it easier and faster as an auto REFINISHER. Now you can learn QUICKLY at home in your spare time from G. King Franklin—the man who writes the auto painting articles for MOTOR AGE and leading magazines.

**A Good Job
or go into
Business**

When you know how to re-finish automobiles you can either take a \$75 to \$100 a week job—or you can open up a little paint shop of your own. A few dollars' worth of brushes and paints are all you need to get started making money fast. Then you can buy Spraying or Duco Equipment out of profits, hire a few helpers and quickly build up a big refinishing plant. This training includes instruction in the BUSINESS end, too.

**A Paint Shop
of Your Own**



**Easy and Quick
to Learn by My
Shop Ticket
Method**

No text-books, no theory, nothing to memorize. But as you go along I tell you how to mix paints and colors, how to select the right materials and tools, how to do any kind of a job in a rapid, professional manner. My SHOP-TICKETS are one-step at a time directions for doing every branch of auto painting and Duco. You don't have to "Study" them, you learn by actually doing the work with materials, tools and equipment I supply without extra charge as a part of this course.

Mail coupon today for free sample Shop-tickets and complete information.
G. King Franklin, Supt.
American Auto Painting School
Dept. 101, 427 S. Ashland Avenue,
Chicago, Ill.

G. KING FRANKLIN



G. KING FRANKLIN, Supt.
AMERICAN AUTO PAINTING SCHOOL,
Dept. 101, 427 S. Ashland Ave., Chicago, Illinois.

Send me proof that you can make me an Auto Painting and Duco expert in six months at home, also sample Shop-tickets and complete information. FREE!

Name.....
St. No.....
City.....State.....

ELECTRICITY



My first job after leaving school took 2 hours and I received \$65.00 for the inspection. I worked up to over \$600.00 a month and expect to clear \$10,000 the first year.
Paul A. Carson.



B.S. Degron, 3 yrs.
No matter what your education or age, you'll find a place at S. O. E., and a course to meet your needs. Send for Free Catalog.

Actual experiments in our shops teach you all branches of electricity.

You Learn by Doing
auto electricity or radio courses fit you for fast advancement. Learn practical electricity in 6 mos.; junior electrical engineering, commercial electrical engineering or electro-technician in 12 mos. Step in the limelight of success. Send for BIG, FREE ILLUSTRATED CATALOG TODAY.

SCHOOL of ENGINEERING of Milwaukee

Dept. P.M.-A 126—415 Marshall St., Milwaukee, Wis.



LEARN

Take a W. A. C. Course in Applied Airplane Engineering. Many men earn \$2000 to \$10,000 a year. Big Free outfit of airplane parts when you enroll. Write for Free catalog.



WESTERN AIRPLANE CORPORATION
"Dept. M-4" Monadnock Bldg. CHICAGO, ILL.

TELEGRAPH-RADIO

\$18 to \$35 a week while training for Radio and Telegraph Operator jobs at \$150 to \$300 per month. Write for particulars.
CHICAGO TELEGRAPH INSTITUTE
Dept. 1-4-7 1338 S. Michigan Avenue, CHICAGO

Free! Learn How to Raise More Chicks, Get More Eggs and Save Feed. Prof. Quisenberry's new 1927 Free Book Now Ready Shows how to raise more chicks—less losses. Money making poultry see reb. Quisenberry's NEW WAY made many poultrymen rich. Send name, address and kind of poultry you like.
American Pty. School Dept. 70 K. C. Mo.

Electricians' Complete Practical Working Library

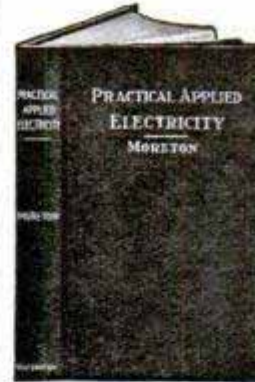

- Alternating Current Theory, Practice and Diagrams. 296 Pages. Cloth.....\$1.50
- Armature and Magnet Winding 270 Pages. Cloth.....\$1.50
- Electrical Dictionary. 320 Pages. Cloth.....\$1.50
- Telephone Handbook. 286 Pages. Cloth.....\$1.50
- Electric Motor Control Systems and Methods. 400 Pages. Cloth.....\$1.50
- Electrical Tables and Engineering Data. 331 Pages. Cloth.....\$1.50
- Electricians' Operating and Testing Manual. 361 Pages. Cloth.....\$1.50

- Electric Motors, Direct and Alternating. 250 Pages. Cloth.....\$1.50
- Electrical Measurements and Meter Testing. 328 Pages. Cloth.....\$1.50
- Modern Electric Illumination. 275 Pages. Cloth.....\$1.50
- Modern Electrical Construction. 440 Pages. Cloth.....\$1.50
- Motion Picture Operation, Stage Electrics and Illusions. 393 Pages. Cloth.....\$1.50
- Wiring Diagrams and Descriptions. 296 Pages. Cloth.....\$1.50
- Practical Applied Electricity. 442 Pages. Cloth.....\$2.00

Any of these books will be sent postpaid to any address in the world upon receipt of price. Catalog free.

POPULAR MECHANICS PRESS
Room 604 200 E. Ontario St. CHICAGO

The Man Who is Astounding America!

What is the mysterious power wielded by this man—a power he also shows others how to use? What is this new method which has started thousands of despairing persons on the road to health, happiness and prosperity?

THOUSANDS upon thousands have been turned away from the great theatres and auditoriums in Chicago, New York, San Francisco, Seattle, Denver, Boston, and practically every great city in America where Dr. Bush has been lecturing! These vast halls could not accommodate half of those who heard of his wonderful powers and had heard how he disclosed the secret of his powers to others!

Those who were ill had been shown how to become well and strong by a method to which other mental science movements were as the first step in a mammoth, far-reaching stairway.

The worried and the nervous had been shown how to rise above their mental and nervous troubles in a single evening and how to attack and solve their problems with a keener mind unhampered by despair.

An Astounding New Power

But that wasn't all. As wonderful as it is to have the secret of mental and physical health in one's grasp—there is a still greater force at work in the universe. This force can be harnessed in such a way as to bring us the MATERIAL things we want—money, power, influence, no matter what it is. And Dr. Bush has harnessed this force; has proved its value in his own case; and has proved time and again that he can show others how to use this power.

Long before the lectures were over the reports began to come in showing how quickly his audiences had been taught to use this wonderful power.

"By your method of visualization I secured the funds to build my home," writes one of Dr. Bush's Chicago listeners. Mrs. Mary Roberts of Denver writes, "My salary was increased

40% in one week by following your psychological method—and my powers of salesmanship were DOUBLED."

"TEN Thousand Dollars would not pay for the benefits I have received." James C. Smith of Somerville, Mass. writes him. Another says, "I was making no money, my health was bad and I was heavily in debt. Now I have a store of my own and am doing a good business. My family and myself enjoy the best of health." A man who learned of this power in Pittsburgh—he had never earned more than \$25 per week—stepped out the first month and made over \$1000. Dr. Bush has thousands of letters like these. They are his proudest possessions.

His Teachings Now in Book Form

Dr. Bush's sole idea in giving these lectures is the same idea that actuated him in his earlier days before he had discovered this amazing new force. Then as an earnest and brilliant young minister of the Gospel he had refused honors and financial returns in order to apply his efforts where they would do good to the greatest number. His lectures are given



David V. Bush
America's Foremost
Author-Lecturer on
Practical Psychology

for the same reason—to teach this new force to everyone who will learn. And to reach still more people he has incorporated his lectures in an absorbingly interesting book, "Applied Psychology and Scientific Living," which will be sent, on FREE TRIAL, to any earnest seeker after knowledge. Luther Burbank said, "Applied Psychology appears to me the most practical and useful work which has been published on these and similar subjects."

When You Need This Book

Are you nervous or depressed? Do you feel old? Have you lost your grip? Have you a worrying disposition? Have you a personality that fails to attract others? Are you timid? Are you misunderstood? Do others seem inclined to give you always the worst of everything? Do you lack the aggressiveness necessary to bring you position and power? Are you in ill health? Have you any chronic disease? Is anyone in your family or among your friends so affected? Are your children wilful and disobedient?

Examine It Free!

But no description can begin to give you even an idea of the startling truths explained and proved in this wonderful book of over 500 pages. The very first page will be a revelation to you just as Dr. Bush's lectures have been a revelation to keen thinking, analytical minds in every city. One enthusiast says: "It can be understood by everyone. And if everyone would read it and then use this new force, humanity would advance 5,000 years overnight."

But you will be the sole judge of this wonderful value. Mail the coupon. This remarkable book will be sent at once. Read it for 5 days. Practice this new force yourself. At the end of that time if you find it the most inspiring, the most valuable means to obtain health, wealth and happiness send us only \$3.50 which, as you will realize, pays only for the cost of printing, advertising and distributing the 500-page book. Otherwise return the book itself within 5 days and you will not owe a penny. But begin to enjoy the benefit of this new force at once. Mail the coupon today. **DAVID V. BUSH**, Publisher, Dept. 164, 225 N. Michigan Ave., Chicago, Ill.

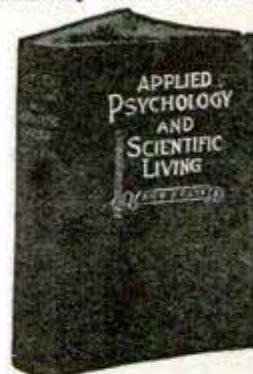

Partial List of Contents

Psycho-Analysis and the Sub-conscious
How to Have Amazing Memory
How to Destroy Fear—Man's Worst Enemy—The Unseen World
What is Love and How to Keep It
How to Be Popular
How to Overcome Failure and Adverse Environment
How to Be Beautiful Through Mysterious Force
Vibration—How to Win Success
How to Develop Personality
How to Conquer Illness
Poverty a Disease—How to Overcome It
How to Double Your Efficiency
Visualization—How to Make Your Dreams Come True
The Mastery of Fate
How to Use Suggestion for Health, Success and Happiness
The Greatest Law in the Universe, Just Lately Discovered, and How to Use It
What the World Owes You and How to Get It
After This Life What?—What is God?
Smile, Smile, Smile
Psychology of Health—Building the Body Beautiful
Long Life and Full of Pep

DAVID V. BUSH, Publisher, Dept. 164
225 N. Michigan Ave., Chicago, Ill.

Please send me a copy of "Applied Psychology and Scientific Living" for approval. I agree to remit \$3.50 or return the book in five days.

Name.....

Address.....

City.....State.....

(Remittance from Foreign countries and U. S. possessions must accompany all orders)



DRAWING *is a way* to FORTUNE

Ali Hafed, a Persian farmer, sold his acres to go out and seek his fortune. He who bought the farm found it contained a diamond mine which made him fabulously rich. Ali Hafed overlooked the great opportunity at his door to go far afield in search of wealth—which illustrates a great truth.

DO YOU LIKE TO DRAW?

If you do it is almost a certain indication that you have talent, a talent which few possess. Then don't follow Ali Hafed's example and look farther for fortune. Develop your talent—your fortune lies in your hand!

Earn \$200.00 to \$500.00 a Month and More

Present opportunities for both men and women to illustrate magazines, newspapers, etc., have never been excelled. Thousands of publishers buy millions of dollars' worth of illustrations every year. Illustrating is the highest type of art—pleasant work, yielding a large income.

THE FEDERAL COURSE IS A PROVEN RESULT GETTER

It is the only Home Study Course which has been built by over fifty nationally known artists—Sid Smith, Neysa McMein, Norman Rockwell, Clare Briggs, Charles Livingston Bull and Fontaine Fox among them.

FREE—"A ROAD TO BIGGER THINGS"

If you like to draw you should read this *free* book before deciding on your life's work. It tells about illustrating as a highly paid, fascinating profession and about the famous artists who have helped build the Federal Course. Just tear out this ad, write your name, age, occupation and address in the margin, mail it to us and we will send you your copy of the book and the sample lesson *free*. Do it right now while you are thinking about it.

Federal School of Illustrating

4137 Federal School Bldg.

Minneapolis, Minn.

MASTER THE TENOR BANJO —by CHORDS



JOHN MARTELL, popular radio artist and instructor, has compiled this new method of instruction for you.

\$7.00

Brings this complete course to your home in 12 weekly lessons—written so you can understand them. No previous knowledge of music necessary.

Enroll now and make progress while others are thinking it over.

Easy terms—10% off for full payment on enrollment or \$2.00 down and \$1.00 each week. Special Banjo offer on request.

Write NEW YORK INSTITUTE OF MUSIC
Dept. 103 143 East 34 St., N. Y. C.

LEARN PIANO TUNING AT HOME

During your Spare Time
and earn \$50 to \$100 a Week



Esney, Long Beach, Cal. says, "never dreamed there was so much money in Piano Tuning. I earned \$265 in ten days." He is just one of many. Our TUNE-A-PHONE MAKES IT EASY. With it any one with ordinary hearing can acquire the knack quickly and accurately by our method. Send for FREE BOOK and GUARANTY PLAN.

BRYANT SCHOOL OF TUNING, 81 Bryant Building, AUGUSTA, MICH.

ENCYCLOPÆDIA BRITANNICA

in the New Form—at a saving of 40%

Write for full details. Address Dept. PM3

THE ENCYCLOPÆDIA BRITANNICA, INC.
342 Madison Ave., New York City

MAKE MUCH MONEY Making and Selling Your Own Goods.

Formulas. Manufacturing Processes. Trade-Secrets. All Kinds. All Lines. Catalog, special circulars free.

W. THAXLY COMPANY, Washington, D. C.

Magic-Tricks-Puzzles

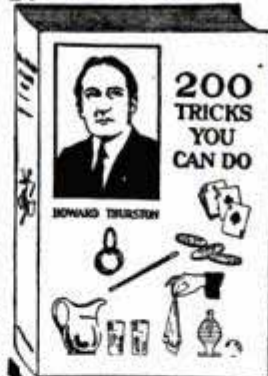

THESE books will enable you to mystify your friends and relatives as well as provide an inexhaustible fund of amusement. Why not develop a worth-while hobby that may lead to profit making on the side. Clubs, Lodges and other organizations are willing to pay entertainers who can mystify audiences.

Tricks and Magic Made Easy. Only such tricks as are easily accomplished. By Squier. \$1.00 Cloth.

200 Tricks You Can Do. For the beginner in magic. By Howard Thurston. No elaborate apparatus required. Cloth. \$1.00

Modern Card Effects and How to Perform Them. The cream of practical card tricks. By DeLawrence and Thompson. \$1.50

Easy Magic for Evening Parties. By Orrin. With illustrations and diagrams. 188 Pages. \$1.75

Modern Magic. By Prof. Hoffmann. A practical complete treatise on the art of conjuring. 563 pages. 318 illustrations. 300 tricks. Cloth. \$2.00

More Magic. By Prof. Hoffmann. Supplementary to Modern Magic. Additional tricks. 470 pages. 140 illustrations. Cloth. \$2.00

Behind the Scenes with the Mediums. By Abbott. Gives every detail of 69 tricks used by famous spiritualistic mediums. Many of these have made the greatest magicians wonder. \$1.50

33 Rope Ties and Chain Releases. By Hull. Illustrated. \$1.00

Real Puzzles. If you can't resist something really absorbing, here is your book—The official book of the National Puzzlers' League. 250 original puzzles to work out. 271 pages. Cloth \$2.00

Send No Money—Simply pay postman price and postage, when he delivers package anywhere in U. S. Elsewhere remit when ordering.

POPULAR MECHANICS PRESS Room 304
200 E. Ontario St., CHICAGO

*Out of the Air
comes your
Opportunity*



An Actual Photo of
One of Our Training
Planes—
A SWALLOW

Learn to Fly by Sweeney System

Here's the great business of the future. The National Air Transport alone has invested \$700,000 on the Kansas City air route. They are spending \$1000 a day to operate an over-night service to New York City. Ambitious men are wanted as pilots and ground mechanics. You can go into postal, government, or commercial work. Flyers are in demand, earning big money at fairs, taking up passengers, etc., \$5 for a 10 minute flight is pretty fine pay!

If You Want to Be a Pilot

The student, if he wishes, goes into the air and qualifies as a pilot under safe and experienced pilots, with double controls for actual flying.

You take all the actual flying necessary to make you a competent pilot. Now when you understand that two to seven hours is all the average man needs to learn expert flying you will appreciate what this ample experience in the air under skilled men will do for you. Aviation is no longer a mystery—no longer a hazard; no, it is a business growing greater and more important. This has been wonderfully demonstrated in the successful flights over the North Pole.

Big Money in Flying

Aviation Mechanics—
\$50-\$125 Week
Riggers—\$50-\$75 Week
Flyers—\$125-\$225 Week
Taxi Service—\$100-\$300
Week
Aerial Photo Pilot—\$200-
\$250 Week
Special Messenger Service—
\$125-\$200 Week
Aerial Advertising—\$225-
\$500 Week
Crop Dusting—\$125-\$200
Week
Crop Survey—\$125-\$225
Week

**4000 hours student
flying without ma-
terial damage. 150
acre flying field.
Hangar and club
house. Seven in-
structors.**

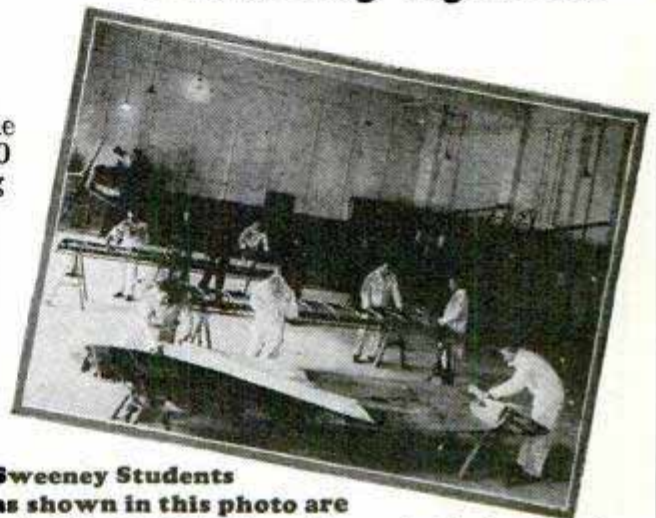

**Sweeney Students
as shown in this photo are**

trained by DOING. Thorough ground school work, under skilled instructors in the construction and repair of recovering wings, tuning motor, etc., learning everything about the mechanical work by actual practice. This fits you as an aviation mechanic. You can build your own plane and do anything required in aviation mechanics and construction and repairing when you have finished this work. You are thoroughly taught motors, etc., and work with thousands of dollars' worth of new material, including all types of engines. Aviation is now playing in commercial activities. Progress is rapid. More men are needed every day. You can qualify as a mechanic, or an engineer, or repair man, or builder; five men on the ground are needed for one man in the air.

SEND NAME TODAY for full details of this aviation mechanical course and photographs of planes and equipment actually used; also full information as to the commercial end of flying and opportunities for young men. No colored students accepted.

— — — SEND THIS NOW — — —

EMORY J. SWEENEY, President
3606 Sweeney Bldg., KANSAS CITY, MO.

Please send me full information about your Aviation Course.

Name.....Age.....

Address.....

Town.....State.....

LEARN TO FLY BY FLYING
Sweeney
SCHOOL OF AVIATION
3606 SWEENEY BLDG., KANSAS CITY, MO.

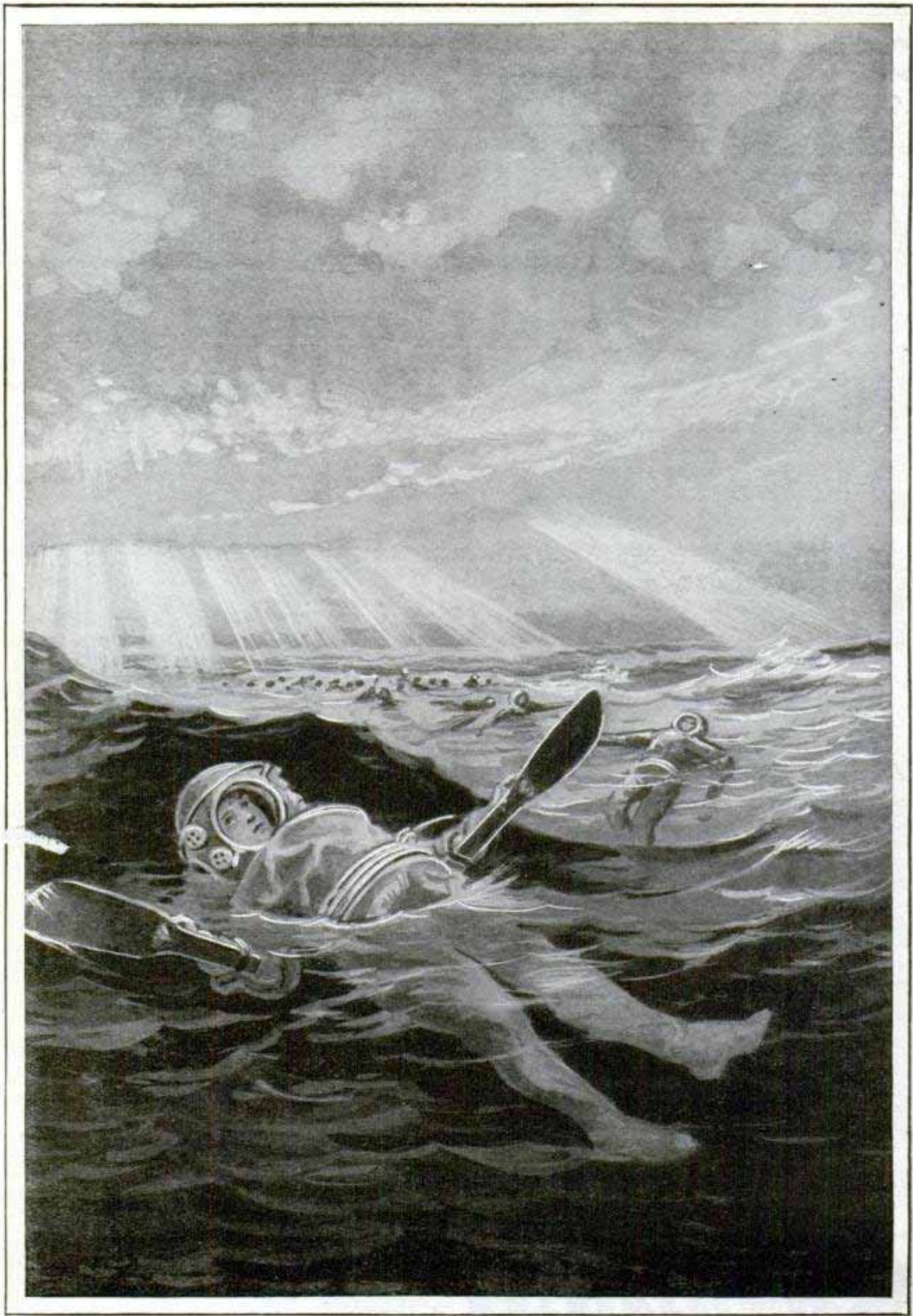

New German Life-Saving Suit with Which the Wearer Can Float on the Surface and Paddle Himself Around with Two Short Blades Attached to the Hands—See Page 544

Popular Mechanics Magazine

REGISTERED IN U. S. PATENT OFFICE

WRITTEN SO YOU CAN UNDERSTAND IT

Vol. 47

APRIL, 1927

1612.

No. 4

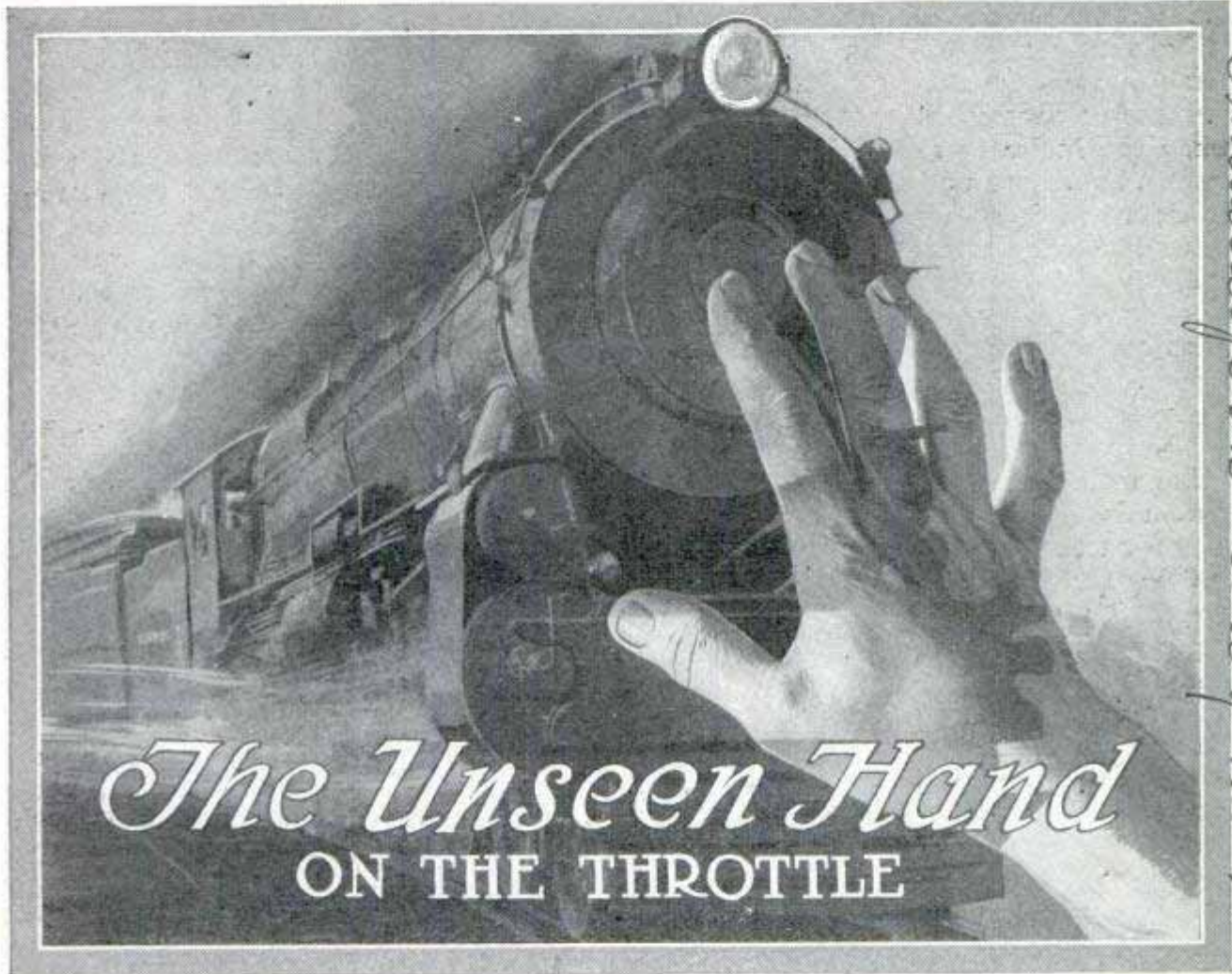

The Unseen Hand ON THE THROTTLE

CAN you imagine a train thundering over the rails at a speed of eighty-five miles an hour, approaching a red danger signal and coming to a halt with the engineer sitting motionless in his cab without attempting to stop the train?

You wouldn't believe it possible, but the Philadelphia and Reading railroad gave such a demonstration recently of its new train-control system, by which it is hoped to make railway service practically fool-proof.

The system enforces obedience to signals and compliance with speed regulations. It applies the brakes automatically, if the engineer exceeds eighty-five miles an hour, or when he goes above forty miles an hour, when caution signals are

against him, and again when he travels more than twenty-five miles an hour under danger-signal indications.

A broken rail or open switch ahead will cause a brake application. If the engineer does not comply with all signal indications and speed regulations, the brakes will bring the train to a stop. Any time the system or equipment fails, the train will be brought to a halt.

A device, inclosed in a steel box and attached to the locomotive, is operated by an electrical current flowing through the rails, which are divided into sections or blocks, each 4,500 feet long. Contact is made by receivers suspended from the front of the locomotive, six inches above the rails, by induction. The electricity

Conf. - Harold J. H. Carter, Editorial Dept
Philadelphia Daily News, 15th St. Cherry, Philadelphia Pa

travels to the equipment case, containing relays, radio-amplifying tubes, where it is stepped up to high voltage and carried to the braking system.

This train control also provides the engineer with a continuous, visible indicator in the cab, from which to determine at all times what speed he may run. Any changes in the condition of the track ahead of him are instantly registered on his cab indicator in sufficient time to enable him to increase or decrease his speed. In short, when the indicator shows an "H" (high speed), he may run at eighty-five miles an hour; when it shows an "M" (medium speed), he may run at forty miles an hour and when "L" (low speed) appears, he must keep his speed within twenty-five miles an hour. If something unforeseen happens ahead of the train, instant warning is given and the brakes will be automatically applied.

The train-control system is operated in conjunction with automatic block signaling, thus regulating the speed of the train to conform with signal indications. So long as the engineer complies with the signals, the control of the train is left entirely in his hands, but should

he fail to recognize them, the system takes hold and either stops the train or reduces its speed. In such cases it applies the brakes but never releases them.

After the brakes have been applied, the engineman has to release them by operating the acknowledging valve, to prove he is alert and in full possession of his faculties. The brakes hold for forty seconds, before they can be released, thus insuring that the train will be brought below the required speed limit.

Such, then, is the system of the automatic train control. Should the engineman die or fall out of his cab, there is no danger of a wreck, killing or injuring passengers riding in a train so equipped.

But a vast amount of work remains to be done on the invention, before it can be used on all railroads. The present cost is very close to \$14,000 a mile. Then again

there is the upkeep of the track. Railroad engineers, however, are working day and night to improve the device and lower the cost of maintenance.

Then will such catastrophes as rear-end collisions in fogs, derailments and other accidents that take a toll of human lives, be eliminated.

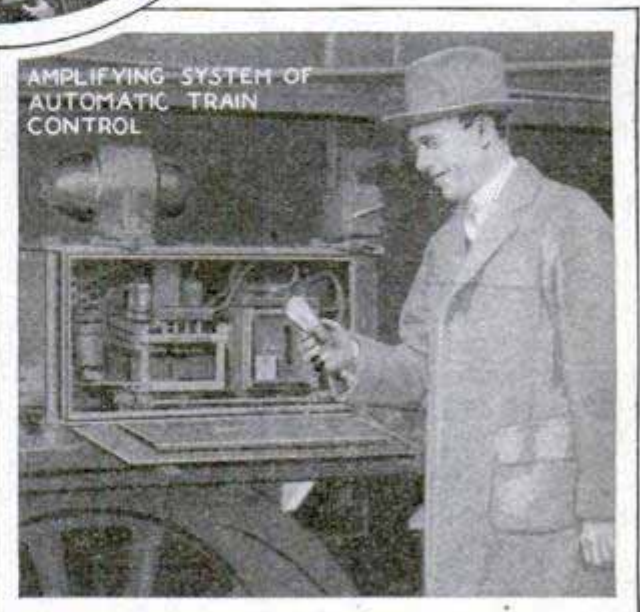
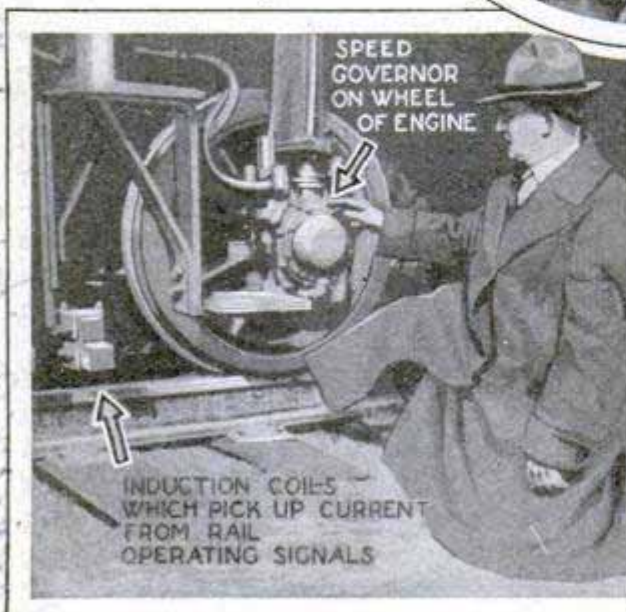
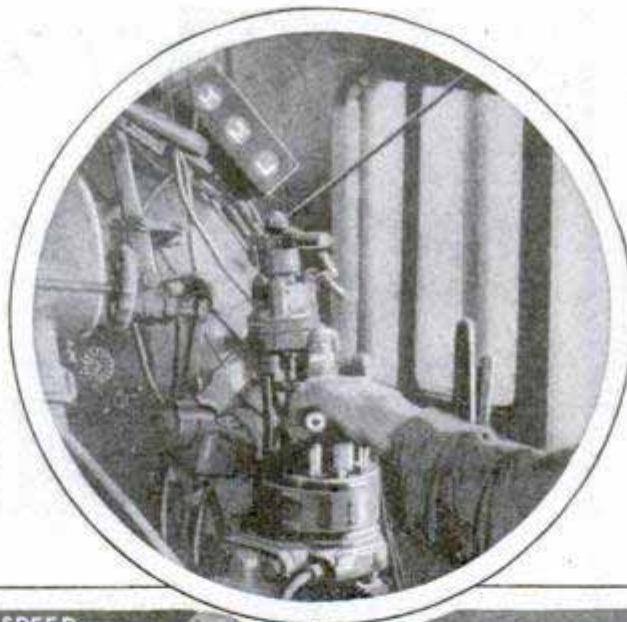

FROM AN ARMORED WARSHIP TO A FLORIDA HOTEL

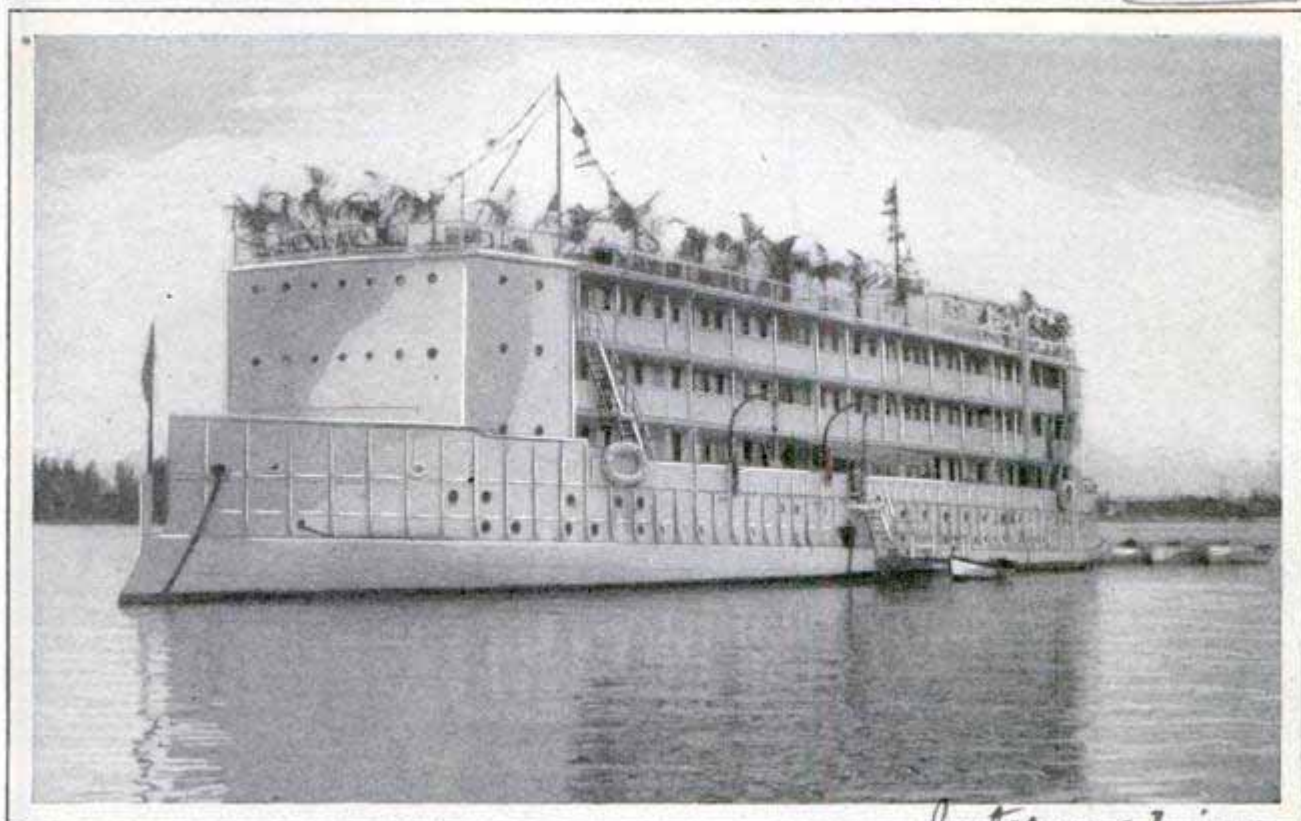

Once a Battleship and Now a Floating Hotel, the Experimental Vessel "Amphitrite" as It Appears Remodeled and Anchored on Lake Worth near Palm Beach, Florida

Instead of being scrapped—the fate of most old war vessels—the “Amphitrite,” an experimental battleship on which the government spent several million dollars, has been converted into a floating hotel. It is now anchored on Lake Worth near Palm Beach, Fla., and has been comfortably arranged to accommodate a large number of guests in suites of rooms equipped with every modern convenience. A large roof garden, hotel connections to the mainland and numerous promenades are special features.

BOOKS WITH COPPER LEAVES IN ODD COLLECTION 1673

Books with palm leaves and strips of copper for pages, others measuring a yard in length, some written on vellum and silk, stitched, folded and rolled volumes as well as many other curious publications were exhibited recently at the Newberry library in Chicago. One of the most interesting specimens was bound between wooden endpieces and richly decorated in gold and lacquer on twelve thin copper sheets, about twice the size of an average automobile license plate. A Sanscrit

Christian Science Monitor

manuscript was bound in elephant hide and others had been laboriously written on parchment or silk. A Turkish book, written between 1600 and 1658, contained an account of the discovery of America. The character of the workmanship on some of the religious volumes was indicated by the kind of ink used.

HOOD LINING PROTECTS MOTOR 1482 AND SAVES FINISH

To reduce the likelihood of freezing in cold weather and to obtain greater efficiency from the motor, a felt and asbestos lining material for the auto hood has been placed on the market. It also protects the paint by maintaining a more even temperature on the outer surface. The lining is so fashioned that the sides which cover the louvers can be removed quickly when driving in hot weather to prevent overheating.



Stephenson Protectahood Corp

Chicago. Simplex Automobile. 9291. A. Michigan Ave. Chicago.

HAZARDS IN DRIVING MONSTER SPEED AUTOMOBILE

1528
Built by Daimler-Benz, Mercedes-Benz, Stuttgart, Germany.
L. Cantalen, London, England.
Description.

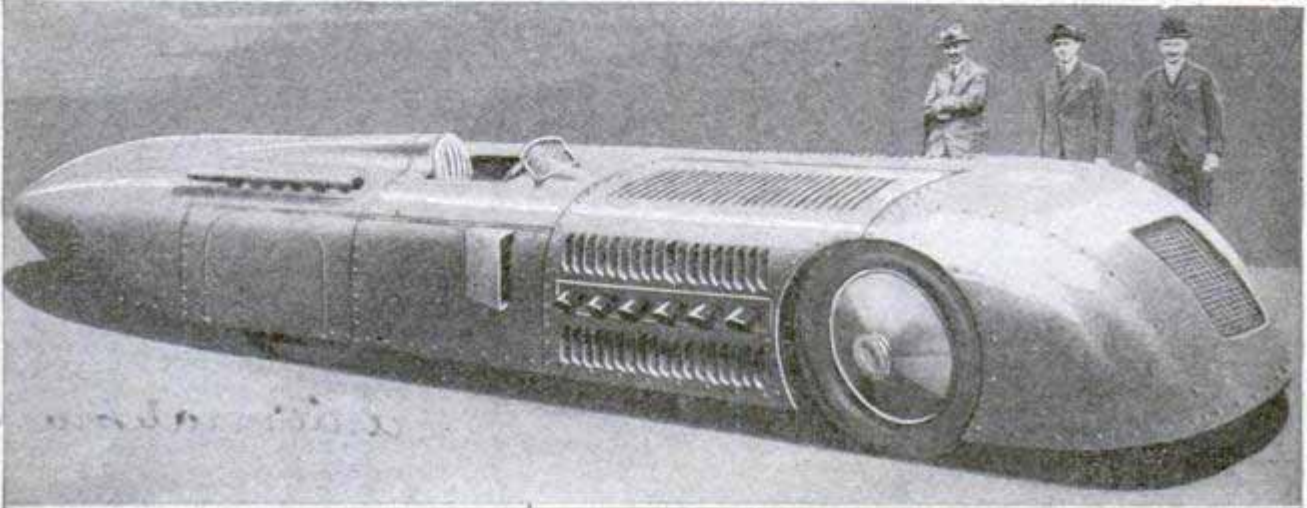
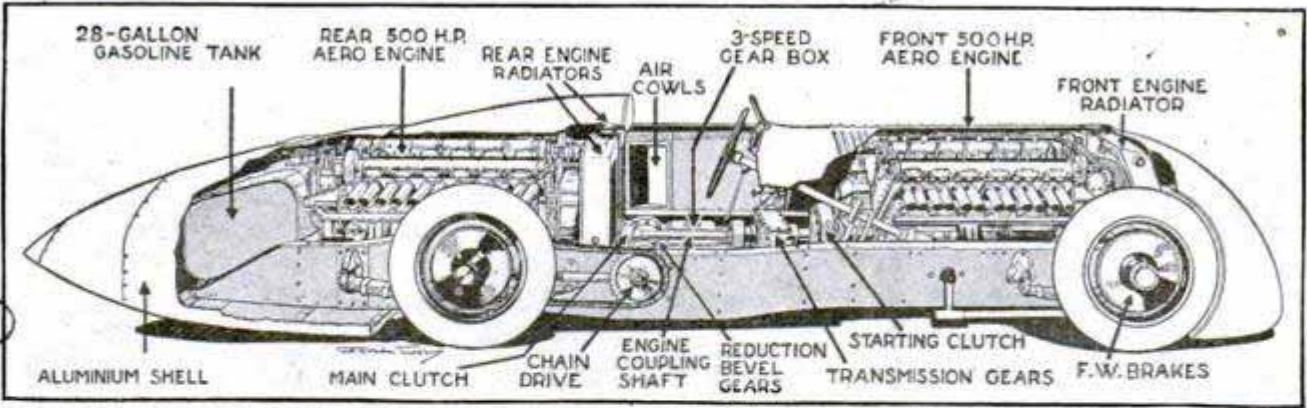

More Than Thirty Feet in Length, This Double-Engine, 1,000-Horsepower Racer Is Expected to Travel Faster Than 200 Miles an Hour over the Sands at Daytona Beach

The new racing automobile, built in England for Maj. H. O. D. Seagrave, to seek speed records on the sands of Daytona beach, Fla., with twenty-five miles of hard-packed straightaway, has two motors developing 1,000 horsepower. The big car had to be brought to America to be let out to full speed because there was no course in England large enough on which to try it. While Maj. Seagrave only expected to make a 200-mile-an-hour record, the car was actually designed for a speed of 220 miles. The present international record of 170 miles an hour is held by an Englishman, J. G. Parry Thomas, though several American drivers have made unofficial records higher than that. The new Seagrave car was built to better these unofficial marks. The builders encountered several unusual problems in constructing the giant, which has one engine over the front axle and one over the rear. They had to modify their body design considerably when they discovered that the car not only had the usual tendency to leave the ground and

fly, which has been encountered with other cars tested at Daytona, but that the rear end wanted to fly higher and faster than the front, with the result that the car would have turned a somersault long before reaching full speed. Another problem was the effect of the wind pressure if the car should be turned slightly out of a straight path while going 200 miles an hour. They found, in experiments, that if the machine deviated as little as ten degrees from a straight course, the enormous wind pressure would turn it around. Experts were consulted to determine how long it took the muscles to answer a signal from the brain, the answer being four-tenths of a second. In that time, at 200 miles an hour, the car would have traveled 120 feet, so it was decided that it would be utterly impossible for the driver to come out of a skid in the usual way if the car should go into one. The body of the unusual car incloses everything, even the wheels, to get away from the wind resistance the tires offer. The two engines, when fully out,

will consume four gallons of gasoline a minute. Seagraves, who is still in his twenties, has been famous abroad for several years because of the frequent records he has set up driving special racing automobile.

82 ft. maroon
10 ft. white
WEATHER STRIP EASILY PUT ON ELIMINATES RATTLING 1661

Several advantages are claimed for an improved kind of weather strip in that it can be applied by a novice, is thoroughly insulated against temperatures and moisture by a rubberized-fabric covering and requires only a hammer and tacks for installation. Being flexible, it is simple to adjust around corners, saving the trouble of mitering, sawing and waste, and it acts as a cushion to keep windows and door from rattling. It also keeps out dust so that it is suitable for use the year around.

GAME OF HUMAN VOLLEY BALL LATEST OUTDOOR SPORT 1491

Firemen and policemen, training for an athletic festival in Los Angeles, introduced something new in sports when they tossed a comrade back and forth in a vigorous version of volley ball. Life nets were used on both sides of a mesh barrier like that used in tennis and, besides affording amusement to spectators and players alike, the game gave excellent training in the use of the nets, which are often the means of saving lives at fires.

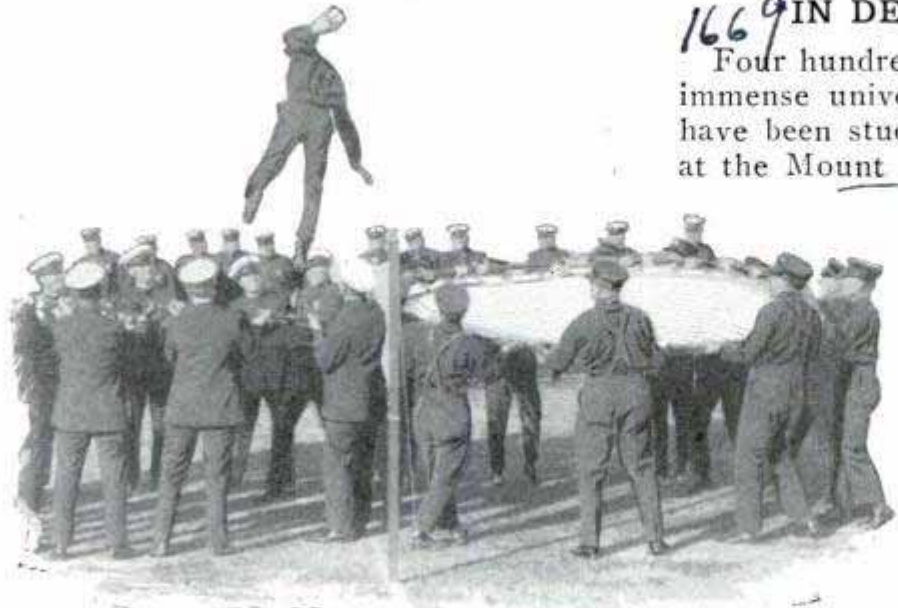

Over the Mesh from One Life Net to the Other; a Game of Human Volley Ball in Progress at Los Angeles

SOUND BOX PRODUCES SLEEP BY MONOTONOUS NOISE

1/18/9
Based on the fact that a softly humming, monotonous sound often serves to



Hum from the Ornamental Box on Table Produces a Soothing Effect to Induce Sleep

induce sleep, a clockwork apparatus patented by a German doctor produces the desired noise for about forty minutes after winding. In order not to awaken the person using it by an abrupt cessation of the sound, this gradually becomes weaker until it finally dies away. The outfit is contained in a small ornamental box which can be placed near the subject.

UNIVERSES OF STARS FOUND 1669 IN DEPTHS OF SPACE

Four hundred spiral groupings of stars, immense universes far beyond our own, have been studied by Dr. Edwin Hubble at the Mount Wilson observatory. Their average diameter is placed at 5,700 light years, one light year being about six thousand billion miles, and they are two hundred million times as bright as our sun, according to the astronomer. He also states that it has taken something like a million years for their light to reach the giant telescope where they were photographed.

from Astrophysical Journal.

Madison Ave + 45th
 HARPOON GUN DEVELOPED FOR OCEAN FISHERMEN
New York

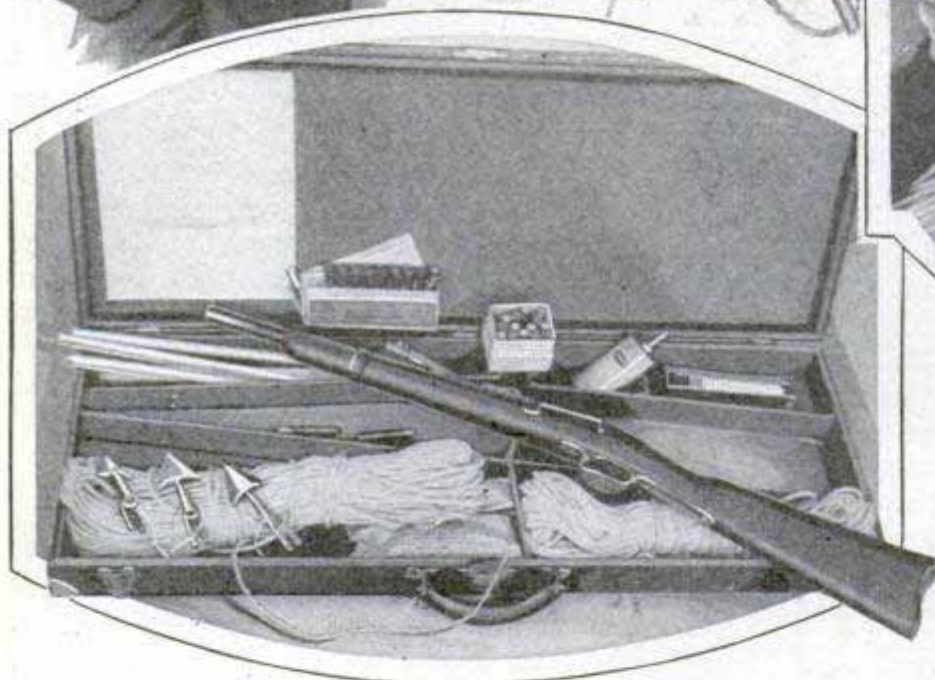

Old Army Carbine Converted into Harpoon Gun for Fishing; Close View of Dart and the Entire Outfit

Fishing for tarpon, sailfish, shark, porpoise, swordfish and other deep-sea game with a rifle harpoon is the latest sport among owners of fast seagoing motor-boats. The harpooner, with practice, it is claimed, can hit a six-inch target at fifty feet, which makes it quite easy to approach within firing range of fish basking near the surface. The basis of the harpoon outfit is the firing mechanism and stock of a Springfield .45-70-caliber cavalry carbine of the 1873 model, fitted with a special barrel, short and

much heavier than usual, with a clear, unrifled bore. The harpoon sticks are short lengths of dowel rod, one end of which slips into the barrel and rests on the end of a blank cartridge, loaded with forty-five grains of black powder. At the other end of the

stick, the harpoon head is loosely fitted. It consists of a bronze spear with two barbs nearly an inch and a half across. Two fingers extending from the head slip alongside the front sight and keep the harpoon lined up until it is shot. A length of wire leader is fastened to the shot line, of which two hanks, containing 300 feet of light line and 150 feet of heavy, come with the gun. In action the harpooner coils the line in a keg or bucket, placed to leeward so that it will not blow back and become tangled with his legs

while running out. One end is attached to the wire leader and the other to a keg buoy, which can be tossed overboard after the line runs out to mark the position of the fish. The gun is provided with an adjustable elevated rear sight to enable the gunner to offset the downward pull of the line.

TALKING MOVIES BY INVISIBLE LIGHT

1577
 Promise of further use of the invisible rays of the spectrum is seen as the result of experiments in employing them to transmit sounds and to project motion pictures. A physics professor at the Massachusetts institute of technology recently showed that the invisible rays could be harnessed to the movies. The pictures were invisible until they sprang into sight on a fluorescent screen. From the success of this experiment, it has been suggested that automobile headlights could project the invisible rays and yet expose autos, bridges, fences and other objects at night if they were covered with a substance which would have a luminous reaction under the influence of the rays.

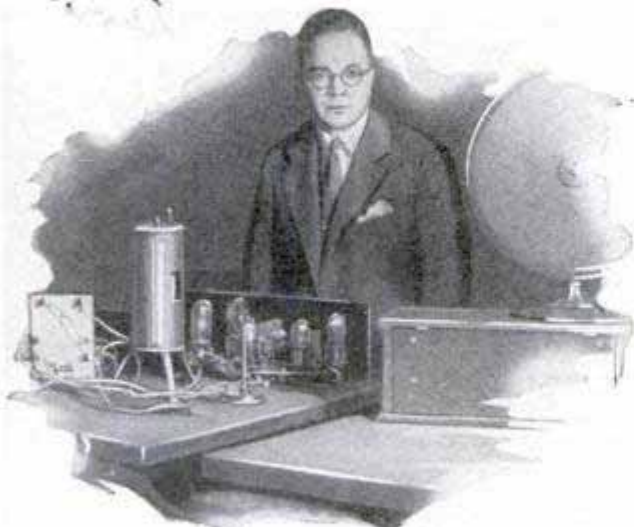

Dr. Donald C. Stockbarger with Part of His Apparatus for Projecting Movies and Sound by Invisible Rays

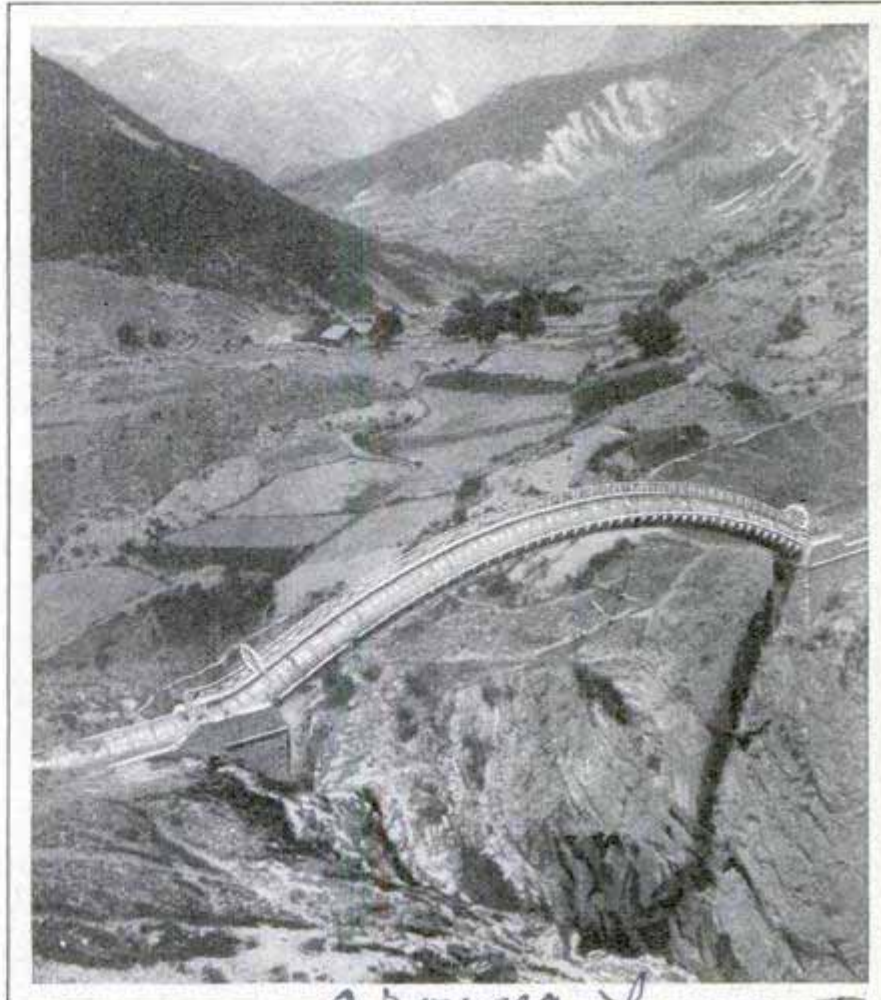

Copyright, Herbert Photos

Where Electricity Leaps a Mountain Canyon; Conduit over Stream in the French Alps More Economical than Cable Span

BRIDGE FOR ELECTRICITY SPANS WIDE MOUNTAIN CHASM

Electric current is supplied to a number of towns in the French Alps through a conduit that at one place in its course, assumes the form of a unique bridge across a deep mountain canyon. Constructing the duct required considerable engineering skill, but the bridge plan saved the expense of extra cable which would have been required in leading the line down and up the sides of the chasm.

ARTESIAN WELLS HEAT HOMES 164 AND PROTECT CROPS

Ranchers near Reno, Nev., are utilizing natural hot water, found in drilling to depths of 100 to 120 feet, for heating their homes and for irrigating to help protect various produce from frosts. The water has a temperature of about 200 degrees Fahrenheit and appears abundant.

near Moana Springs, Nevada



Samuel M. Greer, Left, and John W. O'Leary, President of the U. S. Chamber of Commerce, with Map of Phone Lines

NET OF LONG-DISTANCE PHONES LINKS ENTIRE COUNTRY

The widespread use of the telephone in this country is emphasized not only by the number of instruments in service but by the special long-distance lines which have been installed to speed communication. With the completion, a few weeks ago, of the line linking Seattle, Wash., with the system, hardly any large section of the country is now isolated from long-distance service, as may be seen from the accompanying map.

WAVES AND SUN HARNESSSED TO LIGHT BUOYS

Thousands of dollars are saved yearly by means of the so-called sun valve which automatically lights the lamps on gas buoys and in lighthouses for the protection of shipping. It saves employing many men for the task and is certain of operation. It is so adjusted that when darkness falls, the flow of acetylene gas stored in a large container, is increased. Daylight turns the gas nearly off so that it burns low during the bright hours. Another form of buoy utilizes the action of the waves to operate a pump which in turn affords water for running a small turbine to supply electricity for illuminat-

ing the light. Fog horns or moaning buoys are also rigged to work without the aid of man. Compressed air is furnished by means of a pump actuated by the waves. The only attention required is an occasional oiling. A lightship on the west coast of Scotland has no crew. Its light burns without care and when the vessel rolls, a bell strikes. Dutch engineers have also harnessed the sea to help strengthen the dikes. Jetties are built of reeds, running outward from the embankments. These gradually become covered with sand, owing to the action

of the waves, and by constructing successive jetties after others have become covered, a strong reinforcement for the dike is soon laid down.

TATTOO INSTEAD OF LIPSTICK GIVES PERMANENT EFFECT

Tattooed lips, marked in "Cupid's bow" pattern of red, are reported to be the latest beauty fad in California, regardless of the pain that accompanies the operation. The effect is permanent, saving repeated applications of the lipstick.



Applying the Make-Up That Lasts; the Tattoo Needle Adapted as Substitute for Lipstick

Jul. Photo: 8/28/26

How Youth Won

\$25,000 SWIM

International

Safe and Warm on Shore, Victor of the Long Battle with Tides and Chilling Currents; Young, as He Appeared a Few Moments After He Had Conquered the Catalina Channel

By JOHN ANSON FORD

WHEN George Young, the seventeen-year-old Canadian boy, swam the Catalina island channel to the California mainland, in fifteen hours, forty-seven minutes and thirty seconds, he made a record that stands as one of the greatest and most spectacular feats in the history of athletics.

There were 102 contestants and a first prize of \$25,000. At the start, Young, who had ridden most of the distance from Toronto to California on a motorcycle in company with a pal, was looked upon as merely one more of the big company of unprepared participants who were not aware of the terrific odds against them.

A great many things have been cited as being responsible for the Canadian lad's astonishing victory, but all the worthwhile factors simmer down to just three, and these are worthy of study by any

young person who may be dreaming of winning honors in swimming—endurance, speed, skill.

All his life, Young has helped to support his widowed mother. The beautiful, but cold lakes of northern Ontario's resort district contributed a lot to his endurance. The result was that Catalina channel, in spite of its comparatively low temperature, could not freeze him out.

Speed has been the second element in Young's success. It saved the day for him in the cold channel. It kept him warm and it got him out of the water several hours before many forecasters thought it possible to cross the channel. His self-confidence was well illustrated in a before-the-race talk he had with Capt. Harry Huff, of the tug "Martha," which had been engaged to convoy George. "Meet me just outside the bay,"

—referring to the starting place—the boy had said in giving instructions. “But how will we know you from all the other swimmers?” Huff asked. “Pick out the man first to pass Bird Rock, 300 yards outside the cove,” George answered, “That will be me.”

But speed and endurance would not have won without amazing skill. Some people have referred to George's stroke as “the Carlton.” Young and his trainer say this is hardly correct. They stated that George had gotten some helpful ideas from the young Australian swimmer, Carlton, but that the stroke used was the straight American crawl. However, there is as much difference between Young's execution of the American crawl and that of most swimmers, as there is between Paderewski's and an amateur's performance on a piano.

The crawl is what gives George his great speed. In non-technical terms, the crawl which Young used consists of alternate strokes with the right and left arm, while the legs keep up a continual flutter or kicking from the hips. The arm is brought out of the water, thrust forward and then swung downward and backward through the water until the hand is back near the hip. In the latter position the elbow is somewhat bent to assist in rais-

ing the arm out of the water and thrusting it forward again.

The general direction of the motion of the feet, is at right angles to the plane of the body, the heels rising to within a short distance of the surface of the water. While the movement of the legs is almost continuous, the expert learns to so, use the limbs that each benefits by a recurring though short moment of rest, thus enabling the swimmer to keep up his efforts for a long period of time. The movement is largely from the hips, with a slight bend in the knees and the ankles relaxed. In fast swimming, such as a 220-yard dash or longer spurts, the legs will give eight or more kicks to each stroke, whereas in slower swimming, such as was necessary in the channel, the number of kicks per stroke may be reduced to as little as four.

While endurance, speed and skill were the three essential features of Young's success, co-ordination, balance and relaxation were the underlying principles on which his performance rested. The three things mentioned first were possible only because the boy had learned perfect co-ordination of the arm and leg movements I have described, with his breathing. Many amateur swimmers instinctively develop this timing of the breathing



Greasing-Up before the Swim; Enough Creams and Lubricants Were Used to Stock a Store as Contestants Sought a Protecting Covering from the Cold Waters

with the movement of their limbs, yet many others never get it, and so are always out of breath or lack endurance. Balance is also a vital factor, for in that way no part of the body is taxed unduly and the energy exerted operates to the best advantage. In a long-distance swim perhaps the art of relaxation is of even greater importance. Without it cramps are certain to develop.

Mental poise accompanies, or perhaps creates, the capacity to relax. George says he never doubted his ability to reach the goal, though during the age-long hours of the dark night, it must have seemed a hundred miles away. As the lad blushing stood before a crowd and modestly tried to tell how he swam his way to victory, one could detect this poise that stood him in wonderful stead during the great test.

While the regulations prohibited giving the swimmers any physical support while in the water, attendants were allowed to supply the men and women in the race with food. Some trainers devised long poles with tin pans attached to the outer ends. In these solid and liquid foods were placed and held within reach of the human fishes.

Others tied long-necked bottles to poles. These bottles, when filled with liquid nourishment, were allowed to float in front of the swimmers so that they could refresh themselves with a minimum of effort. Other devices included long rubber tubes through which liquid was transferred by gravity. Chocolate and soups

were the most popular forms of food. Not the least interesting feature of the swim for the spectators was the lavish use of grease. Just before the start of the race, it was apparent that practically every contestant proposed to make his skin impervious to the salt water. Every make of cup grease was in evidence. Va-

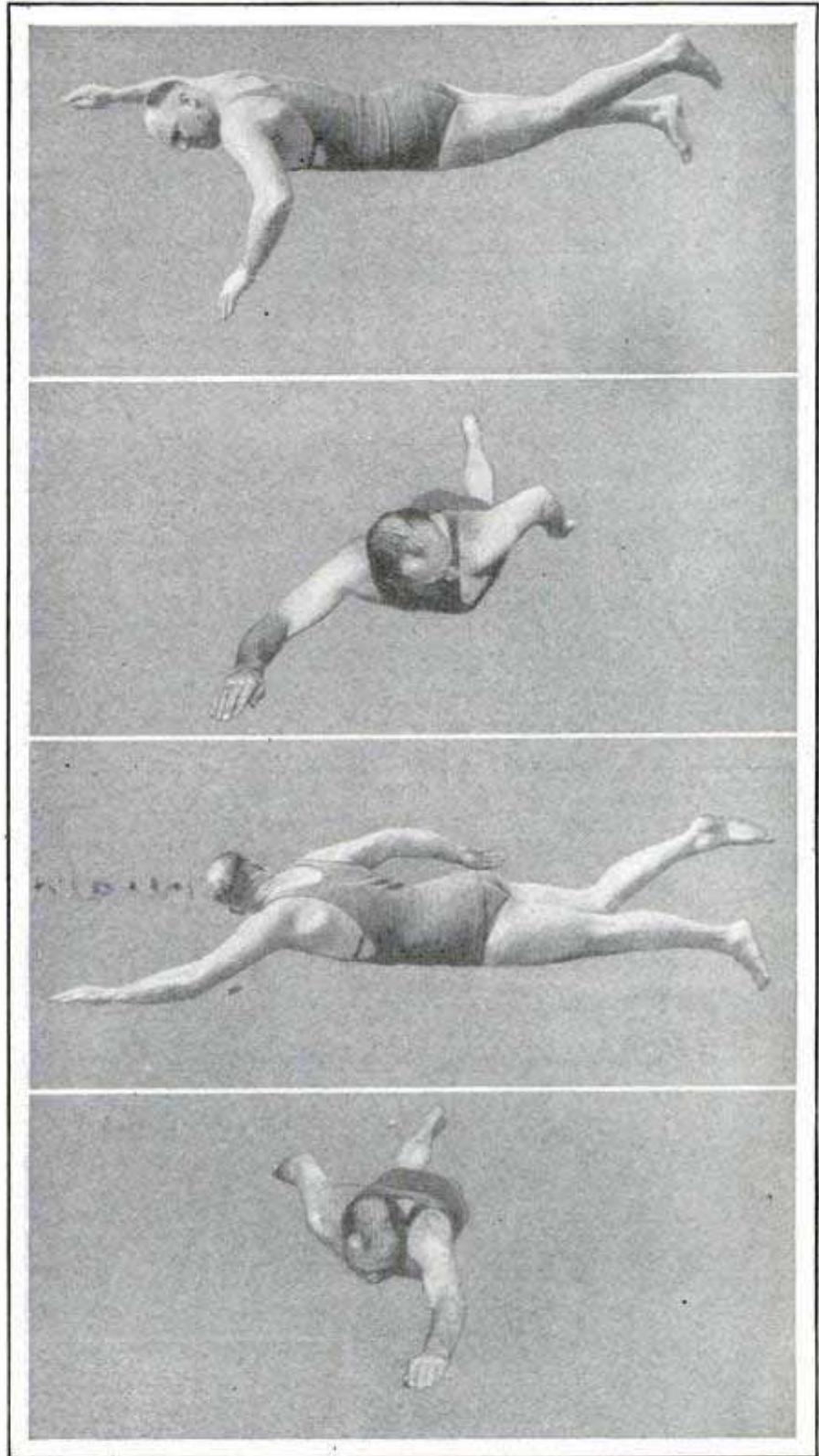

Swimmer in Poses Showing Various Positions of the Crawl Stroke Young Used in His Victorious Channel Feat

rious cosmetics, in quantities sufficient to stock an ordinary drug store or beauty parlor, were employed in giving coatings from head to foot. In every case, the grease was mixed with graphite.

The race started shortly before noon and the great test, which was as much mental as physical, came when dusk set in. Swimming in the daylight, with cheering friends in sight and beautiful water about, is one thing, and plowing along in the dark with water menacingly black is quite another. A count of noses showed that after ten hours just ten contestants remained in the water.

"It was the last two hours and a half that hit George the hardest," said his trainer. "There was a whole hour in which he made only 105 yards, by actual measurement. An ebb tide kept us slipping back from the shore; enough to break your heart. Three times the boy was within a few hundred yards of the finish and every time the water swept him back. No one who was not with us in our little boat can ever know how hard that lad battled out there alone in the

dark in the cold Pacific. But the endurance, speed and skill of youth won, and finally George thrust his tingling body beyond the grip of the tide, only to be confronted with one more menace—a great field of kelp, in which he found himself tangled before he realized the situation. Once more he summoned his strength and, pulling off the weeds, plunged forward in a final spurt that brought his feet to the rocks of Point Vicente light."

**RADIO TO SEND NEWSPAPERS
MARCONI PREDICTS** 1670

That reproduction of entire newspaper pages will soon be flashed across the Atlantic by wireless, is the opinion of Senator Marconi, who believes that "the wonders of radio are not yet by a long way fully disclosed or even realized." Such progress has been made in sending handwriting, typewritten messages, pictures and diagrams by wireless that the transmission of entire newspaper pages is but a logical advance step, according to the inventor.

Herald Tribune 1/27/27

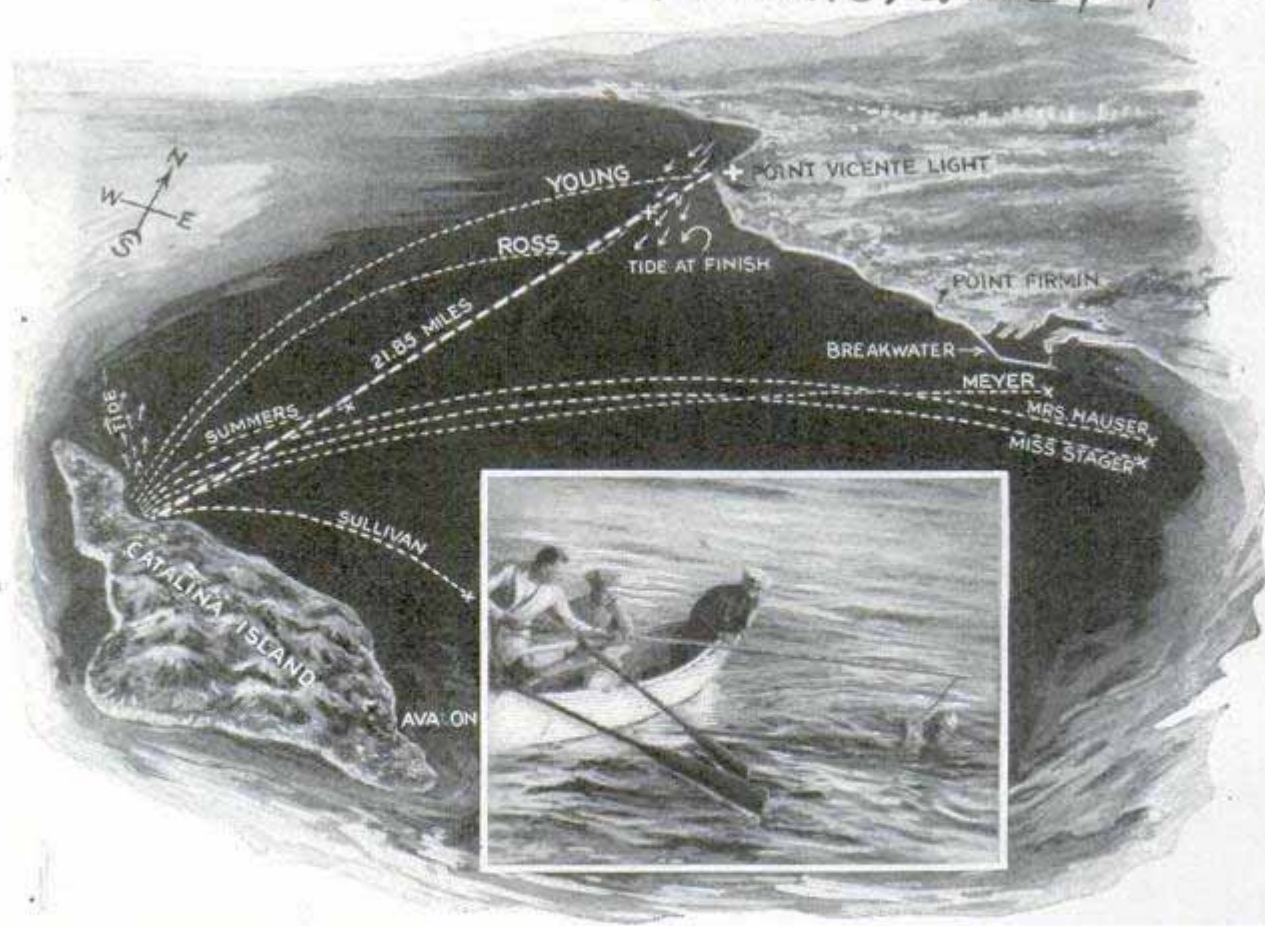

Chart of the Courses Followed by Different Swimmers and Inset Showing a Racer Being Fed from Boat; Note Sullivan's Short Journey; a Few Weeks Later, He Swam the Channel

**HOUSE WITH NO FIRE PERIL
 TO HAVE STEEL FRAME 1668**

"Fireproof throughout" is a common phrase in describing the type of construction in various kinds of buildings, but every insurance company knows that the word "fireproof" is generally used in a relative sense and costly blazes occur almost every day in structures that were supposed to be immune from such damage. However, a two-story, seven-room dwelling in Detroit, Mich., is said to deserve the 100-per-cent fireproof stamp, for it has floors of an asbestos composition laid on concrete supported by steel joists, the walls are of steel-frame units connected with insulating material and metal lath on both sides. A three-coat waterproofed stucco covers the outside walls, while the interior is finished in hard plaster on metal lath, with a dead-air space between. Windows have steel sash, the roof is of steel trusses and covered with cement tile; doors, trim, baseboards, picture moldings and chair rail are steel, enameled to represent walnut; the stair stringers and risers are of steel, also enamel-finished, and the treads are cement mortar on metal lath topped with a composition flooring. The builder asserts that the dwelling cost no more than any frame structure of good materials and workmanship built on the same plan.

**HITCH PERMITS TOWING AUTOS
 AT HIGH SPEED 1505**

Easily attached to the service car, an adjustable hitch insures greater safety in towing automobiles, as it prevents collisions between the disabled vehicle and the one ahead, and keeps the trailer in line and in the proper position on the street. The hitch consists chiefly of a V-shaped bar of two telescoping members, secured by hooks to brackets which are bolted to the rear of the service car. A clamp, attached to a ball-and-socket joint at the end of the bar, can be connected to the front or back of the car that is to be towed. A triangle hitch is also furnished for use with a crane.



Stationary Running in the Training Treadmill; Pugilist Taking Road Work in the Gymnasium with the Canvas Roller Belt to Push with Feet and Grips to Support Part of the Weight

**BOXERS TRAIN IN TREADMILL
 TO DEVELOP BREATHING**

Road work is considered important in the pugilist's training, as it develops the lungs and leg muscles and cultivates endurance. Outdoor practice is not always possible because of the weather, so a substitute has been found in a form of stationary running on a canvas belt on rollers. The apparatus is like a treadmill, the user partly supporting himself by handles at the side. Trainers declare that practically the same results can be obtained from the apparatus as from regular road exercise.

Helium has been produced in minute quantities from hydrogen in Germany.

*Used by Abservatory Boxing Club,
 San Francisco, Calif.*

*The Manley Mfg Co
 Used for*

ART OF SWISS SNOW SCULPTOR RIVALS WORK IN MARBLE

Along with other winter sports, the art of snow sculpture has become increasingly

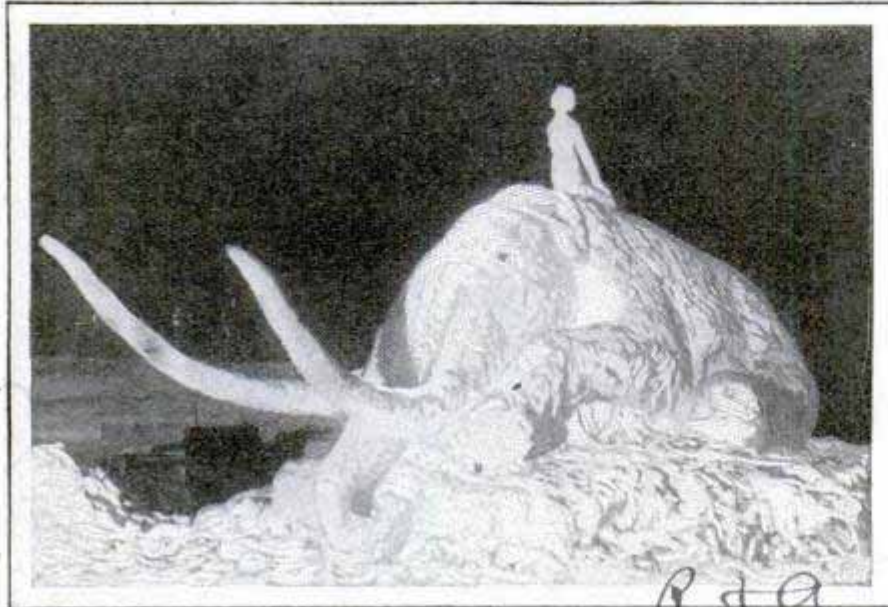

Mammoth Surmounted by Dryad Figure, a Snow Creation by Visitors at Swiss Resort Where Winter Sculpture Is Popular

popular at Arosa, a center of winter fun in Switzerland. Temperature and the texture of the snow are often well suited to the fashioning of beautiful models, as the accompanying illustration of a mammoth and dryad shows. The beauty of the sculpture is best observed at night when lights are thrown upon the models.

SWALLOW BEE-STING POISON TO TEST ITS POWER

Do the sting of the bee and the bite of the spider help cure rheumatism and other ills? Seeking light on these and similar questions with regard to the insects' poisons, a New York physician has been performing some interesting experiments with fifty college students who swallowed capsules containing sugar of milk, vegetable matter or the poisons. The subjects were not told what they had taken and were asked to report on the ef-

fects. Some noted such virulent symptoms that they immediately brought them to the doctor's attention. He was interested to note that virtually all of them were the milk patients and apparently had imagined their ills. The sting of the bee, at least when taken internally, appeared to be less potent than the will to be sick. The size of the potions was increased gradually in order that more definite effects would be obtained.

CHIPS FROM ITALY MAKE MARBLE

Marble chips, too small to be used for ornamental purposes, are shipped to the United States from Italian quarries, mixed with carefully prepared cement and fashioned into slabs which closely resemble real marble. A realistic texture is obtained by using pigments. Plain slabs are cast on concrete tables, while those with irregular edges are made from plaster casts. When they have hardened, they are rubbed down with sand of silica and then finished with a fine honing stone so that the surface will be smooth. A polish with emery dust gives the required gloss. This "manufactured marble" is widely used for table tops, stairs, floors and walls.

SPEAKING TUBE IN HOUSE DOOR HELPS PROTECT HOME



Using the Door Tube, and Close View of the Attachment with Perforated Mouthpiece

To protect the home against intrusion, a speaking tube in the door gives the inmate of the house opportunity to decide whether the voice of a person outside is familiar or not. It is easily installed, requires no batteries or other connections and is adapted to any kind of door.

Mr. Linzi J. Boyd, New York, Homeopathic Medical College and Hospital

Yates and Ch... 7252

Albert S. Burns, 17th St. Bay Plaza, Calif.

1660

829

1586

door done

POPULAR MECHANICS
drw. Colin M. Williamson, C.B.E.
AERIAL MAP MAKING WITH ELECTRIC CAMERA

Williamson Mfg Co. Ltd. Litchfield Gardens, Willesden Green, London, Eng.

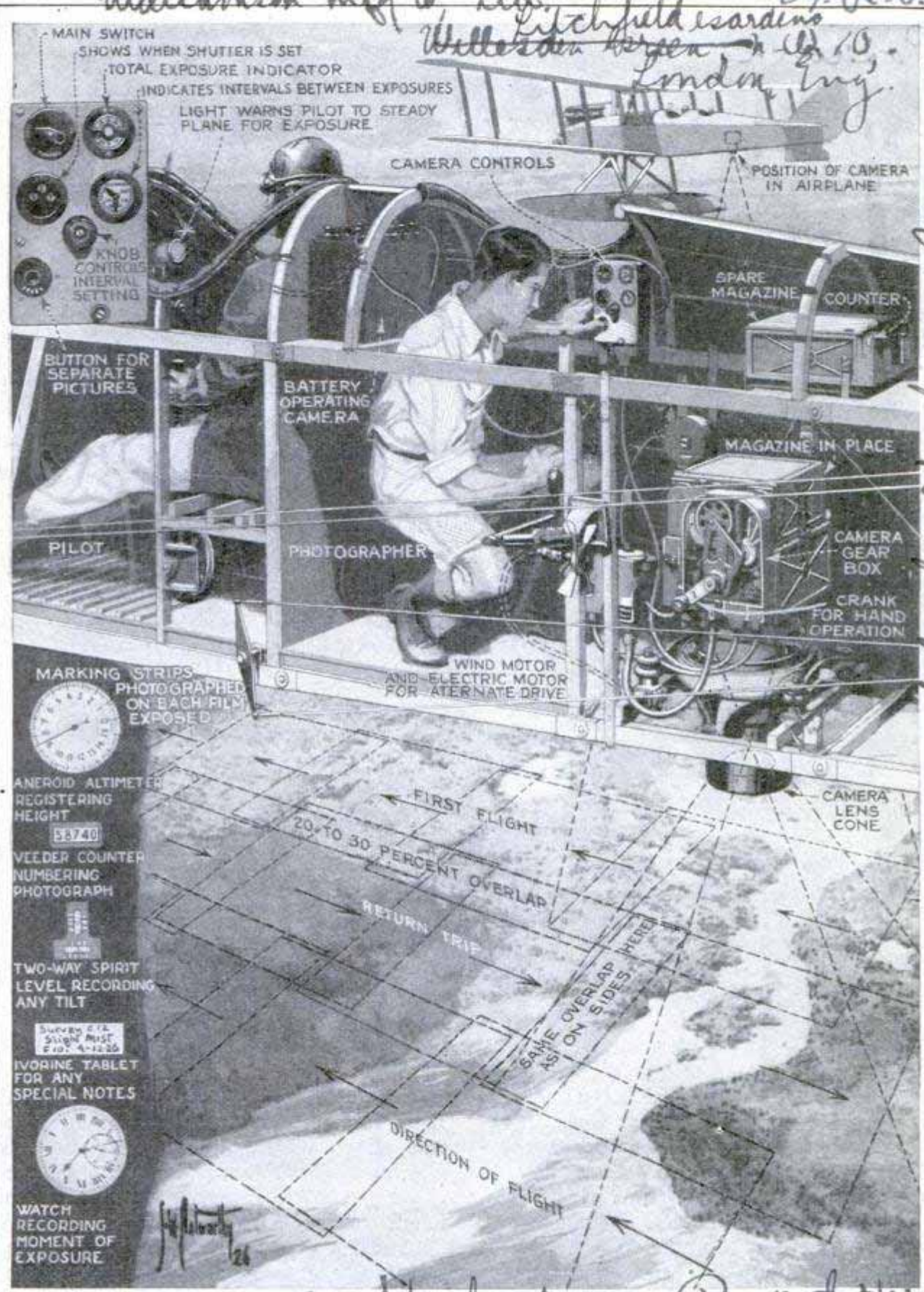

MAIN SWITCH
 SHOWS WHEN SHUTTER IS SET
 TOTAL EXPOSURE INDICATOR
 INDICATES INTERVALS BETWEEN EXPOSURES
 LIGHT WARNS PILOT TO STEADY PLANE FOR EXPOSURE

KNOB CONTROLS INTERVAL SETTING
 BUTTON FOR SEPARATE PICTURES
 PILOT

CAMERA CONTROLS
 POSITION OF CAMERA IN AIRPLANE
 SPARE MAGAZINE
 COUNTER

BATTERY / OPERATING CAMERA
 PHOTOGRAPHER
 MAGAZINE IN PLACE
 CAMERA GEAR BOX
 CRANK FOR HAND OPERATION
 WIND MOTOR AND ELECTRIC MOTOR FOR ALTERNATE DRIVE

MARKING STRIPS PHOTOGRAPHED ON EACH FILM EXPOSED
 ANEROID ALTIMETER REGISTERING HEIGHT
 53740
 VEEDER COUNTER NUMBERING PHOTOGRAPH
 TWO-WAY SPIRIT LEVEL RECORDING ANY TILT
 SUPPLY & SIGHT TEST FROG ANALOG
 IVORINE TABLET FOR ANY SPECIAL NOTES
 WATCH RECORDING MOMENT OF EXPOSURE

Sold by Vickers, Ltd. Vickers House, Westminster, London, England. W. Clatworthy, 26 Roadway, W.I.

© S. W. Clatworthy, *sq. 18. Shakespeare Road, Perne Hill, London SE 24*
 Aerial Map Making Is Made Easier with a New Electrical Camera Which Is Entirely Automatic and Photographs on the Film a Complete Record to Guide in Piecing It Together
Eng

LIFE-SAVING SUIT IS BUILT LIKE DIVER'S DRESS

Pictorial Press Bureau 45 W. 41st St. New York

Posidon

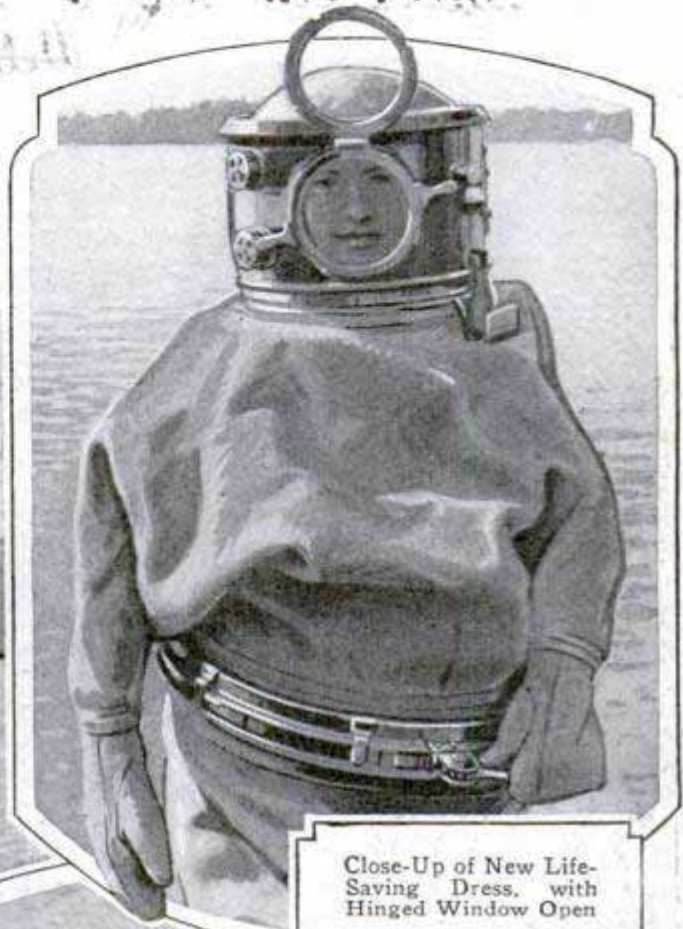

Close-Up of New Life-Saving Dress, with Hinged Window Open

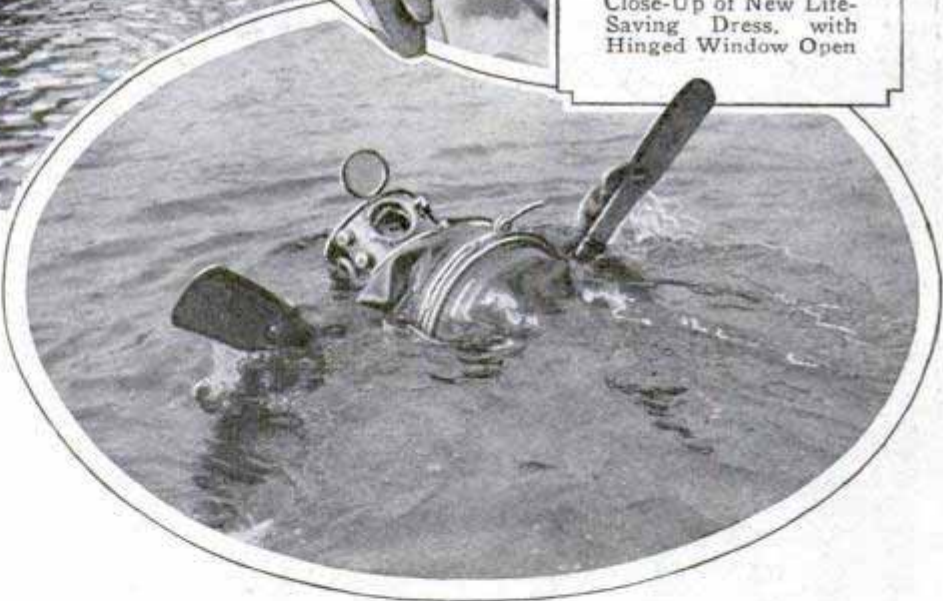

A German Diver Jumping from a Bridge, Above, Wearing a New-Type Life-Preserving Suit Which Makes It Impossible for the Wearer to Stay under the Surface; at the Right, He Has Come to the Top, Opened the Small Window in the Helmet, Fitted to His Hands a Couple of Short Paddles, Which He Had Carried at His Waist, and Is Paddling Himself Along to the Shore

A life preserver which closely resembles a deep-sea diver's outfit has been introduced in Germany. It includes a complete rubberized suit and a helmet of metal, fitted with a window in front of the face, so arranged that it can be opened by the wearer, or closed and made water-tight. In tests, the demonstrator jumped from a high bridge, the fall being great enough to send him several feet under the surface, but, because of the large amount of air the suit contains, its buoyancy was

sufficient to send him to the surface almost immediately. As soon as his head was above water, the diver opened the window to replenish the air supply, fitted short paddles to his wrists and hands, and began rowing himself backward to shore. The inventor claims that in event of shipwreck a wearer of the suit could remain afloat indefinitely, even in a storm, by keeping the window closed most of the time and only opening it at favorable moments to replenish the air supply.

1/21/27

AFRICA GETS GIANT TELESCOPE TO SEARCH FOR NEW STARS

Through a huge telescope that has been completed after many months of work, astronomers propose a ten-year search about the skies from an observatory in South Africa for the purpose of measuring the known double stars and to hunt for new ones. The lens for the instrument was made in Pittsburgh and cost \$25,000. It will be mounted under an electrically operated fifty-foot dome, costing approximately \$30,000.

1816

NOVEL ELECTRIC POWER PLANT REQUIRES NO DYNAMO

Direct current, sufficient to light a forty-room house, is said to have been produced by an electric plant, the parts of which cost only \$80 and which makes use of a system of thermocouples instead of a dynamo. The apparatus is the invention of two eastern investigators, who are said to have discovered an alloy of cheap and abundant metals to make the operation and construction of such generating units practical. The principle of producing electricity, by variation of temperature in two different metals, has been known for more than 100 years, but has not been widely adapted because of mechanical and other difficulties. The heat required is furnished by oil, gas or coal burned beneath a cylinder containing the thermocouples.

1557

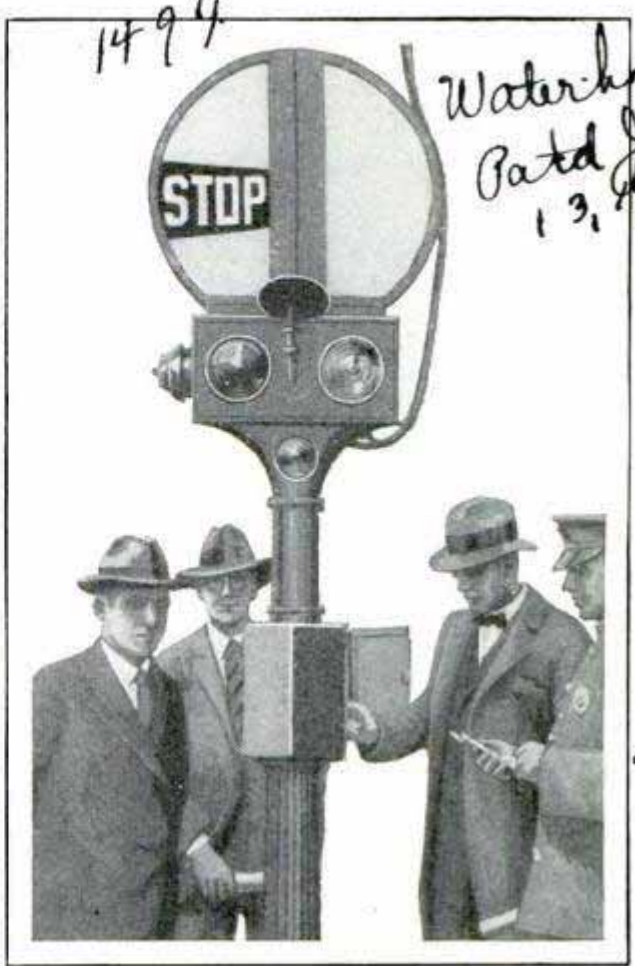

1494

Waterhouse
Patd June
13, 1925.

Universal Traffic Signal Co.,
Paradise, Calif.

Demonstrating the Traffic Signal Which Has Moving Disk, Seen in Top Bracket

TRAFFIC SIGN HAS MOVING DISK FOR STOP AND GO

Lights are supplemented by a moving disk, on which the words "Stop" and "Go" are marked in red and black porcelain enamel, in a traffic sign that also has a bell. The revolving disk is timed to show the signs corresponding to the lights, and the interval is easily regulated according to the volume of traffic. At night, the disk is illuminated with a floodlight so that it can easily be seen at considerable distance. The signal may be operated automatically or by hand.

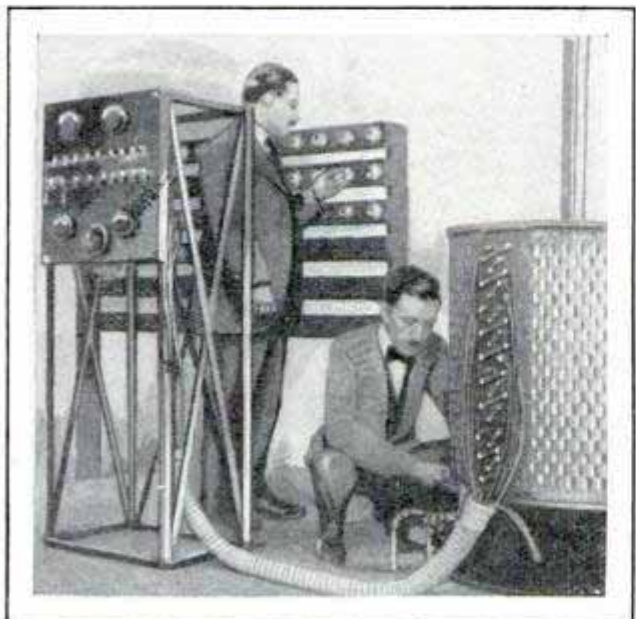

Electric Plant without Dynamo; Cabinet Containing Thermocouples Seen at Right, Switchboard at Left

FIND FIVE NEW KINDS OF FISH IN WESTERN OKLAHOMA

7623

Among five varieties of fish, discovered by members of the University of Oklahoma's zoological expedition in the western part of the state recently, and heretofore unknown, was a third type of black bass. More than 180,000 specimens were gathered on the trip and are being classified for a museum.

Inventors - Alexander Martin and Bruno

World 1/23/27

Rebuilding America's



Head of the Snake God, One of the Most Used Decorations in the Ancient Mayan City of Chichen-Itza

For four hundred years or more, the ruins have been pawed over by soldiers, priests, adventurers, and, later, trained and amateur archaeologists. Now, however, they are not only to give up their last secrets, but one of them, which was once the Mecca of the Maya world, is to be reconstructed as nearly as may be to what it was in its prime.

At Chichen-Itza, the holy city of the Mayas, a party of American archaeologists, representing the Carnegie institution of Washington, has embarked on a ten-year reconstruction program, under agreement with the Mexican government that all the art treasures found shall be preserved at the site as part of a Maya museum.

DOWN in the southernmost part of Mexico, in the state of Yucatan, which raises the sisal for American-made harvester twine, a great race of people lived and died nearly a thousand years before Columbus discovered the new world. At their height, they boasted a civilization as great as the ancient Egyptians; they knew more about mathematics and astronomy than any ancient people, and their builders, stone carvers and artisans in precious metals and other craftsmen turned out work the equal of any produced under the Pharaohs.

Chichen-Itza won its fame because it was the possessor of the sacred well in which Maya maidens were sacrificed to Kukulcan, the god of rain. Not only were the living sacrifices hurled into the sacred well as mates for the god, but gold and jade ornaments, beautiful pottery, carved wood, in fact, every kind of possession that its owner held precious, were cast to the waters, as well as an occasional enemy warrior whose valor was considered sufficient to make him an attractive present.

Yet they died and their cities and marvelous temples fell into ruins. Their civilization was lost mainly because they could not cope with the high cost of living, and their towns fell down largely for the reason that they had never learned to build an arch to hold up the roofs. The high cost of living for the Mayas was due to the fact that they possessed no draft animals to plow their fields, and the agricultural methods they used eventually produced a turf so thick and heavy that their plants could not pierce it.

The sacred well is a huge pit, about 180 feet across and 140 feet in depth, with sides that are nearly vertical, or even undercut in places. Fed by underground streams, it maintains an almost constant water level seventy feet below the ground, making the water seventy feet in depth. A stone causeway, reminiscent of the Via Sacra, or Sacred Way, of Rome, leads from the pool of the temple of Kukulcan, a quarter of a mile away. The roadway is thirty feet broad and at places was elevated twenty-five feet above the surrounding plain so that the religious pro-

All the first Spaniards found were the decaying ruins of great stone cities, wonderful temples and enormous pyramids.

Sacred City



Courtesy the
Carnegie Institution

El Castillo, the Great Temple atop a Pyramid, from Which the Religious Processions Advanced to the Sacred Well, to Throw Maidens In as Sacrifices to the Rain God

cessions moving down from the temple were visible to the thousands packed along the way.

The great temple itself rises atop an enormous pyramid, 200 feet square at the base and seventy-five to eighty feet high, the exact height being difficult to measure because of the debris which time and marauding soldiers have piled about the base. The top of the pyramid was leveled off in a stone terrace, sixty feet square, upon which stands the temple. The pyramid construction is typical of all the Mayan buildings. The sides rise steeply at an angle of fifty degrees, being broken into terraces nine feet high, each terrace faced with cut and perfectly matched stones, fitted so well they required no mortar. On each of the four sides a great stone stairway, not quite so steep, breaks the lines of the pyramid. All Mayan stairs are much steeper than we are accustomed to, with very narrow steps, making it almost impossible to climb them wearing modern shoes. The barefooted or sandaled Maya Indians did not need the breadth of stair step we do.

Each of the stairways is flanked on either side with a stone balustrade carved to represent an enormous serpent, the sacred image of Kukulcan, the body flowing down the pyramid in graceful undulations and each fold marking one of the terrace lifts, while the huge stone head, with bared fangs, is raised at the foot to face the approaching visitors. The problem of the ancient Egyptians in moving the huge stones of the pyramids was no greater than the difficulties the Mayas met in carving and placing the huge sections of these serpents. The heads, which represent fabled feather snakes, have enormous open jaws, exposing the fangs and extended forked tongues, every detail correctly carved, and all, with the exception of the tongue, being made from a single piece of rock.

Two more enormous monolithic serpent heads guarded the main entrance to the temple, facing the distant sacred well. They also served as door posts, dividing the entrance way into three sections. The foreshortened heads were the bases of the columns, and the tails were wrought in-



Four and a Half-Mile Sundial, Used by the Mayas at Copan to Check Their Calendar, and Diagram Explaining How It Worked

to capitals as graceful as any creation on an ancient Grecian column. The triple-vaulted ceiling of the temple, composed of an enormous weight of carved rock, rested on immense beams hewn from wood of the sapote tree, a wood that is almost as hard and heavy as iron. The beams are elaborately carved.

An enormous stone table, supported by curiously carved human figures, originally stood in front of the main doorway, probably having been used in some sacrificial rite. Curiously, the figures supporting the table and all the carved figures in the temple, covering every column, are bearded—the only bearded figures found in the entire city, built as it was by a beardless race. Close examination, however, indicates that the figures were carved to represent covering masks rather than actual faces, and that it is the masks which carry the beards—a fact that only adds to their mystery.

Mayan legends are crammed with stories of a race from beyond the sea, some of the stories indicating that the originals of the bearded figures may have come from the fabled lost continent of Atlantis, while others lead some authorities to believe they may tell of Norsemen who arrived by boat, blown across the ocean long before the time of Leif Ericson, who is reputed to have reached New

England's coast about the year 1000 A. D.

Edward H. Thompson, an American who for more than thirty years owned the plantation which includes the ruined city, collected a vast store of wonderfully carved objects, pottery and other relics from the ruins, and, as a climax to his work, dredged and explored the sacred well and brought up not only the bones of more than ninety unfortunate victims of religious sacrifice, but gold and jade and other objects, the metal of which alone would be worth several hundred thousand dollars if melted down. In "The City of the Sacred Well," T. A. Willard, a friend of Thompson's, tells how the archaeologists recovered a vast quantity of the treasure with a bucket dredge, and finally donned diving suits and descended to the bottom of the seventy feet of water to search out every last object which it might hold.

Nearly all the pottery, bowls, knives and other instruments and utensils had been broken before being thrown to the rain god, for the Mayas believed that all objects had a soul, and that it was necessary to "kill" them by breaking so that the soul of the utensil could accompany the sacrifice victim to the spirit world. One rare find, however, was a wonderfully carved golden sacrificial knife, which probably had been dropped into the pool by accident. There also

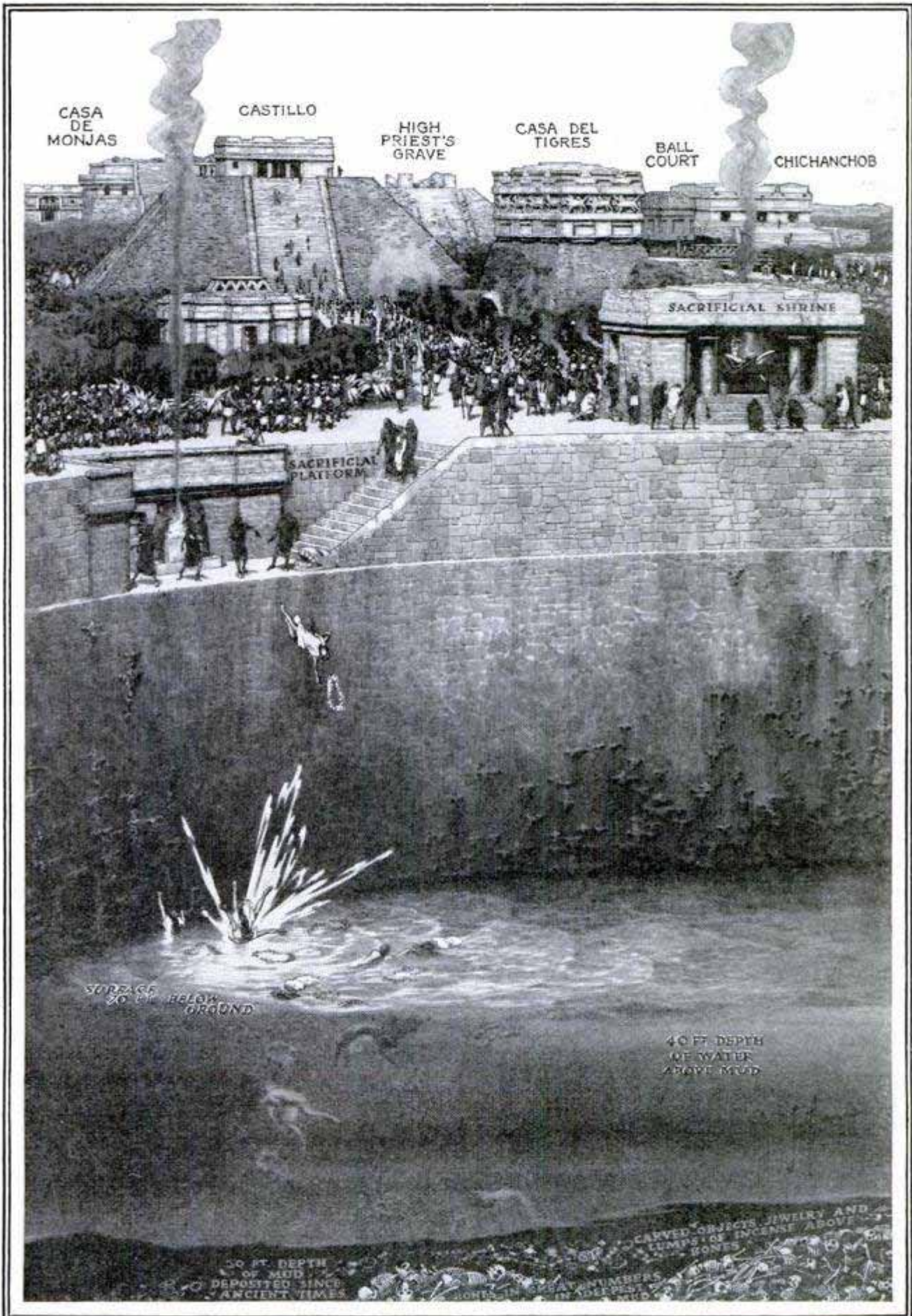

Chichen-Itza's Temples and Sacred Well during a Sacrifice, When the Most Beautiful Maidens Were Hurled into the Water to Be the Brides of the Rain God, as an Artist Reconstructs the Scene

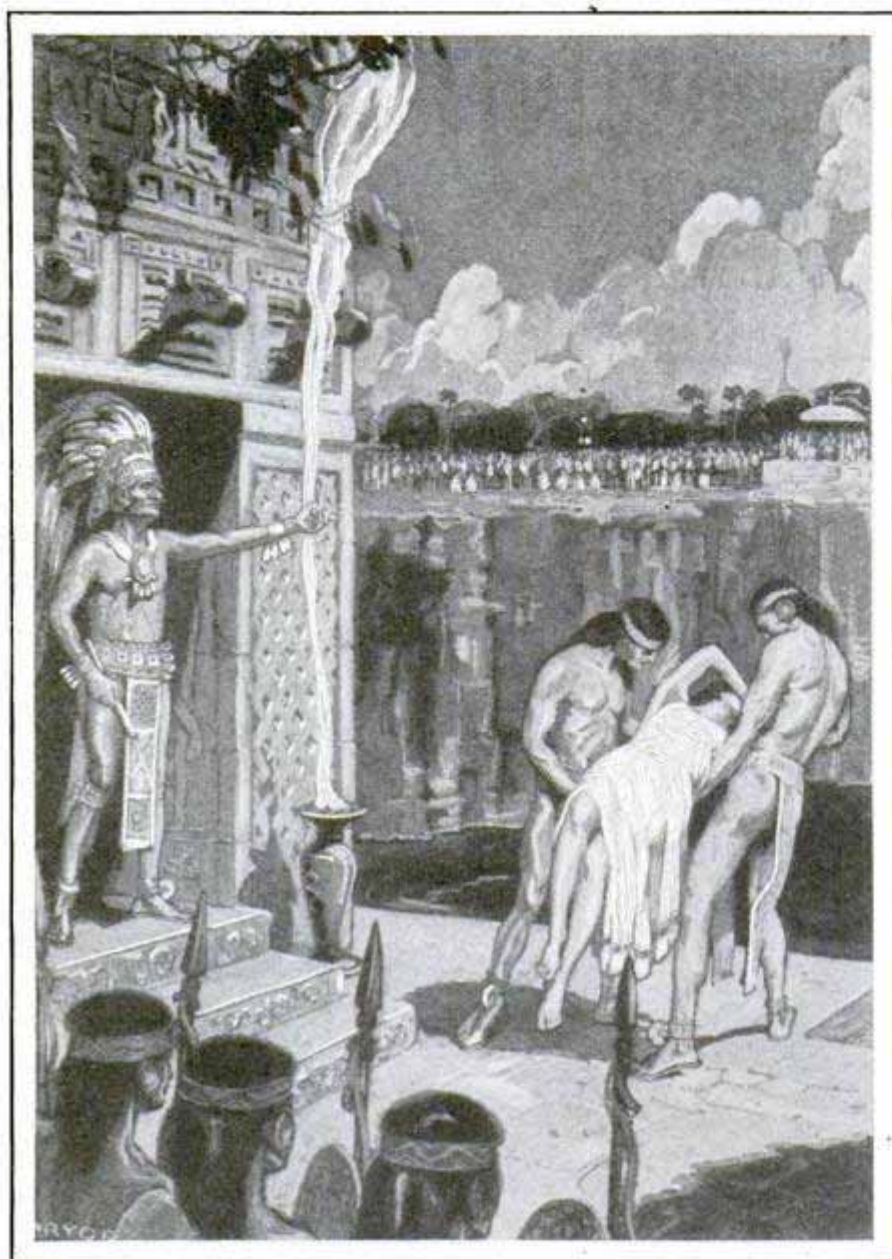

From T. A. Willard's "The City of the Sacred Well," courtesy The Century Company
 The Final Rites of Sacrifice Were Performed in a Small Temple beside the Sacred Well

were many beautiful "hul-ches," or throwing sticks, which served the Mayas in lieu of bows. The throwing stick had a handle with a crosspiece somewhat like a sword guard, except that it contained two holes, for the first and middle fingers. The handle fitted in the palm, with the fingers through the holes. The end was curved over, to hold the end of a short javelin, while the shank of the weapon came up inside the palm, ready to be released when the hul-che was brought forward in the throw.

The large number of jade ornaments recovered from the well add to the mystery of the Mayas, but it may be partly solved by the recent discovery of jade in the Pacific northwest, the first time it

has ever been found outside of Asia. Previous to that discovery, it was assumed the jade had been brought from Asia over the land bridge that once existed at Bering Strait. Comparison with the American jade, however, may only deepen the riddle.

It is their knowledge of astronomy, mathematics and building, that interests the explorers more than their ornaments and worship. One of the ruins of Chichen-Itza, called the Round Tower or Snail Shell, is unique in that it is one of two buildings of Mayan architecture which were neither square nor oblong. The name snail shell comes from a circular inclosed stairway in the building. It is believed the round tower was an astronomical observatory, and observations made from it show that it was possible to sight through opposite windows and observe stars at certain times when they were twenty degrees above the horizon.

Another Maya city, the ruins of Copan, discovered some distance away in Yucatan, has revealed an immense sundial, four and a half miles across, formed by two pillars on hills to the east and west of the city. By sighting from the east to the west stela, or pillar, it was possible to fix the change of the seasons, for the sun set directly behind the western stela on April 9 and September 2. The base of the western pillar has a second depression in which the column formerly was placed, and in that position the sun would set behind it four days earlier in the spring and four days later in the fall, showing that at some period the Mayan calendar had been corrected by simply moving the column. The April date

570

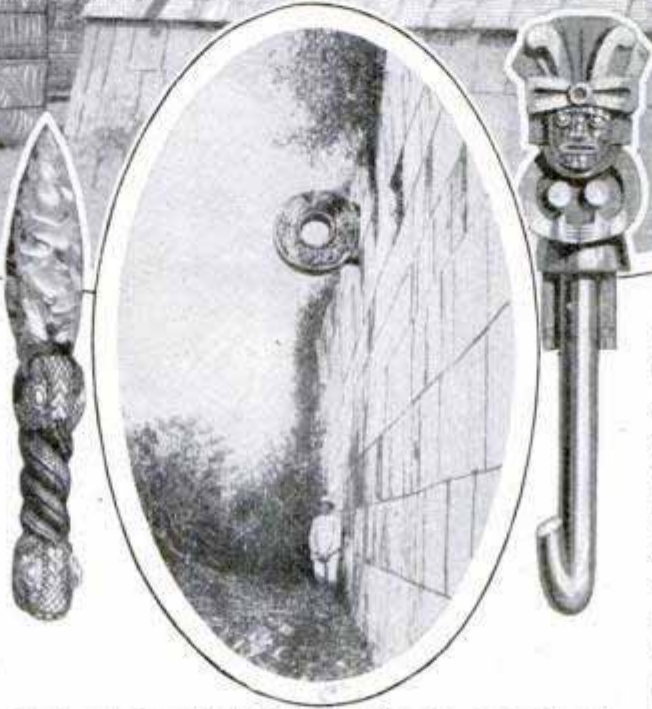
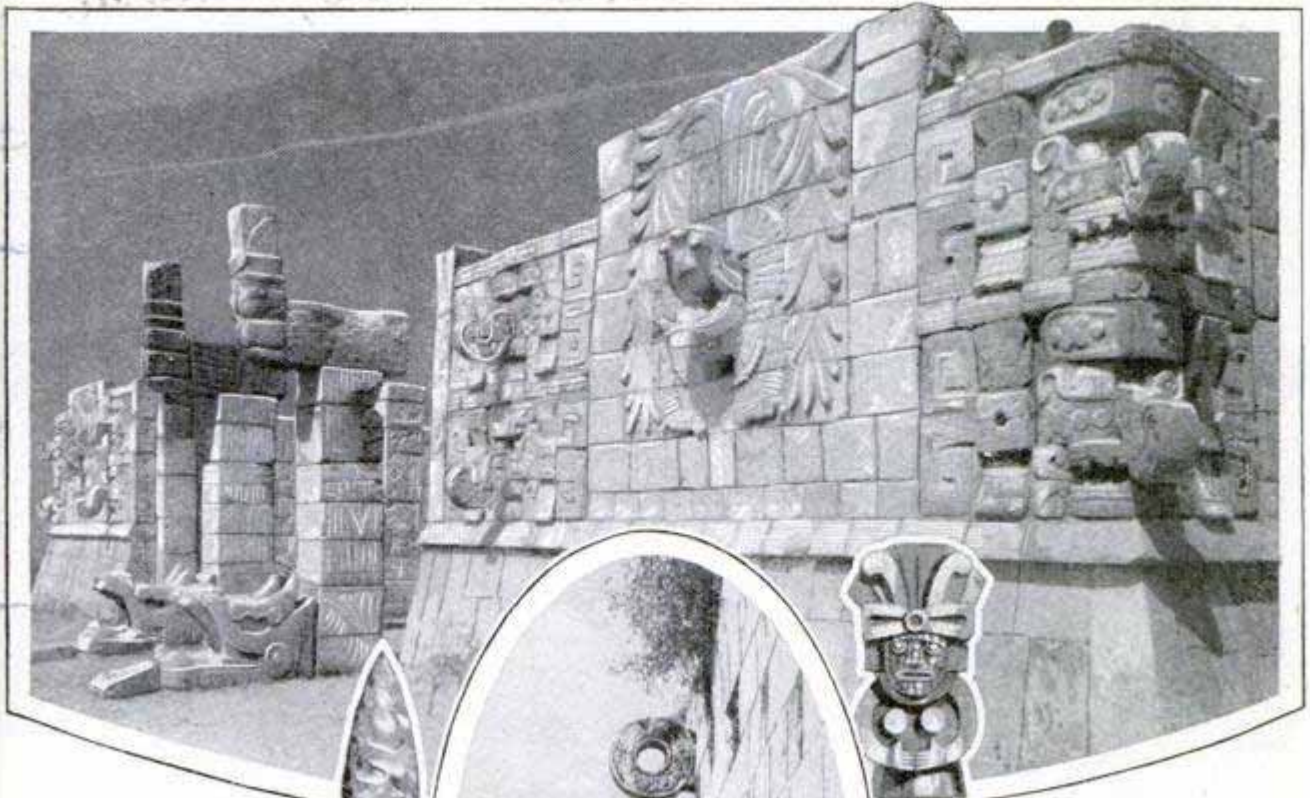

was the Mayan New Year, or beginning of their agricultural year. Both stela bear series of carvings in which many dates have been deciphered, while in the valley there are numerous small pyramids, one of which was erected to mark the passage of each twenty years.

The Maya year contained 365 days, but as they had no leap year, it gradually fell behind at the rate of one day every four years. One of the stela bears a date series which is translated as April 5 of our year 471 A. D., while the other bears a date of April 9, ten years later, with the added information that this date was "O Pop" or the Mayan New Year's day. This not only fixes the new year as beginning on the first day of the agricultural year, but likewise indicates that the moving of the stela occurred in that ten-year period.

The Mayas at Chichen-Itza had an enormous athletic court, almost big enough for a football field, in which they played a game that apparently was a cross

between tennis and basketball. Two big carved-stone rings on opposite sides of the court were used to cage the ball, but, as they were placed vertically and at right angles to the wall, the ball could be batted through them only when the player stood very close to the wall, a fact that probably required the players

to be equally skillful with either hand. At either end of the court there was a small temple with a portico almost Grecian in its style, and the back of one of these porticos was curved outward to form a perfect sounding board, showing the Mayas knew something of acoustics. A whisper can be heard across the court. The main work of the Carnegie institution expedition, under Prof. S. G. Morley, is concentrated at present on the reconstruction of the Court of a Thousand Columns, which takes its name from the vast number of columns in it. Already a great throne and many rooms have been uncovered and the walls restored as far

Implements from T. A. Willard's "The City of the Sacred Well," courtesy The Century Company
 Reconstruction by the Carnegie Institution, Above, of Ruined Temples; Below, the Game Court with Stone "Basket" and a Sacrificial Knife and Throwing Stick

W. H. ... College
Charles Martin National
autochrome plates would not register the moving life under the water, so it was found necessary to make the plates hypersensitive in order that exposures might be reduced to a twentieth of a second. Because of the dampness and excessive heat, this work had to be done at five o'clock in the morning to prevent the emulsion on the plates from melting. But even the hypersensitive plates would not register at depths as much as fifteen feet owing to the reduced power of sunlight; consequently it became necessary to construct a flashlight mechanism which could be operated by the submerged photographer at the right moment. Three small pontoons were built to support a dry-cell battery, reflector and flashlight powder, and the apparatus was so arranged that the diver could handle it and set off the powder. But the assistants who kept pumping fresh air to the man below the surface had to keep close by, yet manage to maintain a safe distance from the powerful charge of flash powder. The camera used in making the pictures was inclosed in a brass case with a plain glass window in front of the lens. Focusing was done with the aid of a reflecting mirror, so that the diver did not have to bend over his instrument, a feat which would have been almost impossible while in his suit and helmet.



Whether Mayan Sculpture Was of Local Origin or Shows Traces of Influence from Overseas, Is a Question Puzzling to Scientists

as the ruined masonry can be fitted together again.

The Maya builders never learned to make an arch, so their only way of supporting a vaulted roof or a doorway too wide to take a capstone, lay in utilizing a corbel, a form of construction in which each successive layer projects slightly past the one below it, until eventually the two sides meet. The corbel, however, is not self-supporting, as is an arch with keystone, and as the Maya limestone is soft, it eventually gave way under the burden, which accounts for the complete collapse of so many of their buildings.

When - \$12.50. Michel - \$13.50.

ELECTRIC HEATER KEEPS AIR CONSTANTLY IN MOTION

Operated from an electric-light socket, a portable heater has 175 openings at the top, permitting the heat to pass through and upward, so that circulation of the air is maintained as long as the current is on. Tests are reported to have shown that this type of heater will heat a room in one-third of the time required by an ordinary reflector unit. It is not intended to heat the whole house but merely one room, such as an office, bathroom or nursery.

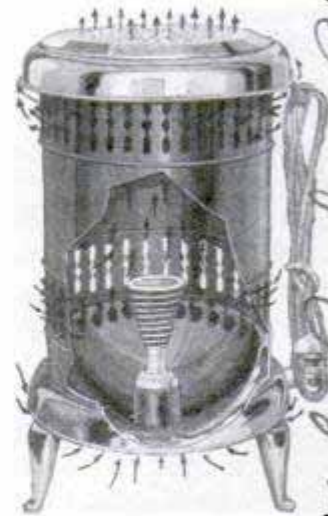

14 E. Jackson Blvd.

SUBMARINE PHOTOS IN COLORS LATEST PICTURE TRIUMPH

Dangers and difficulties were encountered, but successfully mastered recently, in taking natural-color photographs under the sea off the Florida Keys. Ordinary

1476

M. Jones 1/6/27

Rose Mfg Co.

1207

Ferryboat with Tilting Prow for Service between Germany and Denmark; It Can Carry 1,000 Passengers and the "Hinged Nose" Aids in Docking and in Handling Cargo

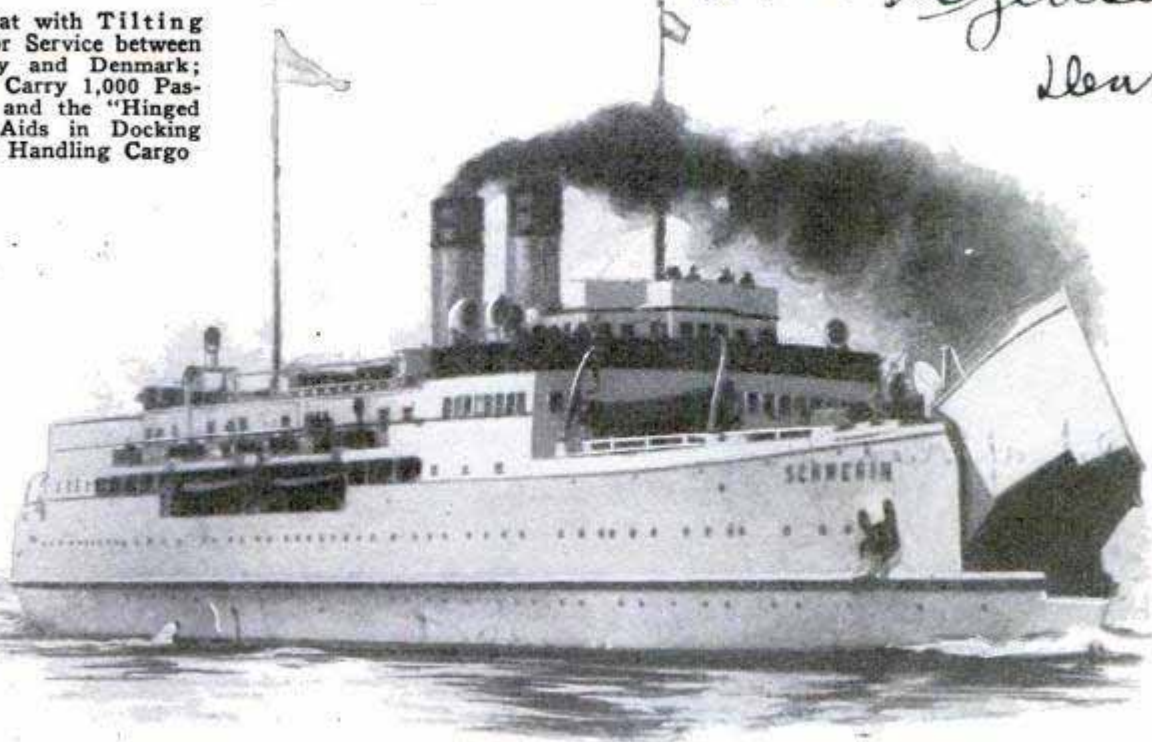

FERRYBOAT HAS TILTING BOW TO SIMPLIFY LOADING

Run by oil-burning motors, a ferryboat operating between Germany and Denmark can carry 1,000 passengers. A special feature is the construction of the bow which tilts up for loading and unloading cargo from the end.

FOOD PROBLEM OF AQUARIUM IS A BIG ONE 1507

Some fish eat meat or insects, others thrive only on certain vegetables, and still others will consume practically anything edible. Preparing the food for the many species of fish that will be housed in the Shedd aquarium in Chicago will require two special rooms equipped with refrigerators and other conveniences, it is estimated, while various parts of the world will be drawn upon for the supplies. The seahorse, for instance, is partial to certain varieties of salt-water

"bugs," vegetarian fishes have a fondness for lettuce and cracked corn, while many of the smaller ones eat condensed foods such as dry shrimps. Some need an occasional extra "dish" as a variation in the fare; hence it will be necessary to give them snails, angleworms, lobsters, frogs and house flies from time to time. The cannibal fishes will be watched carefully to keep them from indulging their desires, and for others that consume living creatures only, many thousands of minnows and shiners will be kept on hand. The fishes will be fed three times a week.

MODEL PLANE MADE TO ASCEND WITHOUT RUNNING START 1092

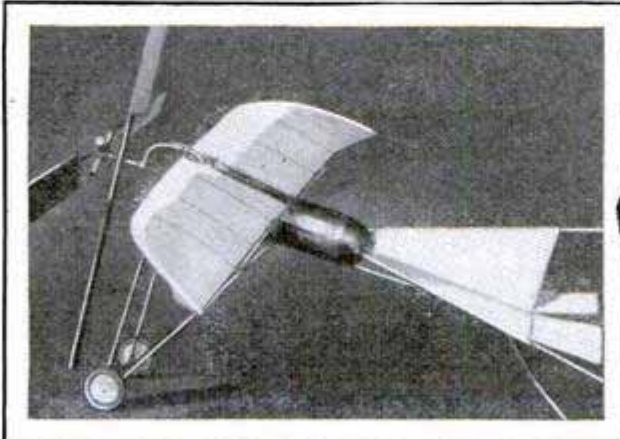

Model of Plane for Perpendicular Ascents and Landings; It Is the Work of a Hungarian Inventor

Further progress in perpendicular flying is said to have been made by a Hungarian inventor, who has devised a model plane that can ascend without a running start and descend straight down. If successful, this will eliminate the need of a wide landing field.

Walter A. Chute Associate Director Mechanical Engineer

1273 *Equipment Co.,*

554

312 N. Craig St. Pittsburgh Pa.

POPULAR MECHANICS

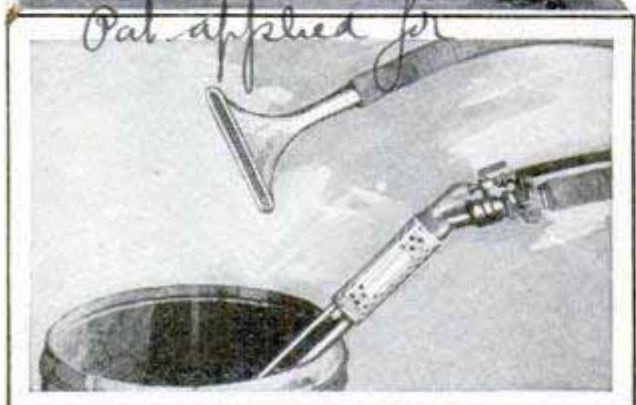

Spray Nozzle in Use, and the Vacuum Attachment for Cleaning Automobiles Inside

AUTO SPRAY GUN AND VACUUM SIMPLIFY CLEANING

For cleaning the automobile, inside or out, two simple attachments, intended to be used with the air-compressor outfit, have been devised to reduce labor and save time. One is a spray nozzle through which water is forced to clean all parts of the automobile, and the other is a vacuum-cleaning attachment with a large nozzle and a smaller one for reaching into crevices. Both are said to be adaptable to low-pressure systems.

USING BOTH YOUR HANDS GIVES YOUR BRAIN A REST

About seventeen out of every 100 babies born are naturally right-handed, three are left-handed and the rest are capable of using either hand with equal ease, it is said. Due to methods of training, by the time the infants are three years old, all except the three who were naturally left-handed will use the right hand for most tasks. It is said that there are more than 400 different kinds of work in which the equal use of both hands is an advantage and, by being able to interchange, a

worker affords his brain an opportunity to rest, to a degree, for the muscles of the left side of the body are controlled by the right side of the brain while the left side controls the muscles on the right side of the body. Several famous men have been almost equally efficient with either hand. Landseer, the artist, could paint two pictures at one time, using both hands, Leonardo da Vinci was equally accomplished, as was Holbein, the portrait painter. Sir Oliver Lodge can use both hands with ease and a British surgeon was noted for the fact that he could employ either hand with equal skill in operations.

TABLE AND TYPEWRITER CASE COMBINED IN ONE

1385

Increasing the usefulness of the portable typewriter, a carrying case, devised by a southern school-teacher, is converted into a serviceable table when unfolded. Besides the typewriter, which is taken without its own case, the container has room for writing materials and a small dictionary. Extended, it provides a spread of thirty by twenty-six and one-half inches, and folded, occupies a space of seven by twelve and one-half by fifteen inches. It weighs only eight and one-

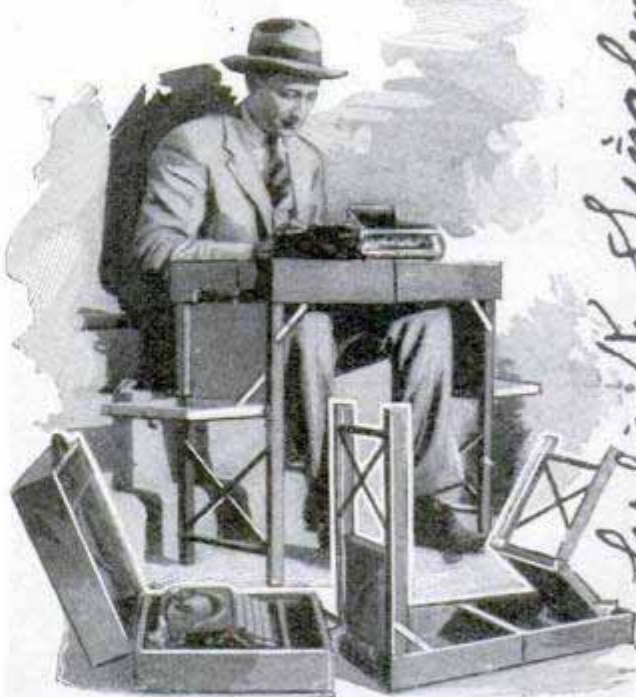

Table Set Up, and Folded as Case to Carry the Portable Typewriter

half pounds. Special catches on the leg joints insure the rigidity of the table.

Desbie, N. Singley, Director of Manual Arts, W. City Schools, Hendersonville.

Ind. Bats 1/15/27

Kingston, N.Y.



Transforming Insect Bodies into Bits of Jewelry of Varied Pattern and Color; Sample Pieces and Mounting a Specimen; Wax Treatments Help Preserve the Insect Bodies After They Have Been Properly Prepared

**MAKING JEWELRY OF INSECTS
NOVEL FRENCH ART**

Thousands of butterflies and beetles are converted into brooches, necklaces, earrings and other articles of jewelry by French artisans who are said to be the most skillful in the world in this unique craft. The beetles are carefully sorted, dismembered and then reassembled and treated with wax, to make them suitable for mounting. Butterfly wings are cut into geometric patterns for mosaic designs, under glass. Sometimes the butterflies are inserted whole between sheets of glass for decorating ash trays, etc.

pressure and are difficult to inflate without a pump. A recently introduced type of equipment of this kind is so constructed that there are a number of inner sections or air chambers, resulting in a tufted and dimpled surface, similar to that of a heavy comforter. The articles can be blown up with the lungs, the load is more evenly



distributed, and they are said to be softer than the ordinary kind. Hot-water bottles are also made in this fashion. When filled, the content does not all run

**AIR-POCKET CAMPING CUSHION
IS EASILY INFLATED 156 7**

Inflated mattresses and cushions, for camping and other purposes, are not new, but most of them present a bulging surface when blown up, require considerable

to the bottom, causing the bottle to assume a bulging or pear-shaped form, and the tufted bottle may be wrapped about the arm or other portion of the body. The outer side is covered with cloth, and repairs may be made with ordinary automobile-tire patching materials.

K-W Rubber Co., Delaware, Ohio

1314

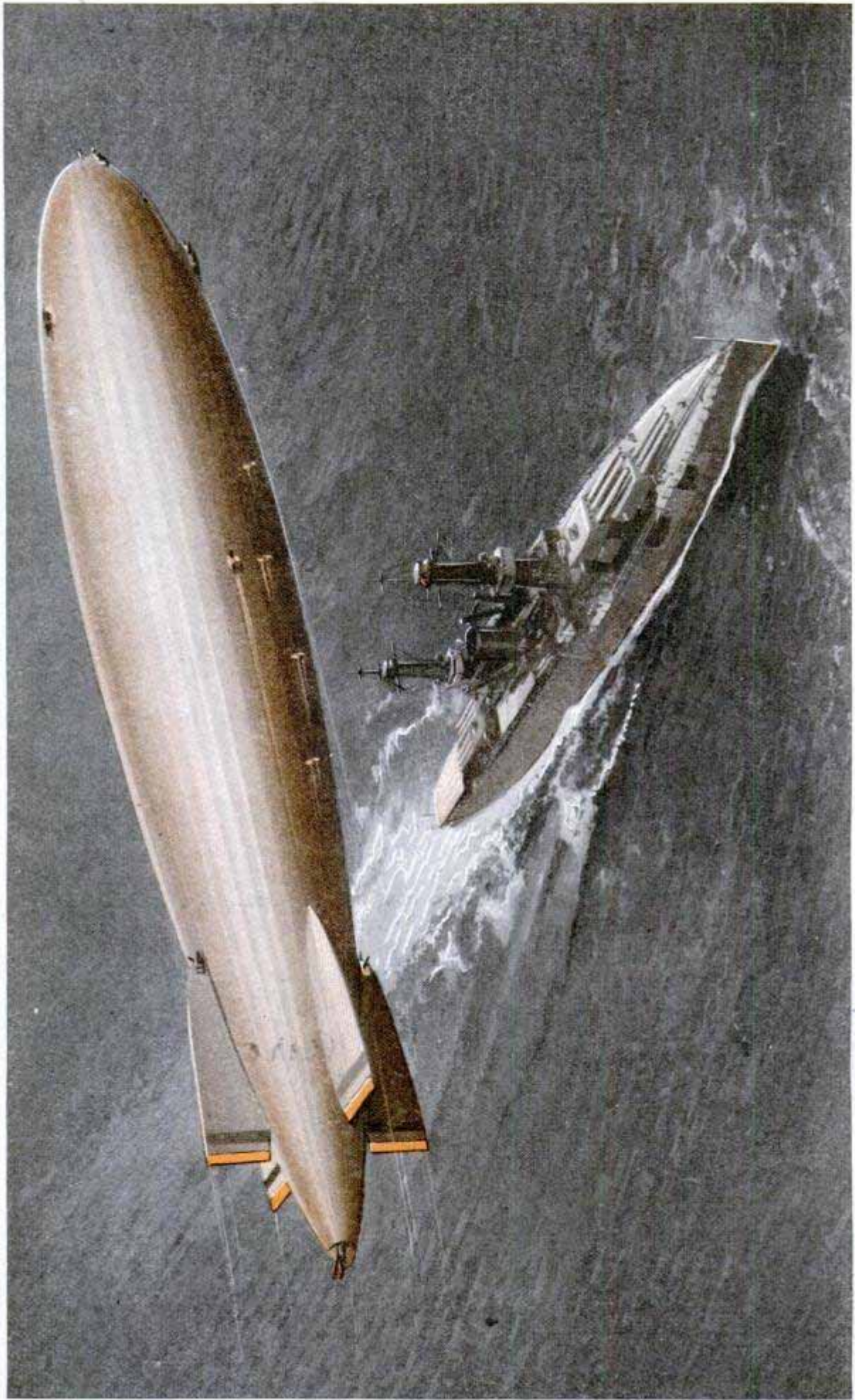

One of Navy's Proposed 6,500,000-Cubic-Foot Airships as It Will Appear in Flight over a Warship; They Will Exceed Most of the Largest Surface Ships in Size, and, Unlike the Ill-Fated "Shenandoah," Will Have No Hanging Control Cabin, the Quarters Being Built into the Hull

Handwritten notes at the bottom of the page, including the number "1314" and some illegible scribbles.

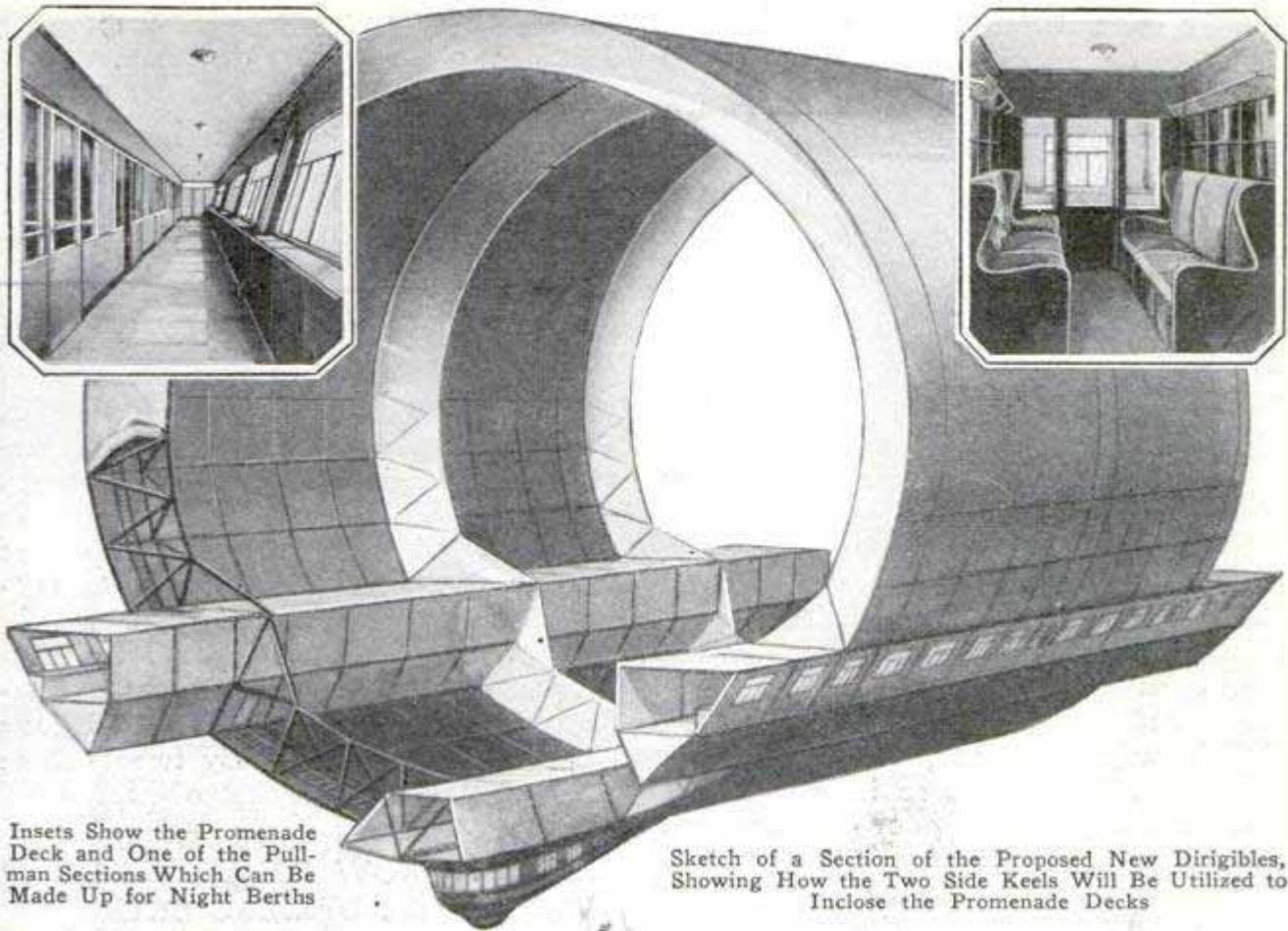

Insets Show the Promenade Deck and One of the Pullman Sections Which Can Be Made Up for Night Berths

Sketch of a Section of the Proposed New Dirigibles, Showing How the Two Side Keels Will Be Utilized to Inclose the Promenade Decks

Air Liners to Have Cabins in Keels

Two Zeppelins Authorized by Congress Will Be Largest in World and Twice the Size of the Ill-Fated "Shenandoah"

RADICALLY different from airships heretofore built, two giant Zeppelins, plans for which have been completed at the Goodyear-Zeppelin factory in Akron, ^{Ohio} not only will be twice the size of previous American-owned dirigibles, but will exceed by more than 1,000,000 cubic feet the pair of aerial giants being built by the British government. Congress has authorized the construction of two Zeppelins of 6,500,000 cubic foot capacity each, whereas the new English ships will have but 5,000,000 cubic feet of space.

Profiting by the destruction of the "Shenandoah," and other lessons learned in the past, the plans call for an entirely new form of construction. Instead of a single keel running the length of the ship to tie together all the circular frames that form the hull, the new ships will have three triangular keels, greatly increasing their strength.

The control cabin and passenger accommodations will be inclosed within the hull, as will be the engines. Heretofore the motors have been carried in small gondolas sticking out from the sides of the ship. The plans for the new craft call for inclosed engine rooms, driving the propellers by means of shafts and gears. The arrangement will permit tilting the propellers through a ninety-degree angle to add their upward thrust to the lift of the ship in taking off.

The ships are to have two complete covers, one on the outside of the ring frames and another on the inside, while within the latter will be the gas cells, so arranged that a shot through one or two, deflating them, will not interfere with the operation of the ship.

Two sets of plans have been drawn, one for a purely military ship and the other for a passenger carrier that can be

Com. Walter E. Burton
1922 Florida Ave. Kenmore, Ohio

1530
1804

readily converted for military use. The latter will have accommodations for 100 passengers, with smoking and dining rooms and even a promenade deck, from the glass windows of which the passengers can look down upon the earth beneath. These ships will have a cruising range of 8,000 miles, or 6,000 miles at full speed of ninety miles an hour. At that speed it would be possible to leave New York Saturday morning and arrive in London Monday morning, while the return trip, owing to the prevailing westerly winds, probably would take a day longer, or from Friday to Monday.

The authorization by congress of the two ships marks the progress in aviation since the "Shenandoah," with less than a third their capacity, was built. It had the slim lines of the earlier Zeppelins, while the new ships, like the "Los Angeles," will have greatly increased girth in proportion to length. The increase in girth gives greater strength, cutting down the extreme length which made it easy for a ship to break its back. Despite a capacity more than three times that of the earlier ship, the new craft will be but 100 feet longer, permitting them to be housed in the present Lakehurst hangar. Money to build a new helium-extraction plant has been asked for, to insure sufficient gas supplies by the time the ships go into commission.

MOST AUTO ACCIDENTS OCCUR IN EARLY EVENING

Between five and six o'clock in the evening is the most dangerous hour for motor-car driving, according to a survey of more than 1,000 accidents by the National Automobile chamber of commerce. Apparently, increasing fatigue during the latter part of the day is an important factor in the situation, for though some of the morning hours have a heavier traffic, the afternoon and evening hours generally show a larger percentage of accidents. While Saturdays and Sundays show the greatest number of fatalities, it is thought that these figures are likely to be misleading and that these days are really no worse than others with respect to accidents if the increased volume of traffic is taken into consideration. Sunday showed a fatality rate only twenty-three per cent greater than that of Monday.

CARVED PROW ON WORK BOAT SHOWS BURMESE SKILL

Carrying cargo in elegantly carved boats would be considered incongruous in this country, but it is done every day in Burma where wood-carving is one of the national arts. Many of the rice boats and other small craft have handsomely figured prows and other adornments. The Burmese have become world-famous as woodworkers and silversmiths.

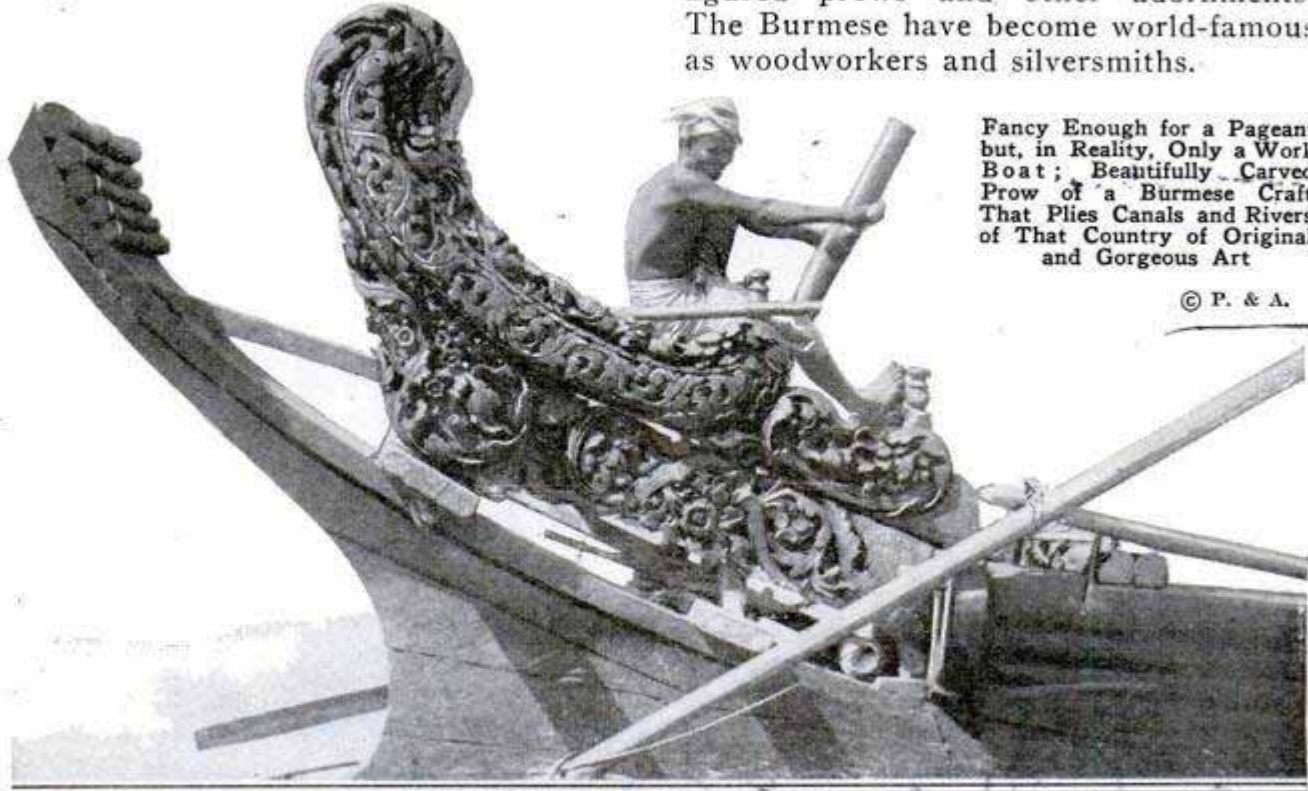

Fancy Enough for a Pageant but, in Reality, Only a Work Boat; Beautifully Carved Prow of a Burmese Craft That Plies Canals and Rivers of That Country of Original and Gorgeous Art

© P. & A.

1326. *W. W. Clowry, Sampsonville 60*
Salvage
 POPULAR MECHANICS *Lab. 1.* 559
Havana, Cuba.

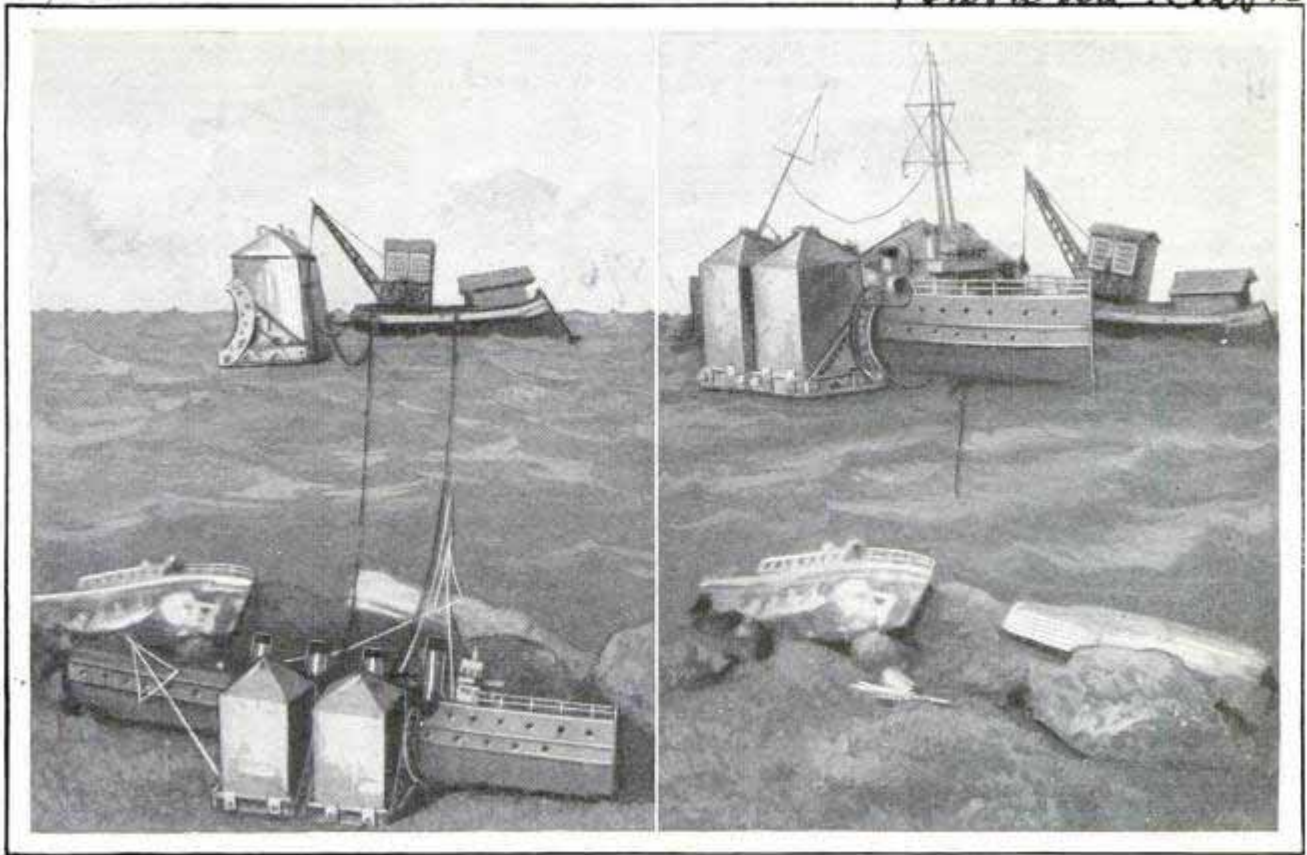

Models Illustrating How a Cuban Inventor Proposes to Raise Sunken Ships; a Feature of the Plan Is That the pontoons Can Be Assembled in Groups According to the Size of the Craft

PONTOONS FOR RAISING SHIPS TESTED WITH MODELS

Ingenious pontoon models have been constructed by a Cuban inventor to demonstrate a system he has developed for raising sunken ships. In a test at Havana, one of the pontoons is said to have lifted twenty-five times its own weight. Among advantages claimed for the plan are the lightness of the tanks and the ease with which they can be grouped and fastened together by frames for tackling large or small vessels. As in other pontoon systems, use is made of compressed air to force the water out of the tanks after they have been submerged, to make them buoyant and so float the wreck, which is hoisted to the surface by means of hawsers passed underneath it.

1544

LIGHTNING STRIKING A VESSEL — THROWS IT OFF COURSE

Compasses were seriously affected on the motorship, "Narragansett" not long ago when a bolt of lightning struck the vessel as it was cruising in the north Atlantic. The needles spun about rapidly, then settled down but with marked devia-

tions. One indicated a westerly course, another an eastern, the difference being as much as twenty-three degrees. To meet the unusual situation and regain the proper course, the officers had a platform erected above the wheelhouse sufficiently high so that the magnetic influences induced in the house by the lightning would not be communicated to the instruments placed on the elevation.

WINDOW WASHER AND DRIER COMBINED IN ONE

1413



Window panes are washed, dried and polished all with one simple instrument that has a rubber sponge on one side and a special squeegee on the other. It is not necessary to put the hands in water when using this tool, as it has a grip in the center for fastening a pole if needed.

In London, forty first-aid stations have been placed at busy traffic centers.

Conk Emmet Doughty
514 2nd St. Washinton

Kristee Mfg. Co. Akron, Ohio.

MOVIE-FILM SPEED REGULATED BY ORCHESTRA LEADER

1514

So that the orchestra conductor may develop better effects, while interpreting the picture with a musical selection, a



Giving the Orchestra Conductor Control of the Motion-Picture Film's Speed; the New Regulator Box

German inventor has devised a speed control for the film, operated by the leader from the pit. With it, he can accelerate or retard the movement slightly, to accompany the music more realistically, without destroying the general effect to the spectators. In many theaters where the music is an important part of the program, the film is given a trial run before it is shown to the public and, at this test, the orchestra leader and assistants calculate the exact time of different passages.

FIND HUGE PETRIFIED FOREST IN TEXAS VALLEY

1594

Nearly 100 miles from the nearest railroad, a petrified forest, said to surpass any previously known, has been discovered in an almost inaccessible valley of the Big Bend region of Texas. Few white persons have visited the locality, and the ground is covered with a thick layer of volcanic ashes and pumicestone, which partly hide some of the stone trunks and indicate that the forest is of great antiquity, for no volcanic disturbances have occurred in the region for hundreds of years. Some of the petrified trees, 100 to 150

Discovered by two geologists, Prof. A. D. Cade, Mr. C. O. Weaver and

feet high, were found standing, and one that had fallen measured several hundred feet. From a distance, the upright trunks have the appearance of natural-rock columns.

WATER SLAP BLACKS THE EYES OF RECORD HIGH DIVER

1596

A new peril of extremely high diving was brought forcibly home recently to a young Italian immigrant who tried to commit suicide by diving off the Manhattan bridge in New York. With his body moving more than ninety feet a second at the end of the 142-foot drop, the slap of the water when he struck blackened both his eyes and sprained his wrist. After hitting the water he decided to live, so began to swim and was picked up by a tug.

NY Herald Tribune 120/27

OIL BURNER THAT USES WATER REDUCES HEATING COST

1537

Greater economy, more heat and less likelihood of explosions are cited among the desirable features claimed for an oil burner that may be adapted to almost any size of furnace. Its distinguishing point is that it consumes a mixture of oil and water with the results suggested above, and the additional advantages that no carbon deposits are formed and odorous fumes are eliminated. The apparatus is arranged in such a way that the small particles of water become covered with a film of the oil while the hydrogen and oxygen in the water are liberated and provide an additional supply of elements for combustion besides the air. With this installation, it is said, special fire-box lining of brick or other materials is not necessary, and the burner can be throttled down to a small oil consumption so that heat may be maintained without waste of fuel.

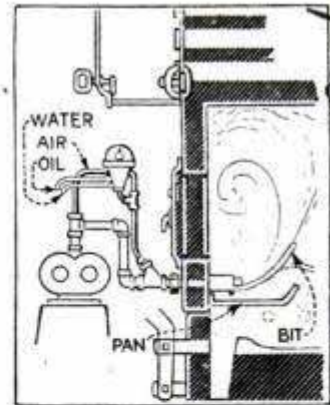

hydro - set fire corp. Oakland, Calif.

5101 E 12th St.

Our Bureau of Information will answer all questions regarding articles appearing in this magazine.

*Pacific Electric Bldg
561
Los Angeles
Calif*



Inspecting the Cables on the Incline Railroad up Mt. Lowe

GUARDING LIVES OF MILLIONS UP "STAIRWAY TO HEAVEN"

In the thirty-eight years that it has been in operation, the incline railway up Mt. Lowe, Calif. *Southern* has taken millions of persons to the summit and, in all that time, there has not been one accident. The record is considered a noteworthy achievement in safety practice, since the "Stairway up to Heaven," as it is called, in places has a sixty-two per cent grade. The cars used are of a special type and are pulled to the top by an endless steel cable which is tested to a 100-ton capacity, but never loaded beyond a five-ton limit. The tracks rest on stringers framed to the ties to prevent creeping, and, as a further safeguard, each car is equipped with a larger stationary cable working through an automatic clutch to hold it in case of accident. The hoist is run by a 100-horsepower electric motor and elaborate safety controls are provided. The operator has before him a miniature model of the railway system, which

shows him the exact position of the cars during the trips. The pulling cable is replaced every year and is inspected weekly. In this task, a skilled cable expert slides slowly down the center rail on a board car, applying the brakes with his feet so that he does not have to walk. He can reach the cables on both sides. Changing the huge line is an exacting task, as the speed of the machinery at the top of the incline must coincide exactly with that of the power reel taking in the old cable at the foot.

SANDER ON HEAVY AUTO TRUCK 1405 PREVENTS SLIPPING

German truck designers have gone to the railroads for one of their latest attachments,

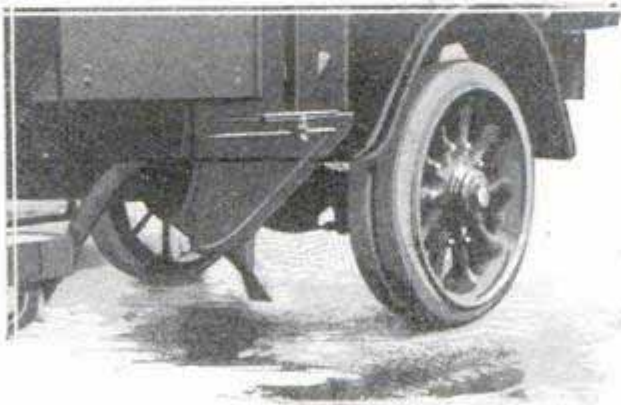

Sand-Distributing Nozzle Is Seen in Center Directly in Front of Rear Motor-Truck Wheels

a sander, which distributes a supply of dry dust in front of the rear wheels to prevent skidding on slippery surfaces. The arrangement is similar to the sanding equipment on a railroad locomotive. The box holds a generous supply and is easily refilled.

Illustrierte Technik für Jedermann

Ann Arbor Mich DEATH TRAPS OF PLANT WORLD WAR ON INSECTS

1262

Of recent years, scientists have been visioning a world freed of its disease-carrying flies and mosquitoes, its gnats and crop-destroying bugs, and the thousands

is found on waste lands, it is one of the most successful hunters of big game, in proportion to its size, in the world. Flies, worms, beetles and bugs of all descriptions are trapped by it, after which the plant proceeds to devour its catch. It consists of a reelike stalk, surmounted by a flower, and several broad-bladed leaves at whose tips are the traps. Each trap is in the form of two lobes set at slightly less than a right angle. Along the outer edge of each lobe, giving it the appear-

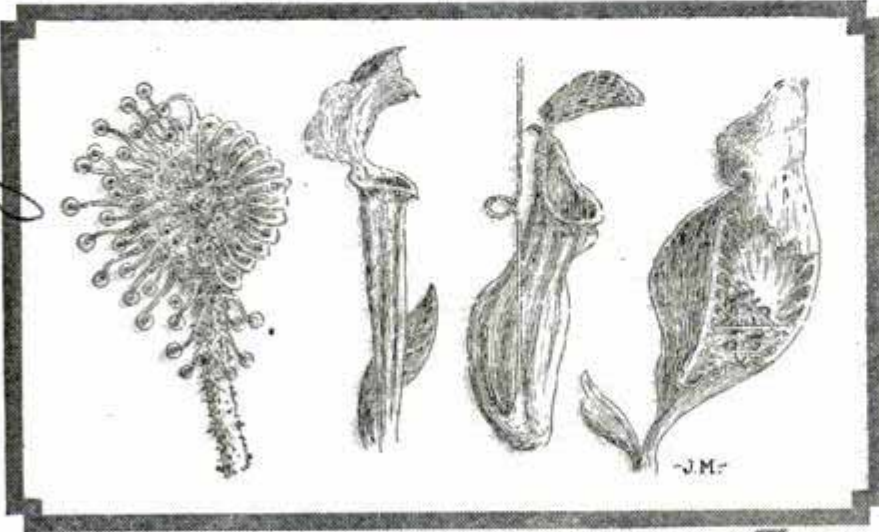

Drawings of the Sundew, Jack-in-the-Pulpit, Lady Slipper, Pitcher Plant and the Venus Fly Trap, Showing Their Honey-Filled Death Chambers and Dangerous Tentacles That Trap Unsuspecting Insects

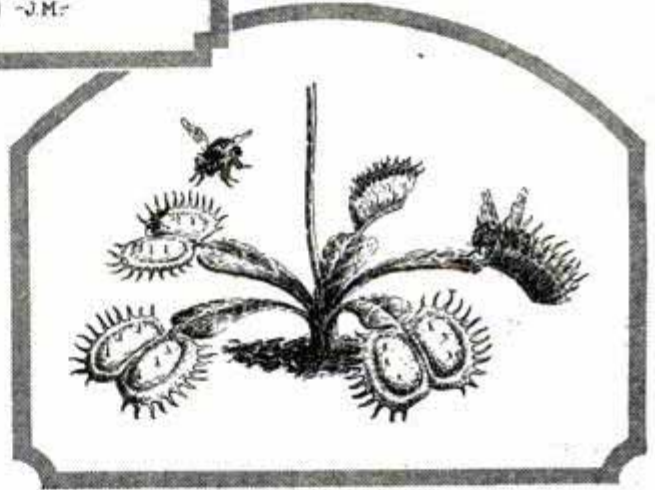

ance of an inverted eyelash, is a row of small thorns. On the inside are three sensitive hairs which spring the trap at the slightest touch.

of other insects with which it is burdened. Curiously enough, it is to the plant world that they have turned for relief instead of to the inventions of man. For nature, compensating for every evil, has created plants which need only be developed in sufficient numbers to destroy the insects. These plants are found all over the globe, and the United States possesses quite a few different species. Down in North Carolina, for instance, is a remarkable plant that preys upon insects. It is called the Venus fly trap. Although it usually

SHOE SOLES GLUED ON INSTEAD OF SEWING OR NAILING

In rebuilding shoes, a process for gluing on the soles instead of sewing or nailing them has been developed with considerable success in foreign countries, and is said to be gaining in popularity here. The method involves the application of special adhesives and the aid of a powerful hydraulic press. One of the most effective presses provides a leather surface on which

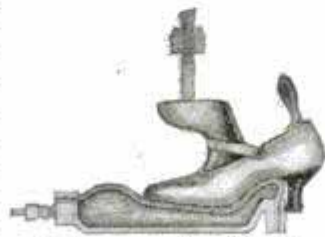

to set the shoe for gluing and when pressure is applied, the leather follows the contour of the old sole evenly, as the water insures even distribution of the force, and a perfectly fitting shoe is the result.

VANISHING SHOW CASES GUARD PRICELESS GEMS 1574

Valued at \$3,000,000, the great Regent diamond as well as many other precious jewels, is on display in a glass case at the Louvre, stared at by scores of visitors daily and apparently in a favorable position for anyone intending theft. But robbers, bent on pilfering the gem collec-

Illinois distributors. Thompson, Ehlers & Austin Ave. Chicago 114 E. Madison Ave. Chicago

Used by Penn Leather Co, 322 N. Third St. Phila.

1/18/29

tion, would meet a surprise should they enter the room at night, for it would be empty save for busts and vases weighing as much as a burglar-proof safe. The jewel cabinets are so arranged that they disappear into skillfully concealed vaults beneath the floor, and the apparatus which lifts and lowers the platforms is also hidden and so complicated that only authorized attendants, who know the secret, could possibly operate it.

YEARLY SOOT FALL IN LONDON SIX TONS TO SQUARE MILE

1389



Soot Meter in Operation; Removing Bottle of Dirty Water for Analysis of Contents

CLOVER THAT PLANTS ITSELF TO AID FARMERS

1582

Government plant testers see considerable savings of time and expense for farmers in two kinds of self-perpetuating clover, which have been under observation at the experiment station near Washington, D. C. On one, the stems bend down and scratch the surface of the ground shortly after the pods have formed, so that the seeds are deposited under favorable growing conditions, unless the soil is too hard. The other kind perpetuates itself even after it has been mowed to within an inch of the ground.

PENCIL AND FLASHLIGHT IN ONE HAS MANY USES

1239

Resembling a fountain pen in appearance, a pencil has a small bulb lighted by a battery inside the holder. It is special-



Drawings Showing the Pencil and Its Light, and Typical Uses

ly adapted to use in a sick room and, as a light alone, is always ready.

From measurements made with an interesting gauge at a London weather office, experts estimate that about six tons of soot fall on every square mile of the city's area in a year. The gauge consists chiefly of a funnel arrangement through which rain water falls and is collected into bottles. Once a month, the content of the bottles is subjected to a chemical analysis and from this examination, the total amount of soot is computed.

LIZARD LIKE BEARDED DRAGON FOUND IN AUSTRALIA 1/6 '17

There are some 1,700 species of lizards and many of them are found in Australia. One, native to that country, is known as the bearded dragon or Jew lizard, and still another is remarkable for the frill about its neck. This lies flat when the creature is not disturbed, but when the animal is attacked or frightened, it is raised like a shield about the head.

About 220 hours of man-power are required to build a low-priced automobile today.

Patented Specialties Co. Securities Bldg Seattle Wash

Mazda Electric Motory. Eveready

*Nickel - \$3.50
Silver - 5.00
Sold - \$8.50*

*A. W. J. B. Urbano
1209 S. 4th St. Seattle*

Amphibolius Barbatulus

305

The ROPE TRICKS



Steer Roping at a Rodeo. Just as It Is Performed in the West

By BOB BECKER *of Association of Commerce, 10 So. La Salle, Chicago*

TRICK roping, a comparatively new sport, is another example of the influence of the west with its cowboys, broncho busters and "lassoers." Ever since the days of Buffalo Bill's wild-west show, boys have tried their hands at throwing a "lasso." Now, with the rodeo or cowboy contests gaining in popularity in all parts of the United States, the youngsters are learning how to handle a small lariat, not for lassoing but to do tricks with it. The trick roper needs a small rope or lariat and that's all.

Hundreds of tricks can be done with a rope, and the object of the sport is to beat the other roper in ease, gracefulness and number of stunts with a spinning loop. Cuba Crutchfield, one of the greatest ropers of the west and instructor in the art for several thousand boys, advises every youngster wishing to learn to handle a lariat to start with not more than sixteen feet of rope. A boy, twelve to sixteen years of age and of average build and height, can usually handle that much rope without trouble. Half to quarter-

inch, closely braided cotton rope is desirable, as a soft strain with no backbone is difficult to spin. So great has been the demand for rope suitable for boys' use that in many large cities the youngster is able to purchase for a reasonable sum a fifteen or sixteen-foot length with a hondo already inserted in it. A hondo (or ring) is a small oval or round piece of metal looking much like a contrivance made to cut holes in a doughnut. It furnishes an opening of constant size through which the rope is threaded so that a loop may be formed. For trick roping, a metal hondo (the word is Spanish) is needed, as it gives weight to the loop and the few ounces thus added make it much easier to handle.

This ring, grooved so that one end of the rope can be curved around it to fit snugly, is held in place by a piece of wire which is run through the end of the lariat and then into the rope. When the wire has been wrapped around these pieces of the lariat, they should be taped until all the wire is covered. The other

of the WILD WEST

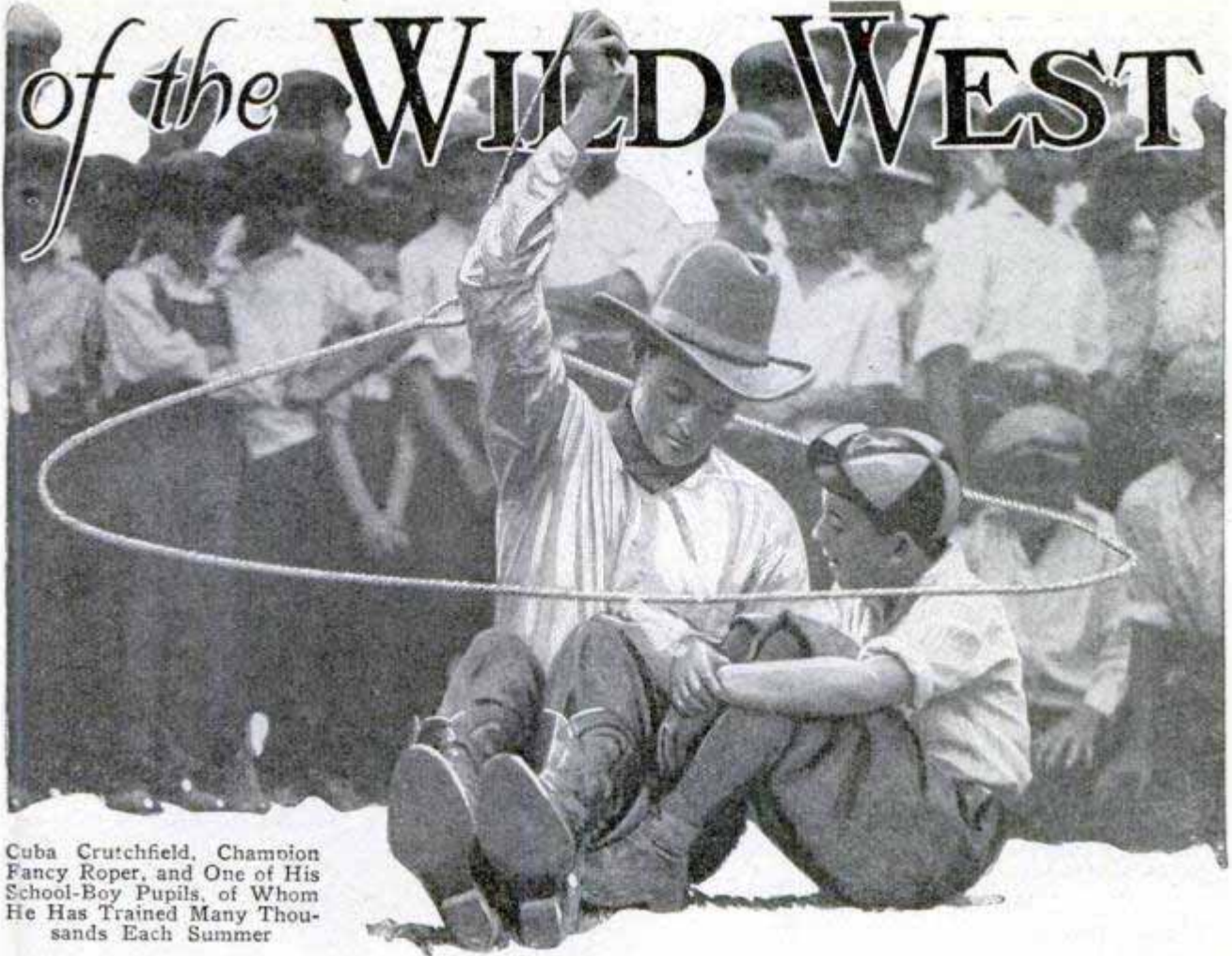

Cuba Crutchfield, Champion Fancy Roper, and One of His School-Boy Pupils, of Whom He Has Trained Many Thousands Each Summer

end of the rope also should be wired, in order to prevent it from raveling, and two or three turns of tape passed around it to cover the wire loops.

Learning how to spin a rope is comparatively easy if one starts right and masters a few simple rules. This is merely a matter of practice. Here are Cuba Crutchfield's instructions to boys (and adults, too!) who would like to learn to spin a loop. He says: "A beginner must know how to assume a correct position if he would learn any tricks. Here is position number one: Stand naturally with your feet spread slightly. Then take the rope in your right hand, about eighteen inches back of the ring, or hondo, and, with the left, 'feed' the rope through the ring until about two-thirds of it is in the loop.

"When this is done, turn the loop so that it is spread out in front and slightly to your right, the metal ring eighteen inches from your hand. Now, as to the position of your fingers, your first two should hold the loop while the last two of your right hand should grasp that part

of the rope not included in the loop. In this way you keep the loop separated from the feeder part. Your left hand is used in much the same way before you start the spin. Your first and second fingers hold the loop while the third and fourth are around the feeder rope, just about halfway between the hondo and the end of the lariat.

"To start spinning the loop requires a quick flip which finishes with a wide, sweeping circular motion of the right hand, so that the loop will start its round-and-round course. When you start the loop spinning, the palm of your right hand is facing out and the loop is to your right. With a movement of your wrist you turn the loop over and at the same time lean over and with your whole arm make a wide sweep toward your body. As you make this turn, release the circle with your left hand and hold the end of the rope in your right hand."

It takes more than one try to get the rope whirling in a perfect circle, but once going, it is not difficult to keep it spinning. And this is the first elemental stunt

305



in all trick roping—learning how to spin it in front of you. The next trick to learn is that of jumping in and out of the loop, as the ability to do this is the basis of dozens of tricks. With the loop whirling one must be able to skip into it with a quick jump and then keep the circle going about the body.

Mr. Crutchfield advises beginners to make changing hands around the body their third trick. Standing in the middle of a spinning circle, the idea is to pass the end of the rope from one hand to the other around the body, meantime keeping the loop going. Boys who enter the trick-roping contests conducted on the playgrounds of large cities are required to master this trick before being eligible to the finals of the contests.

They are also required to learn the "juggling the loop" trick. This is a spectacular piece of rope handling which shows how one can, through practice, become complete master of a six-foot loop. Starting with a circle close to the

ground, the roper gives his loop a powerful upward thrust, which sends the spinning loop above his head so rapidly that the eye can hardly follow it. When it comes down close to the ground, he shoots it skyward again until the loop is soon going up and down alternately at lightning speed.

Next, the trick of "skipping the spoke" requires quick thinking and quick action. In this trick, the roper stands in the center of a spinning loop and jumps over the spoke, or that part of the rope coming from the loop to the hand, as it goes around at great speed. Another trick

is that of handling two small loops at the same time.

The motto "practice makes perfect" is graphically illustrated in trick roping. Although boys (or adults) may learn a

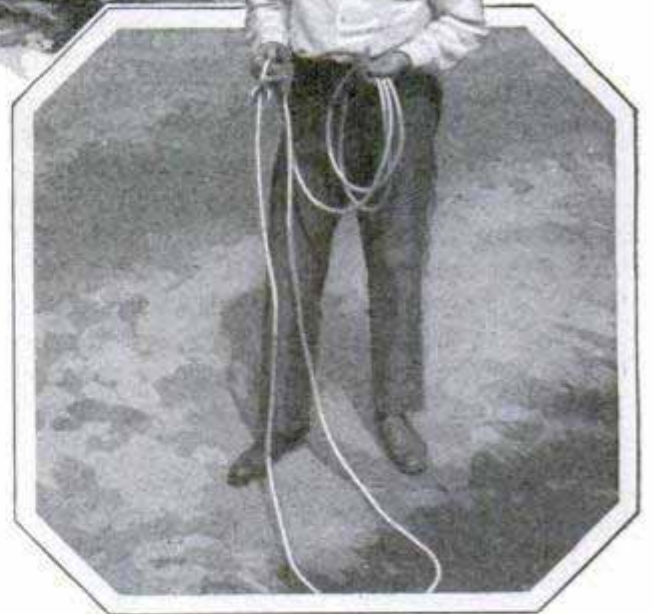
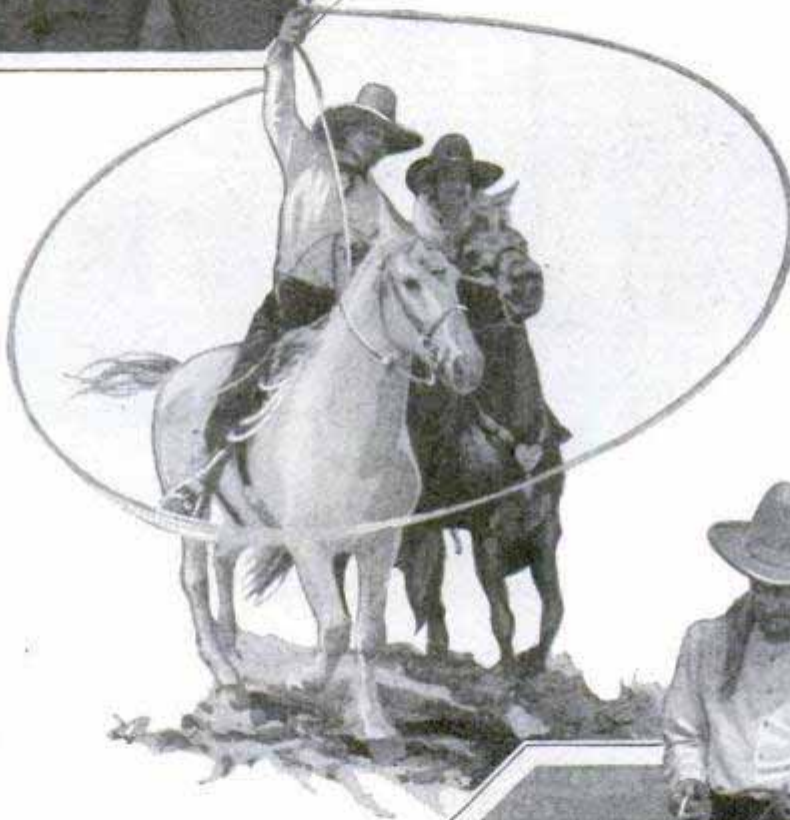

Center © R. R. Doubleday

A Lover's Knot, Center; and, Top and Bottom, Cuba Crutchfield Showing How the Lariat Is Held in Doing Fancy Spinning

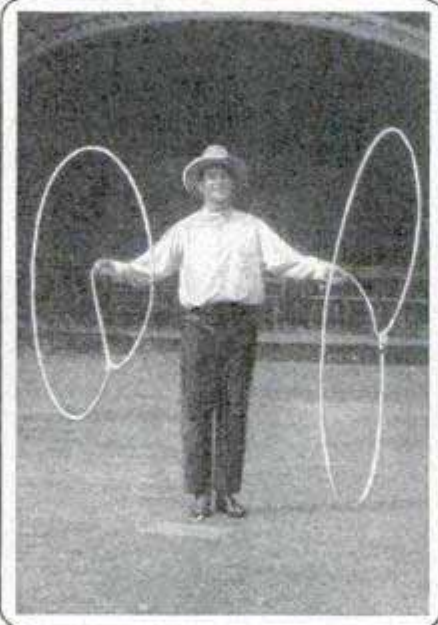
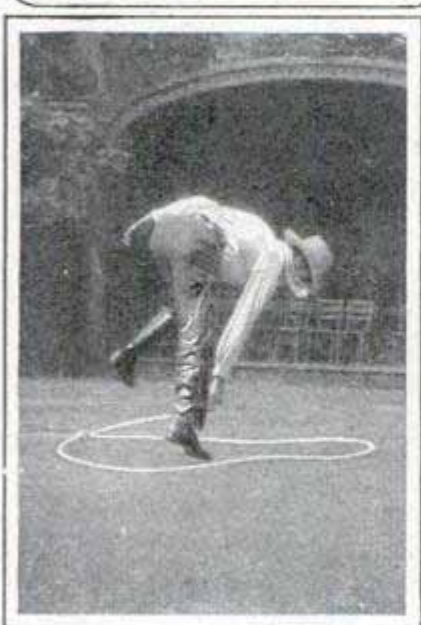
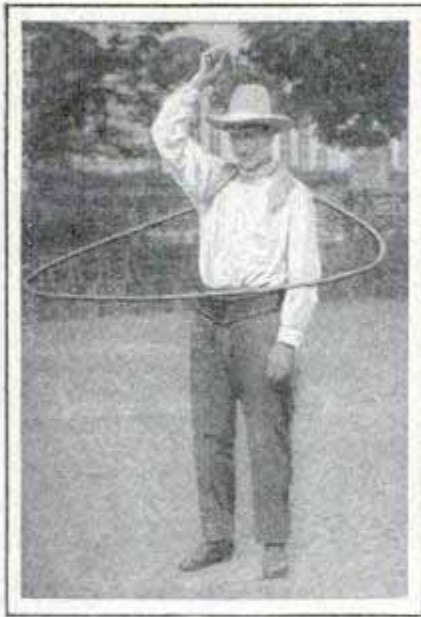

A Few of the Fancy Tricks Crutchfield Teaches His School-Boy Classes; in Photo at Right End of Center Row, the Hands and Feet Alternately Lift, to Clear the Rope as It Revolves

305

number of interesting tricks in a comparatively short time, the professional trick ropers of the west point out that they have been working at this sport for years, trying to originate new tricks and perfect old ones. Crutchfield, a true westerner born in the cattle country of Texas, says that he has been doing trick roping for twenty-four years. Other famous cowboy ropers, like Chester Byers, holder of the world's championship trick and fancy roping title; Bob Calen, Tommie Kirnan, and Johnnie Rufus also testify to the fact that it takes years to learn some of the flashy, spectacular tricks which they perform in rodeo contests, doing them both on foot and on horseback.

Crutchfield originated the roll and somersault tricks, two of the most difficult stunts that a roper (on foot) can attempt. In the first, he rolls over and over on the ground while keeping a loop spinning above him. In the second he starts a whirling loop, crouches and then turns a somersault, meantime keeping the big loop whirling without a waver. He makes two or three backward or forward somersaults in succession which shows complete mastery of the rope and combines acrobatics with rope spinning.

Other difficult and interesting tricks which professional ropers are able to do,

six feet in diameter in front of him. Then he gives it a sharp pull toward his body which brings the loop toward him. At the correct moment he jumps through it and then brings it back again for another jump. In spinning the circle, the roper keeps one foot out of the loop and the other in and then passes the loop under his foot. It takes many a quick skip and jump to do this trick.

Although roping tricks done while the roper is on the ground are interesting and as difficult as any devised, because they involve acrobatics, trick roping from a horse is more spectacular. Here is where the professional ropers are in their element. They spin loops around their horses, throw circles at galloping riders, catch horses by one foot, four feet or around the head and even toss a circle large enough to take in two or three riders. These tricks represent the last word in dexterity, quick thinking, and timing, as several ropers are able to throw a big loop backward at a galloping horse at just the right second to catch either fore or hind feet.

Although a healthful outdoor pastime which aids muscular development and thus is of benefit to boys who aspire to master this new type of western sport, trick roping is of practically no value to the cowhand in his everyday tasks with horses or cattle. It is a sport pure and simple, and like steer riding, steer wrestling and broncho busting a kind of fun that originated in the daily life of a cowpuncher. But of all the cowboy sports, trick roping is the least noisy and that which calls for the greatest dexterity.



Turning a Series of Somersaults or Rolling Over and Over While Spinning the Rope Are Two Tricks Requiring Many Months of Patient Practice

include jumping through the cartwheel, the dog trot and spinning the circle. In the first, the roper starts a circle about



1121 Ash St.

POPULAR MECHANICS

Wernetha & Co.

BLINDS PROTECT HOUSES FROM STORM DAMAGE

1600

Outside window blinds are not extensively used these days except for decoration, but their efficiency in protecting houses and other structures from storm damage has been so convincingly demonstrated that builders are wondering if a mistake has not been made in discarding them. In Cuba, where hurricanes are not uncommon, all buildings are fitted with shutters, and although the Florida storm last year damaged hotels that did have blinds, the havoc was much less than it would have been had there been no protection for the windows, it is believed. If a wind of sufficient strength blows in the glass, a pocket is formed in the interior of the building, giving the storm additional opportunity to cause destruction. By preventing this, the shutter decreases damage.

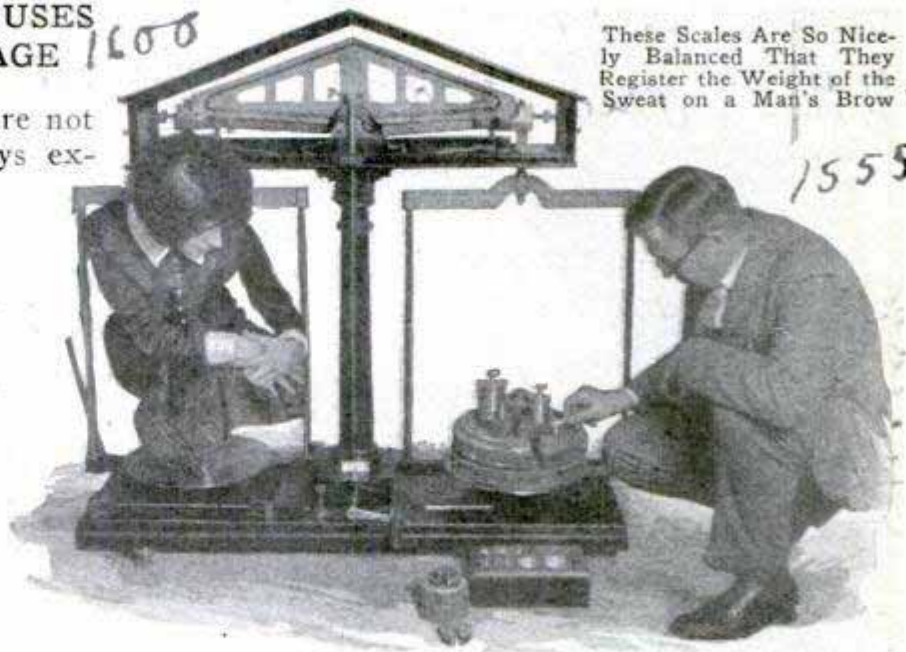

These Scales Are So Nicely Balanced That They Register the Weight of the Sweat on a Man's Brow

1555

SCALES THAT "WEIGH EMOTION" AID MINING TESTS

Investigators of the bureau of mines and of the Pittsburgh experiment station have been conducting a number of interesting tests recently to determine the effects of weather and temperature conditions on workers. In connection with the research, scales so delicate that they could weigh the sweat on a miner's brow to indicate how energy had been expended under certain conditions, were used and so accurately adjusted that it was considered fair to say that they could "weigh emotions,"

since any difference in weight due to nervous excitement or other moods, was recorded. One of the principal uses of the scales was in relation to the amount of heat and moisture that will be thrown off on the average by a large audience assembled in a theater or other public building. These data are considered of great importance to heating and ventilating engineers as well as to health officials.

OBSERVATION BOOTH IS BUILT IN FRONT OF LOCOMOTIVE

1511

For track and tunnel inspection on a western railroad, an engine has been equipped with a glass observation cage in front so that observers may ride close to the rails and obtain an unobstructed view of the entire right of way. The controls are in the cage, so that the engineer may ride with the inspectors and stop the locomotive without the need of signaling. The fireman occupies his usual post in the cab. There is room for several men on the long upholstered seat that extends across the compartment.

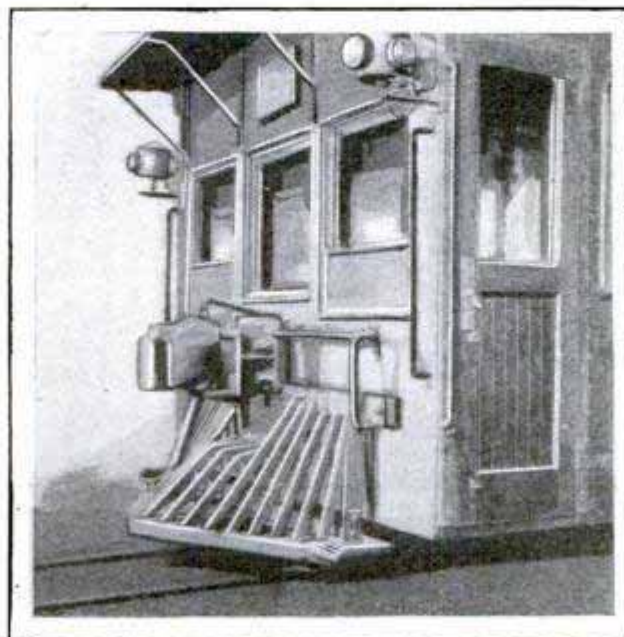

Enabling Inspectors to Gain a Close View of the Track; the Observation Booth on Locomotive

Installed at Denver Roundhouse Southern Railway Colorado

cont. Jos. C. Coyle, 538 Santa Fe Colo

AnSCO Photo products, Inc.
Binghamton, NY
576

U. S. Dept. of Agriculture
Washington, D.C.

POPULAR MECHANICS

CAMERA TAKES FIFTY PICTURES
ON SINGLE ROLL OF FILM

1474

Price - \$20.00

the case.



Illustrating the Size and Operation of the Fifty-Exposure Camera

Weighing only twelve ounces including the film, a small camera now on the market takes fifty pictures on one roll and is so simple to operate and load that it offers distinct advantages to the tourist or other person who wishes to make a pictorial record of a journey at little expense. The camera is approximately two by two and one-half by four inches in size, has a rapid lens and is equipped with a full range of speeds and stops. The negatives, slightly less than an inch square, occupy a roll about the length of a six-exposure film for a camera of post-card size.

They may be printed in sections, that is, several developed on one sheet of paper and then cut apart if desired; can be enlarged to three and one-quarter by four and one-quarter size in a handy enlarging device or be printed on positive motion-picture film for showing on a screen through a

special projector made for this purpose. The film thus replaces glass slides for "still" views. In operation, a small dial on the front of the camera keeps track of the number of exposures made. The winding is done by means of a lever on the back.

STRAWBERRY GROWN ON TREES
TO AID COMPLEXION

Among a number of strange fruits recently brought to this country was a giant strawberry which is said to have properties tending to reduce the weight and improve the complexion of persons who eat it. The berry is found in China, along the coast south of the Yangtze river. It grows on trees, has beautiful flowers, and bears half a dozen crops a year. Efforts will be made to develop it for cultivation in this country.

MEMORIAL TREE MARKS SCENE
OF FAMOUS INDIAN TREATY

Preparations already are being made for celebrating the 150th anniversary of the defeat of the British near Vincennes, Ind., by George Rogers Clark, a victory which contributed largely to the saving of the great middle west to the United States. The plan is to have a weekly observance of the occasion throughout the year 1929. A memorial building is proposed, with



Marking an Important Spot in American History; the Treaty-Tree Tablet Recalling Chief Tecumseh

murals showing scenes of Clark's victory, and the structure later is to be converted into a national shrine. The anniversary will also recall the treaty between Tecumseh, famous Indian chief, and President William Henry Harrison, by which peace was made between the whites and Indians. A memorial tablet has been placed on a tree which stands near the spot where the treaty was made in August, 1810.

Washington
Chicago
318 W. Washington
50 cent
50 or more roll

1415
1398
advertis

1938. *John S. Osborn*
 POPULAR MECHANICS *22 North St. London W. 1, Eng.* 571

SEEING IN THE DARK BY MEANS OF "BLACK LIGHT"

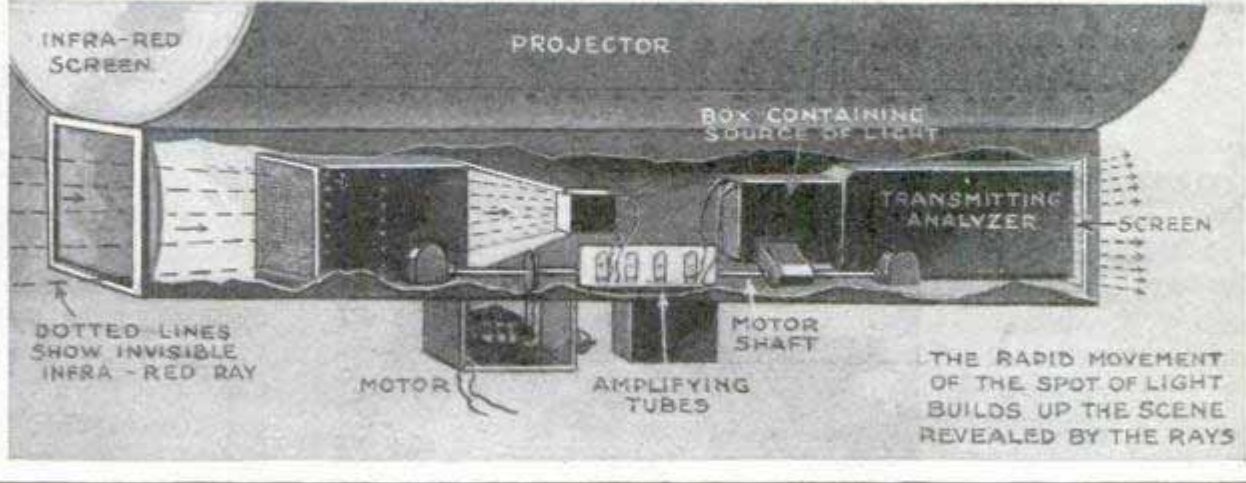
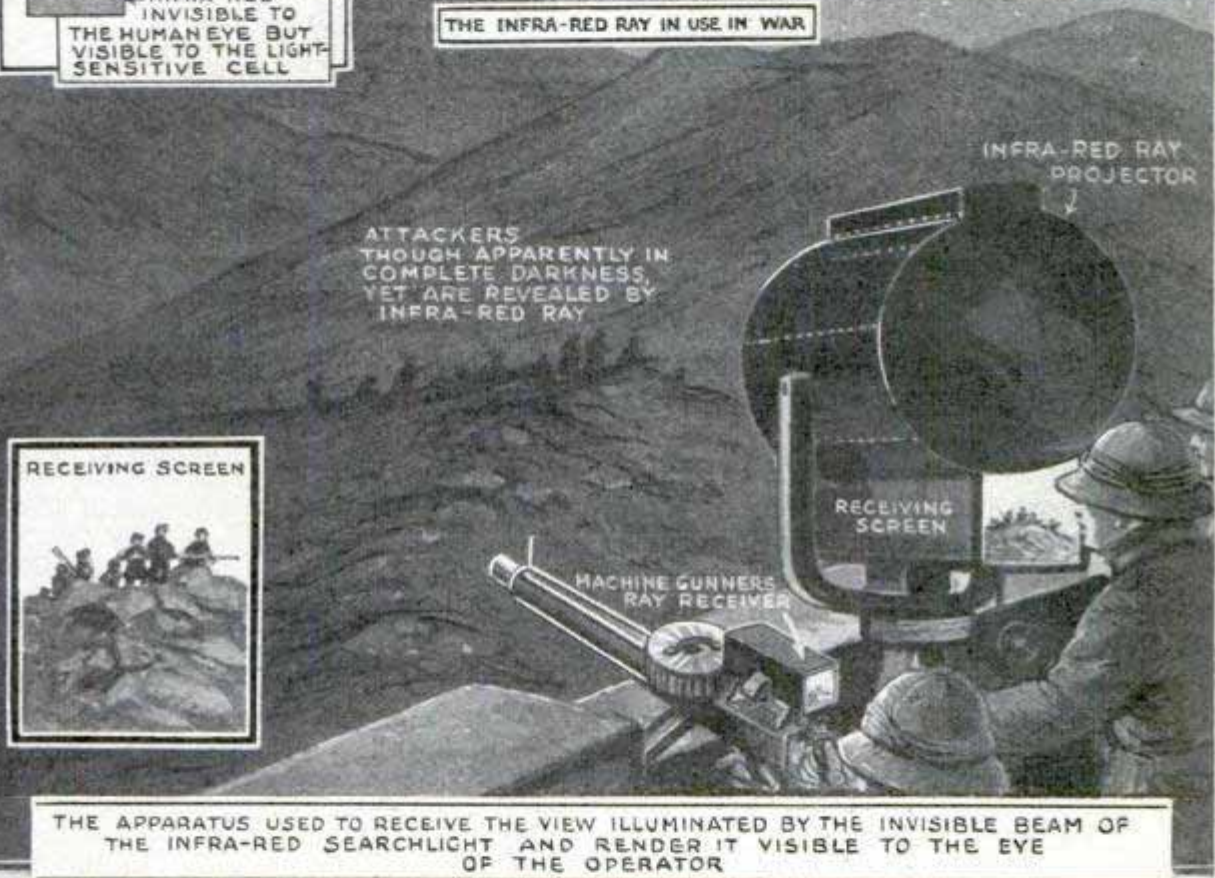
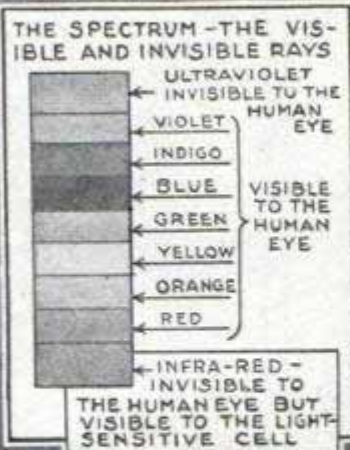

Copyright, The Illustrated London News
 Using Invisible Infra-Red Rays and a Fluoroscope as a Receiving Screen, an English Inventor of Television Apparatus Has Developed an Invisible Searchlight for War Use

Educational Bureau, Westchester Co., Yonkers, N.Y. Lighting



Domestic-Science Class in Traveling Auto Bus; Interior of the Well-Equipped Car for Giving Instruction in Latest Home Practices to Rural Communities

AUTO BUS FITTED AS SCHOOL FOR DOMESTIC SCIENCE

To help spread the doctrine of better health, homes and cooking, a lighting company maintains an auto bus equipped as a school and demonstration room with a capacity of thirty-seven "pupils." With specially trained experts and lecturers in attendance, the traveling "college" visits cities, towns and villages in an area of more than 400 square miles, where housewives can see tests with the latest kinds of cooking equipment, listen to talks on preparing special foods, on buying and other pointers in domestic management. Special attention is given the question of proper illumination for the home, even to matters of correct wiring. Seats are arranged at the sides of the bus, leaving a wide center aisle. A sink with running water,

stove, table, cupboards and space for gas and electrical appliances are features of the equipment. Comfort and safety of visitors are assured by special means for ventilation and an extra door at the rear of the bus for emergency exit.

CHURCH TO RESIST HURRICANES HAS STEEP ROOF

1436 After a severe wind had destroyed a church building in Maryland, extra precautions were taken

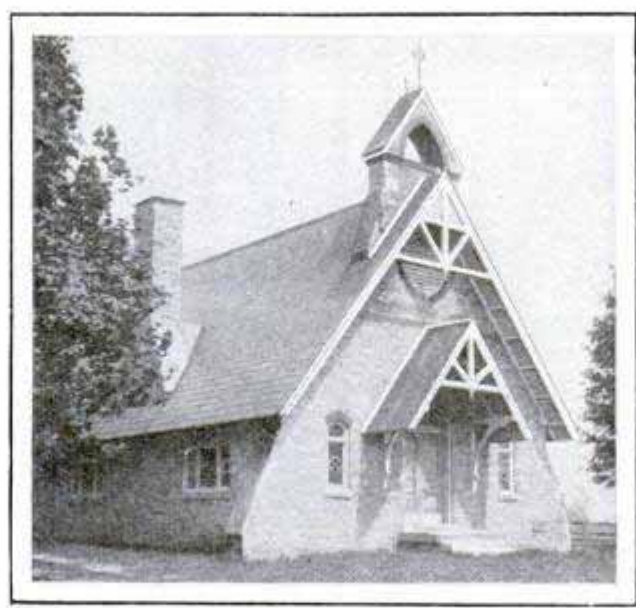

Built with Thick Walls to Defy Tornadoes; Steep Roof Is Intended to Let Winds Slide Off

near Bel Air
near Bel Air
with the new structure, to make it as nearly proof against a repetition of the disaster as possible. It is low and has an extremely steep roof, so that winds can sweep over it without encountering much resistance. The walls are three feet thick and taper up to eighteen inches at the point where the rafters rest. The force of winds is also broken by trees.

*J. Alden
Springfield, Mass*

**MELTING BULLET
MADE TO AID
CRIME WAR**

1534

Composed of glycerin, stearin and an anti-septic compound, a "deathless" bullet, devised by an eastern inventor, is intended to wound a person without killing him. It melts after entering the body, leaving a clean wound, but has force enough to stop a man at twenty feet, and would be fatal if striking a vital spot. A feature of the bullet is that it makes twice as much noise as an ordinary one when fired, so it would be of aid to a citizen in spreading an alarm. Tests showed that it penetrated a one-inch pine board, and it was also shot into a ham to demonstrate its properties.

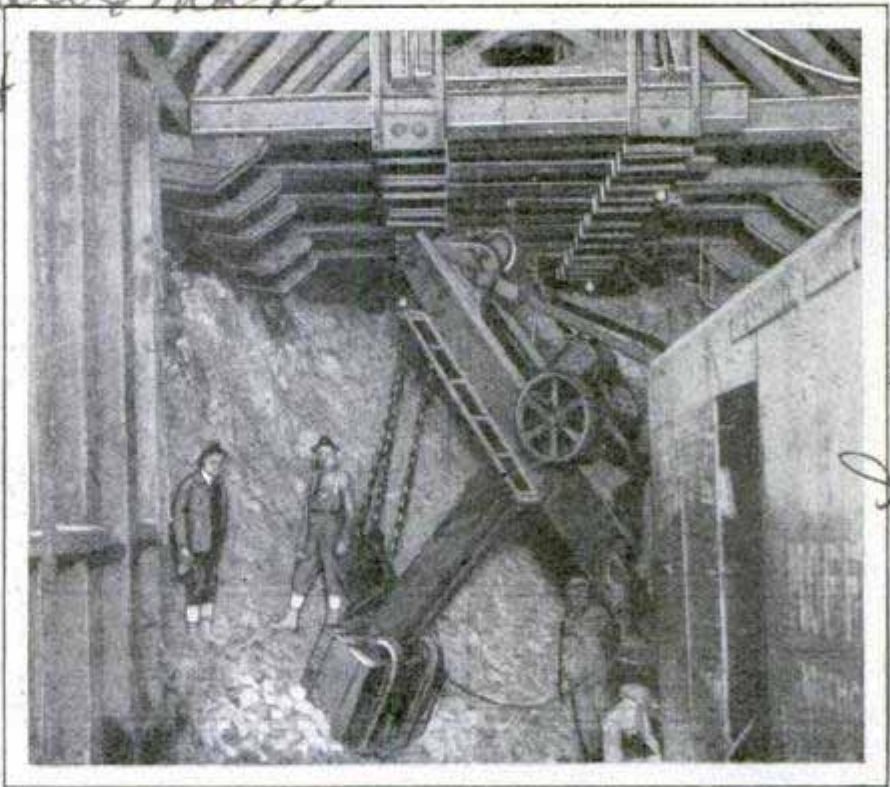

How the Steel "Rib" Holds Up Mountain While Men Pierce Continent's Backbone; Scene in Moffat Tunnel

**STEEL RIB FOR USE IN TUNNEL
PREVENTS CAVE-INS**

Engineers estimate that more than \$2,500,000 will have been saved in labor costs and, doubtless, several lives spared in digging the Moffat tunnel in Colorado, through the use of a huge steel cantilever girder for supporting the top of the passage while timbers are put in place. Three of the girders have been used. Each is sixty-five feet long, ten feet high, eighteen feet wide, and weighs fifty tons. The girder is built of structural steel and somewhat resembles a centipede lying on its back. It has projecting arms which support the arched section of the tunnel roof, while drilling, blasting and timbering of the bench on which it rests are in progress, and, as the work proceeds, it is advanced on a track by means of chains and cables attached to an air hoist. The apparatus is also used to place the enormous timbers which hold up the roof, a task that usually calls for many men and is often attended with disastrous slides. The girder was devised by George Lewis, general manager of the construction work on the tunnel and a mining engineer of many years' experience.

George Lewis, general manager.

**MOTOR CHAIR FOR INVALIDS
IS EASILY CONTROLLED**

1498

For invalids and cripples, a wheeled chair containing an easily operated motor has been introduced in Germany. It

The Invalid Can Take an Outing Unattended, on This Motor Tricycle; Controls Are within Easy Reach and Simple
© Henry Miller

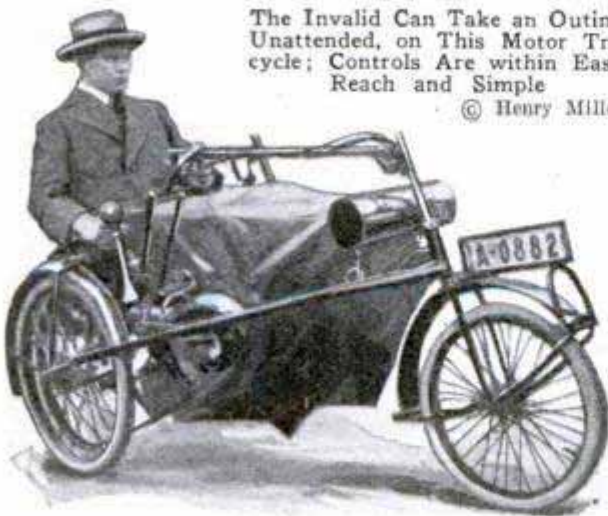

is simple to steer and has been designed with special emphasis on safety.

Regions with the most intense sunlight produce the most highly colored fruits.

maker cannot be located.

HOW ACCIDENTS KILL TWENTY THOUSAND IN YEAR



Common Acts That Result in Hurts and Deaths; Youthful Craftsman Courting Cuts



Inviting a Serious Fall by Standing on Edge of Tub, an Everyday Mistake



It's Fun to Climb, but What if the Porch Rail Happened to Break?



Flirting with Serious Injury or Death by the Use of Oil to Start Fire



Lighting a Match in Clothes Closet, a Common Cause of Costly Blazes



Flatiron Cord Is Ragged and the Inquisitive Child Is Inviting a Tragedy



Both Right and Wrong; Keep Matches off Stove and Have Gas Oven Open in Lighting



Looking for Gas Leaks with a Match and Pretty Sure to Find Serious Trouble



Appears Safe but It Isn't; Never Use Rocking-Chair as a Stepladder

108 E Ohio St

66 Second St. Passaic, N.J.
 POPULAR MECHANICS *Karl Illava* 575

**POCKET RADIO SET
 AID FOR POLICE
 IN CRIME WAR**

Tests with miniature radio-receiving sets by police in an eastern city have been so successful that it is planned to equip the force with the instruments to aid in the war against crime. The set can be carried in a box no larger than a cigaret case and consists of a single vacuum tube, small batteries, collapsible ear phones and an aerial attached to the policeman's sleeve or the lapel of his coat. On the outside of his uniform, there is a tiny electric light, suitably mounted, which flashes a signal from the central station telling him to listen in. The sets are effective over a range of three and one-half miles, according to the inventor, and operate on a wavelength of fifteen meters, too short to interfere with reception by ordinary household wireless. In case of a holdup or other crime, a general alarm spread from the main station would notify every policeman on duty within a few minutes to be on the watch for the fugitives. The news would be broadcast by voice, saving the trouble of learning a code.

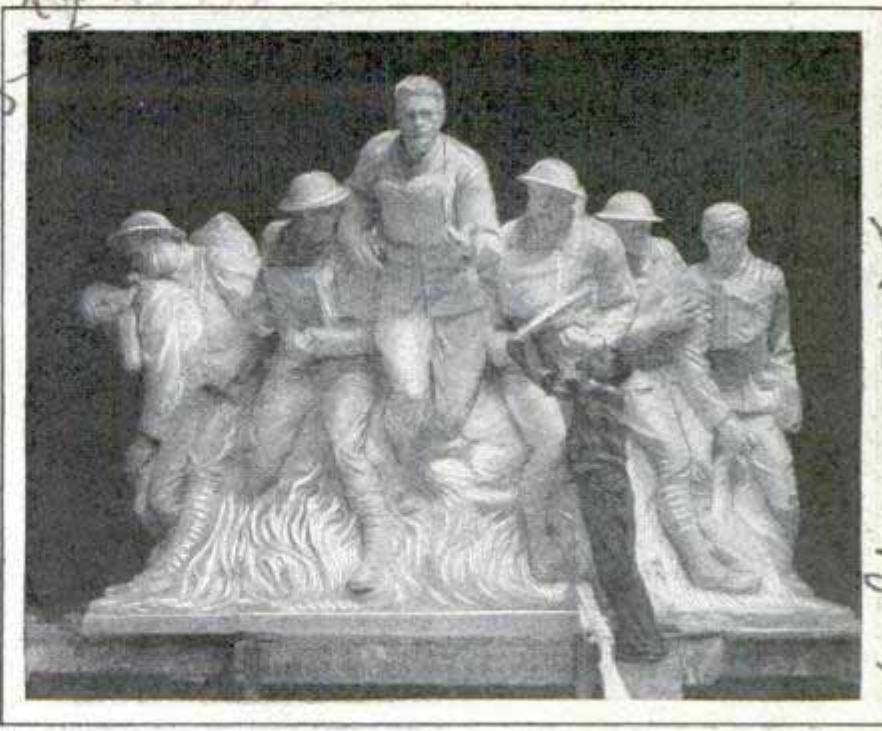

Karl Illava Completing the Clay Model for the War Memorial; He Is Placing a Gun in the Hands of the Charging Figure

**WORLD-WAR MEMORIAL COST
 HUNDRED THOUSAND**

Notable because of the realistic facial expressions of the figures represented, a World-War memorial, erected in New York, cost \$100,000 and took over two years to complete. It shows soldiers in heroic size, as though in action, fighting, charging and suffering the pain of wounds.

**FORTY-TON BANK-VAULT DOOR
 HAS TWENTY BOLTS**

More than forty-five inches thick and secured by twenty steel locking bolts, five inches in diameter, the circular door of a bank vault in a Pennsylvania city is made doubly secure against theft as it is water-tight when closed, preventing the introduction of liquid explosives. The door weighs 80,000 pounds, is more than eight feet in diameter at the front, and is so nicely balanced that it can easily be swung by hand.

**NINETY-FIVE-POUND TOPAZ
 WORTH THOUSANDS**

One of the largest single pieces of topaz in the world has been added to the Smithsonian Institution collection from Brazil. It weighs ninety-five pounds or nearly 250,000 international metric carats, and is valued at approximately \$3,000 in the rough. Another large topaz is in the Field museum of natural history. It weighs in the neighborhood of 100 pounds.



Huge Jewel from Brazil for the Smithsonian Institution; the Ninety-Five Pound Topaz

*Carl V. Shannon,
 Assistant Curator*

*at 66 H. St. and Fifth Avenue,
 South Bethlehem, Pa.*

1264
576



Bridge Game Designed to Be Played with Radio Instructors; the Movable and Washable Tabs Can Be Hidden from Opponents' View, Placed on the Board for Dummy, or Turned Down for Tricks Taken

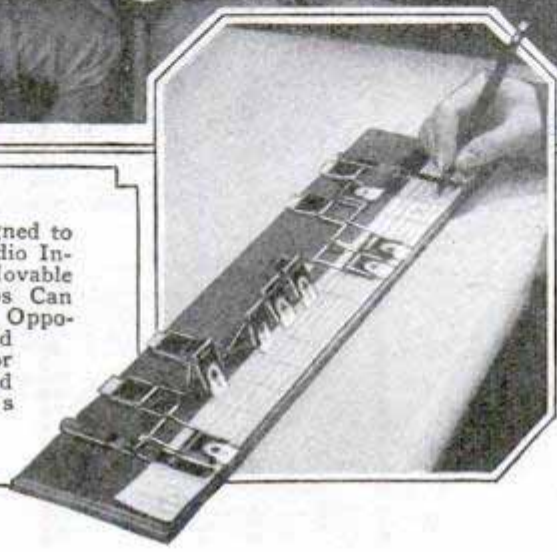

BRIDGE GAME LETS RADIO FANS PLAY LESSONS IN ADVANCE

A bridge game by which radio fans who tune in on the broadcast card lessons, or others who are studying bridge from books, may set up any problem hand and play it over until all its possibilities have been mastered, is one of the newest things in card instruction. The game consists of four boards, one for each player at a full table, or they may be used separately for individual practice. The "cards" are merely "pips" showing the suit and number, and are made of washable celluloid, so they can be used indefinitely. They are held in small leather tabs, from which they can be removed whenever a new hand is set up. The tabs are attached to a long wire rod, enabling the cards to be set up on edge, so that other players cannot see them, laid flat, face up, for the dummy, or turned over, face down, when a trick is taken. A long strip of paper, held down by clips, is ruled so that the sequence in which each card is played

can be jotted down, while the strip is wide enough to record five games, giving a permanent record, for comparison, of how each card was played in each game. Radio fans can take the bridge problems announced in advance, play them several times and record their play, and then save the slips for reference when the same hand is played and broadcast by the bridge expert, comparing the expert's play with the previous trials, and study the mistakes that may have been made.

1499 INSIDE OF ROPE WEARS MOST

Lubricating ropes to keep them in good condition has been found helpful, since the wear and strain is frequently on the interior, where

the twisted fibers cross each other, rub together and are likely to break. Tallow, lard and boiled linseed oil are widely used in treating the fibers to reduce friction. One of the standards for judging rope is the length of its fibers, long and strong ones characterizing the better qualities.

1409 Prairie Farmer 1/27 FLINT GUN FOR LIGHTING GAS REPLACES MATCHES

A modern development of the old system of starting a fire with flints is seen in a household lighter now popular in France.

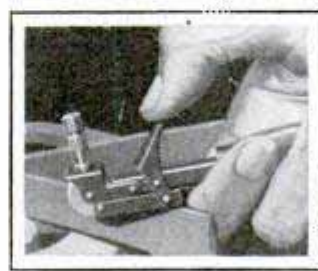

It is essentially a small spark gun using a flint to ignite gas jets or to kindle a blaze. One flint is said to be equivalent to 600 matches and several are

furnished with each lighter. The apparatus eliminates the fire risk from careless throwing away of glowing matches.

*Wm. Frederic M. Helms
7 Rue Vignon*

CHEWING GUM FOR AIR PILOTS HELPS IN DESCENTS 1527

Gum chewing is recommended for pilots by the Royal Air Force flying-training manual, published in England, as it provides saliva and helps overcome the difficulty experienced in swallowing during descents as a result of parched throats. Swallowing aids in equalizing the air pressure within the ears when descending from a high altitude as it opens the narrow passages leading from the back of the throat to the inner side of the eardrum. In sudden downward flights, authorities recommend "clicking the ears," which means pinching the nostrils and forcing air from the chest into the nose until a clicking sound is heard in both ears. The manual also warns against excessive smoking that may lead to throat congestion, and suggests proper care of the teeth as another item of hygiene to which special attention should be devoted.

COOK MODELS HOTEL IN GLASS FROM OLD ELECTRIC LIGHTS 1360

Glass used to support the filaments in old electric-light bulbs is the principal material a pastry cook has employed to fashion a realistic model of a thirteen-story hotel

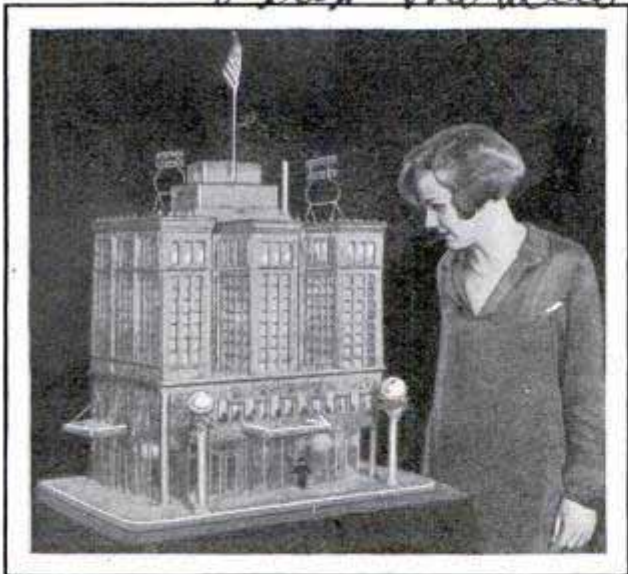

Glass from Discarded Electric-Light Bulbs Was the Principal Material Used in This Model of Hotel

in Cleveland, Ohio. The pieces are fastened together with glue and the replica has glass floors, a tiny piano that plays, chandeliers, figures of dancing couples and other lifelike features.

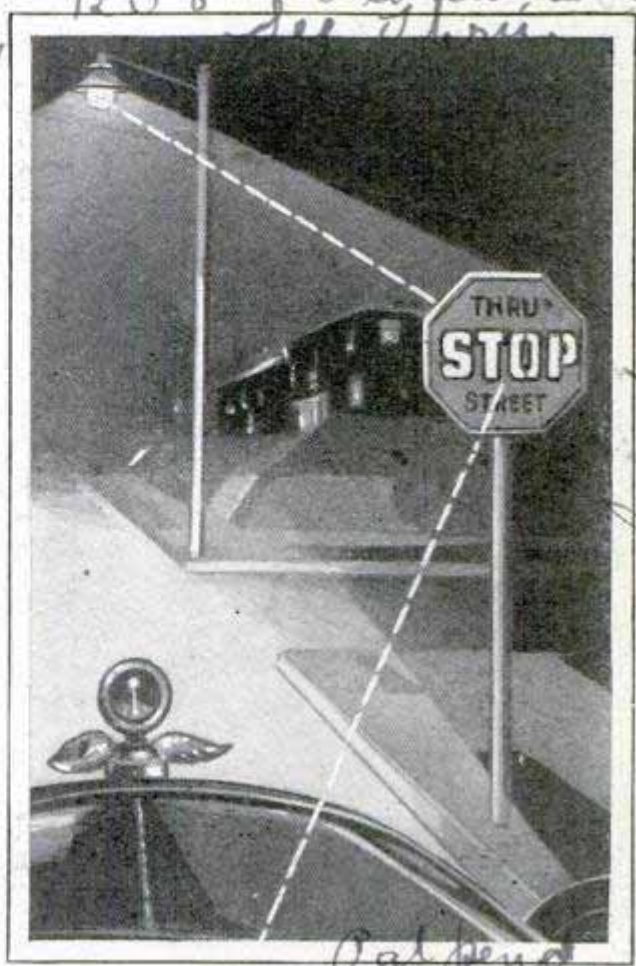

Sketch Showing How Light from Street Lamp Shines through the Transparent Stop Sign

TRANSPARENT AUTO STOP SIGNS LIGHTED BY STREET LAMPS

Fitted with lenses on the rear side, a type of traffic sign now on the market, is distinctly lighted at night by the rays from the street lamps, so that it requires no batteries or wiring. The signals are durably constructed of steel, with legends in raised lettering against a yellow background. In installing them, it is only necessary to see that they are placed in relation to the street lights so that the lenses will receive full illumination.

FIX CENTER OF NORTH AMERICA NEAR DEVIL'S LAKE, N. D. 1548

Recent surveys place the geographic center of the North American continent a few miles west of Devil's Lake, N. D. The spot is at forty-eight degrees ten minutes north latitude and 100 degrees ten minutes west longitude. Since the lake is close to the center, it becomes a natural monument, and, already a noted scenic place, gains additional distinction.

map & information office
 U.S. Board of Surveys

118 N. La Salle Chicago

1602 HOW GRAND OPERA IS BROADCAST FROM STAGE

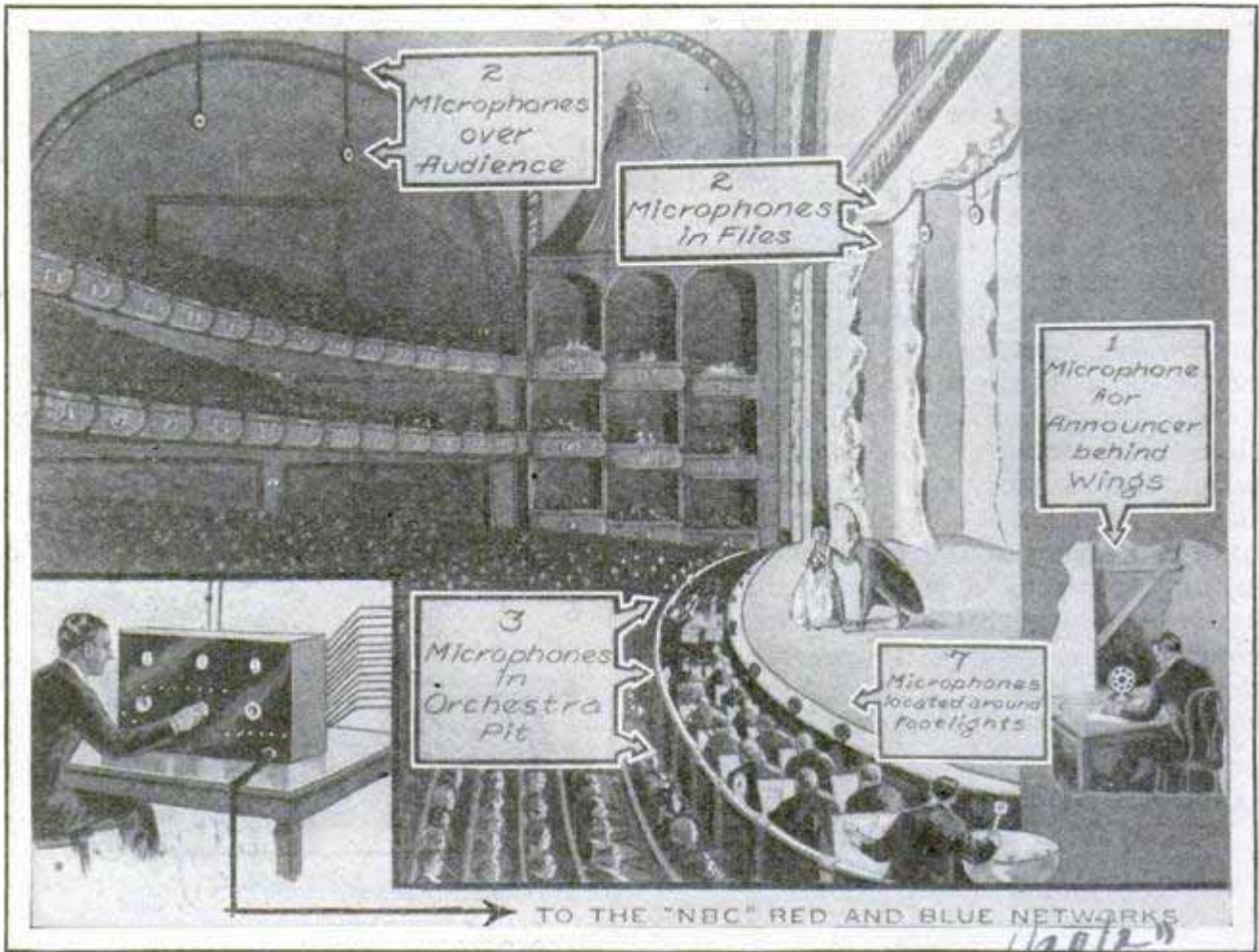

Drawing Illustrating How the Microphones Were Arranged on the Stage and in the Auditorium Theater for Broadcasting an Act from the Opera "Faust"

Courtesy Chicago Evening Post

Successful broadcasting of the second act of the opera "Faust" from the Auditorium theater in Chicago was accomplished by distributing fifteen microphones about the stage, orchestra pit and over the audience, and employing a mixing panel to blend and subdue the tones. The result was pronounced one of the most satisfactory ever achieved in radio trans-

mission of so complex a program—voices, and a large orchestra requiring careful handling in order that the effect might not be spoiled for the radio listener by too much volume from any one set of instruments or by the solo vocal parts being indistinct. For several days before the performance, engineers were busy installing the equipment.

RED DIAMONDS MOST VALUABLE
BLUE ONES NEXT

1653
Instead of being colorless crystals as is popularly supposed, diamonds are found in a great variety of colors and are priced according to their hue as well as their size and freedom from imperfection. Red diamonds are rarest. A small one, found at Kimberley recently, was valued at \$4,500 in the rough. The blue stones are considered next in point of worth, and

the pure grass-green gems third, while yellow diamonds are as cheap as the red are dear. There are brown diamonds of comparatively no value. One of the most costly diamonds is the ten-carat stone purchased by the Emperor Paul of Russia at a price of \$100,000. Orange diamonds are rare and bring large sums. The value of pearls is also based largely on color, the most highly prized being the black ones and next, the pink. One of the largest of this color was taken from

Jul - Osetsa 2 7/2 6

Burchfield
Univ. of Washington

POPULAR MECHANICS

a fresh-water mussel in a tributary to the Mississippi river. It is three-quarters of an inch long and valued at \$40,000. As with diamonds, the yellow pearls are the least valuable. Rubies, sapphires and the topaz are sometimes improved in color by treating them with radium which seems to burn out their impurities.

The Bell on Its Way to the Steamer with the Floating Crane; It Was Moved Alongside the Vessel and Swung Aboard, Then Securely Fastened for the Journey across the Atlantic; It Weighs Nearly Eighteen Tons

Johnston
Croydon,
Eng.

TURN SAWDUST INTO CHARCOAL TO FEED CHICKENS

Charcoal, suitable for feeding to chickens, is being produced by an improved process in the state of Washington by charring sawdust in a rotating retort. It is said that the method is far faster than older processes and, since use is made of material that otherwise would be wasted, an additional saving is realized. Charcoal has been found beneficial to fowls as an aid to digestion.

1637

ELECTRIC WATER-PIPE HEATER DOES AWAY WITH DIRT

Connected to the house water-supply system, an electric heater controlled by a push button is said to be economical and safe, and has the additional feature of being noiseless. When the heating units wear or burn out, they can be replaced without the need of draining the water from the heater, and safeguards are provided to eliminate the danger of overheating.

736

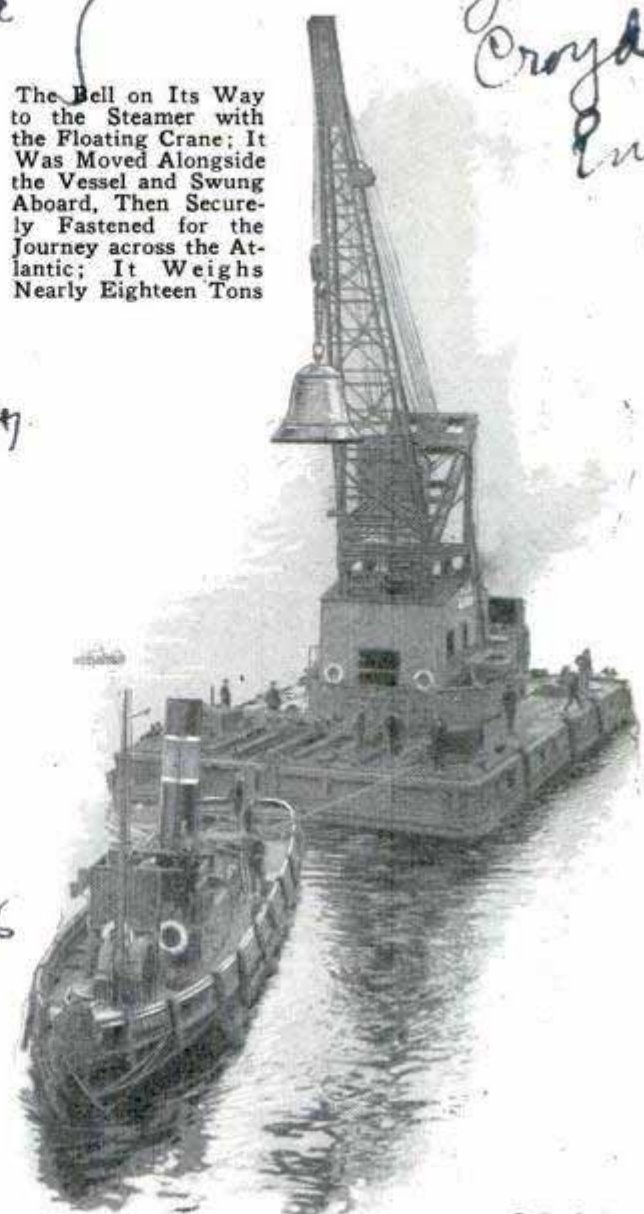

© P. & A.

LOADING BIG BELL ON STEAMER REQUIRES SPECIAL CRANE

Ordinary wharf facilities were unsuited to the loading of a huge bell for a Philadelphia department store at an English port, so a crane on a floating platform was rigged and the bell towed with a tug alongside the steamer. It weighs seventeen and three-fourths tons.

Wanamaker



Hot Water

Electric Heater, Installed with Water-Supply Tank, and the Current Control Panel

FARM-CROP YIELDS PER ACRE GRADUALLY INCREASING

In the older sections of the United States, the farms are not wearing out but are producing greater yields per acre, according to reports. Since 1885, the average yield of corn has increased eighteen per cent, wheat, seventeen per cent, oats, fourteen per cent and potatoes, thirty-nine per cent.

898

Aetna Electric Appliance Co.

Chilean Nitrate Bureau
and
U. S. Bureau of Agricultural

1215 RAISING *a*



By HAROLD

documents are believed to lie in the safes and archives of these drowned ships, but the prize for the salvors is the winning of the half million tons of valuable metals represented by the fittings and armament of the sunken craft. The cost of the operations has reached into six figures, and now only two out of twenty-five destroyers remain to be raised from their grave.

The 28,000-ton battleship "Hindenburg" has concentrated the most strenuous efforts of the divers. Her rotted hull and slimy decks are pressed down with a weight of 56,000 tons of water. Three times, since August, 1926, she has been lifted to the surface, her great rents patched and her port-holes screwed home, and

Diver Going over the Side to Descend to the Sunken German Battle Fleet, While a Companion Stands Ready to Don the Helmet

FAR away from the track of steamers on the lonely coast of the Orkney islands at Scapa Flow, an army of divers for two years past has waged a battle with violent gales and shifting tides and sands for the possession of half a million tons of valuable metals.

They are trying to raise the vast hulks of twenty-two great battleships and cruisers of the former German high seas fleet sent to the bottom by Admiral von Reuter in June, 1919, when he gave the order to open the seacocks and scuttle the vessels to prevent them from falling into the hands of the allies. Important

each time intruding water has burst open her patched rents, and swept her back to the bottom.

The story of the adventures of the divers on the "Hindenburg" is an exciting one. The first man to step on her decks, seventy feet below the surface, quickly pulled on the shot rope for help. A monstrous forest of seaweed, with stalks as thick as a man's wrist and leaves eighteen inches wide, trailing fifteen feet in length, was seen growing out of her sides. The diver tried to wade through this submarine jungle, but was baffled. Several other divers arrived,

4. Original from the
J. W. P. London, England

FLEET from "Davy Jones' Locker"²¹⁵

T. WILKINS, *Eng.*

armed with double-bladed daggers, and slashed their way to the portholes.

Now began a search for the plan of the "Hindenburg." This was necessary to locate all apertures which needed sealing up before the water could be pumped out or expelled by the costly method of compressed air. In the inky blackness below, the diver's electric torch is useless even three inches away from an object, and it is fatally easy for his air line to catch in an unseen cabin doorway as he gropes his way between decks. They found the precious plan in the chart-room, etched on steel and varnished.

Twelve divers then set to work to tunnel under the submerged hull to get to the seacocks under the engine room, by the opening of which the "Hinden-

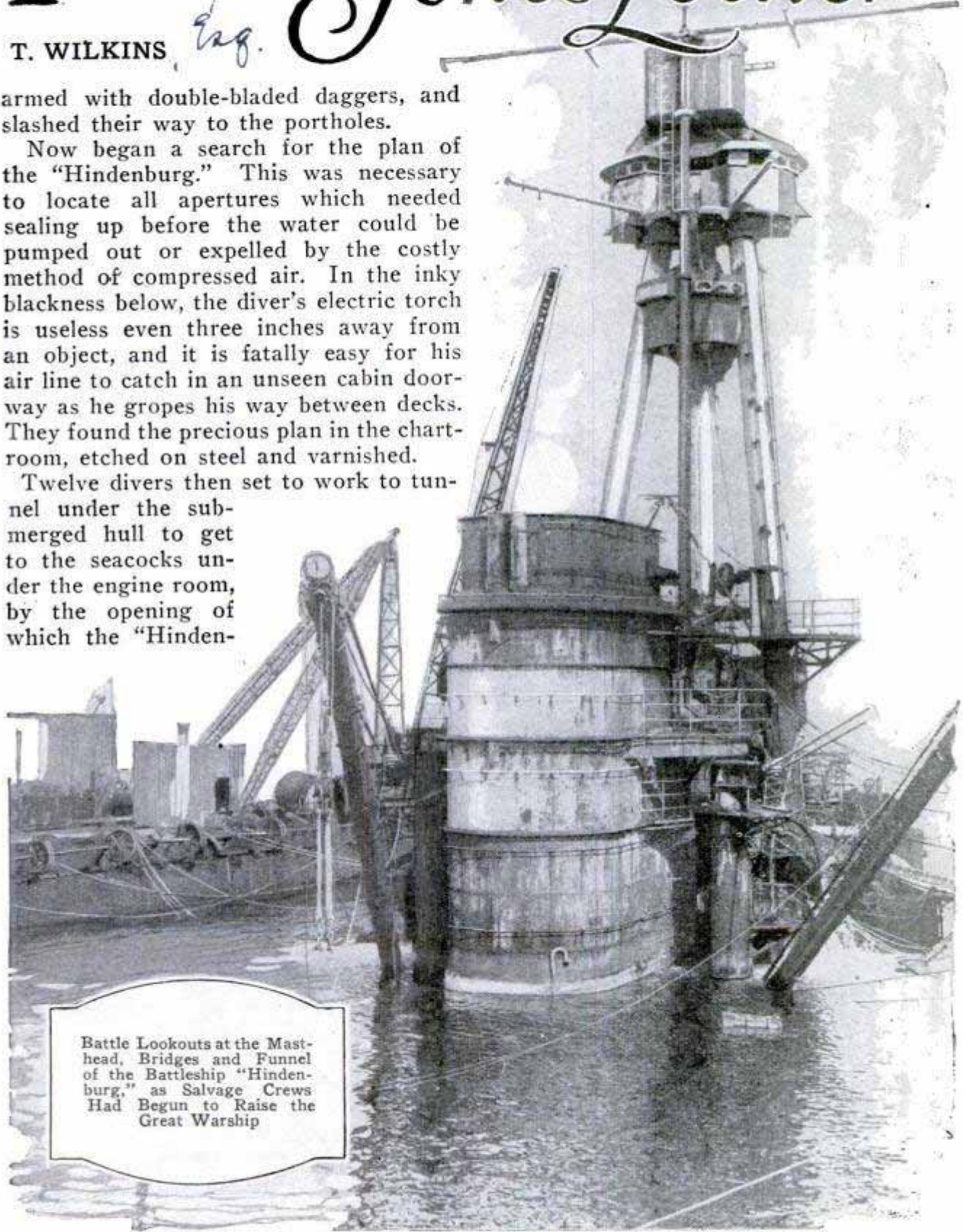

Battle Lookouts at the Masthead, Bridges and Funnel of the Battleship "Hindenburg," as Salvage Crews Had Begun to Raise the Great Warship

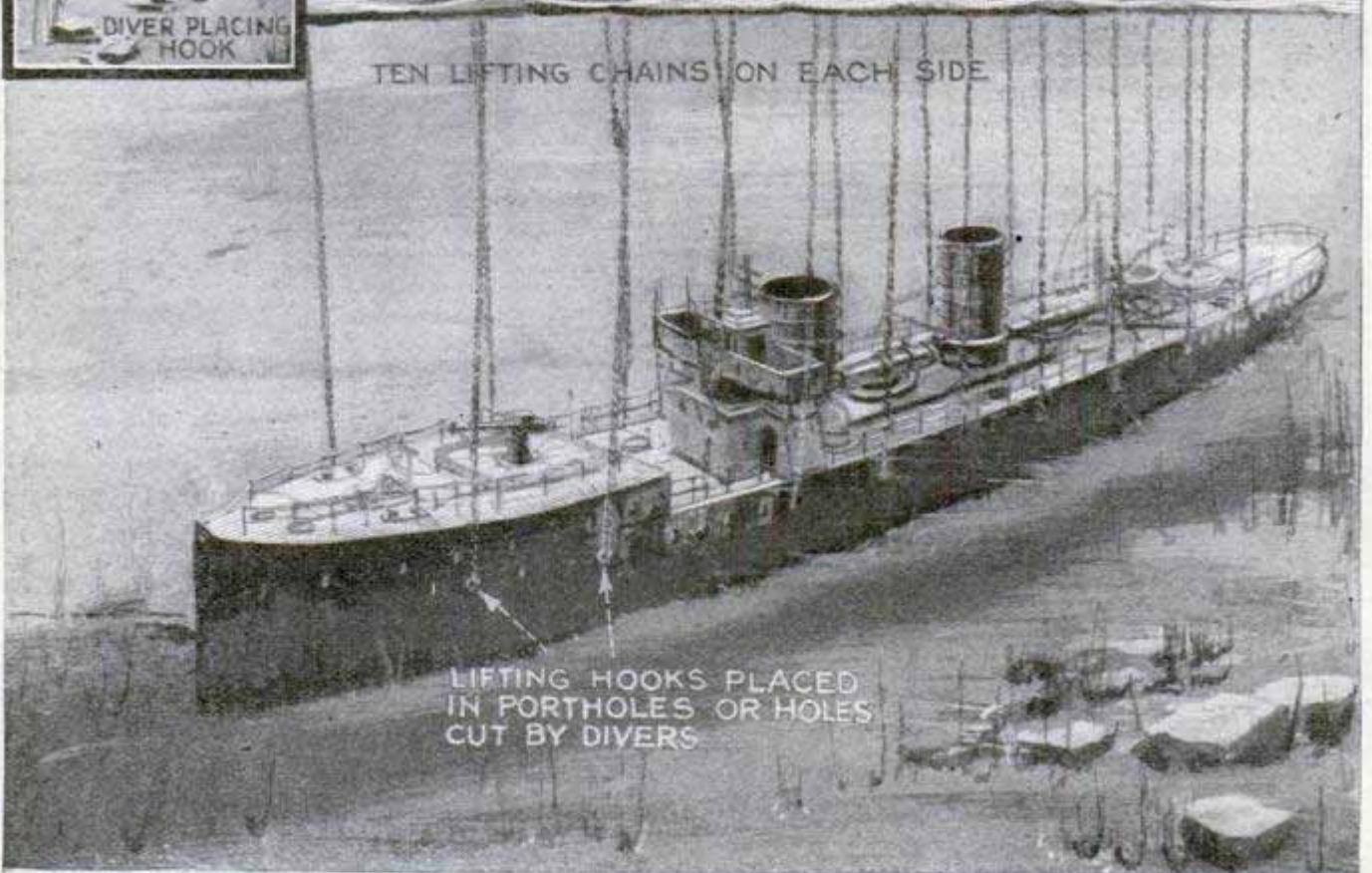
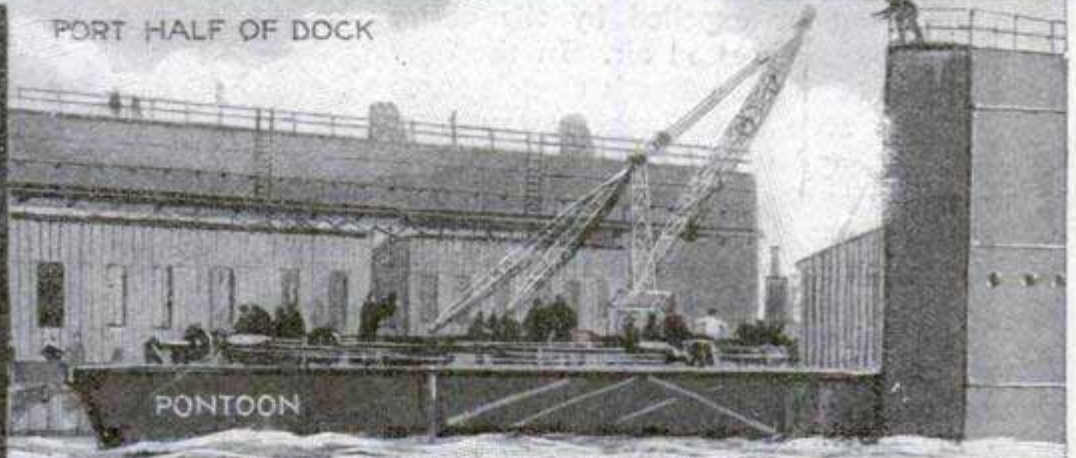
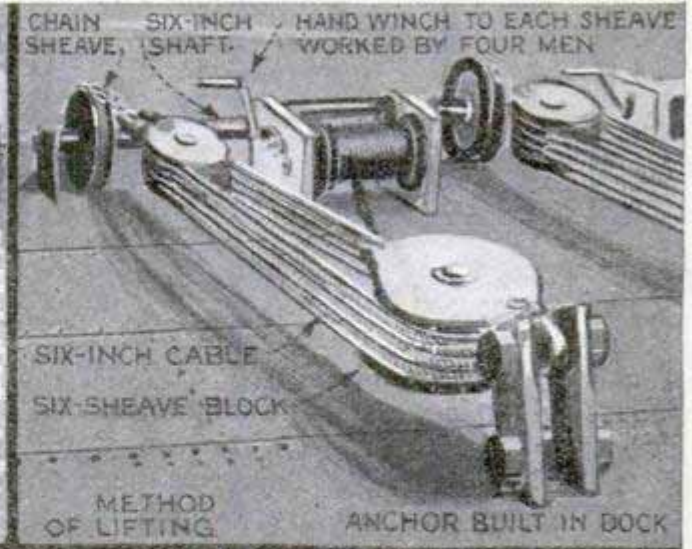
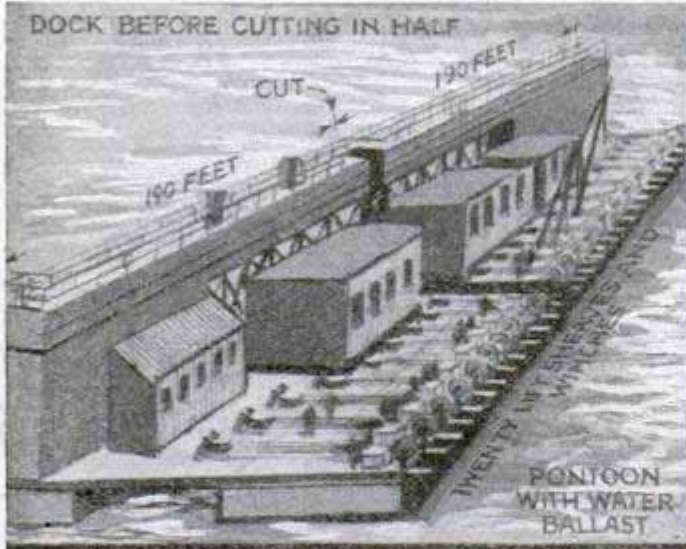

RAISING THE BATTLECRUISER "HINDENBURG"

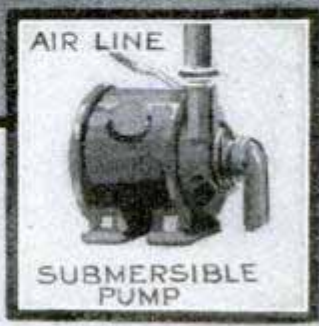
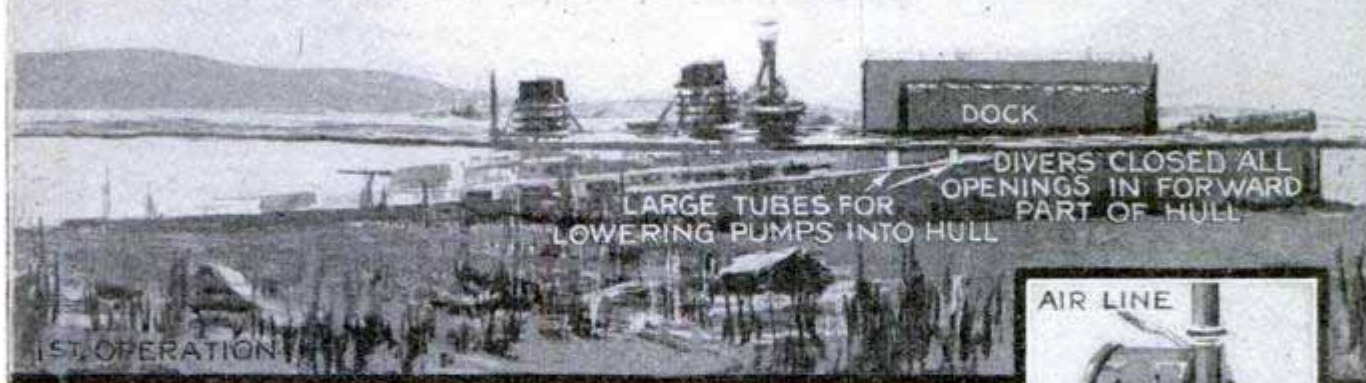

DOCK USED AS PLATFORM FOR PRELIMINARY WORK

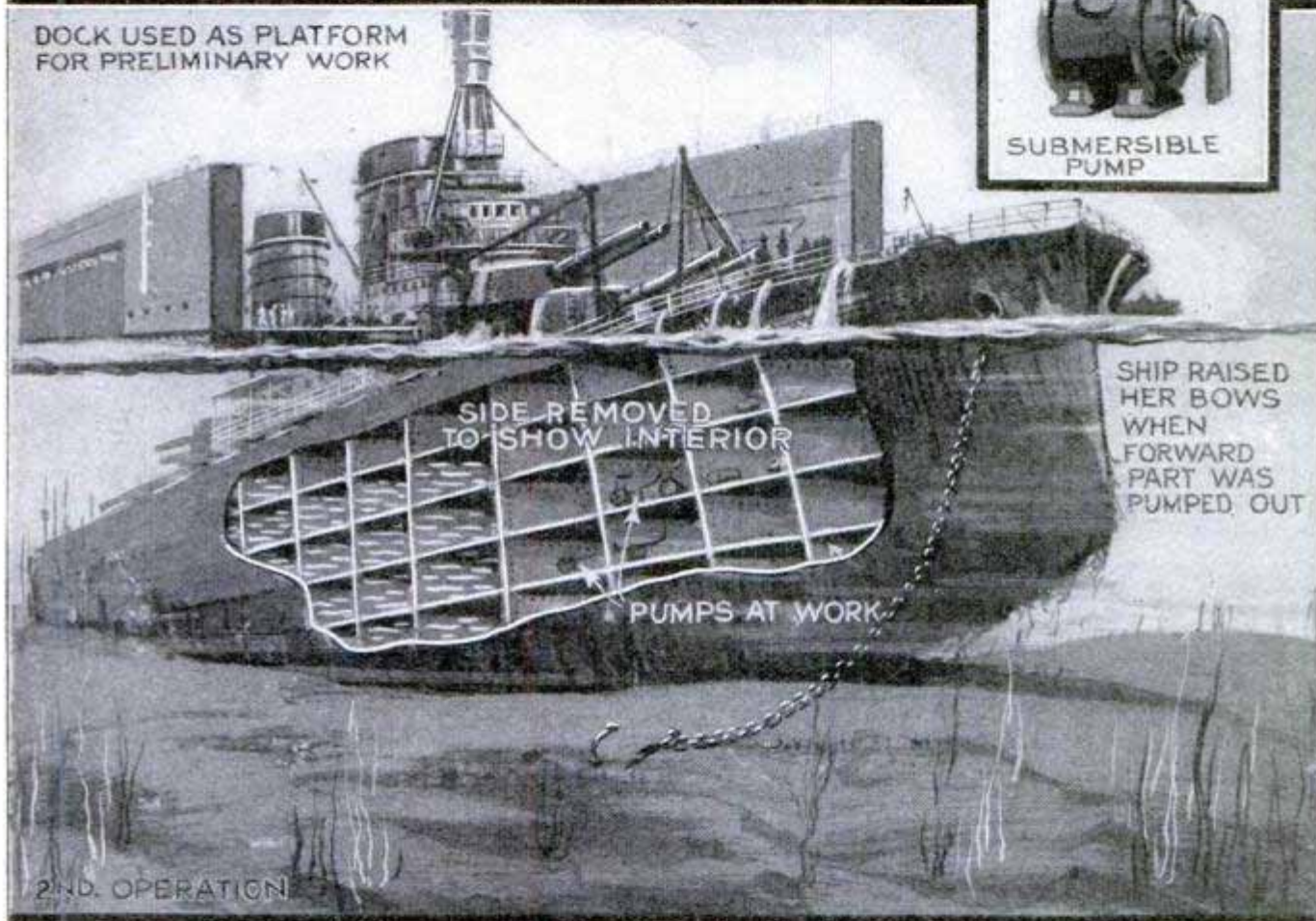

THE SHIP DRAWN INTO SHALLOWER WATER AND GUNS, FUNNELS AND MAST REMOVED



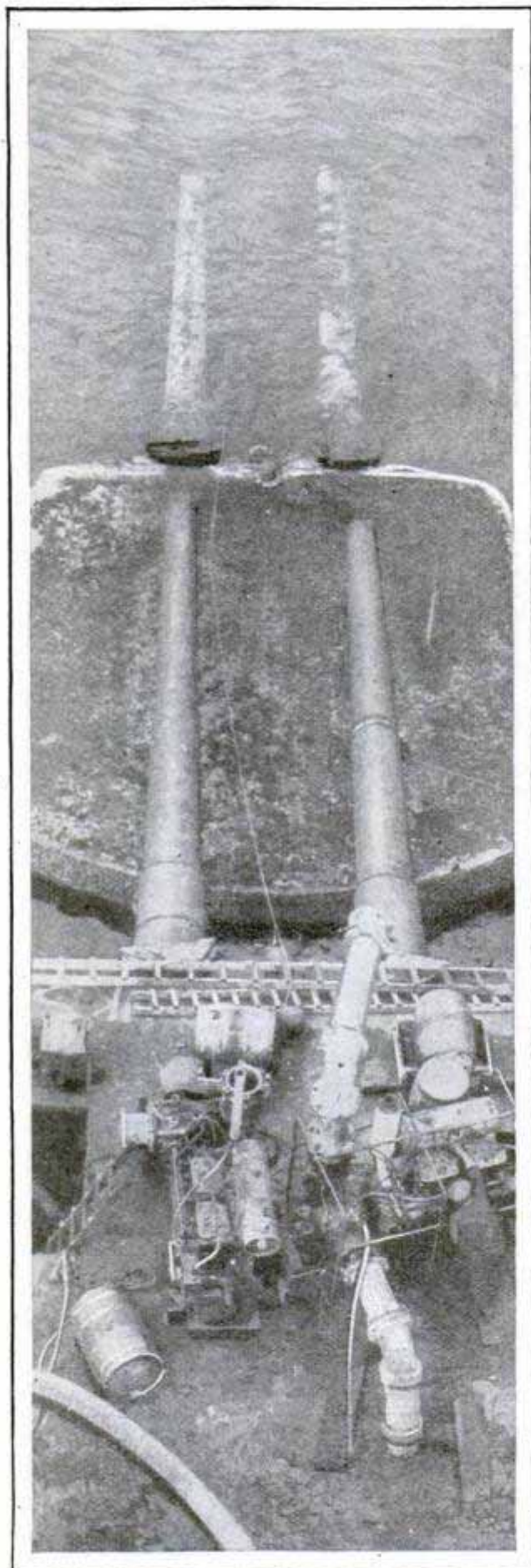

Two Big Guns in the Upper Turret above Water, and the Pair in the Forward Turret Just Visible beneath the Surface

burg" was sunk. Other divers with compressed-air apparatus scraped the barnacles off the ship's bottom and sides. While the divers were busy at this task, three great whales approached and swam round the hull. Forty pumps were started, capable of removing 60,000 tons of water in twelve hours, and seventy divers, working in continuous shifts, began on the work of stopping and sealing 700 holes in the hull. They blasted away rock pinnacles with graduated charges of dynamite, and blew off the ragged edges of the rents in the armorplate, in preparation for the enormous task of applying and water-tightening the patches.

Tough steel, fourteen inches thick, was burned through in sixteen minutes by an electric arc. Such a dazzling light blazed from these arcs that the divers had to wear protecting shields over the windows of their helmets. The rents were stopped, and the portholes sealed, but by this time, the "Hindenburg" had sunk deeper into the ooze of the bottom. Tons of mud had poured into her portholes and powerful jets of water were driven by compressed air upon the mud, expelling it from the hull to the sea bed. Divers then moored pontoons on each side of the sunken battleship. Strong steel hawsers were passed under her hull, and attached to winches on each pontoon, and men strained at windlasses and ropes until the ship swung delicately balanced in the cradle of immense hawsers.

Word was given to the divers: "Stand by to lift 'Hindenburg'"; and on August 19, 1926, in a heavy gale and drenching rain, the flagstaff rose above the water followed by four twelve-inch guns. An hour passed, and the timbers of the upper deck emerged. The pumps were expelling 10,000 tons of water each hour from the hull, but the battleship slowly heeled over to an angle of thirty degrees. Three months of exertion had been wasted—she was flooded and went to the bottom again where she now lies upright with her starboard side anchored down by the sinking of some of the salvaged destroyers. The gigantic task of raising the remaining eleven battleships, three battle cruisers, eight light cruisers and the two destroyers still unsalvaged, probably will take about nine years.

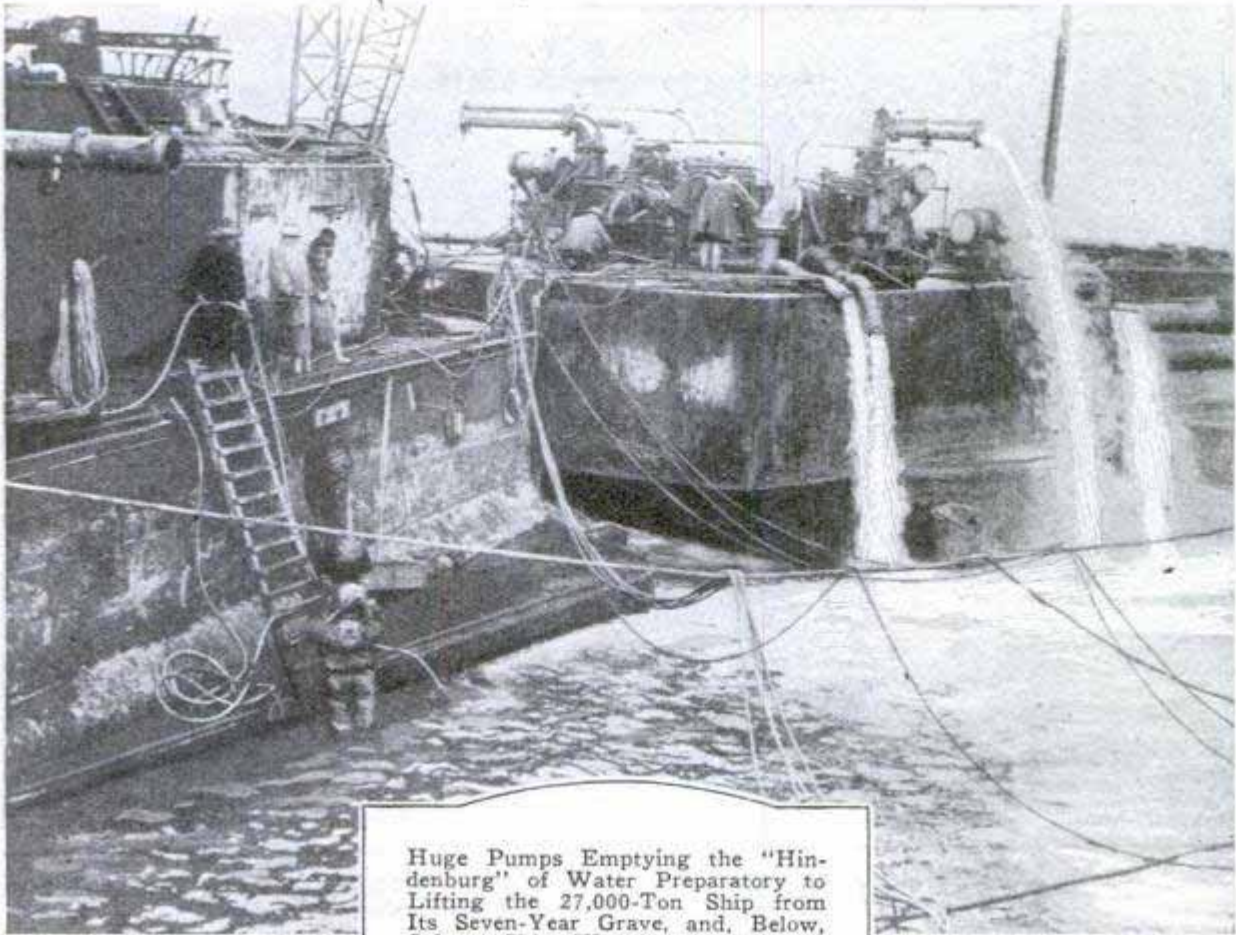

Huge Pumps Emptying the "Hindenburg" of Water Preparatory to Lifting the 27,000-Ton Ship from Its Seven-Year Grave, and, Below, Salvage Ships Working on One German Cruiser, While Other Salvaged Vessels Lie in the Background

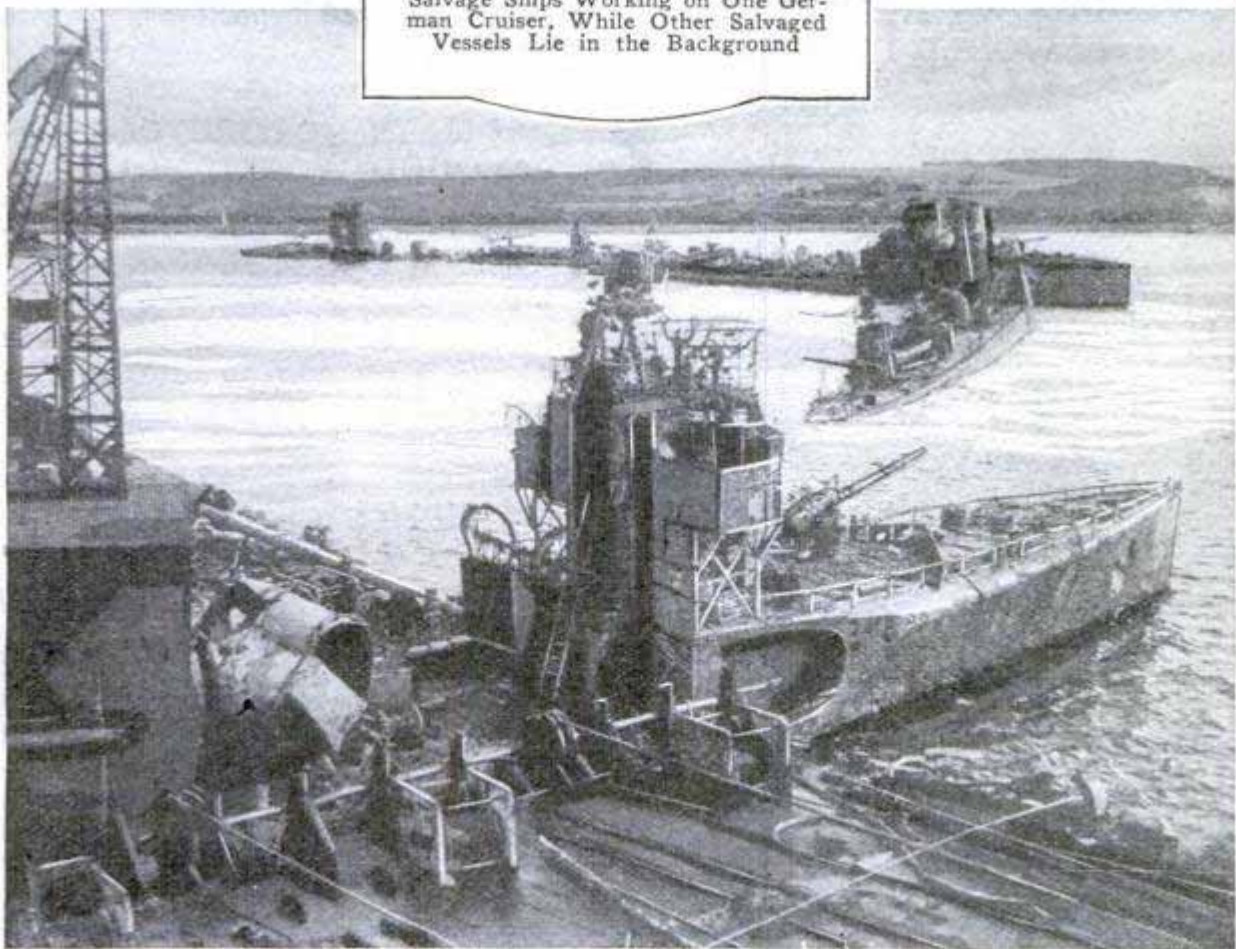

1425
586

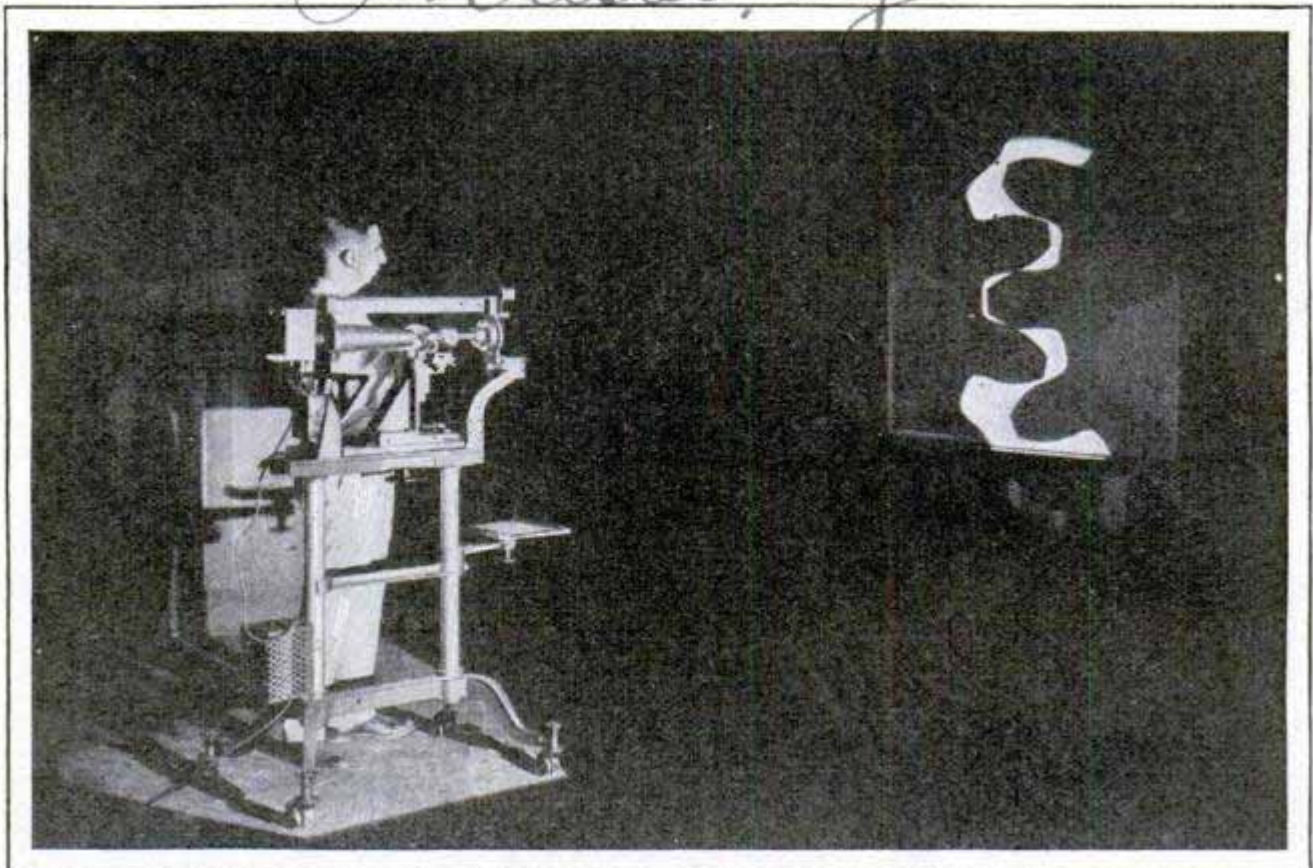

Shadow Picture of Gear Which Clearly Reveals Any Defects in the Cogs; by Comparing This Shadow with a Master Pattern on the Screen, Imperfections Are Quickly Located

HOW SHADOWS HELP TO KEEP THE WORLD IN GEAR

In keeping with the demand for greater accuracy in the manufacture of machine parts, an instrument that makes use of the simple principle of shadow pictures, has been devised for the inspection of gears and other units. It consists chiefly of a microscope and a projection apparatus by which a shadow of the part under observation is cast upon a screen, magnifying an error as small as one one-thousandth of an inch to a quarter of an inch so that it can readily be detected. The shadow cast by the part is compared to a master image that is projected upon the screen at the same time for the purpose of speedily detecting errors. An advantage of the instrument is that it can be operated by persons without special training and yet gives results that only

highly specialized inspectors could achieve without it.

CRUISE IN MOTORCYCLE BOAT AROUND WORLD PLANNED

Plans for a tour around the world from London, in a small motorcycle boat he has designed, are being made by an English inventor. The craft has a sidecar float and is equipped to withstand rough weather and give protection to the occupant. According to reports, he tested the boat with good results on a small body of water at Hampstead heath.

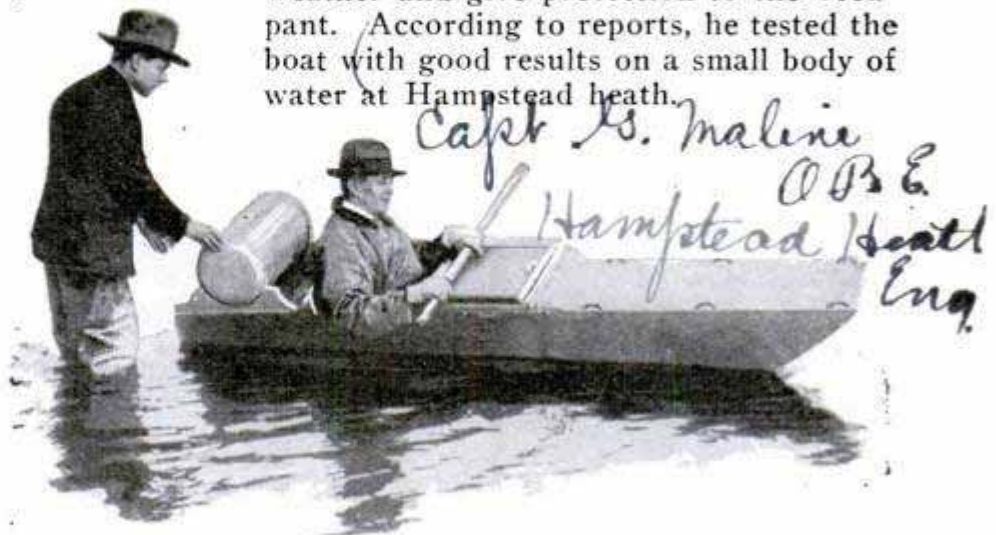

1181
Capt. S. Maline
O.P.E.
Hampstead Heath
Eng.

Designed for World Cruise; the Motorcycle Boat

NEW RIVER REFUGE FOR DUCKS AND WILD GEESE

Blind Children Feeling the Huge Relief Globe, to Gain Knowledge of Geographical Features

Further protection for wild ducks, geese and other fowl has been assured in a new bird reservation recently established by the government on two small islands at the junction of the Columbia and Walla Walla rivers in Washington, which will be known as the Columbia river bird refuge. The rocky islets embrace about eight and one-fourth acres of ground and for many years have been a favorite resting place for wild birds. The fact that the preserve is not easily accessible by man will make it all the more advantageous to the game. It is under the jurisdiction of the U. S. biological survey.



BLIND USE FINGERS TO "SEE" BIG RELIEF MAP

Blind children at the Perkins institute in Watertown, Mass., are taught to study, play and work in spite of their handicap, and much is done toward fitting them to earn their own living. By means of a special globe in relief, they learn geography, their keen sense of touch enabling them to "visualize" the outlines and contours of the continents and countries. The surface of the sphere is especially marked so that they can interpret it easily.

WATCH WITHOUT HANDS TELLS TIME BY MOVING DIAL

A watch without hands, which tells the time through an indicating figure for the hour, appearing in a slot in a revolving dial, has been introduced in France. The edge of the dial is stationary and bears the sixty-minute marks. Inside their circle is a revolving dial bearing an ornamental arrow head, at the tip of which is a small slot in which the figure indicating the hour appears. If the figure showing is eight, for example, and it is under the ten-minute mark, then the time is 8:10. The watch is particularly useful in those continental countries like France where the day is divided into hours numbered from one to twenty-four, instead of a day and night.



ELASTIC SEALING FOR BATTERY WON'T CRACK OR RUN

For sealing storage batteries, filling cases of B-eliminators, and similar work, an elastic material, recently introduced, is said to have distinct advantages in that it will not crack in extremely cold weather and will not run under high temperatures. It is also said to adhere firmly in spite of vibrations, is easily cut for repairs and has a brilliant surface when torched.



Breguet & Co. Rue Edouard VII.

Mitchell-Krand Inc. 17 Vesey St. N.Y.C.

11/10/26

6739 Ridgeland Ave
Chicago

1233



To Help the Pedestrian in Crossing the Street; the Moving Arrow in Center Indicates Walking Time

TRAFFIC-SIGN ARROW TELLS TIME BETWEEN LIGHTS

A revolving arrow which indicates the length of time before the next change, is the feature of a traffic light designed to make driving faster and easier. The pointer, which is visible a block away, turns slowly and points straight upward at the moment the lights change. A driver approaching the signal is thus able to adjust his speed so that he will reach the intersection at a period when the "go" light is on. Many less sudden stops and starts will result, the designer insists. The signal will also reduce the danger of the pedestrian, who often leaves the curb only to find himself in the center of the street when the light signals change.

NATURE'S BALANCE WHEEL

Nature seems cruel at times, especially in the destruction of various forms of life, but if all creatures were allowed to go on multiplying unchecked, serious results soon would follow. Statisticians estimate that if the eggs of a codfish were all allowed to hatch, start their lives and mul-

tiply in turn, but a few years would be required to choke the seas with this kind of fish alone. In less than ten years, rats would greatly outnumber the human population if they lived unmolested. If death did not occur among the birds, in twenty years, the descendants of one pair would number thousands of millions and, in a few seasons, flies would sweep the entire earth if they all multiplied unchecked. Another expert calculates that, if all the human beings born lived to be seventy years old, sixty per cent married and had but two children who also lived to be seventy, in 150 years the earth would be a mass of humanity hardly able to move.

SPEECH PRODUCED BY BELLOWS THROUGH HUMAN HANDS

Using a bellows operated by the foot, an organ-pipe reed and his fingers, an English inventor has succeeded in imitating the human voice with remarkable clearness and fidelity. He can produce the sentence, "Hello, London; are you there?" the reed serving as vocal organs and the fingers as the tongue and lips. The experiment illustrates that the natural voice is largely a mechanical result of muscular and nervous action.

The Speech-Making Apparatus; Air Supplied by Foot Bellows Is "Tuned" by the Hands at the Nozzle



*Mason
Laurel, Miss.*

Exploding Chips ⁱⁿ Guns to Make Lumber

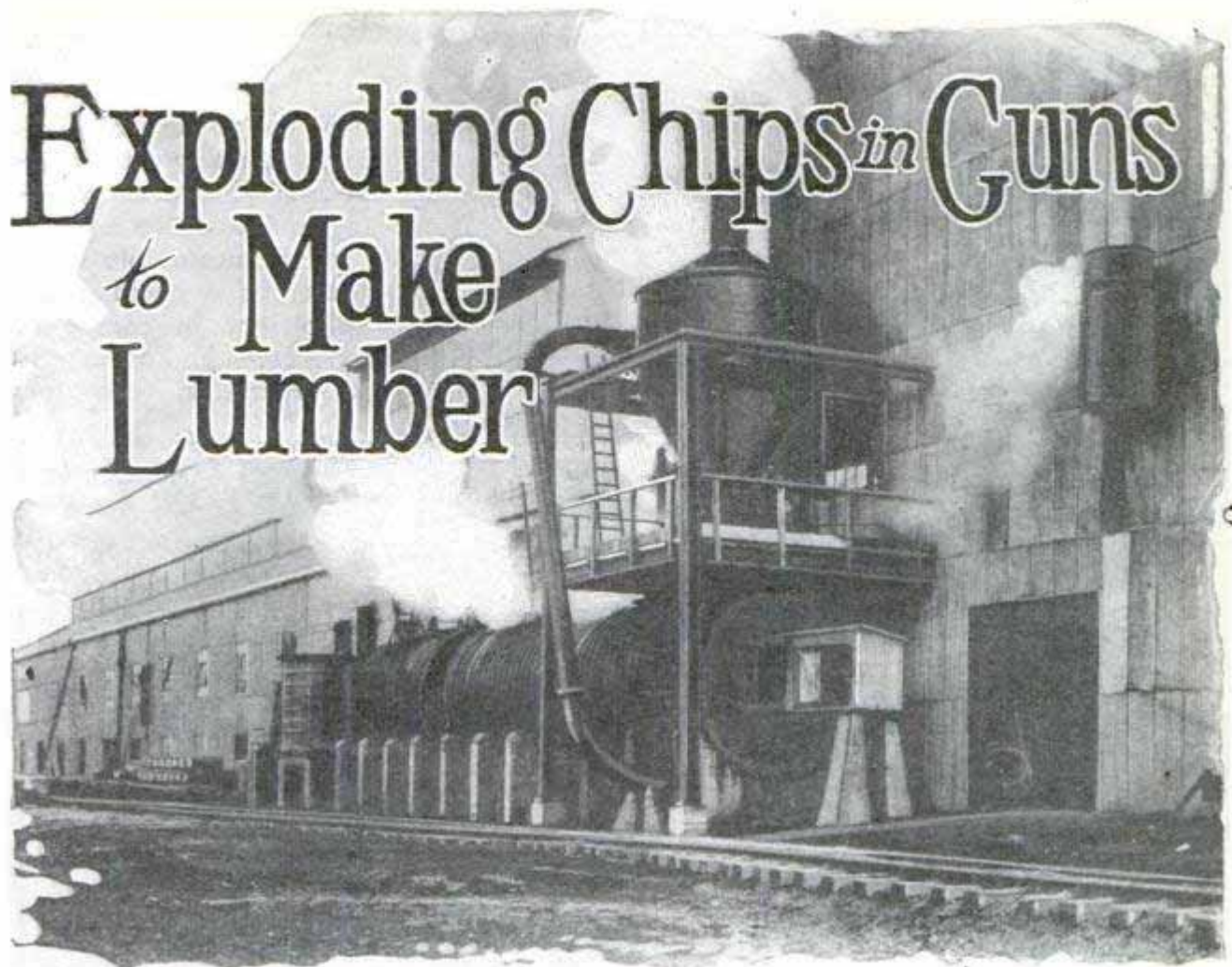

Where the Steam Is Allowed to Escape from the Pulp Material after "Firing" from the Guns; the "Cyclone" at the Wood-Waste Salvage Plant

Sawmill Waste Is Cooked, Turned into Pulp and Then Converted into Boards for Many Uses

IN a new process for utilizing sawmill waste, just launched in Mississippi, the slabs and edgings that formerly went to the trash burner are chopped up, placed in chambers where they are cooked with high-pressure steam, and then shot out in the form of pulp. This is pressed into boards, which are formed without the addition of any binder.

The resulting product differs from the various wood substitutes now on the market, as it consists entirely of wood, from which none of its natural elements have been removed.

The process was originated by W. H. Mason, who achieved fame during the world war by inventing a way of extracting turpentine and rosin from lumber while it was being dried.

At the Mississippi plant, the waste wood is first thrown into a "hog," an inclosed,

heavy iron wheel studded with knives, which reduces the material to chips. The chips are screened, and the smaller fragments and sawdust are sent to the boiler room for use as fuel. The material to be converted into fiber is whisked through a blowpipe to the chip bins.

From these bins it is fed into chambers, known as "guns," built of heavy steel. The guns point downward and are filled at the upper end by means of pipes leading from the bins. The breech of the gun is then closed and steam is admitted for a few seconds. The steam is at the enormous pressure of 1,000 pounds to the square inch and is supplied from boilers that are said to be among the most powerful in the world.

Small ports at the base of the gun are next opened, and the material is shot out at a speed of 6,000 feet a second. This

*Mason
Laurel, Miss.*

*Chicago
111 W Washington*

*From The Pictogram Co.
Box 840, Washinton*

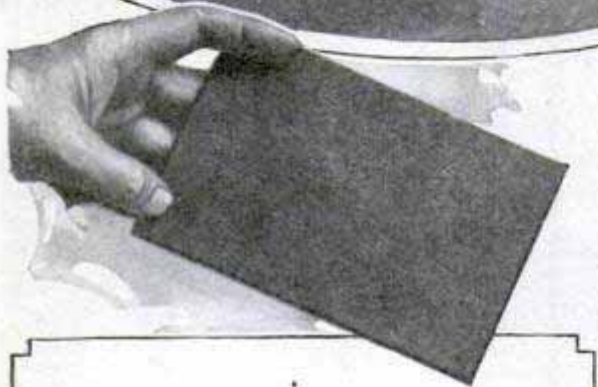
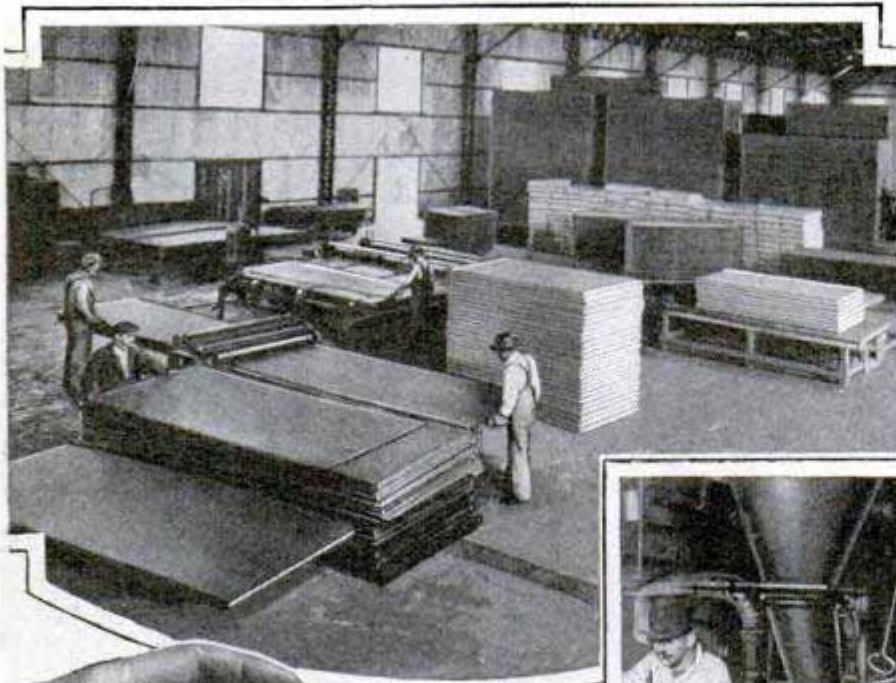

Trimming and Edging the Artificial Insulation Board; the "Guns" Where Steam Pressure Is Applied, and Sample of Product

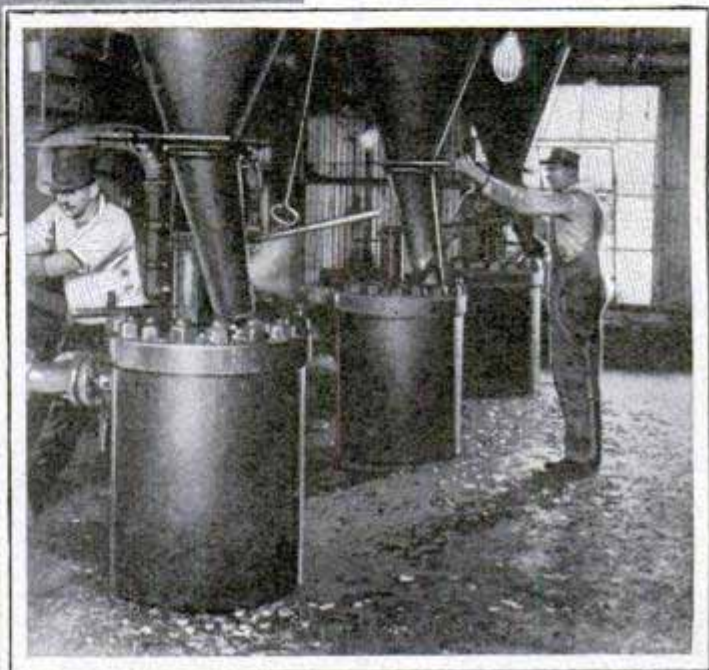

much stronger than ordinary wood. This takes a fine polish, and can be used for furniture, flooring, and many other purposes. It is already being employed by a number of automobile companies as a backing for upholstery in cars that have steel bodies. As it is impervious to water,

violent "explosion" of the boiled chips tears them into tatters, separating the fibers of the wood but leaving each fiber coated with lignin, which serves as a natural cement.

This pulp is next whisked through a long pipe to a "cyclone," in which the steam is allowed to escape into the air. It then goes to a beater, which completes the separation of the fibers, and thence to a machine, similar to that used in paper making for producing it in an endless web, where it is formed and cut into sheets. The sheets are finally taken to steam-heated hydraulic presses, where the board is pressed into shape and the last bit of moisture removed.

Two distinct types of board are made. One is an insulation board, suitable for use in walls, ice boxes, etc. It permits the direct application of plaster or can be decorated without a plaster coat. The other product is a thin grainless board,

it also may prove of use as a durable roof covering.

SLIDING TAB ON FILE CARD AID TO FOLLOW-UP WORK

1452 *Sliding Indicator*
The usefulness of a card-index system, particularly in follow-up references, is increased by a sliding indicator which is attached to a slotted card and simplifies finding data relating to any particular day of the week or month. At the top, the card is printed with numbers indicating the days of the month, the days of the week and the names of the months. The indicator is pointed and also has an open oval, exposing the name of one day at a time. By moving the slide to the proper date for that card and filing the index according

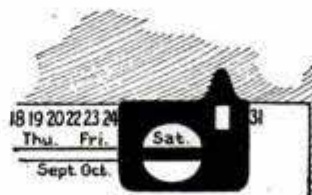

ing the name of one day at a time. By moving the slide to the proper date for that card and filing the index according

*Cleveland Co. Inc.
Havon, Conn.*

Handwritten notes on the right margin, including 'Cleveland Co. Inc.' and other illegible scribbles.

Rubber Co., Akron, Ohio 1912
unmashed photo.
 to a simple date system, it is easy to keep the cards calling for action on special days in an arrangement that tells at a glance, what dates are filled. An additional feature of the system is that the cards may be removed from the file box and carried in a pocket memorandum case.

1532.
RUBBERIZED SILK BATHING SUIT
WEIGHS BUT SIX OUNCES

Several advantages are claimed for a rubber bathing suit recently introduced at a southern beach. It dries quickly so that the wearer may don street clothing within a few moments after leaving the water and without removing the suit. Its elasticity permits free movements, and it weighs but six ounces. The material is a silk fabric which has been rubberized to make it non-absorbent.

TELEPHONE STANDS FOR TAXIS
TO RELIEVE TRAFFIC *1/23*

For the convenience of telephone subscribers and to relieve traffic congestion, Berlin officials have installed fifty telephone stands along the streets for summoning cabs. They are at the service of phone patrons and are intended to reduce the number of idle cabs. By this system, the vehicles will remain in a near-by parking space and respond only when called.

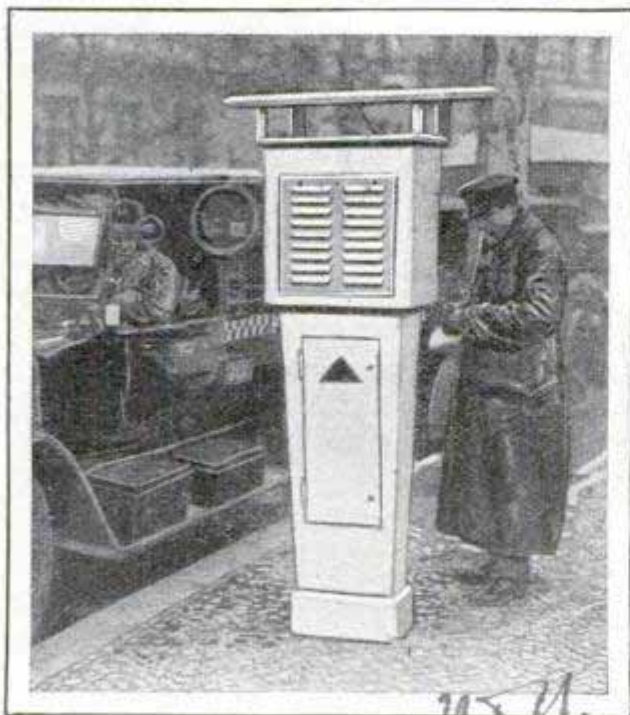

Sidewalk Cab-Telephone Booth in Berlin

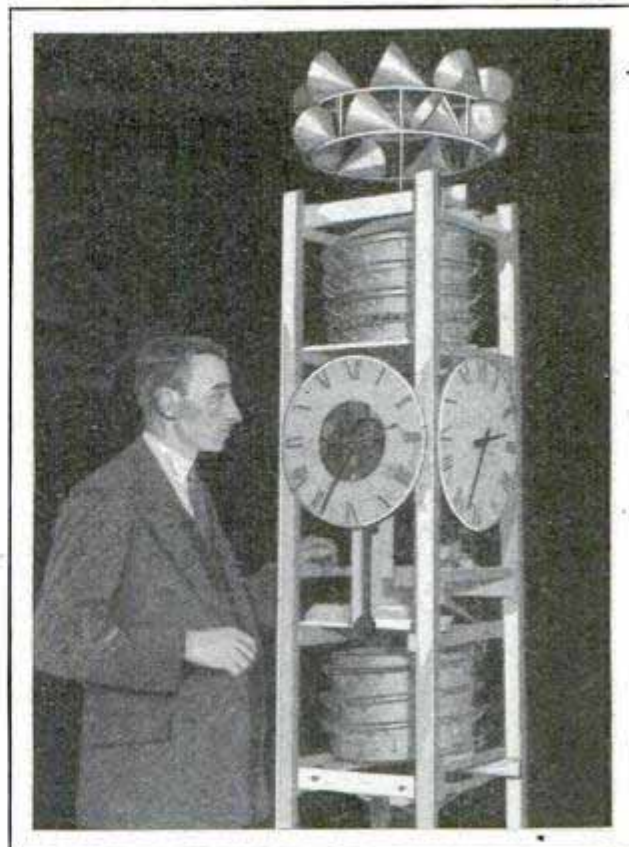

Inventor and His Clock, Showing the Passages down Which the Balls Roll and the Windmill at Top

CLOCK RUN BY BALLS AND WIND
REQUIRES NO WINDING

Frank Padette
 "Perpetual motion—almost," says a San Francisco inventor concerning a clock which he has constructed, and his verdict is regarded as sound, for the clock does run without winding and almost "by itself" except that, now and then, the wind must be relied upon to give it a boost. The driving force is provided by a number of small balls which drop into a cup on the driveshaft and operate the works by their weight. At each quarter of a revolution, when the ball falls from the cup, it is replaced by another. The spent ball rolls down a chute and into an elevator, which is run by a tiny windmill, and is hoisted to the top again to repeat the cycle. There are 250 balls in the clock, sufficient to provide motive power for five days in case the wind does not blow hard enough to operate the elevator.

Popular Mechanics Magazine does not publish the name of the maker or seller of any device described in its pages, but this information is kept on file and will be furnished, free, by addressing our Bureau of Information.

Sells reted

1421

ELECTRIC-LIGHTED RADIO MASTS GIVE BRILLIANT DISPLAY

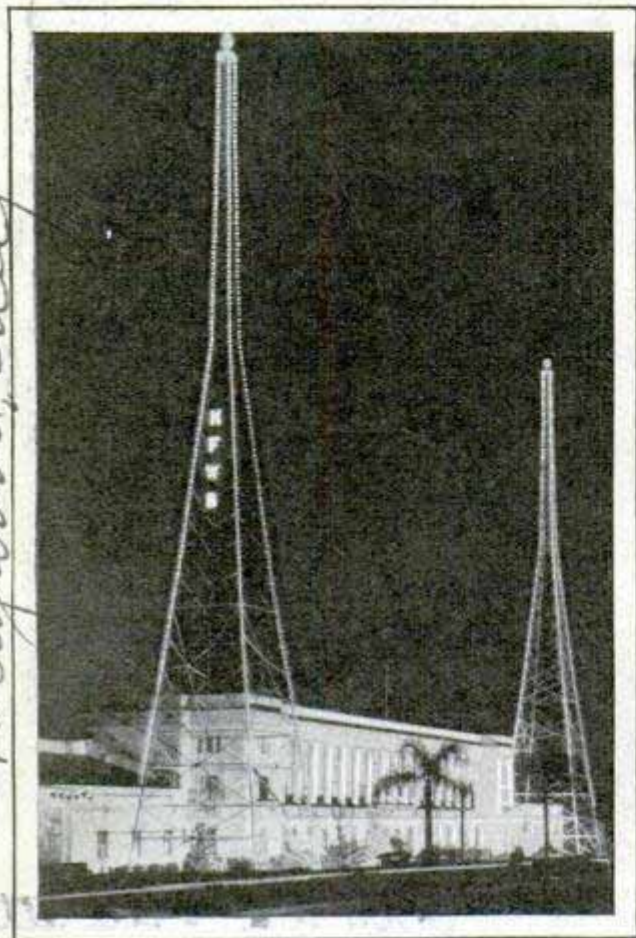

Using Radio Masts for Night Displays; Scene Outside a Los Angeles Motion-Picture Studio

Outlined in brilliant electric lights, the 150-foot radio masts in front of a motion-picture studio in Los Angeles, are visible at a great distance and form a novel setting for the building itself, which is illuminated with floodlights. Since the slender braces of the radio towers can hardly be seen at night, the effect of the chains of light, apparently unsupported, is unusually attractive.

THIEVES ARE TRAPPED BY DYES FISHHOOKS AND WHITEWASH

Piles of coal stored in open yards are sometimes protected against theft by the simple expedient of covering them with whitewash so that any removal can easily be detected. In various hotels, thieves are occasionally trapped by connecting objects with an electric alarm in the manager's office, so that a signal is given in case an attempt is made at removal. One of the most effective aids to the detective at times is methylene blue dye. Money is

treated with it and so leaves a telltale stain on the hands of persons taking the coins or bills. Washing only spreads the evidence, for a stain is left on the towel. After one hotel manager had received repeated complaints of theft from guest-rooms, he arranged an electric signal on the doors and, in the pockets of garments, placed a number of fishhooks. One day the alarm sounded and detectives rushed up to find a man trying to free his hand from one of the hooks in a coat pocket.

INSECT YIELDS CAMPHOR

In a small insect discovered in the forests of Sumatra, an English naturalist sees a possible rival of the camphor tree as a source of the useful drug. The creature secretes a milky fluid which possesses the properties of camphor, it is said, and the suggestion has been made that these insects might be raised artificially, as are silkworms, to produce camphor, which is now obtained from trees.

MODEL GLIDER PLANE SAILED WITH RUBBER BAND

Movements of a real airplane are imitated by a small glider which is shot from a rubber band attached to a small stick or pencil. By changing the wings, and making other adjustments, the glider can be made to loop the loop or fly straight. The parts are assembled with rubber bands to hold them securely in place.

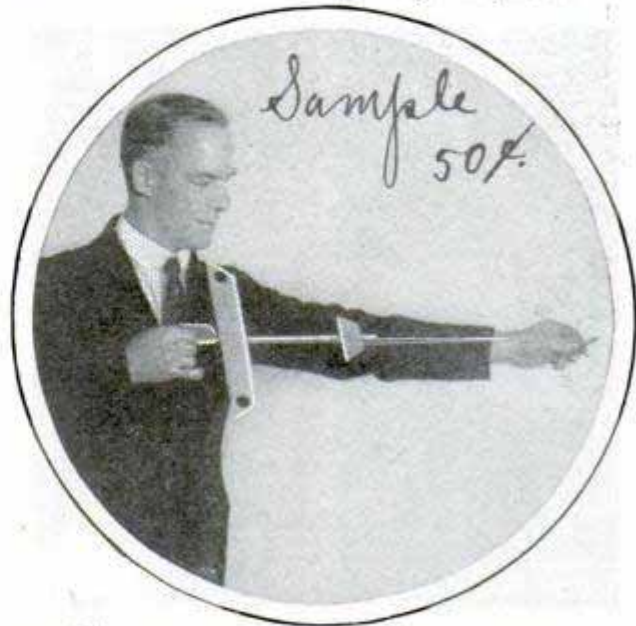

Launching Toy Airplane with Rubber Band, Which Serves as an Effective Catapult

novelty supply house

Warner Bros. in Sunset Blvd Hollywood, Calif.

1914 field live factory in land Chester

Jul Bets 1/16/24

1586

Carl George Holden, Esq

1614

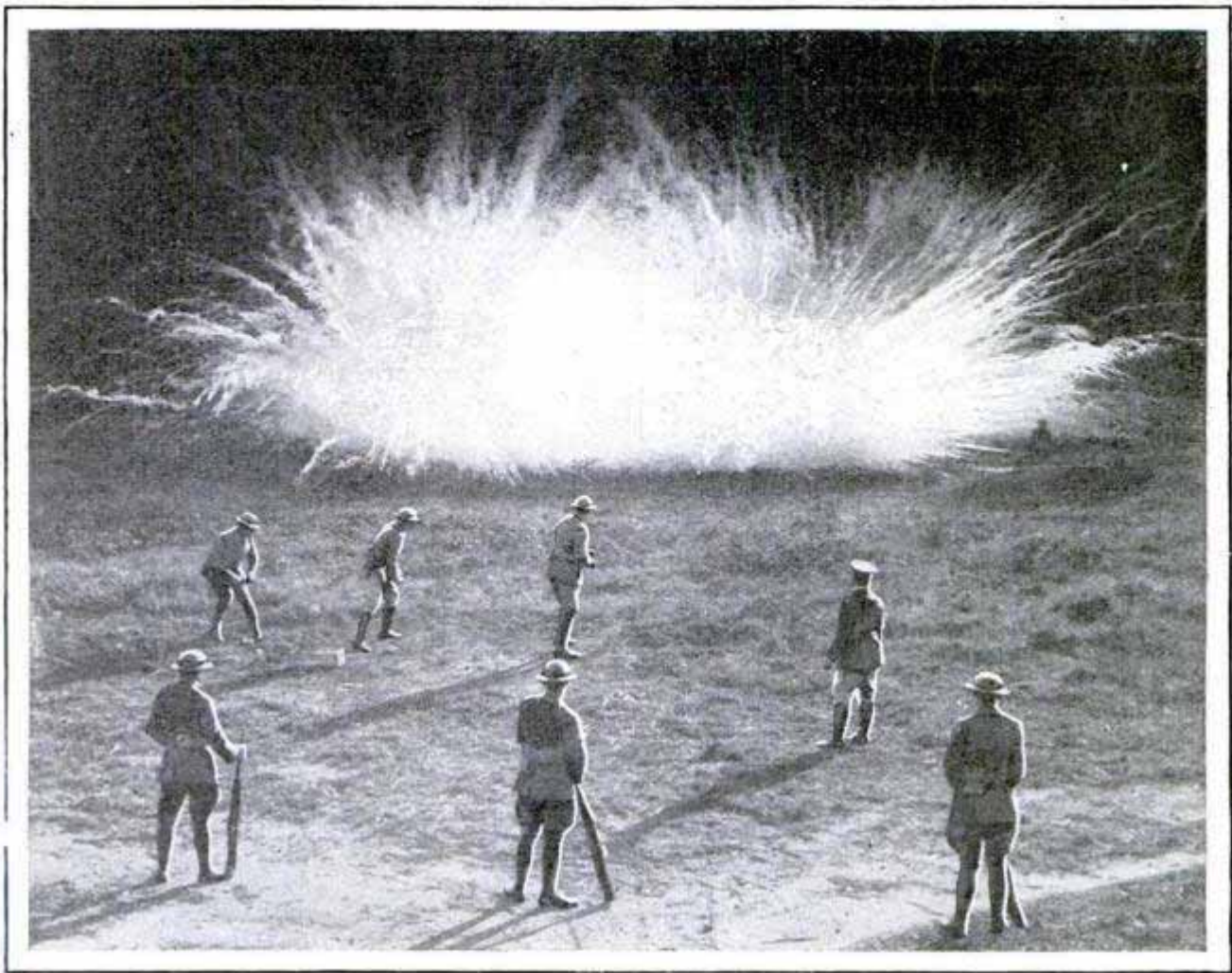

Hand-Grenade Practice during Night Maneuvers at the Presidio; Brilliant Glow of Missiles Burst Lighted a Wide Area and Helped Register Hits

HAND GRENADES REGISTER HITS WITH PUFFS OF SMOKE

Picturesque "blossoms" of smoke dotted the Presidio in San Francisco during recent hand-grenade practice by members of the Thirtieth infantry. The puffs afforded a visible record of the results and showed, according to officers, a high standard of marksmanship.

WORK DONE BY COAL DOUBLED WITH FRAGRANT CHEMICAL

Chemists report fairly successful tests with a white substance that has the odor of the geranium, only more powerful, in obtaining increased service from coal. The "trick" consists in using the chemical in one boiler to run an engine, while the exhaust vapor, still extremely hot, is used to raise steam from ordinary water in a second boiler. The material has been recondensed and reused repeatedly at a pressure of 200 pounds to the square inch

and at a temperature of 800 degrees Fahrenheit, with but little deterioration, it is said. It is slightly heavier than water and is much less expensive than mercury, which has been used in a similar way.

ENVELOPE POST-OFFICE SIGN AIDS TOURIST VISITORS



Finding the post office is an easy task for tourists passing through or visiting a Michigan resort, for a large sidewalk sign in the form of an envelope attracts attention as it projects from the

building. It is fashioned of boards and the design of a letter has been carefully followed except that the stamp is not duplicated, to conform with the law.

Dr. H. A. Slow,

Chemist, Midland Mich.

Conk Cyril E. Lamb,
 309 Ballard St.

Secretary, Commercial Club

1312

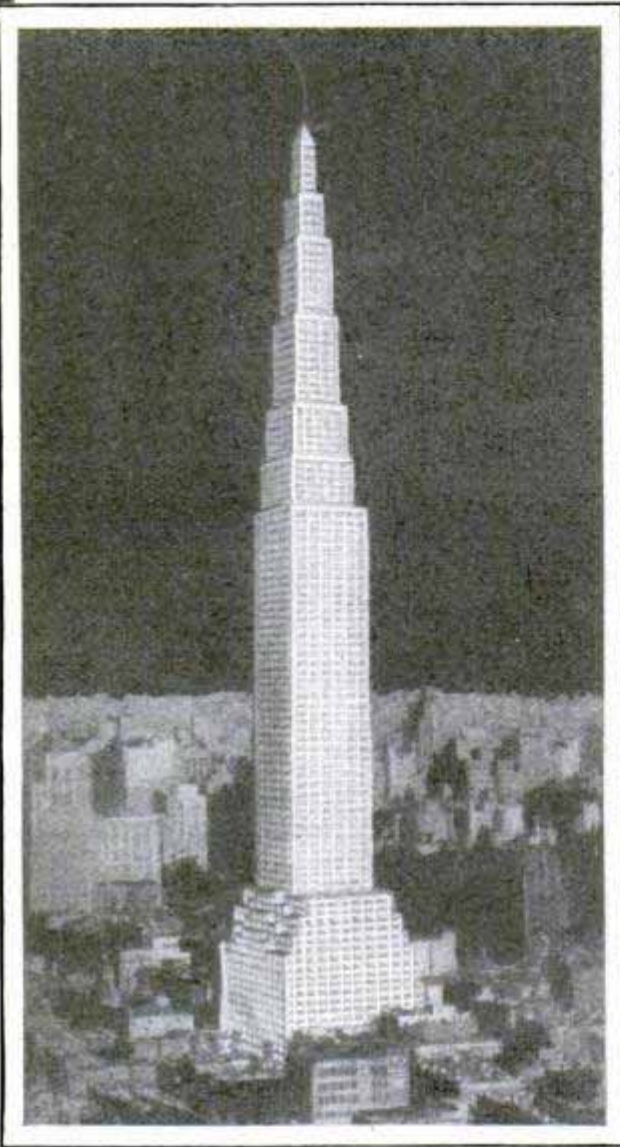

© Hamilton Maxwell, Inc.
Sketch of Proposed Larkin Tower, to Be the Highest Building in the World

PLAN HUNDRED-STORY BUILDING HIGHER THAN EIFFEL TOWER

Patented methods of construction are to be used in the proposed 108-story Larkin tower at Forty-second street, near Eighth avenue, in New York city. A method has been devised to connect the units of the framework so that swaying in a gale will not be greater than in other high buildings, it is believed. The structure will be 1,208 feet high, topping the Woolworth building by 416 feet, the Book tower building in Detroit, Mich., by 335 feet and the Eiffel tower, for nearly forty years the highest structure in the world, by more than 200 feet. The base portion will contain eighteen stories and the tower itself ninety. Besides these, there are two stories below the street level, making 110 in all.

1492

SWIMMING POOLS AS ICE PONDS BRING CITY REVENUE

Gregory, S. Dak., has developed an interesting plan for raising money and serving its citizens, the idea having worked so well that it has helped place the city on a firm financial basis, out of debt. In the park are two concrete basins, one fifty by eighty feet and the other forty by eighty. In the summer time, these are used for swimming, but in the winter they are drained, sterilized and then filled with pure city water. The ice that forms is stored in a municipal ice house and sold during the summer at about half the prevailing price in most towns. It finds a ready market for it is both clear and of better quality than the usual natural pond ice.

1346

GRINDER SAVES USER'S EYES FROM GRIT AND DUST

Several advantages are claimed for a motor-driven horizontal disk grinder, as compared with the vertical type or ordinary emery wheel. It is said to produce a flat finish more easily and is portable; dust, grit and sparks cannot injure the operator, the danger of breaking wheels is eliminated and production is increased, as the worker has a proper support for the arm and can thus feed faster. The unit is especially useful for finishing small parts after the milling and other machine operations have been completed.

Type 1003



642 W. Washington Chicago

Horizontal Disk Grinder in Operation; Sparks and Dust Fly Away from Worker's Face

*Porter-Cable Machine Co
Syracuse, N.Y.*

319



With the "Merry Joeys" of the Tent World

Only Woman Clown Tells of the Clever Tricks Which Win Laughs from the "Townners"

By EARL CHAPIN MAY, *Sharon. Conn.*

THE residents of Clown Alley in the men's dressing room were washing up after the matinee. Each comedian of the tented world stood close to his fellow funsters, as he soused face and hands in cold water that half filled each clown's galvanized-iron pail.

As each face lost the last remnants of make-up, there emerged the veteran Louis Plomonoin with his laughing eyes; Buck Leahy, who doubles on the Roman rings and does a roaring knockabout; Fred Leslie, Clyde O'Neil, Billy West, Steve Buckley and his brother Al; Gay Gibson, and others of the clownish clan.

"Which of you fellows plays the clarinet?" I inquired.

Silence fell upon the group. Its members busied themselves in hanging grotesque costumes on wire racks or packing them in the little flat-topped, iron-bound "professional" trunks which hold

such an amazing quantity of circus stuff. Then Harry La Pearl, chief of Clown Alley because he is both principal and producing clown, replied mysteriously, "The clarinet fellow you're looking for will be in the cookhouse soon."

So in ten minutes Harry, looking not unlike a small-town clothing dealer as he stepped briskly along in his neat sack suit, joined me. We were in the circus backyard, whose walls are of canvas and where one finds the dressing rooms—the women's separated from the men's by the "padroom," where the fat "rosin backs," or principal horses, and the lean jumpers and members of the equine high school are fed and bedded down.

"I guess she's in the cookhouse," was all he said. Threading our way among guy ropes, tent pegs, wagon tongues, horses and elephants gathered at the watering trough, we passed the big top and

by Harry La Pearl

595
 90 Walter Mear's
 Perennial Show



Harry La Pearl, with His Three-Foot Shoes; with His Wife, the Only Woman Clown, in Center; and Below, Mrs. La Pearl in "Merry Widow" Costume

menagerie, steered our course around the sideshow with its flapping banners depicting wild men and sword swallowers, sidestepped the stables now being torn down and loaded for the coming night's railroad run into "tomorrow's town," and thus reached the dining tent.

"The flag's still up," Harry said with relief. "We've got a steward who's keen on enforcing rules. If the flag isn't flying from the cookhouse peak you're out of luck. The dining room is closed." He grinned, then led me to one of twenty long board tables, covered with linen and set with china, glass and plated ware. He bade me sit upon a narrow, hard, blue plank at a table, and beside a fair young woman with luminous eyes. "Meet my wife," he said. Mrs. La Pearl and I shook hands.

After the steak, potatoes, beans, bread, jam and coffee had been dispatched, I reminded Harry, "You said we'd meet the

fellow who plays the clarinet with the rest of your 'Joeys' on the clown band wagon in the street parade and in your clown band number under the big top during the show. That clown was funny. Why don't you introduce me?"

"I have," said Harry, gazing across his coffee cup at his wife. "Loretta La Pearl is the only woman circus clown."

"So you are the 'general,' in green coat with golden epaulets and broad hat with a high cockade, who played the clarinet so painfully in the street parade today?" I demanded. She nodded.

Loretta La Pearl became a clown because she married one seven years ago. She wanted to be with her husband, but he told her there was absolutely no demand for women clowns.

"Then let me make up as a man, and clown with you Joeys from Clown Alley," she pleaded. And she has been at it ever since.



"It's not a hard life, clowning for a circus; not after you get used to it," she says.

"Of course, an hour or so each morning riding on a hard springless seat on the roofless top of a circus wagon, in the sun or rain, is not so nice. Especially when the small boys, who think that nothing can ever hurt a clown, shoot peas with airguns or hurl peanuts at us while we are on parade. And now and then we have a runaway. But nothing really happens that can be called serious.

"Although we have such long parades and I always have to appear a half dozen different times during each afternoon and evening show, I actually am on the job less than six hours a day. And, then, the clowning trade, like any other trade, is filled with tricks. The first trick I learned was how to save myself. You see me do some knock-about stuff and funny falls when I am working on the center stage. Well, when I began to study to be a clown and Harry told me to fall, full length, upon the floor, I nearly broke my back, or thought I did. But by and by I learned the trick of making my rounded



Loretta La Pearl, Above, in One of Her Acts; in the Center, Pete Mardo in Costume, and Below, a Typical Slapstick Scene with the Slapstick About to Be Used

out suffering the least bruise.

"You saw, or you thought you saw

my husband, as principal clown, slap me in the face. He didn't, though. There's a trick in learning to 'take the slap.' The slapper's hand barely touches my unprotected cheek, while my two hands meet, palms inward, right in front of me with a resounding 'smack.' Then one of my hands is raised rapidly to my face—and the 'towners' laugh because they think I really have been slapped. Towners always laugh if they think a clown is being maltreated in some way. But the clown slap is really a bit of sleight of hand.

"So is the explosive slapstick which all clowns use at different times. The detonating cap in such slapsticks explodes, not on the person of the clown attacked, but upon the hand of the clown who wields it. I'm talking now of full-fledged clowns who know their trade.



shoulders take most of the blow. Now I can fall or sprawl almost any way with-

"Now and then Harry joins out an amateur, a youth who is known in his first season as a 'First of May.' Such a youth has confidence, but lacks judgment. We had such a one on our show last spring. He was supposed to slap me, and he did. My cheek stung for many an hour. Another First of May was instructed in slapstick exercise. The slapstick, whether it has a detonating cap or is merely made to give forth sound by flapping its two parts together, is not supposed to hit its victim hard. If you'll watch an old clown working in the ring, you'll see that this is so. But this particular First of May wanted so much to make good that he belabored Harry until we had to poultice him.

"The second-season clowns are known as 'Johnny Come Latelys.' They are the sophomores of the clown school. And the chances are that if First of Mays live through their first season and become Johnny Come Latelys, they may, in time, graduate into principal or producing clowns, such as my husband is.

"Harry originates and stages all the special clown stuff on our show. A real producing clown has to keep up with the times. When Edmund Rostand's 'Chanticleer' was having such a vogue, Harry came out with a clownish 'Chanticleer.' When the 'Merry Widow' waltz was all the rage, Harry did his first walkaround—

along the hippodrome track, you know—in an enormous Merry Widow hat. He originated the dance on shoes, the soles of which are nearly three feet long, more than a dozen years ago.

"I've said that circus life is not hard. I have a lower Pullman berth which I have decorated with cretonne and made as homelike as I can. We rarely get up until eight each morning and we sleep well, although sometimes the engineer in moving the circus train about jerks it a good deal. If the circus lot is a mile or more from where the circus train unloads, we breakfast downtown, but, at any rate, from nine o'clock until eleven we have nothing to do but unpack our costume trunks, mend and wash, read letters and all that. Supper is over at five o'clock. We haven't a thing to do between that time and nearly eight, when we make up for the evening show. You see, it is not bad, although some lots are dusty and sometimes the rains follow us and things get pretty cold and damp."

After the five or six months' circus season ends in October or November, Mr. and Mrs. La Pearl are at home in their comfortable six-room cottage at Huntington, W. Va., where you will find her making potato pancakes or turning out roast chicken with oyster dressing, in which she takes due pride. While she is thus employed, her husband, in overalls,



The Clown Band in Action; Pick Out the Clarinet Player and You Have Found the Only Woman Clown in the Circus World, Loretta La Pearl, Whose Husband Is the Leader

*Measure to
Liana Pappas
Mich.*

is in his shop, in the backyard of their "permanent address," making new shoes or slapsticks or canvas and wool-stuffed "snakes" which aid him in his "Hindu dance." Or he may be designing costumes for the season to come.

At Right, Measuring the Ribbon Roll for Quick Estimate of Amount Remaining; the Bolt-Width Meter and the Lace "Yardage" Recorder

*\$20.00
Paruch
12 19*

\$30.00

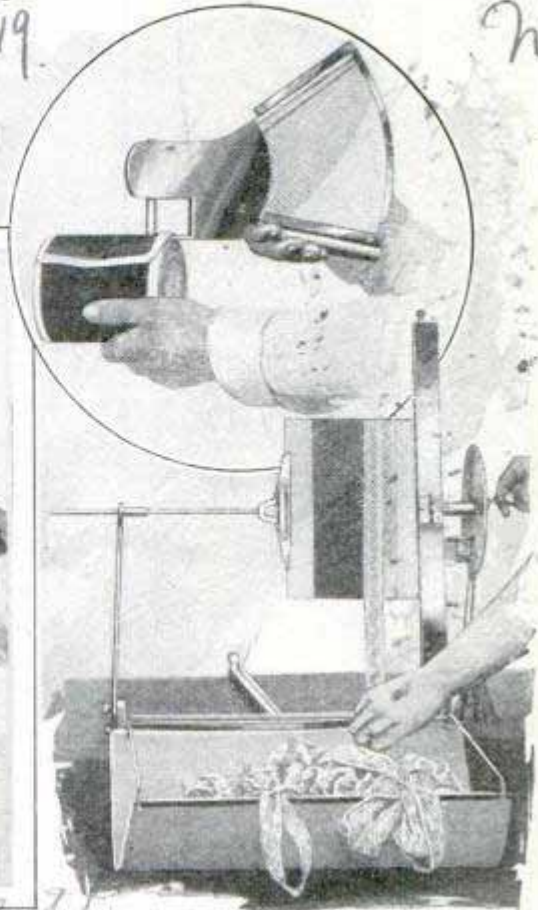

TWINS WHO LOOK ALIKE SIMILAR MENTALLY

Twins who look so much alike that it is hard to tell them apart have other similarities besides that of appearance, according to tests conducted recently at Columbia university, which showed their mental processes were almost identical. The tests were given to 158 pairs and showed that all sets of twins are more alike mentally than brothers and sisters who are separated by a year or more in age. Girl twins and boy twins were more alike mentally than boy-girl pairs. Sixty-three of the pairs were so alike physically that they were almost indistinguishable.

Chicago Daily News. 1/4/27

CAKE MODEL OF BIG BUILDING LIT BY FLOODLIGHTS

Engineers took a hand in the making of a 150-pound cake model of a ten-story building in Fresno, Calif. It was baked in twenty-one specially designed pans, which experts of a utilities company prepared, and was lighted with 121 tiny floodlights to imitate the structure after which it was modeled. The cake was four and one-half feet high and twenty-four by thirty inches in floor area. It was finally cut into 150 pieces and distributed among employees and friends.

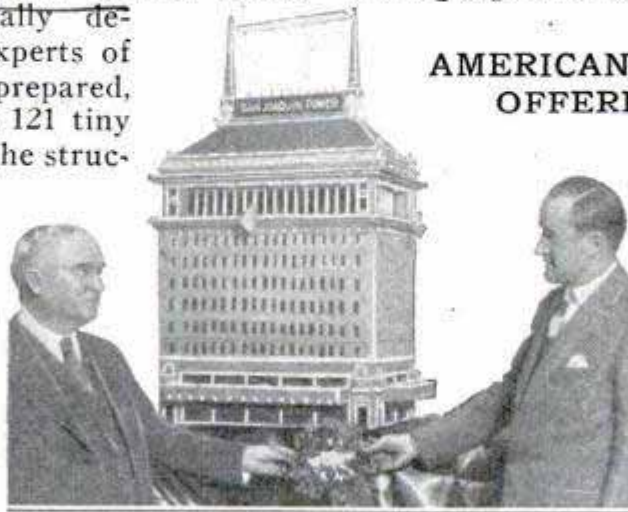

Company Officials and the Illuminated Cake

DRY-GOODS METERS SAVE TIME IN TAKING INVENTORY

Aids to the dry-goods merchant have been introduced to simplify the laborious task of taking inventory. One of them, a cloth meter, gives quick and accurate count of the folds on a bolt, while a chart, used in connection with the meter, indicates the yardage. Another instrument like the cloth meter determines the approximate length of ribbon left on a partly used bolt. A reel for winding laces has a gauge that registers the yardage.

AMERICAN-MADE IDOLS ARE OFFERED TO HINDUS

A number of mid-western firms have sent a representative to India to open an office for the sale of their products. One concern offers to make idols and other objects for the Hindus to be used in their religious rites.

*1319 Jersey Ave. N. Minneapolis, Minn.
1283
Cont. W.G.*

*Presented to A. S. Wishon
President, San Joaquin Light & Power Corp*

1257

Chicago Wood Product Co.
431 S. Dearborn
also E. C. Wood
Esplanade
Wilmington

Sawdust Doll and Sticks of Dynamite, Samples of What Can Be Made from the Wood-Flour Material Prepared from Substance Formerly Wasted



FROM DOLLS TO DYNAMITE IS STORY OF SAWDUST

From sawdust and other mill waste a material known as "wood flour" has been prepared and is now being employed in the manufacture of many useful articles. Among them are inlaid linoleum, dynamite and dolls. Experiments are being conducted to find still other new uses for the substance.

MAN-EATING TIGER WHEN SHOT IS FOUND WEARING COLLAR

A man-eating tiger that had taken an enormous toll of human life in India for many years was finally killed recently—and found to be wearing a collar around its neck. Rear Admiral C. M. Beadnell, who reported the incident in London, said the animal at one time apparently had belonged to a menagerie, but escaped and, with the usual wild fear of man overcome through close contact with people while a captive, the beast turned killer. It was so bold that it would attack an ox-cart in broad daylight, or stalk into a village and walk off with a child under the very eyes of its parents. For years it escaped poison, traps and guns, until finally the price on its head grew so great that the number of hunters became too large for even its skill to

avoid. Admiral Beadnell, who has hunted big game all over the world, also reported a thrilling lion story from one of his trips to Africa. He had shot a large rhinoceros, and was on his way back to camp, when four lions suddenly rose out of the tall grass less than fifty feet ahead. The admiral reached back to take the rifle from his gun bearer, and when it was not placed in his hand looked around to see the native vanishing over a hill in the rear. The lions began to advance. Beadnell unslung his field glasses from around his neck, held them by the strap, and, swinging them around his head, suddenly shouted and started toward the lions, who promptly turned tail and fled.

TABLET IN HONOR OF FRANKLIN PLACED AT FRENCH PORT

The 150th anniversary of Benjamin Franklin's arrival in France was the occasion of ceremonies last December at the port of Auray where he landed. A tablet was erected to his memory and one of the thoroughfares of the town has been named for him. Although France was unwilling to declare open enmity against England at the time of Franklin's visit, the diplomat succeeded in obtaining large loans for America.



Ben Franklin's Memory Is Still Cherished in France; Tablet Erected at Port of Auray

London Daily Mail

1431

12/2/26

1318

Leipzig, Germany

AUTO DRIVERS' SKILL IS TESTED BY MACHINE

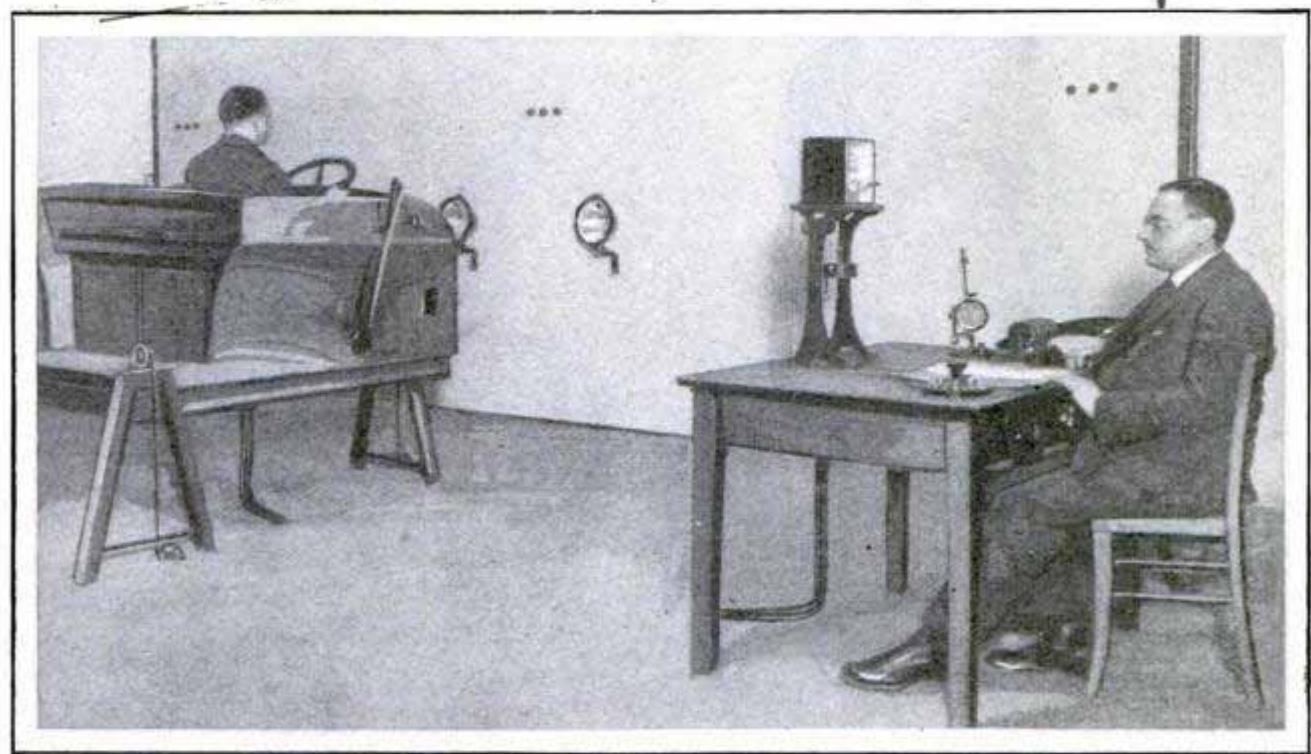

In the Auto Drivers' Testing Laboratory; Traffic Pictures Are Thrown on Screen While Subject Handles Dummy Car as Though Actually Driving

Driving problems that would commonly be encountered on the road are given candidates for chauffeurs' and drivers' licenses in Leipzig, Germany, while they sit in a dummy automobile and manipulate the controls. Close in front of the subject, is projected a motion picture of traffic in a congested district and he is required to govern his "car" as though he were actually driving it on the street. Any mistake made is registered automatically on the tape of a recording apparatus connected with the dummy auto. From the results, the examiners are able to construct a psychological picture of the subject's reactions and form a fairly accurate judgment as to his fitness. How well the candidate endured the strain is measured by a separate bit of mechanism.

1512

SPLITTING GRANITE WITH AIR

The expansive force of compressed air is employed in an interesting way by a granite company in the south. On a sloping hillside, composed of granite that shows no bed planes but splits readily in any direction when started, a three-inch bore is sunk about eight feet deep and the bottom is enlarged by exploding a half stick of dynamite. A small charge

of powder is fired in this hole which starts a horizontal crack or cleavage. Charges increasing in size are exploded until the breakage has extended over a radius of seventy-five or a hundred feet. Then a pipe is cemented into the bore and air is forced in under a pressure of eighty to 100 pounds. The expansion of the air extends the cleavage until it comes out at the surface of the slope. A huge sheet of granite is thus separated.

1406

FURNACE BLOWER SAVES COAL AND MAKES QUICK FIRE

Operated from the lighting socket, a portable fan blower directs a strong air current through the ash door of the furnace or heater. An adjustable, hinged unit at the end of the air tube, permits sending the draft where it is most needed, at the rear, middle or front of the grate. The outfit weighs but twelve pounds and can be used without making any changes in the furnace.

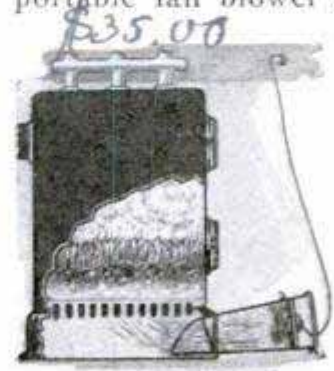

St. Charles Place
City, N.J.
Atlantic
169

Cont. Edwin Tarzige, The Farragut
211 ...

602
388.

QUEER BUILDINGS THAT CATCH EYE IN THE WEST



Replica of the Sphinx, Built for California Real-Estate Office, Attracts Attention of Passers-By, and, at Right, Cottage in a Tree Constructed by Aged Man in One Week

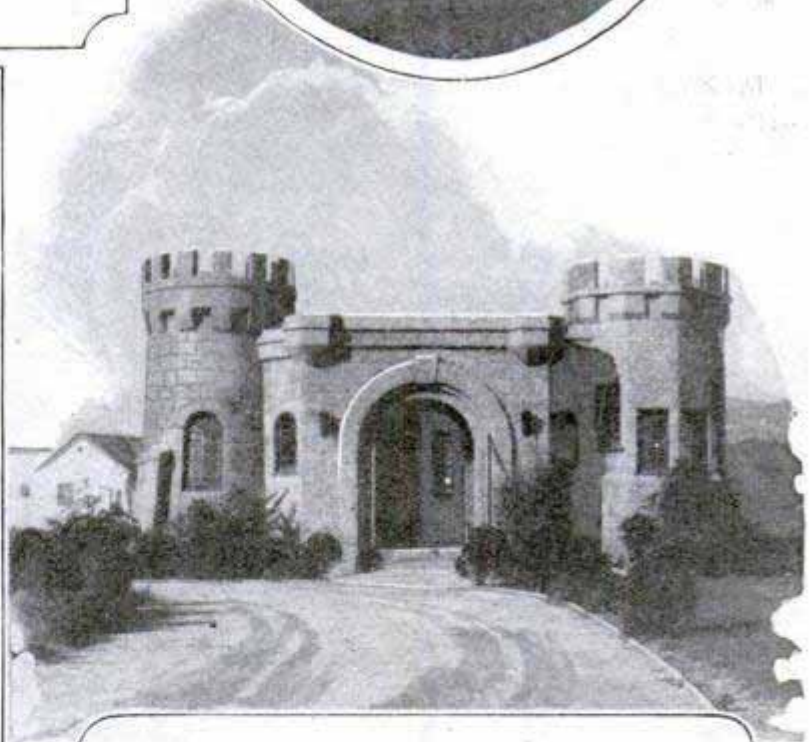
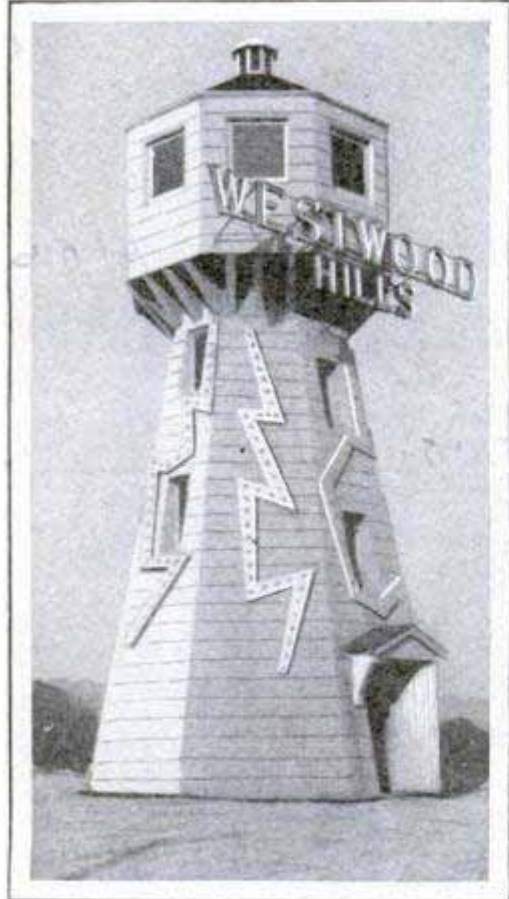
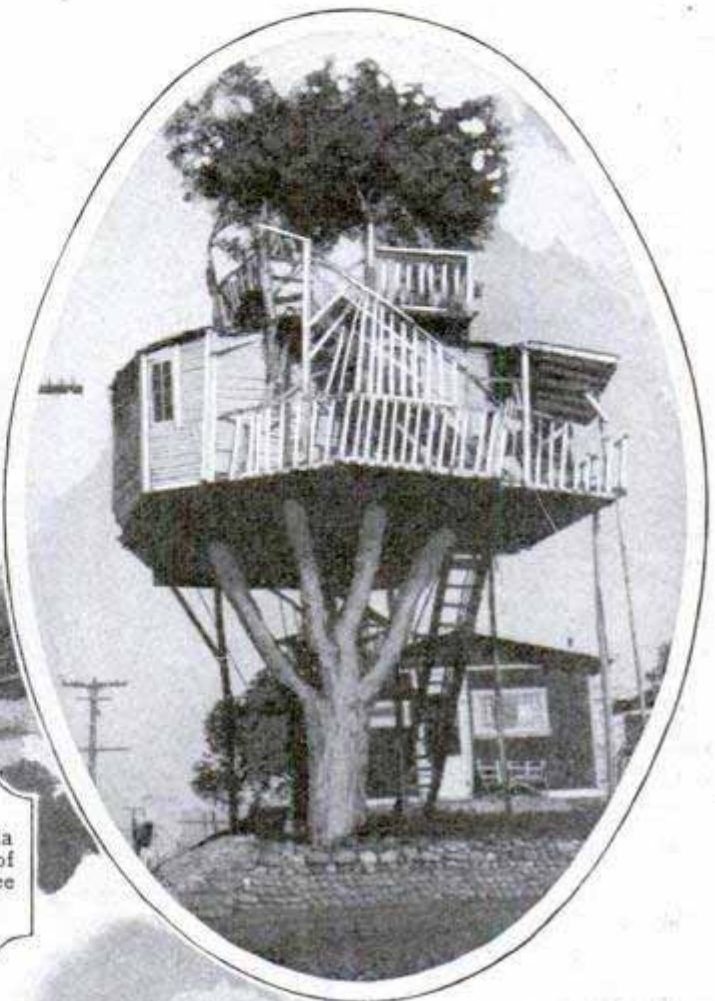

Prospective Buyers Obtain a Good View of Property from This Lighthouse Tower on Subdivision; the Lookout Is Illuminated at Night; Castle at Right Is Real-Estate Salesman's Office and Has a Drawbridge and a Miniature Lake on the Carefully Landscaped Grounds

DIKE OF ICE SHUTS OFF WATER FOR SUBMARINE BUILDING

To facilitate submarine construction at Husum, Germany, an interesting method of shutting off the water has been developed. Instead of using sheet piling or building caissons, a solid ice dike is formed by sinking a system of pipes along the line the dike is to follow and partly filling them with liquid air, which, when evaporating, lowers the temperature to 180 degrees Centigrade below zero. In a few hours, an ice wall, nearly ten feet thick and projecting out of the water about six and one-half inches, is formed and can be maintained as long as liquid air is supplied for continued evaporation, while the shut-off area is pumped out and until a permanent dike is built. The undertaking at Husum aims to shut off the bay by a wall nearly 5,000 feet long and will be followed by larger projects. The method is not applicable everywhere, but lends itself particularly for regulation of river courses and reclamation of land, and is said to be economical.



In the Combination Goldfish Hospital and Home; Distributing Fish among Storage Tanks

LONDON SHOP IS GOLDFISH HOME AND HOSPITAL

Ailing goldfish receive careful treatment at an interesting store in London where the pets are cared for when their owners are away. The proprietor has become known as the fish doctor and is said to do a brisk business as he also keeps a stock of unusual and decorative specimens.

C. Freeman

SAFETY ZONE MARKED BY POSTS TO PROTECT PASSENGERS

Lengths of steel pipe, set firmly eight feet apart in the pavement around the safety zones in Cleveland, Ohio, have been found effective as further protectors of persons getting on and off the street cars. At the entrance to the zone, there is a special bumper post, and an amber light on another post warns the motorist to be cautious.

Com. J. P. Buckley, Secretary of Traffic, City of Cleveland, Ohio

WIND BLOWS GIANT WHISTLE CUT FROM WILLOW TREE

Making willow-tree whistles is a favorite sport in many lands, and the world's record for size is probably held by some English boys who made a whistle ten feet high and twelve inches in diameter, and then let the wind blow it. It was constructed along the same lines as the toy article and roped high in a tree where the mouth end would receive the full blast of the breeze. When a strong wind came up a few days later, it blew the whistle so loudly that it caused considerable alarm until the source was discovered. The whistle finally came to an unlucky end, for an exceptionally strong wind tore it from its moorings.

1526

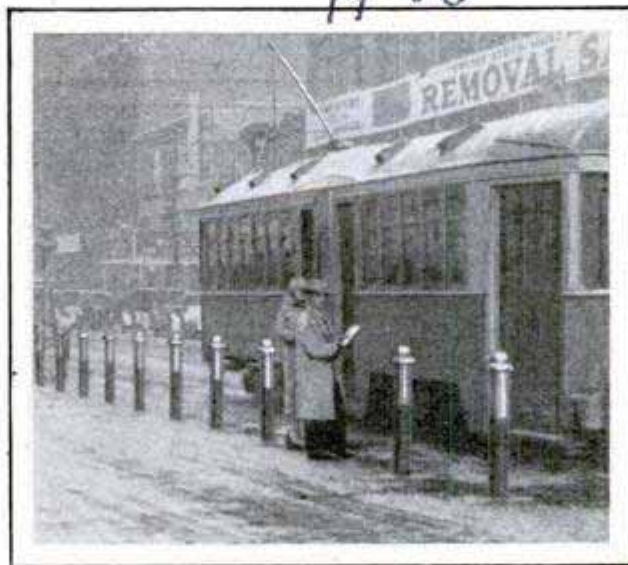

Insuring Cleveland Street-Car Passengers Extra Safety While Waiting; Posts around Safety Zones

1480

*Com. J. Leonard Baxter
46 Arnewood Road
Cleveland*

1280

ELECTRICITY IS USED TO SOLVE CRIME MYSTERY

Crime-Detecting Apparatus Which Outwits the Mind; Young Woman's Heartbeats and Pulse Are Visibly Recorded, to Show Changes in Response to Questions

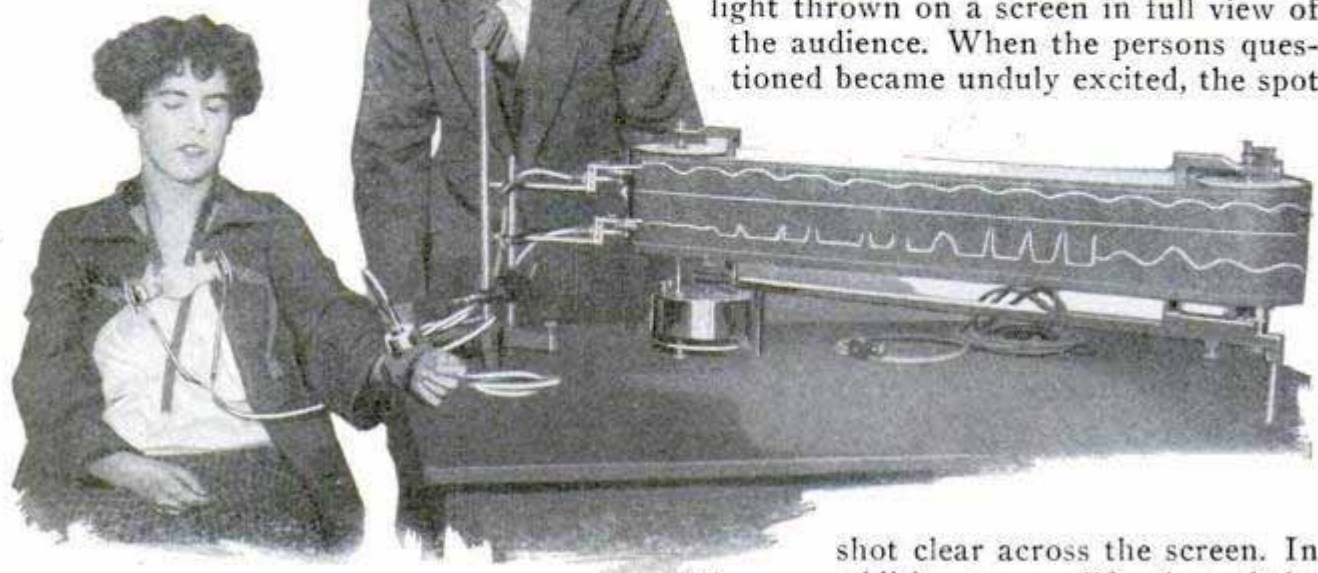

By the application of special electrical instruments, a robbery was solved in less than an hour during an interesting test in New York recently. The demonstration further indicated to what extent science is now able to aid in the war against crime. Three persons in the audience were given sealed instructions and sent from the room. In one message, the holder was required to go to the tenth floor and remove \$10 from an envelope in a coat pocket. When all the subjects had returned, the instruments were adjusted and the reaction of each was studied while questions were asked. By quickened heartbeats, and by a change in the electrical resistance of his skin, due to an effort to conceal the truth, the "culprit" was easily detected. The heart-beat test was made with an improved stethoscope which amplifies the sound of the heart 100,000 times. When the young man who had opened the en-

velope was asked questions bearing on the robbery, the accelerated action of his heart was immediately evident. The change in electrical resistance was made apparent by means of a moving spot of light thrown on a screen in full view of the audience. When the persons questioned became unduly excited, the spot

shot clear across the screen. In addition to amplification of the sound, the heart-measuring instrument translates the beats into lines on a chart so that the pulsations can be detected.

ELEVATOR ON BAGGAGE TRUCK PREVENTS BREAKAGE

To save time and work in handling heavy shipments, such as safes, machinery and crated goods, a baggage truck with an elevating platform, which can be operated by one man, simplifies the task of loading or unloading. The elevator can be raised level with the car floor, thus saving lifting and reducing the likelihood of dropping the goods with consequent breakage. The operation is performed by means of a worm gear and the lift has a capacity of 3,000 pounds. The truck also has a safety handle which locks automatically in a perpendicular position and prevents children or others from stumbling over it. A

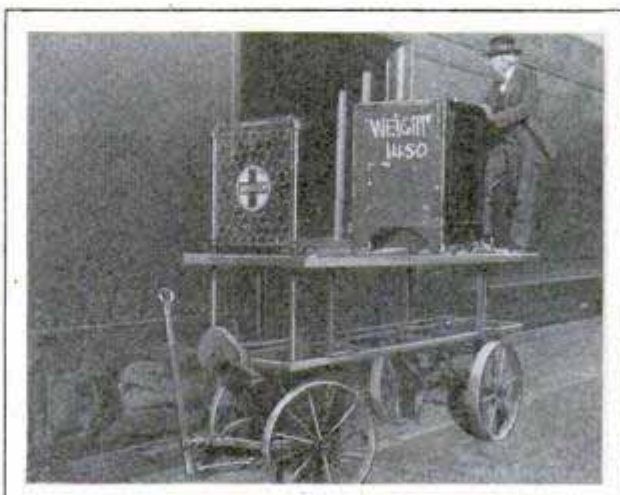

Safe Lifted to Level of Baggage Car on Elevator Truck for Easy Loading

Used by A. J. + S. J. Ry
... ..

*33 Baker, Lockwood Mfg Co,
7th & Wyandotte, Kansas City, Mo.*

wheel lock, thrown in or out of gear from the front, top or rear of the truck, prevents the vehicle from moving when a load is being handled.

1502

HOW THE "BIG TOP" IS MADE

Much has been written of the fascinating life and activity under the circus tent but few persons give a thought to the "big top" itself. The largest circus tents weigh twenty tons or so, about forty per cent in cloth and the rest rope. Instead of being extremely heavy, the material is but slightly heavier than the cloth for the pockets in men's clothing. Some of the larger tops contain as much as nine miles of rope. Most tents do not last longer than a year on the average. Old ones are cut into pieces and sold to farmers as tarpaulins or to interior decorators for covering furniture while papering or painting. An investment of \$10,000 to \$16,000 is not unusual in a single large tent for the big circuses.

RECORD MOTOR FOR AIRPLANE HAS EIGHTEEN CYLINDERS

1156

Experts attribute the success of France in the field of aviation not only to the skill of her flyers but to the efficient equipment her engineers employ. This is illustrated in motors for the planes. An eighteen and a twelve-cylinder type are said to hold more world's records

Paris, France

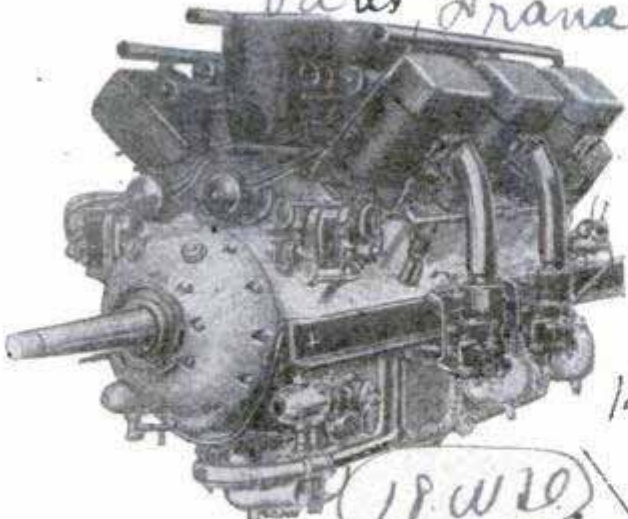

Eighteen-Cylinder Motor for French Airplane, Capable of Developing 700 Horsepower

than any other make. The former develops 700 horsepower and the latter 500.

*Societe des Airplanes The Supervisor of
H. M. Farman, Rue de Public Utilites*



Delivering Shoes for Repair in Sidewalk Hopper That Is Always Open, Though Shop Is Closed

SHOP THAT NEVER CLOSES HAS POST-BOX "ENTRANCE"

1351 Camden Street

Attendants in an eastern shoe-repair shop leave after working hours, but the store really never closes, for customers can deliver shoes to be mended through an opening in a sidewalk post box. Instructions are included with the bundle so that the menders can begin on the shoes the next morning. The proprietors declare that the plan has resulted in a marked increase of business.

COLD AIR PUMPED INTO HOMES AS SUBSTITUTE FOR ICE

1284

Instead of filling the ice box, residents in a Texas city simply turn a jet and a flow of frigid air emerges to preserve food and other supplies. The air is pumped through pipes similar to gas mains from a central plant, and the plan is said to be especially suited to refrigeration in large storage rooms.

1178

ROARING *into the*

and Dr. Van Leeuwen, Dutch scimitar

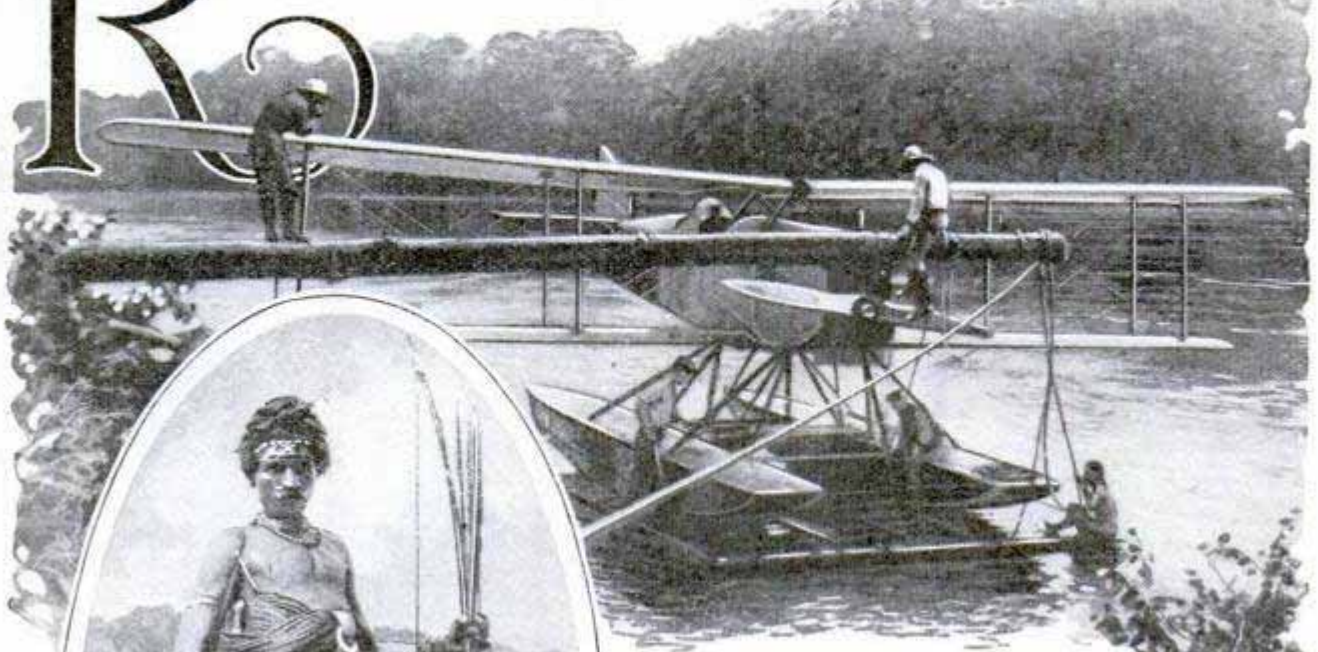

Where Airplanes Were a Curiosity; Rigging the Ship in New Guinea Wilds



Papuan Warrior in His Rattan Armor, Which Shields Him from the Arrows of His Enemies



Prof. Matthew W. Stirling, One of the Leaders of the Expedition with Two Young Papuans, and Dyaks of Borneo Watching the Arrival of the Airplane; the Natives Were Greatly Alarmed When They Saw White Men Drop Out of the Skies

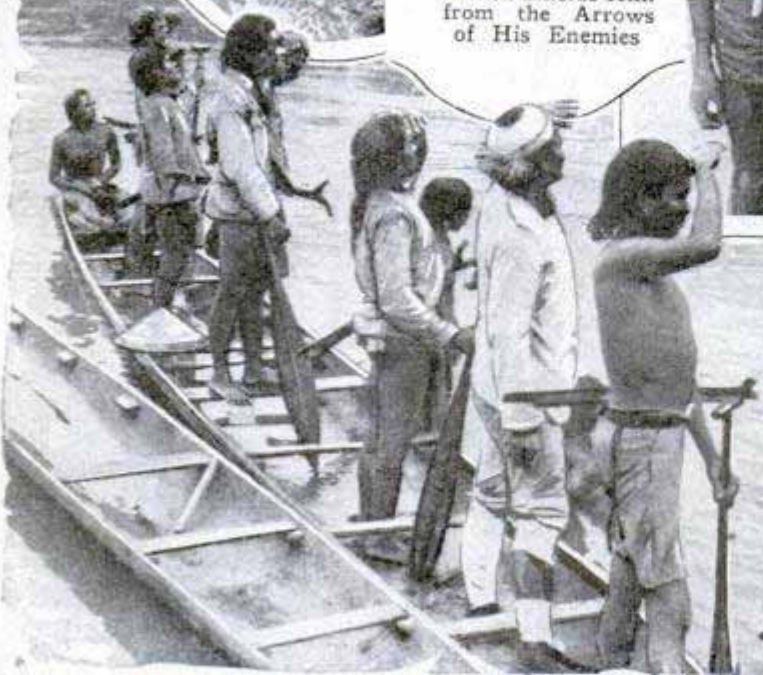

Anthropologist, University of California

LAND of the PYGMIES



After the Thrill of Seeing the Plane, Native Papuans Posed with Members of the Expedition



Left, Dyak Chief after Ride in the Plane, and Boat Maker with Odd Haircut



Lifting the Plane aboard the "Fomalhaut," at Batavia, for the Journey into Jungle Wilds; the Expedition Led to Regions Never Before Penetrated by White Man; the Plane Was Used for Carrying the Necessary Supplies and for Aerial Surveys

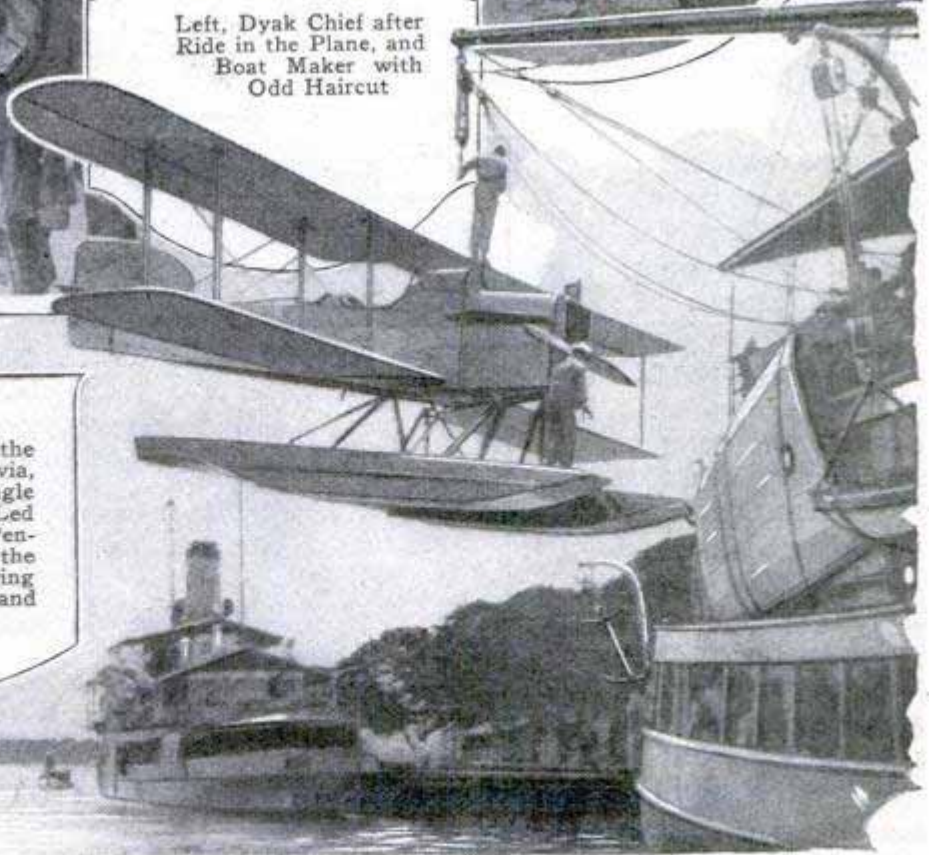

1311 /
608
Com. Francis Stuchie,
17 Boulevard
des Capucins, Paris, France
Canadian High Commissioner

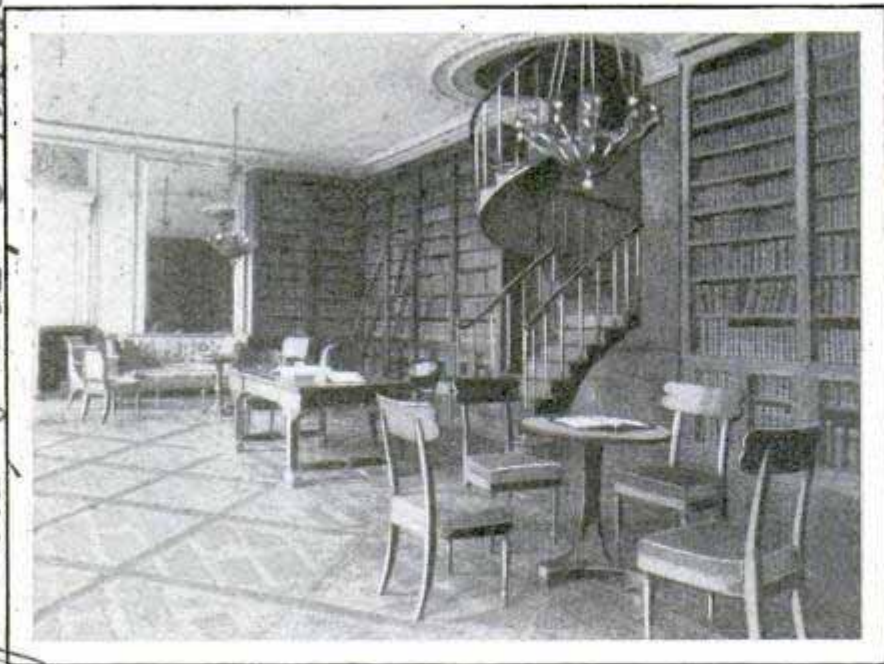

Where Napoleon Read and Pondered; Interior of His Private Library Now Preserved in Fontainebleau Palace

NAPOLEON'S LIBRARY IS SAVED BY AMERICAN MONEY

Napoleon's 4,000 books and his private study have been made secure by recent extensive repairs on Fontainebleau palace, where the priceless collection is housed. The work was financed by the Rockefeller foundation and was directed by Welles Bosworth, an American architect. In 1810, the books were damaged by rain entering through the leaky roof. At that time, Napoleon himself ordered the holes mended. In 1924, it was found that the ancient oak beams had become so worm-eaten that immediate repairs were required. American capital came to the rescue when the French government was unable to finance the task. The work also assures the preservation of the main palace library of more than 30,000 volumes and its rugs, furniture, paintings and other valuable furnish-

ings. Napoleon's private collection was arranged by Barbier, his personal librarian. The books are assembled in orderly fashion in alphabetical order under large brass letters fitted upon the walls near the dull oak cases. Here and there among the prevailing brown bindings, a volume in red morocco, bearing an "N" with the four crowns beneath it, distinguishes a book that had been bound especially for the emperor. The room is about fifty feet square with shelves on three sides, and to the rear is

the narrow staircase that leads to what was Napoleon's private study. The public is not admitted to the library and only the president may withdraw a volume.

NIGHT-FLYING LANES EXTENDED FOR THE AIR MAIL

Success of the air mail is as much a victory for scientific illumination as for any other feature of the task, experts declare, pointing to the fact that, but for the well-lighted landing fields and the beacons that guide the pilots on their course by night, regular schedules could not be maintained, and there would be great loss of time. Extension of the air-mail service has led to the installation of chains of lights on the route between Chicago and St. Louis and on route No. 3 from Chicago to Dallas. One of the huge bulbs for a ten-kilowatt floodlight is shown in the illustration.



Bulb for Ten-Kilowatt Floodlight Used in Guiding the Air-Mail Pilots at Night

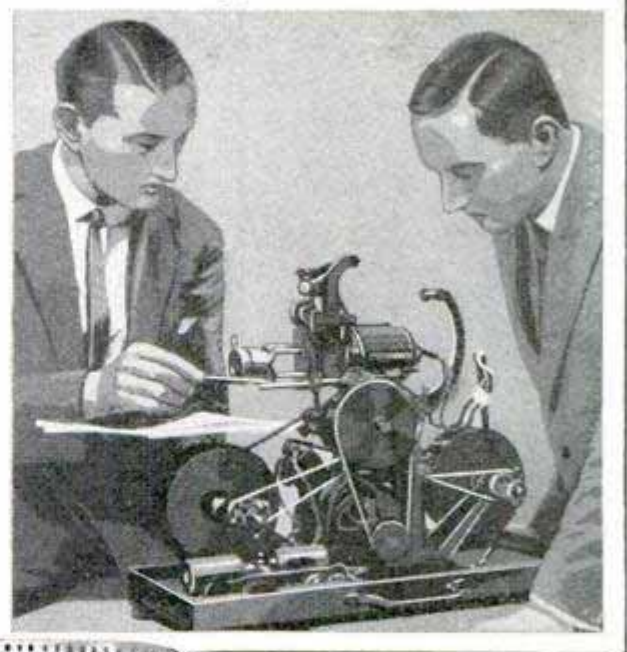
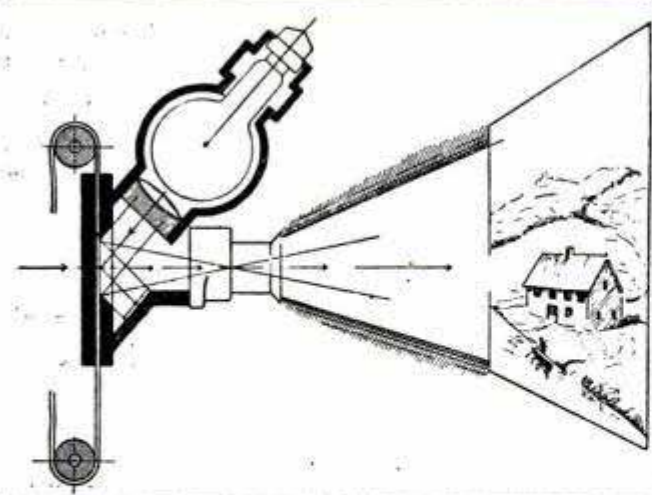
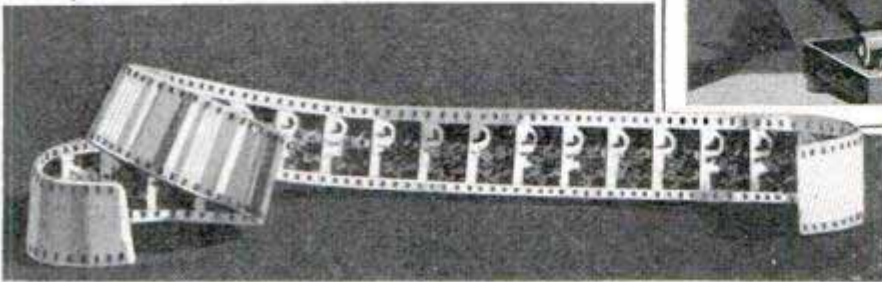

Diagram of the Projector Showing the Reflecting System, the Machine and a Strip of the Copper Band



COPPER BAND AS MOVIE FILM GIVES DEPTH TO SCENES

One of the dreams of the movie fan and producer as well, pictures in three dimensions, that is, with depth as well as breadth and height, seems realized as a result of an invention of two Germans. The usual transparent film is replaced by a copper band, the pictures being photographed upon it and developed in such a manner that a true perspective view of the scene is produced. The "film" is perforated in the usual manner and the mechanical operation of the apparatus is the same as in the ordinary projector, but as the copper strip is not transparent, the light source is placed in front and the image thrown upon the screen is a reflected one. The finished metal strip is said to cost no more than the standard celluloid. The perspective or plastic effect is obtained by making the ex-

posures from four diagonally opposite points and reproducing them as one on the master film. It is also said that pictures can be shown in multi-color effects by a simple process.

VIBRATION PICTURES AID DEAF AND SHOW BULLETS' SPEED 140'7

Vibrations of almost any character are recorded on an instrument developed by an eastern research worker, by which he hopes to aid the deaf, determine the speed of projectiles, measure the recoil action of guns and perform various other interesting and helpful tasks. In assisting the hard of hearing, for instance, the apparatus would afford a picture of the various tones so that the subject could be taught to identify them by sight and thus learn to imitate them with his own voice. The instrument is expected to aid in locating artillery and airplanes.

As Man Talks into Telephone, a Picture of His Voice Is Recorded



Armentis and
 Lovell et al

J. W. Legg, Research Engineer
 Westinghouse Electric

TREES TRAINED TO FORM CHAIR WHILE GROWING



Trees That Grew Up to Become a Chair; Saplings, Trained and Grafted, Formed This Seat

From twenty-eight box-elder seeds, planted eleven years ago, a Wisconsin man has grown a serviceable chair which was sold recently for \$4,000. When the saplings were three years old, they were gradually trained and grafted to take the form of the chair and, after ten years, all the trees but those which formed the legs were cut away. When the supports had grown stronger, they also were cut and the chair trimmed and polished. Only few alterations had to be made.

CARELESS DRIVERS SENTENCED TO SAFETY SCHOOL

Careless motorists in Chicago are being sentenced to attend a safety school where they are taught traffic regulations and why various ordinances have been passed, and are encouraged to ask questions to clear up any misunderstandings they may have. The plan is applied to minor violations, such as failure to stop at boulevards, pass-

ing traffic lights, making wrong turns, etc. As many as 500 persons attend a single class and the lessons are given by a competent traffic official. The school is held each Thursday. Persons who appear more than once at the training class, as a result of a sentence, are lectured severely, and a third offense leads to a fine. Officials believe that the plan supplies a great need for education in proper driving, and although it has reduced the number of cash fines, it is considered a practical influence toward greater safety.

MORE ACCURATE TIME GAUGE TO AID RESEARCH

For laboratory work, where the utmost accuracy is necessary in measuring the speed and duration of phenomena, the bureau of standards has devised a time gauge which registers half-second intervals to an accuracy of within a few parts in 100,000. It consists chiefly of a slotted pendulum which swings past a point of light. As it sways, the light, flashing through the opening, falls upon a sensitive surface and a tiny electric current thus generated is amplified while a moving photographic film records the instant.

VACUUM CLEANER IS RUN BY FRICTION WHEEL

Electricity is not needed to operate a self-generating vacuum cleaner which develops strong suction through the movement of a small fan driven by a friction wheel as the cleaner is run over the rugs and carpets. This unit is said to turn at the rate of 4,000 revolutions a minute, providing sufficient suction to remove lint,

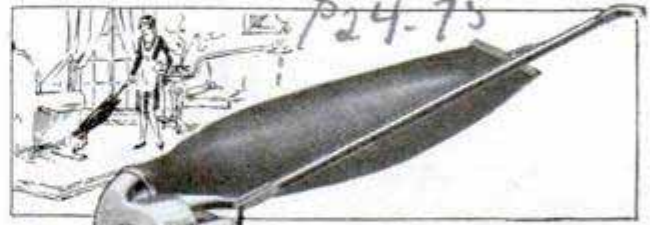

Vacuum Cleaner Which Requires No Cords or Connections; Suction Is Developed by Friction Wheel and Revolving Fan

thread and dirt deeply imbedded in the fabric. It will not injure floor coverings, weighs only a few pounds and saves the bother of cords and other attachments.

John Rubsack

Christian Science Monitor
1/13/27
Prestovac Corp
1030 W. North Ave

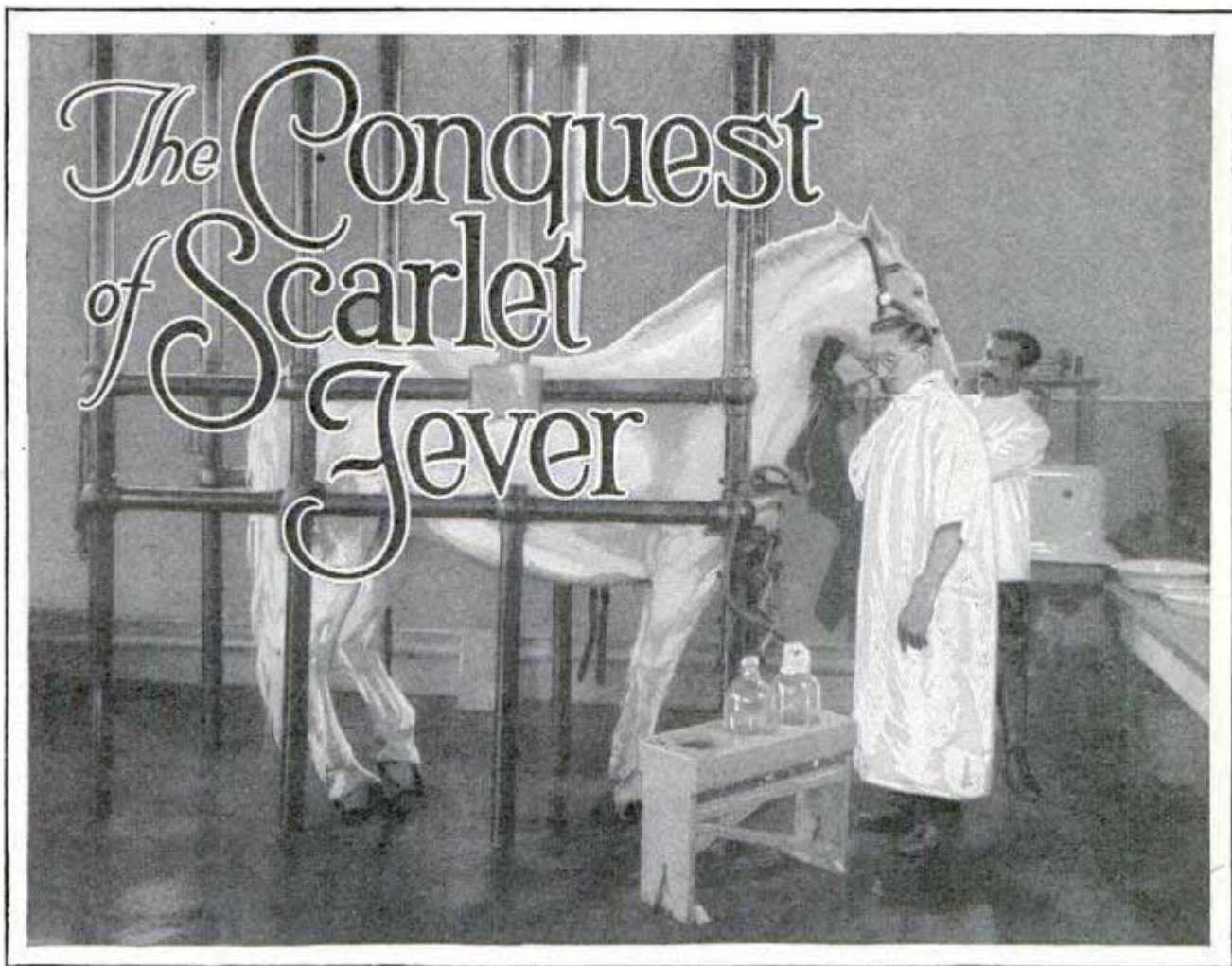

Courtesy E. R. Squibb & Sons

Extracting Antitoxin Serum from an Immunized Horse; a Single Animal in a Year Furnishes Enough Material to Treat from a Thousand to Fifteen Hundred Cases of Scarlet Fever

How Horses Make the Best Factory for Manufacturing Scarlet-Fever Antitoxin

By **FREDERIC DAMRAU, M. D.**

The Roosevelt Arms, 401-8th Ave Brooklyn, N.Y.

WHAT is the most effective machine for making remedies to combat human infections? A horse!

Back in the nineties, when antitoxin for diphtheria first came into use, the value of the horse as a factory for the making of antitoxins first became apparent. And today, in innumerable laboratories, thousands of horses are being sustained for the sole purpose of producing curative serum.

History repeats itself. Two distinguished physicians, man and wife, set about to accomplish, in the case of scarlet fever, what German scientists had done for diphtheria twenty-five years previously. They are Dr. George F. Dick and Dr. Gladys H. Dick. And again the horse was found to be the most satisfactory

machine for making the serum. It was no easy sailing for the Dicks. Only four years ago, the cause of scarlet fever was not definitely known. Of course, everybody knew that the disease must be produced by some germ; but out of the several hundred described in medical books, each of which had already been convicted of causing one or more diseases, it was difficult to pick the one guilty of the crime of scarlet fever.

The Dicks had reason to suspect a blood-dissolving, dot-shaped germ, growing in chains, and they determined to put their theory to the test. A heroine in the form of a young woman, twenty-five years old, volunteered to submit to the experiment. She furnished the proof that scarlet fever is due to this germ by allowing



Dr. George Dick and Mrs. Dick in Their Laboratory, Where They Found the Scarlet-Fever Germ and the Means of Combating It

herself to be inoculated and suffering an attack of it.

The next step was to determine just how the germ conducts its campaign against the human body in cases of scarlet fever. Does it attack the body's cells directly or does it form poisons that travel around the circuit to spread destruction wherever they may strike?

Some germs, like those that cause typhoid, invade the entire body. The diphtheria microbe works in a different way. The germs remain localized in the throat or nose and there manufacture their poisons, called toxins, which are absorbed into the blood and travel around the body, damaging the heart, nerves, kidneys and various other organs.

The Dicks proved that the blood-dissolving germ of scarlet fever manufactures a toxin just like the diphtheria microbe. When an organ is attacked by toxins, it suffers injury. But if the damage is not too great, it promptly sets to work to defend itself. This it does by manufacturing enormous hordes of chem-

ical combinations capable of destroying the toxin. These little substances, the protectors of the body, are known as antitoxins.

The blood of a person who has recently recovered from an attack of diphtheria, will render harmless a broth containing the powerful poison of diphtheria. In other words, the antitoxin of diphtheria renders the toxin inert. That is why antitoxin is curative in the treatment of that disease.

The Dicks proved the same condition of affairs in the case of scarlet fever. That represented a great advance. It pointed the way to a specific remedy for this plague. In other words, the Dicks determined to follow in the footsteps of the pioneers who had

discovered the antitoxin for diphtheria and see if the same results could be attained in scarlet fever.

A horse was chosen to demonstrate the possibility of manufacturing an antitoxin for the cure of scarlet fever. The animal was injected under the skin with filtered broth containing the poison of the blood-dissolving germs of scarlet fever, but not the germs themselves.

At first, there appeared to be but little response to the injection. Then larger doses were given. The horse became drowsy, fed poorly, had fever, and showed an inflammatory swelling at the point where the needle had been pushed into the skin.

After very large doses of the toxin had been injected, as much as half a pint, the animal's blood was tested, to see whether it was able to neutralize the toxin of scarlet fever; in other words, whether scarlet-fever antitoxin had been manufactured. And the result represented a great triumph for the Dicks and a godsend for the thousands of children who



Upper Left, Courtesy E. R. Squibb & Sons; Others from Lederle Antitoxin Laboratories

Preparing the Final Antitoxin, Upper Left; Trying It on Guinea Pigs to Check Its Purity, Right; Making a Chemical Test, Lower Left; and Supplies Waiting to Be Packed

ordinarily fall victims to scarlet-fever infection every year.

Two teaspoonfuls of the horse's blood serum were found to contain sufficient antitoxin to neutralize an amount of the scarlet-fever poison capable of producing the symptoms of the disease in twenty grown-up men.

The final step in this romantic conquest of scarlet fever was the trial of the antitoxin in actual cases of the disease. For the purpose of analyzing the results, the Dicks classified 100 individuals suffering from scarlet fever. There were fifty mild cases and fifty severe ones. In the mild cases, the ordinary treatment for scarlet fever was used; in the severe ones, the antitoxin was administered.

The patients with severe cases of scarlet fever, who received antitoxin, fared much better than those with mild cases, who received no antitoxin. And complications occurred in only four of the patients who received the antitoxin, as against nineteen of those whose cases were mild and who received no antitoxin. So, the practical tests leave no doubt but that the new antitoxin for scarlet fever is a most potent, effective and entirely harmless remedy.

It is only a little more than a year since these discoveries were made and the experiments that confirmed the discoverers' hopes were completed; but already reliable manufacturing chemists are supplying the scarlet-fever antitoxin.

1496

RACE TO TEST THE WORTH OF OIL-BURNING AUTOS

A twenty-four hour race for Diesel-engined automobiles has been announced to be held some time during September on the famous testing course of the In-

shift mechanism or ignition system," L. H. Morrison, secretary of the engineering society, declared. "There will be more than fifty less parts in the engine;

*Worthington Corp
Machinery Corp
Broadway
and Cedar
New York*

DIESELIZED AUTO BASED ON WORTHINGTON OIL ENGINE PRINCIPLE

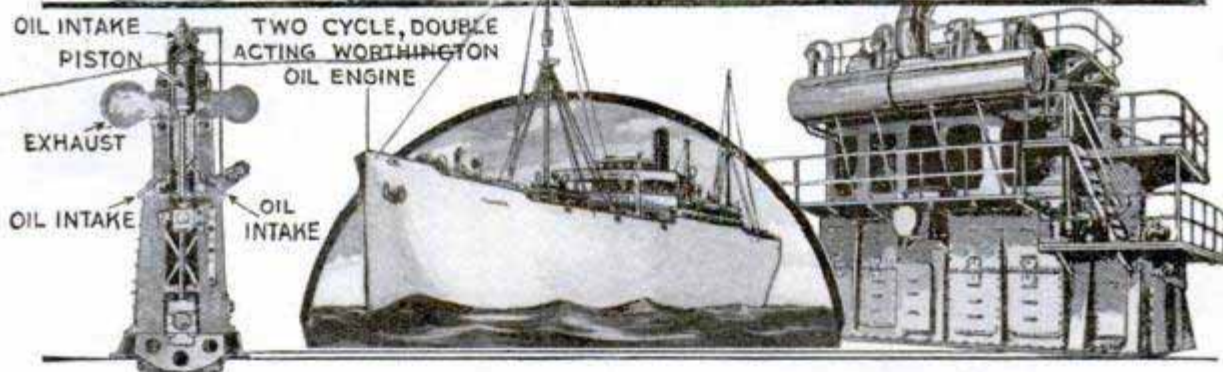
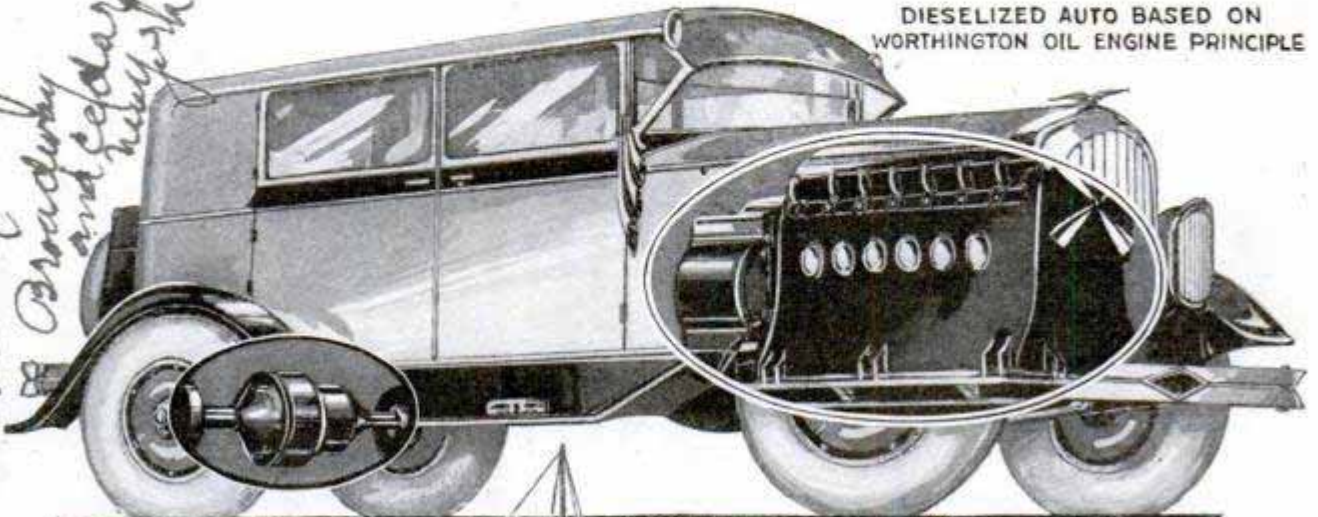

The "Tampa," First Motorized Shipping-Board Vessel with Its All-American Diesel Engine, and Sketch Explaining the Worthington Principle, with Designer's Idea of Car Using It

dianapolis speedway, where gasoline cars have tried out their new developments in 500-mile races for more than a decade. As a result, cars powered by heavy-oil engines, which the more optimistic engineers have been predicting as a development of the next five years, may be brought forward to this year. What a Diesel-engined car should be was discussed at the recent annual meeting of the American Society of mechanical engineers, when leaders in the development of heavy-oil engines declared such automobiles could be run at only twenty to forty per cent of the cost of operating a gasoline car, and likewise would cost much less to build. The fuel oil burned, costing nine cents a gallon, at present prices, should carry the automobile fifty miles, the engineers announced. "It will have no spark plugs, clutch, gear-

it will be several times as powerful as a present-day car of equal size, and will run on almost any oil that will flow through a pipe." Such a motor would be based on the Worthington two-cycle double-acting principle, which was developed for the engines in the "Tampa," first shipping-board vessel to be motorized. The double-acting pistons of these motors develop power on every stroke. It is that principle which the designers expect to utilize in cutting the weight of the engine per horsepower developed. German manufacturers already are building Diesel motors for trucks and heavy passenger cars with a weight of twelve pounds per horsepower.

☛ A dime, coined in 1783 and said now to be worth \$300, was found recently by a New Jersey school girl.

SEEDS TREATED WITH X-RAYS TO INCREASE YIELD 1610

By exposing seeds, bulbs and tubers to "soft" X-rays for a carefully measured period, a Russian botanist reports that he has stimulated their development, resulting in stronger roots and an increased yield. He explains that the soft rays are of longer wavelength than the "hard" rays which have greater penetrating power. Exposure to the soft emanation must be given for an exact time, the investigator declares, and considers his discovery of the proper length of treatment an important advance in the process of submitting seeds to X-rays, an experiment which has been attempted for some time but without encouraging results. It was found that light had the effect of lowering the yield from treated seeds, so that they must be kept in the dark until planting, and too long an interval between the exposure and the sowing also had a harmful effect.

to American Sociological Society
VOICE IS RECORDED ON A WIRE AND REPRODUCED FROM IT 1489

The human voice and other sounds are being recorded on a slender wire and reproduced at will in somewhat the same manner that phonograph records are produced and played. The essential difference is that the wire becomes magnetized in accordance with electrical impulses which it receives while the recording is being done and the reproduction of the sound is made according to like principles. The same

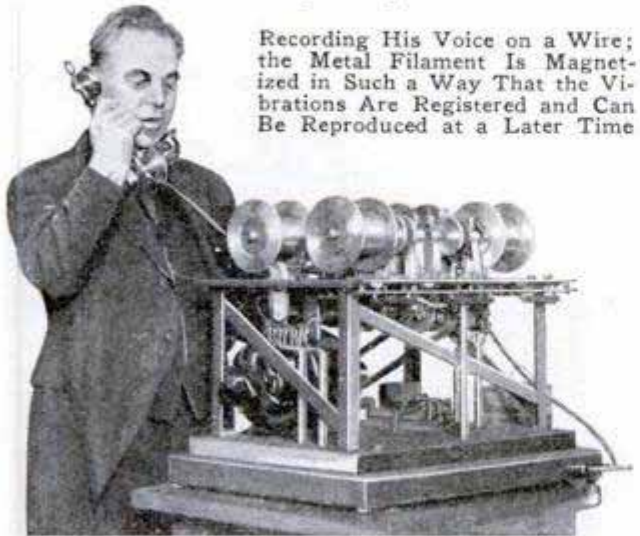

Recording His Voice on a Wire; the Metal Filament Is Magnetized in Such a Way That the Vibrations Are Registered and Can Be Reproduced at a Later Time

method was worked out by Viennese inventors for recording radio programs on steel bands and then playing them later.

*Record Telephone Co
15 W 34 St New York*

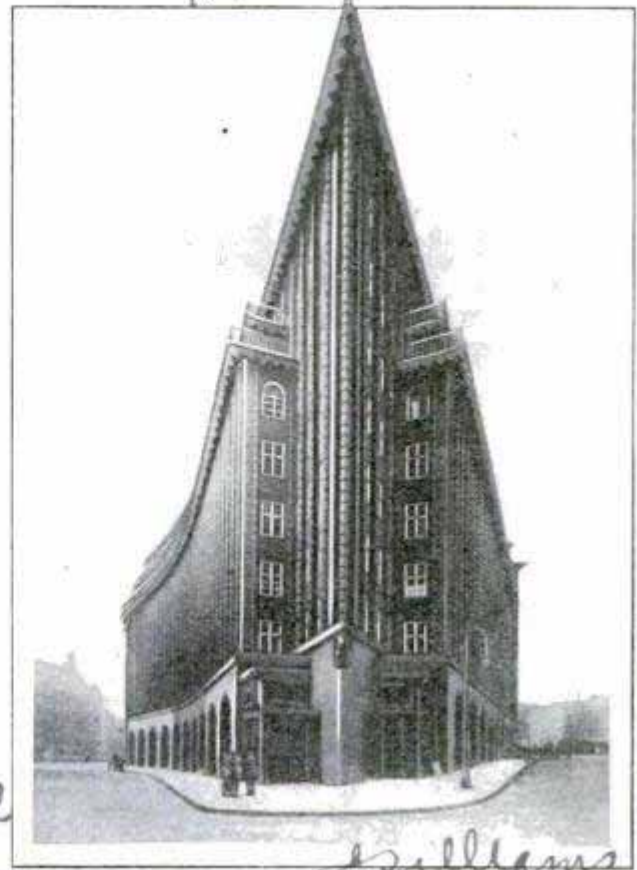

Front of the Chili Building in Hamburg, Germany, Showing the Trend toward the Skyscraper Style

SHIP-SHAPED OFFICE BUILDING RIVALS FAMOUS "FLATIRON"

Late ideas in modern architecture have been developed in the Chili building in Hamburg, Germany, where a trend toward the American type of skyscraper has been noticed. The structure resembles the prow of a huge ship at one corner and, in this particular, is more extreme than the famous Flatiron building in New York city. An additional feature is the application of the elevated sidewalk. The upper floors of the building have promenades on the outside, where the workers may enjoy a bit of fresh air.

PLANE'S BALLOON TIRES WEIGH TWO HUNDRED POUNDS EACH 1613

Dwarfing the automobile's equipment, balloon tires being manufactured for the huge air liners in England are seven and one-half feet in diameter and weigh nearly 200 pounds each. They are made to ease the shock in landings and can withstand a load of eighteen tons. The wheels have hubs twenty inches long and weigh nearly a quarter of a ton a piece.

*M. American.
1/23/27*

QUEER MASKS USED IN DANGEROUS OCCUPATIONS

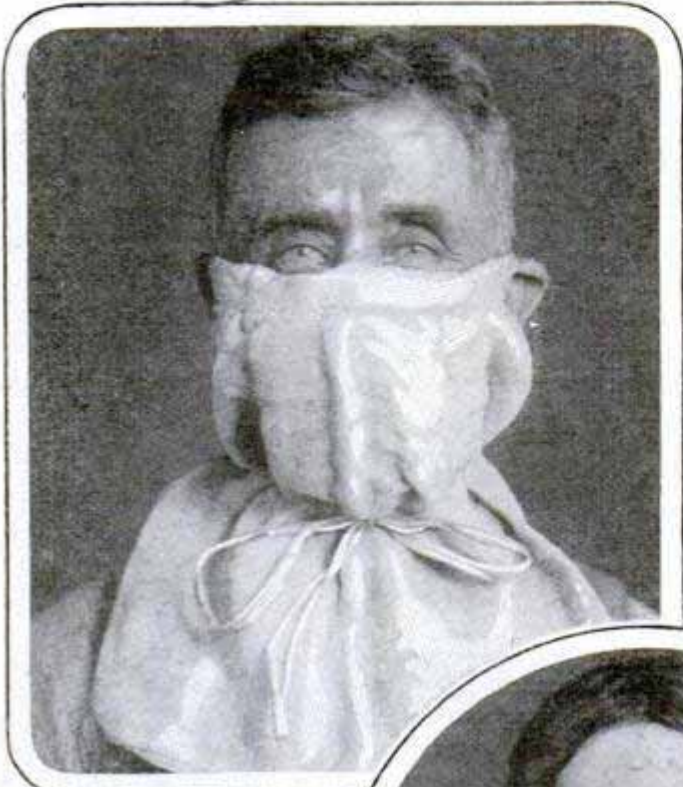

Homemade Respirator of Cheesecloth Used by White-Lead Factory Workers, Above, and a Mask with Tissue-Paper Filters, at Right



A Curious Combination of Hat and Nose Guard That Is Really a New Dust Mask Developed by the Bureau of Mines



The Filter of the Respirator at the Right Is in the Hood, Giving a Very Large Breathing Surface

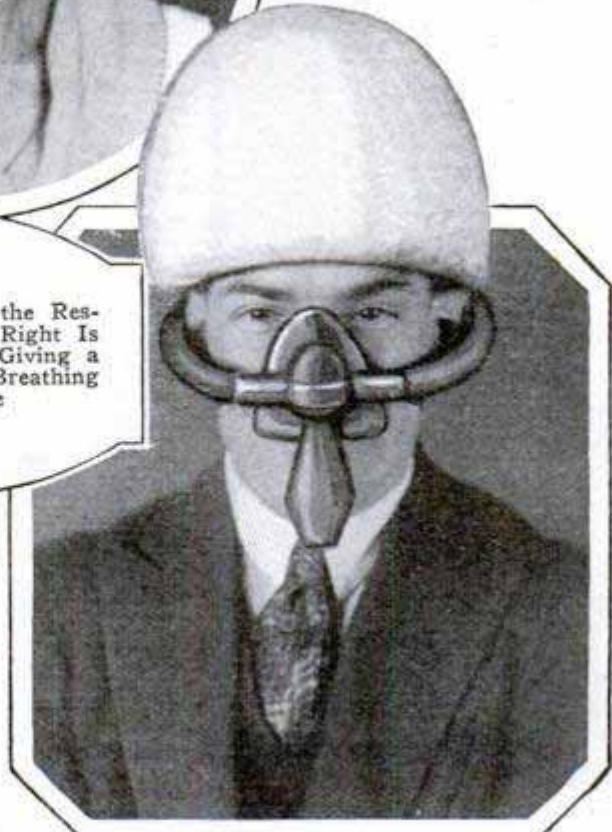

Despite Its Appearance, a Pig Was Not Used as the Model for the Mask Above, Which Uses Several Thicknesses of Woolen Felt to Protect the Wearer from Breathing Dangerous Dust While at Work

Festooned with glistening icicles that are believed to have formed 150,000 years ago, when all northern Europe and Russia were enveloped in ice, a cave twenty-six miles long has been found in the Ural mountains. It abounds with grottoes of extraordinary beauty; the roof is a mass of snow crystals that reflect the colors of the rainbow, and there are wide corridors, at the bottom of which a subterranean river probably flowed many years ago. About a mile from the entrance to the cavern is a small lake, near which were found several objects dating from the time of the Persian King Cyrus, and military fortifications probably built during the fourteenth century were unearthed near by.

1547
SOUNDS ARE RECORDED ON FILM AND REPRODUCED AT ONCE

Records of the human voice and other sounds are made on film in such a way that they are fit for immediate reproduction in an apparatus demonstrated recently in France. The chief novelty of the instrument lies in the method by which the lines made by the recording needle are "fixed" on the film. This is done with the aid of two special liquids, held in containers with small outlets, one liquid being distributed immediately in front of the needle and the other close behind it. The first fluid flows upon the film in a narrow band and makes the material softer so that the vibrations may be registered more perfectly. The other liquid cleans and "fixes" the tiny grooves. The film dries so quickly, according to reports, that it can be rolled on a spool, which is part of the apparatus, and thus is ready for the reproduction of the sounds immediately after they have been recorded.



Courtesy L'Illustration
 Recording the Voice on Film for Immediate Reproduction; Liquid That Fixes Grooves (Makes This Possible)

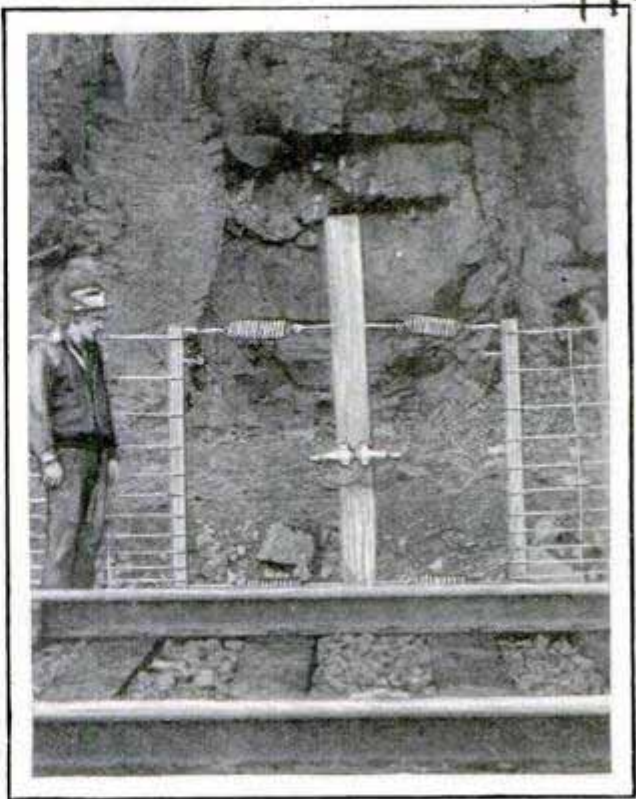

Alarm Fence on Union Pacific Railroad, Which Sets Signal When Rock Slides Strike It

GUARD RAILWAY FROM SLIDES WITH ELECTRIC FENCE

Along a stretch of line where rock slides have caused wrecks in the past, the Union Pacific railroad has installed an electric fence which is intended to give automatic warning when slides occur and thus prevent accidents. When rocks fall down and roll toward the track, they press against the slack wire of the fence, this action, in turn, pulling a switch on the nearest of a series of large posts set at 800-foot intervals. This switch operates the block signal and also affects the safety control in the engine, so that trains can be stopped. The fence is constructed of hog wire and the staples are not driven all the way in, so that the strands will have sufficient slack to operate the signal switch.

Miss Mr. and Mrs. Norton. Johnson - American

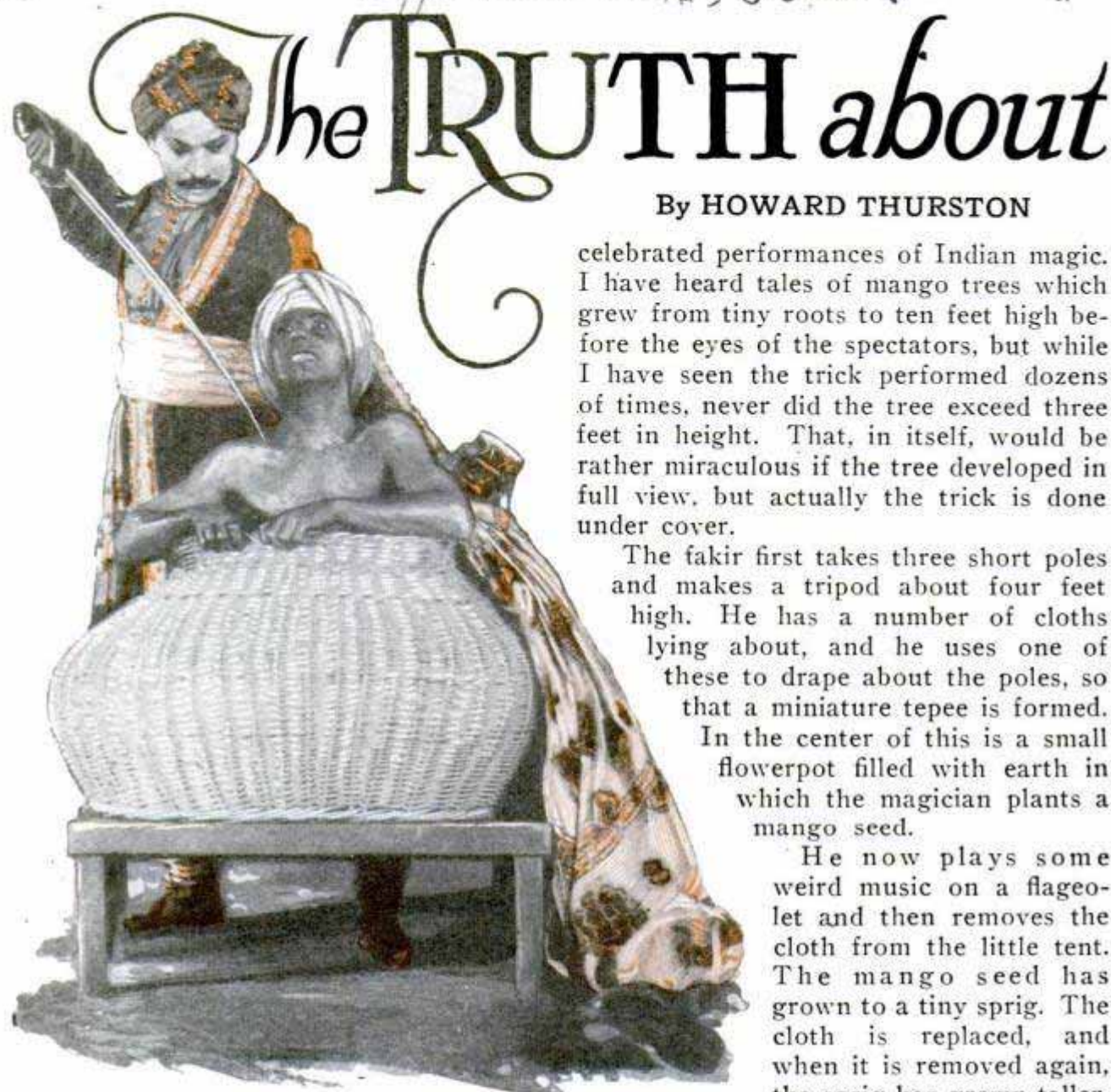

Mohammed, a Hindu Magician Imported by Thurston, Improves on the Basket Trick by Apparently Actually Stabbing the Boy

THERE are magicians in India—thousands of them—and they present certain mysteries which are baffling to the untrained observer. To a magician, however, their methods are simple, and the tricks they perform are far inferior to the illusions exhibited by American conjurers.

The magicians of India are not miracle workers. Their tricks are easily detected by an expert, yet their magic is a real art. The present generation of fakirs show tricks which have been passed down to them by their fathers. Many of the appliances used are of crude construction and this adds to their effectiveness, as they do not excite suspicion.

The "Mango Tree" is one of the most

The TRUTH about

By HOWARD THURSTON

celebrated performances of Indian magic. I have heard tales of mango trees which grew from tiny roots to ten feet high before the eyes of the spectators, but while I have seen the trick performed dozens of times, never did the tree exceed three feet in height. That, in itself, would be rather miraculous if the tree developed in full view, but actually the trick is done under cover.

The fakir first takes three short poles and makes a tripod about four feet high. He has a number of cloths lying about, and he uses one of these to drape about the poles, so that a miniature tepee is formed. In the center of this is a small flowerpot filled with earth in which the magician plants a mango seed.

He now plays some weird music on a flageolet and then removes the cloth from the little tent. The mango seed has grown to a tiny sprig. The cloth is replaced, and when it is removed again, the sprig has grown taller.

This procedure is repeated until finally a two or

three-foot "tree" is developed. Under the loose cloths which are on the ground, the fakir has hidden branches of a mango tree. These he picks up under the larger cloth each time he forms the tent. The tree is merely a branch from a large mango tree, and it is also concealed underneath a cloth close by, with its lesser branches folded together.

The secrets of many good tricks are quite simple; it is the method of performance that creates the mystery. So it is with the smaller tricks of the Hindu fakirs. They present their tricks with an air of mystery which causes the spectators to look for some complex solution, for example, the "Bowl of Rice."

INDIAN MAGIC

The magician has a "lota," a bowl with bulging sides, and fills it to the brim with rice. He takes a knife and inserts the blade into the rice, until the knife is buried to the hilt. Then he calmly lifts the handle of the knife, and lo! up comes the bowl. The fakir swings the knife around his head, defying the law of gravity. The explanation is simple. When the knife is inserted, the rice is pressed into the bulging sides of the bowl, and the blade is gripped so firmly that the whole affair can be lifted at once. When the magician wishes to remove the knife, he gives the blade a twist.

One of the best tricks seen in India is the "Disappearing Bowl." It is performed by only a few magicians in the Madras presidency. A large earthen bowl, about eighteen inches in diameter and twelve inches high, is filled with rice. The performer covers the bowl with a cloth and jumps upon it. The bowl and rice disappear completely. Then the magician calls attention to a tree behind the spectators, and there is the bowl of rice resting securely in the branches.

The original bowl is merely a collapsible wire frame, covered with a soft clay, which is very thin; but, being covered with a varnish, it looks like an ordinary clay jardiniere. Just below the opening of the bowl is a tray containing enough rice to make the jar appear filled. The magician takes two small cloths and holds them together to look like one. He lays them on the ground and puts the bowl upon them. Then he covers the bowl with a larger cloth. During this action, he knocks the soft clay from the bowl, but the wire frame remains upright. When the magician jumps upon the cloth, the frame collapses, and it seems as

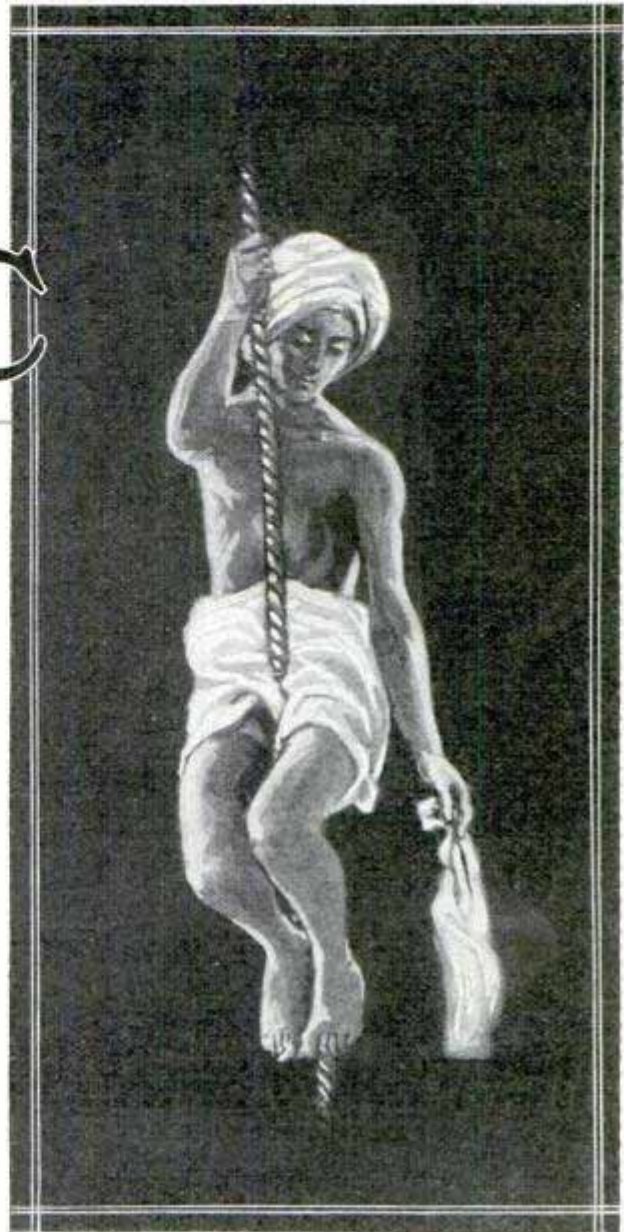

An "Indian Mystery" Which No Indian Has Ever Actually Produced Is Now Done on the American Stage

though the bowl had magically disappeared. In removing the large cloth, the magician takes away the uppermost of the two smaller cloths. Thus the remains of the bowl are disposed of. Before the spectators have recovered from their surprise, the fakir points dramatically to the tree, where his confederate has quietly placed a solid bowl filled with rice.

The "Spinning Shell" is a novel effect produced by Hindu magicians. A fine straw is passed for examination and is planted in a piece of clay, so that it stands erect. Then the fakir balances a small shell on the straw and pours water on the latter. The balanced shell begins to revolve and keeps on spinning rapidly for a short time. The trick lies in the straw. The magician, upon receiving the ex-

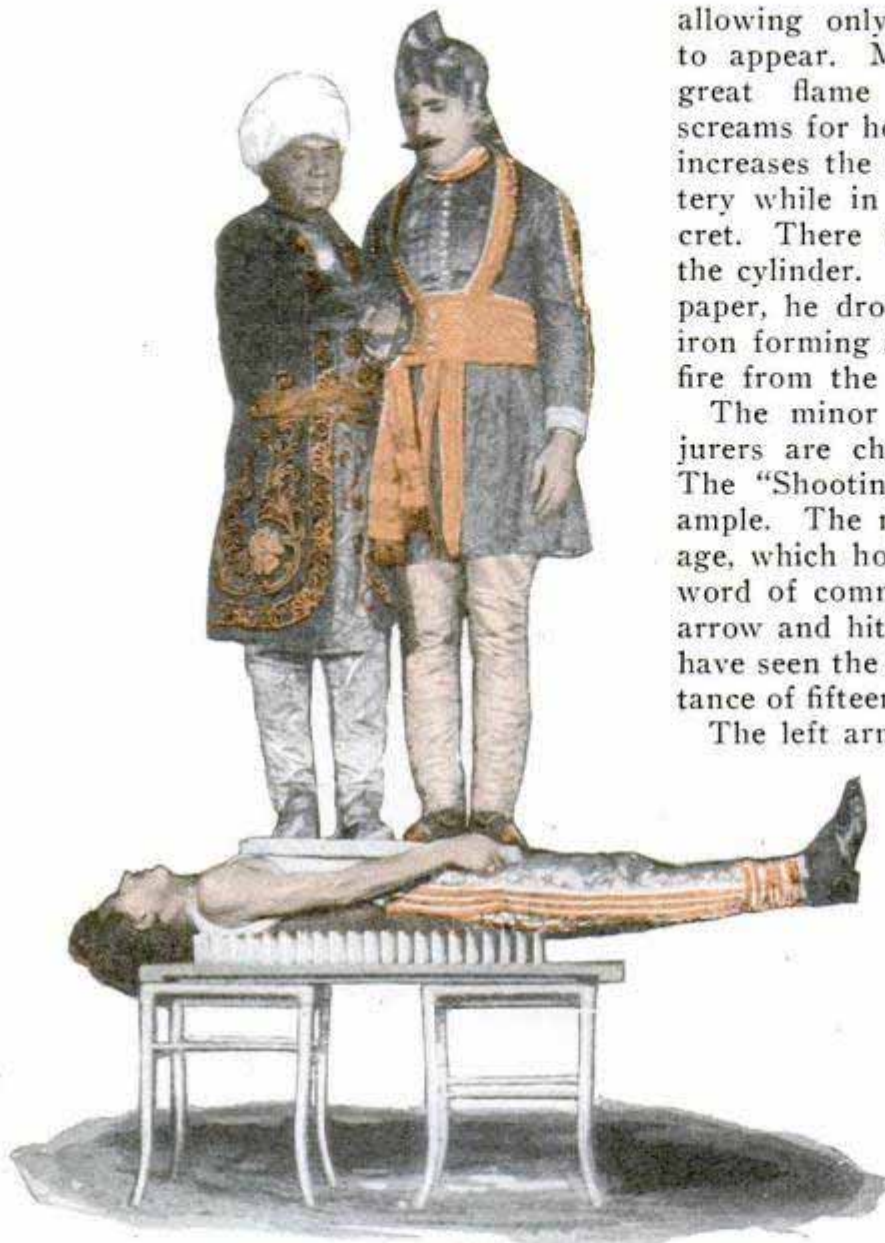

One of the Standbys of the Indian Fakirs, the Man on the Bed of Spikes, as It Is Produced Nightly in the Theater

aminated straw, substitutes a similar straw which is identical in appearance. The second straw, however, has been twisted and dried. Consequently, when water is applied, the straw swells and untwists, causing the shell to revolve.

I recently heard of a traveler, returned from India, who described a most wonderful trick wherein a fire was kindled upon a boy's head. The details are as follows: The boy is placed in a kneeling position, and an earthen cylinder, six inches in diameter, is set upon his head. The fakir fills the tube with paper, pieces of wood and rags, then he pours on a quantity of oil, and sets fire to the contents. A cloth is tied around the boy's head,

allowing only the earthenware cylinder to appear. More fuel is added, and a great flame bursts forth. The boy screams for help, but the magician calmly increases the fire. I witnessed this mystery while in India, and learned the secret. There is a small shoulder inside the cylinder. When the fakir puts in the paper, he drops in a round flat piece of iron forming a partition which keeps the fire from the boy's head.

The minor tricks of the Hindu conjurers are charming in their simplicity. The "Shooting Arrow" is a typical example. The magician has a wooden image, which holds a bow and arrow. At a word of command, the image shoots the arrow and hits a target six feet away. I have seen the arrow hit the mark at a distance of fifteen feet.

The left arm of the image is fixed, and the bow is held in the left hand. The arrow is placed in the bow, the string being fastened in a notch on the side of the arrow. The heavy end of the arrow is pressed into a hole at the right side of the image. The hole contains adhesive wax, and after the arrow has been pressed into it, eight or ten seconds will elapse before the force of the bow will release the arrow and shoot it to the

mark. The magician watches the action of the arrow as it is gradually released, and, at the right moment, commands the image to let it go.

The street entertainers of India perform many interesting and varied feats. I witnessed one of these men who plunged boldly into a tub of boiling water, and remained there for a minute or two. Then he emerged, uninjured by the hot water. The secret lay in the fact that the tub was quite deep, and that it had previously been partly filled with cold water. Then kettles of boiling water were poured in while the crowd was gathering. The performer plunged quickly through the upper layer of hot water, and lay in the cool water beneath. He

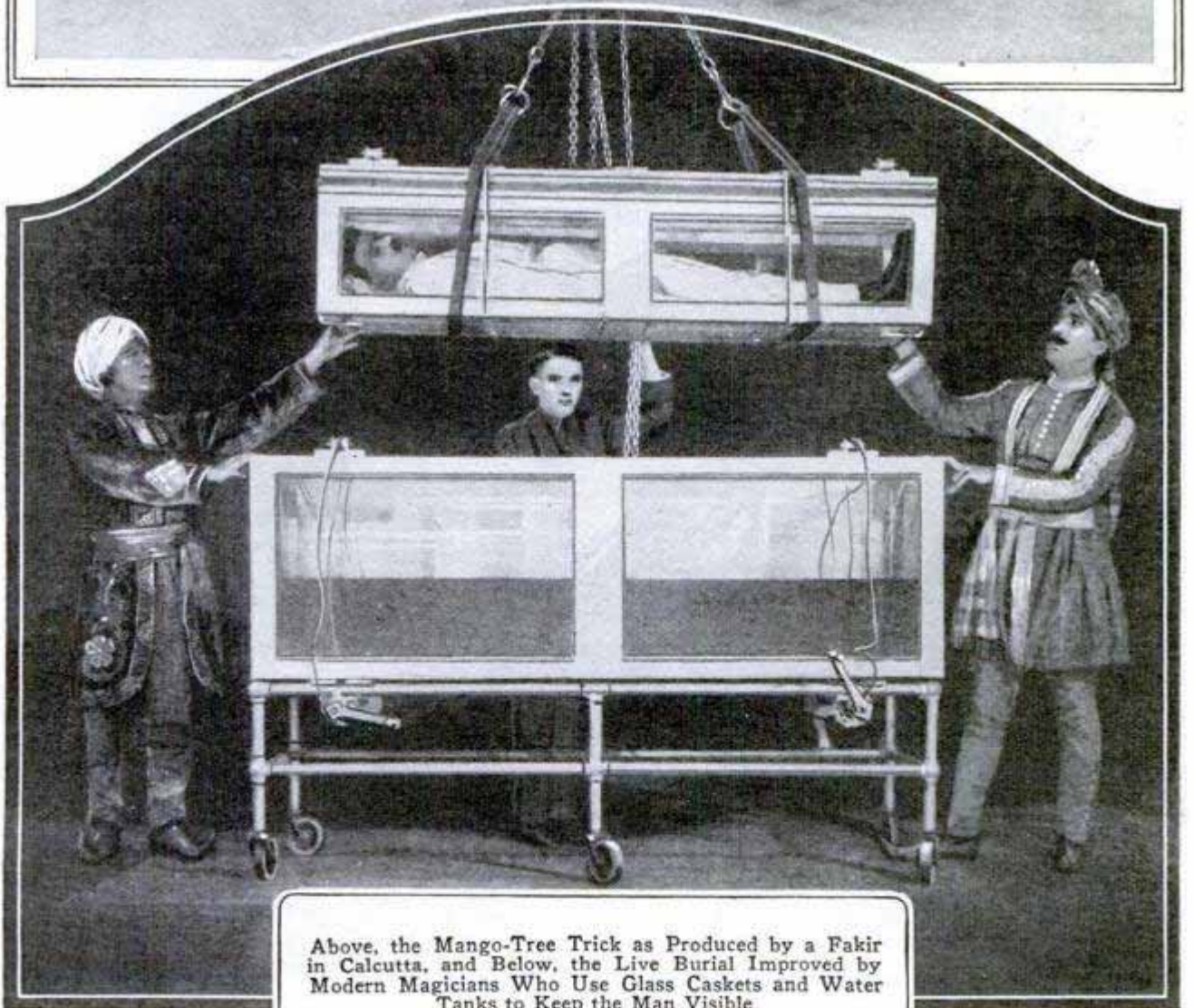
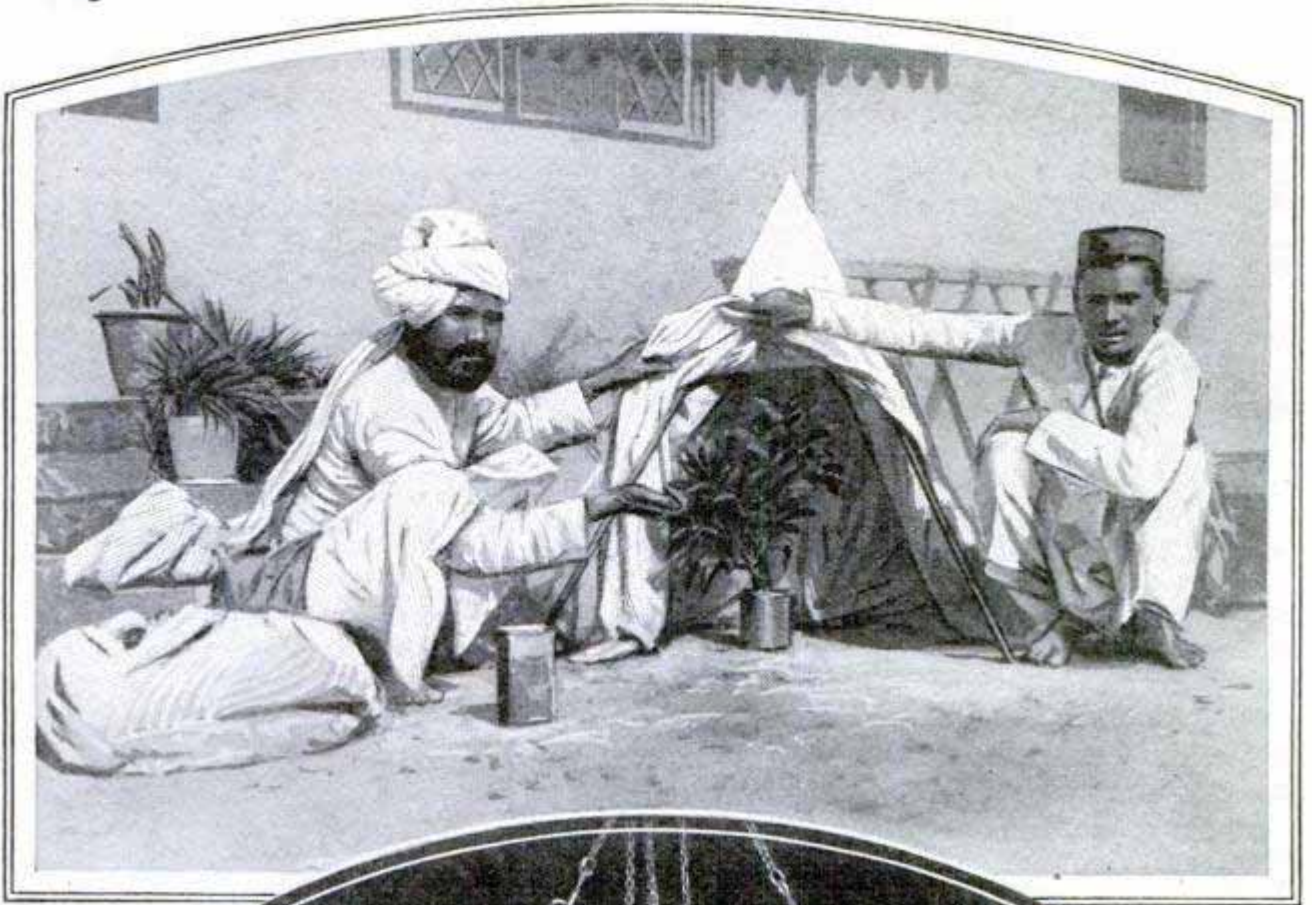

Above, the Mango-Tree Trick as Produced by a Fakir in Calcutta, and Below, the Live Burial Improved by Modern Magicians Who Use Glass Caskets and Water Tanks to Keep the Man Visible

kicked about and caused the hot water to mix with the cold. This reduced the temperature so that he could come out at his leisure.

I had heard many marvelous stories of the celebrated Indian "Rope Trick," supposedly the greatest of all mysteries. Each description bordered on the miraculous; every story involved a master fakir, who took a coil of rope, tossed it into the air and caused it to remain there, suspended. In some accounts, the end of the rope was said to have gone out of sight. Then a boy was supposed to have climbed the rope and disappeared, followed by the fakir, who also vanished.

In the only trick of the kind I saw, the fakir took a coil of rope and tossed it in the air, where it remained rigid like a pole, some six feet in length. He balanced the rope for a moment, then dropped it, and it immediately coiled itself when it struck the ground.

The rope, I soon learned, contained a pliable wire, which made it temporarily rigid. As soon as the rope struck the ground, the impact caused it to coil, and it appeared to be an ordinary piece of rope. I offered a reward of 5,000 rupees to any fakir who could perform the trick of the boy's disappearance, but the reward was never claimed.

Alleged explanations have been given of how the trick could be performed, but they are generally unsatisfactory and impracticable. It has been suggested that the effect was created by hypnotic powers of the yogi. That might be possible, if only one witness were present, but in cases where several persons are said to have witnessed the trick, the theory cannot readily be accepted. Students of hypnotism have declared that "group hypnotism" is an impossibility.

POISON DUST KILLS MOSQUITO WITHOUT HURTING FISH

Spreading fine dust containing poison over marshes and ponds to kill the mosquito larvæ has been effective in many sections, but an objection to the method is that it is injurious to fish and other animal life as well as destructive to vegetation. This drawback is said to have been eliminated in a new poison dust introduced in France. While it is deadly to the mosquito larvæ, it is said not to injure fish or warm-blooded animals nor damage aquatic plants. It is a formaldehyde compound mixed into an extremely fine powder that can be driven by the wind, and is most satisfactorily applied with sand. The cost is about eight cents per acre.



Just After the Seed Has "Sprouted." One of the Steps in the Mango-Tree Trick; the Picture Shows the Multitude of Draperies Used to Hide the Various-Sized Plants until Needed

Daily mail
1/10/27

One Mr. Case - Robinson
Co., Inc
Pleasant Mich. 623

**LOCUSTS DEFY HEAVY GUNFIRE
ALONG TWENTY-MILE LINE**

Giant locusts have been invading the countryside in India, three different swarms having descended upon territory in the Bombay presidency. One "army" was twenty miles long and thirty yards wide. When the insects had settled, heavy gunfire was directed upon them, but did not dislodge them, and several fertile tracts were devastated. Another swarm was five miles long and half a mile wide.

**BOTH TUBES AND BATTERIES
ELIMINATED IN SET**

Hunting for a new method of changing electrical current from alternating to direct, Dr. Palmer H. Craig, of Mercer university, Macon, Ga., has accidentally stumbled on a discovery that, he claims, makes it possible to eliminate both tubes and batteries from radio, while retaining the efficiency and power of an eight-tube receiver. The Craig discovery, which bears on relation to any principle applied in crystal sets, involves the use of a pile of bismuth plates, protected from atmospheric corrosion by a coat of sulphur, and with a pick-up coil of insulated wire wound around them. In action, the pick-up coil responds to the radio signal, and the wave, passing through it, sets up an electrical effect in the pile of plates, which, according to Dr. Craig, may be used either as a detector or as an amplifier. The apparatus requires no current outside that in the radio waves for its operation. Rough laboratory experiments indicate that the device, as an amplifier, is four times as sensitive as an eight-tube receiver, while it is even better as a detector. In addition to being more sensitive than tube sets, it eliminates much of the distortion in such sets.

Physics Dept
1545

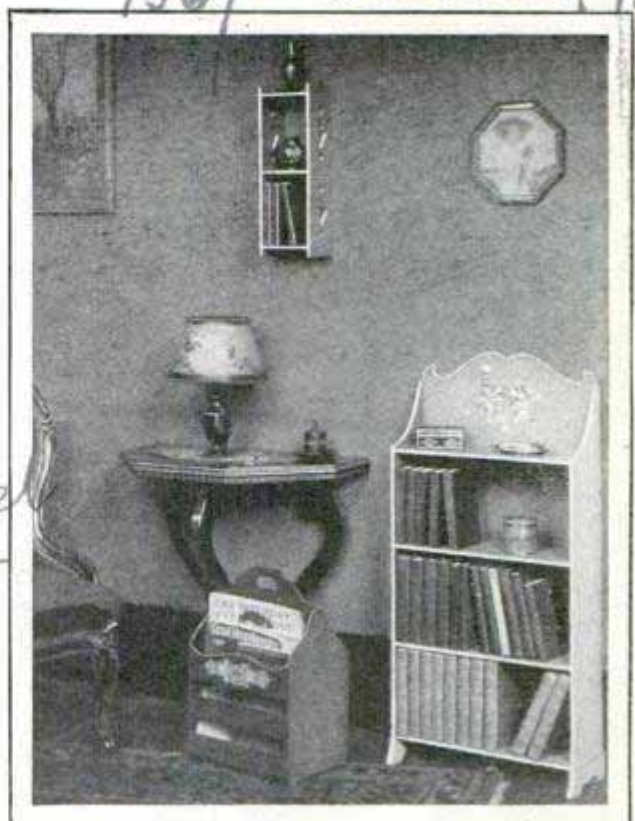

Bookcases and Magazine Basket Assembled from Ready-Fitted Pieces and Decorated at Home

**READY-TO-FIT FURNITURE ADDS
FUN TO HOME DECORATING**

Finding the right object to complete a scheme of room decoration is not always easy, since it is often impossible to obtain the exact color desired or a piece of the proper size. To aid the person who likes to be his own decorator, articles of furniture are available which can be easily put together in a few minutes and are



Dr. Craig with One of His Bismuth-Plate Radio Detectors, Weighing Less Than Half a Pound

of plain wood so that any scheme of decorating may be followed. A convenient bookcase and magazine basket have broad sides suited to painting by hand or being decorated with patterns cut from paper and varnished over. In order to still further facilitate the assembly, grooves are already made in the units so that the shelves and sides can be fitted together.

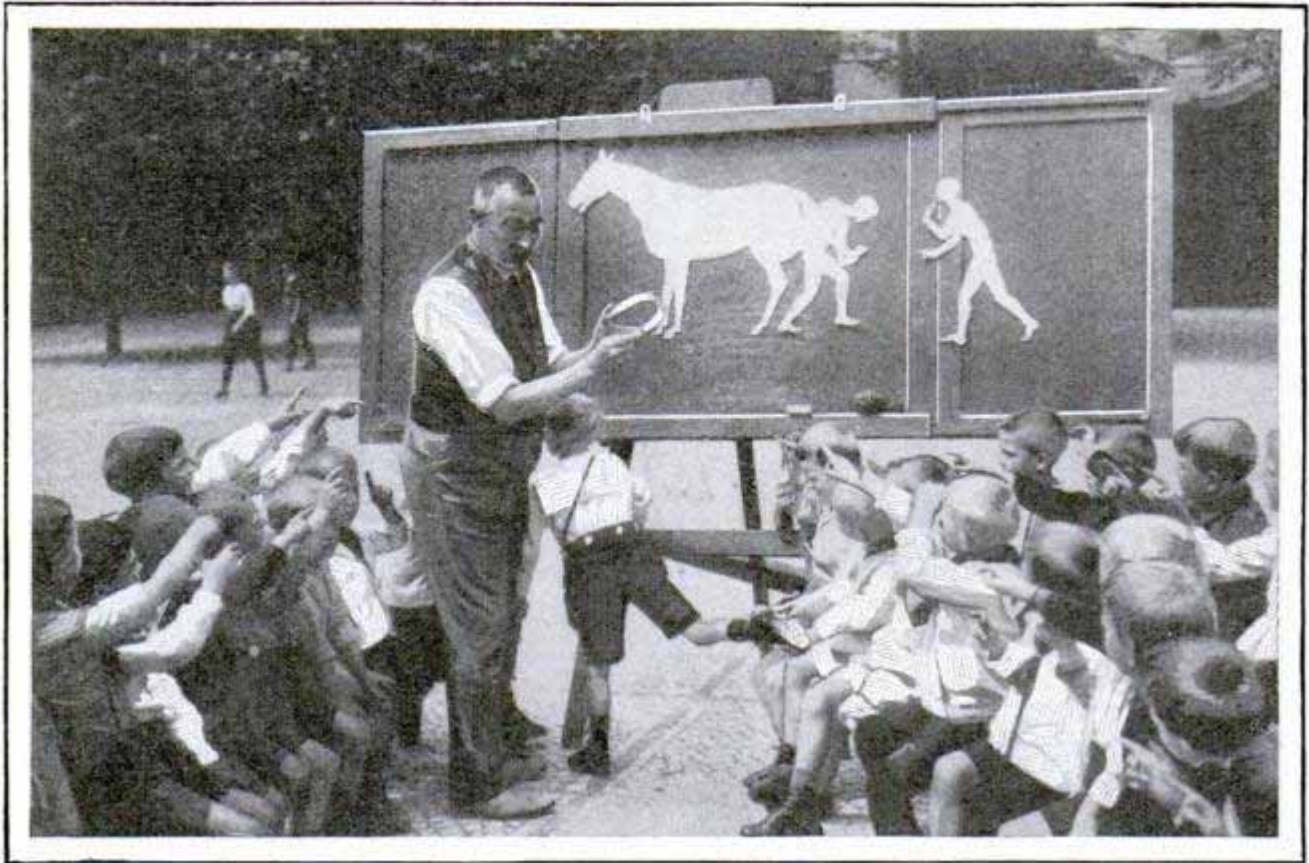

Where School Is Far from Dull; an Outdoor Trades Class in Blacksmithing; with Paper Models and a Willing Pupil as the "Horse," the Teacher Explains Important Points to Eager Listeners

TRADE TAUGHT BY BLACKBOARD AND PAPER MODELS

Charlottenburg

Young boys attending a trade school in Germany, receive interesting lessons in horseshoeing and other crafts from a series of blackboard lectures. The pupils are too small to do the actual work themselves, but they become familiar with the necessary steps by watching the process illustrated with models and drawings on the board. The figures are quickly adjusted to illustrate the correct positions. In one of the classes, a pupil poses as the horse, to make the lesson more graphic.

PASTURE PLANTS IN STRUGGLE FOR SURVIVAL

1429 Pasture plants are in continual war to see which will prove fittest and survive, according to Dr. Herbert C. Hanson, associate professor of botany at Colorado agricultural college. Timothy, red-top, alsike clover and white clover cannot withstand the competition of orchard grass and red clover and will be crowded out if their enemies are not held in check, he has found. At the same time, how-

ever, Kentucky bluegrass, working under the shelter of the other plants and extending its subterranean foothold under their roots, eventually will drive out the victors. Smooth brome grass and meadow fescue often hold their own when cattle are barred.

SELF-THAWING AUTO RADIATOR REDUCES MOTOR ILLS

1342 For quick thawing, an auto radiator is so arranged that when the water reaches the steaming point in the engine, heat and steam pour through small holes in the overflow pipe, starting circulation throughout the radiator. The core is of honeycomb design not likely to burst from freezing, and there is a cover strip over the perforated overflow pipe to prevent a draft through one column of air flues.



perforated overflow pipe to prevent a draft through one column of air flues.

*Eclipse Mfg Co.
Madison Ill.*

**RULES FOR SAFE AIR TRAVEL
ISSUED BY GOVERNMENT** 1417

Commercial aircraft engaged in carrying passengers or merchandise across state or territorial lines must be registered and licensed under regulations issued as the first step toward active governmental supervision of private aviation. Any aircraft flying across a state line, either on a commercial trip or to conduct commercial flying in another state, is required to carry the government license number, just as an automobile does. The aircraft, however, must first pass airworthiness tests to show that it is safe for flying. Other airplanes, not operated in traffic requiring licensing, are to be registered and carry the number allotted to them painted on the side. Pilots' and mechanics' licenses for commercial traffic also are to be issued by the government. Although the rules were effective the first of the year, they will not be rigidly enforced until July 1.

**SKI RUNNERS PRACTICE INDOORS
ON CHEMICAL SNOW** 1379

Slopes covered with chemical snow were arranged in a London department store so that ski runners could practice and demonstrate the essentials of the sport to beginners. The realism of the scene was increased by evergreen trees.



Depicting an Outdoor Sport in London Department Store; Ski Practice on a Slope Covered with Chemical Snow.

Harrod's Dept. Store

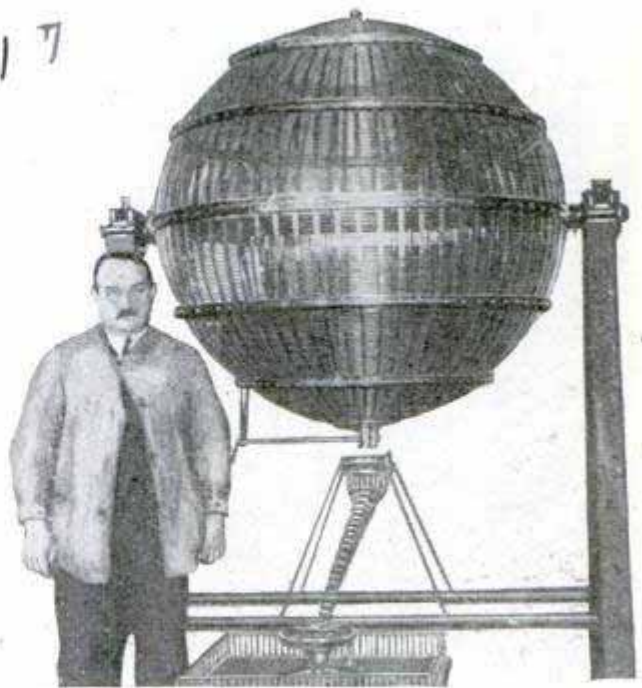

© P. & A.
Fortune Cage at Spanish Lottery; Tickets Are Placed in This Huge Steel Ball for Drawing

**PRIZES IN BIG LOTTERY TOTAL
MILLIONS OF DOLLARS**

HOLDERS of lucky tickets at the annual Christmas lottery in Madrid win fortunes, for the total prizes amount to several million dollars. The tickets are placed in a special steel ball from which the winners are drawn.

Micro Cine

**VEST POCKET MOVIE PROJECTOR
USES FLASHLIGHT BATTERY** 1470

Every man his own motion-picture show. This promises to become a reality as the result of a Swiss engineer's development of a tiny movie projector, not much larger than a cigaret case and using an ordinary pocket flashlight for illumination. If this fails, it is said that the machine can be adapted to use sunlight. The pictures can be displayed on a wall or any other convenient surface and, according to reports, are clear and steady. A special type of small film is used.

*Cont. F. Slossenbach
Director Official*

*1917
Engineer, Philippe
Hansen, Engineer
Hensch Graben No. 1, Bern, Switzerland
New York*

New Worlds *in the* Making

Morehouse's Comet, One of the Wanderers of the Sky Which Occasionally Flash across our Heavens and Then Disappear among the Distant Worlds Far Out in Limitless Space

HOW would you like to live on an earth that had eight moons wheeling around overhead?

Some day one of the neighbors in our universe—Jupiter—may support a race of people who will experience that unusual novelty. Jupiter, biggest of all the sun's planets, is now a world in the making and represents today what our earth was untold millions of years ago, just as our long-dead moon shows what this globe may be at some far distant date.

The eight big planets, of which the earth is one, and the hundreds of smaller ones, all revolving about the sun, form one of the most interesting groups in the heavens. Once there were nine planets, but at some time in the distant past one blew itself into thousands of pieces, and left a lot of little worlds trundling along in its place. The discovery of that long-lost accident, that probably occurred ages before the first man appeared on earth, is one of the most fascinating stories astronomy has ever produced.

Johann Ebert Bode, who died in 1826, discovered that the sun's eight satellites

were divided in two groups, four little ones, our earth, Mercury, Venus and Mars, then a long gap, followed by four big planets, Jupiter, Saturn, Uranus and Neptune. He wrote down their distances from the sun and was struck by the fact that the mileage seemed to increase in some mathematical ratio. From that observation, he evolved Bode's law, which says that if you add four to each figure in the series zero, three, six, twelve, twenty-four, forty-eight, ninety-six, etc., the result will represent the respective distances, in millions of miles, of each planet from the sun.

But after twenty-four, which represents Mars, there was a gap where the planet at forty-eight should have been. So astronomers decided that there must be a small and undiscovered planet there, and set about finding it. Pretty soon they did, but the elation had hardly died when somebody found another planet in the same place, and then another and another, until now more than 600 little ones have been listed, and the list is growing at the rate of about thirty a year. The answer

THE LUNAR ALPS ILLUMINATED BY THE EARTH

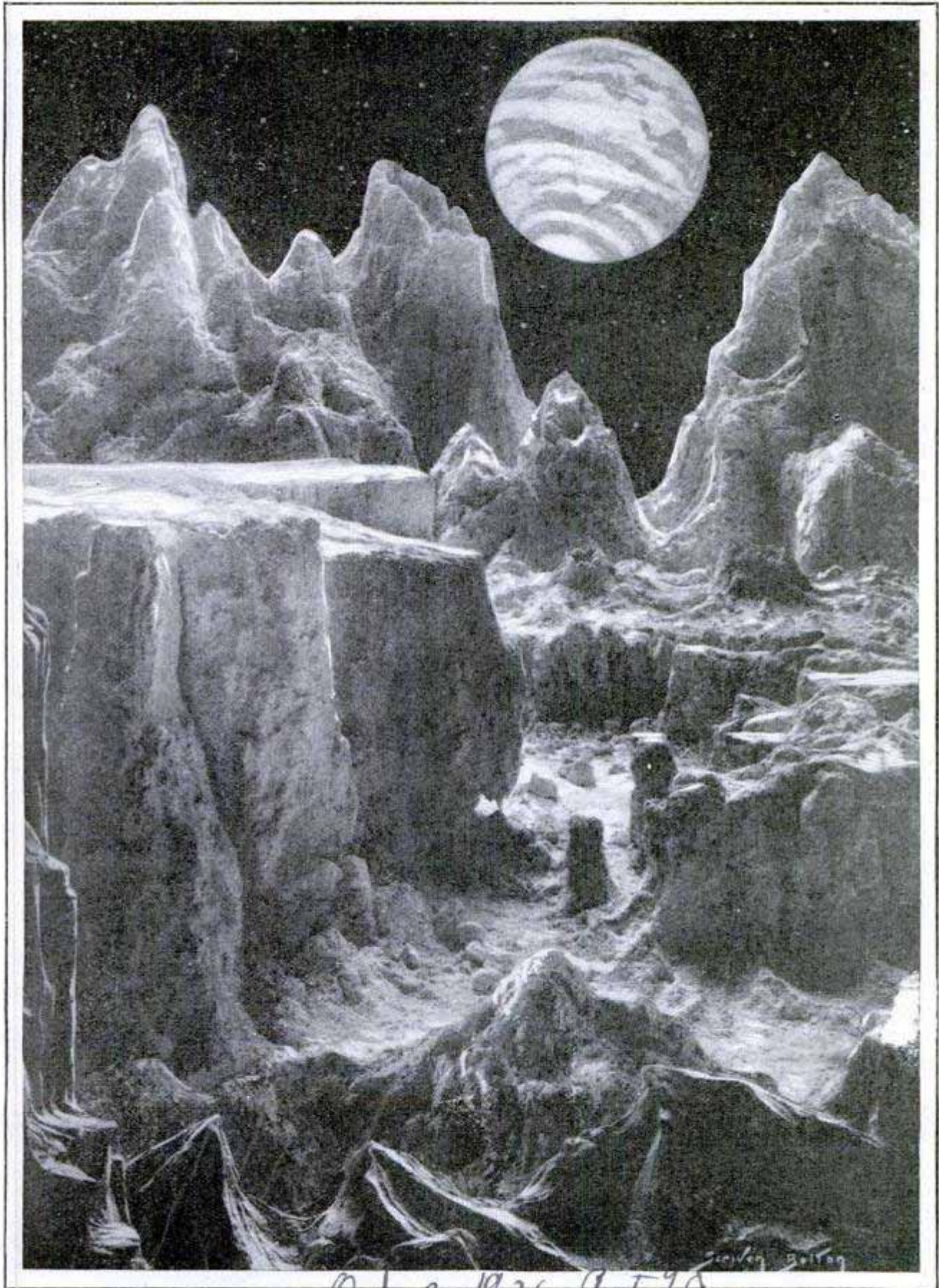

Courtesy Illustrated London News

Oct. 2, 1926 O. 590

Plaster Model Showing Our Earth as It Would Appear from a Valley among the Alp Mountains of the Moon; for Lack of Air and Water to Erode Them, the Lunar Hills Remain as Rough as When Made



Frequently, While Astronomers Photograph the Distant Stars, a Meteor, Entering the Earth's Atmosphere, Burns Up, Making a Straight Streak across the Plate



Some Meteors Are So Large That Parts Survive to Reach the Earth; Above, a Fragment from Canyon Diablo, Arizona; It Is Almost Pure Iron

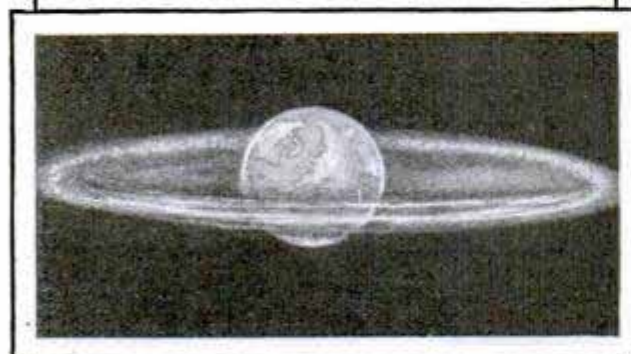

German Scientists Are Interested in a New Theory That Our Earth May Have a Luminous Ring like Saturn's, an Idea That Explains the Ghostly Zodiac Light

was that a big planet had broken up into innumerable small fragments, each of which continued to revolve around the sun in the neighborhood of their parent's old orbit.

If Jupiter, at some distant date, becomes inhabited, the possession of eight moons will not be the only distinction its people can boast, for their years will be as long as nearly twelve of ours—4,332.58 days to be exact. Jupiter is so much farther away from the sun, and its orbit so much bigger than the earth's, that it takes it correspondingly longer to complete a round trip.

The years grow progressively longer and the temperature progressively colder the farther you get away from the sun. If there is any place in our universe for human life to exist today, outside the earth, Venus or Mars would come nearest to it—the one merely being too hot and the other too cold to meet our ideas. Mars is nearly 142,000,000 miles from the sun, compared with our 93,000,000, and the result is an average temperature of ninety below zero at night, with daily changes to about sixty above. The average temperature of Venus is 165 degrees, because it is nearer the sun.

Once you pass Mars on the outward trip from the sun, the distances become truly immense. Jupiter, the first big planet past the gap where the ninth one once was, is nearly 484,000,000 miles away, and has an average temperature of 305 degrees below zero, and that's the chief reason why there may never be people there to enjoy the bright moonlight under its eight moons. Jupiter, though, with a diameter nearly eleven times that of our earth, rests secure with the record of being the biggest of the planets. Saturn, the planet with the queer rings and the ten moons, is almost as big. Uranus is a medium-sized fellow that would only require four or five of our earths to span, and at the outer edge is Neptune, a mere 29,827 miles in diameter, temperature 446 degrees below zero—and a year of 60,187.65 days. In other words, it would take the combined lifetimes of two people over 82 earth-years old to live one year on Neptune!

Our moon, being so close to us, is the best-known object in the sky, and, as it has no vapor to hide its features, the study of its surface has given an accurate idea of what the eventual fate of all celestial

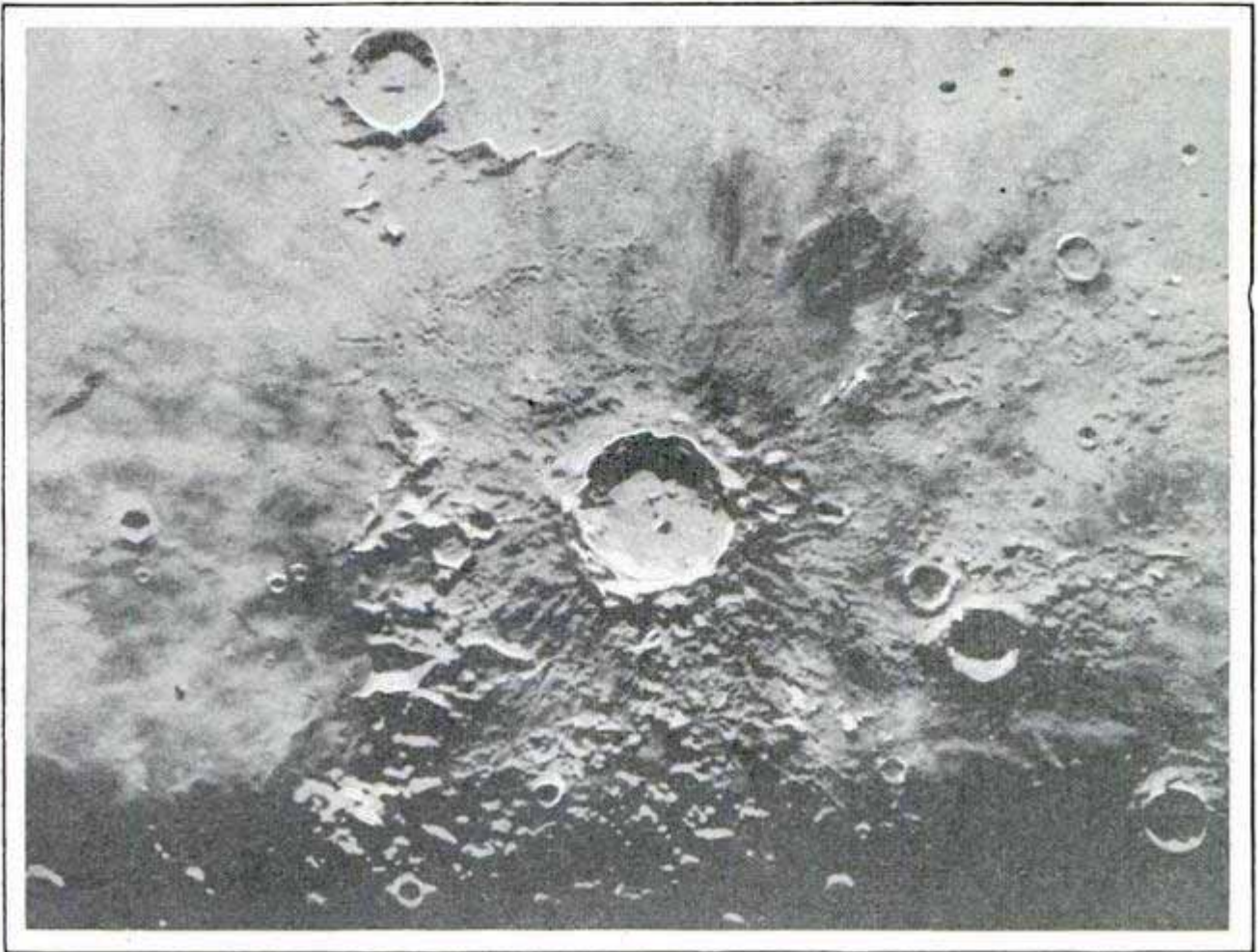

The Crater Theophilus on the Moon Is the Central Depression; the Vast Hole Is 18,000 Feet Deep, and the Central Mountain, Which Casts the Black Shadow, Stands 10,000 Feet High

wanderers may be. The most curious feature of the moon is the way its surface is pitted with giant craters, many of them miles across and often 20,000 feet or more in depth. A lofty wall of earth and rock thrown up around the edge adds to the depth of the valleys, which sometimes have in their center a mountain nearly as high as the surrounding rim. Scientists have long believed that the craters are probably the marks of some long-ago bombardment of the moon by huge meteors. Millions of meteors every year come within the earth's attraction, but comparatively few actually strike. Traveling at tremendous velocity, they are heated to incandescence by friction with the air as soon as they enter it, and are burned up, as a rule, before they can reach the earth. They are familiar as "falling stars." But when a meteor gets too near the moon and is drawn to it, there is no atmosphere to burn it up, so the mass strikes the moon with full force.

Mars and Jupiter, of all the planets, hold the most interest for the earth—the one

because it may possibly harbor living creatures, and the other because of its size, because it is a world in the making which can be studied to learn what our own earth once was like, and because, next to Venus, it is normally the most brilliant of all the planets, easily visible to the naked eye.

Mars is a dying planet, growing colder and colder, until some day it may be as dead and lifeless as our moon. The telescope shows Jupiter as a rapidly rotating globe of gases and vapors. There can be no thought of life, for a surface, in the sense of a solid crust like that of the earth, does not exist. It is believed to be a vast semifluid core surrounded by dense vapors, which in billions of years may evolve into a solid planet.

Some idea of the comparative size of the two, Jupiter and Mars, is gained from the fact that one of Jupiter's eight moons, Ganymede, is almost as big as the red planet. From Jupiter's great bulk some 1,300 worlds the size of our earth could be made. Four of its satellites equal or surpass our own moon in size.



The "Man in the Moon." When Examined at Close Range, Becomes Mountains, Craters and Plains, Erroneously Named "Seas"

One of the curious features of Jupiter, as odd as Saturn's rings or Mars' canals, are the belts, light and dark and many in number, that lie parallel to its equator and seem to be formed of denser vapors than the rest. Two semi-permanent markings appeared on the planet long ago, and have been carefully watched for years. One is called the Great Red Spot and the other the South Tropical Disturbance. The red spot was an oval formation 30,000 miles in length and 7,000 miles wide, first observed in 1871. At first a pale pink, it soon deepened to brick-red, then faded to pink again and gradually almost disappeared, leaving an oval white notch. It drifted around like other cloud formations, but seemed to offer an obstacle to smaller disturbances, turning them aside like an island in the sea.

The South Tropical Disturbance appeared within the last twenty years, grew to four times the size of the red spot, and appears as a dark area terminating in bright, white loops at either end. Sometimes the two areas come in conjunction, and then the latter disappears for a time, only to form again. Some scientists be-

lieve the two spots mark the first efforts of the planet to form a solid crust, and others hold the idea they may portend the birth of another satellite, which Jupiter may be trying to expel from its swirling mass.

The story of these changes, reflecting as they do our own origin, and the observation of the moon as a long-dead world, give the beginning and the end of existence, with our earth midway between the two extremes. From them it may be possible to learn how we originated, and how we finally may disappear.

Yet science is far from satisfied by the knowledge that has been learned from the moon.

There is still the problem of the craters to be solved, the problem of the vast sealike plains, and the mystery of the long white lines that radiate for hundreds of miles from Tycho. They look like mighty ice cracks, but, lacking water, there could be no ice on the moon, so some other explanation must be found.

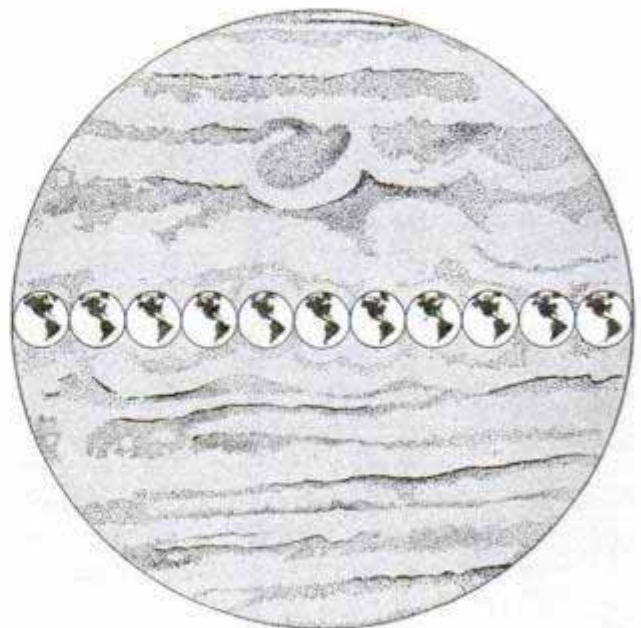

Our Earth Is a Tiny Thing Compared with Jupiter, Also a Satellite of the Sun

POLICE LABORATORY ON WHEELS TO CURB CRIME



German Police Squad with Traveling Laboratory at the Scene of a Crime; besides the Camera, the Outfit Includes Chemicals for Making Analyses, Microscopes and Other Equipment

Enabling detectives to obtain evidence fresh from the scene of a crime, an auto, equipped as a laboratory, has proved of aid in Germany. It carries a searchlight, camera, collapsible table and chairs, medical cabinet and other apparatus. Arrived at the spot, the police can set up their equipment, take photographs, make measurements and obtain other data for complete analysis while on the scene, without making repeated trips back to headquarters with consequent loss of time.

install the box, it is only necessary to remove the rear lower-deck panel and fasten the carrying frame to fender bolts and the flooring on either side.

1447
SLIDING BOX FOR SMALL AUTO GIVES TRUCK SERVICE

Small coupes or roadsters are quickly converted into serviceable carriers for packages, tools and other articles, by means of a sliding box which can be pulled out at the rear and then pushed in and concealed when not in use. It is strongly made of steel, slides on a sleeve frame capable of holding a heavy load, and when opened to extreme length, is sixty inches long with a width of thirty three inches. To



HUGE CONCRETE MIXER RESULT OF STRICT STATE LAW 1559 N.C.

Out of the provision in the law of a southern state requiring that concrete be stirred a minute and a half before it can be poured into road forms, has developed a huge mixer, said to be one of the largest in the world. In most states, the mixture can be poured after only one minute of stirring. Because of the extra time required, the mammoth apparatus was developed to make up for loss that would have been suffered with ordinary equipment. The outfit is practically a double mixer, consisting of two engines, two drums, two booms and buckets and two intake hoppers. It travels on a single chassis on one pair of crawler treads. Three cranes are required to supply it with materials as well as twelve seven-ton and one four-ton gasoline locomotives and 140 narrow-gauge cars. It dumps thirty-two cubic feet of concrete on the roadbed every minute. During the building season in 1926, thirty miles of eighteen-foot pavement were laid with it.

Operated by James E. Heyworth, Elm. Halifax, N.C.

Acme Body Top Co.
Piquette Hill

Mr. H. C. McFoy 1717 St. Paul St. Baltimore, Md.

1289

FELLING BLAST FURNACE TESTS ENGINEERING SKILL

Where a Locomotive Aided Dynamite in Wrecking Old Blast Furnace; the Engine, Attached with Guy Ropes, Pulled as Explosive Was Fired to Keep Structure from Falling in Wrong Direction on Other Buildings

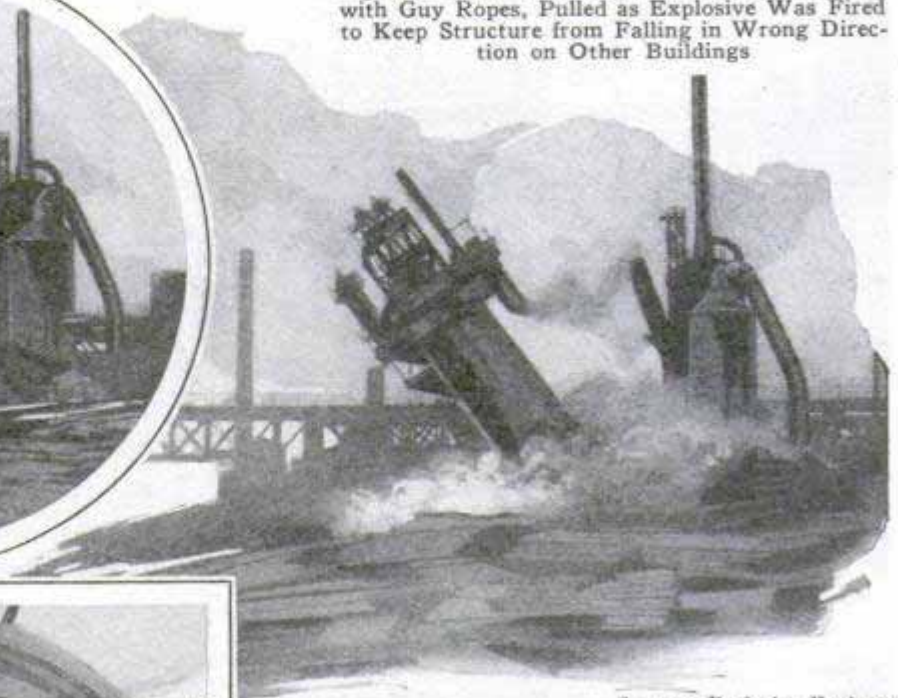
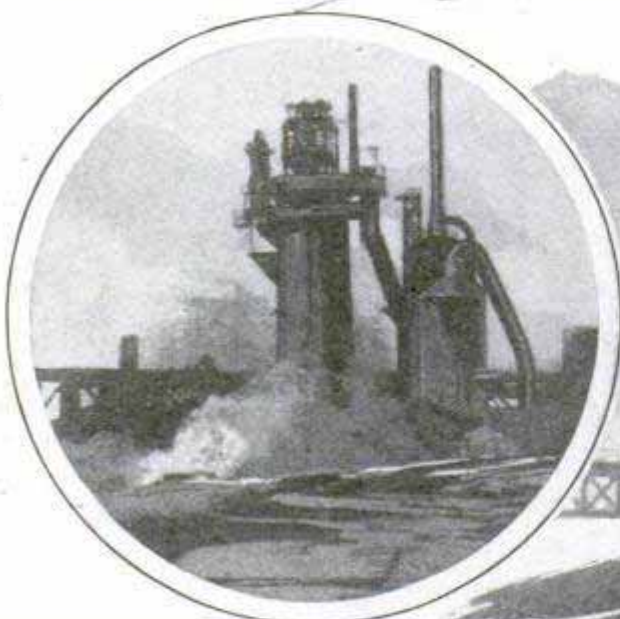

Courtesy Explosive Engineer

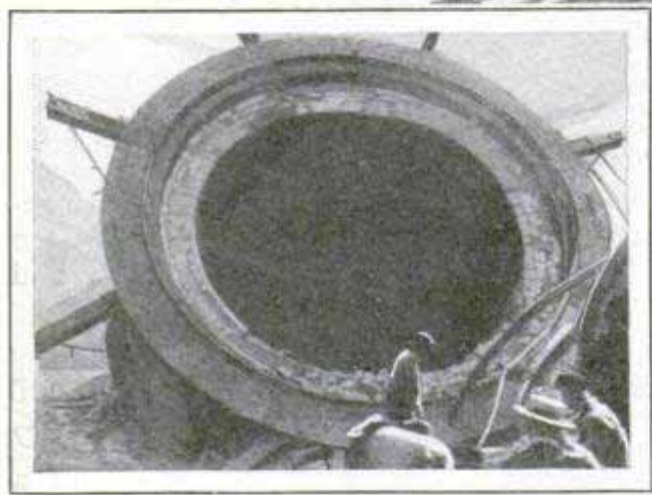

Much engineering skill was involved in the removal of an obsolete blast furnace at the Pittsburgh plant of the American Steel and Wire company. The fur-

nace was 108 feet high and had a maximum diameter of thirty-five feet. One problem was to make sure that the towering structure would fall in the right direction, away from other buildings near at hand. This was solved by using guy ropes, attached to the top and tightened by a slowly moving yard locomotive, pulling in the direction of the desired fall at the moment of the discharge of the dynamite cartridges used for blasting the structure. This plan caused the tower to fall exactly as desired. The explosives were blanketed by bags of sand.

SUPER-OYSTER SOLVES PROBLEM OF IMPROVING ITS RACE

How scientists have finally solved the age-old problem of mating the oyster in captivity, rearing its young and, by selective breeding, improving the racial strain is one of the latest triumphs of the modern laboratory that promises to add millions of dollars to the income of the Atlantic coast states. Dr. William F. Wells, of the New York State conservation commission, solved the problem which had perplexed scientists for generations. The trouble had been that the oyster eggs were so small that they passed

through the filters used to purify the water in which they were kept, and if the water was not purified, they died. Dr. Wells found the solution in putting the eggs into a centrifuge built like an ordinary cream separator. The eggs were thrown outward and adhered to the sides of the machine, while the stale water was drawn off and fresh water added each day. In this way the eggs were hatched and young oysters grown in captivity. In seeking crosses to improve the strain Dr. Wells developed a breed of oysters without the anchor by which they usually attach themselves to some rock. Such oysters occur as freaks in nature and

ref James 12/31/26

1460

soon die, but by raising them for a year in his ponds before throwing them into the sea, he obtained oysters that were able to shift for themselves and grow to maturity. Unlike the usual oyster, whose shell is misshapen and gnarled from conforming itself to the cleft of rock in which it grows, the new type oysters have symmetrical shells, regularly marked.

1444.
PLANT STEAM SIGNAL WHISTLE ELECTRICALLY CONTROLLED

To summon employes of a refinery plant to the telephone, an electrically operated steam whistle sounds long and short blasts in a code, a different signal being given for each man. The impulses governing the whistle originate in a small telephone-type switchboard which is connected to a magnetic switch. The signal is repeated continuously until the person summoned reports through the switchboard. In spite of changes in temperature and storms, the system has functioned efficiently, according to reports, the valve having been operated more than 1,500,000 times since it was installed about a year and a half ago.

1450

STONES FROM ALL THE STATES IN MEMORIAL FOUNTAIN

Legion posts in every state of the union, and several abroad, sent stones for the construction of a memorial fountain to fallen war heroes at Mt. Morris, Ill. In all, 250 were obtained and built into the

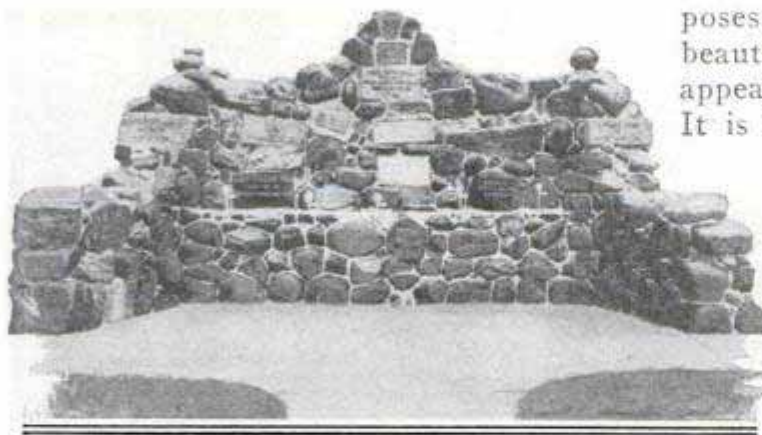

Tributes from Every State and Several Countries Abroad Are Included in This American-Legion Fountain of Many Stones

memorial by former service men. Each stone has the name of the donor engraved upon it.



done to W. S. Boyd
New York

Using Rouge Stick from Tidy Package; Right Quantity Is More Easily Applied

SANITARY LIPSTICK IN PACKAGE LATEST BEAUTY AID

Individual lipsticks, held in a paper carrier like a match package, have been introduced for the woman who is interested in absolute cleanliness as well as beauty. There is enough rouge on each stick for a single application, after which it may be thrown away. The package is conveniently carried in the handbag.

LEATHER FROM THE SEA 410

There are a number of fish that produce serviceable leather for many purposes. The shark yields leather of a beautiful gray or blue color and has the appearance of the finest-grained material. It is tough but easy to work. In some respects, it is said to be superior to ordinary hides. Sturgeons furnish a tough leather often used for lacing belts together. In bygone days, shoes and gloves were manufactured from the skin of the cod, and the same use is being made of the skin of other fishes in a number of places in Europe today. Eelskin is employed for bookbindings and for whip braiding. The skin of the garfish can be polished until it resembles ivory and is utilized in making jewel cases, etc.

Com. Edwin Tarissee
The Farragut

1094.
634

Moore

MOORISH ARCHITECTURE USED IN MEXICAN CHURCH

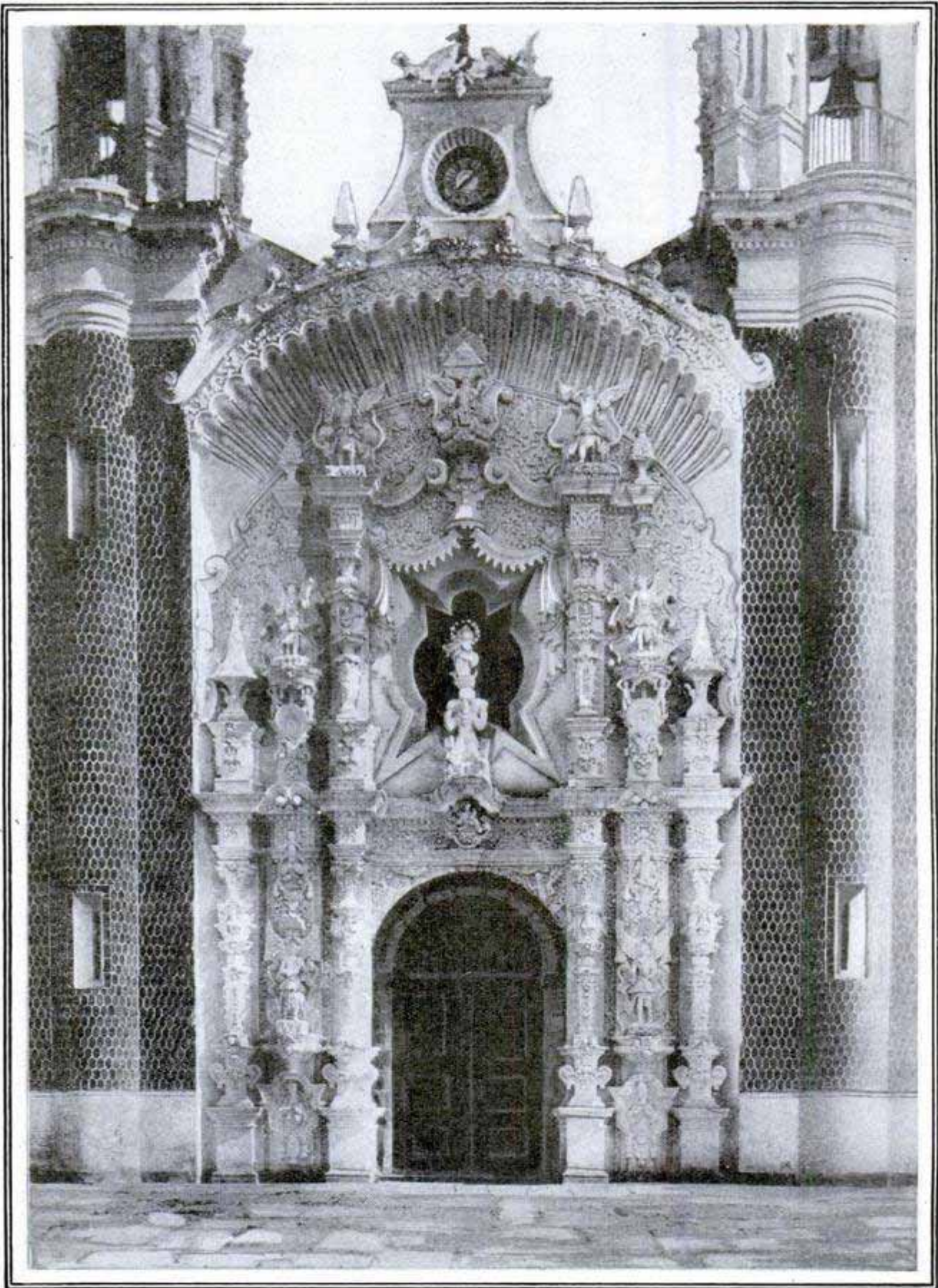

Black-and-White Tile Work with Deep Window Embrasures, Reminiscent of the Moorish Palaces of Old Spain, Set Off the Carved Front of the Sanctuary of Ocotlan, Tlaxcala, Mexico

near Puebla Tlax.

1438

CATHODE RAYS DRAW RUBBER FROM LEAVES OF PLANT

1464

Discovery of a powerful cathode ray by Dr. W. D. Coolidge, of the General Electric company, was followed almost on the day of the announcement, by the question, "What is it good for?" An answer to the query is already suggested by the result of an interesting experiment with the rays on rubber leaves. They were directed from a distance of about an inch upon a leaf of a rubber plant. Within a few seconds after the bombardment of the high-speed electrons issuing from the tube, there was a marked flow of latex, or sap. This has inspired the vision of a rubber plantation with a maze of poles, wires and tubes, the sap being "milked" from the leaves instead of gathered from cuttings in the trunks, as is now the practice. While authorities do not believe that the ray seriously threatens to change the rubber-harvesting methods of the present, they do anticipate that it may have an important part to play in chemical and other experiments on rubber, particularly in vulcanization. The rays already are known to possess properties that have peculiar effects on certain gases.

CLOCK WITH TEN HANDS TELLS TIME IN ALL LANDS

1422

Travelers are spared the difficulty of making time calculations at one of the railway stations in Berlin, as the big clock there has ten hands which show the correct time for as many places throughout the world. The dial is divided into the twenty-four hours for the day and night together, and the hands are marked with the names of the places for which they tell the time.

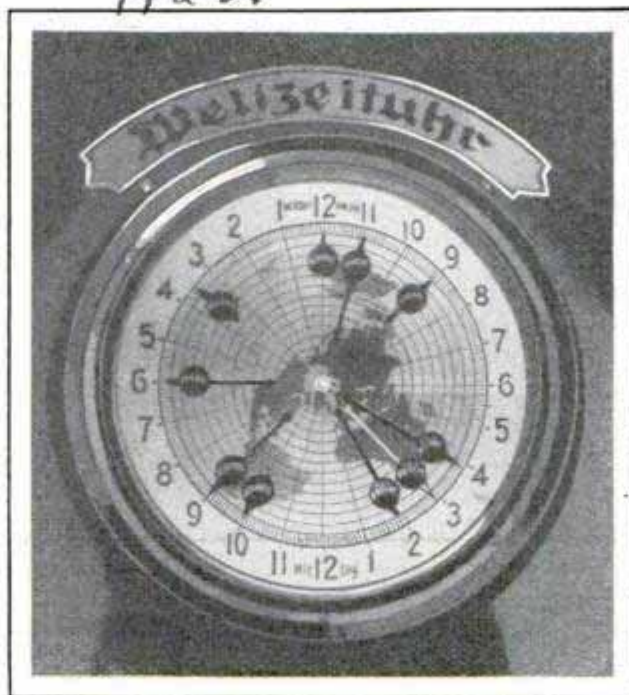

World Clock in Berlin Railway Station; a Glance at Dial Shows Time in Ten Cities



In the "China" Closet of a Motion-Picture Studio; Storing the Plaster of Paris Crockery

CROCKERY IN MOVIES IS MADE ONLY TO BE BROKEN

When the movie comedian breaks a dish over the villain's head, everyone knows that the "china" is a clever imitation of the real article, but few persons realize how thin and fragile the fake crockery is. Made of plaster of paris and painted to resemble genuine pieces, the vases, bottles and other things range from an eighth to one-sixty-fourth of an inch in thickness. This "break-away" stuff is kept in large quantities in almost all the studios, and much of it is so flimsy that a small fraction of all that is made reaches the set without damage. It is used with almost perfect safety, the only danger being that occasionally the base of a piece will become heavy enough to register a more serious shock if it is swung with sufficient force.

Cont. Reville W. Gray, Jr., 584 N. Larchmont Blvd., Tollywood, Calif.



C. E. Mirguet beside Giant Flipper of a Whale Pieced Together for Display as a Museum Specimen

ARTIST BUILDS HUGE WHALES OF BONE AND PLASTER

Fashioning a whale as big as a freight car, or modeling other creatures almost as large, is all in the year's work for C. E. Mirguet, a taxidermist at the national museum. For more than thirty years he has made a specialty of constructing and mounting, in lifelike manner, jungle and sea creatures for museum cases.

FROZEN ORANGES DETECTED IN TROUGH OF WATER

Telling a frozen orange or lemon from a good one is a difficult task, for as the fruit does not fall to the ground after being nipped, there is little or no change on the surface unless the freezing has been very severe, and testing by cutting, of course, ruins it. To simplify the task and to prevent shipping frozen oranges and lemons, a grower devised a "detective" in the form of a long, deep trough filled about two-thirds full of water, which is allowed to flow slowly toward one end. The fruit to be tested are dropped, one at a time, from a chute into the water. Any

frost-bitten ones, being lighter than the sound fruit, bob up more quickly and are caught on screens arranged horizontally in the trough below the water line. The good fruit sink farther, rise more slowly and are caught by other screens. In this way the unfit product is removed and the remainder is graded.

LOCOMOTIVE WHISTLES COSTLY

At least \$8,000,000 is spent yearly by the railways of the United States in blowing the locomotive whistles, according to estimates. Each hour of continuous use for one whistle consumes about four tons of water and 1,200 pounds of coal. Suggestions have been made that the whistle be moved ahead of the smokestack, so that its sound would be deflected much less, and that it be constructed to give a high-pitched note which would have a longer range of audibility.

FRONT AND REAR AUTO SIGNALS REDUCE ACCIDENTS

Warning is given at the rear and at the front of the auto simultaneously for stops and turns by a set of signals operated from a switch at the steering post. They are intended to dispense with the giving of arm signals and can be seen plainly at a distance of 200 feet. Stop and left signs show in red and right is given in green. Since the warning is

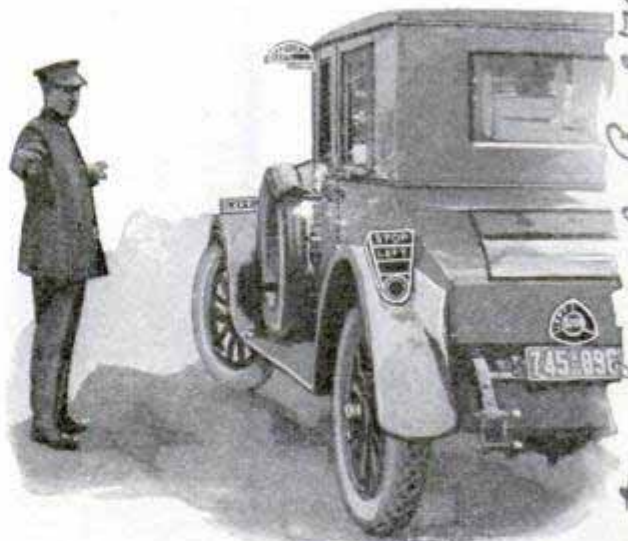

Turning Signs in Front, Sides and Rear of This Car Are Intended to Prevent Accidents

given before the turn is made, there is less danger of mishaps.

*Com. Edwin Tarsse
The Harragut
Washington, D.C.*

*Auto Signal Calif.
California, Calif.
Lonek*

1442

1286

N.Y. Times 1/2/14

1282

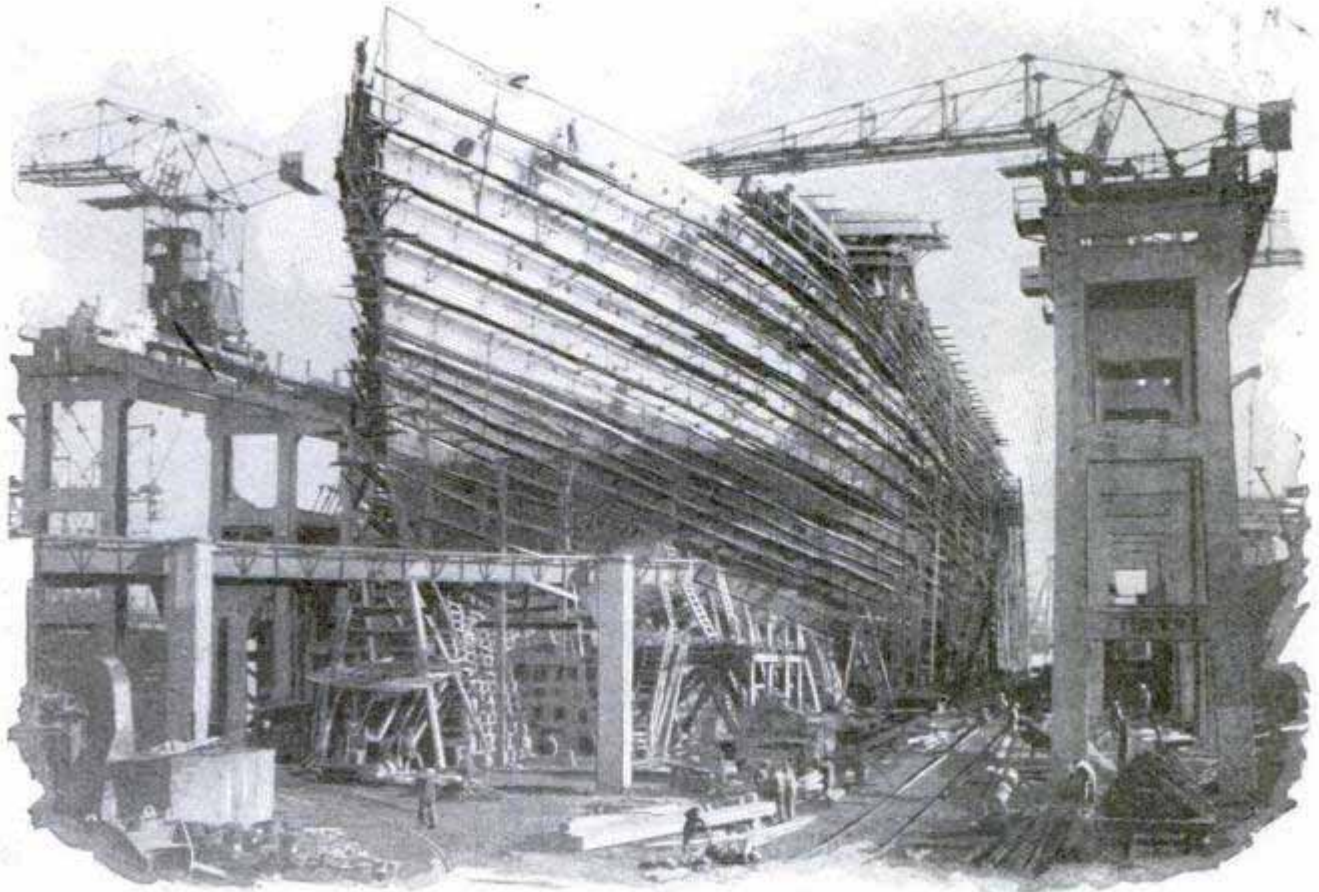

Shortly before the Launching, the Giant Hull of the Steamer "Vulcania," on the Ways at Monfalcone, Italy; Special Steel of High Elastic Properties Was Used in Constructing the Boat

OCEAN LINER WITH NINE DECKS BUILT OF ELASTIC STEEL

The upper parts of the liner "Vulcania," recently launched at Monfalcone, Italy, are constructed of a special steel, which is said to have high elastic qualities, specially suited to ocean service. The boat has a gross tonnage of 24,000 tons, is 631 feet long, seventy-nine and one-half feet wide and has nine decks.

RANGERS READ SNOW METERS THROUGH TELESCOPES 1446

Farmers and others interested in the water conditions for irrigating California lands, consider the depth of snow that falls in the Sierra mountains during the winter an important factor in their calculations. Information concerning the snow is furnished by forest rangers. At one station, a two-day journey through drifts and difficult ground was necessary to scale a peak, make observations and return. To eliminate these trips, a snow meter has been installed on the peak. It consists of a standard marked with cross

arms and notches. From the ranger station, eleven miles away, the gauge can be plainly read with the aid of a powerful telescope. By counting the number of notches not covered by the snow, the observers can compute the depth of the snow without leaving their shelter.

BARBECUE ROASTER FOR STORE FITS ON COUNTER 1394

Suitable for the drug store, restaurant or sandwich shop, a small barbecue roaster occupies only thirty inches of counter space. It is provided with a pump which lifts the drippings from the meat to the top of a revolving axle, around which the contents are placed, and discharges them



over the meat. Pork, beef, fish or fowls may be prepared in this outfit.

*Alder creek head.
Quartered Sequoia*

*Charles Miller
% Anderson Pulley Works*

725

Nov 14

Pat'd
1925

NEW WAYS To avoid

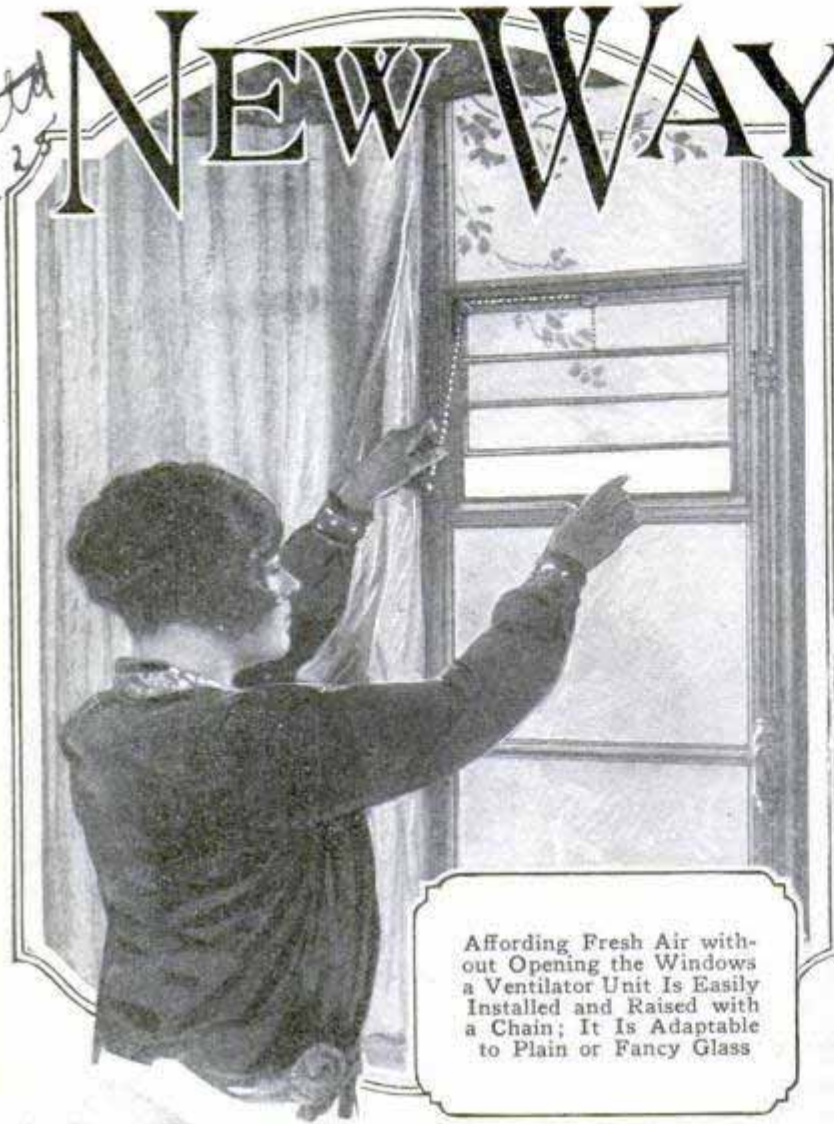

Affording Fresh Air without Opening the Windows a Ventilator Unit Is Easily Installed and Raised with a Chain; It Is Adaptable to Plain or Fancy Glass



Rubber Mat beneath Flowerpot Protects Varnished Surfaces; Ridges Permit Ventilation



Pan with Permanent Strainer Lid Has Handle That Keeps Cool



Both Sides of the Knife Are Sharpened at Once between Small Disks Rotated by Crank

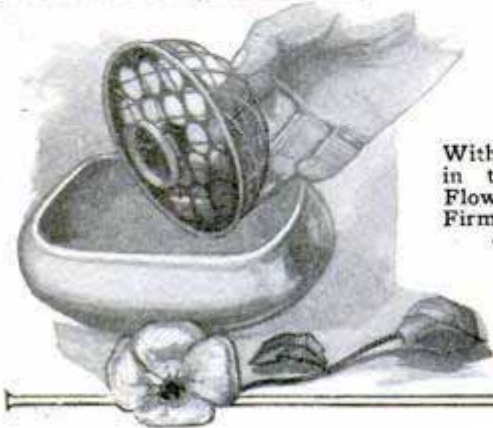

With a Vacuum Cup in the Base, This Flower Holder Sticks Firmly to the Bottom of the Dish



Pits Pop Out of Dates Quickly and without Damaging the Fruit When This Instrument Is Used

588 Washington

Chicago

\$17.50
\$32.00
725

HOME Drudgery

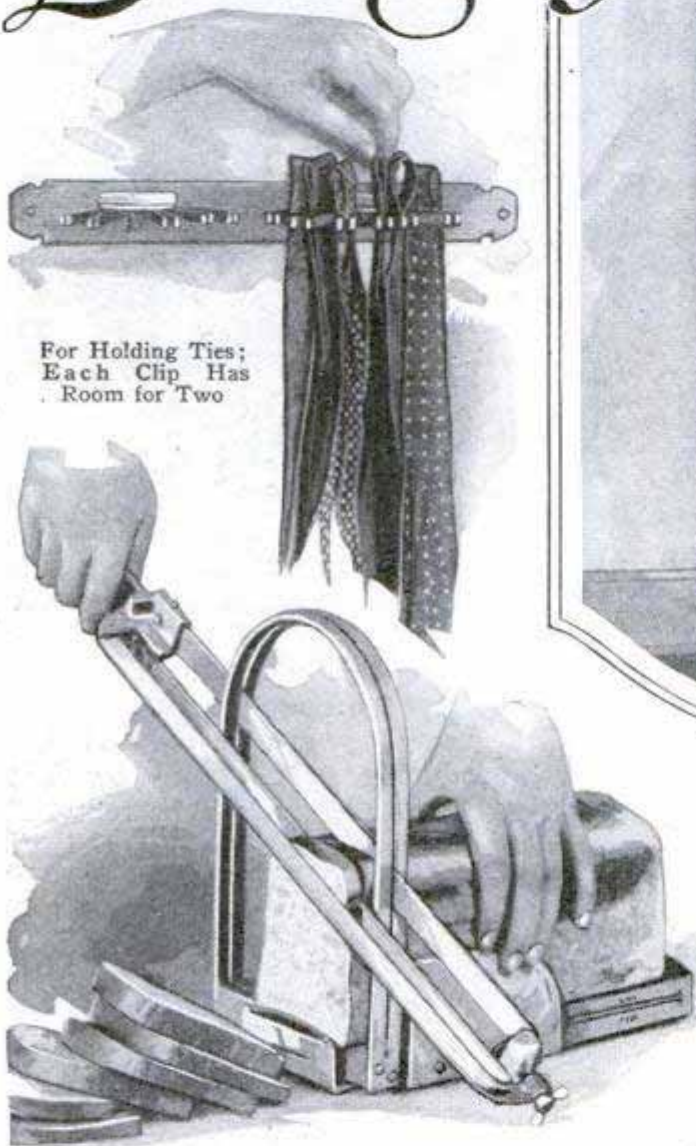

For Holding Ties;
Each Clip Has
Room for Two

Cutting Two Slices
of Bread at Once;
Adjustments Easily
Made for Thick or
Thin Pieces

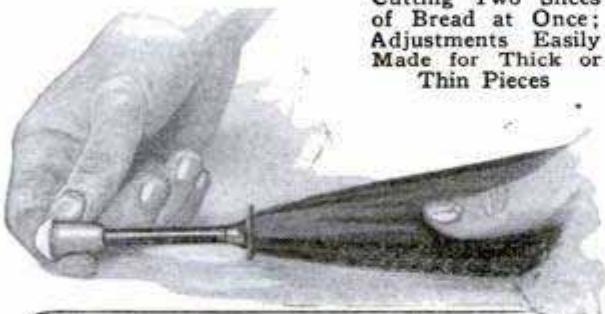

Rubber Tip for Umbrella Prevents
Slipping in Any Location; It Also
Protects Eyes of Others



Portable Wardrobe Keeps
Garments Free from Dust
and Moths; Sides Lock by
Pulling Small Tab; Holder
Is Screwed to Wall



Combination Water Heater
and Cooker Fits Oil, Gas or
Electric Stove

obtain it by addressing Bureau of Information, Popular Mechanics, Chicago

30 & 60 gal. 639

W
S
I

Chicago
MAKING HAY WHILE IT RAINS IS POSSIBLE NOW

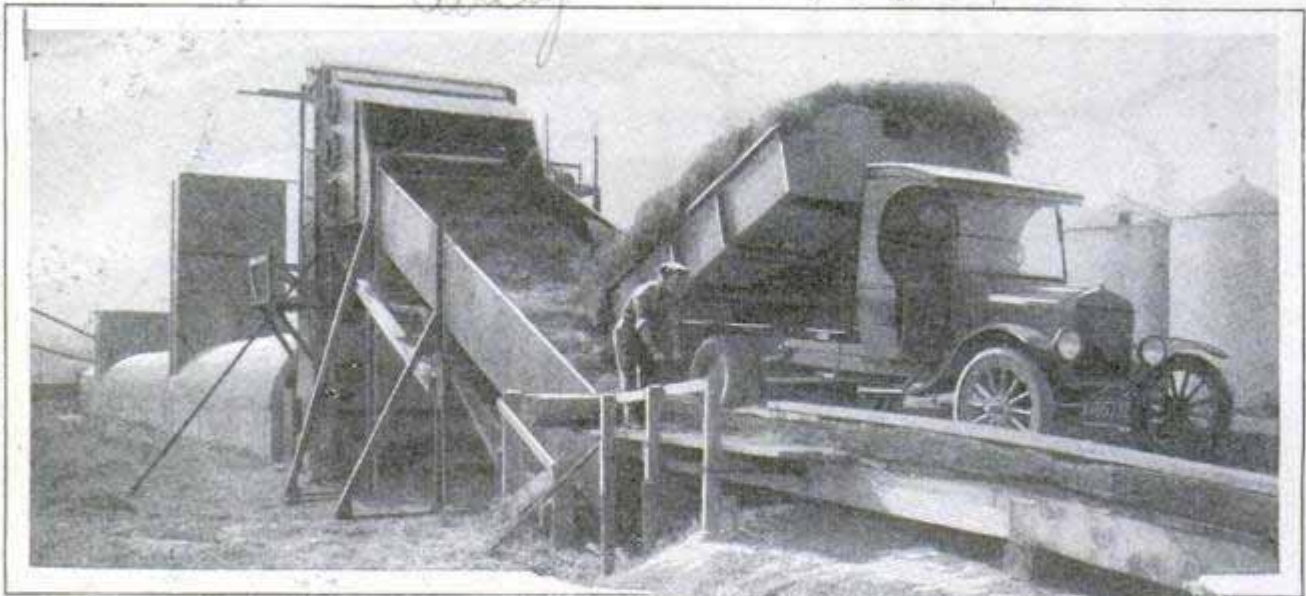

Dumping a Truck Load of Hay onto the Conveyor Which Carries It to a Cutter, and Then Delivers the Shredded Fragments to a Belt Moving through the Drying Tunnel, from Which It Emerges Cured

The best-known farm saying—make hay while the sun is shining—may be banished as a result of the development of successful apparatus to artificially cure green hay, even in a pouring rain. The hay curer makes it possible to save the crop in regions where excessive rainfall during the mowing season prevented curing the grass, so that it was only useful in the meadow. The apparatus is not only a drier, but includes all the equipment, from a special mowing machine to the power grinder that reduces the cured grass to a coarse meal ready to be blown into the silo for storage. The gasoline-driven mower differs from the usual type in that it not only cuts the hay off near the ground, but also cuts it up in twelve-inch lengths, and delivers them into a motor truck driving alongside. From the truck the grass passes onto a conveyor, running through a low steel shed, 160 feet in length and twelve feet wide. Midway between the ends of the curing shed is a furnace to generate the curing heat, while big electric fans circulate the warm air through the grass on the belt below. Moving five feet a min-

ute, it takes the hay but little more than half an hour to pass through the shed, but only twenty minutes' exposure to a temperature of 400 degrees is actually needed to cure the greenest hay. Sixty tons of green hay can be cured in ten hours, producing twenty tons of dried product. The other forty tons represent the moisture that has been evaporated during the process.

**STREAMLINED RACING CAR HAS
 1365 A NOVEL ENGINE**

Mounting a twelve-cylinder airplane engine, with the cylinders cast in blocks of four, necessitating special streamlined bulges on either side of the hood to cover them, a new racing car, built in England by Capt. Malcolm Campbell, embodies a number of unusual features.



New Twelve-Cylinder Racing Car, Showing the Streamlined Side Bulges on the Hood

Four of the engine cylinders stand vertically under the main hood, while the four on either side, projecting at an angle of sixty degrees, fit into the side hoods, through which their short exhaust pipes project. The front axle of the car is more than eight inches long-

napier. Lion motor

W. Watson + Sons Ltd. Manufacturing Optician 313 High Holborn London W.C.1, England

er than the rear one, the front wheels having a track of about five and a half feet. The body is so far underslung under the rear axle, that rear tires two inches larger than those in front are used. Developing slightly over 500 horsepower, the engine is extremely light for its size, weighing only 915 pounds.

POWER FROM OCEAN WARMTH TO PRODUCE ELECTRICITY?

1230

Two French inventors are authors of a plan for utilizing the warmth of surface water on tropic seas and the coldness of the deep waters below to furnish power. A basis for the idea is the fact that warm water can be made to boil by reducing the pressure on its surface. The inventors propose to adapt this principle to a gigantic ocean-power plant in some favorable tropic locality. The warm surface water, which, in many such regions, stays at an average temperature of twenty-six or thirty degrees Centigrade the year around, would be placed in a sort of boiler, atmospheric pressure removed and the consequent steam utilized to turn a turbine before being condensed by cold water from the depths. According to reports, a test outfit used to demonstrate the idea, furnished enough power to light three small electric lamps for eight or ten minutes. Critics declare, however, that such a plant would have to be too large to be practical.

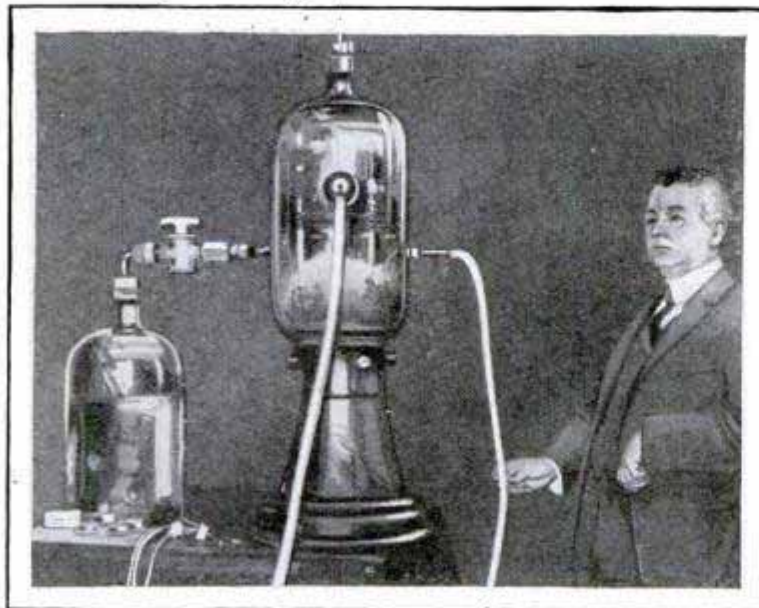

© Herbert Photos
Test Apparatus Which Produced Steam to Run Turbine and Light Small Electric Lamps for a Few Minutes

Dr. M. Claude French scientist



Window Telescope in Use; Figures Seen Are Those of Three at Left of Glass

TELESCOPE LENS ON WINDOW GIVES CLOSER VIEW

Hung in the window, a lens serves as a telescope, bringing distant objects within close range of vision. It is proving popular for country homes, and the supporting bracket obstructs the glass but little.

ABOVE-GROUND STORAGE BEST TO KEEP APPLES

1428

An above-ground cellar, with floor and walls of earth proved a better storage place for apples than either an underground cellar, with similar floor and walls, or a cork-lined storage cellar, according to experiments made by Dr. L. M. Marble, of the American Society of horticultural science. He found that the above-ground storeroom, with its floor at the same level as the surrounding earth, maintained a higher humidity throughout the storage season, and therefore there was less loss in weight of the stored fruit. The tests showed that the higher the humidity was kept, the more moisture the fruit would absorb from the air, and the longer it would remain in such condition as to be fit for sale.

W. Watson + Sons Ltd. Manufacturing Optician 313 High Holborn London W.C.1, England

1212

GIANT FANS WHICH SAFEGUARD HEALTH AND LIFE

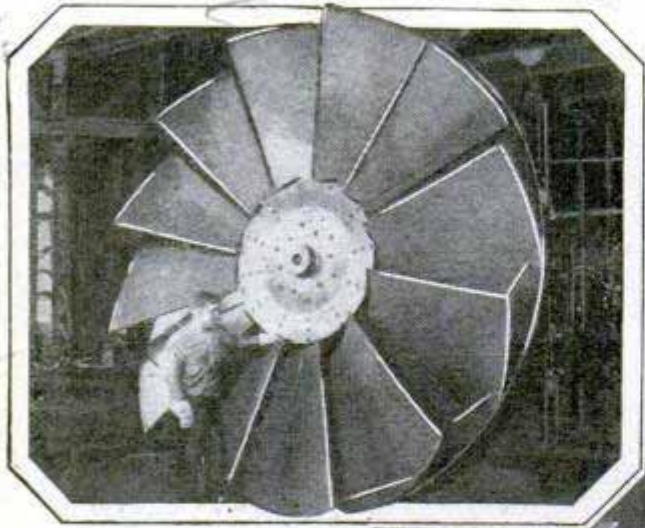

Blower of a Giant Theater Fan, of Which Thousands Are Built to Protect the Health of Patrons in Crowded Movie Houses

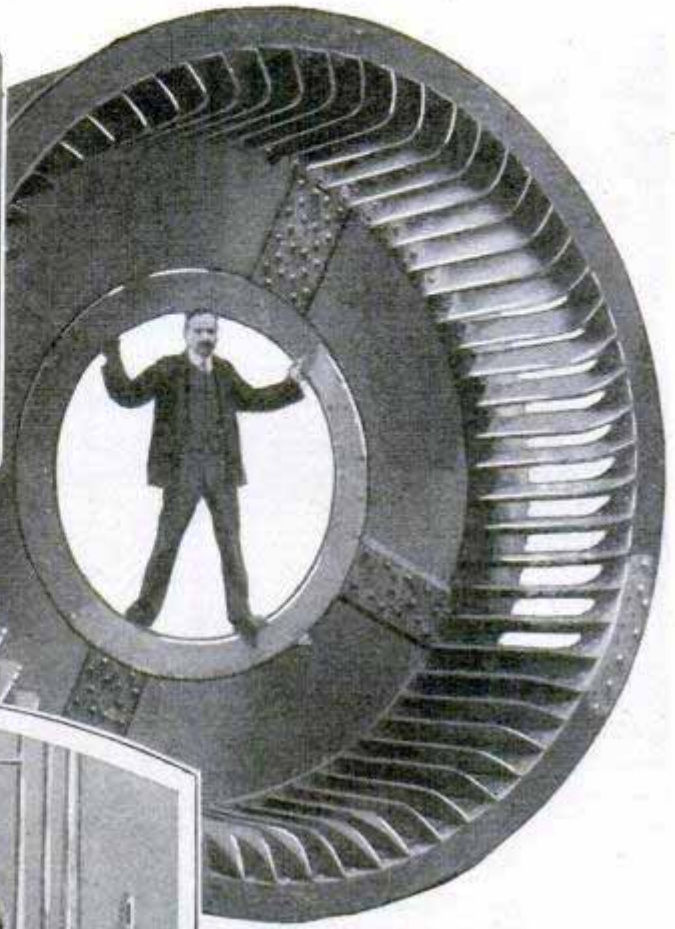

Part of a Fan Capable of Pumping Twenty-Five Tons of Air a Minute, Built for a South African Coal Mine, Is Shown Above, and Below Is Its Huge Rotor Being Assembled Previous to Factory Test

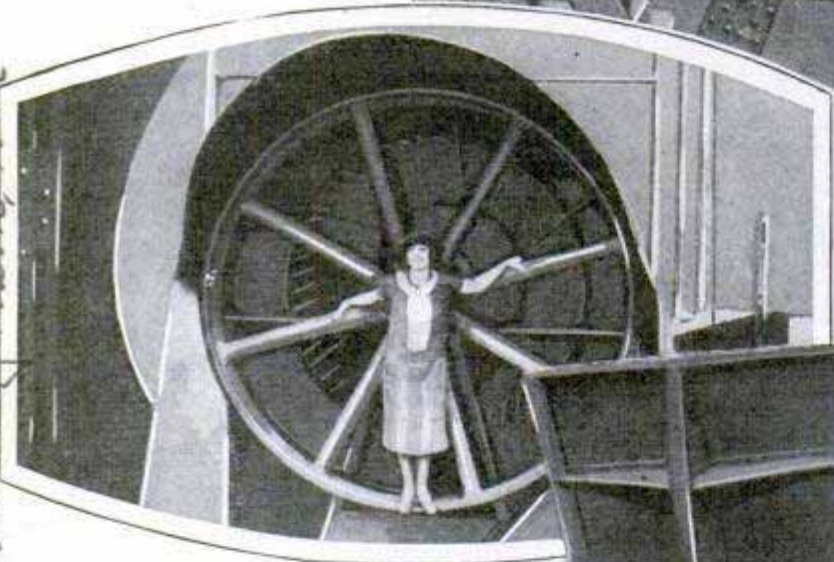

The Young Lady Standing in a Fan on the Roof of a Theater Indicates the Size of the Ventilating Equipment Used to Protect Patrons' Health and Circulate Cool Air in the Summer

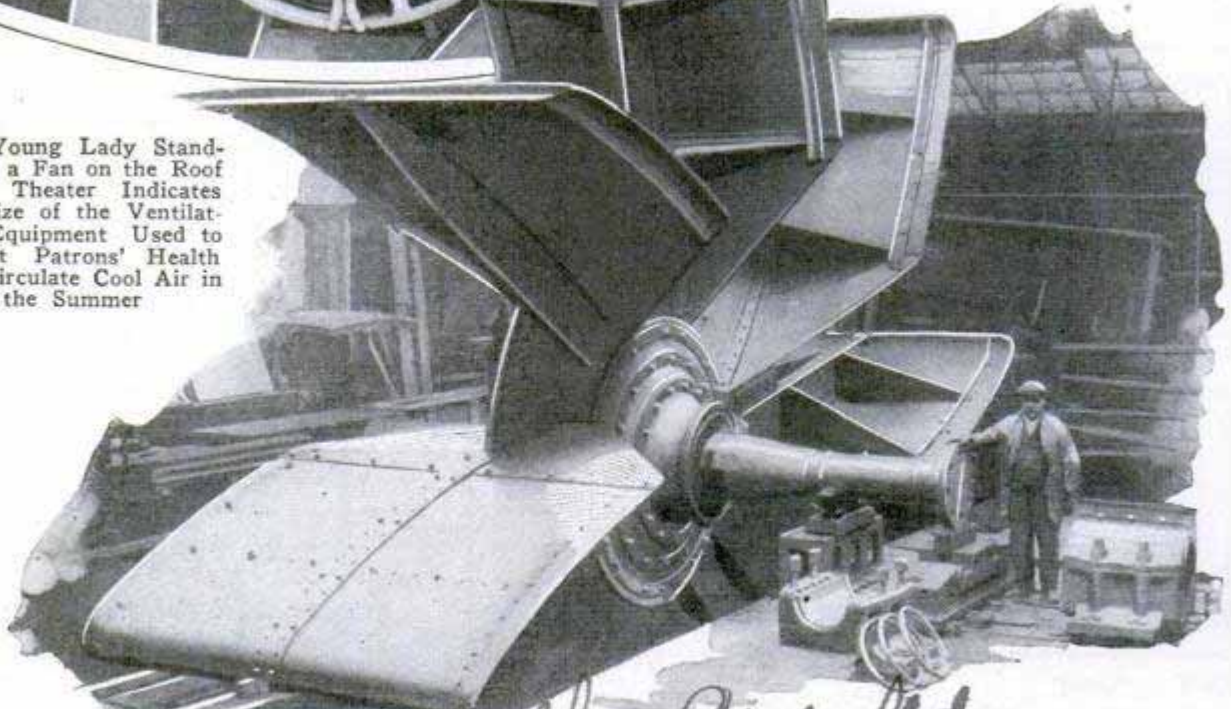

Mrs. Mera Walker Cross Ltd, Bagefield Iron Works, England

Used at Government sold mining Areas, Ltd. Modderfontein, S.A.

HEAVEN PICTURED AS MAN'S
IDEAL ENVIRONMENT

1427

That primitive man's concept of heaven or of a place of abode for the hereafter differs with every race and clime, but always represents the opposite of the ills its holder faced on earth, was demonstrated at the recent convention of the American Association for the Advancement of Science by George T. Renner, Jr., of Columbia university. The tropical-forest resident, he explained, pictured heaven as a remote village in a land of inactivity, with no heat or mosquitoes, while the Eskimo placed heaven in the center of the warm earth and hell up in the cold sky. The Comanche Indian pictured heaven as a prairie full of buffalo, where the hunter never would want for meat, while the more domesticated Todas imagined it as a land of pastures and dairies. Heaven to the ancient Hebrew was a walled city on a hill, protected from the ravages of desert nomads, while the Mohammedan pictures it as a delightful, well-watered oasis and imagines hell to be a scorching place with hot desert winds. Invariably man created his picture of the hereafter by trying to minimize the evils and emphasize the good on earth.

DISK WEEDER FOR RAILROAD
KEEPS BALLAST IN SHAPE

1419

To keep the railroad right of way free from weeds between the ends of the ties and the grass, a car has been adapted with considerable success. There are four sets of disks, with a man to operate each and another man to run the car. The shafts can be set at various angles and distances from the track, to reach weeds growing anywhere within the area covered on each side of the track. Besides cutting out the undesirable growth, the disks prevent the ballast from being scattered and keep it shaped to the desired profile.



Enjoying a Motion-Picture Show While Waiting for Train; the Cabinet and Screen

FREE MOVIES IN RAIL STATION
HELP PASS TIME

Passengers waiting for trains at the Northwestern station in Chicago are entertained by motion pictures displayed in an electrically operated cabinet. The film is projected upon a screen at the top of the box and is automatically adjusted for another showing when it has been run through once. An attendant is not needed. The pictures are of instructive as well as amusing nature, enabling persons to improve their waiting time.

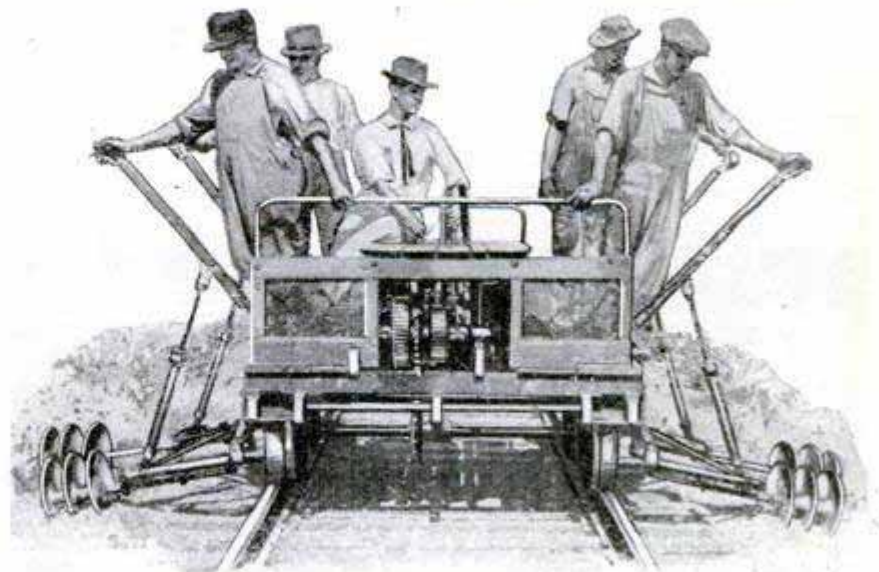

Disk Weeder and Ballast Shaper in Operation on Railroad; the Cutters Are Adjustable to Different Angles and Lengths

Autogram

Myr. Automatic Motion Picture Display
Co., 32 N. Clinton St. Chicago

1290

Cov. N. C. The South

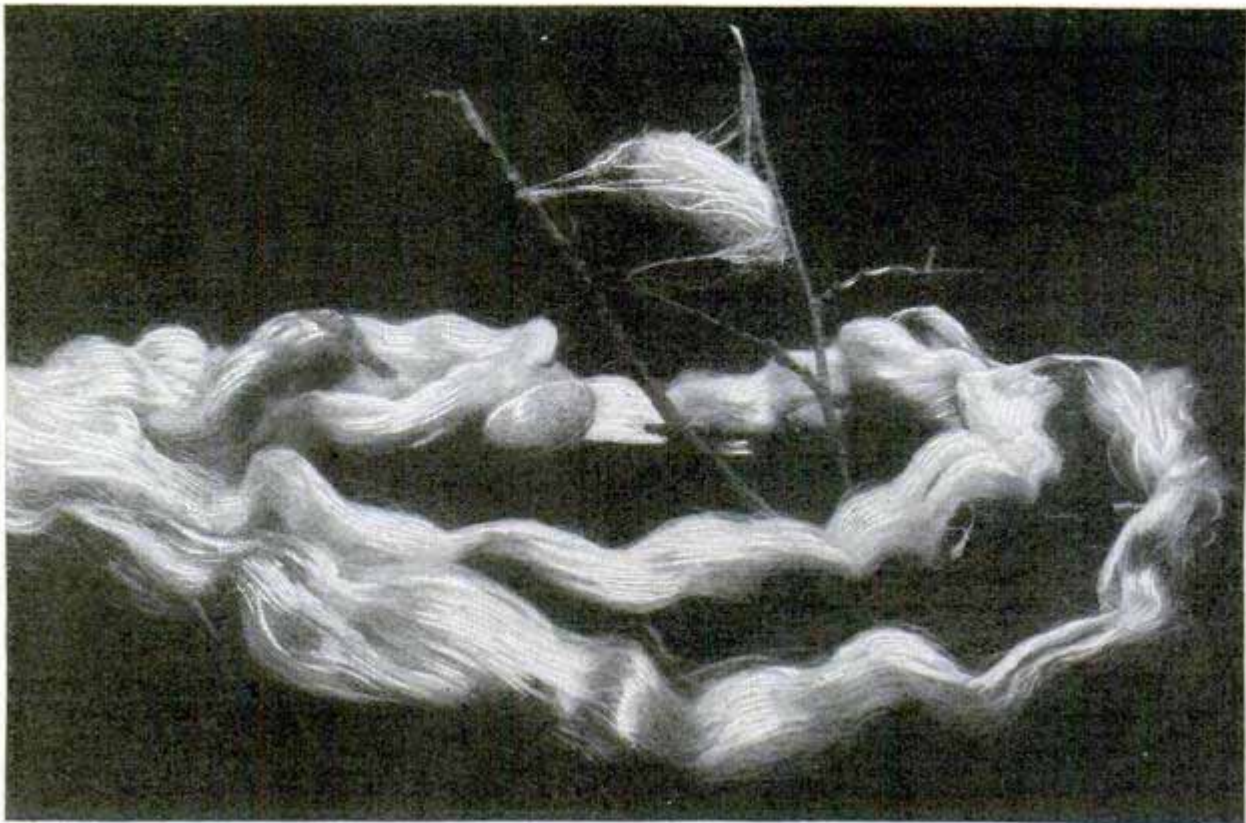
1717 St. Paul St
Baltimore Md.

One Silkworm Cocoon and the Silk It Contained; Silk Gowns and the Transparent Fishing-Line Leaders Come from the Same Source, but Are Produced by a Different Process

Robbing the Silkworm to Snare Fish

How Busy Little Creatures Supply Human Needs from Dresses to Fine Trout Lines

A SILK dress or a fishing line—the silkworm has no preference one way or the other. Left to itself, it will produce the material for the gown, but it also readily supplies the strong line used by the fisherman in casting for trout.

The silk gut of the fishing outfit is merely silk in its initial stage. When the worm approaches maturity, it develops two channels running along the sides of its body. In these ducts there is collected a sticky fluid which will harden into a solid mass if exposed to the air. This is the material which becomes silk gut when extracted before the worm begins to convert it into silk.

The process of producing the line is simple, and consists in killing the worm and soaking the body in strong acetic acid until the gland walls can be removed. The fluid is then drawn out into the form of a fine line, which is stretched between two pins at the ends of a board and left

there to dry. The action of the sunlight causes the material to harden into a semblance of gut, producing a line of extreme strength, lightness and flexibility. An additional property is its almost complete transparency in water, which gives it special value to the sportsman engaged in snaring the wary trout.

Allowed to proceed without interruption, the worm converts the sticky content of the two ducts into the silk fiber of general commerce. Normal development causes the silk glands to become so filled that their pressure makes it impossible for the worm to eat, and starts it on a restless ramble along the branches of the mulberry tree which is its home. In this journey the worm waves its sightless head in the air, seeking twigs to support the filaments about to be disgorged.

The silk growers leave nothing to chance, and the twigs are ready and waiting in a framework which constitutes a

veritable factory for the production of the precious fiber. The process fascinates the watcher. The silk issues from the two glands through an opening in the under jaw, and makes its appearance as two sticky threads. As they emerge, the threads unite into a single filament, cemented together by a viscous fluid. Under exposure to the air this fluid soon hardens.

As wound into the cocoon by the spinner, the silk threads are so fine that 1,200 of them must be placed side by side to occupy the space of a single inch. When the fibrous content is taken out, the threads from a number of cocoons are drawn off together and united into a single strand to give the necessary strength. The unreeling process is conducted by hand or by means of mechanical reels. The composite thread is twisted, the gummy substance boiled out, and the material is then ready to be dyed and woven. One cocoon will produce from 800 to 1,200 yards of thread.

The silkworm is a creature of long and honorable pedigree and a record of val-

uable service covering nearly 5,000 years. The useful career of this creature started more than 2,600 years before the dawn of the Christian era, through the activities of the Chinese Empress, Si-ling, who made the first recorded study of the silkworm and of the handling and weaving of silks. Jealous of their secret, the Chinese rulers decreed death to any person who should reveal the mysterious origin of the fine silks they introduced into world commerce.

The silkworm is inseparable from the mulberry tree. Under a carefully wrought system of propagation and nurture the eggs of the worm are hatched by artificial heat at the season which brings the mulberry

leaves into condition for feeding the new crop of silk producers. The eggs are so tiny as to be invisible to the naked eye, and so light that 45,000 of them tip the scales at something like a single ounce. The hatching takes place on trays covered with perforated paper. An ounce of eggs may produce 30,000 silk-

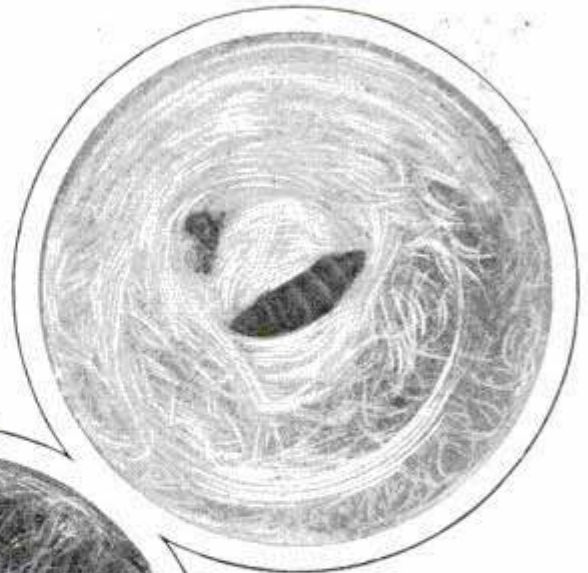

1290
646

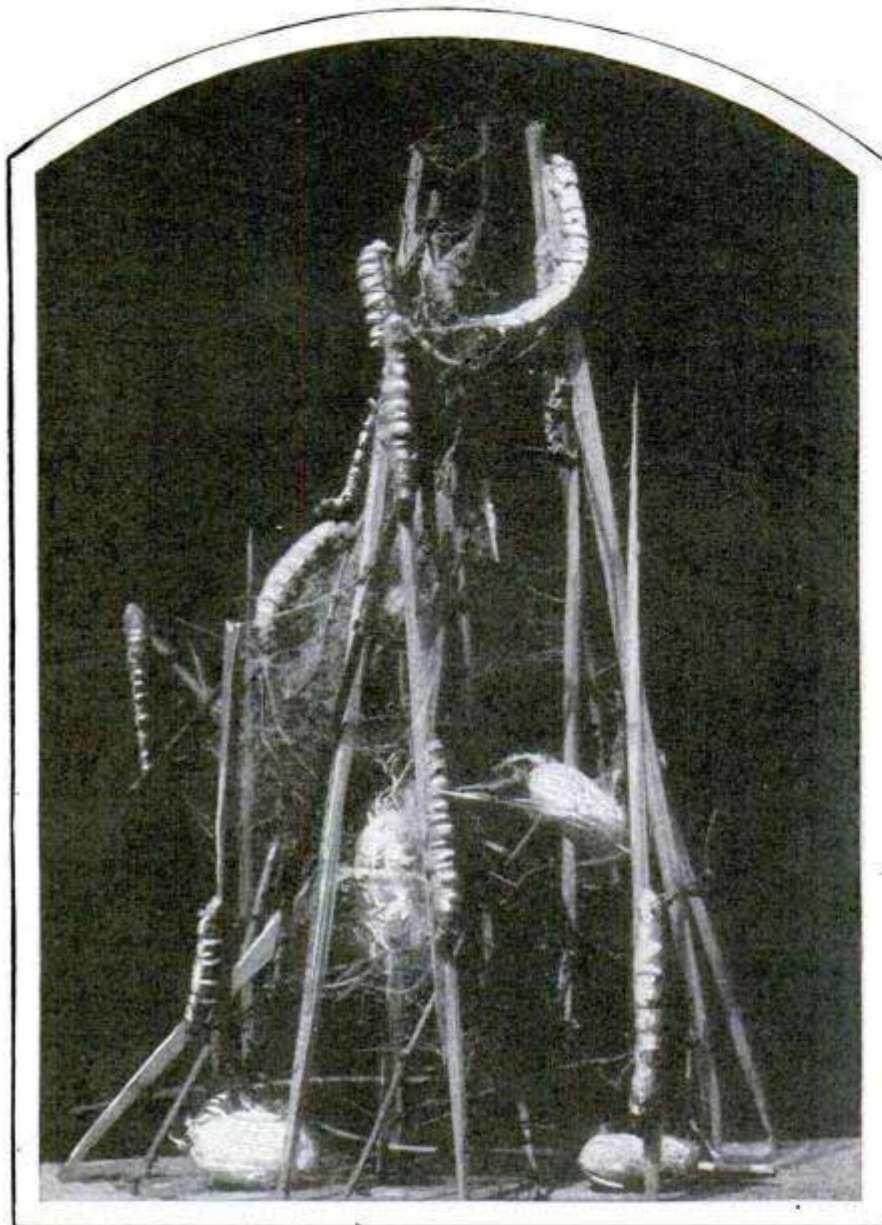

Courtesy American Nature Association

Silkworms at Work among Twigs of Mulberry Spinning Silk That Will Form the Cocoon from Which Silk Thread Is to Come

worms which will reach the stage of cocoon production. During the thirty days of active feeding, the colony will dine to the extent of almost a ton and a quarter of ripe mulberry leaves. Later they will produce 130 pounds of cocoons, yielding only a dozen pounds of silk.

There is much romance in the story of the world's attempts to penetrate the veil of mystery with which the Chinese cloaked the early centuries of silk production. Tradition sets forth that the eggs of the insect and the seed of the mulberry tree were introduced into India by a Chinese princess who smuggled the contraband in the lining of her headdress. When silk fabrics had reached the Roman empire, the Emperor Justinian resorted to various means

of learning the secret of production. His enterprise was aided by two Persian monks who had spent many years in China and had learned the whole art of the rearing of silkworms.

Justinian induced the monks to return to China and smuggle the materials needed for the cultivation of silk, which they effected by concealing a supply of eggs in their hollowed staffs. This stock of silkworms supplied the western world for more than twelve centuries.

1440

FIVE ECLIPSES THIS YEAR

Two eclipses of the moon and three of the sun, as well as the return of several periodic comets, are among the astronomical events slated for 1927. Of the eclipses, only one will attract much attention. It occurs on June 29 and will be visible in England early in the morning, the first eclipse seen there for two centuries. June 15,

an eclipse of the moon will be witnessed throughout the United States at 3:13 a. m., eastern standard time; the moon will be completely hidden by the shadow of the earth. The other eclipse of the moon takes place in December but will not be visible in the United States. Concerning the visits of the comets, astronomers cannot be certain when they will happen. Some time in June, the Pons-Winnecke comet, which returns to the neighborhood of the earth every six years, is expected to be much nearer than usual and visible without optical aid. Encke's comet, which has a period of three and one-quarter years, will be visible through telescopes, it is believed, and there are, of course, chances that others may appear.

Kansas City Star
1/2/27



Samples of Unusual Designs in Venetian Glass; the Material Is So Expertly Made and Handled That It Can Be Worked into Hundreds of Artistic Shapes



Courtesy The Sphere *11/27/26*

MAGIC OF GLASS BLOWERS' ART SHOWN IN VENETIAN PIECES

Craftsmen in glass from Venice long have been noted for their skill in blowing delicate and fantastic figures, and one of the secrets of their art lies in the glass itself. It is extremely light and can be drawn into small canes or rods several hundred feet in length. These tubes are colored beforehand so that the blower can work them into various shapes.

BUS LINES SURPASS RAILROADS IN TOTAL MILEAGE *1,367*

Reports of the interstate commerce commission show that there are more than 22,000 auto busses in operation in the United States, the mileage represented

by the routes being nearly 353,000. The great majority of the lines are operated by motor transport companies.

LIGHT TELLS WHEN GAS IS LOW IN AUTO FUEL TANK *1322*

Mounted on the dashboard, a red electric lamp lights up when the gasoline supply reaches a low point and remains lighted until the tank is replenished. The signal gives ample warning to prevent running out of fuel entirely. Only a screwdriver and pliers are needed to install it, and it forms an ornamental addition to the instrument board.



The H. Y. Brainerd Co., 1945 E. 57th

Ans. J. A. Rogers

Portland, Ore
**BULBS COOKED TO KILL PESTS
BEFORE PLANTING**

1387

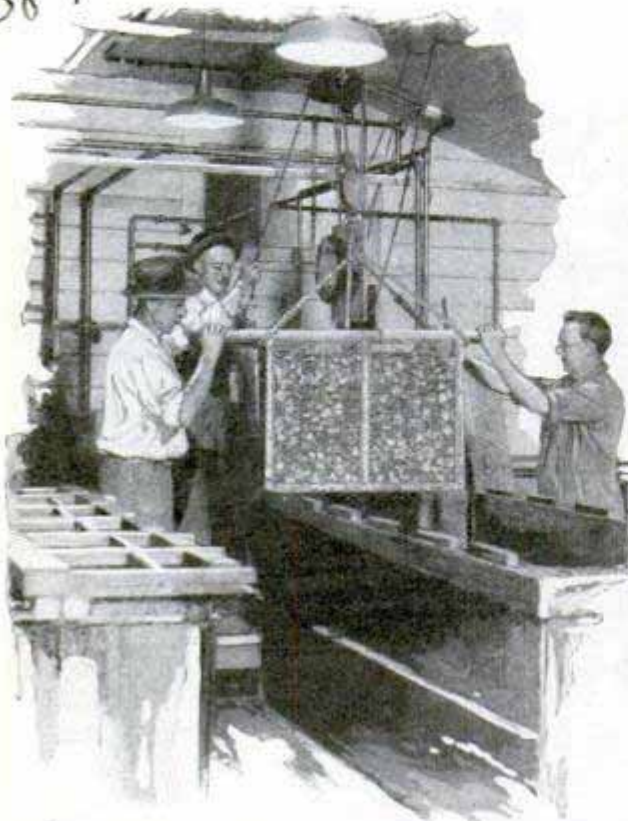

Dipping a Box of Bulbs into the Cooker, to Kill Insect Pests before Planting

To prevent the spread of the "eel-worm," imported bulbs are immersed for two and one-half or three hours in hot water to kill the pests. A specially arranged cooker simplifies the process and insures an even temperature, a highly important factor to prevent damage to the bulbs and yet make sure that the worm will be killed. The outfit handles the bulbs in baskets, or their original shipping containers, and the water is kept between 110 and 111½ degrees Fahrenheit during the treatment. The cooker can be operated by electricity, steam or gas. Small growers in some sections of the northwest have a community cooker that serves a large number of farms.

**MEN ARE SEEN THROUGH WALL
WITH TELEVISION'S AID**

14 14

"Looking in" will be as common as listening in to radio programs, according to the prediction of research workers who have been spending much time of late in experimenting and developing this recent marvel. At a demonstration in London, J. L. Baird, a Scottish inventor who in-

troduced television in England more than a year ago, showed what progress had been made when he permitted persons in a darkened room to see others in an unlighted room through walls. At this test, use was made of the infra-red rays which are invisible to the human eye. In the earlier experiments with television, the subject had to sit under powerful lights which proved harmful.

**SMOKESTACK USED FOR MOVIES
ON OCEAN LINER**

1216

A motion-picture outfit and its operator are to be snugly quartered in one of the smokestacks on the steamer "Malolo," the movies being projected upon a screen mounted at the bottom of the after mast. The funnel is a dummy, as is the case with the second stack on a number of modern vessels. The steel cylinder will afford ample fire protection and shield the instrument from the weather.

Matson Line

**HOUSE MAIL BOX HAS BELL
AND SWINGING DOOR**

1152

For the greater convenience of the carrier as well as the owner, a combination mail box and bell for house use has been introduced. The bell button is just below the door so that the carrier can easily signal his arrival and the door is of the swinging type. It opens one way for mail delivery and the other for mail that is to be removed from the box.

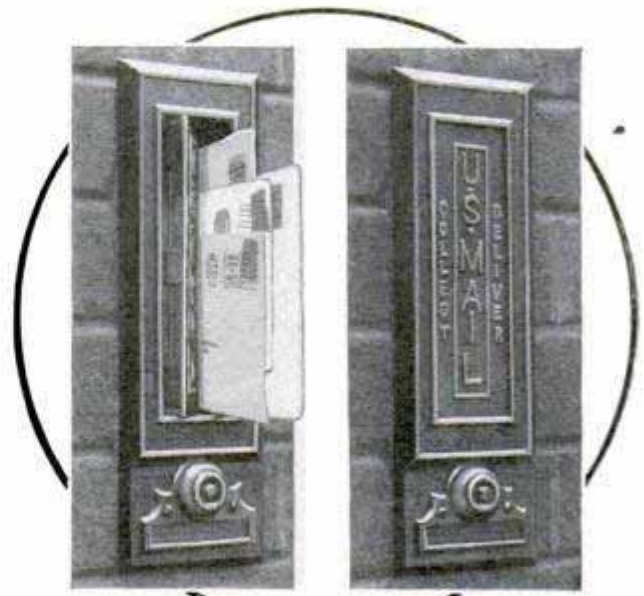

Mail Box with Swinging Door Opened and Closed; Ease of Extraction Is Apparent

Herald Tribune

*American Device Co.
452 1/2 Shaw Ave*

Better Outdoor Aerials

by
S.W. Hull
2048 E. 79th
Cleveland
Ohio.

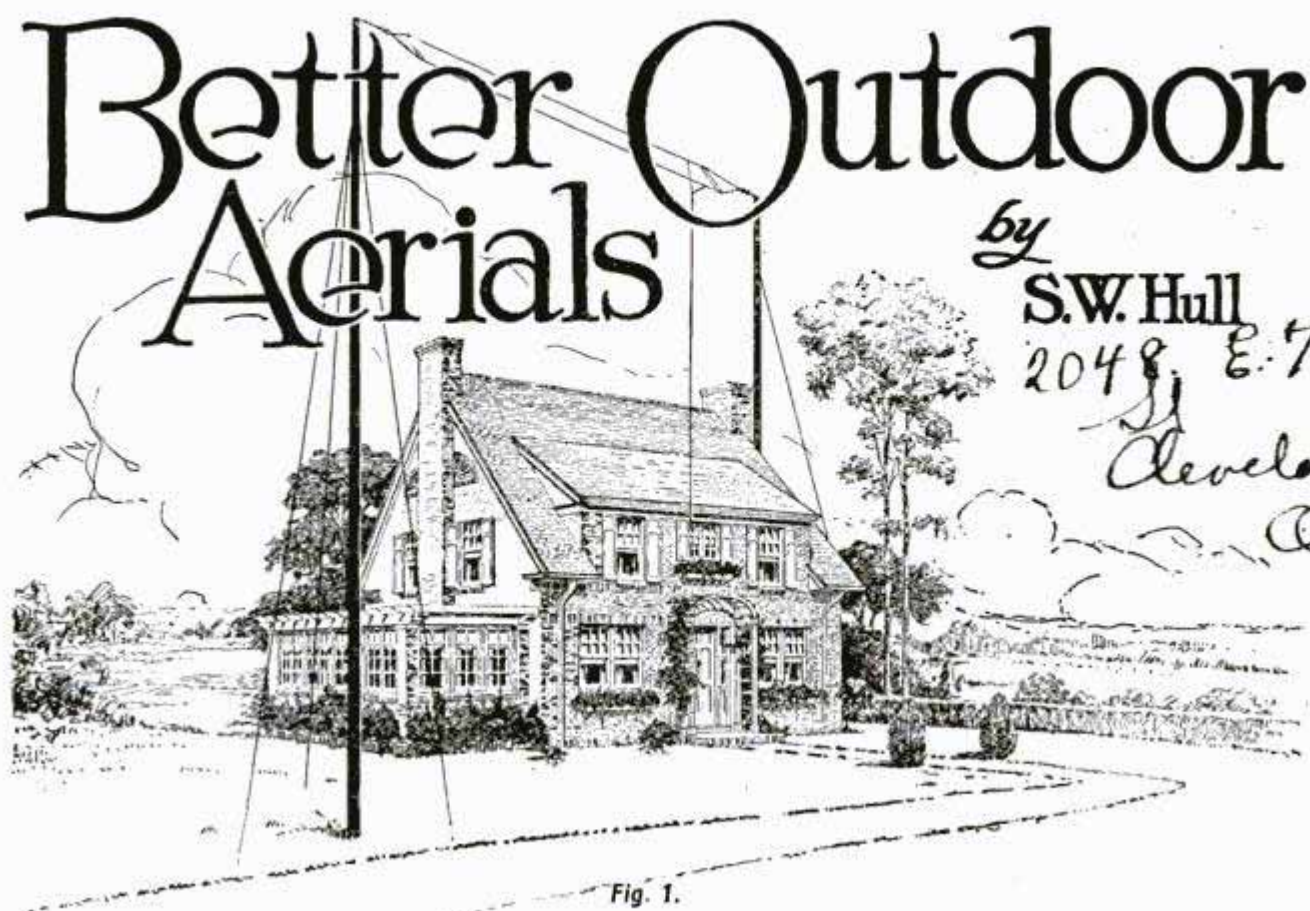

Fig. 1.

ONE of the most important parts of every receiving set is the aerial, or antenna, which picks up, or absorbs, the energy sent out by the broadcasting station. It usually consists of one or more bare copper wires, stretched between insulators, and elevated as high as possible so that it will not come in contact with trees or other obstructions. With warmer weather coming on, outdoor-aerial construction becomes a pleasure, rather than a hardship, and a few hours' work now will earn a reward of long-distance reception during the winter.

While the past years have seen many styles of antennas grow in favor, the outdoor aerial still holds its own. The inverted "L," the "T" and the single-wire straight aerials are the commonest types of outdoor aerials. The inverted "L" aerial gets its name from its shape, shown in Fig. 1. It is widely used and with good results, though it has one defect—its directional property. This, however, is sometimes turned to advantage; it receives the loudest signals when the end to which the lead-in is connected is pointing toward the transmitting station. For example, if you are located at a point on the middle Atlantic seaboard, most of the

distant stations would be located west, and it would be advantageous to run the aerial east and west, taking the lead-in from the west end.

Most satisfactory aerials of the inverted-L type employ two wires when the space between the insulators does not allow a single wire of 50 ft. or more. When it is made with two wires, these should be spaced 3 ft. apart, a light piece of wood being used for a spacer. Such an aerial should be at least 35 ft. above the ground and it is better if it is 50 or 60 ft. high. The lead-in should, of course, be taken from the end nearest the receiving set, and, in all cases, the connections should be carefully soldered. If space is available for a one-wire type, it is a good idea to make the horizontal part and the lead-in one continuous wire. A turn or two around the near insulator will anchor the wire, and no soldered joint is necessary.

The T-aerial, as the name implies, is T-shaped, as shown in Fig. 2. It is free from the directional properties of the L-type, and receives from any direction equally well. A single-wire T-type aerial should be at least 100 ft. long, but if conditions prevent putting up this type, a multi-wire construction must be used.

Four or more wires should be placed at least 2 ft. apart, and the lead-in taken from the middle of each wire. These lead wires should then be bunched and soldered to a single lead-in, or may be taken down fanwise if practical. The lead-in wire to which the bunched leads are soldered should always have the same area, or cross section, of wire as the antenna, to avoid cutting down the capacity of the aerial. This also holds true for the one-wire type, where a separate lead-in wire is soldered to the horizontal section. Generally the multi-wire type is used on apartment houses or other buildings, and in such cases it is best to place it above any other aerial that may be on the same roof.

The straight-line aerial, shown in Fig. 3, has a very short lead-in, coming almost direct to the set. Generally, one end,

might cause. It will be noted that but one mast is required with an aerial of this type; the total length of wire, including the lead-in, should be 100 feet.

When constructing an outdoor aerial of any type, it is necessary to use some form of approved lightning arrester; this device is screwed to the building at a point convenient to the inlet to the set, and is shown in the inset illustration on page 651. It will be noted that the lead-in is taken directly to the set, an extra wire being soldered to the lead-in and taken to the terminal marked aerial on the arrester. The other terminal of the arrester is grounded outside the building. In the same illustration the lead-in is shown coming down over the edge of the roof, and is carried out over an insulator; this should be done in all cases where the lead-in is likely to come in contact with the building. Heavy sleet or high winds will often bring the lead-in in such contact, and the set owner will wonder why the signals come and go, or go altogether. This is easily prevented by careful insulating, and the installation will last almost indefinitely.

When we realize the minute strength of the signals as picked up by the aerial, the importance of good insulation becomes apparent. A

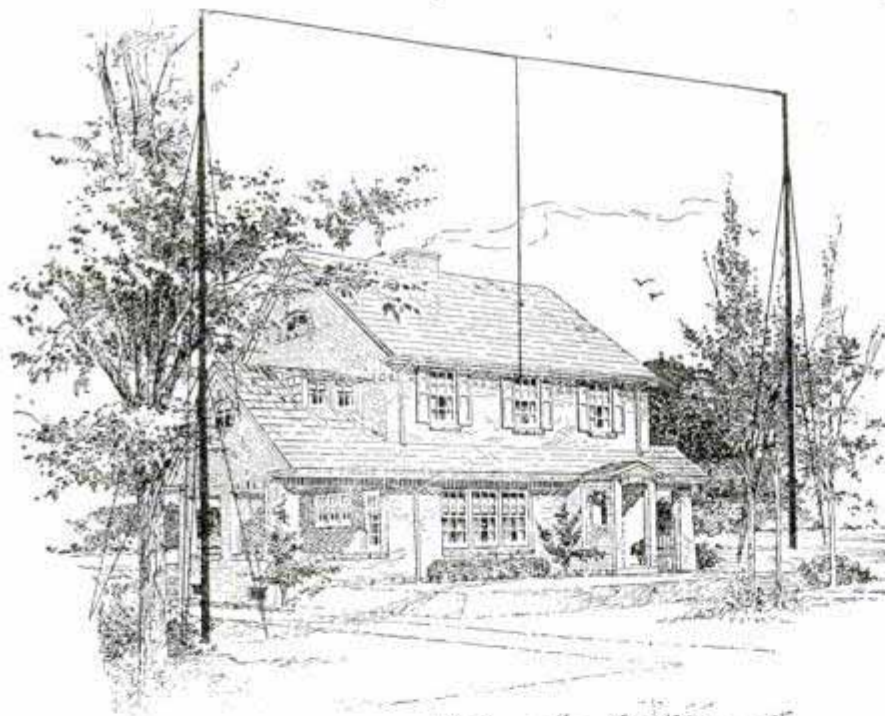

Fig. 2.

preferably the set end, is lowest, the far end being elevated above roof and tree-top interference. This arrangement is favored by many because of its simplicity and efficiency. As in any antenna of the one-wire type, the aerial and lead-in should be in one piece, if possible, in order to cut down any resistance that a poorly soldered joint



Fig. 3

good aerial installation is just as essential as a good set, and before beginning its construction the following details should be kept in mind: Over-all length not over 125 ft.; no close approach to trees or buildings, and the horizontal part as high as possible; furthermore keep the lead-in away from building; make no joints if they can be avoided; use as few insulators as possible; wire should be No. 14 and kept as taut as possible, and clean connections throughout. Height is, of course, also an important factor. There are a number of excellent steel masts now on the market, in both the earth and roof types, which are available in lengths of 20, 40 and 60 ft. The roof type is furnished with an adapter so that it may be mounted on either a flat or a peak roof.

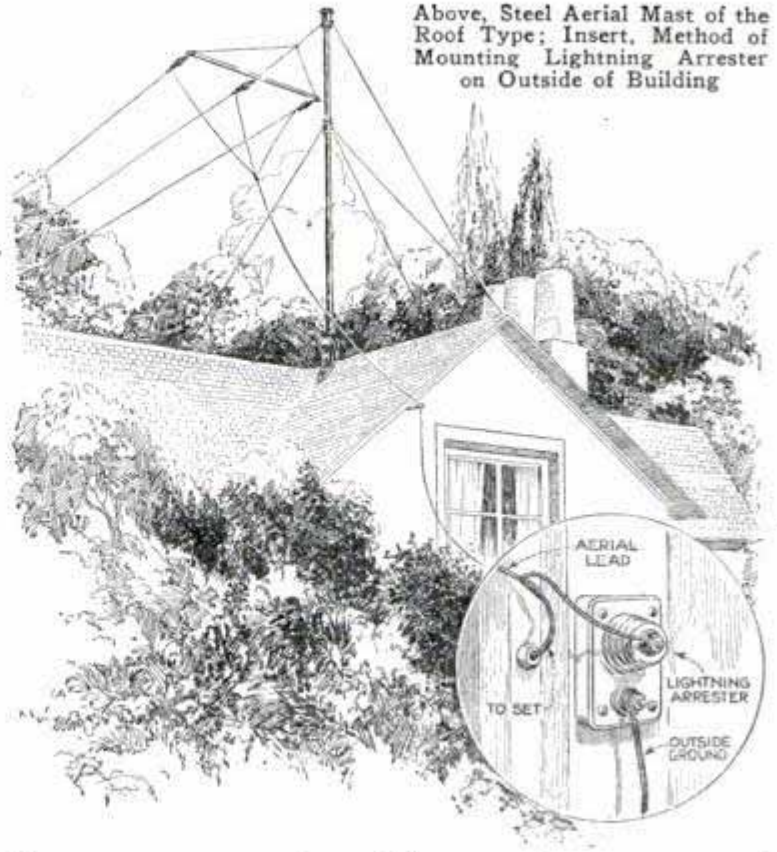

The erection of the mast should receive careful attention. The steel masts referred to are light, strong and easily set up. All guy wires should be galvanized and securely fastened to insure proper wind resistance. It is advisable to use a masthead pulley so that the aerial can be raised or lowered at will with the least possible effort.

The set ground is also a part of your aerial system and should be given careful consideration. The ground lead should be as short as possible, and connected to

a water pipe with a good stout ground clamp. The point of contact should be filed bright, as a poor ground connection renders the entire system inefficient. A good aerial is well worth the trouble it takes to make, for where the average set brings in distant stations occasionally, the man with a first-class aerial will get them consistently, and high-priced radio sets often may prove disappointing or even a total loss, as far as distance reception is concerned, if the aerial is not erected in the proper manner.

881-P

Adjustable Crystal Mounted on Panel

An adjustable crystal of the multi-point type, designed for panel mounting, is shown in the illustration. It is fastened

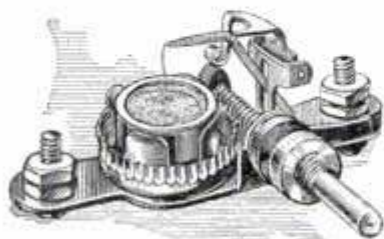

through a single hole in the same manner as a condenser or rheostat, and the 1/4-in. shaft is provided with a knob at the

outer end. This rotates the crystal cup by means of a worm gear and the contact point of the cat whisker is raised and lowered automatically for each new position

by means of a small cam. About 250 sensitive spots on the crystal can be reached before readjusting is necessary.

Setting Rheostats with Milliammeter

If a milliammeter is used in the set, the exact amount of B-battery or plate current consumed is visually checked at all times. When the rheostats are turned too high, an excessive plate current is used while there is little or no increase in volume. The rheostats can be regulated so as to use the minimum amount of B-battery current consistent with good volume. Without a milliammeter there is no way of determining this consumption.

*H. H. Noble & Co.
535 W. 59th St.*

Chicago

All-Metal Receiver Is New Departure

A receiver of practically all-metal construction and with one-dial control, is now attracting attention. The only parts that are not of metal are the tube sockets, which must be mounted on insulation, and the coils, which are wound on bake-

head is need not interest us greatly, but the breakdown stopped the ship. Within ten hours temporary repairs had been made, and the ship was under way again. The chief engineer, one Mr. A. U. Cross, while satisfied that the repair would hold up, naturally desired a more substantial job than could be done with his limited equipment aboard, yet he did not want to tie up the ship for any longer time than necessary at the nearest repair shop—at Colombo, Ceylon. With the usual resourcefulness of the marine engineer, he decided to try his hand at sending a "picture" of the crosshead by radio to the repair shop. Here is a part of the message

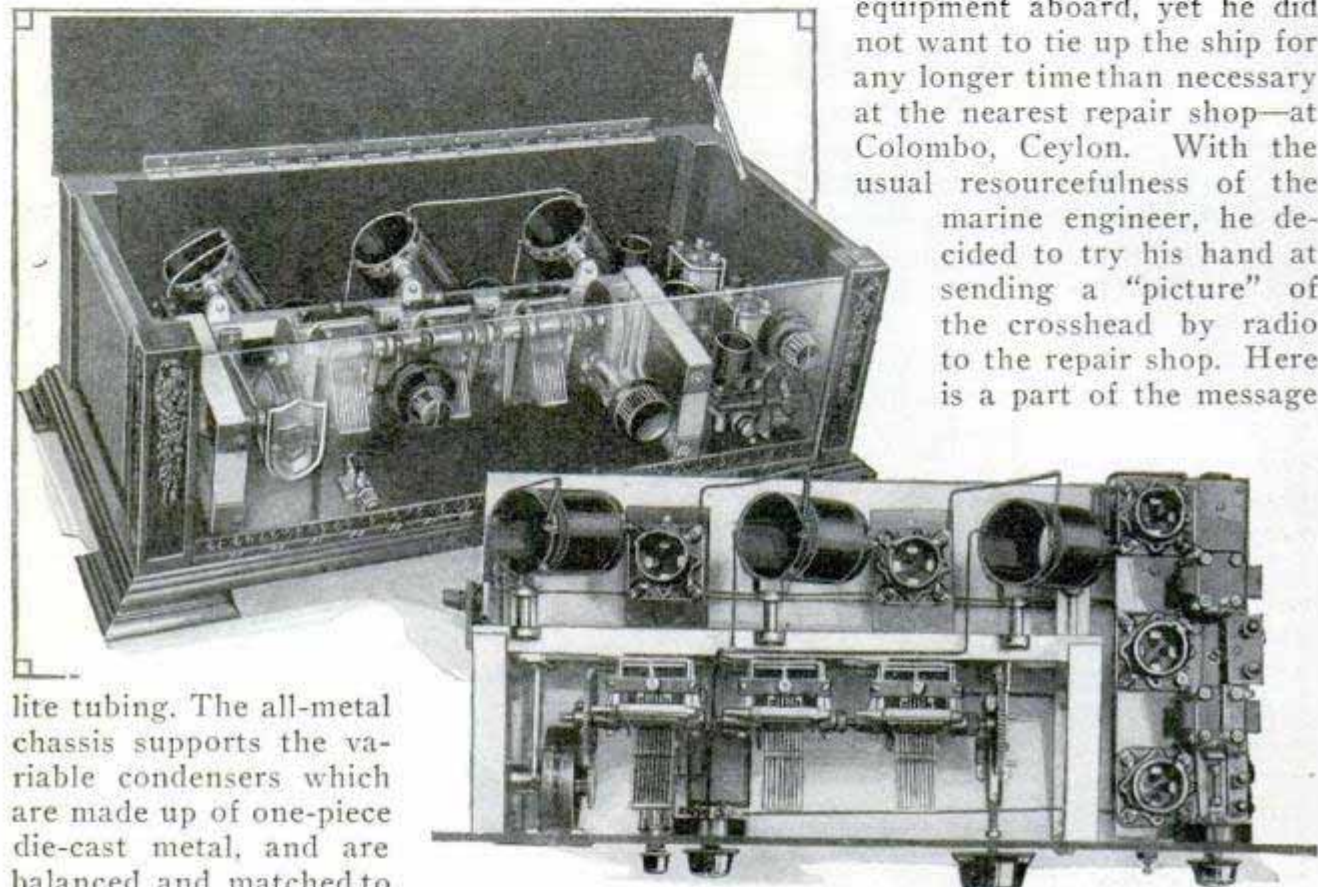

lite tubing. The all-metal chassis supports the variable condensers which are made up of one-piece die-cast metal, and are balanced and matched to make one-dial control practical. Accuracy of tuning is achieved by an ingenious floating worm-gear drive, in which wear is automatically taken up by spring tension. The coils are mounted in a copper shield, thus eliminating pick-up from strong local stations and making selective tuning possible. The tubes are mounted on cushioned sockets, and the audio transformers, assembled with the sockets on a metal base screwed to the chassis, complete the set. The glass front panel shown is used only for display purposes.

Above, Set as It Appears in the Display Cabinet with Glass Front Panel; Below, Complete Unit Assembly Removed from the Cabinet

he sent: "Due noon Monday; require steel crosshead for air pump, forged solid, consisting of center rectangular block having on each side tapered piece terminating in journal pin for link brasses, end of pin having collar. Front elevation over-all length sixteen one-eighth, rectangular center three seven-eighths long, seven deep." There was more of it, but this is enough. On the ship's arrival the job was done.

A Picture by Radio

An Australian ship was proceeding down the Gulf of Aden, a place where the temperature in the engine room reaches 154°, when the air-pump crosshead stripped off its rods. What an air-pump cross-

Radio Soldering Hints

A small electric or plain-heat iron, some wire solder, and a small tin of common soldering paste, make up the simple equipment required to do a good job. Have the iron hot enough to flow the solder on the joint; never brush it on. Use a small bit of flux paste on the end of a toothpick,

Clay - or an. Electric Co
Clayton 653
 1109 - R
 Preventing Tube Vibration *Clayton*

apply it to the joint to be soldered, and then wipe it off, the idea being to leave only a slight film of flux on the joint. The iron must be clean; a dirty iron, or one not hot enough, will not make a good joint, as the heat cannot reach the joint if the end of the iron is corroded. File the soldering copper clean, and tin it well so the solder will stick. Never apply the hot iron to fixed condensers, and use soldering lugs on all instruments likely to be injured by heat. When building a radio set employing exposed coil windings, do not mount these coils on the subpanel until all the soldered joints possible have been completed, as one will often accidentally touch the coils with the iron or drop solder on the windings, causing short circuits. When the coils are mounted and soldering is to be done around them, protect the windings from the iron with a metal shield, and cover the coil with a small cloth to prevent solder from dropping between the turns and damaging the insulation. These precautions refer to all sets, but particularly those employing unprotected solenoid windings, and coils of the toroid or doughnut type.

815-R

New Insulating Material Easy to Work

A new insulating material that is easy to work and is claimed to have exceptional insulating properties is now available.

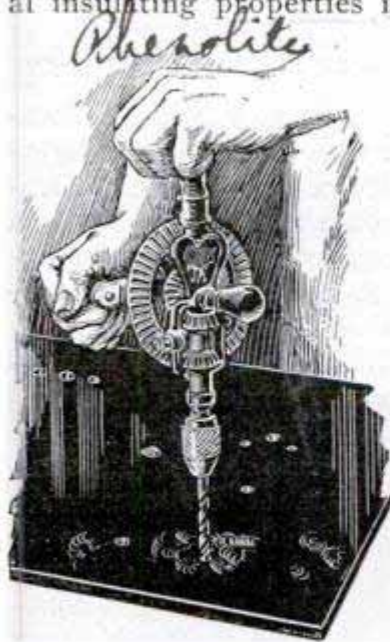

This product is said to combine the strength of steel with the high insulating qualities of rubber and porcelain and the adaptability of wood, and can be sawed, drilled, tapped and punched with ease, clean holes being drilled with

a hand drill, as shown in the illustration. It is suitable for panels, jack spacers, transformers and general insulating, and consists of laminated bakelite, made by carefully impregnating fibrous materials.

Natural Vulcanized Fibre Co

When great volume is developed in the loud speaker, and the latter is on or near the set, a heavy vibration will sometimes be set up in the tubes. The result is a

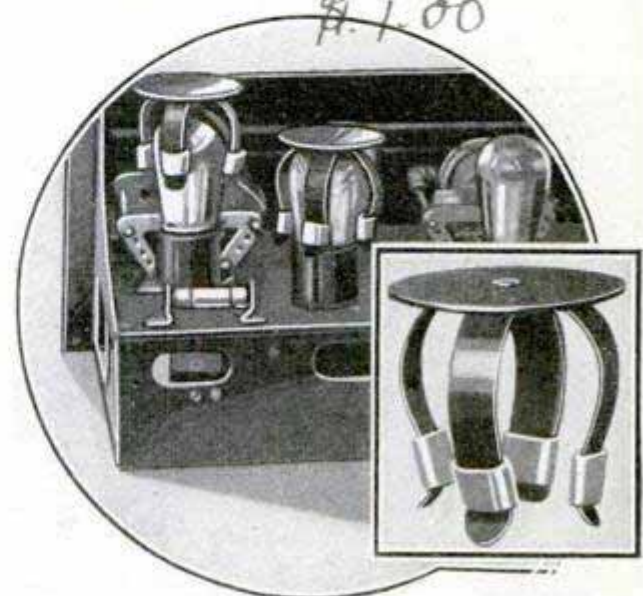

Placed over the Tubes in the Set, the Rubber Fingers Grip the Tube, Preventing Vibration

loud hum from the speaker, which often rapidly increases until it becomes a roar, drowning out the program. The detector tube is the most frequent offender, although any tube in the set may develop the trouble. When the vibrating tube is held by the fingers, the noise will stop. The spring-clip device shown in the photos has been developed to cure this trouble, and usually proves effective.

Doping Coils Increases Resistance

Coils, doped or bound with any of the various preparations used for the purpose of mechanically strengthening them have a higher resistance. This causes a loss of efficiency, and tends to lessen selectivity; if a binder must be used, collodion is best. Coils of the solenoid type are considered to have the highest efficiency. These single-layer coils do not require a binder. A skeleton form can be used with good results; a form of this kind can be made out of bakelite tubing by cutting it away as much as possible without weakening it so it cannot support the winding.

Leads hanging over A-battery vents are soon destroyed by fumes when battery is being charged.

The University of
 N.Y.C. Corp., 50 Park Place
 POPULAR MECHANICS
 New York

654
 1140. Q.

Right, Under-Sub-panel View of Completed Set; Below, Looking Down on the Subpanel

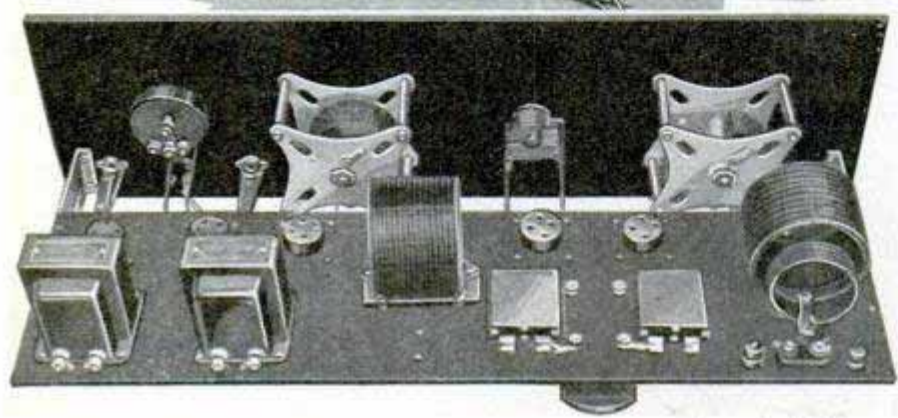
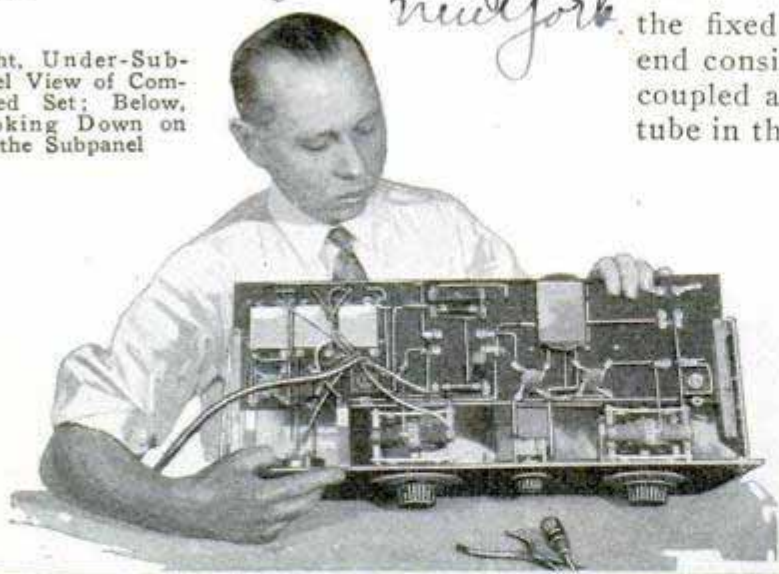

Five-Tube Receiver in Kit Form

A five-tube receiver in kit form, ready to assemble and wire, has lately made its appearance on the market. The circuit, although not radically new, embodies some interesting ideas. The outfit consists of two stages of r. f. amplification, a detector and two stages of audio frequency. Only two tuned circuits are used, the first being the input to the first r. f. tube. The coupling between the first and second tubes is obtained through a fixed r. f. transformer especially designed for the set. The neutralizing or balancing condenser is mounted on the front panel. This permits a slight variation from the neutralizing point and introduces regeneration in the first tube. The signal is built up to a large degree and transferred to

the fixed r. f. transformer. The audio end consists of two steps of transformer-coupled amplification, employing a power tube in the last stage.

Conduit Makes Good Aerial

In apartment houses where rules against bringing the radio lead-in through a front window make it impossible to erect an outside aerial and keep the lead wire within a reasonable length, the metal conduit system will be found to offer a good substitute. Place the radio set near one of the base outlets, which furnishes a handy place for plugging in the battery charger. Loosen one of the screws which hold the brass plate of the outlet and twist the end of the aerial lead around it, then tighten the screw. The entire metal-conduit system of

the building then becomes the aerial. Tried out against the usual inside aerial placed around the picture molding, the electric conduit proved superior, getting greater distance and better volume.

1120-Q

New Unit Replaces Storage A-Battery

Replacing the A-battery with a compact unit connected with the house-lighting circuit, the device shown in the illustration is a welcome addition to modern radio equipment. A steady, un-failing A-current of 6 volts, regardless of how long or how often the set is used, is claimed for this new device. It is stated that there is no hum or distortion, and the instrument operates only while the set is in use. It is designed for receivers employing from four to eight tubes of the standard 1/4-amp. type. Terminals marked A-negative and A-positive are provided.



A Power Device, Showing Lid Removed from Metal Container

Driggs & Stratton Corp,
 1047 Louis St.

An Unusual Homemade Radio Cabinet

By EDWIN M. LOVE

TOO often the amateur radio-cabinet maker confines his work to plain, box-like pieces with square posts for legs. The introduction of curves into a design generally much improves the appearance of the article, and need not materially increase the difficulty of construction. In the design presented here, console lines are followed, but several unusual features are added. Space for a cone-type loud speaker is provided underneath, the diaphragm lying flat, so that only a narrow grill betrays its presence. The case itself is readily detachable from the stand, by the removal of six screws, and a book trough takes the place of the more common stretcher.

The cut on this page shows the front

dowel 2 in. from the upper end, and one 5 in. from the lower end. Let the glue harden while other parts are made.

General construction details of the case are shown on page 656. Glue, edge to edge, two pieces of 1 by 8 by 20-in. material for the partitions, and, for the bottom, two pieces, 2 ft. 9 in. long. The molded lower or long rail is of 1 $\frac{1}{8}$ by 2-in. stock, sized to 1 by 1 $\frac{3}{4}$ -in. Square up two pieces, long enough to make all molded rails, and $\frac{1}{4}$ in. from each edge, on the face sides, plow $\frac{1}{8}$ -in. grooves, $\frac{3}{16}$ in. deep. Then, with plane and chisel, round off the center part to the profile shown in the cross section. Make a rubbing block, 1 in. thick, with an arc of $\frac{15}{16}$ -in. radius worked in the edge, and use it

in sanding the molding smooth. This is really a very easily cut pro-

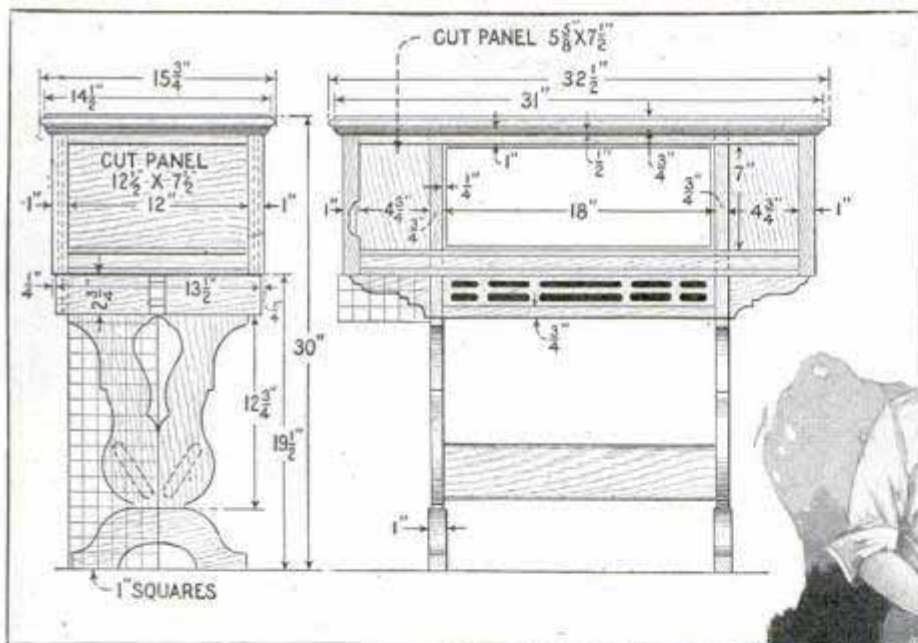

and end elevations of the cabinet, dimensioned for a 7 by 18-in. panel, although a longer panel can be used simply by lengthening the middle section of the case. The outlines for the legs and brackets are easily copied by laying out a piece of paper in 1-in. squares, and locating the intersections of the curves with the squared lines, as they appear on the design. If 14-in. stock for the legs is obtainable, use it; but as such wide material is often difficult to get, it probably will be necessary to glue up for each leg two lengths of 1 by 8-in. stock, 18 in. long, using a $\frac{3}{8}$ -in. hardwood

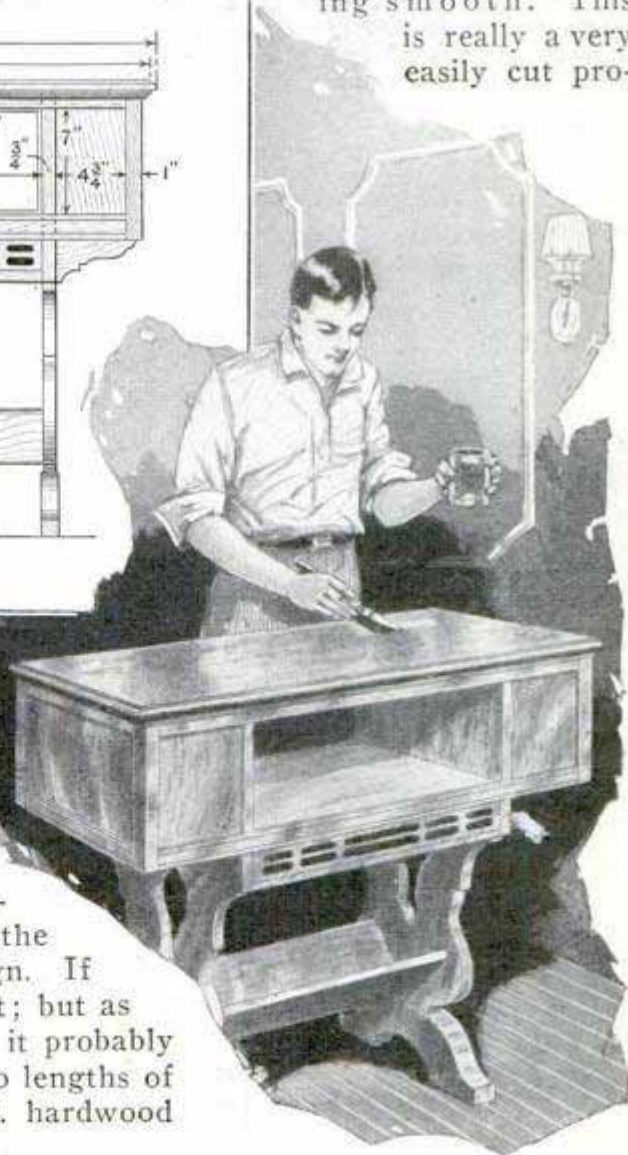

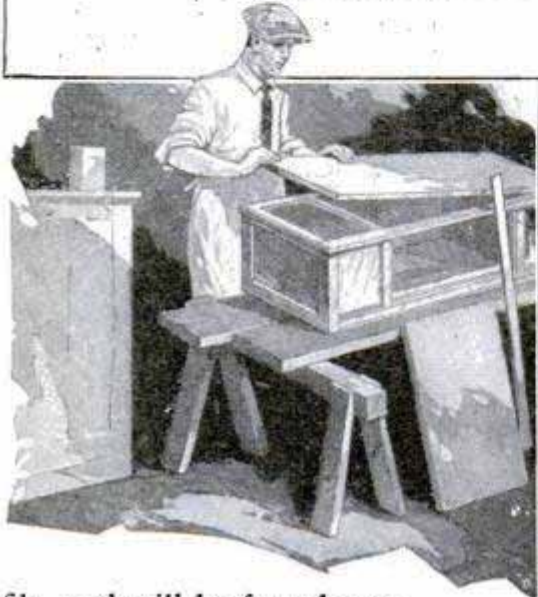
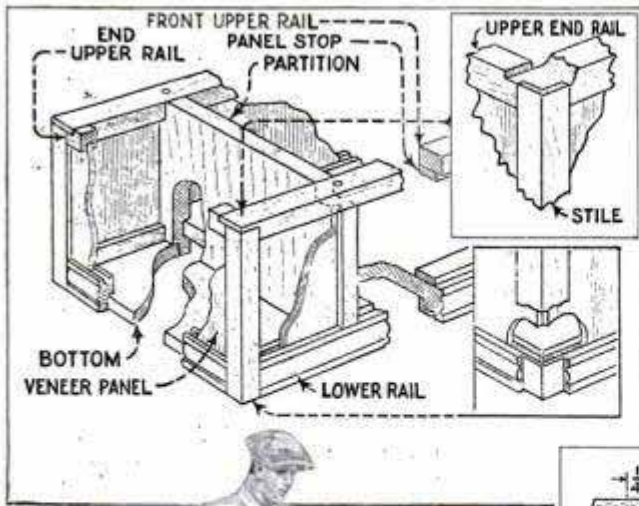

file, and will be found surprisingly rich in appearance.

For the end rails, cut a $13\frac{1}{2}$ -in. length, from each. Plow a $\frac{3}{8}$ by $\frac{1}{4}$ -in. groove $\frac{3}{8}$ in. from the front, on the upper edge of each, and rabbet the back face on the lower edge, $\frac{3}{8}$ by $\frac{3}{4}$ in., as shown, to receive the bottom. Lay off the ends for the mitered tenons, giving the molding a length of 12 in. and the tenons $\frac{3}{4}$ in. These are notched in from the molded faces $\frac{1}{4}$ in. Rip the tenons to thickness before sawing the shoulders. Miter the ends last.

The long rails are somewhat more complicated. Make tenons on each, as for the short rails, giving a length of 2 ft. 5 in. from shoulder to shoulder. For a distance of 5 in. from each shoulder groove the upper edges as in the short rails, to receive the front panels of the battery boxes. Likewise rabbet the backs on the lower edges. This can be done quite easily by accurate gauging, and cutting cross chips with chisel and mallet. Finish the blind ends square, for such bracing effect as they can offer.

The four corner stiles are finished 1 by 1 in., $10\frac{1}{4}$ in. long. Gauge lines $\frac{1}{4}$ in. from each face side, and rip out the back corner strips, $\frac{3}{4}$ by $\frac{3}{4}$ in., as indicated. Smooth the strips with a rabbet plane, and notch the inner faces, $\frac{1}{8}$ in. deep, so that they will fit over the tenons of the upper and lower rails.

The long upper rails are sized exactly to 1 by $1\frac{1}{2}$ in. by 2 ft. 7 in., and the ends notched full width. $\frac{3}{4}$ in. deep and

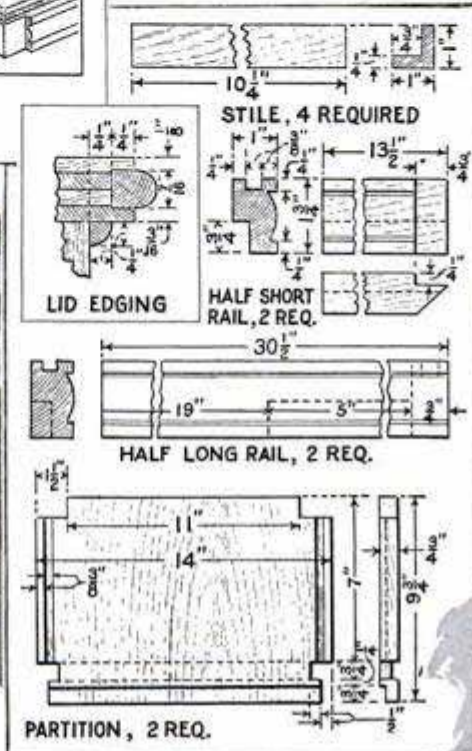

1 in. long. These fit over the stiles and the short-rail tenons. Groove the lower sides $\frac{3}{8}$ by $\frac{1}{4}$ in., $\frac{3}{8}$ in. from the faces, and notch the upper edges of the short rails at the ends, $\frac{1}{4}$ in. deep and $1\frac{1}{2}$ in. long, to take the tenons of the long rails. Also notch the face sides $\frac{1}{4}$ by $\frac{3}{4}$ in. Cut away the inner sides of the grooves $\frac{1}{2}$ in. back from the ends, to fit over the front panels.

Square the partitions as shown, making them 1 ft. 2 in. wide and $9\frac{3}{4}$ in. long, with the upper corners notched 1 by $1\frac{1}{2}$ in. to fit around the upper rails, and the lower ends notched $\frac{1}{2}$ by $2\frac{1}{4}$ in. Dado one side of each, $\frac{3}{4}$ by $\frac{1}{4}$ in., 1 in. from the lower end, and rabbet the lower end

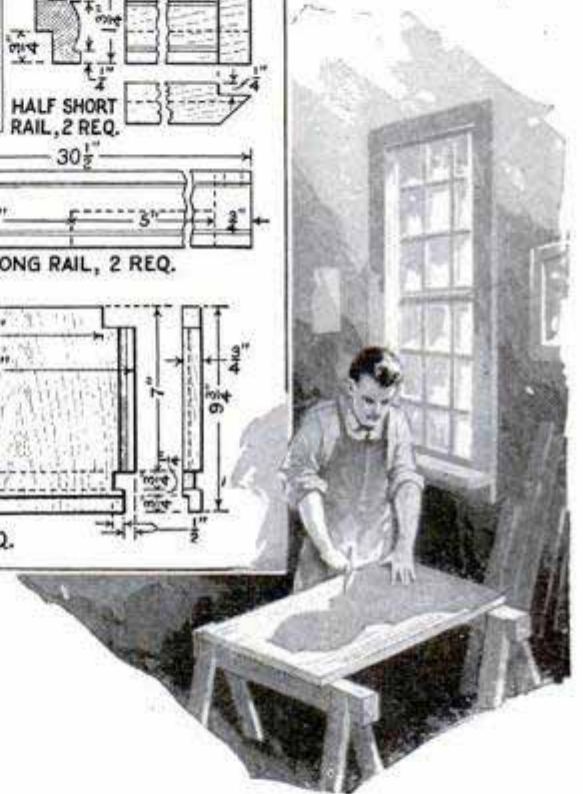

on the opposite side, $\frac{3}{4}$ by $\frac{1}{4}$ in. Notch the dados, $\frac{1}{2}$ in. below the long notches as shown, and groove the rabbet faces, $\frac{3}{8}$ by $\frac{1}{4}$ in., $\frac{3}{8}$ in. from the edges.

Make two front and two back panels of $\frac{3}{8}$ -in. three-ply panel veneer, $5\frac{5}{8}$ by $7\frac{1}{2}$ in.; two end panels, $12\frac{1}{2}$ by $7\frac{1}{2}$ in., and a back panel, 7 by 18 in. Make two short bottoms, $\frac{3}{4}$ by $12\frac{3}{4}$ by $5\frac{5}{8}$ in.; size the inner ends by giving them one coat of liquid glue. Make the long center bottom 1 ft. $6\frac{1}{2}$ in. long and 12 in. wide. Size both ends. Size the end grain of the dados and rabbets in the partitions, and the notches, shoulders, and tenons of the rails.

To assemble the case, proceed as follows: Glue the long bottom into the partition, securing it by driving nails through the partitions, leaving the heads projecting so that they can be drawn. Glue the long rails to the partitions and the long bottom, nailing through the top rail into the partition, and from the rabbet into it, but leaving the heads out so they can be pulled. Apply glue to the rail grooves and the panel edges, and force the front panels into place, immediately wiping off all surplus glue. This is feasible only if veneer is used, since it will not shrink or swell. Glue and nail the end panels between the front ones, again with the nail heads projecting. Glue the upper end rail in place, and then the lower. See that all joints are snug, and that the whole assembly is square, and set aside to dry.

The lid preferably should be five-ply veneer, $\frac{3}{4}$ in. thick, but solid stock can be used, if stout cleats are screwed to the underside, where they will enter the instrument section, out of the way of the batteries. The finished size is $\frac{3}{4}$ in. by 1 ft. 3 in. by 2 ft. 8 in. Plow a $\frac{7}{16}$ by $\frac{1}{4}$ -in. groove all around the edge, $\frac{1}{8}$ in. from the top face, and glue into it a $\frac{7}{16}$ by $\frac{9}{16}$ -in. strip. Make this just thin enough to slide in and out without the need of prying. Slip a piece in a long edge, being sure that

it touches the bottom, and mark the positions of the lid corners. Miter the ends through these points, and replace. Wedge tightly enough to prevent its shifting, and fit the endpieces. With one in place, fit the other edge strip, and then test all in place. When good joints have been obtained, glue the strips in, and round off the edges.

Two or three methods are available in shaping the legs. Trace the pattern on the prepared stock, and saw to the outline with a turning saw, or cut roughly to shape with the handsaw, chisel nearly to the line, and finish with the spokeshave and rasp. Any planing mill will band-saw them and shape the edge for a small price. If it is cut by hand, smooth the

concave curves by filing in diagonal strokes, twisting during the strokes, and lifting on the back movement. Finish with sandpaper. On the lower end, cut a tenon $2\frac{1}{2}$ in. wide, $\frac{3}{8}$ in. thick, centering on the thickness of the stock, and 2 in. long. Rip the cheeks and the edges before cutting the shoulders. Locate the mortises for the trough sides, as shown, remembering that they make

an angle of 90° with each other, and 45° with the center line. If there is any variation, the two legs will be held in a twist. The mortises are 4 in. long. Since the ends are semicircular, a $\frac{3}{4}$ -in. bit can be used for cutting them, but take care that the point does not prick through. Chisel out roughly, and trim to the line, bringing an accurate depth of $\frac{1}{4}$ in. Plow $\frac{3}{8}$ by $\frac{1}{4}$ -in. grooves, $\frac{3}{8}$ in. from the edges at the upper ends, to receive the ends of the speaker grills. Mortise $\frac{1}{4}$ in. deep by $\frac{3}{4}$ by $1\frac{1}{8}$ in. for the ends of the lower grill rails. Make two brackets of 1 by 4-in. stock, allowing $\frac{1}{4}$ in. on the ends to house into the legs. The two trough boards are $\frac{3}{4}$ by 4 in. by 1 ft. $6\frac{1}{2}$ in., with edges rounded. Size the ends.

Make two grill rails of the same length,

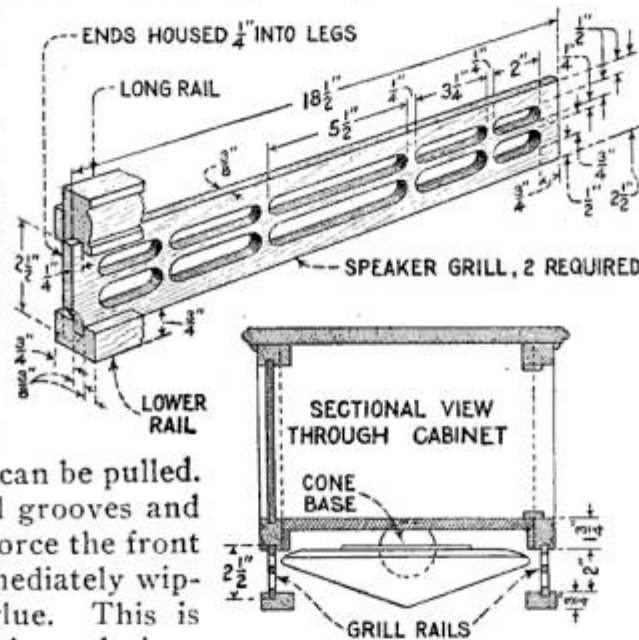

$\frac{3}{4}$ in. thick by $1\frac{1}{2}$ in. wide, plowed $\frac{3}{8}$ by $\frac{1}{4}$ in., $\frac{3}{8}$ in. from the outer edges. Notch the ends $\frac{3}{8}$ by $\frac{1}{4}$ in., to fit the leg mortises, and size the ends. Make two upper rails

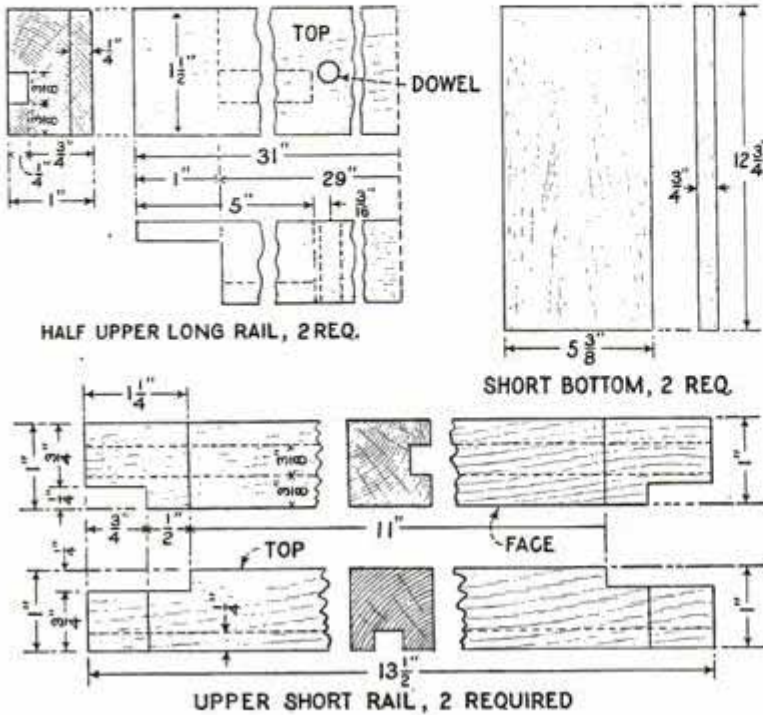

like the lower, but 1 ft. 6 in. long, and without the notches, as they go between the lower ends of the case partitions.

Make two grills of panel veneer, $2\frac{1}{2}$ in. wide and 1 ft. $6\frac{1}{2}$ in. long. Gauge lines, full length, $\frac{1}{2}$ in. from the edges. Divide for the lengths of the openings as follows: $\frac{3}{4}$ in. from each end; 2 in. farther; $\frac{1}{4}$ in.; $3\frac{1}{4}$ in.; $\frac{1}{4}$ in. Bore $\frac{1}{2}$ -in. holes in each space and cut out with a fine keyhole or a bracket saw. Trim the ends smooth, with corners rounded to a radius of $\frac{1}{4}$ in., and sandpaper them.

Assemble the legs with the trough boards and the lower grill rails, and glue in the grills. Screw cleats inside the grill ends, and also inside the upper ends, giving them $\frac{3}{4}$ -in. projection above.

Make two feet to the design shown, of $1\frac{1}{8}$ by 5-in. stock. Cut the mortise before shaping the curves. Then glue in the leg tenons.

Now draw out all nails from the case, and glue the corner stiles in place. Glue in the end bottoms, and miter around the top rail a $\frac{1}{4}$ -in. quarter-round, secured with brads which are drawn when the glue is dry. Bore $\frac{1}{4}$ -in. holes through each long upper rail into the partitions, for the gluing in of dowel pins.

Clean up the cabinet thoroughly and hinge the lid to the back with 2 by 2-in. brass butts, mortised in. Glue strips, $\frac{1}{4}$ by $1\frac{1}{2}$ in., around the radio-panel opening. $\frac{3}{8}$ in. plus the panel thickness from the front, to act as stops for the panel, which is built drawer-style, to pull out from the front. Similar stops are put in the back, $\frac{3}{4}$ in. from the face, for the gluing in of the veneer panel. Finally, glue $\frac{1}{4}$ -in. cleats to the lower rails underneath the bottom.

Secure the speaker to the underside, and hold the case in position by means of two screws through each leg cleat into the partition ends, and one through the tip of each bracket. Scrape and sand out every scratch and all visible glue before finishing.

The original speaker used with this cabinet fitted into a 4 by 12 by 12-in. space. Since there is no bottom to the speaker com-

partment, any size of speaker can be accommodated here and any projection below the grill would usually be unnoticeable. Of course, the width of the grill could be altered to suit a large speaker of unusual "thickness."

Salvaging Old B-Battery

Many B-Batteries, when discarded because of a great drop in voltage, still have a few good cells left. These cannot deliver their power because of the high resistance in the dead cells, but they should not be sacrificed. If the batteries have a cardboard container, tap around the top

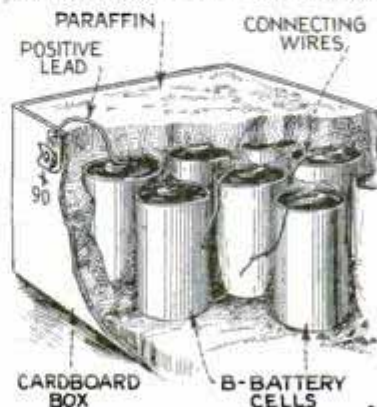

edge with a hammer, carefully chipping away the sealing compound from the cells and taking care not to break the carbon elements in the cells. Remove the connecting wires and binding posts with a soldering iron. Now test each cell with a

small flashlamp; cells that produce only a red glow in the lamp, going out in a few minutes, cannot be reclaimed. Cells that light up the lamp brilliantly may be used in making up a new unit. For this, a container such as a candy box will do nicely. Place the cells in the box in the manner shown in the illustration, connecting them in series. The carbon or top terminal is the positive, and the zinc shell the negative. Solder small flexible leads to these points. The box should be about $\frac{3}{4}$ in. deeper than the cells are high; space the cells about $\frac{1}{4}$ in. apart, and pour in melted paraffin very slowly. It is best to pour in about half an inch at a time, permitting each layer to cool before adding more. The binding posts are tapped off to leads long enough to permit mounting them on the side of the container.

A Good Ground Connection

The importance of a good ground connection for the radio set cannot be stressed too much. It is well known that the ordinary cold-water pipe offers a good ground, and it is generally available. To solder a wire to the pipe is difficult, and while there are a number of good ground clamps on the market, usually, when needed most, they are not at hand. The illustration shows a simple and effective way to secure a good contact.

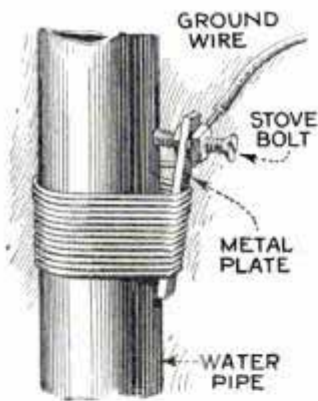

The pipe is first scraped or filed around the portion from which the lead is to be taken; heavy copper wire of about No. 12 size is wound around the pipe and a metal plate, as shown in the sketch. Drill a hole in the plate near the end, and insert a common stove bolt on which are screwed two nuts, one on either side of the plate. By screwing down the bolt, the plate acts as a lever, and the wires are drawn tight on the pipe. One end of the wire is fastened by the upper nut; the other is wound under the first turns, and the No. 12 wire is continued to the ground post of the set.—Harold Zahl, Naperville, Ill.

Added Pin Improves Tube Contact

Trouble is often encountered by poor contact between the tube prongs and socket springs. This may be traced to the fact that there is only one pin on one side of the tube base, which engages with the socket shell. The tube is held down well on the pin side, but the contacts on the opposite side do not make proper connection. This condition is remedied by drilling a hole in the bakelite tube base, tapping it with a 4-32 tap, then driving in a brass machine screw of this size and chipping it off so that about $\frac{3}{16}$ in. projects. In the socket, at the point where the new pin should connect, a slot is made exactly like that on the opposite side. This makes a double-bayonet base, which is sure to pull both sides of the tube down evenly.—Harold P. Strand, Malden, Mass.

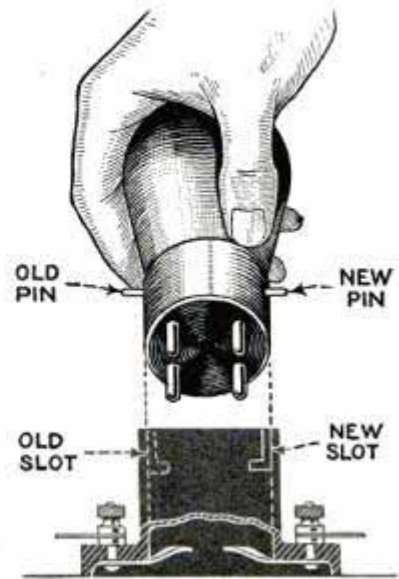

This condition is remedied by drilling a hole in the bakelite tube base, tapping it with a 4-32 tap, then driving in a brass machine screw of this size and chipping it off so that about $\frac{3}{16}$ in. projects. In the socket, at the point where the new pin should connect, a slot is made exactly like that on the opposite side. This makes a double-bayonet base, which is sure to pull both sides of the tube down evenly.—Harold P. Strand, Malden, Mass.

848.02

Detector Crystal Has Vernier Adjustment

A vernier detector crystal, fitted for either panel or subpanel mounting, is now available. The special features are pointed out in the illustration; the automatic spot finder is for the coarse adjustment, and the vernier knob at the front provides a fine contact regulator for obtaining maximum results. The crystal renewal cup at the rear is detachable. The neat design and simple method of mounting make this unit a desirable addition to any crystal radio receiver.

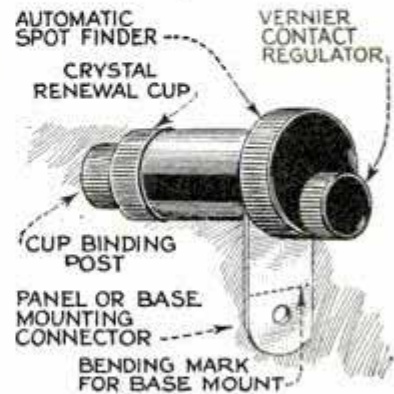

\$2.00

*Wahem & McLaughlin Co.,
225 E. Illinois*

1698
 Dayton, Ohio
 Light-Plant Interference Eliminator

A device for eliminating interference from light plants, and motors of all types, is now available. In plants of the farm-

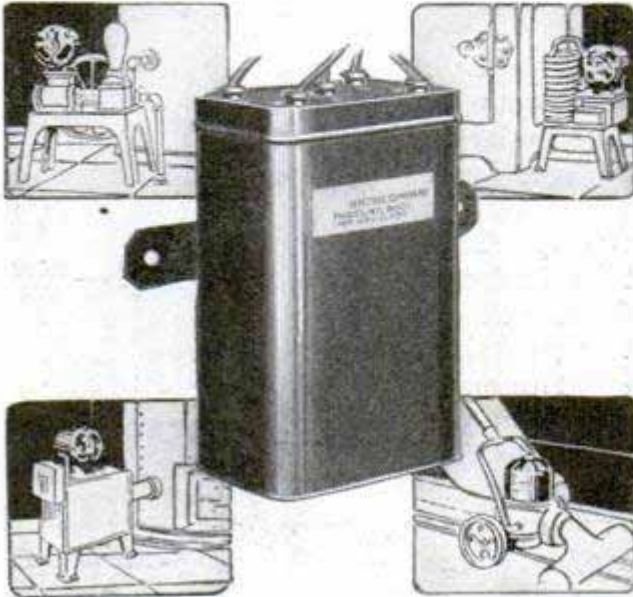

Interference Eliminator Ready for Installation and Various Electrical Trouble Makers

lighting type, the instrument is of special value as interference from this source is very common. Interference from various household electrical apparatus is of frequent occurrence in cities. This device can be used on all such appliances without disturbing the efficiency of the apparatus. It furnishes an easy path for the escape of the interfering vibrations to the ground and builds up a barrier that prevents them from going to the electrical wiring and causing disturbing reradiation, not only in the house but in the whole neighborhood.

Why a Power Tube Is Used

There is, perhaps, no more misleading name among radio terms than "power" tube. The mere addition of a tube of this type to a receiving set will not increase the volume tremendously, as is usually expected, for it is not a source of power. It can, however, handle far greater power than the usual tube, and in this lies its advantage for quality rendition of radio programs. The standard A-type tubes have limited capacity. They can handle the minute currents found in r. f., detector and first audio-stage operations, but for the last amplifying stage they

cannot pass the full power of a multi-tube set without distortion. Therefore the loud speaker is not operated at anywhere near its full capacity. As volume adds the final touch of realism, and as bass notes require far more power than the higher notes, a tube capable of handling this increase without overloading, choking and blurring reception is essential.

Simple Test for Open Secondary

A simple test for an open secondary, where the terminals can be reached with the fingers, often locates the trouble quickly. Wet two fingers slightly and place them across the secondary of the a. f. transformer while the set is in operation; if the volume immediately increases and there is less distortion, the secondary is open at some point. The best remedy, of course, is a new transformer. The explanation of this simple test lies in the grid return provided by the fingers; the tube was choked up because there was no grid return, due to the open winding, and the fingers allowed the charge to leak off, thus increasing the volume.

Decorating the Cone Speaker

The cone speaker is an excellent instrument, but there is something blank about its appearance that makes it unsightly. It may be greatly improved, in fact, it can be made very decorative by ornamenting it with some design such as shown in the illustration. This is simply made by cutting out a parrot from crepe paper and mounting it on the front of the speaker by means of glue or shellac. A



large number of suitable designs may be found on the modern crepe papers used for decorative purposes.

Radio Happenings Far and Near

1163 R.

P & A

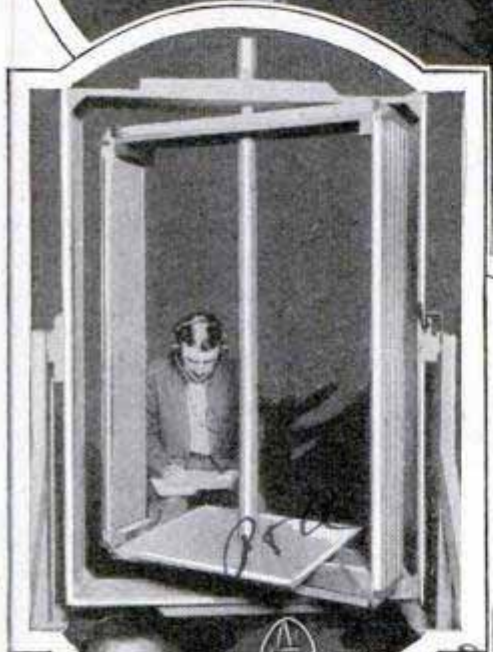
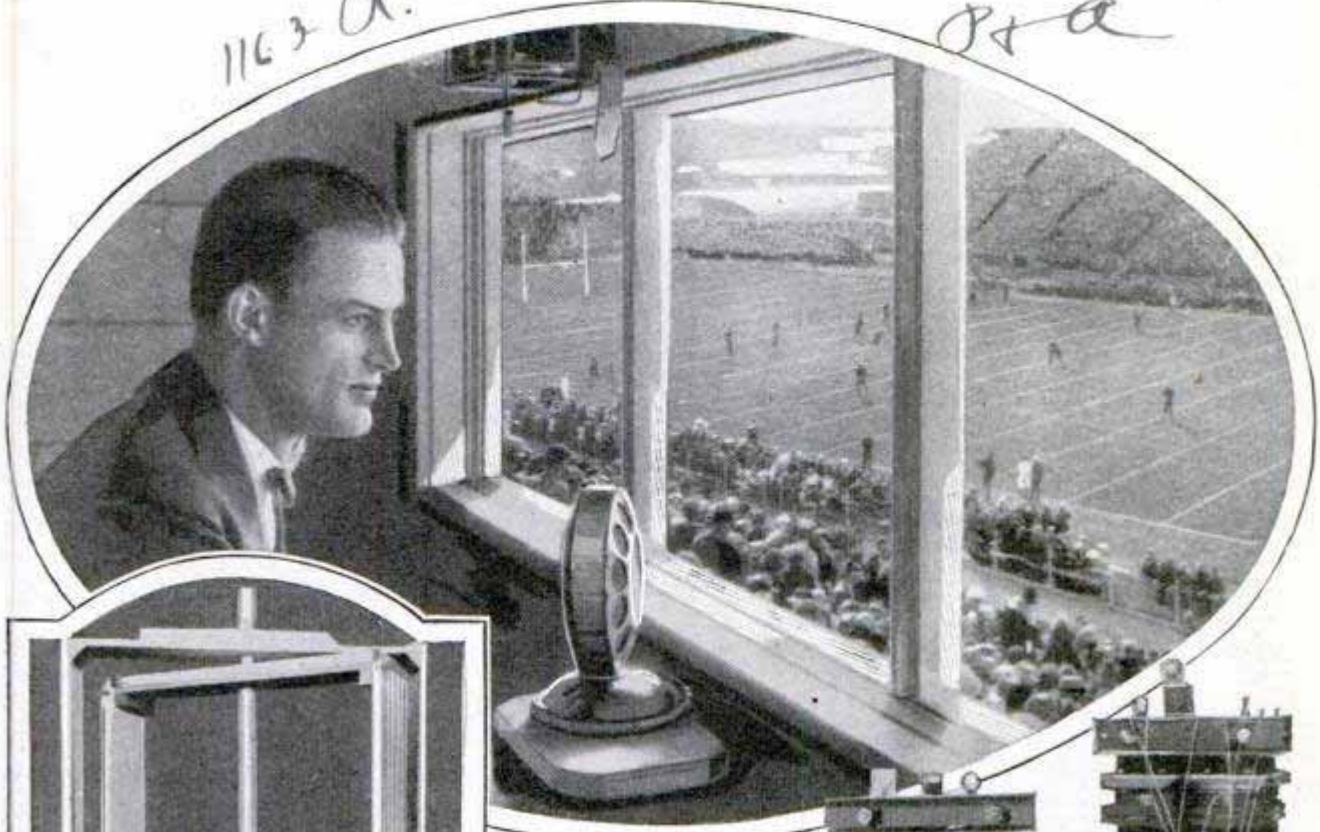

Above, Carl Menzer Broadcasting Grid Game between Universities of Iowa and Minnesota from Inclosure above Grandstand

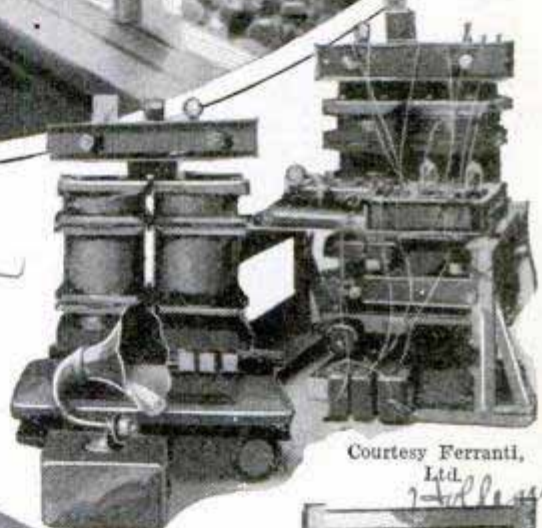

Courtesy Ferranti, Ltd.

Hillwood Eng.



Upper Left, Dr. Austin of Bureau of Standards Making Observations with Giant Double-Axis Loop; Right, Huge A. F. Transformers Used in Test by English Manufacturer to Prove Need for Large Iron Cores; Below, Apparatus Used by WGY to Create the Sounds of a Train

116

Suspended Loop Saves Space

Even a comparatively small loop aerial occupies more table space than the radio

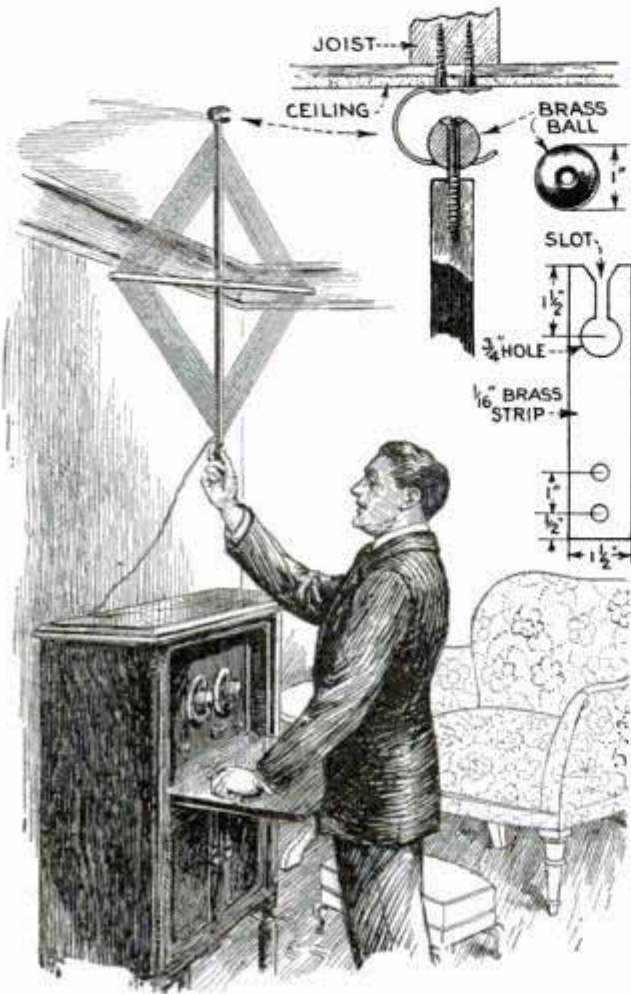

Loop Suspended from Ceiling, and Details Showing Bearing and Mounting Strip

fan is prepared to allow it. A 4-ft. loop for long-distance work is too large for the average living room, if used on the table. One practical solution of the difficulty is to suspend the loop by means of a universal bearing from the ceiling. The bearing shown in the drawing is simple, and permits easy insertion and removal of the loop. When not in use, the loop may be lifted off the ceiling bearing and hung flat against the wall where it will take up very little room. The bearing consists of a 1-in. brass ball screwed to the end of the loop shaft, no further alterations in the loop itself being necessary. A slotted brass strip, fixed to a ceiling joist, supports the ball, the slotted end being just wide enough to admit the screw shank. The ball rests in a $\frac{3}{4}$ -in. hole at the end of the slot. This ball bearing will cause the loop to

hang vertically, and allow it to be turned readily in any direction.—C. A. Oldroyd, Barrow-in-Furness, England.

Placing Coils in the Set

Interaction between coils in a receiver can be minimized or eliminated if some attention is given to the locating of the coils in assembling the set. Coils of the single-layer or solenoid type are the worst offenders, but if placed in the set correctly in relation to the other coils, they will give very little trouble in this respect. Energy will not be transferred by induction into another coil, if the plane of the wires constituting the winding is at right angles to the wires of the other coil.

Simple Tube Tester Employs Lamp

1139-2
A simple and efficient tube tester, employing a small glow lamp, has recently made its appearance on the market. The radio owner without technical knowledge of tube characteristics can use this device to determine the efficiency of the various tubes in the set. The tester shows instantly whether a tube is in condition for satisfactory use and in what capacity the several tubes of a set will operate most efficiently. It does not measure the various elements of the tube separately, but their effective combination under working conditions. To use the instrument, the plug is inserted in the socket of the set and the tube is placed in the tester socket. The rheostat, controlling the filament current to the socket in which the plug is placed, is then turned up till the small lamp in the tester glows.

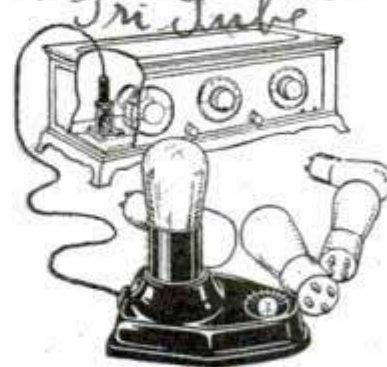

If the lamp does not glow when the rheostat is turned on to full capacity, the tube is not good. Should the lamp glow before the rheostat is turned

on fully, the quality of the tube may be measured by the amount necessary to turn on the rheostat before the glow becomes visible.



AMATEUR MECHANICS

Twenty-Three Miles an Hour from Your Outboard Motor

AT the annual regatta of the Mississippi Valley power-boat association, held at Louisville, Ky., July 4-6, 1926, "Whiz," a 14-ft. step plane, established a new speed record for outboard-motor boats. Over a straightaway course of six miles, covered six times, the average speed was 23.383 miles per hour. This startling speed, for an outboard motor, was due not only to the engine used but also to the design of the hydroplane, and

we take pleasure in presenting complete specifications and drawings for the building of a plane to the same design.

There is only one thing on the drawings that may puzzle the amateur builder, although it is a common practice, and that is the method of indicating angles and bevels. It is very simple, however. It will be noticed that, wherever a bevel is indicated on the cross section of a rib or other part, there is a little triangle

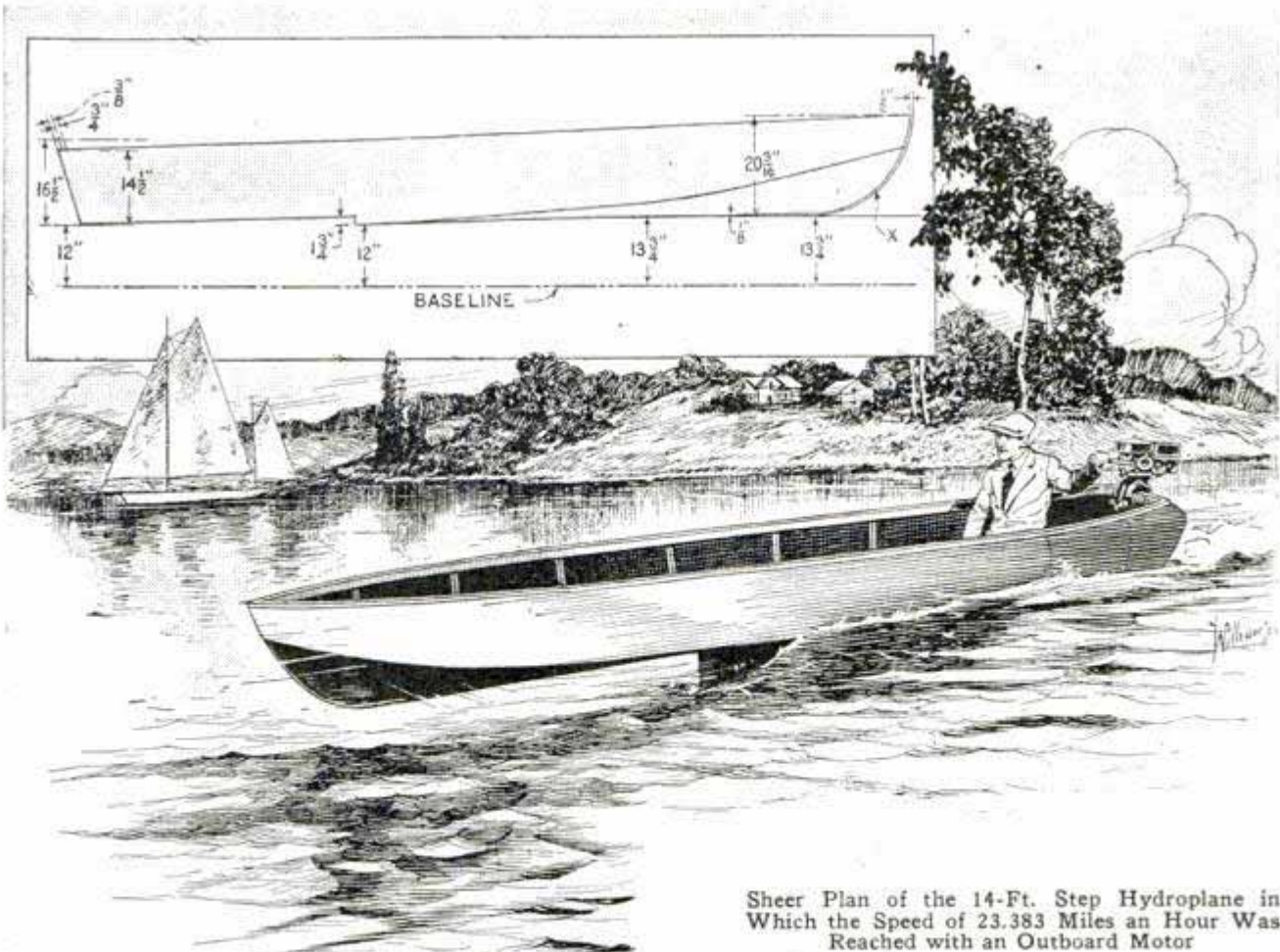

Sheer Plan of the 14-Ft. Step Hydroplane in Which the Speed of 23.383 Miles an Hour Was Reached with an Outboard Motor

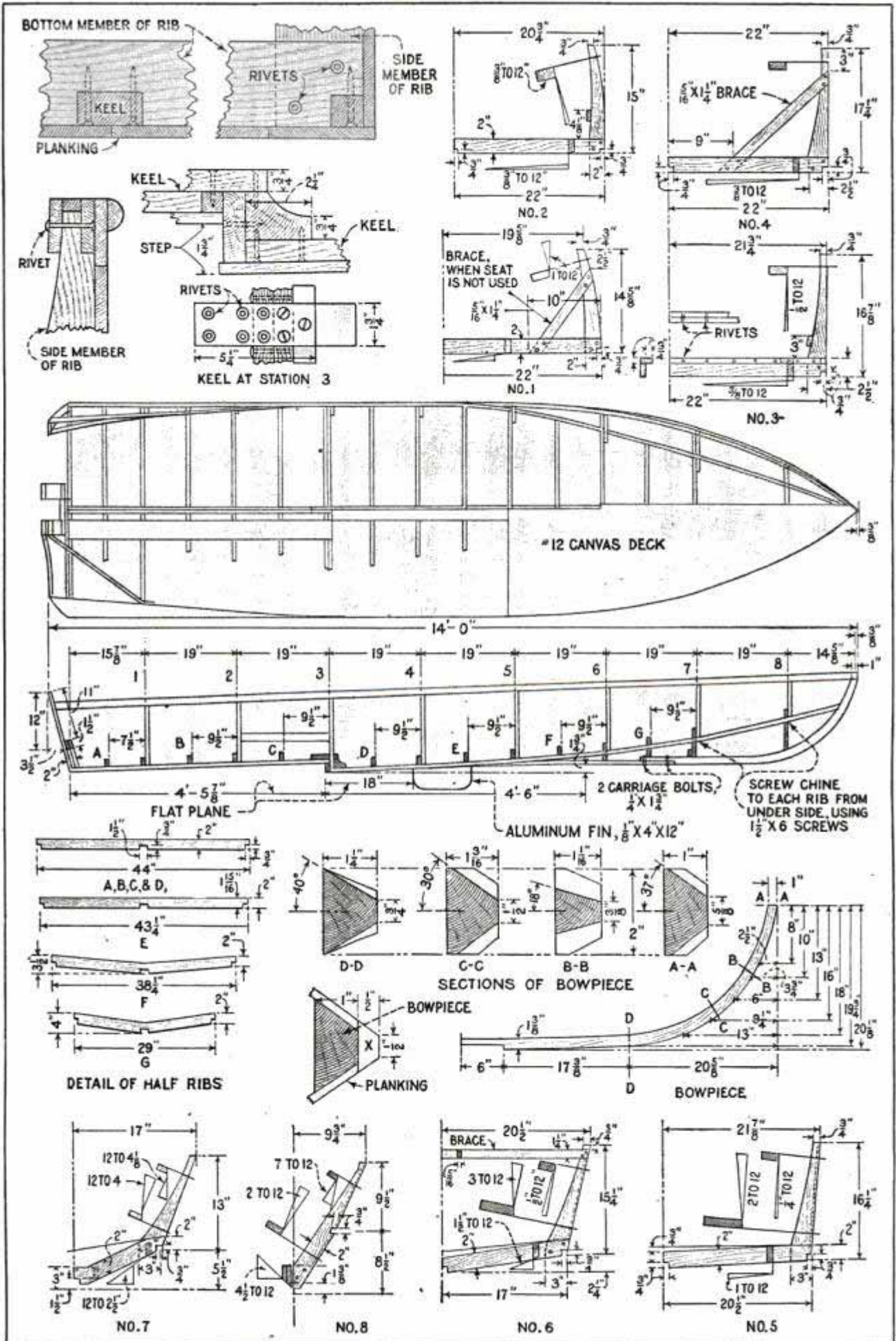

Constructional Details of the Hull of the Hydroplane; Any Boatbuilder Can Assemble a Speed Boat from These Plans, and Even the Amateur Will Not Find It a Difficult Task

close to it, with the figures 1 to 12 in., or similar figures. This simply means that if a right-angled triangle is drawn, the sides adjacent to the right angle being, respectively, 1 and 12 in. long, the side opposite the right angle is at the exact angle of the desired bevel. The method is similar to that used to indicate the steepness of a hill, when we say it has a grade of 1 in 100.

The ribs are of spruce, $\frac{1}{2}$ in. thick, with the exception of the bottom member of rib 3, which is $\frac{3}{4}$ in. thick; all are to be sawed to shape, notched, beveled and assembled according to the drawings. Side and bottom members are joined by copper rivets, and fastened at the proper stations to the keel by two $1\frac{1}{2}$ -in. No. 6 screws through each.

The keel is of spruce, $\frac{3}{4}$ by $1\frac{1}{2}$ in., and is in two lengths, one running from the stern to the step, or station 3, and the other from step to bowpiece. The joint at the bowpiece is fastened with two $\frac{1}{4}$ by $1\frac{3}{4}$ -in. bolts, spaced on $3\frac{1}{2}$ -in. centers.

The bowpiece is of rock elm, 2 in. wide, $1\frac{3}{8}$ in. thick at joint, tapering to 1 in. thick at sheer line. It is in one piece, properly beveled and steam-bent.

The stern is of cedar, $\frac{3}{8}$ in. thick, sawed to shape and nail-fastened (clinched) to the stern frame, which is of $\frac{5}{8}$ -in. spruce.

Chines are of spruce, $\frac{3}{4}$ in. square, each in two lengths, running from stern to station 3, and from station 3 to bowpiece. They are screw-fastened to each rib and half rib, using $1\frac{1}{2}$ -in. No. 6 screws.

Seats are of $\frac{1}{2}$ -in. cedar, 12 in. wide, resting on, but not fastened to, spruce cleats, $\frac{5}{8}$ by 2 in. in size, screw-fastened to ribs 2 and 3.

The gunwales are of $\frac{5}{16}$ by $1\frac{1}{4}$ -in. spruce, notched in ribs at sheer line to receive planking. Inwales are also of spruce, $\frac{3}{4}$ by $1\frac{1}{4}$ in. in dimensions, riveted to ribs and gunwales, as shown in the detail drawing. Battens are of $\frac{5}{16}$ by

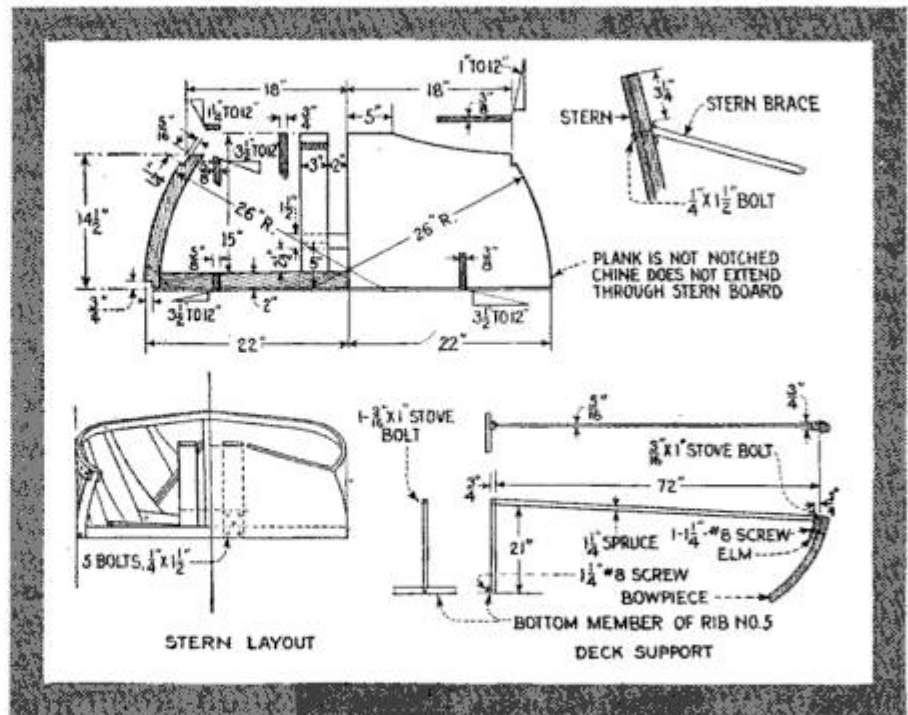

Layout of Stern, Showing Frame and Bracing; Right, Support for Canvas Deck, Which Extends over Forward Part of Hull

$1\frac{1}{2}$ -in. spruce. There are two on each side and four on the bottom.

Planking is of $\frac{3}{4}$ -in. cedar on sides and bottom, screwed to ribs and half ribs and nailed (clinched) to battens, three planks on each side and six on bottom. The flooring is of $\frac{3}{8}$ -in. spruce; two pieces, 4 in. wide, run from stern to station 3, spaced 2 in. apart, and one piece, 4 in. wide, runs from station 3 to station 7. All are nailed to the bottom members of the ribs. The sheer line extends $\frac{1}{4}$ in. above the top of the ribs, and a $\frac{3}{4}$ -in. half-round spruce molding is screwed to the outside of the planking at the sheer line as shown in the detail drawing.

Glue all joints in the frame, also glue the planking to the battens, stern, keel and bowpiece, using Jeffrey's marine glue, C quality. Keep all nails flush and putty all screw heads in planking. The frame is given one coat of good spar varnish after assembly, and the planking one coat before fastening to the frame. After the planking is in place, the entire outside of the hull is given two coats of spar color varnish.

A deck, made of No. 12 canvas, is fastened under the gunwales, extending from the bow to rib No. 5. It is supported at the center by the spruce stringer shown in the detail at the lower right-hand corner of the illustration on this page.

Hotbed on Porch Roof

Here is a hotbed that will appeal to the small gardener or flower lover, as it is distinctly novel and has many useful features. It is located on the porch roof,



Hotbed on Porch Roof Is Convenient and Out of the Youngsters' Reach

within easy reach from the windows, and is covered with a single sash, which is hinged at the lower side so that it can be raised conveniently, chains being used to prevent it from being opened too far. The bottom of the hotbed is covered with metal, and special shallow boxes, about 3 in. deep, fit in under the glass during the flowering season. Where possible, such a hotbed should be placed on a south-sloping porch. The only precaution necessary is to see that there is enough space between the glass and the bottom to provide room for shallow boxes and to give several inches of space for the growing plants. Such a hotbed is also entirely out of reach of youngsters who often have the habit of taking flowers.—Dale R. Van Horn, Walton, Nebr.

Kinks for the Auto Painter

The auto owner who attempts to paint his car for the first time will likely make the mistake of applying the varnish to the body of the car first. This is going at it backward. The first step is to remove such parts as the hood and the headlight rims. These can be suspended from the ceiling and painted at any time. The

next step is to clean and dress the top and the upholstery, for, if this is done after the body is painted, you are sure to do a bad job, because a drop of top dressing on a varnished surface will leave a mark that cannot be removed easily. After the top has received attention, the inside fittings of the car, such as steering-post column and instrument board, brake and gear-shift levers, should be painted and then the wheels and the chassis. For the outside of the body, which is painted last, a new brush should be used if best results are to be obtained, and an old fine-tooth comb should be kept handy to smooth out the hairs of the brush as well as to remove any loose hairs. The above is a good way to remove dirt from the brush, as dipping it in gasoline might result in an uneven coat of paint. Blow the dust and dirt from the cracks and corners of the car with the tire pump before starting the job. This may prevent the finished job from having that disgusting "stuccoed" appearance, which will be an eyesore to you as long as the job lasts.—Glen F. Stillwell, Collinsville, Ill.

Server for Butter Chips

In small restaurants it will be found convenient to bend the two end prongs on an ordinary fork to make a butter server.

The two prongs are bent backward and can be hooked over the edge of the bowl, as shown in the drawing, which makes the server readily accessible as well as sanitary.—F. Minter, Milwaukee, Wis.



Handy Bag Holder

To hold a bag in place while filling it with apples, vegetables, etc., drive four strong nails into the top of an empty barrel having both ends knocked out, and hang the bag inside of the barrel with the upper edge caught evenly on the four nails. The bag can easily be filled, the

top unhooked from the nails and tied up, while the barrel holds it. Remove the barrel and the bag is ready to be taken away. If the contents are to be weighed, first place the empty barrel and the suspended bag on the scales, fill the bag, lift off the barrel and weigh the bag.—Mrs. A. K. Hinkley, Rowley, Mass.

Cleaning Soiled Steel Engravings

Many persons have old-style steel engravings that have become soiled through exposure to the dust and air. To clean them, the following method will be found effective and non-injurious to the print: Prepare a weak solution of chloride of lime and carefully soak the engraving in it until white. Then rinse thoroughly by an immersion in clean running water for several minutes. Steep for half an hour in a flat enameled pan filled with water, in which has been dissolved just a little hyposulphite of soda. Rinse again in clean water and dry between clean white blotters under pressure of weights, or in a press. The result will be an engraving as good as it was originally.

Baby Carrier for the Car

When riding in the rear seat of a car it is quite difficult to hold a baby comfortably, but by providing a carrier the trouble will be eliminated. The carrier shown in the drawing consists of a canvas bag, the open top of which is held rigid by a wood or metal frame. Lengths of brass or galvanized chain and two coil springs, to serve as shock absorbers, are attached as indicated, and the baby will be safe and comfortable. To prevent the crib from lurching, it should be fastened to the back of the front seat near the bottom by means of a short coil spring. —Carlton Groat, The Dalles, Oreg.



Simple Baby Carrier Hung behind Front Seat Is Safe and Comfortable



Hand Spray Used Effectively for Moistening Clothes to Be Ironed

Hand-Spray Clothes Sprinkler

Clothes can be dampened for ironing with a small hand pump of the kind used to spray liquid for killing insects. Fill the container with water and proceed as illustrated. The cloth will be moistened by an even distribution of water.

Attaching Hose to Air Pump

When attaching a rubber hose to an air pump vulcanize the rubber to the metal, to make the connection air-tight. Heat the metal until it is quite hot, force the rubber tubing on and clamp it tightly for a few minutes. The rubber will be softened by the heat and will adhere to the metal, making a much tighter connection than can be had by using a clamp alone. If the metal is roughened with a coarse file, the rubber will stick still better.

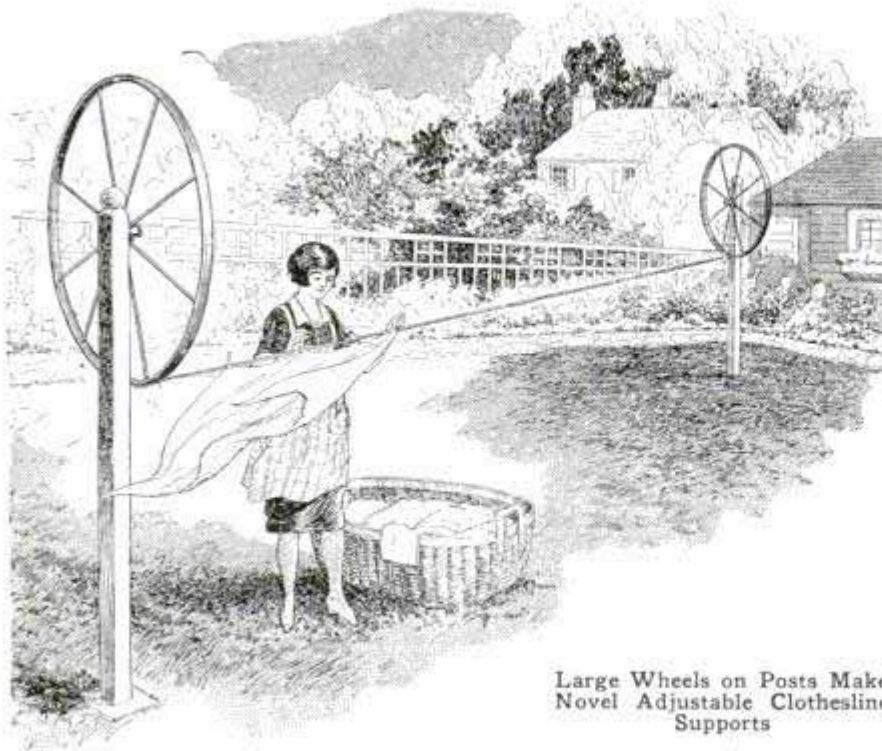

Large Wheels on Posts Make Novel Adjustable Clothesline Supports

Adjustable Clothesline

Two old hayrake wheels, mounted on posts from 20 to 50 ft. apart, make useful, adjustable supports for a clothesline. After the clothes have been hung on the line, the wheels are turned one-half of a revolution to raise the line. A bolt or hardwood pin is pushed into a hole drilled in each post, to hold the spokes of the wheel securely and prevent it from turning. The wheels are approximately 5 ft. in diameter, which permits the line to be raised so high that even long garments will be out of the reach of dogs or children. The posts should be set firmly in the ground and the wheels attached by means of bolts run through the hubs. A large washer should be placed over the end of the bolt to prevent it from being pulled through the hub.—Dale R. Van Horn, Lincoln, Nebr.

Ford Curtain Fasteners

Ford tops and curtains can be repaired, if the curtain fasteners are torn out, by the use of a metal plate, preferably aluminum, about $1\frac{1}{4}$ by 2 in. with the ends cut round and a small hole drilled in each corner. The fastener is mounted in the center of



the plate by drilling two holes for the prongs on the fastener and clinching them on the back side. The plate is sewed to the top, as shown, with the fastener projecting through the hole. The sharp edges are filed down and the plate should be well sewed in place so that it will not shift and cut off the thread.—E. T. Gunderson, Jr., Humboldt, Ia.

Remedy for a Rattling Gear-Shift Lever

If the gear-shift lever on your car tends to vibrate and rattle when

the car is in motion, a simple remedy is as follows: Drill a small hole through the lever, about 2 in. above the floorboards or above the rotating joint in the base of the lever. Then fit a stiff spiral spring around the lever, press the top end down until it is below the hole, and insert a long cotter pin through the latter to hold the spring down.

Reinstalling Shock Absorbers of the Strap Type

With the tool shown in the drawing, it is an easy matter to remove and reinstall strap-type shock absorbers without the laborious process of lying on the floor and pulling the belt by hand.

The tool is made from a length of $\frac{1}{2}$ -in. round stock, about 46 in. long, bent at right angles about 8 in. from one end. The other end is bent to form a hook, 2 in. long. In use, the tool is inserted between the spokes of the wheel, as indicated, and around the strap; it is turned around to wind up the strap, which prevents it from going into

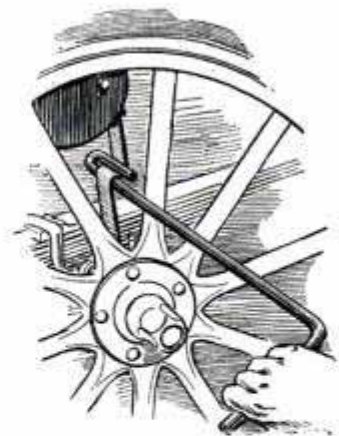

the shock absorber. If disk wheels are used on the automobile, the tool is hooked over the strap in the opposite way, from the inside.—E. V. Willis, Springfield, Mass.

To Prevent Leaky Valves

Leaky and improperly seated valves are sometimes caused by jamming or screwing them down too tight. Particularly in adjusting carburetors, the novice may make this mistake and ruin the valve. A valve or faucet should not be forced, but should be carefully closed and never fully closed when the valve seat is warm. This also applies to a gasoline blowtorch valve, for the contraction of the seat and valve, upon cooling, will ruin the latter. Turn the torch down until only a tiny blaze remains, and then blow this out. This will prevent jamming the valve, and as soon as the torch cools, the valve will be found to be snugly closed.

Flashlight Makes Red Lamp

One photographer devised a satisfactory red lamp by using an ordinary hand flashlight. The lens was removed, the reflector was blackened with India ink, which can easily be washed off with water if need be, and a piece of heavy photographic film, which had been dipped in red dyeing solution such as is used for coloring electric lamps, was placed under the lens. The lamp is light and portable. The film can be dyed other colors to meet varying conditions; a certain shade of green, for instance, for use with panchromatic films, light red or orange for working with printing papers, etc. If a very deep red is desired, this can be obtained by using several thicknesses of dyed film.

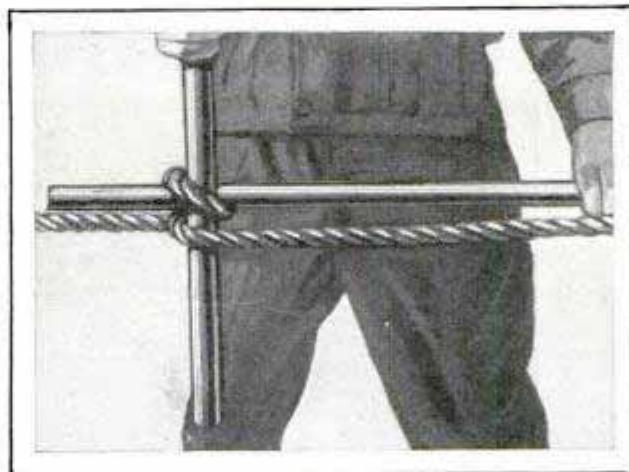

Considerable Force Can Be Exerted with This Improved Windlass

Combination Garage and Summer House

A two-car garage on an Iowa lake has been made to serve as a little summer house, where the family can sit and read

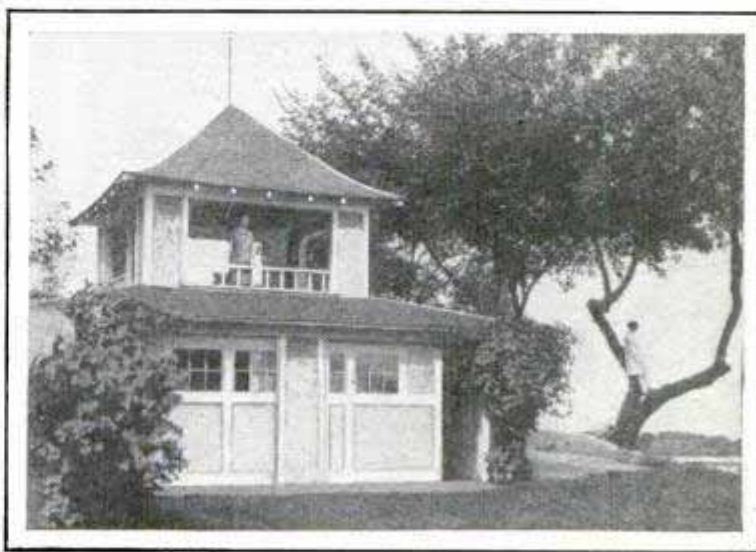

Novel Summer House on Iowa Lake Built on Top of Garage Gives Better View of Landscape

or look out over the lake. Four concrete pillars were built on top of the garage, and a roof, floor and railing provided. Aside from its great economy, the height of this summer house has the advantage of giving a better view.

Making an Emergency Windlass

The photo shows an improvised windlass, which is useful in an emergency. A rope is fastened securely to the two objects between which the force is to be applied. Two heavy rods or pipes are held by the side of the rope, one vertically and the other horizontally, and a hitch is taken around the two as shown. Considerable force can be exerted by turning the horizontal rod, winding the rope around the vertical one. This method may be used to pull an auto out of a mud hole, if a telephone pole or a sturdy fence post is handy for use as a "deadman."

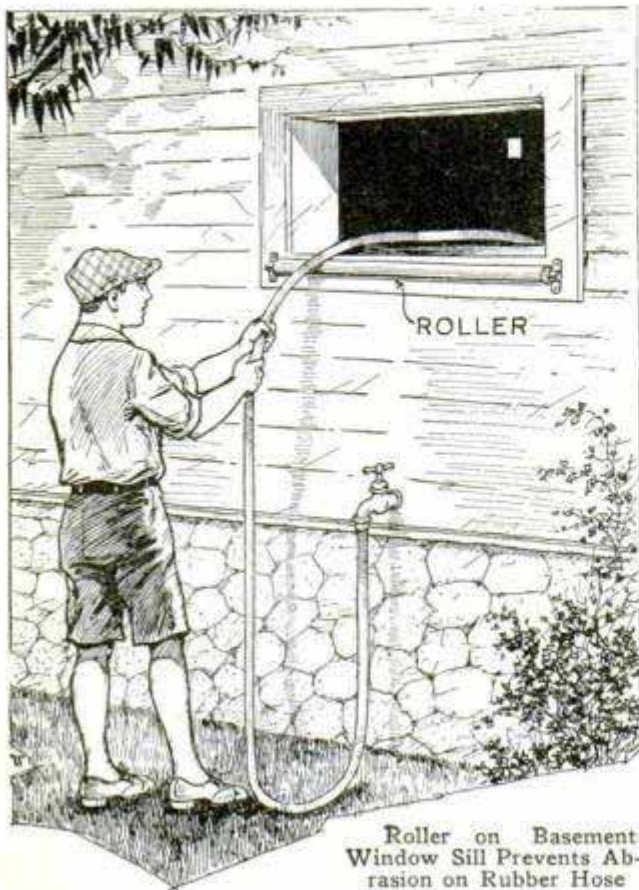

Roller Guard Prevents Abrasion of Hose

Needless abrasion of rubber or fabric hose, caused by dragging it through basement windows or other openings in buildings, can be avoided by means of rollers, which are made by slipping a piece of ordinary iron pipe over a rod, and are mounted both inside and outside the window, and projecting a little above the sills. If the construction of the opening through the building permits, the bar can be set in two drilled holes, while, if only a window-casing edge is available for supporting the roller, the ends of the center rod can be held by U-shaped clamps.

Burglar-Proof Night Latch

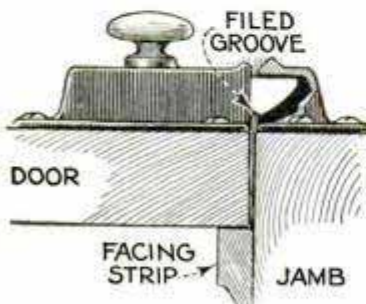

It is possible to pry a sharp blade between the edge of a door and the jamb and open a night latch, but this will be impossible if a groove is filed

across the edge of the tongue, as shown in the drawing. Should anyone attempt

to insert a knife, the point will catch in the groove and the tongue cannot be pushed back. Besides doing this, it is advisable to provide strips of sheet metal on the edge of the door and jamb to prevent the wood from being cut away at this point by thieves bent on gaining entrance.—Thos. H. Duffy, Juniata, Pa.

Emergency Clock Key

Having broken a clock key, an autoist took an old inner tube valve and made a new one. The U-piece and nut were left on to serve as a handle, but the core was taken out. The square, pointed end of a file was driven into the open end, until it was expanded to fit the winding stem. Skate keys can also be made in the same way.—Arthur Flinner, Manhattan, Kans.

Handy Chimney Ladder

It is often difficult to reach high chimneys and in case of a chimney fire this may lead to serious consequences. With this in mind, the caretaker of a church at Missouri Valley, Iowa, made a special ladder, which he bolted to the chimney. This installation is handy, as the chimney is of considerable height and the roof so steep that an ordinary ladder could hardly be used, especially during winter when the roof is frequently covered with snow and ice.

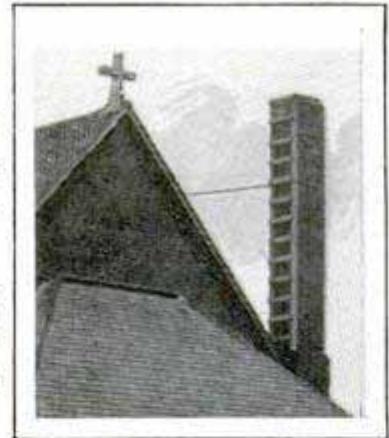

Homemade Fire Extinguisher

A thoroughly dependable fire extinguisher can be made at little cost. Get a small acetylene-gas tank, such as is used to supply illumination for motorcycles. Remove the valve and gauge from the ends of the tank, then, with a rather stiff wire, bent to form a hook at one end, fish out the asbestos filler. This may seem a tedious job but keep at it until you are sure every crumb is dislodged. A power-

ful stream of water from a hose often will wash away large pieces. When the cylinder is thoroughly clean, get a large valve from a discarded inner tube and thread the stem to fit the end from which the pressure gauge was removed. Into the other end, screw an ordinary brass valve of the type used to drain water from automobile radiators, and, if you wish, a short length of copper or brass tubing may be soldered on to this for a nozzle. Make sure that the tank is air-tight, then buy a 5-lb. can of carbon tetrachloride from the druggist, and pour the contents into the prepared cylinder. Any of the standard preparations sold to refill fire extinguishers may be used; you will find carbon tetrachloride an excellent substitute. Then go to an auto-service station and pump the tank up to the highest pressure the service station compressor is set for. You need have no fear about doing this, as the tank is tested for 250-lb. pressure, so it will easily stand up to 100 pounds.—Walter Briggs, Poughkeepsie, N. Y.

Safety Stop on Morris-Chair Back Rest

Often, when it is least expected, the rod which is used to adjust the angle of inclination of a Morris-chair back rest, will slip out of its notch, letting the back of the chair fall. This not only mars the furniture, but may cause injury to the person who is about to seat himself in the chair.

A safety stop to prevent such accidents can be made by putting a screw-eye in the end of each rest support and stretching a piece of doubled picture wire between them, as shown in the illustration.—K. M. Coggeshall, Webster Groves, Mo.

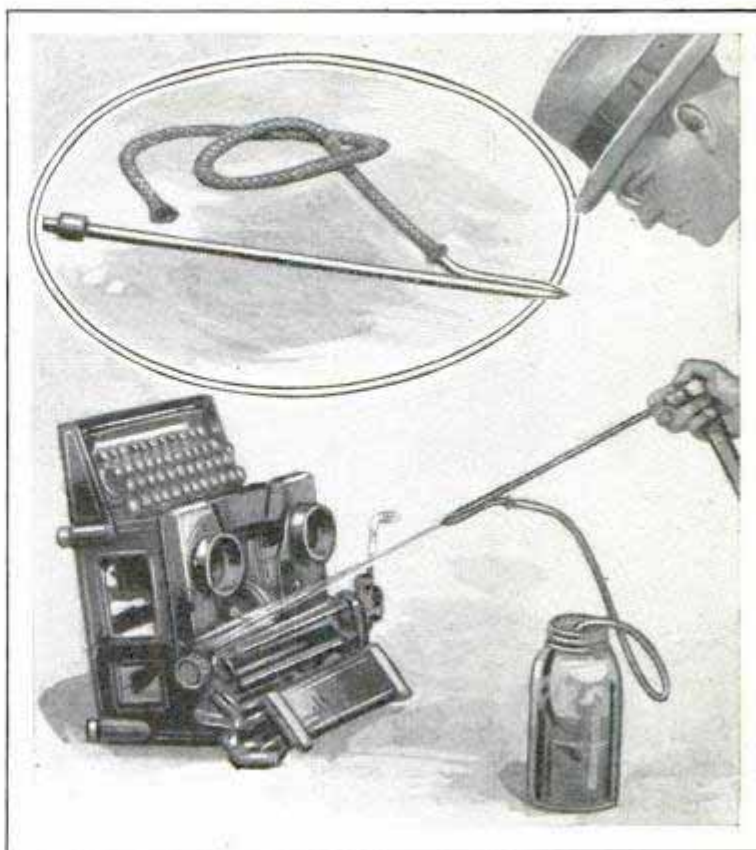
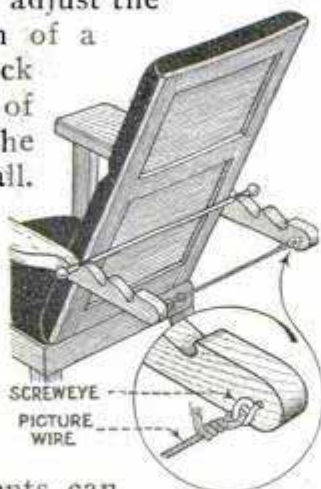

Quick Method of Cleaning Typewriter with Compressed-Air Spray Outfit and High-Test Gasoline

Spray for Cleaning the Typewriter

With the homemade apparatus shown in the photo a typewriter may be cleaned and dried in half an hour. A 12-in. length of $\frac{1}{8}$ -in. copper tubing is flattened at one end, and a 5-in. piece, similarly flattened, is bent to form a blunt curve. The latter piece is soldered to the former, as shown in the detail, to form a double jet. A length of rubber tubing is pushed over the end of the short piece and the other end of the tubing is submerged in a jar containing high-test gasoline or other cleaning fluid. Attach the end of the other tube to a compressed-air line at a garage. The strong spray will clean the typewriter quickly. After cleaning, the tube is removed and the air is used for drying. As gasoline fumes are highly inflammable one should keep away from any open flame while doing the cleaning.—Warren E. Crabtree, Milton, Oreg.

☛ Razor straps should be scraped and cleaned every month or so, to keep the leather from filling up with dirt; put a little soap suds on the strap when using it, to get good results.

Tool for Removing Lamps from Ceiling Fixtures



When putting new lamps into fixtures attached to the ceiling, a step-ladder is usually necessary. However, by rigging up the simple device shown in the drawing, the lamps can easily be removed and replaced from the floor. It consists of

a 5-ft. stick, to the end of which is attached a piece of corrugated cardboard, formed into a cylinder the inside diameter of which is a trifle less than the diameter of the lamp. To strengthen the holder it may be bound with tape. A few carpet tacks are used to fasten it securely to the end of the stick. In use, the holder is pushed over the lamp to grip it firmly and by turning the stick the lamp can readily be put in or removed.—Henry J. Smith, Montreal, Can.

Wiring Accessories to Storage Battery

Frequently when connecting spotlights, horns, stop signals and other electrical devices to the storage battery of a car, the wire is brought under the terminal nut of the battery. This method is, however, rather unsatisfactory as the small wire soon corrodes from the action of the sulphuric acid, and each time the battery is disconnected it is also necessary to disconnect the extra lead. A more satisfactory way is shown

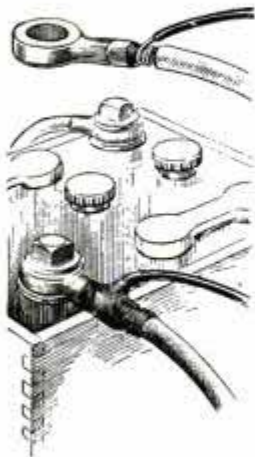

in the illustration. The storage-battery cable is bared and the wire twisted around it and soldered. The joint is then taped and shellacked. This makes a durable and

permanent connection, which will not be affected by acid and does not interfere with the easy removal of the battery.—G. A. Luers, Washington, D. C.

Protection for Radiator Core

Ford radiator cores, of the type used from 1917 to 1923, are often worn through on top by friction of the shell at the rear edge. It is important to keep the fabric strip, which is threaded through the rear edge of the shell, in good condition, and to replace it if it becomes hard or cut through in places. The reason for this is that the fabric keeps the shell from wearing the core and also prevents rattling and squeaking of the hood.

Repair for Water-Pipe Leak

If the water pipe springs a leak during the night or on Sunday, when plumbers are hard to locate, emergency repairs can be made with

a garden hose clip and a piece of rubber, cut from an old inner tube, as shown in the drawing. The hose clip is placed so that one of the metal strips fits over the hole,

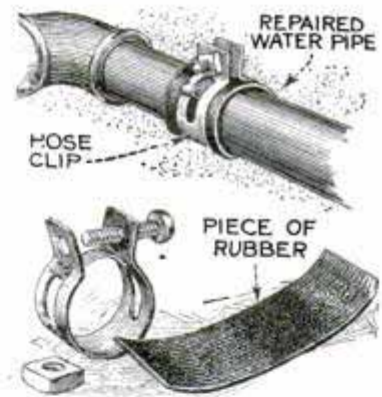

otherwise the water pressure will stretch the rubber until it bursts. Such a repair, while intended only as an emergency remedy, may last for a long time.—Ivan E. Houk, Denver, Colo.

Holes for Seat-Cover Fasteners

The better grade seat covers are attached to closed cars with wood screws having ball heads for glove fasteners in the seat cover. An ordinary small twist drill should be used in drilling the small holes for starting the screws, as the screwdriver slots in the heads are too small to allow them to be driven directly into the average wood frame. There is a layer of soft filling, much like cotton batting, under the upholstery cloth, and

in starting the screws, the filling has a tendency to catch on the drill and wrap about it. This injures the upholstery and makes the screws difficult to start. The holes should be drilled with a forward and backward motion, one turn forward and a quarter turn back. The cotton will not stick to the drill and yet the drill will quickly sink into the wood.—E. T. Gunderson, Humboldt, Iowa.

Homemade Snubbers Prove Effective in Stopping Rebound

Rebound on rough roads is the greatest cause of broken springs, and snubbers are usually provided to offset this action. If the auto owner does not feel justified in purchasing commercial snubbers, he can make some which will be found entirely satisfactory. Obtain two strong coil springs, about 12 in. long, made of $\frac{1}{4}$ -in. wire. Attach to the ends of each spring a piece of $\frac{3}{8}$ -in. steel cable, long enough to reach the front and rear axles, allowing the cable to pass over heavy pulleys attached securely to the frame, as shown in the drawing. Using cable clamps, draw the cables up so tight that the springs of the car will be slightly compressed. The coil springs should be located in the center of the car just behind the running-board apron, and care should be taken to get them in alinement. These snubbers will absorb side sways as well as the vertical rebound of the car,

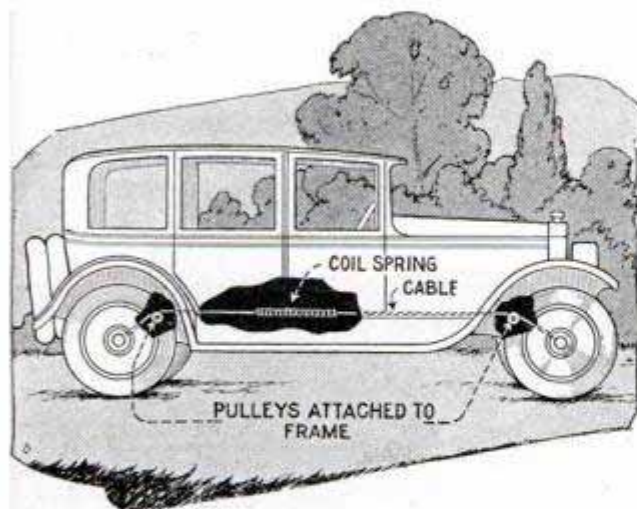

Homemade Snubbers Absorb All Shocks on Rough Roads and Make Riding Comfortable

and the riding qualities of the auto will be found greatly improved.—Geo. G. McVicker, North Bend, Nebr.

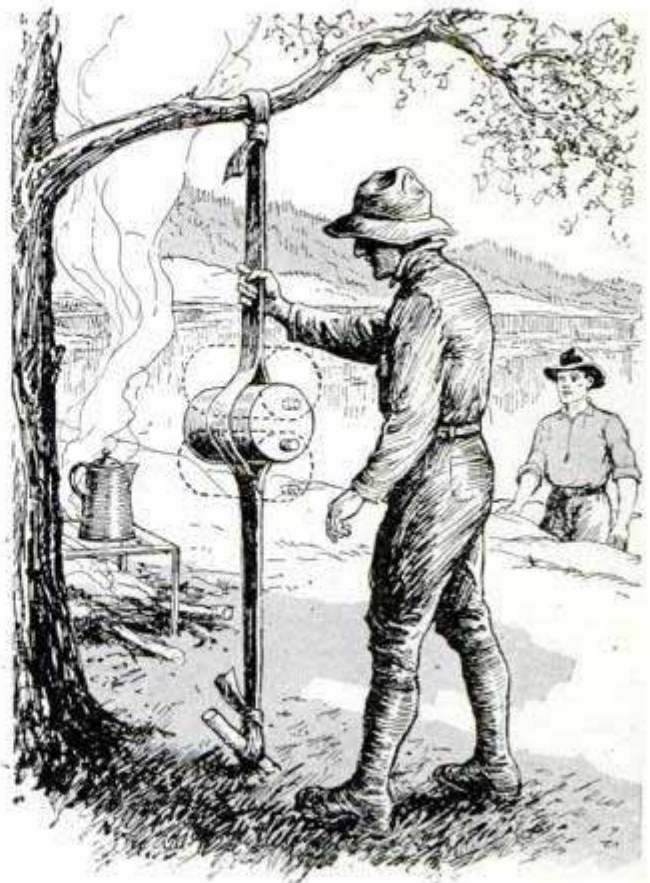

Emergency Churn for Campers Made from Inner Tube and Sirup Pail

Novel Improved Churn

While camping out last summer, a party of fishermen found their supply of butter exhausted, and a farm house in the vicinity could only furnish a jar of sour cream. Taking this to camp, one of the party improvised a churn, which provided fresh butter in a very short time. He set the jar of cream in a near-by spring, cut a discarded inner tube at the valve section, tied one end to a low branch of a tree and stretched the tube so that the opposite end could be tied to a peg in the ground. The tube was then slit in the center to receive a $\frac{1}{2}$ -gal. sirup pail with a tight-fitting lid. A hole was punched in the cover to receive a cork and the churn was ready for use. It was operated by grasping the inner tube above the pail and pulling it up or down, and letting it rebound. The cork was removed occasionally to allow the gas to escape.

Registers are hard to clean with ordinary brooms, or the like, and a good method of cleaning them is to use stove polish on a rag; this enables you to reach the corners and do a good job.

Making Picture Frames

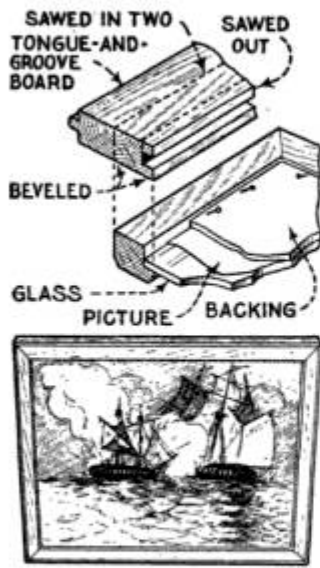

molding from which attractive frames can readily be made.

Very good picture frames can be made from tongue-and-grooved lumber. Saw the lumber the desired width, measuring from the grooved edge. Cut away one side of the groove. Then plane the surfaces and finish with fine sandpaper. This gives a stock of picture-frame

Leaks Stopped with Bullets

Recently an open-top water tank sprung a leak where the iron had been eaten away by rust. I tried soldering, but without success, as the rusted surface would not take the solder. The job was done in the following way: A lead bullet from a .32-caliber cartridge was inserted into the hole, which was enlarged to receive it. A hammer head was held against the bullet on the inside of the tank and the portion of it protruding on the outside was peened over with a riveting hammer as shown in the illustration. The repair shows promise of being a permanent one.—C. M. Wilcox, Torrington, Conn.

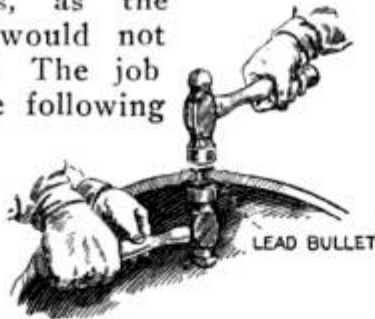

Fire Hazard in Climbing Vines

When vines are allowed to cover a chimney, which leads from a fireplace and touches a shingle roof, there is danger of fire. The vines, some of which become very dry, are easily set afire by a spark, and in one case the blaze spread to the roof. The result was that one side was damaged to such an extent it

had to be entirely replaced and much more damage was caused by water. The vines should be trimmed every year and all the dry, dead branches should be cut off to reduce the fire hazard, and not allowed to climb to the top of the chimney.—John E. Mason, Hamilton, Ont.

Loose Coil Bridge Causes Spark Miss

My Ford occasioned some trouble because of a persistent miss that could not be located. The timer was examined; the plugs, coils and wiring and everything were found to be in good condition. The compression was good and the valves were reground to insure proper seating, but this did not cure the skip. One mechanic noticed that the coil bridges were loose due to improperly tightened nuts and, of course, this did not permit a positive connection. As soon as these were tightened the car operated normally.—Glen F. Stillwell, Collinsville, Ill.

Hookup for Using Doorbells on 110-Volt Lines

When a doorbell is to be operated on a 110-volt light line, it can be done by connecting two 32-cp. lamps in series with the bell and the push button, as shown in the accompanying diagram. Another way is to use only one 16-cp. lamp instead of two and bridge the two terminals of the bell with a 6 or 7-ohm resistance, an ordinary radio rheostat of this capacity or any fixed resistance being suitable for this purpose. A resistance of

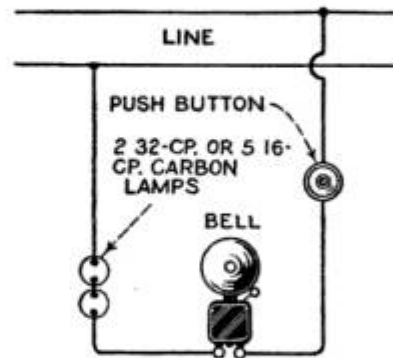

about 7 ohms can be obtained by winding about 25 ft. of No. 21 German-silver wire on a piece of fiber or bakelite taking care that no two

of the turns touch. The ordinary doorbell will stand .1 amp. and requires 2 volts' pressure. So five 16-cp. lamps, which have a resistance of 220-ohms each, will bring 110 volts down to 2 volts and .1 ampere.



The SHIP-MODEL MAKER'S TOOLS

By James Tate



ONE of the beauties of ship-model making as a hobby is that such splendid results can be obtained with a minimum of tools and equipment. Many of us have seen very fine models turned out by sailors during long watches below at sea, with no more tool equipment than a jack-knife, and made of wood from old packing cases, and the beautifully detailed models made by French prisoners of war in England during the Napoleonic struggle were often made from the soup bones from their daily rations, their only tools, also, being their jackknives. However, while there is an element of interest in the fact that a model has been made under such conditions, the amateur who wants to do really good work, as in every other line, should provide himself with tools specially adapted for his hobby. These are not many in number, nor are they expensive, but they will add greatly to the ease with which the model is constructed, as well as to the finished

effect of the work, and besides, they all, of course, can be used for doing all kinds of other work as well.

There is ordinarily a small saw in the place, used for odd jobs, and this will do quite well for the rougher work of cutting off stock, etc., when the model is begun. If no saw is handy, the model maker will do well to get a panel saw, about 16 in. long. Then there is a small dovetail saw made that should be in the modeler's kit; this is about 4 in. long, and has very fine teeth, about 32 to the inch. Even this will be found too coarse for some work, and a still finer

saw can be made from a hacksaw blade, provided with a wooden or sheet-metal back and a wooden handle. The blade should have about 64 teeth to the inch. Further, an ordinary hacksaw frame, with fine-tooth blades, is indispensable, and a coping saw, with blades for both wood and metal, will also be found necessary for such work as cutting lifts to



If the Model Maker Glues Up His Own Hulls, Several Large Clamps Are Essential

*Henry J. Payson & Co.
375 Wabash
Chicago*



PANEL SAW

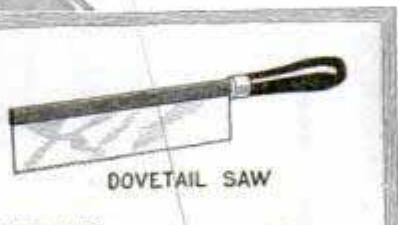

DOVETAILED SAW

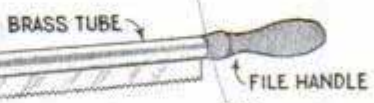

FINE HACKSAW BLADE

BRASS TUBE

FILE HANDLE



COPING SAW



JEWELERS SAW

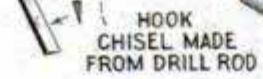

HOOK CHISEL MADE FROM DRILL ROD



OUTSIDE-BEVEL GOUGE



INSIDE-BEVEL GOUGE



SOCKET BUTT CHISEL

SOCKET FIRMER CHISEL



est size of these should be purchased. One model maker fashions his own small chisels from 1/8-in. drill rod, grinding the end down and sometimes bending it, to suit the shape of edge he requires, and driving on a handle made from a piece of dowel rod. A good spokeshave is an indispensable part of the tool equipment;

this may either be of the wooden type, which the writer prefers, or one with a metal body. A

The Hacksaw with the Tube Back Is a Very Useful Homemade Tool, Also the Drill-Rod Chisel Which May Be Made in Any Shape

shape, and operations of a similar nature. There are two styles of the latter tool used by model makers; one is the ordinary coping saw, and the other is the jewelers' saw. The latter is the smaller of the two, and is thus easier to handle on some work, but the ordinary coping saw will answer the purpose just as well for ordinary work.

Chisels and other cutting tools are the next consideration. There should be at least one good-sized chisel in the tool kit, one about 1 in. wide. The best form is the beveled-edge socket chisel, and a paring gouge of similar size should also be obtained. The smaller chisels, 1/2, 3/4 and 5/8-in., and three gouges of similar width, may be of the "butt" or pocket type, with a blade about 3 or 3 1/2 in. long. These short chisels will be found exceedingly handy. For fine work, and for reaching into places inaccessible by means of the ordinary straight chisel, some bent carving tools will be found, if not essential, at least very useful. One maker puts up small carving tools in sets of six, with a variety of cutting edges, and the small-

very good form, although a little more expensive than the ordinary, is a pattern-makers' spokeshave, which can be adjusted for either straight or curved work, as the job in hand may require.

A smoothing plane, while a handy thing to have around, is not essential, since the stock can usually be obtained surfaced at the mill, but a small block-plane, about 3 1/2 in. long, is quite necessary. These are very cheap; in fact, five planes of this size can be obtained at the five and ten-cent stores which are good enough, provided the blade is kept sharp, and this is necessary with all cutting tools, regardless of their quality. There

Carving tools. Callaraigues Curbery & Lept P. M. - Suite D ally. My

15 W. Van Buren, Chicago 677

is a small tool used in making musical instruments, called a thumb plane, which is a very valuable one. The body of this tool is held between the thumb and forefinger, and the "handle" butts against the palm of the hand. In case the reader cannot buy one of these tools, a drawing is given so that he can make it himself. The body is preferably of beech, although any good hardwood with a fine, close grain will do, and is made in two parts, afterward doweled and glued together, for convenience in cutting and filing the small slot and wedge seat. The handle is a short piece of dowel rod, with a hardwood knob on the end. The knob may be a slice from a broomstick, rounded on top and drilled on the bottom for the end of the dowel. The blade may be ground from a piece of hacksaw, or made from similar steel. The bottom of the plane may be flat, concave or convex, for different work, and the cutting edge of the blade ground and honed to suit. The cutter should not project more than a "hair" from the bottom of the plane.

The most important of the cutting tools, after all, is the humble knife. The shape of the handle matters not in the least, nor the cost of the tool,

provided the blade will take and hold a good edge. A couple of "sloyd" knives of different sizes, are also handy, but I prefer a blade somewhat concave along its length, instead of convex as a sloyd knife is; however, that is a matter of taste. Quite good carving knives can be made from broken hacksaw blades, ground to shape and honed to a keen edge; the simplest form of handle for these is made by wrapping layers of tape around the end.

No matter what the cost of a cutting tool may be, the satisfaction it will give depends entirely on the care given the edge, since no tool is better than its cutting edge. Keep the oilstone constantly at hand and give the edge a few licks

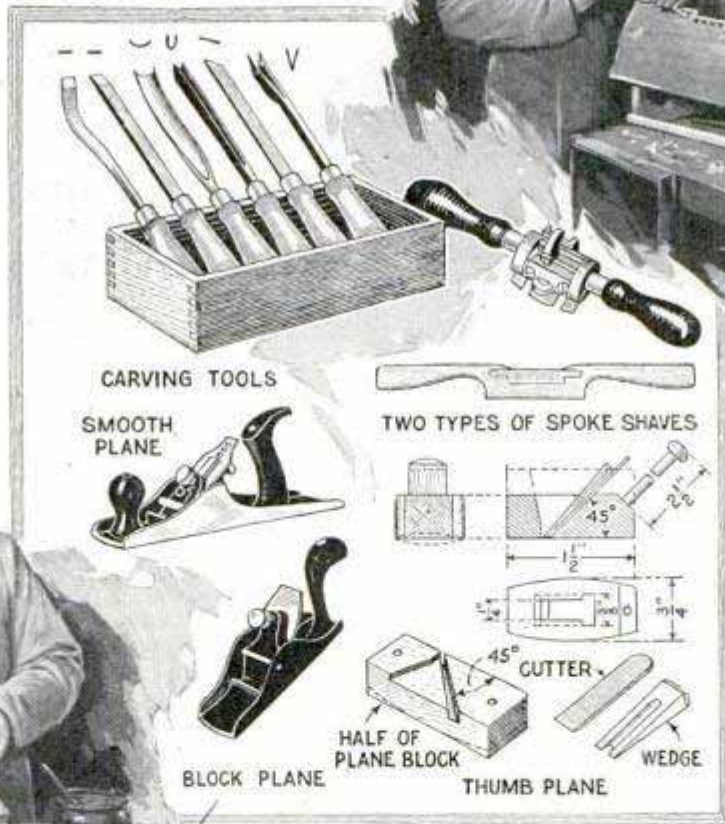

At the Lower Left Are Detailed Drawings for Making a "Thumb Plane," in Case the Reader Cannot Buy This Useful Tool

every once in a while as the tool is used. Tools kept sharp in this way do very much better work than when

they are allowed to become comparatively dull before they are sharpened. In sharpening the carving tools, finish the edges, after honing, on a razor strop, as these tools must have the very best edge obtainable, if clean cuts are to be made.

Next to his cutting tools, the modeler's best friends



Miller Falls Co.
Miller Falls, Mass

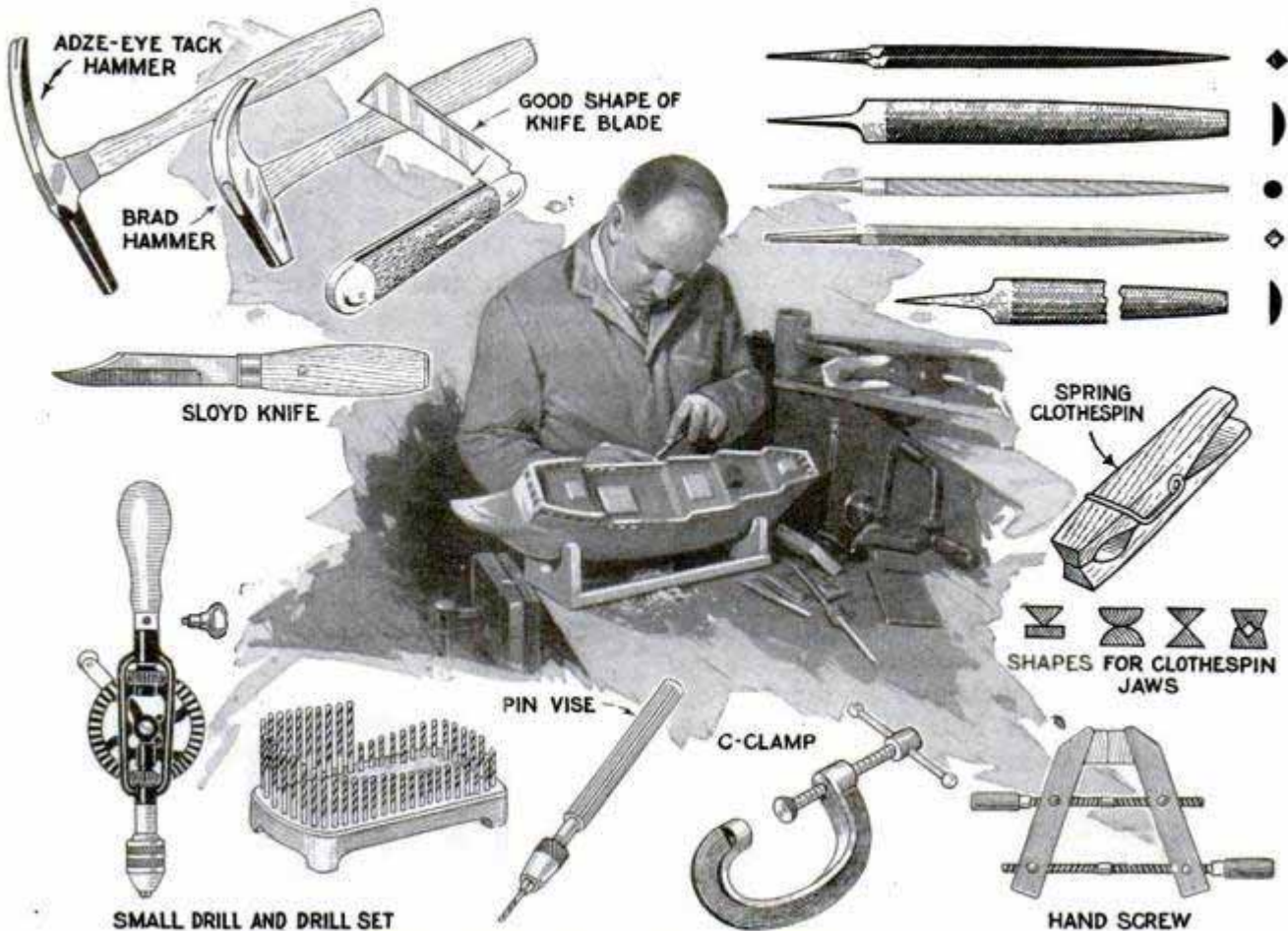

The Pin Vise and the Homemade Clothespin Clamps Are Indispensable in Gluing and Drilling Small Parts; the Knife Blade Will Also Be Found More Useful When Honed to the Shape Shown

are his files. A 10 or 12-in. flat or half-round bastard file will remove a surprising amount of wood from a rough hull in a short time, and there is not nearly the danger of cutting too deeply that there is with a drawknife or chisel. It may not be good woodworking practice to use a file on work of this kind, but the

model maker should not let that worry him. In addition to the large flat file, 6-in. pillar, triangular, square, and round files should be in the kit; the pillar, round and square files should be bastard-cut, and the triangular one a second-cut; an ordinary saw file is fine. These will be found exceedingly handy when making

TO THE MASTER OF THE GOODE SHIPPE "HALVE MAEN":

Dear Captain:

And now we have come to the end of the few months of shipbuilding under your masterly direction, months which should have found a grown man and a father at other things, no doubt, than bruising his fingers and cutting his mitts with planes and drawshaves, gluing the whole cellar from laundry to dog's bed with liquid cows' toenails, extracting slivers like fence rails, cussing in three languages (including Seneca Indian), when my compass steered me wrong in figuring out plans and specifications so clear that my young son could read them, but which, to me, were like the third declension of the irregular verb in Sanscrit; but at last, Captain, she stands on 'er ways as slick an' trim as the blue-eyed barmaid of the Purple Boar tavern, an'—shiver my timbers!—I'm proud of 'er!

The hours spent with my boy and dog while doing your delightful ship have been so very much worth while in the feeling of companionship and understanding which has come to the boy and me as a result of our mutual interest in this ship and its making, I find double return for any trouble and labor. That alone is pay enough, indeed, but

that is not all, for we have learned many things that were mysteries; the way of ships, the meaning of many strange salty terms and expressions which fascinate boys and old boys as long as they live, and the knowing and understanding of which give a new flavor to tales of the sea. Lanyard, crow's nest, gammoning, belaying pin, lubber's hole, crow-foot—they meant nothing to us before, but now, when we read of a sailor on the foretop's'l yard, we see that tar and know he isn't down in the foc's'le The busy professional man like myself I advise, without charge, that he take his boy and his tools, go down to the cellar with those copies of P. M. and learn many worthy things. It will teach him patience, perseverance—and his boy, and when he has 'er done, and the lady of his heart who dwells upstairs pats her two boys on the head and says, "It really looks just like the pictures Mr. Miller made of his ship; put it on that table near the window," he'll feel so darned proud and so thrilled with the feeling of having seen the thing through that he'll no doubt do just what I have already done—start two more.—Dr. E. W. Flagg, Auburn, N. Y.

small parts, especially by the man who is not any too sure of his control over small chisels. In addition to these, a set of needle files should be obtained. These need no handles, and come in seven or eight different shapes; if these cannot be obtained easily, get die sinkers' files. The latter are somewhat similar to the needle files, but are used with small handles. Don't use a rasp instead of the large rough file; the latter will take off almost as much stock in the same time as the rasp, but will leave the work in much better shape for subsequent operations.

As for drills, about the largest ever used for model work is $\frac{1}{2}$ in., and one each of the $\frac{1}{2}$, $\frac{3}{8}$ and $\frac{1}{4}$ -in. sizes should be all that is necessary in the fractional sizes. In the wire sizes, the worker should buy a set numbered from 1 to 60, and a couple each of the No. 65, 70, 75 and 80 sizes. To hold the drills, one of the small hand drills sold for radio work is ideal, except for the $\frac{3}{8}$ and $\frac{1}{2}$ -in. drills. For the small drills, from No. 60 up, and when drilling delicate work, such as futtock holes in crosstrees, get a pin vise from a jewelers' supply house, fasten a drill in it, and drill the hole by twirling the vise with thumb and forefinger.

There will usually be a claw hammer around the house, and for the infrequent occasions on which a large hammer is necessary this will serve nicely. There is far more occasion for several small hammers. Get an 8-oz. ball-peen hammer, a 5-oz. tack hammer and a 7-oz. adze-eye hammer with a long nose and claw, somewhat like an upholsterers' hammer, and you will be well equipped. These need not be expensive, since the work they are called on to do is very light. The writer has some hammers of the kind mentioned that cost only ten cents a piece, and has been using them for years with satisfaction.

Among the miscellaneous tools that will be found handy around the bench are a good square, with at least an 8-in. blade, an awl, a pair of good small tweezers, a crochet hook, and a number of small clamps. The crochet hook seems rather a peculiar "tool," but it will be found very handy in rigging. Among the clamps should be several sizes of small C-clamps; also, if possible, at least two,

opening 6 in., known as carriage clamps, and two regular wood clamps. If you can get a cabinetmaker to glue up your hulls, the large clamps will not be necessary, but the small clamps are essential. Very good clamps for light work can be made from ordinary spring clothespins, the jaws being cut into several different shapes to suit the work.

The individual can add to this stock as he progresses and finds that he needs one or more tools of a size not specified. There are some tools not mentioned that may be preferred for certain work by some modelers, such as a drawknife, and, of course, one needs an oilstone and oil slips for sharpening chisels, gouges, etc., as well as sandpaper of different grades for finishing work.

Safety Fence Prevents Railroad Accidents

In many towns railroads run close to buildings, and to reduce the number of

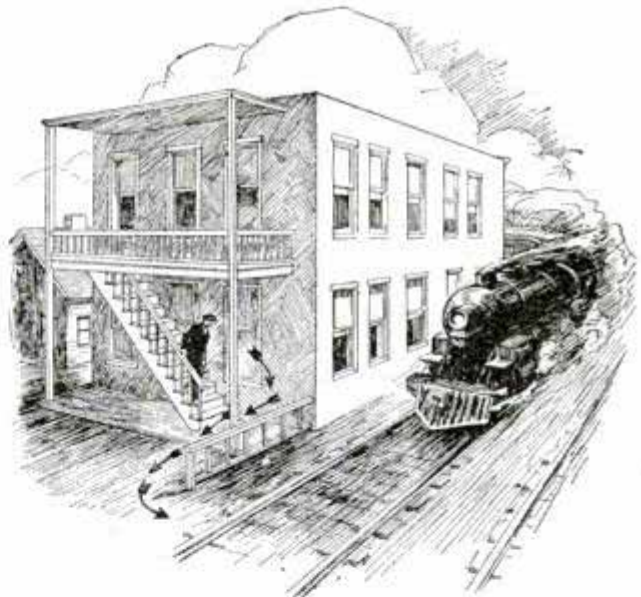

Fence at the Bottom of Stairway Minimizes the Risk of Railroad Accidents

accidents, a safety fence of the kind shown in the drawing will be found effective. When coming down the stairs behind the building a person may not hear or see an approaching train, and unless there is some barrier, he is apt to walk from the steps directly onto the track. A railing, about 3 or 4 ft. high, can be built at the bottom so that a person descending the steps is compelled to follow the route indicated by the arrows, which gives him time and opportunity to see whether or not the track is clear.—J. S. Hagans, Chicago, Ill.

Protection for Chicks in Brooder Coop

Brooder coops for chicks are usually made by nailing lath at intervals across the opening of a box. This however, necessitates the use of screens or boards to close the openings to exclude rats and mice, and prevent the young chicks from getting out too early in the morning. To overcome the extra trouble of propping boards or screen against the coops every evening

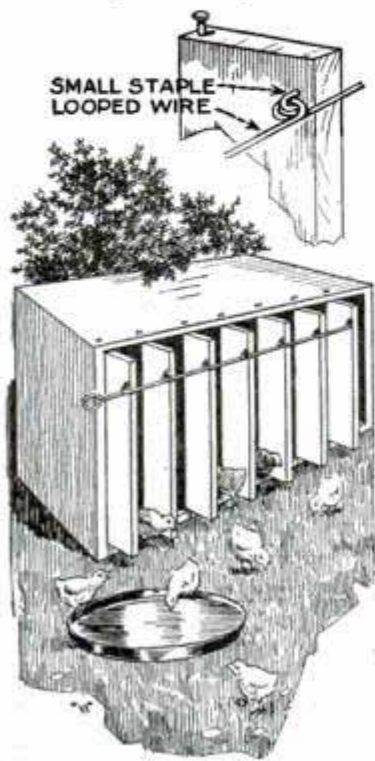

is a simple matter if a few minutes more are spent at the time the coops are made. Strips of lath are cut to fit between the top and bottom of the open front of the coop, and nails are driven at the points indicated to serve as pivots upon which the lath can turn in the same manner as window shutters. A length of wire is bent to a loop at each lath and staples are used to attach the wire as shown. By moving the wire back and forth the shutters of the coop can be opened or closed. No large door is necessary at the front, as the coop is bottomless. This permits the removal of the mother hen when necessary to move or clean the coop.—G. E. Hendrickson, Argyle, Wis.

Equalizing Rear-Wheel Traction

Owing to the differential action of automobile rear wheels, the driver is sometimes at a loss what to do when stuck in a muddy or sandy rut. The trouble is that one wheel provides traction and the other one does not. In many cases one could easily get out without being hauled out by some one, if only the traction of the rear wheels were equalized. This can be done by simply pulling the emergency

brake back just far enough to drag on both wheels, which will make them work evenly. This is only of use, however, where the emergency brake operates on the rear wheels, and is of no value when it operates on the transmission.—E. R. Haan, Chicago.

Hint on Varnishing

In varnishing, the worst trouble is the collection of dust on the treated surface. Any amateur painter can do a good job, however, by observing the following directions: First, a new brush should be used and this be cleaned by tapping it on the palm of the hand to remove loose bristles and dust; then scald the brush in boiling water to soften it and finally let it soak in gasoline for about two hours; after sandpapering the article to be varnished, the surface is carefully cleaned with a rag. Then apply the varnish and let it dry hard. Dust that collects after varnishing may be removed with a paste of pumicestone and oil rubbed with a piece of heavy felt. A fine job will result.

Homemade Colonial Candle Holders

Decorative candle holders of the colonial type are easy to make and cost very little. They consist of a flat piece of bronze or sheet iron about $\frac{1}{16}$ in. thick, cut to a diamond shape, as indicated, and bent at right angles, with a small collar to hold the candle.

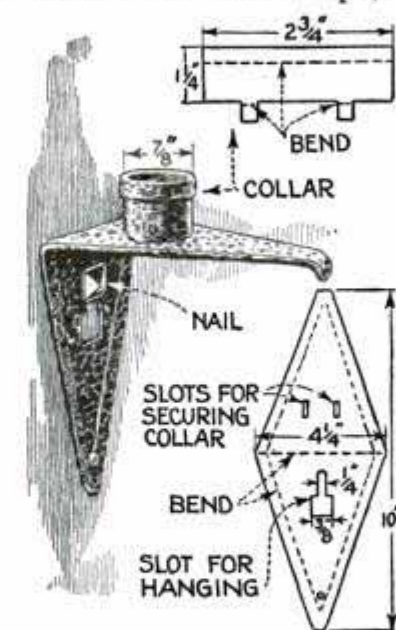

The forge marks are produced by hammering it irregularly, holding the hammer slightly tilted. To match the holder, the head of a large nail is flattened and hammered square. It is driven into the wall so that the holder can be slipped on easily.—G. A. Luers, Washington, D. C.

How to Remove a Stuck Rag from Gun Barrel

A rag that has become lodged in a small-caliber rifle barrel during a cleaning operation may easily be removed in the following way: Measure the gun barrel and get a piece of stiff wire a little over half its length after allowance has been made for a loop at one end. Fashion and sharpen the other end like a crochet hook, so that it will easily pierce the cloth wedged in the rifle. If the end of the cloth cannot be reached, get another piece of wire and split the end with a chisel instead of making a single point. Sharpen these ends and make a few nicks in the ends of both with the punch so that the wire will cling to the rag when the wire is twisted. No matter how firmly the rag sticks, the jagged edges will get such a good hold that it can be pulled out.

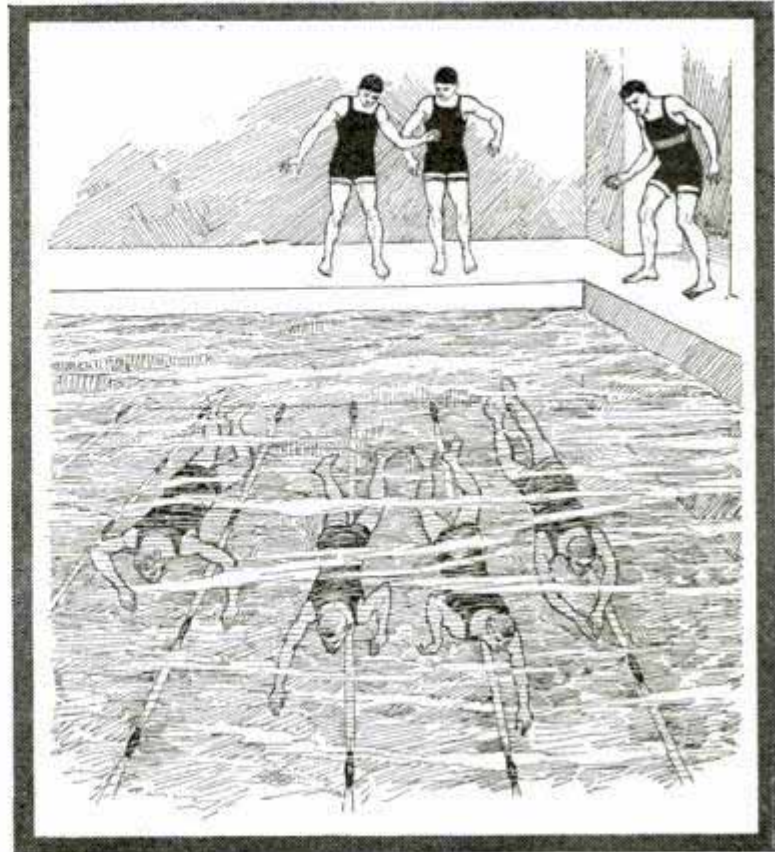

Lengths of White Tape Serve as Guide Lines in Underwater Swimming Contest

Clock-Spring Towel Clip

Towel clips can be made in a few moments from pieces of old clock or phonograph springs, as shown in the illustration.



One end is straightened and drilled to receive two or three small wood screws, with which it is fastened to a wooden base. The other end is turned over as shown, so that when a towel is pushed under it, the spring will grip it securely, but still allow it to be pulled away.—

E. A. Goering, Langenburg, Can.

Lines Guide Underwater Swimmers

When several persons dive at once for an underwater swimming race, they are likely to collide and interfere with each other because of their inability to see the course clearly. This trouble was overcome at one club by marking white guide

lines at the bottom of the pool. A number of lengths of white tape, of the kind used in marking tennis courts, were provided, each being as long as the course. Heavy lead fishline sinkers were fastened to the tape at intervals of 6 or 8 ft. and the tape laid along the bottom in a straight line from the starting to the finishing line. The tapes are spaced far enough apart to prevent interference.—L. B. Robbins, Harwich, Mass.

Arranging Piston Rings

Although it is a well-known practice to stagger the ends of piston rings so that the joints are not in line, the attention of the amateur should be called to this most important detail of assembly, when overhauling his motor. When slipping the piston back in place, take care that the ends of the rings are not above each other for by such an arrangement loss of compression would be sure to follow.—G. C. Douglas, Raleigh, N. C.

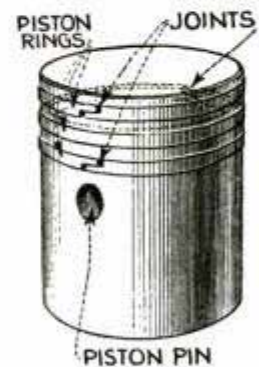

An Effective Ignition Intensifier

By THOS. W. BENSON *3722 N. H. Phila.*

THE problem of intensifying the ignition spark of internal-combustion engines has interested many inventors, judging from the numerous makes of intensifiers that have been placed on the market. Almost without exception they

hence to the plug also, the characteristics of the spark are completely changed. The system becomes a tuned oscillating circuit, and when the breaker points open, the condenser is charged and discharges across the plug a number of times with great rapidity. Therefore, instead of one spark, the charge in the cylinder is subjected to a rapid series of sparks, giving more intense ignition. This change is readily noticed by running the engine with one plug out of its cylinder, when the spark, instead of being thin and purplish in color, is thicker and nearly white.

Practically any arrangement of a condenser and inductance would serve the purpose, but the writer believes the device is re-

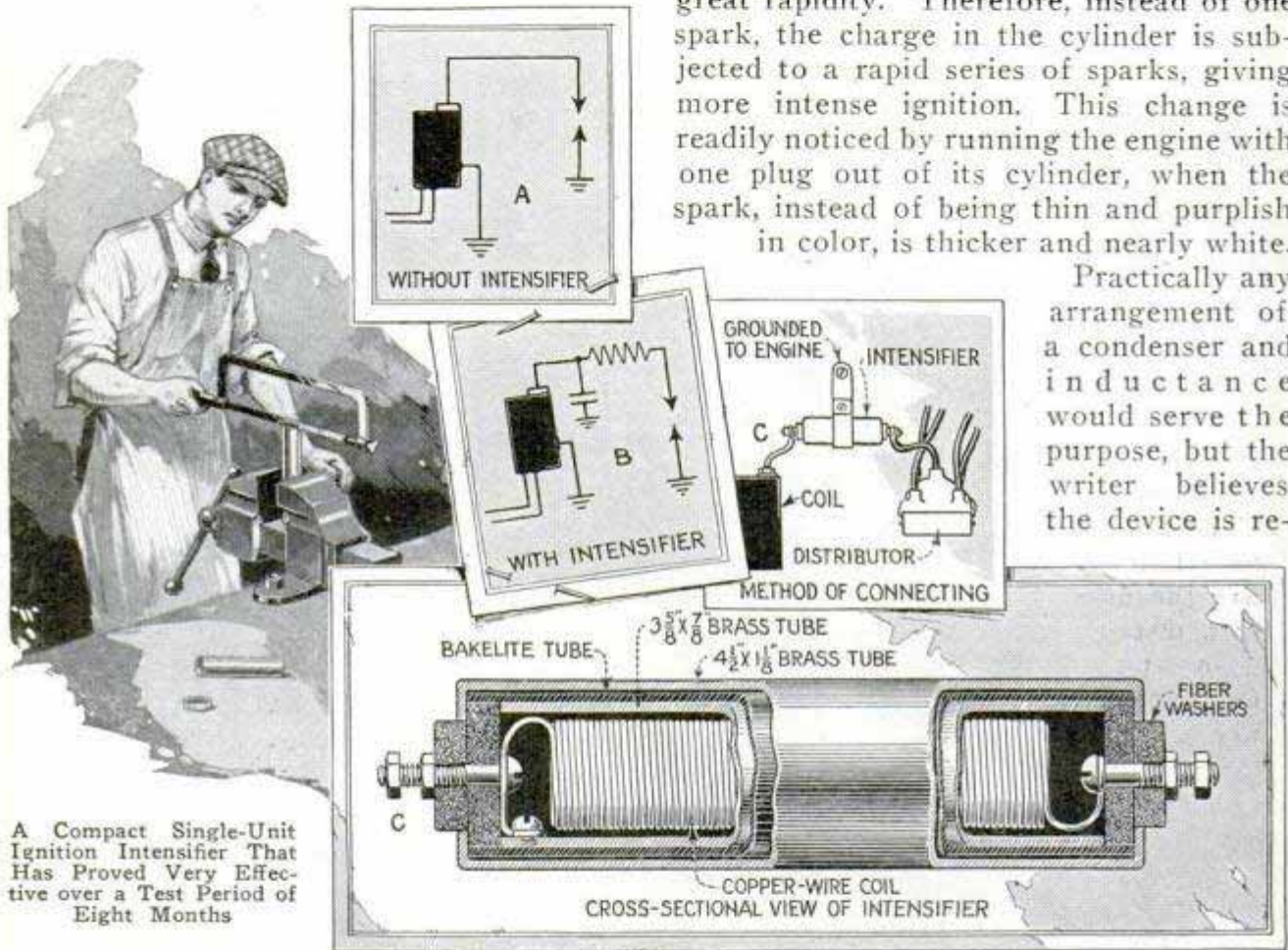

A Compact Single-Unit Ignition Intensifier That Has Proved Very Effective over a Test Period of Eight Months

have been of the series-gap type, and have had their limitations. The writer considered the problem from a different viewpoint and devised an intensifier that has proved very efficient.

The principle of operation may be understood from a study of drawings A and B, particularly by those acquainted with the old spark transmitters used in radio telegraphy. The ignition equipment on all cars using a breaker and distributor gives one spark across the gap each time the breaker points open. Such an arrangement is shown diagrammatically at A. Now, by connecting a condenser across the coil and an inductance in series with the lead to the distributor, and

duced to its simplest form by constructing it as shown in the detail drawing. Exact dimensions need not be adhered to, but are given for guidance. The outer shell is a 4½-in. length of 1⅛-in. brass tubing. The ends of this tube are slotted with a hacksaw for a distance of ¼ in. so they can be bent in to hold the assembly together. Inside the shell is a 4-in. piece of fiber or bakelite tubing, 1 in. in outside diameter with a ⅛-in. wall. The inside plate of the condenser is a 3⅞-in. length of brass tubing, having an outside diameter of ⅞ in. The large fiber washers used in the ends are ⅞ in. in diameter and the smaller ⅝ in. The writer used regular spigot washers

for the purpose. The inductance is made by closely winding No. 14 to 18 cotton-covered copper wire on a $\frac{5}{8}$ -in. mandrel until a coil 3 in. long is made. With the above parts on hand and two brass machine screws and nuts for terminals, the assembly can be started.

First slip the inductance inside the smaller brass tube, and solder one end of it to the inside of the tube or fasten by means of a screw. Bare the wire back of the soldering and wrap it around the head of the screw to be used at the left-hand terminal as shown; then assemble the two washers on the screw and bolt up tight. The brass tube with the inductance inside is then slipped into the fiber tube and positioned about midway of its length. The free end of the inductance can then be pulled out, and the other terminal, with its insulating washers, attached. It is well to identify the terminal that is connected to both the inductance and the inner brass tube with a pencil mark or file scratch, so the device will be connected properly into the circuit.

The final step of assembly is to inclose the whole in the outer brass tube. Prepare the outer shell by slotting the ends for a distance of $\frac{1}{4}$ in., spacing the slots $\frac{1}{4}$ in. apart around the tube. Bend in the strips thus formed at one end of the tube. The fiber tube should now be slipped into place, the smaller washer on the terminal extending out beyond the bent end strips of the tube. The strips at the other end of the tube are then bent over to hold the whole device together.

The method of connecting between the coil and distributor is shown in one of the small drawings. Take care that the marked terminal, connected to inductance and inner tube, and indicated by C in the illustration, is connected to the coil. A bracket holds the device on the engine and grounds it. Eight months' test has proved that it will fire any plug that is not short-circuited.

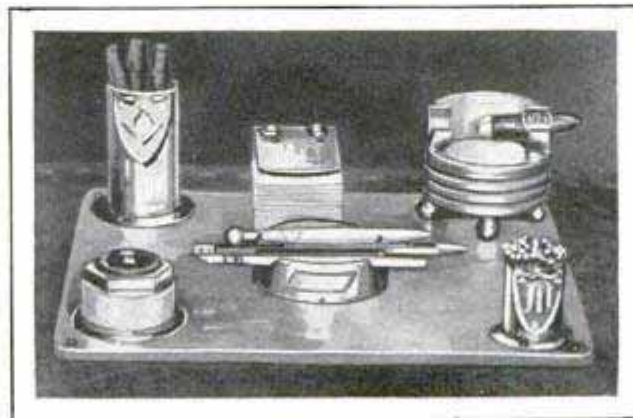

Novel Smoking Tray and Writing Outfit Made from Old Auto Parts

Kink for the Fisherman

If your fishing rod is the cause of sore ribs, provide a leather disk on the end of the handle as shown in the photo. The



Leather Disk Attached to Fishing-Rod Handle Will Serve to Prevent Sore Ribs

disk can be cut from a piece of sole leather and is tacked or screwed to the front end of the handle.—Andrew R. Boone, San Diego, Calif.

Smoking Set from Auto Parts

A novel and handy smoking set was made from various parts of discarded cars. The cigar holder is a piece of the steering post and the end of a coil, and the monogram on it was taken from a radiator cap. A resistance-unit box was used to make the calendar holder. The ashtray is an old piston and the feet are balls taken from a bearing. The pen rack and pin tray are made from an old piston and the pen holder from an old gas line and a spark-plug cap, while the letter opener is formed from the handle of a windshield cleaner and a hood bolt. A brass dash plate and a radiator splash-pan flange were used to make the inkwell, while a water-inlet tube and a dash-lamp bracket made the matchbox. The base on which these parts stand is part of an old aluminum door.

Drain for Yard Hydrant

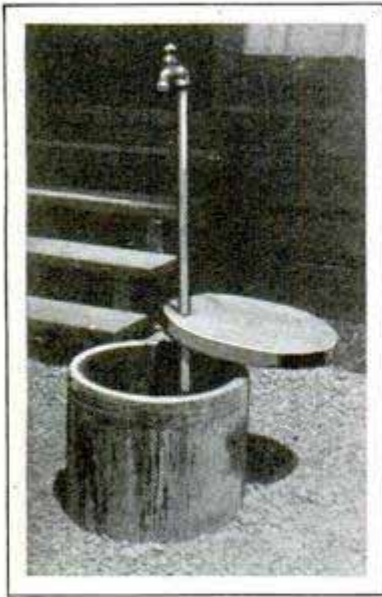

To prevent mud puddles around a yard hydrant, the drain shown in the photo has been found quite practical. A sewer drain, or sink, is installed directly under the hydrant, being sunk about 1 ft. into the ground,

and a large tile is slipped over both. A lid will make a good stand when filling buckets.

Safe Razor-Blade Holder

The problem of disposing of used safety-razor blades so that small children cannot get hold of them may be solved by cutting a slot in the lid of an ordinary tobacco tin and soldering the lid shut. This will hold about a year's accumulation of blades and can then be thrown away without endangering anyone.



Jerky Speedometer Shows Lack of Oil

Most speedometers are driven from the transmission, and, on several popular cars, the driving gear and worm are lubricated from the universal joint. The speedometer should accelerate smoothly with the car, but occasionally it will seem to catch and swing from the correct position, registering from five to ten miles fast at each oscillation, especially when the car is being driven fast. Investigation of a number of cases revealed that it was not the speedometer drive which was at fault but that the grease was entirely

gone from the universal joint due to neglect, and the friction of the gears driving the speedometer was sufficient to cause the jerking. Repacking the joint with grease restored the even movement of the speedometer, not to mention the benefit to the universal-joint bearings.

Simple Way of Regulating a Clock

When a clock is going too fast and the adjustment pin is at the extreme end of the slot toward the slow position, or vice versa, proceed to adjust the clock in the following way: Remove the back of the case and you will notice two little curb pins on each side of the hairspring. These are for the purpose of controlling the expansion of the spring. Open these slightly and then move the regulator back toward the middle of the slot. This adjustment should slow the movement down slightly and the regulation can then be made in the regular manner by the adjustment pin. Pressing these pins together slightly but not enough to bind the spring will have a tendency to increase the speed. Be careful, however, in making the alterations, as a slight opening or closing will be all that is necessary.

Crimping Stovepipe

When house-cleaning time comes and the kitchen stovepipes are taken apart for a thorough cleaning, it often happens that they do not fit snugly when again put together. This would make it necessary to crimp the ends with a tinner's tool, but as this is not usually a part of the home

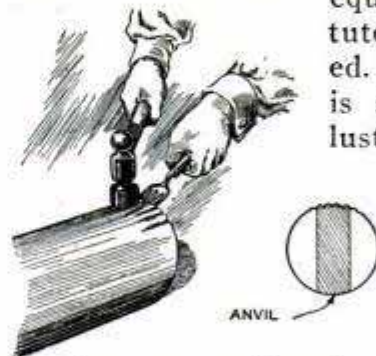

equipment, a substitute must be provided. A simple method is shown in the illustration. An old fork, a hammer and a small block of wood are used to do the crimping.

The block is used as an anvil and the prongs of the fork are pushed over and under the edge of the pipe, as shown, so that light tapping of the hammer will make the crimps in the pipe.

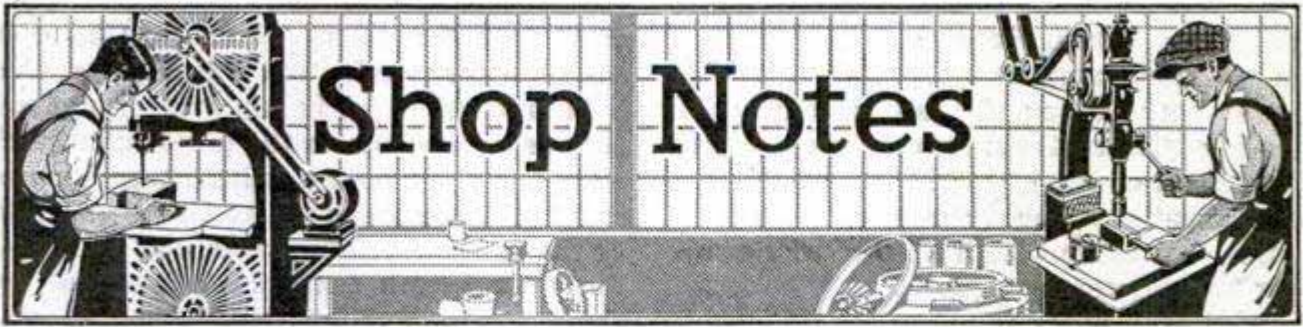

All Shop Notes published in 1926, in book form—Fifty Cents—from our Book Department

How to Buy and Keep Your Paintbrushes

By T. M. JAMES

THERE is probably no tool that the handy man around the house uses more than the paintbrush—nor one that he knows less about. He knows, of course, that there are good and bad brushes, but what constitutes a good brush is a com-

problem: the average man is usually content merely to wash out the brush he has just finished using in turpentine and put it to one side, with the feeling that he has done about all that is necessary. The consequence is that the next time he needs the tool, he finds it almost useless. If it was a good, and consequently an expensive, brush in the first instance, this hits him in the pocketbook, in addition to the annoyance experienced by finding the brush unequal to the job. If it is a cheap brush, it might just as well be thrown away. We will not speak of the habit of simply leaving the brush in the paint for weeks or months, or of putting the brush to one side without even cleaning. Everyone

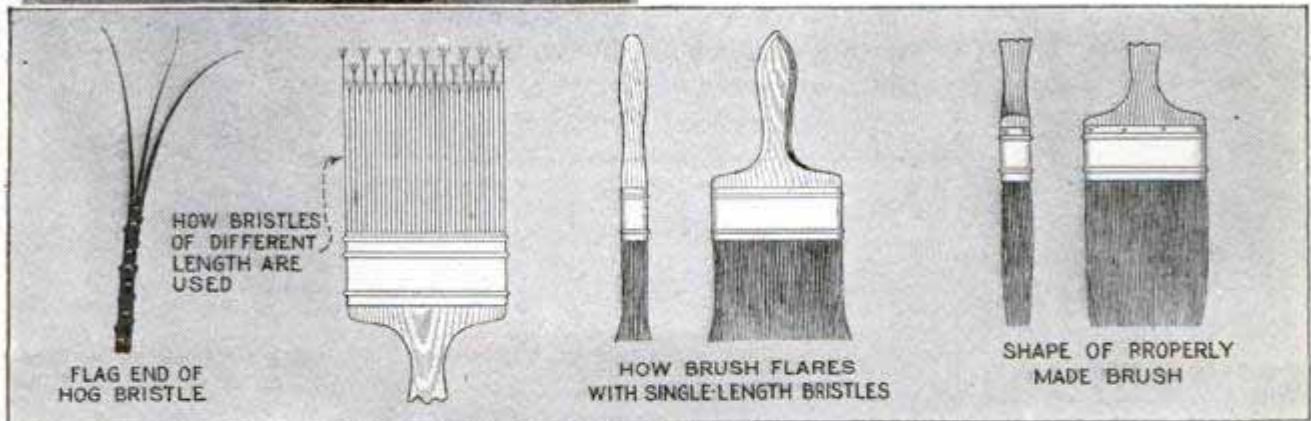

Drawings Show Points to Look For in Good Brushes

plete mystery to the average householder. In addition, the matter of keeping brushes in good condition throughout the year remains a

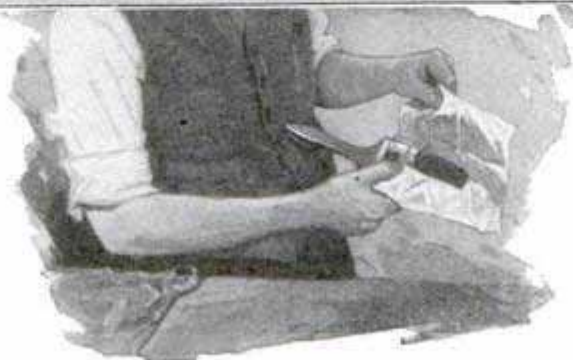

How the Brushes Should Be Wrapped for Storage

knows that this shouldn't be done, and everyone has experienced the consequences at one time or another. The most important part entering into the

construction of a brush is hog bristle. There is no other material that is as good as this for paintbrushes. Hog bristle is horny and elastic and has excellent wearing qualities, and besides this, the peculiar formation of the ends of the bristles renders them particularly good for the purpose. An examination of the bristle under the microscope shows that it has a hard, horny outer shell, composed of minute scales, and a softer pith in the center; it is a little larger in diameter at the root than at the tip, and at the "business" end it branches out into several smaller ends, called the "flag" end, as shown in one of the illustrations. This end really forms a small brush in itself, and is what enables a brush to carry a load of paint well. This characteristic is also largely due to the fact that hog bristles are barbed for their entire length.

The most common substitute for bristle in inferior brushes is horsehair. This has not the flag end found in the bristle, and besides, has not the elasticity and is not barbed like bristle, and consequently it

will not carry the same amount of paint.

A properly made brush is built up of bristles of several lengths. If the bristles were all of one length, the brush would have a decided

"toppy." When the flag ends of the bristles have worn down, a brush of this type will spatter paint and "leak," as the painter calls it. A brush with graduated lengths of bristles, on the other hand, will wear for a long time, without any tendency to these faults. As the flag ends of the longest bristles wear out, those of the next length come into use, and as these wear, the next length, and so on, the brush retaining its good painting qualities until it is worn practically down to the ferrule.

The most important things to observe when buying a brush are the following: The bristles should be long, clean, straight and springy. The brush should feel well-balanced in the hand, and should present a trim, well-made appearance. Even with a certain amount of familiarity with the requirements of a good brush, it is rather difficult for the amateur to be sure that he is getting the best value for his money. The best advice one can give, aside from the foregoing, is to pay a good price for the tool, select only those made by a well-known manufacturer and to avoid cheap brushes, made by an unknown maker as one would the plague. With brushes, as



For Painting Walls, Use a Wide Brush and Save Time

flare at the ends. It is a common error of the amateur to buy a brush because it seems "full," when, as a matter of fact, it may contain too much horsehair, and merely be



For Window Trim, Use a Flat or Oval Sash Brush

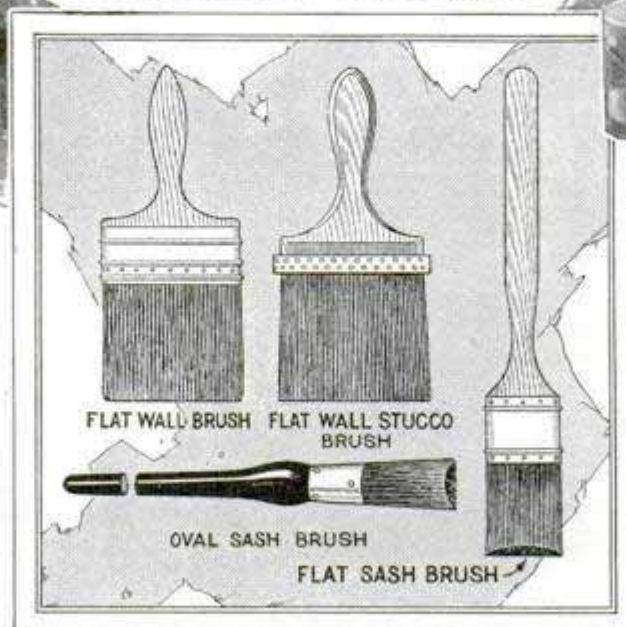

with the tools of all other skilled trades, it is poor economy to buy cheap articles which, in the end, prove dear at any price. The main factor in the life of a brush—given

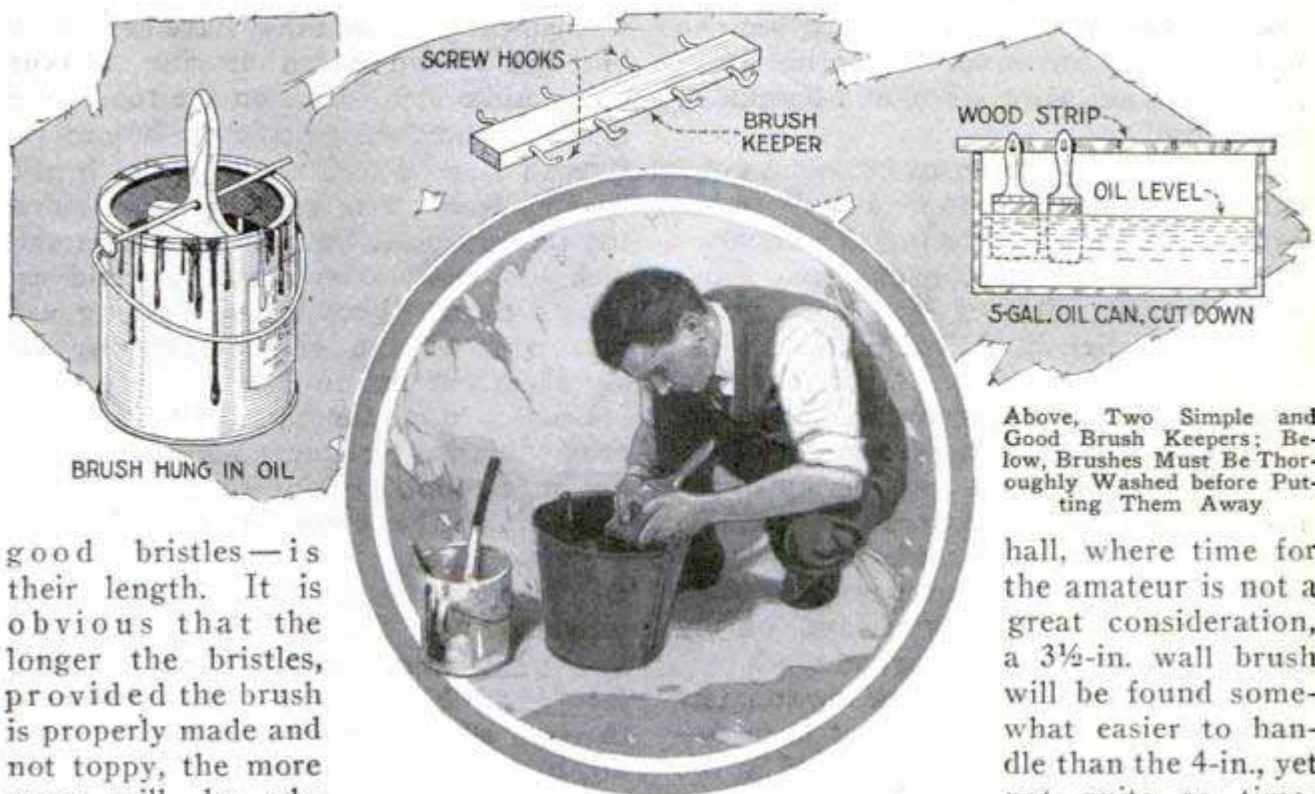

Above, Two Simple and Good Brush Keepers; Below, Brushes Must Be Thoroughly Washed before Putting Them Away

good bristles—is their length. It is obvious that the longer the bristles, provided the brush is properly made and not toppy, the more wear will be obtained from it. The manner of setting the bristles is a matter of judgment on the part of the maker, and the buyer need have no prejudice in behalf of any particular method. Brushes with bristles set in glue, cement or rubber are all perfectly satisfactory, if made by a good maker; while brushes that appear to be set in the same manner, but selling at a low price and not backed by the name of a reliable manufacturer, may be useless, due to the shedding of the hairs.

As to the type of brush that is best for various painting jobs around the house, there are almost as many opinions as there are painters. Some prefer the flat, metal-bound type; others, again, will have nothing but the leather-bound flat stucco brush. Many painters prefer the older type of round and oval brushes for large surfaces. All are good, and the choice depends to some extent on what part of the country the reader is located in. There is one thing that should be taken into consideration, however, and that is the size of the brush. Where large surfaces are to be painted, a 4-in. brush will do the job in a quicker and more satisfactory manner than a 3-in. one, and if a new brush is to be purchased, the larger size should be bought for a job of this kind. For the average small-wall job, such as a bathroom or

hall, where time for the amateur is not a great consideration, a 3½-in. wall brush will be found somewhat easier to handle than the 4-in., yet not quite so time-consuming as the 3-in. size. The bristles should be from 3 to 4 in. long. For painting small work, such as trim and window sash, etc., either a flat or an oval sash brush should be purchased. Flat brushes commonly used are the 1, 1½ and 2-in. sizes, and the bristles should be from 2 to 2½ in. long. The oval brushes are made from 7⁄8 to 1⅝ in. wide and with bristles ranging from about 1¾ to 2¾ in. in length. There is not much choice between the two types. The flat tools will cover the surface quicker than the oval, but the latter, on the other hand, are preferred by many painters for fine work.

The flat varnish brush is the tool for the amateur. This brush is very similar to the flat sash brush, but has a shorter handle, and is made in much greater variety. It is made from 1 to 4 in. wide, and with bristles from 1¾ to 4 in. long. For varnishing floors or other large surfaces, the 3-in. size will be found the most suitable, and the 1 to 1½-in. size for trim and small work. The best grades are made of white French bristles or Chinese black bristles of suitable length and good elasticity.

The varnish brushes used for flowing coats on fine furniture, for flowing on fine enamels, finishing automobiles, etc., form another class that will not be discussed here. Should the reader have oc-

casation to use one of these brushes, he will be well advised to present his problem to a good paint store, and be guided by their advice.

One would not think of buying a good chisel and allowing it to lie around to become rusty and dull during the intervals between use, and yet many men think they do their full duty by a good brush when they stick it, full of the paint just used, in a pail of water. A brush should never, under any circumstances, be stored in water. When a hog-bristle brush is plunged into water, it soaks it up like a sponge, and the next time the brush is dipped in paint or varnish the water is sealed in. The consequence is a soft, flabby brush, with twisted and unruly bristles, which cannot do good work.

Brushes should be cleaned immediately after use. If the job has not been finished, and the brush is to be used in the same paint next day or evening, put the brush in a pot of linseed oil overnight. Don't stand the brush in the pot. Hang it. Drill a hole through the handle to take a stiff wire that will extend from side to side of the pot, and so that the ends of the bristles will be at least $\frac{1}{2}$ in. above the bottom of the pot. If several brushes are to be kept in the same pot, wire hooks can be made to hold them; but don't stand them. Brushes stood on end, no matter in what liquid, will bunch out and curl up at the ends, and then—good-by, good, easy work. Another good scheme is simply to use a piece of hardwood across the top of the pot. Into each edge of the wood strip drive a number of screw-hooks and hang the brushes on them. See that the oil in which the brushes are kept comes well up to but not over the ferrule. When the brushes cannot be stored in an oil bath, work as much paint as possible out of them on a clean board, then wipe them well with old rags, and finally wash out all the paint—every bit of it—in gasoline, benzine or kerosene. Straighten out the bristles and lay the brush on its side until it is dry.

Varnish brushes, or brushes used in enamel, may also be suspended in the oil pot overnight, but be sure to wipe the brush free from the oil before using it in the varnish again. It is really better to store varnish brushes overnight in the

varnish can, in which they have been used, but this would mean leaving the can open, and a skin forms on the top, which must be removed completely before the varnish is used again. A special brush-keeping varnish is sold by paint stores for this purpose, but the amateur's varnish jobs are so few that it would not pay to obtain this. When cleaning varnish brushes, use only turpentine, and lay them out flat to dry.

Brushes used for aluminum, gold and other "bronze" lacquers may be washed out in alcohol, benzine or gasoline, and this should be done immediately after they are used. Shellac brushes should also be washed out in alcohol immediately after use. These are quite often kept in the shellac pot, and this is fairly satisfactory if the pot has a close-fitting lid through which the brush is tightly fitted, but if the top of the pot is open, the ferrule and the bristles around it become "seedy" from the shellac, which hardens between the bristles and afterward flakes off and gets all over the work.

If the brushes are not to be used for a long time, they should be thoroughly washed, with alcohol, turpentine, gasoline or benzine as the case may be, as previously directed, taking care that the bristles are thoroughly cleaned right up to the ferrules, then wrapped with paper, to keep dust and dirt out, and tied with string and laid away flat. Store them on a shelf in a cool room, and place a few mothballs around them. Moths will lay eggs in the bristles, hence the precaution.

All this may seem a lot of work, but it really takes much less time to do than to describe, and, as none but good brushes should be purchased, if the user wants to do decent work, and good brushes cost money, it is really worth while to care for them, not to mention the time saved when the next painting job comes along.

Soldering and Brazing Nichrome

While in the research department of a large concern manufacturing electric-heating appliances, I was called upon to devise a method of welding brass contacts to nichrome ribbon. Nichrome is a hard material to solder or braze, but this difficulty is overcome by fusing borax at

the point where the joint is to be made. The part is then cooled and the fused borax knocked off. This leaves a clean surface on the nichrome to which the solder or brazing compound will adhere. Nichrome wire or ribbon treated as above can be soldered nicely in this way.—Wm. Hoppe, Sunland, Calif.

Preventing Movement of Shifter Handle

Some machines having a fast-and-loose pulley countershaft occasionally start up by themselves, which in many cases is dangerous. The trouble can be prevented in a simple manner on machines that do not need to be stopped or started often. Take a piece of round stock for a weight and drive a length of rod into it. Upset and flatten the other end of the rod and make a stud to fit on the end of the shifter handle. This is slotted and drilled to receive the flattened end of the rod, which is held by means of a pin, and is tightened with a nut. When the handle is moved to the on position, the weight is swung round to the center as shown, and this movement is reversed for the off position. Thus the handle is prevented from working in either direction. The device would be useless in the case of a machine that has to be stopped and started constantly, but many of the modern machines are controlled by a clutch below, the handle only being used to start the clutch pulley. It is to a machine of this type that this safety device applies.

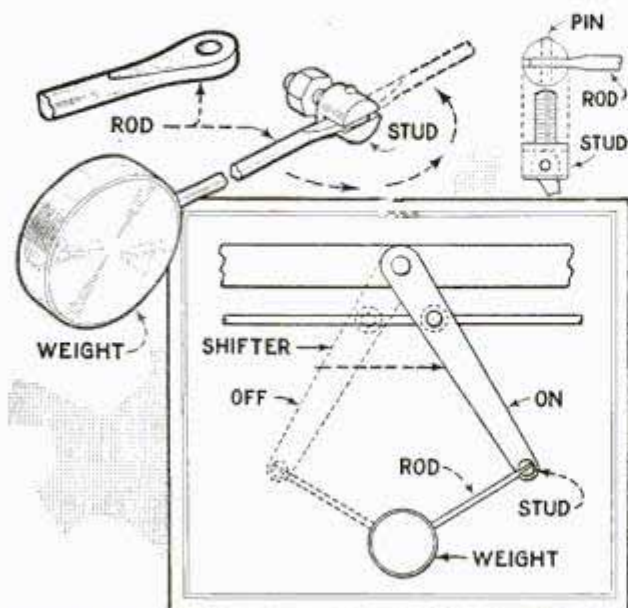

Safety Device for Shifter Handle That Prevents Machine from Starting Too Easily

Piston-Ring Compressor

Where no special tools are available for the purpose, a piston-ring compressor made

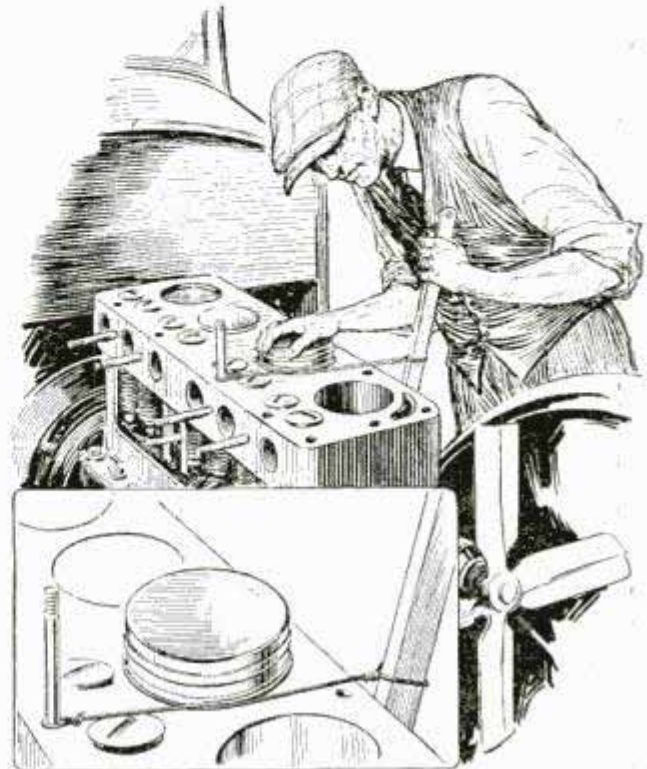

Effective Method of Compressing Piston Rings with Length of Baling Wire

from a length of stovepipe or baling wire and a metal rod or hardwood stick will be found very effective. A loop is made at each end, one end is slipped over a stud driven into the block, the wire is wrapped around the piston ring and the other loop over the rod. Using the latter as a lever, the wire is pulled tight and the ring will be squeezed into place.—Luther Strosnider, Onaga, Kans.

How to Proofread Mimeograph Stencil

One of the stenographers in a New York office discovered a convenient method of proofreading mimeograph "dry" stencils. Instead of holding the stencil up to the light to read, or inking an impression, which makes it necessary to clean the stencil in case a correction has to be made, she places a thin sheet of paper between the fiber sheet and the backing. These new dry stencils have a coating of blue wax, which leaves the color on the sheet under pressure of the type. Thus the entire copy is printed in blue wax on the sheet inserted between the fiber and the backing.

Precast Units for Retaining Wall Provide Strength and Drainage

Much of the cost involved in erecting concrete retaining walls for embankments along highways is in the installation and

and as the face of the wall is open, all surplus moisture drains off without damage. No mortar is used in making these walls. The concrete used is a 1-to-5 mixture of cement and gravel. Steel reinforcing rods, four in number, are laid

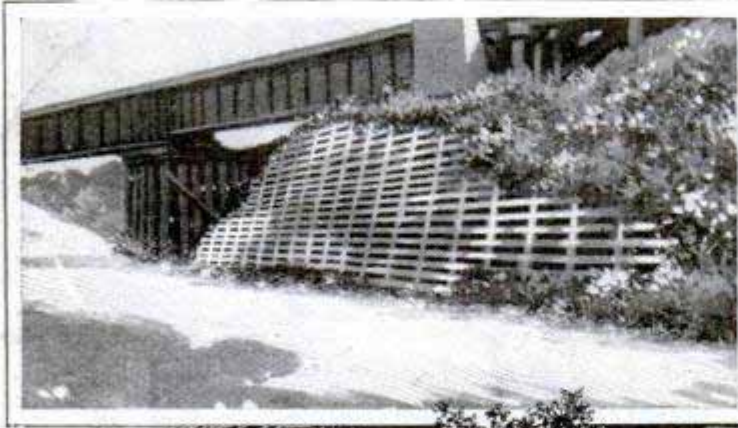

New Type of Concrete Wall, Used on Highways to Prevent Earth Embankments from Washing Out or Breaking Down over the Road, Is Built Up of Slabs, Which Provide Strength and Insure Proper Drainage

removal of the forms. In some cases, too, it becomes necessary to provide adequate drainage. Now and then, when a solid concrete wall is cast under these conditions, the tremendous force exerted on the wall is sufficient to fracture it. This involves more expense and sometimes necessitates renewal. One steep embankment on a main highway leading out of Omaha, Nebr., is faced with a novel and wholly satisfactory concrete wall built up of units, as shown in the drawing. The face rails are 8 ft. long, with interlocking joints at the ends, and of the section shown. They are held in place by means of tie-rod slabs, which have a special head to interlock with the face slabs. As a rule, the tie-rod slabs are about 8 ft. long to insure proper anchorage for the whole wall and about 12 in. square at the ends, while the body is about 6 in. square, but may vary in length. One distinct advantage of this type of wall is that the slabs can be precast where raw materials are convenient and during spare time. There is plenty of flexibility to suit any road condition,

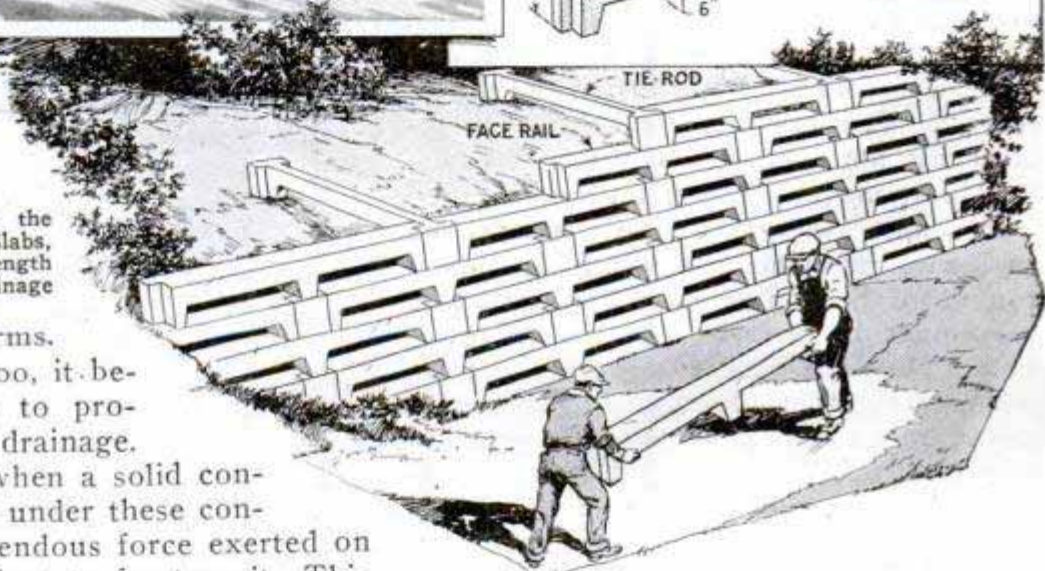
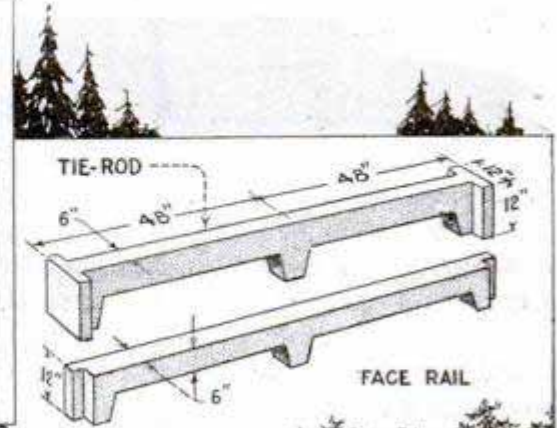

in each unit, the ends being bent at right angles to add greater strength.—Dale R. Van Horn, Walton, Nebr.

Interior Painting

Interior painting is rather expensive and there are many who do their best to cut expenses when building a home. To these it will be of interest to know that Georgia pine, which is much used for interior trim, can be well covered with only two coats of paint before applying the necessary finishing coats of enamel. In other words, two coats of paint are eliminated and much labor saved, as it usually takes from three to four undercoats, properly sanded, to do the work in the ordinary way. In the simpler method, a mixture of seven parts pure linseed oil and one part pure pine tar is used for the

priming coat. This must be rubbed in well with a brush. When dry, apply a coat of pure white lead, thinned with raw linseed oil, with very little drier, and to this add just enough good lampblack to give it a slightly gray tint. Brush out this second coat well so that all chances of blistering will be eliminated. The trim is then ready for the enamel coating, and the grain will not show.—L. H. Georger, Buffalo, N. Y.

Testing Length of Rubber Bumpers

Rubber bumpers on the door frame of closed cars sometimes require adjustment because they do not touch the door when closed. This is due either to wear on the blocks, or warping of the door or frame. As several rubber blocks are used on each door it is difficult to see which are touching the door when closed. A strip of tough paper held at one end from the inside of the door and projecting outward over a rubber block and between the door and the frame will show if it is touching the door when closed. If the paper can be removed easily after the door is closed the rubber block is too short.

Non-Skid Loading Plate

Sheet-iron plates used for loading from platforms to freight cars, or vice versa, often become slippery, and are a fruitful source of accidents. A good method of improving the plate is to weld onto its surface a number of short "ribs," as shown in the photo. They are built up by using welding rods and an acetylene torch.

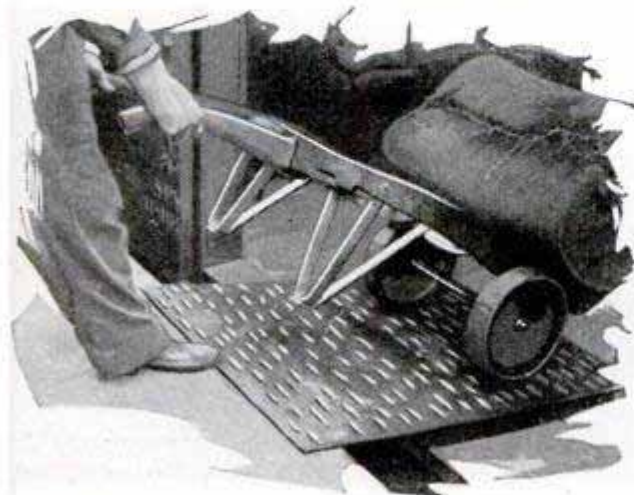

Ribs Welded on Surface of Loading Plate Prevent Trucks from Skidding on It

Staple-Driving Tool

Driving staples is usually a rather awkward task, but with the holder shown in

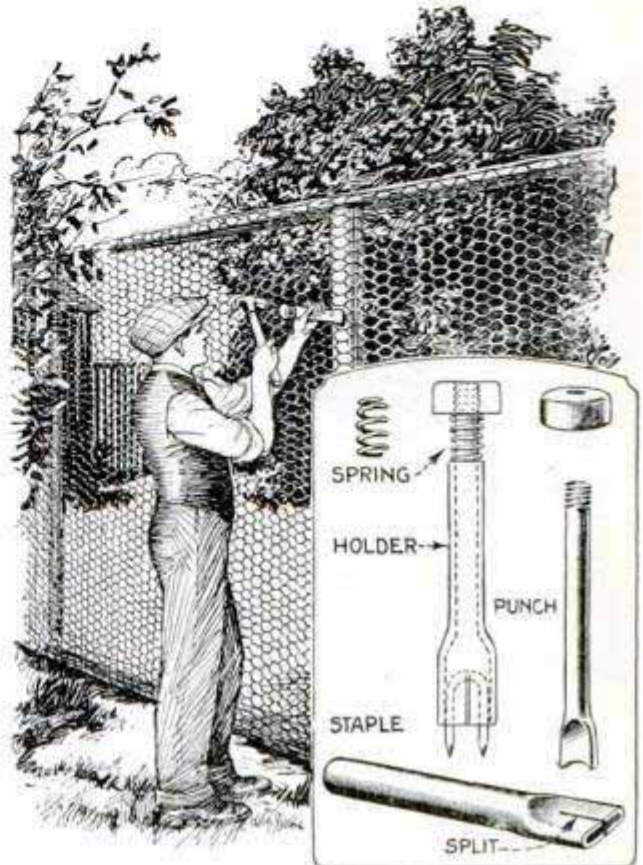

Staple Driver Made from Bolt and Pieces of Metal Tubing Saves Time and Sore Fingers

the illustration it becomes easy, saving time and sore fingers. It consists of a piece of metal tubing, flattened at one end to receive the staple, and a punch made from a bolt, which can be slid up and down in the tube. The head of the bolt is cut off and the end flattened and ground to fit inside the lower end of the tubing, while the threaded portion projects beyond the upper end to receive a small coil spring and a nut. The use of the tool is obvious.

Casting Oil Grooves in Bearings

When pouring bearings, for example the main bearings in a cylinder block, a perfect oil groove can be made by laying in short pieces of match stems of the desired length before the babbitt is poured. A piece of metal is sometimes used for this, but it is difficult to remove, while the wood burns away almost entirely, leaving a good groove.—R. M. Shelton, Dallas, Tex.

Easy Method of Oiling Overhead Shafts with Oilcan Attached to Long Pole

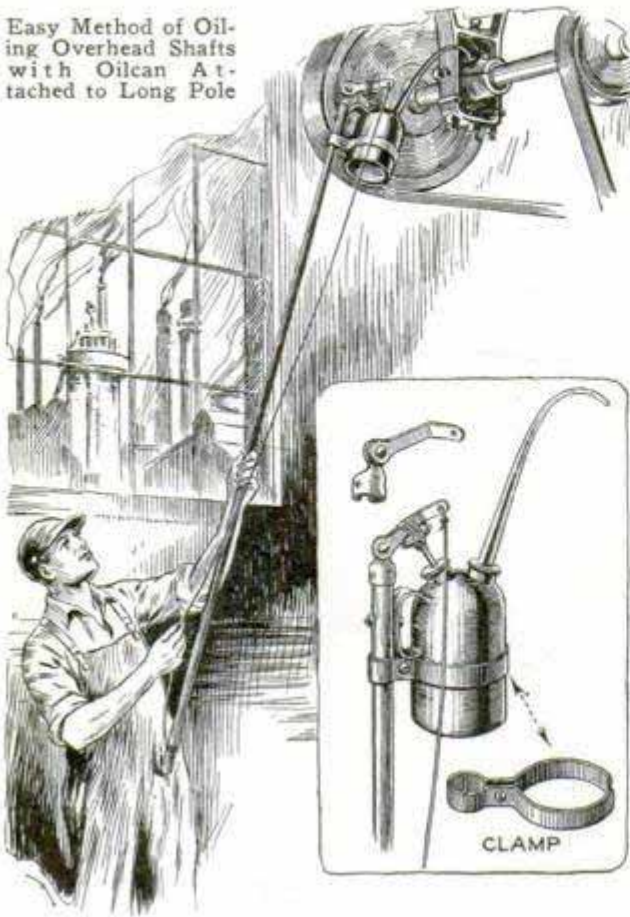

Oiling Overhead Shafts

We found it annoying, while oiling overhead shafts, to carry a ladder, especially when there was quite a bit of machinery around. One mechanic solved the problem by attaching a pump oilcan to the end of a 10-ft. pole. A bent spout, as shown in the drawing, permitted the worker to drop the oil from above the shaft. The oilcan was attached to the pole by means of two pieces of strap iron, bent to fit around the oilcan and the pole and with a $\frac{1}{2}$ -in. flat portion between, which was drilled for a screw. A short lever was made of a strip of $\frac{1}{16}$ -in. stock and pivoted to the upper end of the pole, as indicated. A hole is drilled in one end of the lever to permit the attachment of a cord, which is pulled down to actuate the pump plunger on the oil-

can. When in use, the pole is held in one hand and the lower end steadied against the body, while the cord is pulled with the other hand to discharge the oil.—L. J. Flugel, Chicago, Ill.

Holder for Bendix-Cover Screws

The Ford bendix cover must sometimes be replaced when no special tool is at hand for holding the four small screws. The gasket should be prepared by shellacking one side and dusting the other side with graphite or tire mica. It is stuck in place on the transmission cover with the graphite side out. If the cover must be removed later, the gasket will remain on the transmission cover and be uninjured. The screws on the side next to motor are started and the cover replaced, the slotted screw holes in the cover allowing the edge to be moved under the heads of the screws. The upper and lower screws are easily placed and a holder made of small wire is used to start the screw next to the frame of the car. The holder is made by wrapping one end of a piece of fine wire around the body of the screw. When starting the screw, it is lowered from above with one hand and held at the right place while the screwdriver is used with the other hand. When the screw is well started, the wire is pulled off.—E. T. Gunderson, Jr., Humboldt, Iowa.

Triangular Gluing Table Triples Output

A manufacturer of pianos has solved the problem of increasing the production, on one operation, in the same amount of space by providing a three-sided gluing table of the type shown in the photo. It consists of a triangular framework upon which the sides are fastened, and is supported on a shaft in the center so that a workman can turn and then lock it with any one of its three sides at the top.

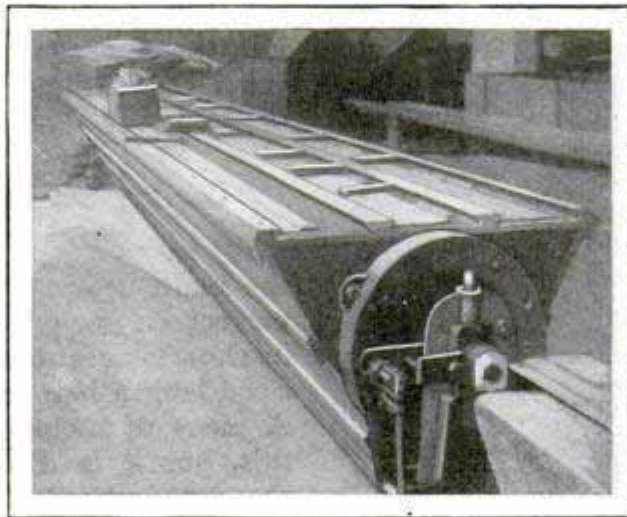

Triangular Gluing Table Rotates on a Horizontal Shaft and Triples Output

Battery Charging with the Farm Engine

By L. B. ROBBINS

NOT all farms are provided with current from the public mains or from their own lighting plant. It is therefore necessary for the owners to take car, truck and radio batteries to town to some charging station when they become low or discharged. Practically every farm of any size, however, does possess a gasoline engine for pumping, ensilage cutting and general work, and where such an engine is of 3 hp. or more, and fastened to a solid foundation, it can easily be used for battery charging without altering it in the least. Engines vary so much in design, size and minor details that specific directions cannot be given to suit all types, but the general idea in this article can be worked out by anyone to suit his own engine. Just carry out the principles of the design, and you will have no trouble in the construction of this simple equipment.

The charging unit consists of a Ford genera-

tor, which can be purchased for a few dollars from any dealer in used-car parts. Also buy a large Ford timing gear, and be sure the pinion on the generator shaft is included. First fit the timing gear to the crankshaft of the engine. This should be on the wheel turning clockwise, and is usually on the right-hand side of the engine, although this depends on the type. It may be necessary to bore out the shaft hole in the gear and enlarge the keyway to fit the shaft. If so, be sure to center it perfectly, then drive it on so it fits near the end of the shaft, as indicated in the drawing.

A wooden frame should then be assembled after the design shown. This consists of two upright pieces of 2 by 6-in. stuff, which are mortised and bolted to a horizontal base of the same material. Set the uprights back a few inches from one end, and bolt a slanting brace between them of any suitable heavy wood.

The rear end

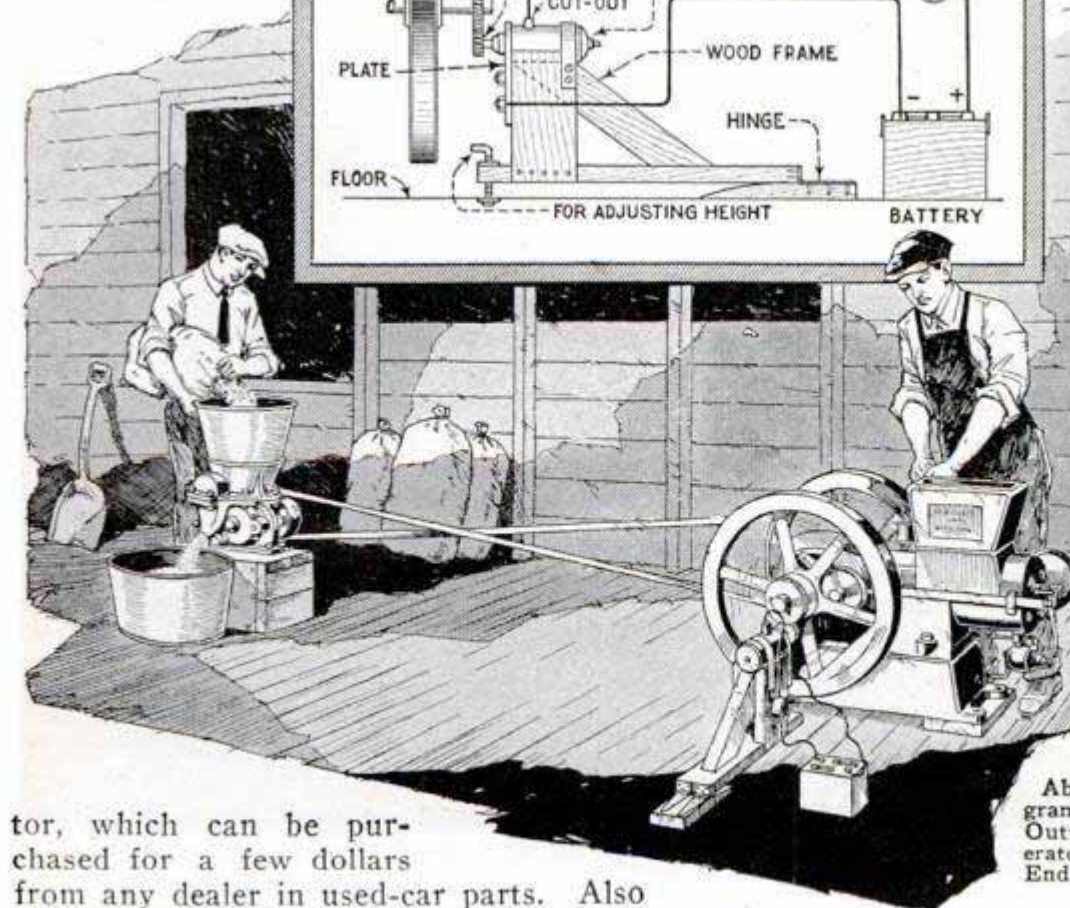
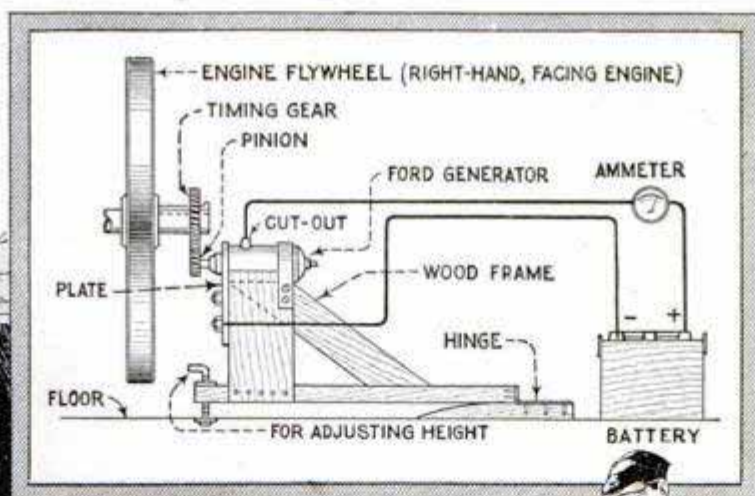

Above, the Wiring Diagram for the Charging Outfit; Below, the Generator Is Driven from the End of the Shaft That Runs Clockwise

of this should be beveled for bolting to the base at the other end. The tops of the brace and the uprights are then cut out to fit the curve of the generator.

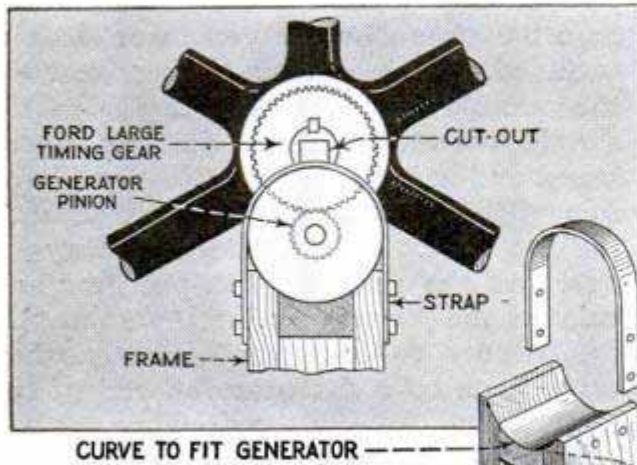

Next make a generator plate of sheet steel, as shown in the detail. The pinion end of the generator should project through the hole, and be bolted to the plate exactly as in the casting in the car. The bottom end of the plate is bolted to the vertical sides of the uprights and brace, as shown, so that the body of the generator rests in the curved timbers provided for it. With the generator in place on the plate, it should be further secured by a metal strap, fitting about it and bolted to the sides of the uprights.

Arrange a block on the floor so that, when the rear end of the frame is hinged to it, the base will be exactly level, the generator pinion engaged with the timing gear on the engine and directly underneath it. An arrangement must then be made so the height can be raised or lowered to provide the right backlash between the gears. This is shown in detail, and consists of a steel plate bolted to the top of the base and a second plate bolted to the floor. A round steel rod, threaded nearly its entire length, is screwed through a hole tapped in the upper plate. It turns freely in a larger hole in the floor plate, where it is held from moving lengthways by a shoulder and flange, or by a pair of small collars, above and below this plate. The rod is bent at right angles at the top for a handle. Then a guide iron should be bolted

to the floor to prevent the base from moving sidewise. This is simply a piece of flat steel bolted to the floor, each end being bent up at right angles to just clear the edges of the base.

Connect one wire to the generator plate and to the negative pole of the battery. The positive wire should then be connected to the cut-out terminal and to the positive battery terminal, with an ammeter inserted as shown, to indicate the rate of charging, although this can be dispensed with if desired.

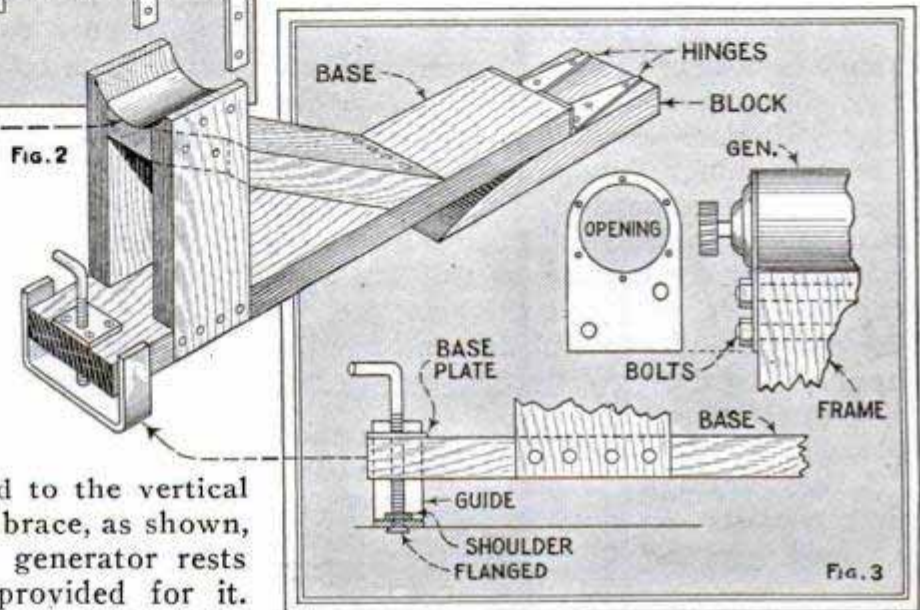

Details of Generator Mounting and Fitting for Disengaging Drive When Generator Is Not Wanted

The height adjuster serves to lower the pinion from the gear when the generator is not to be used. This is necessary when no charging is to be done, because running the generator without a battery in the line will soon burn out the windings. So, when through charging, simply turn the handle of the adjuster rod to lower the free end of the base, which disengages the pinion and allows the engine to run free. Then, when a battery is to be charged, simply reverse the process until the pinion and gear re-engage properly. Keep the gears well greased and oil the pinion end of the generator shaft and the cup at the other.

Such a charging outfit will serve to keep all the 6 to 8-volt storage batteries "up to scratch" and, by using a high charging rate, this can be done in a few hours, while the power pulley at the opposite end of the shaft is doing other work.

Temporary Repair for Broken Shaft Made with Tubing

When a line shaft breaks, or any shaft that is well exposed, a temporary repair can be made with a short piece of heavy pipe. Choose as long a piece of pipe as is practical to use and with an inside diameter as near to that of the shafting as possible. Drill two or three holes through the pipe on each side of the center. These holes should be staggered. Tap them for heavy setscrews, slip the pipe over the broken ends of the shafting and take up on the screws until the shafting is held securely. If the pipe is slightly larger than the shafting, make a shim to take up the slack all around before assembling.—L. B. Robbins, Harwich, Mass.

Traffic Signal for Motor Trucks with Inclosed Cabs

For trucks having closed cabs, a traffic signal of the kind shown will be found useful. It consists of a wooden arm, pivoted at one end on the front of the cab and fitted at the other with a stuffed, white glove. A strong cord is run through a hole in the front of the cab above the signal arm, and a knob tied to the end. When a left turn is about to be made, the cord is pulled and the white glove will rise into plain sight to the left of the cab, as indicated in the illustration.—E. T. Gunderson, Jr., Humboldt, Iowa.



Traffic Signal on a Large Truck Is Useful When Making Left Turns

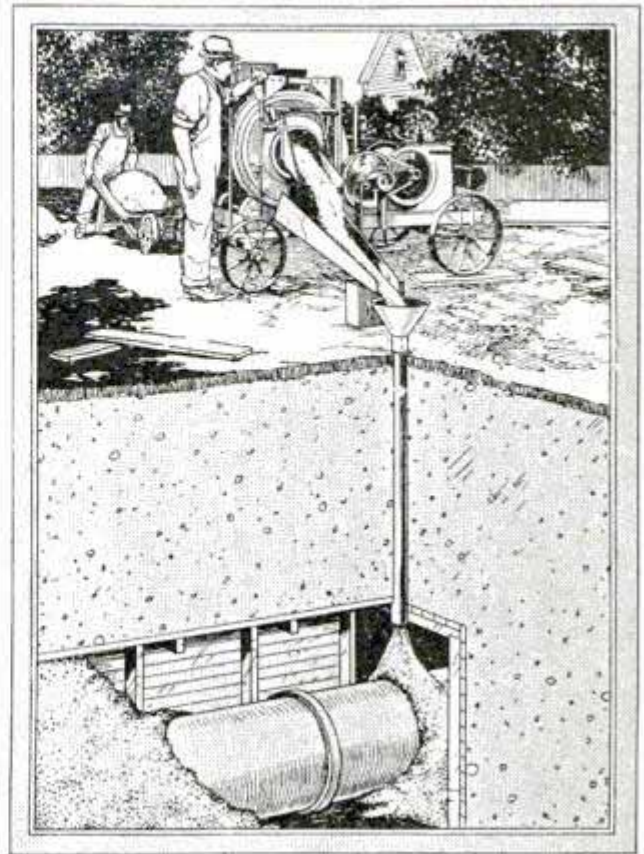

Filling Water-Conduit Tunnel from Above with Lean Concrete through a Six-Inch Spout

Safe Method of Backfilling Tunnel

The drawing shows a safe method of backfilling a water-conduit tunnel, used by a western contractor. Rather than backfill with earth, which would necessitate the dangerous work of pulling out timbers, he leaves the latter in place and fills the tunnels with lean concrete. The concrete is mixed on the ground and is poured into the tunnel, a vertical distance of 10 to 30 ft., through 6-in. well casings which are sunk at 25-ft. intervals. It is then shoveled into place.

Cement Hog Wallow Uses Old Oil

A Nebraska farmer had some material left over after building a concrete foundation and utilized this in making a hog wallow. A wide, shallow trench was dug and the concrete was spread over the surface about 2 in. thick. Old crankcase oil from cars and tractors, is poured into it. The hogs like it, and it has proved more effective than many types of oilers and disinfectants he used previously. During hot weather the wallow is filled with water and a little oil floats on top. During winter oil only is used.

Windshield Frame Makes Sign Mount



A discarded auto-windshield frame makes a good mounting for a sign, as shown in the illustration. While the glass itself can be used to paint the sign on, thin wood may be substituted.

The two standards which support the sign are lengths of ordinary pipe. Besides being novel, the sign is very cheap.—L. I. Thomas, Oak Park, Ill.

Hose Nozzle Made from Pipe Fittings

In many industrial plants, mills and factories, it is customary to provide hose connections for conveniently washing floors, vats, etc. A cheap and easily made nozzle is shown in the drawing. It is simply a short nipple of the proper size inserted in the end of the hose and held in place by a hose clamp. On the other end of the nipple is screwed a common pipe cap, in the center of which has been drilled a hole, $\frac{1}{4}$ to $\frac{3}{8}$ in. in diameter, depending upon the size of the hose. This nozzle delivers a strong, solid stream, which is most effective for washing purposes.—Leslie G. Roller, Cedar Rapids, Iowa.



Keeping Your Brakes in Order

One seldom feels the need of brakes until that nerve-racking moment when even four of them do not seem enough, and because such moments are becoming more common as traffic congestion is getting worse, it is a good plan to look over the brakes each week. This is a job that the auto owner should do himself, for there is probably no one who knows the state of efficiency of the brakes better

than he, and no one will give them closer attention. A mechanic may reline and adjust them properly, but the everyday care is usually left to the owner. Before attempting any adjustment of a brake, one should study its action from the lever back to the drums. If the mechanism is carefully examined, a great many unhoiled joints will be found that may cause trouble. The rusty clevis pins should be oiled and all threaded portions of adjusting rods should be protected from rust by an application of oil or grease. Trouble in adjusting them is thus prevented. Occasionally one of the brake cams will freeze and, when this happens, an easy way of freeing it is to apply a mixture of lubricating oil and kerosene and operate the brake until the cam loosens up. The oil will eventually work its way to the corroded point and end the trouble. Avoid spilling an excessive amount of the mixture on the brake lining, as this will prevent the brake from working. This mixture can be used to advantage in lubricating all the brake mechanism.

Gauge for Setting Calipers in Wood Turning

In turning a number of wooden articles, each having several different diameters, it is very troublesome to use a rule to set the calipers for each diameter. To overcome this difficulty, a wooden gauge, turned down to different diameters, will be found handy. If the gauge is marked to correspond to the diameters, there will be no confusion in setting the calipers.

Wrench for Union Nuts on Small Pipe

An open-end wrench frequently is used for tightening nuts on the joints or unions, of small pipes, on autos, trucks, tractors and gas engines, for the fuel or oiling systems. An improvement over the open-end wrench, which will not always fit these unions, is a socket wrench

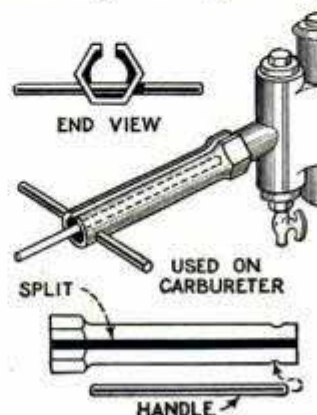

of the type shown in the drawing. A slit is cut in the side, just wide enough to pass over the pipe in the fuel or oil system. A pin will serve as a turning lever or tommy. The tool can be made of steel pipe, by forging one end to grip the nut. If a standard size is not available.

Hotbed Is Built over Brooder House

Last spring I built an extension to the south side of our brooder house and arranged it so as to have a hotbed directly above. The extension was built 2 ft. wide and as long as the brooder house, which was 8 ft. This addition was covered with boards, resting on 2 by 4-in. joists, and the hotbed was built over this. The warmth from the room gave the plants an early start and prevented their freezing, although several times the temperature was as low as 20 degrees.—Geo. G. McVicker, North Bend, Nebr.

Strap for Clamping Tapered Work

Tapered work is very difficult to hold down on a machine table, and as an ordinary flat strap, bearing on the edge, does not clamp it securely, it is customary to wedge the work between supports at the back and straps bearing on the tapering part. This method requires a great deal of time, however, and therefore one shop has devised the special strap shown in the illustration. The same wedging effect is obtained with this single strap as with the straps and supporting pieces. It is, moreover, much handier and preferable in all cases where a top strap is not objectionable.—Harry Moore, Montreal, Can.

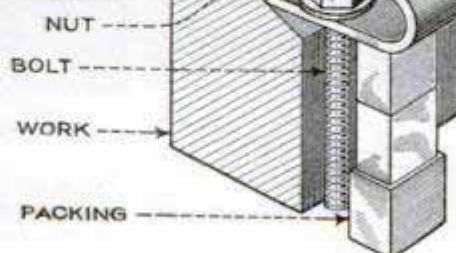

Simple Strap Used to Hold Tapered Work on Machine Table

Tires Protect Pavement from Mower

When traversing paved streets in town or the highways in the country with farm

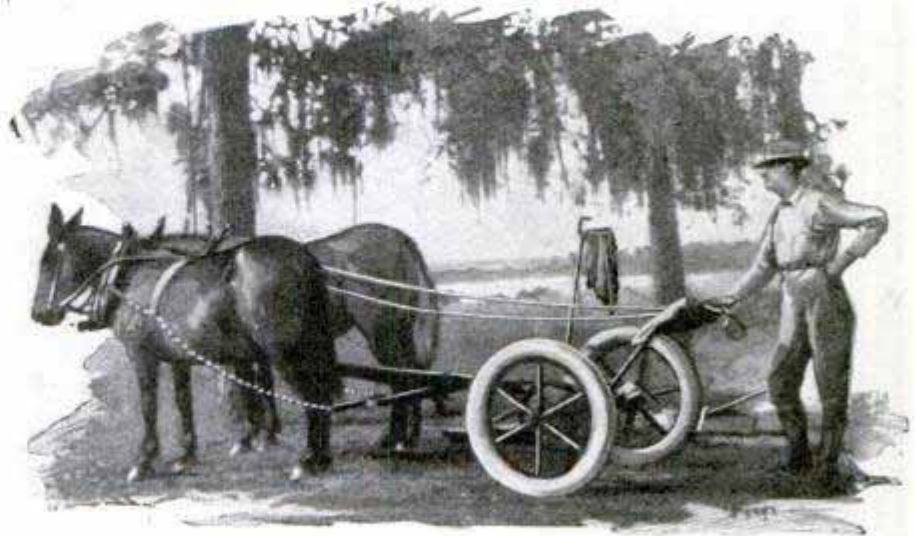

Old Tires Slipped over Wheels of Farm Implements Protect Soft Pavements and Road Surfaces from Injury

implements having wheels provided with cleats or studs, such as mowers, considerable injury often results to the street surface, especially if it is soft, as asphalt. It is often necessary to load these implements on trucks or wagons to transport them in order to prevent such damage. A better and simpler remedy for the trouble is to slip some old tire casings over the wheels, as shown in the photo. If the wheels are too large for a single tire, two casings are cut and slipped on, the section not covered by one tire being covered by a section of another. It will, of course, be necessary to wire short sections of tire to the wheel. The natural shape of the single tire will keep it on the wheel securely.—Herbert C. McKay, Eustis, Florida.

☞ Sometimes it is desired to decorate the walls of a house where the plaster is cracked; most owners use wallpaper, but better results will be obtained, if building paper is applied first or, better still, canvas.

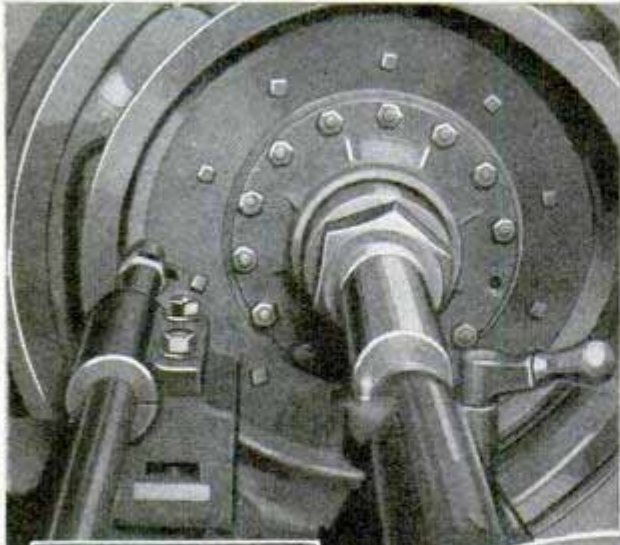

Close-Up of Job at Right, Showing the Type of Tool and Arbor Used

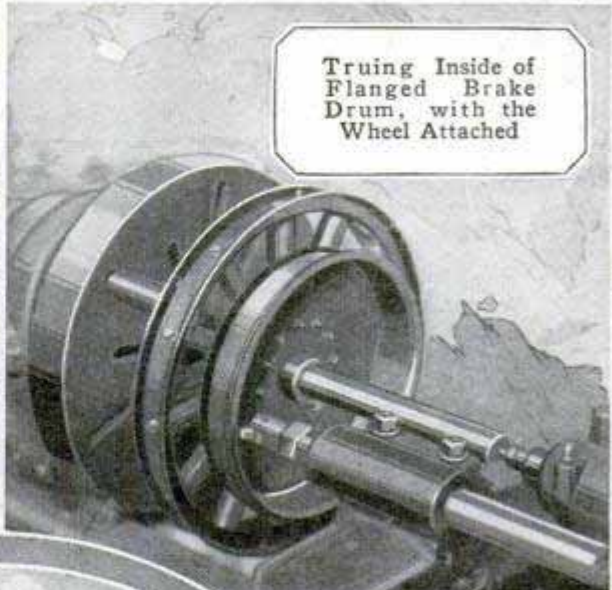

Truing Inside of Flanged Brake Drum, with the Wheel Attached

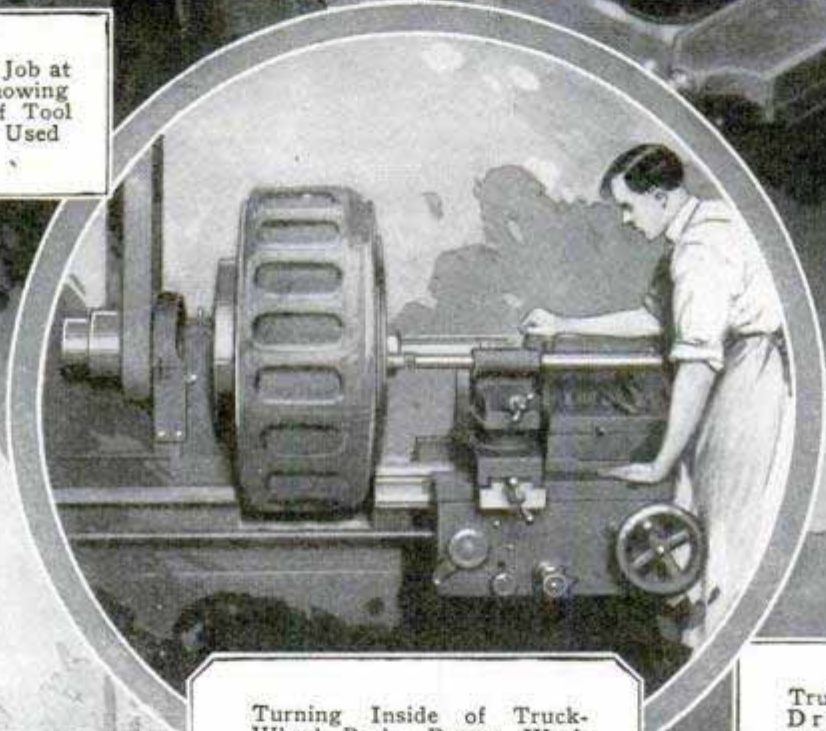

Turning Inside of Truck-Wheel Brake Drum; Work Is Done on Gap-Bed Lathe, Using Raising Blocks under Head and Tailstocks

Truing Brake Drum on a Chain-Drive Truck Wheel

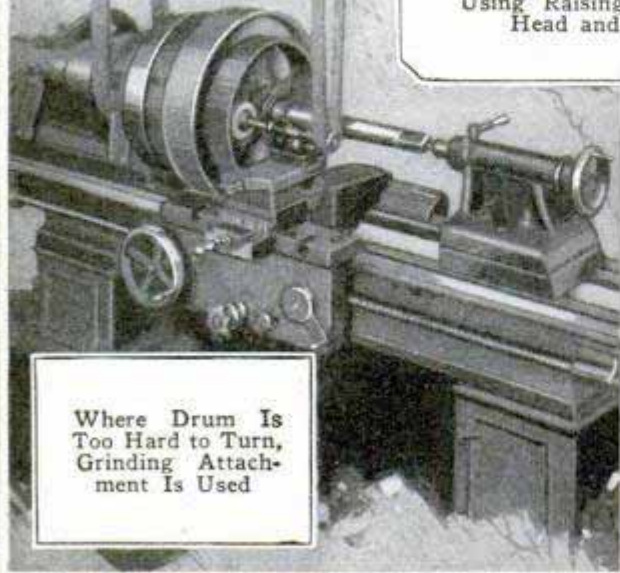

Where Drum Is Too Hard to Turn, Grinding Attachment Is Used

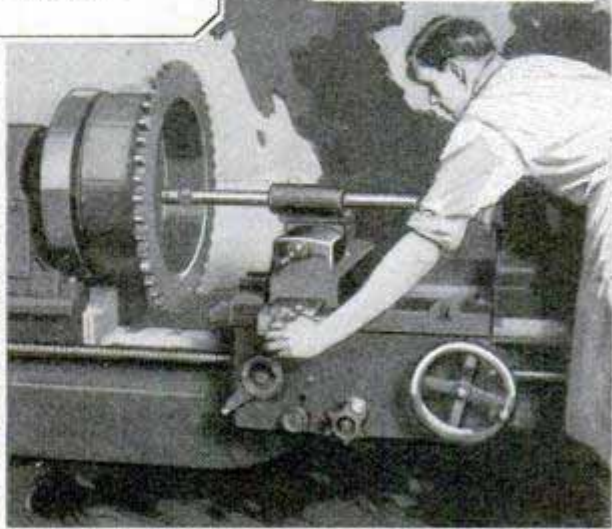

Keeping Truck Brakes Efficient

Lack of trueness in brake drums may result from various causes, such as accidents, wedging of small objects between the drum and the bands, and so on. In any case, to provide proper braking action, the drums must run true and be perfectly round. One untrue drum may cause brake grabbing, skidding and other troubles.

To true a brake drum properly, it should be turned or ground while attached to the wheel on which it is used. This is not always possible, but the drum should never be removed from the wheel if it can be avoided, as rebolting it is almost sure to spring it out of round or warp it in some way. Not only should the drum be left attached to the wheel, but the wheel should be mounted on an arbor and swung on lathe centers while the truing operation is done. The ideal type of lathe for this work is a gap-bed lathe, which has part of the bed next to the headstock removable, so that work of a much larger diameter than the lathe will normally take can be placed in it. Additional swing may be obtained by using specially made blocks for raising the head and tailstocks of the lathe a few inches.

In some cases, bus or passenger-car wheels may be mounted in the lathe on their own axles, but usually it is better to employ a special mandrel.

Where an occasional drum is found too hard to turn, it is trued by the use of a grinding attachment, substituted for the toolpost of the lathe.—Avery E. Granville, Cleveland, Ohio.

Drilling Mica

When cutting or drilling holes in mica or bakelite, the tool often breaks through and leaves a ragged and torn edge. To prevent this trouble, take two boards with smooth, flat surfaces and clamp the material between them, as shown in the illustration, using C-clamps to hold the three together. The pieces of wood should be cut the same size as the bakelite or mica and all the edges should be in

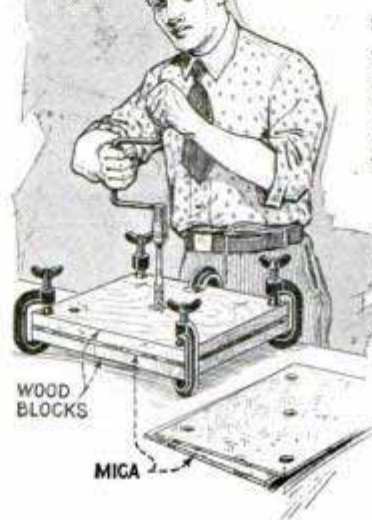

alinement, so that the template can be used on the wood. In the case of bakelite, it is only necessary to clamp a piece of wood below the work, as the drill only leaves a ragged edge on the underside.

Portable Workbench for the Garage

Most auto mechanics like to have a full assortment of tools at hand where they can be reached without going from the workbench to the toolroom or to a wall rack. A sturdy bench, which is portable and can be pulled up beside the car on which the work is done, is a great convenience. The photo shows a workbench and tool tray of this type. The bench is made of 2-in. material and has a lower shelf for holding cans of shellac, oil and some

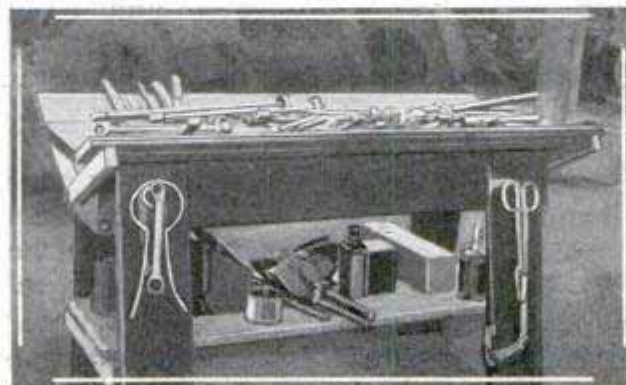

Handy, Portable Workbench for the Auto Mechanic Holds Full Assortment of Tools

of the heavier tools. The top has two sloping sides, which make a tray for containing the tools, so that they will not roll off when the bench is moved from place to place. The legs of the bench are mounted on casters to facilitate shifting to any part of the shop. At night, it can be pushed into the tool room and locked up without removing the tools. If desired, a heavy vise can be mounted at one end.

Hard-rubber balls and old golf balls make good stoppers for washbowls or laundry tubs.

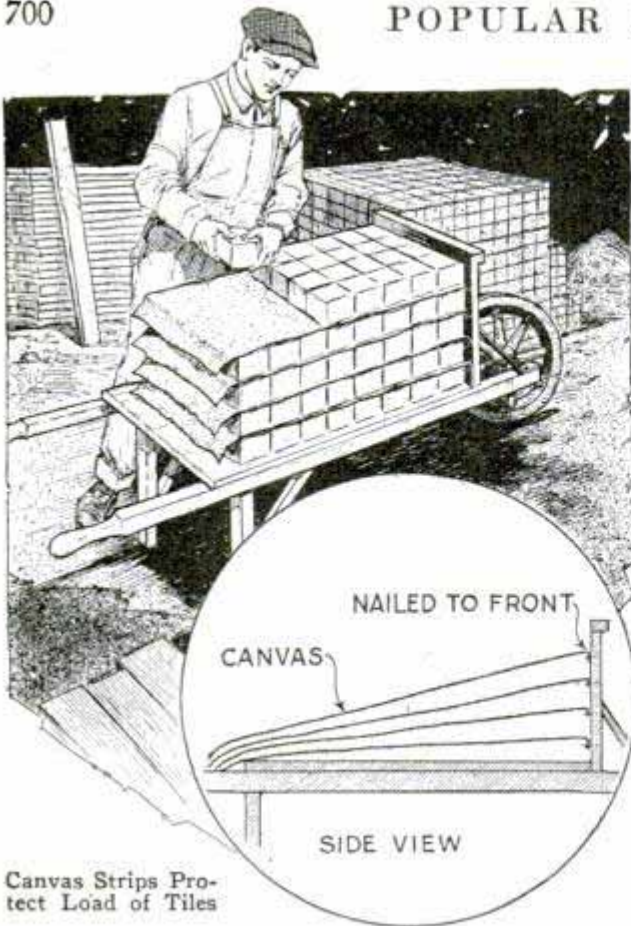

Canvas Strips Protect Load of Tiles

Carrying Tiles on Wheelbarrow

When moving tiles, brick and other similar material on a wheelbarrow the edges are likely to be chipped or otherwise damaged, and for this reason straw is often used between the layers. Straw, however, is not always available, so one builder uses pieces of canvas, one end of which is tacked to the vertical rest of the barrow, as shown in the detail. The pieces are laid between the layers of tile and prevent breakage and chipping.

Pick for Snapping Chalkline



To overcome this difficulty, a Wisconsin sign artist uses the simple little pick shown in the illustration. A piece of fairly heavy tin is cut to the shape shown and the ends are

bent to form a ring that will fit snugly over the tip of the index finger. When stretching the line, it is held in the usual way except that the thumb and second finger of the right hand grasp one end leaving the forefinger free to use the pick.—G. E. Hendrickson, Argyle, Wis.

Filling Holes in Castings

The following formula is for use when holes in iron castings must be filled for appearance' sake, and where strength is not a factor: Sulphur, 50 parts; fine iron filings, 20 parts; graphite, 20 parts; all by weight and powdered. The powder, when mixed, is placed in the holes and melted with a hot iron.—Maynard Bodley, St. Paul, Minn.

How to Count Cards Quickly

When it is necessary to find the number of cards or sheets of paper in a pile, which would probably take a few hours to count in the customary way, a quick, rough estimate can be made by counting a small stack, about $\frac{1}{4}$ or $\frac{1}{2}$ in. high, and then measuring the whole pile. In this manner you will find how many small stacks are equivalent to the large one, and a simple multiplication gives you the number of cards or sheets in the latter.—Julius Duncan, New Orleans, La.

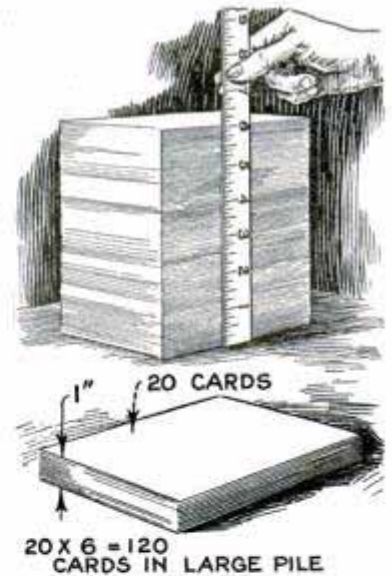

Countershaft Mounted on Auto Springs

A clever method of mounting a small countershaft was shown to me by a local machinist when he pointed out a support consisting of two cast-off auto springs. The springs were bolted to the timbers overhead and the bearings were fitted with bushings to accommodate the countershaft. Then they were slightly spread

and the belting arranged to the machines. As the belting stretched, the tension of the springs automatically took up the slack.—L. B. Robbins, Harwich, Mass.

Starting Joints in Old Piping

Old steam or water pipes that are being taken down often offer difficulty at the joints where turned into fittings. Too much twist will either split the pipe or spoil the fitting. A better way, when other methods fail, is to apply quick and intense heat to the fitting to expand it suddenly. This can be done by pouring a ladleful of hot lead over the fitting in a small, rapid stream, allowing it to collect in a suitable dish below so that it can be returned to the pot before it hardens. The sudden application of heat will expand the fitting and the threads can usually be started immediately after the pouring has been done.

Keyway-Cutting Plane

For cutting keyways on small shafts, the tool shown here will be found quite a timesaver compared with a file and chisel. It is made of a piece of hardwood for the body, about $1\frac{1}{2}$ or $1\frac{3}{4}$ in. thick, $2\frac{1}{4}$ in. high and 12 in. long. The

keyway-cutting tools are $\frac{5}{16}$ by $\frac{3}{4}$ in. or larger. One is used to start the cut and the other to finish it. Backing irons are set into the plane body to support the bits, and a piece of iron, $\frac{3}{8}$ by $\frac{3}{4}$ by 3 in. long and made as shown, is used with the thumbnut to

feed the bit into the work. A very light cut should be made at each stroke of the plane.—Geo. H. Cappel, Wilmer, Ala.

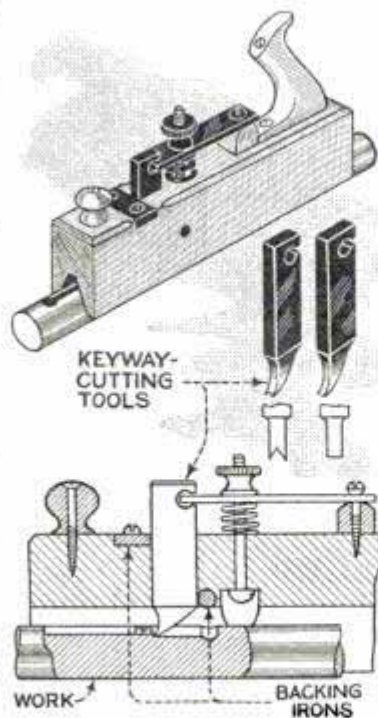

Safe Knife-Switch Thrower

Open knife switches in factories can be mounted near the ceiling and controlled with a length of sash cord, as shown in the drawing.

The switch is mounted on a board which is held vertically by means of braces attached to the joists. A length of rope is tied to the handle of the switch and is passed over two small pulleys attached to the joists on either side of the switch. A knot is tied in the rope a few inches below the pulleys, to prevent pulling one end out of reach.

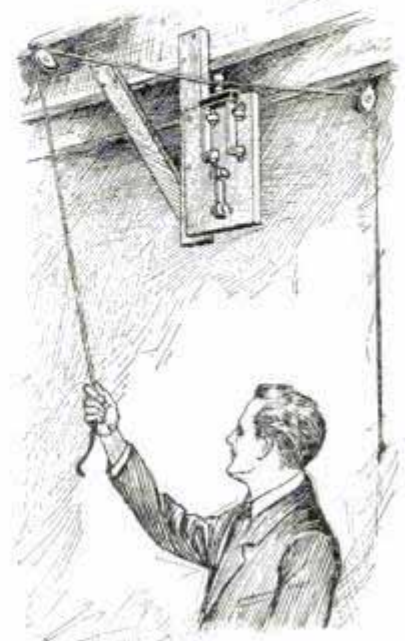

Repair for Loose Tail-Lamp Socket

The socket in Ford tail lamps, up to 1925, is soldered to the body of the lamps and projects below it for the plug. The soldered joint is necessary to ground the current and, if it is broken, the light flickers and goes out. Tools for soldering are not often at hand when this occurs, but an emergency repair can be made by wrapping a small wire around the socket below the body of the lamp. The other end of the wire is pulled tight and tied to the frame of the car. This will keep a steady sidewise pull on the socket and hold it in contact with the body of the lamp, thus grounding the current and keeping the lamp lighted until the connection can be soldered.

It is difficult to remove insulation from the heavy wire used in outdoor wiring with a knife, but if the ends of the wires can be placed upon a stone or some other hard surface, a few hammer blows will flatten and break the toughest insulation so that it can be peeled with the fingers.

Door Keeps Chickens Out of Hog House

A sectional, hanging door for the hog house, as shown in the drawing, will keep

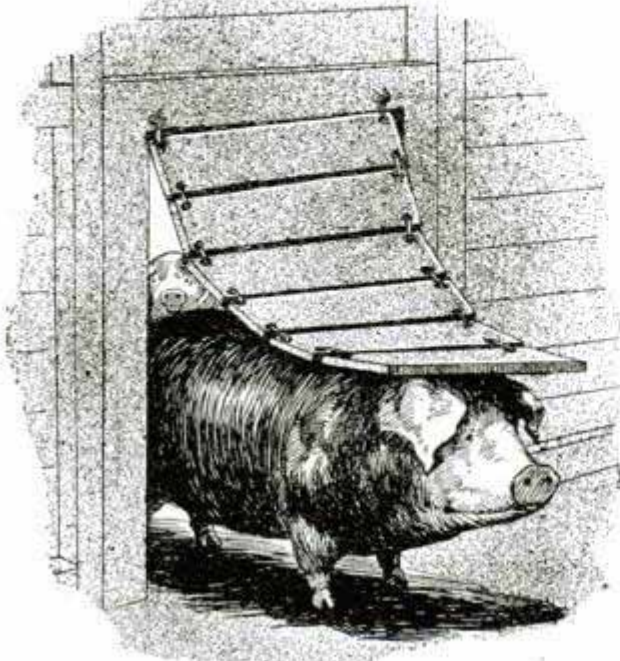

Keeping Chickens Out of Hog House with Sectional Hanging Door

chickens out and does not hinder the hogs. Cut a 6-in. board in lengths equal to the width of the door. Two holes are drilled in the ends of each board so that they can be wired together and the assembly hung in the doorway as shown.—Elmer Raihala, Floodwood, Minn.

Making a V-Type Fan Belt

It became necessary some time ago to get a new V-type fan belt for my car. The price was \$3, which was more than I wanted to pay, so I proceeded to make one. The result was better than anticipated, the belt was entirely satisfactory and the cost was less than 50 cents. I obtained enough scrap sole leather at a shoe-repair shop to make it, and 50 copper rivets. The V-shaped pieces were cut



out as indicated in the drawing, all pieces being made as nearly alike as possible and then riveted together. After riveting, the belt was placed in a vise and the sides planed down to make a smooth surface. The flat side of the belt was also dressed down

a little, care being taken in doing this not to strike the rivet heads.—A. S. Jamieson, Springfield, Mass.

Magnet Tool Replaces Spring in Valve Grinding

If the valve-grinding tool used when overhauling an automobile engine is magnetized, the usual spring under the valve head may be dispensed with, since the valve will be lifted with the tool. Most garages have a coil for remagnetizing magneto magnets, and the end of the grinding tool can be magnetized in this.

How to Drive Small Screws in Deep Slots

In the absence of a magnetized screwdriver or the commercial article fitted with a spring clasp for holding the screw, one is "up against it" when driving a small screw in an awkward place, such as a deep slot. Here is a very simple way to do the job, however. Take a narrow strip of cloth twice the length of the screwdriver. Cut a slit in its center lengthwise like a button-hole, a little longer than the diameter of the screw head. Slip the screw through this slit and hold it in place on the end of the screwdriver by means of the cloth strip, as shown in the illustration. The screw may then easily be slipped in place and the cloth pulled off after the screw has taken hold.—Harry D. Tiemann, Madison, Wis.



To Free Spring Bolt of Hard Grease

When the grease hole in a bolt is drilled lengthwise, the old, hardened grease may be loosened and started out so that the pressure lubricator will do its work by this method, making the removal of the bolt unnecessary. Take off the pressure-lubricator fitting and get a short piece of rod, stiff wire or even a nail squared off at the end, that will just slide in the

grease hole. Start it into the hole a short distance and give it a sharp blow with a hammer. The resulting pressure inside of the bolt will be so great that, in almost every case, when the fitting is replaced and pressure applied as usual with the lubricator, the grease will enter and spread readily.—Sherwood J. Gee, Salt Lake City, Utah.

Lead Content of Tin Easily Determined

It is sometimes necessary to determine the lead content of tin. This can be done as follows: Make a solution of potassium chromate in water. Apply a few drops of acetic acid to the tin which is to be examined, and a white coating will appear. Apply a few drops of the potassium-chromate solution to the white coating and, if the spot turns yellow, the tin contains lead, and the more yellow it appears the more lead it contains.—L. H. Georger, Buffalo, N. Y.

Trick for Cleaning Drain Pipe

It is quite difficult to clean out a side pipe of a drain with a hose, as the end of the hose will not enter the branch. This difficulty can be overcome by removing the nozzle and doubling one end of the hose, as indicated in the drawing, using a lath to push it back to the side pipe, upon reaching which the folded end will snap into it. In ordinary cases of cleaning the long horizontal drain pipes, the nozzle is left on the hose, which is pushed up and pulled back several times, with the water turned on, until the obstruction is removed.—M. W. Lowry, Athens, Ga.

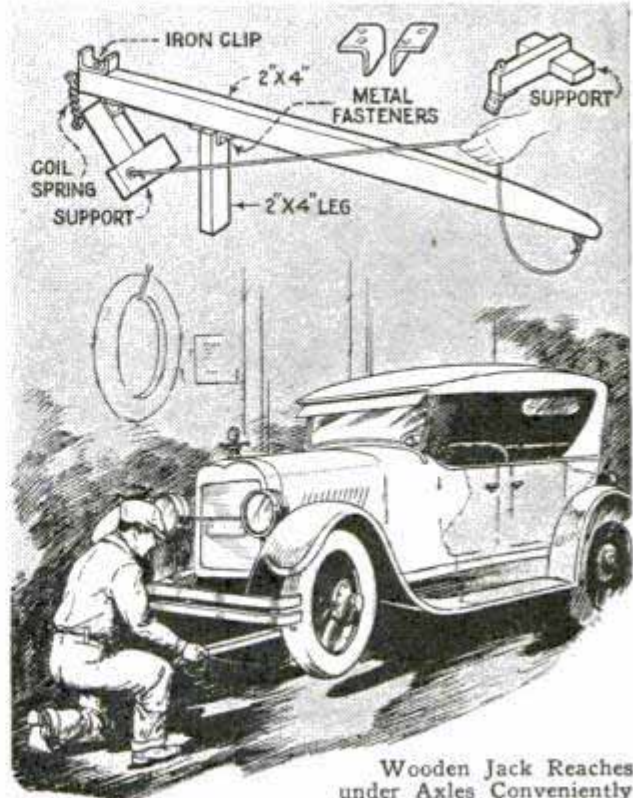
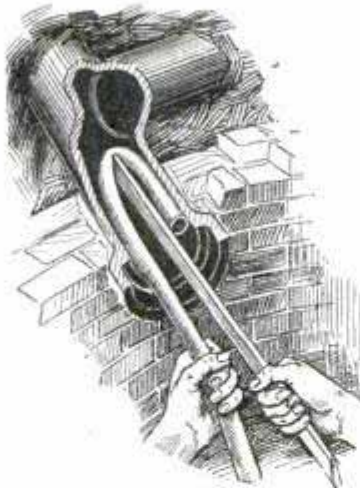

Wooden Jack Reaches under Axles Conveniently

Quick-Acting Auto Jack

When changing tires on a car with bumpers, it is unhandy to use a short-handled jack. Several makes of jacks, with long handles and low-lift positions, are obtainable on the market but a good, wooden jack, which is just as effective, can be made as shown in the drawing, and will prove very serviceable, especially for garage use. A length of 2 by 4-in. wood is fitted at one end with a U-shaped bracket or clip, made from a piece of flat iron. About 1 ft. from the end, a short section of 2 by 4-in. stock is securely fastened by means of heavy angle brackets. On the end, a T-shaped support is hinged and a small coil spring is attached to keep it pulled forward. A cord is fastened to the bottom of the T-support to pull it back. The handle end is planed round for convenience in handling. To use the jack, keep the T-support back by means of the cord, slip the U-clip under the axle, then bear down on the handle. As soon as the axle has been raised sufficiently, release the cord, and let the axle down on the support.

IN accordance with the editorial policy of this magazine never to accept compensation in any form for what appears in our reading pages, and also to avoid the appearance of doing so, we are obliged to omit the name of the maker or the seller of any article described. This information, however, is kept on file and will be furnished free, by addressing Bureau of Information, Popular Mechanics Magazine, Chicago.

12-71

Is This Your Home?

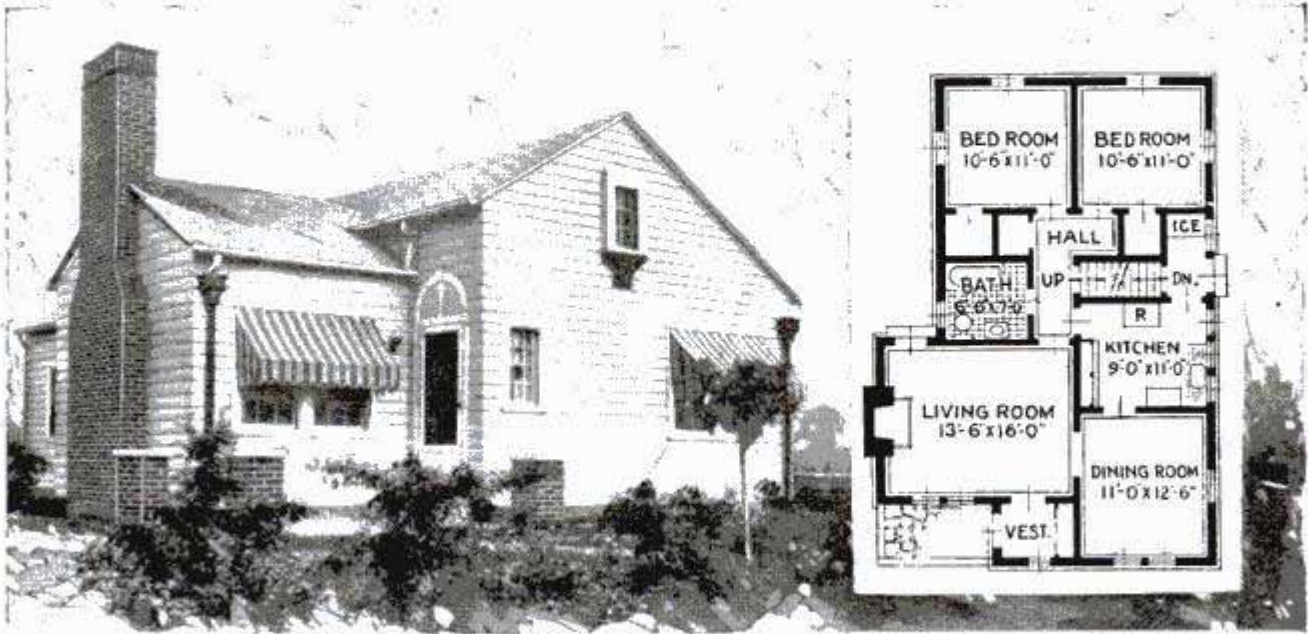

Copyright, Architects' Small House Service Bureau

Plan No. 5D32

QUESTIONS regarding home building addressed to this magazine will be answered by The Architects' Small House Service Bureau of the United States, Inc., controlled by the American Institute of Architects and endorsed by the United States department of commerce. Inclose 10c and self-addressed envelope. Blueprints, specifications and material list for the house shown here may be obtained at nominal cost. Inclose self-addressed stamped envelope for reply. If further information is desired, send 5c and stamped envelope for a 24-page booklet explaining how the Small House Service Bureau functions and showing 12 sample plans. A new booklet, entitled "Fifty Ways to Lower Home Building Costs," illustrated by ten bureau houses actually live^d in, and showing how as much as \$1,000 can be saved on a home, may be obtained for 20 cents.

THE house illustrated here is a typical American bungalow of five rooms. One of the major problems of any one-story dwelling of more than four rooms is to obtain proper ventilation. Inevitably, since there are only four corners, some of the rooms cannot be lighted on more than one side unless there are expensive offsets in the plan. This difficulty has been overcome by equipping the kitchen with a complete wall of windows. In addition, it opens upon the rear entry way in such a manner as to provide two more wide openings for proper ventilation.

There are two bedrooms, each with a large closet. From the rear hallway rises the stairway to the attic and access is had through this hall to the bath and kitchen. The living room, dining room and kitchen are arranged much as they would be in a two-story house.

The living room is provided with a doorway at the side of the fireplace for entry into the garden. The fireplace itself dominates the living room. It may

be flanked on either side by windows, if desired. It is located in such a position that people sitting about it are not disturbed by those passing from the vestibule to the dining room.

The exterior of the house is characterized by the charm and simplicity of the homes of our forefathers built during the Colonial period. The combination of plan and exterior is simple, honest and straightforward, characteristic of the best spirit of our American civilization.

A home builder anxious to secure a distinctive appearance without having to go to extra expense will find in this design just what he wants. Beauty is gained through the skillful spacing of the different parts that make up the walls rather than through the addition of decorative features, such as columns, benches, blinds and hooded canopies.

The construction is of wood with exterior finish of wide shingles. The chimney is common brick, plastered or painted. The roof is shingled. A lot of at least forty-foot frontage is required.

"YANKEE" Drills . . . they work where others can't

WONDERFUL thing to have tools that will do jobs in the easiest, shortest way!

With the drill on the left, you shift from high speed to slow, at a finger-touch. Avoids jamming in drilling through. Saves drills.

At the right is shown a ratchet drill that drills continuously in tight places where crank can be moved only to and fro.

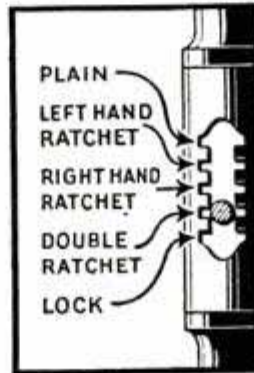

No. 1435 — "Yankee" Hand Drill with Two Speeds, changed instantly without removing drill from work. Length, 11 inch. Weight, 1 lb. 3 oz. Three-jaw chuck. Holds round-shank drills up to $\frac{1}{4}$ inch.

No. 1530 — "Yankee" Ratchet Hand Drill. Five Ratchet Adjustments, including "Yankee" Double Ratchet for continuous drilling in close quarters. Length, $10\frac{1}{2}$ in. Weight, $1\frac{1}{4}$ lb. Three-jaw chuck. Capacity, $\frac{1}{4}$ inch.

Try Them

Look for these drills on the "Yankee" Demonstrator, on your hardware dealer's counter. Try them, and see how slick they work in your own hands.

"Yankee" on the tool you buy means the utmost in quality, efficiency and durability.

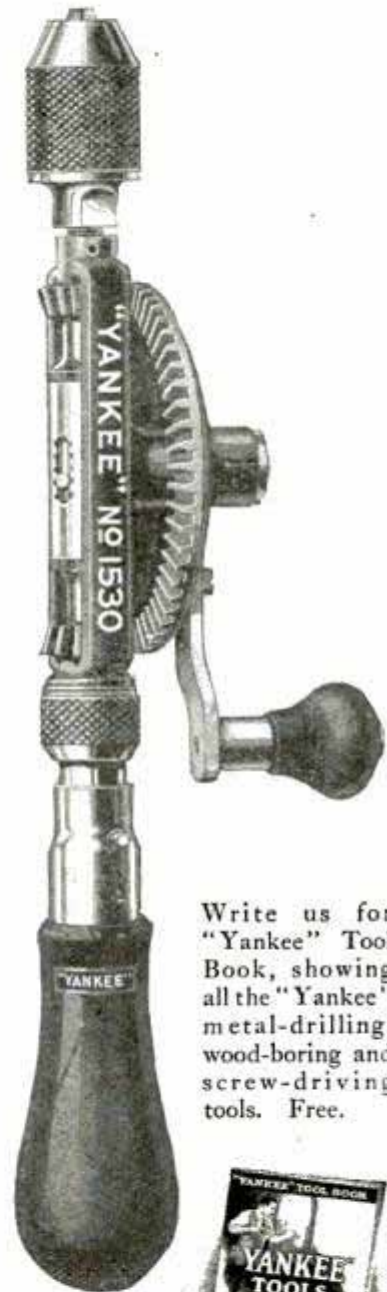

Write us for "Yankee" Tool Book, showing all the "Yankee" metal-drilling, wood-boring and screw-driving tools. Free.



NORTH BROS. MFG. Co., Philadelphia, U. S. A.

"YANKEE" TOOLS

Make Better mechanics

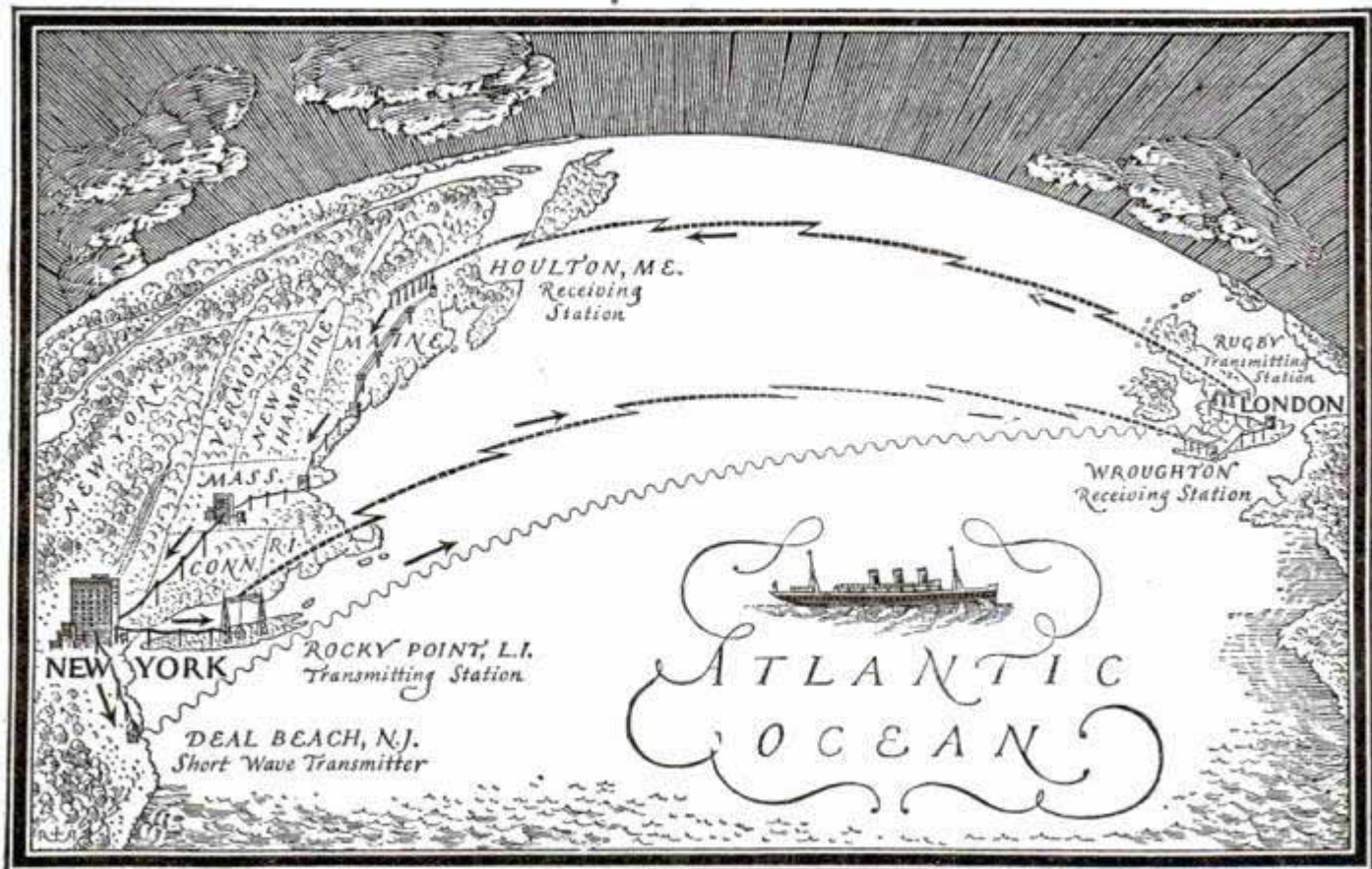

The Radiophone's Meaning

*An Advertisement of
the American Telephone and Telegraph Company*

AN ADVENTURE in communication was made last January when transatlantic radio telephone service was established between New York and London. There had been previous tests and demonstrations. Nevertheless, the fact that at certain hours daily this service was made available to anyone in these cities from his own telephone, created such public interest that for several days the demands for overseas connections exceeded the capacity of the service.

It was then demonstrated that there was a real use for telephone communication between the world's two greatest cities. It was further demonstrated



that the American Telephone and Telegraph Company, with the co-operation of the British Post Office, was able to give excellent transmission of speech under ordinary atmospheric conditions.

In accord with announcements made at that time, there will be a continued effort to improve the service, extend it to greater areas and insure a greater degree of privacy.

It is true that static will at times cause breaks in the ether circuit, but a long step forward has been made towards international telephone communication and more intimate relationship between the United States and Great Britain.

Constant pounding, plus shrinkage, loosens hammer handles

*But you can tighten a PLUMB
just by a turn of the screw*

YOU'VE done it . . . reached for your hammer and found the head wobbled. Wasted your time trying to rewedged it.

But not with a Plumb! When a Plumb Handle loosens (as all handles do) just turn the screw and the head is tight again. (An exclusive Plumb feature.)

The husky Plumb Ball Pein is the hammer for heavy duty. The head is mounted off-center to give power to your blows.

The large eye takes a full-size handle which practically does away with breakage.

The pein is cone-shaped. (Not round.) It spreads rivets instead of mashing them.

For heavy blows, with little effort—for a tool that is always tight and safe—choose the Plumb Ball Pein. Look for the Red Handle and Black Head in hardware stores everywhere.

FAYETTE R. PLUMB, Inc.

Philadelphia, U. S. A.

Plumb Ball Pein

No. HF-373,
weight 1 lb., price
\$1.15 (except in
Far West and
Canada). Heav-
ier weights pro-
portionately
higher.



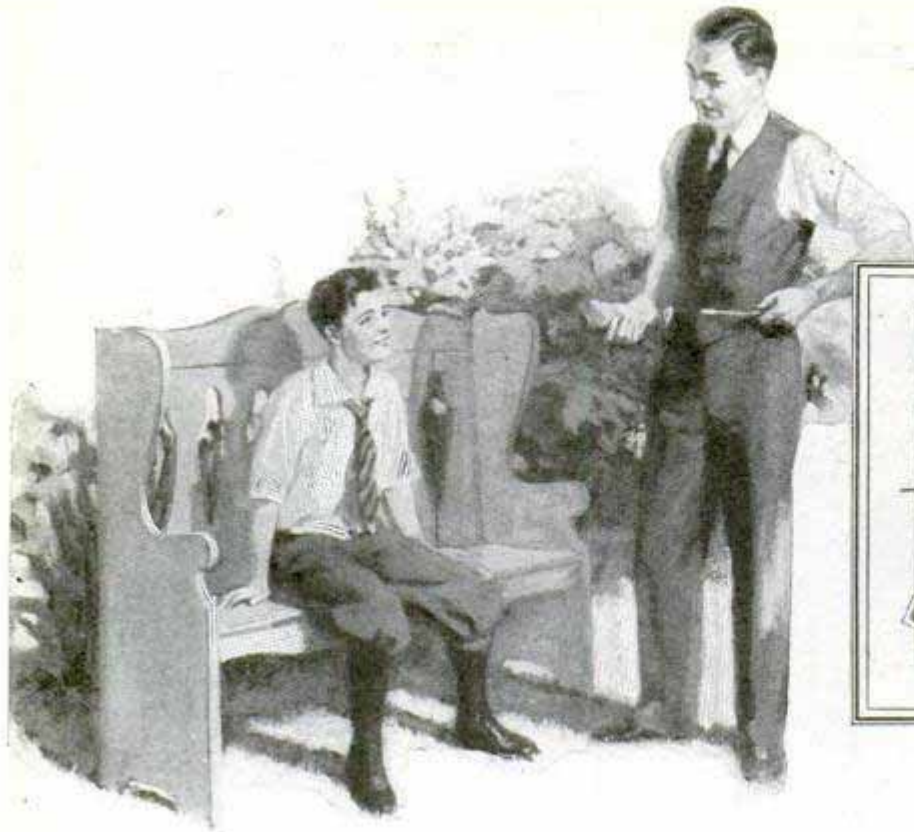

Buy separately
or in assortments

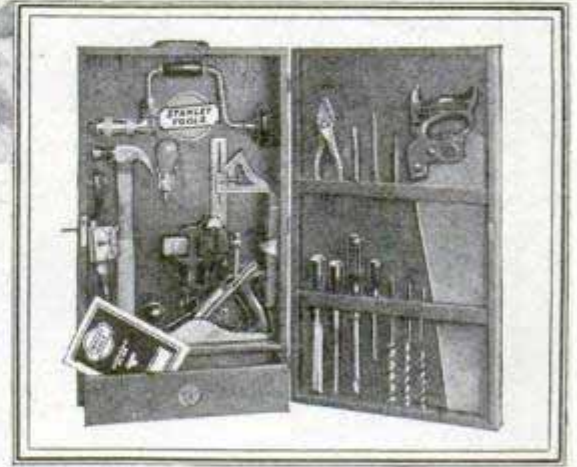

What every garden needs

IS your garden merely a growing place for grass, trees, flowers, or vegetables? Does it offer you an inviting place to rest?

The whole family will use and appreciate a comfortable garden seat. It is so easy to make a garden seat that no garden should be without one or more. Stanley Plan No. 21-D gives complete details for making such a seat.



Confidence in your tools will make any job more enjoyable. The amateur user needs good tools even more than the professional. Stanley Tools can always be depended on, as nearly every American carpenter knows. Thousands of manual training instructors use Stanley Tools in their classes. The Stanley name on a tool

is your assurance of durability, correct design, and right "feel."

You can buy Stanley Tools separately and so collect your own set. For your convenience in buying there are also complete sets of Stanley Tools in chests at a wide variety of prices from \$15 to \$95. Or there are assortments in strong cardboard boxes containing directions for making your own tool chest. Price \$5.00 to \$20.



Your hardware dealer has Plan No. 21-D as well as other Stanley Plans for making useful articles, or he can get them for you. The plans cost only 10c each. Ask him also for Catalog No. 34-D which shows the most complete line of woodworking tools on the market. It is free. If he cannot supply you write to The Stanley Works, New Britain, Conn.

The best tools are the cheapest to use
Ask your hardware dealer



STANLEY TOOLS

Valspar— the finish of a thousand uses



The famous Valspar boiling water test

Reg. U. S. Pat. Off.

SO many uses for Valspar, Clear and in Colors! So many ways in which it serves the man who likes to make things—who is handy with tools and paint brush.

On furniture, for example. Valspar makes old furniture shine like new in any color, makes newly-made chairs, benches, stools, book cases, cabinets and countless other things sparkle in their

For Automobiles, boats and canoes— Valspar will be found invaluable. A coat of color—sporty or conservative as you choose—will work wonders in an afternoon and give remarkable, waterproof protection the year round.

And on a thousand other things— on linoleum, floors and walls, window boxes, picture frames and tools, kitchen tables, sinks and ice-boxes, Valspar proves



A shining, waterproof table for 60c!



To Valspar your Ship Model costs 20c

waterproof and durable finish, or glow with the satin lustre of rubbed-down masterpieces!

Then there's the *kitchen* and *bathroom* where the cheerful Valspar colors make living so much pleasanter—and easier, too, because they are waterproof and easy to clean. (Wives appreciate this feature.)

A new Ford for about \$2.75 worth of Valspar.



its usefulness every day. Send for samples.

The Valspar Colors. Transparent Colors: Enable you to Valspar your woodwork and also color it in Natural wood effects: Light Oak, Dark Oak, Mahogany, Walnut, Cherry and Moss Green.

Solid-Covering Colors: Vermilion, Red—Light and Deep, Blue—Light, Medium and Deep, Green—Medium and Deep, Gray, Brown, Ivory, Orange and Bright Yellow. Also Black, Flat Black, White, Gold, Bronze, Aluminum.

This Coupon is worth 20 to 60 cents

VALENTINE'S
VALSPAR
The Varnish That Won't Turn White
CLEAR AND IN COLORS

VALENTINE & COMPANY, 460 Fourth Avenue, New York

I enclose dealer's name and stamps—20c for each 40c sample can of colors specified at right. (Only three samples of Valspar supplied per person at this special price.) Print full mail address plainly.

Send me these Valspar Colors

- 1.....
- 2.....
- 3.....

Send Free Book

P. M. 4-27

Dealer's Name.....

Address.....

Your Name.....

Address.....City.....

Sure-footed & speedy & &

*in the shoe that
Champions wear*

IN baseball, tennis, boating, camping or everyday wear, Keds give the same speed and ability to make your body obey that has made them the shoe of champions. Boys who wear Keds know this. That's why they insist on genuine Keds.

The rubber in a Keds sole comes from the vast United States Rubber Company plantations in the Far East. A Keds sole will outwear two or even three pairs of ordinary sneakers. Keds have a special Feltex inner sole which keeps the feet cool—finer canvas which keeps a Keds upper from ripping or wearing through.

Keds are made with plain rubber or vulcanized crepe rubber soles, in high or low styles, plain or athletic-trimmed. They cost from \$1.25 to \$4.50 a pair and the name Keds is on every genuine Keds Shoe.

Free Booklet for Boys and Girls

Our 1927 Keds Hand-book of sports gives rules for games and sports, vacation and camping suggestions, and lots of other interesting information. Sent free if you address Dept. 1370, 1790 Broadway, New York City.

United States Rubber Company

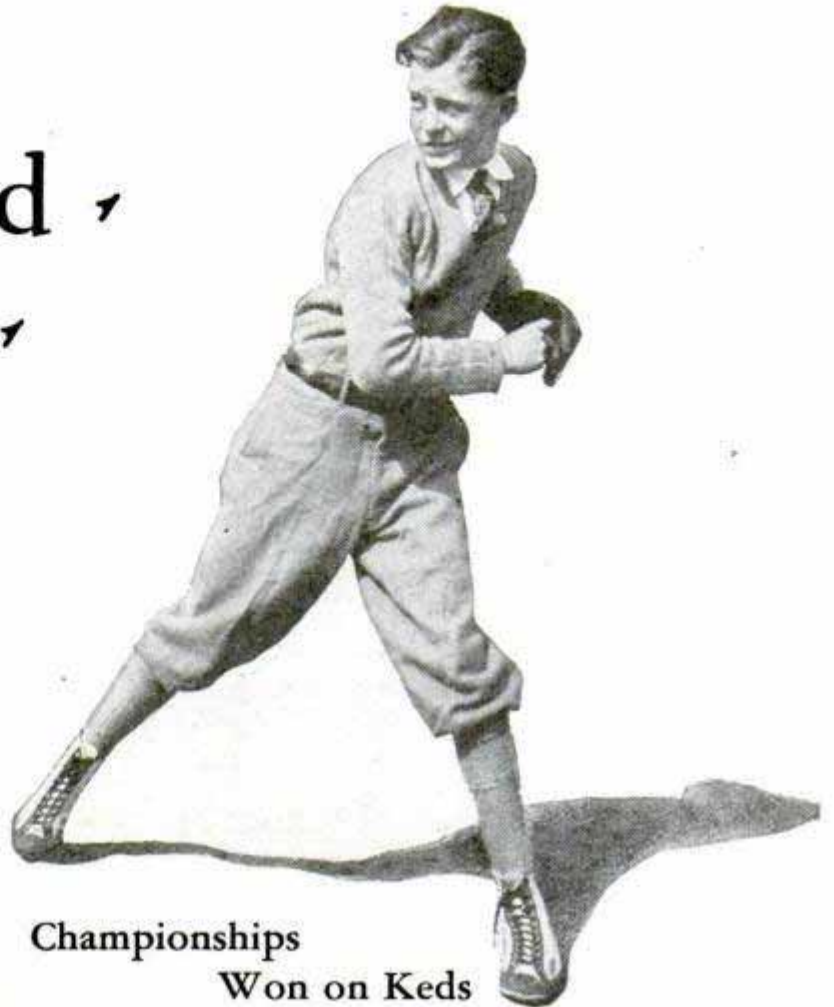

Championships Won on Keds

Last year the feet of tennis champions from Maine to California were shod in Keds. What other shoe for sports ever won such approval? Here is the list:

*National Clay Court Singles
National Veterans' Singles*

*National Women's Indoor Singles
National Women's Indoor Doubles
National Boys' Indoor Singles*

*Intercollegiate Singles
Intercollegiate Doubles
National Indoor Doubles
U. S. Wightman Cup Team
National Women's Singles
National Women's Doubles
National Boys' Singles
National Boys' Doubles*

THE SPORTSTER gray corrugated soles

A sturdy athletic-trim Keds model—built for the hardest wear. Made white with black trim or brown with gray trim.



THE CONQUEST —crepe sole

This Keds model with vulcanized crepe rubber sole gives sure grip and wonderful wear. White or brown.

Keds

Trade Mark Reg. U. S. Pat. Off.



*They are not Keds unless
the name Keds is on the shoe*

“As the twig
is bent—”

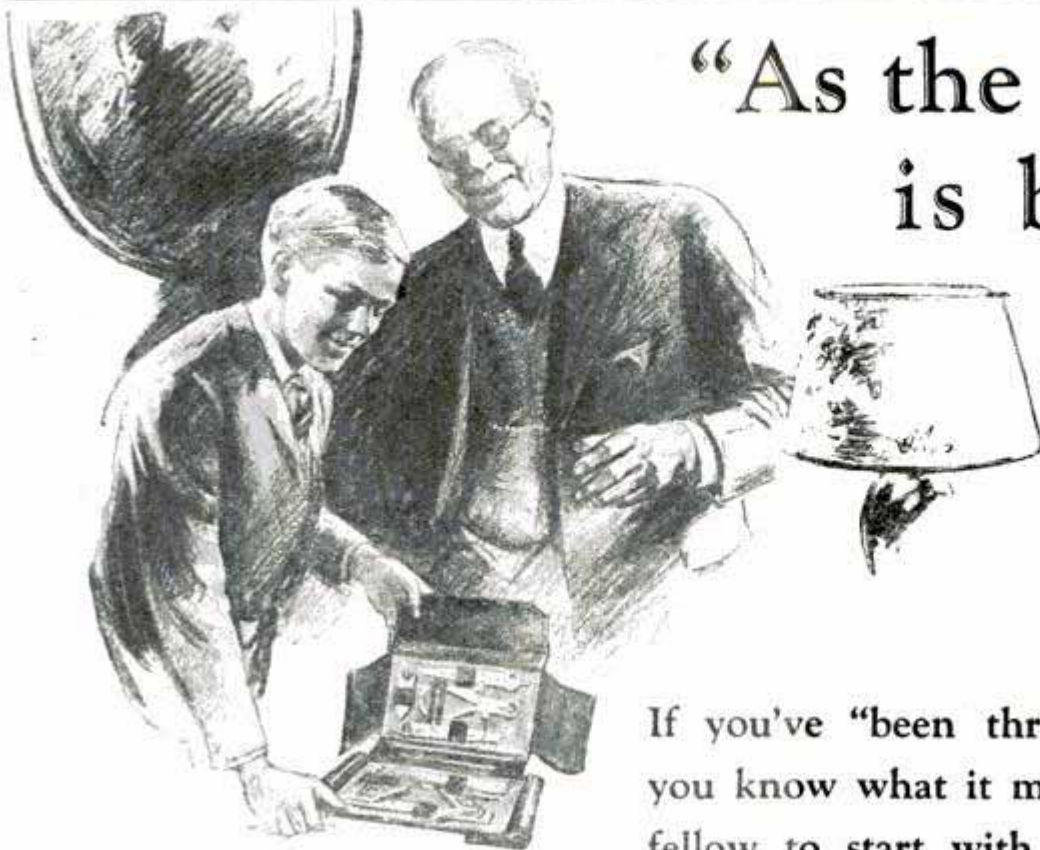

Starrett Apprentice Set No. 900 in a handsome folding leather case contains a 6 inch Combination Square complete, Center Punch, 6 inch Flexible Steel Rule, Center Gage, 4 inch Caliper, 4 inch Outside and 4 inch Inside Calipers with solid nuts, and 4 inch Dividers with solid nuts.

This Set and the Starrett Book for Machinists' Apprentices, Volume I of the famous Starrett Books, gives a fellow a flying start. Ask your dealer. And write us for a free copy of the 352-page Starrett Catalog No. 23"AP."

If you've "been through the mill," you know what it means to a young fellow to start with the right tools. There isn't anything that'll help him more than a set of fine precision tools—Starrett's. Give him a Starrett Apprentice Set, No. 900.

If you're just beginning, here are the tools you need. It's a kit that you'll be proud to show any man, because they're all Starrett's, the tools that two generations of American craftsmen have accepted as the standard for quality and accuracy.

THE L. S. STARRETT CO.
World's Greatest Toolmakers
Manufacturers of Hacksaws Unexcelled
Steel Tapes—Standard for Accuracy
ATHOL, MASS.



Use Starrett Tools

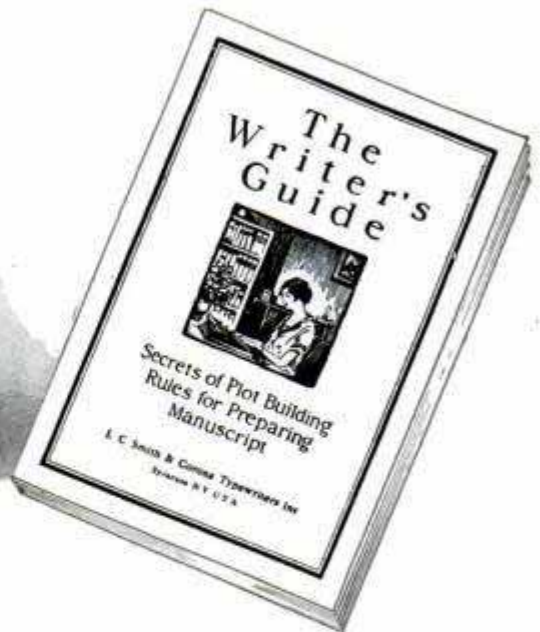

Successful writers use Corona

Most prominent writers prefer Corona because it is not only portable but absolutely dependable. Its light, easy touch makes writing almost effortless, and the neat, legible manuscripts it types are a joy to the heart of a busy editor.

You can own one

This latest Corona is the finest we have ever built—a sturdy, dependable writing machine with full-width (10 inch) carriage, twelve-yard, two-color, self-reversing ribbon, variable line spacer, everything you expect in an office machine. Yet it is compact, portable, easy to carry with you wherever you go.

Standard Keyboard

Corona has the four-row standard keyboard used in all offices and taught in business schools. Back spacer and margin release are conveniently located on the keyboard itself.

Buy on easy terms

A small deposit puts Corona in your home and then you can pay on easy, monthly terms just like rent. Your Corona dealer will gladly accept a used typewriter, any standard make, as part payment. You need not wait another day. Just look up Corona in your phone book and the dealer will send you one for free examination.

The coupon will bring you our latest literature.



Also manufacturers of the
L C Smith Typewriter
the Ball-Bearing Office Machine

Free Book —

tells how to plot short stories and photoplays—how to prepare and submit manuscripts

DO YOU want to be a writer of short stories? Here is a new book which helps you construct your plot—tells how to pick your characters and how to prepare your manuscript.

Should a manuscript be hand-written or typewritten—double spaced or single spaced? What size paper should be used? Where should you put the title and the author's name? Who fixes the price? All these questions and many more are answered in *The Writer's Guide*, just off the press, free if you mail the coupon at once.

L C Smith & Corona Typewriters Inc

Sales offices in principal cities of the world Established 1907

L C Smith & Corona Typewriters Inc, 412 E. Washington St., Syracuse, N. Y.

Without obligation to me, please send me a free copy of *The Writer's Guide*—and complete information about Corona.

Name

Address

I own a typewriter

I should like to know its trade-in value.

Enter This Contest Today

\$2,000.00 IN PRIZES!

108 prizes for models of Studebakers

SIGN and send the coupon below for complete information about Studebaker's Prize Contest for boys. 108 separate awards for the best miniature models of the Studebaker Standard Six Custom Sedan!

Just think—\$2,000 in prizes! Boat motors, long distance radio sets, camping equipment, canoes, latest motion picture kodaks, big sets of tools, sporty luggage, wood and metal working machines, and dozens of other things you would enjoy. Mail the coupon below for full list of awards.

The Studebaker Corporation of America is conducting this unusual contest to encourage craftsmanship among boys. There will be two separate divisions—one for miniature models not more than eight inches long and without moving parts. These may be carved, cast or modeled from any material. The other division will be for models not more than twenty-four inches long which roll on their own wheels—though they need not be self-propelled.

Every Boy Can Compete

Contestants will be divided into two groups—boys of grammar school age and boys of high school age. Prizes are offered for each group. Everyone has a chance to win. Twelve of the national prize winners will also win territorial prizes.

Your miniature reproduction of a Studebaker Standard Six Custom Sedan must be submitted



to your nearest Studebaker dealer before July 1, 1927. You still have time to win a prize but you should sign the coupon and enter today. The winning models will be sent to the Studebaker territorial contest managers, who will select the winners for each territory and award a total of 96 prizes. The territorial winners will then compete for the twelve

national prizes. A committee of prominent judges will decide the national winners.

Send for Booklet of Information

Enter this contest now so you will have time to do your best work. You will have lots of fun—especially if you get your pals to enter, too. You will enjoy your manual training more—and you'll have an equal chance to win one of 108 splendid prizes. Use this coupon *now!*

You pay nothing to enter this contest. You do not have to sell anything. Your family need not own a Studebaker car. Sign and mail the coupon below *now* for complete information and helpful instructions.

THE STUDEBAKER CORPORATION OF AMERICA
South Bend, Indiana

THE STUDEBAKER CORPORATION OF AMERICA
Dept. D-83, SOUTH BEND, INDIANA

Please send me complete information about your prize model contest. I understand that there are no fees nor do I have to buy or sell anything to win.

Name

Address

Town

State

CROSMAN PNEUMATIC .22 RIFLE

Power Without Powder

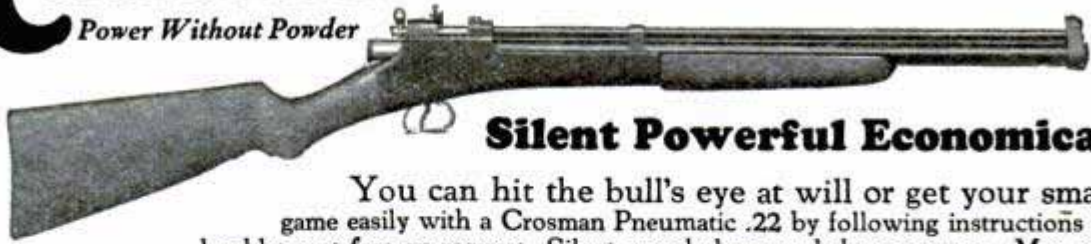

Silent Powerful Economical

You can hit the bull's eye at will or get your small game easily with a Crosman Pneumatic .22 by following instructions in booklet sent free on request. Silent, powderless, smokeless, accurate. Men and boys, experts and amateurs, use this wonder rifle the year 'round for target and small game shooting. Have a shooting gallery in your own home. Kill rats, stray cats, crows, sparrows, woodchucks, rabbits, snakes, prairie dogs, squirrels, etc. Saving on ammunition which cost 1/5 as much as cartridges, pays for rifle. Always ready, because the Crosman never needs cleaning. Try a Crosman at your dealer's. Send postal card now for "Target and Game Shooting," a booklet written by an expert that tells how to become a crack rifle shot. It's free.

FREE
Target
and
Game
Shooting

Crosman Arms Co., Inc., 383 St. Paul Street, Rochester, N.Y.



The strongest man will find "Cornwell" Tools to answer his most exacting requirements for hard usage. . . . No other tools are like them. . . . They withstand the most severe tests that any tools can be put to. . . . Our money back guarantee is behind every tool that fails in any demonstration.

CORNWELL

Hand Forged Tools

Mechanics in all parts of the country boast about "Cornwell" Tools because they do work that no other tools can do. They are made of the finest Swedish Charcoal Process Molybdenum Steel produced under our famous Cornwell Formula. Forged, heat treated and hardened and tempered in oil. . . . Made by hand. . . . NOT drop forged and case hardened.



Money Back Guarantee

You are protected by our guarantee—if you ever saw tools as good as these, return your order and get your money back.

MAIL THE COUPON TODAY

THE CORNWELL QUALITY TOOLS CO., Dept. "J", Cuyahoga Falls, Ohio.

Send me illustrated booklet with prices on full line of "Cornwell" Hand-Made Tools.

..... Occupation
Name.....
Address.....
City..... State.....



BROOKSIDE No. 99

BEST OF ALL STEEL RODS

Perfect casting action — wonderful flexibility, light weight, and remarkable strength—that's Brookside No. 99. A bait casting rod, with built-in quality and extra features that make it the greatest of all-purpose rods.

Made of special tempered spring steel, with patented reinforced tip and second joint. Staggered joints make it cast like a tournament rod. All crystal agate guides and top.

Detachable finger hook. Quality cork handle. In a case of our special design with snap eyelets. List price \$7.00.

Write for illustrated literature about Brookside and other Richardson Rods. There's a Richardson Steel Rod for every fishing requirement and every purse. Also Harrimac, I. D. L. and Our Own landing nets.

Richardson Rod & Reel Co. 528 Lake Shore Drive CHICAGO

Build and Fly Your Own 3ft. Model Aeroplane!



It's the most interesting thing you ever tackled; develops your mechanical ability; teaches the principles of aviation; shows you the parts of big machines, how they are constructed and covered, what makes them fly, and many other things real aviators must know. Any bright boy can do it. Ideal Scale Drawings and Building-Flying Instructions show how. For 25 cents we will send you the complete Drawings and Instructions (3 ft. size) for any one of the following famous airplanes:



Send 5c now for FOKKER North Pole Plane; complete 48 pp. catalog.
Curtiss JN4D-2 Training Plane;
DeHavilland "Round-the-World" Flyer; N C-4 Naval Seaplane; Bleriot, Nieuport or Taube Monoplane; or Cecil Peoli Racer.
Send 25c now and get plans for the one you want to build. (All 8 plans* for \$1.50.)

Ideal Aeroplane & Supply Co.
408 West Broadway, New York
Ask your Dealer for Ideal Models of Real Aeroplanes



\$25.00 PAID DAILY FREE SLICKER for WORKERS

FREE for just a little work on your part WOMEN, MEN WANTED

It's Easy. You show raincoats. We deliver and collect.
WRITE FOR FREE OUTFIT

Super Built Co., Box 453, Desk 2, Chicago, Ill.

BIG PROFITS in a NEW BUSINESS

of your own — No Competition!

Nestler operators make money because they have a real and exclusive service to offer every automobile owner. The Nestler Rubber Fusing Process is the first and only satisfactory method of servicing tires. You convert an old, worn-out tire into one as good as new at one-half the cost. There are Nestler operators in many different localities with flourishing, money-making businesses of their own, all due to the Nestler Plan. Previous tire and garage experience unnecessary. All you need is ambition to work hard to achieve success, and a modest amount of capital to invest in your own business.

Send TODAY for free book, "The Nestler Plan"



This book describes the amazing Nestler Method. Shows how to build up profits in your own exclusive Nestler business.

NESTLER RUBBER FUSING CO. INC.

Dept. 34, 245 West 55th St., New York, N.Y.

10 days free trial

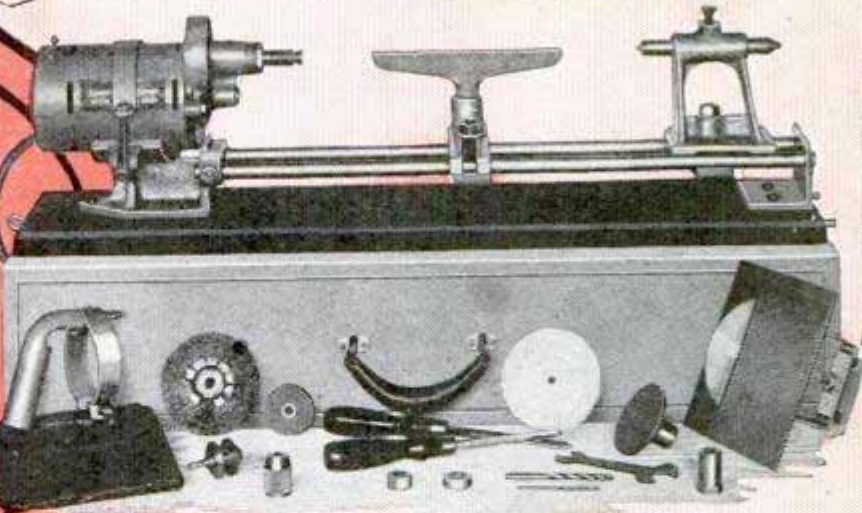

THINK OF IT! 8 TOOLS IN 1

That's what you are getting when you buy one of our new Super SpeedWay Shops. Eight high grade electrically driven tools combined into a new, compact, complete home workshop which will enable you to do any sort of a job your heart desires! The Super SpeedWay Shop shown above gives you complete wood-turning lathe, bench saw, scroll or jig saw, portable electric hand saw, portable wood or metal drill, and all the necessary accessories for both portable and stationary power drilling, buffing, grinding, and cleaning. Simply plug it in on the nearest lamp socket!

Small Down Payment Puts This SpeedWay Shop in Your Home

We make it easy for you to own one of these complete SpeedWay Electrically Driven Shops. All we ask is that you send us a small down payment as evidence of good faith, and we will send you one of these Super SpeedWay Shops at once! The balance you pay in small easy payments which you will never miss. That's a fair and square offer, isn't it?

Make things! AT HOME!

Think of the fascinating, intriguing fun you can have right in your own home with one of these Super SpeedWay Shops. We are sure you will like the Shop—so sure that we will offer you a 10-day free trial on a Super SpeedWay Shop right in your own home. Use it—test it—experiment with it. You will agree with us that it is the huskiest, handiest and fastest wood and metal working outfit you ever clamped your hands on. Simple to operate too! Attach to any light socket, snap on the switch, and singo!—you are making things in your own home.

Don't Pass This Up

We want you to know more about this exceptional Shop. Every tool in it is high grade, built for hard, rugged work. A money-maker for the small-job-man. A priceless boon to the householder. Get the full particulars. Send in the coupon today!

ELECTRO MAGNETIC TOOL CO.
1830 S. 52nd Ave., Cicero (adjoining Chicago), Ill.

Fascinating Fun

Users of the Super SpeedWay Shop are enthusiastic in their praise. They say: "fascinating!" "intriguing!" "interesting!" It's true, too—you can make almost anything—attractive pieces of odd furniture, toys, home and garden improvements, radio cabinets and consoles, bric-a-brac, bookshelves, countless other useful articles. Moreover, you can do buffing, polishing, grinding, and drilling, either at the bench or wherever there is a handy lamp socket. There is a thrill of joy and pride in workmanship when you perform with the Super SpeedWay Shop and Tools.

SpeedWay a Complete Line

Remember—The manufacturers of Super SpeedWay Shop are also the manufacturers of the world's only complete line of Portable electrically driven Saws, Drills, Hammers, and Grinders.

FREE Blue- print Service

Each month for a year we will furnish you a blueprint of your own selection absolutely free, to help you get the maximum fun and service from your Super SpeedWay Shop. Write us for our interesting list.

SpeedWay Shop

Easy to make
things at home



Only
\$10⁰⁰
down

Easy
Payments

Order
NOW!

SEND COUPON NOW!

Dept. 24
Electro Magnetic Tool Co.,
1830 S. 52nd Ave., Cicero (adjoining Chicago), Ill.
Dear Sir: I am interested in the Super SpeedWay Shop.
Please send me full particulars about the ten-day free trial,
free blueprint, and easy payment plan on the Super SpeedWay
Shop and tools.

Name.....

Address.....

City.....

State.....

Lundstrom

IT GROWS WITH YOUR LIBRARY

SECTIONAL BOOKCASE

Endorsed by Over 100,000 Users

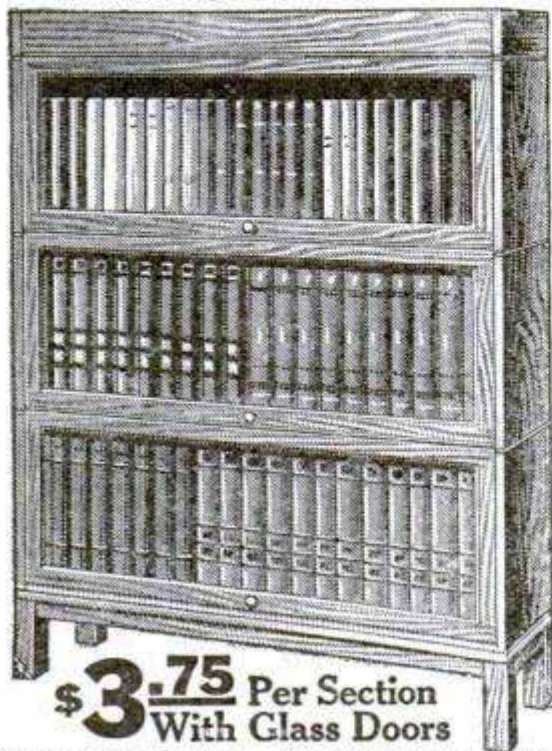

\$3.75 Per Section
With Glass Doors

ON APPROVAL—DIRECT TO USER

Made for and universally used in the finest homes and offices throughout the country. Made in sections of different sizes, combining utility, economy and attractive appearance. Price complete as shown above, with top, base and three book sections with **non-binding, disappearing, felt-cushioned glass doors**, beautifully finished in plain golden oak, \$15.75; without doors, \$13.50. In quartered oak, or in imitation mahogany (willow), with doors \$18.25. In genuine mahogany, with doors, \$23.50. Other styles at correspondingly low prices. **Shipped direct from factory ON APPROVAL** at a considerable saving TO YOU. Write for new catalog No. 21.

THE C. J. LUNDSTROM MFG. CO., Little Falls, N. Y.
Manufacturers of Sectional Bookcases since 1899
Branch Office and Warehouse: Kansas City, Mo.



Going to Rain to-morrow? Consult a

Tycos Stormoguide

If your Dealer cannot supply You, write

Taylor Instrument Companies
ROCHESTER, N. Y.

Canadian Plant, Tycos Bldg. Toronto

There's a Tycos Taylor Thermometer for Every Purpose

Neutral

STARTING

Position-

Fast and Slow Speeds

Forward & Reverse

You can start your Caille motor at the dock, and let it warm up. Then you can glide off—fast or slow, forward or back, by merely raising or lowering your steering handle. \$32.00 puts this wonderful outboard motor on your boat—the rest in easy payments. Get full facts—write today.

CAILLE MOTOR COMPANY
6218 Second Blvd., Dept. C, Detroit, Mich.

4 1/2 Brake
4 1/2 H.P.

SPEED
over 20 miles per hour

MASTER
CAILLE **5** SPEED TWIN



MOTORCYCLES

WE WILL TRUST YOU
Pay As Low As \$2.00 per Week

Hendersons, Harley-Davidsons, Indians

Slightly used and rebuilt. Hundreds to select from.

Send 10c for list today.

MYEROW BROS. CO., 15 Berkeley St., Boston, Mass., U. S. A.



GREEN-ARROW GLARE SHIELD

Adjustable - practical - positive, unequalled protection. Make \$25 to \$50 weekly selling direct to motorists. County Managers appoint agents and multiply income. Write quick for free information, or send 30c for sample for windshield, book of direct selling Auto Specialties and supply of direct sale order blanks.

FRANKLIN COMPANY 712 Kasota Bldg., Minneapolis, Minn.

THIS WONDERFUL INVENTION



converts any ordinary cook stove into a gas stove. OXO-GAS is made from kerosene and air. Cheaper, cleaner and more efficient than coal. Responsible distributors wanted.

GLORIA LIGHT CO.
111-4 N. May St. Chicago, Ill.

I Offer You
\$8.00 a Day
and a

Write quick for new proposition. We offer \$8.00 a day and a new Chevrolet Coach for demonstrating and taking orders for Comer Suits. Spare time. No experience required. Sample outfit free. Write now.



COMER MFG. CO., Dept. W-5122, DAYTON, OHIO



Here's the Mount for Real Sport!

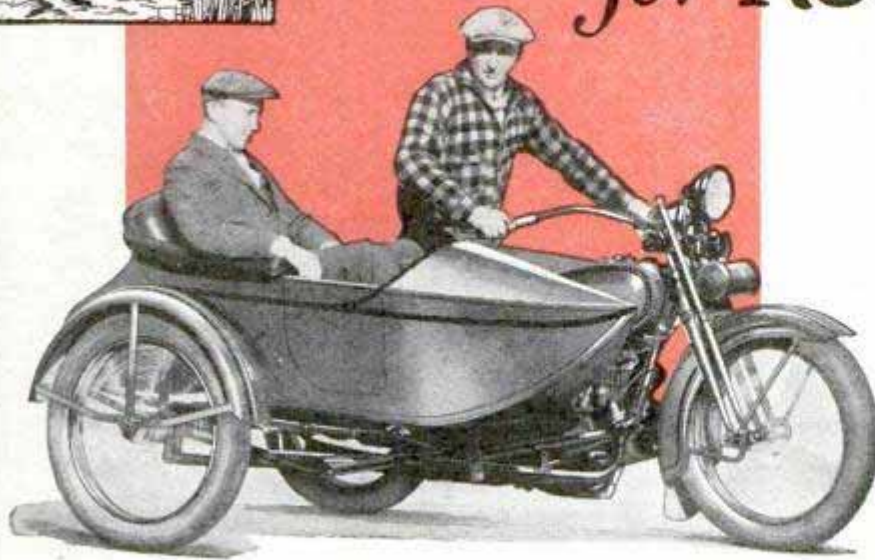

THRILLING power, more speed than you'll ever need, positive dependability in all seasons — that's the Harley-Davidson Twin!

OVER any road or trail it carries you smoothly and comfortably. Ample room in the sidecar for a pal and your outfit. Its upkeep is 'way under any car — only two cents per mile for gas, oil, tires and all. You can buy a Twin as low as \$310 f. o. b. factory — on easy Pay-As-You-Ride terms. See your dealer — send coupon for catalog.

HARLEY-DAVIDSON MOTOR CO., Milwaukee, Wis.

HARLEY-DAVIDSON Motorcycles

Twins and Singles in a wide range of prices. Get our catalog.



The Single — our famous solo mount that travels "80 miles per gallon" and is priced at only \$235, complete, f. o. b. factory.

Mail
the
Coupon

HARLEY-DAVIDSON MOTOR CO.
Dept. P, Milwaukee, Wis.
Interested in Twin Single
Send illustrated catalog.

Name.....
Address.....
.....



JAPANESE ROSE BUSHES

The Wonder of the World

Japanese Rose Bushes bloom all the year round. Just think of it. Six weeks after planting the seed, the plants will be in full bloom. It may not seem possible, but we positively guarantee it to be so. They will bloom every ten weeks, Summer or Winter, and when three years old the bush will be a mass of roses, bearing from five hundred to a thousand roses on each bush. The flowers are in three shades—white, pink, and crimson. The plants will do well both in and out doors. We guarantee at least three bushes to grow from each packet of seed. Price, 10c packet, 3 pkts. for 25c postpaid.

Chinese Fragrant Tree Fern



Just introduced; noted for its rapid growth. An exceptionally pretty ornamental plant. Foliage is rich dark green. Forms grand pyramidal bushes about 5 feet high. Branches very desirable for decorative purposes, wreaths, etc. Seeds 15c pkt., 3 for 40c.

Weather Plant



NATURE'S WEATHER PROPHECY
By mysterious changes that take place, this remarkable plant accurately forecasts the weather many hours in advance. Will grow anywhere all the year around. An interesting house plant. Bearer large, fragrant, pink, butterfly shape flowers. Seeds, 15c packet, 3 for 40c, postpaid

GROUND ALMONDS

Amazingly Prolific—Easily Grown From Seed
The Ground Almond has a flavor that is MOST EXCELLENT, resembling the cocoanut. The meat is snow white, covered with a shell or skin of brown color. It grows close to the surface and anything from 200 to 300 Almonds may be expected from a single nut. There is no trouble whatever in growing any where and in any kind of soil. May be planted any time, and in eight or ten weeks from time of planting you will have an ENORMOUS CROP of the MOST DELICIOUS ALMONDS YOU EVER TASTED. Seeds 15c Pkt.



Perfume Plant



Blooms only at night, giving forth the most delightful scented fragrance for quite a distance. Causes much comment. For house or garden. Also valuable because of rare perfume made from it. SEEDS, 10c pkt., 3 for 25c.

Calabash or Pipe Gourds



A luxuriant and rapid growing climber; thrives anywhere. Produces the ornamental gourds or m which the famous African calabash pipes are made. Grow this interesting vine and make your own. Seeds, with instructions, 15c pkt., 3 for 40c.

SENSITIVE PLANT



Marvel of the Philippines. Leaves curl, fronds droop when touched. Apparently resents interference. A handsome shrub for house or garden; very curious and interesting. Seeds, 15c pkt., 3 for 40c.



Very curious. Produces fruit same size, shape and color of nest eggs. Matures fruit does not crack. Will serve for years as a nest egg, stocking darning, ornamental purposes, etc. Seeds 15c pkt., 3 pkts. for 40c. J.S. & CO.

MAMMOTH PEANUTS

Peanuts can be easily cultivated. Their culture is very simple and exceedingly interesting. Mammoth Peanuts grow to an astonishing size. It is a good producer, very prolific, and the giants have a thick, heavily ribbed protecting shell. The plant is very attractive, the leaves being of odd shape and a handsome green shade, tinted through the center with white. You will derive much pleasure cultivating this interesting species. Seeds 15c pkt., 3 pkts. for 40c.



Musk Plant



A universally admired fragrant for house, flower garden or greenhouse. A very fine foliage plant. Lasts for years. Is of the sweet scented variety, giving forth much fragrance. Also valuable on account of the perfume that can be made from it. Seeds 15c pkt., 3 for 40c.

Japanese Climbing Cucumber



Unusually strong and vigorous growing vine. Attains twice the size of ordinary varieties. Grows readily on fences, poles, trellises, etc. One plant will keep an entire family supplied all summer. Seeds 15c packet, 3 for 40c, postpaid.

GIGANTIC NEW GUINEA BUTTER BEANS

THE NEW EDIBLE VEGETABLE WONDER
Grows to an astonishing size, the Beans measuring from 3 to 6 feet long, and weighing anything from 10 to 16 lbs. and even more. One Bean is sufficient for a family for several meals. Very palatable and rich in nutritious materials. The delicate buttery flavor is much appreciated. The Vines are easily grown, very prolific, and a most welcome and valuable adjunct to your garden. Try them; you will find them the most delicious vegetable you have ever tasted. Imported direct. Unobtainable elsewhere. Sample package of Seeds with full directions for cultivating and cooking. 25c, postpaid.



Kudzu Vine



Most rapid growing vine known. Will grow 20 feet in one week. Luxuriant foliage, lovely purple flowers, very fragrant. Nothing to equal it for shade purposes and quick growth. Seeds 15c packet, 3 for 40c.

Yard Long Bean



Produces enormous crop of long, slender, round pods, of excellent quality for snap beans. Pod grow from 2 to 6 feet in length. Very tender and fine flavor. The vines are rampant growers; an interesting curiosity. Seeds 15c pkt., 3 for 40c

THE REMARKABLE FIREFLY PLANT



A Vine that Blooms at Night
Fills the Atmosphere with Fragrant Aroma
One of the most rapid growing vines known. Under favorable conditions this vine has been known to grow OVER 25 FEET IN A SINGLE WEEK. In a very short space of time indeed the Vine has climbed to a great height, and is covered with IMMENSE FLOWERS, from 5 to 7 inches in diameter. It is, indeed, a great novelty, for, unlike other plants, the flowers OPEN IN THE EVENING, and remain open until about noon the following day. In dull weather they will remain open all day. It is a most INTERESTING SIGHT to watch the opening and closing of the flowers as the clouds appear and disperse. As the flowers open they give forth the most DELIGHTFUL AROMA and the whole atmosphere around is full of scented fragrance. It is always the object of favorable comment, and much curiosity is aroused by people passing at night time as to the cause of the charming aroma, frequently stopping in an endeavor to satisfy their curiosity. PRICE, 19 CENTS packet, two packets for 35 CENTS, POSTPAID. JOHNSON SMITH & CO.

The Great Wonderberry



A luscious berry that may be grown and ripened from seed in any soil or climate in 3 months. The flavor is fine and unsurpassed for eating raw, cooked, canned or preserved in any form. The fruit is blue-black in color, and tastes like a luscious, rich blueberry. One bush will produce an enormous amount of fruit, yielding great masses of rich fruit all Summer and Fall. Packet, 10c, 3 pkts. for 25c, postpaid.

Bush Musk Melon



A vineless Musk Melon, grows in bushes, and thus can be cultivated in the smallest garden. The fruit is of the popular "Jenny Lind" type, but larger, averaging 5 inches in diameter. The flesh is very deep, edible almost to the rind and is colored light green. Fused with salmon toward the center. The quality is superb, lusciously sweet and juicy. Packet of seeds, with full directions for culture, 15 cents, 3 packets for 40 cents, p.p.d.

The Great Umbrella Palm

A Graceful House or Conservatory Plant
Easily Grown From Seed Winter or Summer
The Japanese Umbrella Palm is a semi-aquatic plant. It is easily grown from seed either in a bowl of water or in very damp soil. Probably the most useful, as well as the most interesting method, is to cultivate the plant in a bowl or jardiniere filled with water with two or three inches of good garden soil at the bottom. The seeds soon commence to germinate, and the plant shoots up stems two to three feet high and rapidly assumes a most pretty palm-like appearance, as shown in the engraving. The tops of the stems are surmounted by a whorl of umbrella-shaped leaves, of a waxy appearance. We will send a package of this seed, with full instructions for culture, for only 15c or three packets for 40c postpaid.

Butterfly's Own Bush



This plant is a veritable refuge or haven for butterflies, and it attracts all the most beautiful types of butterflies to the neighborhood. Bees, too, are very fond of it. It is a pretty plant bearing perfectly double flowers, ranging from white to rich crimson, deep red and pink, lilac and other delicate shades. Packet 10 cents, 3 for 25 cents postpaid.

FAMOUS MEXICAN FIREFLY PLANT



Beautiful hedge plant, grows 2 to 2 1/2 feet high and resembling a closely clipped ornamental evergreen. The globe-shaped or pyramidal bushes are close and compact, and of a pleasing light green color. May be grown singly or in the form of a hedge or background. In early autumn the whole bush becomes carmine or blood red, hence the name of Mexican Fire Plant, or "Burning Bush," as it is sometimes called. Selected Seeds, 10c

CROWN OF THORNS



A very curious clove-like plant, can be cultivated indoors or outdoors, the three red blotches on the leaves representing the three wounds of Christ. Has curious thorny seed ball; if loosened at tip the ball is found to consist of a long prickly-edged band wound spirally around the seed cluster, giving the plant its name. Seeds 15c packet, 3 for 40c.

Asparagus Sprengeri



The best plant for hanging baskets. Masses of rich, gleaming foliage droop in a very graceful manner. The foliage when cut for decorative purposes will last for weeks in water. The seed pods are very pretty red berries adding to its beauty. Packet, 25c, 3 pkts. for 65c postpaid.

"Wong-Bok" Chinese Cabbage



Novelty from China and should be grown in every garden. Seems to be a cross between Celery and Cos Lettuce. Flavor is more mild than any other cabbage. Can be served on the table and eaten raw or cooked like cabbage, spinach or lettuce or made into salad. Grows very rapidly, easy to cultivate. You can create quite a sensation by cultivating this remarkable novelty. Seeds, 15c packet, 3 pkts. for 40c.

TREE OF HEAVEN



This splendid ornamental tree is a native of China, and is called the Tree of Heaven, on account of its great beauty. Very hardy, thrives in any soil, no matter how poor, and grows from 6 to 10 feet high from seed the first summer. The leaves are from 5 to 6 feet in any length, giving it a grand appearance. Nothing outside the tropics can rival it for lawn decoration. Large panicles of bloom, followed in season by great clusters of colored seed pods, make the tree a continual thing of beauty. Packet, 15c; 3 packets 40c

SURPRISE FLOWER GARDEN Over Hundred Varieties of Mixed Flower Seeds

MANY RARE AND CURIOUS NOVELTIES
An Abundance of Flowers Assured Throughout the Season
A mixture of easily grown annuals that bloom very soon after sowing the seed; others vary in their time of blooming. Those who cannot give the constant care necessary for finely arranged flower beds will be delighted with the Surprise Wild Flower Garden. Will prove a continual surprise and pleasure, as new varieties and the old garden favorites meet successively throughout the season. There are over a hundred varieties of seeds. Many of the plants may be taken inside as house plants and will bloom during the winter. Fine for children, also teachers for school gardens. Packet, 15 cents, three packets for 40 cents, postpaid. J. S. & CO.



150 Miles on 5 Gallons of Gas GUARANTEED!

or Money Refunded

Just as heat sends the mercury of your thermometer shooting up—so Ford Mileage Records reach new heights with the Blancke Thermostatic Carburetor Control.

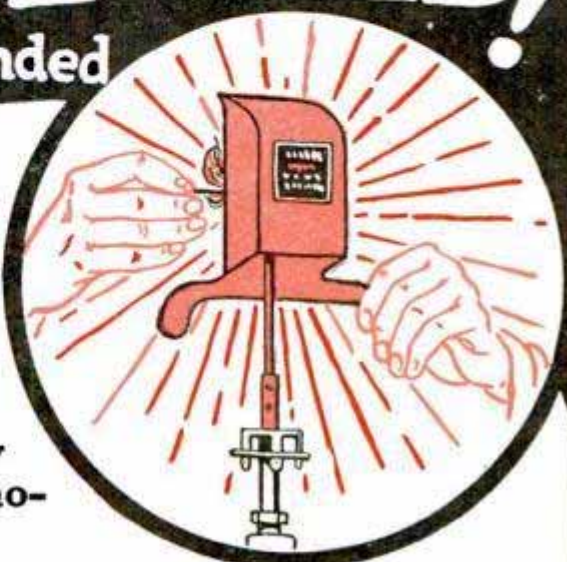

The Same Thermostatic Principle Works Both!

Any thermostatic substance expands with heat and contracts again when cold. On this simple principle the Blancke patented Thermostatic Carburetor Control made Fords run 43.8 miles in Official Public Test. Adams of Joplin, Mo. gets 68 miles on 1 gal. F. W. James of Niantic, Conn. gets 49.3 miles on 1 gallon. Reports from 351,272 public and private tests show average of 32 miles per gallon, breaking world's record for average mileage.

Try Out This Sensational Sure-Fire Demonstration

Heat instantly expands the coil of thermostatic metal in the Blancke Control, and the needle valve on the carburetor slowly turns, admitting only the gas necessary for efficient operation. Cooling, it turns again, just as a faucet is turned on and off, assuring quick starting. It does this automatically—accurately—insuring maximum mileage and power from every atom of gas.

Get Agents' Prices—150% Profit Guaranteed

New Blancke plan combined with amazing demonstration and guaranteed results makes Blancke Control greatest agent's selling success of recent years. Phillips Vickery sold 108 Blancke Controls in 1 day (Profit \$324.00). R. K. Waite, ordered 1000 in 1 month. (Profit, \$3,000.00.) Wires "Get ready another 2,000" Every mail brings similar astounding reports.

You don't need experience to sell the **Blancke Control**. Guaranteed results speak for themselves and fascinating demonstration sells for you.

Makes Starting Easy

In wintriest weather and prevents too rich a mixture in warm weather. Insures proper combustion at all times. Eliminates frequent use of choke when getting under way. You can't help making big money with an article of such remarkable merit, backed by a big national advertising campaign and endorsed by well known companies all over the world.

Get 1 Free to Introduce

Also Blancke Plan that guarantees 150% profit. Starts you without capital in real business of your own, pays you \$300.00 to \$2500.00 and up each month, and gives user Agent New Ford car FREE by time his present one is worn out. Exclusive territory. Sales Guaranteed. Start to make real money—beginning NOW! Send coupon today for sample control and great Distributors plan.

Strongest Guarantee

In automotive history backs sale of Blancke Controls. Guaranteed to give 150 miles on 5 gallons of gasoline on Fords—to practically eliminate carbon formation and its troublesome consequences—to save half oil—to relieve battery strain—make motor run smoother—give better acceleration—allow slower speeds in high gear. Saves half repair bills. Ford owners everywhere are delighted with it, and their boosting promotes sales.

BLANCKE AUTO DEVICES CO.

157 E. Erie St.
Dept. 805-E CHICAGO

Cadillac and Delco Light now use as standard equipment Thermostatic Carburetor Control under Blancke License. You can get no better proof of merit than this.

SALES
Guaranteed

Mail Coupon Now

Blancke Auto Devices Co.
157 E. Erie Street,
Dept. 805-E, Chicago, Ill.
Gentlemen: I should like to get a Blancke Control Free to introduce in my community. Also send details of amazing new Guarantee Plan by which I can make from \$300 to \$2,500.00 a month profit and get a new Ford Free by time my present one is worn out.

Name.....
Address.....
City.....State.....

\$15 a Day
Guaranteed
to Distributors



There's No Hammer Like a MAYDOLE

The experienced carpenter or mechanic will tell you that the Maydole is the finest that human skill, press-forged tool steel and clear, second-growth, air-dried hickory can produce. The Maydole Hammer has been the choice of the craftsman since 1843.

Your dealer sells the genuine Maydole. Ask him to show you one in the style and size you prefer. Heft it! Swing it! Feel that marvelous Maydole "hang." And remember that when you buy a Maydole you're getting all the strength and durability that can be packed into a hammer. It's really the most economical hammer you can buy.

Send for free Pocket Handbook 23 "L"

Give us your name and address and we'll mail you a copy. It's chock full of interesting and valuable information. Write today!

YOUR HAMMER SINCE 1843
Maydole
Hammers

The David Maydole Hammer Co., Norwich, N.Y.

Pliers for those "hurry up" jobs!



When time is at a premium, there is a satisfying certainty about the sure grip of Crescent and Smith & Hemenway Pliers and the quick, clean snip of the wire cutters.

Get them from hardware or accessory dealers.

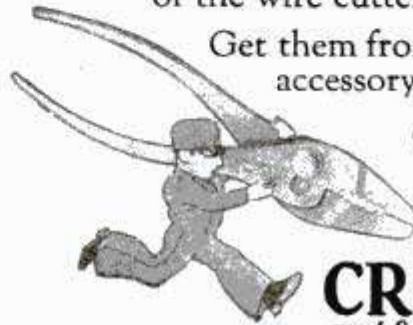

CRESCENT TOOL COMPANY

210 Harrison Street, Jamestown, N. Y.

CRESCENT
and Smith & Hemenway
TOOLS

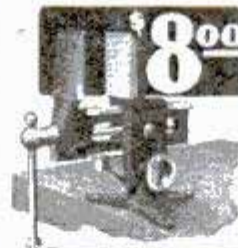

For the Home, Shop, Factory and Farm

This efficiency Swivel Vise is a boon to the user. It automatically locks in any position, and is a time and labor saver. Sent anywhere in the U.S. east of the Rocky Mountains on receipt of \$8.00. Quotation for other points on request. Money back Guarantee. AGENTS WANTED.

THE STEARNS COMPANY
 P. O. BOX 353 CHICAGO, ILL.

SALESMEN MAKE \$100 WEEKLY

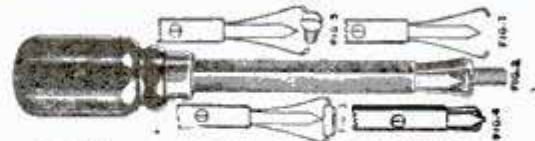

Sell Cox HoldFast Screw Drivers. Only Self-holding—Self-releasing. Sells to auto owners, mechanics, etc. Send 50c for sample and proposition.

S. J. COX, Dept. F, FRANKLIN, PA.



The Finest Saw Money Can Buy

The F. P. M. saw cuts wood, iron and bakelite at any angle. Used and recommended by experts in every line. Unequaled for sturdy, lasting construction and fine workmanship. Blades of finest tempered steel. Get the F. P. M. Saw at any hardware store or order direct.

1 F. P. M. Saw and 7 Blades sent prepaid \$1.00 DEALERS—Write for Discounts—JOBBER

F. P. MAXSON 3722 N. Ashland Ave., CHICAGO

SIMONDS HACK SAW BLADES

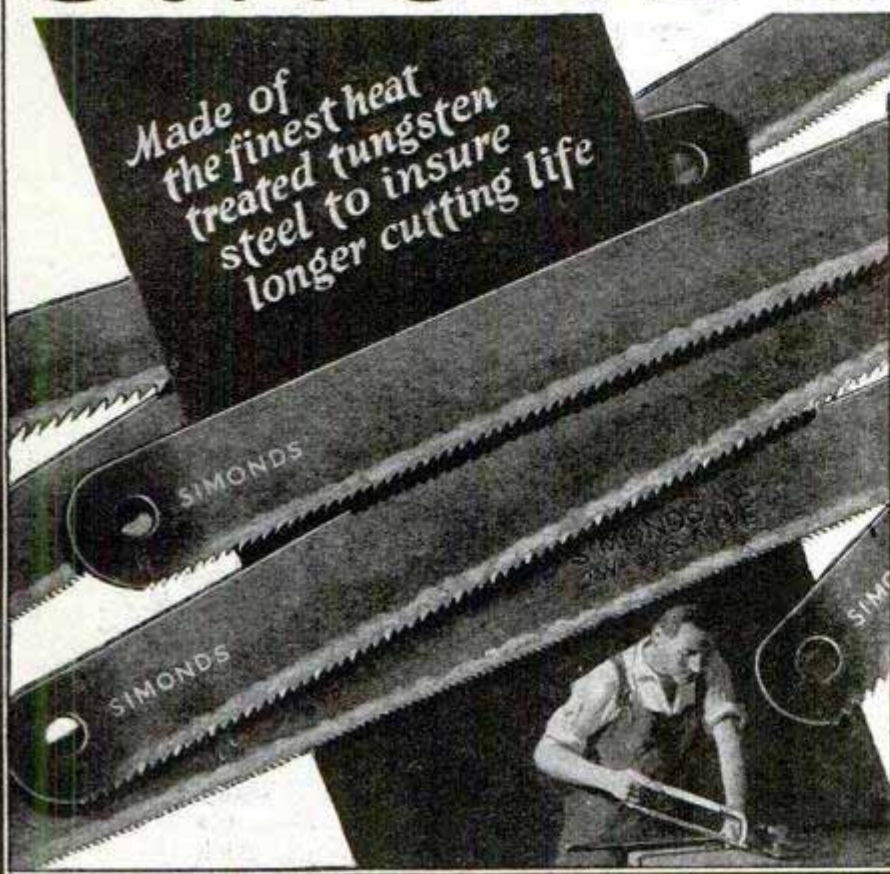

Made of the finest heat treated tungsten steel to insure longer cutting life

NEARLY A CENTURY OF GOOD-WILL BUILDING

SIMONDS' reputation for making fine cutting edges of tempered steel dates back nearly a century to 1832. Therefore, you can accept the Simonds name on Circular, Band, Cross-Cut and Hack Saws, and on Files and Machine Knives, as assurance of well-established excellence—excellence that is apparent in longer service life and greater cutting efficiency. In buying cutting tools, it pays to specify "SIMONDS". Write for copy of booklet, "Hacksaw-ology".

SIMONDS SAW & STEEL COMPANY

Fitchburg, Mass.

"The Saw Makers" Established 1832
Branch Stores and Service Shops in Principal Cities

\$25 to \$45



GET THE NEW IDEA BATES MOTOR SAW — 6 SAWS IN 1 —

Does the work of band-saw, rip-saw, cross-cut, miter, bevel and scroll-saw. A wonder worker for the home shop. Direct drive! Can't stick! Cuts 2" wood. Most amazing variety saw ever invented. Does more, costs less! Not a toy. Write for circular.

BATES MOTORCRAFT COMPANY
Dept. M 28 N. Clinton CHICAGO, ILL.



Gerstner TOOL CHESTS

are made so well, finished so neatly, and are such splendid values that Toolmakers and Machinists everywhere are more than pleased with them. *Catalog free.*

Gerstner Sons

440 Columbia St., Dayton, Ohio



Length over all 30 in.; between centers 14 in. Swing over bed 7 3/4 in. Includes counter shaft, Bronze taper bearings. Weight 60 lbs. No. 11 Lathe, 40 in. over all; 24 in. centers, 7 1/2 in. swing. Price \$75.00. Time Payments if desired.

\$60

The Sypher Mfg. Co., Dept. D, Toledo, Ohio



All for \$1.98 Plus Postage

4" Wall 2" Varnish 1 1/2" Enamel 1" Lacquer 1 1/2" Auto Sash Marker \$1.50 55c 35c 25c Lacquer 75c Tool 15c 10c

SAVE 40% Send for Price List of Paint Brushes of every type. WILLIAM BRUSHES will not shed. All pure bristles, set in rubber, vulcanized to a fine enamel handle, secured by nickel ferrule. Fully guaranteed. Money refunded if not satisfied after examination. Send no money. Order today.

William Brush Co., 87 Nassau St., N. Y. City. (Ag'ts Wanted) Send above combination C. O. D. to

Name Street
Town State



The Handy Tool for the Handy Man

TORIT No. 23 Acetylene Torch

PAT. JAN. 5, 1926

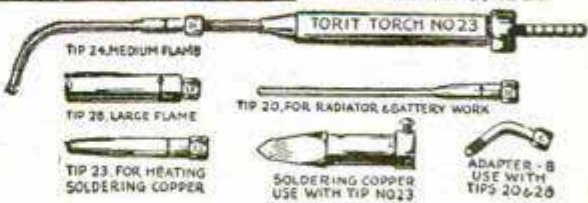

Uses Acetylene Only. No oxygen or air pressure required. Tips suck in air. Simply connect to Presto auto tank, light gas, and the outfit is put to work. Gives Heat Instantly! Beats anything you ever tried for soldering, radiator repairing, melting, lead burning, tempering, heating, light brazing, etc. Consists of torch, 4 tips for different kinds of work, soldering copper, 5 feet rubber tubing, tank connection, and full instructions. All ready to use. Quickly \$7.50 pays for itself. PRICE, complete, without tank.

ST. PAUL WELDING & MFG. CO.
177 West Third Street Saint Paul, Minnesota



WHITING'S CELEBRATED BRUSHES
ADAMS SUPERIOR BRUSHES

From the first to the very last stroke they deliver such a measure of satisfactory service that they have become the Standard Equipment of American Painters. They "break in" quickly—work right, and last long.

TRADE MARK

WHITING-ADAMS
BOSTON
 BRUSH MAKERS FOR 118 YEARS

PARKS
 WOODWORKING MACHINES

Cabinet Shop Special

\$290
with Motor



You ought to have this handy Parks in your shop. It is a compact, complete machine designed just like a big production outfit at one-fifth the cost. Includes 8-inch circular rip and cross cut saw with polished cast-steel saw table, 16-inch band saw with tilting table for bevel-sawing, 6-inch jointer, and motor operating from any light socket. Just plug in and go to work! Fits in a corner of your basement. Does any kind of cabinet and joinery work. Add lathe, shaper and other attachments any time at small cost. For the man who does "odd jobs" in his off time this Parks is a big money maker. Turn out as much as a four-man shop working by yourself.

Write for circular and Parks complete catalog of handy woodworking machinery.

The Parks Ball Bearing Machine Co.
 1500-1540 Knowlton St. Cincinnati, Ohio
 Canadian Factory: 208 Notre Dame East, Montreal, Can.

WITTE ENGINES

200,000 all purpose, all fuel WITTE Engines from 1½ to 30 H.P. in daily use. Sold all over the world, but to honest American farmers at Wholesale, DIRECT Factory Price, Easy Terms and No Interest. The Standard Farm Power.



BUZZ SAW
 One of the 11 WITTE Power Plants. Saws from 3 to 6 inch wood. Popular and useful. Other Log and Tree Saw Outfits.

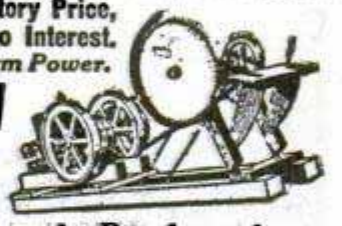

PUMPERS All sizes, for every need. Have water all the time for stock, home, irrigation, etc. Direct gear or belt driven.



Lifetime Guarantee FREE Big New illustrated Catalog just out—shows complete line. How to make money with WITTE Outfits. Solves all farm power problems. 57 years practical experience. Send name—no cost—no obligation.

3 hour Shipping Service.

WITTE ENGINE WORKS
 1743 Witte Building, Kansas City, Mo.
 1743 Empire Building, Pittsburgh, Pa.
 1743 Witte Bldg., San Francisco, Cal.

BURN YOUR NAME ON TOOLS WITH THE ARKOGRAF

PROTECT YOUR TOOLS FROM THEFT
 Write with electricity any name or design on the hardest and finest tools and instruments, or any metal, like writing on paper with pen or pencil. Complete Outfit \$3.50—Prepaid Anywhere. Interesting illustrated circular free. Write today. Agents wanted. ARKOGRAF PEN CO., 1171 E. Stark St., Portland, Oregon



CALCULATIONS

in Office, School, Store and Shop can be neatly made with the Midget Slide Rule. It gives the answer to any problem involving fractions, mixed-numbers, decimals, whole-numbers, roots, powers, Logs, and Trig. Functions. Thousands of these ruler are used by Accountants, Engineers, Clerks, Students, etc. It is the most versatile calculator ever invented. If you have any figuring to do, order a Midget Slide Rule on trial. Made of aluminum with figures on white celluloid. Size 4". Price with Instruction Book, \$1.50. Leather Case, 50c extra. Catalogue Free. Sent C. O. D. if desired. Your money back if you are not satisfied.

GILSON SLIDE RULE CO., Stuart, Florida.



Makes Old Ford a Tractor

Now you can convert that old Ford car into a useful farm tractor without altering any Ford parts. We furnish the traction wheels, drive gears and auxiliary axle and mountings, ready to clamp on to the Ford frame. Pulls 16' plow.

We supply a Belt Pulley also



Write for Free Particulars.
SHAW MFG. CO., Dept. S, Galesburg, Kan.

100 SCALE PLANS

for building old and modern ship models. Send 6 cents for catalog of plans, books, prints, maps and other things that smack of the sea.



SEA ARTS GUILD, 405-A Eleventh Avenue, MILWAUKEE, WIS.

\$542⁰⁰ Earned IN ONE MONTH

A BIG MONEY-MAKING BUSINESS

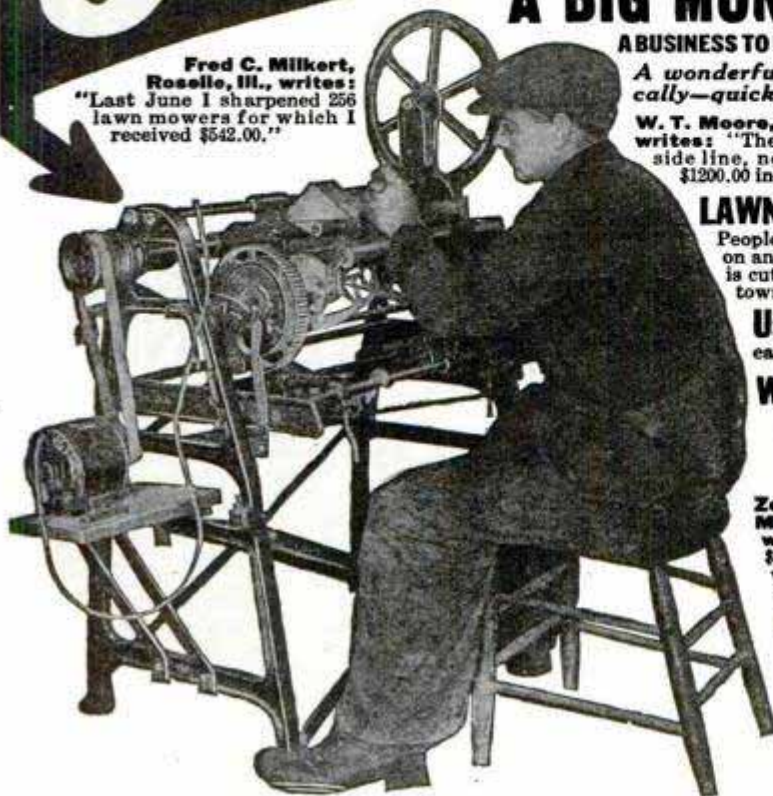

Fred C. Milkert, Roselle, Ill., writes:
"Last June I sharpened 256 lawn mowers for which I received \$542.00."

A BUSINESS TO ENTHUSE OVER—THE "IDEAL" LAWN MOWER SHARPENER
A wonderful invention that sharpens lawn mowers scientifically—quickly—perfectly; does the work as nothing else can.

W. T. Moore, Twin Falls, Idaho, writes: "The Ideal Grinder, as a side line, netted me a profit of \$1200.00 in 90 days."

W. F. Kendt, Buffalo, writes: "I sharpened 994 lawnmowers last season and the receipts were nearly \$2,100 which is not bad for a side line."

LAWN MOWERS SHARPENED TO RAZOR EDGE

People glad—owners delight in mowing lawn with mower sharpened on an "Ideal." Mower runs light—click-click-click and the grass is cut. Build permanent business for yourself. Start Now! No town too small.

Use Your Spare Time If you work at a trade, put an "Ideal" in your basement and earn \$4 to \$6 an hour evenings and Saturday afternoons.

WRITE TODAY for full information of this wonderful money-making machine. **FREE**

THE FATE-ROOT-HEATH MANUFACTURING COMPANY
Plymouth, Ohio

Zeno Brandon, Middletown, Ohio, writes: "I made \$820.70 in 55 days with my "Ideal." Have made as high as \$38.70 in one day."

USE THIS — MAIL IT TODAY

The Fate-Root-Heath Company
818 - 844 Bell Street, Plymouth, Ohio

Please mail free Illustrated Catalog and booklet with scores of letters from "Ideal" owners and pictures of their shops.

Name _____
Address _____

Any Warlitzer Instrument
Try in Your Own Home

See for yourself the superior quality of these famous instruments, the result of 200 years' experience. Every known instrument. No expense for trial. Easy terms if desired.

Send for New Catalog—Free
Rudolph Warlitzer Co., Dept. 1774
Cincinnati Chicago
New York San Francisco
Address city nearest where you live.

Information on any book free. Write Popular Mechanics Press, Chicago, Ill.

Shoot the Best Gun

The NEW BENJAMIN is the finest air rifle ever made. Unlike all others. Has amazing accuracy—shoots hard and far. It's the original American genuine AIR operated rifle. One to six pump strokes compress air to any desired degree of power. Same force as in air drills and air hammers except you control the shooting force. Never loses force—no springs or levers to get out of order. Makes crack shots quickly, inexpensively. Gives years of delightful recreation with utmost safety. At your dealer's, or sent postpaid for \$5.00.

Shoot 5 Days FREE

We give you five days, ammunition supplied, to test the NEW BENJAMIN. If in this time you don't believe it to be the finest air rifle you've ever seen or used, and if you don't believe it is the one and only air rifle for you, return it, postpaid, and your money will be refunded at once.

The NEW BENJAMIN AIR RIFLE

America's Original Air Rifle

\$5 at your dealer's or sent postpaid direct from factory on FREE Trial as above if dealer does not handle it—write for our wonderful offer.

Get This Book and Details FREE

BENJAMIN AIR RIFLE & MFG. CO.
645 N. Broadway, St. Louis, Mo.

Please send your amazing offer and free copy of "The Shooter's Art," telling how to become a crack shot, how to hold, aim, and handle guns and guide others in use of guns.

Name _____
Address _____

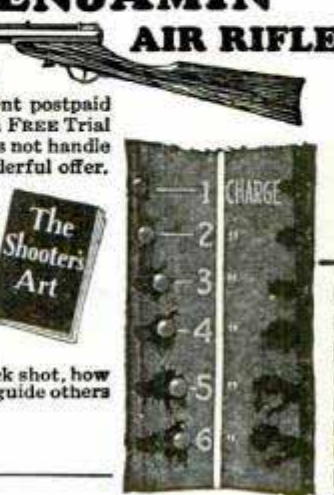

MEN \$10-\$15-\$20 a Day

Commissions Paid Daily

Profitable new field for men who are conscientious and dependable. NO EXPERIENCE NECESSARY. My plan pays biggest commissions in this line, in advance, with extra bonus for producers.

Full or part time \$45 to \$100 weekly **Act Now**

Sell Better Quality All Wool Tailoring \$31⁵⁰

Our astonishing values in tailored-to-order, all-wool suits and overcoats positively sell on sight. We want earnest men AT ONCE who are anxious to Make Money and will help them to establish a steady, big-paying repeat business. No capital required.

We furnish handsome large swatch samples and complete instructions—FREE. Write at once.

W. Z. GIBSON, Inc., 161 W. Harrison Street, Dept. D-516 Chicago



Diamonds

Here at 60% of Market Price

Never in three quarters of a century have we offered such amazing bargains. Hundreds of money-saving opportunities in latest Diamond Bargain List, equalling those shown here.

Here's why we can offer such remarkable values: This 75 year old firm—rated at over \$1,000,000.00 capital—the largest and oldest diamond banking institution of its kind in the world has made loans on Diamonds, Watches, and other jewels in excess of \$25,000,000.00.

Why Pay Full Prices

Costs Nothing to See
Thousands of unpaid loans. Must sell now. Diamonds, Jewels, Watches and other Gems of unusual qualities—at an entirely different price basis—viz: loan values not market values. At our risk we send you any bargain you wish for absolutely free examination. No red tape. No obligation. Don't buy unless satisfied you can not match the bargain at 60 per cent more. *Diamonds of desirable quality at \$125 per carat. Yes, some even lower priced—also finest gems obtainable at higher per carat—but proportionately low bargain prices. Our bargains have guaranteed loan values also, unlimited exchange privilege at full prices.*

Latest List

Diamond Loans

Send at once for latest list. Thousands of unpaid loans and other special advantage bargains. Many from big cash deals direct with European diamond cutters. Every gem described in full detail with exact weight, color, quality, etc. Get details of Free Examination Offer. No obligation. List is free.

MAIL COUPON NOW



\$38⁵⁰
1/2-3/6 Ct
Perfectly
Cut



\$186
1-5/32 Ct.
Blue White



\$55
5/2 Ct Show
cluster



\$62
1/4 Ct
White Gold

Only Opposite Post Office
Without obligation, send me free, your latest Bargain List of Diamonds, Watches and other jewelry.

Jos. DeRoy & Sons
1955 DeRoy Bldg., Pittsburgh, Pa.

Name.....
Address.....
City..... State.....

You can make \$100 a week

Yes, you can make \$100 a week. You can do as well as H. T. Pearl who made \$750 in one month. You can begin like R. L. Marshall who made \$80 in five hours. You don't have to invest any money. Experience is unnecessary—yet you can start right in to make big money. In a short while you can enjoy an income of \$5000 a year for the easiest, most pleasant and fascinating work you ever did.

HUDSON Coach Hudson Coach GIVEN!



We want men and women to represent us everywhere. Wonderful plan. 350 Household Necessities direct from factory to home. Spare time or full time returns amazing profits for easy work. We furnish everything you need to start. In addition to big earnings we offer you a brand-new Hudson Super-Six Coach. Write at once for details of this money-making proposition. We'll send FREE PROOF that you can make \$100 a week in this pleasant, dignified, permanent business.

Write quick for details

The American Products Co.
Dept. 7007
Cincinnati, Ohio

MYERS ELECTRIC IRON CORD HOLDER

A wonderful invention. Keeps cord out of way while ironing. Grips the ironing board. Tested and approved by Good Housekeeping Institute.

AGENTS WANTED
Sample 50 cents postpaid

C. A. MYERS CO.
6339 Woodlawn Ave., CHICAGO, ILL., U.S.A.



NEW KIND OF TIRES

DOUBLE MILEAGE

Mellinger Melenium Cured 15,000 mile tires—shock proof—handsomest, most durable tires made. Cord and Balloons. New process prevents rubber rot. Amazing guarantee. Sensational low prices.

AGENTS 4000 car owners in your territory—\$200,000 business awaiting you. Cash profits, no expense, collection, delivery, adjustment. Garman, Mich., makes \$48.30 in 2 days; Vernal, Miss., sells 25 tires first week. Hundreds double their income first few weeks in spare time.

Write Quick Be first to get introductory demonstrating offer. FREE Melenium Cured Samples, exclusive territory, and tires for yourself if you own a car. Simply send name.



Mellinger Tire & Rubber Co.

WRITE NEAREST OFFICE
Dept. 105, Philadelphia, Pa.

Dept. 105, Kansas City, Mo.
Dept. 105, Oakland, Calif.

Your Coat and Vest Can Be Matched with New Trousers

Save the price of a new suit. We match hundreds of coats and vests satisfactorily every day. Each pair tailored to your measure. 80,000 patterns. We submit sample of cloth for your approval. Just mail your vest or a sample of the suit. *We employ no agents.*

ACME PANTS MATCHERS
Dept. BD 14, 20 W. Jackson, Chicago



RESHAPE YOUR NOSE!

You can safely reshape your nose to beautiful proportions with **ANITA NOSE ADJUSTER**—painlessly, comfortably. Results speedy and guaranteed. Physicians praise it highly. No metal to harm you. Winner of Gold Medal, 1923. **FREE BOOKLET** Write for it today.

THE ANITA CO. Dept. D-12, ANITA Building Newark, N. J.

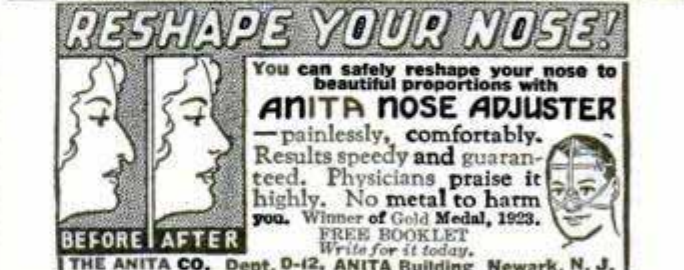

ALL FREE

10 year guar. Watch with chain and ring, large Eastman Roll Film Camera or 22 cal. Hamilton Rifle, yours for introducing finest assorted liquid perfume at 15c a bottle. Send for 20 bottles and choose gift as per offer in our catalog. We trust you—just write to **BELL PERFUME CO., Dep. E153, Chicago, Ill.**





FREE Use of Land For One Year Then 34 Years to Pay

READ this amazing farm offer. Rich fertile land, some of the finest in the world at an average of \$15 an acre—pay 7% down then use it a year, free of charge. Then 34 years to pay.

Low interest—low taxes—no taxes on improvements, buildings, machinery, live stock or personal effects—big yields—that is the secret of the success of Canadian farmers. Many are rich—all are prosperous. You can be, too. Come—see for yourself the chances to become independent—wealthy. Stock, grain, hogs, dairy and mixed farming all thrive here. Western Canada won the Grand Championship of both wheat and oats at the Grain and Hay Show of the 1926 International Live Stock Exposition. You can succeed, too.

Stop Paying the Penalty of High Priced Land

Come, help us bring man power to Canada's fertile acres. We want business-like farmers to build the country. This big railroad offers every inducement.

Good markets, modern schools, roads, churches and amusements make life here desirable—attractive. Thousands of American farmers are prospering here. Don't pour your profits into high priced land. Come to Western Canada.

IRRIGATED FARMS, TOO

In Sunny Southern Alberta we offer irrigable farms that produce wealth in coarse grains, alfalfa, sugar beets, pasture, etc. These lands for sale on the same amazing terms.



You Cannot Buy Until You Investigate

Inspect the land before buying. Special low-priced inspection trips are arranged. Mail the coupon for full information—no obligation.

C. A. VAN SCOY
Supt. of Colonization, Dept. 504
Canadian Pacific Ry. Depot
Winnipeg, Canada



The farm home of J. S. Samis

Read What These Farmers Say:

I started with \$600—now I have 960 acres improved, stocked and paid for.
J. S. Samis, Alberta

Come here and give your children a chance to do well; own your own home and prosper.
Mrs. L. F. Pinkerton, Alberta, Canada

I farm 960 acres; raise thoroughbred hogs and cattle. Raised 19,000 bushels of wheat, oats and barley this year. Come to Canada.
F. J. McLoy

C. A. Van Scoy, Supt. of Colonization
Dept. 504, Canadian Pacific Ry. Depot
Winnipeg, Man., Canada

I am interested in learning more about:

- Prairie Provinces of Canada
 Irrigation Farming in Sunny Alberta
 Business and Industrial Opportunities in Western Canada.

My Name.....

Address.....

Town..... State.....



Print Your Own

Cards, stationery, circulars, tag, labels, paper. Complete Outfits, \$8.85 up, Job Presses \$11 up, Rotary \$149. Card Cutters, \$3. Save money. Print for others, big profits. All easy rules sent. Write for catalog presses, type, paper cards, ink etc. **THE KELSEY CO., H-37, Meriden, Conn.**

LEARN TO Mount Birds

We teach you At Home by Mail to mount Birds, Animals, Heads, Tax Furs and Make Rugs. Be a taxidermy artist. Easily, quickly learned by men, women and boys. Tremendously interesting and fascinating. Decorate home and den with beautiful art. Make Big Profits from Spare Time Selling Specimens and Mounting for Others.
Free Book—Yes absolutely Free—beautiful book telling all about how to learn taxidermy. Send Today. You will be delighted. Don't Delay!
Northwestern School of Taxidermy 1774 Elwood Bldg. OMAHA, NEB.



Now, Only \$39

Let Me Send You the Greatest LOG SAW Offer

—I ever made. One man saws 15 cords a day—easy. Falls trees, saws limbs. Make big money. Use 4 H-P. Engine for other work. Saws faster than 10 men. Shipped from Factory or nearest of 10 Branch Houses. Cash—Easy Terms. Write for 30-Day Trial Offer and big FREE book.

OTTAWA MANUFACTURING COMPANY
1741-W Wood Street, Ottawa, Kan.
Room 1741-W Magee Bldg., Pittsburgh, Pa.

A NEW Pan-American Saxophone For Only \$ 8 a Month!



Why wait and only wish you could play a Saxophone? You can play one *Right Now*. You can have a new PAN-AMERICAN Factory Guaranteed Saxophone for only \$25.00 down and \$8.00 a month. Think of it! You can learn to play a PAN-AMERICAN in three lessons.

PAN-AMERICAN SAXOPHONES are priced unusually low. Pan-American quality has won the endorsement of America's leading Saxophonists. It is worthy of a place in America's finest orchestras.

You Can Play a Pan-American In Three Lessons

Don't delay! This is an amazing offer—for a limited time only. Send coupon now. Learn about this beautifully finished PAN-AMERICAN SAXOPHONE — with the latest key mechanism. Learn how easy it is to pay for your Saxophone. Ask for free catalog of *entire* line of PAN-AMERICAN band and orchestra instruments.

SEND COUPON TODAY

The Pan-American Band Instrument & Case Co., Dept. G-7, Elkhart, Indiana
 YES—Send me complete information on PAN-AMERICAN Saxophones and other band instruments. I would like to learn to play..... (instrument).

Name.....
 Address.....
 City..... State.....

FREE New Book

FACTORY PRICES

Save 1/3 to 1/2

New FREE book quotes **Reduced Factory Prices**. Introduces sensational **5-Year Guarantee Bond** on Stoves, Ranges, Furnaces, 200 styles and sizes. Beautiful porcelain enamel ranges and combination gas and coal ranges in soft grey and delft blue.

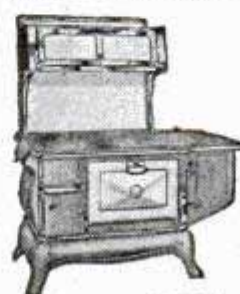

Mahogany porcelain enamel heating stoves. Cash or easy terms—as low as \$3 down, \$3 monthly. 24 hr. shipments. 30 day free trial.

Heating Stoves \$270 up

360 day approval test. Satisfaction guaranteed. 26 years in business, 600,000 customers. Write today for your copy of this FREE book.

KALAMAZOO STOVE CO., Mfrs.
 391 Rochester Ave.

Ranges \$375 up

KALAMAZOO MICH.

"A Kalamazoo Direct to You"
 Trade Mark Registered



A Genuine \$2 Knife for \$1.18 Postpaid
 Handy shaped blade makes this knife best for mechanics, sportsmen and farmers; light but strong; re-sharpened easily. Stag handle. German silver finish; blades file tested, hand forged from razor steel and warranted.

Direct at Factory Prices

Sample \$1.18 3 for \$3.00 Postpaid.

Hand Forged Razor Steel Blades
 Send for our 100-page FREE List and "HOW TO USE A RAZOR."

Maher & Grosh Co.
 106 A St., Toledo, Ohio

NEW VEST POCKET ADDING MACHINE



ADDS, SUBTRACTS, MULTIPLIES, DIVIDES
 Does work of \$300 machine. Guaranteed 5 years. NOT A TOY. Made of steel and indestructible. Million dollar capacity. Fits in pocket. Will not make mistakes. So simple child can operate it. Instructions furnished. Everybody should carry one for figuring.

FREE TRIAL \$2.50 Total Cost

SEND NO MONEY—Just name and address. We will ship Calculator immediately. On delivery pay postman \$2.50 (Plus few cents Postage). (If outside U. S. send cash. If not satisfied after 30 day trial you get your money back. THOUSANDS OF SATISFIED USERS. This is lowest priced practical calculator made. "Why pay more for inferior imitations?" Order from this ad.

Mail Coupon Today

BABY CALCULATOR SALES COMPANY
 Dept. 41, P. O. Box 1118, CHICAGO, ILL., U. S. A.

I am enclosing \$2.50—send adding machine prepaid.
 Send Adding Machine C. O. D. \$2.50 plus postage.
 Name.....
 Address.....
 City..... State.....

AGENTS Write for big commission and territory proposition.

AGENTS 500% PROFIT

GENUINE GOLD LEAF LETTERS

guaranteed to never tarnish. Anyone can put them on stores and office windows. Enormous demand, large profits. Paul Clark says: Smallest day \$28.70. R. L. Reel made \$920 in two months. Write today for free sample and liberal offer to general agents.
METALLIC LETTER CO., 433-B N. Clark St., CHICAGO

DOUBLE YOUR INCOME **SELL PIONEER**
\$23.50 All Wool Tailoring
FULL OR PART TIME

MAKE \$12.00 A DAY FROM START
 Part timemen \$5 an hour selling famous Pioneer tailored-to-measure all-wool suits at \$23.50. Commissions Paid in advance. Striking leather brief case containing 100 large swatch samples furnished—other equally remarkable values at \$29.50 and \$34.50. We train the inexperienced. Men with determination and willingness to work for success write for this big money making opportunity, today.
Pioneer Tailoring Co., 159 W. Harrison St., Dept. D1116, Chicago

EDWARDS WILL SAVE YOU MONEY ON METAL ROOFS

We own our own steel mills, roll our own sheets, make them into high-grade REO METAL SHINGLES, Sidings, Ceilings and Roofings of every type and style for every kind of building. We control every operation from the raw material to the finished roof and we sell direct from our factories to the user. Not a dollar to divide with anybody but the customer! You get better value for less money.

OUTLAST THREE ORDINARY ROOFS

EDWARDS METAL ROOFS are weather-proof, lighting-proof, fire-proof! The galvanizing bends with the metal. No tools required.



LOW-COST ALL-METAL GARAGES

Any size. Any style. Portable. Ready to erect. Complete with frames, doors, sash and hardware. Ornamental,

durable, economical. Blue-prints and complete instructions FREE. Write today. Get our low prices and Free Samples. Ask for Roofing Book No. 150 or for Garage Book No. 150

THE EDWARDS MFG. CO.
400-450 Butler St. Cincinnati, O.



Catch Fish!

Eels, Mink, Muskrats with our new folding galvanized

STEEL WIRE TRAP. Write for our FREE TRAP OFFER and Bargain Catalog. \$1 Box of our famous Fish Bait FREE to introduce our traps. WALTON SUPPLY CO., 3500 JUNIATA AVE., ST. LOUIS, MO.



MAKE FORD Into The "LARK"

\$5.00 Red-i-Kut life size patterns Class-Snap



Famous sure-fit RED-I-KUT life-size patterns and picture instructions show how you can easily convert your Ford into this Fast, Saucy, Sport Car as thousands have done, with easily obtained materials. No need to lay up the car. Rear seat folds, making 4-passenger car. Send 10c coin for actual body photo

and new manual of other distinctive sport body patterns from \$5.80 up—"EKO" Steel "Swing-La" irons, Tops and Windshields. ORDER RIGHT NOW.

KUEMPEL COMPANY, 83 Kuempel Bldg., GUTTENBERG, IOWA

YOU SAVE 40% ON THIS NEW MODERN GUARANTEED Bath Room Outfit

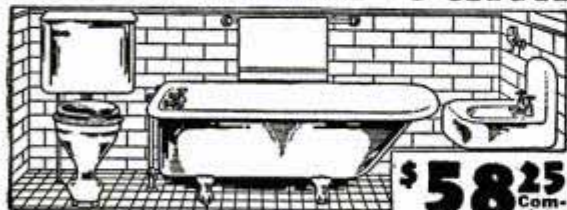

\$58.25 Complete

Our customers say we sell the best goods at lowest prices and give the best service. You save most because we give you

WHOLESALE PRICES

on the best PLUMBING and HEATING SUPPLIES. Everything GUARANTEED or we Refund Your Money. Get our Catalog. Compare our prices with anyone else selling high grade Goods and you will see how much you save.

ESTIMATES AND CATALOG FREE

Send your plan for us to figure, or rough sketch of job.
B. KAROL & SONS CO. 800 S. KEDZIE AVENUE
Dept. 20 CHICAGO

Great *New* Invention for seekers of Health Power Beauty



Elco Health Generators at last are ready for you! If you want more health—greater power to enjoy the pleasures and delights about you, or if more beauty is your desire—write! Ask for the book on these inventions which has just been prepared. It will be sent to you without cost. It tells you how Elco Health Generators aid you in leaving the lethargy and hopelessness of bad health and weakness behind forever. Re-vitalize yourself. Bring back energy. Be wholly alive. Write today!

10 Days Free Trial—Write for FREE BOOK



These great new inventions generate *High Frequency Violet Ray, Mechanical Vibration, Medical Electricity and Ozone.* Combined or separate.

They operate on the electric light in your home or on their own motive power at less than 50 cents per year. Elco Health Generators are positively the only instruments which can give you in one outfit Electricity, Violet Ray—Vibration and Ozone—the four greatest curative agents. Send coupon below. Get the Free Book NOW!



For All These:

- Rheumatism
- Gout
- Lumbago
- Neuralgia
- Sciatica
- Headache
- Neuritis
- Nervousness
- Circulation
- Weakness
- Paralysis
- Eye Trouble
- Asthma
- Hay Fever
- Sore Throat
- Catarrh
- Deafness
- Insomnia
- Pain
- Development
- Skin Disease
- Pimples
- Scalp Disorders
- Obesity

MAIL the COUPON for FREE Book!

Do not put this paper down without sending the coupon. Don't go on as you are with pains and with almost no life and energy. You owe it to yourself to be a better man or woman. You were put here to enjoy life—not just to drag through it. So do not rest another day until you have put your name on the coupon here. That will bring the whole story of these great new inventions. Do it today—now.



Lindstrom & Company
30 West Lake Street, Dept. 93-54, Chicago, Ill.
Please send me your free book, "Health—Power—Beauty" and full information on your 10-day Free Trial Offer.

Name.....

Address.....

Agents Wanted



Time to teach your unruly hair its place!

Let's Go!

All day your hair will lie down now... Try this popular dressing—free

No matter where you go there's one thing you don't have to worry about, today.

And that's your hair.

Once it was straggly looking an hour after you combed it. But today!—

From Maine to California, fellows now use—*Stacomb*. *Stacomb* makes the wildest hair lie smoothly in place, all day long.

Let us send you, free, a generous sample of this hair dressing—which more fellows rely on than any other!

Your hair never looks gummy, with *Stacomb*. Nor dry and brittle, as wetting with water makes it. *Stacomb* is actually beneficial—it helps to prevent dandruff.

Stacomb comes as a combing cream—in jars and tubes—and now in the popular new liquid form as well. All drug stores.

FREE OFFER

Stacomb

Standard Laboratories, Inc.
Dept. BB-6, 113 W. 18th Street, New York

Send me free sample of *Stacomb* as checked:—
Original, cream form New liquid form

Name.....

Address.....

REMINGTON
PORTABLE TYPEWRITER
Dealers and Branches Everywhere



SAMPLE 50c

Agents - Salesmen

New, patented Cigarette and Match Case. Holds a package of cigarettes and box of safety matches. Made of grain finish, black leatherette.

A whirlwind seller—write for particulars on liberal profit proposition.

ALL-IN-ONE SALES COMPANY

Dept. A-4 2810 Portland Ave.
Minneapolis, Minnesota



Enchanting realms that only the canoeist can know

It's great to paddle up some slow meandering stream in a sturdy "Old Town Canoe." It's great to get away from the noise and confusion of the highway, to travel slowly and easily amid the cooling shade of overhanging trees. On streams and lakes there are enchanting realms that only the canoeist can know.

Why not plan to buy an "Old Town" this summer? Truly you cannot get a finer canoe or a better looking one. For "Old Towns" are patterned after actual Indian models. They are sleek, fast and remarkably light in weight. And "Old Town Canoes" are low in price. \$58 up. From dealer or factory.

Free illustrated catalog gives prices and complete information about sailing canoes, square stern canoes for outboard motors, dinghies, etc. Write today. OLD TOWN CANOE Co., 1764 Middle St., Old Town, Maine.

"Old Town Canoes"

LE PAGE'S GLUE

Handiest tool in your workshop.

In bottles, tubes and cans.

Beautiful HOUSES \$900 and BUNGALOWS

CAN BE BUILT FOR AND UP
This and many others in my new book, Building Plans for Modern Homes, will save you hundreds of dollars. One of the most complete and comprehensive books of plans ever published by any architect. New edition just off the press. Nearly 600 floor plans and photographs of Colonial houses, bungalows, etc., costing from \$200 up; gives sizes and cost to build. Sent postpaid for \$3.00.



FREDERICK H. GOWING ARCHITECT
101 Tremont St., BOSTON, MASS.

SHAW MOTOR ATTACHMENT MAKES YOUR BIKE A MOTORCYCLE!

A high grade 2½ H. P. motor attachment quickly clamped on any bike frame. Speed 4 to 40 miles an hour. 90 to 125 miles per gallon of gas. **Special Low Price Now!** Write today for Complete Description and Special Low Prices on SHAW Motor Attachments and the SHAW Complete Motorbicycle. **SHAW MANUFACTURING COMPANY**
Dept. 37 Galesburg, Kansas



Agents \$12.00 a day

NEW Self-Heating IRON

New invention now makes ironing easy in every home. Ends hot stove drudgery. Cuts ironing time in half. Saves steps. Costs one cent for 3 hours use. No attachments. No cords. No tubes. Gives quick regulated heat. Guaranteed. Sells fast. Mrs. Wagner, Ohio, sold 24 in few hours spare time. Moyer, Pennsylvania, made \$164 in one week. You can do as well. Work all or spare time. No experience needed. No capital. New plan. Simply take orders. We deliver and collect. Commissions paid same day you take orders. Send for exclusive territory and FREE OUTFIT OFFER. Write today.



THE AKRON LAMP CO., 34 Iron St., AKRON, OHIO



TELLS ALL ABOUT THE
15 New Features

as well as the many other features of the wonderful Motor that thrilled the world in 1926 by its remarkable speed and power. You will want to know especially about "The Pilot" — a NEW device that steers your boat in any course you choose — straight or curved, without attention from anyone. Leaves you free to cast, or troll or rest. The New—

LOCKWOOD BOAT MOTOR

FORMERLY



also offers you many other advantages—Improvements in Power, in Speed, in Ease of Starting, in Stopping, in Convenience and Durability. Find out all about them before you choose any Motor. Get the facts now.

WRITE FOR FREE FOLDER

Just out — See how Lockwood is blazing the way by advanced engineering methods backed by 23 years of marine engine building experience. (24)

LOCKWOOD MOTOR COMPANY
716 Jackson St. Jackson, Mich.

CATCH FISH EASY WAY!



TRAP & BAIT FREE

Catch Fish, Lobsters, Eels, Crabs etc. in large numbers. Also Skunks, Weasel, Mink, Muskrats and many other fur-bearing animals, with my New Folding Galvanized **STEEL WIRE TRAPS**. They catch them like a fly-trap catches flies. Made in all sizes. Big money makers for trappers and fishermen. Write for Price List, **Free Trap Offer**, and my **Free Formula** for making best bait known for attracting fish and animals. **J. F. GREGORY, Dept. 131, Lebanon, Mo.**

Sport Bodies for Fords AT FACTORY PRICES!

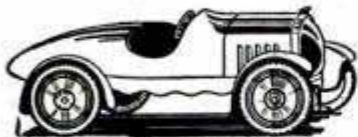

This Model in Grey Prime **\$39.50**

Write for Booklet A-2 Showing Other Models.

SPORT FACTORIES, AURORA, ILL.

Thompson BEATS the World on BOATS

BETTER BOATS at Lower Prices



The BEST that Skill and Experience can Produce TWO BIG FACTORIES

Our complete line of 22 models offers you a variety to choose from. Prompt shipment from factory to you. **Catalog Free—Save Money—Order by Mail** Please state kind of boat in which you are interested.

THOMPSON BROS. BOAT MFG. CO. (20)
201 Ann St., PESHTIGO (Write to either place) WISCONSIN 101 Elm St., CORTLAND NEW YORK

Keep That School-boy Complexion

Shave with Barbasol, and you leave the natural oils right in the skin. Perpetual youth! No brush. No rub-in. Try Barbasol—3 times—according to directions.

“Mister, you’re next!”



Barbasol For Modern Shaving

The Barbasol Company
Indianapolis, Ind.

I enclose 10c. Please send trial tube.

Name.....

Address.....

P-M-4-27



“Independent” GOLD POINT \$2
Lever, Self-Filler Stylopen
“Makes Writing a Pleasure”
Jumbo, \$3.50; Red, \$3.00; Black

J. C. ULLRICH & CO., 161 Washington St., N. Y. Est. 1884 Agents Wanted

NEW! A BIG HIT!

The Little Checkwriter with the Big Protection



Salesmen!

At last! A checkwriter at everybody's price! Sells for \$12.50. Does more than larger machines costing hundreds! Our salesmen cleaning up!

The Arnold Features

1. Pocket size convenience.
2. Handsome nickel plated aluminum.
3. Light weight. Easy to operate.
4. Prints and cuts characters in acid proof ink.
5. Unlimited capacity. Low cost. Easy to ink.
6. Guaranteed for 5 years. Nothing to get out of order.

FREE SAMPLE OFFER! Salesmen! Here's the biggest selling proposition of the year for you. Wonderful opportunity with very liberal commissions to district managers and salesmen.

THE ARNOLD CHECKWRITER CO., Inc., Dept. 18
FLINT, MICHIGAN

PATENT

Protect Your Ideas

Take the First Step Today

If you have a useful, practical, novel idea for any new article or for an improvement on an old one, you should communicate with a competent Registered Patent Attorney AT ONCE. Every year thousands of applications for patents are filed in the U. S. Patent Office. Frequently two or more applications are made for the same or substantially the same idea (even though the inventors may live in different sections of the country and be entirely unknown to one another). In such a case, the burden of proof rests upon the last application filed. Delays of even a few days in filing the application sometimes mean the loss of a patent. So lose no time. Get in touch with me at once by mailing the coupon on the opposite page.

Prompt, Careful, Efficient Service

This large, experienced organization devotes its entire time and attention to patent and trade mark cases. Our offices are directly across the street from the U. S. Patent Office. We understand the technicalities of patent law. We know the rules and requirements of the Patent Office. We can proceed in the quickest, safest and best ways in preparing an application for a patent covering your idea. Our success has been built on the strength of careful, efficient, satisfactory service to inventors and trademark owners located in every state in the Union.

NO CHARGE for Information On How to Proceed

The booklet shown here contains valuable information relating to patent procedure that every inventor should have. And with it I will also send you my "Record of Invention" form on which you can sketch your idea and establish its date before a witness. Such evidence may later prove valuable to you. Simply mail the coupon and I will send you the booklet, and the "Record of Invention" form, together with detailed information on how to proceed and the costs involved. Do this NOW. No need to lose a minute's time. The coupon will bring you complete information entirely without charge or obligation.

My Patent Law Offices
Just Across
Street From
U.S. Pat. Office



NEWS

*Inventors
Write for these*

Free Books

Above is a view of my drafting and specification offices where a large staff of experienced experts are in my constant employ. All drawings and specifications are prepared under my personal supervision.

Strict Secrecy Preserved

All communications, sketches, drawings, etc., are held in strictest confidence in strong, steel, fireproof files, which are accessible only to authorized members of my staff. Feel free to write me fully and frankly. Your case will have my personal attention. It is probable that I can help you. Highest references. But **FIRST**—clip the coupon and get my free book. Do **THAT** right now.

Clarence A. O'Brien

Registered Patent Attorney

Member of Bar of: Supreme Court of the United States; Court of Appeals, District of Columbia; Supreme Court, District of Columbia; United States Court of Claims. Practice confined exclusively to Patents, Trade marks and Copyrights

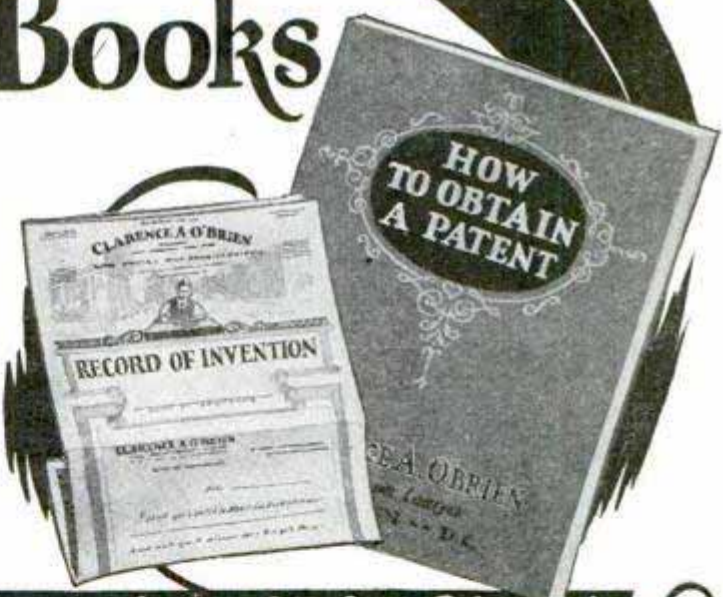

Clip this Coupon and Mail it Now!

CLARENCE A. O'BRIEN, Registered Patent Attorney

70-W Security Savings and Commercial Bank Bldg., Washington, D. C.

Please send me your free book, "How to Obtain a Patent," and your "Record of Invention" form without any cost or obligation on my part.

Name.....
(Important: Write or Print name clearly.)

Address.....

PATENTS TRADE-MARKS AND COPYRIGHTS

Have You An Idea?

Our Offer: FOR THE PROTECTION OF YOUR INVENTION YOUR FIRST STEP

Before disclosing an invention the inventor should write for our blank form

"RECORD OF INVENTION"

This should be signed and witnessed and returned to us together with model or sketch and description of the invention for **INSPECTION and INSTRUCTIONS**

No Charge for the Above Information

**Our Four Books Mailed
Free to Inventors**

Our Illustrated Guide BOOK

HowtoObtain a Patent

Contains full instructions regarding U. S. Patents. Our Methods, Terms, and 100 Mechanical Movements illustrated and described.

Our Trade Mark Book

Shows value and necessity of Trade Mark Protection. Information regarding *Trade Marks and unfair competition in trade.*

Our Foreign Book

We have Direct Agencies in Foreign Countries, and secure Foreign Patents in shortest time and lowest cost.

Progress of Invention

Description of World's Most Pressing Problems by Leading Scientists and Inventors.

We Regard a Satisfied Client as our best advertisement, and furnish anyone, upon request, lists of clients in any state for whom we have secured patents.

**Highest References—Prompt Attention
—Reasonable Terms**

VICTOR J. EVANS & CO.

PATENT ATTORNEYS

Main Offices: 956 9th St., N. W., Washington, D. C.

Opposite U. S. Patent Office

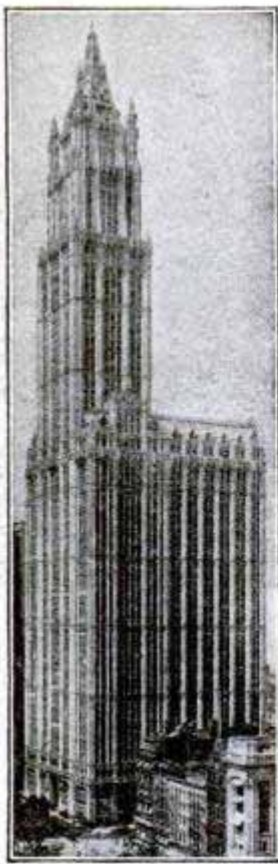

Our New York Office
Suite 1007 Woolworth Bldg.

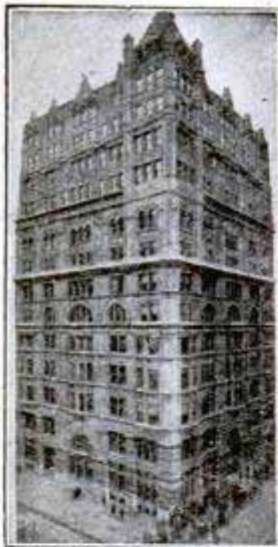

Our Philadelphia Office
Suite 714-15 Liberty Bldg.



Our Washington Office
Victor Building

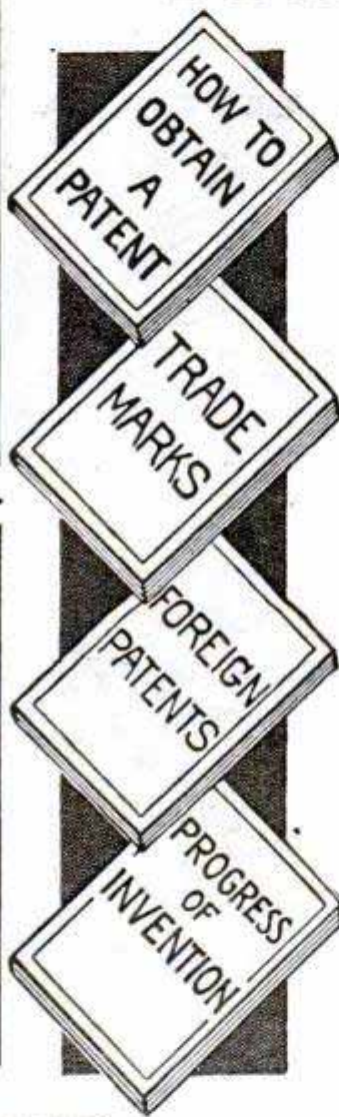

PATENTS TRADE-MARKS AND COPYRIGHTS

IMPORTANT

TO HAVE YOUR CASE MADE SPECIAL AND AVOID DELAY YOU SHOULD HAVE YOUR CASE MADE SPECIAL IN OUR OFFICE to secure protection, save correspondence and secure early filing date in Patent Office. To secure special preparation of your case send \$25.00 on account with model or sketch and description of invention.



MAIN OFFICE, VICTOR J. EVANS & CO.—VICTOR BUILDING, WASHINGTON, D. C.

Our Lawyers Practice in all U. S. Courts and defend Clients in Suits involving Patents, Trademarks and Copyrights

All Communications and Data Strictly Confidential. Interference and Infringement Suits Prosecuted

OUR ORGANIZATION OFFERS PERSONAL SERVICE By Experienced Patent Lawyers, Solicitors and Draftsmen



Our Chicago Office Suite 1114 Tacoma Building



Our Pittsburgh Office Suite 514 Empire Building



Our San Francisco Office Suite 1010 Hobart Building

**FREE
COUPON**

**VICTOR J. EVANS & CO.
PATENT ATTORNEYS**

NEW YORK OFFICES
1007 Woolworth Bldg.

CHICAGO OFFICES
1114 Tacoma Bldg.

PHILADELPHIA OFFICES
714-715 Liberty Bldg.

PITTSBURGH OFFICES
514 Empire Bldg.

SAN FRANCISCO OFFICES
Hobart Bldg.

MAIN OFFICES: 956 9th Street, N. W., WASHINGTON, D. C.

Gentlemen: Please send me *Free of Charge* your books as described on preceding page.

Name

Address

PATENTS

There is no work known which requires a more skillful and exact use of the English language than patent applications. A bungled patent application may deprive you of all profit from your invention. The time, the energy and the expense you have already given deserves the services of an experienced, reliable patent attorney, especially when his fees are moderate.

MUNN & CO. PATENT ATTORNEYS

Associated for 81 years with the Scientific American

1572 SCIENTIFIC AMERICAN BLDG.
24 West 40th Street, New York

523 SCIENTIFIC AMERICAN BLDG.
Washington, D. C.

1312 TOWER BUILDING
Chicago, Ill.

520 VAN NUYS BUILDING
Los Angeles, Cal.

655 HOBART BUILDING
San Francisco, Cal.

Ask for free copy of "Patents — A Book of Facts Every Inventor Should Know" and for "Inventor's Diary." Send for them NOW.

PATENTS

Booklet Free Highest References
Promptness Assured Best Results

Send drawing or model for preliminary examination of Patent Office records.

ALL BUSINESS GIVEN PROMPT AND PROPER ATTENTION

Listed Patent Lawyer in the latest editions of the Rand-McNally Directory of Bankers and Attorneys, of Chicago, Ill.; The Baggott & Ryall Directory of Attorneys, New York City; The Lawyers Guaranteed Directory, Detroit, Michigan; The Lawyers and Bankers Quarterly, published by the Legal Directory Publishing Company of St. Louis, Mo.; the American Lawyers Annual, Cleveland, Ohio.

WATSON E. COLEMAN,
REGISTERED PATENT LAWYER

Victor Building, 724 Ninth Street, N. W.
WASHINGTON, D. C.



PATENTS

Send us sketch or model for advice and exact cost of patent. Our book "How to Obtain a Patent" sent free. It tells how to apply for Patents, Trade Marks, Foreign Patents, Copyrights, etc.; gives information on Patent Procedure; tells what every inventor should know. Thousands of Inventors, who are our clients, are our reference.

CHANDLEE & CHANDLEE, 25 Years' Experience
473 7th St. Washington, D. C.



GEARS ALL KINDS SMALL

The most accurate made and prices reasonable. We carry a complete line of gears in stock for immediate shipment. Can also quote on special gears of all kinds. Send us your inquiries.

WRITE FOR CATALOGUE 10

CHICAGO STOCK GEAR WORKS
105-109 S. Jefferson St., CHICAGO

Have You An Invention?

If so the WORLD PROGRESS will send you upon request sample copy Free containing SUGGESTIONS TO INVENTORS as to Inventions Needed. We invite manufacturers to address us regarding inventions they want.

Subscription for one year 60 cents

WORLD PROGRESS PUB. CO., Inc.

Room 203 Victor Bldg.

WASHINGTON, D. C.



Inventors and Mechanics

Send 10 cents in stamps for

Material Catalog

COLBURN GEAR & MFG. CO.

98 Holmes St., Quincy, Mass.

Information on any book free. Write Popular Mechanics Press, Chicago, Ill.

1000 NEEDED INVENTIONS!

Here is the most remarkable book ever offered to inventors. One Thousand needed inventions listed and described. Arranged as follows: General Problems; Automotive; Mechanical; Electrical; Chemical; Radio; Marine. Separate chapter on the Ten Most Needed Inventions. This book may give you one idea that will win you a fortune. Nothing else like it has ever been published. Compiled at enormous expense. Edited by Raymond Francis Yates, formerly Managing Editor of a leading scientific magazine. Over 100 pages, durably bound. Send no money. Pay postman only \$1.00 plus postage on arrival. (Outside U. S. \$1.20, cash with order.) Money back after 10 days' examination if desired. Limited edition. Write NOW.

BUREAU OF INVENTIVE SCIENCE

DEPT. 34

ROCHESTER, NEW YORK

PATENTS

As one of the oldest patent firms in America we give inventors at lowest consistent charge, a service noted for results, evidenced by many well known patents of extraordinary value. Book, Patent-Sense, free.

LACEY & LACEY

Established 1869

646 F St., Washington, D. C.

INVENTORS PROTECT YOUR IDEAS

Send for our Guide Book, **HOW TO GET A PATENT**, and Evidence of Invention Blank, sent Free on request. Tells our terms, methods, etc. Send model or sketch and description of your invention for INSTRUCTIONS. No charge for the above information.

RANDOLPH & CO.
300 Victor Bldg., WASHINGTON, D. C.

NAME.....

STREET.....

CITY..... STATE.....

Sensational Typewriter Offer



The World's Only Ball Bearing Typewriter

NEVER has there been such a typewriter bargain on as easy terms! A genuine Silent Ball Bearing L. C. Smith at a 40% savings!

Only the L. C. Smith has all these features:

Ball bearings (636 of them) at all points of wear. All the writing visible all the time. Non-shift carriage. 2-color ribbon. All the latest operating conveniences. Beautiful—renewed.

If you decide to keep it
only \$3⁰⁰
DOWN
BALANCE
EASY TERMS

Guaranteed 5 Years

Money cannot buy a better typewriter. U. S. Government bought 50,000. The choice of railroads, big corporations like the Standard Oil Co., etc., because of its exclusive ball bearing feature. Easiest running, longest wearing of typewriters.

Send No Money!

Just mail coupon. Without delay or red tape, typewriter will be shipped you. Use it 10 days. See how speedy and easy it runs—the perfect work it turns out. If not delighted, return at our expense. You'll want to keep it. You can, for \$3 down and \$5 monthly. Now is the time to buy. \$3 worth of extras free. Send coupon now before offer is withdrawn.

40% SAVED by Using this Coupon
SMITH TYPEWRITER SALES CORP.
114-360 E. Grand Ave., Chicago

Ship me the L. C. Smith, F. O. B. Chicago. On arrival I'll deposit \$3 with express agent. If I keep machine, I'll send you \$5 a month until the \$66.70 balance of \$69.70 price is paid; the title to remain with you until then. I am to have 10 days to try the typewriter. If I decide not to keep it, I will repack and return to express agent, who will return my \$3. You are to give your standard 5-year guarantee.

Name.....

Address.....

City..... State.....

Employed by.....

New Kennebec Canoe Catalog

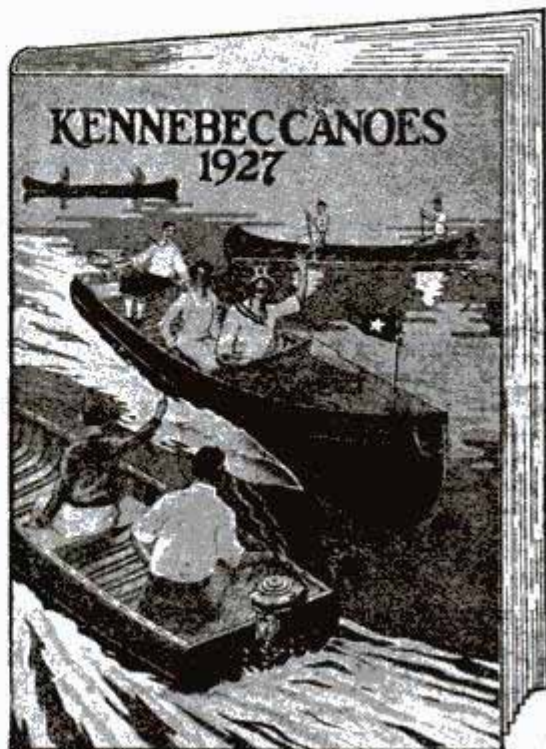

Two books in one are being sent free to readers on request. Turn from one end and you have a catalog of 15 popular Kennebec Canoes in colors, including wonderful new outboard models. Turn the book over and read from the back and you have a fascinating treatise on how to have fun "Where joy reigns supreme."

Write to

THE KENNEBEC CANOE CO.
Dept. PM-31 WATERVILLE, MAINE

Simplified Radio Blueprints

Blueprints for the most popular sets described in Popular Mechanics Magazine can be obtained for a charge just sufficient to cover the cost of production and mailing. The sets for which blueprints are available are:

Simple One-Tube Receiver	April 1926	— 15c
Two-Tube, Loud Speaker Set	May 1925	— 10c
Three-Tube, Cockaday Receiver	April 1925	— 10c
Three-Tube, Low-Loss, Short-Wave Set	Oct. 1925	— 10c
Three-Tube, Loud Speaker, Loop Set	Dec. 1926	— 15c
Three-Tube, 15 to 550 Meter Set	Nov. 1926	— 15c
Four-Tube, Loop Set, for Car or Home	Aug. 1926	— 15c
Five-Tube, Browning-Drake Set	May 1926	— 15c
Six-Tube, Self-Contained Receiver	July 1925	— 10c
Six-Tube, Counterphase Receiver	Feb. 1926	— 15c
Six-Tube, Portable, Loop Set	June 1926	— 15c
Six-Tube, Perfect-Tone Receiver	Nov. 1925	— 10c
Electrolytic B-Eliminator	Feb. 1927	— 15c
Eight-Tube, 1927 Model Superheterodyne; this set of blueprints includes drilling templates and extra photos	Oct. 1926	— 75c
B-Battery Eliminator	Mar. 1926	— 15c
Non-Radiating Unit	May 1926	— 15c
Simple Tube Tester and Chart	July 1926	— 15c
New Perfect-Tone Six	Mar. 1927	— 15c

Address the **RADIO DEPT.**
Popular Mechanics Magazine
200 E. Ontario St., CHICAGO
Back numbers of the magazines describing the construction of the sets can be obtained from our Circulation Department, price 25 cents each.

DIAMONDS

The Old Reliable Original Credit Jewelers
Largest in the World

LOFTIS

BROS. & CO. 'f828

Address Dept. M-894
108 N. State St.
Chicago, Ill.

Genuine Diamonds Guaranteed - CASH or CREDIT

Tremendous Diamond values! Buy from Loftis, the Direct Importer, and be sure of highest quality and most value for your money. Our ring mountings are the latest creations in 18-k white gold, elaborately carved and pierced. Satisfaction guaranteed or money back. Goods sent for your free examination on request.

CREDIT TERMS: Pay one-tenth down; balance weekly, semi-monthly, or monthly at your convenience. All goods delivered on first payment.

SEND FOR FREE CATALOG!

Big 132-page book, illustrating our Diamonds, Watches, Jewelry, Silverware, and gift articles for all occasions, sent absolutely free. Write today.

19-Jewel Adjusted Waltham No. 846—14-k white gold filled; assorted patterns, \$42.50. \$4.25 down and \$1.00 a week.

Railroad Watches—
Guaranteed to Pass Inspection

HAMILTON NO. 992. 21 Jewels, adjusted to 5 positions. Gold-filled 20-year case. \$55

ELGIN'S LATEST RAYMOND, 21 Jewels, 8 adjustments. Runs 40 hours one winding. Gold-filled 20-year case. \$55

ILLINOIS "BURN SPECIAL" 21 Jewels, adjusted to 6 positions. Gold-filled 20-year case. 60 hours one winding. \$50

HOWARD RAILROAD WATCH, 21 Jewels, 5 adjustments, 25-year gold-filled case. \$80

CREDIT AT CASH PRICES

WATCHES



No. 849
\$100
\$2.50 a wk.



No. 851
\$50
\$1.25 a wk.



No. 834
\$75
\$1.75 a wk.



No. 857—Ladies' Wrist Watch, solid 14-k white gold, 15 Jewels.
\$27.50—\$2.75 a month



Wedding Rings
No. 824—The "Elite" \$750
18 k white gold, set with 3 Diamonds, \$22.50
5 Diamonds, \$32.50; 7 Diamonds, \$42.50; 9 Diamonds, \$52.50; 12 Diamonds, \$67.50
Our rat. any bank or banker in U. S.



No. 852
\$37.50
\$1.00 a wk.



No. 859
\$25
\$3.25 a wk.



No. 847
\$150
\$3.75 a wk.

PATENTS

To the Man with an Idea

I offer a comprehensive, experienced, efficient service for his prompt, legal protection and the development of his proposition.

Send sketch, or model and description, for advice as to cost, search through prior United States patents, etc. Preliminary advice gladly furnished without charge.

My experience and familiarity with various arts frequently enable me to accurately advise clients as to probable patentability before they go to any expense.

Booklet of valuable information and form for properly disclosing your idea free on request. Write today.

Richard B. Owen, Patent Lawyer
9-303 Owen Bldg., Washington, D.C.
41-E Park Row, New York City

TRADE-MARKS REGISTERED

DON'T WEAR A TRUSS

BE COMFORTABLE—

Wear the Brooks Appliance, the modern scientific invention which gives rupture sufferers immediate relief. It has no obnoxious springs or pads. Automatic Air Cushions bind and draw together the broken parts. No salves or plasters. Durable. Cheap. Sent on trial to prove its worth. Beware of imitations. Look for trade-mark bearing portrait and signature of O. E. Brooks which appears on every Appliance. None other genuine. Full information and booklet sent free in plain, sealed envelope.



MR. C. E. BROOKS

BROOKS APPLIANCE CO., 107 State St., Marshall, Mich.



United States Capitol

PATENTS

Don't Lose Your Rights To Patent Protection

Before disclosing your invention to anyone send for blank form "EVIDENCE OF CONCEPTION" to be signed and witnessed. As registered patent attorneys we represent hundreds of inventors all over the United States and Canada in the advancement of inventions. The form "Evidence of Conception," sample, instructions relating to obtaining of patents and schedule of fees sent upon request.

LANCASTER & ALLWINE

480 Ouray Bldg. WASHINGTON, D. C.
Originators of forms "Evidence of Conception."

BLUE BOOK ON PATENTS

AND PRIORITY RECORD BLANK GRATIS.

MONROE E. MILLER, PATENT LAWYER
411-2 Ouray Building, WASHINGTON, D. C.
ELECTRICAL AND MECHANICAL EXPERT

PATENTS

Trade Marks, Copyrights, Patent Litigation Handbook with illustrations, 100 mechanical movements. Sent free on request.

ALBERT E. DIETERICH

formerly member examining corps U. S. Patent Office

PATENT LAWYER and SOLICITOR

621-A, Ouray Bldg.
27 Years' Experience Washington, D. C.

DEVITT 8" COMBINATION SAW

13 TOOLS IN ONE

Saw table raised, showing Emery wheel, saw guard and drill attachment.



Planer attachment on saw table.

Showing Sanding disc attached.



Table tilted for beveling.

Dado head attached for grooving.

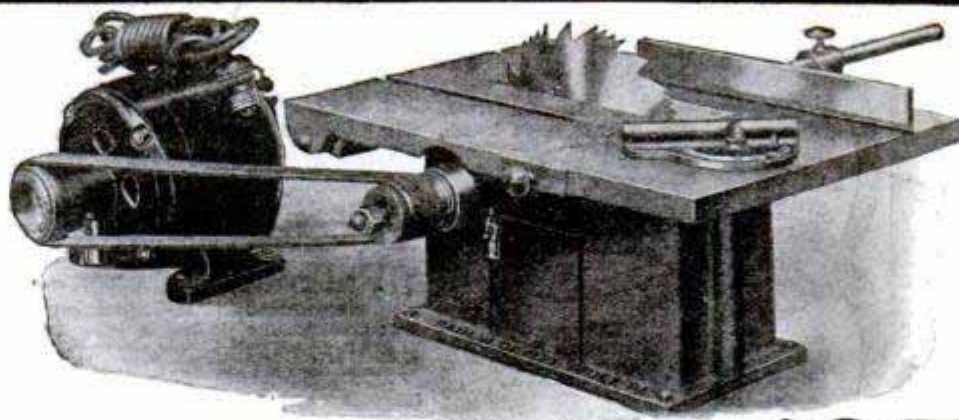

\$35
F. O. B. Phila.

YOU save a great deal of money, time and space by buying a Devitt 8" Combination Saw. Why buy special tools for beveling, grooving, buffing, etc.? The Devitt Combination Saw will rip, cross cut, bevel, miter, groove, mortise, tenon, drill, rabbet, grind, buff and polish. The attachments are easily and quickly adjusted. The saw and motor when set up ready for work occupy very little room. The 1/4 H. P. 60 cycle 110 volt A. C. motor can be run from a light socket and provide power for other purposes when the saw is not in use. A cut up to 2 1/4" can be made with the 8" Combination Saw without planing. The ideal machine for shop, factory or home, complete with attachments: 12"x16" table, 8" Combination Saw, iron pulley for saw table, 10" ripping fence, adjustable cut off miter gauge, motor-specifications as above, 1 1/4" endless leather belt, wood pulley, 8 ft. cord and plug, 6" buffing wheel, 3/4" 3 jaw drill chuck, 5" emery wheel, 6" sander, saw guard, and 2" dado insert. \$35.00 F. O. B. Phila. Height 16", shipping weight, 100 lbs. (Planer attachment to fit on table top will smooth pieces up to 2" wide, \$12.00 extra F. O. B. Phila.)

Write for our beautifully illustrated 4 page circular.

PAUL J. DEVITT 1102 South 2nd Street
PHILADELPHIA, PA.

PLEASURE, PROFIT and POPULARITY for YOU!

Start to Play the Very First Day!



YOU can play the Xylorimba

Extra Money—Hosts of Friends
Loads of Fun Within Your Grasp
Free Trial... Easy Monthly Payments



Fame and Money Broadcasting



Center of Attraction at Gatherings



Big Money at Dances

WHO doesn't want to be the "life of the crowd" at parties, entertain the whole family, and make \$5 to \$25 a night besides?

Earns \$60.00 a Week

Ralph Smith, Chicago, says: "Played 20 minutes at wedding. Received \$20." L. E. Hallman, Reading, Pa., writes: "Within 30 days had more jobs than I could handle and had never played an instrument before." Eight-year-old Michael Howe is playing "big time" vaudeville at reported salary of \$250 a week.

Start to play the very first day, even if you can't read a note. Free lessons, furnished with each instrument, make it easy to learn.

SEND TODAY FOR FREE BOOK!

It tells all about free trial and easy payment plan. Soon you will have your Xylorimba. Have the time of your life learning to play. Then delight and astonish friends and family. Be the center of interest at gatherings. Make real money at dances. It's easy once you make up your mind. Mail coupon today!

MAIL COUPON TODAY!

J.C. Deagan, Inc., Dept. 1454, 1770 Bertran Av., Chicago
Please send me full details on the Free Trial offer and easy payment plan of the Deagan Xylorimba.

Name _____
Address _____

Dealers: We have a plan that will interest you.

MOTORCYCLES



Price \$10 and up purchased through our Co-Operative Plan for as low as \$1.00 down and \$1.00 per week
Indians Harley-Davidsons Ace
Henderson and Clevelands
Send ten cents for Bulletin A.
Motorcycles shipped all parts of the world
WALKER-INDIAN CO., 188 Mass. Ave., BOSTON

"A" Power \$2.95 Unit—Only

SATISFACTION GUARANTEED

Just hook up a new R-B Constant Type Charger with your present "A" Battery and make a complete, trouble-free "A" Power Unit. The new R-B Constant Type Charger, together with the new R-B Semi-Automatic Charging Switch, is hooked up in a moment, and gives you a constant, unvarying source of "A" Current, always at its best, and without any trace of the fading, distortion and frying, spitting noises caused by run-down "A" Batteries. Works on any ordinary house current—alternating or direct. Costs only a few cents a week to operate. Lasts indefinitely. Send us \$2.95 today (bills, money-order or stamps), plus 15c to pay postage charges, and we will send you a new R-B Constant Type Charger, one of the R-B Semi-Automatic Charging Switches, and full instructions for the simple hook-up. No "Extras" of any kind to buy. Use the charger and switch for ten days. If not delighted, return them and we will refund your money.



THE R-B SPECIALTY CO.

Dept. J-6 318 Sycamore St., Cincinnati, O.

AGENTS Big-Quick PROFITS



Tires Hammered Full of Nails, Leak no Air. GALACITE a new Viscous Pneumatic Cement (NOT A LIQUID)

Seals PUNCTURES Instantly—the very moment they occur. **One application made in a minute** without taking tire off wheel or rim does the work. Seals slow leaks and porous tubes. Galacite aids in preserving rubber often doubling Tire Mileage. *Don't confuse with anything else intended for the same purpose. Galacite is new, different, clean and scientifically correct. Made by a long established, highly rated financially responsible concern.*

FREE SAMPLE

AT OUR RISK, MAKE THIS TEST

Hammer as many nails into a tire as you wish—**Pull them out. No air will escape. No pressure will be lost.** If you are not delighted we will pay you for your time and trouble.

AGENTS it will pay you to get the facts and get them NOW. You can't get rich in an hour but you can make immediate, sure, steady profits that are amazing. **No talking. Just drive nails in an old tire. We back our men with powerful advertising helps. Banners Posters, Newspaper Advertisements and circulars.**

FREE SAMPLE Full particulars, big book and a free sample will be sent you postpaid, by return mail. Territory is going fast. **Send no money, just your name, but ACT NOW. JOHNSON & CO. 19 W. Jackson Blvd., Dept. 518, CHICAGO**



When You Want a BLTORCH

That gives 400° more heat—
That's 100% safe—send for

TURNER MASTER No. 45
Only \$7.75, postpaid

TURNER BRASS WORKS, Industry Ave., Sycamore, Ill.



LIGHTING FIXTURES

Ready to hang

Direct from the manufacturer. Completely wired, including glassware. Send for new catalogue No. 28. Just Reduced Prices. *Special Proposition to Dealers.*

Erie Fixture Supply Company, Inc.
Station A
ERIE, PA.



Boils 50 Gallons In Less Than Hour

No Other Compares With This

Improved Oil Burner

Use Ordinary Kerosene or Coal Oil

[Burns Outdoors as Well as Indoors]

THE most remarkable Kerosene Burner ever built. Boils down apple cider, maple syrup, molasses, etc., in half the ordinary time. Ideal burner for dairies, butchers, indispensable on the farm.

PRODUCES TERRIFIC HEAT WITH SILENT BLUE FLAME

**NO NOISE
SMELL
SMOKE
SOOT**

So efficient it produces twice the amount of heat of City gas at half the cost. So simple anyone can install and operate. Double generator assures continuous operation without shut-downs. Nothing to wear out, starts in a jiffy, will last a life time. Every burner guaranteed fully. Write for special introductory price. Free descriptive catalog.



HOME MANUFACTURING CO.

Dept. 63, 18 E. Kinzie Street, CHICAGO

\$6⁰⁰ an Evening!

Get real cash for your spare time right now. Easy to make \$2.00 to \$6.00 and more in an evening. No study or experience necessary. Steady business the year around with the

FOLEY AUTO-MATIC SAW FILER

Files saws automatically twice as fast as hand filers. Does better work—evens up teeth as it files. **The only machine that files and joints a hand saw.** Handles all kinds of saws—hand, band and circular.

Carpenters, contractors, woodworkers, factories, schools—all want this saw filing service. You can cash in on it.

Guaranteed!

The Foley must do its work exactly as claimed or you can return it within 30 days and get your money back. Don't wait a minute—mail the coupon now for complete description and proof of the extra cash you can make with a Foley.

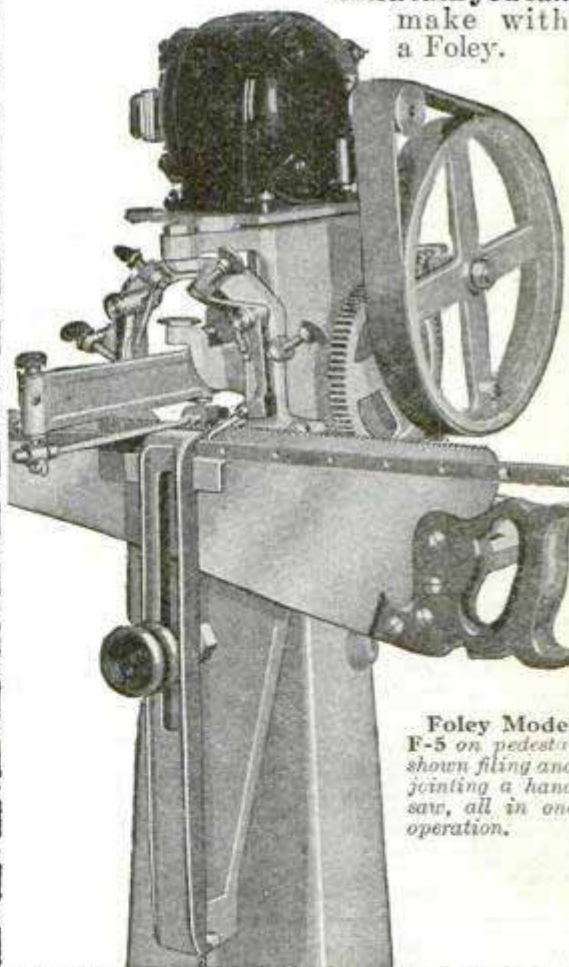

Foley Model F-5 on pedestal shown filing and jointing a hand saw, all in one operation.

FOLEY SAW TOOL CO., Inc.

214 Foley Bldg., 914 E. Lake St.,
Minneapolis, Minnesota.

Send me detailed information about Foley Saw Filers.

Name.....

Address.....

SPECIAL Values
SEND ONLY
A FULL YEAR TO PAY

WB1—Sensational Value! New, elegant Lady's dinner ring, 18K white gold, with 3 genuine blue white diamonds, 2 French blue sapphires. **\$39.75** a month **\$315**

WB2—Think of it! 3 genuine first quality blue white diamonds, popular design, Lady's ring, 18K white gold, \$2.29 per month. **\$29.50**

WB3—Style Leader! Attractive Lady's wristwatch, 14K solid white gold case with ribbon band and white gold clasp. Highest grade, 15 jewel ruby and sapphire movement, lifetime guarantee. \$1.67 per month. **\$22.00**

WB4—The Smartest thing in a lady's ring. Genuine blue white diamond, artistically engraved and pierced, 18K white gold, \$4.56 per month. **\$56.75**

WB5—Massive gentleman's ring, 14K green gold, engraved, genuine radiant blue white diamond, white gold top, \$3.79 per month. **\$47.50**

WB6—Remarkable gentlemen's strap watch sale. Nationally famous Elgin strap watch, in 20-year guaranteed green gold-filled case, radium \$24.50 dial, accurate timekeeper, \$1.88 per month. **\$24.50**

Free Royal Book of Gems
Thousands of special values in genuine diamonds, jewelry and watches. Copy sent at once on request. **No Interest. No Extras.**

ROYAL DIAMOND & WATCH CO.
ESTABLISHED 1895
ADDRESS DEPT E787 170 BROADWAY N.Y.

\$351.00 CLEARED IN ONE DAY

So writes W. H. Adams of Ohio in August 1925. V. A. Marini of California reports \$11275 sales in three months. Jacob Gordon of New Jersey \$4000 profits in two months." Alexander of Pennsylvania "\$3000 profits in four months." Ira Shook \$365 sales in one day. Bram bought one outfit April 5 and 7 more by August 28. Iwata, bought one outfit and 10 more within a year. Mrs. Lane of Pittsburg says "sold 8000 packages in one day. J. R. Bert says "only thing I ever bought that equaled advertisement." John Culp says:



"Everything going lovely. Crispette wrappers scattered all over town. It's good old world after all." Kellogg, \$700 ahead end of second week.

WE START YOU IN BUSINESS

Furnish secret formulas, raw material, and equipment. Little capital required; no experience needed.

Build a Business of Your Own

No limit to the sale of Crispettes. Everybody likes them. It's a delicious food confection. Write for facts about a business that will make you independent. Start now, in your own town.

Profits \$1000 a Month Easily Possible

Send postal for illustrated book of facts. It contains enthusiastic letters from others—shows their places of business, tells how and when to start, and all information needed. Free. Write now!

LONG-EAKINS COMPANY

428 High Street

Springfield, Ohio

MOVIES AT HOME

Many models of genuine MOVIE MACHINES, some as low as \$3.75, all using standard size big theatre films. Our stock of films is the most complete and lowest in price—with an exchange service. Films of leading stars and religious subjects are available. **DON'T DELAY. WRITE FOR FREE INTERESTING CATALOGUE NOW!**



PARAMOUNT MFG. CO.

Dept. 1371

BOSTON, MASS.

AGENTS! EXPERIENCE UNNECESSARY



Science has finally produced it. An instantaneous metal cleaner—neither sloppy liquid nor messy paste. Dry magic floss. Touch it to nickel, copper or brass. The metal shines bright and clean instantly. No hard rubbing! Lightning Silver Cloth does same for Silverware, Lightning Furniture Floss instantly cleans and puts high lustre on Furniture. No liquid! Lightning Products all approved by Good House-keeping Institute. Agents making up to \$20 a day!

AMAZING DISCOVERY ABOLISHES METAL AND FURNITURE POLISH

Imagine! Touch tarnished articles with a Lightning Polishing Cloth or Floss and you make them bright as new. Demonstrations positively astonishing! Every one a sale! Agents collect real money on every call.

Makes a Sensational Demonstration!

Everybody Buys These Products. Housewives buy the Lightning Silver Cloth and Furniture Floss. Autoists buy Lightning Polishing Floss. Sell all three to stores and offices in big quantities. Nothing else like them. Sure big, quick MONEY GETTERS.

Sample Free! Exclusive territory. Real cooperation. Triple profit. Answer this ad at once. Make big money. Easy! Quick! Don't delay. Write NOW! FREE test sample and proposition by return mail.

D. O. LIGHTNING PRODUCTS CORP., 1773 Greenleaf Ave., Chicago

TYPewriter PRICES CUT

World's best makes—Underwood, Remington, Oliver—prices smashed to almost half. **\$2 and it's yours**



All late models, completely rebuilt and re-finished brand new. **GUARANTEED** for ten YEARS. Send no money—big FREE catalog shows actual machines in full colors. Get our direct-to-you easy payment plan and 10-day free trial offer. Limited time—no write today. International Typewriter Ex., 186 W. Lake St., Dept. 494, Chicago

\$20 a Day for You

with our Great Introductory Offer

Giving these \$1.25 Dressmaking Shears FREE with each sale of our wonderful Lucky 11 Asst. for only \$2.00

Store Value \$4.60

\$20 a Day Profit on only 20 Sales

LUCKY 'LEVEN
Looks Like \$5 Worth Gives You \$1 Profit
Some Seller at \$2

My! How They Sell!

You get the attention with the FREE Shears. Walter Harris sold 800 boxes in 6 weeks—Profit over \$600. You can do this too. A baby could sell Lucky 11.

Act Now! Don't wait a minute. Save time by sending \$1.75 for complete outfit including display case, sent postpaid, or better yet send \$10 for 10 boxes, 10 shears and Display Case Free. At least send for illust'd Circulars. Inside Prices and Unique Sales Plans on our 250 products. Send today.
E. M. DAVIS CO., Dept. 5652, CHICAGO, ILL.

If You Are A MAN

worthy of the name and not afraid to work, I'll bet you \$50 that you can't work for us 30 days and earn less than \$200. Think I'm bluffing? Then answer this ad and show me up. Openings for managers. The "Wonder Box" sells on sight.

TOM WALKER
DEPT. 25 • PITTSBURGH, PA.

I made \$93 my first week



"Since then I have earned over \$100 every week," says S. L. Patterson, of Iowa.

NEW! GRAB THIS FREE OUTFIT QUICK!

Many others making big money. No wonder! Millions of interested prospects. A quality product. Puts itching crease in trousers. Takes out bagginess—smooths entire surface—demonstrates in 40 seconds. Sells quick to everyman. Quick, easy profit!

FREE Selling Outfit

Your profits paid in advance. Simply write orders. We deliver and collect. Test it without cost, full time or side line. Send postcard for offer of free demonstrator. Join the big money-makers. Write today.

Folds to 15 inches

THE GETGEY-JUNG COMPANY, D-121 G-J Bldg., Cincinnati, Ohio

Right Out Of a Clear Sky!

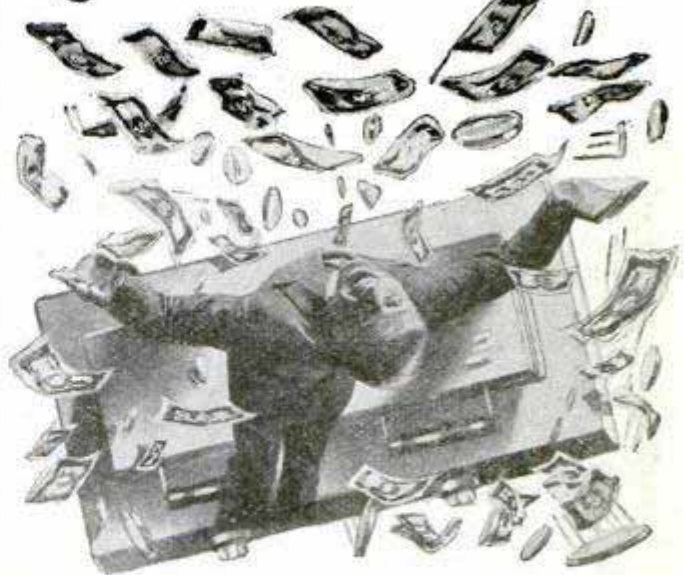

\$1,000 a Month! -From Amazing New Food Business

HERE'S a surprising new opportunity! A new kind of business is now offered every honest, ambitious man and woman under an amazing new co-operative plan! No "may-bes," no red-tape or delay—you open your own business and start making profits the very first hour!

Men, this startling message may sound almost too good to be true—but you won't find a bit of exaggeration in it. Here is a real opportunity to make \$50 to \$200 a week—yes, even \$1,000 a month is not too high a mark to shoot at!

A Remarkable New Food

Three Chicago food experts invented the Brown Bobby greaseless doughnut business. The Brown Bobby idea is patented. No one else can use it.

The greaseless doughnut is a crispy, crunchy, appetizing doughnut cooked by electricity at the rate of 1 dozen every 3 minutes. Everyone likes doughnuts. Millions of old-style doughnuts are sold every day. Now you can make and sell the perfect doughnut—rich as pie or cake, yet easily digested as bread. And here's a secret. Brown Bobbys actually cost way less to make than old-style doughnuts although they sell four times as fast!

The Secret of Big Money

These three experts now offer a complete co-operative plan by which you get one of these new machines, entire shop equipment, advertising material, sales plans, prepared doughnut mix, etc. Everything you need to make money like Minch who cleaned up \$3,000 in 3 months; Mrs. Jane Statts, who became the owner of a big retail store in two months; Costopolis who took in \$6 to \$7 an hour; and hundreds of others who are literally coining money.

\$3,000 in 3 Months!

"My Brown Bobby Business was a success from the first day. I made over \$3,000 my first three months—more money than I had ever made or thought of making in my whole life!"

Thos. Minch, Fla.

Test the Proof—Mail Coupon Now

We can do no more than hint at all the surprising facts in this limited space. But to men who are wide-awake enough to take the hint and act promptly, proof of \$1,000 a month will be sent at once. Also, details of the liberal co-operative plan through which many make enough money the first few days to pay for the entire equipment. Take the hint. Find out how simple it is to make \$50 to \$250 every week. Absolutely no strings to this offer—no obligation. So mail the coupon today.

FOOD DISPLAY MACHINE CORPORATION

Dept. 1354, 22 E. Jackson Blvd., CHICAGO, ILLINOIS

Food Display Machine Corp., Dept. 1354, 22 E. Jackson Blvd., Chicago, Illinois.

Rush me proof of \$1,000 a month—also details of your co-operative plan. It is understood this obligates me in no way whatever.

Name.....
Address.....
Town..... State.....

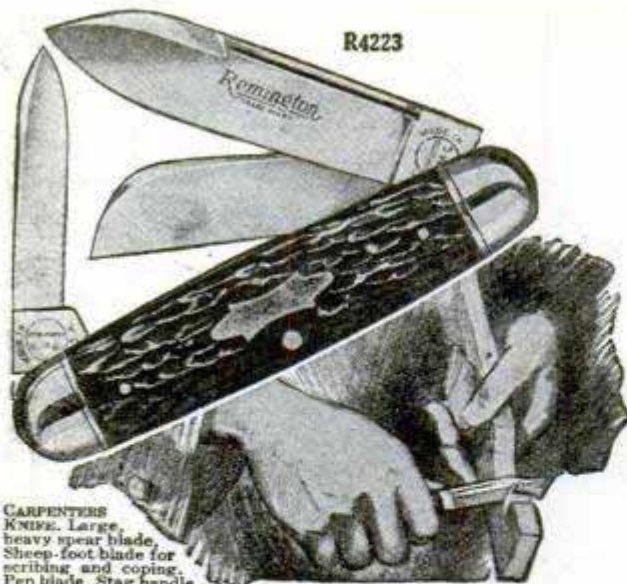

CARPENTER'S KNIFE. Large, heavy spear blade, Sheep-foot blade for scribbling and coping, Pen blade, Stag handle, Nickel Silver bolsters and shield. Brass lining. Length, closed 3 1/4 inches.

Knives for Men Who Make Things

WHITTLING used to be a famous American pastime. It is an art as well as an amusement, but a good knife is necessary to its full development. Perhaps the difficulty in getting fine blades that will take keen, lasting edges has discouraged its devotees. But Remington knives have changed this situation. For over a century Remington has been developing scientific, thorough, and exact heat-treatments for steel. Remington's methods of forging, hardening, and tempering insure blades with the remarkably keen, durable, and uniform cutting edges which are a distinguishing feature of all Remington pocket cutlery.

There is a Remington especially designed for nearly every purpose for which a knife is used. Those shown—carpenter's and mechanic's knives—are sturdy, practical tools, handy for a lot of purposes, but particularly valuable in wood-working and for the hundred-odd uses to which the skilled mechanic puts them. Other patterns in various combinations of blades and handles can be seen at your dealer's. If he hasn't them in stock, he will order them for you. Send us his name and we will mail you a circular describing our carpenter's and mechanic's knives.



MECHANIC'S KNIFE. Equipped with large, strong, sabre blade, Small clip blade, Punch or reamer blade, Stag handle, Nickel Silver bolsters and shield. Brass lining. Length, closed, 3 1/2 inches.

Remington Arms Company, Inc.
Established 1816

25 Broadway New York City

Remington

© 1927—R. A. Co.

Rifles Ammunition Shotguns Game Loads Cutlery Cash Registers

\$30 puts any model **EVINRUDE** on Your Boat



Play as You Pay

FOUR models—8 H. P. Speeditwin 75 lbs.; 4 H. P. Fastwin 49 lbs.; 2 1/2 H. P. Sportwin 44 lbs.; and 2 H. P. Utility Single. Exclusive, copyrighted "Boat-Speed Guide" tells at glance which motor will give you the results you want. Standardized down-payment of only \$30 regardless of model. Standardized, low monthly terms—a long time to pay.

FREE TRIAL GUARANTEE

Within an hour or less you master every detail of starting, stopping, steering, reversing, trolling and speeding. New, Free Trial Guarantee refunds money if not satisfied. That's the confidence we have in Evinrude superiority and in your liking this sport. Every outing is a real vacation. No traffic rules, no way to be reckless. More room than in your car—new things to see, new places to go.

New Evinrude Year Book

Motors in actual colors, 40 interesting pages showing beautiful waterways, speed records—complete facts! Send for free copy today.

EVINRUDE MOTOR COMPANY
2402 27th Street Milwaukee, Wis.

Cheapest Way to Go

to work or school and recreation is on a Mead bicycle. You can have your choice of 44 Styles, colors and sizes. **30 DAYS FREE TRIAL.**

Factory to Rider Do business direct with the makers. We ship on approval. Save time and money. Prices from \$21.50. Best quality, factory prices. Save big money on Tires Lamps, wheels and equipment, low prices. Send No Money, do business direct with makers.

Mead CYCLE COMPANY
DEPT. 110 CHICAGO

Write today for free Catalog, factory prices and marvelous new offer.



The CRESCENT



20' band saw, 4' and 6' bench jointers, No. 12 saw table are adapted for use wherever there is wood work to be done. These machines are small but are substantially built. Ask for circulars.

In the larger sizes we can supply band saws, saw tables, jointers, shapers, variety wood worker, planers, planers and matchers, disk grinders, cut off table, swing saws, borers, hollow chisel mortisers, tenoners, self feed rip saw, universal wood workers.

THE CRESCENT MACHINE CO.
93 Columbia Street, Leetonia, Ohio, U. S. A.

STANDARD GARDEN TRACTOR

A Powerful All-round Tractor for Small Farms, Gardeners, Florists, Truckers, Nurseries, Estates, Fruit Growers, Suburbanites and Poultrymen.

DOES 4 MEN'S WORK

Handles Field Work, Dusting Outfit, Belt Machinery and Lawnmower. Catalog Free.

STANDARD ENGINE COMPANY
3721 Como Ave., S. E., Minneapolis, Minn.



AGENTS AND SIGN MEN

Now Making \$50.00 to \$100.00 and Up Per Week Selling Our **GOLD LEAF SIGN LETTERS**



For store and office windows, board signs, trucks and glass signs. We also make to order script signs and business emblems singly or by the thousands. A permanent business. No capital or experience required. Big demand in every city. Samples and Literature Free.

CONSOLIDATED SIGN LETTER CO. 69X W. Van Buren CHICAGO, ILL.



I Earned \$2200 IN FOUR MONTHS

THIS is Richard A. Oldham. He earned \$2200.00 in four months with a Haywood Tire Repairing outfit. For 20 years he was telegraph operator on the Illinois Central Railway. He is now 58 years old. He answered my advertisement—quit his job—bought a plant and opened a business. He just wrote me: "I have made more in eight months than 2½ years as operator." There are now 500 stations where tire repairing is neglected.

I Must Have 500 Men To Fill These Positions

I have a Big interesting Book to send you. It tells all about tires—gives inside figures and profit. Send for it! What Oldham and others are doing You can do. \$4500 to \$7500 per year is conservative. Open a shop. You can get business all around you. Put out a Haywood Sign and business will come to you. Now get started. Send for the Big Book and start making money.

V. A. FANTUS, Pres.
HAYWOOD TIRE EQUIPMENT CO.
 1244 South Oakley Ave., Chicago, Ill., U.S.A.
 Cable Address Fanbro





To "Show Me" Fellows

Let us show you that the claims men make for this unique shaving cream are true

—Accept, Please, Full 10-Day Tube to Try

GENTLEMEN:

When salesmen call on us, we give them a courteous hearing—then ask for samples.

And since it is a poor rule that doesn't work both ways, we sell Palmolive Shaving Cream on that basis.

Will you accept a testable sized sample—a full 10-day tube?

5 new advantages

1. Multiplies itself in lather 250 times.
2. Softens the beard in one minute.
3. Maintains its creamy fullness for 10 minutes on the face.
4. Strong bubbles hold the hairs erect for cutting.
5. Fine after-effects due to palm and olive oil content.

Just send coupon

This test may mean much to you in comfort. We'll thank you for trying it. Send the coupon before you forget.

THE PALMOLIVE COMPANY
 (Del. Corp.)
 CHICAGO, ILL.



10 SHAVES FREE and a can of Palmolive After Shaving Talc

Simply insert your name and address and mail to Dept. B-1300, The Palmolive Company (Del. Corp.), 3702 Iron Street, Chicago, Ill.

Residents of Wisconsin should address The Palmolive Company (Wis. Corp.), Milwaukee, Wis.

.....

.....

(Please print your name and address)

Collapsible Garment Hanger

big space saver for crowded wardrobes and closets, in your home. Occupies no more space than one hook. Made of best of steel. Nothing to wear out. Send \$1.00 for sample, oxidize finish and we will also include one of our other new specialties, FREE with each order. Satisfaction guaranteed or money back without question.

B. D. GAUSE MFG. CO. ELKHART, INDIANA



Women Simply Can't Resist This Fast-Selling Line

Just show women this exquisite display of dress goods, silks, wash fabrics and you can't keep them from buying. Men and women agents needed to devote full or spare time. Good commissions. Average \$40 to \$85 a week. 1,000 samples furnished. Write quickly.

THE NATIONAL IMPORTING CO.
 Dept. R-6, 569-573 Broadway, N. Y. C. 1000 Beautiful Samples



Italian Accordions

We manufacture and import all kinds of first-class hand-made

ITALIAN ACCORDIONS

the best in the world. Ten year guarantee. Our prices are lower than any other maker's. Free Accordion instructions to buyers. Write for FREE catalog.



RUATTA SERENELLI & CO.
 1014 Blue Island Ave., Dept. P, CHICAGO, ILL.

WATERWAYS ARE NEW HIGHWAYS OF HAPPINESS

this summer~

Enjoy
Your Vacation Hours
Motoring on the Water



THIS summer—know the joy of motoring on the water. Go where you can follow any trail you might desire through shady inlet or clear rippling stream. There is no sport like water motoring. As you hear the call of distant shores you answer, knowing full well that your Johnson will get there and back swiftly and safely.

This year Johnson further enhances its outstanding leadership in the outboard motor industry with four motors that are marvels of mechanical perfection. Revolutionary mechanical developments have greatly increased the power of all twins.

If you are considering the purchase of an outboard motor, you owe it to yourself to see—or better, try one of these new Johnson motors. Johnson dealers are prepared to sell you on easy payments.

The new Johnson Aquaflyer (17-foot mahogany hull, with enclosed Big Twin—speed 18 m. p. h.) was the sensation of the New York Motor Boat Show.

JOHNSON MOTOR CO., 2432 Sample St., South Bend, Ind.
Canadian Distributor: Peterborough Canoe Co.
Peterborough, Ont., Can.

Export Division: 75 West Street, New York, N. Y., U. S. A.

Johnson

Outboard Motors



Get this Book

THIRTY-SIX pages of information on America's finest band instruments.

You can learn quicker and play better on a King. Many exclusive features and improvements make this certain. Rich, brilliant tone and absolute accuracy of tune help you play well at the start. Scientific design, high quality materials and precise workmanship help you play without strain or effort.

Mail the coupon now!

The H. N. White Co., 5211-86 Superior Ave., Cleveland, O.
Kindly send your illustrated catalog.

Instrument.....
Name.....
Address.....
City..... State.....

Chicago Man Discovers Gasoline Miracle!

What is this strange new miracle guaranteed to give up to 50% increase in gasoline mileage, instantly remove all carbon, increase power, speed, pep? Sworn proof backs our guarantee. Nothing ever like it. Not a mechanical device or gas dope. Use it only every 10,000 miles. Costs practically nothing. His called MOTOR-MYSTERY, discovered by the eminent scientist, L. Forgrave. Starting in action. Astounding in results. Save \$200 yearly. Thousands of users and testimonials.



You All Know Him

Try It Free Send no money. We trust you. Write quick for Free Trial, \$100 Week Salary Guarantee to producing Agents, and Free Dodge Plan. Dept. 1A, 6934 N. Clark St. CHICAGO, ILLINOIS

Agents
\$100⁰⁰ A Week
Salary
Guaranteed

A&B Battery Charger ONLY \$2



SATISFACTION GUARANTEED

Charges any type of storage A or B battery, using a few cents worth of ordinary house current, either alternating or direct. Cannot injure battery. Complete directions enclosed. Anyone can operate. No expensive "extras" to buy. Why pay \$10.00 to \$15.00 for a charger when you can get this splendid GUARANTEED R. B. Charger by mailing us two dollars (bills, money order, check or stamps) plus ten cents in stamps or coin to pay mailing costs. Charger will be sent postpaid. If you are not satisfied, return within five days and we will refund your money. Order at once—TODAY.

R. B. SPECIALTY CO.
Dept. J-5 308 East Third St., Cincinnati, O.

Big Money Repairing Balloon Tires This Easy Way

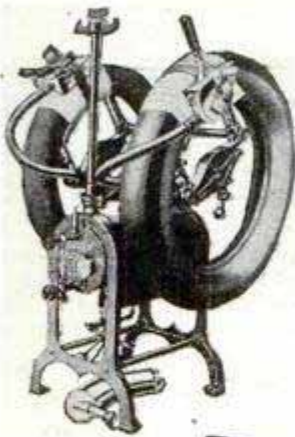

Go into business for yourself. Become independent, well-to-do. Take advantage of tremendous revival in tire repair business. Millions of balloon tires in use now need repairs.

An easy way to make money. Small capital. No experience is needed. Plenty of jobs. Every motorist a prospect.

SHALER

Balloon Tire Vulcanizer

Lowest priced complete tire repair plant. Repairs fabrics, cord and balloon tires. Does just as good work as high priced machines. Anyone can operate it. Made by world's largest manufacturers of tire vulcanizers. Endorsed by leading tire makers and used by hundreds of repair shops. Guaranteed to do first class work.

FREE ON TIRE REPAIRING. Tells how to make big money and become established in business of your own. **WRITE QUICK!**

C. A. SHALER CO., 2704 Fourth St., Waupun, Wis., U.S.A.
World's Headquarters for Tire Repair Equipment

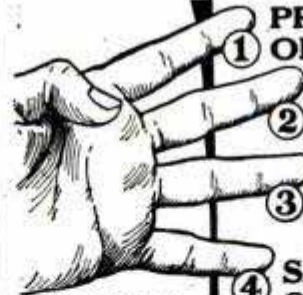

① PROFITS UP TO \$675 OR MORE A MONTH

② SALES INCREASED 100% TO 400%

③ ICE BILLS CUT 33¹/₃% TO 66²/₃%

④ SAVINGS UP TO 80% IN CLERK HIRE

Takes Floor Space Only 3 Ft. Square

"LIQUID" BOTTLE COOLER

Now Clearing \$10 to \$30 a Day for—

Candy Stores, Cigar Stores, Grocers, Roadside Stands, Auto Camps, Theatres, Play Grounds, Fair Grounds, Summer Resorts, Excursion Boats, Dance Pavilions, Amusement Parks, Carnivals, Ball Parks, Railroad Stations, Office Bldg. Lobbies, Hotel Lobbies, Chain Stores, General Stores, Delicatessen Stores, Billiard Parlors, Bowling Alleys, Filling Stations, Garages, Waiting Rooms, Clubs, Golf Courses, Cafeterias, Coffee Shops, Lunch Rooms, Bathing Beaches, Ice Cream Parlors, Drug Stores, Etc.

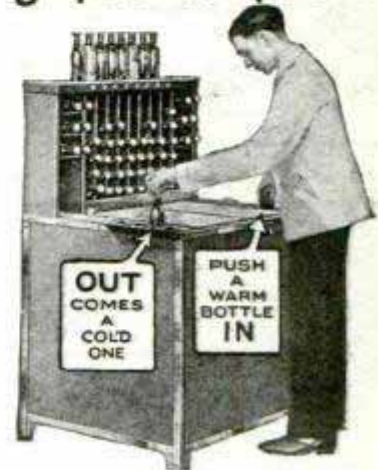

New, Fast Way of Selling Bottled Drinks

WHETHER you sell bottled drinks or have been passing up these profits because of the mess and bother of old fashioned methods, read how the "Liquid" Bottler Cooler makes drink selling as quick, clean, and easy as handing out candy bars.

No more unsanitary ice chests—no more sloppy tubs of ice water—no more wet floors or cold hands. In the "Liquid" Bottle Cooler 144 bottles are always sorted by flavors—a separate cooling tube for each—8 tubes in all—and every one always filled with cold bottles in an ice water bath—quickest cooling method known. To serve any flavor, take warm bottle from reserve rack, push it in proper tube and out comes a cold bottle on the other side. You can't get a cold bottle out until you push a warm one in, so you can't run short. A glance at reserve rack tells you which flavors are getting low and when to reorder.

Ice Savings Pay For It

"Sold 58 cases 1 day—profit \$26.10," writes O. S. Station, Texas. Robins, Philadelphia, says, "Ice savings paid for Cooler many times over." White, Dallas, says, "Ice consumption dropped from 125 lbs. a day to 50 lbs. a day—60% savings." Martin, Minneapolis, says, "Saves me \$15 a week in clerk hire."

Send for "Liquid Profits" Free

Read other amazing proofs in new Book "Liquid Profits." Shows photos of actual installations. Reproduction of Saturday Evening Post color ads about "Liquid" Bottle Coolers—ads that are telling millions why to buy bottled drinks from dealer, who serve them this new way.

"Liquid" Bottle Cooler looks like \$200 to \$500 value yet costs only \$100 on easy terms. One man paid entire purchase price from first 5 days' profits! Big drink season is at hand—get all the facts now.



Send This to

The Liquid Carbonic Corporation,
Dept. P-4, 3100 S. Kedzie Ave., Chicago, Ill.
for Free Book "Liquid Profits" and Easy Terms on
The "Liquid" Bottle Cooler.

Name.....

Street.....

City.....

My Business is.....

My Bottler is.....

DENINGER WILL TRUST YOU

SEND 20c IN STAMPS FOR CATALOGUES
BIG MONEY SAVING FOR YOU

Used and rebuilt motorcycles \$25 to \$100.
used bicycles \$9.50, tandems \$20.

All machines fully guaranteed.
New bicycles and motorcycles
at factory prices, save dealers'
profits. Motorcycle and auto-
mobile tires \$3. Complete line
frames, engines, supplies.

DENINGER PRICE CUTTER, ROCHESTER, N. Y.

PAY AS YOU RIDE

21 Jewel Burlington



Only \$100 Down

The 21-Jewel Burlington is sold to you at a very low price and on the very special terms of \$1.00 down — free examination — small monthly payments.

Free Book Send for the most complete watch book ever produced. 100 designs and engravings in colors. Write for it today. It is free. A postcard will do.
BURLINGTON WATCH CO. 19th St. & Marshall Blvd. Dept. 13-54 CHICAGO

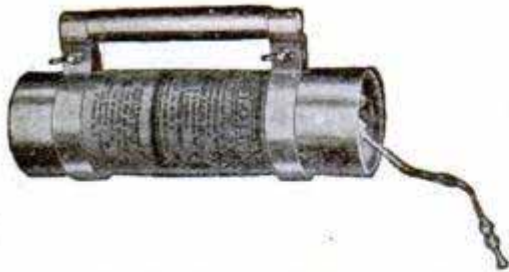

For EVERY blow torch purpose

This handy Prest-O-Lite Gas blow torch outfit is ready to go to work for you on an instant's notice. There is a tip for every kind of job.

Write for full details, mentioning the class of work you do with blow torches.

Every day more Prest-O-Lite Gas blow torches are adopted by thinking mechanics because:

PREST-O-LITE IS QUICKER; no pumping, no generating, no pre-heating. Just turn on the gas and get busy.

IT IS SAFER; the concentrated flame prevents injury to nearby parts.

IT IS EASY ON THE EYES; its non-glare blue flame makes goggles unnecessary.

IT IS BETTER; a wide range of heat under perfect, focused control.

IT IS INEXPENSIVE; simply exchange an empty tank for a full one (paying for the gas only) at any one of the 15,000 or more Prest-O-Lite Gas exchange stations throughout the country.

THE PREST-O-LITE CO., Inc., - Indianapolis

New York - San Francisco

In Canada, Prest-O-Lite Company of Canada, Ltd., Toronto, Ontario

Unit of Carbide and Carbon Corporation

Prest-O-Lite Gas

The Gas of a Thousand Uses

12,000,000 FORD OWNERS
Need This
NEW Timer!

Earn \$100. Weekly
Selling Them!

Automotive engineers claim that the average Ford may wear out from 8 to 10 ordinary Timers. Think of the sales possibilities when you offer the "Dynamo Timer" with a guarantee for the life of the car. You do not have to be a salesman. This amazing Timer sells itself on sight. You make 200 per cent profit on every sale.

Makes Old Fords Run Like New

Once a Ford is equipped with the "Dynamo" the timer can be forgotten—the only thing that will prevent forgetting it will be the noticeable improvement in the running of the car. More power, more mileage, instant starting, amazing pickup, are a few of the features that will make any Ford owner a "Dynamo" booster after he once uses this new Timer.

FREE SAMPLE

To aid our agents, we have arranged a plan that provides them with a Free Sample so they can equip their own car or carry it for demonstration purposes. The unique principles of this wonderful Timer will make themselves apparent to any Ford owner after a minute's examination. Send name and address for Free Sample Offer and particulars of our big money making proposition.

Get Territory Quick

Our agents can easily make \$5,000, \$8,000, yes, even \$10,000 a year. Sparetime workers make \$20.00 and even \$30.00 a day.

John Cable made \$200 in less than 10 days. Many others report tremendous profits. You too can get into the big money class the same as John Cable and others.

DYNAMO TIMER CO.
426-775 Eleventh St., Milwaukee, Wis.



Gibson Mastertone Stringed Instruments

Ralph Dexter
famous banjoist
N.Y.C. uses a Gibson

GIBSON banjos are today's most popular instruments. Snappy, powerful, *musical* tone wins instant admiration, everywhere. Easy to learn, easy to own. Send for catalogs and details of easy payment plan on Gibson banjos, guitars, mandolins, ukeleles.

Gibson Inc., 403 Parsons St.
Kalamazoo, Mich.

New Improved SPORS Fountain Pen. 60 Day Trial. Money back if not pleased

Agents' Sample **65c** Sells for \$1.25. Writes like a \$7 Pen
Make \$10 Daily Easily

LADIES' OR MEN'S STYLE
Comes in Red or Green
GUARANTEED
2 YEARS

Improved Point



F. SPORS CO.

MAKES \$8.40
IN TEN MINUTES

I sold my dozen pens in about 10 minutes. Will order another dozen soon. TRACY KRENZ, Nebraska.

Write for **FREE Wholesale Specialty Catalog.**
227 MAIN ST. LESUEUR CENTER, MINN.

NOW! MAKE THINGS AT HOME WITH THE NEW **RED JACKET** HOME WORK SHOP

SENT ON TRIAL

only \$10.00 down

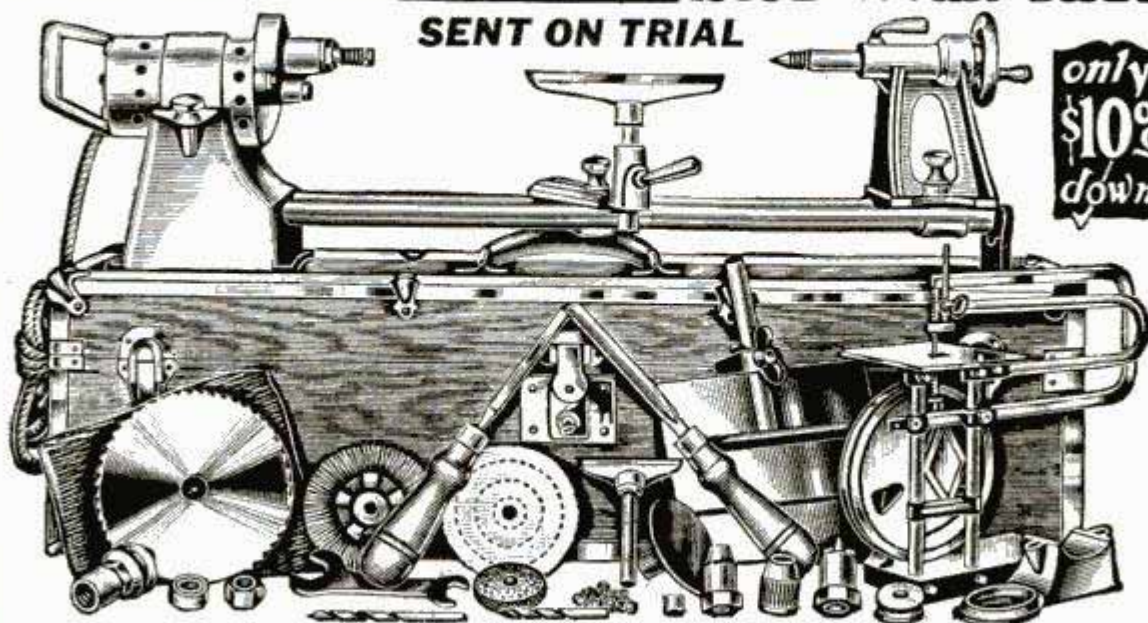

THE HOME CRAFTSMAN'S LATHE Will Make You a Craftsman

A COMPLETE SET OF PRECISION TOOLS electrically driven that will make you an accomplished workman. It is a chest full of tools that has been designed by a master for the private use of tool lovers and men who want to build, construct, invent and create at home. You will be able to make everything — attractive odd furniture, toys, home and garden improvements, all-around manufacturing, repairing.

free CRAFTS COURSE

free BLUE PRINTS

The complete equipment consists of the powerful Red Jacket Motor, with direct drive to an accurate wood turning lathe (capacity 9 in. x 34 in.); a bench saw, that has depth and side gauges; scroll and jig saw; and all accessories for both portable and stationary power drilling, buffing, grinding and cleaning. Attaches to any light socket and converts your work bench into a complete private tool and machine shop.

A SPECIAL CRAFTS COURSE

And blueprint service is free to Red Jacket Shop owners—all that there is to know about handicraft methods, raw materials, woods, carving, sawing, turning, designing, carpentering, decorating, is taught by special correspondence.

BUY ON YOUR OWN TERMS

Only \$10.00 down. Liberal discounts for cash. Easy monthly payment plans. It is no hardship to own a Red Jacket.

INTERESTING LITERATURE FREE

Just send the coupon. You will be surprised with all it contains. Beautiful, instructive, fascinating, interesting.

Everything Explained in Our Literature

THE WACO GUARANTEE
IF IT IS NOT WHAT YOU WANT
When You Get It—SEND IT BACK

WACO TOOL WORKS, 2915 So. Wabash Ave. Chicago, Illinois

Manager, Dept. 104. Please send me particulars about 10-day free trial, free blue-prints and \$10 down payment.

Name.....
Address.....

Save Your Feet

When all else fails, end your suffering with the

Heefner Arch Support

No Metal



Fully patented. It re-adjusts the entire foot. Write for free book and statements from doctors and users.

Heefner Arch Support Co. 650 M. E. Taylor Bldg. Louisville, Ky.

SELLING Pays Big

"Made \$475 in less than an hour"; "Cleared \$16.50 today"; "Have made over \$480.00 this month"; "Wouldn't go back to my old salary job for anything." That's the way salesmen's daily reports read. You, too, can write reports like these. You, too, can make the big money other district salesmen are making. You can have

Your Choice of 1000 BIG PAY JOBS

If you read HOW TO SELL Magazine. Every number filled with hints on how to get in the home, how to convince prospects, etc. Each issue is full of chances to make \$40.00 to \$90.00 weekly in spare or full time. To prove all this we'll send you the next three big issues FREE. Costs you nothing, no obligation. Just send name and address on a postal NOW

HOW TO SELL MAGAZINE
Dept. E-170 Mt. Morris, Illinois

Make Up To \$90 a Week
LEARN HOW FREE!



A touch and it's done

all you need

is heat—and Kester Metal Mender. It's ready to use and with it you can do your own soldering at home as well as an expert. Full directions with each can, enables anybody to solder.



free sample upon request

home as well as an expert. Full directions with each can, enables anybody to solder.

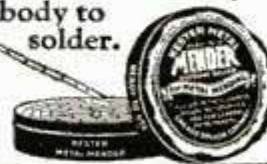

KESTER METAL MENDER

CHICAGO SOLDER COMPANY
4201-247 Wrightwood Ave., Chicago, U. S. A.
Est. 1899

Our 50th Birthday Sale

Celebrating our 50th Anniversary, we are offering these big specials at prices unheard of before. Convince yourself; examine the article of your choice without obligation. Simply send your name and address with the deposit mentioned, and your choice will come for approval and a 15 day trial. If you can duplicate your purchase for less money elsewhere, send it back and your deposit will be refunded. If satisfied, pay the balance in 10 equal monthly payments. Our Charge System is simple, easy, convenient. Prompt delivery, no difficulty, no interest charge, everything confidential.

BUY TODAY
The Modern Way
Terms as low as
\$1 Down

A. Gent's 14-karat green gold Ring with white gold top; AA1 blue-white diamond. \$65. \$5 with order \$3 a month.

B. True Lovers Knot Engagement Ring, hand-carved in 18-karat white gold; AA1 blue-white diamond. \$65. \$5 with order, \$6 a month.

C. Artistic design 18-karat white gold Ring; AA1 blue-white diamond. \$50. \$3 with order; \$4.70 a month.

D. 18-karat white gold carved Wedding Ring; fine blue-white diamonds. \$29.50. \$2 with order; \$2.75 a month.

E. 14-karat white gold Gent's Initial Ring; Old English Initial on genuine Onyx. Mention Initial. \$22.50. \$1 with order; \$2.15 a month.

It's FREE! Send for our Golden Jubilee Booklet

LW-SWEET INC.
Dept. 67-J, 1660 BROADWAY, NEW YORK

Over 3000 other Specials in Diamonds, Watches and Jewelry in this booklet.

F. 17-jewel 14-karat green gold filled case, \$35. \$3 with order. \$3.30 a month.

G. Gold-proof Gent's Strap Watch; 14-karat gold filled case, 15 jewels. \$25. \$2 with order.

H. 14k solid white gold, 4 diamonds; 4 blue sapphires; 15-jewels. \$42.50. \$3 with order \$3.95 a month.

HERE IT IS!

Marvelous Townsend
"B" ELIMINATOR
(Complete)

only
4.95
\$1.00 down
Balance C.O.D.



Direct From Factory at Lowest Price on Record

Great news! For half the price of a set of "B" batteries you can now enjoy greatly improved reception and be done with unreliable "B" batteries. We make the Townsend "B" Eliminator complete in our own factory. That's the reason we can give you at such a remarkably low price a high quality instrument backed by a real guarantee. Users report splendid results. A fine "B" Eliminator at the lowest price on record. Our 10 days Free Trial proves it.

10 Days FREE TRIAL
You are the Judge!

MONEY BACK—If Not Amazed and Delighted

You alone are the judge. We could not afford to make this guarantee if we were not sure of the Townsend "B" Eliminator's splendid performance. Delivers up to 100 volts on any set, on direct or alternating current—any cycle. Gives full wave rectification. Full tone, clarity and volume.

Rush Order Today Simply put your name and address on a piece of paper, pin a \$1 bill to it and get it into the mail at once. Your "B" Eliminator will be sent you promptly. Deposit \$3.95 only with the postman. Try out for ten days—then if not thrilled by improvement in operation, return Eliminator to us and purchase price will be refunded in full. You don't need to put up with battery nuisance another day when it is possible to own a "B" Eliminator at this startlingly low price. Send for it today.

Townsend Laboratories, 713 Townsend Street, Dept. 15, Chicago, Ill.

The man who studies gets ahead. Popular Mechanics Press will advise you what books to read to advance in your trade. 200 East Ontario Street, Chicago, Illinois.

Big 3-ft. Telescope

Makes people and objects miles away seem close. Brings new pleasures to home, farm, camp, travel, sport. See moon and stars as never before. New Ferry "Wonder" telescope has 5 sections—over 3 ft. long open, 12 in. closed. Fully brass bound. Powerful lenses.

FREE! Yes, Absolutely FREE! Handsome leatherette covered Carrying Case, light, strong, complete with strap. Handy for farmers, auto tourists and hikers.

5 Sections 8-Power Lenses Thousands Delighted!

"I am delighted with the 'Wonder' telescope. Today I have been watching submarines 3 miles off the coast."—Philip Brush. "I can see across the Mississippi 3 miles and see people fishing."—M. L. Thorn. "I am nearly 80 years old and if I could not get another would not take \$10.00 for it."—A. R. Walker. "I can tell time on the church clock 5 miles away."—Edward Foster. "Could tell color of aeroplane 4 miles away."—Mrs. L. M. Yarbrough. "I saw a Light House 18 miles away."—Clyde Scribner.

Send No Money

Send name and address and Ferry Wonder 3-ft. Telescope with free Carrying Case will come by return mail. Pay postman special bargain price of \$1.85 plus a few cents postage. Satisfaction guaranteed or your money back. Supply limited.

Order Today! **FERRY & CO., Dept. 1774, CHICAGO**

Let us recommend the best books to study on any subject. Popular Mechanics Press, Chicago, Illinois.

MOVIES IN YOUR HOME

Write for interesting catalog of movie machines and films—Low Prices.

PILGRIM CO., DEPT. 117, MEDFORD, MASS

30 Days' Free Trial
on all MEAD Bicycles

Select from 44 Styles, colors and sizes. You can easily save \$10 to \$25 on your bicycle. Prices \$21.50 and up.

Factory to Rider Do business direct with the makers. We ship on approval for a month's free trial. Rider Agents make big tires, wheels and equipment, low prices. **Send No Money, do business direct with makers.**

Mead CYCLE COMPANY
DEPT. G-110 CHICAGO

Write today for free Catalog, factory prices and marvelous new offer.



WADE AMATEUR MECHANICS, REPAIR SHOPS, INVENTORS, STUDENTS

BENCH LATHE

A real machine tool for the home work bench—capacity 4" dia. x 12" length. For Metal—Wood—Composition Materials. Turning—Facing—Boring—Drilling—Thread Cutting. Accurate—Strong—Quiet—Compact. Slide-rest has travel entire length of bed. Leadscrew inside bed. No. 1 Lathe, plain headstock, \$28.00. No. 2 Lathe, back-gear headstock, \$58.00. Extra for lathes with 18 inches between centers, \$7.00. Complete line of accessories at equally low prices. Write for free catalog.

THE GEROLD CO., Dept. P-33, 120 Liberty St., New York



FREE

New 1927

Radio Catalog

BEFORE you build or buy a radio be sure to consult our new 100 page catalog—sent to you free. All the latest kits, accessories and parts—a million dollar radio stock to choose from.

We Save You Money

We handle only brand new apparatus—standard makes that are fully guaranteed. QUANTITY sale of QUALITY parts explains our low prices. Compare with others and see why thousands of fans look to us as radio headquarters. Write for your copy of this new catalog today.

Chicago Salvage Stock Store
Dept. PM 509 S. State Street, CHICAGO, U. S. A.

Balkite Radio Power Units

FANSTEEL PRODUCTS CO., Inc., North Chicago, Ill.

FREE—OUR NEW 84-PAGE CATALOGUE. FILLED WITH RADIO BARGAINS. Write Today!

RANDOLPH RADIO CORP.

180 N. Union Ave. Dept. 233 Chicago, Ill.

30 DAYS FREE TRIAL

7 Tube—Single Dial RADIO SET



Write TODAY for This Wonderful Offer Direct from Factory!

World's greatest radio. Perfect working, single dial control, 7-tube receiver, shipped to your home for 30 days' free trial. Test it for distance, volume and tonal quality—and if you are not convinced that it is the best single dial set you ever heard, return it to factory.

Metrodyne Super-Seven

Only one dial tunes in all stations. Get 1,000 to 3,000 miles on loud speaker. Easiest set to operate. Highest grade parts used. Magnificent Two-tone Walnut Cabinet.

Big Profits to Agents and Dealers

selling Metrodyne radios. All or part time. Great money making opportunity. Demonstrating set on 30 days' free trial. **WRITE FOR OUR OFFER.**

METRO ELECTRIC CO.

2161 N. California Ave., Dept. 144 CHICAGO, ILLINOIS

Speedway

Type 176



20 times faster than hand Sawing

handy portable electric Saws

Saves Money—Speeds Shipment

A Speedway Saw will do your sawing in less time for less money. Just the tool for maintenance and repair work, alterations: cutting sheathing, bridging, studding, rafters; repairing refrigerators, freight cars, cutting lumber to size right at the pile. Invaluable in the shipping room—will save time, money, and speed up shipments.

3 Handy Sizes—For All Sawing Jobs

SpeedWay Saw, Type 176 (shown above) for cutting wall-board, sheathing, and building material of all kinds: lumber up to 1 3/4 inches; weighs 15 lbs.; built to stand hours of rugged work. Price \$90.00.

\$90

SpeedWay Saw, Type 179, for heavier work, taking a cut in soft or hard wood, up to 2 3/4 inches. Built for continuous hard service. Price \$165.

SpeedWay Saw, Type 180, the Big fellow of the SpeedWay line, handles anything up to 3 3/4 inch cut. For heavy duty wherever there is a light socket. Price \$175.00.

All Speedway Saws have our patented depth gauge. All have our safety guard. All have the motor you can't stall. All have positive switch position and are easy to handle. Will work from any lamp socket.

Write for Special Uses

SpeedWay electrically driven power saws replace muscle power with horse power. If you have a sawing problem write for description and full information along with special applications for these Speedway Saws. Speedway Saws with efficient operation will actually keep money in your pocket.

Electro Magnetic Tool Company
1830 S. 52nd Ave., (Adjoining Chicago) Cicero, Ill.

—SEND COUPON NOW!—



Manager, Dept. 144
Dear Sir: We are interested in Speedway Saws. Please send us complete information and your special applications for Type.....Saw. Also send us information on the rest of the Speedway line of Portable, Electrically Driven tools.

Name.....
Address.....
City.....State.....

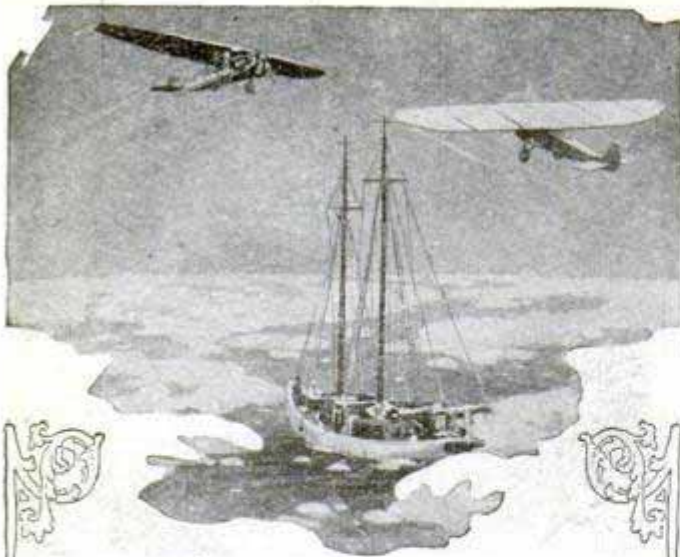

The Crowning Adventure of Burgess Radio Batteries

They flew over the North Pole with Byrd

ON May 9, 1926, history was made . . . American history . . . World history . . . undying history.

Lieut. Commander Byrd in his fearless 1500-mile flight across the top of the world, adds another thrilling triumph to the long, proud list of American achievements.

Radio went along, for radio has become vital to the lives and success of explorers and adventurers. Burgess Batteries went along, sharing the fate—sharing the hardships and the glory of Commander Byrd, the Detroit Arctic Expedition, and Capt. Donald MacMillan.

It is eminently significant that in these glorious triumphs of American courage and American equipment where the test of men and their tools was the test of the survival of the fittest, that the standard products of the Burgess Battery Company were selected, used and "carried on" under extreme and unprecedented conditions.

BURGESS BATTERY COMPANY
GENERAL SALES OFFICE: CHICAGO

Canadian Factories and Offices:
Niagara Falls and Winnipeg



BURGESS RADIO BATTERIES

FROST-RADIO FROST-RADIO FROST-RADIO FROST-RADIO

FROST-RADIO

Replace Them With
Frost-Radio Rheostats

When your rheostats burn out replace them with those bearing the name FROST-RADIO—the kind that cannot burn out. We use only the finest Chromel A or Nichrome wire in our rheostats, and this wire is of sufficient size and has a sufficient number of turns to prevent burnouts due to over-heating. We have a type for every radio requirement, either metal frame type, 50c, or Bakelite type, 75c. Either type, 2 1/2 to 75 ohms. Your dealer has them. Order today.

HERBERT H. FROST, Inc.

160 N. La Salle St.
CHICAGO

MEMBER
RMA

New York
Los Angeles

FROST-RADIO FROST-RADIO FROST-RADIO FROST-RADIO

THIS 68 PAGE RADIO CATALOG FREE

Build your own with 'RASCO' Parts"

RADIO SPECIALTY CO., 98 E. Park Place, New York, N. Y.

American Radio *Now—*

50% DISCOUNT ON RADIO!

BIG NEW 1927 CATALOG-FREE

Dealers, Agents, Set Builders—get our big 1927 Catalog—225 nationally advertised lines, Lowest prices in America! Largest, most complete stock. Radio's latest developments. It's FREE—send for your copy now.

American Auto & Radio Mfg. Co., Inc. 1525 McGee St., Kansas City, Mo.

RADIO AT HALF USUAL COST

Now—we give 30 Days' Free Trial on newest 5-tube—ONE DIAL—Coast to Coast Radio. Buy direct from factory—save half and get 2 year guarantee. Full line table type, consoles or complete outfits at prices that will surprise you. Over 15,000 satisfied owners. Don't buy any Radio until you write us for FREE Catalog, low prices and 30 Day Trial offer.

Westingale Electric Co., 1753 Belmont Ave. CHICAGO

SOLDERALL

METAL IN PASTE FORM

The only convenient metal solder

Every Electrical Connection needs Solderall for perfect reception.

25¢

The SOLDERALL CO., NEWARK, N.J.



Sousa Endorses the Harmonica

"I am a great advocate of the Harmonica," says Lieut. Commander John Philip Sousa, famous bandmaster, "and especially endorse the Harmonica bands which are winning sweeping popularity. This instrument is a foundation for a musical career; and many boys and girls who are now learning music on the harmonica will step into the great symphony orchestras and bands of our country some day."

You can learn to play a Hohner Harmonica with the aid of the Free Instruction Book. Get a Hohner "Marine Band" today and ask for the free book. If your dealer is out of copies, write M. Hohner, Inc., Dept. 181, 114 East 16th Street, New York City



RADIO PANELS OF GENUINE BAKELITE

Cut, drilled and engraved to order. Send rough sketch for estimate. Our complete Catalog on Panels, Tubes and Rods—all genuine Bakelite—mailed on request.

STARRETT MFG. CO. 524 S. Green St. Chicago, Ill.

Turn Dial-get programs everywhere: **30 Days FREE!**



28 in. long

MIRACO RADIO GETS EM COAST to COAST

Users report Miraco Radios get Coast to Coast, Canada to Mexico, loud and clear on speaker; outperform \$100 to \$200 sets. Some hear Europe. Marvellous bargain! Don't buy unless 30 Days Trial proves it Most Selective, Clearest and Most Powerful Distance-Getter among big, fine 5-tube radios. Solid walnut cabinet. Write for **Factory Prices—SAVE Up to 1/2** Every set completely assembled, rigidly tested, fully guaranteed. Ultra-5, \$49.75 list. Speakers, batteries, tubes, etc. at big savings. **Free literature, users' testimony and BIG SPECIAL OFFER** **MIDWEST RADIO CORPORATION** Pioneer Builders of Sets 407 E. Miraco Bldg., Cincinnati, O.

MIRACO *Uritune 5*

USER-AGENTS WANTED Write for discounts

Send for Proof



Outdoor men like **Pocket Ben**

HERE'S a steady, faithful, out-of-doors companion—a friendly little pal to take along when you're roughing it.

You can rely on Pocket Ben to measure the hours and minutes faithfully. He knows when it's starting time, meal-time, bed-time—no guess work about it.

Pocket Ben is Big Ben's brother. The family name "Westclox" on his dial is your assurance of everything true and faithful in a time-keeper.

Sold everywhere—\$1.50. With luminous night-dial, \$2.25.

WESTERN CLOCK COMPANY

LaSalle, Illinois

Remarkable PLASTER for PATCHING



YOU can patch holes and cracks in walls or ceilings easily and quickly with Rutland Patching Plaster. The patch will not shrink as plaster of paris shrinks. Neither will it crack, crumble or fall out. It's as lasting as the wall itself.

Easy for anyone to use because it does not dry or "set" instantly. The handy cartons come all ready to use. Just add water and apply.

Paint, wall-paper and hardware stores sell it. If your dealer hasn't Rutland, we will mail a package direct and you can pay the postman 30c. plus postage. Rutland Fire Clay Co., Dept. V-2, Rutland, Vermont.



Rutland Patching Plaster



New Plan!
makes it easy

\$50⁰⁰ to \$100⁰⁰ Weekly

Selling Shirts Direct to Wearer.
No capital or experience needed.
Spare or full time. Established 1885.
Represent a real manufacturer.

WRITE FOR FREE SAMPLES
MADISON SHIRT MILLS, 562 BROADWAY, NEW YORK

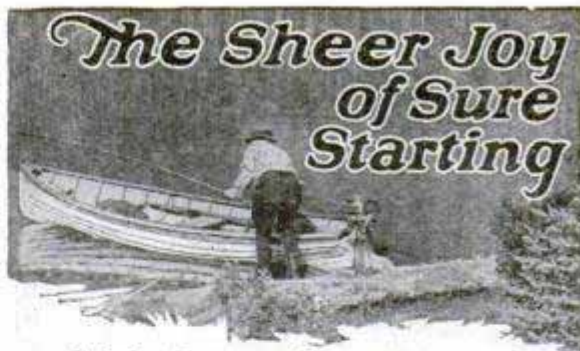

As simple as stepping on the starter button of your car — that's what Elto easy starting means! Merely a quarter-turn flip of the fly wheel—*finger-tip ease* — and your Elto *starts!* Off you speed for favorite fishing grounds, friendly picnic coves, or companionable cruise toward beckoning shores.

Elto *alone* offers easy quarter-turn starting — because Elto *alone* is equipped with full battery-plus-Atwater-Kent ignition. Tens-of-thousands of users know that it is the most vitally important quality ever built into an outboard motor. Send today for catalog, fully describing this and many other Super Elto advantages and refinements.



ELTO OUTBOARD MOTOR COMPANY
Ole Evinrude, President

Dept. A A Mason Street, Milwaukee, Wis.

The
Super Elto
"Starts with a quarter turn"

RADIO LATEST CATALOG OF NEW SETS, PARTS AND KITS **FREE**

Fresh from the press. Shows all the newest standard parts and kits at big savings. Most complete line in America.

Send name and address, also name of friend. Send at once.

BARAWIK COMPANY, 540-551 Monroe Street, Dept. 12, CHICAGO, ILL.

famous "Perfect" **ONLY**

BELIMINATOR 475 Complete



FOR ANY SET
Makes "B" Batteries obsolete. Costs much less than a set of cells. Ends plate current troubles forever. Hook it up just as your old batteries were connected. No "frying" noises caused by old cells. Sharper tuning — more power because of steady flow of current through tubes.

No Extras to Buy

Completely equipped and assembled. Our amazingly low price of \$4.75 covers everything. Just plug in on any light circuit, direct or alternating. Gives power up to 90 volts, using full wave of power supply. Operates any set up to 7 tubes. Thousands of enthusiastic users in all parts of the country.

10 DAYS TRIAL

Money Back If Not Delighted

Just send \$1.00 now. Pay postman balance of \$3.75 (plus few cents postage) when he delivers your Eliminator. Use it 10 days. If not delighted, return in good condition and we will refund your money. Our guarantee protects you absolutely. Reference—Pearl Market Bank, Cincinnati, Ohio.

PERFECT ELIMINATOR CO.

U-3 National Theatre Bldg., Cincinnati, Ohio



Largest Replacement Parts House in the World
Catalog #26
WARSHAWSKY & CO.

Get this book
FREE

NEW & USED
AUTO PARTS

30 TO 80% Saving!

Largest Stock in the World

of new and used replacement parts! Write us **FIRST**—we have many parts impossible to get elsewhere—and you save 30 to 80%.

Write for Your Catalog Today—**FREE!**

WARSHAWSKY & Co.
World's Largest Replacement Parts House
1915-35 S. State St. Dept. PM-4 CHICAGO, ILL.

Wait Just a Moment, Mr.!

Before You Light That Cigarette, Cigar or Pipe—Or Take a Chew of Tobacco—

REMEMBER THIS:

That no man can escape the bad effects of tobacco. Its active principal—nicotine—is a *deadly poison* which, in time, is simply bound to injure your health—perhaps seriously.

Most tobacco users realize this. But when they try to quit unaided they find it next to impossible because of the almost unbreakable hold the habit has on them.

Thousands of inveterate tobacco users have found it easy to quit with the aid of the



Keeley Home Treatment For the Tobacco Habit

A sane, scientific Treatment based on the prescription of Dr. Keeley, who founded the famous Keeley Institute for liquor, drug and tobacco addicts more than 50 years ago. Quickly and completely banishes all craving for tobacco in any form. Contains no habit-forming drugs. No bad after-effects. Not a tobacco substitute. A wonderful tonic. Improves appetite and digestion.

Money-Back Guarantee If, after taking this Treatment according to directions you can honestly say you have not been benefited, we will refund your money.

MAIL COUPON for **FREE BOOK** which gives plain facts about the injurious effects of tobacco and tells how easy it is to quit with the aid of this remarkable treatment.

THE KEELEY INSTITUTE

Dept. P. M.-4

DWIGHT, ILL.

The Keeley Institute, Dept. P.M.-4, Dwight, Ill.

Send without obligation your free booklet telling how to rid myself of the tobacco habit.

Name

Address

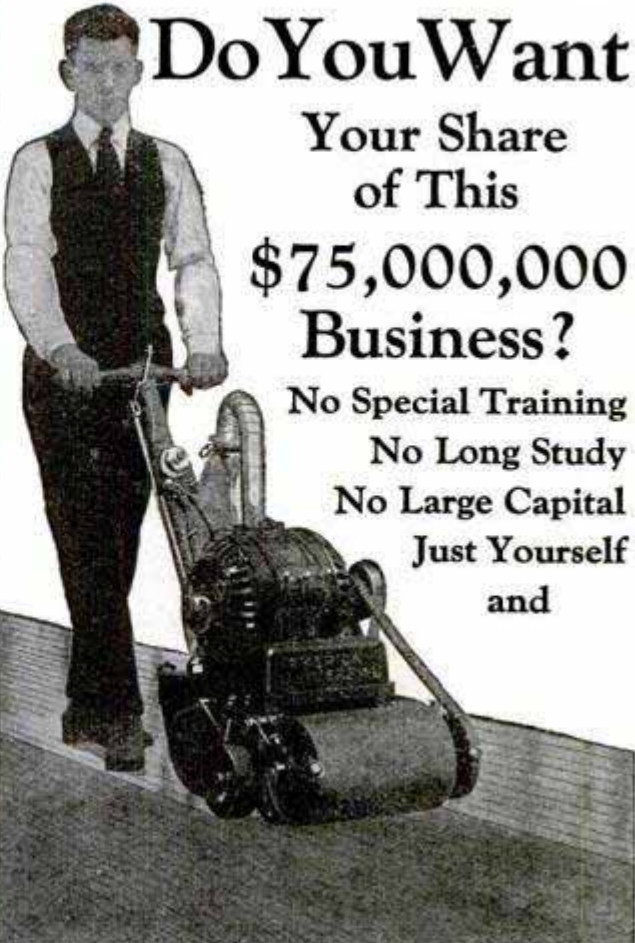

Do You Want
Your Share
of This
\$75,000,000
Business?

No Special Training
No Long Study
No Large Capital
Just Yourself
and

The American Universal FLOOR SURFACING MACHINE

FLOOR SURFACING has become a big business—Over \$75,000,000.00 a year. Not nearly enough operators to handle it. It is pleasant work—always inside. Every new floor has to be surfaced—old floors must be resurfaced. There are no dull seasons.

Hundreds of American Floor Surfacing Contractors are making **\$20.00 to \$40.00 a day.**

There is no trick about it—No long waiting for results. The work is waiting. You can begin at once.

The American Floor Surfacing Machine is electrically operated—As easy to handle as a vacuum cleaner. Does the work of Six hand scrapers. It offers a permanent and profitable business to any man who wants to get out of the uncertain wage earning class. It pays big money and is a real opportunity.

Write today for the American Universal Plan.

The American Floor Surfacing Machine Co.
523 So. St. Clair Street, Toledo, Ohio

The American Floor Surfacing Machine Co.,
523 So. St. Clair St., Toledo, Ohio

Please send me, without obligation on my part, full information about the "American Universal" Floor Surfacing Machine.

Name

Street

City State

LUMINOUS PAINT

Make Your Watches, Clocks, Etc., Visible by Night

The very latest discovery in the scientific world, Hittorb, practically unobtainable until now, has succeeded in producing this remarkable LUMINOUS PAINT, which, applied to the surface of any article, emits rays of white light, rendering it perfectly visible in the dark. THE DARKER THE NIGHT, THE MORE BRILLIANT IT SHINES. Quite simple to use. Anyone—you can do it. A little applied to the dial of your watch or clock will enable you to tell the time by night. You can coat the push buttons or switch plates of your electric lights, match boxes, and innumerable other articles; make your own Luminous Crucifixes, Luminous Rosaries, etc. Small bottle, price 25c. Larger sizes, 50c and \$1 postpaid. JOHNSON SMITH & CO., Dept. 807 RACINE, WIS.

Serpent's Eggs Exploding Cigarettes

Box contains 12 eggs. When lit with a match, each one gradually hatches itself into a snake several feet long, which curls and twists about in a most life-like manner. Price per box, 10c postpaid, 3 for 25c.



CIGARETTE MAKER



Roll your own and save money. Makes them better and quicker besides saving more than half. Use your favorite brand of tobacco. Working useful and handy. Pocket size, weighs 1/2 oz. Made entirely of metal, nickel-plated. Price 25c postpaid.

MIDGET BIBLE

GREAT CURIOSITY
Smallest Bible in the World. Size of a postage stamp. 200 Pages. Said to bring good luck to the owner. A genuine work of art. Must be seen to be appreciated. Make good money selling them to friends, church acquaintances, etc. PRICE 15c each. 3 for 40c, 12 for \$1.35, 100 for \$7.50. Also obtainable in leather binding with gold sides. Price 50c each. 3 for \$1.25, \$4.50 per doz. Magnifying Glass for use with Midget Bible, 15c.



STAGE MONEY



With a bunch of these bills, it is easy for each person of limited means to appear prosperous by flashing a roll of these bills at the proper time and peeling off a genuine bill or two from the outside of the roll, the effect created will be found to be all that can be desired. Prices, postpaid: 40 Bills 20c, 120 for 50c, or \$3.50 thousand postpaid.

Wonderful X-Ray Tube



A wonderful little instrument producing optical illusions both surprising and startling. With it you can see what is apparently the bones of your fingers, the lead in a lead pencil, the interior opening in a pipe stem, and many other similar illusions. A mystery that no one has been able to satisfy is apparently explained. Price 10c, 75c, Johnson Smith & Co.



Good Luck Ring

Quaint and Novel Design

A VERY striking and uncommon ring. Silver finish, skull and crossbone design, with two brilliant flashing gems sparkling out of the eyes. Said by many to bring Good Luck to the wearer, hence its name, Good Luck Ring. Very unique ring that you will take a pride in wearing. ONLY 25 CENTS.

JOHNSON SMITH & CO.

Dept. 807

RACINE, WIS.

A De Luxe Edition of our new 1927 CATALOG mailed on receipt of 25c. Handsome binding. Bigger and better than ever. Only book of its kind in existence. 550 pages of all the latest tricks in magic, the newest novelties, puzzles, games, sporting goods, rubber stamps, unusual and interesting books, curiosities in seeds and plants, etc., unprocurable elsewhere. Remit by Stamps, Coin, Money Order, Check, etc. Unused U. S., Canadian and Foreign Stamps also accepted.

Blank Cartridge Pistol

REVOLVER STYLE

PRICES

50c &

\$1.00

Post-Paid

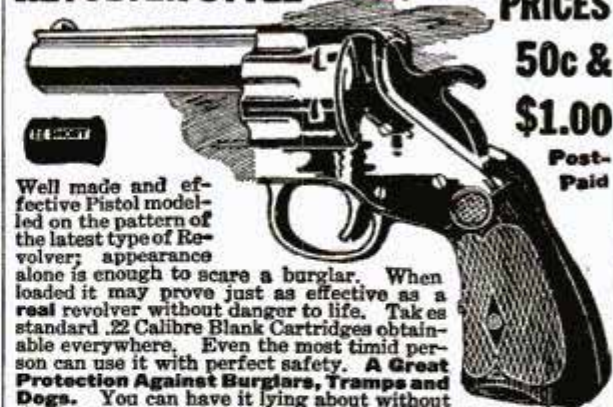

Well made and effective Pistol modeled on the pattern of the latest type of Revolver; appearance alone is enough to scare a burglar. When loaded it may prove just as effective as a real revolver without danger to life. Takes standard .22 Calibre Blank Cartridges obtainable everywhere. Even the most timid person can use it with perfect safety. A Great Protection Against Burglars, Tramps and Dogs. You can have it lying about without the danger attached to other revolvers. PRICE ONLY 50c. Better make and superior quality for \$1.00, Postpaid. Blank Cartridges .22 Calibre, (by express) 50c per 100. Revolver Holster and Strap (Cowboy type) for Blank Cartridge Pistol, 50 cents extra.

BOYS! BOYS! BOYS! THROW YOUR VOICE



Into a trunk, under the bed or anywhere. Lots of fun fooling the teacher, policeman or friends.



THE VENTRILO
a little instrument, fits in the mouth out of sight, used with above for Bird Calls, etc. Anyone can use it. Never Fails. A 16 page course on ventriloquism, the Ventrilo, ALL FOR 10 CENTS

K.K.K.



Everything about the Ku Klux Klan told in a clear, fearless manner. Book tells all—How it started and was oppressed in 1871—The New Ku Klux Klan—How Organized—How Members are Enrolled—Oath of the Klan—Questions for Candidates—Creed—Objects of the Order—Obedience—Fidelity—Pledge of Loyalty—Ku Klux Klan and the Masons—The Jews—The Masons—Real K. of C. Oath—The Negro Ku Klux Klan, etc., etc. Latest and most complete book on the Klan published. Price 35c, Postpaid. Stamps or Coin

Female SEX Indicator Male Sex Indicator



Hold the MAGIC INDICATOR over a man's hand—instantly it moves in a straight line, backward and forward. Hold it over a woman's hand and it describes a complete and continuous circle. The same action can be obtained over a letter written by a man or woman, etc. It is fascinating; baffling. We have never been able to figure out how it's done, but we've never seen it fail. Many novel and entertaining feats may be performed with the Sex Indicator. For example, similar results can be obtained with animals, cats, dogs, rabbits, over birds, chickens, canaries, etc. Also used to predetermine the sex of chickens and birds, etc., in fact it is sold as a patented egg tester in Europe. Price 25c, or 3 for 65c, ppd.

LOOK 35c Look



Wonderful instrument. Greatest thing yet. Nine separate articles in one. Everybody delighted with it. Odd, curious and interesting. Lots of pleasure as well as very useful. It is a double Microscope for examining the wonders of nature. It is also an Opera Glass, a Stereoscope, a Burning Lens, a Reading Glass, a Telescope, a Compass, a Pocket Mirror, and a Laryngoscope—for examining eye, ear, nose and throat. It is worth all the cost to locate even one painful cinder in the eye. Folds flat and fits the pocket. Something great—you need one. Don't miss it. Sent by mail, postpaid. Price only 35c or 3 for \$1.00. JOHNSON SMITH & CO., Dept. 807, RACINE, WIS.



JUST LIKE ORDINARY CIGARETTES. BUT SUCH REAL STARTLERS! The box contains ten genuine cigarettes of excellent quality. They appear so real, but when each cigarette is about one-third smoked, the victim gets a very great surprise as it goes off with a loud BANG! A great mirth provoker yet entirely harmless. Price 25c per box.

Popular Watch Charms



ONLY 15c
3 for 40c; \$1.35 doz.

Very pretty little curiosities and decidedly novel. Fitted with Magnifying Lenses that enlarge the picture to a very surprising degree; in fact, it seems almost incredible that a clear picture could be possible in such a small compass, and how sharp and distinct they show up when you look through. Come in assorted views—Actresses, views of Panama Canal, Lord's Prayer in type, etc.

Mystic Skeleton

A jointed figure of a skeleton 14 in. in height, will dance to music and perform various gyrations and movements while the operator may be some distance from it. 10c pd.

Novelty Badges



Kissing Permit 10c. Garter Inspector 10c. Two very novel metal badges, nickel plated, that you can wear, giving you fun out of all proportion to their trifling cost. 10c, each badge, 3 for 25c, or 75c per doz. postpaid anywhere.

MAGIC FLUTE

Wonderfully Sweet Toned and Musical

The Magic Flute, or Humanatone, is a unique and novel musical instrument that is played with nose and mouth combined. There is just a little knack in playing it which, when once acquired after a little practice, will enable you to produce very sweet music that somewhat resembles a flute. There is no fingering, and once you have mastered it you can play all kinds of music with facility and ease. When played as an accompaniment to a piano or any other musical instrument, the effect is as charming as it is surprising.



COMIC CELLULOID BUTTONS



These Comic Celluloid Buttons provide subjects for pleasant jokes and amusing conversation and thus smooth the way to a more familiar acquaintance and cordial friendship. There are seventy different titles altogether, all very wittily worded and quite unobjectionable. Wear one and see the effect. All four Buttons illustrated above will be sent postpaid to any address for **ONLY 20c** or a dozen, all different, for **45c**.

SURPRISE SOAP

You've heard of people turning green with envy but they haven't turned half as green as the fellow who unwittingly uses this soap. It is an exact duplicate of an ordinary piece of soap. Secret: It contains a chemical which acts like a dye as soon as it comes into contact with water. **PRICE 15c postpaid.**

Every Boy His Own Toy Maker

Greatest boys' book written. Tells how to make a Pinhole Camera, a Canoe, model Railroad, a Telephone, Boomerang, Telegraph Instrument, Box Kite, Talking Machine, Microscope, Electric Motor, Electric Door Bell, Water Wheel, Paddle Raft, a pair of Skis, a Dog Sled, Bird House, Rabbit Yard, etc. 64 pages, 150 illustrations. **PRICE, 10c postpaid; 3 for 25c postpaid.**

REAL PISTOL

Shoots Blank Cartridges

Pull the trigger and it goes off with a loud bang. Pistol is break-open type; illustration shows position for loading. Made entirely of high grade steel, nickel plated, octagon barrel, handsomely engraved handles, complete in box with cleaning rod. **PRICE \$1.75.** Also furnished with pearl handles, **\$2.50.** **BLANK CARTRIDGES, 50c per box of 25.** **JOHNSON SMITH & CO., Dept. 807, RACINE, WIS.**

Miniature Watch Charm Pistol

Exact reproduction of a real pistol; actually fires **Real BLANK CARTRIDGES** of miniature size. Illustration is actual size. **1 1/4 inches long,** with ring at end for attaching to watch chain. Looks like a regular pistol. **Price 15c a Bottle; 3 for 40c.**

RESURRECTION PLANT

One of the most wonderful plants known. Possesses the strange power of turning in a few minutes from an apparently lifeless, dry herb to a **BEAUTIFUL LIVING FERNLIKE PLANT** of a dark green color. Simply place the plant in saucer of water, it will open up and start to grow in 20 minutes. When taken out it will dry up and go to sleep until placed in water again. Fine house plant—summer or winter. **10 cents each or 3 for 25c., 75c per doz., postpaid.**

Microphone Transmitter Button

You can easily make a highly sensitive detectophone by using this Transmitter Button to collect the sound waves. You can build your own outfit without buying expensive equipment. It is simple and inexpensive. You can install an outfit in your home and hear conversations being held all over the house. You can connect up different rooms of a hotel. This outfit was used by secret service operatives during the war. It is being used on the stage. It is ultra-sensitive and is the greatest invention in micro-phones. You can mount the button almost anywhere—card board boxes, stove pipes, still calendars, on the wall behind a picture frame, etc. Button is so light and small it cannot be detected. Persons can be overheard without suspecting it. You can listen in on conversations in another room. A deaf person in the audience can hear the speaker. Connected to phonograph, piano or other musical instrument, music can be heard hundreds of feet away. Button may be used to renew telephone transmitters; often makes an old line "talk-up" when nothing else will. The ideal microphone for radio use; carries heavy current and is extremely sensitive. Amplifies radio signals. Countless other similar uses will suggest themselves. Experimenters find the button useful for hundreds of experiments along the lines of telephones, amplifiers, loud speakers, etc. Many fascinating stunts may be devised, such as holding the button against the throat or chest to reproduce speech without sound waves. **\$5.00** is given to anyone who sends in a new suggestion for the use of the Button providing the manufacturers find it suitable for use in their literature. **PRICE \$1.00 POSTPAID ANYWHERE.**

Send remittance (Postage Stamps accepted) for all articles listed on above and previous page to

MAGICIAN'S OUTFIT

Apparatus and Directions for a Number of Mysterious Tricks Enough for an Entire Evening's Entertainment

ANYONE CAN DO THEM 75c

It is great fun mystifying your friends. Get this Conjuror's Cabinet, and you will be the cleverest fellow in your district. It contains the apparatus for seven fantastic tricks, including: The Disappearing Rose, that, when placed on the lapel of your coat, vanishes from sight at will; the Magic Vase and Ball Trick; the Wooden Ball is placed inside, and upon replacing the lid has disappeared and is found in someone else's pocket; The Magic Note, with which you can apparently cut your finger almost in two; the Wonderful Card Trick (a card is placed in an envelope, and when opened an entirely different card is found); The Disappearing Coin Box & Coin is placed in the little wooden barrel, and, when opened again, is found to have vanished entirely, or can be made to change into a coin of another denomination; The Famous Dissolving Penny Trick; The Glass Goblet and Vanishing Coin Trick (a coin is dropped into a glass of water, and when the water is poured out the coin has vanished). With the tricks described above we send full printed instructions for performing each trick, so that anyone can readily perform all the tricks to the great amusement of their friends or the public. Any boy of ordinary intelligence, with this Cabinet of Tricks in his possession, can give a parlor entertainment not inferior to some regular magicians. Besides the tricks contained in the Cabinet, there are many other feats and illusions fully explained with full printed instructions, for which you easily make or procure the necessary apparatus. This unexcelled Cabinet of Tricks for **ONLY 75 CENTS POSTPAID TO ANY ADDRESS.**



Great Fire Eater

Most Sensational Trick of the Day!

With the Fire Eater in his possession any person can become a perfect salamander, apparently breathing fire and ejecting thousands of brilliant sparks from his mouth, to the horror and consternation of all beholders. Harmless fun for all times, seasons and places. If you wish to produce a decided sensation in your neighborhood don't fail to procure one. We send the Fire Eater with all the materials, in a handsome box, the cover of which is highly ornamented with illustrations in various colors. **Price of all complete only 30 cents, postpaid.**



SQUIRT ROSE

25c

A REAL STARTLER. This is the most popular of all squirt tricks. The flower in your coat looks so fresh and sweet that everyone is tempted to inhale the delightful perfume. Then is the moment to press the bulb. Gee! Wilikens! Don't they jump! There is a very long rubber tube that easily reaches to the pocket of your coat or trousers, and the bulb is large enough to make a dozen shots a kit one loading. **PRICE 25c each, or 3 for 65c postpaid.**



PISTOL, OPERA & FIELD GLASS

PRICE POSTPAID, \$1.00



It is made in the shape of and looks like a regular Automatic Pistol. No one is likely to stop and ask you whether it is real or not. This is likely to prove itself very handy in an emergency. On pressing the trigger it opens up, as shown in the illustration at the right, revealing nine most useful articles—Opera and Field Glass, Telescope, Mirror, Magnifying Glass and Burning Lens, Reading Glass, Sun Disc, Sun Compass, etc. In the handle of the revolver there is a place for various pocket necessities, such as First Aid Articles, Buttons, Pins, etc. The Pistol is of sheet metal, blued finish, that can be carried comfortably in pocket. **PRICE \$1.00.**

SURPRISE MATCHES

More fun than fighting with your wife. Look just like ordinary matches. Put up in boxes just like regular Safety Matches. As the victim tries to light one he gets quite a surprise. **PRICE 10c per box, 3 boxes for 25c, or 12 for 75 cents.**



SEEBACKROSCOPE

By merely placing this clever instrument to your eye, you can see what is going on behind your back, and some times you see very interesting things when no one thinks you are looking. Why it is just like having eyes at the back of your head. **PRICE ONLY 25 cents, postpaid, 3 for 50 cents.**



NEW BOOK ON ROPE SPLICING

A most practical handbook giving complete and simple directions for making all the most useful knots, hitches, rigging, splices, etc. Over 100 illustrations. All about wire rope attachments, lashing, blocks, tackles, etc. 37 Heraldic Knots illustrated. Of great value to mechanics, riggers, campers, boatmen. **Price 20 cents postpaid.**



The "Little Giant" Typewriter

A First Class Writing Machine For \$1.50

A perfect little typewriter for \$1.50. There are thousands of persons who would like to use a typewriter but whose needs and business do not warrant the expense attached to the purchase and use of a fifty or seventy-five dollar machine. To such persons we confidently recommend our Little Giant. It is strongly made, but simple in construction, so that anyone can quickly learn to operate it, and write as rapidly as they would with pen and ink. The letters of the alphabet most frequently used are so grouped as to enable one to write rapidly, the numerals 1 to 10, and the punctuation marks being together. With this machine you can send your best girl typewritten love letters, address envelopes, make out bills, and do almost any kind of work not requiring a large, expensive machine. With each typewriter we send a tube of ink and full printed instructions for using the machine. **Price complete \$1.50 by mail postpaid to any address in the world.**



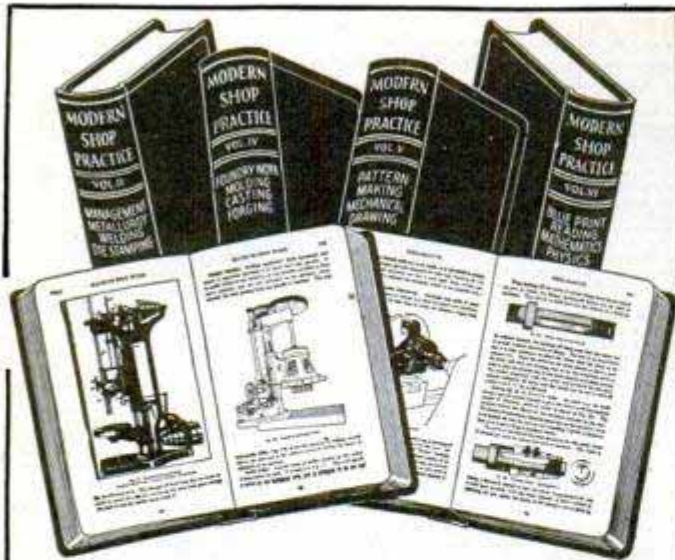

Better Jobs For Shop Men

There are more good jobs than men to fill them. You have just as good a chance to get one of these Better Jobs as the next man. It's not just enough to know how to grind a tool or to set a machine, you ought to know why it's done that way. We've found a way to tell you this and thousands of other things you ought to know in such an interesting way that you won't call it study—6 big books, brim full of interesting explanations, drawings and photographs, arranged in such a way that any man can easily understand them. Literally, thousands of MONEY MAKING FACTS all carefully classified under our JIFFY INDEX which makes everything instantly accessible.

These subjects and dozens of others fully covered:

- | | |
|-----------------------|--------------------|
| Machine Shop Practice | Jigs and Fixtures |
| Production | Foundry Work |
| Metallurgy | Forging |
| Welding | Pattern Making |
| Die Stamping | Mechanical Drawing |
| Tool Making | Blue Print Reading |

Amazing No Money Offer

We don't ask you for a penny, we don't want you to even make a deposit. Just send your name and address and the full set of six big books will be sent to you at once. Keep them 10 full days. Look them over; read and examine them, look up any subject, then if you realize what these books will do in the way of helping you make more money, you may keep them by sending only \$2.00 then and \$3.00 per month until the special low price of only \$24.80 has been paid. If you send now, we will make you a consulting member of the American Technical Society with full consulting privileges with 18 experts. You are also entitled to the service of our employment department without charge in helping you find a better job for which you can qualify. This is a Great Offer—do not delay. Use the coupon.

American Technical Society, Dept. M-419
Drexel Ave. & 58th St., Chicago.

You may send me for Free examination, the six big books on Modern Shop Practice. If I decide to keep them I will send you \$2.00 in ten days and then \$3.00 per month until the special low price of only \$24.80 has been paid, otherwise I will return the books and owe you nothing.

Name

Address

City.....State

Our BUREAU OF INFORMATION will answer all questions regarding articles appearing in this magazine

YOU CAN BUILD IT QUICK WITH A BOICE!

Boice-Crane Bench Machines are capable of handling a large volume of work because of their amazing speed. Being portable they save thousands of steps and hours of time. The complete line consists of Band Saws, Jointers, Jig Saws, Lathes, Drills, Mortisers and Circular Saws.



14" Band Saw
Has table 12" x 14" which tilts 45 degrees. Bronze bearings. Saws 7" stock. 14" wheels. Uses blades 1/4" to 1/2" wide.

Books of Designs

Over 250 working plans of all sorts of furniture and toys are contained in Boice's books of designs. These books are valuable to all woodworkers and are listed and fully described in our new booklet.

Send 10c for new 64-page booklet containing helpful information and describing complete line of Boice-Crane Machines and books of designs. SEND NOW!

W. B. & J. E. BOICE, Dept. P. M. 4-C, Toledo, Ohio



Jointer

Has extra long tables 36" over all. Safety head with knives 4 1/2" wide. Ball bearings. Fence tilts 45 degrees both ways. Does moulding.



Handisaw Model 3
Swings 8" saw, cuts 2 3/4" stock, dados 1 1/2" deep by 1 1/4" wide. Does sanding, grinding, grooving, moulding, mitering and rabbeting.

Boice-Crane machines driven by 1/2 to 1/2 h. p. motor attached to light socket. Sold with or without motor.

MAKE LARGE PROFITS WITH
HB PAINT SPRAY

\$25.00 A DAY PROFIT

You and the wonderful new HB Paint Spray Outfit can do the work and get the wages of 5 men with brushes. Paint Houses, Barns, Factories, Automobiles, Furniture—do any paint job in 1/2 the usual time.

PAINTING BY NEW, QUICK METHOD:
No special experience necessary. Pays for itself on easy monthly payments with practically no expense to you. Full information in Bulletin P. Write today to
Hobart Bros. Co., Box 472, Troy, Ohio

NEW EASY TERMS—QUICKLY PAYS FOR ITSELF

CAL. 30-40

KRAG CARBINE STYLE

The Choice of those who know. 5 shot, 22 inch Barrel. A few used, but service-able, for \$9.75. Shipping weight, 13 lbs. Shipping extra. \$15

Krag Rifle	\$12.50	KRAG Sporting Rifles	\$14.00
Springfield 45 Shot Gun	4.75	SPRGFLD. 45 Carbines	4.50

Krag Bayonets 40 cents each. Postage Extra—Shipping Weight 2 1/2 lbs.

Terms Strictly Cash. No C. O. D. Shipments.
Catalogue Free on Request.

W. STOKES KIRK, 1627-P. M., North 10th St., Phila., Pa.

MAKE A MOTORCYCLE OUT OF YOUR BICYCLE with a STEFFEY MOTOR ATTACHMENT. RELIABLE—ECONOMICAL—EFFICIENT. Easy to attach. Fits any wheel. Send stamp for circulars.

STEFFEY MFG. CO., Dept. P, 3924 Fairmount Ave., Phila., Pa.

CALIFORNIA ROSE DIAMOND FREE

To all Gem-Lovers answering this ad we will send this month **ABSOLUTELY FREE**, all charges prepaid, a one carat perfect cut and polished **CALIFORNIA ROSE DIAMOND** of exquisite beauty. We do this to advertise our marvelous **NEW GEM** the **CALIFORNIA STEEL BLUE DIAMOND**, not a genuine diamond but positively matching **SIDE BY SIDE** the finest \$500.00 first water diamond in cut-brilliance, and dazzling rainbow fire. Amazingly low in price, brilliancy guaranteed for life. Mail postal today for **FREE GEM** and actual photos of Steel Blue Diamond.

California Diamond Co. Dept. 12 Monterey, Cal.

NEED A BETTER GRIP ON MATHEMATICS?

SEND for a copy of "Mathematics for the Practical Man," only \$1.50. By common sense methods it removes the mystery and difficulties so that algebra and even calculus are made simple.

Assuming your knowledge is limited to arithmetic you quickly and easily gain a working knowledge of Algebra, Geometry, Trigonometry and Calculus. Simply pay postman when he hands you the package.

Popular Mechanics Press
Room 102!
200 E. Ontario Street, Chicago

WINS FIRST PRIZE

COST
\$4.98

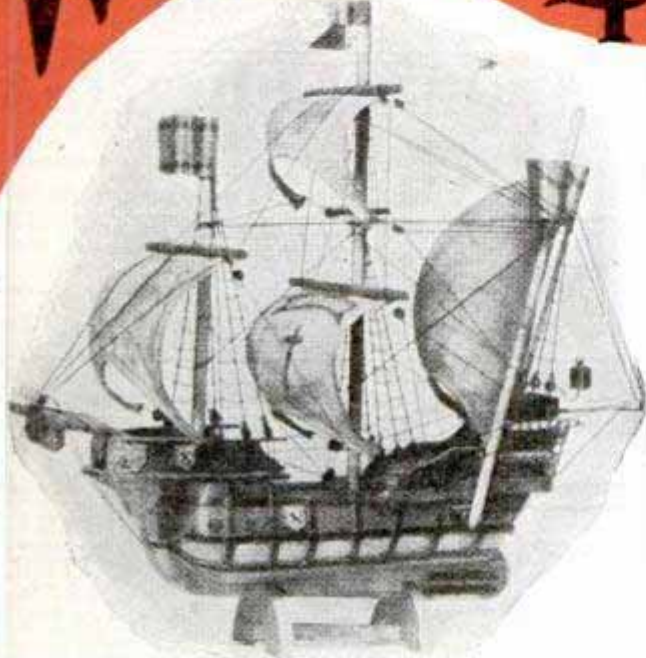

SANTA MARIA

The Flagship of Columbus in the Discovery of America.
Size: Height 25 inches, Width 11 inches, Length 27 inches.



MAYFLOWER

The Ship that Brought the Pilgrims to America.
Size: Height 25 inches, Width 9 inches, Length 27 inches.

Easy to Build Prize Winners in a Few Hours

No Tools Needed Other Than a Small Hammer

Mrs. Clara J. Bierbower of Philadelphia, Pa., after completing a Model of the Santa Maria from our \$4.98 cut to fit parts was so pleased and delighted with the Model that she entered it in a Model Contest held by the Publishers of Science and Invention Magazine. This Model was entered against hundreds of other models from all parts of the country and **Won First Grand Prize.** Mrs. Bierbower's Santa Maria was awarded the Grand Prize Worth More Than \$100.00 for Its Decorative Beauty and Simplicity of Construction. While Mrs. Bierbower was delighted, she said, "that it was not a surprise as the Model was the most beautiful of its kind that she had ever seen." The parts We Will Send You are Identical with the Ones Used by Mrs. Bierbower. There Were No Parts Used in This Prize Winning Model Other Than Those Supplied in Our Regular \$4.98 Complete Kits. Why Pay \$100.00 or More for a Ship Model When You Can Build a Beautiful Prize Winner from Our Parts. We supply you with every part to build these Models with a full detailed diagram and instruction sheet showing and explaining every operation, including the rigging and painting. Hull and parts are of wood. This is not a cheap cardboard imitation.

The World's Largest Builders of Ship Models

MINIATURE SHIP MODELS
3618-20-22-24 Baring St., Philadelphia, Pa.

Shipping Weight 6 Lbs. Canadian and Foreign Orders Must Be Accompanied by Money Order for \$4.98 Plus Sufficient Amount for Postage. Ask Postmaster the Amount. All Orders Shipped the Same Day as Received.

MINIATURE SHIP MODELS, Dept. 7,

3618-20-22-24 Baring St., Philadelphia, Penna.

Please send me at once the complete set of cut to fit parts,

ready to assemble for the Model.....

I will pay the postman \$4.98 plus postage (a few cents).

PLEASE PRINT NAME AND ADDRESS PLAINLY TO AVOID DELAY.

Name.....

Street or R. F. D.....

City.....

State.....



TROUBLE LAMP SELLS ON SIGHT

Men! Here at last is the perfected auto trouble and service lamp—three steps ahead of the field. It has more uses, sticks more firmly in place, has double the magnetic power. Makes possible a far more convincing demonstration. Sold under our own Two-Way Selling Plan. Right now, the big auto and touring season, is the clean up time.

BIG SEASON NOW

WE do not believe in extravagant claims to salesmen. And we don't have to make them with a proposition like this. We are just going to give you the facts—and let you decide for yourself. And then we are going to quote a few of the hundreds of actual letters from Salesmen—original letters which we have in our files and can show anybody, at any time.

Fits Any Car

The Burns Magnetic Light plugs into a light socket on any car. "Magnetic" means that it sticks to any iron or steel surface. It's an emergency lamp for reading maps, for repairing tires or engine trouble—it has endless uses. Can be demonstrated anywhere because it sticks to radiators, stove, typewriter, scale knife or any similar metal article—so you don't have to have a car to sell it.

Sell Dealers—\$50 From One Sale

One of our men, Shaffer, actually made \$67 in one day selling to car owners. But that's only one of your big markets. Sell to dealers—auto accessory shops, garages, battery stations, hardware and electrical stores. Grab at this red hot seller quick.

I'll Show You How

Don't send a penny. Just write and learn the full details of our Two-Way Selling Plan and how you can get a Burns Light on 10 days free trial. I'll tell you exactly how Hicks made \$195 in six days, Preston \$22 in fifteen minutes, and Shaffer \$67 in one day. No cost. No obligation. Simply mail the coupon.

CONSOLIDATED SPECIALTIES CORPORATION, Dept. 14-D
21 West Elm Street
CHICAGO, ILLINOIS



—MAIL THIS TODAY—

Consolidated Specialties Corp., Dept. 14-D,
 21 West Elm St., Chicago, Illinois.
 Yes, send me right away without cost or obligation all the facts about the Burns Magnetic Lamp and your Two-Way Selling Plan.

Name.....
 Address.....
 City..... State.....



BRAND NEW IDEA GRAB THIS QUICK

Make \$300.00 Every Week

No experiment. Test shows idea works. Drug and department stores. They put on your sale on 25% basis. We tell you how to do it and furnish advertising copy (for your local paper) containing coupon offering beautiful bottle Narcissus Perfume at 39c, regular \$1.00 seller. Every bottle has flashy label and comes in attractive box. Costs you only \$13.50 per gross. Takes in over \$56.00. Face Powder, regular 75c seller, \$15.00 per gross. Five full size assorted samples of each will be sent \$1.00 postpaid. Get started today while the idea is new. Write now. Our catalog showing many other items, all at bargain prices, is yours for the asking. National Soap & Perfume Co., 512 W. Huron St., Dept. A-7, Chicago, Ill.

FREE RADIO MAP

Size 28 x 33 inches with rule for measuring distances. List of radio stations, with call letters, and wave length, FREE if you send us names and addresses of five friends who have radios and what kind.

A. A. VIKING, 124 W. Austin Ave., Chicago

RADIO GREATEST RADIO BARGAIN \$18.45



in U. S. 5-Tube Chassis
 Coast to coast reception. Certified circuit. Dealers write for special proposition. AGENTS WANTED. Write today for folder.

A. J. MUSSELMAN, Inc.
 723 Machinery Hall CHICAGO, ILL.



Do You Know the Secret of Quality Reproduction?

"The Secret of Quality" tells you simply and concisely how to get the most out of your amplifier—how to get quality. This 96 page booklet is yours for the asking—it's free. Write for your copy.

SILVER-MARSHALL, INC., 840 W. Jackson Blvd., Chicago, U. S. A.

BUCHSTEIN'S FIBRE LIMB



is soothing to your stump—strong, cool, neat, light. Easy payments. Braces for all deformities. D. BUCHSTEIN CO. 610 3rd Ave., So. MINNEAPOLIS, MINN.

Send for Catalog Today

FORDS no freezing no boiling!

Great Gas Saving

No need for winter fronts, summer pumps, or gas savers. The wonderful *Airlock does all three*. An absolutely genuine article which prevents freezing or boiling in any climate running or standing. It fuelizes and decarbonizes besides. Installed like a motometer. Makes an amazing demonstration. Sells like machine guns fire. Agents with Fords make \$50 daily. Free trial always. Address

AIRLOCK PRODUCTS
 Box 588 Burnett, California

Send me Agents free trial offer of your sensational Airlock.

Name.....
 (Print plainly)

Address.....

Time, Labor and Money Saving Ideas for Auto Repairmen

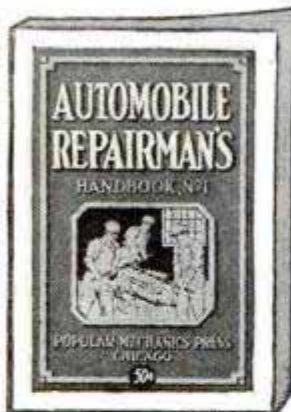

334 Valuable Discoveries made by Hundreds of Auto Mechanics are contained in our Automobile Repairman's Handbook. 337 Illustrations.....Price 50c

301 Ways to use drills, drill presses, taps and dies with more effectiveness are given in our Drilling and Thread Cutting Handbook.

298 Illustrations.....Price 50c

259 Kinks furnished by 106 of the most successful Lathe Operators are found in our Lathe Handbook.

212 Illustrations.....Price 50c

These three books (regular \$1.50 value) are offered for a limited time only for 98 cents plus the postage. Pay postman when he delivers the package. If outside U. S. send remittance and include 15 cents extra for postage.

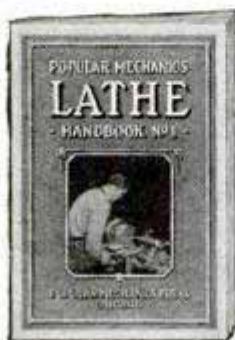

POPULAR MECHANICS PRESS
Room 604
200 E. Ontario St. CHICAGO

Books on 30 Subjects

Popular Mechanics Press has specialized in supplying books on any subject. Look over this list. Check the books you want, and mail this advertisement as your order blank. Catalog with lists on 2,000 subjects free.

AMATEUR MECHANICS How to Make and How to Mend.....\$0.75	MILLWRIGHT Erecting and Operating Machinery.....\$2.00
AUCTION BRIDGE M. C. Work's Latest Book.....\$2.00	MIRRORS Silvering.....\$1.00
AUTOMOBILE ELECTRICITY Electrical Trouble-Shooting on the Motor Car...\$4.00	OUTDOOR OCCUPATIONS Outdoor Opportunities.....\$2.00
BLUE PRINTS Blue Print Reading...\$2.00	PLUMBING Plumber's and Fitter's Handbook.....\$1.00
BOYS How to Put on an Amateur Circus.....\$1.75	PUZZLES Real Puzzles.....\$2.00
BUILDING TRADES Building Trades Handbook.....\$1.00	RADIO Modern Radio Receiving.....\$5.00
CHALK TALKER Chalk Talk and Crayon Presentation.....\$1.25	RUSTIC WORK Rustic Carpentry.....\$1.00
CHEMISTRY Chemists' Handbook...\$1.00	SHEET METAL Sheet Metal Work...\$2.00
DICTIONARY Self Pronouncing. Large Type—1100 pages...\$1.25	SHIP MODELS Clipper Ship. How to Make.....\$2.50
ELECTRIC SIGNS Electrical Advertising...\$5.00	STEAM ENGINEER Steam Engineer's Handbook.....\$1.00
ELECTRICITY Practical Applied Electricity.....\$2.00	STEEL SQUARE A B C of the Steel Square.....\$1.00
FORD Ford Standard Electrical Equipment.....\$2.00	STORAGE BATTERY Making, Repairing, Rebuilding.....\$5.00
FURNITURE Finishing, Decoration and Patching.....\$5.00	TOOLS (Using) Tinkering with Tools...\$2.00
GARDENING Garden Guide.....\$1.50	TRAFFIC MANAGER Traffic Handbook.....\$1.00
LETTERING AND DESIGN For Artists and Advertisers.....\$3.00	WINDOW TRIMMER Handbook of Window Display.....\$5.00
	WOOD FINISHER Wood Finishing, Plain and Decorative.....\$2.00

---SEND NO MONEY---

Just check the books you want, and mail the whole advertisement. It is your order blank. When postman hands you books, pay him the price and the postal charges. If outside the U. S. remit when ordering and include 10 cents per book extra for postage.
POPULAR MECHANICS PRESS, Room 704, 200 East Ontario St., Chicago, Ill.

You Have From Now Until 1928 to Pay!

If you act quick!—we will send you a Bulldog Pipeless Furnace for free inspection. Then, if you want it, you have from now until 1928 to pay. Get our special offer at once! Find out NOW about this amazing fuel saver! Write TODAY!

Comes Completely Erected!



2½ Tons Heats 5 Rooms!

"There is no heater to compare with the Bulldog. I burned 2½ tons of coal last winter and heated 5 rooms and bath."

—Walter Geary, Gloucester, Mass.

That's what the Bulldog does with coal! Here's what it does with about the lowest grade of fuel you can think of!

"I can run my Bulldog Furnace steady for fourteen days in normal weather conditions on the actual cost of 50 cents." So writes F. R. Redetzke, of Cleveland, North Dakota, and he adds: "Hard to believe, is it? That's what some of my neighbors thought until I showed them! We have an unlimited amount of green screenings in this country. That's the fuel I am using."

Write! Send today for our free book and Special Offer "From Now until 1928 to Pay"—in small monthly payments—**if you act quick!** Factory connections in both East and West. We ship from nearest point. Get ready for winter NOW! Mail this coupon TODAY!

Bulldog Furnace Co.

Babson Bros., Sole Distributors
19th and California Ave., Dept. 13-54 Chicago, Ill
Without obligating me in any way please send me your free catalog and special offer on the Bulldog Pipeless Furnace.
(Print name and address plainly.)

Name

Address

GREAT NEWS! FOR Edison Cylinder Phonograph Owners

ENORMOUS improvements in recording have made the present-day Blue Amberol Records so real and lifelike that living artists actually seem to be performing right in your own home. And, equally important, these vastly improved records may be obtained by mail direct from Thomas A. Edison's laboratory at the factory price of 35c each (plus nominal mailing charges). Try a single record and your own ears will convince you that the new Blue Amberol Records are far superior to any disc record using needles. There are still two generations of fun and enjoyment in your Edison Cylinder Phonograph if it is only oiled and adjusted occasionally. Send direct to Thomas A. Edison's laboratory for records. All orders are filled immediately and delivered right at your door as fast as the mails can rush them to you. Write for descriptive catalog and let us send you a list of the latest records every month. This signature is your guarantee.

Thomas Edison

Cylinder Phonograph Division P. M.
THOMAS A. EDISON, Inc.
Orange, N. J.

Name

Address

City.....

EVERY MOTORIST
NEEDS ONE

A New Winner For Agents



Sell the Autolog—a constant, accurate record of the gas and oil cost of your car. Saves money and trouble and tells you exact cost of operating your car. Beautifully nicked and guaranteed to last a lifetime. Takes but a minute to attach to any steering wheel.

Every auto owner wants one the minute he sees it. Now the record of his car's performance can always be before him. Big firms

find the Autolog an easy, inexpensive way to keep track of the cost of operating their fleets of cars. They buy Autologs by the dozen.

100% PROFIT—Autologs retail for \$1. and cost you only \$6.00 a dozen. For every dollar you invest in Autologs, two dollars return to your pocket. **ORDER A SAMPLE TODAY** Send for our easy selling plan and \$1 for sample, or better still, send \$6 for a dozen and begin making money at once. Orders shipped same day received. Every Autolog comes neatly packed in an attractive, display box with complete instructions for installing. Write today and reserve your territory.

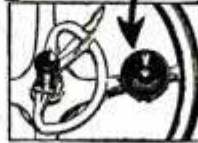

Dept. 41 **KIT SERVICE CO., Inc.**
209 Centre St., New York, N. Y.



FOY'S BIG BOOK, in Colors

A complete guide to successful Poultry and Squab Raising. Low prices on CHICKS, Breeding Stock and PIGEONS. Write Today! FREE!

FRANK FOY, Box 18, Clinton, Iowa



HOW A BOY BUILT UP A GREAT SQUAB FARM



Started small in backyard when at school with no money, now has \$30,000 plant, ships to New York 150 bbls. squabs yearly, receiving \$75 to \$100 a barrel. You can do the same. Send for this book. Price is fifty cents but we will mail it to you for the names and addresses of four of your friends and your own name and address. Write today!

Plymouth Rock Squab Co., 634 A St., Melrose High., Mass.

RAISE BELGIAN HARES

NEW ZEALAND REDS—Chinchillas—Flemish Giants **MAKE BIG MONEY**—We supply stock and pay you following prices for all you raise: Belgian Hares \$2 each—New Zealand \$3 each—Chinchillas \$4 each—Flemish Giants \$5 each. 32-page illustrated book, catalog and contract, also copy of Fur Farming magazine, tells how to raise skunk, mink, fox, etc., for big profits, all for 10c. Address

OUTDOOR ENTERPRISE CO., Box 25, Holmes Park, Mo.



68 BREEDS Valuable New Poultry

Book Free—100 Pages. Fine Pure-bred Northern raised chickens, ducks, geese, turkeys, eggs, baby chicks, incubators & brooders at lowest prices. America's great industry. My 45th year. **W. A. Weber, Box 28, Mankato, Minn.**



30 DAYS TRIAL—2 BIG MONEY MAKERS

Let us tell you how HB Silent Twin Automatic Air Service will increase your business and bring you bigger profits without expense to you.

Write for Bulletin MA.

Get in on the really big profits of Automotive Electrical Service with this HB Test Bench. Does the work of \$600 outfits but costs you practically nothing—pays for itself with big profits besides.

Write for Bulletin MT.

THE HOBART BROTHERS CO., Box M-471, Troy, Ohio
PRACTICALLY NO INVESTMENT

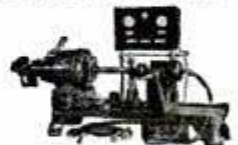

WRITE FOR DETAILS

ZENITH Super-Power Head for FORDS!

\$35 CASH PUTS IT ON YOUR CAR!

75 miles per hour and more—50% to 100% more power—big savings on gasoline. All these advantages come from a ZENITH Overhead Valve System on your FORD. Only \$35 cash brings you ZENITH Super-Power Head, balance easy \$4 weekly payments. Install it NOW for spring driving. Aviation timing for FORDS with ZENITH Hi-Speed Camshaft. Only \$8 and \$14. ZENITH Water Pump needed on every FORD, \$4 and \$6.50. Also ZENITH Radios and Cabinets. Write for free circulars. Get our agents' moneymaking proposition.

ZENITH AUTOMOTIVE MFG. CO., 4418 Olive St., ST. LOUIS, MO.

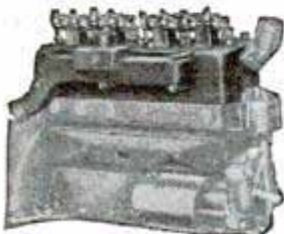

ZENITH WATER PUMP
\$4.00 and \$6.50

Sargent planes pay for themselves

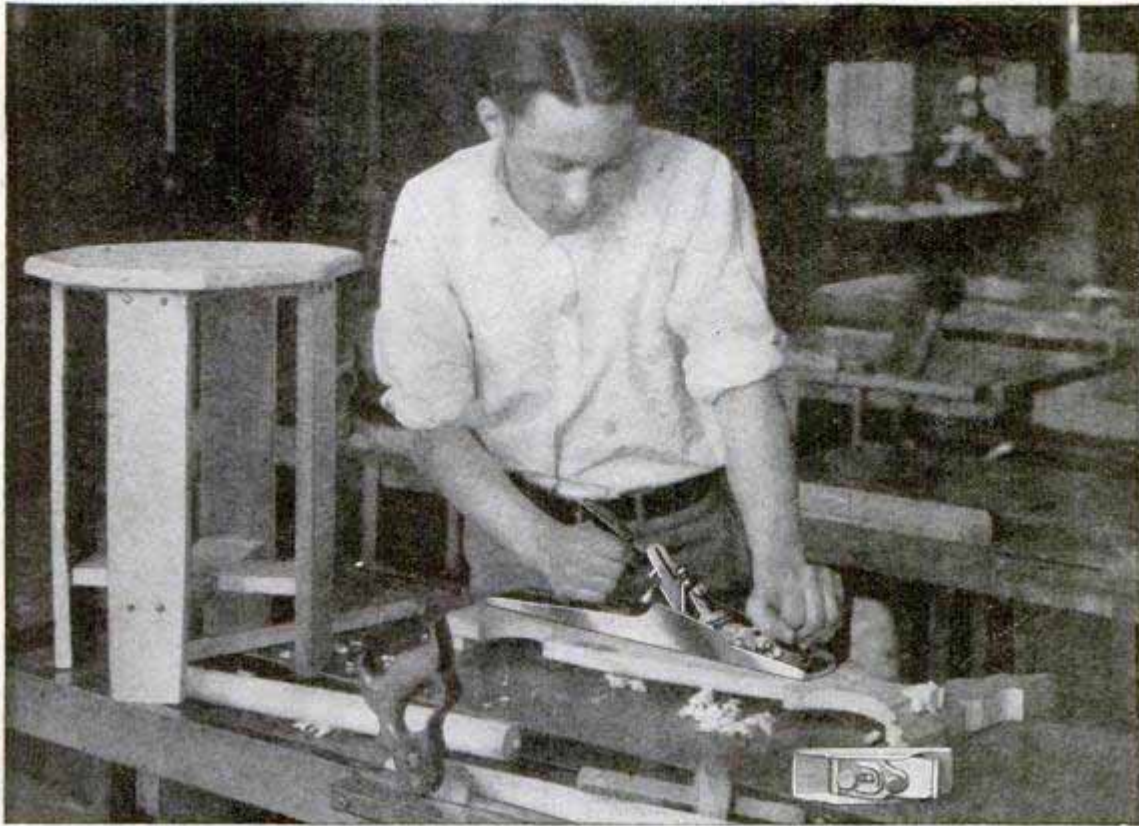

PERHAPS not in actual dollars and cents, for you may not be paid for the work you do with them. But they pay by saving time and trouble, and in the way they last. Yet these strictly professional tools are not expensive by any means—costing less than you would expect to pay for such good planes. They will care for practically every planing job that comes to a school or home workbench.

Sargent Auto-Set Bench Planes are as much as two pounds lighter than old-style planes of same size. That's one result of modern design and construction. They are simpler in adjustment. The cutter may even be removed,

SARGENT & COMPANY, *Manufacturers*

sharpened and replaced without disturbing the original adjustment—and that's quite a remarkable feature. The cutter, as in every Sargent plane, is of chromium steel. Experience through many years indicates that chromium is the most satisfactory alloy to add to straight carbon steels to secure an increase in cutting efficiency, toughness, wear-resistance. Expert chemists and actual use have confirmed this.

Be sure to get a Sargent Auto-Set, and a Sargent steel block plane which can't be beat for end work or the smaller jobs of finishing. See them at your hardware dealer's and write us today for descriptive booklet.

49 Water Street, New Haven, Conn.

SARGENT PLANES

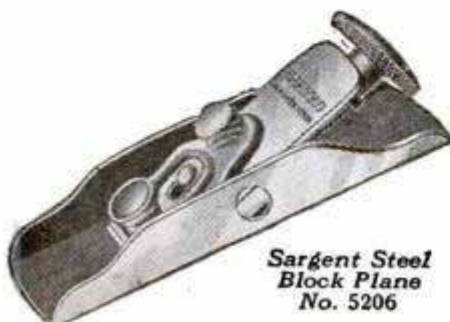

*Sargent Steel
Block Plane
No. 5206*

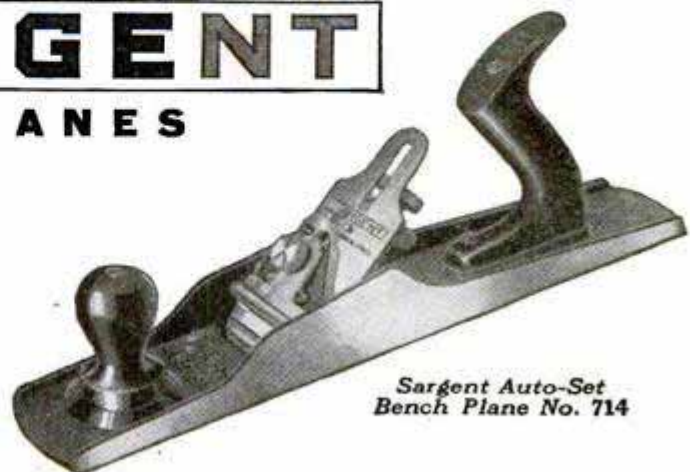

*Sargent Auto-Set
Bench Plane No. 714*

Reduce This Fleshy Spot



DON'T weaken yourself with starvation diets—don't strain your heart with violent exercises. Here's a wonderful new invention which gives you an instant appearance of slimmness and quickly reduces the actual fat—without any danger, discomfort or disagreeable self-denial.

Take Off 2 to 6 Inches With New Self-Massaging Belt

The moment you put on this wonderful, new, self-massaging belt your waist is instantly reduced from 2 to 6 inches—but, better still, you should actually grow thinner day by day. Your stomach disorders, constipation, backaches and shortness of breath generally disappear as the sagging internal organs are put back in normal place. You are filled with a wonderful new energy and will probably look and feel 10 to 15 years younger.

Like Having a Private Masseur

This new, wonderful Well Reducing Belt produces the same results as an expert masseur—only quicker and cheaper. It not only reduces your waistline when you put it on, but is so constructed that every movement you make, every breath you take, imparts a constant, gentle massage to every inch of your abdomen. In a few weeks, inches of fat should actually disappear.

The Well Belt is made of the same kind of scientifically treated rubber that is used by hundreds of professional athletes and jockeys and is highly endorsed for its healthful principles by physicians everywhere. Satisfaction guaranteed or your money instantly refunded without question. The Well Co., 94 Hill St., New Haven, Conn.



THE WEIL COMPANY
94 Hill Street, New Haven, Conn.

Gentlemen: Please send me, without obligation, complete description of the Well Scientific Reducing Belt and also your special 10-day trial offer.

Name.....

Address.....

City.....State.....

Helping You Do Many Jobs PLASTIC WOOD



Wherever wood needs replacing, **PLASTIC WOOD** will do the job quickly—and permanently. This remarkable material handles like putty and hardens into tough, water-tight wood.

As it comes from the can, **PLASTIC WOOD** can be moulded in the fingers and is so adhesive that it sticks to metal, cloth or wooden surfaces. It hardens on exposure to air and can be worked with any wood working tools. Nails will not split it. Takes paint, stain and varnish like any wood.



Try it for filling cracks, mending furniture, or any woodworking job.

Sold at Hardware and Paint Stores. ¼ lb., 35c; one pound, \$1.00.

Addison-Leslie Company
40 Bolivar Street, Canton, Mass.

Please send me ¼ lb. can of **PLASTIC WOOD** for which I enclose 35c.

Name.....

Address.....

(Please write plainly)

BUILD YOUR OWN GRANDFATHER'S CLOCK



We furnish blue prints, finishing material and instructions. Buy the works, dial, weights and pendulum from us at surprisingly low prices. You make a fine profit building artistic clocks for your friends.

Plain Works As Low As \$5.00. Others with Chimes At All Prices. Ask for Attractive Free Offer.

AMERICAN CZECH COMPANY
1670 Ruffner Street
Philadelphia

play safe

Don't gamble with the success of your set or eliminator—wherever a variable resistor is specified use **CLAROSTAT**, the greatest variable resistor. It covers entire range; has a carrying capacity of 20 watts.

American Mech. Labs., 285 N. 6th St., B'klyn, N. Y.

Send 25¢ for 32 page illustrated book



A Partnership and \$90 a Week in My Big Shoe Business



Agents! Salesmen! Write or wire for amazing new plan which gives you \$90.00 a week and big share of profits besides. Bigger income than ever before. You take orders for stylish, popular-priced shoes for women. Low factory prices get orders quick. You don't need experience. You don't invest a penny. I furnish everything.

Profit-Sharing Unit and Sample Shoes FREE

I send you complete outfit containing five real shoes to show friends; also sales book showing how to succeed and actual profit-share to make you partner at once. Write or wire immediately. No obligation.

Rodger Wilson, Desk P-111, Style-Arch Co. Cincinnati, Ohio



PUSH NO MORE

Here is the newest invention in Lawn Mowers. No more "pushing" on hot days—just follow and guide the new

BOB-a-LAWN The Pushless Lawn Mower

Operated and propelled by 1 H. P. gasoline motor. Handy lever on handle controls everything. Anyone can operate it. Cuts on hill or terrace; heavy or light grass. Send for free circular.

Agents Wanted to demonstrate and sell the Bob-a-Lawn for home lawns, parks, cemeteries, court house yards, etc. Special price for Agent's Sample.

Cushman Motor Works
1015 N. 21st St., LINCOLN, NEBR.
Eastern Distributors,
Power Units, Inc.,
743 Jackson St., Jackson, Mich.



You can now own a Typewriter!

only
\$3⁰⁰ DOWN
and it's
YOURS

Be up-to-date—know the pleasure and convenience of having one in your own home. You'll be amazed at the uses every one in your household will find for this real Underwood typewriter. Every member of the family will use and enjoy it! Don't send a cent—but do get our big special offer—our valuable book on typewriters and typewriting—FREE.

Any One Can Learn to Operate a Typewriter

You can learn to write on this standard-keyboard machine in one day, it's so simple that even a child can use it. A week after the expressman has brought it, you'd feel LOST without it. A trial will PROVE it—and doesn't cost you a penny!

Special Free Trial Offer!

We don't want a penny now. Nor any money at all unless this proves the typewriter bargain of your life. The trial is FREE. If you buy, our easy terms make it a pleasure to pay. There's no excuse now, for not owning a typewriter—and the finest make! We include all tools, a cover, etc., all complete, all ready to write. Write us now. Deal direct; we are the largest factory of the kind.

Our plan gives you the opportunity of a thorough trial before you buy. You run no risk whatever. You start to pay for your typewriter AFTER you have found it the only machine for you! But get the facts before this lot of machines is all in use. Clip the information coupon before you turn the page. It will pay you! Note the very useful book you will receive free! Write for full particulars at once.

The Greatest Typewriter Offer Ever Made

If you know typewriters, you know the perfect work and the ease and speed of a Shipman-Ward rebuilt Underwood typewriter. New machines are guaranteed for only one year; WE GUARANTEE EVERY ONE OF OUR MACHINES FOR FIVE YEARS! If you have never owned a typewriter, start with the finest! You can try this one at our risk. But, the time to act is NOW. Don't miss out on this present bargain offer whereby you can get this genuine Underwood at a big savings. Don't do longer without the convenience of a typewriter.

FREE! Get our catalogue free; lowest prices and terms. A manual free, too; valuable instruction for learning rapid typing, useful pointers for all who use a typewriter, business forms, social correspondence, work for others, etc.

Clip Coupon NOW!

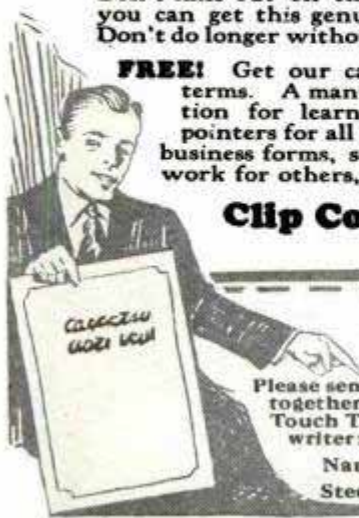

MAIL TODAY!

Shipman-Ward Manufacturing Company,
2124 Shipman Building, Chicago, Illinois.
Please send me your big Free Trial Plan and Typewriter Book,
together with your special offer on prices, terms, free course in
Touch Typewriting and also how I can make money with this type-
writer; without obligation. This is not an order.

Name.....
Street or R. F. D..... City..... State.....

STOP THAT LEAK WITH SMOOTH-ON No. 1



YOU can apply Smooth-On with radiator full or empty, hot or cold, without removal from the car and without putting inside anything that clogs the circulation.

Merely roll the Smooth-On into a stiff putty, press it against and into the leak with your thumb or pack it into the defect with a knife blade or screw-driver, and scrape off the excess. The leak will stop instantly, and the repair is permanent. For a few cents and in a few minutes you will have avoided all the delays and expense of a professional repair job that couldn't be any better.

Bursted Water Jackets. Water jackets of automobile, stationary or marine gas engines which have developed long or short cracks or have even had pieces broken entirely out from freezing can be made thoroughly and lastingly serviceable by similar repair, or by applying Smooth-On under straps or a plate.

Smooth-On No. 1 can be used in a hundred ways in the household, and it often saves from \$50.00 to \$100.00 on the first job.

Keep a can of Smooth-On No. 1 with your tool kit and some day when caught with a repair job you will thank yourself for your forethought.

Get Smooth-On No. 1 in 7-oz., 1-lb. or 5-lb. tins at any hardware store or if necessary direct from us.



Write for
FREE BOOK



FREE

This booklet tells how to stop not only water leaks in radiators, bursted water jackets, and at loose hose connections, but also how to stop gas leaks from the tank, gasoline lines and exhaust system, and oil leaks at gaskets and at cracks in crank or gear case. It also tells how to make headlight posts, nuts, hub caps and bolts and grease cups stay tight, and shows dozens of simple money saving Smooth-On repair jobs.

Sent free if you return the coupon
SMOOTH-ON MFG. CO.
Dept. 37, 574 Communipaw Ave.
JERSEY CITY, N. J.

Do it with SMOOTH-ON

SMOOTH-ON MFG. CO., Dept. 37,
574 Communipaw Ave., Jersey City, N. J.
Please send the free Smooth-On Repair Book.

Name.....

Address.....

P. M.

Let Me Tell You Why Every Ford You See is Worth \$1.75 to You..

To a man with vision—one who will say: "I'll make your car ride 100% smoother, without spring rattles or spring squeaks, or give you a set of 'Ride Air' Cushions free"—that fellow can easily earn \$17.50 for only 2 hours' work, equipping Fords and other cars with "Ride Airs." And I'll prove that to you absolutely if you'll write me now. Just 5 minutes spent on each Ford you see means \$1.75 profit on a \$2.50 sale. No bolts—nothing to remove—no holes to bore.



C. F. Hamilton,
Sales Manager

The Biggest Money Maker Ever Offered to Men Who Will Work 2 to 3 Hours a Day

Never before has such a phenomenal money maker been offered to men who like "the selling game"! You don't have to spend hours ringing door bells seeking prospects, they pass you on the street, they stand at the curb, in parking places, garages—in fact wherever there's a road or an automobile you have an absolute prospect! We have any number of men who are now making \$100 to \$150 a week easy and only working 4 to 5 hours at that, in fact last year opened the eyes of hundreds of fellows to the fact that "Ride Airs" were unquestionably the biggest money maker they ever tackled!

In 6 Months Last Year My Men made \$123,800.00

—and they didn't even begin to scratch the surface. There are over 22,000,000 automobiles on the road today with over 3,000,000 "Ride Airs" in use, yet that represents less than 1% of the prospects awaiting "Ride Air" men in 1927. It is the quickest selling automobile necessity ever invented—the product of an automotive mechanical engineer. It is the only device of its kind that positively makes old cars ride like new, eliminates the necessity of spring lubrication and guaranteed to last the life of the car.

Automobile Experts say Ride Airs are the Greatest Invention in 10 Years

They have been tested out over a period of 3 years under the most severe condition by skeptical automobile engineers everywhere, and without exception they have had the absolute stamp of endorsement of a number of the biggest men in the automobile field.



"Ride Airs" not only take all the rough spots out of the road, but improve the riding qualities 100% regardless of what make shock absorbers it may now be equipped with—and best of all they only cost the owner \$2.50 to \$5.00 according to the car, and your profit is \$1.75 to \$5.00 per sale. When you write me, which I know you are going to do today, I'll tell you all about this big money making opportunity, send you a FREE sample, also a certificate which will entitle you to a complete set of "Ride Airs" for your own car without one cent of cost to you whatsoever. Write or wire me NOW!

C. F. HAMILTON, Sales Manager
Desk P. M. 2—528-532 West 27th St., LOS ANGELES, CAL.

Don't Get Stuck!

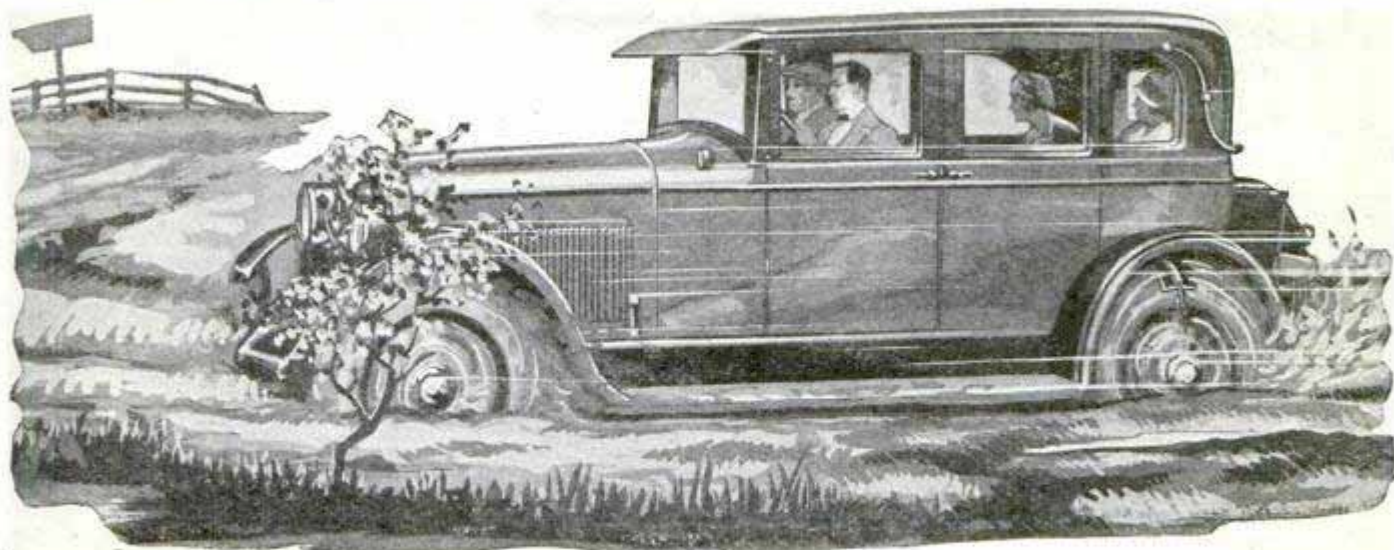

Mud—Sand and Snow Bring Agents \$60 a day

Now motorists drive in the deepest mud, sand and snow without the slightest danger of getting stuck—an amazing new (patented) wheel device is revolutionizing winter and spring driving. Sells like wildfire—G. H. McLeod made \$60 first day out

So marvelous is this wonderful new, simple invention that it is absolutely impossible to get stuck, even in the deepest mud, snow or sand. Ordinary tire chains aren't in it with this new unfailing device. Every day we receive letters of praise from some one of our many thousand satisfied users, telling of pulling through deep snow or sand.

Gold Mine to Agents

Imagine driving a heavy seven-passenger sedan 28 miles over Missouri's black Gumbo roads with the mud and water hub deep all the way. Naturally, when autoists hear of a remarkable device like this, they don't rest in peace until they own a set for their own car. No wonder the popularity of this simple invention—the GETS-U-OUT TIRE LUG—as this amazing accessory has been called, has won nation-wide popularity and praise. No wonder experts claim it the greatest auto invention of the age.

Amazingly Simple

This amazing new, simple, unfailing device is now conceded by



salesmen everywhere to be the most sensational direct selling proposition ever known. Old and long standing sales records are being broken every day by this astounding new device. Emil Kahn made \$231 profit the first week; Chas. Moore cleaned up over \$47 a day for eleven consecutive days—and all without the slightest bit of previous selling experience. GETS-U-OUT is really and truly a hard-hitting self seller.

20,000,000 Live Prospects

Practically every car owner in the United States, Mexico, and Canada—over 20,000,000—is a good live prospect for a set of GETS-U-OUT TIRE LUGS and you make \$2.50 and more on every sale. Think of the big cash profits waiting for someone right there in your locality. Honestly, never before has a product with such universal appeal and big profits been offered through exclusive direct sales channels.

FREE Sample Offer

To fill in every unclaimed sales territory and further introduce this remarkable invention, Mr. Paul B. Coats (the inventor) will send a complete sample set, at his own risk. Not only that, but he will lay before you the greatest wide-open offer sales plan known—five to twenty-five sales from one demonstration.

Just send the coupon below at once for full details of our special limited introductory sample offer. This is your opportunity to make big money and lots of it. Don't let the chance slip away from you. Mail the coupon right now!

CLIP AND MAIL

OPPORTUNITY COUPON

Mr. Paul B. Coats,
Chicago Tire Lug Co., Inc.,
832-338 W. 47th St., Chicago.

Send me your FREE Trial Offer, and your Special Agents' Proposition. This request obligates me in no way whatever.

Name.....

Address.....

City.....State.....

Chicago Tire Lug Company

(Incorporated)

832-338 West 47th Street

Chicago, Ill.



Swinging, Swaying Tantalizing Tunes

The lure of jazz is yours with a Buescher True-Tone Saxophone. Young folks are enamored by these tantalizing tunes. They love that syncopation.

If you want to be popular—if you want to be admired—favored, get this wonderful instrument. At home, at parties, everywhere, the Saxophone player is the center of attraction.



TRUE-TONE Saxophone
Easy to Play
Easy to Pay

You don't have to "study" the Saxophone as you do other instruments. There is no practice drudgery. You don't have to be "talented." Three lessons sent free with the instrument start you. In a week you can play popular airs. No teacher needed.

It's all fun, and even though you're only out for pleasure now, you can, in 90 days' time, if you wish, join a band or orchestra.

First class Saxophonists make big money. Try it out free for six days in your own home.

Free Saxophone Book

Send the coupon! Or a postal for full particulars and copy of Saxophone Book! Mention any other instrument in which you may be interested. No obligation. Do this today. (112)

BUESCHER BAND INSTRUMENT CO.
Everything in Band and Orchestra Instruments
1992 Buescher Block Elkhart, Ind.

Buescher Band Instrument Co., 1992 Buescher Block, Elkhart, Ind.	
Gentlemen: I am interested in the instrument checked below:	
Saxophone.....	Cornet..... Trombone..... Trumpet.....
(Mention any other instrument interested in)	
Name.....	
St. Address.....	
Town.....	State.....

Get back your winning muscles

Get into form for outdoor sports with Absorbine, Jr.—a rubdown that keeps out stiffness and puts back the old strength.

\$1.25 a bottle at your druggist's

W. F. Young, Inc. Springfield, Mass.

Absorbine Jr.
THE ANTISEPTIC LINIMENT

EASY \$100 a Week

FUGO FIRE EXTINGUISHER

Unusual opening for live agents in every locality. Make \$5000 or more a year—*easy*. Fugo—the instantaneous automatic fire extinguisher—needed and wanted in every home, store, theatre, garage, shop, school, automobile, etc. Cheapest fire protection available today. Within reach of all.

1 Qt. Size \$5.00 2 Qt. Size \$7.50

Recharged in a jiffy.

Amazing 30-second demonstration clinches sale—each one sold sells others. Territory going fast. Write at once for wonderful proposition that will **MAKE YOU BIG MONEY.**

THE NATIONAL FORMALET CO.
6535 Metta Ave., N. E. Cleveland, Ohio

Will Finance Patents

of commercial value, royalty basis, manufactured for \$5.00 and under. Mail model and copy of patents or full details.

KAMSTONE HOLDING CORPORATION
41 East 42nd Street, NEW YORK

HAIR GROWS!

when our Vacuum Cap is used a few minutes daily. Sent on 60 days' FREE trial at our expense. No drugs or electricity. Stops falling hair, cures dandruff. A postal brings illustrated booklet.

MODERN VACUUM CAP CO.
558 Quincy Denver, Colorado

For Better Filament Control on your radio set use the **NEW Lynch EQUALIZOR** in place of rheostats. \$1 complete with mounting. At your dealer's or post-paid. Money back if dissatisfied. In ordering, state number and types of tubes in your receiver. **ARTHUR H. LYNCH, Inc.,** Manufacturers of the **Lynch Metallized Resistor**, 250 West 57th Street, NEW YORK, N. Y.

Fibre-Lite Limbs **BRACES AND TRUSSES**

DO NATURE'S WORK. GREAT INVENTION. EASY TERMS. AGENTS WANTED. WRITE FOR FREE FIBRE SAMPLE. **WORMAN CO.** 252-P HENNEPIN AVE. MINNEAPOLIS, MINN.

Make Decorative Metal Articles

Pictures and instructions for making: book ends, desk sets, jewelry, desk clocks, drawer pulls, hinges, bookmarks, stationery rack, candlestick, letter holder, whisk broom holder, and many similar articles. Send no money. Just write a postal for "Metal Work and Etching", our 88-page book. Pay postage and 98c to postman.

Popular Mechanics Press, Room 710, 200 E. Ontario St., Chicago, Ill.

Please Mention Popular Mechanics

GOODELL-PRATT



High-speed, High-power Bench Grinder—485. Handy for bench and household use. High-grade Abrasive Wheel, 5 x 1". Adjustable Work Rest. Finished in red and black enamel, 6 1/2" high above bench \$10.00



Goodell-Pratt Electric Drill. Sizes from 3/4 to 3/8". Light and Heavy Duty, for 110 and 220 A. C. or D. C. Steady drilling doesn't overheat these Drills. Vital parts readily accessible. These drills retail from \$36 to \$99

Automatic Drill—185. Mr. Punch. Push, and the tool returns. Drill points carried in handle. Length 10". Beautifully polished and nickled, including 8 drill points from 1/16 to 11/64" \$2.75

All-steel Mitre Box—1285. Cannot bend or break, or become inaccurate. Angles more acute than 45° are secured by side attachment. Gauge can be regulated to saw any desired depth. Equipped with 28 x 5" first quality Back Saw \$27.50

Bench Vise—161. Moderately priced. Cut steel feed screw and guide rods insure rigidity. Jaws machined after assembly, so they meet accurately. Steel parts polished, iron parts enameled. 2" jaws, opening 2". Weight 3 1/4 lbs. \$2.60



GOODELL-PRATT



Ratchet Bit Brace—7010. 10" sweep. Steel clad head on roller bearings. Chuck sockets and shells of malleable iron; forged steel jaws. Square shank bits. Polished and nickled . . . \$3.75

Automatic Screwdriver—111. Reversible, for driving or drawing screws. Can be used ratchet or plain. Handle finished in mahogany. Length, extended, with blade 19". Including 3 tool steel blades \$3.10

Saw Vise—745. Jaws hold saw for their entire length. 10", are self-aligning and can be taken out by removing single screw. Ball and socket gives flexibility in filing positions. Clamps to any bench 3/4 to 2 1/4" thick. Stands 9 1/2" above bench. Weight 5 pounds. \$5.00

Two-speed Hand Drill—51. Black enameled frame. Handle cap unscrews to hold drills. Takes round-shank drills, 0 to 1/2". Steel parts nickled. 14 1/2" long. Without drills \$3.50

Floor Scraper—469. Mahogany finished hardwood handle, 11" long, and set at correct angle. Reversible 3 x 4 1/2" blade of finest tool steel, hardened and tempered to hold good cutting edge. Wing adjusting nut and curved pressure plate. Weight 1 1/4 pounds \$1.65



THE ten carpentry tools pictured here are single examples of the sizes in which each is made. The catalog also features all kinds of tools for machinists, and professional and amateur mechanics.

400 pages of fine tools *FREE*

Select your tools from this catalog—then buy them from your hardware store, mill supply or automotive supply dealer

THIS 400-page catalog is used by carpenters, mechanics, and machinists—who select from its pages the tools they need—and buy them through their local hardware or mill supply man.

You, too, will find this a pleasant and easy way to buy tools. A three-page index helps you find what you want—at once. Clear, easily understood descriptions and good pictures leave nothing for you to guess at.

Whether you make your living with tools

or use them to follow a hobby, you need this catalog, with its 400 pages of pictures and information.

Goodell-Pratt Tools will serve you well for years. No finer tools are made than those that bear the name of Goodell-Pratt.

Select your needs from this catalog; then buy them from your nearest dealer. If he doesn't carry the Goodell-Pratt line, write us for the name of a dealer who can supply you.

For the catalog, address

GOODELL-PRATT COMPANY *Toolsmiths* GREENFIELD, MASS., U. S. A.

MAKERS OF MR. PUNCH

GOODELL-PRATT

1500 GOOD TOOLS

Be the Life of the Party



Play a Tune in 10 Minutes
 Popularity—new friends—money-making opportunities come to those who can play!

Now you can pick up your favorite stringed instrument and play a tune almost instantly. NO knowledge of music needed. NO expensive lessons. NO weeks of tiresome practice. Play tunes from the start. Play by numbers. Surprise and astonish your friends. **Amazing new invention** makes it easy to play Ukulele, Banjo Ukulele, Tenor Banjo, Guitar, Mandolin. Just press the keys and play.

Trixie Friganza, famous Vaudeville Star, wrote: "I played in 3 minutes and never touched a stringed instrument before."
 John A. Cruser: "I was skeptical about anyone playing tunes instantly but have changed my ideas completely."
 W. F. Mat his: "Your advertisement didn't tell the half of it."
 Mrs. A. Kasen: "My friends and I play wonderful tunes. The more we play the better it gets."

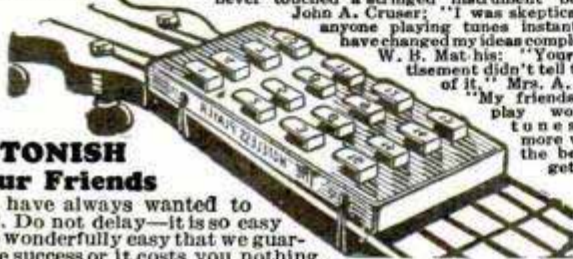

ASTONISH Your Friends

You have always wanted to play. Do not delay—it is so easy—so wonderfully easy that we guarantee success or it costs you nothing.

SEND FOR FREE BOOK!

More popularity—more fun from life—new friends—money-making opportunities. If you want to play tunes at once—send today for a free book about **Ferry E-Z Playing stringed instruments**. Soon you, too, can know the joy of making your own music. "No play; no pay." E-Z Playing Instruments are sold complete or the E-Z Player can be attached to your own stringed instrument in a jiffy.

Mail coupon today

FERRY & CO., Dept. 9774, Chicago, U. S. A.

Send free book telling how I can get more fun out of life, make more friends, have greater opportunities for getting ahead by learning to play my favorite stringed instrument in 10 minutes. No obligation.

Name.....

Address.....

City..... State.....

DIAMONDS WATCHES JEWELRY

LOWEST PRICES • BIGGEST VALUES • EASIEST TERMS
A WHOLE YEAR TO PAY 10-DAY FREE TRIAL
 Write today for our **BIG FREE BARGAIN CATALOGUE!**
STERLING DIAMOND & WATCH CO., Inc.
 DIAMOND IMPORTERS • \$1,000,000 STOCK • ESTABLISHED 1879
 1540 Broadway Dept. 2237 New York City

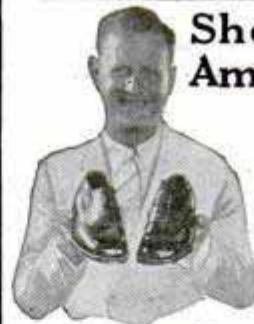

Shoe Expert Invents Amazing New Fitting Discovery

The amazing sensation of the shoe world is the "six actual measure" invention used by **Tailor-Made Shoe System**. People everywhere by thousands demand this wonderful new way for perfect fit, long wear and style.

TAILOR-MADE SHOES A SENSATION

You Can Earn \$50 a Week Extra

More representatives are needed at once to earn \$50 to \$75 a week extra. No experience required. Merely show these wonderful shoes for men, women and children. 75 styles tailor-made in 60 different leathers. Less than store prices. We show you how. Your own shoes without cost. Write at once. No matter what you are doing now, this is a wonderful opportunity for you to start in spare time and earn big money.

TAILOR-MADE SHOE SYSTEM
 932 Wrightwood, Dept. WA4, Chicago, Ill.

GOOD TUBES DESERVE

Nothing else will do—to insure self-adjusting filament control, utmost tube performance, longest tube life. Insist on Amperite. Eliminates hand rheostats. Simplifies wiring. Price \$1.10 complete. Sold everywhere. Write for Free Radiall Book giving season's popular hook-ups and construction data to Dept. P. M. 4.



RADIALL COMPANY
 50 Franklin St.
 New York

AMPERITE

The "SELF-ADJUSTING" Rheostat

"Interlox" as well as outside—two rules in one. Quick acting—no folding. Strong, durable. Any length, 2 to 8 ft., 20c lineal ft. If not at dealers, sent post-paid.

MASTER SLIDE RULE
The SPEEDY RULE
 for Accurate **INSIDE** Measurements
MASTER RULE MFG. CO., 813 E. 136th St., NEW YORK

Dealers and Agents: Write for attractive proposition.



U. S. HEADQUARTERS
 Mauser & Luger Carbine
 Webley Air Pistols, Rifles, Shotguns, Merkel Bros. Over and under Trap-guns, Mannlicher-Schoenauer Ammunition. 72 PAGE ILL. CATALOG 25c.
A. F. STOEGER, Inc.
 224 East 42nd St., New York



MODEL SHIP BUILDERS

Give your boat a true model appearance. Rig her up with true scale parts and have your efforts appreciated. Send for interesting booklet containing parts, plans, etc.

Model Ships Supplies, Dept. M, 44 Whitehall St., New York City, N. Y.

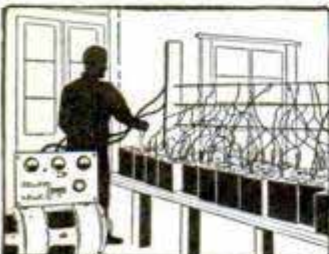

HB ONE DAY BATTERY CHARGING PAYS \$150 to \$300 MONTHLY PROFITS

Get in the moneymaking **One Day Battery Charging business now**. Big demand for One Day Charging Service for auto and radio batteries. Over 12000 shops now making big monthly profits with One Day Charging. **Only \$35 cash puts moneymaking HB One Day Charging outfit in your shop**. Easy terms on balance—let your big monthly profits pay for outfit. No experience needed. **Complete operating instructions free with each outfit**. 30 days' free trial in your shop on moneyback guarantee. Ask for money saving prices on HB Automatic Air Compressors, Motors, Tire Buffers, Grinders, etc. Write for free bulletin 26.

HOBERT BROS. CO. Box M47 TROY, OHIO

NOW ONLY \$35 PUTS THIS MONEY MAKING SERVICE IN YOUR SHOP





What Sport! What Fun!

-with these two famous *Indian* "pals"

R EADY, fellows? Now's the time! For healthful outdoor sport—for comfortable travel at less than carfare—for getting quickly to business or pleasure—hop on an Indian "pal"!

Smooth, quiet, powerful—safe! Easily handled. Always dependable. Takes you anywhere, anytime, at a fraction of carfare cost—a cent a mile or less. Only an In-

dian gives thrills like this—real motoring at its best!

Easy to Own

Call on your nearest Indian dealer. Let him demonstrate the Indian Prince and the Indian Scout—the two "pals" that cut the heart out of travel cost. Easy pay-as-you-ride plan enables anyone to own an Indian. Coupon below brings illustrated catalog—FREE! Mail it today for the complete interesting story of these two famous models.

Dealers! A few good territories still open. Real opportunity for ambitious men. Write now!

Indian Motorcycle Co.

SPRINGFIELD, MASS.

Check nearest age to help us suggest the model for your requirements.

THE INDIAN PRINCE The Solo Single

Learn to ride in 5 minutes. Climbs steepest hill on high. Speeds to 50 miles per hour. Low saddle. 3-speed transmission. Two-unit electrical system. Light, sturdy. 90 miles per gallon. Less than 1c per mile operating cost. Price with complete electrical equipment \$225 F. O. B. Springfield, Mass.

INDIAN SCOUT The Solo Twin

Twin-cylinder smoothness, acceleration and power, combined with light weight, low saddle, ease of handling. 65 miles per gallon. 1c per mile. Highest used-value. Thousands delivered 7 years ago in use today. Price with complete electrical equipment \$285 F.O.B. Springfield, Mass.

Motor the Indian Way

Lowest initial cost!
Lowest upkeep!
No garage bills!
No traffic delays!

Indian Motorcycle Co.,
Dept. P-4, Springfield, Mass.

- Send me your illustrated Catalog describing the Prince and the Scout.
- Check this square if you are interested in our money-making proposition to dealers.

Name _____

Address _____

City _____

State _____

Age 12 to 16

16 to 20

over 20

How Thick Is a Page of POPULAR MECHANICS?

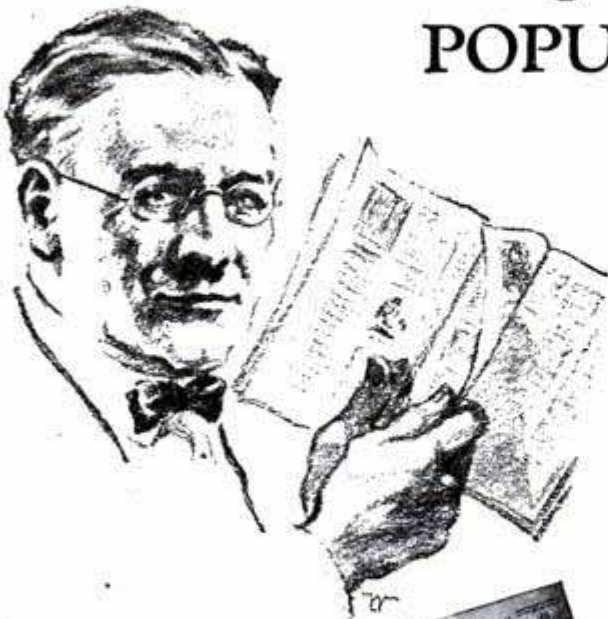

THE thickness of a page of this magazine—.0027 of an inch—is several times as great as the variation frequently allowed in machine tool work.

For making measurements twice, four and frequently ten times as fine as this, mechanics the world over rely on Brown & Sharpe precision tools.

These tools are used in both commercial manufacturing and the finest of tool work. They are used every day in making fine measurements in mechanical industries where accuracy is a paramount point.

It pays to look for the Brown & Sharpe trade mark when selecting precision tools. For it represents performance recognized everywhere as the world's standard of accuracy.

Hardware dealers can supply you—or write for Catalog No. 30.

BROWN & SHARPE MFG. CO.
Providence, R. I., U. S. A.

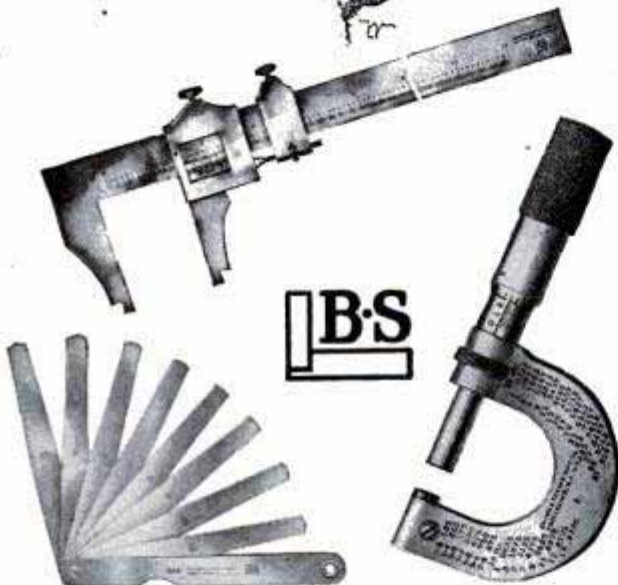

BROWN & SHARPE TOOLS

"World's Standard of Accuracy"

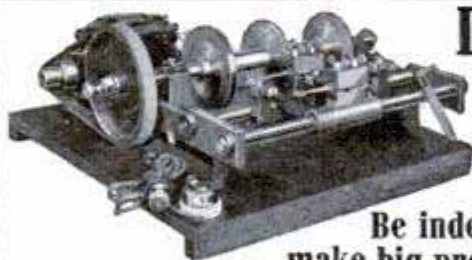

Don't Be a Slave

Be independent and
make big profits with the

BEISSER KEY MACHINE

You can start a business of your own, no experience necessary. Only machine that will cut ALL KINDS of keys perfectly. No hand filing required. Also first keys by number without need of taking locks apart. Write Today for Full Particulars.

BEISSER KEY MACHINE CO.

407 Fort Street, East

Detroit, Michigan

The Big-Money Idea in Tailoring



2-price line \$23.50 and \$31.50

Supplies every demand for low price and fine QUALITY—meets ALL competition. We furnish everything FREE, we set you up in the Tailoring business, and show you how to make big money. Part or full time salesman. No tailoring experience needed with the WRIGHT wonder line.

Good for \$50 to \$100 a Week

Big Sample Outfit FREE. No waiting, no red-tape or delay if you'll state in first letter name, address, age, territory wanted, clothing experience if any, other selling experience, references, etc. Write today.

WRIGHT & CO., Quality Tailors
2300 Wabasha Ave., Dept. 305, CHICAGO, ILLINOIS

I Want to send you
a **Santa Fe**
Mogul Heavy Duty Watch
For You to see and
examine

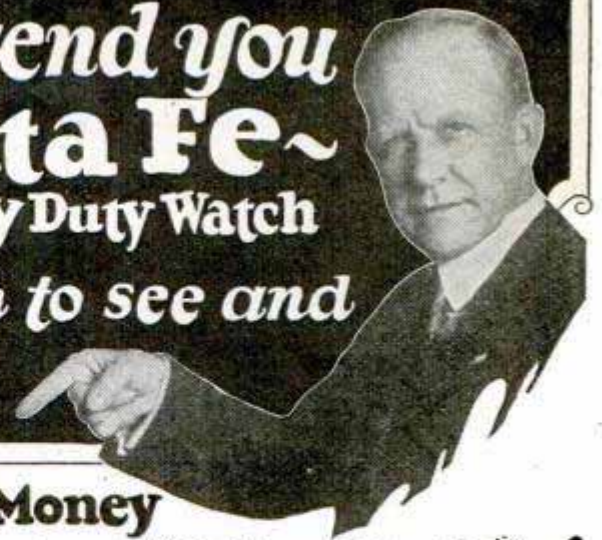

Send No Money
Watch Sent on 30 Day Free Trial

The 21 Jewel

“Santa Fe Mogul”

Designed Especially for Rough and Hard Service.

The Heavy, dust proof railroad “Santa Fe Mogul,” is the last word in watch perfection—heavy, sturdy, handsome—it was constructed to fill the demand for a watch that would meet the most rigid requirements for the protection of the movements under heavy and severe service and at the same time built along artistic, beautiful lines. The heavy thick crystal and Montgomery railroad dial is another feature.

Save $\frac{1}{3}$ to $\frac{1}{2}$ Your Money

By purchasing the Santa Fe Mogul NOW. Not only are you getting advantage of our new low price and special terms, but you will get the very last word in watch perfection.

Send for Watch Book

illustrating in beautiful colors hundreds of designs and combinations in cases in the POCKET WATCH, MEN'S STRAP WATCH and LADIES' WRIST WATCH. You can have your name or monogram and any emblem you may desire engraved in the Case to suit your own ideas. Write today for Free Watch Book, and make your selection at once, while this offer lasts.

FREE A limited offer! With every Santa Fe Mogul a beautiful gold chain or strand of exquisite pearls. Write today.

Mail Coupon for both Watch and Diamond Catalog

SANTA FE WATCH COMPANY

46 Thomas Building

TOPEKA, KANSAS

(Home of the Great Santa Fe Railway)

Santa Fe Watch Company,
46 Thomas Building,
Topeka, Kans.

Please send prepaid and without obligation your Watch Book Free, explaining your “No Money Down” Offer on the Santa Fe Mogul Watch.

Name.....

Address.....

City..... State.....



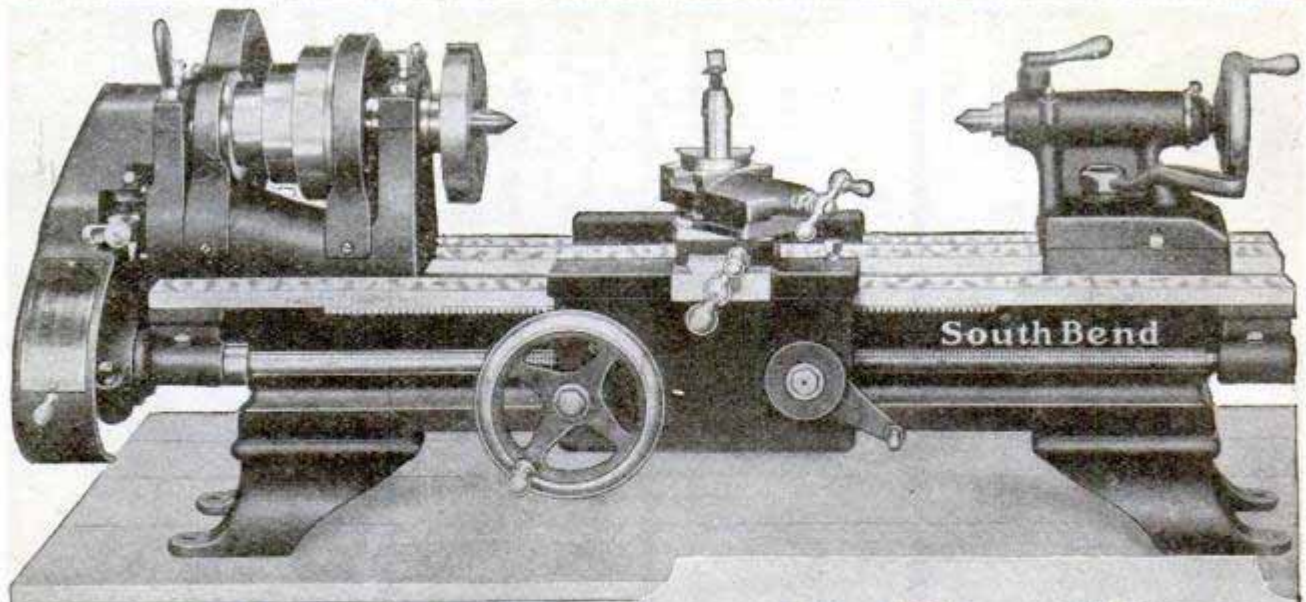

No. 22 Junior — 9'x3'
Back Geared
Screw Cutting
Bench Lathe **\$150**
(Easy Terms If Desired)

**A Good Lathe
At a Moderate Price**

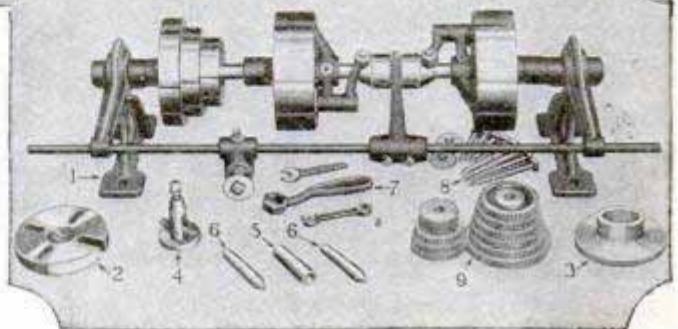

Countershaft and Equipment Included in Price

This is our regular 9'x3' Standard Change Gear Lathe—a high grade tool of accuracy and precision—stripped of parts not needed in the average shop. It is a practical tool for the small shop where a wide range of work must be taken care of.

Specifications

Swing over bed 9 1/4 inch
Length of bed 3 ft.
Size of Centers No. 2 Morse
Taper
Distance Between Centers 18"
Hole through Spindle 3-4 inch
Net weight Lathe C'shaft 375
lbs.

Features

Powerful Back Geared Head
Stock
Six Spindle Speeds
Headstock Spindle Ground all
Over
Phosphor Bronze Spindle Bear-
ings
Power Feed to Carriage
Set-over Tail Stock
Graduated Compound Rest
Micrometer Graduated Collars
on Cross Feed and Com-
pound Rest

Attachments

Draw-in Collet Chuck
Graduated Taper Attachment
Milling and Keyway Cutting
Attachment
Electric Grinding Attachment
Turnstile Bed Turret
Chucks, and many other at-
tachments

Some of the Work You Can Do

This lathe is equipped to cut standard screw threads, right or left, 4 to 40 per inch, machine pistons, reface valves, true armatures, undercut mica, turn bore, chuck, drill, ream, face, file, polish, and many other jobs coming into the general repair shop.

Only 1/4 H. P. Motor Required

The No. 22 Junior Bench Lathe can be driven from overhead countershaft or 1/4 H. P. Reversible Motor, connected to light socket.

Send for Bulletin No. 22-J describing in detail this precision lathe, and showing some of the work that can be done.

South Bend Lathe Works
620 E. Madison St. South Bend, Ind.

The New Line of South Bend Lathes

In the past 20 years over 35,000 South Bend Lathes have been built and are giving satisfactory service in all lines of work.

South Bend Lathes are built in two types—Quick Change Gear and Standard Change Gear Lathes. Quick Change Gear Lathe provides screw cutting without removing gears, while Standard Change Gear Lathes are equipped with loose change gears for this purpose.

There is a South Bend Lathe for every job—from 9-in. to 24-in. The most popular sizes are listed below.

Size of Lathe	Quick Change	Standard Change
9'x 3'	\$ 258.00	\$ 228.00
11'x 4'	308.00	268.00
13'x 5'	387.00	337.00
16'x 6'	521.00	461.00
18'x 8'	693.00	628.00
21'x10'	1032.00	949.00
24'x12'	1437.00	1338.00

For complete details write for illustrated Catalog No. 87.

SOUTH BEND LATHES

NEW AUTO GAS SAVER FREE

GIVES AMAZING MILEAGE AND PEP!

New Moisture Humidifier and Gas Saver for all makes of Cars, Trucks and Tractors Invented by Illinois Man



Walter Critchlow has perfected a wonderful NEW Vapor Humidifier and Gas Saver that beats anything ever gotten out. This amazing new invention is a Vapor Moisture device, which makes engines run all the time with the same wonderful efficiency they do on a cool night. It causes autos to give amazing mileage and automatically frees them from hard carbon, plug and valve troubles. Ford owners report 28 to 66 miles on one gallon. Some of the best records reported by users are:

Miles		Miles		Miles	
Buick	31 1/2	Hudson	29 1/2	Overland	43
Cadillac	27 1/2	Hupmobile	32 1/2	Packard	27 1/2
Chevrolet	42	Jewett	27 1/2	Paige	26 1/2
Chrysler	32 1/2	Marmon	24 1/2	Pierce Arrow	29
Dodge	33 1/2	Nash	31	Reo	30 1/2
Essex	34	Oakland	33	Star	41 1/2
Ford	66	Oldsmobile	34 1/2	Studebaker	31
				Willys-Knight	31

And Hundreds of Other Wonderful Records

66 Miles on 1 Gallon
Geo. B. Cousins, Ill.: "Last Sunday with the VIX on, we drove up to Nuttal, 33 miles, and back, a total of 66 miles, on a trifle over 1 gallon of gasoline."

58 Miles on 1 Gallon
George H. Wheeler, Mich.: "I have the VIX on my Ford, which has been averaging me 38 miles to the gallon."

52 Miles on 1 Gallon
Ambrose Dolney, Mich., FARMER: "I live 26 miles out of town. It used to take 2 1/2 gallons to go to town and back, but now with the VIX I do it easily on 1 gallon."

48 Miles per Gallon
Chas. J. Jabonsek, Texas. (SWORN - AFFIDAVIT): "The VIX on my Ford is great. Got 48 miles per gallon on 138-mile trip with 14 miles in black mud and chains on. Previously, averaged 18 to 20 miles."

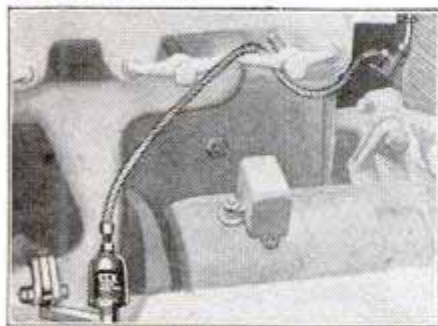

Model "A-1" Vix Vapor Humidifier and Gas Saver Attached on Ford

Model "A-1" is for FORD cars, delivery wagons and trucks—Model "B" (not shown here) is for all other makes of cars, trucks and tractors including Fords and Fordsons, (1927 Ford with new Holly Fuelizer requires Model "A-2" or "B.") Easily attached in a few minutes. Everything furnished including complete pictured instructions. 5 models to fit every auto, truck, tractor and motor boat. \$4.00 to \$25.00 each at retail, installed.

Moisture in the Engine Gives Amazing Results

By using the VIX Vapor Humidifier and Gas Saver, a fog of vapor moisture passing through the engine supports the combustion, and enables the motor to run on a LEANER fuel mixture. With vapor moisture mixed into the fuel—you can drive with FASTER spark and LEANER gas mixture. The monoxide carbon gas in your engine (caused by unexploded and wasted gas and oil) crystallizes into and forms hard carbon. By this VIX process, MOISTURE is introduced into the engine in the CORRECT amount required; the oxygen from the water vapor is absorbed upon contact by the monoxide carbon gas (a natural chemical action) and are then expelled through exhaust valves in the natural operation of the engine BECAUSE both are MOIST and cannot crystallize or harden or become baked. You get ENORMOUS power, speed and mileage, no hard carbon, easy starting, faster pickup and a snappier, peppier motor. VIX works wonderfully in Winter with all non-freeze and alcohol radiator solutions. It uses the alcohol vapor, and turns it into FUEL and POWER at a BIG SAVING and shows almost unbelievable results in easy starting, increased mileage and no hard carbon accumulation.

Men with Cars Make \$148.00 Weekly

VIX sells on DEMONSTRATION. It Makes a SENSATIONAL Demonstration. With our FREE TESTER DEVICE—and your hood up to show VIX in operation—a few pulls of the Dash Control to show MAGNIFICENT BURST of ENGINE SPEED WHEN YOU OPEN IT UP—this Demonstration is STARTLING—ASTOUNDING—CONVINCING!

It means QUICK SALES—BIG PROFITS. Interested Car Owners are found everywhere—ALL desirous of using LESS gas and oil—and everyone is immediately interested when you start SHOWING and DEMONSTRATING.

1 VIX FREE OFFER

Mr. Critchlow, the Inventor and Manufacturer, offers 1 VIX FREE to introduce. Write him for one at once. He also wants County and State Distributors who can make \$500 to \$2,500 monthly. MAIL THE COUPON TODAY.

Walter Critchlow Inventor and Manufacturer
805-D4 Street Wheaton, Ill., U. S. A.

Big Cash Profits

\$4,939.66

in

3 1/4 MONTHS

This amazing new patented VIX is a DEMONSTRATING device. Car owners cannot resist its STRONG DEMONSTRATIVE appeal. Direct factory distributors and agents can easily earn BIG, QUICK PROFITS in spare or full time. One man actually made \$4,939.66 in 3 1/4 months—another made

\$1,656.40 in 58 Days

Neither had previous experience. Read the monthly earnings reported by "spare time" distributors listed below:

Frank Hanfelder, \$107.00	H. B. Phelps, \$105.00
Wm. Fraser, \$189.00	H. C. Daniel, \$107.00
Louis A. Carlin, \$80.00	E. Schaefer, \$96.00
M. H. Werline, \$143.00	W. M. Hardy, \$132.00
P. S. Lange, \$117.00	W. R. Moser, \$81.00
R. Stefanchy, \$189.00	James Faton, \$126.00

Do you want to do as well? Do you want to build a business of YOUR OWN? Do you want to do what others are doing—make money FASTER, take life EASIER, be outdoors where HEALTH abounds, get more of the BETTER THINGS of life and GET AHEAD QUICKER?

APPRECIATES SALES HELP
OLDS SIX—I am getting good results with the VIX'S I have put on. I sold Mr. Plymate whose inquiry you forwarded me. Thank you very much for sending me those inquiries—J. A. ROLES.
ALL CUSTOMERS BOOSTERS
(Mr. Lane has had 54 VIX'S since writing letter below)
CHEVROLET—Have received the VIX—have tried it cut—very it has them all started. All auto owners I have sold are boosters.—J. R. LANE.

Every Auto Driver Knows This

HIS CAR RUNS BETTER ON A COOL, MOIST EVENING THAN ON A HOT DAY; and therein is our wonderful sales possibilities—and YOURS—if YOU become our distributor—to impart to every car owner—that wonderful night driving effect that we all recognize—with the added POWER—PEP—PICKUP—MILEAGE and SMOOTH RUNNING EFFECT.

MAIL THIS COUPON TODAY

GOOD FOR 1 VIX VAPOR HUMIDIFIER FREE

Write Address Plain—Fill Out and Mail This Coupon. **WALTER CRITCHLOW, Inventor and Manufacturer** 805-D4 Street, Wheaton, Ill., U. S. A.

Please rush me full particulars how to get 1 VIX Vapor Humidifier and Gas Saver FREE. Also how I can make \$500 to \$2500 a month as your County or State distributor if I decide to accept after making tests on my own car first.

Name.....
Postoffice.....State.....
R.....Box.....St. and No.....
(Mark Plain wanted with X)
1—Just a User: No Agency wanted.....
2—Please reserve me this County, or several Counties, or Entire State. Name which.....



Salary increased 300% in few months

Chief draftsman of big company received big increase even before he had completed his course with the I. C. S.

"AT THE time I started my I. C. S. course I was working in a paper mill," writes A. J. Hutchins, Chief Draftsman for the American Strawboard Company.

"Before I had completed the course I was called upon to make drawings in one of the company's largest mills and was appointed Superintendent of Construction at an increase in salary of 300 per cent."

Every mail brings letters from students of the International Correspondence Schools telling of increases in salary due to spare-time study.

Why don't you study too and prepare for a real job at a real salary? You can do it if you really try.

Just mark and mail the coupon and we will send you complete information about the I. C. S. Drafting courses or any other course in which you are interested.

INTERNATIONAL CORRESPONDENCE SCHOOLS Box 5643-E, Scranton, Penna.

Without cost or obligation on my part, please tell me how I can qualify for the position, or in the subject, before which I have marked an X:

- | | |
|---|--|
| <input type="checkbox"/> Mechanical Drawing | <input type="checkbox"/> Structural Drafting |
| <input type="checkbox"/> Draftsmen's Course | <input type="checkbox"/> Ship Drafting |
| <input type="checkbox"/> Electrical Engineering | <input type="checkbox"/> Architectural Drawing |
| <input type="checkbox"/> Electric Lighting | <input type="checkbox"/> Architect |
| <input type="checkbox"/> Mechanical Engineer | <input type="checkbox"/> Architects' Blueprints |
| <input type="checkbox"/> Machine Shop Practice | <input type="checkbox"/> Contractor and Builder |
| <input type="checkbox"/> Railroad Positions | <input type="checkbox"/> Concrete Builder |
| <input type="checkbox"/> Gas Engine Operating | <input type="checkbox"/> Structural Engineer |
| <input type="checkbox"/> Civil Engineer | <input type="checkbox"/> Chemistry <input type="checkbox"/> Pharmacy |
| <input type="checkbox"/> Surveying and Mapping | <input type="checkbox"/> Automobile Work |
| <input type="checkbox"/> Metallurgy <input type="checkbox"/> Mining | <input type="checkbox"/> Airplane Engines |
| <input type="checkbox"/> Steam Engineering <input type="checkbox"/> Radio | <input type="checkbox"/> Agriculture and Poultry |
| | <input type="checkbox"/> Mathematics |
- BUSINESS TRAINING COURSES**
- | | |
|--|---|
| <input type="checkbox"/> Business Management | <input type="checkbox"/> Salesmanship |
| <input type="checkbox"/> Industrial Management | <input type="checkbox"/> Advertising |
| <input type="checkbox"/> Personnel Organization | <input type="checkbox"/> Better Letters |
| <input type="checkbox"/> Traffic Management | <input type="checkbox"/> Show Card Lettering |
| <input type="checkbox"/> Business Law | <input type="checkbox"/> Stenography and Typing |
| <input type="checkbox"/> Banking and Banking Law | <input type="checkbox"/> English |
| <input type="checkbox"/> Accountancy (Including C.P.A.) | <input type="checkbox"/> Civil Service |
| <input type="checkbox"/> Nicholson Cost Accounting | <input type="checkbox"/> Railway Mail Clerk |
| <input type="checkbox"/> Bookkeeping | <input type="checkbox"/> Common School Subjects |
| <input type="checkbox"/> Private Secretary | <input type="checkbox"/> High School Subjects |
| <input type="checkbox"/> Spanish <input type="checkbox"/> French | <input type="checkbox"/> Illustrating |

Name.....
 Street.....
 Address.....
 City..... State.....
 Occupation.....

If you reside in Canada, send this coupon to the International Correspondence Schools Canadian, Limited, Montreal

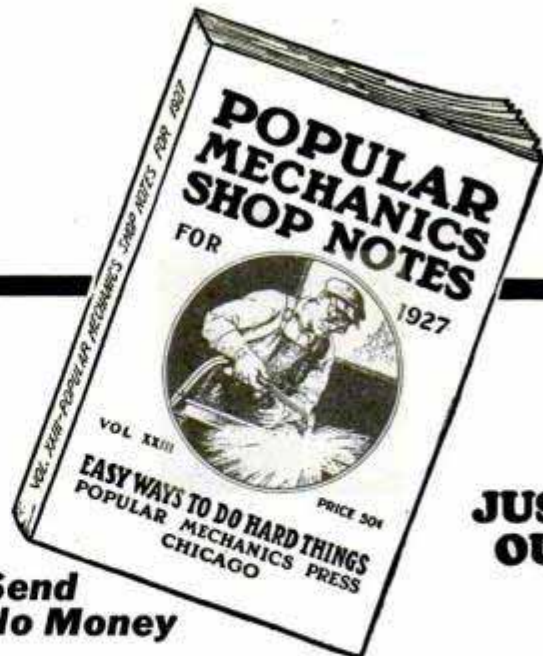

Send No Money

JUST OUT

Shop Notes

479 Articles

FOR 1927

374 Pictures

This announcement will be welcomed by thousands because they have learned that each yearly issue of Shop Notes contains dozens of short cuts that save time and money. Every article is written by some man who has tried the idea and found it worth money. The variety of subjects covered is one reason why so many buy Shop Notes each year. In many ways the 1927 issue surpasses previous numbers. The following brief list will give you an idea of the variety of subjects covered.

SOME OF THE SUBJECTS

- | | | | | | | | | | | | | | | | | | |
|-----------------------|-------------------------|-------------------|-----------------------|------------------|---------------------------|-------------------|--------------------------|---------------------------|----------------------|-----------------|-------------------------|-------------------|-------------------------|--------------------|---------------------------|-------------|---------------------|
| Auto Repairing | Battery Care and Repair | Lapping Bushings | Bracing Fence Corners | Novel Cab Stands | Cleaning Lantern Chimneys | Outside Hay Chute | Repairing Air Compressor | Durable Nests for Poultry | Boxes for Cream Cans | Shop Tools | Electrical Equipment | Homemade Elevator | Wines | Cleaning Enamel | Concrete Working Ideas | | |
| Carpenters' Shortcuts | Fitting Made Easy | Ventilation Plans | Tool Boxes | Printers' Helps | Making a Blowtorch | Garage Equipment | Irrigation Canals | Jewelers' Kinks | Draftsman's Kinks | Lathe Operator | Electroplater | Cabinet Worker | Lumber Yard Management | Mechanical Drawing | Farmer's Helps | Micrometers | Sheet Metal Working |
| Painter's Equipment | Motorist's Helps | Storekeeper | Pattern Making | Drainage | Outdoor Air Press | Workbench | Welding | Plumbing | Using Spindle Drills | Making Grinders | Raising Vertical Piping | Cutting Wallboard | Rubber Stamp on Thimble | Pin Stamping | Service Station Attendant | Lettering | |

6,000 Ideas on All Shop Work

There are now 16 volumes of Shop Notes available. And this unrivaled library of shop helps may be had for a special price of \$7.50. If you do not have the back numbers of Shop Notes, you should purchase the entire library. The following are now available:

- 1908, 1912, 1913, 1914, 1915, 1916, 1917, 1919
 1920, 1921, 1922, 1923, 1924, 1925, 1926, 1927

Amateur's Guide PROFESSIONAL'S HANDBOOK

Both amateurs and professionals find Shop Notes of wonderful value. The articles are so clearly written and so thoroughly illustrated that even a boy can follow them. Teachers of Manual Training should have the complete library.

SEND NO MONEY

Don't send a penny. Just fill in the coupon with your name and complete address, indicate whether you want the whole library or the special offer of 1927 Shop Notes and Lathe Handbook for 98 cents. When the books are delivered to you, pay the postage and deposit price of books with postman.

SPECIAL OFFER COUPON

POPULAR MECHANICS PRESS,
200 E. Ontario St., Room 714, Chicago, Ill.

Send me, as per your special offer the following books. I will pay postage and the price of books when they arrive. My money will be refunded if I am not satisfied. (Check what you want.)

- 1927 Shop Notes and Lathe Handbook, 98 cents Complete Shop Notes Library (16 vols.) \$7.50

Name.....
 Street and No.....
 City..... State.....

"Why-It's a Whole Machine Shop!"



This Amazing 17-Ounce Tool Conquers 60-Lb. Kit!

The most revolutionary hand tool ever invented. Does the work of other tools costing over \$50—truly a tool of 1000 uses. Just the "hand-grip" of a tiny rubber band holds a hard bearing ball—the hardest-to-hold thing known—against a 300 Pound Pull!

Grips with 1 Ton Direct—128 Tons Per Sq. In. Pressures through its 10-to-1 Leverage Power-Gear Transmission. In addition, the Grip LOCKS!

Among Thousands of Large Users are the MAKERS of Buick, Chevrolet, Nash, Packard, Reo, Studebaker, etc. Automobiles, Fisher Bodies, etc.; who with their employes have bought Kits in quantities of 500 to 1000! Studebaker has approved it for use in its Service Stations throughout the World. Thousands of housewives are using it too, because it does so many useful and amazing things so easily, so instantly. And even a woman's hand applies a HALF-TON Giant's Grip! Every Auto and Home Owner—every man who ever uses any tools needs it every day.

World Flight Equipment

It was standard equipment for the U. S. WORLD FLIGHT and the U. S. S. Shenandoah. Creates a sensation everywhere. Just its astounding 1-Ton Grip makes it worth ten times its cost. The amazing EIFEL-FLASH Plie-Rench is a true Ratchet WRENCH—Parallel Pliers—Speed VISE, and more. Instantly and automatically it LOCKS its death-grip Jaws on the

most worn and chewed nuts in the tightest places—and T U R N S THEM! AND—in the EIFEL-FLASH Plie-Rench KIT—weighing only 1 1/2 lbs.—you get a complete UNIVERSAL Tool Service that beats any number of other hand tools weighing 60 lbs. and costing \$50.00.

AGENTS \$200 a Week

Plie-Rench representatives earn amazing incomes demonstrating this wonderful new tool. One man alone sold nearly 10,000 in just one state. Fastest seller known. Factories buy by hundreds. Every auto and home owner buys. We have wonderful special proposition to agents. Mail coupon for full details. Why not earn \$75 to \$200 and more a week, spare or full time?

Whole Kit in 1 Tool

You get in a Royal Blue Leatherette HOLSTER, the 8 1/2" Universal Plie-Rench with 2 EXTRA Jaws—a PIPE Jaw—and a WIRE Jaw—each giving undreamed of performance. Instantly (in 1/5 second) you insert the Jaw you need, and as quickly snap a One-Ton Grip on work of any possible kind, or shape, or size from 0-in. to 1 1/2-in.! And—nothing Ever can get away from that grip! HAVE YOU EVER HEARD OF A TOOL THAT WORKS LIKE THIS—it actually out-grips a 40-lb. Vise, and applies a 1-TON grip at the very jaw-tips. Will remove broken studs, taps, drills, etc., with next-to-nothing to hold on. Yet its smooth grip will hold a hair and coil a spring of hair-fine piano wire!



The Universal Plie-Rench

For every kind of Pliers, Nut Wrench, Vise, Clamp, and Spring-making Work—Everywhere.



The Pipe Plie-Rench

For every kind of Pipe Wrench and Pliers Work; Chewed Nuts that no other tools can budge, etc.



The Wire Plie-Rench

For every kind of Wire, Tire Chain, Cable and Spring Work; and the Special work other Tools won't do.

Guaranteed

The Plie-Rench KIT is positively guaranteed. It has stood the most trying tests of time and service. Of thousands—the First Commander of the U. S. World Flight said—"It should form part of the equipment of each and every Airplane and Automobile." One Engineer said—"I have used my Plie-Rench for 5 years and wouldn't be without it for \$100—and I mean it!"

Special Introductory PRICE \$3.65 ONLY Regular Price \$5.00

Thousands fortunate enough to be able to see the astonishing performance of this marvelous Plie-Rench KIT are glad to pay the regular price of \$5.00. You can TRY this amazing performance on your own work in your own way for 2 weeks, and if the Plie-Rench KIT has not EARNED FOR YOU in that time the value of its price—just return it, and your money will be refunded as fast as the mails can carry it. Also, with your Plie-Rench KIT you receive a valuable Manual of Mechanics that every man should have. It tells in 64 pages and 145 illustrations some of the marvels of "The Plie-Rench Way"—the quicker, better, and easier way to do every kind of mechanical work.



Make use of the Coupon below, get this incomparably better tool KIT for the price of just one ordinary tool—let the marvelous Plie-Rench with its versatile 3 Jaws SPEAK FOR ITSELF as no Steel Jaws ever spoke before!



Every person using the coupon to order a Plie-Rench KIT will receive absolutely FREE our wonderful E-F ANGLE Screwdriver. It has 7 working edges 1/8-in. to 3/4-in. wide and is so strong it does the work of many screwdrivers—large and small. Handles auto lights and removes bottle caps. Fits keyring and key-tainer. "The World's Greatest Small Tool"—yours FREE with the KIT.

THE FLASH SALES CORP'N
DP-4809 N. Ashland Ave., CHICAGO, ILLINOIS

MAIL TODAY!

The Flash Sales Corp'n, DP-4809 N. Ashland Ave., Chicago, Ill.

1. Rush your amazing new Eifel-Flash Plie-Rench KIT, \$3.65 on arrival (U.S. only). It is understood I may return Kit within 2 weeks and get My Money Back if not delighted.

2. Send me user literature.

3. Am interested in Salesman's Big Proposition.

Name.....
R. F. D.....
St.....
P. O. City.....
State.....

I will pay post-man return Kit within 2

Long prophesied
Often attempted
Makeshifts frequently employed
Here at last!

CROSLLEY

Radio Energy

with only a
switch to snap

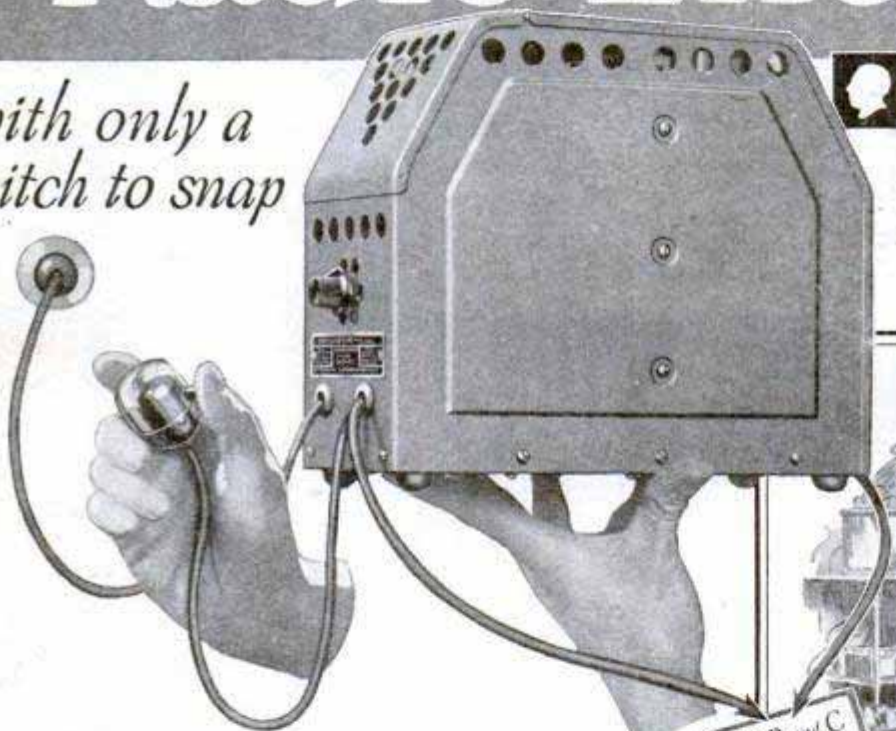

A B and C Radio Power

from house current outlet direct into the radio with no more attention or thought than you bestow on a vacuum cleaner or the electric iron.

This wonder box weighs only 13 lbs., stands 9 inches high and is 4 inches wide, and is about half the size of an ordinary A storage battery. It is a mechanical device transforming ordinary 110 volt 60 cycle house lighting power into smooth, quiet radio energy for the new Crosley radios without slightest interfering hum and with the certainty of an electric motor. Price..... **\$50**

Crosley radios designed for use with this marvelous power supply are the AC-7, a 6-tube table model at \$70, and the AC-7-C, a 6-tube console at \$95. See these wonderful sets at any Crosley dealer's, or write Dept. 15 for descriptive literature.

Crosley sets are licensed under Armstrong U. S. Patent No. 1,113,149, or under patent applications of Radio Frequency Laboratories, Inc., and other patents issued and pending. Prices slightly higher west of the Rocky Mountains.

THE CROSLLEY RADIO CORPORATION
CINCINNATI, OHIO POWEL CROSLLEY, Jr., Pres.

To A.B and C
Binding
Posts

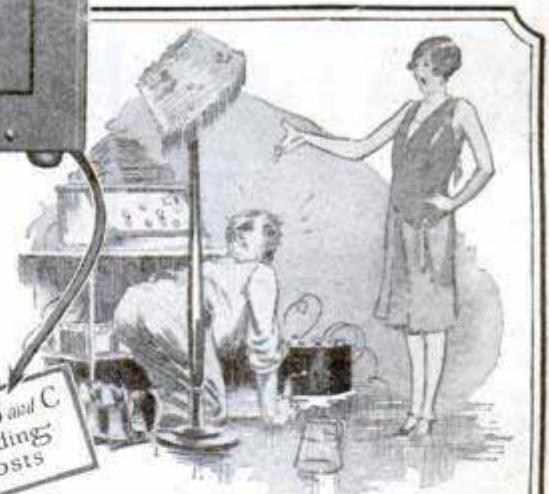

- No more batteries to fuss with.
- No more batteries or battery charger to water.
- No failure of the power plant just as you sit down to a fine program.
- No batteries to recharge.
- No batteries to renew.
- No apologies to make to callers because "the batteries must be getting low."
- No upsetting the house to have the radio serviced.
- NO MORE** annoyances from the power supply end of your radio. A snap of the switch is the only demand your radio makes upon you from **NOW ON.**

LOWER WHOLESALE PRICES
 THAN EVER BEFORE
 On Highest Quality,

INSTALL YOUR OWN

PLUMBING AND HEATING



Royal Bathroom Outfit

EASY TERMS
SAVE HALF
FREE PLANNING SERVICE

The Hardin-Lavin Company founded over 50 years ago has from the beginning specialized in Highest Grade Plumbing and Heating to the consumer direct at wholesale. Our newest catalog is just off the press and brim full of bigger bargains than ever before. Send for your copy today. Lower wholesale prices than we have ever quoted will save you from one-third to one-half on everything in Plumbing and Heating.

HOT WATER HEATING PLANT CUT-TO-FIT GUARANTEED

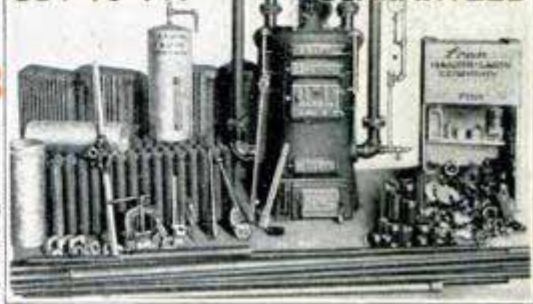

Complete Hot Water Heating Plant ready for shipment with set of installing tools, diagrams, and New Easy Method of self-installing instructions. Complete outfits as low as \$200

Top Quality - Bottom Prices

Our vast buying power, nearness to raw material market, our centrally located plant and complete shipping facilities combine to give you bottom prices on top quality goods. Every Plumbing Outfit or Heating Plant you buy from us has behind it our Bonded Guarantee, our million dollar plants and our reputation for 50 years' economy service to experienced buyers. A transaction with us is not completed until your order has reached you in perfect condition and is installed and working satisfactorily. We have built our business by adding extra service to special values and developing and perfecting the now famous Hardin-Lavin New Easy Method of self-installing which means to you time and money saved.



PIPELESS HEATING PLANT

Grade A Quality Guaranteed Plumbing Outfits

In our new catalog just issued, you will find everything in latest designs of Plumbing Fixtures and Heating Supplies:— Built-in Tubs, Pedestal Lavatories, One Piece Deep Apron Kitchen Sinks, Laundry Tubs, Hot Water Heating Plants, Steam Heating Plants, Pipeless Heating Plants and Warm Air Pipe Heating Plants as well as Fixtures, Radiators, Accessories, Pipe, Fittings, etc., all of the highest quality possible to manufacture at Lowest Wholesale Prices. Hardin-Lavin New Easy Method of self-installing enables you to put in your own Plumbing or Heating. No experience needed to follow this new method which saves you days and dollars. Crystal-clear diagrams and instructions guide you every step of the way. All materials come to you factory-fitted and ready for quick assembly. There is no guess work and when the job is finished an expert will approve it.



Send for Your **FREE Copy Today**

FULL OF BIG BARGAINS!

Special! Deferred Payments

In addition to quality goods at wholesale prices, new easy installing method, free plans, and all the other Hardin-Lavin advantages, we have now arranged so that you can BUY ON EASY TERMS. Nowhere else can you find so unusual and complete a combination of merchandise, service and accommodation. Added to all this—without charge—is the co-operation of our corps of Engineering Experts.



WATER SUPPLY SYSTEM

Our Label and Bonded Guarantee Protects You Fully!



The Hardin-Lavin Label has found its way into every state of our nation and to every civilized country on the globe. Wherever you see it, you will find Plumbing satisfaction of the highest degree or the most efficient type of Heating apparatus. Quality and durability GOES IN before our name and label GOES ON.

Everything you buy from us is backed by this label and our bonded guarantee.

MAIL COUPON TODAY FOR FREE BARGAIN CATALOG

Hardin-Lavin Company,
 107-17 W. Pershing Road,
 Chicago, Illinois. P. M.-4-27

Gentlemen: Please send me your free bargain catalog with special wholesale prices and easy terms. I am interested in:

<input type="checkbox"/> Hot Water Heating Plants	<input type="checkbox"/> Warm Air Furnaces
<input type="checkbox"/> Steam Heating Plants	<input type="checkbox"/> Water Supply Systems
<input type="checkbox"/> Pipeless Heating Plant	<input type="checkbox"/> Bathroom Outfits

NAME

ADDRESS

CITY..... STATE.....

Thousands of customers testify to the fact that we have saved them money, time, expense and dissatisfaction. You take risk when you buy a Heating Plant or Plumbing Outfit from us because our engineering staff has okeyed everything before it leaves our plant. **ASK FOR FREE ESTIMATE.** Let this trained group of Plumbing and Heating Engineers help you. Write them freely for advice and information. Ask for estimate without obligation. Send a rough sketch of arrangement of your rooms if possible and they will design an outfit exactly for your home that will meet all of your individual needs. Thousands of home owners, contractors, farmers, mechanics and nationally known institutions have benefited from these made-to-order Hardin-Lavin designs. This help from our engineering staff is free and backed by 50 years of knowing how. They will show you many trade secrets, kinks and wrinkles that will surprise you with big savings of money, time and labor. **WRITE TODAY.**

You can buy on Easy Terms



No More
Blades to
Buy

365
Keen Shaves
A Year
From The
Same Blade

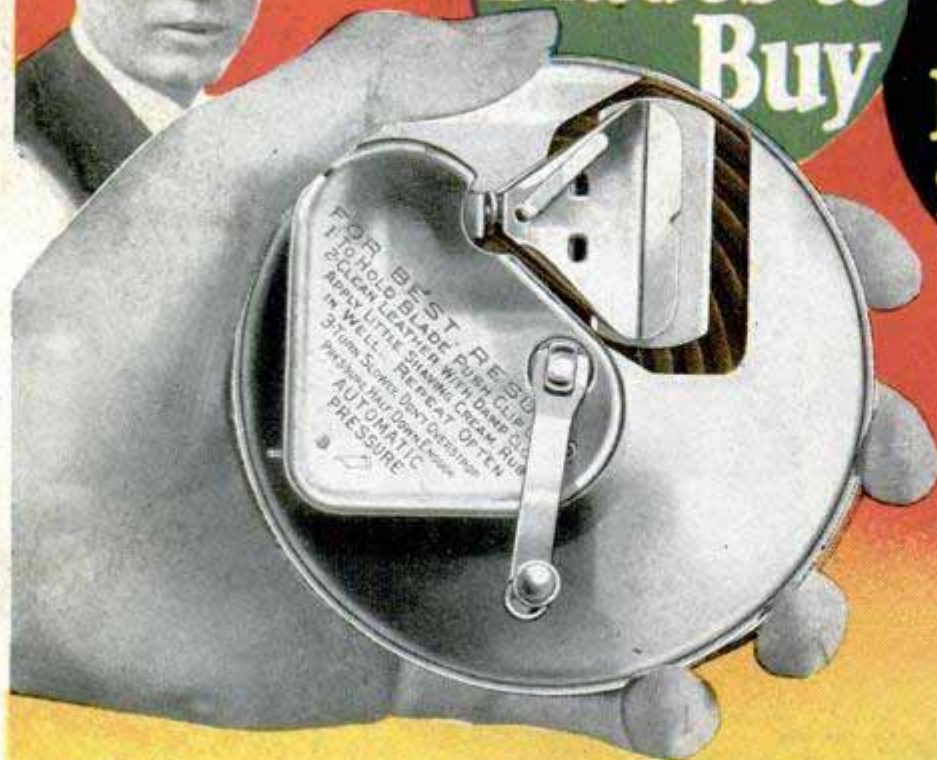

KRISS-KROSS
Fits All Makes
of Blades

Amazing Invention Revolutionizes Shaving

THINK of it! 365 keen, cool shaves a year from the same blade! That's what the revolutionary invention of a St. Louis man is doing for American shavers everywhere!

KRISS-KROSS marks the beginning of a new era in shaving comfort and economy. Its performance is so sensational that it seems hardly fair to call it a stropper. Rather it is a super-stropper or blade-rejuvenator! Almost literally, it makes a new blade out of an old one every day. No longer do you find that your blades "die" after five or six shaves. KRISS-KROSS "brings 'em to life" a surprising way, week after week and month after month—and endows them with a keenness that they seldom possess when brand-new!

Magic Diagonal Stroke

KRISS-KROSS employs the famous diagonal stroke, same as a master barber uses. Never before has anyone captured the secret of reproducing it automatically. Eight "lucky leather grooves" do the trick in 11 seconds with a precision it takes a master barber years to attain.

But that's not all. KRISS-KROSS embodies still another feature that has hitherto baffled mechanical reproduction. It stropps from heavy to light. It's absolutely uncanny the way the strokes start with strong pressure and grow lighter and lighter until an adjustable, automatic jig flies up and

notifies you that your blade is ready—ready with the keenest cutting edge that steel can take!

Fits All Blades

KRISS-KROSS produces unbelievable sharpness and prolongs the life of any razor blade for months and even years. Fits all brands and makes except Durham. Eliminates 83% of shaving costs and ends all bother about remembering to buy new blades! No more "raking" and scraping with dull ones, either! KRISS-KROSS solves your blade problem for all time and gives you keen, velvet-smooth shaves forever!

Sensational Offer

And now for my surprising offer. To introduce KRISS-KROSS to those who have not yet seen it, I am giving with it Free a new kind of razor. Possesses remarkable features. Instantly adjustable to any shaving position. A flip of the finger makes it (1) T-shape; (2) straight (old style); or (3) diagonal (new way). Gives a sliding instead of pulling stroke. Simply zips right through the toughest crop of whiskers and leaves your face satin-smooth and cool. Comes with 5 special-process blades and is entirely unlike anything you ever saw before!

Send Coupon To-day!

Send for details and information on these surprising new KRISS-KROSS inventions today. See for yourself exactly how uncanny and ingenious they are. Read the amazing praise of enthusiastic users. Clip the coupon for illustrated description and free razor offer. Mail it today!



3-Way Razor Free

Most astonishing razor you ever saw. Really 3 razors in one. Adjustable to any shaving position. Novel feature reduces beard resistance 45%.

Agents!

Make excellent money with KRISS-KROSS. H. King made \$66 in one day. N. C. Paige made \$104 in 3 days! Others average \$350 and up to \$750 a month! Spare-time workers, Office and Factory men make up to \$6 and \$12 extra a day showing KRISS-KROSS to friends and fellow employees. Get details at once. Check bottom of coupon and mail it tonight!

Rhodes' **KRISS KROSS**
STROPPER

Rhodes Mfg. Company, Dept. D-371
1418 Pendleton Ave., ST. LOUIS, MISSOURI

Largest Manufacturers of Mechanical Stoppers in the World

Rhodes Mfg. Co., Dept. D-371,
1418 Pendleton Ave., St. Louis, Mo.
Without obligation, please send me illustrated description and full details of your special introductory offer on KRISS-KROSS super-stropper and FREE 3-way razor.
Name.....
Address.....
City..... State.....
I am interested in making money as authorized KRISS-KROSS representative.