

POPULAR MECHANICS

MAGAZINE

WRITTEN SO YOU CAN UNDERSTAND IT



SEE PAGE 426

M. GUNDLACH

ATKINS

SILVER STEEL SAWS



Mr. Happy Man Says—

“See These



New Hack Saw Blades at Your Hardware Store”

NOW—At YOUR Hardware Store—You can get the wonderful NEW Atkins Hack Saw Blades of “Silver Steel” for hand use.

Actual tests show these NEW blades cut SIX times longer than any ordinary hack saw blade. They hold their edge better—cut quicker and easier—save you time, money and material.

It pays to be sure the name ATKINS is on the blade. Atkins leads in saw development. Look for the counter display shown above—At Your Hardware Store.

If your dealer cannot supply you, tell us what kind of metal you are cutting, enclosing 25c, and we will send you a sample “SILVER STEEL” blade.



E. C. ATKINS & CO., Est. 1857, 426 So. Ills. St., Indianapolis, Ind.

Leading Manufacturers of Highest Grade Saws for Every Use; Saw Tools, Saw Specialties, Plastering Trowels and Machine Knives

WITH ALL THEIR EXCLUSIVE FEATURES • CONN INSTRUMENTS COST NO MORE

Precision

is the secret of Conn's superior Quality

MEAUREMENTS and adjustments to the thousandth of an inch in the manufacture of Conn instruments give a mechanical precision which is the basis of superior musical quality.

The easy blowing, perfect valve, slide or key action, perfect scale and beautiful tone of all Conn instruments are the result of exclusive mechanical features and processes, developed in our great experimental laboratory, the largest of its kind in the world.

Start now to cultivate your musical "bump." Be popular, welcome everywhere, entertain yourself and your friends; enter a fascinating professional career if you choose. With an easy-playing Conn you make rapid progress, play popular tunes in a short while.

FREE TRIAL, Easy Payments on any Conn for Band or Orchestra. Choose any instrument, cornet, trumpet, trombone, saxophone, flute, clarinet, oboe, drum, etc. With all their exclusive features Conns cost no more! Send coupon now for free literature and details of free trial offer.

CONN
BAND
INSTRUMENTS
WORLD'S LARGEST MANUFACTURERS

Mail This Coupon

C. G. Conn, Ltd. 331 Conn Bldg. Elkhart, Ind.
Please send free literature and details of trial
offer on (Instrument) _____

Name _____

St. or R. F. D. _____

City, State _____

County _____

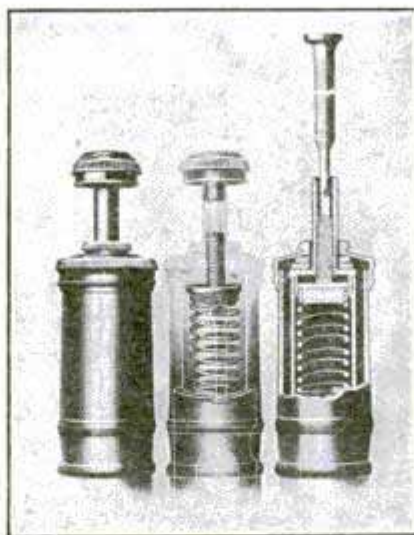

Adjustable tension valves are an exclusive Conn feature of exceptional value to the player. By means of this feature it is possible to adjust the valve action to suit the pleasure of the player. The construction of Conn valves assures easy, lightning-like action.



Conn Saxophones embody many exclusive, easy-playing features.



The Conn Victor Cornet is hailed by artists as "the world's best."



Many models of Conn Trombones fill every playing need.

CULTIVATE YOUR MUSICAL "BUMP"

This One





He just couldn't sell

• • perhaps it's *comedones*

HE couldn't figure it out. He knew his sales talk was good, yet buyers wouldn't let him get started. They put him off as soon as they saw him. There was a reason—though he little suspected it was *comedones*.

* * *

It is a misfortune to suffer from comedones—the scientific name for blackheads. What's more, you may not even be conscious of them, though others notice them. Comedones often interfere with business success, for you can't be clean cut and attractive when they are present. Do *you* wonder why

you don't get ahead? Perhaps it's *comedones*.

Pompeian Massage Cream helps you overcome *comedones*. It gets in where comedones form, rolls out all the dirt and oily secretions.

It stimulates a healthy circulation, keeps the pores open, and gives you a clean, ruddy complexion.

Try this treatment: After you shave, spread Pompeian Massage Cream generously over your face—and rub. Continue to rub until the cream rolls out. Note how dark the cream looks. That's the dirt that was in your pores.

Don't let comedones form. Use Pompeian Massage Cream every day—especially when engagements demand that you look your best. To get the full benefit, use Pompeian Massage Cream regularly at home after shaving. Your face will feel and look like a million dollars. 60c jars at all drug stores.



Use at Home
after Shaving

TEAR OFF NOW! YOU MAY FORGET

THE POMPEIAN LABORATORIES
Dept. 45, Cleveland, Ohio

Gentlemen: I enclose 10c (a dime, coin preferred)
for a special trial tube of Pompeian Massage Cream.

Name.....

Street
Address.....

City..... State.....

SEND FOR 10-DAY TRIAL TUBE

For 10c we will send a special trial tube containing sufficient cream for many delightful massages. Positively only one trial tube to a family on this exceptional offer. Use this coupon now.



For Men!

Popular Mechanics Magazine

200 E. Ontario Street, Chicago, U. S. A.

H. H. WINDSOR, Founder

H. H. WINDSOR, Jr., Editor and Publisher

London: Hachette & Cie.,
16-17 King William Street, Charing Cross, W. C. 2

Paris: Hachette & Cie.,
111 Rue Reaumur

Melbourne: Gordon & Gotch
509-513 Little Collins St.

ISSUED MONTHLY

SUBSCRIPTION:

SINGLE 5 CENTS

In United States and its possessions, also Canada, Cuba, and Mexico, per year, postpaid \$2.50

To all other countries in the Postal Union 3.00

All subscriptions are discontinued at expiration. Please examine the date printed on your wrapper.

Entered as Second Class Matter Sept. 15, 1903, at the Post Office at Chicago, Illinois, under Act of March 3rd, 1879.

Entered as Second Class Matter at the Post Office Department, Canada.

Published monthly by POPULAR MECHANICS CO.

Copyright, 1927, by Popular Mechanics Co.

Copyright in Australia. Copyright in France

Vol. 47

Contents for March 1927

No. 3

Advertising	
drug sign on mail box aids "shop early" campaign	446
letters on sheet of wood advertise lumber ports	364
secondhand auto as sign on roof	403
Aerial Photography—air photos record time, place and height	421
Aerial Warfare—horses shadows hide troopers from airmen	461
Agriculture—U. S. animal farm yield	371
Airplane	
dance floor in cabin	421
for oriental air line	383
France builds giant plane	375
fuel saving air propeller tested	370
how it feels to be shot from a gun	436
picks up message with lead "fish"	376
sky fighter skeleton shows relation of parts with sleeping berths	464
Anchor—for airplane carrier weighs fifteen tons	356
Animal—tiny with big brain found in ocean	356
Antique—keeping alive art treasures	419
Archaeology	
digging up history with a pick	412
emperor's treasure ships to be raised	452
lost tomb of early martyrs found	446
where oldest dated stones were found	457
Art—secrets of oriental revealed	357
Athletics—armor of modern knight	386
Automobile—study auto's jars with jiggling chair	449
Automobiles—Design	
car speed changed without steps by cone gear	362
sliding panel for auto door	389
three wheeled auto runs eighty miles an hour	360
Automobiles—Equipment and Supplies	
can carrier on running board	384
step plate tilts to serve as luggage carrier	451
stop meter for autos	423
Automobiles—Fuel	
mixer for small cars	441
Automobiles—Horn	
imitates human voice	441
swan auto hisses to make pedestrians stop	366
Automobiles—Tires—steel armor for auto tires	433
Automobiles—Wheel	
extra rear	376
has caterpillar tread for travel in mud	418
Average, Law of—harnessing life's strangest law	404
Balloons—wires hung from to trap airplanes	358
Billiards—in swimming tank	422
Blind—monthly magazine for	367
Boats and Boating	
airplane wing on boat increases its speed	447
automatic bailer for boats	385
Bottle—oil shot from siphon	383
Brake—safety air brake indicator	360
Bridge	
high for motor tourists	467
memorial bridge of concrete	417
Building	
city office needs studied to curb overbuilding	384
club worth million and a half	382
convention hall will seat forty thousand	378
dance hall built on top of old furnace	461
Building Construction	
house built of bubbles mixed with concrete	447
house frame braced to resist hurricanes	368
houses to resist cyclones must be well braced	465

Canal—airial monorail over	401
Cap—auto with slitted visor	375
Carson, Kit—home restoration at Taos New Mexico	416
Caves—fairylands in underworld	380
Chart—reminder for motorists	388
Church	
forest of domes forms queer roof of	448
remodeled into summer home	409
Cigar—boxes hung in cigar case for neat appearance	461
City—of future to be forest of towers	377
Coal—digging with dynamite	446
Compass—tells time on sunny day	439
Curler—eyelash	409
Divers—chain bound sack to save lives of	432
Door—costing five thousand dollars in castle	361
Ducks—wild caught by hand on baited box	358
Earthquakes—many predicted this year	361
Efficiency—Industrial—effect of heat on workers	415
Electric Wiring—short circuit tests on wire	369
Electricity—use of doubled in five years	363
Fashion—school of models	379
Feather—Hawaiian cape of valued at millions	391
Fence—built for day every seven years	364
Fire—fighting summer fires with snow	468
Fishing—triple gaff hook for big fish	358
Flashlight—and gun in one	411
Flowers—modeled of butter	439
Fog Horn—terrifying man-made noise to save ships	358
Forest Fire—ranger's bridge aids in fighting	459
Fossil Remains—give picture of life million years ago	467
Fountain Pen—blotter tip on	401
Fuel—synthetic coal from rubbish	417
Fur—coat ranching	442
Garages	
beauty and utility in small	434
floors kept clean with grease absorbent	363
Gas—natural supplied in steel bottles	441
Glaciers—growing in Europe	423
Habitation—homes underground	427
Hats—handles for women's	411
Holder—for check book stubs	399
Horses—gasoline cavalry displaces	428
Hot Springs, Arkansas, has Eiffel tower for visitors	379
House Plans	528
Household Devices	462
Huller—for peas and beans	435
Ice	
giant crusher frees ships locked fast in	390
made for movies while sun shines	365
pictures in colored	361
Kite	
carried by ski runner	466
dragonlike for Japanese prince	449
man carrying	426
Knife—that uses razor blade	382
Letter Opener—hand power	430
Machinery—picture of world ruled by	424
Mask—protects girl's face	368
Mental Test—"thrill" indicator	422
Merry-Go-Round—model of	389
Meter—that measures blushes	364
Mirror	
double rear vision	472
special, for styles shows many views	391
Model	
artist evades decree by carving church	370
doll's palace	369
seven-foot cathedral of over thousand pieces	356

[Continued on Page 4]

House, Fault proof

So cross Atlantic 3 ps

ask Thrane on dynamite 434
Canal, dug with dynamite 446

AMATEUR MECHANICS

Automobiles—Equipment—carrying spare valves	497
Automobiles—Lubrication—stopping wheel grease leaks	500
Automobiles—Repairing	
keeping floorboards tight	489
temporary repair for leaky vacuum float	494
Automobiles—Tires—inner tube clamp	504
Bed—leather stop holds it in place	505
Birds—small bungalow for wrens	499
Boats and Boating—protecting canoe for ice travel	493
Bootjack—for overshoes	489
Chimney—forcing draft through	505
Cigaret—how to make a radio cigaret box	495
Clothes Hanger—keeping crease in coat sleeves	504
Clothespin—holder	501
Copper—hammered copper plaque	502
Curb—bridge for driveway	506
Drawing Board—desk drafting board	499
Elevator—plate safeguards door	507
Flowers—preserved with celluloid	501
Ford Car—extension grips for door handles	488
Glass	
buttons and hairpin mend broken panes	506
soap pencil keeps paint off panes	494
Hammer	
“dumb-boy” aids in riveting	490
for use on polished surfaces	494
Heater—water coil in range	508
Insulation (Heat)—simple method of conserving heat	498
Lampshade—ornamented with signatures	489
Latch—quick acting thumb	492
Level—improvised for farm use	498
Musical Instruments—chimes from auto drums	490
Pipe—repair for leaky water	506
Pipe (Tobacco)—improving it	494
Pump—sanitary drinking fountain on	507
Puzzle—how to make a magnetic maze	491
Shaving Brush—rubber cup on	497
Sink—repair for trap	505
Storage Battery—carrier for	489
Street Construction—design saves storm sewer cost	501
Table—repair for split top	497
Tennis—improvised marker	500
Tie Clasp—substitute a paper clip	507
Trunk—for outboard motor	487
Weather Vane—wind driven tumbling clown	508

SHOP NOTES

Automobiles—Repairing—removing piston pins	522
Automobiles—Tires—spare tire forms front bumper	516
Belting—protecting against weather	525
Chart—table of decimal equivalents	526
Cone—how to turn a large	515
Corkscrew—substitute for	513
Electric Wiring—crimping terminals	513
Ford Car	
repair for tie rods	526
universal engine overhaul stand	509
Garages—Equipment and Supplies—device keeps water	
hose from freezing	519
Grass—narrow curb walks protect	525
Holder—for valves, screw bolts and sleeves	519
Hose—attached to driveway brush for cleaning	527
Latch—shop trailer	518
Lathe—tool made from broken tap	519
Lock—for blacksmiths' tool rack	527
Magnifying Glass—cover protects	514
Mail Box—figure of Uncle Sam	513
Maul—with interchangeable head facings	512
Pipe	
hinged joint in pump supply pipe	525
thawing out frozen water pipes	511
Plumbing—discarded films and phonograph records for	
pipe joints	516
Pole—power line straightener	521
Roof—counterweight for adjustable haystack	520
Saw—how to start a keyhole	516
Sawbuck—helps raise log	522
Signal—for overloaded trucks	512
Stand—portable, for riveting tips	520
Tape—how to prevent line from kinking	524
Telephone—amplifier overcomes noise in shop	514
Tobacco—forced ventilation prevents shed burn	523
Tool Box—wire mesh useful for drawer bottoms	513
Torch—powerful gasoline	517
Turnbuckles—old truss rods make useful	523
Vise—holding tapered parts in vise	516
Wagon—feed rack on	511
Wheelbarrows—one way traffic for	524
Window—one weight for two	518
Woodwork—blower clears chips from	515

Monument—millstones used in memorial to heroes of	
Revolution	400
Motor Truck—special, for builders	455
Motorbus—sliding top on motor coach	422
Moving Picture	
cobwebs made to order for movies	458
thrillers of an auto race	385
why you can't believe all you see in movies	388
Music—venting sounds to interpret movie dramas	414
Musical Instrument—mouth organ and harp in one	356
Navigation—traffic lights seen on ocean highways	460
Navy	
old warships rebuilt	411
tripods to replace cage masts on battleships	410
two-in-one warship	363
Number Plate—lighted for house	423
Nut (Mechanical)—spring lock for bolt nuts	456
Ore Crusher—million pound	384
Pearls—grown on farm from eggs	360
Pencil—held by finger clip	427
Petroleum—thrills in hunt for black gold	392
Photography	
deer takes own photograph	415
vacuum photo-plate cleaner	432
Picture—lost treasure of pictures found on house walls	399
Pop Corn—improved	471
Porch—patients' turns on pivot with sun	446
Poultry—electric light on hen coop	470
Printing—rotary printer for photos	400
Radio—hope of seeing by, brought nearer to fact	359
Radio Apparatus	
homemade back-mounted dials	485
insulator is self-cleaning	476
latest facts and freaks	477
log and clock combined	482
navy's radio stations guide many ships	362
pin jack voltmeter has double range	483
screw forms panel marker	485
Radio Application	
links arctic outpost to civilization	450
lives saved by radio at sea	368
Radio B-Eliminator—preventing B-eliminator hums	486
Radio Battery—tester	486
Radio Condenser—variable, employing bakelite shaft	484
Radio Loop—you can build this box type loop	473
Radio Phone—kink for deaf	484
Radio Receiver	
armchair with built-in receiver	484
new perfect tone six	479
Radio Switch—permits selection of speaker	476
Radio Tube—has cushion built in	483
Railroad	
convict railroad coach	465
hobos cause of hot boxes on cars	361
Road	
crookedest rail line will be auto road	431
high speed elevated, for automobiles	355
Safe—hidden in wall or floor	421
Safety Devices and Measures—rough strip in road center	450
aids auto safety	450
Sander—vacuum, is portable	431
Saving and Savings—banks in schoolrooms help pupils	418
save money	418
Sculpture	
carving a mountain	367
carving figures in clay bank artist's hobby	451
girl models chum in cement	465
Seal—three-ton elephant seal fed from hand	431
Ships—fins on hull increase speed	366
Skating—practice on planks for winter	362
Smokers' Accessories—vest pocket tobacco case	357
Soils—water absorber for	382
Statue—golden calf's ancestor found in ancient statuette	384
Steel—stainless, being tested for rifle barrels	384
Street Traffic—school's own traffic police	403
Suitcase—for airplane travel	456
Swamp—aquatic harvesting machines	402
Tank—sunk into position saves digging	441
Telephone	
from New York to London	353
thirty tons of switchboard for new theater	455
Thermostat—for spark plug	370
Tires—pumped as auto runs	466
Torpedo—flying, has range of one hundred miles	370
Toy	
blocks of soft rubber	450
shrapnel turned into	459
Umbrellas—old, seen in near and distant lands	440
Washington, George—in civilian dress in statue	423
Wolf—caged, jumps for meals	357
Wood—painted part outlasts wood of ancient signs	378
X-Ray—gauge is safety measure	415

Used Cutting Machine for Lakes and Rivers 402

slugging for Black 392
metaphor 4 [4]
copy 4 53
are

New Ideas on Home Decoration

WHETHER you are a practical decorator, furniture finisher, design artist or only a home owner, these practical books will give you new and up-to-date methods of securing the most beautiful effects. Each book fully illustrated. By their help you can secure results worth many times the cost. Study the list:



FURNITURE, FURNITURE FINISHING, DECORATION AND PATCHING

Period Furniture and Modern Styles, etc., illustrated and described and methods of finishing explained. A new invaluable book. 400 pages, cloth, \$5.00.

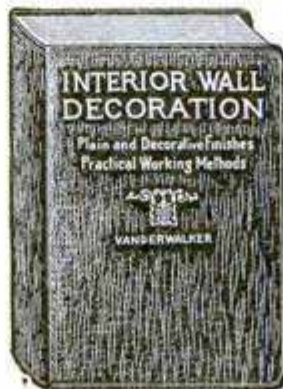

INTERIOR WALL DECORATION

The new artistic and novelty finishes and how they are obtained. New ideas for home owner and decorator. 450 pages, leatherette, \$4.00.



STUDIO HANDBOOK—LETTER AND DESIGN

A new book for artists and others, with every conceivable style of letter and design. Invaluable to advertisers. 233 pages, leatherette, \$3.00.

The Ross Crane Book of Home Furnishing and Decoration	\$3.00
Mixing of Colors and Paints	2.00
Wood Finishing, Plain and Decorative	2.00
House Painting Methods	2.00
The Art of Sign Painting	4.00
Scene Painting and Bulletin Art	4.00
"A Show At" Sho' Cards	4.00
Art of Show Card Writing	4.00
Strong's Book of Designs	4.00

New Stencils and Their Use	\$1.25
Automobile Painting	1.50
Modern Painter's Cyclopaedia	2.00
Estimates, Costs and Profits	1.50
New Hardwood Finishing	1.50
The Signist's Modern Book of Alphabets	1.50
The Amateur Artist	1.50
Owens' Paint Guide	1.00
Chalk Talk and Crayon Presentation	1.25
Graining and Marbling75

We also publish over 200 pay-raising books on **Electricity, Automobile construction, care, maintenance and painting, Machine Shop Practice, Steam Engineering, Railroading, Carpentry and Building, Business, Bookkeeping, French, Spanish and German Without a Teacher, General Instruction and Reference Books, Handbooks, Farm Books, etc.** All fully described in catalog **SENT FREE.** Write today.

FREDERICK J. DRAKE & CO.

Publishers

1008 Michigan Ave. CHICAGO

Drake Books Are for Sale at All Book Stores

**Frederick J. Drake & Co.,
1008 Michigan Avenue,
Chicago, Ill.**

Gentlemen:

I enclose \$..... for which send me postpaid the books checked on this page.

Please send me, free, postage paid, your illustrated catalog which lists and describes over 200 Practical Mechanical Books for Home Study.

Name.....

Address.....

.....

Would you
like *two*
pay checks
instead
of one—
each week
in 1927
?



A. DEUTZ & BROTHER
CORPORATE EXPONENTS OF
HARDWARE
AND AGRICULTURAL IMPLEMENTS
MACHINERY & SUPPLIES
LAREDO TEXAS

LaSalle Extension University,
Chicago, Illinois.

Gentlemen:

My schooling stopped when I was fourteen; and when I first enrolled with LaSalle for training in Higher Accountancy I was earning only \$150 a month.

Yet that training enabled me to make certain suggestions to the firm I worked for which resulted in a trip to Washington with all expenses paid and a commission of \$2,126. That alone paid for the training seventeen times over!

Since then I have followed thru with two other LaSalle courses; I am now on my fourth. And for two years past my earnings have been in excess of \$11,000 a year.

I used to think you were too extravagant in your claims for LaSalle training. Now I honestly believe you are too conservative. Why don't you tell the full truth about what LaSalle can do and is doing to lift men out of the low-pay class and put them in command of the really important places in the business world?

Sincerely yours,

E. J. Dryden
Auditor

FRANKLY—are you in earnest in wishing to increase your income, but doubtful as to the aid you could get from home-study business training?

E. J. Dryden, of Laredo, Texas, was doubtful, too. But he determined to **try**, and to measure his results by the good old sign of the dollar!

He was earning \$150 a month when he started with LaSalle. His course in Higher Accountancy was completed in eighteen months. His salary-increase paid for the training **plus \$1.00 an hour for every hour spent in study.**

After his first lesson in Business Management, dealing with Selling, he tried out his newly acquired knowledge. **In six weeks he made \$750 in commissions working after hours.**

He has since followed thru with Commercial Spanish, and is now completing his fourth course—in

American Law and Procedure. For two years past his earnings have been better than \$11,000 a year.

Again we ask—are you **in earnest** in your desire to increase your salary?

Send for Free Book About Your Own Field

You are faced with a problem—and the only way you can solve it is to get the facts.

A special 64-page booklet describes the opportunities in your field of business and outlines a definite plan that will enable you to realize them.

The coupon will bring this booklet to you free—and with it your copy of "Ten Years' Promotion in One," all without obligation.

Dreaming—wishing—you've had enough of that! Send for those booklets **NOW.**

Find Yourself Thru LaSalle!

LA SALLE EXTENSION UNIVERSITY, Dept. 364-R CHICAGO

I shall be glad to have your 64-page booklet about the business field I have checked below. Also a copy of "Ten Years' Promotion in One," all without obligation.

- | | |
|---|--|
| <input type="checkbox"/> Business Management | <input type="checkbox"/> Traffic Management—Foreign and Domestic |
| <input type="checkbox"/> Higher Accountancy | <input type="checkbox"/> Railway Station Management |
| <input type="checkbox"/> Modern Salesmanship | <input type="checkbox"/> Banking and Finance |
| <input type="checkbox"/> Law; Degree of LL. B. | <input type="checkbox"/> Personnel Management |
| <input type="checkbox"/> Commercial Law | <input type="checkbox"/> Modern Business Correspondence and Practice |
| <input type="checkbox"/> C. P. A. Coaching for Advanced Accountants | <input type="checkbox"/> Expert Bookkeeping |
| <input type="checkbox"/> Effective Speaking | <input type="checkbox"/> Business English |
| <input type="checkbox"/> Modern Foremanship | <input type="checkbox"/> Commercial Spanish |
| <input type="checkbox"/> Industrial Management | |

Name Present Position

Street City State



these books free

BUILDERS TRADE GUIDES

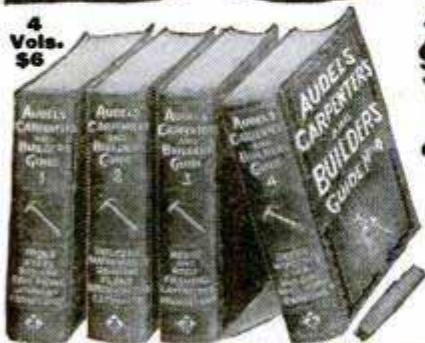

4 Vols. \$6

AUDELS CARPENTERS AND BUILDERS GUIDES—4 VOLS. \$6

Inside Information for Carpenters, Builders, Joiners, Building Mechanics—all Woodworkers. **1600 pages; 3700 diagrams; flexible; pocket size.** Short-cut instructions, new methods, ideas, solutions, plans, systems—money saving suggestions. An easy progressive course for the apprentice. A practical daily helper and Quick Reference for the master worker. A Helping Hand to Easier and Better Work and Better Pay. To get this aid for yourself, simply fill in and mail the FREE COUPON below.

INSIDE TRADE INFORMATION ON:
 How to use steel square; How to file and set saws; How to build furniture; How to use mitre box; How to use chalk line; How to use rules; How to make joints; Carpenters' arithmetic; Mensuration problems; Estimating strength of timbers; How to set girders and sills; How to frame houses and roofs; How to estimate costs; How to build houses, barns, garages, bungalows, etc.; How to read and draw plans; Drawing up specifications; How to excavate; How to use settings 12, 13 and 17 on the steel square; How to build hoists and scaffolds—skylights; How to build stairs; How to put on interior trim; How to hang doors; How to lath—lay floors; How to paint.



"Audels Guides worth four times their price—handy too as I carry them in pocket for reference." W. J. Bates, Knoxville, Pa.



4 Vols. \$6

AUDELS PLUMBERS AND STEAMFITTERS GUIDES—4 VOLS. \$6

A new set—just out! A practical, illustrated, Reference Library and Study-Course for Master Plumbers, Journeymen and Apprentice Steamfitters, Gas Fitters and Helpers, Sheet Metal Workers, Draughtsmen, Master Builders, Engineers and all Building Trade Students. **1670 pages; 3642 diagrams; flexible; pocket size.** Guides explain all the principles, advances and short cuts of the Plumbing and Heating trade. Contains instructions on how to figure and estimate jobs. Use FREE COUPON below to examine, without obligation, this valuable work.

INSIDE TRADE INFORMATION ON:
 Soldering, tinning, joint wiping, bending, beating. Pipe—iron—steel, threading. Mathematics, tables, physics. Materials—iron, steel, copper, brass, lead, tin, antimony. Sheet metal—galvanized—plate. Sanitation, syphonage, tanks. Drainage, sewage, purification. Fixtures—bath—kitchen. Pipe fittings, soil pipe, tools. Laying out work. Roughing. Screwed fittings, flanges, joints. Pipe bending, examples. Elbows. Heating, ventilation, refrigeration. Water supply, mains, wells, tanks. Gas-fittings. Underwriters. Sheet metal work, problems, methods, brazing, heating, lead burning. Welding, various welds, methods. Blacksmithing, forges, tools.



"Audels Guides are practical, easy to understand, reliable. Cover the field in plain language." W. F. Arminger, Annapolis, Md.



4 Vols. \$6

AUDELS MASONS AND BUILDERS GUIDES—4 VOLS. \$6

A new, complete, illustrated trade reference library, for Bricklayers, Cement Workers, Plasterers, Tile Setters and Stone Masons, including a practical outline of Steel Construction. **1100 pages; 2067 diagrams; flexible; pocket size.** A practical Trade Assistant explaining modern methods of masonry construction. Easy to understand and apply. A reliable and authentic reference work and study-course for Master Journeyman and Young Mechanic. Use FREE COUPON below and find out for yourself, without obligation, whether this set will benefit you.

INSIDE TRADE INFORMATION ON:
 Bricklaying, tools, materials; Brick designs, patterns, bonds; Setting frames and foundations; Mortars, scaffolds, estimating; Mortars and mortar mixing; Tile setting, mosaic, hollow tile; Straight edge test, trowelling; How to figure brick work; Safe loads, piers, chimneys; Boiler settings, anchors, fire stops; Laborables; Concrete, forms; How to figure concrete work; Stucco—on old and new buildings; Plastering—wood lath—metal; Plasterers agreement; Plastering on various surfaces; Stonemasonry; Cutting, finishing, estimating stone; Derricks, rigging; Steel construction; Fire proof; How to read blue prints.



"Audels Masons Guides are the best books on the subject. Have laid brick 12 years and am able to judge." H. A. Sonnett, Corlies, Pa.

PRACTICAL ELECTRICITY — 1 VOL. \$4

Audels Handy Book of Practical Electricity is a simplified Ready Reference and Study Course in one pocket size, leather bound volume—for Engineers, Professional Electricians and Students. **1040 pages; 2600 diagrams; flexible red leather bound.** A reliable authority and handy helper for every electrical worker. Contains important and valuable wiring diagrams, calculations, machine sketches, helps on maintenance and repair. Use this FREE COUPON today and find out, without obligation, how this handy book will help you in your daily work.



Complete in one handy, red leather bound volume

1040 Pages 2600 Diagrams

INSIDE TRADE INFORMATION ON:
 Electro-Therapeutics, X-Rays, Shoeks, Welding, Brazing, Radio Hook-ups, Motion Pictures, Telephone, Telegraph, Cranes, Bells, Elevators, Pumps, Tools, Ship Drive, Railways, Vehicles, Automobile Electric Systems, Ignition, Generation, Lighting, Plant Management, Power Plans, Armature Winding, Repairing, A. C. Motors and Apparatus, D. C. Motors and Apparatus, Alternator Construction, Dynamos, Wiring Diagrams, Sign Flashers, Cable Splicing, Power Wiring, Outside Wiring, Switches, Lighting, Rectifiers, Converters, Transformers, Fuses, Circuit Breakers, Rheostats, Electro Plating, Electrolysis, Storage Batteries, Magnetism, Electrical Energy, Conductors, Insulators, Static, Dynamic, Radio Electricity, Applications, Ready Reference and Index Covering the entire field of Modern Electricity.

Learn More and You Will Earn More!

Know your job and you'll never be without one. The skilled man is always in demand. Knowledge is power. Learn your trade thoroughly by easy reading. This coupon is your opportunity for advancement and better pay. You risk nothing in sending for Audels Guides for free examination. Send it NOW!

FREE EXAMINATION COUPON

THEO. AUDEL & CO.,
 65 W. 23 ST., NEW YORK CITY

Please mail me for free examination the books marked (x) below. If I find them satisfactory, I agree to mail \$1 in 7 days, on each set ordered, and to further mail \$1 monthly on each set until I have paid the purchase price.

4 CARPENTERS GUIDES \$6 4 PLUMBERS GUIDES \$6

4 MASONS GUIDES \$6 1 ELECTRICIANS HANDY BOOK \$4

NAME

ADDRESS

OCCUPATION

EMPLOYED BY.....3T30

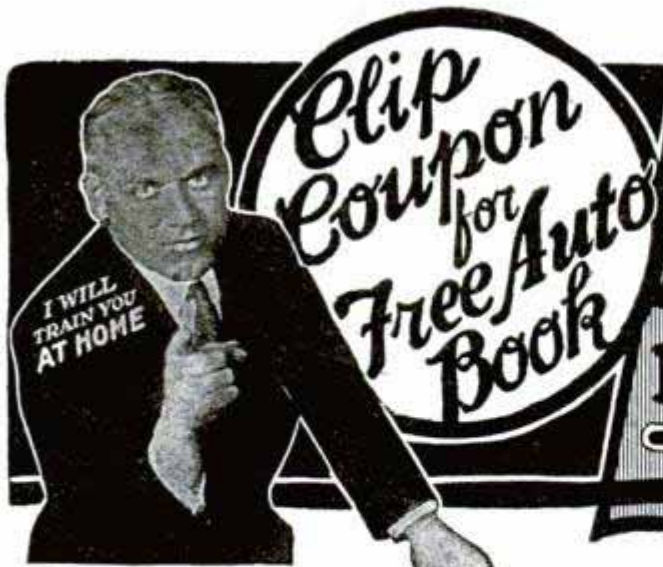

Clip Coupon for Free Auto Book

BE AN AUTO EXPERT
 - Earn up to \$10,000 a year -
Go to School AT HOME the Cooke "JOB-WAY"
FREE Auto Book

PROOF! See What I Can Do For YOU!

Send coupon for this amazing **FREE BOOK** right now. See what it has done for others. See what it can do for you! Just think of this! —Walter Mayville, Harold Lester, M. J. Morrison, Herbert Trask, Allen Pomeroy and dozens of others without previous auto experience—In only a few months after enrolling—were in business for themselves, making **Big money**. My Free Book tells you all about their wonderful, **QUICK** successes. Send for it.

Start to Make Money Quick!
 You don't have to wait to finish to make real money with Cooke "Job-Way" training. Many of my students make money right in the very first few weeks.

\$215 in a Single Week!
 Only 15 weeks after enrolling, Ernest B. Tucker, Cotton, Minn., wrote me he was making as much as \$215 in a single week! That's the kind of **QUICK RESULTS** you want! Find out what you can do today!

Raises His Salary Almost 300% in 7 Short Months
 Cooke "Job-Way" boosted the salary of Gust Alvaras, Box 172, Parkerton, Wyo., a foreigner with little education, from \$18 a week to \$50 a week in only 7 months and he gives my training full credit.

GET THE FACTS!

Send for this remarkable **FREE Auto Book**. Get all the facts about this amazing "quick results" Training Method. See what others did. Find out what you can do.

ACT NOW!

MAIL THIS "JOB-WAY" COUPON

B. W. COOKE, Directing Engineer CHICAGO MOTOR TRAINING CORPORATION, Dept. 316, CHICAGO, ILL. 1916 Sunnyside Avenue. Also send me **FREE Auto Book** and proof that you will show me the **QUICK WAY** toward a **BIG JOB** and a **RAISE IN PAY**. Also send your **4 Outfits Offer**. It is understood that this obligates me in no way.

4 BIG OUTFITS INCLUDED Free of Extra Cost

Tools, Test Bench, All equipment included **Free of extra charge**. Also 308 wiring diagram charts. Wonderful Offer Now. Act quick, Clip coupon for full details.

My training includes **ALL Electrical work—Ignition, Starting, Lighting—All Mechanical and Welding, Brazing, Vulcanizing—also Business Course, Salesmanship, Advertising, Buying, How to Keep Simple Books—also Auto Magazine, also 4 Outfits**. Nowhere else I know of, can get you **ALL** this training.

Common Schooling All You Need Men between 15 and 60 and with little education quickly and easily learn in the class with **BIG PAY** executives. I back you up with the entire resources of this great Institution. Employment service for your whole life. Also Lifetime Consultation service. Notice on this page what a few of my students have done—then send for my **Free Auto Book** right away! Address me personally.



GET Results QUICK

The World's Biggest Business Needs You!

If you're earning a cent less than \$50 a week, clip coupon now. Get my Free Book. Let me show you how Five Thousand Million Dollars are spent every year for **Auto Upkeep** alone. Let me show you how salaries are raised—doubled—tripled in such **quick time** it's **positively amazing!** Look at this—from \$33 a week to \$226 in a **SINGLE WEEK** is what Cooke "Job-Way" did for Bernard Rumpel, 365 Edison Place, Glendale, N. Y., only 10 months after enrolling!

No other business offers you so many wonderful opportunities. Job way is the training that is bringing such marvelous quick results. Get all the facts. Send for my Free Book Today!

Earn Up to \$150 a Week!

Don't sell your time for low pay. Raise your **PAY QUICK**. Be a **Big Pay** man. My book will show you the way.

Learn Right at Home!

Keep your present job. Get started for **Big Pay QUICK** as an **Auto Expert**, through Cooke "Job-Way", quickly, easily, right in your own home. Send for my free book: it shows you how successful I've been and how successful I am. Being a practical **Directing Engineer, Owner and Head** of this Institution, I know what practical money making training you need to become a **BIG PAY MAN** and to get **QUICK RESULTS** and that training I give you.

The Only "Job-Way" Training on Earth!

B. W. Cooke is in no way connected with any other person or training of similar name. Nowhere else can you get the original, genuine copyrighted Cooke "JOB-WAY" training. I train you with Tools which I give you and illustrated **JOBS—not books**. Find out how "Job-Way" fits you for **Big Pay**. Learn what it has done for others, see what it can do for you. Mail coupon to me right now!

B. W. COOKE DIRECTING ENGINEER CHICAGO MOTOR TRAINING CORPORATION 1916 Sunnyside Avenue Dept. 316 CHICAGO

Name
 Address

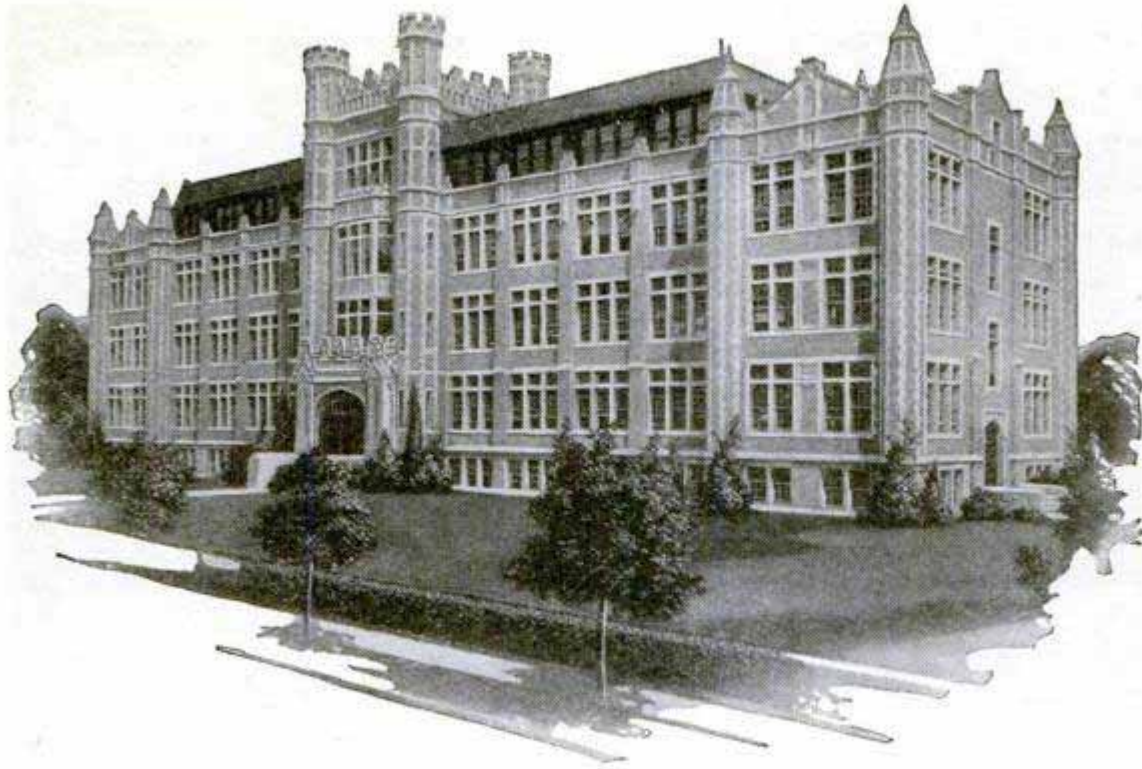

Go to High School at Home

You can secure a high school education right at home by studying the splendid new courses recently prepared by the International Correspondence Schools.

These courses are equivalent to the courses given in resident high schools. They have been specially arranged for men and women who wish to meet college entrance examinations, to qualify for a business position, or to make up the education they missed when forced to leave school too soon.

The College Preparatory Course, the High School Commercial Course and the High School English Course include English, algebra, ancient, medieval, modern and U. S. History, physiology, literature, geography, Latin, book-keeping, drawing, geometry, shorthand, physics, chemistry, salesmanship, advertising, civics, trigonometry, economics, American business law, corporation finance, money and banking, business and trade economics, etc. A diploma is given at graduation.

The lessons are easy to understand and you will make rapid progress because you will be *in a class by yourself* and you will study under the guidance of instructors who are sincerely interested in helping you to get ahead and achieve the bigger things in life.

Just mark and mail the coupon and we will gladly send you interesting free booklets

describing the High School Courses of the International Correspondence Schools or any other subject in which you are interested.

INTERNATIONAL CORRESPONDENCE SCHOOLS

Box 5634-E, Scranton, Penna.

Without cost or obligation, please send me one of your booklets and tell me how I can qualify for the position or in the subject *before* which I have marked an X:

- College Preparatory Course
- College School Commercial Course
- High School English Course
- High School Vocational Course
- High School Agricultural Course

- | | |
|--|---|
| <input type="checkbox"/> Business Management | <input type="checkbox"/> Salesmanship |
| <input type="checkbox"/> Industrial Management | <input type="checkbox"/> Advertising |
| <input type="checkbox"/> Traffic Management | <input type="checkbox"/> Better Letters |
| <input type="checkbox"/> Business Law | <input type="checkbox"/> Show Card Lettering |
| <input type="checkbox"/> Banking and Banking Law | <input type="checkbox"/> Stenography and Typing |
| <input type="checkbox"/> Accountancy (including C.P.A.) | <input type="checkbox"/> English |
| <input type="checkbox"/> Nicholson Cost Accounting | <input type="checkbox"/> Civil Service |
| <input type="checkbox"/> Bookkeeping | <input type="checkbox"/> Railway Mail Clerk |
| <input type="checkbox"/> Private Secretary | <input type="checkbox"/> Common School Subjects |
| <input type="checkbox"/> Spanish <input type="checkbox"/> French | <input type="checkbox"/> Illustrating <input type="checkbox"/> Cartooning |

TECHNICAL AND INDUSTRIAL COURSES

- | | |
|---|--|
| <input type="checkbox"/> Electrical Engineering | <input type="checkbox"/> Architect |
| <input type="checkbox"/> Electric Lighting | <input type="checkbox"/> Architects' Blueprints |
| <input type="checkbox"/> Mechanical Engineer | <input type="checkbox"/> Contractor and Builder |
| <input type="checkbox"/> Mechanical Draftsman | <input type="checkbox"/> Architectural Draftsman |
| <input type="checkbox"/> Machine Shop Practice | <input type="checkbox"/> Concrete Builder |
| <input type="checkbox"/> Railroad Positions | <input type="checkbox"/> Structural Engineer |
| <input type="checkbox"/> Gas Engine Operating | <input type="checkbox"/> Chemistry <input type="checkbox"/> Pharmacy |
| <input type="checkbox"/> Civil Engineer | <input type="checkbox"/> Automobile Work |
| <input type="checkbox"/> Surveying and Mapping | <input type="checkbox"/> Airplane Engines |
| <input type="checkbox"/> Metallurgy | <input type="checkbox"/> Navigation |
| <input type="checkbox"/> Steam Engineering | <input type="checkbox"/> Agriculture and Poultry |
| <input type="checkbox"/> Radio | <input type="checkbox"/> Mathematics |

Name.....

Street Address.....

City..... State.....

Occupation.....

Persons residing in Canada should send this coupon to the International Correspondence Schools Canadian, Limited, Montreal, Canada.



THEN CHOOSE AVIATION!

Are you eager for a life of constant thrills, constant excitement and fascinating events? Do you crave adventure, popularity, admiration, and the applause of great crowds? Then why not get into the Aviation Industry—the greatest adventure since time began—the greatest thrill ever offered to man?

Think what Aviation offers you. Thrills such as you never had before! The praise and plaudits of the multitude. Ordinary salaries from \$75 to better than \$400 a week! And a chance to get in on the ground floor where rewards will be unlimited!

Aviation is growing so swiftly that one can hardly keep track of all the astonishing new developments. Air-mail routes have just been extended to form a vast aerial network over the entire U. S. Airlines and airplane factories are springing up all over the country. Men like Henry Ford are investing Millions in the future of commercial Aeronautics in America! The possibilities are so tremendous that they stagger imagination!

Everything is set for the greatest boom in history. The fortunes that came out of the automobile industry and out of motion pictures will be nothing compared to the fortunes that will come out of Aviation! There is just one thing holding it up:—lack of trained men! Even in the beginning thousands will be needed—and generously paid. The opportunities open to them cannot be over-estimated. Those who qualify quickly will find themselves on the road to undreamed of money—success—popularity—and prominence!

ARE you a red-blooded, daring he-man?

Easy to Become an Aviation Expert

\$50 to \$100 a Week

Get into this thrilling profession at once while the field is new and uncrowded. Now—by a unique new plan—you can quickly secure the basic training for one of these wonderful high salaried jobs, at home, in spare time. Experts will teach you the secrets—give you all the inside facts that are essential to your success. And, the study of Aviation is almost as fascinating as the actual work itself. Every Lesson is chock-full of interest—and so absorbing that you actually forget you are studying. But best of all are the ultimate rewards you are fitting yourself to gain!

Fascinating—Daring—Big Paying

- Prepare Now for One of These Positions
- Aeronautical Instructor \$60 to \$150 per week
 - Aeronautical Engineer \$100 to \$300 per week
 - Aeronautical Contractor Enormous Profits
 - Aeroplane Repairman \$60 to \$75 per week
 - Aeroplane Mechanician \$40 to \$60 per week
 - Aeroplane Inspector \$50 to \$75 per week
 - Aeroplane Salesman \$5000 per year and up
 - Aeroplane Assembler \$40 to \$65 per week
 - Aeroplane Builder \$75 to \$200 per week

Send for FREE Book

Send the coupon for our new, free book, just out—"Opportunities in the Airplane Industry".



It is vitally interesting, reads like a romance and tells you things about this astonishing profession you never even dreamed of. This book is so fascinating it could easily sell for a dollar. We offer a limited number FREE. Write for yours today.

American School of Aviation
Dept. 1353, 3601 Michigan Ave., Chicago, Ill.

AMERICAN SCHOOL OF AVIATION,
Dept. 1353, 3601 Michigan Ave., Chicago, Ill.

Without any obligation please send me FREE book "Opportunities in the Airplane Industry." Also information about your course in Practical Aeronautics.

Age.....

Name.....

Address.....

City..... State.....

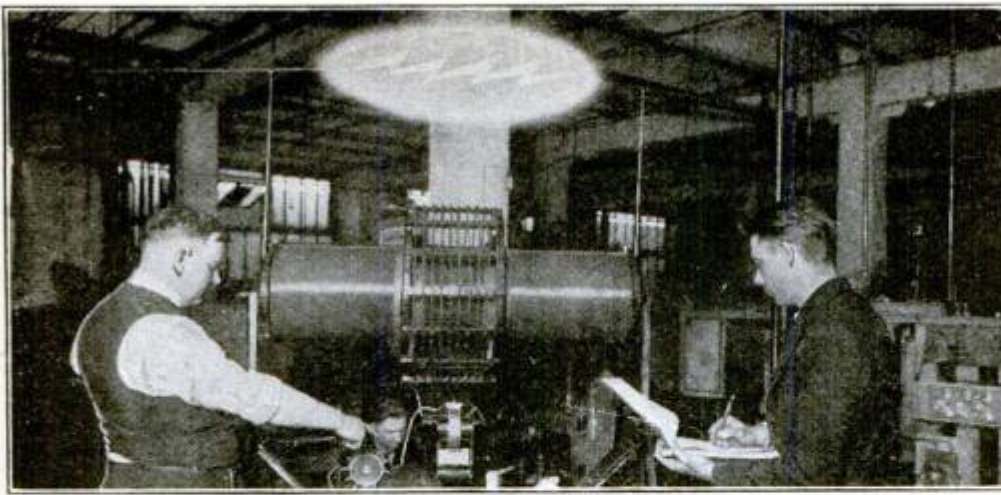

**500,000
VOLTS**

'Artificial lightning' being developed in Coyne School. Spark of 500,000 volts is shown jumping 30 inches. This gigantic Tesla Coil is the same as that used by Steinmetz, absolutely harmless, because of high frequency.

LEARN ELECTRICITY Without Books or Lessons *in 12 Weeks!*

By Actual Work — In the Great Shops of Coyne



ANYONE who can see and understand the English language can master electricity in 90 days. I teach you with as complete an outlay of electrical apparatus as was ever assembled in any institution—30-foot control board—2-story transmitting stations—skeleton houses, huge motors of all kinds—dynamos—sub-stations—automobiles—switchboards—In one department we generate enough electricity to supply a small city!

No Books—No Lessons—No Classes

Experts teach you without books or classes. They guide you every step of the way with individual attention. You do the actual work on real full-size machinery in full operation. Take motors for instance. Instead of learning from books and charts—you actually build motors. You can't help but know all about them. Anyone can learn this fascinating way.

No Experience Necessary

That's how my methods make men master electricity in 12 wonderful weeks. You don't need experience—Coyne training starts from the very beginning. You don't need advanced education—you learn by doing. Age is no handicap—Coyne students range from 16 to 46.

Triple Your Earning Power

I don't need to tell you about the opportunities in electricity. They are too many and too amazing to mention. Ordinary jobs run \$50—\$75—\$150 a week. And Coyne training fits you for the biggest positions. There is no limit to your earning power.

COYNE ELECTRICAL SCHOOL

H. C. LEWIS, President, Founded 1899

1300 W. Harrison St., Dept. 37-72, Chicago, Ill.

Any number of Coyne men are making up to \$800 a month. Demand for Coyne men far exceeds the supply. Our employment bureau secures dozens of positions weekly.

Earn While You Learn

We help students to secure part-time jobs to earn a good part of their living expenses while studying.

FREE R. R. Fare to Chicago

Right now I am including free railroad fare to Chicago and complete courses in Radio and Automotive Electricity without extra charge.

All Details Sent Free

This school is 28 years old—Coyne training is tested—proven beyond all doubt—endorsed by electrical industry. You can find out everything absolutely free. Simply mail the coupon and let me send you the big, free Coyne book of 150 photographs—facts—jobs—salaries—opportunities. See what Coyne training can do for you in just 90 days! This does not obligate you. So act at once. Just mail coupon.



GET THIS FREE BOOK

Mr. H. C. Lewis, Pres.,
COYNE ELECTRICAL SCHOOL,
Dept. 37-72,
1300 W. Harrison St., Chicago, Ill.

Dear Mr. Lewis:

Without obligation send me your big free catalog and all details of Free Railroad Fare to Chicago, Free Employment Service, Free Radio and Free Automotive Courses and how I can "earn while learning." I understand I will not be bothered by any salesman.

Name.....
Address.....
City.....State.....

Magic

Learned Easily
at Home



Dr. Harlan Tarbell, internationally known magician and teacher of some of the world's greatest magicians.

Astonish Your Friends

Gain the magnetic popularity that makes you the center of any crowd. Business and social success is assured the man who can perform mystifying tricks. You can earn big money on the side or as a professional, as well as being the most popular person in your crowd. Why envy others' skill? You can learn Magic yourself, quickly and easily.

**The First
and Only
Course
in Magic**

*ever offered to the
public teaching
Real Professional
MAGIC*

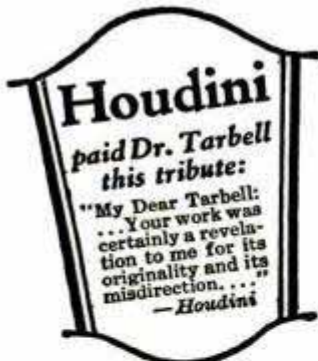

**Earn \$250 to
\$1000 a Month**

even sleight of hand, generally supposed to require long practice, is NOW made simple to learn. For Dr. Harlan Tarbell, one of the really Great Magicians, has finally opened up the secrets of his profession in a completely illustrated course offered at a merely nominal cost. Through the wonderful Tar-

bell system you will be able to mystify and entertain your friends. After that Dr. Harlan Tarbell takes you through the entire maze of sleight of hand, card tricks and elaborate stage diversions. The apparently superhuman doings of the accomplished magician becomes as simple as ABC.

Mail This Coupon NOW!

Tarbell System, Inc., Studio 13-53
1920 Sunnyside Avenue, Chicago, Illinois
Gentlemen: Without any obligation send me your free literature and information all about your wonderful "Tarbell Course in Magic." Also tell me about your great Special Price Offer and Easy Payment Plan—offered NOW for limited time only.

Name.....

Address.....

Age.....

Great Special Offer!

There is a tremendous demand for magic entertainment. Clubs, Lodges, Charity and Social affairs—all will pay high fees to the man who knows Magic. Dr. Harlan Tarbell really gets as high as \$250 for a half hour's work right now. Opportunity everywhere to make money aside from your regular occupation. Salesmen find it a tremendous asset. Find out all about this unprecedented opportunity to learn Magic. Learn about the great Special Price and Easy Payment Offer we are making Now, for a limited time only. The coupon brings full details without any obligation. *Mail it TODAY.*

Tarbell System, Inc.
1920 Sunnyside Ave., Studio 13-53 Chicago, Ill.

Another Britannica Triumph!

Huge Britannica Presses Kept Running
Continuously for Four Solid Months To
Catch Up With Overwhelming Demand

New 13th Edition

ENCYCLOPAEDIA BRITANNICA

In the Compact **NEW FORM** 32 Volumes
bound as 16

YOU CAN SAVE 40%

If You Act NOW!

THE amazing success of this new 13th Edition of the ENCYCLOPAEDIA BRITANNICA has not been entirely unexpected. But the tremendous demand for this new Britannica in the world-famous NEW FORM has taken the publishers completely by surprise.

Past Records Smashed

Already, more than 25,000 sets have been delivered in the NEW FORM, and orders are still pouring in.

To meet this overwhelming demand, it has been found necessary to

utilize every one of the huge Britannica presses for NEW FORM production. Another special order for a million pounds of Britannica Opacity Paper has just been delivered, and within another week it will be possible to make prompt deliveries.

If you want *your* set of the new Britannica in the preferred NEW FORM, you have no time to lose. This announcement will bring another flood of orders which will quickly exhaust the available supply.

How You Save 40%

By the use of the famous Britannica Opacity Paper, which is made to order in tremendous quantities, a considerable saving is effected.

By printing from the *same plates* as are used in the Cambridge Issue, thousands of dollars are saved, because this makes it unnecessary to reset the 33,000 pages of type.

And, finally, by binding the 32 volumes as 16 (2 vols. in 1 cover) the binding costs are reduced one-half.

Contents Are Identical

In the Cambridge Issue and the NEW FORM the contents are *identical*. Nothing is omitted—nothing altered. Here are the 28 vols. of the latest standard edition, 3 supplementary vols. and an enlarged index, making a total of 32 vols. All the 45,000 special articles are here—all the magnificent color pages—all the beauty of workmanship.

This is the *only* work of reference ever published that gives you *all* the worthwhile knowledge in the world. No other book ever written has approached it in authority and completeness.

A Million Facts for Instant Use!

Here, in 33,000 pages, are 45,000 separate articles—over a million facts—written by more than 2,500 of the great world leaders in every branch of human activity. No matter how important *your* position may be, if you haven't the Britannica at hand to give you information you *must have* in a hurry, you are holding yourself back from higher achievements of which you are capable.

This NEW BOOKLET FREE

Get all the facts about the new Britannica in the NEW FORM at a saving of 40%. You have no time to lose. This new Booklet, fresh from the press, will tell you all about this Amazing Bargain Offer. Send for it now—it's FREE. Just fill in and mail this Coupon TODAY. Drop it in your nearest mail box before the last collection tonight.

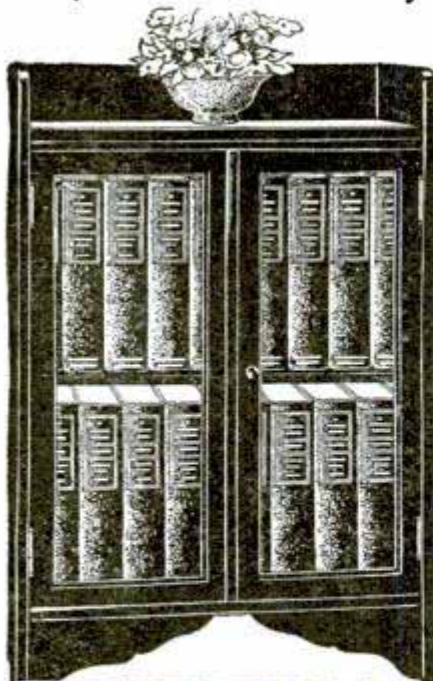

MAIL THIS COUPON TODAY

The ENCYCLOPAEDIA BRITANNICA, Inc.
342 Madison Avenue, New York PM7-A1

Please send me, without obligation on my part, your FREE Booklet; also NEW FORM Bargain Offer [40% saving]; and full particulars of your Easy Payment Plan.

Name

Address

City State

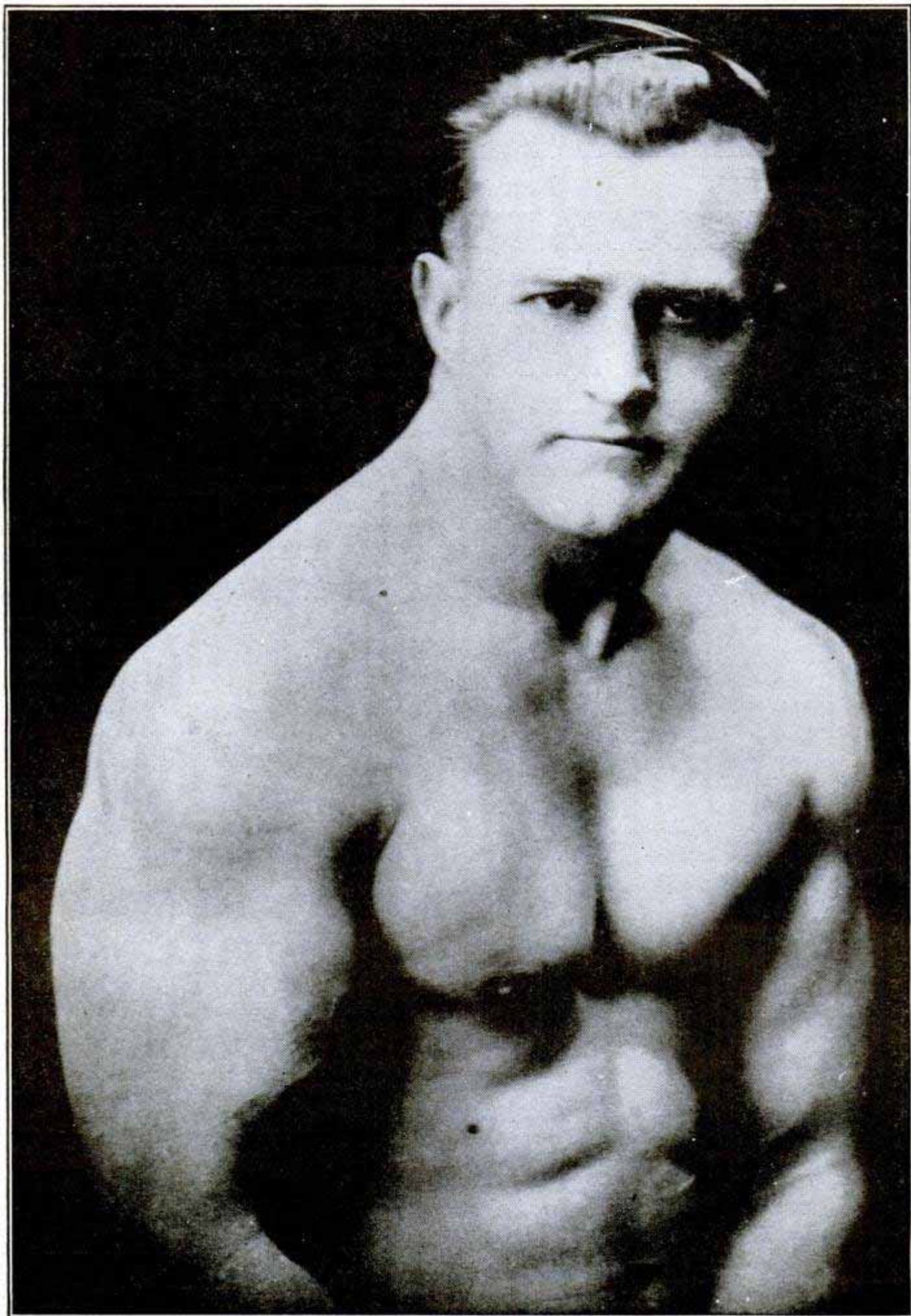

EARLE E. LIEDERMAN, *The Muscle Builder*
Author of "Science of Wrestling," "Muscle Building," "Secrets of Strength," "Here's Health," "Endurance," etc.

Will You Be No. 100,007?

A Dream That Came True 100,006 Times

By Earle E. Liederman

Years ago, I dreamed and hoped for the day when I would be able to help my fellow young men. I wished they could enjoy my robust health and muscle. I knew everyone admired muscles. I wanted a chance to show everyone how easy it is to have real muscular development. My dream has come true! Yes, fellows, 100,006 times I have taught that many men the secret of having steel muscles. As I write, my list is just over the hundred thousand mark. My muscle secrets must be told. I want to help every live wire realize his wildest dreams and ambitions when it comes to muscular development.

Now You'll Enjoy Life

I don't care who you are or what you look like—I'll guarantee to put muscles on you. I know. I was a weakling, too. I didn't only prove it to myself—I have proven to every last man who was game enough to go through with my system.

Here's How I Work

First of all—I make Aladdin look like a piker. I have no lamp, but the magic of what I do has developed over 100,000 healthy, muscular bodies. Yours ought to be one of them. As soon as you get on the job it will. I don't indulge in guess-work. My system rebuilds your body from head to foot. After a few days you will notice a feeling of new life—springy step, a snap and sureness that you knew nothing about.

I put you through a course you'll enjoy every minute—I enlarge your muscles, harden them; train them; I'm the muscle builder! You'll get real chest expansion. If you want big, show-off muscles, you can have them. If you want a beautifully formed symmetrical athletic body that will instantly respond to strength, speed and pep—that's the kind of body I'll build for you—yes, that's the kind of body I give all my happy boys.

Come Along on My Muscle Express

Remember, I can thank my muscles and my secret for my success. You have the same chance—if you will only grab it by signing the coupon below and rushing it to me. You want to act quick or your chance will peter out. Get aboard the Muscle Express. I send you at express speed on the way to health and strength.

My Guarantee

Remember, I don't just promise results—I guarantee them. Before thirty days roll by, I'll put one solid inch on your arm and two inches on your chest. This is just one of the surprises I have ready for you. I have a bag full of others and the beauty of it all is that it's so easy—never tiresome—and almost like playing.

Take My Tip

It's worth a ton of just talk or idle hope. Make up your mind now, this very second, that you are going to be strong, full of pep and ambition. Before long you will be surprising your friends by the change in your physique—your chest will stick out like a balloon. You'll have color in your cheeks—your arms will fill your coat sleeves—those legs of yours will hold you up like they never did before—you'll be real muscle all over—your walk will assure the world you are "there." You will have the same chance I had to make money out of your new strength, vitality and pep. Let me repeat—write now—this very second, because you might forget and miss out. I don't mean maybe or perhaps. If you are a "doubting Thomas" I dare you to call my bluff—make me prove it—it doesn't cost a cent to find out. Action is the only thing that counts in this "musclizing" business—take my tip and rush the coupon for my big illustrated free book.

Send For My New
64 Page Book

"Muscular Development"

IT'S FREE

It contains forty-eight full-page photographs of myself and some of the many prize-winning pupils I have trained. Many of these are leaders in their business professions today. I have not only given them a body to be proud of, but made them better doctors, lawyers, merchants, etc. Some of these came to me as pitiful weaklings, imploring me to help them. Look them over now and you will marvel at their physiques. This book will prove an impetus and a real inspiration to you. It will thrill you through and through. The book is yours. I want you to have it with my compliments. Keep it. This will not obligate you at all, but for the sake of your future happiness and health, do not put it off. Send today—right now before you turn this page.

EARLE E. LIEDERMAN

Dept. 2003, 305 Broadway, New York City

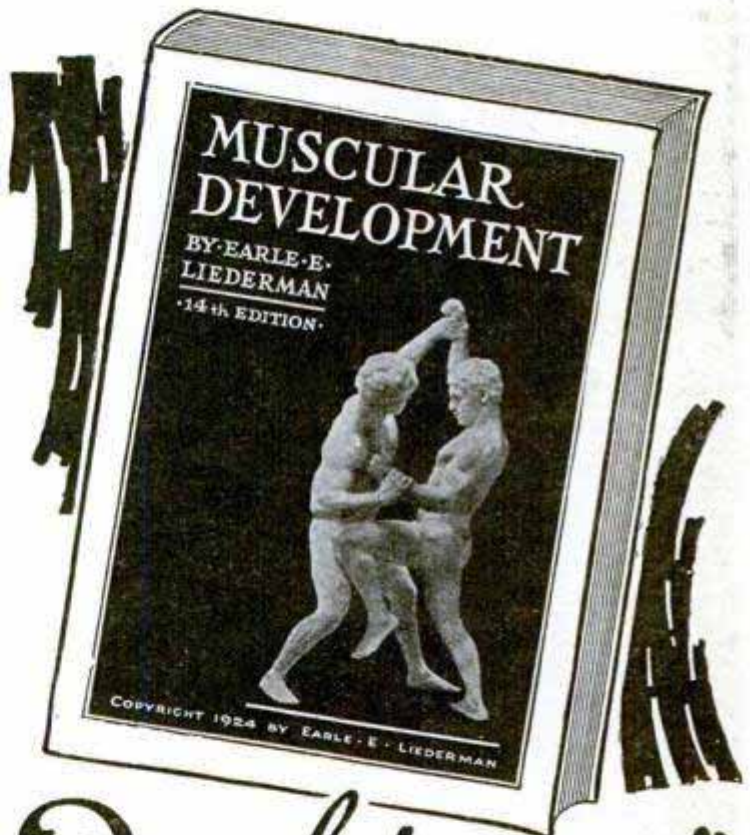

**It
Is
F
R
E
E**

DON'T
SEND ONE
PENNY

YOUR
NAME AND
ADDRESS
ON A
POSTAL
WILL DO

EARLE E. LIEDERMAN

Dept. 2003, 305 Broadway, New York City

Dear Sir:—Without any obligation on my part whatever please send me a copy of your latest book, "Muscular Development."

Name.....

Street.....

City..... State.....

(Please write or print plainly)

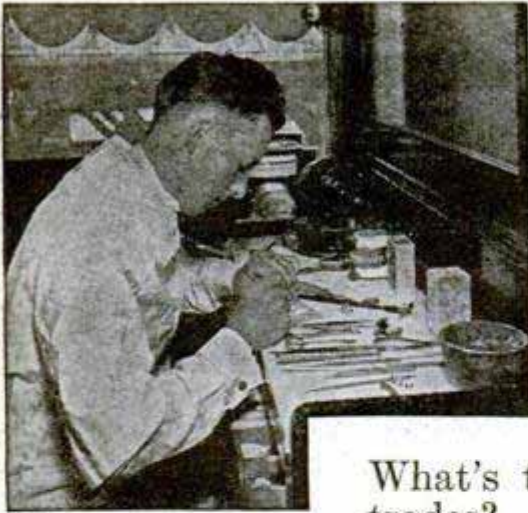

This Dental Laboratory Expert earns UP TO \$20 a day!

What's the use of training for the old, overcrowded trades? If you're going to prepare for big-salaried jobs or a profitable business of your own GET INTO THE FASTEST GROWING PROFESSION—*"Laboratory Dentistry."* Biggest opportunity for success of the century, because there are many more jobs than there are experts to fill them, because there are a dozen cities crying for Laboratories for each EXPERT capable of operating one!

Easiest, pleasantest work you ever saw! Your own boss, money and success yours from the very beginning. You can start with a "shoe-string." We prepare you in a few months to run a business of your own, to do any job. Common schooling, ability to use your fingers ALL YOU NEED! Free R. R. Fare to Chicago, Cleveland, Detroit, Boston or Philadelphia for a limited time!



Jobs Up to \$125 a Week!

In a business where there are many times as many jobs as Experts, salaries are high, hours are easy, opportunities are everywhere! Dentists recognize the high-standing of our graduates. No books here—learn with tools and instruments. Start quick—get ready in a few months for your big opportunity! Mail Coupon today!

Rubber Plates

Learn to make partial upper or lower plates with soldered, cast or wire clasps, with palatal bars; with lingual bars. McCarrie-trained Students learn to make full rubber plates of every type, including Vulcanite base-plates, butted gums, carved gums, etc.

CROWNS

Here's only a small part of your practical training in Crown-work: Two-piece, seamless, open-face, Richmond, cast-base porcelain, Carmichael, split-pin, carved (swaged) cusp, cast cusp, etc.

BRIDGE WORK

Complete training in both fixed and removable bridgework. Interchangeable teeth, gold dummy, Sanitary porcelain dummy jobs—Roach, Gilmore, Bischoff and all forms of cast-clasp work is taught—not with books but in actual Laboratory.

METAL BASE DENTURES

Cast bases of Aluminum, Watt's metal, etc., are included in your training. Both centrifugal and air pressure casting machines are used. Free Book contains complete list of subjects in course.

FREE!
R. R. Fare
TO
Chicago
Cleveland
Detroit
Boston
OR
Phila.

64,000 DENTISTS NEED LABORATORY WORK!

Only a few hundred Laboratories in all the U. S.—most of them in the larger cities. Dentists can't afford to do their own mechanical jobs. They can buy the services of a Laboratory Expert at about \$3.00 an hour and sell their own time at \$6 to \$15 an hour. Dentists will encourage you to learn mechanical Dentistry, start a "Lab" of your own, give them quicker service than sending their work to other cities. Dentists can't wait and keep their patients waiting. Ask your Dentist.

WE HELP YOU OPEN A LABORATORY OF YOUR OWN!

Many of my graduates open a Laboratory of their own. To encourage more men to go into this wonderful Mechanical profession, we will help you find a good location for your Laboratory, and help you towards success. Write for complete information on how you can find yourself in a profitable business of your own after you become a Dental Laboratory Expert.

INTERESTING BOOK—FREE!

Right this minute there are openings for 150 Dental Laboratory Experts in locations where they can do a business of \$5,000 to \$20,000 a year. But you can't cash in, take advantage of these OPPORTUNITIES until you're Trained. Catalog tells you how quickly and easily you can get ready, how hundreds of others have SUCCEEDED! Tells you how you learn in a few months BY DOING ACTUAL LABORATORY JOBS in the world's greatest Dental Laboratory Schools. Brings you FREE R. R. Fare offer and other big inducements. Write for free Book today!

EARN while you LEARN!
Day students make all or part cost of course by part-time night work. Night students can find plenty of good jobs "to see them thru."
We'll help you!

McCarrie School of Mechanical Dentistry

1338 S. Michigan Ave.
Dept. 72 Chicago, Ill.

McCarrie School of Mechanical Dentistry
1338 S. Michigan Ave., Dept. 72, Chicago, Ill.

Without obligation, please send me your Free R. R. fare offer and free Book with complete information about how I may become a Mechanical Dentist. How you will help me open a Laboratory, how you will help me find a job while I take my training, etc.

Name.....
St. No. or R. F. D.....
City..... State.....



**NOW!
FREE!**

**Raised My Pay
700%**

This Amazing Book Showed Me How

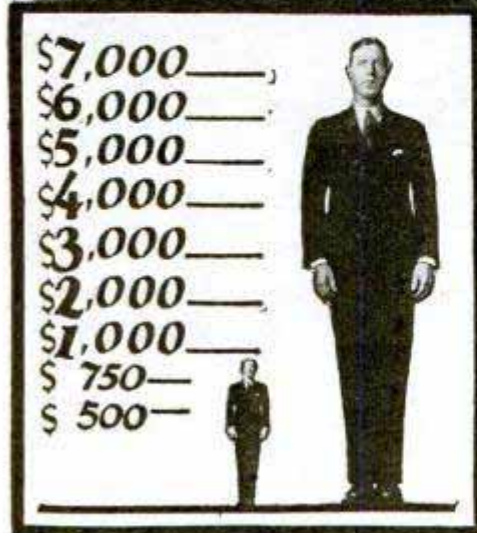

This is Perhaps the Most Remarkable Book Ever Printed. It Has Proved the Turning Point in the Careers of Thousands Who Were Ambitious for Bigger Pay! If You Ever Aspired to Earn \$10,000 a Year or More—Read It Without Fail!

CAN you imagine how a man feels when his earning capacity quickly jumps 700% in a few months? Can you imagine how you would feel if your salary suddenly became *seven times* greater than ever before?

That is exactly what happened to O. A. Jones of Missouri, after reading the amazing book pictured above. Between its covers, he discovered something he had never even dreamed of before—a certain force that lifted him out of the routine rut and set him on the road to \$10,000 a year!

Unusual? Not at all. This surprising book has done the same for hundreds of others. For example, O. D. Oliver read it and quickly saw the way to increase his pay from \$200 a month to \$1,000 a month. C. W. Birmingham of Ohio read it and jumped from \$15 a week to \$7,500 a year. C. V. Champion of Illinois read it and became President of his company at a salary exceeding \$10,000 a year!

THE SECRET OF BIG EARNINGS

How did they do it? What did the book show them? Just this: Every one of these men realized that a knowledge of salesmanship and the *ability to sell* brings bigger rewards than anything else in modern business today! But until they saw the contents of this book—"Modern Salesmanship"—they had no idea that they, *too*, could win quick success through salesmanship. They believed that this golden field of endeavor was forever barred to them. But they were wrong—and this unusual book opened the way to the success that they had formerly despaired of attaining!

SALESMEN ARE MADE—NOT BORN!

Yes! Any man of ordinary intelligence can become a successful salesman! Just as you learned the alphabet, you can master the secrets of selling as taught by the National Salesmen's Training Association.

Reason it out for yourself. Salesmanship is governed by rules and laws. There are certain ways of saying and doing things to make men act as you want them to: certain ways of getting exactly what you go after! Once you have mastered these fundamental rules, your success is governed only by your energy and ambition!

BIG DEMAND FOR TRAINED SALESMEN

City and traveling sales positions are open in every line all over the country. For years, thousands of leading firms have

called on the N. S. T. A. to supply them with salesmen. Employment service is free to both employers and members and thousands have secured positions through this service.

FREE TO EVERY MAN

If we were asking two or three dollars a copy for "Modern Salesmanship," you might hesitate. But it is now **FREE**. We cannot urge you too strongly to take advantage of this opportunity to see for yourself what salesmanship has done for others—and what the National Salesmen's Training Association stands ready and willing to do for you. No matter what your opinion is now, "Modern Salesmanship" will give you a new insight into this fascinating and highly-paid profession.

Mail the coupon now!



Dept. C-12, N. S. T. A. Bldg.
Chicago, Ill.

National Salesmen's Training Association
Dept. C-12, N. S. T. A. Bldg., Chicago, Ill., U. S.
Please mail me **FREE** your illustrated book, "Modern Salesmanship" and particulars of membership in your association and its Free Employment Service.

Name

Address

City.....State.....

Age.....Occupation.....

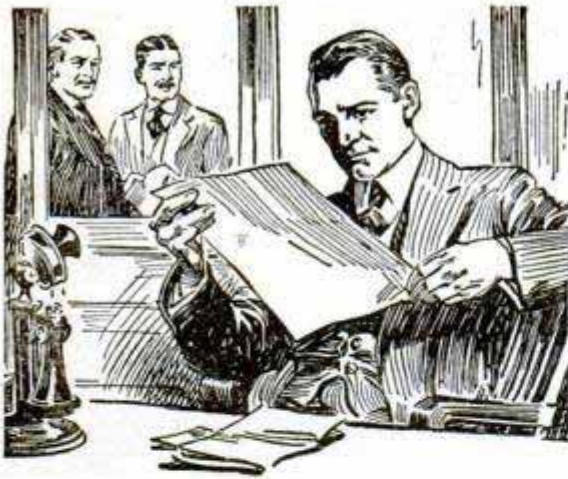

"I wish we had more men like him"

"I've given him two promotions in the last year and he's made good each time.

"I always feel safe in moving him up because I know that he's preparing himself to handle bigger work.

"The International Correspondence Schools keep me advised of the progress he is making and I've encouraged him to keep on. His spare-time studying certainly has made him a valuable man to this firm."

Why don't *you* study and get ready for promotion too? We'll be glad to help you if you will only make the start. And the way to do that is easy.

Choose the work you like best in the coupon below; then mark and mail it to the International Correspondence Schools today. This doesn't obligate you in the least, but it will bring you information that will help to start you on a successful career. This is your opportunity. Don't let it slip by.

Mail the Coupon for Free Booklet

INTERNATIONAL CORRESPONDENCE SCHOOLS
Box 3639-E, Scranton, Penna.

Without cost or obligation, please send me a copy of your booklet, "Who Wins and Why," and full particulars about the course before which I have marked X in the list below:

BUSINESS TRAINING COURSES

- | | |
|--|---|
| <input type="checkbox"/> Business Management | <input type="checkbox"/> Salesmanship |
| <input type="checkbox"/> Industrial Management | <input type="checkbox"/> Advertising |
| <input type="checkbox"/> Personnel Organization | <input type="checkbox"/> Better Letters |
| <input type="checkbox"/> Traffic Management | <input type="checkbox"/> Show Card Lettering |
| <input type="checkbox"/> Business Law | <input type="checkbox"/> Stenography and Typing |
| <input type="checkbox"/> Banking and Banking Law | <input type="checkbox"/> English |
| <input type="checkbox"/> Accountancy (Including C.P.A.) | <input type="checkbox"/> Civil Service |
| <input type="checkbox"/> Nicholson Cost Accounting | <input type="checkbox"/> Railway Mail Clerk |
| <input type="checkbox"/> Bookkeeping | <input type="checkbox"/> Common School Subjects |
| <input type="checkbox"/> Private Secretary | <input type="checkbox"/> High School Subjects |
| <input type="checkbox"/> Spanish <input type="checkbox"/> French | <input type="checkbox"/> Illustrating <input type="checkbox"/> Cartooning |

TECHNICAL AND INDUSTRIAL COURSES

- | | |
|---|--|
| <input type="checkbox"/> Electrical Engineering | <input type="checkbox"/> Architect |
| <input type="checkbox"/> Electric Lighting | <input type="checkbox"/> Architects' Blueprints |
| <input type="checkbox"/> Mechanical Engineer | <input type="checkbox"/> Contractor and Builder |
| <input type="checkbox"/> Mechanical Draftsman | <input type="checkbox"/> Architectural Draftsman |
| <input type="checkbox"/> Machine Shop Practice | <input type="checkbox"/> Concrete Builder |
| <input type="checkbox"/> Railroad Positions | <input type="checkbox"/> Structural Engineer |
| <input type="checkbox"/> Gas Engine Operating | <input type="checkbox"/> Chemistry <input type="checkbox"/> Pharmacy |
| <input type="checkbox"/> Civil Engineer | <input type="checkbox"/> Automobile Work |
| <input type="checkbox"/> Surveying and Mapping | <input type="checkbox"/> Airplane Engines |
| <input type="checkbox"/> Metallurgy <input type="checkbox"/> Mining | <input type="checkbox"/> Agriculture <input type="checkbox"/> Navigation |
| <input type="checkbox"/> Steam Engineering | <input type="checkbox"/> Mathematics <input type="checkbox"/> Radio |

Name.....

Street Address.....

City..... State.....

Occupation.....

Persons residing in Canada should send this coupon to the International Correspondence Schools Canadian, Limited, Montreal, Canada



Double Your Pay This Easy Way

SCORES of ambitious fellows earn splendid weekly incomes simply by using their spare time making show cards for local stores. Every retailer in your neighborhood will pay big money for clever sales-producing display cards. Learn at home through easy professional method prepared by show-card experts. Earn \$25 to \$50 a week spare time—\$50 to \$75 a week in full time. Business of your own. Wonderful future. Many students earn while they learn.

Send for new illustrated booklet, "Quick Success in Show Card Making." Also for details of Attractive Offer given to new students. No obligation. Write now to

WASHINGTON SHOW CARD SCHOOL
Dept. 303-E, 1117-15th St., N. W., WASHINGTON, D. C.

MUSIC LESSONS FREE



Write today for our FREE booklet. It tells how to learn to play Piano, Organ, Violin, Mandolin, Guitar, Banjo, etc. Beginners or advanced players. Your only expense about 2c per day for music and postage used. **American School of Music, 51 Manhattan Bldg., Chicago**

STAMMERING
easily, permanently corrected. Win happiness and success. Ask for full information and special phonograph record. Send dime for postage 153 Stinson Ave., The LEWIS INSTITUTE, Detroit

Learn Watchwork, Jewelrywork and Engraving A fine trade commanding a good salary, and your services always in demand. Address **Horological, Dept. P, Bradley Institute, PEORIA, ILLINOIS**, for our latest catalog.

GOV'T. POSITIONS

\$35 TO \$75 WEEKLY

- | | |
|---|---|
| <input type="checkbox"/> Railway Mail Clerk | <input type="checkbox"/> Meat Inspector |
| <input type="checkbox"/> P. O. Clerk | <input type="checkbox"/> Special Agent (investigator) |
| <input type="checkbox"/> Forest Ranger | <input type="checkbox"/> Stenographer-Typist |
| <input type="checkbox"/> File Clerk | <input type="checkbox"/> Immigrant Inspector |
| <input type="checkbox"/> Matron | <input type="checkbox"/> City Mail Carrier |
| <input type="checkbox"/> General Clerk | <input type="checkbox"/> U. S. Border Patrol |
| <input type="checkbox"/> Chauffeur-Carrier | <input type="checkbox"/> Typist |
| <input type="checkbox"/> Skilled Laborer | <input type="checkbox"/> Seamstress |
| <input type="checkbox"/> Watchman | <input type="checkbox"/> Steno-Secretary |
| <input type="checkbox"/> Postmaster | <input type="checkbox"/> Auditor |
| <input type="checkbox"/> RFD Carrier | |

Ozment's Service Bureau, Dept. 111, St. Louis, Mo.

Send me particulars about positions marked "X"—salaries, locations, opportunities, home instruction, etc.

NAME.....

ADDRESS.....



STATION WOC
RAVENPORT

HERE'S WORK THAT IS
ALMOST ROMANCE!

Now Owns a Radio Store
"The Radio business is rushing just now. Building many Super Heterodynes, also doing installation and repairing. To your course I owe all my success in the Radio profession." A. J. Ommott, Bowman, N. Dak.



Controls First Car by Radio
"I operate the portable broadcasting station in rear car, driving front car by Radio control. Will operate this car from New York to Frisco—13 months trip. Then we take the car around the world—a three years' tour. I owe it all to you." Leo Paul, New York City.



You Can Do What These Men Did!

I Will Train You at Home to Fill a Big-Pay Radio Job

Get into the great new Big-pay Industry—Radio. If you're earning a penny less than \$50 a week, clip coupon now. Send for AMAZING FREE BOOK, "Rich Rewards in Radio." Why go along at \$25 or \$35 or \$45 a week, many are now earning \$50 to \$250 in the same six days, as a Radio Expert? Hundreds of N. R. I. trained men are doing it—why can't you? I'll train you just as I trained them—just as I trained the men whose letters you see on this page. I'll teach you quickly at home in your spare time and start you on the road to become an expert in Radio, the Easy, Fascinating Big Money field.



Read the true stories printed in this border—of men who got out of the rut



Chief Engineer Station WEMC

"Please communicate with my own junior operators here who want to increase their knowledge of Radio. Being a graduate of your course I know they could do nothing better for themselves than study it for it is the way to success in this profession." John E. Fetzer, Chief Engineer, Station WEMC, Benton Springs, Michigan.



Photo shows Graduate E. F. Spadoni in his own Radio store at Chicago, Ill. "Your course gets the credit," says Spadoni.

Big Jobs Go to The TRAINED EXPERT

It's the thoroughly trained man who gets the big jobs in this profession—paying \$75, \$100, \$200 a week and up. Free book gives all the facts. Hundreds of N. R. I. trained men are today holding down good, big jobs in the Radio field—men like you—men like those whose stories I show you here. You can prepare just as they did by new practical methods, learn right at home in your spare time. Lack of experience no drawback—common schooling all you need. Our tested clear methods make it easy for you. Our years of experience in the big field of Radio means that we can train you as we have thousands of others.

Clip Coupon Now for FREE BOOK

Most amazing book on Radio ever written—full of facts and pictures—tells all about the great Radio field, how we prepare you and help you start. You can do what others have done—GET THIS BOOK. Send coupon today—no obligation.
J. E. Smith, Pres.
NATIONAL RADIO INSTITUTE
Dept. C-85
Washington, D. C.

These Instruments Given FREE of Extra Cost

All instruments shown here and others sent to all my students free of extra cost under special offer. Clip coupon now—find out all about this big unequalled offer while you still have time to take advantage of it. This training is intensely practical—these instruments help you do the practical work.

My Radio Training is the "Famous Course That Pays for Itself"

Make more money quick when you take up this practical course.



\$70 in one Day for T. M. Wilcox

"I am in business for myself and recently made \$70 in one day. I was an electrician of rich experience and was occupying a splendid position as telephone superintendent when I enrolled with your course believing it would open up greater opportunities—have not been disappointed. Estimate that Radio will be worth tens of thousands of dollars to me in the next few years." T. M. Wilcox, Belle Island, Newfoundland.

I show you how to increase your earnings almost from the start of your course through practical pointers I give you. Howard B. Luce of Friedens, Pa., made \$320 in 7 weeks during his spare time. D.H. Sutt of Newport, Ark. writes "While taking the course I earned in spare time work approximately \$900." Earl Wright of Omaha reports making \$400 in a short time while taking his course—working at Radio in his spare time only! Sylvester Senso, 207 Elm St. Kaukana, Wis., made \$500. These records not unusual—these men are a few of hundreds.

And when you graduate, my big Free Employment Department helps you get the job. You get just the same preparation and assistance toward success we gave E. W. Novy, Chief Operator of Station WRNY, Erle Chambers, Radio Engineer for Stewart-Warner, J. E. Fetzer, Chief Engineer of Station WEMC. The National Radio Institute, established 1914, today offers you the same opportunity these men had under a contract that pledges you full satisfaction or money refunded on completing our training. Mail coupon TODAY for my big Free Book and proof!

Originators of Radio Home Study Training

Kimball With WMAQ Chicago

"Accepted a position with the Chicago Daily News Station WMAQ. My income practically doubled, thanks to your fine course. I handle all consultation also do operating." Keith Kimball, Station WMAQ, Chicago, Ill.



Promoted to Big Job

"Just been made Sales Manager of this Radio firm—received a very good increase in pay. Up to present have been getting salary which in 3 months enabled me to purchase a new car." R. Jones Bay City Mich.



MAIL THIS NOW!

J. E. SMITH, President
NATIONAL RADIO INSTITUTE
Dept. C-85, Washington, D. C.

Dear Mr. Smith: Without obligating me in any way, send me your free book "Rich Rewards in Radio" and all information about your practical, home-study Radio course.

Name Age

Street Address

Town State

SEND THIS COUPON



"—send this man in first!"

"If he's as good as his handwriting, he's the kind of man I want in this business"

A CLEAR, legible business hand is one of your biggest assets—the lack of it, may prove your greatest drawback. Men of real ability have been kept out of big jobs because they could not write well. Don't allow a ragged, scrawly, illegible hand cause men to under rate your ability—don't let it stand between you and the interview on which your future success depends.



Modern business is largely conducted by correspondence—your signature is the first impression others receive. The typewriter has not reduced the need for good handwriting—on the contrary, it has increased the need. Men and women who can write well are in greater demand than ever before.

I Teach By Mail Turn your spare time into profitable study—an hour or so daily will quickly make you a good penman, and open to you the door of greater opportunity. My method gives you the same careful, personal instruction you would receive, were we in the classroom together.

Easy to Learn No matter what your age or present work, you can become a master penman in a short time by following my simple instructions. My method differs from any offered by schools and colleges—takes you on a direct route to RESULTS. The Tamblyn Method has the endorsement of America's leading business men.

Over 20 Years of Success— The Tamblyn Method is no experiment—it is tried and proven. The same efficient methods which I employed in some of the largest business colleges are now available to you, in your own home in spare time, at very small cost. Grasp this opportunity today.



Your name on a postal or the coupon below will bring you a free copy of my book, "How to Become a Good Penman," which tells of results accomplished by others, and illustrates by word and picture the details of my method. This book may be the turning point in your career—send for it today. YOUR NAME elegantly written on a card if you enclose 2c postage.

F. W. TAMBLYN 418 Ridge Bldg. KANSAS CITY, MO.

F. W. TAMBLYN, 418 Ridge Bldg., Kansas City, Mo.

Please send me, without cost or obligation, your FREE BOOK "How To Become A Good Penman."

Name.....

Address.....

Town.....State.....

Wrestling Book

Learn at Home **10c**

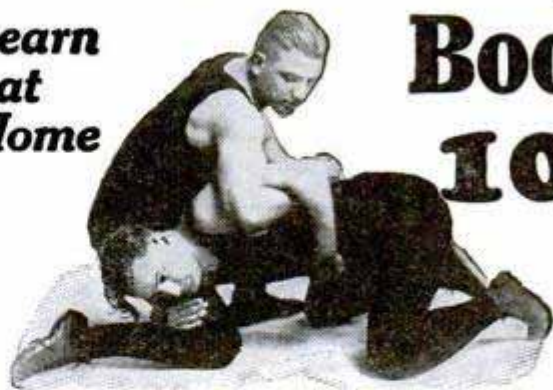

Men, Boys be perfect physically. Learn right in your own home from **WORLD'S CHAMPIONS** how to be an expert **WRESTLER**. Learn secret trick holds, blocks, breaks and pinning holds. Learn how to defend yourself against bigger, stronger men. Learn Jiu-jitsu. Also most wonderful course in **PHYSICAL CULTURE** ever discovered. The world renowned **FARMER BURNS AND FRANK GOUGH** are authors of these splendid lessons. Learn to be a real athlete. You can if you'll try. Have a beautiful attractive body that all will admire. Surprise your friends, and the "bully" with your great ability. Learn to protect yourself, your mother, sister or sweetheart. Have perfect health, ability.

Only 10c Send only 10c coin or stamps, for 32 page book, **ILLUSTRATED**, giving full particulars. Tells the secrets of the big Champions; gives many tricks, holds and other valuable information. A costly book which we send for only 10c—the cost of packing and postage. Don't miss it. Don't delay. **SEND TODAY—THIS MOMENT.** State your age.

Farmer Burns School, 1773 Railway Exchange Bldg., Omaha, Neb.

LEARN PIANO TUNING AT HOME

Send for **FREE** copy of the 28th ANNIVERSARY EDITION of our book "Winning Independence." Read how students master **TUNING** with our **Tune-A-Phone**, and **WHY** our graduates head the profession in all parts of the world. With Bryant's patented devices, tools, charts, and lessons, one learns quickly and easily. Low tuition, easy terms, Diploma granted. **MONEY-BACK GUARANTY.** \$10 to \$25 a day, exceptional opportunities, and an ideal profession await you. **BRYANT SCHOOL OF TUNING (71) Bryant Bldg., Augusta Michigan**

Learn to PAINT SIGNS and SHOW CARDS

We quickly teach you by mail, or at school, in spare time. Enormous demand. Big future. Interesting work. Oldest, foremost school. **EARN \$50 TO \$200 WEEKLY**

John Vassos, N. Y., gets \$25 for single show card. Crawford, B. C., says: "Earned \$200 while taking course." Send today for free information, samples and guarantee.

DETROIT SCHOOL OF LETTERING
150 Stimson Ave. Est. 1899 Detroit, Mich.

"STAMMERING Its Cause and Cure"

You can be quickly cured if you stammer. Send 10 cents, coin or stamps, for 288 page cloth bound book on Stammering and Stuttering. It tells how I cured myself after Stammering and Stuttering for 20 years. **BENJAMIN N. BOGUE** 6941 Bogue Building, 1147 N. III. St. Indianapolis

LEARN WATCHMAKING

and become independent. We help you secure a position. Easy to learn. Send for **FREE CATALOG.**

ST. LOUIS WATCHMAKING SCHOOL, Dept. 5. ST. LOUIS, MO.

200 Kinds of IRON, WOOD and WIRE PUZZLES.

Leader and Illustrated List **10 cents.** Western Puzzle Works, St. Paul, Minn.

PIANO JAZZ

By Note or Ear. With or without music. Short Course. Adult beginners taught by mail. No teacher required. Self-Instruction Course for Advanced Pianists. Learn 259 styles of Bass, 684 Syncopated Effects, Blue Harmony, Oriental, Chime, Movie and Café Jazz, Trick Endings, Clever Breaks, Space Fillers, Sax Slurs, Triple Bass, Wicked Harmony, Blue Obligato, and 247 other Subjects, including Ear Playing. 133 pages of **REAL Jazz**, 25,000 words. A Postal brings our **FREE Special Offer.**

Waterman Piano School, 1826 W. Adams St. Los Angeles, Cal.

ELECTRICITY

Complete Study Course and Pocket Library \$10



SHIPPED FREE

A set of **HAWKINS GUIDES** is a true friend to the electrical worker. It tells you how to do any job the right way—without guessing or taking chances.

Hawkins Guides put all the facts about modern electrical engineering at your finger tips. Therefore your chances for advancement in the electrical field are unlimited.

HAWKINS GUIDES DOUBLE YOUR VALUE



Electricity is king! It is the ruling force of today—transportation, communication, light, heat, power—indeed every modern activity is dependent on electricity. Industry is crying for electrical men that know their jobs!

Hawkins Guides teach you all you need to know about electricity in easy, step-by-step lessons. Daily spare time reading of the Guides will greatly increase your value to yourself and your employer in a few weeks. Hundreds of our friends have written us and told us this!

ing of the Guides will greatly increase your value to yourself and your employer in a few weeks. Hundreds of our friends have written us and told us this!

READERS OF HAWKINS GUIDES KNOW HOW



"You can't stump him on an electrical job." "He certainly knows his business." "Certainly have to hand it to him for knowing how." —These are the things employers say about our friends who are readers of **Hawkins Guides**. No matter what question or problem comes up the Ready Reference Index enables you to give an expert answer at once.

HAWKINS STARTS YOU WHERE OTHERS LEFT OFF

Why should you work at low wages when easy reading of **HAWKINS GUIDES** will give you the money-making knowledge of the expert? Easy daily reading of the Guides will teach you in a few months what it has taken the expert a lifetime to learn!

With **HAWKINS GUIDES** in hand you have a running start to success in the electrical field. You will actually begin where others left off!



NOW!

This coupon is your golden opportunity. Tear it out—send it now!

FOR EXAMINATION!

REAL ELECTRICAL EDUCATORS

"Hawkins Guides at \$10 is the best investment I have ever made. Am able to take up almost any electrical job and have never gone to an electrical school."—B. Roessler, Oenaville, Texas.

AS EASY AS A. B. C.

"Everything in Hawkins Guides is very plain and anybody can read and understand them as easy as A. B. C."—J. Knight, Tobyhanna, Pa.

OTHER ENTHUSIASTIC READERS SAY

"Worth ten times their price." "Helped me to two raises in four months." "Better than a school of instruction." "Studied them when I was laid up and got further ahead than if I had been on the job."

Hawkins Guides Explain These Points So You Can Easily Understand:—

Magnetism—Induction—Experiments—Dynamos—Electric Machinery—Motors—Armatures—Armature Windings—Installing of Dynamos—Electrical Instrument Testing—Practical Management of Dynamos and Motors—Distribution Systems—Wiring—Wiring Diagrams—Sign Flashers—Storage Batteries—Principles of Alternating Currents and Alternators—Alternating Current Motors—Transformers—Converters—Rectifiers—Alternating Current Systems—Circuit Breakers—Measuring Instruments—Switch Boards—Wiring—Power Stations—Installing—Telephone—Telegraph—Wireless—Bells—Lighting—Railways. Also many Modern Practical Applications of Electricity and Ready Reference Index.

Hawkins Guides—10 POCKET SIZE NUMBERS

Each number easy to carry around and read in spare time. Big type and clear diagrams. Easy to study and learn. Durable, flexible binding—gold edges. 3,500 pages—4,700 illustrations. Shipped free for examination. Pay only \$1 a month if satisfied. Price of set, complete, \$10.

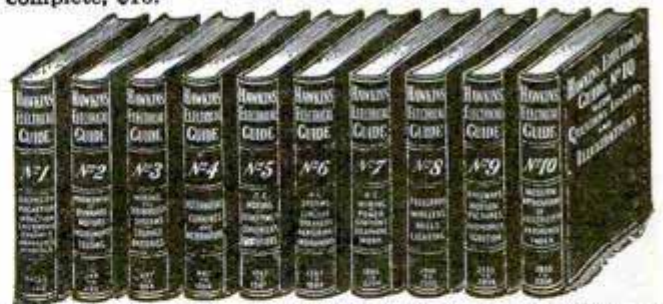

EXAMINE GUIDES FREE!

Let the Guides themselves demonstrate their practical value to you—as a study course, reference work and complete electrical library. You are the judge. Simply send this coupon. No obligation unless you are entirely satisfied. Tear out on dotted line—fill in—mail it NOW!

\$1 PER MO.

FREE EXAMINATION COUPON

Theo. Audel & Co., 65 W. 23rd St., New York City

Please send me (postpaid) for my approval **Hawkins Electrical Guides**, 10 numbers (price \$1 each). If satisfactory I will mail you \$1 in 7 days and further mail \$1 monthly until purchase price of \$10 is paid.

Name.....

Address.....

Occupation.....

Employed by..... 3T30

A Quick, Sure Way to a Big Income is to RAISE POULTRY



Easy to make \$1000 a Year Spare Time- \$5000 and up Full Time

Let the Other Fellow Pay YOU the Fancy Prices



When you go into a store and pay 75c to \$1.00 for a dozen eggs, did it ever occur to you that YOU might be getting the 75c to \$1.00 instead of the other fellow? Did it ever occur that a small back yard or vacant lot flock of poultry would pay enormous profits, if properly managed, and require very little of your time? In this country, where 85% of the people live in cities, and live right, want the best of everything—they will pay and pay well for fresh eggs and poultry meat. There will be a QUICK, sure demand for every egg or bird you produce. Poultry raising offers a golden opportunity. Is there any good reason why YOU shouldn't take advantage of it?

Start Small, Grow Fast, Sure Methods Bring Quick Success

Start small, if you like, just as hundreds thousands of others have started. Then, by following the sure, tried, proved, money-making methods which we will give you, you can grow as fast as you wish. Many of our students who began with the idea of having the BEST for their own tables and getting living expenses, too, soon found in this fascinating, healthful, profitable business, the quick road to a large, steady, full-time income. You can get into a business of your own—one that will make you YOUR OWN BOSS with an income of \$5,000 a year and UP—or you can make \$1.00 to \$3.00 for EVERY hour of your spare time. Let me show you HOW!

Surprise Yourself—Let this FREE Book Open Your Eyes

All I ask is a chance to PROVE that you can CASH-IN on my forty years experience as Commercial Poultryman and former Senior Poultryman in the U. S. Dept. of Agriculture. A chance to prove that the poultry business DOES have big opportunities for you—and that regardless of your location, whether in a city, a town or on the farm—I and the staff of experts associated with me—can show you the way to real SUCCESS and independence, just as we have already shown thousands of others. My new FREE book on "How to Raise Poultry for Profit" will be an eye-opener. Clip the coupon and send for it today. Do it now—this minute. You have everything to gain by—quick action!

READ! What Others Are Doing

"The results I am getting from your methods speak for themselves. In a flock of 65 fowls, I have gotten 888 eggs from the first of the month up to date (the 23rd). BRADY CHANCE, Dewey, Okla.

"Your course on poultry raising is the most practical and complete in the country. You have opened up a pleasant and profitable way for me to gain an independent living." S. ANDERSON, Barrington, R. I.

"The information contained in your course has been of such great help to me that I would not take \$1,000 for what I have gained." L. M. WRIGHT, Federalburg, Md.

"I consider my enrollment with the National Poultry Institute the best investment I ever made." Mrs. J. W. CRAWLEY, Farmville, Va.

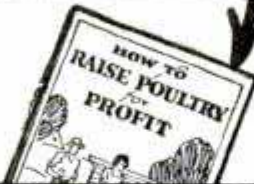

\$2500 DRAWING COURSE for \$298



Haven't you often wished that you could draw cartoons, illustrate some idea, sketch some pretty face, etc.? You can do all of these things. One of America's most famous Cartoonists and Illustrators has developed a great, simple system for success in all branches of Commercial Art. This system has revolutionized the entire theory of drawing. It means that drawing can be as easy for you as writing—much simpler than learning shorthand, bookkeeping or typewriting. We are now placing this original system for learning Drawing, Art and Cartooning, consisting of 34 lessons with over 500 illustrations, within reach of every one. If you will devote a few hours each week to the Course WE ABSOLUTELY GUARANTEE that you will learn to draw and draw well before you have half finished the Course. If we fail to make this claim good, we will refund every cent paid us. By eliminating a large office force for answering correspondence, expensive catalogs, etc., we are enabled to make a price of \$2.98, the cheapest price ever known for a high-grade, home study course. Many have sent us letters similar to that of Rob't P. Davis of Detroit, who wrote: "I can't see how you ask so little, when others with inferior Courses get from \$20 to \$60 for theirs. It is more than I expected." Learn to draw. It is a big asset, no matter what field you are in.

Send No Money

Just order the course, and \$2.98 on arrival pay postman plus a few cents postage, payment in full for the entire Course and Free Drawing Outfit. If not entirely satisfied, return within five days and we will REFUND MONEY. Address:

FREE: If you order the course at once, we will include a drawing outfit, consisting of artist's pencils, pens, paper, erasers, thumb tacks, etc., enabling you to go to work without any additional cost.

LEDERER SCHOOL of DRAWING, Dept. 2868-D, Chattanooga, Tenn. Orders from outside the U. S. A. are payable \$3.28 cash with order.

ELECTRICAL ENGINEERING

Course for men of ambition and limited time. Over 4000 men trained. Condensed course in Theoretical and Practical Electrical Engineering including the closely related subjects of Mathematics and Mechanical Drawing taught by experts. Students construct motors, install wiring, test electrical machinery. Complete course

IN ONE YEAR

Prepare for your profession in the most interesting city in the world. School established 1893. Send for catalog BLISS ELECTRICAL SCHOOL 433 Takoma Ave. WASHINGTON, D. C.

LEARN WATCH REPAIRING



You can learn by our modern and original system of instruction every part of the Watch Repairing Trade at home as good or better than at a shop. You can earn money while learning and secure a well paying position or start in business after completing our course of instruction. Good watch repairers are always in demand and earn from \$50 to \$75 per week. For particulars apply to the Wisconsin School of Watch Repairing 166 Mason St., MILWAUKEE, WIS.

TELEGRAPHY

(Morse and Wireless) and RAILWAY ACCOUNTING taught thoroughly. Big salaries; great opportunities. Oldest, largest school. Endorsed by Telegraph, Railway, Radio, and Government officials. Expenses low—opportunities to earn large portion. Catalog free. DODGE'S INSTITUTE, Jones St., Valparaiso, Ind.



WHY NOT spend Spring, Summer and Fall gathering butterflies and insects? I buy hundreds of kinds for collections. Some worth \$1 to \$7 each. Simple outdoor work with my instructions, pictures, price-list. Send 10 cents (not stamps) for my illustrated Prospectus before sending butterflies. MR. SINCLAIR, DEALER IN INSECTS, Dept. 6, Box 1424, San Diego, Calif.

Book on Law Free



Write today for this new book. It tells you how a law training will shorten your road to success. It also carries a vital and inspiring message to every ambitious man! Find out about the opportunities that await the law trained man. Find out how you can learn law right in your own home. No obligations. The book is absolutely FREE. Write Today—now while we are making a special reduced tuition offer. American Correspondence School of Law 3602 Michigan Ave. Dept. 1353, Chicago, Illinois

FREE BOOK TELLS HOW

NATIONAL POULTRY INSTITUTE, Dept. 411-F, Washington, D. C.

Gentlemen: I want to know more about the opportunities for me in the poultry business and about your plan for helping me make \$1,000 to \$5,000 a year and up. Send FREE book.

Name.....
Address.....

Avoid Loose Thinking— Get your facts from Nelson's

Clear vision comes from clear thinking; clear thinking can come only from accurate knowledge and accurate information. Clear thinking based upon dependable facts marks the successful man—the man of decision and action. Nelson's Loose-Leaf Encyclopaedia is a complete Reference Library, accurate, concise, authoritative. It covers the whole field of knowledge from the dawn of civilization to the present day. Fifteen minutes a day with Nelson's will enable you to think clearly, to decide promptly, to be a leader among men.

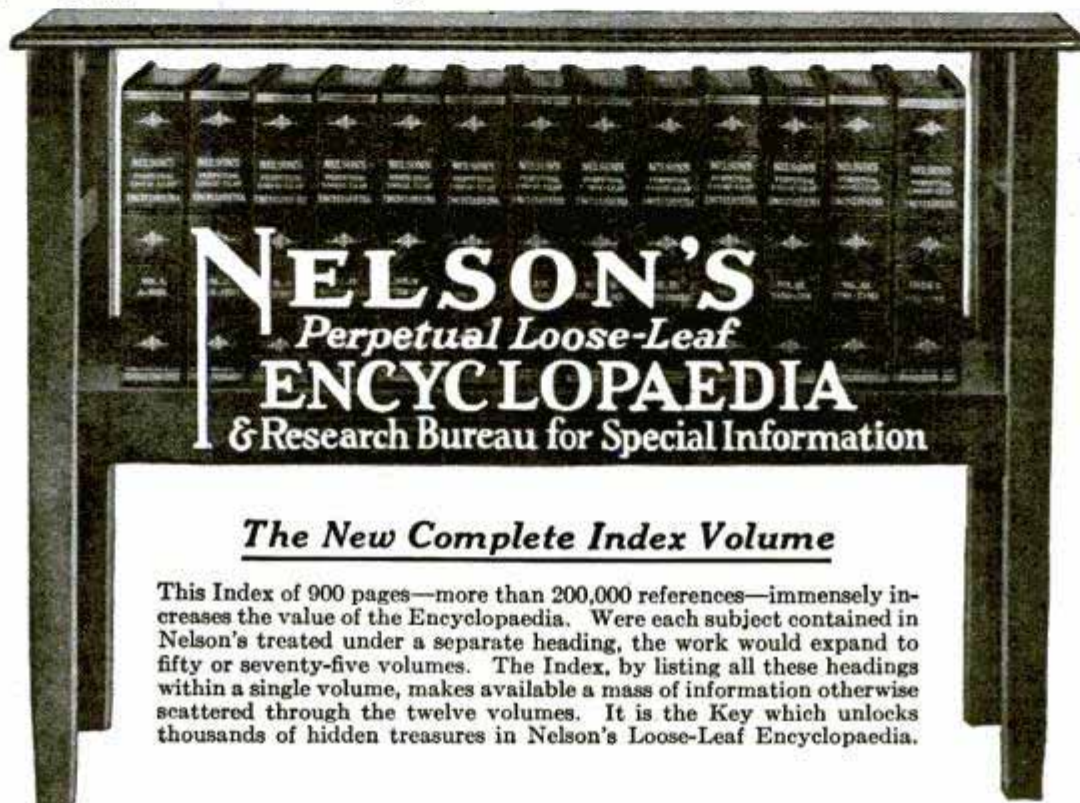

The New Complete Index Volume

This Index of 900 pages—more than 200,000 references—immensely increases the value of the Encyclopaedia. Were each subject contained in Nelson's treated under a separate heading, the work would expand to fifty or seventy-five volumes. The Index, by listing all these headings within a single volume, makes available a mass of information otherwise scattered through the twelve volumes. It is the Key which unlocks thousands of hidden treasures in Nelson's Loose-Leaf Encyclopaedia.

THE GREAT AMERICAN ENCYCLOPAEDIA

Dedicated, by permission, to

Calvin Coolidge, President of the United States

Always Down to Date Nine times out of ten, the information you want is of current issue. All Encyclopaedias, except Nelson's, are deficient in this important thing. The information which is obsolete is worse than none at all. You do not use a City Directory that is two years old. Why use an Encyclopaedia that is five or ten years old? Every six months all subscribers to NELSON'S receive their Renewal Pages—250 pages or more—between 500 and 700 pages each year—to keep NELSON'S accurate and down to date.

Nelson's FREE Research Bureau

FOR SCIENTIFIC REPORTS AND SPECIAL INFORMATION AND CORRESPONDENCE. Every purchaser of Nelson's is entitled to FREE membership in this Bureau. If at any time you are in doubt on any subject, old or new, write to this Bureau with the positive assurance that you will promptly receive the latest obtainable and most dependable information.

This Wonderful Encyclopaedia

brings you the knowledge of the centuries. It stands ready to answer any conceivable question in Aeronautics, Agriculture, Astronomy, Biography, Biology, Botany, Chemistry, Education, Electricity, Engineering, Mechanics and Machinery, Geography and Geology, History, Law, Mathematics, Medicine and Surgery, Military and Naval Science, Music, Literature and the Fine Arts, Political Science, Sociology and Economics, Religion, Sports, Technology, Manufactures.

FREE Educational Reading Courses

A Reader's Guide to Nelson's Loose-Leaf Encyclopaedia, including thirty-three (33) courses on as many subjects—from Aeronautics to Zoology—is furnished WITHOUT COST to all subscribers. These reading courses are declared by educational authorities to be equal to a college course in each of these departments.

THOMAS NELSON & SONS

Publishers Since 1798

Originators of the Loose-Leaf Reference System
P.M.M. 381 Fourth Ave., New York City

Send me, FREE, your Book of Specimen Pages with full information of your offer telling how I can own Nelson's Loose-Leaf Encyclopaedia on the Budget Small Monthly Payment Plan.

Name.....

Street.....

City..... State.....

(Adv. Copyright, 1927, by Thomas Nelson & Sons)



DRAWING is a way to FORTUNE

ALI HAFED, a Persian farmer, sold his acres to go out and seek his fortune. He who bought the farm found it contained a diamond mine which made him fabulously rich. Ali Hafed overlooked the great opportunity at his door to go far afield in search of wealth—which illustrates a great truth.

Do You Like to Draw?

If you do, it is almost certain that you have talent, a talent which few possess. Then don't follow Ali Hafed's example and look further for fortune. Develop your talent—your fortune lies in your hand!

Earn \$200 to \$500 a Month and More

Present splendid opportunities in the field of illustrating never excelled. Publishers buy millions of dollars' worth of illustrations every year. Illustrating is the highest type of art and it is fascinating as well as profitable.

The Federal Course includes illustrating, cartooning, lettering, poster designing, window card illustrating, etc. No one artist is competent to give instruction in all these branches. That's why the Federal School has established its "Master Course," in which every subject is written by a specialist. No other School can offer a course nearly comparable. No other institution in the country has such an array of artists as are on the Federal Staff.

Federal Course Gets Results

Its authors include such nationally known artists as Sid Smith, Neysa McMein, Fontaine Fox, Charles Livingston Bull, Clare Briggs, Norman Rockwell and over fifty others. Exclusive lessons and drawings especially prepared by them are included in the Federal Home Study Course. They guide you from simple sketches to complex illustrations having a high market value.

Mail in the coupon below today and we will send you our free illustrated booklet, "A Road to Bigger Things."



Federal School of Illustrating

Federal School of Illustrating,
3137 Federal School Bldg., Minneapolis, Minn.

Name.....Age.....

Occupation.....

Address.....

.....

ELECTRICITY LEARN IN 12 WEEKS

Finlay method of practical Electrical instruction (now in 24th successful year) prepares you for big paying position in 12 short weeks. Learn by doing actual electrical work. **Double and Triple your income.** Send at once for free Finlay catalog and full details regarding this wonderful business. Enroll any time. Completely equipped shops and laboratories. Faculty of highly trained experts. Certificates awarded. Students assisted to positions. Success can be yours. Write today and get the facts. Ask about One and Two-Year Courses.

FINLAY ENGINEERING COLLEGE
117 Finlay Building KANSAS CITY, MO.

Anyone CAN LEARN

No talent or experience necessary. Fascinating work. Pays big money. Complete instruction book tells about: Alphabets, Colors, How to Mix Paints, Show Cards, Window Board and Wall Signs, Ready made letters, Gilding, Tricks of the Trade, also gives 100 Alphabets and Designs. Book bound in flexible imt. leather-gold edges, and four half bearing Show Card Pens. Sent postpaid \$3.00. (C.O.D. \$1.10 ex. Ogilvie Pub. Co., 57 Ross St. Dept 20; N.Y. City

**EARN MONEY IMMEDIATELY—
WE FURNISH EQUIPMENT TO START!!**

LEARN WATCH REPAIRING

Be a watchmaker—you can learn this profitable trade by correspondence in a few weeks in your own home by the DeSelms Chart System. After you complete the course you will know a watch from A to Z. You will know just what the matter is and how to repair one. When you graduate you will be a practical watchmaker and repairer and competent to fill any position. Positions for our graduates. Ask for our Free Book. It explains our system and terms.

THE DeSELMS WATCH SCHOOL
LOGANSPORT, INDIANA



Welding

Become a Welding Expert! Then earn top wages or go into business for yourself. We train you at Home, in your Shop, or on the Job. "Kerr's Training Course for Welders" is a thorough course in practical experience, covering all metals. It trains you in WHAT TO DO and HOW TO DO IT. Write at once for terms and enrollment card. (State if you have the use of a welding outfit.)

KERR'S WELDING SCHOOL Dept. 2, 752 N. Broadway
LOS ANGELES, CALIF.

MEN WANTED

TO LEARN

Motion Picture Projection

\$2,000 to \$4,000 a Year

Quickly learned. Short hours, big pay. Best equipped school in Michigan. Projectionists for Movie Houses and Road Shows.

MOVIE OPERATORS SCHOOL
61 Sproat Street, DETROIT, MICHIGAN

FOREST RANGERS

Men wanting forest ranger, mail clerk, or other government positions, write for particulars.

MOKANE, 236, DENVER, COLO.

BIG VALUE FOR 10 CTS.

6 songs, words and music; 25 Pictures Pretty Girls; 40 Ways to Make Money; 1 Joke Book; 1 Book on Love; 1 Magic Book; 1 Book Letter Writing; 1 Dream Book and Fortune Teller; 1 Cook Book; 1 Base Ball Book, gives rules for games; 1 Toy Maker Book; Language of Flowers; 1 Morse Telegraph Alphabet; 12 Chemical Experiments; Magic Age Table; Great North Pole Game; 100 Conundrums; 3 Puzzles; 12 Games; 30 Verses for Autograph Albums. All the above by mail for 10 cents, and 2 cents postage.

ROYAL SALES CO., Desk 319, Norwalk, Conn.





Suddenly I Broke Away and Held Them Spellbound

As I review that tense dramatic moment when I electrified that meeting, it all seems strange and weird to me. How had I changed so miraculously in three months from a shy, diffident "yes" man to a dynamic, vigorous he-man? How had I ever dared give my opinion? Three months before nobody ever knew I held opinions!

ALL my life I had been cursed with a shy, timid, self-conscious nature. With only a grammar school education I could never express ideas in a coherent, self-confident way. But one day my eye fell upon a newspaper article which told about a wonderful free book entitled "How to Work Wonders with Words,"—a book that was causing widespread comment from coast to coast—a book that was being read not only by millionaires, but by thousands of others. It discussed men like me and explained how we could overcome our handicaps.

At first I was skeptical. I thought these defects were a part of my natural makeup—that I would never be able to overcome them. But some subtle instinct kept prodding me to send for that free book. I lost no time in sending for it, as I was positively amazed at being able to get cost free a book that made absolutely plain the secrets that most successful men have used to win popularity, distinction, money and success.

As the weeks wore on, and I absorbed the principles of this remarkable method, I became conscious of new physical and mental energy, a new feeling of aggressiveness, and a resurrected personal power that I never dreamed I possessed. Then came that day in the general meeting when the president called on the assembled department heads and assistants for suggestions on the proposed new policy.

Three months previously, the forces of indecision, timidity, and inability to talk in public would have held me to my seat. But suddenly that new power took possession of me and drove me to my feet. That wonderful 15-minute daily training at home had taught me to forget myself and think only of my subject. Almost automatically the ideas which had heretofore lain dormant in a mental jumble, now issued with a vigor, clearness and enthusiasm that astounded me no less than my

boss and associates. And I noticed with silent exultation the rapt, intent look on my audience as my story unfolded itself smoothly and eloquently.

To-day the men whom I used to greet deferentially I now meet with an air of cool equality. I am asked to conferences, luncheons, banquets, etc., as a popular after-dinner speaker. And my talents are not confined to business matters but have made me an interesting conversationalist at social affairs. I am meeting worth-while people, I own a good job, a good home, a good car. I am the happiest man that ever lived.

And I frankly and candidly admit that I owe all of these blessings to that wonderful little free book "How to Work Wonders with Words."

Send for This Amazing Book

This new method of training is fully described in a very interesting and informative booklet which is now being sent to everyone mailing the coupon below. This book is called "How to Work Wonders with

**Now Sent
FREE**



Words." You are told how to bring out and develop your priceless "hidden knack"—the natural gift within you—which will win for you advancement in position and salary, popularity, social standing, power and real success. You can obtain your copy absolutely free by sending the coupon.

North American Institute,
3601 Michigan Ave., Dept. 1353
Chicago, Illinois

NORTH AMERICAN INSTITUTE
3601 Michigan Ave., Dept. 1353, Chicago, Illinois.

Please send me FREE and without obligation my copy of your famous book "How to Work Wonders with Words."

Name.....

Address.....

City..... State.....

WHAT 15 MINUTES A DAY WILL SHOW YOU

- How to talk before your club or lodge
- How to address board meetings
- How to propose and respond to toasts
- How to make a political speech
- How to tell entertaining stories
- How to make after-dinner speeches
- How to converse interestingly
- How to write better letters
- How to sell more goods
- How to train your memory
- How to enlarge your vocabulary
- How to develop self-confidence
- How to acquire a winning personality
- How to strengthen your will-power and ambition
- How to become a clear, accurate thinker
- How to develop your power of concentration
- How to be the master of any situation



High School Course in Two Years!

You Want to Earn Big Money!

And you will not be satisfied unless you earn steady promotion. But are you prepared for the job ahead of you? Do you measure up to the standard that insures success? For a more responsible position a fairly good education is necessary. To write a sensible business letter, to prepare estimates, to figure cost and to compute interest, you must have a certain amount of preparation. All this you must be able to do before you will earn promotion. Many business houses hire no men whose general knowledge is not equal to a high school course. Why? Because big business refuses to burden itself with men who are barred from promotion by the lack of elementary education.

Can You Qualify for a Better Position

We have a plan whereby you can. We can give you a complete but simplified high school course in two years, giving you all the essentials that form the foundation of practical business. It will prepare you to hold your own where competition is keen and exacting. Do not doubt your ability, but make up your mind to it and you will soon have the requirements that will bring you success and big money. **YOU CAN DO IT.**

Let us show you how to get on the road to success. It will not cost you a single working hour. Write today. It costs you nothing but a stamp.

American School

Dept. H-374, Drexel Ave. and 58th St., Chicago

American School

Dept. H-374, Drexel Ave. and 58th St., Chicago

Send me full information on the subject checked and how you will help me win success.

- | | |
|------------------------------|----------------------------|
| Architect | Business Law |
| Building Contractor | Lawyer |
| Automobile Engineer | Machine Shop Practice |
| Automobile Repairman | Mechanical Engineer |
| Civil Engineer | Shop Superintendent |
| Structural Engineer | Employment Manager |
| Business Manager | Steam Engineer |
| Cert. Public Accountant | Foremanship |
| Accountant and Auditor | Sanitary Engineer |
| Bookkeeper | Surveyor (& Mapping) |
| Draftsman and Designer | Telephone Engineer |
| Electrical Engineer | Telegraph Engineer |
| Electric Light & Power | High School Graduate |
| General Education | Wireless Radio |
| Vocational Guidance | Undecided |

Name.....
Address

PREPARE FOR AN ART CAREER

—thru the only school operated as a department of a large art organization. Commercial Artists trained the "Meyer Both Way" earn as high as \$10,000 per year. We today have hundreds of students who had previously studied art elsewhere. Why? Because your instruction is based upon our everyday experience in meeting the art needs of leading advertisers. Home study instruction. Write for illustrated book telling of the success of our students.

MEYER BOTH COMPANY
Michigan Ave. at 20th St., Dept. 16, Chicago, Ill.



LEARN FRENCH ON YOUR PHONOGRAPH

New Conversational Method evolved in Europe and just introduced in America by the I. C. S. School of Languages. Endorsed by French Embassy. You learn French as if you were living in France. Records fit any phonograph.

Write to-day for descriptive booklet

INTERNATIONAL CORRESPONDENCE SCHOOLS
Box 5640-E, Scranton, Penna.

Write and Speak MASTERLY ENGLISH



Learn correct English with Sherwin Cody's new invention. No rules to memorize. Like a fascinating game. Spare-time study, 15 minutes each day, quickly gives you masterly command of English. Interesting booklet sent free. Write today. Sherwin Cody School of English, 53 Searle Building, Rochester, N. Y.

MINSTRELS Musical Comedies and Reviews, with full instructions for staging. You can stage your own show with our books. Full line of plays, stage songs, crossfire, monologues, afterpieces, vaudeville acts and make-up. **CATALOGUE FREE**
T. S. DENISON & CO., 623 So. Wabash, Dept. 19, CHICAGO

LEARN PHOTO-ENGRAVING

Earn \$200 to \$500 monthly. Photo-Engraving and Photography taught by largest college of its kind in the world. Established 1893. Big demand for graduates. **Write for free book.** Illinois College of Photography, Box 437, Effingham, Ill.

Skin Troubles

Cleared up—often in 24 hours. To prove you can be rid of Pimples, Blackheads, Acne Eruptions on the face or body, Barbers' Itch, Eczema, Enlarged Pores, Oily or Shiny Skin, simply send me your name and address today—no cost—no obligation. **CLEAR-TONE** tried and tested in over 100,000 cases—used like toilet water—is simply magical in prompt results. You can repay the favor by telling your friends; if not, the loss is mine. **WRITE TODAY.** **E. S. GIVENS, 428 Chemical Bldg., Kansas City, Mo.**



Never Lonely Now!

Since I Found This Quick Easy Way to Play The Piano - Without a Teacher!

LESS than a year ago I was friendless, lonely, unhappy. Then came the amazing event that changed my whole life. Suddenly I found myself with hosts of friends—the life of every party. I was popular everywhere!

Here's how it happened! Somehow I've never had the knack of making friends. I was never noticed at a party. But I had nothing to offer! No musical ability—no gift of wit—nothing to entertain others. So I was left to dreaded solitude.

One night my spirits were at their lowest ebb. I could stand it no longer. Anything was better than that lonely room. I wandered out into the deserted streets.

Suddenly the sound of jazz and happy laughter caught my ear. Through the open window I could see the party.

Everything seemed to center around the young man playing the piano—Tom Buchanan. How I envied him! He had all the things I longed for—but didn't have! I was just an outsider.

All the way home I kept thinking of that scene through the window. The next evening I dropped in to see Tom. He greeted me cordially and to amuse me he played the piano. When he had finished, I said enviously:

"Tom, I would give anything to play the piano like that. I wish I had had a teacher when I was a kid—like you!"

Tom smiled and said, "Dick, I never had a teacher in my life! In fact, not so long ago, I couldn't play a note."

"Impossible," I exclaimed. "How did you do it?"

The New Way to Learn Music

Then he told me about a wonderful new short-cut method of learning music that had been perfected by the U. S. School of Music. No teacher, no weary scales and tiresome hours of practice.

You played real music from the start. When I left Tom, it was with new hope. That very night I wrote for the Free Book and Demonstration Lesson.

Three days later they arrived. I was amazed! I never dreamed that playing the piano could be so simple—even easier than Tom had pictured it.

The course was as much fun as a game. And as the lessons continued they got easier. Although I never had any "talent" I was playing my favorites—almost before I knew it. Nothing stopped

me. I soon could play jazz, ballads, classical numbers, all with equal ease.

Then came the night that proved the turning point of my whole life. Once more I was going to a party, and this time I had something to offer.

What a moment that was when our hostess, apparently troubled, exclaimed:

"Isn't it a shame that Tom Buchanan can't be here. What will we do without someone to play the piano?"

Amazed at my confidence, I spoke up.

"I'll try to fill Tom's place—if you're not too critical."

Everyone seemed surprised. "Why, I didn't know he played!" someone behind whispered.

Quietly I sat down and ran my fingers over the keys. As I struck the first rippling chords of Nevin's lovely "Narcissus," a hush fell over the room. I could hardly believe it, but—I was holding the party spellbound.

When I finished, you should have heard them applaud! Everyone insisted I play more. Only too glad, I played piece after piece. I—who had been an outsider—was now the life of the party!

Before the evening was over, I had been invited to three more parties. Now I never have a lonesome moment. At last I am popular. And to think it was all so easy!

You, too, can learn to play your favorite instrument by this remarkable easy "at home" method that has helped almost half a million people all over the world to increased pleasure and financial gain. And there's nothing marvelous about it. It's just a common sense practical method—so simple you don't have to know the slightest thing about music. You find your progress amazingly rapid because every step is clear and easy to understand.

Free Book and Demonstration Lesson

Our wonderful illustrated free book and our free demonstration lesson explain all about this remarkable method. They prove just how any one can learn to play his favorite instrument in almost no time and for just a fraction of what old slow methods cost.

If you really want to learn to play—if new friends, good times, social popularity, and increased income appeal to you—take this opportunity to make your dreams come true. Now! Sign the coupon and send it before it's too late. Instruments supplied when needed, cash or credit. U. S. School of Music, 73 Brunswick Bldg., New York City.

U. S. SCHOOL OF MUSIC,
73 Brunswick Bldg., New York City

Please send me your free book, "Music Lessons in Your Own Home," with introduction by Dr. Frank Crane, Demonstration Lesson and particulars of your Special Offer. I am interested in the following course:

.....

Have you above instrument?.....

Name.....

Address.....

City.....State.....

PICK YOUR INSTRUMENT

- | | |
|-------------------------------------|-----------|
| Piano | Violin |
| Organ | Clarinet |
| Ukulele | Flute |
| Cornet | Saxophone |
| Trombone | Harp |
| Piccolo | Mandolin |
| Guitar | Cello |
| Hawaiian Steel Guitar | |
| Sight Singing | |
| Piano Accordion | |
| Voice and Speech Culture | |
| Harmony and Composition | |
| Drums and Traps | |
| Automatic Finger Control | |
| Banjo (Tenor, Plectrum or 5-String) | |

BOYS

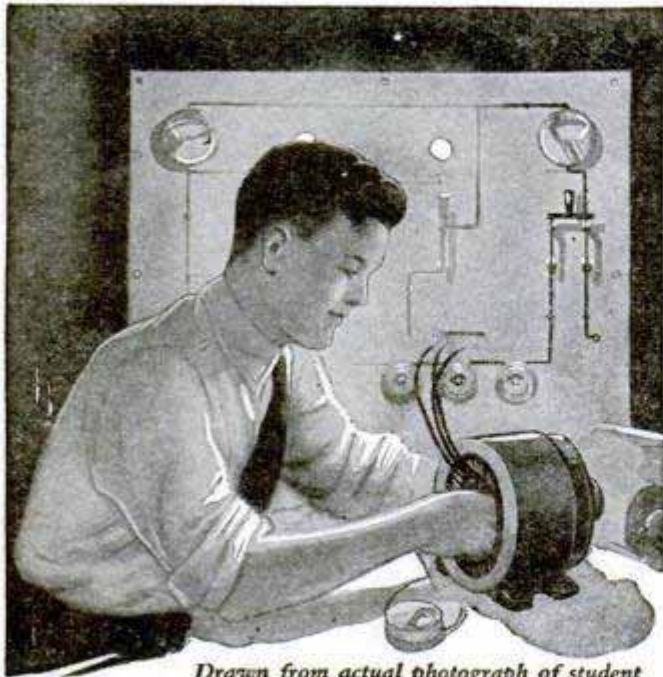

Drawn from actual photograph of student doing spare time electrical work

Learn Electricity Make Big Money

How would you like to earn two or three dollars every evening after school and prepare yourself for a fine big job at the same time? Here's the opportunity of a lifetime for you fellows who like Electricity. Begin right now to prepare yourself for a regular man's size job in this fascinating field. Your chances for a big success are simply wonderful—the pay is big (thousands of men earn \$70 to \$200 a week) and advancement comes swift and sure.

I Will Train You at Home
With my easily earned, spare time Electrical Course I will train you at home like I have trained hundreds of other boys who are now big successful men. It will not interfere with your school work and you can earn more than the small cost of the course doing odd electrical jobs in your spare time. The Course pays for itself. I will show you how to get this work and how to do it. Some of my boy students make \$10 to \$15 a week this way.

Tools, Apparatus and Radio Course
—Given Without Extra Charge

Send me the coupon below and I will tell you all about the big outfit of tools, apparatus and instruments and a new Radio Course that I am giving to my students for a limited time. I will send you my big interesting Electrical Book and a sample lesson, too—all Free. You will be tickled with the things I will send you Free. Mail the coupon right now.

L. L. COOKE, Chief Engineer
Chicago Engineering Works

Dept. O13 CHICAGO

Look What This Boy Is Doing

"Although the School term is coming to a close, and I am pretty busy with my examinations, I manage to keep up with my electrical studies and work."

"I guess I forgot to tell you I am now in business for myself. Am doing fine, but owe it all to you. If it had not been for your Course, I, being under age, could not have secured my license in this town. But I got it, and now have all the work I can do, averaging \$20 to \$30 a week, thru spare time work."

"I went out on a job tonight after school, on which I made \$3 and brought home another on which I made \$2.50—\$5.50, for 4 hours' work and no material furnished by me."
ROGERS SMITH,
1215 Chestnut St.,
Greenville, N. C.

Use This "FREE BOOK" Coupon

L. L. COOKE, Chief Engineer,
Chicago Engineering Works,
Dept. O13 2150 Lawrence Avenue, Chicago

Send me your Big Outfit Offer, your big Electrical Book, Sample Lesson and particulars of your Electrical Course and Extra Radio Course. This will not obligate me in any way.

Name.....

Address.....

This Coupon only for use of boys 15 years old or more.

RUSSELL PATTERSON



Makes a
\$150
Drawing
in a
Few Hours!

—and now teaches you his original methods in a series of 20 snappy lessons — brimful with sparkling interest from the very start — a departure from the purely conventional. This training constitutes the last word in Humorous Illustration, teaching a New Art for a New Age—a pleasant relief from the old style, standardized instruction. Learn to draw the dashing, peppy types that are all the rage as exemplified by Mr. Patterson's numerous contributions to magazines. Let him teach you his clever technique. What profession could compare with this in its irresistible appeal or sheer earning power? Write now for full information.

**Russell Patterson School of
Humorous Illustration**

Michigan Ave. at 20th St., Dept. 12
CHICAGO - - - ILLINOIS

WANT WORK AT HOME?

Earn \$18 to \$60 a week RETOUCHING photos. Men or women. No selling or canvassing. We teach you and furnish WORKING OUTFIT given with each enrollment. Limited offer. Write today.
Artercraft Studios, Dept. 50, 3900 Sheridan Rd., Chicago

A Test Every Man Past 40 Should Make

Medical authorities agree that 65% of all men past middle age (many much younger) are afflicted with a disorder of the Prostate gland. Aches in feet, legs and back, frequent nightly risings, sciatic pains, are some of the signs—and now, a member of the American Association for the Advancement of Science has written a remarkably interesting Free Book that tells of other symptoms and just what they mean. No longer should a man approaching or past the prime of life be content to regard these pains and conditions as inevitable signs of approaching age. Already more than 10,000 men have used the method described in this book to restore the prostate gland to its proper functioning. Send immediately for this book. If you will mail your request to the Electro Thermal Company, 2167 Main Street, Steubenville, Ohio—the concern that is distributing this book for the author—it will be sent to you absolutely free, without obligation. Simply send name and address. But don't delay, for the edition of this book is limited. Western Office, Suite 21-K, 303 Van Nuys Bldg., Los Angeles, Calif.

A FRANTIC CALL FOR MEN WHO CAN READ BLUE PRINTS OF BUILDINGS

Leads Quickly to Jobs Paying \$4,000 to \$12,000 a Year

See how easy it is to get in the building game. Nowhere else does such simple training count for so much. Nowhere else can a man make \$4,000 to \$12,000 a year so quickly and so easily. Nowhere else are there so many countless thousands of openings as there are with contractors, builders, and real estate firms, who are constantly calling for men who can read blue prints. Six billion dollars a year is spent for building. Trained men are at a premium in this gigantic industry. Untold thousands are needed at steady salaries far above the scale wage.

90 DAYS EASY TRAINING PUTS YOU IN THE 6 BILLION DOLLAR BUILDING FIELD

NO longer is it necessary to start at the bottom of the building trades and spend years to work up. Now you can get three years' training in three months. There are no barriers to your success in the great outdoor building field. You do not need more than a common school education. We train you at home, in spare time, by the fascinating blue-print method with lessons that are as easy to read as your newspaper.

These tested plans come to you from one of the oldest and largest schools of building construction and superintendence in the country. This course is endorsed by leading contractors and master builders. These tested, practical plans and lessons are the kind of training that puts men in \$5,000 to \$15,000 jobs and in profitable building and contracting businesses of their own. You learn from actual blue print plans—from practical building experts—you learn how to read all the plans, estimate the costs and supervise the entire construction of a building—you learn everything a contractor has to know when he undertakes the construction of a building.

Amazing opportunities are open to you when you know blue prints, plans, estimating and construction. There is building superintending—the best outdoor profession on earth—that pays handsome salaries and often a bonus for efficient work. Clifford Scholl went from clerk to Ass't. Superintendent at 49% increase in salary in 8 months. Thousands of builders and contractors need men like Clifford Scholl.

IF YOU LIVE IN OR NEAR CHICAGO

Visit our School for Builders, open day or evening. Thousand men attend each year. Enter any time. You can get the same training at home, by mail. Same plans; same lessons; same instructors. The Coupon brings all facts Free.

Every Job Must Have A Contractor

The building field is wide open for men who want to go into business for themselves. Henry Mehl, Pa., a policeman, now owns his own contracting business. Burgert, Ill., stepped into a foremanship at 200% increase in salary. Busch, Kan., writes, "I have been offered \$300 a month several times." Boyes, Can., writes, "Your school has increased my wages 40% already." Patrick, Mich., says: "My salary has been increased 92%." Marchand, La., writes, "I am getting along fine. My salary is now increased 196%."

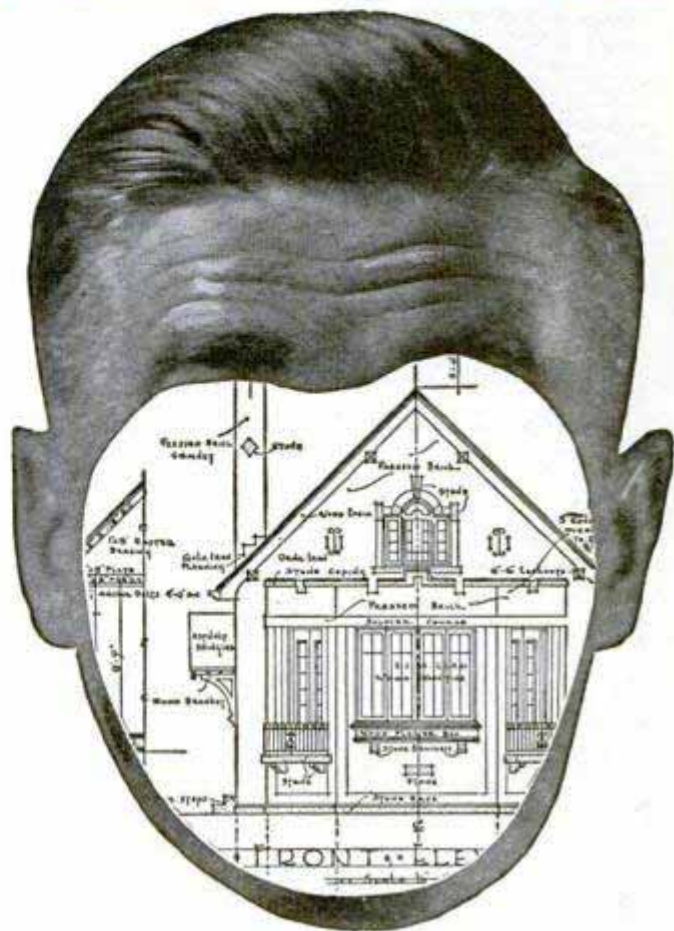

If you really want more money—if you hope to own a business of your own—get into the building business . . . no matter what your job is now. No overcrowding in this tremendous field—room for thousands every day. Why buck competition in crowded industries where only a few men can succeed?

Clerk or carpenter—office man or bricklayer—salesman or superintendent—it makes no difference. You can get into the building business quickly . . . easily. Or if you are in it at present, get this training now, that you must have for success.

FREE Trial Lesson

Simply mail the coupon below for an intensely interesting free book "How to Read Blue Prints," and full information. See what fascinating fun this first trial lesson is. Get these facts before you. See what amazing opportunities open up for you in the Six Billion Dollar Building Field. Don't wait or delay. Act now. Simply mail the coupon below.

Chicago Technical School for Builders

Dept. C-140, Chicago Tech Bldg.,
118 E. 26th St., Chicago



Chicago Technical School for Builders,
Dept. C-140, 118 E. 26th Street, Chicago, Ill.

Send me, without obligation, your free book, "How to Read Blue Prints" and full details of the course and the opportunities in the Building Field. It is understood that no salesman will call on me.

Name

Address

City State

Age Occupation



TRAVEL FOR "UNCLE SAM"

RAILWAY MAIL CLERKS

\$1900 to \$2700 a Year
Mail Coupon Before You Lose It

Steady Work—No Layoffs—Paid Vacations—Common Education Sufficient
MEN—BOYS, 18 UP—RUSH COUPON

FRANKLIN INSTITUTE, Dept. G-176, Rochester, N. Y.
 Sirs: Rush to me without charge: (1) Sample Railway Postal Clerk and City Mail Carrier coaching; (2) tell me how to get a U. S. Government job; (3) send 32 page book with list of many positions now obtainable and full particulars.
 Name -----
 Address -----

BART SUPPLIES
 Quality art materials at lowest prices. Save on everything you need. Convince yourself—send today for catalog.
 BART SUPPLIES, 427 Eastie Bldg., MINNEAPOLIS, MINN.

Big Money at Home
 Men and women—Learn wonderful *surcraft*. Quick, sure profits at home. Have a business of your own. No investment. Volume unlimited. Send Now—Free Book
 N. W. Fur Co., 1773 Sunderland Bldg., Omaha, Neb.

PATENTS

Booklet Free Highest References Promptness Assured Best Results
 Send drawing or model for preliminary examination of Patent Office records.

ALL BUSINESS GIVEN PROMPT AND PROPER ATTENTION

Listed Patent Lawyer in the latest editions of the Rand-McNally Directory of Bankers and Attorneys, of Chicago, Ill.; The Baggott & Ryall Directory of Attorneys, New York City; The Lawyers Guaranteed Directory, Detroit, Michigan; The Lawyers and Bankers Quarterly, published by the Legal Directory Publishing Company of St. Louis, Mo.; the American Lawyers Annual, Cleveland, Ohio.

WATSON E. COLEMAN, Victor Building, 724 Ninth Street, N. W.
REGISTERED PATENT LAWYER WASHINGTON, D. C.

\$20,000,000 DAILY WAGES

Paid to AUTO MECHANICS

Get your name on the payroll of America's biggest industry and be fixed for life. Auto Mechanics "who know their stuff" are in demand everywhere—never so many jobs as right now waiting for trained men to fill them. No apprenticeship. No education required. No Labor Union to join—steady work at big pay. No strikes.

Wages \$75 to \$150 Weekly
 are paid to thousands of auto experts. Others make more as owners of garages and repair shops. Write today for my remarkable special reduced tuition offer including your railroad fare. Write to my nearest School.

Learn in 8 Weeks Ten thousand men have been qualified by my practical, easy-to-learn Shop Method of teaching with real tools on real equipment. I guarantee your money back if I fail. No book study.

I Pay Your Railroad Fare TO CINCINNATI, CHICAGO OR CLEVELAND without extra charge
 My eight weeks' course is complete. No extras to pay for. This offer is limited. Save one-third while it lasts. Act promptly. Mail the coupon today. Remember "Mac" is one of the world's largest operators of Auto, Tractor and Electrical Training Schools.

Ask for My Big Book — Tells Everything

MAIL THIS COUPON FOR MY GREAT OFFER

McSWEENEY, Auto, Tractor and Electrical SCHOOLS
 Dept. 14-ZC, Cleveland, Ohio, Cincinnati, Ohio, Chicago, Ill.

Please send your Special Offer and Big FREE Illustrated Book.

Name.....
 Address.....
 City..... State.....

McSWEENEY SCHOOLS
 Auto, Tractor and Electrical
 Dept. 14-ZC
 Cleveland, O. Cincinnati, O. Chicago, Ill.

AUDELS ENGINEERS & MECHANICS GUIDES

EXAMINE FREE!



\$12
Complete Set
8 Guides

For Every

**Engineer
Mechanic**

**Machinist
Electrician**

**Fireman; Oiler
Engineer Student**

THIS Master Set is a gold mine of daily, practical helps for workers in every branch of engineering. A self-educating study course for the student; the standard reference work for the chief. Thousands of rules, tables, calculations and diagrams make it easy to read and learn. Latest inside information on theory and practice of modern engineering for reference study and review. Thousands of new short-cuts that make the job easier. Examine free! Pay \$1 a month (less than 4c a day) if satisfied that this set will help you to a better job—or make your present job easier.

AUDELS STANDARD LIBRARY

With Questions and Answers That Solve Your Problems

EASY TERMS

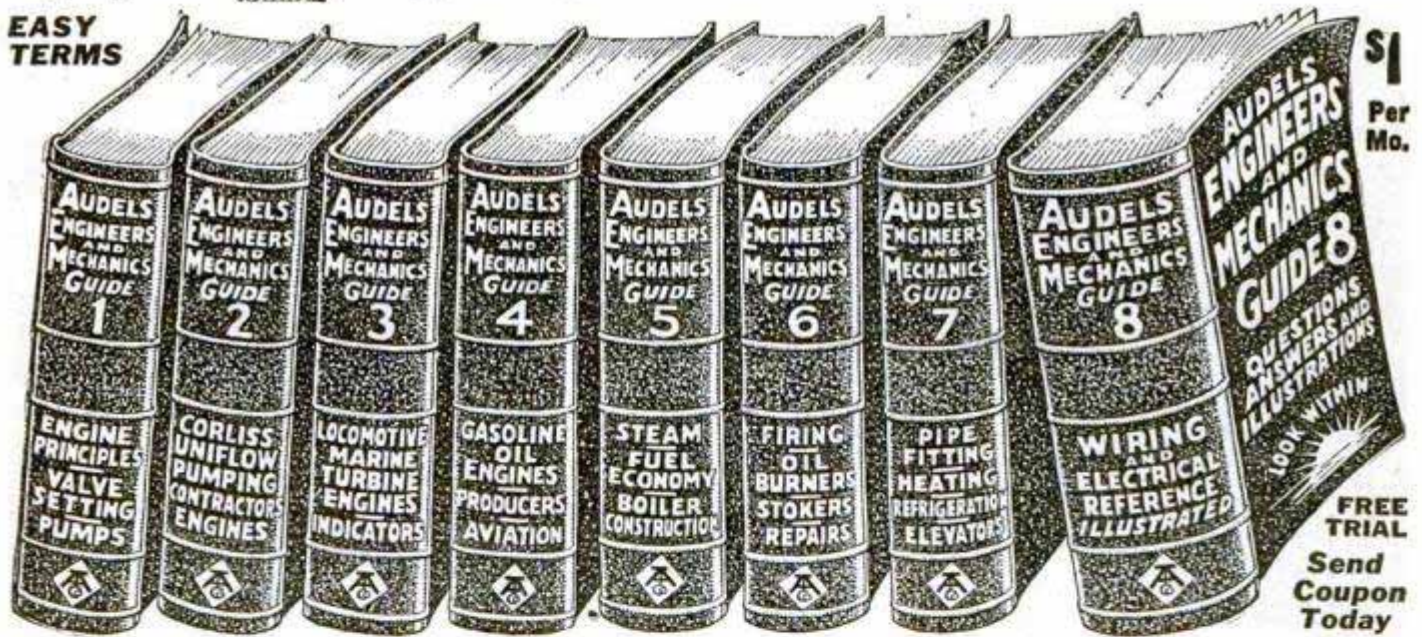

8 GUIDES—8754 PAGES—4750 ILLUSTRATIONS—POCKET SIZE

8 pocket numbers with Ready Reference Index. 8754 pages. 4750 illustrations. Easy to read. Highly endorsed. A good help in securing Engineer's License. Price \$12; terms, \$1 per month. Free Trial.

INFORMATION: — In A Handy Form. Answers to Your Questions and Problems. Here is a partial list of the subjects covered:—**Engine Principles, Valve Setting, Pumps, Corliss Engines, Uniflow Engines, Pumping Engines, Contractors Engines, Locomotives, Marine Engines, Turbine Engines, Gas Engines, Oil Engines, Indicators, Producers, Aviation, Steam, Fuel Economy, Boiler Construction, Firing, Oil Burners, Stokers, Boiler Repairs, Pipe Fitting, Heating, Refrigeration, Elevators, Dynamos, Motors, Lighting, Wiring, Electrical Diagrams, Radio, Electrical Reference and Calculations.**

FREE BOOK—FOR LIMITED TIME.



While the edition lasts, "Audel's Answers" will be included with each set of Audel's Guides. Contains special information for those who want to go before the board to get a license. Makes Engineers exams. easy. Send this coupon at once.

THEO. AUDEL & CO., 65 West 23rd St., New York City.

Send me AUDELS ENGINEERS AND MECHANICS GUIDES, 8 numbers, \$12 and "Audel's Answers" for free examination. If satisfactory, I will send you \$1 in 7 days, then \$1 monthly until \$12 is paid.

Name

Address

Occupation

Employed by

CHEMISTRY



THE Chemical Industry now ranks fourth among the industries of the United States and it offers a splendid opportunity for ambitious men.

Arthur D. Little emphasized this very point in his speech before the American Institute of Chemical Engineers when he said: "Industrial developments along new lines are everywhere in progress and they call upon the chemical engineer for new equipment and new methods of production and control."

One of the best ways for you to prepare for a good position in this fascinating field is through the home-study courses in Chemistry offered by the International Correspondence Schools.

These courses are complete and practical because they were prepared by some of the best-known chemists in this country, including:

ALLEN ROGERS, B.S., M.S., Ph.D.—Head of Department of Industrial Chemistry, Pratt Institute.

ANDREW M. FAIRLIE, B.S.—Consulting Chemical Engineer for the Tennessee Copper and Chemical Corporation; American Zinc, Lead and Smelting Co.; American Zinc Oxide Co., and the Baugh Chemical Co.

L. M. TOLMAN, Ph.D.—Formerly Chief Chemist, Wilson & Co. Now Vice-president, United Chemical and Organic Products Co.

BRADLEY STOUGHTON, B.S.—Head of the Department of Metallurgy, Lehigh University.

OWEN L. SHINN, Ph.D.—Professor of Applied Chemistry, University of Pennsylvania.

Qualitative and Quantitative Analyses Outfits are supplied with these I. C. S. Courses at special prices for your laboratory work at home, and the courses are so arranged that you get just the help you need to secure a good position in the work you like best.

Just mark and mail the coupon and we'll gladly send you Free Booklets describing the I. C. S. CHEMISTRY COURSES or any other course in which you are interested.

Mail the Coupon for Free Booklet

INTERNATIONAL CORRESPONDENCE SCHOOLS
Box 5635-E, Scranton, Penna.

Without cost or obligation, please send me one of your booklets, and tell me how I can qualify for the position or in the subject before which I have marked an X:

- | | |
|--|--|
| <input type="checkbox"/> Analytical Chemistry | <input type="checkbox"/> Analytical and Industrial Chemistry |
| <input type="checkbox"/> Chemical Engineering | <input type="checkbox"/> Short Chemistry Course |
| <input type="checkbox"/> Industrial Chemistry | <input type="checkbox"/> Pharmacy |
| <input type="checkbox"/> Metallurgical Chemistry | |

Also courses specializing in the Chemistry of the following industries

- | | |
|--|--|
| <input type="checkbox"/> Manufacture of Leather | <input type="checkbox"/> Manufacture of Iron |
| <input type="checkbox"/> Manufacture of Cottonseed Oil | <input type="checkbox"/> Manufacture of Steel |
| <input type="checkbox"/> Manufacture of Petroleum | <input type="checkbox"/> Manufacture of Sugar |
| <input type="checkbox"/> Manufacture of Sulphuric and Hydrochloric Acids | <input type="checkbox"/> Manufacture of Soap |
| | <input type="checkbox"/> Manufacture of Cement |

- | | |
|---|---|
| <input type="checkbox"/> Electrical Engineering | <input type="checkbox"/> Steam Engineering |
| <input type="checkbox"/> Electric Lighting | <input type="checkbox"/> Architect <input type="checkbox"/> Radio |
| <input type="checkbox"/> Mechanical Engineer | <input type="checkbox"/> Architects' Blueprints |
| <input type="checkbox"/> Mechanical Draftsman | <input type="checkbox"/> Contractor and Builder |
| <input type="checkbox"/> Machine Shop Practices | <input type="checkbox"/> Architectural Draftsman |
| <input type="checkbox"/> Railroad Positions | <input type="checkbox"/> Concrete Builder |
| <input type="checkbox"/> Civil Engineer | <input type="checkbox"/> Structural Engineer |
| <input type="checkbox"/> Surveying and Mapping | <input type="checkbox"/> Airplane Engines |
| <input type="checkbox"/> Metallurgy <input type="checkbox"/> Mining | <input type="checkbox"/> Mathematics |

Name.....

Street Address.....

City.....State.....

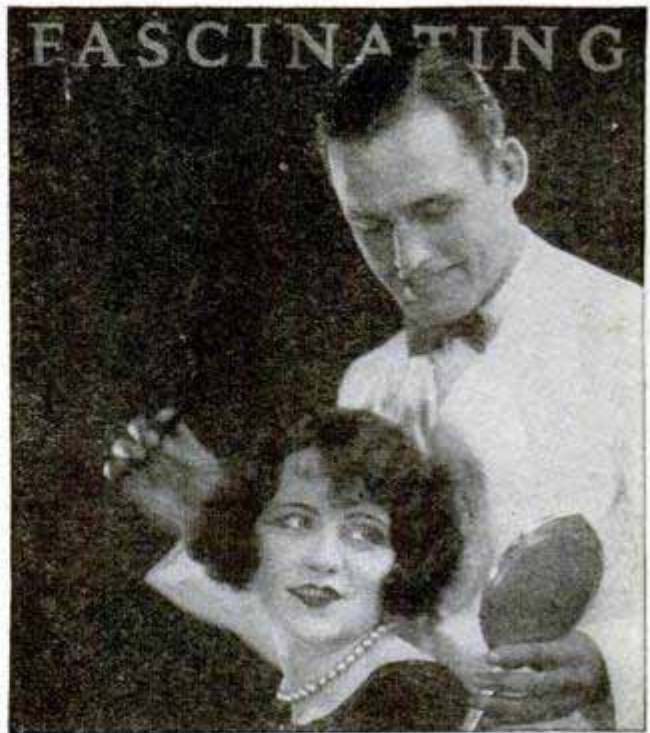

Ladies' Patronage has made BARBERING one of the splendid paying professions of the day. 60,000 MOLER GRADUATES know MODERN BARBERING IS EASY TO LEARN—QUICK TO EARN—CLEAN and FASCINATING. Write for catalog B-3.

Address the Branch of the MOLER SYSTEM OF COLLEGES nearest you. (Street address not needed)

- | | | |
|------------------|------------------|--------------------|
| Chicago, Ill. | Detroit, Mich. | Memphis, Tenn. |
| New York, N. Y. | Denver, Colo. | Dallas, Tex. |
| St. Louis, Mo. | New Orleans, La. | Houston, Tex. |
| Kansas City, Mo. | Omaha, Nebr. | San Antonio, Tex. |
| Cincinnati, Ohio | Milwaukee, Wis. | Toronto, Ont., Can |
| Cleveland, Ohio | Atlanta, Ga. | |

Comedies, Dramas, Musical Comedies and Revues, Minstrel Choruses, Songs, Blackface plays. Everything for Burnt Cork Shows and All Amateur Entertainments. Monologs, Dialogs, Speakers. **PLAYS** Vaudeville Acts How to Stage a Play Make-up Goods CATALOGUE FREE T. S. DENISON & CO., 623 So. Wabash, Dept. 9, CHICAGO



Wonderful, new device, guides your hand; correct your writing in few days. Big improvement in three hours. No failures. Complete outline FREE. Write C. J. Ozment, D-34, St. Louis, Mo.

DON'T WEAR A TRUSS

BE COMFORTABLE—

Wear the Brooks Appliance, the modern scientific invention which gives rupture sufferers immediate relief. It has no obnoxious springs or pads. Automatic Air Cushions bind and draw together the broken parts. No salves or plasters. Durable. Cheap. Sent on trial to prove its worth. Beware of imitations. Look for trade-mark bearing portrait and signature of C. E. Brooks which appears on every Appliance. None other genuine. Full information and booklet sent free in plain, sealed envelope.



MR. C. E. BROOKS

BROOKS APPLIANCE CO., 107 State St., Marshall, Mich.



Be The Life of Any Party!

LEARN TENOR BANJO

Now you can have the joy of being your own musical self—the thrill of popularity—new friends—happier evenings—more money-making opportunities—if you wish. You can be admired and wanted everywhere, counted in on every party, because you are a clever entertainer on America's most popular instrument—the Tenor Banjo.

For the first time in the history of my long playing career—five years with Isham Jones' Recording Orchestra—I am now in position to offer you my famous Home Study Tenor Banjo Course. I call it "The Key to Successful Banjo Playing." It is my Course—compiled after years of study and experience with the tenor banjo—the instrument I helped to develop. I am now using this Course successfully in my school, the Chicago Tenor Banjo Institute, and am training beginners, advance students, and professional artists, to reach new heights of popularity and bigger pay jobs.

Easy to Play the McNeil Way

This course can now be yours. Just as if I were sitting at your elbow teaching you the correct finger positions—melody, chords, harmony, etc., etc. My Course is a personalized "A-to-Z" Course. It includes everything you will ever want to know about Tenor Banjo playing. An added feature to help you is the phonograph record—played by myself, illustrating breaks, jazz strokes, etc., etc.

Be the Life of Any Party!

If you are really eager to learn to play, if you honestly yearn for popularity and increased income, then act now. Write today for free booklet and details.

Charles McNeil, Studio Director,
CHICAGO BANJO INSTITUTE
 Dept. 1353, 3345 N. Lincoln St., Chicago, Ill.

Mr. Charles McNeil, Studio Director,
 Chicago Banjo Institute,
 Dept. 1353, 3345 N. Lincoln St., Chicago.

Dear Sir: I would like to find out more about your Home Study Tenor Banjo Course. Without obligation, please send me literature and full information.

Name.....
 Address.....
 City.....State.....

YOU ARE NEEDED IN TRAFFIC INSPECTION



EARN UP TO
\$250 PER MONTH
 Salary and Expenses

I need many men to fill important positions in this fascinating and profitable railway work, sometimes called Traffic Observation. You'll be away from office or shop and practically your own boss—seeing new sights and places every minute. It's healthful, dignified work where you report only to high officials and are rapidly advanced.

No Previous Experience Necessary

For eight years, I have trained men for Traffic Inspection, and upon completion of 3 months' spare time, home study course placed them in good positions. Any man of normal intelligence can qualify, regardless of previous training. I will train you on the same basis, and upon completion assist you to a position paying at least \$120 per month salary plus expenses—or refund your money.

Traffic Inspection appeals to live men. It gives variety, independence and opportunity—gets them away from monotonous desk and dirty shop—gives them a chance to "be somebody."

Let me show you what Traffic Inspection holds for you. Send coupon today.

James T. Jarrel, Pres., Div. 2, Standard Business Training Inst., Buffalo, N. Y.

Standard Business Training Inst.,
 Division No. 2, Buffalo, N. Y.

Yes, I'd like to know something about Traffic Inspection. Send me your free booklet "A Profession of Protection."

Name.....
 Address.....

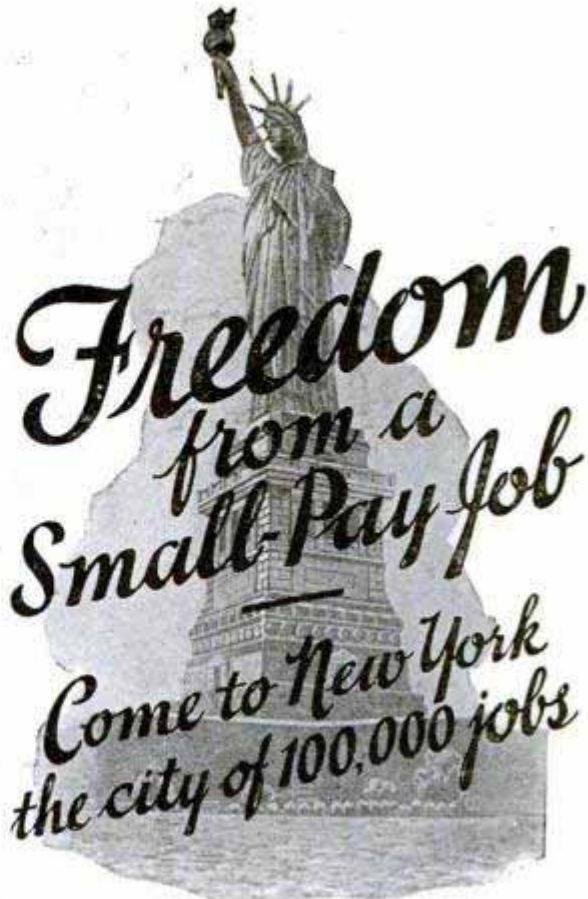

ANY MAN who can read and write and use a pair of pliers can become an electrical expert and free himself forever from the long hours and drudgery of a small pay job.

And you can learn the BIG PAY profession of electricity right in New York City—the heart of the electrical world—the city of 100,000 jobs. At the same time you are learning the BIG PAY profession you can be enjoying the sights and wonders of New York, the modern Bagdad.

Be An Electrical Expert

Graduates of the NEW YORK ELECTRICAL SCHOOL are in demand by all the big electrical companies. Or, if you prefer the independence of a business of your own, there are thousands of opportunities for efficient, dependable men to become electrical contractors. When you are your own boss the money you can make is limited only by your own energy and ability.

Personal Instruction

The NEW YORK ELECTRICAL SCHOOL is not a correspondence school. You learn by doing—by personal instruction on full size standard electrical equipment under the personal supervision of trained instructors.

At N. Y. E. S. you train your hands and mind at the same time. You learn the theories of electricity—and then you are shown how to put the theories into actual practice by solving the problems with your own hands.

The man who has learned electricity by actually doing electrical work under intelligent personal instructors can go to any part of the world and be sure of a good living. There are N. Y. E. S. graduates in all the countries of the world.

Write today for the 48-page booklet giving full information about the N. Y. E. S. Course and showing pictures of the equipment available for your personal use in our two seven-story buildings. Mail coupon now! The New York Electrical School, 44 W. 17th Street, New York.

The New York Electrical School
 44 W. 17th Street, New York

Please send me FREE your 48-page booklet. It is understood that this request puts me under no obligation.

Name.....
 Address.....

O. C.
MILLER

Director
Extension
Work
American
School



The American School

A million Dollar *No-Profit* Educational Institution, now offers men a *double service*—training for a specific job, then help in finding the job. For one small price, on terms of only \$5.00 a month, you are now assured of definite benefits, both in position and salary. Write for complete information—*today!*

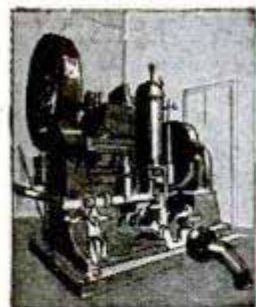

No machine can be built until the Draftsman first builds it on paper. My training prepares you for this work.



Never has the world seen anything like the building boom of today. This has created enormous demand for real Draftsmen.

5 BIG-PAY Branches

The big money in Drafting goes to men who specialize in Machine Design, or Electrical Drafting, or Architectural Drafting, or Structural, or Automotive. It is not enough merely to know general Drafting practice. You must know how to calculate and design and plan original work. You need many Engineering subjects to fill the kind of a Drafting position that pays \$60 to \$125 a week. The American School now includes this specialized training in its Drafting course.

Costly Drafting Outfit Given!

Fine, imported instruments like these help you learn Drafting quickly and easily. These standard quality, full size instruments, board, table, triangles, T square, ink, protractor, etc., given to every student without extra cost.

O. C. Miller, Director Extension Work

The American School

Drafting

to prove you can

We have invented a new, simplified way to teach Drafting—the first real improvement in Drafting home instruction in history. We want you to see a few of these new Job-lessons, try them, test your own ability to master them—without one penny of cost or obligation. For instance, you will see how we get away from the “copying” methods used in the past, so you develop into a DRAFTSMAN, instead of a “tracer.” See for yourself the ingenious new method which compels you to think, to solve problems, to do actual Drafting-room jobs from the very first lesson!

A New, Rapid, Simplified Training

Copying drafting lessons prepares you to be only a “tracer.” This new “Job-Method” gives you actual drafting-room jobs in a new one-step-at-a-time way. With pictures which you can understand almost without reading the “lessons.” And that is why the American School-trained Draftsmen can qualify for a good job at big pay when they graduate.

Win Success Thru Drafting

Drafting is easy, fascinating work. Short hours. Big pay. And the Draftsman is always in line for promotion to executive positions. This training is complete. It includes high school subjects (if you need them) and all the Engineering and Mathematics Drafting experts require.



FREE Job Service!

The American School now offers its students and graduates, without cost, the services of an efficient employment department keeping in constant touch with employers of Draftsmen all over the U. S. We have placed hundreds of men in good, big-pay Drafting positions. We've made this training so complete, so practical, so easy to master, that our students are bound to make good. And so, because the demand for real Draftsmen continues to exceed the supply and because this training actually prepares men for good Drafting positions we back it with a Free Employment Service.

Dept. D-374
Drexel Avenue and
58th St., CHICAGO

Lessons *Actually* FREE

learn at home in spare time!
Draftsmen Wanted!
\$60 to \$125 a Week!

yourself. Plan your future in Drafting. Even if you have only common schooling, even if you know nothing of Drafting, we guarantee to make you a real Draftsman or to refund your money! Special surprise offer right now to the first 500 men who answer this ad—reduced price, easy terms. Coupon brings complete information.

70,000 fine jobs advertised last year. Get ready to fill one. Get out of the rut. Make something of

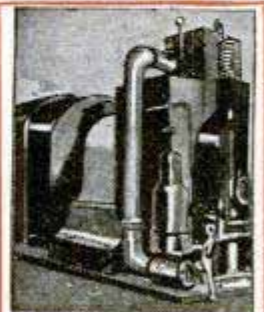

Electricity needs Draftsmen who know Electrical principles as well as general Drafting practice. I give you this training.



The demand for Draftsmen experienced in concrete and structural steel work is enormous. Many big-pay positions open.



Every great Auto factory employs Draftsmen who specialize in Automotive work—men who design bodies, plan engines, etc.

I Will Make This Contract With You



American School
 —the Million Dollar
 Educational Institution



WHEN you enroll for our home-training in Drafting, we agree to give you:

1. Complete Drafting training, by the new Practice-Method.
2. Professional Drafting Outfit, as illustrated.
3. We will help you get a good Drafting position at a substantial increase in pay,

4. or we'll refund every cent of your money.

O. C. Miller
 Director Extension Work

Coupon Brings 3 Lessons FREE!

Get them. Test your own ability to learn Drafting and get ready for a fine job and big pay.

Coupon also brings surprise offer, and complete information about your opportunities for success in Drafting. *Mail It Today!*

Read These Letters!

City of Chicago
 Department of Buildings
 Gentlemen: The same day I received my diploma I got word that I was one of the two candidates who had successfully passed the examination for Deputy Commissioner of Buildings of the City of Chicago, a position paying \$3600 per year.

There were eight applicants examined besides myself, all men well known to the architectural and engineering profession. Seven of these failed to obtain a passing grade of 70%. My grade was 84.69.

Inasmuch as I failed to pass this same examination three years before, my present success is mainly due to the knowledge gained through your School.

Yours very truly,
ROBERT KNIGHT

Got His Draftsman's Job

"I wanted to let you know how I came out in getting that job at the Brownell Co., Dayton, Ohio. I was to start and have a trial at Drawing, and I am still in the Drawing room. The engineer seems to like the work I make, and also the other draftsmen. I thank the School very much for getting me in at this place, because your letter of recommendation helped me a whole lot to get the job."

BERNARD WEBER,
 730 St. Nicholas Ave., Dayton, O.

Liberty High School
 Bethlehem, Pa.

Dear Sirs:—This is to thank the American School for all that you have done for me since I signed up for the Drafting and Design Course.

In the eight years since then, I have gradually climbed from the position of tracer to that of Head of the Department of Machine Drawing and Design in our magnificent new \$2,000,000 High School here, at many times the salary which I received at that time.

The officials of the Pennsylvania State Department, and Dr. Wm. C. Ash of the University of Pennsylvania, all claim that our course in Drafting and Design is the best now being taught in this state. Every drafting graduate that we have turned out has proved successful, and one is now Chief Draftsman in a local steel concern. Yours sincerely,
J. S. LEAR

Has Charge of Large Jobs

"Even before I had finished my course, I was put in charge of large construction jobs in different cities. I have been doing that ever since, and the jobs are getting larger all the time. I owe my success to the American School because of the knowledge I gained in mathematics and calculations."

ELMER L. LAMB,
 1306 Smith St., Peoria, Ill.

3 Drafting Lessons *Actually* FREE

O. C. MILLER, Director Extension Work
AMERICAN SCHOOL

Dept. D-374, Drexel Ave. and 58th St., Chicago.

Rush 3 Free Drafting Lessons, Job and Raise Offer, complete information, money-back guarantee, etc., to prove I can become a real Draftsman at home in spare time.

Name.....

Street No.....

City..... State.....

WINS \$1,000.00

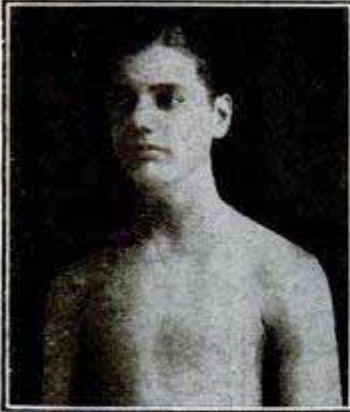

BEFORE Taking the TITUS Course

HERE'S my prize winner for 1926! \$1,000.00 in cash and a solid gold medal awarded to Harry Politi for the greatest improvement in physical development. Nation-wide contest proves another amazing demonstration of Titus training!

FELLOWS, it was a wow! On December 31st my 1926 muscle-building contest ended with a bang. Many famous authorities of the physical culture world were present, and you should have heard their exclamations of wonder as the records of thousands of applicants were presented to the jury.

Talk about building muscles! You can't blame me if I feel proud of what I did for those boys.

And even those who didn't win a cash prize, won something better than any amount of money—perfect health and perfect bodies.



AFTER 30 Days of TITUS TRAINING

TITUS (Dept. P-112),
105 East 13th Street,
New York, N. Y.

Sure I want your book. Send me "Better Built Bodies," packed with muscle-building facts, health hints and photographs of famous strong men you have trained. I don't pay a penny—I don't obligate myself to anything.

Name

Address

Town.....State.....

Panther Muscles or CLUMSY BEEF?

FREE

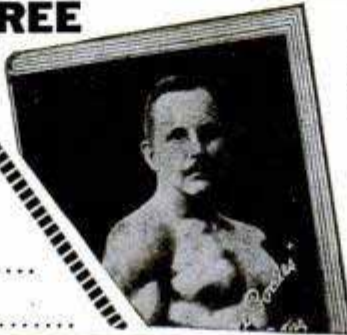

Which do YOU want? Do you want the long, rippling muscles of a panther—terrific in power, swift and sure in action? Those are the muscles that make CHAMPIONS—muscles that THINK! Muscles under perfect control. Not beef! Not fat! Not clumsy POUNDS!

Fellow, if that body of yours is worth 2c—invest it in a stamp and shoot the coupon along NOW for your copy of the most wonderful book of this kind ever written. Also full particulars of my \$2,000.00 Prize Contest for 1927.

No strings, no obligations—Better Built Bodies is yours—FREE!

TITUS, 105 E. 13th St. (Dept. P-112) NEW YORK CITY, N. Y.



Get into the electric wiring field—big money for you

Great demand in wiring field. These books prepare you.

KINKS; helps; short cuts; practical, on-the-job electrical data, written particularly to help wiremen, trouble shooters, maintenance men, armature winders, electrical contractors and students. The whole wiring field covered; concrete and usable details about new and better ways for doing the kind of work you have to do.

American Electricians' Library
6 volumes, 2000 pages, illustrated, \$16.00 payable \$2.00 in ten days and \$2.00 a month

The books tell you all you must know about conduit wiring, armature winding, wiring for lighting circuits and switches, wiring for machinery, circuit troubles, circuit testing, or electrical machinery erection. Through a study of this great set you can push yourself into a big-pay job for life.

See it FREE — Send no money — ACT

FREE EXAMINATION COUPON

McGraw-Hill Book Co., Inc.
370 Seventh Avenue, New York

Send me the American Electricians' Library for 10 days' free examination. If satisfactory, I will send you \$2 in 10 days and \$2 monthly until the full price, \$16, is paid. If not wanted, I will return the books at your expense. Upon receipt of my first payment of \$2.00, I am to receive a copy of Braymer and Roe's REWINDING SMALL MOTORS free of charge.

Name

Address

Position

Company P.M. 3-1-27

You Can Study at Home in Spare Time or Specialize At the School Under Personal Direction



BIG money. Fascinating work. Unlimited field. Chance to own your business. Many earn \$50 to \$200 weekly. Easy and quick to learn. We teach you in your spare time—few hours weekly—at home or school. Thousands of successful graduates. Original and largest school devoted exclusively to this profession. Complete, thoroughgoing courses in all branches: Sign

Earn \$50 to \$200 Weekly

Painting, Show-Card Writing, Poster Designing and Commercial Lettering. Write for information and Strong's "Book of Facts."

STRONG'S DETROIT SCHOOL OF LETTERING
171 Stimson Ave. Est. 1899 Detroit, U. S. A.
For 100-page catalog of sign and show-card tools and materials, address Supply Dept.

Learn Watchwork, Jewelrywork and Engraving

A fine trade commanding a good salary, and your services always in demand. Address **Horological**, Dept. P, Bradley Institute, PEORIA, ILLINOIS, for our latest catalog.

PUNCTURE-PROOFS Tires in ONE minute

Agents—Big—Quick Profits

Tires hammered full of nails, leak no air. Amazing new invention banishes puncture trouble forever. Punctures heal instantly. Stops slow leaks. Preserves rubber. Increases tire life. Clean, scientifically correct. Not a Liquid.

FREE SAMPLE Immediate—

Tremendous profits. No talking—just drive nails in an old tire. **GET THE FACTS.** Territory going fast. Full particulars—Big Book and a **FREE SAMPLE** postpaid by return mail. **Send No Money**, just your name but **ACT NOW.**

C. F. JOHNSON & CO. 19 W. Jackson Blvd. Dept. 505, CHICAGO



YOUR *Great Opportunity* to learn the **AUTO BUSINESS**

SENSATIONAL ANNOUNCEMENT By One of The Finest Auto Training Schools in the World!

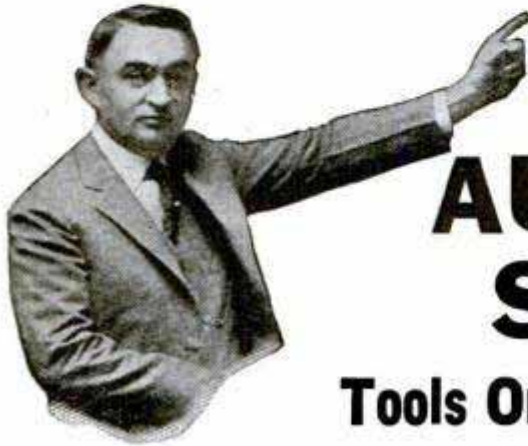

New—Low Priced AUTO MECHANICS SHOP COURSE

Tools Only—No Books—No Classroom Work

Quality training for the greatest business in the world is now within reach of all. I am offering for a limited time only, a complete course in Auto Mechanics—Shop and Garage Work, for scarcely more than the price of your railroad fare! This new course includes auto electricity and is not surpassed by any Auto Mechanics Shop Course in the country. It is all practical instruction, no books, no classroom work. Classes are forming now. This is your marvelous opportunity to get a complete course in auto mechanics if you act at once.

Work With Real Tools on Latest Model Cars

I'll teach you by real practice how cars are made and how to repair them. The big auto factories in Detroit endorse our training and place in our shops chassis of latest model cars for my students to work on. You learn by working on newest standard and up-to-date automobile equipment. Detroit, the auto center of the world, is the logical place to learn autos. This school knows how to train you right, and that is what you want and need to make the most money in this fascinating business.

Mail Coupon TODAY for all Particulars

Mail me the coupon today and I'll send you full particulars of the greatest auto training opportunity in the world. I'll send you my big FREE Catalog and will tell you how you can get a good paying job—how you can go into business for yourself—how you can now learn auto mechanics for scarcely more than the price of your railroad fare! Mail the coupon or send me a postal card today.

Michigan State Automobile School

303 Auto Building, 3729 Woodward Ave., Detroit, Mich.

*Costs Scarcely More
Than the Price
of Your R.R. Fare!*

What This Amazing Offer Means to You—

By enrolling at once in this new low-priced Auto Mechanics Shop Course, you can learn the big-paying auto business in an amazingly short time and for a very special tuition rate. I decided to add this new course to our regular courses in automobile training (which continue as before) so that I'll have plenty of men to help fill the coming Spring and Summer demand for garage men and auto mechanics. This course may be withdrawn at any time so I urge you to send for full particulars at once while this marvelous opportunity lasts.

A. G. Jeller
Pres.

The coupon will bring you all details of the new Auto Mechanics Shop Course together with full information about the other famous "Michigan State" Courses in automobile training. Clip and mail it NOW.

Michigan State Automobile School,
303 Auto Building,
Detroit, Michigan.

Send me free and without obligation, full information about your new Auto Mechanics Shop Course and tell me about Detroit training to make the most money. Also send me FREE your big new illustrated Catalog and Automobile Training Book.

Name.....

Street No. or R. F. D.....

City and State.....

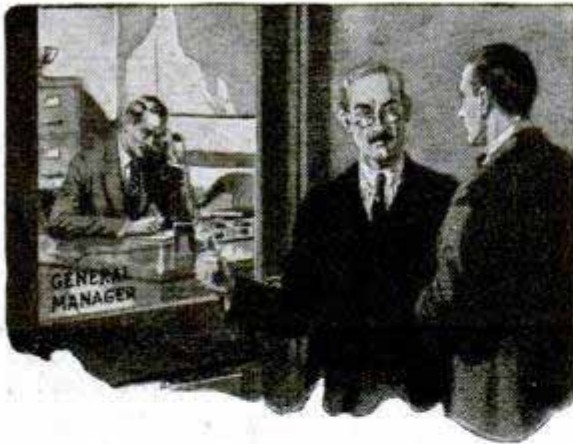

—“and now he’s in the firm”

“I REMEMBER when he first came here. The Boss put him to work helping Charley Moore.

“He didn’t know much about the business then, but I noticed that he was quick to learn and that he was always studying those I. C. S. textbooks in his spare moments. The fellows laughed at him and said he was wasting his time. But he smiled that quiet smile of his and kept right on.

“Pretty soon we saw that the Boss was taking an interest in his work, and the next thing we knew he was made foreman—then assistant superintendent—then superintendent—then general manager—and now he’s a member of the firm.

“It goes to show what spare-time study will do for a man. I might have his job today if I had only studied with the I. C. S. when he did.”

If you want to make more money, show your employer you’re trying to be *scarf* more money. If you want a bigger job, show him you’re willing to *prepare* for it.

There’s a simple, easy way to do it. For 35 years the International Correspondence Schools have been training men and women right in their own homes whenever they had a little time to spare. Thousands of men and women have stepped up in just this way. More than 180,000 are studying now. Ten thousand are starting every month.

Can you afford to let another priceless hour pass without finding out what the I. C. S. can do for you? Here is all we ask—without cost, without obligation, mark and mail this coupon.

INTERNATIONAL CORRESPONDENCE SCHOOLS Box 5637-E, Scranton, Penna.

Without cost or obligation, please send me a copy of your booklet, “Who Wins and Why,” and full particulars about the course before which I have marked X in the list below:

BUSINESS TRAINING COURSES

- | | |
|--|---|
| <input type="checkbox"/> Business Management | <input type="checkbox"/> Salesmanship |
| <input type="checkbox"/> Industrial Management | <input type="checkbox"/> Advertising |
| <input type="checkbox"/> Personnel Organization | <input type="checkbox"/> Better Letters |
| <input type="checkbox"/> Traffic Management | <input type="checkbox"/> Show Card Lettering |
| <input type="checkbox"/> Business Law | <input type="checkbox"/> Stenography and Typing |
| <input type="checkbox"/> Banking and Banking Law | <input type="checkbox"/> English |
| <input type="checkbox"/> Accountancy (Including C.P.A.) | <input type="checkbox"/> Civil Service |
| <input type="checkbox"/> Nicholson Cost Accounting | <input type="checkbox"/> Railway Mail Clerk |
| <input type="checkbox"/> Bookkeeping | <input type="checkbox"/> Common School Subjects |
| <input type="checkbox"/> Private Secretary | <input type="checkbox"/> High School Subjects |
| <input type="checkbox"/> Spanish <input type="checkbox"/> French | <input type="checkbox"/> Illustrating <input type="checkbox"/> Cartooning |

TECHNICAL AND INDUSTRIAL COURSES

- | | |
|---|--|
| <input type="checkbox"/> Electrical Engineering | <input type="checkbox"/> Architect |
| <input type="checkbox"/> Electric Lighting | <input type="checkbox"/> Architects’ Blueprints |
| <input type="checkbox"/> Mechanical Engineer | <input type="checkbox"/> Contractor and Builder |
| <input type="checkbox"/> Mechanical Draftsman | <input type="checkbox"/> Architectural Draftsman |
| <input type="checkbox"/> Machine Shop Practice | <input type="checkbox"/> Concrete Builder |
| <input type="checkbox"/> Railroad Positions | <input type="checkbox"/> Structural Engineer |
| <input type="checkbox"/> Gas Engine Operating | <input type="checkbox"/> Chemistry <input type="checkbox"/> Pharmacy |
| <input type="checkbox"/> Civil Engineer | <input type="checkbox"/> Automobile Work |
| <input type="checkbox"/> Surveying and Mapping | <input type="checkbox"/> Airplane Engines |
| <input type="checkbox"/> Metallurgy <input type="checkbox"/> Mining | <input type="checkbox"/> Agriculture <input type="checkbox"/> Navigation |
| <input type="checkbox"/> Steam Engineering | <input type="checkbox"/> Mathematics <input type="checkbox"/> Radio |

Name.....

Street Address.....

City..... State.....

Occupation.....

Persons residing in Canada should send this coupon to the International Correspondence Schools Canadian, Limited, Montreal, Canada

MAN ALIVE!

This Amazing Device Adds \$6750 A Week To Your Income



Ve Po Ad—the most sensational invention of the age! This remarkable little vest-pocket adding machine does the work of a \$300 machine. Adds up to a Million! Never gets out of order. Fully guaranteed. More than 100,000 in use!

Sells For \$2.95 — You Make \$1.35

Less than 10 sales a day brings you \$67.50 a week. Ve Po Ad astounds and fascinates. Positively accurate. Made of finest etched brass and handsomely cased in blue leatherette cover. Astonishing money saving value for \$2.95! Hundreds of prospects—merchants, grocers, butchers, farmers, garage men, salesmen—all need Ve Po Ad and buy like a flash on a minute’s demonstration. You make 100% on each sale!

Get One FREE

No wonder salesmen are dropping everything to take up this record-smashing, fast-selling adding device. Shapiro out in California has made over \$475 a week selling Ve Po Ads. You can make money just as fast. No experience necessary. Write immediately for full details about FREE Ve Po Ad we will give you.

Reliable Typewriter & Adding Machine Corp.
184 West Washington St., Dept. 43, Chicago, Ill.

WRITE FOR PROFIT

“Frederick Palmer has been of inestimable help to me in improving my technique.”

Alex. McLaren



“THE Palmer method of teaching the technique of writing is better than any that I have ever known of,” writes Alex McLaren, author of “Scrambled Brains,” “Superlative Savvy” and other popular adventure stories. “If I had taken the Short Story Course when I was first trying to write, I would have saved years of struggle.”

The Palmer Institute can take the guesswork out of your writing. It can equip, quicken, enrich your talents—make you alert to markets—help you write stories that sell. Even many professional writers have been helped by Palmer training.

PALMER INSTITUTE OF AUTHORSHIP Palmer Building, Hollywood, Cal.

49-Q

CLAYTON HAMILTON - President
FREDERICK PALMER - Vice-president

Please send me, without any obligation, details about the course I have checked.

- Short Story Writing English and Self-Expression
 Photoplay Writing

Name.....

Address.....

All correspondence strictly confidential
No salesman will call upon you

No More Razor Blades To Buy!



365 KEEN SHAVES A Year With One Single Blade

"I want to say that KRISS-KROSS Stropper is the best thing I ever saw. I have been using *one* blade continuously for one year and nine months and have no idea how much longer it will last."
C. S. Stephenson, Okla.

Inventor Discovers Amazing New Way to Shave! -Without Buying Blades!

K EEN, velvety shaves forever and no more blades to buy! That's what the astonishing invention of a St. Louis man offers the great army of American shavers today!

KRISS-KROSS is destined to revolutionize all existing traditions of shaving! Its performance is so sensational that it seems hardly fair to call it a stropper. Rather it is a *super-stropper* or blade-rejuvenator! No longer do you find that your blades "die" after five or six shaves. KRISS-KROSS "brings 'em to life" a surprising way! Actually—you can take a blade right out of a fresh package and improve it as much as 100% in eleven seconds with KRISS-KROSS!

MAGIC DIAGONAL STROKE

KRISS-KROSS employs the famous *diagonal stroke*, same as a master barber uses. Never before has anyone captured the secret of reproducing it automatically. Eight "lucky leather grooves" do the trick in 11 seconds with a precision it takes a master barber years to attain. Stropps from *heavy to light*. Adjustable, automatic jig flies up and notifies you that your blade is ready—*ready with the keenest cutting-edge that steel can take!*

KRISS-KROSS produces unbelievable sharpness and prolongs the life of any razor blade for months and even years. Fits all brands and makes except Durham. Eliminates 83% of shaving costs and solves your blade problem for all time!

SENSATIONAL OFFER

And now for my surprising offer. To introduce KRISS-KROSS, I am giving with it Free a new kind of razor. Possesses

remarkable features. Instantly adjustable to any shaving position. A flip of the finger makes it (1) T-Shave; (2) straight (old style); (3) or diagonal (new way). Gives a *sliding* instead of *pulling* stroke. Simply zips right through the toughest crop of whiskers. Made of *rustless* metal. Comes with 5 special-process blades and is entirely unlike anything you ever saw before!

GET FREE OFFER

Send for full information on these surprising new inventions today. KRISS-KROSS products are never sold in stores. You deal direct with me or my authorized representative. Write for illustrated description and full details of free razor offer. It's even more remarkable than I can tell you in this short space. Clip the coupon now. Mail it today.

Agents \$30 a Day and Up

Make big money with KRISS-KROSS. Giving away FREE razors boosts your profits amazingly. H. King made \$66 in one day. N. C. Paige made \$104 in 3 days! Others average \$350 and up to \$750 a month! *Spare-time* workers, *Office* and *Factory* men make \$6-\$12 extra a day showing KRISS-KROSS to friends and fellow employees. S. Kantala made \$154 extra just working evenings 3 weeks. Get details at once. Check bottom of coupon and mail it tonight!

Rhodes Mfg. Co., Inc., Dept. C-371,
1418 Pendleton Ave., St. Louis, Mo.

Without obligation, please send me illustrated description and full details of your special introductory offer on KRISS-KROSS super-stropper and FREE 3-way razor.

Name.....

Address.....

Town..... State.....

() Check here if interested in making money as authorized KRISS-KROSS representative.

Rhodes KRISS KROSS

RHODES MANUFACTURING CO. STROPPER

Dept. C-371 1418 Pendleton Ave. ST. LOUIS, MO.

Largest Manufacturers of Mechanical Stroppers in the World.

These men are making big money



\$475 a Month

Dear Chief: I have just bought a 5-passenger sedan and my income now amounts to about \$475 a month—\$118 a week. Before I took your Course I never made over \$50 a month. Herman Wittenberg, 1930 Grand Concourse, Bronx, New York.



\$150 a Week

Dear Mr. Cooke: Business is going strong, paying me now over \$600 a month above expenses. I must thank you again for my success, because it was your wonderful Course and method of instruction that put me where I am. W. E. Pence, Albany, Oregon.



Pay Tripled

"Since starting your course, my pay has gone up to over three times what it was before. You have lived up to every promise you made to me, and done much more besides." R. A. Lamb, 2101 W. Baltimore St., Baltimore, Md.

Learn
to be an
**Electrical
EXPERT**
Get a Big Pay
Job with a
future

Get into Electricity, the field of Big Pay and Big Opportunities, and know how it feels to make REAL money! Thousands have done it—many of them, men who had never made more than \$20 or \$30 a week in their lives. Yet, as a result of "Cooke" training these men have become Electrical Experts — are today earning \$70 to \$200 a week in the world's fastest growing business!



EXPERT CONSULTING SERVICE.
Given without cost to every Cooke student. Use this service as often as you please.



ELECTRICAL LABORATORY One of the best in the United States. Cooke Students have full use of this Laboratory without charge.

"Cooke" Training

"Cooke" Training Will Help You Too

My now famous Work-Sheet and Job-Ticket Method will help you just as it has helped so many other men. It is the result of 10 years successful experience in training thousands of men in Electricity—is practical and thorough—as sound as a dollar and as simple as A-B-C. There's nothing like it under the sun for putting men in the Big Money class!

5 Big Outfits to Work With

With my training you learn to do by doing. Five big Working Outfits go to you without extra cost. These tools and apparatus are all you need. They enable you to get actual experience "on the job"—and they help to make everything as clear as daylight. The work is interesting, even fascinating—and you become an Electrically trained man in this Big-Pay field almost before you know it!

Learn to Earn — \$3500 to \$10,000 a year —With L.L. Cooke Training



Gives You all these Extra Advantages

**Lack of
Schooling
No Drawback**

You don't need to be afraid to tackle "Cooke" training because you didn't get very far in school. Nine out of every ten of my "boys" never finished the grades. And most of them knew nothing about Electricity. Yet look at them today!—Big-Pay men in the world's Best-Paying industry. They are happy in their work—sure of their jobs—certain of the future. Can you say as much?

Mail Coupon for Book of Facts

This big Book won't cost you a penny—won't obligate you in any way. But it may do for you what it has done for hundreds of others—double and even triple your earnings in a few months' time. Send for it today. Learn of the wonderful opportunities now open in Electricity—of the big-pay jobs that are waiting for trained men. Fill out the coupon right now and mail it.

L. L. COOKE, Chief Engineer
L. L. Cooke School of Electricity
Owned and Operated by
CHICAGO ENGINEERING WORKS, Inc.
CHICAGO

**Satisfaction or
Your Money
Back**

Remember, there are no "ifs" or "buts" about it—with my training you must learn Electricity RIGHT. My guarantee protects you. It reads that if you are not entirely satisfied back goes your money, every penny of it. And back of me in this Guarantee is the Chicago Engineering Works, a \$2,000,000 Corporation. So why wait? Why not make up your mind right now to say good-bye forever to your petty job and jump into this fascinating Big-Pay profession?

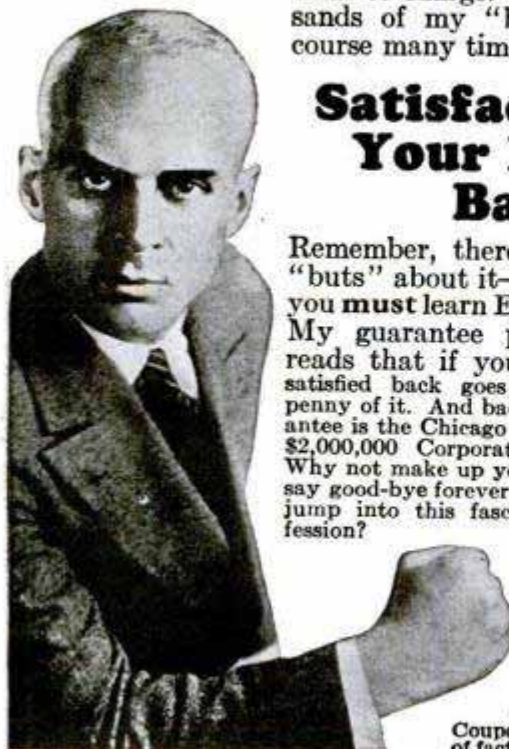

CHIEF ENGINEER COOKE—The man who has trained and helped many thousands of other men into big pay electrical jobs in all parts of the world. Mail Coupon for his big free book of facts.

Free Book Coupon



L. L. Cooke, Chief Engineer,
Dept. 13, 2150 Lawrence Ave.,
Chicago, Illinois.

You may send me the big FREE Book that tells about "Cooke" training and the opportunities Electricity now offers to trained men. This will not obligate me and no agents will call.

Name.....

Address.....

City.....State.....

Residents of Canada may send this coupon to R. A. Farrow, Special Representative, 7 Medbury Lane East, Windsor, Ont., Canada.

Discovered!

The Scientific Secret of Caruso's Amazing Vocal Power

A post mortem of Caruso's throat showed superb development of his *Hyo-Glossus* muscle—again proving the soundness of Eugene Feuchtinger's theories of voice production.



Eugene Feuchtinger, A. M., Musician-Scientist, who discovered this scientific method for developing the voice.

The arrow points to the all-important *Hyo-Glossus* muscle, the "keynote" of the Physical Voice Culture method.

The Great Discovery

Professor Feuchtinger, A. M.—famous in the music centers of Europe—discovered the secret of the *Hyo-Glossus* muscle. He devoted years of his life to scientific research and finally perfected a system of voice training that will develop your *Hyo-Glossus* muscle by simple, silent exercises right in your own home.

Since the Professor brought his discovery to America—over 10,000 happy pupils have received his wonderful training.

100% Improvement Guaranteed

The Perfect Voice Institute guarantees that Physical Voice Culture will improve your Voice 100%. You are to be your own judge—take this training—if your voice is not improved 100% in your own opinion, your entire tuition will be refunded.

Inspiring Book FREE Send the coupon below and we'll send you FREE this valuable work, "Physical Voice Culture". You assume no obligation. It may be the first step in your career. Do not delay.

Perfect Voice Institute

1922 Sunnyside Ave., Studio 13-53 Chicago

Perfect Voice Institute 1922 Sunnyside Ave. Studio 13-53 Chicago

Please send me a copy of your new book, "Physical Voice Culture", FREE. I understand that it is mine to keep and there is no obligation on my part. I am interested in

Singing Speaking Stammering Weak Voice

Name

Address

Age

CAMERA FREE

Without Extra Charge

Your Choice—\$100 Professional MOTION PICTURE Camera or Professional View Camera

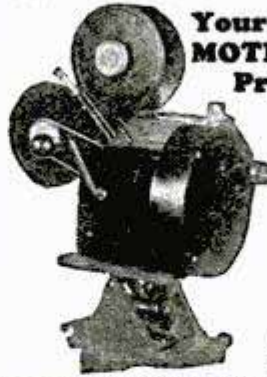

BE a Motion Picture Cameraman, Portrait, News or Commercial Photographer. Earn a handsome salary or own a studio and set your own prices! No experience needed. Spare time work. Big money to be made while you are learning!

Learn Photography

A few minutes a day at home fits you for a big paying position and you get your choice of these standard professional cameras without a penny of extra cost.

Instruction also given in our great New York studios. Cameramen and photographers are always in demand. You can quickly qualify for this easy, fascinating work.

Earn \$75 to \$250 a week

Big money in all branches. Hundreds of positions now open pay \$75 to \$250 a week and more! The most interesting profession in the world. Write for FREE BOOK.

Send name and address for big, new, illustrated book on Professional Photography. Explains amazing opportunities. Write for your copy tonight!



NEW YORK INSTITUTE OF PHOTOGRAPHY Dept. 49 10 West 33rd St., New York City

Write NOW for FREE BOOK

Now You Can REALIZE YOUR AMBITIONS

You have a secret dream you want to realize—a great ambition you want to accomplish. But each day brings you no nearer your goal, although you work as hard as you can! Wherein lies this great secret of success? It's simply "knowing how." The **Keystone Success System** is a homestudy course that reveals the "knowing how," which, when intelligently applied, makes for your success—the realization of all your ambitions.

FREE!

THE BOOK OF SUCCESS

The "Book of Success" is inspiringly written for those who really want to succeed. It costs you nothing. Send for it today!

J. S. OGILVIE PUBLISHING CO.
57 Rose St., Dept. 75 New York



Learn to Fly

Billions of dollars will be created and spent through the development of aviation. Thousands of positions will be open for those who are prepared.

Prepare now! Complete Home Study Course in Aviation arranged by America's foremost aeronautical society. Authentic yet inexpensive.

Course complete with blueprint of airplane \$5.00.

Send money order or check or write for further information.

THE AMERICAN SOCIETY FOR PROMOTION OF AVIATION

522 Fifth Ave., Dept. X, NEW YORK

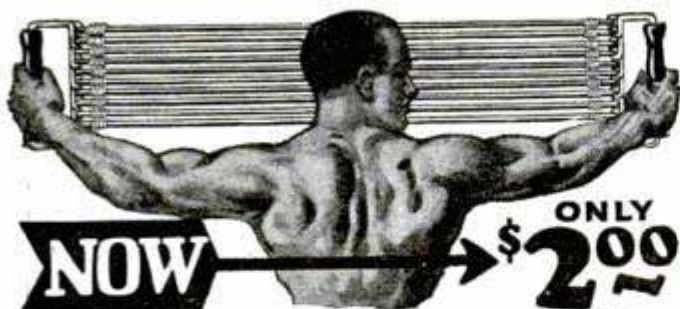

NOW → **ONLY \$2.00**
Giant Chest Expander

and

Progressive Exerciser

Be a muscular marvel. Have the muscles of a superman. Become strong for your health's sake or to astound your friends with extraordinary feats which only men of giant strength can do. In a few short weeks you will easily do stunts which now seem difficult—then real muscles and strength will be yours—and yours to keep.

Send No Money Use This Money Saving Coupon

If you want exercise to just keep in good shape you can reduce the strength of the Progressive Exerciser by eliminating as many cables as you wish. If you want great resistance so as to build up big solid muscles, then use the full strength.

How the Giant Chest Expander and Progressive Exerciser is Made

The Giant Chest Expander and Progressive Exerciser is made with new live, springy rubber so as to give it long wearing and great resisting qualities. Do not pay more for an exerciser that has forty or less rubber strands to each cable. Get the best and most durable. The Giant Progressive Exerciser has 50 strands of the finest rubber procurable to each cable.

Free Instructions

We do not think it enough to send you an exerciser worth double what we ask, but for a limited time, we will also include instructions absolutely free. These instructions are interesting and simple to follow—they show you the short cut to health and strength. Order today before this wonderful offer is withdrawn.

Your Guarantee

The Giant Chest Expander is sold with a guarantee that you will say it is the finest you ever saw or your money back.

5 Cables or double 10 Cables for strength for \$2

The double strength exerciser has resistance of over 200 lbs. for \$4

How to Order—Send No Money

Sign your name and address to coupon below and get your Giant Exerciser at the present low introductory price by return mail. The price is made low because we want everyone to enjoy muscles and strength at the lowest possible cost. Don't pay more—order from us—get the most for your money. Use coupon now.

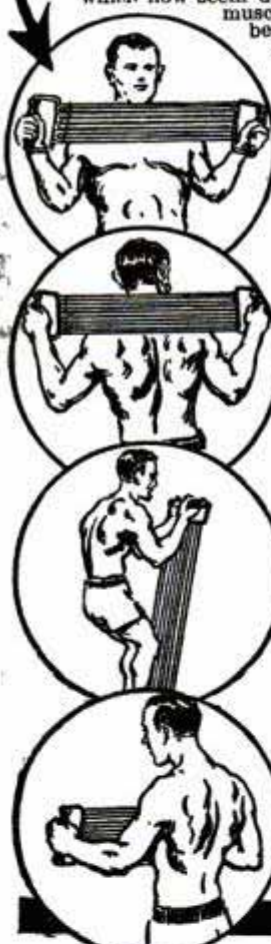

PROGRESSIVE EXERCISER CO.,
 4003 Langdon Bldg.,
 Broadway and Duane Street, New York

Please send Your 10 cable Progressive.
 Your 5 cable Exerciser.

Check the Exerciser you want, and it will be sent you by return mail. Pay postman introductory price, plus few cents postage on arrival. It is understood that if you are not entirely satisfied with your exerciser you may return it within 5 days and get your money back.

Name.....
 Street.....
 City..... State.....
 If you live outside the United States, send cash with order.

HAIR GROWS!



when our Vacuum Cap is used a few minutes daily. Sent on 60 days' FREE trial at our expense. No drugs or electricity. Stops falling hair, cures dandruff. A postal brings illustrated booklet.

MODERN VACUUM CAP CO.
 558 Quincy Denver, Colorado

NO JOKE TO BE DEAF

—EVERY DEAF PERSON KNOWS THAT



I make myself hear, after being deaf for 25 years, with these Artificial Ear Drums. I wear them day and night. They stop head noises and ringing ears. They are perfectly comfortable. No one sees them. Write me and I will tell you a true story. how I got deaf and how I make you hear. Address



GEO. P. WAY, Artificial Ear Drum Co. (Inc.)
 80 Hoffman Bldg., 2539 Woodward, Detroit, Mich



BOW LEGS and KNOCK-KNEES UNSIGHTLY

Those afflicted with BOW LEGS should wear the "PERFECT LEG FORMS" and overcome this deformity. Trousers hang perfectly straight. Made of the highest grade Aluminum Sanitary, Light and Durable. Easy to put on or off. Send for booklet showing photos of men with and without the "PERFECT LEG FORMS."

PERFECT SALES CO.
 140 N. Mayfield Ave. Dept. 5 Chicago, Ill.

SKIN-TROUBLES

ANDRE'S ACNE CREAM is Excellent for all Skin Troubles

no matter how severe or chronic. Pimples, Blackheads, Eruptions on face or body. Eczema, Barbers' Itch, Scabs, Crusts, Pustules, Enlarged Pores, Oily, Shiny or Itching Skin. Lightens Freckles, softens and whitens the skin. Immediate Results. Write for full particulars.

Andre & Co., 4029 Cottage Grove Av. Suite 451, Chicago, Ill.

Wait Just a Moment, Mr.!

Before You Light That Cigarette, Cigar or Pipe—Or Take a Chew of Tobacco—



REMEMBER THIS:

That no man can escape the bad effects of tobacco. Its active principal—nicotine—is a deadly poison which, in time, is simply bound to injure your health—perhaps seriously.

Most tobacco users realize this. But when they try to quit unaided they find it next to impossible because of the almost unbreakable hold the habit has on them.

Thousands of inveterate tobacco users have found it easy to quit with the aid of the

Keeley Home Treatment For the Tobacco Habit

A sane, scientific Treatment based on the prescription of Dr. Keeley, who founded the famous Keeley Institute for liquor, drug and tobacco addicts more than 50 years ago. Quickly and completely banishes all craving for tobacco in any form. Contains no habit-forming drugs. No bad after-effects. Not a tobacco substitute. A wonderful tonic. Improves appetite and digestion.

Money - Back Guarantee If, after taking this Treatment according to directions you can honestly say you have not been benefited, we will refund your money.

MAIL COUPON for FREE BOOK which gives plain facts about the injurious effects of tobacco and tells how easy it is to quit with the aid of this remarkable treatment.

THE KEELEY INSTITUTE

Dept. P. M.-3 DWIGHT, ILL.

The Keeley Institute, Dept. P.M.-3, Dwight, Ill.

Send without obligation your free booklet telling how to rid myself of the tobacco habit.

Name.....
 Address.....

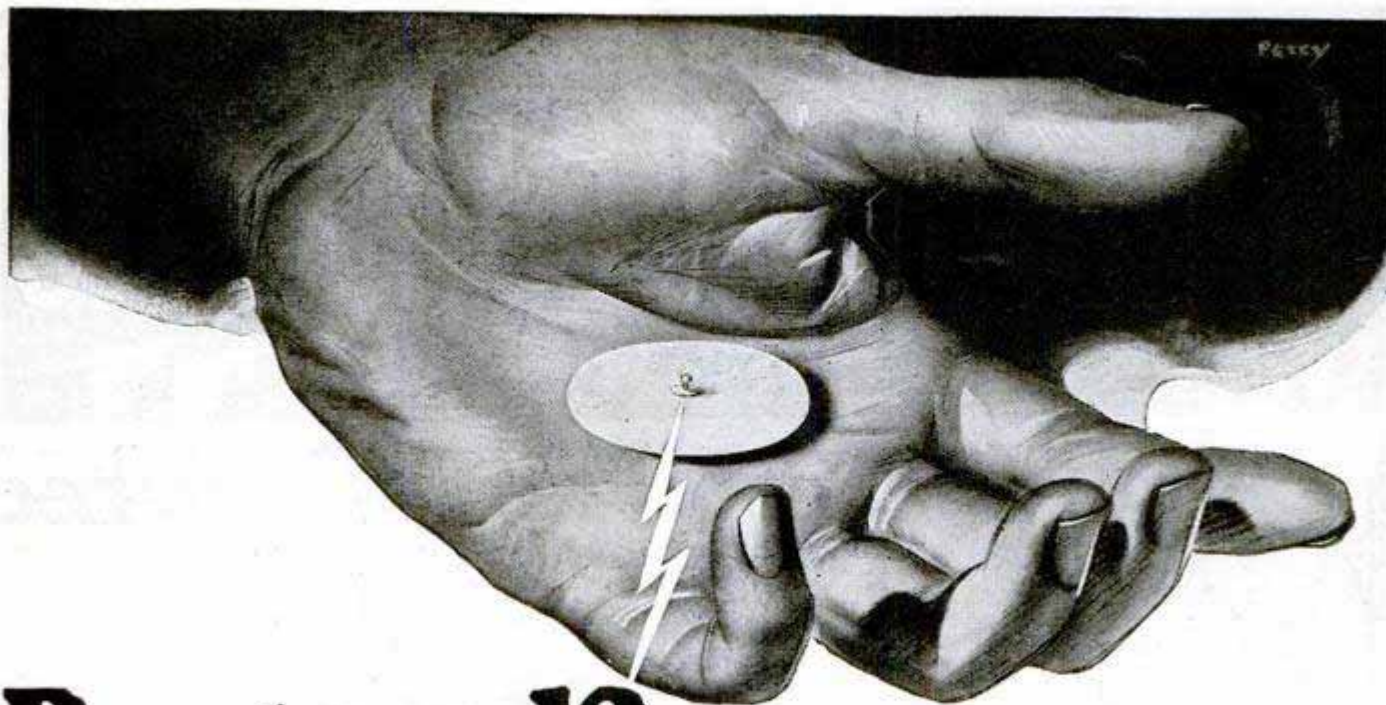

Ruptured?

Magic Dot Must Prove Its Case In 30 Seconds or Cost Nothing!

Are You Too, One Who Is Allowing "White Spot" To Rob Him of Cure? You Know How Nature Cures Cuts, Sprains, Strains and Breaks of Other Kinds But You Have Not Thought About Rupture! Why Don't You Get Well? Is The "White Spot" Preventing Your Cure Also? Learn How a Tiny Discovery Little Larger Than a Quarter Anchors Rupture and Eliminates Ancient Methods.

Clever Sample **FREE**

THE large pad you are now wearing likely slips at times. Do you realize what it means to you when your support slips? When the truss slips and the rupture comes out, can't you see that practically all the healing Nature may have done is now undone? Magic Dot prevents the slipping so common in ancient methods. Magic Dot is tiny. It is on or off in an instant. Can you possibly imagine the comfort, security and chance for quick cure that this delightful discovery should bring?

A Padlet That Breathes Air

This astonishing little circle anchors the lightest, flesh-soft padlet you possibly can imagine. It is made of a new kind of material composed of air cells called "Airtex" which breathes air in and out with each movement of the body. Airtex can be removed from the body and washed completely—every particle of it—in two minutes. Magic Dot anchors the padlet while one runs, walks, exercises. Airtex padlet can be much smaller than the older pads because it can't shift—Magic Dot anchors it firmly. Possibly it may be difficult for you to imagine just what Airtex is like, how it is "air-cooled," how it is ventilated, why perspiration can be eliminated from it so easily! That you may see Airtex and learn the truth we will send you a sample absolutely free if you write at once.

An Offer That Means Something

Because Magic Dot usually convinces everyone who sees it almost instantly, because Airtex is such a delightful new comfort and such a new cleanliness, we make this offer: Write today for our free booklet about New Science System. We will also send you an order blank which will allow you to order New Science System with the understanding that you may make a simple test with Magic Dot and Airtex Pad, and then if it does not convince you of the revolutionary comfort and security possible, you are not to wear the outfit a second, send it back and get your money.

Are You Getting Well?

Try this test. Press your thumb against the flesh of your arm tightly. Just as your truss pad presses against your tender abdomen. Remove your thumb after a minute or two and note the "white spot" that remains for an instant. Why is the spot white? It means that the pressure of your thumb kept blood from flowing properly beneath it.

The only way Nature can repair a cut, burn, sprain, break or broken bone is with plenty of free-flowing blood. You have a big "white spot" beneath the pad of your truss—and its existence means that you are not getting full blood flow in the region where repair is needed. Why not give the common sense method a chance? Why not relieve all this cruel pressure you possibly can with Magic Dot and cool pleasant Airtex? No matter how long you have been ruptured you owe it to the only body you will ever have—to personal pride and cleanliness—to at least see Magic Dot and Airtex. Since there is no obligation involved, do it now!

NEW SCIENCE INSTITUTE

2134 Clay Street

Steubenville, Ohio

New Science Institute,
2134 Clay St., Steubenville, Ohio.

Without any obligation send me free Airtex sample and interesting booklet about New Science System. Tell me about the simple experiment that I can try which must prove to me that Magic Dot really anchors Airtex to my fullest expectations.

Name.....

Address.....

City.....State.....

Swear Off Tobacco

Tobacco Habit Banished Let Us Help You

Quick Results

Trying to quit the tobacco habit unaided is often a losing fight against heavy odds, and may mean a serious shock to your nervous system. So don't try it! Make the tobacco habit quit you. It will quit you if you will just take **Tobacco Redeemer** according to directions.

It doesn't make a particle of difference whether you've been a user of tobacco for a single month or 50 years, or how much you use, or in what form you use it. Whether you smoke cigars, cigarettes, pipe, chew plug or fine cut or use snuff—**Tobacco Redeemer** will positively remove all craving for tobacco in any form in a few days. Your tobacco craving will usually begin to decrease after the very first dose—there's no long waiting for results.

Tobacco Redeemer contains no habit-forming drugs of any kind and is marvelously quick, scientific and thoroughly reliable.

Not a Substitute

Tobacco Redeemer is in no sense a substitute for tobacco, but is a radical, efficient treatment. After finishing the treatment you have absolutely no desire to use tobacco again or to continue the use of the remedy. It helps to quiet the nerves, and will make you feel better in every way. If you really want to quit the tobacco habit—get rid of it so completely that when you see others using it, it will not awaken the slightest desire in you—you should at once begin a course of **Tobacco Redeemer** treatment for the habit.

Results Absolutely Guaranteed

A single trial will convince the most skeptical. Our legal, binding, money-back guarantee goes with each full treatment. If **Tobacco Redeemer** fails to banish the tobacco habit when taken according to the plain and easy directions, your money will be cheerfully refunded upon demand.

Let Us Send You Convincing Proof

If you are a slave of the tobacco habit and want to find a sure, quick way of quitting "for keeps" you owe it to yourself and to your family to mail the coupon below or send your name and address on a postal and receive our free booklet on the deadly effect of tobacco on the human system, and positive proof that **Tobacco Redeemer** will quickly free you from the habit.

Newell Pharmacal Company
Dept 300, Clayton Station, St. Louis Mo.



Free Book Coupon

NEWELL PHARMACAL CO.,
Dept. 300, Clayton Station, St. Louis, Mo.

Please send, without obligating me in any way, your free booklet regarding the tobacco habit and proof that **Tobacco Redeemer** will positively free me from the tobacco habit or my money will be refunded.

Name.....

Street and No.....

Town..... State.....



Tobacco Tells on
Nervous System



Tobacco Ruins
Digestion



Tobacco Stunts
Boy's Growth



Tobacco Robs
Man of Vitality



Tobacco Steals
from You the
Pleasures, Com-
forts, Luxuries
of Life

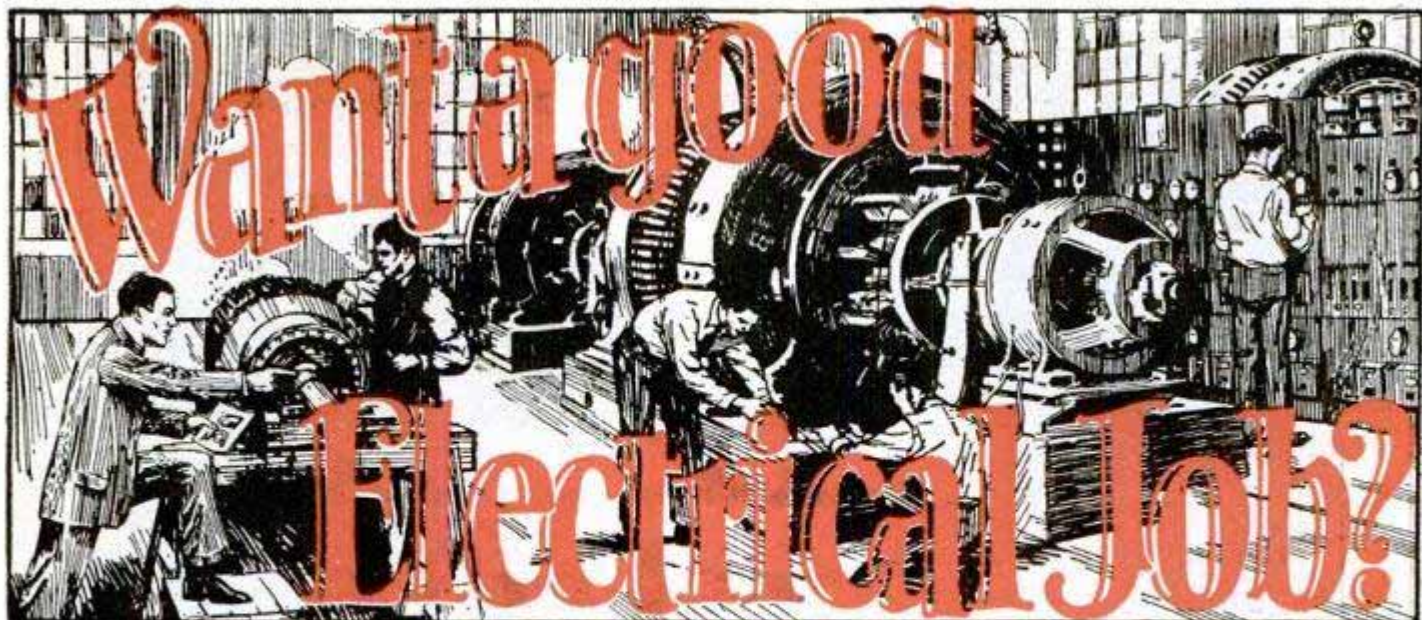

\$60 to \$125 A WEEK

LEARN Electricity — as we present it to you for home-study, and you will find **MORE** and **better-paid** opportunities open to you than in any other field. For Electricity is the **GIANT** of industries—the fastest growing business on earth! This is the Electrical Age. **Qualify—prepare** for the big, urgent demand for Electrical **EXPERTS**, and you can stop worrying for the rest of your life!



Guaranteed Training!

Built by 29 Noted Engineers

AS far as we know, the American School is the **ONLY** home-study school organized as an **educational** institution, **NOT FOR PROFIT**. We have been training men deprived of real preparation for a successful career, right in their own homes, in spare time, for **over 30 years**. We have engaged engineers from General Electric, Westinghouse, Commonwealth Edison, Massachusetts Institute, and other great corporations and universities, to develop a complete, simplified, and thorough course of instruction which definitely prepares men for fine Electrical jobs and increased salaries. In any case where these results do not follow, we **guarantee** to refund the small amount charged for tuition.

So now you know in advance what this training will accomplish—you take absolutely no risk of loss or disappointment. **Coupon** brings complete information!

Chief Engineer Dunlap, Electrical Divn.

The American School

Dept. E-374, Drexel Ave. & 58th St. CHICAGO

Free Job Service!

Read this guarantee! Back of it is the responsibility—the 30-year honorable reputation, of a million-dollar institution. And back of it, too, is the kind of home-training, the **QUALITY** of preparation for a well-paid Electrical job which justifies a promise of **definite** benefits in position and salary. Every student, every graduate is eligible **WITHOUT EXTRA COST** to the employment service we provide. In addition to the large expert staff in our offices, we now have over 80 representatives personally calling on employers of Electrical Experts in many of the leading industrial cities of America. Look into this!

If you are now earning \$40 a week or less,
I Guarantee
to help you get a
Job paying at least
50% more than you
earn today, with-
in 60 days after you
finish, or money
refunded.



Chief Engineer Dunlap

Start with the Coupon!

5 Electrical Job-Tickets Absolutely FREE!

Sooner or later, you feel you're going to break away from the monotonous grind, the hard work and small pay and **blank future** of your present job. Why not face the music **NOW**? Look into Electricity—find out if it offers you your best chance for success. **Look into the combination training and employment service we offer.** See if you can resist our written guarantee. Get the 5 Electrical Job-Tickets I will send you absolutely Free—and ask yourself if **YOU** can't master Electricity at home in your spare time by our new, simplified, rapid Job-Ticket method.

Start right now—with this coupon, and begin your climb upward to a better job and bigger pay!

Chief Engineer Dunlap, Electrical Divn.
The American School
Dept. E-374, Drexel Av. & 58th St., Chicago

Without cost or obligation, send me 5 Electrical Job-Tickets, details of your sensational Training-and-Employment offer, and facts about my chances in the great Electrical industry.

Name.....

St. No.....

City..... State.....



\$2500 Reward!

For the Capture of an Unknown Man

Twice he had entered the St. Clair Mansion. What was he after? Who? What was in danger?

Berteau, the famous detective, had warned St. Clair that the mysterious marauder would come again. And now—a noise in the passage! The creak of an opening door. A shot in the dark! A capture!

Is this wounded stranger the mysterious intruder? Who could tell? Yet Berteau identified the man without hesitation and won the \$2500 reward.

How did he do it? Easy enough for the Finger Print Expert. He is the specialist, the leader, the cream of detectives. Every day's paper tells their wonderful exploits in solving mysterious crimes and convicting dangerous criminals.

More Trained Men Needed

The demand for trained men by governments, states, cities, detective agencies, corporations, and private bureaus is becoming greater every day. Here is a real opportunity for YOU. Can you imagine a more fascinating line of work than this? Often life and death depend upon finger print evidence—and big rewards go to the expert. Many experts can earn regularly from \$3,000 to \$10,000 per year.

Learn at Home in Spare Time

And now you can learn the secrets of this science at home in your spare time. Any man with common school education and average ability can become a Finger Print Expert in a surprisingly short time.

Course in Secret Service

FREE

UNIVERSITY OF APPLIED SCIENCE

Dept. 13-53—1920 Sunnyside Ave., Chicago, Illinois

Gentlemen:—Without any obligation whatever, send me your new, fully illustrated, FREE book on Finger Prints and your offer of a FREE course in Secret Service Intelligence and the Free Professional Finger Print Outfit.

Name

Street Address

City and State

For a limited time we are making a special offer of a professional Finger Print Outfit, absolutely Free, and Free Course in Secret Service Intelligence. Mastery of these two kindred professions will open a brilliant career for you.

Write quickly for fully illustrated free book on Finger Prints which explains this wonderful training in detail. Don't wait until this offer has expired—mail the coupon now. You may never see this announcement again! You assume no obligation—you have everything to gain and nothing to lose. Write at once—address

University of Applied Science

Dept. 13-53

1920 Sunnyside Avenue, Chicago, Illinois

Classified Advertisements

WORLD'S BEST WANT AD MEDIUM

Advertisements in this section, 30 cents per word, each insertion, minimum 10 words, payable in advance. To be inserted under proper classification in April issue, copy should be in our office February 18th.

ADVERTISING AGENCIES

ADVERTISERS—To buy, sell or to secure agents, salesmen, you can place your 24-word ad. in the following 15 leading Sunday papers for only \$15; circulation over 2,000,000: Age-Herald, Birmingham; Gazette, Little Rock; Journal, Atlanta; Star, Indianapolis; Register, Des Moines; Courier-Journal, Louisville; Times-Picayune, New Orleans; Star, Kansas City; World-Herald, Omaha; Courier, Buffalo; Enquirer, Cincinnati; Press, Pittsburgh; Commercial-Appeal, Memphis; News, Dallas; Journal, Milwaukee. Proof of insertion guaranteed or Money Refunded. 52-page rate book sent free. Frank W. Lenhoff Advertising Agency (established 1897), 600 North Michigan Blvd., Chicago.

A TEN Dollar Ad may put your proposition over. \$10 pays for a 4 line 24 word classified ad one Sunday in 10 of the largest newspapers. Reach over 7 million readers. Minneapolis Tribune, Buffalo Courier, St. Louis Post-Dispatch, Pittsburgh Press, Indianapolis Star, Atlanta Journal, Detroit Free Press, Birmingham News, Cincinnati Enquirer, Little Rock Gazette. Free catalogue showing other lists of newspapers and magazines sent on request. Ankrum Advertising Agency, 22 West Jackson Blvd., Chicago. Largest classified advertising agency in the world.

ADVERTISING Service. Over 25 years' experience building up advertisers. We prepare, plan and place magazine, newspaper and classified advertising. Also write folders, circulars, letters, etc. Describe briefly your proposition. Send your recent advertising matter, proofs of ads, etc. (if any). We will send you "Advertising Simplified," latest book of rates and valuable information. Ask Dun's, Bradstreet or any publication about us. Charles H. Touzalin Agency, 708 Union Trust Bldg., Chicago, Ill.

ADVERTISE in the classified section of newspapers and magazines, to secure help, money, or to sell. 24-word advertisement in nine big Metropolitan papers \$10.00. Nearly two million circulation. Many other bargain lists. Write for Free 58-page Directory No. 26. Brinckerhoff Advertising Agency, 37 W. VanBuren, Chicago.

ADVERTISE in 24 Big Sunday Newspapers, 24 words \$15.00. Excellent for securing Agents, Salesmen, and Business Opportunities. Catalog listing 1,000 leading Dailies, Weeklies, Mail Order Magazines, Everything. Free. Wade Advertising, Baltimore Bldg., Chicago.

ADVERTISE—Newspapers, Magazines, Country papers—classified (Want Ads)—display space. Free catalog. Martin, 37B West 39th, New York.

SIX Word Line—355 rural weeklies \$3.55. Admeyer, 4112-M Hartford, St. Louis.

FOR ADVERTISERS

ADVERTISE Free. Your 30 word advertisement free if you send \$1.00 for yearly subscription to National Salesman's Magazine. Start Right! Start Small! Quick Results! Select Salesman's List for Sale. New positions advertised make \$30 to \$200 weekly. New Business Ideas, Advertising, Selling, Promoting Plans Easily Mastered. 10c copy. None Free. National Salesman's Magazine, 2213 Lawrence Ave., Chicago.

PENCILS Advertising Name, Address, Business imprinted on pencils. \$4.75 Gross. A fine pencil. M. A. Brown, Silvis, Ill.

YOUR 25 words once and year's subscription 25c. Capener's Monthly, Box 511, San Jose, Calif.

LETTERS, Advertising Copy for Folders, Booklets, Etc. Thomas E. Kern, Bedford, Ind.

CUTS, Drawings \$1.50. Window Cartoons, 6. \$1.50. GPO, Bx471, New York.

ADVERTISE 30 words 439 Rural Newspapers \$12.65; Inch \$35.12. Thompson Service, 818 Oak St., Cincinnati.

75 MAGAZINES 5c word, \$3 Inch. Information. Porter, 9416a 115th St., Richmond Hill, N. Y.

ADVERTISE in 275 country newspapers, 28 words, \$10. Keator, Hartford Bldg., Chicago.

25 WORDS 88 magazines; \$1.00. Thrice \$2.00. Smith's Service, 1194, Wenatchee, Wash.

SALES PROMOTION

\$50 TO \$50,000 Daily Sales Developed During 28 years for clients by our direct mail plans, copy, campaigns. One product, 1923, an idea; this year \$100,000 orders booked. Fifty year old concern desired 50 national representatives in 1925; we produced 40 in three months. 700 dealers in 10 months at \$3 each for another. Ten years Sales Promotion Manager Larkin Co. Submit sales problems for Free diagnosis. James C. Johnson, 118A Woodbridge Ave., Buffalo.

YOU Profit By My Sales Promotion Experience. New propositions a specialty. Write fully. Vernon Baker, Elyria, Ohio.

SALES Letters, Advertising. Sales Tex Ad Shop, Box 32, Adrian, Mich.

AUTOMOBILE SUPPLIES

SAVE 40—80%. New and Used Automotive Parts, 2,000 models. Bankrupt supplies, 5,000 bargains. Sport shields, \$5.00, roadster tops, \$10.00, complete touring, \$15.00. Wheels, radiators, generators. Brightman Auto Exchange, 321 Windsor Ave., Hartford, Conn.

CHARGE Batteries and make real profits. You can buy the new model "BT" Scioto Battery Charger for \$50 when ordered direct. Start a Battery Shop for \$135.94. Get Catalog. Adams-Barr, Columbus, Ohio.

BANKRUPT Stock, \$5.00, automatic windshield wipers \$2.50—\$25.00 Dozen. Stewart Marshall, Jr., Rome, Ga.

MIRRORS Resilvered at Home. Costs Less 5 cents per square foot; you charge 75 cents. Immense profits plating auto parts, reflectors, tableware, stoves. Refinishing metalware, etc. Outfits furnished. Details Free. Write Sprinkle, Plater, 77, Marlon, Ind.

AUTO repairmen, send \$1.00 for my method of increasing profits. \$100.00 to \$1,000.00 per year in spare time. Box 613, Sallisau, Okla.

VULCANIZING Auto Tires is a Paying Business. We have Plants near you from \$50 up. Catalog Free. Instruction Book \$1. Equipment Exchange, 108 East 11th, Los Angeles, Calif.

HEADLIGHT Telltales securely attached to lens. No drilling. 25c and 50c a pair. The Handy Dental Specialty Co., Somerville, Mass.

MAGNETOS, Starters, Generators, Ignition systems, spark plugs, part, timing chains, repairing. Meinert Magneto Co., 1759 E. 21st St., Cleveland, Ohio.

1 AUTO Gas Saver Free. To introduce. All makes. Amazing mileage increase. Critchlow, C1-805, Wheaton, Ill.

RADIATORS and Emblems at wholesale prices. All standard make cars. Send for price list and save money. Imperial Auto Supply Co., 1119 So. Wabash Ave., Chicago.

AUTO Emblems. Any Lodge. Write. North Central Distributors, Dept. J, Ashland, Ohio.

AUTOMOBILES

PATENTS. Time counts in applying for patents. Don't risk delay in protecting your ideas. Send sketch or model for instruction or write for Free book "How to Obtain a Patent" and "Record of Invention" form. No charge for information on how to proceed. Communications strictly confidential. Prompt, careful, efficient service. Clarence A. O'Brien, Registered Patent Attorney, Security Bank Building (directly across street from Patent Office), Washington, D. C. See pages 138 and 139.

SHOP Notes for 1927. Get your copy now. Only a limited edition. Contains all the articles published in the Shop Notes department of Popular Mechanics Magazine during 1926. Send No Money. Just write a postal and we'll send 1927 Shop Notes and any one of the other following numbers: 1908, 1912, 1913, 1914, 1915, 1916, 1917, 1919, 1920, 1921, 1922, 1923, 1924, 1925, 1926. Pay postman 98 cents and the postage when he hands you the two books. Popular Mechanics Press, 200 E. Ontario St., Room 903, Chicago, Ill.

AUTOMOBILE SERVICE EQUIPMENT

EARN big money with HB Universal Test Bench. Best paying work in automotive service field. Requires practically no investment. Thomas reports two days each month carry the small monthly payments. Write for free bulletin TB. Electrical Testing Co., Box M-374, Troy, Ohio.

AUTO Repair Shop Lathe 9"x3", Back Geared, Screw Cutting; price, including countershaft and equipment, \$150.00. For truing armatures, refacing valves, finishing pistons, making bushings, thread-cutting, etc. Write for No. 33 Auto Mechanics Hand Book describing this lathe. South Bend Lathe Works, 736 East Madison St., South Bend, Ind.

LEONARD clearing \$300 every month with Battery Charging Shop. Gives full credit to HB One Day System, enabling him to charge batteries in 1/2 the time required by old methods. Big opportunity in your community. Requires small space—pays for itself as it goes with a profit besides. Write for free bulletin CP. Rapid Charger Co., Box M-375, Troy, Ohio.

YOU can make more money selling accessories, tires, batteries, gas, oil and all auto supplies. Dependable Air Service brings the business to your door. Best form of advertising for anyone selling to car owners. Lowest priced air outfit on the market on easy monthly terms insures your having better air service than the other fellows. Write for bulletin AC. Silent Twin Compressor Co., Box M-373, Troy, Ohio.

COMMUTATOR and valve truing lathe. Jefferson Mfg., North 2nd St., Fairfield, Iowa.

FOR FORD OWNERS

FORD Owners. Spend cents. Save Dollars. Our Book, The Ford Manual, tells you secrets of your car. How to start it if you lose switch Key. Explains troubles that baffle you. 250 repair operations, time and wiring diagrams. All for 40 cents postpaid. Ford Manual, 1920 Kearny St., N. E., Washington, D. C.

DON'T run out of gas! New invention reserves emergency gallon in 1926-27 Ford tanks. No extra container, no need to get out of car. Attach in 10 minutes. Simple. Guaranteed. Big Money for agents. Write for Free Trial Offer. Successories Sales Co., 5940 Vancouver Ave., Detroit, Mich.

PATENT Spark Plug Burns Oil. Nothing Better for Motors Pumping Oil. Sample \$1.00. Agents Wanted. Motor Spark Co., Monongahela, Pa.

1 AUTO Gas Saver Free. To introduce. All makes. Amazing mileage increase. Critchlow, C2-805, Wheaton, Ill.

UNDERSLUNG with "RKO" Swing Lo Irons. See "Red-i-Kut" ad page 146.

FORD Electrical Equipment Troubles—Locate and remedy them easily yourself with the aid of our book "Ford Standard Electrical Equipment." Why pay big garage bills? Battery, Ignition, Starting and Lighting covered. Order to-day. When postman hands you the package pay him \$1.98 and the postage. Popular Mechanics Press, Room 903, 200 E. Ontario St., Chicago, Ill.

MOTORCYCLES, BICYCLES AND SUPPLIES

OVERSTOCKED Used Motorcycles. 1923 Indian Chief \$95.00, 1923 Harley Davidson \$95.00, 1923 Henderson DeLuxe \$120.00. Two hundred others; write for free list. Myerow Brothers Co., 15 Berkeley St., Boston, Mass.

SEND stamp for Bargain Bulletin. All makes rebuilt motorcycles at lowest prices. Used parts half price. Ash Motor Corporation, Rochester, N. Y.

SLIGHTLY used motorcycles, all models; prices right. Accessories, tires, parts. Send for literature. Harley distributors, Harp Bros., 3139 Grand River, Detroit, Mich.

DON'T buy a Bicycle Motor Attachment until you get our prices. Shaw Mfg. Co., Dept. 27, Galesburg, Kans.

NEW and used Motor Cycle Parts. Tower Cycle Co., 3604 Kingsland Ave., Pine Lawn, Mo.

AUTOMOBILE—Make your own motor car, toy size, operated with motorcycle engine. Any boy can make it. Costs little aside from engine. Full directions with drawings and dimensions in *The Boy Mechanic*, Book 3. Send No Money. Pay postman postage and \$2. Popular Mechanics Press, Room 903, 200 E. Ontario St., Chicago, Ill.

AVIATION

AIRPLANES, motors, supplies; 100 H. P. Gnome Rotary Motors \$75.00 Florida; 28 H. P. Lawrence Motors \$125.00; Curtiss 90 H. P. slightly used \$250. Sheep-lined leather helmets \$5.00; non-shatterable goggles; oval \$2.50, wide-vision \$4.00. Temperature gauges with 12 ft. tubing \$7.50. Leather breeches \$12.00, leather coats \$18.50, or sheep-lined \$23.50. Aerial Camera \$100. Airplane Turnbuckles 15c. Logan Aircraft, 716 W. Superior, Cleveland, Ohio.

TEN lessons in the air of twenty minutes each will make you a pilot by our advanced method of training. This, together with our five weeks' shop course, at \$100.00, makes America's oldest aircraft factory the most popular flying school. Work after class hours guaranteed. Special winter and spring evening course, including shop work, field and flying, \$190.00. Employment furnished during the day, paying \$20.00 to \$40.00 per week. Heath Airplane Company, Chicago, Ill.

PATENTS. Time counts in applying for patents. Don't risk delay in protecting your ideas. Send sketch or model for instruction or write for Free book "How to Obtain a Patent" and "Record of Invention" form. No charge for information on how to proceed. Communications strictly confidential. Prompt, careful, efficient service. Clarence A. O'Brien, Registered Patent Attorney, Security Bank Building (directly across street from Patent Office), Washington, D. C. See pages 138 and 139.

HEATH propellers, winners in speed in efficiency at the Philadelphia light plane races, are individually designed and when used on airplanes, sleds, boats, etc. they will give real results. Prices surprisingly low. Send 4c for propeller circular. Blueprints of new Heath sport plane now ready. Easy and inexpensive to build, using motorcycle engine. Blueprints \$5.00. Heath Airplane Company, Chicago, Ill.

THE Age of the Air Is Here. For reliable information on both airplane building and flying we recommend "Aeroplane Construction and Operation," by Rathbun, a book used in Government Schools. All features of construction treated. Send no money. Pay postman \$2.50 and postage. Popular Mechanics Press, Room 903, 200 E. Ontario St., Chicago, Ill.

AIRPLANES. Send for free cuts, and plans of our wonderful two place, companion type, small, high lift wing monoplane, and information how to build this ship, and be sure it will fly, also propeller literature. Crawford Airplane Mfg., 2225 American Ave., Long Beach, Calif.

DICTIONARY of Aviation, \$3.90. Languages Publishing Company, 8 West 40th Street, New York.

PREPARE in Your Spare Time to Fly and Build Airplanes. Flying and Evening Shop Course \$150.00. Shop Course only, \$15.00. Wallace Aircraft Co., 4710 Irving Pk. Blvd., Chicago, Ill.

BIGGEST, Best Catalog Model Air-planes. Parts Supplies; 5c postpaid. Ideal Company, 165½ Spring Street, New York.

CURTISS 0x5 ninety horsepower motors in good used condition for one hundred and fifty dollars. Suitable for ice sled, wind wagon, motor boat, automobile or airplane. Carl Ort, York, Penna.

THE American School of Aviation announces a new correspondence course in Mechanics of Aviation. A thorough training in Practical Aeronautics. American School of Aviation, Dept. 1861, 3601 Michigan Ave., Chicago, Ill.

AIRPLANE propellers, full size, 8 feet diameter, copper tipped, cost Government \$75.00, sacrificed at \$3.50. Air Transport, Carle Place, N. Y.

WANTED: Three-Cylinder Lawrence, 60 H. P. Aviation Motor. M. Mickelson, Box 23, Callaway, Minn.

WANTED—Men to begin a career in Aviation. No experience required. You start at home. Write Dept. K-3, Western Airplane Corporation, Chicago.

AIRPLANE, boat, sled propellers. Build speedy "Aerodrive" sleds, boats from our blueprints of either type, priced at \$1. Fine leather helmets only \$3. Aircraft supplies. Everything aeronautical! Ostergaard Aircraft, 4269 North Narragansett, Chicago.

SEND dime for 13 inch mounted prop-eller and circulars on free three foot model aeroplane. No selling. Aero Shop, 3050 Huribut Ave., Detroit, Mich.

AERONAUTICS! Are you keeping pace with the new developments? "Aeroplane Engines in Theory and Practice," by Rathbun describes engines fully. Used as a text in Government Schools and includes all makes. For Mechanician, builder and flyer. Send no money. Just order on a postal. When postman hands you book, pay him \$2.50 and postage charges. Popular Mechanics Press, Room 903, 200 E. Ontario St., Chicago.

BOOKS AND PERIODICALS

ESSAY Contest! First prize \$500.00. Postal brings particulars. Confederalia Publishing Company, River Rouge, Mich.

HYPNOTISM wins health, wealth, fame, love. 25 Easy lessons and 248 page illustrated reference guide \$2.00. Popular Institute, P430, Milwaukee Ave., Chicago.

DYKE'S Automobile Encyclopedia. Latest 14th edition. Information on repairing and adjusting every part of all motor cars. How to find trouble, and fix it. Send No Money. Pay postman the postage and \$6. Popular Mechanics Press, Room 903, 200 E. Ontario St., Chicago, Ill.

STENOGRAPHY—Pitman Light-Line Book, 25c, with Squaring-Circle, Interest Problems. Marr, Teacher, B605, Nashville, Tenn.

FOODS from Twenty Lands. Popular Mechanics new Cook Book made up of recipes sent by our readers from 20 countries. Many delightful foreign dishes, and many American ones, too. Only a few copies for sale. Send No Money. Just order on a postal. When postman hands you book, pay \$1.50 and postage charges. Popular Mechanics Press, Room 903, 200 East Ontario St., Chicago, Ill.

LEARN Spanish. Many opportunities in Spanish countries. Home study books, correspondence exchange with students in Spanish countries, magazines, newspapers, etc. Information free. Garcia Co., Vidriera Payret, Havana, Cuba.

MAGICAL Mysteries Book, describing sixty brilliant tricks of leading magicians, only 25c. Schembri, Box 1124, Detroit, Mich.

FORTUNE-TELLING and Dream Book, big 66-page size, 25c. G. Elsea, Bowling Green, Ohio.

BOOKS, all kinds 5c. U. Library, Hesse Sta., Boston, Mass.

CURIOUS Books, Unique Novelties, Stunning Pictures, Samples, 10 cents Prepaid. Linds, 214 W. 34th Street, New York.

REPAIRS about home easily made with instructions in our new book. Tells exactly how to use tools, sharpen tools and cutlery, repair furniture and cabinets, upholster, work metal, solder, work glass, paint, stain, varnish, hang paper, repair plumbing, repair furnace, repair electrical equipment, repair shoes, repair harness, repair gloves, repair concrete work. Send No Money. Just write a postal and ask for "The Practical Book of Home Repairs." When postman hands you the book, pay him \$2.50 and the postal charges. Popular Mechanics Press, Room 903, 200 East Ontario St., Chicago, Ill.

AUTHORS write for circular "Cooperative Book Publishing." Meador Company, 27 Beach, Boston, Mass.

"COLOR Mixing Guide" \$1.00—Book Stores. Fine Arts Pub. Co., 2033 College, Indianapolis, Ind.

HOW to Make and How to Mend. 1,000 articles telling how to repair almost everything in use or needed about a home or farm. Many illustrations, formulas and trade secrets. Especially for amateur mechanics. Send no money. Just ask for "How to Make and How to Mend." Pay postman postal charges and \$1.00. Popular Mechanics Press, Room 903, 200 East Ontario St., Chicago, Ill.

PICTURES AND POSTCARDS

CEYLONESE Girl Models, 20 different, Dollar bill. National Art Photo Galleries, 10 Temple Road, Colombo, Ceylon.

JOIN Live Postcard club, Membership Lists including Catalog 10c. Harvey Teeple, Decatur, Ind.

ART Pictures, Books and Novelties. Catalog 10c. Howard Sales Co., Dept. 15, 1188 Folsom St., San Francisco, Calif.

TRUE-BLUE friends exchange postcards, stamps. Membership, 25c. Club Book, 10c. Ericson, Elroy, Wis.

EXCHANGE Postcards, Letters—anything! Join best Exchange. Membership 25c. List 10c. Popular Exchange, Windsor, N. C.

GAMES, ENTERTAINMENTS AND PLAYS

PLAYS, musical comedies and revues, minstrel music, blackface skits, vaudeville acts, monologs, dialogs, recitations, entertainments, musical readings, stage handbooks, make-up goods. Big catalog free. T. S. Denison & Co., 623 S. Wabash, Dept. 11, Chicago.

VENTRILOQUISM taught almost anyone at home. Small cost. Send 2c stamp today for particulars and proof. George W. Smith, Room S-151, 125 N. Jefferson Ave., Peoria, Ill.

100 LIGHTNING Chalk Talk Stunts \$2.00. Cartoonist, 2925 Euclid, Kansas City, Mo.

READ sealed messages in dark; mes-sages retained by audience; burned message appears on blank slate; spirit message appears on slate in sitter's presence; spirit rappings; spirits appear in the dark; answer questions written on folded papers while blindfolded. All this you can do with directions in "Behind the Scenes with the Mediums." 69 best secrets of mediums fully exposed. The best because most baffling, yet all easy to do. Send No Money. Just write a postal. Pay postman \$1.50 and postal charges. Popular Mechanics Press, Room 903, 200 East Ontario Street, Chicago, Ill.

MAGIC TRICKS, BOOKS AND JOKER NOVELTIES

FOR something different, send 10c for "Fun-Magic-Mystery." New 80-page Book of 500 Tricks. Also contains Catalog largest line Magic Tricks and Supplies in South, at lowest prices. Send 10c today! Lyle Douglas, Station A, Dallas, Texas.

NEW Sensational Wrist Shackle Escape only 85c complete. Wonderful bargains in other tricks and illusions. Catalogs free. Sample trick 10c. F. & R. Co., Dept. F, Holoken, N. J.

MAGIC—Tricks, Books and Supplies. For Amateurs as well as the great professionals. Anyone can learn through our instructions. Feature Acts in Mind-Reading, Spiritualism, Rope Ties, etc. Large illustrated Professional Catalog, 20c. Chicago Magic Co., 140 So. Dearborn St., Dept. B, Chicago, Ill.

MAGIC easily learned with our modern tricks and instructions. Astonish others. Packet of secrets and new illustrated catalog of magic for stage and parlor, 10c. Piedmont Novelty Shop, Box 631, Danville, Va.

FREE—Our puzzle, trick, game, joke, Novelty Catalog. Wright & Son, 601-G Indiana Ave., Peoria, Ill.

ESCAPE from Sacks, Rope Ties and Chains. Easy with these complete instructions. Give an entire evening's entertainment and mystify the "wise ones." Let them tie you hand and foot, place you in a bag and seal the bag. In a minute you are out. Complete instructions in "33 Rope Ties" and "Sack Escapes." Send No Money. Pay postman \$1.50 and postal charges for these two books. Popular Mechanics Press, Room 903, 200 East Ontario St., Chicago, Ill.

BOOKS, Games, Magic Tricks, Puzzles, Novelties. Catalog Free! Makary, R-339 Mountain St., Pittsburgh, Pa.

ELECTRIC Fun! Seventy stunts, 110 volts, \$1. Tacutting, Campbell, Calif.

FIVE card tricks and catalogs 25c. Midwest Novelty Sales, 7609 Drexel, Chicago.

MAGICAL mysteries—Entertaining Novelties, tricks, puzzles. Catalogue free. Schembri, Box 1124, Detroit, Mich.

FREE with \$25 order die box. Send 20c for our large catalogue of tricks, wigs, sensational escapes. Oaks Magical Co., Dept. 548, Oshkosh, Wis.

FIFTEEN tricks you can do. Catalog, Special Offer, 10c. Chester, 403 North State, Chicago.

ILLUSTRATED Magic Catalog 7c. Lynn's, 105 Beach, Jersey City, N. J.

250 MAGIC Tricks, Magical Mysteries, 15 cents. Phenix, 7740 Langley, Chicago.

BOOKS, Magic, Mysteries, Magic Tricks, Novelties. Catalog Free. Singer, 555, Hancock, Wis.

MAGIC tricks. Card tricks. Coin tricks. Hypnotism, Ventriloquism. 64 page books. Complete guides 10c each. Geo. Fenner, 2401 Jefferson, Louisville, Ky.

STAMP COLLECTING

HOW About A New Stamp Album? A new edition (1927) of the famous International Junior Album is just off the presses, bigger than ever, for it includes late 1926 stamps, and now has more than 21,000 stamp spaces as well as thousands of illustrations. This is just the album you want—the most popular album ever made. Send us your order now. No. 1, Attractive blue cover, red back and corners, \$4.00. No. 2, Bound in cloth, gilt lettering, \$5.00. Forwarding extra, weight 6 lbs. Popular Scott Seal Packets. Every stamp guaranteed genuine or money back. No foreign post cards, revenues or reprints. No. 68, 100 diff. from 50 diff. countries, 25c. No. 8, 1000 diff. general coll. \$1.00. No. 3, 2000 diff. general coll., \$4.00. No. 152 100 diff., Europe, 10c. No. 146, 200 diff. Austria, 25c. No. 178, 100 diff. Hungary, 10c. No. 202, 50 diff. Wurtemberg, 25c. No. 67, 100 diff. French Cols., 40c. Scott Stamp and Coin Co., 1 West 47th St., New York, N. Y.

500 DIFFERENT Stamps for 25c! Big Collection 500 Different Stamps from Bosnia-Herzegovina, Crete, Epirus, Hong Kong, Iceland, Kenya and Uganda, Liberia, Malta, Nyassa, Tanganyika, Wallis and Futuna, Zanzibar, and other "hard" countries. Catalogue value \$10.00. Price only 25c to Approval Applicants! Special Bargains: 1,000 different 79c; 15 triangle stamps 49c; 100 Africa 50c; 100 Asia 60c; 100 Balkan States 35c; 100 British Colonies 25c; 100 French Colonies, 30c; 100 Portuguese Colonies 50c; All 8 packets for \$3.00! Illustrated Lists Free. Loma Stamp Co., 2221 Madison Ave., San Diego, Calif.

THE Mystery Packet! Stamps from lands of Cannibals, sun worshippers, wild savages! including Albania, Bosnia, Chad, Congo, Cochin, Dominican, Guadeloupe, Gold Coast, Kouang-Teheou, Malay, Togo, Travancore, Ubangi, and other far-off places. Hundred stamps (all different) 5 cents to approval applicants only. Illustrated lists free. Write Today! Special 500 all different stamps 30c, 1,000 same 89c; 50 different German Colonies \$1.78; 100 same (fine) \$4.55; 150 same \$9.00. C. D. Reimers, 9 Flatiron Building, Fort Worth, Texas.

ANCHERS \$\$\$ Outfit—only 12c! Fine triangle stamp; set German stamps with (pre-war) value forty million dollars (interesting!); perforation gauge, mme. scale; small album; airmail set; scarce stamp from smallest republic on earth; newspaper set; packet good stamps from Travancore, Johore, Dutch Indies, etc. Entire outfit for 12c to approval applicants! (Nice pocket stock book, value 25c, with every order!) Ancher Stamp Co., 148½ Clerk St., Jersey City, N. J.

\$1.00 FREE. Black U. S. Postage. Given Away with each order. Pioneer Stamp Album with 500 illustrations, 150 different stamps from 40 countries, Syria, Lebanon, Hejaz, Liberia, New French Colonies, British, Portuguese Colonies, South Africa, Australia, 500 hinges, 36 page illustrated catalogue, All for 15c. Big Commission to Agents for the Best approval sheets of stamps ever offered. Write for sample outfit. Hussman Stamp Co., Dept. M, 620 Olive St., St. Louis, Mo.

BRITISH North America, 60 diff. 30c. Approvals, Lists Free. Reid, 608 Yonge St., Toronto.

SNAPS—Offer No. 1—300 Different Foreign, 60 Different U. S. Stamps including \$1 and \$2 values. All For 25c Offer No. 2—70 different Foreign Stamps from 70 Different Countries, including Africa, Asia, Australia, Europe, West Indies, etc., Only 16c. Offer No. 3—Stamp Album, providing spaces for 2,220 stamps, with 700 illustrations, packet of 500 different stamps, 500 hinges and millimeter measure, all for only 50c. A big bargain. Free with each order, our pamphlet which tells "How To Make a Collection Properly"; also price list of albums—supplies and hundreds of bargains in sets and packets. Queen City Stamp Company, Room 36, 604 Race Street, Cincinnati, Ohio.

MYSTIC'S "Queer Country" Packet!! Contains scarce stamps from the following strange lands: San Marino, Antioquia, Congo, Cyprus, Fiji Islands, Gwalior, Hyderabad, Iceland, Jhind, Kenya, Uganda, Lebanon, Monaco, North Borneo, Nyassa, St. Thomas Prince, Port Guinea, Siam, Sierra Leone, Tanganyika, Trinidad Tobago, Ubangi, Upper Volta, Wallis Futuna, Zanzibar. Get this wonderful packet of "freak countries" and make your friends envious! Price only 10c to approval applicants! Write today. Mystic Stamp Company (Dept. 8), Camden, New York.

TEN Cent Packets: 10 Bosnia; 9 Cameroons; 25 Canada; 10 Ceylon; 8 Chad; 15 China; 6 Congo; 7 Dahomey; 7 French Oceania; 11 Jamaica; 3 Kenya; 8 Monaco; 25 Portugal; 10 Togo; 3 Tanganyika; and 60 others. 10c Each or 11 for \$1.00. Price list of sets and packets free. Mower, 12 Geary St., San Francisco.

MOST Sensational values; over 140 diff. Algeria, Airplanes, Azerbaijan, Barbadoes, Cameroun, Gabon, Guyane, Irish set, large French Colony packet, largest stamp, 40 year old U. S. gauge, etc., for 10c to approval applicants. List free. 100 diff. U. S. 25c—1,000 hinges 9c—50 Bavaria 7c. Hawkeye Stamp Co., Cedar Rapids, 39, Iowa.

OUR Latest 20-page U. S. and Canadian price list free. Stanley Gibbons, Inc., 37 Ann St., New York City.

BIG Free Offer. Large illustrated list of good stamps and sets at bargain prices; also fine packet 47 different stamps from Cameroons, scarce Costa Rica (cat. 30c), Niger Coast, etc.—all absolutely free. Enclose 4c for postage, etc. Shaw Stamp Co., Bear River, Nova Scotia, Canada.

1,000 UNITED STATES and Foreign Mixed, 25c. "Johndel," 1472 Grace St., Chicago, Ill.

3,000 DIFFERENT, fine, \$8.50 prepaid, registered. Overman, Birch Tree, Mo.

DIME approvals. Modern assortments. Sets—Packets—Singles. Free Premiums. Marney's, 400 Broadway, East St. Louis, Ill.

200 DIFFERENT 7c. 100 U. S. 25c. U. S. Stamps; Foreign Packets. Lists Free. Midwest Stamp Co., Kemper Bldg., Kansas City, Mo.

"INTERNATIONAL" Set and Packet Collection! Six sets: "Jubilee," "Charity," "Airmail," "Eagles," "Prisoners," "Pictorials." Four Packets: British, French, Dutch Colonies; Precancels; Bulgaria; "International" 15c to approval applicants. Deering Fairmount, Marlborough, Mass.

FREE Collection to Beginners. Also Approvals. Brousseau, 92 5th Ave., New York City.

BEAUTIFUL Picture Stamps Sent Free. Paul Cornish, Schenectady, N. Y.

FREE—To approval applicants. Premium stamps and 115 different. F. T. Rudolph, Box 341, Clarkdale, Ariz.

1/2 AND UP approvals. C. Schulz, 7638 Norton, Hollywood, Calif.

FREE: Three dandy unused sets to approval applicants enclosing 2c postage. A surprise packet, cataloguing over \$2.50 for only 25c to first 50 answering this advertisement. Kahn Company, Ardmore, Okla.

150 DIFFERENT for dime to approval applicants. Douglas Kemp, 24 Suffolk, Toronto, Canada.

3 IRISH stamps to Approval Applicants. 2c Postage. Jones, 828 South Williams, Denver, Colo.

NEWFOUNDLAND Stamp Bargains! 38 Scott's varieties \$1; 25 for 25c; 15 for 10c; 80 for \$10.00. Illustrated Catalogue 10c. Rev. Butler, St. Georges, Newfoundland.

BEST one cent approvals in America. F. P. Hand, 1117 So. 60th St., Philadelphia, Pa.

\$1,000,000.00 FREE in German Stamps, Three Dandy Sets, Free to those requesting our approvals. No Single stamps but all in sets. The Quickest, Easiest and Cheapest way of completing your collection. Kahn Company, Ardmore, Okla.

50 DIFFERENT United States 10c. 60% approvals. Reference please. Seidenberg, Baroda, Mich.

APPROVALS, 1/2, 1c. Tausig, 2701 Ave. J., Brooklyn, N. Y.

SPECIALS—7 Lithuania Angels 35c, 4 Ingermanland 8c, 8 Epirus Argrovastiron 25c with our approvals. Noemus Stamp Company, 312 East 23rd Street, New York.

150 GOOD mixed foreign stamps, 3 cents. Stanton, Niantic, Conn.

SELLING Out—3,000 Foreign Stamps 50c. Craven Stamp Co., Thompsonville, Conn.

100 DIFFERENT Stamps 10 cents. 1,000 Different \$1.00. Harry Shacklett, 3837 West Pine Blvd., St. Louis, Mo.

150 DIFFERENT Stamps 10 cents. Evans, Box 366, Reading, Pa.

80 STAMPS 2c. 1,000 (15c) hinges 8c. Postage extra. Abrams, 2549 N. 30th, Philadelphia.

200 STAMPS, Bargain List, Magazine 15c. Harvey Teeple, Decatur, Ind.

105 DIFFERENT, from 53 countries, 10c. Luffbery, Port Orange, Florida.

100 FINE American precancels 27c. Durso, 25 Mulberry, New York City.

TANGANYIKA—Four Varieties, 15c. Bechuanaland, 6c. Liberty, 3974 Arsenal, St. Louis, Mo.

25 JAPAN, 30 Danzig, 25 British Col., 25 Czecho. All different, for 25c. 200 Different, 10c. Set Liberia Triangle 10c. 15 Airmail 20c. Hanisch Stamp Co., Sixth St., Racine, Wis.

25 DIFF. revis, cat. \$10.00—50c. Hartman, 3803 Humboldt, Denver, Colo.

STAMPS—Five Liberia (Triangles) and 75 Different, 20c. Troeger, (215 Elm Ave., La Grange, Ill.

16 VARIETIES Armenia 5c, Approval Applicants. Vincent Lorimer, Monmouth, Ill.

FRENCH Colonies Free—Jungles, Tigers, Native Chief. 2c postage. Empire Stamp Co., Toronto, Canada.

EXCHANGE stamps, postcards. Membership, 25c. Club Book, 10c. Erickson, Elroy, Wis.

FREE! 100 Different to approval applicants. Reference. Morrison, 2 Sheridan, Lawrence, Mass.

NEW SOUTH WALES—10 varieties. 15c prepaid. Allison, Angola, Ind.

FREE! 12 scarce Azerbaijan to approval applicants. Penna. Stamp Co., Greensburg, Pa.

FREE—"Ten" Portuguese Colonials to approval applicants. Prall, Somerville, New Jersey.

FREE set of 3 Eritrea stamps with 100 different foreign stamps for a dime. B. Nagle, 1101 Marion, Reading, Pa.

100 DIFFERENT Austria 10c. Stevens Stamp Co., Walden, N. Y.

WEIRD, Mysterious, Grotesque stamps of the Odessa Hunger issue, portraying Ghosts, Phantoms, etc., and our "Famous Foreign Packet," only 10c to approval applicants. Scarce South African triangle free if you send references. Flower City Stamp Co., St. Thomas, Ontario.

65 VARIETIES British Colonials and 1,000 Hinges 25c. Approvals if Requested. Atlas Stamp Company, West Somerville, Mass.

MAGNIFICENT Packet Foreign Stamps, Beauties from Distant Lands, (Many Richly Colored unusual designs) free for 2c. Gray Stamp Company, Toronto, Canada.

24 VARIETIES Cuban stamps, 10 cents. List of 6,000 low-priced stamps free. Address Chambers Stamp Co., 111P, Nassau St., New York City, N. Y.

COVERTO Packet, 250 varieties unused and used stamps 15 cents. Covert Stamp, 39 State, Rochester, N. Y.

1,000 ALL different stamps \$1.00. New price list of all United States stamps free. Voorhees, 7 South Dearborn St., Chicago.

PACKET of 23 stamps, no two countries alike. Packet hinges. Set of \$1 and \$2 U. S. Rev., all for 5c. P. M. Miami Stamp Co., Toledo, Ohio.

STAMPS, 100 all different. Postage 2c. Lists free. P. M. Quaker Stamp Co., Toledo, Ohio.

FREE! Loose Leaf Postage Stamp Album at rate of 8 pages each month given with subscription to monthly Journal. Send 2c stamp for prospectus. United Stamp Co., Marquette Bldg., Chicago, Ill.

1,000 UNUSED Stamps 75c; 1,000 different, 80c; 2,000, \$3.50; 3,000, \$9.00. Fred Onken, 630 79th Street, Brooklyn.

PENNY Approvals that Satisfy. Neil Gronberg, Box 5441, Philadelphia, Pa.

108 STAMPS, Chad, etc., album, 4c to approval applicants. Hill, Leonard St., Waltham, Mass.

109 DIFFERENT, Abyssinia, Azerbaijan, Zanzibar, etc. 10c to Approval Applicants. Floyd Marsh, 524 Hamilton Ave., Indianapolis, Ind.

STAMPS at 50% to 90% discount. Fine stock. Mammoth Lists free. 100r, 802 State Life Building, Indianapolis, Ind.

BUY collections without purchasing duplicates. Write Farley Stamp Co., Auburndale, Mass.

STAMPS—1,000, 25c; 500 different, 30c; 1,000, 80c; 2,000, \$3.25. Album holds 2,000 stamps, 60c. Michael, 4444 Clifton, Chicago.

STAMPS on approvals 1/4c up. Free premium. Herbert Keigwin, Middletown, N. Y.

1,000 DIFFERENT Fine Stamps—69 cents. Approvals. Kenilworth Stamp Co., Ridgewood, N. J.

TRIANGLES! 75% Discount—Special approval sheets with each 5c packet containing set triangles, 2 sets war tax, set airplane, U. S. stamp before 1880, etc.; over 100 different stamps. Murray Stamp Co., 515A Tower Bldg., St. Louis.

110 NEW Europe All Different, a wonderful collection cataloging several dollars, free to collectors requesting our Net Approvals. Postage 2 cents. Badger Stamp Co., Milwaukee, Wis.

TRIANGLES—Ten different triangle stamps 10c to approval applicants. Paul Revere Stamp Co., Box 24, Back Bay, Boston, Mass.

JUNGLE Packet contains stamps from Abyssinia, Congo, Kenya, Nyassa, Mozambique, Ubangui, Tanganyika and other savage lands. Only 10c to approval applicants. Fenway Stamp Company, 161 Massachusetts Ave., Boston, Mass.

FREE Hungary Charity No. 565 to 567 and a surprise packet given to those requesting for my 1, 2, and 3c approvals, and also my 50% discount. Chas. W. Schmidt, P. O. Box 4832, Frankford Station, Philadelphia, Pa.

STAMPS, 100 varieties, Africa, Brazil, Peru, Cuba, Mexico, etc., 10c. 50 different U. S. 25c; 1,000 mixed, 40c; 1,000 hinges, 10c. List free. C. Stegman, 5941 Cote Brillante, St. Louis, Mo.

500 DIFFERENT only 25c (regular price 50c), many unused, from British, French, Italian and Portuguese Colonies, Chile, Fiume, Guatemala, Persia, Siam, etc., to all approval applicants. Big bargain lists free. Victoria Stamp Co., London, Can.

BORNEO, Malay, Liberia and 105 other Different Foreign Stamps, Hinges and Lists with Approvals 9c. 55 Different United States, including Commemoratives, 10c. Fennell Stamp Co., Dept. M, St. Louis, Mo.

To approval applicants enclosing 10c for our Marvel Packet of 55 different from Gabon, Togo, etc., we will send—absolutely free—a genuine scarce South African triangle stamp! Curhan Stamp Co., Gloucester, Mass.

105 CHINA, etc. 2c. Album (500 illustrations) 3c. Bullard, Sta. A, Boston.

STAMPS sent on approval at 70% discount. Reference required. Emory Renoll, Hanover, Pa.

UNITED STATES—Send on approval. Send me your want list. Ref. Please. M. Hanna, New Kensington, Pa.

1,000 MIXED U. S. and Foreign Stamps 25c. Phil Lunsted, Cape Cottage, Me.

FREE, 200 different stamps to approval applicants. Auburn Stamp Co., 767 Irving, Syracuse, N. Y.

FOREIGN Revenues, Telegraphs, Locals, envelopes, rails, etc. pretty, different, cheap. Stamped Marine Policy free to applicants with references. Vanderhoof, 1114 Logan, Denver, Colo.

200 DIFFERENT stamps 10c; 1,000 Hinges 10c. R. H. Carlton, 380 W. So. Temple, Salt Lake, Utah.

110 DIFFERENT Stamps, many unused, high values, free to collectors requesting our Net Approvals. Postage 2 cents. Christensen, Milwaukee, Wis.

1,000 NICELY mixed stamps, 25c; 1,000 hinges, 10c; 2,000, 17; post free. Approvals. Price lists. Sunshine Stamp Co., Box 823 B, Salt Lake, Utah.

RARE COINS

RARE Coin Book 50c: Illustrates all the coins of the United States, Mexico, Central and South America; also the prices we pay for rare U. S. coins. There is no other publication, at even twice the price, that can compare with this book which is entitled "Coins of the Americas." Send for our \$2.00 set comprising fifty-cent piece, twenty-five-cent piece and ten-cent piece (all early dates); also five-cent silver, three-cent pieces, silver and nickel, two-cent piece, large cent, and half cent. Coin Bulletin mailed free to collectors regularly. If interested, write for a sample copy. Gutttag Bros., 16 Exchange Place, New York City.

50 FOREIGN coins 50c, 25 for 30c, 10 attractive Mexican bills 50c, 10 large foreign bills 35c, 10 Confederate bills 35c, Roosevelt medal 15c, War medals 50c. Revolutionary War currency 35c, 20-cent piece 55c, Liberty head \$1, 2 over 100 years old 75c, Large copper cent over 100 years old 25c, Illustrated coin book 10c. Nagy, 8P South 18th, Philadelphia.

SPECIALS in United States Commemorative Half Dollars. Lexington \$1.19. Monroe \$1.19. Lincoln \$1.29. Maine \$1.33. Norse American \$1.43. Pilgrim \$1.33. Trade Dollars \$1.19. 1,000 German Mark and bargain Price List 5c. Arcy, Box 483, Muskogee, Okla.

48 DIFFERENT Bills \$1.00. \$ Coins 25c. Brooks, 2725 1/2 Live Oak, Dallas, Texas.

40 OLD coins, all different \$1.00. 200 all different coins, fine, \$5.00. Stone Mountain Half-Dollar Unc. \$1.00. 20 different Broken Bank Bills \$1.00. Claud Denney, Box 315, Dallas, Texas.

UNITED STATES Coins, Medals, Relics bought. Any quantities. Frank Saco, 735 45th St., Brooklyn, N. Y.

AMERICAN Liberty-Head Nickel; Russian Note, Russian Coin and Catalogue 20c. Confederate Bill, White Metal Coin, and Catalogue 10c. Geo. Best, Cedar Rapids, Iowa.

OLD Money Wanted. Will pay \$100.00 for 1894 Dime, S. Mint, \$50.00 for 1913 Liberty Head Nickel (not Buffalo). Big premiums paid for all rare coins. Send 4c for Large Coin Folder. May mean much profit to you. Numismatic Co., Dept. H, Fort Worth, Tex.

CALIFORNIA gold Quarter 27c; half 52c. 1820 cent 25c; 1809 1/2c 50c; Washington \$1/2, \$1. A. Wylie, Wheaton, Illinois.

OLD Coins, Large Spring Selling catalogue of coins for sale free. Catalogue quoting prices paid for coins, ten cents. William Hesslein, 101A Tremont Street, Boston, Mass.

CALIFORNIA Gold—Quarter Size, 27c; 1/2 size, 53c; 3c Piece and Catalogue, 10c. Norman Shultz, Box 746, Salt Lake, Utah.

44 DIFFERENT Coins \$1.00. 100 different \$3.50. 4 different 10c. Otto Oddehon, Box 681, Kansas City, Mo.

GET Profit and Pleasure in collecting Old Coins. Send 10c for Large Illustrated Coin Catalogue. You'll be delighted with it. Send for it right now. B. Max Mehl, Numismatist, Mehl Bldg., Dept. P, Fort Worth, Texas. Largest Rare Coin Firm in the U. S.

UNITED STATES, Large Cent, two-cent bronze, three-cent nickel and Bargain List, 25c. Fifteen dates large cents, \$1.00. George Coffin, Greenwood Mountain, Me.

FOR BOYS

ELECTRIC Toys—Fractional hp. Motors. Electric Steam Engines. Catalogue 10c. Manhattan Co., 333a W. Manhattan Blvd., Toledo, Ohio.

FAMOUS Bailey Handbook—The book that prepares you to pass the examination for any grade of license for Stationary, Marine and Diesel Engineers, Firemen and Boiler Inspectors in any state of the Union or any province of Canada. Flexible cover. Handy Pocket Size. Pay Postman \$2.00 plus the postage when he hands you the package. Popular Mechanics Press, Room 903, 200 E. Ontario St., Chicago, Ill.

FILMS for Toy Machines. 200 feet \$1.50 Postpaid. Dixie Film Co., Box 2042, Memphis, Tenn.

IDEAS for those who like to tinker with tools, and for professional carpenters. 40 articles on saws and sawing, 17 on benches and bench equipment, 22 on doors and door hanging, 18 on lumber, 13 on mitering, 74 on tools, 22 on shop equipment, and many others—366 in all, and 229 illustrations. Send No Money. Just write a postal. Pay postman postage and \$1.50. Popular Mechanics Press Room 903, 200 E. Ontario St., Chicago, Ill.

FUN making things. Four large profusely illustrated books telling how to make almost everything from a sail boat to a toy automobile propelled by a motorcycle engine. Now \$2 per book or \$7 for the four if ordered at once. Send No Money. Just write a postal saying, "Send the Boy Mechanic Library." Pay postman \$7 and postage. For single books, specify either Book 1, Book 2, Book 3, or Book 4. Popular Mechanics Press, Room 903, 200 E. Ontario St., Chicago, Ill.

CAMERAS AND PHOTO SUPPLIES

PHOTOGRAPHIC equipment and accessories of every description are listed and illustrated in our 228-page catalogue. It will pay you to secure a copy which is issued free, as our prices are low. We also deal in used goods which are sold under the same guarantee as new goods. Ask for our Bargain Book. Central Camera Co., Dept. E115, 112 S. Wabash Ave., Chicago, Ill.

MAKE money in Photography. Learn quickly at home. Spare time or full time. New plan. Nothing like it. No experience necessary. Write for particulars. American School of Photography, Dept. 3432, 3601 Michigan Avenue, Chicago.

HUNDRED Best Markets for Your Photographs. Booklet gives names, addresses, wants. Written by a successful correspondent. 20c silver. R. Snyder, Publisher, 18 Derne St., Boston.

HAVE You a Camera? Write for Free sample of our big magazine, showing how to make better pictures and earn money. American Photography, 116 Camera House, Boston, 17, Mass.

KODAK Film—Special Trial Offer—Your next roll developed 5c, prints 3c each. Beautiful 6x10 mounted Enlargement 40c. Sameday Service. Fleet Photo Service, 1210 G., N. W., Washington, D. C.

BIG Money Saved on Photographic Lenses and Apparatus—goods exchanged; repairing done. Ralph J. Golsen, 1128 Argyie St., Chicago, Dept. P.

FILMS Developed. Special Trial Offer. Any Size Kodak film developed 5c, prints 3c each. Trial 6x10 Enlargement in handsome folder 40c. Overnight Service. Roanoke Photo Finishing Co., 209 Bell Ave., Roanoke, Va.

GERMAN Cameras, Lenses. Bargains. Bartro, 6436 Hotel St., Los Angeles, Calif.

MOTION PICTURES

FILMS: \$3.00 per reel up. Comedy, Western, Cartoon, Drama, Serial, Educational, Special Features. Best Movie Stars. Free List. Toy Film 200 Feet Postpaid \$1.50. Dixie Film Co., Box 2042, Memphis, Tenn.

NEW and Rebuilt Projectors for Theaters, Schools, Churches, Traveling Shows. Supplies and Complete Theater Equipments. Bargain Prices. Free Catalog. Monarch Theatre Supply Co., Memphis, Tenn.

\$\$\$ FOR Ideas. Photoplay Plots revised, criticized, copyrighted, marketed. Send for free booklet. Universal Scenario Company, 244 Security Bldg., Santa Monica and Western Ave., Hollywood, Calif.

SEND \$2.00 for startling new Cinemeter. Gives exact exposure for all Movie Cameras or lenses. Fits pocket. Free Bargain List of Motion Cameras. Bass Camera Company, 109 North Dearborn Street, Chicago, Ill.

MOVIE Apparatus. New \$150 Spring Motor Movie Camera, leather case, \$37.50. Eastman Standard Negative Film 2 1/2 cents a foot. Motor driven suit case projectors \$50 to \$100. Movie Printer \$25. Movie developing outfit \$20. Air Brush \$5. Ray, 296 5th Ave., New York.

MOVIE Film 1c ft., 150 ft. \$1. Reels \$2.75 up. Stamp Brings Samples and List. X. Sales Co., Box 1506, New Haven, Conn.

LOOK Boys! Genuine Movie Machines Low as \$7.00 Postpaid. Free Catalogue. D. F. Elder, Dept. C, Chelsea, Mass.

FILM Bargains. 100 foot "Tom Mix" Westerns or comedies, 90 cents. Alton Films, 205 Brush Creek, Kansas City, Mo.

PICTURE Machines; Bought, Sold and Exchanged. Get our lists. Craig Brothers, Box 225, Montgomery Center, Vermont.

SCENERY TO RENT

WORLD'S Most Beautiful Settings for operas, plays, minstrels. Amelia Grain, Philadelphia.

EDUCATIONAL AND INSTRUCTION

YOU can have a business profession of your own and earn big income in service fees. A new system of foot correction; readily learned by anyone at home in a few weeks. Easy terms for training; openings everywhere with all the trade you can attend to. No capital required or goods to buy, no agency or soliciting. Address Stephenson Laboratory, 1 Back Bay, Boston, Mass.

STORY Ideas Wanted for photoplays and magazines. Big demand. Accepted in any form for revision, development and submission to markets. Send manuscript for free criticism. Booklet mailed on request. Universal Scenario Company, 403 Security Bldg., Santa Monica Blvd. and Western Ave., Hollywood, Calif.

COMPLETE course in Checkers, 20 methods, 1,000 colored illustrations. Instructions for making all the plays \$2.00. John Prenzler, Halifax, Pa.

CARTOONING and Commercial Art. 25 lessons, 300 illustrations, 2 clothbound volumes and drawing outfit \$5 postpaid. Catalog Free. Nu-Way Art School, 220-B Graham Ave., Brooklyn, N. Y.

DRAW Faces, Figures, etc. Mail \$2.50 for Home-Study Course and five Original Drawings. Criticism on your work Free. Otto Hueser, 4356 No. Lincoln St., Chicago, Ill.

SPEECHES. No matter where you must speak, here is help. 366 pages of instruction and anecdotes, toasts and complete speeches for the amateur or professional. Send No Money. Simply write a postal for "Speeches, Their Preparation and Delivery." Pay postman postal charges and \$1.25. Popular Mechanics Press, Room 903, 200 East Ontario St., Chicago, Ill.

BE a Laboratory Expert. Earn from \$300 to \$500 Monthly. Study Microbiology Sanitation. Day, Evening classes, Diplomas, Degrees Granted. 71-piece outfit Free to students. Write for our Free Prospectus To-Day. International College of Microbiology, 2517 N. 76th Ave., Chicago, Ill.

FORGED decorative articles. Andirons, fireplaces, scroll and grille work, lamps, candle sticks, coat hangers, knockers and other hand-forged decorative articles can be made with instructions in new printing of "Hand Forging," by Thomas F. Googerty. Profusely illustrated. Send no money. Write a postal asking for Hand Forging. Pay postman postage and \$2.00. Popular Mechanics Press, Room 903, 200 East Ontario St., Chicago, Illinois.

FIREMEN, Brakemen, Baggage men (white or colored), sleeping car, train porters (colored). \$150-\$250 monthly. Experience unnecessary. 810 Railway Bureau, East St. Louis, Ill.

WORLD-ROMIC System, Masterkey 5,000 languages. Primers, \$1.98; Arabic, Chinese, French, German, Italian, Japanese, Russian, Spanish. Languages, 8 West 40th, New York.

MEN wanting forest ranger positions, \$1,500-\$2,400. Write for particulars and list Natl. forests. Mokane, A-21, Denver, Colo.

EARN \$25 weekly, spare time, writing for newspapers, magazines. Experience unnecessary. Details Free. Press Syndicate, 981 St. Louis, Mo.

DOUBLE Entry Bookkeeping mastered in 60 hours with 8 keys; guaranteed; diplomas. International Bookkeeping Institute, Dept. 8, Springfield, Mo.

MAKE a Telescope; Join ranks of enthusiastic group of amateur astronomers. Fascinating subject treated in new book, only one published in America. "Amateur Telescope Making." Pay postman \$2 and few cents postage on delivery. Popular Mechanics Press, Room 903, 200 East Ontario St., Chicago, Ill.

USED educational matter. Lowest prices; terms. Catalog free. Mention Subject. Fred Goetz, 440-A Sansome, San Francisco.

USED educational matter sold on re-purchase basis. Also rented and exchanged. Money-back guarantee. Catalog free. (Books, etc. bought.) Lee Mountain, Pisgah, Ala.

COMPLETE book on Magic. 563 pages; 318 illustrations. Hundreds of tricks. The standard book for years. Make money giving magic entertainments. Send No Money. Just ask for Prof. Hoffman's "Modern Magic." Pay postman postal charges and \$2.00. Popular Mechanics Press, Room 903, 200 East Ontario St., Chicago, Ill.

RADIO OUTFITS AND SUPPLIES

FIVE Tube Receivers; List \$35. Agents Price \$16.50. Six Tube Sets \$19.75. Write for proposition. Seminole, C427 East 16th, New York.

MARVELOUS Radio Values, 5 tube sets 70% off; 4 tube set \$10.00; 5 tube chassis \$18.50. Solid mahogany cabinets \$3.50. Speaker cabinets \$7.50. All guaranteed. Write for folder. Cycle Mfg. & Supply Co., 549 Washington, Chicago.

START a Radio Business for \$100.00 or less, large profits. I will take care of all technical details free. Write me. A. J. Musselman, Machinery Hall, Chicago.

WANTED; Radio ideas or patents to develop or manufacture. What have you? Frostholm Bros., Syracuse, N. Y.

300-MILE "Pocket" Radio, \$2.00. No Tubes nor Batteries required. Useful and practical, loudspeaker volume. Order direct today. Spencer Laboratories, 116 Atlas, Akron, Ohio.

STORAGE battery soldering iron heat in ten seconds. Guaranteed, price \$3.00. Orlando Electric Specialty Co., Box 599, Orlando, Fla. Agents wanted.

NO more battery troubles! Wonderful invention eliminates "B" batteries. Costs only \$7.95. Details on page 158, Roll-O Radio Co., Cincinnati, Ohio.

HOFF'S Radio Trouble Finder, illustrated, remedies 103 possible ailments; includes log calls, prints, plans, various parts, models, Radio dictionary. Price \$1.00 postpaid. Essanay, Dept. M, 7638 S. Peoria St., Chicago, Ill.

WE have in stock kits of approved parts for Laurence Cockaday 27 receiver \$85.20, Hammerlund-Roberts Hi-Q \$63.05, American Power Pack \$63.50. Dealers write for discounts. Radio Service Co., Box 144, Knoxville, Iowa.

BUILD Trologos Victoreen Superhetrodyne eight tube in line. The Radio Hook-up they are all talking about, gets stations everywhere. You can build it in a few hours. \$1.00 for blue prints and full particulars. Complete set of parts \$72.00, guaranteed. Trologos Company, 216 East Pearl St., Cincinnati, Ohio.

DISCOUNT on Anything Wanted Radio. G. Simms, Lake, New York.

RADIO trouble finder, log, dictionary. A new illustrated 64-page book. Pocket size. Sent postpaid for 25c, coin or stamps. Patrick-Mahoney Co., Dept. A, P. O. Box 931, Schenectady, N. Y.

RADIO Up-to-the-Minute, 1926 edition. Telegraphy, radio reception, vacuum tubes, telephony, how to build receivers, broadcasting, all treated in new book. Send No Money. Pay postman \$1.25 and postage. Just write postal for "Radio Up-to-the-Minute." Popular Mechanics Press, Room 903, 200 East Ontario St., Chicago, Ill.

TRADE AND TECHNICAL SCHOOLS

BIG \$\$\$ in new radio field. Learn the Eclipse way. No expensive equipment to buy. Your first job will pay for the Eclipse Course. Endorsed by experts. Write for Free particulars—today. Eclipse Radio Schools, 22 East Twelfth Street, Cincinnati, Ohio.

LEARN Bricklaying at home or in school run by contractors. Catalog free. Associated Building Employers, K400, A. B. E. Building, Grand Rapids, Mich.

BIG opportunity for you in advertising. Write, Dymont, C4, 4417 Second Boulevard, Detroit.

TELEGRAPHY—Both Morse and Wireless—taught thoroughly and quickly. Tremendous demand. Big salaries. Wonderful opportunities. Expenses low; chance to earn part. School established fifty years. Catalog free. Dodge's Institute, Fern St., Valparaiso, Ind.

GET a Foreman's job in any trade. You will earn more money. Become an expert Blue Print Reader. You can do it in spare time. My training will advance you quickly. Write now—tell me what trade you want—I will send my plan at once. Carroll Rumsey, 265 Drexel Building, Philadelphia, Penna.

BIG Pay Jobs. Learn Sign Painting, Decorating, Paperhanging, Show Card Writing, Graining and Marbling by practical training in a few weeks. Chicago Painting School, 148 West Austin Ave., Chicago.

BUSINESS OPPORTUNITIES

HIRE yourself as Boss! \$250 a week easily made making these Big-selling Specialties. 300% to 900% Profit. Investment Small. No machinery needed. Let me show you how to make Heetit the New German anti-freeze preparation for Radiators; Fibro-seal Guaranteed Puncture Proof; Para-alkine, no-cement Instant Weld Patch; Super-Radiolyte, 20-minute Battery charging liquid, and 30 other big money-makers in the House-hold, Food Beverage and Toilet Specialty lines. Valuable Literature Free! Miller, Chemist, 1706-C Jetton, Tampa, Fla.

READ The Mail Order News—America's Pioneer Mail Trade Journal. Quarter Century Old. Approximately 600 pages yearly of valuable information for beginners an established mail-order houses. Analyzes mail-order business, its opportunities. Practicable mail-order ideas, legitimate money-making schemes, instructive articles. Tells how to start, what to sell. Published monthly. Subscription \$3.00 yearly. Send 25c for sample copy. None free. Mail Order News, 360 Bristol Bldg., New York.

100 QUICK Profit, Honest, Guaranteed Workable Mail Order Plans and Specifications with complete detailed methods used in every successful mail order business. A high-class complete publication, finished in 1926. Covers all departments of the mail order business. Also teaches you clearly to originate plans of your own and put them into immediate operation. The only work of its kind ever published. Written by fully competent and reliable authority. Mail Order Service, Box 93, Omaha, Nebr.

ARTIFICIAL marble sanitary flooring instructions, covering wood or cement flooring 1/2 inch thick, fireproof, waterproof, all colors, low cost. Ornamental casting, concrete, plaster, papier-mache decorations, garden furniture, statuary, flexible molds. 17 years instructing the public; particulars and illustrations free. Chris. Mahler, Huntington, N. Y.

ENTER a new business. Earn \$3,000 to \$6,000 yearly in professional fees making and fitting a foot specialty, openings everywhere with all the trade you can attend to; easily learned by anyone at home in a few weeks, at small expense; no further capital required, no goods to buy, job hunting, soliciting or agency. Address Stephenson Laboratories, (1) Back Bay, Boston, Mass.

PATENTS. Time counts in applying for patents. Don't risk delay in protecting your ideas. Send sketch or model for instruction or write for Free book "How to Obtain a Patent" and "Record of Invention" form. No charge for information on how to proceed. Communications strictly confidential. Prompt, careful, efficient service. Clarence A. O'Brien, Registered Patent Attorney, Security Bank Building (directly across street from Patent Office), Washington, D. C. See pages 138 and 139.

CHARTERS: Delaware; best, cheapest; free forms. Colonial Charter Co., Wilmington, Del.

MAKE Big Money at Home or in spare time outside. Easy. New. Distinctive. Steady work. Many ways without selling. Men or women. Free. Ceedsons, 3570 West 25th St., Cleveland, Ohio.

AN Independent income for life. Operate at home or travel. Valuable information free. V. Santschi, Glenellyn, Ill.

OPERATE money-making mail-order business in spare time. Write for free particulars. Triangle Mail Order Service, 600 Blue Island Ave., R31, Chicago.

I AUTO Gas Saver Free. To introduce. All makes. Amazing mileage increase. Critchlow, C3-805, Wheaton, Ill.

15c PUTS your name on mailing list year. Receive offers, magazines. Kentucky Agency, Covington, Ky.

MAIL Order Information, where to buy goods, Specialties, imprint circulars, everything for mail order business 25c. Harvey Teeple, Decatur, Ind.

ARE You Old at Forty? See our advertisement on page 28 of this issue. The Electro Thermal Company, 2167 Main Street, Steubenville, Ohio.

MAKE Money silvering mirrors, refinishing auto headlights, tableware, metal plating bedsteads, chandeliers. Outfits furnished. International Laboratories. Dept. 71, 309 5th Ave., New York.

POSTAL Success, instructive articles of mail selling. Copy 10c. Porter Publications, 9416 115th St., Richmond Hill, N. Y.

AVERAGE \$1.00 and up per hour refinishing furniture. Painting experience useful but unnecessary. Write for particulars. Bairs Furniture Refinishing System, P. O. Box 2327, Cleveland, O.

MAKE money manufacturing house numbers, signs, etc. Investigate! Radiant Co., 118 Davenport, Detroit, Mich.

SIGNS and Showcards Easily painted with Letter Patterns. Large variety of Styles and Sizes. Write for free samples. John Bahn, a2120 Neva Ave., Chicago.

MODERN Mail Order Methods. A new book that tells how to operate a mail-order business successfully. Write for free circular. Patrick-Mahoney Co., Dept. M, P. O. Box 931, Schenectady, N. Y.

BUILD Business by repairing tires on our Vulcanizers. Cost little to own and little to operate. Investigate. Adams-Barr, Columbus, Ohio.

MAKE Money at Home—making toys. We show you how. Send \$1 for complete working drawings and instructions. DeKalb Designing Co., Decatur, Ga.

FREE Mail Order information. Write today enclosing stamp. Mason, 3900 Broadway, Room 5, Chicago.

BE Your Own Boss. An Investment of \$3.20 starts you in business, and the way to big money. Write, New Way Manufacturing Company, 2362 University Ave., St. Paul, Minnesota.

MAKE Much Money—Making and Selling Your Own Goods. Formulas, Manufacturing Processes, Trade-Secrets. All kinds. All lines. Catalog, special circulars free. B. Thaxly Co., Washington, D. C.

MIRRORS Resilvered at Home. Costs Less. 5 cents per square foot; you charge 75 cents. Immense profits plating like new; brassy worn-off autoparts, reflectors, tableware, stoves, etc. Outfits furnished. Details Free. Sprinkle, Plater, 127, Marion, Ind.

\$13.80 DAILY in advance (Sworn Proof) Introducing New Insured Hosiery. Guaranteed one year. No capital or experience required. Your Pay Daily. Monthly bonus besides. Spare time pays you big. We supply samples. Silk hose for your own use. Free. Macohee Hosiery Company, Road 2583, Cincinnati, Ohio.

"HOW To Make Ten Dollars A Day With Your Kodak." Illustrated book. Make money with pictures of things people are interested in. Postpaid \$1.50. R. Snyder, Publisher, 18 Derne St., Boston, Mass.

START Profitable Mail Order Business. Particulars Free. The Wholefield Company, Akron, Ohio.

WE Start You in Business, furnishing everything; men and women, \$30.00 to \$100.00 weekly operating our "New System Specialty Candy Factories" anywhere. Opportunity lifetime; booklet free. W. Billyer Ragsdale, Drawer 4, East Orange, N. J.

ANYBODY Can Make Automatic Water Pump for Fords. Buy Parts at Any Hardware Store for Few Cents. Full Instructions \$1.00. Rytting, Shelley, Idaho.

RAISE Money for invention, any business proposition. Inexpensive, reliable method. Interstate Service, Elizabeth, N. J.

RESPONSIBLE manufacturer wants competent men to manage office and salesmen. \$300 to \$1,500 necessary; will allow expenses to Trenton if you qualify. Address Manager, 536 Forst Richey Bldg., Trenton, N. J.

I MADE \$30 a Week Home. French Breading. 15 years' experience; Free Booklet tells. Ashbrook 67, Marengo, Ohio.

UNPATENTED Ideas Can Be Sold. I tell you how and help you make the sale. Free particulars (Copyrighted). Write W. T. Greene, 810 Jenifer Building, Washington, D. C.

MAKE money at home in mail order paint business, with us, no experience or capital required. We furnish everything. Details 19c. Gill Paint Mfg. Co., Wisconsin Rapids, Wis.

MAKE toys and novelties at home. Big profits. Instructions and illustrations, 25c. Astrolite Company, Sharpsburg, Pa.

LEARN to Manufacture—It pays big profits. We teach you how. Start spare time. Few dollars. At home. We show you how to sell. Write for free circular. Hearting System, 2202 Wyoming, St. Louis, Mo.

"SCHEMER," Alliance, Ohio, 36 p. monthly, prints Schemes, Tips, Formulas. Subscriber reports \$25,000 from three; another \$10,000 from one. Try it! Year, \$1.00; 3 months, 30c.

NEW Office Business you can handle at home. Make money any time. Send addressed reply envelope. Owen Coe, 129 East 59th St., New York.

PATENTS Procured; Trade Marks Registered—A Comprehensive, experienced, prompt service for the protection and development of your ideas. Preliminary advice gladly furnished without charge. Booklet of information and form for disclosing idea free on request. Richard B. Owen, 30-Owen Bldg., Washington, D. C., or 41-R Park Row, New York.

GOOD Money easily earned at home spare time silvering mirrors, glass embossing, chipping, frosting, gold leafing, etc., Patterson & Co., Brooksville, Ky.

DELAWARE Incorporator. Charters; Fees Small; forms. Chas. G. Guyer, 901 Orange St., Wilmington, Del.

CHEMICAL Expert will furnish Formulas and Trade Secrets. All lines. Lists Free. W. L. Cummings, Ph. D., 228 Gordon Ave., Syracuse, N. Y.

LEARN the collection business. Good income, quick results. Interesting booklet, "Skillful Collecting" free. National Collectors Assn., Long St., Newark, Ohio.

EARN \$10 daily silvering mirrors, plating and refinishing metalware, autos, chandeliers, bedsteads, headlights. Outfits furnished. E. Deede Laboratories, 1133 Broadway, New York.

DON'T gamble in mail order business. Be sure. Free circular puts you wise. MacRae, M40 Oregonian Building, Portland, Ore.

MECHANICS, painters, carpenters, start furniture refinishing, painting, handyman shop on nearly nothing; winning plan brings customers quickly. John Braceland, 1439 So. Ninth, Philadelphia, Pa.

\$750,000,000 MAIL order business in 1925. Many grow rich in this great trade. Sell merchandise, information, patented articles various preparations. Breniser's Famous Mail Order Handbooks tell how. Eleven brochures \$3. One book with complete catalog, 25c; none free. Breniser, (Established 1900), 1607 Sansom, Philadelphia.

START Battery Business of your own. Instructions 50c. Lyons, Box 4257 Tampa, Fla.

NOW that you have read all these offers, send 25c for Detailed Information. (None free.) "How" and "What" to Sell by Mail; through Agents, or Direct; We want 100,000 Representatives! Opportunity is knocking—Answer! (Last Chance for 25c!) Beginning September, 1927, "Information" will cost 50c! Surety Service, Dept. 273, Rochester, N. Y.

TELEGRAPHY

TELEGRAPHY—Both Morse and Wireless—taught thoroughly and quickly. Tremendous demand. Big salaries. Wonderful opportunities. Expenses low; chance to earn part. School established fifty years. Catalog free. Dodge's Institute, H St., Valparaiso, Ind.

CHEMISTRY

CHEMICAL Service. Working formula or process prepared for your special purpose for \$5.00. Write me. W. Steadman Richards, Industrial Chemist, Box 2402, Boston, Mass.

EXPERIMENTERS' laboratory apparatus. Chemicals. List 5c. Chemical Apparatus Co., 4402 West End, Chicago.

FORMULAS AND TRADE SECRETS

STAYCOMB Formula, 25c—Write to Rickett, 2654 Earp St., Philadelphia, Pa.
24 VERY Good Formulas Only 50c. Winters Specialty House, Olmsted Falls, Ohio.

SELF-SHAVING Cream. No razor, brush or soap. Simply rub on, wash off and you are shaved. Use yourself and save money; selling to others will bring enormous income. Formula Free with a year's subscription to Worthwhile at 25c. Formulas, Processes and Recipes in every issue. Sample copy, 5c. Worthwhile, D-11, 130 Cady Street, Rochester, N. Y.

SPECIAL formulas for Manufacturing and Business purposes. Any one you want, including full manufacturing instructions and where to get all supplies, sent for \$5. Satisfaction guaranteed. Announcements of latest formulas for quick-selling seasonal products sent monthly without charge. Write today. National Information Bureau, 316E Shephard Building, Grand Rapids, Mich.

MAKE Much Money—Making and Selling Your Own Goods. Formulas, Manufacturing Processes, Trade-Secrets. All kinds. All lines. Catalog, special circulars free. B. Thaxly Co., Washington, D. C.

10,000 FORMULAS. A real Gold Mine of money-making ideas. Tells how to make almost everything under the sun. You can make and sell cosmetics, muckage, anti-freeze solutions, battery solutions, beverages, cheese, chewing gum, cleaning preparations, extracts, hair preparations, inks, bluing, leather polish, mirrors, perfumes, polishes, typewriter ribbons, carbon paper, washing powders, liquid soap, and hundreds of other profitable articles. Send No Money. Just write a postal for "Henry's 20th Century Book of Formulas." Pay postal postage and \$4. Popular Mechanics Press, 200 E. Ontario St., Room 903, Chicago, Ill.

GET Dividends From Your Formulas. "Cash In" on Them for Real Money. Particulars Free. Pacifico, Prineville, Ore.

LATEST Formula Bargains—2c. "Hawkins," 215M Las Animas, Colorado Springs, Colo.

ARE You Old at Forty? See our advertisement on page 28 of this issue. The Electro Thermal Company, 2167 Main Street, Steubenville, Ohio.

FORMULAS, Cosmetics of the finest grade. Six for \$1.00. W. A. Riedesel, Isabella, Calif.

RELIABLE formulas for all purposes \$5. Let us solve your problems. Chemical Testing Laboratories, Box 2961, Boston.

SAWDUST, chemicals makes Sanitary Flooring. Directions \$1.00. Universal Supply Co., Auburn, N. Y.

FORMULAS, Guaranteed Best Chemical Science can devise. Stamp brings big bunch valuable literature describing Latest Reliable Processes for Manufacturing All Lines. Don't Buy till you've received these Profitable Propositions. No recipe-book Trash. 29 years giving satisfaction. Miller Chemist, 1706-U Jetton, Tampa, Fla.

500 FORMULAS including Luminous Paint—Renewing Dry Batteries—Resilvering Mirrors—Gas Tonic, Puncture Plugger, 25c. Catalog Free. Ideal Book Shop, Park Ridge, Ill.

INCREASE your income—"Selected Opportunities" listing 24 business plans, two formula charts, \$1.00. Robert Smeriglio, P207 Stillwater, Stamford, Conn.

9,000 FORMULAS. \$2 each. Money refunded or your need supplied. Ernest COUNTRYMAN, 1450 S. State, Syracuse, N. Y.

15,000 FORMULAS in "Scientific American Cyclopedia of Formulas." Includes following and many others: accidents and emergencies, agriculture, alloys and amalgams, artists' materials, beverages, cements, glues, pastes, muckages, bleaches, renovating, coloring metals, dyeing, glass, heat treatment of metals, household formulas, ice cream, confectionery, chewing gum, lapidary work, exterminating vermin, lubricants, paints, varnishes, photography, condiments, canning formulas, rubber, soap, candles, soldering, toilet preparations, perfumes, waterproofing, fireproofing, writing materials. Send No Money. Just write a postal. When postman hands you book, pay \$7.50 and postal charges. Popular Mechanics Press, Room 903, 200 East Ontario St., Chicago, Ill.

AGENTS WANTED

LANOWA Polishing Cloth-Mitten Duster Combination selling like wildfire. 200% profit. Appoint agents. Free sample and territory. Fraser Products, 305-J 43rd, Kansas City, Mo.

\$25 TO \$50 a week—\$1 to \$2 an hour spare time in easy, pleasant occupation. Thousands of men and women are making this income with the famous Ho-Ro-Co Soaps, Perfumes, Toilet Articles, Specialties. Over 200 items; quick sales, appeal in every home. La-Em-Strait Hair Dressing, the fastest seller wherever introduced. Write at once for Free Sample Case offer—the best yet. Ho-Ro-Co., 791 Ho-Ro-Co Bldg., St. Louis, Mo.

AGENTS—\$13.80 Daily in advance, introducing New Insured Hosiery for men, women, children. Must wear or replaced free. 57 styles, 39 colors including latest "Silk to the Top" Ladies' Hose. Nyland made \$595 in one month. Edwards, \$460.60. Mrs. Bone, \$425.45. Why not you? Even spare time should pay you \$3.00 an hour. No experience needed. We furnish samples. Silk hose for your own use Free. New Plan. No matter what you are now doing, write quick. Maccabee Company, Road 2563, Cincinnati, Ohio.

AGENTS—Best seller; Jem Rubber Repair for tires and tubes; supersedes vulcanization at a saving of over 800 per cent.; put it on cold, it vulcanizes itself in two minutes, and is guaranteed to last the life of the tire or tube; sells to every auto owner and accessory dealer. For particulars how to make big money and free sample, address Amazon Rubber Co., Philadelphia, Pa., Dept. 505.

AGENTS—Everybody runs out of Gas. New invention reserves emergency gallon in 1926-27 Ford tanks. No extra container, no need to get out of car. Attach in 10 minutes. Guaranteed. Big money for agents. Write for Free Sample Offer. Successor Sales Co, 5930 Vancouver Ave., Detroit, Mich.

\$13.80 DAILY in advance (Send for sworn proof) Introducing New Insured Hosiery. 57 styles, 40 colors, guaranteed seven months. No capital or experience required. You simply take orders. We deliver and collect (or you can deliver, suit yourself). Credit given. Pay You Daily, monthly bonus besides. Spring line now ready. We furnish samples. Spare time will do. Milton Mathews, Road 5763, Cincinnati, Ohio.

SELL Radiator Drain Valve that every automobile owner wants. Don't get under car to drain radiator. Operated from dashboard. Hot-Spark Equalizer and Adjustable Bronze Endthrust Bearings, makes old Fords run like new. All three samples worth \$4.25, sent with excellent agents proposition for \$2.00. George Mfg. Co., 1806 E. 3rd, Amarillo, Texas.

SELL Tailor-Made Shoes. Sensational new fitting discovery eliminates foot troubles; makes walking a pleasure. 75 men's and women's styles. 60 leathers. Prices lower than stores. Big commissions. Free outfit. Free sample shoes. Tailor-Made Shoe System, 932 Wrightwood, Dept. OA3, Chicago.

SELL Surety, the Original, Genuine, Powdered Hand Soap and make \$5,000 yearly. We furnish sales plans, advertising and Free Samples. Write Quick. Surety Mfg. Co., Dept. 56, 26 W. Washington St., Chicago.

\$25.00 DAILY selling Raincoats and Slickers \$2.95; Newest colors, red, blue, green, etc. Outfit free. Commissions daily. Elliott Bradley, 241 VanBuren, Dept. 800, Chicago.

1 AUTO Gas Saver Free. To introduce. All makes. Amazing mileage increase. Critchlow, C5-805, Wheaton, Ill.

\$8.00 TO \$16.00 daily easy, introducing "Chieftain" Fine Quality, Guaranteed Tailored Shirts. Just show samples, write orders. We deliver and collect. Your pay Every Day. No capital or experience necessary. Spare time pays you big. Send today for Free Samples. Cincinnati Shirt Company, Lane 1583, Cincinnati, Ohio.

NO Difference what you are selling, you can increase your sales 500% by giving our \$1,000 policies as free premiums. Costs you nothing. Name your line and write, National American Benefit Association, B201, Willow Hill, Ill.

AGENTS make big money selling watch dog burglar alarms; retails for \$1.00; your profit 100%. Particulars free. Turk Mfg. Co., 32 No. Jefferson St., Chicago, Ill.

BIGGEST Little Thing Out. Universal Household Device, day in day out and year round where chairs are used. Big money making Harvest to Agents. Sample post paid 50 cents. Write for particulars. Jos. Bouska & Son, Bridgeport, Wash.

WOMEN—\$2 an hour spare time; new idea sanitary necessity; sells on sight; every woman buys; new feature never before used; designed by physician; revolutionizes old uncomfortable methods; pay every day; no deliveries, no collections, no experience or capital required. Particulars mailed in plain envelope. Don't delay. Write Mrs. Mary P. Coleman, Meriden, Conn.

\$100-\$200 WEEKLY, New Specialty; Weekly Salary guaranteed against commission. Reliable house Guarantee repeat business. All-year seller. Give age, references, lines sold and one now selling. Treasurer, 602 Cedar Rapids, Iowa.

AGENTS and salesmen to sell Household Utility to Retail Stores. State territory protected. No side line. Big earnings to conscientious men who know selling game. Prestovac Corp., 1030 W. North Ave., Chicago, Ill.

SALEMEN Wanted. Nationally advertised, universally needed product. Sells to Stores, Garages, Factories, Schools, Homes, Farmers, Auto Owners. Used by everybody. Big demand, ready sale. Big commissions. Complete sales training given. Credit extended to customers. Sample can be easily carried. Concern rated very high—established many years. Opportunities for lifetime job at big pay. Address Territory Manager, Dept. 68, Post Office Box 983, Dayton, Ohio.

BRAND new plan. Make \$45 a week and up and get your own clothes free. Profits paid in advance. Any man can easily earn this and more, just showing our wonderful outfit and taking orders for our high-grade tailoring. Free suit to each agent. Handsome carrying case outfit of large real cloth samples—everything furnished free. Spencer Mead Company, Sherman and Harrison Sts., Dept. D817, Chicago.

WOMEN! \$2.15 an Hour for your full or spare time! You can make that much distributing famous Royce Flavoring Extracts, Rare Perfumes, Complexion Aids, etc.—225 preparations. Quality unexcelled since 1879. Permanent profitable business easily established. Write for interview. The Abner Royce Company, 208 Royce Bldg., Cleveland, Ohio.

AGENTS: Steady income \$240 month. A business of your own. Over 200 fast sellers. We furnish selling outfit. Write quick. Stuart & Co., Dept. 231, Newark, New York.

CALIFORNIA perfumed beads selling like hot cakes. Agents coining money. Big profits. Catalog free. Mission Factory P, 2328 W. Pico, Los Angeles, Calif.

YOU can positively make \$100 a week with our superior proposition. Let us prove it. American Products Company, 9021 Monmouth, Cincinnati, Ohio.

SELL delicious food product to homes. Spare time or whole. Liberal profit. Repeat orders certain. Appoint sub-agents. Sample and Selling Plan Free. Cream of Chocolate Co., 40 Central, Waltham, Mass.

MAKE Much Money—Making and Selling Your Own Goods. Formulas. Manufacturing Processes. Trade-Secrets. All kinds. All lines. Catalog, special circulars free. B. Thaxly Co., Washington, D. C.

SEND name and address for Free introductory copy of Salesology Magazine. Contains one thousand money-making opportunities, offered by big reliable firms. Your chance to better your present income. Just mail post card. No obligation. Salesology Magazine, Desk A-2, 500 N. Dearborn St., Chicago, Ill.

SENSATIONAL Profits! Mexican Blue-Flash Gem matches finest Diamond; absolutely deceives experts; sells on sight! The only guaranteed low-price diamond substitute! Write quick for free \$5 Sample Case proposition! Mexican Gem Company, Monterey, Calif.

\$20 DAY easy earnings. Article absolutely wanted every home. Superior Steam Cookers. Wonderful booklet How to Sell Goods free. Fagley Halpen, Desk 40, Philadelphia.

TAKE orders Doyl-Ette table cloths, attractive colors. Genuine Du Pont Fabrikoid. No laundering. Wipe with damp cloth. Looks like linen. Make \$30.00-\$75.00 weekly. Samples Free. Doyl-Ette Corp., A-1018 Wabash, Chicago.

SELL Radium Water Generators. Entirely new, fast seller, repeat orders sure. Permanent income. Ask why today. Radium Refinery, 2209 Broadway, Oakland, Calif.

MAKE money silvering mirrors, refinishing auto headlights, tableware, metal plating bedsteads, chandeliers. Outfits furnished. International Laboratories, Dept. 71, 309 5th Ave., New York.

NOTHING sells like shoes. Every person a prospect. Take orders for Mason Shoes direct from factory. 85 stunning styles. Amazingly low priced. No experience needed. Free Outfit. Mason Shoe Mfg. Co., Dept. BA-40 Chippewa Falls, Wis.

JUST Out—Patented Apron. No strings or straps; on or off instantly; \$20 a day easy; every demonstration a sale; over 100% profit; commissions daily; write today for free offer. Staput Co., Dept. 203, St. Louis, Mo.

REAL Money selling a great new Health Invention generating Violet Ray, Vibration, Electricity and Ozone. Exclusive Territory now open. Write today. Lindstrom & Co., 30 W. Lake St., Dept. 13-53, Chicago.

FIBRE Brooms—detachable handles, fine finish. Good profits, repeat sales. The Fibre Broom People, 147 New Jersey Ave., Brooklyn, N. Y.

ACTIVE men to distribute repeating 50 candy specialties to dealers and jobbers. Full co-operation. Universal Sales Company, 631-B Wilson Ave., Brooklyn, N. Y.

GOLDEN Opportunity! Make Genuine Gold Leaf Sign Letters at home spare or full time. No experience or capital required. Replaces painted signs. Cost 1/2. Uncrowded field. We start you in big money-making business. Samples and details free. Swaringer Letter System, Box 706-X, Wichita, Kan.

AGENTS—Mac's Liniment (Liquid Mustard Plaster) for Coughs, Rheumatism; Mac's Black Lotion for Psoriasis, Wounds, Sore Gums, Piles. Mac Chemical Corp., 74-A West St., New York.

\$100 WEEKLY representing large Direct to Wearer Company. Complete shirt, necktie and work clothes line. Unbeatable combination means selling everyone. Advanced commission and bonus. Sales Compelling Outfit Free. Howard Shirts, 1213 VanBuren, Dept. M14, Chicago.

START in a permanent business of your own selling guaranteed Hosiery and Underwear worn all over the world. No capital or experience needed; many representatives make \$3,000 to \$5,000 per year. Become our district manager—get others working for you. Write for details to Malloch Knitting Mills, 573 Grant St., Grand Rapids, Mich.

AGENTS \$240 month and new automobile. Introduce finest line latest style silk hosiery. Your pay daily in advance. Extra bonus besides. No experience needed. Samples furnished. Silk hose free. We give you extra fine silk hose for your own use. Write for special offer. Jennings Hosiery Co., Dept. 2431, Dayton, Ohio.

AGENTS \$180 month. Bonus besides. Introduce finest line guaranteed hosiery. 126 styles, colors. For men, women, children. Finest pure thread Japanese Silk. All fancy combinations of silk and lisle. Novelty and Sport numbers, full fashioned, chiffon, wool, etc. Must wear 6 months or new hose free. New sales plan. Credit given. Auto furnished. Spare time satisfactory. Write for samples. Wilknit Hosiery Co., Dept. 1831, Greenfield, Ohio.

AGENTS—To Sell the New Featherweight All Purpose Waterproof Coat. Weight only 26 ounces, latest styles and colors. Men's \$4.98, Women's \$3.98. Liberal Commissions. Write today for sales plan. Featherweight Coat Company, 5710 Euclid Avenue, Cleveland, Ohio.

OUR New Household Device washes and dries windows, sweeps, cleans walls, scrubs, mops. Complete outfit costs less than brooms. Over half profit. Harper Brush Works, 132 3rd St., Fairfield, Iowa.

OUR Luminous Crucifix Shines in the Dark. Every one amazed at the wonderful effect. Easily demonstrated. Easily sold. W. G. Hannan Co., Dept. B, 2539 So. State St., Chicago.

100 PERCENT Profit on Every Sale. Sell guaranteed Beauty Creations, Food Products and Medicines. Credit given. Write the Tru-San Company, Department MEC, Memphis, Tenn.

FINANCIAL Independence is yours if you want it. Selling McNeess Products will mean for you permanent business that will pay you \$50 to \$100 a week for life, you will be your own boss. No one can take your business from you. Our help insures your success. Send for proof and information. Furst-McNeess Co., 506 Sunlight Bldg., Freeport, Ill.

SALESMEN—Harrison's exclusive New York Style Clothes pay you \$15 a day. Tailored of finest 100% virgin wools. Priced \$15.00 to \$25.00 below others. Collect advance commissions on every order. De Luxe outfit sells for you. Experience unnecessary. Valuable territories open. Write for new, elaborate outfit. S. Harrison Bros., Inc., Drawer 200, 133-141 West 21st Street, New York City.

1 AUTO Gas Saver Free. To introduce. All makes. Amazing mileage increase. Critchlow, C4-805, Wheaton, Ill.

AGENTS make \$10 daily with our new adjustable waterproof aprons and fifty other fast sellers. B & G Rubber Co., Dept. 134, Pittsburgh, Pa.

DISTRICT Managers—Agents: Capable men and women financially able to create and sustain branch office for new low-priced household necessity in big demand. Agents also wanted. For particulars write Pittsburgh Sanatory Supply, Inc., Wilkensburg, Pa.

AGENTS—New tool chest. Newest thing out. 8 tools in one. Carry in hip pocket. Use it every day. Men buy at sight. Fine leather case. Agents making big success. Write quick. Novelty Cutlery Co., Chest 431, Canton, Ohio.

300% PROFIT—Whirlwind selling household, store, office necessity; fast repeater; free sample. Chapman Company, Room 200, 332 East 31st, Kansas City, Mo.

THANCO Vanilla—Bottle Yourself! Concentrated; add water! free labels. Crushes competition! 500% profit! Immense seller! Other concentrated products. Write Thomas Manufacturing Company, Indianapolis, Ind.

AGENTS: Make \$500.00 monthly. Pay daily. No investment. Rhinestone initial buckles and novelties. Sell easy everywhere. Exclusive territory. Chaton Novelty Co., 606 Blue Island, Chicago.

AGENTS make \$3.00 an hour taking orders for our 40 Fascinating Kitchen Specialties. No competition. Write quick. General Products Co., Dept. 7-K, Newark, N. J.

BIG pay to agents selling Mother Hubbard Food and Household Specialties and Toilet Preparations. New Selling plan. Mother Hubbard Co., 558 Congress, Chicago.

KLEENZIT Kleening Pencil Removes spots and stains from men's garments and similar fabrics. Simply mark spot with cleaning crayon and erase with brush-pad moistened with water. Sells readily at 35c to 50c. Big profit. Sample 25c. Argyle Specialty Co., Argyle, Wis.

A WINNING line for 1927. 50 essential household articles. A live wire can easily make \$50 per week. Home Supply Corp., Asbury Park, N. J.

AGENTS cleaning up. Brand New Auto Specialty. Nothing like it. Going Big. 300% Profit. Exclusive territory. Sample Free. Aerial Electric Co., 131 W. Kinzie, Chicago.

SELLING Like Blazes! Eleven piece toilet goods assortment at \$2.25 with two piece carving set Free to your customers. 100% Profit. Davis Product Co., Dept. 56, 1321 Carroll, Chicago.

AGENTS. Greater Profits. year round sales; complete guaranteed line dress and work shirts, overalls, coveralls, work pants, playsuits. \$10-\$25 daily easy. We show you. Complete outfit Free. Nimrod Shirt Co., Dept. 8, 4922-28 Lincoln Ave., Chicago.

GIVE away 50c dustpan Free, to advertise No-Rub Silver Polish. Seven hours work daily will net you \$30.00 to \$70.00 a week. Write quick for details of this sensational offer. Chicago Metal Polish Co., H-214 W. Kinzie St., Chicago.

\$25 DAILY selling \$10 slickers for \$2.98; also full selections of other raincoats; quick deliveries; all colors. Outfit Free. American Waterproof, 724P Roosevelt, Chicago.

REAL money for you. Our combination Aluminum Cooking set easy to sell. No delivering, no collecting. Make \$10 to \$15 daily. Espy-Riddle Co., Dept. 2, 2325 Carson St., Pittsburgh, Pa.

\$100 WEEKLY. Hundreds making it. Selling marvelous auto invention. One size—fits all cars. Easily demonstrated Pocket size. Installed in 3 minutes. We guarantee sale. Send for free introductory sample offer and Crew Managers or Local Agents proposition. Mae Auto Products Company, Dept. 903, 6355 Broadway, Chicago.

AMBITIOUS Men Earn \$8-\$10 Daily. Pleasant work. Write today. Ideal Stairway Equipment Co., Dept. 5, Canton, Ohio.

\$18 TO \$25 daily. Biggest selling line of 2-piece suits, \$9.95 and \$12.50; 3-piece wool suit, \$17.95 (regular \$28.00 value). All-wool overcoat, \$18.50. Splendid raincoats, slickers and boys' suits. Biggest commissions. Free outfit. "Jim" Foster, Inc., Dept. 42-C, 2250 S. Spaulding Ave., Chicago, Ill.

SELL Show-Cards. New Line. Big Profits. Quick Sales. Particulars Free. Elfko, 525 South Dearborn St., Chicago.

AGENTS Wanted to sell Men's Hats direct from Factory. Send for Catalogue. Model Hat Mfg. Co., Dept. 5, East Orange, N. J.

AGENTS. Two Bits Every Two Minutes. Here's 25c profit on new household specialty you can sell in two minutes. The Pantong—something brand new. A red hot seller. Full time or sideline. Write to The Tyler Mfg. Co., Dept. CL-11, Muncie, Ind.

WANT Distributing Agent for Handslick, powdered hand soap; removes anything from hands; everybody a customer; sample free. Solar Products Co., J-2142 S. Troy, Chicago.

OH, Hello! why didn't I see this before. Christy's Iron Rust and Stain Remover sells like blazes. Write for free sample. Christy, Inc., 5067 Lakeway, Newark, New York.

AGENTS are cleaning up with National Fibre House Brooms and Auto Mitten Dusters. Send for Free Catalog and Sample Offer. National Fibre Broom Co., St. Louis, Mo.

VANILLA Salesmen—Try our Concentrate. Add water and bottle. Beats them all. Profit biggest. Sample. Trask, Mfg'r, East Vassalboro, Maine.

\$50.00 WEEKLY easy. Applying Gold Initials on Automobiles. No experience needed. \$1.45 profit every \$1.50 job. Free Samples. "Ralco Monograms," 1043 Washington, Boston, Mass.

\$11.50 PROFIT, on 50c outfit complete. Hair Tonic in powder form. Simply add water and bottle. Everything furnished. Casey Company, 1043 Washington, Boston, Mass.

HUSTLERS don't skip this. Money-back guarantee. New patented Ford invention. Money saver. 500 sold by one agent in one day. Sample demonstrator postpaid for \$1.00. Retail price \$2.00. Nu Idea Mfg. Co., Inc., Dallas, Texas.

CAN you sell Ford size tires at \$3.50 each? Write for plan. Details free. American Accessories Co., Station 431, Cincinnati, Ohio.

OUR latest Lingerie, Neckwear, Scarf line is unequalled for making money. Write for details. Public Service Mills, 725-F Sip Street, Union City, N. J.

ELECTRIC Window Flasher sign with changeable letters \$15.00. Brilliant day and night. Retail only \$15.00. Particulars free. National Display, 124 W. 18th, New York.

SEND three references for Samples. 15 Hosiery Styles; 50 colors. \$10.00 Dinner Set Free to customers. S. Q. S. Desk D., Lexington, Ky.

DISTRICT Agents—Sell \$23.50 All Wool Union Made Suits and Topcoats for large, old established firm. Wonderful values; one price. Liberal commissions in advance; money back guarantee. Expensive 3x13 swatch outfit Free. Protected territory. Write 1-D. Harvey, Box 00, Chicago, Ill.

FREE—Large wholesale Specialty Catalog, showing latest best sellers from all parts of the world. Spors Co., Lesueur Center, Minn.

YOU can be your own boss with our Key-Check outfit. Good for \$5 a day stamping names on pocket key checks, fobs, etc. Sample check with your name and address. 20 cents. Pease Die Works, Dept. M, Winchester, N. H.

FREE—Extra Pants with wonderful \$29.75 Suits. Make \$85 weekly. Wonderful \$23.50 line. Big Profits. Free Outfit. Jay Rose, Tailors, 413G, South Wells, Chicago.

AGENTS to introduce new Griddle Greaser. Sample dozen by mail, \$1.00. A. Jensen, R. 6 B. 86, Stockton, Calif.

EVERY Woman Wants a Sewing Set. Home Sewing Sets contain 142 useful sewing articles. \$4 an hour easily made with this 50c seller. Prentice-Lee, 147 East 23rd St., New York.

POWER Tire Pumps for Fords. Claggett Mfg. Co., Marlboro, Md.

AGENTS, Salesmen, Crewmen—You'll Have the Devil's own time finding a better seller than "Zippo." Splendid profit on snappy 50c "Go-Getter" repeat article that sells on a ten second demonstration. Works while you watch it! Demonstrates value while others waste time making claims. New development! Greatest scientific triumph of the age! It's the berries! Write immediately for complete proposition. Karam-Smith Company, 603 Bozan Street, Fort Wayne, Ind.

AGENTS make \$10.00 Daily selling Non-Splash Water Filters on sight. Best canvasser's article on market. Investigate. Write for particulars, Desk 14, Seed Filter Company, 73 Franklin Street, New York.

WE Pay \$50 a Week and Expenses and give Ford Auto to men to introduce poultry and stock compounds. Imperial Co., D23, Parsons, Kan.

\$20.00 DAILY Easy selling amazing rain-proof caps. Made-to-measure. Finest fabrics and styles. Big advance profits. Free outfit and free cap offer. Taylor Cap Manufacturing, Dept. X-51, Cincinnati, Ohio.

\$50,000. PICTURE Man Friedman made canvassing. Beginners can make \$100.00 weekly with my sales talk. Experienced men make more. Free book. "Profits in Portraits" explains. Samples Free. Picture Man Friedman, Dept. 8-E, 541 W. Lake, Chicago.

AGENTS—Make a dollar an hour. Sell new kind of sharpeners. Sharpens all knives and tools quickly. Demonstrating sample free. Premier Mfg. Company, Dept. 65, Detroit, Mich.

AGENTS—Our new selling plan means quick sales and big profits. Toilet Articles, Perfumes, Household Products. We credit you. Carlisle Co., Dept. PM, Huntington, W. Va.

OVER 100% Profit. Self Lighting Gas and Cigar Lighters; Everybody interested, repeat business. Sell individuals, dealers, subagents. Particulars Free. P. Bernhardt, 127 West 30th St., New York.

NEW invention—Big Seller—400% profit. Liquid Quick Mend for Hosiery and fabrics. Every woman buys. Hundred other fast sellers. J. E. Johnson Co., Dept. 451, 5145 Wentworth Ave., Chicago.

MILLIONS stolen. Remarkable new \$5.00 Check Protector stops forgery. Inks, protects two colors. Sensational sales, profits. Write Safety Devices Corp., Grand Rapids, Mich.

AGENTS Wanted—\$45 to \$85 a week selling shirts. Commissions in advance. We deliver and collect. Write today. Fashion Wear Shirts, Dept. C-942, Cincinnati, Ohio.

LOOK no further! Here's your money-maker. Write for Harrison's New Shirt outfit. Big samples. Fine portfolio absolutely free! Tailored Shirts generously cut. Reinforced. Handsomely finished. Made like custom-tailored shirts, but sell quick at amazingly low prices. No experience or capital necessary. Write for territory, and Free Equipment. S. Harrison Bros., Inc., Drawer 201, 133-141 West 21st St., New York City.

SALESMEN, agents, distributors sell new marvelous shock absorbers; fits all cars; installed quickly; retails \$10; big profits. Anchor Electric Co., 559 Jackson, Chicago, Ill.

GOLD Leaf Window Letters and Script Signs. No experience; 500% profit. Samples free. Consolidated, 69-U West Van Buren, Chicago.

SHOW Rubber Goods, Aprons, Stepins Take Orders. We deliver. Advance Pay. American Rubber Products, Dept. 308, Pittsburgh, Pa.

SALES Agents—Take orders High-Grade Tailored Neckwear. Guaranteed for 6 months. Insured never to roll, twist, stretch or bunch. Not sold in stores. Samples furnished. Write quick. Better Made Cravat Co., Wholesale Dept. 6, Columbus, Ohio.

NOVELTY bedspreads. Silk and cotton fabrics. Guaranteed. Reasonably priced. Every housewife wants one. Liberal territory and commission. Write Rainbow Novelty Mills, Grover, N. C.

AGENTS Wanted—To sell "Advassuits"—attractive, one-piece work suits with name or trademark of wearer embroidered on back. Big demand from employees of filling stations, garages, creameries, ice and coal companies, transfer men, etc. Quick sales. Liberal commissions. No investment required. Selling outfit Free. Advassuit Co., 221 West 7th St., Kansas City, Mo.

\$18 TO \$25 daily. Biggest selling line of 2-piece suits, \$9.95 and \$12.50; 3-piece wool suit, \$17.95 (regular \$28.00 value). All-wool overcoat, \$18.50. Splendid rain-coats, slickers and boys' suits. Biggest commissions. Free outfit. "Jim" Foster, Inc., Dept. 641, 2250 S. Spaulding Ave., Chicago, Ill.

SELL Better Quality All-Wool Made-to-Order Suits at \$31.50. Profitable new field for men who are conscientious and dependable. No experience necessary. Full or part time—\$45 to \$100 weekly and liberal bonus. Commissions paid in advance. We furnish handsome large swatch samples and complete instructions free. Write W. Z. Gibson Inc., 161 W. Harrison St., Dept. C517, Chicago.

DON'T sell for others. Employ agents yourself. Make your own products. Toilet articles, household specialties, etc. 500% profit. We furnish everything and show you how. Valuable booklet free. Write at once. National Scientific Laboratories, 1942 W. Broad, Richmond, Va.

FREE Outfit—\$10-\$15 daily. Guaranteed all-wool tailored trousers less than store prices. Quick sales. Big money. Pay daily. Free trousers offer. Hutchins Pants Co., Dept. 150, Cincinnati, Ohio.

NEW fast selling household specialties. County distributors wanted. Write today. Hess Manufacturing Company, Freeport, Ill.

GET set for life with regular income. Join 42 year old company. Many representatives with us 5 to 25 years. Make \$25 to \$75 weekly supplying free premiums with quality household products. Great Eastern Coffee & Tea Co., Dept. C-1040, St. Louis, Mo.

BIG Profits: Steady Income our line food products, toilet articles, soaps. No cash or experience needed. Sample case free. Write Linro Co., Dept. 242, St. Louis, Mo.

NEW Way to Make Money—We show you how. Earn \$15 a day taking orders for our fine made-to-measure tailoring. Your own suit absolutely free. Write today for new style, convenient, portfolio outfit, large all wool samples, etc. Furnished free. Progress Tailoring Company, Dept. C2171, Chicago.

MIRRORS Resilvered at Home. Costs Less 5 cents per square foot; you charge 75 cents. Immense profits, plating like new: brassy worn-off autoparts, reflectors, tableware, stoves, etc. Outfits furnished. Details free. Sprinkle, Plater, 128, Marion, Ind.

TAKE orders with amazing new tailoring side-line for clothes guaranteed to wear full year. \$40 weekly extra, easy. Special patterns free. Write Palmer Clothing Co., Dept. 200, Chattanooga, Tenn.

GREAT neckwear line now free! Features finest quality neckwear at factory prices. Collect big commissions daily. Write for Free tie offer and Free outfit. Nawco Neckwear, Desk 3-B1, Covington, Ky.

AGENTS—500% profit selling genuine gold window letters; Scripts. Experience unnecessary. Free sample. Premier Letter Co., 121 N. Francisco, Chicago.

AGENTS—N-R-G Laundry Tablets, the old reliable moneymaker for live agents. Millions sold—200% profit—sales waiting for you. Clothes washed spotlessly clean in 10 minutes without rubbing. Free samples. N-R-G Company, 230 W. Superior, Chicago.

WANTED—County representatives to market 3A garage Door Holders. Simple Automatic Action instantly attracts Garage Owners, Builders, etc. Write for attractive proposition. Knowson-Stevenson Company, Ann Arbor, Michigan.

AGENTS: This one skipped means money lost. Write immediately. Postal Box 457, Madison Square, New York.

10 EASY sales daily, profit \$1,000 month! Amazing vaporizer practically doubles gasoline mileage! Tests show 63% increase! Exhaustively tested by Carnegie Institute Technology! Sensational seller! Territory! H. Phillis Mfg., St. Louis.

AGENTS: Only Home Pea and Bean Huller on Market. Sells year round. Weight one pound. Retail \$1.00. Home Pea & Bean Hulling Machine Co., Marietta, Ohio.

BIG Money easily made without peddling or outfits. Free particulars. Elite, 38 Elizabeth St., New York.

AGENTS—I want 500 ambitious men and women who want to make big money fast. "Doc" Barber sold 72 in 4 hours. Profit \$64.80 (sworn proof). Every woman buys on ten-second demonstration. New self-wringing mop that really wrings dry, without wetting hands. No gears, bolts or screws. Simple, practical, perfect. Last a lifetime. Weighs only two pounds. Price \$1.50; your profit up to 150%. Exclusive protected territory. Write quick! Delphos Mop Co., 1013 Tenth St., Delphos, Ohio.

AGENTS: Salesmen—Sell New Thermo-static Automatic Carburetor Control Attachment for Fords. Big profit, full or part time. Increases mileage 50-100%. Attached in two minutes. No drilling. Cadillac now using Thermo-static Carburetor Control under Blanche license. Sales guaranteed. \$15.00 a day Guaranteed to Distributors. Write today. Blanche Auto Devices Co., Dept. 805-CX, 157 E. Erie St., Chicago.

NEW Camera. Regular black and white photos finished quickly inside camera. Make money selling cameras, taking photos or doing both. Crown Company, Dept. 481, Norwalk, Conn.

300% PROFIT: Whirlwind selling household, store, office necessity. Fast repeater. Free sample. Chapman Company, Room 200, 332 East 31st, Kansas City, Mo.

ARTIFICIAL stone houses, \$100! (Patent applied for.) These houses indestructible. Scientific American says. Agents' bonanza. D. Bradley, Box 1586, Cincinnati.

AGENTS, portraits, photo-pillow tops, frames, sheet pictures, medallions, photo-jewelry, guaranteed hose, laundry tablets, food products, toilet requisites, luminous crucifixes. Catalogue 50 specialties free. 30 days' credit. Jas. C. Bailey Co., Dept. C3, Chicago.

MAGIC Polishing Cloth—great seller—big profit. Try this cloth—it's a moneymaker. Full size samples free. Get this proposition. Newton Co., 166 Main St., Newark, New York.

AGENTS—just like striking an oil well. New money-making advertising specialty. Particulars free. Suburban, Box 10, Mt. Washington, Ohio.

JUST off the press. "Radio Trouble Shooter." How to find all radio troubles and fix it. Illustrated. Sample copy \$1.00. Particulars free. Publisher, Box 10, Mt. Washington, Ohio.

BIG earnings. Square Deal Policy. Sell "Spire Quality Shoes" direct to ladies. Big values, snappy styles, \$4.00 up. Money Back Guarantee. Protected Territory. Write! Spire Shoe Co., Dept. F206, Cincinnati.

\$40.00 SUITS for \$23.50! All one price. Union made of finest quality Virgin Wool. You don't have to know anything about selling clothing. We guarantee your success if you are honest and willing to work. Write at once. William C. Bartlett, 850 Adams, Dept. 96, Chicago.

AMAZING Large Cash Commissions Introducing Beautiful \$3.95 and \$4.95 Fit-to-Measure Guaranteed Shoes. Actual Samples Furnished. Write for Your Territory. Style Arch Shoe Co., Dept. P-113, Cincinnati, Ohio.

WOMEN! \$2.15 an Hour for your full or spare time, distributing famous Royce Flavoring Extracts, Perfumes, Complexion Aids, etc.—225 preparations. Quality unexcelled since 1879. Permanent, profitable business easily established. Write for interview. The Abner Royce Company, 308 Royce Bldg., Cleveland, Ohio.

CASH Paid for Butterflies, Insects. See Sinclair Display Advertisement on Page 22.

ARE You Old at Forty? See our advertisement on page 28 of this issue. The Electro Thermal Company, 2167 Main Street, Steubenville, Ohio.

SANITARY cover turns milk bottle into convenient pitcher, and prevents milk from spilling. Agents make big money full or spare time. Sample 35c. Write Lock Box 1281 Chicago.

INCREASE your income. Men, women, make money during spare hours. "Greater Incomes" for January. Contains information, legitimate opportunities, schemes, tips, that can be turned into money. 20c copy only 10c. "Greater Incomes," Guilford, Conn.

1 AUTO Gas Saver Free. To introduce. All makes. Amazing mileage increase. Critchlow, C6-805, Wheaton, Ill.

ATTENTION—Men: Men wanted in this community with sales ability, also those capable of directing other salesmen, to place our Brite-Lite direct with automobile owners. Brite-Lite—the magnetic auto light, is creating a sensation everywhere. It lights when all others fail. Territory allotted to those capable of producing volume sales. The men selected will be made direct factory representatives with a liberal contract. The Brite-Lite sells itself. Write for further details, giving references and past sales experience. Electrical Products Mfg. Co., 8 Centre St., Newark, N. J.

PATENTS. Time counts in applying for patents. Don't risk delay in protecting your ideas. Send sketch or model for instruction or write for Free book "How to Obtain a Patent" and "Record of Invention" form. No charge for information on how to proceed. Communications strictly confidential. Prompt, careful, efficient service. Clarence A. O'Brien, Registered Patent Attorney, Security Bank Building (directly across street from Patent Office), Washington, D. C. See pages 138 and 139.

AGENTS: Write quick for amazing offer. Samples and auto furnished. \$17.50 daily plus bonus. Introduce new line hosiery guaranteed 7 months. New sure-fire selling plan gets big business. Start on credit. Samples furnished. Betterknit Textile Co., Dept. 33, Greenfield, Ohio.

\$75 WEEKLY Man or Woman Wanted with ambition and industry, to distribute Rawleigh's Household Products to steady users. We train and help you so you can make up to \$100 a week or more. No selling experience necessary. Pleasant, profitable, dignified work. Write today. W. T. Rawleigh Co., Dept. IL8253, Freeport, Ill.

GOLD Leaf Window Letters and Script Signs. No experience; 500% profit. Samples Free. Consolidated, 69-U West Van Buren, Chicago.

WOULD \$100.00 per week interest you? Millions of photos all over the Country just crying to be made into beautiful artistic medallions. We have new plan. Lowest Prices. Speedy service. Experienced agents losing money every day they put off writing us. Art Medallion Co., Department C, Corner Campbell & Jackson, Chicago, Ill.

SELL Super-Power, the blue wonder crystals. Latest automobile product. Sells like a flash. Saves gas, increases power and pep, removes carbon while driving. Guaranteed harmless. Just pour into gas tank. Steady repeat article. Your profit 100 to 182%. Particulars free, write today. Cassard Specialty Laboratories, 31A Fountain Street, Grand Rapids, Mich.

GOLD-LEAF Sign Letters; make and sell; 1,000% profits. Particulars. Johnston Co., Quincy, Ill.

\$500 MONTHLY proposition. Particulars Free. B. Davis, 1726 Roosevelt Rd., Chicago.

"MAKE And Sell Your Own Goods"—Tremendous Profits; No machinery; No experience; We show you how; Write quick for Free Book. Clover Laboratories, (P) Parkridge, Ill.

\$16 A DAY Easy—I start you in auto accessory business; no investment; no experience necessary. Landin, 3433 Montrose Ave., Chicago.

GENUINE Gold Leaf Letters anyone can put on Store windows. Guaranteed to never tarnish. Large Profits. Enormous Demand. Free Samples. Write today. Metallic Letter Co., 438-D North Clark, Chicago.

"LIQUID-LEATHER" Fills Holes in Shoes, Rubbers, Tires. Dries Instantly. Pliable, Waterproof. Just Imported from France. Tube Retail 75c—Cost 35c. Sells Housewives, Sub-Agents. Nulife Leather, Hartford, Conn.

REMNANT Store, Bethel, Ohio. Greatest Dry Goods Bargains on Earth. Agents and Dealers.

WILLIAMS' No-Water Hand Soap, in tubes, has taken Auto owners by storm; washes dirtiest hands perfectly clean without water; easy demonstration makes quick sale. 150% profit. Williams Co., Dept. 245 Montclair, N. J.

\$320 PROFIT First Three Days' Sales for Zindel, Illinois, with Money Quick Action Auto Rim Tool. Profit \$2 tool. Exclusive territory for hustling agents. Earn \$10 to \$50 cash daily, \$75 to \$300 weekly year round. M. Morey Rim Tool, Blissfield, Mich.

AGENTS—Clever Invention! Inkspoon makes every pen a fountain pen. Fast office seller; big profit, demand increasing everywhere. Exclusive territory offered. Sample free. H. Marul Company, Tribune Bldg., New York, N. Y.

EARN \$10 daily silvering mirrors, plating and refinishing metalware, autos, chandeliers, bedsteads, headlights. Outfits furnished. E. Decie Laboratories, 1133 Broadway, New York.

AUTO owner tire agent wanted each locality to use and take orders for hand-made Mellinger cord and balloon tires; guarantee bond 15,000 miles; shipped prepaid on approval; get your tires free; no capital or experience required; make \$100 to \$300 weekly. Write for wholesale prices and sample kit. Address Mellinger Tire Co., Dept. 400, Kansas City, Mo., or Dept. 400, Philadelphia, Pa., or Dept. 400, Oakland, Calif.

NO Dull Times Selling Food. People must eat. Federal distributors make big money; \$3,000 yearly and up. No capital or experience needed; guaranteed sales; unsold goods may be returned. We furnish you with sample case, license and Free Samples for customers—Sure repeat orders. Exclusive territory. Ask now! Federal Pure Food Co., A2307 Archer, Chicago.

AGENTS—Here's a New One. "Best-ever Powdered Hand Soap." Sells like wildfire. Marvelous Discovery. Removes grease, paint, ink, oil, in fact anything from the hands. Cannot harm skin. 150% Profit. Great Repeater. Agents simply coin money. "Free Samples Get the Business." Write immediately. Bestever Products Co., 1937 E. Irving Park, Chicago.

AGENTS—Steady Income. Large manufacturer of handkerchiefs and dress goods, etc., wishes representative in each locality. Factory to consumer. Big profits, honest goods. Credit given. Send for particulars. Freeport Mfg. Co., 59 Main St., Brooklyn, N. Y.

POLMET—The Wonderful Polishing Cloth that cleans all metals without liquid, paste or powder. Approved by "Good Housekeeping" and "Modern Priscilla"—sells fast at 25c. Sample free. Gale & Co., Inc., 15 Edinboro St., Boston.

MAN in each town to plate auto parts, reflectors, bathroom fixtures, refinish beds, mirrors, chandeliers; by new method. No capital or experience required. Simple plan of manufacturing at home starts you in big money-making business. Outfit furnished. Free particulars and proofs. Gun Metal Co., Ave. H. Decatur, Ill.

REPLATE brassy worn-off Automobile parts, Reflectors, Bath Room Fixtures, Worn Spoons, Forks, etc., with pure silver. Looks like new. Use U-Kan-Plate Polish. Positively no mercury. \$1.00 half pints. Post Paid. Satisfaction Guaranteed. Agents wanted. Dept. A, U-Kan-Plate Co., Philadelphia.

AUTOMOBILE Specialties. Guaranteed formulas for all latest money makers. Lowest prices. Write for free lists. Murphy, Chemist, Tujunga, Calif.

WANTED: Local and State Representatives for famous ready made Artistic Signs, price tickets, etc. No competition. Full protection. Large profits. For particulars write Artistic Signs, 799R Broadway, New York.

BIG Money and Fast Sales. Every owner buys Gold Initials for his auto. You charge \$1.50; make \$1.35. Ten orders a day easy. Write for particulars and free samples. American Monogram Co., Dept. 40, East Orange, N. J.

AGENTS: 500% profit. "Happy Home Make Shampoo" builds your own big business. Martin of Indiana made \$75.00 in one day. Missouri man made \$750.00 one month. Exclusive territory. Geo. A. Schmidt & Co., Dept. P, 236 W. North Ave., Chicago.

AGENTS, both sexes, we manufacture and control new household article. Fast seller. Big profits. Exclusive territory. Write now. Connolly, 123 Liberty St., New York.

MOCCASIN Manufacturer Wants Agents Everywhere to sell a complete line of moccasins to wearers. Entire new line. No competition, repeat orders. Get details. Daley Moccasin Co., Fort Covington, N. Y.

WE Start You Without a Dollar. Soaps, Extracts, Perfumes, Toilet Goods. Experience unnecessary. Carnation Co., Dept. 2480, St. Louis.

SELL men's neckwear; wonderful proposition. Astor, 318-M Broadway, New York.

AGENTS—Make a dollar an hour. Sell Mendets, a patent patch for instantly mending leaks in all utensils. Sample package free. Collette Mfg. Co., Dept. 404, Amsterdam, N. Y.

AGENTS—Send for Free Sample "Fret-not" Washday Wonder. Big Profit. You don't have to talk; if she doesn't buy at sight, leave sample. Exclusive territory. Credit given. Empire Specialties Co., 1549 N. Wells, Dept. 101, Chicago.

AGENTS make \$100 week placing advertising Cigar Lighters with glass front. Every dealer wants one. Write for free plan. Drake Mfg. Co., Dept. M, Milwaukee, Wis.

BIG Profits. Sell "No-Splash" 4-Strainer Water Filters. Fast sales, lowest prices; send for 6 dozen, \$1.80 postpaid. Jones Mfg. Co., 243E2 Franklin St., Boston, Mass.

LAST Call! Fall in. Here's a Money Maker! Supreme Shirts give 100% satisfaction. Proposition, Kit Free. Supreme Shirt Co., 276-M Fifth Ave., New York.

MANUFACTURE Very Latest, Biggest-selling Advertisements yourself—No Machinery; investment small—All lines. Stamp brings Valuable Interesting Literature explaining how others sell your products and big bunch lists Guaranteed Formulas. 300 to 1,200% profit to you. Reliable Information Only. No "Master Formula" trash. Miller, Chemist, 1706-V Jetton, Tampa, Fla.

AGENTS—Sell 5c fast selling candy specialties to stores. Big profits. Lorrac Products Co., Albany, N. Y.

AGENTS—Stamping names on Pocket Key Protectors; sample Check with your name and address, 25c. Stamping Outfits. Emblem Checks, Check Fobs, Name Plates. Hart Mfg. Co., Desk 2, 303 Degraw St., Brooklyn, N. Y.

A BUSINESS of Your Own—Making Sparkling Glass Name and Number Plates, Checkerboards, Signs, Big Book and Sample Free. E. Palmer, 512 Wooster, Ohio.

AGENTS—New Plan, makes it easy to earn \$50.00 to \$100.00 weekly, selling shirts direct to wearer. No capital or experience needed. Represent a real manufacturer. Write now for Free Samples. Madison Company, 566 Broadway, New York.

GET Our Free Sample Case—Toilet articles, perfumes and specialties. Wonderfully profitable. La Derma Co., Dept. A, St. Louis, Mo.

AGENTS wanted—To sell Ray-O-Lite cigar and gas lighters. Big earnings. Sample 50c. Rapid Mfg. Co., 799-E Broadway, New York.

AGENTS: Big Money Monogramming by Transfer method. Catalog Showing Over 50 Styles and Particulars Free. Motorists' Accessories Co., Mansfield, Ohio.

FREE Sample. "Rain Shield Wiper." Retail \$1.00—Cost (25 cents). Sold Clear and Rainy Days. No Cloth—No Paste—No Attachment. (1) Rub keeps windshield clear 48 hours. Experience Unnecessary. NuLife Corporation, Hartford, Conn.

\$60-\$200 A WEEK. Genuine Gold Letters for store windows. Easily applied. Free samples. Liberal offer to general agents. Metallic Letter Co., 438-B North Clark, Chicago.

GOLD Sign Letters. \$9.75 for Thousand. Non-Tarnishable. Free sample. Catalogue. Atlas Sign Works, 1032 E. 55th St., Chicago.

HIGH-GRADE SALESMEN WANTED

\$100 PER week—Just Show It and Collect. "Sure-Hold," the screw-driver with fingers that hold the screw and start it where human fingers cannot reach. Positively Sells on Sight. Every mechanic is waiting to buy. Millions Will Be Sold. Made in 3 sizes (to handle any screw or bolt). Sell for \$1.00, \$1.10 and \$1.25 each or \$3.35 per set. To Agents only. Upon receipt of \$2.35 (money order or currency) we will send you sample set by parcel post, prepaid, with agents' confidential price list and full particulars, showing you how to make \$100 Per Week. If you prefer, send 50 cents postage and pay postman \$2.00 upon receipt of sample set. Money Back Guarantee. If you are not delighted with our proposition return the "Sure-Holds" and we will immediately return your money. You take no risk. Biggest Money Maker Today. No Competition. We Guarantee the Sale. Automobile Free. Be First. Sure-Hold Screw Driver Company, Jefferson and Third, Desk X, Seattle, Wash.

WANTED—Tailoring Salesmen, make \$60 to \$125 per week. We are the largest made-to-measure tailoring house in the country, furnishing elaborate sample equipment. Over 150 all wool fabrics sell at \$23.50, \$29.50, \$34.50 and \$43.50 which includes commissions of \$3.50 to \$8.50 and bonus. Guaranteed absolute satisfaction, perfect fit, best workmanship, or no sale. We maintain an absolute 6-day delivery schedule. Write for our line and all accessories to be sent free. Tell us all about yourself. Edward E. Strauss & Co., Inc., Dept. 101, 402 So. Market St., Chicago.

TAILORING Salesmen Who Must Make \$5,000 Annually. We offer the wonder line of the age. Samples yard-and-a-third long—the kind regular tailors show. Absolute satisfaction or money back guarantee. Every garment individually cut, bench tailored. Finest fabrics. No charge for extra sizes or special styles. Suits \$29.50 to \$47.50. Highest commissions. Big bonus to producers. Beautiful Spring line ready. Write today and include three business references. Hamilton Tailoring Co., Fourth & Central, Cincinnati, Ohio.

WONDERFUL Opportunity for reliable man as representative of \$1,000,000.00 firm showing nationally advertised line of staple merchandise to business men. Basic necessity—steady repeater. Underselling competition 30%—Earnings start big, grow larger. Our men earn \$50.00, \$100.00 and more weekly—full or spare time. No experience needed. A few exclusive territories are open. Write for full information—Free. J. B. Simpson, Dept. 1316, 843 Adams St., Chicago.

EXPERIENCED Tailoring Salesmen; Sell the most complete line of Boys and Young Men's Clothing direct to consumer; suits, topcoats, novelty suits, longies, slickers, etc. Chest sizes 22 to 42. Guaranteed values; biggest commissions; free business stimulator. Spring Line ready. Sample outfit free to real workers. Write now. Craig-Wilson, Inc., 10 Waverly Place, New York, N. Y., Dept. P3.

TAILORING Salesmen—The biggest direct selling proposition today. 2 Suits or Suit and Topcoat for \$29.50. Your commission \$5.00. Large Size swatches, 16x29 inches double. Domestic, Imported Cloths. All colors, all patterns. Compact Sales Kit. Just show the Kit, and take orders. Write us about yourself. We'll send you a Kit Free. Write today. International Dundee, 189 Greene Street, New York, Dept. PM3.

MR. BRUSH Salesmen—Old Established New York Brush Manufacturers require services of men in all territories to sell their extensive line of Sanitary Twisted in Wire Brushes. We pay larger commission than any other Brush House in the country. Write immediately for our proposition. Wire Grip Sanitary Brush Corporation, 15 Mercer Street, New York.

BECOME Your Home Town's Leading Business Man. Big money. Easy work. Selling groceries, coffee, canned goods, auto oils, direct to consumer. Undersell competition. Free gifts. Commission Advanced. Liberal Credit Plan. No Experience or capital necessary. Lovrin & Browne, C-1615 So. State, Chicago.

YEAR round line. No competition. Permanent income. Oldest, largest, most reliable house in field. Bigger profits. Souvenir Pencil Co., Dept. C5, Cedar Rapids, Ia.

SALESMEN—Become Independent. Own Your business, experience unnecessary selling our \$7,500.00 Accidental Death; \$50 Accident; \$25 Sick Weekly Benefits—\$12.50 Yearly. Other Amounts proportionate. Guaranteed steady income from renewals. \$250.000 Deposited Insurance Department. Universal Policy, Dept. A, 30 Clinton St., Newark, N. J.

OFFICE specialty salesmen wanted. Exclusive agencies. Dibb Manufacturing Company, Minneapolis.

NEW Advertising Novelty. "Oil-Memo" clamps on dash of auto. Big money-maker. Live-wire salesmen wanted. Full time or side-line. Strictly commission basis. Free samples. Give references or experience in first letter. Jubilee Mfg. Co., 16 Sta. C, Omaha, Nebr.

SALESMEN: Are you dissatisfied? If you are not making as much money as you should for the work you do—get our proposition. We have salesmen who had no previous road experience who will have to pay income taxes on over \$5,000 for 1926. If they can make money selling our line to retailers, why not you? Salesmanager, Box S-1029, Cedar Rapids, Iowa.

TAILORING Salesmen for the Emerson Master Built suits and topcoats. Finest tailoring at \$23.50, \$28.50, \$36.50, and \$42.50; profits \$3.50 to \$7.00, plus bonus. 150 samples. Protected territory. Unique Sales Plan develops prospects. Write me fully; include 3 references for quick action. Emerson Wholesale Tailors, Dept. 1001, 635-7 Arch St., Philadelphia, Pa.

GOLD Leaf Window Letters and Script Signs. No experience; 500% profit. Samples Free. Consolidated, 69V West Van Buren, Chicago.

100 MORE active men to introduce Chief-tain Guaranteed Tailored Shirts 3 for \$4.95. Latest novelties, colors. Dickman, Illinois, in 3 weeks made \$589; Sinton, Texas, in 12 days, \$219.60; Bend, Iowa, in 16 days, \$334.80. Why not you? No experience or capital needed. We deliver and collect. Full working outfit Free. Cincinnati Shirt Company, Lane 2943, Cincinnati, Ohio.

TOOL Salesmen—Mechanics—Distribute guaranteed line auto repair tools. Exclusive business of your own. Show 71 samples in case. Big commissions. Quality Tools Corporation, New Wilmington, Pa.

GREAT neckwear line now free! Features finest quality neckwear at factory prices. Collect big Commissions daily. Write for Free tie offer and Free outfit. Nawco Neckwear, Desk 3-B, Covington, Ky.

MEN—Sell dependable shrubbery, fruit trees, etc. Steady demand. Complete operation. Commissions paid weekly. Write Perry Nurseries, Dept. R-3, Rochester, N. Y.

SALESMEN—Amazing new drugless health product in big demand. \$6.50 profit on every sale. The \$2,500,000,000 spent yearly for health assures you a tremendous market with no dull seasons. Exclusive territory. Write for special offer. Radiumized Applicator Co., 1303-P, Fillmore, Buffalo, N. Y.

MILLIONS of business men waiting for Brand New indispensable \$10.00 office utility saving hundreds of dollars annually. One man sold sixteen in three hours. Splendid profits. Write quick for trial offer and exclusive Virgin territory. Lightning Calculator Co., Dept. FT, Grand Rapids, Mich.

MOTION—Color—Light plus changeable letter system make ours the last word in window salesmen. Actually boosts sales 200% to 400%. Every show window means an interested prospect. Get the facts and start pocketing \$100 weekly. Display Products Company, A409 East 31st, Kansas City, Mo.

PAVED Road Maps—Handy, inexpensive for advertising and premiums. Sell on sight. Full or sideline. Proposition, samples on request. George F. Cram Company, Indianapolis.

BIG Season Just Ahead—Advertising Pencils more popular every day—every business prospect—our line repeats—Big commission—Established 1902. North American Pencil Works, 126 A8 So. Clinton, Chicago.

SALESMEN: Make big money selling Guaranteed Oils, Paints, Direct To Users, Sales Easy. Tiona Refining Co., Cleveland.

DISTRICT Salesmen Make \$30.00 a Day, taking orders for Goodwear tailored-to-measure clothes at sensational new low price. \$25.00 Sales Outfit Free. Exclusive Territory. Prefer married man, 30 years old or over, and permanent resident in district. Address Dept. 836, Goodwear Chicago, Inc., 844 West Adams, Chicago.

SALESMEN—Every tailoring salesman should sell. "Real Blue Serge" 2 pants non-fade suits. A \$60.00 suit that sells Direct From Factory for \$34.95. Write for particulars. The Real Blue Serge Co., 10 N. 22nd St., Philadelphia, Pa.

\$10 TO \$20 daily easily earned selling shoes for the largest direct to wearer concern in the world at saving of \$2 to \$3 pair. Some good protected territory still open. Doublewear Shoe Co., Minneapolis, Minn.

WONDERFUL Invention. Seals Fifty Envelopes minute. Sells on sight at \$3.50. Exclusive territory. Kendall Sealer Co., B2, Jaffrey, N. H.

WANTED—High-Class Salesmen calling on Plants and Industrials to sell The Klay Universal Gear, Pulley and Wheel Pullers. No competition, Quick Sales, Large Commissions. The Scott & Ewing Co., Bluffton, Ohio.

SIDE-LINE Salesmen to connect us with Agents to sell our Auto Mitten Dusters. No money needed. No goods to sell. Pay weekly commissions on all orders received from men you appoint. National Fibre Broom Works, St. Louis, Mo.

COLLECTS Money from the Dead-Beats. Retail \$5.00—Cost \$1.00—Profit \$4.00. "New Method." Every Storekeeper, Doctor buys quickly. Wonderful Money Getter. Federal Association, Hartford, Conn.

WALKER made \$165 first day selling Collection System. Pays ten for one. We show you how. Adjustment Bureau, Mobile, Ala.

SALESMEN—Are You Making Enough Money? Let us show you how to make Big Profits with Jiffy Washing-Tablets. No experience required. Write for Free Sample and Plans. Jiffy Soap Products Co., Dept. A, Dayton, Ohio.

TAKE orders for coffee, sugar, flour, meats, canned goods, staple groceries also paints, radio sets, tires, auto and tractor oils. No capital or bond required. We deliver and collect. Permanent business. Big pay. Write at once. Hitchcock-Hill Co., Dept. 50, Chicago.

TRAVELING Salesmen Calling on Retail Stores wanted by large manufacturer of fast-selling specialties entirely different from the average. Year-round sales, main or sideline. Big commission paid immediately on original and repeat business. Opportunity for well paid and permanent connection with old-established firm. If not making \$150 weekly, write today. Union Specialty Works, Dept. 222, Boonville, N. Y.

\$60-\$200 A WEEK. Genuine Gold Letters for store windows. Easily applied. Free samples. Liberal offer to general agents. Metallic Letter Co., 438-A North Clark, Chicago.

FOUR \$7.50 sales to merchants net you \$20.00 daily. Sayers Systems, 2803 Sheffield Ave., Chicago, Ill.

ANY Salesmen Can Sell Them! Merchants everywhere use punchboards. Someone sells them, why not you? Collect big commissions daily. Newest, largest, elaborate catalog sent upon request. Lincoln Sales Co., 9 So. Clinton, Chicago, Dept. D.

NOW that you have read all these offers send \$1.00 for Detailed Information. (None free.) We want Partner-Salesman. We pay 50% on net profits! No capital necessary. Only those whose past record is such that they may be bonded need apply! Department 273. Empire Adjustment Bureau, 25 Exchange St., Rochester, N. Y.

HELP WANTED

U. S. GOVERNMENT wants men. \$1,700-\$1,900 and up at start. Railway Mail clerk examination coming. Let our expert (former Government examiner) prepare you for this and also Rural Carrier, Post Office, Customs, Internal Revenue, and other branches. Write today for free booklet. Dept. 8, Patterson School, Rochester, N. Y.

MEN Wanted to Silver Mirrors and Make \$10.00 a day. Best Instructions, \$1.00. Elmer Gutknecht, 445 Idaho St., Milwaukee, Wis.

CASH paid for butterflies, insects. See Sinclair Display Advertisement on Page 22.

MEN to train for locomotive firemen on railroads nearest their homes—everywhere; beginners \$150-\$250 monthly; promoted, locomotive engineer, \$3,000-\$4,000 yearly. Best paying positions on railroads. Railway Association, Desk M1, Brooklyn, N. Y.

EVERYDAY Greeting Cards easy seller. Sample box 75c. Particulars free. Messenger, Stillwater, N. Y.

GOVERNMENT Jobs. Become Railway Mail Clerks. Men 18-35, \$1,900. Common education sufficient. Particulars with sample coaching—Free. Write immediately. Franklin Institute, Dept. G-16, Rochester, N. Y.

MEN, prepare for Forest Ranger job; \$125-\$200 mo. and home furnished; permanent; hunt, fish, trap. For details, write Norton, 226 McMann Bldg., Denver, Colo.

WOULD you risk a 1c postal against the chance to make \$5 to \$15 daily in spare time with an absolutely new line of Insured Hosiery, guaranteed 12 months? Your Pay Daily. Monthly bonus extra. Magnificent sample outfit furnished. If so, send name and address now to Maccohee Company, Road 2603, Cincinnati, Ohio.

U. S. GOVERNMENT Jobs. Become Railway Postal Clerks, (\$158-\$225 month.) City Carriers—Postoffice Clerks, (\$142-\$192 month.) Rural Carriers, (\$175-\$255 month.) Men 18 up. Steady work. Paid vacation. Common education sufficient. Experience unnecessary. Sample coaching and full particulars free. Write today sure. Franklin Institute, Dept. G-3, Rochester, N. Y.

IMMENSE Profits Silvering Mirrors at Home. Plating autoparts, headlights, tableware, stoves, etc. Outfits furnished. Details Free. Write Sprinkle, Plater, 287 Marion, Ind.

\$158 MONTH. Men 18 up. Railway Postal Clerks. 25 coached Free. Write immediately. Franklin Institute, Dept. G16, Rochester, N. Y.

WE Start You in Business, furnishing everything. Men and women, opportunity to earn \$35 to \$100 weekly operating Ragsdale's original "New System Specialty Candy Factories" anywhere; wholesale or retail. Big commercial candy book free. W. Hillier Ragsdale, Drawer 350, East Orange, N. J.

MEN wanting to prepare for forest ranger or railway mail clerk examinations Write Mokane, A-23, Denver, Colo.

GOVERNMENT positions pay \$35 to \$75 weekly. We help you get them. Big List Free. Write, Mr. Oment, 101, St. Louis-Mo.

EARN \$10 daily silvering mirrors, plating and refinishing metalware, auto, chandeliers, bedsteads, headlights. Outfits furnished. E. Decle Laboratories, 1133 Broadway, New York.

MEN Wanted—prepare as firemen, brakemen, colored train or sleeping car porters, wire for application blank; experience unnecessary; first class roads, no strike. Name position wanted. Railway Institute, Dept. 35, Indianapolis, Ind.

BECOME a Landscape Architect. Uncrowded profession of wonderful opportunity for money-making. Easily mastered by mail. Earn while you learn. Write for book. American Landscape School, 56-E, Newark, N. Y.

SILVERING Mirrors, French Plate. Easily learned; immense profits. Plans free. Wear Mirror Works, Excelsior Springs, Mo.

\$35.00 WEEK. Boys—Men—wanted. Learn Auto Repairing. Sample lessons—Free. Franklin Institute, Dept. G-400, Rochester, N. Y.

MAKE money silvering mirrors, refinishing auto headlights, tableware, metal plating bedsteads, chandeliers. Outfits furnished. International Laboratories, Dept. 71, 309 5th Ave., New York.

MANUFACTURE sypup machines for \$3.00. Sells for \$12.00. Money savers for druggists, soda fountains, any flavor. Forex Laboratory, R. 6, Station C., Milwaukee, Wis.

DON'T prepare for any Civil Service Examination without seeing our catalogue, Free. Columbian Correspondence College, Washington, D. C.

MAILING LISTS

99% GUARANTEED Mailing lists. Accurate. Reliable. Guaranteed. The kind that produces business; compiled for every possible business or individual. Lists of every kind of any business or individuals compiled for your individual needs anywhere. Catalogue and information on request. National List, 847 Broad, Newark, N. J.

300 GENUINE Names \$1.00; all good buyers. George Brennan, Box 1300, 1329 3rd Ave., New York City.

MAILING Lists—Guaranteed 98% correct lists, any classification, \$4.00 thousand. Capey Supply, Dept. 6, 1237 Hamilton, Flint, Mich.

TYPEWRITERS AND SUPPLIES

UNDERWOOD Typewriters—only \$3.00 down. Easy monthly payments. Low prices at less than manufacturers. 10 days' free trial. Rebuilt, all worn parts replaced. Just like a new machine. 5-year guarantee. Write for a big free catalogue B-151. Shipman-Ward Mfg. Co., 1513 Shipman Bldg., Chicago, Ill.

TYPEWRITERS—All standard makes; genuine values; guaranteed. Typewriter Works, Ada, Okla.

ROYAL Typewriter No. 10 \$40.00. L. C. Smith No. 8 \$35.00, Underwood Typewriter No. 5 \$38.00, Remington Typewriter No. 10 \$35.00. Perfect Condition \$5.00 down, balance C. O. D. Lion Co., 2218 Lawrence, Chicago.

TYPEWRITERS, all standard makes, thoroughly re-manufactured by the famous "Young Process" and shipped direct from factory to you on 10 days' trial. Guaranteed 5 years. Easy monthly payments. Write today for free catalog. Young Typewriter Company, Dept. 5743, 654 W. Randolph St., Chicago.

100 TYPEWRITERS Free. Overstocked. Rent Rebuilt Underwood or Remington \$3.00 month. If you pay its value in rental, we give machine free. Particulars free. Pittsburgh Typewriter Exchange, 945 Hersch Bldg., Pittsburgh, Pa.

TYPEWRITERS, all standard makes. \$10 up. Fully guaranteed. Free trial. Write for complete illustrated lists. Northwestern Typewriter Exchange, 121 N. Francisco Ave., Chicago.

PRINTING, ENGRAVING AND MULTIGRAPHING

CIRCULARS 5,000 5 1/2 x 8 1/2 \$11. 3 1/2 x 6 four-page folders, \$14. All Printing Lowest Prices. Samples. Garrison Press, Harrisonburg, Va.

ANNOUNCEMENT! February-March-"B-Co." nationfamed, Colored engraved Letterheads and Envelopes, \$2.50 thousand; 300, \$1.25. (New customers \$1.00 premium.) Switch to Influential, Business-Promoting Stationery, Backlund Co., Detroit Lakes, Minn.

TRY to beat these prices. 5000 letterheads, 20 lb. Hammermill Bond, \$11.25. 5000 3X envelopes, \$8.75. Other prices and samples on request. The Low Cost Printers, 121 W. 21st, New York.

PRINTING Outfits, Presses, type, supplies. 4c stamps for information. Wm. E. Nicholas, M-36 Clifton Ave., Everett, Mass.

150 BOND letterheads and 150 envelopes printed \$1.50. Lehman Sales Company, Box 249, Duluth, Minn.

250 EACH Hammermill Bond Letterheads, Envelopes, \$3.00. Samples, Midland Press, 543 West Hickory, Kankakee, Ill.

"NEARGRAVURE" Process Printed Stationery—better—exquisite—unique—distinctive—Samples—Sollidays, Knox, Indiana.

HAMMERMILL Bond Letterheads or Envelopes Prepaid 500—\$2.25—1,000—\$4.00. Industrial Press, 510 Jefferson St., Jefferson City, Mo.

150 CARDS sent postpaid for \$1.00. Size 3 1/2 x 2"; best bristol; neatly printed with name, business, address (up to five lines). Satisfactory, quick service. Franklin Press, 200 Broadway, Newport, Minn.

ENVELOPE Specialists—5,000 6 1/2 24-lb. \$9.50. Prompt service. Samples free. Lawrence Envelope Co., 6-B, No. Franklin St., Chicago.

1,000 6 1/2 COLUMBIAN envelopes, \$3.50; 3,000, \$9.75; 5,000, \$15.00. H. Robinson, Park Boulevard, Dormont, Pa.

100 CALLING cards and genuine leather case \$2.00; over one line 10c line extra. 200 standard Business Cards \$1.00; over 5 lines 10c line extra. Sample for stamps. Business Card Specialty Shop, Q552, Jackson, Mich.

COMMERCIAL Printing. Prices Right. Samples Free. The Fox Press, Frankfort, N. Y.

BUSINESS Outfit, 500 each, Business Cards, Letterheads, Envelopes, Billheads, \$10.00. A. A. Israel Company, Box 169, GPO, New York City.

LETTERHEADS, Envelopes, Business Cards, Statements. Jean McLane, 1215 Russell Ave., Bethlehem, Pa.

POSTPAID—500 envelopes \$2.50; 150, \$1.00. A. Sturm, Stratford, Wis.

\$3.00 DELIVERED. 500 Watermarked Bond Letterheads 8 1/2 x 11. 250 envelopes. Money with order. Lowest prices all printing. National Printing, Goshen, Ind.

250 HOWARD bond Letterheads or Envelopes, \$1.75; 500, \$2.75; 1,000, \$4.00. Wilco Press, 1110 Capitol Bldg., Dept. C, Chicago, Ill.

COMMERCIAL Art, Illustrating, Letterheads, Cut Service. Fred Sipe, Harrisonburg, Va.

FOLDERS—1,000 3 1/2 x 6, 900 words, \$4.00. Dretwon, Box 1951, Fargo, N. D.

GUMMED Labels, 500 name and address, 2 lines 35c, 3 lines 55c. Catalogue. Eastern Label Co., B, Clintonville, Conn.

250 LETTERHEADS, 250 white envelopes printed and mailed \$3.00. Samples printing free. Sunco, Mohawk, N. Y.

MAKE your own cuts. New simplified method, cheap. Complete illustrated instructions, \$1. F. Record, 247 So. Broadway, Room 10, Los Angeles, Calif.

MULTIGRAPH typewriting business Correspondence, two dollars thousand. Hammermill Bond letterheads four dollars. Mayera Corporation, Monmouth, Ill.

250 BOND Letterheads, Envelopes, Billheads, Cards, \$1.35 Each. Economic Press, Leonia, N. J.

SUPERIOR quality printing; attractive samples free. Kay Press, 546 Thurston, Rochester, N. Y.

GUMMED Labels, with name, Business and address, 500—30c; 1,000—50c. P. Wetzell, Valhalla, N. Y.

DISTINCTIVE—Artistic Business Stationery that Creates Confidence. 1,000 Letterheads or Envelopes \$3.00. Samples. Moulton Printing Company, 1410-P East 8th, Kansas City, Mo.

WE print Stationery, Booklets, Catalogs, Circulars. Samples. Commercial Press, Batavia, Ohio.

QUALITY Printing! Reasonable Prices! Send for Free Standardized samples and prices. Folders, Circulars, Catalogs our specialty. Ernest Fantus, 525 South Dearborn, Chicago.

500 TWO-COLOR Letterheads \$2.60. Samples. Mailpress, 4744-R, Twelfth Detroit.

QUALITY Printing by expert printers. Reasonable. Write. Harold Williams, Sycamore, Ohio.

20 LB. Bond Letterheads, 6 1/2 Envelopes, Billheads, Statements! \$3.00 thousand. Cash with order. Press, Box 428, Middletown, N. Y.

PRINTING, OUTFITS AND SUPPLIES

PRINT your own cards, stationery, circulars, paper, etc. Complete outfits, \$8.85; Job Presses, \$11, \$29; Rotary, \$149. Print for others, big profit. All easy, rules sent. Write for catalog presses, type, paper, etc. Kelsey Company, F-11, Meriden, Conn.

PRINTING Outfits—Presses, type supplies, type novelties. Send stamp for catalogue. Model Press, York, Penna.

PRINTING Presses—Type—Supplies. List for 2c stamp. (Bargains.) Foster, 4342 North Robey, Chicago.

DUPLICATORS AND DEVICES

YOU can make 50 to 100 copies of a letter, notice, etc., at a cost of three cents on a Hever Quality Duplicator. Write for free trial offer. The Hever Duplicator Co., 14 S. Wells St., Chicago, Ill.

"STENCIL-DUPLICATOR" 8x11 \$10 (Complete). Copies like mimeograph. F. Gerwin, Dale, Okla.

RUBBER STAMPS

YOUR name handsomely moulded in fancy letters upon a rubber stamp \$1.00 plus 10c for postage. Please print name. R. Skeffington, 18 Bullfinch St., Boston, Mass.

ADDING MACHINES

NEW \$3.50 Automatic Adding Machine. Adds, Subtracts, Multiplies. Absolutely accurate. Capacity 999,999.99. Fully guaranteed. 75,000 pleased users. Makes adding easy, positive, quick. Eliminates Mistakes. Saves Time. Postpaid \$3.50. Bassett Co., 1458 D Hollywood Ave., Chicago.

FREE trial. Marvelous Calculator. Adds, Subtracts, Multiplies, Divides automatically. Work equals \$300.00 machines. Five year guarantee. Price only \$15.00. Write today for free trial offer. Special: \$3.00 Pocket Calculator, only \$2.00 cash. Lightning Calculator Co., Dept. E, Grand Rapids, Mich.

FOR SMOKERS

AGED leaf tobacco. Select chewing 3 pounds \$1; 10—\$3. Best smoking, 10—\$2.50. Good, 10—\$2. Regular, 10—\$1.50. Prompt shipment. Money back if not pleased. Co-Operators, Murray, Ky.

TOBACCO Postpaid, guaranteed Best Mellow, Juicy red leaf chewing, 5 lbs. \$1.40; 10, \$2.50. Best smoking 20c lb. Merk Hamlin, Sharon, Tenn.

CIGARS, hand-made wonderful flavor, 10c retail quality. 19 in can, postpaid only \$1. (or C. O. D.). Order today. Hoffbauer Bros., 580 52nd St., Brooklyn, N. Y.

LOOK! Five pounds good mellow smoking tobacco, \$1.00. Five pounds chewing \$1.25. Quality and satisfaction guaranteed. Farmers' Club, 57, Hazel, Ky.

HOMESPUN Tobacco—Chewing, 10 lbs. \$2.00; smoking, 5 lbs. \$1.00; 10, \$1.75. Aged in bulk, mellow and sweet. Satisfaction guaranteed. Farmers' Union, Mayfield, Ky.

SEND \$1.25 Box finest quality mild cigarettes. Sample package 10c silver or stamps. Pocket tin Special Pipe Tobacco 10c. Direct-to-Smoker. French Tobacco Co., Dept. 21, Statesville, N. C.

LEAF Tobacco to Consumer. Satisfaction Guaranteed. Best Chewing 20c lb. Smoking 10c; you pay postage 10 lbs. up. Collier Tobacco Pool, Martin, Tenn.

TOBACCO: Kentucky Sweet Leaf. Mellow with age. Fine flavor. Smoking, 15 lb. \$1.50. Chewing, \$2.25. Pay when received. Ernest Choate, Wingo, Ky.

FOR MEN

FURNITURE. Make Furniture at Home. Popular Mechanics books tell how to make all pieces. "Mission Furniture and How to Make It, Book 1, Book 2, Book 3." Send No Money. Just write a postal. Pay postman postage and \$3. Popular Mechanics Press, Room 903, 200 East Ontario St., Chicago, Ill.

DRAFTING. Learn Mechanical Drawing. Big demand for men. Pocket-size. Start at beginning and learn by a series of simple lessons. Send No Money. Just write postal for "A Practical Course in Mechanical Drawing." Pay postman postage and \$1. Popular Mechanics Press, Room 903, 200 E. Ontario St., Chicago, Ill.

BOATS AND LAUNCHES

BOATMEN: Parts to convert Ford Motors, lightweight base-Watercooled manifold. Coupling-Rearstarters. Write for circulars. Standard Mfg. Co., 230 Hawley St., Rochester, N. Y.

BOAT Building Plans for amateurs. Rowing, sailing, speed, cruising. Free catalog. Rudder Publishing Company, 9 Murray Street, New York.

BUILD your own boat for this season's use using Brooks Knock-Down parts or patterns. 55 Models, 9' to 40'; send 25c for complete catalog. Brooks Boat Co., Inc., Rust Ave., Saginaw West Side, Mich.

NEW Boat Book telling how to make 21 kinds of boats. Also many other helpful ideas on boating. Profusely illustrated. With this we include the big book, "Outdoor Sports the Year Round." Directions for making all sorts of devices for outdoor recreation. Send no money. Simply pay the postman \$1.98 plus postage when books are delivered. Popular Mechanics Press, Room 903, Popular Mechanics Building, Chicago, Ill.

HUBBELL Marine Coolers convert Ford engines into marine motors. Booklet free. Ford speedboat, easily built, blueprint and directions, sixty cents. C. C. Hubbell, 14B Cottage St., East Norwalk, Conn.

COMPLETE plans and specifications for building clipper ships in bottles, \$1.00. Rojahn, 519 DeKalb Ave., Brooklyn, N. Y.

CLIPPER Ship materials \$5.00. List Model Fittings dime. Roy Hancock, 323 Douglas Ave., Portsmouth, Va.

RARE chance to buy brand new marine engine direct from factory at reduced price. Only seven to be sold; ten, eighteen, twenty-five and sixty H. P. Catalogue mailed. C. B. Drake, 507 Cherry St., Philadelphia, Pa.

BRASS wood screws, caulking cotton, good used outfits, except engine. Wm. H. Baker, Pond St., Quincy, Mass.

SHIP Models—Worth-while—Easy to make. Decorative ships. Picturesque Barbary Pirate Felucca and Beautiful Spanish Treasure Galleon (both 17th century). Instructions so simplified that any handy person can make these models with a few household tools almost without expense. No personal knowledge of ships or naval architecture required. New book only one of its kind. Pay postman \$2.50 plus postage when book is delivered. Popular Mechanics Press, Room 903, 200 East Ontario St., Chicago, Ill.

FOR THE HOME

GRANDFATHER'S Clock Works, \$5.00. Build your own case; instructions free; make good profits selling your friends. Clock works with chimes for old or new cases. Write for full particulars. Clock Co., Ruffner St., Philadelphia.

WORKBENCHES—Steel Legs Cheapest. For Home, Shop, Garage. Circular Free. Perrin Co., Port Huron, Mich.

CEDAR chests only \$11.65—"Red-1-Kut" complete with rich copper trim—you assemble and save half—send for pictures. Kuempel Furniture Company, Guttenberg, Iowa.

SEND \$2.50 for 50 lbs. large Missouri hickory nuts. Guaranteed. C. D. Wright, Sumner, Mo.

REFRIGERATING Machine, Homemade. Operates successfully. Gives better service than ice. This and 328 other practical articles in our book "Home Mechanics." Just ask for this and "Handbook for Women" containing 394 valuable household helps and pay postman 98 cents and postage for the two books. Popular Mechanics Press, Room 903, 200 East Ontario St., Chicago, Ill.

BUY—Exchange—Sell! Many of our readers have for sale or exchange the article you are looking for—and lots of them are looking for the very items you want to turn into cash. Get together! Let our two million five hundred thousand readers know your 'shes—they'll help you! Send your ad today to M. L. Rund, Manager Classified Advertising, Popular Mechanics Magazine, Chicago.

WATCH REPAIRING

ALL makes of Watches repaired by experts. Write International Watch Service, Box 5P, Fordham Station, New York.

ANTIQUES, WAR RELICS AND INDIAN GOODS

FOR Dens. European battlefields' relics; also medals. Illustrated catalogue and sample war photographs, 25c. Welsh, 1889 Albany Ave., Brooklyn, N. Y.

SEND 5c for fine new list Indian relics, antique firearms. F. E. Ellis, Webster Groves, Mo.

DEEP Sea Wonders, 20 for 25c. Ray Oviatt, Sarasota, Fla.

PHONOGRAPHS AND RECORDS

BUILD your own phonograph. We furnish everything. Catalog sent free. American Phonograph Co., 4116 West 24th Place, Chicago.

MUSIC AND MUSICAL INSTRUMENTS

SONG Poem Writers—Write Ray Hibeler, D1, 2104 N. Keystone Ave., Chicago.

DOLLARS to Cornetists—Trombonists! High notes, attack, tonguing made easier. Information sent free. Paul D. Placide, 628 East 29th St., Baltimore, Md.

PIANO Jazz! 15 Easy lessons teaches, beginners. Wonderful Jazzy Ear Piano Playing. Circulars? Write "Piano Bill," Toronto 3, Canada.

REAL Jazz Piano lessons. Latest Hits, taught quickly at home. Booklet and Sample Lesson Free. Address Studio, 7 United Schools of Popular Music, P. O. Box 1959, Boston, Mass.

JAZZ—How to Play "Hot" Jazz on Piano, Sax, Tenor Banjo, Uke. 75c each. Circulars mailed. Winn School, 44 West 34th St., New York.

CORNETISTS—Trombonists—Saxophonists—Clarinetists. Get "Free Pointers." Name instrument. Virtuosi School, Buffalo, N. Y.

PLAY Song-O-Phone band instruments. No Practice—No musical education necessary. Clubs, Fraternal Orders, Amateur and Professional Performers write for catalog. Songophone Co., 546 Wythe Ave., Brooklyn, New York.

RADIO Created A Demand for good songs. I write music. Lyric writers and music composers. Get my circular. Hanson, P. O. Box 4218, Takoma, Washington, D. C.

SONG Poem Writers Address Monarch, 1472 Broadway, Dept. 104, New York.

SONG lyrics solicited—A different proposition. Richard Broughton, Sioux Falls, S. Dak.

I BUY, Sell, Publish Songs. Chester Escher, 455 Wayne St., Jersey City, N. J.

VIOLINS—Genuine handmade masterpieces. Get Details. John Lehto, 935 14th, San Pedro, Calif.

WRITE Songs. Big money and reputation. Write for information. J. Gordon Pub. Co., 201 N. Hoyne Ave., Chicago.

I WANT Song Poems. Casper Nathan, 3544 N. Racine, Chicago.

SONG Poem Writers—Stamp brings "Song Writers' Guide." Wm. Van Beaver, B1-1239 Elm St., Green Bay, Wis.

SHARPS and Flats—Free. Very interesting. Send for it Today. Harry L. Alford, 192 No. State St., Chicago, Ill.

VIOLINS, Deep, Mellow, Soulful—on credit. Easy terms for wonderful instrument. Get details today. Gustav F. Henning, 2424 Gaylord St., Denver, Colo.

"MUSIC Composed" to words. Bauer Bros., (formerly of Sousa's Band), Oshkosh, Wis.

PATENT ATTORNEYS

PATENTS. Time counts in applying for patents. Don't risk delay in protecting your ideas. Send sketch or model for instruction or write for Free book "How to Obtain a Patent" and "Record of Invention" form. No charge for information on how to proceed. Communications strictly confidential. Prompt, careful, efficient service. Clarence A. O'Brien, Registered Patent Attorney, Security Bank Building (directly across street from Patent Office), Washington, D. C. See pages 138 and 139.

PRACTICAL, useful inventions wanted for live patent buyers. Write for proposition. American Patents Corporation, Barrister Building, Washington, D. C.

INVENTORS having ideas to patent: Write for Booklet explaining Co-operative Plan for handling your applications. Tells how to sell and safeguard your inventions at lowest cost. Ralph Burch, Patent Lawyer, Jenifer Bldg., Washington, D. C.

PATENTS Procured. Prompt Service, Personal, careful and efficient service. Highest references. Moderate fees. Send sketch or model for actual search and advice. George P. Kimmell, Master of Patent Law, 54E, Legal Bldg., Washington, D. C.

ESTABLISHED 1864. Milo D. Stevens Company, Free Booklet, Patents, Trade-Marks, Copyrights, Offices, Monadnock Block, Chicago; Barrister Building, Washington, D. C.

INVENTORS Universal Educator—contains 900 mechanical movements; 50 perpetual motions. Tells how to obtain and sell patents. Suggests new ideas. Explains how to select your attorney and avoid patent sharks. Special Price, \$1.00 post-paid. Albert E. Dieterich, 621B Ouray Bldg., Washington, D. C.

RICHARD E. BABCOCK, Patent Lawyer, Washington Loan & Trust Bldg., Washington, D. C. Booklet.

PATENTS—Send for form "Evidence of Conception" to be signed and witnessed. Form, fee schedule, information free. Lancaster and Allwine, Registered Patent Attorneys in United States and Canada, 221-Ouray Bldg., Washington, D. C.

PATENT and Trade Mark Lawyers, Mason, Fenwick & Lawrence, Washington, D. C. Established sixty-five years. Best references. Other offices, New York and Chicago. Write us.

MONROE E. MILLER, Ouray Bldg., Washington, D. C., Patent Lawyer; Mechanical, Electrical Expert. Booklet and Priority Record blank gratis.

PATENTS Procured: Trade Marks Registered—A comprehensive, experienced, prompt service for the protection and development of your ideas. Preliminary advice gladly furnished without charge. Booklet of information and form for disclosing idea free on request. Richard B. Owen, 30-Owen Bldg., Washington, D. C., or 41-R Park Row, New York.

MILLIONS spent annually for ideas! Hundreds now wanted! Patent yours and profit! Write today for free book—tells how to protect yourself, how to invent, ideas wanted, how we help you sell, etc. American Industries, Inc., 500-Victor Bldg., Washington, D. C.

"INVENTOR'S Advisor," the valuable Patent book with 139 mechanical movements and illustrations, sent free upon request. M. M. Labiner, Patent Attorney, 3 Parkrow, New York.

INVENTORS—Write for our Guide Book, "How to Get Your Patent" and Evidence of Invention Blank. Send model or sketch of your invention for our prompt examination and instructions free. Randolph & Co., Dept. 430, Washington, D. C.

PATENTS, Trade-Marks, Designs. This firm has 27 years' experience and gives expert personal service at reasonable rates. We properly protect your invention. Write for free information and exact cost of procuring patent before proceeding. John B. Thomas & Co., 902 F St., N. W., Washington, D. C.

UNPATENTED Ideas Can Be Sold. I tell you how and help you make the sale. Free particulars (Copyrighted). Write W. T. Greene, 807 Jenifer Building, Washington, D. C.

"INVENTORS' Guide" sent free on request; this book contains illustrations of patented inventions and gives valuable information and advice for all who have original ideas or improvements. Frank Ledermann, Registered Attorney and Engineer, Woolworth Bldg., 1712, New York.

INVENTORS: Send sketch or model for advice and exact cost of patent. Ask for our Free book: "How to Obtain a Patent." Tells what every inventor should know. Established twenty-eight years. Highest references. Prompt service. Reasonable charges. Chandler & Chandler, 474 Seventh, Washington, D. C.

LACEY'S Patent Sense. Valuable book free. See ad page 143.

PATENTS—Write for our Guide Books and "Record of Invention Blank" before disclosing inventions. Send model or sketch of your invention for Free Inspection and Instructions. Terms Reasonable. See advertisements on pages 140 and 141. Victor J. Evans & Co., 934 Ninth, Washington, D. C.

OBTAIN Patents Through Us; We Finance Applications. Patents Bureau, Times Building, St. Louis, Mo.

UNITED STATES and Foreign Patents and Trade Marks; Low rates; easy terms. H. Sanders, Registered Patent Attorney, 7 Rand McNally Building, Chicago.

CARL MILLER, Registered Patent Attorney, McGill Building, Washington, D. C. Write for Instructions.

PATENTS. Booklet free. Highest references. Best results. Promptness assured. Send model or drawing for preliminary examination. Watson E. Coleman, Patent Lawyer, 724 Ninth St., Washington, D. C.

PERCY S. WEBSTER, 203 Saving and Loan Building, Stockton, California. Long established organization. Patent booklet free.

FOR INVENTORS

PATENTS. If you have an invention which you wish to patent you can write fully and freely to Munn & Co., for advice in regard to the best way of obtaining protection. Please send sketches, or a model of your invention and a description of the device, explaining its operation. All communications are strictly confidential. Our Hand-Book on Patents is sent free on request. This explains our methods, terms, etc., in regard to Patents, Trade Marks, Foreign Patents, etc. "Scientific American" contains Patent Office Notes, Decisions of interest to inventors and particulars of recently patented inventions. Munn & Company, Solicitors of Patents, 1523 Scientific American Building, 24 W. 40th St., New York City; 524 Scientific American Bldg., Washington, D. C.; 1313 Tower Bldg., Chicago, Ill.; 666 Hobart Bldg., San Francisco, Calif.; 521 Van Nuys Bldg., Los Angeles, Calif.

PATENTS. Time counts in applying for patents. Don't risk delay in protecting your ideas. Send sketch or model for instruction or write for Free book "How to Obtain a Patent" and "Record of Invention" form. No charge for information on how to proceed. Communications strictly confidential. Prompt, careful, efficient service. Clarence A. O'Brien, Registered Patent Attorney, Security Bank Building (directly across street from Patent Office), Washington, D. C. See pages 138 and 139.

INVENTORS—Write for our Guide Books and "Record of Invention Blank" before disclosing inventions. Send model or sketch of your inventions for our free inspection and instructions. Terms reasonable. See advertisements on pages 140 and 141. Victor J. Evans & Co., 157 Ninth, Washington, D. C.

REDESIGNING, Selling and Promoting Patents. High grade Model making and Drafting service at reasonable rates. All our work is strictly confidential and guaranteed. L. C. Johnson Engineering Works, 3405 North Clark St., Chicago, Ill.

UNPATENTED Ideas Can Be Sold. I tell you how and help you make the sale. Free particulars (Copyrighted). Write W. T. Greene, 806 Jenifer Building, Washington, D. C.

I AM in touch with hundreds of moneyed men and manufacturers who wish to buy good inventions. Write Hartley, 38 Court St., Bangor, Me.

IF you have a practical, useful invention to sell, write for proposition. American Patents Corporation, Barrister Building, Washington, D. C.

PATENTS wanted by manufacturers, send description, Box 126, Dowagiac, Mich.

PATENTS Procured: Trade Marks Registered—A comprehensive, experienced, prompt service for the protection and development of your ideas. Preliminary advice gladly furnished without charge. Booklet of information and form for disclosing idea free on request. Richard B. Owen, 30-Owen Bldg., Washington, D. C., or 41-R Park Row, New York.

INVENTORS Universal Educator—contains 990 mechanical movements; 50 perpetual motions. Tells how to obtain and sell patents. Suggests new ideas. Explains how to select your attorney and avoid patent sharks. Price (revised edition) \$1.00 postpaid. Albert E. Dieterich, 621-Ourray Bldg., Washington, D. C.

INVENTORS: If your invention was worth patenting, the patent is worth experienced handling, in your wish to sell it. I Sell Patents. Established in 1900. Charles A. Scott, 773PM Garson Ave., Rochester, N. Y.

LACEY'S Patent Sense. Valuable book free. See ad page 143.

GET your own patents. Legal blanks, complete instructions \$1. Cutting Sons, Campbell, Calif.

PATENTS FOR SALE

OUTRIGHT—Royalty; 3 Patents, 3 Applications on ships Log, Tank Gauge, Tank Alarm. R. Star, 84 Flushing Ave., Brooklyn, N. Y.

SPARK plug patent. Manufacturing costs twenty-two cents. Inventor can't finance distribution. Box 61, Gilbert, Ia.

OUTRIGHT or Royalty. Carpenters' Scriewing Gauge. For stair treads, casings, thresholds, etc. Pressed from metal, best tool ever made for the purpose. Pat. issued Sept. 28, 1926. David Moore, South Lancaster, Mass.

ROYALTY. Patented Adjustable Vaginal Syringe. Harvey I. Spang, Lebanon, Pa.

MANUFACTURERS! Sanitary Razor Blade that can't be resold as new. Patent No. 1,581,968. For Sale. Juan Llobet, Obrapia 71, Havana, Cuba.

OUTRIGHT or Royalty, two-piece receptacle for household, office or factory use. Emptied without removing. Manufactured at very low cost. H. H. Bergh, Marquette, Mich.

MULTIPLE valve grinder, outright or royalty. Grind any number of valves on an automobile engine by hand, all in one operation. Can be sold by mail. Box 3,000, 1329 Third Avenue, New York City.

TO Manufacturers—Sale or Royalty. Patent No. 1,607,933. Whitney Book Trolley, adjustable table. A. Whitney, Big Timber, Mont.

INVENTIONS of all kinds: Glassware, Hardware, Stones, Leather, Cloth, Paper, Toys, etc. Carl March, 3239 N. Ashland Ave., Chicago, Ill.

OUTRIGHT or Royalty. Patented retail fabric measure device; measures and cuts outright—100% accuracy; simple—1/4 centator costs. McDermott, 74 Buckingham, Hartford, Conn.

OUTRIGHT—Locomotive and tender coupling that stops swaying. Assures quiet, steady travel and eliminates certain engine repairs. George Dawson, 362 St. George St. Moncton, N. B., Canada.

OUTRIGHT or Royalty. Device for removing insulation from wire. Fred Harrison, Jr., DeKalb, Illinois.

CARRYING Apparatus, for stores, wholesalers, manufacturers. Outright or Royalty. Howard Larson, West State Street, Salamanca, N. Y.

AUTOMATIC Pencil Sharpener. New Shear Cut Method produces lasting point. No. 1,609,538. Outright or Royalty. C. B. Cronan, 50 Andover St., Worcester, Mass.

FOR Sale or Royalty. My new improved Split Sewing Machine Needle is easily threaded. A needle that can be threaded by a person with very poor eye-sight. If interested, will send sample. Address: John T. Raper, Route 2, Lucama, N. C.

FOR Sale—Patent, Improved Flour Sifter, outright or Royalty Basis. Harry Nakagawa, Tanana, Alaska.

DANDY Camp Patent. On market. Sells well. Earl Sanders, Pawnee, Ill.

WHY let your patents lie idle? Tell our two million five hundred thousand readers about it! The majority of our readers are especially interested in new ideas and inventions. Ask me to tell you how other inventors successfully sold their patents. M. L. Rund, Mgr., Classified Advertising, Popular Mechanics Magazine, Chicago.

CLOTH Pin which does away with the hardships of hanging out clothes in cold weather. Box 437, Fosston, Minn.

NO-COST Water Heating Gas Burner, water heated by byproduct of gas used for other purpose. J. A. Frisk, 3839 Roscoe St., Chicago, Ill.

WONDERFUL life saving device made of rubber to clean windows outside from inside room. R. Greenberg, 1226 42nd, Brooklyn.

MONORAIL sled, two patents. If energetically pushed will supersede the flexible flyer. Faster, safer, easier steered. C. T. Rogers, 23 E. 14th, New York.

PATENT Auto Chain. Sale or trade. Consider partner, or manufacture. Elton Beck, Herrick, Ill.

OUTRIGHT or Royalty. Improved stick pin. Chas. Ross, Goldendale, Washington.

FOR Sale—Patent—Air Cooler, for Hospitals, Theaters, Private Houses, making the air cool, sanitary and comfortable. E. Crispin, 1200 Royal Court, Los Angeles, Calif.

IMPROVED pipe diestock. Great labor saver, especially valuable to electricians. Richard C. Fleming, 5387 Holcomb Ave., Detroit, Mich.

FOR Sale. Simple Lock. Seven Shapes. Many Uses. M. E. Blatchery, 120 1/2 So. Main St., Hutchinson, Kan.

ELECTRICAL

ELECTRICAL Kinks on all phases of practical electricity. 47 ideas on wiring, 45 on making electrical devices, 19 on lighting, 5 on transformers, 5 on motors, 8 on generators, 11 on switches, 22 on testing, 12 on repairing, 11 on battery manufacture and repair, 5 on telephones, and 9 on electricians' tools. 214 articles, 162 pictures. Send no money. Just write postal for "Electrical Kinks." Pay postman postage, and \$1.50. Popular Mechanics Press, Room 903, 200 E. Ontario St., Chicago, Ill.

DIESEL Engines—Marine, Locomotive, Stationary. Growing importance of the Diesel Engine cannot be overestimated. This new book should be in the hands of every student of mechanical engineering. 500 pages, 280 illus. Pay postman \$5 and postage when he delivers book. Popular Mechanics Press, Room 903, 200 E. Ontario St., Chicago.

ELECTROPLATING. New printing of popular book by H. C. Reetz. Complete instructions for plating with all kinds of metals. Send no money. Just write a postal asking for "Electroplating." Pay postman the postage and \$1.00. Popular Mechanics Press, Room 903, 200 East Ontario St., Chicago, Ill.

SURVEYING INSTRUMENTS

LARGEST stock of new and used surveying instruments in the country direct from factory. Satisfaction guaranteed or money refunded. Wissler, 619 N. Broadway, St. Louis, Mo.

MODELS AND MODEL SUPPLIES

PATENTS. Time counts in applying for patents. Don't risk delay in protecting your ideas. Send sketch or model for instruction or write for Free book "How to Obtain a Patent" and "Record of Invention" form. No charge for information on how to proceed. Communications strictly confidential. Prompt, careful, efficient service. Clarence A. O'Brien, Registered Patent Attorney, Security Bank Building (directly across street from Patent Office), Washington, D. C. See pages 138 and 139.

MODEL Steam Engines, Boilers and Model Pipe line fittings. Model Making Supplies. Send 20c for this year's illustrated catalogue and hand book. Bathe Mfg. Co., Dept. D, 5214 Woodland Ave., Philadelphia.

I BUILD models of new inventions. Benjie Nortwed, Ethan, S. Dak.

LET our experience be your guide. Models that are models; Tools and equipment for economic manfg. Patterns of all types; manufacturing in all branches. Satisfaction guaranteed. United Machinery Company, Cincinnati, U. S. A.

WE have in Stock all kinds of Hard and Soft Woods. For Model, Inlaying and Scroll Work. Write us your requirements. Geo. Wild, 510 East 11th St., New York.

MODEL steam engines and boilers. Boat and boiler fittings. Send 10c stamp for catalog. Refunded with first order. Model Machine Shop, P. O. Box 5, Station Y, New York City.

MODELS, Tools, Dies and General manufacturing. Logan Machine Co., 126 S. Clinton St., Chicago, Ill.

SPECIAL machine builders, tool and die makers, inventor's models, production work of all kinds. Dept. L, Quality Hardware & Machine Co., Ravenswood and Thorndale Avenues, Chicago, Ill.

MODELS, Experimental Work, Light Manufacturing, and Stamping. Frostholt Bros., Syracuse, N. Y.

HULIT & Co., General Model Makers, 625 W. Jackson, Chicago, Ill. Specializing in high-grade model work on inventions of merit. Complete Equipment, Experienced Workmen.

WE make working models for inventors and do experimental work and carry a complete stock of brass gears and model supplies. Send for catalogue. The Pierce Model Works, Tinley Park, Ill.

MANUFACTURING

INVENTIONS developed and manufactured. Any material. Models, instruments, tools. Lowest prices. Established twenty years. Swanberg, 5124 N. Kildare Ave., Chicago.

WANTED to manufacture on royalty basis patented mechanical or electrical articles of general use. Give full information, accurate specifications. Vi-Rex Co., 2304 Warren Ave., Chicago, Ill.

SPECIAL Machinery or parts, dies, tools, metal specialties, models, special gears, stock gears and model supplies. Send for Catalogue. The Pierce Model Works, Tinley Park, Ill.

MANUFACTURING Models, Dies, Stampings, Brass Work, one or thousands. Baum's Metal Specialties, Kansas City, Mo.

WIRE goods made to order. Cooley Mfg. Co., 539 N. Western Ave., Chicago.

DIES, Jigs and Stamping. Acme Tool Co., Mason City, Iowa.

MACHINERY, TOOLS AND SUPPLIES

16" SPRINGFIELD Crank Shaper \$200, 20"x10" Bradford Lathe, \$625. 16"x16"x4" Hendy Planer, \$210. No. 60 Head Cylinder Grinder \$750. 10"x20" Landis Piston Grinder \$300. 10" Drill Press with chuck, \$19. Complete line of machinery and supplies. We sell on terms. Write for catalogue. Cincinnati Machinery & Supply Co., 218 E. Pearl St., Cincinnati, Ohio.

PIPE second hand, guaranteed suitable for all practical purposes with new threads and couplings, sixteen feet and over; cut to your requirements, also Boiler Tubes, New Fittings, Pfaff & Kendall, 102 Waydell St., Newark, N. J.

START a business of your own, small investment required doing Nickel, Copper and Silver Plating. This work is in big demand. Full information free. Electro Platers Supply Co., 547 Considine Ave., Cincinnati, Ohio.

CONCRETE Building Block Machines and Molds. Catalogue free. Concrete Machine Co., 5 N. Main St., St. Louis, Mo.

UNIVERSAL Millers—dividing heads, equipment—Brown Sharpes \$250.00, Garvin \$350.00. Lucas & Son, Bridgeport, Conn.

NEW 12 inch Portable Band Saws, complete with 1/4 H. P. motors, ready to run. Price, \$75.00 each. Botwinik Brothers, Inc., 67 Water St., New Haven, Conn.

SURPLUS machinery from our shop. Lathes, Shapers, Milling Machines, Drill Presses, and small tools, real bargains, act quick. Electro Platers Supply Co., 547 Considine Ave., Cincinnati, Ohio.

OTHERS have successfully sold their machinery through our columns—so can you. Ask me for proof. M. L. Rund, Manager, Classified Advertising, Popular Mechanics Magazine, Chicago.

ENGINES, MOTORS AND DYNAMOS

NEW full 1/4 HP, 110 volts, AC, 60 cycle grinder and buffer, equipped with 6" wheels, enclosed motor \$15.75 each. New 1/4 HP, 110 volt, AC motors, 60 cycle, with pulley \$16.00 each. Prompt shipments. Westinghouse new 1,000 Watt, 32 volt, light and power generators, ready to run, while they last \$48.00 each. General Distributing Co., Security Bldg., Duluth, Minn.

1/4 HORSE Alternating and direct current used motors \$6.50. 1/2 H. P. 110 V. Universal motors \$2.75 each. Gas and gasoline engines slightly used sizes five to twenty horse. Also other bargains. Queen City Electric Co., 1736 Grand Ave., Chicago, Ill.

GOVERNORS for all auto engines where used for power plants. Send for circulars. A. C-S Governor Co., Springville, N. Y. or 215 W. Manchester, Los Angeles.

ALTERNATING Current Motor Bargain, 1/4 Holtzer-Cabot—\$7.50. Many other specials. Send for new list or tell us your needs. Hyre Electric Company, 615 MX South Dearborn St., Chicago.

1/4 H. P. A. C. motors \$6. 1/2 H. P. \$5. New Repulsion type motors, 1/2 H. P. \$28. 1 H. P. \$38. New exhaust fans, A. C. scoop blade, 18 inch, \$37.50. W. L. Stege Electric Co., 25 So. Clinton St., Chicago, Ill.

MOTORS—New GE 110 or 220 volt 60 cycle Single Phase 1/4 HP, \$11.90; 1/2 HP, \$28.53; 1 HP, \$38.50. Mail \$3 check or money order. We will ship COD anywhere. Motor Specialties Co., Crafton, Penna.

BLACKSMITHS

BE a Master Mechanic Blacksmith and Expert Tool Maker and Dresser with colored tempering charts. Price \$1.00. Valuable samples free. W. M. Toy, Sidney, Ohio.

BENDING MACHINES

THE famous Hossfeld Wrenchless Universal Bender is the last word in bending machines; bends metal, cold or hot, into most any conceivable shape, including Eye-bolts and Automobile Spring Eyes. Bends up to 1" bars or 1 1/4" Pipe cold. Used by the largest corporations, yet so inexpensive that even a farm shop need not be without one. Send for Circular. Hossfeld Mfg. Co., Box 344, Winona, Minn.

FOR SALE—MISCELLANEOUS

ADDRESSOGRAPHS. Letter Folders. Multigraphs, Envelope Sealers, Duplicators. Less than half price. Guaranteed. Pruitt Co., 117 No. Market, Chicago.

FOR Sale Butterkist Popcorn machine and Peanut roaster, Grand, Electric used nine months \$250. Cost \$1,000.00. Swift Book Shop, Adrian, Mich.

TELL an army of 3,000,000 live readers all about your offer! If you have anything to sell, buy or exchange, or if you have any reasonable proposition, tell our readers all about it—they'll respond quickly. Our booklet "How to Create More Business" contains some very interesting, helpful facts. Write today for your copy—it's free. M. L. Rund, Manager Classified Advertising, Popular Mechanics Magazine, 200 E. Ontario St., Chicago, Ill.

WANTED—MISCELLANEOUS

MAIL us your discarded Jewelry, Gold, Crowns and Bridges, Watches, Diamonds, Silver, Platinum and old False Teeth. Money promptly mailed. Goods returned if offer refused. United States Smelting Works (The Old Reliable), Dept. 71, Chicago.

REAL ESTATE, FARM AND ORCHARD LANDS

LAND Free if planted to bananas. Bananas bear a full crop the second year. \$5.00 monthly will plant five acres, which should pay \$1,500 profit annually. Reliable Companies will cultivate and market your bananas for one-third. Bananas ripen every day and you get your check every 90 days. For particulars address Jantha Plantation Co., Empire Building, Block 307, Pittsburgh, Pa.

POULTRY Land \$5 down, \$5 monthly buys 40 acres Southern Mo. Price, \$200. Send for list. Box 22-N, Kirkwood, Mo.

STROUT'S New Farm Catalog. Money-saving guide to money-making equipped farms, summer places, village homes; 126 illus. pages covering many states. Copy free. E. A. Strout Realty Agency, Inc., 255-P Fourth Ave., New York, or 7-MT, South Dearborn St., Chicago.

FOR Sale—Hotel summer resort, 110 acres of land on Lake Almanor, 25 miles from Mt. Lassen, Northern California. For information, write owner, N. A. Olsen, Chester, Calif.

OZARKS—10 acres near White River and proposed power dam, \$100, \$5 monthly. Alvin Zimmerman, 1802 N. 5th, Kansas City, Kans.

SELL your property quickly for cash, no matter where located. Don't pay big commission. Particulars free. Real Estate Salesmen Co., Desk B, Lincoln, Nebr.

PECAN-Orange-Fig Groves "On the Gulf" Monthly payments. Guaranteed care. Big, quick returns. Suburban Orchards, Dept. M, Biloxi, Miss.

VERY choice sites for fine suburban homes can be made of this eighty acres adjoining beautiful Stone Park in Sioux City; only \$500 per acre buys it. Joseph H. Hill, Realtor, Sioux City, Iowa.

\$10 IS all I ask down on 20 acres in Mich. Potato Belt. Very easy terms. Near markets, lakes and streams. Write for particulars now. G. W. Swigart, P1276 First Natl. Bank Bldg., Chicago.

POULTRY

No. 1 LOW Booking Terms; Super-Test accredited chicks. All kinds. Our low prices and good service get the orders. Three color catalog free. Missouri State Hatchery, Dept. 711, Butler, Mo.

KEEP Chickens? Tell us the breed and how many and we'll send you free a copy of the most interesting poultry journal ever published. Poultry Item, Box 71, Sellersville, Pa.

OUR Baby Chicks are from high-egg bred, inspected flocks. Big—sturdy. Grow like weeds! Sent postpaid, safe delivery guaranteed. Plymouth Rocks, Rhode Island Reds, Leghorns, White Wyandottes, Minorcas, Buff Orpingtons, Anconas. Quality chicks. Low Prices. Catalog Free. Mary Maude Farms, Box 122, Portland, Ind.

RABBITS

MAKE Big Profits With Chinchilla Rabbits. Real money makers. Write for facts. Conrad's, 852 California Bldg., Denver, Colo.

ROOTS AND HERBS

HERB Doctor Book—10 cents. 250 receipts for making herb medicine. Hazzard Company, Box 1, Vanderveer Park, Brooklyn, N. Y.

DOGS AND PETS

BEAGLES, foxhounds, coonhounds, setters, pointers, collies, shepherds, greatdanes, St. Bernards, toy dogs. Catalog 10c. Lester Brown, White Hall, Md.

RAISE guinea pigs. Pay better than poultry or rabbits; easy to raise; little space required. Particulars and booklet how to raise free. Cavies Distributing Co., 3102 Grand Ave., Kansas City, Mo.

FOXES, raccoons, muskrats, skunk, ferrets, rabbits, squirrels, mink, opossums. B. Timman, Caledonia, Minn.

SKUNKS—breeders—Bred females all grades. Choice males. Squirrels, coons, opossums, foxes, rabbits, pigeons. Catalog 10c. Lester Brown, White Hall, Md.

PHOTOGRAPH of Strongheart's father, Nores v. d. Kriminalpolizei. Size with mat frame 12x14 in. Price \$1.00. C. T. Bartel, Box 40, River Grove, Ill.

PERSONAL

INGROWING Nails may be successfully treated at home without pain; results guaranteed. Copyrighted instructions \$1.00. Eugene S. Eaton, Box C-553, Bandon, Ore.

FREE: Valuable book telling the uses of Roots and Herbs. Box 29, Station L, New York.

SEND 25c coin and your date of birth for forecast of your vibrations for 1927. Aryel Synclare, Numerologist, Box 25, Patton, Calif.

TOBACCO or Snuff Habit Cured or no pay. \$1.50 if cured. Remedy sent on trial. Superba Co., N3, Baltimore, Md.

WONDERFUL health book for only 10c (publisher's price \$1.00). Appreciated by every reader, sick or well. Teaches health the natural way, also suggest reliable self treatment of disease. Address, Author, Box 437, Seattle, Wash.

FORTUNE-TELLING by cards (plain instructions), mystic secrets, etc.—all 10c. G. Elsea, Bowling Green, Ohio.

LEARN how to read character from the face. Send 10c and 2c stamp. Josef J. Brubender, Port Washington, Wis.

ANSWERS to mathematical problems of office, store, shop, bank, farm, or factory. Explains and simplifies every principle of arithmetic, mechanics and mensuration. Send No Money. Just ask for Ropp's Calculator. Pay postman \$1.00 and postage. Popular Mechanics Press, 200 E. Ontario St., Room 903, Chicago, Ill.

DO you want good live agents—fellows who can get the business? Ask me how others are doing it. I'll gladly render the necessary assistance without cost to you. Address, M. L. Rund, Mgr. Classified Advertising, 200 E. Ontario Street, Chicago.

MISCELLANEOUS

MIRRORS resilvered at home. Costs less 5 cents per square foot; you charge 75 cents. Immense profits plating auto parts, reflectors, tableware, stoves. Refinishing metalware, etc. Outfits furnished. Details free. Write Sprinkle, Plater, 288, Marion, Ind.

ARTIFICIAL eyes fitted by mail, \$5. Free booklet explains. Ramsdell Optical Company, Moline, Ill.

\$1.25 AND your old Waterman Pen for new No. 52 Waterman Pen; 25c extra for clip. Nichol, 33 So. Tenth, Philadelphia, Penn.

POP Corn, delicious and tender five pounds shelled delivered for one dollar. Roy Nefzger, Spencer, Iowa.

SAVE One Dollar and Fifty Cents on Genuine Bausch & Lomb Pocket Magnifier. Three Magnifiers in One For Only One Dollar. Optix Company, Pershing Square Building, New York.

FLYING Squirrels—cutest, oddest pets; unequalled show window attractions; easily raised in small space. Mated pair \$3.00, two pairs \$5.00, safe delivery guaranteed. Wildwoods Fur Farm, Woodville, Texas.

CATCH 2 and 3 mink Nightly Satisfaction Guaranteed. Instructions \$1.00. A Robertson, Hawarden, Iowa.

FORTUNES in Mines and Minerals. Ore specimen 10c. Minerals for sale. Buskett, Joplin, Mo.

CASH paid for butterflies, insects. See Sinclair Display Advertisement on Page 22.

I CATCH from 45 to 50 foxes in from 4 to 5 weeks' time. Can teach any reader of this magazine how to get them. Write for particulars. W. A. Hadley, Stanstead, Quebec.

CUTS anybody can make. Simple, cheap process. \$1. Specimens, particulars, 2c stamp. M. Day, Windfall, Ind.

HOMEOPATHIC and Biochemic preparations sent postpaid to all parts of the world. Manual and booklets free. Halsey Bros. Co., 645 St. Clair St., Chicago, Ill. Established 1855.

AMATEUR Cartoonists: Make money in spare time with new cartoon selling plan. Write Smith's Service, PM1194, Wenatchee, Wash.

WEEDS—Cut them with cutter bar on Shaw Garden Tractor. Also plows, cultivators and runs belt machinery. Low prices. Immediate delivery. Shaw Manufacturing Company, Department C, Galesburg, Kans.

SHORTCUTS in figures. The quickest ways of working all problems. Instructions for drilling yourself to become rapid with figures. Complete, yet simplicity itself. Send No Money. Just write a postal for "Shortcuts in Figures." Pay postman \$1.25 and postage. Popular Mechanics Press, Room 903, 200 East Ontario Street Chicago, Ill.

ST-STU-T-T-TERING and stammering cured at home. Instructive booklet free. Walter McDonnell, 46 Potomac Bank Bldg., Washington, D. C.

RECEIVE big mail. Quarter (coin) puts name on List. Fletcher, Box 6759, Philadelphia, Pa.

GOLD Ink Visiting Cards artistically written; A great novelty. 12 cards \$1.00. T. Kromer Art Co., 553 Almyra Ave., Youngstown, Ohio.

KINKS on Metal Work. 419 discoveries for anyone who works with metal. For mechanic, machinist, or the man who tinkers at home. 287 illustrations. Send No Money. Just write a postal asking for "Machinist's Kinks." When postman hands you book, pay postage and price of book, \$1.50. Popular Mechanics Press, Room 903, 200 E. Ontario St., Chicago, Ill.

WOLF and Coyote Exterminator Capsules—With formula and instructions; got 9 coyotes one night, brought \$121.50; free circular. George Edwards, Livingston, Mont.

ARTIFICIAL Eyes. Booklet free. Denver Optic, 539 Quincey, Denver, Colo.

TATTOOING Supplies Direct from Manufacturer. "Waters," 965 Puttnam, Detroit.

OUTDOOR Opportunities. Instructions for raising and selling rabbits, guinea pigs, milch goats, silver foxes, ferrets, white rats, white mice, dogs, cats, pigeons, pheasants, bantams, canaries, bees, frogs, mushrooms, ginseng, and golden seal. All profitable on town lot. Send No Money. Simply write a postal and say: "Send me Outdoor Opportunities." Pay postman \$1.50 and postal charges. Popular Mechanics Press, Room 903, 200 East Ontario St., Chicago, Ill.

ELECTRICITY MADE EASY



The Big Opportunity for Men Who Like Electricity!

Actual Work with Actual Tools on Actual Equipment. The Coleman System enables you to learn quickly and easily. Instructors are all thorough, practical, electrical men.

They Tell You Why—They Show You How—They Have You Do It.

This system never fails when a student means business.

ALL ELECTRICAL SUBJECTS TAUGHT

House-wiring on skeleton house; armature-winding on real armatures; radio hook-ups on real sets; automobile electricity on live cars; motor repairing on D. C. and A. C. Motors; lead-burning and re-building on storage batteries right off the car; practical work and real "cashable" Knowledge; electric welding; electric refrigeration, ranges and household appliances; power plant work; power and light switchboards; automobile starting, lighting and ignition.

COLEMAN GRADUATES MAKE GOOD

No electrical job too hard for a Coleman graduate. Every man tested on all jobs before leaving school. His diploma is my certificate of his good work and dependability. Each man proves his own skill by real tests. He must stay on each training job until it is finished and the machine works.

BIG MONEY IN ELECTRICITY

Trained electricians earn \$200.00 to \$600.00 a month. \$320,000,000 paid in wages in U. S. to electrical workers last year. Your name should be on this pay-roll now. I will tell you how.

WRITE FOR FREE BOOK AND SPECIAL RATE

You will be surprised how quickly you can learn, and how low my tuition rates are.

WM. H. COLEMAN, President

COLEMAN ELECTRICAL SCHOOL
1628 Main Street KANSAS CITY, MO.

CLIP AND MAIL THIS COUPON TODAY

Wm. H. Coleman, President,
COLEMAN ELECTRICAL SCHOOL,
1628 Main Street, Kansas City, Mo.

Dear Sir:

I want to learn about your school. Please send me free and postpaid your catalogue which will tell me how to get an electrical training at your special tuition price. This places me under no obligation.

NAME.....
ADDRESS.....
TOWN..... STATE.....

This Tenor Banjo FREE

WORTH \$18



When You Enroll

This handsome full size, professional tenor banjo is yours when you enroll. We want to make one thousand new friends this month. We want to present one of these wonderful, delightful instruments as a gift to each of one thousand readers of this magazine—and here's why. Before becoming a professor, and a lover of music, particularly the tenor banjo, Prof. Six yearned and yearned for the possession of a genuine, professional instrument, the same kind used by the big, successful professionals of the world. Now we want you to succeed. We want to help every music-lover that we can, attain success, and this gift offer is made to pave the way for you, and no previous musical knowledge is necessary.

We have another surprise for you! Not only do we start you on the way to popularity, success and fame by supplying you with an instrument that you can compare to any used or displayed in your town, but under personal supervision you will be given, by mail, the benefit of Professor Harry S. Six's twenty-two years' experience as director of Glee and Instrumental clubs of New York University. We don't just send you a lot of printed words and instructions and trust to luck that you will catch on. Our method is different and has proven to be the simplest devised by man—that is why we claim you'll be able to play in thirty minutes. Put us to the test.

Learn in 30 Minutes With My Picture Method

Arthur Brisbane, the highest paid journalist in the world, once said that "a single picture is worth a thousand words." He was right, for it stands to reason, when you take your instrument in hand along with the actual photographs of our professor in action as your guide, it is easy to imitate and do the right thing. But that is not all.

Phonographic Records Free We also furnish as an additional guide, phonographic records of our professor playing the piece you are learning, along with our thorough, printed and illustrated, easy-to-read course.



Doesn't that sound easy? It is easy. If you could sit at our desk and see the letters and telegrams from our pupils you would be convinced that we have perfected the simplest, yet most highly efficient course to insure your mastery of the tenor banjo.

Don't Send a Single Cent

Investigate offer today. Don't put off until tomorrow, because you might forget and miss this wonderful opportunity. It might be the turning point in your career. Don't send a single cent. Just drop a line—use coupon or postal card will do—telling you are interested in receiving full particulars about course and to reserve one regular eighteen dollar, full size professional tenor banjo for you, which is offered as a gift. Act quickly, because there may not be enough gift banjos to go around for the million or more readers of Popular Mechanics. This does not obligate you in any way. Therefore, do not hesitate—put in your reservation now, this very minute. You will soon join our happy army of enthusiastic finished tenor banjo musicians.

EARN BIG MONEY

Hundreds have started orchestras and are making money.

FREE BANJO COUPON

New York Academy of Music
Studio 103-100 Fifth Ave., New York

Please rush all free information relative to your Tenor Banjo Course and reserve a gift banjo for me. This obligates me in no way whatever.

Name.....

Address.....

City..... State.....

Let LIEUT. WALTER HINTON Teach You to FLY!

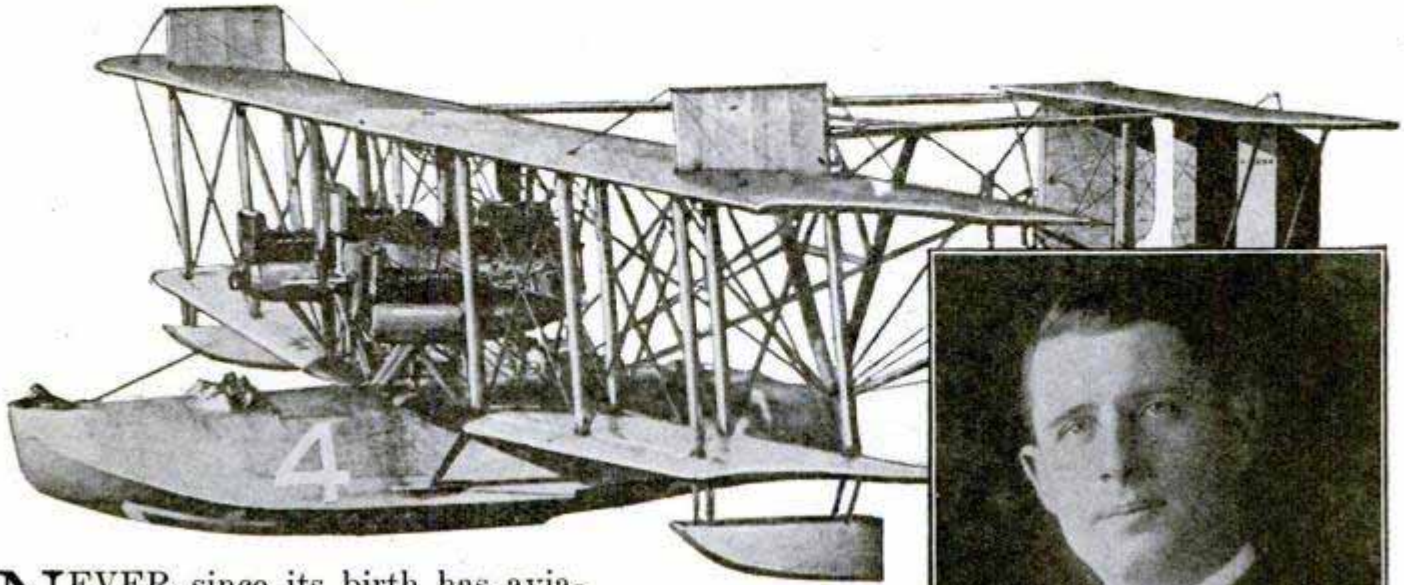

NEVER since its birth has aviation needed so many trained men as it does today! And the demand for skillful pilots and mechanics is constantly increasing.

You know that the transportation of mail, express, freight and people is fast taking to the air. **Men are needed** and the returns are excellent.

As you have watched planes soaring overhead you have admired the men controlling them,—perhaps imagined yourself in their place. Now the opportunity of **getting there** is yours!

Lieut. Walter Hinton, the first man to pilot an airplane **across the Atlantic Ocean**, the famous pilot of the N.C.4, now gives **you** the benefit of his knowledge of flying.

\$100 per Week and More

Pilots, designers, testers, aerographers, mechanics, aviation engineers, receive salaries of \$100 per week **and more!** Men are needed for the forest reserves, for crop dusting, for carrying mail, express and other light cargo. Opportunities are almost limitless.

Learn at Home

Now **you** can enter this most fascinating and adventurous field and collect **your** share of the profits. You can prepare yourself in **your own home**, in your spare time, without leaving your present occupation! You can have one of the **most famous flyers in the world** for your instructor!

THE FAMOUS PILOT OF THE N.C.4

Lieut. HINTON, former U. S. Navy aviator and instructor, pilot of the NC-4, first flying machine to cross the Atlantic, pilot on the famous New York to Brazil "Amity Flight," the first air voyage between the Americas, in 1922-1923; pilot on the "Rice" Expedition up the Amazon, to the River of Doubt and scores of others.

Now let him teach you to fly!



FREE "How to Fly" By Lieut. Walter Hinton

Put the coupon below in the mail **now, tonight**, before you go to bed!

It will bring you this new, illustrated book, full of pictures of his most famous flights, many taken where white man had never been before, "How to Fly" by the famous pilot himself, and particulars about his complete course of instruction that teaches **you** practical Aviation.

Aviators Preparatory Institute
Dept. 43 475 Fifth Avenue New York City

Aviators Preparatory Institute,
Dept. 43, 475 Fifth Ave.,
New York, N. Y.

I would like to know how Lieut. Hinton can teach me how to fly. Send me the illustrated book without obligation.

Name.....

Address.....

City.....State.....

PAIN and DISEASE

Quickly Conquered by

VIOLET RAY

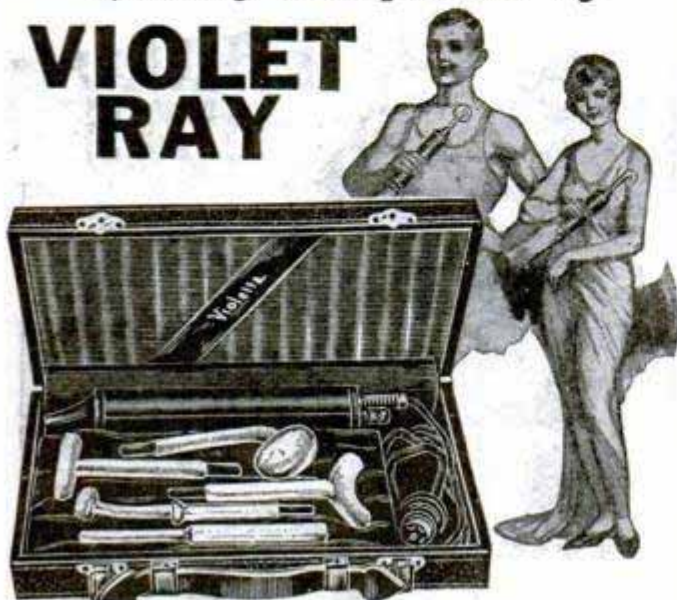

Let us tell you how thousands of men and women suffering from rheumatism, neuritis, paralysis, nervousness, skin diseases, headaches, constipation, sprains, prostate trouble, goitre and many other ailments, even hay fever and asthma, have found quick relief—new health and vitality with this marvelous, scientific invention. Pains vanish almost instantly.

Violetta

Ten Days FREE Trial
For Health—Beauty—Vigor

Endorsed and used by hospitals, sanitariums and physicians. Every home can now have one. Saves hours, days, months of suffering. No medicine. Painless, pleasant treatment. Only the violet ray can penetrate to every nerve affected. Simple, safe, painless—anyone can use VIOLETTA. Why suffer pain and poor health when you can try VIOLETTA 10 days FREE.

This Book FREE

Tells all about violet rays—how this marvelous discovery by Nikola Tesla, the electrical wizard, now brings this mysterious curative power to all. Contains many astounding testimonials from our thousands of satisfied users. Send for the facts and our liberal trial offer today. Mail the coupon now.

VI-REX CO., Dept. 331
2304 Warren Avenue, Chicago



VI-REX CO., 2304 Warren Ave., Dept. 331 Chicago

Please send me your free book on Violet Rays and details of your 10 days' free trial offer.

Name.....

Address.....

City..... State.....

Ailment.....

\$30 a Day for District Salesmen

Responsible man, 30 years old or over, and permanent resident in community, can make \$30.00 a day and up as District Salesman, taking orders for our finest, tailored-to-order clothes at sensational new low price. No investment necessary. We supply everything, give exclusive territory to producers, pay highest cash commissions daily and big monthly bonus besides. Write at once to Dept. 835.

GOODWEAR Chicago, Inc.

844 West Adams Street

CHICAGO

Name.....

Address.....

Town.....

State.....

FREE to OUR STUDENTS



A Brand New High-Grade Fine Tone Violin, Tenor Banjo, Hawaiian Guitar, Banjo, Cornet, Ukulele, Banjo Ukulele, Guitar or Mandolin: Take your choice. We will give you FREE of charge any instrument you select and teach you to play it by a wonderful new easy home-study method at a cost of only a few cents a day for lessons. Our method is so simple and easy to understand anyone can learn to play their favorite instrument in a very short time. No teacher or talent required—just a little practice every day and before you realize it you will be able to play "JAZZ" and "CLASSICAL" music on sight. Most pupils learn to play by note with the first four lessons. Remember the instrument is FREE. We give it to you when you enroll for a full course of lessons. No charge for it now or ever. A few cents a day for lessons is your only expense and you pay while you learn. Over 400,000 pupils have learned to play by our system of teaching. Write today for booklet and full particulars about this wonderful FREE INSTRUMENT offer and how you can get an instrument and first lessons for inspection and trial. No obligation if you are not satisfied with instrument and lessons. Write today. CHICAGO CORRESPONDENCE SCHOOL OF MUSIC, INC. 1632 North Halsted Street., Dept. 276, Chicago, Illinois

Learn to PAINT SIGNS and SHOW CARDS

We quickly teach you by mail, or at school, in spare time. Enormous demand. Big future. Interesting work. Oldest, foremost school. **EARN \$50 TO \$200 WEEKLY** John Vassos, N. Y., gets \$25 for single show card. Crawford, B. C., says: 'Earned \$200 while taking course'. Send today for free information, samples and guarantee. **DETROIT SCHOOL OF LETTERING** 154 Stimson Ave. Est. 1899 Detroit, Mich.



Learn Watchwork, Jewelrywork and Engraving

A fine trade commanding a good salary, and your services always in demand. Address **Horological**, Dept. P, Bradley Institute, PEORIA, ILLINOIS, for our latest catalog.

Learn Auto Mechanics with "Privileged" Students

In Brooklyn - The Heart of New York City. Free Catalog. Brooklyn Engineering Institute (Operated by Bedford Branch Y. M. C. A.) 1125 Bedford Avenue, Brooklyn, N. Y.

Factory to Rider

Saves \$10 to \$25 on the **Ranger Bicycle** you select. You can have your choice of **44 Styles, colors and sizes**. Delivered free on approval, **express prepaid, for 30 DAYS' FREE TRIAL**. Bicycles, \$21.50 up. **\$5 a Month** if desired. Possession and use at once on our Liberal Easy Payment plan. Parents often advance first payment.

Tires best quality, at factory prices, **express prepaid**. Lamps, wheels and equipment, low prices. **Send No Money**, do business direct with makers.

Mead CYCLE COMPANY DEPT. 110 CHICAGO

Write today for free Ranger Catalog, factory prices and marvelous easy payment terms



Now You Smarty

You Are Paying the Penalty

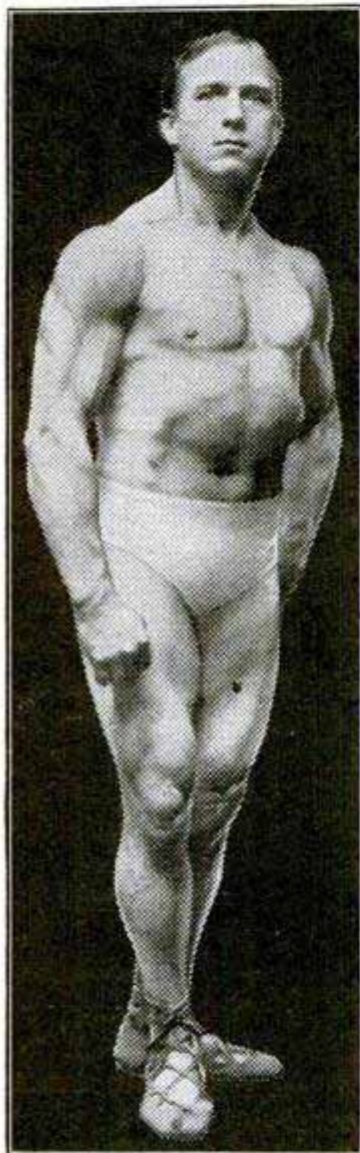

STRONGFORT
Builder of Men

happy life. **STRONGFORTISM**

Send for My Free Book

"PROMOTION AND CONSERVATION OF HEALTH, STRENGTH, AND MENTAL ENERGY." It will tell you frankly how I can make you over into a vigorous specimen of vital manhood. It is filled with astonishing facts about the body that will prove a revelation and give you new hope for a future joyous life. It is worth its weight in gold. Send for your copy **RIGHT NOW**.

STRONGFORT INSTITUTE
LIONEL STRONGFORT, DIRECTOR,
PHYSICAL AND HEALTH SPECIALIST
DEPT. 312 NEWARK, NEW JERSEY, U.S.A.

You were a wise guy. You were young, you were vigorous and peppy. Batting around nights until all hours of the morning didn't faze you in the least. Four hours sleep!—three hours sleep!—that made no difference. Oh, you were smart!—and you did love those wild parties with the boys and girls—the wilder the better. You were always set—the sky was the limit. "Where will we go from here, boys?" "Go! Go! Go! It was a great life! Nothing like it—"Wine, women and song!" Pshaw! you didn't feel any bad effects of the high speed at which you were going. You felt fine. You were strong and you loved to brag about the many "big times" you had. If you stayed up all night, the bolder the boast. Oh! you were very smart! But **NOW—**

You're Worried—Your Pep Is Gone!

You awaken in the morning all tired out, sluggish, nervous, constipated, dizzy, with headaches and a nasty taste in your mouth. Your eyes—black rings under them, bloated, bloodshot, and burning. You go to your work, not with energy and ambition, but with a slouch and a frown. Work drags. Your head is befogged—you can't think straight. You feel miserable. You are wretched.

Why is it? Ah—you are paying the penalty for those wild days of youth. The terrible mistakes you then made, the terrific pace at which you traveled, the awful abuse of your body, have come in for a reckoning. You are dejected, hopelessly discouraged. Ahead of you you can see nothing but misery and despair, and an unhappy life.

Let Me Restore Your Strength!

No matter how far down you have gone, I can and will help you. I don't care how serious the mistakes were, how much you dissipated, or how badly you abused your body. I don't care how miserable and wretched you are now—how weak and sickly—how wasted—

Strongfortism Will Bring You Back

—not with medicine or dope—but with the aid of Nature. You cast Nature aside in those days of early, frivolous youth. But Nature didn't cast you aside—she only stepped back and is waiting for you to beckon her to come. I will show you how to work with Nature. I will build you up inch by inch—internally and externally—until you are a robust, powerful fellow—a real He-man who will command respect and admiration wherever you go. I have done this for thousands of others and I will do it for you, through my original and unailing methods of

STRONGFORTISM

Science of Health and Strength

A new life will dawn for you. A new energy will grip you. You will be chock full of ambition. Your head will be high, your shoulders erect, your eyes bright, your cheeks radiant with color.

STRONGFORTISM has lifted thousands of weak, ailing, discouraged men out of the bog of hopelessness and despair and placed them on the straight road to health, happiness and prosperity. **STRONGFORTISM** has aided Nature in overcoming such ailments as Constipation, Nervousness, Rheumatism, Catarrh, Bad Blood, Poor Memory, etc., as well as the ruinous results of neglecting and abusing the body.

STRONGFORTISM gave these men renewed confidence, vitality, ambition, and fitted them for the joys of a healthy, will do the same for you.

Send this **FREE** Consultation Coupon
ABSOLUTELY CONFIDENTIAL

Mr. Lionel Strongfort, Strongfort Institute, Dept. 312, Newark, N. J.—Please send me absolutely free my copy of your book, "**PROMOTION AND CONSERVATION OF HEALTH, STRENGTH AND MENTAL ENERGY.**" I am enclosing ten cents (one dime) to help cover mailing expense, etc., and have marked (x) before the subjects in which I am most interested.

- | | | |
|-------------|-----------------|---------------------|
| .. Catarrh | .. Overweight | .. Great Strength |
| .. Colds | .. Constipation | .. Lung Troubles |
| .. Asthma | .. Weak Back | .. Round Shoulders |
| .. Headache | .. Weak Eyes | .. Stomach |
| .. Rupture | .. Rheumatism | .. Disorders |
| .. Thinness | .. Nervousness | .. Increased Height |
| .. Pimples | .. Short Breath | .. Muscular |
| .. Insomnia | .. Weak Heart | .. Development |

Other Ailments.....
Name.....
Age..... Occupation.....
Street.....
City..... State.....

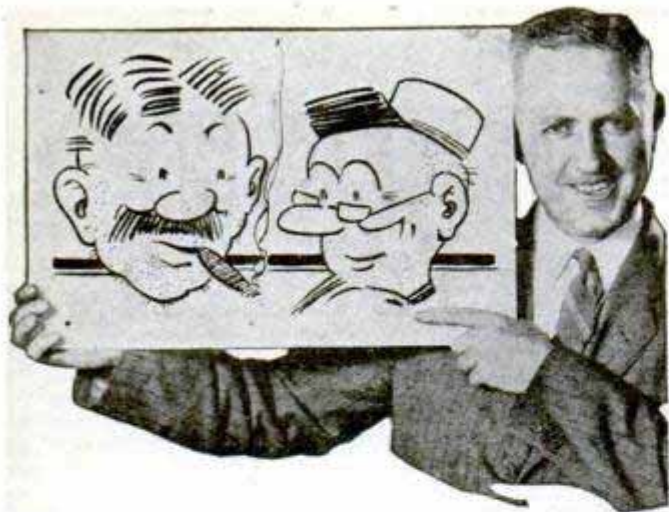

\$100 a Week in This Fascinating Work

\$50 to \$250 a Week Paid to Good Cartoonists! You Can Easily Learn This Fascinating Profession Right at Home in Spare Time. Send for Free Booklet Explaining Method.

THERE isn't a more attractive or highly paid profession today than cartooning. Millions of dollars are spent every year for good cartoons by the 20,000 or more newspapers and magazines in the United States alone. Capable cartoonists earn \$50 to \$250 a week. Fontaine Fox, Briggs, Bud Fisher, Sid Smith and others **make more money** than the presidents of many corporations. Think of it!

Quick Easy Way to Learn Cartooning

Yet of all the professions cartooning is now positively one of the easiest to learn. You don't need to know a thing about drawing. Through our amazingly simple method many who never dreamed they could draw have easily learned cartooning. You too—without any apparent talent at all—can easily learn to dash off side-splitting cartoons that may mean ease and independence for you within a surprisingly short time. You learn right at home, yet your work receives the personal correction of our successful cartooning instructors. Many students actually sell enough work during their training to pay for it.

Mail Coupon for Free Book

Learn more about the wonderful money-making opportunities in cartooning, and how this method makes it easy for you to learn. Read about our students—their success—what they say—how easy it was—actual reproductions of their work—how they made big money while studying. Booklet entirely free. Send for it **NOW**. **Washington School of Cartooning, Room 303-E, 1113-15th St., N. W., Washington, D. C.**

**WASHINGTON SCHOOL OF CARTOONING,
Room 303-E, 1113-15th St., N. W., Washington, D. C.**

Please send me without obligation, your illustrated **FREE BOOKLET** on Cartooning.

Name.....
(Write Name Plainly)

Address.....

City.....State.....

If under 16 years, please state age.....

Take Pictures



MAKE MONEY

We train you quickly at home. No experience necessary. Full time or spare time. Splendid opportunities now in Modern Photography. This is the picture age. Newspapers, magazines, advertisers, and manufacturers use thousands of photographs every year. Portrait photographers also make more money today than ever before. Commercial photography also a big pay field.

Get into business for yourself, or make money on the side. New plan. Nothing else like it. You can also make money while learning. Easy method. Quick results assured.

SEND FOR FREE BOOK

Write at once for interesting book "Opportunities in Modern Photography," and full details.

**AMERICAN SCHOOL OF PHOTOGRAPHY
3601 Michigan Ave. Dept. 1353 Chicago, Ill.**



Hotels Start You With Salaries up to \$3,500 a Year — with your living

HOTELS, restaurants, clubs, apartments, institutions, schools, colleges, hospitals, etc., everywhere need trained men and women—salaries to start up to \$3,500 a year with your living usually included. Over 70,000 high-class positions paying \$2,500 to \$10,000 a year are open every year in the hotels of the United States. Almost \$1,000,000,000 in new hotels and clubs being built in 1927, will need nearly 200,000 trained men and women. You can have one of these high-class big-pay positions, fascinating work with meals and luxurious apartment usually furnished **FREE!** No previous experience necessary. The Lewis Schools guarantee to give you the valuable knowledge that it has taken some of the most successful hotel men years to obtain. We train you by mail in your spare time at home and put you in touch with big opportunities. Our students employed by leading hotels everywhere. Send today for Free Book, "Your Big Opportunity," showing how we can train you for one of these splendid positions, and explaining our Money-Back Agreement.

LEWIS HOTEL TRAINING SCHOOLS
Charter Member of National Home Study Council
Room AD-388 Washington, D. C.

LEWIS HOTEL TRAINING SCHOOLS, Room AD-388, WASHINGTON, D. C.

Send me without obligation the Free Book, "Your Big Opportunity"

Name.....

Address.....

City.....State.....

Can you fix it

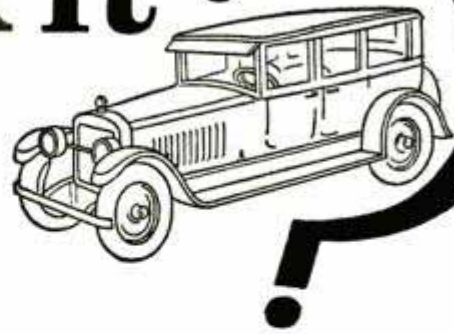

New books have "jiffy index," making all facts instantly available. You find anything you want to know in a moment, in this brand new 1926 edition.

These books tell how

HERE are the most interesting, the most practical books we have ever published on automobile construction, operation and repairs. Brimful of facts, photographs and explanations so easy to understand that anyone can learn how in almost no time.

Over 2000 pages, with diagrams, blueprints and everything else needed to make anyone an authority on automobiles.

Whether you want to qualify as garage owner, auto repair expert or merely wish to know how to keep your own car 100% efficient, you will welcome these books, especially on our

No Money Offer

This plan brings this valuable information within the reach of everyone. You don't send us a single penny. You don't have to pay us anything—just send your name and address and we'll send you the complete set of 5 volumes, specially bound in Flexo covers.

Read them carefully; keep them 10 days; find out anything you want to know, and then if you want to keep them, send only \$2.00 then and \$3.00 per month until the special low price of \$24.80 is paid. There is no further obligation.

American Technical Society Membership Free

This is a great organization for the publishing and spreading of specialized knowledge—we have over a million dollars of resources, enabling us to get the cooperation of the largest automobile manufacturers and dealers, who have furnished us plans and photographs. If you send NOW for this new edition of Automobile Engineering, we will include a Consultation Membership in this great organization.

Eighteen automobile experts will be ready to help you at all times. You can write or wire any time for special information. Answers will be sent to you promptly—without cost.

EMPLOYMENT SERVICE FREE

In addition to all this, those who send now will be entitled to the services of our EMPLOYMENT DEPARTMENT without charge. We are in daily contact with firms all over the country who need good men and are willing to pay big. This service costs you nothing. Don't miss this special offer. Send now.

Don't Hesitate

There are no strings to this offer—it means just what it says. Send name and address on the coupon and ALL of the five books—the complete set—will be sent to you for examination.

Remember one fact only which you can find in these books may save you an expensive repair or help you to a better job.

Learn All About Autos

Get these five big books on this liberal offer and learn all the things you want to know about autos.

Carburetors, engines, springs and spring suspension, brakes, 4-wheel drives, lubrication systems—all are fully covered.

These complete and comprehensive auto books are yours if you want them on this easy plan. Send for a set NOW; there's nothing to pay.



You don't have to read the books through; the index enables you to put your finger on the information wanted in a jiffy.

For Free Offer, Use Coupon

American Technical Society,
Spec. Dept. A-319, Chicago, Ill.

I would like to look at the 5 Auto Books described above. Send them on your FREE offer. I will examine them carefully and return them in 10 days unless I like them; in which case I will send you \$2.00 then and \$3.00 per month until the total price of only \$24.80 is paid. You are to also send me Free Consulting Membership Certificate in the American Technical Society and I am entitled to the services of your employment department without charge.

Name.....

Street.....

City.....State.....

Reference.....



His Salary Was Raised while others were reduced

"Up to the time I enrolled for a course with the International Correspondence Schools, I had only a grade-school education. Since enrolling, I have advanced to a much better position, where my salary is nearly four times as much as I was making previously. I would not be able to hold my present position had I not taken your Course. Recently I received a nice increase in salary, while other men were being reduced."

Read that last sentence again—"Recently I received a nice increase in salary, while other men were being reduced."

There could be no better proof of the value of an I. C. S. course than that. It shows that the trained man is given preference over all others and paid more money, even in slack times, if his work deserves it. It shows that there are always bigger, better jobs open for men who have the foresight to prepare for them in spare time.

Why don't you study and get ready too? We'll be glad to help if you will only make the start.

Choose the work you like best in the coupon below; then mark and mail it to the I. C. S. today. This doesn't obligate you in the least, but it will bring you information that will start you on a successful career. This is your opportunity.

Mail the Coupon for Free Booklet

INTERNATIONAL CORRESPONDENCE SCHOOLS
Box 5638-E, Scranton, Penna.

Without cost or obligation, please send me a copy of your booklet, "Who Wins and Why," and full particulars about the course before which I have marked X in the list below:

BUSINESS TRAINING COURSES

- | | |
|--|---|
| <input type="checkbox"/> Business Management | <input type="checkbox"/> Salesmanship |
| <input type="checkbox"/> Industrial Management | <input type="checkbox"/> Advertising |
| <input type="checkbox"/> Personnel Organization | <input type="checkbox"/> Better Letters |
| <input type="checkbox"/> Traffic Management | <input type="checkbox"/> Show Card Lettering |
| <input type="checkbox"/> Business Law | <input type="checkbox"/> Stenography and Typing |
| <input type="checkbox"/> Banking and Banking Law | <input type="checkbox"/> English |
| <input type="checkbox"/> Accountancy (including C.P.A.) | <input type="checkbox"/> Civil Service |
| <input type="checkbox"/> Nicholson Cost Accounting | <input type="checkbox"/> Railway Mail Clerk |
| <input type="checkbox"/> Bookkeeping | <input type="checkbox"/> Common School Subjects |
| <input type="checkbox"/> Private Secretary | <input type="checkbox"/> High School Subjects |
| <input type="checkbox"/> Spanish <input type="checkbox"/> French | <input type="checkbox"/> Illustrating <input type="checkbox"/> Cartooning |

TECHNICAL AND INDUSTRIAL COURSES

- | | |
|---|--|
| <input type="checkbox"/> Electrical Engineering | <input type="checkbox"/> Architect |
| <input type="checkbox"/> Electric Lighting | <input type="checkbox"/> Architects' Blueprints |
| <input type="checkbox"/> Mechanical Engineer | <input type="checkbox"/> Contractor and Builder |
| <input type="checkbox"/> Mechanical Draftsman | <input type="checkbox"/> Architectural Draftsman |
| <input type="checkbox"/> Machine Shop Practices | <input type="checkbox"/> Concrete Builder |
| <input type="checkbox"/> Railroad Positions | <input type="checkbox"/> Structural Engineer |
| <input type="checkbox"/> Gas Engine Operating | <input type="checkbox"/> Chemistry <input type="checkbox"/> Pharmacy |
| <input type="checkbox"/> Civil Engineer | <input type="checkbox"/> Automobile Work |
| <input type="checkbox"/> Surveying and Mapping | <input type="checkbox"/> Airplane Engines |
| <input type="checkbox"/> Metallurgy <input type="checkbox"/> Mining | <input type="checkbox"/> Agriculture <input type="checkbox"/> Navigation |
| <input type="checkbox"/> Steam Engineering | <input type="checkbox"/> Mathematics <input type="checkbox"/> Radio |

Name.....

Street Address.....

City..... State.....

Occupation.....

Persons residing in Canada should send this coupon to the International Correspondence Schools Canadian, Limited, Montreal, Canada

Why Good Dancers Are Popular

EVERYONE admires and wants to dance with the person who knows the latest steps. There is no need of being a wallflower! By my remarkable new easy method anyone can learn the newest dances at home in a few hours. Much less expensive than from a personal teacher. No music or partner needed. So simple even a child can learn quickly. **Almost one half million have learned dancing by mail. Your own success is guaranteed.**



Posed by Edna Murphy and Arthur Murray

To prove I can quickly and easily make you an accomplished dancer, I will send you **FREE** my 32 page book and TEST LESSON. To pay the cost of mailing, handling, etc., send 10c. Learn in private—surprise your friends. Act now and be a good dancer soon!
ARTHUR MURRAY, Studio 707, 7 East 43rd St., NEW YORK

MUSIC LESSONS FREE

In Your Home



Write today for our **FREE** booklet. It tells how to learn to play Piano, Organ, Violin, Mandolin, Guitar, Banjo, etc. Beginners or advanced players. Your only expense about 2c per day for music and postage uscd.

American School of Music, 50 Manhattan Bldg., Chicago

Health Food Directory

How to select the proper foods for gaining weight; reducing; building vitality; disease resistance; constipation; building muscle, etc. Rates and tabulates standard branded foods. No other book like it. 150 pages of valuable information. Special price 25c, postpaid. 1 limited edition.

Macfadden Publications, Inc., Dept. P.M. 3, 1926 B'way, N.Y. City

A Great Book Free with this pay-raising library

For a short time only we will give every subscriber to the New Library of Machine Shop Practice a copy of French's Engineering Drawing—the greatest book on mechanical drawing ever written. This book makes drawing as plain as day—tells you all about instruments, plans and methods—and prepares you to handle any drawing job you will ever have to do. It comes to you absolutely free with

Machine Shop Practice

9 volumes—3065 pages—3608 illustrations
(A combined home study course and reference library)

The New Machine Shop Library is written for practical men. It gives you the best methods for every kind of machine shop work. It explains machine tools and their operation, drawing and design, tool work, gears and grinding, jigs and fixtures, automatic screw machines and their tools and all of the mathematics you will ever have to use. It is plainly written, completely illustrated—the very best kind of help to the machine-shop man who wants to advance himself.

Sent

FREE



No money down—only 7c a day

FREE EXAMINATION COUPON

McGraw-Hill Book Co., Inc., 370 Seventh Ave., New York

Send me for 10 days' free examination the New Library of Machine Shop Practice. If satisfactory, I will send you \$1.50 in 10 days and \$2.00 monthly until the special price of \$19.50 is paid. If not wanted, I will return the books at your expense.

On receipt of my first payment of \$1.50, it is understood that I am to receive, free of charge, a copy of French's Engineering Drawing.

Signed.....

Address.....

City and State.....

Position.....

Employer..... P.M.3-1-27

Chosen Traffic Manager for \$3,000,000 Corporation

A Warehouse of the
David Pender Grocery Co.



L. H. WINDHOLZ,
President,
David Pender Grocery Co.



W. B. JESTER,
Traffic Manager,
David Pender Grocery Co.

How LaSalle Helped W. B. Jester Find Big Opportunity

The Path All Clear for Real Achievement

"If the credit for Mr. W. B. Jester's very able handling of our Traffic Department is yours, I want to compliment you on a well finished product. Mr. Jester has made a splendid impression upon me, and I feel fortunate in having him associated with the new Company."

(Signed) L. H. WINDHOLZ, Pres.
David Pender Grocery Company

"The Opportunity of a Lifetime"

"The new management of the David Pender Grocery Company—now a \$3,000,000 corporation—plans to greatly expand our present organization. We now have two hundred and sixty-one (261) stores in our Chain and we plan to have three hundred (300) by the end of this year.

"I feel that this is the opportunity of a lifetime, and I cannot tell you how greatly I appreciate all that LaSalle has done—thru its training in Traffic Management—to qualify me for this position." (Signed)

W. B. JESTER, Traffic Manager
David Pender Grocery Company

"Be ready"—that is W. B. Jester's answer to the question, "How can I win promotion?" and Mr. Jester's advancement to the Traffic Managership of the great Pender chain of grocery stores, with headquarters at Norfolk, Va., is mighty good proof that the one word *ready* holds the secret to success.

"From the time I accepted a position in the receiving department of the D. Pender Grocery Company, I had always wanted to become a Traffic Manager," writes Mr. Jester, "and to this end I pursued traffic work evenings, relying for aid on LaSalle Training in Traffic Management.

"The savings I was able to effect proved the worth of this training to my employers, and on January 1st, 1919, I was appointed Traffic Manager of the D. Pender Grocery Company and Pender-Dilworth Company.

"At that time I regarded the position chiefly as a stepping-stone.

"Today, I see clearly what such training can readily lead to, for I have recently been retained as Traffic Manager of the new David Pender Grocery Company—a three-million dollar corporation."

Send for Free Book—"Opportunities in Traffic Management"

Traffic men—whether you are in the industrial field or railroad field—your future can be just as big as you wish to make it!

Men in other fields—do you know it is conservatively estimated that as many as 80,000 firms are in immediate need of Traffic Managers?

"I would not take \$50,000 for my knowledge of Traffic Management," writes H. E. Stiffler, Traffic Manager of the Marion Steam Shovel Company, Marion, Ohio—and his increased earning power is the reason why.

Hundreds of LaSalle trained men have proved these opportunities—and have doubled and tripled their salaries as a result. The plan they followed—the plan you can follow, too—is outlined in a 96-page book, "Opportunities in Traffic Management." LaSalle will gladly send it to you free.

Balance the two minutes that it takes to fill out the coupon against the rewards of a successful career—then clip and mail the coupon NOW!

LASALLE EXTENSION UNIVERSITY

THE WORLD'S LARGEST BUSINESS TRAINING INSTITUTION
FIND YOURSELF THRU LASALLE!

LASALLE EXTENSION UNIVERSITY CHICAGO

Dept. 364-1R

Other LaSalle Opportunities: LaSalle opens the way to success in every important field of business.

If more interested in one of the fields indicated below, check here:

- | | |
|---|--|
| <input type="checkbox"/> Business Management:
Training for Official, Managerial, Sales and Departmental Executive positions. | <input type="checkbox"/> Banking and Finance. |
| <input type="checkbox"/> Higher Accountancy:
Leading to position as Auditor, Comptroller, Certified Public Accountant, Cost Accountant, etc. | <input type="checkbox"/> Modern Foremanship
and Production Methods. |
| <input type="checkbox"/> Modern Salesmanship. | <input type="checkbox"/> Personnel and Employment
Management. |
| <input type="checkbox"/> Law: Training for Bar; LL.B. Degree. | <input type="checkbox"/> Railway Station
Management. |
| <input type="checkbox"/> Industrial Management. | <input type="checkbox"/> Commercial Law. |
| <input type="checkbox"/> Modern Business Correspondence and Practice. | <input type="checkbox"/> Expert Bookkeeping. |
| | <input type="checkbox"/> Business English. |
| | <input type="checkbox"/> Commercial Spanish. |
| | <input type="checkbox"/> Effective Speaking. |
| | <input type="checkbox"/> C. P. A. Coaching for Advanced Accountants. |



I would welcome an outline of your salary-doubling plan, together with a copy of "Opportunities in Traffic Management," also copy of "Ten Years' Promotion in One," all without obligation.

Traffic Management:

Training for position as Railroad or Industrial Traffic Manager, Rate Expert, Freight Solicitor, etc.

Name

Address

free! Present Position

mail coupon now Age

DO YOU LIKE TO DRAW?

HAVE you a liking for drawing, for sketching people and scenery and putting your thoughts upon paper? **Would you like to turn your talent for drawing into money?** It is a fascinating and immensely profitable hobby to be able to sketch quickly and easily the people you see about you, pretty scenery, trees and old houses.

DID YOU EVER THINK what a pleasant and profitable profession is open before anyone with a talent for drawing? Commercial Artists and Illustrators make big incomes, the work is extremely interesting and enjoyable and is exceptionally well paid. Many artists engaged in this work make from \$5,000 to \$10,000 a year and more drawing for newspapers and advertisers. Huge prices are paid for Illustrations, Cartoons and Designs for Advertisements and Posters. Editors, publishers and advertisers are always looking for new and interesting drawings and are willing to pay good prices for them.

OPPORTUNITIES ABOUND in this wonderful profession for anyone who has a liking for drawing. No profession offers such opportunities today as does Commercial Art and Illustrating. The tremendous increase in advertising and illustrated publications has created such a demand for competent artists that the field of commercial art and illustrating is a real gold mine for the man or woman who likes to draw.

LEARN AT HOME There is no need for you to leave your home in order to study this delightful and absorbingly interesting art. You can study anywhere under our resultful system of correspondence instruction with which you have the help and guidance of artists high in their profession.

Copy this Sketch

→
and send it to us for
Free Criticism

and let us judge for you whether you have a talent for Drawing. The criticism is entirely free and places you under no obligation whatever.

**2 ILLUSTRATED
BOOKS
FREE**

**2
BOOKS
FREE**



Let us also send you an actual Specimen Lesson Book, Number Twenty-five from our Course of Instruction as supplied to regular students.

This lesson Book is entitled "How I Do My Work" and has been written and illustrated by eight prominent artists. Each artist explains in simple language the working methods which he uses in his own studio. This Book contains forty illustrations of which fourteen are in color.

"Drawing for Pleasure and Profit" is another book which we will send you free. It is an unusual publication of real value to anyone with a liking for Drawing and gives you hundreds of very interesting facts about Illustrating, Commercial Art and Cartooning. We will send you these two books absolutely **FREE** when returning your sketch.

**THE NORTH AMERICAN
SCHOOL OF DRAWING**
(Incorporated)

521 Henkel Bldg.

Buffalo, N.Y.

**And Still
It Leaks
No
Air**

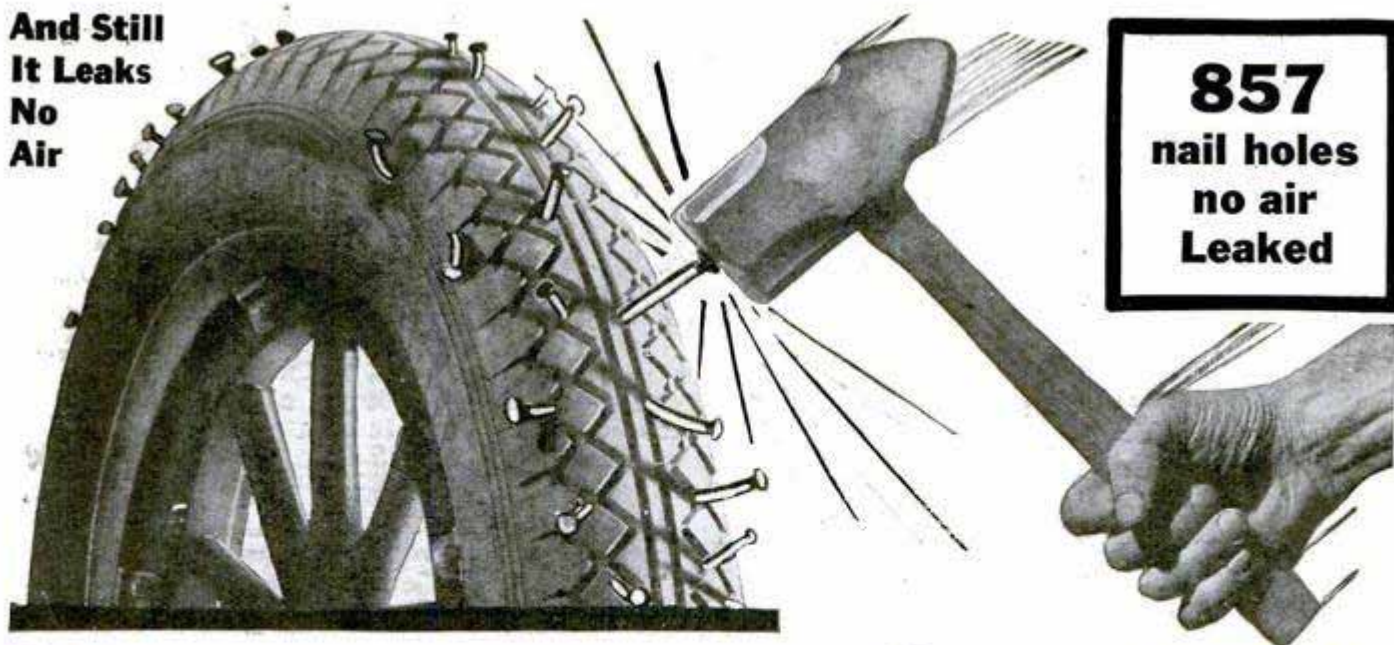

**857
nail holes
no air
Leaked**

Punctures Sealed Without Removing Tires

Get tire troubles off your mind forever! No longer need you wrestle with tight rims and patched tubes. This amazing fluid seals punctures automatically as they occur. Now used by over 500,000 car owners. Get free sample offer.

\$15 to \$30 A DAY!



NO wonder many distributors are cleaning up big cash profits in full or spare time with Aer-Pruf! Read what India Rubber and Tire Review says about the Aer-Pruf tests made by foremost

authorities: "The result of the actual tests are in agreement with the contention of the manufacturer—that a pneumatic tire (meaning Aer-Pruf treated tires) has been produced that is practically proof against puncture from nails."

The reports on Aer-Pruf are astounding. Steve Temple drove 3,000 miles on a tire punctured 49 times—no air leaked. Bernard Houska's tire was punctured 150 times on one long trip—and no air leaked. And N. T. Spiers, an Aer-Pruf distributor, has driven 1100 nail holes and spikes in one Aer-Pruf treated tire, without air leaking out.

Seals Punctures Automatically

Aer-Pruf is not a tire filler. It is a simple harmless fluid that circulates through the tube. When a puncture occurs and the nail is withdrawn the air forces the fluid into the puncture—thus the air is stopped and the hole mended. It seals punctures as small as a tack—as large as a 20-penny spike. It

also seals slow leaks, valve leaks and porous tubes. It helps to prevent cracked sidewalls and rim cuts. It prolongs the life of the tire by preventing running on flat or semi-flat tires.

Accept This Offer

The inventor will accept your challenge to test this tire-protection on your car at his risk. He will also send full details of a wonderful money-making plan for your spare or full time. Send this coupon. It doesn't cost a cent.

AER-PRUF MFG. CO.

Dept. C-3187

Mitchell, S. D.

**\$57 in a
Day**

Big cash profits are being made by Aer-Pruf distributors. Frank Ryman made \$57 in one evening. Dubois made \$9 in 5 minutes. Bright made \$32 in two hours.

Free Test Offer

AER-PRUF MFG. CO.,
Dept. C-3187, Mitchell, S. D.

Yes, send me full details of your free test offer and your money-making plan for distributors. This does not obligate me in any way.

Name.....

Address.....

City..... State.....

Like Finding a \$20 Bill!

HERE'S your chance to save \$20.02 on your set of muscle building apparatus with a complete course of instructions!
Here's a bargain in *Health*—a bargain in *Strength*—a bargain in *New Life* for YOU. You could pay up to \$50 or \$60 for similar apparatus and instruction elsewhere, but you couldn't get a better outfit at any price!

High Tension 10-Cable Exerciser

This is the Champion Muscle Builder of the World! It is made with steel reinforced handles—the strongest made, Everlasting quality throughout! When used with my Scientific Course of instruction you will almost see your muscles grow. Every muscle and organ in your body will feel like new.

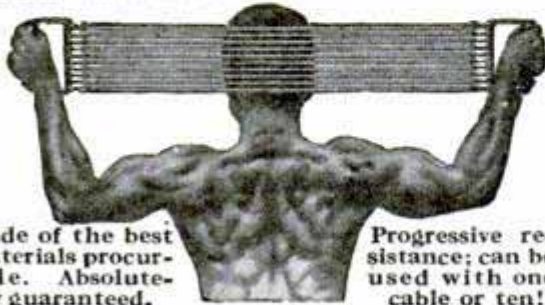

Made of the best materials procurable. Absolutely guaranteed.

Progressive resistance; can be used with one cable or ten!

HENRY VICTOR, Dept. M-107
109 East 13th Street, New York City

Gentlemen: Send me your complete outfit and the two FREE books. I enclose the bargain price of only \$4.98. If I am not satisfied, I will return the outfit immediately and my money will be refunded.

Name.....
Address.....
City..... State.....

Read This List—

Complete scientific course of instruction in *Body Building*—Worth \$10.00; CHAMPION PROGRESSIVE TEN CABLE MUSCLE BUILDING EXERCISER—Worth \$10.00; Victor Master Grip (Patented in all countries)—Worth \$ 5.00

Total \$25.00

Victor Master Grip

This machine will increase your forearm and wrist muscles to an unbelievable development. It is progressive and can be used with (1) mild; (2) medium; (3) strong springs. It is also a grip tester, registering from 1 to 100 per cent.

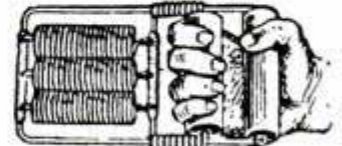

Professional strong men and athletes everywhere praise the Victor Master Grip. No training apparatus is complete without one.

And You Get These Two Books FREE

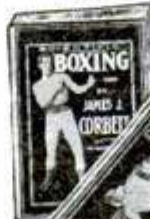

"Boxing" an illustrated book by James J. Corbett and "Wrestling" by Frank Gotch will be sent with your apparatus FREE, if you hurry. Both books are filled with inside dope on boxing and wrestling. I have only a few copies of each left. Get yours by mailing the coupon now, TONIGHT—before you go to bed.

HENRY VICTOR, M-107, 109 E. 13th St., New York City

AT HOME LEARN TELEGRAPHY AT HOME

TEACH YOURSELF in half usual time, at trifling cost, with the wonderful Automatic Transmitter, **THE OMNIGRAPH**. Sends unlimited Morse or Continental messages, at any speed, just as an expert operator would. Adopted by U. S. Government, and leading Universities, Colleges and Telegraph Schools. Catalog 6 cents.

OMNIGRAPH MFG. CO., 13-19 Hudson St., NEW YORK

LEARN TO DRAW!

Remarkable book just off the press—"COMMERCIAL ART AND CARTOONING." Explains how to make illustrations for Books, Advertisements, etc. Also tells how to become a successful Cartoonist. **NO CORRESPONDENCE COURSE—Everything complete in this book—14 chapters, over 125 illustrations.** Tells about Elementary Drawing; Still Life; Pen, Ink, Charcoal and Crayon Work; Wash and Figure Drawing; etc.

Cartooning, Bound Flexible, Imitation Leather—Gold top. Worth \$5.00. Sent postpaid for \$2.00 (C. O. D. 17c extra).

Ogilvie Pub. Co., 57 Rose St., New York, Dept. 133.

Learn Advertising at HOME

Many of the highest paid men in the world are advertising men. You can learn easily and quickly at home during your spare time. We guarantee satisfaction. Bigger opportunities now in advertising than ever before. Constant demand for our graduates at splendid pay.

Send for FREE Book. Giving interesting information and vital facts—just what you want to know about advertising. Write today.

PAGE-DAVIS SCHOOL OF ADVERTISING
Dept. 1353 3601 S. Michigan Ave., Chicago, U. S. A.

Win \$3500.00 Find the Twin Bags!

Here's a—NEW—puzzle. If you're a puzzle fan—CAN YOU FIND THE TWIN BAGS? NO, they're not all alike—even though they look alike. Only two of these bags are identical in every way. Some have the \$ sign, others not; some have line under penny ciphers, some no lines, some have comma between the 3 and 5, some two tie strings, some none, some one string out to right, others to left.

Each one is different from the rest except two—find them—mark them with a cross—send your answer. \$3000.00 first prize—399 others, and duplicate prizes in case of ties. If you find the twin bags I will give you 8000 points toward first prize and tell you how to get additional easy 1000 points that wins—only 9000 points wins the \$3000.00

\$500.00 EXTRA FOR PROMPTNESS—making total first prize YOU CAN WIN \$3500.00. SEND NO MONEY—nothing to buy now or ever—just find the twin bags—mark them and answer today.

F. G. STAYTEN, Advertising Mgr., Room 235 54 W. Illinois St., Chicago, Ill.

Tools FREE

of ANY Extra Charge

Also a Drafting Table
Act NOW!



This is NOT a "Student's" Outfit but an Imported Set of Professional Drafting Instruments, a Chief's Drafting Table, and Standard Supplies.

Yours for the Asking!

No Extra Cost Whatever. No Conditions except to Reply Promptly. This offer Open

to All who Speak Up NOW!

Scores of Firms are in need of Draftsmen now—and I need you. Many offer to take BEGINNERS, at \$50 a WEEK. Graduates can start at \$90 and \$100! GET BUSY!

Every industry in this country is using draftsmen in droves! In twenty-five years, I've never been harder pushed to turn out enough new men. In fact, it's the shortage that brings you this wide-open offer of all instruments—a real drafting table—full working outfit—complete, standard supplies—even paper and pencils and ink! No extra charge for any of them. That's how I hope to get the required men in record time.

Drafting is the field for any man who wants to get somewhere. For men who want to be heard from. Want work that counts, and pay that makes working worth while and lifeworthy living.

I'll teach you draftsmanship by practical methods that make a man easily and quickly finish the whole course. I use modern methods; I employ every short-cut; but I leave nothing out that you have to know to earn \$3500 to \$10,000 a year as a practical draftsman.

LEARN AT HOME but on the same kind of actual drafting room jobs we assign you from our own drafting rooms. It isn't hard to do. Drafting isn't "drawing." You don't need "talent." If you are interested and can read and write, I give you the training to become a good draftsman. (Dobe-trained men are draftsmen and chiefs in big concerns all over the country—and many have made good abroad.)

This Opportunity Doesn't Call for Cash, so Don't Pass It Up for Lack of Ready Money

Please don't beat yourself by thinking of your finances at this time! It isn't money I want now—it's men. You, if you mean business. What I am after is your application. Once I get that, you'll get action. I'll have you ready to draft for important pay—in any engineering or industrial line you like—before you know it. So get my proposition in front of you this week! Then, if you do enroll, you're in line for my free outfit offer.

WELL PAID JOBS are soon sighted by men under Dobe training! They get offers before they're through. Are often spoken for months ahead of graduation. And I have students from 17 years of age to 51 at present time! So: first of all, and right now, send this coupon for my new free book Successful Draftsmanship; fully illustrated; explains everything.



YES!

That's Chief Draftsman Dobe's answer to "Can I Succeed in Drafting?"

YES!

Does Dobe really turn out practical draftsmen in a few months?

YES!

Is there always such a big call for men who can draft as Want Ads in the newspapers show at the present time?

YES!

Do I actually get all instruments and supplies without one dollar's extra cost?

YES!

FREE TOOLS COUPON

CHIEF DRAFTSMAN DOBE

1951 Lawrence Ave., Div. 13-53, Chicago

Send me free and postpaid Successful Draftsmanship Book and material telling all about your home course, terms, etc.

Name..... Age.....

Address.....

Make That Dream Come True!

Haven't you often pictured yourself playing the Hawaiian Guitar, a happy crowd around you, everybody enjoying and admiring your playing? Now you can reach your goal—and play all the latest hits just as the Hawaiians do!



You can play the
HAWAIIAN GUITAR
just like the Hawaiians!

\$15
HAWAIIAN GUITAR
with Genuine Seal Grain
Fabrikoid Cover
FREE
when you
enroll



Get the advantage of expert instruction by Kolomoku, Kalaluki, Ferera and Seville—every one famous as both player and teacher. Even if you never touched a musical instrument in your life, under their direction you make rapid headway—you will be astonished when you see how easy it is!

**This Sweet Toned
Hawaiian Guitar**

In genuine Fabrikoid Case—and complete playing outfit including picks, steel playing bar, etc. I sent you free when you enroll. Retailers ask \$15 or more for a similar outfit without the case. Remember, there are no extras—we furnish everything with the course.

Learn In Spare Time

Pick up your guitar at any time and play. Your lessons are always handy—you can always refer to them. You are never hurried or forced. And no waiting for a class to form—start now—go ahead as fast as you like.

Pay as You Play

Small first payment starts you. And the entire 52-lesson course comes to just a few cents a lesson! Begin now.

We Guarantee

in writing to teach you. And after graduation we coach and advise you without charge. Over 45,000 successful graduates.

Tenor Banjo and other courses—Violin, Tiple, Tenor Guitar, Banjo Ukulele, Ukulele—under well-known instructors. Write for information.

FIRST HAWAIIAN CONSERVATORY OF MUSIC, INC.

9th Fl., Woolworth Bldg., Dept. 348, New York, N. Y.

Approved as a Correspondence School Under the Laws of the State of New York

SEND THIS COUPON FOR LIBERAL OFFER!

First Hawaiian Conservatory of Music, Inc.
9th Fl., Woolworth Bldg., Dept. 348, New York, N. Y.

Please mail full information about your 52-lesson Hawaiian Guitar Course. I am not obliged to enroll unless I want to.

Name _____
Address _____
City _____ State _____

\$75 A WEEK BUILDING RADIO SETS

now being made

Join the Radio Association of America. Let it train you to build and repair sets, to be the "radio doctor" of your community. \$3.00 an hour easily made in spare time.



\$500 Earned in Spare Hours

Lyle Folliet, Lansing, Mich., writes: "Have already made over \$500 in spare time." He is just one of many. Our members are starting radio stores, securing better positions, passing radio operator examinations, qualifying as big-pay Radio Experts, as well as making money spare time.

Join the Association Now! By our Special Plan your membership need not cost you a cent. Number of these memberships limited. Write for details NOW!

RADIO ASSOCIATION OF AMERICA, 4513 Ravenswood Ave., Dept. P-M-3, Chicago, Ill.

Don't Envy The Plumber BE ONE!

\$11.00-\$16.00 PER DAY and work **EVERY** day,
is the Plumber's wage.

Every skilled workman will tell you that Plumbers have the best of it. WINTER and SUMMER the Plumber is busy at top wages. No skilled Plumber is ever out of a job—compare his opportunities with any trade, plus the opportunities of having your own shop.

We teach you Plumbing with **TOOLS** (not books) under Licensed Master **PLUMBERS** in one of the finest equipped schools in America. We make you a Plumber, every branch is taught thoroughly—Lead Work—Blue Print for plan reading—all other tricks.

LEARN IN 8 to 12 WEEKS without previous experience.

If you are making less than \$60.00 a week you owe it to yourself to investigate. Get **FREE** catalog that tells in pictures and words how we teach this trade. Special rates now.

UNIVERSAL PLUMBING SCHOOL
2030 Troost Ave. KANSAS CITY, MO.

Learn to MOUNT Birds and Animals

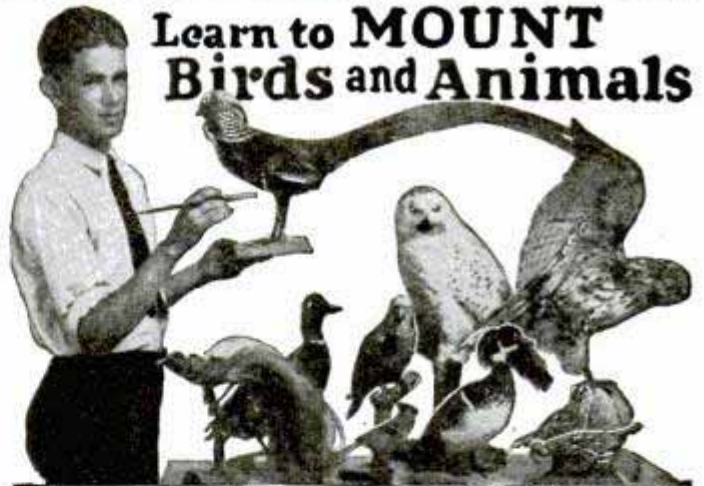

Learn at Home by Mail

Be a taxidermist. Learn to mount **BIRDS, ANIMALS, GAME HEADS, FISH**. Wonderful fascinating new art. All secrets revealed. Easily, quickly learned by men, women and boys. Decorate home and den with nature's finest art. **SPORTSMEN** save your trophies. **BIG PROFITS** for spare time. Sell your mounted specimens and mount for others. Have a business of your own. Big demand, high prices. Learn from old reliable school, 20 years' experience.

FREE! Beautiful illustrated book, "How to Learn to Mount Game," with dozens of photos of mounted specimens. Yours for the asking—**FREE**—Write Today. Taxidermy is a **NECESSITY** for sportsmen and nature lovers—**INVESTIGATE**. Get this wonderful **FREE BOOK NOW**—no obligations. Send Coupon Today!

Northwestern School of Taxidermy
1773 Elwood Bldg. Omaha, Neb.
Send me your free illustrated book "How to Mount Game." Also tell me how I may learn this fascinating art easily and quickly by mail. No obligation.

FREE BOOK COUPON
Name _____
Address _____

Learn

Electricity

Earn
\$1.00
per Hour
to
\$25,000
per Year



FREE
RAILROAD
FARE TO
CHICAGO
Included

*Repairing a
50-Horsepower
Motor in the big
Greer Shops*

HOW much money did you earn last year? Was it enough? If it was you are wasting your time reading this page. If it wasn't, then this information is your key to a lifetime of the **big earnings** that mean future independence.

The whole civilized world is covered with a network of **electric wires and cables**. They are overhead, under the ground, concealed behind walls. They are carrying power for factories, for electric lighting, telephones, radio, household appliances and a million other things. Follow these wires and you will find the **high-paid men** who control the electricity. Follow the Greer course of electrical training and you will be **one of these high-paid men**.

The Greer Shops have trained over 60,000 men for better jobs and bigger pay. The big fireproof Greer

Building is filled with the best training equipment money can buy. Experienced instructors make everything seem so easy you can't help but learn. Hundreds of motors, rotary converters, generators, telephone and radio outfits to work on.

Twelve short weeks in the Greer Shops will teach you what you need to know if you want more money. Your loved ones at home will gladly spare you from home for that short time. Because it will mean better things for you and for them—for life.

Automobiles Too!

While you are learning Electricity here you can learn the auto trades too—at an amazingly low combination price. You save 37½ per cent by taking both courses. Actual shop training in both electricity and automobiles. 75 to 100 real automobiles, all makes, in our shops at all times for actual repair work.

Mail the coupon below. It brings complete information about each course, free railroad fare and cost of training. Do it NOW!

Greer

College of Electrical Engineering
Dept. 301
CHICAGO, ILLINOIS

FREE Employment Service

Our employment department is ready to help you—while in training and for life. Day and evening classes. Low cost. Easy terms.



Using the "Wrecker Crane" in the Automobile repair department. Here you learn about all up-to-date auto equipment—by actually using it. Real experience on all makes of cars, under supervision of an expert.

ERWIN GREER, President, Greer College
Dept. 301, 2024 S. Wabash Ave., CHICAGO.

Please send me your **FREE BOOK** and offer for Electrical Automotive course
It is understood I am not obligated in any way

Name

Address





"We couldn't save a cent"

"I HADN'T received a raise in years and my small salary scarcely lasted from week to week. Margaret scrimped and saved and did all her own washing and housework, but the bills kept piling up and I could see she was always afraid I would lose my position. But still I kept drifting along in the same old rut.

"Then one day I met Tom Wilson, who used to work right beside me. He told me he was making \$5000 a year and had a nice home in the suburbs, a new car and everything. I asked him how he happened to get ahead so fast. 'Oh, I got tired working for a small salary,' he said, 'so I started studying at home through the International Correspondence Schools.'

"That woke me up. I told Margaret that if the I. C. S. could help a man like Tom Wilson it could help me. So I cut out that I. C. S. coupon and mailed it to Scranton.

"It certainly was a lucky day for me. In four months I received a raise in salary and before the end of the year I was next in line for manager of my department. We've got a car of our own now and a bank account that's growing every day."

How do you stand when your employer checks up his men for promotion? Does he think of you? Is there any reason why you should be selected? Ask yourself these questions. You must face them squarely if you expect advancement and more money.

At least find out what the I. C. S. can do for you. It doesn't cost you a penny or obligate you in any way to ask for full particulars, but that one step may change your entire life.

Mail Coupon for Free Booklet

INTERNATIONAL CORRESPONDENCE SCHOOLS Box 5636-E, Scranton, Penna.

Without cost or obligation, please send me a copy of your booklet, "Who Wins and Why," and full particulars about the course before which I have marked X in the list below:

BUSINESS TRAINING COURSES

- | | |
|--|---|
| <input type="checkbox"/> Business Management | <input type="checkbox"/> Salesmanship |
| <input type="checkbox"/> Industrial Management | <input type="checkbox"/> Advertising |
| <input type="checkbox"/> Personnel Organization | <input type="checkbox"/> Better Letters |
| <input type="checkbox"/> Traffic Management | <input type="checkbox"/> Show Card Lettering |
| <input type="checkbox"/> Business Law | <input type="checkbox"/> Stenography and Typing |
| <input type="checkbox"/> Banking and Banking Law | <input type="checkbox"/> English |
| <input type="checkbox"/> Accountancy (including C.P.A.) | <input type="checkbox"/> Civil Service |
| <input type="checkbox"/> Nicholson Cost Accounting | <input type="checkbox"/> Railway Mail Clerk |
| <input type="checkbox"/> Bookkeeping | <input type="checkbox"/> Common School Subjects |
| <input type="checkbox"/> Private Secretary | <input type="checkbox"/> High School Subjects |
| <input type="checkbox"/> Spanish <input type="checkbox"/> French | <input type="checkbox"/> Illustrating <input type="checkbox"/> Cartooning |

TECHNICAL AND INDUSTRIAL COURSES

- | | |
|---|--|
| <input type="checkbox"/> Electrical Engineering | <input type="checkbox"/> Architect |
| <input type="checkbox"/> Electric Lighting | <input type="checkbox"/> Architects' Blueprints |
| <input type="checkbox"/> Mechanical Engineer | <input type="checkbox"/> Contractor and Builder |
| <input type="checkbox"/> Mechanical Draftsman | <input type="checkbox"/> Architectural Draftsman |
| <input type="checkbox"/> Machine Shop Practice | <input type="checkbox"/> Concrete Builder |
| <input type="checkbox"/> Railroad Positions | <input type="checkbox"/> Structural Engineer |
| <input type="checkbox"/> Gas Engine Operating | <input type="checkbox"/> Chemistry <input type="checkbox"/> Pharmacy |
| <input type="checkbox"/> Civil Engineer | <input type="checkbox"/> Automobile Work |
| <input type="checkbox"/> Surveying and Mapping | <input type="checkbox"/> Airplane Engines |
| <input type="checkbox"/> Metallurgy <input type="checkbox"/> Mining | <input type="checkbox"/> Agriculture <input type="checkbox"/> Navigation |
| <input type="checkbox"/> Steam Engineering | <input type="checkbox"/> Mathematics <input type="checkbox"/> Radio |

Name.....

Street Address.....

City..... State.....

Occupation.....

Persons residing in Canada should send this coupon to the International Correspondence Schools Canadian, Limited, Montreal, Canada

LAW

THIS BOOK
FREE!

Study at Home

Become a lawyer. Legally trained men win high positions and big success in business and public life. Greater opportunities now than ever before.

Earn \$5,000 to \$10,000 Annually!

We guide you step by step. Degree of LL.B. LaSalle law graduates practicing in every state. We furnish all text material, including 14-volume Law Library. Low cost. Easy terms. Valuable, interesting 96-page book free. Send for it NOW.

LaSalle Extension University, Dept. 364-L, Chicago



Drum Lessons With the Outfit

With each genuine Ludwig Trap Drum Outfit we furnish an instruction method. Ludwig drum sets from \$32.50 up. Call on your music dealer or write us for full particulars. Send for free catalog.

World's Largest Makers of Drums and Banjos

LUDWIG & LUDWIG

1611 N. Lincoln St.

Chicago, Ill.

HELP WANTED MALE

RESTAURANTS and eating places of every description, everywhere, demand trained men as managers, assistant managers, buyers, dietitians and other executives. The shortage of men in this field is your golden opportunity to secure a well-paying, dignified position at once. Training is the only requisite. This we can quickly give you during spare time by mail.

Write today for details!

LEWIS RESTAURANT INSTITUTE
Dept. A-17 Washington, D. C.

MAKE MUCH MONEY

Making and Selling Your Own Goods.

Formulas. Manufacturing Processes. Trade-Secrets. All Kinds. All Lines. Catalog, special circulars free.

W. THAXLY COMPANY, Washington, D. C.

YOU CAN OIL PAINT

Amazing new method teaches men or women to earn after first lesson. OIL PAINT photos—portraits, landscapes or art subjects. Earn \$18 to \$50 and more a week. OIL PAINT OUT-FIT GIVEN. Send now for free illustrated book. PICTORIAL ART STUDIOS, Inc. Dept. MP, 2731 No. Clark St., Chicago

Want a Red Jacket? SEE PAGE 127

Work for "Uncle Sam"

\$141⁶⁷ to \$275 MONTH

ON REGULAR
MAIL CARRIERS
(City or Rural)

FRANKLIN
INSTITUTE
Dept. G 304

Rochester, New York



Steady—common education sufficient. Big chance for men, 18 up.

Rush to me, WITHOUT CHARGE 32-page book with full particulars telling how to become a mail carrier or Post Office Clerk. Send sample coaching.

Mail
Coupon
Today
Sure

Name.....

Address.....

Last Night I played for the Radio



Only a Few Months Ago I Was Just a "Listener-In"—but Last Night They Broadcast Me—the Thrill of My Life!

THE real opportunity finally came after I had learned to play *by ear*. I played each piece without a note—popular songs with their moaning, soulful strains of jazz.

Scheduled on the program from 8 to 8:30, how I did watch that big hand tick off the minutes and when 8 o'clock came, with nerves tense, I stepped briskly to the piano and listened to the announcer broadcast that I was to play. All seemed like a miracle in the quiet of that studio, especially when I thought of the thousands who were going to hear me.

After my introduction I started to play and for a full half hour entertained my listeners—thousands of them—and told how I had learned to play the piano *by ear*. All during that performance the telephone was ringing and ringing—people phoning that I play their favorite airs. The next day hundreds of letters poured in, complimenting me on my program and asking when I would broadcast again and how they, too, could learn to play the piano *by ear*.

A miracle? No. If you can just hum a tune and have the urge to play, you may do the same. I never had time or patience to learn by the old fashioned note method—it takes years and lots of money. The Niagara Method *by ear* teaches you how to become a master of Jazz, Syncopation and melody.

It is So Simple—Learning is Real Fun. Nothing hard or tedious. You follow the easily understood instructions and soon actually learn to play in your spare time AT HOME—the easier pieces at first—and then the "blues" and jazz. No tiresome scales—no arpeggios—no weary hours of practice—no teacher at your back, making you nervous and irritable. The Niagara Method is the short cut to piano mastery.

You Learn PIANO by Ear

Even if you have never played a note—in three months you may become a Jazz Master—but don't put it off. Make your resolution now and to-day write for the "Niagara Secret." It's free. Enclose 10c (coin or stamps) and you will also receive the book "How to Entertain at the Piano."

NIAGARA SCHOOL OF MUSIC
153 Niagara School Bldg., Niagara Falls, N. Y.
RONALD G. WRIGHT, Director

Free Book



CLIP THIS COUPON NOW!

NIAGARA SCHOOL OF MUSIC
153 Niagara School Bldg., Niagara Falls, N. Y.
Without obligation mail me your book "The Niagara Secret." I enclose 10c for book "How to entertain at the Piano."

Name _____
Street _____
City _____ State _____

ENGINEER, estimator for structural steel and ornamental iron work shop, located in Northern Florida. Must have considerable experience and be capable of making complete estimates. Also capable of doing some sales work. Apply by letter, immediately stating fully age, salary desired and where you are now employed.
ORNAMENTAL iron draftsmen wanted Permanent positions for capable draftsmen. State experience, age and first letter. The Boss, 3915 Box 416.
WANTED—A first-class ornamental iron draftsman, competent to take charge and develop an efficient ornamental iron department; none but thoroughly experienced men will be considered. Apply by mail, giving complete outline of experience, salary expected, and date available. Iron Works, 28th Street.

WANTED!

Ornamental Iron Draftsmen—at Big Pay!

Here's one profession where the job goes after the man. Beginners get \$65 a week. Would you like to earn \$500 a month or more in a high-grade position, with splendid chances to advance? The competent Ornamental Iron Draftsman has the highest paid job in drafting.

Get Into This Growing Business—NOW!

It was almost unknown 25 years ago. Today hundreds of architects and ornamental iron manufacturers cannot find good men. Read the classified ads above, clipped from recent trade papers. We are receiving requests constantly for qualified men.

Large office buildings, stores, theatres, etc., use ornamental iron and bronze costing hundreds of thousands of dollars for entrances, stairways, store fronts, elevators, etc. It has become a big, permanent factor in modern building construction.

vious experience necessary. Practical from A to Z. 22 years' experience back of this Course. We help you get a good position as soon as you can qualify, without charge.

Get This Book

Look into this—now! Get this book "KNOWLEDGE, Your Greatest Asset," post yourself on this business, and learn what rapid progress is possible if you start with the right training. Mail the coupon now or write us, giving your age and occupation.



American Institute of Ornamental Iron & Bronze
3019 Hennepin Ave.
Minneapolis, Minn.

Please send book "KNOWLEDGE Your Greatest Asset."

Age..... Occupation.....

Name.....

Write address plainly in margin

Learn at Home

The ordinary draftsman cannot do this work, but he can learn in spare time. The American Institute Course gives you a thorough training in everything the ornamental iron draftsman must know. No books or higher mathematics, or pre-



Learn Drafting in 4 Months

CHICAGO TECHNICAL COLLEGE

If you are earning less than \$50 a week, here's a vital message that concerns you. The field of Drafting needs wide awake men quick . . . men who are serious about their future. 4 months from today you can be firmly established in drafting's fertile field. Young men with this training earn \$60 to \$100 a week . . . and more.

Here is interesting work. Contact with big business, big men, real go-getters. "Send us more draftsmen" is the call that comes to us, from engineering, electrical and architectural firms, railroads and the country's great building industry where billions are being expended each year. Train with us and you hurdle the low pay handicap. Earn big money. Better living. More for you . . . more for your family.

FREE 72-Page Book

Find out about this 23-year old school. The organization, men behind it, and our short time courses in Engineering, Electricity, Architecture and Building. This book gives you the facts you want to know. Gives you a vivid picture of the important part you can play in a surging industry. You will want this book . . . will need it. Just mail the coupon. It costs you nothing.

23rd Year



In 4 Months at Chicago Tech

In Spare Time At Home

If you can't come to Chicago, learn Drafting at home. Your spare time is enough. Same practical course. Same short-cut methods. Quick, easy - yet thorough.

TRIAL LESSON FREE

Test yourself and see how easy to learn Drafting by Chicago Tech method. Trial lesson sent FREE if interested in home-study. Mark coupon.

Spend 4 happy months at Chicago. Center of engineering progress. Here at this old established and well known school for engineers and draftsmen, 16 weeks of fascinating study and you leave for home. All set to make big money. Equipped to reap rich rewards. Specially trained to enter a field teeming with opportunities. A common schooling is all you need. Practical instructors. Part time work available; earn while you learn. Free employment service. Living accommodations arranged for. Day or Evening Classes. Athletics. Enter any time. Graduates quickly get good jobs. Take the step that has meant so much to thousands of our graduates . . . and will mean as much to you. Send no money, just fill in coupon and mail now, today.

MAIL COUPON TODAY

CHICAGO TECHNICAL COLLEGE
Dept. C-400, 118 E. 28th St., Chicago, Ill.

Please send me, without obligation, free and postpaid, your 72-page Blue Book and facts about how to qualify for a good drafting job in 4 months.

Name.....

Address.....

Town or City..... State.....

Age..... Occupation.....

At Chicago Tech. or by Home Study. Mark choice with an "x"

CLIP and MAIL COUPON-NOW

From Messenger Boy to \$300 a Week Dancer

He danced his way to success. You CAN too. A short time ago a mere messenger boy, today Valodia is earning \$300.00 a week dancing in big Broadway hits—"Artists and Models,"

"Katja" and the smart Cafe de Paris. Betsy Rees, Vestoff trained star, premiere danseuse of the Keith-Albee Orpheum Circuit makes \$225 a week. Another pupil, Beryl Sweeney, teacher of stage and classical dancing earns \$300 a month in Utica, N. Y. Hundreds of Vestoff graduates everywhere earn handsome incomes.



WORLD'S GREATEST BALLET MASTER TRAINS YOU AT HOME

In just a few thrilling weeks, Veronine Vestoff, former solo dancer with Pavlova trains you in your own home for a fascinating career in stage or classical dancing. The amazing Vestograph brings you the actual dance steps in motion pictures.

WRITE FOR FREE BOOKLET

Just send name and address for beautiful, illustrated booklet; tells how you can learn stage dancing at home, how to make big money on the stage, in the movies or in teaching. Write today.

VERONINE VESTOFF ACADEMIE DE DANSE,
Dept. 273,
100 West 72nd Street, New York, N. Y.

LAW Free Book

Write today for FREE 128-page book, "THE LAW TRAINED MAN," which shows how to learn law in your spare time and earn more money. Qualify for a high salaried executive position or prepare to enter the practice of law. Study at home through the Blackstone Course prepared by 80 prominent legal authorities including CHIEF JUSTICE WILLIAM HOWARD TAFT. Blackstone graduates practicing law everywhere. LL. B. degree conferred. Magnificent 25 volume law library furnished immediately upon enrollment. Moderate tuition fee. Low monthly terms. Money Back Guarantee. Write for book today.

Blackstone Institute, Inc., 4753 Grand Blvd., Dept. 53 Chicago
America's Foremost Non-Resident Law School





BE AN OFFICER in the U.S. Coast Guard \$1700 Up to \$7,500 Yearly

\$780 yearly at the U.S. Academy while training. You rank Ensign to Captain in service. Age requirements 18 to 24. Write Dept. M, for information.
COAST GUARD PREPARATORY SCHOOL
4000 Ga. Ave. N. W. Washington, D. C.



Deafness

Perfect hearing is now being restored in all cases of deafness caused by Catarrhal troubles, Relaxed or Sunken Drums, Thickened Drums, Roaring or Hissing Sounds, Perforated, Wholly or Partially Destroyed Drums, Discharge from the Ears, etc.

Wilson Common-Sense Ear Drums

require no medicine but effectively replace what is lacking or defective in the natural ear drums. They are simple devices, which the wearer easily fits into the ears where they are invisible. Soft, safe and comfortable. Write today for 168-page book on deafness giving full particulars and many testimonials. The hearing of thousands of grateful users has been restored by these "little wireless phones for the ears."

**Free Book
on Deafness**

WILSON EAR DRUM CO., Incorporated
433 Todd Building LOUISVILLE, KY.

LEARN *to* FLY

1000 Ambitious Young Men
WANTED

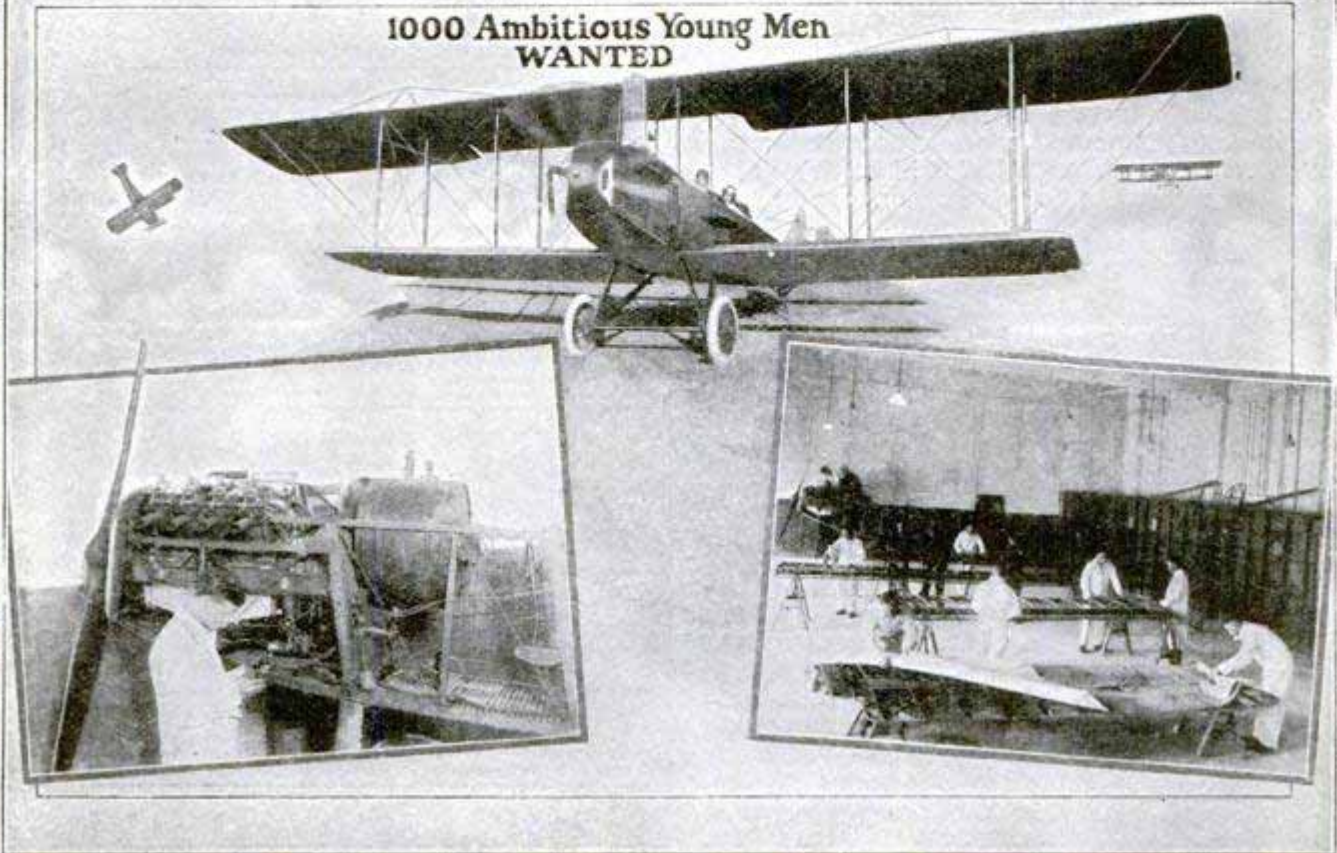

Sweeney System of Practical Airplane Mechanics

These photographs show how Sweeney students are trained by DOING. After thorough ground school work, under skilled instructors in the construction and repair of planes, recovering wings, tuning motor, etc., learning everything about the mechanical work by actual practice, the student then, if he wishes, goes into the air and qualifies as a pilot under safe and experienced pilots, with double controls for actual flying. Here's the great business of the future. The National Air Transport alone has invested \$700,000 on the Kansas City air route. They are spending \$1000 a day to operate an over-night service to New York City. Ambitious men are wanted as pilots and ground mechanics. At the great SWEENEY SCHOOL you learn not only by doing, but you get personal instruction.

THE SWEENEY SYSTEM

is divided into two parts. **FIRST:** You are thoroughly taught in the ground school. This fits you as an aviation mechanic. You can build your own plane and do anything required in aviation mechanics and construction and repairing when you have finished this work. You are thoroughly taught motors, etc., and work with thousands of dollars' worth of new material, including all types of engines—**SECONDLY:** After completing this work, if you want to be a

pilot, you take all the actual flying necessary to make you a competent pilot. Now when you understand that two to seven hours is all the average man needs to learn expert flying you will appreciate what this ample experience in the air under skilled men will do for you. Aviation is no longer a mystery—no longer a hazard; no, it is a business growing greater and more important. This has been wonderfully demonstrated in the successful flights

over the North Pole and also in the big part Aviation is now playing in commercial activities. Progress is rapid. More men are needed every day. You can qualify as a mechanic, or an engineer, or repair man, or builder; five men on the ground are needed for one man in the air, but if you want to become a pilot you easily master the work and can go into postal, government, or commercial work. Flyers are in demand, earning big money at fairs, taking up passengers, etc., \$5 for a 10 minute flight is pretty fine pay!

Opportunities in FLYING

Aviation Mechanics—
\$50-\$125 Week
Riggers—\$50-\$75 Week
Flyers—\$125-\$225 Week
Taxi Service—\$100-\$300
Week
Aerial Photo Pilot—\$200-
\$250 Week
Special Messenger Service—
\$125-\$200 Week
Aerial Advertising—\$225
\$500 Week
Crop Dusting—\$125-\$200
Week
Crop Survey—\$125-\$225
Week

SEND NAME TODAY for full details of this aviation mechanical course and photographs of planes and equipment actually used; also full information as to the commercial end of flying and opportunities for young men.

—SEND THIS NOW—

EMORY J. SWEENEY, President
3506 Sweeney Bldg., KANSAS CITY, MO.

Please send me full information about your Aviation Course.

Name.....Age.....

Address.....

Town.....State.....

SWEENEY SCHOOL OF AVIATION

LEARN TO FLY BY FLYING
Sweeney
SCHOOL OF AVIATION
3506 SWEENEY BLDG., KANSAS CITY, MO.

LEARN TO DRAW CARTOONS

To Show You How Quickly and Easily You Can Do So

I'LL TEACH YOU

to draw comic faces like these in 15 minutes. Send me your name and address, and let me mail you a Test Lesson Chart which will teach you how to draw comic faces.



FRECKLES

Mere words cannot express my appreciation of the course of lessons I received from the Landon School.

Merrill Blosser.



BRANNER

WINNIE WINKLE

When I consider the small investment I made in taking your course and the enormous profits I am making now I feel like a profiteer.

M. M. Branner.



REG'LAR FELLERS

I attribute my success to the thorough and highly competent course I received from you.

Gene Byrnes.

Whether you think you have talent or not, make this interesting test.

I want to show you that with the aid of my PICTURE CHART METHOD of teaching original drawing you can learn to draw as easily as you learned to write. Every step in producing original heads, figures, animals, and all details of original cartoon drawing are PICTURED in an extensive series of Charts, and the text with each lesson shows how to apply the various steps in producing original drawings of your own. This plan is endorsed by nationally known newspaper artists and is today recognized as the most effective method of teaching drawing ever devised.

RESULTS TELL THE STORY

Here are three of the famous characters created by Landon students who have attained national reputations as Comic Strip Cartoonists. Former students of this School are producing cartoons on political and national affairs, sports, comic strips, etc., for leading newspapers and syndicates all over the United States and Canada. Many newspapers now employ from two to five students of this School; one big newspaper employs nine. Many successful students who prefer to work at home are selling their drawings by mail. The record of results produced by this school is evidenced by the demand for Landon graduates.

Send NOW for complete information and sample Picture Chart to test your ability. Please state your age, and enclose 6c in stamps for postage.

C. N. LANDON, Director.

The Landon School
1238 National Bldg., CLEVELAND, OHIO



Home-Study Training Aviation

Be an airplane expert!

Aviation is new! It is the field of wonderful opportunities today! It is not crowded. It offers every man of average ability a chance to become an Airplane Expert. We are looking for ambitious, daring, red-blooded fellows who want to make Big Pay in a clean, fascinating field. Airplane Experts can find steady employment—anywhere, any time.

PAYS BIG MONEY—QUICK!

Ask for Details and Big Airplane Catalog

WESTERN AIRPLANE CORPORATION
Aeronautical Training Division Dept. M-3
Suite 402-3-4-5 Monodnock Block Chicago, Ill.



\$1,000 Reward

I will pay ONE THOUSAND DOLLARS IN GOLD for proof of any business course that has helped as MANY men and women make as MUCH money, in as SHORT a time, as my new Real Estate System. Send name and address at once for FREE COPY of my new book. It tells how, with my new system, you can quickly become a successful Real Estate Specialist—How you can start in your spare time—How you can build a big-profit business of your own—How you can make the biggest money of your life. Address PRESIDENT, American Business Builders, Inc., Dept. 44-CC, 18 East 18 Street, New York.

Paint Like An Expert

"The Expert House Painter," by A. Ashmun Kelly, tells you exactly how to paint walls, woodwork, floors, brick, concrete, roofs, metal work, structural iron, etc., etc. Gives tested formulas for paint mixtures, causes of painters' troubles, and 131 practical methods.

Easy with Directions Like These to Follow

This book enables you to get real professional results without previous experience. Every detail made plain. Do all your own home painting and save money.



Sent on 5 Days' Approval—Send No Money

Over 280 pages of concise, easily-used information. Handy volume, cloth bound. Pay postman only \$3.00, plus few cents postage. Money refunded if you return it within 5 days.

Catalog of Mechanical and Engineering Books FREE!

All standard works on Paper-Hanging, Interior Decoration, Wood Finishing, Mechanical Drafting, Auto Mechanics, etc.

SEND FOR IT NOW

DAVID McKAY CO.

Dept. 23, 604 S. Washington Sq., PHILADELPHIA, PA.

DAVID McKAY CO., Dept. 23, 604 S. Washington Sq., Philadelphia, Pa.

Send me "The Expert House Painter" by A. Ashmun Kelly, with your Free Catalog. I will pay postman \$3.00 plus postage, you to refund if I return book in 5 days. [] Check here if you wish catalog only.

Name

Address

City.....State.....

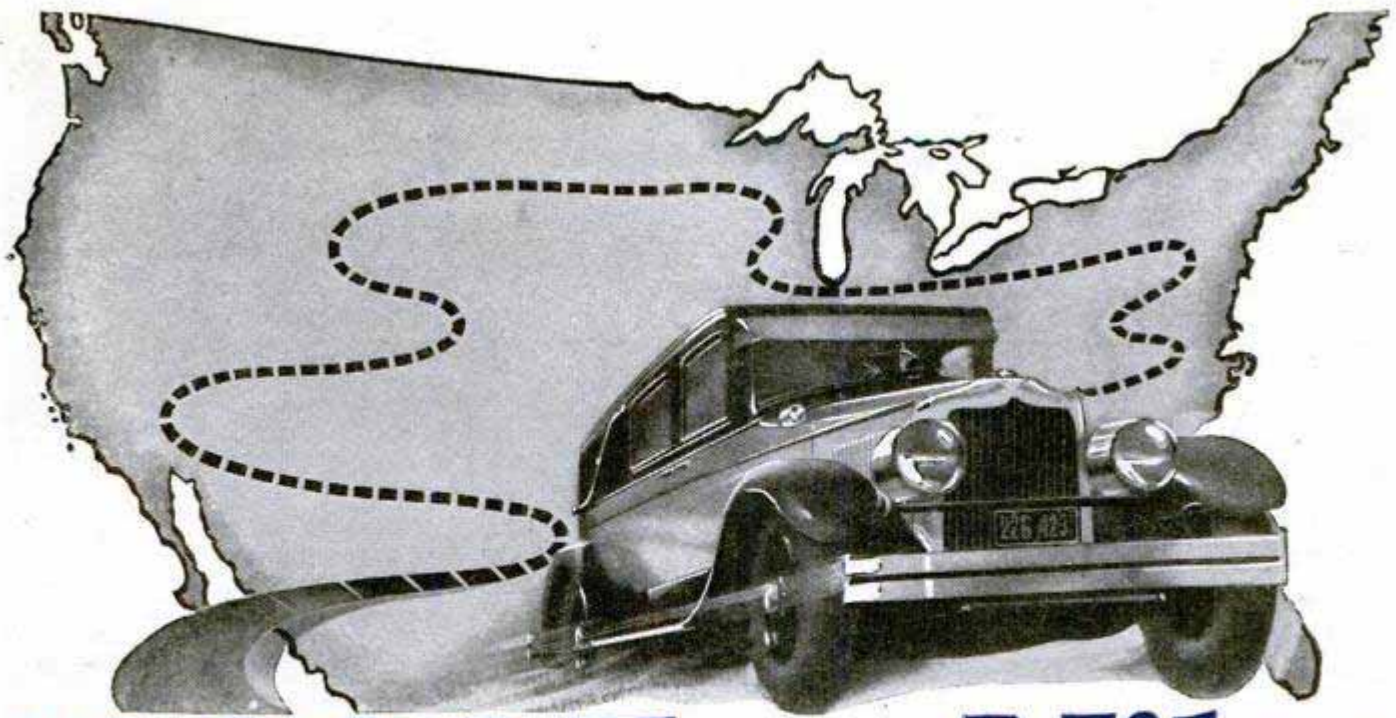

10,000 Free Miles of Gasoline!

On a 3,000-mile trip, J. R. Wood reports that his Oldsmobile ran 30 miles per gallon where before he got only 17 miles—due to an amazing device now used by over a million car owners! At this rate, if his car lasts 23,000 miles he will get 10,000 free miles of gasoline. Write the inventor now to test the device on your car at his risk.

\$75 to \$200 in a Week

Thousands Report Sensational Records

40 Miles on a Gallon

"We have tried them out. Ford got 40 miles on a gallon."
—F. S. Carroll.

Saves 50%

F. A. Cole writes he put one on a Studebaker Special Six. Reports a saving of 50% in gasoline.

36 Miles on 1½ Gallons

"Yesterday I made a trip of 36 miles and used only 1½ gallons."
—L. L. Robinson.

43 Miles on a Gallon

"We have tried them out. Chevrolet got 43 miles."
—F. S. Carroll. Rex Dean, another Chevrolet owner, reports he got 25 miles a gallon. Took the device off and mileage dropped to 19. Put it back and mileage moved up to 25.

Almost Double

J. R. Wood writes he increased mileage on his Oldsmobile from 17 miles a gallon by actual count on 3,000 miles.

International Trucks

Saves 41%

"I find it better than you recommend it. On the International Truck we use, we are saving by positive test 41% in gas and our engine uses less oil."
—Geo. Bell.

OVER a million Stranskys have been installed on practically every make of automobile, also on trucks, tractors, stationary engines, marine engines and aeroplane. Many of them after three to eight years of constant practical tests report increased mileage, more power, less carbon and no spark plug trouble. Seldom has such an invention so taken America by storm. No wonder Williams made \$48 in three hours and Foster \$137.50 in a week!

HOW IT WORKS

J. A. Stransky, former candidate for Governor of South Dakota, is the inventor of this device. It is a simple little piece not much larger than a dollar coin and a 12 year old boy can install it. It is automatic and self-regulating. It operates on a universally-recognized engineering principle that has been approved, after exhaustive tests, by experienced auto drivers, automobile dealers, and expert mechanics.

Official tests have proved that most cars waste 30% of the gasoline power through improper combustion, and we have thousands of unsolicited testimonials like the following: Ford, 20 to 40 miles on a gallon, Star, 25 to 42, Chevrolet, 30 to 43, Hudson, 19 to 21, Overland, 19 to 31, Nash, 19 to 22, Hupmobile, 32 to 37, Buick, 18 to 32, Studebaker, 23 to 27, Cadillac, 12 to 18—and so on. Are you getting that many miles per gallon now?

J. A. STRANSKY MFG. CO.
Dept. C-10 PUKWANA, S. DAK.
Resources \$500,000.00

GOOD-BYE CARBON

Not the least remarkable news from car owners is that this amazing device has banished carbon and spark plug trouble. Naturally when gas is more thoroughly vaporized raw gasoline cannot enter the cylinders to score and pit—a constant menace to every car. Furthermore, this device permits a new easy way to remove carbon already formed; the same cleansing principle as used on the famous Diesel engine.

DARING TEST OFFER

Mail the coupon now for free test offer. The inventor will pay a cash forfeit if the test fails to save gas. Ambitious men—speak up! \$75 to \$200 in a week is a fair expectation as our distributor. Other men have earned at this rate, full and spare time. Every car owner wants to see this nationally advertised proposition; we give you exact plan to follow that can net you \$75 to \$200 in a week. The coupon brings you full details without obligation. Act now.

\$48 IN 3 HOURS

My gas bill has been cut in half. I have removed every particle of carbon from my engine. Since I installed it, my engine runs as good as new, starts easier and quicker. I went out Saturday about three hours and secured 16 orders.—
J. A. Williams.

FREE COUPON

L. G. Stransky, General Manager,
J. A. Stransky Mfg. Co.,
Dept. C-10, Pukwana, So. Dakota

Yes, tell me how I can test this way to save my gasoline—at your risk. Also send me your money-making distributor's plan. This request does not obligate me to order anything at any time.

Name.....

Street (or rural route).....

City (P. O.).....State.....

Thousands of Trained Men Needed Now

BIG PAY

Up to \$150 Weekly ~ \$10 to \$25

EVERY DAY ANYWHERE

The ONE Great "Open-Shop" Trade. No Scabbing Because No Union to join. No Strikes. No Apprenticeship. Steady Work.

No big union membership fee, no apprenticeship, no Labor Business Agent stands between you and BIG WEEKLY WAGES—a steady job in America's greatest industry. What good is training that you can't sell? Choose the right trade. Thousands more men wanted to repair America's 22,000,000 cars and tractors.

8 Weeks' Training Makes You An AUTO AND TRACTOR MECHANIC

McSweeney students are earning up to \$10,000 per year.

Learn with real tools on real equipment at either of my three great schools. No book study. No schooling required. Mac's SHOP WAY Means Bigger Pay.



D. M. Collins, Williamsville, West Virginia, writes, "After finishing McSweeney training, I started in as manager of a garage at \$300 per month."

I PAY

Your R. R. Fare to Cleveland, Chicago or Cincinnati

Don't miss this extraordinary opportunity! Write quick for my Special Reduced Tuition Offer and big 68 page book. Mail the coupon.

M'SWEENEY

AUTO, TRACTOR and ELECTRICAL SHOPS

Dept. 14YC, Cleveland, O., Chicago, Ill., Cincinnati, O.

Mail This Coupon to Either Address Above
Please send your Big Free Book and Special Offer.

Name.....

Address.....

City..... State.....

\$10 to \$20 A DAY

BEST TRADE BY FAR
Interior Decorating—House Painting—Paperhanging—Sign Painting—Show Card Writing—Graining and Marbling.
YEAR ROUND WORK AT BIG PAY
or start a business of your own. A few weeks' training at low cost will put you in the Big Pay Class.

Write today for big free catalog.

MR. BARR, c/o CHICAGO PAINTING SCHOOL
144 W. AUSTIN AVENUE CHICAGO



1927 Chic Book FREE

By Prof. T. E. Quisenberry
Chic secrets and his new way revealed. Money-making ideas from well-known experts. You can put them into cash at once. Less losses—More Chics guaranteed. All this in big FREE Book. Just send name, address and kind of poultry you like. EXTRA—Free Bulletin tells what to do each month. Don't fail to send for these today. Absolutely FREE.

AMERICAN POULTRY SCHOOL
Dept. 70 Kansas City, Missouri

IF YOU STAMMER

Write for my free book "Millard's Advanced Natural Corrective Course" and a free copy of my speech magazine. 10,000 cases successfully treated. Est. 24 years. Largest school for stammerers in world. Millard Inst. of Normal Speech, 2317 Millard Bldg., Milwaukee, Wis.



"BECOME A LIGHTNING TRICK CARTOONIST"

Send \$1.00 for Laugh Producing Program of 23 Trick Drawings with Instructions. Catalog of Chalk Talk Supplies Free. BALDA ART SERVICE, Dept. 1, Oshkosh, Wis.

LEARN WATCHMAKING AND ENGRAVING



BY OUR PROFIT-SHARING PLAN OUR GRADUATES SUCCEED

One of our Iowa students started in a very small way—now doing over \$30,000 a year. Another in Wisconsin, over \$10,000 the first year. Day or night classes. Call or write for FREE BOOK

Chicago School of Watchmaking, Dept. 2801, 4844 Lincoln Avenue, CHICAGO



Learn SIGN AND SHO-CARD Lettering

Fascinating work. Pays \$50 to \$200 weekly. Vassos gets \$25 for a sho-card. Some posters bring \$300. Many earn while learning. Study in spare time. Learn quickly. For facts and guarantee write: DETROIT SCHOOL OF LETTERING, 1737 Stinson, Detroit, Michigan.

Learn In **10 WEEKS** at Home
Earn Big Money In this Gigantic, Fascinating Field!

AERO-SYSTEMS, INC.
Offers You a Remarkably Low Priced High-Grade RADIO COURSE

WE GUARANTEE TO REFUND TUITION IF YOU ARE NOT SATISFIED WHEN YOU COMPLETE THE COURSE

Now you can get a complete RADIO course at a ridiculously low price. Train to become a high-salaried expert or merely to make and understand your own sets. Write for particulars before price goes up.

Aero-Systems, Inc., Dept. 103
19 South Wells Street, CHICAGO, ILL.
MAIL THIS COUPON NOW!

AERO-SYSTEMS, INC., Dept. 103, 19 S. Wells St., Chicago

Please send me full particulars of your amazingly low-priced Radio course.

Name.....

Address.....

To Men Getting
BALD
Here's My Contract

Give Me 15 Minutes
a Day for 30 Days

and I'll give you
new hair or no cost

By **ALOIS MERKE**
Founder of the Merke
Institute, 5th Avenue,
New York



I DON'T care whether your hair has been falling out for a year or 10 years—whether you've tried one remedy or a hundred remedies. Give me 15 minutes a day and I guarantee to give you a new growth of hair in 30 days or I won't charge you a penny.

At the Merke Institute, 5th Avenue, New York, which I founded, many people have paid as high as \$100 for results secured through personal treatments. Now through my Home Treatment I offer these same results at a cost of only a few cents a day or money instantly refunded.

In most cases of baldness the hair roots are not dead, but dormant—asleep. Ordinary tonics fail because they treat only the surface skin. My treatment goes beneath the surface—brings nourishment direct to dormant roots and stimulates them to new activity.

Free Book Explains Treatment

"The New Way to Make Hair Grow" is the title of a 32-page illustrated book which explains the Merke Treatment—tells what it has done for thousands—contains valuable information on care of hair and scalp. This book is yours Free—to keep. Mail coupon TODAY! Allied Merke Institutes, Inc., Dept. 163, 512 Fifth Ave., N. Y. C.

Allied Merke Institutes, Inc.,
Dept. 163, 512 Fifth Ave.,
New York City

Please send me in a plain wrapper—without cost or obligation—a copy of your book, "The New Way to Make Hair Grow," describing the Merke System.

Name.....
(State whether Mr., Mrs. or Miss)

Address.....

City..... State.....

Hawaiian Guitar

FREE

Worth
\$18

When You Enroll

This Hawaiian Guitar expert and professor wants the opportunity to welcome you as a student so you will quickly learn how to play a Hawaiian Guitar—yes, you will be able to play just like the native Hawaiians. To get you started and help your musical success, which will bring you popularity, you will receive a beautiful Hawaiian Guitar, the same as the one pictured, free when you enroll. Our short cut method of instruction will enable you to play a piece almost from the first lesson. Rush coupon for full particulars today and we will reserve a gift Hawaiian Guitar for you.



Play Quickly

With our short cut method of instruction you will quickly learn how to play Hawaiian Guitar, which will bring you popularity and social success. You learn to play from notes. If you never had any musical training, you will quickly get on, because our nine experts have perfected a course of home instruction which is as simple as learning A, B, C's.

Picture and Phonograph Record Method Easy

We don't depend upon printed lessons only for your success, but we also furnish pictures of our professors playing, diagrams, charts and phonograph records for each lesson. This practically brings our professors from our studio to your own home and enables you to listen to their playing just as if they were actually in front of you. To prove this is easy, we will send you your first lesson free. Rush coupon now.

HAWAIIAN STUDIO No. 5203
of New York Academy of Music
100 Fifth Avenue, New York, N. Y.

Please rush your Free book, "How to Learn Hawaiian Guitar," and my first free lesson. Also reserve a gift Hawaiian Guitar for me. This obligates me in no way whatever.

Name.....

Address.....

City..... State.....

make money DRAWING

If you have natural ability to draw—which only a limited number possess—develop it through proper training for a career as a Commercial Artist. Many Federal Students are earning \$3500, \$4000, \$5000, and \$6000—some as high as \$10,000 and \$12,000 yearly.

The right training can save you several years' time, and bring you quickly to a worth while income. The Federal School has won a reputation as "the School famous for successful students." The Federal Course is practical from A to Z, and gives you personal criticisms on your lessons. Send today for book, "YOUR FUTURE" giving all the facts about this fascinating home-study course.

Federal School of Commercial Designing
626 Federal Schools Bldg. Minneapolis, Minn.



TELEGRAPH-RADIO

\$18 to \$35 a week while training for Radio and Telegraph Operator jobs at \$150 to \$300 per month. Write for particulars.

CHICAGO TELEGRAPH INSTITUTE

Dept. 1-3-7 1338 S. Michigan Avenue, CHICAGO



Daring Men in Demand! Aviation Needs You! You Can Earn \$100 to \$300 Weekly!

PREPARE NOW
For Big Pay Jobs

- Aviators**
\$75 to \$300 weekly
- Aviation Mechanics**
\$50 to \$150 weekly
- Aeronautical Instructors**
\$75 to \$250 weekly
- Airplane Builders**
\$75 to \$200 weekly.

And numerous other positions.

Fascinating, Big Paying positions are open to trained men. The U. S. government wants you for its mail routes. Private aviation enterprises—like European Commercial air lines—are springing up in every section of the United States. Aeroplane building gives promises of unheard-of production during 1927.

TRAIN UNDER REGISTERED U. S. PILOTS

They have prepared a course for you packed full of interesting data, facts, lectures, blue prints and bulletins of the industry, 30 LESSONS WITH OVER 400 ILLUSTRATIONS. This course qualifies you

for U. S. Civil service. Our NATIONAL AERO EMPLOYMENT SERVICE assists you in securing excellent positions.

A \$10 down payment enrolls YOU! This can at any time be applied on Complete Flying Course to be taken at our airport in Chicago.

**MAKE AN AVIATOR'S DECISION! DECIDE NOW!
MAIL THIS COUPON TODAY!**

Chicago Aeronautical Service, Inc.
Dept. E, 608 S. Dearborn St., Chicago, Ill.

Without any obligation send me Free booklet about your "Home Course in Aeronautics." Also information about practical Ground School and Actual flying.

NAME.....

ADDRESS.....

CITY..... STATE.....

FORD OWNERS THROW AWAY THE OLD TIMER

Latest Invention—"FORDYNAMO"

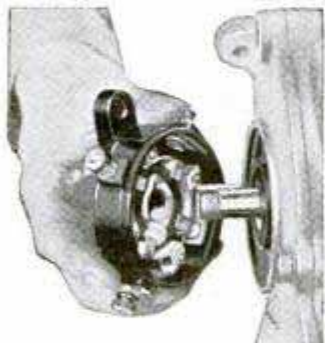

Absolutely Guaranteed

POSITIVELY MARVELOUS

The FORDYNAMO is a complete high class ignition distributing unit to be used in place of the common timer on all Ford cars, trucks and tractors. Built on an entirely different basis. Does away with all roller contacts. No oiling or attention necessary. Gives an instant positive spark. Will not miss at any speed.

Users Say "IT'S WONDERFUL"

The most pleasing results are expressed in letters received from satisfied users saying—"It is the most wonderful device put on a Ford car."

EASY TO PUT ON

The FORDYNAMO was designed for easy installation and is easily put on by anyone, it does not require mechanical service.

LABORATORY TESTS SHOW OVER 60,000 MILES

Research Laboratory tests show at a speed of 1100 R.P.M. (equal to 55 miles per hour) for 1111 hours or a total of over 60,000 miles, showed very little wear and working perfectly.

SPECIAL OFFER TO USERS

A Special Introductory Offer is extended to the first user in each locality.

BE FIRST IN YOUR LOCALITY

Of course we must give preference to the first person in each locality so mail the coupon TODAY.

BETTER HURRY

COSTS NO MORE THAN AN ORDINARY TIMER

EXCEPTIONAL OFFER TO LOCAL DISTRIBUTORS

On account of the extensive Advertising Campaign a very large demand is created, and as this demand must be supplied we are anxious to establish distributors everywhere. This opportunity gives those who apply early the advantage of all the business possible in their territory. Opportunities like this are unusual. Previous selling experience unnecessary.

\$60 TO \$120 PER WEEK EASY

Ordinary profits do not belong in this class, here is a proposition that arouses the interest of every Ford Owner to the buying point.

ECLIPSE TIMER MFG. COMPANY

2901 Meinecke Avenue

MILWAUKEE, WIS.

MAIL THIS TODAY
 ECLIPSE TIMER MFG. CO.
 2901 Meinecke Ave., MILWAUKEE, WIS.
 Gentlemen: Please mail me free particulars at once.
 NAME.....
 ST. or R. F. D.....
 CITY.....
 STATE.....

"Now I'm in business for myself—and making money—thanks to my National Training!"

Here's your opportunity to get into the big-pay auto repair business. Employers are offering \$50 to \$125 a week for real Auto Experts. There's a serious shortage of skilled repairmen. Car owners go out of their way to patronize men who know their business.

Over 16,000 men have increased their earnings by National training. In this world-famous, 22-year-old school of shops you learn to repair every kind of auto by actual work with master mechanics. You learn in months what takes years as an apprentice. As a National Trained Auto Mechanic you are always sure of steady work and highest pay.



S. Cross learned to repair autos at National, and his shop at San Pedro and Florence Sts., Los Angeles, is swamped with work.

Write for big FREE AUTO BOOK telling how National will train you to get a Big Pay job quick!

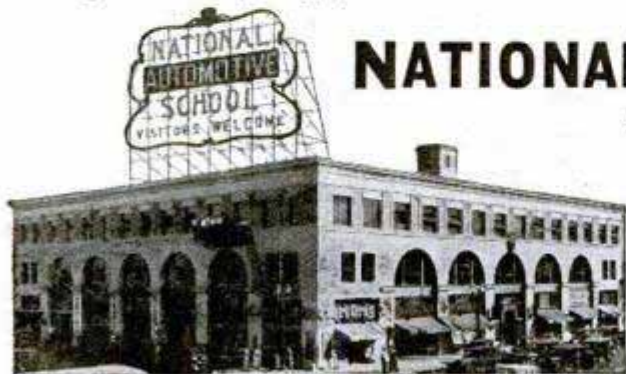

NATIONAL AUTOMOTIVE SCHOOL LOS ANGELES, CALIFORNIA

National Automotive School, Dept. 668, 4006 Figueroa St., Los Angeles, Calif.
 Send me your big FREE Auto Book telling how I can get steady work and highest pay in the Automotive Industry.

Name.....
 Address.....
 City.....State.....



PICK THE JOB YOU WANT

There's a way to get it



Men don't just fall into easy jobs or big pay positions—they prepare for the big chance before it comes.

Make up your mind today what you want to be, then take the first step at once. You don't have to go to college to get ahead. Other men have gone there for you and have put the things they learned there and through years of practical experience into easily understood books which give you a short cut to a better and bigger job.

We have picked 13 of the best paying professions and have published for your benefit new editions of the most practical, the most valuable books we have ever printed on the subjects covered.

JIFFY INDEX

Our new Jiffy Index makes each book a quick reference work—no time need be wasted in search or study—put your finger on the facts you want instantly.

PAY-RAISING BOOKS

Automobile Engineering, 5 volumes, over 2,000 pages	\$24.80
Civil Engineering, 9 volumes, 3,900 pages, 8,000 pictures	29.80
Business Management, 8 volumes, 2,500 pages, well illustrated	29.80
Fire Prevention and Insurance, 4 volumes, 1,500 pages, 600 pictures	14.80
Electrical Engineering, 4 volumes, complete in every way	19.80
Modern Shop Practice, 6 volumes, 2,300 pages, 2,500 pictures	24.80
Steam and Gas Engineering, 7 volumes, 3,300 pages, 2,500 pictures	24.80
Law and Practice (with reading course), 13 volumes, 6,000 pages, illustrated	49.80
Telephony and Telegraphy, 4 volumes, 1,728 pages, 2,000 pictures	14.80
Sanitation, Heating and Ventilating, 4 volumes, 1,454 pages, 1,400 pictures	14.80
Drawing, 4 volumes, 1,578 pages, 1,000 pictures, blue prints, etc.	14.80
Employment Management and Safety Engineering, 7 volumes, 1,800 pages, 540 illustrations, charts and diagrams	24.80
Architecture, Carpentry and Building, 5 volumes, includes 58 beautiful architectural plates free	24.80

SHIPPED FREE

Words alone cannot describe the full value these books may be to you, so we ship Free for Examination. Pick the set you want, the price is plainly shown, but **Send No Money**; just your name and address, and the books will be sent promptly.

Take ten full days to read, test and examine them. You'll realize at once what a tremendous force for your future they can be.

After ten days you send only \$2.00; then \$3.00 per month until the balance is paid. **There Are No Interest Charges of Any Kind**; the price shown is the total.

EMPLOYMENT SERVICE

For the benefit of red-blooded men who look forward to bigger earnings and greater responsibilities—which we give through these books—we conduct a complete employment department and include this service without cost. We are in close touch with a great many employers whose needs you might never hear of except through us.

AMERICAN TECHNICAL SOCIETY,
Dept. X319, Chicago, U. S. A.

Please send me set of.....

for 10 DAYS' examination. I will examine the books thoroughly and if satisfied, will send \$2.00 within 10 days and \$3.00 each month until I have paid the special price of \$..... If I decide not to keep the books I will return them at your expense at end of ten days.

Name.....

Address.....

Reference.....

Learn How to BOX

JIMMY DeFOREST BOXING COURSE

Has Developed Champions by Mail

Hundreds of DeForest Trained-
By-Mail Boxers Are Making
Good in the ring today!



In 20 weeks under the System of Jimmy DeForest, World's Greatest Trainer and Maker of Champions, you will master the priceless knowledge that has made champions, and started hundreds of boys on the road to Fame and Fortune.

Promising pupils are brought to the front at once. With the co-operation of an Advisory Board of prominent promoters who are enthusiastic about this plan, thirty boys are selected from all weight classes every six months and recommended to leading promoters for engagements.

Champions Give DeForest Course Sole Credit for Success

Champions and other students who are making good in the squared circle, publicly proclaim that the DeForest Course is responsible for their achievements. Head in the "Golden Age of Boxing" the amazing and almost unbelievable stories of John Nemis, welterweight champion of Maritime Provinces, Jimmy Robb, George Tasker, Buel C. Murphy, and other stars. Boys who were rank amateurs are today earning big money. Novices are developed into topnotchers.

Greatest Physical Training System in the World

The DeForest Course is the greatest physical training system in the world. Weaklings have been made strong and men physically rebuilt, energy, strength and courage developed. Prominent men and leaders in all walks of life, including Prof. T. W. Seeley, famous Physical Culturist, box regularly to keep themselves fit.

Read This Gripping Book

Send today for the now famous book, "The Golden Age of Boxing," greatest book of its kind ever written, full of valuable information, photos of great boxers and pupils who became successes over night. Full outline of the DeForest Course. This book will thrill you. Write now.

JIMMY DeFOREST BOXING COURSE 347 Madison Ave., Box 615, NEW YORK CITY

Fat Men

This new self-massaging belt [not only makes you look thinner INSTANTLY—but quickly takes off rolls of excess fat.

DIET is weakening—drugs are dangerous—strenuous reducing exercises are liable to strain your heart. The only safe method of reducing is massage. This method sets up a vigorous circulation that seems to melt away surplus fat. The Well Reducing Belt, made of special reducing rubber, produces exactly the same results as a skilled masseur, only quicker and cheaper.

Every move you make causes the Well Belt to gently massage your abdomen. Results are rapid because this belt works for you every second.

Fat Replaced By Normal Tissue

From 4 to 6 inches of flabby fat usually vanishes in a few weeks. Only solid, normal tissue remains. The Well Reducing Belt is endorsed by physicians because it not only takes off fat, but helps correct stomach disorders, constipation, backache, shortness of breath and puts sagging internal organs back in place.

Special 10-day Trial Offer

Send no money. Write for detailed description and testimonials from delighted users. If you write at once, you will receive a special 10-day trial offer. The Weil Company, 93 Hill Street, New Haven, Conn.

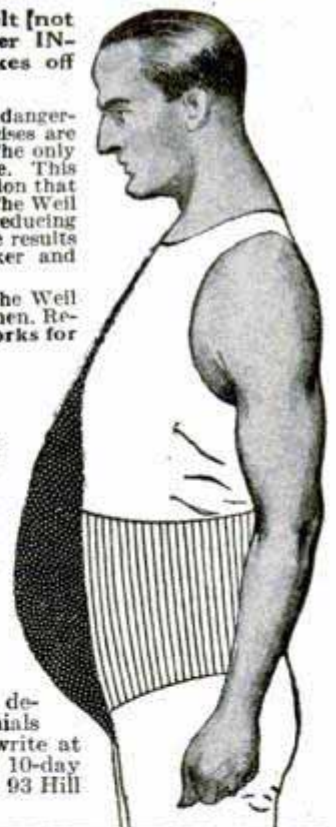





THE WEIL COMPANY, 93 Hill St., New Haven, Conn.

Gentlemen: Please send me complete description of the Well Scientific Reducing Belt, and also your Special 10-day Trial Offer.

Name.....

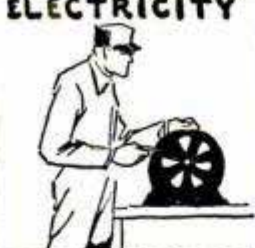
Address.....

City..... State.....

<p>BRICK LAYING</p>  <p>\$14⁰⁰ A DAY</p>	<p>ELECTRICITY</p>  <p>\$75 A WEEK</p>	<p>AUTO PAINTING</p>  <p>\$50⁰⁰ To \$125⁰⁰ A WEEK</p>	<p>STRIPING</p>  <p>\$2⁰⁰ AN HOUR</p>	<p>PLUMBING</p>  <p>\$300⁰⁰ A MONTH</p>
---	---	--	--	---

YOUR OPPORTUNITY

Learn One of these

BIG PAY TRADES

QUICK

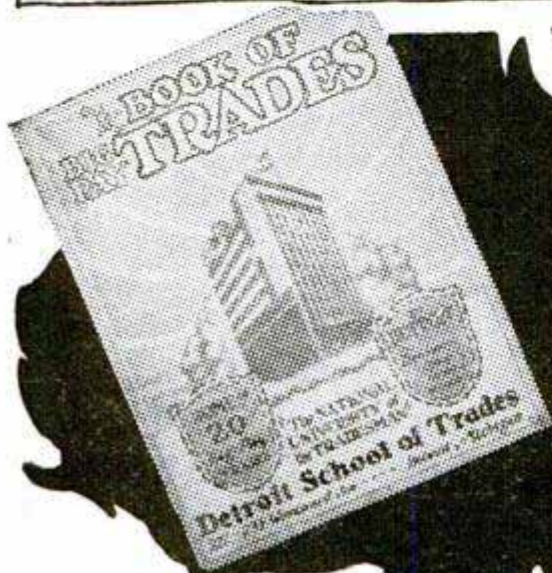

Don't spend months in school or digging through dry books. Here you learn by doing with tools on actual jobs—you learn right—and you learn quick. Before you know it you're ready for big pay right here in Detroit.

DON'T Work At a Hard Low-Pay Job Another Day!

Get out of the grease—leave the rut forever—say "Good bye" to low pay. Take your choice of the clean, big pay jobs and start earning \$50 to \$100 a week right from the start in a real trade.

Get This New Big Pay Book

The Most Amazing Door to Quick Big Money You've ever seen. Twenty trades. Pick the one you are best suited for. Work at a job you like. Learn your trade, quick. This book is free.

Steady Work in Detroit's Big Plants

Scores of Big plants, body plants, auto plants, wheel makers, tool makers, designers, finishers, striper—hundreds of real estate developments and new buildings—plenty of work inside or outside—at big pay. Steady work the year around for men who know their trades.

BIG PAY JOBS GALORE Not Enough Men

The Detroit School of Trades teaches 20 big pay trades. You don't have to learn some old, low-pay, worn-out business. Send for the book, look through, pick the money you want in the trade you want to learn. Then come here, we'll teach you how and help you get a job. Over three hundred of our men now working in one body plant. Hundreds of others in other plants. Hundreds more needed.

Think of These Facts

Hansen made \$183 for one week's work in bricklaying. Brooks jumped from \$35 a week to \$65.85 the first week he left school. Augustine was making \$6.00 a day—learned plastering and makes \$12 a day. Hundreds double their pay. You can do as well. Remember it doesn't cost you a penny for this book. Risk one postage stamp now on what may be the opportunity of a lifetime. Read it, be convinced. Come and see. Succeed for yourself. Send coupon at once. Don't delay. The Detroit School of Trades can do big things for you.

FREE
Send Coupon
10-DAY

Come and Work In Dynamic DETROIT

A great city—big—throbbing with life—growing—filled with opportunity—crying for men to take big pay for doing the jobs that need doing. Building trades booming. Automotive trades—real trades—always good—get into the spirit of a big city, fastest growing most dynamic in America—do big things with big men—succeed with success in this City of Wonderful Opportunity

TOP WAGES

are paid only to men with training. This is a practical school of "grown-up trades for grown-up men" and you get both training and practical experience. When you leave the Detroit School of Trades you are ready to take your place with the biggest wage earners in your chosen trade. Send at once for big Free book

CHOOSE

In This Great School We Teach These Big-Pay Trades

- Bricklaying--\$1.50 to \$1.65 per hour
- Plastering--\$1.50 per hour
- Plumbing--\$1.25 to \$1.75 per hour
- Carpentry -- \$60.00 to \$125.00 per week
- Electrical--\$10.00 to \$14.00 per day
- Sign Painting--\$1.00 to \$2.00 per hour
- Paper Hanging--\$10.00 and up per day
- Interior Decorating--\$10.00 to \$14.00 per day
- Plan Reading and Estimating--\$70.00 to as high as \$250 a week
- Auto Mechanics--\$1.00 to \$2.00 per hour
- Auto Painting--\$9.00 to \$12.00 per day
- Auto Trimming--\$9.00 to \$14.00 per day
- Metal Finishing--\$10.00 per day
- Acetyline Welding--\$1.00 to \$2.00 per hour
- Tool Making--\$70.00 to \$200.00 per week

Detroit School of Trades, Dept. 13 Detroit, Mich.

Send me Free and without obligation your big new book of **BIG PAY TRADES**. I am interested in

the _____ trade

Name _____

Address _____

City _____ State _____

DETROIT SCHOOL OF TRADES
DEPT. 13 DETROIT, MICHIGAN

Learn to Draw This Easy at Home Way



These Five People Learned to Draw —now earn real money

NOW you can quickly learn to draw through the remarkable home study method of the Washington School of Art. It's easy—it's fun—and, as for financial results, just read these actual letters from five former students!

\$5 to \$15 for Single Drawing!

"I receive \$5 to \$15 for making single drawings and I am now making money that would never have been mine had I not taken your course." *Miss A. M., Sciotoville, Ohio.*

Earns \$20 in 10 Minutes!

"I have received as much as \$20 for 10 minutes' work. My college fees are paid entirely through money earned in this manner." *Dorton, Peckham, Nevada.*



Has Made \$25 An Hour!

"I wouldn't trade art for any other profession. I have made as much as \$25 an hour, and during the last six months have never fallen below \$2 an hour." *C. C., Fort Ritner, Ind.*

Makes At Least \$100 A Week!

"I am now making at least \$100 a week for my work, not bad for a young man of twenty years." *P. C. R., Orlando, Fla.*



\$50 for One Drawing!

"The instruction in composition and decoration has enabled me to produce drawings, requiring less than an hour's work each, which I have sold for as high as \$50." *C. W. LaRowe, Columbus, Ohio.*

FREE BOOK

Write for wonderful free book describing the developments and opportunities in Commercial Art and for full details of this quick, easy method of learning to draw. Attractive offer to new students. No obligation. Mail postcard or letter NOW!

WASHINGTON SCHOOL OF ART, Inc.
Room 303-E, 1115-15th St., N. W. Washington, D. C.

QUIT WISHING AND WAITING EARN

\$3500 to \$5000 a Yr.

MAKING CROWNS, PLATES, BRIDGES, etc. for DENTISTS

Three Months'
Training
Will Qualify
You for
Success



Hundreds More
Dental Mechanics
Needed Now
and Demand
Is Increasing

YOU LEARN BY DOING

Individual instruction—no classes whatever. Each student is taught by practical work but is given theoretical training as well. Through our regular clinic, conducted by M. Stein, D.D.S., advance students are also given practice in precious metals on actual cases.

FREE R. R. FARE—OTHER ASSISTANCE

Besides providing the best of training at the lowest possible cost and refunding the student's R. R. fare to our nearest school, we secure jobs for those who need to earn while learning. Free Tools and Materials, Easy Terms. For full information just write today for Free Bulletin No. 2.

BODEE DENTAL INSTITUTE

Established over 35 years

New York Philadelphia
1755 Broadway 1305 N. Broad St.

Buffalo Brooklyn
501 Washington St. 85 Court St.

Don't Let Anybody BULLY YOU



Learn Scientific Tricks of Physical Mastery

By a few simple tricks you can have any assailant at your mercy quick as a flash. The astounding secrets of self-defense, used by the New York Police, are revealed in the marvelous, officially recognized system—

Captain Wallander's Course All Complete In Physical Training Manual By Capt. A. W. Wallander

Commander Physical Training, New York Police

A complete course in physical culture. Scores of gripping action photos showing just how to throw a bigger man and overpower him—disarm a hold-up thug—build up muscle—keep in fighting trim. Hundreds of health hints, too: care of the feet, prevention of colds, correct posture, walk without fatigue. This is the genuine book used by the New York Police, now available TO YOU.

Easy to Learn Let Capt. Wallander give you his great secrets and detective tricks. You'll hardly believe that such valuable knowledge could be learned so easily.

ALL YOURS IN WORLD'S MOST AMAZING COURSE

In Physical Culture and Police circles this volume is world famous. Send immediately for your copy. **DON'T SEND MONEY NOW.** Send coupon today. When volume arrives, pay the postman \$1.97, plus few cents postage. If you are not satisfied return volume and get money back. **\$1.97**

SIEBEL PRESS, 34-E W. 20th St., New York.

Send me Capt. Wallander's Physical Mastery Course as contained in the "Physical Training Manual."

Name.....

Address.....

City..... State.....

(\$2.25 U. S. Cash with order outside the U. S. A.)

Sam and George stepped right into Big-Pay Jobs as National ELECTRICAL ENGINEERS

Only a few months ago these boys were wondering how to earn a living. Now they have steady, interesting work at good pay. Their employers praise their skill and are helping them to speedy success!

National-Trained Electrical Men Now Earning \$50 to \$200 a Week!

There's a good job waiting for you, too, in the world's highest-paid profession—ELECTRICITY! National will prepare you for an expert's pay by actual training with master instructors on latest equipment and tools in a million-dollar school of shops. Over 16,000 men have increased their earnings by National training. Mail coupon—and learn how this 22-year-old world-famous institution can help you get a better job at higher pay.



"I am having no difficulty in handling my duties as Power Plant Operator for the Southern California Edison Co.—thanks to National training."—Sam Bowerman, Barish, Calif.

"I have had steady employment ever since leaving National and have been offered several different jobs. I owe my success to your expert instructors and fine equipment."—George S. Heilig, Sherman, Calif.

success to your expert instructors and fine equipment."—George S. Heilig, Sherman, Calif.

Send for this FREE Electrical Book Now!

NATIONAL ELECTRICAL SCHOOL

LOS ANGELES CALIFORNIA

National Electrical School, Dept. 504, 4006 Figueroa St., Los Angeles, Calif.

Send me your Free Book describing National training and Electrical Opportunities.

Name.....

Address.....

City..... State.....



Wanted—Cartoonists!

Increasing demand for cartoonists cannot be filled. Get in on the big money by learning the Manuel Rosenberg way through THE MANUEL ROSENBERG COURSE IN CARTOONING—based on fifteen years' experience as cartoonist on Scripps-Howard and other newspapers. Complete Course teaching drawing and cartooning—100 big illustrated lessons postpaid, for only \$5.00—or only five cents a lesson. Send postal order, check or currency—or we will send it C. O. D., you to pay postman. Write TODAY!

MANUEL ROSENBERG, Room 3, Artists' Bldg., Cincinnati, Ohio

1 Auto Gas Saver FREE

TO INTRODUCE. FOR ALL MAKES.

Spare or Full Time FACTORY AGENCIES WANTED EVERYWHERE
BIG MILEAGE INCREASE
BIG PROFITS TO ANY MAN WITH CAR
 CRITCHLOW, Inventor. C 7-805, WHEATON, ILL., U. S. A.

Be Bigger Than Your Job

Acquire specialized knowledge in Applied Industrial Engineering as taught in a personal training, home-study Course, by the only School affiliated with a company of successful Industrial Engineers. Write, today, for literature.

ESTES MANAGEMENT FOUNDATION
 4747 Broadway, CHICAGO



—Be a Railway Postal Clerk

Get \$1900 to \$2700 a Year
 EASY WORK—LONG VACATIONS

Why work hard for small pay? Uncle Sam offers you a fine position as a Railway Postal Clerk. Travel on fast trains sorting mail. Travel expenses paid. \$1900 a year TO START. \$100 RAISE EVERY YEAR until you reach TOP PAY.

FREE Information About These Fine Jobs

Let Arthur R. Patterson help you qualify for a position as a Railway Postal Clerk or in Customs, Internal Revenue, Departmental, Immigration, Postmaster, Postoffice, and Rural branches. He trained thousands now in Civil Service. Write for FREE BOOK. Tells how Mr. Patterson coaches you to pass exams. Also read his Money Back Agreement. Mail coupon now.

ARTHUR R. PATTERSON, Civil Service Expert
 PATTERSON SCHOOL, Dept. 83, Wisner Bldg., Rochester, N.Y.

Arthur R. Patterson, Civil Service Expert
 Patterson School
 Dept. 83, Wisner Bldg.
 Rochester, N. Y.

Sir: Send me without charge your catalog describing Railway Mail Clerk and other Civil Service positions.

Name.....Age.....

Address.....City.....State.....

**10 DAYS' TRIAL
SEND NO
MONEY**



**NO
NEED
FOR A
NEW
PHONOGRAPH**

New PHONIC Reproducer

**makes an up-
to-the-minute
Phonograph out
of your old one!**

\$3.85

**Direct
from
Factory**

Now at last you can say goodbye to the squeaky, nasal, rasping, metallic tone of your phonograph. Now you can have the beautiful, natural, full-rounded tone of the expensive new machines which are startling the world. Yet you need not buy a new phonograph if you have an old one. The reproducer is the HEART of any phonograph—and the New PHONIC reproducer makes your old phonograph like an entirely new one. Based on the new PHONIC principle. Makes you think the orchestra or artist is in the same room.

Gives the New Tone and Volume of Latest New Phonographs

Tones never before heard are clearly distinguished when the new PHONIC reproducer is used. Test it on an old record. Hear the difference yourself. Listen to the deep low notes and the delicate high notes. Hear how plainly and clearly the voice sounds. Note the natural tone of the violin and the piano, and the absence of "tinny" music. You'll be amazed. The new PHONIC reproducer is ideal for dancing or for home entertainments. Its volume is almost double that of the ordinary reproducer.

10 Days' Trial—Send No Money

You cannot realize how wonderful the New PHONIC is until you hear it. That is why we want to send it to you on 10 days' trial. Send no money now—just the coupon. Pay the postman only \$3.85 plus a few pennies postage when the New PHONIC arrives. Then if you are not delighted, send it back within 10 days and your money will be refunded. If sold in stores the price would be at least \$7.50. Our price only \$3.85. Over 350,000 people have dealt with us by mail. You take no risk. Mail the coupon now for 10 days' trial. **BE SURE TO STATE THE NAME OF PHONOGRAPH YOU OWN.**

**NATIONAL MUSIC LOVERS, Inc., Dept. 583
327 West 36th Street, New York**

Please send me a New PHONIC reproducer for.....

.....I will pay the postman \$3.85
(give name of Phonograph) plus few cents postage. If I
am not satisfied after trial, I will return your reproducer within
10 days and you guarantee to refund my money.

Name.....

Address.....

City.....State.....

Outside U. S. \$4.10, cash with order.

Electricity

A Practical Training

in this great profession will make your successful future a certainty.

The School of Engineering of Milwaukee has specialized for 23 years in training young men for



ELECTRICAL ENGINEERING

With a B. S. Degree in 3 years

Junior Electrical Engineering—12 months to 18 months, depending upon previous education. Graduates are technically trained electrical experts. **Commercial Electrical Engineering**—1 year for high school graduates. **Electrical Refrigeration**—3 months. **Automotive Electricity**—a 3 to 6 months' course will make you a highly paid specialist on all types of starting, lighting and ignition systems. **Armature Winding**—and Motor Generator Repair—thorough 3 months' course. **Practical Electricity**—6 to 12 months' course to become a Master Electrician.

We will Aid You Earn Your Way Partly through College. through our practical plan of co-operative employment. Board and room at cost. Student activities, orchestra, daily broadcasting WSOE. **NEW TERM NOW ORGANIZING.** Write NOW for latest catalog and full details. Mention age, education and course of interest.

SCHOOL of ENGINEERING of Milwaukee

P. M. 327-163 Onelda Street Milwaukee, Wisconsin

LEARN MECHANICAL DENTISTRY IN THREE MONTHS



and qualify to earn \$2,000 to \$5,000 a year.

FREE employment service enables you to **EARN WHILE LEARNING** this NEW money-making Profession. Age no barrier and no previous training required. The only school in New York where students **learn by doing** actual work in gold before graduation. **Individual instruction.** Dry or night sessions. Write NOW for free catalog P and **SPECIAL TOOL OFFER**
N. Y. SCHOOL OF MECHANICAL DENTISTRY
Penn Arcade, 147 W. 33rd Street New York
FREE RAILROAD FARE

Better Handwriting

Easily learned, on wonderful new patented device. Children like it, adults pleased. Agents wanted. Sample 98c. Write for information today. **VIC. HANSEN, WALLACE, IDAHO**

Big Money for You as an Automobile Mechanic

These four practical books, written by five well known teachers of automobile practice, will teach you right in your own home during your leisure time just what you need to know about automobile troubles and repair. They will teach you automobile construction, maintenance and repair as experts know them and will help you to earn an expert's pay.

Practical Automobile Library: Four Books—\$1.50 in 10 days and \$2 monthly for 6 months—only \$13.50 in all!

Hundreds of question-answering diagrams—hundreds of clearly-marked illustrations—make the books plain and readily understandable. All the explanations and descriptions are clear, simple, direct. Every chapter is packed with definite, step-by-step, how-to-do-it information. Here is your opportunity to enter a big-pay field.

Sent FREE

Send No Money
Mail the Coupon



FREE EXAMINATION COUPON

McGRAW-HILL BOOK CO., Inc., 370 Seventh Ave., New York

Send me for 10 days' free examination the New Practical Automobile Library. If satisfactory I will send you \$1.50 in 10 days and \$2.00 monthly until the special price of \$13.50 is paid. If not wanted, I will return the Books at your expense.

Signed

Address

City and State

Position

Employer

P. M. 3-1-27

Men Wanted

ELECTRICAL
\$200 a Month up
All Kinds of Jobs



AUTOMOTIVE
700 million dollars paid
to auto men every year.
Drivers, mechanics,
garage men wanted
everywhere.



OTHER TRADES
Painting, Batteries, Welding,
etc., offer jobs \$50 a week up.
Radio offers new
opportunities.

Sweeney men, trained in the Million Dollar School, with tools, not books, are cashing in everywhere. Good jobs, big pay, independence! Do the work you like. Get on a train—come right NOW—join our enthusiastic classes and be ready for a real Job in a few short weeks!

If you are mechanically inclined, why delay any longer? You know the Sweeney School is the place to learn thoroughly and with tools not books. Just pack your bag and start for Kansas City. Fit yourself for the thousands of real mechanical jobs that are ready for Sweeney trained men. What I have done for thousands of other men without previous experience or schooling, I can do for you. 4,500,000 cars and trucks in 1926—4 million to be produced in 1927; 20 million old cars running; the business is growing so fast, not enough trained men can be found to run, repair and keep them going! Wake up to the biggest opportunity of your life. It's HERE—NOW!

JOBS COME RIGHT NOW. If you are mechanically inclined, if you like to work with tools, you will learn under the "Sweeney System," by actually doing the work, everything about all kinds of automobiles, oxy-acetylene welding, vulcanizing, battery work, electrical work, aviation, building and repairing Radio sets. No experience or education needed. No books are used. You work on complete gas engine and electrical equipment unsurpassed by any school. Over \$200,000 invested, \$50,000 Radio Station WHB. You'll get dirty and greasy, but you'll learn by the "Sweeney System" that fits you for big pay jobs at \$50 a week and up, waiting for Sweeney trained men.

Sweeney System of Practical Instruction

There's only one place where you can get this training—it's at the world-famous **Sweeney Automotive and Electrical School of Kansas City.** There's only one Sweeney School. There's only one "Sweeney System." No other school offers or can give you the "Sweeney System" training that not only trains you to fill big paying jobs but saves you time and money. This training is making big money for 70,000 Sweeney Graduates. I estimate 20,000 of them own a good paying business.

Learn a Good Trade

One that will pay you \$200 to \$500 a month and more. Get in the biggest business in the world—the Automotive Business. Make more money in 1927 than you ever dreamed possible. I want to prove that you can do what thousands of men just in your position have done as a result of "SWEENEY TRAINING." I say, take up the AUTO BUSINESS NOW. Learn it at SWEENEY'S—Kansas City, Mo.

LEARN A TRADE—
Sweeney
AUTOMOTIVE & ELECTRICAL SCHOOL
3531 SWEENEY BLDG. KANSAS CITY, MO.

GET THE BEST TRAINING

The Sweeney Auto School offers you the greatest opportunity you ever had. A big reduction in tuition—a Million Dollar Building—10 stories high—over 12 acres of floor space devoted to the "Sweeney System of Practical Instruction" under expert instructors. Just across the plaza from the Union Station, short distance from the beautiful new Two Million Dollar Memorial Building. Recreation after work; swimming pool, entertainment, band and orchestra, Radio Broadcasting Sta., WHB. Remember **THERE'S ONLY ONE SWEENEY AUTO SCHOOL—ONLY ONE "SWEENEY SYSTEM."**

My FREE Book Tells You

- How to run a garage anywhere.
- How to learn several good trades.
- How to travel and see the world.
- How to fit yourself for prosperity.
- How to get a good mechanical job.
- How to learn to be a chauffeur or truck driver.
- How to learn to repair any make of car.
- How to weld.
- How to learn batteries and auto tires.
- Shows how easy it is to learn.

FREE

Get my big FREE catalog. It shows hundreds of actual photographs of men at work in my magnificent new school. Tells all about wages, profits, opportunities in auto business. Explains step by step how you learn. I will gladly send you a copy beautifully illustrated. I'll tell you how to get into business for yourself. No colored students accepted.



EMORY J. SWEENEY, President
3531 Sweeney Bldg., Kansas City, Mo.

Please send me your Free catalog and special offer.

Name.....Age.....

Address.....

Town.....State.....

YOU CAN DRAW

A Comic Face

If You Follow This Method

TRY IT

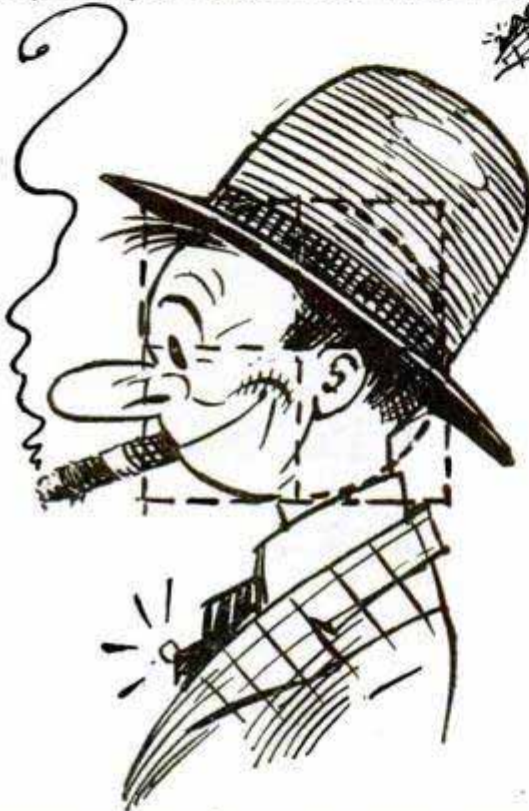
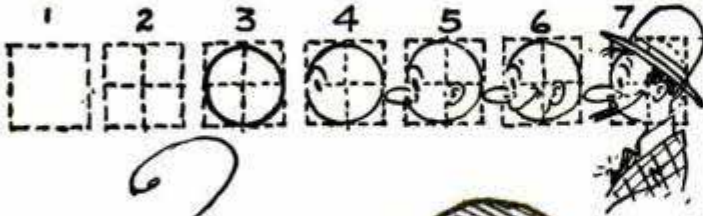

Take your pencil and draw lightly a square (any size). Then add to it with pencil as shown in the small squares above. Erase all pencil guide lines after the drawing is completed. You can draw any kind of comic face by simply changing the shape of the nose, forehead, chin, etc.

Send in your drawing and let us see what you can do. You may have more natural ability than you think you have. Some of the **cleverest cartoonists are former students.** They started right at the bottom, and are now making **good money.** It is not hard to learn to draw **originals** when you are shown in a **practical way.** The method above is only one of many **simple methods** explained in the first part of the course.

We don't offer any "grand prizes," or "free materials" to encourage enrollments. The school is endorsed by well known cartoonists because they know what **Cartoonist Evans can, and will do.**

Send six cents in stamps for **Portfolio of Cartoons** and full information about the school, and learn how to draw pictures which you can sell. **The Course Is Not Expensive.**



The W. L. Evans School of Cartooning

"The School That Has the Reputation"

821 Leader Bldg., CLEVELAND, OHIO

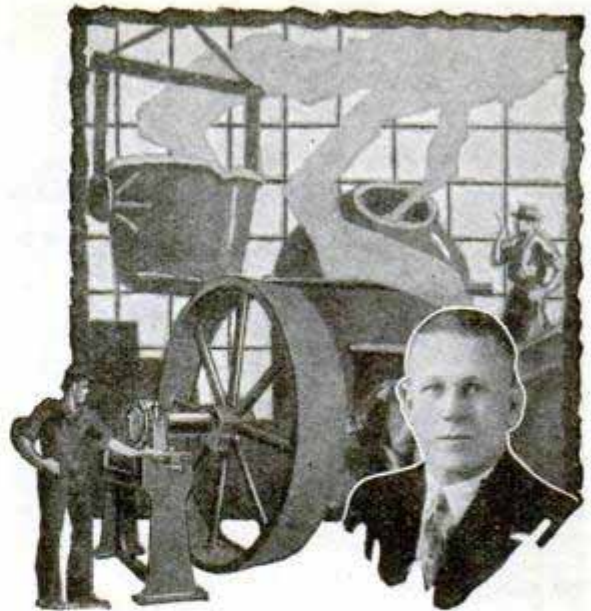

An Easier Way to Make Money!

What chance has the wage-earner?

"A mighty good one," says Ralph H. Berndt—but read his story . . .

Berndt had had only an elementary education. He was assistant roller at the Carnegie Steel Mills, Youngstown, Ohio.

"Realizing that hands and feet would not do for me any longer," he writes, "I decided to give my brain a business training." Today, thanks to Higher Accountancy training with LaSalle, he is Auditor for W. C. DuComb Co., Inc., Detroit—with easier hours, work that he likes, and a larger income. "LaSalle," he adds, "has been the instrument to my success."

Send for Free Book—

"Accountancy, the Profession that Pays"

"Get the facts—then use the facts—to get results." That's a slogan of ours, writes W. C. DuComb, president. And you'll agree it's good sound sense!

The facts about LaSalle training in Accountancy and the opportunities in this highly profitable field are clearly outlined in a 64-page book which LaSalle will send you free. It started Berndt on the path to success. No earthly reason why it can't do just as much for you.

If you have the urge and the will to increase your income—clip and mail the coupon NOW.

— — — Find Yourself Thru LaSalle! — — —

LA SALLE EXTENSION UNIVERSITY

The World's Largest Business Training Institution

Dept. 364-HR

Chicago

I should be glad to have your 64-page book, "Accountancy, the Profession that Pays," also a copy of "Ten Years' Promotion in One," all without obligation.

Higher Accountancy—

Training for positions as Auditor, Comptroller, Certified Public Accountant, Cost Accountant, etc.

Other LaSalle Opportunities

LaSalle opens the way to success in every important field of business. If more interested in one of the fields indicated below, check here:

- | | |
|---|--|
| <input type="checkbox"/> Business Management | <input type="checkbox"/> Personnel Management |
| <input type="checkbox"/> Modern Salesmanship | <input type="checkbox"/> Banking and Finance |
| <input type="checkbox"/> Traffic Management | <input type="checkbox"/> Modern Business Correspondence and Practice |
| <input type="checkbox"/> Railway Station Management | <input type="checkbox"/> Expert Bookkeeping |
| <input type="checkbox"/> Law—Degree of LL.B. | <input type="checkbox"/> C. P. A. Coaching |
| <input type="checkbox"/> Commercial Law | <input type="checkbox"/> Business English |
| <input type="checkbox"/> Industrial Management | <input type="checkbox"/> Commercial Spanish |
| <input type="checkbox"/> Modern Foremanship | <input type="checkbox"/> Effective Speaking |



Name

Present Position

Address

NEW!

Eveready Layerbilt
"B" Battery No.
486, the Heavy-
Duty battery that
should be specified
for all loud-speaker
sets.



The Layerbilt patented construction revealed. Each layer is an electrical cell, making automatic contact with its neighbors, and filling all available space inside the battery case.

DIFFERENT!

For greatest economy all loud speaker sets require the new Eveready Layerbilt "B" Batteries

IT WILL pay you, in convenience and reliability as well as in dollars and cents saved, to use this remarkable battery.

The reason for the Eveready Layerbilt's surprising performance lies in its exclusive, patented construction. No other battery is like it. It is built in flat layers of current-producing elements, making practically a solid block. The layers make connection with each other automatically, and occupy all available space inside the battery case. Layer-building packs more active material in a given area, and makes those materials produce more electricity.

Every loud-speaker set should use Heavy-Duty batteries, for they alone offer economy on modern receivers. When you buy new "B" batteries be sure to get the Heavy-Duty size, and remember that the Eveready Layerbilt has proved to be the longest lasting, most economical of all Heavy-Duty batteries.

Our laboratories are continually testing batteries and in all our tests we have yet to find a battery that is equal to the new improved and radically different Eveready Layerbilt "B" Battery No. 486. The development and perfecting of this remarkable

battery is an outstanding battery-building achievement. It is the result of many years' experience plus the facilities and resources of the pioneer manufacturers of all dry cell batteries.

NATIONAL CARBON CO., Inc.
New York San Francisco

Unit of
Union Carbide and Carbon Corporation

Tuesday night is Eveready Hour
Night—9 P. M., Eastern Standard
Time

WEAF—New York
WJAR—Providence
WEEL—Boston
WTAG—Worcester
WFI—Philadelphia
WGR—Buffalo
WCAE—Pittsburgh
WSAI—Cincinnati
WTAM—Cleveland
WWJ—Detroit

WGN—Chicago
WOC—Davenport
WCCO—Minneapolis
KSD—St. Paul
KSD—St. Louis
WRO—Washington
WGY—Schenectady
WHAS—Louisville
WSB—Atlanta
WSM—Nashville

1145

Just appeared in Berlin.
new observatory.

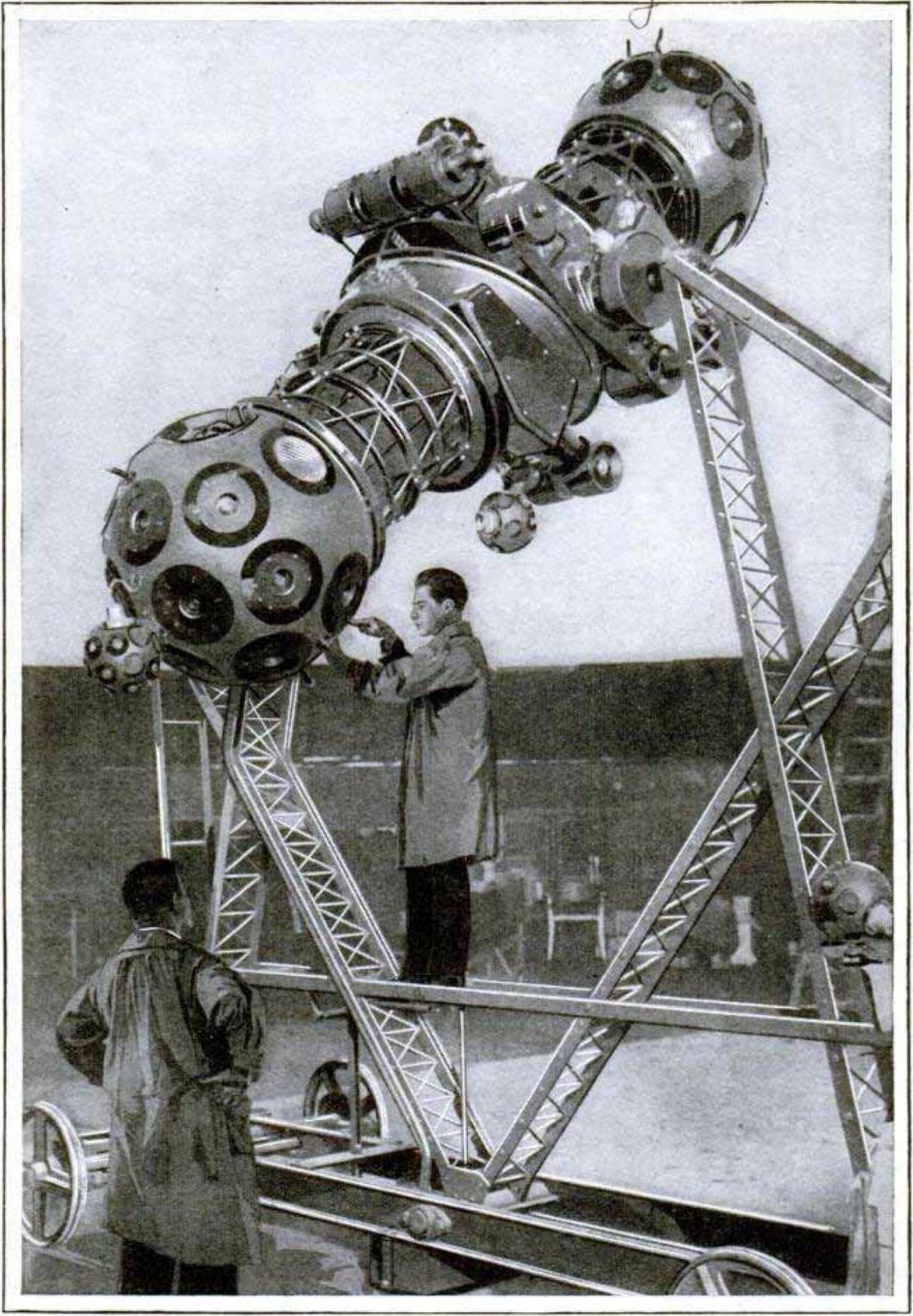

A Modern Magic Lantern That Reproduces Thousands of Stars and the Whole Solar System on a Dome, to Show the Movement of Heavenly Bodies

Planisphere

Popular Mechanics Magazine

REGISTERED IN U. S. PATENT OFFICE

WRITTEN SO YOU CAN UNDERSTAND IT

Vol. 47

MARCH, 1927

No. 3

1297 "HELLO LONDON!" *Phone Spans Atlantic*

WHY an American says "Hello" when he picks up his telephone receiver, whereas an Englishman usually opens the conversation with "Are you there?" became an international question early in January, when regular transatlantic radio-telephone service was opened between New York and London.

With the new service, every subscriber in New York can telephone anybody in London over his own house or office phone connection—provided he is willing to pay the price. The long-distance rate to London is \$75 for the first three minutes or any part thereof, and \$25 for each additional minute. And if the connection is established but the person is not in, the transatlantic telephone companies charge \$10 for reporting that fact.

Engineers on both sides of the Atlantic have been in more or less regular communication since 1923, but it was not until a few weeks ago that the companies were ready to announce the service to be sufficiently reliable for general use. It still is necessary to allow for atmospheric interference by remitting the charge for any

time the connection may be interrupted. For the present the service will be in operation from 8:30 a. m. to 1:00 p. m. New York time, which corresponds to 1:30 p. m. to 6:00 p. m. in London, that being the only part of the day when the business hours of the two cities coincide.

Unlike the usual telephone line, where both parties talk back and forth over the same wire, the first transatlantic telephone employs two routes, separated at places by many hundreds of miles, though both sides of the conversation are carried on the same wavelength. When the New York subscriber speaks to London, his voice passes through the telephone exchange and down to Rocky

Point, L. I., where it goes on the air bound for Wroughton, England.

From New York to Rocky Point, there is seventy miles of land wire; then a 3,300-mile jump through the air across the sea, and a final land wire trip of ninety miles from Wroughton to London.

As the Englishman starts to reply, the apparatus is automatically switched and his voice goes northwest from London eighty-five miles by land wire to

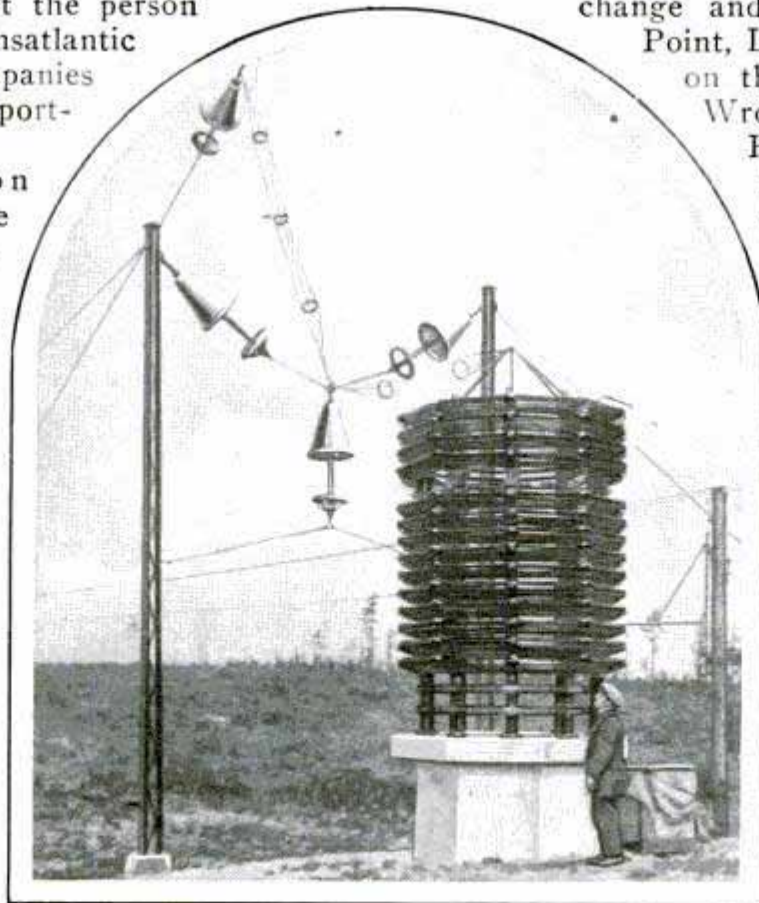

Where American Words Take the Air; the Outdoor Tuning Inductance at the Rocky Point Transmitting Station on Long Island

New York Times 12/10/26

1295

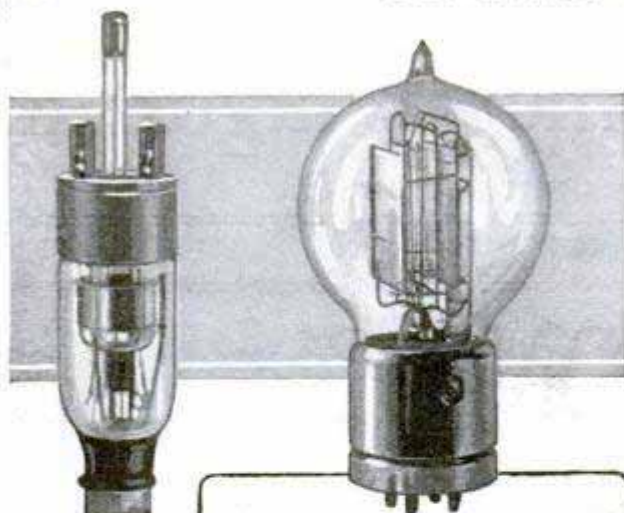

Ten-Kilowatt Radio Broadcasting Tube and a Vacuum Repeater Tube Used to Relay Conversation over Wires for Long Distances

are handled abroad, so they would be familiar with the procedure of setting up the connection overseas.

For customers, the telephone engineers advise that talk across the Atlantic should be carried on in quiet, even tones, without shouting, and in the well-modulated voice used in conversation with a person in the same room.

London may be placed in telephonic communication with Australia, South Africa and Canada within a few weeks, and at a much cheaper rate than that charged for the New York calls, owing to the fact that the Marconi short-wave beam ap-

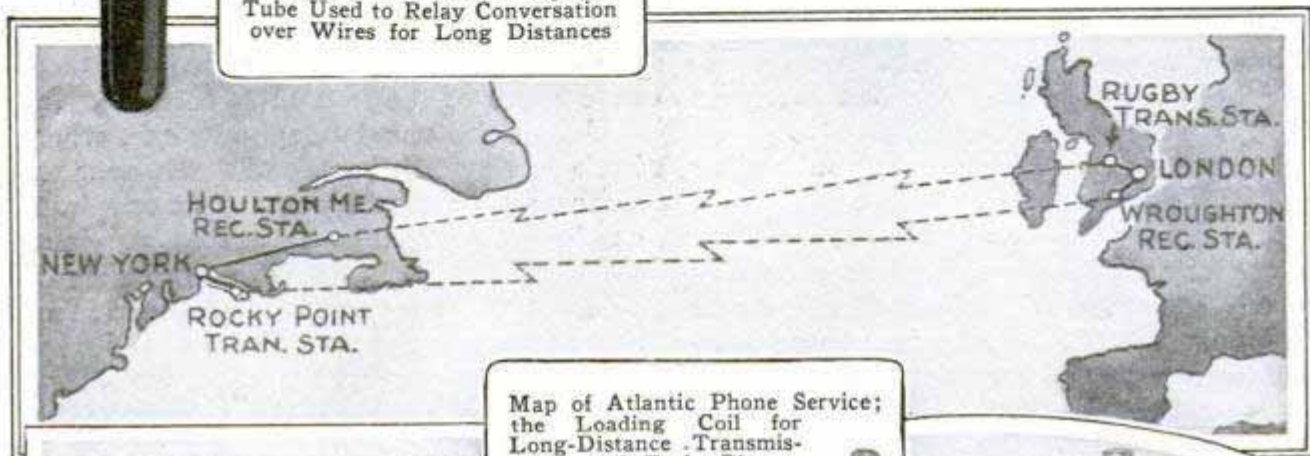

Map of Atlantic Phone Service; the Loading Coil for Long-Distance Transmission, and Early Phone

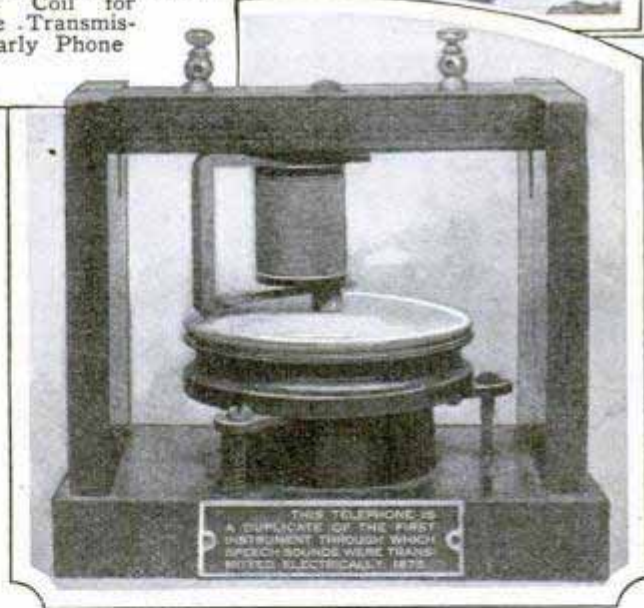
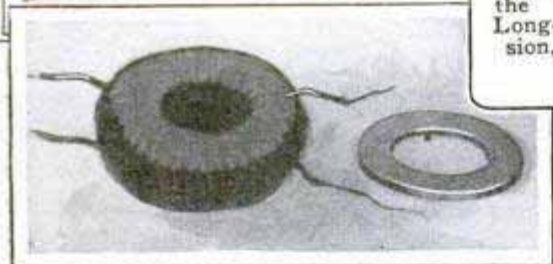

Rugby, where it is broadcast to be picked up 2,900 miles away at Houlton, Me., and sent on the final lap, 600 miles down the coast, to New York city. The switching on and off of the two circuits, done automatically as one talker stops and the other begins, permits the company to economize in ether space by using a single wave band for both sides of the conversation, instead of two separate bands, as would otherwise be necessary.

Telephone girls at both terminals of the service were specially picked for having the voices most suitable for radio transmission, with low steady intonation, so as to avoid excessive variation in the frequency of the sound waves. They were then taught the names of the different exchanges in the city at the other end, and given lessons in the way ordinary calls

paratus is available, instead of employing the long waves, as is done on the present transatlantic service. Experimental telephone calls to Canada, a distance of 3,000 miles, have been carried on for some time, and occasional successful experiments have been made in reaching Australia, a distance of 12,000 miles from London. Eventually it is intended to link every part of the empire with the British isles.

1252
HIGH-SPEED ELEVATED ROAD FOR AUTOMOBILES

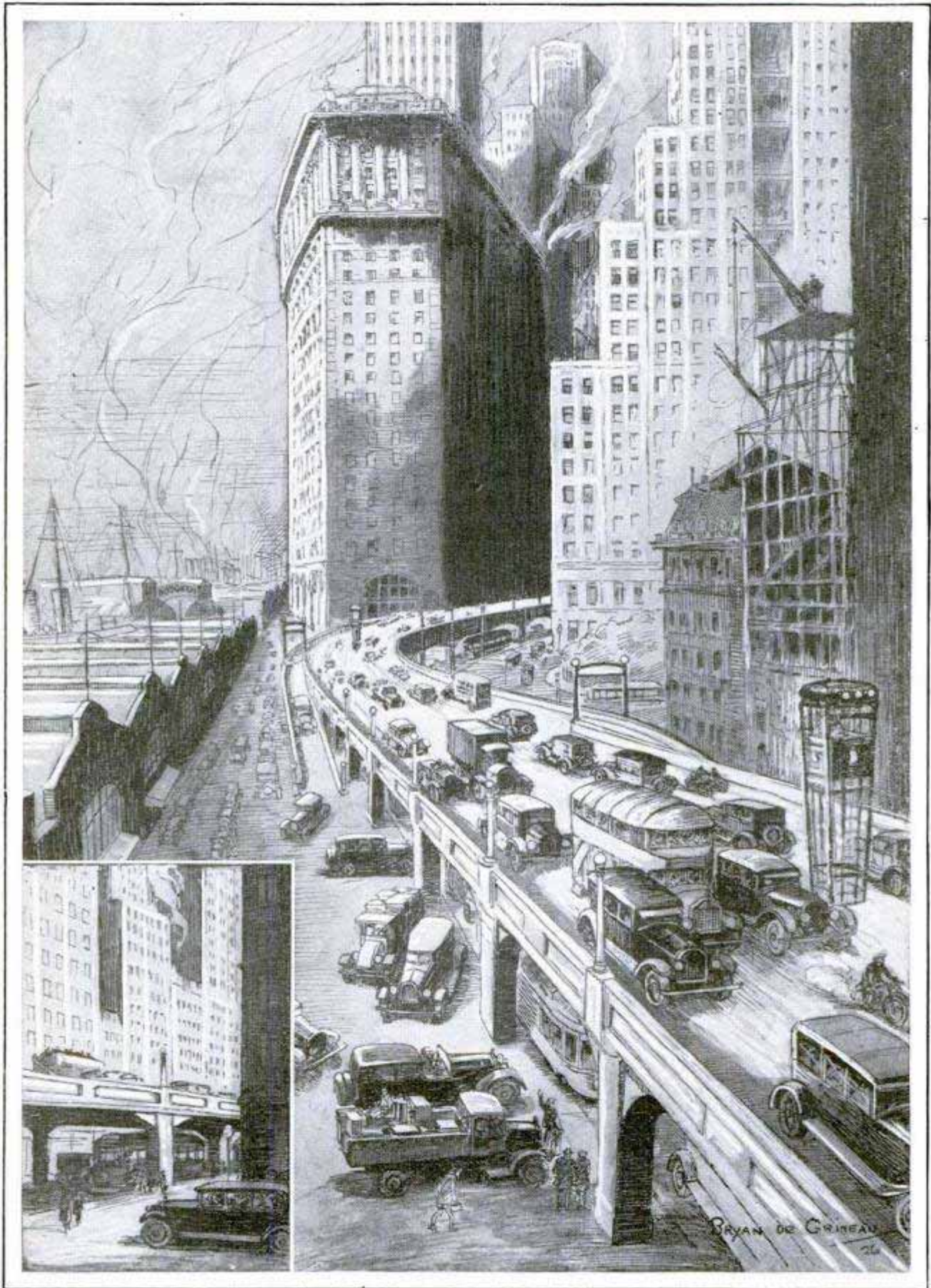

Courtesy the London Motor 11/30/26
Artist's Drawing of New York's Proposed Four-Mile Elevated Motor Road from the Canal Street Docks up Eleventh Avenue toward Riverside Drive

Built by Alan J. Cooper,
 356 POPULAR MECHANICS
 Rising Star, Texas

also at St. Mary's College

1249

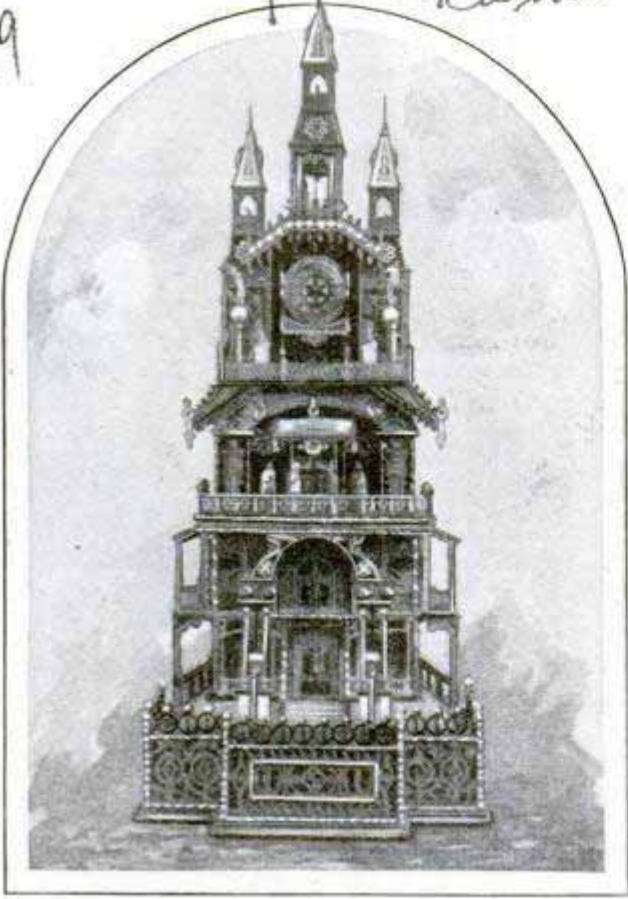

Model Cathedral Fashioned with Pocketknife and Scroll-saw; Figures of Apostles in Center

SEVEN-FOOT CATHEDRAL MADE OF OVER THOUSAND PIECES

Tiny chimes play eight different tunes, the hours are tolled and the figures of four Apostles march slowly through a curtained door as the music sounds in an electric-lighted model cathedral, seven feet high. Pocketknife and scrollsaw were the principal tools used in fashioning the model, which contains 1,080 pieces of wood of sixteen different kinds, painted in twenty-seven various shades and colors. The model was finished in about nine months, the designer devoting only his spare time to the task.

ANCHOR FOR AIRPLANE CARRIER WEIGHS FIFTEEN TONS

To hold fast the navy's aircraft carriers, anchors weighing fifteen tons have been ordered. This is in keeping with an axiom of the sea that for every ton of ship, there should be a pound of anchor: Tests are being made with a type of stockless anchor which is said to provide greater holding power without a corresponding increase in weight.

Ans. J. H. Hardecker,
 410 Paris Ave.

TINY ANIMAL WITH BIG BRAIN FOUND IN OCEAN

Too small to be seen by the unaided eye, a tiny animal discovered in ocean water has a nerve center or brain more complex than that of the bee and it can build a new house for itself in less than two minutes, according to Arthur S. Campbell, of the University of California. This creature is found by the million but is so delicate that it dies in twenty or twenty-five minutes after being taken out of the water. Little has been known of it except through its shell, discovered in the stomachs of larger organisms.

MOUTH ORGAN AND HARP IN ONE LATEST MUSICAL NOVELTY

Players of harmonicas can produce their own accompaniment on a novel instrument on which a California inventor has applied for a patent. The mouth organ is inserted in a slot on the harplike part of the outfit, and its tones issue from the sound hole, blending with those of the strings. Cords are played with the aid of keys, the fingering being simple. The instrument is said to be suited especially for accompanying a human voice and, with it, two persons can achieve most of the effects of a five-piece orchestra.



Playing the Combination Harp and Mouth Organ; Note the String Keys for Left Hand

Harmochord Co
 3440 Wilson Ave

SECRETS OF ORIENTAL ART REVEALED BY SCULPTOR



Allan Clark at Work on One of His Painted Wooden Heads, Modeled in Oriental Style; Below, His Orientalized Head of Galli-Curci



Something new in sculpture, introducing bizarre color effects, has been brought back from the orient by Allan Clark, a young American sculptor who spent three years in the Far East. He not only uses inlays of different-colored woods, but employs lacquers and gold leaf to get unusual effects. In a bust of Mme. Galli-Curci he carved the work from mahogany and finished it in black and red lacquers and gold leaf, while the face itself is done in an unusual olive tint. A large comb is finished in red lacquer and a Chinese shawl, draped over the diva's shoulders, is done in green, blue and gold, the colors of the original. The oriental effect not only is carried out in the decorative colors, but the head and face itself are given a distinctly Chinese treatment. While in the orient with the China expedition from Harvard, Clark visited the ancient cave temples there, spent much time with the actors of Japan, studying their stage costumes and effect, and also made studies of old inlay work in Java, Korea, Siam, Tibet and Burma.

fore the wolf can capture it. Walking about the cage does not give the animal sufficient exercise for the muscles on its back and shoulders, the keepers say, to keep it in good physical condition. The lack is supplied by the daily jumping.

CAGED WOLF GETS EXERCISE BY JUMPING FOR MEALS

1285

To give a timber wolf in a Texas zoo sufficient exercise, park officials have installed a pole upon which the animal's meal of raw meat is placed, just high enough to necessitate expert jumping be-

*Marsalis Park
Dallas*

VEST-POCKET TOBACCO CASE REDUCES WASTE

1275



Holding a day's supply of tobacco, an attractive metal case fits the vest pocket and has a double lid, one affording a small aperture through which pipe or cigarette paper may be

filled without spilling. To replenish the carrier, both lids are opened.

*Smokers Products Co. Inc.
42 Walnut St. N. J.*

1194

Diaphone

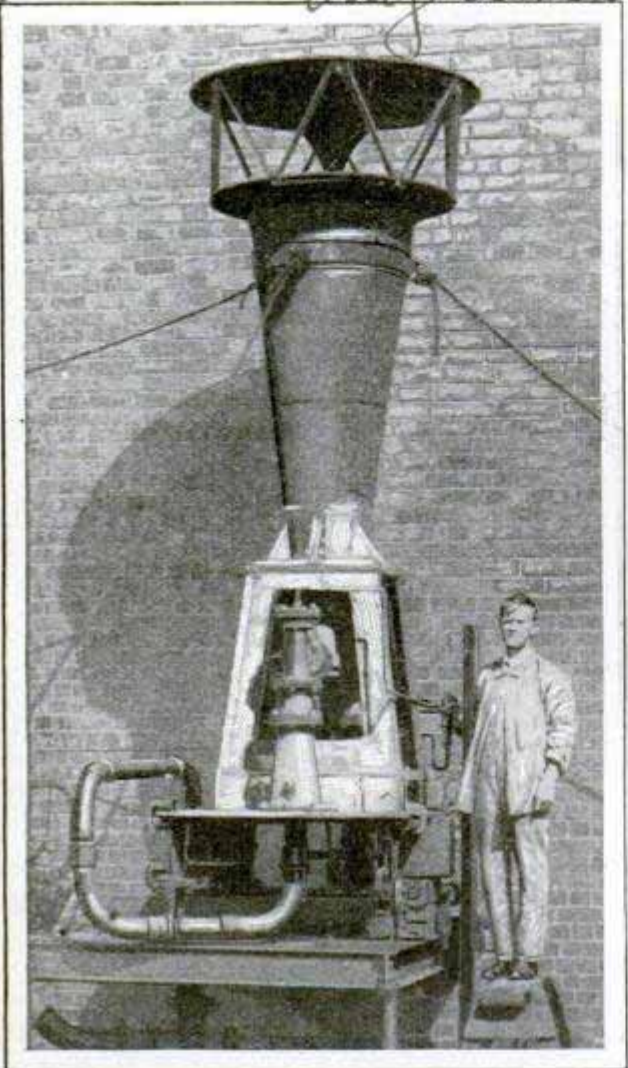

Fog Horn That Produces the World's Most Terrible Noise and Can Be Heard Forty Miles

TERRIFYING MAN-MADE NOISE TO SAVE SHIPS IN FOGS

A new type of fog horn, whose makers boast that it produces the most terrible noise ever heard, is being installed in British and Canadian lighthouses to save ships from destruction. Some idea of what the noise of the fog horn is like may be gained from the fact that one installed at Cape Race, Newfoundland, has been heard forty miles out at sea. The giant horn, which is operated by compressed air, is called a diaphone.

WIRES HUNG FROM BALLOONS TO TRAP AIRPLANES

1315

Experiments are being conducted by the United States army on a balloon-and-wire plan for protecting cities and other areas from airplanes. The balloons are to be sent to altitudes of several thousand feet, and from each, strands of small steel

Goodrich Tire & Rubber Co Akron, Ohio

detective and hunter Dallas, Texas

wire of great strength are suspended. The wires are intended to tangle airplane propellers and other parts, causing the craft to fall, and are so fine that they are invisible beyond a short distance.

WILD DUCKS CAUGHT BY HAND ON BAITED BOX 1396

Mexicans along the Rio Grande have devised a clever scheme for catching wild ducks that alight where the river is not too deep. A hollow box, with holes punched in the top to hold ears of corn or other grain, is placed on the water. A Mexican dives beneath it and stands with his head hidden from view by the floating and apparently harmless box. When a duck alights for the bait, the hunter sticks his hand from beneath and grabs the bird. Game wardens declare that one man can catch as many as fifty ducks in one day by this method.

1298 TRIPLE-GAFF HOOK FOR BIG FISH PREVENTS ESCAPE OF CATCH

Devised especially for ice or still fishing, a triple hook, easily attached to any line, securely traps the fish and holds it until landed. The hooks are self-adjusting for various sizes of fish and not only prevent escapes but also protect the line

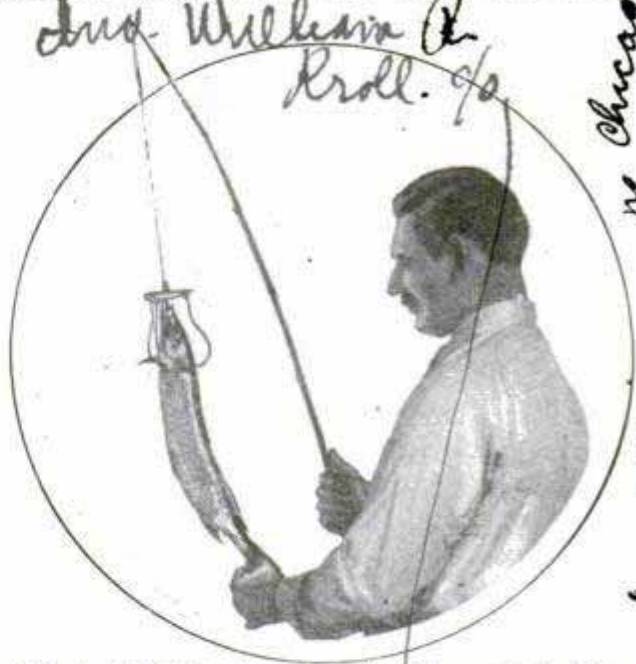

Fish in Gaff, Showing How the Three Hooks Close about Head near Gills

from breaking. A slip loop holds the gaff any desired distance above the baited hook.

Automatic Trap Tackle Co. Letter ret.

Chicago agent

milwaukee, Wis.

HOPE OF SEEING BY RADIO BROUGHT NEARER FACT

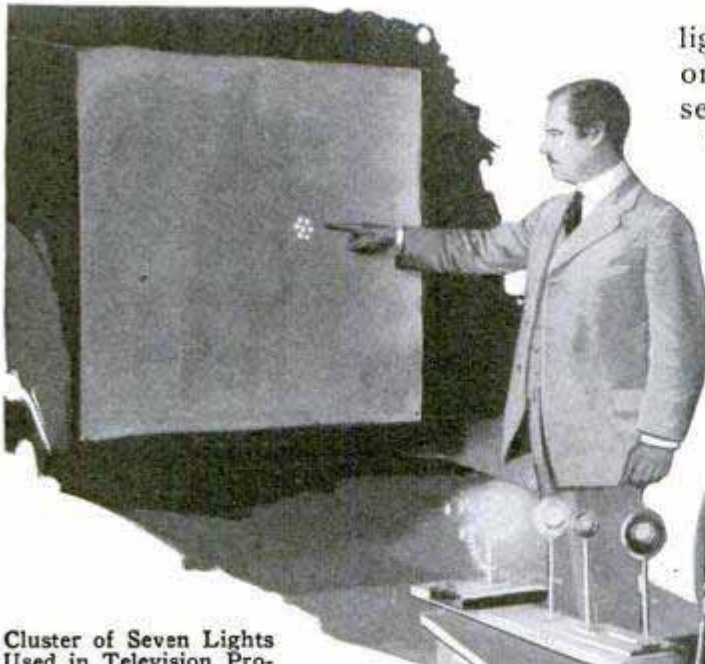

Cluster of Seven Lights Used in Television Projector by Means of Which Dr. E. F. W. Alexanderson Expects to Reproduce Moving Objects by Radio

Television—the radio transmission of the actual image of a distant person or event—is entirely practical with equipment already available, provided the apparatus can be speeded up sufficiently, according to Dr. E. F. W. Alexanderson, of the General Electric company and the Radio Corporation of America. He estimates that it will take about ten years, however, to bring television to the point where it will render a useful public service.

The problem is entirely one of speed. In his laboratory he has transmitted a radio picture in two minutes, as compared with the ten or more minutes taken only a year or so ago. But before movies, or an image of an actual event, can be transmitted satisfactorily, each separate picture must be painted on the screen in one-sixteenth of a second, the same rate at which a movie projector operates in flashing the pictures on the screen.

“It is easy enough to design a television system that will transmit something like 40,000 picture units a second,” Dr. Alexanderson says. A picture unit is one of the parts in which a picture is divided for transmission, the photo-electric cell sending each unit as a separate electrical impulse, while the receiving apparatus, a light valve, turns the impulses back into

light and projects them one after the other on the screen, but so rapidly that the eye sees them all as one picture.

“The images obtained with 40,000 units a second,” the engineer explains, “are so crude that they have no practical value. Our work has shown us that we need an operating speed of 300,000 units a second to get sixteen complete pictures in that time—so the problem is simply one of perfecting photo-electric cells,

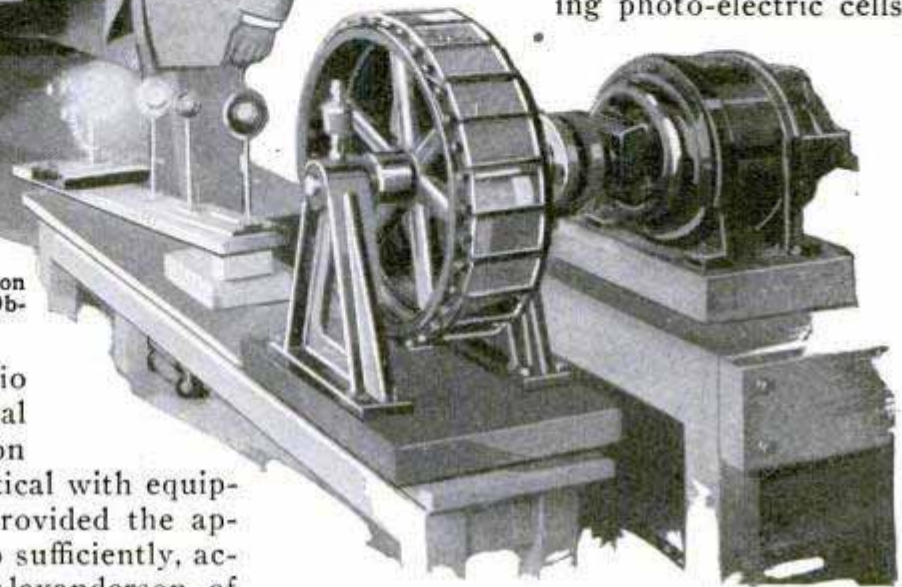

light valves and radio modulators capable of transmitting impressions at that rate.

Dr. Alexanderson's projector is unique in that he utilizes seven separate lights, instead of a single one. Each of the seven lights scans the picture, and paints a crude image of what it sees, but the lights are so arranged that all their beams converge, and blend so that they produce an optical illusion of a single picture, with the seven parts fused into one good image.

In his experiments he has found a way to eliminate static interference with picture transmission by introducing a “threshold valve” into the circuit, so that nothing is received unless the signal strength exceeds the current value fixed by the valve.

When radio-picture entertainments arrive, however, he suggests that static, fading and other transmission difficulties may be overcome by what he describes as “brute force,” which is simply the linking up by wire of many radio stations to supply sufficient power for good results.

1330
360

THREE-WHEELED CAR RUNS EIGHTY MILES AN HOUR

Tricycle Auto
Which Develops
High Speed and
Saves Fuel, Run-
ning Forty Miles
on a Single Gallon
of Gasoline



Sandford

Forty miles on a gallon of gasoline is the record made by a three-wheeled automobile owned by a New York woman and said to be the first of its kind introduced in this country. It has a two-cylinder motor and develops a speed of nearly eighty-five miles an hour.

PEARLS ARE GROWN ON FARMS FROM EGG OF PARASITE

On display recently in a drug-store window in Little Rock, Ark., were 2,000 pearls produced at a river farm near by, where the gems were grown for the market. They were raised from tiny seed pearls transplanted from a mussel into another bivalve. The seed is formed, not around a tiny grain of sand, as is widely believed, but around the minute egg of a certain kind of water parasite. Pearls cannot be produced in all waters because this parasite is not found everywhere, according to a pearl expert. After the seed has been transplanted, seven years are required before the pearl is ready for gathering. The transfer operation is a delicate one. If the seed is placed too near the edge where the shells of the mollusk come together, it will be cramped and ill-formed. If two seeds are too close together, a slug will result, caused by the pearl-producing material growing over both. The substance is deposited in layers, one each year. When

pearls are peeled, this structure is apparent, as the material breaks where the year's growth begins. The mollusks can push themselves about with a sort of foot which protrudes from their shell, but their speed scarcely exceeds a few inches an hour. If they become too active, a wire fence is sometimes placed around their beds to restrain them. In all, there are some 110 variations in the luster and color of the pearls so that grading is an exacting task.

SAFETY AIR-BRAKE INDICATOR TO HELP PREVENT WRECKS

For railway trains and street cars, a western inventor has devised an indicator which tells if the air brakes are not working. It consists of a signal, attached to the end of a freight or passenger car, and is so adjusted that, when the air is applied, it protrudes from a housing and shows the engineer or other members of the crew that the brakes are responding properly. If there is a defect, the signal will not appear.

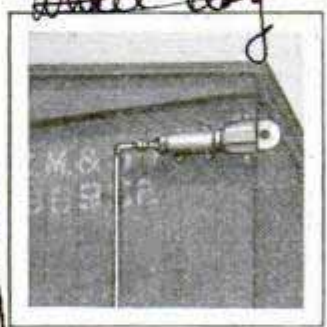

The visibility of the signal and its simplicity have led to its approval by the mechanical departments of several roads.

*Mr. Bert Stockwell
1231 Prudent Bldg.
Tacoma Wash*

Owner Mrs. Wm. M. Wright

1383

*Richard Byulis, owner,
Spring River Pearl Farm,
Ark*

MANY EARTHQUAKES THIS YEAR SCIENTIST PREDICTS

1384

Earthquakes will shake the world in many places during 1927, according to the predictions of Raffaele Bendani, an Italian scholar whose forecasts of such occurrences have attracted wide attention in past years. Southern Europe, Central America, particularly in the isthmus region, and the Greek archipelago, will be visited by temblors early in the year, he declares, while the summer will witness disturbances in Japan, Mexico, the Pacific coast not far from regions visited in 1909, and in the central Mediterranean area. During the second half of the year, earthquakes will be registered in the Antilles as well as the Philippine and Aleutian islands and the southern coast of Alaska, Bendani predicts. Also, volcanic eruptions will take place in Central America and central Asia, he believes.

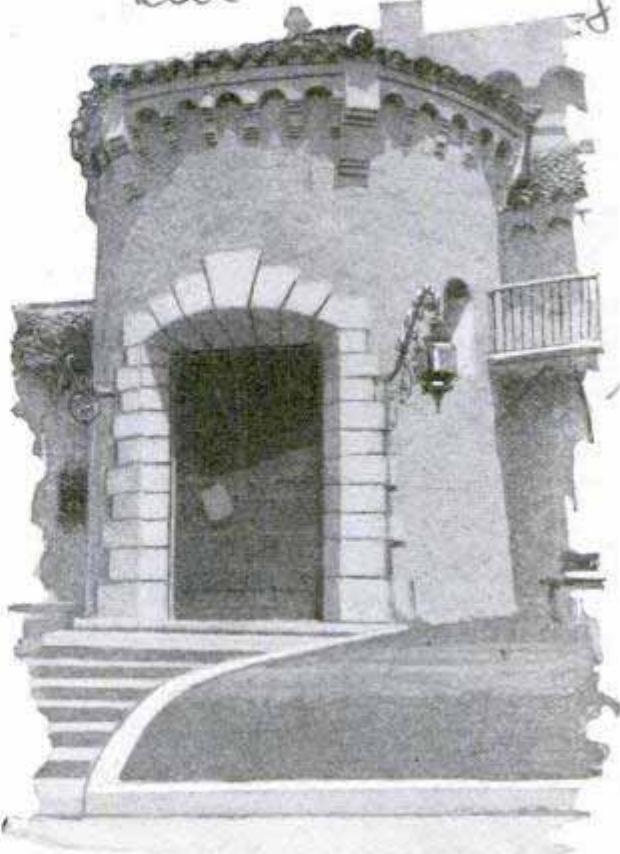

Entrance to Palatial California Home, Showing the Imported Spanish Door Which Cost \$5,000

PICTURES IN COLORED ICE RIVAL BEAUTY OF STAINED GLASS

1338

Lacking snow for building houses and men, Chicago school children found a sport even more amusing in making beautiful windows of colored ice. Upon panes of ordinary glass, little walls of putty were



Colored-Ice Design on Pane of Glass

fastened to make the designs and into the spaces thus marked off, mixtures of cold-water dyes in different colors were poured. After freezing, a firm, transparent "window" was formed. The crystalline structure, visible when the pane was held to the light, added to its beauty.

Miss Myrtle Karsten,
Director of girls' activities
at [unclear] Chicago

FIVE-THOUSAND-DOLLAR DOOR IN CALIFORNIA CASTLE

Castles in Spain, or at least parts of them, are being brought to America to beautify homes here. One of the features of a residence near San Diego, Calif., is the mahogany door which was imported from Spain at a cost of \$5,000. The dining table was also brought from an old Spanish castle. Moorish and Norman designs have been incorporated in the structure as well as more modern notes, such as the pipe organ back of a loft above the huge fireplace. Ornamental light brackets at the door add to the beauty of the entrance.

HOBOS CAUSE OF HOT BOXES ON RAILROAD CARS

Vagrants cause the railroads various troubles, but one of the most serious and yet least known is their contribution to hot boxes and consequent delays to trains. This they do by removing the waste from the journal boxes to make fires. The material provides a lasting, hot blaze and is often stolen while trains are in the yards or on the sidings

Chicago
12/10/26

A. Lushner (Germany Berlin)

11/18/26

1148

SKATERS PRACTICE ON PLANKS FOR WINTER SEASON

To keep in training for the ice-skating season, German experts practice in a



Skating Lessons in Summer on Slippery Planks

plank-lined trench which has a turf bottom to break the force of falls. The boards are smooth and slant at an angle to give effective drill in balancing and movement.

NAVY'S RADIO STATIONS GUIDE EIGHTY THOUSAND SHIPS

An outstanding example of the remarkable growth of wire and wireless communication is seen in the service rendered by the United States navy. Fifteen years ago, the headquarters office in the navy department was manned by one telegraph operator who stood only one watch of eight hours daily, assisted by a part-time messenger. Today, the staff numbers 139, including skilled land-wire telegraphers, radio operators, communication traffic specialists, accountants and executives, who maintain reliable service with vessels anywhere on the seas. Last year, more than 14,000,000 words were handled. Of this number, nearly 5,000,000 were for other branches of the government, weather reports, market quotations, financial matters, and the like, resulting in a saving of about \$850,000. In one year, 83,171 vessels were furnished a total of 184,206 directional radio bearings by the navy's fifty-six radio-compass stations located on both coasts. This service was fur-

nished American and foreign vessels alike, and doubtless prevented many disasters. Among recent outstanding achievements of the department are the efficient radio communication with the MacMillan and Amundsen polar expeditions and the international ice-patrol reports. The service is now being amplified by broadcasting weather maps to ships.

CAR SPEED CHANGED WITHOUT STEPS BY CONE GEAR

A type of gear box, developed in England, gives a continuous range of speed changes without the steps or stops incident to the shifting of gears of the usual type. Both the driving and the driven shaft

have two cones, with ridge-like teeth on the inner side, which engage the side sliding laminations of a driving chain. The distance between the cones on each shaft is variable, so if they are held close together the chain is forced up to the edge of the cones, while if they are spread apart the chain slips down toward the center. A screw device with two arms, working on the same principle as a carpenter's clamp, takes care of the adjustment of the cones, forcing one pair together while al-

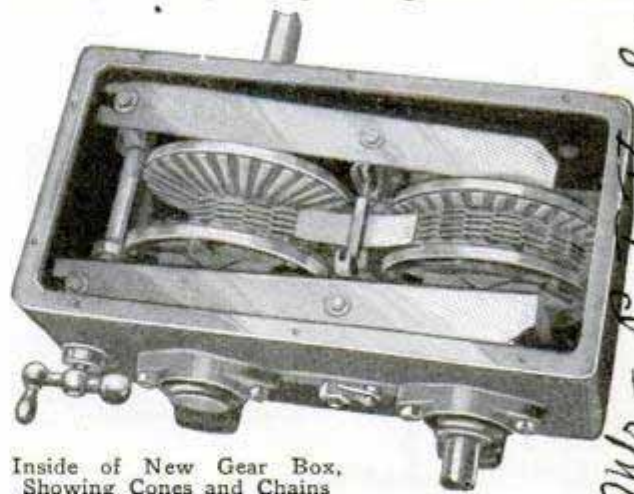

Inside of New Gear Box, Showing Cones and Chains

lowing the other pair to spread apart, or vice versa. The speed range, from a step down to a step up, is limited only by the size of the cones. A reverse gear is incorporated if desired.

National Physical Laboratory Engineering Dept London

Verne Amundsen Navy Dept Washington, D.C.

Mr. J. F. T. Spear Syddigate Ltd. Westminster, S.W.1, England

7 Princes St.

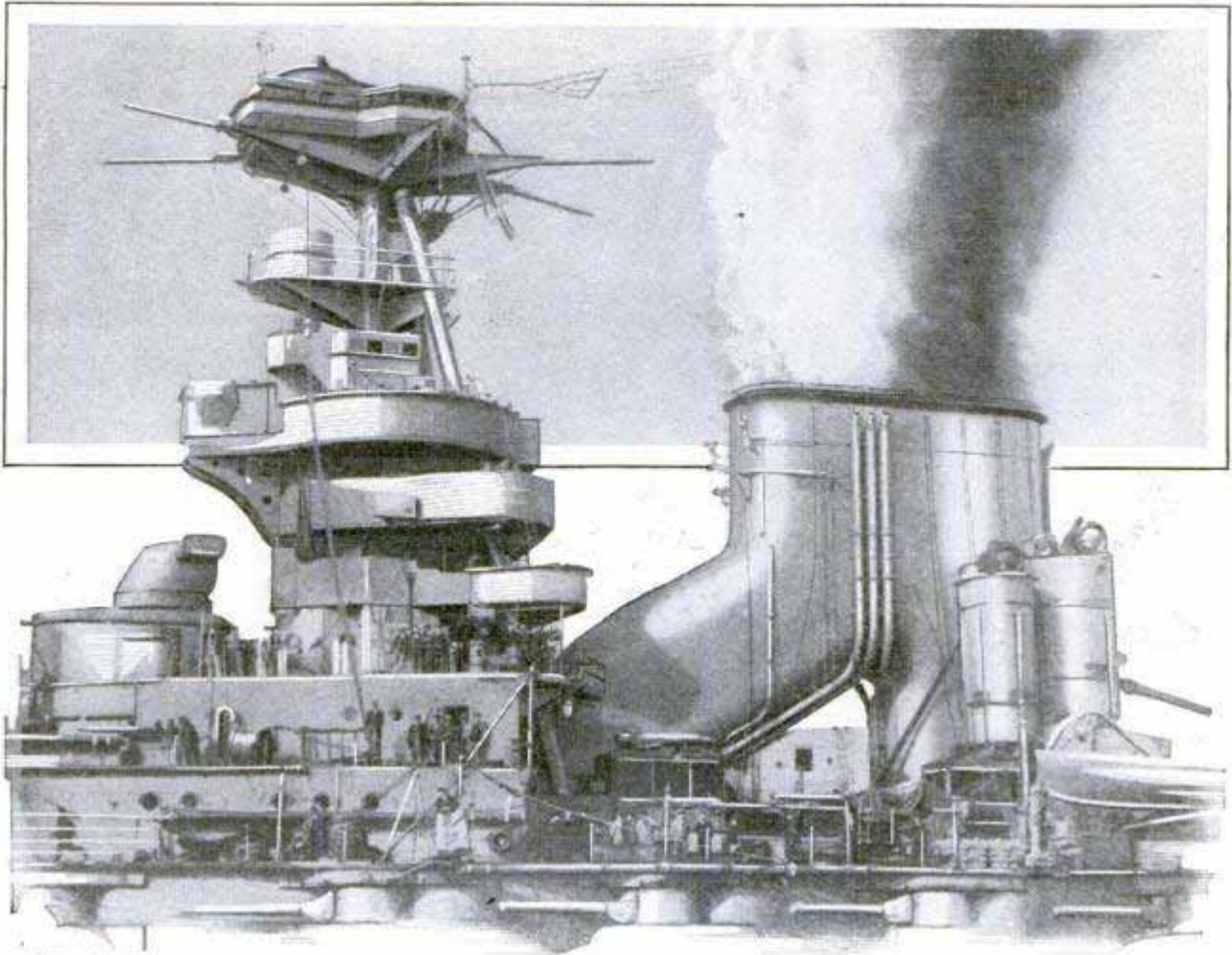

© P. & A.

British Ironclad "Warspite" and Its Double Funnel; This Arrangement Affords More Room for the Conning Tower Which Also Presents Several New Features

TWO-IN-ONE WARSHIP FUNNEL LATEST NAVAL STYLE

One of the most noticeable features of the British warship "Warspite" is its new type of funnel, a single opening being provided for two smokestacks. The plan is said to give reduced visibility at long range, thereby helping to protect the ship from gun fire.

USE OF ELECTRICITY IS DOUBLED IN FIVE YEARS 1382

That the present is rightfully called the electric age is apparent from government reports showing that during the five years between 1920 and 1925, the consumption of electricity throughout the country increased by fifty-one per cent and in some states as much as eighty-five per cent. In actual increase, the middle Atlantic states were ahead with 5,950,000,000 kilowatt-hours, while the increase for all the states was 22,315,000,000 kilowatt-hours.

Geological Survey.

Other sections showing high increases were the east north central with seventy-eight per cent, the west south central with seventy-nine per cent and the Pacific states, where the increase amounted to fifty-eight per cent.

GARAGE FLOORS KEPT CLEAN WITH GREASE ABSORBENT 132



Oil and grease are said to be removed quickly from the garage floor with the aid of an absorbent material now on the market. It is scattered on the spot, pressed into the oil and then swept up, leaving

the floor clean. The substance is non-combustible and may be used several times until saturated.

*The Floor Floor Co.
Buffalo, NY
50¢ per box and 50¢ per 100*

*Highland Spencer
Bartlett*

Recording Instrument on Table at Rear Registers Warmth of Girl's Blush



American Society of Heating and Ventilating Engineers!

1356

Grand Central Palace, New York
Spun at Power Show at
METER THAT MEASURES BLUSH TO IMPROVE BUILDINGS

Engineers interested in the proper warming and ventilating of buildings have developed a heat meter which is so sensitive that it will record the effect of a blush. The instrument is being used to determine factors in heat transmission and is expected to afford data for better building.

FENCE IS BUILT FOR DAY ONCE EVERY SEVEN YEARS

1396
For just one day, every seven years, a fence is erected around a small triangular plot of sidewalk in front of a large office building in Atlanta, Ga., in accordance with the state property laws. They provide that land used for public purposes for seven entire years at a stretch becomes the property of the public. This particular piece is privately owned and to prevent its becoming part of the public's possessions, it is fenced off for one day, defeating the letter of the law and preserving the owner's title. A brass plate in the walk bears the inscription "private property."

Hart Bldg

HOW AN AIRPLANE FLIES

1393

Seventy-five per cent of the sustaining power that keeps an airplane up is represented by suction on the top surface of the wing, according to engineers at the government flying field in Dayton, Ohio. They explain that the wing acts as a wedge, "splitting" the air and sending it streaming back and up almost vertically. This rush of air creates a partial vacuum above the wing back of the thickest part, and it is this vacuum, combined with the pressure of the air beneath, which does three-fourths of the sustaining work, the engineers assert.

LETTERS ON SHEETS OF WOOD ADVERTISE LUMBER PORT

1347

Writing paper made from sheets of spruce veneer, so thin it takes a pile of eighty to make one inch, is used by the chamber of commerce of Hoquiam, Wash., to advertise the city as the world's leading lumber market. The veneer, which is produced by a box and basket manufacturer for use in his product, is flexible, folds easily and takes typewriter ink as well as any linen or wood-pulp paper. Hoquiam, which is an Indian word meaning "Hungry for Wood," got its name when the Indians observed that

Hoquiam, Wash.
Veneer Co
Harbor
Grays

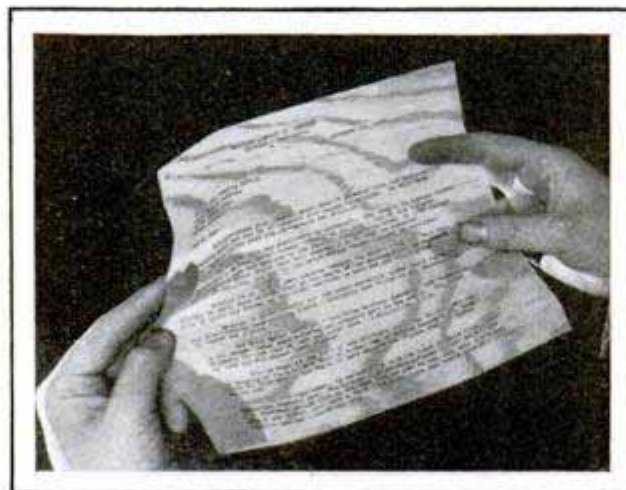

Letter Typewritten on Sheet of Wood So Thin It Can Be Folded; Note the Dark Grain Marks

an enormous pile of driftwood collected in the harbor on both flood and ebb tides. The city won the leadership in the lumber market in 1924, when it was the first port to ship more than a billion board feet in a single year, and in 1925, the business exceeded that figure by approximately fifty per cent.

1915
Cosmopolitan Productions, 1540 Broadway

ICE IS MADE WHILE SUN SHINES FOR MOVIE SET

New York

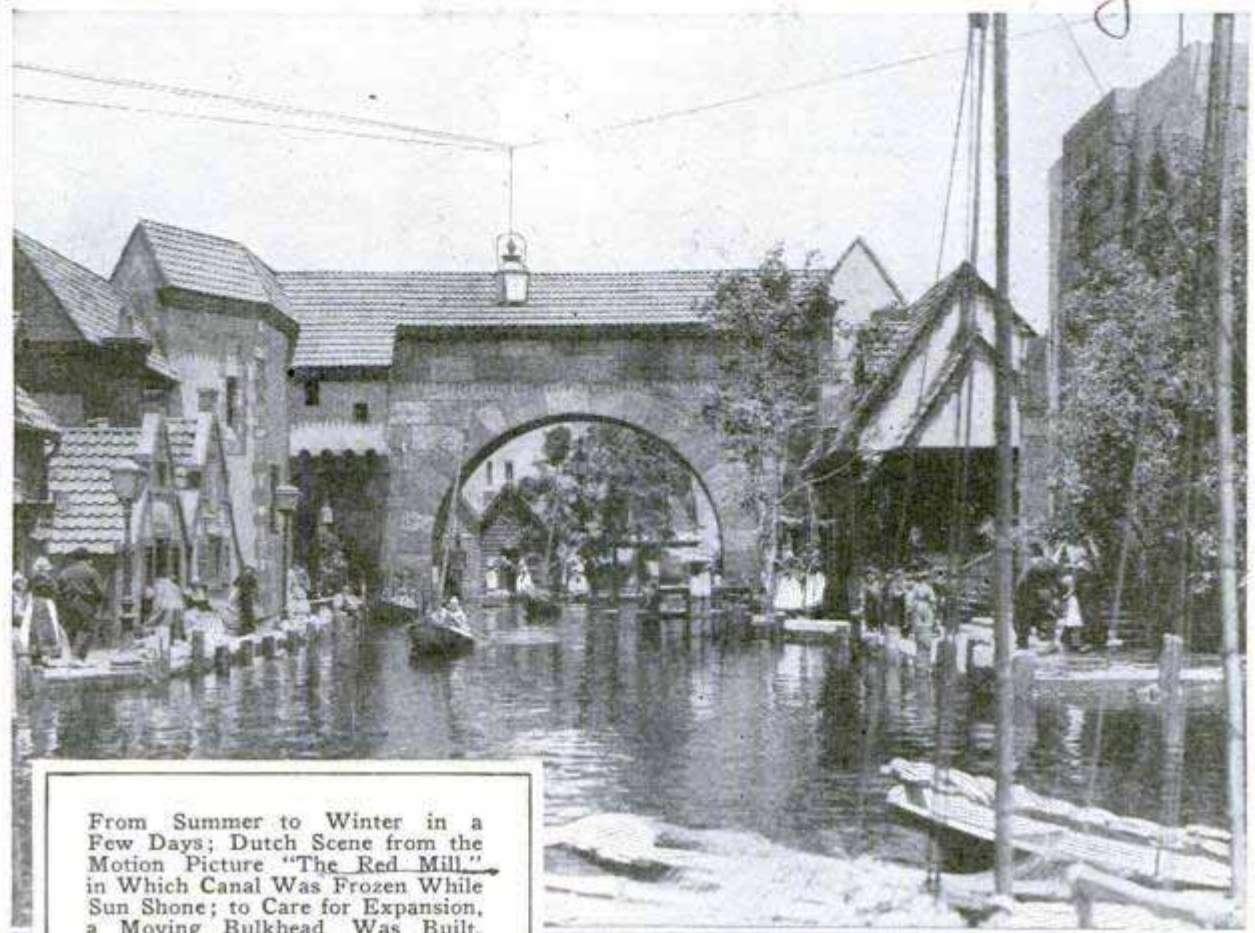

From Summer to Winter in a Few Days; Dutch Scene from the Motion Picture "The Red Mill" in Which Canal Was Frozen While Sun Shone; to Care for Expansion, a Moving Bulkhead Was Built, and the Freezing Plant Was Large Enough to Supply a Whole City

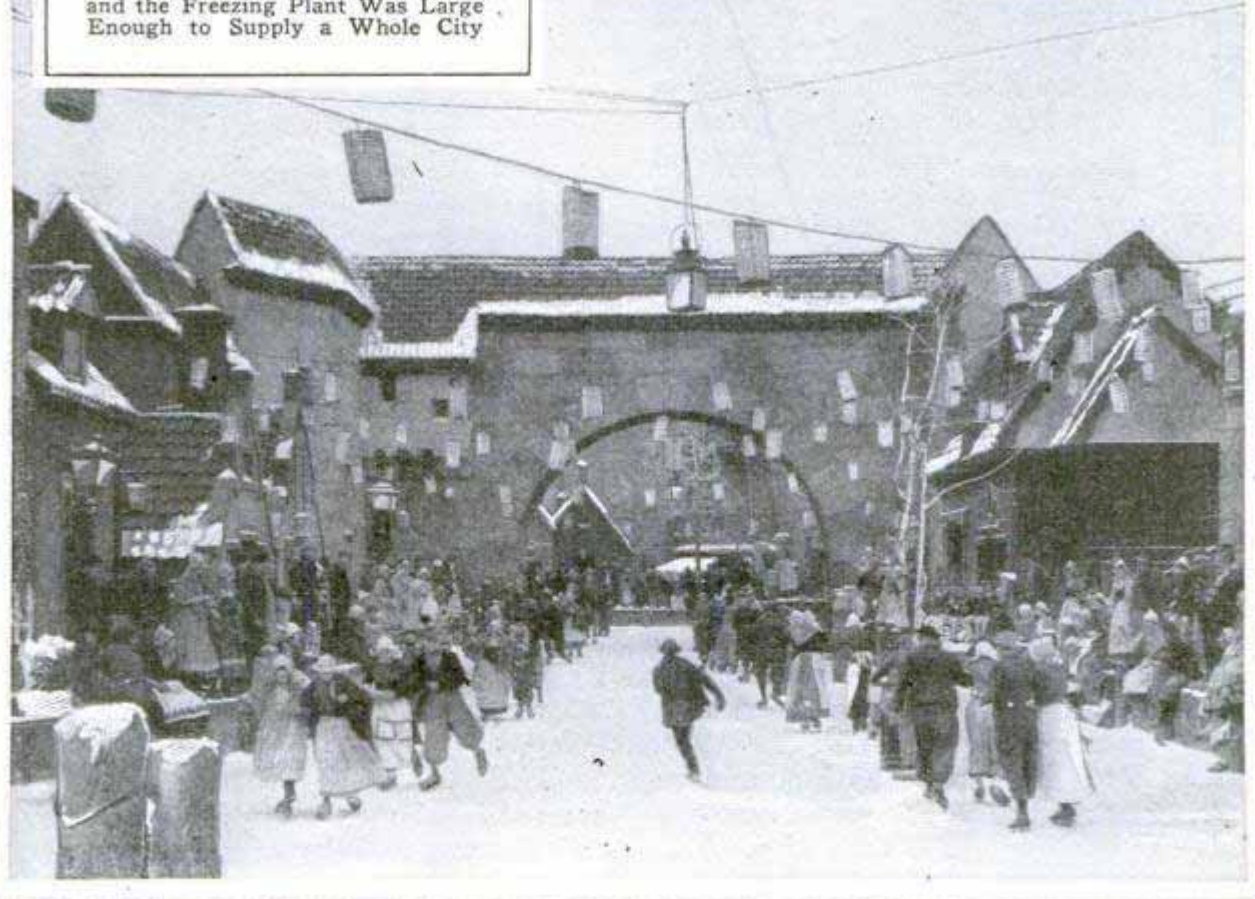

1193



Alleg

Swan Auto, Owned by Motorist in India; Exhaust Gas from Engine Hisses through Mouth to Warn Pedestrians

SWAN AUTO HISSES TO MAKE PEDESTRIANS STEP BACK

Motorists in India like originality in their cars, so one wealthy owner has had a special body built like a swan, while the front springs end in grotesque heads reminiscent of the griffins carved on medieval buildings. A multi-toned exhaust horn has been provided for emergency use, and the usual warning signal is given by the swan opening its mouth and hissing in realistic fashion at pedestrians who get in the way. The hiss is provided by exhaust gas from the engine. Instead of the usual headlights, a single globe surmounts the swan's head like a crest or comb, and a ring of smaller lamps is fitted around its throat, forming a sort of necklace.

REINDEER INDUSTRY IN ALASKA BRINGS LARGE RETURNS

More than 350,000 reindeer, distributed in 110 herds, are now being kept in Alaska, according to the department of agriculture, and the average gross increase is between thirty-three and forty-five per cent annually. Within recent years, the raising of the animals has become an important industry. They are known as "three-way" producers, useful for food, clothing and for transportation, and in some sections, are supplanting the dog teams for hauling. The cost of production averages only about \$1 a year for each reindeer, while prices of \$10 or \$12

are realized in the butcher markets. Between 1918 and 1925, nearly 2,000,000 pounds of reindeer meat were exported from Alaska. The government is endeavoring to improve methods of control and management of herds and the grazing facilities. It is said that the country can afford pasturage for at least 3,000,000 animals.

FINS ON SHIP'S HULL INCREASE SPEED

To reduce fuel consumption and increase the speed of ships, wing fins attached to either side of the hull have been devised by an English engineer. The idea is based on an interesting and probably little-known feature of navigation. With the ordinary form of ship water flows upward to the propeller so that part of that unit's work is to make the flow of water move in a horizontal direction. The purpose of the fin is to deflect the streamline horizontally without reducing the speed of the water to the propeller. Tests with the attachment on a motorboat resulted in a twenty-five-per-cent reduction in fuel consumption, while the astern speed was in-

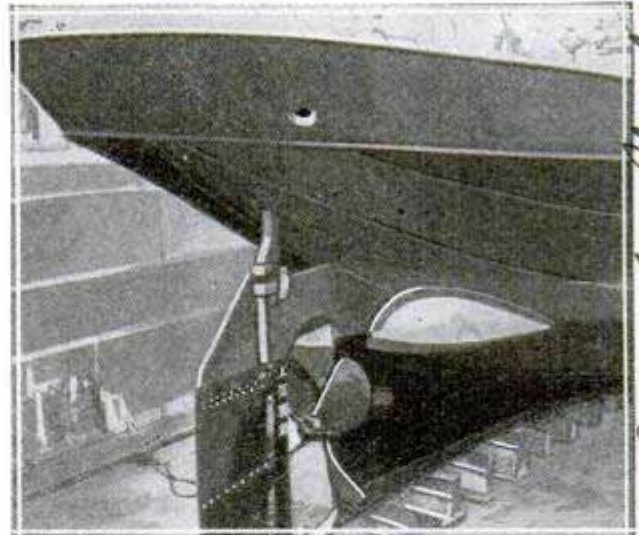

Deflecting Fins Attached near Propeller Are Said to Reduce Fuel Consumption and Increase Speed

creased by about twenty per cent. In addition it was found that the steering qualities of the vessel were improved in a quite considerable degree.

J. Hind Percod,
Newcastle-on-Tyne,
Eng.

and it is not a...
building...
Hind Percod...
Palmer's...
Ship

Chicago Daily News 12/23/26

1279
1317

CARVING A MOUNTAIN TO TELL NATION'S STORY

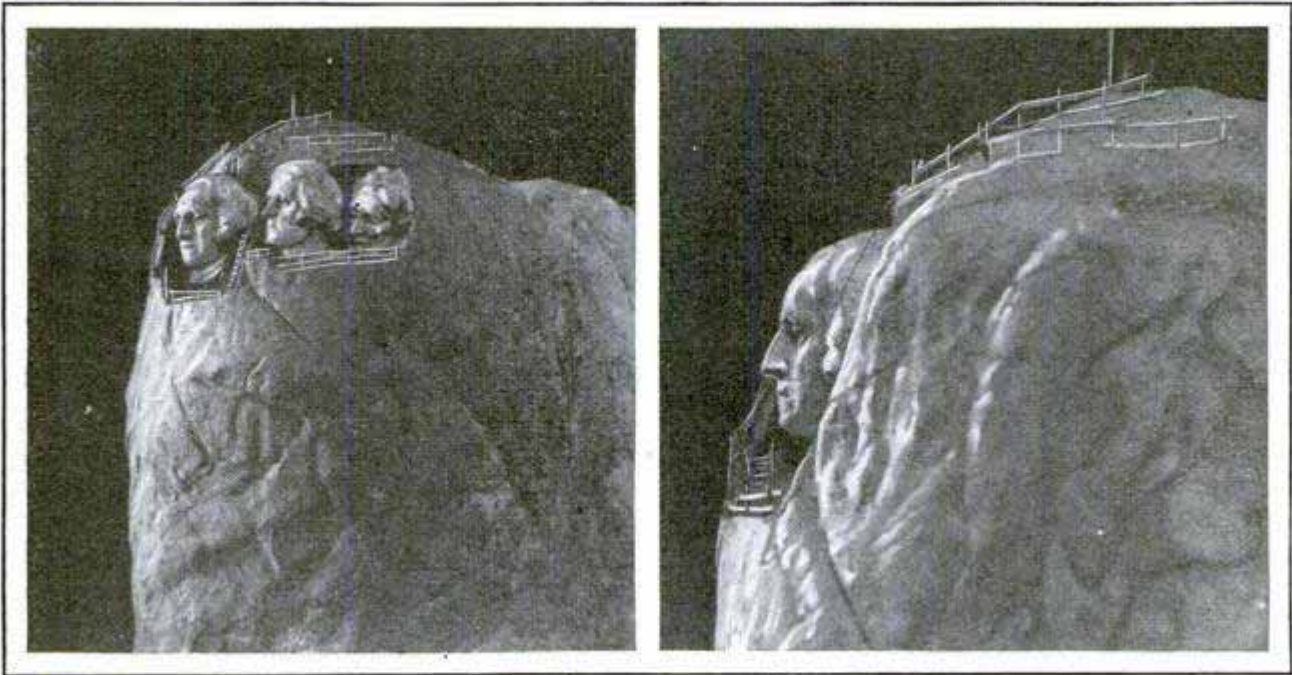

© Gutzon Borglum

Models Illustrating How Faces of Washington, Jefferson and Lincoln Will Look When Carved on Natural Stone Monument; a Huge Tablet Will Be Inscribed on the Other Side of the Mountain

On Mt. Rushmore, in the Black Hills of South Dakota, Gutzon Borglum, the sculptor, is preparing to tell, in gigantic symbols, the story of the development of a nation. One side of the natural monument will bear the figures of Washington, "the creator," Jefferson, "the expansionist," Lincoln, "the preserver," and Roosevelt, who, in the words of Mr. Borglum, "in completing the passage to India by building the Panama canal, fulfilled the prophecy of Columbus." On the west side, in letters fourteen feet high, will be carved a huge tablet bearing the great dates in the history of the United States and simple statements of the significance of each. The figures of the men will be 200 feet high. The sculptor chose the theme for this work from the Louisiana Purchase, which led to the expansion of the nation, and traced its history back to the copper plates buried

by the agents of the French king in taking possession of land, near Pierre, S. Dak., in 1742.

MONTHLY MAGAZINE FOR BLIND ¹²⁷⁶ HAS SIXTY PAGES

As a result of special presses and other apparatus developed by a blind man, persons who suffer a similar affliction are able to enjoy a monthly magazine. Its first appearance was so successful that it has now been increased to sixty pages and has national circulation. For the first time in their lives, many blind subscribers have been able to read advertisements and other matter common to the usual publication. Heretofore, most of their reading matter has been limited to books, and in some localities few of these have been obtainable. The magazine is printed in raised characters

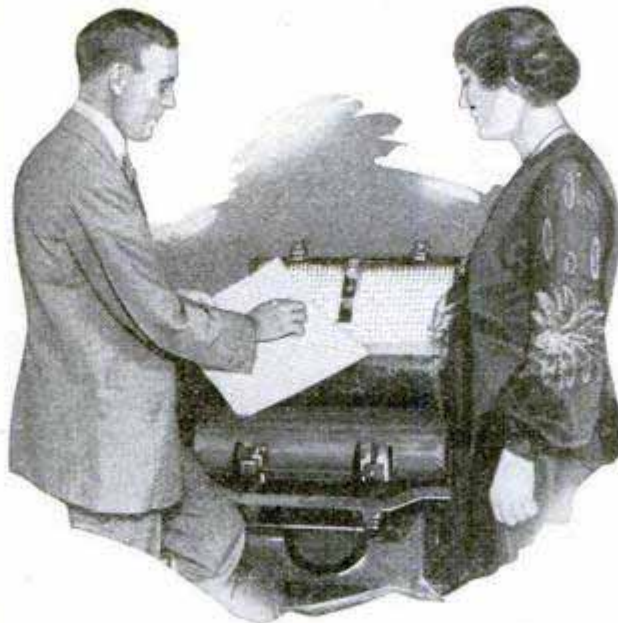

One of the Presses That Prints the Magazine for the Blind, and a Sample Page

The Braille Mirror
Published by J. Robert
St. Louis, Mo.

BEAUTY MASK PROTECTS GIRLS IN BASKETBALL GAME

1203

Members of a New York girls' basketball team have found various types of



International

Taking No Chances of Spoiling Her Looks; Girl Basketball Player with Face Mask

masks effective in protecting their faces and hair during strenuous games. The equipment includes boxing headgear and football helmets, but a modification of a divers' headpiece has proved especially popular. It shields the entire face and has openings for the eyes and the mouth.

HOUSE FRAME HEAVILY BRACED TO RESIST HURRICANES

1112

Last year's storms in the south taught the builders valuable lessons and have led to the adoption of new styles of construction. One, illustrated here, developed by the southern pine association, is notable

New Orleans, La.

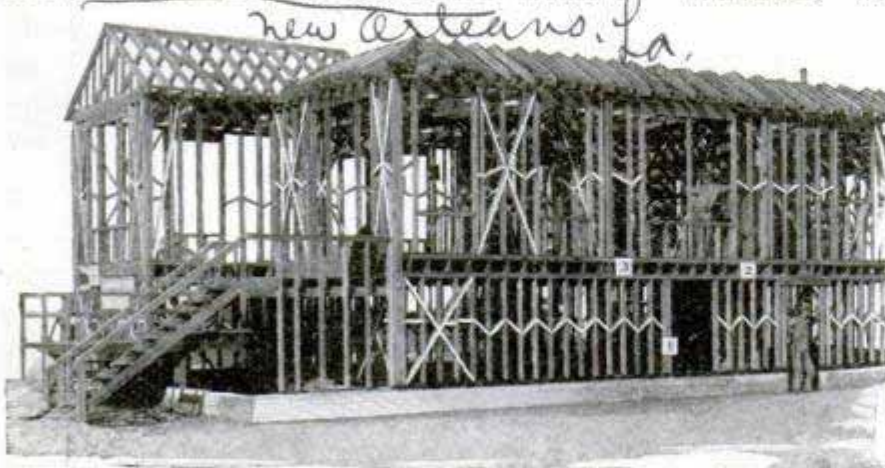

Specially Braced Framework Intended to Reduce Damage in Case of Severe Winds; an Outcome of Recent Hurricanes

for the fifteen points of bracing that it provides to insure greater rigidity and strength. The cost is said to be but six per cent more for lumber and five per cent more for labor over the usual methods, for the framework only. The type shown here is suitable either for wooden, stucco or brick-veneer finish.

MANY LIVES SAVED BY RADIO IN STORMY YEAR AT SEA

247

Losses at sea would have been far greater than they were during 1926, had it not been for the radio, mariners declare. The year was marked by unusual severity in storms. Incomplete figures show that more than 400 craft were lost in the Florida hurricane and nearly 100 in Havana harbor in the Cuban blow. For the first three months, Lloyds register showed 124 vessels lost as compared with 105 for the first three months of 1925. Last October, the British sloop "Valerian" turned turtle, but the cruiser "Capetown," summoned by the SOS of the radio operator, who went down with the sloop, arrived in time to save nineteen of the 103 persons who were on the ill-fated ship. Wireless played an as important, although not so spectacular, part as human beings in the rescue of the men from the "Antinoe" by the crew and officers of the "President Roosevelt." During the general strike in England, more than 1,000 vessels were allowed to sail without radio operators, although the policy was challenged by the house of commons. A few ships must rely on themselves, as before the days of the wireless. The "Manchester Producer," with a cargo of cattle, had no radio equipment. The steering gear broke during a January storm and for weeks the vessel was adrift. The cattle had to be thrown overboard. The ship was finally found, after a month, by a Dutch tug and towed to the Azores. The tragedy probably would have been prevented, had the "Manchester Producer" been fitted with radio equipment.

Chicago Evening Post

12/13/26

Rooms in the Tiny Doll's Palace Showing the Detailed Furnishings and Decorations; Every Piece Has Been Built on a Scale of an Inch to the Foot

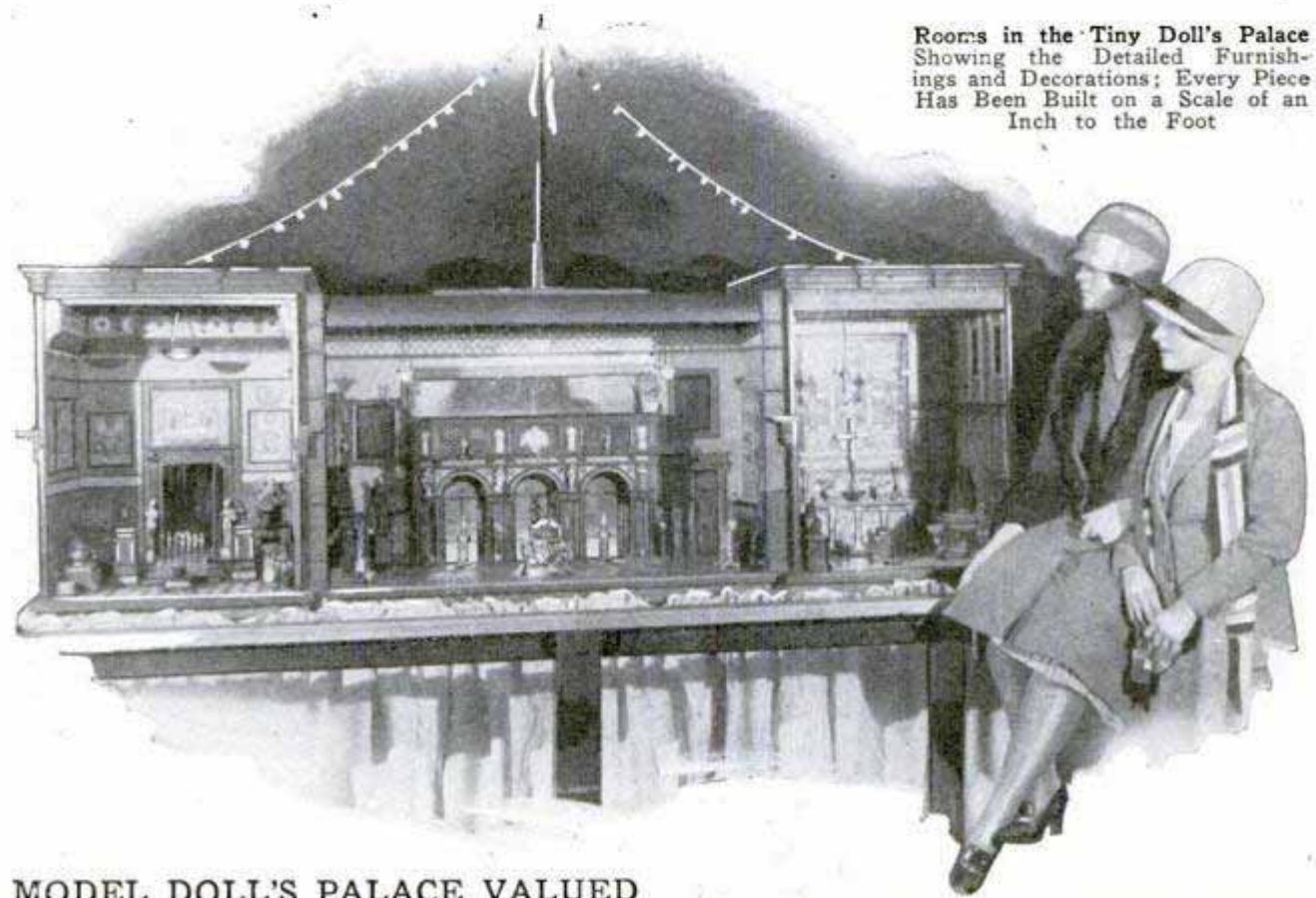

MODEL DOLL'S PALACE VALUED AT HUNDRED THOUSAND

Fashioned on a scale of one inch to the foot, an elaborate model palace exhibited in New York is valued at more than \$100,000. It covers an area of sixty-three square feet and is twenty-seven inches high. Details, such as the furniture, etc., are carefully reproduced.

MEN OF TODAY ARE BIGGER THAN KNIGHTS OF OLD 1224

Stories of conquests by the brave knights of old often leave the impression that all of these men must have been of giant physique. That this is not the fact is shown by a collection of armor recently sold by the Chicago historical society. Of several suits of steel, none was big enough for the average-sized twentieth-century man. One was so small that it was barely large enough

for a woman, and the odd helmets, gauntlets and other accouterments were of correspondingly small size.

SHORT-CIRCUIT TESTS ON WIRE SHOW CABLE STRENGTH 1222

High-tension electric wires were purposely short-circuited during recent tests in Chicago to determine what type of cable is best suited to withstand such emergencies without danger of communicating the rupture to other cables in the same line. The experiments were made in connection with the establishment of a 132,000-volt electric-power ring about the city, part of which will be run underground. Lines carrying 12,000 volts were chosen for the demonstrations, and the results indicated that the type of conduit now used is not broken by short-circuiting, the only serious damage being the burning away of the cable.

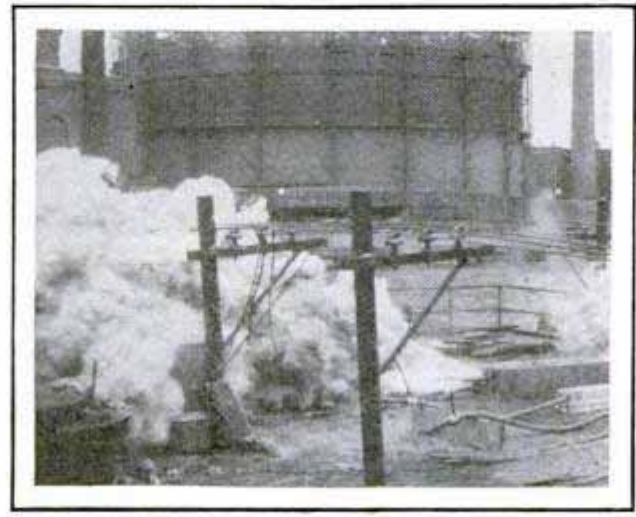

Smoke from Short-Circuited High-Voltage Wires

Minneapolis Tribune
 Cont. P.A. Jenkins
 Suite 1100 72711 Adams St.

21 Welbur Ave.
Long Island City, N.Y.

12



Church Front Whose Creator Escaped a Death Sentence by Making the Work Last a Life Time

ARTIST EVADES DEATH DECREE BY CARVING CHURCH

The Cathedral of Zacatecas, Mexico, has one of the most elaborately carved church facades in the country, but the work of carving was never finished. The stone carver who started the work, later committed a crime and was sentenced to death, but given a reprieve to complete the job, after which the sentence was to be carried out. Knowing that his life was safe so long as the church task lasted, the carver worked out such an elaborate design that it could not be finished in one man's life time, so he finally died of old age, and the church was never completed.

FLYING TORPEDO HAS RANGE OF ONE HUNDRED MILES

Designed to hit targets 100 miles away, an aerial torpedo was ready for use by the United States just before the close of the war, it has been revealed. Details of the mechanism are being kept secret, but it is now known that plans were in readi-

ness to put out 10,000 of the flying guns, and experts declare that they would have been extremely effective against armies and fortifications far out of range of any other kind of ordnance.

THERMOSTAT FOR SPARK PLUG AIDS IN STARTING AUTO

Regulation of the spark gap is achieved in a plug recently introduced by means of a thermostat control which makes it easier to start the car. It is set to give an opening of .015 inch when cold and .030 inch when hot, the smaller gap facilitating a start after the motor has cooled, and the full opening providing the proper condition for normal operation. The change is produced by a piece of metal that expands and contracts.

FUEL-SAVING AIR PROPELLER TESTED FOR OCEAN TRIP

Wings ninety feet long, four air-cooled motors of 225 horsepower each, and a special type of propeller with many blades, are proposed features of the new airplane that is being planned for a non-stop flight from New York to Paris. One of the advantages of the propeller is that it requires less fuel, according to reports. The ship will be designed to prevent a repetition of the disaster that overtook the

Examining the Many-Bladed Propeller Proposed for the Airplane to Make Another Transatlantic Flight

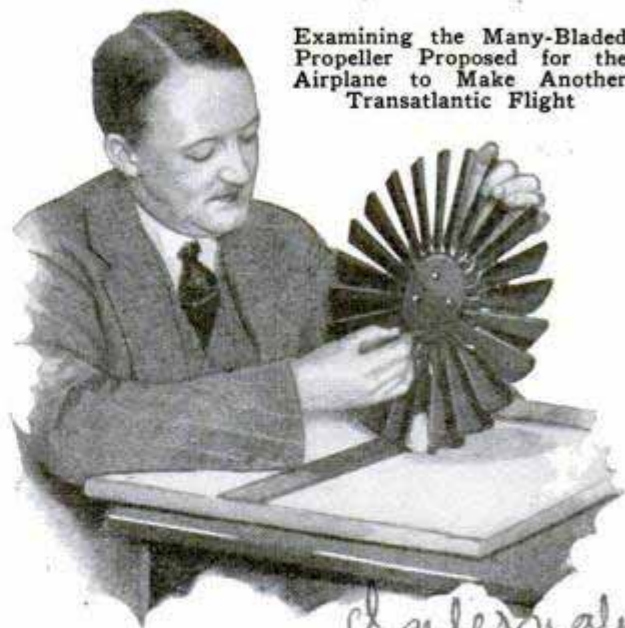

International

Fonck-Sikorsky plane when it crashed to the ground and was burned as it was starting for France last year.

Told by William L. Saunders Chairman U.S. Naval Consulting Board.

Dr. Ermer Ambrose Sperry.

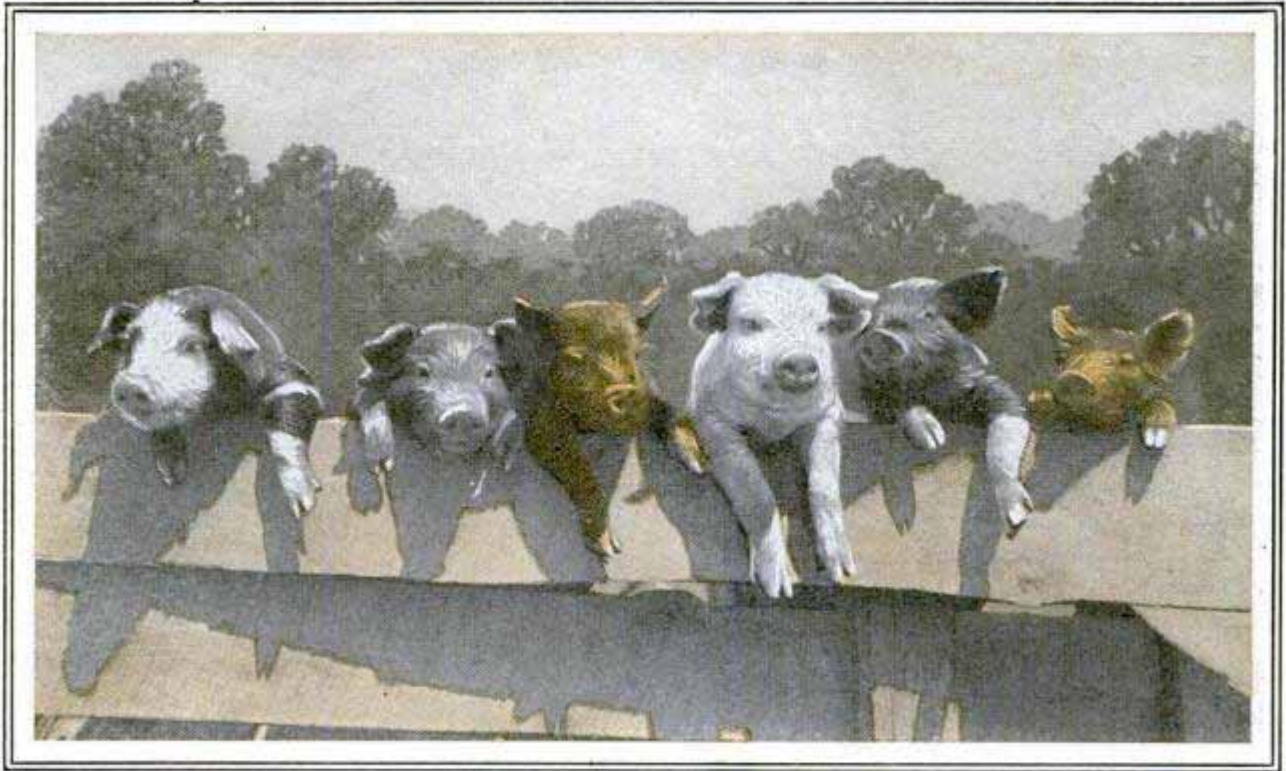

Young Prize Porkers of the Government Experimental Farm Line Up along the Fence to Pose for the Camera at Beltsville, Where Uncle Sam Studies Farming Problems Scientifically

How Uncle Sam Runs World's Finest Farm

How Tough a Steak Is and Other Puzzling Problems of Animal Industry Solved at Agricultural Proving Grounds

HOW tough is a steak? Most everybody has applied the tooth test and has his own scale of judging, but as teeth and jawbone power differ, no two might agree. So Uncle Sam has set out to standardize the study of meat on delicate recording machines.

That is just one of the thousand and one farm problems that are being solved at the Beltsville farm, near Washington, claimed to be the world's finest. The navy runs a proving ground where it tries out new cannon, and Beltsville is the proving ground of the American live stock and allied industries.

If farmers could always market their beef cattle when the meat is at its best, the higher prices would mean millions in additional revenue. So the government is seeking to determine what makes the best meat and when it is at its prime. If every sheep had just a bit more and bit thicker wool, the crop would put millions more in sheep raisers' pockets. Therefore Uncle Sam at Beltsville is investigating wool. If all pigs, by proper feeding, could be

shaped up with firm flesh before marketing, the large quantities of soft or oily pork which burden the market would be eliminated, and the hog rancher would have a surer income. The department of agriculture farmers are working on that, too. There are scores and hundreds of these farm problems, the solution of each of which means a very important farm relief, for it puts money directly into the farmer's pocket through his own effort. But aside from the specific problems, the government farm is investigating many more to establish important theories in animal raising. For example, 40,000 guinea pigs, the progeny, through twenty-six generations, of the original family at Beltsville, have been studied, and the greatest collection of genetic records ever gathered prepared to fix the basic laws of inherited traits and characteristics. The findings are important not only because of the financial value to stock raisers, but they may even throw light on the inheritance traits of human beings.

The proving farm has found how to

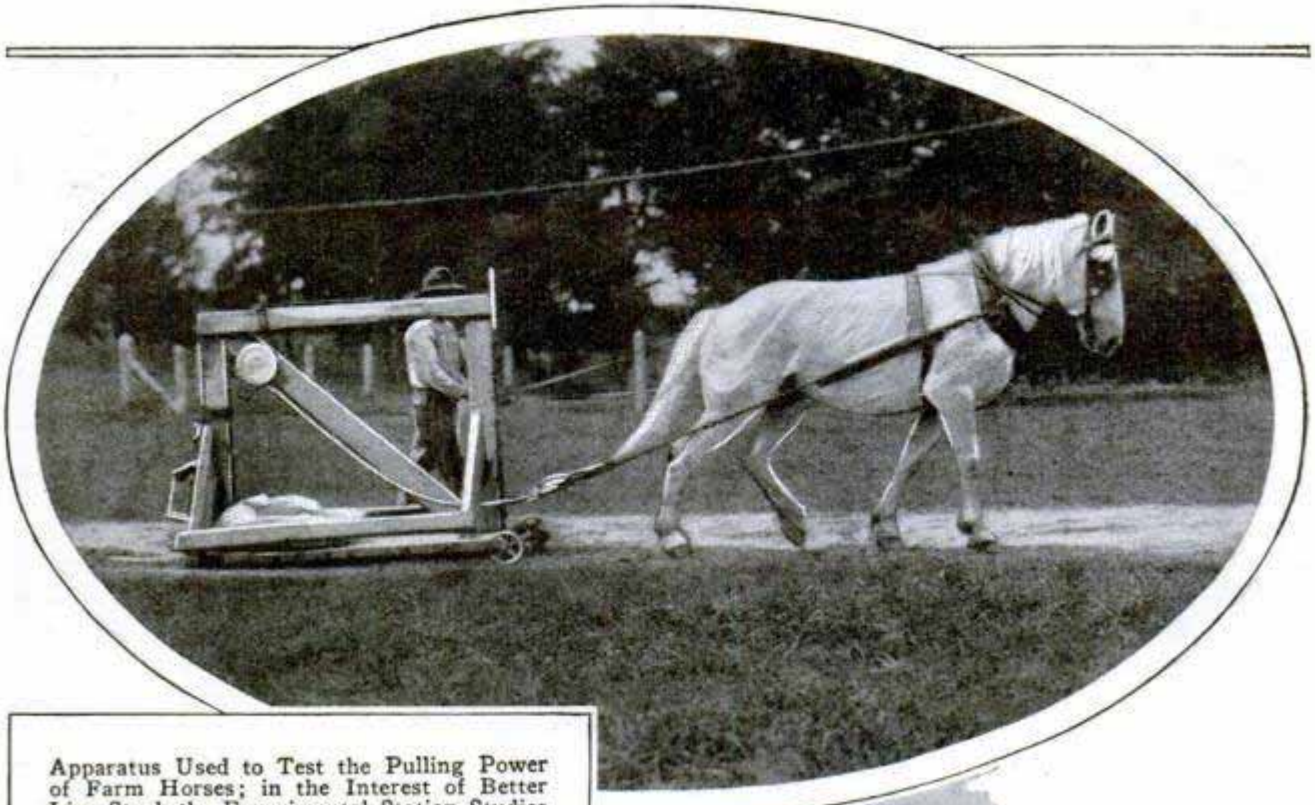

Apparatus Used to Test the Pulling Power of Farm Horses; in the Interest of Better Live Stock the Experimental Station Studies the Value of Various Sizes and Breeds of Animals in Order to Formulate Standard Specifications for the Best Horse for Each Farm Purpose; the Government Has Developed the Morgan Breed, Also, for Cavalry Mounts and Artillery Horses, and Is Now Experimenting with Crossbreeding of Other Strains

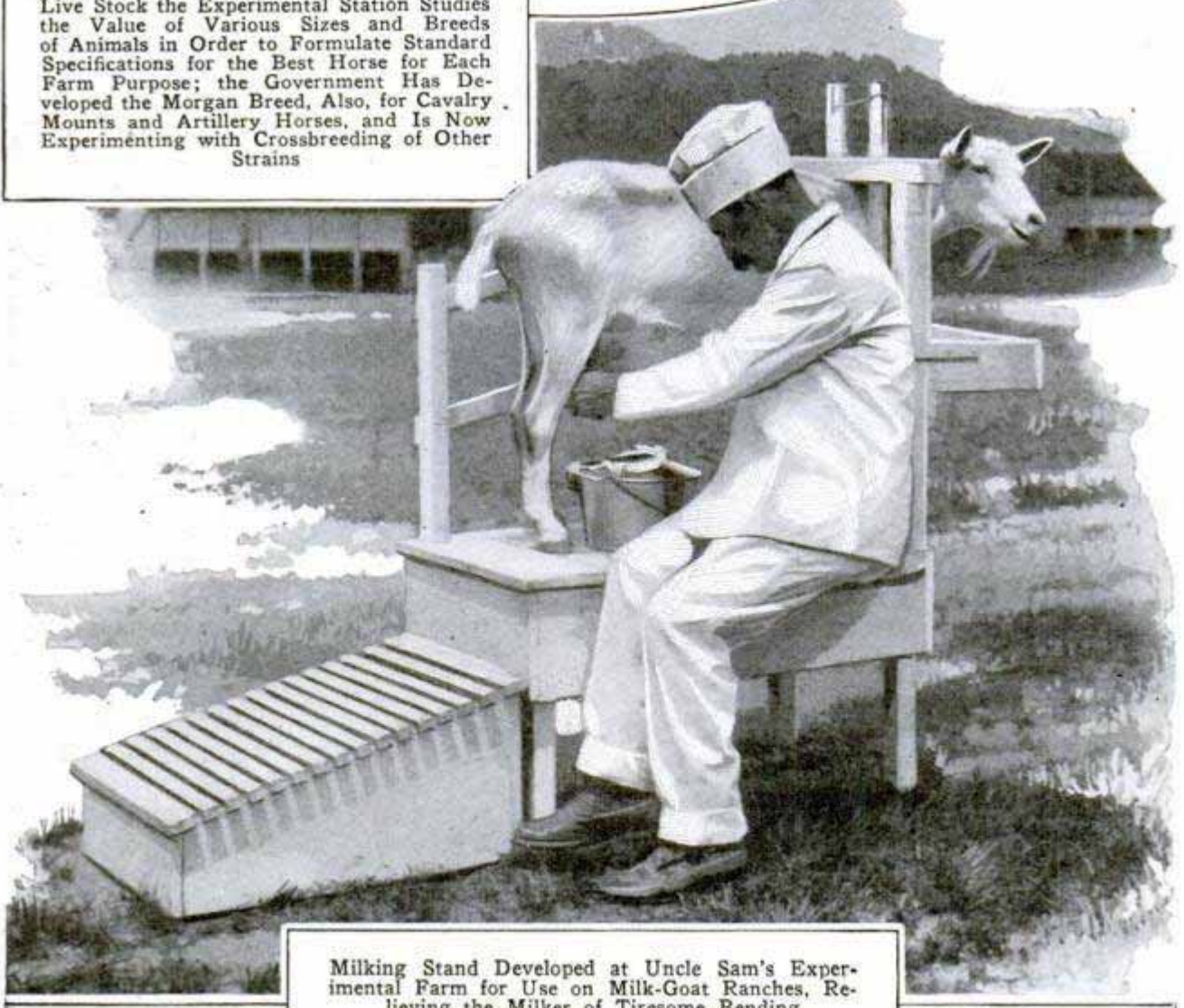

Milking Stand Developed at Uncle Sam's Experimental Farm for Use on Milk-Goat Ranches, Relieving the Milker of Tiresome Bending

add a fraction of an inch to the average wool growth of a sheep. That means more money for the farmer, and probably cheaper clothing, too. The machines that test the strength of meat fibers in the effort to eliminate inferior, tough and stringy products from the market will pay dividends to the rancher, and they likewise hold promise of cheaper food for the consumer.

If all the pests and parasites that infest live stock can be eliminated, as many already have been, both farmer and consumer again will profit. And so it goes through all the list of experimental work. Folklore and scientific fact are being tested out side by side. Just recently, the department, after exhaustive experiments, announced that the common belief that planting should be done during certain phases of the moon had no foundation in fact, thus exploding another fallacy that has been observed by millions of small farmers. A long time ago the same investigators took up the problem of the danger to swine from glass bottles in the refuse fed to them, for it was an ancient belief that powdered glass caused death. They tested the belief by feeding glass to all kinds of animals, and found it didn't harm them.

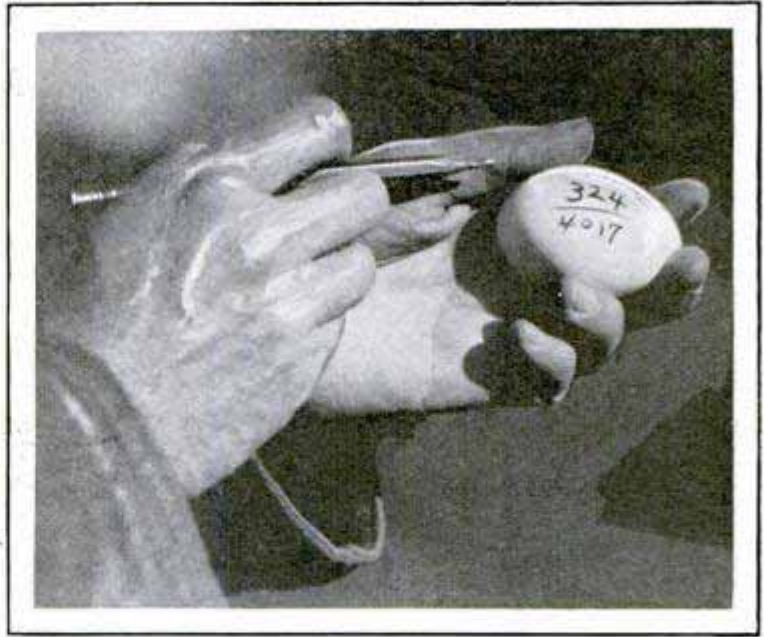

All Eggs Laid by Hens in the Beltsville Flocks Are Marked for Identification So That the Parentage of Every Chick Is Known

Another field of work is the developing of new types of animals through crossing of existing strains. Because of the hardihood of the zebra, it was thought a cross between it and the domestic mule might produce a better grade of work animals. Imported zebras were mated with common asses, and the zebroids raised and broken, but, while they were strong and good workers, they inherited the bad tempers of both sides, and so had to be abandoned as draft animals.

Developing milk goats to provide a new food product, useful also in the cure

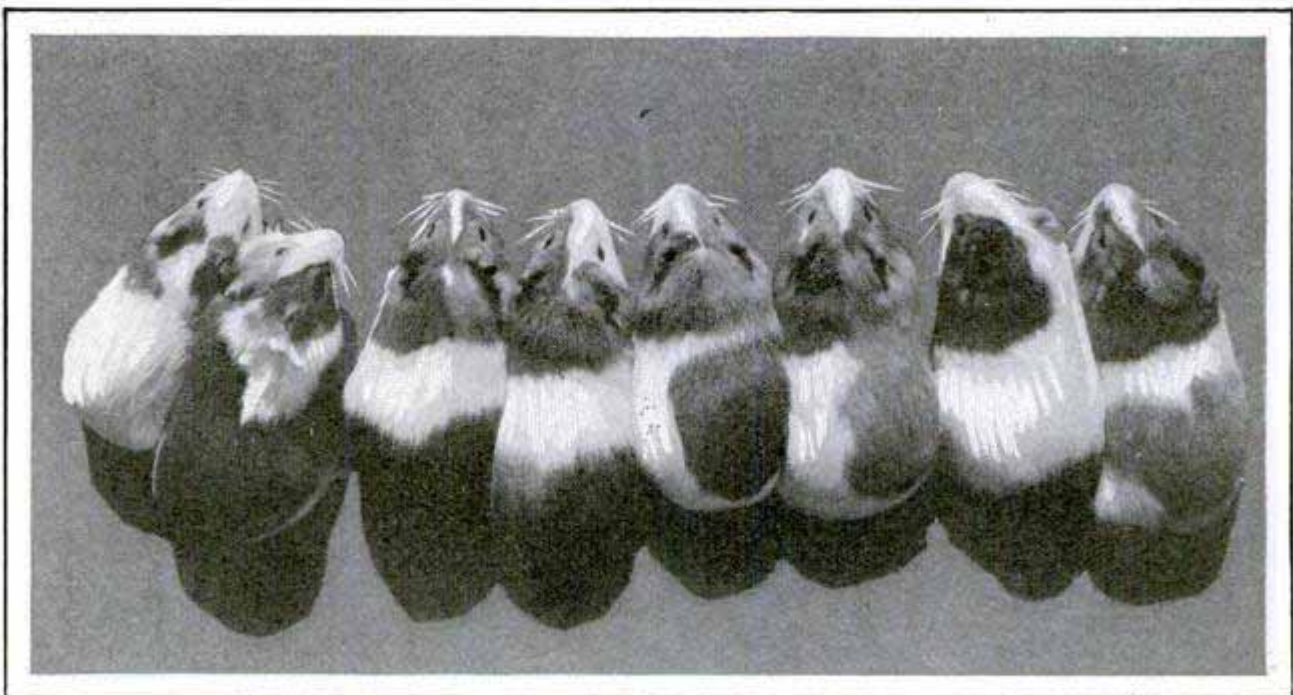

The Most Detailed Genetic Records Ever Assembled Have Resulted from the Study of 40,000 Guinea Pigs, Covering Twenty-Six Generations of the Original Family

of some diseases, the department has improved the breed of goats to the point where two 110-pound animals will yield as much milk a year as a 1,100-pound cow.

Beltsville boasts a model abattoir suitable for a small city. In this modern plant, swine, sheep and cattle, fed at the co-operating state experiment stations or at Beltsville, are slaughtered and studied. Valuable information has been gained which has revolutionized certain practices of the packing industry.

In the poultry establishment, more than 7,500 chickens of four popular breeds are raised annually. By careful selection and proper crossing, pullets and hens have been produced which now lay from 250 to 300 eggs a piece in one production season. The breeding and feeding tests have added millions of dollars to the profits of the American poultry industry. Methods of controlling pests and parasites have been perfected, new and satisfactory systems of feeding have been developed and all the important riddles of egg farming have been solved as they have arisen.

Uncle Sam has proved that he can grow out-of-season chickens as well in confine-

ment under artificial conditions as on the range. Translated into terms of the restaurant menu, this means that you can enjoy the finest broilers in the dead of winter even though their production formerly was restricted to the period of the poultry-pasturing season. Codliver oil, yellow corn, sunlight, green feed and certain minerals hasten growth and make tender meat.

By trap-nesting the flocks and breeding only from the best pullets, the government flocks are increasing marvelously in egg-producing ability. Gains of as much as 60 to 75 eggs in a single generation have been recorded by painstaking selection and mating. Uncle Sam trap-nested 1,200 pullets and 500 yearling hens during last fall and winter, which is typical of the extensive scale upon which this work is conducted.

The completely equipped model dairy farm specializes in four leading breeds, produces milk for research and experimentation and delves into cow-farming perplexities which would never, otherwise, be attempted. A twenty-five-year breeding experiment is a topline. It is a comparative test of the merits of line breeding as contrasted with outbreeding.



Even a Model Abattoir Is Operated on the Experimental Farm, and Experts from Various Organizations Judge the Carcasses for a Final Check on the Meat Animals Grown

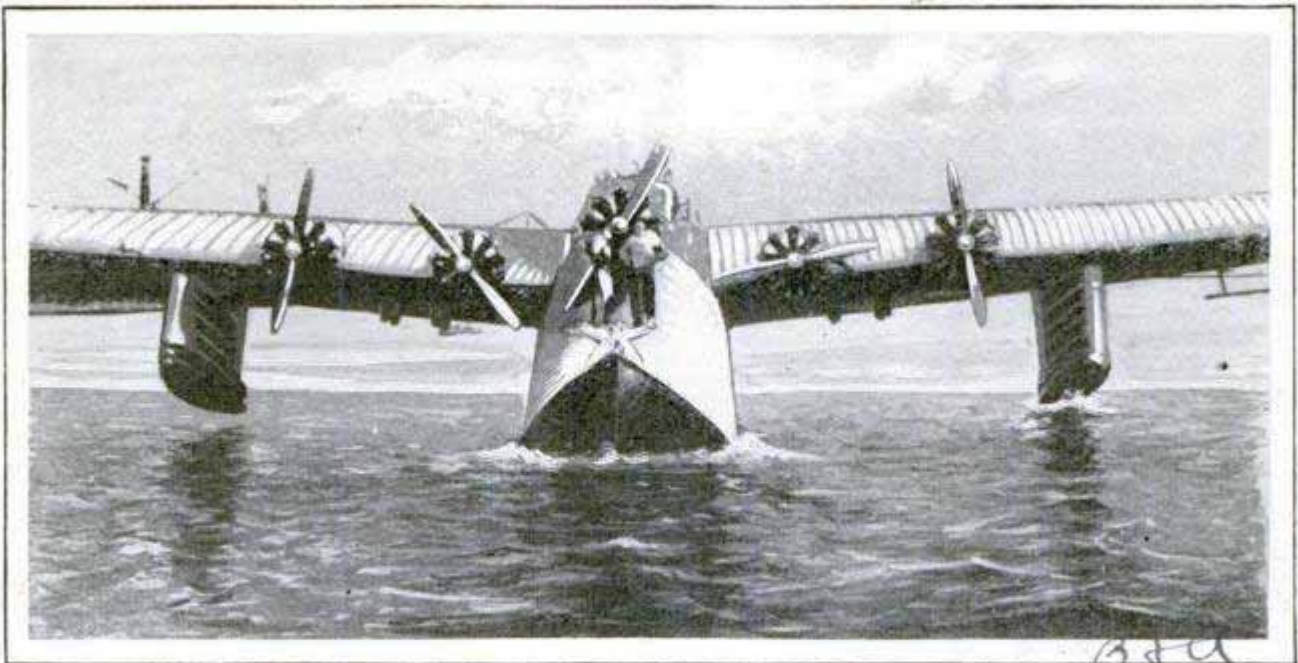

One of the Latest Units for Travel in the Skies, the Five-Engine French Flying Boat Which Can Carry Twenty Tons of Bombs; Note Men in Front of Central Motor

FRANCE BUILDS GIANT PLANE WITH FIVE MOTORS

Claimed to be the biggest hydroairplane in the world, a new ship, constructed in secret by the French government, is powered with five big air-cooled motors, and is capable of carrying twenty tons of bombs in addition to its crew and equipment. Some idea of the size of the ship, which is a monoplane built on the thick-wing principle adapted for all-metal aircraft, is gained by comparison with the size of the two aviators standing in front of the central engine and propeller.

ously, the loss was 6.6 tons, a corn plot was reduced by 17.8 tons, while a rotation of corn, wheat and clover lost only 2.3 tons to the acre, showing that an alternating system of planting not only prevents too rapid depletion of the soil in richness but reduces its erosion.

AUTO CAP WITH SLITTED VISOR PROMOTES MOTOR SAFETY

German automobile drivers are wearing a special cap with a long visor that has slits in it to permit seeing through and yet shields the eyes from the glare of ap-

HOW CROPS PREVENT EROSION SHOWN BY TESTS

Interesting demonstrations, illustrating how crops prevent the soil from wearing away, have been conducted at the Missouri experiment station. The test field was a small plot with a slope equivalent to 3.68 inches to each 100 feet. Under average rainfall of 35.87 inches, it was shown, by collecting the run-off in tanks and weighing the sediment that ran off, a cultivated field without a crop would wear away at the rate of forty-one tons to the acre each year. That meant that it would take but twenty-four years to remove seven inches of surface soil over the entire acre. Sod land lost but .28 ton of dirt per acre each year. Where wheat was grown contin-



Copyright, Henry Miller
Wide-Visored Motorist's Cap with Slits Which Prevents Glare from Reaching the Eyes

proaching lights. It also protects the face from wind, is comfortable and, in the daytime, is a shade from the sun.

*from Chicago Bulletin
#63, at Columbia, Mo*

cannot locate maker

12/17/26

1168. *W. H. O'Leary, Kans*

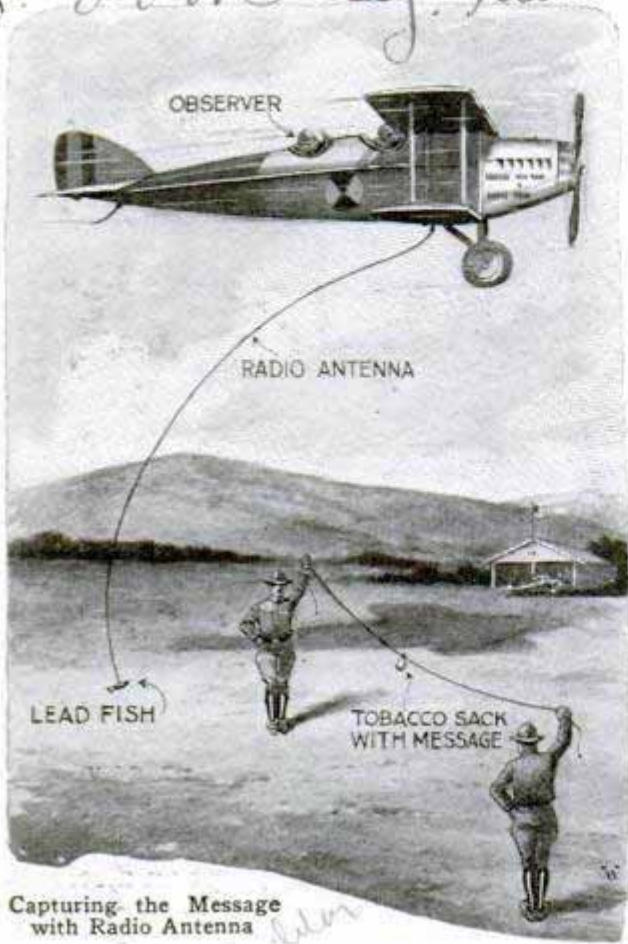

Capturing the Message with Radio Antenna

AIRPLANE PICKS UP MESSAGE WITH LEAD "FISH"

1167

When the two-way radio apparatus failed, observers on the ground were perplexed as to how they could give instructions to occupants of an airplane during recent army maneuvers. The problem was solved by tying the dispatch in a tobacco sack weighted with small stones and attaching that to a string about twenty feet long, which was held taut by two men. The pilot, informed by the panel signal to stand by for instructions, descended close enough to see what was going on, then returned presently with the radio antenna unreeled. As he approached the men holding the string, he throttled the engine, allowing the lead "fish" at the end of the aerial to hang more nearly vertical. It caught the cord and the message was hauled

into the cockpit. This method is now in general use for communication in the air corps when the radio sets do not work and when the panel signals will not give sufficient data.

STOVEPIPE MADE INTO ARMOR TO SUPPLY COLLECTORS

1335

Collectors of medieval armor have so depleted the genuine supplies that clever forgeries of stovepipe and sheet iron are appearing on the market, according to reports. The Metropolitan Museum of Art has announced protection against such frauds in the form of a two-reel motion picture which is to be shown twice a day, illustrating what constitutes a genuine "tin suit." The layman is surprised to learn that a coat of chain mail weighed only about thirty pounds and that a complete suit of armor worn by a knight, weighed less than the pack carried by an American doughboy during the World War. Some of the suits of chain mail contained a quarter of a million links. Rust and other traces of old age are applied to the fake suits with acids and it is reported that some unscrupulous dealers exhibit the bogus suits in old castles to help deceive the gullible purchaser. The armor-making capitals of the world were Milan, Italy, and Augsburg, Germany.

EXTRA REAR WHEELS FOR AUTO AID WINTER TRAVEL

1261

To help push the auto through mud and snow, an extra pair of rear wheels that can be attached as quickly as a tire is changed, has been devised. They are chain-driven, sprockets connecting the extra and the original pair of wheels, and for travel through deeper snow, a pair of runners is slipped under the front wheels. Tests through drifts and mud have proved the complete success of the arrangement, according to reports.

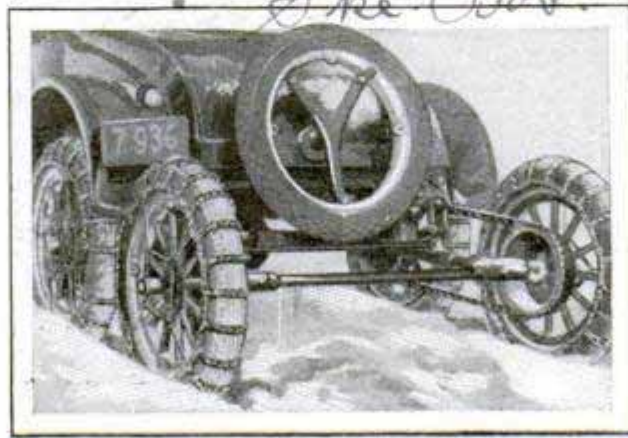

Extra Rear Wheels Attached to Auto for More Traction in Snow and Mud

The Auto Attachment

1128

at 20 million of ...
american skyscrapers at
International Art Center

CITY OF THE FUTURE TO BE A FOREST OF TOWERS

310 Riverside Drive New York

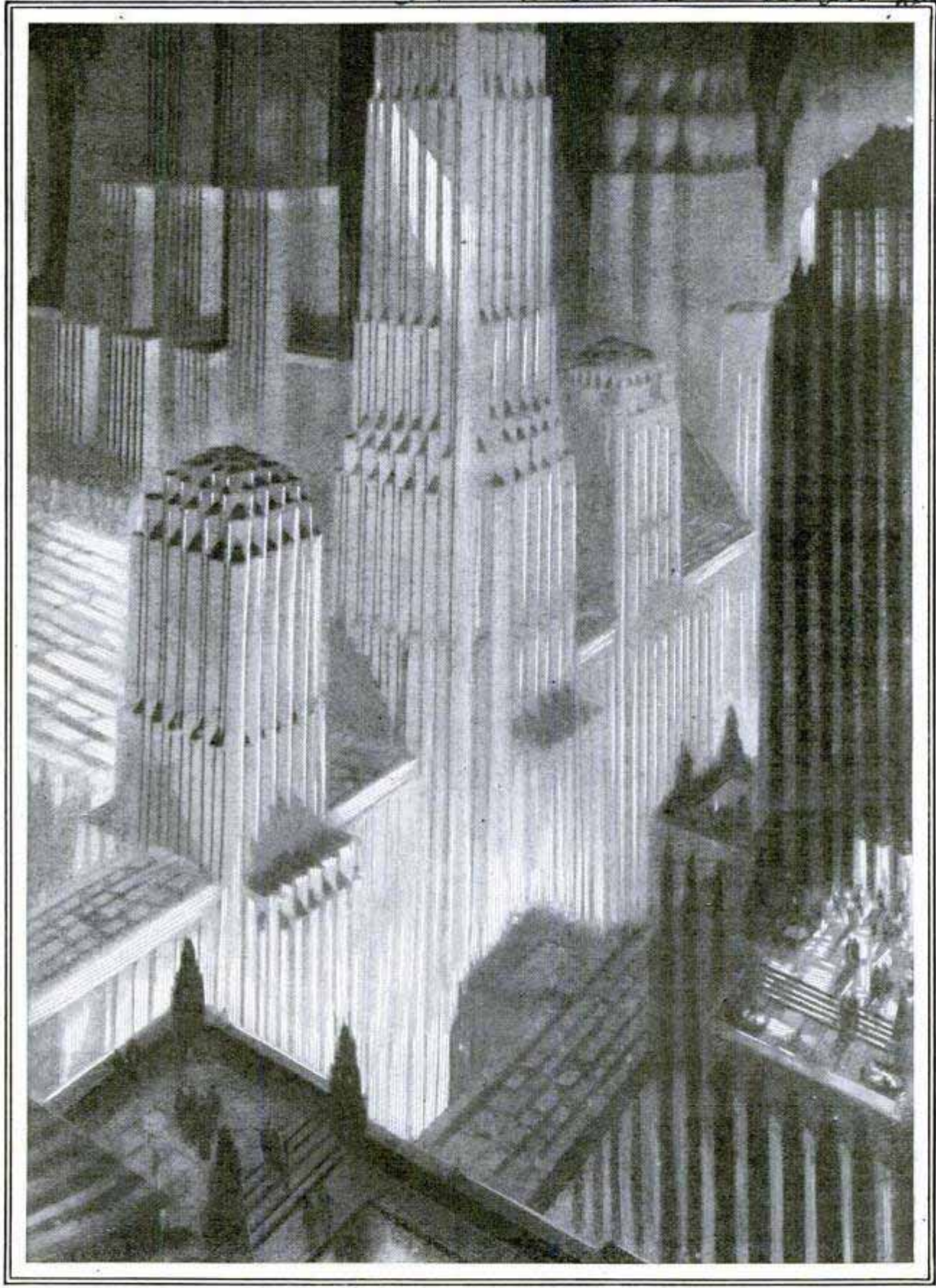

An Architect's Vision of the City of Tomorrow; Sketch of Future Skyscraper Center by Hugh Ferriss; "Corrugated Towers" with Tapering Tips Increase Effect of Height

Hugh Ferriss, New York City.

1919



Atlantic City's New Convention Auditorium, Which Will Seat Forty Thousand People and Be Big Enough for Indoor Football Games and Similar Large Sporting Events

CONVENTION HALL WILL SEAT FORTY THOUSAND

Atlantic City is building a convention hall to seat 40,000 people, expecting to have it completed in time for the summer conventions this year. The enormous auditorium will be 350 feet wide and 650 feet deep, big enough not only for conventions, but also for indoor football games, circuses and athletic events of all descriptions. Thirty thousand visitors will be seated on the main floor and stage and another 10,000 in the balcony. Radio amplifiers will be installed so that everyone can hear the words of a speaker. The stage will have a width of 100 feet and a depth of fifty, while the wings will be 180 feet wide on either side, sufficient to handle enormous pieces of scenery. In addition, there are to be fine dressing rooms and scenic and lighting equipment. The front section of the building is to contain space for art exhibits, and a small hall with a seating capacity of 3,000. Above it, other rooms will provide

space for permanent exhibits of various sorts. The building will front on the boardwalk. Parking space in the basement for 1,100 automobiles and two restaurants with room for 1,000 diners will be other features.

PAINTED PART OUTLASTS WOOD OF ANCIENT SIGN

How paint keeps wood from weathering was graphically illustrated by an old "no hunting" sign. The letters, originally painted in red on a smooth surface, after a period of exposure, stood out in relief because the bare wood had gradually worn away. This was not brought about by rot organisms but by the repeated swelling and shrinking from changes in temperature and alternate rain and sunshine. While paint is not completely proof against moisture or



A Natural Etching on Wood; the Painted Letters Stand Out in Relief against Weathered Background

fungi, it affords an excellent protection against weathering, since it retards the absorption of dampness sufficiently to lengthen the life of the wood itself.

More Products Laboratory

1777 St. Paul St.

1159

Baltimore, Md

RICH DEPOSIT OF POTASH FOUND IN SOUTHERN OIL FIELDS

1251

Vast deposits of potash, sufficient to care for the world's needs for 1,000 years, according to estimates by United States geologists, have been discovered in the cores taken from oil wells in Texas and New Mexico. The material lies less than 1,000 feet below the surface, and analysis shows that it contains nearly fifteen per cent of potassium salts valued for fertilizer. This is said to be richer than that from the famous mines in Prussia and Alsace, where large quantities of potash have been found at depths ranging from 3,500 to 5,000 feet. With the late processes for taking nitrogen from the air and this wealth of potash close at hand, the United States will be less dependent upon foreign countries for fertilizer supplies.

SCHOOL FOR FASHION MODELS AIDS STYLE DISPLAYS

1153

Before mannequins are fitted to display hats and garments in some of the larger model shops, they must undergo special training. This is given under the eyes of critical observers, while the candidates endeavor to learn the proper walk and carriage by balancing books on their heads as they parade. Other details, such as the movements of hands and arms, are also considered important.



Where Tourists Enjoy Views of a National Park; the Observation Tower at Hot Springs Resort

U. S. HAS AN "EIFFEL" TOWER FOR PARK VISITORS

Popularity of the Hot Springs national park in central Arkansas has increased, from the tourists' point of view, because of the observation tower the government has erected on the top of a mountain. Although it is but 165 feet high and, with the summit below it, gives an elevation but two-thirds as high as that of the famous Eiffel tower in Paris, it affords an excellent view of the surrounding country. An elevator carries visitors who do not wish to climb the stairs, and the structure is strongly built of steel and concrete. Last year, the park counted 265,000 tourists, a number comparing favorably with the 220,000 American travelers who were registered in Paris.



© P. & A. Candidate Models Learning to Walk and Pose While Balancing Books on Heads; a Fashion-School Stunt

Mannequin Training Salons, London, England

1059

Mr. Alhai Vincent Wilson
Takoma Park
Washington DC

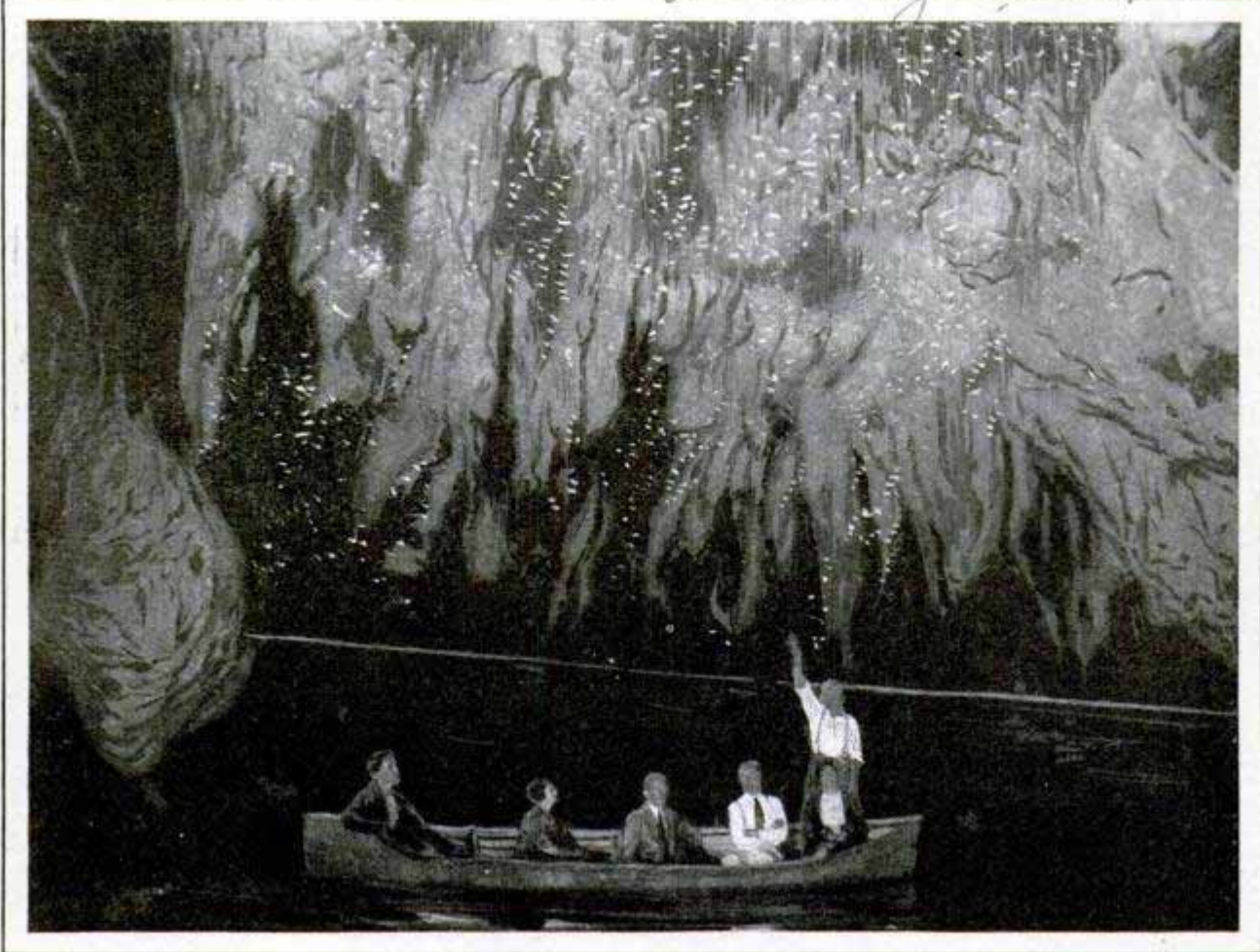

Stalactite Hall in New Zealand Cavern Which Is Lighted by Myriads of Glowing Worms That Spread Their Webs from the Walls and Light Them to Lure Their Prey into Reach

Exploring Fairylands of the Underworld

CAVES filled with gleaming stalactite columns hanging from vast chambered roofs and lighted by the gleaming torches of myriads of glow worms have been discovered in New Zealand and are being opened for public exploration. The system of limestone caverns, which in appearance and extent rival the famous Mammoth cave group in Kentucky, is unique in that the surface of the ground is equally remarkable, with pits and fountains and other scenery that resembles the Yellowstone park.

Most remarkable of all, though, are the glow worms that illuminate the glistening stalactite halls with a ghostly light. The worm is the only known one of its kind that is an insect eater, and its lighting equipment is used to lure food into its web. The cavern ceilings and walls are covered with millions of the webs, each coated with a sticky substance. In a slender tube in the center of the web lives the

larva of a fly, which lights up its home with a pale glow to attract the midges flying above the underground rivers that thread through the caverns.

The glow worms apparently have a keen sense of hearing and are easily frightened, for if a word is spoken by the visitors or a strange sound is made the myriad lights flick out as abruptly as though an electric switch had turned them off. After silence is restored, there is a pause, and then they come blinking on again.

The cavern group for many years was the homeland of the savage Maoris. It was not until little more than thirty years ago that the caves were discovered by white men. Now the New Zealand government has erected a rest camp at one of the caves, called Waitoma, and constructed an automobile road from the nearest railroad, six miles away. A second of the caves, called Ruakuri by the Maoris, is only a short distance from the Waitoma.

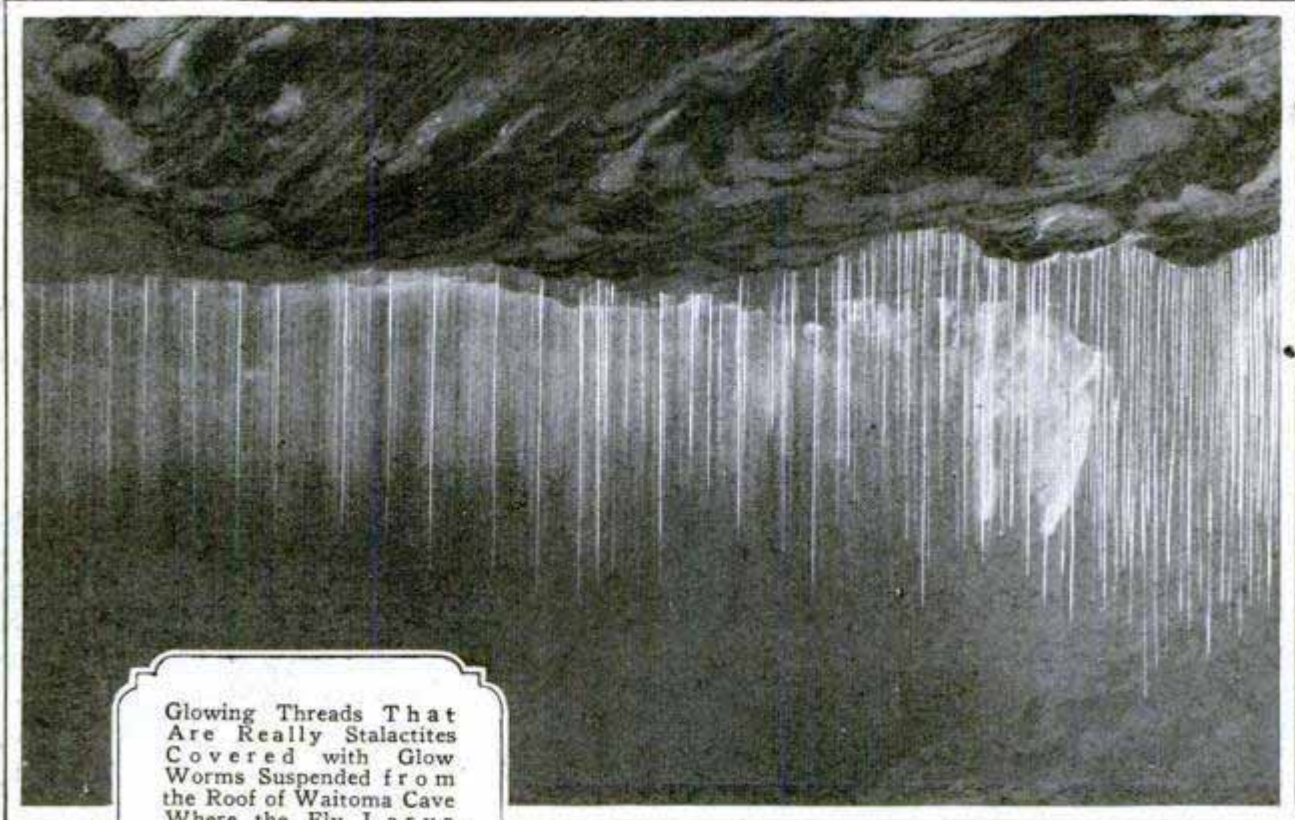

Glowing Threads That Are Really Stalactites Covered with Glow Worms Suspended from the Roof of Waitoma Cave Where the Fly Larva Uses Its Light to Trap Insects for Food. Above, and, Below, an Underground River Flowing through Ruakuri Cavern, the "Cave of the Dogs," Where the Maoris Formerly Hunted the Wild Animals for Their Fur

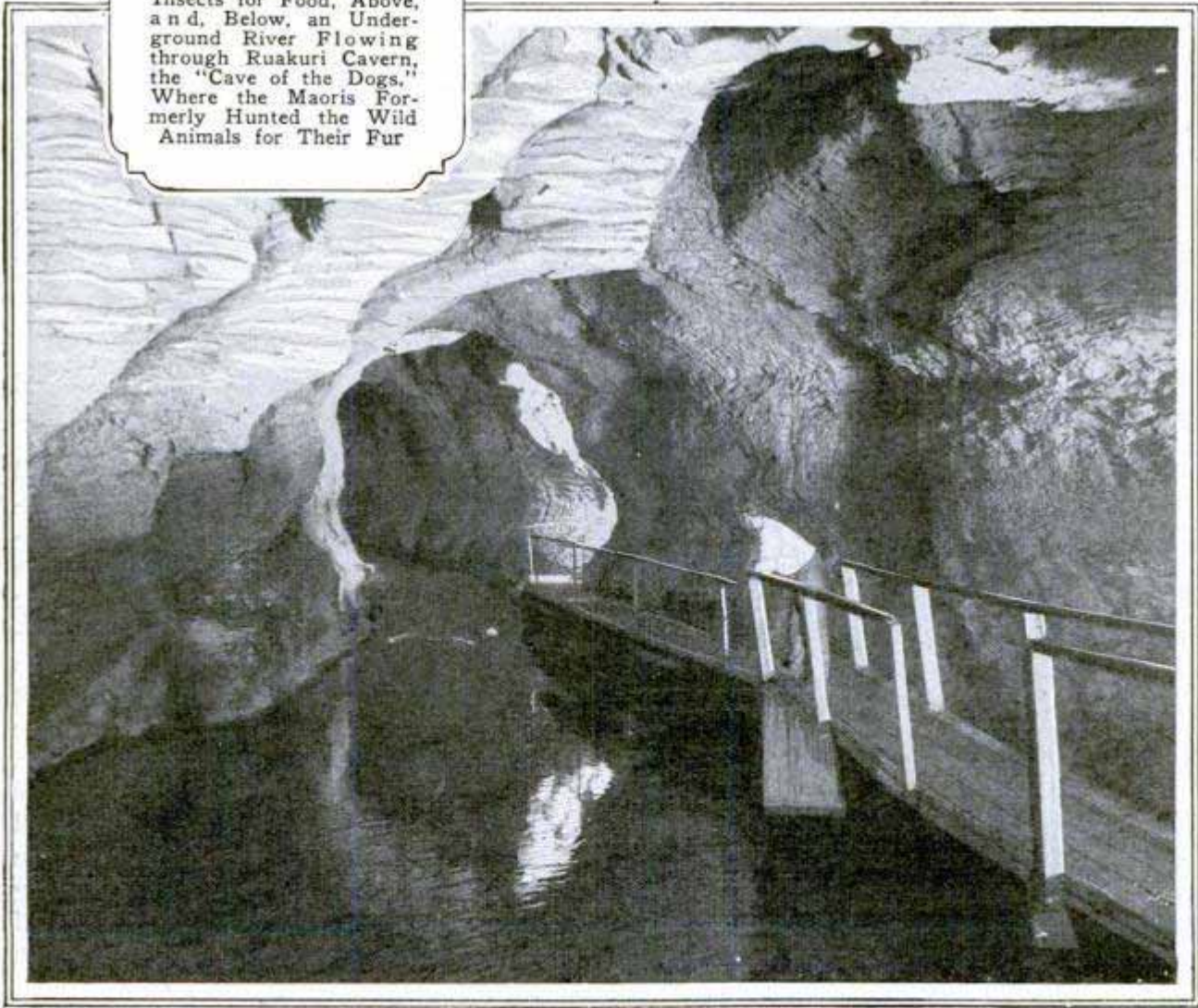

Pat # 1,608,917
Dec 4 1924

American Builder Dec. 1926

1158

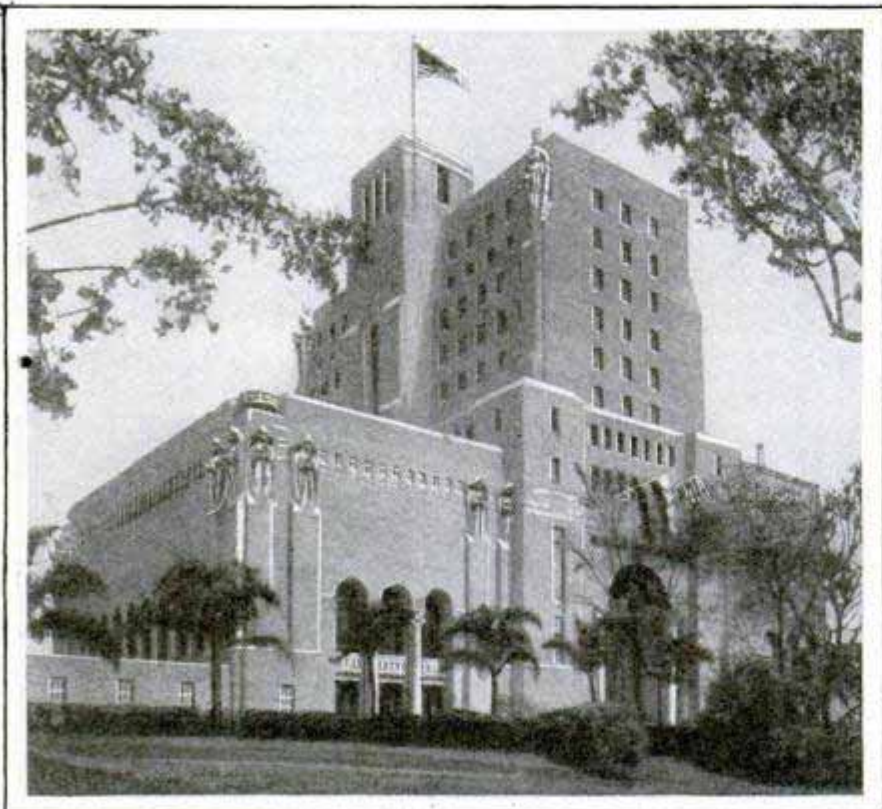

Elks' Club Building in Los Angeles, Showing Combination of Architectural Styles and Use of Figures for Decoration

HANDSOME CLUB BUILDING COST TWO AND A HALF MILLION

Unusual architectural features have been combined in the Elks' new club building in Los Angeles, recently completed at a cost of \$2,500,000. From the central portion, several stories rise in diminishing masses, suggesting the skyscraper, but the two wings of the building are designed along the lines of a monument, with arches and human figures. Gothic, Romanesque and Renaissance styles are applied in it, while the roof of the clubhouse has a patio, following the Spanish traditions of California and permitting a view of the surroundings. A lodge room, 135 feet long and seventy-five feet wide, and a \$50,000 organ are outstanding features.

POOR YEAR FOR RADIO DISTANCE EXPERT DECLARES

121

In the opinion of Dr. J. H. Dellinger, chief of the radio laboratory of the bureau of standards, the year 1927-28 will be the poorest for long-distance wireless reception since 1922. After this period, an improvement will be noted until 1933. His views are based on a sunspot cycle of

eleven years. The last sunspot minimum was in 1922. Since that time, conditions should have grown progressively worse, reaching a climax about 1928, when reception should improve as the sunspots disappear.

WATER ABSORBER FOR SOIL TO AID PLANT GROWTH

123

Plant growth is limited in many regions, not because of insufficient moisture but because the rainfall runs off or evaporates too quickly. A material which promises productive cultivation in these semiarid sections has been introduced by a Michigan circuit judge.

In effect, it provides millions of tiny reservoirs to retain the moisture where it can be reached by the plant roots. It is a mineral substance and is to be applied at the proper depth in lump, powder or emulsion form, to establish a water-holding layer. Marked success with it has been reported from experiments in which lawns and golf courses have been treated.

KNIFE THAT USES RAZOR BLADE HAS EXTRA ATTACHMENTS

96



Several useful articles are combined in a pocket-knife that employs a discarded razor blade for its cutting edge and is flat, to take up but little room. Bottle opener, corkscrew, twine and cigar cutter, and a nail file and cleaner are included, making the knife a small

compact article. When closed, the blade is safely shielded.

Eschsch Nfg Co
New Haven, Conn

W. J. Waddis, Farmington, Conn.

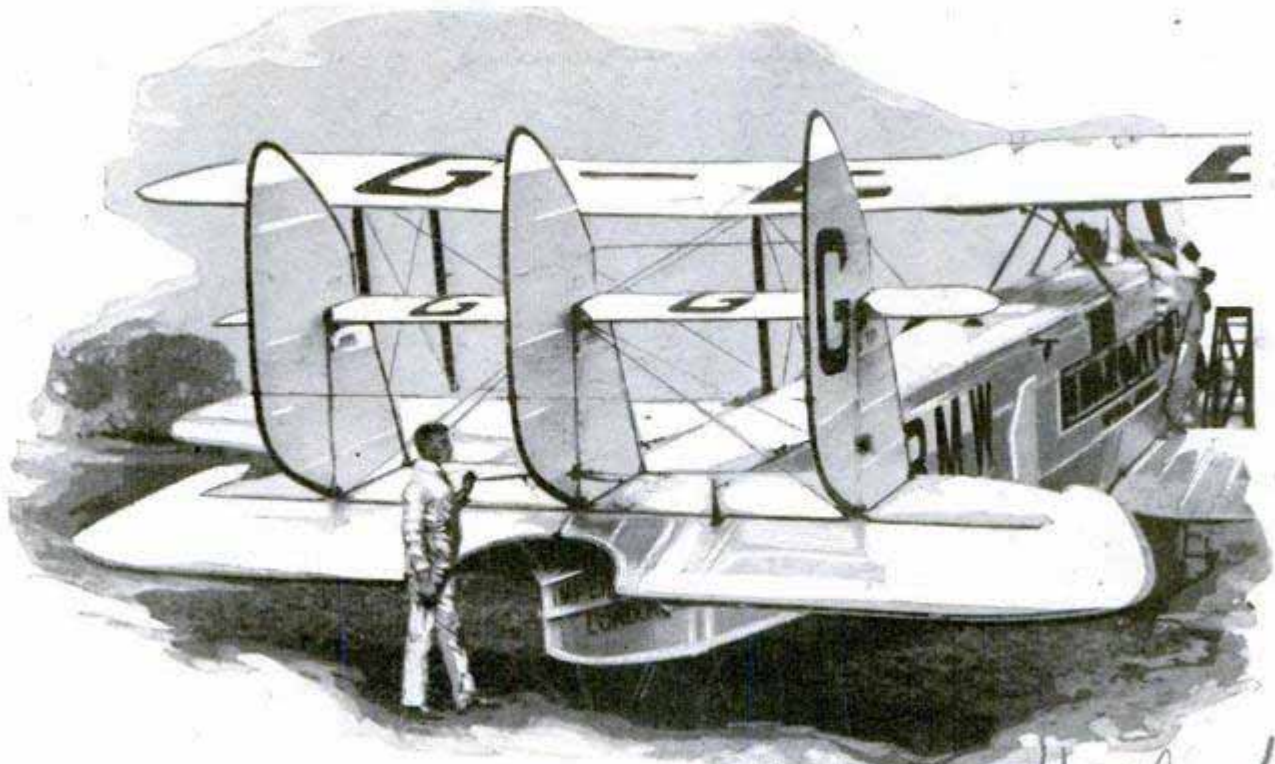

For Air Journeys between Africa and India; the Three-Engine Plane That Flies between Cairo and Karachi; It Has a Speed of 117 Miles an Hour

Herbert

PLANE FOR ORIENTAL AIR LINE SPANS EIGHTY FEET

Latest developments in flying are represented in the monster airplane for the line between Cairo and Karachi, linking Africa to India. It has three engines designed to keep the plane aloft at a speed of 117 miles an hour, is fifty-six feet long with a wing span of eighty feet. The craft is of the so-called "Hercules" type.

CUT DOOR IN COW'S STOMACH TO ANALYZE FOOD

To solve a question as to the cow's digestive processes, investigators at the Pennsylvania agricultural experiment station have cut an opening in the stomach of a live animal so that its food can be analyzed. The contention was made that the cow's milk would contain vitamine B even when that substance was not present in the food con-



White Line Indicates a Stream of Oil Being Shot at Auto Spring

sumed, since it was believed that the vitamine was manufactured during digestion. To determine this, the incision was made in the stomach in such a way that samples of the organ's contents could be taken for analysis. The operation was performed with the aid of local anæsthetics.

OIL SHOT FROM SIPHON BOTTLE LUBRICATES AUTO SPRINGS

Squeaky portions of the automobile body, the springs, and other places difficult to reach, can be easily lubricated without soiling the fingers or clothing by a special oil which is shot from a bottle with a strong siphon action. The contents of the unit is under considerable pressure and the outlet mechanism is so arranged that a penetrating stream is directed until almost the last drop has been used. The outfit is recommended for prevention of corrosion on battery terminals, loosening bolts, etc.

Mr. L. S. Bechtel

Zip Abrasive Co 6007 Euclid Ave

Zip Abrasive Co 6007 Euclid Ave

1122

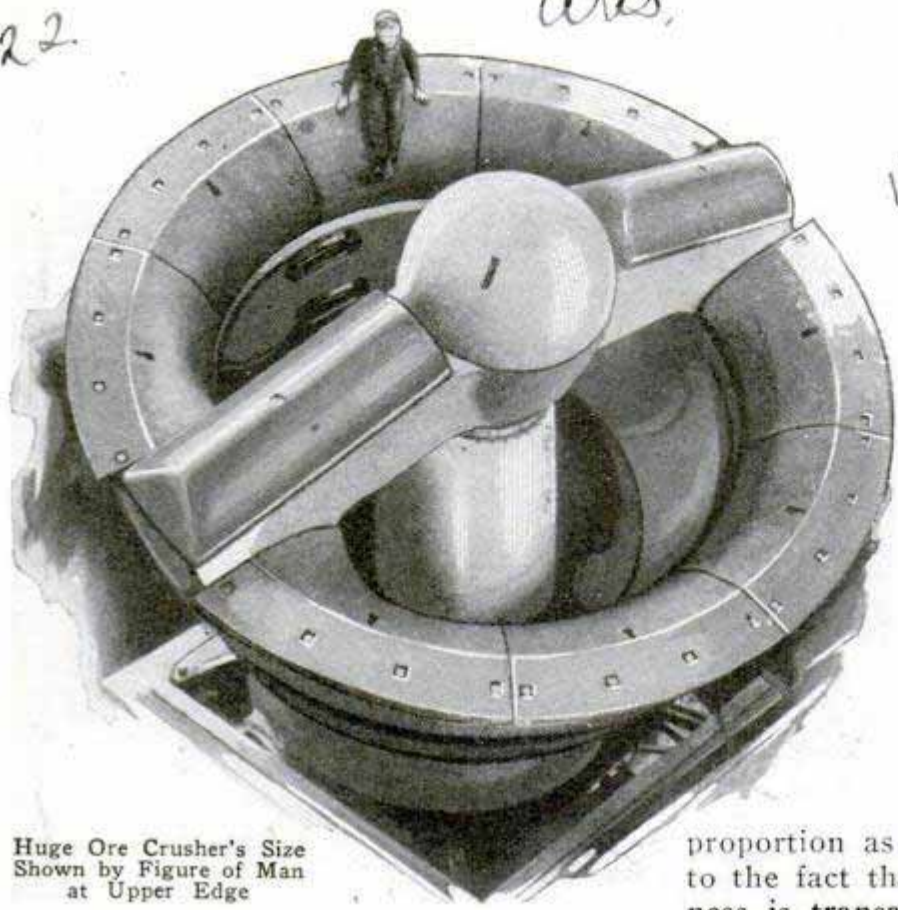

Huge Ore Crusher's Size Shown by Figure of Man at Upper Edge

MILLION-POUND ORE CRUSHER SHIPPED TO CHILE

Shipping experts had to prepare special equipment to handle two gigantic ore crushers which were sent from Milwaukee, Wis., to a mining company in Chile. The ponderous units each weighed about a million pounds.

FIND GOLDEN CALF'S ANCESTOR IN ANCIENT STATUETTE

Among other articles of royal treasure taken from the tomb of a king of Palestine who ruled some 3,700 years ago, was a statuette of a golden calf, fifteen or eighteen inches high. It is thought to be the forerunner of the idol of Moses' time, 500 years later. On a breast ornament, also taken from the tomb of the unknown monarch, was a design of the Egyptian cow goddess, probably the prototype of the golden calf of the Hebrews, according to Dr. James H. Breasted, of the University of Chicago. All the treasures were of Egyptian workmanship, showing that the culture of the Nile was dominant in Palestine and that the king probably was a vassal of pharaoh. The gold on the statuette is thin and worth only a small sum.

Oriental statuette University of Chicago

CITY-OFFICE NEEDS STUDIED TO CURB OVERBUILDING

1183 Four square feet of office space per capita is the normal requirement of an average American city, according to findings of the national association of building owners and managers. A survey was made recently to determine the causes responsible for the overproduction of office space in many cities, following the building boom of the last few years. It was shown that cities which are capitals of states do not absorb commercial-office space in the same proportion as other cities, chiefly owing to the fact that a large amount of business is transacted in state offices. The bank clearings, business done and the population were found to be important factors in determining the office space needed.

RUNNING-BOARD CAN CARRIER SAVES AUTO UPHOLSTERY

1136 Adjustable to cans of different sizes, carrier attached to the automobile running board, clamps milk cans, egg crates and similar articles securely and makes it easier to load and unload them, as they



do not have to be lifted so high. The sides that grip the can are lined with leather for greater safety. The carrier also spares the interior of the car which is often damaged by the practice of transporting shipments of cream and other produce inside. Several brackets may be attached to one running board.

Stainless steel is being tested by the army ordnance department in rifle barrels.

Chicago Hibbard Spencer Bartlett

Auto
Knoff-Peterson Mfg. Co. 127 Lincoln Ave. St. Louis, Mo.

HOW MOVIE THRILLERS OF AUTO RACE ARE MADE

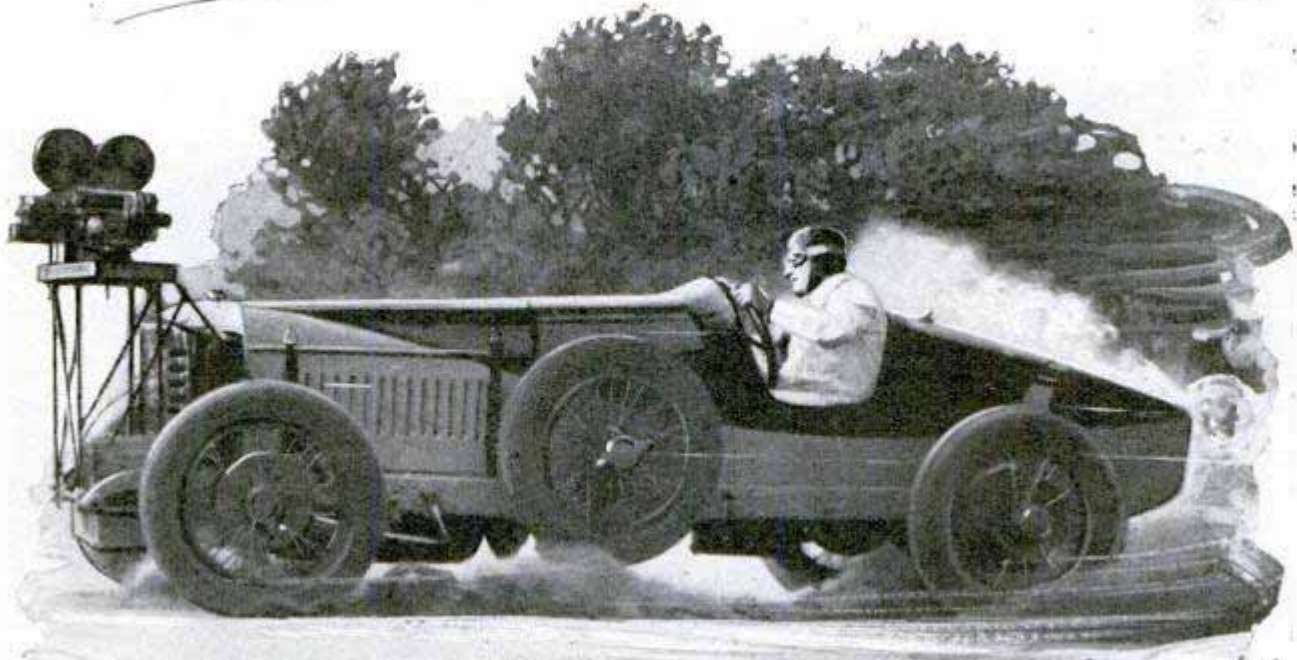

Motion-Picture Camera Attached to Front of Auto for Recording Facial Expressions of Driver during a Racing Scene; It Turns Automatically

*Reginald Henry
at Bel Monte Calif.*

Secured to the radiator of the car and accurately focused, a motion-picture camera is adjusted to register the expression on the driver's face. The plan has proved especially effective in taking racing scenes, for instance, when much of the action can be told by facial and other details.

ing surface of approximately an acre and a half. It will have four motors of 1,000 horsepower each, will weigh, without fuel, thirty-five and one-half tons and will carry 2,700 gallons of fuel. For its 100 passengers, sleeping cabins will be provided and the crew will number twelve or fourteen. The other plane has been described as a "flying wing." In effect, it is to be a huge hollow unit so arranged that the weight is distributed to proportionate parts of the carrying surface instead of being concentrated in one or more bodies.

Junkers Aeroplane Works, Germany

AIRPLANES TO CROSS ATLANTIC IN ROUND TRIP A WEEK ¹¹⁷³

Interest of the flying world is being directed toward Germany, where two private firms are preparing airplanes for flights across the Atlantic with a view toward establishing regular schedules and carrying more than 100 passengers on weekly round trips. Tests with one of the ships are expected shortly. A full-size model already has been constructed. Both companies are incorporating new principles in the flying craft. One type has two bodies, each seventy-eight feet long, a wing spread of 265 feet and total carry-

AUTOMATIC BAILER FOR BOATS TO PREVENT SINKING ¹¹¹⁰



Model of Boat with Self-Bailing System and Ventilating Unit, to Prevent Sinking

Designed especially for small craft such as pleasure, life and fishing boats, an automatic bailing system is intended to quickly rid a vessel of water even if it carries an excess load. In connection with this, a safety ventilator has been constructed to prevent the entrance of water without hindering the air supply.

See complete

*Dr. Fred E. Nelson
of Seattle and York*

944

The ARMOR of the



Roller-Skate Hockey Requires an Outfit like That of the Ice Game



Gleason, Goal Keeper of Princeton's Ice-Hockey Team, in His Heavily Padded Suit



Friedman, Michigan Football Star; the Helmet, Shoulder, Hip and Leg Pads Are the Chief Parts of the Player's Armor



Dempsey Soaring with Tommy Loughlin; Both Wear Ear Masks



Cricket Captain G. E. W. Bowyer, Wearing Lattice Leg Guards and Finger Protectors

Modern Knight



Type of Gas Mask Worn by Students at University of California during Instruction in Mine Rescuing

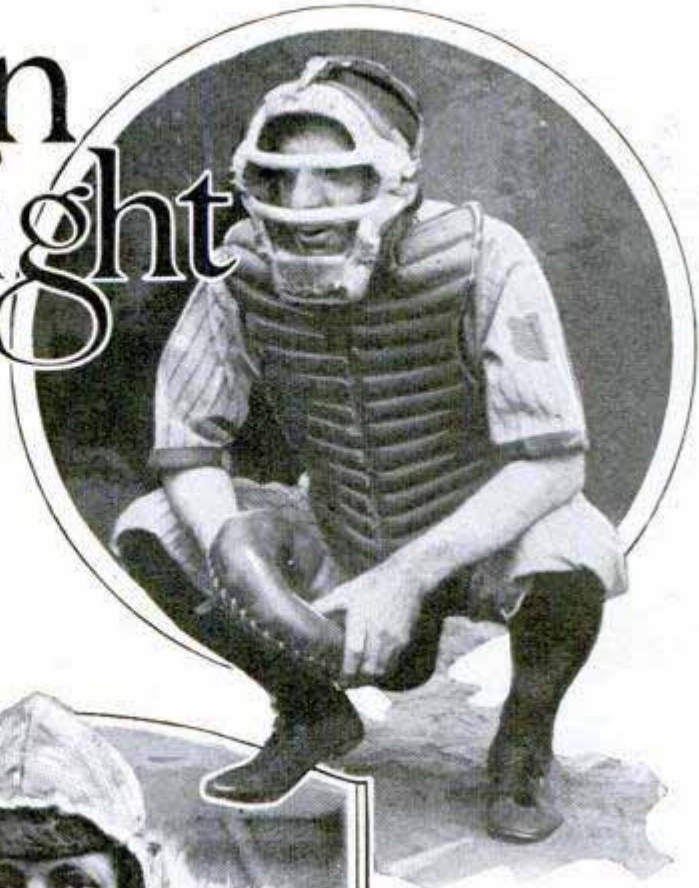

Gen. Smedley Butler, of Philadelphia Police Fame, Poses in Baseball Catcher's Uniform; the Latest Masks Are Designed to Afford a Less Obstructed Vision and to Slip Off More Easily than the Old Ones



Lieut. Comm. Byrd Found Need of Warm Clothing in Arctic Flying



Coach F. Darrie Ulat in the Latest Armor for Ancient Sport of Fencing

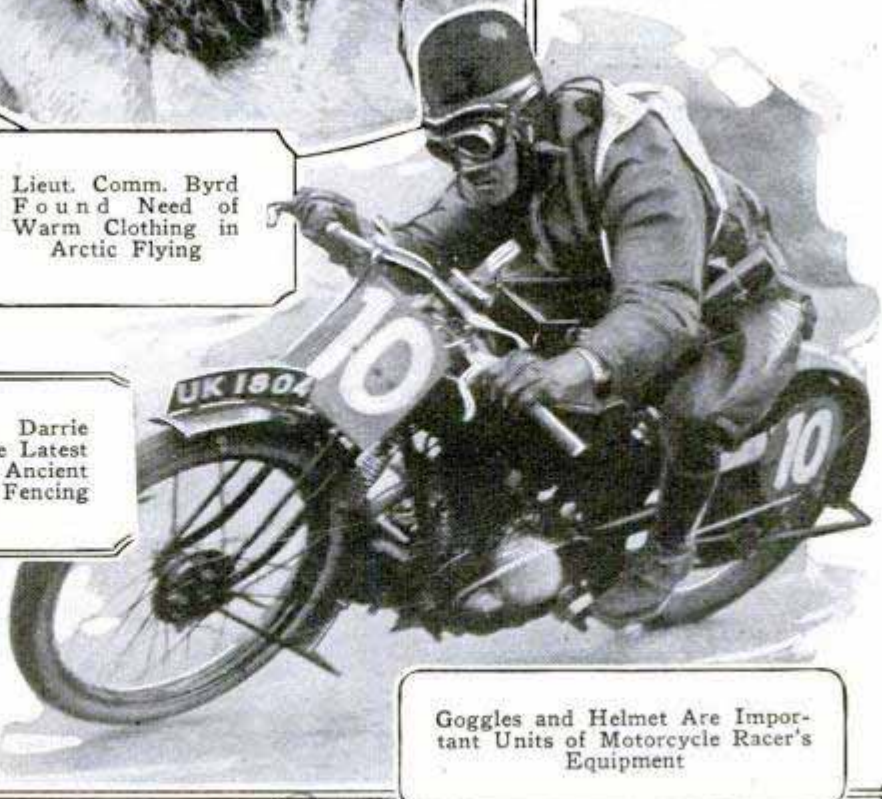

Goggles and Helmet Are Important Units of Motorcycle Racer's Equipment

P.A.

WHY YOU CAN'T BELIEVE ALL YOU SEE IN MOVIES

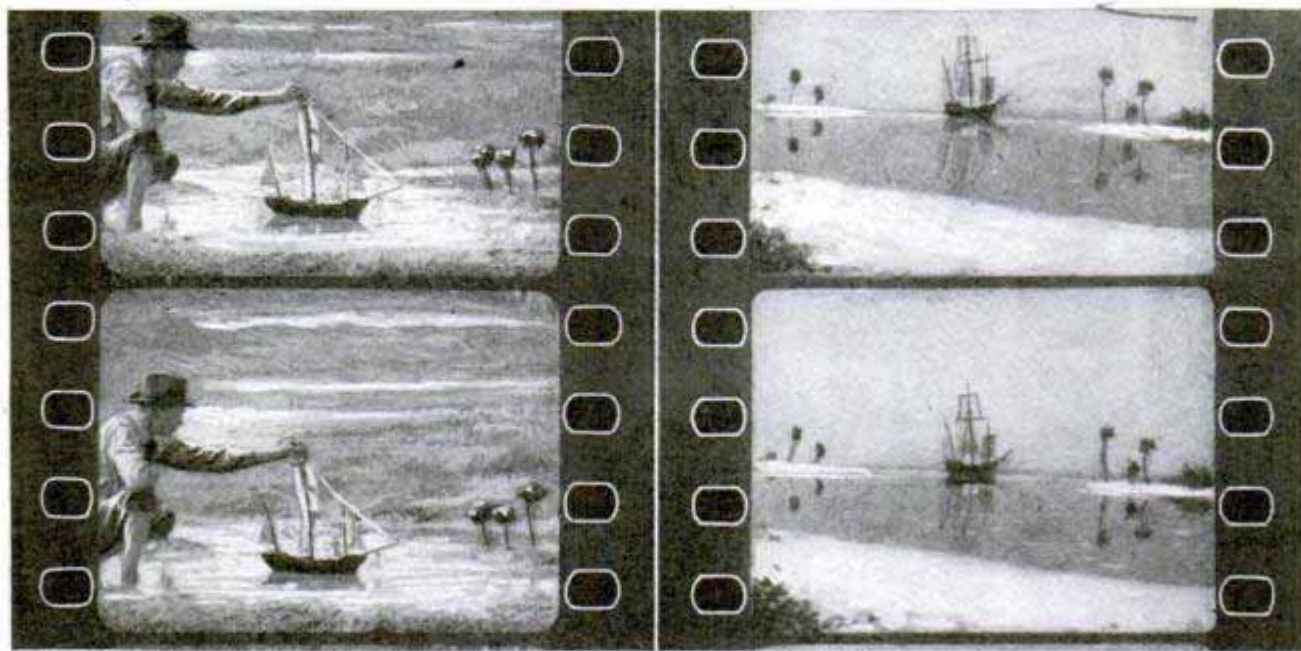

Reality and What the Camera Made of It; an Interesting Example of the Art of Picture Faking; at the Left, Adjusting the Model Ship for the Scene at Right

There flashes on the silver screen a bit of tropical seascape, a beach of white sand, a little bay opening out into the ocean between two sandspits on each of which palm trees rise. Along the shore glides a ship such as Columbus commanded. "Looks like Florida," a spectator remarks, "but where did they get the ship?" It wasn't Florida. There was no ocean. There were no palm trees. It was just a good job of magnifying miniatures, a process frequently used in the motion-picture studios and one that the novice with his own movie camera can practice with much enjoyment. The ship was a twenty-inch model. The "ocean" was an artificial pond, about twelve feet square and six or eight inches deep, and the sky and horizon were represented on a canvas screen standing in the water. Sand and twigs with a bunch of feathery leaves to imitate the palm trees were used for the beach. The palm leaves in the

foreground were borrowed from a genuine tropical film and double-printed into the scene in making the positive. The ship was navigated by black threads under the water. The camera was set sufficiently close so that the scene covered the entire "frame" and was cranked at high speed.

REMINDER CHART FOR MOTORIST TELLS WHEN TO CHANGE OIL

Hung on the garage wall, a disk chart helps keep a record of oilings and tire changes on the car. An inner card is divided into a series of numbers from 500 to 40,000, representing mileage, and by turning it, figures appear at intervals of 500 to 2,000, to denote when it is time to renew the cylinder oil, light machine oil and cup grease. A similar record is presented at the upper edge of the chart on another disk, to keep track of the time when each tire had been changed.

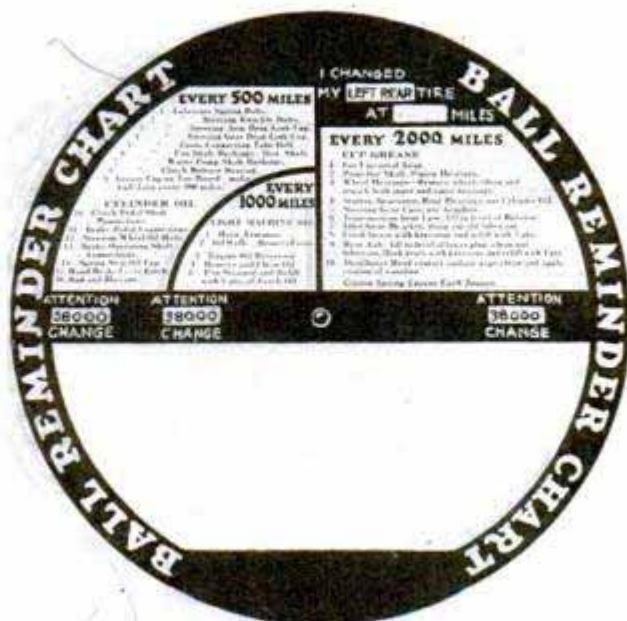

When Did You Last Change the Motor Oil? This Disk Tells and Shows When a New Supply Is Needed

The Ball Co., 97 54 W. Madison St., Chicago

**AIRSHIP GONDOLA
CAN BE USED AS
MOTORBOAT**

1182

Detachable from the envelope of an airship, an all-metal car can be used as a motorboat. It is constructed of duralumin, the aluminum alloy, and the propellers are above the water. In other particulars, it is operated much like the ordinary water craft. It is thought that the arrangement will be of great aid in emergencies, as it can be quickly disconnected for rescue work along the coast and attached again to the airship hull, which can be withdrawn to a safe distance from the shore, while the car is being used on the surface.

Paul Krebbing with His Model Merry-Go-Round. Made in Spare Time

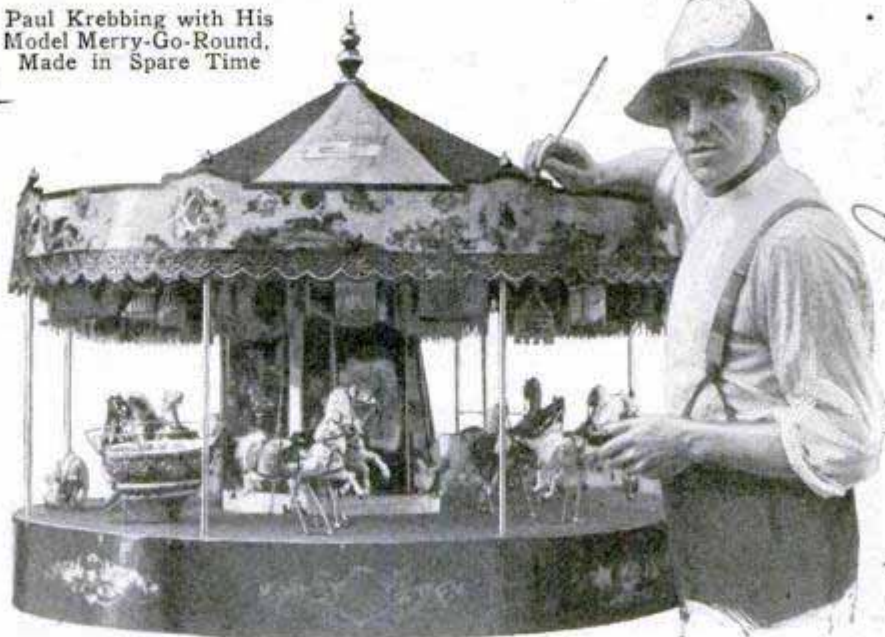

1131

Paul Krebbing, Los Angeles Calif.

**MODEL OF MERRY-GO-ROUND
RUN BY ELECTRIC MOTOR**

Most of the features of the standard-size apparatus are duplicated in a tiny merry-go-round a California craftsman has completed. It is operated by an electric motor, tiny horses and goats gallop and tubs move while music is furnished from a small organ. Electric lights and a dancing doll are additional details.

**SLIDING PANEL FOR AUTO DOOR
AIDS SIGNALING**

1132

Opened much more quickly and easily than the regulation auto door glass, a sliding panel allows the driver to reach into mail boxes or give arm signals with less trouble. It is installed simply by low-



Mail Carriers Find the Sliding Panel Easier to Open than the Glass of the Auto Door

ering the main glass, slipping the frame in place and cranking the door pane up until it comes firmly against the inserted unit. For winter driving, this arrangement is considered an improvement, as it permits ventilation without admitting too much cold air.

Habig Mfg. Co.
1085 N. Meridian St.

**URGE REFUGE FOR GAME BIRDS
TO PRESERVE SUPPLY**

1174

Creation of bird sanctuaries throughout the country, where wild fowl may nest and feed in safety, is proposed in a federal game-refuge bill, and sportsmen are recommending its adoption to check the rapid decrease in the number of birds. The plan includes the establishment of public shooting grounds, adjacent to the preserves. According to experts ducks in the western part of the country are threatened with extinction, unless ways are found to combat a form of paralysis which afflicts them after drinking contaminated water. This disease is widespread near Great Salt Lake. It afflicts other marsh birds as well as ducks and, when least prevalent, takes a toll of 30,000 to 100,000 yearly, while more than 1,000,000 ducks alone are killed in the worst years. The salts in the waters have made them poisonous to the fowls. The malady does not prove fatal if the birds can get to fresh water in time.

New York Herald Tribune 12/9/26

GIANT CRUSHER FREES SHIPS LOCKED FAST IN ICE

1124

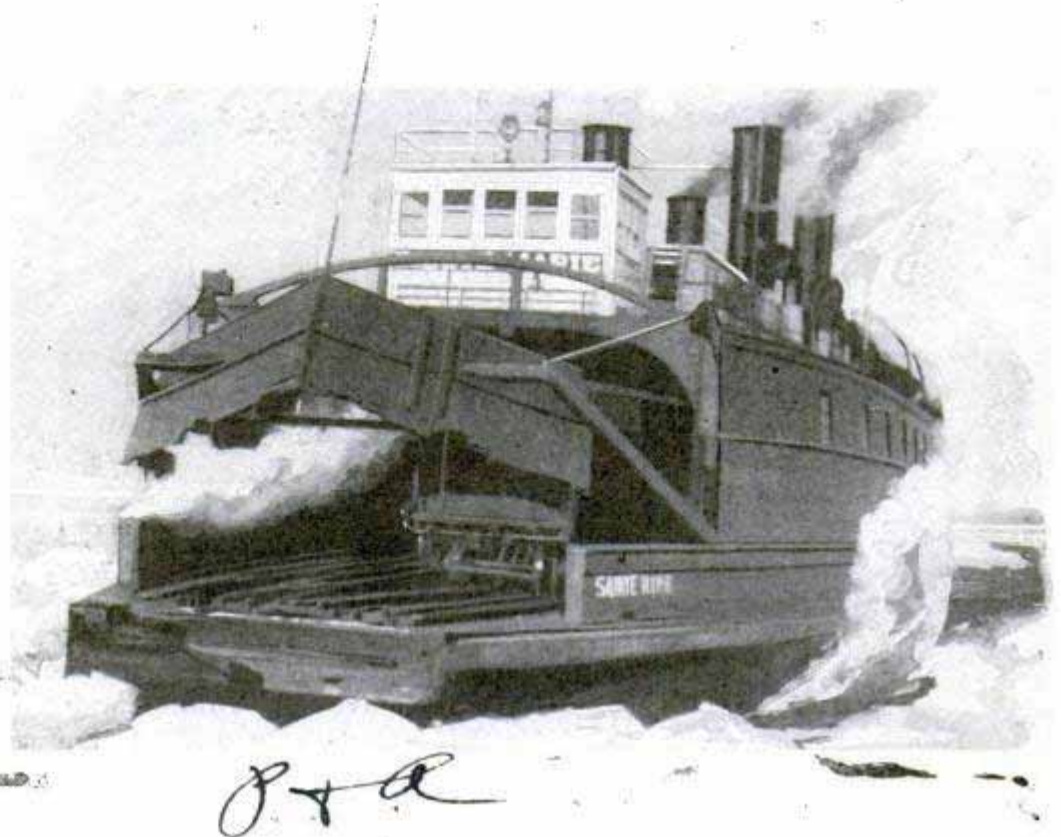

Car Ferry "Sainte Marie" with Its Plow Raised Ready for an Attack on the Ice Jam in the St. Mary's River; for a Time, the Blockade Threatened to Trap the Crusher

Equipped with a huge plow that can be raised or lowered, the giant car ferry "Sainte Marie," built to keep the route between Mackinaw City and St. Ignace clear of ice, nearly met its equal in a jam that tied up more than 100 vessels and cargo valued at \$25,000,000 early last December. With engines racing at top speed, the battering ram was launched in repeated attacks against the frozen barrier before the blockade was finally broken. Three powerful tugs assisted by yanking a steamer

into the opened channel, thus releasing other ships. The car ferry's huge size, generally an aid, was a handicap to a degree, for it had to be managed cautiously lest its bulk become trapped in the ice and the tie-up still further complicated. The jam occurred in the St. Mary's river, the gateway from Lake Huron into Lake Superior. Great cakes of ice, wedged between the narrow cuts on each side of Neebish island at the head of the river, formed the difficult barrier.

AIR-MAIL PILOTS EARN AS HIGH AS NINE THOUSAND YEARLY

1255 Good pay as well as the lure of excitement, partly explains why there is such a large waiting list of candidates for positions as air-mail pilots. Salaries range from \$4,000 to \$9,000 a year. There is a base pay of between \$2,000 and \$3,600, depending upon the length of service, and,

in addition, a mileage rate for service. For daylight flying, pilots are paid five cents a mile between Cleveland and Cheyenne, six cents between Cheyenne and Reno, and seven cents between New York and Cleveland and Reno and San Francisco. The scale is doubled for night flying. Not long ago, two superintendents of flying fields returned to piloting, attracted by the pay and the excitement of the work.

Chicago Daily News 12/13/26

1130

HAWAII FEATHER-CAPE IS VALUED AT MILLION

1160

One of the wonders of the National museum in Washington is a ceremonial cape, once the property of Hawaiian kings. It is made of thousands upon thousands of tiny feathers and is valued at \$1,000,000. The garment was presented to Commodore J. H. Aulick, of the United States navy, in 1841, by King Kamehameha III and is one of the handsomest specimens of the art of feather-cape making in existence. Skilled hunters captured the birds, a species now extinct, and from each was obtained only a tuft of three to five little feathers for which a price equivalent to \$1.50 was paid for three. They were arranged so smoothly that the finished cape resembled plush. The crescent design was worked in red and yellow feathers. The cape is forty inches long, eleven and one-half feet around the lower edge and twenty-three inches about the collar. From fifty to 100 years were required to complete it and only kings were permitted to wear it. Garments such as this were in reality a refined form of war paint. Their primary use was as a military decoration.

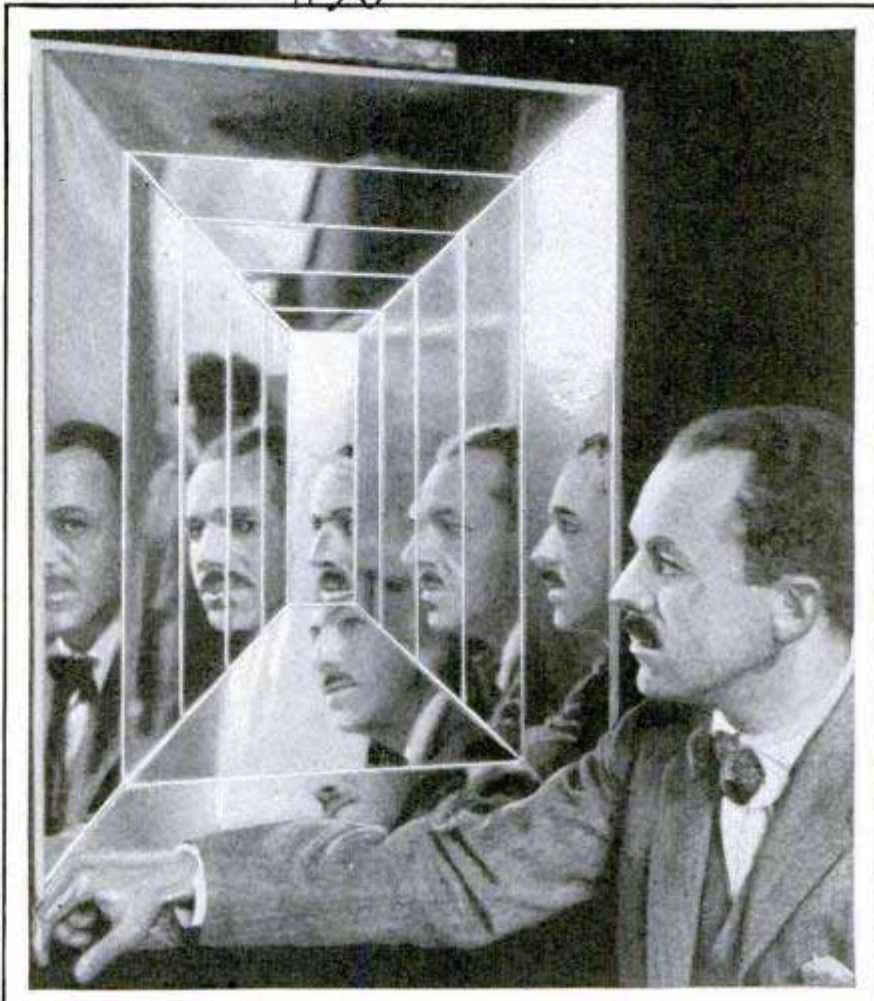

Without Twisting or Turning the Head, Several Different Views Are Presented from This Multiple Mirror

SPECIAL MIRROR FOR STYLES SHOWS MANY VIEWS

Profiles, silhouettes and front views as well are revealed by a multiple mirror a French fashion expert has devised. At one sitting, a prospective hat buyer, for instance, can see how the piece will look from many angles.

MAGNETS LOCATE SUNKEN AUTO LOST IN DEEP POOL

1174

Following a fatal automobile accident in an eastern city, the car, which had fallen into a deep pond and disappeared, was located by a simple and ingenious expedient. Several magnets were tied to a rope and dragged along the bottom in a line from the tracks left by the wheels. The men holding the cable felt a tug when the magnets were attracted to the steel of the car and the auto was soon hauled from under thirty feet of water, where it had stopped not far from shore.

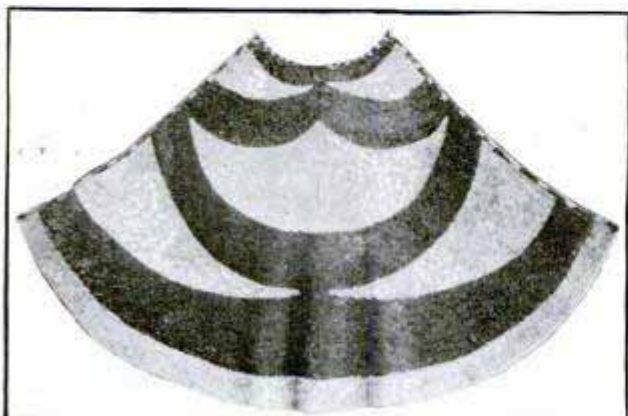

Worth a Fortune; the Feather Cape Once Owned by Hawaiian Kings and Worn at Formal Ceremonies

Little Pond, Plymouth Mass

927

1349 La Veta Terrace,
Los Angeles, Calif.

Thrills in the Hunt

HOW would you like to stand over the mouth of a hole a couple of thousand feet deep, waiting for twenty quarts of nitroglycerin, propelled by a flood of black oil, to come up and hit you in the stomach? John Larkin, one of the best well shooters in the west, had that experience a few years ago, and lived to tell about it. It was just one adventure in the life of an oil man, where the drillers shake hands with death every day.

Larkin had been employed to improve a well which had been flowing by fits and starts, like a Yellowstone park geyser. The improving process consisted in dropping five-gallon canisters of explosive down the casing and then firing them off by a "chaser," a heavy metal weight sent speeding down the sand line by which the nitro was lowered.

The well was gushing every half hour. Immediately after one gush had subsided, Larkin eased down the first can of explosive and touched it off. After the next flow of oil ceased, he sent down a second bomb and exploded that. Still the well didn't work right, so he waited until after another oil spurt, and began to lower the shot canister. Suddenly he felt the weight on the line ease up, and realized the well had begun to flow, and the twenty quarts of nitro was riding back to the surface on top of a speeding column of oil.

There was time to run to safety before the can blew out of the



for Black Gold



well mouth, but Larkin began hauling in the shot line, trying to keep up with the approaching shell. As it drew near he leaned over the well mouth, caught the can in his arms, while the detonator cap buried itself in his stomach so far that it left a scar the rest of his life. Yet Larkin rolled clear, while a column of oil spurted over the derrick top.

Shooting wells is only one of the many hazardous occupations connected with the getting of gasoline to keep millions of automobiles running. The stuff is dangerous to everybody that handles it, from the driller in the field to the tank-wagon driver who pours it into the filling-station reservoir. In a western state, one summer afternoon a couple of years ago, an oil worker climbed the ladder of a steel tank containing 55,000 barrels of gasoline. He started across the roof of the tank. A flash of fire shot into the heavens and the ground trembled. When the smoke cleared away, underwriters found part of one of the victim's shoes half a mile away. On the heel was a little iron disk. The verdict was that this had hit the head of a bolt on top of the tank and

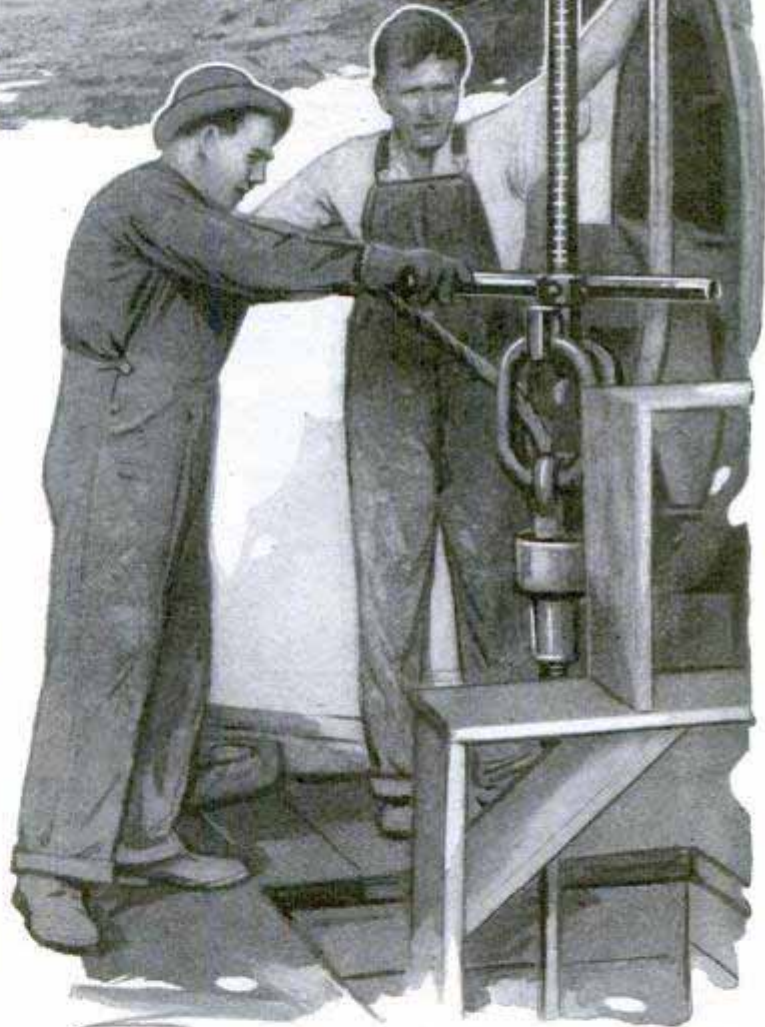

Oil-Well Firemen Fighting a Blazing Gusher, Above, and Drillers on the Derrick Floor Unclamping the Tools from the Cable

had thrown a spark, igniting gasoline vapors and causing the explosion.

Another day a drilling crew was at work in a well which was not thought to be near an oil-sand zone. One man was working on a platform in the upper part of the derrick. Suddenly there was a rumbling



Drilling on the Brink of a 900-Foot Chasm, at South Mountain, California, Where Unusual Obstacles Add to the Danger of the Crew Searching for the Hidden Treasure

sound. The tools and drill pipe began coming up out of the hole. The men on the derrick floor ran. The man higher up jumped out into space. He chanced to land in a sump hole that was half full of mud and water, and was but slightly injured. The derrick and equipment were strewn all over the surrounding landscape by the gas blowout which followed.

These are mere incidents in the day's work of the oil-well driller. They have been happening ever since Col. E. L. Drake completed America's first oil well at Titusville, Pa., August 27, 1859. That hole was sixty-nine feet deep. It produced twenty barrels of oil a day. Two years ago California gave the world its deepest producing well—E. J. Miley's Athens No. 6. It flowed 1,000 barrels the first day, from a depth of 7,591 feet.

One of the greatest spectacles in the history of petroleum, and one which thrilled thousands of spectators as well as the men who drilled the hole, was staged on the Maricopa flat in central California, seventeen years ago. The Union Oil company took over from a small outfit the Lakeview No. 1, a hole 1,655 feet deep, crooked as a dog's hind leg, and full of battered casing and tools. The stuff in the hole was passed by sidetracking, and the hole was drilled to 2,200 feet.

While the crew was drilling ahead, it heard the sullen rumble of gas, and scurried for the open. Quicker than a cyclone takes the roof off a barn, the derrick disappeared. The sky became a black blotch of petroleum, and within an hour rivers of oil were swirling out across the flat desert country, as though there had been a cloudburst. While the well gushed oil several hundred feet into the air, at a rate which was estimated at from 65,000 to 90,000 barrels a day, the oil men grabbed mule teams and scrapers, and built temporary earthen reservoirs wherever a gully promised to hold a few thousand barrels of the golden flood. Finally a high embankment was graded up around sixteen acres, known as "the cornfield," and the oil was drained into it. The company estimated that the well spouted 9,000,000 barrels of oil before it was brought under control.

In the Signal Hill field, at Long Beach, Calif., two crews were recently drilling wells on adjoining town lots. The holes

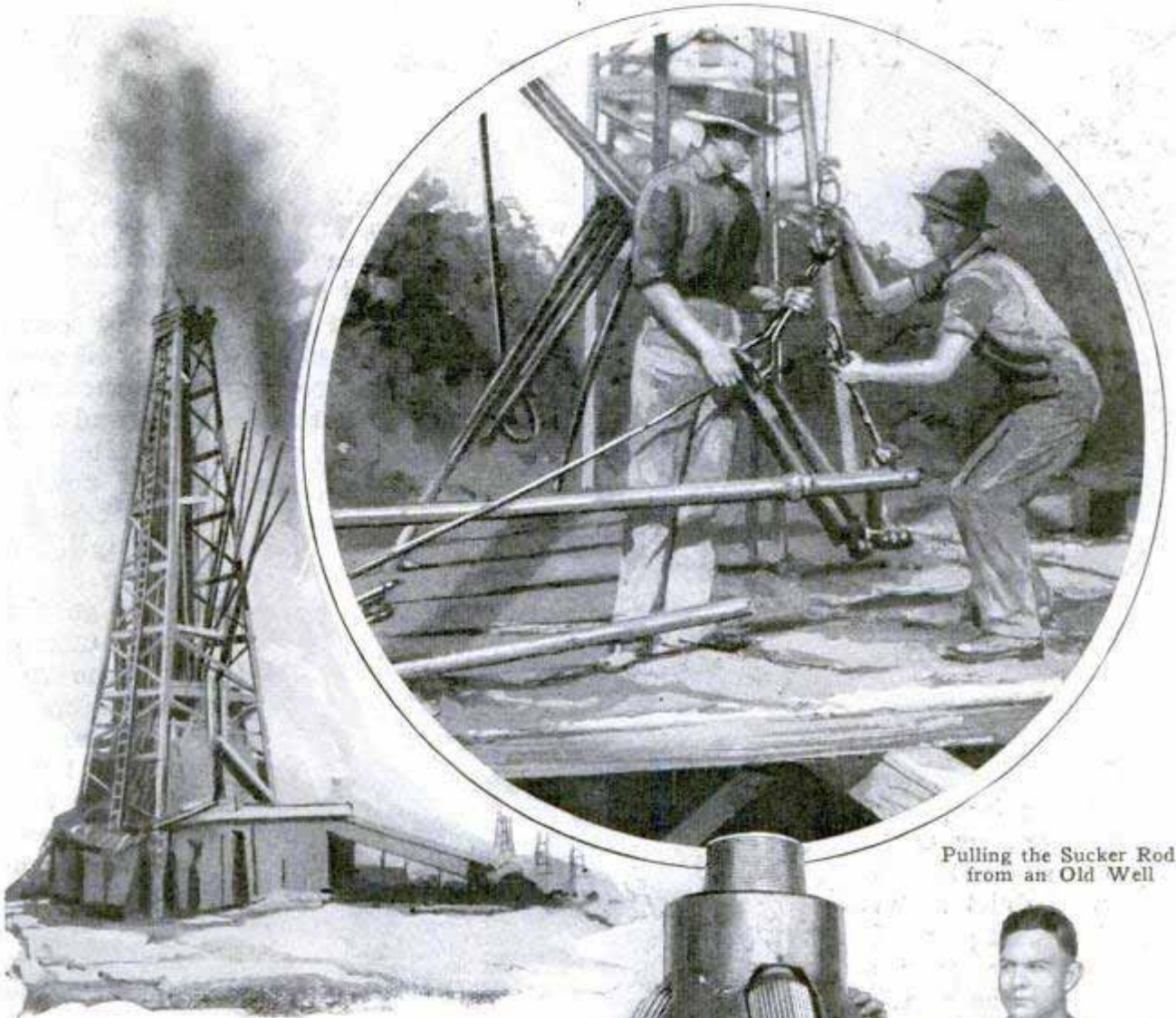

Pulling the Sucker Rod from an Old Well

Beginning of the End of the Derrick, When a Well on the Osage Reservation in Oklahoma Developed a Gas Blowout and Started to Collapse

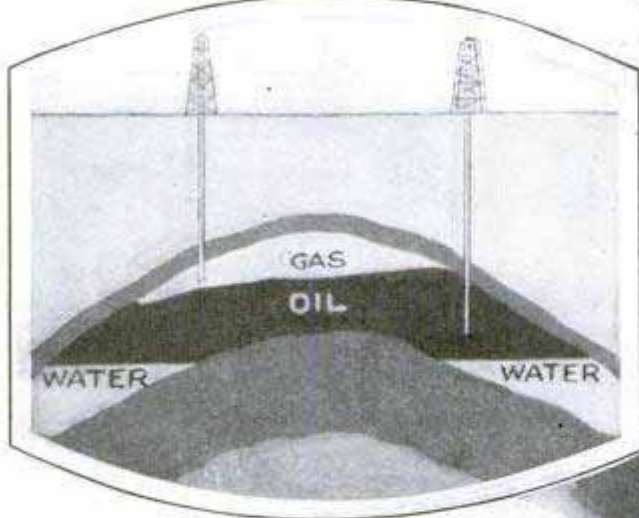

Showing How Gas Can Be Forced down the Well at the Left to Increase the Subterranean Pressure and Drive the Oil up the Well at the Right; at Right Is a New Style Drill That Sinks and Reams a Twenty-Four Inch Hole, While the Top Rollers Enable It to Cut Its Way Back Up through a Cave-In

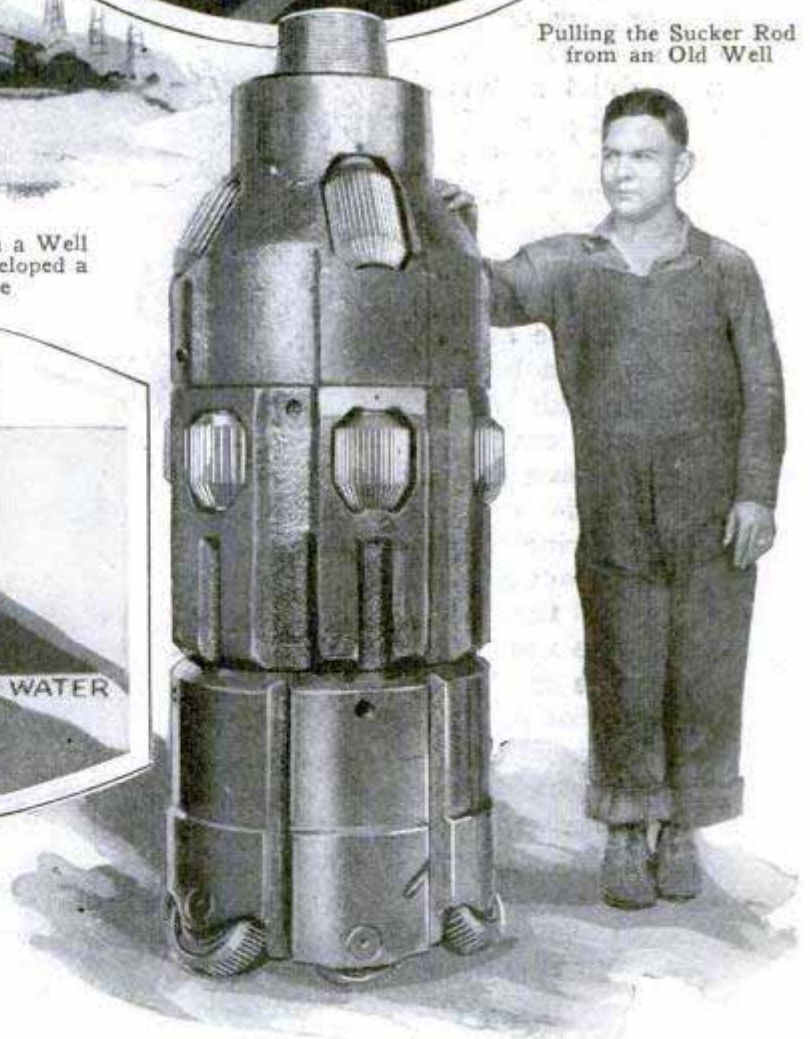

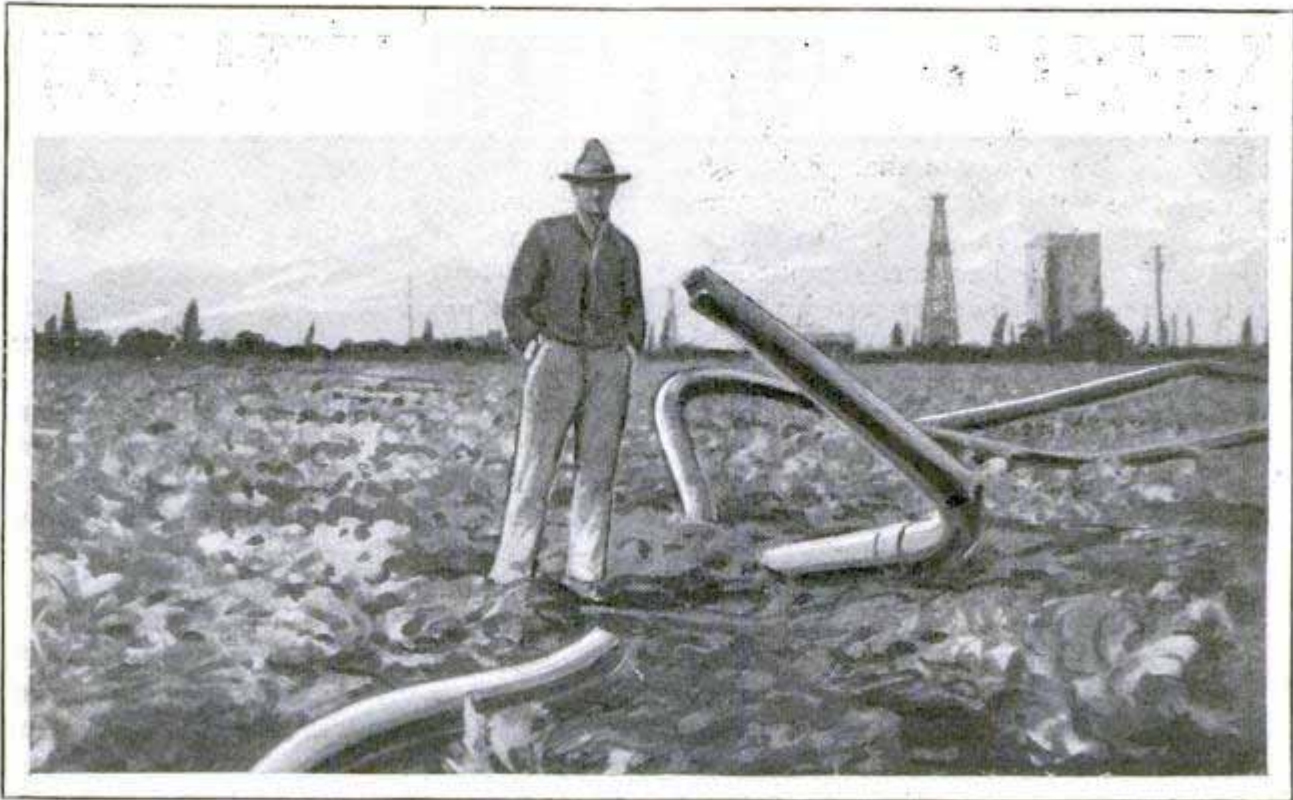

Twisted Ruins of a Heavy Iron-Pipe Line, Which Had Been Buried Underground Before a Leak Caught Fire and Blew the Steel Tubing into These Strange Bends and Loops

gas, but no one succeeded in earning the money. Finally the government took a hand, and put out the fire.

Mexico furnishes one of the most notable instances of a gas blowout. It occurred at Dos Bocas, between Tuxpam and Tampico, in 1909, starting from a seepage of fuel oil to a boiler. This fire burned six weeks, and during that time the well flowed millions of barrels of water near the boiling point. Fluid and flames from this blowout rose 1,500 feet in the air and were visible eighty miles out to sea. The estimated flow of oil per day, from this hole, was 125,000 barrels.

There are many ways to treat oil-well fires and gassers. If the gas pressure is not too great, live steam is sometimes employed to smother such a fire. Occasionally it is blown out by dropping a shot of high explosive over the mouth of the well. Sometimes a well is capped. As a rule each case requires individual treatment and considerable mechanical ingenuity. Fishing jobs, as they are termed, give oil drillers a great many real thrills. Sometimes the drill unscrews itself at the bottom of the hole and falls off. Sometimes the drill collar is lost. Occasionally the bailer drops off and falls into the hole, or some other piece of equipment gets lost

in the hole. At such times the crew can only try first one fishing tool and then another (there are scores of different kinds), and keep fishing until it either catches the fish or gives up in disgust, sidetracks the fish and proceeds with a crooked hole. Fishing jobs at 2,500 feet have been known to last several months and occasionally a year, while in a 6,800-foot hole in southern California the crew recently picked up a lost drill collar in thirty-three hours.

If the hole is not too deep, a skillful driller can often tell by the feel of the fishing tools how to carry on such work, but in the deep holes he can only keep fishing and trust to luck. Occasionally, when a solid formation will permit it, the drillers lower a batch of wax or other similar material and take an impression of the condition. From this they can sometimes study the problem and devise some new mechanical method of solving it.

The limit, in fishing jobs, was recently reached at Abilene, Tex., where the Sanger Oil and Refining company, according to well-authenticated reports, employed a human fishhook to save a well. An eighteen-inch hole, down 110 feet, had a bit lost and wedged at bottom. After working for days the crew gave the hole up as lost.

92

About to turn away, the head driller seized Dick Rawleigh, a little negro boy, who had been looking on. He offered Dick \$25 to go down the hole head first and get the bit. Dick was afraid that there were snakes in the hole, but he was finally prevailed upon to tackle the job. The drillers rigged him into a harness, strapped his legs together, and then lowered him head downward, with a cable in one of his hands.

The first trip down he remained several minutes, but failed to hitch onto the bit. After being pulled up and shown how to fasten his line, he went back down with the cable, and that trip he caught the fish, and saved the hole. This incident is recounted by Texans as one of their outstanding heroic episodes of the oil fields.

The drillers generally get a thrill out of the job when they undertake to drill out a shot of high explosive which has been covered by a crumbling formation in the hole. Depths must be gauged to a nicety and tools run with the utmost caution, to avoid drilling into the shell and perhaps exploding it at the wrong level.

The most modern form of oil-well shot is T.N.T., lowered in canisters on the sand line and

fired by dropping a "chaser" down the line, or perhaps with a time-clock mechanism in the torpedo itself, or else by an electric spark from a switch controlled at the surface of the earth. Most of these shots are now equipped with the time clocks to explode the charge if other methods fail.

Drilling deep wells nowadays provides special thrills of its own. A few years ago the Standard Oil company drilled a 7,200-foot hole at Santa Fe Springs and got a fine supply of boiling water, but nothing else. The world's record for depth, however, is held now by a Chancellor-Canfield Midway Oil company hole at Brea-Olinda, Calif., which has reached 8,046 feet and will be sunk to 10,000, if nothing happens to the equipment. At that depth a fishing job would be practically impossible, while the danger of one being necessary is very great, as the strain on a rotary drill increases with the length of the drill rod.

Despite the fact that the well has been drilled past 8,000 feet and may go to 10,000, the oil company does not really expect to get oil at such a depth. All it is seeking is a better knowl-

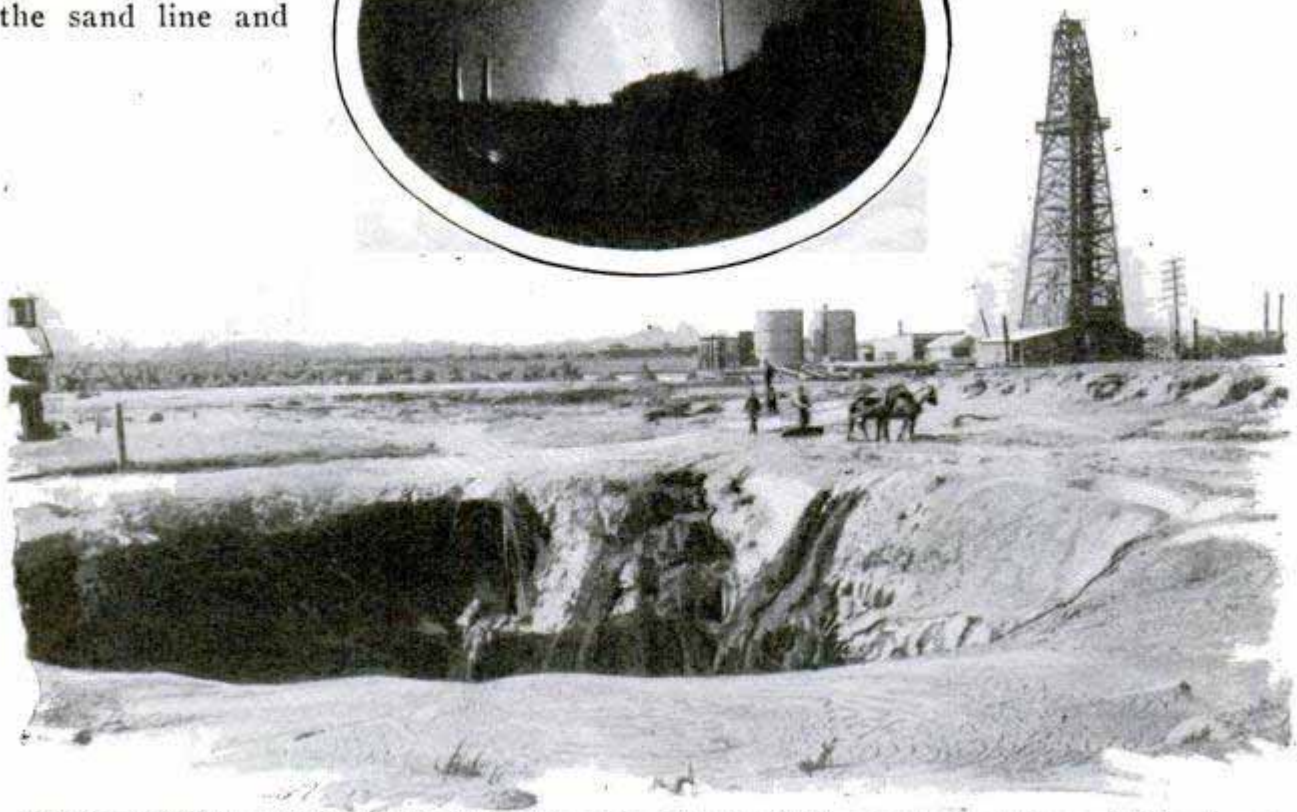

Crater Left Where a Derrick Once Stood; Gas Blew Out the Well, and the Inset Shows It Burning at Night; Fire Is a Constant Menace Which Takes Heavy Toll of Life and Property

edge of the strata two miles down, and some first-class experience in deep-well drilling. At 8,000 feet the temperature in the well reached 233 degrees Fahrenheit, and had been increasing at the rate of one degree each fifty feet.

Deep or shallow—it's all the same. Those who drill oil wells, even as those who go down to the sea in ships, ride with the reaper of souls, and garner a harvest of thrills, perhaps comparable only to those which are experienced by deep-sea divers, firemen, miners, and others who work at hazardous occupations.

ASTRONOMICAL CLOCK CONTROLS CITY'S STREET LIGHTS 1097

Street lamps on part of the system in St. Louis, Mo., are turned on at sunset and off at sunrise by an astronomical clock without the aid of human hand. The instrument adjusts itself to seasonal variations, saving current and eliminating the need of an attendant except for an occasional cleaning. At the proper time in the evening and in the morning, contacts on a drum in the clock operate the circuits which carry the lighting load. In case of trouble, protective relays are provided for every kind of emergency. For inspecting and testing, the system also can be operated by hand.

HOLDER FOR CHECK-BOOK STUBS PREVENTS BLOTTING 1292

Keeping the stubs out of the way while making out checks is often a bothersome task, but the trouble is eliminated by a little spring holder that is easily inserted and quickly removed. It holds the used stubs away from the new one, permitting free entry and decreasing likelihood of blotting.



Installed by Westinghouse Electric & Mfg. Co.

Union Electric Light & Power Co.

Novelty Sales Adv. Co.
215 Brisbane Avenue



The House of Pictured Walls in Prague; Designs Were Revealed When Workmen Removed Coating of Paint and Dust

LOST TREASURE OF PICTURES FOUND ON HOUSE WALLS

While at work, not long ago, on the renovation of an ancient building in Prague, or Praha, as the Czechoslovakian capital is now known, repairmen uncovered an art treasure that had long been hidden. The walls of the structure were decorated with skillfully designed figures, producing an effect similar to that on pottery, and, when the outer coatings of dust and paint were removed, the lost pictures were clearly revealed. They had been worked in plaster, a resemblance to bas-relief being obtained by laying a coat of white over one of black and then removing enough of the upper coating to expose the black in the desired designs and patterns.

There are more than 22,000,000 automobiles in the United States, or about one to every five persons.

The Occ. J. Co.
214 S Spring St

12/2/26

400

POPULAR MECHANICS

1057 Los Angeles, Calif

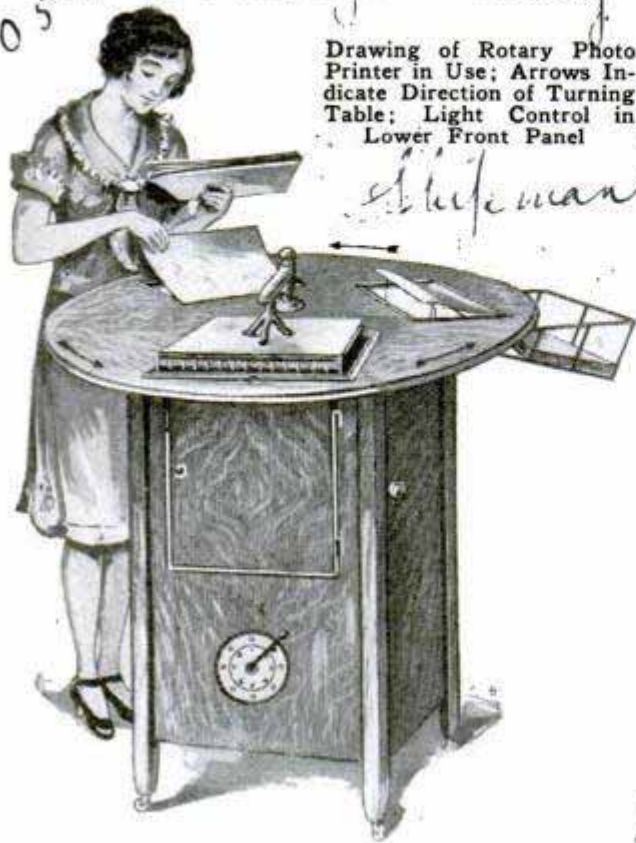

Drawing of Rotary Photo Printer in Use; Arrows Indicate Direction of Turning Table; Light Control in Lower Front Panel

Shifman

ROTARY PRINTER FOR PHOTOS SAVES TIME AND EXPENSE

For photographers, a rotary printer, fitted with six 100-watt lamps and a pilot light, makes 900 prints an hour and is adjusted to give exact alinement and perfect margins with little trouble. The lighting is controlled by a cranking device, and a fan keeps the negative from curling and the plate glass cool under continuous printing. The entire outfit can be run in or out of the workroom at will so that there is no lifting. It is said to do the work of five or six hand printers.

COAST-TO-COAST AIR MAIL IN DAY PROMISED SOON

Loss of but one business day on air-mail deliveries between the Atlantic and Pacific coasts is the aim of the post office department, and realization is promised as soon as the last leg of the route, between Salt Lake City and the Pacific coast, is lighted. That will permit planes to leave at the close of the business day instead of in the morning, and to deposit mail on the opposite side of the continent in time for early delivery on the second morning. Under such a schedule, Saturday night's mail from New York would

get the same service to the Pacific coast as to Brooklyn, and San Francisco would have as favorable delivery to New York as to Oakland. During the fiscal year ended June 30, 1926, government-operated routes carried 353,641 pounds of mail, and 2,256,137 miles were flown, nearly a million of them at night. Receipts have been increasing at such a rate that the total for 1927 promises to double that of 1925. According to Postmaster-General New, the authorization of individual contracts for transporting the air mails greatly stimulated commercial aviation and led to an extension of the service. The government is now considering a route down the Atlantic coast for direct service between Boston and the tip of the Florida peninsula, with possible extension to Cuba.

MILLSTONE USED IN MEMORIAL TO REVOLUTIONARY HEROES

107 Stones from an old gristmill have been employed in a monument to Revolutionary War soldiers at Honesdale, Pa. One forms the base against which a bronze tablet, bearing the names of the men, has been placed, and part of the foundation for the upright section is formed by a second stone. The grooved surface of the upper one produces a decorative pattern about the tablet.



Old Gristmill Stones Adapted to an Artistic Purpose; Revolutionary War Monument at Honesdale, Pa.

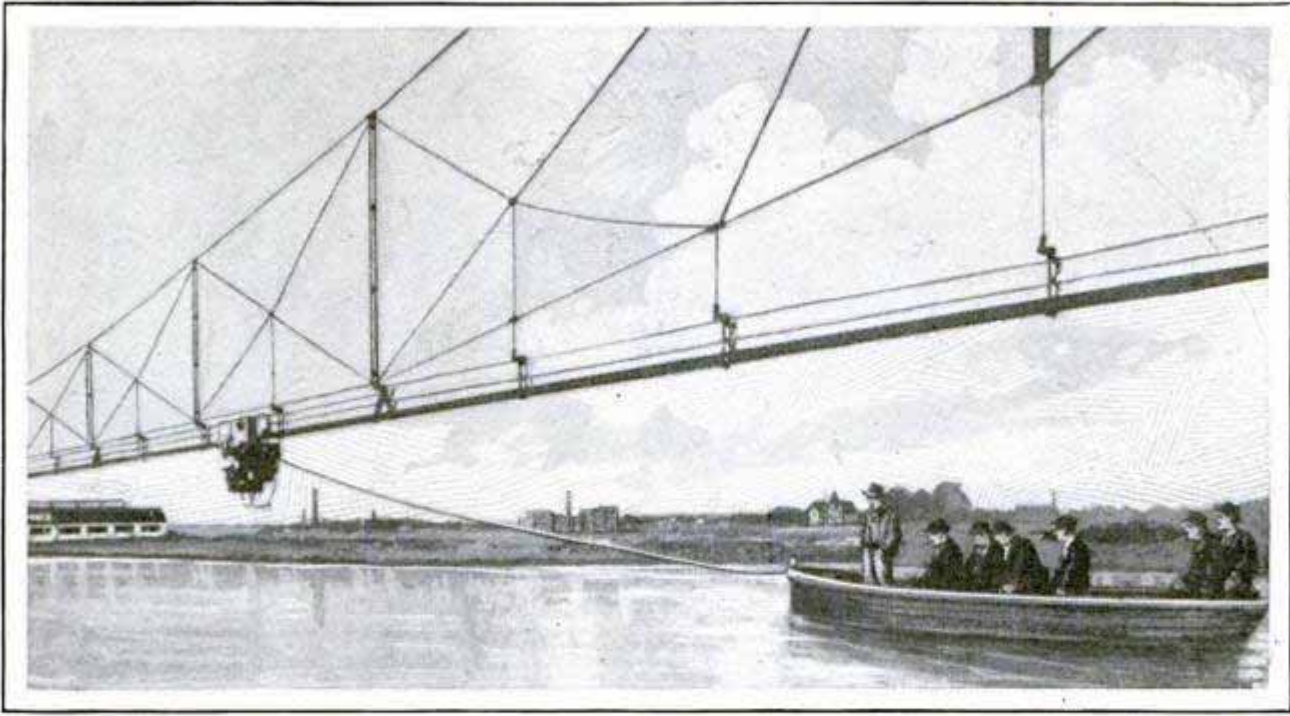

As the Monorail Tug Would Appear over Water; the Experiments Were Conducted with a Boat Load of Persons on a Grass Plot, and Proved Successful

AERIAL MONORAIL OVER CANAL TO PULL CANAL BARGES

Towing barges by a motor car suspended from a monorail over a canal or at one side, is the interesting system tested recently in Germany. During the experiments, a boat load of passengers was dragged over a smooth grass plot to show how the outfit would perform when put to work with water barges.

MARCONI SEES NEW RADIO ERA IN SHORT-WAVE BEAMS

Short-wave wireless, sent around the world in a narrow beam by his system of directional aeriels, will revolutionize radio communication, according to Senator Marconi. Beam transmitters have already been installed in England to connect Great Britain with Canada, South Africa and Australia. The short-wave station, which needs much less power because the signal is concentrated in one direction instead of being spread to all points of the compass, can be installed and operated for about one-tenth of the cost of long-wave wireless, with the result that it will bring considerable reduction in the cost of sending messages. The powerful beam, which can be sent immense distances even in daylight and without much static interference, also promises to help solve the

problems of wireless picture transmission and, possibly, television, according to the inventor. The beam apparatus is shielded on one side by a curtain of wires which blanket that side, so that signals go in only one direction.

BLOTTER TIP ON FOUNTAIN PEN HELD BY POCKET CLIP

Fitting on the end of the fountain-pen cap and secured by the clip that fastens to the pocket, a



number of little blotters are always available just as an eraser is provided for the pencil user. They are in layers, so that a new one can easily be exposed and, besides absorbing ink

the cushion they form helps protect the pen cap against breakage.

The Popular Mechanics Bureau of Information offers its free service to all readers of this magazine. Names and addresses of manufacturers and dealers in articles described, and any other details in our possession, will be promptly furnished by the Bureau.

*308 Peoples Bank Bldg
 1082
 Dr. G. W. Brittain,
 District Manager,
 Cannon City Life Insurance Co.,
 Leadville, Colo.*

*Chicago Tribune
 11/22/26*

1030

Isorgas Memorial Institute of Michigan

AQUATIC HARVESTING MACHINES RECLAIM SWAMPS

Tropical and Preventive Medicine Chicago

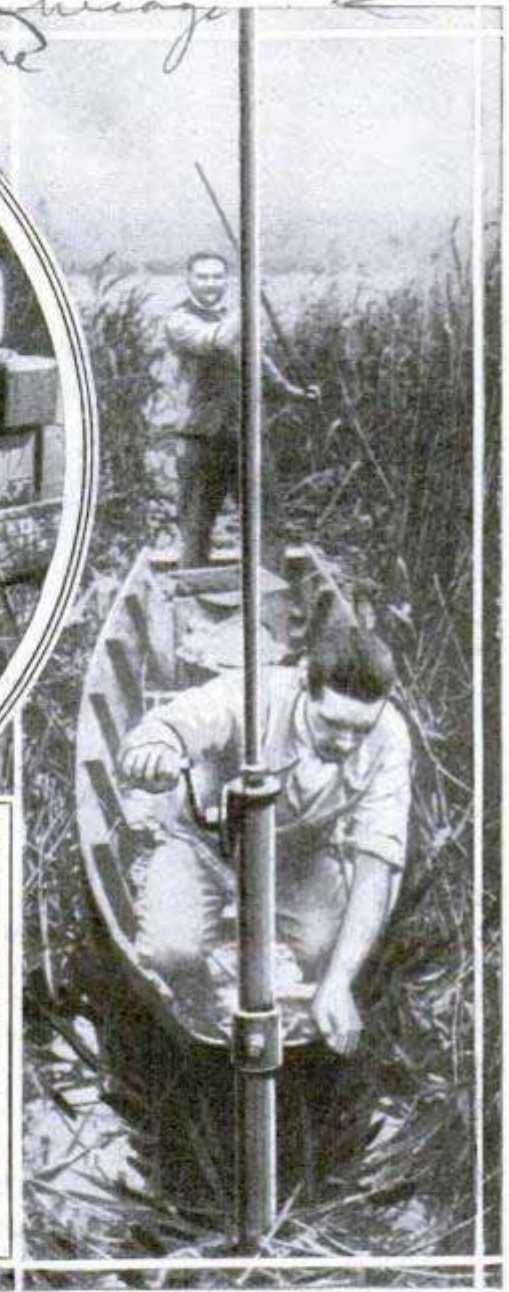
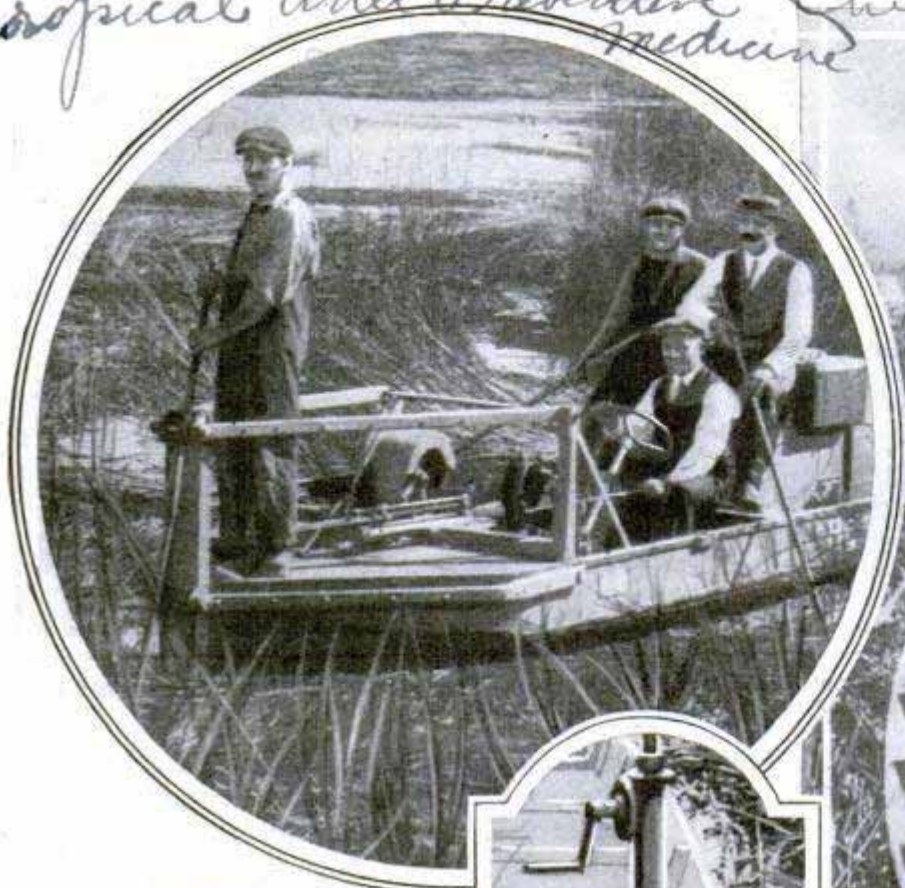

How France Clears Swamps, So That Fish Destructive to Mosquitoes May Be Propagated; Harvesters That Cut Marsh Weeds and Clear the Water of Aquatic Growths

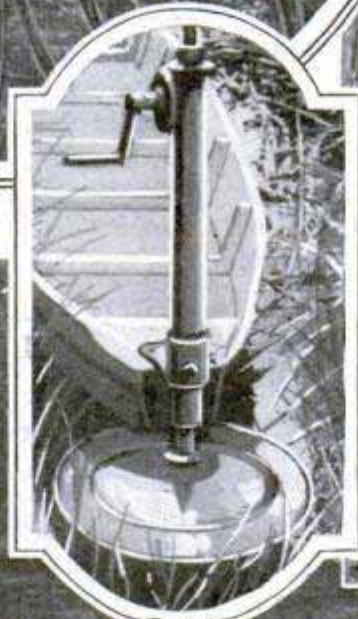

In Center, Circular Knife for Shearing Plants and, Above, Operating the Cutter; Below Is Combination Clipper and Rake to Remove Grass

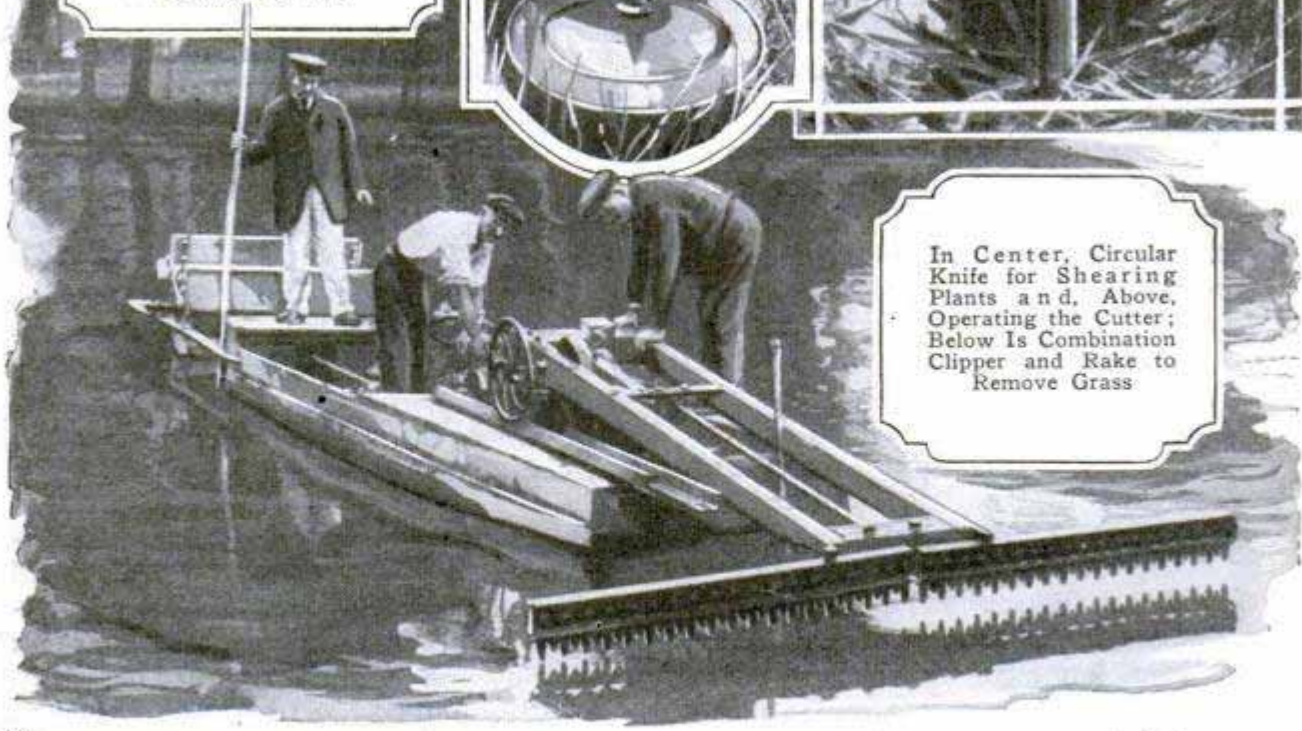

u 6 u

Compressed Air See 1926

WHAT IT MEANS TO RUN A TRAIN

In the popular mind, the engineer of a train has little to do but keep his eyes on the track and his hand on the throttle while the fireman shovels coal. In reality, their jobs involve much more than this, as is shown by a survey of a 200-mile run on an eastern railroad. A careful count was kept and revealed that, on the trip, the crew performed 5,123 individual acts and expended thirty-eight foot-tons of effort: The steam throttle was operated 928 times; whistle, 268; brake valve, 90; blower valve, 1,100; air fire door, 945; bell ringer, 200; sand leech, 80; right injector, 700; left injector, 30; water-gauge tests, 30, and equalizing brake and discharge valve, 752. Besides all these activities, there was the road to watch and all its signals.

7-15

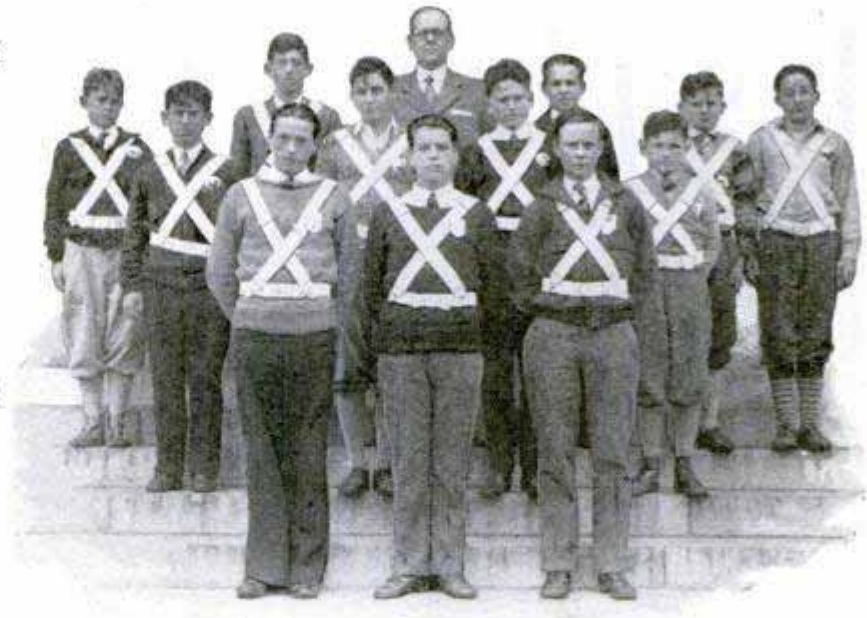

Squad of Schoolboy Traffic "Police," Appointed to Keep Order When Classes March from One Room to Another

SCHOOL'S OWN TRAFFIC POLICE KEEP ORDER IN HALLS

A squad of student traffic policemen has been appointed at a high school in Boston to keep order and prevent loud talking while classes pass through corridors from one room to another. The force is under the supervision of the principal, but has its own officers. The members wear distinctive belts and shoulder straps on duty.

Wentworth Junior

SECRET OF SWIFTER AIRPLANE SOUGHT FROM TROPIC FLY

Airplane designers have turned from study of the gull and the soaring eagle to a Brazilian fly for suggestions that may lead to faster aircraft. The insect is about the size of a bumblebee and is said to fly at the rate of 815 miles an hour, about half as fast as a rifle bullet. An American naturalist, standing beside a canyon in Brazil, was attracted by the insect when he saw it flash past him, a blur of orange. Search revealed that it was a variety of deer fly. Engineers are now studying the streamlines and motive plant of the insect.

1078

SECONDHAND AUTO ON ROOF SERVES AS SHOP SIGN

As a substitute for the usual painted or lighted sign, an automobile-repair man in a western city placed a secondhand car on the roof where it would attract the attention of passers-by. The auto was no good for further service and cost less than a new sign, saving more than could have been realized had the car been sold for junk.

1807

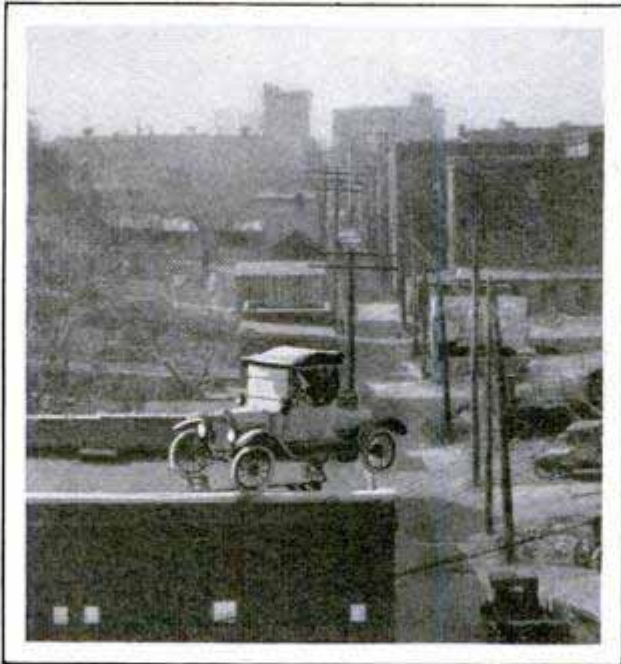

Out of Date but Still in Service; Ancient Auto on Roof as Repair Shop Sign

One of the products of petroleum is glycerin.

Com. Lem J. Lichtenstein 50 of 1 N. Franklin Phila.

Kansas City, Kans

439

City of Washington
Takoma Park
Washington, D. C.

Harnessing Life's

IF you toss a penny once or a hundred times, the chances are exactly equal that it will fall with either head or tail uppermost. But at the end of your hundred tosses, or a thousand or a million tosses, the total number of heads and the total number of tails are sure to be almost the same.

That last fact is the basis of the law of averages, a curious rule that can be applied to picking a site for a store, stocking it with goods, planning restaurant meals, selling insurance and a hundred and one other activities.

Most everybody knows that insurance rates are decided from elabo-

rate calculations based on past experience, a system of averages by which the company can bet with surety not on your life—for you are like the penny tossed once, and may either live or die—but on the average lives of a vast number of people, a whole day's tossing of the penny as it were. But would you believe that, when the restaurant chef serves corned-beef hash with poached egg on Friday, December 11, he knows just how many orders to prepare, because his past records tell him how many customers the restaurant will have on that day and date, and what proportion of them will want corned-beef hash with poached egg? The records of a large hotel or restaurant show just that. By consulting them, it is possible to order a day or two in advance the ingredients of every dish to be served, with assurance that the amount will not be far out either way.

That chain stores, particularly those dealing in cigars and drugs, have a habit of being found on



More People Will Walk Down One Side of a Street Than Will Patronize the Other, So the Chain Stores Get the Average Totals before Picking a Location for a New Establishment

Strangest Law

the best business corners in town practically everyone has observed, but do you know why? Their location is not a matter of chance, but one of careful calculation. They first make actual counts of the number of people passing a given point, and then, from past experience and the law of averages, calculate what proportion of the passers-by would be customers, and even what their average expenditure each day would be.

If you were entering the millinery business you would be told by manufacturers that you should have in stock only a small percentage of women's hats that are large and a great number that are small. If you sell ready-made clothing, you will be told to stock a certain percentage of stout sizes for fat men. If you are selling shoes and doubt the advice given you by the manufacturers, you might play a little game by way of testing out the law of averages. Stop, say, 500 persons on the street at random and ask them the size of their shoes. Then, in order to try out the law, go to another city or to another street, and ask another 500, and your answer will check up with the advice of the shoe manufacturers, and the two streets will give you the same results. All because each 500 will have practically the same percentage of people who wear number nine shoes.

To get a working understanding of the law of averages for your own purposes,

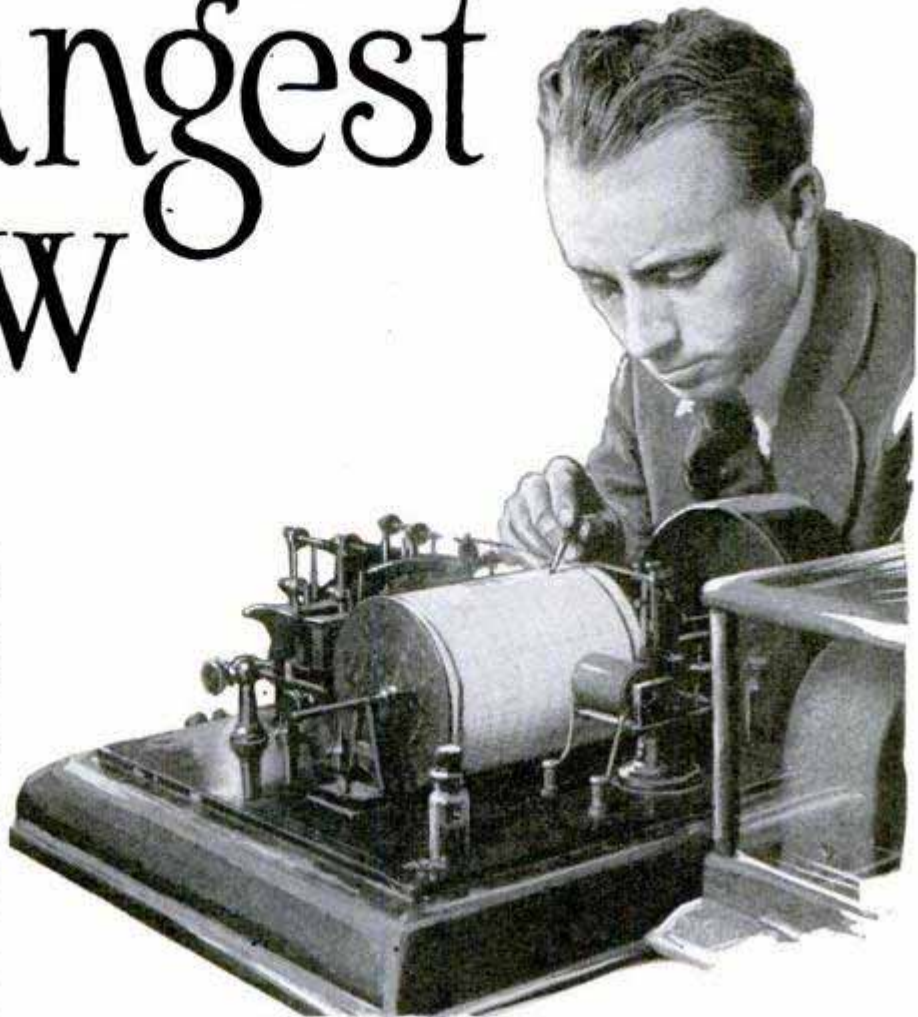

When the Weather Man Reads His Recording Thermometer He Is Contributing to Tables of Averages Used by Many Merchants

for your own home, you begin by keeping records. It is certain that the accurate knowledge possessed by life-insurance companies is all a matter of accurate records. It may be that Lloyd's will take a risk as to the weather on a certain day when a championship fight is to be held out of doors. The promoter is obliged to choose a holiday in order to attract the largest crowd. Next he goes to his insurance broker and takes out a policy covering his loss, should it rain. The insurance company in turn asks the weather bureau for data covering some fifty years of records as to the state of the weather, say, on Labor day. On the basis of the records, the company is bound to win in the long run. It is protected by the law of averages.

And speaking of the weather, what is apparently more fickle? "Every time you plan an outing it rains," you say, but it is far more likely that the records of the weather bureau will show that your

chance for a clear, pleasant day will be pretty generally even.

The weather bureau of every city in the United States is being constantly used in order to help business. Recently a great company making electric fans sent to all its agents throughout the country elaborate charts which, based on forty years' records, told just when to advertise fans, when to stock up and how many days of the year fans would be expected to sell. This was all based on weather condi-

the manager of the advertising director. Either the weather bureau or past store records will be consulted, while the advertisement stands ready to be run on last-minute orders. But, strange as it may seem, it is not the downright rainy day that worries the management so much as a stormy or threatening morning. In fact, according to the law of averages, Mrs. Jones will sally forth on a fair morning to buy through the lure of the newspaper bait. Should she, however, encounter a shower along about noon, she will decide to stay in town to eat her lunch and, because she has nothing else to do, will buy more merchandise than if the day had remained clear.

On the morning of April 3, 1917, men smoked more cigars than usual. All that day they continued to consume large numbers of cigars. In fact, Tuesday, April 3, was a record-breaking day for cigars all over the United States. This was really most surprising because, as

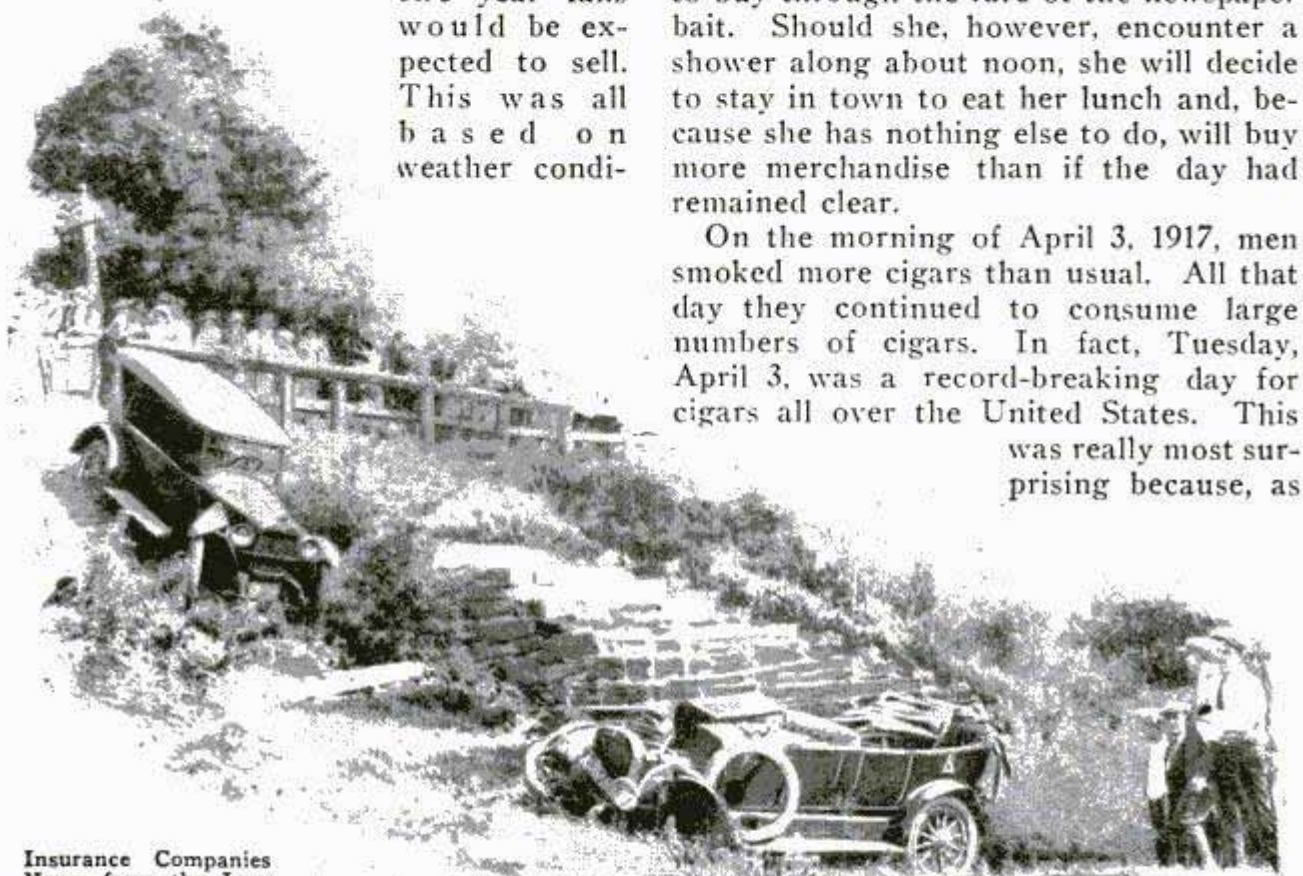

Insurance Companies Know from the Law of Averages Just About How Many Automobiles Will Be Wrecked This Way

tions—humidity, rainfall, heat, and so on.

Newspaper publishers are showing an uncanny understanding of the law of averages in relation to the weather. They have learned, for instance, that a newsboy will sell 149 papers on a clear Sunday morning, but when the weather threatens to be disagreeable they will print more, for the same boy will sell 211. Thus the weather report means more than a mere announcement each day.

Then there are the department stores. They have a sale planned which must attract a certain number of people in order to dispose of a certain quantity of goods. "But what about the weather?" inquires

a rule. Tuesday is a dull day in the tobacco business. According to the law of averages, men stock up on Saturday and replenish on Monday. The reason was that on the previous night the president had appeared before a joint session of congress and delivered his message asking for a declaration of war. The next day men read their papers and became more thoughtful. Much ordinary business was forgotten and men were inclined to smoke and talk and sit and think. Thus the law

of averages throughout the nation was proved by the conduct of all the men.

In St. Louis is a well-known hardware firm that is constantly making some use of the law of averages. For example, each day they take the little stacks of sales slips that come in by mail from the men on the road and weigh them. Thus they know without further study, just how much money the sales represent. Each ounce of the little slips means so many dollars. One slip may be for a bill of goods mounting into thousands, and the next may cover a quarter's worth of nails. But two equal stacks of the slips average a certain amount which, experience has shown, varies but a few cents.

This same company gathers all sorts of other information because it has found that each has its place in the successful operation of business. For example, they ask their men to send in daily reports on the weather, temperature, rainfall and on crop conditions. They even arrange to get information on the state of the weather in England. In getting this, they are merely obtaining advance knowledge as to certain business that the law of averages assures them will be theirs in time. For an unusually warm, rainy spring in England will mean an earlier demand on English manufacturers for pruning shears, scythes and such articles. This in turn will mean that the manufacturers will be less able to make prompt shipments of such goods to America. Wholesalers in this country, therefore, must either get their orders in early or arrange to get the goods from some other source.

Also a rainy March and April in any section of the United States means that there will be a big demand for scythes and sickles and lawnmowers in June.



People Who Leave Their Change Contribute an Average of Twenty Dollars a Day to the Circus, the Law Reveals

Under the law of averages, a certain number of men out of each thousand will buy lawnmowers, but the number who get new ones depends upon how luxuriously the grass grows. Just so a dry spring and sales of garden hose have their relation.

In the treasury department at Washington there is a man who plays with the law of averages and obtains answers to legislative questions which will affect the whole United States. This man is Joseph S. McCoy, who is listed merely as an actuary, yet, although not in the public eye, he takes a set of figures and another lot of numbers and puts them together according to the law of averages and so finds out what you and your neighbors will do as regards income taxes, tariff and a lot of other things.

When the Underwood tariff bill was being drawn, McCoy was called upon to give information as to the way people would pay the various amounts. The congressmen wanted to know just how much money the bill would bring in. It happened that on one item the tax was

ten per cent and some had planned on increasing it to thirty per cent. It was McCoy who estimated with wonderful precision how much the tax would bring in and whether a certain item could be made to bear the higher or the lower tax.

Then congress wanted to know what the population of the United States would be in 1910. They asked in 1901. And when the census was completed it was found that McCoy came within one per cent of the count. At other times McCoy was asked regarding the number of men who belonged to clubs when a tax on clubs was being considered, and regarding the people who go to the movies. His answer to these questions was simple. He inquired of every man that he met to how many clubs he belonged, if any, and he asked his wife how often she went to a movie and asked her to ask her friends. Thus, by counting on human nature in Washington, he was able to learn what women in Kansas and California would do. His estimate as to those who go to the movies was that 12,000,000 people do each day. Some of the motion-picture

producers at first disputed his figures, but when they checked up by their own records, they admitted that he had obtained an accurate estimate.

When you go to the circus, you and all the others will contribute about \$20 a day because you go away from the ticket window without your change. Circus men have found out that these walk-aways are worth that much to them and they count on it. But the bigger the crowd and the more excitement, the more change will be left. In many cases it is the habit of people to do certain things that have made men and women, able to appreciate the fact, rich.

The cigar store and the chain drug store can tell from year to year what their losses will be as judged by the weather. A certain velocity of wind will mean so much and rain will mean so much. According to the weather, they know how many men will use the telephone; therefore they place the instruments so that people must go through the store in order to reach them and, perhaps, be induced to buy something they see in passing.



Photos © Nat'l Photos

Uncle Sam Knows Just What He Can Expect to Find Each Year in All the Packages Sent to the Dead-Letter Auctions for Sale, as a Result of Figures Compiled over Many Years

of Commerce
X-RAY STOPS THEFTS OF DIAMONDS AT MINES

1899
Workers in the South African diamond mines are easily foiled by means of X-rays when they swallow choice stones in an effort to steal them. The rays reveal the diamond as it registers on the photograph. Another method the miner-thieves sometimes attempt is to hide a gem in a deep cut on their feet. By giving the workers six months vacation each year, less dissatisfaction has arisen and consequently fewer attempts at stealing, according to a representative of the South African government.

ELECTRIC TOASTER BORN OF "HIGHBROW" TESTS

1113
Not long ago, learned investigators were engaged in laboratory tests, trying to determine which metal burned up at the slowest rate under the strain of carrying an overload of electricity. No one knew at the time, but these experiments were to give the world the electric toaster. The heating element in these units so successfully resists the current that it lasts a long time and has made the toaster a practical household aid. Academic arguments over electricity and other matters are still in progress, and the results, while not all adaptable, are often applied for the general good. Some scientists believe that the electron can be still further divided into systems of its own and the opposition offered to their arguments recalls that, for a long time, scholars held the atom to be the smallest particle of matter, but have now abandoned that theory in view of the evident structure of atoms in negative and positive charges.

Tennessee Daily News

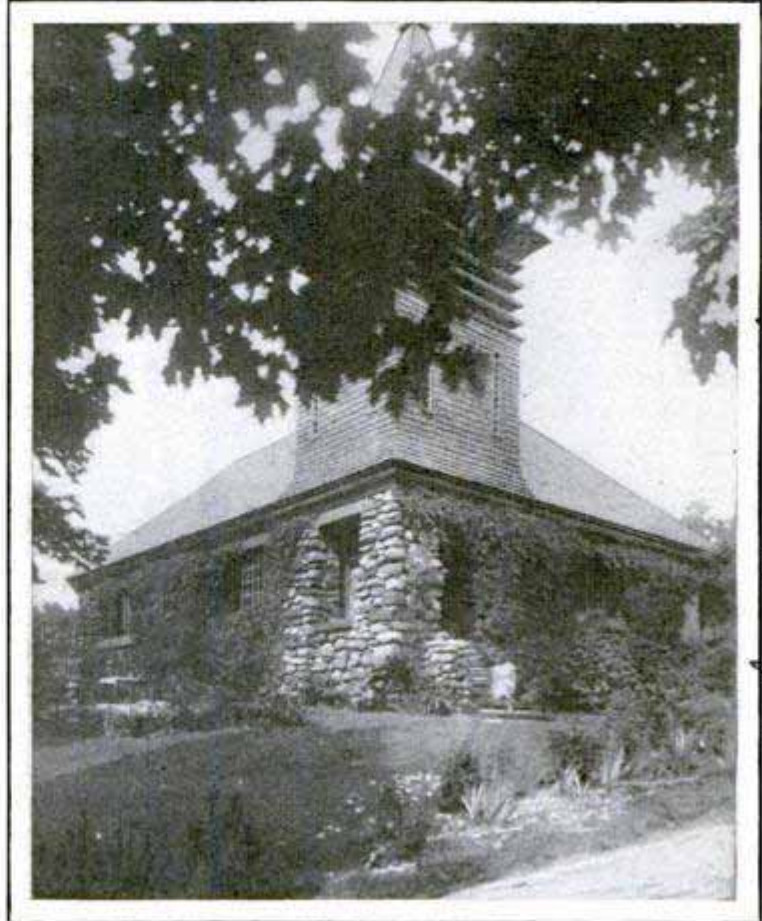

Now Used as a Summer Residence; the Country Church with Front Veranda Remodeled into Vacation Home

STONE CHURCH IS REMODELED INTO SUMMER HOME

at Scarborough, N.Y.
Abandoned by the congregation, a New York church, built of native field stone, was purchased and remodeled into a summer home. The structure was altered but slightly on the exterior and the inside was divided into rooms and fitted with modern conveniences.

*Owned by Henry Stillman
Director, All Theatres
New York City*



1077
EYELASH CURLER IS THE LATEST BEAUTY AID

Without heat or cosmetics, the eyelashes can be curled by a simple hand instrument that clamps them between soft pads. By application of gentle pressure for a moment, it bends them into a curl that will last for days.

Curving Lashes with the Curler; Gentle Pressure Applied for a Moment or Two Is Sufficient

*The Stuckel Co, Inc.
107 Clinton Ave. N.*

TRIPODS TO REPLACE CAGE MASTS ON BATTLESHIPS

Lowy

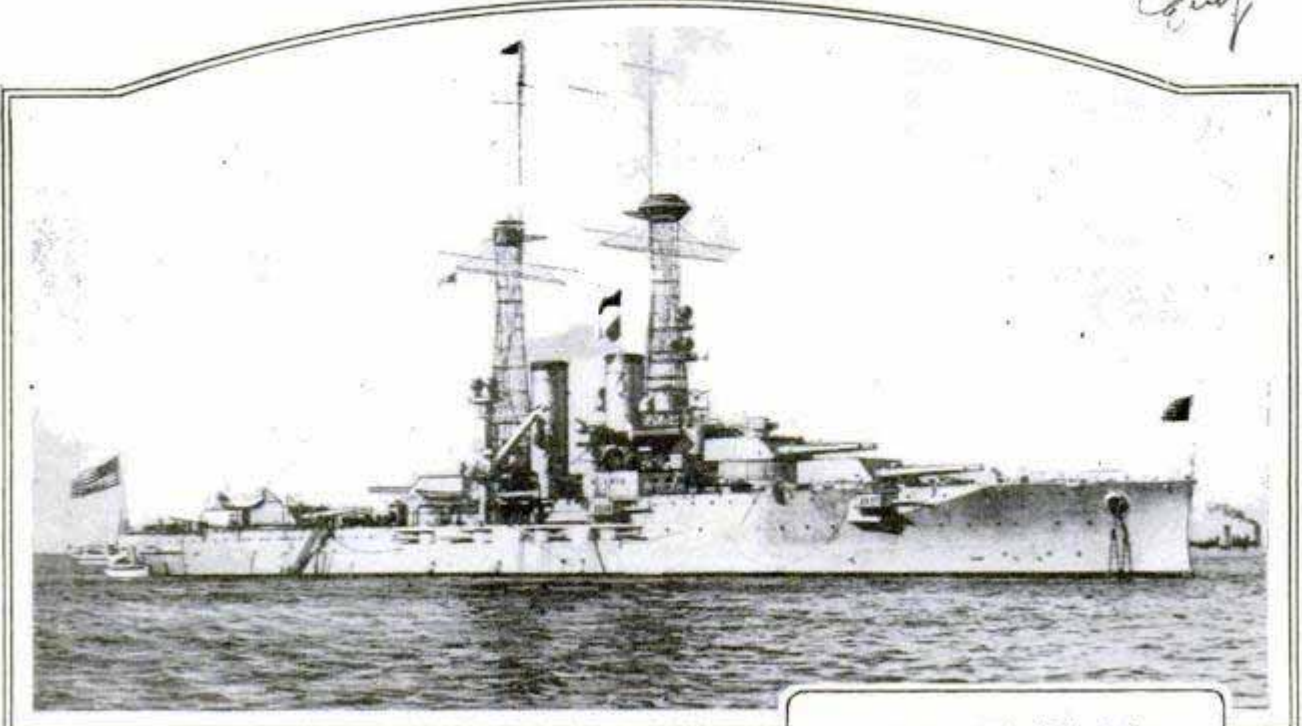

Battleship "Florida" before, Above, and after, Below, Extensive Alterations; One Cage Mast and One Smokestack Have Been Eliminated

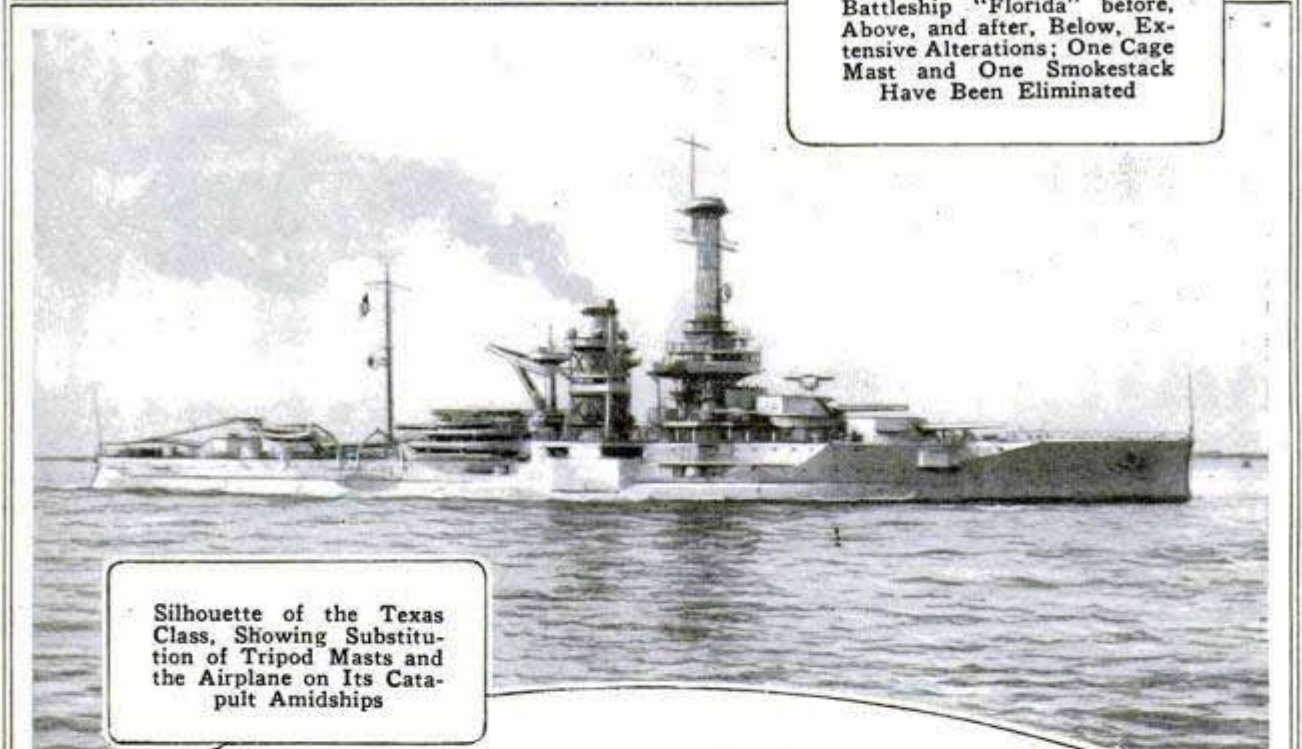

Silhouette of the Texas Class, Showing Substitution of Tripod Masts and the Airplane on Its Catapult Amidships

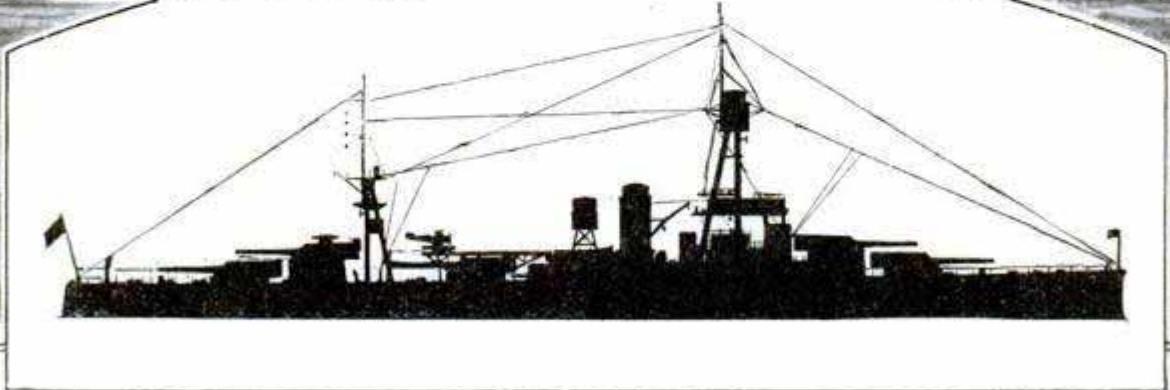

may newyork police 11

OLD WARSHIPS ARE REBUILT TO MAKE LONGER CRUISES

To keep abreast of the times, radical changes have been made in the equipment of three United States battleships and alterations are in progress on three others. The "Texas," "Arkansas" and "Florida" have been remodeled. The "New York," "Wyoming" and "Utah" will be ready for duty in their new form in a few months. The modernization program, when completed, will increase the cruising radius of the six ships to that of the other twelve battleships of the fleet. The "Texas" was converted from a coal to an oil burner, additional plating was placed on the protective deck as defense against aerial bombs and high-angle gunfire, a powder-impulse catapult was installed for launching airplanes, "blisters" were added to the underwater hull for submarine, bomb and mine protection, and the mainmast was removed and replaced by a low mast just forward of the number three turret, while a new tripod mast was installed between turrets three and four. There is now but one smokestack instead of two and the cage or latticework masts have been replaced by tripod masts.

BLOOD PUMPED BY ELECTRICITY AFTER HEART STOPS *1126*

Possibility of prolonging life by artificial circulation after the heart and lungs have ceased to function is seen as a result of experiments by Russian investigators, who have devised an electrical apparatus that takes over the duties of the natural organs. Blood was kept flowing through the severed head of a dog for half an hour. During this time, signs of life were noticed, such as opening of the eyes, reaction to light and movements of the ears.

news item from Moscow in Herald. Examiner 12/1/06



Double-Purpose Weapon for Police, the Combination Flashlight and Revolver, to Surprise Criminals and Aid in Firing

FLASHLIGHT AND GUN IN ONE TO AID CRIME WAR

To throw light on the target, a revolver is fitted with a strong flashlight. The weapon is intended especially for police use against marauders in the dark.

HANDLES FOR WOMEN'S HATS LATEST LONDON FAD *997*



To save the crown of the brimless women's hats now in vogue in London, stiff felt handles have been attached so that the hats may be more easily removed. They are made to harmonize with the other trimmings.

☐The light from Sirius, the dog star, is equivalent to about forty times that given off by our sun.

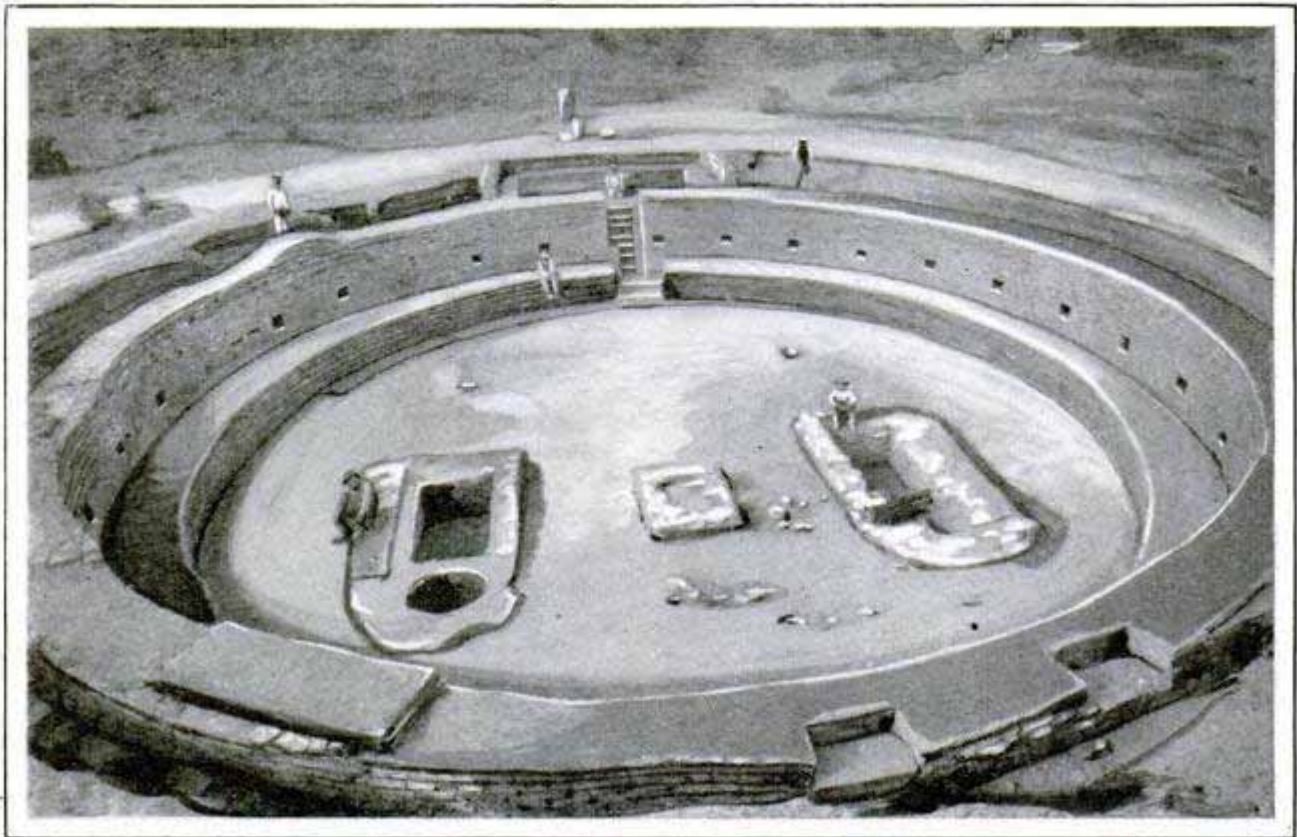

Ceremonial Kiva, or Round House of the Ancient Pueblo Dwellers, After the Ruins Have Been Excavated and Partially Restored; the Southwest Indians Were the First Apartment-House Builders

Digging Up History with a Pick

DOWN in the southwest they dig up their unwritten American history with a pick, dust it off with a whiskbroom and piece it together bit by bit like the fragments of a broken pottery bowl.

The direct descendants of the ancient Pueblos are still living in the region, almost as primitive a people as their forefathers. Many of them are employed during the summer to work on excavations of the ruins of their former homes. Of their prehistoric ancestors they know nothing except a few legends. It is up to the scientist in charge to write the history of these forgotten peoples from the relics of their life and customs which they left behind them in the abandoned villages.

An archaeologist approaching a site which he intends to excavate, first makes a detailed description, with photographs, of the undisturbed ruins, measuring the area of the mound and the height at various points. From the appearance he estimates the original height of the walls, the number of rooms in each group with the location of kivas, or circular council chambers, and the ground plan of the village.

He collects all fragments of pottery which he can find on the surface and then engages a crew of Indian or Mexican laborers to do the excavating.

The workmen first clear off the loose stones left exposed on top of the mound. These they pass along from hand to hand to a spot outside the mound proper where they will be piled, perhaps for restoration purposes later on. Then the men start to work with picks, shovels and wheelbarrows to clear out the earth that covers the ruins. They brush off every scrap of pottery, bone or wood. If the rooms are to be left open, the "bone diggers" carry off the filling of earth and stones.

The archaeologist usually digs out a burial site himself. He works slowly with a trowel and inspects every bit of dirt removed. He uncovers the bones with a soft brush, replaces pottery and other mortuary offerings surrounding the body and photographs the remains. From such discoveries he can tell not only the stature, age and sex of the person buried, but something of the culture of the times in which he lived.

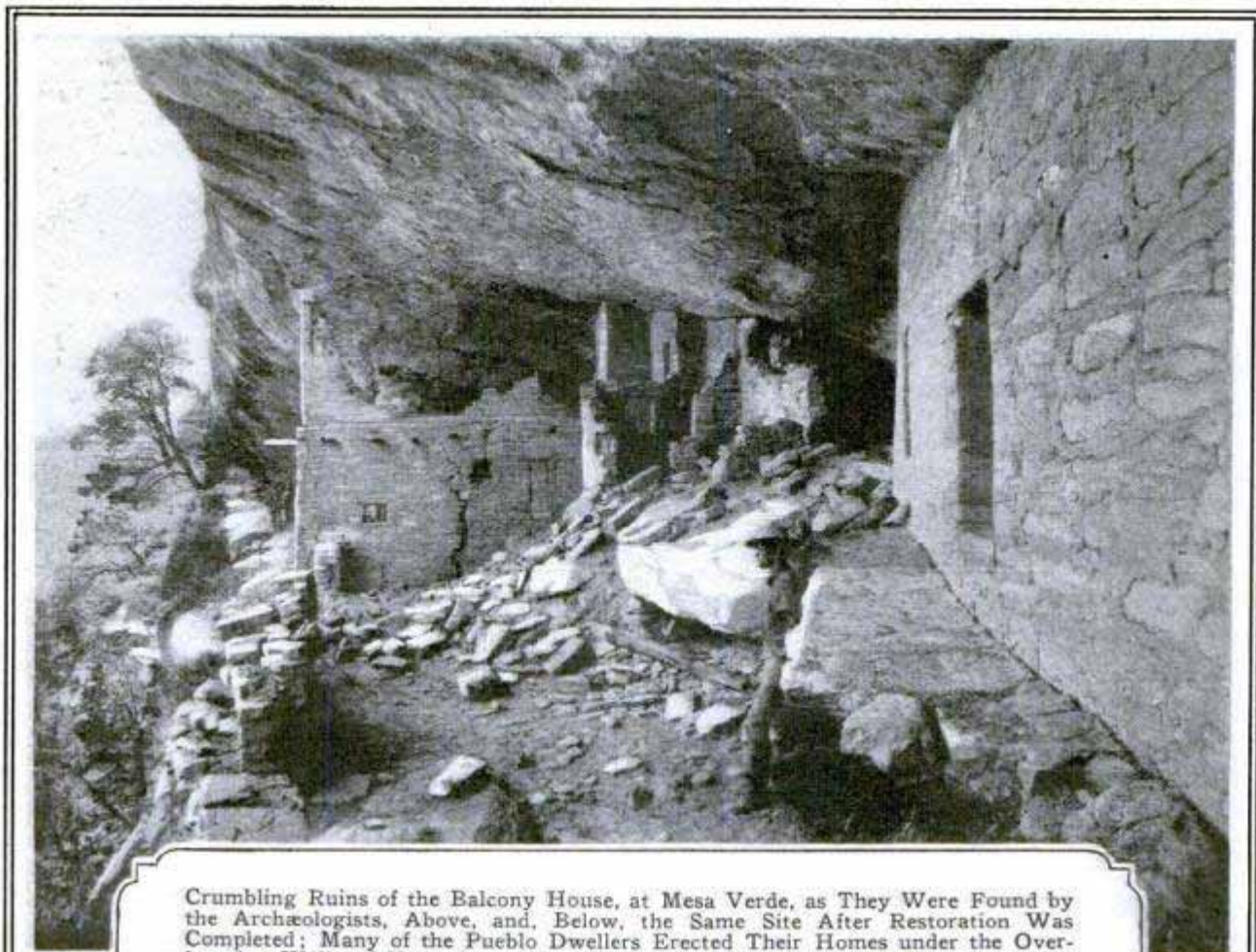

Crumbling Ruins of the Balcony House, at Mesa Verde, as They Were Found by the Archæologists, Above, and, Below, the Same Site After Restoration Was Completed; Many of the Pueblo Dwellers Erected Their Homes under the Overhanging Walls of Huge Natural Caves, and in This Way They Were Protected from the Complete Ruin That Befell Homes in More Exposed Sites; the Caves Not Only Gave Protection from the Weather, but Limited Attack to the Front

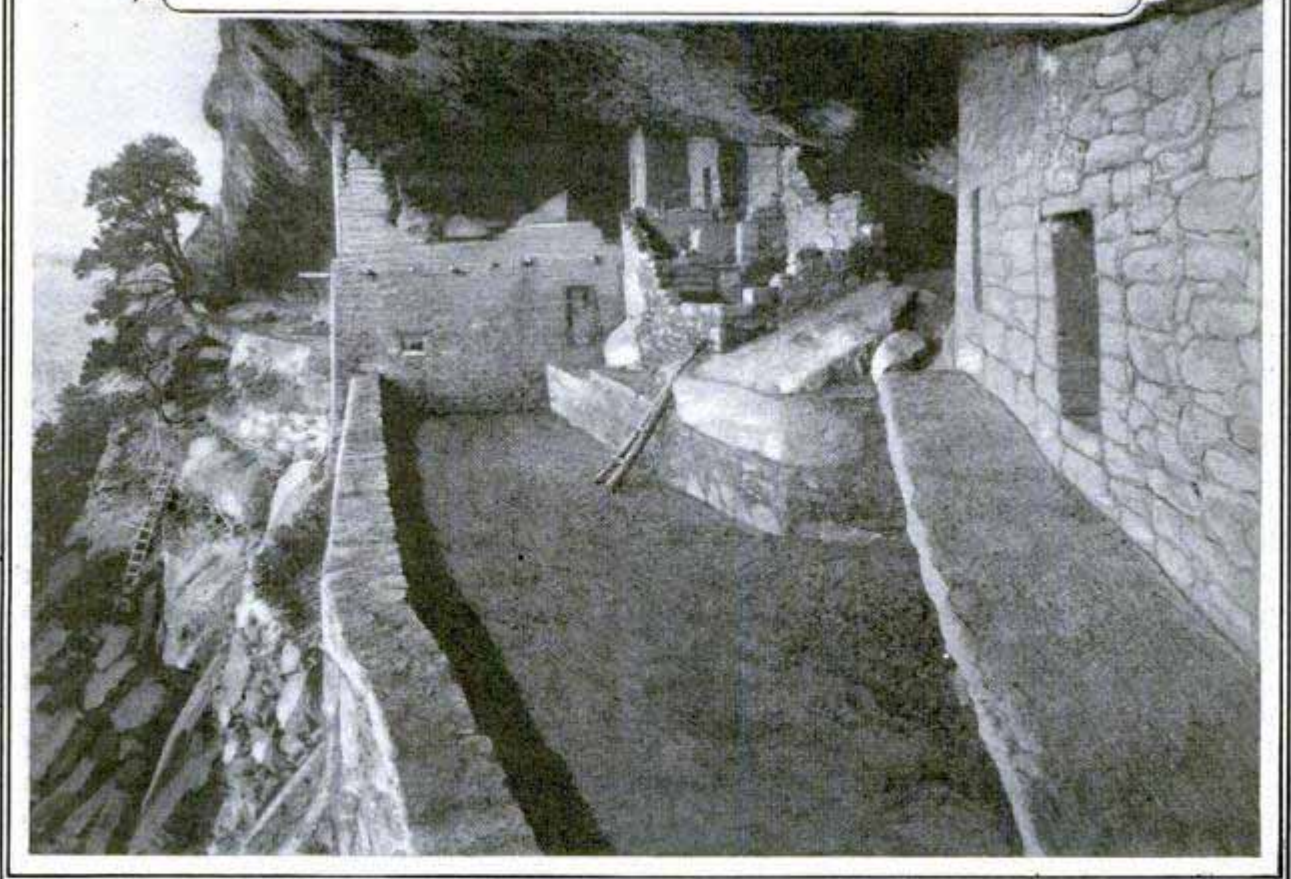

INVENTING SOUNDS TO INTERPRET MOVIE DRAMAS

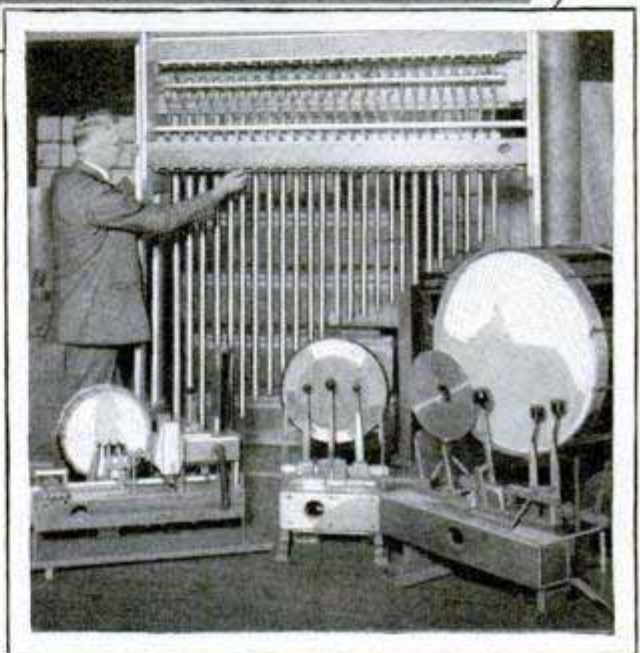
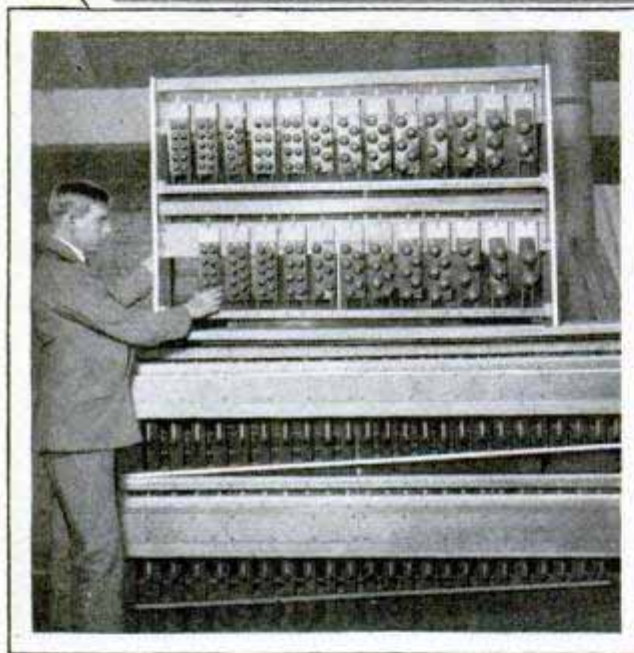
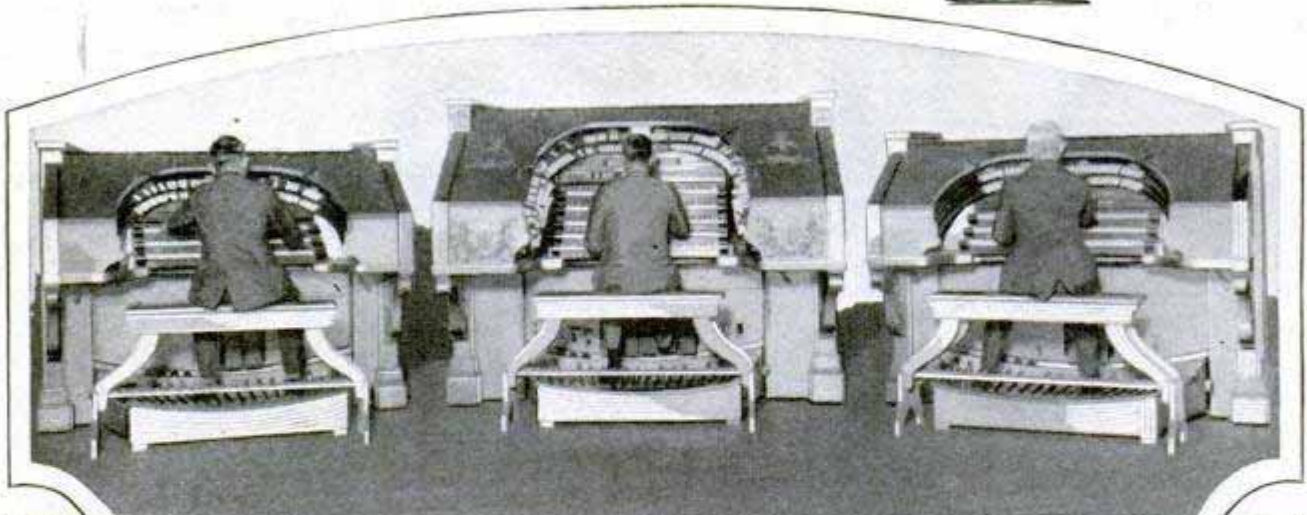

Playing the Three Consoles of the Mighty Organ, All Parts of One Unit, and Some of the Instruments It Contains, Sleigh Bells, Chimes and Sets of Drums

Tones that tell stories are the pipe organ's contribution to the movies. Its hundreds of voices are the result of many experiments by skilled musicians and craftsmen who are constantly seeking new effects and combinations for better interpretation of the films. This is illustrated in the instrument for Roxy's theater in New York, the largest unit organ ever built for a playhouse. Its resources are so vast that three organists are needed to operate it. For this purpose, it has three specially designed consoles or key desks. Many tones impossible to the ordinary organ are produced by this instrument, which is essentially a great organ and an orchestra in a single unit. One set of pipes plays the peculiarly shrill tones associated with oriental music and danc-

ing, and the note of the post horn, a special trumpet often used with the tallyho coach, is also reproduced. The organ contains a complete set of drums and traps for symphony or jazz music and every known percussion instrument including the piano, marimba, celeste, xylophone, chimes, orchestra bells and harp. Sleigh bells are seldom heard in the streets, but this organ contains a whole set of them, which are jingled by the action of small bellows. Special trap effects to fit scenes in the pictures afford realistic imitations of an aeroplane, train, automobile horn, siren and many other objects. Practically every tone color of the symphony orchestra can be reproduced. The organ is of the electro-pneumatic type, that is, electricity is used to convey the impulse from

the key and compressed air is the power by which the mechanism that produces the tones is operated.

1116
**EFFECTS OF HEAT
 ON WORKERS**

Several time-honored ideas have been shattered and the importance of maintaining proper atmospheric conditions in factories, foundries and mines has been emphasized by tests conducted by the bureau of mines and the public-health service as to the effects of heat on workers. In the course of the tests, it was discovered that a robust man, stripped to the waist, could work for an indefinite period without injury in a temperature of ninety degrees Fahrenheit with a relative humidity of 100 per cent. Another experiment showed that drinking ice water in large quantities after long exposure to high temperature and great exertion was not harmful. One man drank a quart in fifteen minutes without any injurious effects. The investigation also revealed that sweat dropping into the eyes is a common cause of optical trouble among workers. A small quantity introduced into the eye, when normal, caused the organ to become sore and inflamed and perspiration from the arms and chest was found to be even more harmful. The experimenters recommended that workers who are exposed to great heat wear sweat bands to protect their eyes. The tests were conducted in laboratories and carefully constructed rooms.



Wide World
 Trapped by the Camera; Flashlight Photo Young Deer Took of Itself When It Stepped on Hidden Trigger in Brush

**DEER TAKES OWN PHOTOGRAPH
 WITH HIDDEN FLASH**

Carefully concealed in the underbrush, a camera and flashlight registered an excellent photograph of a young deer feeding in the Pocono mountains of Pennsylvania. The flash was sprung by a trap hidden in the leaves. Similar photos are not uncommon, but few show the subject at such close range and accurate focus.



© Henry Miller
 Dr. Strauss of Vienna with Gauge by Which He Measures the Intensity of X-Rays

**X-RAY GAUGE MAKES
 EXPOSURE SAFE**

To prevent injury to patients through exposure to X-rays of too great intensity, a gauge devised by a physician in Vienna shows the strength of the rays being used and how much of them has been consumed in a treatment. The instrument is intended not only to safeguard the patient but also to reduce waste of the precious rays.

1054

FRONTIER DAYS LIVE AGAIN IN KIT CARSON HOME



Kit Carson's Home, Where the Noted Indian Fighter Spent His Final Years, as It Looks since the Restoration; Photos of Carson and His Grave in the Cemetery of the Ranch

Restoration of part of the home of "Kit" Carson, scout, plainsman and Indian fighter, at Taos, N. Mex., has revived interest in one of the most romantic figures the west has produced. Three men of his day stand out in history—Buffalo Bill, Jim Bridger and Carson—and because of his unusual prowess as a marksman and his daring as a scout, the latter, though he died in 1868, is as well known as Col. Cody himself. Long before the first gold miners rushed overland to California, Carson had gained his place as the most famous man among all the trappers from the Mississippi to the Pacific and from the Canadian line to the Mexican villages in the south. Born in Missouri, he went west at the age of eighteen, in 1826, accompanying a party of traders down the Santa Fe trail. From that time on until his death, he spent practically all his life in the heart of the Indian country. His ranch at Taos, where he made a few brief visits between almost continuous Indian wars, became the rallying point for the scattered white settlers whenever they were threatened by the Apaches, so the restored house has historical interest aside from having been

his home. When Carson and his wife both died, in 1868—his death the result of privations while fighting on the Union side throughout the war—the place was allowed to fall into decay. Rain and wind gradually eroded the adobe walls, so that, so far, only three of the ten rooms the ranch house contained have been restored.

ALUMINUM STREET-CAR BODY TO INCREASE SAFETY

Decrease in the operating costs of street-railway systems and greater safety for passengers are foreseen in a street car of aluminum. All parts except the windows, doors, wheels, axles, springs and gears are of this material in an alloy said to be as strong as steel but only one-third as heavy. The windows and doors are made of plate glass, which has proved effective in automobile service. In manufacturing the cars, the alloy is heated until it has the consistency of jelly, then it is forced through dies that give it the desired shapes. A car exhibited in Cleveland, Ohio, weighed only 34,000 pounds, about four tons less than the ordinary steel car

*Cleveland Railway Co
Cleveland, Ohio*

at Aborn, Ohio

Livery Ave. N.E.

Minneapolis, Minn. 417

of the same size. According to officials of the railway company there, this reduction in weight will effect a saving of fifteen per cent in the consumption of electric power, or an economy of some \$150,000 in Cleveland every year.

ONE BUILDING ACCOMMODATES CHURCH AND APARTMENTS 1137

Convenience and simplification of the financing problem are sought in a combination church and apartment building constructed in an Ohio city. The auditorium, Sunday-school rooms and other church departments are in the front portion and the living quarters at the rear. Rentals from the apartments are expected to cover all the interest and deferred payments on the church debt and, when this has been cleared, will provide a steady income. The apartments have been arranged in such a way that they can be converted into additional church quarters when the need arises. The minister and his family will occupy one suite.

SYNTHETIC COAL FROM RUBBISH CUTS FUEL COSTS 1040

Rubbish, old shavings and other waste are treated with a special liquid and pressed into bricks for fuel by a Viennese chemist. The pieces are said to give a hot fire and a wagon load of the material can be obtained for a small price.

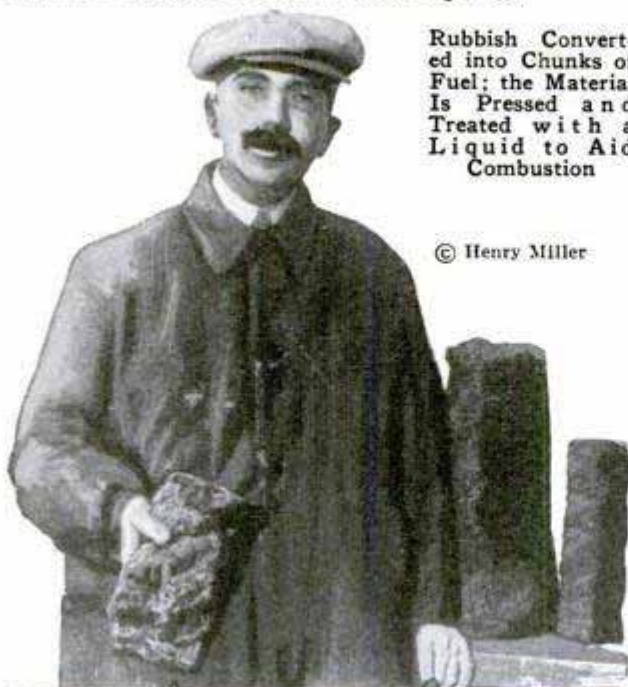

Rubbish Converted into Chunks of Fuel; the Material Is Pressed and Treated with a Liquid to Aid Combustion

© Henry Miller

Johann Ludwig

MEMORIAL BRIDGE OF CONCRETE NEARLY MILE LONG 1067

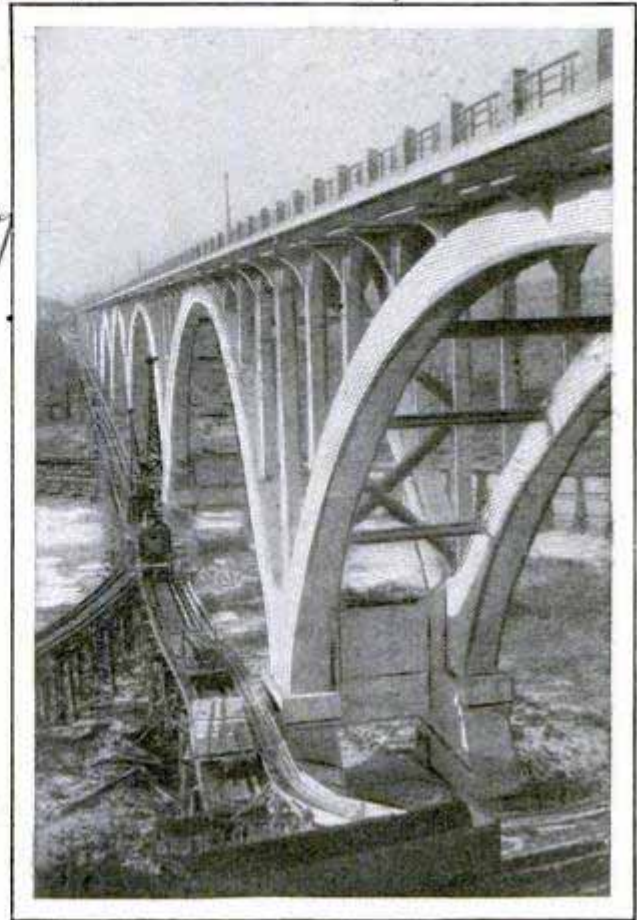

Concrete Arches of the Memorial Bridge between Fort Snelling and Mendota, Minnesota

Dedicated to Minnesota gunners who lost their lives in the World War, the concrete bridge, between Fort Snelling and Mendota, over the Minnesota river is 4,119 feet long and 200 feet above the surface at the center span. Exclusive of sidewalks, it has space for five lines of vehicles abreast. The foundations extend to solid rock at an average depth of eighty feet below the ground level. The viaduct will be of great service to persons in the southern part of the state by making Minneapolis more accessible.

DECK FOR CHILDREN ON LINER SIMPLIFIES TRAVEL 857

Caring for small children while on ocean voyages has been simplified on two steamers in the New York-California trade by the addition of a special deck for the youngsters. Here they can play games, dig in sand boxes and otherwise amuse themselves in safety under the supervision of an attendant.

*Panama-Pacific Line
Manchuria and
Mongolia*

1225
no record of myr

at plant of Hatfield
Automatic Wheel Co



in Berlin

German School Boys Depositing Money in Classroom Bank; Amounts Are Registered on Card

BANKS IN SCHOOLROOMS HELP PUPILS SAVE MONEY

School children of the United States banked more than \$20,000,000 during the last school year, official reports from the 11,371 schools where savings systems have been instituted, show. The sum represents the deposits of more than 4,000,000 boys and girls, or eighty per cent of the total enrollment in places where the system is in operation. According to W. Espey Allig, of the American bankers' association, the plan was, in a large measure, the outcome of thrift inspired during the World War. In many Berlin schools,

automatic banks have been installed as an incentive to the youngsters to save. Each child has a card for registering its deposits and, when a certain amount is reached, a city savings bank credits the sum to the child on its account.

336 Esuld prd. Co. Baltimore

PNEUMATIC STREET-CAR WHEEL 1263 STANDS HEAVY TESTS

Promise of improved street-car service is seen in a pneumatic wheel which has withstood severe preliminary tests in Baltimore, Md. It consists chiefly of an inflated rubber tube in a metal container around the hub of each wheel, the weight of the car being borne by the tube, which does not come in contact with the rail. Heavy pressure tests failed to break the rubber. Engineers believe that the wheel, if successful, will permit further improvement in the adoption of roller bearings, a feature which has not been practical because of the jolts and jars. Savings of power are also anticipated.

AUTO HAS CATERPILLAR TREAD FOR TRAVEL IN MUD

1049

Automobile and tractor are combined in a car introduced in England. It has a caterpillar tread on each side and is lowered or raised by the motor. When it is in contact with the ground, the main wheels are elevated and the car is propelled by the tread. *at Camberly*

When Caterpillar Unit Is Lowered, Main Wheels Are Elevated and Car Is Propelled by Tread; the Change Is Quickly Made Back to the Big Wheels for Ordinary Travel

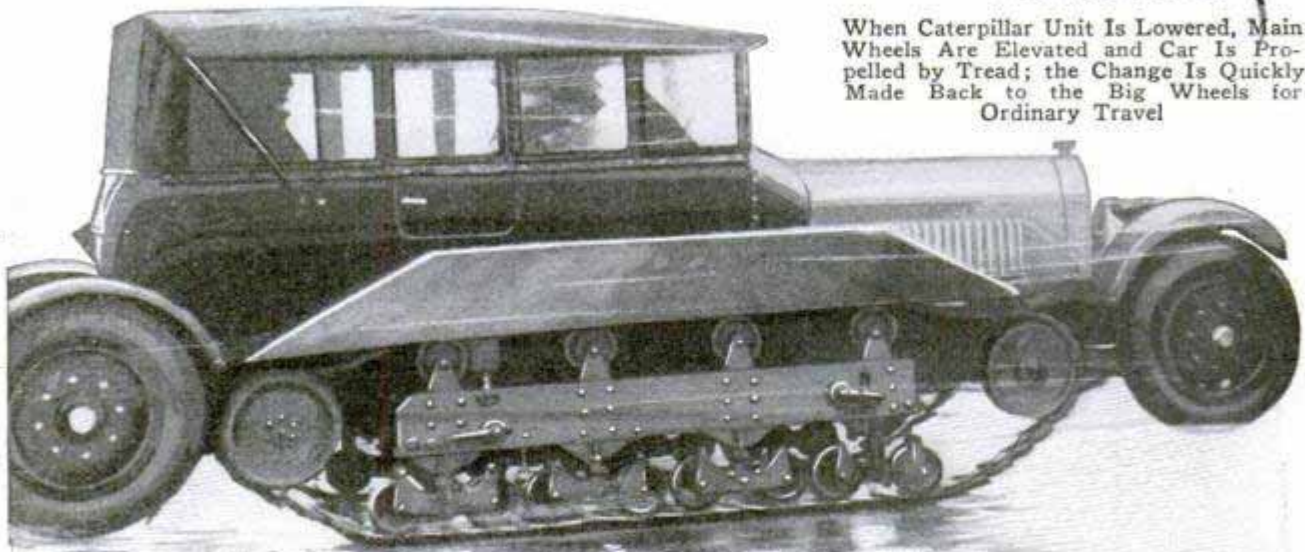

Keeping Alive Art Treasures of Dead Centuries

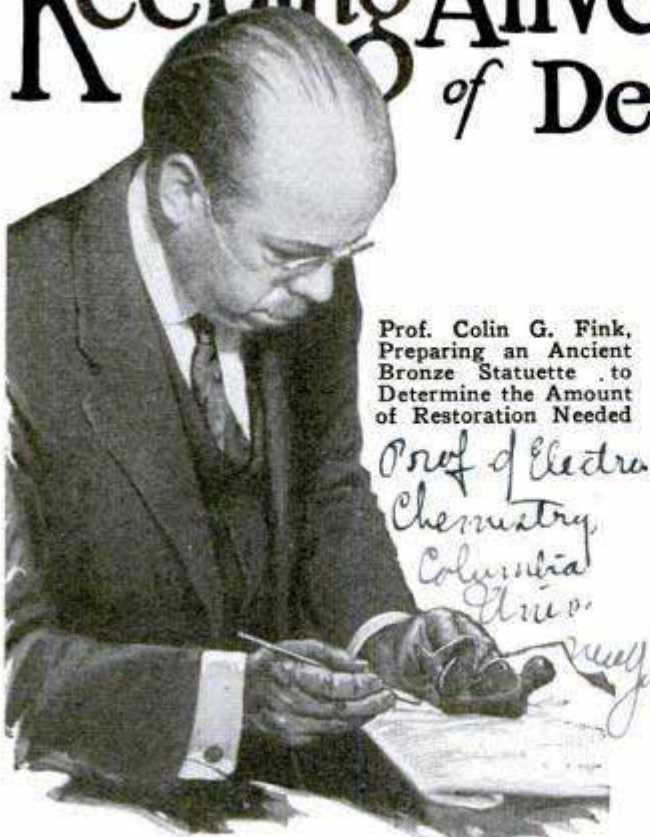

Prof. Colin G. Fink, Preparing an Ancient Bronze Statuette to Determine the Amount of Restoration Needed

*Prof of Electro
Chemistry
Columbia
Univ.*

By JOHN CHAPMAN *Kew Farm
Apts. Kew Gardens, L.I.C.
ny*

much for it, and now no physician visiting his millionaire client could give a more thorough examination than the curator gives the hawk every day.

There is a little pin point of decay on one of the bird's bronze feathers. It is the dreaded bronze disease—a kind of cancer. Just what causes it is not yet exactly known, but it is contagious, and one case of bronze disease may threaten the life of other unprotected exhibits. In seeking a cure, the Metropolitan called in Dr. Colin G. Fink, of Columbia university, who has developed almost magical methods for the restoration of apparently hopelessly corroded ancient treasures.

Bronze disease shows itself by a fine green dust at the base of the platform on which the exhibit is mounted. The grains are so fine that unless the bronze is incased in glass they will blow away. Thus comes the contagion. If such dust is found, the bronze is minutely examined, and an area, sometimes no larger than a pinhead, spotted where the bronze is rough in appearance and lacks the beautiful luster which perfect metal shows.

How bronze disease starts has not yet been determined, but Dr. Fink has noted that when a speck of lampblack or coal soot is placed on a clean sheet of copper, the speck soon becomes the center of a corroding area. He believes it may be caused by a trace of sulphuric acid in the carbon speck; or it might be the action of one of the constituents of the atmosphere, such as ammonia.

In Dr. Fink's process against bronze disease, as well as with restoration of corroded bronzes, the object is hung in a weak solution of caustic soda by means of soft-copper wires. The negative pole of a direct-current lighting circuit is attached to these wires, and the current is applied, the positive poles being iron objects hung on either side of the bronze. Under the electrical influence, a layer of spongy copper takes the place of the dis-

ASK your doctor if he knows how to keep a mummy in good health. Or a stone tomb. Or a bronze warrior. He will want to know what the joke is, and may remark that such things don't get sick.

But at the world's greatest storage house of "dead" things, the Metropolitan Museum of Art in New York, one of the big problems is a constant battle with disease, and an expert staff is kept constantly at work detecting and preventing ailments which may cause the ruin of priceless art treasures. Years have been spent in this research and, only recently, cures and preventives have been found that will preserve exhibits for a longer time than has heretofore been possible. The experts say the difficulty is not in finding exhibits but in maintaining their health after they are brought to our unfriendly climate.

A sick hawk is now under observation in the office of the curator. It is a beautiful bronze thing, priceless, and older than Christianity. The nearest it ever came to being alive, except perhaps in the imagination of some worshipping Egyptian, was when it was molten metal. It lay preserved for centuries, but the unhealthy American climate has been too



Bronze Head from Ancient Greece Being Placed in the Vat for Electrolytic Treatment to Restore the Original Metal

eased spot, and this is brushed off. Then the bronze patient is given a coating of lacquer, which does not change its color, but must be renewed every four years.

Ancient finds for museums do not usually arrive in a perfect state of health. Many of them have been victims of chronic disease for centuries, and the change often aggravates these ailments and cuts short the lives of the exhibits.

Bronzes present one of the biggest prob-

lems. Often, archæologists will find a perfect specimen like the hawk, which develops no ailment until it has been on exhibit for years. More often, bronze statues, ornaments and utensils are in an apparently hopeless state of corrosion when discovered.

Old Egyptian bronzes have been buried in peat mud, water or Sahara sand. Those found in peat mud are well preserved. Water bronzes are slightly corroded. It is in bronzes dug out of the earth that most trouble is encountered. Egypt was once an ocean bed, and its sandy soil is filled with salts, the action of which causes corrosion. Such bronze has been found to have an outer porous green crust which is not bronze at all, but copper, silver, tin or lead compounds.

Beneath this, there is usually a core of copper oxide, which is smooth and still bears most of the imprints of the creating artist's handiwork.

Before scientists took up a detailed investigation, the outer crust was often knocked off by mechanical means, or taken off with acid which might injure the precious smooth metal beneath. Now, with Dr. Fink's process, the outer crust is cleaned off by electric action, and the

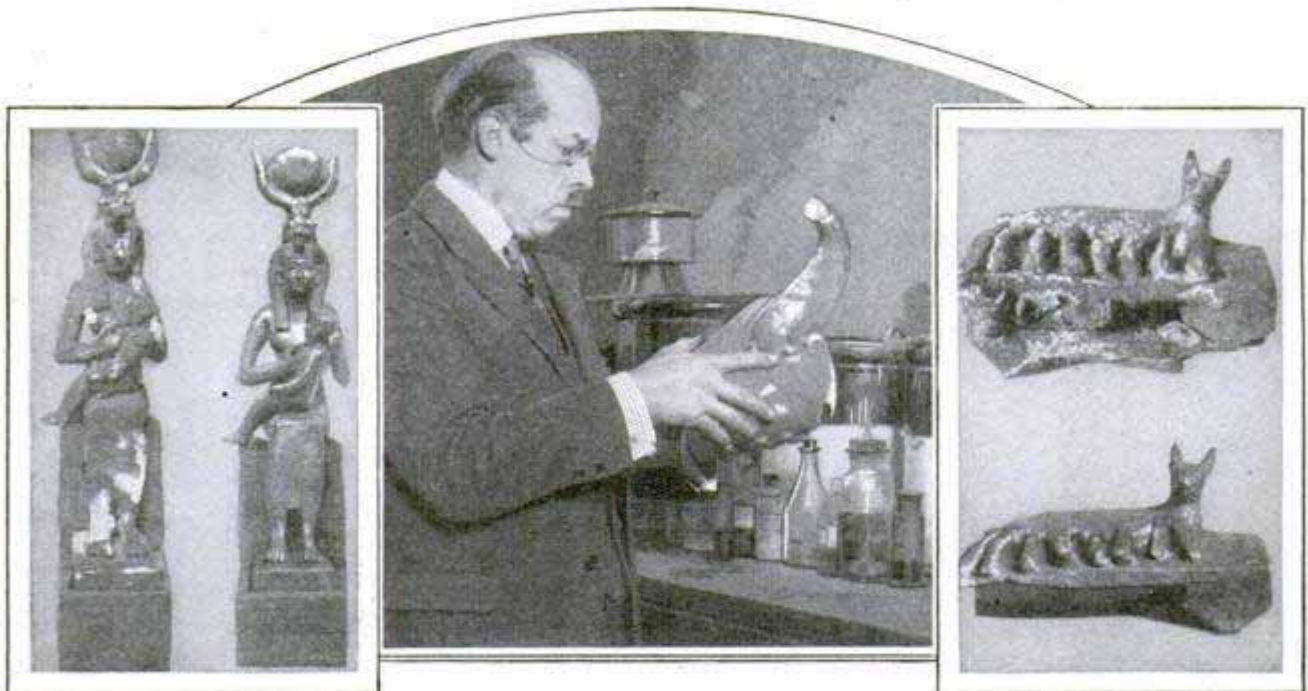

Bronzes, before and after Restoration, Showing an Egyptian Statue and a Dog and Its Family; Center, Prof. Fink with a Completely Corroded Bronze Made in Egypt 3,000 Years Ago

metal core within revealed. In this way, bronzes that have been completely corroded and have no trace of their original alloy, have been restored to beauty.

A corroded bronze object is hung in the electrolytic bath until free emission of gas indicates that the corroded part has been broken down into porous copper. Now comes the ticklish part. After a careful washing, the object is examined, and if it looks as if there were hard metal beneath the copper sponge, the sponge is wiped off with a soft brush. If it is apparent that corrosion has gone all the way through and there is no bronze beneath, the object is rapidly dipped into weak nitric acid, and then into water.

When the smooth oxide surface stands revealed, with much of the long-dead artist's craftsmanship engraved thereon, the object is treated with a chemical which gives it the beautiful color of ancient bronze, and dried in an oven. Then a lacquer covering is applied.

Nearly everyone has seen in some museum beautiful iridescent glass—perhaps a relic of buried Pompeii, or an Egyptian tear vase. This glass, which has taken its iridescent sheen through centuries of burial, may quickly decay when brought to light, due to the condensation of water from the atmosphere. Such glass must be given a protective coating before it can be exhibited.

Even stones from supposedly imperishable tombs will waste away in unhealthy museum atmosphere unless preventive measures are taken. Limestone is most apt to have a chronic disorder which, if not cured, will cause the stone to crumble away to ruin. The source of the ailment is again traceable to salts in the earth. These salts penetrate the body of the stone, and moisture will bring about decay.

When the museum receives stones from some buried tomb, the surfaces to be preserved are treated with a special solution. Then the stone is carefully lowered into immersion tanks so that the surface to be preserved is barely out of the water. Days and weeks of soaking, with frequent changes of water, gradually draw out the salts. Then the stone is dried, and soaked in paraffin until it will absorb no more. Often a section of a tomb will absorb several hundred pounds of melted paraffin.



International
Enjoying a Dance in Airplane at Altitude of 2,000 Feet; Music by Phonograph or Radio

DANCING IN AIRPLANE'S CABIN LATEST TRAVEL LUXURY

Dancing among the clouds is now almost a literal reality on the air line between London and Paris, for there is a small ballroom space in the cabin of one of the new ships where passengers may enjoy themselves during the ride. The photograph was taken at 2,000 feet.

HIDDEN SAFE IN WALL OR FLOOR RESISTS THIEVES AND FIRE

1133
For installation in homes or offices, a safe with removable lock boxes, can be almost entirely concealed as it has no protruding parts. The tumbler lock has more than 130,000 combinations which may be changed in a few seconds by a simple adjustment. To further protect the safe against damage by fire it is insulated with asbestos.



further protect the safe against damage by fire it is insulated with asbestos.

D. A. Wall Safe Co. Inc.
831 W. 8th St.
San Francisco, Calif.

*(Cont. Mess. Beaumont + Hohmann Advertising)
 5-22 American Squab Bldg
 Los Angeles, Calif*

1245

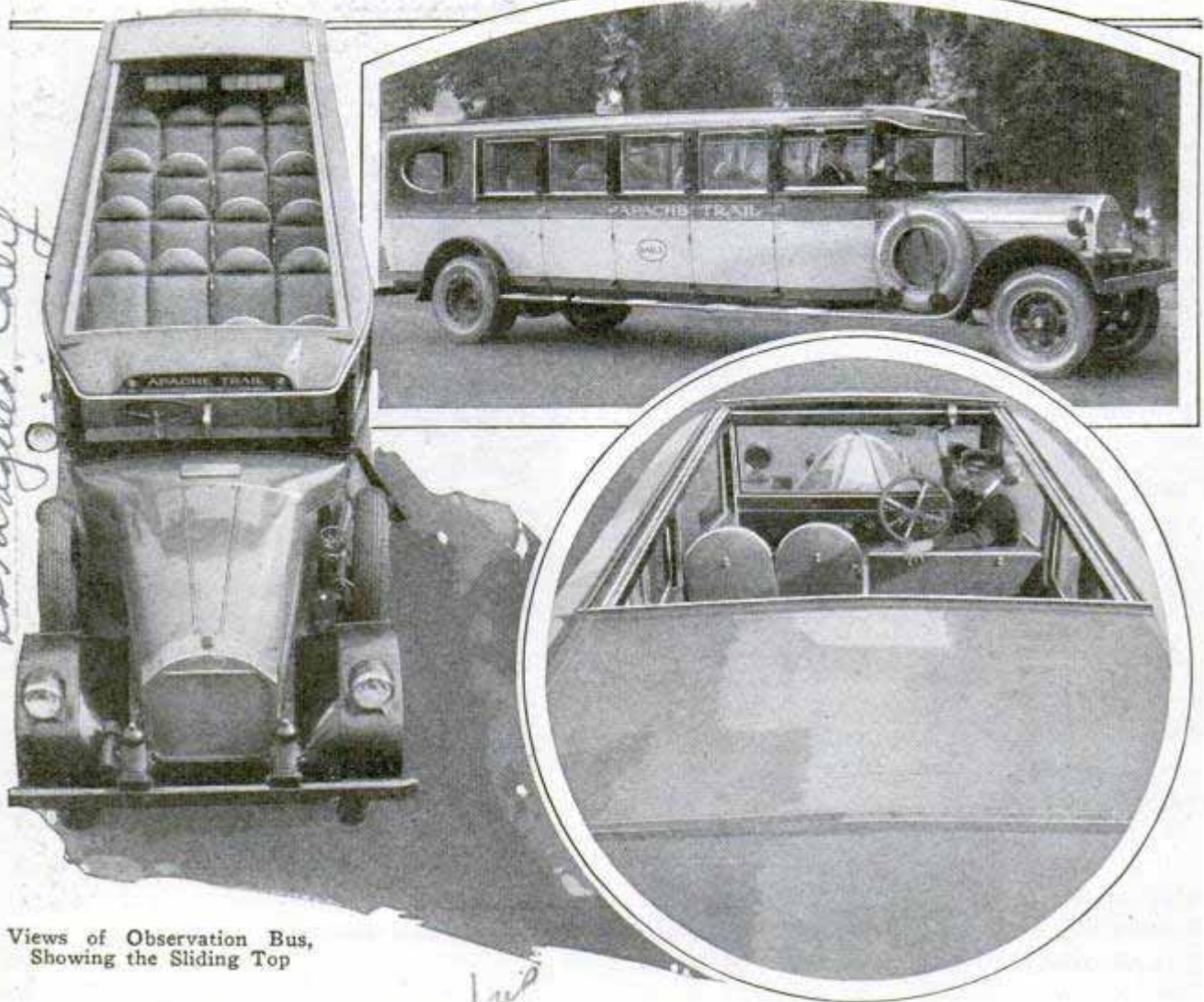

Views of Observation Bus, Showing the Sliding Top

SLIDING TOP ON MOTOR COACH GIVES OVERHEAD VIEW

Tourists are able to enjoy an unobstructed view of the scenery along the Apache trail in Arizona from a motor coach with a top that slides back, converting the vehicle into one of the open type in a few seconds. The roof is made in sections of light steel. The units are operated by chains with a crank controlled by the driver. When pulled back, they rest over the baggage compartment. At the slightest indication of stormy weather, the driver can crank the three moving sections back into position above the passengers. Reclining seats also aid the

occupants, as they permit an upward look without discomfort. The sliding top has been designed to eliminate rattling regardless of its position.

THRILL INDICATOR ALSO TELLS 1195 MACHINE TROUBLES

Irregularities in the motion of machines of almost any kind are registered on a sensitive "thrill" indicator so that inspectors may detect trouble and make adjustments before a breakdown. The unit pictures action in a tabulated code on a strip of paper, and any abnormal jars or vibrations are clearly shown. The indicator is also adapted to the study of movements of the human body.

Sensitive Recording Instrument Which Registers Irregularities in Machine Movement, Helping to Locate Trouble



at Power Show at Grand Central

GLACIERS GROWING IN EUROPE TO LOWER TEMPERATURES?

That the earth's temperatures may be affected by the increase in the size of glaciers in the Alps, is the possibility advanced by a French scientist. From a series of measurements, it has been determined that glaciers in French Savoy have been advancing seventy to 150 feet a year and have gained in volume from 15,000,000 to 250,000,000 cubic feet at the same time. Some of the huge masses of ice are 600 feet thick. One of the most interesting glaciers is the Bossons, the central one on Mount Blanc. Instead of advancing in a mass, it has an oscillating movement, going forward first on one side then on the other and in the middle, like a heavy man who throws his shoulders forward alternately as he walks.

Stopmeter

STOP METER FOR AUTO TESTS STRENGTH OF BRAKES 1221

Accurate measurements of the efficiency of the auto brakes can be taken with the aid of a small meter, which is placed level in the bottom of the car or held firmly against some convenient support. Readings are taken on a dial which shows, by numbers, in how many feet the vehicle would have stopped had it been moving at a speed of twenty miles an hour when the brakes were applied. In making a test, the auto should be run at between fifteen and thirty miles an hour and then



brought to a full stop. The reading is taken when the dial momentarily pauses. The instrument can be read when a stop is made from ten miles an hour. It is of handy size and weighs about one pound.

☐The Popular Mechanics Bureau of Information offers its free service to all readers of this magazine. Names and addresses of manufacturers and dealers in articles described, and any other details in our possession, will be promptly furnished by the bureau.

Mather Mfg. Co. 44 Bedford St. Boston, Mass.

\$35.00



Sculptor Standing beside Heroic Statue of Washington, Shown in Dress of a Civilian

WASHINGTON IN CIVILIAN DRESS - PORTRAYED IN STATUE

Almost all statues of George Washington show him in military dress, but a monument recently unveiled in Portland, Oreg., departs from the tradition in that it displays the father of his country in civilian attire. The bronze statue is ten feet high, and is the work of Pompeo Coppini, a New York sculptor.

LIGHTED HOUSE-NUMBER PLATE HELPS PROTECT HOME 1234

Easily installed and illuminated by current from the doorbell circuit, a lighted house-number plate is visible at all times, aiding callers and also helping to guard the premises. No expensive conduit is necessary as wire may be run from the reflector to the bell transformer, and the light operates at so small expense that it may be left going day and night.

The Beldin Co. Inc. Escondido, Calif.

Pryne & Co. d. m. Angeles, Oakland and San Francisco
Pacific coast distributor

1229

Ufa Studios

FEATS OF SCIENCE HELP MOVIES GIVE VIVID

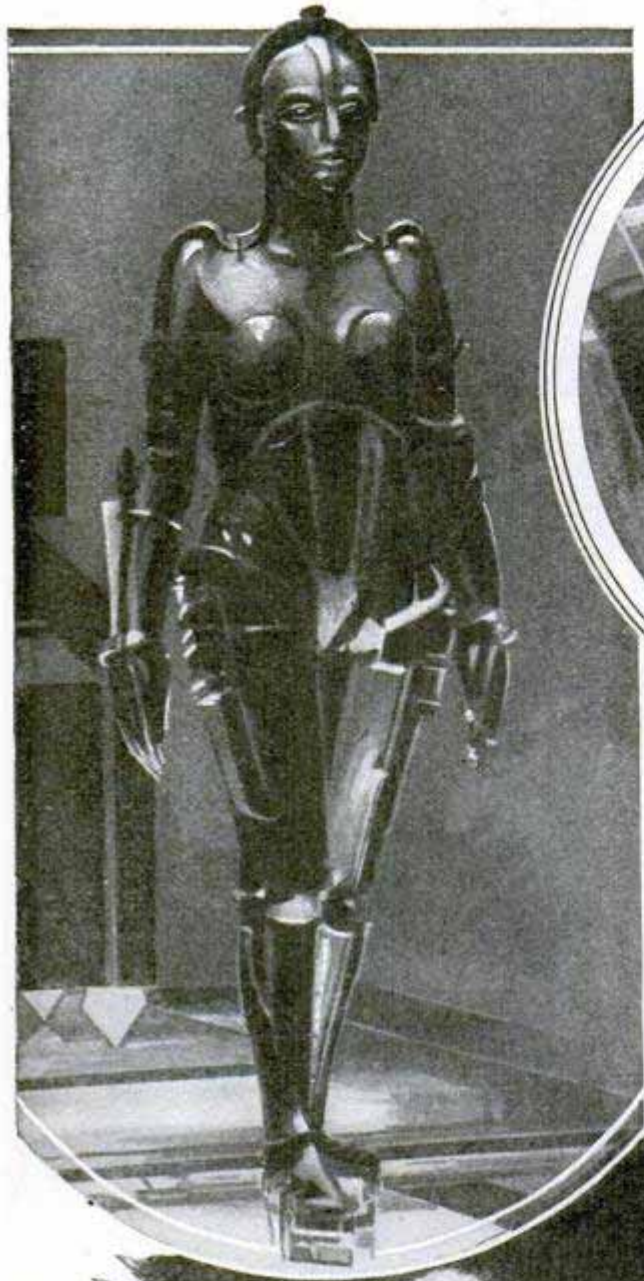

Mitropeles

A New German Film, Based on the Old Robot Story, in Which a Mechanical Person, Created by an Inventor, Becomes a Frankenstein Monster, Has Been Produced in Germany, Utilizing Novel Electrical Effects in an Unusual Manner; at the Left Is the Mechanical Woman, and, Above, the Heroine, Who Is Imprisoned in a Glass Cage and Used as a Model by the Crazy Inventor; Below He Is Seen with the Model and His Own Creation Taking Form in the Background; a Tesla Coil, Producing Artificial Lightning Effects, Transmits Glowing Brush Discharges along the Wires Leading from the Cage

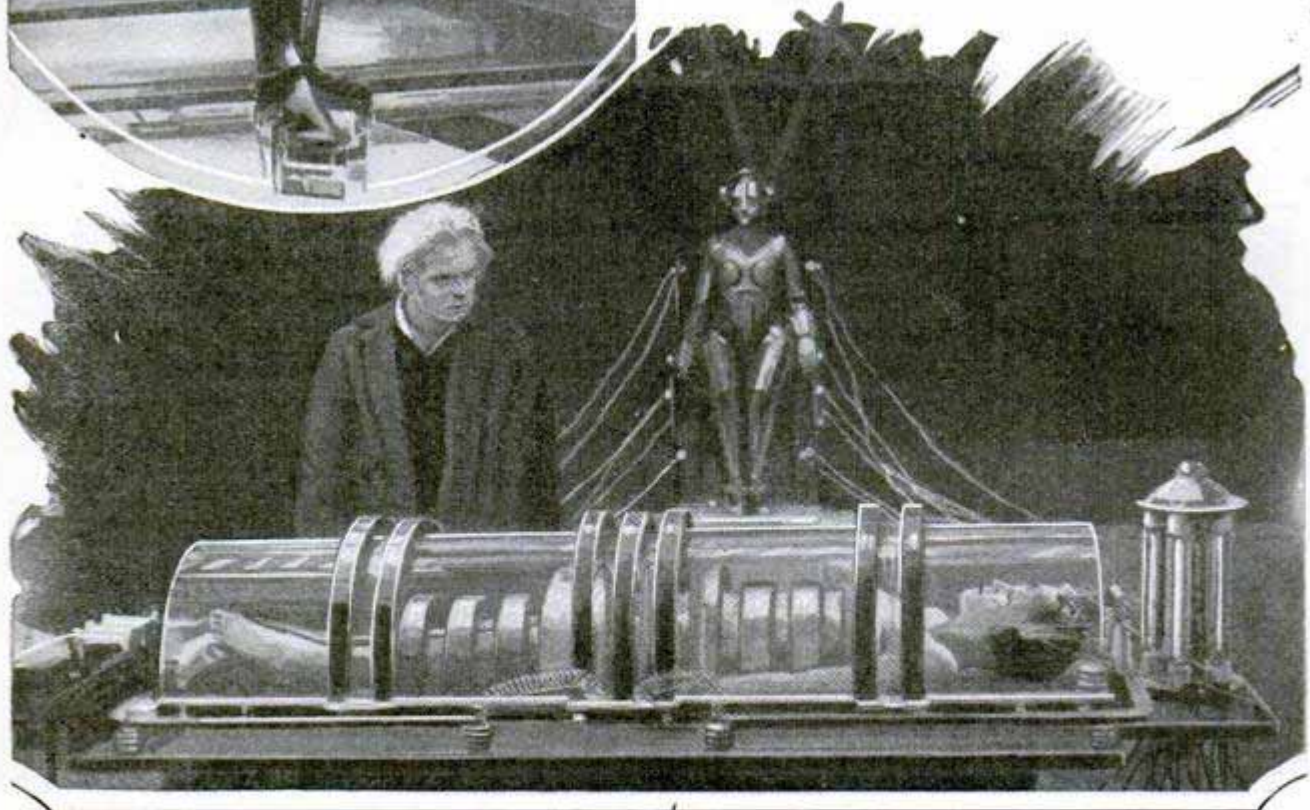

424

The Sphere 11/27/26

Illustrierte Zeitung Berlin 11/25/26

Courtesy

PICTURE OF A WORLD RULED BY MACHINES

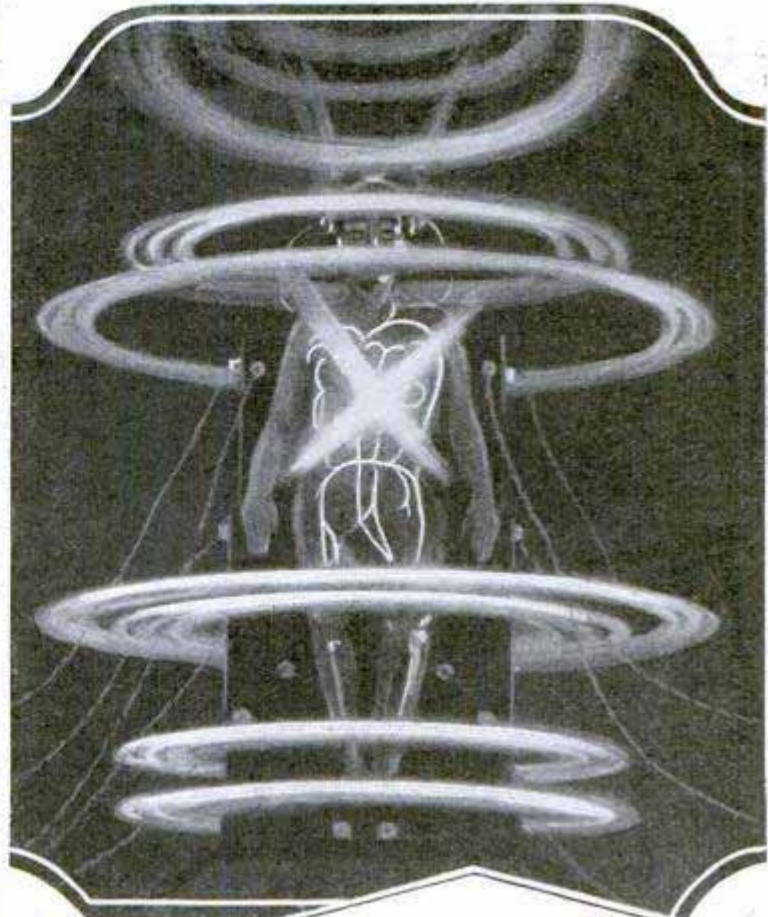

Above Is Rotwang, the Engineer of the Film, Ready to Throw in the Switch Which Starts the Machine for Modeling a Mechanical Figure from the Living Heroine

Two Views of the Wonderful Electrical Effects Achieved by Employing a High-Frequency Current of Tremendous Voltage; the Living Model Is Visible in the Glass Cage Shown Below

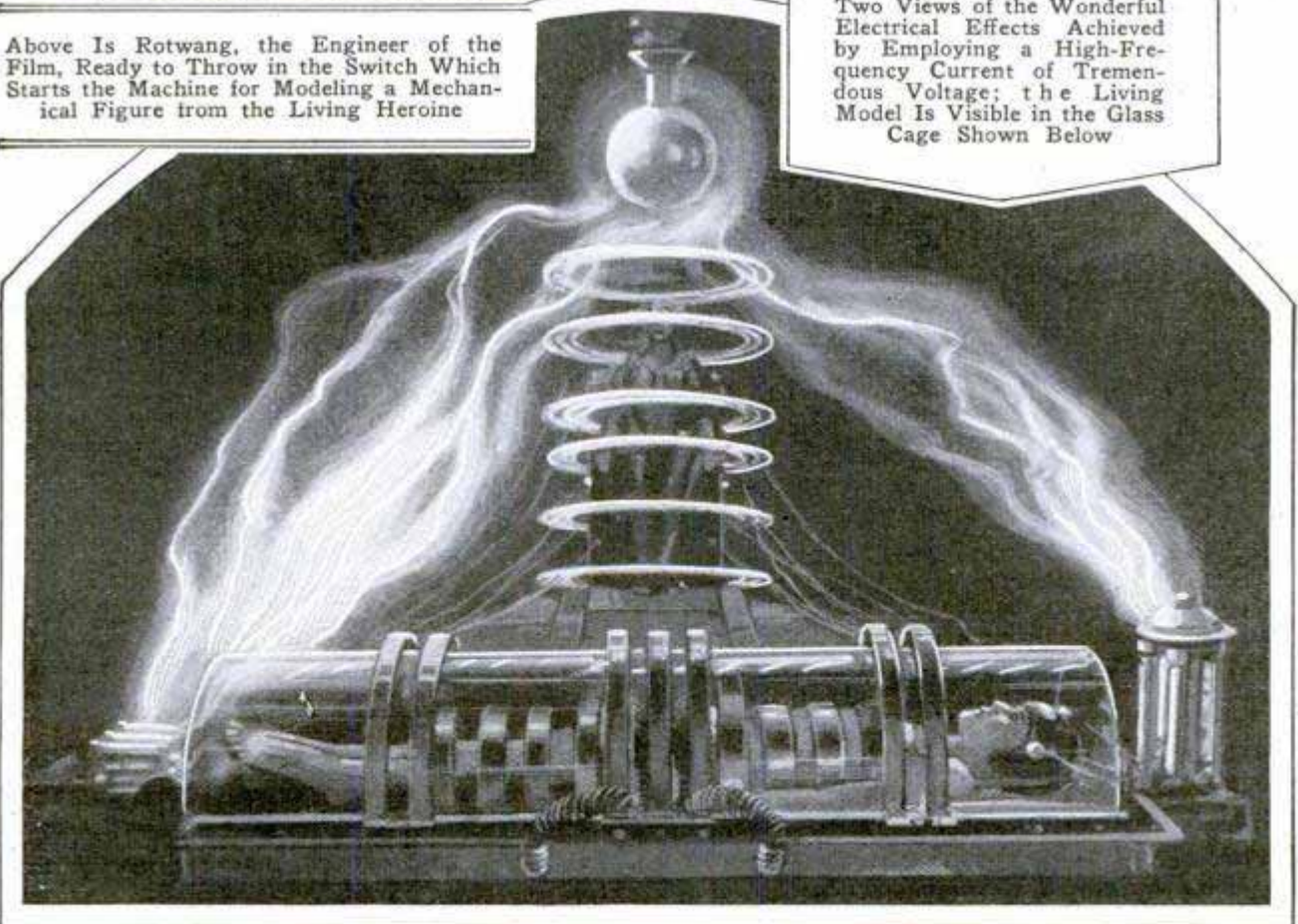

MAN-CARRYING KITE IS STEADIER THAN BALLOON

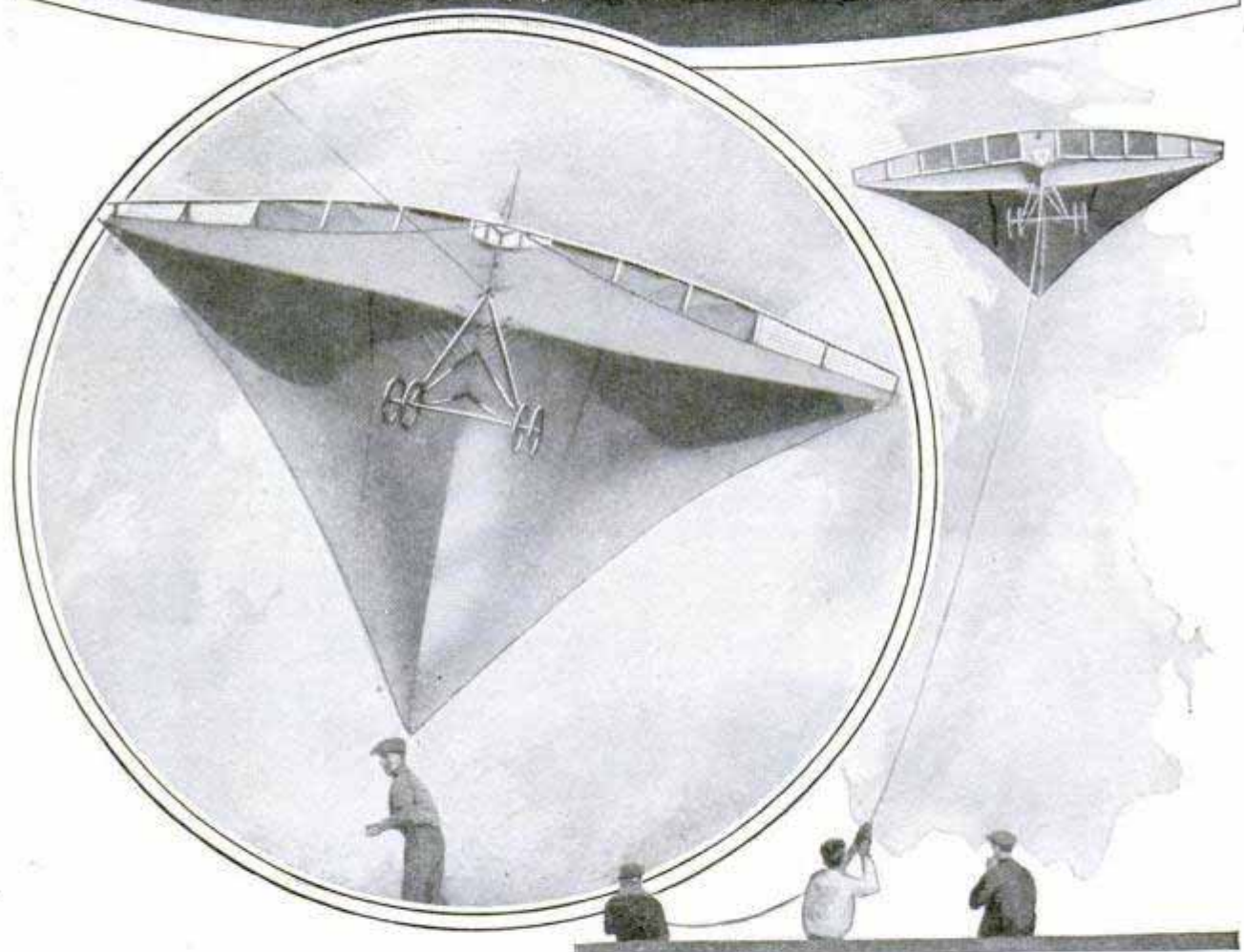

Demonstration of the Kite's Strength and Views of It in Flight; More than 200 Successful Trials Have Been Made with It, Lifting 186 Pounds

Steadier in the air than a balloon, and less easily damaged, a huge kite devised by a western craftsman has been tested for observation purposes. It is said to have lifted 186 pounds. One of its useful features is that it maintains a nearly stationary position when aloft. More than 200 trial flights were made with the kite and, according to the testers, its maxi-

imum capacity for load-lifting has not yet been reached.

Among possible uses suggested for it are included the taking of aerial photographs where a flying machine is not available, and, for observations during actual warfare, it would be able to carry an airman to a sufficient height to get information, while the kite would not present as

Dr. George A. Argabri, Los Angeles, Calif.

1108

*Beardsley
Walcott New York
Rd*

big a target as the ordinary balloon. It has a wheeled carriage and bracing on the upper part similar to those of a plane.

AUTO "PEP" COMES HIGH 1303

More than one-fourth of the gasoline which the motorist buys is used to obtain a quick get-away, according to Prof. A. C. Willard of the University of Illinois. In the average automobile, the maximum power is realized when the carburetor is set to mix twelve pounds of air with one of gasoline. This, however, is not the most economical mixture, as there is not enough air to burn all the gasoline. The most economical mixture, the one in which all the gasoline is consumed, is when sixteen pounds of air are mixed with one of gasoline. Demanding "pep" rather than economical operation, the motorist sets his carburetor to give the "one-twelve" mixture, even though, in so doing, he sacrifices twenty-five per cent of the heat value it is possible to get out of the fuel.

PENCIL HELD BY FINGER CLIP TO PREVENT LOSS 1192

Keeping the pencil always in readiness for use, a clip holds it to the finger and yet permits free use of the hand for other purposes. It is intended chiefly for messengers, clerks and draftsmen, fits either the right or left hand, and prevents the annoyance of mislaying the pencil, which usually happens when it is most needed.

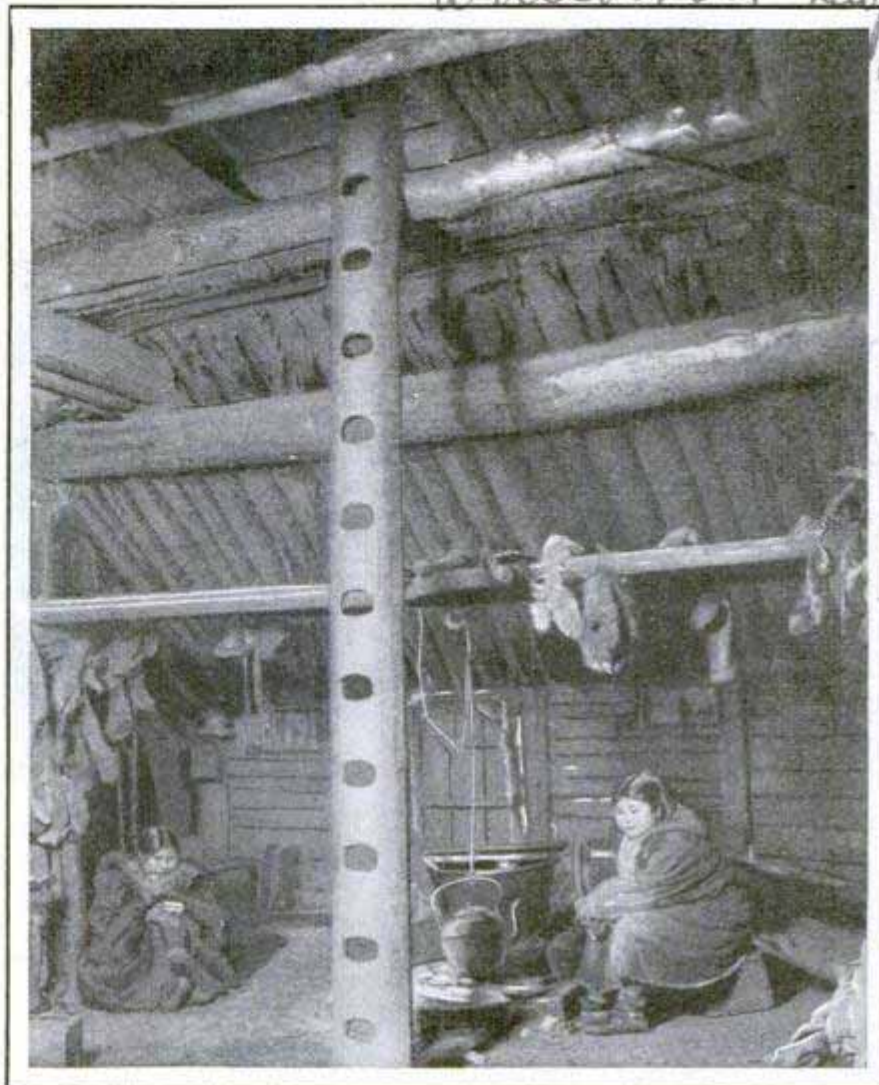

Interior of Home in Far North, Showing the "Staircase," a Split Log with Holes for Climbing Up and Down

HOMES NEAR TOP OF WORLD HALF UNDERGROUND

Dwellers along the Pacific shores of northeastern Asia, near the Arctic circle, and in other parts of the frozen north, have strange houses partly above and partly below ground. The cellar portion is shielded from the cold and warmly lined. A feature of these abodes is the ladder stairway. It is simply a split log with holes in it for hands and feet.

COLORED SAILS ON ICE BOATS REPLACE NUMBERS 7232

Instead of using numbers to identify the ice boats of a racing club, the sails were dyed different colors. The plan proved effective, as the boats could be distinguished at a considerable distance and the differences in shades were also registered on photographic plates.

*Boat Club, Munich
Morris Clemens*

*Stenton & Co.
2923 Hennepin Ave
Police Division*

Gas Tank of the Polish Army,
Carrying Cylinders of Poison
Chemicals, Which Are Spread
through the Megaphone-Like
Projectors

Photos Courtesy: The Sphere

11/20/26

1163
6 great new
London
E.C. 4,
England

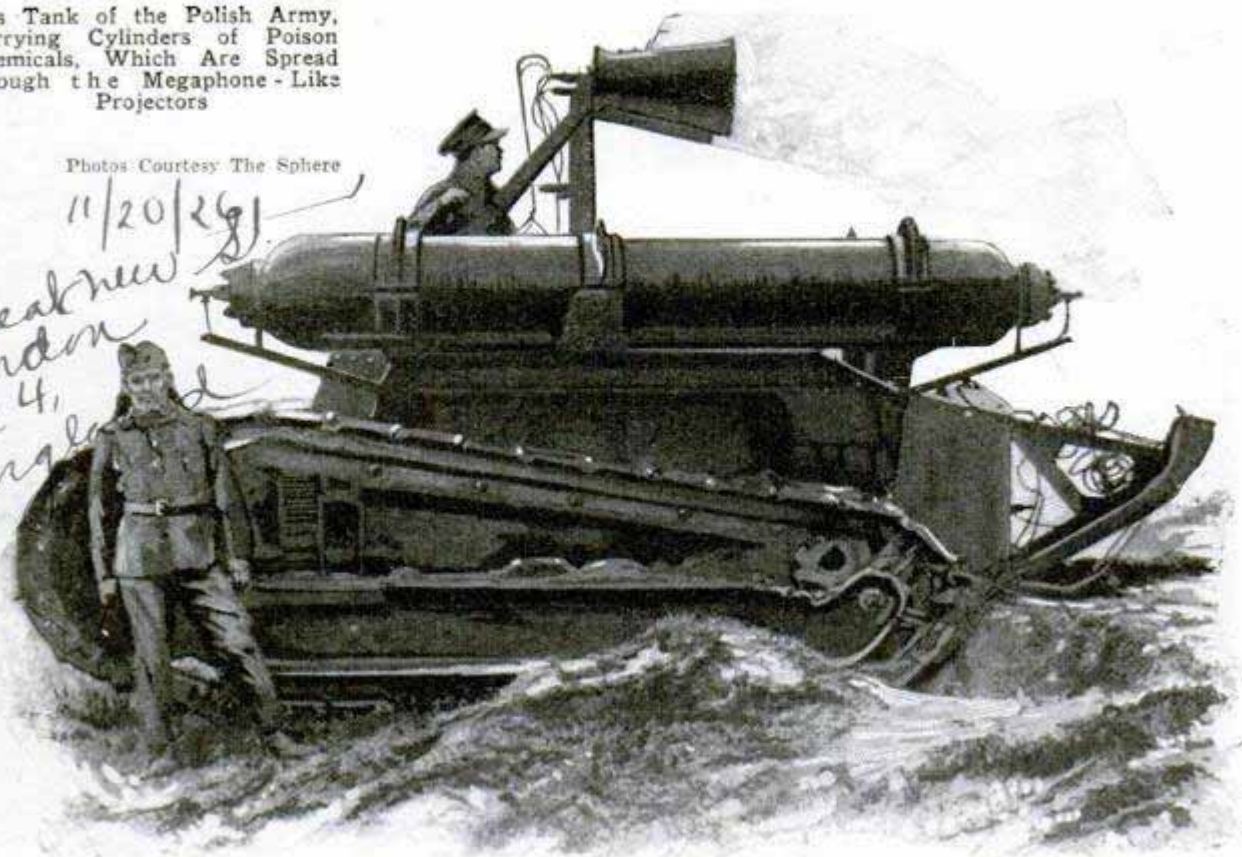

Gasoline Cavalry Displaces Horses

British One-Man Tanks, Armed with Machine Guns, Are Capable of Traveling Thirty Miles an Hour

DAYS when armored knights went forth to battle on steel-clad horses were revived recently when the British army demonstrated its newest weapon, one-man tanks, to replace cavalry horses. Equipped with both caterpillar tread and rubber-tired wheels, either of which can be placed in operation at will, the little tanks are capable of making thirty miles an hour on smooth roads, and can go any place that a horse can be ridden, and get there much quicker.

Added to that advantage, the cavalryman on the gasoline steed is completely sheltered behind bullet-proof steel, and instead of a rifle or sword carries a one-man machine gun capable of firing more than 100 shots a minute. Unlike the unwieldy hand rifle, the machine gun, securely mounted on the tank, can be operated while charging at full speed.

On a road or over smooth ground, the baby tanks ride on three rubber-tired

wheels and are steered by motorcycle-type handlebars, operating the single small wheel in the rear. When the wheels are raised and the caterpillar tread brought into action, the same handlebars do the steering in the same way that an ordinary caterpillar truck is managed.

Demonstrating the gasoline cavalry before a meeting of the dominion premiers, the British army also brought out all its latest big tanks. There were giants mounting five revolving turrets, four with machine guns and one armed with a three-pound gun. They were real moving forts, bigger and better armed than anything used in the late war, yet capable of surprising speed and able to go anywhere and over any kind of country.

Another regiment of the big forts carried the latest type of anti-aircraft guns, mounted to fire at high angles and capable of sending shrapnel shell against enemy planes thousands of feet up in the air. In

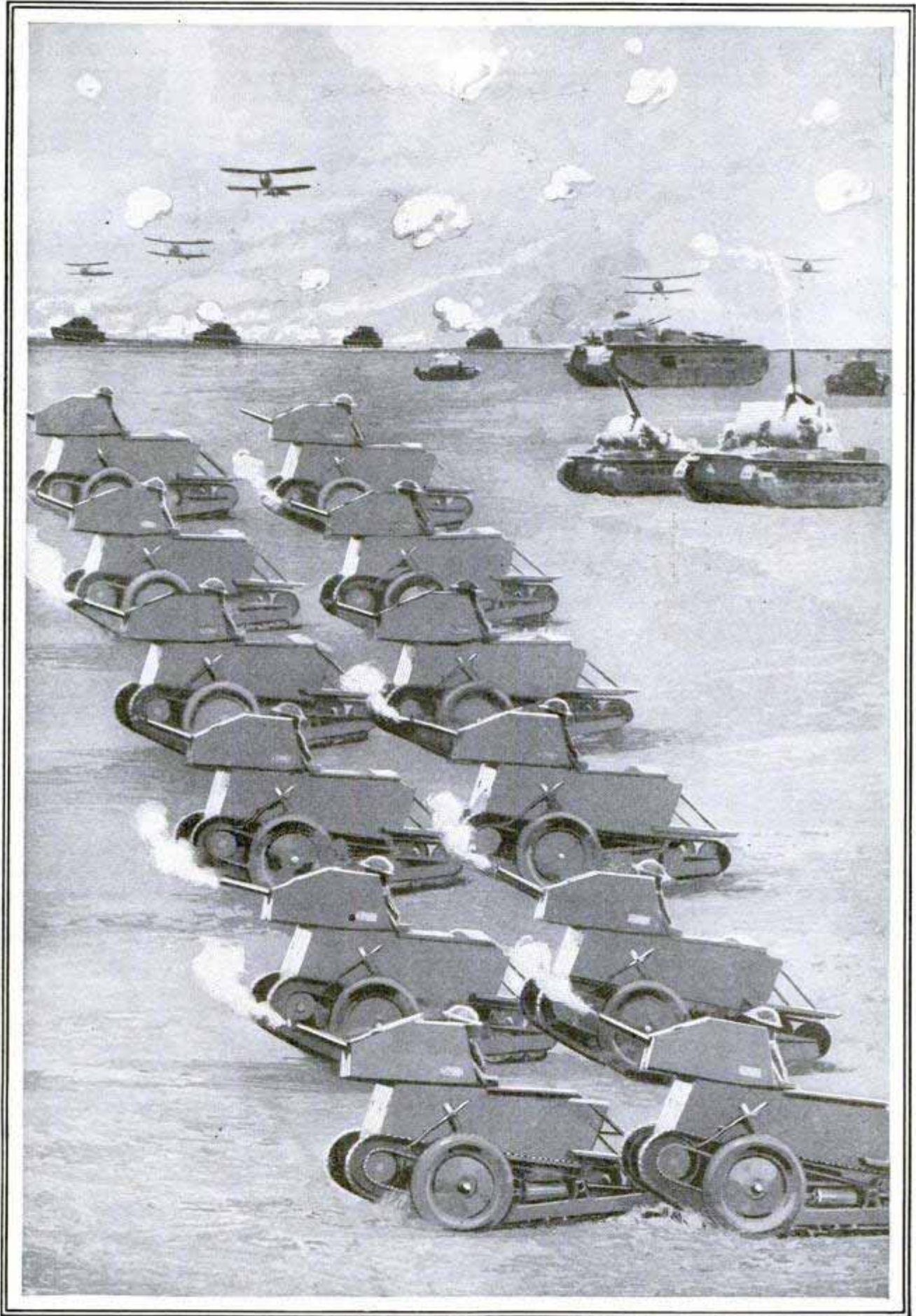

"Gasoline Cavalry" of England, Mounted on One-Man Tanks, Advancing to the Attack at War Games Played before the Dominion Premiers; Note Anti-Aircraft Tanks in the Rear

between the big tanks and the baby cavalry, were whole companies of two-man

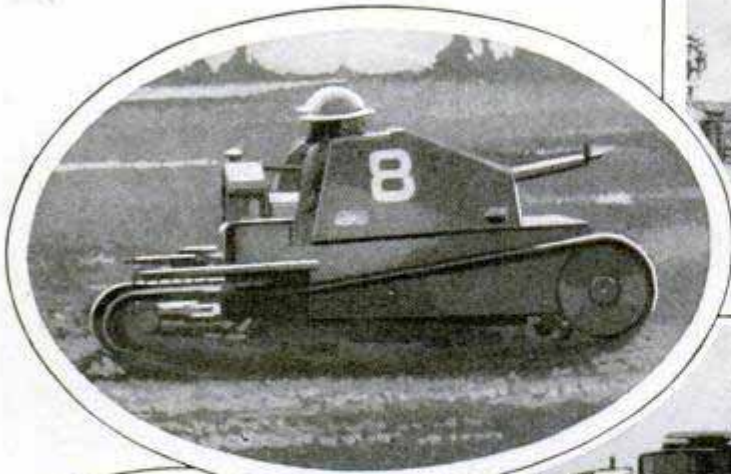

Small Two-Man Tank. Above, and at the Right, a Movable Fortress, the Great Five-Turret Battle Tank; Above It Is a Tractor Tank Hauling a High-Angle Anti-Aircraft Gun

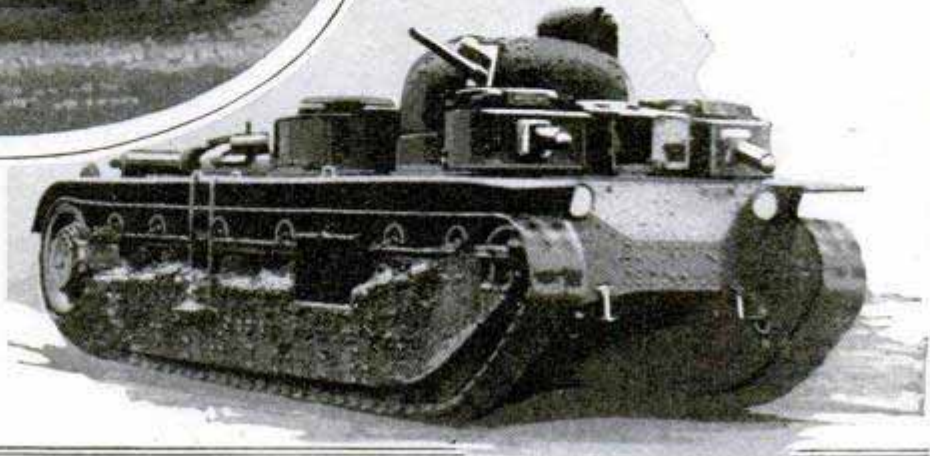
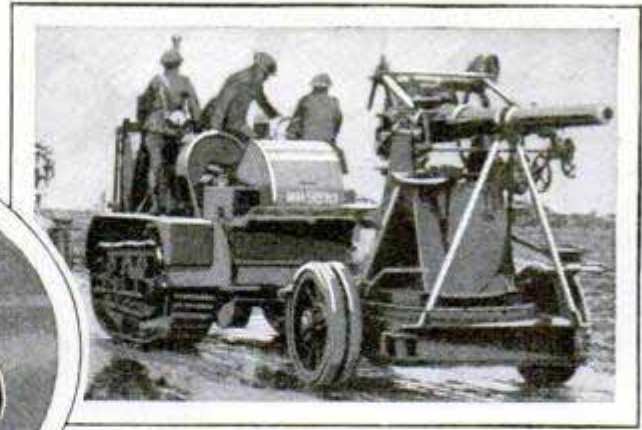

tractors, carrying heavy machine guns and with one man to operate the tank while the other tends to the gun.

The caterpillar tread also was applied to all forms of army transport. In one display, a big field gun was dragged along by ten horses, while the gun crew trudged behind, making two and a half miles an hour. Past the plodding horses flashed huge tractors, pulling the same type of gun at thirty miles an hour, with the entire gun crew riding the tractor, so that, in actual war, they would arrive at the battlefield fresh and sound instead of tired out from a long march.

Batteries of anti-aircraft guns mounted on rubber-tired wheels followed, drawn by fast tractors. After them came staff cars, standard touring cars and limousines, except that their rubber-shod wheels could be lifted clear of the road by lowering a caterpillar tread, so that they could cross any kind of rough ground and go through ditches and trenches with the same ease as a tank.

Gasoline armies are attracting more and more attention in all the European countries. Recently the Polish army brought out a new form of tank carrying huge steel cylinders on its roof, each filled with

poison gas under tremendous pressure. Above the cylinders, a pair of megaphone-like horns release the gas and send it out in dense clouds. Leading an infantry attack, it is thought the gas tank might put most of the enemy out of action, so the soldiers following it would only have to "mop up" and take over the trenches.

HAND-POWER LETTER OPENER SAVES OFFICE TIME

1294 For the office where the volume of mail does not justify the installation of a power letter opener, a hand-operated unit is worked on somewhat the same principle as the larger machines and is said to give satisfactory results.



It consists of an arrangement of sharp steel cutters and a disk that is fitted against the edge of the envelope. To slit the container, the opener is simply run along the edge after it has been adjusted. There is no danger of damaging the contents.

Uptown Supply Co.,
1709 Arthur Ave
Chicago

**CROOKEDEST RAIL
LINE WILL BE
AUTO ROAD** 133

Steps have been taken to transform the Mt. Tamalpais and Muir Woods railway, in California, into a motor highway. The line, known as the "crookedest in the world" because of its 287 curves, was built in 1896, to make available to tourists the scenic panorama visible from the top of Mt. Tamalpais, and, for years, the little cogwheel engines have chugged their way to the summit without an accident or interruption in service. The guest books in the tavern at the beginning of the line, show that persons from practically every country in the world have made the trip up the mountain on the tiny, twisting railroad. It will be reconstructed into an auto toll road, as it is thought that such a thoroughfare will be of greater service.

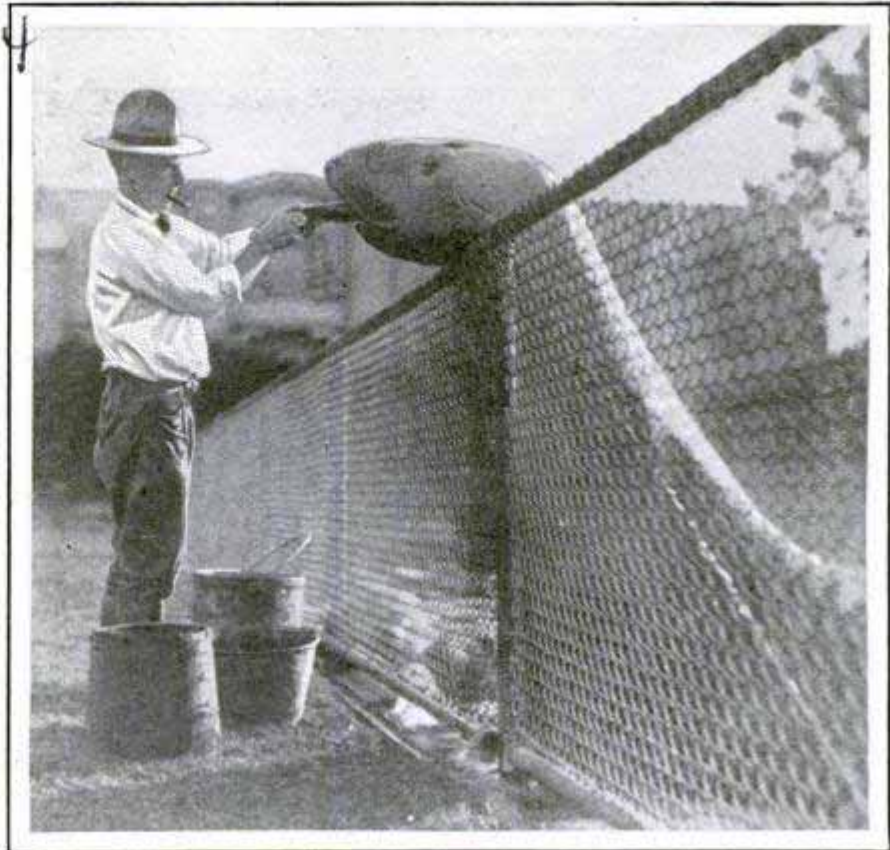

Giving the Elephant Seal Its Morning Ration of Fish; the Three-Ton Creature Has Been in Captivity Less Than a Year

THREE-TON ELEPHANT SEAL FED FROM KEEPER'S HAND

Most seals in the zoos have to swim for their food, but the 6,000-pound elephant specimen in San Diego, leans leisurely against the fence and swallows its meal of fish directly from the keeper's hands. The huge creature was captured about a year ago on Guadalupe island, off the coast of Lower California.

1345

WHY WOMEN ALIGHT BACKWARD

The tendency of women to alight from a street car or other vehicle while facing to the rear is explained by an eastern scientist on the grounds of heredity. He declares that when our ancestors sat in trees, the mother carried her offspring on her left hip with her arm around it, leaving the right arm free for protection. This fixed habit has been retained through the ages so that now, when a woman instinctively loads her left arm with bundles, the right hand is free, but since the exits are almost always on the right, she naturally turns to the rear in using her right arm and hand to steady herself while alighting from the vehicle.

VACUUM SANDER IS PORTABLE AND ELIMINATES DUST 1248

Operated from an electric-light socket, a portable sanding outfit is equipped with a vacuum unit which takes up the dust and also prevents clogging or gumming, as when used on old varnished floors, desks or other furniture. It is especially adapted to new floors, but will perform all classes of work from heavy-duty roughing or planing to the finest finishing, the manufacturers assert. It weighs only thirty pounds and the motor is designed for power and long life.

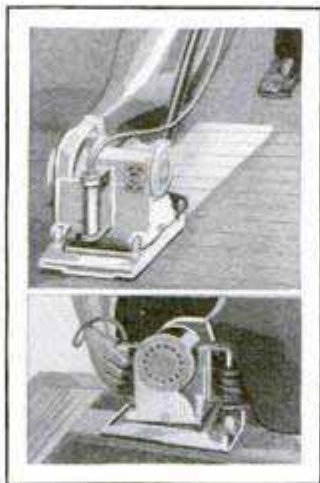

Illustration for sander

Clarke Sanding Machine Co
622 W. Lake St.

Committee on Pub. Utility Information
79 W. Market, Chicago 90

News Bulletin
12/20/26

new Winterfeldstr 24

Berlin W 30 Germany

CHAIN-BOUND SACK TO 'SAVE THE LIVES OF DIVERS

1210

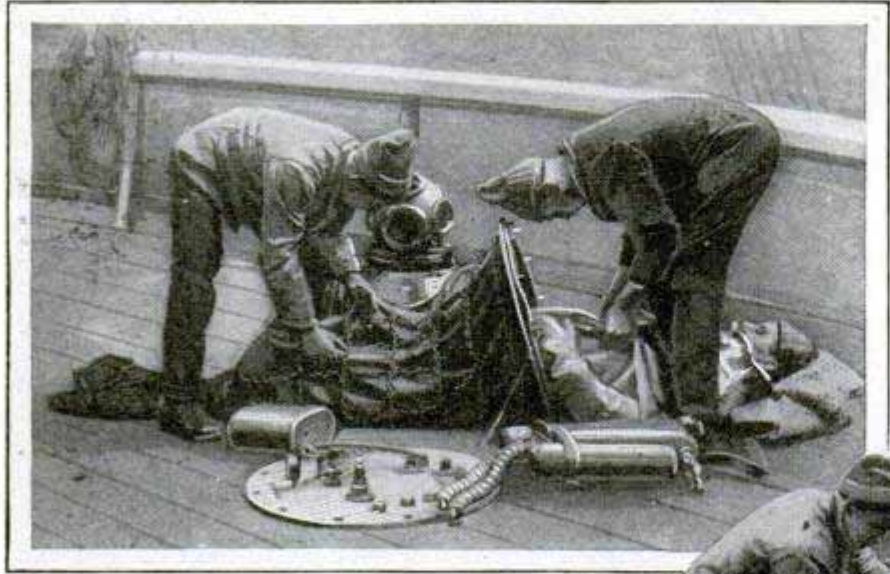

introduced to revive the occupant by restoring the pressure to a point near that at the depth to which he was submerged. The pressure is then decreased slowly so that the diver may be accustomed to the gradual change. In ad-

Rapid changes in pressure are likely to have ill effects on divers. For instance, a too sudden ascent from a great depth and the consequent decrease in pressure often result in faintness, giddiness, neuralgia and more serious symptoms. To prevent these afflictions, a special dress, or sack, has been devised in which the diver is placed after he comes up. The top is screwed on tightly and compressed air is

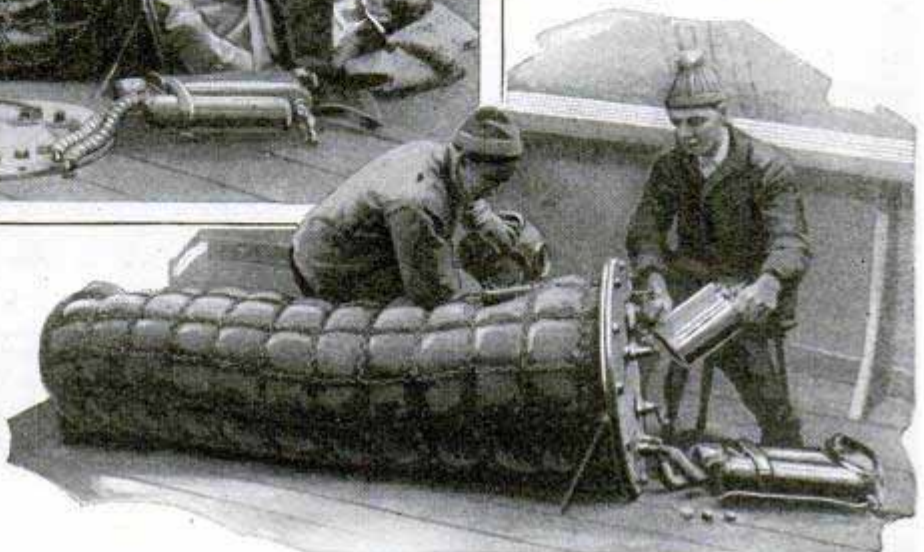

Placing Diver in the Chain Sack and Administering the Compressed Air and Oxygen After Bag Has Been Sealed

dition to the compressed air, oxygen is released into the dress in carefully regulated quantities. The subject is released when normal air conditions are reached.

DOUBLE SPEED OF AIR MAPPING WITH NEW LENS

Aerial photographs for mapping purposes can be taken in half the time formerly required with a new lens developed by the bureau of standards. This is but one of the contributions the bureau has made to American progress during the last year. The organization's activities involved the making of nearly 180,000 tests with a fee value of \$675,046; contact was maintained with industry through eighty advisory committees, and a large number of research associates were sent to the bureau representing thirty-six industries. Development of a process which has increased the life of paper currency and a device to hold radio stations on their assigned wavelengths are among the out-

standing accomplishments of the bureau. Savings in the production of commonly used articles were reported as a result of practices recommended by the government experts. A committee has a standard building code under work.

VACUUM PHOTO-PLATE CLEANER SAVES TIME AND WORK

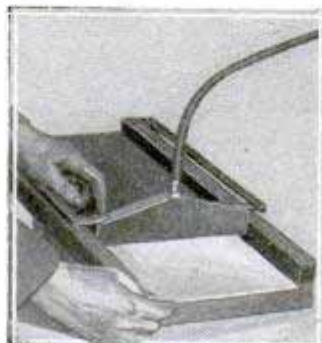

Operating on the vacuum principle, a cleaner for camera plates, devised at the bureau of agricultural economics, simplifies the work and insures better results.

drw. H. C. Wilcox

Christian Science Monitor 12/13/26

Calif

1161

GOLF COURSE ON OIL FIELDS HAS UNIQUE HAZARDS

1269

Golf has been placed within the reach of several hundred employes of a California oil company by the conversion of tank farms and fields into courses. The idea originated when the construction program on a large tank-farm site was abandoned after eight of the reservoirs had been erected. The tank bases were flat and smooth, making satisfactory greens, and the earthen dikes, intended for fire walls, proved excellent bunkers. Holes and derricks on one of the fields form effective hazards and, on one of the courses, the presence of a number of rattlesnakes lends additional interest to the game. It is said to be common for a player to kill one or two snakes while making one round. The courses are kept in condition by company employes and incidental expenses are defrayed by small monthly assessments on the persons who are using the grounds.

STEEL ARMOR FOR AUTO TIRES REDUCES PUNCTURE ILLS

1150

Advantages of both a solid and a pneumatic tire are said to be derived from a sectional steel armor, which is covered with a strip of hard rubber and placed over the regular tire. The outer coating is vulcanized to the armor. Besides re-

armor plate

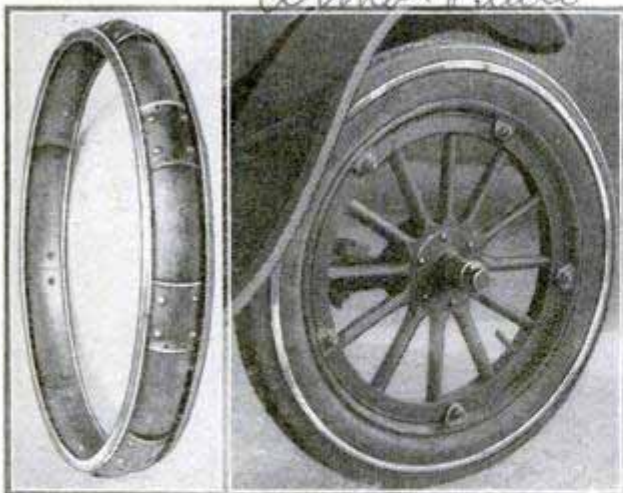

Tire Armor at the Left and Assembled at Right, Showing Outer Strip of Hard Rubber

sisting punctures, this arrangement is said to make the car run more easily, and there are no more jolts than with the ordinary tire. A postman's auto, fitted with the armor, ran 50,000 miles without a flat tire.

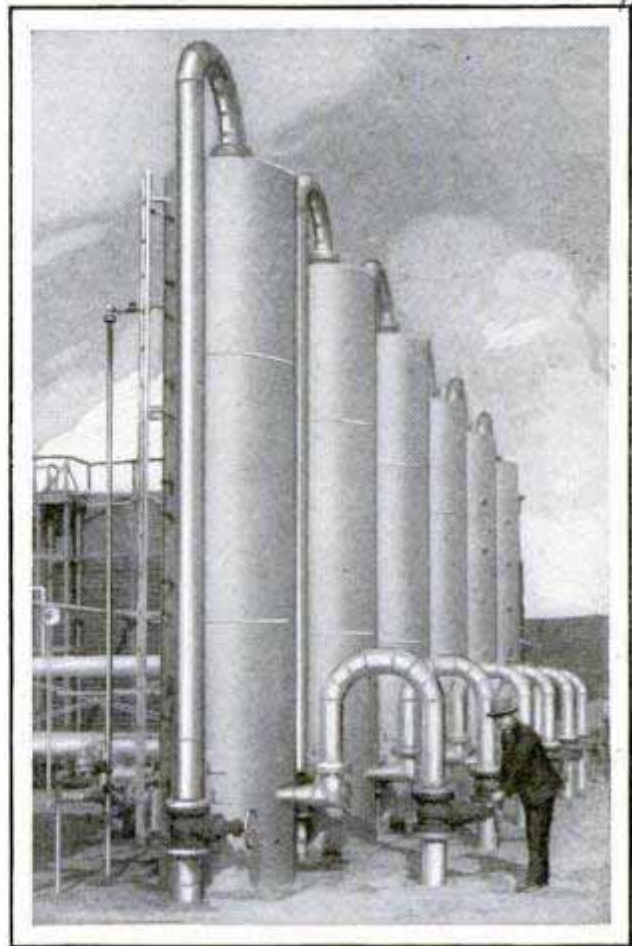

Big Plant Where Gasoline Is Absorbed from Domestic Gas; General View of Extracting Units

FUEL FOR AIRPLANES SALVAGED FROM GAS MAINS

By means of a new process, high-test gasoline, especially suited for airplane fuel, is being salvaged in large quantities from ordinary natural gas intended for domestic purposes. As the gas passes through the incoming mains, it is diverted into huge absorbers, which extract the gasoline and send the "dried" gas on its way to the consumer in even better condition for use, since it will not blacken the kitchen utensils. The process is considered especially interesting because conventional tests showed that the gas had a negligible gasoline content. Two plants are now being operated in California and one in Wyoming, and the product is being marketed to a number of airports or mixed with lower grades to make fuel for automobiles. The equipment for the largest plant occupies nearly three acres and has a capacity of 15,000 gallons of gasoline a day. The apparatus is so nearly automatic that only two men are required for each eight-hour shift. About 50,000,000 cubic feet of gas passes daily.

Dr. W. Boyd Hammond -
 Process used by Standard Engineering Co.

Wyckoff Mfg Co,
 71st Street
 New York

Sales Dept. 519 California St.
 San Francisco

912 California av.
Los Angeles, Calif.

BEAUTY AND UTILITY COMBINED IN SMALL GARAGES

Efforts to get originality and beauty into a family garage have led to many unusual buildings, far removed from the usual shed type. The one pictured at the top of the page is of French-Norman architecture and particularly adapted for a home with large grounds, for the corner tower provides adequate storage space for the garden tools, hose and similar equipment. The building is of inexpensive construction, the wooden frame being covered with cream-colored stucco, set off by rough wood finished in a dark-brown stain, while the upper lights of the doors are crossed by olive-green spindles. An unusual weather vane topping the tower, showing the cow jumping over the moon, adds a novel touch.

For a home of rustic type or in a rustic environment, the second garage, giving the appearance of a reconstructed antique, is quite suitable. The roof not only is concave in the sides, but the peak is as sway-backed as a hard-worked horse. The

sides are finished in dark-brown stucco, with gray-stained beams adding the time-worn touch, while the roof shingles are stained in brown, red, blue and tan, intermingled at random.

A third type, employing a pattern laid up in stone, is built of rough cobbles of various sizes, while the woodwork is painted white, with dark-green trim, the latter being offset by the bright red of the tile roof.

Garage architecture has progressed a long way from the days of the woodshed type, and in many modern designs, the same care and attention have been applied as in planning the house itself.

1402

FISH THRIVE ON IODINE

Fish in pools treated with iodine showed more rapid growth than others, according to reports of tests at the Kansas hatcheries. Several experiments were conducted with the chemical as a stimulant to development, while comparisons were made with fish kept in untreated water.

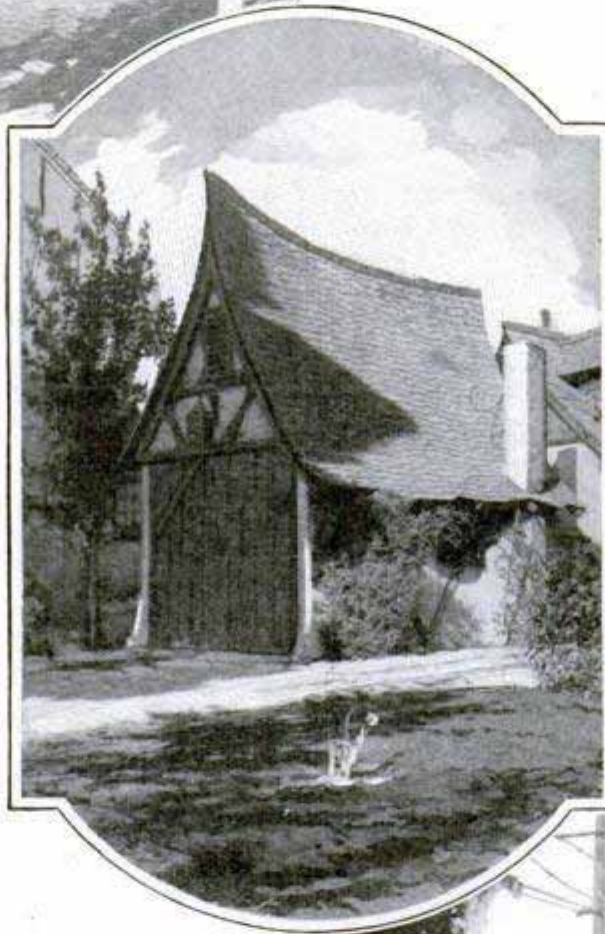

SKY-FIGHTER SKELETON SHOWS RELATION OF PARTS

Visitors at an exhibition in Madrid obtained a clear idea of the arrangement and mechanism of a huge airplane for battle purposes, as it was shown in skeleton form with most of the equipment installed. The metal



Courtesy The Sphere *11/13/26*
Skeleton of Huge Fighting Plane Shows Rigid Bracing of Wings, Position of Fuel Tanks, Cockpit and Other Features; Exhibited at Madrid Exposition

ribs and braces, wing structure, position of guns, fuel tanks, pit and other features were plainly observable.

SIGN LANGUAGE AT SAWMILLS SUBSTITUTE FOR TALKING

To make themselves heard above the noise of the saws, workers at the mills have developed a curious sign language. Rubbing the stomach signifies approval, "go ahead" or O. K. If the boss is about, stroking the chin or combing an imaginary mustache gives warning. "Stop" is indicated by holding up one hand, palm forward; "sleepy," head to one side with hand against ear; "help wanted," right hand on muscle of left arm which is bent to indicate strength; "it's raining" or "going to rain," hands spread out, palms down, while the fingers are worked to indicate falling drops; "talk-

ing too much," moving the hands to signify a wagging jaw; "disgust," holding the nose and waving the other hand at the offending object as if to say, "go away." The language changes very little except as modifications of machinery necessitate new "words," and the system is used with few variations in most large sawmills.

HULLER FOR PEAS AND BEANS SAVES HOUSEWIFE TIME *1188*

Preparing peas or beans for cooking can be done in less time and without staining or injuring the fingers with the aid of a simple huller that quickly removes the contents from the pods. It is clamped to the kitchen table and turned with a crank. Rollers press the peas or beans into a dish, while the pods fall aside. A wider huller is furnished for lima beans and may be run by hand or by motor.

Extracting Peas from Pods with Sheller That Saves the Fingers



Mr. Frances Es. Coleman, 33.5 Montgall, Av. P.T. Ma

Pea + Bean Hulling Machine Co.,

Marietta Ohio

493

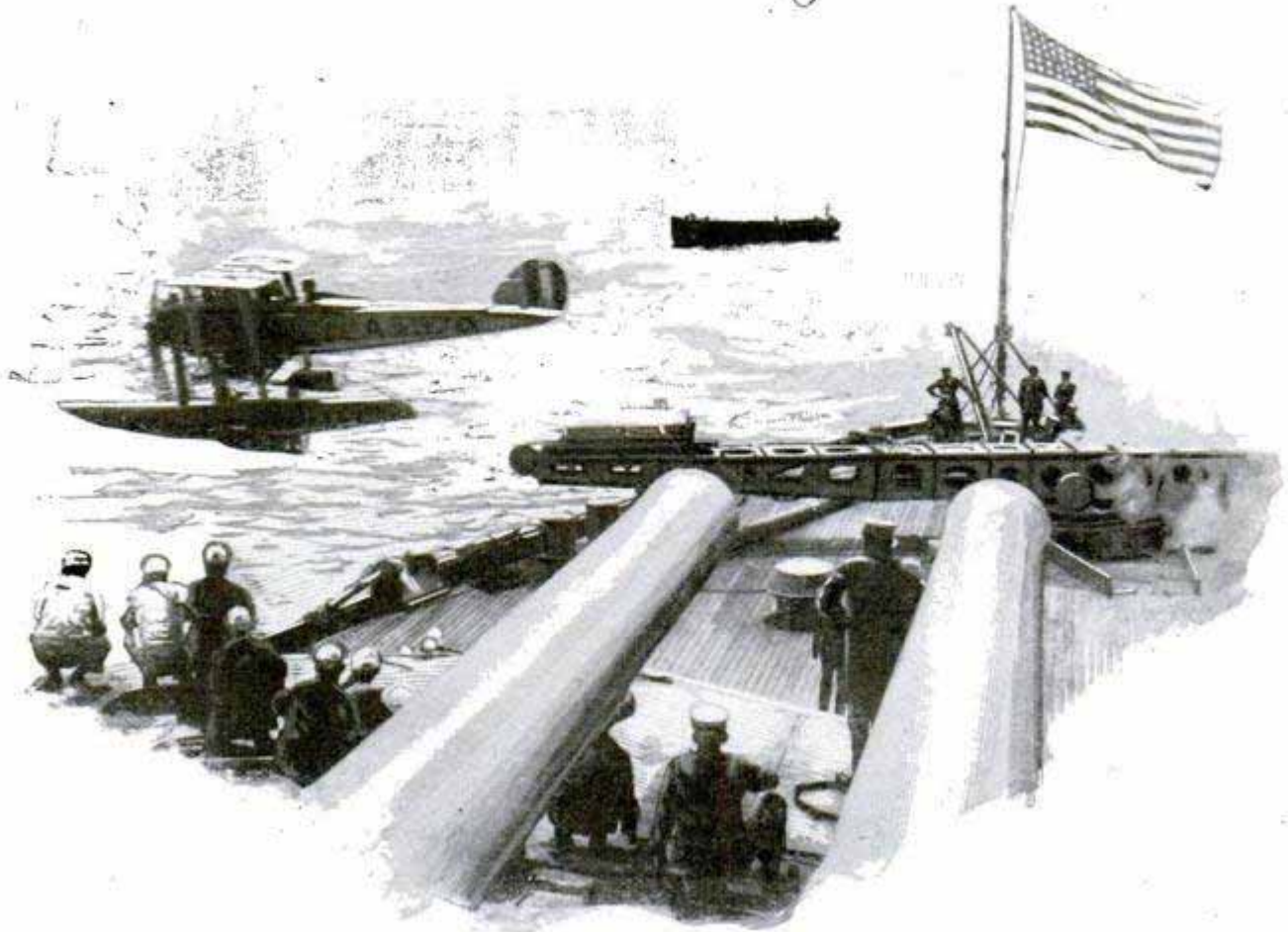
1752-17th St. N.W.
Washington, D.C.

Shot into the Air; the Plane Has Just Left the Traveling Carriage, Which Is Visible at the Left End of the Catapult; to the Right, the Smoke from the Powder Charge Is Seen

How It Feels to Be Shot from a Gun

Aviators Fired into the Air by Gunpowder ^{Aero}Catapults Saved from Broken Backs or Necks by Padded Rests

A TERRIFIC blow to the solar plexus. The stomach wall driven in by a crushing blow from the air. Head held tight against a padded back rest that keeps the neck from snapping off. A tingling sensation through the muscles of the stomach and abdominal walls.

That's how it feels to be shot out of a gun while sitting in the pilot's seat of a fast little scout plane. The gun is the new gunpowder catapult of Uncle Sam's battleships. From a standing start to sixty miles an hour in fifty feet and in a fraction of a second is the record, and such an acceleration would break a man's neck and back if both were not carefully protected.

These catapults have replaced earlier equipment operated by compressed air. Their advantage lies in the sureness of operation and the much higher speed at-

tained by the craft in a shorter distance. If you have ever been jerked off your feet by the sudden starting of a street car—a starting that probably doesn't exceed more than ten miles an hour in fifty feet—you can get some idea of how it would feel to reach a speed of a mile a minute in the same distance.

The little single-seater scout and combat planes, which are the main aerial armament of battleships, have been specially designed to meet the terrific strain on the pilot's body during the fraction of a second he is taking to the air. The whole back of the seat is a deeply padded, form-fitting cushion, extending up into a head-rest, also deeply padded, that just fits the head and neck. When the pilot takes his place, he carefully squirms around until he establishes perfect contact from seat

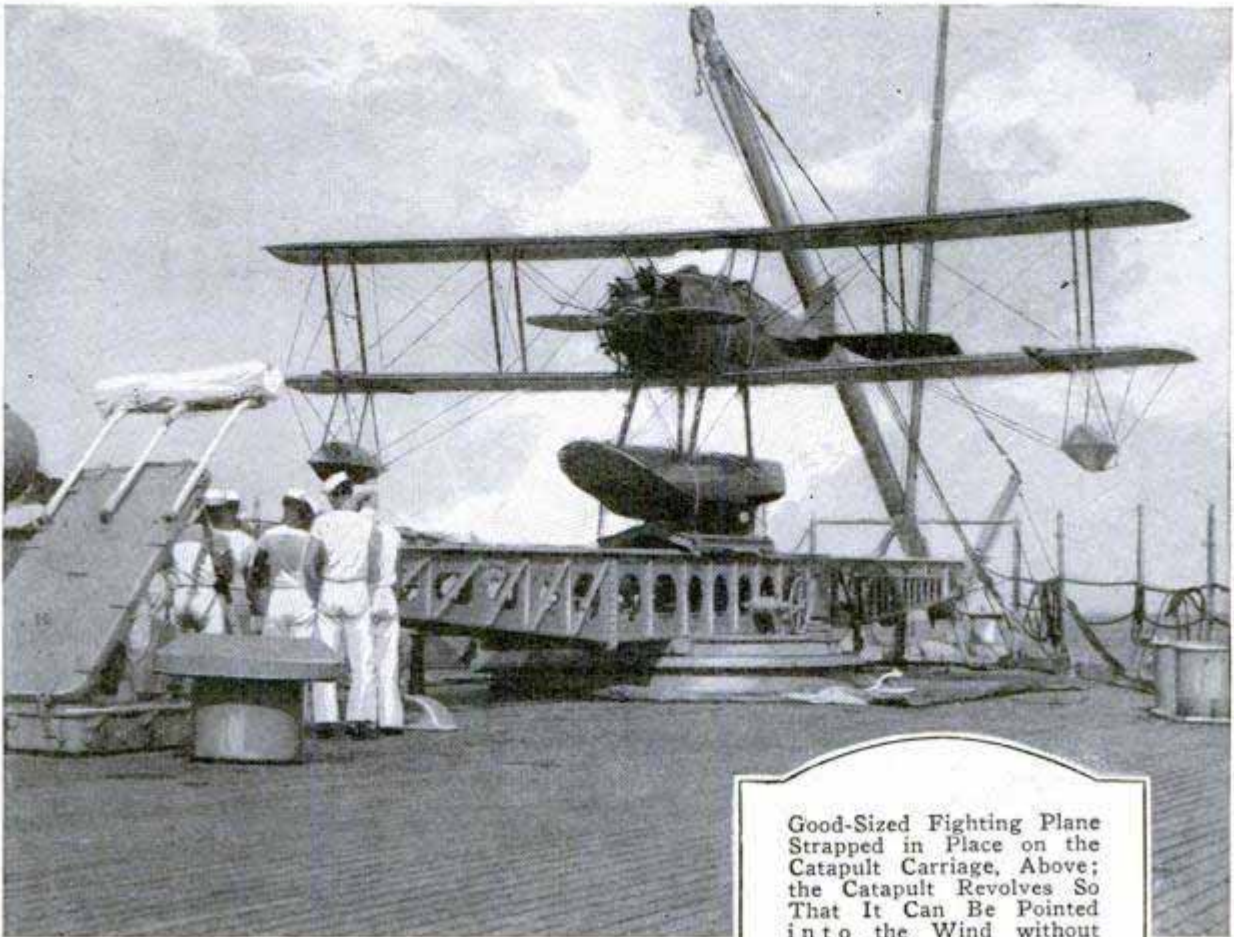

Good-Sized Fighting Plane Strapped in Place on the Catapult Carriage, Above; the Catapult Revolves So That It Can Be Pointed into the Wind without Changing the Course of the Ship, Unless the Wind Is Dead Ahead; Below Is the Original Catapult, Used by Prof. Langley in His Unsuccessful Effort to Fly His Airplane

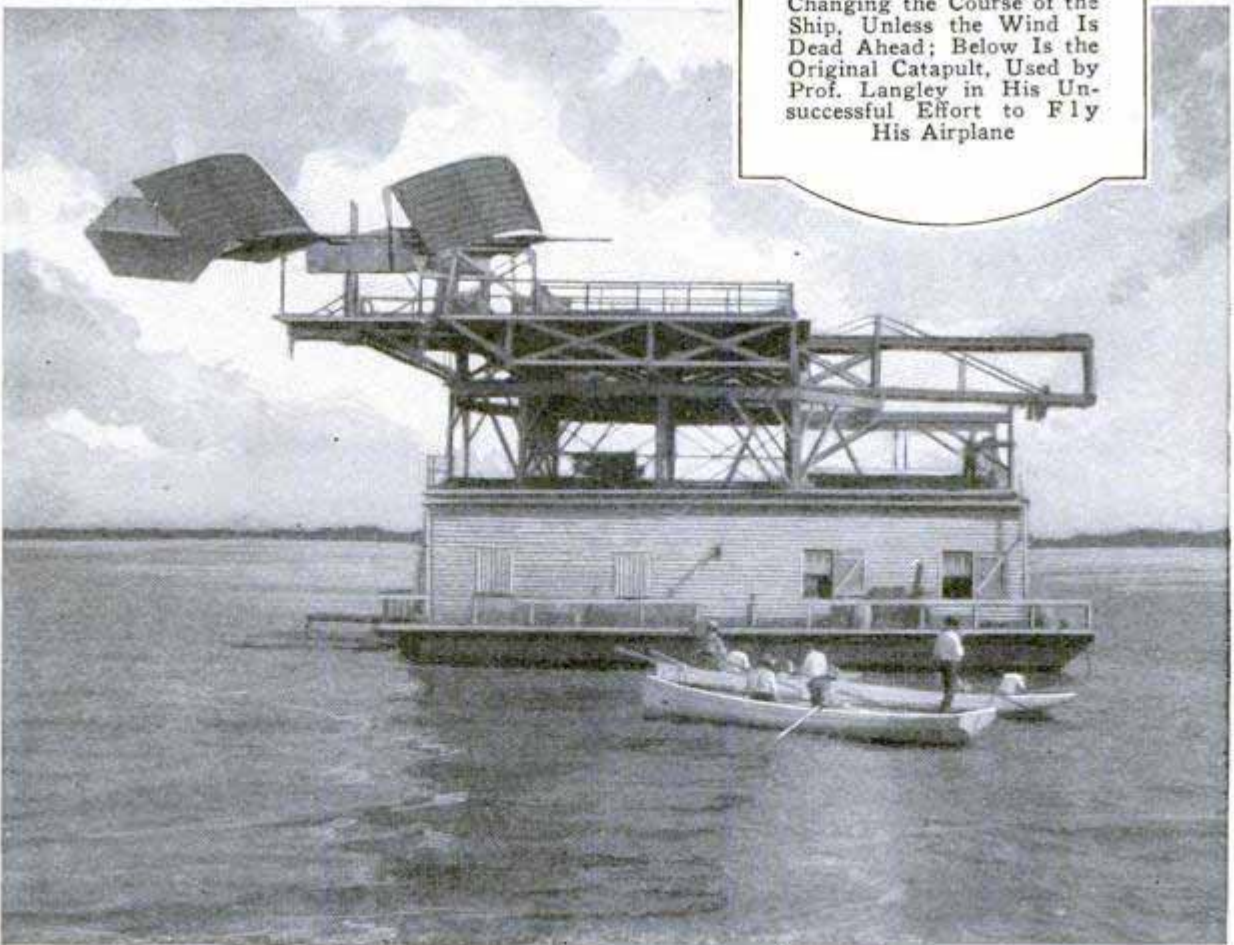

cushion to top of head, then gives the signal to shoot.

The plane itself is mounted on a carriage on the catapult runway. The powder charge is touched off by electricity, and forces out the piston which operates the launching gear. Like a shell from a big gun, the airplane, with engine turning at flying speed, flashes across the deck on its carriage, whips loose through its own momentum and darts over the side, sinking in a slow glide momentarily until the propeller gets a good "bite" in the air and pulls the ship upward. The operation is over in a few seconds, but until the pilot has done it many times and learned to control his stomach muscles, he rides away with a tingling sensation that lasts for some minutes.

The craft catapulted from battleships

are sea planes, with landing pontoons so that, when they return, they can drop into the water alongside and then be hoisted aboard. Successful launching experiments have also been made with flying boats, having boat hulls. The aircraft carrier "Langley," and the two new carriers being added to the navy, also will have planes with regular landing wheels, so they can fly back and alight on the broad, unobstructed decks. Arresting gear developed by the navy bring them to a stop within a few feet after the wheels touch the deck. The aircraft carrier is turned so that the plane can head into the wind and drop on the deck at the stern, straddling arresting-gear cables, which carry hooks that pick up the drag load, first a small amount and then gradually increasing weight until the plane stops.

MILLION-DOLLAR PIER HOLDS 1093 HUNDREDS OF AUTOS

Wide parking space for cars is one of the features of the recreation pier recently constructed at St. Petersburg, Fla. Autos

can be lined along nearly the whole length of the way from the mainland, and there is additional room for them at the end of the pier, where a pavilion and other conveniences for visitors are provided. The improvement cost about \$1,000,000.

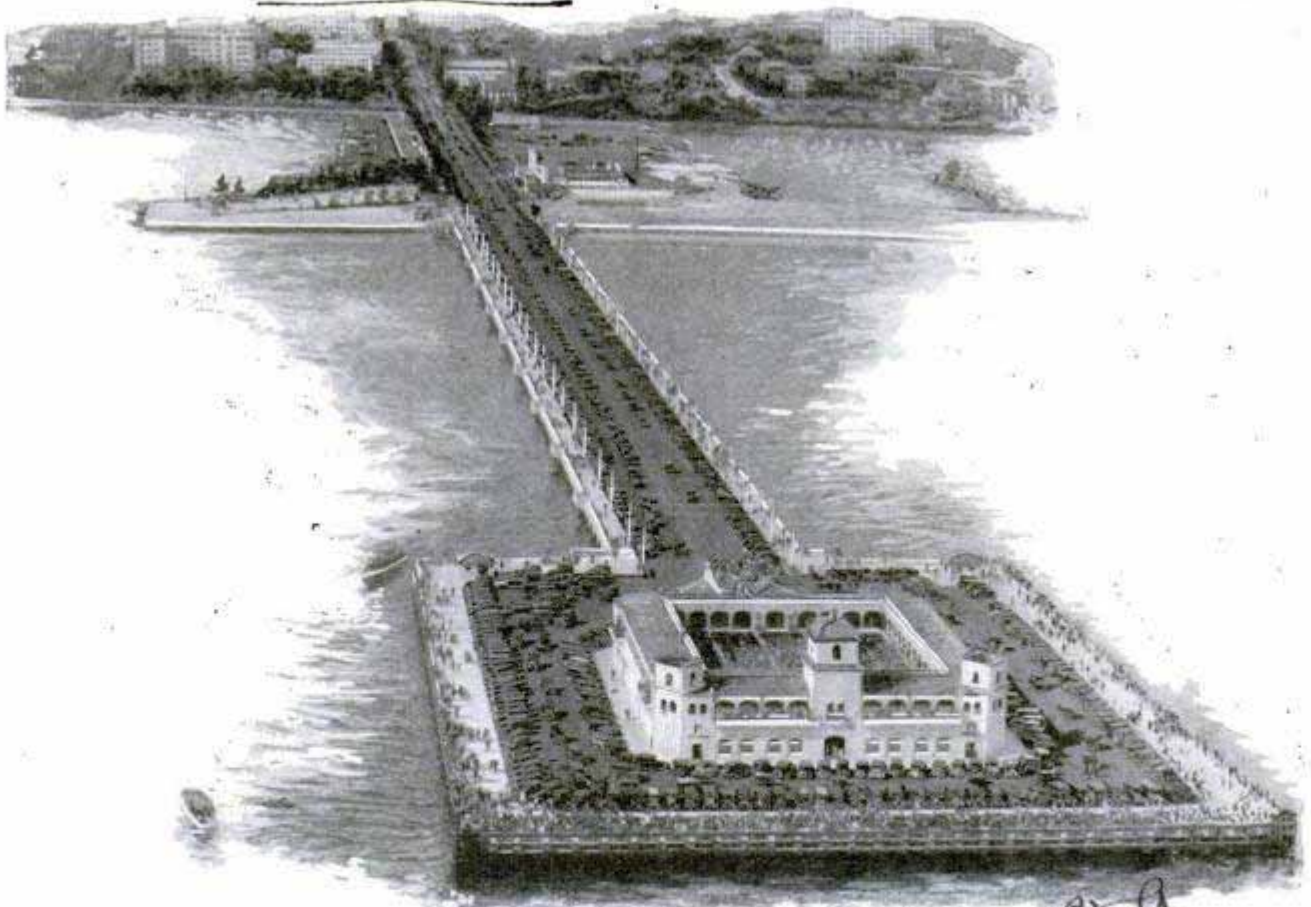

Where You Can Take Your Auto with You to the Beach; the Million-Dollar Recreation Pier at St. Petersburg, Fla., Showing the Pavilion and Roomy Parking Spaces

FOLDING TOWER AIDS FIREMEN AND OIL-WELL DRILLERS

Modeled upon the principle of the collapsible periscope, a folding tower, developed by a California inventor, is said to have possibilities of wider application and improved service over similar units because of its compactness when folded and the rapidity with which it can be extended. For an oil derrick, for instance, the inventor asserts that it can be constructed to be raised 150 feet high and yet will be not more than twenty-five feet when collapsed. For a fire-fighting tower, it could be made to rise to 500 feet, going up at the rate of 100 feet a minute and having a carrying capacity of 2,600 pounds.

129

NOVEL COMPASS TELLS TIME ON ANY SUNNY DAY

1204

A timepiece that requires no winding, but tells time through a combination of compass bearings and the angle of the sun, is a recent invention. It is compact, so that it can be folded and carried in the pocket like a watch. It comprises a small compass and a revolving plate, with two vertical arms, the plate being held at various angles

by a notched bracket, to compensate for differences in latitude. A table of corrections furnished with it gives the compass variation at points throughout the country, so that the instrument can be turned until the needle points to the true north. The table is revolved, after being set at the proper

angle for the latitude, until a sun beam falls on a hair line. A pointer then shows the correct time. The instrument can also be used to take accurate bearings on distant points, a feature that makes it useful for hunters and fishermen, campers, boy scouts, woodmen and many others.



James C. Moran & Sons,
Chestnut & Elbow Sts.
Providence, R.I.



These Roses, Molded of Butter, Are Accurately Colored and Difficult to Tell from Real Ones

FLOWERS MODELED OF BUTTER IN REFRIGERATOR STUDIO

Working in a heavy fur coat, cap and tall Russian boots, a San Francisco woman models realistic blossoms in butter for display purposes. Her studio is a refrigerator and her gardens flourish on ice. Vegetable dyes are used to reproduce the colors. Careful study of the nature of the substance has enabled the sculptor to achieve successful results even with very small flower designs.

TRIBUTE PAID "BUFFALO BILL" IN LOG MUSEUM

1292

In honor of the late William F. Cody, "Buffalo Bill," a log museum patterned after the famous "T E" ranch house of the great scout is being constructed in Cody, Wyo. It will be made fireproof to protect the valuable souvenirs and exhibits which will be housed there, to reflect, as far as possible, the wild west of "Buffalo Bill's" time. It is expected that the museum will be opened and dedicated in June, when the official opening of Yellowstone park occurs in Cody.

Mr. Cookley
Taylor St. San Francisco, Calif.
Mrs. Alice
950
Mrs. Agnes B. Chamberlin
Pres. Buffalo Bill Museum
As a contribution
Cody, Wyo.

ODD UMBRELLAS SEEN IN NEAR AND FAR LANDS

1097

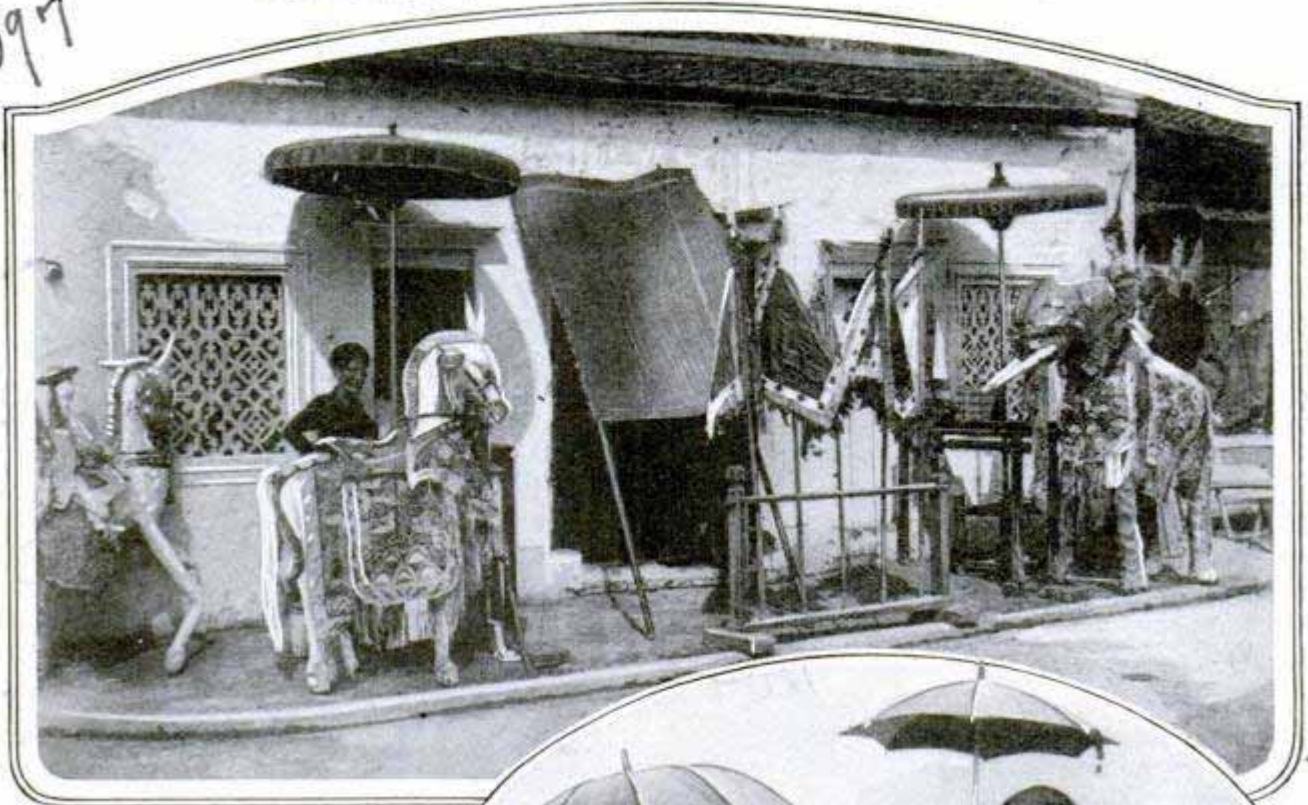

Umbrellas in the Far East Are Designed for Shade Rather than for Keeping Off Rain

© Keystone View Co.



Big Ones and Little Ones, the Umbrellas of Civilization Are Made to Fit Every Occasion

Big Headdresses Require Much Protection, Even Though the Umbrella Is Almost as Big as the User

Japanese Umbrellas Are Bowl-Like Hats, While the Breakfast-Food Effect Is Worn to Shed Rain



Keystone

TANKS ARE SUNK INTO POSITION TO SAVE DIGGING 1302

When a New Zealand contractor encountered extremely soft soil while making excavations for large concrete sewage tanks, he suspended digging operations, built the tanks at ground level and then sunk them to the required depth by allowing them to settle of their own weight plus that of railroad rails piled on top of them. It was only necessary to remove part of the ground within the diameter of the tanks which were thirty feet across and twenty-two feet high. During the work, an interesting find was made in the form of trees imbedded in clay, apparently remains of a submerged forest.

3/4 yd. heavy duty clamshell crane

NATURAL GAS SUPPLIED HOMES IN STEEL BOTTLES 1134

For households in localities where city gas is not available, supplies of the natural product for cooking and heating are furnished in steel containers which are refilled when emptied. The gas is in liquid form in the drum, but returns to its original state, when released at the burner, with an admixture of thirty-nine parts of air. It is said to give a hot, blue flame that forms no carbon or soot, and the cost compares favorably with that of manufactured gas, about one and one-half cents per burner hour.

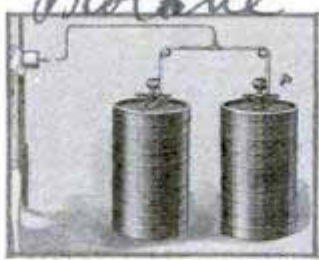

Propane

In home installations, two drums are furnished, one being kept in reserve for use when the other is taken to the service station for refilling. Outfits of portable type are obtainable for camping.

PAPER RAINCOATS 1169

Raincoats of waterproof paper are among the most recent articles to be made of this material. A thriving Wisconsin firm is turning out 15,000 of the garments yearly. Other products include kitchen aprons, vests for hunting and fishing, school-book bags, slippers for bathing beaches, radiator covers, children's caps and golf caps. A crepe variety, specially treated, has proved effective.

Advance Paper Co.

Marquette Wis



Lopezophone

1279

HORN IMITATES HUMAN VOICE WITH CONTRALTO NOTES

Vincent Lopez and Jeanne Gordon Demonstrating the Possibilities of New Horn
Casa Lopez, 247 W. 54

One of the latest orchestral novelties is a huge horn that is said to produce tones similar to those of the human voice. This is most noticeable on contralto registers, according to reports, a demonstration being given while an opera star sang as the horn was blown.

FUEL MIXER FOR SMALL CARS 1088 SAVES GASOLINE

Gravity plays an important part in the operation of an automatic fuel regulator for small automobiles. It is adjusted to provide a richer mixture when going up hill and a lean mixture on down grades, so that waste of fuel is avoided and the right strength is furnished when needed. It is easily installed, taking the place of the hot-air stove on the motor. The needle valve in the carburetor should be turned down about one-quarter turn and the spark lever advanced four or six notches after the mixer has been put in.

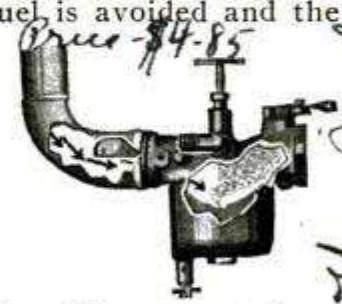

Price \$4.85

Quistart Vaporizer

The Motor Equipment Co. Chantow, Iowa.

J. Phelobing, Christchurch, New Zealand
Union Bottled Gas Co. Inc. 400 2 Clearhorne
Protane Corp. Erie, Pa. 145 10th St.
Advance Paper Co.
Marquette Wis

62

Association, 312 Platt Bldg.
South Bend, Ind.

Fur Coat



Typical Pirogue Trail through the Louisiana Marshes; along Such Narrow Waterways the Boat Trappers Place Their Traps for the Millions of Muskrats That Inhabit the Swamps

By BOB BECKER, *Chamber of Commerce Chicago*

MUSKRAT pelts that a few years ago were considered worthless to the trade but are now the backbone of America's fur industry; and the largest muskrat ranch in the United States where some years ago a few French-speaking trappers operated—these are the most recent developments in the Louisiana muskrat business, which today produces approximately 50 per cent of all the rat pelts used by the manufacturers of furs. That these unusual and dramatic changes in America's fur industry should take place in a subtropical part of the United States which, according to popular belief, is a poor producer of good fur, is another interesting angle of the Gulf coast development, as heretofore Canada and Alaska have been considered the heart of America's fur production, and one would naturally look to the north country for the latest and most scientific innovations in growing and handling fur.

And as if Louisiana were not doing enough to produce muskrat skins on a large scale and along the most scientific lines, it offers to the fur men a novel labor-saving device in the clothes wringer. Down there in the great coastal marshes where more than 6,000,000 rat skins were taken in a single season (1924-5), the French-speaking Cajan trappers use an ordinary clothes wringer to flesh the pelts, an operation that no section of the country had ever thought of before the coastal trappers showed the way.

Mile after mile of coastal marshes with lagoons, lakes, ponds and luxuriant aquatic growths; millions of ducks, geese and other water birds; soft-voiced, easy-going Frenchmen, some of whom trace their origin to the Acadians whose tragic story has been immortalized in Longfellow's "Evangeline"; muskrats so abundant that their moundlike homes of cut grass look

Ranching in Swampland

like haycocks in a meadow—this is Louisiana's rat country, an area so foreign in atmosphere because of the use of French that the visitor has the impression that he has entered a part of France instead of being on American soil. In this land of Cajans, ducks and French drip coffee, have evolved the most modern methods of rat ranching, all in line with strict conservation.

You travel way to the western border of Louisiana to see what has been called the biggest rat ranch on the continent. Orange, Texas., just across the Louisiana line, was my destination when I started out for this ranch which is owned by the Starke land company. There C. O. Leedy, the manager, provided a speedy launch for our party and then down a winding river we sped to the heart of the rat country. From the river



Cajan Trapper and His Catch; the Cajans of Swampland Are the Descendants of Longfellow's Evangeline and Other Acadian Exiles

you enter upon a system of man-made canals dug by the company so that their territory (approximately thirty-five by fifteen miles in extent) is accessible to trappers.

After seeing the broad sweep of the Louisiana marsh which extends along the Gulf coast you can readily understand why Louisiana produces more pelt bearers than any state in the Union, and even exceeds the total fur take of all the provinces of the Dominion of Canada together. As far as you can see there is nothing but water

and then more water; aquatic grasses and other types of swamp vegetation; ponds, bayous, little lakes, mud, ducks, muskrat houses, and an occasional "chenier" or ridge. That ridge business fools the visitor at first. In most any part of the United States a ridge is a decided elevation. Down there in the flat, monotonous "aquatic prairie," a ridge is just a little rise that dominates a part of the marsh from the magnificent elevation of two or three or four feet! Here a few cattle are placed



to feed upon the rich grasses, but sometimes it is a race between the stock and the wild geese for the grass as countless thousands of these big game birds consider the cheniers their cafeterias.

In this fascinating lowland country the Starke company has developed the most serviceable pelt-drying method that has ever been seen in the land of muskrats. Applying up-to-date business practices to the fur business—which is probably the oldest industry in the world, as even in the Stone Age early man killed the beasts of the field for their pelts—the company constructed a drying house which means easier handling of skins, and more perfect pelts when the buyer comes around. They built a long shed with a good roof so that no rain could penetrate. Then a giant rack, capable of holding 70,000 pelts on wire stretchers, was constructed in such a way that it could be rolled out of the shed onto a platform on sunny days or pushed into rainproof



Surplus Fat Is Squeezed Off in a Common Clothes Wringer. Top; Above Is a Typical Trapper's Camp Pitched on Stilts to Keep It from Sinking into the Swamp



Fur Buyers Visit the Trapper's Camps to Inspect and Purchase the Drying Skins

quarters when inclement weather makes it impossible to dry skins outdoors. This ingenious rat-drying "train" is today the most outstanding progressive step toward production and efficiency in Louisiana's giant muskrat business. In the past, the trappers always hung their skins on racks outside their tents or cabins. They were usually at the mercy of the weather. The result was many a spoiled pelt. Louisiana's newest large-scale rat ranch has abolished this wasteful primitive method by the invention of this exceedingly practical drying rack.

To follow a trap line is like a trip through an overpopulated bird land. In the north, running a line in a marsh means walking from one set to another. Down in the Louisiana marsh, the trappers find it either impossible or far too hard work to plow through the water and sticky mud, so they cut a narrow "trena" or channel through the vegetation. Along this highway their

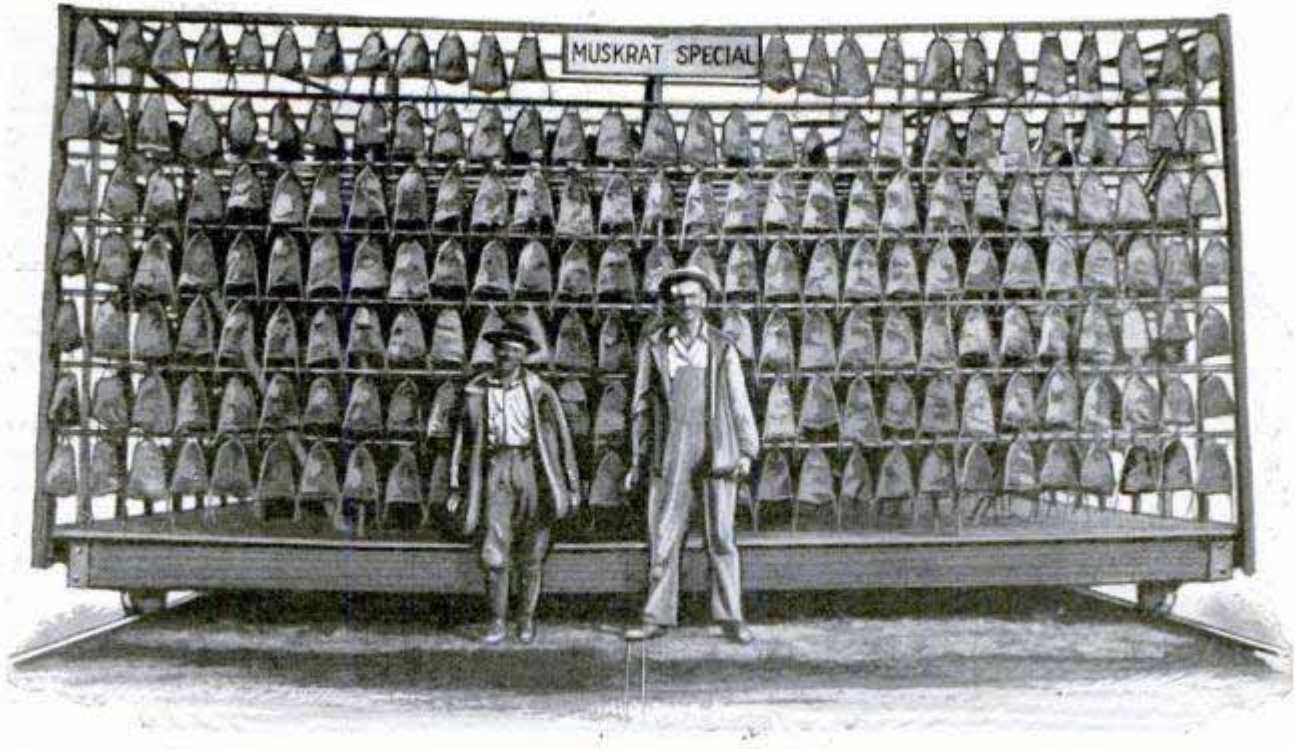

An End View of a Loaded Drying Rack with 70,000 Skins, Hauled Out into the Sun; at the First Hint of Rain the Pelts Can Be Whisked Inside in a Moment

traps are set and the entire string is made accessible by a pirogue or shallow-draft duck boat. Where the water is but a few inches deep on the floor of the marsh, the trapper brings in a horse, hitches it up to the little pirogue and rides on the trena highway which is lined by tall grass and quacking waterfowl.

The most interesting feature, however, is not the value of the pelts taken from the marsh. It is the conservation policy developed to insure that the coastal marshes will always produce a rat crop that runs into the millions. In 1924-25 the pelts harvested from the marshlands were valued at \$5,142,896.95. Last season the small Louisiana rats were scarce, ow-

ing to a drought. They brought an exceptionally good price. Dame Fashion has decreed silver muskrat a popular skin for ladies' coats. This kind of fur grows on the body of the Louisiana rats; so they were valuable. Facing a short rat crop the Starke company inaugurated a conservation policy on their big ranch, with the mandate that there should be no trapping in order to conserve breeding stock for this season. This brought into action something that the native trappers had not seen before—"muskrat wardens," living in small shacks built on stilts above the marsh. They patrolled the lowlands to see that the no-trapping injunction was strictly obeyed by every one.

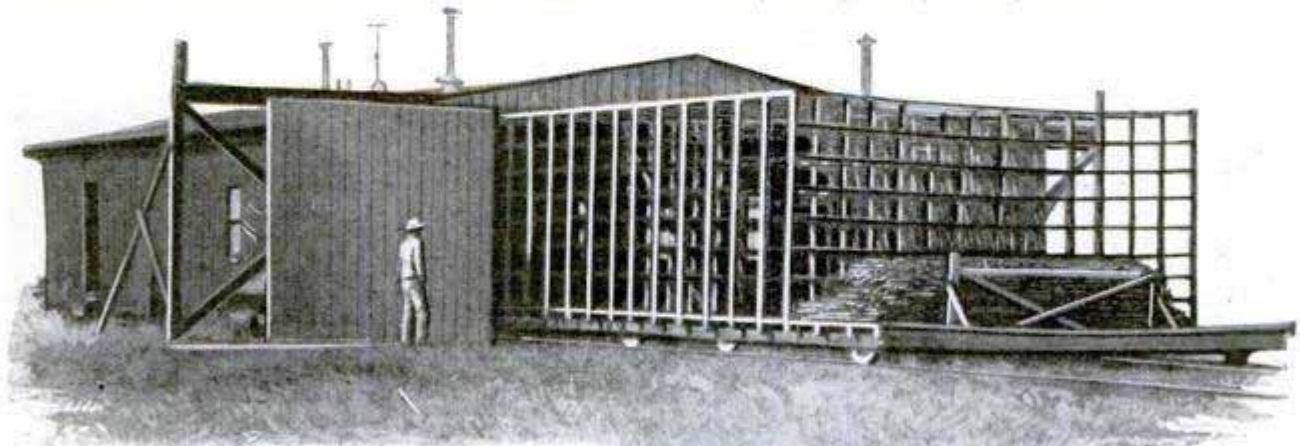

Drying Sheds Are Built like Huge Aircraft Hangars, with Racks That Run on Railroad Wheels and Track, and Each Capable of Holding Many Thousand of the Pelts

Paul de Nemours Co. Wilmington Del.

Chas. DeLille Chase

DRUG SIGN ON MAIL BOX AIDS "SHOP EARLY" CAMPAIGN

1349



Copyright, Herbert Photos
Parcel-Post Box Used for Drug-Store Sign; the Other Side Bears a "Shop Early" Reminder

Converting the sides of a parcel-post receiving box in front of his store into a billboard, a Massachusetts druggist accomplished a double purpose in painting a sign on the box. He advertised his firm and also aided the post office department's drive for early mailing during the holiday season by including in the sign a message urging early buying. Permission to use the box in this way was granted by the local postmaster.

LOST TOMB OF EARLY MARTYRS FOUND AT EPHEBUS

Workmen clearing away debris around the excavations at Ephesus recently uncovered what scientists pronounce to be the long-sought catacombs of the early Christian martyrs, known as the "seven sleepers of Ephesus." The story goes that seven young Christian men, about 250 A. D., hid themselves in a cave to escape their pursuers. Their refuge was discovered and the entrance to the cave blocked. Nearly 200 years later, a shepherd discovered the cave, found the inmates and awoke them from the sleep that had seized them shortly after their imprisonment. The emperor Theodosius II heard of the marvel, hastened to the cave and is said to have

Excavators - Prof. Hail, Theimer and Miller of Vienna. Prof Adolf Heisigman, Univ. of Berlin. 139

listened to the martyrs' narrative of how they had been kept alive, as a confirmation of belief in the resurrection of the dead. After they had delivered their message they again fell asleep, the legend has it. In the ruins of the tombs, many lamps of designs depicting early Christian scenes were found.

DIGGING CANAL WITH DYNAMITE CHEAPER THAN DREDGING

1356

Dynamite scored an effective victory over dredges in constructing a drainage canal beside a road through swampland in Louisiana. In less than half a day, a channel was blasted out while a month would have been required, had dredges been used, engineers report. The charge was set off by electricity, the sticks of dynamite, placed along the canal site, being connected with wires. By the use of a button, an excavation ranging from seven to ten feet deep and between thirty to forty feet wide was instantly made along the highway. Contractors estimated that the work would have cost \$1.50 per cubic yard by dredging. With the dynamite method, the cost was twenty cents per cubic yard.

Behrman Highway from Alquis New Orleans, Louisiana

PATIENTS' PORCH ON A PIVOT TURNS WITH SUN

1358

Small living porches at a Dutch tuberculosis sanitarium are built on pivots so that they can be turned toward or away

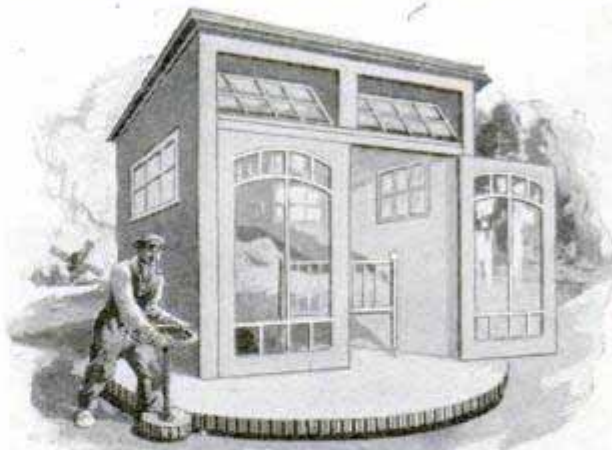

Turning the Porch to Admit More Sunlight, a Feature of Dutch Sanitarium

from the sun as the patient needs or desires. The unit is closed on three sides and is just large enough to contain a reclining chair or bed, table and bookstand.

Told by Cornelia Van Kory Journal of Outdoor Life

AIRPLANE WING ON BOAT INCREASES ITS SPEED



"Miss Spitfire V," with Airplane Wing Attached, Made Fifty-Eight Miles an Hour in a Recent Test; the Boat, without This Aid, Previously Sped at More than Forty-Seven Miles an Hour

A speed record made by the motorboat "Miss Spitfire V" was increased by over ten miles when an airplane wing was attached to the craft. In a race off San Diego bay, the boat attained the speed of 47.05 miles an hour and later made fifty-eight miles with the wing.

HOUSES ARE BUILT OF BUBBLES — MIXED WITH CONCRETE

Building with bubbles suggests an impractical fancy, but a California inventor is doing exactly that, with the aid of concrete, and already has several dwellings and a schoolhouse to show for his plan. The bubbles, imprisoned in a special lather or foam, are mixed with the cement and partly replace the usual aggregate of sand and pebbles. The result is literally a bubblestone, the porosity and lightness of which may be varied according to the

amount of solid material used. Cubic-foot blocks weigh from fifteen pounds to 150 pounds each. In the uncured stage, the mixture is like soft cheese. It may be sliced with a wire or sawed, but when it has set, it is like any other cement product, yet has several distinctive features. Nails can be easily driven into it without causing breaks or fractures. They may then be withdrawn, while the hole is filled with cement mortar, and inserted again, thus becoming firmly imbedded. The material is said to be excellent for insulation

purposes, is highly resistant to fire and can be adapted to a wide variety of forms, such as blocks, slabs, tile, boards and shingles. It is successfully employed for floor fill, reinforcing, partitions, decorations, pipe, refrigerator and incinerator insulation. The buildings already made of the bubble mixture are of grooved blocks, bound together with steel rods and cement.

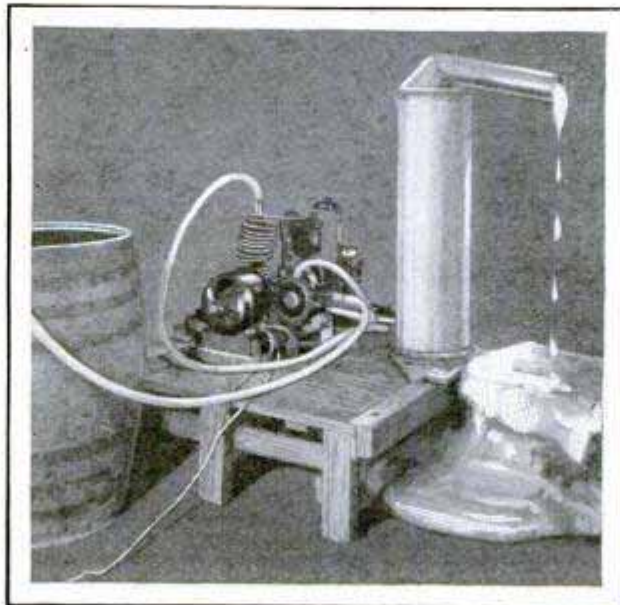

Preparing the Bubble Foam Which Is Mixed with Concrete, to Form New Building Material

Bubblestone Co. 809 Bancroft Way
Berkeley, Calif.
1st National Bank

1089
448

1220 La Salle Ave

POPULAR MECHANICS

Minneapolis Marin

FOREST OF DOMES FORMS QUEER ROOF OF CHURCH

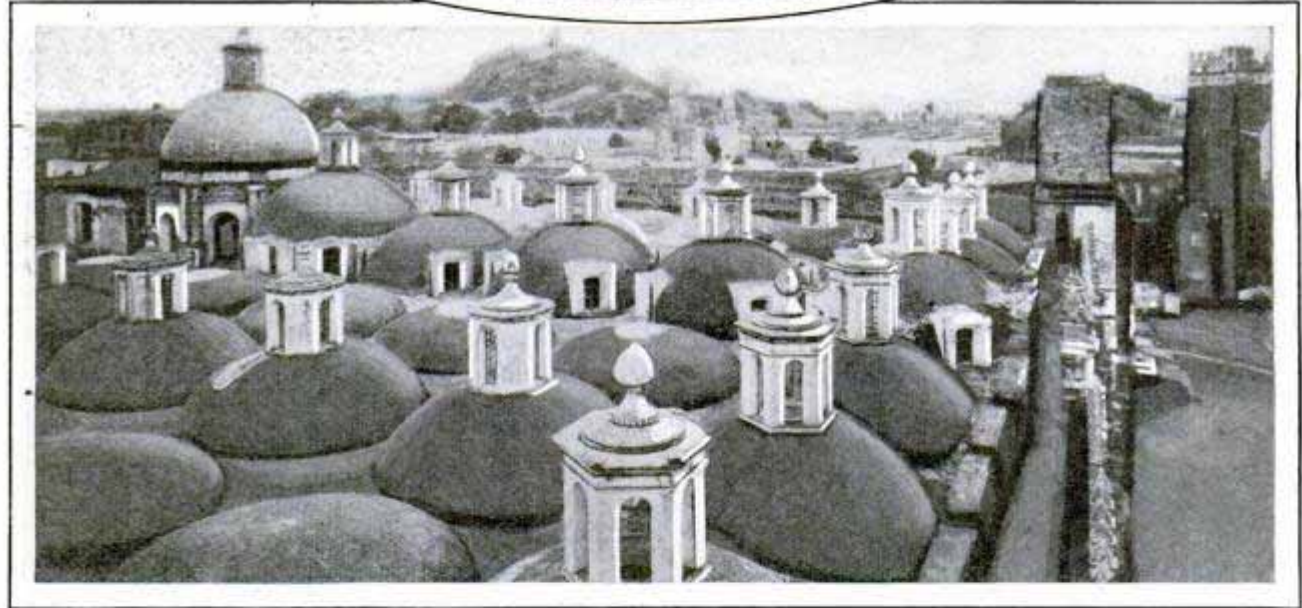

The Church of the Seven Naves, at Cholula, Mexico, Has Sixty-Four Columns, Forming the Seven Naves, and Surmounted by Forty-Seven Domes, Giving the Roof an Unusual Appearance

A church roof consisting largely of forty-seven small domes, an unusually odd architectural arrangement, is one of the features of Cholula, Mexico. The church which was one of those taken over by the Mexican government last summer, when it ordered enforcement of the law against foreign priests, is called the "Church of the Seven Naves," because, instead of the wide clear spaces typical of Gothic architecture, the interior is split up into a series

of naves by sixty-four large columns, which in turn support the many small domes of the roof.

SHIPS BUILT IN DRYDOCKS ARE EASIER TO LAUNCH

The old way of building ships on shore and then sliding them into the water may be abolished as a result of naval experiments with a shipbuilding drydock on

Marine Engineering
12/26 P. 909

Puget sound. The launching ways which have been used for generations have grown more and more unsatisfactory as the size of ships increases. They require elaborate framework to support the vessel while it is sliding to the water, and, even then it is hard to avoid undue strains on some parts, while, after the ship has left the ways the problem of stopping it, particularly if the shipyard is on a narrow river, is serious. When the aircraft carrier "Lexington" was launched at Fore river, it attained a speed of nineteen feet a second as it left the ways. To bring the ship to a stop an elaborate system of chain drags was used, requiring a considerable expenditure of time and money. The navy shipbuilding drydock, on the other hand, cost less than a well-equipped building way, and when a ship is completed, it is only necessary to fill the dock with water, open the gates and tow the hull out. A dock for shipbuilding is smaller and cheaper than an ordinary drydock, which must be deep enough to allow the biggest ship to pass over its sills, a requirement that necessitates forty feet of water over the sills now. The navy dock needs but nineteen feet of water to accommodate the biggest ships, for the hull as launched, without superstructure, engines, guns and interior fittings, is much lighter than a completed ship, and hence floats much higher. While the new dock was under construction, two 10,600-ton ships, the "Nitro" and "Pyro," were laid down and completed in it and were ready to be launched about the time the dock was completed.

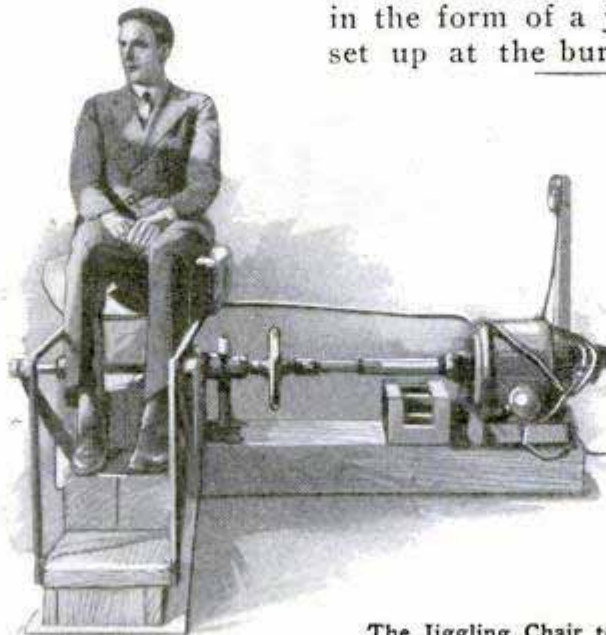

The Jigging Chair to Test Auto Jolts

Huge Kite Made for the Japanese Crown Prince; It Resembles Both a Dragon and a Bird

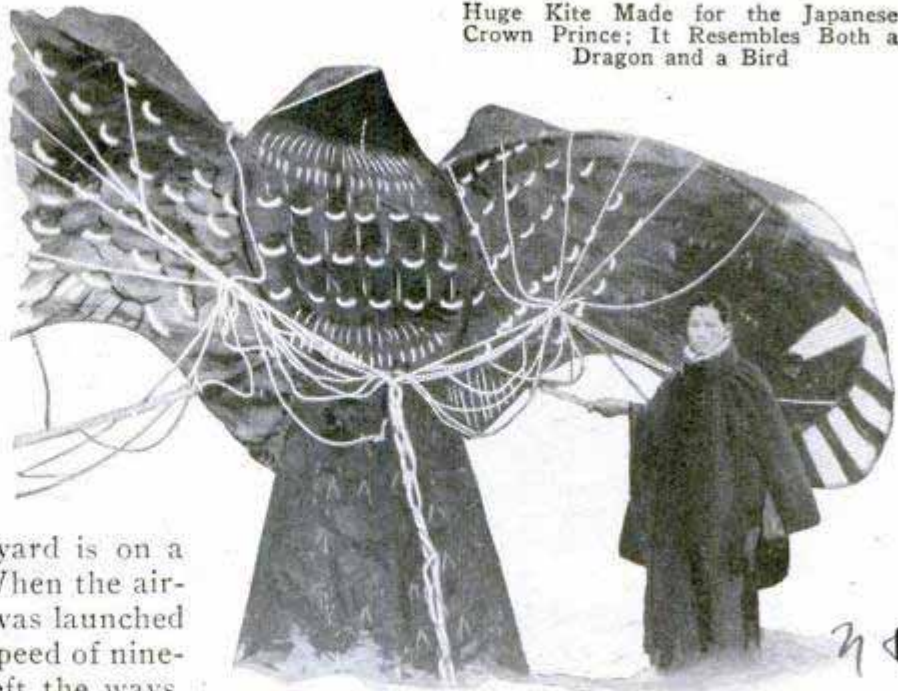

BIG KITE FOR JAPANESE PRINCE MODELED AFTER DRAGON

Kite flying is both a sport and a ceremony in Japan, and expert craftsmen are trained to construct elaborate pieces for use on holidays and other occasions. Not long ago, a huge dragon kite was made especially for the crown prince. It has wide, curving wings on each side of a dragonlike center.

STUDY AUTO'S JOLTS AND JARS WITH JIGGLING CHAIR 1169

To learn more about the secrets of the auto's movements, a "bucking broncho" in the form of a jigging chair has been set up at the bureau of standards. Its

movements can be amplified to varying degrees and the vibrations increased from 100 to 1,000 per minute. Tests made with human subjects show that some vibrations as small as one to two one-thousandths of an inch, are very disagreeable to certain autoists, while others do not notice motions which are much stronger.

1679 Mr. Woodward Bldg
 514 POPULAR MECHANICS
 Washington, D.C.
RADIO LINKS ARCTIC OUTPOST TO CIVILIZATION

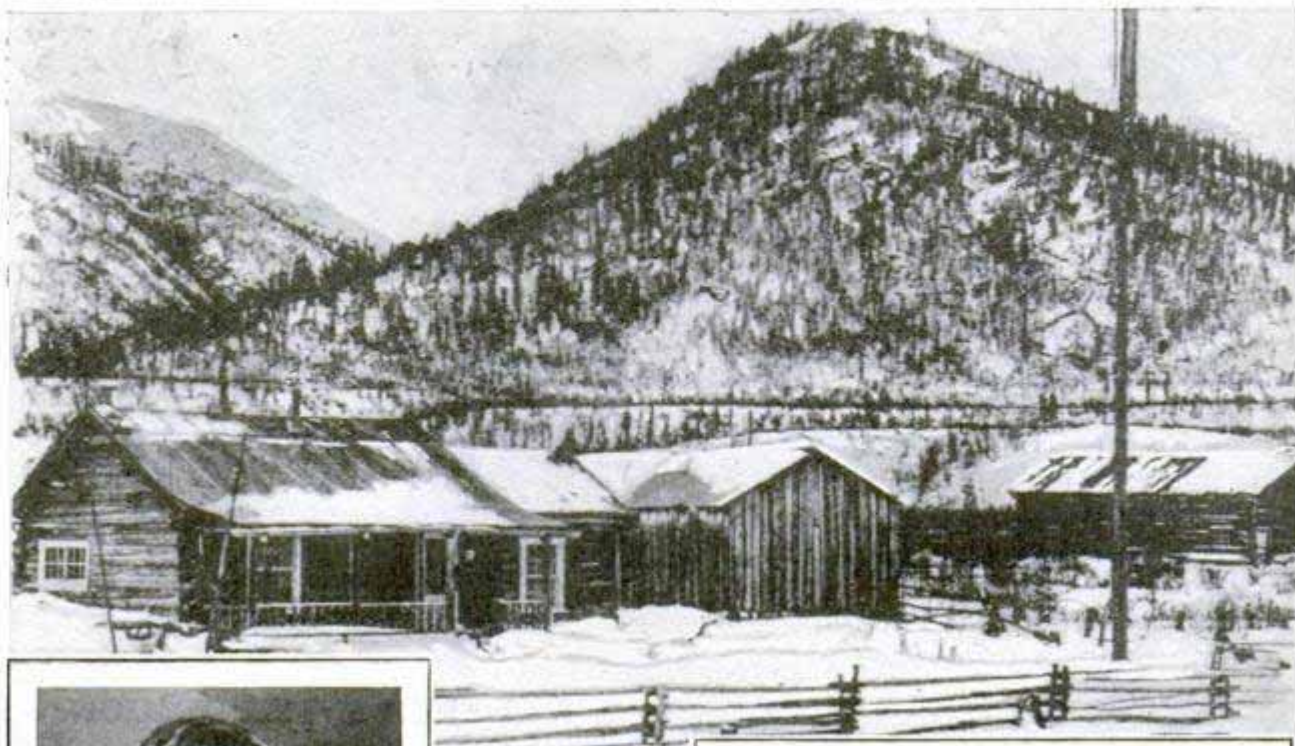

Private Ulen, His Home in Wiseman, Alaska, and His Dog Team; as United States Commissioner, Postmaster, Head of School Board and Radio Operator, He Is Town's Leading Citizen

Although he is but a private in the United States army, Elmer J. Ulen is recognized as the most important resident in Wiseman, Alaska, on the Arctic circle, for he is operator of the army's farthest-north radio station. Through him, the little town receives the latest news from the outside world and can make known its needs. Besides running the station for the signal corps, Ulen is United States commissioner, postmaster and head of the school board.

would be sufficiently low to permit driving over it in case of necessity, but would discourage drivers from taking the wrong side of the road, especially on curves, supporters of the plan declare.

**ROUGH STRIP IN ROAD CENTER
 (4) AIDS AUTO SAFETY**

In place of the white-painted line down the center of automobile roads a raised strip of rough pavement has been proposed to the highway research board. It

**TOY BLOCKS OF SOFT RUBBER
 1083 PREVENT ACCIDENTS**



Children like to throw their blocks about with consequent risk of personal injury and damage to the furniture. These

hazards are eliminated in a new form of block, made of soft, sponge rubber, stamped with figures and letters, and which can be washed when soiled.

*Oakhill Rubber Co
 Oakhill, Ohio.*

11 B road St
Lyons Ny

news over
471
St Joseph Mo

SWIVEL GRIP TO FASTEN SPRING PREVENTS BREAKAGE

Springs are securely fastened to doors, chests and other articles by means of a quickly adjusted grip, in combination with a swivel hook that permits turning to prolong the life of the spring and give better results. The base of the fastener is fitted with a number of curved arms, which are inserted between the coils at the end of the springs. They serve to equalize the pull, preventing undue strain on any one part, and hold securely, yet can be removed easily without damaging the coils.

STEP PLATE TILTS TO SERVE AS LUGGAGE CARRIER

Equipped with a strong spring concealed in the hinge, a step plate for the auto running board can be tilted back and luggage held between it and the side of the car. The spring maintains a tight grip on the piece, so that it is not likely to fall out, and no ropes or straps are needed. The plate is easily attached to any running board and has rubber lining to prevent marring the articles and to help hold them.

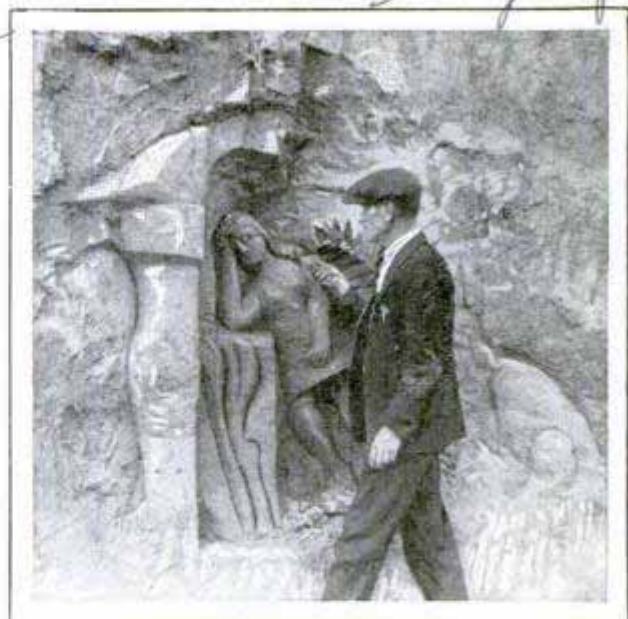

Albert Goff, Carving Figures and Designs from Clay Bank with Trowel, the Only Tool He Uses

CARVING FIGURES IN CLAY BANK ARTIST'S OUTDOOR HOBBY

With a trowel as his only implement and a clay bank as his studio, a mid-western artist has attracted considerable attention by the carvings he makes as an outdoor diversion. He has not studied sculpture and makes no pretense at finished work, but his human and animal figures are rendered with great accuracy. Much skill is required in planning and cutting a group so that the bank will not cave in.

RULES OF THE SKY

Traffic rules for aviators have been compiled by the English air ministry, governing the question as to what type of craft has the right of way and applying to less important details. For instance, flyers are required to carry safety matches, are not allowed to take dogs along, cannot drop leaflets from their planes and must not maneuver in a way likely to cause annoyance to persons on the ground. This would automatically prohibit flying close over cities or above great crowds of people gathered at shows or athletic contests. The traffic rule of the sky there, is that aeroplanes must give way to airships and balloons, while a balloon is given the right of way over an airship.

Kansas City James
12/6/26



Auto Step Plate with Spring, and How It Tilts Back to Hold Things of Various Shapes and Sizes

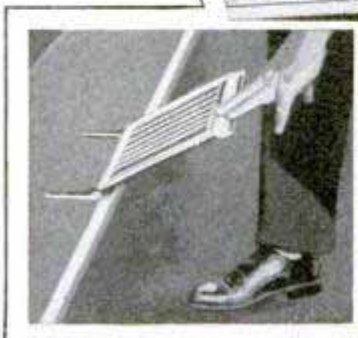

Howard Wilcox
Island Central Terminal
70 E 115 St New York

1050 Proj. ...

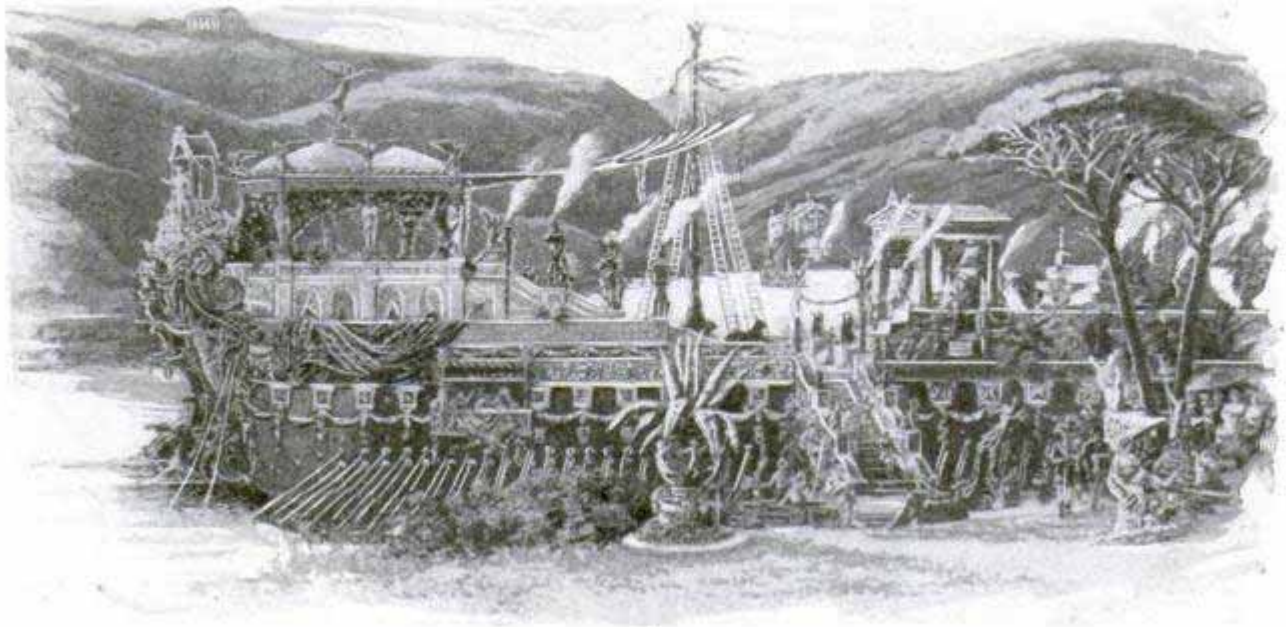

Reconstruction of Caligula's Larger Galley as It Probably Appeared When Moored at the Shore of Lake Nemi, Where the Mad Emperor Used It as a Country Palace

Emperor's Treasure Ships to Be Raised

Italians Plan to Drain Lake to Recover Art Objects Hidden by Sinking of Caligula's Royal Barges

ORDERS for the draining of Lake Nemi, fifteen miles from Rome, have been given by Premier Mussolini, to enable the Italian museums to recover the vast store of priceless art treasures carried down 1,900 years ago, when the royal barges of Emperor Caligula sunk to the bottom. There were two of the vessels, one 198 feet long and sixty-six feet broad, which now lies fairly near the shore, and a larger ship, 231 feet in length and seventy-eight feet in breadth, lying some distance farther out in ninety feet of water.

The smaller vessel, divers have found, is in a fairly good state of preservation and has intact practically all of its priceless ornaments, including metals, ceramics, terra cottas and mosaics, as well as all the interior machinery and equipment of the emperor's household. The larger ship, the location of which was found as long ago as the fifteenth century, has been almost denuded of deck fittings of bronze, gold and other metals by searchers who have explored the bottom with grappling hooks

and torn away everything the grapples would fasten on.

Draining of the lake may result in the complete restoration of the smaller ship and its refloating as a permanent museum of Roman life just as a Cæsar lived it. The engineering task is not especially difficult, inasmuch as the lake is somewhat higher than Lake Albano. A tunnel will be driven from Nemi to the lower lake and the water drained off, while a dock will be built and cofferdams fitted around the smaller ship, so that it may be repaired and raised. The tunnel will then be stopped up permanently and the lake allowed to refill.

The two royal barges, which were used partly in connection with religious ceremonies and partly as pleasure palaces for the emperor, were really just that—floating palaces. They were anchored near the shore in front of a temple of Diana, which is now being unearthed. The two formed a striking marvel of naval construction and an unusual expression of im-

Illustrated London News 10/14/24 Kansas City Star 7/25/26

7050

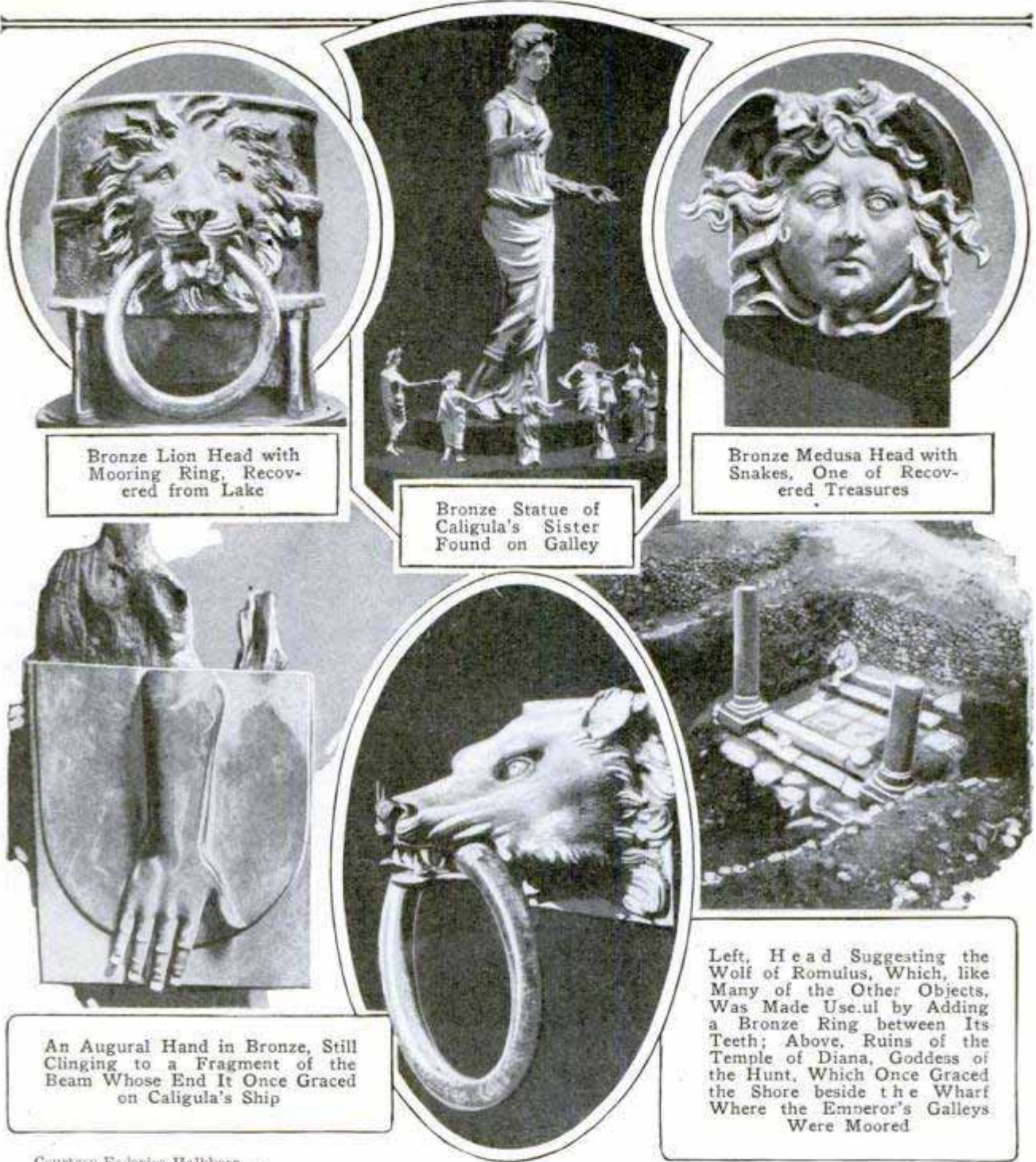

Bronze Lion Head with Mooring Ring, Recovered from Lake

Bronze Statue of Caligula's Sister Found on Galley

Bronze Medusa Head with Snakes, One of Recovered Treasures

An Augural Hand in Bronze, Still Clinging to a Fragment of the Beam Whose End It Once Graced on Caligula's Ship

Left, Head Suggesting the Wolf of Romulus, Which, like Many of the Other Objects, Was Made Useful by Adding a Bronze Ring between Its Teeth; Above, Ruins of the Temple of Diana, Goddess of the Hunt, Which Once Graced the Shore beside the Wharf Where the Emperor's Gallies Were Moored

Courtesy Federico Halbherr

perial luxury, reproducing in their ornaments and fittings, mosaic pavements, terraces, altars, fountains, statues and decorations of bronze and gold all the splendor of the imperial mansions on the Palatine.

Antiquarians believe that the immense weight of bronze, gold, silver and marble that went into their embellishment was largely responsible for their early sinking. No mention of them is found in later Roman historians, but their memory was handed down from antiquity by folk legends, and led the renowned architect of the renaissance, Leon Battista Alberti, to

attempt to raise them in the fifteenth century. He succeeded, using grappling hooks, in bringing up some bits of wood and some metal ornaments. In 1885-89 the British ambassador, the late Lord Savile, did considerable fishing in the lake and brought up numerous metal and marble objects, which were placed in an English museum. Italian scientists also have gathered quite a collection of beautifully carved and molded ornaments.

The emperor Caligula, at whose command the galleys were built, outshone all the Cæsars in extravagance. According

to Seutonius, "he surpassed all the prodigals that ever lived in the devices of his profuse expenditures; inventing a new kind of bath, with strange dishes and suppers; washing in precious unguents, both warm and cold; drinking pearls of immense value in vinegar, and serving up for his guests loaves and other victuals modeled in gold."

Caligula became emperor in 37 A.D. His bent for the gorgeous and bizarre probably reached its height in his pleasure galleys. Investigation by divers indicates that the ships really were country estates, with decks surmounted by marble palaces, columned temples, numerous elaborate baths and galleries, and even carefully tended terraces, planted with growing trees and vines, as well as shrubs and flowers. The emperor also owned a pair of wonderful galleys with poops studded with precious stones and sails of many colors, built for tours along the sea coast, but, being subject to seasickness, he preferred the quiet waveless expanse of the

inland lake when he went yachting. Dining in the great marble banquet hall of the imperial barge, however, was not always a pleasure to the emperor's guests, for the host had a peculiar sense of humor that found outlet in slaying his supper companions. Seutonius relates that one night at dinner the emperor burst into laughter, and the consuls who reclined on the couches on either side of him asked what was the matter, to which the mad monarch replied that he was amused at the thought of how easily he could have both their throats cut!

When he was killed in 41 A. D. by a tribune of the Praetorian guard there was general rejoicing in Rome.

If Mussolini's project succeeds, though, the reconstruction of the scene of a Caesar's pastimes may astonish the world by its magnificence. The museum will be unique in that the works of the long dead artists will be displayed in their original surroundings, just as they were when the emperor and his guests used them.

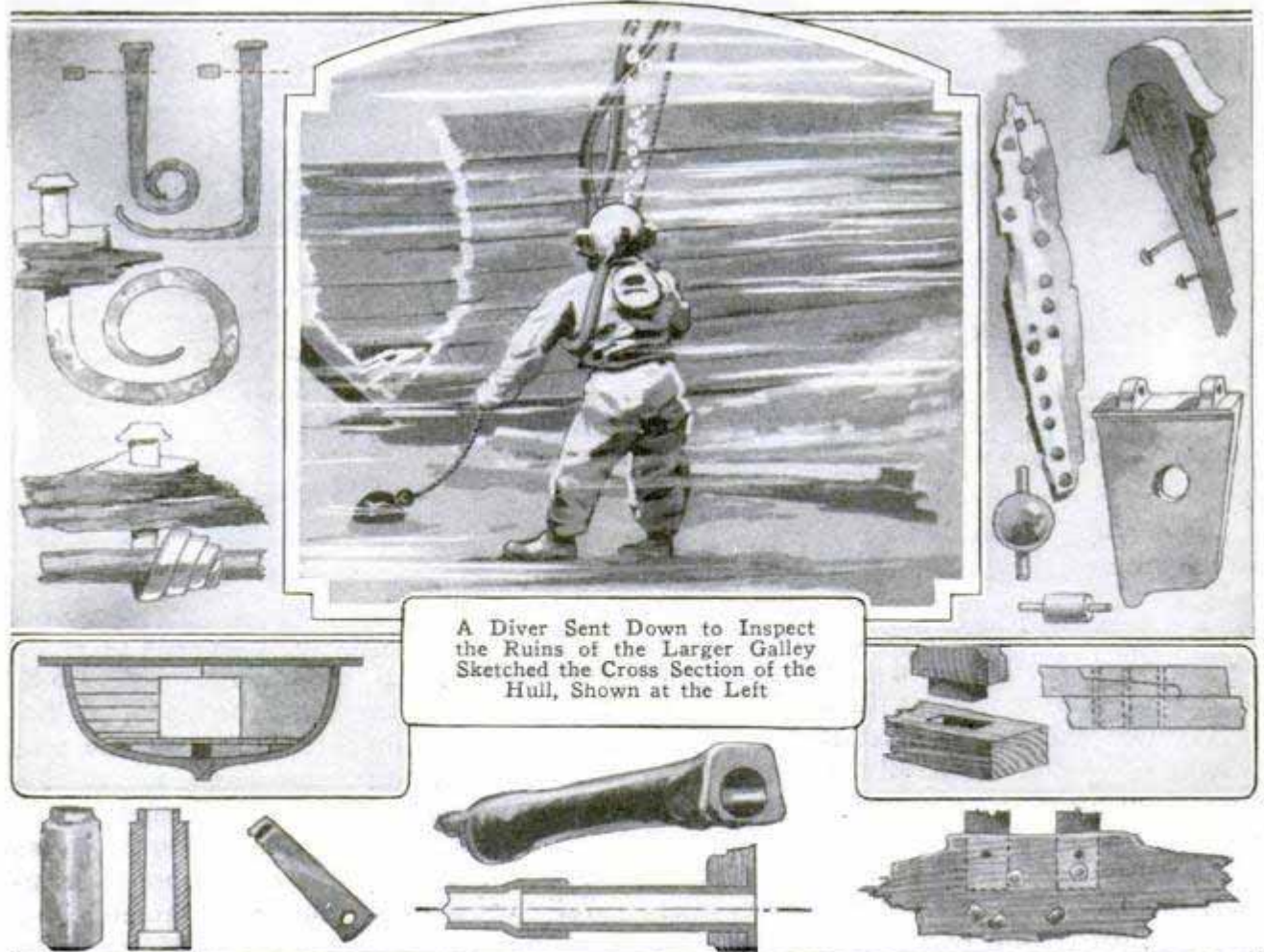

Metal Ship Fittings, Including Nails, Stanchions and Bits of Terra Cotta and Wooden Parts, Recovered from the Lake; Note the Mortise and Tenon Used by the Roman Builders

*George J. Esage
Spokane, Wash*

REFINING PROCESS IS SUITABLE FOR COMPLEX ORES

Complex ores which cannot be economically treated by ordinary processes are reduced to bars of alloyed metals which can be sold to smelters, by a method developed by two western chemists. Their system is a patented combination of operations, said to be specially adapted to small-scale workings. A reduction plant near Spokane, Wash., represents an investment of but \$3,500 and employs only five men, but is said to be operating at a profit. After smelting, the metal is available in bars containing lead, zinc, copper, gold, silver, bismuth and antimony, which has been produced at a purity of 99.4 per cent from ores out of mines in northern Idaho. One of the inventors of the process is a high-school chemistry instructor.

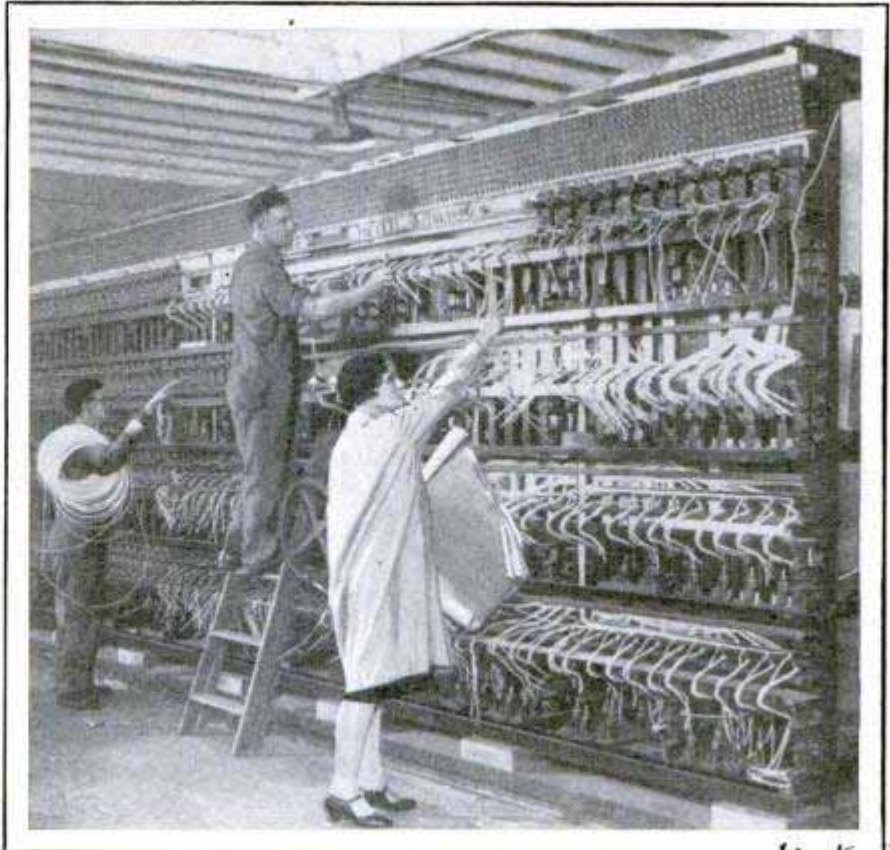

Miss Gertrude Stroobaut Directing Assembly of Roxy Theater Switchboard at Chicago Plant Where It Was Made

SPECIAL TRUCK FOR BUILDERS KEEPS STREETS CLEAR

While erecting a building, a western contractor kept the streets free from stored materials by installing a special truck and track system to haul brick, mortar, tile and other supplies from a central distributing point to the workmen. Mortar was mixed away from the building and then taken to the masons in large portions, as needed. Trucks were loaded with brick at the yard and removed from the wheeled platforms at the scaffolds, where they were hoisted in as a unit.



Loaded Brick Carriers Are Hauled to Building Directly from Yards, Saving Piles in Street

THIRTY TONS OF SWITCHBOARD FOR NEW THEATER

Lights sufficient to illuminate a city of 15,000 to 20,000 persons are controlled through a single switchboard for the new Roxy theater in New York. It contains between six and eight miles of wire, weighs approximately thirty tons and has 1,200 controls. A feature of the installation is the dimming mechanism. This permits a great saving in space. The board is but twenty-one feet long, whereas, with the usual type of dimming devices, it would have been seventy-five feet

long, to afford the same service. An additional point of interest is that a young woman made practically nine-tenths of the drawings for the complicated board and helped supervise its assembly. Only part of the equipment is shown in the photograph.

*Cont E. H. Thomas
512 Melborn Bldg
Seattle Wash*

Racine Wis 1084

Tribune 12/26

New York branch - 350 5th Ave.



Airplane Suitcase Open Showing Removable Compartment and Bars like Those of a Wardrobe Trunk to Hold Garments

SUITCASE AS WARDROBE TRUNK FOR AIRPLANE TRAVEL

Constructed on the lines of a wardrobe trunk, a suitcase has been devised with a view to adaptability to airplane travel. It is especially serviceable, however, for journeys by rail, boat or auto because of its compact size and large capacity. Equipped with hangers, retainer bars, compartment trays and other trappings of a trunk, it is small enough to be slipped under a sleeping-car seat and is light and durable. One size will hold twelve dresses, three pairs of shoes and forty-two other items, while the largest size will contain four men's suits, six shirts and fifty-one other garments.

SCRATCH-PROOF AUTO BODIES OF COLORED METAL

Material for automobile bodies that does not show scratches and has a surface resembling glazed porcelain is reported to have been discovered by a German electrical engineer through a process of alloying aluminum with other metals. The result is said to be a "built-in" finish that can be produced in varying colors.

From Pittsburg Chronicle Telegraph

B. B. Brodka

EXPERT SCOFFS AT BORN-FLYER IDEA

Anyone with average intelligence, after a few hours of competent instruction, can learn to operate an airplane alone, according to Sir Alan Cobham, the British aviator. He declares that there is little similarity between military and commercial flying and that to succeed at the latter, a person does not have to be a "born flyer." Six clubs in England are turning out aviators every week, he reports. Army flyers are required to take difficult tests because of the dangerous maneuvers they must perform in battle service, and it has been

said that only a born flyer could pass. Such examinations are not necessary in commercial flying, Sir Alan points out and says that the common idea that there is "something wonderful" about flying, is not well founded. The era of private airplane ownership is rapidly approaching, he believes, and it promises to revolutionize our habits as much as the universal ownership of automobiles has done.

SPRING LOCK FOR BOLT NUTS PROTECTS THREADS

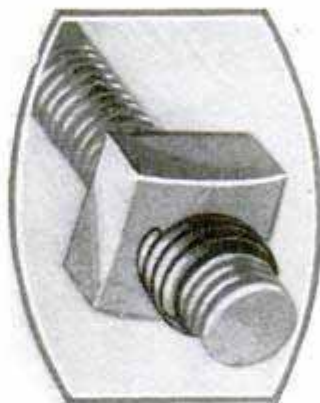

To secure the nut after it has been screwed upon the bolt, a lock of twisted steel is quickly attached. Besides preventing the nut from becoming loose, it protects the threads. It is easily removed.

["A "bug bourse" has been established in Berlin where insects are bought and sold for study.

Drawer Mfg Co
Richmond

1047 Professor Leonard Woolley,
Joint Expedition, British
Museum and University of
Pennsylvania

WHERE THE OLDEST DATED STONES WERE FOUND

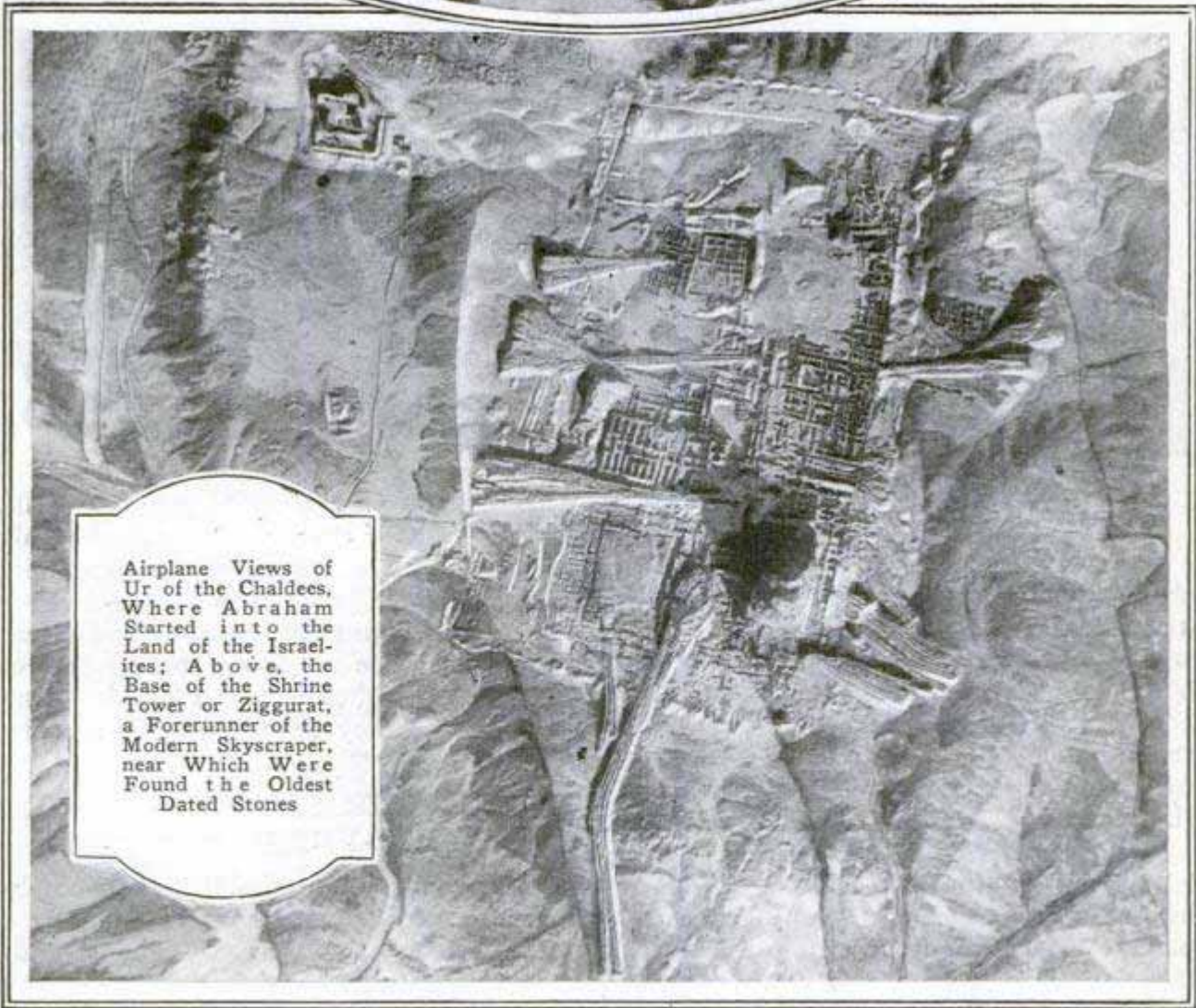

Airplane Views of
Ur of the Chaldees,
Where Abraham
Started into the
Land of the Israel-
ites; Above, the
Base of the Shrine
Tower or Ziggurat,
a Forerunner of the
Modern Skyscraper,
near Which Were
Found the Oldest
Dated Stones

COBWEBS MADE TO ORDER ADD REALISM TO MOVIES

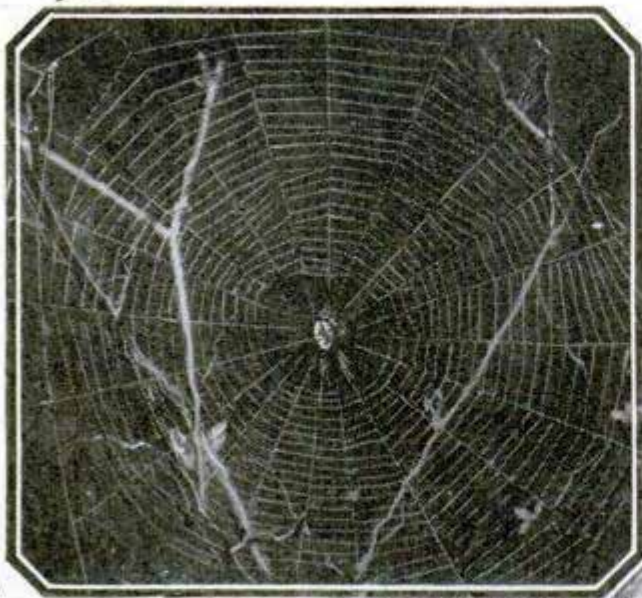

Nature's Own Spider-Made Web, Above, Is Duplicated in More Lasting and Easily Photographed Strands by the Cobweb Machine Invented in a Movie-Studio Shop; Below Is the Machine, and, at the Right, a Mechanic Is Adding Realism to the Old-Home Set by Stretching Tiny Strands across the Lock and from the Knocker

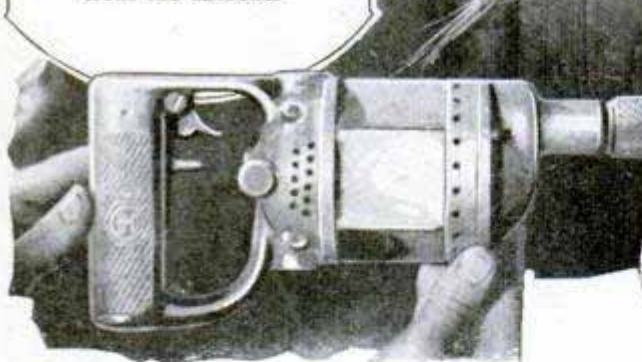

and dangling from lamps and beams. The work was slow and laborious, and then the intense heat of the studio lights soon melted the filmy webs away, so that it all had to be done over again.

Then a movie mechanic, watching a candy-floss machine, got an idea and made the first electric spider. A two-bladed fan

A machine that makes better cobwebs than a spider can produce recently was awarded a patent in Washington. Electricity is driving the spider out of his own business because the movies want their cobwebs in a hurry, just where they want them, and, for photographic purposes, found an artificial cobweb more real than the real thing itself.

For several years special cobweb makers have been employed to build the realism into sets representing ancient and dusty places. With a pot of glue and a stick they trailed long strands patiently through the air and built cobwebs across corners

was added to an electric portable drill, and in front of the fan was placed a pair of cups, with a space, where they join, through which the cobweb material, a mixture of liquid rubber, glue and ether, can ooze. The air from the fan drives the heavy liquid off in strings, which hang to whatever they touch and dry quickly.

HUMAN-HAIR STOCKINGS WORN BY RICE-FIELD WORKERS

In a Japanese household the hair combs are saved until there is enough to make a pair of stockings. The strands are spun into long threads and woven into hose of varying qualities, the best of

*Only George H. Holden, Esq.
 Highfield View, Japan
 Paris Photo Field*

992

which are eagerly sought by workers in the rice fields. These stockings are worn over the ordinary hose, the belief being that human hair is a preventive of cold to those subjected to constant exposure in the inundated rice fields.

1138

FOREST RANGER'S BRIDGE AIDS IN FIRE FIGHTING

Thanks to a forest ranger's ingenuity, autos can now be driven across the Chetco river, in the Siskiyou national forest in Washington, and swifter access gained to the region in case of fires or other emergencies.

The structure was largely made from rough materials taken from the woods, low timber piers, stringers and cross members with three-inch planks hauled from the nearest sawmill and laid lengthwise. Poles fastened to the piers serve to keep the wheels on the planks. The bridge is now used by the half dozen settlers along the road who aided in the undertaking.

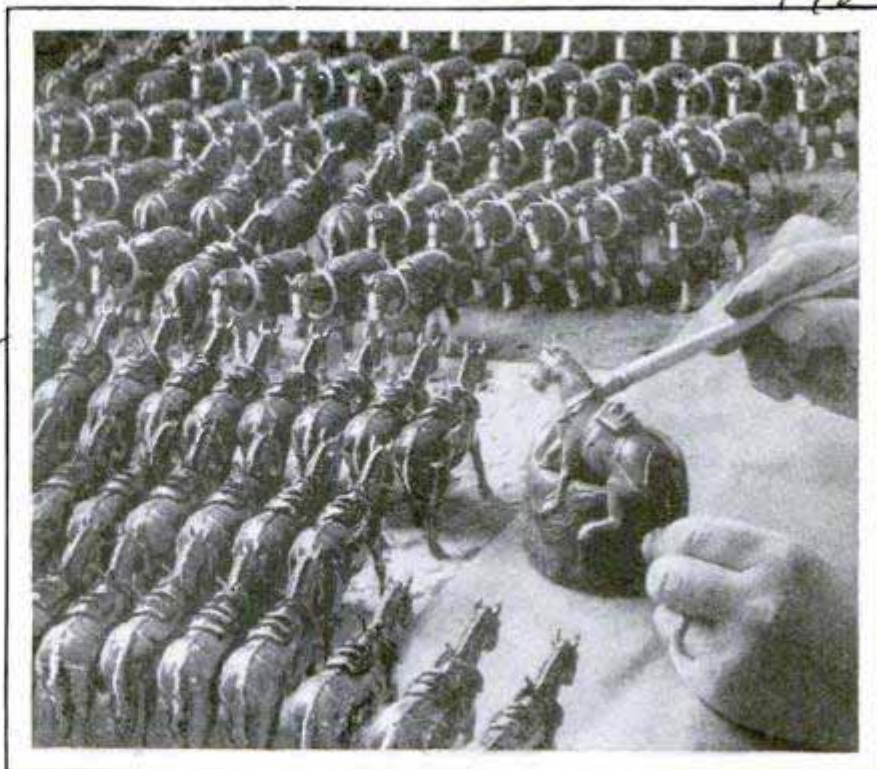

Painting Toy Horses, Freshly Cast from Shrapnel That Was Intended for Guns of War; Tons of the Metal Are Being Used

SHRAPNEL TURNED INTO TOYS AS PEACE-TIME SERVICE

at Hornsey

Another instance of war materials being used for the purposes of peace is seen at an English factory where shrapnel removed from shells is being melted and cast into toy models of horses and other animals. Nearly 300 tons of the metal has been prepared for the castings and a large staff of craftsmen is employed in the work of producing, painting and finishing the interesting and well-executed toys for the market.

ICE SAW RUN BY SMALL MOTOR TRAVELS STRAIGHT LINE

Mounted on sled runners and propelled by traction from the saw teeth, an ice cutter run by a small automobile motor, travels at the rate of 175 to 200 feet a minute, depending upon the depth of the cut, and is so constructed as to reduce vibration to a minimum. A double chain drive permits an equalized pull and the cutter is equipped with a gauge that insures an absolutely straight line of travel. In the December issue of Popular Mechanics, this cutter was erroneously described as being propelled by means of a caterpillar or roller type of drive.

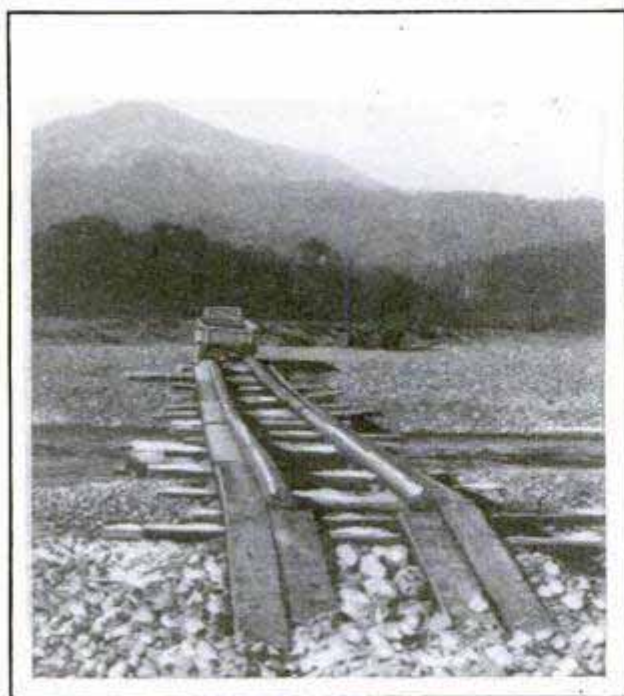

Helping the Auto through the Mountains, a Forest Ranger's Bridge in the Siskiyou National Preserve

\$600.00 J.A.B. Ossining, NY

Way Lee Saw Co. 111 Depeyster St. NY

1091
 Hofmannstr. 25, Dresden A. 21
 Germany

TRAFFIC LIGHTS SEEN ON THE OCEAN HIGHWAYS



Automatic Gas Buoy, Showing the Underwater Tank That Holds the Fuel, and, at Right, Type of Lightship Employed off English Coasts



Traffic Lights at Sea Are Sometimes Run Down by Reckless "Drivers," as This Mast of a Ship That Failed to Heed the Warning Signal Shows

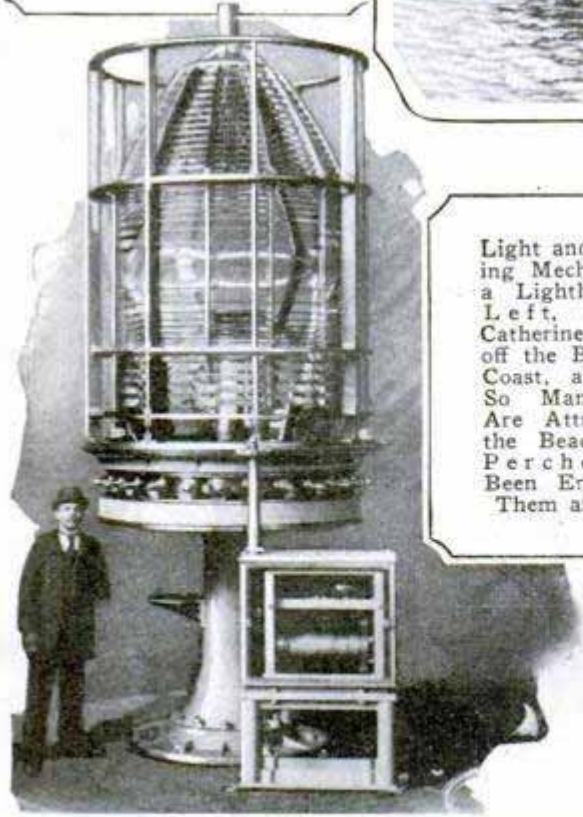

Light and Revolving Mechanism of a Lighthouse, at Left, and St. Catherine's Light, off the British Coast, at Right; So Many Birds Are Attracted to the Beacon That Perches Have Been Erected for Them around It



Time and Money



Adjustable Ironing Board Can Be Raised or Lowered to Various Heights, Permitting Use While Sitting Down, If Desired to Rest the Feet; It Folds Up Flat for Storing in Small Space

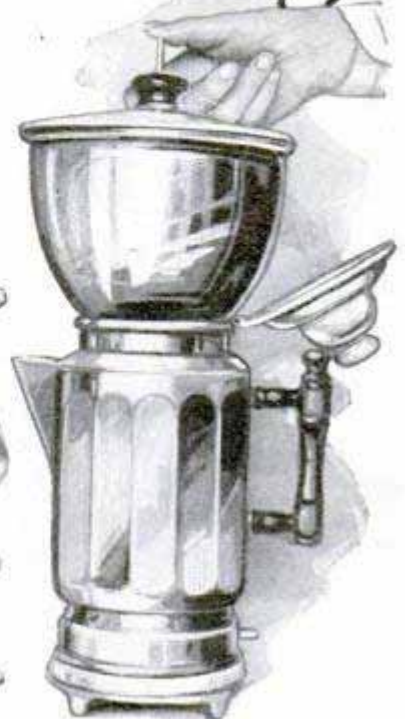

For Making Tea or Coffee, This Attachment Fits Ordinary Pot or Electric Percolator; After Water Seeps through Contents, Handle Is Raised, Permitting Liquid to Drip into Pot

Pusher on Kitchen Fork Gently Removes Food without Breaking or Sticking, and Protects Fingers from Burns

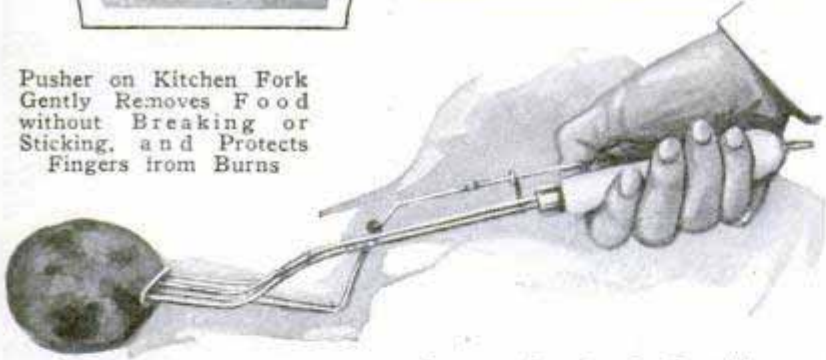

Compact Ironing Outfit with Cord, Carried in Washable Bag, Is Convenient in Traveling; the Handle Is Detachable and the Iron, Turned Upside Down, Slips into the Stand

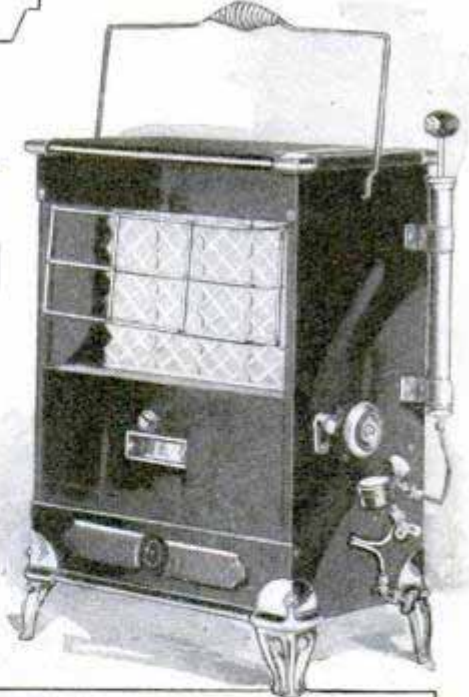
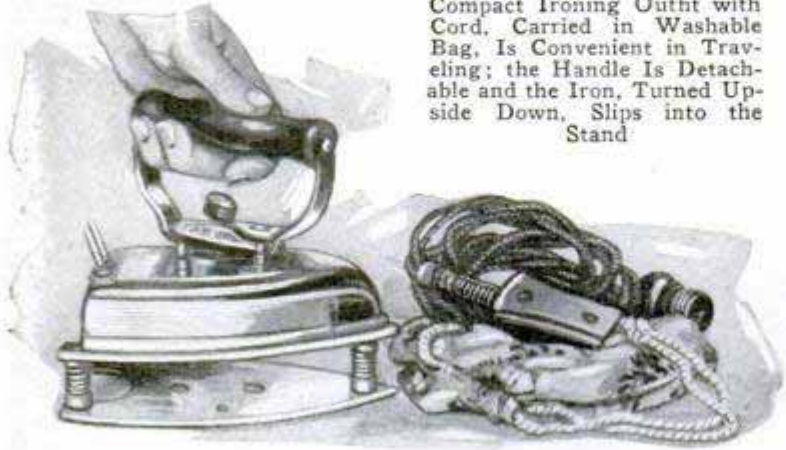

Portable Radiant Heater Burns Gasoline, a Gallon Being Sufficient for Eight Hours' Steady Use; Pump on Right Supplies Air, and Gas Is Generated Quickly

Saving Things for Your Home

SPECIAL ADVERTISING SECTION

\$3.95



Aluminum
Broiler, with Pan Below to Catch Juice for Gravy. Eliminates Fires and Smoke While Preparing Steaks

no smoke



Folding Kitchen Table on Wheels Is a Serving Cart and Stand in One Article; Rubber Tires Prevent Noise and Scratches; the Top Is of Enameled Steel

Safety Knife Sharpener Is Shielded, to Protect the Fingers, and Is Said to Give a Keener and More Durable Edge without Wearing Down the Steel



Washable Inner Soles to Keep the Feet Comfortable and Lengthen Life of Shoes



Bath Stool Has Compartment and Adjustable Rest Inside for Shining Shoes and Storing Equipment; Rubber Tips on Legs Protect the Floor

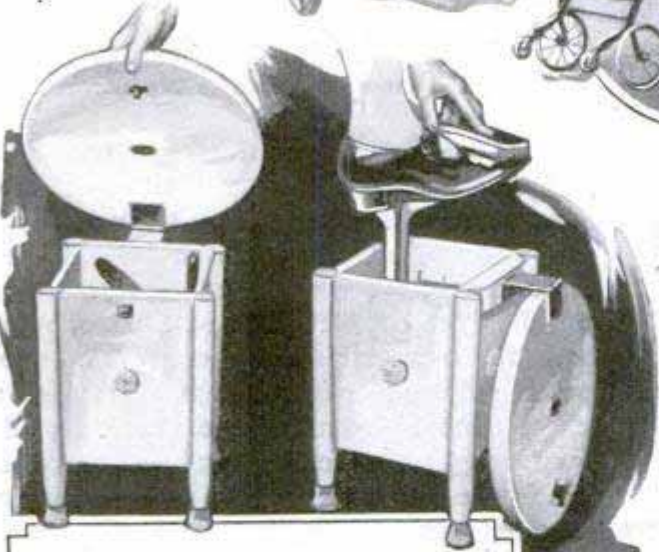

Co., Greenwich, Conn.

obtain it by addressing Bureau of Information, Popular Mechanics Magazine, Chicago.

PLANE FOR NIGHT FLIGHTS HAS SLEEPING BERTHS

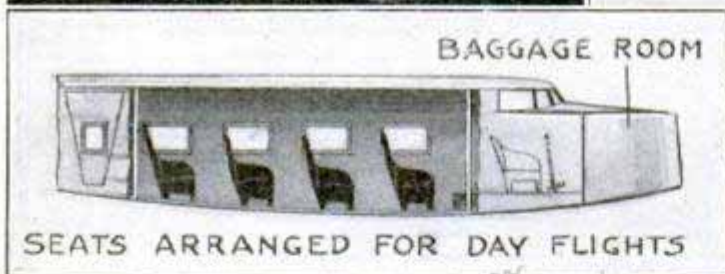
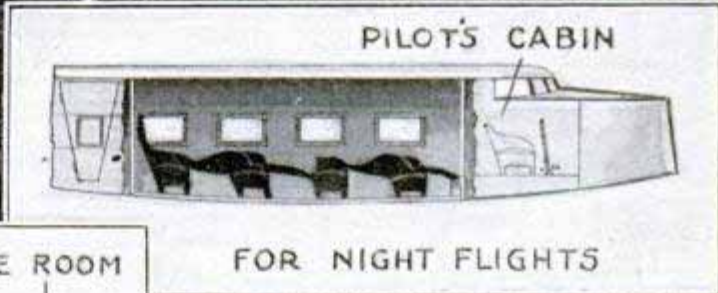
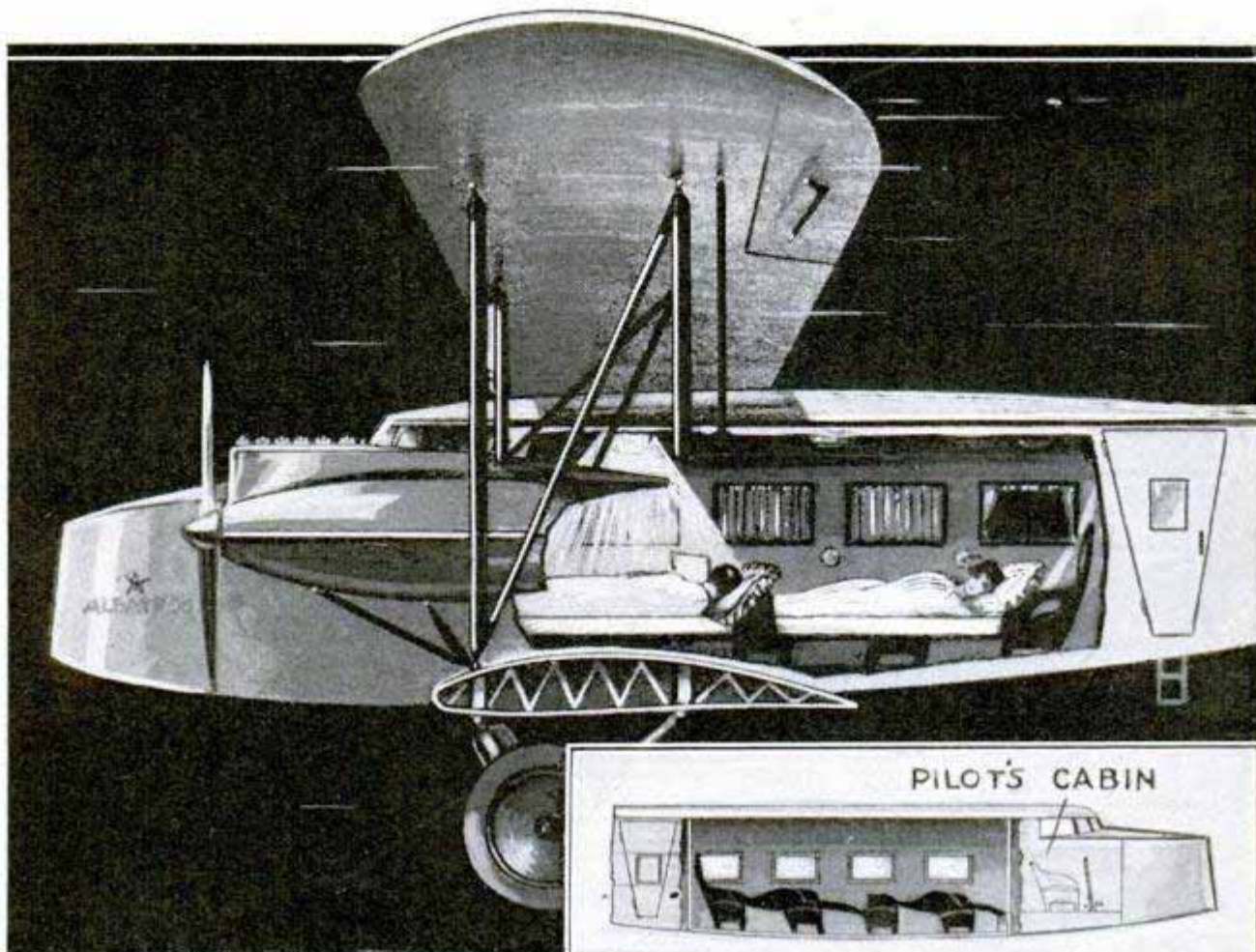

Diagrams of the Sleeping-Car Airplane, Showing How Berths Are Arranged; Space at Rear of the Cabin Is Washroom

Cabin seats in an airplane making night journeys between Berlin and Königsberg, have hinged backs which may be lowered to form comfortable berths for passengers. A washroom and space for luggage are additional features of this sleeper of the skies. To decrease the weight, fabric has been used in place of all-metal construction, but the struts and skeleton are of steel tubing and duralumin.

HEAT IS HARDER THAN COLD TO KEEP IN VACUUM

It is easier to keep things cold than hot in a vacuum bottle. The explanation lies in the tendency of heat to rise, and the fact that the opening of the bottle is at the

top. The average user thinks of heat and cold as two separate things, but the bottle manufacturer knows he is dealing with only one factor, heat, which is why the bottle neck is always made as small as possible, yet of sufficient size to provide room for introducing the contents. Hot liquids or foods can be kept warm for a longer time by turning the bottle upside down, to get the neck leakage at the bottom. One manufacturer of large vacuum shipping cans for milk found in experiments that the rise in heat in the contents of a five-gallon can was sufficient to produce a temperature difference of as much as two or three degrees between the milk in the bottom part of the container and that at the top.

Vacuum Can Co.
25 S. Hoyme Ave.

1007 *mul. Morris, d. l. h.*
465

**U. S. PRODUCTION OF GOLDFISH
TWENTY MILLION YEARLY** *1076*

More than 190,000 persons in the United States are engaged in fisheries or the fishing industries, a business that represents an investment of \$202,000,000, according to the annual report of the bureau of fisheries. Fish culture is steadily developing in this country, supporting the contention that an acre of water can be made to produce as much nourishing food as an acre of land, the report shows. About \$200,000 worth of trout eggs are produced by commercial firms each year and surplus fish are marketed at good prices. The annual output of goldfish is approximately 20,000,000, valued at \$350,000. More than 150,000 acres of oyster grounds are under lease, from Massachusetts to Florida.



Young Sculptress beside Model of Her Friend; the Bust Forms an Attractive Garden Piece

**CONVICT RAILWAY COACH HAS
CELLS FOR PRISONERS** *1009*

German prison officials are taking no chances at letting convicts escape while on railroad journeys. A special car, with cells, heavily barred doors and big locks, is used when prisoners are to be transported. The method presents an interesting contrast to the custom in this and some other countries where convicts ride in ordinary cars with guards.

**GIRL MODELS CHUM IN CEMENT
AS GARDEN ORNAMENT**

As a mark of esteem for her girl friend, a young woman in Illinois modeled her portrait in cement and set it upon a slender pedestal in the garden. She took the idea from Lorado Taft's statue of "Blackhawk" on the cliffs of the Rock river.

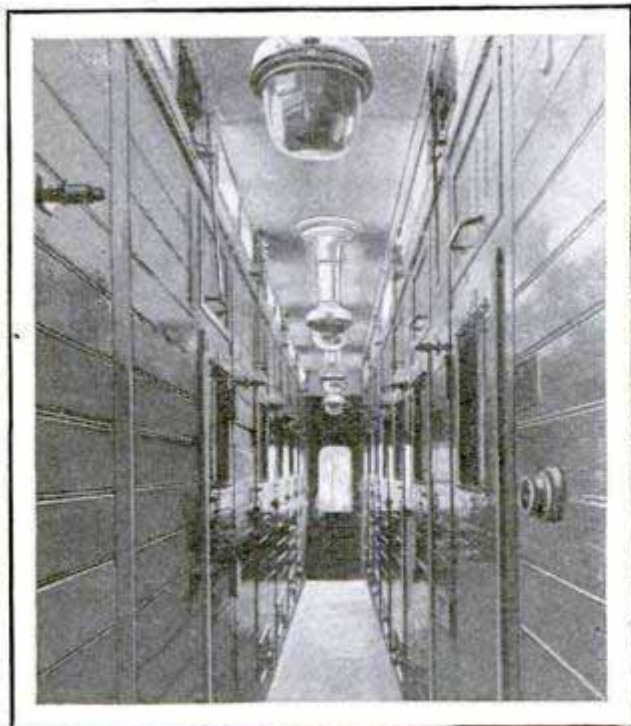

© Henry Miller
Interior of German Convict Car; It Is Essentially a Prison on Wheels

**HOUSES TO RESIST CYCLONES
MUST BE WELL BRACED** *1103*

Engineers of the lumber manufacturers' association have pointed out two precautions that should be followed in building a house, to make it as strong as possible against tornadoes. The suggestions were developed after inspection of the destructive effects of hurricanes in the south. A first requisite, the engineers hold, is that the sills of the building should be strongly anchored to a monolithic concrete foundation which should be as massive and deep as cost considerations will permit. In the second place, the roof structure should be strongly bolted or nailed to the wall and afford little opportunity for the wind to take effect under the eaves.

*transportation. Bldg
Washington
d. l. h.*

John L. Bruggs Architect

922



Using the Wind to Aid the Skis; Kite Pulling Runner over Smooth Snow

KITE CARRIED BY SKI RUNNER SERVES AS TRACTOR

Ski runners prefer calm days as the wind often proves a serious handicap. But a way has been found to harness the breezes by using a special kite. It is held by five guy strings which keep it at such an angle that a wind of moderate strength will cause it to pull the ski runner along on smooth snow or ice.

ICE PLANT TO COOL REINDEER IN SOUTHERN PARK 1101

To keep six reindeer in a Dallas, Tex., park cool and comfortable, an ice plant with ventilating system is to be installed in a small inclosure on their lot. The plan was adopted when one of the animals died shortly after arriving from its northern home, owing to the heat.

marialis

FAULT-PROOF HOUSE TO SHOW WAY TO BETTER HOMES

1080

To demonstrate the best in building at moderate cost, a test dwelling, near New York city, is designed to be proof against fire, sound, moisture, heat and cold. Materials were selected and used with a view to reducing expense. For instance, the cost of using brass for water-supply pipes was offset by a saving in brick, both whole and broken kiln-run being employed for facing. The builders were instructed to lay up paneling on the outside chimneys in a way to save time and cost. A concrete foundation was laid, and light steel beams were imbedded in the brick walls to carry gypsum floors and partition-wall fill. The steel framing was installed to prevent structural sagging. The house is intended to convince prospective builders that it is practical to erect, for a reasonable amount, a type of dwelling that will not entail high maintenance expense and yet will be comfortable and attractive. It is thought that such an abode would inspire the confidence of investors and stimulate home building and owning.

TIRES PUMPED AS AUTO RUNS THROUGH HOLLOW SPOKE

1035

Automatic pumps that inflate the tires while the car is running, and whenever the pressure gets below a certain point, have been introduced to prolong the life of the tire and save the motorist time and trouble. The pump is contained in a hollow steel spoke of the wheel. The valve of the inner tube fits into this spoke. A plunger is actuated by a short rod extending from the side and coming in contact with a cam on the front axle. With each revolution of the wheel, the plunger makes a complete stroke. The pump is regulated according to the strength of its spring. For instance, if the tire pressure goes below thirty-five pounds, the plunger will begin to pump in air until the normal pressure is restored.

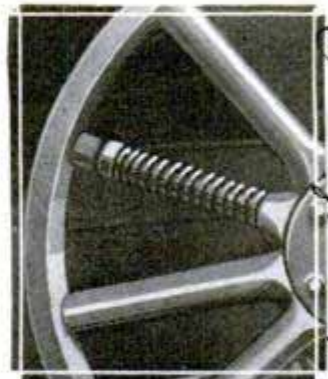

(Anna O. Gray) Rock Kans

Eastern Brick Association
Lead Service Light Builders
100 E. 45 St. New York City
Automatic Tire Pump Co. Rock, Kansas

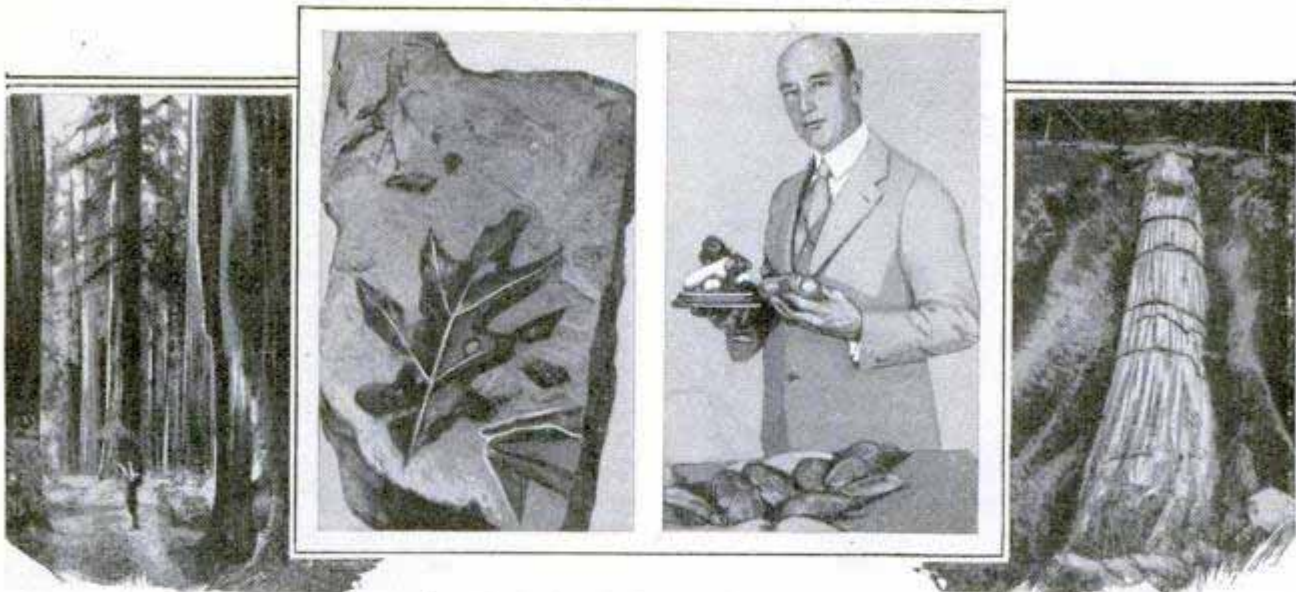

Redwood Forest of Today; Fossil Oak Leaf; Prof. Chaney Studying Fossil Specimens, and a Giant Petrified Tree; from Relics Such as These, Scientists Endeavor to Picture the Past

**FOSSILS GIVE PICTURE OF LIFE
MILLION YEARS AGO**

Redwood forests 1,000,000 years ago covered a much wider area than they do now, according to Prof. R. W. Chaney of the University of California. This is the conclusion from fossils found in parts of the state where the trees long since have disappeared. Petrified trunks and imprints of leaves give investigators clues to the character and extent of vegetation many centuries ago.

**RADIO ATTACHMENT FOR PIANO
ELIMINATES MICROPHONE**

Connected to the sounding board of a piano, a radio unit permits broadcasting music from the instrument without a microphone and, in receiving, converts the piano into a huge loud speaker. According to reports of experiments with the device, it improves the tone qualities, especially of piano numbers, while the metallic sounds and microphonic roaring are entirely eliminated. Manufacturers see a stimulus to the piano business as a result of this invention, and some are planning to substitute it, a radio set and talking machine for

the self-playing apparatus. In broadcasting, the unit is connected directly to the amplifier circuit and, for receiving, it is wired to the radio set.

1006

**HIGH BRIDGE SPANNING CHASM
TO SERVE MOTOR TOURISTS**

Motorists who desire to visit the inner regions of Idaho will be spared a long and dangerous grade crossing over the Snake river by the high bridge which is being constructed over the stream near Twin Falls. It will be 1,400 feet long and 476 feet high, one of the loftiest in the world. The cost is estimated at \$650,000. The Snake river is famous for its bridges. Just a few miles upstream from the one now under construction, a suspension bridge, 345 feet high, spans the canyon.

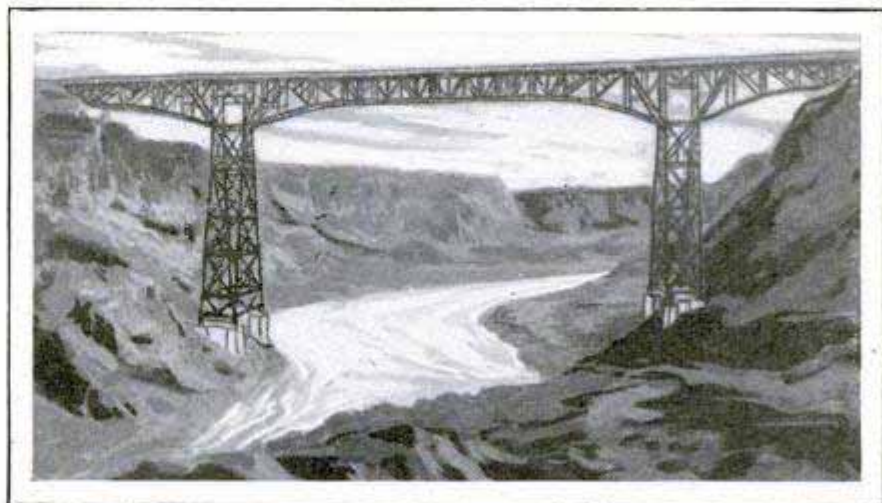

Sketch of High Bridge over Snake River as It Will Appear When Finished; It Will Link Two Counties

To be manufactured by Radio Corporation of America
 and Frank W. Adair and
 64 Broad St

804 Bank Bldg Washington 20 C



Forest Rangers Weighing a Sample from the Five-Foot Snowfall in Holy Cross National Forest, Colorado, in Order to Determine Its Density and Water Content

Fighting Summer Fires with Winter Snows

Danger Periods Detected and Warnings Issued as Result of Survey That Keeps Check on the Moisture

LOCATIONS for next summer's dangerous forest fires are being picked out now by forest service rangers and arrangements made to fight the conflagrations that will be started by lightning, and bar campers from the government forests during the danger period.

Ability to pick out in the winter the places where the following summer's worst fires will occur has come as one result of the extension of the weather bureau's work to the forestry service. The conditions which cause forest fires to reach dangerous proportions are the direct result of light snowfalls during the winter, so constant check of the weather during the last few months has given the rangers a fair idea of what the coming summer's work will be.

The weather-reporting service in the national forests is only three years old, but already it has uncovered so much important information about the effect of

low relative humidity and wind conditions on forest fires that the service has hopes of mastering the subject thoroughly and of enabling the rangers to anticipate danger and be prepared to snuff out bad fires as soon as they break out. Starting in the western states, the fire weather-warning service issued during the summer months has been extended to all the northern and eastern states having either national or state forests. From Washington a careful check is kept on conditions in each state, and, whenever they approach the combination which has been found to be most adapted to spreading fires, a special warning is sent out, and wardens and forest rangers recruit their forces and prepare to give fight before the fires spread.

Snowfall surveys made during the winter form the main basis of the service. Weather-bureau markers, laid off in feet, have been erected throughout the forests to measure the depth of winter snow, and

Regular Weather-Reporting Stations Are Maintained throughout the National Forests; Little Latticed Houses, Like That at the Right, Protect Thermometers and Delicate Instruments from Damage, Yet Keep Them Exposed to the Weather; Below Is a Typical Station with Electrical Wind-Velocity and Other Recorders, Which Write Their Own Record from Minute to Minute on Clock-Driven Charts in Some Distant Ranger Cabin

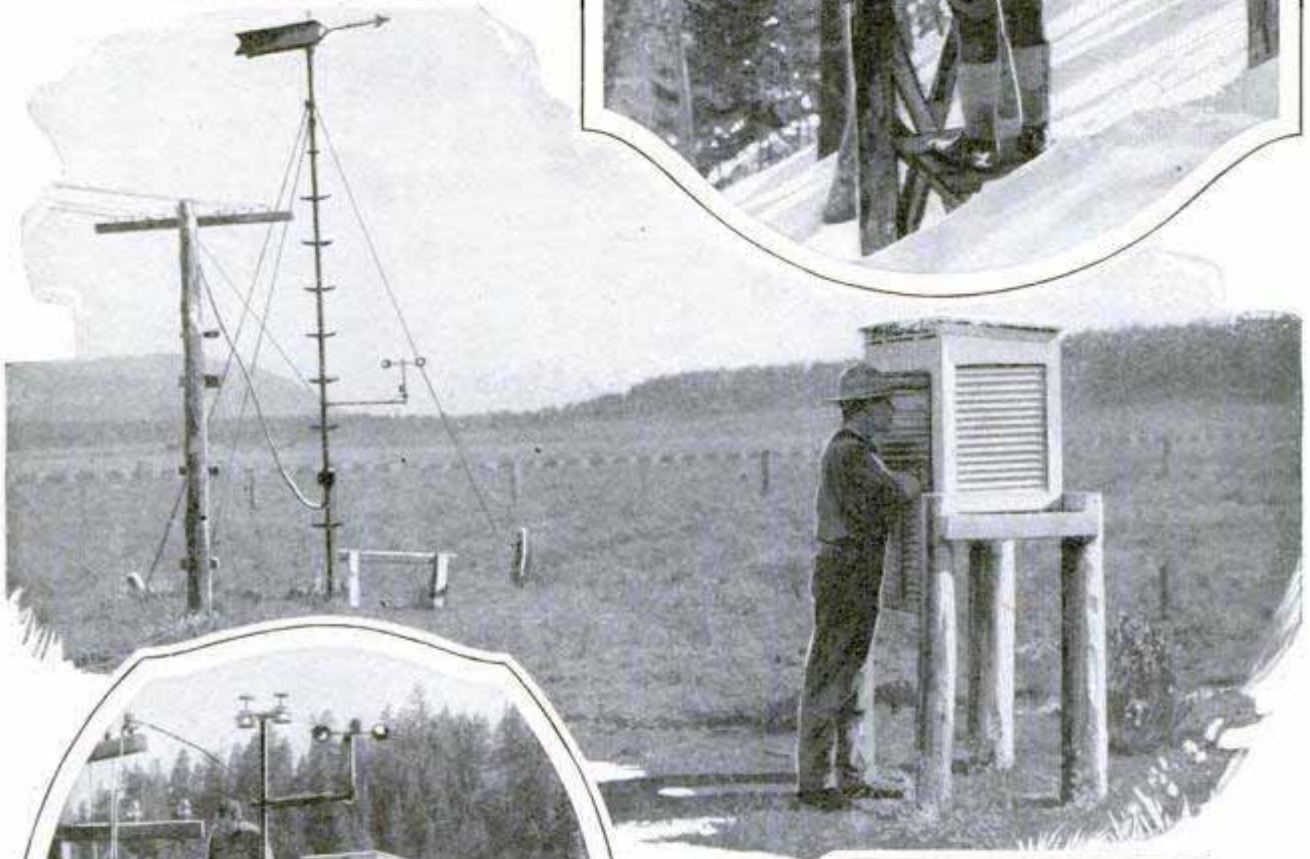

The Amount of Moisture That Falls as Snow and Rain, and the Rate of Evaporation Are Important in the Forests

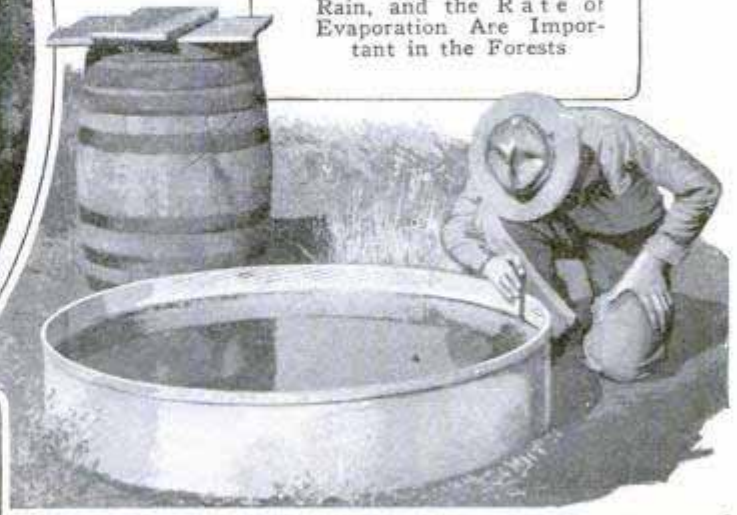

Above Is the Weather Tower at the Rocky Mountain Experiment Station Where Seedlings for Re-forestation Are Grown

in addition the rangers who take the frequent readings also carry scales and a tube in which they take up a sample of the snow and weigh it to get its density—the gauge of its water content. After the snow has disappeared, they continue to check the moisture in the ground, to determine whether the moss and fallen leaves and pine needles are damp enough to prevent their burning. At the same time daily readings of the relative humidity, or moisture in the air, and the wind velocity and direction enable the weather bureau to calculate exactly when the danger period arrives and ends.

The value of the weather service, however, is not confined altogether to fire prevention. One of the most complete weather-bureau observation posts in the country has been installed at the Rocky mountain forest-experiment station, a huge government nursery where seedlings for reforestation are raised and forest problems studied. Wind direction and velocity recorders, high and low-temperature thermometers, recording barometers, psychrometers for measuring humidity and other instruments, are checked daily, and their readings compared with the growth of the trees, to determine the effect of various kinds of weather on plant growth.

Here, the forestry service starts its seed-

lings in greenhouses where the daytime temperature is kept at seventy-seven degrees and that at night at fifty-seven, for it has found that this range is best suited to the plants. It likewise knows that the yellow-pine seedlings should be planted on southern exposures, where the ground temperature at midday may be thirty to fifty degrees higher than on the cool northern slopes, where the spruce and Douglas fir thrive.

The fire-warning service has been so successful that many of the lumber camps in the west shut down immediately when dangerous conditions are reported, in order to avoid possibility of starting a fire from sparks from the engines. One lumber operator, who declined to heed a warning last year, lost \$60,000 worth of logs and equipment in a fire that occurred the same day the warning was issued.

ELECTRIC LIGHT ON HEN COOP

Dallas TO FOIL THIEVES 1162

To stop further thefts of his fowls, a Texas poultry raiser placed an electric light on the coop and adjusted it in such a way that, when the door was opened, the high-powered bulb was illuminated and a bell rang. The arrangement proved successful, according to the police.



Photos Courtesy U. S. Weather Bureau

Snow Markers Are Only Painted for Five-Foot Depths; Frequently the Forest Ranger Has to Dig Down to Find the Board, and Then Measure Up to the Top of the Snowfall

NEW RAY TO STOP ANCHOR ICE *HO 5*

Having had marked success in destroying ice jams by blowing them up with thermite, a heat-producing mixture, Dr. Howard T. Barnes, of McGill university, is endeavoring to prevent the formation of anchor ice, that which accumulates near the bottom of open water. For this purpose, he has devised a lamp which projects a special ray, intended to imitate sunlight in keeping the water below the surface free from ice. Tests of the ray in the upper St. Lawrence river were to be supplemented by the taking of photographs of ice "growing" under water. An ordinary camera, shielded to keep out moisture, and a special optical device to obtain proper lighting, were prepared for this particular work.

MORE POPS PUT INTO POP CORN BY IMPROVED EAR *10 40*

Pop corn with ears only three inches long but having nearly 1,000 kernels to the ear has been developed by an Iowa corn specialist through crossing a stub variety with a high grade of sweet corn. It is said to yield twenty-four sacks of popped corn to the pound, whereas the ordinary kind gives but twelve or fifteen sacks. In the selection process, the chief objectives were maximum yield per acre, tenderness and flavor, and maximum number of kernels.

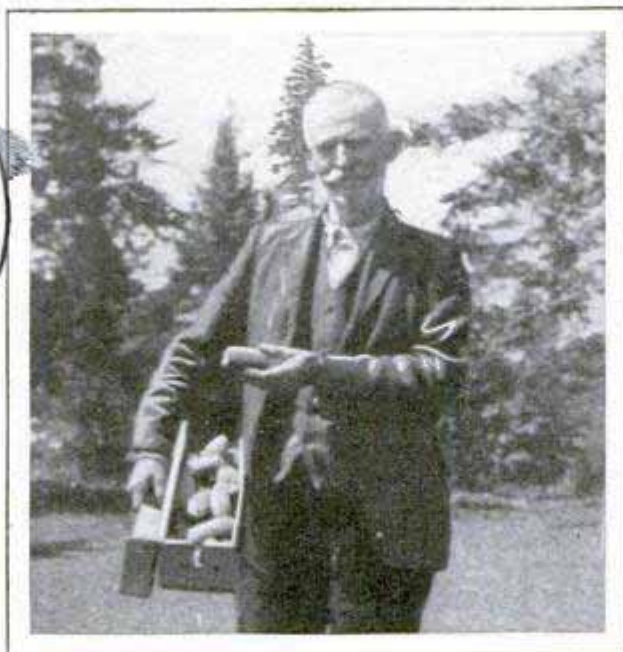

Pop-Corn Culturist with Sample Ears of the New Variety; It Has Nearly 1,000 Kernels to the Ear

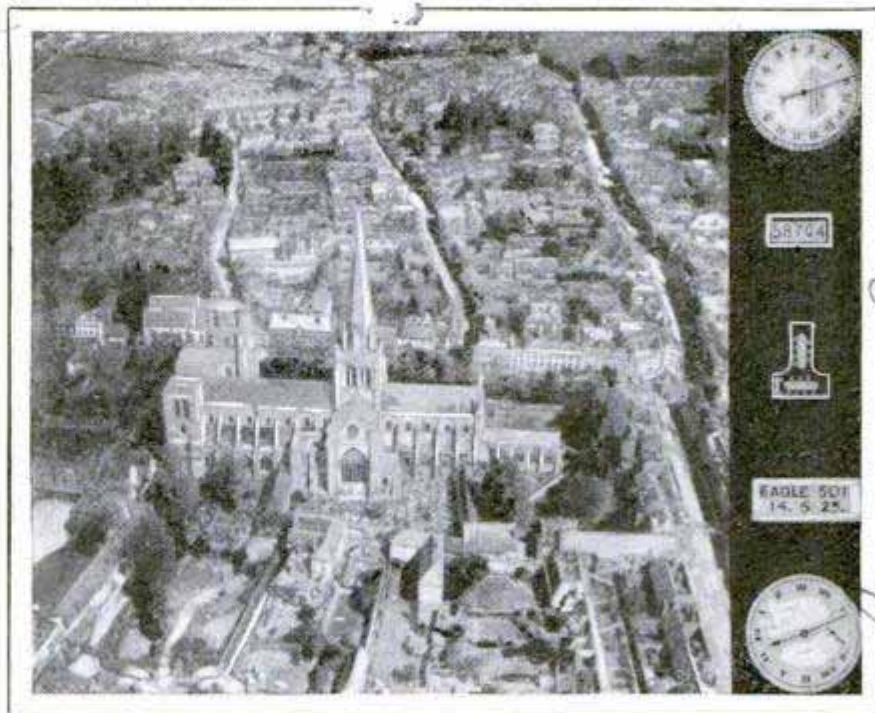

Oblique Picture Taken with New Aerial Camera, Showing Strip Which Records Time, Altitude, Angle and Other Information

AIR PHOTOS RECORD THE TIME, PLACE AND HEIGHT

An English aerial mapping camera not only photographs the ground, but on a strip at the edge of the same negative notes the time, the altitude, the angle at which the picture was taken, gives the film a serial number and provides a space for special identification marks, including the title and date. The camera can be set to take pictures automatically at the proper interval for any given height, so that when the separate negatives are assembled they will overlap sufficiently to permit matching the parts, or it can be operated independently to take snapshots between the timed exposures. In addition, a small electric lamp with red globe, placed in front of the pilot, is operated by the camera, lighting five seconds before each exposure.

Sold by Vickie's Ltd. Williamson W. Alderley Green. N.W. 10 London E.C. 4. England. Letchfield Gardens. Mfg Co. Ltd

Cont. Mrs. J. S. Clark, The Oregon, Iowa

W. A. Perry, Cresco, Iowa.

97 4
472



of Pasadena, California

When the Swimming Pool Becomes a Game Table; Playing Water Billiards with Floating Balls Gives Many Opportunities for Trick and Fancy Shots

**BILLIARDS IN SWIMMING TANK
LATEST WATER SPORT**

As a diversion between swims, a game of billiards played in the water with balls that float and a regulation cue, has been found popular in a California city. The motion of the pool adds to the difficulty of the shots and allowance has to be made for the resistance of the water, but players declare that the game affords as many opportunities for the exercise of skill as does the table variety.

from behind, does not interfere with the windshield wiper and its back is protected from the weather by moisture-proof pads. The glass gives a view through both side windows as well as from the rear.

**GREYHOUND AS COYOTE KILLER
HELPS PROTECT SHEEP.**

Trained greyhounds have been enlisted by western sheep raisers in the war against the coyote. Two of the dogs made a record in a few weeks last fall when they killed twenty-two of the marauders. Their speed enabled them to overtake the swift coyote and they learned how to work together, one dog grabbing the prey by hind leg while the other sprang at its throat. In severe winters especially, the coyote does great damage to the flocks and it is a menace to poultry the year around. The government and the states co-operate in efforts to exterminate the animals. Professional hunters and poisoners are employed, and in most western states a bounty is given for a coyote scalp. At certain times of the year, the pelt is valuable for fur. The use of greyhounds is considered unusual, for although the dogs were known to be faster than the coyote, many did not believe that they would be a match for the brutes when cornered, for then the coyote, generally a coward, is a savage fighter.

1069

**DOUBLE REAR-VISION MIRROR
PROMOTES MOTOR SAFETY**

An unobstructed view of the rear of the road is furnished both the driver and the other occupant of the front seat from a

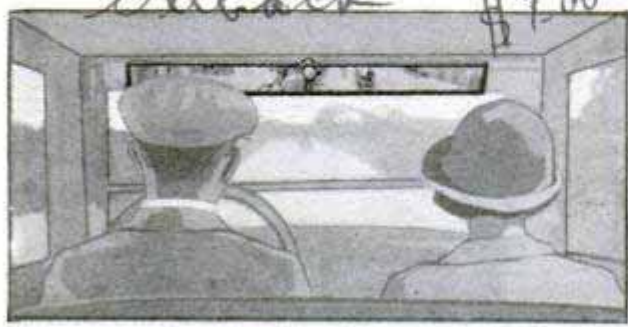

Double Rear-View Mirror Casts Reflections from Side of Road as Well as from Behind

double mirror now on the market. It is easily adjusted to prevent headlight glare

*H.A. Smith Mfg Co.,
185 N. Water St. Rochester*

4 miles N.W. Nelson, owned by W.C.

You Can Build This Box-Type Loop

By HERBERT C. MCKAY

MORE and more sets are being designed for use with a loop, and this efficient and convenient collector of energy is gradually replacing the troublesome outside aerial and ground. Many radio owners are not aware that almost any set using five or more tubes will work with a loop, and, by making a few changes, practically any set using a vacuum tube detector.

Loops are of infinite variety, but the type most favored is the box or solenoid. The pancake or concentric form is highly directional, but slightly less sensitive than the box type. While the latter is usually square in shape, it has been found that, by making the vertical sides longer than the horizontal, the loop will be more efficient. This

allows more wire in the vertical plane, and as the total length of wire that can be used is limited, the advantages are obvious. In making a loop, the maximum capacity of the condensers in the set must be taken into consideration. If small .00025-mfd. variable condensers are used, the total length of wire should be about 160 ft., for

.00035-mfd. condensers, 112 ft., and with .0005-mfd. condensers, about 86 ft. A variation of about 10 per cent either way will not matter greatly.

Aside from the wire length, dimensions may be varied to suit the builder's individual taste. The loop shown in the illustration and diagrams, was made from odds and ends, yet the finished assembly presents a neat appearance. The materials required are: Two pieces of $\frac{3}{8}$ -in. ply-

wood, 7 by 14 in.; one broomstick, 26 in. long; 6 ft. of lampcord, three binding posts, sufficient loop wire to suit the condensers in the set, and a phone or horn plug. The two end supports and the feet are cut from the plywood. One piece of plywood is laid out as shown in Fig. 1, and supplies one support and two feet, as shown in Figs. 2 and 3. The other piece is laid out in the same manner, but only the support piece is cut from this. Before boring the center holes in the supports, the broomstick is cut to length and the lower end tapered; then the hole in the lower support is drilled so that it will be a tight fit on the stick when driven on $2\frac{1}{2}$ in. from the end. The top support is bored

a drive fit for the top of the stick. Before mounting the supports, lay out and saw the wire slots. Starting at the center of each support, square marks across the circular edges, $\frac{1}{2}$ in. apart, and make a saw cut on each mark, exactly $\frac{1}{4}$ in. deep. This completes the supports.

The foot piece shown in the lower sketch, Fig. 3, has a $\frac{1}{2}$ by $\frac{1}{2}$ -in.

notch cut in the center of the upper edge; the other foot has a similar notch in the lower edge, so that the two pieces lock together at right angles. After the joint has been glued and the glue has set, a hole is drilled vertically through the joint to take the spindle of the loop. The hole should be a close, but not a binding, fit for the $\frac{3}{16}$ -in. brass spindle; the bottom of the broomstick is drilled as shown in the diagram for the spindle.

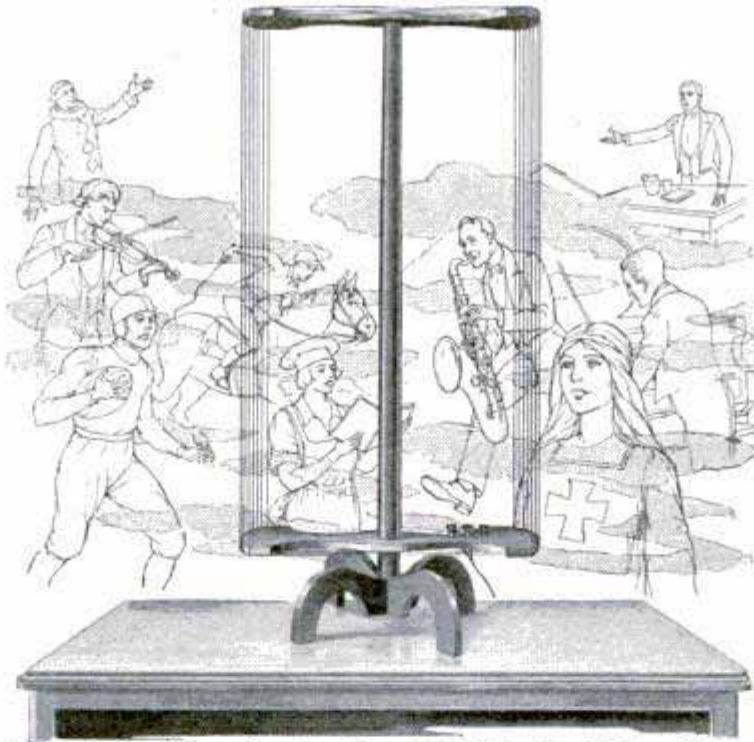

A Simple, but Attractive Box Loop That May Be Made at Home from Scraps of Wood, Some Wire and a Brass Rod

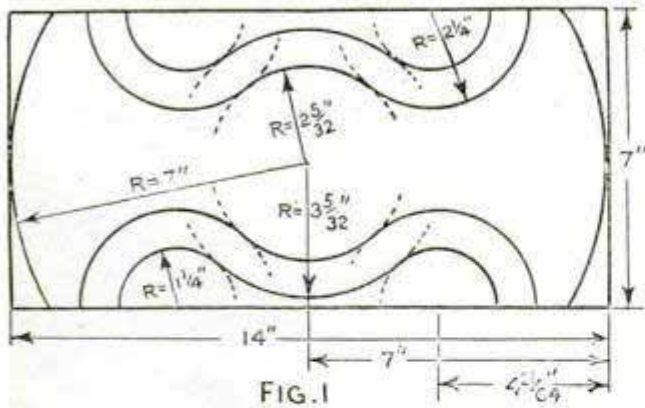

FIG. 1

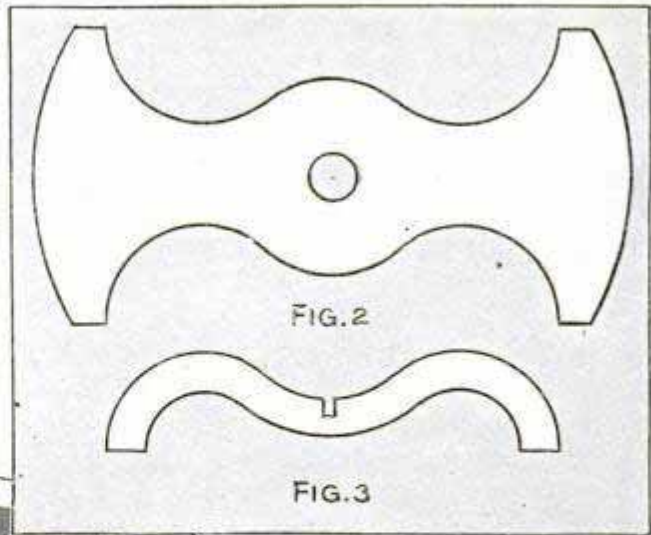
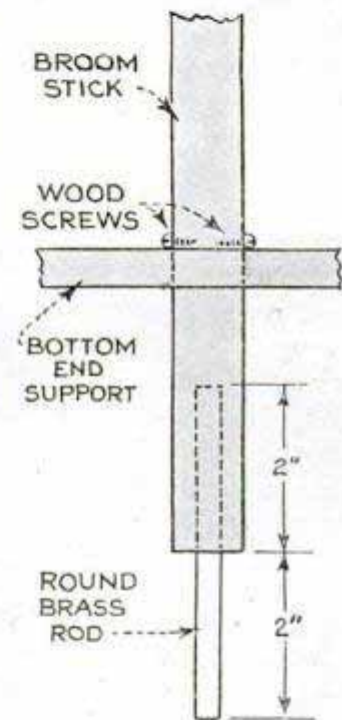
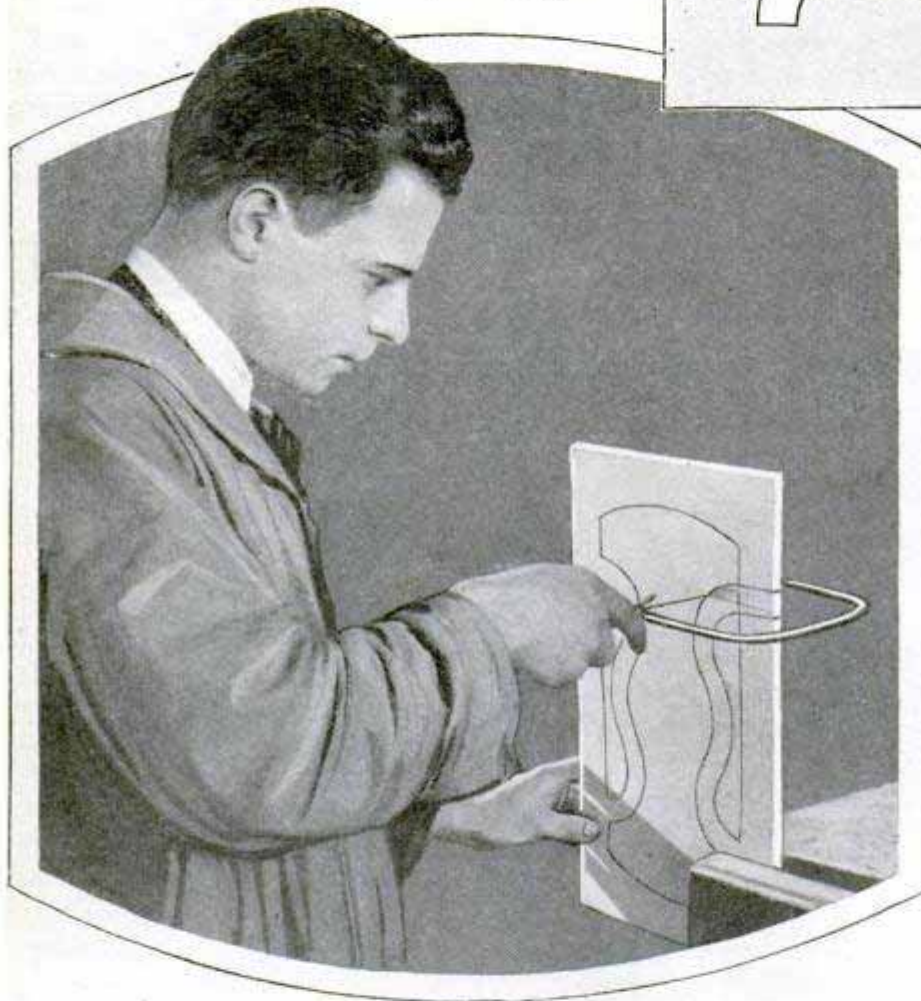

FIG. 2

FIG. 3



Using standard silk-covered loop wire, bare one end of the coil, and solder it to

In the assembly, the bottom support is driven onto the stick, then two small round-head wood screws are driven into the stick just above the support. Next, the upper support is forced into place, taking care to keep it parallel with the lower one, and a heavy screw is driven into the top of the stick to act as a wedge. The assembly is stained to match the cabinet, and, when this is dry, a coat of shellac is applied. After several hours' drying this is followed by several coats of good furniture wax, well polished.

Three binding posts are mounted on the lower support, as shown in Fig. 4.

one of the outer binding posts. Wind the wire in the slots, stretching it enough to prevent sag. When all the wire is wound on the frame, solder the free end to the other outside binding post. The center binding post is connected to a separate lead taken from the exact center of the winding. Scrape the insulation carefully so as not to cut the small wires, and solder this lead carefully. If the wire is of the enameled type, the enamel must also be scraped off before soldering the connections. Set the loop on the foot piece, and it is ready for use.

Sets that are not designed for use with

a loop, will, of course, not give as much volume with the loop, and its use is not advised for long-distance reception with sets of this type. Fig. 5 shows the necessary connections for using a loop with the ordinary tuned r. f. sets, without disturbing the wiring of the set. An ordinary horn plug is connected to the outer loop leads, and the set may be used either with the loop or the outside aerial. The double-circuit jack makes this a very simple operation. When the loop is used the tuning coil is cut out entirely, the loop leads going direct to the grid and filament, with the condenser (not shown) shunted.

The jack is placed anywhere convenient on the front panel near the tuning coil. The center binding post on the loop is used for superheterodynes, and sets using a three-tap loop. This center tap is also useful with sets employing the common two-tap loop, as one of the outside leads can be dropped and the center lead used, making the loop tune sharper and cut out troublesome local interference. A good loop decreases static, and its directional effect is a great aid in tuning out interfering stations. Weak signals are built up by turning the loop so that it points to the transmitting station.

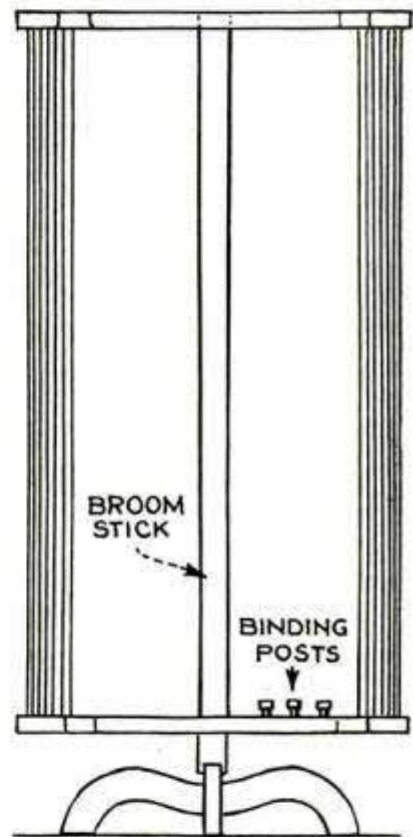

FIG. 4

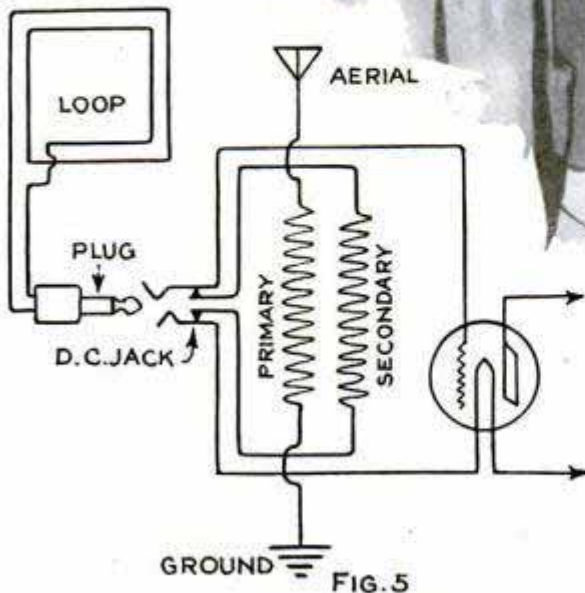
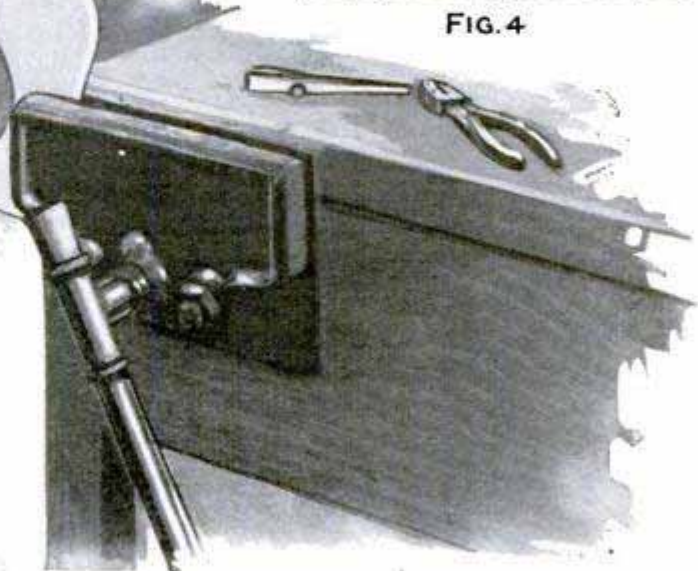
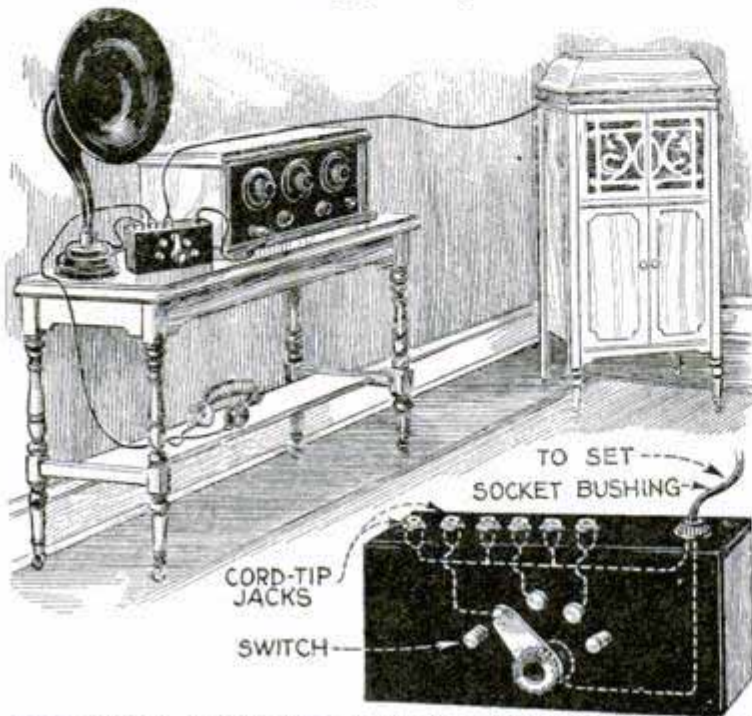

FIG. 5



Switch Permits Selection of Speaker

A device for switching from one speaker to another, or from speaker to headphones, is shown in the accompanying sketch. The danger of reversing polarity when dis-



Above, Switch Box in Use, Showing Leads Run to Speakers of Various Types; Lower Right, X-Ray View of the Box

connecting and reconnecting leads, and all other inconveniences, attending such connections, are eliminated by the use of this simple switch box. Make a small wooden box out of $\frac{1}{4}$ -in. stock, $5\frac{1}{2}$ in. long, 3 in. wide and $1\frac{3}{4}$ in. high, outside measurements. One side and the top of the box are made of scrap bakelite. A hole is drilled at one end of the top panel to take a small rubber bushing, for the leads from the set. Six cord-tip jacks are then mounted in a row on this panel, as shown in the diagram, to receive the tips from the various units; binding posts may be used in place of the jacks, if desired, but the latter make a neater and more convenient job. The bakelite side is now drilled to take a switch lever, and switch points and stops are mounted as shown in the lower right-hand view.

The wiring is very simple, and is indicated in the diagram by the dotted lines. A single phone cord, having tips at one end, makes a neat connection from the switch box to the set. One lead of this cord is connected to the switch lever; the other lead is connected to every other jack. The remaining three jacks are con-

nected separately to the contact points. The wiring inside the box should be done with flexible, insulated wire, so that, when the box is assembled, there will be no danger of breaking the wires, or accidentally making a short circuit. Then the two bakelite sides of the box are screwed in place with small wood screws, after which the box may be stained to match the wood used in the cabinet. It is also a good idea to glue a piece of felt to the bottom of the box, to prevent scratching surfaces on which it may be placed. This little switch box is also practical for the dealer for use when demonstrating speakers of various types. In this case, the number of pairs of jacks used will correspond to the number of speakers to be demonstrated.—W. J. Langan, Freeport, Ill.

Novel Insulator Is Self-Cleaning

An interesting antenna insulator of the self-cleaning type has recently been put on the market by an English manufacturer. Radio fans living in cities or industrial regions frequently will have noticed a gradual decrease in signal strength if their sets are connected to an outside antenna. This is caused by a deposit on the insulators which allows part of the energy to leak to the ground. The new insulator overcomes this difficulty by means of a small wind-propelled fan, as shown in the illustration. The hard-rubber insulating rod is kept permanently polished and free from deposit by the action of the fan, which is kept rotating by the slightest breath of wind. The center of the fan unit is formed by a hard-rubber bushing that fits



easily over the central rod, the rotary unit traveling back and forth on this rod as the wind direction changes. For the British navy, large insulators of this type have been developed, some having a diameter of 18 inches.

The Roswell Engineering Co., 45, 98 White Lion St. London E.C. 1, Eng.

Latest Radio Facts and Freaks

35 7452

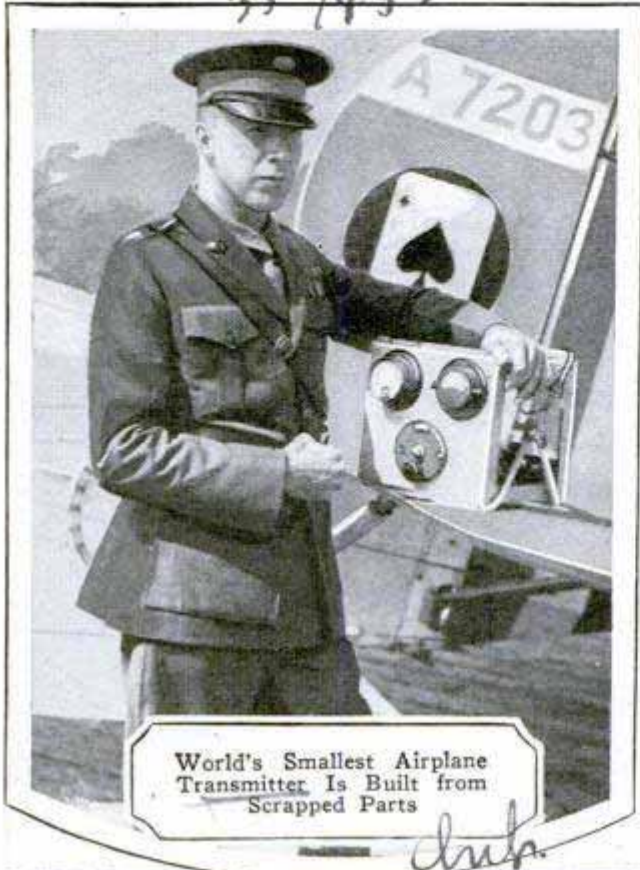

World's Smallest Airplane Transmitter Is Built from Scrapped Parts

dup.

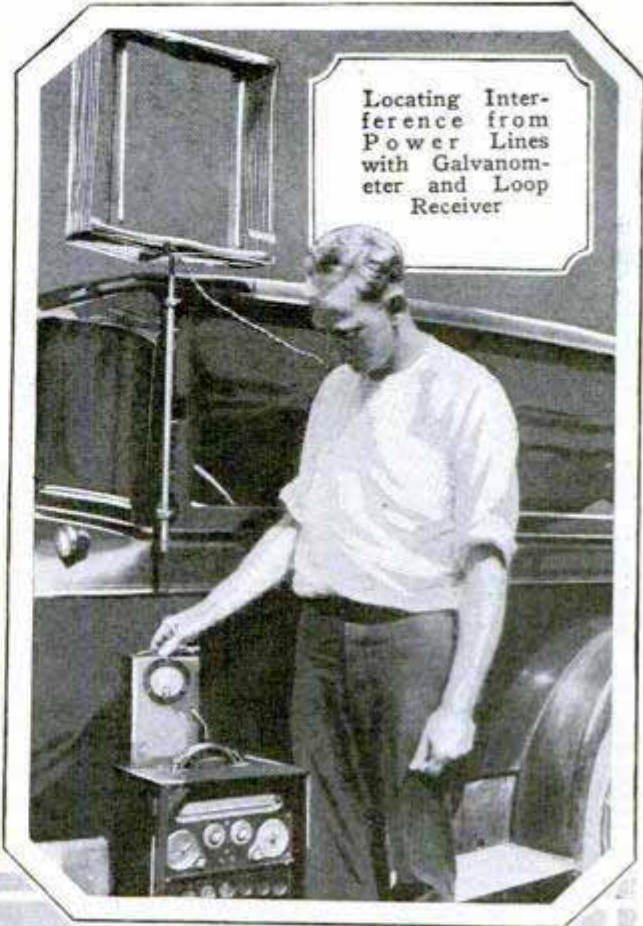

Locating Interference from Power Lines with Galvanometer and Loop Receiver

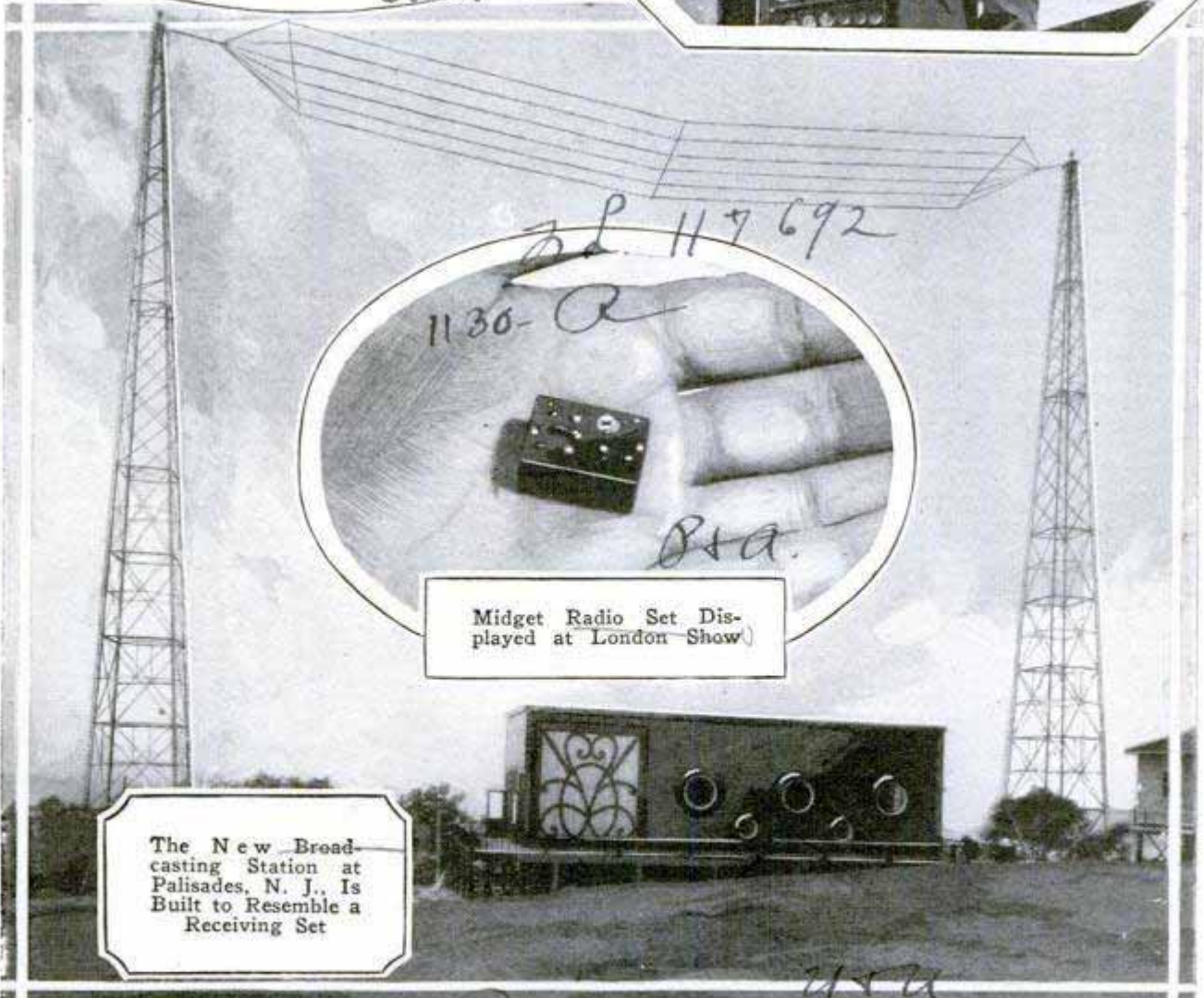

2P 117692

1130-Q

B.A.

Midget Radio Set Displayed at London Show

The New Broadcasting Station at Palisades, N. J., Is Built to Resemble a Receiving Set

1082-Q

882N500C

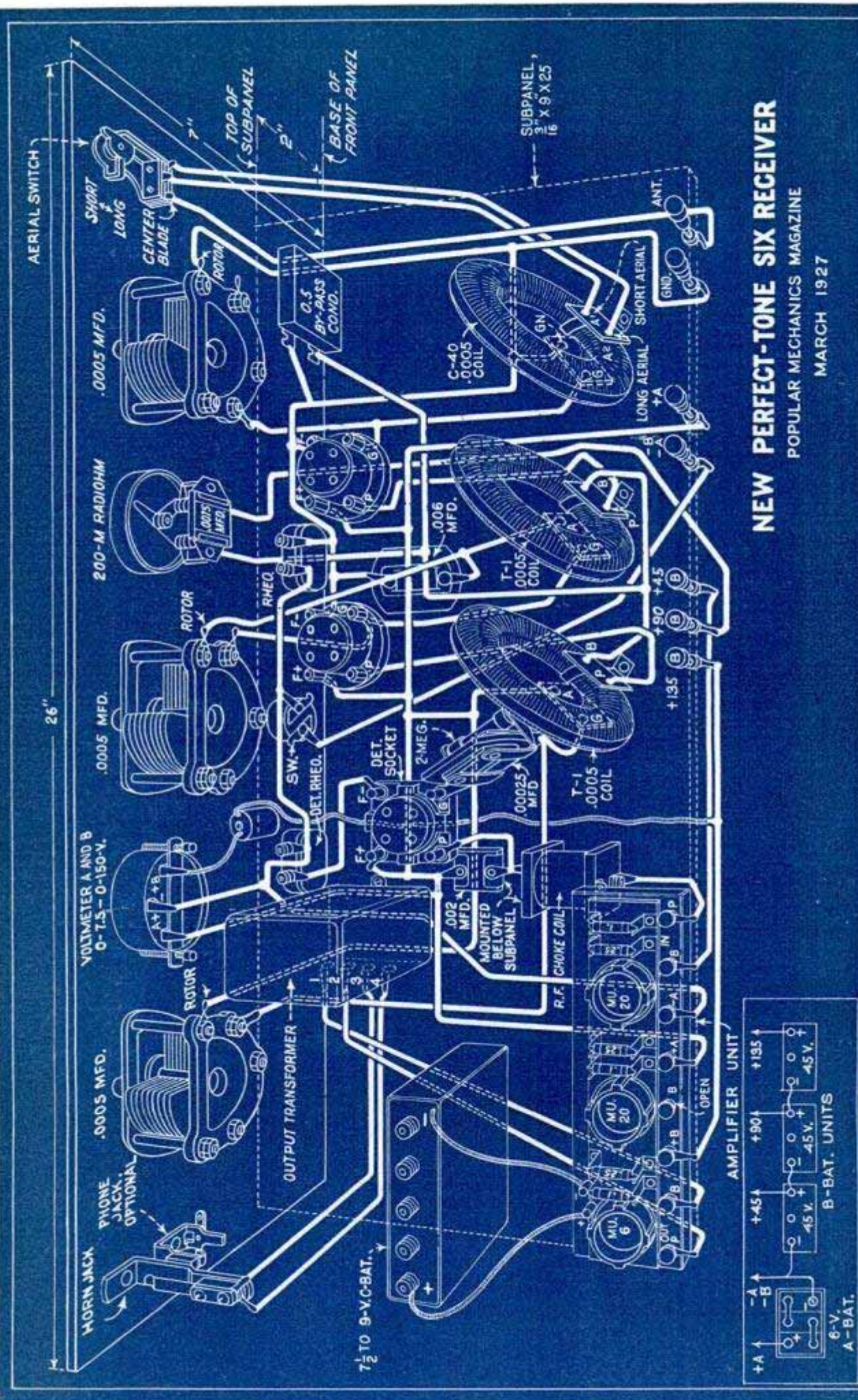

NEW PERFECT-TONE SIX RECEIVER

POPULAR MECHANICS MAGAZINE

MARCH 1927

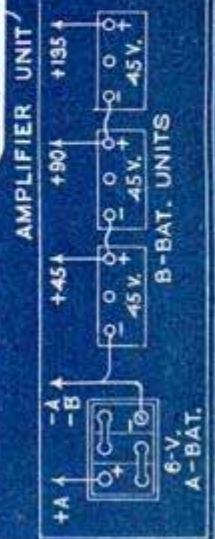

New Perfect-Tone Six Has Important Improvements

by Frank L. Brittin

WE made no mistake in naming the Perfect-tone six, described in the November, 1925, issue; it has proved one of the most popular sets ever designed in Popular Mechanics radio laboratory. We could not improve the tone, so we tried to improve the set in every other possible way. The result is a receiver equal in many respects to a superheterodyne; it is as easy to build as an ordinary three-tube set, does not howl when tuning from one station to another, and has, in addition, increased range and better selectivity.

An output transformer is used between the power tube and the loud speaker, thus increasing the handling power of the latter, and with a good speaker music is faithfully reproduced in all its original beauty. Perfectly balanced resistance-coupled a. f. amplification, low-loss r. f. coils, and a simple means of suppressing oscillation make this a real set for music lovers, while there is plenty of volume on distant stations for the DX fans, added to simplicity of operation and good selectivity. Those who built the first model will find no change in original parts necessary, the only additions required being a few fixed condensers, an output transformer, a 200,000-ohm variable-resistance, r. f. choke coil, and some changes to be made in the resistance-coupled amplifier.

The A and B voltmeter is optional with



the builder. Do not use the wiring of the old model, but remove all wires, and rebuild the set to conform with the new circuit. For those who are building the set for the first time, all details are shown in the photos and diagrams. The circuit is very simple and anyone who can solder two wires together can build the set. The full-page simplified wiring diagram shows all instruments in their relative positions, and the connections both above and below the subpanel. Before starting the set, carefully study this diagram and the

photos. Do not attempt to wire the set from the latter; they are not for that purpose, and it is impossible to trace wires in a small photo.

When selecting the parts, follow the specifications carefully; good parts must be used, for no highly efficient instrument can be built with poor parts. Use solid wire solder,

and paste flux. This paste comes in small 10-cent tins, and should be used very

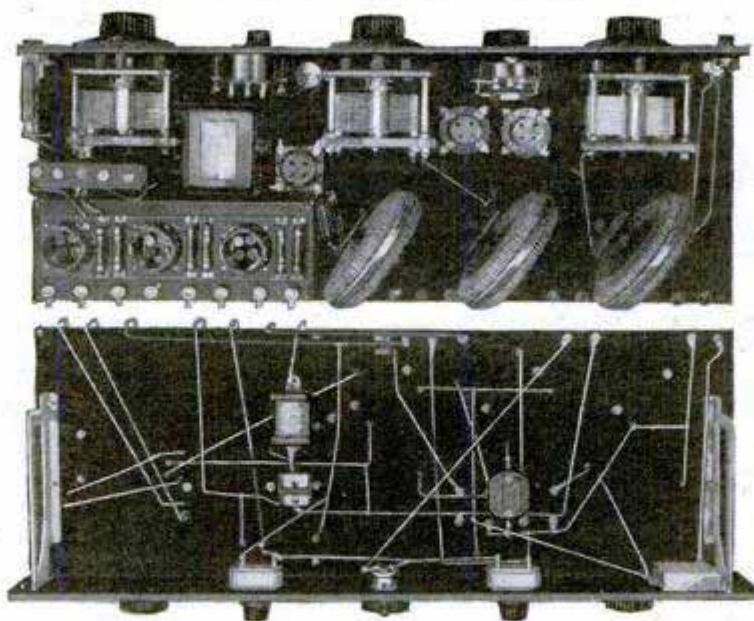

Top and Bottom Views of the Completed Receiver; Note the Angle at Which the Coils Are Set

sparingly; a minute amount applied to the connection is all that is required. Full-sized drilling templates for the panels are available for those who wish them. Mount all the instruments on the front panel first, as shown in the photo above the schematic diagram. The phone jack below the horn jack may be left out if desired, as the volume may be reduced for phones with the variable resistance or with a modulator horn plug. It will be noted in the wiring diagram that no connections are made to the small jack. For those who wish to connect it for phones on detector output only, all that is necessary is extra leads tapped off the B and P input posts of the amplifier unit. This, however, is not advised, as it adds undesirable wiring to the set, and is only suggested for those who requested it on the former model.

Assemble the instruments on the subpanel in the positions shown in the photo; the r. f. coils should be placed at an angle of about 58° , but the exact positions of the other parts are not critical. Place soldering lugs under all terminals that are to be connected, and, when mounting the lugs on the output transformer, be careful that they do not touch the case; then mount the brackets on the subpanel. The front panel is now screwed in position, a small brass angle bracket being used at the rear center of the subpanel for an additional support. Two similar angles hold the C-battery in position, just in front of the amplifier unit.

The set is now ready to be wired. If the amplifier unit is not provided with C-

battery posts for the last stage, these posts must be added. An inspection of the underside of the unit will show that one resistor terminal is connected with the A-negative post on the last tube socket by means of a short metal strip. This metal strip and its screws are removed, and two small binding posts are substituted for the screws. The negative side of the C-battery is then connected to the post on the resistor clip and the positive to the negative-A post on the last tube socket. The location of these C-battery posts is clearly shown in the large wiring diagram. Make all leads on the underside of the panel as direct as possible from point to point. Note that the leads to some of the tube sockets are connected to the ends of long screws through the socket bases. This cannot be done with all types of sockets, and if the sockets are not of a type that can be used in this manner, place soldering lugs under the binding posts and drill holes in the subpanel so that the wires may be run up to the lugs. As little wire should be used in the circuit as possible, and it will be found that by keeping the leads separated it is not necessary to use spaghetti. Most of the fixed condensers as well as the r. f. choke coil are mounted under the subpanel. The .5 mfd. by-pass condenser is mounted flat against the back of the front panel in the position shown, and held in place by the subpanel bracket.

When the wiring is completed, connect the A-battery and test out the filament circuit by placing one tube successively in each socket. It will be noted that one

MATERIAL LIST

- | | |
|---|--|
| 1 front panel, 3-16 by 7 by 26 in. | 1 by-pass condenser, Sangamo or Tobe-Deutschmann, .5 mfd. |
| 1 subpanel, 3-16 by 9 by 25 in. | 1 Sangamo fixed condenser, .006 mfd. |
| 1 set Thorola coils, type 43, for r. f., .0005 mfd. | 1 Sangamo fixed condenser, .002 mfd. |
| 3 variable condensers, .0005 mfd. (any good straight-line capacity type, not straight-line frequency). | 1 Sangamo fixed condenser, .0075 mfd. |
| 1 Samson r. f. choke coil, type 85. | 1 Sangamo fixed condenser, .00025 mfd., with gridleak clips. |
| 1 Centralab radiohm, 200,000 ohms. | 1 gridleak, cartridge type, 2 meg. |
| 2 Bradley-stats. | 7 binding posts with engraved tops. |
| 1 push-pull switch. | 1 strip brass, 1-16 by $\frac{1}{2}$ by 6 in., for small brackets. |
| 1 Hoyt type 17, or similar type, A and B voltmeter, 0 to 7.5, and 0 to 150 volts. | 1 C-battery, 7 $\frac{1}{2}$ to 9 volts. |
| 1 standard open-circuit jack. | 2 Daven MU-20 tubes. |
| 1 Gem jack, open circuit, short type. | 1 Daven MU-6 tube. |
| 1 spring-suspended socket, X-type. | 3 tubes, 201-A or 301-A type. |
| 2 sockets, X-type, and good low-loss make. | 17 6-32 round-head, brass machine screws, $\frac{1}{2}$ in. long. |
| 1 Yaxley, midget, aerial switch. | 4 6-32 round-head, brass machine screws, 1 $\frac{1}{2}$ in. long. |
| 1 S-M output transformer, type 221. | 10 6-32 round-head, brass machine screws, 8 in. long. |
| 1 three-stage resistance-coupled, a. f. amplifier unit; Daven, Lynch or Muter, with resistors arranged as shown in diagram. | 10 2-ft. lengths No. 14 round tinned-copper busbar. |
| 1 pair Benjamin brackets. | 4 doz. soldering lugs, long round-hole type. |

rheostat controls the detector tube, and the other the two r. f. tubes, but the A-battery supply is taken directly to the amplifier unit as the MU-tubes used here require no rheostat. But if tubes of any other kind than those specified in the material list are to be employed in the amplifier unit, an automatic filament con-

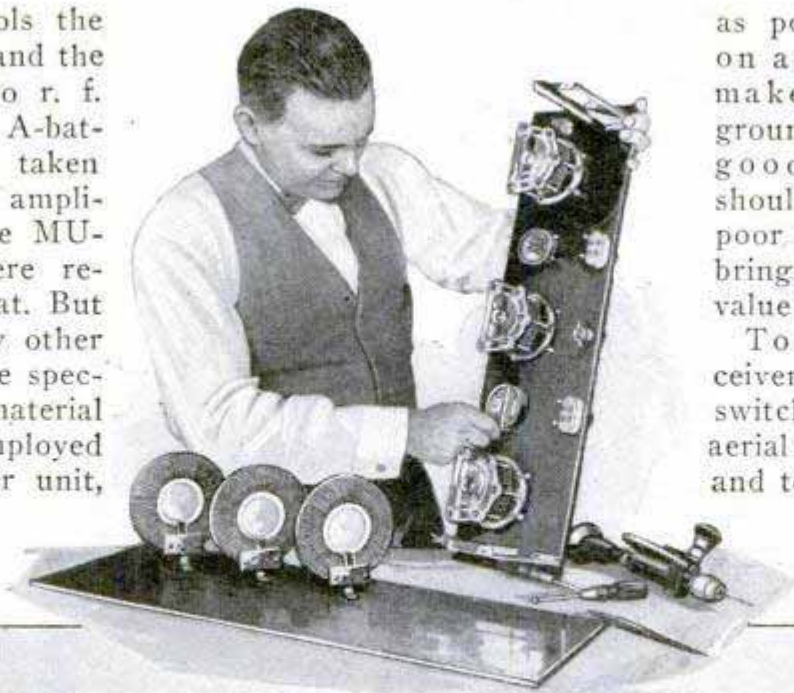

as possible. A clamp on a cold-water pipe makes an excellent ground for the set. A good loud speaker should be used, as a poor speaker will not bring out the real tonal value of the set.

To operate the receiver, turn the aerial switch to the "short" aerial position for locals, and to the "long" position for distant stations. Turn

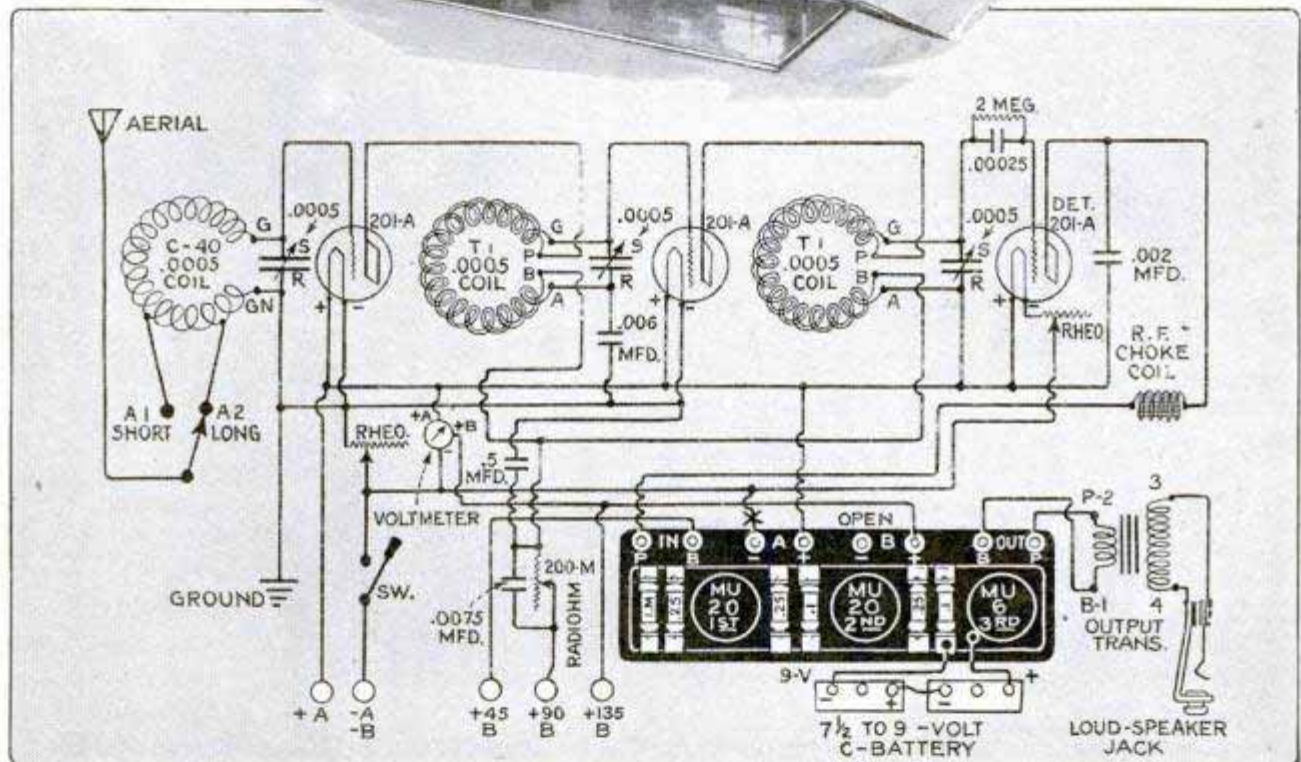

Above, Partly Assembled Panel and Subpanel; Below, Schematic Diagram of Set for Those Who Prefer to Work from One of This Type

trol, either a ballast or an amperite, is necessary at the point marked X in the schematic diagram. This is in the direct A-negative lead to the unit. If 201A-type tubes are to be used, employ a $\frac{3}{4}$ -amp. filament control, and if a power tube other than the ones specified, use a 1-amp. Do not attempt to place mixed tubes of the standard and MU-types in the amplifier unit. When the filament circuit is found to be correct, connect the B-batteries, ground and aerial wires. Use a single-wire aerial, 80 to 100 ft. long, including the lead-in, and as short a ground wire

on the filament switch, plug in the speaker, and slowly turn on the rheostats until a faint swishing sound is heard in the speaker. Rotate all the dials, in step, until the station comes in clearly; now adjust the radiohm or volume control to give the desired volume, and turn up the rheostats to the point that gives the best results. It will be found that the dial readings will be about the same for all stations, if each dial is adjusted so that it reads 100, or the highest dial reading, when the plates of the condensers are all in. This adjustment can be made with the

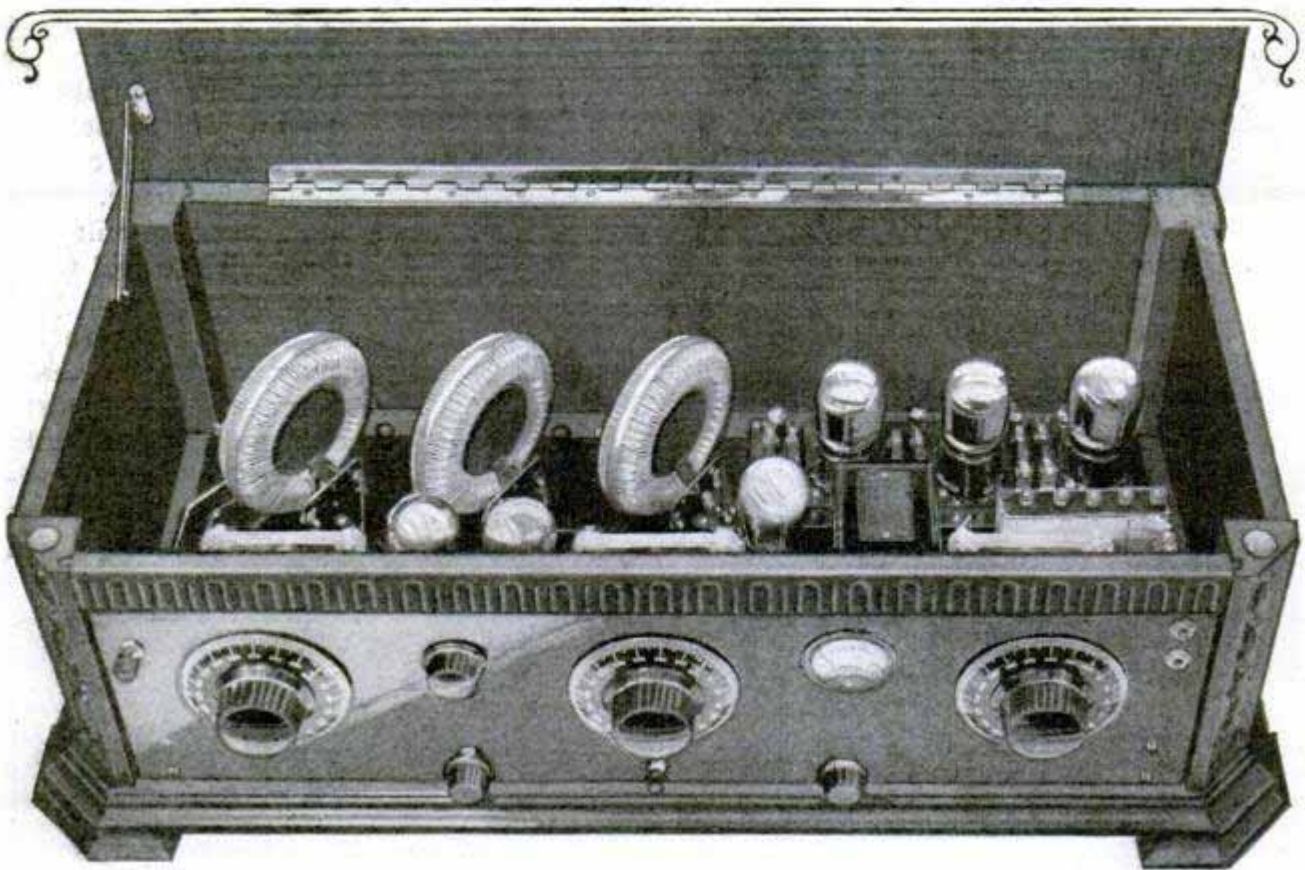

setscrews holding the dials in position on the condenser shafts.

Large blueprints of the wiring diagram, as well as full-size drilling templates of

the front panel and subpanel, may be obtained from Popular Mechanics radio department, 200 E. Ontario st., Chicago, for 15 cents. Specify blueprint No. 118.

Radio Log and Clock Combined

Two necessary accessories for the radio set—a means of logging stations and a clock or watch to check the time of the various programs listed—are combined in the handy device shown in the illustration. The construction of the mounting is simple. Cut a piece of 4-in. bakelite or cardboard tubing 2 in. long, and square the edges with a file or sandpaper. If cardboard is used, it may be painted black to match the bakelite front disk. The latter is cut from a piece of scrap bakelite so as to fit inside the tubing. Cut out a hole, the size of the watch crystal, below the center point of the disk, smooth the edges with a file and bevel both sides. The

watch is held in place by means of a strip of spring brass, mounted as shown at the right. A switch lever or rheostat shaft is used above the watch, to hold a disk of celluloid or bristol board on which the various stations are to be marked. A small slot is cut in the front disk at a point near the edge of the celluloid disk and the edges are beveled neatly. The station disk is mounted on the shaft by means of a nut on either side, to hold it firmly in position. The disk is turned

by the knob and the stations are logged through the slot with a pen or pencil. The base is a piece of panel material, 4 in. long and 2 in. wide, in which two holes are drilled and countersunk for flat-head machine screws to hold the tubing and to mount the

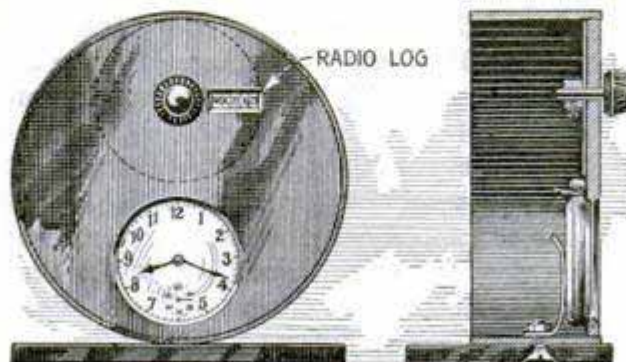

Left, Front View of Completed Unit, Station-Logging Disk Indicated by Dotted Lines; Right, Section

clip for the watch. This may be of the dollar variety, and the assembly looks neat on or near the set.

When Buying Storage Batteries

Remember that the storage battery must deliver sufficient power to operate the set for a reasonable length of time; ampere-hour capacity determines the storage battery's value. If this capacity is accurately represented, the buyer knows just what service to expect. The capacity of a storage battery depends upon the amount of active materials which the battery contains, and the integrity and skill of the manufacturer determine how well the lead plates and the acid solution, which constitute the active battery elements, are proportioned to each other. The size of the case is no indication of capacity; a large box may contain less active material, and therefore less capacity, than a smaller case designed by another manufacturer. Weight is another uncertain indication, nor is the number of plates always a good index of battery capacity. For example, various types of storage batteries, each having a capacity of 100 amp.-hr., have been designed for radio use; one has 9 plates, another has 11 and another 13 plates. All have a true capacity of 100 amp.-hr., and are good batteries.

Tube Has Built-In Cushion

A new tube designed to prevent microphonic noises due to vibration, has a ring of soft resilient crepe rubber in the base of the tube in the position shown in the illustration. With this mounting, set and loud-speaker vibrations will not reach the tube and interfere with the tonal quality, it is claimed. The tubes are designed to fit any standard socket and have the new X-type bases, so that no change in the set is necessary to use them.

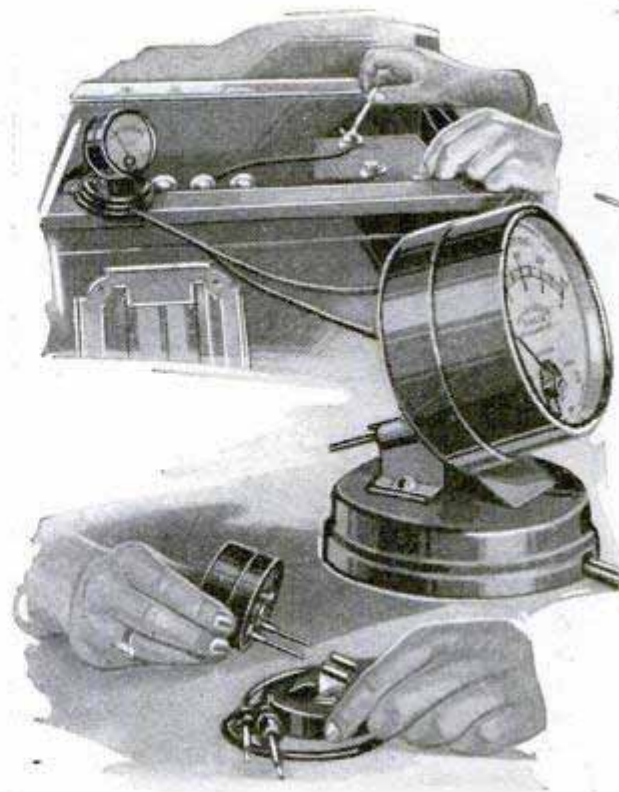
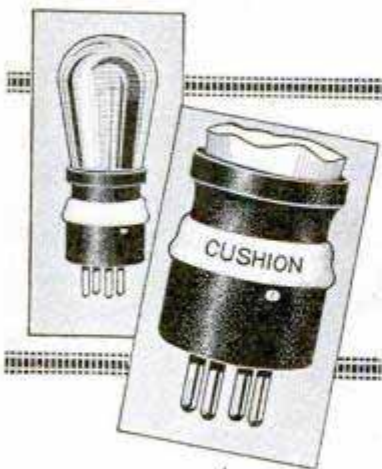

Double-Range Voltmeter, Showing Method of Testing B-Batteries; Below, Mounted on High-Range Stand

Pin-Jack Voltmeter Has Double Range

A practical double-range voltmeter of the pin-jack type is now available for use with any type of receiving set. The instrument is made in two combinations: 4 to 160 volts for use with sets operated with 3-volt tubes, and 8 to 160 volts for use with sets employing 5-volt tubes. The stand is equipped with a pair of 30-in. permanently attached flexible cables for testing the batteries or locating circuit troubles. A pair of pin jacks are supplied with each instrument in order to permit the user to mount them on the panel if desired. Some manufactured sets are already equipped with jacks for this type of voltmeter; the pin jacks should be connected directly to the filament terminals on the bases of the tubes whose voltage is to be measured.

ⓄThe tinsel used in phone and loud-speaker cords is easily broken, and is very difficult to solder, as it has a tendency to burn. Hence it is best to replace a broken horn or phone cord with a new one. If a tip comes off, wind a short length of fine wire around the bared tinsel end before applying the soldering iron. Be sure the iron is not too hot and use flux sparingly.

Electrical Department
 Newark N. J.
 Weston

*The Van Horne Co.
Franklin, Ohio.*

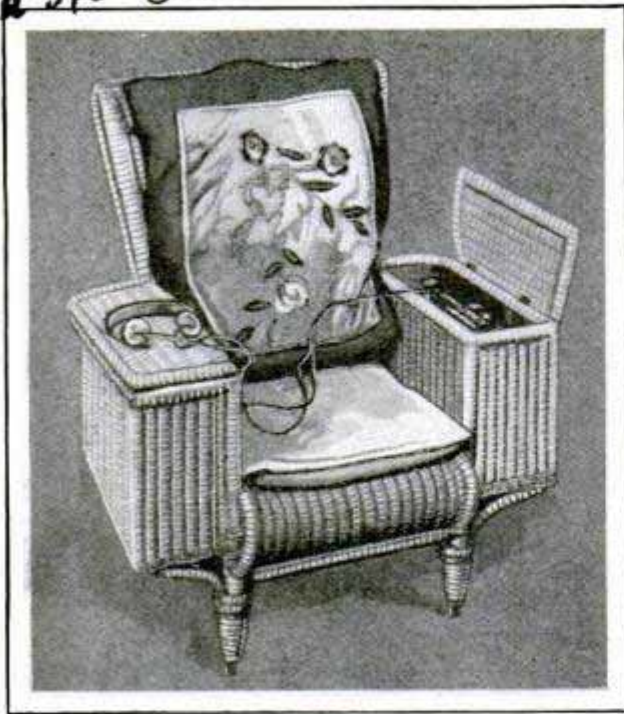

Radio Armchair, Showing Lid of Receiver Compartment Open

Armchair with Built-In Receiver

A novel radio receiver in the form of an armchair was exhibited at a show recently held in London. Each arm of the chair is a wicker box containing radio apparatus, the set on one side and batteries on the other. Placing the headphones within easy reach, the listener-in may enjoy radio entertainment without leaving his chair.—H. T. Wilkins, London, Eng.

Variable Condenser Employs Shaft of Insulating Material

A variable condenser employing a bakelite shaft strikes a distinctly new note in construction of such instruments. This condenser is of the straight-line-frequency type. The construction details are indicated in the diagram, cross-section view, No.

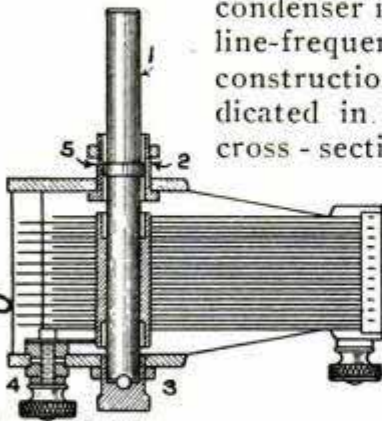

1 showing the shaft of solid bakelite; No. 2, the brass bushing, acting as a forward bearing and mounting stud, and No. 3, the rear bearing. The insulated binding post, with spring wiping contact for the rotor plates, is shown at

4; No. 5 is a brass contact ring fastened to the shaft. The shaft furnishes the insulation between the rotor and stator plates. The instrument is mounted in a U-shaped frame, eliminating the usual side strips of insulating material and their attendant supporting ribs, and permitting the use of an all-metal frame. The bakelite shaft is claimed to be practically wear-proof, a diameter reduction of only .002 in. being noted after a test of 250,000 revolutions made on a stock shaft.

Headphone Kink for the Deaf

Headphones may be fitted with wide-mouth nursing-bottle nipples for sound concentration. This method has been employed successfully by a member of the staff of one of the large broadcasting stations. By this simple expedient, radio programs are now enjoyed by deaf persons who otherwise would not be able to hear them. The nipples are slipped over the phone unit in the manner shown in the illustration, the small hole at the end of the nipple first being enlarged to about 1/8 in. Phones so equipped are comfortable to the ears. The same kink is suggested for DX listeners, enabling them to pick up faint distant stations.—O. W. Timm, Eagle Rock, Calif.

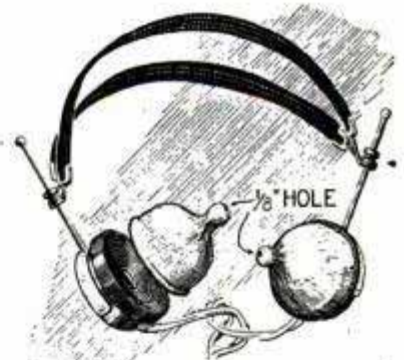

Test Lamp for Storage B-Batteries

The average owner of storage B-batteries has little or no facility for making correct tests on each cell, a procedure that really is of great value, especially after the battery is a year or more old, for then single cells quite often have become defective, rendering the whole battery inoperative. The ordinary pocket meter with a scale reading to 50 volts is of little value when endeavoring to ascertain the condition of a single pair of plates, as they seldom register accurately with so little pressure across the terminals, but a

Bruno Radio Corp. 40 Bayrider Ave. Long Island City N.Y. 9670

test lamp possesses all the desirable features that the meter lacks. Get a 3-volt flashlight bulb and solder a short length of stiff copper wire to each of the two contacts on the base. Test your battery, one cell at a time, by touching a wire of the test lamp to the positive and negative terminals. The little bulb should burn with almost normal brilliancy if the cell under test is in good condition and charged, a dim glow or no light at all indicating a defective cell. If only two or three cells in a block of 48 volts are found defective, they may be shorted out by soldering or twisting a bit of copper wire from positive to negative of each offending unit, without noticeably affecting the efficiency of the B-battery as a whole.—J. Walter Briggs, Poughkeepsie, N. Y.

Screw Forms Panel Marker

The simple panel marker for dial setting shown in the drawing consists of a small flat-head machine screw mounted directly above the dial. The head of the screw is countersunk flush with the panel, and the slot is then filled with white lead or similar substance. To lay out the hole for the marker without scratching the panel, clamp a piece of heavy wrapping paper to the panel over the position of the dial. Locate the hole for the condenser shaft, and draw a vertical line through its center. Place the dial temporarily on the shaft and trace the outline of the dial on the paper. At the crossing of the outline of the upper half of the dial with the vertical line, make a center-punch mark, deep enough so that the drill will not slip when drilling the hole. Remove the paper, and drill, and countersink the screw-head hole, then place the marker on the panel.—Geo. F. Helpap, Saginaw, Mich.

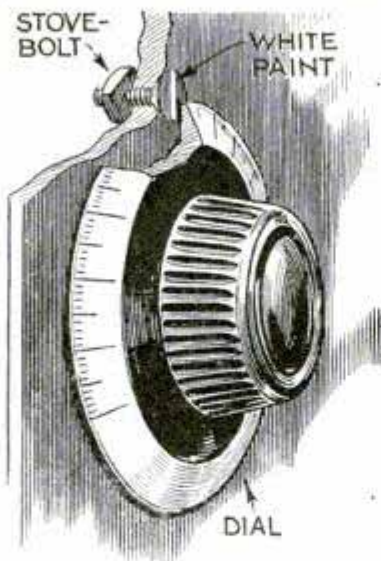

Homemade Back-Mounted Dials

Back-mounted dials with a small portion of their edges projecting through the panel for localized control of variable condensers and other units are usually

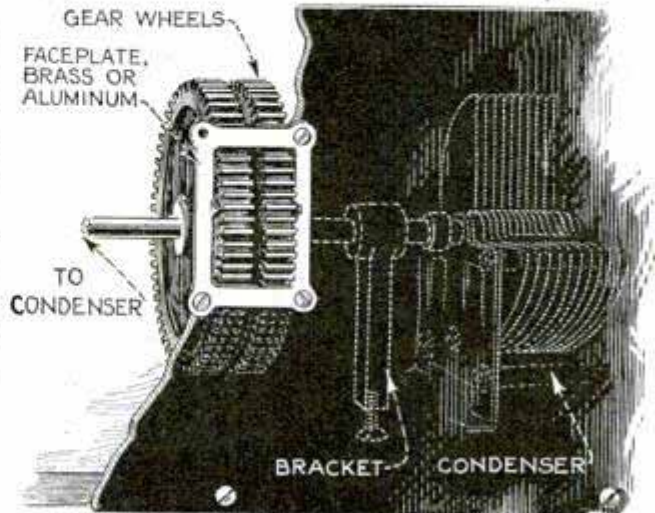

Homemade Back-Mounted Dial That Can Be Easily Made at Small Cost

confined to manufactured sets, since they have not been generally available to the home builder. However, the experimenter can obtain the same general results with the gear assembly shown in the illustration, at small cost. A gear taken from a telephone magneto, or one of similar type that may be found about the workshop or secondhand store can be used. The teeth are ground down, and painted in various colors, so that stations can be logged by color. The faceplate is of brass or aluminum, the slot or "window" being cut to suit the gears. By using telescoping tubes for the condenser shafts, several of these wheels may be placed together, or they can be spaced across the panel as desired.

How to Rejuvenate Dry Cells

Dry cells are never really dry; they contain a moist paste. This fact explains why the cells run down if kept near radiators or in other warm places. Frequently the paste, or "electrolyte," dries up before the other exhaustible elements of the battery weaken; if holes are then punched in the zinc covering of the cells and the entire battery soaked in a strong solution of salt water, they will often show marked signs of rejuvenation for a short while.

Preventing B-Eliminator Hums

Hums are a frequent source of annoyance in many of the cheaper types of B-

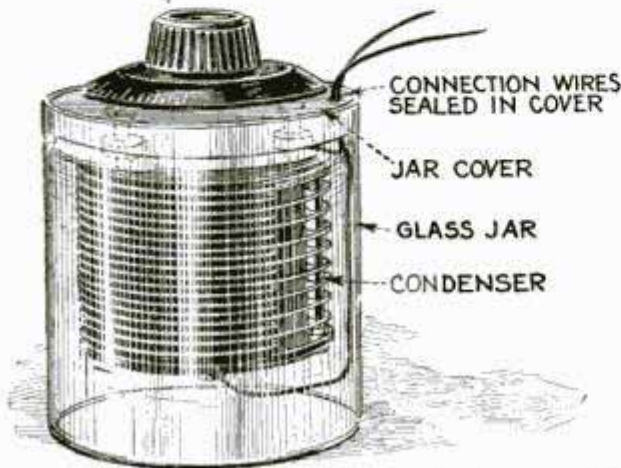
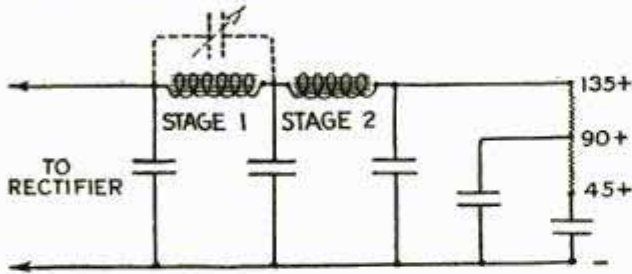

Above, Wiring Diagram Showing Condenser to Be Added in Dotted Lines; Below, Condenser in Jar

eliminators. This annoyance can be done away with by means of the simple homemade apparatus to be described. Without going into the theory, the filter of the eliminator does one of two things. It either short-circuits or chokes the hum left in the current from the rectifier. In the more expensive eliminators, these two functions are combined in the filter, while in the cheaper types the filter is usually designed to short-circuit the hum only. The wiring diagram given herewith shows the hookup of the higher-priced instrument, and a variable condenser is indicated across the first-stage choke coil, in dotted lines. The condenser makes that stage function in the same manner as a wave trap would cut out objectionable stations. If your eliminator does not contain a condenser of this type, it is easy to build and install it in your present equipment. Obtain a .001-mfd. variable condenser with end plates and insulation of bakelite. It need not be of the newer type, an old straight-line capacity condenser being quite suitable. Next provide a covered glass jar that will hold the condenser so that the rotary plates may

be moved in and out without obstruction. Mount the condenser on the underside of the cover, with the shaft projecting through the top so that the rotor can be turned when the condenser is in the jar. Fill the jar with distilled water and place the condenser in the jar, taking care that the water covers the topmost plate of the condenser completely. Seal the jar so that no water can spill and you have a condenser of about .081-mfd. capacity, as the dielectric constant of distilled water is 81 times that of air. Connect the condenser in the position shown in the diagram, and adjust the circuit under operating conditions. Turn on all the tubes in the set, and listen for the hum in the loud speaker. Slowly turn the variable condenser from zero to maximum, listening closely for the hum to die. No special care need be taken with the connection wires except that they should be sealed in the cover of the condenser.—Arthur Kennedy, Paterson, N. J.

A Battery Cell Tester of Novel Design

A cell tester for the A-battery that is used exactly like the cell tester for automotive use is now available. The pointed metal prods, shown in the illustration, are



pushed into the terminals of each cell in the battery, and the reading is noted on the small meter conveniently mounted at the end of the handle. A specially designed scale gives directly the different conditions of the battery. The meter has its zero

in the center, so that no attention need be paid to the polarity of the prods in use. This instrument permits the operator to obtain the correct reading of each cell in the battery under load conditions.

*Hoyt Electrical Works
Instrument Dept.
Pawcatuck, Conn.*



A Trunk for Your Outboard Motor

By JOHN EDWIN HOAG

ONE of the greatest advantages of the outboard motor for lovers of water sports is its portability. This advantage, however, is lost to those who travel to water locations on trains, because they have no suitable container in which the motor can be shipped as baggage. Railroad regulations prohibit acceptance of parcels other than trunks, or handbags, as personal baggage and these must be in good order and sufficiently substantial to withstand the rough handling. Thus, for the lack of proper containers, most outboard motors have to go by express.

This Trunk for the Outboard Motor Accompanies the Owner to the Lake at Ordinary Baggage Rates. Saving Considerable Money for Express

After paying out a lot of money, the writer decided to solve the container problem once and for all. The result is the trunk shown in the accompanying photographs. The trunk itself is a good substantial one of the "dress" model, of sufficient length to take the outboard motor.

Into the bottom of this trunk I built the assembly of oak partitions and blocking shown in the illustrations. The motor fits into this without removing any part other than the steering handle. Moreover, it is held absolutely immovable. It is supported against rubber pads at the

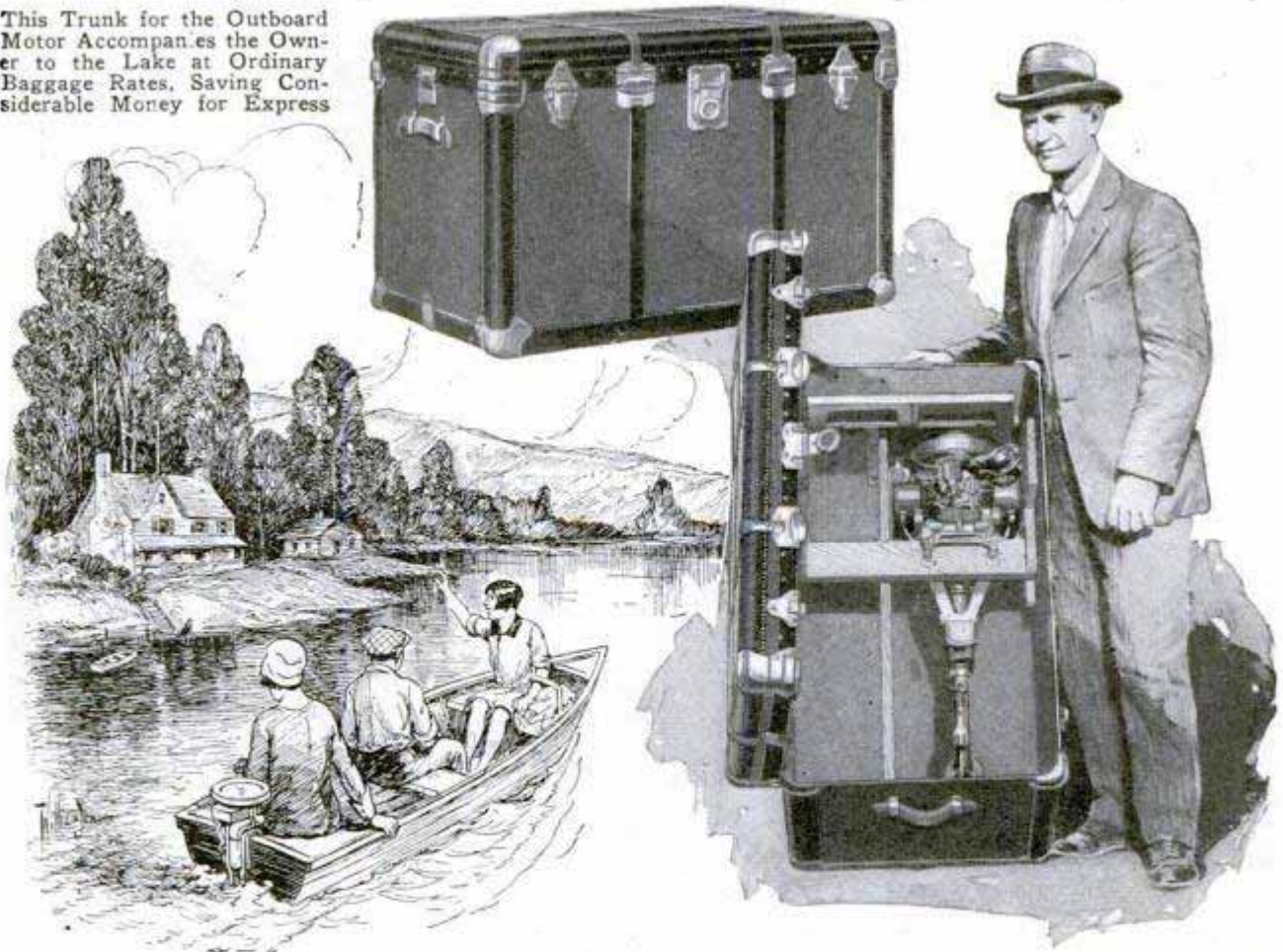

ends of the cylinders and the top of the flywheel. It is also held by the screw clamps by which the motor is ordinarily attached to the stern of the boat, and by a slotted oak block that holds the end of the propeller shaft.

The crosspiece to which the screw clamps are secured is of 2 by 4-in. wood. The ends of this fit into slotted members at the two sides of the trunk so that the member is removable. With this arrangement, packing and unpacking of the motor are easy.

In packing it is only necessary to nest the motor into position. The cross member is slipped into place and the motor clamps screwed down upon it; the motor is then immovable no matter how roughly the trunk is handled. In removing it from the trunk, the screw clamps are loosened,

the cross member released and the motor lifted out. After that, it is about half a minute's job with a screwdriver to replace the steering handle, and the motor is ready to be put into service.

To gain additional strength, and provide convenient packing places for tools and other equipment, an oak partition is built down the length of the trunk. Thus, all motor duffel, and most of an ordinary camping outfit, fishing tackle, etc., can be packed in the bottom of the trunk. The regular trunk till is then available for clothing and lighter articles.

The advantage of this trunk arrangement over anything commercially marketed is the fact that the motor is carried as a unit virtually ready to use. It is not necessary to pack it in a half-dismantled condition, and the arrangement provides a method of packing that complies with all requirements of railroad or steamship bag-

gage regulations. It also affords space for tools, clothing, gasoline and oil containers, and all the usual equipment that every out-board-motor owner needs.

It should be mentioned that all wooden fittings for this assembly are made of clear, straight-grained oak, and are secured to the main walls of the trunk with round-head brass bolts, put in from the outside, then riveted over the nuts and soldered on the inside. The cost for wood and hardware, exclusive of the trunk it-

self, and labor, was about \$6. But this cost will be more than repaid by avoiding the usual express charges on the very first trip afield. Another great advantage is that everything needed for the motor is at hand at all times, and that all equipment can be kept under lock and key at the camp; this is sometimes

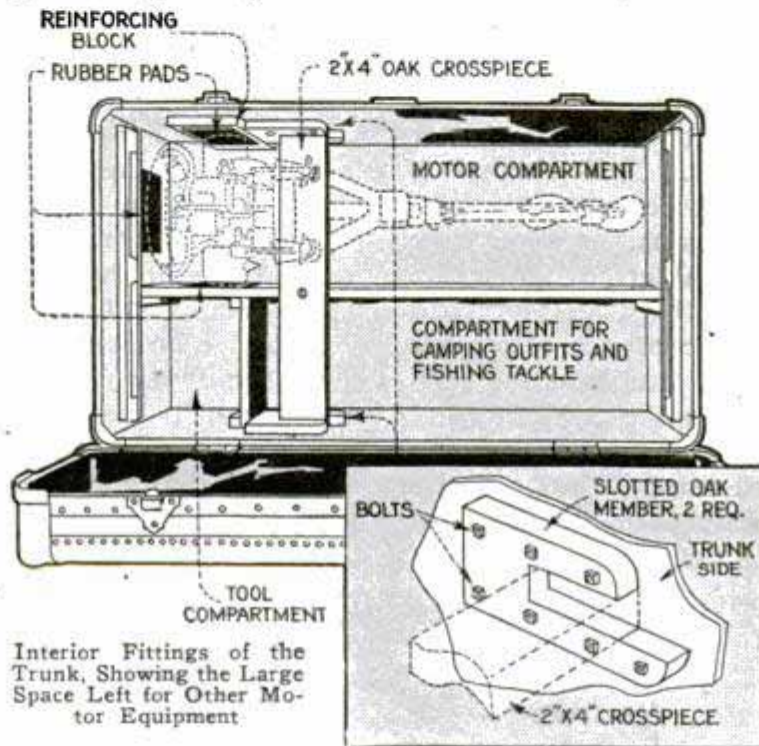

very desirable. The time to equip your trunk is right now, so as to have it ready for the first summer trip.

Extension Grips for Door Handles

The inside door handles on Ford closed cars, models 1919 to 1923, project through the top of the door just inside of the glass. There is so little room between the handles and the glass that it is difficult to grasp them quickly, and finger marks are made on the glass. A pair of extensions for use on the spark and throttle levers can be attached to the handles on such cars, as they are of the same size and shape as the throttle lever and will furnish a much better grip. The extensions are clamped with setscrews and usually remain tight on the handle. A piece of heavy cloth may be coated with liquid glue and dropped over the handle with the ends hanging down.

When the extension is pressed down over this and the screws tightened, it will be firmly held. The handles of later models are shaped differently and do not lend themselves to this improvement.

Why Varnish Blisters Outdoors

Outdoor varnished surfaces frequently blister. This is due to the treatment of the wood before the varnish is applied. Amateurs employ shellac for almost everything and this substance has been used to seal the grain of many doors and other fittings outdoors. However, shellac applied to such purposes is fatal to the permanence of a job. The reason is that heat of any kind will raise the shellac, causing blisters. Oil and other substances can be used to seal the grain just as well as shellac, so there is no reason for taking any chances with it.

A Bootjack for Overshoes

Did you ever stand out on a cold porch, trying to force a rubber off one foot with the toe of the other foot? I often did and that is why I made the bootjack shown in the drawing, and fixed it so I

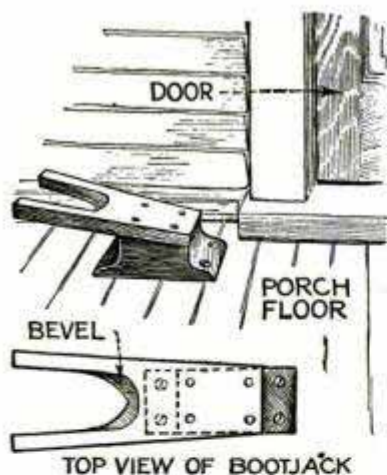

could fasten it on our porch every winter, when needed. There is not much to its construction, and it helps you to get into the house quickly.—T. H. Duffy, Juniata, Pa.

Carrier for Storage Batteries

For garage and service-station use, an old pair of ice tongs makes a handy tool for lifting and carrying storage batteries. To fit in the fingerholes of the battery case, it may be necessary to grind down the ends of the hook slightly and round them off. Wrapping them with tape will also help in sustaining the grip and prevent marring of the surface of the battery.

Novel Lamp Shade

As a decided novelty in the line of lamp shades we cut parchment to the proper



Novel Lamp Shade Made of Parchment and Ornamented with Signatures

size, then ornamented it with the signatures of friends. When the shade was completely covered with names, it was mounted in a frame and two coats of spar shellac were applied to give it a finished appearance. After this had dried, the edges were bound with tape and the shade was complete.—James Clark McGuire, Jr., Albany, N. Y.

Keeping Floorboards Tight

Rattling floorboards in an automobile are very annoying. It is, however, an easy matter to remedy this. Remove the rear right-hand bolt from the top of the gear case, and substitute a stud long enough to project about $\frac{1}{2}$ in. above the floor. Seat the stud and then screw a nut down over it. This will act as a lock and hold the gear-case cover down tightly.

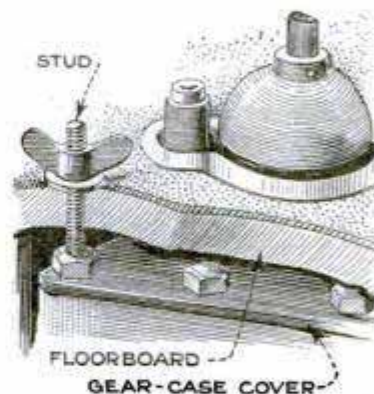

A hole is then drilled in the floor to admit the head of the stud, and a large iron washer and wingnut are provided to keep the floorboards tight.

Western Orchestra Successfully Uses Old Auto Brake Drums for Chimes

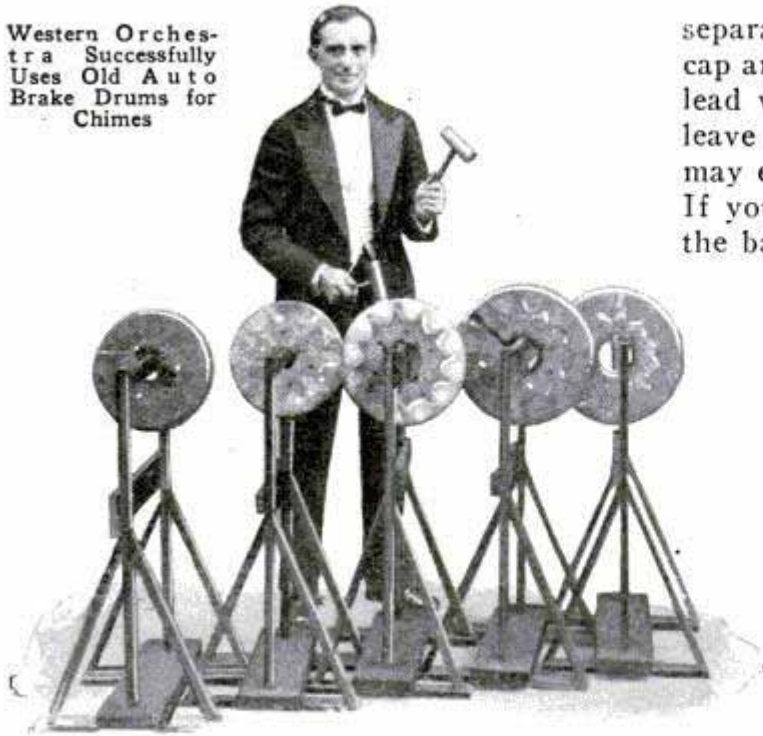

Orchestra Chimes from Auto Drums

Have you noticed, when relining the brake bands on the rear wheels of your car, the clear, silvery tone the brake drum produces when you accidentally strike it with the hammer? A western orchestra leader uses the drums for playing beautiful chime solos and a number of obbligato accompaniments. So excellent are the results obtained that the orchestra has adopted them as permanent parts. Here is a valuable suggestion for amateur orchestras, which cannot afford to purchase a set of manufactured chimes. The brake drums on different automobiles vary in size and hence in pitch and tone.—L. W. Pedrose, Seattle, Wash.

Determining Amount of Water in Storage Battery

The storage battery of an automobile is likely to be the most neglected part of the car for it is usually tucked away in the least accessible place and the car owner forgets to add water to keep it in good condition. It is easy to construct and install a dash signal that will tell at a glance when it is time to refill the battery. Drill a small hole in one of the rubber vent caps and force a short lead strip through this aperture, allowing it to project downward until it dips into the electrolyte and almost touches the top of the

separators. Remove the prepared vent cap and carefully fill any holes around the lead with hot sealing wax, being sure to leave one small pinhole through which gas may escape when the battery is charging. If your car has the negative terminal of the battery grounded to the frame, screw the cap with its lead electrode into the top of the cell nearest the positive end. Fasten with solder a length of well insulated copper wire to the exposed end of the electrode and extend it to a push button, mounted in any location convenient to the driver's hand, and then to a 6-volt 2-cp. lamp on the dash. As long as there is sufficient solution in the battery, this lamp will light when the button is pressed, but when the liquid drops too low the lamp will fail to respond. Some electric systems ground the positive wire, and this must be determined at the start, for, if your car is thus wired, it will be necessary to screw the prepared vent cap into the cover of the cell nearest the negative end.

"Dumb-Boy" Aids Riveting

Mechanics often need a helper to hold a heavy hammer under the surface of a plate which is being riveted. However, help is unnecessary if a "dumb-boy" of the kind shown in the drawing is used. It consists of a pivoted arm on a tripod, with a sledge hammer fastened to one end of the arm and a counterweight to the other.

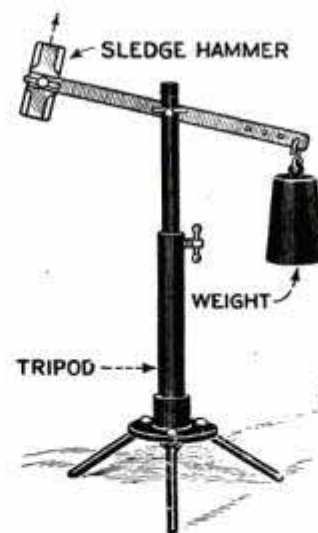

The hammer is adjustable and can be set at different angles and held there by means of a thumbscrew. Holes at the other end of the arm allow the counterweight to be hung at different points to vary the pressure of the hammer against the underside of the plate being riveted. Of course, the tripod is also made adjustable to various heights.

How to Make a Magnetic Maze Puzzle

By H. F. GOODWIN

HERE is an easily made maze that is sure to interest the puzzle fan, as it is so arranged that the maze itself is invisible to the operator. It is simple in construction, can be made in a short time and involves practically no expense except for the magnets. The other materials needed are some cigar boxes, which any tobacco dealer will be glad to give you, three paper clips of the kind illustrated, some strong glue and a sheet of thin but tough cardboard. The four magnets needed should be of the horseshoe type, about 2 in. long, and can be bought in any five and ten-cent store.

First remove the cover from a perfectly sound cigar box. The best box for this purpose is one having metal hinges on the cover and a flange running around the top over which the cover fits. After removing the cover, the flange should be planed off. Then take the bottom piece of another box, making sure that it is perfectly straight, and trim the edges so that it will fit snugly in the bottom of the first box. This forms the floor in which the pegs are inserted. Now take four magnets and glue them together so as to form one magnet of the required strength. In order to slide freely when the box is tilted the magnet is furnished with sliding feet. These are simply the heads of the brass paper clips, the prongs of which have been cut off with scissors, and are glued to the bottom of the magnet as illustrated.



An Easily Made Puzzle That Will Take a Lot of "Solving" and Provide Amusement for Hours at a Time

When the magnet is ready, place it on the floor of the box and move it around the inside edge of the box, marking its height with a pencil. This should be done very carefully. With the floor still in

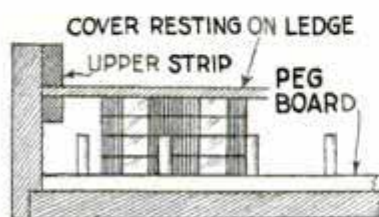
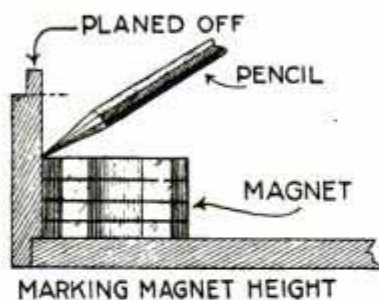

place, cut out thin strips of wood, which, when glued around the inside edge, will come exactly even with the pencil marks. This ledge forms the support for the cardboard cover. With the floor and ledge in place but not fastened permanently, take a pencil and dot the floor where the pegs are to be inserted, using the magnet as a guide. These dots should be placed in staggered rows, and it will be found, by a little practice, that they can be placed quite closely, as the inside edge of the magnet slides around and pivots on the pegs.

Take out the floor and insert the pegs, which should be only about one half the height of the magnet. Return the floor to the box and glue in the inside ledge. Now you are ready for the cardboard cover. This should be cut so that, when laid flat in the box, it is supported by the ledge. The cardboard is ruled off into checkerboard squares and has two squares on diagonal corners raised on small pieces of cardboard so as to allow the iron man or checker to slide underneath. These raised corners are decorated, respectively, with a diamond and a heart cut from old playing cards. A smaller diamond is glued on the face of the iron checker.

Before permanently fixing the cover to the box it is advisable to try out the puzzle. This can be done by placing the magnet in the box and, while holding the cover on with your fingers, tilting the box back and forth so as to see if the magnet slides freely, using the iron checker as an indicator. Though the magnet should be unhampered in its action, it is very important that the cardboard cover be laid di-

rectly on the magnet so that they touch. Now is the time to make any alterations that are necessary.

If everything is correct, put in the magnet and place the cover in position; then glue strips of wood around the inside edge. Have these strips even with the top and extend them down so as to almost, but not quite, touch the cardboard. This allows for a slight give to the cover so that the magnet will not be bound. If desired, you can use the hinges that came with the cigar box to make a hinged flap, as shown in the illustration. This permits the removal of the cardboard cover at any time.

The object of the puzzle is to move the checker from the space under the raised square marked with the diamond to that under the square marked with the heart by merely tilting the box. It will be apparent that the movement of the checker is controlled entirely by the concealed magnet which prevents the checker from sliding along any other path on the checkerboard than the magnet follows in the box. The magnet becomes hooked upon various pegs and the operator, being unable to see these posts or to know what is impeding the progress of the checker, will have great difficulty in bringing it into the desired space.

In tilting the box, one caution should be observed and that is not to jerk it too abruptly so as to cause the checker to leave the magnetic influence. If this does happen, the checker can be anchored again by simply letting it slide over the cover until it comes to rest over the magnet.

Quick-Acting Thumb Latch

An ordinary thumb latch usually fails to work if the door to which it is attached



is quickly shut. This annoyance can easily be eliminated by attaching a safety pin to the door to form a downward-acting spring, as shown in the drawing. By this means the latch will be snapped down into its seat even though the door may be slammed

shut violently.—Dexter W. Allis, Asbury Grove, Mass.

Protecting the Canoe for Ice Travel

Canoes on runners solve the transportation problem of northern Maine guides and settlers during the ice-breaking period

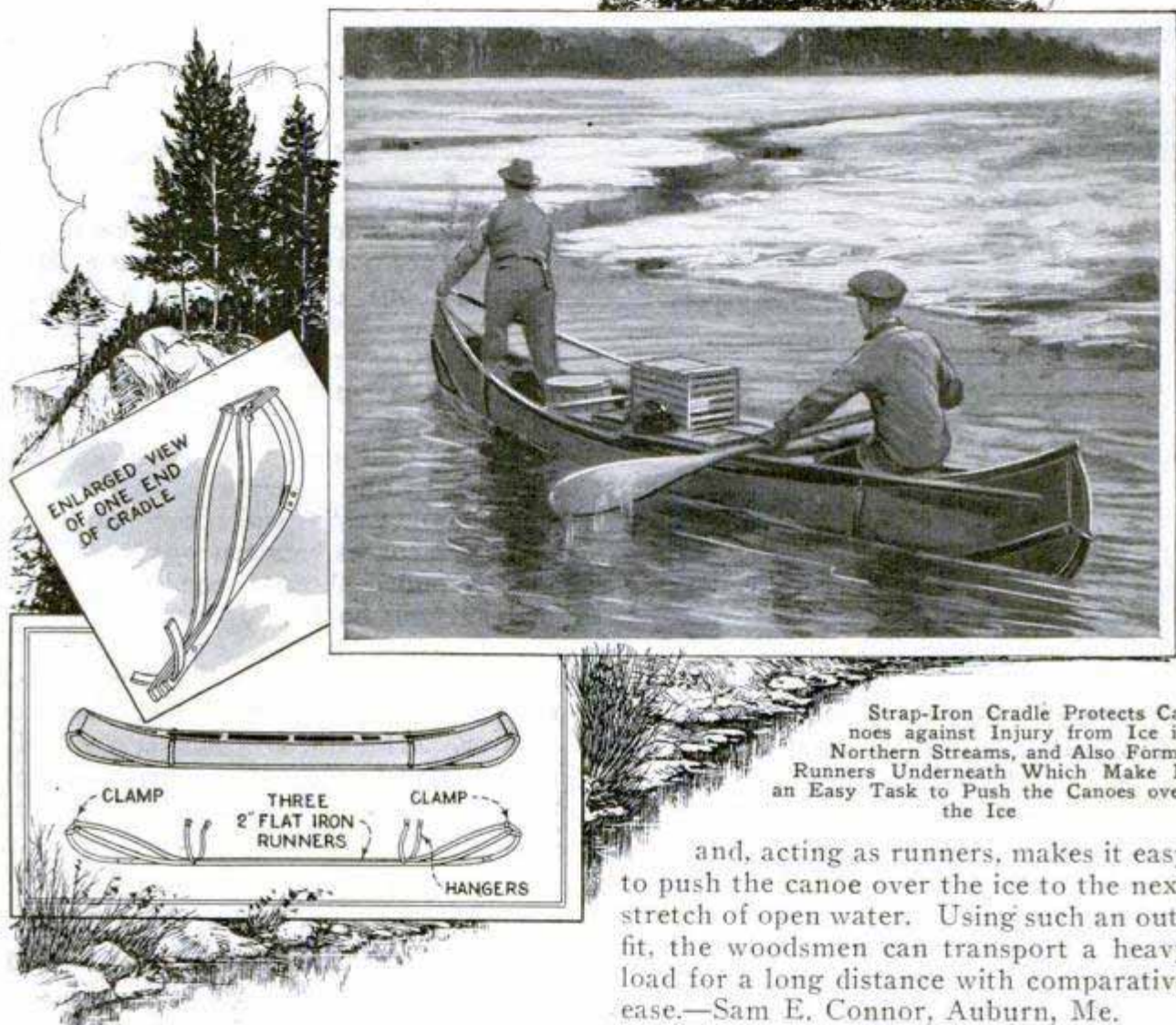

Strap-Iron Cradle Protects Canoes against Injury from Ice in Northern Streams, and Also Forms Runners Underneath Which Make It an Easy Task to Push the Canoes over the Ice

and, acting as runners, makes it easy to push the canoe over the ice to the next stretch of open water. Using such an outfit, the woodsmen can transport a heavy load for a long distance with comparative ease.—Sam E. Connor, Auburn, Me.

of spring. Without such an arrangement, it would be impossible for weeks to cross the large bodies of water at that season, which would seriously interfere with their food supply. The method of fitting a canoe for this service is to make a cradle of 2-in. strap iron into which the canoe fits. The cradle is securely fastened to the boat by means of clamps at both ends and a set of hangers, about 4 ft. from the ends. Three lengths of 2-in. strap iron, extending the entire length of the bottom, constitute the runners. When there are open stretches of water to be crossed, the cradle does not hamper handling the canoe with paddles. Upon reaching ice, the craft is run upon it. The iron cradle protects it from injury by the rough ice,

Removing Ink Stains from Wood Floors

Ink stains can be removed from polished or bare wood surfaces in a few moments. For a polished or varnished surface, mix powdered pumicestone and linseed oil to a light, creamy mass, and rub the spots with a piece of felt or heavy-bodied cloth dipped in the mixture. Always rub with the grain and continue until all the ink disappears. On a bare wood floor apply repeated coatings of liquid oxalic acid with a brush. The liquid is made by dissolving a tablespoonful of oxalic-acid granules in 1 pt. of hot water and is used cold. This acid is poisonous only in large doses, but care is recommended nevertheless.—Francis W. Henry, Pottsville, Pa.

Hammer for Use on Polished Surfaces



It is impossible to hammer on a polished wooden or metal surface without making dents. An ordinary hammer will never do the work unless the head has been padded in a suitable manner. The kink shown in the drawing will be found satisfactory. Purchase a rubber crutch tip and force this over the head. Now you can do the work without any danger of marring the finish.

Improving the Pipe

Smokers will find that a pipe can be improved by drilling a small hole in the bowl, as shown in the accompanying illustration. The hole should be no larger than the diameter of a pin. Besides insuring a nice, cool smoke, this will also help the draw.—E. E. Burgess, Jr., Baltimore, Md.



Temporary Repair for Leaky Vacuum-Tank Float

Occasionally the float in the auto vacuum tank will spring a very small leak and load the float with gasoline. When this occurs far from a service station, it is considered a difficult repair job. One autoist, however, overcame the trouble in a novel way. The tank head was removed and the float and mechanism taken out. The float was placed on a hot stone and the leak located by the jet of vapor forced out. The opening was enlarged slightly so that the gas could be poured out. Then a soft match stick was carefully whittled to fit

the hole and driven in until the hole was well sealed. A drop of water swelled the wood, and there was then no danger of its coming out. After the tank had been re-assembled, the driver reached home without trouble and the repair lasted until a permanent job could be done several days later.—L. B. Robbins, Harwich, Mass.

How Amateurs Can Read Fast Code

Amateurs who cannot receive the code over telegraph sounders can take down fast messages accurately by using a strip of paper, about $\frac{1}{2}$ in. wide, and a strip of carbon paper of the same width over it. The end of the paper is inserted between the bar in the sounder and the frame that it hits against. As the sounder goes up and down the paper is slowly pulled through it, and deciphered afterward. The dots and dashes will show plainly, as well as the spaces between words. If the paper is pulled through too fast or too slowly, it will be hard to read. With a little practice in pulling the paper through, any amateur can take down messages practically as accurately as an experienced operator, although, of course, he will have to take his time in deciphering them, at least to begin with.—Thos. F. Johnson, Curoo, Tex.

Soap Pencil Keeps Paint Off Panes

Numerous articles have been devised for the removal of paint from window panes, but prevention is better than cure, and by using the simple soap pencil shown in the illustration, it is an easy matter to prevent paint drops from sticking to the glass. Cut a bar of laundry soap to a wedge shape and use this to make a wide



mark on the glass along the edge of the sash. With ordinary care, this will keep paint off the glass, and spots on the soaped part will come off when the soap is washed away after the paint is dry.—G. E. Hendrickson, Argyle, Wis.

How to Make a "Radio" Cigaret Box

By H. C. McKAY

THIS cigaret box is one which will be welcomed by the great army of radio fans. In appearance it is a small, one-dial receiver, but when the dial is turned in either direction, a cigaret is delivered at the top of the cabinet. The parts required are given in the material list on page 496.

The slopes and guards are first made. The slopes are set against the back panel, their upper ends $\frac{1}{4}$ in. from the top, and the lower ends 1 in. lower than the upper. A greater slope will allow the cigarets to bind against the sides of the lifts, preventing proper operation. The beveling of the edges of these pieces presents the greatest difficulty in making the box. This is rendered easier by first attaching the slopes to the guards, leaving square edges projecting. When the two are fastened together, the proper bevel may be provid-

ed by plane and sandpaper. These slopes are perfectly plain except for the bevels.

The guards are $3\frac{1}{2}$ in. wide, $3\frac{5}{8}$ in. high and made of $\frac{3}{8}$ -in. plywood. A central slot is cut in each, as shown. This slot is $\frac{3}{8}$ in. wide; it starts $\frac{3}{4}$ in. from the bottom of the piece and is $2\frac{1}{8}$ in. long. In the guard and slope assembly, all joints should be glued. They can be further strengthened by the use of 1-in. brads, set slightly below the surface. The inner slopes, with their guards, are set against the rear panel and secured to it by screws, making sure that these assemblies conform strictly to the outlines inscribed upon the rear panel before assembly.

The lifts are also made of $\frac{3}{8}$ -in. material and cut as shown. The central hole has upper and lower edges rounded, while the sides are square. The two long slots,

This Cigaret Box Should Please the Confirmed Radio Fan, Since It Looks Like a One-Control Receiver; Note the Suggested Headset Ash Receivers



cut near the edges, are for the springs. When the piece is completed, two screw-eyes, with a maximum outside diameter of $\frac{1}{4}$ in., are set in the upper ends of these

from one end and tapped for a 6-32 machine screw. A piece of square brass bar, $\frac{1}{4}$ by $\frac{1}{4}$ by 7 in., is bent in the center to form an angle of 165° . At the exact cen-

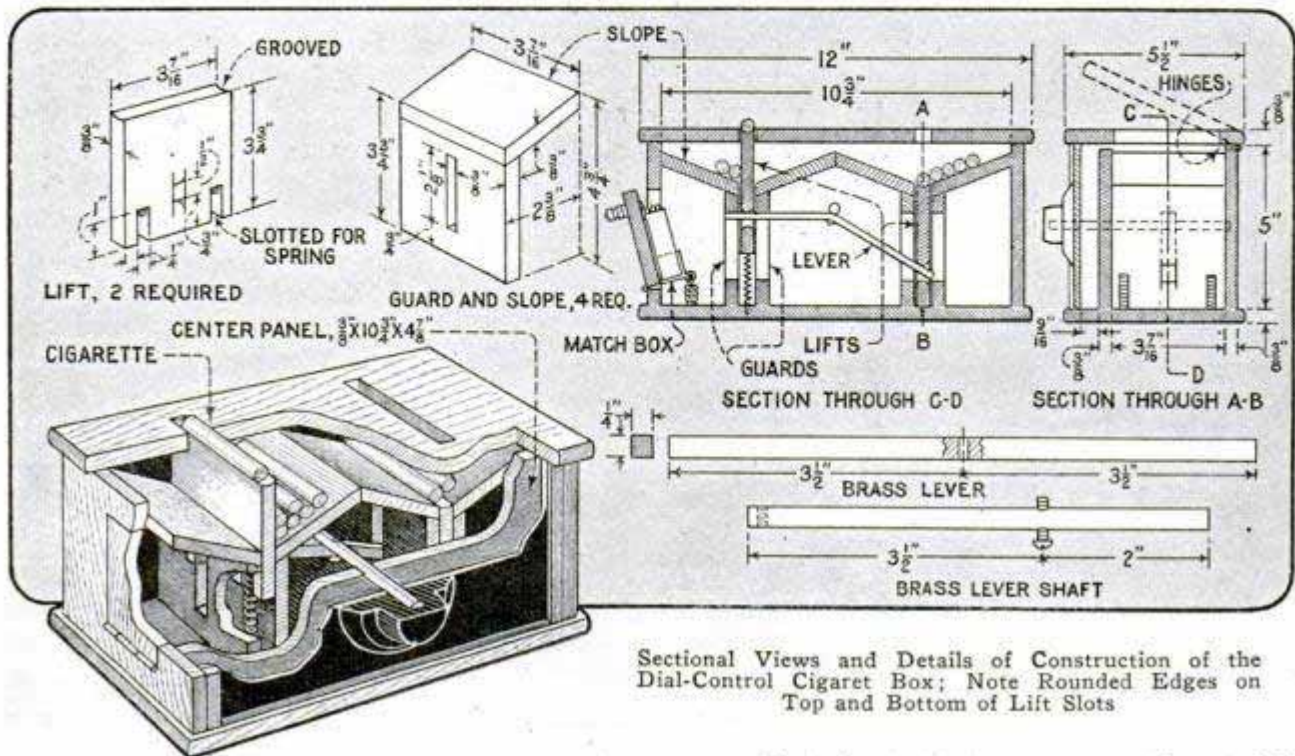

slots. The lift is then set against the guards already placed, and two more screweyes set in the bottom of the box, in positions corresponding to the two in the slots. It will be noticed that the top of the lift is concave.

The springs used in assembly are $\frac{3}{16}$ by $\frac{3}{4}$ in., of very light wire. Two springs are placed in each lift and attached to the screweyes already placed.

When the lifts are in place, the outer slopes with their guards are put in the same way as the inner ones. After this is done, the lift should be free to rise and fall with not more than $\frac{1}{64}$ in. clearance on each side.

The assembly is now laid upon the workbench, back down, and a $\frac{1}{4}$ -in. hole bored $\frac{1}{4}$ in. deep in the exact center of the back panel. A $\frac{1}{4}$ -in. round brass rod is cut $5\frac{1}{2}$ in. long. A hole is drilled 2 in.

ter, a hole is drilled and tapped for a 6-32 machine screw. A $\frac{1}{2}$ -in. 6-32 machine screw is set in this bar. The bar is then inserted through the lift and guards, at one side, and thrust far enough to allow the other end to be inserted in the lift and guards on the opposite side. It is then raised to the round bar, centered and the screw set into the bar. This is somewhat awkward, but a short screwdriver will facilitate the operation. Before proceeding farther, tilt the bar first to one side and then the other, to see if the lift drops to its lowest possible position when the bar is entirely depressed. When in this position, the top of the lift should be barely below the tops of the slope, so that a cigarette will roll into place. Then reverse the motion of the bar and see if the lift is raised from $\frac{1}{4}$ to $\frac{3}{8}$ in. above the level of the top of the back panel. If so, the bar

MATERIAL LIST

- 1 top, 12 by $5\frac{1}{2}$ by $\frac{3}{8}$ in.
- 2 ends, 5 by 5 by $\frac{3}{8}$ in.
- 2 outer slopes, $2\frac{3}{4}$ by $3\frac{1}{2}$ by $\frac{3}{8}$ in.
- 2 lifts, $3\frac{7}{16}$ by $3\frac{3}{4}$ by $\frac{3}{8}$ in.
- 2 inner slopes, $2\frac{3}{4}$ by $3\frac{1}{2}$ by $\frac{3}{8}$ in.
- 1 guard, $3\frac{3}{8}$ by $3\frac{1}{2}$ by $\frac{3}{8}$ in.
- 1 piece of brass, $\frac{1}{4}$ by $\frac{1}{4}$ by 7 in.

- 1 bottom, 12 by $5\frac{1}{2}$ by $\frac{3}{8}$ in.
- 1 back, $10\frac{3}{4}$ by 5 by $\frac{3}{8}$ in.
- 1 center panel, $10\frac{3}{4}$ by $4\frac{7}{8}$ by $\frac{3}{8}$ in.
- 1 front panel, same size as back.
- 1 $\frac{1}{4}$ -in. round brass shaft, $5\frac{1}{2}$ in. long.
- 1 3-in. radio dial.
- 2 3-16-in. coil springs, $\frac{3}{4}$ in. over all.

Screws, stain, black enamel.

is O. K. The central panel has a $\frac{1}{4}$ -in. hole in its exact center. It is set in place and screwed to the guards and slopes. Be very careful that no screw goes so near the edge that the wood is forced out against the lifts which would bind them and prevent proper action. Then the sides are put into place and screwed to the back panel, the bottom, the outer slopes and the center panel.

The top has two slots $\frac{7}{16}$ in. wide and $3\frac{3}{16}$ in. long cut in it, to correspond exactly to the position of the lifts when they are raised. It is best to set the top in place temporarily, raise the lifts, draw a line around them to mark the position of the holes and then cut the slots with these marks as a guide. The top is then fastened to the box with a pair of hinges at the rear. Try the lifts and see if they rise and fall easily.

Stain and finish the box in any desired manner. The front panel has a $\frac{1}{4}$ -in. hole bored in its exact center. It is given a coat of black paint and then a coat of black enamel. This is allowed to dry before the final assembly. When the whole box is thoroughly dry, the front panel is set in place and fastened. The $\frac{1}{4}$ -in. round bar should extend from $\frac{1}{2}$ to $\frac{5}{8}$ in. from the front surface of this panel. A 3-in. radio-condenser dial is set upon this shaft and the box is complete.

Place eight or ten cigarets in each side of the box. When the dial is turned slightly in either direction, one cigaret will be delivered at the top of the cabinet. If desired, a small door can be made in one end as indicated.

Rubber Cup on Shaving Brush

To prevent lather from running down one's arm when using a shaving brush, a rubber washer attached to the brush will be found to be convenient. The washer may be cut from a discarded inner tube and, when stretched over the ferrule of the brush, forms a cone-shaped cup, which catches the lather.



Repair for Split Table Top

Split table tops can easily be repaired by means of metal inserts driven into the edge as shown. The metal insert is a piece of thin sheet iron, bent to an S-shape. It is driven into the edge of the table after pulling the

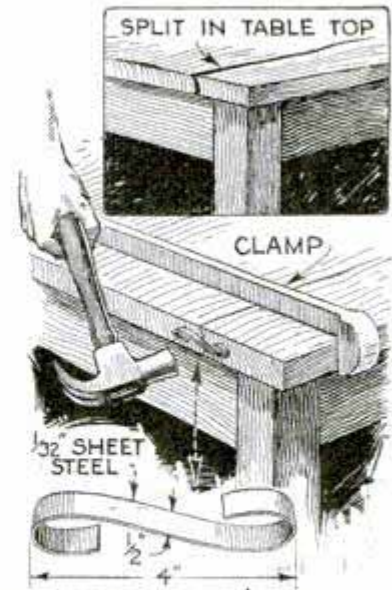

edges of the break together with a large carpenters' clamp. It is, of course, also a good idea to run some glue down into the crack before clamping.

Carrying Spare Valves

Often the motorist puts the small tin box containing extra valves under the seat in the tool box and later, when he needs a valve, finds the box has been crushed by the tools and the valves scattered and damaged. A good place to put valves in is the pump handle. Drill a hole in it,

as shown in the illustration, and provide a cork, that fits the hole snugly.—G. A. Luers, Washington, D. C.



Electric Drill Used for Cleaning Automobile Bodies

Auto bodies finished with ordinary paint often become dull while the paint is still smooth and hard. A coat of varnish can be applied with good results without removing the paint in such cases. A rotary wire brush held in an electric drill makes a fast tool for cleaning and smoothing the surface. A brush of ordinary stiffness will not roughen the paint.

Improved Level for Farm Use

In laying out portions of the farm, sighting for building foundations, laying

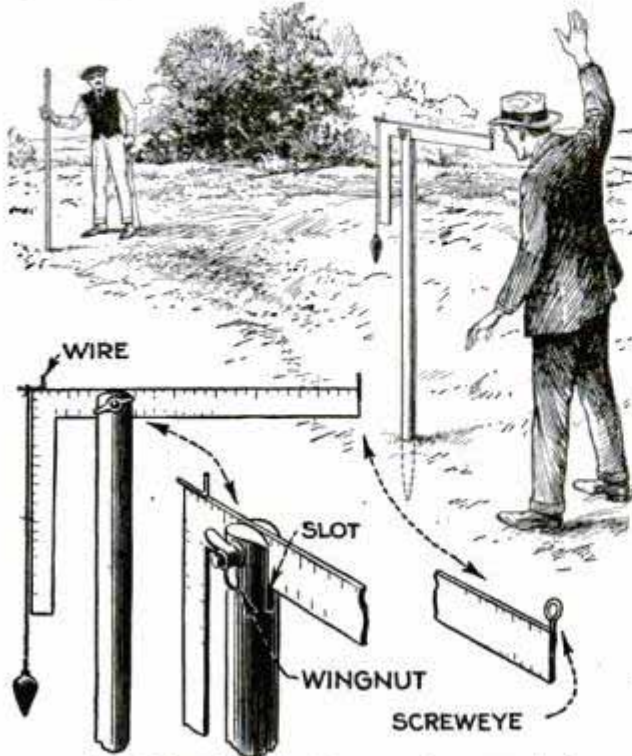

Improved Level Made from a Carpenters' Square Proves Satisfactory for Farm Use

drain tile, etc., a surveying level is useful. An improvised one, which is easily and cheaply made from a carpenters' square, is shown in the illustration. Drill a hole in the long leg of the square, 5 or 6 in. from the corner. Choose a stake, about 6 ft. long, and saw a slot down in the center at the top and bolt the square in it as shown, using a wingnut to make it adjustable and providing some washers to take the wear. A short length of steel wire, bent at right angles, is soldered to the corner of the square so that one leg points vertically about 1 in. and the other extends horizontally the same distance. A small screw-eye is soldered to the front end of the square so that its center will be at the same height as the end of the vertical wire at the corner. Hang a plumb bob from the horizontal wire as indicated and arrange the cord just clear of the vertical edge of the square. To use the level, push the stake vertically into the ground and point the level toward the target, which is held by an assistant. Set the square in such a position by means of the wingnut that the cord holding the plumb bob will hang parallel to the vertical side

of the square, which makes the horizontal side perfectly level. The target is raised so that it can be seen by sighting through the screw-eye in line with the vertical wire, like sighting a gun. A straight line from the horizontal edge of the level to the point sighted on the target will then also be perfectly level.—L. B. Robbins, Harwich, Mass.

Removing Iodine Stains and Grease Spots

Iodine is a stand-by in the home first-aid kit, but care is needed in its use, to avoid spilling it upon fabrics, on which it makes disfiguring stains. One of the simplest and best means of removing such stains from white goods is the following: Soak the cloth in clean limewater, which has been heated to the boiling point, a few minutes' immersion usually being sufficient whether the fabric is new or old, then rinse the cloth carefully in clear water before drying. Grease spots of animal or vegetable origin also may be removed by soaking in limewater, rinsing with clear water and finally washing the fabric with soap.

Simple Method of Conserving Heat

One can hardly realize how much heat is lost by radiation from several feet of furnace smoke pipe. Several years ago I found a method of utilizing this heat. A pipe, about 1 in. larger in diameter than the smoke pipe, was slipped over the latter as shown in the drawing. The lower end was left open to admit air while the upper end was closed by stuffing it with asbestos packing. A small pipe connects the upper end of the sleeve to a hot-air pipe. It is well to make a slip or telescope joint here so that the pipe can be removed for cleaning. The sleeve around the smokepipe should be well covered with asbestos paper.—W. O. Hendrickson, Argyle, Wis.



Preventing Squeaking Brakes

Nearly every autoist has suffered the annoyance of squeaking brakes. In most cases the work of relining the brakes can be traced to the owner's garage, or else to a garage employing inexperienced mechanics. In either case, noisy brakes could have been prevented by attention to one or two details. One is the setting of the copper rivets holding the lining. Projecting rivets scraping on the brake drums is the principal cause of squeaking and the preventive or cure is obviously to hammer down the rivets well below the surface of the lining. Of course, the proper tools must be used to do this without injuring the lining. The best rivets to use are the tubular type. Another cause of noisy brakes is a brake band bent out of true, so that the ends are drawn in against the drum before the main part of the band. Any lining near the end of the brake band is soon worn off and the metal ends scrape on the drums, which makes noise and wears down the drum. Care in relining, adjusting and equalizing the brakes at the time of renewal is well worth the effort in the saving of trouble, money and annoyance, not to mention the possibility of accidents which might result from the failure of the brakes.

Desk Drafting Board

It happens occasionally that the desk has to be used for drafting and the sliding leaf on one side can be adapted to this purpose as follows: Brass clips are screwed to the top of the leaf so that they will grip the paper securely when it is slipped under them. A small T-square can be made from a 12-in. rule, with a crosspiece screwed on, as indicated. This arrangement, of course, presupposes the use of the standard 8 by 10-in. office paper or some similar size.—Deane B. Caldwell, Cedar Rapids, Iowa.

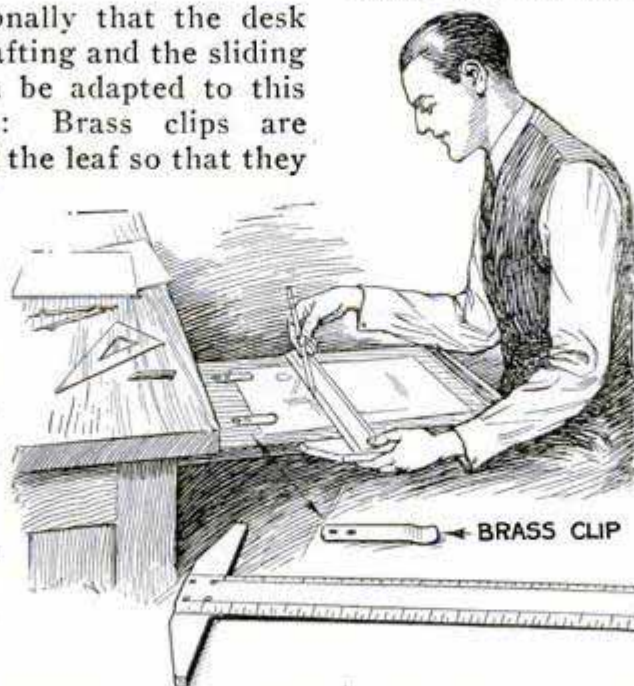

Sliding Leaf of Desk Used as Drawing Board with Brass Springs to Hold Paper

Novel Wren House
Which Children Can
Make as Advocated by
School Superintendent



Small Bungalow for Wrens

Unlike most other birds, wrens like to live by themselves and a small house especially suitable for them is shown in the photo. It consists of a base upon which six cigar boxes are mounted, each having a small hole drilled or cut in one end, as indicated, to provide an entrance for the birds, and a wooden roof over which asphalt shingles are laid to add to its appearance. A miniature fence is made of colored wooden balls, drilled for nails, with which they are attached to the base. The balls are also drilled to receive lengths of light dowel rod for the horizontal members of the fence. The roof is tied to the corner posts with heavy twine and an ornamental flag is fastened to the peak.

☞ To make a storm door from a screened one, tack a strip of roofing paper over the screen.

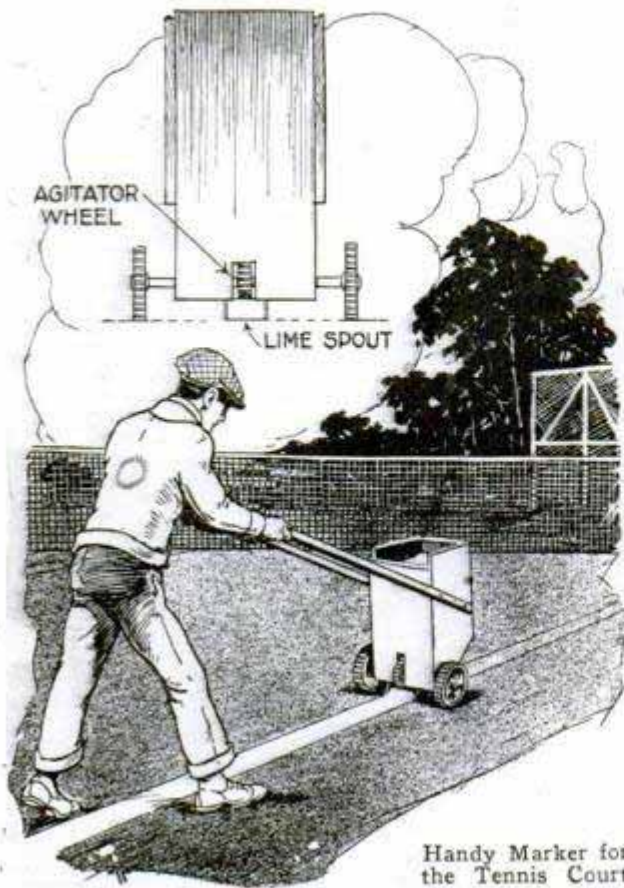

Handy Marker for the Tennis Court

Improved Tennis Marker

An efficient tennis marker can be made from materials that may be found in the junk pile of almost any garage. The one shown in the illustration was made from an oblong box, with a small shaft for an axle, to which were keyed three timer gears, two large ones for wheels and a smaller one to act as an agitator for the marking material. The small wheel rotates in a groove in the bottom of the box and its gear segments feed the lime out of a tin spout the width of the line to be marked. This device overcomes the greatest difficulty of the sifter type of marker in that it can be filled in a short time.—Maurice E. Miller, Addison, N. Y.

Chain Used as Bottle Cleaner

Cleaning bottles seems to be one of the bugbears of housework. An excellent method is to use a small chain. Tie a string to one end of the chain and then drop the chain in and hold onto the string from the outside. Pour a little water or other cleaning liquid in the bottle, close the opening and shake well. The chain will scrape around and remove all the

sediment. This method will thoroughly clean milk and vinegar bottles, kerosene reservoirs on oil stoves and the like.

Stopping Rear-Wheel Grease Leaks

When Ford rear wheels leak grease, it usually indicates that there is an excessive amount of lubricant in the differential housing and this should first be determined before attempts are made to stop the leak. If the grease is thin and gritty it should be removed and, in order to do this, it is necessary to draw it out with a grease gun having a long spout, as there are no provisions for draining the differential. The grease should be kept to the level of the filler plug, but if it still continues to leak at the wheels, new felt washers should be put in. The wheel is removed and the outer axle-shaft roller bearing hooked out with a piece of stiff wire. The washers may be jammed far into the axle housing with a long screwdriver or rod, and the bearings replaced together with the customary outer felts. In replacing these, it is a good plan to lubricate them with cup grease, as this prevents friction, which otherwise might destroy them very quickly. However, new washers will not always stop bad leaks. If so, leather washers cut to fit the axle shaft should be used in addition and sometimes will be found quite effective. In

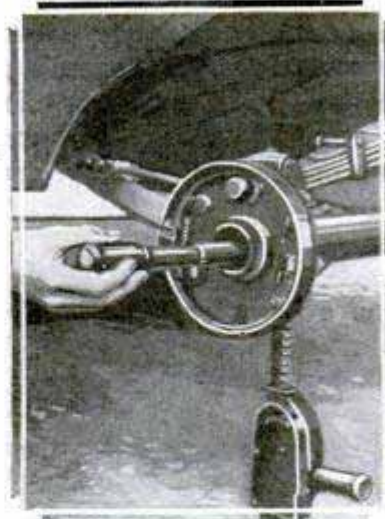

some cases a long piece of heavy wire, twisted around the axle, will stop the leak. It acts like a screw in forcing the grease back into the differential. Probably the most effective method of ending this

annoyance is that of drilling a $\frac{1}{4}$ -in. hole in the bottom of the axle housing, near the innermost end of the outer axle-shaft roller bearing. This admits air into the housing, causing a back pressure, and thus effectively stops the leak.

Flowers Preserved with Celluloid

The curator of the Academy of Science in Lincoln Park, Chicago, recently hit upon a scheme that is worthy of attention of all who are interested in preserving flowers. He discovered that a coat of liquid celluloid, or collodion, over the mounted specimen will give it just the protection desired. The solution is poured into a shallow pan, and the mounted specimen is immersed in this until the celluloid has settled on the plant and card. It is then withdrawn from the bath and hung up to dry. A clip of any sort can be used to attach the card to a string. Put a plate or piece of paper beneath to catch the drippings. The use of the liquid celluloid in many cases has been found to restore faded colors and bring out their original freshness. The coat of celluloid protects the plant from dust and moisture and, in case the card gets soiled, it can be sponged off without harm to the plant. If the collodion gets too thick due to evaporation, add a little ether, which can be purchased at a druggist's.—H. H. Slawson, Chicago.

Handy Clothespin Holder

Paper bags for carrying purchases, provided by exhibitors at fairs and by many storekeepers, can be made into clothespin holders by simply cutting an oval hole in each side, as shown in the illustration. The bags themselves are too deep for this use, but when openings are made as suggested, 4 to 6 in. from the bottom, the hand is easily inserted to pick a pin. The type of bag referred to is that fitted with string handles. By using a hook bent to an S-shape the holder can be suspended from the line and slipped along it with ease.



Paper Bag with an Oval Hole Cut in Each Side Makes a Handy Clothespin Holder

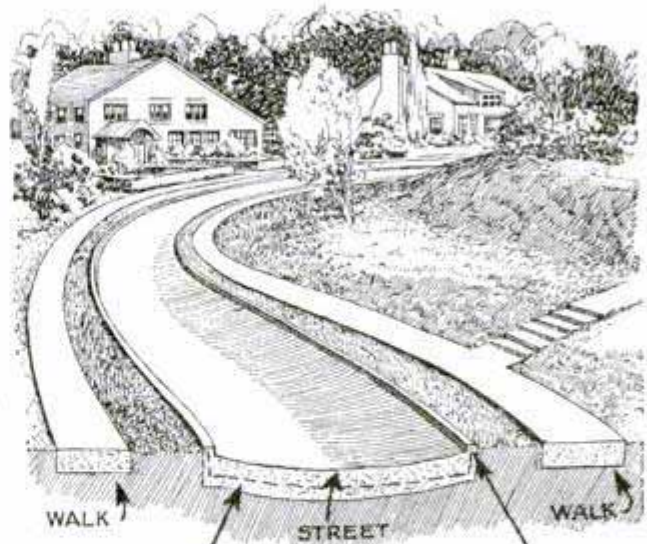

Streets in a Western City, Designed to Carry Off Storm Water, Save Cost of Storm Sewers

Street Design Saves Storm-Sewer Cost

One western city, exposed to heavy rainfalls of comparatively short duration, but where snow is unknown, has found that, in many cases, it can save the cost of storm-sewer installation by building the street pavements with concave surfaces instead of convex, as shown in the illustration. This doubles the area available for carrying flood run-off without requiring the construction of high curbs at the sides. Because of the short duration of the rainfall the streets are never impassable for more than an hour at a time. The pavements are built on grades steep enough to prevent the deposition of sand and silt. Steel reinforcing should be placed in the concrete near the center of the slab and should be bent upward at the edges so as to tie the curbs to the roadway.

One more car noise can be eliminated by cutting a piece from an old inner tube and fastening it behind the lock holding a spare tire.

One more car noise can be eliminated by cutting a piece from an old inner tube and fastening it behind the lock holding a spare tire.

Make a Hammered-Copper Plaque

By E. R. HAAN

IF you are artistically inclined and would like to do some work in hammered copper with figures in bold relief, as illustrated in this article, go to a hardware store and get a few ordinary nail sets, at a cost of 10 cents each, an 8-oz. and 13-oz. ball-peen hammer and some pieces of No. 18 gauge sheet copper, having these pieces cut to the size of the plaques. Be sure that the surface of the copper is not scratched or marred as this will ruin the work.

First get a picture or design from a newspaper or magazine, or, if you can draw satisfactorily, make it your-

do this, as shown in Fig. 1, while a short piece of dowel rod will allow you to get into recesses of the background, as shown in Fig. 2. The piece of copper will be distorted considerably,

but the design will stand up roughly in relief. Lay the plaque, face up, on a double thickness of corrugated cardboard obtained from an old box, and you will be able to improve the rough outline with the dowel punch and hammer, as



Hammered-Copper Work Is an Interesting Hobby and Copper Plaques in Bold Relief Appeal to Those Who Are Artistically Inclined

self. Trace the design on the surface of the copper by using typists' carbon paper. Go over the weak carbon lines with a soft lead pencil to bring them out clearly. Hold the lower jaw of a wood clamp in a bench vise securely, and bring the upper jaw of the clamp down over the design, to protect it while the background is being forced down about $\frac{1}{4}$ in. from the edge of the design. In doing this, the work has to be shifted a number of times in the clamp, and care must be taken to strike only the background at this stage of the job. A wooden punch and a hammer are used to

shown in Fig. 3. The reverse side of the plaque is shown in Fig. 4.

The next step is one of the most important in the whole process—that of annealing the copper. By pounding and stretching the plaque, the copper becomes very hard and brittle, which makes it extremely difficult to work, and if the work is continued while the copper is hard, it may be cracked. To overcome this, the plaque is heated to a cherry red and immersed in water. This makes it so soft again that it can readily be bent and hammered. The heating can be done by holding the plaque

over a gas flame, over a coal fire, or by applying the flame of a blowtorch, as shown in Fig. 7.

Laying the plaque, face down, on a double thickness of corrugated cardboard, shape the design by using wooden punches and a hammer, the faces of the punches being slightly rounded to prevent sharp dents in the design, where these are not wanted. Now use the ball-peen hammer on the background, as shown in Fig. 5. This hammering is done on an anvil or heavy piece of steel and, after the background is hammered, the plaque is again annealed. The nail sets are ground down, as shown in Fig. 6, and the ends are polished to remove the grinding scratches; if this is not done they will show up on the copper. Take punch No. 5 and, starting about $\frac{1}{8}$ in. from the design, punch the background down, until you have come to the very edge of the design, as shown in Fig. 8. Here it is necessary to be careful, as the design can easily be spoiled by a few misdirected

a straight line, about $\frac{1}{4}$ in. long. Give the finishing touches to the shape of the design from the reverse side of the plaque on corrugated cardboard as before.

Get 15 cents' worth of liver of sulphur from the drug store and crush the pieces to powder form, dilute them in water, and apply this solution to the background with a brush, as shown in Fig. 9. The copper will turn black where the solution touches it, so be careful not to get it on the design. Get some fine jewelers' polishing cloth and proceed to polish the figure. If available, use a buffing wheel for a finishing polish, and also buff the black coloring from the high spots of the background. Then apply transparent lacquer.



This Work Can Be Done at Home with a Ball-Peen Hammer, Woodworkers' Clamp, Vise and a Number of Nail Punches Ground to Suit the Work

blows. Anneal again and proceed to straighten out the plaque by bending it by hand and also by striking it on the background. A $\frac{1}{4}$ -in. border can be made along the edge of the plaque with punch No. 12, which produces

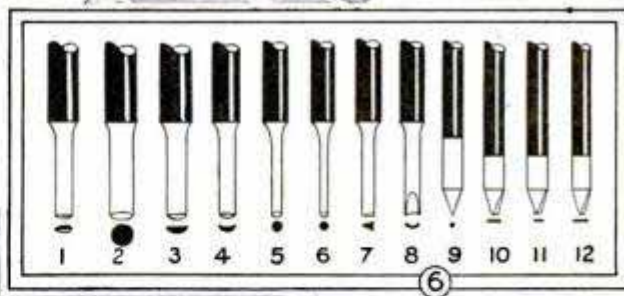
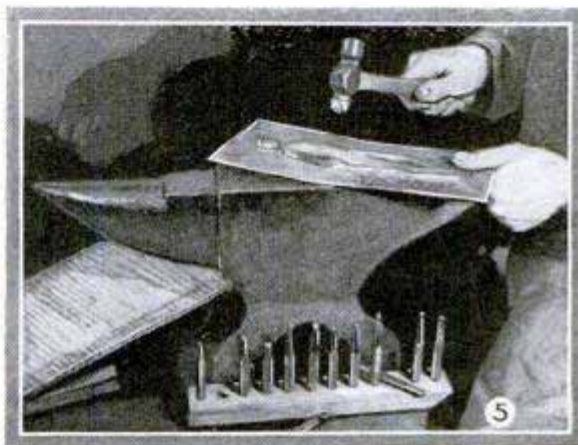

Clamp to Hold
Inner Tubes
Makes Quick
Repair on the
Road Possible



Handy Inner-Tube Clamp

When repairing inner tubes on the road, a clamp of the kind shown in the drawing will be found convenient. It consists of a base of 1-in. wood and a length of $\frac{3}{4}$ -in. strap iron, bent to a U-shape to fit snugly around three sides of the wooden base. The ends of the iron clamp are drilled and it is then attached to pivot on one end of the base, as indicated. In use, the tube is placed on the base, with the place to be patched in the center, and the clamp is then brought down to hold the tube securely while it is patched.—Vincent J. McMurtry, Chicago.

An Underwater Flashlight

When something is dropped into a dark cistern or a shallow well, or when for any other reason it becomes necessary to make a search in dark water, place a pocket flashlight in a fruit jar and screw down the cover, with a new rubber ring in place, to make sure that it is watertight. The lens of the light should point toward the bottom of the jar and the jar must be weighted so that it will sink. Bind waxed cord securely around the neck of the jar to hold it. The wax will prevent the cord from slipping. An interesting use of the

underwater flashlight can be made at night from a boat, if the water is smooth or if a "water telescope" is available. If the water is fairly clear, fish below the jar can be seen or the bottom can be examined if the water is not too deep. A water telescope is simply an open tube without a top and with a piece of glass fastened in the bottom. Its purpose is to provide an undisturbed surface without reflections through which to gaze. The user thrusts the closed end into the water. Looking through it, he can see objects at great distances under the surface. Fishermen in the West Indies use the water telescope, and the glass-bottomed boats of the Bermudas and Santa Catalina are built on the same principle.—Edwin Tarrisse, Washington, D. C.

How to Break In a Pipe

To break in a new pipe, remove the stem and make a plug of soft wood to replace it. Then fill the bowl with hot—not boiling—water. Let it stand for one or two minutes and repeat the operation half a dozen times. The last time leave the water in the bowl overnight. Wipe it dry the next morning, replace the stem, and the pipe is ready to give you an enjoyable smoke.—H. Z. Sanders, Tulsa, Okla.

Keeping Crease in Coat Sleeves

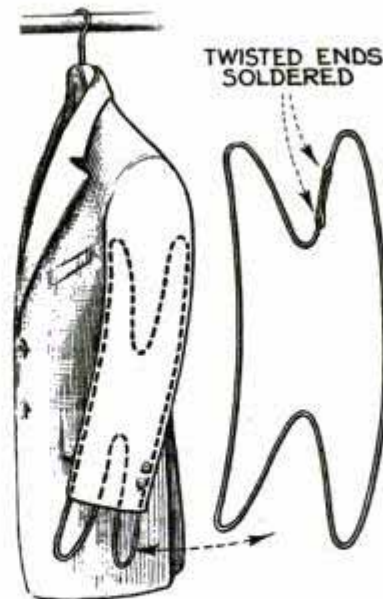

When coats or dresses are suspended from hangers for any length of time, the body of the garment may preserve its shape, but the sleeves soon become wrinkled and lose their creases. To insure the neat appearance of the entire garment,

it is only necessary to insert one of the spring devices shown into each sleeve. These springs are made from heavy wire.

bent to fit inside the sleeves so as to stretch them a trifle, as indicated, the ends being twisted and soldered together at a point where the joint will not touch the fabric.—G. E. Hendrickson, Argyle, Wis.

Safety-Razor Blade Kink

New safety-razor blades sometimes have a tendency to "pull." Many blades are discarded for this reason that would otherwise be made to give good service. The blades are sometimes honed slightly more on one side, which causes a deflection of the edge, curling it somewhat the opposite way. By turning the blade over the objection will be overcome, and this may be done several times before renewing the blade.—Charles E. Forgette, Plattsburg, N. Y.

Forcing Draft through Chimney

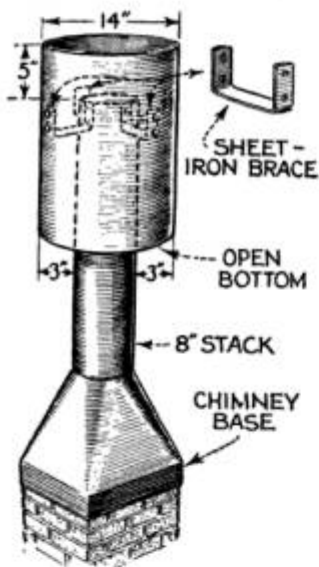

Chimney draft can be forced by the addition of a cylinder on the end of the chimney. There should be an open space of 3 or 4 in. between the chimney and the cylinder. Iron strips bent to the shape shown in the detail are riveted on and hold the cylinder in position securely. The cylinder should project about 5 in. above the chimney. This arrangement will work equally well no matter from which direction the wind blows.

Emergency Stain Remover

When working about the car in good clothes, to make some minor adjustment on the engine, you may get a grease spot on your sleeve. The soap compounds used by mechanics for washing grease off their hands, and which are usually kept around the garage, can be used to remove the stains. It is applied by means of a moist cloth and then washed off.

Leather Stop Holds Bed in Place

Pull-out beds of the kind shown in the drawing sometimes have the tendency to slide a few inches out of place, owing to slight irregularities in the floor surface. Various kinds of hooks and latches could be used to hold the bed in place, but these would be too



conspicuous, so the problem was solved by placing a small leather stop in front of each caster. The stops were made from pieces of old sole leather obtained from a neighborhood cobbler. They were beveled at the ends and screwed down to the floor in front of the casters, as indicated. It is not difficult to pull and push the bed over these obstructions and they will prevent the bed from sliding out.

Simple Repair for Sink Trap

After pulling out the clean-out plug from the trap on the laundry tub accidentally, I made a neat and satisfactory repair as shown in the drawing. A sheet-lead patch was bent to conform to the curvature of the

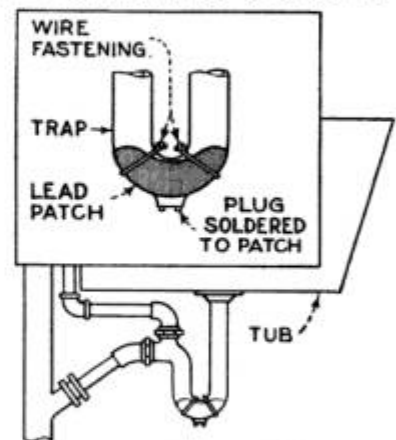

trap and a hole cut in the center into which the plug with its thimble was soldered. The patch was then lined with soft putty and pressed against the

trap where it was securely held by two heavy wires twisted around the pipe. This emergency repair served its purpose well.—Frank Small, Toronto, Can.

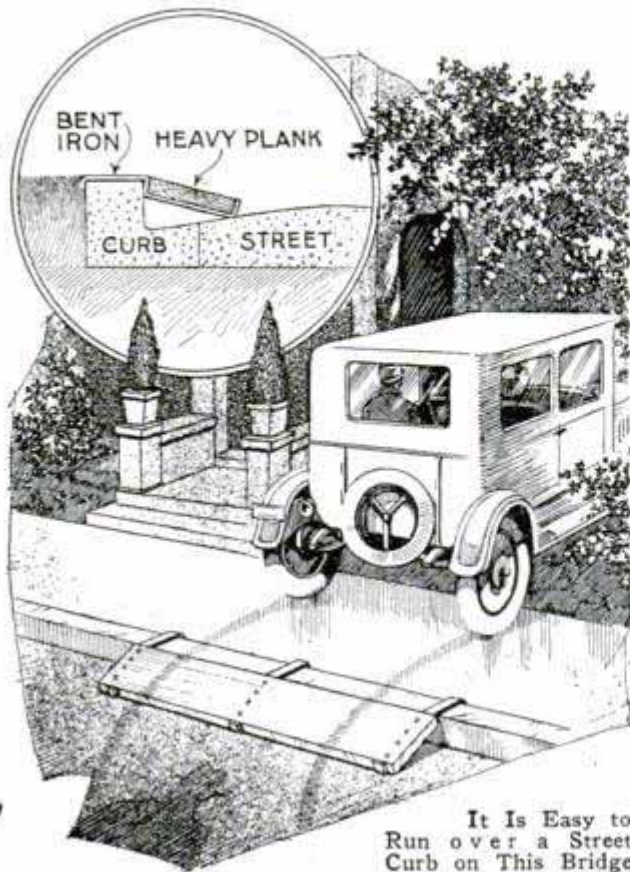

It Is Easy to Run over a Street Curb on This Bridge

Curb Bridge for the Driveway

This curb bridge is equally good for temporary or permanent use as an approach to a private driveway. Three supports, made of $\frac{3}{8}$ -in. flat iron, are bent to form hooks, as indicated in the cross-section view. They are placed at the ends and center of a 2-in. plank of suitable length. Bolts are used to fasten the hooks to the plank and the bridge is hooked over the curb as shown.—Lester P. Young, Culver, Ind.

Repair for Leaky Water Pipe

One morning upon waking we found the bathroom floor flooded with water and soon discovered that this was due to a leaky pipe. An emergency repair had to be made at once, so I got a small screw and a rubber washer, placed these in the leak, as shown, and ran a length of soft wire around the pipe, and through the groove in the screwhead, twisting the ends together with a pair of pliers. This drew the screwhead and washer up against the leak



firmly and stopped it effectively until a more permanent repair could be made.—C. M. Wilcox, Torrington, Conn.

Matching New Wood with Old

When a new piece of wood is to be set into old wood, which often happens in repair work, it is a simple matter to match the two in color. If the new piece is too dark, bleach it by applying a solution (used when cold) of one large tablespoonful of oxalic-acid granules in 1 pt. of hot water with a brush, until it is the same as the old. If it is lighter, give it one or more coats of liquid ammonia, until it matches. Then stain, fill and varnish the surface in the usual way.—Francis W. Henry, Pottsville, Pa.

Buttons and Hairpin Mend Broken Glass Panes

When a window pane is broken so that it needs a support in the center to keep the pieces from dropping out, the method shown in the illustration will be found serviceable. Two buttons and a hairpin are used. The hairpin is slipped through two holes of the first button, through the crack or hole, and then through the second button on the other side of the glass. Then the two ends of the hairpin are grasped with a pair of pliers and drawn up and twisted until tight. The raised rims on the front of the buttons should bear against the glass.—Dr. Halliburton, Moberly, Mo.

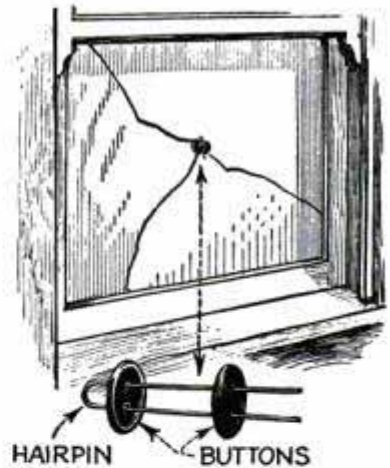

Tips for Sewing-Machine Users

If the top thread used in a sewing machine is wiry and hard, the loop through which the shuttle passes will not form correctly and this will result in skipped or missed stitches. This fault can be corrected by applying whale or sperm oil to

the thread. Moisten a small piece of sponge and attach it to the machine so that the thread will absorb oil as it rubs over the sponge.

Here are three ways to remove the needle when it is stuck or held fast in the needle bar: One is to remove all the threads and run the machine at high speed; the second, to take out the needle screw, put a needle with the point broken off in the screw hole and pry or force the tight needle out of the bar, and the third is to tap or hit the needle bar gently with a piece of wood.

To prevent the shuttle or bobbin thread from spilling or coming out of position, use a soft-finish thread underneath, especially on high-speed work or when long rows are to be sewed. If new needles are tight in the bar and have to be forced up, the needle hole can be made larger by grinding a needle flat at the top of the shank, leaving a fine burr. Move the needle up and down in the hole and the burr will scrape sufficient metal away to enable new needles to be inserted very easily. The take-up spring tension should never exceed that of the top-thread tension when a correct lockstitch is desired.—J. D. Calvert, London, Can.

Plate Safeguards Elevator Door

After an elevator operator had his fingers caught and injured in the sliding collapsible gate, a safety guard was fastened under the handle as shown in the illustration. It consists of a piece of $\frac{1}{16}$ -in. sheet metal attached to the edge of the door securely by the same screws that hold the handle on. This will not interfere with the operation of the door in any way. The edges are carefully filed down to make a neat job and avoid injury from them.—Frank Harazim, New York City.



Ordinary Farm Pump Converted into a Sanitary Drinking Fountain

Sanitary Drinking Fountain on the Pump

It is an easy matter to install a sanitary drinking fountain on an ordinary pump. Drill and tap a $\frac{1}{2}$ -in. hole in the top of the spout and get a 2-ft. length of $\frac{1}{2}$ -in. copper tubing. Clean the tubing thoroughly and then thread one end so that it can be screwed into the tapped hole. Bend the tubing carefully so that it passes back to the pump, where it is wired on securely. Then the other end is bent up vertically, as indicated. A wooden plug is made to fit the spout snugly and is tied to the pump with a length of chain or rope. In use, the spout is plugged, causing the water to rise in the tubing when one pumps. The pressure on the handle determines the height of the stream.—L. B. Robbins, Harwich, Massachusetts.

A Substitute Tie Clasp

An ordinary paper clip will serve as an efficient tie clasp, as shown in the photo. If you have facilities for providing a plating bath, the clip may be gold or silverplated, thereby improving its appearance considerably.—K. B. Murray, Sturgis, Mich.



Tumbling Clown Agitated
by Air Current Caught in
Funnel Forms Novel
Weather Vane

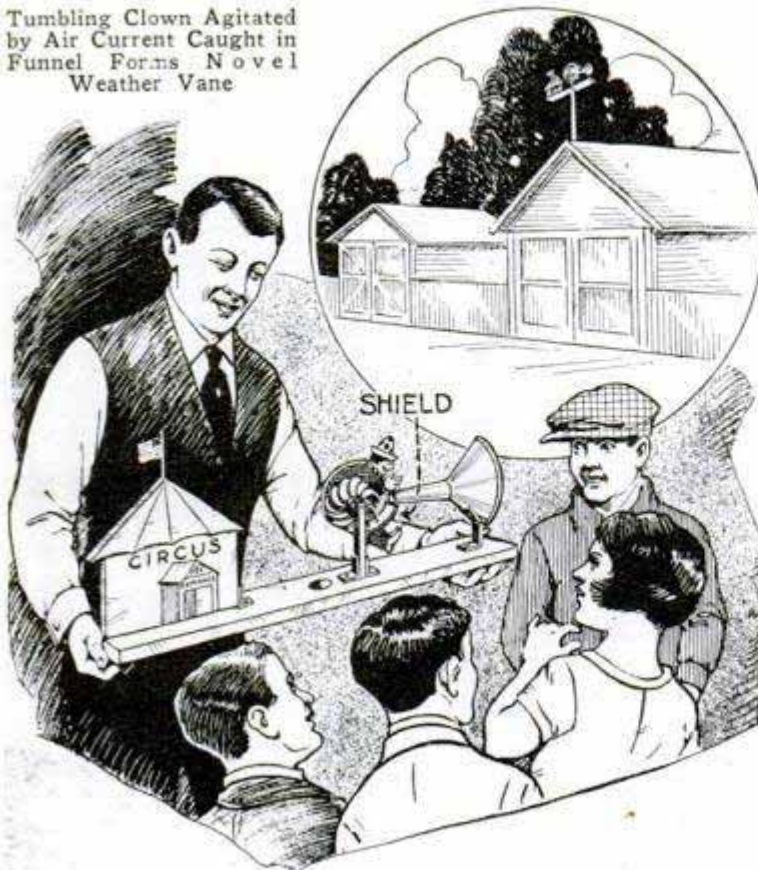

Wind-Driven Tumbling Clown

Quite a novel departure in weather vanes is shown in the drawing. The device consists of a length of 1 by 4-in. wood for a base, a piece of sheet metal cut and painted to represent a circus tent, a small turbine wheel with a figure of a clown attached, and a funnel. A hole is drilled in the center of the base so that it can swing readily on a vertical shaft attached to the top of a post or building. A flange is provided on the shaft to support the vane. The sheet-metal circus tent is attached to one end of the base and the clown and funnel at the other end so that the base will be perfectly balanced when set on the shaft. The turbine is made by tacking a number of tin blades to an ordinary wooden spool and the figure of the clown, which is also cut from sheet metal, is soldered to the edge of these blades. The tur-

bine is mounted on a short wooden post which is high enough to allow the clown to rotate without touching the base. A strip of tin is attached to the turbine post and is bent to form a windshield on the lower part of the turbine to prevent it from turning in the wrong direction. The funnel is attached in a similar way so that it directs the air on the blades of the turbine just above the windshield and causes the clown to turn back somersaults rapidly.—Lester P. Young, Culver, Ind.

Removing "Frozen" Clincher Tire

It frequently happens that the bead of a clincher tire becomes firmly stuck in the rim due to rust. Place the deflated tire and rim or wheel under the middle of the front axle, mount the jack on the tire, close to the bead, and jack the car up. If necessary, do this at 6-in. intervals around the tire on each side. Before using the rim again apply soapstone powder liberally to prevent future trouble.—J. W. McFarlane, Toronto, Can.

Hot-Water Coil in Range

The faucet shown in the photo is connected to the hot-water coil in the range so that warm water is available immediately after the fire has been started. This feature is of special value when the hot-water tank is upstairs and the water must run through a long pipe to reach the kitchen sink. Another advantage is that large containers, such as wash boilers and tea kettles, can easily be filled since it is only necessary to slide the empty boiler under the faucet. By this means the customary practice of carrying many pails of water from the kitchen sink to the stove is eliminated.

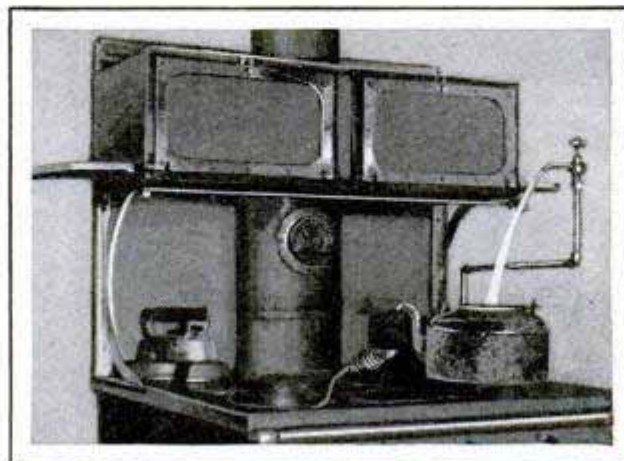

Connecting a Water Faucet to Water Coil in Stove Gives Hot Water at Once

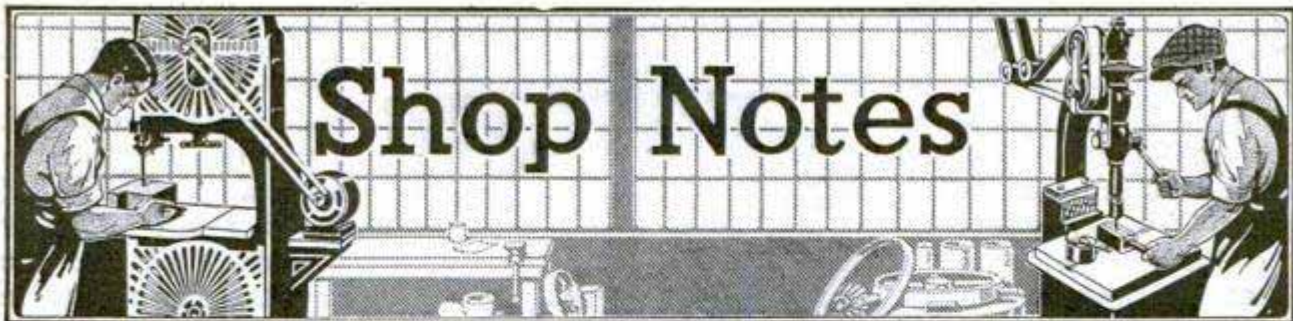

All Shop Notes published in 1926, in book form—Fifty Cents—from our Book Department

A Universal Engine-Overhaul Stand

By RAY F. KUNS

A STAND which is practically universal in movement can readily be made up from a few pieces of pipe, some plates and a little round stock. It is designed to handle the Ford engine when it is removed for overhaul. It will cut the time for this operation very materially, as well as add to the satisfaction of working by providing a convenient piece of equipment.

The device is designed to grip the engine on the left-hand side. The plate J is made up to fit the cylinder block and crankcase casting. Two capscrews, marked X, are used to bolt the plate to the water-manifold boss on the cylinder block. Two lugs, F, are welded to the lower edge of the formed plate so that they will correspond to two

of the crankcase-to-cylinder-block bolt holes, which are removed before placing the plate in position for mounting the engine on the stand. When constructing the stand, this plate should be worked

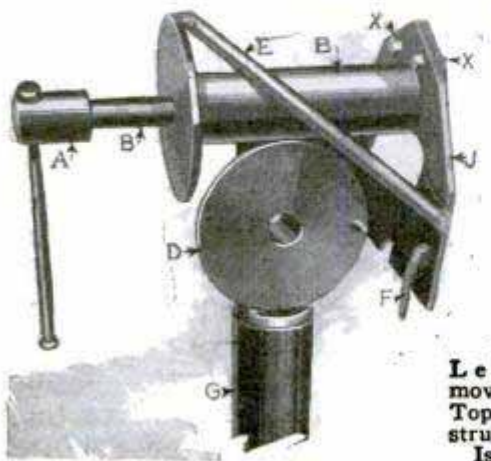
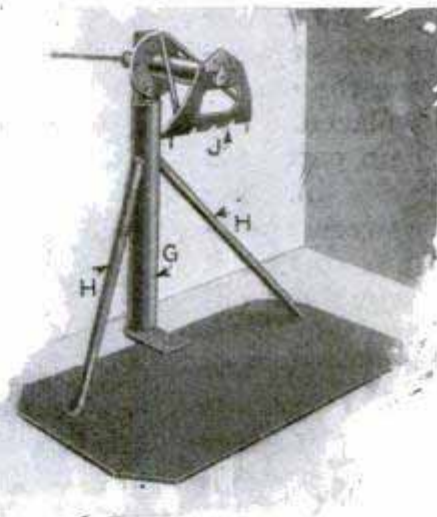
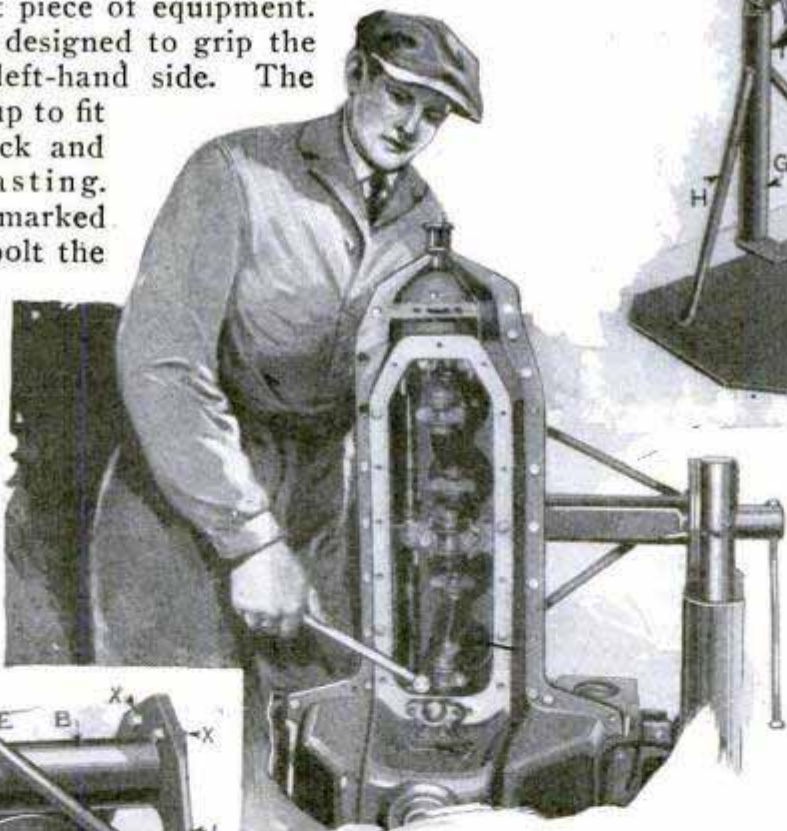

Left, Arm Removed and Set on Top to Show Construction; Plate C Is at the Left

out first and fitted to a Ford block. The heavy spindle, B, is shouldered down to fit into a 1-in. hole drilled through plate J. Counter-sunk-head

screws are then run through the plate into the shoulder of the spindle, to anchor the parts together. The end of the spindle, passing through the plate, may be riveted over to add to the strength.

The inner end of B also is turned down to 1 in. and has threads chased on it. The length of this shoulder is 4 in., which al-

lows it to go through the post or column and the handle with its draw nut to have ample purchase for tightening when the engine is in place. The plate C is screwed to the inner shoulder of B, as was the plate J on the outer shoulder. Two $\frac{3}{4}$ -in. round-steel braces, E, are run from plate to plate as shown, to form braces and take the strain of the engine weight. They serve this purpose no matter in what position the engine is placed. The main part of B is $9\frac{1}{4}$ in. long between shoulders, so that it throws the engine out 10 in.—far enough to clear the post and braces with the starter in place.

The flange or plate, D, is the same size as its mate C (about $\frac{3}{8}$ in. thick by 8 in. in diameter). A number of $\frac{1}{2}$ -in. holes are drilled around the flange C and one, at the same radius, in the flange D. When the head is assembled on the column, the two flanges come together and are clamped tight by the screw threads of the draw nut when turned by the handle. A pin through the holes in the flanges holds the head rigid.

The column G is made from a piece of 3-in. pipe, but an old axle housing would do just as well. The center of the head should be $32\frac{1}{2}$ in. from the floor, and

proper allowance should be made for this. A piece of round steel is machined to a drive fit in the upper end of the column. One side of this is then milled or shaped to receive the plate D. The other side has a spot milled flat to receive the draw nut. This piece is then secured in the top of the column by means of rivets or dowels.

This stand was made with a plate for a base, in order to allow it to be moved to any point of the shop. The base is $\frac{5}{16}$ by 24 by 48 in. The braces, H, are welded to the base plate and to the column. It will also be noted that the column has a base support

made from a piece of flat stock which is used to attach the post to the base and at the same time set it back. The weight of the engine should come over the center of the base.

If it is desired to do away with the large iron plate for the base and have the device screwed to the floor in a permanent position, the old axle hous-

ing would be ideal. Half of a discarded Ford housing might be found and the differential-housing end bolted right to the floor. It might be necessary to run braces similar to H from the column, but they could be carried to the rear where they would be less in the way than those shown.

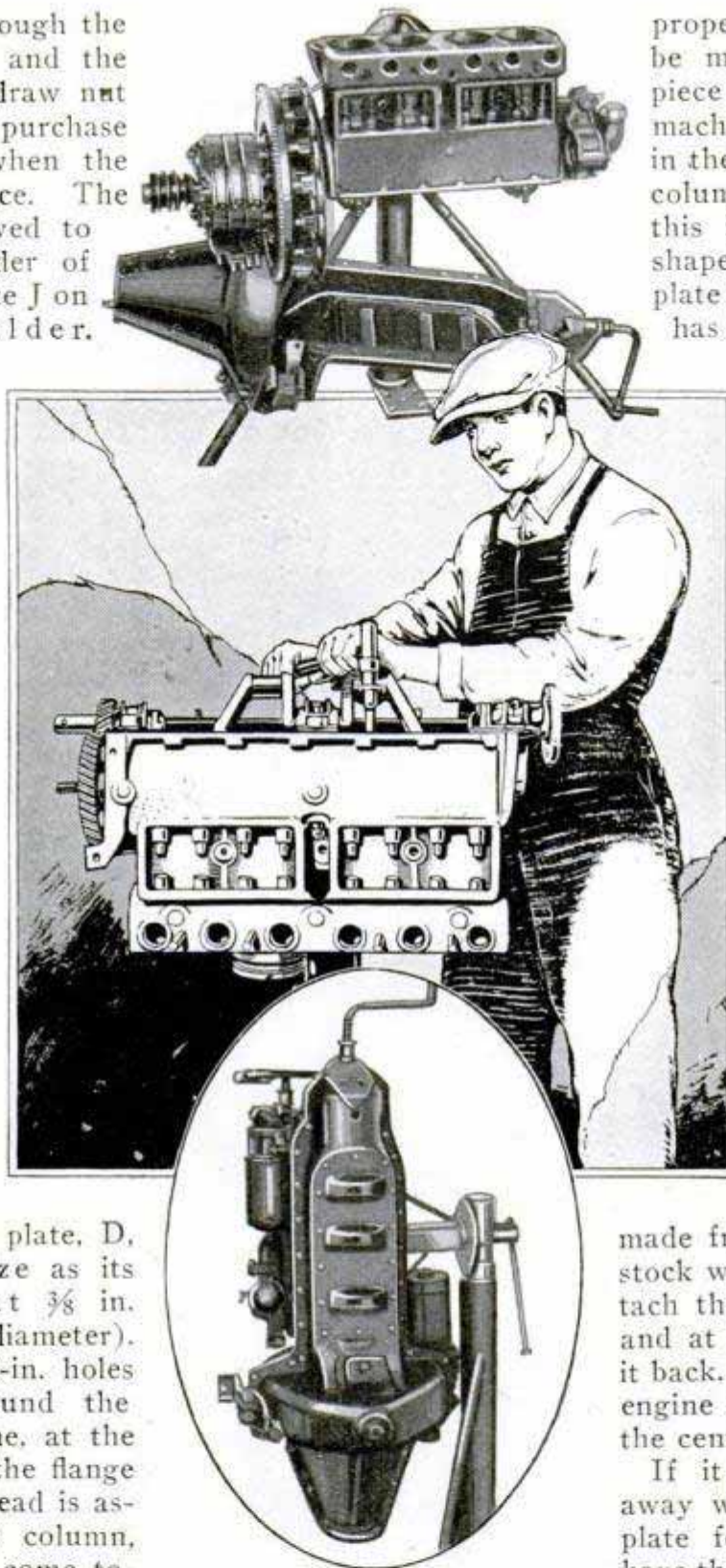

Two Views of the Stand in Use, Showing How the Engine May Be Swung

In the stand shown, the base was made from the plate in order that no difficulty be experienced in running the floor crane, with an engine swinging in it, right up to the head for mounting. Thus the objection of a heavy base support is overcome.

As suggested above, the Ford engine may be swung to any position in this stand without removing any of the accessories, and can be disassembled to the last bolt leaving only the block. Bearings may be taken up or refitted and the engine then built up again, and, after the work is done, it is lifted, complete, from the stand and dropped into the car frame.

Good Pipe Joints from Lead Wool

Everyone does not possess a lead furnace for making pipe joints, but even without this, a good job can be done. Lead wool, which looks like fine excelsior, can be had at plumbing-supply houses and can be rolled into a most convenient strand for ordinary calking purposes. This material has been found to be very efficient in stopping leaks under cellar floors, where the house-service piping comes through the concrete, and the calking can be done with a hammer and ordinary tools. In using this material, no heating or melting of the lead is necessary.—L. H. Georger, Buffalo, N. Y.

Feed Rack on Wagon Saves Time

The feed rack shown in the photo is mounted on a wagon and is readily detachable. It is filled directly from the stack or mow and is driven to the yard, where the cattle can feed from it. At the base, on either side, is a feed box for grain, which serves also to catch loose hay. It was found that the stock can get at the hay on this rack much more easily than from a stationary rack built on the ground.—George B. Harrison, Council Bluffs, Iowa.



Movable Feed Rack Which Saves Time and Has Been Found Convenient on the Farm



Semicircular Shield Keeps Heat around Frozen Pipe and Hastens Thawing

Thawing Out Frozen Water Pipes

When a blowtorch is used to thaw out frozen water pipes much of the heat is wasted, as only a small portion of the flame strikes the pipe. By using a shield of the kind shown in the drawing, which tends to confine all the heat of the flame around the pipe, the work can be done much more quickly. The shield is made from a piece of galvanized sheet iron bent to a semicircular shape and provided with a wooden handle, which enables the user to hold it in any position. The wooden handle is attached by means of small angle brackets as securely as possible, to prevent it from coming loose when the shield gets hot. A better way would be to fasten a 6-in. length of $\frac{1}{2}$ or $\frac{3}{4}$ -in. pipe to the shield in the same manner and then insert a wooden handle into the opening of the pipe at the other end.—Jesse L. Blickenstaff, North Manchester, Ind.

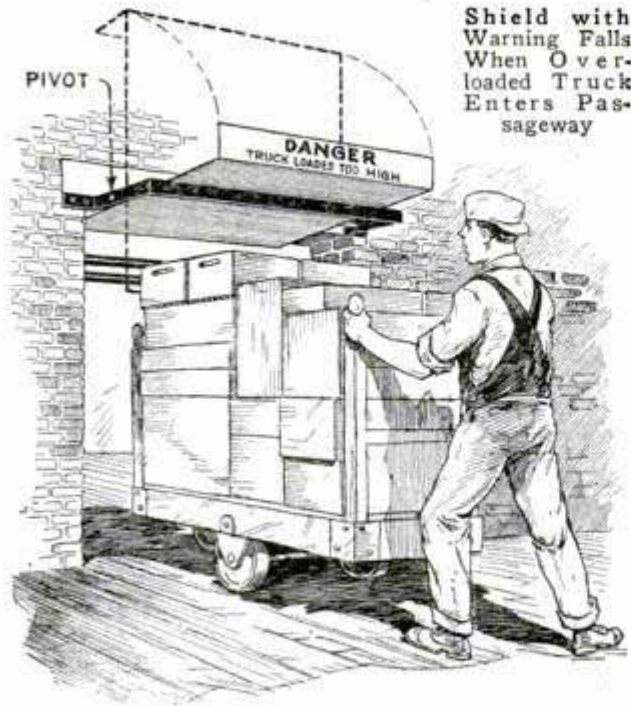

Drop Signal for Overloaded Trucks

While passages in factories or warehouses, leading from one department to another for transferring materials on hand trucks, usually are sufficiently high to clear an ordinary load, occasionally someone overloads a truck and jams it in the opening, causing the topmost portion of the load to be pushed off. To avoid such occurrences, one factory uses an effective signal, which warns a truckman at once if his load is too high to clear the steam pipes running across the top of the passage. It consists of a strap-iron bracket bolted above the doorway and a sheet of metal pivoted in the bracket by two pins so that, when raised against the wall, its lower edge is level with, or a little below the lowermost steam pipe. The top is bent at right angles and the warning is painted on this part. If a truck is loaded too high, the load

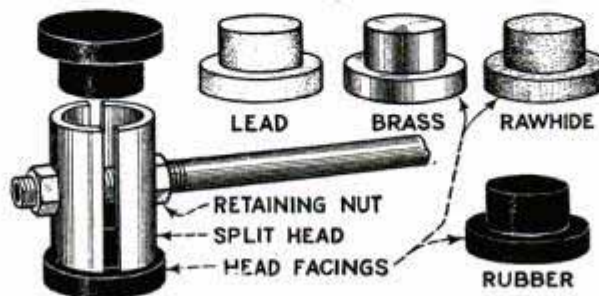
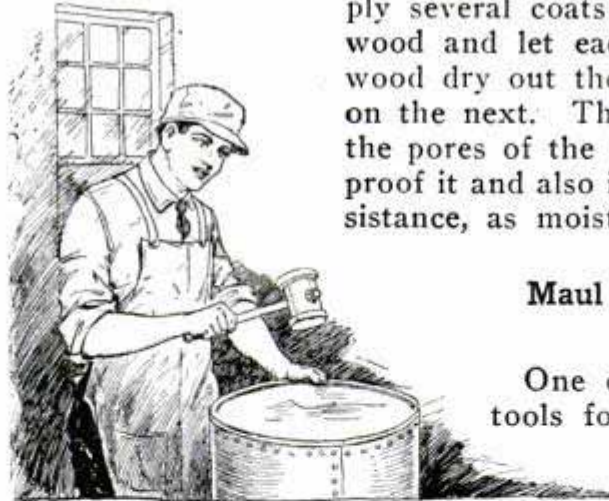

Shop Maul Fitted with Interchangeable Head Facings for Different Uses

catches the metal sheet, causing it to fall with a loud crash on the bracket and at the same time exposes the danger sign.

Drying Printed Matter Quickly

Merchants in all branches employ mimeographing machines for advertising purposes. These machines print through a typed stencil and the ink feed may be regulated so that the printing is light or heavy. In most instances, however, the operator, desiring clearness of print, forces the feed so that the printed sheets falling into the receiving tray become more or less smudged from contact with one another. To prevent this, a Wisconsin merchant has a slow-speed electric fan directing a draft of air against the pile of printed sheets as they drop into the basket. This causes a cushion of air to be retained between the sheets, which prevents smudging. The printed matter is then ready for folding almost immediately.

To Make Wood Fireproof

Fairly open-grained wood that is to be used in heated locations and in electrical machines can be fireproofed in the following way: Dissolve waterglass in warm water and allow the solution to cool. Apply several coats of the solution to the wood and let each one harden and the wood dry out thoroughly before putting on the next. The waterglass penetrates the pores of the wood and this will fireproof it and also increase its electrical resistance, as moisture cannot enter.

Maul with Interchangeable Head Facings

One of the most serviceable tools for mechanics is a maul having interchangeable head facings. It consists of a tubular head, split lengthwise, and a small pipe handle held by two nuts, as shown. The facings are made of brass, lead, rawhide and rubber and held by tightening the nuts.

Reversing Auto Quickly

How to shift gears into reverse when the car is moving forward is a kink worth knowing in preparation for an emergency, when it is not only necessary to stop but also to move backward immediately. This was the means of preventing accidents on several occasions on a mountain road near Denver, Colo. To shift into reverse when the car is moving forward is to invite disaster to the gears, but the same effect as stopping the car can be obtained by jamming the brakes tight enough to lock the wheels before shifting. Then, unless the clutch is still spinning, a quiet shift is possible and the car can be reversed, when it stops so quickly that an otherwise unavoidable collision is averted. A driver making daily mountain trips with a tourist car on narrow roads mastered this trick in preparation for meeting a fast downward bound car, which is sometimes unable to stop in a short distance.

Crimping Electric Wire Terminals

When crimping the shell-type wire terminals around electric cables, the method shown in the illustration has been found

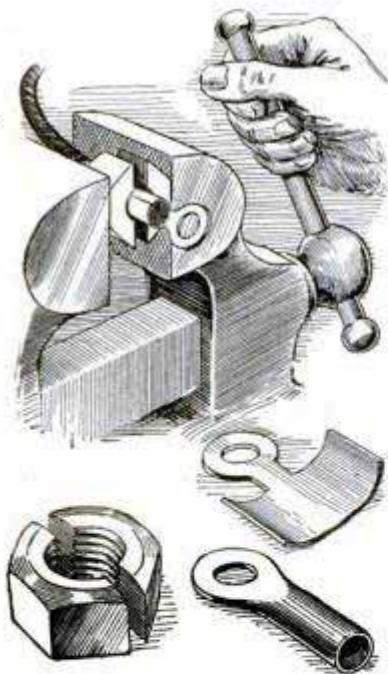

entirely satisfactory. An ordinary nut, preferably one having coarse threads, is split. It is placed about the terminal, gripped in the vise and pressure brought on it with the vise jaws. Some years ago, in a shop where the writer was employed, we made up special crimping dies to do this work at a

cost of approximately \$30 each. Split nuts would have saved practically all of this cost.—G. A. Luers, Washington, D. C.

☐ Wire mesh is useful for drawer bottoms in tool cases where dirt may accumulate.

Mail Box Held on Extended Arms of Figure Made and Painted to Resemble Uncle Sam

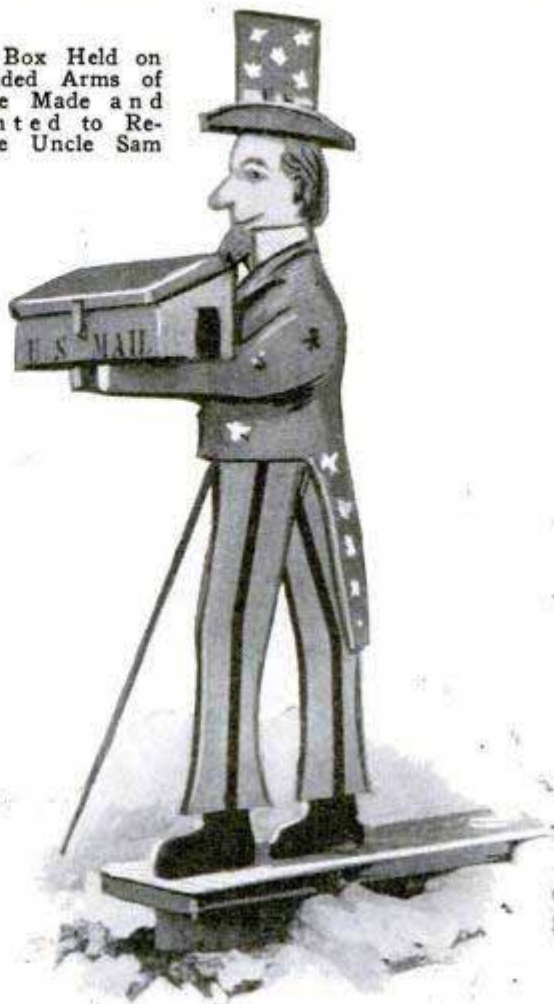

Uncle Sam Mail Box

Instead of the customary post with the mail box attached, one farmer cut out a figure of a man and painted it to resemble Uncle Sam. The arms extend horizontally to hold the mail box, which is fastened to them by means of small angle brackets. The figure is mounted on a 2-in. plank, which serves as a base, with heavier brackets. As an additional support, a 1/2-in. iron rod is attached to the body and to a short post level with the ground.—C. F. Hollingshead, Reading, Mich.

Paint Mixed with Drill Press

An excellent method of thoroughly mixing paint, shellac, etc., is to place the can under a high-speed drill press. A propeller, made by locking an oblong flat piece of metal between two nuts on a small rod, is clamped in the chuck of the drill press. The flat ends are given a slight twist to give them the shape of propeller blades. White-lead paint mixed in this way is almost as smooth as enamel.

Telephone Amplifier Overcomes Noise in Shop

The noise of machinery often made it difficult to use the telephone in an adja-

phone receiver and the other pair to the amplifying circuit. A rheostat is inserted in the filament line and a headset in the output circuit. These connections are shown in the diagram. Dry cells to op-

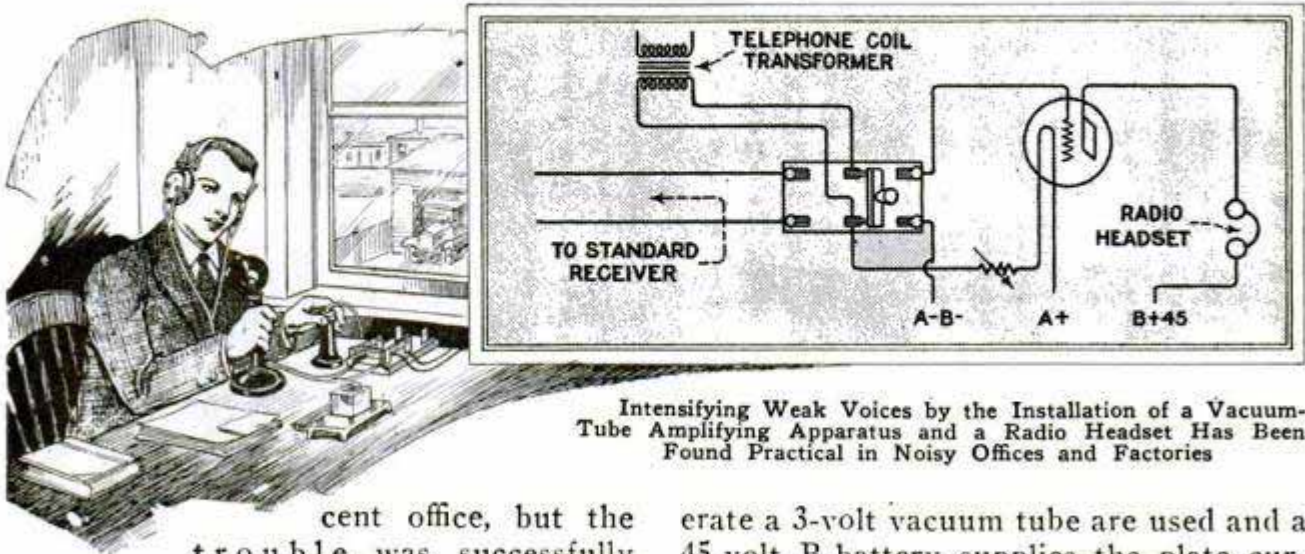

Intensifying Weak Voices by the Installation of a Vacuum-Tube Amplifying Apparatus and a Radio Headset Has Been Found Practical in Noisy Offices and Factories

cent office, but the trouble was successfully overcome by adding a radio vacuum tube and a headset, as shown in the drawing. To install them, disconnect the receiver cord from the transformer in the base of the telephone box and run wires from the disconnected terminals to the knife terminals on a double-pole double-throw switch. Connect one pair of end terminals of the switch to the standard tele-

erate a 3-volt vacuum tube are used and a 45-volt B-battery supplies the plate current. When the switch is thrown to the left it connects with the telephone receiver in the usual way, but when it becomes necessary to have more power, the switch is thrown to the right and even weak voices will be amplified considerably. By the use of a double headset all noises from the shop machinery will be shut out.—R. F. Starzl, LeMars, Iowa.

Cover Protects Small Magnifier

The photo shows a simple method of protecting a small magnifying glass. Get an old snuff box, or similar container, and



Tin Cover for the Magnifying Glass Is Made from Old Snuff Box

cut a small notch in the side for the handle. Then fill the box with soft cloth

of the kind used to clean the glass. The cover fits down firmly over the lens and protects it against breakage and scratching.

Acid-Proof Wooden Sinks

When wooden sinks are used in factories, laboratories, etc., it is often desirable to make them water and acid-proof. Common paints soon peel off and even commercial roofing paint, thinned with gasoline, will not last long. An excellent method of attaining this end is the following: First dry the wood by scraping and heating it until all the moisture is driven out. Heat some pure block asphalt in a suitable receptacle and, when well softened, add raw linseed oil in the proportions of 8 oz. of oil to 1 gal. of the melted asphalt. Stir thoroughly, then pour the paint into the sink and spread as rapidly as possible with a stiff brush. It dries so quickly that only a small space

can be covered at a time before the mixture sets. When the sink is completely covered you should take a plumbers' blowtorch and play the flame on the asphalt until it sinks into the wood and melts down to a fairly smooth surface. Keep the flame moving back and forth so that the wood will not be overheated.—L. B. Robbins, Harwich, Mass.

Wet Cloth Strip Prevents Burning of Pie Crust

In making pies, especially pumpkin pie, which has to be baked longer than others, the housewife often finds that the rim of the crust is overbaked or burnt. To avoid this, cut or tear a strip of clean cloth, about 1½ in. wide and long enough to encircle the pie. Just before placing the pie in the oven, dip this strip in water and cover the rim of the crust, allowing part of the strip to hang over the edge. The additional moisture retards the baking of the rim enough to prevent it from becoming too crisp, or burning. After the pie has been taken from the oven, the strip can readily be removed.—Mrs. M. R. Wells, Cleveland, Ohio.

Substitute for Corkscrew

Photographers, whose chemicals come in bottles with wide mouths and flat corks, which have a tendency to go in too far or may even be forced into the bottle, will find the kink shown in the drawing a practical preventive of this trouble. By pushing a nail through the cork from the bottom side, a good handhold is provided. The stopper will remain air-tight owing to the resiliency of the cork.—E. E. Zahm, Glendale, California.

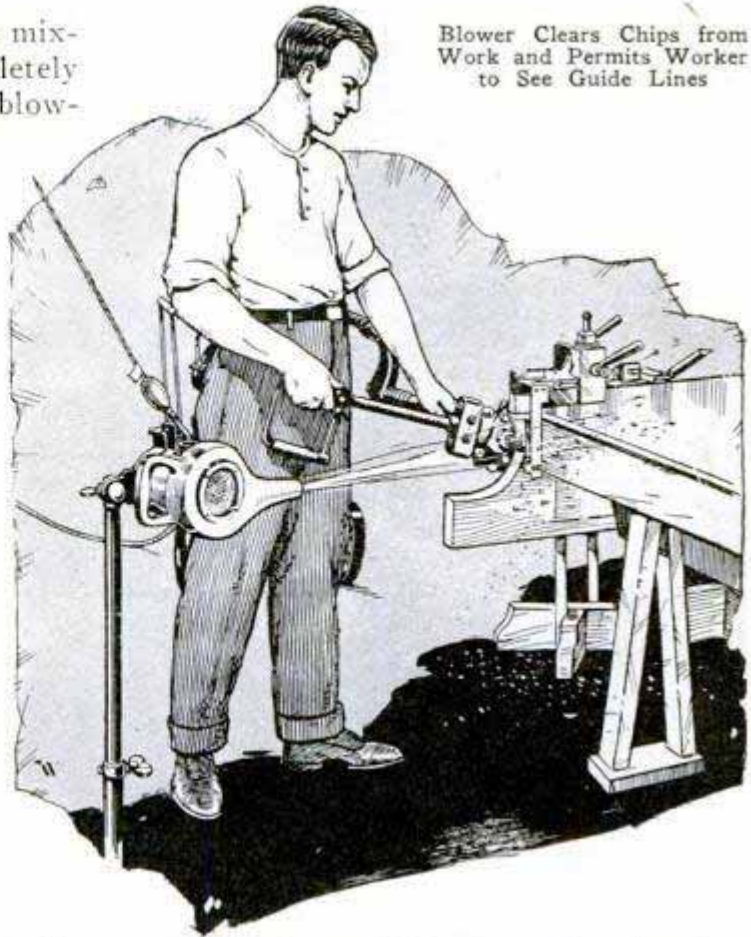

Blower Clears Chips from Work and Permits Worker to See Guide Lines

Blower Clears Chips from Woodwork

On many operations with woodworking tools, it is difficult to follow layout lines, due to the accumulation of chips or sawdust on the work. One piano-manufacturing concern overcomes this trouble in a very simple way, by mounting a portable blower near the work, and directing the blast so as to blow away the chips. The illustration shows how the blower is used during the operation of cutting the radius on a grand-piano end frame.

Improved Cement Mixer Lasts Longer

Because of the gritty nature of sand and cement, concrete-mixing machines are short-lived. This is especially true of bearings supporting the shaft that passes through the mixer. A contractor of the middle west has improved his mixers by adding to the end of each a pipe screwed into the bearing inside of the oil-cup hole and connecting this pipe to a 2-gal. water tank supported about 12 in. above the bearing. This gives sufficient pressure to make the water flow slowly through the bearing into the mixer, thus washing the cement and sand from the surfaces.

Spare Tire Serves as a Bumper without Interfering with Cooling of Radiator



Spare Tire Forms Front Bumper

On many trucks there is no suitable place to mount the spare tire, so one truck owner attached it in front of the radiator, as shown. The framework is made by fastening pieces of heavy flat iron to the tie-rod between the headlights and to the part of the chassis below the radiator, the ends of the frame being bent at right angles. Mounted in this position, the tire will not interfere with the cooling and it also acts as a bumper.—Dale R. Van Horn, Walton, Nebr.

How to Start a Keyhole Saw

Instead of boring one large hole to start a keyhole saw, drill about five or six $\frac{1}{8}$ -in. holes in line, as close together as possible, then run the drill through them at an angle. While turning the drill, lift it slowly to the vertical position, and you will have a neat slot all ready to start the saw and not even a bad corner.—John A. Blaker, West Auburn, Mass.

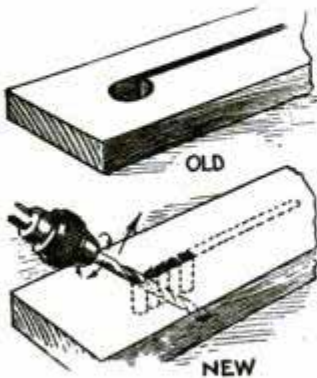

Discarded Films and Phonograph Records for Pipe Joints

A man who owns a plumbing and pipe-fitting business has found that gaskets made from discarded films are useful in flange and union couplings on hot and cold-water lines. He claims the results obtained are just as good as if sheet rubber were used and the cost is nothing. In trying them on steam lines where the flange faces had been finished on a planer, he found the results fairly good, but, if the least bit of roughness existed on the faces, the joint usually would leak. In another case a 10-in. phonograph record was used as a gasket between two flanges on a 3-in. hot-water pipe line, a hole being cut in the center of the record. The joint was perfectly tight with 125-lb. pressure on the line and remained tight for several years.

Holding Tapered Parts in Vise

Where irregular or tapered parts are to be held in the vise, the adjustable block shown in the illustration will be found a valuable aid. It is made up as a triangle, with the two shorter sides scalloped or recessed for the spool holder. The spool is flanged so that the block will not slip vertically. The clamping face of the block will seek the taper on the work. The recesses or scallops allow the spool to be set so that the block will distribute the grip of the vise jaws evenly along the work.

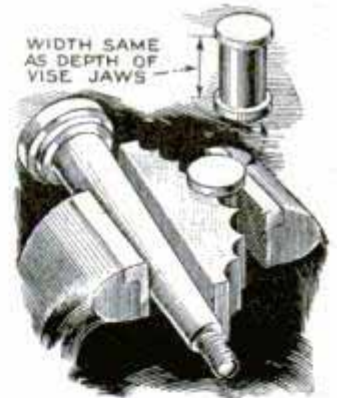

Marble Slab for Surface Plate

I find that a discarded marble top, so often found on old furniture, makes an ideal surface plate, as they are heavy and usually ground to a true surface. I use one for this purpose and also a large piece of another for a saw table. It is easy to work and the saw slot can be cut with an old saw, keeping it wet with water while doing this.—H. E. Van Buren, Rapid City, S. Dak.

A Powerful Gasoline Torch

By FLOYD MOORE,

*403 N. 7th St.
Chariton Iowa*

THE torch shown in the accompanying drawings can be made in a short time from few materials, and will prove very convenient in the small shop. It provides plenty of heat for all ordinary soldering operations, and will melt a pound of lead in five minutes.

First build the torch, using $\frac{1}{2}$ -in. tubing and a $\frac{1}{2}$ -in. petcock for the main body. The torch is about 10 in. long, over all, the shorter nipple, nearest the generator, being 3 in. long, and the one at the torch end about 6 in. A piece of $\frac{1}{8}$ -in. brass or copper tubing is fitted to the $\frac{1}{2}$ -in. one, in the manner shown in the drawing, soldering all joints perfectly, and a brass plug made for the outer end of the torch. This plug is from $\frac{3}{16}$ to $\frac{1}{4}$ in. wide, a tight fit in the end of the tubing, and has a $\frac{1}{8}$ -in. hole drilled in the center to take the end

Now for the generator. Take a quart fruit jar, remove the cap and drill three holes across the top. The center hole is covered by a screw cap, cut from an old oilcan. In one of the two outer holes is soldered a piece of $\frac{1}{2}$ -in. tubing, 2 in. long, 1 in. extending above the top of the cap, and in the other hole, a similar tube, but extending to within about $\frac{1}{2}$ in. of the bottom of the jar. Use a new rubber on the jar, and screw the cap down tight, after filling the jar with gasoline to a point just below the shorter tube. The tank used with this outfit was an old Prestolite tank, but any similar tank will do. Remove the old hose connection on the tank and replace it with a tire-valve stem, soldered in. This can be done without altering the tank in any way. The valve stem has a hole drilled midway on one side,

A Simple but Powerful Soldering Torch That Will Prove Very Useful in the Small Shop, and Can Be Assembled from Odds and Ends; It Will Melt a Pound of Lead in Five Minutes

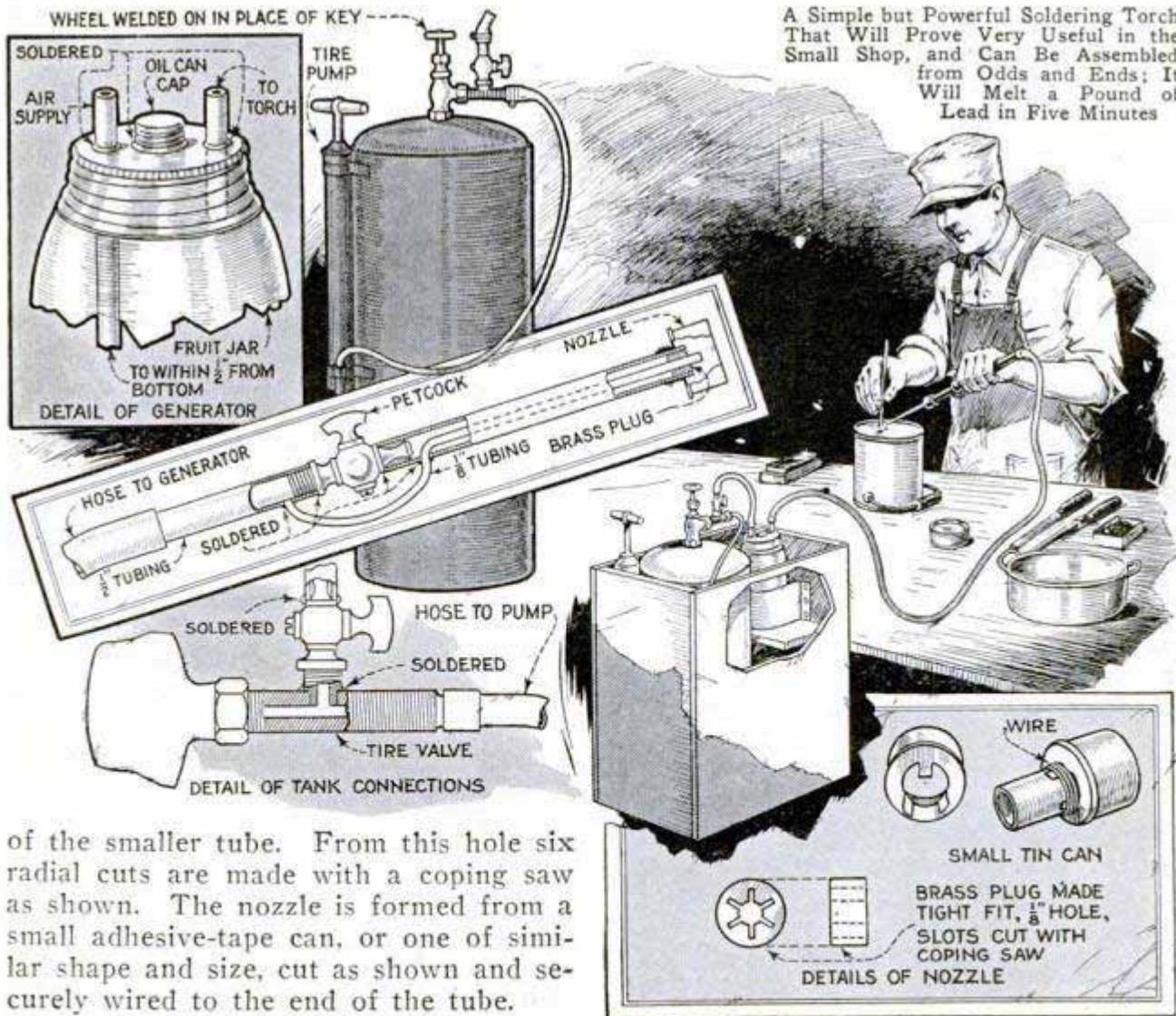

of the smaller tube. From this hole six radial cuts are made with a coping saw as shown. The nozzle is formed from a small adhesive-tape can, or one of similar shape and size, cut as shown and securely wired to the end of the tube.

over which is soldered a petcock with a short piece of tubing on top, as shown. The hose leading to the generator goes on here, and the hose to the torch leads from the short tube of the generator. The petcock on the side of the valve stem must be turned off when more air is to be pumped into the tank. The air pressure

is furnished by a tire pump, attached to the valve stem.

To light the torch, open the torch petcock, and then the air valve and cock on the tank. The air goes down the long tube into the generator, and, bubbling up through the gasoline, carries the vapor to the torch. It can be ignited with a match.

One Window Weight Used for Two

Instead of using four 5 or 6-lb. weights between windows I get two 9-lb. weights,



and hang them as shown in the illustration. Each sash cord must be cut twice as long as it is for the old method and the weight is attached to a small awning pulley by means of a length of wire passed through the

eye of the pulley. This runs on a sash cord fastened to both windows and passes over the pulleys in the casing, as indicated. The advantage of this method is that it eliminates the possibility of tangled cords. —G. F. Sutton, Sedalia, Mo.

Cause of Flickering Headlights

Flickering headlights are sometimes caused by loose connections in the socket at the junction block, the switch or, occasionally, by a bare wire coming in contact with the metal frame of the car. One auto owner, who experienced this trouble, discovered that a headlight wire, which passed between the hood and the frame, had become bared, and had shorted the entire lighting system, causing the lights to flicker and go out whenever the wire came in contact with the frame. On another occasion the same trouble was traced to a bare tail-light wire. If both

the headlights flicker and go out, it is a fairly sure indication that the trouble is caused by a short. If only one flickers, a loose connection usually is responsible.

How to Arrange Countershaft for Two Speeds

It is sometimes an advantage, in a shop where very little screw cutting is done on the lathe, to have the countershaft arranged for two speeds. This is done by placing a large pulley on the line shaft and not crossing the belt. Of course, in this case the lathe cannot be reversed. This method has been used in a shop for years and found quite an advantage. By using the cone pulleys and back gears, twelve cutting speeds may be obtained.

Simple Shop-Trailer Latch

Trouble with shop trailers unhooking from the tractor can be eliminated by providing a latch to hang over the head of the hook as shown in the illustration. The latch is made from a length of flat iron or steel bent over to swing on a short length of rod, which is screwed to the body of the trailer. The lower end of the latch,

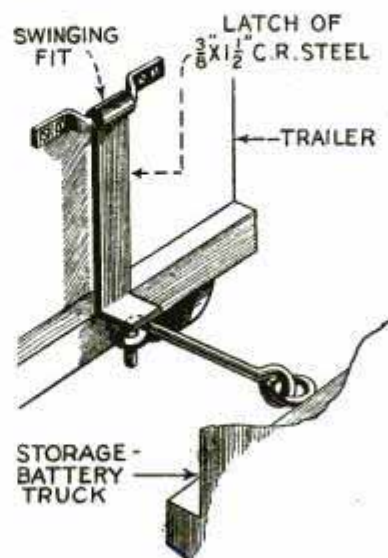

which is bent at right angles, fits over the head of the hook and prevents it from rising. When the trailer is detached, the latch is raised and the hook disengaged from the bolt. —Aug. Mathieu, Chicago.

Waterproofing Auto-Step Plates

Rubber step plates on auto running boards do not fit closely enough to keep mud and water from entering under them and causing rust, but by applying storage-battery sealing compound hot to the boards in a heavy layer and pressing the plates down into it, the rust is prevented. The compound must be soft when the plates are installed, to make a water-tight fit, and it is best to warm also the running board with a torch, to keep the compound liquid for some time. The step plates must be bolted to the running boards, as usual, to keep them in place.

Holder for Valves, Screw Bolts and Sleeves

When overhauling some truck motors, the mechanics used a device consisting of flat pieces of spring steel, with the ends slightly bent out, for lifting valves during the seating process. The use of the device is clearly shown in the illustration. After they are inserted in the slot of the

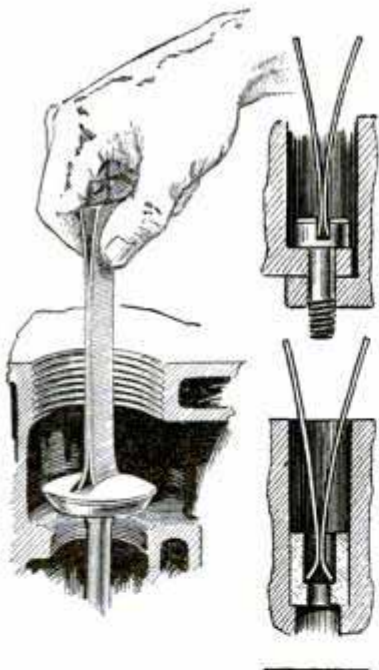

valve, the ends in the hand are pressed together, which causes the lower ends to grip the valve securely. Slotted machine screws can be removed or replaced with the device, and even circular parts, such as sleeves and bearings, can be held quite firmly with it.

Defects in Leather Belts

Having considerable trouble with poor leather belts, which broke frequently, the following method of finding defects in a belt was found successful: Put the belt in a vinegar bath; this will bring up all defects, such as poor fibers, by swelling and darkening the leather.

Device Keeps Water Hose from Freezing

Auto-service stations often have a water hose handy for the autoist to fill his radiator, and during winter the hose is likely to freeze, which may ruin it. A good method of protecting the hose from freezing is to inclose it in a double-walled box with sawdust packed between the two walls for insulation. Heat is provided inside by means of an electric lamp.

A double-walled sliding door, equipped with a handle and a counterweight, allows the motorist to get at the hose inside. The box inclosing the hose is about 5 ft. high.—Mrs. R. L. Riggs, Fort Smith, Ark.

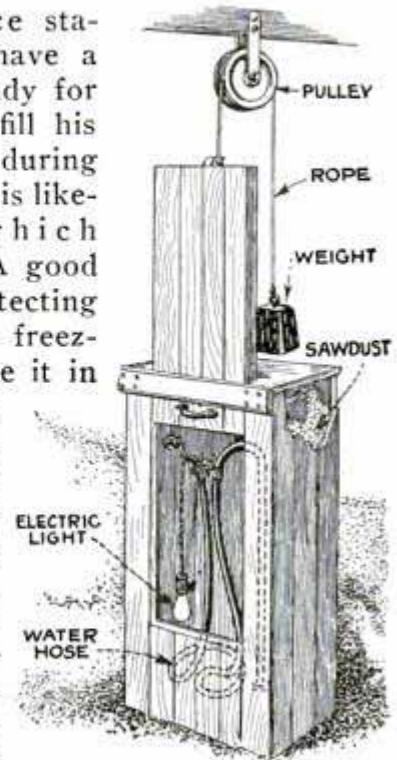

Lathe Tool Made from Broken Tap

One of the problems in most shops is the salvage of broken tools, among which a large number of taps are usually found. When a tap is so broken that an inch or more of the threaded portion is left, make a holder as shown in the drawing. Get a piece of bar machine steel, and drill the end, tap it out the same as the broken tap, and slot it an inch or so. Then saw off the end of the bar. Insert the piece of broken tap with one set of teeth outward and clamp it firmly with a screw, which is threaded in a hole also drilled through the bar as shown. This makes a good "chasing" tool, which will often be found useful in lathe work.—Donald B. Templeton, Lynbrook, N. Y.

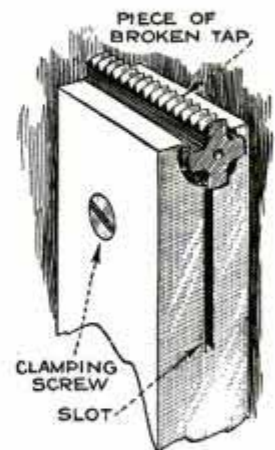

Portable Stand Holds Riveter Tips

In a Denver steel shop the small, portable stand shown in the illustration makes the carrying of an assortment of tips for

the rivet gun an easy matter. Besides, they are always at hand



Portable Stand
for Riveting Tips
Saves Time

instead of lying about the floor of the shop, so that the right tip can be found at once. Four light legs, 6 in. long, are welded to the bottom of a $\frac{1}{4}$ -in. metal plate, 12 in. square. In this twelve holes are drilled or punched to receive the tips. A small rod, with a hoop in the top end, is welded to the top of the plate to serve as a handle.—Jos. C. Coyle, Denver, Colo.

To Keep Windshield from Rattling

On Ford closed cars, of earlier date than 1924, the lower windshield frame is clamped by two knobs, which pass through slotted ears on the frame and into brackets on the body. When the clamps are tightened, the ends of the windshield frame are often spread apart as there is no bar across the top of the glass. This leaves the glass loose so that it will rattle. Washers should be slipped over the shaft of the clamping knob, nearly filling the

space between the ear on the frame and the body bracket. This prevents pulling the frame out of shape when the clamps are tightened. If washers that are too thick are used, the windshield frame will not move easily when the clamps are loosened. If the washers can be turned easily with the fingers when the clamps are loose, their thickness is about right.

Method of Handling Wet Photos

Large prints, when wet, have a tendency to stick to the bottom of the tray and delay in picking them out may cause overdevelopment. If you are using a large tray, lay a piece of corrugated glass in the bottom. It can be obtained by carefully knocking the wooden frame off a glass washboard. If necessary, it can be reduced in size with a glass cutter. The large corrugations make it an easy matter to slip the finger nails under the edge of the prints to remove them. Small trays can be similarly fitted by using a piece of corrugated rubber matting, such as fastened on auto running boards. A washing in water occasionally will clean off old developer.—L. B. Robbins, Harwich, Mass.

Counterweights for Adjustable Haystack Roof

Concrete blocks with eyebolts cast in their ends make excellent counterweights for the adjustable haystack roof shown in the photo. The corners of the roof are cut out to fit around the posts, which serve as guides to hold the roof in place.

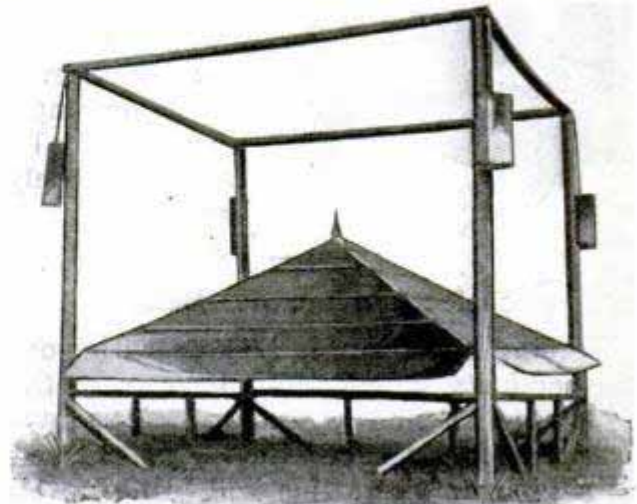

Concrete Blocks Attached to Adjustable Haystack Roof
Make It Easy to Handle

A Power-Line Pole Straightener

The very useful device shown in the illustration was made by a contractor who undertook to straighten up a five-mile power line, the poles of which had twisted, owing to too much tension on one side.

The device itself consists of a 12-ft. hickory or ash pole, 4 by 3 in. in size at the small end and 8 by 3 in. at the large. The latter carries the $\frac{1}{4}$ by 3-in. iron strap,

A blow with a sledge sinks the lugs into the wood, and the chain is caught in the slot of the clamp. While this is being done, a man climbs the pole and loosens the wires from the insulators. While he stays there, the team is started and driven a few feet until the pole is straight.

The after treatment, shown in the insert sketch, was found necessary every

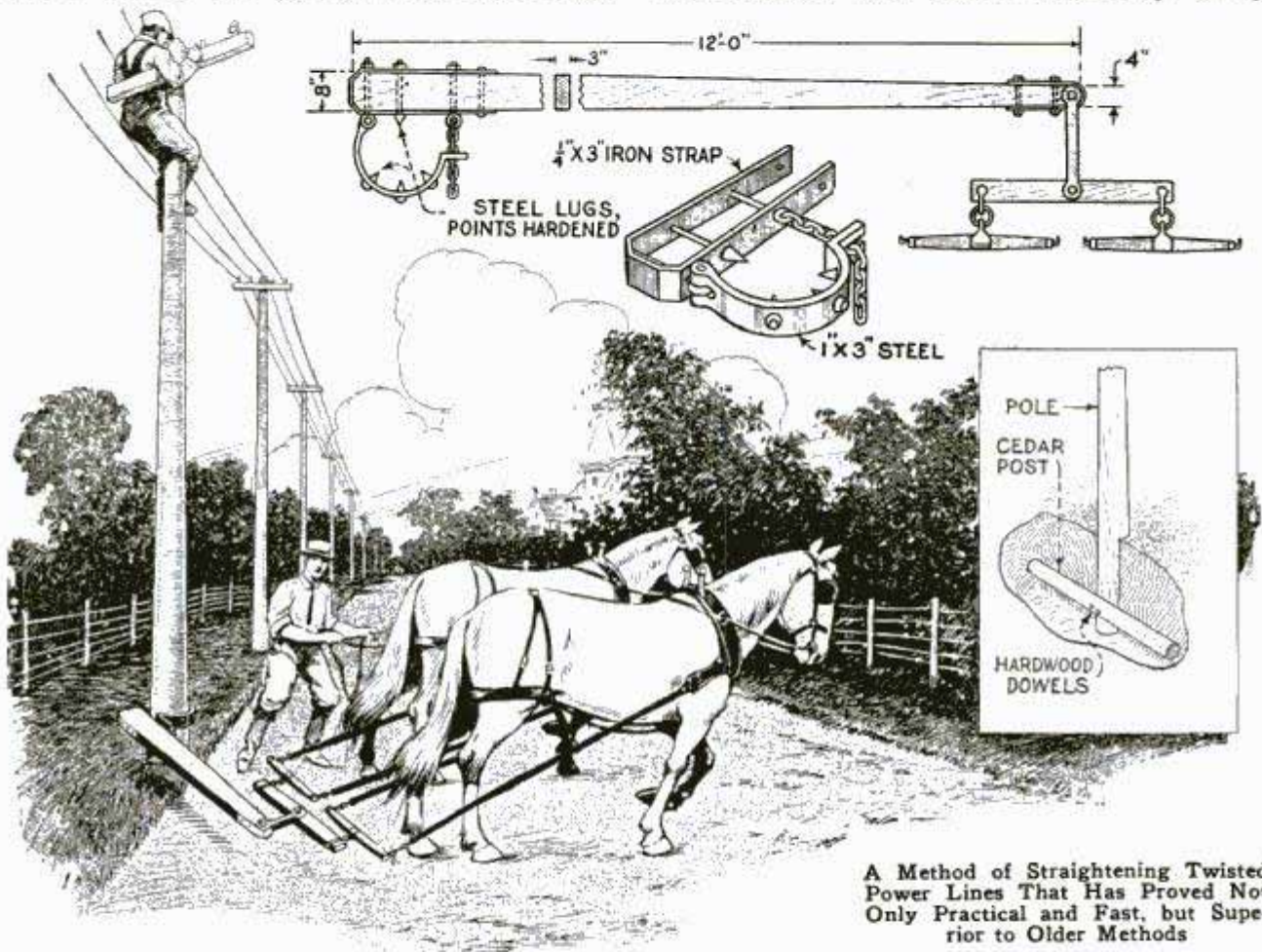

A Method of Straightening Twisted Power Lines That Has Proved Not Only Practical and Fast, but Superior to Older Methods

shown in the drawing, and on one side is a pointed steel lug, forged on the end of a bolt. A 1 by 3-in. steel clamp is also fastened to the large end by means of an eyebolt, and fitted with lugs. The open end of the hinged clamp is slotted to take the links of a heavy logging chain, the end of which is fastened to the pole by an eyebolt. The device should be as well made as possible and only good, sound lumber should be used for the pole and its doubletree.

Application is very simple. The chain is unclamped and the straightener clamp placed around the line pole to be straightened, either at the ground level, or, if the wood is unsound there, about 6 in. above.

fourth pole, but this depends, to some extent, on the amount of twist. Some small lines can be straightened successfully by the strength of two men only, as the leverage of the straightener is sufficient for their pull. The best time for the job is in the early spring, just as the frost leaves the ground.

This method has proved far superior to the usual one of removing the crossarms and making new cuts for them in the pole. Not only is the pole weakened by this practice, but there is more danger of electrocution in the operation, if the line is live, and usually but few lines can be cut off for the length of time necessary.—Arthman N. Capron, Athelstan, Can.

Removing Piston Pins

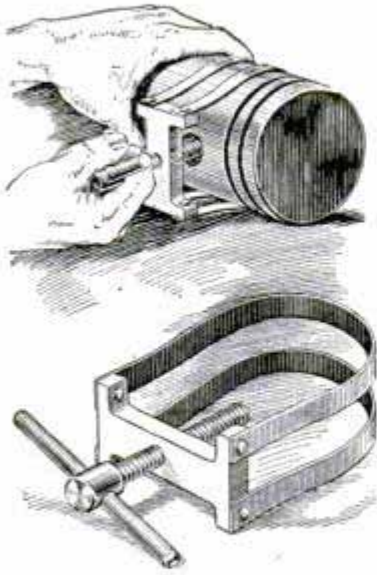

In removing piston pins, many garage men resort to the customary bad habit of driving them out with a hammer and punch, which usually results in marring the piston and often in breaking it. This trouble can be entirely eliminated by using the tool shown in the illustration. It consists of a couple of straps of thin flat iron attached to a piece of $\frac{1}{2}$ -in. stock, as shown, and a screw, which is driven down by hand to force the piston pin out. By using this tool the piston cannot be injured in any way.

Small Auto Drains Flooded Cellar

After each heavy spring rain we usually find from 2 to 10 in. of water in our cellar and there is no way of draining it out. Last spring we obtained a $1\frac{1}{4}$ -in. rotary gear pump and connected the shaft of the pump to the hub of one of the rear wheels of our car. The pipe leading to the cellar kept the pump body from turning. The wheel of the auto was raised by means of a jack under the axle. The other wheels were blocked, and the arrangement pumped the water up at the rate of about two barrels per minute.—Geo. G. McVicker, North Bend, Nebr.

Carbide on Castings Shows Cracks

Most large shops use dismantled machinery as a supply for parts for new constructions, thus saving expense by avoiding pattern and casting costs. There is always the danger, however, that castings from old machinery will contain cracks, making them unsafe for reuse, and these cracks are often not evident. One large machine shop has a simple method of locating such faults. The castings are first

washed in the usual cleaning fluid, to remove old grease and dirt. Then they are painted with slaked carbide, which is allowed to dry, leaving a white surface over the metal. If cracks exist, they will be revealed in a short time by black lines on the white surface. This is due to the grease in the cracks, which is drawn out and shows in sharp contrast to the white carbide. All axles and frame parts, which are to be subjected to strain, are treated in this manner as well as any other castings likely to have concealed flaws. As a result, about five per cent of the castings were discarded as unsafe last year.

Sawbuck Helps Raise Log

Sometimes it is troublesome to lift a large log up on a sawbuck, but with the buck shown in the drawing the task will always be easy. It has a 7-ft. base made of 2 by 4-in. stock. The long leg, bent at the upper end as indicated by the dotted lines, is an old cultivator beam and the other leg is made of two lengths of 1 by 4-in. wood. In use, the device is placed so as to straddle one end of the log and by pulling the base down, as indicated by

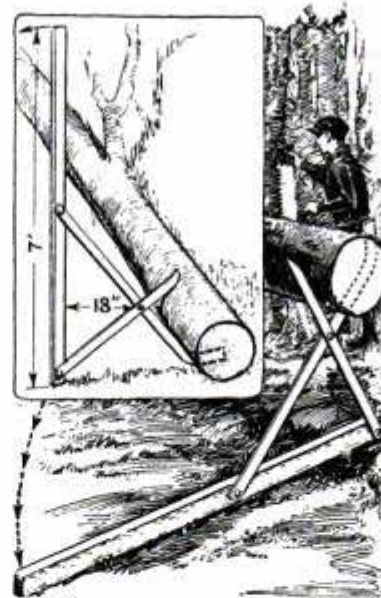

the arrows, the log can be raised with little effort. This article is a correction of one published in the October, 1926, issue, where it was erroneously stated that both legs were made of 1 by 4-in. wood.—Luther Strosnider, Onaga, Kans.

Fuel for Bee Smoker

One of the best and most easily obtainable materials for fuel in a bee or rodent smoker is made from gunny sacks. Strips, about 6 in. wide and 16 to 20 in. long, are cut and rolled to such size as to go into the chamber of the smoker. A cord is

... tied around the rolls to hold them together until ready for use. Previous to putting them into the smoker, cut the cord and allow them to loosen. A little crank-case oil (used) may be applied to the sacking to produce more smoke and cause the cloth to burn better.

Forced Ventilation Prevents Shed Burn in Curing Tobacco

Shed burn, which is one of the troubles encountered by tobacco raisers, takes place soon after the plant is hung in the shed and before it is cured. This heating or burning usually occurs during heavy, damp weather when it is almost impossible to ventilate the shed properly. To eliminate the trouble, one tobacco raiser ventilated his shed by placing a 3-hp. electric motor, belted to a blower, on a two-wheeled truck which could be pulled through the passage of the shed. A flexible pipe was placed over the outlet of the blower so that air could be directed between the hangers in the different bents. On damp mornings the shed is ventilated from the center to the outside with this outfit. Temperature and humidity readings are taken every fifteen minutes. It

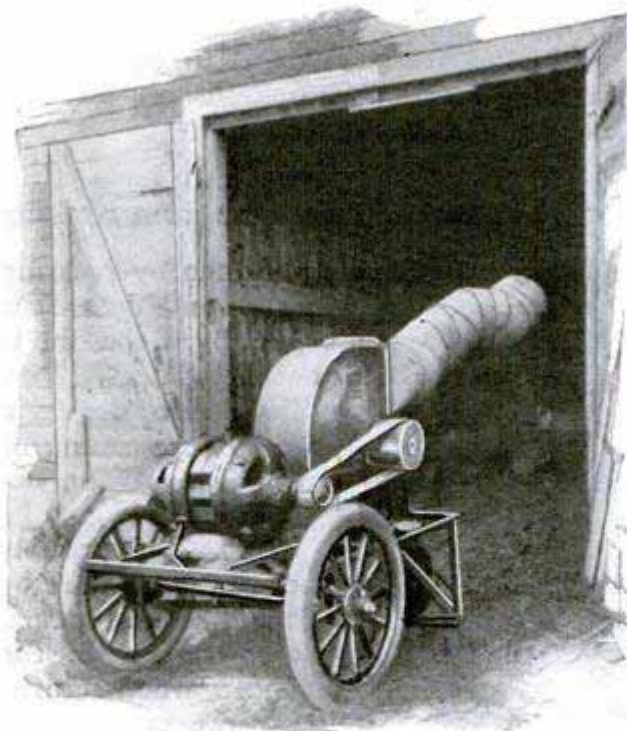

Portable Blower Provides Forced Ventilation for Tobacco Shed and Prevents Shed Burn

requires about two hours to ventilate a 125-ft. shed.—J. G. Wynn, Madison, Wis.

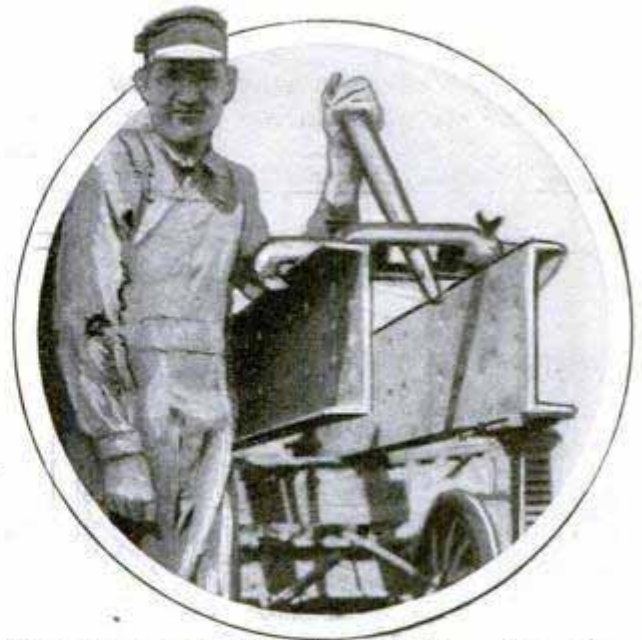

Large Turnbuckles Made from Old Truss Rods Prove Handy in Steel Shop

Old Truss Rods Make Useful Turnbuckles

Time and labor are saved at a Denver steel shop in straightening heavy steel beams of various kinds by the use of the improvised turnbuckle shown in the photo. It is made from heavy truss rods, 2 ft. in length and bent at each end to hook over the flange of I-beams, channel or Z-irons. If these are close together, as in the photo, one or more of these turnbuckles are applied to the straight parts of the beams to hold them, while a jack is used to force any humps into place. The turnbuckles are easily tightened with a strong stick or rod, and as they are not seriously affected by heat, they may be set very close to the flame of a torch without risk of damaging them.—Jos. C. Coyle, Denver, Colo.

How to Paint Cement Surfaces

There are times when it is necessary to paint some cement surfaces as quickly as possible or just as soon as the cement has dried out. Although this ordinarily is too soon for painting, it can be done successfully in the following way: To 1 gal. of water add 12 oz. of sulphuric acid and brush this mixture over the wall, using an old brush. This will provide a surface that is free of any excess of lime and makes a good painting job possible. Do not let the mixture come in contact with skin or clothing.—L. H. Georger, Buffalo, New York.

One-Way Traffic for Wheelbarrows

Elevated planks for wheelbarrow tracks are a familiar sight during the erection of

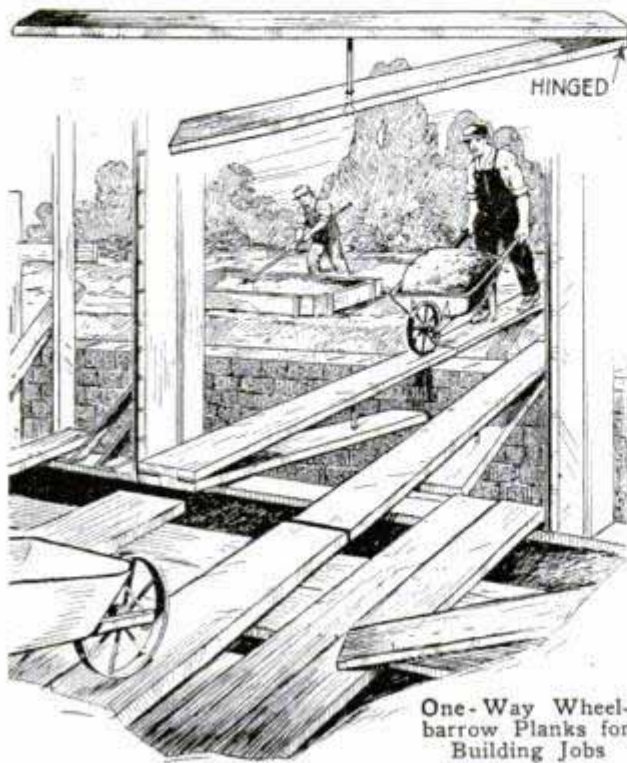

buildings. When a number of barrows are being used, two plank ways are essential, but it often happens that two men will start from opposite ends of the same plank, which means, of course, that one of them must back up to clear the way for the other. A building contractor in an eastern city, finding it of no avail to give orders that this practice should be strictly avoided, had a couple of runways made so that it was impossible to wheel a barrow both ways. Two planks, one a little longer than the other, are hinged together, and an eyebolt is screwed into the underside of the longer one, while a hole is bored in the other, large enough to clear the eye. A piece of rope is threaded through the eye and the hole, and both ends are knotted so the planks can be separated a convenient distance. These runways were used to bridge the gap between a tempo-

rary loading platform and the doorways in the building. Material dumped on the platform was carried inside in wheelbarrows, some doorways being used for going in and others for coming out, and the planks were placed accordingly. It will be seen that the weight of the bottom plank raises the hinged end of the top plank so that it is impossible to push the barrow over it, while, from the other end, a barrow can be wheeled in the ordinary way. As the workman proceeds with his barrow across the plank to the opposite end, that end is pressed down so there is no bump when the barrow leaves it. A nail on each side of the runway, at both ends, keeps it from working sideways and a short space is left between it and the planks laid on the surface at either end. By adjusting the knots, the plank can be made to rise to any suitable height.—Harry Moore, Montreal, Can.

Timing by Oil-Filled Priming Cup

When timing auto engines having priming cups, the cup in the front cylinder should be partly opened and filled with fairly heavy oil. When the piston is coming up on the compression stroke, air bubbles pass through the oil in the cup and agitate it sufficiently to be easily seen. When the piston reaches top dead center, the bubbling suddenly stops.—E. T. Gunderson, Jr., Humboldt, Iowa.

How to Prevent Tape Line from Kinking

Many tape lines are ruined by twisting the tape as it is being wound up. This is likely to happen especially if the line is wound up in dark or windy places. New lines also have a tendency to kink or curl quickly on becoming slightly damp. This trouble can be prevented by using a lead pencil as shown in the photo, when returning the tape to the case. It will wind rapidly without the least danger of kinking.

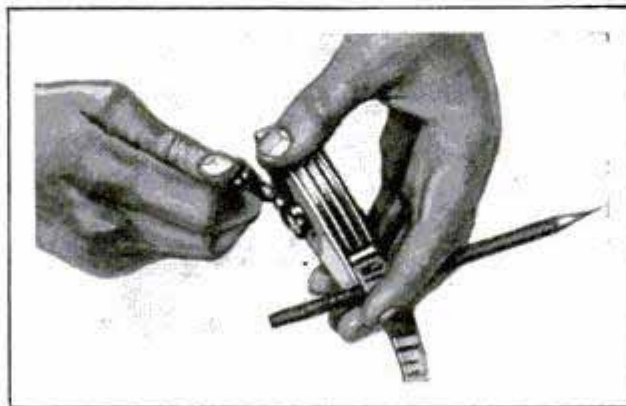

Slip a Pencil under the Tape Line While Winding It to Prevent It from Kinking

Kink for Stenographers

Sometimes it is necessary for a stenographer to use a typewriter when the keys are so cold that the fingers become numb. This can easily be overcome by raising the typewriter on some books, about 1 in., and placing a lighted electric lamp under the keyboard. A dark cloth can be wrapped around the bulb to prevent glare. The keys will be kept just warm enough to permit typing with comfort.

Hinged Joint in Pump-Supply Pipe

On most farms the pipe connecting the windmill pump with the water tank is attached to the spout by means of a cast-iron bowl with a wire bail. This is a satisfactory arrangement as long as the mill is employed merely to pump water into the tank, but when it is necessary to remove the pipe so that pails or cans may be filled, it means a waste of time. To simplify the attachment and removal of the pipe, one farmer conceived the idea of placing the latter on a permanent sup-

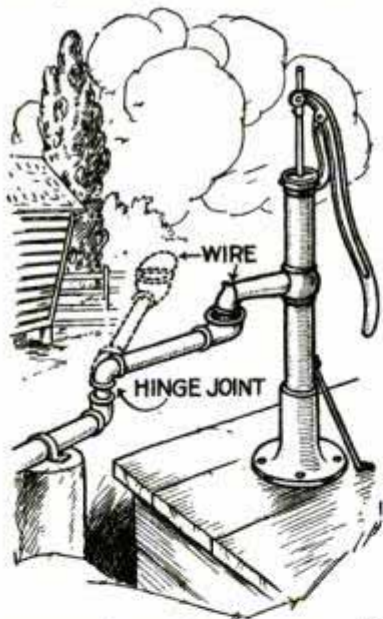

port and providing a hinged joint at the point indicated in the drawing. This joint is made by putting two elbows and a short nipple in the pipe line, about 3 ft. from the pump, and allows the bowl to be swung toward or away from the pump. The bail holds the bowl securely beneath the spout when in place. This improvement is especially desirable where women or children have to fill the water pail at the pump.

It is almost impossible to paint a wall in a satisfactory manner unless properly sized; a good size can be made by thinning varnish with gasoline. The first coat should be dry before applying the next.

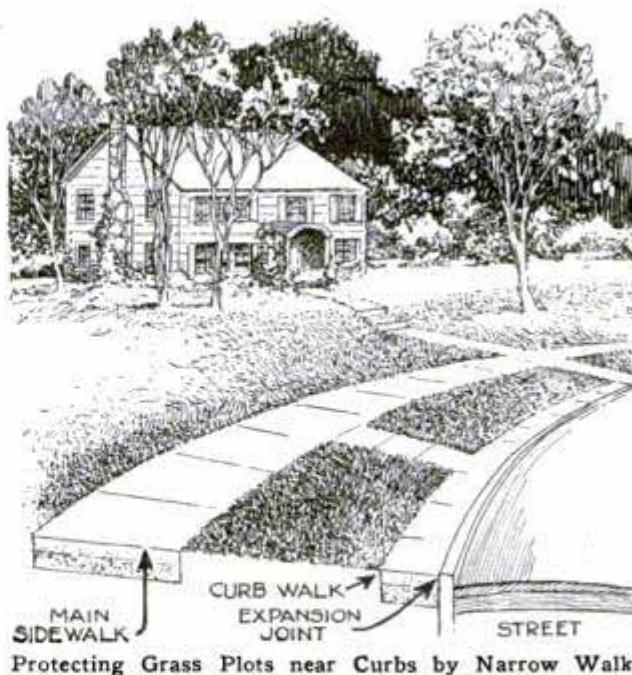

Narrow Curb Walks Protect Grass

The problem of keeping grass in parkways between curbs and sidewalks from being trampled down by pedestrian traffic can be solved by laying narrow concrete walks along the curbs. These walks are made about 2 ft. wide and 5 in. thick, and are separated from the curbs by bituminous expansion joints, as shown in the drawing. They are connected to the main sidewalks by crossings, about 50 ft. apart, which provide means of reaching the former without stepping on the grass.

Protecting Belts Exposed to the Weather

It is often necessary to run belting outdoors, where it may be injured by the weather if not covered. A simple and effective cover can be made from an ordinary sheet-metal drum, split open with an acetylene torch, and set over the belt as shown in the drawing.

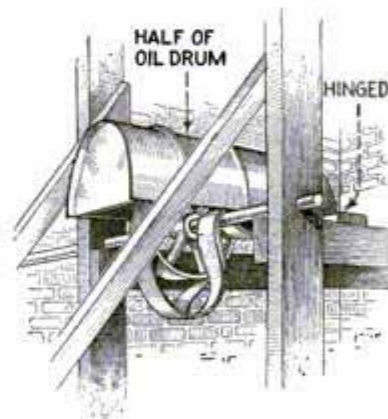

Two strap hinges are attached to the end of the cover so that it can be raised and turned back when the belt is to be mounted.

How to Turn a Large Cone

A large cast-iron cone was required in the blacksmith shop, for the purpose of

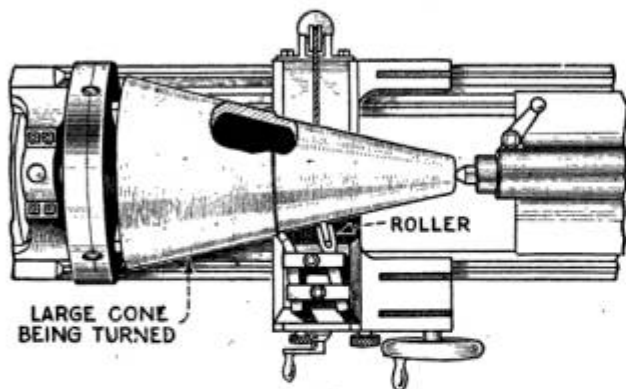

Simple Method of Turning Large Cone on a Lathe

enlarging and rounding up different sizes of forged rings. The method of turning the cone is shown in the drawing. A short portion at the small end was first turned by means of the compound rest. The cross-slide screw was then removed and a holder with a roller was placed in the tool rest along with the cutting tool, and a rope and weight were attached to the cross slide to keep the roller in contact with the surface of the cone. When the lateral power feed was engaged, the tool was forced out gradually by the action of the roller on the cone surface.—Jas. H. Rodgers, Toronto, Ontario, Canada.

Removing Film-Pack Tabs with Scissors

Any film pack will leak occasionally, and the film that gets fogged is invariably the one that the photographer was most anxious to obtain. I had a number of valuable negatives ruined in this way, until I decided to determine the cause and find a remedy if possible. A careful examination showed that the films are fogged by the operation of tearing off the

cover tabs after the paper has been pulled out of the pack to bring the next unexposed film into position. As a remedy I experimented by refraining from tearing off the paper tabs. Instead of tearing them off I provided myself with a pair of blunt-pointed scissors. After an exposure is made, the paper tab is pulled out as before, but not torn off. Frequently I exposed the whole pack letting the paper tabs hang out until the last photo had been taken. Then, the tabs are carefully cut off with the scissors. Of course, if the whole pack is not to be used at once, it is as easy to cut them singly.—John Edwin Hoag, Los Angeles, Calif.

Repair for Ford Tie-Rods

Old-model Fords were fitted with front-wheel tie-rods having a ball forged on the right end, while an adjustable nut was provided at the other end. The ball often wears out first, and it is then customary to get a new tie-rod, although this is otherwise in good condition. To avoid this unnecessary expenditure a simple repair of the kind shown in the illustration can be made. Turn the rod end for end and replace the adjustable yoke with the new-style yoke and removable ball. This will leave the old ball on the left end of the tie-rod where it will not interfere with steering.—E. T. Gunderson, Jr., Humboldt, Iowa.

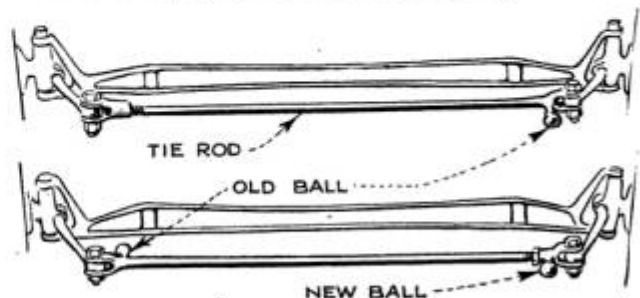

Repair on Ford Tie-Rod Eliminates Expense of Purchasing a New One

FREE

THERE is nothing more useful in shop or drafting room than a table of decimal equivalents. We have prepared a stout, well-printed table, 16½ in. wide and 23 in. long, suitable for the wall of office or shop, and one or more copies of this will be mailed free to anyone who desires it. This is offered you merely as a service. Send us your name and address, and your copy will be sent at once, carefully wrapped and postpaid. Address Popular Mechanics Magazine, 200 E. Ontario St., Chicago, Ill.

Using Tongueless Cultivator

A tongueless cultivator is a very awkward implement to handle when one horse of the team walks faster than the other or when one horse stops to take a bite of corn. To remedy the tendency of the cultivator to line down or run sideways in such cases, the inside two tugs of the team may be crossed, hitching the tug from each horse across to one end of the singletree of the other horse.—Geo. G. McVicker, North Bend, Nebr.

Lock for Blacksmiths' Tool Rack

A tool rack that can be locked is often desirable to a blacksmith. That shown consists of a number of heavy shelves in a frame and is easily made. Suitable holes in these allow the tools to be suspended with the heads resting on the shelves. A plank or heavy board is hinged to the framework over each shelf as indicated. In the frame as well as in the ends of the

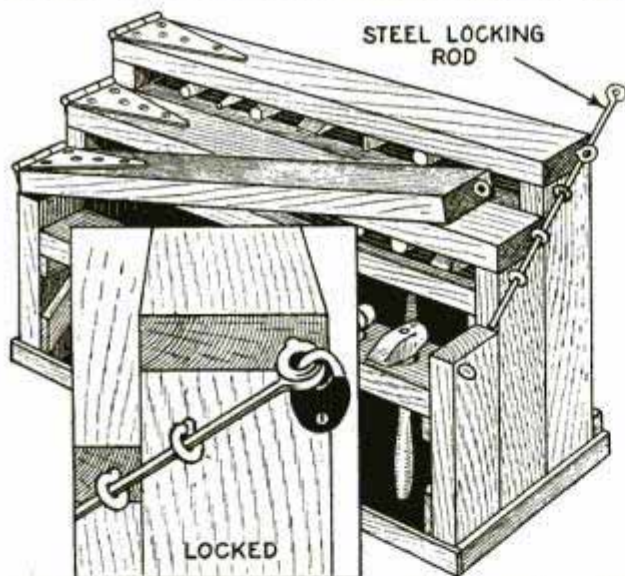

A Padlock, a Steel Rod and Some Screweyes Securely Lock This Tool Rack

hinged planks, heavy screweyes are driven, so that a long steel rod can be passed through all of them. One end is bent to form an eye, and a padlock is used in the topmost screweye and the loop of the rod, to prevent removal of the latter, as shown in the detail.



Attach a Water Hose to the Driveway Brush to Help Clean the Walk or Driveway

Hose Attached to Driveway Brush Aids in Cleaning Cement Walks

A wide brush, of the type called a "driveway brush," is often used for cleaning floors and walks. It is a good plan to tape or wire a garden hose to the handle of the brush, with a moderate stream of water directed on the bristles. The user can then scrub without stopping and the brush will be kept supplied with enough water to wash away the dirt. Another advantage is that the water prevents the bristles from breaking as they often do when used dry.

Driving Nails in Hardwood

To facilitate driving nails in hardwood, first drill a hole in the end of your hammer handle, fill it with melted beeswax or paraffin and insert each nail in the wax before you drive it into the wood. This method is also good for driving nails that have become slightly rusty and will enable you to drive screws into wood quickly and with much less effort than an untreated screw requires.—Mrs. Russell Durham, Belton, Tex.

IN accordance with the editorial policy of this magazine never to accept compensation in any form for what appears in our reading pages and also to avoid the appearance of doing so, we are obliged to omit the name of the maker or the seller of any article described. This information, however, is kept on file and will be furnished free, by addressing Bureau of Information, Popular Mechanics Magazine, Chicago.

828

Is This Your Home?



Copyright, Architects' Small House Service Bureau

Plan No. 4A5

QUESTIONS regarding home building addressed to this magazine will be answered by The Architects' Small House Service Bureau of the United States, Inc., controlled by the American Institute of Architects and endorsed by the United States department of commerce. Inclose 10c and self-addressed envelope. Blueprints, specifications and material list for the house shown here may be obtained at nominal cost. Inclose self-addressed stamped envelope for reply. If further information is desired, send 5c and stamped envelope for a 24-page booklet explaining how the Small House Service Bureau functions and showing 12 sample plans. A new booklet, entitled "Fifty Ways to Lower Home Building Costs," illustrated by ten bureau houses actually lived in, and showing how as much as \$1,000 can be saved on a home, may be obtained for 20 cents.

THE house illustrated here shows how the dignified colonial style can be satisfactorily applied to a modern home of small dimensions.

One of the features is a comfortably large living room dominated by a brick fireplace with adjoining bookcase of the same height as the mantel shelf and with panel doors.

Six or seven people can be served at the extension dining table, with drop leaf, built into one end of the large well-planned kitchen. One of the seats has a hinged cover to give additional storage space under it. There are two long deep drawers under the seat built against the bathroom wall and these are accessible from the bathroom. Two good-sized bedrooms and bath occupy practically one-half the floor space. This house can be built at a reasonable cost because of its straightforward plan and lack of features which require extras in the way of labor, millwork, etc. Its charm lies in its simplicity and adherence to colonial style.

A porch like the one on this house is always welcome. It measures eight feet wide by twenty-nine feet long. Another feature is the unusual closet space. Besides the fine kitchen equipment of cupboards and a closet in each bedroom, there is a coat closet in the entrance vestibule, a linen closet in the hall and abundant storage space on the second floor.

The house contains four rooms and bath on the first floor—two bedrooms, a living room, and combination kitchen and dining room. The second-floor bedroom has a closet and cross ventilation, as indicated in the plan. There is also a large storage room and space to finish off another bedroom if desired. The place calls for a full basement.

Colonial tradition is faithfully followed in this house, for it is of frame construction with brick base course, brick chimney, shingle roof, and exterior carried out in wide bevel siding. To keep the spirit of the style the body of the house has been painted white, the roof and blinds green.

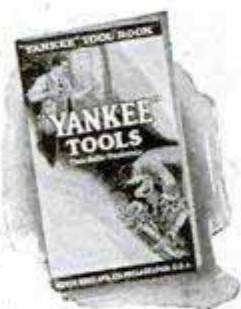

FREE
New "Yankee" Tool
Book

This interesting little book is for all lovers of fine Tools. It tells just what you want to know about all the famous "YANKEE" Tools for making work easier and quicker.

The Ratchet *adds speed*

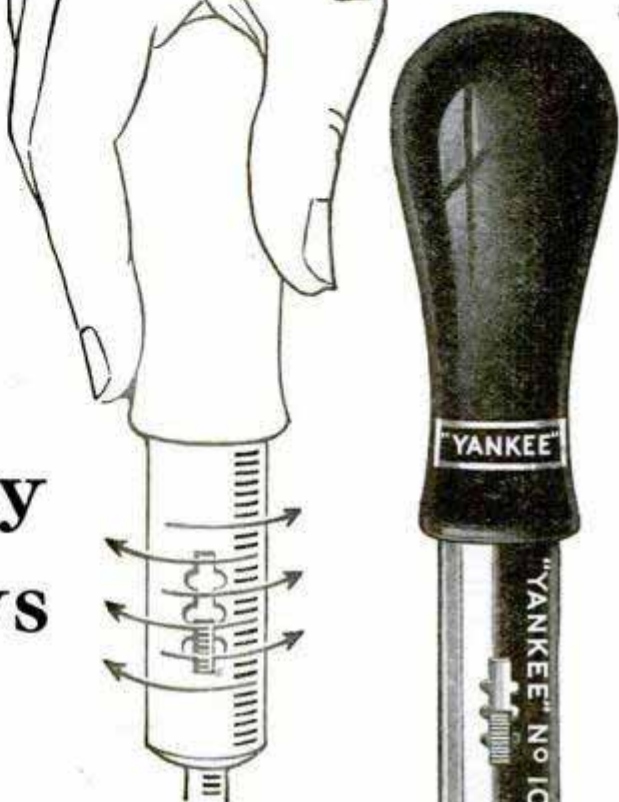

Try this "YANKEE" Way of Driving Screws



You just turn to and fro . . . easy like . . . without letting go of handle. A slick ratchet movement drives screw home. Saves time and strength.

Ask your dealer for the "YANKEE" Ratchet Screwdriver.

Three adjustments: Right and Left Ratchet, and Rigid.

No. 10—With ratchet shifter moving lengthwise with tool (see illustration). Eight sizes: 2- to 12-inch blades.

No. 11—Same as No. 10, except shifter moves across tool.

No. 15—With "Yankee" Thumb-turn on blade (see illustration), for starting wobbly screws with thumb and forefinger. Six blade lengths, 2- to 8-inch. All blades, $\frac{3}{16}$ diameter.

Some Other "YANKEE" Tools

Plain Screw-drivers
Spiral Screw-drivers
Ratchet Bit Braces
Ratchet Breast and Hand Drills
Automatic Push Drills
Automatic Feed Bench Drills
Ratchet Tap Wrenches
Vises—Removable Base

Dealers Everywhere

Sell "YANKEE" Tools

"Yankee" on the tool you buy means the utmost in quality, efficiency and durability.

NORTH BROS. MFG. CO., PHILADELPHIA, U. S. A.

"YANKEE" TOOLS

Make Better mechanics



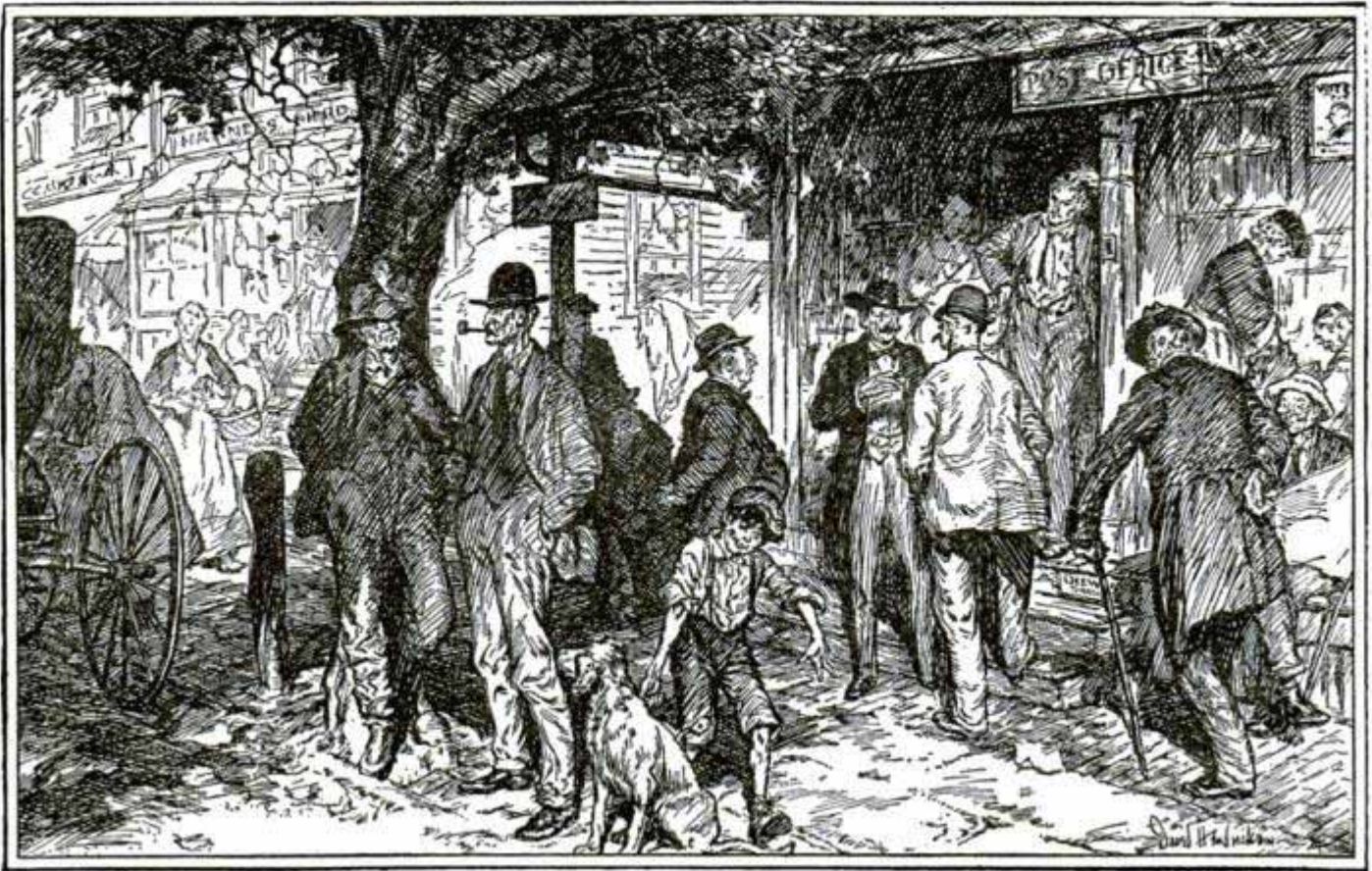

The Meeting Place

*An Advertisement of
the American Telephone and Telegraph Company*

It is not so long ago since people met in town hall, store or at the village post-office, to talk over matters of importance to the community. Then came the telephone to enable men to discuss matters with one another without leaving their homes.

With the growing use of the telephone, new difficulties arose and improvements had to be sought. Many of the improvements concerned the physical telephone plant. Many of them had to do with the means of using the apparatus to speed the connection and enable people to talk more easily.

This need for improvement is continuous and, more than ever, is a problem today. Speed and accuracy



in completing seventy million calls daily depends upon the efficiency of Bell System employees and equipment as well

as upon the co-operation of persons calling and those called and numerous private operators.

It is not enough that the average connection is made in a fraction of a minute or that the number of errors has been reduced to a very small percentage.

The American Telephone and Telegraph Company and its associated Bell Telephone Laboratories have practically for their sole task the making of the telephone more serviceable and more satisfactory—as a means of conversing with anyone, anywhere, any time.

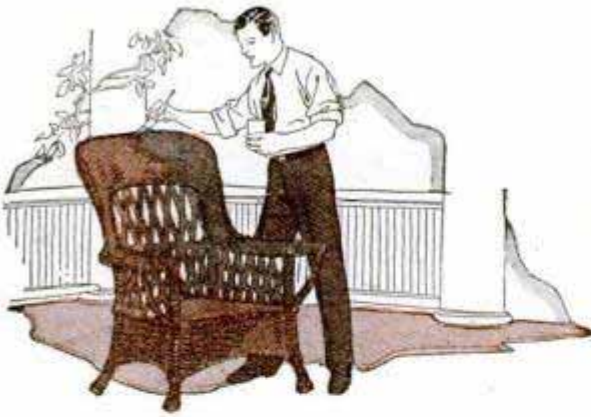

Marvelous New Finish for the Handy Man!

TEN years of intensive research are embodied in Valspar Brushing Lacquer, the newest product of Valentine Laboratories. Beautifies and protects all wood and metal surfaces—makes them stand hard service and prolonged wear.

Use it on your carpentry work, radio cabinets, floors, furniture, woodwork, tubs, medicine chest, etc. Outdoors, too—on front doors, porch furniture, garden implements, boats, canoes, etc.

Water-proof! Heat-proof! Weather-proof! Valspar Lacquer flows from the brush like good enamel and gives the satiny finish of a hand-rubbed surface without the hard work.

For automobiles — Valspar-Enamel

Everyone wants to drive an up-to-date, good looking car. A coat or two of Valspar-Enamel will make your car look like new. Covers the surface with a solid coat of beautiful color—and costs so little. Any man or woman can apply it.

The Valspar Lacquer Colors are: Cardinal Red, Nile Green, Jonquil Yellow, Persian Lilac, Palm Green, French Gray, Java Brown, Italian Blue, India Ivory, Holland Blue, Oriental Green, Coral Sand, Black, Argentine Orange, Peacock Blue, Chinese Red.

The Valspar-Enamel colors are: Red—Light or Deep; Blue—Light, Medium or Deep; Green—Medium or Deep; Vermilion, Gray, Brown, Ivory, Orange and Bright Yellow; also Black, White, Aluminum, Gold, Bronze and Flat Black.

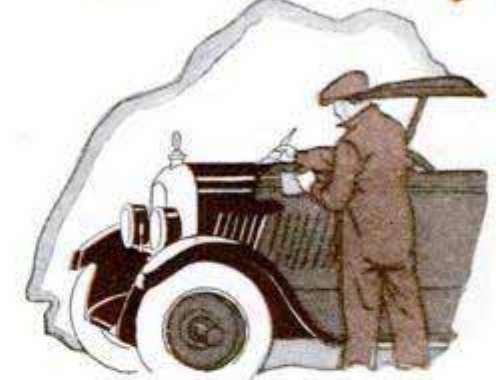
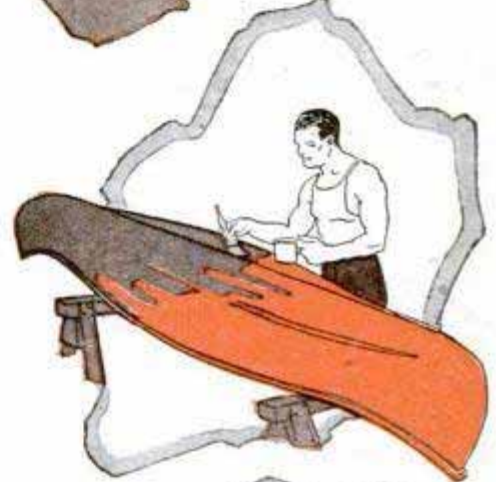
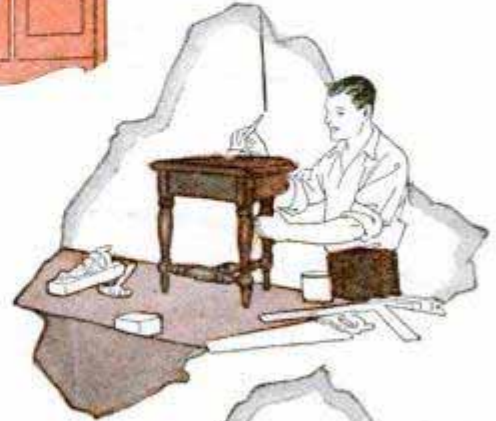

This coupon
is worth 20 to 40 cents

VALSPAR BRUSHING LACQUER

VALENTINE & COMPANY,
460 Fourth Avenue, New York

I enclose dealer's name and stamps—
20c a piece for one 40c sample can checked
at right. (Only one sample of Valspar
Brushing Lacquer and one of Valspar-
Enamel supplied per person at this price.)

Print full mail address plainly

Dealer's Name.....

Address.....

Your Name.....

Address..... City.....

Valspar Lacquer

Color.....

Valspar-Enamel

Color.....

P. M. 3-27

*Buy separately
or in assortments*

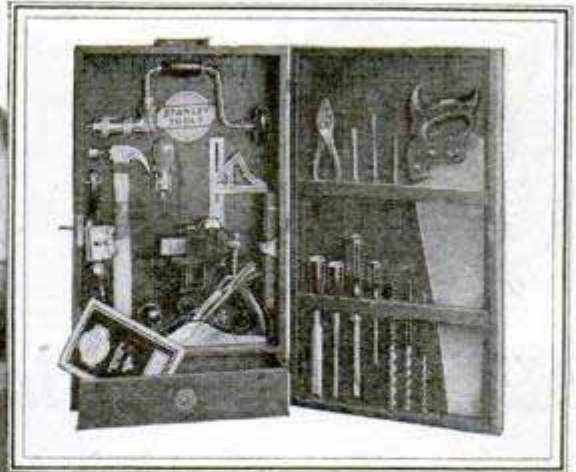

Are your books in order?

YOU keep most of your books in book cases. But how about those volumes which are in active use? Are they scattered about? A table book rack will keep them orderly and always at hand.

Stanley Plan No. 1-D will show you how to make one. All details of construction are clearly given. Sent on receipt of 10c.



Of course you realize the importance of using good tools. The amateur user needs good tools even more than the professional. Nothing is more discouraging than to have your work go wrong when you are in the midst of an interesting job. Most carpenters use Stanley Tools because they know from first-hand experience that the Stanley

name assures correct design, right "feel," and durability. And Stanley Tools are first choice in thousands of manual training classes.

You can buy Stanley Tools separately and so collect your own set. For your convenience in buying there are also complete sets of Stanley Tools in chests at a wide variety of prices from \$15 to \$96. Or there are assortments in strong cardboard boxes containing directions for making your own tool chest. Price \$2.15 to \$20.



Your hardware dealer has Plan No. 1-D as well as other Stanley Plans for making useful articles, or he can get them for you. The plans cost only 10c each. Ask him also for Catalogue No. 34-D which shows the most complete line of woodworking tools on the market. It is free. If he cannot supply you write to The Stanley Works, New Britain, Conn.

The best tools are the cheapest to use
Ask your hardware dealer



STANLEY TOOLS

LOOK!

Run Any Radio from your Electric Current

And remember, it makes no difference what kind or what make radio set you have, PHILCO Socket Powers will give you both A and B radio power from your electric light current—dependably and constantly. Here is your opportunity to do away with the ordinary "A" storage battery, dry cell batteries, and "B" batteries.

One switch controls everything. Snap it "ON" and from your house current you get a strong, steady flow of A and B power. Snap it "OFF" and your radio is silent.



No Hum No Distortion

Philco Socket Powers will give you radio reception without the least hum; without the least distortion. Your electric lighting current will now operate your radio set smoothly and perfectly—any kind or any make of set.

No more recharging to do; no more dry batteries to replace; no more fuss; no more bother, and better still, improved reception. *Everything contained in ONE Cabinet.*

Yours On Very Easy Payments

You can buy a PHILCO AB Socket Power on *Easy Payment Terms* from any Philco dealer in your town. You merely make a small first payment—balance monthly.

Go to your Electrical Dealer, Department Store, Electric Light Company, Music Dealer or Battery Service Station; tell them you read this advertisement and you want the PHILCO RADIO SOCKET POWER.

Installation FREE

No matter where you live there is almost sure to be an authorized PHILCO dealer near you who will deliver a brand-new Philco Socket Power to your home on the day and hour you desire. He will connect it to your radio set at no additional cost to you.

The Philco dealer in your community guarantees you complete satisfaction.

Trade In Your Old Storage Battery

Yes, any one of the many thousands of Philco dealers will make you a very liberal trade-in allowance for your old "A" storage battery on the purchase of a brand-new Philco Radio AB Socket Power.

It makes no difference what make of "A" storage battery you now have or how old or worn out it may be, the Philco dealer will give you a surprisingly liberal allowance.

Mail This Coupon Now

Visit the Philco dealer, or if you prefer, mail this coupon to us and we will give you the full details direct from the factory. We will send you complete information on our Easy Payment Plan and Trade-In Allowance offer for your old storage battery.

Sign your name and address to this coupon, and mail it to us today. The coupon is not an order. It does not place you under the slightest obligation. It is merely a request for the full details and free illustrated literature describing these famous Philco Socket Powers.

Philadelphia Storage Battery Co.
Philadelphia, Pa.

Dept. 1433

PHILCO Radio "AB"
Socket Power

© H.B.B.

Special Coupon

Philadelphia Storage Battery Co.,
Ontario and C Streets,
Philadelphia, Pa. Dept. 1433

Gentlemen:

Please send me, without cost, illustrated literature describing the famous Philco Radio AB Socket Power. I also desire full details of your Easy Payment Plan and Trade-In Allowance offer. It is understood that this request places me under no obligation.

_____ Name _____

_____ Address _____

_____ Name of your radio set _____

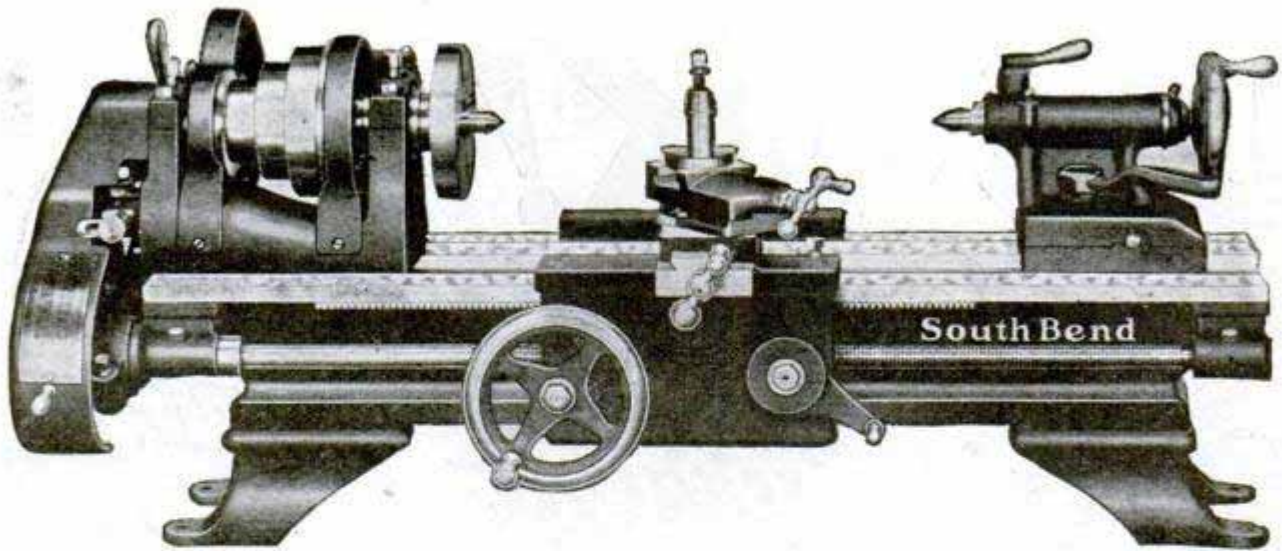

9 in. x 3 ft.
Back Geared
Screw Cutting

**Bench
Lathe**

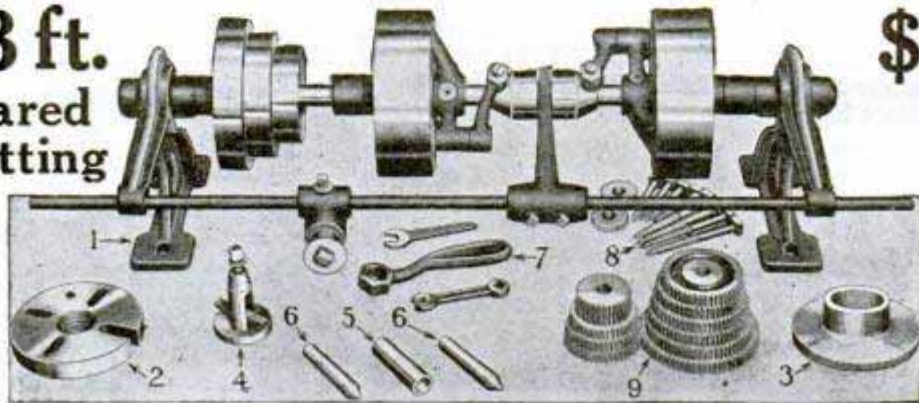

\$150

Price
Includes
Counter-
shaft and
Equipment

THE 9-in. South Bend Back Geared Screw Cutting Bench Lathe is a precision tool capable of turning out accurate machine work of all kinds within its capacity.

Brief Specifications

BACK GEARED HEAD STOCK with 3 Step Cone gives six changes of spindle speeds.

GROUND HEAD STOCK SPINDLE is made of special carbon steel. Has $\frac{3}{4}$ -inch hole its entire length for machining long bars and rods through Collet and Lathe Chucks.

PHOSPHOR BRONZE SPINDLE BEARINGS are hand scraped to perfect bearing, adjustable for wear.

COMPOUND REST is graduated 180 degrees and can be clamped to operate at any angle required.

The Compound Rest Feed Screw and the Carriage Cross Feed Screw are both equipped with Micrometer Graduated Collar reading in thousandths of an inch.

PRECISION LEAD SCREW is $\frac{3}{4}$ inches in diameter, 8 threads per inch. The finest precision thread gauges, taps, etc., can be made to meet the most exacting requirements.

POWER FEED to the carriage, by clamping the split nuts on the lead screw.

SCREW THREADS can be cut as follows, either right or left, including $1\frac{1}{2}$ pipe thread: 4, 5, 6, 7, 8, 9, 10, 11, $11\frac{1}{2}$, 12, 13, 14, 16, 18, 20, 22, 24, 26, 28, 30, 32, 36, 40, with the change gears supplied with the lathe.

This lathe can be driven from overhead countershaft or can be Motor Driven. $\frac{1}{4}$ H. P. Reversing Motor required connected direct to light socket.

Write for Bulletin 22-J for Detailed Description

SOUTH BEND LATHE WORKS

619 East Madison St.

South Bend, Indiana

Easy Payment Plan if Desired

Attachments

Draw-in Collet Chuck
Graduated Taper Attachment
Milling and Keyway Cutting Attachment
Electric Grinding Attachment
Electric Mica Undercutter
Turnstile Bed Turret
Thread Indicator
Adjustable Thread Cutting Stop
Step Chuck and Closer
6-in. 4 Jaw Independent Chuck
4-in. 3 Jaw Universal Chuck
Drill Chuck, etc.

The New Line of South Bend Lathes

In the past 20 years over 35,000 South Bend Lathes have been built and are giving satisfactory service in all lines of work. There is a South Bend Lathe for every job—from 9" to 24". The most popular sizes are listed below.

Size	Quick Change	Standard Change
9" x 3'	\$ 258.00	\$ 228.00
11" x 4'	308.00	268.00
13" x 5'	387.00	337.00
16" x 6'	521.00	461.00
18" x 8'	693.00	628.00
21" x 10'	1032.00	949.00
24" x 12'	1437.00	1338.00

For complete details write for illustrated Catalog No. 87 sent postpaid on request

SOUTH BEND LATHES

SAFE + COMFORTABLE + EASY TO RIDE

Save

time!

save money
—have lots of fun, too



WITH a Harley-Davidson Single you can get to work and back, run errands, and ride around evenings in half the time you would spend on street cars or busses. And at far less cost! One cent per mile! On week ends and holidays you will get a world of pleasure out of the healthful outdoor sport of motorcycling. It adds a new joy to vacations, too.

The Single is easy to ride and control—safe. Parks in any 2x8 foot space—convenient. Travels 80 miles on a gallon—economical. Powerful Ricardo-head motor.

Easy to buy, too. Ask your Harley-Davidson dealer about his Pay-as-you-ride Plan. Price complete with 3-speed transmission and full electric equipment, \$235 f. o. b. Milwaukee

Mail the coupon for literature.

HARLEY-DAVIDSON MOTOR CO.
DEPARTMENT P. MILWAUKEE, WIS.

Big sales opportunities in open territories.

The
HARLEY-DAVIDSON
[New-Type Motorcycle] *Single*

Mail  Now

HARLEY-DAVIDSON MOTOR CO.
Dept. P, Milwaukee, Wis.

Interested in Single
 Interested in your Dealer Proposition.
Is my territory open?

Name _____
Address _____





We Advise Men— “Don't Buy, Yet—

Accept, first, a 10-day tube of this unique shaving cream to try”

GENTLEMEN:—

We've been in business enough years to know that major success of a product rests entirely upon the merits of the product itself—not upon advertising, not upon “selling talk.”

So from the beginning we asked nobody to buy Palmolive Shaving Cream; but first to accept, free, a 10-day tube to try.

We think it will surpass your present favorite in 5 important ways. Please mail the coupon, prove the point at our expense.

These 5 advantages

1. Multiplies itself in lather 250 times.
2. Softens the beard in one minute.
3. Maintains its creamy fullness for 10 minutes on the face.
4. Strong bubbles hold the hairs erect for cutting.
5. Fine after-effects due to palm and olive oil content.

Just send coupon

Your present method may suit you well. But still there may be a better one. This test may mean much to you in comfort. Send the coupon before you forget.

THE PALMOLIVE COMPANY
(Del. Corp.)
CHICAGO, ILL.



3460

10 SHAVES FREE and a can of Palmolive After-Shaving Talc

Simply insert your name and address and mail to Dept. B-1289, The Palmolive Company (Del. Corp.), 3702 Iron St., Chicago, Illinois.

Residents of Wisconsin should address The Palmolive Company (Wis. Corp.), Milwaukee, Wis.

.....
.....
(Please print your name and address)

4 1/2 Brake H.P.

SPEED
over 20 miles per hour

MASTER ⁵ SPEED TWIN
CAILLE



SEND for FREE BOOK

The only outboard motor with neutral starting position—the only one with fast and slow speeds forward and reverse—the only one where the hand that steers controls all speeds by merely raising or lowering the steering handle. Other features—practically vibrationless—safety tilting—light weight—the famous Caille guarantee—easy payment plan.

THE CAILLE MOTOR COMPANY
6218 Second Blvd., Dept. B., Detroit, Mich.

Pay as You Play
\$32.00



puts a motor on your boat. The rest in easy payments.



EASY TO BUILD THINGS

“S-B” Big Economy Wood Metal Saw. A real tool. Strongly built. Fully guaranteed. Tilting table, 10x13. 6" combination saw. Adjustable top. Replaceable Phosphor Bronze Bearings. Ripping capacity 2". **\$19.90**

F. O. B. Chicago
JUST THE TOOL FOR BUILDING THINGS AT HOME
Radio, Patterns, Carpenter Work and numerous other practical and useful articles. Without grinding attachment. Write for circular.

saw, \$17.00. We also manufacture Motor-Driven Saws, Bench and Stand Type. Send for descriptive circular.

Scott-Bansbach Machinery Co., Dept. 327, 130 S. Clinton St., CHICAGO, ILLINOIS

For Home Work — Shop and Factory

This Drill was designed particularly for the amateur, experimenter, and manufacturer of radio equipment, and is adaptable for any work within the range of its capacity.

It is equipped with a swinging adjustable table, ball thrust spindle, chuck capacity 0" to 3/4", and 1-6 H. P. Ball Bearing Motor. Has three speeds and grinding attachment. Write for circular.

Manufactured by

H & D MACHINERY CO.
P. O. Box 2 WHITMAN, MASS.

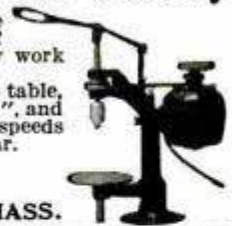

Italian Accordions

We manufacture and import all kinds of first-class hand-made

ITALIAN ACCORDIONS

the best in the world. Ten year guarantee. Our prices are lower than any other maker's. Free Accordion instructions to buyers. Write for FREE catalog.



RUATTA SERENELLI & CO.
1014 Blue Island Ave., Dept. P, CHICAGO, ILL.

10
days
free
trial

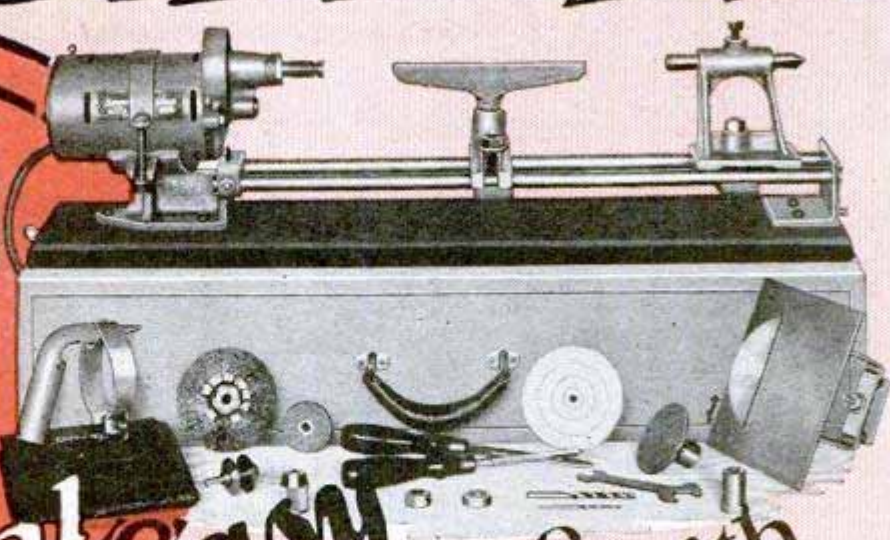

Easy to Make things with SpeedWay Shop

8 powerful motor-driven tools

Think of it! The Super-SpeedWay Shop shown above gives you a complete wood-turning lathe, bench saw, a scroll or jig saw, a portable electric hand-saw, and all the necessary accessories for both portable and stationary power drilling, buffing, grinding, and cleaning.

In other words, this outfit is an efficient, home workshop which will enable you to do any sort of a job your heart desires. The Super-SpeedWay Shop attaches to any light socket and will convert your workbench into a complete tool and machine shop, right in your own home!

A small down payment puts this Handy Shop in your home

We want to make it as easy as possible for you to own one of these complete Super-SpeedWay electrically driven Shops. All you have to do is to give us a small down payment of \$10.00 as evidence of good faith and we will ship you one of these Shops—immediately! You pay for the balance as you use it—in small easy monthly payments.

Fascinating fun

Users of the Super-SpeedWay Shop are enthusiastic in their praise. They say: fascinating, intriguing, interesting. It's true, too—you can make almost anything—attractive pieces of odd furniture, toys, home and garden improvements, radio cabinets and consoles, bric-a-brac, bookshelves, countless other useful articles. Moreover, you can do buffing, polishing, grinding and drilling, either at the bench or wherever there is a handy lamp socket. There is a thrill of joy and pride in workmanship when you perform with the Super-SpeedWay Shop and Tools.

Don't pass this up!

We want you to know more about this exceptional Shop. Every tool in it is high grade, built for hours of hard, rugged work. A money-maker for the small-job man. A priceless boon to the householder. Get the full particulars. Send in the coupon today!

Electro Magnetic Tool Co.
Department 23
1830 S. 52nd Ave., CICERO, ILL.
(Adjoining Chicago)

Handy articles

Just look! Above are shown a few of the handy articles which enthusiastic users of the Super-SpeedWay Shop and tools are making every day right in their own home. Why not write us for full information?

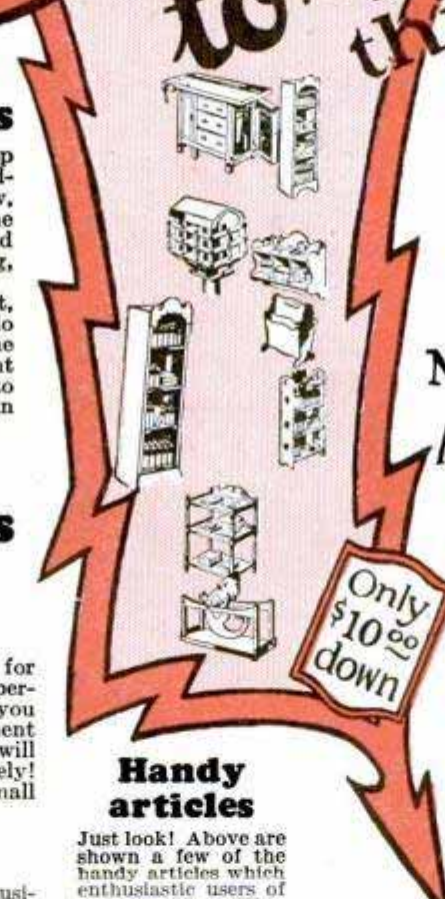

Only \$10.00 down

Just what you have been waiting for! A compact and efficient electric workshop for you men who are handy with tools, for you mechanically-inclined men, and for you men who like to experiment and make things at home. For the first time in the history of our business we are able to put this Super-SpeedWay Shop before you at a price which you can afford. Our offer is a fair and square, straight-from-the-shoulder offer, from manufacturers of SpeedWay Portable Electric Tools, famous the world over, for more than a decade.

Make things! AT HOME!

We are offering you this Super-SpeedWay Shop and tools on a ten-day free trial plan right in your own home. Test it—experiment with it. Use it as if it were your own. We know you will find it the handiest, fastest metal and woodworking outfit you have ever laid your eyes on. Attach to any light socket, snap on the switch and zingo! The job is under way!

Don't delay—Write today

Now—while you are thinking of it, tear out the coupon below and send it in to us. We want to tell you more about the Super-SpeedWay Shop and tools. We want to tell you about our ten-day free trial plan. We want to tell you about our small down payment—how you pay the balance in easy terms. As you use, you pay. We want to tell you everything about this wonderful Super-SpeedWay Shop.

ACT NOW!

That's why we say—don't delay. For a limited time only we are making this special offer on the SpeedWay Shop and tools. If you want to be in on it, fill out the coupon and send it in NOW.

SEND COUPON NOW!

FREE Blueprint Service
Each month for a year we will furnish you a blueprint of your own selection absolutely free, to help you get the maximum fun and service from your Super-SpeedWay Shop. Write us for our interesting list

Dept. 23
Electro Magnetic Tool Co.
1830 S. 52nd Ave., Cicero, Ill.
Dear Sirs: I am interested in the Super-SpeedWay Shop and tools. Please send me full particulars about the ten-day free trial, free blueprint, and easy payment plan on the SpeedWay Shop and tools.

Name.....
Address.....
City..... State.....

Big Money Repairing Balloon Tires This Easy Way

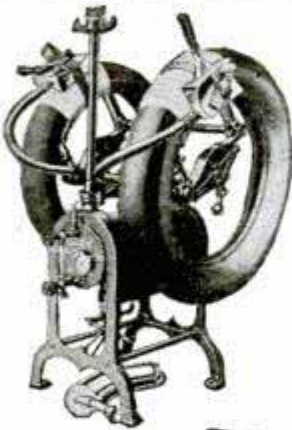

Go into business for yourself. Become independent, well-to-do. Take advantage of tremendous revival in tire repair business. Millions of balloon tires in use now need repairs.

An easy way to make money. Small capital. No experience is needed. Plenty of jobs. Every motorist a prospect.

SHALER

Balloon Tire Vulcanizer

Lowest priced complete tire repair plant. Repairs fabrics, cord and balloon tires. Does just as good work as high priced machines. Anyone can operate it. Made by world's largest manufacturers of tire vulcanizers. Endorsed by leading tire makers and used by hundreds of repair shops. Guaranteed to do first class work.

FREE ON TIRE REPAIRING. Tells how to make big money and become established in business of your own. WRITE QUICK!

C. A. SHALER CO., 2703 Fourth St., Waupun, Wis., U.S.A.
World's Headquarters for Tire Repair Equipment

New and Used Auto Parts at 30 to 80% Saving

Our stock of new and used replacement parts is the largest in the world. No matter what you need, write to us for prices. You will save from 30 to 80% and parts can be obtained from us which it is impossible to get elsewhere.



Get Our Big Parts Book—FREE

Our Big 80-page Parts Catalog is the largest book of its kind ever issued. Everything for the automobile at cut prices—less than regular wholesale.

An enormous volume of business and quantity purchases make our low prices possible. Nationally advertised products. All new except where specified—Timken Axles and Bearings—Brown-Lipe Transmissions—Pistons—Rings—Hayes and Firestone Wheels—Rims—Tires—Tubes—also a complete line of Accessories. If it's for an auto, you will find it listed in our big parts Book.

Write Today for Your Copy—It's FREE

WARSHAWSKY & CO.
World's Largest Replacement Parts House
1915-35 So. State St., Dept. PM-3, CHICAGO, ILL.

TYPewriter PRICES CUT



Your choice of the World's best typewriters—Underwood, Remington, Oliver—full size, late model, completely rebuilt and refinished brand new. Prices smashed down to half. Act quick.

\$2 and it's yours

Free Trial

Just send your name and address and we will mail you our complete **FREE CATALOG** prepaid, fully describing and showing actual photographs of each beautiful machine in full colors. Tells every detail of our direct-to-you small-payment plan. Write now for tremendous saving. No obligation whatever. Still time if you act now.

International Typewriter Exchange
186-188 W. Lake Street. Department 394 Chicago, Ill.



BUY YOUR TIRES WHOLESALE

Famous BEARCAT CORDS on 35,000 Cars in Chicago

Thousands of motorists have gladly paid 10% more than standard retail prices for the famous BEARCAT Cords and Balloons. Different, better cord construction—6 plys instead of 4—extra heavy tread of finest grade new, live, tough rubber. Highest quality tire made. Mileage records almost unbelievable. Positively smartest tire in America. Looks different than any other. Old company and real **GUARANTEE** protects buyer.

Car Owner Agents! Up to now, BEARCATS have been sold mostly to millions who have heard of them but who never before could buy them. Retail price is now no higher than other standard makes. Be our agent. Cash in. Start by getting your tires at 1-3 off. No strings to our offer. Write at once for our confidential wholesale prices and agent proposition. Exclusive territories.

SIMPLEX TIRE & RUBBER CO. 2035 MICHIGAN AVE. Dept. 16 CHICAGO

\$20 a day and a Hudson Coach Given!

Would you like to make \$20 a day? Would you like to have a steady income of \$100 a week—over \$5000 a year? In addition to these big earnings,

would you like to get a Hudson Coach? If you would, this is your chance. We need men and women to represent us everywhere. Experience is unnecessary. We furnish everything you need. We tell you what to say, how to make money.



If you will follow a few simple instructions, \$20 a day is easy.

GET THE FACTS

Edgar Morris cleaned up \$210 profit his first two weeks. J. B. Smith cleared \$53 in two days. Mrs. Terwilliger netted \$13.20 profit in a few minutes' time. You can do as well—either in full time or spare hours. The money is waiting for you. Write today. Find out how easily you can make \$20 a day or more and in addition get a new Hudson Super-Six Coach.

THE AMERICAN PRODUCTS CO. Dept. 7006 CINCINNATI, OHIO

Newest Invention! SPORS Pen

No wonder it's so easy to make \$20 a day when you can distribute these new unbreakable self-filling Fountain Pens with latest improvements.

IMPORTED GUARANTEED FOR TWO YEARS
—WRITES LIKE A \$7 PEN.

Your Sample Pen Costs You ONLY **65¢** Sells for **\$1.25**

FREE
SILK NECK RIBBON TO MATCH WITH EACH LADIES' STYLE PEN

FREE

There Are Dollars to Be Made

almost every time you turn around. Fountain Pens are always in demand. Nearly everyone uses them, especially when they can get a Fountain Pen like ours for only \$1.25 that writes as good as a pen selling for three and four times this price.

60 DAYS' TRIAL
MONEY BACK IF NOT PLEASED

If you cannot make at least \$10.00 a day, all you have to do is to return unsold goods to us any time within 60 days and we will refund your money at once.

Could we give you a guarantee like this if we had any doubt that the average person cannot make at least \$10 a day?

7
BEAUTIFUL COLORS:
Red, Green, Yellow, Purple, Mahogany and Green Molot

Big Specialty Catalog showing Best Sellers from all parts of the world.

WHY THE PENS SELL LIKE HOT CAKES

Large ink Container.

Ink feed. Even Flow. Can't clog or leak.

MAKES \$8.40 IN TEN MINUTES

I sold my dozen pens in about 10 minutes. Will order another dozen soon.
TRACY KRENZ, Nebraska.

MADE \$16.50 IN ONE DAY'S SPARE TIME

I received my sample pen yesterday and sold 22 pens in my spare time.
M. E. McDOWELL, Indiana.

NEW 'IMPROVED POINT'. Writes as smooth as a pencil on any kind of paper. Eight grooves for ink to feed. Easily taken out and cleaned. Will not leak, blot nor clog. Extra points sell for 15c each.

The barrel and cap are made of the very best and strongest Unbreakable Material, and with usual care will last a life-time.

STRONG ATTACHED CLIP

Biggest improvement ever made in pen industry. Small airtight place for point keeps ink from drying and writes the instant it touches the paper without first shaking the pen.

F. SPORS & CO.,
127 Main St., Lesueur Center, Minn.

- Send me one Spors pen, 65c c. o. d., plus postage.
 - Send me 12 Spors pens, \$6.42 c. o. d., plus postage.
 - Send me 36 Spors pens, \$18 c. o. d., plus postage.
 - Send me catalog, no obligation on my part.
- Mark X opposite proposition interested in.

Name.....

Address.....

City.....State.....

DEVITT 8" COMBINATION SAW

13 TOOLS IN ONE

Saw table raised, showing Emery wheel, saw guard and drill attachment.



Planer attachment on saw table.

Showing Sanding disc attached.



Table tilted for beveling.

Dado head attached for grooving.

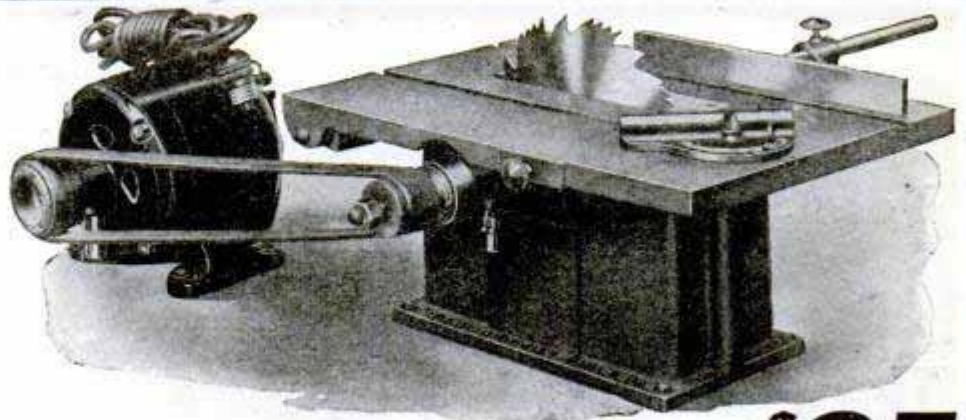

\$35
F. O. B. Phila.

YOU save a great deal of money, time and space by buying a Devitt 8" Combination Saw. Why buy special tools for beveling, grooving, buffing, etc.? The Devitt Combination Saw will rip, cross cut, bevel, miter, groove, mortise, tenon, drill, rabbet, grind, buff and polish. The attachments are easily and quickly adjusted. The saw and motor when set up ready for work occupy very little room. The 1/4 H. P. 60 cycle 110 volt A. C. motor can be run from a light socket and provide power for other purposes when the saw is not in use. A cut up to 2 1/4" can be made with the 8" Combination Saw without planing. The ideal machine for shop, factory or home, complete with attachments: 12"x16" table, 8" Combination Saw, iron pulley for saw table, 12" ripping fence, adjustable cut off miter gauge, motor-specifications as above, 1 1/4" endless leather belt, wood pulley, 8 ft. cord and plug, 6" buffing wheel, 3/4" 3 jaw drill chuck, 5" emery wheel, 8" sander, saw guard, and 2" dado insert. \$35.00 F. O. B. Phila. Height 16", shipping weight, 100 lbs.

(Planer attachment to fit on table top will smooth pieces up to 2" wide, \$12.00 extra F. O. B. Phila.)

Write for our beautifully illustrated 4 page circular.

PAUL J. DEVITT 1102 South 2nd Street PHILADELPHIA, PA.

Own a CORONA

The portable typewriter built like an office machine. Has four-row keyboard and big-machine features throughout. Write to



L. C. Smith and Corona Typewriters, Inc.
112 E. Washington St., Syracuse, N. Y.

MOTORCYCLES



Price \$10 and up purchased through our Co-Operative Plan for as low as \$1.00 down and \$1.00 per week Indians Harley-Davidsons Ace Henderson and Clevelands

Send for Bulletin A.

Motorcycles shipped to all parts of the world
WALKER-INDIAN CO., 188 Mass. Ave., BOSTON

250 POWER MICROSCOPE

MADE IN U.S.A.

\$16-50

Educational and entertaining, this fine instrument familiarizes young and old with life around us that is invisible to the unaided eye. Tiny insects appear as monsters. Plant and mineral life reveal new beauties in form and color. Ideal for students, home, office, dentists, physicians, scientists and laboratory. Precise optical qualities, giving variable magnification from 100 to 250 diameters. Tilting stand. Black finish, nickel trim. Complete with plush lined case, prepared slide and instructions. 100 Power Model with same precise optical qualities and finish, without tilting stand, \$8.50. At your dealer or direct, post-paid. Money back guarantee.



Further information free upon request.

Wollensak Optical Company
893 Hudson Ave., Rochester, N. Y.

FREE 1000 Illustrations ELECTRIC FIXTURE CATALOG!



Write today for your copy. Save 50% direct from Manufacturer. No Middleman's Profit. OUR SPECIAL: 8 Room Electric Set, ready to hang, \$24.50—Other bargains.



UNITED LIGHTING FIXTURE CO.
83 Flatbush Ave. Dept. P, Brooklyn, N. Y.

Buy a Brookside 99 the finest of Steel Rods



Here's the greatest of all bait casting rods. Casts with the ease of a tournament rod. Combines flexibility with rugged strength and light weight. Made of special tempered spring steel. Patented features—reinforced tip and second joint—and joints are staggered for perfect casting action. All crystal agate guides and top. Detachable finger hook. Quality cork handle. In a case of special design, with snap eyelets. List price \$7.00. If your dealer can not supply you write us. Richardson makes steel rods for every fishing requirement and every purse.

Write for the new Richardson catalog. Sent free. Fully describes all Richardson Steel Fishing Rods and "Harrimac" collapsible landing nets. Send for your copy now.

RICHARDSON ROD AND REEL CO.
528 Lake Shore Drive, CHICAGO

7 Tube Set

Single Dial Radio

30 DAYS FREE TRIAL

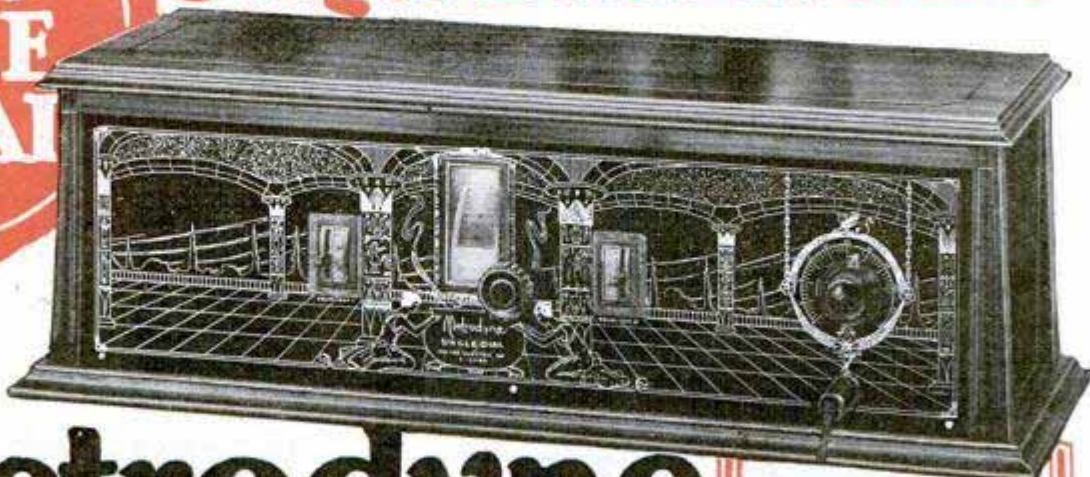

The Metrodyne

ONLY ONE DIAL TO TUNE

Retail Price
\$75

Completely Assembled
BIG DISCOUNTS TO AGENTS AND DEALERS

Wonderful offer direct from the factory! The world's greatest radio. A perfect working, single dial control, 7 tube receiver. And just to prove our claims, we will ship it to your home for 30 days' free trial. Test it under all conditions. Test it for distance, volume and tonal quality — and if you are not convinced that it is the best single dial set you ever heard, return it to the factory. We don't want your money unless you are completely satisfied.

BIG PROFITS TO AGENTS AND DEALERS
Our Agents and Dealers make big money selling Metrodyne Sets. You can work all or part time. Demonstrate the superiority of Metrodynes right in your home. Metrodyne Radios have no competition. Lowest wholesale prices. Demonstrating set on 30 days' free trial. Greatest money-making opportunity. Send coupon below—or a letter—for our agent's proposition.

Metrodyne Super-Seven Radio

A single dial control, 7 tube, tuned radio frequency set. Approved by America's leading radio engineers. Designed and built by radio experts. Only the highest quality low loss parts are used. Magnificent, two-tone walnut cabinet. Artistically gilded genuine Bakelite panel, nickeled piano hinge and cover support. All exposed metal parts are beautifully finished in

24-k gold. Easiest set to operate. Only one small knob tunes in all stations. Dial is electrically lighted so that you can log stations in the dark. Volume control regulates reception from a faint whisper to thunderous volume, 1,000 to 3,000 miles on loud speaker! The Metrodyne Super-Seven is a beautiful and efficient receiver, and we are so sure that you will be delighted with it, that we make this liberal 30 days' free trial offer. You to be the judge.



METRODYNE SUPER SIX RADIO

ON 30 DAYS' FREE TRIAL

6 Tube Set
\$48.50
RETAIL PRICE
Completely Assembled

Wonderful 6 tube, long distance radio set. Approved by America's leading Radio Engineers. Easy to operate. Dials log easily. Tune in your favorite stations instantly on the same dial numbers every time. No guessing. 30 days' free trial.

Mr. Howard of Chicago said, "With 5 Chicago Stations on the air I tuned in 17 out-of-town stations, including New York and San Francisco on loud speaker very loud and clear.

We are one of the pioneers of radio. The success of Metrodyne sets is due to our liberal **30 Days' Free Trial Offer**, which gives you the opportunity of trying before buying.

MAIL THIS COUPON 
or send a postal or letter. Get our proposition before buying a radio. Deal direct with manufacturer—**Save Money.**

Mail COUPON Below!

Let us send you proof of Metrodyne quality

C. J. Walker, Mariposa, Calif., writes: "Received my Metrodyne Single Dial set O. K. I believe that these one-dial sets are going to be excellent sellers. I had no trouble in tuning in stations enough to satisfy anyone, so you will please send me another set."

Roy Bloch, San Francisco, Calif., writes: "Very often we travel from New York to the Hawaiian Islands quickly—from station to station—by means of the little tuning-knob which operates the electrically-lighted dial. The Metrodyne Single Dial Set is much easier to operate than any radio set I've ever seen."

We will send you hundreds of similar letters from owners who acclaim the Metrodyne as the **greatest radio set in the world**. A postal, letter or the coupon brings complete information, testimonials, wholesale prices, and our liberal 30 days' free trial offer.

METRO ELECTRIC COMPANY
2161-71 N. California Ave., Dept. 143
Chicago, Illinois

Gentlemen:
Send me full particulars about Metrodyne 6 tube and 7 tube sets and your 30 days' free trial offer.

Name.....
Address.....

If you are interested in AGENT'S proposition, place an "X" in the square

METRO ELECTRIC COMPANY
2161-71 N. California Ave., Dept. 143, Chicago, Illinois



JAPANESE ROSE BUSHES

The Wonder of the World

Japanese Rose Bushes bloom all the year round. Just think of it. Six weeks after planting the seed, the plants will be in full bloom. It may not seem possible, but we positively guarantee it to be so. They will bloom every ten weeks, Summer or Winter, and when three years old the bush will be a mass of roses, bearing from five hundred to a thousand roses on each bush. The flowers are in three shades—white, pink, and crimson. The plants will do well both in and out doors. We guarantee at least three bushes to grow from each packet of seed. Price, 10c packet, 3 pkts. for 25c postpaid.

Chinese Fragrant Tree Fern

Just introduced, noted for its rapid growth. An exceptionally pretty ornamental plant. Foliage is rich dark green. Forms grand pyramidal bushes about 6 feet high. Branches very desirable for decorative purposes. wreaths, etc. Seeds 15c pkt., 3 for 40c.

Weather Plant

NATURE'S WEATHER PROPHECY By mysterious changes that take place, this remarkable plant accurately forecasts the weather many hours in advance. Will grow anywhere all the year around. An interesting house plant. Bears large, fragrant, pink, butterfly shape flowers. Seeds, 15c packet, 3 for 40c, postpaid

GROUND ALMONDS

Amazingly Prolific—Easily Grown From Seed The Ground Almond has a flavor that is MOST EXCELLENT, resembling the coconut. The meat is snow white, covered with a shell or skin of brown color. It grows close to the surface and anything from 200 to 300 Almonds may be expected from a single nut. There is no trouble whatever in growing anywhere and in any kind of soil. May be planted any time, and in eight or ten weeks from time of planting you will have an ENORMOUS CROP of the MOST DELICIOUS ALMONDS YOU EVER TASTED. Seeds 15c Pkt.



Perfume Plant

Blooms only at night, giving forth the most delightful scented fragrance for quite a distance. Causes much comment. For house or garden. Also valuable because of rare perfume made from it. SEEDS, 10c pkt., 3 for 25c.

SENSITIVE PLANT

Marvel of the Philippines. Leaves curl, fronds droop when touched. Apparently resents interference. A handsome shrub for house or garden; very curious and interesting. Seeds, 15c pkt., 3 for 40c.

Calabash or Pipe Gourds

A luxuriant and rapid growing climber; thrives anywhere. Produces the ornamental gourds from which the famous African calabash pipes are made. Grow this interesting vine and make your own. Seeds, with instructions, 15c pkt., 3 for 40c.

Japanese Nest Egg Gourd

Very curious. Produces fruit same size, shape and color of nest eggs. Matured fruit does not crack. Will serve for years as a nest egg, stocking cabinet, ornamental purposes, etc. Seeds 15c pkt., 3 pkts. for 40c. J.S. & CO.

MAMMOTH PEANUTS

Peanuts can be easily cultivated. Their culture is very simple and exceedingly interesting. Mammoth Peanuts grow to an astonishing size. It is a good producer, very prolific, and the giant nuts have a thick, heavily ribbed protecting shell. The plant is very attractive, the leaves being of odd shape and a handsome green shade, tinted through the center with white. You will derive much pleasure cultivating this interesting species. Seeds 15c pkt., 3 pkts. for 40c.

Musk Plant

A universally admired favorite for house, flower garden or greenhouse. A very fine house plant. Lives for years. Is of the sweet scented variety, giving forth much fragrance. Also valuable on account of the perfume that can be made from it. Seeds 15c pkt., 3 for 40c.

Japanese Climbing Cucumber

Unusually strong and vigorous growing vine. Attains twice the size of ordinary varieties. Grows readily on fences, poles, trellises, etc. One hill will keep an entire family supplied all summer.

Gigantic Butter Beans

The New Edible Vegetable Wonder Grows to an astonishing size. The Beans measuring from 3 to 6 feet long, and weighing anything from 10 to 16 lbs., and even more. One Bean is sufficient for a family for several meals. Very palatable and rich in nutritious materials. The delicate Buttery Flavor is much appreciated. The Vines are easily grown, very prolific, and a most welcome and valuable adjunct to your garden. Try them; you will find them the most delicious vegetable you have ever tasted. Imported direct. Unobtainable elsewhere. Sample package of Seeds with full directions for cultivating and cooking. 25c, postpaid.

Kudzu Vine

Most rapid growing vine known. Will grow 20 feet in one week. Luxuriant foliage, lovely purple flowers, very fragrant. Nothing to equal it for shade purposes and quick growth. Seeds 15c packet, 3 for 40c.

Yard Long Bean

Produces enormous crop of long, slender, round pods, of excellent quality for snap beans. Pods grow from 2 to 5 feet in length. Very tender and fine flavor. The vines are rampant growers; an interesting curiosity. Seeds 15c pkt., 3 for 40c

THE REMARKABLE FIREFLY PLANT



A Vine that Blooms at Night Fills the Atmosphere with Fragrant Aroma One of the most rapid growing vines known. Under favorable conditions this vine has been known to grow OVER 25 FEET IN A SINGLE WEEK. In a very short space of time indeed the Vine has climbed to a great height, and is covered with IMMENSE FLOWERS, from 5 to 7 inches in diameter. It is, indeed, a great novelty for, unlike other plants, the flowers OPEN IN THE EVENING, and remain open until about noon the following day. In dull weather they will remain open all day. It is a most INTERESTING SIGHT to watch the opening and closing of the flowers as the clouds appear and disperse. As the flowers open they give forth the most DELIGHTFUL AROMA and the whole atmosphere around is full of scented fragrance. It is always the object of favorable comment, and much curiosity is aroused by people passing at night time as to the cause of the charming aroma, frequently stopping in an endeavor to satisfy their curiosity. PRICE, 19 CENTS packet, two packets for 35 CENTS, POSTPAID. JOHNSON SMITH & CO.

The Great Wonderberry

A luscious berry that may be grown and ripened from seed in any soil or climate in 3 months. The flavor is fine and unsurpassed for eating raw, cooked, canned or preserved in any form. The fruit is blue-black in color, and tastes like a luscious, rich blueberry. One bush will produce an enormous amount of fruit, yielding great masses of rich fruit all Summer and Fall. Packet, 10c, 3 pkts. for 25c, postpaid.

Bush Musk Melon

A vineless Musk Melon, grows in bushes, and thus can be cultivated in the smallest garden. The fruit is of the popular "Jenny Lind" type, but larger, averaging 6 inches in diameter. The flesh is very deep, edible almost to the rind and is colored light green, flushed with a tinge of red toward the center. The quality is superb, lusciously sweet and juicy. Packet of seeds, with full directions for culture, 15 cents, 3 packets for 40 cents, p.p.d.

The Great Umbrella Palm

A Graceful House or Conservatory Plant Easily Grown From Seed Winter or Summer The Japanese Umbrella Palm is a semi-aquatic plant. It is easily grown from seed either in a bowl of water or in very damp soil. Probably the most usual, as well as the most interesting method, is to cultivate the plant in a bowl or jardiniere filled with water, with two or three inches of good garden soil at the bottom. The seeds soon commence to germinate, and the plant shoots up stems two to three feet high and rapidly assumes a most pretty palm-like appearance, as shown in the engraving. The tops of the stems are surmounted by a whorl of umbrella-shaped leaves, of a waxy appearance. We will send a package of this seed, with full instructions for culture, for only 15c or three packets for 40c postpaid.

Butterfly's Own Bush

This plant is a veritable refuge or haven for butterflies, and it attracts all the most beautiful species of butterflies to the neighborhood. Bees, too, are very fond of it. It is a pretty plant with bearing pretty double flowers, ranging from white to rich crimson, deep red and pink, lilac and other delicate shades. Packet 10 cents, 3 for 25 cents postpaid.

FAMOUS MEXICAN FIREFLY PLANT

Beautiful hedge plant, grows 2 to 2 1/2 feet high and resembling a closely clipped ornamental evergreen. The globe-shaped or pyramidal bushes are close and compact, and of a pleasing light green color. May be grown singly or in the form of a hedge or background. In early autumn the whole bush becomes carmine or blood red, hence the name of Mexican Fire Plant, or "Burning Bush," as it is sometimes called. Selected Seeds, 10c

CROWN OF THORNS

A very curious clover-like plant, can be cultivated indoors or outdoors. The three red blotches on the leaves representing the three wounds of Christ. Has curious thorny seed ball; if loosened at tip the hull is found to consist of a long prickly-edged band giving the plant its name. Seeds 15c packet, 3 for 40c.

Asparagus Sprengeri

The best plant for hanging baskets. Masses of rich, gleaming foliage droop in a very graceful manner. The foliage when cut for decorative purposes will last for weeks in water. The seed pods are very pretty red berries adding to its beauty. Packet, 25c, 3 pkts. for 65c postpaid.

"Wong-Bok" Chinese Cabbage

Novelty from China and should be grown in every garden. Seems to be a cross between Celery and Cos Lettuce. Flavor is more mild than any other cabbage. Can be served on the table and eaten raw or cooked like cabbage, spinach or lettuce or made into salad. Grows very rapidly, easy to cultivate. You can create quite a sensation by cultivating this remarkable novelty. Seeds, 15c packet, 3 pkts. for 40c.

TREE OF HEAVEN

This splendid ornamental tree is a native of China, and is called the Tree of Heaven, on account of its great beauty. Very hardy, thrives in any soil, no matter how poor, and grows from 6 to 10 feet high from seed the first summer. The leaves are from 5 to 6 feet in any length, giving it a grand appearance. Nothing outside the tropics can rival it for lawn decoration. Large panicles of bloom, followed in season by great clusters of colored seed pods, make the tree a continual thing of beauty. Packet, 15c; 3 packets 40c

SURPRISE FLOWER GARDEN

Over Hundred Varieties of Mixed Flower Seeds MANY RARE AND CURIOUS NOVELTIES An Abundance of Flowers Assured Throughout the Season A mixture of easily grown annuals that bloom very soon after sowing the seed; others vary in their time of blooming. Those who cannot give the constant care necessary for finely arranged flower beds will be delighted with the Surprise Wild Flower Garden. Will prove a continual surprise and pleasure, as new varieties and the old garden favorites flower successively throughout the season. There are over a hundred varieties of seeds. Many of the plants may be taken inside as house plants and will bloom during the winter. Fine for children, also teachers for school gardens. Packet, 15 cents, three packets for 40 cents, postpaid. J. S. & CO.

THIS WONDER WORKING SHOP

Will Make You a Craftsman

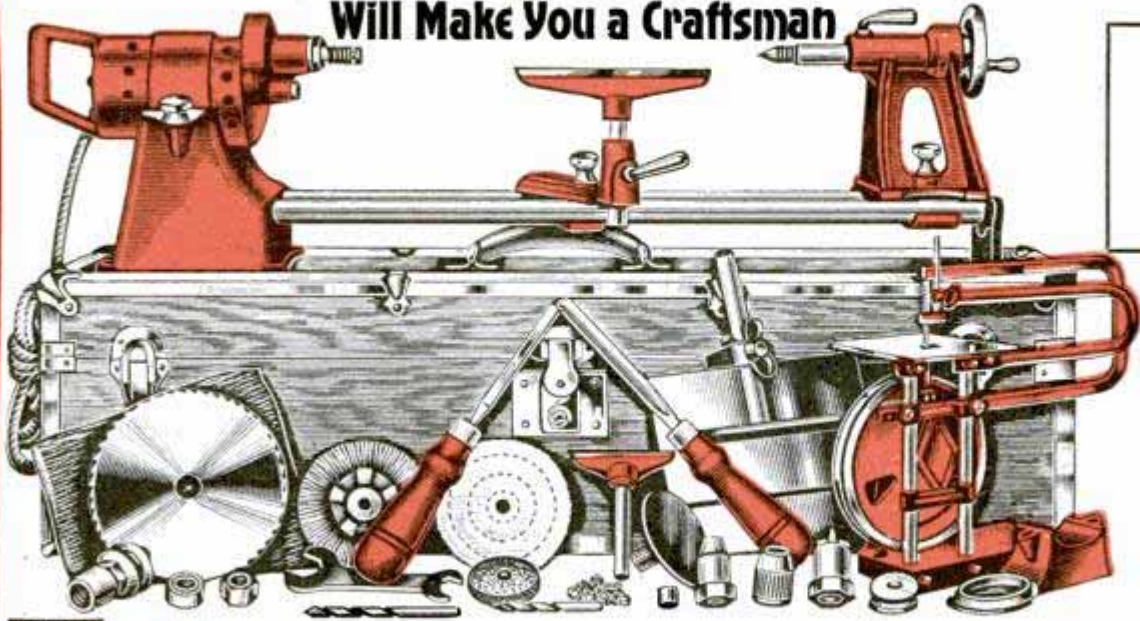

only
\$10.00
down

**SENT
ON
TRIAL**



A COMPLETE SET OF PRECISION TOOLS electrically driven that will make you an accomplished workman. It is a chest full of tools that has been designed by a master for the private use of tool

lovers and men who want to build, construct, invent and create at home. You will be able to make everything — attractive odd furniture, toys, home and garden improvements, all around manufacturing, repairing.

The Red Jacket 1927 model is a perfect woodworking equipment and has my O.K.

*Wm. L. Aylward,
Mastercraftsman*

NOW! MAKE THINGS AT HOME WITH THE NEW **RED JACKET** HOME WORK SHOP

The complete equipment consists of the powerful Red Jacket Motor, with direct drive to an accurate wood turning lathe (capacity 9 in. x 34 in.); a bench saw, that has depth and side gauges; scroll and jig saw; and all accessories for both portable and stationary power drilling, buffing, grinding and cleaning. Attaches to any light socket and converts your work bench into a complete private tool and machine shop.

THE WACO GUARANTEE

IF IT IS NOT WHAT YOU WANT WHEN YOU GET IT—SEND IT BACK

SPECIAL CRAFTS COURSE

And blueprint service is free to Red Jacket Shop owners— all that there is to know about handcraft methods, raw materials, woods, carving, sawing, turning, designing, carpentering, decorating, is taught by special correspondence.

BUY ON YOUR OWN TERMS

Only \$10.00 down. Liberal discounts for cash. Easy monthly payment plans. It is no hardship to own a Red Jacket.

INTERESTING LITERATURE FREE

Just send the coupon. You will be surprised with all it contains. Beautiful, Instructive, Fascinating, Interesting.

Everything Explained in Our Literature

Active Dealers and Agents Wanted

These are genuine electric tools. They are not toys or fragile in any respect. Created for "handy" men. So compact, reliable and efficient that you can accomplish any job with it, and so inexpensive that any one can own it. Unconditionally guaranteed. Our literature is very interesting and fascinating and explains everything. Don't delay. Learn all about the Red Jacket Home Work Bench now.

- Turning
- Sawing
- Winding
- Spinning
- Grinding
- Buffing
- Polishing
- Cabinet Making
- Scroll Sawing
- Drilling
- Repairing
- Dove tailing
- Pointing
- Joining
- Sharpening
- Sanding
- Scratching
- Carving
- Successful Masterpieces



10 DAYS' FREE TRIAL

Our literature tells you how to start a job of your own. If you are not pleased return the Shop.

2 OUNCES

of interesting reading will be sent you gratis. Send the coupon below. Sit back—see what we send you. It's free.

Mail This to Waco

Learn All About the Red Jacket

WACO TOOL WORKS,
2915 So. Wabash Avenue, Chicago, Illinois.

Manager, Dept. 103. Please send me particulars about 10-day free trial, free blue-prints and \$10 down payment.

Name.....

Address.....



free
CRAFTS
COURSE

free
BLUE
PRINTS



"What's the Best Hammer?"

"That's easy. The one with 'D. Maydole. Made in U. S. A.' stamped on the head. Ask me about some other tool and I might have a job deciding but every man that knows tools 'll tell you that there's only one hammer with the 'hang,' strength and durability of a Maydole—and that's ANOTHER Maydole."

Maydole Hammers are the result of eighty-four years of accumulated skill and experience devoted exclusively to fashioning fine hammers. Heads are PRESS-FORGED of tool steel; handles are of clear, second growth, air-dried hickory, put on "for keeps."

Maydole Hammers are made in all types and weights. Ask your dealer to show you the genuine Maydole.

And write us for a free copy of interesting and valuable Pocket Handbook 23 "L."

YOUR HAMMER SINCE 1843
Maydole
Hammers
 The David Maydole Hammer Co., Norwich, N.Y.

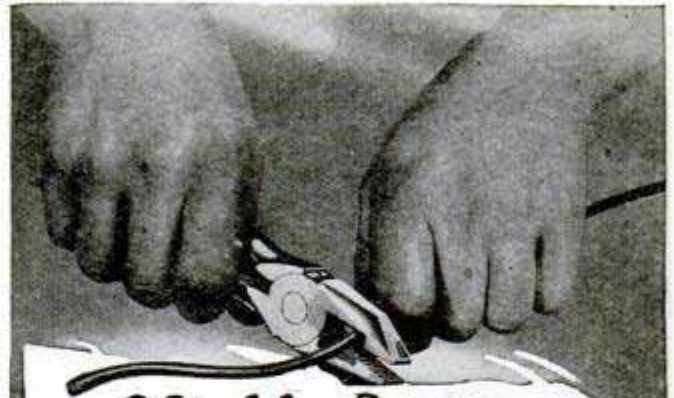

Nimble fingers of tireless steel!

Crescent Wrenches, Pliers, Screwdrivers, Hack-saws, Cold Chisels, Punches, Auger Bits, and other small tools lend deftness and speed because of their skilled design. Their hardened steel, moreover, resists the knocks and wear of continued usage. Ask your hardware dealer.

CRESCENT TOOL COMPANY
 210 Harrison St., Jamestown, N. Y.

CRESCENT and Smith & Hemenway TOOLS

Hand-Made TOOLS of Amazing Strength

THE amazing strength and service of Cornwell Quality Tools is attested by more than 100,000 mechanics throughout every state in the Union. You can do things with Cornwell Tools that cannot be accomplished with any other tools because of their high quality and phenomenal strength.

CORNWELL Quality Tools

Only the finest Swedish Charcoal Process Molybdenum Steel, produced under our famous Cornwell Formula, enters into these hand-made tools. Forged, heat treated, hardened and tempered in oil. NOT drop forged and case hardened.

Let Us Demonstrate

Ask for salesman to call and show you many startling demonstrations that no other tools in the world will stand. Or send for free descriptive booklet, order tools, and make these tests at our risk.

Money-Back Guarantee

If you ever saw tools as good as these, return your order and get your money back. This is the strongest guarantee for any tools on the market and shows our complete faith in our product.

Mail this Coupon for New Free Book

The Cornwell Quality Tools Co., Dept. H, Cuyahoga Falls, Ohio.
 Send me illustrated booklet with prices on full line of Cornwell Hand-Made Tools.
 Name..... Occupation.....
 Address.....
 City..... State.....

SIMONDS FILES

from steel to finished
product every SIMONDS file
is made to meet a definite need

BACKED BY A NEAR-CENTURY'S EXPERIENCE

Simonds Files are made from Simonds Steel produced in a Simonds mill with characteristic Simonds regard for durability, strength and each file's adaptability to the work for which it will be used. The superiority of Simonds products—Circular, Band, Cross-Cut and Hack Saws, Files and Machine Knives—is founded on a near-century of experience in making cutting tools of tempered steel.

"The Saw Makers"

SIMONDS SAW AND STEEL COMPANY, Fitchburg, Mass.
Branch Stores and Service Shops in Principal Cities

Established 1832

BURN YOUR NAME ON TOOLS WITH THE ARKOGRAF

PROTECT YOUR TOOLS FROM THEFT
Write with electricity any name or design on the hardest and finest tools and instruments, or any metal, like writing on paper with pen or pencil.
Complete Outfit \$3.50—Prepaid Anywhere
Interesting Illustrated circular free. Write today. Agents wanted.
ARKOGRAF PEN CO., 1171 E. Stark St., Portland, Oregon



\$25 to \$45

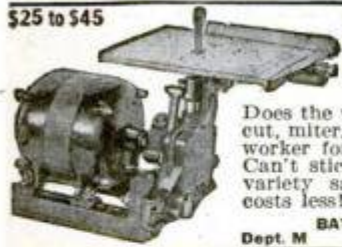

GET THE NEW IDEA BATES MOTOR SAW — 6 SAWS IN 1 —

Does the work of band-saw, rip-saw, cross-cut, miter, bevel and scroll-saw. A wonder worker for the home shop. Direct drive! Can't stick! Cuts 2" wood. Most amazing variety saw ever invented. Does more, costs less! Not a toy. Write for circular.

BATES MOTORCRAFT COMPANY
Dept. M 28 N. Clinton CHICAGO, ILL.

**Tight Handles—Send for booklet
"HOW TO KEEP TOOL HANDLES TIGHT"**
Fayette R. Plumb, Inc., 4857 James St., Philadelphia

YOU NEED SARGENT PLANES

See them at your hardware dealer's. For booklet write
Sargent & Company, Manufacturers
49 Water Street New Haven, Conn.



The CRESCENT

20" band saw, 4' and 6' bench jointers, No. 12 saw table are adapted for use wherever there is wood work to be done. These machines are small but are substantially built. Ask for circulars.

In the larger sizes we can supply band saws, saw tables, jointers, shapers, variety wood worker, planers, planers and matchers, disk grinders, cut off table, swing saws, borers, hollow chisel mortisers, tenoners, self feed rip saw, universal wood workers,

THE CRESCENT MACHINE CO.
93 Columbia Street, Leontonia, Ohio, U. S. A.



TOOL CHESTS of QUALITY

for Machinists and Tool makers
are shown in our free catalog.
Write for it to-day.

H. Gerstner & Sons

439 Columbia St., DAYTON, OHIO

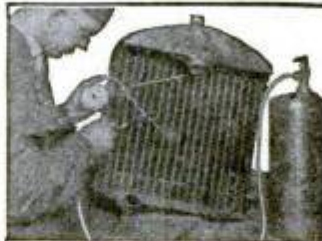

*The Handy Tool
for the Handy Man*

TORIT No. 23 Acetylene Torch

PAT. JAN. 5, 1926



Uses Acetylene Only. No oxygen or air pressure required. Tips suck in air. Simply connect to Presto auto tank, light gas, and the outfit is put to work. *Gives Heat Instantly!* Beats anything you ever tried for soldering, radiator repairing, melting, lead burning, tempering, heating, light brazing, etc. Consists of torch, 4 tips for different kinds of work, soldering copper, 5 feet rubber tubing, tank connection, and full instructions. All ready to use. Quickly \$7.50 pays for itself. PRICE, complete, without tank, \$7.50

ST. PAUL WELDING & MFG. CO.
177 West Third Street Saint Paul, Minnesota

PARKS

WOODWORKING MACHINES

Cabinet Shop Special

\$290

with Motor

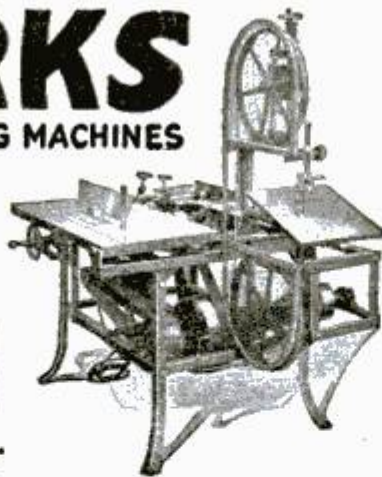

You ought to have this handy Parks in your shop. It is a compact, complete machine designed just like a big production outfit at one-fifth the cost. Includes 8-inch circular rip and cross cut saw with polished cast-steel saw table, 16-inch band saw with tilting table for bevel-sawing, 6-inch jointer, and motor operating from any light socket. Just plug in and go to work! Fits in a corner of your basement. Does any kind of cabinet and joinery work. Add lathe, shaper and other attachments any time at small cost. For the man who does "odd jobs" in his off time this Parks is a big money maker. Turn out as much as a four-man shop working by yourself.

Write for circular and Parks complete catalog of handy woodworking machinery.

The Parks Ball Bearing Machine Co.

1500-1540 Knowlton St.

Cincinnati, Ohio

Canadian Factory: 208 Notre Dame East, Montreal, Can.

Do Wonderful Chemical Tricks and Experiments with CHEMCRAFT Junior!



Make ink, dye cloth, test water and soil. Puzzle your friends with magic chemical tricks: write secret letters with invisible ink; pour brown, blue and black liquid from a pitcher of water, make magic writing paper. You can do these and many other stunts with this wonderful outfit. Get yours now. Order at once and we will include the new 1927 "Boy's Hand Book of Chemistry," a regular 25c book containing 60 pages of experiments, formulae, chemical facts and money-making ideas. Both for only **35c**

THE PORTER CHEMICAL CO.
113 Summit Ave., Hagerstown, Md.

FREE! CATALOG ON CANARIES

Big Bargains on Singing Canaries, Parrots, Fancy PETS Birds, Gold Fish, Cages, Seeds and Remedies. Large Illustrated Booklet on their Care and Breeding FREE

CHICAGO BIRD and CAGE CO.

422 S. State St., Dept. 142, Chicago, Ill.



All for \$1.98 Plus Postage

4" Wall 2" Varnish 1 1/2" Enamel 1" Lacquer 1 1/2" Auto Sash Marker \$1.50 55c 35c 25c Lacquer 75c Tool 15c 10c

SAVE 40% Send for Price List of Paint Brushes of every type. WILLIAM BRUSHES will not shed. All pure bristles, set in rubber, vulcanized to a fine enamel handle, secured by nickel ferrule. Fully guaranteed. Money refunded if not satisfied after examination. Send no money. Order today. William Brush Co., 87 Nassau St., N. Y. City. (Ag'ts Wanted) Send above combination C. O. D. to

Name.....Street.....Town.....State.....

WITTE ENGINES

200,000 all purpose, all fuel WITTE Engines from 1 1/2 to 30 H.P. in daily use. Sold all over the world, but to honest American farmers at Wholesale, DIRECT Factory Price, Easy Terms and No Interest. The Standard Farm Power.



WICO Magneto Equipped

BUZZ SAW

One of the 11 WITTE Power Plants. Saws

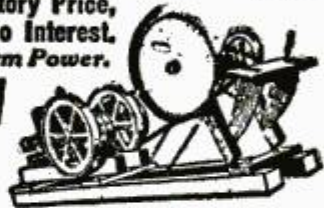

from 3 to 6 inch wood. Popular and useful. Other Log and Tree Saw Outfits.

PUMPERS All sizes, for every need. Have water all the time for stock, home, irrigation, etc. Direct gear or belt driven.

Lifetime Guarantee

FREE Big New illustrated Catalog just out — shows complete line. How to make money with WITTE Outfits. Solves all farm power problems. 57 years practical experience. Send name — no cost — no obligation.



3 hour Shipping Service.

WITTE ENGINE WORKS

1743 Witte Building, Kansas City, Mo.
1743 Empire Building, Pittsburgh, Pa.
1743 Witte Bldg., San Francisco, Cal.

30 Days' Free Trial on all MEAD Bicycles

New 1927 models now ready for delivery direct from our factory. Astonishing new prices and terms. Do not buy until you get them. Write today for beautiful 1927 catalog.

\$5 a MONTH — if desired. Earn the small payments with your bicycle.

Tires wheels, lamps, horns, equipment at half usual prices. Send No Money. Write for our marvelous prices and terms.

Mead CYCLE COMPANY DEPT. 110 CHICAGO



Write us today for free catalog



CALCULATIONS

in Office, School, Store and Shop can be instantly made with the Midget Slide Rule. It gives the answer to any problem involving fractions, mixed numbers, decimals, whole numbers, roots, powers, Logs, and Trig. Functions. Thousands of these rules are used by Accountants, Engineers, Clerks, Students, etc. It is the most versatile calculator ever invented. If you have any figuring to do, order a Midget Slide Rule on trial. Made of aluminum with figures on white celluloid. Size 4". Price with Instruction Book, \$1.50. Leather Case, 50c extra. Catalog Free. Sent C. O. D. if desired.

Your money back if you are not satisfied.

GILSON SLIDE RULE CO., Niles, Mich.

SOLDERALL

METAL IN PASTE FORM



The only convenient metal solder

Every Electrical Connection needs Solderall for perfect reception 25c

The SOLDERALL CO., NEWARK, N.J.

KINKADE GARDEN TRACTOR AND POWER LAWNMOWER

A Practical, Proven Power Cultivator for Gardeners, Suburbanites, Truckers, Florists, Nurserymen, Fruit Growers.

AMERICAN FARM MACHINE CO. 1058-33rd Ave. S. E., Minneapolis, Minn.



Catalog Free

FREE Kalamazoo Book of Factory Prices
Factory Price Sale
Now Ready



Save 1/3 to 1/2

New FREE book quotes **Reduced Factory Prices**. Introduces sensational **5-Year Guaranteed Bond** on Stoves, Ranges, Furnaces. 200 styles and sizes. Beautiful porcelain ranges and combination gas and coal ranges in soft grey and delft blue. Mahogany porcelain enamel

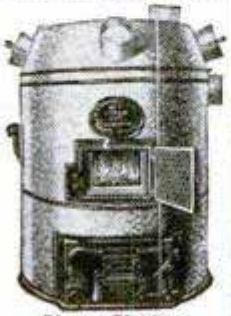

Pipe or Pipeless Furnaces \$59⁹⁵ up

Ranges \$37⁷⁵ up

heating stoves. Cash or easy terms—as low as \$3 down, \$3 monthly. 24 hour shipments. 30 day **free** trial. 360 day approval test. Satisfaction guaranteed. 26 years in business, 600,000 customers. Write today for your copy of this FREE book.

KALAMAZOO STOVE CO., Mfrs.
 391 Rochester Ave.
KALAMAZOO MICH.

"A Kalamazoo Direct to You"
 Trade Mark Registered

Agents \$12⁰⁰ a day
NEW Self-Heating IRON

New invention now makes ironing easy in every home. Ends hot stove drudgery. Cuts ironing time in half. Saves steps. Costs one cent for 3 hours use. No attachments. No cords. No tubes. Gives quick regulated heat. Guaranteed. Sells fast. Mrs. Wagner, Ohio, sold 24 in few hours spare time. Moyer, Pennsylvania, made \$164 in one week. You can do as well. Work all or spare time. No experience needed. No capital. New plan. Simply take orders. We deliver and collect. Commissions paid same day you take orders. Send for exclusive territory and **FREE OUTFIT OFFER**. Write today. **THE AKRON LAMP CO., 33 Iron St., AKRON, OHIO**



MEN \$10-\$15-\$20 a Day
Commissions Paid Daily

Profitable new field for men who are conscientious and dependable. **NO EXPERIENCE NECESSARY**. My plan pays biggest commissions in this line, in advance, with extra bonus for producers. **Act Now**
Full or part time \$45 to \$100 weekly

Sell Better Quality All Wool Tailoring \$31⁵⁰

Our astonishing values in tailored-to-order, all-wool suits and overcoats positively sell on sight. We want earnest men **AT ONCE** who are anxious to **Make Money** and will help them to establish a steady, big-paying repeat business. No capital required.

We furnish handsome large swatch samples and complete instructions—**FREE**. Write at once.

W. Z. GIBSON, Inc., 161 W. Harrison Street, Dept. C-516 Chicago



WURLITZER
 THE WORLD'S LARGEST MUSIC HOUSE



200 Years Ago in the little town of Schoeneck lived Hans Adam Wurlitzer, Master Violin Maker. His shop was a gathering place for musicians of the time, for he was a true craftsman.

When he died his shop passed into the hands of his eldest son, and for seven generations, down to the present day, the descendants of Hans Adam Wurlitzer have carried on his work.

Today in every Wurlitzer instrument you will find a quality, a character, that could not come from mere excellence of manufacture. It is the heritage of these seven generations of music craftsmanship.



Try any Wurlitzer Instrument in your Own Home

YOU may now have any Wurlitzer instrument for a generous free trial in your own home. Examine the instrument, show it to your friends, play it as much as you wish. No obligation to buy—no expense for the trial. We make this liberal offer because we want you to try for yourself these wonderful instruments, the result of 200 years' experience in musical instrument building. Easy payments are arranged to suit your convenience. This is your opportunity to try a famous Wurlitzer instrument in your own home.



Send for New Catalog

The greatest musical catalog ever published. Over 3,000 articles—every known instrument described and illustrated; many of them shown in full colors. Gives you lowest prices and all details of Free Trial, Easy Payment plan. All sent **FREE**—no obligation.

Send this Coupon

THE RUDOLPH WURLITZER CO., Dept. 1773
 120 W. 42nd St., New York 117 E. 4th St., Cincinnati
 329 S. Wabash Ave., Chicago 134 Golden Gate Ave., San Francisco

Send me absolutely free, your new illustrated catalog, with prices and description of every known musical instrument. Also tell me how I may try any instrument in my own home and pay for it in small monthly sums. No obligation.

Name

Address

City.....State.....

Instrument.....

(State instrument in which you are interested)

Copyright, 1927, The Rudolph Wurlitzer Co.

Suppose You Were Offered Diamonds at 60% of Market Price

Suppose a reason you rarely think of makes possible here radically low prices, even for finest quality diamonds. Thousands of representative people, bankers, lawyers, merchants, others—continually reap this real advantage. Everything sent for Free Examination. This 3/4 century, oldest, largest diamond banking institution in the world, rated over \$1,600,000.00,—converts into cash the diamonds on which money was loaned and not repaid. Loan values, a fraction of market values, are the price basis. Diamonds too from big cash deals direct with European cutters. Must sell now

Why Pay Full Prices

When Much Less Buys the Same See this 3/4 less 1/16 ct., snappy solitaire for \$69.50. Try to match at \$115.00. Examine free any bargain at our risk. Startling, legitimate offers here of diamonds at 60% of market price. Send now for full details. Diamonds of unusual qualities (also watches) from unpaid loans, offered at radically low prices based on mere loan values. Then, too, we have hundreds of diamonds from big, cash, European deals with diamond cutters, who sacrificed these gems away under the market. Send now for our latest offers of this internationally known cash headquarters.



Unpaid Loan Listings Ready As low as \$60 a Carat

Radically different from a catalog. List accurately describes every diamond in full detail with guaranteed exact weight, color, quality, etc. Explains Guaranteed Cash—like Insurance Policy Loan guarantee. Also Unlimited Exchange privilege at price paid us. Gives full details of free examination offers. Don't wait, the very diamond you want may be in this very list at a price that will amaze you. Costs nothing to see. Write today. A postal will do, or—Mail Coupon NOW!

JOS. DE ROY & SONS
Only Opposite Postoffice
1954 De Roy Bldg., Pittsburgh, Pa.

Without obligation to buy, send me free, in plain envelope, your Latest Bargain List of Diamonds, Watches, and other Jewels.

Name _____

Address _____

City _____

State _____
References by Permission:—Bank of Pittsburgh, N. A.; Marine National Bank; Union Trust Co., Pittsburgh, Pa. Your bank can look us up in the mercantile agencies.

KENNEBEC CATALOG—FREE

24 pages in colors. Shows 15 models, including wonderful 1927 JOY-BOY OUTBOARD MOTOR CANOE, Esquimaux-style Kyak and new WHIZ-BOY Speed Boat (20 miles per hour with Outboard motor).

MAIL CARD FOR CATALOG

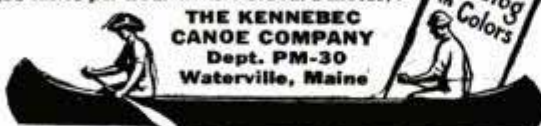

THE KENNEBEC CANOE COMPANY
Dept. PM-30
Waterville, Maine



A Motor Boat—for half the cost!



The Super Elto clamps on any open boat—gives all motor boating pleasures at amazingly small cost. Powerful, speedy, reliable. Light and portable. Write today for intensely interesting catalog!

Elto Outboard Motor Co.
Ole Evinrude, Pres.
Dept. 541 Mrs. Home Bldg.
Milwaukee, Wis.

The Super Elto

"Starts With a Quarter Turn"

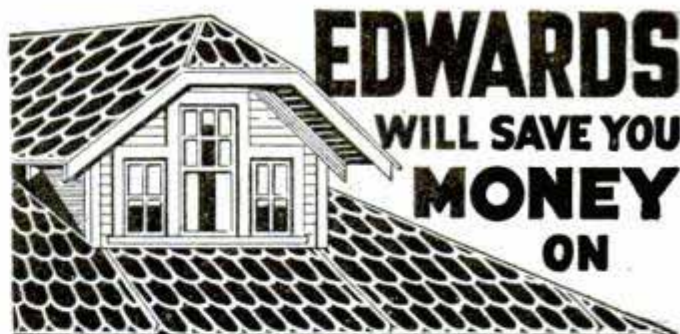

EDWARDS WILL SAVE YOU MONEY ON

METAL ROOFS

We own our own steel mills, roll our own sheets, make them into high-grade REO METAL SHINGLES, Sidings, Ceilings and Roofings of every type and style for every kind of building. We control every operation from the raw material to the finished roof and we sell direct from our factories to the user. Not a dollar to divide with anybody but the customer! You get better value for less money.

OUTLAST THREE ORDINARY ROOFS

EDWARDS METAL ROOFS are weather-proof, lightning-proof, fire-proof! The galvanizing bends with the metal. No tools required.



LOW-COST ALL-METAL GARAGES

Any size. Any style. Portable. Ready to erect. Complete with frames, doors, sash and hardware. Ornamental, durable, economical. Blue-prints and complete instructions FREE.

Write today. Get our low prices and Free Samples. Ask for Roofing Book No. 150 or for Garage Book No. 150

THE EDWARDS MFG. CO.
300-350 Butler St. Cincinnati, O.



You—and This New Machine Can Earn \$500 a Month



Operate a Tire Repair Shop

70,000,000 Tires in use. America's greatest opportunity for men with small capital. We furnish everything—\$100 and up. Easy payments. We train you FREE right at home. Start making money at once. Write today for Free Book of Opportunity.

Haywood Tire Equipment Co. 1344 S. Oakley, Chicago

Catch Fish!



Eels, Mink, Muskrats with our new folding galvanized STEEL WIRE TRAP. Write for our FREE TRAP OFFER and Bargain Catalog. \$1 Box of our famous Fish Bait FREE to introduce our traps. WALTON SUPPLY CO., 3500 JUNIATA AVE., ST. LOUIS, MO.

Thompson BEATS the World on BOATS

BETTER BOATS at Lower Prices



The BEST that Skill and Experience can Produce TWO BIG FACTORIES

Our complete line of 22 models offers you a variety to choose from. Prompt shipment from factory to you. Catalog Free—Save Money—Order by Mail Please state kind of boat in which you are interested.

THOMPSON BROS. BOAT MFG. CO. (20)
201 Ann St., PEBSHTIGO (Write to either place) 101 Elm St., CORTLAND WISCONSIN NEW YORK



Infantile Paralysis

How proud I was to see Raymond coming home walking flat down on the sole of his foot. Too bad I didn't know about your sanitarium sooner. Will never forget your wonderful institution and will advise others to take their cripples to you.
MRS. ROSE RACZYK,
 50 Peck St.,
 Buffalo, New York

Raymond Raczyk came to McLain Sanitarium 10 years after an attack of Infantile Paralysis crippled his left leg and foot. Photos and mother's letter tell the rest.

McLain Sanitarium (established 1898) is a private institution devoted to the treatment of crippled children and young adults. No surgical operation requiring chloroform or general anaesthetics. Plaster Paris not used. Patients received without delay. Parents retain full charge of children if desired.

WRITE FOR FREE BOOKS "Deformities and Paralysis," and "References," which show and tell of McLain Sanitarium's facilities for treating Club Feet, Infantile Paralysis, Spinal Diseases and Deformities, Hip and Knee Disease, Wry Neck, Etc. Also illustrated magazine, "Sanitarium News," mailed free every 60 days.

McLAIN ORTHOPEDIC SANITARIUM
 902 Aubert Ave., St. Louis, Missouri, U.S.A. KR-731

Great New Invention

for seekers of

Health Power Beauty



Elco Health Generators at last are ready for you! If you want more health—greater power to enjoy the pleasures and delights about you, or if more beauty is your desire—write! Ask for the book on these inventions which has just been prepared. It will be sent to you without cost. It tells you how Elco Health Generators aid you in leaving the lethargy and hopelessness of bad health and weakness behind forever. Re-vitalize yourself. Bring back energy. Be wholly alive. Write today!

10 Days Free Trial—Write for FREE BOOK



Elco Electric Health Generators

These great new inventions generate *High Frequency Violet Ray, Mechanical Vibration, Medical Electricity and Ozone.* Combined or separate.

They operate on the electric light in your home or on their own motive power at less than 50 cents per year. Elco Health Generators are positively the only instruments which can give you in one outfit Electricity, Violet Ray—Vibration and Ozone—the four greatest curative agents. Send coupon below. Get the Free Book NOW!



For All These:

- | | |
|-------------|-----------------|
| Rheumatism | Asthma |
| Gout | Hay Fever |
| Lumbago | Sore Throat |
| Neuralgia | Catarrh |
| Sciatica | Deafness |
| Headache | Insomnia |
| Neuritis | Pain |
| Nervousness | Development |
| Circulation | Skin Disease |
| Weakness | Pimples |
| Paralysis | Scalp Disorders |
| Eye Trouble | Obesity |

MAIL the COUPON for FREE Book!

Do not put this paper down without sending the coupon. Don't go on as you are with pains and with almost no life and energy. You owe it to yourself to be a better man or woman. You were put here to enjoy life—not just to drag through it. So do not rest another day until you have put your name on the coupon here. That will bring the whole story of these great new inventions. Do it today—now.



Lindstrom & Company

30 West Lake Street, Dept. 93-53, Chicago, Ill.
 Please send me your free book, "Health—Power—Beauty" and full information on your 10-day Free Trial Offer.

Name.....

Address.....

Agents Wanted

SPECIAL OFFER—EXPRESS PREPAID AND

TYPEWRITER PRICES REDUCED

ON ALL STANDARD MAKES



FREE TRIAL

Big bargains, easy payments on late model Underwoods, Royals, L. C. Smiths, Remingtons etc.—perfect machines expertly remanufactured by the "Young Process" guaranteed like new for five years. Shipped direct from our factory to you at big saving. Our big illustrated catalog sent free and without obligation to buy. Write for yours today.

Young Typewriter Co., Dept. 1103, 654 W. Randolph St., Chicago, Ill.

AGENTS 500% PROFIT GENUINE GOLD LEAF LETTERS

S guaranteed to never tarnish. Anyone can put them on stores and office windows. Enormous demand, large profits. Paul Clark says: Smallest day \$28.70. R. L. Reel made \$920 in two months. Write today for free sample and liberal offer to general agents.
METALLIC LETTER CO., 433-B N. Clark St., CHICAGO

THIS WONDERFUL INVENTION



converts any ordinary cook stove into a gas stove. OXO-GAS is made from kerosene and air. Cheaper, cleaner and more efficient than coal. Responsible distributors wanted.

GLORIA LIGHT CO.
 111-3 N. May St. Chicago, Ill.

CRACKED WALLS

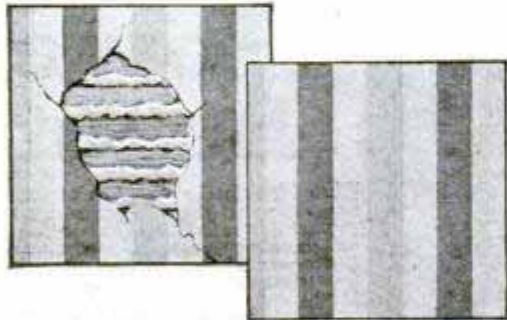

made good as new!

WHEN you fill a crack or hole with Rutland Patching Plaster, the wall looks as good as new. And the patch is as lasting as the wall itself.

Rutland Patching Plaster will not crack, crumble or fall out. It will not shrink as plaster of paris shrinks. It's easier to use than plaster of paris, because it does not get hard or "set" instantly. Comes in handy cartons. You just add water and apply.

Paint, wall-paper and hardware stores sell it. If your dealer hasn't Rutland, we will mail a package direct and you can pay the postman 30c plus postage. Rutland Fire Clay Co., Dept. V-1, Rutland, Vermont.



Rutland Patching Plaster



Agents - Salesmen

New, patented Cigarette and Match Case. Holds a package of cigarettes and box of safety matches. Made of grain finish, black leatherette.

A whirlwind seller—write for particulars on liberal profit proposition.

ALL-IN-ONE SALES COMPANY
Dept. A-3 2810 Portland Ave.
Minneapolis, Minnesota

SAMPLE 50c

Don't go into the woods without the CEEBYNITE a Taylor Compass

If your Dealer cannot supply You, write
Taylor Instrument Companies
ROCHESTER N.Y.
Canadian Plant, Tycoo Bldg. Toronto
There's a Taylor or Taylor Thermometer for Every Purpose

Part-Time Men Get This Suit FREE

Make \$45 a Week and up
Cash profits paid in advance
No question about it, any man can easily earn \$45 a week and up, just showing our wonderful outfit and taking orders for our high-grade tailoring. Never before such low prices and beautiful styles.

Your Own Clothes FREE
To introduce our unbeatable values, classy styles and perfect tailoring, we make this introductory free suit offer to those who qualify—something different, better, bigger, more liberal than any offer ever made.

Handsome Carrying Case Outfit
of large real cloth samples—everything furnished FREE.
Write today for free suit and big, money-making offer

SPENCER MEAD CO., Wholesale Tailors, Dept. C816, Chicago

Beautiful HOUSES \$900 and BUNGALOWS CAN BE BUILT FOR AND UP

This and many others in my new book, Building Plans for Modern Homes, will save you hundreds of dollars. One of the most complete and comprehensive books of plans ever published by any architect. New edition just off the press. Nearly 600 floor plans and photographs of Colonial houses, bungalows, etc., costing from \$200 up; gives sizes and cost to build. Sent postpaid for \$3.00.

FREDERICK H. GOWING ARCHITECT
101 Tremont St., BOSTON, MASS.

Do Your PRINTING

Cards, stationery, circulars, tag, labels, paper. Complete Outfits, \$8.85 up, Job Presses \$11 up, Rotary \$149. Card Cutters, \$3. Save money. Print for others, big profits. All easy rules sent. Write for catalog presses, type, paper cards, ink etc. **THE KELSEY CO., P-37, Meriden, Conn.**

EASY \$100 a Week FUGO FIRE EXTINGUISHER

Unusual opening for live agents in every locality. Make \$5000 or more a year—easily. Fugo—the instantaneous automatic fire extinguisher—is needed and wanted in every home, store, theatre, garage, shop, school, automobile, etc. Cheapest fire protection available today. Within reach of all.

1 Qt. Size \$5.00 2 Qt. Size \$7.50

Recharged in a jiffy.
Amazing 30-second demonstration clinches sale—each one sold sells others. Territory going fast. Write at once for wonderful proposition that will **MAKE YOU BIG MONEY.**

THE NATIONAL FORMETAL CO.
6535 Metta Ave., N. E. Cleveland, Ohio



Why Don't You Play a Hohner Harmonica?

Anyone may quickly learn to play real music on a Hohner Harmonica with the aid of this Free Instruction Book.

See how easy it is! Read the simple directions, look at the charts and pictures, take your Harmonica, hold it as shown and *blow-draw, blow-draw*. In a short time you will master the scale; and when you can play the scale you will soon be playing favorite melodies to the delight of yourself and friends

Get your harmonica today and be sure it's a Hohner. And ask for the Free Instruction Book. If your dealer is out of copies, write M. Hohner, Inc., Dept. 181, 114 East 16th St., New York.

"Tune-in" on Your Radio for the "Hohner Harmony Hour" Musical Programs.



Your Coat and Vest Can Be Matched with New Trousers

Save the price of a new suit. We match hundreds of coats and vests satisfactorily every day. Each pair tailored to your measure. 80,000 patterns. We submit sample of cloth for your approval. Just mail your vest or a sample of the suit. We employ no agents.

Enclose return postage if vest is sent.

ACME PANTS MATCHERS
Dept. B C 14 20 W. Jackson, Chicago

Ask for Keds by name

They are not Keds unless the name Keds is on the shoe

100 SCALE PLANS



for building old and modern ship models. Free catalog of plans, books, prints, maps and other things that smack of the sea.

SEA ARTS GUILD, 405-A Eleventh Avenue, MILWAUKEE, WIS.



Make your hair lie down this easy way

So Long— UNRULY HAIR!

Keep it in place with the dressing more fellows use than any other . . .

Unruly pestiferous cow-licks—that pop up like a Jack-in-the-box the minute your hair brush is out of sight!

Give them the gate!—they never will be missed. Train your stubborn, fractious hair to lie in place, *all day long*.

A little Stacomb will turn the trick! Will make your hair lie down—and stay down too.

More fellows use Stacomb than any other hair dressing. Stacomb never leaves your hair gummy looking. Nor dry and brittle, as wetting with water makes it. Stacomb is beneficial—it helps to prevent dandruff.

Stacomb comes as a combing cream—in jars and tubes—and also in the popular new liquid form. All drug stores.

FREE OFFER *Stacomb*

Standard Laboratories, Inc., Dept. BB-5, 113 W. 18th Street, New York

Send me free sample of Stacomb as checked:
Original, cream form New liquid form

Name.....

Address.....

I Pay Men \$40 A DAY!

S.W. Allen of California made \$40.80 in one day's "joyful work"! Hundreds of other men are reporting amazing incomes—many of them doubling and tripling their former salaries.



Just Wear This FREE Cap

Just wear this beautiful hand tailored FREE RAIN-PROOF Cap. When your friends see it, nine out of ten will want one like it. They can't resist the *Rain Proof* idea—it's so new and unique. You can make a splendid income in full or spare time. No experience is needed. "I haven't found a man who doesn't fall for the made-to-measure idea," writes Chas. Horstman. Send at once for FREE Selling Outfit. Taylor Cap Mfgs., Dept. X-21 Cincinnati, O.

Going to Build Remodel or Repair?

DON'T think of building a new home or repairing an old one without a copy of our free woodwork catalog.

To those who contemplate building or remodeling, this book is a valuable work of reference. In it are found the latest ideas and most advanced styles for everything in millwork. It illustrates and describes windows and sash of all kinds, including porch and storm sash, doors, frames, mouldings, screens, porchwork, stairwork, hardwood flooring, interior finish, cabinet work—in fact, practically everything in manufactured millwork. Every article in the book shows a low money-saving price direct to you.

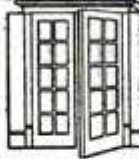

FREE ESTIMATES

Send us your lumber and millwork bills for a free estimate. Let us quote prices on your material and tell you the exact amount of freight. Then compare our prices with others. This service costs you nothing and places you under no obligation whatever.

CHICAGO MILLWORK SUPPLY CO., 1444 W. 37th St., Chicago, Ill.
PLEASE SEND ME YOUR FREE BOOK

Name _____
Town _____
State _____
Occupation _____

St. No. _____

Book is Free

Women Simply Can't Resist This Fast-Selling Line

Just show women this exquisite display of dress goods, silks, wash fabrics and you can't keep them from buying. Men and women agents needed to devote full or spare time. Good commissions. Average \$40 to \$85 a week. 1,000 samples furnished. Write quickly.



THE NATIONAL IMPORTING CO.
Dept. P-6, 569-573 Broadway, N. Y. C. 1000 Beautiful Samples

PLASTIC WOOD

Makes Repair Work Easy

Handles like Putty—Hardens into Wood



Every time you work with wood you need PLASTIC WOOD to make the job perfect.

As it comes from the can PLASTIC WOOD can be moulded in the fingers and stuffed into holes and cracks. When hardened it may be whittled, planed or turned on a lathe. Nails will not split it—takes paint, stain and varnish like any wood.

Automobile body builders, boat builders and cabinet makers are using PLASTIC WOOD most successfully. Householders now can buy it from Hardware and Paint Stores. 1/4 lb. can, 35c; one pound can, \$1.00.

ADDISON-LESLIE COMPANY

40 Boliver Street, Canton, Mass.

Please send me 1/4 lb. can of PLASTIC WOOD for which I enclose 35c.

Name

Address

YOU CAN PLAY
the **"JAZZITHA"**
the one string
Hawaiian Guitar

Play all the popular melodies at once and surprise yourself and friends. No lessons or knowledge of music necessary. The music is written in numbers.
The JAZZITHA is 19 inches long, nicely finished in lacquer. Comes with pick, bar and 10 son leadet, and

FREE—3 extra strings worth 25 cents.
SEND NO MONEY—pay the postman \$1.47 plus postage on delivery.
No C.O.D.'s to Canada or foreign countries. Send money order (only) for \$1.75. This includes postage.
Extra—5 music books, 5 latest and different songs in every book, 25c. each book, the 6 books for \$1.00

THE JAZZ STUDIOS, Dept. 587
2512-41st Ave. Long Island City, N. Y.
Please print your name and address plainly

Agents!

\$20 a day

HANDIEST TOOL IN THE KITCHEN. Housewives all say "Just what I want." The *Ideal Fiber Cutter* is a real household aid. Tested and Approved by Good Housekeeping. Two minute demonstration sells it—**100 PER CENT PROFIT.** Boorem, Pennsylvania says, "Have bought my home and car with Cutter profits." Bassett, Washington, new agent, writes, "Made \$7.50 in 2 hours today." You can do as well. No experience needed. Work spare or full time. Write for details.

THE TYLER COMPANY, Dept. M-7 Muncie, Indiana

CLASS PINS 25c
NEW CATALOG FREE!

DESIGNS SHOWN SILVER PLATE 25/EA. \$275 DOZ. STERLING SILVER 40/EA. \$400 DOZ. GOLD PLATE 35/EA. \$350 DOZ.
3395 1 OR 2 COLORS ENAMEL, ANY LETTERS AND DATE. 3499

BASTIAN BROS. CO., 728 BASTIAN BLDG. ROCHESTER, N.Y.

"Independent" GOLD POINT
Lever, Self-Filler Stylopen
"Makes Writing a Pleasure"
Jumbo, \$3.50; Red, \$3.00; Black

\$2

J. C. ULLRICH & CO., 161 Washington St., N. Y. Est. 1881 Agents Wanted

NEW! A BIG HIT!

The Little Checkwriter with the Big Protection

Salesmen!
At last! A checkwriter at everybody's price! Sells for \$12.50. Does more than larger machines costing hundreds! Our salesmen cleaning up!

The Arnold Features

1. Pocket size convenience.
2. Handsome nickel plated aluminum.
3. Light weight. Easy to operate.
4. Prints and cuts characters in acid proof ink.
5. Unlimited capacity. Low cost. Easy to ink.
6. Guaranteed for 5 years. Nothing to get out of order.

FREE SAMPLE OFFER! Salesmen! Here's the biggest selling proposition of the year for you. Wonderful opportunity with very liberal commissions to district managers and salesmen.

THE ARNOLD CHECKWRITER CO., Inc., Dept. 18
FLINT, MICHIGAN

Build and Fly Your Own 3ft. Model Aeroplane!



It's the most interesting thing you ever tackled; develops your mechanical ability; teaches the principles of aviation; shows you the parts of big machines, how they are constructed and covered, what makes them fly, and many other things real aviators must know. Any bright boy can do it. Ideal Scale Drawings and Building-Flying Instructions show how. For 25 cents we will send you the complete Drawings and Instructions (3 ft. size) for any one of the following famous airplanes:

Send 5c now for FOKKER North Pole Plane; complete 48 pp., Curtiss JN4D-2 Training Plane; DeHavilland "Round-the-World" Flyer; N C-4 Naval Seaplane; Bleriot, Nieuport or Taube Monoplane; or Cecil Peoli Racer. Send 25c now and get plans for the one you want to build. (All 8 plans for \$1.50.)



Ideal Aeroplane & Supply Co.
408 West Broadway, New York
Ask your Dealer for
Ideal Model Aero-
planes

Agents-Just Out!

NEW AMAZING INVENTION

One device makes window washing 75 percent easier.



Washes, dries, polishes windows in a jiffy. Every housewife wants it. No more ladders to climb, no mussy rags or sponges to wring. Hands never touch water.

Make \$90.00 a Week Easily

Quickly Sells fast. Simply show it and take orders. Make 100 per cent Profit. No experience needed. We show you how. Send for Catalog of this and 47 other Quality Rubber Products. Direct from Akron, the Rubber City. FREE Outfit to hustlers. *Write quick. Kristee Mfg. Co., 403 Bar St., Akron, Ohio



Now, Only \$

39

Let Me
Send You the
Greatest LOG SAW Offer

Put the OTTAWA
Working For You

—I ever made. One man saws 15 cords a day—easy. Falls trees, saws limbs. Make big money. Use 4 H-P. Engine for other work. Saws faster than 10 men. Shipped from Factory or nearest of 10 Branch Houses. Cash—Easy Terms. Write for 30-Day Trial Offer and big FREE book.

OTTAWA MANUFACTURING COMPANY
1741-W Wood Street, Ottawa, Kan.
Room 1741-W Magee Bldg., Pittsburgh, Pa.

Start a Business of Your Own

Vulcanizing part of the 90 Million Auto Tires now in use is a desirable and Profitable Business.

EASY TO LEARN We give you instructions Plants \$100 and up Our free Catalog tells you how to save 50% on a plant we have near you. Instruction Book for a \$1.00 bill.

Equipment Exchange, 118 E. 11th St., Los Angeles, Calif.



STOP FORD CRANKSHAFT END-PLAY!

C-A ADJUSTABLE BEARING corrects and prevents end-play without removing motor. Eliminates many troubles. Easy to install—simply drop pan. Only \$3.75. Ask your dealer or sent prepaid by ADJUSTABLE BEARING CO., Dept. F, 405 Virginia Ave., Indianapolis, Ind.



MOTORCYCLES

WE WILL TRUST YOU
Pay Us While You Ride

Hendersons, Harley-Davidsons, Indians

Slightly used and rebuilt. Hundreds to select from.

Send 10c for list today.

MYEROW BROS. CO., 15 Berkeley St., Boston, Mass., U. S. A.

6-Room ALADDIN

\$598

ALL MATERIALS
READI-CUT

WE PAY THE
FREIGHT

You can
buy all
materi-
als for a complete home di-
rect from the manufacturer
and save four profits, on the
lumber, millwork, hardware and labor.

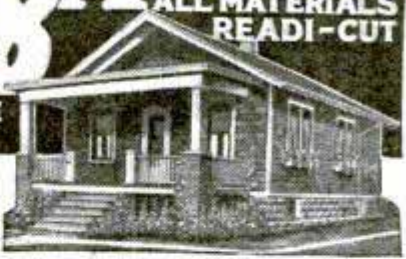

4-Room ALADDIN \$382



4 different floor plan arrangements of this cottageshown in free catalog. 1 and 2 bedroom plans, with and without bath.

5-Room ALADDIN \$498

Living room, dining room, two bedrooms, kitchen. Three other plans, with and without bath. Aladdin certified lumber throughout.



7-Room ALADDIN \$696



Living room, dining room, kitchen, three bedrooms, bath, closets. Three other plans. All materials readi-cut.

Story and a Half ALADDIN \$789

Story and a half semi-bungalow, second floor available for 2 bedrooms. Two floor plan arrangements. Any handy man can erect these houses.



PRICE INCLUDES all lumber cut-to-fit; highest grade interior woodwork, siding, flooring, windows, doors, glass, paint, hardware, nails, lath, roofing, with complete instructions and drawings. We guarantee safe arrival of complete materials and **Pay the Freight** to destination. Many styles of year around dwellings, summer cottages and garages to choose from. Write nearest mill today for **FREE Money-Saving Catalog No. 372.**

The ALADDIN Co., BAY CITY, MICHIGAN
Wilmington, North Carolina; Portland, Ore.; Toronto, Ont.

PATENT

Protect Your Ideas

Take the First Step Today

If you have a useful, practical, novel idea for any new article or for an improvement on an old one, you should communicate with a competent Registered Patent Attorney AT ONCE. Every year thousands of applications for patents are filed in the U. S. Patent Office. Frequently two or more applications are made for the same or substantially the same idea (even though the inventors may live in different sections of the country and be entirely unknown to one another). In such a case, the burden of proof rests upon the last application filed. Delays of even a few days in filing the application sometimes mean the loss of a patent. So lose no time. Get in touch with me at once by mailing the coupon on the opposite page.

Prompt, Careful, Efficient Service

This large, experienced organization devotes its entire time and attention to patent and trade mark cases. Our offices are directly across the street from the U. S. Patent Office. We understand the technicalities of patent law. We know the rules and requirements of the Patent Office. We can proceed in the quickest, safest and best ways in preparing an application for a patent covering your idea. Our success has been built on the strength of careful, efficient, satisfactory service to inventors and trademark owners located in every state in the Union.

NO CHARGE for Information On How to Proceed

The booklet shown here contains valuable information relating to patent procedure that every inventor should have. And with it I will also send you my "Record of Invention" form on which you can sketch your idea and establish its date before a witness. Such evidence may later prove valuable to you. Simply mail the coupon and I will send you the booklet, and the "Record of Invention" form, together with detailed information on how to proceed and the costs involved. Do this NOW. No need to lose a minute's time. The coupon will bring you complete information entirely without charge or obligation.

My Patent Law Offices
Just Across
Street From
U.S. Pat. Office



Above is a view of my drafting and specification offices where a large staff of experienced experts are in my constant employ. All drawings and specifications are prepared under my personal supervision.

NEWS

Inventors Write for these Free Books

Strict Secrecy Preserved

All communications, sketches, drawings, etc., are held in strictest confidence in strong, steel, fireproof files, which are accessible only to authorized members of my staff. Feel free to write me fully and frankly. Your case will have my personal attention. It is probable that I can help you. Highest references. But **FIRST**—clip the coupon and get my free book. Do **THAT** right now.

Clarence A. O'Brien

Registered Patent Attorney

Member of Bar of: Supreme Court of the United States; Court of Appeals, District of Columbia; Supreme Court, District of Columbia; United States Court of Claims. Practice confined exclusively to Patents, Trade marks and Copyrights

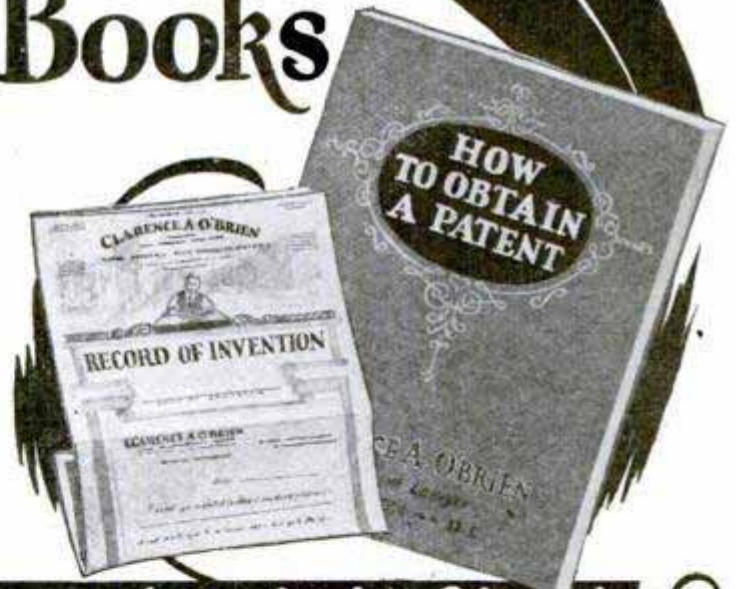

Clip this Coupon and Mail it Now!

CLARENCE A. O'BRIEN, Registered Patent Attorney

70-V Security Savings and Commercial Bank Bldg., Washington, D. C.

Please send me your free book, "How to Obtain a Patent," and your "Record of Invention" form without any cost or obligation on my part.

Name.....
(Important: Write or Print name clearly.)

Address.....

PATENTS TRADE-MARKS AND COPYRIGHTS

Have You An Idea?

Our Offer: FOR THE PROTECTION OF YOUR INVENTION YOUR FIRST STEP

Before disclosing an invention the inventor should write for our blank form

"RECORD OF INVENTION"

This should be signed and witnessed and returned to us together with model or sketch and description of the invention for INSPECTION and INSTRUCTIONS

No Charge for the Above Information

Our Four Books Mailed Free to Inventors

Our Illustrated Guide BOOK

HowtoObtain a Patent

Contains full instructions regarding U. S. Patents. Our Methods, Terms, and 100 Mechanical Movements illustrated and described.

Our Trade Mark Book

Shows value and necessity of Trade Mark Protection. Information regarding *Trade Marks and unfair competition in trade.*

Our Foreign Book

We have Direct Agencies in Foreign Countries, and secure Foreign Patents in shortest time and lowest cost.

Progress of Invention

Description of World's Most Pressing Problems by Leading Scientists and Inventors.

We Regard a Satisfied Client as our best advertisement, and furnish anyone, upon request, lists of clients in any state for whom we have secured patents.

Highest References—Prompt Attention —Reasonable Terms

VICTOR J. EVANS & CO. PATENT ATTORNEYS

Main Offices: 956 9th St., N. W., Washington, D. C.

Opposite U. S. Patent Office



Our New York Office Suite 1007 Woolworth Bldg.



Our Philadelphia Office Suite 714-15 Liberty Bldg.



Our Washington Office Victor Building



PATENTS TRADE-MARKS AND COPYRIGHTS

IMPORTANT

TO HAVE YOUR CASE MADE SPECIAL AND AVOID DELAY YOU SHOULD HAVE YOUR CASE MADE SPECIAL IN OUR OFFICE to secure protection, save correspondence and secure early filing date in Patent Office. To secure special preparation of your case send \$25.00 on account with model or sketch and description of invention.



MAIN OFFICE, VICTOR J. EVANS & CO.—VICTOR BUILDING, WASHINGTON, D. C.

Our Lawyers Practice in all U. S. Courts and defend Clients in Suits involving Patents, Trademarks and Copyrights

All Communications and Data Strictly Confidential. Interference and Infringement Suits Prosecuted

OUR ORGANIZATION OFFERS PERSONAL SERVICE By Experienced Patent Lawyers, Solicitors and Draftsmen

**FREE
COUPON**

**VICTOR J. EVANS & CO.
PATENT ATTORNEYS**

NEW YORK OFFICES
1007 Woolworth Bldg.

CHICAGO OFFICES
1114 Tacoma Bldg.

PHILADELPHIA OFFICES
714-715 Liberty Bldg.

PITTSBURGH OFFICES
514 Empire Bldg.

SAN FRANCISCO OFFICES
Hobart Bldg.

MAIN OFFICES: 956 9th Street, N. W., WASHINGTON, D. C.

Gentlemen: Please send me *Free of Charge* your books as described on preceding page.

Name.....

Address.....



Our Chicago Office
Suite 1114 Tacoma Building



Our Pittsburgh Office
Suite 514 Empire Building



Our San Francisco Office
Suite 1010 Hobart Building

PATENTS

"Any claim which is broader than the described invention is void even where the invention is valid and could have supported a valuable claim."

——— *Walker on Patents.*

Making your patent claims exactly fit your invention is a task for a patent attorney of skill and experience.

MUNN & CO. PATENT ATTORNEYS

Associated for 81 years with the Scientific American

1572 SCIENTIFIC AMERICAN BLDG.
24 West 40th Street, New York

523 SCIENTIFIC AMERICAN BLDG.
Washington, D. C.

1312 TOWER BUILDING
Chicago, Ill.

520 VAN NUYS BUILDING
Los Angeles, Cal.

655 HOBART BUILDING
San Francisco, Cal.

Ask for free copy of "Patents — A Book of Facts Every Inventor Should Know" and for "Inventor's Diary." Send for them NOW

PATENTS

Booklet Free Highest References
Promptness Assured Best Results

Send drawing or model for preliminary examination of Patent Office records.

ALL BUSINESS GIVEN PROMPT AND PROPER ATTENTION

Listed Patent Lawyer in the latest editions of the Rand-McNally Directory of Bankers and Attorneys, of Chicago, Ill.; The Baggott & Ryall Directory of Attorneys, New York City; The Lawyers Guaranteed Directory, Detroit, Michigan; The Lawyers and Bankers Quarterly, published by the Legal Directory Publishing Company of St. Louis, Mo.; the American Lawyers Annual, Cleveland, Ohio.

WATSON E. COLEMAN,
REGISTERED PATENT LAWYER

Victor Building, 724 Ninth Street, N. W.
WASHINGTON, D. C.



PATENTS

Send us sketch or model for advice and exact cost of patent. Our book "How to Obtain a Patent" sent free. It tells how to apply for Patents, Trade Marks, Foreign Patents, Copyrights, etc.; gives information on Patent Procedure; tells what every inventor should know. Thousands of Inventors, who are our clients, are our reference.

CHANDLEE & CHANDLEE, 25 Years' Experience
473 7th St. Washington, D. C.

PATENTS

Trade Marks, Copyrights, Patent Litigation Handbook with illustrations, 100 mechanical movements. Sent free on request.

ALBERT E. DIETERICH
formerly member examining corps U. S. Patent Office
PATENT LAWYER and SOLICITOR

621-A, Ouray Bldg.
27 Years' Experience Washington, D. C.



GEARS ALL KINDS SMALL

The most accurate made and prices reasonable. We carry a complete line of gears in stock for immediate shipment. Can also quote on special gears of all kinds. Send us your inquiries.

WRITE FOR CATALOGUE 10

CHICAGO STOCK GEAR WORKS
105-109 S. Jefferson St., CHICAGO

Let us recommend the best books to study on any subject. Popular Mechanics Press, Chicago, Illinois.



Inventors and Mechanics

Send 10 cents in stamps for
Material Catalog

COLBURN GEAR & MFG. CO.
98 Holmes St., Quincy, Mass.

INVENTORS

who derive largest profits know and heed certain simple but vital facts before applying for Patents. Our book *Patent-Sense* gives those facts; sent free. Write

LACEY & LACEY
Established 1869
646 F St., Washington, D. C.

1000 NEEDED INVENTIONS!

Here is the most remarkable book ever offered to inventors. One Thousand needed inventions listed and described. Arranged as follows: General Problems; Automotive; Mechanical; Electrical; Chemical; Radio; Marine. Separate chapter on the Ten Most Needed Inventions. This book may give you one idea that will win you a fortune. Nothing else like it has ever been published. Compiled at enormous expense. Edited by Raymond Francis Yates, formerly Managing Editor of a leading scientific magazine. Over 100 pages, durably bound. Send no money. Pay postman only \$1.00 plus postage on arrival. (Outside U. S. \$1.20, cash with order.) Money back after 10 days' examination if desired. Limited edition. Write NOW.

BUREAU OF INVENTIVE SCIENCE
DEPT. 33 ROCHESTER, NEW YORK

INVENTORS PROTECT YOUR IDEAS

Send for our Guide Book, **HOW TO GET A PATENT**, and Evidence of Invention Blank, sent Free on request. Tells our terms, methods, etc. Send model or sketch and description of your invention for **INSTRUCTIONS**. No charge for the above information.

RANDOLPH & CO.
300 Victor Bldg., WASHINGTON, D. C.

NAME.....

STREET.....

CITY..... STATE.....

Shoot the Best Gun

The NEW BENJAMIN is the finest air rifle ever made. Unlike all others. Has amazing accuracy—shoots hard and far. It's the original American genuine AIR operated rifle. One to six pump strokes compress air to any desired degree of power. Same force as in air drills and air hammers except you control the shooting force. Never loses force—no springs or levers to get out of order. Makes crack shots quickly, inexpensively. Gives years of delightful recreation with utmost safety. At your dealer's, or sent postpaid for \$5.00.

Shoot 5 Days FREE

We give you five days, ammunition supplied, to test the NEW BENJAMIN. If in this time you don't believe it to be the finest air rifle you've ever seen or used, and if you don't believe it is the one and only air rifle for you, return it, postpaid, and your money will be refunded at once.

The NEW BENJAMIN AIR RIFLE

America's Original Air Rifle

\$5 at your dealer's or sent postpaid direct from factory on FREE Trial as above if dealer does not handle it--write for our wonderful offer.

Get This Book and Details FREE



BENJAMIN AIR RIFLE & MFG. CO.
645 N. Broadway, St. Louis, Mo.

Please send your amazing offer and free copy of "The Shooter's Art," telling how to become a crack shot, how to hold, aim, and handle guns and guide others in use of guns.

Name _____

Address _____

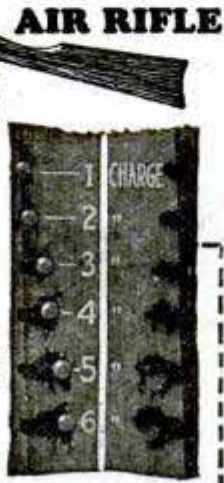

United States Capitol

PATENTS

Don't Lose Your Rights To Patent Protection

Before disclosing your invention to anyone send for blank form "EVIDENCE OF CONCEPTION" to be signed and witnessed. As registered patent attorneys we represent hundreds of inventors all over the United States and Canada in the advancement of inventions. The form "Evidence of Conception," sample, instructions relating to obtaining of patents and schedule of fees sent upon request.

LANCASTER & ALLWINE

480 Ouray Bldg. WASHINGTON, D. C.

Originators of forms "Evidence of Conception."

PATENTS

To the Man with an Idea

I offer a comprehensive, experienced, efficient service for his prompt, legal protection and the development of his proposition.

Send sketch, or model and description, for advice as to cost, search through prior United States patents, etc. Preliminary advice gladly furnished without charge.

My experience and familiarity with various arts frequently enable me to accurately advise clients as to probable patentability before they go to any expense.

Booklet of valuable information and form for properly disclosing your idea free on request. Write today.

Richard B. Owen, Patent Lawyer
9-303 Owen Bldg., Washington, D. C.
41-E Park Row, New York City

TRADE-MARKS REGISTERED

Have You An Invention?

If so the WORLD PROGRESS will send you upon request sample copy Free containing SUGGESTIONS TO INVENTORS as to Inventions Needed. We invite manufacturers to address us regarding inventions they want.

Subscription for one year 60 cents

WORLD PROGRESS PUB. CO., Inc.
Room 203 Victor Bldg. WASHINGTON, D. C.

BLUE BOOK ON PATENTS

AND PRIORITY RECORD BLANK GRATIS.

MONROE E. MILLER, PATENT LAWYER
411-2 Ouray Building, WASHINGTON, D. C.
ELECTRICAL AND MECHANICAL EXPERT

STOP USING A TRUSS



Reduced Fac-Simile Gold Medal



Grand Prix

STUART'S PLAPAO-PADS are different from the truss, being mechano-chemical applicators made self-adhesive purposely to hold the distended muscles securely in place. No straps, buckles or spring attached—cannot slip, so cannot chafe or press against the pubic bone. Thousands have successfully treated themselves at home without hindrance from work—most obstinate cases conquered. Soft as velvet—easy to apply—**inexpensive.** Awarded Gold Medal and Grand Prix. Process of recovery is natural, so afterwards no further use for trusses. We prove it by sending Trial of Plapao absolutely **FREE**. Write name on Coupon and send TODAY.

PLAPAO CO., 733 Stuart Bldg., St. Louis, Mo.

Name.....

Address.....

Return mail will bring Free Trial Plapao.

No Wonder This Amazing New Puncture Proof Is Sweeping U.S.

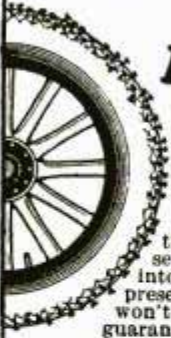

At last the perfect puncture proof! Aer-Seal, tested thousands of times by big users, positively prevents punctures. Yet does not deaden tires! This amazing new semi-fluid seals so air can't escape. Drive nails into tires without loss of air! Actually preserves tires. Cannot injure them! It won't freeze, won't soil, is absolutely guaranteed.

AGENTS \$200 A WEEK

Aer-Seal representatives earn amazing incomes with fascinating 3 minute demonstration. No experience necessary. Aer-Seal is sweeping the country, selling like wildfire. And no wonder! Aer-Seal is the scientific preparation inventors have searched for since days of the bicycle!

FREE—So amazingly simple to treat your tires, Aer-Seal acts instantly. Puncture-proof balloons same as others. And so certain is the inventor that you'll be delighted, so positive you will say like other thousands this is the most wonderful tire treatment ever discovered that we offer you without cost enough to treat four tires. Try it, test it under full guarantee of money back, plus 50c for your trouble, if not satisfied. Write at once for this amazing FREE offer. Know real tire protection. Send name and address. Try it entirely at our risk.

AER-SEAL MFG. CO. Dept. F, Singmaster Bldg. FT. WAYNE, IND.



Length over all 30 in.; between centers 14 in. Swing over bed 7 3/4 in. Includes counter shaft, Bronze taper bearings. Weight 60 lbs. No. 11 Lathe, 40 in. over all; 24 in. centers, 7 3/4 in. swing. Price \$75.00. Time Payments if desired.

\$60

The Sypher Mfg. Co., Dept. D, Toledo, Ohio

Rider Agents Wanted

Select from the 44 Styles, colors and sizes of Ranger Bicycles. Ride and exhibit sample Ranger and make money. Delivered free, express prepaid, on approval. Factory-to-Rider bicycles \$21.50 up. \$5 a Month on any Ranger if desired. Boys and girls easily save the small monthly payments. Parents often advance first payment.

Tires best quality, at factory prices, express prepaid. Lamps, wheels and equipment, low prices. Send No Money, do business direct with makers.



MEAD CYCLE COMPANY
DEPT. 110 CHICAGO

Write today for free Ranger Catalog, factory prices and marvelous easy payment terms.

Sport Bodies for Fords AT FACTORY PRICES!

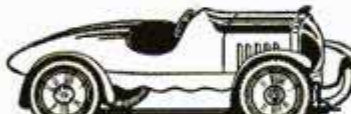

This Model In Grey Prime **\$39.50**

Write for Booklet A-2 Showing Other Models.

SPORT FACTORIES, AURORA, ILL.

MOVIES IN YOUR HOME

Write for interesting catalog of movie machines and films—Low Prices.

PILGRIM CO., DEPT. 117, MEDFORD, MASS.

AGENTS AND SIGN MEN

Now Making \$50.00 to \$100.00 and Up Per Week Selling Our GOLD LEAF SIGN LETTERS

R For store and office windows, board signs, trucks and glass signs. We also make to order script signs and business emblems singly or by the thousands. A permanent business. No capital or experience required. Big demand in every city. Samples and Literature Free.

CONSOLIDATED SIGN LETTER CO. 69X W. Van Buren CHICAGO, ILL.

Sensational Typewriter Offer



Yours for 10 Days - FREE

The World's Only Ball Bearing Typewriter

NEVER has there been such a typewriter bargain on as easy terms! A genuine Silent Ball Bearing L. C. Smith at a 40% savings!

Only the L. C. Smith has all these features:

Ball bearings (536 of them) at all points of wear. All the writing visible all the time. Non-shift carriage. 2-color ribbon. All the latest operating conveniences. Beautiful—renewed.

If you decide to keep it only **\$3.00** DOWN BALANCE EAST TERMS

Guaranteed 5 Years

Money cannot buy a better typewriter. U. S. Government bought 50,000. The choice of railroads, big corporations like the Standard Oil Co., etc., because of its exclusive ball bearing feature. Easiest running, longest wearing of typewriters.

Send No Money!

Just mail coupon. Without delay or red tape, typewriter will be shipped you. Use it 10 days. See how speedy and easy it runs—the perfect work it turns out. If not delighted, return at our expense. You'll want to keep it. You can, for \$3 down and \$5 monthly. Now is the time to buy. \$3 worth of extras free. Send coupon now before offer is withdrawn.

40% SAVED by Using this Coupon

SMITH TYPEWRITER SALES CORP.
113-360 E. Grand Ave., Chicago

Ship me the L. C. Smith, F. O. B. Chicago. On arrival I'll deposit \$3 with express agent. If I keep machine, I'll send you \$5 a month until the \$65.70 balance of \$69.70 price is paid; the title to remain with you until then. I am to have 10 days to try the typewriter. If I decide not to keep it, I will repack and return to express agent, who will return my \$3. You are to give your standard 5-year guarantee.

Name.....

Address.....

City..... State.....

Employed by.....

You Can Play a Pan-American Clarinet!



Everybody likes a Clarinet, the sweetest singer of them all. Clarinet players are in constant demand, at big salaries. The Pan-American Clarinet is a beautiful solo instrument for home, church, school, or private entertainment. Famous band leaders learned the Clarinet first! You can! They are so easy to blow—and to learn to play.

Remarkably LOW-PRICED
Pan-American Clarinets are called "the greatest value for the money on the market" by America's foremost band and orchestra leaders. Tested and found superior by the leading artists. Send coupon below today for our remarkably low price offer. Easy Payment Plan—and catalog of complete line of Pan-American Band and Orchestra instruments.

SEND NO MONEY MAIL COUPON

FREE TRIAL OFFER

The Pan-American Band Instrument & Case Co.,
Elkhart, Indiana Dept. G-6

YES—Send me complete information on PAN-AMERICAN Clarinets and other band instruments. I would like to learn to play..... (instrument)

Name.....
Address.....
My local Music Dealer is.....

NEW VEST POCKET ADDING MACHINE

ADDS, SUBTRACTS, MULTIPLIES, DIVIDES
Does work of \$300 machine. Guaranteed 5 years. NOT A TOY.
Made of steel and indestructible. Million dollar capacity. Fits in pocket. Will not make mistakes. So simple child can operate it. Instructions furnished. Everybody should carry one for figuring.

FREE TRIAL \$2.50 Total Cost

SEND NO MONEY—Just name and address. We will ship Calculator immediately. On delivery pay postman \$2.50 (Plus few cents Postage). (If outside U. S. send cash). If not satisfied after 10 day trial you get your money back. **THOUSANDS OF SATISFIED USERS.**
This is lowest priced practical calculator made. "Why pay more for inferior imitations?" Order from this ad.

Guaranteed

Mail Coupon Today

BABY CALCULATOR SALES COMPANY
Dept. 41, P. O. Box 1118, CHICAGO, ILL., U. S. A.

I am enclosing \$2.50—send adding machine prepaid.
 Send Adding Machine C. O. D. \$2.50 plus postage.

Name.....
Address.....
City..... State.....

AGENTS Write for big commission and territory proposition.



A recipe for sheer contentment

ONE "Old Town Canoe." One shining inland lake. One well-seasoned partner. Two bags of duffie.

Stow the duffie amidships as your partner takes his place in the bow. Now ease the "Old Town" onto the lake and hop aboard. Stroke the water gently with your paddle—deep easy strokes. Soon, perhaps, you'll find yourself whistling softly to the rhythm of your swing.

"Old Town Canoes" glide forward at the slightest dip of the blade. Strong and sturdy too. Priced \$58 up. From dealer or factory.

Free illustrated catalog shows sailing canoes, square stern canoes for outboard motors, dinghies, etc. Write today. **OLD TOWN CANOE Co., 1763 Middle Street, Old Town, Maine.**

"Old Town Canoes"

MAKE FORD Into The "LARK"
\$5.00 Red-i-Kut life size patterns Class—Snap



Famous sure-fit RED-I-KUT life-size patterns and picture instructions show how you can easily convert your Ford into this **Fast, Saucy, Sport Car** as thousands have done, with easily obtained materials. No need to lay up the car. Rear seat folds, making 4-passenger car. Send 10c coin for actual body photo and new manual of other distinctive sport body patterns from \$5.50 up—"KKO" Stee "Swing-Lo" Irons, Tops and Windshields. **ORDER RIGHT NOW.**

KUEMPEL COMPANY, 82 Kuempel Bldg., GUTTENBERG, IOWA

MOVIES In Your Home



Our marvelous, practical **Movie Machines** sell as low as \$3.75 post-paid, and use same size film as big theatres. We also have wonderful films at lowest prices—with a new film exchange service. **Don't Miss This!**
Write NOW for Free Catalogue.
PARAMOUNT MANUFACTURING CO.
Dept. MD, Boston, Mass.

SHAW MOTOR ATTACHMENT

MAKES YOUR BIKE A MOTORCYCLE!
A high grade 2 1/2 H. P. motor attachment quickly clamped on any bike frame. Speed 4 to 40 miles an hour. 90 to 125 miles per gallon of gas. **Special Low Price Now!** Write today for Complete Description and Special Low Prices on SHAW Motor Attachments and the SHAW Complete Motorbicycle.

SHAW MANUFACTURING COMPANY
Dept. 37 Galesburg, Kansas



Direct at Factory Prices

Sample \$1.18 3 for \$3.00 Postpaid

Hand Forged Razor Steel Blades
Send for our 100-page FREE List and "HOW TO USE A RAZOR."

Maher & Grosh Co.
106 A St., Toledo, Ohio



A Genuine \$2 Knife for \$1.18 Postpaid
Handy shaped Blade makes this knife best for mechanics, sportsmen and farmers; light but strong; re-sharpened easily. Stag handle. German silver finish; blades file tested, hand forged from razor steel and warranted.

El Diablo RAZOR STEEL No 57



Hanging Book Shelves

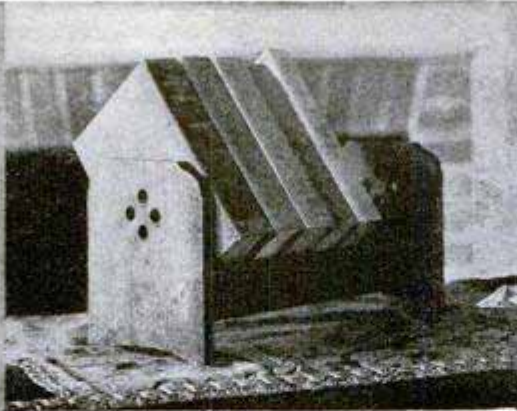

Book Trough



End Table



Handiest Tool in your Work Shop

Perhaps you have never thought of the special advantages of using LePage's Liquid Glue. It is always ready for immediate use. No weighing, soaking or heating is required. The quality is always the same. It "sets" slowly enough so that you have plenty of time to place the joints together exactly as they should go. Slow setting also allows LePage's to penetrate the wood, increasing the strength of the joint. LePage's Liquid Glue is equal in strength to any animal glue. Buy a can for your workshop. It is the easiest, quickest, handiest form of glue. Insist on LePage's.

Recipe for making LePage's Gesso

To make one cup of LePage's Gesso, you need 1 gill can of LEPAGE'S GLUE, 1 1/4 cups whiting, 3 teaspoons linseed oil and 3 teaspoons varnish. Place whiting in mixing bowl and pour in slowly in this order, LEPAGE'S GLUE, linseed oil, and varnish. Mix until smooth. All ingredients obtainable at nearest hardware store.

Attractive Furniture you can make yourself

LEPAGE'S Craft Books will show you how

DESIGNED by an expert, attractive, artistic, useful and easy to make. This briefly describes the furniture pieces which LePage's NEW Craft Books will show you how to make in your home work shop.

"LePage's Work Shop Book" contains complete directions for making a taboret, footstool, hanging book shelves, book trough, end table with book trough, and a number of simple things which perhaps your boy would like to make. The printed directions for making, step by step, are supplemented by dimension drawings and illustrations made from photographs of the finished pieces of furniture.

LePage's "Practical Suggestions for the Home Work Shop" will help you come closer to equalling the skill of the trained cabinetmaker. It tells you how to make strong joints with glue, and with glue in its most convenient form—LePage's Liquid Glue.

This book also shows you how

to cover up small defects in your craftsmanship. Now and then a tool will slip and an error is made. Or there are holes to be filled where nails or screws have been countersunk. Or the edges of a joint are not exactly even. A simple new way to repair these defects is with the use of LePage's Gesso instead of putty. LePage's Gesso will stick to any surface—wood, metal, glass, etc., and will stand 1,000 lbs. breaking strain as explained in the books. It can be sandpapered, planed and painted or stained just like wood. We give you in the small panel at left a simple formula for making LePage's Gesso, but of course we tell you more about it in the books themselves, together with practical information on decorating your finished articles with Gesso.

Send 10 cents for these NEW LePage's Books

The practical and useful help of these two books is yours for only 10 cents. Just write your name and address on the coupon below, tear the coupon out and mail it to us today with 10 cents in coin or stamps, and we will at once send you a copy of each, postage paid. Address LePage's Craft League, Dept. RR-6, Gloucester, Mass. Tear out the coupon now so you will not forget it.

MAIL THIS COUPON

LePage's CRAFT LEAGUE, Dept. RR-6, Gloucester, Mass.

Gentlemen: Enclosed you will find 10 cents (coin or stamps) in payment for "LePage's Practical Suggestions for the Home Work Shop," and "LePage's Work Shop Book." Please send a copy of each to:

Name.....
 Street.....
 City..... State.....

LEPAGE'S GLUE

Bottles, Tubes, Cans



\$1.00 DOWN
and We'll
Send This—

**Drill
&
Saw
Kit**

—handy and husky

Man alive! What a handy, efficient machine shop the new Speedway Drill and Saw Kit is! It works from any nearby lamp socket. Just the tool for your garage, workshop or repair bench. A real money maker and time saver for the small job.

A POWERFUL PORTABLE DRILL. The electric drill in the Kit is either a portable or stationary drill for 1/4-inch holes in steel or 1/2-inch in wood. Just turn the switch and zingo!—the job is under way.

A HANDY PORTABLE SAW. Just attach the blade, with guard, and your drill becomes a handy, husky portable saw, ready to go to work on any sort of a job.

GRINDS—BUFFS—POLISHES. The Speedway Drill and Saw Kit comes equipped for polishing silverware, headlights, hardware. The 2-inch emery wheel takes care of your grinding jobs. Kit complete is packed in a neat pressed steel case.

ONLY \$1.00 DOWN

Pin a dollar bill to the coupon and we will ship this Speedway Drill and Saw Kit to you at once, payable \$10.00 on delivery, balance in easy monthly payments.

Ten Days' Free Trial

Our free trial plan enables you to test out this handy Speedway Drill and Saw Kit in your own home. If it does less than we claim for it, send it back.

DON'T DELAY—WRITE TODAY

Write today for full information on the new Speedway Drill and Saw Kit.

ELECTRO MAGNETIC TOOL CO.

1830 S. 52nd Ave. (Adjoining Chicago) CICERO, ILL.

— SEND COUPON NOW —

Manager, Dept. 143.
Dear Sir: Here is my dollar bill. Please ship me at once the handy Speedway Drill and Saw Kit. I will pay \$10.00 on receipt; \$12.50 in 30 days, and \$12.50 in 60 days. Total cost to me, \$36.00.

Name.....

Address.....

City..... State.....

(If information only is wanted on ULA Drill and Saw Kit, tear off just above the address line and send to us.)



**MASTERLITE
POCKET LIGHTER**

**EVERY SMOKER
BUYS ON SIGHT!**

Every smoker instantly appreciates the wonderful convenience of this pocket lighter. Lights without flint or friction and no wind can blow out the flame.

**100% PROFIT
REPEAT SALES
ASSURED**

Sells instantly to smokers and dealers at big profits. Guaranteed for life. Each sale builds an everlasting repeat business. \$3.00 brings sample dozen in handsome display box with our sure-fire selling plans. MasterLite retails at 50c. Sells on a Flash Demonstration at over 100% Profit.



SAMPLE
50c



**RADIO GAS LIGHTER
SELLS TO EVERY USER OF GAS**

Lights Mantles, Gas Stoves, Jets and Heaters | Hold Directly Over Gas Flow, Lights Instantly

Retails 25c. Profit 18c. To save time enclose \$1.00 for sample dozen, \$10 for gross, with self-selling plans.

For a year of heavier Profits in lighter sales, send your order now.

Masterlite Mfg. Co. 110-G East 23rd Street NEW YORK



**DARCHE "CALL-ME" ELECTRIC
ALARM AND LIGHT CLOCK**

Will ring until you get up and STOP it. No home complete without one. Can be used as an "alarm clock" or "mantel clock." With a little effort on your part you can get one.

FREE OUR OFFER TELLS YOU HOW

Agents, here is a big money-maker, no competition, sells on sight. A good punch board proposition. Write today for our descriptive literature. An ideal GIFT for any occasion. Mahogany finish. Size 10 1/2 x 8 1/2 x 4. This applies to U. S. only.

Darche Mfg. Co., 643 Washington Blvd., Chicago

Information on any book free. Write Popular Mechanics Press, Chicago, Ill.

**21 Jewel
Burlington**



Only \$1.00 Down

The 21-Jewel Burlington is sold to you at a very low price and on the very special terms of \$1.00 down — free examination — small monthly payments.

Free Book Send for the most complete watch book ever produced. 100 designs and engravings in colors. Write for it today. It is free. A postcard will do.
BURLINGTON WATCH CO. 19th St. & Marshall Blvd. Dept. 13-53 CHICAGO

\$2,000.00 IN PRIZES!

108 Awards to Boys Who Build Best Models of a Studebaker Custom Sedan

BOYS!—The Studebaker Corporation of America is offering \$2,000 in prizes, 108 separate awards for the best small model of a Studebaker Standard Six Custom Sedan!

Prizes are unusually attractive—latest motion picture kodaks, long distance radiosets, boat motors, wood and metal working machines, big sets of tools, sporty luggage, camping equipment, canoes, and dozens of other things you want. Mail the coupon below for full list of awards.

If you like to whittle, model or make things, enter this contest today. Tell your friends about it. See who wins the finest prize.

Prizes for Boys of All Ages

Contestants will be divided by age into two groups—boys in grammar school and boys in high school. Your model will first be entered in a local elimination contest at the nearest Studebaker dealer's. The winning models from each city and town will be sent to the territorial contest managers to compete for 96 territorial prizes. Winners in each territory will then compete in the national contest. Twelve grand prizes will be awarded the winners by a committee of nationally known judges.

You may submit either a miniature model not more than eight inches long, without any moving parts; modeled, cast or carved from any material. Or you may submit a model not more



than twenty-four inches long which will run on its own wheels—though it need not be self-propelled. Separate prizes are offered for each type of model and for each group of contestants.

Enter Now—Get Full Particulars

This extraordinary contest opens immediately and will close on July 1, 1927. Your model must be received by your nearest Studebaker dealer by that date. You can get full particulars, simple rules, and a manual of instruction by filling out the coupon below and mailing it NOW!

You pay nothing to enter this contest. You do not have to sell anything. Your family need not own a Studebaker car. It is just a real opportunity for you to demonstrate your skill and perhaps win one of the 108 valuable prizes. Get your pals to enter—but be sure you sign and send in your coupon RIGHT NOW!

THE STUDEBAKER CORPORATION OF AMERICA
South Bend, Indiana

THE STUDEBAKER CORPORATION OF AMERICA
Dept. 83, SOUTH BEND, INDIANA

Please send me complete information about your prize model contest. I understand there are no fees nor do I have to buy or sell anything to win.

Name.....

Address.....

Town.....State.....



R7483

General Utility Knife

A blade for every purpose. Large spear blade for heavy work. Small clip blade. Pen blade. Stag handle. Nickel Silver bolsters, lining, and shield. Length, closed, 3 3/8 inches.



Trust the Name Remington—
the Hallmark of Good Steel

YOU can't tell whether a knife blade is made of good steel by looking at it, feeling it, or blowing your breath on it. But if you could tell quality in one of these ways, you would always buy a Remington knife.

For over a century Remington has been developing scientific, thorough, and exact heat-treatments for steel. Remington's methods of forging, hardening, and tempering insure blades with the remarkably keen, durable, and uniform cutting edges which are a distinguishing feature of all Remington pocket cutlery.



R 4223
Carpenter's Knife.

You will appreciate the practical advantages of Remington knives designed expressly to meet the exacting requirements of the carpenter and skilled mechanic.

Large, heavy spear blade. Sheepfoot blade for scribing and coping. Pen blade. Stag handle. Nickel Silver bolsters and shield. Brass lining. Length, closed, 3 3/4".

Add one of these useful Remingtons to your kit. Here are two practical patterns illustrated. Others in various combinations of blades and handles may be seen at your dealer's. If he hasn't them he will gladly order them for you. Send for a circular describing Remington carpenter's and mechanic's knives.

REMINGTON ARMS COMPANY, INC.

25 Broadway Established 1816 New York City

Remington

© 1927 R. A. Co.

Rifles Ammunition Shotguns Game Loads Cutlery Cash Registers

Ingersoll
YANKEE
\$150



High in Quality
Low in Price
A Trusted Name
and a
Famous Guarantee



Lighting Fixtures
READY TO HANG

(Direct from the Manufacturer)
Completely wired, including glassware. Send for New Catalogue No. 27. Just reduced prices.
Special proposition to DEALERS.

ERIE FIXTURE SUPPLY CO.
STA. A ERIE, PA.

I Offer You
\$8.00 a Day
and a



Write quick for new proposition. We offer \$8.00 a day and a new Chevrolet Coach, for demonstrating and taking orders for Comer All-Weather Topcoats and Raincoats. Spare time. No experience required. Sample outfit free. Write now.

COMER MFG. CO., Dept. W-5121, DAYTON, O.

Men and Women

Want more money? Then write me today for FREE Outfit. No experience necessary. I'll show you how to sell Harrison Tailored Shirts. Beautiful assortment. 9 out of 10 men and women order from DeLuxe samples. Quality higher—prices lower than at stores.

\$100 A WEEK

Harrison agents are making big money. So can YOU. Tell me about yourself. I'll send you FREE and postpaid my new gold-stamped, order-taking traveling case. If you are sincere and ambitious, write me. Henry W. High, Pres., Harrison Shirt Co., Dept. 32-C, 133-141 West 21st Street, New York, N. Y.



“Have you got these new ones?”



No. 470 Stair-Gage Fixtures

Every man who uses a steel square will want these handy little attachments. They're inexpensive and take up only a small corner of the tool chest but they're mighty convenient to have.

“A man's got to keep up-to-date these days or he'll find himself out of luck. And th' only way t' do it is t' keep his tool kit up-to-date.”

“Take these new Starrett's. Every one of 'em a real help to a man who wants to do his work better, quicker and easier. They keep you a jump ahead of the other fellow.”

See these new Starrett Tools at your hardware store. Write us for full information and Catalog 23 “AP.”

THE L S STARRETT CO

World's Greatest Toolmakers
Manufacturers of Hack-saws Unexcelled
Steel Tapes - Standard for Accuracy
ATHOL, MASS

570

Use Starrett Tools



No. 320K Steel Rule with Klip

The Klip will appeal to the thousands of men who always carry a rule in their pocket.



No. 151 Hack-saw Frame

Designed for work in close quarters. Handy around the house and car, too.



No. 520 Stainless Steel Tape

A tape that cannot rust. No need to scour the figures off trying to keep it clean. In 50, 75, and 100 ft. lengths with leather case and push button handle.

No. 22-C New Drill Point Gage

Combines a handy drill point gage for small drills with hook rule, plain rule, depth gage, try square and slide caliper.



No. 66 Thickness Gage

Has twenty six leaves making a complete set from .0015 to .025.





The Biggest thing you can do For YOUR Boy

Fun; good friends; health in mind and body; a pleasant, easy way to work his way through college; these are the extras thrown in when you start your boy with a Buescher True Tone Saxophone.

Playing any wind instrument develops lungs and chest, trains memory and makes for mental discipline. Tests prove that music students invariably stand at the head of their classes in all other studies at school.

Your Boy may be a Winner

Any boy who can whistle a tune can quickly master any Buescher Instrument. We recommend starting with the Saxophone only because it is easiest to learn. Many boys master scales the first hour and play tunes the first week. Your boy may make another Tom Brown if you give him a chance with a Buescher.

We make it easy for you

Buescher goes the limit to get you started. Six days' free trial, any instrument you choose. Easy terms of payment or discount for cash. Three lessons free with new Saxophone. Play as you pay. Satisfaction guaranteed. Send coupon below for complete details. It will be the biggest thing you ever did for your boy.

BUESCHER BAND INSTRUMENT CO.
Everything in Band and Orchestra Instruments
1892 Buescher Block Elkhart, Indiana

BUESCHER True Tone Band and Orchestra INSTRUMENTS

Mail This Coupon NOW

BUESCHER BAND INSTRUMENT CO. 353
1892 Buescher Block, Elkhart, Ind.
Gentlemen: Without obligating me in any way please send me your free literature. I am interested in the instrument checked below.
Saxophone Cornet Trumpet Trombone Tuba
Mention any other.....
How old are you?.....Do you play any instrument?.....What?.....
Write plainly, Name, Address, Town and State
in Margin Below

Send only \$100 with Order

**WRIST WATCH
4 DIAMONDS
4 SAPPHIRES**

FR6—Special offer to lady's wrist watch; solid 14 Kt. white gold band engraved case set with 4 genuine diamonds and 4 French Blue Sapphires; 15 jewel movement. Lifetime guar. **\$39.75** netice

**A full year to pay
All transactions
strictly confidential
10 DAYS FREE TRIAL**

Pin only \$1 to your order, and your choice comes to you parcel post prepaid on 10 Days FREE Trial. Then pay postman only \$1 more on delivery, and after free trial pay balance in 12 equal monthly payments. Satisfaction guaranteed or your money back.

**FREE
"Royal Book of Gems"**

Thousands of special values in genuine diamonds, watches and jewelry illustrated. Your copy sent immediately on request.

No interest, no extras

FR7—Newest design. Lady's 18 Kt. solid white gold mounting set with large size sparkling blue white genuine diamond. Unusual value. **\$56.75**

FR8—Exquisite dinner ring, 15 Kt. solid white gold mounting beautifully hand pierced; set with 6 heavy genuine diamonds and 2 French Blue Sapphires. Special. **\$56.75**

ROYAL DIAMOND & WATCH CO.
ESTABLISHED 1895
ADDRESS DEPT 1776, 170 BROADWAY N.Y.

10 DAYS FREE TRIAL - MONEY BACK IF NOT SATISFIED

THE NEW **INKOGRAPH** SELF FILLER
IMPROVED GREATEST VALUE EVER OFFERED

The Perfect Writing Instrument **\$1.50**

Writes with ink easy as a lead pencil. Won't skip, blot, scratch, leak or soil hands. Its steady uniform flow of ink improves handwriting.

DEALERS
Send for Catalog

Makes three carbon copies with original in ink. Guaranteed—Send No Money. Pay postman \$1.50 plus postage.

INKOGRAPH, CO., Inc.
197-21 Centre St., New York City

AGENTS Send for Inkograph or write for Sales plan booklet which tells how to make big money

BIG PROFITS in a NEW BUSINESS

Helping Motorists Save 1/2 Their Tire Bills!

Even if you are making "good money", you can greatly increase your income in a new all-year-round business of your own where you will be steadily building larger and larger future profits—limited only by your efforts. You can pay out of your earnings. Already, throughout the world, hundreds of ambitious men have begun to realize the very large profits to be made in this new uncrowded branch of the Automobile field—now opened up because of the famous **NESTLER RUBBER FUSING PROCESS**

Only a Nestler Operator is permitted to perform this Process and only one Nestler Operator is permitted to operate in any community. The automobile owner can now obtain 75% more mileage from tires he usually throws away. For the first time new rubber is perfectly fused directly to the old thread. Old tires can now be made practically new.

EASILY LEARNED
Our special instructions and manual enable men to perform this Process in short time. Only 6 major operations required.

GET THE FACTS
Investigate this well-paying business. Write today for free booklet *The Nestler Plan*. Don't delay.

THE NESTLER PLAN

NESTLER RUBBER FUSING CO. INC.
Dept. M-3, 245 West 55th Street, New York City, N. Y.

Copyright 1925
Shipman-Ward Mfg. Co.

Save on the price, and get a FIVE year guarantee

All tools, cover, etc., included

A Genuine Underwood

\$3 and it's yours

Own a Typewriter!

Act NOW, and Get a FREE Trial of this ACE of Writing Machines!



Speak up, if you want one! Underwood typewriters are so popular this lot we're completing now won't be long in selling! Rebuilt from top to bottom—every single worn part replaced. New typewriters are guaranteed for a year; we guarantee this one five years! That's our Better-Than-New Guarantee. And we guarantee a big saving!

You can learn to write on this standard keyboard Underwood in a day. In a week, you'll feel lost without it! The free trial will prove it. Our rebuilt plan gives you the best machine and a big saving!

Don't send a cent, but do get our

special offer—valuable book on typewriting—free.

Pay Like Rent

Three dollars puts this Underwood in your home—small monthly payments soon make it yours for good if you want to keep it—but send no money now. Just get our offer. Clip and mail coupon. There's no excuse now for not owning a typewriter—and the finest make! We include all tools, cover, etc., all complete, all ready to write. Write us now. Deal direct; we are the largest factory of the kind.

Get our catalog free; quotes lowest prices and most liberal terms in exist-

ence. We'll send a manual free, too; it contains valuable instruction for learning rapid typing, useful pointers for all who use a typewriter.

FREE NEW BIG BOOK ON TYPEWRITERS

SHIPMAN-WARD MFG. CO.
2123 Shipman Bldg., Chicago

Please send FREE, full offer, catalog, typing manual, and outline your free course in Touch Typewriting.

Name

St. or RFD

P.O.

START TO PLAY the VERY FIRST DAY!



*Pleasure, Profit and
Popularity for You!*

YOU can play
the Xylorimba

**Extra Money—Hosts of Friends
Loads of Fun Within Your Grasp
Free Trial... Easy Monthly Payments**



Fame and Money
Broadcasting



Center of Attraction
at Gatherings



Big Moneyfat
Dances

WHO doesn't want to be the "life of the crowd" at parties, entertain the whole family, and make \$5 to \$25 a night besides?

Earns \$60.00 a Week

Ralph Smith, Chicago, says: "Played 20 minutes at wedding. Received \$20." L. E. Hallman, Reading, Pa., writes: "Within 30 days had more jobs than I could handle and had never played an instrument before." Eight-year-old Michael Howe is playing "big time" vaudeville at reported salary of \$250 a week.

Start to play the very first day, even if you can't read a note. Free lessons, furnished with each instrument, make it easy to learn.

SEND TODAY FOR FREE BOOK!

It tells all about free trial and easy payment plan. Soon you will have your Xylorimba. Have the time of your life learning to play. Then delight and astonish friends and family. Be the center of interest at gatherings. Make real money at dances. It's easy once you make up your mind. Mail coupon today!

MAIL COUPON TODAY!

J.C. Deagan, Inc., Dept. 1453, 1770 Berteau Av., Chicago
Please send me full details on the Free Trial offer and easy payment plan of the Deagan Xylorimba.

Name _____

Address _____

Dealers:
We have a
plan that
will interest
you.



**Save
more
than
ever**

This 6 Room Bungalow **\$1493**
NOW FREIGHT PAID

Price includes everything complete—lumber cut-to-fit, FREIGHT PAID to your station.

New Low Prices Our customers claim average savings of 47% over local prices. This year reduced prices make possible still greater savings.

We Loan You Money to Build

We ship you any home you select, ready to erect, and ADVANCE YOU CASH to help you build. You pay us in small amounts monthly, just as you pay your rent—and your rent money is saved instead of spent. Send 25c in coin today for beautiful Color Book of Sterling Home Plans and you can be living in a home of your own a month from now.

COLOR BOOK OF Sterling Home Plans 25c

INTERNATIONAL MILL & TIMBER CO.
734 S. Wenona Ave. BAY CITY, MICH.



ALL FREE

10 year guar. Watch with chain and ring, large Eastman Roll Film Camera or 22 cal. Hamilton Rifle, yours for introducing finest assorted liquid perfume at 15c a bottle. Send for 20 bottles and choose gift as per offer in our catalog. We trust you—just write to **BELL PERFUME CO., Dep. D153, Chicago, Ill.**



NEW KIND OF TIRES DOUBLE MILEAGE

Mellinger Melenium Cured 15,000 mile tires—shock proof—handsomest, most durable tires made, Cord and Balloons. New process prevents rubber rot. Amazing guarantee. Sensational low prices.

AGENTS 4000 car owners in your territory—\$200,000 business awaiting you. Cash profits, no expense, collection, delivery, adjustment. Garman, Mich., makes \$48.30 in 2 days; Vernal, Miss., sells 25 tires first week. Hundreds double their income first few weeks in spare time.

Write Quick Be first to get introductory demonstrating offer. FREE Melenium Cured Samples, exclusive territory, and tires for yourself if you own a car. Simply send name.



Mellinger Tire & Rubber Co.

WRITE NEAREST OFFICE
Dept. 105, Philadelphia, Pa.

Dept. 105, Kansas City, Mo.
Dept. 105, Oakland, Calif.

REMINGTON
PORTABLE TYPEWRITER
Dealers and Branches Everywhere



WADE AMATEUR MECHANICS, REPAIR SHOPS, INVENTORS, STUDENTS

BENCH LATHE A real machine tool for the home work bench—capacity 4" dia. x 12" length. For Metal—Wood—Composition Materials. Turning—Facing—Boring—Drilling—Winding—Thread Cutting. Accurate—Strong—Quiet—Compact. Slide-rest has travel entire length of bed. Leadcrew inside bed. No. 1 Lathe, plain headstock, \$28.00. No. 2 Lathe, back-gear headstock, \$58.00. Extra for lathes with 18 inches between centers, \$7.00. Complete line of accessories at equally low prices. Write for free catalog.

THE GEROLD CO., Dept. P-32, 120 Liberty St., New York

Get into the **MAIL ORDER Business**

We supply you with catalogs with your name imprinted on cover. Buy stock from us as you need it. Good merchandise at strictly wholesale. Sample catalog and information FREE.

J. KRINSLEY CO. 1622 S. Clifton Dept. R, B CHICAGO

ENINGER WILL TRUST YOU

SEND 20c IN STAMPS FOR CATALOGUES
BIG MONEY SAVING FOR YOU

Used and rebuilt motorcycles \$25 to \$100, used bicycles \$9.50, tandems \$20. All machines fully guaranteed. New bicycles and motorcycles at factory prices, save dealers' profits. Motorcycle and automobile tires \$3. Complete line frames, engines, supplies.

DENINGER PRICE CUTTER, ROCHESTER, N. Y.

PAY AS YOU RIDE

**MAKE A SHIP
FREE BLUEPRINTS
RED JACKET**

WITH YOUR
SEE PAGE 127

Look *sent on* Approval

Adjusted to the Second
Adjusted to Temperature
Adjusted to Isochronism
Adjusted to Positions.
21 Ruby and Sapphire Jewels
25 Year Gold Strata Case
Your choice of Dials
(Including Montgomery R. R. Dial)
New Ideas in Thin Cases

The 21 Jewel Santa Fe Special

We will send this famous watch, express prepaid, for you to examine, to inspect, to admire, to approve, without one penny advance payment. Examine the watch and be convinced it's the best watch buy you ever saw. Just a small payment down, the balance in easy MONTHLY payments. You use the watch while paying for it.

Save 1/3 to 1/2 of Your Money

By purchasing this Famous Santa Fe Special Watch. Not only are you saving money from the present day prices of watches, but you can still secure the "Santa Fe Special" Watch, at the same low prices and terms that have made our watches famous.

Ladies' Wrist Watches

Artistic, dependable ladies' wrist watches — perfect timepieces, beautiful hand engraved cases in white or green gold. Send for New Watch Book and see the new shapes and designs. Sent on approval and sold on payments.

Write for "Santa Fe" Watch Book

Clip the coupon, fill out and receive the FREE WATCH BOOK just off the press. All the newest watch case designs in white or green gold, fancy shapes and thin models are shown. Read our easy payment offer. Wear the watch 30 days FREE. Watch sent for your examination and approval without a penny down. Nothing to risk. See the watch before you buy. Write for New Book Today and Select Your Watch. Mail Coupon.

SANTA FE WATCH COMPANY

36 Thomas Building, Topeka, Kansas
(Home of the Great Santa Fe Railway)

A LIMITED OFFER!

With every Santa Fe Special, a beautiful gold chain or strand of exquisite pearls. Write while offer lasts.

FREE BOOK COUPON

Santa Fe Watch Co.,
36 Thomas Building,
Topeka, Kansas.

Please send me prepaid and without obligation your New Watch Book, Free, explaining your "No Money Down" Offer on the Santa Fe Special Watch.

Name.....
Address.....
State.....



Men in every walk of life
now wear Strap Watches

"You don't need musical talent to play this Sax"... says Milton Sills



"With the new Lyon & Healy simplified saxophone persons like myself—without any special musical talent—can learn to play quickly and easily."
Milton Sills

YOU'VE always wanted to play some kind of musical instrument. Now you can profit from Milton Sills' discovery and learn to play the most popular instrument of all—a saxophone! Here is your chance to win good times, new friends, extra spending money for yourself. If you can whistle a tune you can play this new Lyon & Healy Sax.

Play one of these!

Lyon & Healy Trumpet. "Conical Bore" throughout. Easier to play. The most remarkable professional instrument ever produced. In silver with gold bell. \$110.00 in case. Washburn Banjo, the most musical, resonant, far-reaching (by test) professional banjo made. \$60 to \$500.



Amazing Beauty of Tone

You learn quickly because we have simplified the fingering, made it easy for you to play, easy to produce full, rich tones. That's why amateur musicians like Sills prefer the new Lyon & Healy. Leading professional players in famous orchestras are delighted with its accurate adjustment, improvements in action for hair-trigger finger work, exactness in pitch and resonant and mellow tones. *Completely made in Lyon & Healy's own factories and guaranteed by this, the most famous music house in the world.*

Easy Payments!

Learn how easy it is to purchase one of these professional instruments on our special time payment plan. Many write they pay for theirs out of extra pocket money earned by playing as they pay.

Free Instructions Free Trial

Use coupon for details of six-day, Free Trial, Free Lessons Offer. Teaches you to play tunes without learning written music. Not obtainable anywhere else. Free, with a Lyon & Healy Sax.

Lyon & Healy

Everything Known in Music
277 S. Wabash Avenue, Chicago

Mail the Coupon Today!

LYON & HEALY, Factory Sales Division
277 S. Wabash Ave., Chicago
Send Free your new Saxophone Book with details of Free Trial Offer, "Easy to Pay" plan and Free Instructions.

Name _____
Street _____
City _____ State _____
Instrument _____

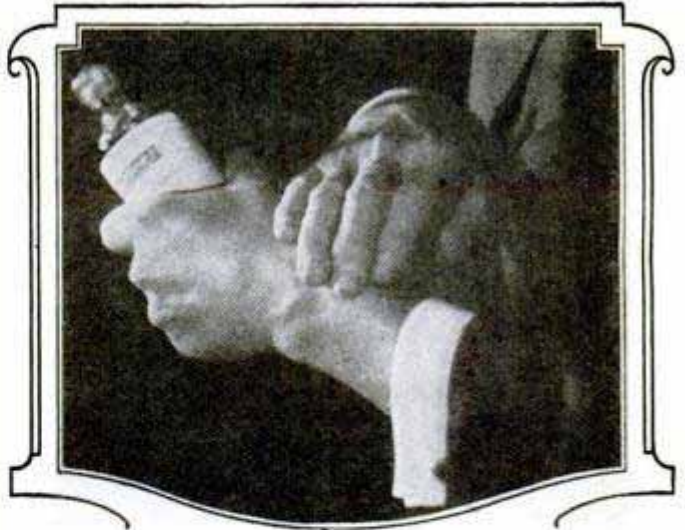

Rub in Absorbine, Jr.

Changing weather often brings muscular or rheumatic pains. Absorbine, Jr. will give prompt relief.

Always keep Absorbine, Jr. handy—it is a dependable "first aid". Read "Timely Suggestions", packed with each bottle.

Send for free trial bottle

W. F. YOUNG, Inc. Springfield, Mass.

Absorbine Jr.
THE ANTISEPTIC LINIMENT

FREE

NEW 1927 Radio Catalog

WRITE TODAY TO

Chicago Salvage Stock Stores

509 S. State St. Dept. PM Chicago, U. S. A.



MORE THAN a score of new circuits—all the latest and best. Complete parts at prices that mean big savings for you. And all the latest parts and accessories as advertised in current radio magazines. The largest, most complete and up-to-date radio stock in the world. Yours to choose from in this new catalog. Write for your copy.

Be Your Own Boss with

The NEW FOLEY Automatic SAW FILER

**New Model F-5
Power Drive
filing a hand saw.**

**Furnished on ped-
estal or bench type.**

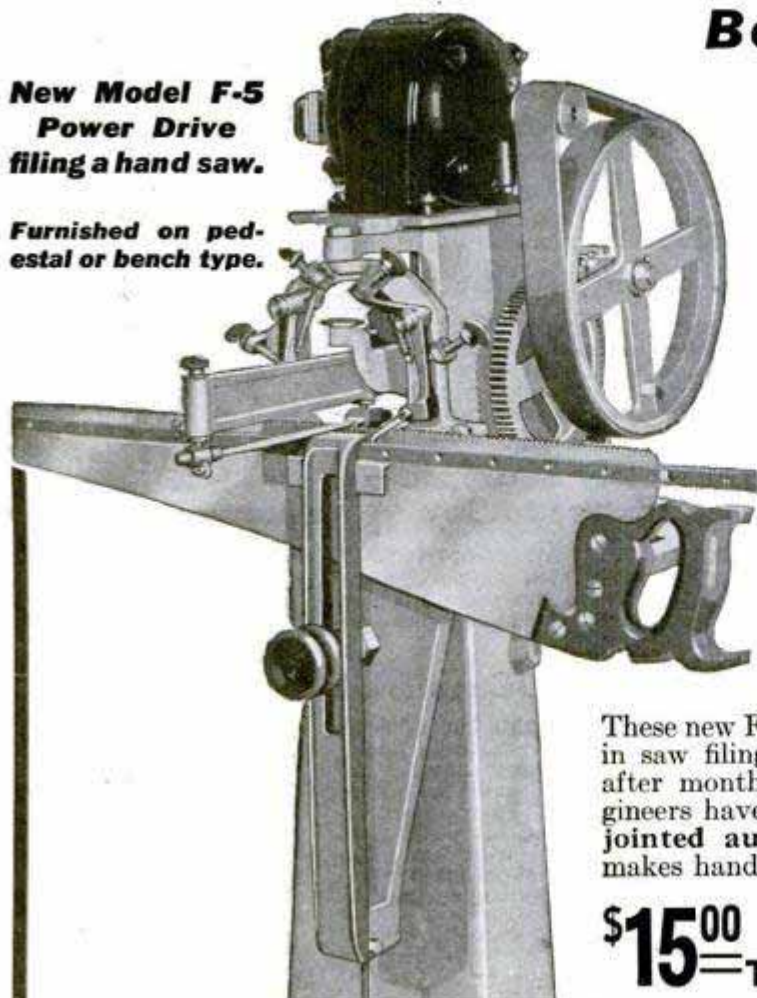

These new Foley Automatic Saw Filers are a startling advance in saw filing methods! They're different, better—perfected after months of research and exhaustive tests. Foley engineers have developed a new principle by which the saw is **jointed automatically as it is filed!** The new Foley makes hand filing as out of date as cranking an automobile.

\$15⁰⁰ TO \$20⁰⁰ A DAY

can be made in your own business with this fast, accurate saw filer. Here's a business that's not overcrowded with competition, a cash business—no credit losses—a business for whose service there is a big, steady, year 'round demand everywhere, a business that requires very little capital to start—a clean, dignified business.

You get 50 cents or more for filing each saw, and \$1.25 to \$1.50 for re-toothed saws. You can file 6 to 8 saws in one hour with one machine. The Foley quickly pays for itself and goes on earning profits year after year.

The Only Machine that Files ALL Saws

No other machine or the most expert hand filer can compete with the New Foley Automatic. It files cross-cut and rip, back, panel, mitre box and other hand saws; meat saws, band saws and circular cross-cut saws. It will retool saws perfectly. The New Foley does such perfect work, saws will cut better than new. You can build a big, permanent trade.

Your Satisfaction Guaranteed

You can use the New Foley for 30 days in your own shop. Test it on all kinds of saws. If after this fair trial you are not satisfied, if the machine does not do what is claimed for it, your money will be refunded. You can't lose—and you have a lot to gain by getting all the facts, so—

Mail the Coupon Now!



**New Model F-3
Hand Drive**

**FOLEY SAW
TOOL CO., Inc.**
213 Foley Bldg.,
914 East Lake Street,
MINNEAPOLIS, MINN.

Please send me full details on
the new Foley Saw Filers.

Name.....
(Write your address plainly in margin)

"B" ELIMINATOR

Money Back if Not Satisfied!

"Marvelous!" "Unbelievable!" "What a bargain!" Every day we receive scores of letters from users of this amazing new Roll-O "B" Battery Eliminator praising this invention to the skies. It does all that any higher priced "B" Eliminator can do—and more!

Forget Battery Troubles Forever

Just hook up this Roll-O Eliminator to your set and sit back to the greatest radio pleasure of your life. No more batteries to worry about. Enjoy better reception, sharper tuning. Don't

worry because "B" batteries run down and spoil reception.

Operates on All Sets

Works perfectly on any direct or alternating current, giving up to 90 volts current and using full wave of the power supply. Hooks up in a moment to any set up to six tubes. Constant voltage assures more power.

Completely Equipped— No Extras to Buy

Delivered to you completely equipped, together with simple, easy instructions. Made to last years. Solidly built in beautifully finished metal case with genuine Bakelite top.

Order Today—10 Days Trial

Now, for no more than the cost of good "B" Batteries you can own a Roll-O Eliminator that will make batteries unnecessary forever. Pin a dollar bill to coupon and mail to-day. Postman will deliver Eliminator to you. Deposit \$6.95 (plus few cents postage) with him. Use Eliminator 10 days. If not delighted return it within ten days and receive your money.

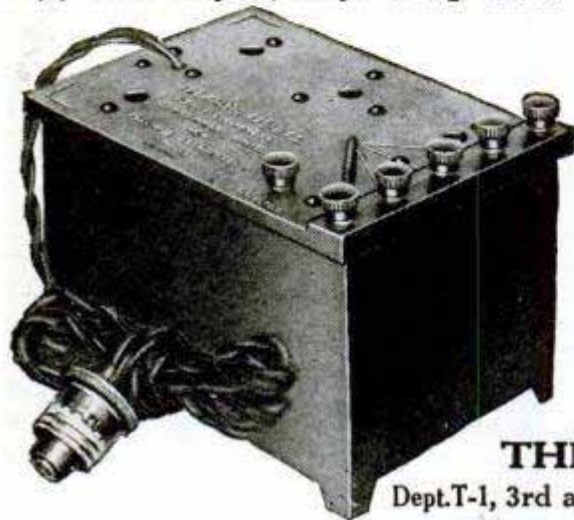

THE ROLL-O RADIO CO.

Dept. T-1, 3rd and Sycamore Sts., Cincinnati, O.

only
\$7.95
\$1.00 Down
Balance
C.O.D.

**READ
This Proof!**

"I received the 'B' Battery Eliminator and am greatly pleased with it. We did not know we had a good radio till we hooked up your Eliminator. To me it is a 100% perfect Eliminator." Louis Horian, Detroit, Mich.

"I received the Eliminator and will say its performance is all I could ask." Martin Tower, Waterman, Cal.

"I have your 'B' Eliminator and like it very much. It has given me very good service." A. J. Marshall, Perth Amboy, N. J.

"Recently received a 'B' Eliminator. Works fine." A. P. Richards, Akron, Ohio.

"The Eliminator is working perfectly." R. G. Stevens.

"'B' Battery Eliminator received and worked satisfactory. Please send another at once." L. M. Yacst, Zanesville, Ohio.

**RADIO PANELS
OF GENUINE BAKELITE**

Cut, drilled and engraved to order. Send rough sketch for estimate. Our New Catalog on Panels, Tubes and Rods—all genuine Bakelite—mailed on request.

STARRETT MFG. CO. 524 S. Green St. Chicago, Ill.

FIVE TUBE RADIO

\$25.00

**AGENTS
WANTED
BIG
COMMISSION**

Demonstrating agent wanted; every county. Exclusive to right man. Sell what public wants—five tube, long distance, loud speaker radio with single dial control. Price within reach of all, \$25.00 retail; liberal discount to agents. Sell in spare time—evenings. No selling or radio experience necessary. Territory going fast. 100 page Radio Book FREE. Write today—don't delay. **G. G. FISCHER, 122 W. Austin Ave., Chicago**

fix it yourself

Cheer up—now you can mend metalware as easily and perfectly as a mechanic! All you need is a touch of heat and Kester Metal Mender.



The pleasure of watching the bright, flowing solder, plug a hole or mend a break is only exceeded by the satisfaction of knowing you have done something useful.

Your hardware dealer can supply you with a can of this household solder.

free sample upon request



KESTER METAL MENDER

CHICAGO SOLDER COMPANY
4201-246Wrightwood Ave., Chicago, U.S.A.
Est. 1899

RADIO BOOK FREE

Tells how you can make big money in world's newest and greatest field. Presents lifetime opportunity in Radio. Right now we want live agents and dealers in every locality, \$60 to \$100 a week easy.

40% TO 60% PROFIT

FREE Simply send name for this big illustrated book explaining liberal profit proposition and how to get latest radio goods at wholesale. Also prices on parts, sets and accessories and amazing special offers—all free. Write today.

STANDARD RADIO CO. 1402 Walnut Street KANSAS CITY, MO.

5 Tube Set
only \$39.50 RETAIL

These Coils Improve Any Radio Receiver!

T. R. F. KIT

List
\$12⁰⁰



This set of supersensitive Aero Tuned Radio Frequency Coils has never failed to improve the performance of any radio receiver. Tremendously increased power, extreme selectivity, and improved tone quality are sure to result from their use.

This kit of Aero Coils has a much lower high frequency resistance than other types of inductances. You should use them in any circuit, if you want the best possible results.

FREE Big 8-page 4-colored layout system (actual size blue prints) and complete instructions for building the 5-tube Aero-Dyne Receiver free with each kit. Also insert showing how to wire for a power tube if desired. Extra copies, 75c each.

Get these Aero Coils from your dealer. If he is out of stock, order direct from the factory.

AERO PRODUCTS, Inc.

Dept. 107, 1772 Wilson Ave., CHICAGO, ILL.



THIS 68 PAGE
RADIO
CATALOG

FREE

Contains 75 Radio "Hook-Ups," 200 Illustrations, 650 articles, 8 page Log Book of all U. S. Broadcast Stations.

"Build your own with 'RASCO' Parts"
RADIO SPECIALTY CO., 98 E. Park Place, New York, N. Y.

INDISPENSIBLE

for 100%
Tube Efficiency

Only Amperite supplies automatically the self-adjusting filament current your tubes require. Eliminates hand rheostats. Simplifies wiring. Insist on Amperite. Accept nothing else. Price \$1.10 complete. Sold everywhere. Write for Free Hook-Ups and construction data to Dept. P. M.-3.

RADIALL COMPANY
51 Franklin St., NEW YORK CITY

AMPERITE

REG. U. S. PAT. OFF.

The "SELF-ADJUSTING" Rheostat



This is the Burgess Radio "A" Battery

A SPECIALLY designed "A" battery for radio service. There is nothing like it in its field.

Proportioned to permit ease of handling and convenience of cabinet assembly and storage, you may expect this new Burgess creation to give you the length of service and dependability under all conditions for which all products of Burgess are noted.

If you are using the ordinary type of No. 6 "A" battery, we suggest that you learn for yourself from the Burgess Radio "A" the measure of service you have a right to expect.

Ask Any Radio Engineer

BURGESS BATTERY COMPANY

GENERAL SALES OFFICES: CHICAGO

Canadian Factories Sales Offices: Niagara Falls and Winnipeg

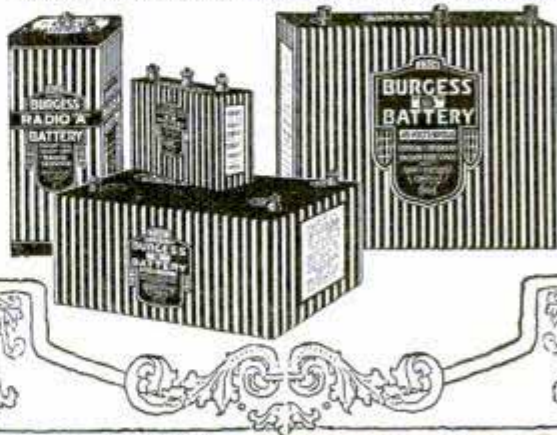

BURGESS RADIO BATTERIES

**30 Days
FREE TRIAL**

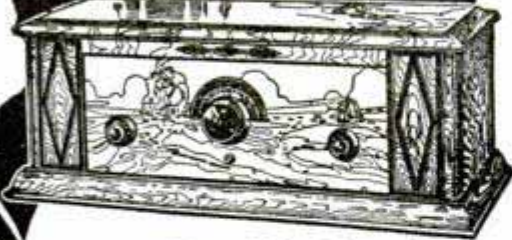

New One Dial Radio

NOW! Westingale offers the last word in Radio. One Dial control—lowest factory prices—30 Days' Trial—Money Back Guarantee. Why not have the **NEWEST** Radio? Why pay high prices? Why take chances when you can put a **New 1927 WESTINGALE** in your home for 30 Days' Trial on the absolute guarantee that if you don't find it the biggest and best value you have ever seen—You Don't Have to Keep It.

Westingale 5 tube sets—One or Two-Dial Models are most beautiful and powerful sets made—and easiest to operate. Music, Sports—market reports from Coast to Coast on loud speaker. Newest two-tone period style cabinets with Renaissance design on front panel embossed in dull gold.

5 Tube—2 Dial \$47.00
5 Tube—1 Dial 57.00

Agents—Dealers

Your own Radio Free. Get demonstrator set and make \$100 a week easy. Full or spare time. Big discount on first set placed in each locality. Be first—write today for dealers' discount and full particulars.

Unbeatable for appearance, performance or price. Don't buy any radio until you send for our **FREE 1927 Catalog** which pictures and describes these two last minute models, and get our liberal 30 Days' Trial Offer.

Westingale Electric Co.,
Dept. 180
1751 Belmont Ave., Chicago

Fansteel Products Company, Inc.
North Chicago, Illinois

The man who studies gets ahead. Popular Mechanics Press will advise you what books to read to advance in your trade. 200 East Ontario Street, Chicago, Illinois.

LYNCH METALLIZED

WARRANTED FIXED RESISTORS

THE vital importance of a silent, accurate resistor cannot be overestimated. Comprising a concentrated metallized deposit one-thousandth of an inch thick, upon a glass core and sealed forever within the tube, each Lynch Resistor is warranted absolutely noiseless, permanently accurate, dependable! Guaranteed accuracy—10%; in production they average 5%. .25; .5; 1; 2; 3; 4; 5; 6; 7; 8; 9; 10 Meg., 50c. .025; .09; .1 Meg., 75c. Single mounting, 35c; Double, 50c. If your dealer cannot supply you, send stamps, check or money order. We ship postpaid same day order is received.

Dealers—Get on our mailing list; we keep you posted on new developments. Write us today!

ARTHUR H. LYNCH, INC.



4-26-A
250 W. 57th Street
New York, N. Y.

FREE!

This
**84 PAGE
RADIO
BOOK**

SAVE 1/3 to 1/2



**The World's Largest
Exclusive Radio Mail Order House**

will send you—**FREE**—this wonder catalog of radio bargains containing over 2000 items of everything in **RADIO**, including all the latest Sets, Kits, and Parts, at rockbottom prices that **Save you 1/3 to 1/2**

5-TUBE SETS AS LOW AS \$24.90
5 LATEST 1927 MODELS

Table and Console models with built-in loud speakers. Beautiful, genuine mahogany and walnut cabinets. All sets at amazingly low prices.

SEND FOR BOOK TODAY

We cannot begin to tell all about this wonderful Radio Book. Simply send letter or postal, and this **bargain radio catalog** will come to you **absolutely free**. Write Today.

RANDOLPH RADIO CORP.
180 N. Union Ave., Dept. 225, Chicago, Ill.

\$45 Buys This Motor Cycle

It's a Harley-Davidson, 16 H. P., twin chain drive, magneto and clutch. It has power and can get up and go on the open road at a speed which thrills. This is only one of hundreds of bargains in used motor cycles which you can get. Send for Free Catalog. It tells of big bargains and tremendous values in used motor cycles. Repairs quickly done. Motor cycles exchanged. Send us your machine to be overhauled.



Oliver Cycle & Motor Co., 1045 N. Grand Ave., St. Louis, Mo.

RADIO LATEST CATALOG OF NEW SETS, PARTS AND KITS **FREE**

Fresh from the press. Shows all the newest standard parts and kits at big savings. Most complete line in America.

Send name and address, also name of friend. Send at once.

BARAWIK COMPANY, 540-551 Monroe Street CHICAGO, ILL.

A&B Battery \$2
Charger ONLY

SATISFACTION GUARANTEED



Charges any type of storage A or B battery, using a few cents worth of ordinary house current, either alternating or direct. Cannot injure battery. Complete directions enclosed. Anyone can operate. No expensive "extras" to buy. Why pay \$10.00 to \$15.00 for a charger when you can get this splendid **GUARANTEED R. B. Charger** by mailing us two dollars (bills, money order, check or stamps) plus ten cents in stamps or coin to pay mailing costs. Charger will be sent postpaid. If you are not satisfied, return within five days and we will refund your money. Order at once—**TODAY.**

R. B. SPECIALTY CO.
Dept. H-1 308 East Third St., Cincinnati, O.

I made



my first week

"Since then I have been earning over \$100 every week selling the Stay-Prest Trousers Presser."—S. L. Patterson of Iowa.

You, too, can make these big profits selling this wonderful new invention. Every man who sees it wants two to six at once.

SELL Stay Prest TROUSERS PRESSERS

They went like wildfire from the start. It was the very thing men everywhere had been hoping someone would invent. It's a common thing for a salesman to sell six to one customer. ANYONE CAN SELL THEM! The Stay-Prest keeps pants always pressed. Puts in knife-edge crease, removes baggy knees and smooths out entire surface. Easy to use—takes only a few seconds. Saves nap of cloth. Looks right. Folds to 15-inch package. Over 1,000,000 satisfied customers prove that the article is right. Thousands in your territory just waiting for you to write their orders.

Look At These Records

- \$33** G. M. Stewart, W. Va., tried selling this big repeater in spare time and made \$33 his first week, so decided to devote full time to it.
- \$17** S. D. Matthews, Minn., gave this a trial as a side line. He made \$17 in his first two hours and decided to devote his full time to the work.
- \$500** J. W. Varner, Iowa, made over \$500 the first month he sold this big money-making specialty.
- \$32** Mrs. Helen Rhodesby, Oklahoma, made \$32 the first day she tried selling this device. She is now one of the most successful "salesmen" of it.

Your Profits in Advance

Your profits in advance on this big new specialty and sells quickly—average sale made in 8 minutes. 40% profit for you. Big repeater. You simply write orders. We ship and collect.

Folds to Small Pack 15in. Long



FREE To Any Man or Woman

Special offer enables you to obtain Special Selling Outfit absolutely free—everything you need to take orders. We guarantee you will make sales. The Stay-Prest folds up into a neat, light, compact case, easily carried. Outfit has everything necessary for you to begin at once to make \$20 a day—\$35 to \$50 a week spare time—or \$100 to \$150 a week for full time. Simply mail the coupon and make the quickest money of your life.

THE GETGEY-JUNG CO.
C-121, G & J Building, Cincinnati, Ohio

The Getgey-Jung Company,
C-121 G & J Bldg., Cincinnati, Ohio.
Please send me full information about the "Stay-Prest" Trousers Presser and your New Selling Plan.

Name.....
Address.....
City..... State.....

Let Me Tell You Why Every Ford You See is Worth \$1.75 to You..

To a man with vision—one who will say: "I'll make your car ride 100% smoother, without spring rattles or spring squeaks, or give you a set of 'Ride Air' Cushions free"—that fellow can easily earn \$17.50 for only 2 hours' work, equipping Fords and other cars with "Ride Airs." And I'll prove that to you absolutely if you'll write me now. Just 5 minutes spent on each Ford you see means \$1.75 profit on a \$2.50 sale. No bolts—nothing to remove—no holes to bore.



C. F. Hamilton, Sales Manager

The Biggest Money Maker Ever Offered to Men Who Will Work 2 to 3 Hours a Day

Never before has such a phenomenal money maker been offered to men who like "the selling game"! You don't have to spend hours ringing door bells seeking prospects, they pass you on the street, they stand at the curb, in parking places, garages—in fact wherever there's a road or an automobile you have an absolute prospect! We have any number of men who are now making \$100 to \$150 a week easy and only working 4 to 5 hours at that, in fact last year opened the eyes of hundreds of fellows to the fact that "Ride Airs" were unquestionably the biggest money maker they ever tackled!

In 6 Months Last Year My Men made \$123,800.00

—and they didn't even begin to scratch the surface. There are over 22,000,000 automobiles on the road today with over 3,000,000 "Ride Airs" in use, yet that represents less than 1% of the prospects awaiting "Ride Air" men in 1927. It is the quickest selling automobile necessity ever invented—the product of an automotive mechanical engineer. It is the only device of its kind that positively makes old cars ride like new, eliminates the necessity of spring lubrication and guaranteed to last the life of the car.

Automobile Experts say Ride Airs are the Greatest Invention in 10 Years

They have been tested out over a period of 3 years under the most severe condition by skeptical automobile engineers everywhere, and without exception they have had the absolute stamp of endorsement of a number of the biggest men in the automobile field.

"Ride Airs" not only take all the rough spots out of the road, but improve the riding qualities 100% regardless of what make shock absorbers it may now be equipped with—and best of all they only cost the owner \$2.50 to \$8.00 according to the car, and your profit is \$1.75 to \$5.60 per sale. When you write me, which I know you are going to do today, I'll tell you all about this big money making opportunity, send you a FREE sample, also a certificate which will entitle you to a complete set of "Ride Airs" for your own car without one cent of cost to you whatsoever. Write or wire me NOW!



C. F. HAMILTON, Sales Manager
Desk P. M. 1—527-531 West 27th St., LOS ANGELES, CAL.

LUMINOUS PAINT

Make Your Watches, Clocks, Etc., Visible by Night

The very latest discovery in the scientific world. Hitherto, practically unobtainable except at an exorbitant price, we have at last succeeded in producing this remarkable LUMINOUS PAINT, which, applied to the surface of any article, emits rays of white light, rendering it perfectly visible in the dark. THE DARKER THE NIGHT, THE MORE BRILLIANT IT SHINES. Quite simple to use. Anyone—you can do it. A little applied to the dial of your watch or clock will enable you to tell the time by night. You can coat the push buttons or switch plates of your electric lights, match boxes, and innumerable other articles; make your own Luminous Crucifixes, Luminous Rosaries, etc. Small bottle, price 25c. Larger sizes, 50c and \$1 postpaid. JOHNSON SMITH & CO., Dept. 804 RACINE, WIS.

Serpent's Eggs

Box contains 12 eggs. When lit with a match, each one gradually hatches itself into a snake several feet long, which curls and twists about in a most life-like manner. Price per box, 10c postpaid, 3 for 25c.



CIGARETTE MAKER



Roll your own and save money. Makes them better and quicker besides saving more than half. Use your favorite brand of tobacco. Neat, useful and handy. Pocket size, weighs 1/2 oz. Made entirely of metal, nickel-plated. Price 25c postpaid.

MIDGET BIBLE

GREAT CURIOSITY Smallest Bible in the World. Size of a postage stamp. 200 Pages. Said to bring good luck to the owner. A genuine work of art. Must be seen to be appreciated. Make good money selling them to friends, church acquaintances, etc. PRICE 15c each, 3 for 40c, 12 for \$1.35, 133 for \$7.50. Also obtainable in Leather Binding, with gold edges. Price 50c each, 3 for \$1.25, \$4.50 per doz. Magnifying Glass for use with Midget Bible, 15c.



STAGE MONEY

With a bunch of these bills, it is easy for each person of limited means to appear prosperous by flashing a roll of these bills at the proper time and peeling off a genuine bill or two from the outside of the roll, the effect created will be found to be all that can be desired. Prices, postpaid: 40 Bills 20c, 120 for 50c, or \$3.50 thousand postpaid.



Wonderful X-Ray Tube

A wonderful little instrument producing optical illusions both surprising and startling. With it you can see what is apparently the bones of your fingers, the lead in a lead pencil, the interior opening in a pipe stem, and many other similar illusions. A mystery that no one has been able to satisfactorily explain. Price 10c, 3 for 25c, 1 dozen 75c. Johnson Smith & Co.



Good Luck Ring

Quaint and Novel Design

A VERY striking and uncommon ring. Silver finish, skull and crossbone design, with two brilliant, flashing gems sparkling out of the eyes. Said by many to bring Good Luck to the wearer, hence its name, Good Luck Ring. Very unique ring that you will take a pride in wearing. ONLY 25 CENTS.

Exploding Cigarettes



JUST LIKE ORDINARY CIGARETTES. BUT SUCH REAL STARTLERS! The box contains ten genuine cigarettes of excellent quality. They appear so real, but when each cigarette is about one-third smoked, the victim gets a very great surprise as it goes off with a loud BANG! A great mirth provoker yet entirely harmless. Price 25c per box.

Popular Watch Charms

ONLY 15c



Very pretty little curiosities and decidedly novel. Fitted with Magnifying Lenses that enlarge the picture to a very surprising degree; in fact, it seems almost incredible that a clear picture could be possible in such a small compass, and how sharp and distinct they show up when you look through. Come in assorted views—Actresses, views of Panama Canal, Lord's Prayer in type, etc.

Mystic Skeleton

A jointed figure of a skeleton 14 in. in height, will dance to music and perform various gyrations and movements while the operator may be some distance from it. 10c + pd.

Novelty Badges



Kissing Permit 10c Garter Inspector 10c Two very novel metal badges, nickel plated, that you can wear, giving you fun out of all proportion to their trifling cost, 10c, each badge, 3 for 25c, or 75c per doz. postpaid anywhere.

MAGIC FLUTE

Wonderfully Sweet Toned and Musical

The Magic Flute, or Humanatone, is a unique and novel musical instrument that is played with nose and mouth combined. There is just a little knack in playing it which, when once acquired after a little practice, will enable you to produce very sweet music that somewhat resembles a flute. There is no fingering, and once you have mastered it you can play all kinds of music with facility and ease. When played as an accompaniment to a piano or any other musical instrument, the effect is as charming as it is surprising.



Blank Cartridge Pistol

REVOLVER STYLE

PRICES

50c &

\$1.00

Post-Paid



Well made and effective Pistol modeled on the pattern of the latest type of Revolver; appearance alone is enough to scare a burglar. When loaded it may prove just as effective as a real revolver without danger to life. Takes standard .22 Calibre Blank Cartridges obtainable everywhere. Even the most timid person can use it with perfect safety. A Great Protection Against Burglars, Tramps and Dogs. You can have it lying about without the danger attached to other revolvers. PRICE ONLY 50c Better make and superior quality for \$1.00, Postpaid. Blank Cartridges .22 Calibre, (by express) 50c per 100. Revolver Holster and Strap (Cowboy type) for Blank Cartridge Pistol, 50 cents extra.

BOYS! BOYS! BOYS! THROW YOUR VOICE

Into a trunk, under the bed or anywhere. Lots of fun fooling the teacher, policeman or friends. THE VENTRILO a little instrument, fits in the mouth out of sight, used with above for Bird Calls, etc. Anyone can use it. Never Fails. A 16 page course on ventriloquism, the Ventrillo, ALL FOR 10 CENTS



Everything about the Ku Klux Klan told in a clear, fearless manner. Book tells all—How it started and was oppressed in 1871—The New Ku Klux Klan—How Organized—How Members are Enrolled—Oath of the Klan—Questions for Candidates—Creed—Objects of the Order—Obedience—Fidelity—Pledge of Loyalty—Ku Klux Klan and the Masons—The Jews—The Masons—Real K. of C. Oath—The Negro Ku Klux Klan, etc., etc. Latest and most complete book on the Klan published. Price 35c, Postpaid. Stamps or Coin

Female SEX Indicator Male Sex Indicator

Hold the MAGIC INDICATOR over a man's hand—Instantly it moves in a straight line backward and forward. Hold it over a woman's hand and it describes a complete and continuous circle. The same action can be obtained over a letter written by a man or woman, etc. It is fascinating; baffling. We have never been able to figure out how it's done, but we've never seen it fail. Many novel and entertaining feats may be performed with the Sex Indicator. For example, similar results can be obtained with animals, cats, dogs, rabbits, over birds, chickens, canaries, etc. Also used to predetermine the sex of chickens and birds, etc. In fact it is sold as a patented egg tester in Europe. Price 25c, or 3 for 65c, postpaid.



LOOK 35c Look

Wonderful instrument. Greatest thing yet. Nine separate articles in one. Everybody delighted with it. Odd, curious and interesting. Lots of pleasure as well as very useful. It is a double Microscope for examining the wonders of nature. It is also an Opera Glass, a Stereoscope, a Burning Lens, a Reading Glass, a Telescope, a Compass, a Pocket Mirror, and a Laryngoscope—for examining eye, ear, nose and throat. It is worth all the cost to locate even one painful cinder in the eye. Folds flat and fits the pocket. Something great—you need one. Don't miss it. Sent by mail, postpaid. Price only 35c or 3 for \$1.00



JOHNSON SMITH & CO.

Dept. 804 RACINE, WIS.

A De Luxe Edition of our new 1927 CATALOG mailed on receipt of 25c. Handsome binding. Bigger and better than ever. Only book of its kind in existence. 550 pages of all the latest articles in magic, the newest novelties, puzzles, games, sporting goods, rubber stamps, unusual and interesting books, curiosities in seeds and plants, etc., unobtainable elsewhere. Remit by Stamps, Coin, Money Order, Check, etc. Unused U. S., Canadian and Foreign Stamps also accepted.

COMIC CELLULOID BUTTONS



These Comic Celluloid Buttons provide subjects for pleasant jokes and amusing conversation and thus smooth the way to a more familiar acquaintance and cordial friendship. There are seventy different titles altogether, all very wittily worded and quite unobjectionable. Wear one and see the effect. All four Buttons illustrated above will be sent postpaid to any address for **ONLY 20c** or a dozen, all different, for **45c**.

SURPRISE SOAP

You've heard of people turning green with envy but they haven't turned half as green as the fellow who unwittingly uses this soap. It is an exact duplicate of an ordinary piece of soap. Secret: It contains a chemical which acts like a dye as soon as it comes into contact with water. **PRICE 15c postpaid.**

KEYLESS LOCKS

These clever locks cannot be opened unless you know the combination. No key necessary. For your locker, bicycle, tool chest, mail box, thousands of uses. Shackle and tumblers nickel plated. Weighs trifling over one ounce. Small, yet strong. Secret and full instructions with each lock. **PRICE 25c** or 3 for **65c postpaid.**



Every Boy His Own Toy Maker

Greatest boys' book written. Tells how to make a Pinhole Camera, a Canoe, model Railroad, a Telephone, Boomerang, Telegraph Instrument, Box Kite, Talking Machine, Microscope, Electric Motor, Electric Door Bell, Water Wheel, Paddle Raft, a pair of Skis, a Dog Sled, Bird House, Rabbit Yard, etc. 64 pages, 150 illustrations. **PRICE, 10c postpaid; 3 for 25c postpaid.**

INVISIBLE INK

The most confidential messages can be written with this ink, for the writing **Makes No Mark.** Cannot be seen unless you know the secret. Invaluable for many reasons. Keep your postals and other private memorandums away from prying eyes. Great fun for playing practical jokes. **Only 15c a Bottle; 3 for 40c.**

REAL PISTOL

Shoots Blank Cartridges



Exact reproduction of a real pistol; actually fires **REAL BLANK CARTRIDGES** of miniature size. Illustration is actual size. **1 1/4 inches** long, with ring at end for attaching to watch chain. Loads like a regular pistol. Pull the trigger and it goes off with a loud bang. Pistol is break-open type; illustration shows position for loading. Made entirely of high grade steel, nickel plated, octagon barrel, handsomely engraved handles, complete in box with cleaning rod. **PRICE \$1.75.** Also furnished with **pearl handles, \$2.50. BLANK CARTRIDGES, 50c per box of 25. JOHNSON SMITH & CO., Dept. 804, RACINE, WIS.**

RESURRECTION PLANT



One of the most wonderful plants known. Possesses the strange power of turning in a few minutes from an apparently lifeless, dry herb to a **BEAUTIFUL**

LIVING FERNLIKE PLANT of a dark green color. Simply place the plant in saucer of water, it will open up and start to grow in 20 minutes. When taken out it will dry up and go to sleep until placed in water again. Fine house plant—summer or winter. **10 cents each or 3 for 25c., 75c per doz., postpaid.**

Microphone Transmitter Button



You can easily make a highly sensitive detectophone by using this Transmitter Button to collect the sound waves. You can build your own outfit without buying expensive equipment. It is simple and inexpensive. You can install an outfit in your home and hear conversations being held all over the house. You can connect up different rooms of a hotel. This outfit was used by secret service operatives during the war. It is being used on the stage. It is ultra-sensitive and is the greatest invention in micro-phones. You can mount the button almost anywhere—card board boxes, stove pipes, stiff calendars, on the wall behind a picture frame, etc. Button is so light and small it cannot be detected. Persons can be overheard without suspecting it. You can listen in on conversations in another room. A deaf person in the audience can hear the speaker. Connected to phonograph, piano or other musical instrument, music can be heard hundreds of feet away. Button may be used to renew telephone transmitters; often makes an old line "talk-up" when nothing else will. The ideal microphone for radio use; carries heavy current and is extremely sensitive. Amplifies radio signals. Countless other similar uses will suggest themselves. Experimenters find the button useful for hundreds of experiments along the lines of telephones, amplifiers, loud speakers, etc. Many fascinating stunts may be devised, such as holding the button against the throat or chest to reproduce speech without sound waves. \$5.00 is given to anyone who sends in a new suggestion for the use of the Button providing the manufacturers find it suitable for use in their literature. **PRICE \$1.00 POSTPAID ANYWHERE.**

Send remittance (Postage Stamps accepted) for all articles listed on above and previous page to

MAGICIAN'S OUTFIT

Apparatus and Directions for a Number of Mysterious Tricks Enough for an Entire Evening's Entertainment

ANYONE CAN DO THEM 75c



It is great fun mystifying your friends. Get this Conjuror's Cabinet, and you will be the cleverest fellow in your district. It contains the apparatus for seven first-rate tricks, including The Disappearing Rose, that, when placed on the lapel of your coat, vanishes from sight at will; the Magic Vase and Ball Trick (a Wooden Ball is placed inside, and upon replacing the lid has disappeared and is found in someone else's pocket); The Magic Nail with which you can apparently cut your finger almost in two; the Wonderful Card Trick (a card is placed in an envelope, and when opened an entirely different card altogether is found); The Disappearing Coin Box (a coin is placed in the little wooden barrel, and, when opened again, is found to have vanished entirely, or can be made to change into a coin of another denomination); The Famous Dissolving Penny Trick; The Glass Goblet and Vanishing Coin Trick (a coin is dropped into a glass of water, and when the water is poured out the coin has vanished). With the tricks described above we send full printed instructions for performing each trick, so that anyone can readily perform all the tricks to the great amusement of their friends or the public. Any boy of ordinary intelligence, with this Cabinet of Tricks in his possession, can give a parlor entertainment not inferior to some regular magicians. Besides the tricks contained in the Cabinet, there are many other feats and illusions fully explained with full printed instructions, for which you easily make or procure the necessary apparatus. This unexcelled Cabinet of Tricks for **ONLY 75 CENTS POSTPAID TO ANY ADDRESS.**

Great Fire Eater

Most Sensational Trick of the Day!

With the Fire Eater in his possession any person can become a perfect salamander, apparently breathing fire and ejecting thousands of brilliant sparks from his mouth, to the horror and consternation of all beholders. Harmless fun for all times, seasons and places. If you wish to produce a decided sensation in your neighborhood don't fail to procure one. We send the Fire Eater with all the materials, in a handsome box, the cover of which is highly ornamented with illustrations in various colors. **Price of all complete only 30 cents, postpaid.**

SQUIRT ROSE

25c

A REAL STARTLER. This is the most popular of all squirt tricks. The flower in your coat looks so fresh and sweet that everyone is tempted to inhale the delightful perfume. Then is the moment to press the bulb. Geow! Illikens! Don't they jump? There is a very long rubber tube that easily reaches to the pocket of your coat or trousers, and the bulb is large enough to make a dozen shots with one loading. **PRICE 25c each, or 3 for 65c postpaid.**

PISTOL, OPERA & FIELD GLASS

PRICE POSTPAID, \$1.00

It is made in the shape of and looks like a regular Automatic Pistol. No one is likely to stop and ask you whether it is real or not. Thus it is likely to prove itself very handy in an emergency. On pressing the trigger it opens up, as shown in the illustration at the right, revealing nine most useful articles—Opera and Field Glass, Telescope, Mirror, Magnifying Glass and Burning Lens, Reading Glass, Sun Dial, Sun Compass, etc. In the handle of the revolver there is a place for various pocket necessities, such as First Aid Articles, Buttons, Pins, etc. The Pistol is of sheet metal, blued finish, that can be carried comfortably in pocket. **PRICE \$1.00.**

SURPRISE MATCHES

More fun than fighting with your wife. Look just like ordinary matches. Put up in boxes just like regular Safety Matches. As the victim tries to light one he gets quite a surprise. **PRICE 10c per box, 3 boxes for 25c, or 12 for 75 cents.**

SEEBACKROSCOPE

By merely placing this clever instrument to your eye, you can see what is going on behind your back, and sometimes you see very interesting things when no one thinks you are looking. Why it is just like having eyes at the back of your head. **PRICE ONLY 25 cents, postpaid, 3 for 50 cents.**

NEW BOOK ON ROPE SPLICING

A most practical handbook giving complete and simple directions for making all the most useful knots, hitches, rigging, splices, etc. Over 100 illustrations. All about wire rope attachments, lashing, blocks, tackles, etc. 37 Heraldic Knots Illustrated. Of great value to mechanics, riggers, campers, boatmen. **Price 20 cents postpaid.**

The "Little Giant" Typewriter

A First Class Writing Machine For \$1.50

A perfect little typewriter for \$1.50. There are thousands of persons who would like to use a typewriter but whose needs and business do not warrant the expense attached to the purchase and use of a fifty or seventy-five dollar machine. To such persons we confidently recommend our Little Giant. It is strongly made, but simple in construction, so that anyone can quickly learn to operate it, and write as rapidly as they would with pen and ink. The letters of the alphabet 1 to 10, and the punctuation marks being together. With this machine you can send your best girl typewritten love letters, address envelopes, make out bills, and do almost any kind of work not requiring a large, expensive machine. With each typewriter we send a tube of ink and full printed instructions for using the machine. **Price complete \$1.50 by mail postpaid to any address in the world.**

JOHNSON SMITH & CO. Dept. 804 Racine, Wis.

\$10 to \$30 a Day Clear Profit from New Invention

Takes only
3 sq. ft.
floor
space



**Liquid Bottle Cooler
brings crowds to—**

- Cigar Stores
- Grocers
- Roadside Stands
- Theatres
- Play Grounds
- Candy Stores
- Fair Grounds
- Amusement Parks
- Railroad Stations
- Office Bldg. Lobbies
- Chain Stores
- Billiard Parlors
- Gas Filling Stations
- Waiting Rooms
- Clubs
- Drug Stores, Etc.

**Liquid Bottle Cooler
serves a Cold bottle
every three seconds**

SALES of bottled drinks increased 100% to 400% by the Liquid Bottle Cooler—profits as high as \$675 a month and more in season—ice bills reduced 1/2 to 2/3—clerk hire cut as much as 80%. These and similar amazing reports are flooding in from 20,000 dealers. Now that we've started full page advertising in the Saturday Evening Post, the public will more than ever prefer drinks served this quick, clean, cold way.

Many average \$10 to \$30 a day clear profit. Some even higher, according to location and crowd. "Sold 840 bottles at the fair in two hours," writes one. Another says: "Averaged 100 cases a week all last summer. One day made \$68.10." So clean, quick and handy that dealers who would never sell bottled drinks the old way are now making fine incomes from the Liquid Bottle Cooler.

144 Bottles Always Assorted

by flavors in the Liquid Bottle Cooler—a separate cooling tube for each—8 tubes in all—and every one always filled with cold bottles in an Ice Water Bath—the quickest cooling method known. To serve any flavor called for, just take warm bottle from reserve rack above, push it in proper tube, and out comes the flavor wanted, clear, sparkling and cold.

You can't get a cold bottle out until you push a warm one in, and a glance at reserve rack tells you when to reorder any flavor—you can't run short.

Let Profits Pay for It

The Liquid Bottle Cooler looks like \$200 to \$500, yet costs only \$100 on easy terms. Scores of dealers quickly paid entire purchase price out of profits. One dealer did it in five days.

Write for "Liquid Profits," Free!

Get all the facts in new book, "Liquid Profits." We'll send it free if you give name of local bottler. Mail coupon now.

**FREE!
SEND THIS**



The Liquid Carbonic Corporation

Dept. P-3, 3100 S. Kedzie Ave., Chicago, Ill.

Send Free Book "Liquid Profits" and Easy Terms on the Liquid Bottle Cooler.

Name.....
Street.....
City..... State.....
Local Bottler is.....

BIG BARGAINS! only \$6.45 8 Day Watch value \$15.

Runs 8 Days

Remarkable offer! Wonderful imported 8 day watch for only \$6.45. Never sold at this low price. Own this "wonder" watch. Keeps perfect time for 8 days with one winding. No larger than an ordinary watch. Has 6 jewel movement with exposed balance wheel—shows action of movement. Stem wind and stem set, solid nickel, hinge back case. Silver finished dial.

Send no money—Pay postman \$6.45 plus a few cents postage on arrival. Satisfaction guaranteed or money refunded. Act quickly!

ESGEE WATCH CO.
Box 120 Madison Square Station,
Dept. 50, New York

YOU CAN EASILY EARN FOUR MEN'S WAGES

Practically no investment. No payroll to meet. Start in your garage or any small space. HB Quick Spray Method of Refinishing Autos with duco, paint or lacquer enables you to easily do the work of four men the old way. Pays for itself on easy monthly payments with Big Profits for you at same time. Write today for Bulletin P8.

Hobart Bros. Co., Box M372, Troy, Ohio

BUCHSTEIN'S FIBRE LIMB

is soothing to your stump—strong, cool, neat, light. Easy payments. Braces for all deformities.

D. BUCHSTEIN CO.
610 3rd Ave., So.
MINNEAPOLIS, MINN.

Send for Catalog Today

Let us recommend the best books to study on any subject. Popular Mechanics Press, Chicago, Illinois.

New Hair Quickly —or you pay nothing!



A new and scientific home method. First one endorsed by Science. **Marvelous Infra-Red Rays** simply applied

A noted surgeon has discovered an amazing way to give hair-growing tissues new life. Called Dermo-Ray. In 30 days no more dandruff. No more falling hair. And new where hair-roots are actually dead. *These results within 30 days—or you don't pay a cent.*

To use Dermo-Ray you must have electricity at home. For Dermo-Ray operates from light socket. You put on light weight silk cap, then attach plug, sit down and read or rest a short time each day. Coils in cap produce marvelous Infra-Red Rays science has found. A delightful mild warmth is all you feel.

Send no money. Order nothing

Coupon brings opinions of authorities, facts, prices, terms. Learn by mailing coupon today, how you may have beautiful healthy hair.

FREE TRIAL OFFER

The Larson Institute
26 East Huron St., Chicago, Ill. Dept. 14

Gentlemen: Send me at once without obligation full particulars—in plain envelope, about 30-day free trial of Dermo-Ray.

Name.....
Address.....
City..... State.....

Buy Direct From Mill!

Save \$200 to \$2,000 on your home. We furnish all materials, shipped direct to your station. Highest quality guaranteed.

Plan-Cut Lowers Costs Amazingly

Studs, joists, rafters, sheathing cut to plan at mill. No costly hand-sawing! You or carpenters begin building at once. Saves 30% labor and 18% lumber waste. So simple many do own building.



Gordon-Van Tine Home No. 623
5 rooms and bath—
Materials—
\$1162

Book of 100 Homes FREE!

Tighter, Stronger Construction Send for This 140 Page Book

These homes are designed by skilled architects. Then parts are sawed, notched and cut to exact blueprints. Every joint and angle meets with scientific accuracy. You get strongest, warmest house possible to build.

Shows photos, floor-plans, descriptions, 3 to 9-room town and country homes, bungalows, cottages, Colonial, color illustrations, full specifications; describes our famous Plan-Cut system. Wholesale prices. Clip coupon or mail post-card for Book today.

Build at Known Cost

One guaranteed price covers all materials we furnish, including hardware and paint. No extras. Wholesale prices insure further saving.

Gordon-VanTine
(Established 1865)
PLAN-CUT Homes



Garages
\$79
Up

Gordon Van Tine Company
940 Case Street, Davenport, Iowa
Satisfaction Guaranteed or Money Back.
Please send me Book of 100 Home Plans.

Name.....
Address.....

BUY SILK TIES DIRECT
from the manufacturer at wholesale. Make 100 to 200% profit. Spring novelties, plaids, stripes and figures.

\$39.00 GROSS
or sample dozen \$35.00. Sells readily at 50c and up. Better grades \$6.00 and \$9.00 per dozen. Excellent values. Wonderful money makers. Unexcelled side line for shirt and hosiery salesmen. Any unsalable ties will be exchanged. We defy competition.

P. M. Rodresal Mfg. Co., 8 E. 23rd St., New York
Established in 1907

CAL. 30-40

KRAG CARBINE STYLE
22 inch Barrel, 5 shot Box
NEW. Shipping weight, 13 lbs. Shipping Extra.

Krag Rifle.....	\$12.50	KRAG Sporting Rifles.....	\$14.00
Springfield 45 Shot Guns ...	4.75	SPRGFLD. 45 Carabines.....	4.50

Krag Bayonets 40 cents each. Postage Extra—Shipping Weight 2 1/2 lbs.
Terms Strictly Cash. No C. O. D. Shipments.
Catalogue Free on Request.

W. STOKES KIRK, 1627-P. M., North 10th St., Phila., Pa.

Make \$12 A DAY

GIVING FREE ROGERS SILVER

DO YOU know how it feels to make \$12 a day? You can experience that feeling if you'll take a tip from C. W. Richardson. How did he do it? Simply by showing people how to get quality groceries at amazing low prices—and offering them a choice of 400 free gifts, including the famous Rogers Silver!

FREE Sales Outfit This is an old, yet new proposition. You represent a house established forty years. You pay no deposit for the sales kit—it's FREE! Learn how the Great Eastern plan makes every call a sale. See for yourself why it makes you \$75 to \$100 a week. Why delay? Write now to the Great Eastern Coffee & Tea Co., Dept. C-190, 801 Franklin Ave., St. Louis, Mo. Est. 1884.

Agents! \$10 a Day!

Sell Hutchins made-to-measure trousers at factory prices. Sensational values, big saving, makes men buy quick. Many order two and three pairs. Collect your big profit in advance. \$10 to \$20 a day is easy. Many make more. Seal of Ohio cleared \$33 in one day. No experience necessary. We show you how.

Outfit and Trousers FREE

Send no money—just name and address on postal. Big new outfit with scores of new patterns, new line men's belts, full instructions and FREE PANTS offer sent at once. Write quick! Best season right now.

HUTCHINS PANTS CO.
Dept. 160-C, Cincinnati, Ohio

ONE DAY BATTERY CHARGING PAYS BIG YOU CAN CLEAR \$150 to \$300 MONTHLY PROFITS

Thousands of HB users are making big profits every month. Every car owner and radio owner wants quick, reliable One Day Charging. Get their business with an HB One Day Battery Charger. Small cash payment brings you complete outfit on 30 days' trial with moneyback guarantee. Only \$16.50 monthly pays for your HB, easily made many times over by your increased battery charging business. Get an HB now. Start making \$150 to \$300 clear monthly profits. Write for free bulletin 326.

HOBART BROS. CO. Box M37 TROY, OHIO

MAKE YOURS THE BUSY SHOP WITH HB ONE DAY BATTERY CHARGING

There are over 400 different Brown & Sharpe Micrometers. Sizes may be had to measure from 0 to 24".



Vernier graduations, machine cut, are uniformly accurate for fine measurements.

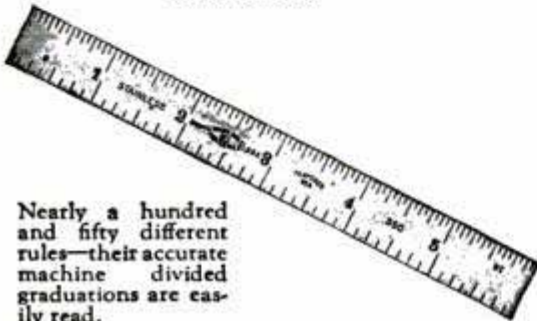

Nearly a hundred and fifty different rules—their accurate machine divided graduations are easily read.



Brown & Sharpe Combination Squares, Sets and Protractors are reliable precision tools. Over 400 different styles and sizes.



Speed indicators, and test indicators for nearly every requirement.



Everywhere the Brown & Sharpe trade-mark is recognized as THE WORLD'S STANDARD OF ACCURACY

The world of mechanics, toolmakers, students, motor service and repair men—the man of skill and training—invariably looks for the Brown & Sharpe trade-mark when selecting precision tools.

This trade-mark is symbolic of the highest standard of accuracy to the world of which we speak—a world accustomed to dealing in thousandths of an inch and often in one ten-thousandths of an inch.

The accuracy of Brown & Sharpe precision tools has made their name synonymous with "standard" wherever such tools are used.

It has always been the custom of Brown & Sharpe to sell its precision tools through hardware and supply dealers. Your dealer carries them. Let him supply your needs and ask him for No. 30 Catalog.

BROWN & SHARPE TOOLS

BROWN & SHARPE MFG. CO., Providence, R. I., U. S. A.

HERE IT IS!

Marvelous Townsend
"B" ELIMINATOR
(Complete)

only
4.95
\$1.00 down
Balance C.O.D.



Direct From Factory at Lowest Price on Record

Great news! For half the price of a set of "B" batteries you can now enjoy greatly improved reception and be done with unreliable "B" batteries. We make the Townsend "B" Eliminator complete in our own factory. That's the reason we can give you at such a remarkably low price a high quality instrument backed by a real guarantee. Users report splendid results. A fine "B" Eliminator at the lowest price on record. Our 10 days Free Trial proves it.

10 Days FREE TRIAL
You are the Judge!

MONEY BACK—If Not Amazed and Delighted

You alone are the Judge. We could not afford to make this guarantee if we were not sure of the Townsend "B" Eliminator's splendid performance. Delivers up to 100 volts on any set up to six tubes, on direct or alternating current—any cycle. Gives full wave rectification. Full tone, clarity and volume.

Rush Order Today Simply put your name and address on a piece of paper, pin a \$1 bill to it and get it into the mail at once. Your "B" Eliminator will be sent you promptly. Deposit \$3.95 only with the postman. Try out for ten days—then if not thrilled by improvement in operation, return Eliminator to us and purchase price will be refunded in full. You don't need to put up with battery nuisance another day when it is possible to own a "B" Eliminator at this startlingly low price. Send for it today.

Townsend Laboratories, 713 Townsend Street, Dept. 15, Chicago, Ill.

WHO SAID "FREE" AIR?

You'll make more money selling Accessories, Gas, Oil, Tires, Batteries and other Auto Supplies—if you give **BETTER AIR SERVICE THAN THE OTHER FELLOWS**. An HB Silent Twin Automatic Air Compressor will bring you the business. Beltless, powerful, **ABSOLUTELY DEPENDABLE**. Only \$12 monthly for a few months.

Write for bulletin AC9—today.

HOBART BROTHERS CO., Box M371, Troy, Ohio



ILLINOIS MAN INVENTS NEW FORD GAS SAVER

Walter Critchlow, 426 C Street, Wheaton, Ill., has patented a new gas saver that beats anything ever gotten out. On tests Fords showed as high as 66 miles on a gallon. "Last Sunday, with the VIX on, we drove up to Nuttall, 33 miles and back, a total of 66 miles on a trifle over 1 gallon of gasoline," says Geo. B. Cousins of Alton, Ill. This new invention saves gas and oil, makes a Ford start instantly in coldest weather and completely decarbonizes the engine. Mr. Critchlow offers 1 free to quickly advertise. Write him for one. He also wants County and State Distributors who can make \$500 to \$2500 per month.

\$244.00 PROFIT One day!

R. W. Helmer reports this from Minnesota on **Tripple Auto Reflectors**.

Wonderful device—100% more light and no glare! Pocket big money waiting for you now

—Whirlwind seller, makes astounding demonstration, low cost, agents cleaning up, 300% profit, big repeater, sells on sight. Over 300 sets sold in one town of 2000 people. **GET YOUR SAMPLE FREE TODAY—Wire or Write.**

AERIAL ELECTRIC CO.
130W. Kinzie St.
CHICAGO

38,000 CANDLEPOWER NO GLARE!

IF YOU CAN USE AN EXTRA \$20.00 BILL

write for this

FREE BOOK



You can save \$20.00 in no time by using

SMOOTH-ON No.1

to do your own household repairing—and in addition you will have that proud "I-did-it-myself" feeling.

Here is what one enthusiast did with two 35-cent cans:—A \$25 lamp stand loose in base, two big leaks in heating furnace smoke pipe, loose hammer handle, and three loose hooks in tiled bath room wall were all put into good usable condition at an average cost of 10 cents each for the seven repairs—and \$20.00 easily saved over what would have been paid to professional fixers or for new parts.

By using Smooth-On to make dozens of the simple repairs necessary in every home, you can save enough to pay your radio upkeep, buy yourself or your wife a camera, a bull pup or some other pleasure-giving article that you would otherwise hate to spend the money for.

The free Smooth-On Repair Book will show you how an astonishing number of home and automobile repairs are as easy for you to make as for somebody else.



Mail the coupon for a free copy and get Smooth-On No. 1 in 7-ounce or 1 or 6-pound can from any hardware store.

SMOOTH-ON MFG. CO.
Dept. 37, 574 Communipaw Ave.
JERSEY CITY, N. J.

Do it with **SMOOTH-ON**

SMOOTH-ON MFG. CO., Dept. 37,
574 Communipaw Ave., Jersey City, N. J.

Please send the free Smooth-On Repair Book.

Name.....

Address.....

Return this coupon for a FREE copy of Booklet

\$18⁰⁰ Builds a 20-MILE OUT-BOARD MOTOR BOAT



Complete details and plans in

THE RUDDER, January Issue

Price 25 Cents

The Rudder is the oldest boating magazine.

25 Cents a Copy—\$2.00 a Year

Subscription sent today will include the special double number for March. Single copies of March, 50 cents.

Send for Catalog of Boating Books and Plans for Amateur Boatbuilders

The Rudder Publishing Company

15 Murray Street, New York

New—Wonderful Soldering Iron and Blow Torch In One!

Saves time, trouble and money for EVERY householder, farmer, auto owner, mechanic, tinsmith, radio fan, plumber, electrician, dentist, jeweler, painter, printer, garage, repair shop.

For every handy man! Pays for itself in one job! Enables you to do easily a lot of work that would otherwise require a plumber or tinsmith. Needs no pump or pressure system—no stove—no charcoal pot—no separate blow torch. No fussing! No trouble.

Burns an hour at less than 1/2 cent for gasoline. Ready in a jiffy! Remove copper point and you have an ideal BLOW TORCH for burning off old paint, tempering tools, thawing frozen pipes, etc., etc.



Send No Money 10 Days FREE Trial

The Justrite will be sent you prepaid complete, with sal ammoniac and solder, for ten days' trial. When it arrives simply pay postman \$3.00. If not satisfied after 10 days, just mail it back and your \$3.00 will be returned at once. Write us TODAY!

Agents!

Get our extremely liberal offer NOW! Sales come so fast you'll be amazed! Our agents tell us that just as soon as people see how the Justrite works and how much time and trouble it saves, they want it! Nine times out of ten a demonstration means a sale. Drop us a postcard for our extremely liberal offer. Do it TODAY!

Justrite Mfg. Co., Dept. 13-53
2071 Southport Ave. Chicago, Ill.

One Year

To Pay



No. CS2—Price \$62.00
\$2 Down and \$5 a Month

This big cluster of seven best grade sparkling blue white diamonds is set in **SOLID PLATINUM** in this solid white gold ring. Guaranteed to stand any test.

18 KARAT

No Red Tape

10 Days Trial

SEND NO MONEY You pay \$2.00 to postman after you get this ring. *If you keep it, pay only \$5.00 a month for 12 months. If you are not satisfied after seeing the ring, return it in 10 days and we will return your money—every cent. You take no risk in ordering this beautiful, flashing diamond cluster ring. Pay for it in monthly installments, like putting money in a bank.

Cluster Looks Like \$600 Solitaire

You now can buy this gorgeous ring at the wholesale price. Compare it with similar rings at \$100.00. We guarantee it to stand any test or comparison. It is the greatest bargain ever offered by any Diamond Importer. We will give you 8% more than you paid for it when you exchange it for a larger diamond ring.

WRITE FOR JEWELRY CATALOGUE

This beautiful diamond cluster ring is a sample of the unexcelled values we offer our customers. A thousand and one other selections are shown in our catalogue. Brings our store into your home.

STERLING DIAMOND & WATCH COMPANY

(Diamond Importers—\$1,000,000 Stock—Est. 1879)

1540 Broadway Dept. 2236 New York, N. Y.

FREE CONE SPEAKER PEDESTAL



Have you a 3 foot Cone—this latest type radio speaker is conceded far superior to the old horn type for tone. Let us show you how to build a 3 foot cone speaker in 30 minutes (so easy a 12 year old child can do it) with a screwdriver and a pair of scissors. We furnish everything complete, from circular cut paper and unit to cement, all for only \$12. NOTHING ELSE TO BUY.

To those who order NOW we will give FREE our beautiful \$10 wood turned CONE PEDESTAL built especially for the 36-inch cone type speaker. Take advantage of this offer—SEND \$12 and we will send you this pedestal and a speaker outfit—equal to any \$60 manufactured cone on the market. Satisfaction guaranteed.

LEE SALES CO. 150 NASSAU STREET NEW YORK

RAISE BELGIAN HARES

NEW ZEALAND REDS—Chinchillas—Flemish Giants
MAKE BIG MONEY—We supply stock and pay you following prices for all you raise: Belgian Hares \$2 each—New Zealand \$3 each—Chinchillas \$4 each—Flemish Giants \$5 each. \$2-page illustrated book, catalog and contract, also copy of Fur Farming magazine, tells how to raise skunk, mink, fox, etc., for big profits, all for 10c. Address

OUTDOOR ENTERPRISE CO., Box 25, Holmes Park, Mo.

Chicago Man Discovers Gasoline Miracle!

What is this strange new miracle guaranteed to give up to 50% increase in gasoline mileage, instantly remove all carbon, increase power, speed, pep? Sworn proof backs our guarantee. Nothing ever like it. Not a mechanical device or gas dose. Use it only every 10,000 miles. Costs practically nothing. It is called **MOTOR-MYSTERY**, discovered by the eminent scientist, L. Forgrave. Startling in action. Astounding in results. Save \$200 yearly. Thousands of users and testimonials.

Try It Free Send no money. We trust you. Write quick for Free Trial, \$100 Week Salary Guarantee to producing Agents, and Free Dodge Plan. **M-M LABORATORIES** Dept. 1, 6934 N. Clark St. CHICAGO, ILLINOIS



You All Know Him

Agents \$100⁰⁰ A Week Salary Guaranteed

\$351⁰⁰ CLEARED ~ IN ONE DAY

So writes W. H. Adams of Ohio in August 1925. V. A. Marini of California reports \$11275 sales in three months. Jacob Gordon of New Jersey \$4000 profits in two months." Alexander of Pennsylvania "\$3000 profits in four months." Ira Shook \$365 sales in one day. Bram bought one outfit April 5 and 7 more by August 28. Iwata, bought one outfit and 10 more within a year. Mrs. Lane of Pittsburg says "sold 8000 packages in one day. J. R. Bert says "only thing I ever bought that equaled advertisement." John Culp says:

"Everything going lovely. Crispette wrappers scattered all over town. It's good old world after all." Kellog, \$700 ahead end of second week.

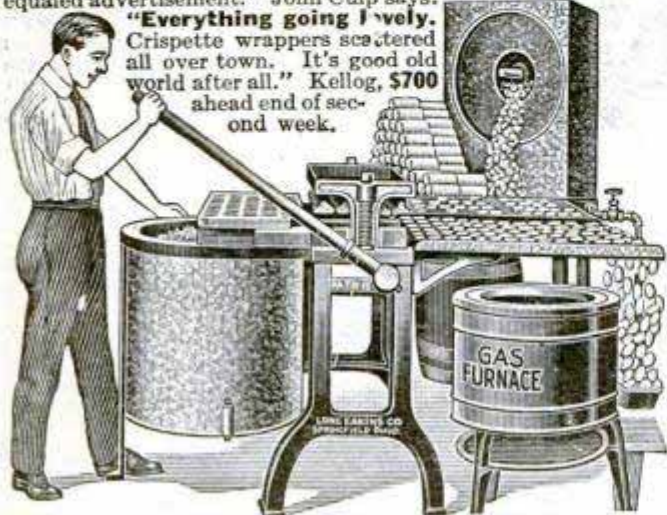

WE START YOU IN BUSINESS

Furnish secret formulas, raw material, and equipment. Little capital required; no experience needed.

Build a Business of Your Own

No limit to the sale of Crispettes. Everybody likes them. It's a delicious food confection. Write for facts about a business that will make you independent. Start now, in your own town.

Profits \$1000 a Month Easily Possible

Send postal for illustrated book of facts. It contains enthusiastic letters from others—shows their places of business, tells how and when to start, and all information needed. Free. Write now!

LONG-EAKINS COMPANY

328 High Street

Springfield, Ohio

**MAKE ANYTHING
ON YOUR
RED JACKET
SEE PAGE 127**

\$10 a Day for You



Many making more while establishing a permanent business for themselves. Introduce our big line by giving a Carving Set FREE to each customer ordering our 11 Piece Toilet Goods Assortment at \$2.25. NO FANCY TALK. Experience unnecessary. Walter Harris

**SOLD 800 IN 6 WEEKS
-PROFIT OVER \$600**

You make big money right from the start.

What more could you ask while introducing a line of Soaps, Toilet Articles, Food Specialties, Polishes, Remedies, etc. at Attractive Prices?

250 Products. All repeaters—100% Profit. 30 Years on Market. Send for illustrated Circulars, Inside Prices and Unique Sales Plans. Act now—TODAY.

Send for illustrated Circulars, Inside Prices and Unique Sales Plans. Act now—TODAY.

E. M. DAVIS COMPANY

Dept. 5651

Chicago, Ill.

Eventually— Why Not Now?

The Gold Medal shave is the one you get with Barbasol. No brush. No rub-in. All clean, fast, and cool. Use Barbasol—3 times—according to directions.

"Mister, you're next!"



Barbasol

For Modern Shaving

The Barbasol Company
Indianapolis, Ind.

I enclose 10c. Please send trial tube.

Name.....

Address.....

P-M-3-27



\$25.00 PAID DAILY

FREE SLICKER for WORKERS
for just a little work on your part
WOMEN, MEN WANTED

It's Easy. You show raincoats. We deliver and collect.
WRITE FOR FREE OUTFIT

Super Built Co., Box 453, Desk 2, Chicago, Ill.

AGENTS! EXPERIENCE UNNECESSARY



Science has finally produced it. An instantaneous metal cleaner—neither sloppy liquid nor messy paste. Dry magic floss. Touch it to nickel, copper or brass. The metal shines bright and clean instantly. No hard rubbing! Lightning Silver Cloth does same for Silverware. Lightning Furniture Floss instantly cleans and puts high lustre on Furniture. No liquid! Lightning Products all approved by Good House-keeping Institute. Agents making up to \$30 a day!

**AMAZING
DISCOVERY
ABOLISHES
METAL AND FURNITURE
POLISH**

Imagine! Touch tarnished articles with a Lightning Polishing Cloth or Floss and you make them bright as new. Demonstrations positively astonishing! Every one a sale! Agents collect real money on every call.

Makes a Sensational Demonstration!

Everybody Buys These Products. Housewives buy the Lightning Silver Cloth and Furniture Floss. Autoists buy Lightning Polishing Floss. Sell all three to stores and offices in big quantities. Nothing else like them. Sure big, quick MONEY GETTERS.

Sample Free! Exclusive territory. Real cooperation. Triple profit. Answer this ad at once. Make big money. Easy! Quick! Don't delay. Write NOW! FREE test sample and proposition by return mail.
D. N. LIGHTNING PRODUCTS CORP., 1773 Greenleaf Ave., Chicago

What \$1 Will Do!

Yes, only \$1 will bring your choice of these Big Bargains for your approval and 15 DAY TRIAL. Simply pin \$1 bill to this ad, indicate your selection and mail it TODAY. If you can duplicate your selection for less money elsewhere, send it back and your \$1 will be refunded. If satisfied, pay balance in 10 equal monthly payments. NO RED TAPE—PROMPT DELIVERY. DEALINGS CONFIDENTIAL.

B80—Ladies 18K White Gold Ring; beautiful design. AA 1 Blue-white Diamond. \$50 \$4.90 a Month.

B81—Ladies hand-engraved 18K White Gold Birthstone Ring set with 2 Blue-white Diamonds. Any birthstone furnished. \$25. \$2.40 a Month.

B82—Ladies hand-carved 18K White Gold ring, with 3 Blue-white Diamonds. \$45. \$4.40 a month.

B83—Gents 14K Solid Gold hand-engraved Ring with AA1 Blue-white Diamond set in White Gold square top. \$42.50. \$4.15 a Month.

B84—14K White Gold Wrist Watch; 4 Blue, white Diamonds; 4 Blue Sapphires. Guaranteed 15 Jewel movement. \$42.50. \$4.15 a Month.

B85 Famous Bulova Gents Strap Watch 14K Gold filled case, guaranteed 15 Jewel movement. \$28.50. \$2.75 a Month.

B86—12 size 21 Jewel Illinois Victor Watch; 14K Green Gold filled case. Price \$45. \$4.40 a Month



3000 Big Bargains in Diamonds, Watches and Jewelry shown in the catalog. Send for it Today—FREE.

L.W. SWEET Inc. DEPT. 67-H 1660 BROADWAY NEW YORK

Big 3-ft. Telescope

Only \$1.85

Makes people and objects miles away seem close. Brings new pleasures to home, farm, camp, travel, sport. See moon and stars as never before. New Ferry "Wonder" telescope has 5 sections—over 3 ft. long open, 12 in. closed. Fully brass bound. Powerful lenses.

FREE! Yes, Absolutely FREE! Hand-some leatherette covered Carrying Case, light, strong, complete with strap. Handy for farmers, auto tourists and hikers.

5 Sections 8-Power Lenses Thousands Delighted!

"I am delighted with the 'Wonder' telescope. Today I have been watching submarines 3 miles off the coast."—Philip Brush. "I can see across the Mississippi 3 miles and see people fishing."—M. L. Thorn. "I am nearly 80 years old and if I could not get another would not take \$10.00 for it."—A. R. Walker. "I can tell time on the church clock 5 miles away."—Edward Foster. "Could tell color of aeroplane 4 miles away."—Mrs. L. M. Yarbrough. "I saw a Light House 18 miles away."—Clyde Scribner.



Send No Money

Send name and address and Ferry Wonder 3-ft. Telescope with free Carrying Case will come by return mail. Pay postman special bargain price of \$1.85 plus a few cents postage. Satisfaction guaranteed or your money back. Supply limited.

Order Today! **FERRY & CO., Dept. 9773, CHICAGO**

AGENTS CAN OPENERS MUST GO!

\$4.50 AN HOUR

Just Showing New DEVICE!

NEW invention now makes old style can openers obsolete. Flips entire top out of any size can, round, square or oval, at turn of crank. Simple. Absolutely safe. Lasts a lifetime. Housewives wild about it. Agents cleaning up fortunes.

FREE OUTFIT Big FREE OFFER now ready for first 300 men. Territories being snapped up fast. Send quick for details. Address

Central States Mfg. Co., 4500 Mary Ave. Dept. C-700, St. Louis, Mo.



64 BREEDS Most Profitable chickens, ducks, turkeys and geese. Choice, pure-bred northern raised. Fowls, eggs and incubators at low prices. America's great poultry farm. At it 34 yrs. Valuable 100-page book and catalog free.

R. F. Neubert Co., Box 908, Mankato, Minn.

FREE Book HOW TO FEED AND CARE FOR CHICKS

Gives Money Making Secrets of Poultry Raising. Tells how to hatch, care for and feed chicks until fully grown. Gives plan of Poultry and Brooder Houses, Describes Miller's "IDEAL" INCUBATORS with Patented Egg Turning Traps, Oil and Coal Burning BROODERS. Eggs for hatching—Baby Chicks—BARGAIN PRICES. WRITE TODAY!

J. W. MILLER CO., Box 12, Rockford, Ill.



HOW A BOY BUILT UP A GREAT SQUAB FARM



Started small in backyard when at school with no money, now has \$30,000 plant, ships to New York 150 bbls. squabs yearly, receiving \$75 to \$100 a barrel. You can do the same. Send for this book. Price is fifty cents but we will mail it to you for the names and addresses of four of your friends and your own name and address. Write today to

Plymouth Rock Squab Co., 634 A St., Melrose High., Mass.

FOY'S BIG BOOK, in Colors

A complete guide to successful Poultry and Squab Raising. Low prices on CHICKS, Breeding Stock and PIGEONS.

Write Today! FREE! **FRANK FOY, Box 18, Clinton, Iowa**



PLANS for Poultry Houses

All styles, 150 illustrations; secret of getting winter eggs, and copy of "The Full Egg Basket." Send 25 cents, **INLAND POULTRY JOURNAL, Dept. 74, Indianapolis, Ind.**



68 BREEDS Valuable New Poultry Book Free—100 Pages. Fine Pure-bred Northern raised chickens, ducks, geese, turkeys, eggs, baby chicks, incubators & brooders at lowest prices. America's great industry. My 45th year. **W. A. Weber, Box 28, Mankato, Minn.**

When You Want a BLOTORCH

That gives 400° more heat—That's 100% safe—send for

TURNER MASTER No. 45 Only \$7.75, postpaid

TURNER BRASS WORKS, Industry Ave., Sycamore, Ill.



PLUMBING - HEATING WATER SYSTEMS

SAVE UP TO 40%

Wonderful bargains—everything guaranteed. Full line of plumbing and heating supplies. Hot water, steam heating plants and fixtures and water systems at big savings.

Install Them Yourself Finest materials all brand new and perfect. Tell us your wants and mail us a rough sketch of your rooms.

SEND FOR PRICE LIST



B. KAROL & SONS CO., 800 S. KEDZIE AVE. Dept. 20 CHICAGO

"I Made \$3,000 in 3 Months from the New Food Sensation Greaseless Doughnuts"

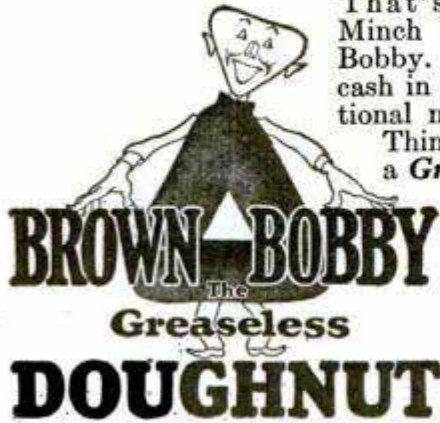

That's what Thomas Minch did with Brown Bobby. You, too, can cash in big on this sensational new food product. Think of it! Actually a **Greaseless Doughnut!**

Mrs. Nelson, Rockford, Ill., makes Brown Bobbys at home. "Sold 90 doz. last week. Will sell 3 times that many this week. Wonderfully easy."

Fair Store, Chicago, says: "It's a great money-making device." "The demand for Brown Bobby is beyond my wildest expectations," writes Jas. O'Connor, Chicago. So it goes everywhere. Investigate!

Big Profits for YOU!

Millions of greasy doughnuts are sold daily, hard as they are to digest. What a mammoth market for Brown Bobby! Cooked without a trace of grease to a golden brown—crisped to a feathery lightness—Brown Bobby is positively the food sensation of the age. No one thought a doughnut could be made without grease. But WE did it. And YOU can get in on the first easy profits.

Simple, Easy and Sure

Get this! With one simple, inexpensive, electrically operated machine, you can turn out a full dozen Brown Bobbys every 3 minutes—cost, less than 1c each. No baking skill required. Just add water to our patented "Mix." No bother. No boiling grease. No odor. A child can do it. Big money for women making Brown Bobbys at home. Tremendous opportunities in every town for a thriving business on a surprisingly small investment. Wherever there are hungry people, Brown Bobby is a sure hit. In lunch rooms, drug stores, wherever food is sold Brown Bobby offers a chance for amazing profits. Special openings for Brown Bobby Specialty Doughnut Shops in every town.

Write Quick! Be the first in your locality to get the first easy profits. Whatever your present line-up, let us present you a plan that will be feasible and full of opportunity for a steady, paying business. Just mail the coupon! Get the facts now. Profits are waiting.

FOOD DISPLAY MACHINE CORP.
28 E. Jackson Blvd., CHICAGO, ILL.

Food Display Machine Corp., Dept. 13-53
28 East Jackson Blvd., Chicago, Ill.

Gentlemen: Please send me the plan by which I can cash in on Brown Bobby, the Greaseless Doughnut. It is understood that this obligates me in no way whatever.

Name.....
Street.....
City..... State.....

You Have From Now Until 1928 to Pay!

If you act quick!—we will send you a Bulldog Pipeless Furnace for free inspection. Then, if you want it, you have from now until 1928 to pay. Get our special offer at once! Find out NOW about this amazing fuel saver! Write TODAY!

Comes Completely Erected!

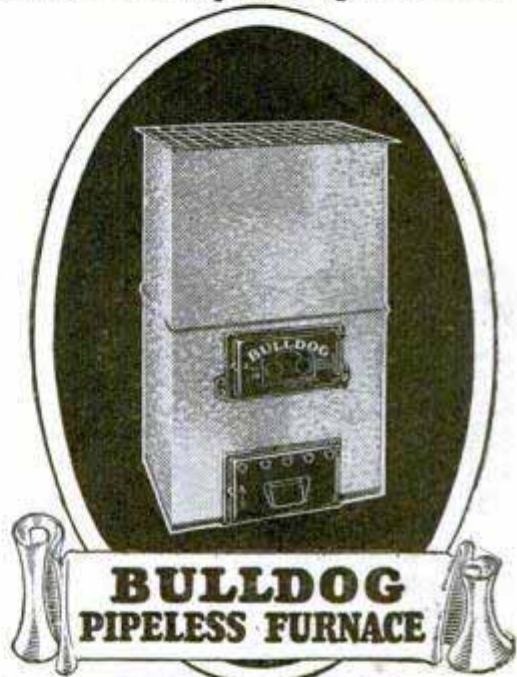

2½ Tons Heats 5 Rooms!

"There is no heater to compare with the Bulldog. I burned 2½ tons of coal last winter and heated 5 rooms and bath."
—Walter Geary, Gloucester, Mass.

That's what the Bulldog does with coal! Here's what it does with about the lowest grade of fuel you can think of! "I can run my Bulldog Furnace steady for fourteen days in normal weather conditions on the actual cost of 50 cents." So writes F. R. Redetzke, of Cleveland, North Dakota, and he adds: "Hard to believe, is it? That's what some of my neighbors thought until I showed them! We have an unlimited amount of green screenings in this country. That's the fuel I am using."

Write! Send today for our free book and Special Offer "From Now until 1928 to Pay"—in small monthly payments—if you act quick! Factory connections in both East and West. We ship from nearest point. Get ready for winter NOW! Mail this coupon TODAY!

Bulldog Furnace Co.

Babson Bros., Sole Distributors
19th and California Ave., Dept. 13-53 Chicago, Ill
Without obligating me in any way please send me your free catalog and special offer on the Bulldog Pipeless Furnace.
(Print name and address plainly.)

Name.....
Address.....

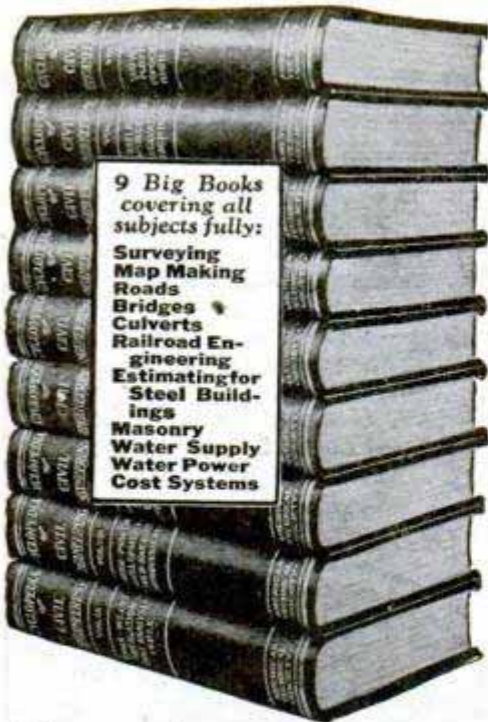

Want to make more money ? Be a Civil Engineer

Here is an easy way to learn. You hold your future in your own hands. If you have a grammar school education, and want the advantages of knowledge usually gained in college, you will welcome this new system of reading at home. No long hours of grinding study; just the meat of every subject told in such a simple way that anybody can understand.

These books were prepared by men who were experts, they are full of boiled down facts and easily learned methods which save time and study. Civil Engineers are more important than ever; steel buildings, bridges, highways, railroads and harbor projects make Engineering more important than almost any other profession.

If you want to get ahead—try this easy way We Ship Nine Books FREE

This is a "straight-from-the-shoulder" offer to men who want a big future. If you could hear half the stories of success we receive, you would not hesitate a minute. Send for the books now; just your name and address; and we'll ship the entire set of nine volumes. Keep them ten days, then if you realize how valuable they are to you, send only \$2.00, and after that only \$3.00 per month until the small total of only \$29.80 is paid. A free membership in the American Technical Society will be included if you send NOW. This entitles you to full consultation privileges with 18 engineering experts.

The special jiffy index puts facts at your finger tips

AMERICAN TECHNICAL SOCIETY, Dept. C-319, Chicago
You may send me, for Free examination, your nine new books on Civil Engineering. Unless I return them in ten days I will send you \$2.00 as first payment, then \$3.00 per month until the special price of only \$29.80 is paid. Include membership in the American Technical Society FREE.

Name

Address

City.....State.....

Reference.....

SM

Do You Know the Secret of Quality Reproduction?

"The Secret of Quality" tells you simply and concisely how to get the most out of your amplifier—how to get quality. This 96 page booklet is yours for the asking—it's free. Write for your copy.

SILVER-MARSHALL, INC., 840 W. Jackson Blvd., Chicago, U. S. A.



New Plan! makes it easy
\$50⁰⁰ to \$100⁰⁰ Weekly

Selling Shirts Direct to Wearer.
No capital or experience needed. Spare or full time. Established 1885. Represent a real manufacturer.

WRITE FOR FREE SAMPLES
MADISON SHIRT MILLS, 562 BROADWAY, NEW YORK

Boils 50 Gallons In Less Than Hour

No Other Compares With This

Improved Oil Burner

Use Ordinary Kerosene or Coal Oil

[Burns Outdoors as Well as Indoors]

THE most remarkable Kerosene Burner ever built. Boils down apple cider, maple syrup, molasses, etc., in half the ordinary time. Ideal burner for dairies, butchers, indispensable on the farm.

PRODUCES TERRIFIC HEAT WITH SILENT BLUE FLAME

**NO NOISE
NO SMELL
NO SMOKE
NO SOOT**



So efficient it produces twice the amount of heat of City gas at half the cost. So simple anyone can install and operate. Double generator assures continuous operation without shut-downs. Nothing to wear out, starts in a jiffy, will last a life time. Every burner guaranteed fully. Write for special introductory price. Free descriptive catalog.

HOME MANUFACTURING CO.

Dept. 53, 18 E. Kinzie Street, CHICAGO



Auto Owners Wanted

To Introduce and Use HYDRO Insured TIRES. Hydro Agents make money selling

the only Tires in the World Insured for One Year against all road hazards regardless of mileage. HYDRO TIRES sell fast because they have no competition in price; no rival in quality; no imitation in appearance and no equal in the Insured Protection to the user. Insurance Policy with every tire. Are made by the only tire factory in America selling its own product through authorized Salesmen-Agents. We offer opportunity of lifetime to establish profitable tire business of your own. No capital required. Sales kit and advertising helps furnished. Exclusive territory granted. Write today for catalog and complete information about the Hydro Agency Plan.

HYDRO Insured TIRES
The Most Beautiful Tire in America

HYDRO-UNITED TIRE CORPORATION, Address Dept. PM 11, POTTSTOWN, PA.

Ride A Ranger

The finest bicycle ever built. 44 Styles, colors, sizes; made in our new factory. SAVE \$10 to \$25 by direct from the factory purchase. Delivered free on approval, express prepaid, for 30 Days' Free Trial. Easy Payments, if desired.



Tires best quality, at factory prices, express paid. Lamps, wheels, horns, equipment and repairs at unusually low prices. Send No Money, do business direct with makers.

Mead CYCLE COMPANY
DEPT. D-118 CHICAGO

Write today for free Ranger Catalog, factory prices and marvelous easy payment terms.

FORDS No Freezing and No Boiling Plus Great Gas Saving. AIRLOCK

does it absolutely. Sells like machine guns fire. Free trial always. Fords demonstrating make \$50 daily.

AIRLOCK PRODUCTS CO., Box 588A, BURNETT, CALIFORNIA

72 Sales In 4 Hours!

We want 500 ambitious men and women to accept exclusive territory and make big money fast! "Doc" Barber sold 72 in 4 hours, profit \$64.80 (sworn proof). Every woman buys on 10-second demonstration. New, wonderful self-wringing mop that REALLY wrings dry, without wetting hands. No gears, bolts or screws. Simple, practical, perfect. Lasts a lifetime. Weighs only 2 lbs. Price \$1.50. Your profit up to 150%.



Write Quick! If you want exclusive territory, you must hurry! You need no experience. The mop sells itself. But hurry! Write today, sure!

Delphos Mop Company, 16-23, 10th Street, Delphos, O.



Outdoor sport with a real "kick"—at 1¢ a mile!

GET ready fellows—Spring's just around the corner. Prepare now for those glorious days of outdoor fun. Whether you like hunting, fishing, camping, touring, let an Indian Motorcycle be your guide.

Only 1¢ a mile! No traffic to worry you—no parking problems—no garage bills. Restful comfort—easily handled—smooth—rugged—flexible—and trusty as your closest pal!

There's an Indian model for every type of rider. Through the Indian Club Plan only \$1 starts you and then easy payments. Send for free illustrated catalogue of 1927 models or better still, visit your nearest Indian Dealer for a free demonstration.

Indian Motorcycle Co.

DEPT. P-3 SPRINGFIELD, MASS.

Dealers

A few good territories open. Our proposition is a winner for ambitious men. Mail coupon now.

Mail Coupon

and please check nearest age to help us suggest the correct model for your requirements.

Be Our Guest
Indian Day
February 22nd

A big party is being planned at the store of your nearest Indian Dealer. Come and bring the ladies! Music. Fun. Surprises galore! Valuable souvenirs for everybody.



INDIAN MOTORCYCLE CO., Dept. P-3
Springfield, Mass.

- Send me Free illustrated Catalogue describing the 1927 Indians.
 Check this square if you are interested in our money-making proposition to dealers.

Name.....

Address.....

City..... State.....

Age 12 to 16 16 to 20 over 20



Pocket Ben

For men who like to be on time

POCKET BEN was raised with Big Ben, Baby Ben and all his other Westclox brothers. They set him a good example and he lives up to it.

You can rely on him for sturdiness and truthfulness, traits that are traditional with the Westclox family.

You'll find Pocket Ben at the stores in your locality. Price \$1.50, with luminous dial \$2.25.

WESTERN CLOCK COMPANY
LaSalle, Illinois

WE PAY FREIGHT
5 ROOMS AND PORCH
BATH INCLUDED - **\$548⁰⁰**



Others \$379⁰⁰ up
BUILD YOUR OWN HOME
Save \$300 to \$800
AND MORE

Buy all materials direct from manufacturer—saving four big profits! Guaranteed materials. Factory-cut. No waste. 40% less labor. Most remarkable money-saving prices ever offered!

HANDSOME BIG FREE!
CATALOG

Prices include all lumber, millwork, roofing, lath, hardware, paints, nails. Plans furnished FREE. Freight paid east of Mississippi and North of Mason-Dixon line, also Minnesota, Iowa, Missouri.

Write for catalog now
LEWIS MFG. CO., Dept. 123, BAY CITY, MICH.
Send Postcard

Independence and Big Profits!

Why Be a Slave?

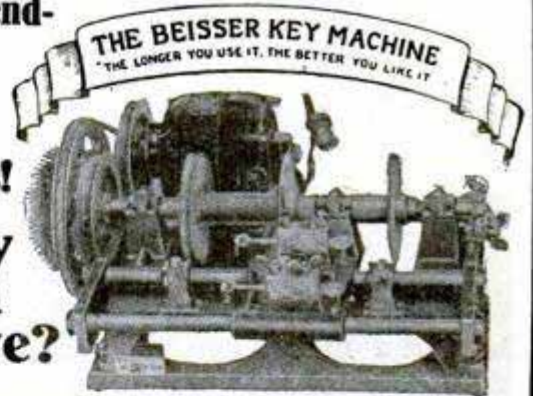

Be your own boss and make more money besides. Only a small investment for a Beisser Key Machine and you start a business of your own; no experience necessary. **WE TEACH YOU HOW.** The only machine that will cut any kind of key perfectly, by number, without need of taking locks apart, including first keys for

cars and automobile locks. With our instructions you also learn how to open and repair all kinds of locks; become an expert locksmith and safe man. We have put hundreds of others in the way of making big money. Very simple and easy to learn and very profitable. Write our School Dept. for full details and **BE INDEPENDENT FOR LIFE!**



BEISSER KEY MACHINE CO.
407 E. Fort Street, School Dept., Detroit, Michigan



FREE Use of Land For One Year Then 34 Years to Pay

READE this amazing farm offer. Rich fertile land, some of the finest in the world at an average of \$15 an acre—pay 7% down then use it a year, free of charge. Then 34 years to pay.

Low interest—low taxes—no taxes on improvements, buildings, machinery, live stock or personal effects—big yields—that is the secret of the success of Canadian farmers. Many are rich—all are prosperous. You can be, too. Come—see for yourself the chances to become independent—wealthy. Stock, grain, hogs, dairy and mixed farming all thrive here. Western Canada won the Grand Championship of both wheat and oats at the Grain and Hay Show of the 1926 International Live Stock Exposition. You can succeed, too.

Stop Paying the Penalty of High Priced Land

Come, help us bring man power to Canada's fertile acres. We want business-like farmers to build the country. This big railroad offers every inducement.

Good markets, modern schools, roads, churches and amusements make life here desirable—attractive. Thousands of American farmers are prospering here. Don't pour your profits into high priced land. Come to Western Canada.

IRRIGATED FARMS, TOO

In Sunny Southern Alberta we offer irrigable farms that produce wealth in coarse grains, alfalfa, sugar beets, pasture, etc. These lands for sale on the same amazing terms.



You Cannot Buy Until You Investigate

Inspect the land before buying. Special low-priced inspection trips are arranged. Mail the coupon for full information—no obligation.

C. A. VAN SCOY
Supt. of Colonization, Dept. 503
Canadian Pacific Ry. Depot
Winnipeg, Canada



The farm home of J. S. Samis

Read What These Farmers Say:

I started with \$600—now I have 960 acres improved, stocked and paid for.
J. S. Samis, Alberta

Come here and give your children a chance to do well; own your own home and prosper.
Mrs. L. F. Pinkerton, Alberta, Canada

I farm 960 acres; raise thoroughbred hogs and cattle. Raised 19,000 bushels of wheat, oats and barley this year. Come to Canada.
F. J. McLoy

C. A. Van Scoy, Supt. of Colonization
Dept. 503, Canadian Pacific Ry. Depot
Winnipeg, Man., Canada
I am interested in learning more about:
 Prairie Provinces of Canada
 Irrigation Farming in Sunny Alberta
 Business and Industrial Opportunities in Western Canada.

My Name.....
Address.....
Town.....State.....

THIS AIR RIFLE FREE

Great sharpshooter! Free for selling only \$2 worth of Chewing Gum at 5c a package. No Extra Money.
MONARCH GUM COMPANY, Dept. 27, Cincinnati, Ohio

Women Children Men

New, Simple, Popular Device for Enforced Correct Posture

Gives development of Lungs. Corrects round shoulders stooping, gives Vitality, Energy to body for all ages. Instantly adjustable, comfortable, fully guaranteed. Send height and weight. Complete only \$3.75. Order today, Write for our Booklet "Correct Posture."

NEVADA CO.

Dept. 28, Nevada Bldg., 2025 Broadway, N. Y. CITY



Sloping



With Brace

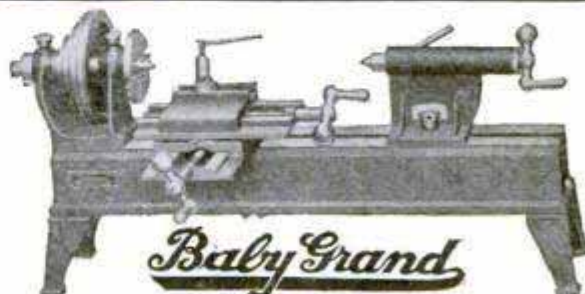

Baby Grand

A practical lathe for shop or home. Cone or Back Geared Head; 6" swing, 12" or 18" between centers; speed 180 to 1750 R. P. M. Will do wood or metal turning. Low price, high quality. Send for complete information on Baby Grand Lathe, Drill, Grinder, etc.
The Watson Mfg. Co., 103 Watson Bldg., Toledo, O., U. S. A.

DIAMONDS

The Old Reliable Original Credit Jewelers
Largest in the World

LOFTIS

BROS. & CO. 'f358

Address Dept. L-894
108 N. State St., Chicago, Ill.

WATCHES

Genuine Diamonds Guaranteed - CASH or CREDIT
Tremendous Diamond values! Buy from Loftis, the Direct Importer, and be sure of highest quality and most value for your money. Our ring mountings are the latest creations in 18-k white gold, elaborately carved and pierced. Satisfaction guaranteed or moneyback. Goods sent for your free examination on request.

CREDIT TERMS: Pay one-tenth down; balance weekly, semi-monthly, or monthly at your convenience. All goods delivered on first payment.

SEND FOR FREE CATALOG!
Big 132-page book, illustrating our Diamonds, Watches, Jewelry, Silverware, and gift articles for all occasions, sent absolutely free. Write today.

19-Jewel Adjusted Waltham No. 846-
14-k white gold filled; assorted patterns, \$42.50. \$4.25 down and \$1.00 a week.

Railroad Watches -
Guaranteed to Pass Inspection

HAMILTON NO. 992. 21 Jewels, adjusted to 5 positions. Gold-filled 25-year case. \$55

ELGIN'S LATEST RAYMOND. 21 Jewels, 8 adjustments. Runs 40 hours one winding. Gold-filled 20-year case. \$55

ILLINOIS "BUNN SPECIAL." 21 Jewels, adjusted to 6 positions. Gold-filled 25-year case. 60 hours on one winding. \$50

HOWARD RAILROAD WATCH. 21 Jewels, 8 adjustments, 25-year gold-filled case. \$80

CREDIT AT CASH PRICES

No. 849
\$100
\$2.50 a wk.

No. 851
\$50
\$1.25 a wk.

No. 834
\$75
\$1.75 a wk.

No. 857 - Ladies' Wrist Watch.
solid 14-k white gold, 15 Jewels.
\$27.50 - \$275 a month
\$2.75 down

Wedding Rings
No. 824 - The "Elite" \$750
18-k white gold.
Set with 3 Diamonds, \$22.50
5 Diamonds, \$32.50; 7 Diamonds, \$42.50; 9 Diamonds, \$52.50; 12 Diamonds, \$67.50
Our ref. any bank or banker in U. S.

No. 852
\$37.50
\$1.00 a wk.

No. 859
\$125
\$3.25 a wk.

No. 847
\$160
\$3.75 a wk.

Adana Automatic Self-Inking PRINTING MACHINE

\$11

Complete Plant



THIS massively constructed Printing Machine is the most wonderful of its kind. There are now over 10,000 users of these plants, many saving enormously in their own work, others making an excellent living.

Will print any class of matter from a **CHEMIST'S LABEL** to an **ILLUSTRATED MAGAZINE** including Perforating, Creasing and Box-making. The finest malleable iron and mild steel used in construction. Simplicity to the extreme. No special skill required. Large numbers of boys are producing their School and Scout Magazines. Printers' metal type, case, complete accessories, and excellently illustrated instructional book included. **POSTAGE \$3 EXTRA.** Write for illustrated particulars in two colors and samples of work, "POPULAR PRINTING." 40 Page Magazine 8 cents. Post free.

THE "ADANA" AGENCY (Dept. P.A.2)
34 King Street, Twickenham, Middlesex, England

Printers should write for particulars of new system of supplying First-Class Founders' Type

SEND FOR BOOKLET

AND FREE PRINTS—IT TELLS YOU HOW TO
Build a Better Set Than You Can Buy

Most practical, easy to build receiver yet devised — it's NEW yet not revolutionary. Proven by test. The outstanding 1927 success because of its simplicity, volume and wonderful range.
Write for Booklet.

HENRY-LYFORD

RECEIVER

With the Deliberately Unbalanced Circuit

Endorsed and approved by every worth-while Radio magazine — because the endorsement is deserved.

UNIVERSITY RADIO MFG. CORP.
48 Park Place, New York

A Plug-in Coil Receiver With A Deliberately Unbalanced Circuit

Interlox

MASTER SLIDE RULE

Takes accurate inside or outside measurements

MASTER RULE MFG. CO., 813 E. 136th St., New York

Dealers and Agents: request attractive proposition



Works fast. Slides in and out quickly. Durable made of brass trimmed boxwood. Any length 2 to 8 feet, 20 cents per lineal foot. If not at dealer's, sent postpaid.

Handy Tools for Handy Men!

Men everywhere find it easy to build things of wood with Boice-Crane Machines. New 64-page illustrated booklet explaining how to perform many wood-working operations sent postpaid upon receipt of 10c. Also shows complete line of Boice-Crane Circular Saws, Jig Saws, Band Saws, Mortisers, Jointers, Lathes, Drills and explains our money-back guarantee.

14' Band Saw
Table 12"x14" tilts 45 degrees. Saws 7" stock. Uses blades 3/16" to 1/2" wide. Bronze bearings.

Handisaw Model 2
Does ripping, mitering, grooving, sanding, grinding and drilling with ease and accuracy. Table 10"x13". Saw 7" dia. Cuts 2 1/2" stock. Dadoes 5/8"x5/8". Cuts moulding.

8' Bench Lathe
Does turning, drilling, sawing, sanding, grinding and jig sawing in wood or soft metal. Swings 8". Capacity 19" C-C.

Designs of Furniture
Over 300 designs of Furniture, Toys, etc., listed in Boice's six new books. Valuable to all woodworkers.
Send 10c for catalog of Boice-Crane machines and list of Books of Designs.

W. B. & J. E. Boice
Dept. P. M. 3-C, Toledo, Ohio

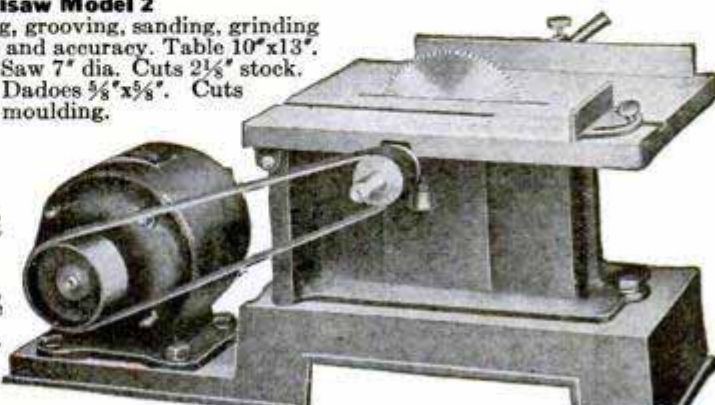

Makes Old Ford a Tractor

We supply you with all equipment for converting your old Ford into a sturdy, serviceable tractor. Does plowing, cultivating, harrowing—everything that a high priced tractor can do.



Tractor No. 84 pulling a 16-inch plow. Notice that our latest improved equipment no longer requires sawing off rear end of Ford frame.

Pulls 16" Plow, Discs, Seeds, Cultivates, Runs Belt Machinery

Now you can easily make your old Ford into a handy tractor and put it to work. Gives you the convenience and economy of power farming at extremely low cost. We have made thorough tests on these Fords, tractorized with Shaw equipment, which prove that they do all kinds of farm work just as well as a big expensive tractor. It handles a 16 in. plow nicely. Easily pulls a 7 ft. disc harrow. Cultivates 15 to 20 acres a day. Pulls a seeder. Handles five 31 in. lawn mowers, and pulls a heavy steel road drag with two persons riding the drag. Runs belt machinery. Keep it busy all year long, running feed grinders, concrete mixers, lathes, wood saws, pumps, etc. Special Crawford fan keeps engine cool even when doing heavy traction or belt work.

PAYS FOR ITSELF IN ONE SEASON

By saving time, money and labor the tractorized Ford will pay for itself in one short season. It serves the purpose of a high-priced tractor at a small fraction of the cost. Cheap to build or buy. Runs 2 hours on a gallon of gas. Costs but a few cents an hour to operate.

EASY TO BUILD—EASY TO BUY

We furnish complete blue prints, easy-to-follow instructions and parts for building this tractorized Ford. We tell you just how to attach the drive wheels, how to gear it, etc. Makes it easy for anyone with a monkey wrench and screw-driver to do the job in a short time. You don't have to be a mechanic. It's so simple you can't possibly go wrong.

If you do not wish to build it yourself, you can buy one complete, ready to run at low cost from a local dealer in your territory. Mail the coupon below for detailed literature and our low factory prices.

SHAW MANUFACTURING COMPANY
Dept. S4 GALESBURG, KANSAS

Mail Coupon NOW

Shaw Mfg. Co.,
Dept. S4, Galesburg, Kans.

Please send me the items checked below. No obligation on my part.

If you order blue prints enclose \$1.50 to cover our Engineering Department's actual cost.

Literature on "Making My Ford a Tractor." Complete Blue Prints for "Making My Ford a Tractor." 22 page Shaw Du-All Tractor Catalog.

Name.....

Address.....

State.....

Mail the coupon today—find out how easy and cheap it is to build or buy this sturdy tractor.

Here's the Shaw "Du-All" Garden Tractor with Cutter Bar Attachment. Mows grasses, weeds. Plows, cultivates, runs belt machinery. Send for free catalog.

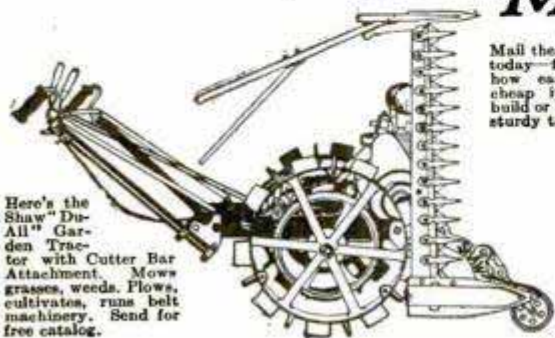

Here's a tractorized stock model Ford at work in the field. The reliability and economy of the Ford car are well known. Equipped with Shaw Tractor parts it makes a very dependable tractor.

"Very Satisfactory"

SHAW MFG. CO.

"I have Tractor together and have been working it for a few days. I have worked it two days now with no stops. I find that it will prove very satisfactory in this locality. I have tried it on hills and although it has to dig its toes in some, it makes them all on high gear. In fact, I never use the low gear. The thing which has also pleased me very much is the fact that in 10 hours run for two times now I have consumed but 4 gallons of gas. I was very much surprised for I had in mind that it would take 7 or 8 for a day's run."

H. S. CHAMBERS,
Manistee, Michigan.

Be the Life of the Party



Play a Tune in 10 Minutes

Popularity—new friends—money-making opportunities come to those who can play!

Now you can pick up your favorite stringed instrument and play a tune almost instantly. NO knowledge of music needed. NO expensive lessons. NO weeks of tiresome practice. Play tunes from the start. Play by numbers. Surprise and astonish your friends. **Amazing new invention** makes it easy to play Ukulele, Banjo Ukulele, Tenor Banjo, Guitar, Mandolin. Just press the keys and play.

Trixie Friganza, famous Vaudeville Star, wrote: "I played in 3 minutes and never touched a stringed instrument before."
 John A. Cruser: "I was skeptical about anyone playing tunes instantly but have changed my ideas completely."
 W. H. Mathis: "Your advertisement didn't tell the half of it."
 Mrs. A. Kasen: "My friends and I play wonderful tunes. The more we play the better it gets."

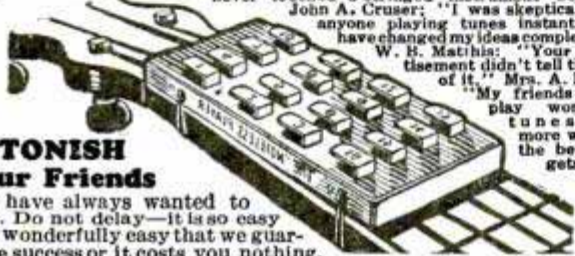

ASTONISH Your Friends

You have always wanted to play. Do not delay—it is so easy—so wonderfully easy that we guarantee success or it costs you nothing.

SEND FOR FREE BOOK!

More popularity—more fun from life—new friends—money-making opportunities. If you want to play tunes at once—send today for a free book about **Ferry E-Z Playing** stringed instruments. Soon you, too, can know the joy of making your own music. "No play; no pay." E-Z Playing instruments are sold complete or the E-Z Player can be attached to your own stringed instrument in a jiffy.

Mail coupon today

FERRY & CO., Dept. 1773, Chicago, U. S. A.

Send free book telling how I can get more fun out of life, make more friends, have greater opportunities for getting ahead by learning to play my favorite stringed instrument in 10 minutes. No obligation.

Name

Address

City..... State.....

FROST-RADIO FROST-RADIO FROST-RADIO FROST-RADIO

FROST-RADIO

BAKELITE and METAL FRAME RHEOSTATS

The neatest, most compact and most serviceable rheostats made. Have smooth-working contact, bakelite pointer knob, single hole mounting. Finest nichrome or chromel A wire; wide resistance strip keeps rheostat cool under heaviest load. A type to suit every requirement from 25 to 75 ohms. Bakelite type, list 75c. Metal Frame Type, list 50c. Your dealer has them.

HERBERT H. FROST, Inc.

160 N. La Salle St. CHICAGO

MEMBER **RMA**

New York
Los Angeles

FROST-RADIO FROST-RADIO FROST-RADIO FROST-RADIO

AGENTS Big-Quick PROFITS

Tires Hammered Full of Nails, Leak no Air. GALACITE a new Viscous Pneumatic Cement (NOT A LIQUID)

Seals PUNCTURES Instantly—the very moment they occur. One application made in a minute without taking tire off wheel or rim does the work. Seals slow leaks and porous tubes. Galacite aids in preserving rubber often doubling Tire Mileage. Don't confuse with anything else intended for the same purpose. Galacite is new, different, clean and scientifically correct. Made by a long established, highly rated financially responsible concern.

FREE SAMPLE

AT OUR RISK, MAKE THIS TEST
 Hammer as many nails into a tire as you wish—**Pull them out. No air will escape. No pressure will be lost.** If you are not delighted we will pay you for your time and trouble.

AGENTS It will pay you to get the facts and get them NOW. You can't get rich in an hour but you can make immediate, sure, steady profits that are amazing. No talking. Just drive nails in an old tire. We back our men with powerful advertising helps. Banners, Posters, Newspaper Advertisements and circulars.

FREE SAMPLE Full particulars, big book and a free sample will be sent you postpaid, by return mail. Territory is going fast. Send no money, just your name, but **ACT NOW.**
JOHNSON & CO. 19 W. Jackson Blvd., Dept. 504 CHICAGO

FREE SAMPLE! OUTFIT!

SIX MILLION DOLLARS Profits made by Rawleigh Retailers last year! Get into the big money making class. Establish your own business. Sell necessities. Enormous demand. Easy sales, profits big, no experience needed. Backed by largest Company of its kind in the world. Best Localities being chosen fast. Write quick for free sample offer. Get busy!

The W. T. RAWLEIGH Co.,
 Dept. I L 8262
FREEPORT ILL.

BIG BOOK OF AUTO SUPPLIES

TIRES TUBES & AUTO SUPPLIES

Mailed Free—Postpaid
 We want every car owner to have our Big New Complete Book of Auto Accessories. Write for a Free copy and see for yourself what you save.

NEW LOW TIRE PRICES

Every tire brand new stock and fully guaranteed. Prices also cut on Tubes, Batteries, Tops, Timers, Bumpers, Water Pumps, Radiators, Windshield Cleaners, Carburetors, Spotlights—all Repair Parts, Tools, etc. No matter what you need, this New Book will save you money. Send for it.

BROWN LYNCH SCOTT Co.

816 MAIN ST. MONMOUTH, ILL. (8)

WE SHIP IN 10 HOURS **BLS** OR REFUND 5 PER CENT

\$542⁰⁰ = Earned IN ONE MONTH

That is What Fred Milkert Earned

Not a dream—not a myth, but a reality. Fred C. Milkert, Roselle, Ill., owns and operates an Ideal Lawn Mower Sharpener—a wonderful invention that sharpens lawn mowers *scientifically*—*quickly*—*perfectly*: does the work as nothing else can. It is

A Big Business—A Permanent Business A Business to Enthuse Over—Money Making

The IDEAL Lawnmower SHARPENER

is a wonderful, but simple, machine that sharpens all makes of Lawnmowers perfectly, scientifically, without dismantling the mower.

Just pick up the mower, set it in the Ideal, make a few simple adjustments and proceed to sharpen. In 15 minutes after you pick up the mower it is ready for the lawn, and you have made \$1.50 to \$2.00—depending on the charge you fix.

Special Grinding Wheel Attachment for sharpening grass shears, hedge shears, sickles, scythes, axes, etc., etc. Will add many dollars to your income.

Skate Sharpener Attachment Included Sharpens all makes of skates—including hockey, with shoe attached. The "Ideal" earns money all the year round.

USES LITTLE POWER Operated by $\frac{1}{4}$ H. P. Motor, attached to your lamp socket; or direct from your line shaft. If you have no power, turn by hand.

WRITE TODAY for full information of this wonderful money-making machine.

Mr. Milkert writes: "The Ideal Lawnmower Sharpener put me in business, starting in the basement of my home and forcing me now for the third time to move into bigger quarters. Today the dream of my life—a shop of my own—is realized. With a machine like yours and a little hustle any man can have a business of his own and be independent."

W. F. Kendt, Buffalo, writes: "I sharpened 994 lawnmowers last season, and the receipts were nearly \$2,100.00 which is not bad for a side line."

Earns \$820 in 55 Days

Zeno Brandon, Middletown, Ohio, writes: "I made \$820.70 in 55 days with my 'Ideal.' Have made as high as \$38.70 in one day."

\$1200 Net in 90 Days

W. T. Moore, Twin Falls, Idaho, writes: "The Ideal Grinder, as a side line, netted me a profit of \$1200.00 in 90 days."

Use Your Spare Time If you work at a trade, put an Ideal in your basement and earn \$4 to \$6 an hour evenings and Saturday afternoons. **E. W. McCormick, Saginaw, Mich. writes:** "Five years ago I bought an Ideal Sharpener on which I have ground over 5,000 lawnmowers. In the last few weeks I worked at my trade, Machinist, full time 9 hours a day. I also ground 97 mowers which netted me \$114.10 clear gain."

A. C. Alexander, Omaha, Neb. writes: "I am a moving picture machine operator and work from 1:00 P. M. to 11:00 P. M. I paid \$30 a month shop rent and \$40 a month for newspaper ads, yet in 3 months my 'Ideal' paid for a new Ford Car and made me a good sum besides, all in my spare time."

Mowers Are Dull Owners are looking for a place to get them sharpened. Mowing the lawn dreaded because of dull or improperly sharpened mower. Lawn mowing healthful, invigorating and pleasant when mower is "ideally" sharpened. You do the work scientifically—you are in big demand.

LAWN MOWERS SHARPENED TO RAZOR EDGE

People glad—owners delight in mowing lawn with mower sharpened on an "Ideal." Mower runs light—click-click and the grass is cut. Build permanent business for yourself. Start Now!

Write Today—FREE Detailed illustrated catalog and booklet "Let George Say It," with scores of letters from "Ideal" owners and pictures of their shops.

The Fate-Root-Heath Mfg. Company
Dept. G., Plymouth, Ohio

There will be rain, and sunshine, and grass. This year make Long Green out of Lawn Green.

USE THIS—Mail it Today

The Fate-Root-Heath Mfg. Co.
Dept. G., Plymouth, Ohio

Please mail at once free illustrated Catalog and Booklet "Let George Say It."

Name

Address

Fred C. Milkert, Roselle, Ill. writes:
"Last June I sharpened 256 lawnmowers for which I received \$542.00."

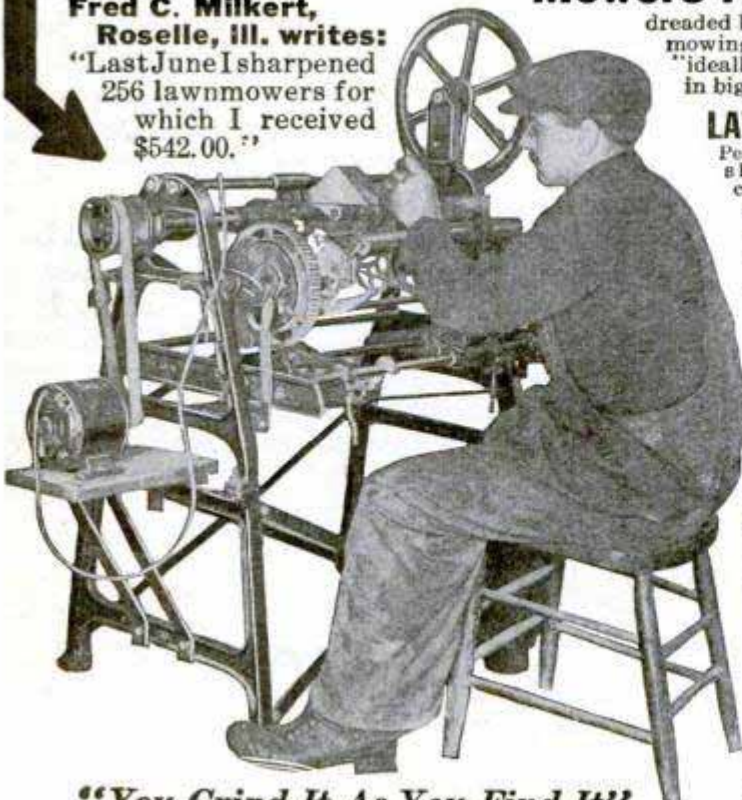

"You Grind It As You Find It"

GOODELL-PRATT



All Steel Mixer Box—1285. Cannot bend or break, or become inaccurate. Angles more acute than 45° are secured by side attachment. Gauge can be regulated to saw to any desired depth. Equipped with 28 x 5" first quality Back Saw . . . \$27.50.



Ratchet Hit Brace—7010. 10" sweep. Steel clad head on roller bearings. Head and handle finished with rubber enamel, ebony effect. Chuck sockets and shells of malleable iron, forged steel jaws. Chucks hold all sizes of square shank bits. Beautifully nickled . . . \$3.75



Automatic Drill—185. Mr. Punch. Push, and the tool returns. Drill points carried in handle. Length 10". Beautifully polished and nickled, including 8 drill points from 1-16 to 11-64" . . . \$2.75

Two Speed Hand Drill—5%. Black enameled frame. Handle unscrews to hold drills. Takes round shank drills, 0 to 3-8". Steel parts nickled. 14 1/2" long. Without drills . . . \$5.50

Automatic Screwdriver—111. Reversible, for driving or drawing screws. Can be used ratchet or plain. Handle finished in mahogany. Length with blade 19". Including 3 tool steel blades . . . \$3.10



GOODELL-PRATT



Goodell-Pratt Electric Drill. Sizes from 1/4" to 5-8". Light and Heavy Duty, for 110 and 220 A. C. or D. C. Steady drilling doesn't overheat these Drills. Self-oiling bearings require only occasional attention. Vital parts readily accessible. These drills retail from \$36.00 to \$99.00



Micrometer Caliper—2-R. Graduated to read by 1-1000 from 0 to 1 inch. Ratchet mechanism on the Thimble assures equal pressure, when used by different persons . . . \$12.00



Bench Vice—161. Moderately priced. Cut steel feed screw and guide rods insure rigidity. Jaws machined after assembly, so they meet accurately. Steel parts polished, iron parts enameled. 2" jaws, opening 2". Weight 3-3-8 lbs. \$2.00



High speed, high power Bench Grinder—485. Handy for bench and household use. Gears are enclosed and packed in grease. High Abrasive Wheel, 5 x 1" Adjustable Work Rest. Finished in red and black enamel, 6 1/2" high above bench . . . \$10.00

Brest Drill—6. 16" long. Adjustable Brest Plat. Polished Hardwood Handles. Machine-cut Gear Teeth. Two speeds. All-steel Chuck for round shanks 0 to 1/2" . . . \$6.20



THE tools pictured here are examples taken from the range of sizes in which each is made. These and all other Goodell-Pratt tools come in many types.

This Book brings your hardware store to your home

HOW often have you skimmed through your dealer's stock of fine tools and wished you had all day to linger over it?

You'll get something of that same thrill—and even more actual information—from the Goodell-Pratt 400-page catalog.

Over 1500 Good Tools—pictured and described

You can go over them at your work-bench or in your easy-chair. You can take the catalog to your dealer and, instead of vague efforts to make him understand what you want, you can show him exactly what it looks like.

This book brings you the complete line.

If you want a vise, it helps you pick the right size—tells you how wide the jaws open—what thickness bench you can clamp it to. If it's a drill, you'll know its capacity and what points come with it. A three-page index quickly locates the tools you want to find.

With this book it is easier for you to buy—easier for your dealer to sell. It's free, of course. Write us for your copy today. Buy Goodell-Pratt Tools from your hardware dealer—or write us for the name of a nearby dealer who sells them.

No finer tools are made than those that carry the name of Goodell-Pratt.

GOODELL-PRATT COMPANY, GREENFIELD, MASS., U. S. A.

MAKERS OF *Toolsmiths* MR. PUNCH

GOODELL-PRATT

1500 GOOD TOOLS

COMPARE WITH ANY 6^{to} 8 TUBE SETS

30 DAYS FREE IN YOUR HOME

Retail \$
LIST Price
now only **49⁷⁵**
GET SPECIAL OFFER
One year GUARANTEE

You Don't Send a Penny. Mail Coupon for Special Offer

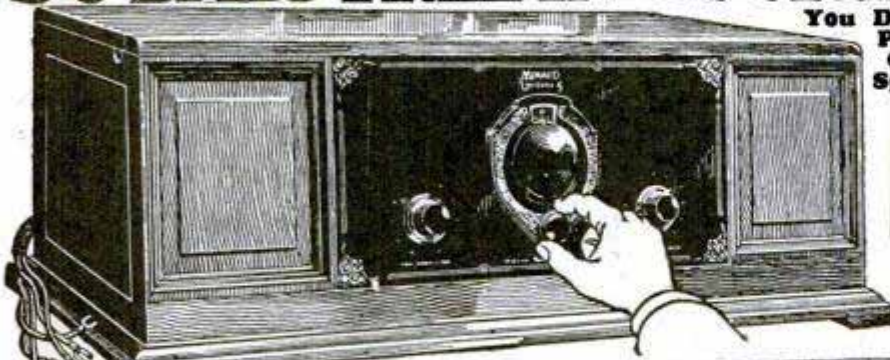

Built like-to look like-and perform like \$200 sets

Real Single Dial Control!

Magnificent Big Powerful Miraco "Unitune-5" Get Special Offer! Amazing Low Price!

The celebrated Miraco Ultra—U. S. Navy type circuit, has also been adapted to Single Dial Tuning—without sacrifice of selectivity, volume, clearness, power, tone, or distance getting **QUALITY!** In the magnificent big Miraco Unitune, above shown, you turn one vernier knob for stations everywhere. Beautiful hand-rubbed, piano-hinged, solid walnut cabinet, 28 in. long, 15 in. deep, 10 in. high. Sloping Bakelite panel is walnut finished to match. Also offered on 30 days' free trial!

Greatly Reduced

Wholesale Prices! Tested and approved by all of Radio's Highest Authorities

Big Discounts to User-Agents who will allow friends to listen to their MIRACOS.

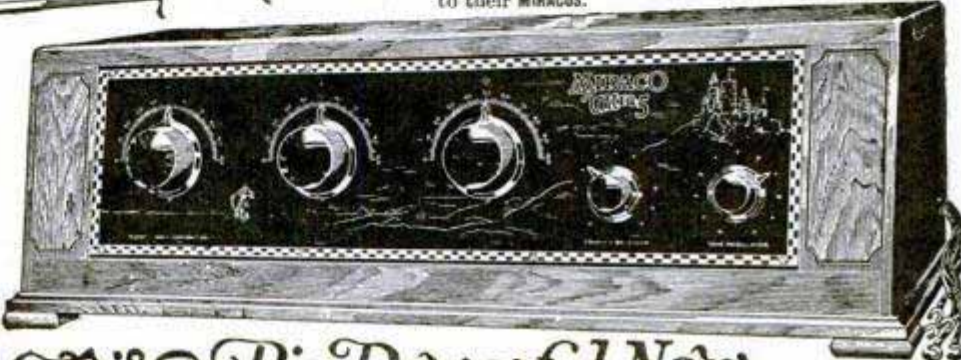

27 in. Long
Fine Walnut Cabinet

Big Powerful New MIRACO

ULTRA-SELECTIVE LONG DISTANCE RECEIVERS —EASY ON CURRENT

Guaranteed UNBEATABLE Among Big, Fine Sets

UNLESS 30 DAYS of actual enjoyment, use and comparison in your home proves your Miraco the most selective, clearest toned and most powerful distance getter among ANY sets using up to 8 tubes—don't buy it! Be thoroughly convinced entirely at our risk. Your verdict final—absolutely no strings to OUR offer. Satisfaction UNCONDITIONALLY guaranteed by America's big, old, reliable makers of FINE sets—Midwest Radio Corporation—7th successful year. Many, many thousands of enthusiastic users throughout U. S. A. and Canada. Get their testimony. Get the amazing new low wholesale prices and Special Offer! Mail coupon or postal.

Operate From Light Socket or Batteries

Miracos are latest, up-to-minute, models with newest features. Unsurpassed for quiet, low-cost, operation with A and B light socket power supply units or batteries. Power tubes and more than 90 volts of "B" can be used, although the amazing power built INTO a Miraco makes this unnecessary. Coupon brings full information, users' testimony, Amazing Special Offer!

Reduced Factory Prices — Save Lots of \$\$\$

Tremendously greater sales this season have made possible BIG reductions on our sets and accessories. Save MORE THAN EVER by dealing direct with Midwest. Or make big profits selling your friends. Get User-Agents' AMAZING Special Offer on Free Demonstrating Outfit (no red-tape, no contract to sign). Our offer will ASTONISH you. Clip coupon NOW.

7th ANNIVERSARY SPECIAL!

Only \$19.95 net—an unheard-of price for a high-grade fully guaranteed 5-tube radio! It's the new \$30 (retail list) Miraco Compact—14" wide, finished in brown mahogany. Can't be equaled anywhere near the price in quality of construction, selectivity, distance-getting power, tone, ease and economy of operation—let 30 days' trial prove this! Complete with high-grade accessories—nothing else to buy—only \$49.85 net. Act quick—supply limited. Get Special Offer! Another bargain, direct from factory. Coast to Coast range. Powerful, selective; clear, sweet tone.



\$19⁹⁵

All the Proof you want is waiting for You!

Coupon or postal brings reports from hosts of users in your vicinity and elsewhere proving that Miraco sets at rock-bottom money-saving factory prices, outperform sets costing up to four times as much. You can also buy speakers, tubes, batteries, etc., at big savings from us! Get our proposition before spending money elsewhere.

MIDWEST RADIO CORPORATION
Pioneer Builders of Sets

407-X Miraco Building
Without obligation, send free literature, testimony of users, AMAZING SPECIAL OFFER or full particulars of your big money-saving factory-price proposition on Guaranteed Miraco sets and all radio supplies. () Agent () User () Dealer

NAME
ADDRESS

This Coupon is NOT an Order



Coast to Coast and Foreign Reception Certified by Miraco users

MIRACO RADIO GETS 'EM COAST TO COAST
Send for Proof!
Notice! Enormous sales again enable us to add hosts of costly new features, latest refinements and up-to-the-minute improvements. Miracos this year are still better—more beautiful—more selective—more powerful for less money than ever before.

USER-AGENTS WANTED — WRITE!
Reports from users everywhere leave little for us to add. These are only a few of the many in our files and which we receive daily. Send coupon for plenty of additional proof and testimony of nearby users.

Coast to Coast With One Dial First Evening

I set up the Miraco Unitune about 5 P. M. and heard 35 stations. New York to California, the first evening. The fifth station I heard was Schenectady, N. Y., about 2,000 miles from here. The eighth was Pittsburgh. Heard other stations in Illinois, Nebraska, Missouri, Oklahoma, Colorado, Iowa, Texas, Kansas, California, Catalina Island, Utah. C. D. KRABEL, Sterling, Colo.

Has Tried 50 Makes—Finds Miracos Best

Having owned and operated over 50 radio receivers, some of the most expensive, well-known makes, including super-heterodyne, I believe I know what standards a radio must meet to be absolutely satisfactory. In my estimation, the Miraco Ultra and Unitune are the most beautiful, efficient and selective receivers I have ever used. They are as good as the best and better than most at any price. H. P. AEBERLI, Orchlee St., N. S., Pittsburgh, Pa.

Cuts Thru Chicago Locals—Gets Coast to Coast on Single Dial

I live in a part of Chicago surrounded by powerful broadcasting stations, where costliest sets have failed to prevent interference. With my single dial Miraco Unitune, however, I have repeatedly astonished neighbors and friends by cutting through all the 17 or 18 Chicago stations and pulling in programs from Florida to California and up to Canada, clear and loud on the speaker. Every night is "silent night" for us so far as getting coast to coast. KFI, Los Angeles, and other California stations come in so loud I have to turn down the counterbalancer. I also separate the many Chicago locals. The Unitune is the most selective set I have ever heard of, and the tone quality is marvelous. And so big, handsome and easy to work—we just turn one dial and sweep the continent for programs. S. E. GUIN-TER, Addison St., Chicago.

Tunes Out Nearby Local With One Dial

Unitune One Dial set highly satisfactory. Find no difficulty in picking up and separating stations from 226 to 526 meters. Logged about 40 in ten days. I successfully tune out WCWS, Bridgeport—only 4 miles from my home—in 2 1/2 points on the single dial. EDGAR R. THOMAS, Stratford, Conn.

Gets Distance Easy With One Dial

Unitune sure brings in far distant stations and is easy to tune. It is a marvelous set. LOUIS ULLSPERGER, Sterling, Neb.



Amazing Sure-Fire Demonstration

sells by thousands new automatic attachment that sworn public tests prove makes Fords run

43.8 Miles on 1 Gallon of Gas

Agents everywhere report astounding results. R. K. Waite ordered 1000 Blancke devices in *one month*. (Profit \$3000.00). Wires, "Get ready another 2000." Clyde B. Jones sold 63 devices in one day. (Profit \$189.00). You don't need experience.

What Is This Sensational Demonstration?

The instant heat touches the Blancke Thermostatic Carburetor Control, the needle valve on the carburetor slowly turns before the fascinated eyes of spectators. As it cools the needle valve turns back again. It is easy to understand why immensely superior results can be obtained with this accurately adjusted automatic instrument—to see why Blancke Thermostatic Carburetor Control in official public and private tests showed 43.8 per gallon of gas. 250,000 tests averaged 32 miles per gallon. *Guaranteed to give over 30 miles per gallon on Fords.*

Starts Coldest Motor Instantly

even on wintriest days without use of choke. Guaranteed results combined with amazing demonstration make Blancke Control greatest agent's selling success of recent years.

Get One Free to Introduce

Also Blancke Plan that starts you without capital in a real business that pays you \$300.00 to \$2500.00 and up each month. Exclusive Territory. Sales guaranteed. Start to make big money—beginning NOW! Send coupon today for sample Blancke Control and great Distributor's Plan.

BLANCHE AUTO DEVICES CO.

157 E. Erie St. Dept. 805-C Chicago, Ill.

Mail This Important Coupon Today!

Blancke Auto Devices Co.,
Dept. 805-C, 157 E. Erie St.,
Chicago, Ill.

Gentlemen: I should like to get a Blancke Control Free to introduce in my community. Also send details of amazing new Guarantee Plan by which I can make from \$300.00 to \$2,500.00 a month profit.

Name.....

Address.....

City.....State.....

Strongest Guarantee In Automotive History

backs sale of Blancke Controls. Guaranteed to give over 30 miles per gallon on Fords — to practically eliminate carbon formation and its troublesome consequences —to save half oil—to relieve battery strain—make motor run smoother — give better acceleration—allow lower speeds in high gear. Starts motor immediately in any weather without use of choke and saves half repair bills. Ford owners everywhere are delighted with it and their boosting promotes sales.

SALES Guaranteed

\$15.00 a Day Guaranteed to Distributors

Cadillac and Delco Light now use as standard equipment Thermostatic Carburetor Control under Blancke License. You can get no better proof of merit than this!

Why—"It's a Whole Machine Shop!"

Amazing 17-Ounce Tool Conquers 60-Lb. Kit!

The most revolutionary hand tool ever invented. Does the work of other tools costing over \$50—truly a tool of 1000 uses. Just the "hand-grip" of a tiny rubber band holds a hard bearing ball—the hardest-to-hold thing known—against a 300 Pound Pull!

Grips with 1 Ton Direct—128 Tons Per Sq. In. Pressures through its 10-to-1 Leverage Power-Gear Transmission. In addition, the Grip LOCKS!

Among Thousands of Large Users are the MAKERS of Buick, Chevrolet, Nash, Packard, Reo, Studebaker, etc. Automobiles, Fisher Bodies, etc.; who with their employes have bought Kits in quantities of 500 to 1000! Studebaker has approved it for use in its Service Stations throughout the World. Thousands of housewives are using it too, because it does so many useful and amazing things so easily, so instantly. And even a woman's hand applies a HALF-TON Giant's Grip! Every Auto and Home Owner—every man who ever uses any tools needs it every day.

World Flight Equipment

It was standard equipment for the U. S. WORLD FLIGHT and the U. S. S. Shenandoah. Creates a sensation everywhere. Just its astounding 1-Ton Grip makes it worth ten times its cost. The amazing EIFEL-FLASH PlierRench is a true Ratchet WRENCH—Parallel Pliers—Speed VISE, and more. Instantly and automatically it LOCKS its death-grip Jaws on the most worn and chewed nuts in the tightest places—and TURNS THEM!

AGENTS \$200 a Week

PlierRench representatives earn amazing incomes demonstrating this wonderful new tool. One man alone sold nearly 10,000 in just one state. Fastest seller known. Factories buy by hundreds. Every auto and home owner buys. We have wonderful special proposition to agents. Mail coupon for full details. Why not earn \$75 to \$200 and more a week, spare or full time?

Whole Kit in 1 Tool

You get in a Royal Blue Leatherette HOLSTER, the 8 1/4" Universal PlierRench with 2 EXTRA Jaws—a PIPE Jaw—and a WIRE Jaw—each giving undreamed of performance. Instantly (in 1/5 second) you insert the Jaw you need, and as quickly snap a One-Ton Grip on work of any possible kind, or shape, or size from 0-in. to 1 1/2-in.! And—nothing Ever can get away from that grip! HAVE YOU EVER HEARD OF A TOOL THAT WORKS LIKE THIS—it actually out-grips a 40-lb. Vise, and applies a 1-TON grip at the very jaw-tips. Will remove broken studs, taps, drills, etc., with next-to-nothing to hold on. Yet its smooth grip will hold a hair and coil a spring of hair-fine piano wire!



The Universal PlierRench

For every kind of Pliers, Nut Wrench, Vise, Clamp, and Spring-making Work—Everywhere.



The Pipe PlierRench

For every kind of Pipe Wrench and Pliers Work; Chewed Nuts that no other tools can budge, etc.



The Wire PlierRench

For every kind of Wire, Tie Chain, Cable and Spring Work; and the Special work other Tools won't do.

Guaranteed

The EIFEL-FLASH PlierRench KIT is positively guaranteed. It has stood the most trying tests of time and service. Of thousands—the First Commander of the U. S. World Flight said—"It should form part of the equipment of each and every Airplane and Automobile." One Engineer said—"I have used my PlierRench for 5 years and wouldn't be without it for \$100—and I mean it!"

Special Introductory

PRICE \$3.65 ONLY

Thousands fortunate enough to be able to see the astonishing performance of this marvelous PlierRench KIT are glad to pay the regular price of \$5.00. You can TRY this amazing performance on your own work in your own way for 2 weeks, and if the PlierRench KIT has not EARNED FOR YOU in that time the value of its price—just return it, and your money will be refunded as fast as the mails can carry it. Also, with your PlierRench KIT you receive a valuable Manual of Mechanics that every man should have. It tells in 64 pages and 145 illustrations some of the marvels of "The PlierRench Way"—the quicker, better, and easier way to do every kind of mechanical work.

Make use of the Coupon below, get this incomparably better tool KIT for the price of just one ordinary tool—let the marvelous PlierRench with its versatile 3 Jaws SPEAK FOR ITSELF as no Steel Jaws ever spoke before!



FREE!

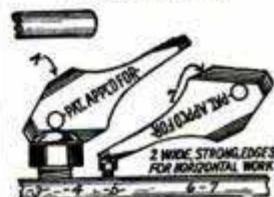

Every person using the coupon to order a PlierRench KIT will receive absolutely FREE our wonderful E-F ANGLE Screwdriver. It has 7 working edges 1.8-in. to 3/4-in. wide and is so strong it does the work of many screwdrivers—large and small. Handles auto lights and removes bottle caps. Fits keyring and key-tainer. "The World's Greatest Small Tool"—yours FREE with the kit.

THE FLASH SALES CORP'N

CP-4809 N. Ashland Ave., CHICAGO, ILLINOIS

Mail Coupon!

The Flash Sales Corp'n, CP-4809 N. Ashland Ave., Chicago, Ill.
 1. Send me rush your amazing new Eifel-Flash PlierRench KIT. I will pay \$5.00 on arrival. It is understood I may return kit within 2 weeks and ask My Money Back, if not delighted.
 2. Send me user literature.
 I am interested in Salesman's Big Proposition.
 Name.....
 Route No.....
 City.....
 P. O. Box.....
 State.....

**CROSLLEY 1927
RADIOS**

Each set giving the utmost in radio enjoyment at its price. All prices slightly higher west of the Rocky Mountains. All prices are without accessories.



The 5-50—\$50

Enthusiastic owners report amazing performance—a drum delivering stations loud, clear and sharp; such an almost imperceptible turn of the drum apart. Write station letters on drum, return to them at will. Single drum Station selector, Acuminators, power tube adaptability and all metal chassis that shields the units from each other. Beautifully finished. Mahogany cabinet, rose gold trimmings.



The 5-75 Console—\$75

This set includes ideas for radio reception perfection not found in any other radio. Marvelous exclusive Crosley "Crescendon" and "Acuminators" increase volume on distant stations and bring in programs entirely missed and passed by an ordinary one-dial control radio. Console model stands 40 inches high. The Crosley Musicone is skillfully built into the cabinet in a manner which is both an artistic and an acoustical triumph. Ample space for batteries and accessories.



**"6 Tube RFL-90"
Console, \$90**

Introducing the double drum station selector! Crosley's winning non-oscillating perfectly balanced tuned radio set. Includes Musicone skillfully built into exquisite console mahogany cabinet of two-tone finish to match finest surroundings. Room for batteries and all accessories; 40 inches high; 30 1/2 inches wide.



**The Crosley
Musicone**

The secret of the popularity of this biggest selling loud speaker on the market lies in its actuating unit. This and NOT the cone shape is the reason for its perfect reproduction of all audible sound. BEWARE of imitations. There is only one genuine Musicone. It is built solely by Crosley under mass production methods which makes its unmatched value possible.

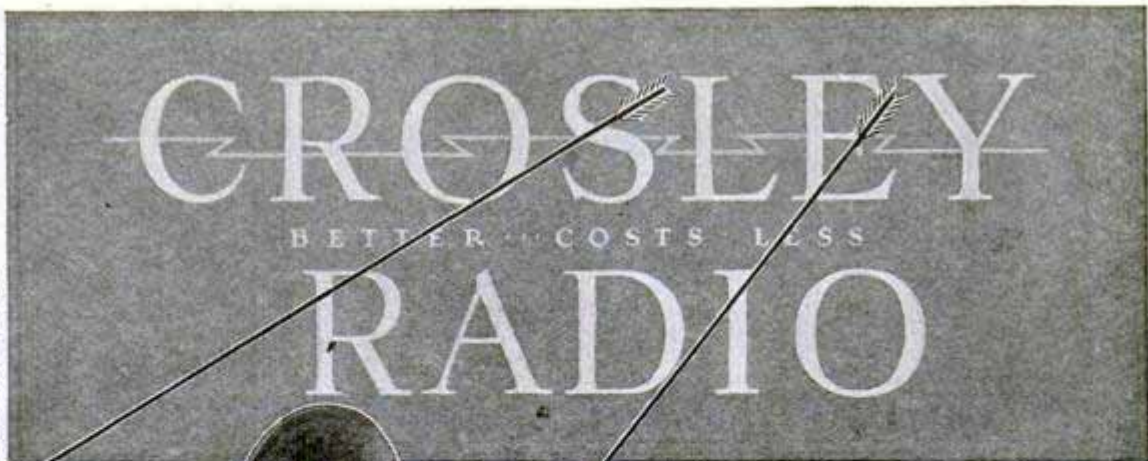

"as long as I can pick up 27 programs in 30 minutes beside our 3 locals interference won't bother me

"I sat down the other night with this Crosley set. One control. Beginning at one end of the broadcasting wave band, I tuned in 27 stations, loud and clear, just like the Cincinnati stations, three of which were going full blast. I listened to each program; identified it; didn't hear any others in the background, and passed on to the next,—all with one finger. It was between 7:00 and 7:30 P. M. Central Standard Time.

The air was certainly full. Some of the stations were less than a dial marking apart. It is amazing how the jiggers they call "acuminators" helped on such fine separation.

Even using a hundred-foot aerial the local stations were easy to go through. One of them only a few blocks from my home.

Some radio, I call it! \$50.00 seems too little. I'd like to see some two-hundred-dollar sets do as well!"

Write Dept. 15, for Catalog

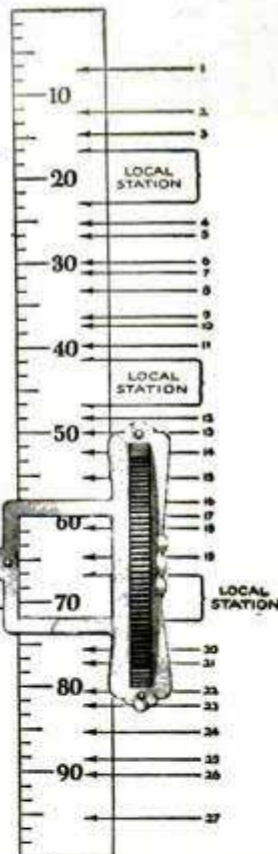

The above scale reading shows how stations picked up by Mr. X—appeared on the Crosley graphic drum station selector. Name on request.

**Single Drum
Control
\$ 50.**

Prices slightly higher West of the Rocky Mountains.

**THE CROSLLEY RADIO CORPORATION
CINCINNATI, OHIO**

Powel Crosley, Jr., Pres.

Crosley sets are licensed under Armstrong U. S. Patent No. 1,113,149, or under patent applications of Radio Frequency Laboratories, Inc., and other patents issued and pending.

LOWER WHOLESALE PRICES THAN EVER BEFORE
On Highest Quality,

INSTALL YOUR OWN

PLUMBING AND HEATING

EASY TERMS **SAVE HALF**



The Hardin-Lavin Company founded over 50 years ago has from the beginning specialized in Highest Grade Plumbing and Heating to the consumer direct at wholesale. Our newest catalog is just off the press and brim full of bigger bargains than ever before. Send for your copy today. Lower wholesale prices than we have ever quoted will save you from one-third to one-half on everything in Plumbing and Heating.

Top Quality - Bottom Prices

Our vast buying power, nearness to raw material market, our centrally located plant and complete shipping facilities combine to give you bottom prices on top quality goods. Every Plumbing Outfit or Heating Plant you buy from us has behind it our Bonded Guarantee, our million dollar plants and our reputation for 50 years' economy service to experienced buyers. A transaction with us is not completed until your order has reached you in perfect condition and is installed and working satisfactorily. We have built our business by adding extra service to special values and developing and perfecting the now famous Hardin-Lavin New Easy Method of self-installing which means to you time and money saved.

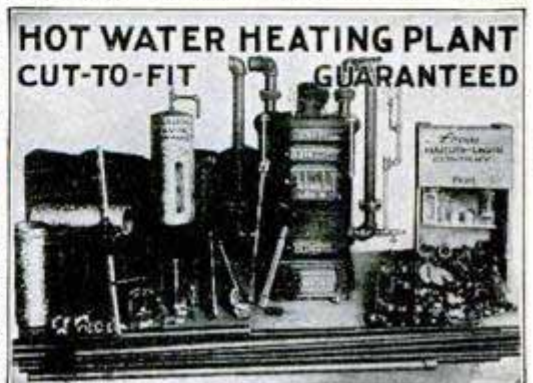

HOT WATER HEATING PLANT CUT-TO-FIT GUARANTEED

Complete Hot Water Heating Plant ready for shipment with set of installing tools, diagrams, and New Easy Method of self-installing instructions. Complete outfits as low as . . . \$200

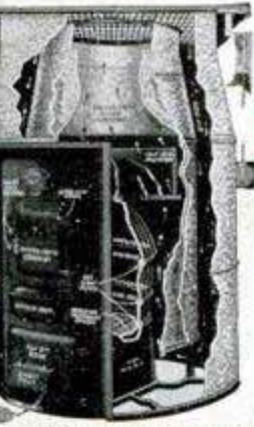

PIPELESS HEATING PLANT

Grade A Quality Guaranteed Plumbing Outfits

In our new catalog just issued, you will find everything in latest designs of Plumbing Fixtures and Heating Supplies:— Built-in Tubs, Pedestal Lavatories, One Piece Deep Apron Kitchen Sinks, Laundry Tubs, Hot Water Heating Plants, Steam Heating Plants, Pipeless Heating Plants and Warm Air Pipe Heating Plants as well as Fixtures, Radiators, Accessories, Pipe, Fittings, etc., all of the highest quality possible to manufacture at Lowest Wholesale Prices. Hardin-Lavin New Easy Method of self-installing enables you to put in your own Plumbing or Heating. No experience needed to follow this new method which saves you days and dollars. Crystal clear diagrams and instructions guide you every step of the way. All materials come to you factory-fitted and ready for quick assembly. There is no guess work and when the job is finished an expert will approve it.



Send for Your **FREE** Copy Today

FULL OF BIG BARGAINS!

Special! Deferred Payments

In addition to quality goods at wholesale prices, new easy installing method, free plans, and all the other Hardin-Lavin advantages, we have now arranged so that you can BUY ON EASY TERMS. Nowhere else can you find so unusual and complete a combination of merchandise, service and accommodation. Added to all this—without charge—is the co-operation of our corps of Engineering Experts.



WATER SUPPLY SYSTEM

Our Label and Bonded Guarantee Protects You Fully!



The Hardin-Lavin Label has found its way into every state of our nation and to every civilized country on the globe. Wherever you see it, you will find Plumbing satisfaction of the highest degree or the most efficient type of Heating apparatus. Quality and durability GOES IN before our name and label GOES ON.

Everything you buy from us is backed by this label and our bonded guarantee.

MAIL COUPON TODAY FOR FREE BARGAIN CATALOG

Hardin-Lavin Company, 107-17 W. Pershing Road, Chicago, Illinois. P. M.-3-27

Gentlemen: Please send me your free bargain catalog with special wholesale prices and easy terms. I am interested in:

- Hot Water Heating Plants
- Steam Heating Plants
- Pipeless Furnace
- Warm Air Furnaces
- Water Supply Systems
- Bathroom Outfits

NAME

ADDRESS

CITY..... STATE.....

Thousands of customers testify to the fact that we have saved them money, time, expense and dissatisfaction. You take no risk when you buy a Heating Plant or Plumbing Outfit from us because our engineering staff has okayed everything before it leaves our plant. **ASK FOR FREE ESTIMATE.** Let this trained group of Plumbing and Heating Engineers help you. Write them freely for advice and information. Ask for estimate without obligation. Send a rough sketch of the arrangement of your rooms if possible and they will design an outfit exactly for your home that will meet all of your individual needs. Thousands of home owners, contractors, farmers, mechanics and nationally known institutions have benefited from these made-to-order Hardin-Lavin designs. This help from our engineering staff is free and backed by 50 years of knowing how. They will show you many trade secrets, kinks and wrinkles that will surprise you with big savings of money, time and labor. **WRITE TODAY.**

You can buy on Easy Terms

HIGHEST QUALITY HARDIN-LAVIN CO. Lowest Prices
 107-17 W. PERSHING ROAD, EST. 1876 CHICAGO, ILLINOIS

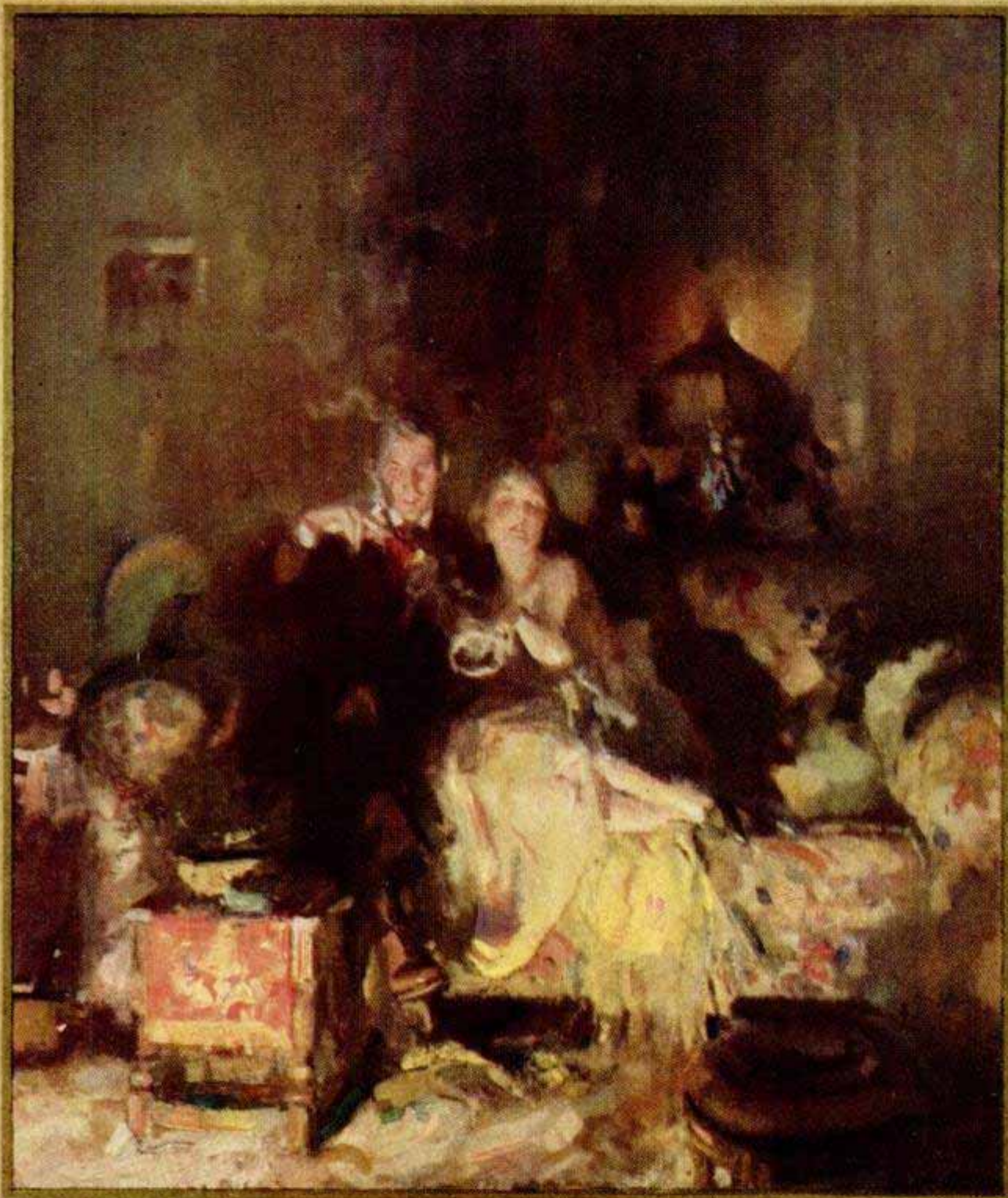

Rings of Contentment

